

This is a repository copy of *Assessment study report of indirect declaration techniques to determine total bio-based content*.

White Rose Research Online URL for this paper:
<https://eprints.whiterose.ac.uk/83085/>

Version: Published Version

Monograph:

Clark, James Hanley orcid.org/0000-0002-5860-2480, Farmer, Thomas James orcid.org/0000-0002-1039-7684 and Sherwood, James Richard orcid.org/0000-0001-5431-2032 (2015) *Assessment study report of indirect declaration techniques to determine total bio-based content*. Report. KBBPPS

10.13140/2.1.3235.8727

Reuse

Items deposited in White Rose Research Online are protected by copyright, with all rights reserved unless indicated otherwise. They may be downloaded and/or printed for private study, or other acts as permitted by national copyright laws. The publisher or other rights holders may allow further reproduction and re-use of the full text version. This is indicated by the licence information on the White Rose Research Online record for the item.

Takedown

If you consider content in White Rose Research Online to be in breach of UK law, please notify us by emailing eprints@whiterose.ac.uk including the URL of the record and the reason for the withdrawal request.



KBBPPS

Knowledge Based Bio-based Products' Pre-Standardization

**Work package 4
Biomass Content**

Deliverable N° 4.5: Assessment study report of indirect declara- tion techniques to determine total bio-based content

Public

Version: 1
York, 07/01/2015

prepared by:

James Clark, Thomas Farmer, James Sherwood
Green Chemistry Centre of Excellence, Department of Chemistry
University of York, Heslington, York, UK, YO10 5DD

Tel.: +44 1904 322559

Email: james.clark@york.ac.uk

Partner website: <http://www.york.ac.uk/chemistry/research/green/>

Project website: www.KBBPPS.eu

KBBPPS

Work Package 4: Biomass content

Deliverable 4.5: Assessment study report of indirect declaration techniques to determine total bio-based content

The research leading to these results has received funding from the European Union Seventh Framework Programme (FP7/2007-2013 under grant agreement n° KBBE/FP7EN/312060/"KBBPPS".

The sole responsibility for the content of this publication lies with the authors. It does not necessarily reflect the opinion of the European Communities. The European Commission is not responsible for any use that may be made of the information contained therein.



Table of contents

Table of contents.....	3
List of tables.....	9
List of figures.....	31
List of schemes.....	39
1 Summary.....	42
2 Introduction.....	44
2.1 Aims and objectives.....	44
2.2 The concept of bio-based content.....	45
2.2.1 Radiocarbon analysis.....	46
2.2.2 Elemental analysis.....	47
2.2.3 Stable isotope analysis.....	49
2.2.4 Mass balance approach.....	51
2.3 Standardisation and certification schemes relating to bio-based content.....	57
2.3.1 BioPreferred.....	57
2.3.2 OK biobased.....	58
2.3.3 DIN Biobasiert.....	59
2.3.4 Association Chimie du Végétal (ACDV).....	59
2.3.5 BASF-TÜV SÜD mass balance for the use of renewable feedstocks in integrated production processes.....	63
2.3.6 ISCC-plus sustainability certification.....	66
2.3.7 Supply chain book-and-claim.....	67
2.3.8 EU Ecolabel.....	67
2.3.9 Traceability and chain of custody claims.....	69
3 Direct measurement of bio-based content and its role alongside indirect bio-based content calculations.....	70
3.1 Calculation of bio-based carbon content.....	70
3.1.1 Sample preparation.....	71
3.1.2 Liquid scintillation-counter method.....	71
3.1.3 Beta-ionisation.....	72
3.1.4 Accelerator Mass Spectrometry.....	72
3.2 Calculation of bio-based content with stable isotope analysis.....	73
3.3 Examples of bio-based content measurement applied to molecules.....	75
3.3.1 Methyl oleate.....	76
3.3.2 Polyethylene terephthalate.....	76
3.3.3 Bio-ethanol and ethyl acetate.....	77
3.3.4 Vanillin.....	79



3.4	Advantages and limitations of direct bio-based content	81
4	Atom connectivity	83
4.1	Calculation of bio-based content with atom connectivity methods	83
4.1.1	Definition of atom connectivity methods	83
4.1.2	Selection of atom connectivity molecule case studies	90
4.2	Examples of bio-based content calculations for bulk chemicals based on atom connectivity	94
4.2.1	Acetic acid.....	96
4.2.2	Glycerol.....	99
4.2.3	<i>p</i> -Xylene.....	100
4.2.4	1,4-Butanediol.....	104
4.2.5	Adipic acid.....	105
4.2.6	2-Ethoxyethyl acetate.....	109
4.2.7	Butylated hydroxytoluene	111
4.2.8	Acetyl tributyl citrate	113
4.2.9	Ammonia.....	115
4.3	Examples of bio-based content calculations for lubricant base oils based on atom connectivity	117
4.3.1	Methyl oleate.....	118
4.3.2	Neopentyl glycol distearate	119
4.4	Examples of bio-based content calculations for plastics based on atom connectivity	123
4.4.1	Polyethylene	125
4.4.2	Poly(lactic acid)	127
4.4.3	Poly(ethylene terephthalate).....	128
4.4.4	Poly(butylene adipate terephthalate)	130
4.4.5	Poly(vinyl acetate).....	132
4.4.6	Poly(vinyl alcohol)	134
4.4.7	Poly(ethyl acrylate).....	135
4.4.8	Poly(dodecyl acrylate)	141
4.4.9	Sodium polyacrylate	144
4.4.10	Polyurethane.....	146
4.5	Examples of bio-based content calculations for solvents based on atom connectivity	150
4.5.1	Methanol	151
4.5.2	Ethyl acetate	153
4.5.3	Ethyl lactate	154
4.5.4	Acetone.....	155
4.5.5	2-Methyltetrahydrofuran	157
4.5.6	<i>N</i> -Methylpyrrolidinone	158



4.5.7	Dimethyl isosorbide	160
4.6	Examples of bio-based content calculations for surfactants based on atom connectivity	163
4.6.1	Hydrogen dodecyl sulphate and the sodium salt	164
4.6.2	Sodium laureth sulphate.....	168
4.6.3	Cocamidopropyl betaine.....	174
4.6.4	<i>N</i> -Dodecylpyridinium chloride.....	175
4.7	Examples of bio-based content calculations for fine chemicals based on atom connectivity	179
4.7.1	Aspirin.....	180
4.7.2	Vanillin	182
4.7.3	<i>p</i> -Cymenesulphonamide	184
4.8	Examples of bio-based content calculations for formulations and composites based on complementary elemental analysis	187
4.8.1	Starch polymer blends.....	188
4.8.2	PBAT-PLA polymer blend	191
4.8.3	Polyurethane with polyamide.....	198
4.9	Advantages and limitations of using atom connectivity for indirect determination of bio-based content	201
5	Mass balance	208
5.1	Mass balance and book-and-claim methods	208
5.1.1	Rules and interpretation of mass balance.....	208
5.1.2	Mass balance Method A: The determination and allocation of the average bio-based content in a final product within a predefined time period using attribution	215
5.1.3	Mass balance Method B: The determination by calculation and allocation of the average bio-based carbon content and average bio-based content.....	224
5.1.4	Mass balance Method C: The determination of the average bio-based content by calculation of fossil carbon savings.....	232
5.1.5	Mass balance Method D: Stoichiometrically limited determination of the average or minimum bio-based carbon content and average bio-based content	237
5.1.6	The use of the book-and-claim principle for mass balance methods.....	239
5.2	Mass balance case study: Platform molecules	244
5.2.1	Mass balance case study: Gasification.....	244
5.2.2	Thermocracking of naphtha and its downstream products.....	252
5.3	Mass balance case study: Esterification processes for commodity compounds....	271
5.3.1	Ethyl acetate	271
5.3.2	Biodiesel	281
5.3.3	Polyethylene terephthalate.....	284
5.4	Mass balance case study: Fine chemical synthesis.....	290
5.4.1	Sodium laureth sulphate.....	290



5.4.2	Vanillin	302
5.5	Mass balance case study: Polymer blends	309
5.5.1	Starch polymer blends.....	311
5.5.2	PBAT-PLA blend	317
5.6	Formulation and composite assembly	329
5.6.1	Water based paint	329
5.6.2	Insulation panel.....	330
5.6.3	Cleaning product versus composite curing resin	331
5.7	Advantages and limitations of different mass balance approaches	342
5.7.1	Inter-methodology comparison	342
5.7.2	Allocation of fluctuating biomass feedstocks: Feedstock variation	349
5.7.3	Allocation of fluctuating biomass feedstocks: Integrated production facilities.....	351
5.7.4	Allocation of intermediates and products: Storage and transport.....	355
5.7.5	Allocation of intermediates and products: Storage and transport with losses.....	360
5.7.6	Allocation of intermediates and products: Changes to storage or transport policy	362
5.7.7	Allocation of intermediates and products: Production by synthesis.....	365
5.7.8	Allocation of intermediates and products: Formulation	375
5.7.9	Summary of mass balance	378
6	Indirect bio-based content assessment	384
6.1	Instructions and guidance for applying mass balance.....	385
6.2	Applications of calculated total bio-based content	394
6.2.1	Application of (indirect) total bio-based content	394
6.2.2	Compatibility with future renewability assessments	398
7	Conclusion	402
8	Annex A: Atom connectivity	403
8.1	Calculated radiocarbon and elemental analysis of chemical products	403
8.2	Methanol and acetic acid.....	406
8.3	Glycerol and fatty acid methyl esters.....	411
8.4	<i>p</i> -Xylene.....	415
8.5	1,4-Butanediol.....	419
8.6	Adipic acid.....	421
8.7	2-Ethoxyethyl acetate	425
8.8	Butylated hydroxytoluene and acetone.....	428
8.9	Acetyl tributyl citrate	432
8.10	Ammonia.....	436
8.11	Neopentyl glycol distearate	438
8.12	Polyethylene	441
8.13	Products of lactic acid	444
8.14	Terephthalate derived polymers	448



8.15	Polyvinyl acetate and polyvinyl alcohol.....	454
8.16	Polyacrylate products.....	458
8.17	Polyurethane.....	473
8.18	Ethyl acetate.....	477
8.19	2-Methyltetrahydrofuran.....	480
8.20	N-Methylpyrrolidinone.....	482
8.21	Dimethyl isosorbide.....	485
8.22	Hydrogen dodecyl sulphate and the sodium salt.....	488
8.23	Sodium laureth sulphate.....	493
8.24	Cocamidopropyl betaine.....	499
8.25	N-Dodecylpyridinium chloride.....	503
8.26	Aspirin.....	506
8.27	Vanillin.....	508
8.28	p-Cymenesulphonamide.....	510
9	Annex B: Mass balance.....	513
9.1	Gasification mass balance calculations.....	513
9.1.1	Total bio-based content calculation by mass balance Method A.....	514
9.1.2	Total bio-based content calculation by mass balance Method B.....	514
9.1.3	Total bio-based content calculation by mass balance Method C.....	515
9.2	Naphtha processing mass balance calculations (ethanol synthesis).....	519
9.2.1	Total bio-based content calculation by mass balance Method A.....	519
9.2.2	Total bio-based content calculation by mass balance Method B.....	520
9.2.3	Total bio-based content calculation by mass balance Method C.....	521
9.3	Naphtha processing mass balance calculations (2-ethoxyethyl acetate synthesis) 524	
9.3.1	Total bio-based content calculation by mass balance Method A.....	525
9.3.2	Total bio-based content calculation by mass balance Method C.....	528
9.4	Ethyl acetate production mass balance calculations.....	532
9.4.1	Total bio-based content calculation by mass balance Method A.....	533
9.4.2	Total bio-based content calculation by mass balance Method C.....	534
9.5	Bio-diesel manufacturing mass balance calculations.....	537
9.5.1	Total bio-based content calculation by mass balance Method A.....	537
9.5.2	Total bio-based content calculation by mass balance Method B.....	538
9.5.3	Total bio-based content calculation by mass balance Method C.....	539
9.6	Polyethylene terephthalate mass balance calculations.....	541
9.6.1	Total bio-based content calculation by mass balance Method A.....	542
9.6.2	Total bio-based content calculation by mass balance Method B.....	544
9.6.3	Total bio-based content calculation by mass balance Method C.....	545
9.7	Sodium laureth sulphate mass balance calculations.....	548
9.7.1	Total bio-based content calculation by mass balance Method A.....	549



9.7.2	Total bio-based content calculation by mass balance Method B.....	551
9.7.3	Total bio-based content calculation by mass balance Method C	553
9.7.4	Total bio-based content calculation by mass balance Method D (seasonal variation)	555
9.8	Synthetic vanillin mass balance calculations	560
9.8.1	Total bio-based content calculation by mass balance Method A.....	560
9.8.2	Total bio-based content calculation by mass balance Method B.....	561
9.8.3	Total bio-based content calculation by mass balance Method C	561
9.9	Mass balance calculations describing starch polymer blends	563
9.9.1	Total bio-based content calculation by mass balance Method A.....	563
9.9.2	Total bio-based content calculation by mass balance Method B.....	564
9.9.3	Total bio-based content calculation by mass balance Method C	566
9.10	PBAT-PLA mass balance calculations.....	568
9.10.1	Total bio-based content calculation by mass balance Method A.....	569
9.10.2	Total bio-based content calculation by mass balance Method B.....	573
9.10.3	Total bio-based content calculation by mass balance Method C	575
9.11	Cleaning product	578
9.11.1	Total bio-based content calculation by mass balance Method A.....	578
9.11.2	Total bio-based content calculation by mass balance Method B.....	580
9.11.3	Total bio-based content calculation by mass balance Method C	580
9.12	Composite curing resin.....	582
9.12.1	Total bio-based content calculation by mass balance Method A.....	582
9.12.2	Total bio-based content calculation by mass balance Method B.....	584
9.12.3	Total bio-based content calculation by mass balance Method C	584
10	List of standards and pre-standardisation research reports.....	586
11	References	590



List of tables

Table 2-1 Minimum bio-based content by class for the USDA BioPreferred programme as of June 2013.	58
Table 2-2 The assignment of bio-based content from elemental analysis and atom connectivity for a partially bio-based ethyl acetate product.	62
Table 2-3 The confidence level decision process for synthetic chemicals assessed under the ACDV certification scheme.	63
Table 2-4 Examples of ACDV confidence levels for synthetic chemicals with values presented in green matching the assigned confidence level (high, medium, or low).	63
Table 2-5 Methane equivalents for bio-based feedstocks and traditional fossil resources. ...	64
Table 2-6 Mass balance data for a hypothetical example of esterification to give ethyl acetate.	65
Table 2-7 Quick screen of possible bio-based content conclusions for partially bio-based ethyl acetate.	66
Table 2-8 Selected EU Ecolabel requirements for four different product categories.	68
Table 3-1 Available methods of radiocarbon isotope ratio analysis.	70
Table 3-1 Stable isotope ratios for ethanol and its co-reactants and products (calculated for ethyl acetate).	79
Table 3-2 A comparison of direct bio-based content methods.	81
Table 4-1 Assignment of bio-based hydrogen atoms according to different atom connectivity rules.	86
Table 4-2 Assignment of bio-based nitrogen atoms according to different atom connectivity rules.	87
Table 4-3 Assignment of bio-based oxygen atoms according to different atom connectivity rules.	87
Table 4-4 Assignment of bio-based sulphur atoms according to different atom connectivity rules.	88
Table 4-5 Assignment of bio-based atoms other than carbon, hydrogen, nitrogen, oxygen and sulphur according to different atom connectivity rules.	89
Table 4-6 List of molecules applied as case studies in combined radiocarbon analysis and elemental analysis discussions.	91
Table 4-7 Allocation of bio-based content for acetic acid made from syngas.	97
Table 4-8 Allocation of bio-based content for acetic acid made from bio-ethanol.	98
Table 4-9 Allocation of bio-based content for glycerol made from vegetable oil transesterification.	100
Table 4-10 Allocation of bio-based content for <i>p</i> -xylene made from hydroxymethylfurfural.	102
Table 4-11 Allocation of bio-based content for <i>p</i> -xylene made from isobutanol.	103



Table 4-12 Allocation of bio-based content for 1,4-butanediol made from succinic acid.....	105
Table 4-13 Allocation of bio-based content for adipic acid made from glucaric acid.....	107
Table 4-14 Allocation of bio-based content for adipic acid made from benzene.....	109
Table 4-15 Allocation of bio-based content for partially bio-based 2-ethoxyethyl acetate..	110
Table 4-16 Allocation of bio-based content for butylated hydroxytoluene made from toluene.	112
Table 4-17 Allocation of bio-based content for acetyl tributyl citrate made from citric acid. .	115
Table 4-18 Allocation of bio-based content for ammonia made from nitrogen and hydrogen gases.	117
Table 4-19 Allocation of bio-based content for methyl oleate made from vegetable oils.	119
Table 4-20 Allocation of bio-based content for neopentyl glycol distearate made from vegetable oils.	122
Table 4-21 Allocation of bio-based content for polyethylene made from ethylene.....	126
Table 4-22 Allocation of bio-based content for polyethylene made from bio-ethanol.....	127
Table 4-23 Allocation of bio-based content for poly(lactic acid) made from sugar.....	128
Table 4-24 Allocation of bio-based content for polyethylene terephthalate made from bio- based ethylene glycol.....	130
Table 4-25 Allocation of bio-based content for poly(butylene adipate terephthalate) made from bio-based 1,4-butanediol.....	132
Table 4-26 Allocation of bio-based content for polyvinyl acetate made from acetic acid.	133
Table 4-27 Allocation of bio-based content for poly(vinyl alcohol) made from poly(vinyl acetate).....	135
Table 4-28 Allocation of bio-based content for poly(ethyl acrylate) made from fossil derived feedstocks.....	137
Table 4-29 Allocation of bio-based content for poly(ethyl acrylate) made from bio-ethanol.	138
Table 4-30 Allocation of bio-based content for poly(ethyl acrylate) made from glycerol.	140
Table 4-31 Allocation of bio-based content for poly(ethyl acrylate) made from bio-based feedstocks.....	141
Table 4-32 Allocation of bio-based content for poly(dodecyl acrylate) made from bio-based dodecanol.....	142
Table 4-33 Allocation of bio-based content for poly(dodecyl acrylate) made from bio-based acrylic acid.	144
Table 4-34 Allocation of bio-based content for sodium polyacrylate derived from glycerol. .	146
Table 4-35 Allocation of bio-based content for soy derived polyurethane made from epoxidised soy oil.	149
Table 4-36 Allocation of bio-based content for methanol made from fossil derived feedstocks.	152
Table 4-37 Allocation of bio-based content for ethyl acetate made from bio-ethanol.	154
Table 4-38 Allocation of bio-based content for ethyl lactate made from fermentation products.	155



Table 4-39 Allocation of bio-based content for acetone made from fossil derived feedstocks.	156
Table 4-40 Allocation of bio-based content for 2-methyltetrahydrofuran made from furfural.	158
Table 4-41 Allocation of bio-based content for <i>N</i> -methylpyrrolidinone made from glutamic acid.	160
Table 4-42 Allocation of bio-based content for dimethyl isosorbide made from sorbitol.	162
Table 4-43 Allocation of bio-based content for hydrogen dodecyl sulphate made from vegetable oil.	166
Table 4-44 Allocation of bio-based content for sodium dodecyl sulphate made from vegetable oil.	168
Table 4-45 Allocation of bio-based content for sodium laureth sulphate (with a short PEG chain) made from vegetable oil.	171
Table 4-46 Allocation of bio-based content for sodium laureth sulphate (with a long PEG chain) made from vegetable oil.	172
Table 4-47 Allocation of bio-based content for cocamidopropyl betaine made from vegetable oil.	175
Table 4-48 Allocation of bio-based content for <i>N</i> -dodecylpyridinium chloride made from vegetable oil.	177
Table 4-49 Allocation of bio-based content for aspirin made from benzene.	182
Table 4-50 Allocation of bio-based content for vanillin made from guaiacol.	184
Table 4-51 Allocation of bio-based content for <i>p</i> -cymenesulphonamide made from limonene.	186
Table 5-1 The scope and claims of the four mass balance methods.	214
Table 5-2 Mass balance material flows a hypothetical manufacturing process.	220
Table 5-3 The methane equivalents assigned to the feedstocks of this hypothetical case study demonstrating mass balance Method A.	222
Table 5-4 Naphtha and vegetable oil cracking mass balance data over a pre-defined time period.	231
Table 5-5 A demonstration of mass balance Method D.	238
Table 5-6 Energy content data for gasification feedstocks.	248
Table 5-7 Mass balance Method D describing starch and coal gasification to give carbon monoxide.	252
Table 5-8 Naphtha cracking product distribution by mass. Conversion is assumed to be complete.	253
Table 5-9 Energy content data for the naphtha and natural gas feedstock inputs required to produce 2-ethoxyethyl acetate.	261
Table 5-10 Total bio-based content by mass balance Method A for different combinations of feedstocks.	264



Table 5-11 Total bio-based content by mass balance Method B for different combinations of feedstocks.....	266
Table 5-12 Fossil carbon savings by mass balance Method C for different combinations of feedstocks for every 100 kg of product.....	267
Table 5-13 Total bio-based content by mass balance Method D (including inorganic feedstocks) for different combinations of feedstocks in the production of 2-ethoxyethyl acetate.....	269
Table 5-14 Total bio-based content by mass balance Method D (excluding inorganic feedstocks) for different combinations of feedstocks in the production of 2-ethoxyethyl acetate.....	269
Table 5-15 Mass balance Method B interpretation of the production of ethyl acetate by the esterification of bio-ethanol and acetic acid.....	279
Table 5-16 Mass balance Method B interpretation of the production of equal quantities of ethyl acetate produced by the esterification of synthetic ethanol and acetic acid and bio-based ethyl acetate from bio-ethanol via the Davy-Sasol method.....	280
Table 5-17 Mass balance Method D applied to the ACDV ethyl acetate case study.....	281
Table 5-18 Mass balance Method D applied to a mixture of petrochemical ethyl acetate and bio-based ethyl acetate made by the dehydrogenation of ethanol.....	281
Table 5-19 Total bio-based content of methyl laurate as calculated using mass balance Method D.....	284
Table 5-20 Bio-based carbon content of methyl laurate as calculated using mass balance Method D.....	284
Table 5-21 Poly(ethylene terephthalate) attribution units and consequent bio-based content claims from mass balance Method A derived from different feedstock and recycling options.....	287
Table 5-22 Calculation of total bio-based content according to balance Method D for poly(ethylene terephthalate) made from bio-ethanol.....	289
Table 5-23 Mass balance Method D applied for the calculation of bio-based carbon content of poly(ethylene terephthalate).....	289
Table 5-24 Different interpretations of fossil carbon savings for sodium laureth sulphate.....	299
Table 5-25 The total bio-based content of sodium laureth sulphate according to mass balance Method D when made from bio-naphtha.....	300
Table 5-26 The bio-based carbon content of sodium laureth sulphate according to mass balance Method D when made from bio-naphtha.....	300
Table 5-27 The total bio-based content of sodium laureth sulphate made from vegetable oil as calculated using mass balance Method D.....	301
Table 5-28 Mass balance Method D applied to triglyceride derived sodium laureth sulphate for the calculation of bio-based carbon content.....	301
Table 5-29 Bio-based content of sodium laureth sulphate products with calculated bio-based carbon values given in brackets.....	302



Table 5-30 Full mass balance data for vanillin production from guaiacol.	303
Table 5-31 Mass balance Method D for the calculation of total bio-based content of vanillin made from bio-based guaiacol.	307
Table 5-32 Bio-based carbon content of vanillin as calculated by mass balance Method D.	308
Table 5-33 Calculation of total bio-based content according to balance Method D for a starch polymer blend.....	315
Table 5-34 Mass balance Method D applied for the calculation of bio-based carbon content of a starch polymer blend.	315
Table 5-35 Mass balance Method A conclusions regarding the total bio-based content of poly(lactic acid)-poly(butylene adipate terephthalate) blended products, including when isobutanol is replaced with petrochemical <i>p</i> -xylene.	323
Table 5-36 Mass balance Method B applied to the total bio-based content and bio-based carbon content of poly(lactic acid)-poly(butylene adipate terephthalate) blended products in different proportions.	325
Table 5-37 Fossil carbon savings according to mass balance Method C applied to the manufacture of a 1:4 blend of poly(butylene adipate terephthalate) to poly(lactic acid).....	326
Table 5-38 Calculation of total bio-based content according to balance Method D for a 1:4 blend of poly(butylene adipate terephthalate) to poly(lactic acid).....	327
Table 5-39 Mass balance Method D applied for the calculation of bio-based carbon content for a 1:4 blend of poly(butylene adipate terephthalate) to poly(lactic acid).	328
Table 5-40 The ingredients and their contributions to the bio-based content of a formulated paint product.	330
Table 5-41 A list of feedstocks needed in order to produce a cleaning product or a resin composite.....	332
Table 5-42 Atom connectivity results of bio-based content for a cleaning product and a composite resin.	337
Table 5-43 Mass balance results of bio-based content for a cleaning product and a composite resin.	338
Table 5-44 Total bio-based content of a cleaning formulation according to mass balance Method D.....	339
Table 5-45 Total bio-based content of a composite curing resin according to mass balance Method D.....	339
Table 5-46 Bio-based carbon content of a cleaning formulation according to mass balance Method D.....	340
Table 5-47 Bio-based carbon content of a composite curing resin as calculated using mass balance Method D.	340
Table 5-48 A summary of mass balance Method D calculations for a cleaning product and a composite resin.	341
Table 5-49 The non-ideal product selectivity of naphtha feedstocks.	352



Table 5-50 Various claims of total bio-based content assuming losses or batch allocation or fluctuating feedstocks in the production of dimethyl adipate.	365
Table 5-51 Mass balance Method D calculation of total bio-based content for sodium laureth sulphate produced from a bio-based dodecanol intermediate.....	367
Table 5-52 Mass balance Method D calculation of bio-based carbon content for sodium laureth sulphate produced from a bio-based dodecanol intermediate.....	368
Table 5-53 Mass balance Method D calculation of total bio-based content for sodium laureth sulphate produced with a bio-based hydrophilic section.	369
Table 5-54 Mass balance Method D calculation of bio-based carbon content for sodium laureth sulphate produced with a bio-based hydrophilic section.	369
Table 5-55 An example of seasonal feedstock input fluctuations with percentage of ethylene contribution also indicated.	370
Table 5-56 The division of bio-based ethylene and conventional ethylene whilst prioritising biomass input into oligomerisation in the production of sodium laureth sulphate.	371
Table 5-57 Mass balance Method D calculation of total bio-based content for sodium laureth sulphate when seasonal variation influences the bio-based content and biomass is prioritised into the oligomerisation pathway.	372
Table 5-58 Mass balance Method D calculation of bio-based carbon content for sodium laureth sulphate when seasonal variation influences the bio-based content and biomass is prioritised into the oligomerisation pathway.	372
Table 5-59 The virtual separation of bio-based ethylene and conventional ethylene for the production of sodium laureth sulphate without prioritisation of biomass input into a specific pathway.....	373
Table 5-60 Mass balance Method D calculation of total bio-based content for sodium laureth sulphate when seasonal variation influences the bio-based content.....	374
Table 5-61 Mass balance Method D calculation of bio-based carbon content for sodium laureth sulphate when seasonal variation influences the bio-based content.	375
Table 5-62 Data for two ingredients of a formulation made from variable amounts of biomass.	376
Table 5-63 The total bio-based content of a formulation accounting for the fluctuating feedstocks that created the ingredients.	376
Table 5-64 Seasonal total bio-based content describing the formulation ingredients.....	377
Table 5-65 Overview of the different mass balance approaches.....	379
Table 6-1 A demonstration of the calculation required to produce a value of bio-based carbon content.	390
Table 8-1 Bio-based carbon content and elemental analysis data for chemical products of relevance to the ACDV certification scheme.....	403
Table 8-2 Indirect bio-based content allocation for methanol (Method 1).....	406
Table 8-3 Indirect bio-based content allocation for methanol (Method 2a).....	407
Table 8-4 Indirect bio-based content allocation for methanol (Method 2b).....	407



Table 8-5 Indirect bio-based content allocation for methanol (Method 3).....	407
Table 8-6 Indirect bio-based content allocation for methanol (ACDV method).....	407
Table 8-7 Indirect bio-based content allocation for acetic acid from syngas (Method 1).....	408
Table 8-8 Indirect bio-based content allocation for acetic acid from syngas (Method 2a)....	408
Table 8-9 Indirect bio-based content allocation for acetic acid from syngas (Method 2b)....	408
Table 8-10 Indirect bio-based content allocation for acetic acid from syngas (Method 3)....	408
Table 8-11 Indirect bio-based content allocation for acetic acid from syngas (ACDV method).	409
Table 8-12 Indirect bio-based content allocation for acetic acid produced by fermentation (Method 1).....	409
Table 8-13 Indirect bio-based content allocation for acetic acid produced by fermentation (Method 2a).....	410
Table 8-14 Indirect bio-based content allocation for acetic acid produced by fermentation (Method 2b).....	410
Table 8-15 Indirect bio-based content allocation for acetic acid produced by fermentation (Method 3).....	410
Table 8-16 Indirect bio-based content allocation for acetic acid produced by fermentation (ACDV method).....	410
Table 8-17 Indirect bio-based content allocation for methyl oleate (Method 1).	411
Table 8-18 Indirect bio-based content allocation for methyl oleate (Method 2a).	412
Table 8-19 Indirect bio-based content allocation for methyl oleate (Method 2b).	412
Table 8-20 Indirect bio-based content allocation for methyl oleate (Method 3).	412
Table 8-21 Indirect bio-based content allocation for methyl oleate (ACDV method).....	412
Table 8-22 Indirect bio-based content allocation for glycerol (Method 1).	413
Table 8-23 Indirect bio-based content allocation for glycerol (Method 2a).	413
Table 8-24 Indirect bio-based content allocation for glycerol (Method 2b).	413
Table 8-25 Indirect bio-based content allocation for glycerol (Method 3).	413
Table 8-26 Indirect bio-based content allocation for glycerol (ACDV method).	414
Table 8-27 Indirect bio-based content allocation for <i>p</i> -xylene from isobutanol (Method 1). .	415
Table 8-28 Indirect bio-based content allocation for <i>p</i> -xylene from isobutanol (Method 2a).	416
Table 8-29 Indirect bio-based content allocation for <i>p</i> -xylene from isobutanol (Method 2b).	416
Table 8-30 Indirect bio-based content allocation for <i>p</i> -xylene from isobutanol (Method 3). .	416
Table 8-31 Indirect bio-based content allocation for <i>p</i> -xylene from isobutanol (ACDV method).....	416
Table 8-32 Indirect bio-based content allocation for <i>p</i> -xylene from dimethylfuran (Method 1).	417
Table 8-33 Indirect bio-based content allocation for <i>p</i> -xylene from dimethylfuran (Method 2a).	417



Table 8-34 Indirect bio-based content allocation for <i>p</i> -xylene from dimethylfuran (Method 2b).	418
Table 8-35 Indirect bio-based content allocation for <i>p</i> -xylene from dimethylfuran (Method 3).	418
Table 8-36 Indirect bio-based content allocation for <i>p</i> -xylene from dimethylfuran (ACDV method).	418
Table 8-37 Indirect bio-based content allocation for 1,4-butanediol from succinic acid (Method 1).	419
Table 8-38 Indirect bio-based content allocation for 1,4-butanediol from succinic acid (Method 2a).	419
Table 8-39 Indirect bio-based content allocation for 1,4-butanediol from succinic acid (Method 2b).	420
Table 8-40 Indirect bio-based content allocation for 1,4-butanediol from succinic acid (Method 3).	420
Table 8-41 Indirect bio-based content allocation for 1,4-butanediol from succinic acid (ACDV method).	420
Table 8-42 Indirect bio-based content allocation for adipic acid synthesised by the oxidation of glucose (Method 1).	421
Table 8-43 Indirect bio-based content allocation for adipic acid synthesised by the oxidation of glucose (Method 2a).	421
Table 8-44 Indirect bio-based content allocation for adipic acid synthesised by the oxidation of glucose (Method 2b).	422
Table 8-45 Indirect bio-based content allocation for adipic acid synthesised by the oxidation of glucose (Method 3).	422
Table 8-46 Indirect bio-based content allocation for adipic acid synthesised by the oxidation of glucose (ACDV method).	422
Table 8-47 Indirect bio-based content allocation for adipic acid synthesised from benzene (Method 1).	423
Table 8-48 Indirect bio-based content allocation for adipic acid synthesised from benzene (Method 2a).	423
Table 8-49 Indirect bio-based content allocation for adipic acid synthesised from benzene (Method 2b).	423
Table 8-50 Indirect bio-based content allocation for adipic acid synthesised from benzene (Method 3).	424
Table 8-51 Indirect bio-based content allocation for adipic acid synthesised from benzene (ACDV method).	424
Table 8-52 Indirect bio-based content allocation for 2-ethoxyethyl acetate synthesised from bio-ethanol (Method 1).	425
Table 8-53 Indirect bio-based content allocation for 2-ethoxyethyl acetate synthesised from bio-ethanol (Method 2a).	426



Table 8-54 Indirect bio-based content allocation 2-ethoxyethyl acetate synthesised from bio-ethanol (Method 2b).	426
Table 8-55 Indirect bio-based content allocation for 2-ethoxyethyl acetate synthesised from bio-ethanol (Method 3).	426
Table 8-56 Indirect bio-based content allocation for 2-ethoxyethyl acetate synthesised from bio-ethanol (ACDV method).	427
Table 8-57 Indirect bio-based content allocation for petrochemical butylated hydroxytoluene (Method 1).	429
Table 8-58 Indirect bio-based content allocation for petrochemical butylated hydroxytoluene (Method 2a).	429
Table 8-59 Indirect bio-based content allocation for petrochemical butylated hydroxytoluene (Method 2b).	429
Table 8-60 Indirect bio-based content allocation for petrochemical butylated hydroxytoluene (Method 3).	430
Table 8-61 Indirect bio-based content allocation for petrochemical butylated hydroxytoluene (ACDV method).	430
Table 8-62 Indirect bio-based content allocation for petrochemical acetone (Method 1).	430
Table 8-63 Indirect bio-based content allocation for petrochemical acetone (Method 2a). ...	430
Table 8-64 Indirect bio-based content allocation for petrochemical acetone (Method 2b). ...	431
Table 8-65 Indirect bio-based content allocation for petrochemical acetone (Method 3).	431
Table 8-66 Indirect bio-based content allocation for petrochemical acetone (ACDV method).	431
Table 8-67 Indirect bio-based content allocation for acetyl tributyl citrate from citric acid and syngas (Method 1).	433
Table 8-68 Indirect bio-based content allocation for acetyl tributyl citrate from citric acid and syngas (Method 2a).	434
Table 8-69 Indirect bio-based content allocation for acetyl tributyl citrate from citric acid and syngas (Method 2b).	434
Table 8-70 Indirect bio-based content allocation for acetyl tributyl citrate from citric acid and syngas (Method 3).	434
Table 8-71 Indirect bio-based content allocation for acetyl tributyl citrate from citric acid and syngas (ACDV method).	435
Table 8-72 Indirect bio-based content allocation for ammonia (Method 1).	436
Table 8-73 Indirect bio-based content allocation for ammonia (Method 2a).	436
Table 8-74 Indirect bio-based content allocation for ammonia (Method 2b).	437
Table 8-75 Indirect bio-based content allocation for ammonia (Method 3).	437
Table 8-76 Indirect bio-based content allocation for ammonia (ACDV method).	437
Table 8-77 Indirect bio-based content allocation for neopentyl glycol distearate from syngas and propene and fatty acids (Method 1).	439



Table 8-78 Indirect bio-based content allocation for neopentyl glycol distearate from syngas and propene and fatty acids (Method 2a).	439
Table 8-79 Indirect bio-based content allocation for neopentyl glycol distearate from syngas and propene and fatty acids (Method 2b).	439
Table 8-80 Indirect bio-based content allocation for neopentyl glycol distearate from syngas and propene and fatty acids (Method 3).	440
Table 8-81 Indirect bio-based content allocation for neopentyl glycol distearate from syngas and propene and fatty acids (ACDV method).	440
Table 8-82 Indirect bio-based content allocation for polyethylene from petroleum (Method 1).	441
Table 8-83 Indirect bio-based content allocation for polyethylene from petroleum (Method 2a).	441
Table 8-84 Indirect bio-based content allocation for polyethylene from petroleum (Method 2b).	442
Table 8-85 Indirect bio-based content allocation for polyethylene from petroleum (Method 3).	442
Table 8-86 Indirect bio-based content allocation for polyethylene from petroleum (ACDV method).	442
Table 8-87 Indirect bio-based content allocation for polyethylene from bio-ethanol (Method 1).	442
Table 8-88 Indirect bio-based content allocation for polyethylene from bio-ethanol (Method 2a).	443
Table 8-89 Indirect bio-based content allocation for polyethylene from bio-ethanol (Method 2b).	443
Table 8-90 Indirect bio-based content allocation for polyethylene from bio-ethanol (Method 3).	443
Table 8-91 Indirect bio-based content allocation for polyethylene from bio-ethanol (ACDV method).	443
Table 8-92 Indirect bio-based content allocation for polylactic acid (Method 1).	444
Table 8-93 Indirect bio-based content allocation for polylactic acid (Method 2a).	444
Table 8-94 Indirect bio-based content allocation for polylactic acid (Method 2b).	445
Table 8-95 Indirect bio-based content allocation for polylactic acid (Method 3).	445
Table 8-96 Indirect bio-based content allocation for polylactic acid (ACDV method).	445
Table 8-97 Indirect bio-based content allocation for ethyl lactate (Method 1).	446
Table 8-98 Indirect bio-based content allocation for ethyl lactate (Method 2a).	446
Table 8-99 Indirect bio-based content allocation for ethyl lactate (Method 2b).	446
Table 8-100 Indirect bio-based content allocation for ethyl lactate (Method 3).	447
Table 8-101 Indirect bio-based content allocation for ethyl lactate (ACDV method).	447
Table 8-102 Indirect bio-based content allocation for polyethylene terephthalic acid from bio-ethylene (Method 1).	449



Table 8-103 Indirect bio-based content allocation for polyethylene terephthalic acid from bio-ethylene (Method 2a).	449
Table 8-104 Indirect bio-based content allocation for polyethylene terephthalic acid from bio-ethylene (Method 2b).	449
Table 8-105 Indirect bio-based content allocation for polyethylene terephthalic acid from bio-ethylene (Method 3).	450
Table 8-106 Indirect bio-based content allocation for polyethylene terephthalic acid from bio-ethylene (ACDV method).....	450
Table 8-107 Indirect bio-based content allocation for poly(butylene adipate terephthalate) synthesised from bio-based 1,4-butanediol (Method 1).	451
Table 8-108 Indirect bio-based content allocation for poly(butylene adipate terephthalate) synthesised from bio-based 1,4-butanediol (Method 2a).	452
Table 8-109 Indirect bio-based content allocation for poly(butylene adipate terephthalate) synthesised from bio-based 1,4-butanediol (Method 2b).	452
Table 8-110 Indirect bio-based content allocation for poly(butylene adipate terephthalate) synthesised from bio-based 1,4-butanediol (Method 3).	452
Table 8-111 Indirect bio-based content allocation for poly(butylene adipate terephthalate) synthesised from bio-based 1,4-butanediol (ACDV method).....	453
Table 8-112 Indirect bio-based content allocation for polyvinyl acetate made with renewable acetic acid (Method 1).	455
Table 8-113 Indirect bio-based content allocation for polyvinyl acetate made with renewable acetic acid (Method 2a).	455
Table 8-114 Indirect bio-based content allocation for polyvinyl acetate made with renewable acetic acid (Method 2b).	455
Table 8-115 Indirect bio-based content allocation for polyvinyl acetate made with renewable acetic acid (Method 3).	456
Table 8-116 Indirect bio-based content allocation for polyvinyl acetate made with renewable acetic acid (ACDV method).	456
Table 8-117 Indirect bio-based content allocation for polyvinyl alcohol (Method 1).....	456
Table 8-118 Indirect bio-based content allocation for polyvinyl alcohol (Method 2a).....	456
Table 8-119 Indirect bio-based content allocation for polyvinyl alcohol (Method 2b).....	457
Table 8-120 Indirect bio-based content allocation for polyvinyl alcohol (Method 3).....	457
Table 8-121 Indirect bio-based content allocation for polyvinyl alcohol (ACDV method).	457
Table 8-122 Indirect bio-based content allocation for fossil derived polyethyl acrylate (Method 1).....	460
Table 8-123 Indirect bio-based content allocation for fossil derived polyethyl acrylate (Method 2a).....	460
Table 8-124 Indirect bio-based content allocation for fossil derived polyethyl acrylate (Method 2b).....	460



Table 8-125 Indirect bio-based content allocation for fossil derived polyethyl acrylate (Method 3).....	460
Table 8-126 Indirect bio-based content allocation for fossil derived polyethyl acrylate (ACDV method).....	461
Table 8-127 Indirect bio-based content allocation for polyethyl acrylate made with bio-ethanol (Method 1).....	461
Table 8-128 Indirect bio-based content allocation for polyethyl acrylate made with bio-ethanol (Method 2a).....	461
Table 8-129 Indirect bio-based content allocation for polyethyl acrylate made with bio-ethanol (Method 2b).....	461
Table 8-130 Indirect bio-based content allocation for polyethyl acrylate made with bio-ethanol (Method 3).....	462
Table 8-131 Indirect bio-based content allocation for polyethyl acrylate made with bio-ethanol (ACDV method).....	462
Table 8-132 Indirect bio-based content allocation for polyethyl acrylate made from bio-based acrylic acid (Method 1).....	462
Table 8-133 Indirect bio-based content allocation for polyethyl acrylate made from bio-based acrylic acid (Method 2a).....	463
Table 8-134 Indirect bio-based content allocation for polyethyl acrylate made from bio-based acrylic acid (Method 2b).....	463
Table 8-135 Indirect bio-based content allocation for polyethyl acrylate made from bio-based acrylic acid (Method 3).....	463
Table 8-136 Indirect bio-based content allocation for polyethyl acrylate made from bio-based acrylic acid (ACDV method).....	464
Table 8-137 Indirect bio-based content allocation for bio-based polyethyl acrylate (Method 1).....	464
Table 8-138 Indirect bio-based content allocation for bio-based polyethyl acrylate (Method 2a).....	464
Table 8-139 Indirect bio-based content allocation for bio-based polyethyl acrylate (Method 2b).....	464
Table 8-140 Indirect bio-based content allocation for bio-based polyethyl acrylate (Method 3).....	465
Table 8-141 Indirect bio-based content allocation for bio-based polyethyl acrylate (ACDV method).....	465
Table 8-142 Indirect bio-based content allocation for poly(dodecyl acrylate) made from bio-based acrylic acid (Method 1).....	467
Table 8-143 Indirect bio-based content allocation for poly(dodecyl acrylate) made from bio-based acrylic acid (Method 2a).....	467
Table 8-144 Indirect bio-based content allocation for poly(dodecyl acrylate) made from bio-based acrylic acid (Method 2b).....	467



Table 8-145 Indirect bio-based content allocation for poly(dodecyl acrylate) made from bio-based acrylic acid (Method 3).....	468
Table 8-146 Indirect bio-based content allocation for poly(dodecyl acrylate) made from bio-based acrylic acid (ACDV method).....	468
Table 8-147 Indirect bio-based content allocation for poly(dodecyl acrylate) made from vegetable oil components (Method 1).....	468
Table 8-148 Indirect bio-based content allocation for poly(dodecyl acrylate) made from vegetable oil components (Method 2a).....	469
Table 8-149 Indirect bio-based content allocation for poly(dodecyl acrylate) made from vegetable oil components (Method 2b).....	469
Table 8-150 Indirect bio-based content allocation for poly(dodecyl acrylate) made from vegetable oil components (Method 3).....	469
Table 8-151 Indirect bio-based content allocation for poly(dodecyl acrylate) made from vegetable oil components (ACDV method).....	470
Table 8-152 Indirect bio-based content allocation for sodium poly(acrylate) made from bio-based acrylic acid (Method 1).....	471
Table 8-153 Indirect bio-based content allocation for sodium poly(acrylate) made from bio-based acrylic acid (Method 2a).....	471
Table 8-154 Indirect bio-based content allocation for sodium poly(acrylate) made from bio-based acrylic acid (Method 2b).....	471
Table 8-155 Indirect bio-based content allocation for sodium poly(acrylate) made from bio-based acrylic acid (Method 3).....	472
Table 8-156 Indirect bio-based content allocation for sodium poly(acrylate) made from bio-based acrylic acid (ACDV method).....	472
Table 8-157 Indirect bio-based content allocation for a polyurethane (Method 1).....	475
Table 8-158 Indirect bio-based content allocation for a polyurethane (Method 2a).....	475
Table 8-159 Indirect bio-based content allocation for a polyurethane (Method 2b).....	475
Table 8-160 Indirect bio-based content allocation for a polyurethane (Method 3).....	475
Table 8-161 Indirect bio-based content allocation for a polyurethane (ACDV method).....	476
Table 8-162 Indirect bio-based content allocation for ethyl acetate from bio-ethanol (Method 1).....	478
Table 8-163 Indirect bio-based content allocation for ethyl acetate from bio-ethanol (Method 2a).....	478
Table 8-164 Indirect bio-based content allocation for ethyl acetate from bio-ethanol (Method 2b).....	478
Table 8-165 Indirect bio-based content allocation for ethyl acetate from bio-ethanol (Method 3).....	478
Table 8-166 Indirect bio-based content allocation for ethyl acetate from bio-ethanol (ACDV method).....	479
Table 8-167 Indirect bio-based content allocation for 2-methyltetrahydrofuran (Method 1).....	480



Table 8-168 Indirect bio-based content allocation for 2-methyltetrahydrofuran (Method 2a).	480
Table 8-169 Indirect bio-based content allocation for 2-methyltetrahydrofuran (Method 2b).	480
Table 8-170 Indirect bio-based content allocation for 2-methyltetrahydrofuran (Method 3).	481
Table 8-171 Indirect bio-based content allocation for 2-methyltetrahydrofuran (ACDV method).	481
Table 8-172 Indirect bio-based content allocation for <i>N</i> -methylpyrrolidinone from glutamic acid (Method 1).	482
Table 8-173 Indirect bio-based content allocation for <i>N</i> -methylpyrrolidinone from glutamic acid (Method 2a).	483
Table 8-174 Indirect bio-based content allocation for <i>N</i> -methylpyrrolidinone from glutamic acid (Method 2b).	483
Table 8-175 Indirect bio-based content allocation for <i>N</i> -methylpyrrolidinone from glutamic acid (Method 3).	483
Table 8-176 Indirect bio-based content allocation for <i>N</i> -methylpyrrolidinone from glutamic acid (ACDV method).	484
Table 8-177 Indirect bio-based content allocation for dimethyl isosorbide from sorbitol (Method 1).	486
Table 8-178 Indirect bio-based content allocation for dimethyl isosorbide from sorbitol (Method 2a).	486
Table 8-179 Indirect bio-based content allocation for dimethyl isosorbide from sorbitol (Method 2b).	486
Table 8-180 Indirect bio-based content allocation for dimethyl isosorbide from sorbitol (Method 3).	486
Table 8-181 Indirect bio-based content allocation for dimethyl isosorbide from sorbitol (ACDV method).	487
Table 8-182 Indirect bio-based content allocation for hydrogen dodecyl sulphate (Method 1).	490
Table 8-183 Indirect bio-based content allocation for hydrogen dodecyl sulphate (Method 2a).	490
Table 8-184 Indirect bio-based content allocation for hydrogen dodecyl sulphate (Method 2b).	490
Table 8-185 Indirect bio-based content allocation for hydrogen dodecyl sulphate (Method 3).	490
Table 8-186 Indirect bio-based content allocation for hydrogen dodecyl sulphate (ACDV method).	491
Table 8-187 Indirect bio-based content allocation for sodium dodecyl sulphate from vegetable oil (Method 1).	491



Table 8-188 Indirect bio-based content allocation for sodium dodecyl sulphate from vegetable oil (Method 2a).....	491
Table 8-189 Indirect bio-based content allocation for sodium dodecyl sulphate from vegetable oil (Method 2b).....	491
Table 8-190 Indirect bio-based content allocation for sodium dodecyl sulphate from vegetable oil (Method 3).....	492
Table 8-191 Indirect bio-based content allocation for sodium dodecyl sulphate from vegetable oil (ACDV method).....	492
Table 8-192 Indirect bio-based content allocation for sodium laureth sulphate (PEG trimer) from vegetable oil (Method 1).....	495
Table 8-193 Indirect bio-based content allocation for sodium laureth sulphate (PEG trimer) from vegetable oil (Method 2a).....	495
Table 8-194 Indirect bio-based content allocation for sodium laureth sulphate (PEG trimer) from vegetable oil (Method 2b).....	495
Table 8-195 Indirect bio-based content allocation for sodium laureth sulphate (PEG trimer) from vegetable oil (Method 3).....	496
Table 8-196 Indirect bio-based content allocation for sodium laureth sulphate (PEG trimer) from vegetable oil (ACDV method).....	496
Table 8-197 Indirect bio-based content allocation for sodium laureth sulphate (PEG decamer) from vegetable oil (Method 1).....	496
Table 8-198 Indirect bio-based content allocation for sodium laureth sulphate (PEG decamer) from vegetable oil (Method 2a).....	497
Table 8-199 Indirect bio-based content allocation for sodium laureth sulphate (PEG decamer) from vegetable oil (Method 2b).....	497
Table 8-200 Indirect bio-based content allocation for sodium laureth sulphate (PEG decamer) from vegetable oil (Method 3).....	497
Table 8-201 Indirect bio-based content allocation for sodium laureth sulphate (PEG decamer) from vegetable oil (ACDV method).....	498
Table 8-202 Indirect bio-based content allocation for cocamidopropyl betaine from vegetable oil (Method 1).....	501
Table 8-203 Indirect bio-based content allocation for cocamidopropyl betaine from vegetable oil (Method 2a).....	501
Table 8-204 Indirect bio-based content allocation for cocamidopropyl betaine from vegetable oil (Method 2b).....	501
Table 8-205 Indirect bio-based content allocation for cocamidopropyl betaine from vegetable oil (Method 3).....	502
Table 8-206 Indirect bio-based content allocation for cocamidopropyl betaine from vegetable oil (ACDV method).....	502
Table 8-207 Indirect bio-based content allocation for <i>N</i> -dodecylpyridinium chloride from pyridine and vegetable oil (Method 1).....	504



Table 8-208 Indirect bio-based content allocation for <i>N</i> -dodecylpyridinium chloride from pyridine and vegetable oil (Method 2a).....	504
Table 8-209 Indirect bio-based content allocation for <i>N</i> -dodecylpyridinium chloride from pyridine and vegetable oil (Method 2b).....	504
Table 8-210 Indirect bio-based content allocation for <i>N</i> -dodecylpyridinium chloride from pyridine and vegetable oil (Method 3).....	505
Table 8-211 Indirect bio-based content allocation for <i>N</i> -dodecylpyridinium chloride from pyridine and vegetable oil (ACDV method).....	505
Table 8-212 Indirect bio-based content allocation for aspirin from phenol (Method 1).	506
Table 8-213 Indirect bio-based content allocation for aspirin from phenol (Method 2a).....	507
Table 8-214 Indirect bio-based content allocation for aspirin from phenol (Method 2b).....	507
Table 8-215 Indirect bio-based content allocation for aspirin from phenol (Method 3).	507
Table 8-216 Indirect bio-based content allocation for aspirin from phenol (ACDV method).	507
Table 8-217 Indirect bio-based content allocation for synthetic vanillin (Method 1).....	508
Table 8-218 Indirect bio-based content allocation for synthetic vanillin (Method 2a).....	509
Table 8-219 Indirect bio-based content allocation for synthetic vanillin (Method 2b).....	509
Table 8-220 Indirect bio-based content allocation for synthetic vanillin (Method 3).....	509
Table 8-221 Indirect bio-based content allocation for synthetic vanillin (ACDV method).	509
Table 8-222 Indirect bio-based content allocation for <i>p</i> -cymenesulphonamide from limonene (Method 1).....	510
Table 8-223 Indirect bio-based content allocation for <i>p</i> -cymenesulphonamide from limonene (Method 2a).....	511
Table 8-224 Indirect bio-based content allocation for <i>p</i> -cymenesulphonamide from limonene (Method 2b).....	511
Table 8-225 Indirect bio-based content allocation for <i>p</i> -cymenesulphonamide from limonene (Method 3).....	511
Table 8-226 Indirect bio-based content allocation for <i>p</i> -cymenesulphonamide from limonene (ACDV method).....	512
Table 9-1 Mass balance data for coal gasification.	513
Table 9-2 Mass balance data for starch gasification.	513
Table 9-3 Mass balance equations for the gasification of starch to give carbon monoxide by mass balance Method A.	514
Table 9-4 Mass balance equations for the gasification of starch to give carbon monoxide by mass balance Method B.	515
Table 9-5 Mass balance Method C applied to carbon monoxide made by starch gasification (100% total bio-based content).....	517
Table 9-6 Mass balance Method C applied to carbon monoxide made by starch gasification (20% total bio-based content).....	518
Table 9-7 Mass balance data for the conversion of conventional naphtha to ethanol.	519
Table 9-8 Mass balance data for the conversion of bio-naphtha to ethanol.	519



Table 9-9 Mass balance equations for the conversion of bio-naphtha to ethanol using mass balance Method A.	520
Table 9-10 Mass balance equations for the conversion of a mixed naphtha feed (1:1 by mass) to ethanol using mass balance Method A.....	520
Table 9-11 Mass balance Method C applied to ethanol made from bio-naphtha.....	522
Table 9-12 Mass balance Method C applied to ethanol made from equal quantities of bio-naphtha and conventional naphtha.....	523
Table 9-13 Mass balance data for 2-ethoxyethyl acetate made from naphtha and natural gas.	524
Table 9-14 Mass balance data for 2-ethoxyethyl acetate made from naphtha and coal.	524
Table 9-15 Mass balance data for 2-ethoxyethyl acetate made from naphtha and starch reforming.	525
Table 9-16 Mass balance data for 2-ethoxyethyl acetate made from naphtha and fermentation.	525
Table 9-17 Mass balance equations for the conversion of bio-naphtha (and natural gas) to 2-ethoxyethyl acetate using mass balance Method A.	526
Table 9-18 Mass balance equations for the conversion of bio-gas (and conventional naphtha) to 2-ethoxyethyl acetate using mass balance Method A.	526
Table 9-19 Mass balance equations for the conversion of bio-naphtha (and coal) to 2-ethoxyethyl acetate using mass balance Method A.	527
Table 9-20 Mass balance equations for the conversion of starch and naphtha to 2-ethoxyethyl acetate using mass balance Method A.	527
Table 9-21 Mass balance equations for the conversion of bio-naphtha (and coal) to 2-ethoxyethyl acetate using mass balance Method A.	528
Table 9-22 Mass balance Method C applied to 2-ethoxyethyl acetate made from bio-naphtha and natural gas.....	529
Table 9-23 An interpretation of the synthesis of 2-ethoxyethylacetate using mass balance Method C when fermentation replaces natural gas.....	530
Table 9-24 An interpretation of the synthesis of 2-ethoxyethylacetate using mass balance Method C when fermentation replaces coal gasification.	531
Table 9-25 Mass balance data for partially bio-based ethyl acetate as proposed by ACDV.	532
Table 9-26 Mass balance data for bio-based ethyl acetate made only from bio-ethanol (to be blended with petrochemical ethyl acetate).....	532
Table 9-27 Mass balance data for conventional ethyl acetate made from petrochemical feedstocks (to be blended with wholly bio-based ethyl acetate).....	532
Table 9-28 Mass balance equations for the conversion of bio-ethanol (and natural gas) to ethyl acetate using mass balance Method A.....	533



Table 9-29 Mass balance equations for the conversion of bio-ethanol (and natural gas) to ethyl acetate using mass balance Method A beginning with glucose as the fermentation feedstock.....	534
Table 9-30 Mass balance Method C applied to ethyl acetate made from bio-ethanol and natural gas.	535
Table 9-31 Mass balance equations for the conversion of glucose (and natural gas) to ethyl acetate using mass balance Method C by displacing naphtha as a feedstock.	536
Table 9-32 Mass balance data for a biodiesel manufacturing process.....	537
Table 9-33 Mass balance equations for the production of bio-diesel (FAME) using mass balance Method A.	538
Table 9-34 Biomass and fossil material mass flows during vegetable oil transesterification for the calculation of total bio-based content according to mass balance Method B.....	539
Table 9-35 Biomass and fossil material mass flows during vegetable oil transesterification for the calculation of bio-based carbon content according to mass balance Method B.....	539
Table 9-36 Mass balance Method C applied to vegetable oil transesterification.	540
Table 9-37 Mass balance data for partially bio-based poly(ethylene terephthalate) made from bio-ethanol.	541
Table 9-38 Mass balance data for partially bio-based poly(ethylene terephthalate) made from bio-ethanol <i>via</i> bio-naphtha.	541
Table 9-39 Mass balance Method A applied to partially bio-based poly(ethylene terephthalate) made from bio-ethanol where methanol is treated as a waste.	542
Table 9-40 Mass balance Method A applied to partially bio-based poly(ethylene terephthalate) made from bio-ethanol where methanol is recycled.	543
Table 9-41 Mass balance Method A applied to partially bio-based poly(ethylene terephthalate) made from bio-naphtha where methanol is treated as a waste.	543
Table 9-42 Mass balance Method A applied to partially bio-based poly(ethylene terephthalate) made from bio-naphtha where methanol is recycled.	544
Table 9-43 Biomass and fossil material mass flows describing poly(ethylene terephthalate) synthesis for the calculation of total bio-based content according to mass balance Method B.	544
Table 9-44 Biomass and fossil material mass flows describing poly(ethylene terephthalate) synthesis for the calculation of bio-based carbon content according to mass balance Method B.	545
Table 9-45 Fossil carbon savings in poly(ethylene terephthalate) when bio-ethanol is a feedstock.....	546
Table 9-46 Mass balance Method C calculations for a process making poly(ethylene terephthalate) from bio-naphtha.	547
Table 9-47 Mass balance data for sodium laureth sulphate production from vegetable oil..	548
Table 9-48 Mass balance data for sodium laureth sulphate production from naphtha as the only carbon based feedstock.....	549



Table 9-49 Mass balance Method A description of the production of sodium laureth sulphate (SLS) from triglycerides.	550
Table 9-50 Mass balance Method A description of the production of sodium laureth sulphate (SLS) from triglycerides (excluding hydrogen sulphide from calculations).	550
Table 9-51 Mass balance Method A description of the production of sodium laureth sulphate (SLS) from naphtha as the only carbon containing feedstock.	551
Table 9-52 Biomass and fossil material mass flows describing the synthesis of sodium laureth sulphate from vegetable oil for the calculation of total bio-based content according to mass balance Method B.	552
Table 9-53 Bio-based carbon and fossil material mass flows describing the synthesis of sodium laureth sulphate from vegetable oil for the calculation of bio-based carbon content according to mass balance Method B.	552
Table 9-54 Biomass and fossil material mass flows describing the synthesis of sodium laureth sulphate for the calculation of total bio-based content according to mass balance Method B for a process without vegetable oil.	552
Table 9-55 Bio-based carbon and fossil material mass flows describing the synthesis of sodium laureth sulphate for the calculation of bio-based carbon content according to mass balance Method B for a process without vegetable oil.	553
Table 9-56 Fossil carbon savings in sodium laureth sulphate (SLS) when vegetable oil is a feedstock.	554
Table 9-57 Fossil carbon savings in sodium laureth sulphate when bio-naphtha is the only carbon containing feedstock.	555
Table 9-58 Spring data for a mass balance Method D calculation of total bio-based content for sodium laureth sulphate when seasonal variation influences the bio-based content.	556
Table 9-59 Spring data for a mass balance Method D calculation of bio-based carbon content for sodium laureth sulphate when seasonal variation influences the bio-based content.	556
Table 9-60 Summer data for a mass balance Method D calculation of total bio-based content for sodium laureth sulphate when seasonal variation influences the bio-based content.	557
Table 9-61 Summer data for a mass balance Method D calculation of bio-based carbon content for sodium laureth sulphate when seasonal variation influences the bio-based content.	557
Table 9-62 Autumn data for a mass balance Method D calculation of total bio-based content for sodium laureth sulphate when seasonal variation influences the bio-based content.	558
Table 9-63 Autumn data for a mass balance Method D calculation of bio-based carbon content for sodium laureth sulphate when seasonal variation influences the bio-based content.	558
Table 9-64 Winter data for a mass balance Method D calculation of total bio-based content for sodium laureth sulphate when seasonal variation influences the bio-based content.	559
Table 9-65 Winter data for a mass balance Method D calculation of bio-based carbon content for sodium laureth sulphate when seasonal variation influences the bio-based content.	559



Table 9-66 The bio-based content of synthetic vanillin made from guaiacol according to mass balance Method A.	560
Table 9-67 Biomass and fossil derived material mass flows describing the synthesis vanillin for use in mass balance Method B calculations.	561
Table 9-68 Bio-based carbon and fossil carbon mass balance data for the manufacture of vanillin from guaiacol.	561
Table 9-69 Mass balance Method C calculations applied to the synthesis of vanillin.	562
Table 9-70 Ingredients for blends of starch plasticised with glycerol and poly(ethylene) amounting to 100 kg of product.	563
Table 9-71 Mass balance Method A applied to a formulation consisting of 75 wt% of petrochemical poly(ethylene) and plasticised starch.	564
Table 9-72 Biomass and fossil material content in the ingredients of a starch blend (3:1 poly(ethylene) to starch) for the calculation of total bio-based content according to mass balance Method B.	565
Table 9-73 Biomass and fossil material content in the ingredients of a starch blend (3:1 poly(ethylene) to starch) for the calculation of bio-based carbon content according to mass balance Method B.	565
Table 9-74 Biomass and fossil material mass flows describing the synthesis of the ingredients in a starch blend according to mass balance Method B.	565
Table 9-75 Biomass and fossil material mass flows describing the synthesis of the ingredients in a starch blend according to mass balance Method B.	566
Table 9-76 Mass balance Method C for the calculation of fossil carbon saving in the production of a starch blend with poly(ethylene).	567
Table 9-77 Mass balance data for the manufacture of different blends of poly(lactic acid) and poly(butylene adipate terephthalate) made from bio-based <i>p</i> -xylene with the plasticiser acetyl tributyl citrate included.	568
Table 9-78 Mass balance data for the manufacture of a poly(lactic acid) and poly(butylene adipate terephthalate) containing fossil derived <i>p</i> -xylene blend with the plasticiser acetyl tributyl citrate included.	569
Table 9-79 Total bio-based content by mass balance Method A for a poly(lactic acid) and poly(butylene adipate terephthalate) blend (1:4 by mass) in which the 1,4-butanediol monomer is bio-based.	570
Table 9-80 Total bio-based content by mass balance Method A for a poly(lactic acid) and poly(butylene adipate terephthalate) blend (1:4 by mass) in which the 1,4-butanediol and terephthalate monomers are bio-based.	571
Table 9-81 Total bio-based content by mass balance Method A for a poly(lactic acid) and poly(butylene adipate terephthalate) blend (4:1 by mass) in which the 1,4-butanediol and terephthalate monomers are bio-based.	572



Table 9-82 Material flows in the production of a poly(lactic acid) blend with poly(butylene adipate terephthalate) (1:4 by mass) for the calculation of total bio-based content according to mass balance Method B in which the terephthalate monomer is fossil derived.	573
Table 9-83 Material flows in the production of a poly(lactic acid) blend with poly(butylene adipate terephthalate) (1:4 by mass) for the calculation of bio-based carbon content according to mass balance Method B in which the terephthalate monomer is fossil derived.	573
Table 9-84 Material flows in the production of a poly(lactic acid) blend with poly(butylene adipate terephthalate) (1:4 by mass) for the calculation of total bio-based content according to mass balance Method B in which the terephthalate monomer is bio-based with the mass flows of an analogous process but without losses in the conversion of isobutanol to <i>p</i> -xylene given in brackets.	574
Table 9-85 Material flows in the production of a poly(lactic acid) blend with poly(butylene adipate terephthalate) (1:4 by mass) for the calculation of bio-based carbon content according to mass balance Method B in which the terephthalate monomer is bio-based with the mass flows of an analogous process but without losses in the conversion of isobutanol to <i>p</i> -xylene given in brackets.	574
Table 9-86 Material flows in the production of a poly(lactic acid) blend with poly(butylene adipate terephthalate) (4:1 by mass) for the calculation of total bio-based content according to mass balance Method B in which the terephthalate monomer is bio-based.	575
Table 9-87 Material flows in the production of a poly(lactic acid) blend with poly(butylene adipate terephthalate) (4:1 by mass) for the calculation of bio-based carbon content according to mass balance Method B in which the terephthalate monomer is bio-based....	575
Table 9-88 Assessment of fossil carbon saving in the production of a poly(lactic acid) blend with poly(butylene adipate terephthalate) (1:4 by mass) made from bio-based 1,4-butanediol and bio-based terephthalate.....	576
Table 9-89 Assessment of fossil carbon saving in the production of a poly(lactic acid) blend with poly(butylene adipate terephthalate) (1:4 by mass) made from bio-based 1,4-butanediol and bio-based terephthalate by reaction stoichiometry when process losses are ignored. .	577
Table 9-90 Total bio-based content by mass balance Method A for a cleaning product formulation.	579
Table 9-91 The calculation of total bio-based content according to mass balance Method B for a cleaning product.	580
Table 9-92 The calculation of bio-based carbon content according to mass balance Method B for a cleaning product.	580
Table 9-93 Calculation of bio-based carbon metrics for a cleaning product using mass balance Method C.	581
Table 9-94 Total bio-based content by mass balance Method A for a composite resin.	583
Table 9-95 The calculation of total bio-based content according to mass balance Method B for a cleaning product.	584



Table 9-96 The calculation of bio-based carbon content according to mass balance Method B for a cleaning product.....584

Table 9-97 Fossil carbon savings for a composite curing resin product made from a triglyceride.....585



List of figures

Figure 1-1 A reaction schematic for the production of poly(ethylene terephthalate from bio-ethanol.	43
Figure 2-1 A schematic of the radiocarbon method principle of bio-based carbon content determination.	47
Figure 2-2 Carbon isotopic composition ranges for samples of material from different feedstocks.	50
Figure 2-3 The distribution of stable isotopes found in ethanol samples.	51
Figure 2-4 A schematic of the mass balance principle.	53
Figure 2-5 A demonstration of ‘book-and-claim’ where certificates are traded between equal amounts of the same product in different locations.	55
Figure 2-6 A demonstration of ‘attribution’ where a quantity of biomass derived content is spread across different products of a biorefinery and redistributed to a favoured product stream.	56
Figure 2-7 An example of a Vinçotte certificate of bio-based content.	59
Figure 2-8 The DIN Biobasert label for articles of greater than 85% bio-based carbon content.	59
Figure 2-9 Rules of atom connectivity.	61
Figure 2-10 The synthesis of ethyl acetate from bio-ethanol (red atoms are assumed to originate from fossil sources, green atoms are assumed to be from biomass).	61
Figure 2-11 A schematic of an esterification reaction presented as a mass balance assuming no losses.	65
Figure 3-1 A hypothetical sugarcane-petroleum derived composite characterised by ^{13}C : ^{12}C isotopic analysis. The region of overlap between the possible results of a fossil based material (red) and a supposedly 50% sugarcane derived material (dark green) is indicated by the dashed lines.	74
Figure 3-2 The synthesis of some representative bio-based products from bio-ethanol.	78
Figure 3-3 Estimation of stable isotope ratios of carbon and hydrogen for ethanol and its co-reactants and products.	79
Figure 3-4 Experimental stable isotope ratios for authentic vanillin samples.	80
Figure 4-1 A summary of bio-based content atom connectivity method results for bulk chemicals (as an inorganic compound ammonia is not included).	95
Figure 4-2 Atom allocation assignments for acetic acid made from syngas.	96
Figure 4-3 Atom allocation assignments for acetic acid made from bio-ethanol.	98
Figure 4-4 Atom allocation assignments for the glycerol produced in bio-diesel production.	99
Figure 4-5 Atom allocation assignments for <i>p</i> -xylene made from hydroxymethylfurfural.	101
Figure 4-6 Atom allocation assignments for <i>p</i> -xylene made from isobutanol.	103



Figure 4-7 Atom allocation assignments for 1,4-butanediol made from hydrogenated succinic acid.	104
Figure 4-8 Atom allocation assignments for sugar derived adipic acid.	106
Figure 4-9 Atom allocation assignments for petroleum derived adipic acid.	108
Figure 4-10 Atom allocation assignments for partially bio-based 2-ethoxyethyl acetate.	110
Figure 4-11 Atom allocation assignments for butylated hydroxytoluene.	112
Figure 4-12 Atom allocation assignments for acetyl tributyl citrate made from citric acid.	114
Figure 4-13 Atom allocation assignments for ammonia.	116
Figure 4-14 A summary of bio-based content atom connectivity method results for bio-based lubricants.	118
Figure 4-15 Atom allocation assignments for methyl oleate.	119
Figure 4-16 Atom allocation assignments for neopentyl glycol distearate.	121
Figure 4-17 A summary of bio-based content atom connectivity method results for different bio-based plastics.	124
Figure 4-18 A summary of bio-based content atom connectivity method results for polyacrylates.	125
Figure 4-19 Atom allocation assignments for fossil derived polyethylene.	126
Figure 4-20 Atom allocation assignments for bio-polyethylene.	127
Figure 4-21 Atom allocation assignments for poly(lactic acid).	128
Figure 4-22 Atom allocation assignments for poly(ethylene terephthalate).	129
Figure 4-23 Atom allocation assignments for poly(butylene adipate terephthalate).	131
Figure 4-24 Atom allocation assignments for poly(vinyl acetate)	133
Figure 4-25 Atom allocation assignments for poly(vinyl alcohol).	134
Figure 4-26 Atom allocation assignments for fossil derived ethyl acrylate monomer.	136
Figure 4-27 Atom allocation assignments for bio-ethanol derived ethyl acrylate monomer.	138
Figure 4-28 Atom allocation assignments for glycerol derived ethyl acrylate monomer.	139
Figure 4-29 Atom allocation assignments for wholly bio-based ethyl acrylate monomer.	140
Figure 4-30 Atom allocation assignments for the dodecyl acrylate monomer produced from bio-dodecanol.	142
Figure 4-31 Atom allocation assignments for glycerol derived dodecyl acrylate monomer.	143
Figure 4-32 Atom allocation assignments for renewable sodium polyacrylate.	145
Figure 4-33 Atom allocation assignments for a soy oil derived polyurethane.	148
Figure 4-34 A summary of bio-based content atom connectivity method results for different bio-based solvent products.	151
Figure 4-35 Atom allocation assignments for petrochemical methanol.	152
Figure 4-36 Atom allocation assignments for ethyl acetate from bio-ethanol esterification.	153
Figure 4-37 Atom allocation assignments for ethyl lactate made from fermentation products.	155
Figure 4-38 Atom allocation assignments for fossil derived acetone.	156
Figure 4-39 Atom allocation assignments for furfural reduced to 2-methyltetrahydrofuran.	157



Figure 4-40 Atom allocation assignments for <i>N</i> -methylpyrrolidinone made from glutamic acid.	159
Figure 4-41 Atom allocation assignments for dimethyl isosorbide.	161
Figure 4-42 A summary of bio-based content atom connectivity method results for bio-based surfactants.	164
Figure 4-43 Atom allocation assignments for bio-based hydrogen dodecyl sulphate.	165
Figure 4-44 Atom allocation assignments for sodium dodecyl sulphate made from vegetable oil.	167
Figure 4-45 Atom allocation assignments for sodium laureth sulphate.	170
Figure 4-46 The calculated total bio-based content and anticipated bio-based carbon content of sodium laureth sulphate according to atom connectivity Method 2b made from either vegetable oil fatty acids or bio-based ethylene.	173
Figure 4-47 Atom allocation assignments for cocamidopropyl betaine.	174
Figure 4-48 Atom allocation assignments for <i>N</i> -dodecylpyridinium chloride.	176
Figure 4-49 A summary of bio-based content atom connectivity method results for fine chemicals from renewable resources.	180
Figure 4-50 Atom allocation assignments for aspirin.	181
Figure 4-51 Atom allocation assignments for synthetic vanillin.	183
Figure 4-52 Atom allocation assignments for <i>p</i> -cymenesulphonamide.	185
Figure 4-53 Comparisons between the bio-based content of different poly(ethylene)-starch blend ratios.	190
Figure 4-54 The structure of poly(butylene adipate terephthalate) copolymer.	191
Figure 4-55 The synthesis of acetyl tributyl citrate.	192
Figure 4-56 The bio-based carbon content (by carbon mass) of different PLA-PBAT blend also containing the plasticiser ATBC.	197
Figure 4-57 The total bio-based content (by mass) of different PLA-PBAT blend also containing the plasticiser ATBC.	197
Figure 4-58 Comparisons between the bio-based content of different ratios of a polyurethane and polyurea mixture.	200
Figure 4-59 A comparison between atom connectivity Method 1 and atom connectivity Method 2b relative to bio-based carbon content.	202
Figure 4-60 A comparison between atom connectivity Method 2b and the atom connectivity approach from the ACDV certification scheme.	204
Figure 4-61 A comparison between atom connectivity Method 3, plant derived content only as calculated by atom connectivity Method 3, and also the ACDV approach (indicated as the dashed black line).	206
Figure 5-1 A schematic overview of the mass balance principle.	209
Figure 5-2 A demonstration of attribution of fossil resource savings.	217
Figure 5-3 A hypothetical manufacturing process demonstrating mass balance.	219



Figure 5-4 Hypothetical manufacturing process with the product limiting flow highlighted and mass flows indicated in mass units (kilograms).	221
Figure 5-5 A general example of mass balance Method B in practice.....	226
Figure 5-6 Mass balance approach to calculate the amount of bio-based carbon/fossil carbon saved in the global supply chain in a dedicated facility with mass flows described in units of kilograms.....	234
Figure 5-7 Mass balance approach to calculate the amount of bio-based carbon/fossil carbon saved in the global supply chain for the production of product D/D* in a non-dedicated facility with mass flows described in units of kilograms.....	236
Figure 5-8 An illustration of material and certificate conversion incorporated within the mass balance approach.....	237
Figure 5-9 A conceptual example of the book-and-claim approach.	242
Figure 5-10 A Sankey diagram representing coal gasification.	245
Figure 5-11 A Sankey diagram representing biomass gasification.....	246
Figure 5-12 A Sankey diagram representing biomass gasification without accounting for the surplus water used in the process.	247
Figure 5-13 The effect on bio-based content by mass balance Method B as the amount of starch is increased in a gasification feedstock.	249
Figure 5-14 The effect on fossil carbon savings as the amount of starch is increased in a gasification feedstock producing 100 kilograms of carbon monoxide.....	251
Figure 5-15 A Sankey diagram representing the conversion of both conventional naphtha and bio-naphtha into ethanol by splitting the process into separate virtual fossil and biomass resource sub-streams.....	254
Figure 5-16 Attribution of bio-based content for ethylene (C ₂), propylene (C ₃) and butenes (C ₄) thermocracking product streams.	255
Figure 5-17 The effect on the bio-based content of ethylene as the amount of bio-naphtha is increased in the feedstock according to calculations by mass balance Method B.....	256
Figure 5-18 A hypothetical example of non-ideal behaviour in a mixed feedstock stream...257	
Figure 5-19 Fossil carbon savings based on the final product ethanol (in red) and the feedstock (in blue) per 100 kg of ethanol product manufactured according to mass balance Method C.....	259
Figure 5-20 A Sankey diagram showing the production of 2-ethoxyethyl acetate from conventional naphtha and natural gas (methane).	260
Figure 5-21 A Sankey diagram detailing the combined coal gasification and conventional naphtha cracking process as a means of obtaining 2-ethoxyethyl acetate.	262
Figure 5-22 Fermentation to acetic acid as part of the manufacture of 2-ethoxyethyl acetate on a Sankey diagram where fossil derived naphtha is another feedstock.	263
Figure 5-23 Mass balance Method A attributed bio-based content values from the naphtha feedstock onto 2-ethoxyethyl acetate (not the full bio-based content value that also contains a contribution from a second feedstock).	265



Figure 5-24 Fossil carbon savings based on the final product (in red) and the feedstock (in blue) per 100 kg of 2-ethoxyethyl acetate product relative to two different reference procedures.	268
Figure 5-25 Acetyl group atom origins for 2-ethoxyethyl acetate.	270
Figure 5-26 Combinations of feedstocks for ethyl acetate manufacturing.	272
Figure 5-27 A Sankey diagram of the production of partially bio-based ethyl acetate. Numbers refer to relative masses.	274
Figure 5-28 A Sankey diagram describing ethyl acetate production while also indicating flows of biomass, atoms from water, and petroleum-derived material. The widths of arrows indicate mass flows. Grey boxes are processes. Green arrows indicate biomass. Blue arrows describe the flow of atoms derived from water. Red arrows indicate fossil based material.	275
Figure 5-29 Flow of material divided by source. Same key as Figure 5-28. Within the 'feed' segment, the areas of the darker coloured boxes are representative of the relative masses of biomass, water, and petroleum derived materials in the feedstocks.	276
Figure 5-30 A Sankey diagram of the production of partially bio-based ethyl acetate adopting ethanol as one of the feedstocks.	278
Figure 5-31 A Sankey diagram describing the production of bio-diesel. Mass flows too small to be proportionally represented are displayed as conventional arrows.	282
Figure 5-32 The use of bio-ethanol in the production of partially bio-based poly(ethylene terephthalate).	285
Figure 5-33 A Sankey diagram of poly(ethylene terephthalate) production from naphtha.	286
Figure 5-34 Mass balance Method B calculations for variable proportions of bio-ethanol in a process for poly(ethylene terephthalate) production.	288
Figure 5-35 A Sankey diagram describing the process of manufacturing the surfactant sodium laureth sulphate containing a triethylene glycol moiety.	292
Figure 5-36 A Sankey diagram describing the process of manufacturing the surfactant sodium laureth sulphate from naphtha derived ethylene.	294
Figure 5-37 The process of manufacturing the surfactant sodium laureth sulphate containing a triethylene glycol moiety from vegetable oil and conventional naphtha with biomass mass flows highlighted in light green and fossil derived mass flows highlighted in light blue and finally the major product being partially bio-based highlighted in light orange.	296
Figure 5-38 The process of manufacturing the surfactant sodium laureth sulphate containing a triethylene glycol moiety from bio-based naphtha with biomass mass flows highlighted in light green and fossil derived mass flows highlighted in light blue and finally the major product being partially bio-based highlighted in light orange.	298
Figure 5-39 A simplified Sankey diagram describing the process used to manufacture synthetic vanillin from guaiacol.	304
Figure 5-40 The process of manufacturing vanillin from bio-based naphtha with biomass material flows highlighted in light green and fossil derived mass flows highlighted in light blue and finally the partially bio-based outputs highlighted in light orange.	305



Figure 5-41 The proportion of fossil savings possible by increasing the amount of natural guaiacol in a vanillin production plant up to a maximum of 124 kg for every 100 kg of vanillin produced.	306
Figure 5-42 A hypothetical formulation of ingredients A to F with the bio-based content and fossil carbon saving indicated for each ingredient and the formulation as a whole.	310
Figure 5-43 The mass given in kilograms of each ingredient in a hypothetical formulation of total mass 100 kg.	310
Figure 5-44 A Sankey diagram indicating the processes that combine to give the ingredients of a starch blend plastic material.	312
Figure 5-45 The difference between the mass contribution of each bio-based component in a starch polymer blend and the attributed total bio-based content (mass balance Method A) assuming each ingredient is bio-based.	313
Figure 5-46 Mass balance Method B calculations of bio-based content and bio-based carbon content of a starch blended plastic based on the ingredients contained within the formulation or the original feedstocks.	314
Figure 5-47 The certification mark awarded by DINCERTO for products containing 85% bio-based carbon or more.	316
Figure 5-48 The amounts of starch required in 100 kg of a blend with poly(ethylene) to secure a calculated total bio-based content of 85%.	317
Figure 5-49 The synthesis of monomers and a plasticiser to use in the manufacturing of a blend of poly(lactic acid) and poly(butylene adipate terephthalate) (1:4 mass ratio).	318
Figure 5-50 A Sankey diagram representing the production of poly(lactic acid) and subsequent formulation to produce a blend of poly(lactic acid) and poly(butylene adipate terephthalate) with a 1:4 mass ratio also containing acetyl tributyl citrate.	319
Figure 5-51 The synthesis of monomers and a plasticiser to use in the manufacturing of a blend of poly(lactic acid) and poly(butylene adipate terephthalate) (4:1 mass ratio).	321
Figure 5-52 A Sankey diagram representing the production of poly(lactic acid) and subsequent formulation to produce a blend of poly(lactic acid) and poly(butylene adipate terephthalate) with a 4:1 mass ratio also containing acetyl tributyl citrate.	322
Figure 5-53 The maximum possible contributions by each individual feedstock chemical towards total bio-based content calculated according to mass balance Method A for different polymer blends.	324
Figure 5-54 The mass contributions by each individual feedstock chemical towards the different blends of poly(lactic acid) and poly(butylene adipate terephthalate).	324
Figure 5-55 A Sankey diagram (left) for the production of an insulation panel (right).	331
Figure 5-56 A Sankey diagram for the combined synthesis of the ingredients for a cleaning product.	333
Figure 5-57 A Sankey diagram for the combined synthesis of the ingredients for a resin composite.	334



Figure 5-58 The ingredients of the cleaning product with atom connectivity assignments (Method 2b).....	335
Figure 5-59 The ingredients of the composite curing resin with atom connectivity assignments (Method 2b).....	336
Figure 5-60 The comparison between direct and indirect methods of obtaining bio-based carbon content for various products.....	343
Figure 5-61 The comparison between different indirect mass balance methods of obtaining total bio-based content and atom connectivity Method 2b for various products.	344
Figure 5-62 The comparison between different indirect mass balance methods of obtaining total bio-based content and atom connectivity according to ACDV calculations for various products.	345
Figure 5-63 The comparison between applications of mass balance Method D and bio-based carbon content.	346
Figure 5-64 A comparison between atom connectivity Method 2b and mass balance Method B and Method D for the indirect calculation of total bio-based content.....	347
Figure 5-65 An engineering process diagram for the manufacture of ammonia from nitrogen gas and a hydrocarbon hydrogen source including schematic key.	348
Figure 5-66 An example of how variable feedstocks can change total bio-based content over time.	350
Figure 5-67 A confirmation that fluctuations in biomass input do not change the year average total bio-based content of products compared to this steady state equivalent.....	351
Figure 5-68 A hypothetical example of non-ideal behaviour in a mixed feed thermal cracking process.	352
Figure 5-69 Allocated bio-based content of cracked naphtha product streams with 75% bio-naphtha in feedstock. Key: dark green = ideal bio-based portion; dark red = ideal fossil derived content; light green = allocated bio-based content of experimental yield; light red = allocated fossil derived content of experimental yield.	353
Figure 5-70 Allocated bio-based content of cracked naphtha product streams with 50% bio-naphtha in feedstock. Key as in Figure 5-69.....	354
Figure 5-71 Allocated bio-based content of cracked naphtha product streams with a fluctuating bio-naphtha content in the feedstock. Key as in Figure 5-69.	354
Figure 5-72 The total bio-based content allocated to products of naphtha thermocracking with different biomass feedstock amounts.	355
Figure 5-73 Examples of how palm oil sustainability certificates are redistributed after transportation.	357
Figure 5-74 A hypothetical situation in which solid pellets are divided into batches, where green indicates the bio-based product and red indicates an identical but fossil derived product.	359
Figure 5-75 A second hypothetical situation in which solid pellets of mixed origin are divided into batches.....	360



Figure 5-76 A demonstration of the effect of losses incurred during transportation or storage.	361
Figure 5-77 A Sankey diagram describing the production of a dimethyl adipate as an intermediate for polymers with mixing of adipic acid early in the production chain.	363
Figure 5-78 A Sankey diagram describing the production of a dimethyl adipate as an intermediate for polymers with mixing of dimethyl adipate late in the production chain.	364
Figure 5-79 A Sankey diagram describing the process of manufacturing the surfactant sodium laureth sulphate from an ethylene intermediate.	366
Figure 5-80 The first scenario of sodium laureth sulphate production.	367
Figure 5-81 The second scenario of sodium laureth sulphate production.	368
Figure 5-82 The third scenario of sodium laureth sulphate production with biomass feedstock fluctuation.	370
Figure 5-83 The fourth scenario of sodium laureth sulphate production with biomass feedstock fluctuation.	373
Figure 5-84 The variable bio-based content of sodium laureth sulphate according to mass balance Method D.	374
Figure 5-85 The total bio-based content of a formulation calculated by assuming the worst case losses in the production chain or proportional losses.	377
Figure 5-86 A flow diagram representing events in the production chain that determine how mass balance can be applied.	382
Figure 6-1 Survey of the 'Agrobiobase' online database for products of potentially variable total bio-based content.	385
Figure 6-2 A schematic describing the production chain for a bio-based product.	386
Figure 6-3 A schematic describing the production chain for a bio-based product divided into a virtual biomass processing mass balance (blue) and a virtual fossil sub-mass balance (brown).	388
Figure 6-4 An example of virtual separation in a carbon mass balance.	389
Figure 6-5 An example of virtual separation in a carbon mass balance with proportional losses allocated to each virtual sub-mass balance.	391
Figure 6-6 An abstract schematic of a life cycle describing a bio-based product but specific to its carbon content. Mass balance for indirect total bio-based content calculations resides within the 'production' segment.	397
Figure 6-7 Renewability definitions applied pictorially within the context of the life cycle of a bio-based product.	399
Figure 6-8 A schematic of the life cycle describing a bio-based product specific to its carbon content annotated with complimentary tools and standards and where they apply.	400



List of schemes

Scheme 4-1 The oxidation mechanism of ethanol to acetic acid.....	97
Scheme 4-2 The chemical equation for syngas production. Red atoms are fossil derived. Blue atoms originate from water.	104
Scheme 4-3 A plausible general alcohol oxidation mechanism with nitric acid as an oxidising agent.	106
Scheme 4-4 The oxidation of <i>p</i> -cymene.	111
Scheme 4-5 The general esterification mechanism when the two carboxylate oxygen atoms are not regarded as equivalent.	120
Scheme 4-6 The reduction of fatty acids.	141
Scheme 4-7 The formation of diols from soy oil shown for one fatty acid group only.	147
Scheme 4-8 Starch-poly(ethylene) blend made from starch.	188
Scheme 4-9 The general transesterification of triglycerides labelled in the style of atom connectivity Method 3.....	189
Scheme 4-10 A fermentation route to poly(lactic acid) from corn starch.	192
Scheme 4-11 Typical petrochemical routes to 1,4-butanediol indicating the distribution of bio-based hydrogen atoms with those derived from natural gas in red and those from water in blue.	194
Scheme 4-12 A fermentative route to 1,4-butanediol.....	195
Scheme 4-13 The synthesis of bio-based terephthalic acid from isobutanol.	195
Scheme 4-14 The oxidation of cyclohexane to give adipic acid.	196
Scheme 4-15 A bio-based route to adipic acid.	196
Scheme 4-16 The synthesis of a typical polyurethane from methylene diphenyl diisocyanate and a diol.....	198
Scheme 4-17 The liberation of carbon dioxide from methylene diphenyl diisocyanate and subsequent polyurea synthesis.	199
Scheme 5-1 2-Ethoxyethyl acetate sectioned into naphtha derived portions in green and the acetate group highlighted in blue.....	266
Scheme 5-2 Esterification of bio-ethanol.	272
Scheme 5-3 Bio-based ethyl acetate by Davy-Sasol method.....	279
Scheme 5-4 The synthesis of sodium laureth sulphate from triglycerides.	291
Scheme 8-1 Two methods of displaying the distribution of hydrogen atoms from fossil and water sources in methanol.....	405
Scheme 8-2 The synthesis of acetic acid from syngas.	406
Scheme 8-3 An alternative synthesis of acetic acid by bio-ethanol oxidation.....	409
Scheme 8-4 The synthesis of fatty acid methyl esters (FAMES) and glycerol from vegetable oil.	411



Scheme 8-5 The synthesis of <i>p</i> -xylene from isobutanol.....	415
Scheme 8-6 The synthesis of <i>p</i> -xylene <i>via</i> 2,5-dimethylfuran.	417
Scheme 8-7 The synthesis of 1,4-butanediol by the hydrogenation of succinic acid.	419
Scheme 8-8 The synthesis of adipic acid from the oxidation the reduction of glucose.	421
Scheme 8-9 Petrochemical feedstock synthesis for adipic acid.	423
Scheme 8-10 The synthesis of 2-ethoxyethyl acetate using bio-ethanol.....	425
Scheme 8-11 The synthesis of butylated hydroxytoluene (BHT) and acetone from toluene.	428
Scheme 8-12 The synthesis of acetyl tributyl citrate (ATBC) from only citric acid and syngas.	433
Scheme 8-13 The synthesis of ammonia from its constituent elements.....	436
Scheme 8-14 The synthesis of neopentyl glycol distearate from syngas and propene and fatty acids.....	438
Scheme 8-15 The synthesis of polyethylene by fermentation or from the cracking of saturated hydrocarbons in fossil resources.....	441
Scheme 8-16 The synthesis of polylactic acid by fermentation and polyesterification.	444
Scheme 8-17 The synthesis of ethyl lactate by fermentation and esterification.	446
Scheme 8-18 The synthesis of polyethylene terephthalic acid from bio-ethylene and terephthalic acid from fossil based <i>p</i> -xylene.	448
Scheme 8-19 The synthesis of poly(butylene adipate terephthalate) from bio-based 1,4- butanediol and other petrochemical reactants.	451
Scheme 8-20 The synthesis of polyvinyl acetate from the esterification of bio-based acetic acid and alcoholysis to give polyvinyl alcohol.	454
Scheme 8-21 The possible syntheses of ethyl acrylate from acrylic acid and ethanol (products indicated in dashed boxes).	459
Scheme 8-22 Two possible syntheses of dodecyl acrylate from acrylic acid and dodecanol (products indicated in dashed boxes).	466
Scheme 8-23 The synthetic route to poly(sodium acrylate) from biomass.	470
Scheme 8-24 The synthesis of a polyurethane from epoxidised soy oil.	474
Scheme 8-25 The synthesis of ethyl acetate from bio-ethanol.....	477
Scheme 8-26 The synthesis of 2-methyltetrahydrofuran from furfural.....	480
Scheme 8-27 The synthesis of <i>N</i> -methylpyrrolidinone from glutamic acid.	482
Scheme 8-28 The synthesis of dimethyl isosorbide from sorbitol.....	485
Scheme 8-29 The synthesis of sodium dodecyl sulphate from vegetable oil <i>via</i> hydrogen dodecyl sulphate.	489
Scheme 8-30 The synthesis of sodium laureth sulphate from vegetable oil.	494
Scheme 8-31 The synthesis of cocamidopropyl betaine from vegetable oil.	500
Scheme 8-32 The synthesis of <i>N</i> -dodecylpyridinium chloride from pyridine and vegetable oil.	503
Scheme 8-33 The synthesis of aspirin from phenol.	506



Scheme 8-34 The synthesis of vanillin from guaiacol.	508
Scheme 8-35 The synthesis of <i>p</i> -cymenesulphonamide from limonene.	510



1 Summary

As established in the KBBPPS description of work, and reiterated on the project website (www.bio-based.eu/kbbpps), the project aims to increase the uptake of standard test methods and certification schemes for bio-based products. It is envisaged that the development and application of standards for the bio-based product industry will have positive long-term effects on the development of a European bio-based economy. Higher quality and greater sustainability of bio-based products should increase the satisfaction of end-users at all levels, and improve the economic viability of bio-based product utilisation. Finally, public acceptance of bio-based products can be increased through ensuring and verifying the sustainable sourcing of raw materials, the effective bio-content and clear indication of their (comparative) functionality in relation to regular products. These positive effects will result in faster growth of the bio-based product industry and increased share of bio-based in the total use of final (consumer) products and intermediates up to 2020 and beyond.

The effective determination of total bio-based content of products has been a challenge for certification bodies. The ability to determine the total bio-based content of a product is an obvious prerequisite for developing the market for bio-based products. Currently, the state of the art in terms of bio-based content determination is restricted to biogenic carbon content. The methodology is typically based on accelerated mass spectrometry to resolve the relative concentrations of carbon isotopes ($^{14}\text{C}/^{12}\text{C}$) in a sample. Results based on the radiocarbon methodology are expressed as the fraction of the bio-based carbon relative to the total carbon content of the sample. The presence of other elements introduces a disparity between bio-carbon content and total bio-based content; some products have very few heteroatoms, such as lubricants, while more typically bio-based products such as PLA and starch composites have relatively high amounts of oxygen.

One ambition of the project is to establish a means of complete biomass content evaluation, progressing from what exists at present. Sample preparation has already been addressed in [KBBPPS deliverable report D3.1](#) and [KBBPPS deliverable report D4.3](#). Subsequent output will address direct methods of bio-based content determination ([KBBPPS deliverable report D4.4](#) and [KBBPPS deliverable report D4.6](#)). This report covers approaches for the indirect calculation of total bio-based content. Indirect methods are useful when the bio-based product is not manufactured in a dedicated facility, causing potential fluctuations in the amount of biomass incorporated into the final article. The choice of potential methods is large, and how they are put into practice can vary the output dramatically.



The example of poly(ethylene terephthalate), PET, is useful to demonstrate the different conclusions of the indirect calculation methods. It is currently produced as a partially bio-based material made from bio-ethanol and contains 20% bio-based carbon content (Figure 1-1). Of the atoms incorporated into the product, those that were originally contained within the bio-ethanol feedstock amount to 15% of its total mass. If assuming that atoms bonded to bio-based carbon atoms are themselves also bio-based the calculated bio-based content increases to over 30%. This value is more representative of the balance between fossil resource feedstock and biomass feedstock in the production chain, which is often skewed by the presence of mineral and inorganic feedstocks such as water and oxygen. If mineral feedstocks are included in the contribution towards the calculation of total bio-based content the value approaches 50%.

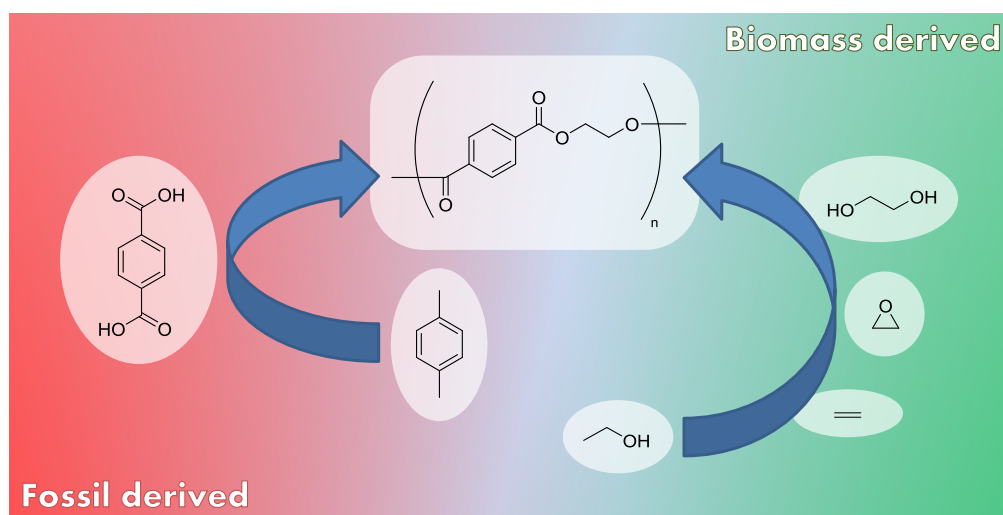


Figure 1-1 A reaction schematic for the production of poly(ethylene terephthalate) from bio-ethanol.

To decide upon the most robust and widely applicable approach, a number of case studies were completed. During the course of this report indirect methods for the calculation of total-bio-based content have divided into two categories: atom connectivity and mass balance, each containing four different approaches. More than thirty bio-based products have been assessed with these methods. This report also contains a series of recommendations regarding the implementation of indirect methods for the calculation of total bio-based content.



2 Introduction

2.1 Aims and objectives

Analysis based on ^{14}C radiocarbon methods is expressed as a fraction of bio-based carbon relative to the total organic carbon (as in [ASTM D6866](#)) or alternatively as a function of the total carbon content in the sample (as in European standard [CEN/TS 16640](#)), but in some cases the whole biomass weight fraction can differ substantially from the bio-based carbon weight fraction of a product. Biomass itself is generally oxidised whereas petrochemicals are hydrocarbons. Thus complimentary approaches to bio-based content determination are desirable. Direct determination of bio-based carbon content is also restricted to products that consistently contain the same quantity of bio-based carbon content, otherwise the analysis is unrepresentative.

The biomass derived content of a particular product is not a simple measurement that only concerns the final article, as it may be that significant non-biomass (typically petroleum) derived resources are utilised elsewhere in the supply chain. These chemicals, or at least their by-products, may not actually end up in the final formulation.

Application of a standard test method and testing scheme for the determination of biomass content that is not solely dependent on ^{14}C analysis and applicable to, for example, bio-polymers presents another possibility. There are issues around functionality bottlenecks and as such it may be a better option to assess the biomass content based on that functionality rather than based on composition alone. A robust calculation based methodology based on the functionality of a product will be developed to ensure standardisation and acceptance of a protocol.

The aim of this report is to help with the development of a method with which to calculate the bio-based content of chemical products indirectly. Approaches must be flexible to account for fluctuating biomass feedstocks in non-dedicated production facilities and incorporate other elements in addition to carbon. Recommendations are proposed on the basis of case study findings, examining the limitations of different approaches to atom connectivity and mass balance methodologies.



2.2 The concept of bio-based content

The motivation of an EU mandated drive towards a bio-based economy is the promotion of a sustainable basis to chemical product manufacturing in Europe [EU M/429, EU M/492]. This is a concern because of the inherent unsustainability of the competing petroleum chemical industry, which is the only other resource for the production of organic compounds. It is intended that the application of standards and certification systems in the European bio-based product industry will have positive long-term effects on the overall development of bio-based product markets. The KBBPPS project aims at increasing the uptake speed of standards and certification systems for bio-based products by producing pre-normative research.

The definition of the term bio-based, and the initiative to enhance the bio-based economy, has established a distinction between biomass sources of chemicals and other sources of the elements, presumed to be fossil based and undesirable. Both EU mandates do not mention fossil feedstocks, with a statement by the EC competitiveness council, calling for the “*fostering emergence of markets with high economic and societal value*”, providing the rationale for a bio-based economy on the basis of jobs, sales, and monetary value [EU M/429].

As for the analytical measurement of bio-based content, only for carbon is the distinction between bio-based atoms and fossil derived atoms made unambiguous. For this purpose radioisotope analysis analogous to the radiocarbon dating techniques used by archaeologists can be used [Norton 2006, Norton 2007]. This is known as direct bio-based content analysis. Beyond carbon, the other elements used in the synthesis of commodity chemicals and speciality formulations alike come from a variety of sources, but most are absent from fossil based hydrocarbon feedstocks. Nevertheless, there is an interest and a perceived demand from suppliers and business consumers alike in calculating bio-based content on a total mass basis. In order to do this a number of calculation methods are in development that address bio-based content on a mass basis or by using attribution units. This is achieved either by monitoring the mass flow inputs and outputs of a manufacturing process to track biomass feedstocks as they are incorporated into end products, or through a means of assigning the atoms within a molecule (the product) as bio-based origin where appropriate.

To attain direct bio-based content measurements only the radioisotope ratios of carbon are presently used, and perhaps stable isotope ratios will also be used in the future [Ehleringer 1989]. These techniques are briefly summarised in this introduction because integration of direct and indirect bio-based content calculations will be addressed later. The techniques and methods applied in indirect bio-based content determination are explained in greater detail. Atom connectivity and mass balance approaches form the basis of the meth-



ods described this report. Application of these methods in certification schemes is addressed in the following section. The calculation of total bio-based content forms the basis of much of this report, with greater considerations dedicated to renewability entertained in the concluding arguments.

2.2.1 Radiocarbon analysis

The determination of the bio-based carbon content of products using the radiocarbon method has been described in detail in a new European technical specification **CEN/TS 16640**. Refer to this document for information on the methods and equipment used for this analysis. This follows the standard **ASTM D6866** on the same topic.

The amount of ^{14}C in an article (expressed as a ratio relative to the more common ^{12}C isotope) is proportional to its bio-based carbon content. The proportion of this unstable isotope found in the atmosphere is translated into biomass by photosynthetic processes. With a half-life of 5730 years there is no ^{14}C present in fossil resources. This exact same analysis is not applicable to any other elements, not least because none of the other elements prevalent in biomass (O, H, N, S, *etc.*) possess unstable isotopes with measurable half-lives to act as an indicator of age. There is virtually no oxygen and very little nitrogen found in fossil resources which makes this type of analysis redundant for most elements anyway.

Standard test method **ASTM D6866** specifies that calculations are based on organic carbon content, with carbonates removed with an acid pre-treatment akin to archaeological sample pre-treatments. The equivalent European documentation allows for bio-based carbon content to be calculated on the basis of total carbon content. This way speciality products such as graphene and carbon fibre can be considered if made (partially or completely) from biomass. Reporting of values for bio-based carbon content is done as a percentage of total organic carbon or total carbon. In this report total bio-based content will also be examined by including and excluding inorganic content and comparing the difference.

To obtain a value of bio-based carbon content, complete combustion of the sample is carried out to provide quantitative recovery of all carbon present in the form of carbon dioxide. Analysis of the $^{14}\text{C}/^{12}\text{C}$ isotope ratio can be performed using one of the following techniques (Figure 2-1). Also refer to **KBBPPS deliverable report D3.1**. Radiocarbon analysis and its role in complimentary bio-based content calculations is covered in overview in the following chapter.

- Liquid scintillation-counter method (LSC): Indirect determination of the ^{14}C isotope abundance of the sample through the emission of β particles (measured by their interaction with scintillation molecules) (**ASTM D6866**).



- Beta-ionisation (BI): Indirect determination of the ^{14}C isotope abundance of the sample through the emission of β particles using a Geiger-Müller detector (**ISO 13833**).
- Accelerator mass spectrometry (AMS): direct determination of the isotope abundance of ^{14}C relative to ^{12}C [Brock 2010].

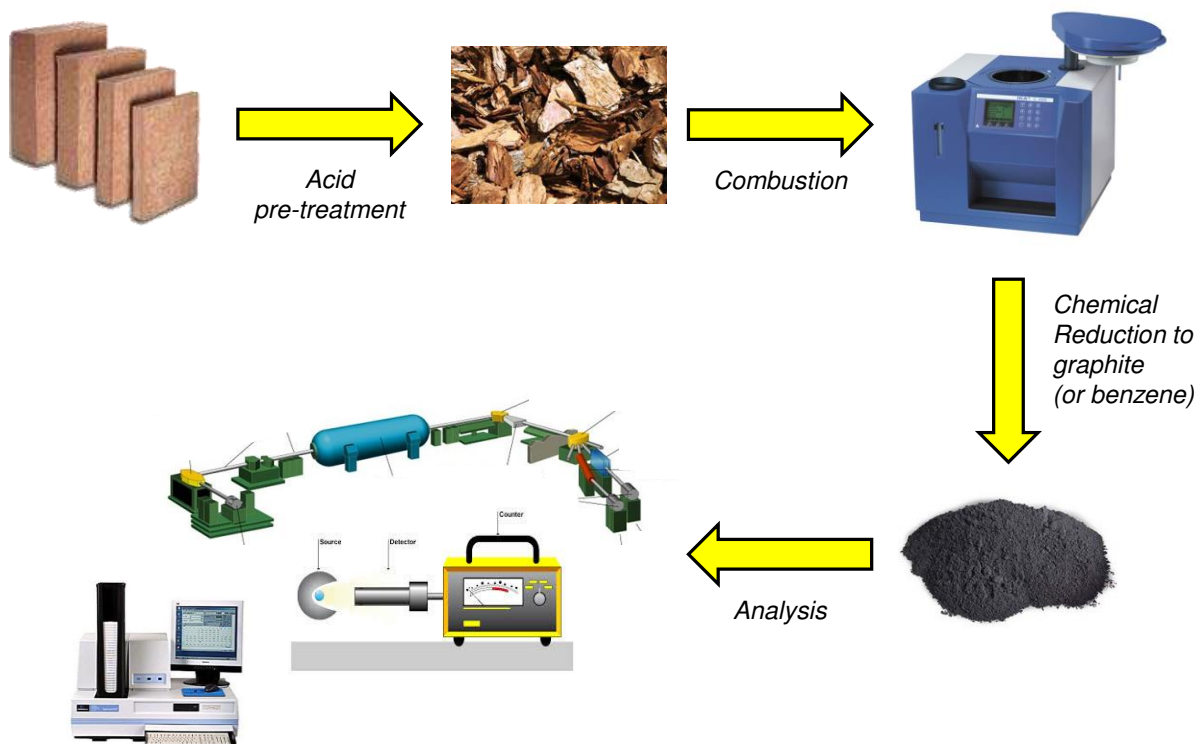


Figure 2-1 A schematic of the radiocarbon method principle of bio-based carbon content determination.

2.2.2 Elemental analysis

Radiocarbon analysis can only return a value for bio-based content derived from the carbon atoms present in the sample. This limits the value of the information obtained to just one of the different elements that bio-based products are comprised of. The perspective that chemicals (bio-based or otherwise) are the sum of their elemental parts is useful, because certain attributes of elements can be analysed in ways that reveal their origin (not just radiodating).

Elemental analysis returns data on the mass contribution of carbon, hydrogen and nitrogen atoms contained within the sample (CHN analysis). Oxygen content is performed separately, for the method of CHN analysis uses excess oxygen to combust the sample. Using less conventional apparatus, more elements can also be detected such as sulphur and



chlorine, but usually simultaneous detection of elements (at least of carbon, hydrogen, and nitrogen) is used [Kirsten 1983].

A small quantity of sample, usually of the order of 2 mg of material, is placed in a tin vessel and sealed. Inside the elemental analyser, temperatures exceeding 1250 K in an oxygen enriched atmosphere combusts the sample [University of York 2013]. To ensure complete combustion, a tungsten oxide catalyst is present to yield carbon dioxide, water, and nitrogen oxides deriving from the sample. A reducing oven consisting of a column packed with copper at 893 K reduces nitrogen oxides to dinitrogen gas. So that only carbon dioxide, water, and nitrogen proceed onto the chromatographic stage, chemical traps that remove corrosive sulphurous oxides and HCl are required. Gas chromatography is performed on the mixture of combustion products to obtain the corresponding amounts of carbon, hydrogen, and nitrogen originally present in the sample. The detection of the gases can be performed by detecting changes in thermal conductivity compared to the carrier gas (helium), and that is proportional to the amount of the component present [Kirsten 1983]. The sensitivity of the apparatus when assessing a sample of 2 mg is sufficient enough to result in an error of only 0.3 wt% in most cases.

For the determination of oxygen up to 5 mg of sample is required, but a silver vessel is used and not the more routine tin capsule. A helium atmosphere replaces the more usual oxygen atmosphere for obvious reasons. The oxygen present in the sample is converted to carbon monoxide through a reaction with a nickel-carbon composite [Preston 1992]. Gas chromatography is required to separate CO from nitrogen gas which may be evolved depending on the composition of the sample. The separation of these two gases is important because the consequence of not chromatographically resolving the nitrogen is the over-estimation of the oxygen content. This is because the molecular mass of nitrogen gas and carbon monoxide are the same (28 g mol^{-1}). Detection is once again by thermal conductivity measurements.

A typical elemental analysis result for CHN analysis might read as 50.0% carbon, 5.6% hydrogen, and 0.0% nitrogen (all on a mass basis). This corresponds to the theoretical elemental composition of PLA. The remaining 44.4% of material mass is made up of oxygen atoms and could be analysed separately. Elemental analysis does not give any indication as to the bio-based content of the sample, which in the case of PLA would be expected to be a completely bio-based material (radiocarbon analysis should provide a consistent result of 100% bio-based carbon content). However a composite material of PLA and calcium carbonate sulphate would yield different results without an acid pre-treatment, as would an article that was a mixture of PLA and calcium sulphate. Again, no indication of bio-based content would be arrived at through elemental analysis. Similarly, PET products made from the transesterification of fossil derived methyl terephthalate and bio-based ethylene glycol have a



theoretical elemental analysis of 62.5% carbon and 4.2% hydrogen, and a measured bio-based carbon content of 20%. The link between this data and a value of total bio-based content can be arrived at if the mechanism of chemical synthesis for the bio-based product in question is understood. That way the source of each atom (fossil resources, biomass, *etc.*) can be traced through to the final product. Results must be consistent with the radiocarbon analysis of bio-based carbon content while elemental analysis is used as a type of verification. This principle has been adopted by ACDV as a certification scheme for total bio-based content determination [ACDV 2013]. The calculation technique is known as atom connectivity, in which the association of each heteroatom to its nearest bonded carbon atom is used to assign a total bio-based content. Knowledge of the exact manufacturing process is not required although the chemical composition of each chemical component in the article is needed, as are the general rules of chemical reactivity. From the bio-based carbon content each carbon atom must be assigned as bio-based or otherwise for the remaining elements to be able to adopt the origin of their neighbouring carbon atoms. Sometimes an understanding of the chemical synthesis (if relevant) helps the assignment. The elemental analysis is needed to verify the composition. How the ACDV certification scheme for the calculation of bio-based content is applied is fully described in the next section. A greater variety of atom connectivity methods are also presented later on in this work.

2.2.3 Stable isotope analysis

The application of elemental analysis in the context of bio-based content determination does not afford a definitive result in the same way that the direct method of radiocarbon analysis does. A different result is achieved depending on the consensus adopted, as is true of all indirect methods of bio-based content calculation. Instead, a characteristic of each element dependant on its source could be employed for a direct biomass content analysis as is the case for carbon. Stable isotopic ratio analysis may become useful in this regard. The ratios of naturally occurring and non-decaying isotopes that exist for many elements differ under natural influences, making the identification of their geographical origin or source possible [Ehleringer 1989]. The relative ratio of the oxygen isotopes ^{16}O and ^{18}O is dependent on the effect of temperature on the water cycle. Ratios of the stable carbon isotopes (^{12}C and ^{13}C) in atmospheric carbon dioxide are changed during photosynthesis and can be measured in the resulting biomass and downstream products [Suzuki 2010]. Corn and sugarcane, two popular bio-chemical feedstocks, have evolved a different carbon fixation process to ancient plant species that disfavors the ^{13}C isotope to a greater extent (C_4 metabolism instead of C_3 metabolism). The following diagram shows the distribution of stable carbon isotopes in different carbon resources (Figure 2-2) [Meier-Augenstein 1999, Suzuki 2010]. The notation is presented as $\delta^{13}\text{C}$ and expressed as a ratio relative to a standard in parts per thousand.



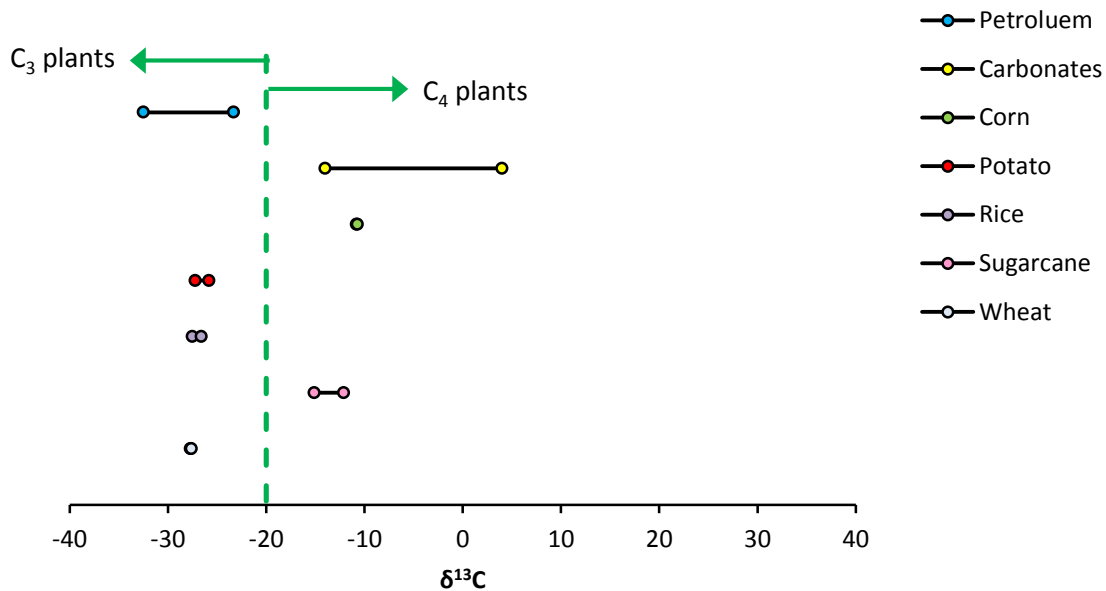


Figure 2-2 Carbon isotopic composition ranges for samples of material from different feedstocks.

Even if ^{14}C isotope analysis remains the cornerstone of analytical bio-based content determination methods, stable isotope ratios may act as at least a supplementary means of providing further information about the other elements rather than solely relying on indirect methods. Coupled with elemental analysis to determine the amount of each element in a bio-based product, stable isotope analysis could allow for a total bio-based content calculation (or at least a verification). The feasibility of this approach is limited somewhat by the broad ranges of stable isotope ratios, rather than precise values, which define the possible origin of that element. However the combination of different stable isotope analyses increases the precision of this method for single component articles, *e.g.* distinguishing bio-ethanol (C_3 and C_4 plants) from synthetic ethanol made by the hydration of ethylene (Figure 2-3) [Ishida-Fujii 2005].



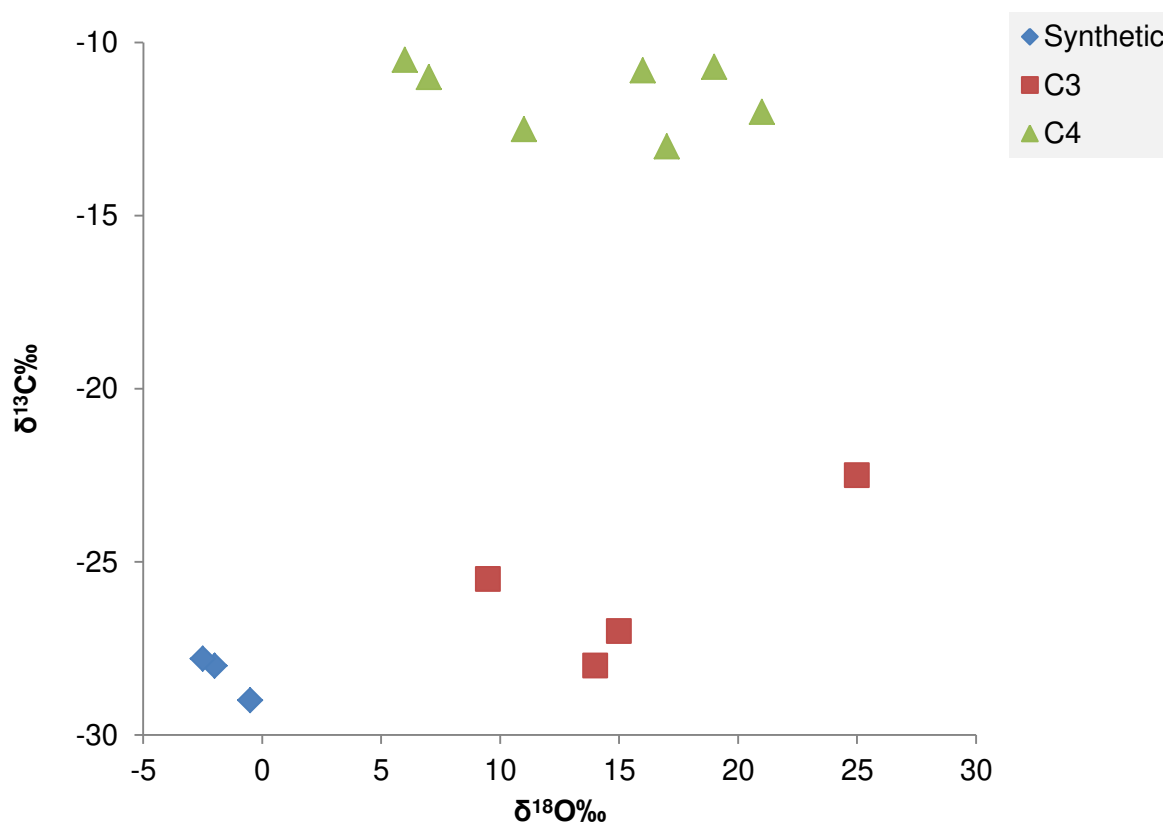


Figure 2-3 The distribution of stable isotopes found in ethanol samples.

Stable isotopes are determined using a sensitive mass spectrometry technique known as isotopic ratio mass spectrometry (IRMS) [Meier-Augenstein 1999, Schmidt 2004]. Research into the application of stable isotope analysis for the biogenic analysis bio-based products is underway within the KBBPPS project, and is expected to be published privately alongside this report ([KBBPPS deliverable report D4.4](#)).

2.2.4 Mass balance approach

Bio-based feedstocks and ingredients are now used to produce and formulate articles that are wholly or partly bio-based. With the growth in volume of bio-based resource consumption for chemical and fuel production, and the associated increase in feedstock diversity, chain of custody approaches risk becoming impractical. This is due to the challenges associated with the segregation of bio-based and fossil derived feedstocks, and the limitations of this system with regard to creating an association with the properties expressed by articles (such as bio-based content), and not just following the location of goods.



Direct methods of determining a bio-based content for an article address the proportion of bio-based material that is physically contained within the final product (*i.e.* radiocarbon analysis to give a measure of bio-carbon content). Direct analysis is the optimal solution for analysing bio-based products where possible. For articles produced in dedicated facilities using dedicated supply chains this is feasible. This is likely to be the case for high value articles produced at small scale and sometimes for processes utilising technologies that are incompatible with the petrochemical industry (*e.g.* fermentation) where the only option is to develop new facilities. However in the emerging bio-based economy, existing capital equipment for use in bulk manufacturing processes is likely to continue to be used, with biomass gradually supplanting the conventional fossil based feedstocks. Therefore, with a mixed feed of biomass and petroleum feedstocks, direct determination of the bio-based content in a product is not always valid. Feedstock variability is one concern, and co-products will incorporate the biomass feedstock input to different extents. The relative proportions of the mixed feedstock used in many manufacturing processes will fluctuate to match the variable price of the feedstocks and accommodate seasonal biomass availability. The use of existing infrastructure within production systems improves economic sustainability through savings in operational and capital expenditure. By lowering the risk for any potential investment in the emerging sector of bio-based products, and co-producing articles in existing installations (maximising economies of scale) the basis and future prospects for the bio-based economy are hopefully safeguarded. Standards should then encourage this growth by recognising these products.

Mass balance is the identification of equal material input and output for a process. Sometimes material loss during the process will mean the total mass of the product and any by-products and waste streams will be less than the feedstock use (Figure 2-4). An overview of mass balance approaches, in combination with allocation and 'book-and-claim' devices, has been prepared ([CEN/TC 411/WG 3 document N110b](#)). Mass balance can provide information of the proportion of biomass used in the production of a bio-based product, and provide complimentary information to analytical bio-based content methods. These methods can be used to establish a footing for various claims (*e.g.* calculating the fossil feedstock saving). Mass balance methods are especially applicable in integrated production facilities and in complex global supply where calculating the bio-based content of chemical products with precision is difficult. Definitions of the key terms used in this paragraph are provided below for clarification (also see [CEN/TC 411/WG 3 document N110b](#)).

- Mass balance: *The relationship between the material input and output within a system in which the output from the system cannot exceed the input into the system.*



- Allocation: *Partitioning the input flows of a process between output flows within physical limits. The use of this term has evolved with time to become distinct from attribution.*
- Attribution: *Partitioning the output of biomass derived material from a process between products without justification derived from the physical mass flow.*
- Book-and-claim: *A method to transfer, by means of certificates, a defined chemical product claim from that product at one location to the same chemical product at a different location, without any material transport or other physical connection.*

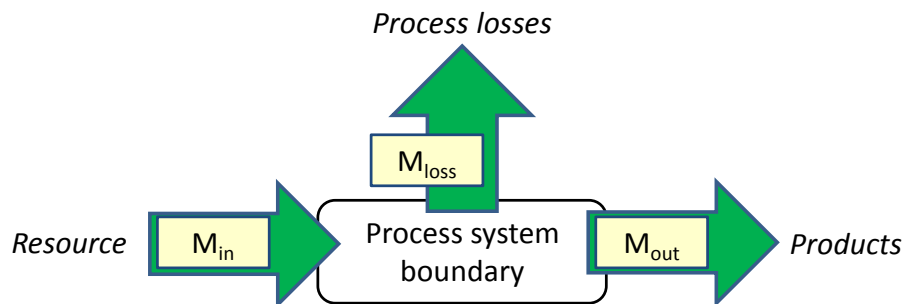


Figure 2-4 A schematic of the mass balance principle.

Depending on the consensus adopted, mass balances can be performed to calculate results with a number of possible data outputs, but should complement and enhance the use of analytical approaches of bio-based content determination when applicable and not cause any conflict or confusion. When analysis is not appropriate (*e.g.* there is variable bio-based content) mass balance should be able to compensate for this. The different varieties of mass balance methods are summarised here briefly, and put into practice in *Chapter 5* with the use of a series of case studies. Other possibilities regarding the framework for alternative mass balance approaches are also considered elsewhere in this report.

- Fossil resource savings (mass balance Method A). The allocation of the average bio-based content within a predefined time period can be used to make various claims essentially describing the extent that material fossil resources have been replaced, *e.g.* fossil resource and carbon dioxide savings. This is not applicable to energy usage.
- The determination of the average bio-based content and the average bio-based carbon content within a predefined time period (mass balance Method B). Claims of allocated bio-based content are derived from a bio-based carbon mass balance supplemented by atom connectivity. The rules of this method are developed from those out-



lined in the 'material balance' working draft of WG 3 ([CEN/TC 411/WG 3 document N104](#)).

- Fossil carbon savings (mass balance Method C). This mass balance method determines the mass of bio-based carbon and hence the mass of fossil carbon savings in consecutive chemical reaction routes based on input/output quantities in global production systems using stoichiometric chemical reaction pathways and proven yields.
- Qualities shared by mass balance Method B and Method C have been reimagined for mass balance Method D. This is a material balance derived from actual mass flows, using allocation techniques if needed but primarily relying on reaction pathways and yields. Feedstocks are traced upstream until they can be considered wholly bio-based or fossil derived or inorganic (the latter meaning not containing carbon). The proportion of each feedstock present within the product indicates the average bio-based content.
- In addition, the 'book-and-claim' methodology uses results of the mass balance methods to assign and transfer certificates for customer communication. Certificates can be issued based on fossil feedstock savings, calculated bio-based content, bio-based carbon content or the fossil carbon savings of products.

It should be noted that both analytical and mass balance approaches are not applicable to describe the sustainability of bio-based products within the context of this report, unless the applicant has performed separate sustainability assessments. 'Book-and-claim' for the purpose of sustainability is already in use for the palm oil industry but is orthogonal in its usage to the types of bio-based content mass balance described here [GreenPalm 2014]. Mass balance systems utilising 'allocation' and 'book-and-claim' are performed within a defined time interval and pre-defined geographical boundaries. These claims derived from mass balance approaches do not provide information on the actual physical properties of products, but rather represent the biomass incorporated into the production input of an article. Mass balance methods for calculation of the amount of biomass used in the production of articles within a defined time interval should be standardised for quality control and comparability.

For the purpose of this report (in the context of the KBBPPS project) attribution and 'book-and-claim' tools will receive less attention and the focus is placed on the calculation of the intrinsic bio-based content of an article. Approaches to the calculation of total bio-based content that do not reflect the actual amount of biomass incorporated into the product are currently under scrutiny within the relevant standardisation committee and working groups (*i.e.* [CEN/TC 411/WG 3](#)). Diagrams visualising 'book-and-claim' (Figure 2-5) and attribution



(Figure 2-6) follow. A 'book-and-claim' system allows for a property to be changed from one batch to another (equal sized) batch of the same chemical. This is currently done for sustainable palm oil amongst other products through the transfer of certificates [GreenPalm 2014]. Attribution is less strict in terms of the swapping of bio-based content from one product to any other product, but they should originate from the same production facility. Attribution has uses when the production chain is complex and the final distribution of biomass between various product streams is unknown.

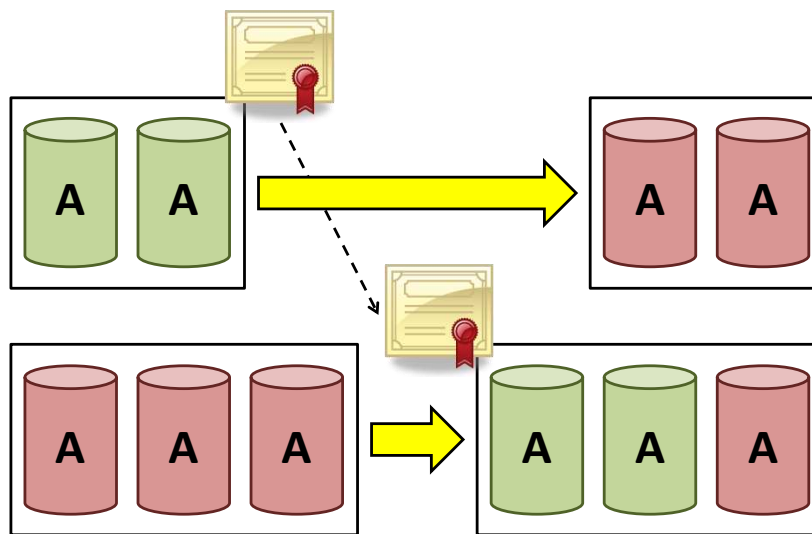


Figure 2-5 A demonstration of 'book-and-claim' where certificates are traded between equal amounts of the same product in different locations.



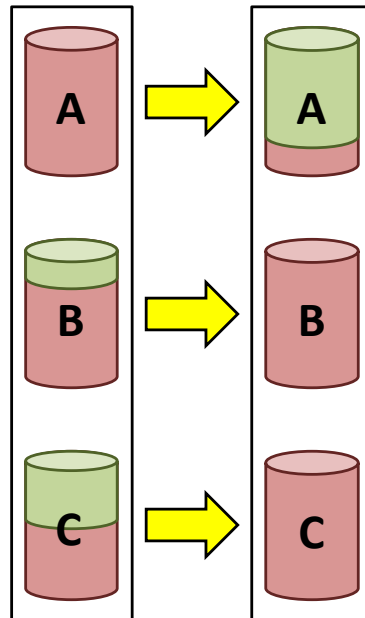


Figure 2-6 A demonstration of 'attribution' where a quantity of biomass derived content is spread across different products of a biorefinery and redistributed to a favoured product stream.

Another reason for focusing on the intrinsic total bio-based content is so the extension of these methods into renewability and sustainability assessments can be investigated in complete life cycles, as will be attempted in a future Open-Bio project deliverables ([Open-Bio deliverable report D3.5](#)). If this proves successful than the role of 'attribution' and 'book-and-claim' tools could be studied at a later date.



2.3 Standardisation and certification schemes relating to bio-based content

Certification schemes and the standards they are based on establish a consensus regarding bio-based content claims, and facilitate market growth with improved consumer confidence. The principal bio-based content standard is **ASTM D6866**. It contains the test method for bio-based carbon content as a percentage of organic carbon. Built around this test method is the USA Department of Agriculture certification scheme known as 'BioPreferred' [BioPreferred 2014]. European certification schemes for organic products also designed primarily around bio-based carbon content have been developed by Vinçotte in Belgium [Vinçotte 2013], and TÜV Rheinland DIN CERTCO in Germany [DIN CERTCO 2014]. The Association Chimie du Végétal (ACDV) of France has developed a different approach that complements radiocarbon analysis with elemental analysis and atom connectivity assignments to offer an indirect calculation of bio-based content [ACDV 2013]. This latter approach is being scrutinised by a technical group of the European standardisation committee for bio-based products with the intention of developing it into a test method (**prEN 16785**).

Mass balance claims are being used by different companies with different intentions. As far as bio-based content is concerned, the first certification scheme has been developed by TÜV SÜD and implemented by BASF to calculate fossil resource savings with a mass balance methodology [TÜV SÜD 2013]. This allocation approach is examined in greater detail within this report as part of a pre-normative research effort to assist the development of bio-based content standards with CEN. Although the method has been met with resistance thus far (for it permits attribution) it is helpful here for the comparison.

2.3.1 BioPreferred

As part of a national procurement initiative in the USA, 'BioPreferred' designates categories of bio-based products that are required for purchase by federal agencies and their contractors [BioPreferred 2014]. As a part of this process, the minimum bio-based content is specified which varies according to the product class (Table 2-1). Accordingly the US Government and its contractors are required by law to purchase products that are bio-based where reasonably available. Bio-based products that had a significant market share in 1972 do not qualify for Federal procurement preference or for certification and labelling. Under future consideration are the designation of bio-based intermediates and manufacturing feedstocks [BioPreferred 2014].



Table 2-1 Minimum bio-based content by class for the USDA BioPreferred programme as of June 2013.

Product category	Minimum bio-based carbon content
Construction	
Carpet	7%
Insulating foam	7%
Plastic lumber	23%
Structural wall panels	94%
Food service	
Disposable cutlery	48%
Groundskeeping	
Fertiliser	71%
Sorbents	89%
Industrial fluids	
Penetrating lubricants	68%
Slide way lubricants	74%
Penetrating liquids	79%
Janitorial	
Spot remover	7%
Floor strippers	78%
Personal care	
Cuts, burns, and abrasions ointment	84%
Shaving products	92%
Miscellaneous	
Bedding, bed linens and towels	12%

2.3.2 OK biobased

The 'OK biobased' certification scheme assigns labelling according to classes of bio-based content, with a 'star-rating system' employed from one star to four stars (Figure 2-7) [Vinçotte 2013]. Only one star is awarded to products containing between 20% and 40% bio-based carbon content. Two stars indicate up to 60% bio-based carbon content. Three stars are awarded to products in the 60-80% bio-based carbon content range. Finally bio-based carbon content that exceeds 80% is represented with the four star label in Figure 2-7.





Figure 2-7 An example of a Vinçotte certificate of bio-based content.

In addition to a minimum bio-based carbon content of 20%, the total organic carbon content of the article must equal or exceed 30%. Measurement of bio-based carbon content is conducted under the rules of **ASTM D6866**. Fuels are not covered by this certification scheme.

2.3.3 DIN Biobasiert

The DIN 'Biobasiert' (bio-based) certification scheme is essentially of the same format as 'OK bio-based'. The minimum bio-based carbon content is specified as 20% of total organic carbon and the amount of organic carbon should at least equal that of inorganic carbon (*i.e.* $\geq 50\%$ organic carbon) [DIN CERTCO 2014]. Classification is also used, with articles containing 20-50% bio-based carbon content covered the lowest class, those with between 50% and 85% bio-based carbon in the intermediate class, and finally bio-based products exceeding 85% bio-based carbon content able to carry the label shown in Figure 2-8.



Figure 2-8 The DIN Biobasiert label for articles of greater than 85% bio-based carbon content.

2.3.4 Association Chimie du Végétal (ACDV)

The approach used with carbon (based on radioisotope measurements) to determine the bio-based carbon content of a sample does not translate to other elements, such as oxygen, nitrogen and hydrogen. However the relative content of each element in a sample can be determined by elemental analysis (without indicating the proportion of biomass included).



Typical elemental analysis records carbon, hydrogen, and nitrogen (CHN) content but specialised equipment is also capable of determining oxygen or sulphur.

The certification scheme devised by ACDV (Association Chimie du Végétal, France) uses the direct analysis of bio-based carbon through radioisotope analysis, and elemental analysis to verify the composition of bio-based products [ACDV 2013]. Because elemental analysis does not differentiate between the possible sources of each element, the combination of bio-based carbon content measurements using ^{14}C isotope analysis and (CHNO) elemental analysis does not directly give the total bio-based content of a sample. Radiocarbon analysis is preferably performed using the standard test method described in [CEN/TS 16640](#), although the equivalent tests in [CEN/TS 16137](#) (specific to plastics) and [ASTM D6866](#) are also acceptable. An allocation of the number of hydrogen, oxygen, and nitrogen atoms originating from biomass is decided by the supplier (the declaration) using a process of calculation called atom connectivity, from which a total bio-based content by mass is calculated for the article. This method can be applied to synthetic chemicals and formulations.

The rules of atom connectivity as proposed by ACDV require that if oxygen, hydrogen, or nitrogen atoms are bound to a carbon atom derived from biomass, they too are considered to be bio-based in origin (Figure 2-9). This is reiterated in a guide to bio-based product terminology ([PAS 600](#)). When a chemical reaction has been used to make a molecule from mixed feedstocks (biomass and fossil resources) standard organic chemistry rules of reactivity apply for the assignment of the elements as bio-based or otherwise. For typical industrial chemical reactions the mechanisms are known and these can be used to assign the origins of the atoms. Because heteroatoms are considered as either bio-based or otherwise by adopting the consensus that they assume the origin of the closest bonded carbon atom, a knowledge of the synthesis is most important for the designation of carbon atoms as bio-based or not. When an atom is bonded to multiple carbon atoms then it too must be assigned as bio-based or otherwise by employing the standard organic chemistry rules of reactivity. The specifics of the production facility are not necessary to know, for often the bio-based carbon atoms can be deduced from within a molecular structure by comparison to known reaction pathways and the chemical nature of the feedstocks.



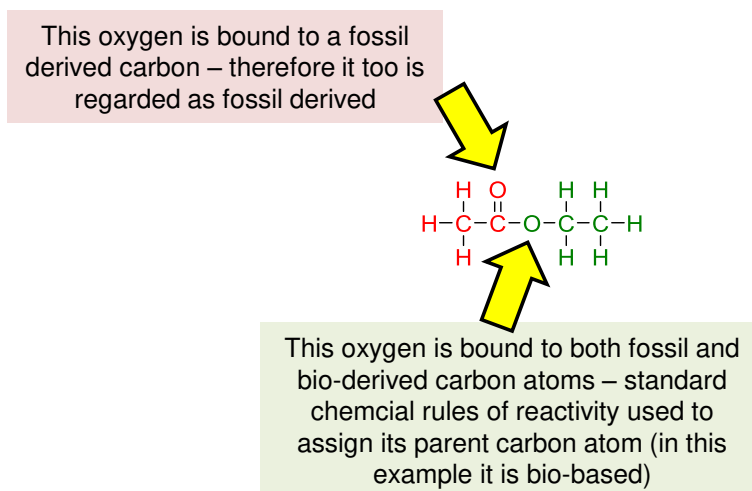


Figure 2-9 Rules of atom connectivity.

The test example given by ACDV in their documentation is of esterification, where esters derived from the condensation of an acid with an alcohol retain the oxygen atom once belonging to the alcohol (Figure 2-10) [ACDV 2013]. Note that this is true of the most regularly occurring A_{AC2} mechanism but not of the less common alkylation mechanisms of esterification, which would obviously change the real bio-based content of the product. An example of the calculation for ethyl acetate made from bio-ethanol and acetic acid is tabulated below (Table 2-2). The elemental analysis for carbon, hydrogen and oxygen must be consistent with the molecule in question. Then the atom connectivity assignment of bio-based content is reported as a mass percentage of the total molecule. Results need to be reported on a dry basis to permit consistency in verification and produce a useful value of bio-based content not diluted by water. For the ACDV example of bio-ethanol reacting with acetic acid, a result of 51% total bio-based content is arrived at. Conveniently the bio-based carbon content should be 50% (two of the four carbon atoms originate in bio-ethanol) but the closeness of the two values is not guaranteed in other bio-based products.

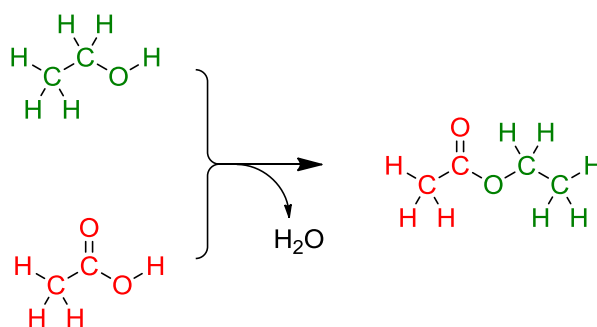


Figure 2-10 The synthesis of ethyl acetate from bio-ethanol (red atoms are assumed to originate from fossil sources, green atoms are assumed to be from biomass).



Table 2-2 The assignment of bio-based content from elemental analysis and atom connectivity for a partially bio-based ethyl acetate product.

Fraction	C	H	O	Total
Fossil fraction (from acetic acid)	27.3%	3.4%	18.2%	48.9%
Bio-based fraction (from ethanol)	27.3%	5.7%	18.2%	51.1%
Total	54.5%	9.1%	36.4%	100.0%

For products obtained by formulation, this method is applicable provided that each of the constituents of the product have first been analysed according to the method above and the statement declaring the total bio-based content of each constituent has been validated. The bio-based content of each ingredient is scaled according to its weighting in the formulation to give the total bio-based content of the formulation. Carbon radioisotope analysis is equally applicable to mixtures as it is to pure compounds and this part of the certification process remains.

The results obtained by the analytical methods can differ from the stated values in the declaration for several reasons, including natural variation in biomass and analytical error. Accordingly the results are reported according to pre-set confidence levels. The determination of the bio-based carbon content of the sample, according to the method specified in **CEN/TS 16640**, can produce an error of $\pm 3\%$. Elemental analysis errors are typically of the order of $\pm 0.3\%$. Three confidence levels have been established to deal with discrepancies between the values given in a statement (the declaration based on theoretical values) and values resulting from testing the bio-based carbon content, total carbon content, total hydrogen content, total oxygen content and total nitrogen content, as relevant. The confidence levels for synthetic chemicals (*i.e.* not formulations) are rated high, medium, and low (Table 2-3). The magnitude of the discrepancy between stated value and experimental analysis determines the confidence level applied. If a level of high confidence is achieved, then the calculated total bio-based content is validated as stated. When the medium confidence level is granted, the stated bio-based content is rounded down to the next multiple of five. When only the low confidence level can be granted, the stated value for total bio-based content is reduced to the multiple of five after the next (*e.g.* 42% is corrected to 35%). To achieve one of these confidence levels, the level of accuracy needed must apply to the bio-based carbon content and at least two of the elemental analysis results (picked from carbon, hydrogen, oxygen and nitrogen). If analysis falls outside these confidence limits, relative to the values quoted in the supplier's statement, then certification is not granted (Table 2-4). Test examples should be available in **KBBPPS deliverable report D4.4**. Example 1 falls within the high confidence level, example 2 is regarded with medium confidence, and example 3 is only deserving of the low confidence level as defined in draft standard **prEN 16785**.



Table 2-3 The confidence level decision process for synthetic chemicals assessed under the ACDV certification scheme.

Level	Bio-based carbon content error	Total carbon content error	Total hydrogen content error	Total oxygen content error	Total nitrogen content error
High	±3.0%	±0.4%	±0.2%	±0.4%	±0.4%
Medium	±4.5%	±1.0%	±0.5%	±1.0%	±1.0%
Low	±6.0%	±2.0%	±1.0%	±2.0%	±2.0%

Table 2-4 Examples of ACDV confidence levels for synthetic chemicals with values presented in green matching the assigned confidence level (high, medium, or low).

Values	Bio-based carbon content	Total carbon content	Total hydrogen content	Total oxygen Content	Bio-based content
<i>Example 1 – High confidence</i>					
Statement	25.0%	50.0%	5.6%	44.4%	56%
Analysis	25.9±3.0%	49.8±0.4%	5.7±0.2%	44.5±0.4%	56% validated
<i>Example 2 – Medium confidence</i>					
Statement	40.8%	53.0%	9.0%	24.2%	52%
Analysis	40.1±4.5%	52.1±1.0%	8.8±0.5%	22.5±1.0%	50% validated
<i>Example 3 – Low confidence</i>					
Statement	47.3%	50.2%	7.2%	42.6%	67%
Analysis	42.2±6.0%	47.5±2.0%	7.9±1.0%	40.8±2.0%	60% validated

These confidence levels are relevant to direct bio-based content analysis, where total bio-based content is validated using total atomic mass contributions (bio-based and fossil derived atoms). For this work on indirect calculation of bio-based content (Chapter 4), only the atom connectivity aspect of this certification scheme is relevant.

2.3.5 BASF-TÜV SÜD mass balance for the use of renewable feedstocks in integrated production processes

The chemical manufacturer BASF has initiated the development of mass balance methods for tracking biomass in their processes. In collaboration with the certification organisation TÜV SÜD, they have developed a mass balance approach by allocation for use in integrated production plants where biomass has replaced a fossil derived feedstock within the existing infrastructure [TÜV SÜD 2013]. The development of the mass balance method was designed in cooperation with customers, associations and other stakeholders with the intention that existing plants and technologies along the value chain can continue to be used. The share of biomass can be allocated to chemical products at the end of the production



chain, but is presently used to indicate fossil savings accrued during the process. For example, the introduction of bio-naphtha and biogas (methane) into chemical plants as feedstocks displaces the equivalent fossil derived feedstock (for olefins and syngas production respectively). The drop-in replacement of one petroleum feedstock for its bio-based analogue is assessed using 'attribution units' and is not performed on the basis of mass. The choice of attribution units (or indeed mass directly) as a means of comparison between an entirely petroleum based process and one with biomass substituted into it, depends on the mass balance method. The mass balance developed by TÜV SÜD for BASF and reported in **CEN/TC 411/WG 3 document N93** uses 'methane equivalents', defined as the net calorific value (also known as the lower heating value) of a feedstock relative to that of methane (Table 2-5). In this work methane and natural gas and bio-gas are assumed to all have a lower heating value of 50.0 MJkg⁻¹. The decision to replace mass with methane equivalents as an example of an attribution unit has been taken in order to generate credits that can be freely allocated to a product and then attributed to different products from the process or beyond the stoichiometric limits of total bio-based content that would restrict a straightforward material balance for example.

Table 2-5 Methane equivalents for bio-based feedstocks and traditional fossil resources.

Feedstock	Lower heating value /MJkg ⁻¹	Methane equivalent	Relative energy content
Hydrogen	119.9	0.417	240%
Natural gas	53.8	0.929	108%
<i>Bio-gas</i>	<i>53.8</i>	<i>0.929</i>	<i>108%</i>
Methane	50.0	1	100%
Butane	45.8	1.093	92%
Naphtha	44.3	1.13	88%
<i>Bio-naphtha</i>	<i>44.3</i>	<i>1.13</i>	<i>88%</i>
Bio-diesel	43.9	1.139	88%
Crude oil	42.8	1.169	86%
Vegetable oil	40.7	1.23	81%
Benzene	40.6	1.233	81%
Butanol	33.1	1.511	66%
Ethanol	26.8	1.853	54%
<i>Bio-ethanol</i>	<i>26.8</i>	<i>1.853</i>	<i>54%</i>
Methanol	19.4	2.574	39%
Glycerine	16.9	2.957	34%
Dry wood	15.8	3.159	32%

To demonstrate the procedure, a simple example has been given. Full analysis of this mass balance method and alternative mass balance calculations is provided at a later point.



Considering the synthesis of ethyl acetate (Figure 2-10), the use of bio-ethanol instead of synthetic petrochemical ethanol presents a fossil resource saving and introduces some bio-based content into the final product. These attributes can be validated on a mass basis, or in the case of this particular mass balance approach, in terms of methane equivalents. Ethanol has an energy content equivalent to 54% of an equal mass of methane (1.853 in methane equivalents). Acetic acid has an approximate energy value of about 3.7 methane equivalents, demonstrating how calorific value decreases with increased oxidation and highlighting the difference between biomass and fossil derived hydrocarbon chemicals. The simple mass balance is presented as Figure 2-11 with mass flows tabulated immediately afterwards (Table 2-6). It is crucial that the input (feedstocks) have an equal mass to the outputs of the system, including losses as well as products. Here the process is simplified to ignore losses and assumes complete conversion of the feedstocks.

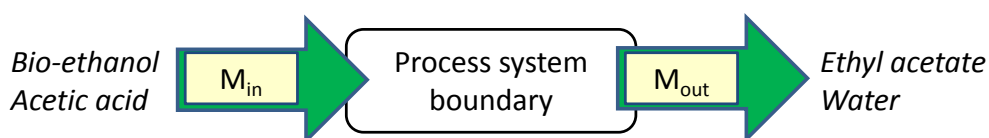


Figure 2-11 A schematic of an esterification reaction presented as a mass balance assuming no losses.

Table 2-6 Mass balance data for a hypothetical example of esterification to give ethyl acetate.

Stream	Mass /kg	Methane equivalent	Mass-methane equivalents
Ethanol	184	1.853	341
Acetic acid	240	3.7	889
Ethyl acetate	352		
Water	72		
Losses	0		
Total			1230

The combined allocation of methane equivalents to the process as a whole is the sum of each input (in the chosen attribution units) multiplied by the mass of each feedstock. This means the total attribution units, now associated to the product ethyl acetate, is attribution units per 352 kg. The attribution units associated to the product are derived from the feedstocks, and not its own inherent properties. Now suppose that a fully petrochemical process is supplanted by an equivalent procedure using bio-ethanol. Dividing the 1230 attribution units by the methane equivalents of ethanol indicates that 664 kg of ethanol would need to be employed as a feedstock and incorporated into the final article to translate to a completely bio-based ethyl acetate product as validated by this mass balance method. The maximum input of bio-ethanol is limited by the reaction stoichiometry to 184 kg, which corresponds to 28% total bio-based content. This can be reported as a 28% fossil resource saving. Similarly



by replacing all the fossil derived acetic acid with bio-based acetic acid, another 72% total bio-based content is contributed to the final product.

Obviously the value obtained for bio-based content by this mass balance method is different to that acquired from the ACDV certification scheme and from radiocarbon analysis (Table 2-7). A mass balance on the basis of actual mass flows (such as a material balance) would highlight that a 43% fossil resource saving in terms of the feedstock mass had been made (*i.e.* the mass of bio-ethanol is 43% of the total feedstock mass of ethanol and acetic acid combined). The result according to Mass balance Method B or Method D will be different again, being derived instead from the bio-based content contained within the product. Results would fluctuate throughout the year if synthetic ethanol was substituted back into the process because of biomass price or availability issues, but this is the strength of mass balance as it is flexible in this regard. The following chapters provide greater detail into the scope and limitations of each bio-based content method and how they can be used together in a harmonious fashion in light of their usually contradictory conclusions.

Table 2-7 Quick screen of possible bio-based content conclusions for partially bio-based ethyl acetate.

Method	Bio-based carbon content	Total bio-based content	Fossil savings
Radiocarbon method	50%		
Atom connectivity		51%	
Mass balance (attribution units)			28%
Bio-based feedstock (mass)			43%
Mass balance (material balance)		51%	

2.3.6 ISCC-plus sustainability certification

Sustainability of bio-fuels has been introduced as a requirement within the EU [2009/28/EC]. Certification of sustainability is provided by recognised voluntary schemes [EC Energy 2014]. One of these certification schemes is provided by ISCC (International Sustainability and Carbon Certification). This organisation also provides equivalent certification for bio-based products, ISCC-plus [ISCC-plus 2014]. The ISCC-plus certification scheme has a set of mandatory requirements including the sustainability of the production area and chain-of-custody. The latter can be achieved through mass balance allocation or physical separation of materials. In addition there are optional, voluntary sustainability criteria relating to greenhouse gas emissions and biodiversity.



A draft standard **prEN 16751** concerning sustainability criteria has been developed by CEN/TC 411, containing many of the same requirements as the third party ISCC certification. However, in both instances the proportion of biomass derived material in the bio-based product is not relevant or reported. The requirements apply to the biomass production and the production chain. All the biomass must be regarded as sustainable.

2.3.7 Supply chain book-and-claim

'Book-and-claim' is a method by which to offset negative characteristics of a product (or gain a positive attribute) by purchasing certificates generated when an identical material is produced adhering to this standard. One prominent example has been established for sustainable palm oil [GreenPalm 2014]. For every tonne of sustainably produced palm oil produced, the responsible party can sell one certificate to a manufacturer using palm oil in their products. This transfers the quality of sustainability with a 'book-and-claim', in a virtual sense of course, to an equal quantity of palm oil not produced in a sustainable fashion. The use and transfer of certificates eliminates 'double counting' of sustainable palm oil. Over 11 million of these certificates have been sold [GreenPalm 2014]. The need for third party verification means this approach of 'book-and-claim' is beyond the role of a standard.

The sustainability of a product cannot be analytically deduced from the article and so the transfer of certificates does not result in a conflict of data. The money generated by this scheme can be reinvested into sustainable oil crops. However bio-based content can be inferred through appropriate analysis and so the implementation of bio-based content certificates would result in bio-based products without certification and fossil derived articles possessing certificates suggesting the product is derived from biomass. The same is true however of total bio-based content when it is allocated across batches of product. If a variable total bio-based content because of fluctuating biomass inputs is averaged across a fixed time period analysis will not verify the claim of bio-based content.

2.3.8 EU Ecolabel

The EU Ecolabel is an environmental label dedicated to distinguishing products of high environmental benefit yet maintaining high performance [Ecolabel 2014]. Labelling categories span a variety of different product groups. Three of those relevant to the primary bio-based product classes are paints (containing solvents), lubricants, and hand dishwashing detergents (containing surfactants). There is not a product category dedicated to plastics as such, but some plastic containing products such as televisions are covered. Some of the requirements of these Ecolabel categories are described in Table 2-8.



Table 2-8 Selected EU Ecolabel requirements for four different product categories.

Paints	Lubricants	Detergents	Televisions
<i>Manufacturing</i>			
Restricted sulphur and chlorine waste streams	Certain chemicals are not permitted in the formulation.	The amount of packaging allowed is limited.	Certain chemicals are not permitted in the construction of the product.
		Certain chemicals are not permitted in the formulation.	
<i>Use</i>			
Limits on the amount of volatile aromatic hydrocarbons present.	The <u>bio-based content</u> of the formulation is given (minimum values are product type specific).	Performance must match or exceed that of a reference detergent.	Energy consumption is restricted.
Performance requirements regarding water resistance, adhesion and fungal resistance.	Technical performance criteria must be met (established by relevant standards).		The lifetime of the product must exceed two years, with replacement parts offered up to seven years after production ceases.
<i>Disposal (end of life)</i>			
The product must not contain certain metals or dangerous substances.	Aquatic toxicity must comply with stated limits.	Surfactants must be biodegradable.	The product must be easily disassembled to assist recycling.
	Non-biodegradable bio-accumulating substances are prohibited.		

Although many of the EU Ecolabel criteria are not directly relevant to bio-based content, some highlight the important implications of using bio-based products. If the performance of a bio-based product is inferior to that of a petrochemical product it has replaced, then more material may be required, or the article will need replacing with a faster turnaround. For bio-based products of relatively low bio-based content (implying high fossil de-



rived content), the demand for fossil feedstocks could actually be enhanced when replacing conventional high performance petrochemical products. It follows that the combination of a method for establishing bio-based content and a more holistic certification scheme to ensure the performance of bio-based products is satisfactory might be mutually beneficial. An assessment into the suitability of the EU Ecolabel criteria for bio-based products is being explored as part of the EU funded Open-Bio project (www.open-bio.eu), a sequel of sorts to KBBPPS in terms of pre-standardisation research.

2.3.9 Traceability and chain of custody claims

In many sectors the origin of the components in their products is important. Producers of paper will often have sustainability commitments and so need to use correctly certified wood (**PEFC ST 1003**). To minimise environmental footprint certain plastics are recycled, and their use in new products can be certified based on standards for the traceability of recycled material (**EN 15343**). These existing standards begin to demonstrate the demand for means of establishing the origin of articles. Thus a type of total bio-based content assessment would be a welcome addition to compliment traceability standards and related practices. In return traceability standards help marshal total bio-based content calculations, especially if expanded out beyond a single contained production facility.



3 Direct measurement of bio-based content and its role alongside indirect bio-based content calculations

3.1 Calculation of bio-based carbon content

Bio-based content analysis is presently achieved through the measurement of carbon isotopes and is not based on the article as a whole. A strong knowledge base in ^{14}C determination analytical techniques, the choice of reference samples, and sample preparation is available from the field of archaeological radiodating, described in [KBBPPS deliverable report D4.3](#). Three methods have been developed to measure $^{14}\text{C}/^{12}\text{C}$ ratios and are described in this report using the following titles: Proportional scintillation-counter method (LSC), beta-ionisation (BI), and accelerator mass spectrometry (AMS) (Table 3-1). These techniques correspond to Method A, Method B, and Method C respectively, in accordance with the nomenclature established in [CEN/TS 16640](#) on which this section of this report is based. Note that the naming of these methods is different to that in [ASTM D6866](#) although the same three are covered (in recent versions beta-ionisation method has been removed from [ASTM D6866](#) because of its reported poor accuracy and technical complexity). Throughout this report radiocarbon analysis can generally be taken to imply AMS analysis, as although the apparatus is large, expensive, and complex to operate, it is available in specialist institutes and prices for analysis are dropping as increased demand is satisfied with the opening of new facilities [Accium 2012]. The greater accuracy of AMS compared to other methods is helpful for reproducibility, especially if complex mixtures are being analysed. The high throughput of AMS analysis is also helpful.

Table 3-1 Available methods of radiocarbon isotope ratio analysis.

Method	Technical level	Additional requests	Duration of measurement	Relative standard deviation	Instrument costs
LSC	Simple	Normal laboratory	4-12 hr	2-10%	Low
BI	Complex	Low background laboratory and a gas purification device	8-24 hr	0.2-5%	Low
AMS	Very complex	Large installation and graphite conversion device	10-30 min	0.2-2%	High



3.1.1 Sample preparation

Complete combustion of the sample is carried out in such a way to provide the quantitative recovery of all the carbon present in the sample as carbon dioxide gas order to yield valid results. Because only the carbon atoms are part of the bio-based content analysis, destruction of the sample through combustion has no impact on the analysis of bio-based carbon content. The different apparatuses in which a sample can be combusted include bomb calorimeters and tube furnaces. After combustion the resulting gases are collected in a gas bag. When LSC is used for analysis, the carbon dioxide is captured as a carbamate solution with the addition of a suitable scintillation liquid. When BI or AMS techniques are used, the carbon dioxide shall be reacted with a basic sodium hydroxide solution or on a suitable solid absorption material. Alternatively the carbon dioxide can be trapped by means of a cryogenic trap. This latter technique is frequently used in test laboratories. New methods of analysis such as thermal gravimetry are also being investigated as possible pre-treatment methods of combustion as in [KBBPPS deliverable report D4.1](#).

If combustion in a bomb calorimeter or sealed quartz combustion tube is chosen, only the carbon dioxide can be collected and this analysis must be conducted separately to any other bio-based content analysis. With combustion apparatus, such as an elemental analyser (EA) as used in elemental analysis, it is possible to separate the combustion gases and potentially use them each individually for either elemental analysis, stable isotope analysis (IRMS) or radiocarbon analysis in a concerted, hyphenated analytical procedure. The isotopic analysis pre-treatments performed at the Oxford Radiocarbon Accelerator Unit are based on EA-IRMS, in which a 50:1 split of combusted material is established to retain a large portion of the carbon dioxide sample for graphitisation prior to AMS [Brock 2010]. Carbon and nitrogen stable isotope ratios are analysed from the minor combustion gas stream. There is an obvious match between this type of procedure and the need for more complete but synergistic bio-based content analyses.

3.1.2 Liquid scintillation-counter method

Liquid scintillation counter (LSC) method determines the isotope abundance of ^{14}C indirectly, through its emission of β particles due to the radioactive decay of the ^{14}C isotope. The β particles are observed through their interaction with scintillation molecules ([KBBPPS deliverable report D3.1](#)). The carbon dioxide formed by the combustion of a bio-based product is trapped in a carbamate solution. This solution is mixed with an organic solution containing the scintillation molecules and the ^{14}C activity of this mixture is measured in a liquid scintillation counter. The background count rate is subtracted to give a net count rate. The ^{14}C activity is obtained by normalising the net count rate to the count rate of the reference standard (NIST oxalic acid SRM).



3.1.3 Beta-ionisation

The beta ionisation (BI) method determines the isotope abundance of ^{14}C indirectly. Like LSC, this method uses the emission of β particles by ^{14}C due to the radioactive decay of the ^{14}C isotope (KBBPPS deliverable report D3.1). It detects β particles by means of discharge current pulses between high-voltage electrodes in a proportional gas counter. Those pulses are initiated by the emission of beta particles. To use this method, the sample has to be in the form of carbon dioxide or converted to carbon dioxide. The carbonate as obtained from the combustion of a bio-based product is converted to carbon dioxide by acidifying the solution with acid. The sample is counted for several days in a low-level counting system to reach the number of counts desired for statistical precision. As stated previously, the complexity of the experiment and the fact it is prone to error means other techniques are preferred.

3.1.4 Accelerator Mass Spectrometry

The accelerator mass spectrometry (AMS) method determines the presence of ^{14}C directly and not evidence of it through radioactivity measurements. The carbon atoms in the graphitised sample are converted into a beam of ions. The formed ions are accelerated in an electric field, deflected in a magnetic field and detected in ion detectors resulting in the determination of the relative isotope abundances of these ions [Hellborg 2008]. AMS is a form of mass spectrometry that uses a high potential electrostatic field, specifically forming only C^{n+} ions ($n = 1$ to 4) and excluding all other ionic species. This greatly enhances sensitivity without compromising selectivity. With AMS the bio-based fraction of carbon is determined from the $^{14}\text{C}/^{12}\text{C}$ ratio. The isotopic ratios are determined relative to the appropriate primary reference material. The total carbon content is not determined with this technique and is determined separately.



3.2 Calculation of bio-based content with stable isotope analysis

Suitable substrates for isotopic ratio mass spectrometry (IRMS) are typically obtained as they are for elemental analysis: by combusting a sample to give, for example, carbon dioxide for carbon isotope analysis. The combustion can be performed in elemental analysis apparatus. Although water is the chemical basis of hydrogen elemental analysis, hydrogen gas is required for IRMS. Reduction of water to hydrogen gas can be done with uranium or zinc [Preston 1992]. The different gases are separated by gas chromatography and analysed sequentially in a continuous flow system. For oxygen stable isotope ratio analysis, carbon monoxide is produced separately for testing as it is in traditional elemental analysis. The use of gas chromatography coupled with IRMS to give compound specific IRMS could be applied to certain bio-based product types [Brenna 1997, Meier-Augenstein 1999, Schmidt 2004]. This is a powerful tool in the analysis of mixtures, which otherwise could not be studied with stable isotope analysis due to an averaging effect rendering the observed isotope ratios as meaningless. There are limitations to compound specific IRMS. Firstly the components need to be volatile to be separated by the GC stage. Therefore the analysis of plastics, the largest bio-based product market, is not possible with this technique.

Stable isotope analysis is proven to be able to distinguish between some varieties of bio-plastics and competing petroleum products [Suzuki 2010], and between bio-ethanol and non-renewable synthetic ethanol [Ishida-Fujii 2005]. The most prevalent use of stable isotope analysis is in food origin tracking to protect premium products in the market and establish proof of their authenticity [Rossmann 2007]. The difference between organic and conventionally farmed products [Laursen 2013], drinks made from fruit concentrates and those not diluted from concentrates [Koziet 1995], synthetic vanillin and natural vanillin [Greule 2010], and olive oil squalane and shark liver squalene [Jame 2010], are just some examples. The location in which foodstuffs were grown is also traceable by stable isotope analysis [Santato 2012, Zhao 2014].

There is obvious potential here for the application of stable isotope ratios towards bio-based product analysis. However the isotopic ratios observed fall within variable data ranges and are not discrete values as is the case for radiocarbon analysis. As a demonstration of this, a blend of fossil derived polyethylene, and bio-polyethylene (of an equal mass contribution) can be considered. The experimental ^{13}C isotopic analysis of this hypothetical blended article could provide a carbon isotopic composition of anything between -23.8‰ and -17.7‰ if sugar cane was the biomass feedstock (Figure 3-1). The lower end of this range overlaps with the domain covered by crude oil, and so with this analysis it could be concluded that the article is 0% bio-based. Conversely if the best possible -17.7‰ ^{13}C isotopic composition was observed then this could represent anything up to 85% bio-carbon content. Obviously this



extremely large range of possible answers is far from satisfactory. Therefore stable isotope analysis is generally limited to individual chemicals of a single origin and not mixtures.

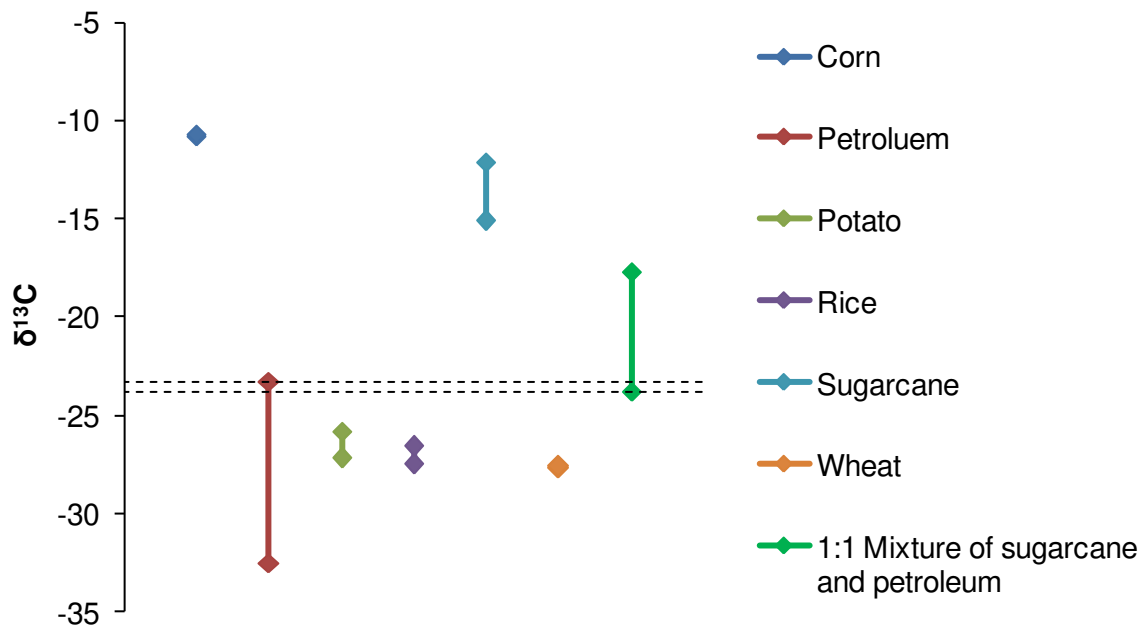


Figure 3-1 A hypothetical sugarcane-petroleum derived composite characterised by $^{13}\text{C}:^{12}\text{C}$ isotopic analysis. The region of overlap between the possible results of a fossil based material (red) and a supposedly 50% sugarcane derived material (dark green) is indicated by the dashed lines.

Specialised method development can however make stable isotopes a viable and analytically precise method by which to assess bio-based content. This is achieved with the loss of broad applicability, each product requiring its own specific analysis. Coca-Cola Corporation's plant bottle PET product for instance is successfully analysed for bio-based carbon content by stable carbon isotope analysis [Picarro 2014a, SpecialChem 2011]. Details are limited, with the process patent pending [SpecialChem 2011]. Poly(ethylene terephthalate) is returned to in the following section.



3.3 Examples of bio-based content measurement applied to molecules

Organic chemicals that are found to be 100% bio-based from a radiocarbon analysis are likely to be largely independent of fossil resources in terms of all the other elements as well (energy use in manufacturing is not within the scope of this report). Realistically the only common exception is created by hydrogenation of biomass or a bio-based platform molecule. However the mass contribution of hydrogen is small enough that total bio-based content is not majorly impacted. Even hydrogenation of the smallest olefinic molecule, ethylene, only results in a 7% increase in mass in making ethane. Stable isotope analysis would not be effective in resolving the quantity of fossil derived hydrogen in a bio-based product because the mixture of bio-based and fossil derived hydrogen would usually render the analysis inconclusive (refer to the example demonstrated in Figure 3-1 for carbon stable isotope analysis).

The determination of bio-based content from radiocarbon and stable isotope analysis is addressed in this section. After atom connectivity and mass balance methods have been explained and applied to selected case studies the results will be compared to these discussions on direct bio-based content. References to the anticipated results of radiocarbon analysis are continually made when indirect approaches to total bio-based content are discussed in Chapter 4 and Chapter 5. It is important that all methods that can be used in combination for bio-based content are not contradictory, and so it is prudent to address direct bio-based content analysis for a small sample of bio-based products here in this report. Similarly where direct approaches fail and indirect methods must be used, the expected result should not be strongly dependant on the type of calculation chosen. The methods should substitute for one another. Instances in which direct analysis of bio-based content can fail to produce the anticipated result include when marine biomass is used, fermentation of fossil derived intermediate chemicals, and if biomass is grown next to where fossil fuel combustion occurs. Data from *Beta Analytic Inc.* has demonstrated a 5% depletion in ^{14}C in the foremost and latter instances [Darden Hood, private communication, 2014].

Examples for this brief overview of direct bio-based content analysis have been picked to cover different feedstocks: Methyl oleate is mainly derived from vegetable oil; polyethylene terephthalate (PET) can be partially bio-based using a sugar derived diol monomer; bio-ethanol is wholly sugar derived and can be valorised into other bio-based chemicals such as ethyl acetate; finally vanillin is synthesised from the guaiacol in essential oils or sometimes a lignin feedstock, but premium food products utilise naturally occurring vanillin.



3.3.1 Methyl oleate

Biodiesel is a major product in the bio-based economy [2009/28/EC]. Although its use is primarily for fuel, fatty acid methyl esters (FAMEs) do find some use in solvent and lubricant base oil applications [da Silva 2013, Wildes 2002]. Methyl oleate is the methanol transesterification product of the major triglyceride component of rapeseed oil [Turley 2008]. The methanol used is fossil derived. The result is an article that contains 94.7% bio-based carbon (18 of every 19 carbons).

Stable carbon isotope ranges for vegetable oils and FAMEs are known [Kelly 1997, Panetta 2011]. The mean $^{13}\text{C}/^{12}\text{C}$ isotopic ratio of oleic acid from rapeseed oil is 29.1‰, measured relative to a reference material [Kelly 1997]. The variation across species is minimal (*e.g.* -29.5‰ when from palm oil). Usually stable isotope analysis of FAMEs is performed to obtain data on the parent fatty acid, and so the contribution of the methanol transesterifying agent is subtracted by calculation. With this approach a value for palm oil oleic acid carbon isotope ratio was obtained at -29.2‰ [Panetta 2011]. The comparison was extended across canola oil, soy oil, peanut oil, olive oil, and corn oil. Only corn derived oleic acid showed a notable difference in isotopic carbon composition (-16.1‰), and freed itself from the $\delta^{13}\text{C}$ range occupied by fossil based products (complimentary data in Table 3-1). Corn and sugarcane (C_4 metabolism plants) feedstocks can be distinguished from fossil products by stable carbon isotope analysis but many other bio-based products cannot. In the case of a FAME, spectroscopic or a mass spectrometric analysis would be better positioned to ascribe a judgement concerning bio-based content onto the article than stable isotope analysis, because there is no equivalent petrochemical product (structural analysis of bio-based products is presented in [KBBPPS deliverable report D4.1](#)). Identification of the chemical structure would be more definitive in this instance than an isotopic analysis.

3.3.2 Polyethylene terephthalate

Stable carbon isotope analysis can be used instead of radiocarbon analysis, even on the products of integrated manufacturing processes which use fossil and biomass resources, when the scale of production makes cost a strong driver. Cavity Ring-Down Spectroscopy (CRDS) has been proven as a viable technique for the determination of stable isotope ratios in small molecules, including carbon dioxide. Information on this technique, based on near-infrared spectroscopy, is available elsewhere [Picarro 2014b]. This means bio-based products can be combusted in the fashion familiar to radioisotope analysis sample preparation and the combustion products then analysed. Analysis of the resultant spectra can be compared to comprehensive reference spectra in the literature in order to identify peaks corresponding to $^{12}\text{CO}_2$ and $^{13}\text{CO}_2$ [Perevalov 2006, Perevalov 2008]. The correlation between



stable isotope ratios inferred by this spectroscopy technique and spectrometry (IRMS) is linear [Berryman 2011].

The relevance of this technique to bio-based products is being proven in the testing of partially bio-based poly(ethylene terephthalate). The Coca-Cola Corporation are implementing CRDS as a means of verifying the bio-based content of their 'PlantBottle™' product [SpecialChem 2011]. The details of this specific analytical process are not publically available, but it may be assumed that the ethylene glycol monomer of the PET product comes from a consistent source (*e.g.* Brazilian sugarcane) and so the stable carbon isotope ratio is steady over time. If the finished product is analysed and not just the monomer intermediate then the anticipated stable isotope ratio will be different, with ethylene glycol responsible for only two of every ten carbon atoms in PET. However the stable isotope ratio would still be consistent and recognisable against a reference material. A comparison to a verified (radiocarbon tested) sample would be prudent also.

3.3.3 Bio-ethanol and ethyl acetate

Bio-ethanol is a fermentation product and is 100% bio-based, obtained from a variety of different biomass sources [Sánchez 2008]. Fermentation can also be used to then oxidise ethanol to acetic acid *via* its aldehyde intermediate [Fukaya 1992], as can chemical oxidation [Gorbanev 2012, ICIS 2010]. The additional atoms incorporated into acetic acid originate in water, with the labile protic hydrogen atom of acetic acid readily exchanging with water anyway. In fact, the sugar or cellulose feedstock required to make bio-ethanol also has exchangeable hydroxyl groups and so downstream products such as ethyl acetate contain a large proportion of water by mass incorporated into their molecular structure. Ethyl acetate can be made from the Fischer esterification of acetic acid and ethanol, in which either reactant could be bio-based. Alternatively an oxidation-hydrogenation sequence will produce ethyl acetate directly from ethanol independently of acetic acid. These transformations are summarised as Figure 3-2.



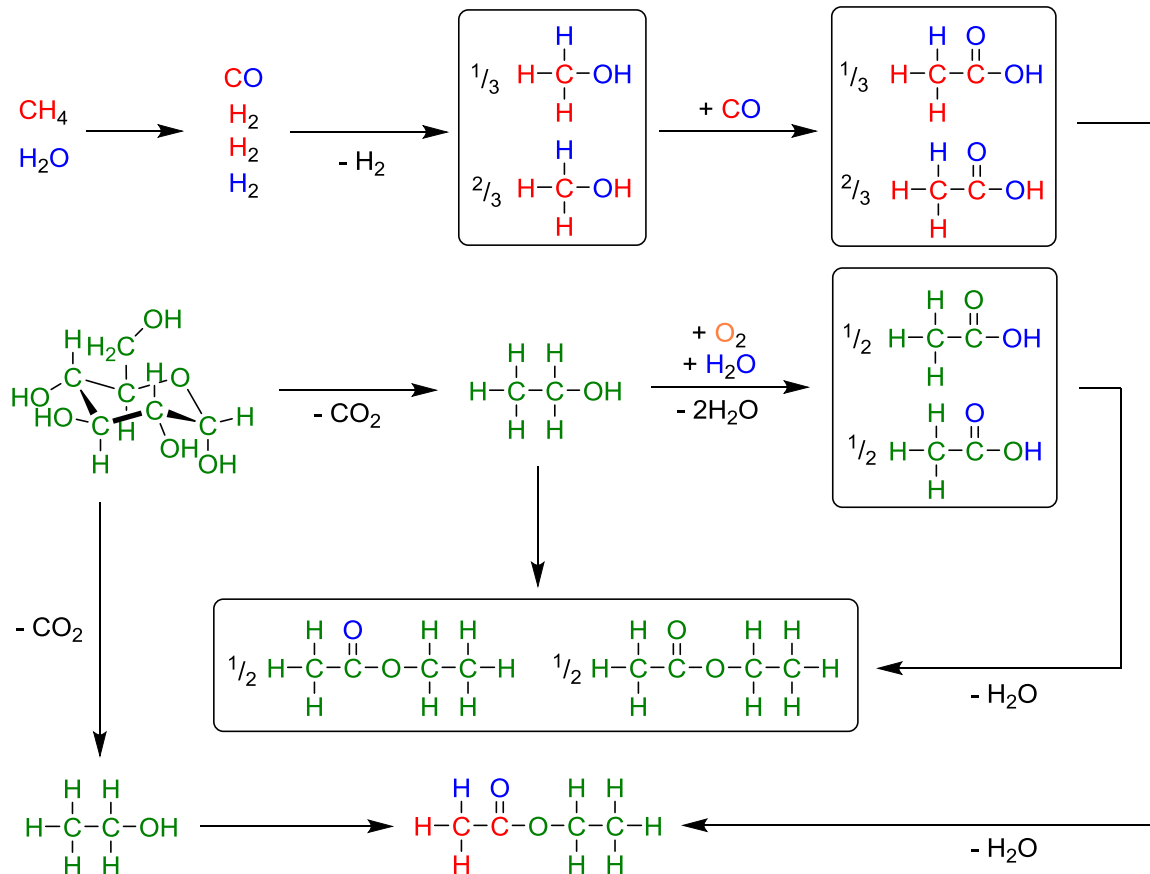


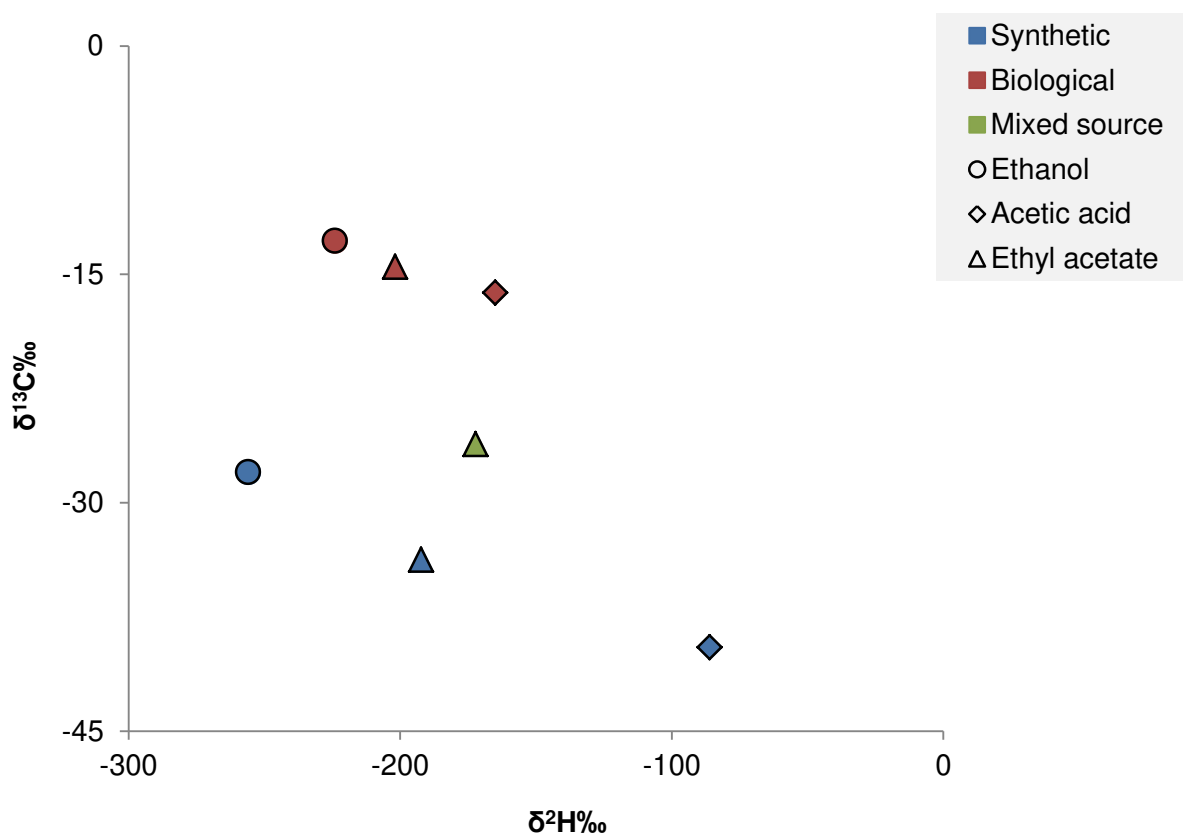
Figure 3-2 The synthesis of some representative bio-based products from bio-ethanol.

Sugar cane derived articles can be identified as bio-based from their carbon isotopes. However blended products can lose this distinction unless multiple stable isotopes are used. In theory the stable hydrogen isotopic ratios of ethanol, acetic acid and ethyl acetate can be employed in combination with carbon isotopic data to identify the origin of these chemicals. Data in Table 3-1 is calculated for ethyl acetate based on the inclusion of elements from the reactants using literature stable isotope ratios. It appears possible to distinguish between ethyl acetate molecules produced from fossil resources, biomass, or the synthesis from bio-ethanol and fossil derived acetic acid using the results of this theoretical case study (Figure 3-3). Radiocarbon analysis would verify any of these routes to any of these bio-based products. Stable isotope analysis is not on its own sufficient to determine bio-based content.



Table 3-1 Stable isotope ratios for ethanol and its co-reactants and products (calculated for ethyl acetate).

Molecule	Origin	$\delta^{13}\text{C}$	$\delta^2\text{H}$	$\delta^{18}\text{O}$	Ref.
Ethanol	Synthetic	-28.0	-256	20.4	Yamada 2007
	Biological	-12.8	-224	12.7	Ishida-Fujii 2005
Acetic acid	Synthetic	-39.5	-86		Lee 2013, Oba 2007
	Biological	-16.2	-165		Hattori 2010
Ethyl acetate	Synthetic	-33.8	-192		
	Mixed	-26.2	-172		
	Biological	-14.5	-202		

**Figure 3-3** Estimation of stable isotope ratios of carbon and hydrogen for ethanol and its co-reactants and products.

3.3.4 Vanillin

The stable isotope composition of vanillin is important in the food sector. The use of the limited supply of naturally extracted vanillin in premium products is validated with stable isotope checks. The original ^{13}C isotope ratio test has been superseded with a combined



hydrogen and carbon isotope ratio analysis [Greule 2010]. This is because synthetic vanillin can be artificially enriched with a radiocarbon labelled methoxy group. Rather than cleave the methoxy group with hydroiodic acid and analyse the resulting catechol derivative, the double isotope ratio test approach permits the sampling of very small quantities of vanillin. Naturally extracted vanillin can be resolved from synthetic varieties manufactured from lignin or guaiacol using this method (Figure 3-4) [Greule 2010]. Radiocarbon analysis is not useful here in the food sector because synthetic vanillin is still bio-based. In this instance indirect methods that examine the production chain are valuable (chain-of-custody and traceability standards exist for various products), in addition to stable isotope analysis.

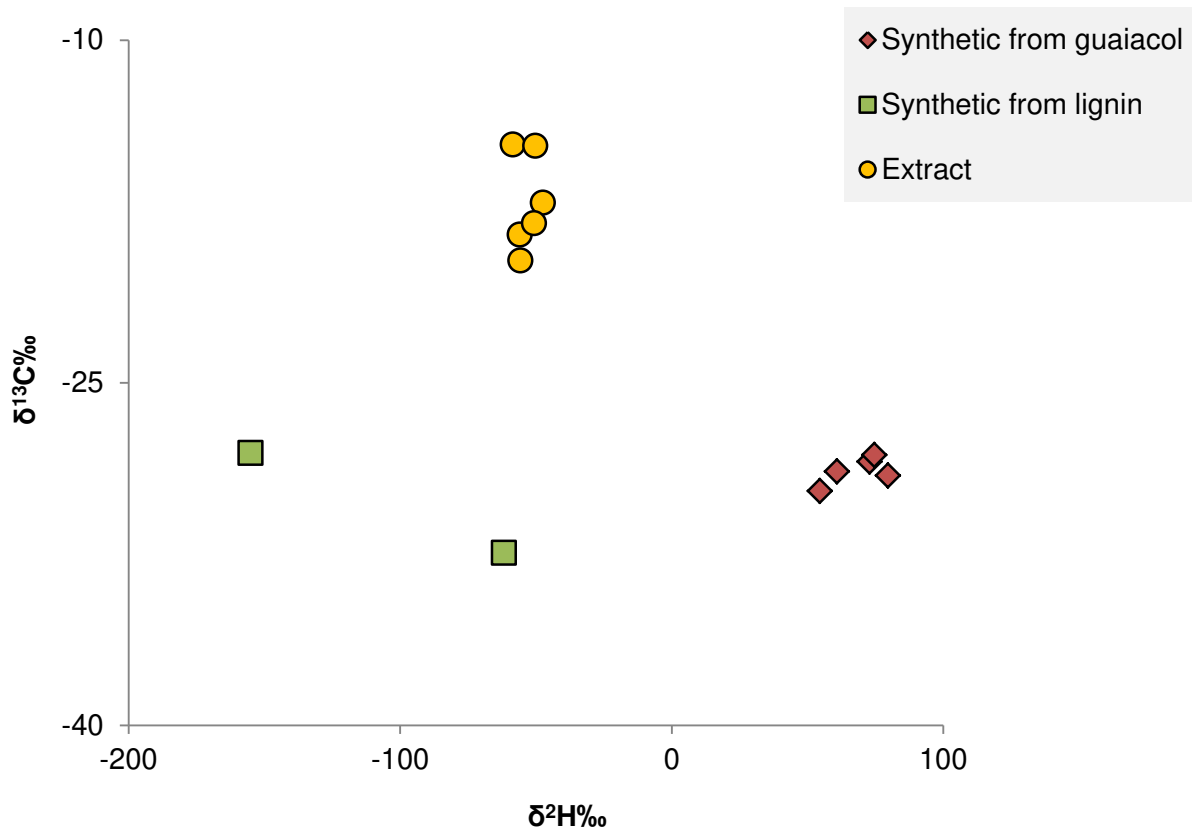


Figure 3-4 Experimental stable isotope ratios for authentic vanillin samples.



3.4 Advantages and limitations of direct bio-based content

Direct bio-based content is already established as a reliable method for the determination of bio-based carbon content by radiocarbon analysis. It will also need to act as an anchor point for many indirect total bio-based content methodologies. The reason indirect approaches are required to supplement direct analytical methods is that the radiocarbon method is limited to carbon, and total bio-based content determination by stable isotope analysis is insufficient as a broadly applicable means of determining total bio-based content (Table 3-2). However stable isotope analysis is useful for specific products. It can also assist in chain-of-custody verification that might form a complementary aspect to bio-based content approaches.

Table 3-2 A comparison of direct bio-based content methods.

	Radiocarbon method	Stable isotope analysis
Advantages	<ul style="list-style-type: none"> • Definitive. • Standardised multiples times and recognised by several certification bodies. • Isotopic doping unlikely (for economic reasons). 	<ul style="list-style-type: none"> • Multiple complimentary datasets can be formed for different elements. • Can also differentiate between biomass sources for sustainability criteria.
Limitations	<ul style="list-style-type: none"> • Only accounts for one type of element. • Production composition variation with time not accounted for. 	<ul style="list-style-type: none"> • Data ranges, not definitive values, restrict its utility. • Can be manipulated with isotope doping. • Production composition variation with time not accounted for.

It would appear that although radiocarbon analysis will remain the primary method of determining bio-based content for products of dedicated bio-refineries (continuous, non-fluctuating input of biomass), its shortcomings would be complemented by indirect methods of calculating bio-based content (particularly on a total mass basis). In turn these new methods must be harmonious when used in combination with direct approaches, and that is why a considerable portion of this report has thus far been dedicated to understanding direct bio-based content analysis. Not only could indirect total bio-based content determination extend bio-based content considerations to cover all of the elements found within bio-based products (not just carbon and a select few other atoms with an amenable quantity and abundance of different stable isotopes), it would permit the determination of bio-based content for products from non-dedicated facilities in which the bio-based (carbon) content is variable. Indirect bio-based content approaches should also apply to dedicated facilities and equate to direct



analysis. What follows is an assessment of the principal indirect total bio-based content methods (atom connectivity and mass balance). More challenging case studies that involve fluctuating biomass input (non-dedicated facilities) then follow in Chapter 5.7. Synergy with direct analysis of bio-based (carbon) content is also considered.



4 Atom connectivity

4.1 Calculation of bio-based content with atom connectivity methods

To supplement bio-based carbon analysis, the use of complementary elemental analysis and a consensus on atom connectivity to determine bio-based content has been discussed in terms of the ACDV certification scheme [ACDV 2013], but not in the context of actually applying this procedure to bio-based products and also using different consensuses on how to apply the atom connectivity. Without elemental analysis or radiocarbon isotope analysis, atom connectivity is an indirect protocol for the determination for total bio-based content. This is how this methodology has been approached in this report. The elemental analysis is a verification tool, but only for the proportion of different atoms contained within the molecule, making no indication of the bio-based content. Radiocarbon analysis would provide a direct analytical verification of bio-based carbon content and validate a calculation using atom connectivity for the total bio-based content. Throughout this chapter it will be assumed ^{14}C measurements would verify the suggested allocation of bio-based carbon content.

Over thirty chemicals are assessed in this report in order to explore the horizontal applicability of atom connectivity methods. The robustness of the ACDV method in comparison to similar bio-based content determination methods using atom connectivity can also be ascertained through this broad screening of bio-based products. Results of radiocarbon analysis and elemental analysis are assumed to be consistent with the theoretical values used throughout when discussion returns to the ACDV interpretation of total bio-based content.

4.1.1 Definition of atom connectivity methods

As part of an evaluation of the ACDV method for total bio-based content determination, currently in the process of being adopted by the TC 411 standardisation committee for bio-based products as [prEN 16785](#), three new atom connectivity approaches for molecules have been designed and applied for the purpose of this report. By comparing the different methods, their strengths and weaknesses are highlighted. Agreement between methods (including alternative direct and indirect approaches) could be seen as indicative of a reliable result. As with the ACDV method, formulations are treated differently, but can be thought of as the sum of their parts if atom connectivity is applied to each individual component.



- Atom connectivity Method 1 is more feedstock orientated than the following approaches, and requires that individual ingredients in a synthetic procedure are designated as either wholly fossil derived or bio-based (this approach is similar to some mass balance methods discussed Chapter 5). The atoms attributed to these start materials are then identified in the structure of the product and a bio-based content calculated as a percentage of the molecular mass of that bio-based product. Atom connectivity Method 1 is not directly reliant on any specific analytical data (*i.e.* a $^{14}\text{C}/^{12}\text{C}$ ratio) but should be checked against such data. As practiced in the ACDV certification scheme, elemental analysis is compatible with atom connectivity Method 1 in order to verify the relative quantity of each element.
- Atom connectivity Method 2 is consistent with the ACDV methodology. Using bio-based carbon assignments and atom connectivity, the results can be interpreted in two ways. Firstly, atom connectivity Method 2a requires no chemical synthesis knowledge once the bio-based carbon atoms in the article have been identified. It is consistent with the definition of bio-based content provided by the BSI in **PAS 600:2013**, which has the sub-clause “*if oxygen and/or hydrogen atoms are bound to a biomass carbon structure, they are considered to be part of the bio-based content*”, as found in the ACDV certification scheme where it also applies to nitrogen. This is extended to all non-carbon atoms in this interpretation of atom connectivity. Atom connectivity Method 2b is a slight modification of this procedure, correcting atom connectivity assignments according to standard chemical rules, usually making the results equate to those of atom connectivity Method 1 and the ACDV method (Figure 2-9). The ACDV approach does differ in its consideration of atoms beyond carbon, hydrogen, oxygen and nitrogen, with all other atoms taken as bio-based [ACDV 2013]. The implications of this are addressed in conclusion.
- Whereas the previous methods require the clear, but binary distinction between plant and fossil sources of elements, atom connectivity Method 3 divides the origins of atoms into five categories to provide greater accuracy and accountability, but at the cost of higher complexity and a more significant risk of error. In addition to fossil resources and biomass, elements are obtained from water, the major atmospheric gases (molecular oxygen and nitrogen), and mineral resources by the chemical manufacturing industries. Using a more precise determination of elemental origin, atom connectivity Method 3 does not actually rely on any atom connectivity principles because elements no longer need to be allocated an origin. The result for total bio-based content is calculated as the combined mass of plant, air, and water derived atoms divided by the total molecular mass.



How these rules are applied to different atoms are described in the following tables, with carbon always assigned to be consistent with direct ^{14}C bio-based content methods: hydrogen (Table 4-1), nitrogen (Table 4-2), oxygen (Table 4-3), sulphur (Table 4-4), and finally the other elements (Table 4-5). In these tables, the rules as they apply to a given element and the specific atom connectivity method are abbreviated to the chemical symbol of the element followed by the number of the atom connectivity method, so for example the rule of assigning the origin of nitrogen atoms by atom connectivity Method 2a is coded by '**N2a**'. The rules have been described for inorganic compounds as well when specific instruction is needed, although calculations will show this is beyond the useful scope of this methodology. In formulations inorganic components will be considered as fossil based except for in atom connectivity Method 3. The equation for total bio-based content *via* atom connectivity is displayed below, followed by the modified equation specific to atom connectivity Method 3.

$$\text{Total biobased content} = \frac{\sum M_{\text{bio}}}{\sum M_{\text{bio}} + \sum M_{\text{fossil}}}$$

$$\text{Total biobased content} = \frac{\sum M_{\text{bio}} + \sum M_{\text{air}} + \sum M_{\text{water}}}{\sum M_{\text{bio}} + \sum M_{\text{air}} + \sum M_{\text{water}} + \sum M_{\text{fossil}}}$$



Table 4-1 Assignment of bio-based hydrogen atoms according to different atom connectivity rules.

Code	Convention
H1	Known precursors are designated as wholly plant based or fossil based, and this convention is followed through the reaction pathway for hydrogen atoms after any chemical modification to give the final product. Ingredients are taken as the platform molecules where possible, not their pre-cursor biomass resource (<i>e.g.</i> ethanol not glucose) or the whole biomass to avoid ambiguities regarding chemical composition. However the designated platform molecule should not be the product of multiple chemical feedstocks reacting (<i>e.g.</i> methane not syngas). Hydrogen atoms of an unknown origin in organic molecules are ascribed as being fossil based.
H2a	Hydrogen atoms adopt the origin of the carbon atom they are directly bonded to. Radiodating should be used to justify the number of bio-based carbon atoms. Other carbon atoms are assumed to be fossil derived. Knowledge of the chemical synthesis (if relevant) is needed to differentiate between the location of bio-based carbon atoms and the fossil derived carbon atoms within the structure. If bonded to a heteroatom which in turn is bonded to a single carbon atom, the origin of the carbon to which that heteroatom is bonded to is used. If the heteroatom to which the hydrogen atom in question is itself bonded is in turn bonded to more than one carbon atom, then the designated origin of the hydrogen atom is split equally between those of the neighbouring carbon atoms. More than one consecutive heteroatom separating a hydrogen atom from the nearest carbon atom will be treated in the same fashion. The least number of bonds will be used when assigning a hydrogen atom to its nearest parent carbon atom. For inorganic compounds this convention is not directly applicable, but in the absence of carbon it can be based on the highest ranking element present (by atomic mass) if relevant.
H2b	Instead of splitting the assigned origin of a hydrogen atom when it is equally closely bonded to multiple carbon atoms, knowledge of the synthesis can be used to identify the parent carbon atom and then to state that the hydrogen atom is either bio-based or fossil-derived.
H3	The origin of hydrogen atoms is decided on the basis of the synthesis of the compound, assuming any syngas used comprises of two thirds fossil derived hydrogen content. Hydrogen atoms originating from water are specified as such, and any syngas used comprises of one third water derived hydrogen content. The synthesis of fossil based compounds should be derived from the use of oil refinery products (methane, ethylene, <i>etc.</i>). Renewable feedstocks should be based on distinct chemicals (<i>e.g.</i> pectin not orange fruit peel).



Table 4-2 Assignment of bio-based nitrogen atoms according to different atom connectivity rules.

Code	Convention
N1	As <i>H1</i> describes, but for nitrogen atoms.
N2a	Similar to <i>H2a</i> , the closest bonded carbon atom dictates the prescribed origin of the nitrogen atom. In the advent of a tie (<i>e.g.</i> diethyl isopropyl amine) where the neighbouring carbon atoms are of different origins, then the origin of the nitrogen atom is split equally.
N2b	Instead of splitting the assigned origin of hydrogen atoms when they are equally closely bonded to carbon atoms, any knowledge of the synthesis can be used to state the atom as either bio-based or fossil derived.
N3	Sources of nitrogen are allocated according to this hierarchy: the nitrogen content of ammonia and all derivable products is thought of as originating in the air; nitrogen atoms contained in a renewable chemical feedstock (<i>e.g.</i> amino acids) are bio-based; and finally remaining nitrogen atoms, perhaps of an unknown origin, must be considered as fossil derived.

Table 4-3 Assignment of bio-based oxygen atoms according to different atom connectivity rules.

Code	Convention
O1	As <i>H1</i> describes but for oxygen atoms. Note that carbon dioxide should be treated as fossil based unless traceability to a bio-based source is proven (<i>e.g.</i> fermentation). Nevertheless the oxygen in non-biogenic carbon dioxide must come from oxygen in the air, although this is only recognised in atom connectivity Method 3.
O2a	Similar to <i>H2a</i> , the closest bonded carbon atom dictates the prescribed origin of the oxygen atom. In the advent of a tie (<i>e.g.</i> ethyl acetate) where the neighbouring carbon atoms are of different origins, then the origin of the oxygen atom is split equally.
O2b	In the advent of a tie (<i>e.g.</i> ethyl acetate) where the neighbouring carbon atoms are of different origins (see <i>H2b</i>), then the origin of the oxygen atom is decided from any knowledge available concerning the synthesis.
O3	It is assumed that oxygen cannot be non-renewable. It is not present in fossil resources in any meaningful quantity. Based on this premise, oxygen is allocated as originating from biomass, water, air, or a mineral origin only.



Table 4-4 Assignment of bio-based sulphur atoms according to different atom connectivity rules.

Code	Convention
S1	As <i>H1</i> describes but for sulphur atoms.
S2a	Similar to <i>H2a</i> , the closest bonded carbon atom dictates the prescribed origin of the sulphur atom. In the advent of a tie (<i>e.g.</i> ethyl phenyl sulphone) where the neighbouring carbon atoms are of different origins, then the origin of the sulphur atom is split equally.
S2b	As <i>H2b</i> but for sulphur atoms. Note that in the present draft of the technical specification produced by CEN/TC 411/WG 3 that is dedicated to atom connectivity, derived from the ACDV certification scheme, sulphur atoms are always considered as bio-based according to prEN 16785 . Otherwise atom connectivity Method 2b is essentially the same as the ACDV method.
S3	Sulphur was historically produced from mineral reserves, but increasingly now from the hydrogen sulphide found in natural gas. The Claus process is able to liberate the elemental sulphur [Hermes 2014]. It shall be assumed that all sulphur originates from a petrochemical resource, except for the following exception of sulphur already present and contained within a plant based chemical feedstock (<i>e.g.</i> cysteine) or natural minerals incorporated into composites (<i>e.g.</i> calcium sulphate) which should be considered as bio-based and mineral in origin respectively.



Table 4-5 Assignment of bio-based atoms other than carbon, hydrogen, nitrogen, oxygen and sulphur according to different atom connectivity rules.

Code	Convention
X1	Inorganic materials as part of composites can be attributed as being mineral derived (<i>e.g.</i> calcium carbonate, steel) and separate from bio-based content calculations if the adopted consensus allows it. Otherwise they are considered as fossil derived. The origins of inorganic atoms present in organic molecules are decided based on the original feedstock as for <i>H1</i> . Ionic species are treated as if a covalent bond bridged the charged atoms. In the instance of charge resonance, the bond is proportioned accordingly between all atoms involved.
X2a	When a part of organic molecules, the closest bonded carbon atom dictates the origin of the element as either bio-based or fossil derived. In the advent of a tie (<i>e.g.</i> diethyl phenyl phosphate) where the neighbouring carbon atoms are of different origins, then the origin of the heteroatom is split equally.
X2b	When a part of organic molecules, the synthetic route is used to assign the origin of carbon atoms, then allocation of inorganic atoms occurs as with other elements. Note that in the present draft of the technical specification produced by CEN/TC 411/WG 3 dedicated to atom connectivity, derived from the ACDV certification scheme, atoms other than CNHO are always considered as bio-based (prEN 16785). Otherwise atom connectivity Method 2b is essentially the same as the ACDV method.
X3	Atoms other than C, H, N, O, and S are considered to be of a mineral origin. The mass contributions of these atoms are ignored from calculations.

In atom connectivity methods, any assigned bio-based content is not guaranteed to be a true reflection of the origin of a molecule because elements obtained from water, the atmosphere, and mineral resources are attributed to either a bio-based or ‘non-bio-based’ feedstock, and depends on the consensus adopted. For the purpose of atom connectivity Method 3, five feedstock sources are identified. Calculations are presented in this report in such a way that elements derived from water and atmospheric gases are included in bio-based content claims under the rules of atom connectivity Method 3. There are no feedstock sustainability concerns for water, molecular oxygen, or molecular nitrogen, and accordingly by including elements from these resources in bio-based content claims, the bio-based economy is unhindered. The mass contribution of elements from mineral sources are removed from this calculation process, so that the proportion of bio-based content is calculated on the basis of the mass of the bio-based elements as a function of all organic content.

It is important to reiterate that atom connectivity methods are anchored to an accurate assignment of bio-based carbon atoms, which in turn requires reliable radiocarbon analysis. From an analytically verified value for bio-based carbon content, the correct carbon atoms



within the chemical structure of the molecule must be allocated as bio-based. Without the correct designation of all the bio-based carbon atoms present, these methods of atom connectivity are not effective (except perhaps atom connectivity Method 1). With respect to the remaining elements, for the most part it is assumed in this report that elemental analysis data would be consistent with the idealised chemical structures provided.

4.1.2 Selection of atom connectivity molecule case studies

The aforementioned methods by which to assign bio-based content have been applied to more than thirty case studies. Examples were selected so that a variety of different lubricants, plastics, solvents and surfactants were covered, as well as some commodity chemicals and fine chemicals. These case studies do reflect the popularity of each application to a certain degree, but article diversity was prioritised over market representation. Some molecules, as listed in Table 4-6, were included because of a particular peculiarity that arises in the calculation of bio-based content. Formulations and composites are treated separately.



Table 4-6 List of molecules applied as case studies in combined radiocarbon analysis and elemental analysis discussions.

Category	Name	Bio-based carbon content (origin of bio-based content)
<i>Bulk chemicals</i>		
	Acetic acid	0% (syngas) 100% (fermentation)
	Glycerol	100% (vegetable oil)
	<i>p</i> -Xylene	75% (furan Diels-Alder) 100% (isobutanol)
	1,4-Butanediol	100% (fermentation)
	Adipic acid	100% (glucose redox)
	2-Ethoxyethyl acetate	33% (bio-ethanol)
	Butylated hydroxytoluene (BHT)	0% (toluene oxidation and alkylation)
	Acetyl tributyl citrate (ATBC)	30% (citric acid esterification)
	Ammonia	<i>n/a</i> (Haber-Bosch process)
<i>Lubricants</i>		
	Methyl oleate	95% (vegetable oil)
	Neopentyl glycol distearate	88% (synthetic ester)
<i>Plastics</i>		
	Polyethylene	0% (petroleum) 100% (bio-ethylene)
	Polylactic acid (PLA)	100% (fermentation)
	Polyethylene terephthalic acid (PET)	20% (bio-ethylene glycol)
	Polybutylene adipate terephthalate (PBAT)	36% (bio-succinic acid)
	Polyvinyl acetate (PVAc)	50% (bio-acetic acid)
	Polyvinyl alcohol (PVA)	0% (hydrolysed PVAc)
	Polyethyl acrylate	0% (petroleum) 40% (via bio-ethanol) 60% (via 3-hydroxypropanoic acid) 100% (bio-based)
	Polyurethane	53% (soy oil polyol)



Table 4-6 (continued) List of molecules applied as case studies in combined radiocarbon analysis and elemental analysis discussions.

Category	Name	Bio-based carbon content (feedstock or process)
<i>Solvents</i>		
	Methanol	0% (syngas)
	Ethyl acetate	50% (bio-ethanol ester)
	Ethyl lactate	100% (fermentation)
	Acetone	0% (cumene process)
	2-Methyltetrahydrofuran (2-MeTHF)	100% (furfural)
	<i>N</i> -Methyl pyrrolidinone (NMP)	80% (glutamic acid)
	Dimethyl isosorbide	75% (sorbitol cyclisation)
<i>Surfactants</i>		
	Hydrogen dodecyl sulphate	100% (lauric acid)
	Sodium dodecyl sulphate	100% (lauric acid)
	Sodium laureth sulphate	67% (short PEG chain) 38% (long PEG chain)
	Cocamidopropyl betaine	63% (lauric acid)
	<i>N</i> -Dodecylpyridinium chloride	71% (lauric acid)
<i>Fine chemicals</i>		
	Aspirin	11% (synthetic)
	Vanillin	88% (guaiacol)
	<i>p</i> -Cymenesulphonamide	100% (limonene)

With each example, a summary of the atom connectivity results is presented as a series of tables for the remainder of this chapter, accompanied by a discussion of its chemical synthesis in general terms with extra detail in cases where the reaction mechanism is not obvious. Atoms from biomass are drawn in green in subsequent schemes, with fossil derived atoms in red, water derived atoms in blue, atoms of an atmospheric origin in orange, and elements from mineral resources highlighted in grey. Especially for hydrogen atoms, the exact position of atoms with particular elemental origins may not be indicated because of a distribution of possible locations within the chemical structure. However the correct number of elements from each resource is always indicated. Coloured boxed outlines drawn around atoms are similarly colour coded when their origin is assigned by atom connectivity methods, as are shaded boxes filling in portions of molecules for atom connectivity Method 1 designations. Black boxes enclosing multiple versions of a molecule signify that the distribution of elements by origin cannot be represented by a single chemical schematic and is only applicable to atom connectivity Method 3 (see Figure 4-2 for examples of all these diagram conventions). Greater detail concerning the indirect allocation of total bio-based content under



each atom connectivity method is presented in Annex A, as are full synthesis schemes and the necessary theoretical elemental analysis data (Table 8-1).



4.2 Examples of bio-based content calculations for bulk chemicals based on atom connectivity

Platform molecules are the select number of chemical intermediates that give rise to the diversity and complexity of chemical articles our contemporary society demands. They are also often useful chemicals in their own right, and much of the chemical market place is the purchase and supply of these intermediates. The petrochemical industry relies on ethylene, propylene, butylene, butadienes, benzene, toluene, and xylenes as its platform molecules from petroleum [Weissermel 1993]. Natural gas is needed for syngas production, and increasingly with the advent of cheap shale gas higher hydrocarbons such as ethylene are being produced from methane. These platform molecules are not necessarily obvious products of biomass processing. The next step along production provides the commodity or bulk chemicals, immediately derived from the platform molecules. It is expected that fossil derived and bio-based bulk chemicals will share more similarity than the precursor platform molecules from the two resources. Eight organic chemicals are addressed here, as is ammonia because it features in the synthesis of many downstream bio-based products.

The results of this screening are presented here in this preamble as an introduction to the chemicals and their perceived bio-based content (Figure 4-1). The products discussed are mostly either totally bio-based or wholly fossil derived according to their likely bio-based carbon content. This is generally true for intermediates that have not gone through many chemical transformations from the feedstock. One exception is *p*-xylene, where in Figure 4-1 'Xylene (1)' is *p*-xylene produced from isobutanol, whereas 'Xylene (2)' is produced from dimethylfuran. The other exceptions are 2-ethoxyethyl acetate and acetyl tributyl citrate (ATBC). Case studies in later product classes show a greater diversity in their combination of bio-based and fossil derived ingredients. In (Figure 4-1) the entry for acetic acid and adipic acid are the carbohydrate derived products. Their petrochemical variants are also discussed in the following sections.



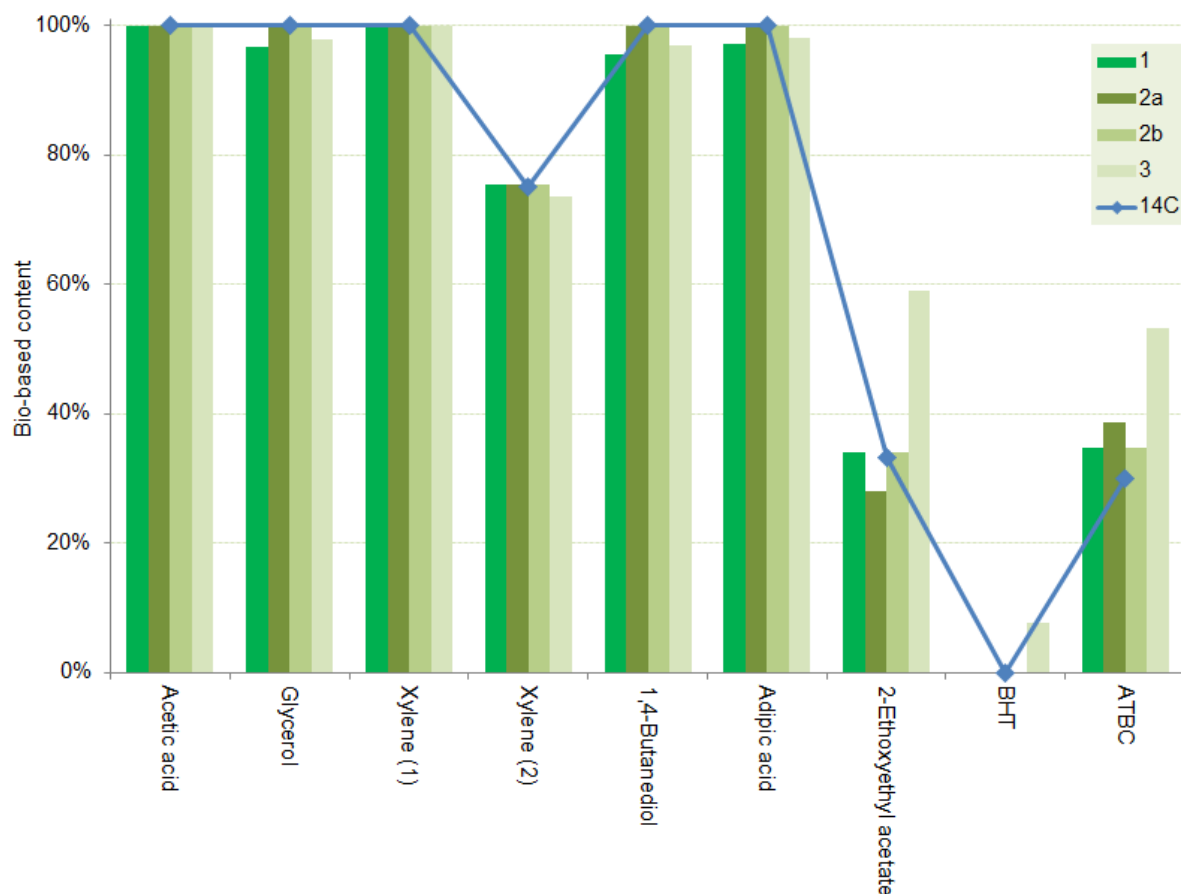


Figure 4-1 A summary of bio-based content atom connectivity method results for bulk chemicals (as an inorganic compound ammonia is not included).

The following chemical discussions will feature a summary of the different atom connectivity methods and diagrams demonstrating their applications. Coloured atoms represent the origin, be it fossil (red), biomass (green), water (blue), the atmospheric gases oxygen and nitrogen (orange), or mineral (grey). Carbon atoms are drawn in green or red as would be allocated from bio-based carbon analysis. For atom connectivity Method 1, Method 2a, and Method 2b the remaining atoms adopt the origin of the neighbouring carbon atoms. For mass balance Method 3 all atoms have individual assignments. In instances where the positioning of an atom is statistically distributed across two or more possible positions, this is not fully accounted for. In the case of acetic acid for example, four hydrogen atoms, one third water derived and the remainder fossil derived, are distributed throughout the molecule in an unbiased manner. This cannot be shown in a single molecular diagram so multiple schemes are provided and an indication of the abundance of each is given. The exact position of each atom with its specific origin as ascribed by atom connectivity Method 3 is not shown, but ultimately the total mass of bio-based atoms is what is important. The other atom connectivity approaches, including that of ACDV, do not suffer from this complexity. Discussion of the



conclusions arising from the application of these methods is provided at the end of the chapter.

4.2.1 Acetic acid

Acetic acid for industrial purposes is produced by the carbonylation of methanol, which in turn is produced from methane *via* syngas [Weissermel 1993]. Interest in the alternative oxidation of ethanol, which is already performed for food grade acetic acid, has been prompted by the large quantities of bio-ethanol becoming available [Gorbanev 2012]. Using most methods of atom connectivity, acetic acid is assigned as wholly fossil derived or entirely bio-based depending on which process is used, as is intuitive from the feedstocks. However in reality synthetic methanol and carbon monoxide (and therefore acetic acid) are reliant on the oxidation of their precursor methane by water (Chapter 4.5.1). Thus acetic acid from the petroleum refinery is substantially composed of transformed water (Figure 4-2).

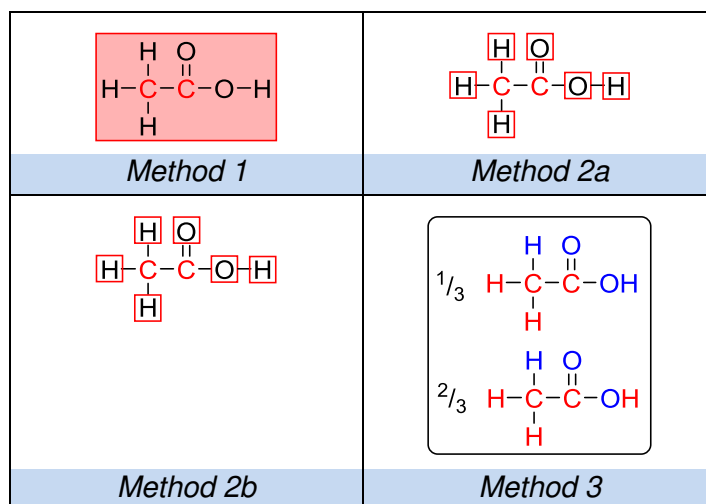
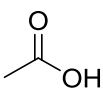


Figure 4-2 Atom allocation assignments for acetic acid made from syngas.

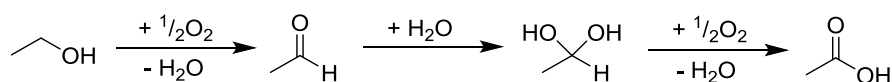
The ACDV certification scheme procedure (equivalent to atom connectivity Method 2b) and related atom connectivity methods would indicate 0% bio-based content for acetic acid made from syngas (Table 4-7). If water is considered as a feedstock, and tracked into the acetic acid product, then 56% of the mass of acetic acid is accounted for by atoms once of water, and only 44% is therefore fossil derived. This is significantly different from all other indirect methods of bio-based content, including radiocarbon analysis which would indicate 0% bio-based carbon content (remember that in atom connectivity Method 3 plant, air, and water sources of atoms are included within the calculation of total bio-based content).



Table 4-7 Allocation of bio-based content for acetic acid made from syngas.

Acetic acid	Origin	Method			
		1	2a	2b	3
<i>Petrochemical</i>					
	Fossil	100%	100%	100%	44%
	Plant				
	Water				56%
	Air				
	Mineral				
	'Bio-based'	0%	0%	0%	56%
	¹⁴C analysis	0%			
Synthesis					
$\text{—OH} \xrightarrow{\text{CO}} \text{CH}_3\text{COOH}$					
<i>Carbonylation of methanol yields acetic acid.</i>					

Oxidation of bio-ethanol to make acetic acid with bacterial fermentation processes does not actually introduce atmospheric oxygen into the product as might be expected. Instead an additional oxygen atom and a hydrogen atom are introduced from a molecule of water after a dehydrogenation step (Scheme 4-1) [Smith 2007]. The intermediate geminal diol, containing one original oxygen atom from bio-ethanol, and a water derived oxygen atom, eliminates a molecule of water upon further oxidation. Statistically the carbonyl oxygen is equally as likely to be of biomass origin or water derived, with the resonance structure of acetic acid meaning both oxygen atoms are equivalent. The reaction of the intermediate aldehyde with water, exchanging out the bio-based oxygen atom is not considered here but is a possibility, which in turn would affect the calculation. The result does not change for atom connectivity Method 3 as water derived content is included within the total bio-based content calculation. The convention adopted in these atom connectivity methods does not allow for such reactions, or recognise that through photosynthesis and water-cellulose hydroxyl exchange, the oxygen atoms in sugar derived products have originated from water anyway. As a rule, primary fermentation products such as bio-ethanol and lactic acid will be regarded as 100% bio-based, even in atom connectivity Method 3, despite the fact that carbohydrate hydroxyl groups are labile with respect to exchange with water.

**Scheme 4-1** The oxidation mechanism of ethanol to acetic acid.

The implication of the reaction mechanism on atom connectivity is minimal in this example because the 100% bio-based carbon content dictates the allocated origin of the remaining elements (Figure 4-3). As water derived elements are contained with the definition of bio-based content for atom connectivity Method 3 (Table 4-8), a 100% bio-based content for bio-acetic acid is also reached with this approach. Therefore no discrepancy between the different atom connectivity methods is observed.

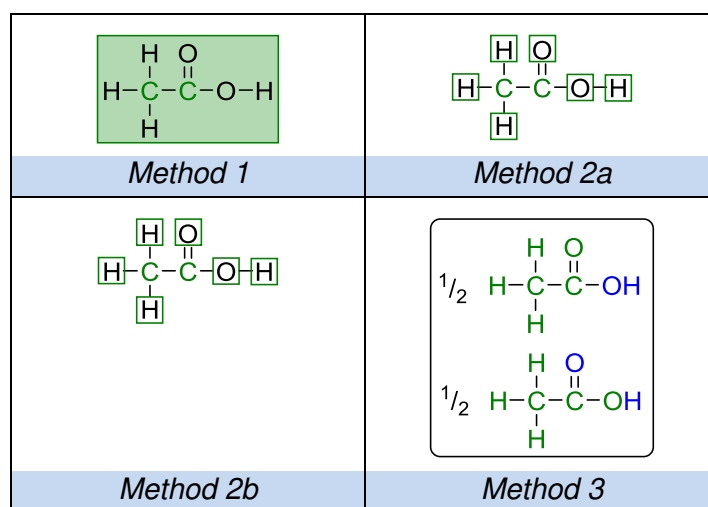
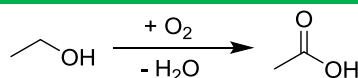
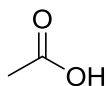


Figure 4-3 Atom allocation assignments for acetic acid made from bio-ethanol.

Table 4-8 Allocation of bio-based content for acetic acid made from bio-ethanol.

Acetic acid	Origin	Method			
		1	2a	2b	3
<i>Fermentation</i>					
	Fossil				
	Plant	100%	100%	100%	72%
	Water				28%
	Air				
	Mineral				
	'Bio-based'	100%	100%	100%	100%
	¹⁴C analysis	100%			
	Synthesis				



Bacterial fermentation in air proceeds via acetaldehyde and then a diol intermediate is produced after attack by water.



It should be noted that in this example a fermentation process has been mechanistically analysed, but this happens to be consistent with other chemical methods of oxidation. It is permitted by all atom connectivity approaches that fermentation products may be treated as completely bio-based. It can be assumed from this case study that the downstream products of bio-based acetic acid, made from oxidised bio-ethanol, would contribute 100% total bio-based content the portion of the molecule that contains the acetic acid atoms regardless of the atom connectivity approach used. We have already seen that the calculation of atom connectivity Method 3 using five atomic origins (fossil, plant, water, air, mineral) might be problematic. If the current consensus of including air and water derived atoms within the total bio-based content is retained petrochemical acetic acid is 56% bio-based (not 0%), but remove this stipulation and bio-acetic acid is 72% bio-based (not 100%).

4.2.2 Glycerol

Glycerol is regarded as a bio-based product since the demand for biofuels has created surplus glycerine [Ciriminna 2014]. The carbon atoms are certainly bio-derived, but the transesterification of triglycerides with fossil based methanol introduces hydrogen atoms into the molecule that are not bio-based, mirroring the precedent set previously in the example of acetic acid (also see Chapter 4.5.1 concerning methanol). The impact of this is small given the low atomic mass of hydrogen, but it does affect atom connectivity Method 1 in which the ingredients are taken to be a vegetable oil and fossil derived methane (Figure 4-4). Because of the 100% bio-based carbon content, the ‘true’ atom connectivity approaches (Method 2a and Method 2b) produce a value of total bio-based content approaching the maximum, if not 100% (Table 4-9).

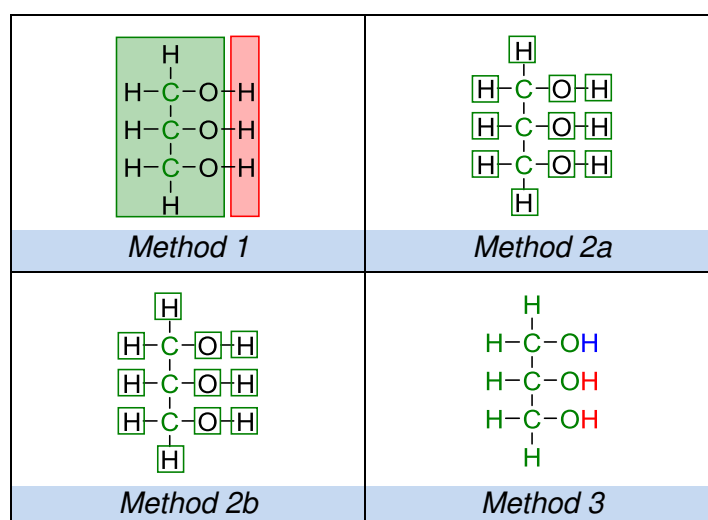
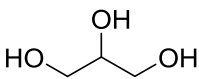


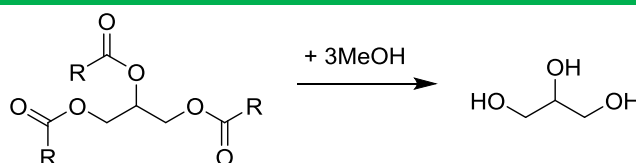
Figure 4-4 Atom allocation assignments for the glycerol produced in bio-diesel production.



Table 4-9 Allocation of bio-based content for glycerol made from vegetable oil transesterification.

Glycerol	Origin	Method			
		1	2a	2b	3
	Fossil	3%			2%
	Plant	97%	100%	100%	97%
	Water				1%
	Air				
	Mineral				
	'Bio-based'	97%	100%	100%	98%
¹⁴ C analysis	100%				

Synthesis



The transesterification of triglycerides gives glycerol. The methanol is derived from syngas.

4.2.3 *p*-Xylene

The platform molecule *p*-xylene is historically obtained along with other low molecular weight aromatics by the separative distillation of reformat gasoline from paraffinic crude oil [Weissermel 1993]. This *p*-xylene is completely fossil derived and is not considered any further in this section. Contemporary production of *p*-xylene is moving towards renewable feedstocks with three possible routes in development. As a direct replacement for the current petrochemical process, carbohydrate can be pyrolysed to yield a mixed stream of aromatic compounds [Karanjkar 2014]. These products are entirely bio-based and do not need to be subjected to the rigorous atom connectivity study presented here.

Processes for producing aromatic compounds such as *p*-xylene from furans is an interesting topic of research at present [Xiong 2014]. A Diels-Alder reaction followed by a dehydration should yield *p*-xylene from 2,5-dimethylfuran and ethylene. A quarter of the carbon atoms are petrochemical in origin if the ethylene is considered to be fossil derived (75% bio-based carbon content). Atom connectivity will associate two hydrogen atoms with the fossil derived carbon atoms and the total bio-based content is calculated as very similar to the total bio-based carbon content. When considering the process of transforming hydroxymethylfurfural, itself synthesised by the reduction of glucose or fructose [Binder 2009], into 2,5-



dimethyl furan by hydrogenation, the hydrogen atoms of syngas hydrogen introduce some extra fossil derived and water derived atoms into the final product (Figure 4-5). However this has little bearing on the total bio-based content calculation (Table 4-10) because of the low atomic mass of hydrogen atoms.

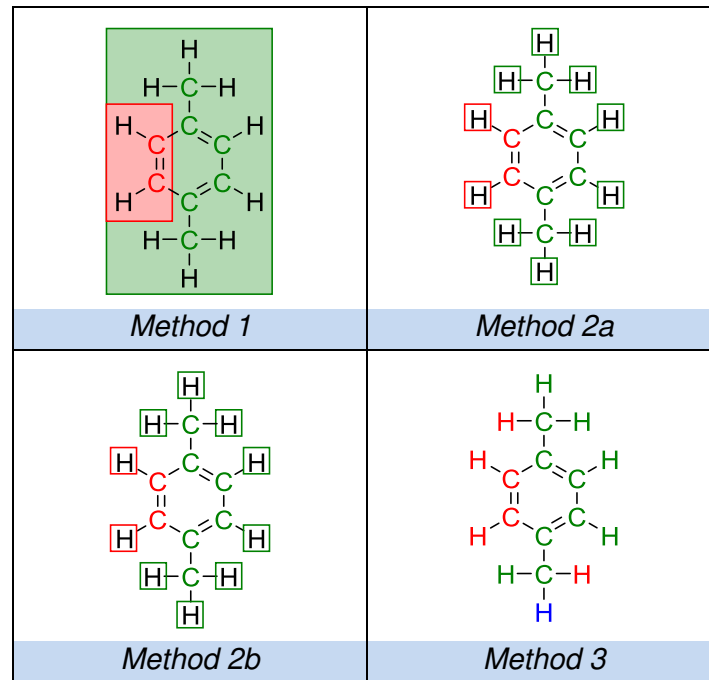
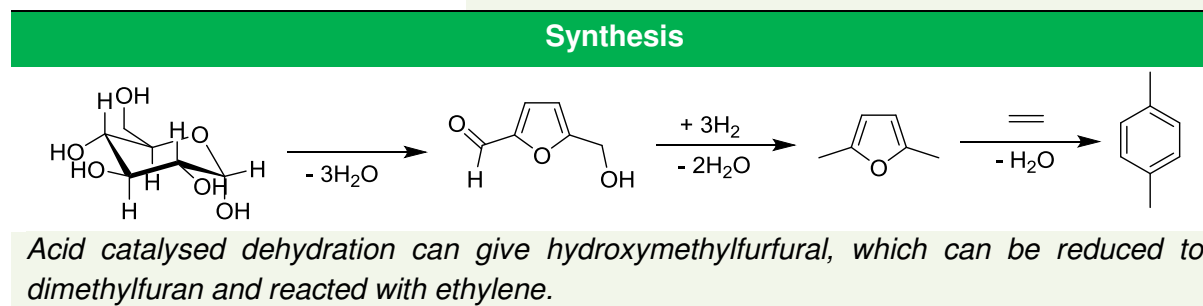
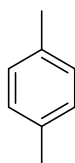


Figure 4-5 Atom allocation assignments for *p*-xylene made from hydroxymethylfurfural



Table 4-10 Allocation of bio-based content for *p*-xylene made from hydroxymethylfurfural.

<i>p</i> -Xylene	Origin	Method			
		1	2a	2b	3
<i>Furan derived</i>					
	Fossil	25%	25%	25%	26%
	Plant	75%	75%	75%	73%
	Water				1%
	Air				
	Mineral				
	'Bio-based'	75%	75%	75%	74%
	¹⁴C analysis	75%			



For the synthesis of *p*-xylene as an intermediate in the production of poly(ethylene terephthalate), a process requiring the reduction of isobutanol from fermentation then an oxidative aromatisation step has been developed [Peters 2011]. Although the mechanism is not straightforward, and the process consists of multiple steps, the resulting product can be calculated as being 100% bio-based according to the atom connectivity conventions applied in this work (Figure 4-6 and Table 4-11).



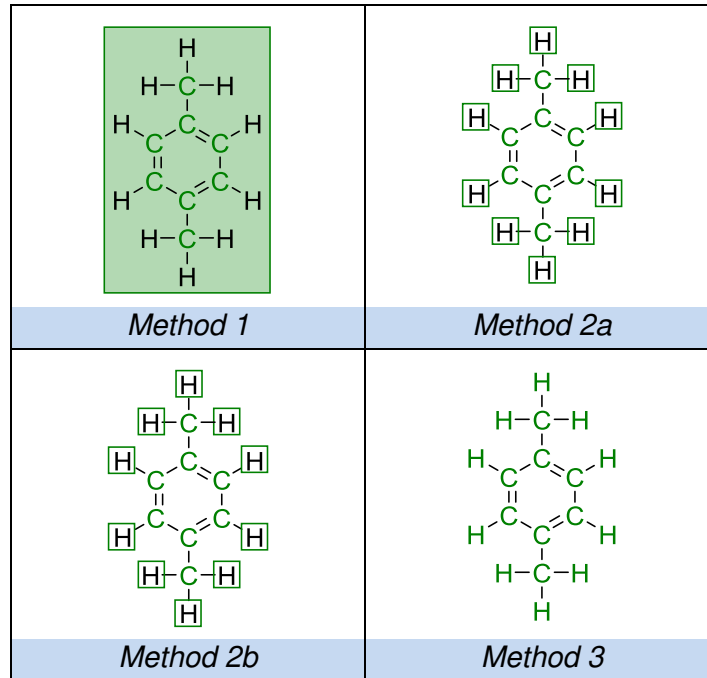
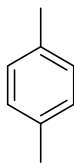


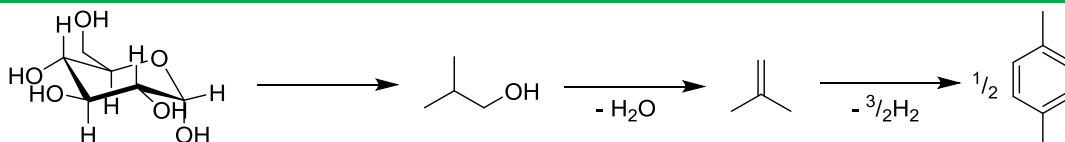
Figure 4-6 Atom allocation assignments for *p*-xylene made from isobutanol.

Table 4-11 Allocation of bio-based content for *p*-xylene made from isobutanol.

<i>p</i> -Xylene	Origin		Method		
<i>GEVO process</i>	1	2a	2b	3	
	Fossil				
	Plant				
	100%	100%	100%	100%	100%
	Water				
	Air				
	Mineral				
	'Bio-based'				
	100%	100%	100%	100%	100%
	¹⁴C analysis				
	100%				



Synthesis

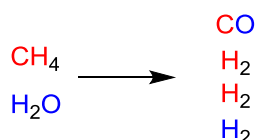


*Fermentation of sugar to give isobutanol, followed by dehydration produces bio-based isobutene. A dimerisation and dehydrogenation results in *p*-xylene.*



4.2.4 1,4-Butanediol

The hydrogenation of succinic acid made by fermentation gives 1,4-butanediol, a versatile intermediate and formulation ingredient. Regarding its origin, hydrogen gas is treated as the syngas component (Scheme 4-2), although other sources and production methods of hydrogen exist with more or less fossil derived content. Hydrogenation introduces a C—H bond. The origin of the bonded carbon atom dictates the assigned origin of the hydrogen atom according to the ‘true’ atom connectivity principle. Hydrogenation processes are the most recurrent manner in which atom connectivity Method 1 differs from atom connectivity Method 2b (the latter being largely equivalent to the ACDV method) (Figure 4-7). Because the assignment of a limited number of hydrogen atoms is the only conflict between the atom connectivity approaches, the total bio-based content is calculated to be close to 100% regardless of the methodology used (Table 4-12).



Scheme 4-2 The chemical equation for syngas production. Red atoms are fossil derived. Blue atoms originate from water.

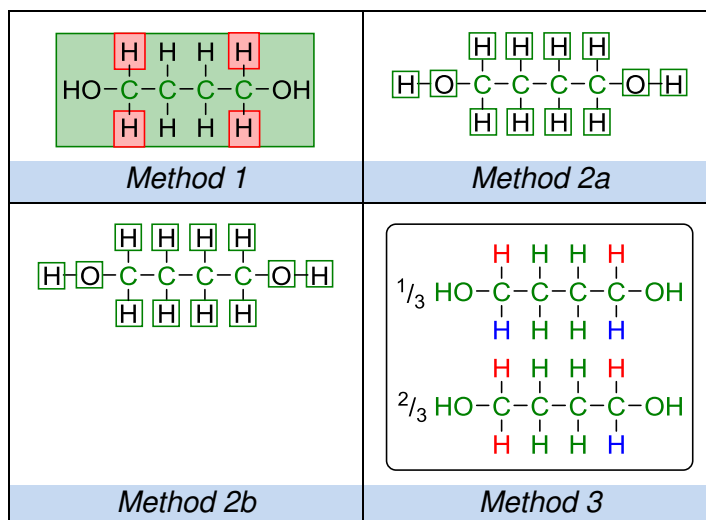
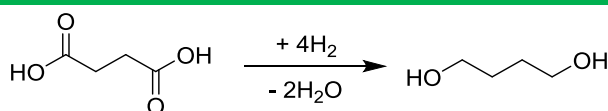
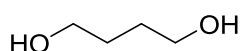


Figure 4-7 Atom allocation assignments for 1,4-butanediol made from hydrogenated succinic acid.



Table 4-12 Allocation of bio-based content for 1,4-butanediol made from succinic acid.

1,4-Butanediol	Origin	Method			
		1	2a	2b	3
	Fossil	4%			3%
	Plant	96%	100%	100%	96%
	Water				1%
	Air				
	Mineral				
	'Bio-based'	96%	100%	100%	97%
	¹⁴C analysis	100%			



Fermentation to give succinic acid is followed by a hydrogenation.

From Table 4-12 we can tell that atom connectivity Method 2a and Method 2b cover up the inclusion of fossil derived chemicals in the synthesis of the 1,4-butanediol. Atom connectivity Method 1 and Method 3, which are not true atom connectivity approaches in the strictest sense, recognise the presence of fossil derived content. Although of marginal significance in this example, this does demonstrate a weakness. Concerning hydrogenation, this will never pose a serious issue. The nitrogen contained in petrochemical pyridine will be bonded to fossil derived carbon atoms so that is not an issue either. Perhaps the sulphur originating in the hydrogen sulphide of natural gas reserves could introduce a significant discrepancy if bonded to a bio-based portion of a molecule. Sulphur features in discussions of surfactants but otherwise is largely absent from bio-based products.

4.2.5 Adipic acid

Adipic acid is a key component of nylon polymers. The monomer can be produced by oxidising glucose to the intermediate glucaric acid, followed by hydrogenation. As such the product contains 100% bio-based carbon. As was the case for 1,4-butanediol, hydrogenation introduces fossil derived content, which is recognised in atom connectivity Method 1 (Figure 4-8).



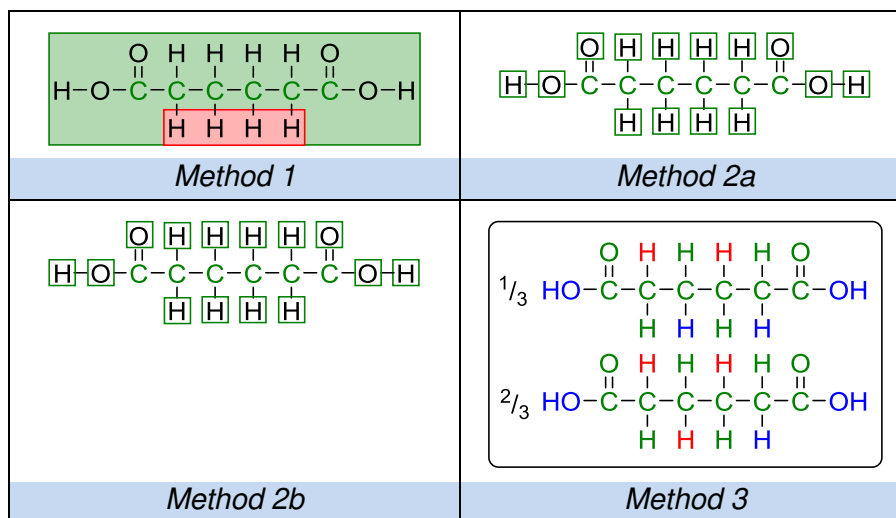
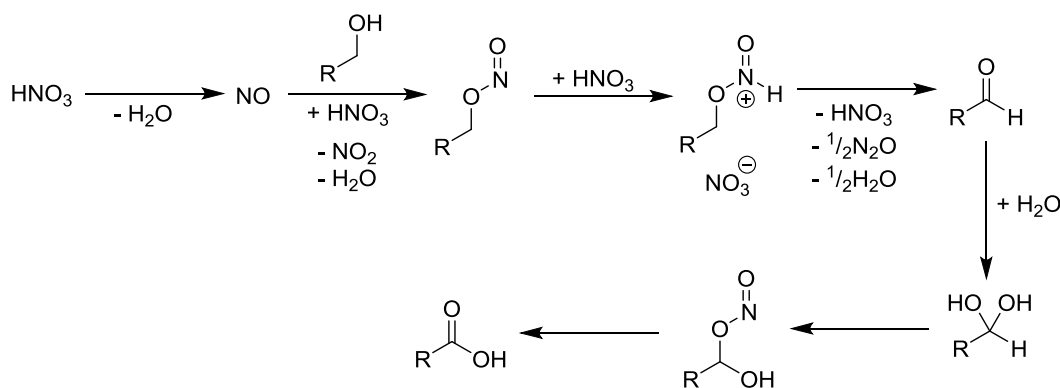


Figure 4-8 Atom allocation assignments for sugar derived adipic acid.

The oxidation process provides a different means of achieving the same chemical transformation discussed previously as the bacterial oxidation of ethanol to acetic acid (Scheme 4-1). However, instead of oxygen gas being reduced to water, nitric acid is reduced to nitrous oxide and/or nitric oxide [Aellig 2011, Joshi 2005, Moodie 1986]. This chemical redox process introduces water derived atoms into the substrate, not those contained within nitric acid directly (Scheme 4-3). Nitric acid is produced commercially from the reaction of nitrogen dioxide with water, with all elements sourced from either the atmosphere (nitrogen and oxygen) or water [Hauben 1943]. This being the case, the impact on a calculated total bio-based content is minimal regardless of the exact interpretation taken of the oxidation mechanism. Because this mechanism and many others are not necessarily well understood, atom connectivity methods that require the implementation of standard chemical reactivity rules are not always robust.

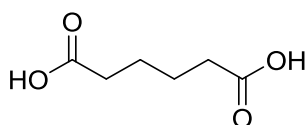


Scheme 4-3 A plausible general alcohol oxidation mechanism with nitric acid as an oxidising agent.

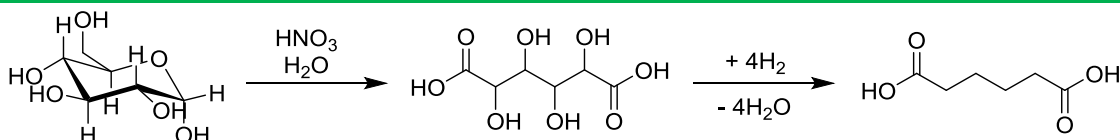


Table 4-13 Allocation of bio-based content for adipic acid made from glucaric acid.

Adipic acid	Origin	Method			
		1	2a	2b	3
<i>Sugar derived</i>					
	Fossil	3%			2%
	Plant	97%	100%	100%	74%
	Water				24%
	Air				
	Mineral				
	'Bio-based'	97%	100%	100%	98%
	¹⁴C analysis	100%			



Synthesis



Glucose is oxidised through a redox reaction with nitric acid to give glucaric acid, which is then reduced to adipic acid.

The typical synthesis of adipic acid is based on a benzene feedstock. Reduction of the benzene with hydrogen, then oxidation to a cyclohexanone and cyclohexanol mixture is achieved using oxygen, and then finally a nitric acid oxidation to adipic acid is required. The completely fossil derived carbon backbone of the article dictates the atom connectivity assignments. The molecular oxygen and nitric acid oxidations introduce a significant mass fraction of non-fossil derived content that is only reflected in atom connectivity Method 3 (Figure 4-9).



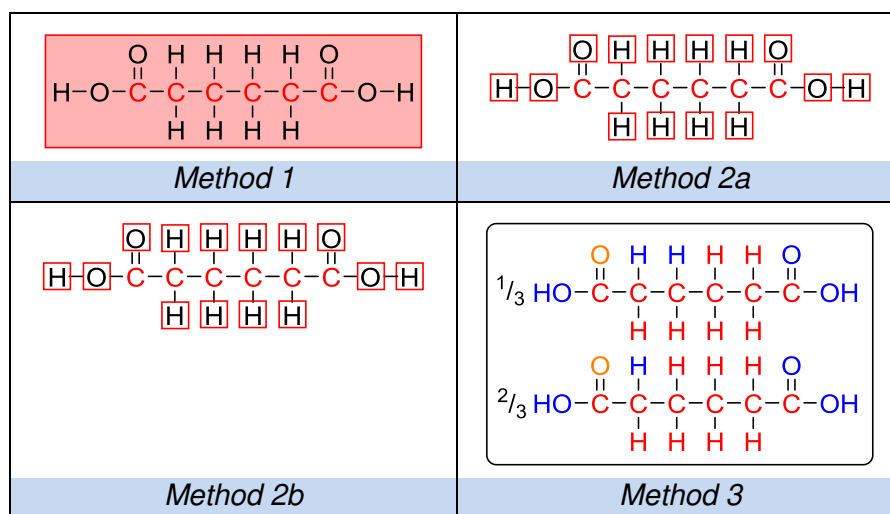


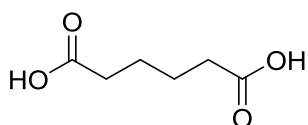
Figure 4-9 Atom allocation assignments for petroleum derived adipic acid.

For an article with 0% bio-based carbon content, to arrive at a value of 46% total bio-based content (using atom connectivity Method 3) is unexpected, perhaps unreasonable given that only elements originating in water and atmospheric oxygen gas contribute to this. As expected, no actual plant material is contained within adipic acid made from benzene (Table 4-14). Once again the other atom connectivity methods (e.g. atom connectivity Method 2b) provide an answer comparable to the expected bio-based carbon measurement.

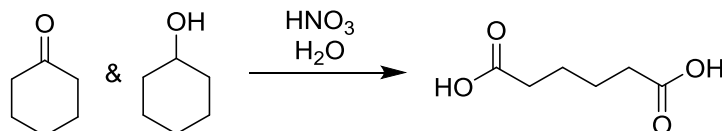


Table 4-14 Allocation of bio-based content for adipic acid made from benzene.

Adipic acid	Origin	Method			
		1	2a	2b	3
<i>Petrochemical</i>					
	Fossil	100%	100%	100%	54%
	Plant				
	Water				35%
	Air				11%
	Mineral				
	'Bio-based'	0%	0%	0%	46%
	¹⁴C analysis	0%			



Synthesis



A mixture of cyclohexanol and cyclohexanone made from the oxidation of cyclohexane is further oxidised with a nitric acid solution.

4.2.6 2-Ethoxyethyl acetate

A molecule of 2-ethoxyethyl acetate incorporating one equivalent of bio-ethanol will be 33% bio-based according to direct radiocarbon methods. Atom connectivity Method 1 and atom connectivity Method 2b are in agreement and are closely aligned with the bio-based carbon content. This occurs because each of the three reactants (bio-ethanol, ethylene oxide, and acetic acid) possess two carbon atoms and one oxygen atom that are retained in the final article, making each segment similar in mass. In actual fact the three oxygen atoms each come from a different resource (Figure 4-10).



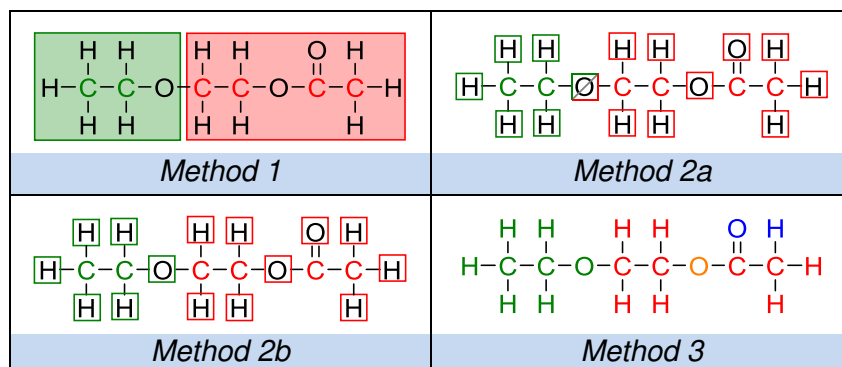
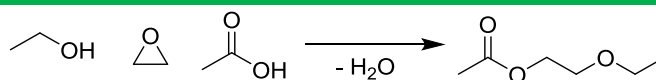
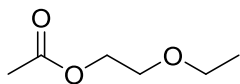


Figure 4-10 Atom allocation assignments for partially bio-based 2-ethoxyethyl acetate.

This is the first case study thus far that is a combination of organic, carbon containing fossil derived components and bio-based components. This is reflected in atom connectivity Method 2a in which element allocation is performed without applying the standard rules of chemical reactivity. The oxygen ether bridge between the fossil derived and bio-based fractions of the 2-ethoxyethyl acetate molecule is not assigned to one or the other portion, but instead shared. The result is a lower total bio-based content for the molecule of 28% (Table 4-15). By not assigning the oxygen atoms as fossil derived, atom connectivity Method 3 produces a much higher value for bio-based content, more than double that of atom connectivity Method 2a.

Table 4-15 Allocation of bio-based content for partially bio-based 2-ethoxyethyl acetate.

2-Ethoxyethyl acetate	Origin	Method			
		1	2a	2b	3
	Fossil	66%	72%	66%	41%
	Plant	34%	28%	34%	34%
	Water				13%
	Air				12%
	Mineral				
	'Bio-based'	34%	28%	34%	59%
	¹⁴C analysis	33%			

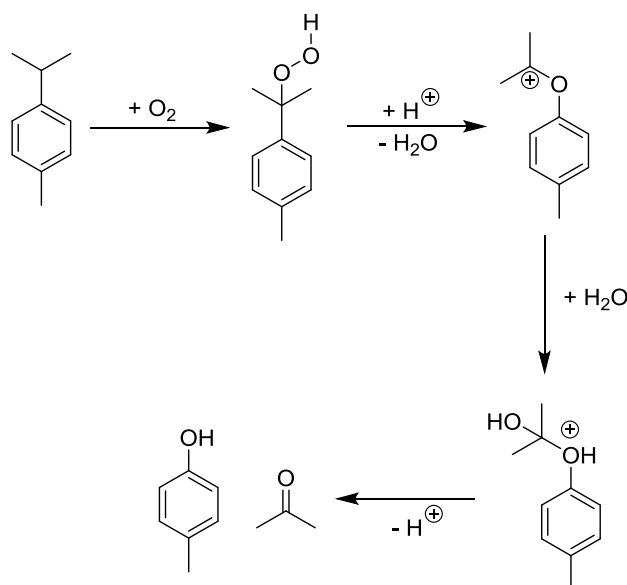


Ethanol is reacted with ethylene oxide to give 2-ethoxyethanol that is then esterified with acetic acid.



4.2.7 Butylated hydroxytoluene

The synthesis of the petrochemical antioxidant butylated hydroxytoluene (BHT) consists of the alkylation of toluene with propylene to give *p*-cymene, an oxidation step producing cresol, then further alkylation with isobutene [Weissermel 1993]. The choice of oxidation step is not immediately obvious from the structure of the product, but is famous for the co-production of acetone. Oxidation of *p*-cymene with molecular oxygen involves a rearrangement and then hydrolysis to afford the intermediate *p*-cresol (Scheme 4-4). Note that limonene can be transformed into *p*-cymene [Clark 2012a], offering the basis for a bio-based route to BHT.



Scheme 4-4 The oxidation of *p*-cymene.

The oxidation step introduces an atmospheric oxygen atom and water derived hydrogen atom, but this is not recognised by atom connectivity unless all resource inputs are followed through the synthesis (Figure 4-11). These non-fossil derived atoms contribute 8% of the molecular mass and so do not greatly impact the calculated bio-based content (Table 4-16).



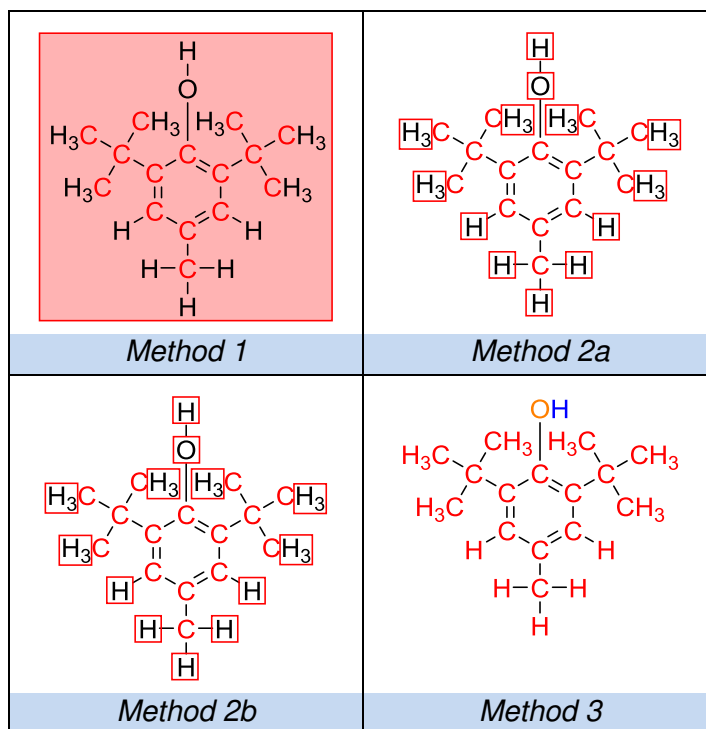
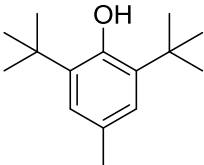
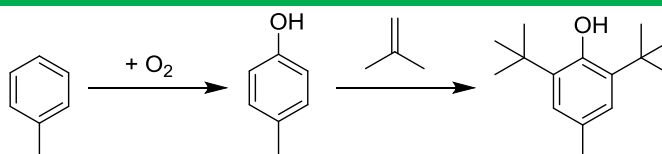


Figure 4-11 Atom allocation assignments for butylated hydroxytoluene.

Table 4-16 Allocation of bio-based content for butylated hydroxytoluene made from toluene.

Butylated hydroxytoluene	Origin	Method			
		1	2a	2b	3
	Fossil	100%	100%	100%	92%
	Plant				
	Water				1%
	Air				7%
	Mineral				
	'Bio-based'	0%	0%	0%	8%
	¹⁴ C analysis	0%			

Synthesis



Of several processes in operation, oxidation of toluene via *p*-cymene gives *p*-cresol which can then be alkylated with isobutene.



4.2.8 Acetyl tributyl citrate

A common plasticiser, acetyl tributyl citrate is based on esterified citric acid. Although prevalent in citrus fruits, it is economically more attractive to produce citric acid from sugar using a fermentation strategy [Max 2010]. Esterification with petrochemical 1-butanol (from hydrated butene) and acetic anhydride (from carbonylation of methyl acetate, a by-product of acetic acid production from syngas) affords the final product with a 30% bio-based carbon content. As was found for 2-ethoxyethyl acetate, the combination of bio-based and fossil derived parts to the molecule means that by using atom connectivity Method 2a some oxygen atoms are shared (Figure 4-12). Accordingly, total bio-based content is improved following this consensus. Only the result of atom connectivity Method 3 (53%) differs greatly from the anticipated value of bio-based carbon content for the compound (30%), although the actual plant based content, ignoring water derived atoms, is similar at 35% (Table 4-17).



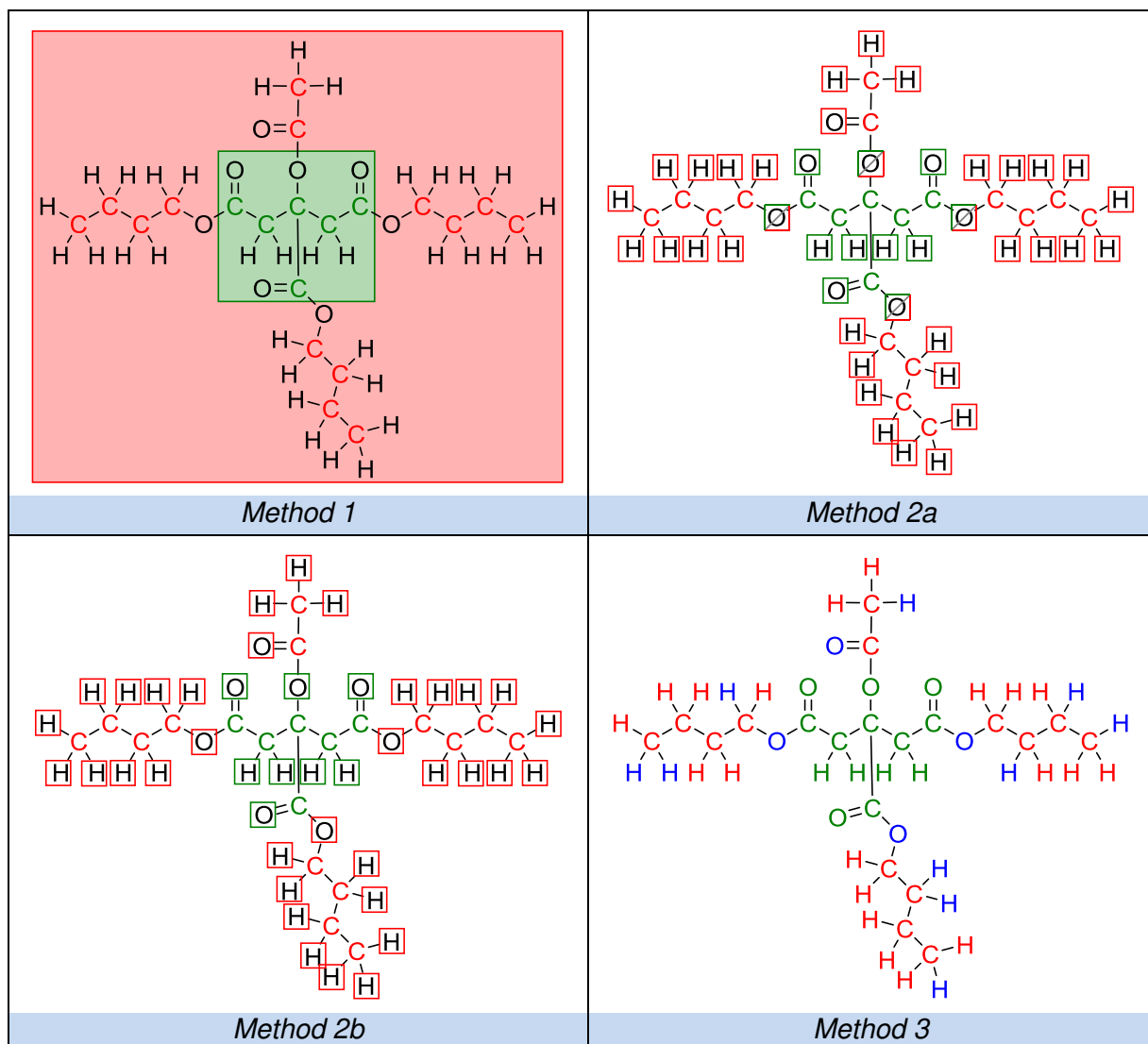
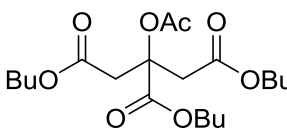
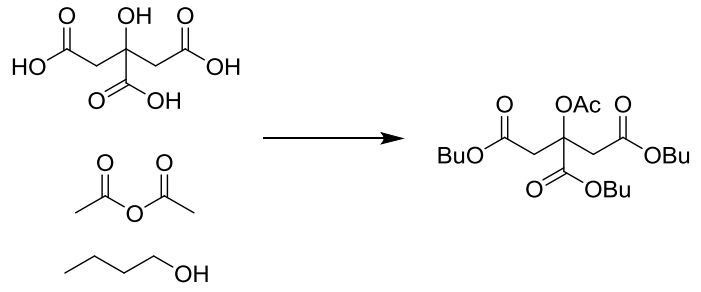


Figure 4-12 Atom allocation assignments for acetyl tributyl citrate made from citric acid.



Table 4-17 Allocation of bio-based content for acetyl tributyl citrate made from citric acid.

Acetyl tributyl citrate	Origin	Method			
		1	2a	2b	3
	Fossil	65%	61%	65%	47%
	Plant	35%	39%	35%	35%
	Water				18%
	Air				
	Mineral				
	'Bio-based'	35%	39%	35%	53%
	¹⁴ C analysis	30%			
Synthesis					
					
<p><i>A number of esterifications are required to produce ATBC. Acetic anhydride and butanol are syngas derivatives. Citric acid may be bio-based.</i></p>					

4.2.9 Ammonia

Ammonia is not an organic compound and so it is not within the scope of bio-based products pre-standardisation research. Nevertheless it is an interesting molecule to examine because it is the precursor to all nitrogen containing petrochemicals, with the exception of pyridines that can be distilled from certain crude oil fractions [Weissermel 1993]. Ammonia will also vital for the production of synthetic bio-based products. Nitrogen is present in amino acids and so the origin of any nitrogen in bio-based molecules will have to be considered carefully.

The synthesis of ammonia is performed in the Haber-Bosch process, in which nitrogen gas from the atmosphere and hydrogen gas (from syngas) are catalytically converted to ammonia. In atom connectivity Method 1, it must be assumed that ammonia is fossil derived. Otherwise, in the absence of carbon, the correct origin of the nitrogen atom dictates the assignment of the hydrogen atoms (Figure 4-13). The actual origin of the hydrogen atoms is



dependent on the chosen method of production, and for this the steam reforming of methane has been assumed to be the source of hydrogen.

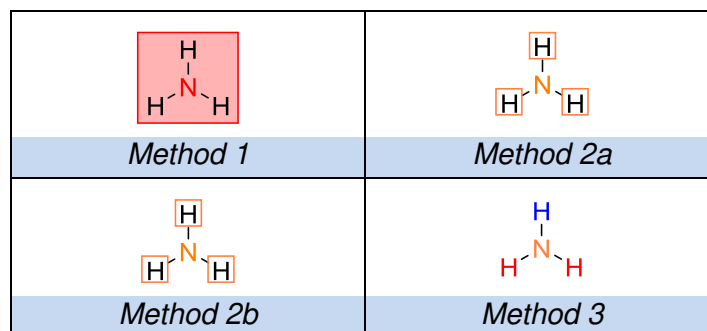



Figure 4-13 Atom allocation assignments for ammonia.

The indirect bio-based content assignments are quite abstract, and should not be applied to the inorganic ammonia as a chemical in its own right (Table 4-18). The value of these calculations is how they translate into downstream articles. Nitrogen containing polymers, solvents, surfactants and fine chemicals are scrutinised later in this chapter. The ‘true’ atom connectivity approaches of Method 2a and Method 2b will not need the assignment of nitrogen as derived from air as it will adopt an origin from the nearest bonded carbon atom(s). If contained in a formulated product, ammonia as an ingredient, perhaps as a salt or present within a mixture of gases, would not contribute to the total bio-based content. The mass of ammonia might be ignored in certain mass balance approaches if inorganic materials are excluded from calculations.



Table 4-18 Allocation of bio-based content for ammonia made from nitrogen and hydrogen gases.

Ammonia	Origin	Method			
		1	2a	2b	3
	Fossil	100%			12%
	Plant				
	Water				6%
	Air		100%	100%	82%
	Mineral				
	'Bio-based'	0%	100%	100%	88%
¹⁴C analysis		n/a			
Synthesis					
$\begin{array}{c} \text{N}_2 \\ 3\text{H}_2 \end{array} \longrightarrow 2 \begin{array}{c} \text{H} \\ \\ \text{H}-\text{N}-\text{H} \end{array}$					
<i>The Haber-Bosch process converts nitrogen into ammonia.</i>					

4.3 Examples of bio-based content calculations for lubricant base oils based on atom connectivity

Bio-based lubricants require as a minimum 25% bio-based carbon content (**CEN/TR 16227**). Base oils derived from vegetable oils are comfortably within this requirement. Two examples are covered here: methyl oleate and neopentyl glycol distearate (Figure 4-14). Generally the differences between the methods of calculating bio-based content are not pronounced for lubricants, because chemically they primarily consist of bio-based hydrocarbon chains of bio-based origin that require little interpretation through atom connectivity calculations. Lubricants as sold are not just the base oil, but complex formulations of various additives needed to modify the properties of the lubricant and impart stability. Although not addressed here in Chapter 4.3, the lubricant formulation would need to be understood, and atom connectivity applied to all ingredients and the total bio-based content of the article would then be derived from the mass of each ingredient and its individual bio-based content. Unfortunately many components of a lubricant are supplied as mixtures of unknown composition, and these would have to be regarded as fossil derived. Direct analysis of bio-based carbon content would however permit some judgement to be made (e.g. if 0% bio-based carbon content by analysis, then 0% total bio-based content could be inferred).



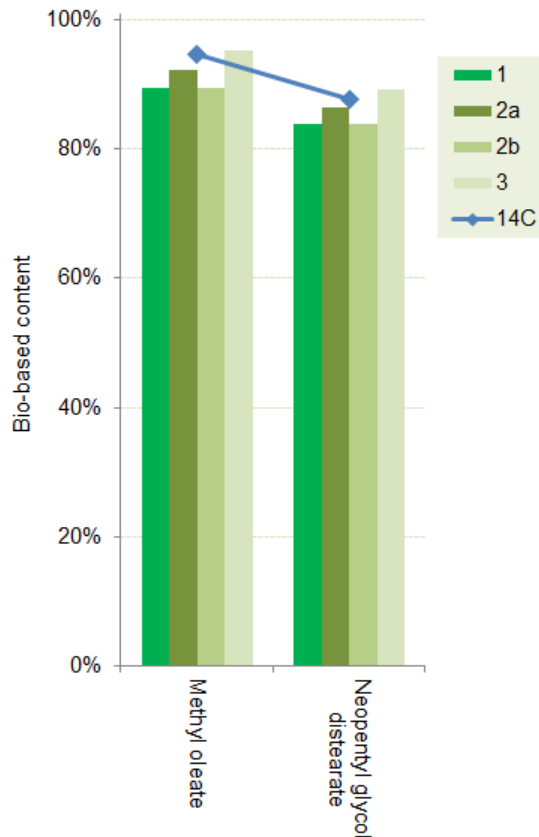


Figure 4-14 A summary of bio-based content atom connectivity method results for bio-based lubricants.

4.3.1 Methyl oleate

Fatty acid methyl esters (FAMES) are suitable as certain types of lubricant base oil, depending on the application conditions [Erhan 2000]. Comprising of a large bio-based acyl unit and a fossil derived methoxy- group, the bio-based carbon content is high (Figure 4-15). For the example of methyl oleate the bio-based carbon content is 95%. This value is matched by atom connectivity Method 3 for total bio-based content by recognising the water derived oxygen atom of the precursor compound methanol (Table 4-19). Other atom connectivity approaches give slightly lower values for total bio-based content but without any outstanding differences.



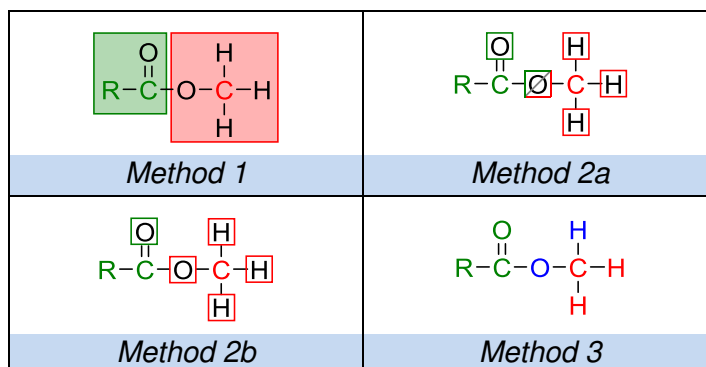
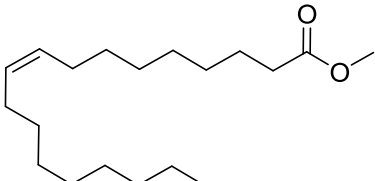
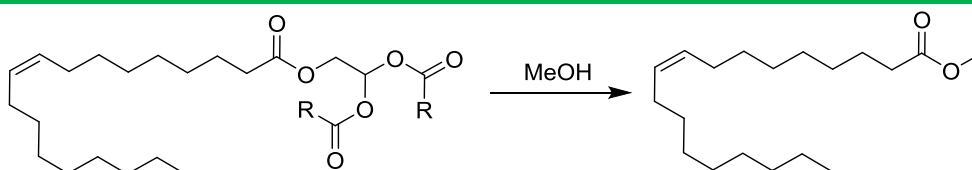


Figure 4-15 Atom allocation assignments for methyl oleate.

Table 4-19 Allocation of bio-based content for methyl oleate made from vegetable oils.

Methyl oleate	Origin	Method			
		1	2a	2b	3
	Fossil	10%	8%	10%	5%
	Plant	90%	92%	90%	90%
	Water				6%
	Air				
	Mineral				
	'Bio-based'	90%	92%	90%	95%
¹⁴C analysis	95%				

Synthesis



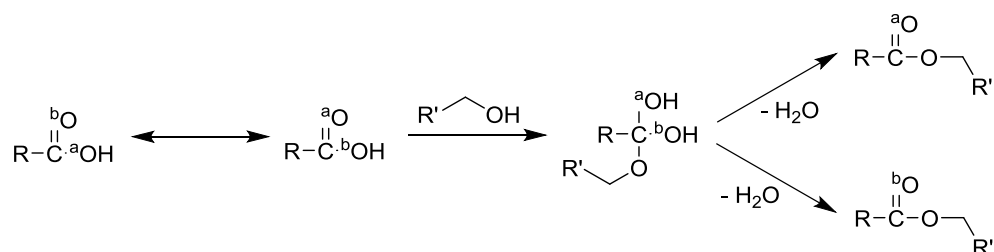
Transesterification of triglycerides gives bio-diesel, which can also be used as lubricant in certain applications.

4.3.2 Neopentyl glycol distearate

A synthetic ester suitable as a base oil for lubricants can be made from the fatty acids obtained from vegetable oils and neopentyl glycol. Hydrolysis of a triglyceride results in long chain carboxylic acids featuring an oxygen atom from the original biomass and an oxygen atom from water. Due to resonance of the carboxylate functional group and the symmetrical activated complex of the esterification reaction, upon esterification an equal 1:1 ratio of the



different oxygen atoms remains (Scheme 4-5). This is not obvious but must be considered in atom connectivity Method 3.



Scheme 4-5 The general esterification mechanism when the two carboxylate oxygen atoms are not regarded as equivalent.

The neopentyl glycol is synthesised from propylene and syngas, and so neopentyl glycol distearate is only partially bio-based (Figure 4-16) [Weissermel 1993]. The theoretical bio-based carbon content can be calculated as 88%. The intermediate diol contains six hydrogen atoms from syngas (that being the number of hydrogens in propylene), and hence two must be derived from water. With one of the hydroxyl hydrogen positions occupied by a syngas hydrogen atom, statistically the final product contains five syngas hydrogen atoms, and so 5/3 are designated as being derived from water in atom connectivity Method 3 (Table 4-20).



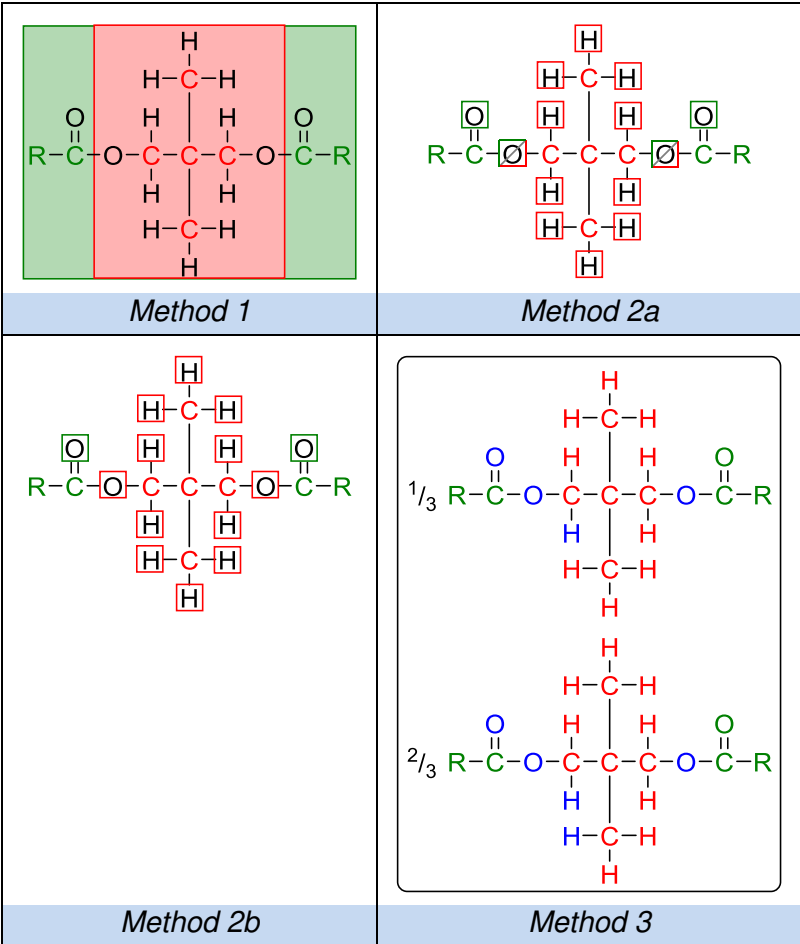
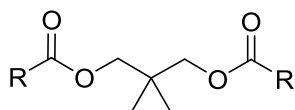


Figure 4-16 Atom allocation assignments for neopentyl glycol distearate.

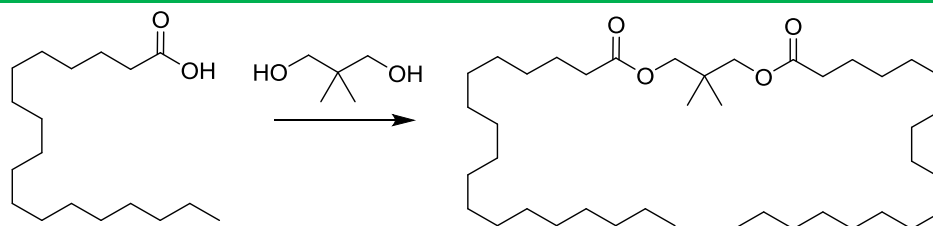


Table 4-20 Allocation of bio-based content for neopentyl glycol distearate made from vegetable oils.

Neopentyl glycol distearate	Origin	Method			
		1	2a	2b	3
	Fossil	16%	14%	16%	11%
	Plant	84%	86%	84%	81%
	Water				8%
	Air				
	Mineral				
	'Bio-based'	84%	86%	84%	89%
	¹⁴C analysis	88%			



Synthesis



Fatty acids from the hydrolysis of vegetable oil are esterified with a oxidation resistant but non-renewable diol.

All atom connectivity methods are similar in their conclusions, which in turn closely reflect the bio-based carbon content. Within the slight variation observed, atom connectivity Method 3 gives a slightly higher value of total bio-based content, closer to the calculated value of bio-based carbon content. This is also true of methyl oleate. In the bulk chemical case studies atom connectivity Method 3 consistently gave values of bio-based carbon content that were much higher than all other methods of bio-based content determination. It appears that in substances that are relatively reduced, the overestimation of bio-based content provided by atom connectivity Method 3 is curbed. By bearing a similarity to analytical bio-based carbon content, it can be foreseen that more confidence will be ascribed to the use of these indirect bio-based content methods.



4.4 Examples of bio-based content calculations for plastics based on atom connectivity

Bio-plastics are the major class of bio-based products in terms of market size of those covered in this report (present and potential). In this section, single chemical polymer products will be assessed. Composites and blends are considered at a later point. Of the ten polymers, generally atom connectivity in its purest sense (atom connectivity Method 2a and Method 2b) is reliable and consistent with the expected results of radiocarbon methods of bio-based carbon content determination (Figure 4-17 and Figure 4-18). Atom connectivity Method 3 tends to provide higher values of bio-based content, even when there is no biomass derived carbon in the article, which sometimes applies to atom connectivity Method 1 as well. A more detailed insight is provided for polyacrylate products, which vary in composition, and potentially vary in resource use (Figure 4-18). Because atom connectivity Method 2b (strongly related to the ACDV certification scheme method) is generally consistent with the likely conclusions of bio-based carbon analysis, it too would seem suitable as a complementary method of describing total bio-based content. However by deriving total bio-based content only from the bio-based carbon content it does not offer anything beyond a more conceptually pleasing reporting method for the bio-based content. The actual total bio-based content is not calculated. With currently available techniques, a realistic calculation of the total bio-based content of articles can only be achieved using a mass balance approach. What we need to know for the development of atom connectivity is can it be substituted in place of mass balance when the latter is not feasible, without changing the result of the calculated total bio-based content. To be able to remark on this a large number of case studies are required. Conclusions are presented in Chapter 4.9.



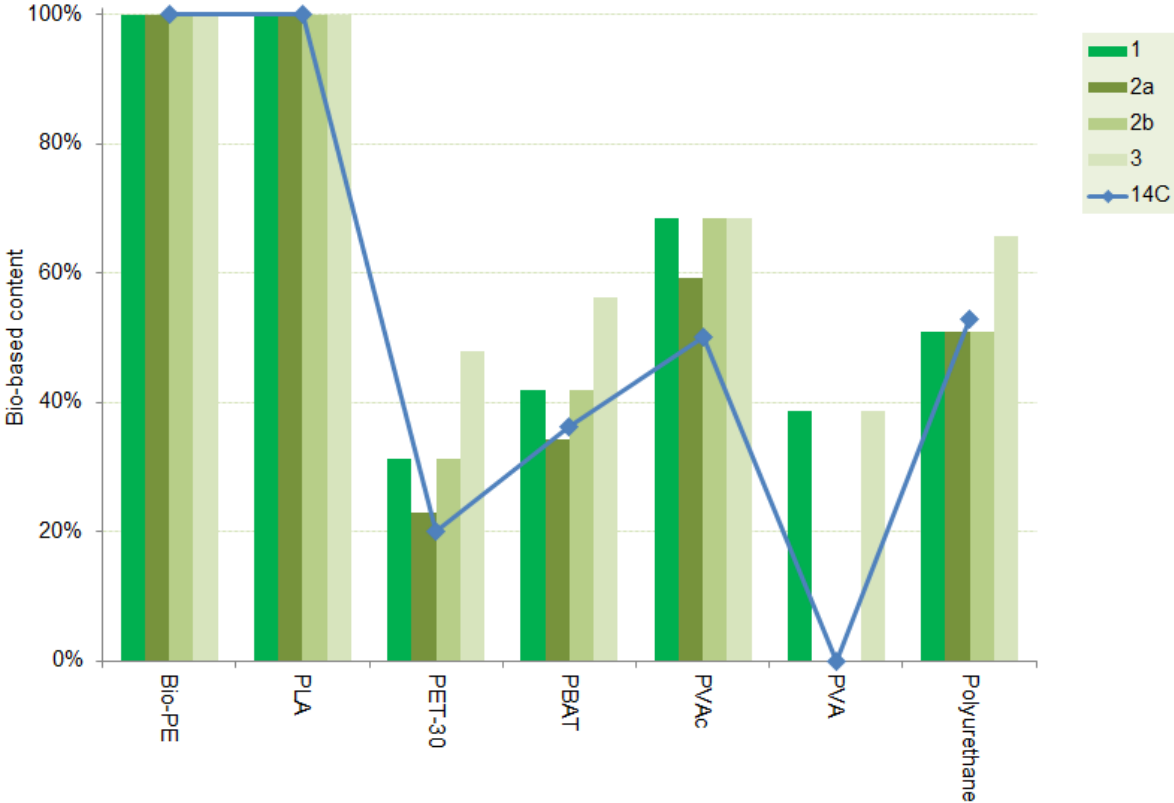


Figure 4-17 A summary of bio-based content atom connectivity method results for different bio-based plastics.



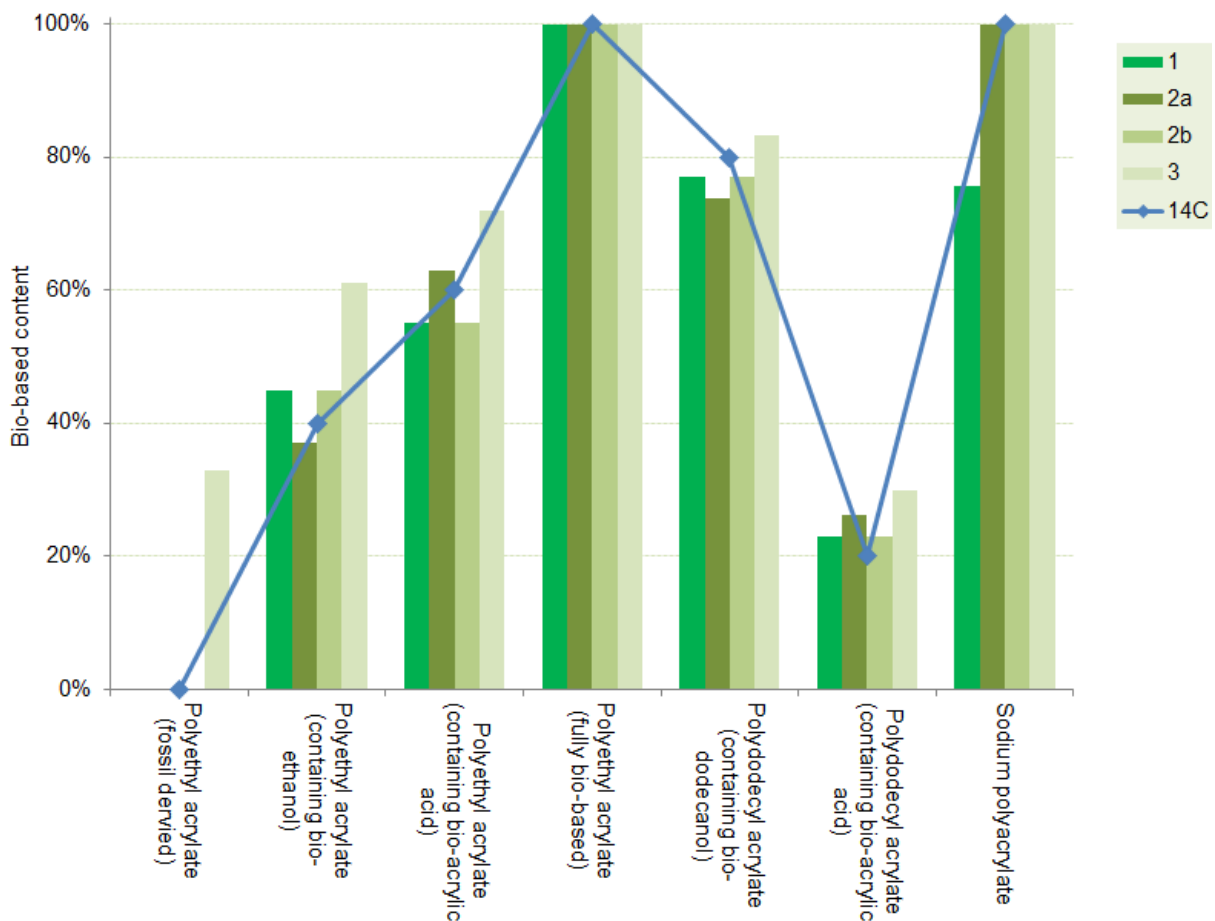


Figure 4-18 A summary of bio-based content atom connectivity method results for polyacrylates.

4.4.1 Polyethylene

There is interest in producing renewable polyethylene because it is ubiquitous throughout the world as a versatile material for many varied applications. Bio-based content determination will be important in the future to distinguish between bio-based polyethylene, fossil derived polyethylene, and blends of both in varying proportions including recycled plastics. At present there are two options with regards to feedstock options; the vast majority of polyethylene is manufactured from fossil derived ethylene, while bio-based ethylene made by dehydrating bio-ethanol is now online but limited in volume [Moser 2013]. Accordingly the bio-based content of these products is either 0% or 100%. The atom connectivity assignments are presented here for petrochemical polyethylene (Figure 4-19, Table 4-21) and bio-based polyethylene (Figure 4-20, Table 4-22) for completeness.



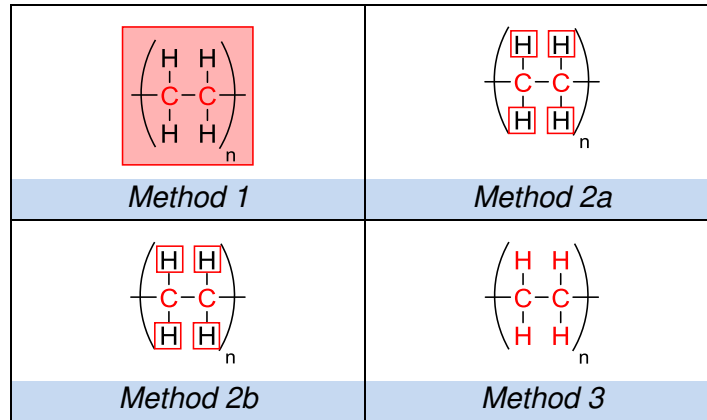
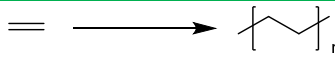


Figure 4-19 Atom allocation assignments for fossil derived polyethylene.

Table 4-21 Allocation of bio-based content for polyethylene made from ethylene.

Polyethylene	Origin	Method			
<i>Petrochemical</i>		1	2a	2b	3
	Fossil	100%	100%	100%	100%
	Plant				
	Water				
	Air				
	Mineral				
	'Bio-based'	0%	0%	0%	0%
	¹⁴C analysis	0%			
Synthesis					
					
<i>Polymerisation of ethylene.</i>					



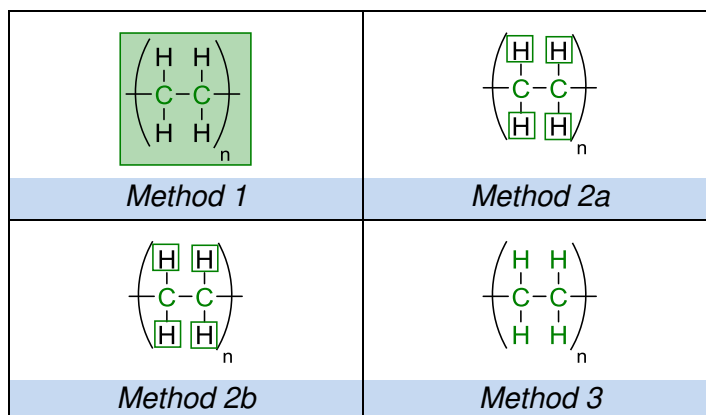
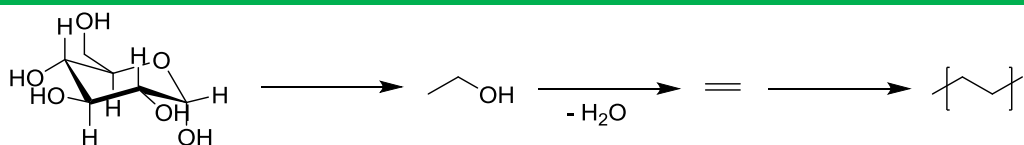
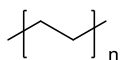


Figure 4-20 Atom allocation assignments for bio-polyethylene.

Table 4-22 Allocation of bio-based content for polyethylene made from bio-ethanol.

Polyethylene	Origin	Method			
<i>Fermentation</i>		1	2a	2b	3
	Fossil				
	Plant	100%	100%	100%	100%
	Water				
	Air				
	Mineral				
	'Bio-based'	100%	100%	100%	100%
	¹⁴C analysis	100%			



Dehydration of bio-ethanol give ethylene ready for polymerisation.

4.4.2 Polylactic acid

Poly(lactic acid) (PLA) has generated significant interest as a bio-based polymer and is now present as a component of some bio-based products [Garlotta 2001]. Lactic acid is produced by fermentation and polymerised *via* its dimer. The monomer is isolated from the fermentation broth as its calcium salt. Although this has no impact on the bio-based content of the downstream polymer, it is a significant proportion of the mass use requirement during



the manufacturing process. It is wholly bio-based (Figure 4-21), and consistent with bio-based carbon analysis (also 100%) (Table 4-23).

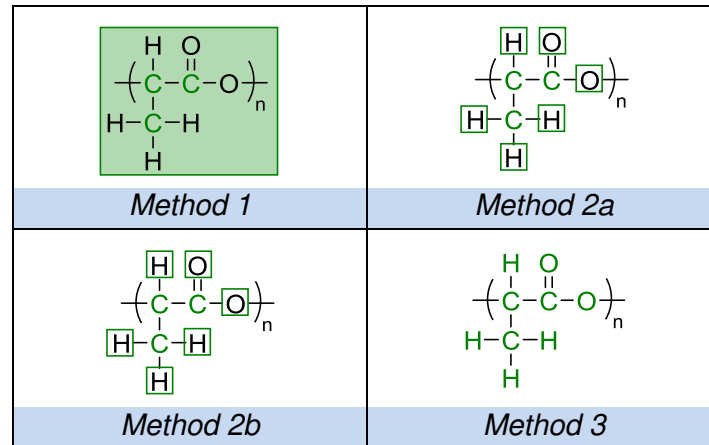
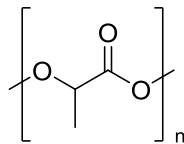


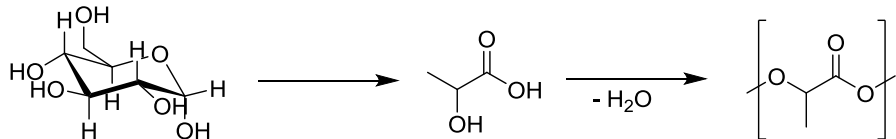
Figure 4-21 Atom allocation assignments for poly(lactic acid).

Table 4-23 Allocation of bio-based content for poly(lactic acid) made from sugar.

PLA	Origin	Method			
		1	2a	2b	3
	Fossil				
	Plant	100%	100%	100%	100%
	Water				
	Air				
	Mineral				
	'Bio-based'	100%	100%	100%	100%
	¹⁴ C analysis	100%			



Synthesis



Fermentation of sugar can yield lactic acid which is polymerised to make polylactic acid.

4.4.3 Poly(ethylene terephthalate)

A pivotal position in the bio-based economy will be taken up by partially renewable poly(ethylene terephthalate), or PET, due to the abundance of articles composed of this ma-



terial [European Bioplastics 2012]. The ultimate goal is the manufacture of completely bio-based PET, and although research and development is at an advanced stage [Peters 2011], at present bio-based PET is made through the transesterification of fossil derived methyl terephthalate and bio-based ethylene glycol [Coca-Cola 2014]. The chemistry is quite routine and well established, with petrochemical ethylene substituted for dehydrated bio-based ethanol. Oxidation of both the ethylene and *p*-xylene, then the hydration of ethylene oxide and methanol esterification of terephthalic acid, affords the final reactants. As a result the oxygen atoms in PET are atmospheric oxygen and water derived in a 3:1 ratio (Figure 4-22).

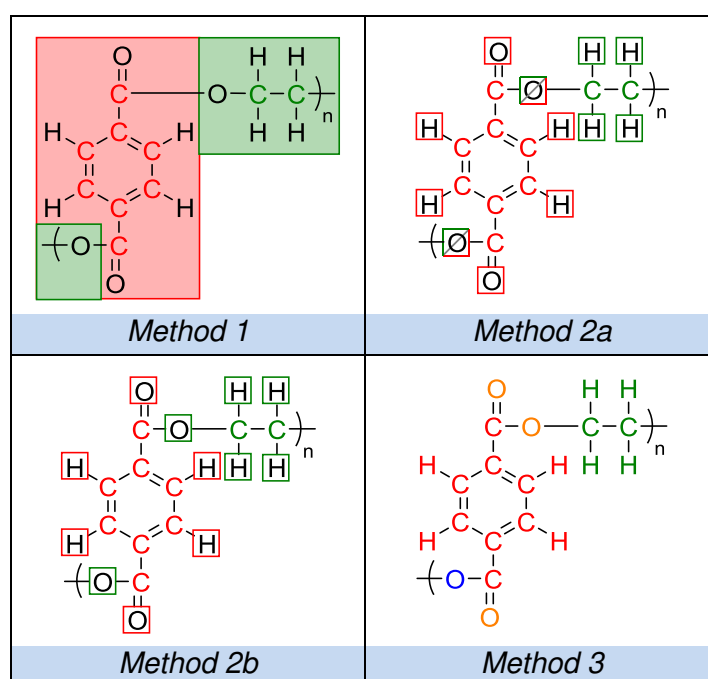
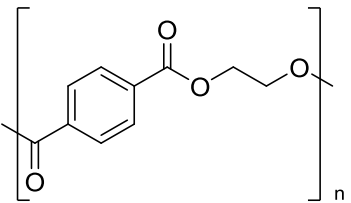


Figure 4-22 Atom allocation assignments for poly(ethylene terephthalate).

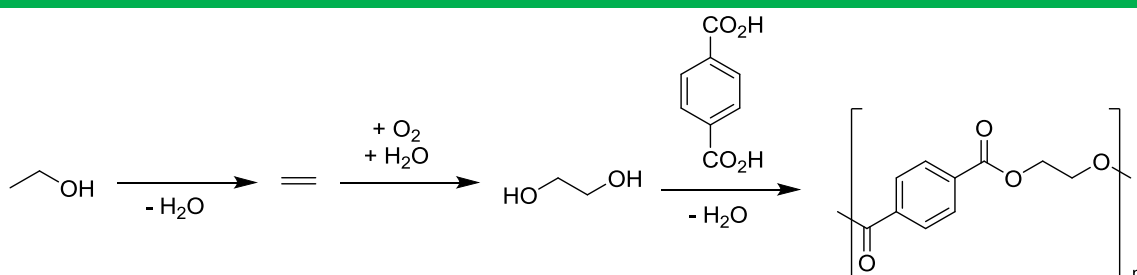
The bio-based carbon content of PET made from bio-based ethylene glycol is 20%, actually under the minimum standard in Europe (that being 25%; CEN/TS 16137). Following atom connectivity Method 1 and Method 2b (Table 4-24), the relative quantity of oxygen atoms associated with bio-based carbon atoms is high, and a value for total bio-based content is returned at 31%. This is notably higher than the bio-based carbon content. Atom connectivity Method 3 is more generous still, for now all the oxygen atoms are considered bio-based (although actually all sourced from either water or air). The spread of total bio-based content values across the different atom connectivity methods is quite broad with a data range of 25%, and none lower than the anticipated bio-based carbon content.



Table 4-24 Allocation of bio-based content for polyethylene terephthalate made from bio-based ethylene glycol.

PET-30	Origin	Method			
		1	2a	2b	3
	Fossil	69%	77%	69%	52%
	Plant	31%	23%	31%	15%
	Water				8%
	Air				25%
	Mineral				
	'Bio-based'	31%	23%	31%	48%
¹⁴ C analysis	20%				

Synthesis



Polyethylene glycol terephthalate made from ethylene glycol derived from bio-ethanol.

4.4.4 Poly(butylene adipate terephthalate)

Poly(butylene adipate terephthalate), PBAT, is another terephthalic acid derived polymer. It can be blended with bio-based polymers such as PLA, although it is not itself bio-based. Comprised of three monomers, there is however scope for introducing renewable content into PBAT. For this example the diol, 1,4-butanediol (Figure 4-7), is taken to be bio-based (Figure 4-23). Assuming an equimolar ratio of the two ester functionalities, the atom connectivity approaches can be calculated as shown in Figure 4-23 ($m = n$). The non-equivalence of the oxygen atoms in one of the carboxylic acid groups of adipic acid (in terms of their origin at least) results in an average of only 1.5 water derived oxygen atoms per repeating unit for every eight oxygen atoms according to atom connectivity Method 3.



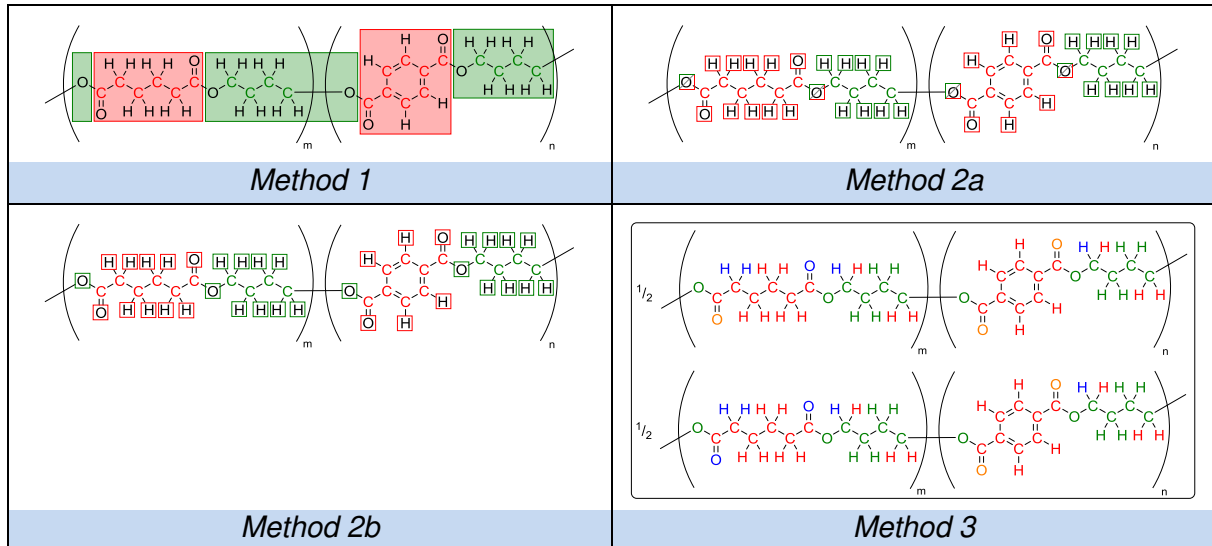
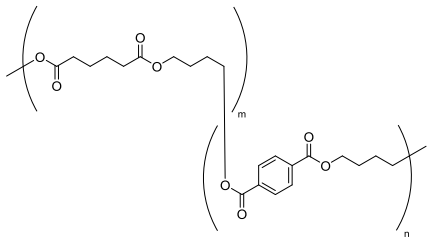


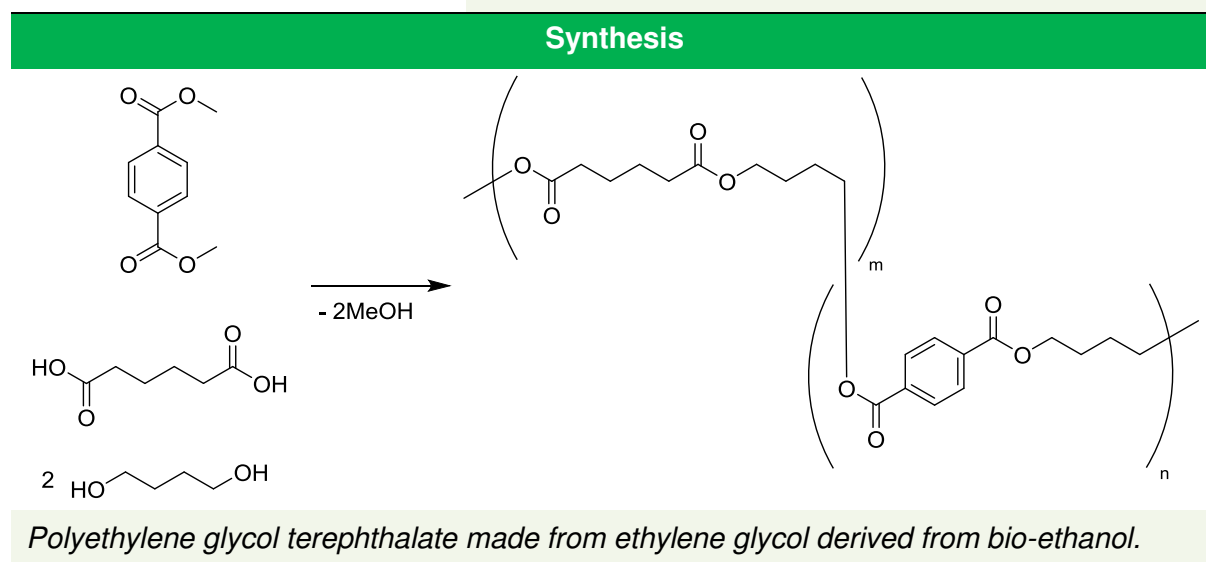
Figure 4-23 Atom allocation assignments for poly(butylene adipate terephthalate).

With a bio-based carbon content of 36% (8 in every 22 atoms), each atom connectivity method except atom connectivity Method 2a exceeds this benchmark figure for total bio-based content (Table 4-25). The range of possible answers for a total bio-based content is broad, but not quite as variable as was previously observed for PET. The possibility of using different ratios of the diacid monomers in the polymerisation adds to the prospect of variation even within each atom connectivity method, especially if bio-based acids were incorporated.



Table 4-25 Allocation of bio-based content for poly(butylene adipate terephthalate) made from bio-based 1,4-butanediol.

PBAT	Origin	Method			
		1	2a	2b	3
	Fossil	58%	66%	58%	44%
	Plant	42%	34%	42%	40%
	Water				7%
	Air				9%
	Mineral				
	'Bio-based'	42%	34%	42%	56%
¹⁴ C analysis	36%				



4.4.5 Poly(vinyl acetate)

Poly(vinyl acetate) is fossil derived, but as it is comprised of two C₂ units, it lends itself to a possible synthesis from bio-ethanol in the future. Acetic acid (e.g. oxidised ethanol) is reacted with the epoxide of ethylene to give the monomer precursor to poly(vinyl acetate) in this hypothetical example. If it is assumed that bio-based acetic acid is used as a reactant, then the final article is 50% bio-based according to its organic carbon content. Atom allocation is straightforward (Figure 4-24), once the mechanism is understood to be able to assign the oxygen atoms with confidence (see Annex A, Scheme 8-20). The atom connectivity methods do not differ in their conclusions, except that atom connectivity Method 2a underestimates the total bio-based content (Table 4-26). Total bio-based content is greater than bio-based carbon content according to all conventions.



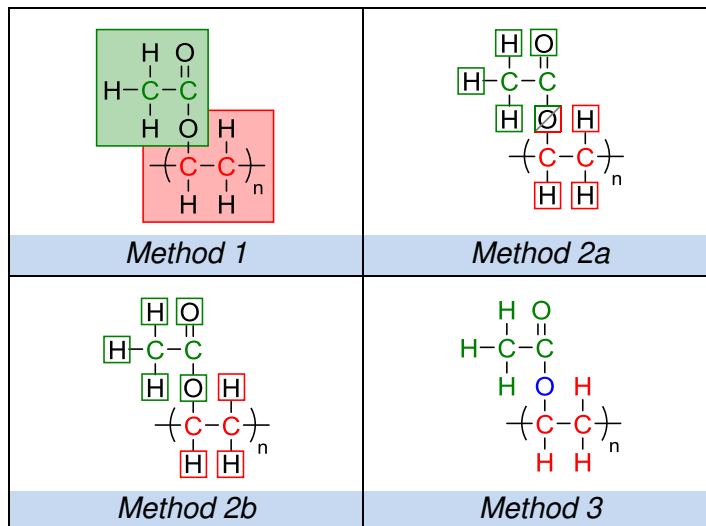
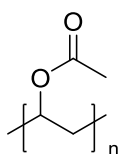


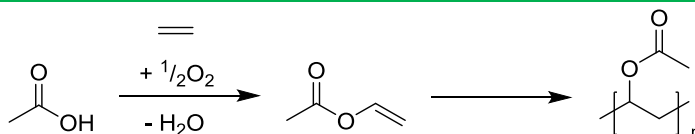
Figure 4-24 Atom allocation assignments for poly(vinyl acetate)

Table 4-26 Allocation of bio-based content for polyvinyl acetate made from acetic acid.

Polyvinyl acetate	Origin	Method			
		1	2a	2b	3
	Fossil	31%	41%	31%	31%
	Plant	69%	59%	69%	50%
	Water				
	Air				19%
	Mineral				
	'Bio-based'	69%	59%	69%	69%
	¹⁴ C analysis	50%			



Synthesis



Ethylene oxidatively coupled to bio-based acetic acid (from fermentation) and polymerised.



4.4.6 Poly(vinyl alcohol)

A prevalent but unsustainable polymer product, poly(vinyl alcohol) (PVA) is made from poly(vinyl acetate) [Weissermel 1993]. Instead of the obvious hydrolysis, alcoholysis is used to produce the final article. One hydrogen atom is added to the PVA molecule from the alcohol used to cleave poly(vinyl acetate). Depending on the source of this alcohol the bio-based content of the resulting PVA will be slightly modified. It has been assumed here that the alcohol is petrochemical, synthesised from the hydration of a fossil derived olefin. Accordingly a water derived hydrogen atom is introduced into PVA (Figure 4-25).

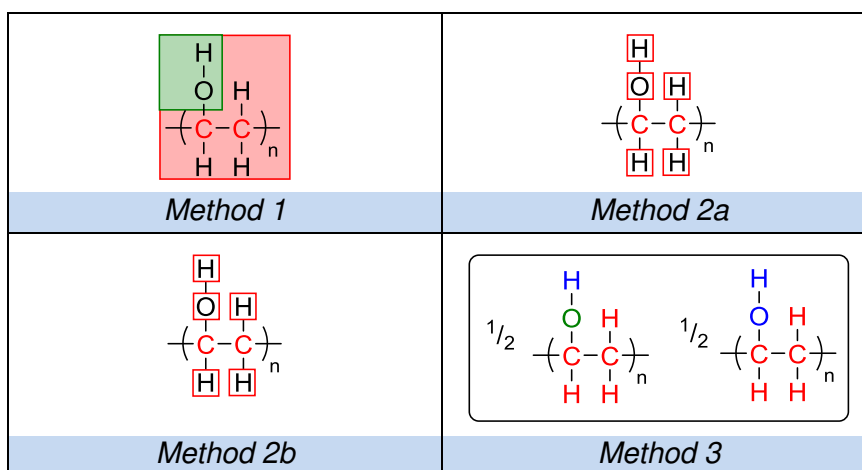


Figure 4-25 Atom allocation assignments for poly(vinyl alcohol).

Within this case study there is a considerable difference between the atom connectivity approaches. Atom connectivity Method 2a and Method 2b concur with the proposed 0% value for bio-based carbon content, as is unavoidable using 'true' atom connectivity all derived from bio-based carbon content (Table 4-27). In atom connectivity Method 1, the reactants are considered and a total bio-based content attributed accordingly. It was decided for the purpose of atom connectivity Method 1 that PVA is the product of ethylene and acetic acid, as it was for the intermediate product poly(vinyl acetate). The result is that the alcohol group (an oxygen atom and a hydrogen atom) is defined as originating from the bio-based acetic acid. At least this is true for the oxygen atom. Atom connectivity Method 3 produces the same result of 39% total bio-based content (Table 4-27).



blended input streams of the same reactant both fossil derived and bio-based) are addressed here. Firstly the entirely fossil derived product is presented in Figure 4-26. Atom connectivity Method 3 differs from the other protocols and indicates a substantial total bio-based content at 33% despite the absence of bio-based carbon. This is largely delivered through the oxygen atoms; one coming from water and the other derived from atmospheric molecular oxygen. Because the organic feedstocks are ethylene (the precursor to ethanol) and propylene (oxidised to acrylic acid) atom connectivity Method 3 is not consistent with other atom connectivity methods or radiocarbon analysis, and does not fit the common perception of a bio-based product in this instance (Table 4-28).

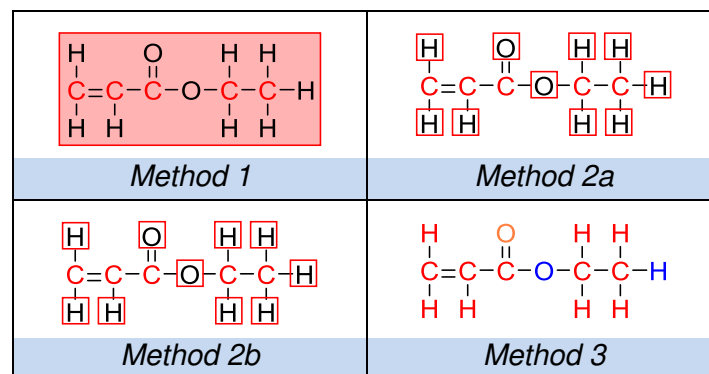
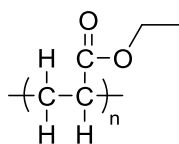


Figure 4-26 Atom allocation assignments for fossil derived ethyl acrylate monomer.

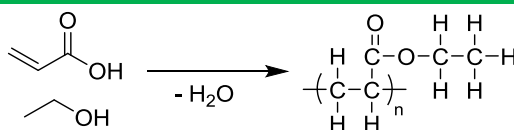


Table 4-28 Allocation of bio-based content for poly(ethyl acrylate) made from fossil derived feed-stocks.

Polyethyl acrylate	Origin	Method			
		1	2a	2b	3
Petroleum					
	Fossil	100%	100%	100%	67%
	Plant				
	Water				17%
	Air				16%
	Mineral				
	'Bio-based'	0%	0%	0%	33%
	¹⁴C analysis	0%			



Synthesis



Esterification of ethanol and acrylic acid, followed by alkene radical polymerisation affords the polyacrylate.

One interesting outcome for the future is the possibility of partially bio-based polyethyl acrylate. Bio-based acrylic acid is a technology in its infancy, but would provide a greater degree of bio-based content than the use of bio-ethanol with conventional petrochemical acrylic acid. However the costs of production would suggest the latter is more reasonable to expect despite its lower bio-based content. The bio-ethanol derived poly(ethyl acrylate) is 40% bio-based according to its organic carbon content. All but atom connectivity Method 3 are consistent with this to a reasonable extent. Atom connectivity Method 2a splits the assigned origin of the bridging oxygen atom and the consequence is a lower calculated total bio-based content (Figure 4-27). Atom connectivity Methods 1 and 2b are almost as close to matching the likely bio-based carbon content as atom connectivity Method 2a, but with a more reasonable assignment of one bio-based oxygen atom and one fossil derived oxygen atom, even though that latter oxygen atom has its origins in atmospheric oxygen (Table 4-29).



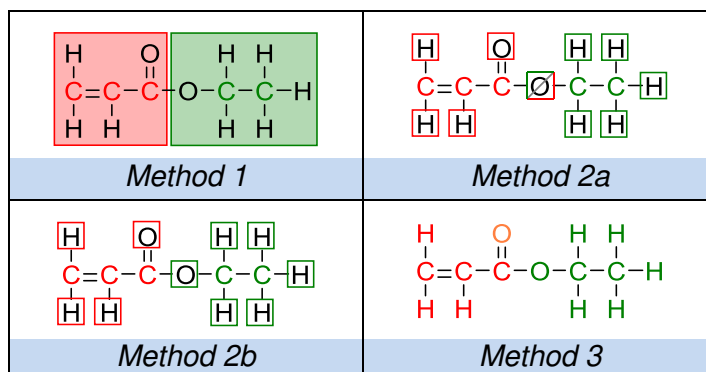
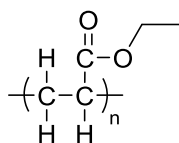


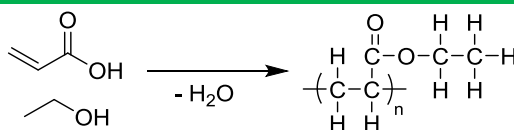
Figure 4-27 Atom allocation assignments for bio-ethanol derived ethyl acrylate monomer.

Table 4-29 Allocation of bio-based content for poly(ethyl acrylate) made from bio-ethanol.

Polyethyl acrylate	Origin	Method			
		1	2a	2b	3
<i>Bio-ethanol</i>					
	Fossil	55%	63%	55%	39%
	Plant	45%	37%	45%	45%
	Water				
	Air				16%
	Mineral				
	'Bio-based'	45%	37%	45%	61%
	¹⁴C analysis	40%			



Synthesis



Bio-ethanol is used to give the ethyl acrylate monomer in its reaction with acrylic acid, and the monomer polymerised.

The alternative partially bio-based poly(ethyl acrylate) product is obtained from 3-hydroxypropanoic acid. This is a fermentation product made from glycerol [Ashok 2011]. All fermentation products are being treated as entirely bio-based (wholly plant derived for the purposes of atom connectivity Method 3). This does not normally present any conflict as sugars and cellulose are the most common fermentation feedstocks. However adopting this consensus is problematic when the substrate is not itself wholly bio-based. This is the case for glycerol, which contains some fossil derived hydrogen (Figure 4-4). Given the mass contribution of hydrogen in the molecule is low, this is not a major issue and does not give rea-



son to question the consensus that fermentation products can be claimed as entirely bio-based. Accordingly the hydrogen atoms bound to the carbon atoms of the acrylic acid portion of the polymer are all considered bio-based (Figure 4-28).

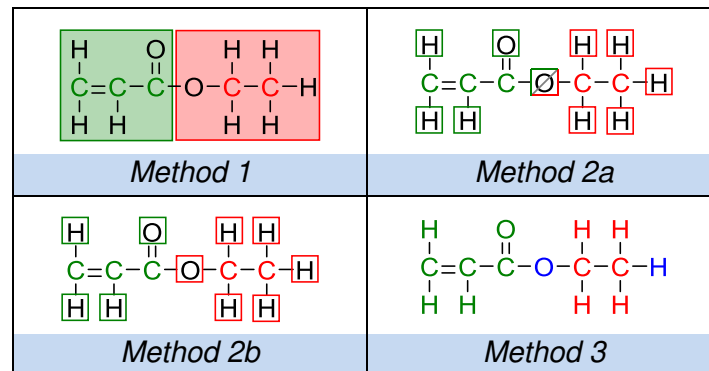


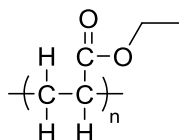
Figure 4-28 Atom allocation assignments for glycerol derived ethyl acrylate monomer.

The indirect assignment of total bio-based content for this glycerol derived poly(ethyl acrylate) is essentially the reverse of the previous bio-ethanol derived product. Only for atom connectivity Method 3 is this not reflected in the reported total bio-based content, which stands at 72% (Table 4-30). By not considering oxygen atoms as fossil derived, atom connectivity Method 3 will produce high values of total bio-based content for bio-based products of mixed origin.

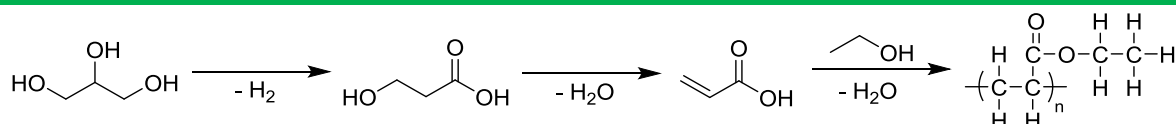


Table 4-30 Allocation of bio-based content for poly(ethyl acrylate) made from glycerol.

Polyethyl acrylate	Origin	Method			
		1	2a	2b	3
<i>Glycerol derived</i>					
	Fossil	45%	37%	45%	28%
	Plant	55%	63%	55%	55%
	Water				17%
	Air				
	Mineral				
	'Bio-based'	55%	63%	55%	72%
	¹⁴C analysis	60%			



Synthesis



Glycerol can be fermented to 3-hydroxypropanoic acid which is dehydrated to acrylic acid for use in the synthesis of polyacrylates.

The 100% bio-based carbon poly(ethyl acrylate) made from bio-based acrylic acid and bio-ethanol contains atoms exclusively from plant resources (Figure 4-29). Without fossil derived carbon atoms, the reaction between two fermentation products is unable to produce an article considered to be anything else than 100% bio-based (Table 4-31). As such the different atom connectivity approaches offer no conflict.

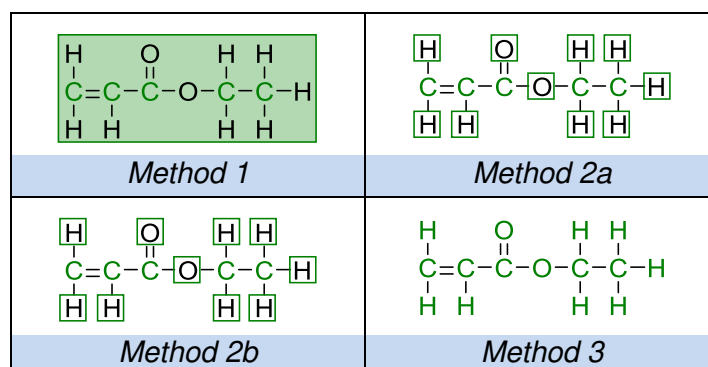
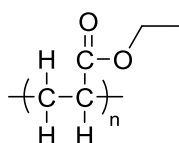
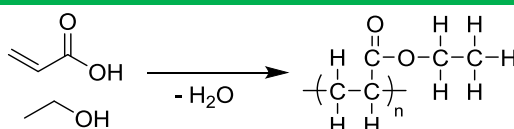
**Figure 4-29** Atom allocation assignments for wholly bio-based ethyl acrylate monomer.

Table 4-31 Allocation of bio-based content for poly(ethyl acrylate) made from bio-based feedstocks.

Polyethyl acrylate	Origin	Method			
		1	2a	2b	3
<i>Bio-based</i>					
	Fossil				
	Plant	100%	100%	100%	100%
	Water				
	Air				
	Mineral				
	'Bio-based'	100%	100%	100%	100%
	¹⁴C analysis	100%			



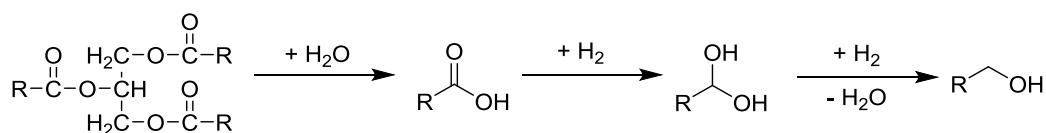
Synthesis



Bio-based reactants afford an entirely bio-derived polymer.

4.4.8 Poly(dodecyl acrylate)

An analogue of poly(ethyl acrylate) is poly(dodecyl acrylate). To make this fatty polyester 1-dodecanol produced by the reduction of lauric acid could be used. The hydrolysis of a vegetable oil triglyceride introduces a water derived oxygen atom, which remains in half of the reduced alcohol intermediate (Scheme 4-6). As a result, the application of atom connectivity Method 3 produces a complex result (Figure 4-30). The remaining atom connectivity approaches can be followed through to completion by applying the standard rules of chemical reactivity.

**Scheme 4-6** The reduction of fatty acids.

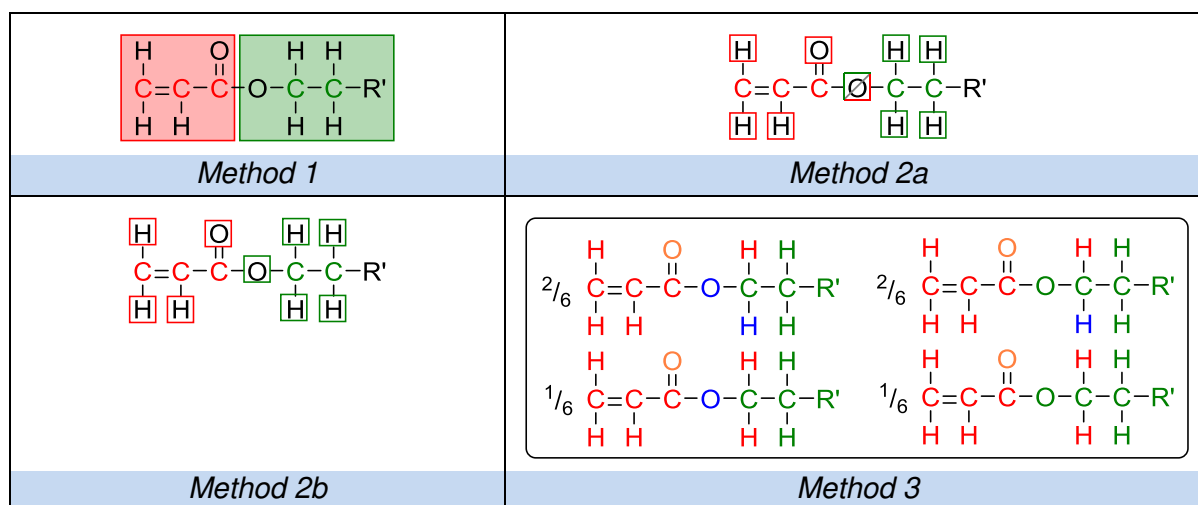
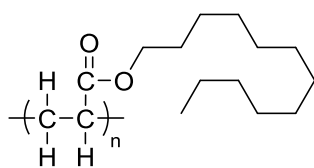


Figure 4-30 Atom allocation assignments for the dodecyl acrylate monomer produced from bio-dodecanol.

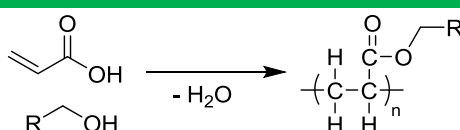
With an expected bio-based carbon content of 80%, atom connectivity method 2b (equivalent in this instance to the ACDV certification scheme methodology) produces a reasonable outcome of 77% total bio-based content. In fact all approaches were satisfactory, helped by the significant bio-based portion of the molecule dictating the result (Table 4-32).

Table 4-32 Allocation of bio-based content for poly(dodecyl acrylate) made from bio-based dodecanol.

Polydodecyl acrylate	Origin	Method			
		1	2a	2b	3
<i>Fatty acid derived</i>					
	Fossil	23%	26%	23%	17%
	Plant	77%	74%	77%	73%
	Water				4%
	Air				7%
	Mineral				
	'Bio-based'	77%	74%	77%	83%
	¹⁴C analysis	80%			



Synthesis



Bio-based alcohol affords the partially bio-derived polymer.



As is true of poly(ethyl acrylate), the acrylate moiety of dodecyl acrylate and its polymer could be derived from glycerol, transformed to 3-hydroxypropanoic acid by fermentation and then dehydrated. Now it is assumed the dodecyl group is fossil derived. Atom connectivity is generally representative of the total bio-based content that would intuitively be ascribed to the molecule (Figure 4-31). Calculated total bio-based content ranged from 23% to 30% (Table 4-33) depending on what consensus was followed. As is evident from other ester case studies, the decision to associate the oxygen atom of synthetic petrochemical alcohols with a fossil feedstock is incorrect but helpful in aligning the analytical bio-based carbon content and calculated total bio-based content claims, reducing confusion that may arise when a large disparity in bio-based content claims emerges.

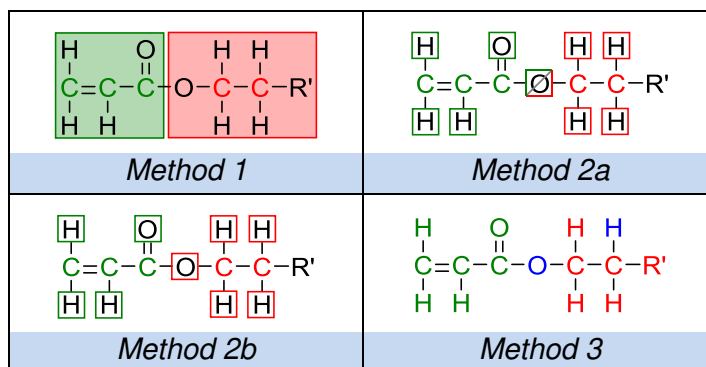
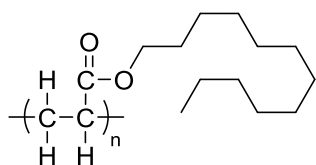


Figure 4-31 Atom allocation assignments for glycerol derived dodecyl acrylate monomer.

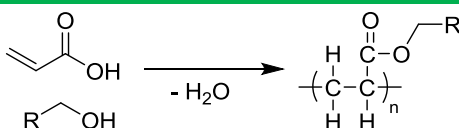


Table 4-33 Allocation of bio-based content for poly(dodecyl acrylate) made from bio-based acrylic acid.

Polydodecyl acrylate	Origin	Method			
		1	2a	2b	3
<i>Glycerol derived</i>					
	Fossil	77%	74%	77%	70%
	Plant	23%	26%	23%	23%
	Water				7%
	Air				
	Mineral				
	'Bio-based'	23%	26%	23%	30%
	¹⁴C analysis	20%			



Synthesis



Glycerol can be fermented to 3-hydroxypropanoic acid which is dehydrated to acrylic acid for use in the synthesis of polyacrylates.

4.4.9 Sodium polyacrylate

The sodium salt of poly(acrylic acid) is a useful water absorbent [M² Polymer Technologies 2014]. It can be made from polyacrylic acid by a neutralisation reaction with sodium hydroxide. With an ionic compound, the atom connectivity approaches must be able to incorporate non-covalency in chemicals. This is missing from the ACDV certification [ACDV 2013]. In atom connectivity Method 1 the sodium cation is considered to come from a fossil resource (or at least not bio-based). However atom connectivity by attributing an origin through the closest bonded carbon atom results in the sodium atom being denoted as bio-based (Figure 4-32). Ionic bonds can be treated as covalent bonds for the purpose of atom connectivity by assuming the bond links the atoms bearing the charge.



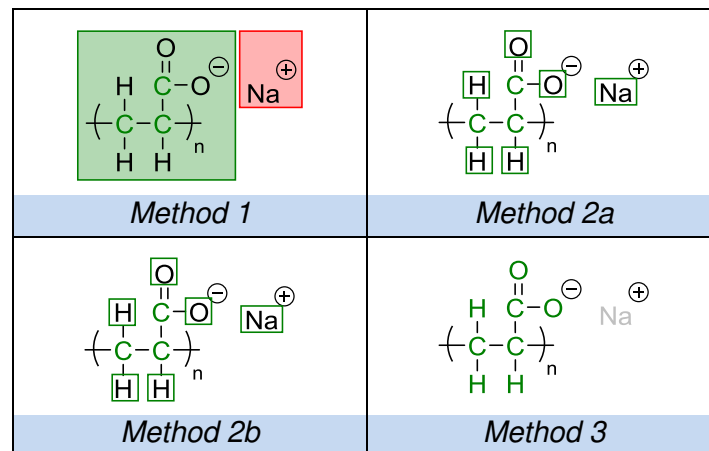


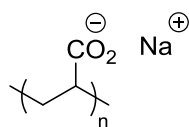
Figure 4-32 Atom allocation assignments for renewable sodium polyacrylate.

Taking the sodium cation as not from biomass (atom connectivity Method 1), the bio-based content of sodium polyacrylate is 76%, assuming complete salt formation is achieved from the precursor poly(acrylic acid) (Table 4-34). The ACDV certification scheme, were it applicable to ionic compounds, is reliant on CHNO elemental analysis. As with atom connectivity Method 2b it assigns a 100% total bio-based content to sodium polyacrylate because atoms other than carbon, hydrogen, nitrogen and oxygen are automatically considered as bio-based as is also described in [prEN 16785](#). Atom connectivity Method 2b will always produce the conclusion of 100% bio-based content if all the carbon atoms are bio-based. Atom connectivity Method 3 ignores inorganic mineral sourced content and so 100% bio-based content is found once again.

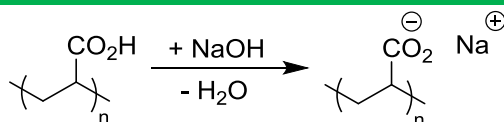


Table 4-34 Allocation of bio-based content for sodium polyacrylate derived from glycerol.

Sodium polyacrylate	Origin	Method			
		1	2a	2b	3
<i>Glycerol derived</i>					
	Fossil	24%			
	Plant	76%	100%	100%	76%
	Water				
	Air				
	Mineral				24%
	'Bio-based'	76%	100%	100%	100%
	¹⁴C analysis	100%			



Synthesis



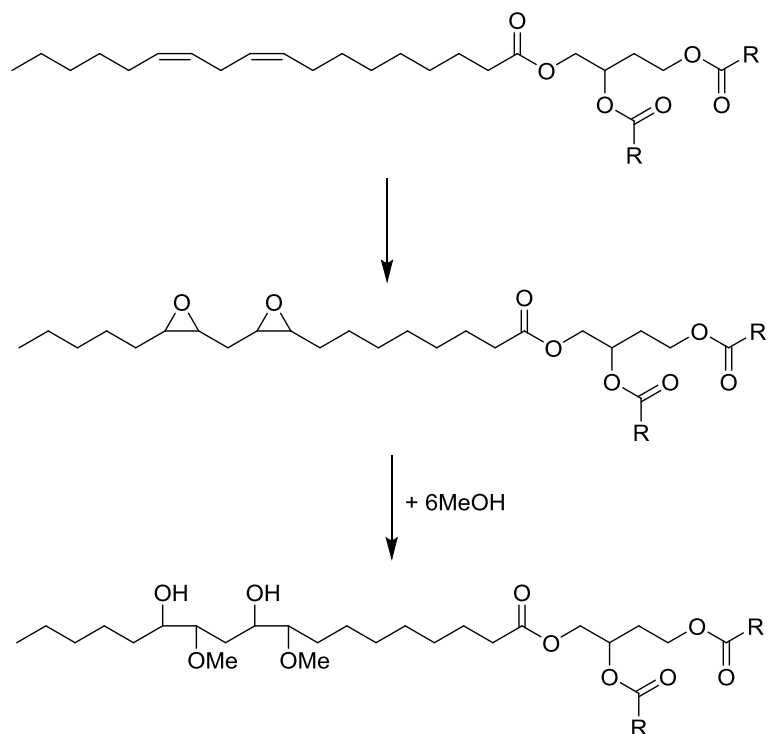
Glycerol can be fermented to 3-hydroxypropanoic acid which is dehydrated to acrylic acid. The sodium salt of poly(acrylic acid) is formed upon treatment with sodium hydroxide.

4.4.10 Polyurethane

Polyurethanes are a class of polymer made from diisocyanates and diol monomers [Weissermel 1993]. The properties of the final article can be adjusted by adding water into the polymerisation reaction, which causes the liberation of carbon dioxide gas at the expense of synthesising some polyamide rather than all polyurethane. The carbon dioxide is trapped and creates a porous foam material [Chian 1998, Weissermel 1993]. For the purpose of this atom connectivity study only the polyurethane compound will be considered.

This case study is based on a polyol made from soy oil [Tan 2010]. This triglyceride will be assumed to be the trilinoleic ester for the purpose of calculating the atom connectivity. Doubly unsaturated, linoleate esters can be epoxidised then reacted with methanol to form diols. As part of a triglyceride this produces six alcohol groups per molecule (Scheme 4-7). The vegetable oil could be transesterified with excess methanol using a basic catalyst to liberate the diols as FAMES, but in this example the glyceride is kept intact. A reaction with an isocyanate, of which methylene diphenyl diisocyanate is one of the most popular for polymer formation, results in the polyurethane.





Scheme 4-7 The formation of diols from soy oil shown for one fatty acid group only.

The diisocyanate is fossil derived, and it so happens that when combined in an addition reaction with the functionalised soy oil (three molar equivalents of diisocyanate are required for each triglyceride), that approximately equal proportions of the resulting polymer are fossil derived and bio-based. Atom connectivity Method 2a and Method 2b are equivalent because an equal number of bridging oxygen atoms between fossil and biomass derived carbon atoms originate in petrochemical methanol as they do in the epoxidised soy oil (Figure 4-33). In atom connectivity Method 3 those epoxide oxygen atoms are considered to be derived from molecular oxygen condensed from the atmosphere.



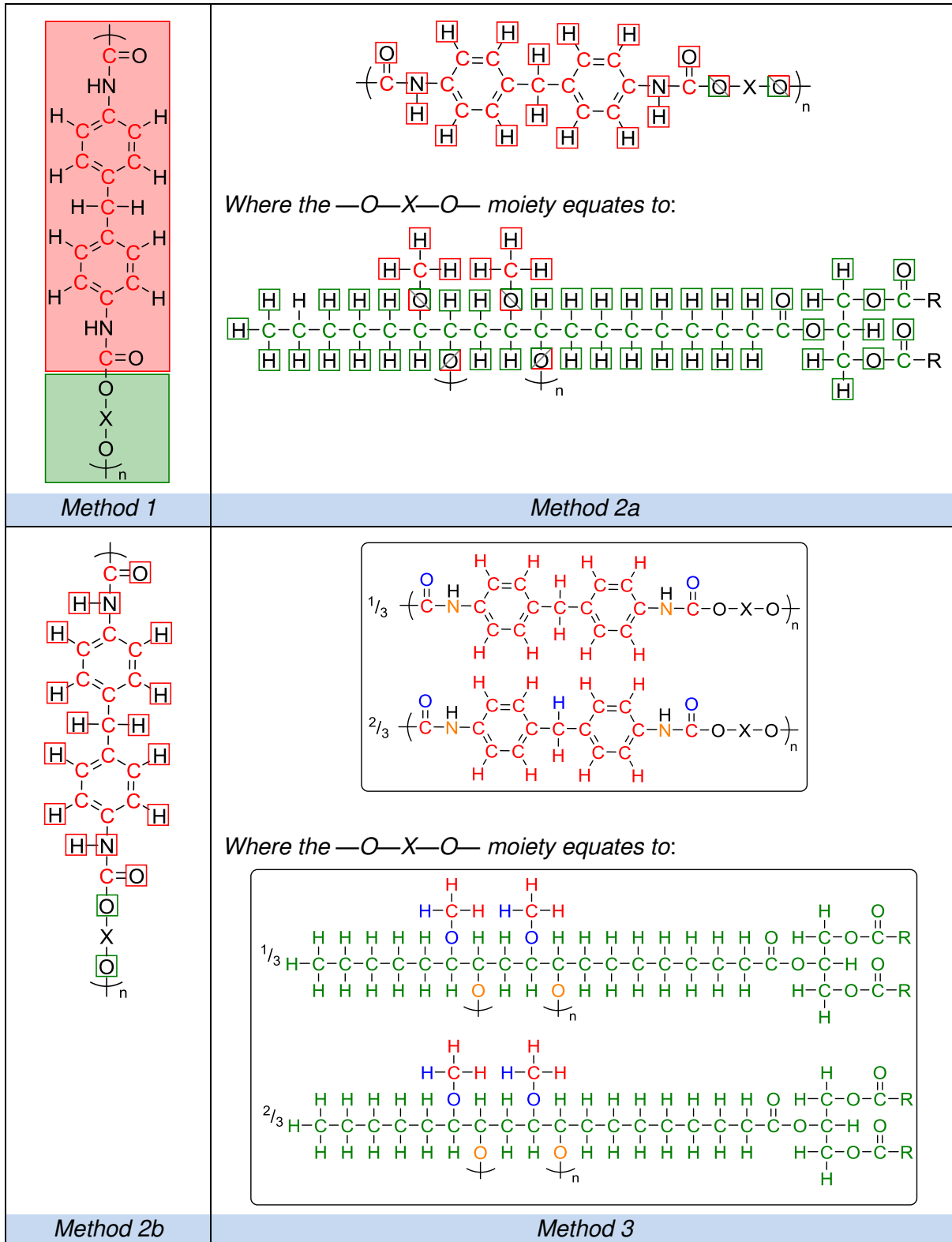
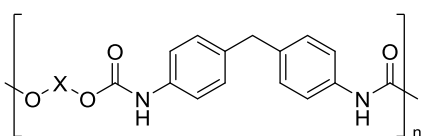


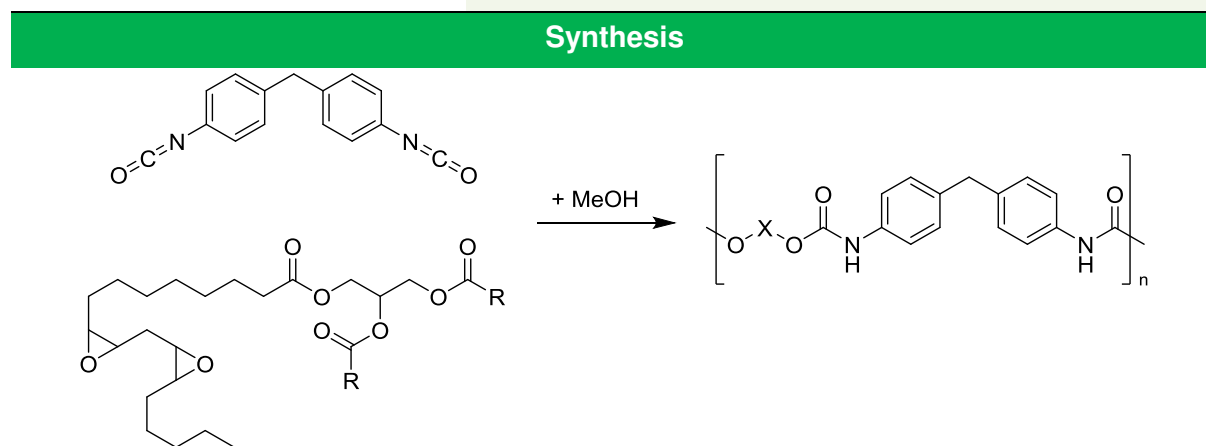
Figure 4-33 Atom allocation assignments for a soy oil derived polyurethane.



Total bio-based content is similar to bio-based carbon content (53%) for three of the atom connectivity methods (Table 4-35). Atom connectivity Method 3 is more generous as none of the heteroatoms are now considered as fossil derived. A more likely polyurethane product would consist of a blend of diol precursors, but atom connectivity Method 3 is still likely to differ from the conclusions of the other atom connectivity approaches.

Table 4-35 Allocation of bio-based content for soy derived polyurethane made from epoxidised soy oil.

Soy derived polyurethane	Origin	Method			
		1	2a	2b	3
	Fossil	49%	49%	49%	34%
	Plant	51%	51%	51%	46%
	Water				10%
	Air				9%
	Mineral				
	'Bio-based'		51%	51%	51%
¹⁴ C analysis		53%			



Epoxidised soy oil is reacted with methanol to form a polyol (HO-X-OH) which in turn is reacted with an isocyanate to give a polyurethane.



4.5 Examples of bio-based content calculations for solvents based on atom connectivity

Solvents are a major class of petrochemical, used in formulation and manufacturing processes. They will be vital in delivering bio-based products to the marketplace, as well as being renewable themselves [Gu 2013]. The total bio-based content of seven examples of prospective and actual bio-based solvents has been theoretically assessed using the calculations of atom connectivity methods. Generally the atom connectivity methods are in agreement and closely match the anticipated bio-based carbon content which helps acceptance of this indirect method of bio-based content determination. Exceptions occur when there is no bio-based carbon in the molecule, under which conditions atom connectivity Method 3 perhaps overestimates total bio-based content compared to expectation (Figure 4-34).

The greatest discrepancy occurs for the case study demonstrated by ACDV in their certification scheme. The partially bio-based ethyl acetate could be determined as having a total bio-based content anywhere from 42% up to 70% (Chapter 4.5.2). However the ACDV rules of atom connectivity closely correlate to the 50% bio-based carbon content of this molecule and strengthens the position of this methodology as a robust calculation technique for the verification of bio-based products by providing the intuitive answer.



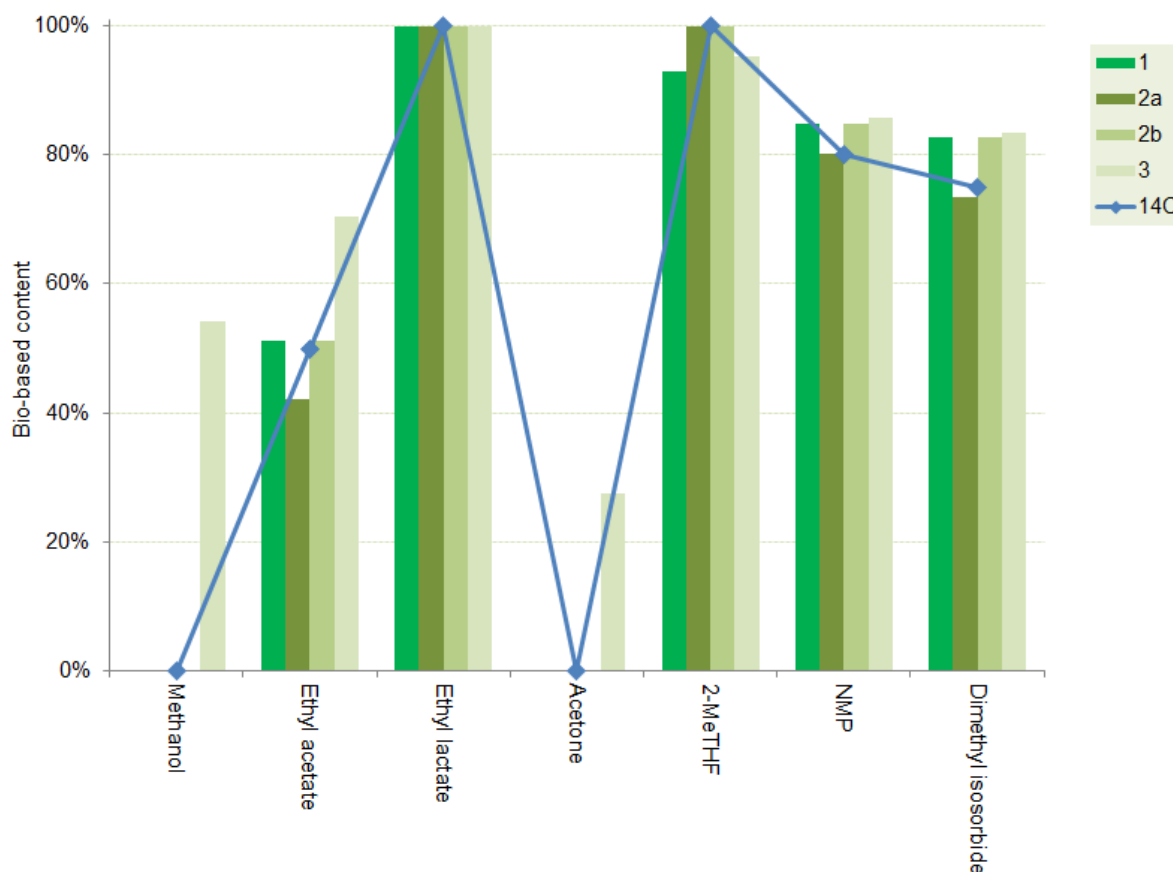


Figure 4-34 A summary of bio-based content atom connectivity method results for different bio-based solvent products.

4.5.1 Methanol

Methanol is a key building block in the synthesis of many organic chemicals. One of these, acetic acid, was the first of these case studies (Table 4-7). It is produced from syngas, specifically the reduction of carbon monoxide. Syngas from natural gas could be substituted for reformed bio-gas, in which case the product would be bio-based. Here the fossil derived version is analysed as there is more scope for erroneous atom connectivity conclusions. Indeed atom connectivity Method 3 will not associate the oxygen atom as fossil derived (Figure 4-35). Steam reforming means that some of the hydrogen atoms in methanol actually come from water as well. As a result the total bio-based content of petrochemical methanol is calculated to be 54% with atom connectivity Method 3 (Table 4-36). Such a high oxygen to carbon ratio will present problems for atom connectivity Method 3. Although it is correct to say that the oxygen atom of methanol is not fossil derived, in this case its contribution to bio-based content is perhaps misleading.



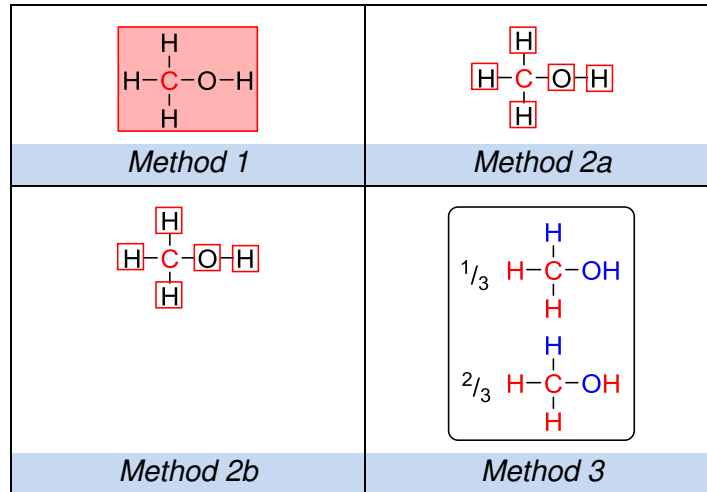
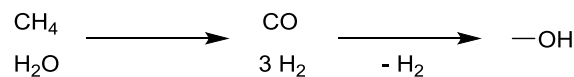


Figure 4-35 Atom allocation assignments for petrochemical methanol.

Table 4-36 Allocation of bio-based content for methanol made from fossil derived feedstocks.

Methanol	Origin	Method			
		1	2a	2b	3
—OH	Fossil	100%	100%	100%	46%
	Plant				
	Water				54%
	Air				
	Mineral				
	'Bio-based'	0%	0%	0%	54%
	¹⁴C analysis	0%			

Synthesis



Syngas is used to make methanol, which in turn is sourced from natural gas and water. All products upgraded from syngas hydrogen have a 2:1 distribution of fossil derived and water derived hydrogen atoms.



4.5.2 Ethyl acetate

An ester of two distinct parts (an alcohol and a carboxylic acid reactant), ethyl acetate was chosen by ACDV to demonstrate the application of their certification scheme [ACDV 2013]. The atom connectivity applied to a molecule made from bio-ethanol and fossil derived acetic acid has already been addressed in passing (Figure 2-9 and Figure 2-10). The more commercially viable ethyl acetate products that are wholly bio-based [Colley 2004], or traditional in their fossil feedstocks offer little ambiguity when assessed with atom connectivity methods of total bio-based content determination. The exception would be for atom connectivity Method 3 applied to a fossil derived product, for the oxygen atoms would be considered as bio-based. There is a quite even split between bio-based elements and fossil derived elements in the partially bio-based ethyl acetate (Figure 4-36).

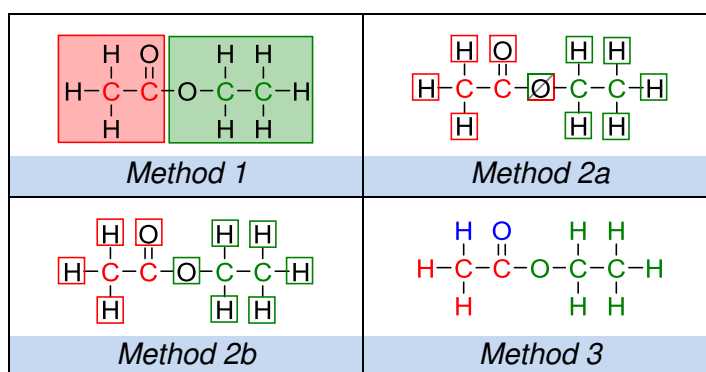
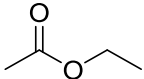


Figure 4-36 Atom allocation assignments for ethyl acetate from bio-ethanol esterification.

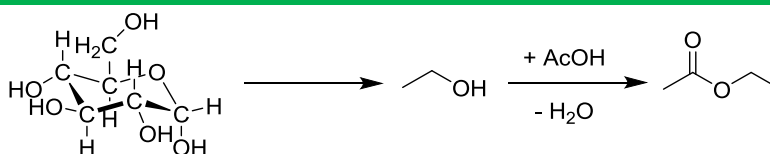
Assuming the A_{AC2} mechanism of esterification (Scheme 4-5), the atom connectivity approaches that reflect the bio-based carbon content more accurately are atom connectivity Method 1 and Method 2b (Table 4-37), which rarely differ from each other. Atom connectivity Method 3 is considerably higher in its estimation of total bio-based content than the other approaches at 70%. This is true even though the plant derived content is calculated as the same across all the approaches except for atom connectivity Method 2a. In atom connectivity Method 3 the heteroatoms within fossil derived portions of the molecule are reassigned to be included within the total bio-based content calculation, elevating the total bio-based content.



Table 4-37 Allocation of bio-based content for ethyl acetate made from bio-ethanol.

Ethyl acetate	Origin	Method			
		1	2a	2b	3
	Fossil	49%	58%	49%	30%
	Plant	51%	42%	51%	51%
	Water				19%
	Air				
	Mineral				
	'Bio-based'	51%	42%	51%	70%
¹⁴C analysis	50%				

Synthesis



Methanol used to make acetic acid, which in turn is sourced from natural gas and water. Esterification with ethanol from fermentation yields partially bio-based ethyl acetate.

4.5.3 Ethyl lactate

Ethyl lactate is another ester product, currently available as entirely derived from biomass [Cellulac 2014]. The reaction between lactic acid and bio-ethanol is performed to give ethyl lactate under typical acid catalysed conditions [Martino-Gauchi 2007]. The reactants are fermentation products, and the consensus adopted here is that fermentation products are considered to be wholly bio-based regardless of what the fermentation feedstock is. Consequently ethyl lactate must be considered as 100% bio-based, as the atom connectivity methods testify (Figure 4-37 and Table 4-38). The chemical feedstock required for the production of bio-ethanol and lactic acid is carbohydrate in both cases, and so the 100% total bio-based content concluded in all four instances is probably justified.



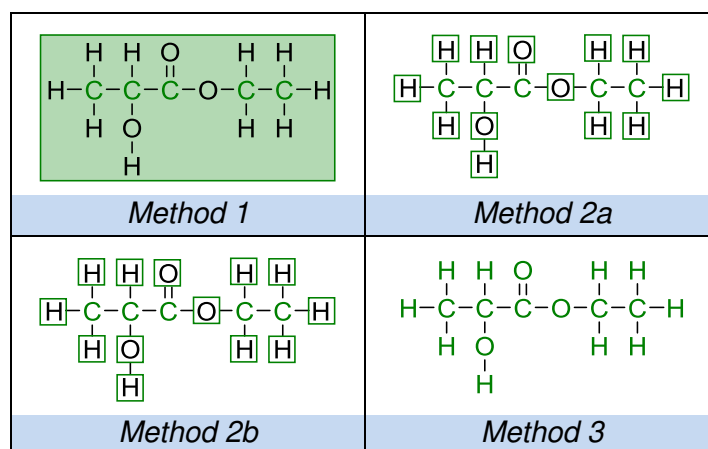
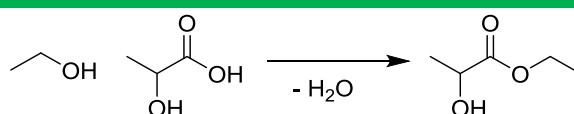
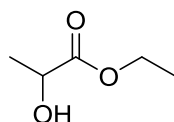


Figure 4-37 Atom allocation assignments for ethyl lactate made from fermentation products.

Table 4-38 Allocation of bio-based content for ethyl lactate made from fermentation products.

Ethyl lactate	Origin	Method			
		1	2a	2b	3
	Fossil				
	Plant	100%	100%	100%	100%
	Water				
	Air				
	Mineral				
	'Bio-based'	100%	100%	100%	100%
	¹⁴C analysis	100%			
Synthesis					



The reactants are both the products of fermentation. Esterification produces the hydroxy ester ethyl lactate.

4.5.4 Acetone

Acetone is the co-product of the cumene process, to which the oxidation of toluene to give *p*-cresol is analogous (Scheme 4-4). As the latter has already been addressed as part of the BHT case study, the synthesis of acetone from propylene needs only to be summarised in brief. The oxidation of acetone can be performed directly by treating propylene with oxygen, but it is more common to cleave isopropylarenes with an oxidative hydrolysis [Weisser-



mel 1993]. The oxygen of the water reactant forms the carbonyl of acetone, which is reflected in atom connectivity Method 3 (Figure 4-38). The water derived oxygen atom means acetone is considered to be 28% bio-based in line with atom connectivity Method 3 (Table 4-39), despite the lack of any bio-based carbon atoms.

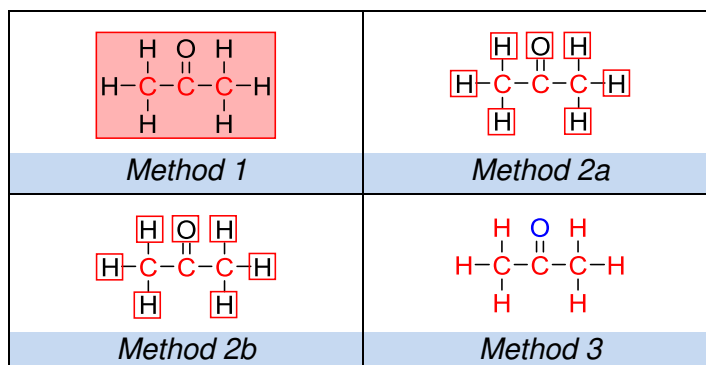

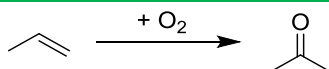


Figure 4-38 Atom allocation assignments for fossil derived acetone.

Table 4-39 Allocation of bio-based content for acetone made from fossil derived feedstocks.

Acetone	Origin	Method			
		1	2a	2b	3
	Fossil	100%	100%	100%	72%
	Plant				
	Water				28%
	Air				
	Mineral				
	'Bio-based'	0%	0%	0%	28%
	¹⁴C analysis	0%			

Synthesis



Oxidation of petroleum derived propene gives acetone, although most commonly the process is achieved via the alkylation of benzene with the propene followed by oxidative cleavage to give phenol as a co-product.

Propylene (and more widely ethylene) are created by the thermal cracking of crude oil. Hydrocracking is also performed on crude oil but does not yield olefins directly [Weissermel 1993]. Upgrading of methanol to olefins is not considered here and so the propylene feedstock can be designated as consisting of only fossil derived elements for the purpose of



atom connectivity Method 3. The subtle differences between the production methods of propylene means errors in atom connectivity assignments can exist without the end-product supplier being aware.

4.5.5 2-Methyltetrahydrofuran

One of the most iconic of the neoteric bio-based solvents, 2-methyltetrahydrofuran (2-MeTHF) is the product of furfural hydrogenation [Aycock 2007]. Furfural is produced by the action of strong acids on pentose sugars such as xylose, causing a series of dehydrations [Rong 2012]. The intermediate is then hydrogenated. Applying atom connectivity Method 1 hydrogen gas and furfural are regarded as the ingredients, although no difference in the outcome is observed if xylose is taken as the feedstock instead of furfural. Fossil derived hydrogen creates a difference between atom connectivity Method 1 and Method 2b (Figure 4-39), as was the case for 1,4-butanediol (Figure 4-7) and adipic acid (Figure 4-8) although the mass contribution of hydrogen atoms is inevitably too low to have a major impact on the calculated total bio-based content. All the atom connectivity methods produce a value for total bio-based content that approaches, if not equals 100% to match the bio-based carbon content of the article (Table 4-40).

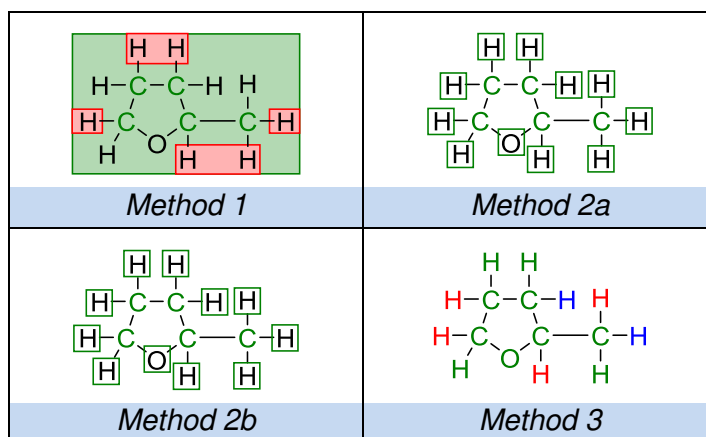
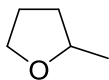


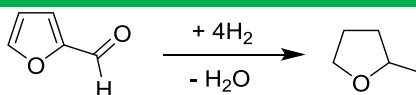
Figure 4-39 Atom allocation assignments for furfural reduced to 2-methyltetrahydrofuran.



Table 4-40 Allocation of bio-based content for 2-methyltetrahydrofuran made from furfural.

2-MeTHF	Origin	Method			
		1	2a	2b	3
	Fossil	7%			5%
	Plant	93%	100%	100%	93%
	Water				2%
	Air				
	Mineral				
	'Bio-based'	93%	100%	100%	95%
¹⁴C analysis	100%				

Synthesis



Sugars are dehydrated with strong acid to furfural and then hydrogenated with syngas hydrogen.

4.5.6 N-Methylpyrrolidinone

The element nitrogen has not featured prominently up to this point. It was in the inorganic molecule ammonia and in the polyurethane case study. However N-methylpyrrolidinone (NMP) represents the first case study in which a nitrogen atom is bound to both bio-based carbon atoms and fossil derived carbon atoms. This has implications for atom connectivity method 2a (Figure 4-40). The nitrogen atom of bio-based NMP originates in an amino acid feedstock [Lammens 2010], but following the rules of atom connectivity Method 2a the nitrogen atom must be assigned as 2 parts bio-based, one part fossil derived.



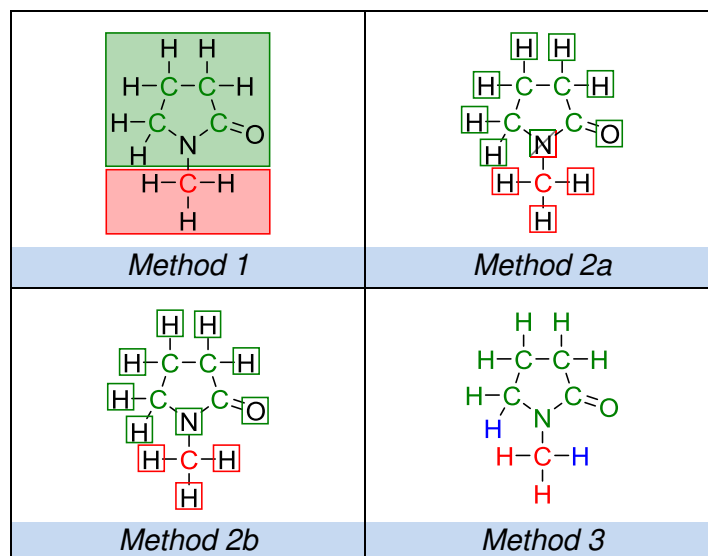


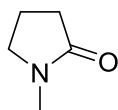
Figure 4-40 Atom allocation assignments for *N*-methylpyrrolidinone made from glutamic acid.

The analytical bio-based carbon content of NMP should be 80% when made from glutamic acid and methanol. This figure is matched with atom connectivity Method 2a but every atom connectivity method is a good approximation of this value (Table 4-41). The presence of water derived hydrogen atoms, introduced during the decarboxylation and synthesis of methanol is recognised in atom connectivity Method 3.

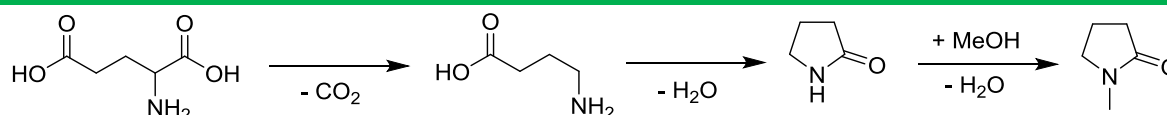


Table 4-41 Allocation of bio-based content for *N*-methylpyrrolidinone made from glutamic acid.

<i>N</i> -Methylpyrrolidinone	Origin	Method			
		1	2a	2b	3
	Fossil	15%	20%	15%	14%
	Plant	85%	80%	85%	84%
	Water				2%
	Air				
	Mineral				
	'Bio-based'	85%	80%	85%	86%
	¹⁴C analysis	80%			



Synthesis



The amino acid glutamic acid is decarboxylated enzymatically, cyclised and methylated.

4.5.7 Dimethyl isosorbide

Isosorbide is made by the hydrogenation of glucose, followed by its own intramolecular bicyclisation and further dehydration [Roquette 2010]. It is alkylated by an activated equivalent of methanol; dimethyl sulphide is one popular option. This means the four bio-based oxygen atoms of isosorbide are all retained from the precursor sugar (Figure 4-41). The mechanism and choice of methylation conditions needed, changing the origin of the atoms within dimethyl isosorbide, are not obvious. However the purpose of this work is not the analysis of a 'black box' system but an analysis of the production chain. Only radiocarbon analysis is able to deduce a value of bio-based (carbon) content from the article without further information about the product.



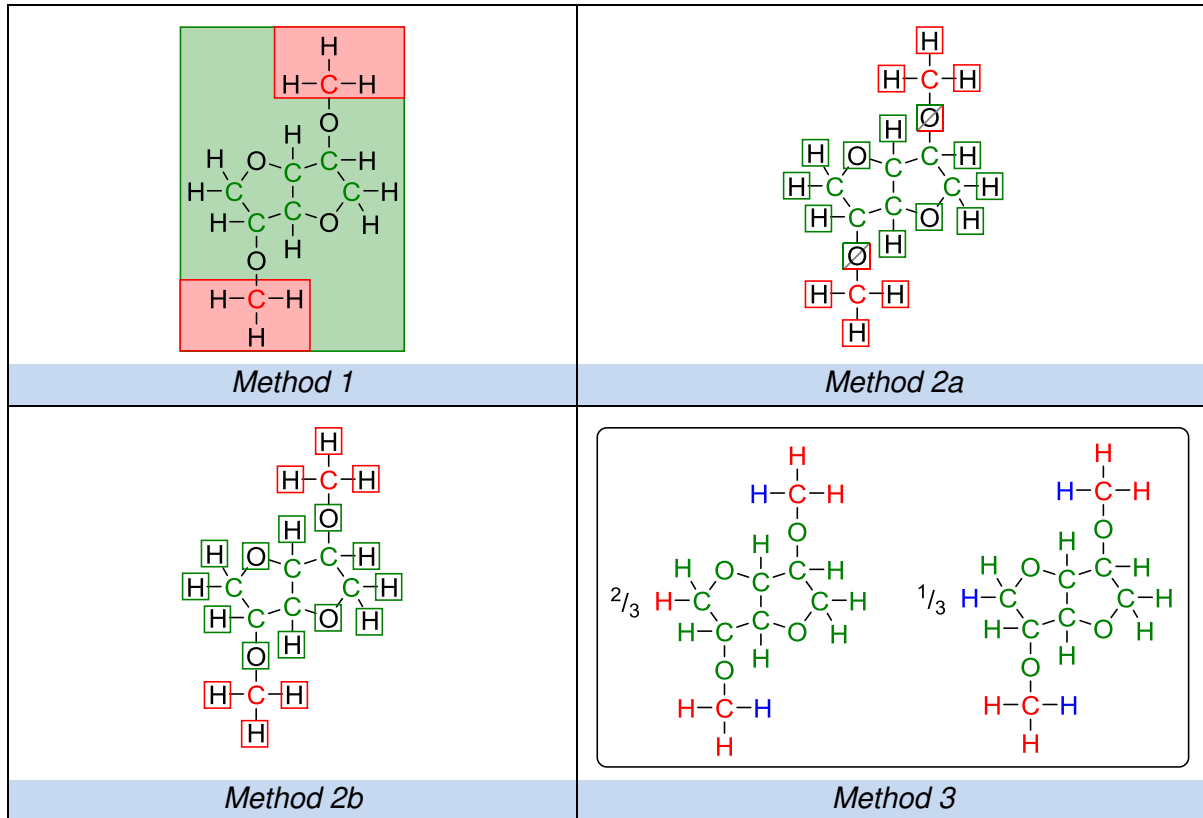


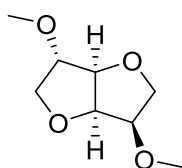
Figure 4-41 Atom allocation assignments for dimethyl isosorbide.

Atom connectivity methods tend to result in relatively high values for total bio-based content. With a bio-based carbon content of 75%, atom connectivity Method 2a most closely matches this value (Table 4-42). The more involved approaches, atom connectivity Method 2b and Method 3, produce a higher value of 83%, as does atom connectivity Method 1.

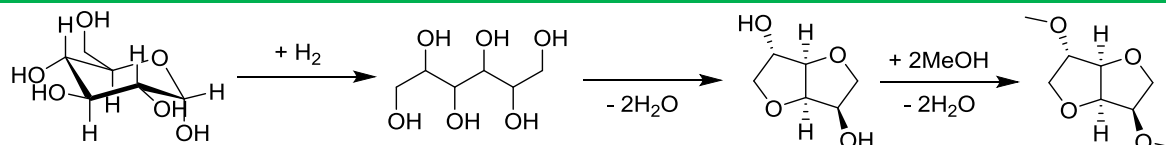


Table 4-42 Allocation of bio-based content for dimethyl isosorbide made from sorbitol.

Dimethyl isosorbide	Origin	Method			
		1	2a	2b	3
	Fossil	17%	26%	17%	17%
	Plant	83%	74%	83%	82%
	Water				1%
	Air				
	Mineral				
	'Bio-based'	83%	74%	83%	83%
	¹⁴C analysis	75%			



Synthesis



Glucose is hydrogenated to sorbitol. Cyclisation yields the isosorbide. Methylation cannot be achieved with methanol directly by displacing the alcohol groups but instead dimethyl sulphate or another alkylating agent is used.



4.6 Examples of bio-based content calculations for surfactants based on atom connectivity

Unlike the previous product classes, the diversity of elements and ions within surfactants has produced a range of conflicting results. None of the four different variations on atom connectivity are able to consistently describe a reasonable value of bio-based content for surfactants. Quite often the total bio-based content is far below what would be the expected amount from the bio-based carbon content (Figure 4-42). However atom connectivity Method 3 still tends to offer much inflated values compared to other approaches. The results of the ACDV methodology are also included because, applicable to surfactants more than any other product class, the automatic designation of atoms other than carbon, hydrogen, oxygen and nitrogen as bio-based has notable implications. With sulphur atoms typically fossil derived (not bio-based), many surfactants may have non-representative claims of bio-based content attributed to them. Counter ions of sodium or chlorine are obtained from minerals and so an assessment only permitting of bio-based or fossil derived content is limited. However the ACDV atom connectivity approach produces the least discrepancy in a comparison to direct bio-based carbon analysis than any other atom connectivity method. Specific details for each product follow.



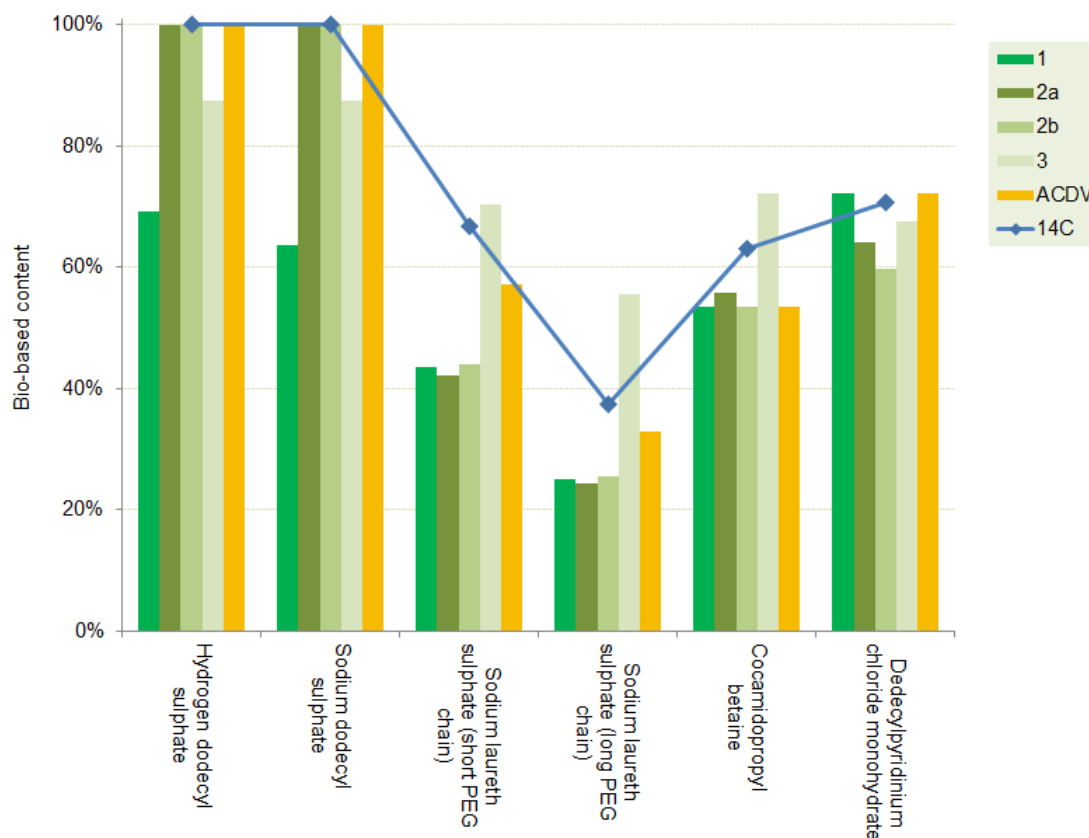


Figure 4-42 A summary of bio-based content atom connectivity method results for bio-based surfactants.

4.6.1 Hydrogen dodecyl sulphate and the sodium salt

Anionic surfactants are common ingredients in a variety of formulations. They tend to be based on a dodecyl (lauryl) hydrophobic moiety. The precursor to sodium dodecyl sulphate is hydrogen dodecyl sulphate. It is of interest to scrutinise both molecules and observe the effect on indirect bio-based content calculations when the sodium cation is introduced. As a functionalised fatty alcohol from vegetable oil, hydrogen dodecyl sulphate is predominately bio-based (Figure 4-43). Treating the ingredients as lauric acid (formed from the hydrolysis of coconut oil), hydrogen (to reduce the fatty acid), and sulphur trioxide, atom connectivity Method 1 differs from atom connectivity Method 2b. The latter assumes the entire molecule is bio-based because all of its carbon atoms are plant based. Applying the rules of atom connectivity Method 3, the sulphur trioxide is recognised as the product of sulphur obtained as hydrogen sulphide found in natural gas reserves and oxidised by atmospheric oxygen. The total bio-based content can be calculated as anywhere between 69% and 100% (Table 4-43). Atom connectivity Method 2a and Method 2b equal the 100% bio-based carbon content.



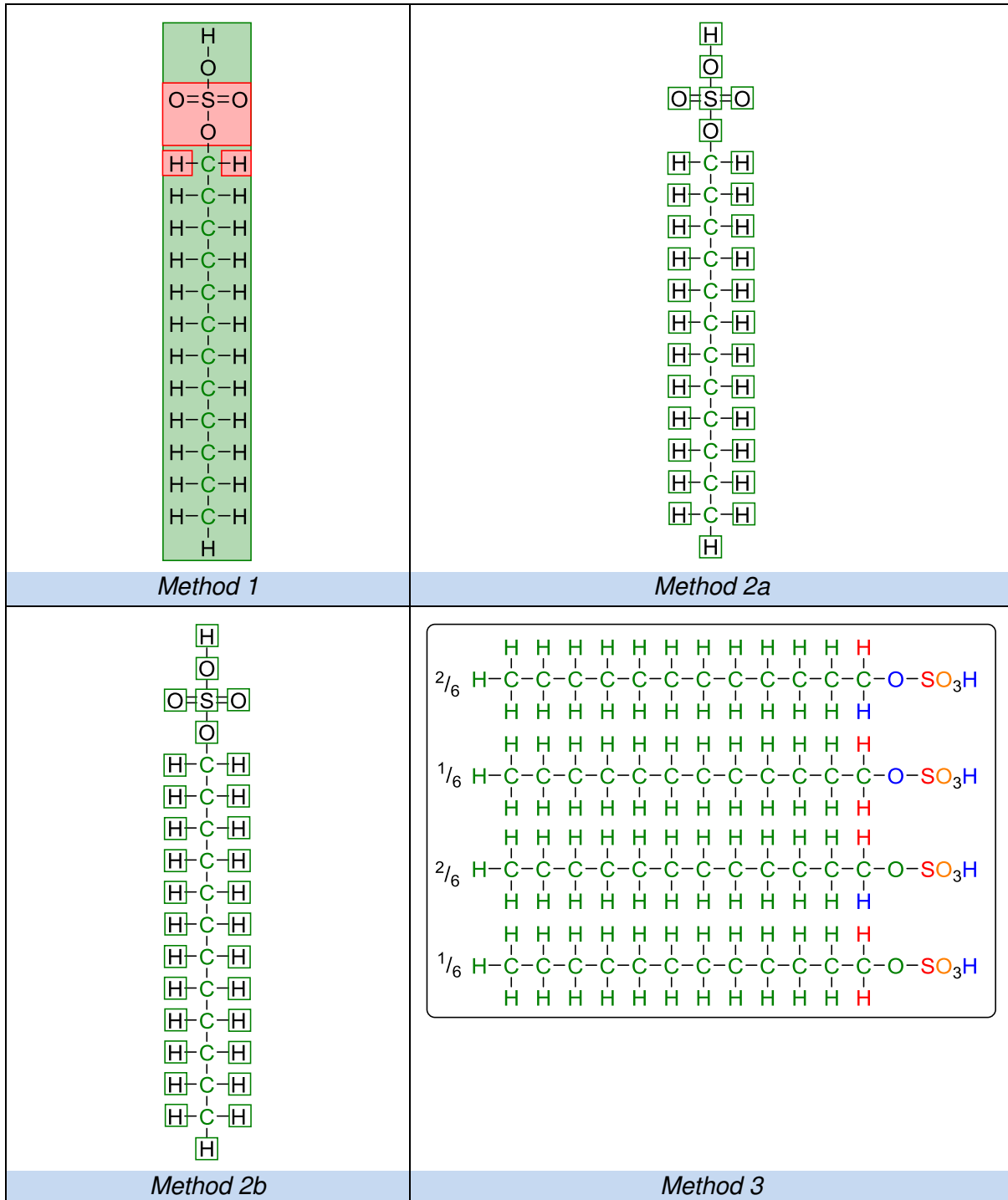
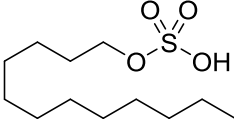


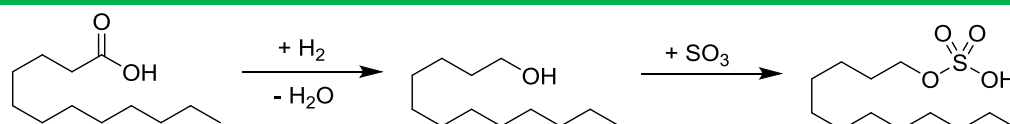
Figure 4-43 Atom allocation assignments for bio-based hydrogen dodecyl sulphate.



Table 4-43 Allocation of bio-based content for hydrogen dodecyl sulphate made from vegetable oil.

Hydrogen dodecyl sulphate	Origin	Method			
		1	2a	2b	3
	Fossil	31%			13%
	Plant	69%	100%	100%	66%
	Water				4%
	Air				18%
	Mineral				
	'Bio-based'	69%	100%	100%	88%
¹⁴C analysis	100%				

Synthesis



Made from lauric acid rather than the conventional petroleum 1-dodecanol synthesis.

By reacting hydrogen dodecyl sulphate with sodium hydroxide, the neutralisation process produces a broad utility surfactant in sodium dodecyl sulphate. Although the hydrophobic portion of the molecule can be made cheaply from ethylene using Ziegler–Natta type catalysts [Weissermel 1993], the use of the fatty acids contained within vegetable oils is a promising source of surfactants [Foley 2012]. The introduction of the sodium cation has no effect on the result of atom connectivity calculations by atom connectivity Method 2a and Method 2b (Figure 4-44). The ions will be treated as if they were covalently bonded for the purpose of atom connectivity. This imagined covalent bond is between the sodium cation and any of the three equivalent oxygen atoms that can be thought of as sharing the single negative charge. Because the terminal oxygen atoms are equivalent this does not influence atom connectivity calculations.



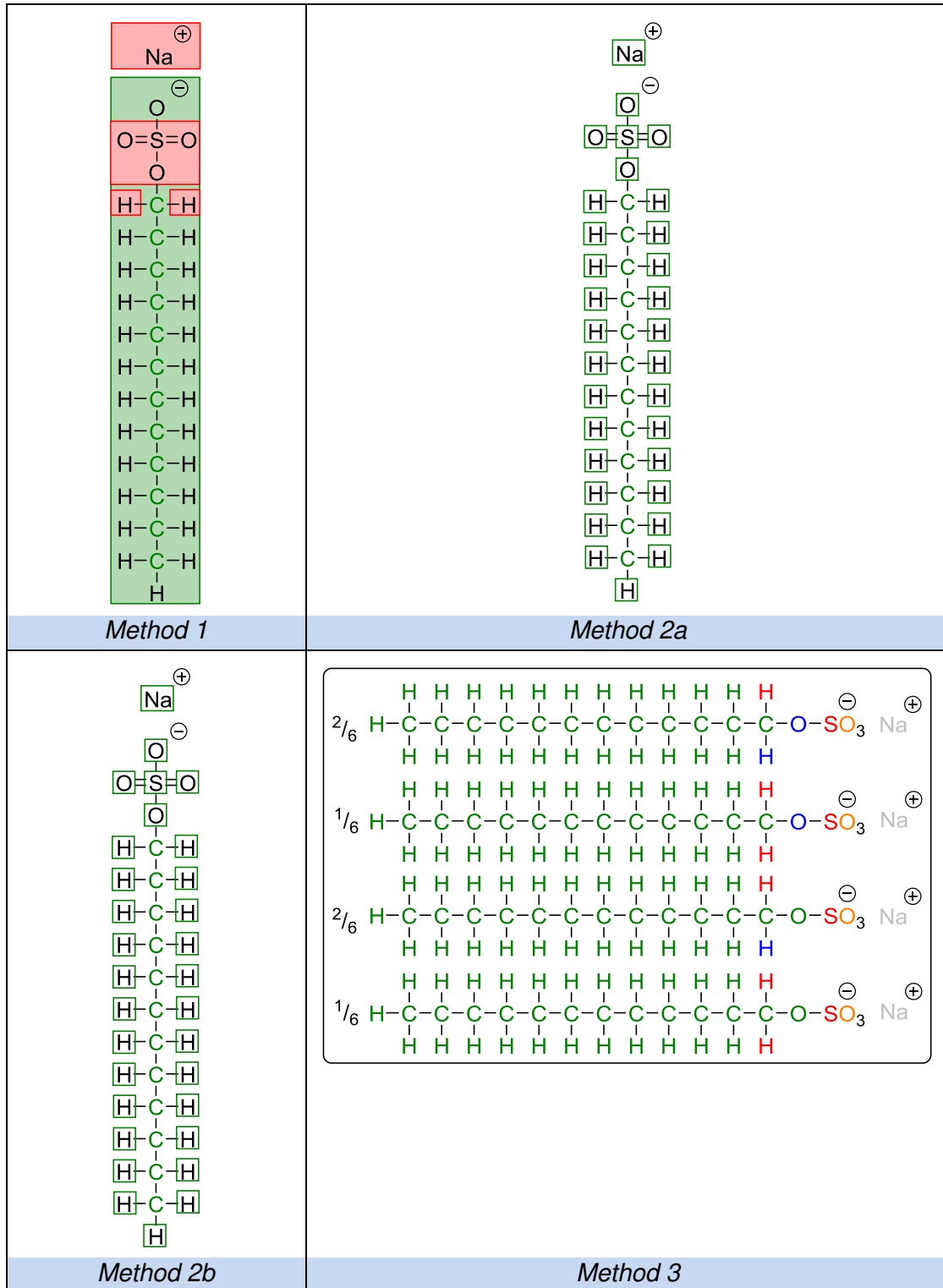
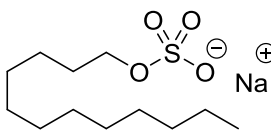


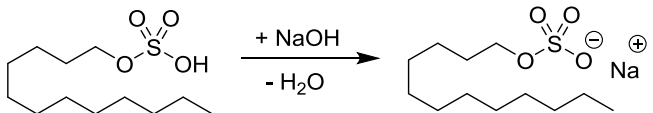
Figure 4-44 Atom allocation assignments for sodium dodecyl sulphate made from vegetable oil.



The sodium is regarded as fossil derived in atom connectivity Method 1, reducing the total bio-based content from 69% for hydrogen dodecyl sulphate to 64% (Table 4-44). Other atom connectivity methods are not strongly impacted. The ACDV certification scheme rules of atom connectivity state atoms other than carbon, hydrogen, oxygen and nitrogen are bio-based. However because all the carbon atoms in this example of sodium dodecyl sulphate are bio-based, the whole molecule will be regarded as 100% bio-based when following the rules of either atom connectivity Method 2b or the original ACDV atom connectivity approach (in the latter sulphur and sodium are automatically allocated as bio-based). Therefore, in this instance at least, the presence of sulphur and sodium does not introduce any variability into the result obtained. Note that the total bio-based content as calculated with atom connectivity Method 3 does not incorporate the mass of inorganic mineral elements (sodium in this instance).

Table 4-44 Allocation of bio-based content for sodium dodecyl sulphate made from vegetable oil.

Sodium dodecyl sulphate	Origin	Method			
		1	2a	2b	3
	Fossil	36%			12%
	Plant	64%	100%	100%	61%
	Water				3%
	Air				17%
	Mineral				8%
	'Bio-based'	64%	100%	100%	87%
	¹⁴C analysis	100%			

Synthesis	
	
<i>Salt formation from intermediate to give surfactant.</i>	

4.6.2 Sodium laureth sulphate

Related to sodium dodecyl sulphate, sodium laureth sulphate possesses an additional polyether segment within its molecular structure based on poly(ethylene glycol). If the polyether portion of the molecule is derived from petrochemical ethylene, and the hydrophobic region is made from a vegetable oil resource, then the resulting surfactant will be partially



bio-based. The extent of the bio-based content of sodium laureth sulphate depends on the length of the poly(ethylene glycol) moiety (Figure 4-45).



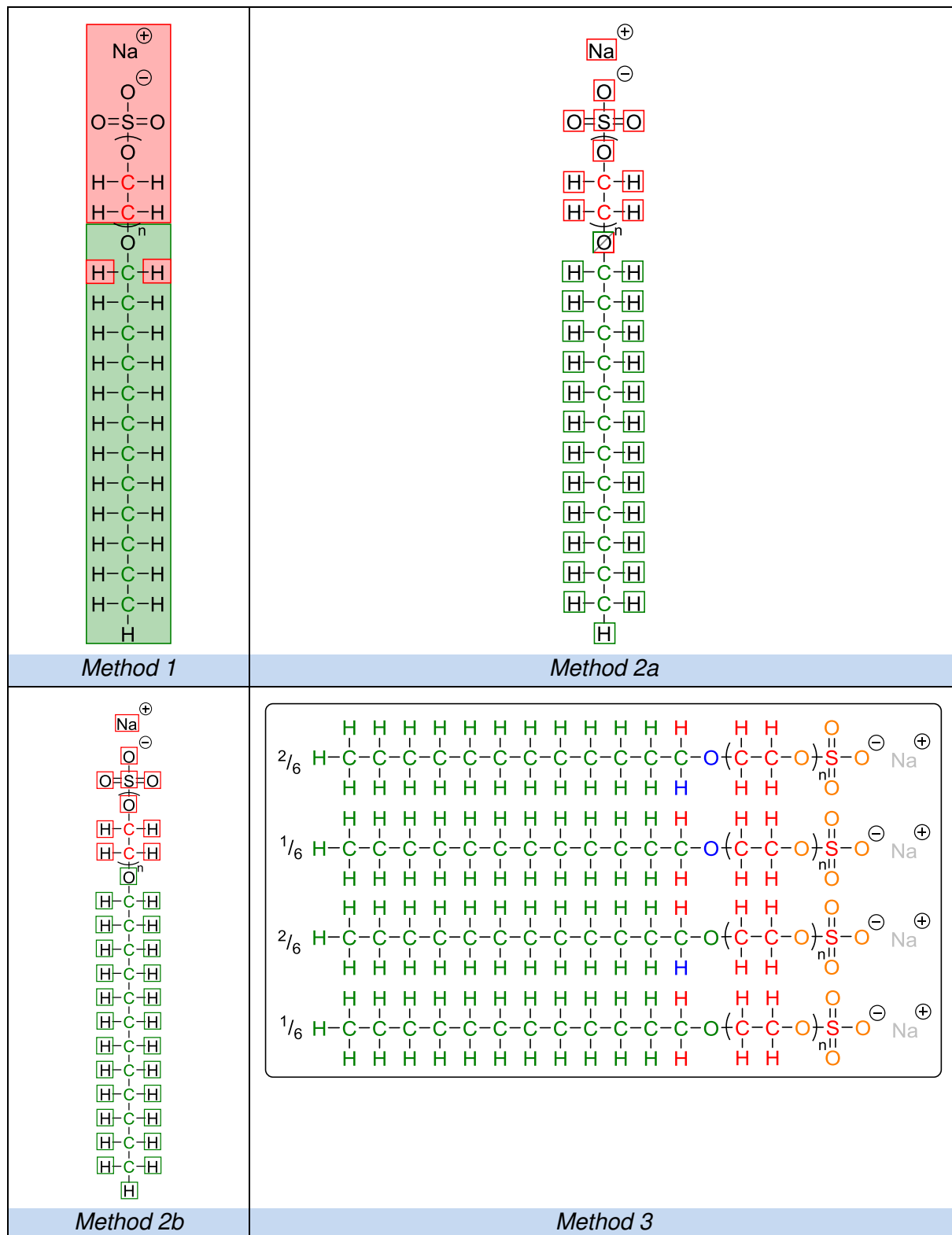
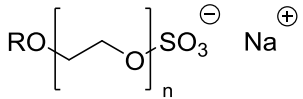


Figure 4-45 Atom allocation assignments for sodium laureth sulphate.

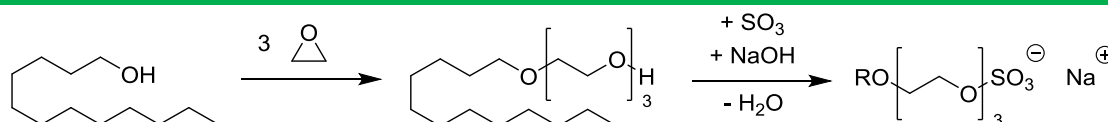


Two possible versions of this chemical are presented here. The first contains an ethylene glycol trimer. Atom connectivity Method 3 provides the best match between total bio-based content and the bio-based carbon content of 67% (Table 4-45). As an inorganic atom, the mass contribution of sodium is excluded according to the rules of this particular calculation, resulting in a value of 70% total bio-based content. The poly(ethylene glycol) portion of the molecule separates the bio-based alkyl chain from the anionic sulphate group. Consequently the polar head group is now considered as fossil derived using atom connectivity Method 2a and Method 2b (Figure 4-45), whereas for sodium dodecyl sulphate it is associated with the accompanying bio-based content (Figure 4-44). Accordingly the calculated total bio-based content can be as low as 42%. In this case study more than others the conclusions of atom connectivity are shown to be fickle. Insertion of the PEG oligomer has changed how other atoms are regarded (in terms of their origin).

Table 4-45 Allocation of bio-based content for sodium laureth sulphate (with a short PEG chain) made from vegetable oil.

Sodium laureth sulphate	Origin	Method			
		1	2a	2b	3
<i>PEG chain n = 3</i>					
	Fossil	56%	58%	56%	28%
	Plant	44%	42%	44%	42%
	Water				2%
	Air				23%
	Mineral				5%
	'Bio-based'	44%	42%	44%	70%
¹⁴C analysis	67%				

Synthesis



An additional epoxide ring opening step is introduced into the sodium dodecyl sulphate synthesis to give the laureth sulphate sodium salt. The ether chain length can be tuned.

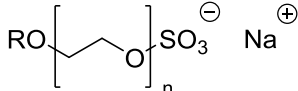
Atom connectivity Method 1 has assumed the ingredients are lauric acid, hydrogen gas, ethylene oxide, and sodium hydroxide. There is a slight difference between atom connectivity Method 1 and atom connectivity Method 2b with respect to the assignment of hydrogen atoms as either fossil derived or bio-based, but due to the high molecular weight of the molecule this is not apparent at the reported level of accuracy (Table 4-45). Under the



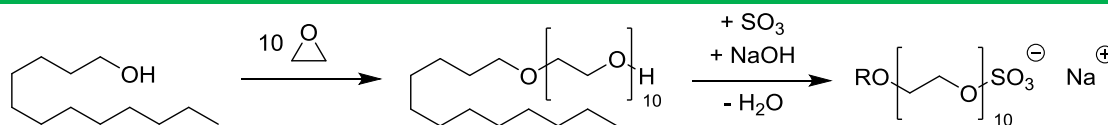
rules of ACDV bio-based certification, total bio-based content is calculated at 57% due to the assignment of sulphur and sodium as bio-based.

Increasing the poly(ethylene glycol) chain length to ten monomer units, the bio-based carbon content reduces to 38%. Aside from the ACDV interpretation (33% bio-based), atom connectivity is unable to generate a total bio-based content that can reasonably approximate this value. The oxygenated fossil derived portion of the molecule accounts for about three quarters of the molecule by mass which is reflected in the atom connectivity calculations (Table 4-46).

Table 4-46 Allocation of bio-based content for sodium laureth sulphate (with a long PEG chain) made from vegetable oil.

Sodium laureth sulphate <i>PEG chain n = 10</i>	Origin	Method			
		1	2a	2b	3
	Fossil	75%	76%	75%	43%
	Plant	25%	24%	25%	24%
	Water				1%
	Air				29%
	Mineral				3%
	'Bio-based'	25%	24%	25%	56%
¹⁴C analysis	38%				

Synthesis



An additional epoxide ring opening step is introduced into the sodium dodecyl sulphate synthesis to give the laureth sulphate sodium salt. The ether chain length can be tuned.

It is possible, depending on the added value resulting from bio-based content certification (as perceived by suppliers and procurers), that feedstock inputs into the production of sodium laureth sulphate might be tuned depending on the final product produced at a given time. A short chain polyether version is best made from vegetable oil to maximise bio-based content, if not made wholly bio-based. Conversely when the polyether segment is long the ethylene required to make poly(ethylene glycol) derivatives is more valuable than vegetable oil in terms of maximising the bio-based content imparted. With respect to bio-based carbon content the crossover point is reached with a six unit polyether chain (meaning both the lauryl alkyl chain and the PEG segment contain twelve carbons each). For total bio-based con-



tent the crossover point is lower, with near equivalence achieved when four ethoxy monomer units are present (Figure 4-46). Factors such as feedstock price will also influence the choice of feedstock and dictate the resulting bio-based content. In instances where limits are established to define a minimum permissible total bio-based content (e.g. for labelling criteria), the upstream implications on feedstock selection and product composition should be considered. Manufacturers may be encouraged to incorporate shorter polyether chains into their vegetable oil derived surfactants to improve bio-based content even if this negatively impacts the functionality. Ecolabels introducing performance criteria should prevent this. Sodium dodecyl sulphate may be used within formulations in greater quantities in order to substitute the proportionally less bio-based sodium laureth sulphate (on a mass basis). If an emphasis on total bio-based content incentivises a change in bio-based feedstock choices (e.g. from the fatty acids in vegetable oils to ethylene made from bio-ethanol) there may be a 'knock on' effect in other interlinked sectors.

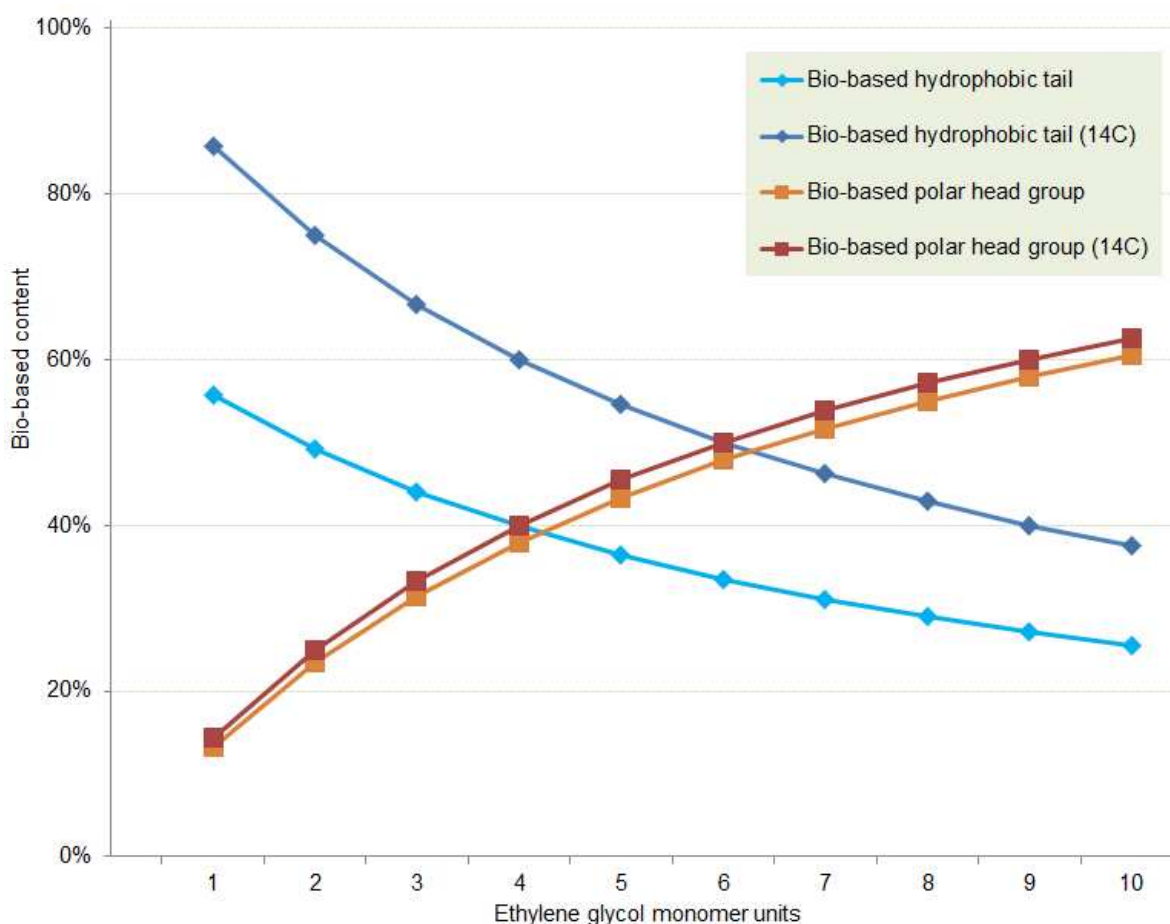


Figure 4-46 The calculated total bio-based content and anticipated bio-based carbon content of sodium laureth sulphate according to atom connectivity Method 2b made from either vegetable oil fatty acids or bio-based ethylene.



Thinking beyond this hypothetical case study, it should be appreciated that in reality the composition of the surfactant is uncertain. The hydrophilic section is usually one to three monomers in size and the surfactant is supplied as an aqueous solution. The manufacturer should know the feedstock quantities used and so mass balance might be a more appropriate approach. For a formulator surfactants are usually incorporated as part of a complex mixture which will make applying atom connectivity difficult.

4.6.3 Cocamidopropyl betaine

A common zwitterionic surfactant is cocamidopropyl betaine. As evidenced in its name, the molecule consists of a lauric acid derived portion and a betaine polar head group. Because of the quaternary ammonium moiety and as a zwitterion it is a single molecule, there are no complications with assigning bonds between charged ions. The fatty acid derived hydrophobic region is the bio-derived portion of the molecule (Figure 4-47).

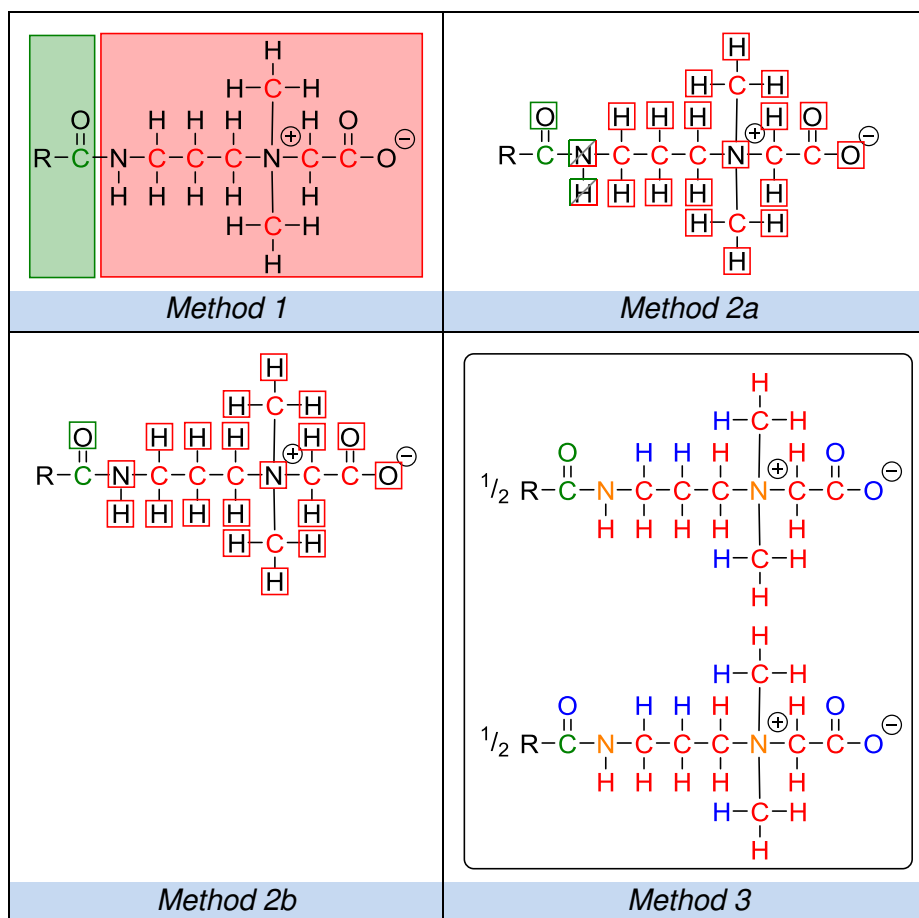
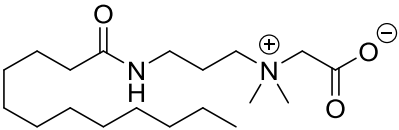


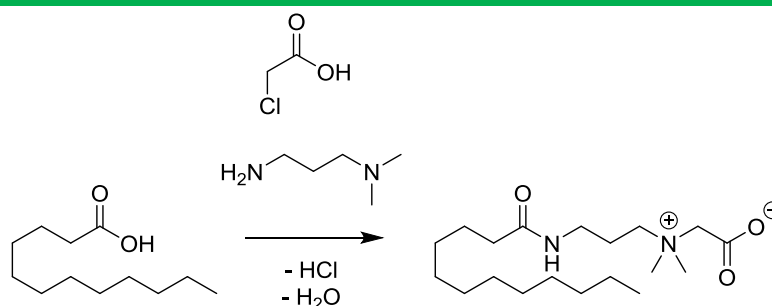
Figure 4-47 Atom allocation assignments for cocamidopropyl betaine.



As was the case with sodium laureth sulphate, atom connectivity Method 3 awards a significantly greater total bio-based content than the bio-based carbon content, while the remaining atom connectivity approaches underestimate bio-based content if equivalence with bio-based carbon is considered the target (Table 4-47). The plant based content is considered fairly constant across the atom connectivity methods. Atom connectivity Method 3 claims the heteroatoms from the fossil derived portion of the molecule and allocates them as bio-based in origin. This is also the cause of the much larger bio-based content value obtained with atom connectivity Method 3 in the sodium laureth sulphate case study, and is regularly observed when a lipophilic bio-based portion of a molecule is supplemented with an oxidised petrochemical moiety.

Table 4-47 Allocation of bio-based content for cocamidopropyl betaine made from vegetable oil.

Cocamidopropyl betaine	Origin	Method			
		1	2a	2b	3
	Fossil	46%	44%	46%	28%
	Plant	54%	56%	54%	51%
	Water				13%
	Air				8%
	Mineral				
	'Bio-based'		54%	56%	54%
¹⁴C analysis		63%			
Synthesis					



Amidation of a fatty acid (or ester derivative) is followed by functionalisation to give a betaine moiety and hence an amphoteric surfactant.

4.6.4 N-Dodecylpyridinium chloride

Cationic surfactants are typically ammonium salts. Alkylated pyridine is produced in the reaction between fossil derived pyridine and haloalkanes. The halide acts as the counter-



ion in the product. Pyridine is found in certain crude oil fractions, so unusually, the nitrogen atom of pyridine is fossil derived [Weissermel 1993]. Analogues of pyridine are typically synthesised and so the nitrogen atom would then inevitably come from ammonia. Applying atom connectivity Method 2a, the nitrogen atom, being tetravalent, is allocated as one part bio-based, three parts fossil derived (Figure 4-48). Although there is only two fossil derived carbon atoms bonded to nitrogen one is regarded as being connected with a double bond (in reality aromaticity resonance makes the situation less transparent).

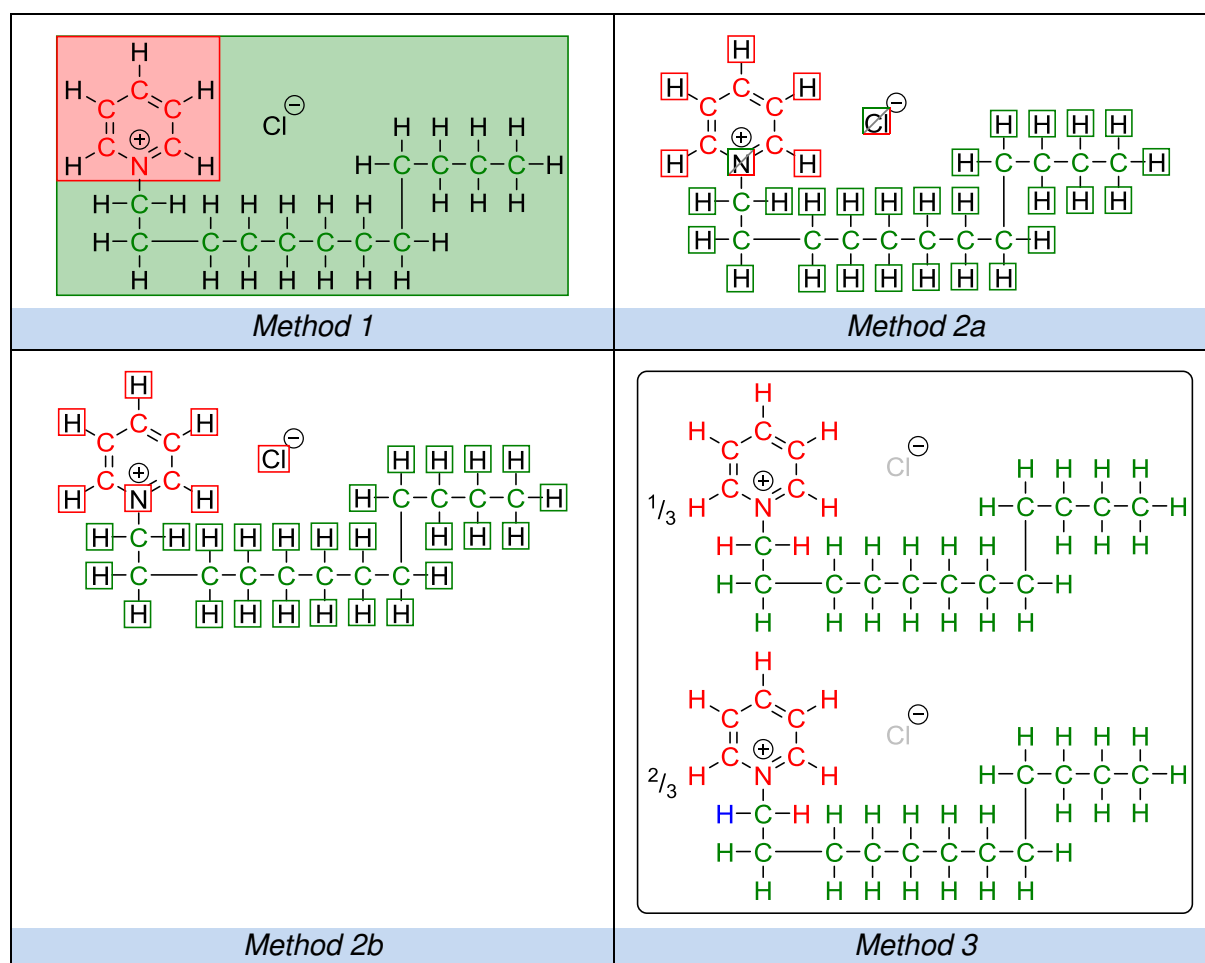


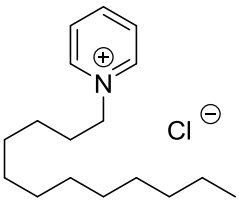
Figure 4-48 Atom allocation assignments for *N*-dodecylpyridinium chloride.

With an anticipated analytical bio-based carbon content of 71%, atom connectivity Method 1 and Method 3 are able to deliver similar calculated values of total bio-based content (Table 4-48). In atom connectivity Method 2a and Method 2b, the chlorine atom is assigned a fossil origin (three quarters fossil derived by atom connectivity Method 2a). Atom connectivity to chlorine is decided by assuming a covalent bond between the charge bearing elements. The origin of the nitrogen atom thus dictates the attributed origin of the chloride anion, in turn transposed from the neighbouring carbon atoms. By taking 1-chlorododecane

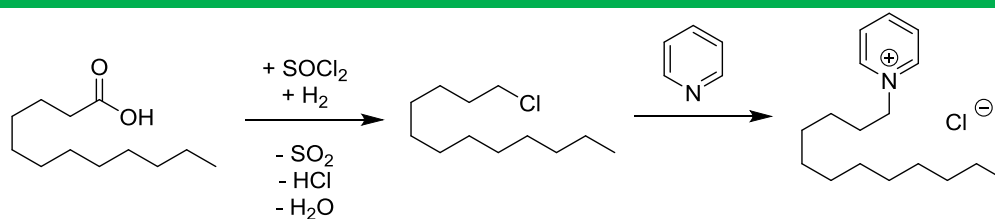


as one of the ingredients, along with pyridine, atom connectivity Method 1 considers the chloride anion of *N*-dodecylpyridinium chloride as bio-based and maximises the total bio-based content that can be calculated. The consensus on what constitutes an ingredient is loosely defined and will affect the results. Alternatively, and more correctly, by taking the ingredients to be lauric acid, an inorganic chlorinating agent (*e.g.* thionyl chloride), hydrogen gas, and pyridine, the total bio-based content decreases to 59% and thus more similar to atom connectivity Method 2a and Method 2b, but away from the anticipated value of bio-based carbon content.

Table 4-48 Allocation of bio-based content for *N*-dodecylpyridinium chloride made from vegetable oil.

<i>N</i> -Dodecylpyridinium chloride	Origin	Method			
		1	2a	2b	3
	Fossil	28%	36%	40%	28%
	Plant	72%	64%	60%	59%
	Water				0.2%
	Air				
	Mineral				13%
	'Bio-based'	72%	64%	60%	68%
¹⁴C analysis	71%				

Synthesis



A fatty acid can be converted into an acyl chloride by a number of chlorinating reagents and then reduced to a chloroalkane. Nucleophilic alkylation of pyridine gives a cationic surfactant.

Following the ACDV rules of atom connectivity, the chlorine is considered as bio-based, as it can be with atom connectivity Method 1. The resulting bio-based content is the same as that of atom connectivity Method 1 at 72% (Figure 4-48). Thus across the different surfactant case studies the ACDV method has produced the greatest similarity to direct bio-based carbon content. Throughout it has been assumed that this is beneficial, although mass balance approaches have yet to be examined and consistent similarity between the indirect methodologies may in fact be better so that they might be interchanged more easily. Regard-



less of the exact approach adopted, it should be broadly applicable (in a horizontal manner) and different atom connectivity methods should not be used for each product type in order to preserve the ability to make fair comparisons between products and harmonise the system.



4.7 Examples of bio-based content calculations for fine chemicals based on atom connectivity

In terms of chemicals high value end products are often components of essential oils, or derivatives of natural extracts. Because of this, there is a market for cheaper synthetic versions of these chemical products, and the opportunity for the fraudulent sale of petrochemical products in place of natural products. Both aspirin and vanillin are associated with natural products but are mass produced from petrochemical resources. Certification of total bio-based content would assist natural products in the marketplace.

Atom connectivity of these often structurally complex molecules has produced variable results depending on the approach taken (Figure 4-49). Not one of the atom connectivity methods applied in this work consistently calculates a total bio-based content comparable to the bio-based carbon content. The ACDV consensus (also atom connectivity Method 2b) is able to provide reasonable results, except perhaps that the total bio-based content of aspirin is calculated at 25% whereas the bio-based carbon content is only 11%. With 25% bio-based carbon being set as a minimum threshold for various product types (e.g. [CEN/TS 1613](#), [CEN/TR 16227](#)), if the same is applied to total bio-based content then in the case of aspirin this becomes significant. Depending on the approach to bio-based content that is taken, the award of certification may be made easier and not represent the true plant derived material of the article. Atom connectivity Method 1 and Method 3 often provided outlying results compared to the average found for other approaches.



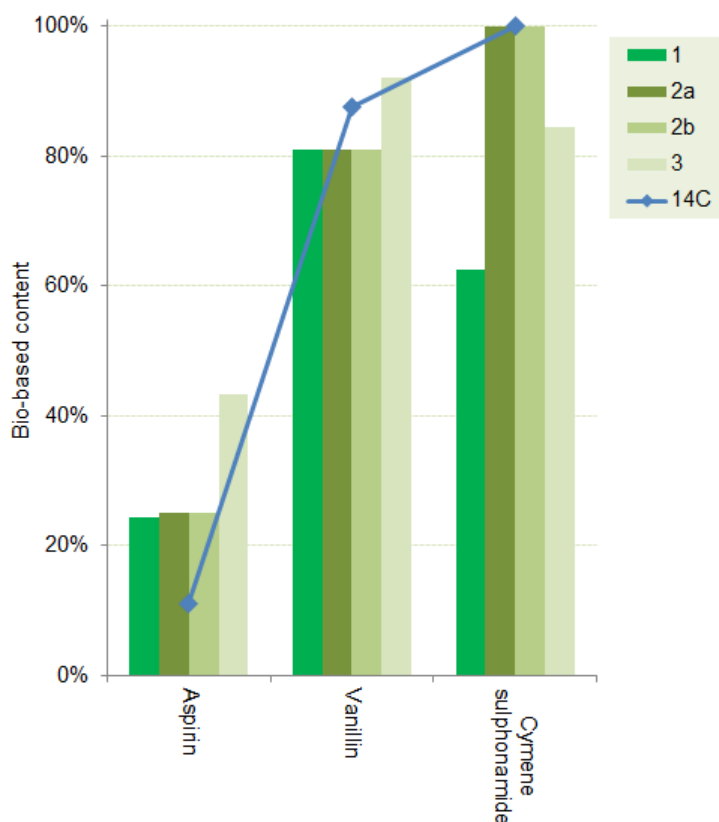


Figure 4-49 A summary of bio-based content atom connectivity method results for fine chemicals from renewable resources.

4.7.1 Aspirin

Aspirin is the acetyl ester of salicylic acid, the latter a natural product found in willow bark with medicinal properties. Even though the association of aspirin with natural salicylic acid persists, the huge scale of aspirin mass production relies on the petrochemical feedstock phenol to satisfy the global demand for inexpensive medicines. The carboxylation of phenol followed by acetylation results in a single bio-based carbon atom assuming bio-based carbon dioxide is used (11% bio-based carbon). Atom connectivity is straightforward, with the carboxylation of phenol with bio-based carbon dioxide producing the salt of salicylic acid, which is then acidified with sulphuric acid to introduce a water derived hydrogen atom on the carboxylic acid group as recorded in atom connectivity Method 3 (Figure 4-50). Esterification does not introduce further plant derived content when salicylic acid is converted to aspirin with acetic anhydride.



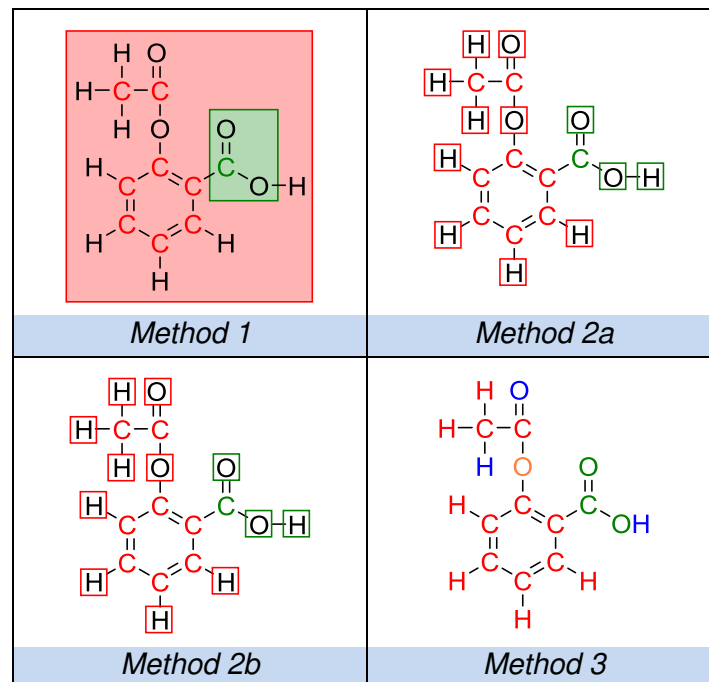
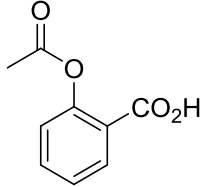


Figure 4-50 Atom allocation assignments for aspirin.

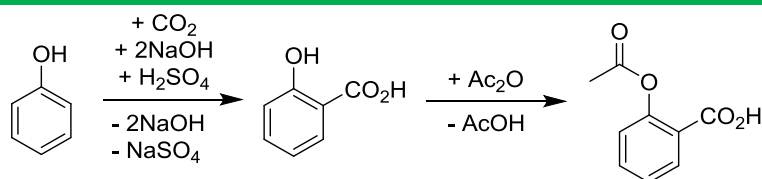
The low bio-based carbon content is accounted for by the carboxylic acid group. As a highly oxidised carbon atom within a molecule in an otherwise relatively low oxidation state, the total bio-based content can be calculated as rather quite high, at least double the bio-based carbon content (Table 4-49). Atom connectivity Method 3 produces a result of 43% total bio-based content, almost four times higher than the bio-based carbon content would be. Thus carboxylation with bio-derived carbon dioxide (plentiful and available as a by-product of the fermentation industries) has the potential to skew total bio-based content calculations beyond anticipated results. This is not to say the result is wrong, but perhaps not intuitive based on the synthesis.



Table 4-49 Allocation of bio-based content for aspirin made from benzene.

Aspirin	Origin	Method			
		1	2a	2b	3
	Fossil	76%	75%	75%	57%
	Plant	24%	25%	25%	24%
	Water				10%
	Air				9%
	Mineral				
	'Bio-based'	25%	25%	25%	43%
¹⁴C analysis	11%				

Synthesis



Phenol is carboxylated and esterified.

4.7.2 Vanillin

Similar to aspirin, vanillin is regarded as a natural compound, but to meet demand synthetic vanillin is often made from petrochemical phenol. The intermediate of this process, guaiacol, is present as a major component in some essential oils and so this can serve as a bio-based feedstock for the production of bio-based, if not natural vanillin. Here the synthesis from bio-based guaiacol is assumed, and the additional aldehyde functionality introduced *via* glyoxylic acid [Fatiadi 1974]. Accordingly a carbon atom, a hydrogen atom, and an oxygen atom are added to the bio-based feedstock molecule with the loss of a hydrogen atom from the guaiacol (Figure 4-51). Atom connectivity produces results for bio-based content that are generally consistent with each other, except for the allocation of a hydrogen atom and an oxygen atom as originating from water (instead of fossil derived) in atom connectivity Method 3 (Table 4-50).



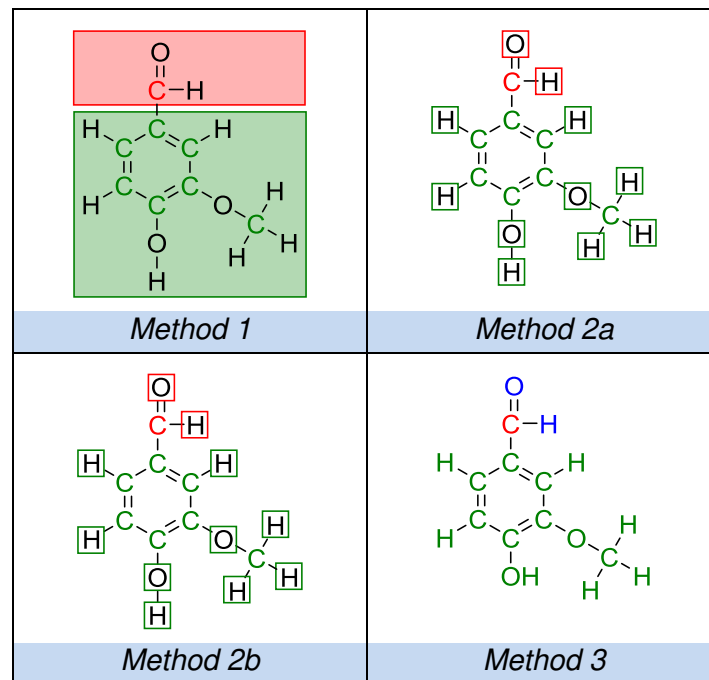
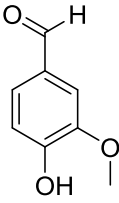


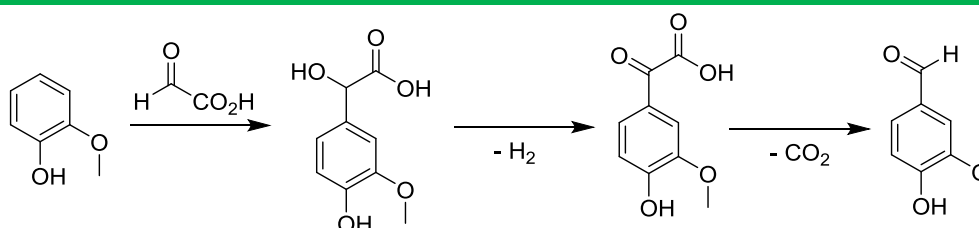
Figure 4-51 Atom allocation assignments for synthetic vanillin.



Table 4-50 Allocation of bio-based content for vanillin made from guaiacol.

Vanillin	Origin	Method			
		1	2a	2b	3
	Fossil	19%	19%	19%	8%
	Plant	81%	81%	81%	81%
	Water				11%
	Air				
	Mineral				
	'Bio-based'	81%	81%	81%	92%
¹⁴C analysis		88%			

Synthesis



Synthetic vanillin is made by the functionalisation of guaiacol to give the aldehyde. Guaiacol is commonly produced as a petrochemical, but it is also found in natural oils and is assumed to be bio-based in this exercise.

4.7.3 *p*-Cymenesulphonamide

Limonene is an important component of citrus fruit essential oils and can be transformed into a number of bio-based molecules of interest, and is useful in its own right [Clark 2012b, Clark 2013a, Clark 2013b, Paggiola 2014]. Oxidation from limonene to *p*-cymene is achievable [Martin-Luengo 2010], and permits further transformations onto terephthalic acid for (bio-based PET) [Colonna 2011], BHT and acetone (Scheme 4-4), and a range of catalysts based on *p*-cymene-2-sulphonic acid [Clark 2012a, Clark 2013c]. Reaction of *p*-cymene-2-sulphonic acid with an amine gives a sulphonamide product, as found in some medicinal products. Considering *p*-cymene, sulphur trioxide, and ammonia as the ingredients, atom connectivity Method 1 differs from atom connectivity Method 2a and Method 2b (not a common occurrence, Figure 4-59). The latter assume the article is entirely bio-based because of its 100% bio-based carbon content (Figure 4-52). The conclusion of atom connectivity Method 3 resides between the other approaches, with a calculated 84% bio-based content (Table 4-51). The atomic mass of sulphur, oxygen and nitrogen means that atom connectivity Method 1 offers a total bio-based content as low as 62% which is significantly



different to other approaches to indirect bio-based content and could be regarded as unsatisfactory given the 100% bio-based carbon content. However there is value in distinguishing between sulphur atoms coming from the hydrogen sulphide in natural gas reserves, and bio-based sulphur possibly obtained from amino acids. The ACDV approach always assumes the petrochemical sulphur is bio-based (and for *p*-cymenesulphonamide a 100% total bio-based content).

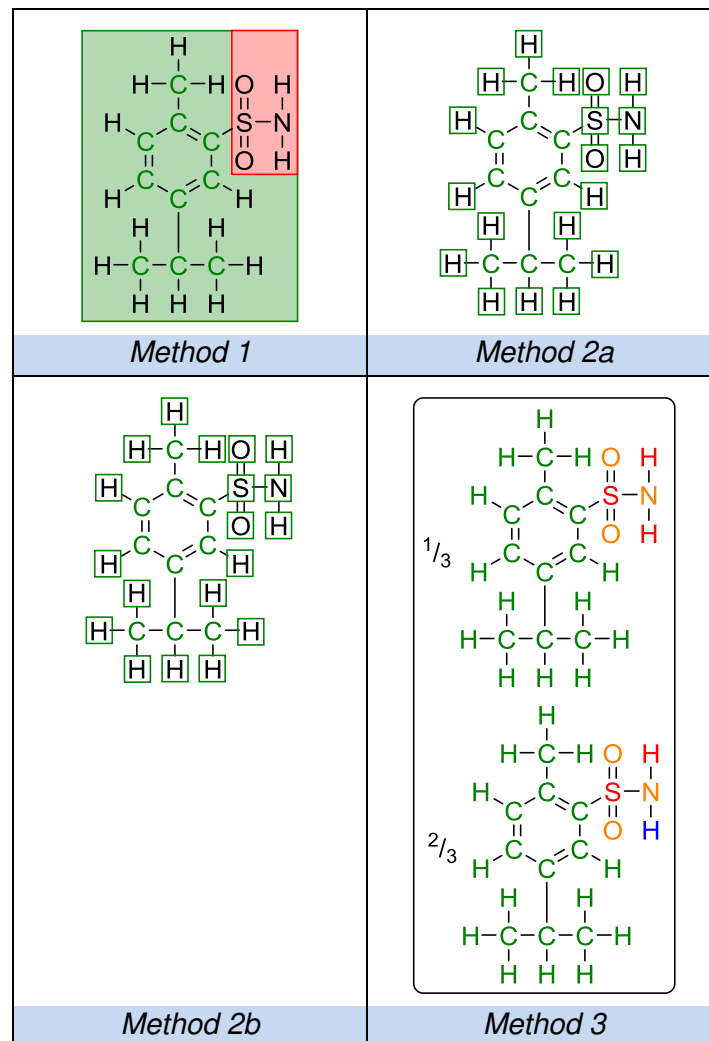
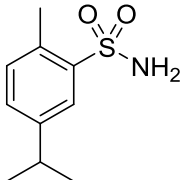
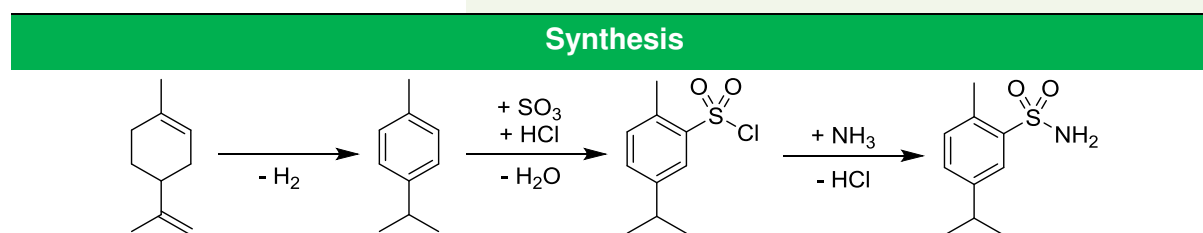


Figure 4-52 Atom allocation assignments for *p*-cymenesulphonamide.



Table 4-51 Allocation of bio-based content for *p*-cymenesulphonamide made from limonene.

<i>p</i> -Cymenesulphonamide	Origin	Method			
		1	2a	2b	3
	Fossil	38%			16%
	Plant	62%	100%	100%	62%
	Water				0.3%
	Air				22%
	Mineral				
	'Bio-based'	62%	100%	100%	84%
¹⁴C analysis	100%				



Limonene is oxidised to p-cymene, which is functionalised through a sulphonamide moiety.



4.8 Examples of bio-based content calculations for formulations and composites based on complementary elemental analysis

The application of the ACDV certification scheme to formulations is relatively simple [ACDV 2013]. Only ingredients that possess certification for their individual values of bio-based content apply. Components of a mixture without certification are assumed as without bio-based content. For applicable substances the calculation of bio-based carbon content and total bio-based content can be performed with the following equations. Bio-based carbon content can be applied analytically to the finished formulation using [CEN/TS 16640](#) or equivalent standards. The same principles can be applied to all atom connectivity approaches, where total bio-based content is found according to the mass contribution of each bio-based ingredient within the formulation.

$$B_c/100\% = \frac{\sum B_{ci} \cdot C_i \cdot x_i}{\sum C_i \cdot x_i}$$

B_c is the bio-based carbon content of the mixture.

B_{ci} is the bio-based carbon content of component 'i'.

C_i is the carbon content of component 'i'.

x_i is mass of component 'i'.

$$B/100\% = \frac{\sum B_i \cdot x_i}{\sum x_i}$$

B is the total bio-based content of the mixture.

B_i is the total bio-based content of component 'i'.

x_i is mass of component 'i'.

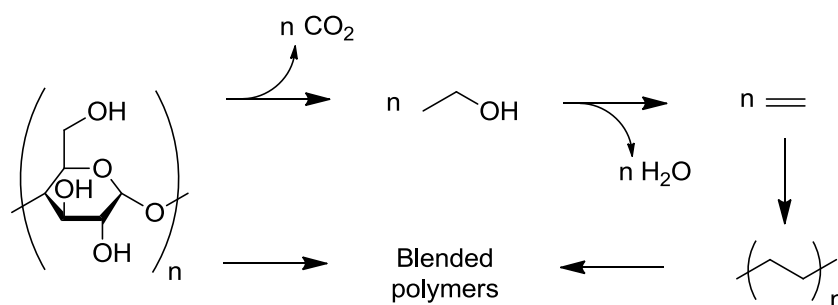
Within the draft standard “*Bio-based products - Determination of the bio-based content using the radiocarbon analysis and elemental analysis*” [prEN 16785](#), the approach to formulated products is different. A declaration is provided concerning the bio-based carbon content and total bio-based content according to atom connectivity, but validation is performed by ^{14}C isotope analysis only. Analysis and calculation are performed on a dry mass basis.



In this section three examples of plastic mixtures will be discussed in terms of atom connectivity for determining the bio-based content of formulations by calculation. Polymer blends involving starch, mixtures of PLA and PBAT, and polyurethane are featured. The equations just presented will serve all atom connectivity methods but given the precedent set by the ACDV bio-based certification scheme, atom connectivity Method 2b as an analogous methodology developed for this work will be the focus for the following case studies, as it is when incorporated into mass balance Method B in Chapter 5.

4.8.1 Starch polymer blends

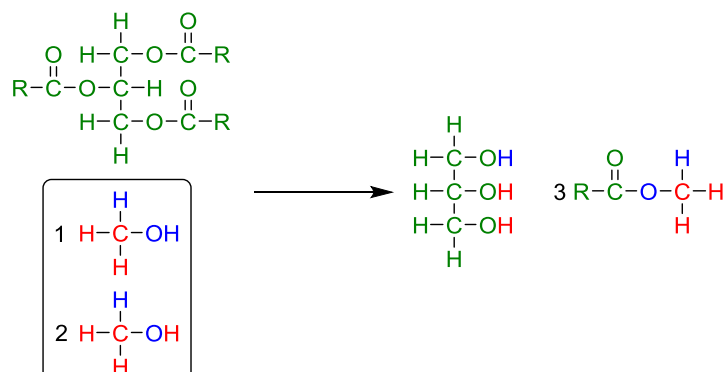
Starch can be extruded with traditionally petroleum derived plastics to form blended materials [Huneault 2012]. The starch is often gelatinised with glycerol before making a blend with poly(ethylene) [Prinos 2004]. Native starch is wholly bio-based. With respect to bio-poly(ethylene), Braskem produce poly(ethylene) from bio-ethanol for bottle caps and other products [Moser 2013]. This opens the possibility for poly(ethylene) products produced as a blend of the bio-based and petroleum derived polymers, but commercialisation of pure bio-based poly(ethylene) seems to be viable for premium products, negating the need for a blend with equivalent non-renewables. As such a blended plastic product of starch and poly(ethylene) where both ingredients are carbohydrate derived is possible (Scheme 4-8).



Scheme 4-8 Starch-poly(ethylene) blend made from starch.

Glycerol can be used to plasticise the starch. The alcoholic moieties of glycerol are liberated from their native triglyceride with methanol, presumed as made from natural gas (Scheme 4-9). As two thirds of hydrogen atoms originating from syngas are derived from natural gas this means that two hydrogen atoms of the eight in a molecule of glycerol are, on average, petroleum-derived (2.2 wt% of the molecular mass, as accountable by atom connectivity Method 3). However when using atom connectivity Method 2b, because all three of the carbon atoms in glycerol are plant derived, the whole molecule is considered bio-based.





Scheme 4-9 The general transesterification of triglycerides labelled in the style of atom connectivity Method 3.

Considering a blend of 25 wt% starch, 75 wt% bio-based poly(ethylene), and a 2:1 starch to glycerol ratio left over from the gelatinisation process, then the product is likely to be thought of as wholly bio-based. Not so obvious is that (stoichiometrically, meaning the limit of efficiency) only 40% of the biomass feedstock is incorporated into the final product. This is because of fermentation losses (carbon dioxide) and water removed in the dehydration of ethanol. The process by which glycerol is obtained from triglycerides should not be considered in the same way because of the value of the main product of this synthesis (*i.e.* FAME biodiesel). Discussions of this sort regarding feedstock use are more necessary in the following chapter dedicated to mass balance.

For formulations, the ACDV certification scheme for bio-based products requires that the supplier calculates the bio-based content and bio-carbon content of the product by treating it as the sum of its constituent parts [ACDV 2013]. In this case starch, poly(ethylene) and glycerol would have to gain certificates declaring their bio-based content. In the case of starch, as a natural product it is automatically considered as 100% bio-based. Bio-based content assignments for components that match those in the ACDV database are accepted. If no data exists those ingredients are designated as petroleum derived (0% bio-based). Ultimately, formulations within the rules established by ACDV are only subject to ^{14}C analysis as the one and only direct indicator of bio-based content, so for this example of a PE-starch blend 100% bio-based carbon should be correctly identified, and indirectly a total bio-based content of 100% should be assigned (as long as all the ingredients have been certified individually). Confidence levels are applied depending upon the discrepancy between calculated and analytical bio-based carbon content and so total bio-based content can be rounded down.

Increasing the ratio of bio-based poly(ethylene) over starch has no discernible effect on the bio-based content of the final product if both polymers are carbohydrate derived. When conventional petrochemical poly(ethylene) is used the bio-based content will vary. The



data in Figure 4-53 is not linear in this instance because the influence of the third component, glycerol, that is not expressed in the ratio of poly(ethylene) to starch but always present at 50 wt% relative to the starch. These values are easily to calculate using the equations presented at the beginning of Chapter 4.8. Other methods of determining the total bio-based content indirectly by atom connectivity will change the output slightly.

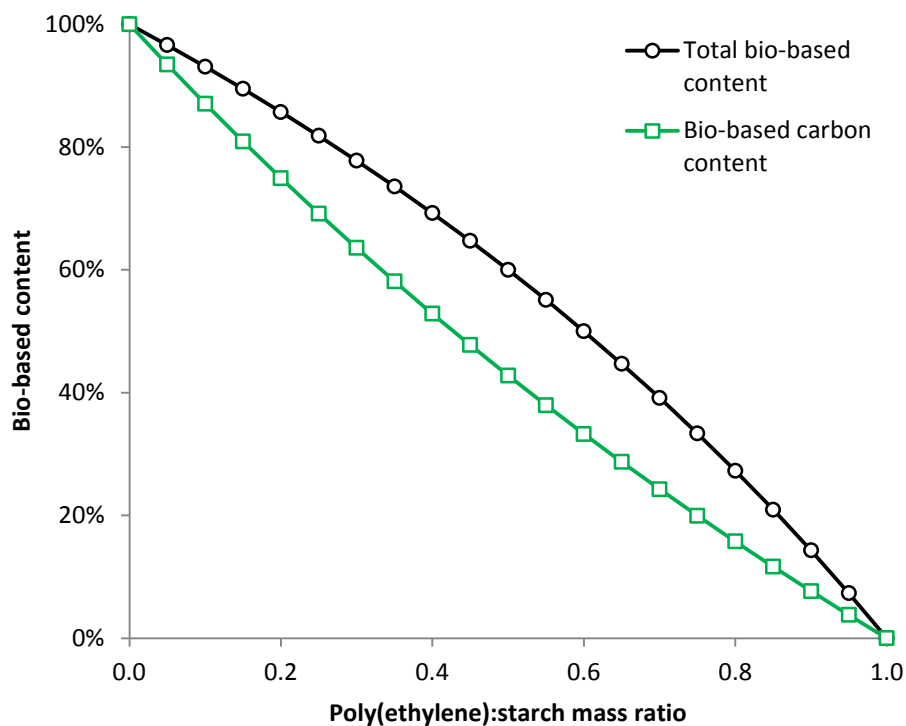


Figure 4-53 Comparisons between the bio-based content of different poly(ethylene)-starch blend ratios.

Because the total bio-based content value is validated through a bio-based carbon content measurement, there is quite a 'leap of faith' required in accepting the final value of total bio-based content (refer to [prEN 16785](#)). It would suggest that atom connectivity is not the best tool for calculating the total bio-based content of formulations. In this particular instance there is another problem caused by the possibility of a non-dedicated facility, utilising either fossil derived poly(ethylene) or bio-based poly(ethylene) or indeed a mixture. Fluctuation of the feedstock means the atom connectivity calculation must be applied to the fossil and biomass streams using a virtual separation of the two by calculation. Effectively a mass balance is calculated which has further implications concerning the boundary of the system *etc.* and so that purpose is better suited to the methods documented in Chapter 5.



4.8.2 PBAT-PLA polymer blend

The company BASF have commercialised poly(butylene adipate terephthalate) (PBAT) under the name *Ecoflex* (Figure 4-54). They also make a polymer blend consisting of PBAT and PLA called *Ecovio* [BASF 2014]. This is slightly different to the previous polymer blend case study because one of the component polymers is a co-polymer, and a tuneable ratio of the sub-unit proportions is possible. An experimental procedure in the literature for blending PBAT and PLA by extrusion advocates the use of the plasticiser acetyl tributyl citrate (ATBC) [Coltelli 2008]. A range of compositions of PBAT are feasible and several will be explored here as the PLA-PBAT blend case study. To begin, the synthesis of the component parts of the blend will be addressed individually.

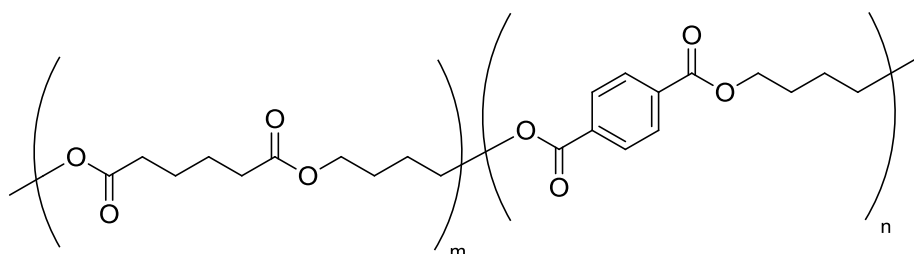


Figure 4-54 The structure of poly(butylene adipate terephthalate) copolymer.

The plasticiser acetyl tributyl citrate (ATBC) is quite common in consumer products because it is biodegradable and non-toxic. It is made by the esterification of citric acid with three equivalents of 1-butanol, followed by a reaction with acetic anhydride (Figure 4-55). The by-products of this two-step synthesis are water and acetic acid. It shall be assumed that the citric acid required for the ATBC synthesis is bio-based. The resulting total bio-based content is 35% by calculation using atom connectivity Method 2b (30% bio-based carbon content) (Figure 4-12).



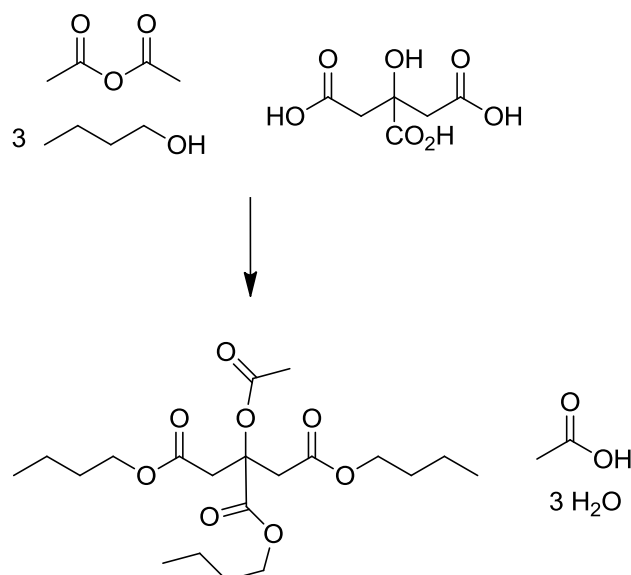
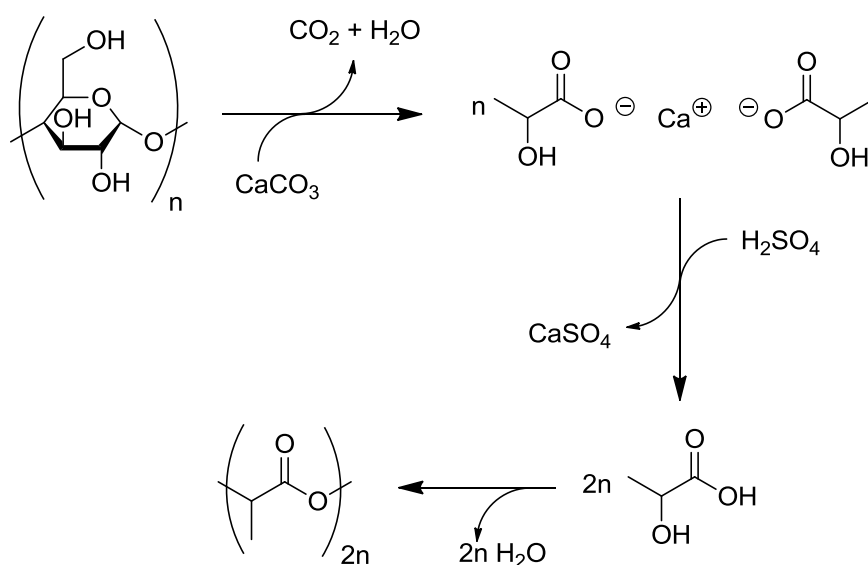


Figure 4-55 The synthesis of acetyl tributyl citrate.

Poly(lactic acid) (PLA) is likely to be bio-based given the interest in this field, although once it was produced by hydrolysis of the adduct formed by acetaldehyde and hydrogen cyanide. Lactic acid is isolated from a fermentation broth as its calcium salt and later acidified (Scheme 4-10). The cyclic dimer (lactide) is formed and then polymerised to PLA, although direct polymerisation is also known. All the carbon atoms of PLA are bio-based, arising from a fermentation of starch, and therefore under the ACDV certification scheme (represented here with the mostly analogous atom connectivity Method 2b) the polymer is considered as wholly bio-based.



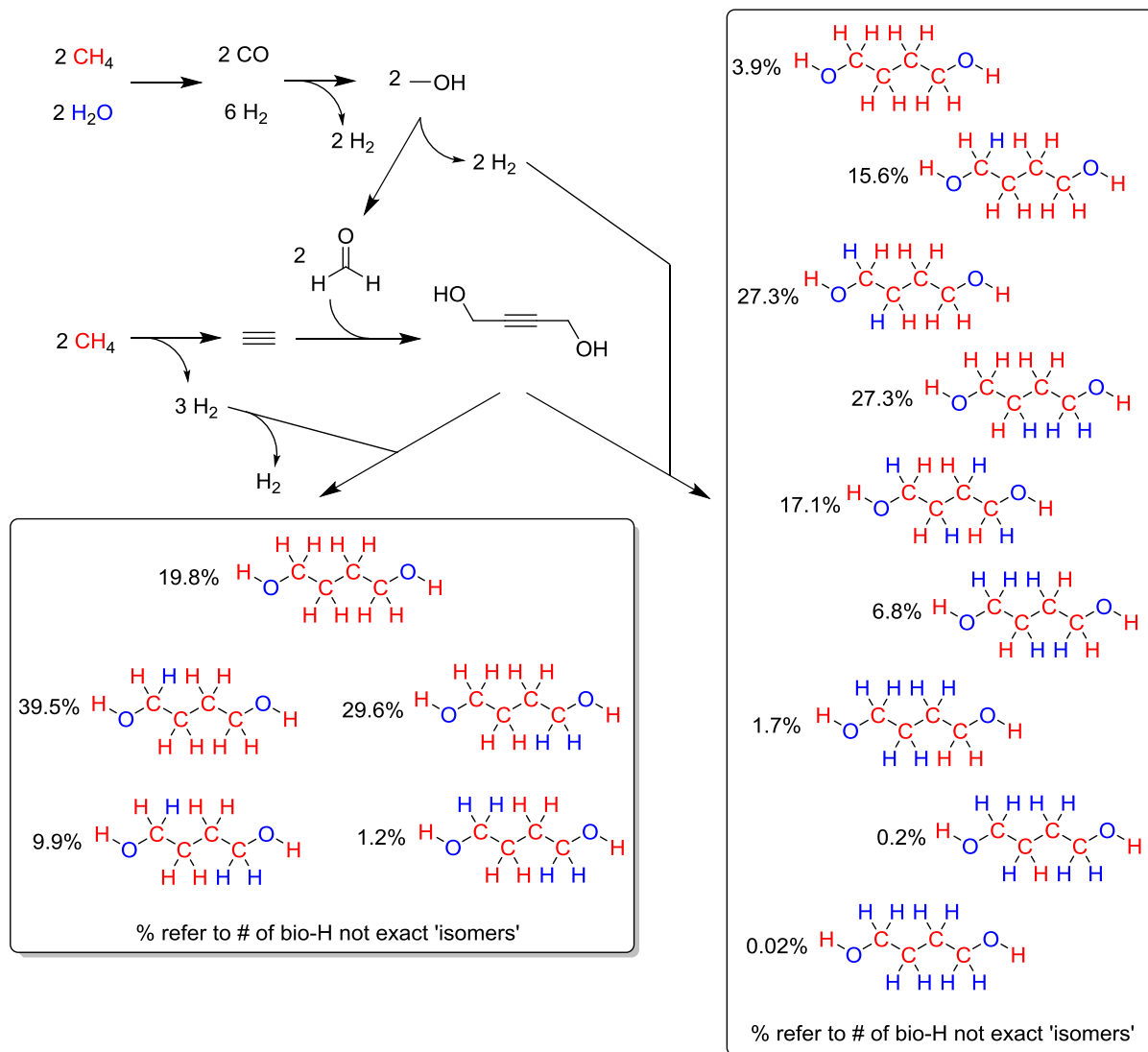
Scheme 4-10 A fermentation route to poly(lactic acid) from corn starch.



The final component, PBAT, is a co-polymer consisting of the esterified products of terephthalic acid and adipic acid with 1,4-butanediol. The process for making PBAT shall be treated as the separate esterification of adipic acid and the transesterification of dimethyl terephthalate, both with 1,4-butanediol, and then the reaction between these polyesters in whatever proportion necessary to give the desired copolymer. The ratio of the two components in the *Ecoflex* product is assumed to be equal at 1:1, and the ratio of PBAT to PLA in the final blend of *Ecovio* will be varied in the following calculations. Earlier in this chapter PBAT was considered as being made from bio-based 1,4-butanediol (Figure 4-23). This resulted in a calculated total bio-based content for PBAT of 42% (atom connectivity Method 1 and Method 2b), with an anticipated bio-based carbon content of 36%. Other combinations of feedstocks are possible.

Generally 1,4-butanediol is the product of a reaction between formaldehyde and acetylene, ending in a hydrogenation (Scheme 4-11). Hydrogen gas is produced at two stages of the process, once from the familiar steam reforming reaction, but also in the oxidation of methane to acetylene. If a choice of either of these hydrogen streams was available for the final hydrogenation to give 1,4-butanediol from 1,4-hydroxy-2-butyne, then the final bio-based content in the product would be slightly different but only appreciated by atom connectivity Method 3. Because the number of hydrogen atoms in 1,4-butanediol coming from syngas is not a multiple of three, the statistical distribution of bio-based hydrogen can be indicated with the following diagram in which the percentage likelihood of a given number of bio-based hydrogen atoms occurring in a molecule of 1,4-butanediol is provided (Scheme 4-11). This is more detailed than the overall outlook used up to now in the previous case studies, but is helpful to demonstrate that what could be perceived as a simple chemical process is actually quite complicated and difficult to understand. Because conventionally 1,4-butanediol is made from the reaction between acetylene and formaldehyde, a ACDV atom connectivity calculation would assign the whole molecule as being petroleum derived and the actual origin of the hydrogen atoms is of no consequence.

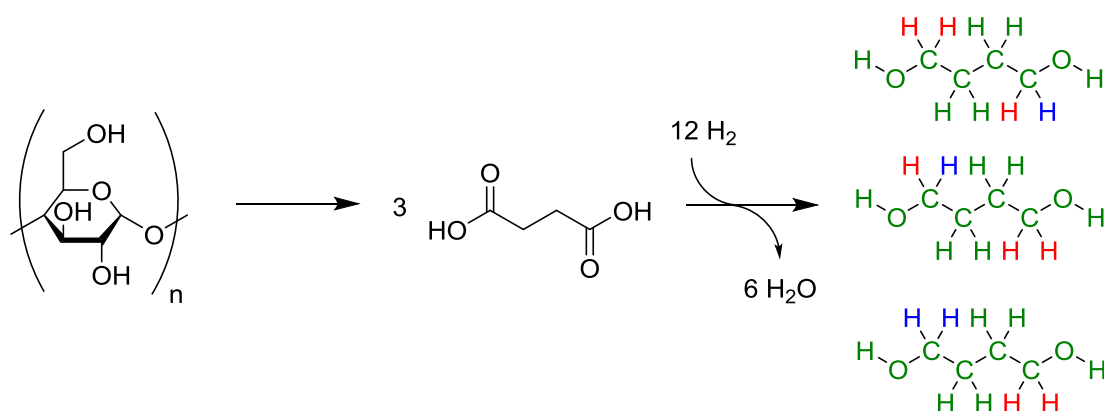




Scheme 4-11 Typical petrochemical routes to 1,4-butanediol indicating the distribution of bio-based hydrogen atoms with those derived from natural gas in red and those from water in blue.

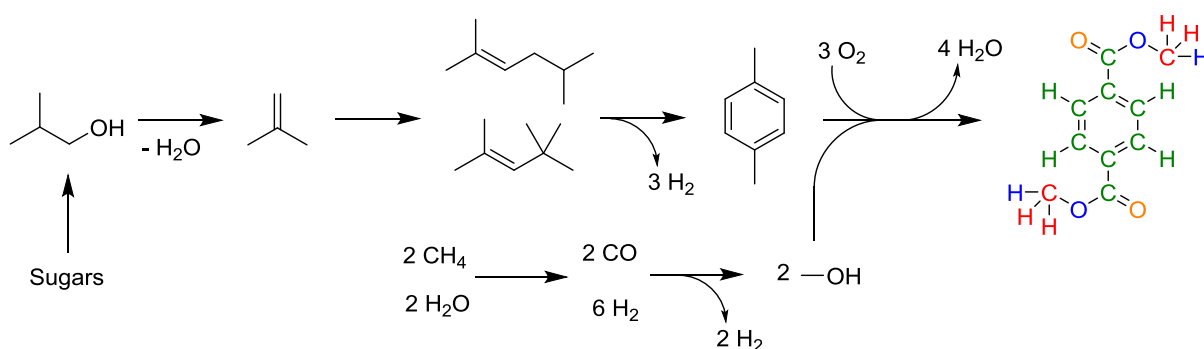
The chemical manufacturer BASF has announced plans to make bio-based 1,4-butanediol, one of many companies commercialising this product [Biofuels Digest 2013]. Bio-succinic acid plants are already operational, and this fermentation product can be reduced with hydrogen to give the diol instead of a direct fermentation process (Scheme 4-12). As for the actual fermentation process, the precise balanced chemical equation is extremely complex, but this is not problematic as fermentation products are treated as entirely bio-based under the rules of indirect total bio-based content approaches. Hydrogenation will result in a small amount of petroleum derived (hydrogen atom) content, but at near-negligible levels on a mass basis and not accountable through atom connectivity anyway.





Scheme 4-12 A fermentative route to 1,4-butanediol.

Progress towards renewable *p*-xylene manufacturing will facilitate bio-based terephthalic acid in the near future. This is with the intention of producing wholly bio-based PET, but other terephthalate esters would also be viable products. *p*-Xylene has historically been obtained from crude oil. The alternative process of making *p*-xylene from biomass is achieved by starting with isobutanol, a fermentation product (Scheme 4-13) [Peters 2011]. For purification, the dimethyl ester is made, and this can be transesterified with 1,4-butanediol to give a polymer. Hence the terephthalic acid moiety can be bio-based, although with the use of methanol some petroleum derived material may be involved in the manufacturing process. A declaration regarding bio-based terephthalic acid would indicate 100% total bio-based content using the indirect method of ACDV or atom connectivity Method 2b.

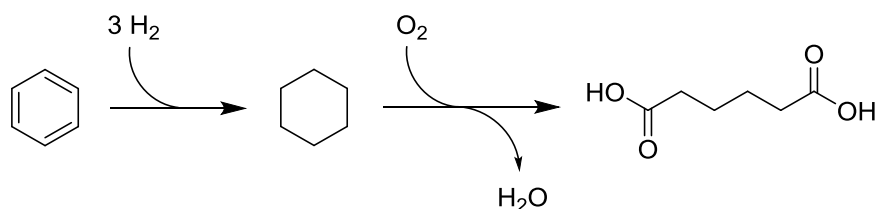


Scheme 4-13 The synthesis of bio-based terephthalic acid from isobutanol.

Adipic acid is traditionally made by the oxidation of cyclohexane, in turn produced by hydrogenating benzene (Scheme 4-14). The process is two steps, *via* an intermediary mixture of cyclohexanol and cyclohexanone (Scheme 8-9). The catalysts and auxiliaries are largely inorganic, including metal acetate salts [Weissermel 1993]. The renewable oxygen (O_2) content, when combined with the water derived hydrogen atoms incorporated into the intermediate product, contributes a surprising 46% non-petroleum content, by mass, from the

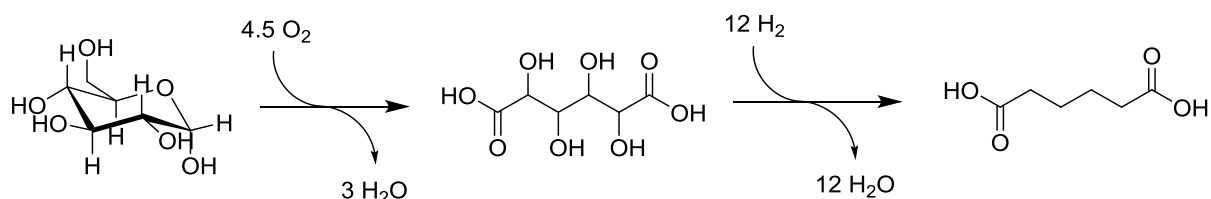


air and water derived atoms, into what is usually considered a totally petroleum derived product (Table 4-14). This is only recognised by atom connectivity Method 3.



Scheme 4-14 The oxidation of cyclohexane to give adipic acid.

Renewable adipic acid has been a target for some time given its use in producing nylon [Beardslee 2012]. Progress is being made with regards to a route from glucose *via* gluconic acid (Scheme 4-15). Once again a hydrogenation is required. In applying the assumptions made by ACDV in their total bio-based content calculation approach, the conclusion of a wholly bio-based product would be arrived at (also shared by atom connectivity Method 2b, Table 4-13). Analytical radiocarbon isotope ratio determination should concur.



Scheme 4-15 A bio-based route to adipic acid.

Thus there are many permutations that could be considered, each affecting the total bio-based content of the final article. Here the benefit of replacing the terephthalate moiety of PBAT with a bio-derived equivalent is addressed. Otherwise only the 1,4-butanediol portion of the PBAT component is consistently presumed to be bio-based. The effect of changing the relative amount of bio-based PLA with respect to PBAT can also be calculated. The amount of plasticiser (ATBC, derived from citric acid) is one tenth of the mass of PLA in each example. The variation in bio-based carbon content is exaggerated when the renewable content of PBAT is lower (Figure 4-56). The same applies to indirect total bio-based content calculations (Figure 4-57).



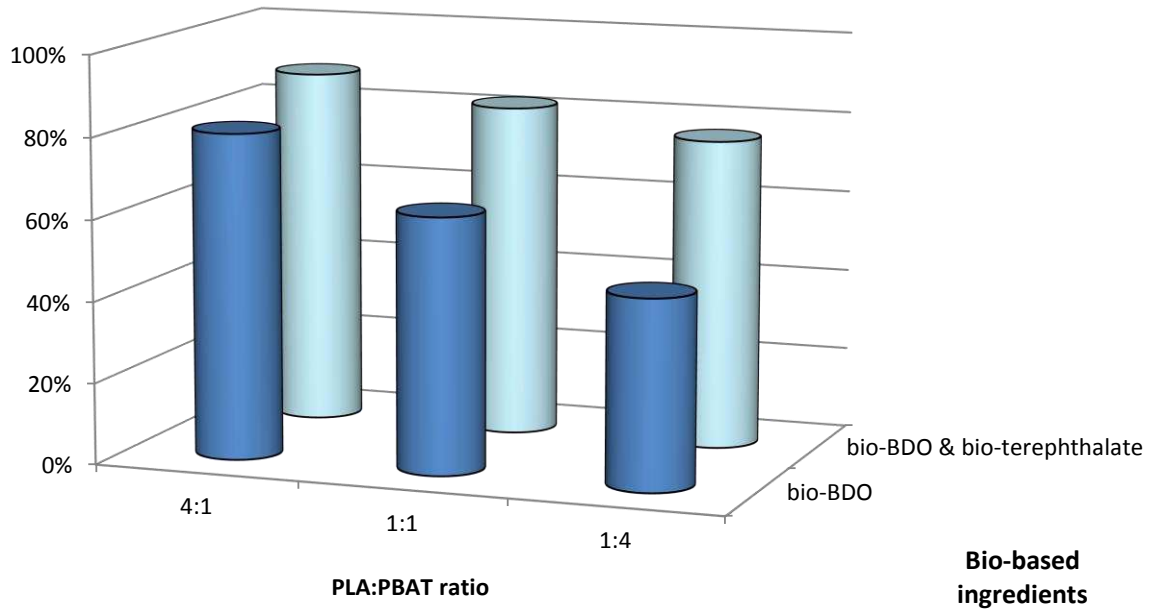


Figure 4-56 The bio-based carbon content (by carbon mass) of different PLA-PBAT blend also containing the plasticiser ATBC.

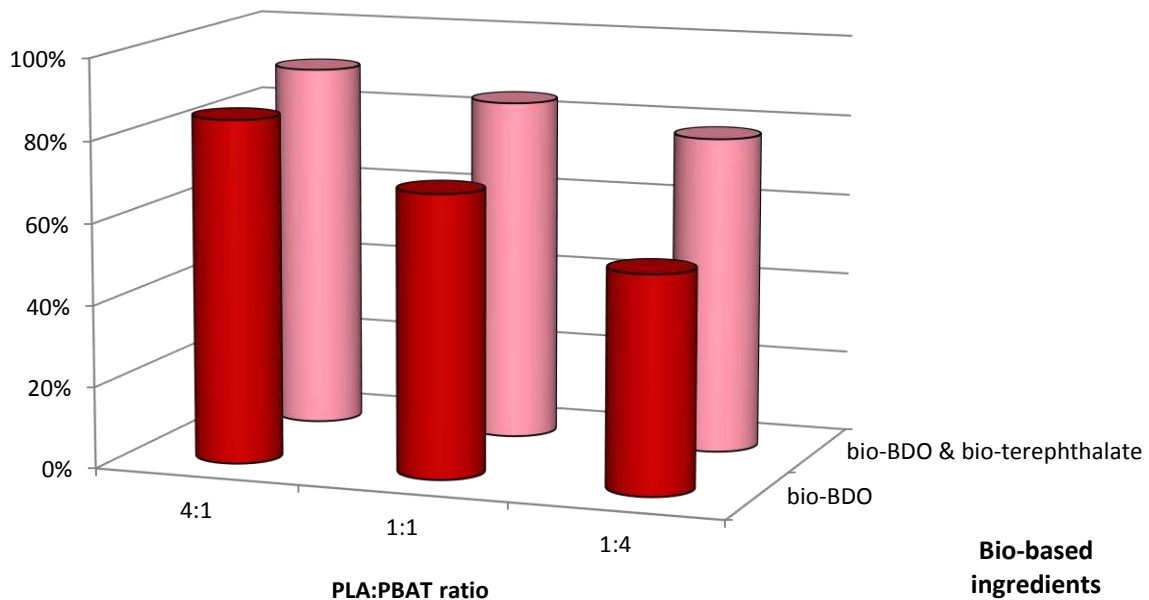


Figure 4-57 The total bio-based content (by mass) of different PLA-PBAT blend also containing the plasticiser ATBC.

The trends for both bio-based carbon content (Figure 4-56) and total bio-based content (Figure 4-57) are analogous. The most bio-based content is found in the predominately PLA blend including bio-based terephthalate (90% total bio-based content). This reduces to

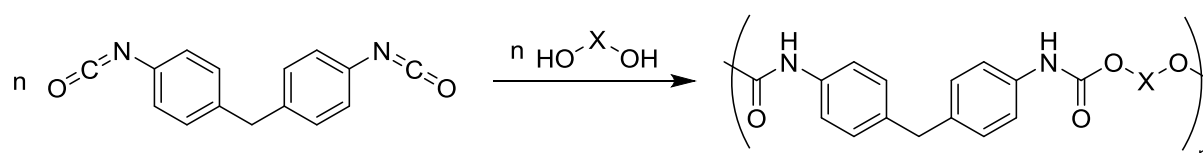


84% when fossil derived terephthalate is used. The lowest total bio-based content was 53% when PBAT is the major polymer component (78% when bio-based terephthalate is present). The conclusions of atom connectivity are unchanged when Method 1 or the ACDV interpretation are used.

If a manufacturer purchases each component monomer from different suppliers, it would be possible to recreate the total bio-based content analysis shown here if each ingredient is provided with an accurate declaration of total bio-based content. However the effort required to do so is quite considerable as this case study on each of the component parts of the final article has attempted to demonstrate.

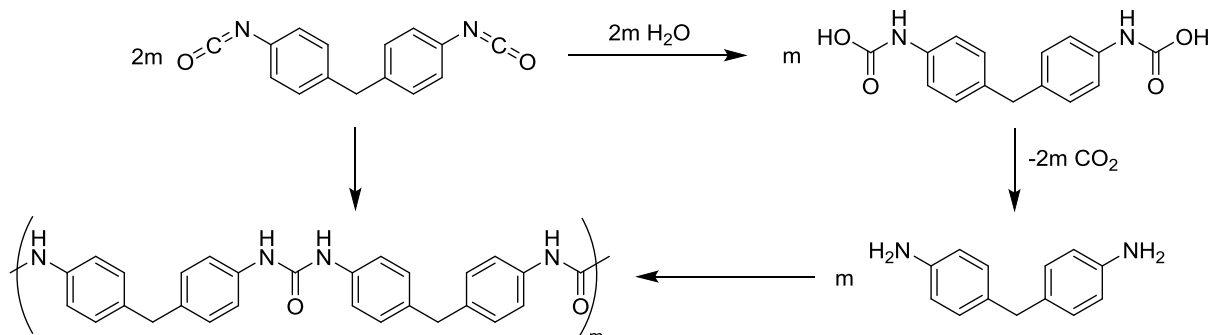
4.8.3 Polyurethane with polyamide

A polyurethane is produced from the reaction of a diol and a diisocyanate (Scheme 4-16). Porous polyurethane polymers can be made by partially hydrolysing the polymer precursor. The reaction of isocyanates with water creates a carbamate, which in turn liberates carbon dioxide resulting in an amine. This amine will react with remaining isocyanate to give a *N,N*-disubstituted urea (Scheme 4-17). Thus porous polyurethanes, made by the so-called blow reaction, are actually a mixture of the polyurethane and a polyurea. The carbon dioxide creates gas bubbles within the polymer as it forms producing the desired density and porosity. This carbon dioxide will diffuse out of the finished article and so will pay no further part in bio-based content calculations.



Scheme 4-16 The synthesis of a typical polyurethane from methylene diphenyl diisocyanate and a diol.





Scheme 4-17 The liberation of carbon dioxide from methylene diphenyl diisocyanate and subsequent polyurea synthesis.

The amount of carbon dioxide required for each application will vary, and proportionally the amount of polyurea present in the formulation will also change. In the example used in Chapter 4 (Scheme 4-7), the diol was made from an epoxidised triglyceride, while the diisocyanate is fossil derived. Thus as the amount of liberated carbon dioxide is increased by adding water, there is less demand for the diol as the original amount of diisocyanate is exhausted. As such the bio-based content may vary as the proportion of reactants is changed, or some free diol might be present within the material and the liberation of fossil derived carbon dioxide is beneficial to the total bio-based content of the article. The total bio-based content of the polyurethane, as calculated indirectly by atom connectivity Method 2b, is 51% while the polyamide is fully fossil derived. The calculation of total bio-based content is apparently simple given that one component is (partially) bio-based and the other is not if no free diol is assumed to be present (Figure 4-58). The resulting bio-based carbon content and total bio-based content calculations are very similar.



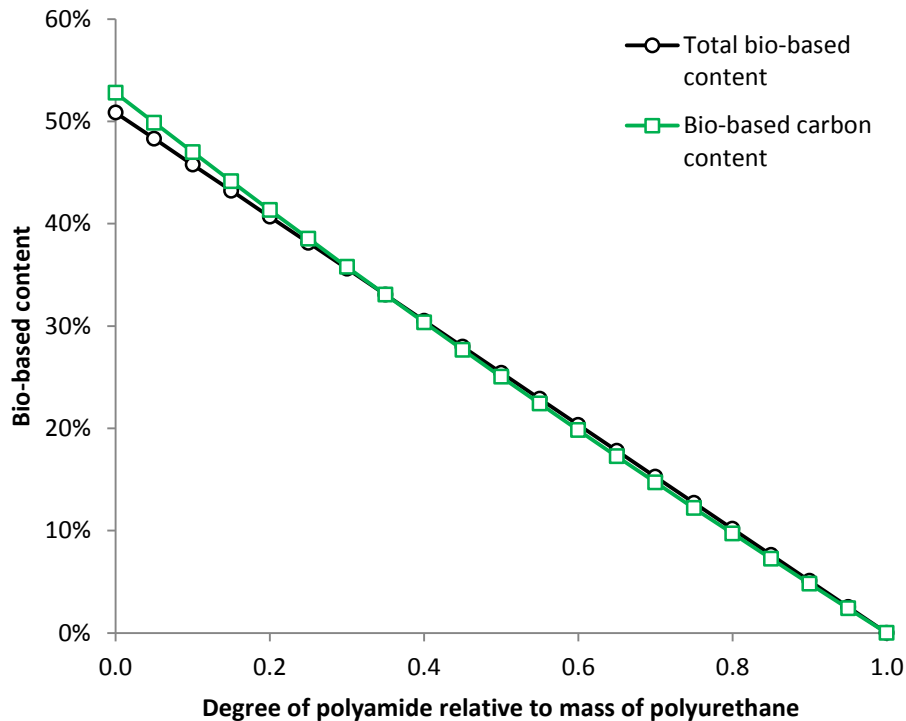


Figure 4-58 Comparisons between the bio-based content of different ratios of a polyurethane and polyurea mixture.

The calculations used to produce Figure 4-58 require that the ratio of the two components is known. In reality not much decomposition of isocyanate is required to produce an appreciable volume of carbon dioxide gas but the precise ratio of polyurethane to polyamide is only known indirectly from the quantity of water added to cause the reaction. Therefore without knowing the exact composition of the article atom connectivity is difficult to use with confidence. Spectroscopy could assist identification of the components but the problem of ill-defined mixtures or more commonly variable content is not restricted to just this case study.



4.9 Advantages and limitations of using atom connectivity for indirect determination of bio-based content

The different atom connectivity approaches have provided contrasting results. Atom connectivity Method 2a will not be considered further as it would seem that the assignment of atom connectivity on the basis of the rules of chemical reactivity is entirely possible, making atom connectivity Method 2a redundant. Atom connectivity Method 2b was more useful overall and generally it is interchangeable with the ACDV rules of atom connectivity. Atom connectivity Method 1 in turn produced similar results to atom connectivity Method 2b (Figure 4-59). Occasionally atom connectivity Method 1 creates an outlying result for the determination of total bio-based content. Compared to atom connectivity Method 2b this approach can underestimate the total bio-based content of articles with high bio-based content (100% bio-based carbon content). This affects surfactants with inorganic head groups. Adapting the rules of atom connectivity Method 1 can produce the opposite effect, as was demonstrated for dodecylpyridinium chloride (Chapter 4.6.4). This was once instance in which the designation of the primary feedstocks caused an issue. Clear rules and guidance would need to be developed to avoid improper use of this approach. Another occasion when atom connectivity Method 1 produces a higher determined total bio-based content than atom connectivity Method 2b is for the example of PVA, produced by the hydrolysis of PVAc (Figure 4-25). Under the rules of atom connectivity Method 1 the alcohol functionality is considered bio-based because it was assumed that bio-based acetic acid was used as a reagent.



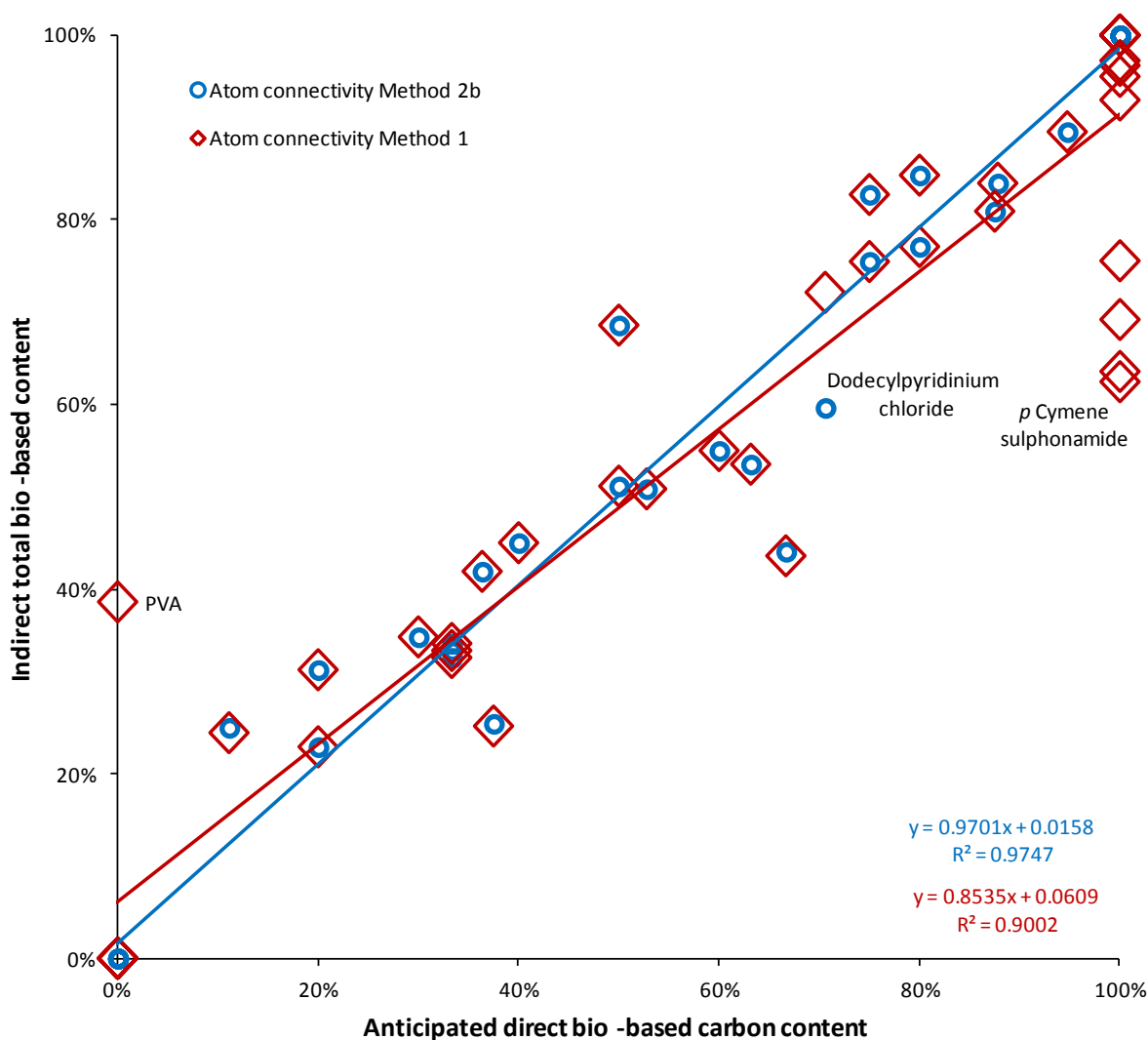


Figure 4-59 A comparison between atom connectivity Method 1 and atom connectivity Method 2b relative to bio-based carbon content.

Atom connectivity Method 1 is very much like a mass balance calculation and requires much the same level of knowledge as a mass balance. It is not a true atom connectivity methodology as the bonds between the different atoms do not determine the bio-based content. Instead the feedstocks are defined as bio-based or fossil derived. However the total bio-based content is calculated based on the chemical structure of the final product. Because it is not a mass balance, atom connectivity Method 1 is unable to deal with fluctuations in biomass feedstock input without becoming a mass balance. In the following chapter mass balance Method D essentially assumes the role of atom connectivity Method 1.

Atom connectivity Method 2b is an extended version of the ACDV certification scheme rules. The latter only applies atom connectivity rules to hydrogen, oxygen, and nitro-



gen atoms. Carbon atoms can be assigned as bio-based from direct analysis and knowledge of the synthesis. The ACDV certification scheme uses elemental analysis and reports total bio-based content according to confidence levels depending on how well calculation and experimental analysis correspond to each other (^{14}C and total elemental mass only, not total bio-based content). Other elements not routinely analysed by elemental analysis are simply regarded as bio-based for convenience. When simply discussing indirect methodologies for the calculation of total bio-based content, without the constraints of analysis, atom connectivity can be extended to all non-carbon atoms, as practiced in atom connectivity Method 2b. This sometimes creates a disparity between atom connectivity Method 2b and the ACDV approach when elements such as chlorine, sodium, and sulphur are present in an article (Figure 4-60). Usually no difference between the two methods exists, and when the value of total bio-based content arrived at is not the same (as for surfactants) it is an inorganic portion of the molecule that is responsible. The presence of mineral content and its assignment as either bio-based or fossil derived has repeatedly caused a problem with the calculation of total bio-based content. An attempt to isolate and resolve this issue was made in the form of atom connectivity Method 3.



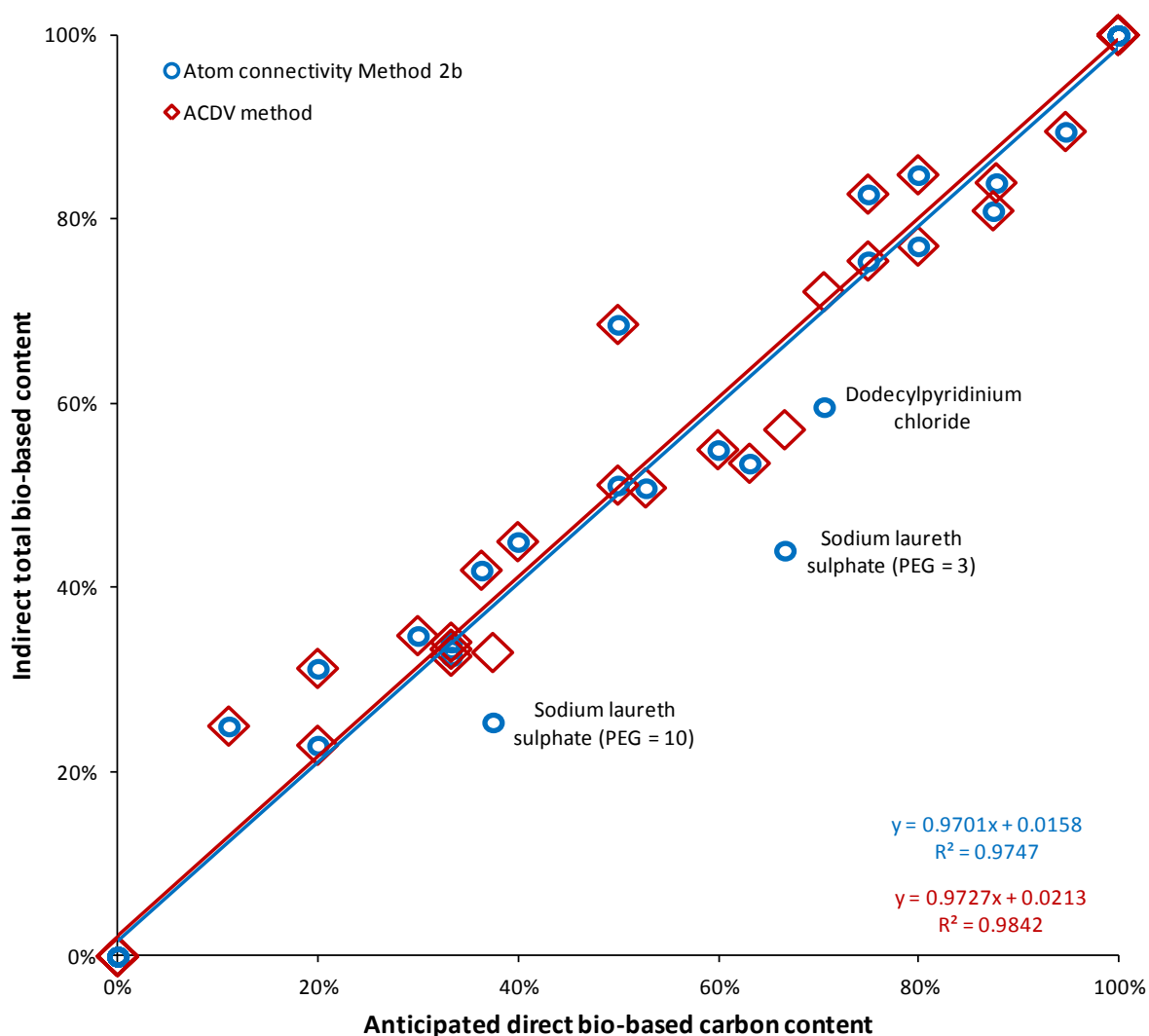


Figure 4-60 A comparison between atom connectivity Method 2b and the atom connectivity approach from the ACDV certification scheme.

Of the two indirect approaches displayed in Figure 4-60, the methodology from the ACDV certification scheme demonstrates the superior correlation with bio-based carbon content. This is a good indicator of horizontal consistency across different product types. However if an indirect calculation of total bio-based content is intended simply to flesh out an analysis of bio-based carbon content it serves very little purpose beyond providing access to the more satisfying claim of total bio-based content rather than just the bio-based carbon content. Radiocarbon analysis is limited of course to just the carbon content and methods that provide a total bio-based content are appealing. Atom connectivity cannot offer a true value of total bio-based content, only one in which non-carbon atoms are bio-based by association regardless of their actual origin. Mass balance, in certain forms, can offer a more realistic calculation of total bio-based content.



Instead of judging accuracy relative to bio-based carbon content, consistency (and therefore the ability to be interchangeable) with other indirect methods of total bio-based content may be preferable. If this were true, formulators could produce end-products using ingredients delivered with total bio-based content analysis certificates, and then their own mass balance could be applied to calculate the total bio-based content of the final article. Attempts at atom connectivity for mixtures were possible in theoretical case studies (Chapter 4.8), but potential issues have been identified, Mass balance may prove to be a preferable technique. However for chemicals produced in dedicated facilities atom connectivity is by far the more appealing approach to calculate the total bio-based content due to the ease of its application. Complex integrated biorefineries with poorly defined reaction pathways and multiple product streams, and formulations are more difficult scenarios for atom connectivity to deal with.

The nomenclature surrounding bio-based products is moving towards the binary distinction between bio-based and fossil derived content, or a combination of the two in the case of partially bio-based products. We have seen throughout Chapter 4 that sometimes this simple two way separation is skewed by feedstocks that cannot be considered to be either biomass or petrochemical. Water and oxygen gas in particular contribute a significant portion of the final mass of manufactured chemicals in general. Water is a feedstock for biomass, reacting with carbon dioxide to produce sugars in photosynthesis. Labile hydroxyl groups rapidly exchange with water and so much of what is considered biomass is actually water derived. Atom connectivity Method 3 was designed to overcome this by grouping non-fossil derived content as part of the calculation of total bio-based content and ignoring mineral feedstocks like sodium chloride. However the result is that many chemicals without any bio-based carbon content have a total bio-based content sometimes as high as 50% or more (Figure 4-61). This is not great for consistency, and represents some petrochemicals as bio-based. If just the plant derived content of bio-based products is used for the value of total bio-based content (without considering water or atmospheric gases as bio-based) then many products with 100% bio-based carbon content will have total bio-based content values of much less (Figure 4-61). Although direct bio-based carbon analysis and calculated total bio-based content are reasonably proportional for partially bio-based product examples, given the large data skews at the extremes of bio-based carbon content atom connectivity Method 3 will not be pursued further. Another reason for not continuing to use atom connectivity Method 3 is that the origin of some atoms will not be precisely known. For instance, throughout Chapter 4 hydrogen gas has been assumed to be syngas hydrogen, although there is no way of knowing that if hydrogen is supplied to the bio-based product manufacturer and not produced in-house.



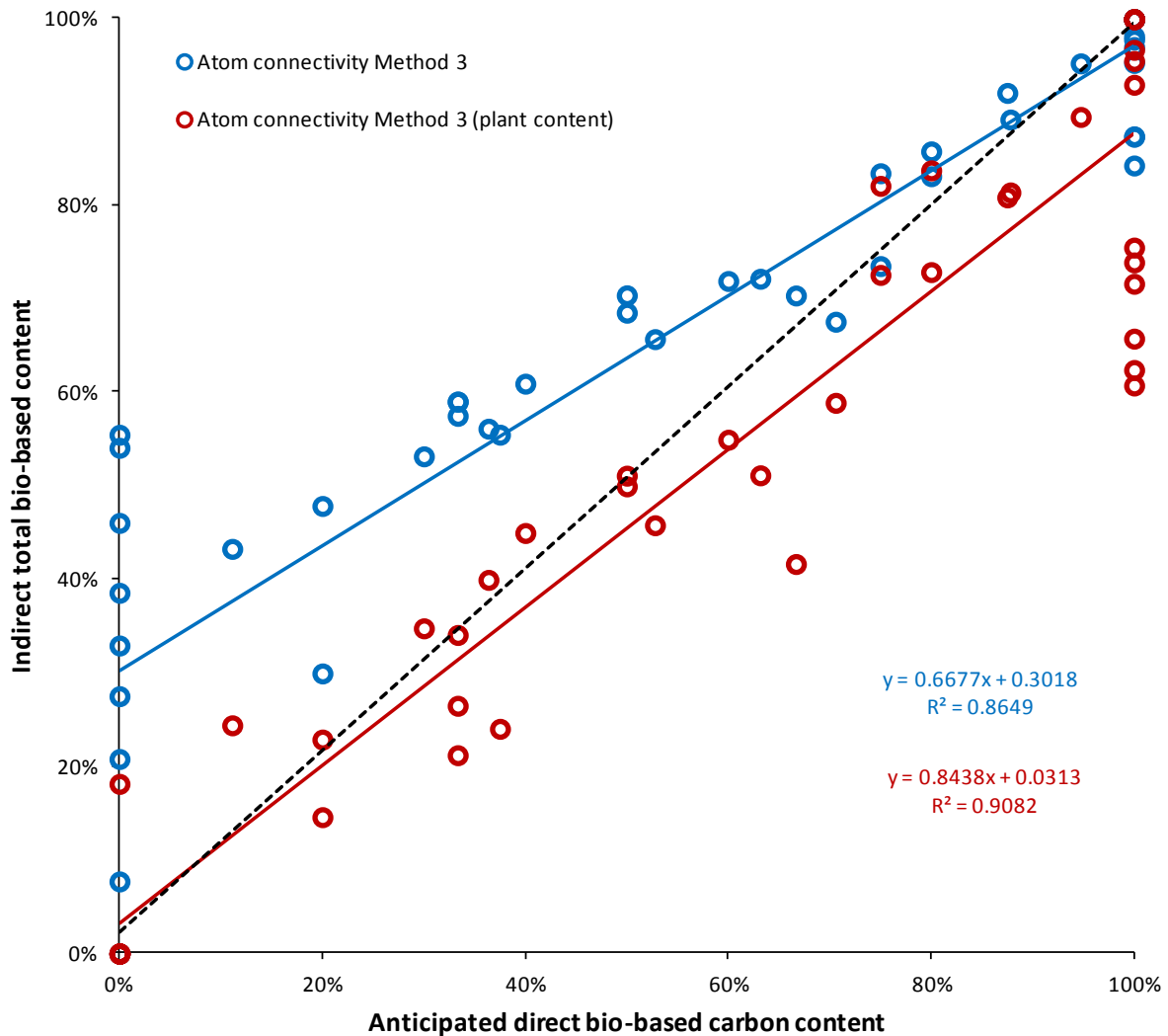


Figure 4-61 A comparison between atom connectivity Method 3, plant derived content only as calculated by atom connectivity Method 3, and also the ACDV approach (indicated as the dashed black line).

Reporting total bio-based content as the ratio of plant derived content to fossil derived content (ignoring mineral, non-carbon containing feedstocks) could prove to be a convenient if a somewhat 'dishonest' solution, avoiding some of the issues arising with the current interpretation of atom connectivity Method 3. In a direct comparison between biomass and fossil resources, the possible range of total bio-based content should be between 0% and 100%. This is not the case if elements from other sources (water, air, mineral) are also included in the assessment. When the chemical identity of an article means it can never be calculated to be 100% bio-based, this could be confusing to customers and business. If the maximum bio-based content of a product is low, say 22% (as would be true of dimethyl sulphate according to atom connectivity Method 3, being mainly inorganic in origin) a validated claim of 20% bio-



based content would represent a good deal of fossil resource saving yet appear to be a poor claim if 100% is the expected maximum. More on the role of inorganic/mineral feedstocks is considered as part of the subsequent mass balance discussions of Chapter 5. This conundrum also applies to formulations with a lot of mineral content, perhaps sodium chloride in a shampoo for example.

The atom connectivity methodology referred to throughout this work as belonging to ACDV is now the basis of a draft European technical specification. A test method for the determination of total bio-based content is based on radiocarbon isotope analysis and atom connectivity for hydrogen, oxygen, and nitrogen atoms as described in [prEN 16785](#), while the general procedure is also reported in [CEN/TR 16721](#). The declared total bio-based content cannot be validated directly, but an elemental analysis is used to suggest the correct proportions of each element are present, bio-based or otherwise. Extending atom connectivity to all non-carbon atoms would not be verifiable in this way and accordingly no recommendations to adapt the proposed standard have been suggested in this report. However this is direct determination of bio-based content. When dealing with indirect calculations of total bio-based content no analysis is necessarily involved. However, if direct and indirect approaches to determine the total bio-based content are to both use atom connectivity, it must be applied with the same rules.

How atom connectivity influences mass balance is explored in the following chapter, where atom connectivity Method 2b is incorporated into mass balance Method B. This allows the full scope of atom connectivity to be explored. [CEN/TC 411/WG 3 document N104](#), regarding material balance, suggests atom connectivity (as in the ACDV approach) can be used to create values of total bio-based content for the feedstocks or ingredients of a process (synthesis or formulation) but no specific test method exists to explain this further. It is important that within the remit of indirect calculation for total bio-based content atom connectivity and mass balance are compatible. Atom connectivity Method 2b will be used as the primary approach to total bio-based content determination when relevant within the subsequent discussions on mass balance (Chapter 5). Only for bio-based products containing elements other than carbon, hydrogen, nitrogen and oxygen will the preference for atom connectivity Method 2b have an effect. When this is the case, the approach to atom connectivity developed by ACDV should be used to preserve the relationship between direct and indirect methodologies.



5 Mass balance

5.1 Mass balance and book-and-claim methods

In this chapter the mass balance methods that have all at one time been considered by **CEN/TC 411/WG 3** will be explained and each applied in a number of case studies to demonstrate how they work in practice and what limitations are present. Equally as important is the susceptibility of the mass balance to be manipulated to enhance the claim of bio-based content or to provide misleading results. This will reduce confidence in bio-based products and hinder the growth of the European bio-based economy. It is also possible that calculation or verification is too difficult for a particular method. Some approaches have since been rejected as appropriate for bio-based content claims by CEN/TC 411, the reasons for which will be demonstrated in this work with case studies. Firstly the general concept of mass balance and the rules of application are explained.

5.1.1 Rules and interpretation of mass balance

The principle of mass balance can be expressed mathematically as the following equation and represented by the subsequent diagram (Figure 5-1).

$$\sum M_{in} = \sum M_{out} + \sum M_{loss}$$

$\sum M_{in}$ is the (mass) sum of the total material inputs.

$\sum M_{loss}$ is the sum of the total material losses during processing, by mass.

$\sum M_{out}$ is the (mass) sum of the total material outputs, by origin, distributed among the manufactured or semi-finished products.



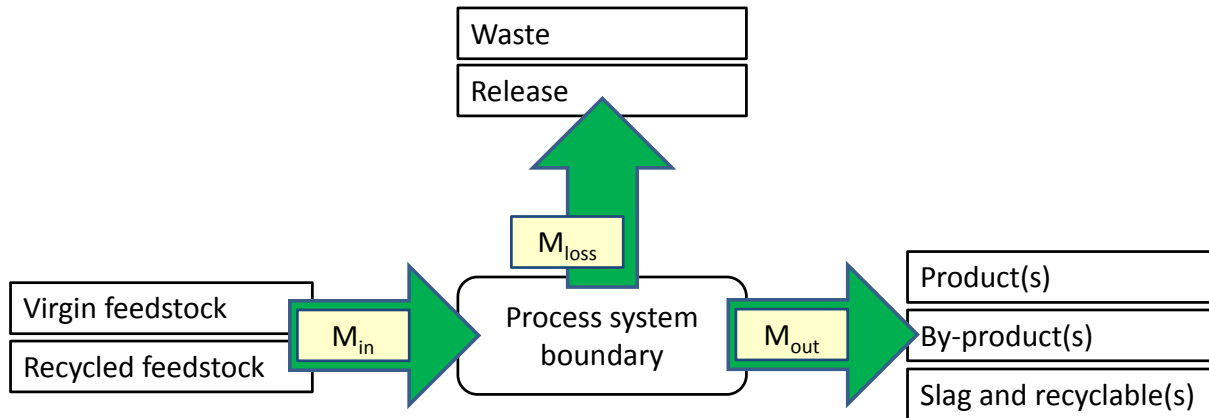


Figure 5-1 A schematic overview of the mass balance principle.

Thus mass balance is the movement, or flow, of matter through a process that may transform feedstocks into other substances and locations. It can be divided into material flows of different inputs of varying origins to assist bio-based content calculations. Creating virtual sub-mass balances describing the biomass flow and the fossil flow separately must be performed in such a way that summation of the sub-mass balances gives the full mass balance. This approach of virtual pathways is common in LCA treatments and should not present a problem should all data regarding the production chain be known.

Expanding upon the overarching mass balance definition and equation, the following basic rules for employing mass balance methods have all at one point been proposed by CEN/TC 411/WG3 as possible criteria to govern mass balance as an indirect method of determining bio-based content.

- It is necessary to ensure traceability of total mass, biomass, mass of bio-based carbon/fossil carbon savings, or fossil resources saving from the feedstock through internal processes and material flow management up until the release of the final products.
- Mass balance accounting should be conducted based on pre-defined chemical reaction pathways of consecutive chemical reactions that are being performed in the production process. If raw materials or products are processed and/or losses are involved, appropriate conversion factors should be used to adjust the size of the consignment accordingly (step by step approach). The error related to the estimation of losses and/or closing the mass balance should be reported.
- The mass balance can only be performed in a fixed time period, which shall be clearly defined. A rolling 12 month interval can be used. In this report discussions will typical-



ly be presented with a 12 month mass balance time period, which reflects the seasonality of typical biomass crops.

- In industrial process plants, measures must be introduced to ensure the mass entering and leaving must balance within the designated time interval are equal. This can be done in various ways (*e.g.* stoichiometric chemical reaction information and proven yields). Integrated systems involving multiple processes with shared chemical inputs or intermediates must be proportioned between the different processes appropriately. Erroneous measurements must be detectable.
- In a mass balance system, depending on the method, a material has a calculated bio-based content or savings in fossil resources, only if it can be verified.

The system boundaries are to be defined completely and the mass balance approach can be used in each step of the processes within those boundaries. For example, a process including one reaction, one transport path and one storage, the mass balance can be done in the complete system where the input is on the reaction site and the output on the storage site, or the mass balance can be performed for each step.

- The system boundaries must have traceable relations (*e.g.* reaction, transportation) between biomass input, bio-based product output, possible co-products, and waste.
- Accounting shall be achieved over an appropriate period of time within pre-defined system boundaries. The system boundaries can include multiple processing steps along the production pathway such as feedstock production, intermediate feedstock collection, transportation between different sites, conversion processes, warehousing and storage. The system boundaries must guarantee that the claims made using the method stay within the rolling interval.
- Mass balance accounting can be established along complex supply chains that span over multiple production locations as long as the product flow follows consecutive chemical reactions and as long as the individual production sites are linked by transportation or pipeline. Allocation between unlinked production facilities (virtual allocation) is not permissible, and is revisited in the following 'book-and-claim' discussions.
- The system boundaries must guarantee that the bio-based feedstock (and all bio-based input) is of bio-based origin or provide a proof of the bio-based nature or certificate at the point of entry of the biomass into the system. The same applies for claims of renewability or sustainability for example, although this is out of scope for the work presented here.



The different mass balance methods identified and discussed in this report are classified as follows. Firstly, mass balance Method A can be considered as a mass balance approach with attribution, and was developed by TÜV-SÜD on behalf of BASF [TÜV SÜD 2013]. Attribution was previously defined as “*the partitioning the output of biomass derived material from a process between products without justification derived from the physical mass flow*”. A complimentary discussion on this certification scheme is provided in *Chapter 2.3.5*. The underlying calculation is based on ‘methane equivalents’ as a standard unit instead of more familiar and obvious units of mass. In using methane equivalents to describe and equate chemical process feedstocks, the concept can be defined as the relative mass of that feedstock required to equal the energy content (expressed as lower heating value) of a given amount of methane. For example 2.574 kg of methanol has the same energy content as 1 kg of methane, whereas only 0.417 kg of hydrogen is able to provide the energy of 1 kg of methane. Both for fossil and renewable feedstocks, the calculation uses a conversion rate to translate data into this standard unit (*i.e.* methane equivalents) according to the lower heating value of the feedstock. The lower heating value is related to calorific content. The translation of chemical intermediates and final products into the standard unit of methane equivalents is not based directly on its lower heating value but on the amount of fossil feedstock that is consumed in its production. Only materials listed with recognised lower heating values can be considered by this method as a feedstock (Table 2-5). Additional feedstocks may be approved by the respective certification body on a case by case basis. The output of mass balance Method A is the saving of fossil feedstocks achieved by replacing a feedstock with biomass. It can be applied for integrated production systems where the unit of measurement (*i.e.* methane equivalents) supports the calculation of fossil resources savings claims. The input material savings are put in relation to the output material within the frame of the attribution unit accounting system following coherent chemical reaction pathways. The calculation boundaries are set broadly, around an integrated site.

Mass balance Method B: entitled “*the determination by calculation and allocation of the average bio-based carbon content and average bio-based content*”, requires that bio-based content and bio-based carbon content are calculated using proven yields of bio-based production and using stoichiometric chemical reactions in single chemical reactions or in subsequent chemical reaction. The bio-based reaction pathways are recommended to be verified using suitable analytical approaches (*e.g.* ^{14}C radiocarbon measurements as described in **EN 15440**, **CEN/TS 16640**, and **ASTM D6866**) if at all possible. The information given by the mass balance method could be used for allocation of total bio-based content when appropriate. If the quantity of biomass used is less than the stoichiometric limit, the final product could be split into batches that reflect the virtual sub-mass balance flows. The assignment of total bio-based content in this work under mass balance Method B will be achieved for the mass flows (input, followed through to the output) using atom connectivity Method 2b.



The next method, mass balance Method C, operates by calculating the fossil carbon savings of a product. The mass balance method determines the mass of bio-based carbon and hence the mass of fossil carbon savings in consecutive chemical reaction routes based on input/output quantities in global production systems using stoichiometric chemical reaction pathways and proven yields. Thus the output is similar in style to that of mass balance Method A while the means of calculation is akin to mass balance Method B. This mass balance system is applicable to complex and coherent chemical reaction pathways (multiple sites, multiple steps) where the processing of bio-based feedstock and production of the bio-based product can be globally distributed among multiple locations linked through transportation (*i.e.* physical material transfer is required and not virtual allocation or transfer of certificates that impart adopted characteristics). The unit of measure is mass of bio-based carbon which is traced by the mass balance system through various production steps. The result is reported as the mass of bio-based carbon relative to the total mass of the product, although alternative reporting styles will be trialed.

The final mass balance approach, mass balance Method D, is an attempt to complete a mass balance by identifying the original feedstocks of a process as either biomass, fossil resource, or mineral/inorganic (as in mass balance Method A) and assigning the proportion of each feedstock present in the final product(s). Each input must not be a combination of different precursor feedstocks, thus complicating assignment its origin. For example ethylene from an oil refinery is an acceptable feedstock, but ethylene oxide is not as an inorganic feedstock (oxygen) has been incorporated. Fermentation products such as bio-ethanol are acceptable feedstocks. Although in principle this approach is the same as mass balance Method B, atom connectivity is not used. The final total bio-based content is calculated from the proportion of biomass feedstocks present in the final product by means of following the stoichiometric reactions and yields of each process. Losses must also be measured to complete the mass balance. The calculation of bio-based content is also possible and mirrors the procedure of mass balance Method C. Allocation of total bio-based content may be necessary depending on the production, storage and transportation chain.

Additionally, 'book-and-claim' methodologies use the result of the mass balance methods to transfer and generate certificates (*e.g.* for fossil feedstock savings, calculated bio-based (carbon) content, or calculated fossil carbon savings). The proposed mass balance or book-and-claim approaches can enhance the use of bio-based feedstocks throughout complex supply chains where fluctuation of biomass input makes direct analysis unrepresentative over time. The methods can be applied to finished and semi-finished products of integrated production plants or production sites where fossil-based and bio-based feedstocks are used interchangeably and alternating in the feed of the system. 'Book-and-claim' methodologies shall be applied to the same products (*i.e.* chemicals with identical CAS numbers). As such bio-based content and fossil savings cannot be attributed to inappropriate articles.



The principle is already in use in other sectors, but its validity towards bio-based products is yet to be demonstrated.

The goal of the mass balance systems, depending on the method, is to support the calculation of fossil resource savings or calculated bio-based content in the production of an article. The ideal choice of the individual mass balance approach depends on the set-up of the chemical production processes, the supply chain, the production site set-ups, and the requirements/information needed for business to business communication and business to consumer communication. All methods are based on the mass balance principle but differ in methods of calculation (unit of measure), the intended claims as well as the system boundaries. The applicability of the methods and the differences of the three approaches are illustrated in Table 5-1. However it may not be suitable to propose numerous approaches as this will result in discrepancies and undermine confidence in mass balance calculations.



Table 5-1 The scope and claims of the four mass balance methods

	Method A	Method B	Method C	Method D
System boundary	The balancing of renewable raw materials is permissible over different operating units within an integrated chemical production system.	Variable but limited to the European geographical area. Not applicable for global allocation.	Based on consecutive chemical reactions. Those reactions can include multiple sites that are linked.	Mass balances are based on consecutive chemical reactions in global production systems.
Unit of measure	A standard unit of 'methane equivalents' is derived from the lower heating value of the feedstock.	Bio-based content or bio-based carbon content.	Mass of bio-based carbon	Bio-based content or bio-based carbon content.
Calculation	Attribution.	Stoichiometric pathways (and allocation).	Stoichiometric pathways.	Stoichiometric pathways (and allocation).
Claims	Fossil resources savings, based on certificates.	Average bio-based content or average bio-based carbon content over a predefined period of time.	Fossil carbon savings in global supply chain.	Average bio-based content or average bio-based carbon content over a predefined period of time.
Verification	Method is based on 3 rd party certification [TÜV SÜD 2013].	Verification may be performed using an analytical approach. Verification may be performed using a 3 rd party.	Analytical verification may be possible (for feedstocks and by-products as well as products).	Verification may be obtained for bio-based carbon content. Stable isotopes could verify feedstock origin.



5.1.2 Mass balance Method A: The determination and allocation of the average bio-based content in a final product within a predefined time period using attribution

The allocation of the average bio-based content using fossil resource savings within a pre-defined time period (through attribution) can be used to make various claims essentially describing the extent that fossil resources have been replaced, *e.g.* fossil resource and carbon dioxide savings. The biomass allocation, where mass flows are converted to other transferable units, can only be performed in a connected system with a defined boundary, and where the input feedstock is used in different production paths without defined distinction. In this methodology methane equivalents are the chosen attribution unit, meaning the energy content of the material relative to the lower heating value (net calorific value) of methane. The biomass feedstock is allocated to a certain product by taking into account the following principles:

- The mass balance for each process step is based on real measured inputs, outputs and losses.
- The measuring system includes the feedstock, chief products, by-products, and waste.
- The material flows are clearly defined and are possible to trace.
- All transformation processes, from feedstock to product, are within the defined system boundaries.
- The production pathway follows consecutive chemical reactions.

The biomass allocation to a product follows these defined steps:

- The mass balance stops on the last process where the final article is the output (usually one of several outputs).
- All input materials shall be traced back, process by process, to the original feedstocks using mass balance (also relevant to mass balance Method D).
- The mass balance for each process step is aggregated in order to have an overall mass balance for the product, within the system boundary.
- An attribution unit (*e.g.* methane equivalents) is defined.



- All feedstocks are converted to the attribution unit. By adding the converted allocated units of all feedstocks, it is possible to obtain the amount of attribution units required for the product.
- A bio-based feedstock coming into the system boundary is transformed into the attribution units in order to allocate them to a product.

The attribution system for production is based on the contribution of each component required for the final product according to its manufacturing process. This approach will allow a certificate of 100% bio-based to a product that is obtained from bio-based and fossil feedstocks. In order to attribute up to 100% fossil resource savings or bio-based content to a specific product, a reference unit is needed. This unit shall be completely, clearly and transparently defined. This reference unit can be used for the allocation of biomass to products produced within the same system boundary considering the consecutive chemical reactions. Methane equivalents is a unit that can be used for the allocation.

The overall mass balance does not allow attribution of bio-based content or fossil resource savings to a product based on mass ([CEN/TC 411/WG 3 document N110b](#)). A chemical cracking unit might introduce an amount of vegetable oil to partially substitute some petroleum, and as a mass replacement the two feedstocks are not equivalent. Hence a conversion of mass of the feedstock to the attribution unit is required. This conversion should also follow a mass balance principle. As a result of this conversion, it is possible to establish the amount of attribution units required for the production of the final product within the system boundary. Any bio-based feedstock can also be converted to the attribution unit. After knowing the amount of attribution units required for a product according to the process by which it is made, it is possible to attribute bio-based feedstocks to the product in any percentage up to 100% biomass allocation. In this case it is recommended to have standard claims already included in relevant standards, to make clear that the degree of allocation does not stand for the quantified bio-based content of a product. The potential for confusion requires that this approach is carefully managed. This is also the reason for referring to these products as 'fossil resource saving' and not 'bio-based'.

A mass balance calculation starting from the raw materials input in complex inter-linked processes may not reasonably be performed in some cases. Therefore, a mass balance can be performed starting from one defined final product. The objective of a mass balance approach in an attribution system is to obtain the amount of raw feedstock, which might be associated to a given product, needed for the production of that finished article within the system boundary. In order to have a clear and transparent mass balance calculation, a step by step approach is needed. This approach starts with the definition of the final product as



output of a defined process. All inputs and losses from this process should be completely defined. In an allocation system biomass proportions do not have to be tied to the specific raw materials or intermediates, and therefore there is no need for the product identity to be maintained (Figure 5-2). There is a risk that this be exploited for marketing purposes and might undermine the robustness of this mass balance method. Figure 5-2 shows attribution up to a maximum of 100% fossil resource savings for three products created by a single process using a biomass feedstock. The quantity of biomass (replacing fossil resources) on a mass basis can be assigned to the various products up to the total of 25 kg. Actual biomass content and how it is distributed (including into the losses) is not relevant. Although this example is on a mass basis, the same principle applies when attribution units are used. The mass balance calculation will take into account at least all input materials for the processes in operation. This approach will be performed continuously until only raw feedstocks are input to the system (common to mass balance Method D). As a result it is possible to define an overall mass balance calculation for a product only based on the feedstocks, where the difference of mass represents the losses of the system.

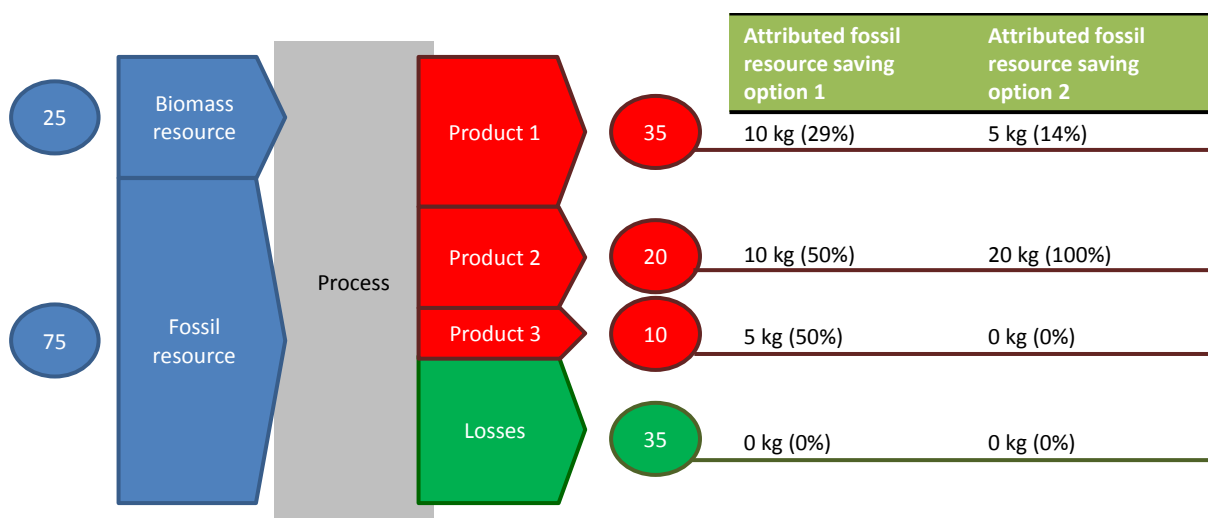


Figure 5-2 A demonstration of attribution of fossil resource savings.

An example from **CEN/TC 411/WG 3 document N93** is useful to demonstrate how mass balance Method A can be put into practice. The case study is a hypothetical production facility consisting of three processes (Figure 5-3). The designated product of interest is output 3.1, or O3.1 in abbreviation, to indicate it is the first output stream of the third process. Similarly I1.1 is the first input stream of the first process, and L2.2 is the second loss stream of the second process. Because mass balance must be applicable to individual processes and the plant as a whole (without overlap) the labelling of output streams must be conducted even when it equates to a subsequent input. For example, in Figure 5-3, output 2.1 is the same as input 3.2. In many cases the output of one process that corresponds to the input of the following process will yield surplus intermediate. Sequential processes must be scaled to



equate the mass balance. The mass flows of each stream are given in Table 5-2 as reported for each process individually. These values need to be normalised to give a complete manufacturing route to the identified final article.



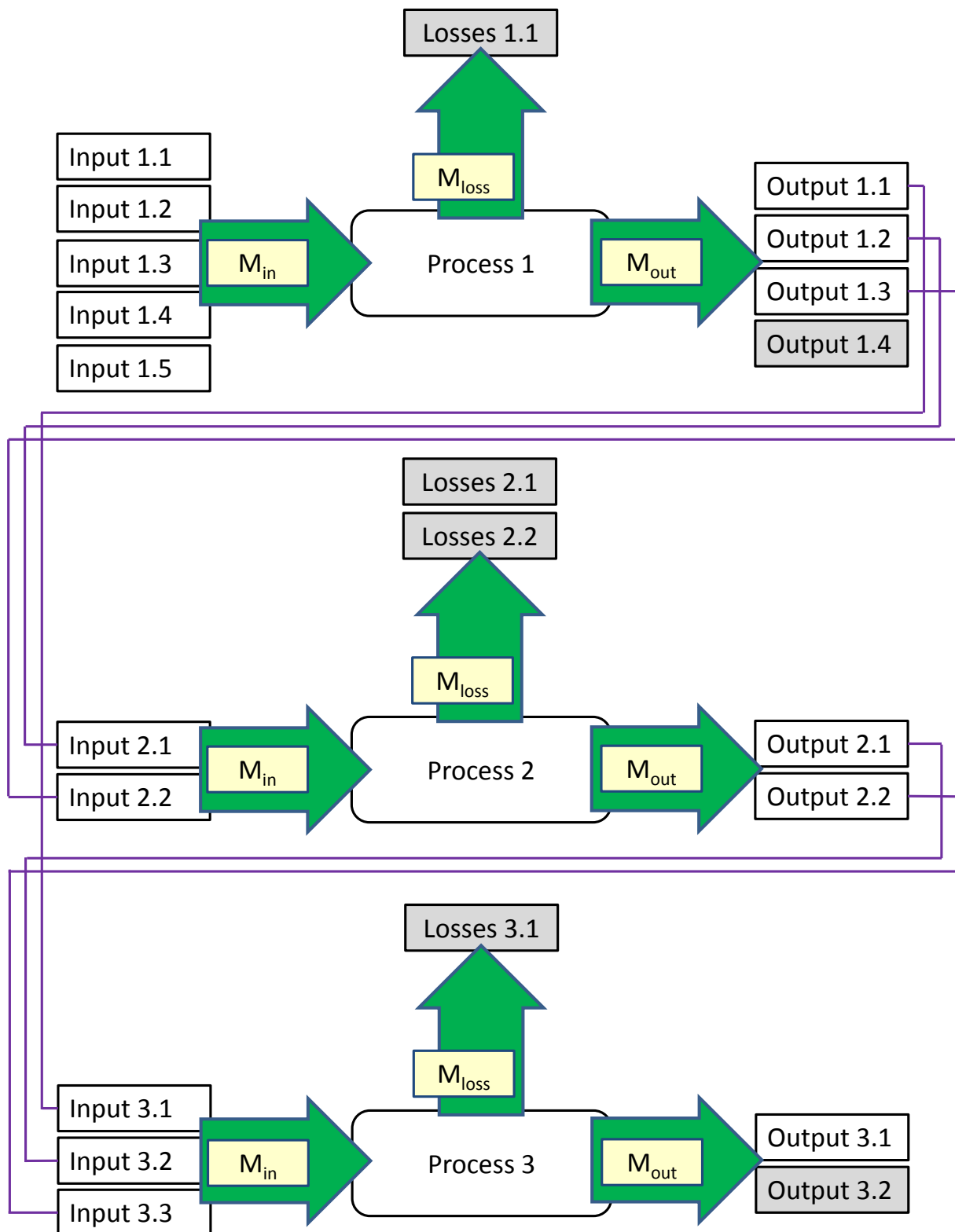


Figure 5-3 A hypothetical manufacturing process demonstrating mass balance.



Table 5-2 Mass balance material flows a hypothetical manufacturing process.

Process	Stream	Connection	Mass /kg
Process 1			
	I1.1		45
	I1.2		80
	I1.3		50
	I1.4		28
	I1.5		45
	O1.1	I3.1	100
	O1.2	I2.1	54
	O1.3	I2.2	20 (productivity limiting flow)
	O1.4		26
	L1.1		Unspecified (<i>48 by mass balance</i>)
Process 2			
	I2.1		89
	I2.2		69
	O2.1	I3.2	100
	O2.2	I3.3	34 (productivity limiting flow)
	L2.1		Unspecified (<i>loses total 24</i>)
	L2.2		Unspecified (<i>loses total 24</i>)
Process 3			
	I3.1		80
	I3.2		16
	I3.3		76
	O3.1		100
	O3.2		Unspecified (<i>unaccounted mass totals 72</i>)
	L3.1		Unspecified (<i>unaccounted mass totals 72</i>)

The process volumes in Table 5-2 can be scaled to indicate the quantity of feedstock input required to produce a given mass of a specific product anywhere within the system boundary. In this case O3.1 has been chosen as the product of study. Figure 5-4 demonstrates that tracing back from the final product through the different processes means that the mass flow values given for Process 1 and Process 2 need to be revised to match demand as the output of one process becomes the input of the following. This identifies production limiting mass flows (*i.e.* no surplus material is created) and results in surpluses that are not relevant to the production of O3.1 (Figure 5-4).



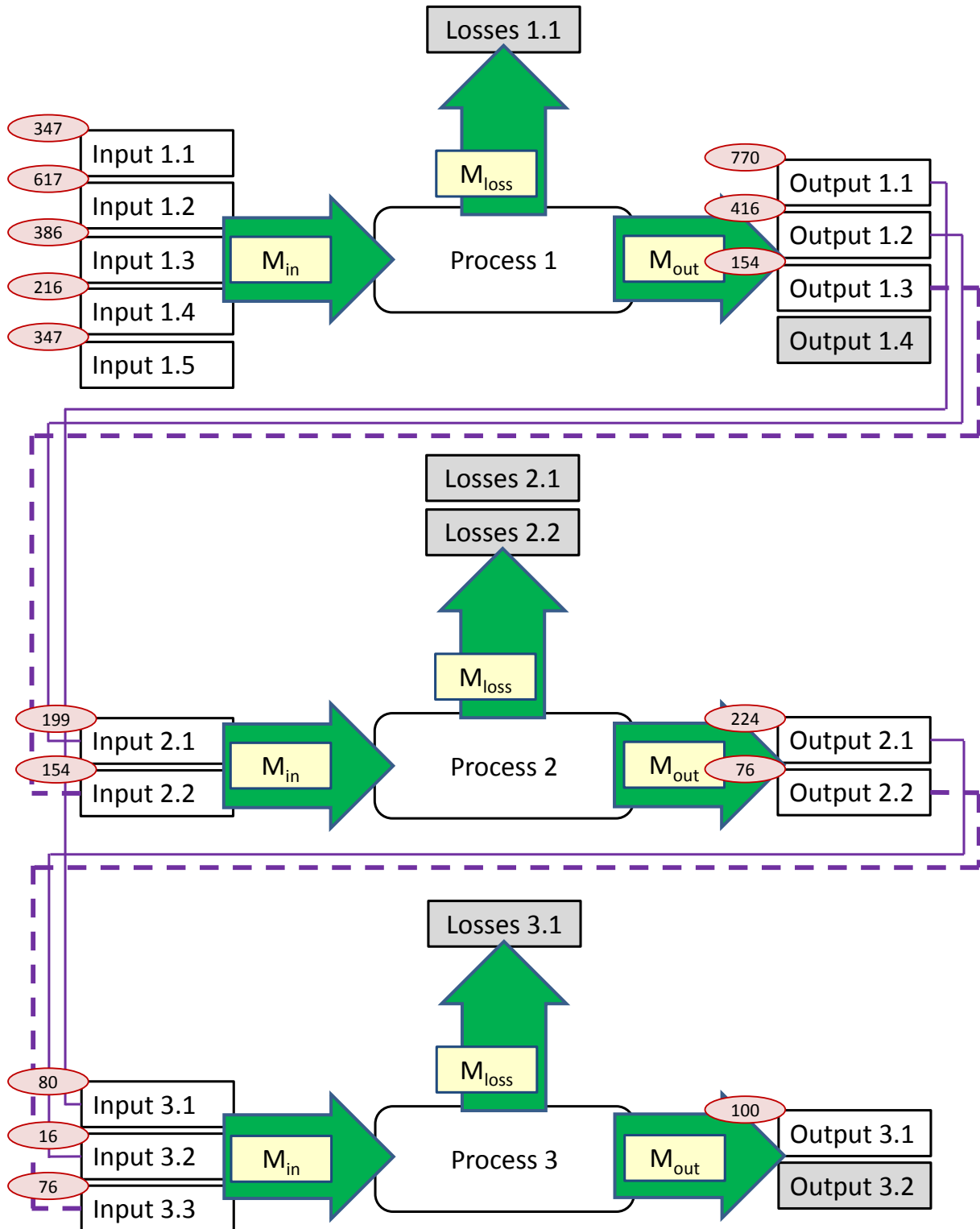


Figure 5-4 Hypothetical manufacturing process with the product limiting flow highlighted and mass flows indicated in mass units (kilograms).



From Figure 5-4 we can recognise that a combined feedstock requirement (I1.1, I1.2, I1.3, I1.4 and I1.5) equal to 1910 kg is required to produce 100 kg of O3.1. Of course mass balance Method A uses methane equivalents as its base unit and so the conversion must be made. Assuming the feedstocks are all fossil derived, and the methane equivalents of these feedstocks are as displayed within the following calculation (Table 5-3), then product O3.1 is assigned 2037 attribution units; this value being attributed to the minimum quantity of all the feedstocks required to produce 100 kg of O3.1 and taken to mean the mass of the combined feedstocks that would have the same calorific content as an amount of methane equal in mass to the actual feedstock input. This expression is the preferred manner to calculate this concept as presented in the existing protocol within [CEN/TC 411/WG 3 document N93](#). The relative energy content could be used instead of methane equivalents as given in Table 5-3 to give a value for the mass of methane that would have the same calorific value as the total feedstocks (1859 kg in this instance). Relative energy content is simply the inverse of methane equivalents.

Table 5-3 The methane equivalents assigned to the feedstocks of this hypothetical case study demonstrating mass balance Method A.

Feedstock	Lower heating value /MJkg ⁻¹	Methane equivalent	Relative energy content
I1.1	41.6	1.2	83%
I1.2	45.5	1.1	91%
I1.3	62.5	0.8	125%
I1.4	33.3	1.5	67%
I1.5	55.6	0.9	111%

$$\begin{aligned}
 \text{O3.1 attribution units} &= \sum \text{Input mass} \cdot \text{methane equivalent} \\
 &= (1.2 \cdot 347\text{kg}) + (1.1 \cdot 616\text{kg}) + (0.8 \cdot 385\text{kg}) + (1.5 \cdot 216\text{kg}) + (0.9 \cdot 347\text{kg}) \\
 &= 2037 \text{ kg}
 \end{aligned}$$

To test the allocation of bio-based content onto O3.1 we can presume one feedstock, I1.1, is replaced by biomass with a methane equivalent value of 0.7. Mass balance Method A depends on having a mixed feedstock stream of biomass and fossil derived material which can be compared to an equivalent process utilising only fossil inputs. If a plant is dedicated to the chemical synthesis of ethyl esters, then synthetic ethanol could be replaced with an equal quantity of bio-ethanol. If the plant has always operated using a feedstock of bio-ethanol the mass balance can be calculated theoretically for a supposed synthetic ethanol upgrading plant. In this example, a petroleum feedstock is replaced in favour of a different, bio-based material. Some processes, such as the chemical modification of cellulose, have no petrochemical equivalent. It could be assumed there is an identical fossil resource utilising pro-



cess but it is not helpful to claim fossil resource savings for traditionally bio-based products (including sugars and starches, wood products, *etc.*). The basis of the commodity chemical industry is process chemistry such as gasification where a number of feedstocks can be used to produce the same spectrum of products (hydrogen, carbon monoxide, carbon dioxide) [Weissermel 1993]. However to produce the same quantity of a specified product after switching to a new feedstock it is certainly an inevitability that the mass input to the system would change. For now 347 kg of the fossil derived I1.1 feedstock (1.2 methane equivalents) is being changed for an equal mass of a chemically different biomass feedstock (0.7 methane equivalents).

The attribution units previously attributed to O3.1 are divided by the methane equivalents associated with the biomass feedstock to give a value for the quantity of biomass required to be able to assign 100% bio-based content to O3.1 (or another product of the operators choosing). This value happens to be 2910 kg, whereas the actual mass flow of I1.1 (*i.e.* the biomass feedstock) is only 347 kg (12% of this target). Therefore the final product (O3.1) can only be claimed as being 12% bio-based (specifically 12% fossil resource saving) using this method. Equating the ‘fossil resource saving’ to ‘bio-based content’ is helpful leading up to latter comparisons to the other mass balance approaches even if it is not the correct reporting format.

$$\frac{\text{O3.1 attribution units}}{\text{Methane equivalents of biomass feedstock}} = \frac{2037 \text{ kg}}{0.7} = 2910 \text{ kg}$$

This value of 12% bio-based content for O3.1, calculated by addressing the feedstocks of the process in terms of their energy content has no bearing on the actual bio-based content of O3.1 (theoretically possible to be any value, 0-100%), or the proportion of biomass introduced into the plant (which here is 18% on a mass basis). Because this mass balance is inherently based on the comparison to a totally petrochemical process (or connected processes) the conclusion of mass balance Method A can be expressed as fossil savings, which would be 347 kg of feedstock material (18% of the total feedstock mass) or 416 attribution units (20% of the total 2037 attribution units). There is an obvious variation in the results depending on how they are expressed. The actual, analytical, bio-based content of the product O3.1 cannot be estimated with the information provided.

Although these calculations are performed on the basis of producing 100 kg of the target product, O3.1, the results are expressed as percentages and actually relate to the feedstock not the product. Therefore the claim of 12% bio-based content could be applied to the nominated product, or potentially 12% of the O3.1 produced could be claimed as wholly bio-based and the remainder possessing no indirectly attributed bio-based content. In effect two classes of the same, chemically identical, product could be manufactured: one with bio-



based content attributed to it and another without. This could lead to abuse of the mass balance allocation method, for the product could be sold at an elevated price to certain sectors carrying the bio-based certification while the remaining 88% of the exact same product would command the usual, lower market price. Intuition dictates the bio-based content that can be applied *via* the mass balance principle must not exceed the actual possible maximum bio-based content inherent from the structure of the product. This is a stipulation when applying mass balance Method B or Method D which are truer bio-based content calculation systems independent of attribution units.

5.1.3 Mass balance Method B: The determination by calculation and allocation of the average bio-based carbon content and average bio-based content

Mass balance Method B is used to trace biogenically sourced constituents through all conversion pathways of a chemical manufacturing process, from feedstock up until the production of the final article. It bears a greater similarity to conventional bio-based carbon content analysis and atom connectivity than other mass balance approaches and so is likely to have the greatest compatibility with direct methods of bio-based content determination. It is best represented within CEN/TC 411 documentation by [CEN/TC 411/WG 3 document N104](#). The method has two sections. Firstly a calculation section where mass balance is applied in order to trace the flow of biomass. Then allocation of total bio-based content follows, utilising the results from the mass balance and atom connectivity derived from an assignment of the bio-based carbon atoms. This mass balance method is applicable for the determination, by calculation, of the average bio-based content (or the average bio-based carbon content) in a product within a defined timeframe/interval. The calculated average bio-based content (or bio-based carbon content) can be allocated to a product when the biomass feedstock input fluctuates, but by using allocation a claim for a determined content is no longer valid in a literal sense, and should thus be clearly communicated. The mass balance for each process step must be created from actual measured inputs, outputs, losses. When fluctuation of biomass input presents issues in applying atom connectivity, virtual sub-mass balances are needed to perform the calculation. Virtual sub-mass balances with no biomass input do not require atom connectivity calculations as they contain no bio-based content.

How to arrive at the final conclusion of bio-based content and/or bio-based carbon content is briefly demonstrated in Figure 5-5 before being explained subsequently in more detail. The output equals the mass of the input flows. It is supposed that a process utilising biomass and fossil resources is split into two virtual streams. The total biomass and fossil resource use over the pre-defined time period is shown as equalling 25 kg in both cases. Therefore the additional mineral resource is split into two streams of 10 kg each. One is required for biomass functionalisation and the other for reaction with the fossil feedstock



stream. Then the intermediate chemical is pumped into a container, possibly for transport (for expanded system boundaries, multiple mass balances are needed). Depending on the nature of the intermediate, the fluctuating biomass input could create a layering effect within the vessel (as might be expected for pellets of polymer), meaning when batches are removed for further functionalisation the exact proportion of bio-derived intermediate in each is not known. Even if there is not a measurable storage time the fluctuating biomass input will cause variance in the bio-based content. To address this an average can be calculated. With the division of the process into virtual sub-mass balances, 35 kg of bio-based material is distributed across the three products and a waste stream. According to atom connectivity, applied to the virtual biomass sub-mass balance, 10 kg of mineral resource (assumed here not to contain carbon) is reacted with 25 kg of biomass, and so 35 kg of 100% bio-based intermediate must result (atom connectivity Method 2b). This is eventually distributed across the products according to known reaction pathways and yields. It must be confirmed that these allocated values of bio-based content do not exceed the maximum possible stoichiometric limit. If any losses had occurred earlier in the production chain a loss of bio-based content would have to be allocated. A minimum bio-based content could also be determined, although this might be 0% depending on the variation pattern when the biomass input fluctuates. If undefined losses occur during the process, an accurate minimum bio-based content would have to assume all the losses were biomass (up to the limit dictated by the biomass flow over the pre-defined time interval). Minimum bio-based content claims are more compatible with product specific bio-based product standards that require a minimum bio-based (carbon) content (e.g. [CEN/TS 16137](#), [CEN/TR 16227](#)).



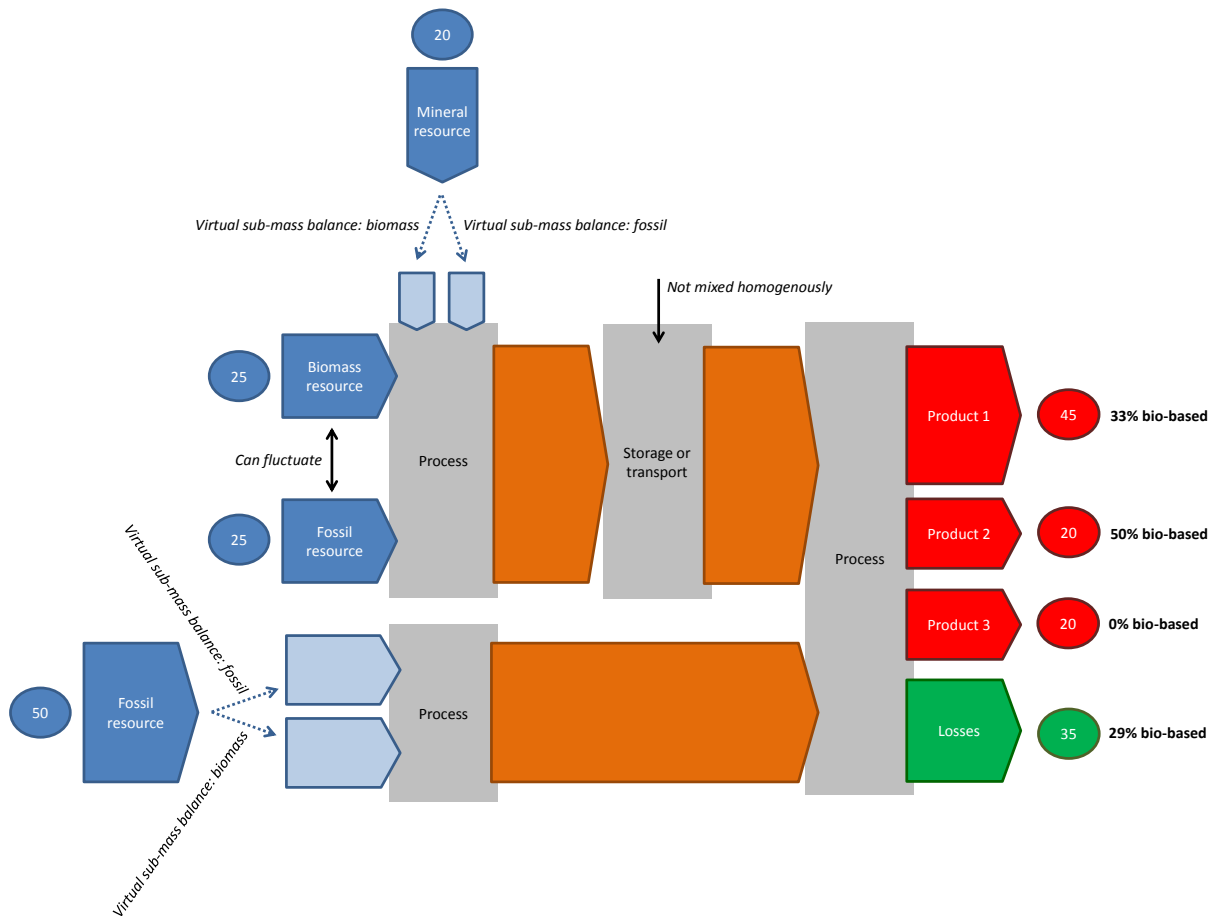


Figure 5-5 A general example of mass balance Method B in practice.

The mass balance for the determination by calculation of bio-based content and bio-based carbon content are in accordance with the general rules as stated previously in this chapter. The mass balance can only be performed for a fixed time period of production, which shall be clearly defined. A rolling twelve month interval is sensible given the seasonality of plant crops. The traceability of total mass, biomass, mass of bio-based content and/or mass of bio-based carbon must be guaranteed through the internal processes and material pathways up until the creation of the final products. Importantly, the mass balance should be based on pre-defined and understood chemical reaction pathways involving the biogenic constituents as they are transformed by chemical reactions through the production process. It is recommended that the bio-based reaction pathways are verified using suitable analytical approaches where possible (e.g. radiocarbon measurement as described in [EN 15440](#), [CEN/TS 16640:2013](#) and [ASTM D6866](#)). This verification could be performed and approved by a third party to provide an independent check over the mass balance claims. If the biomass input is not fluctuating then test method described in [prEN 16785](#) is applicable for the direct determination of total bio-based content (using atom connectivity). Note that ^{14}C radio-



carbon isotopic analysis is not always accurate, even when the biomass feedstock is not fluctuating. It has been observed that marine biomass is depleted in ^{14}C (limestone carbon dioxide is also available to the plant) [Darden Hood, private communication, 2014]. A similar effect can occur then biomass is grown in fossil carbon dioxide-rich environments (5% underestimation of bio-based content). In addition the fermentation of petrochemicals into new products is incompatible with radiocarbon analysis. Mass balance provides a method by which to calculate bio-based content without direct analysis in these specific scenarios, as well as when biomass feedstocks are fluctuating. Broader mass balance approaches considering recycled content or the renewability/sustainability of bio-based products are compatible with the mass balance approaches described here.

Mass balance Method B, for the determination by calculation of bio-based content and bio-based carbon content, is operated in accordance with established system boundaries as stated previously. The system boundaries are defined within the needs and purposes of the user. However expanded system boundaries needs to utilise multiple mass balance systems for validation and calculation purposes. However the system boundaries may not be expanded beyond the European geographical area **CEN/TC 411/WG 3 document N93**.

A mass balance based on the inputs (feedstocks and intermediates) and output flows (intermediates, final products and losses) of bio-based materials is established within the defined system boundaries, summarised with this equation.

$$\sum M_{bio,in} = \sum M_{bio,out} + \sum M_{bio,loss}$$

$\sum M_{bio,in}$ is the mass of the sum of the total input of biomass.

$\sum M_{bio,out}$ is the sum of the outputs of biomass distributed among the manufactured or semi-finished products.

$\sum M_{bio,loss}$ is the sum of the biomass lost during processing.

For products that are partially bio-based, an additional mass balance for the total mass flow is needed in order to calculate the bio-based content of the final product, logically following the same format when expressed mathematically.

$$\sum M_{in} = \sum M_{out} + \sum M_{loss}$$

$\sum M_{in}$ is the sum of the mass of the total material inputs of all origins.



$\sum M_{loss}$ is the sum of the total material losses during processing, by mass.

$\sum M_{out}$ is the sum of the total material outputs, by mass, distributed among the manufactured or semi-finished products.

The bio-based content as expressed as a percentage of total product mass, x_{bio}^{mass} , can then be determined for the finished product or final article.

$$x_{bio}^{mass} = \frac{M_{bio,prod}}{M_{total,prod}} \times 100\%$$

$M_{bio,prod}$ is the biomass in the final or semi-finished product, by mass.

$M_{total,prod}$ is the total mass of the final or semi-finished product.

Similarly, for the determination (by calculation) of bio-based carbon content, a mass balance based on the inputs and outputs of the bio-based components is to be established within the defined system boundaries.

$$\sum M_{bc,in} = \sum M_{bc,out} + \sum M_{bc,loss}$$

$\sum M_{bc,in}$ is the sum of the inputs of total bio-based carbon, by mass (either actual or via certificate).

$\sum M_{bc,out}$ is the sum of the outputs of total bio-based carbon, by mass, distributed among the manufactured or semi-finished products (actual or on a certificate basis).

$\sum M_{bc,loss}$ is the sum of the bio-based carbon, by mass, lost during processing.

For products that are partially bio-based, an additional mass balance on total carbon is needed in order to calculate the bio-based carbon content, X_{bc}^{tc} , of the final product.

$$\sum M_{tc,in} = \sum M_{tc,out} + \sum M_{tc,loss}$$

$\sum M_{tc,in}$ is the sum of the inputs of total carbon by mass.

$\sum M_{tc,out}$ is the sum of the outputs of total carbon, by mass, distributed among the products of the process.



$\sum M_{tc,loss}$ is the sum of the total carbon, by mass, lost during processing.

The bio-based carbon content, x_{bc}^{tc} , (expressed as a percentage of the total carbon content), can then be determined for the semi-finished or final product.

$$x_{bc}^{tc} = \frac{M_{bc,prod}}{M_{tc,prod}} \times 100\%$$

$M_{bc,prod}$ is the mass of bio-based carbon in the final article.

$M_{tc,prod}$ is the mass of the total carbon in the final article.

Under the original TC 411/WG 3 proposal within **CEN/TC 411/WG 3 document N93**, input certificates can be stored perpetually within the defined time period for the later allocation of bio-based content (or bio-based carbon content). Allocation can be performed through multiple processing steps using multiple mass balances systems or through a single processing step within a singular mass balance system. A mass balance system may have a broader system boundary following consecutive reactions within an interlinked production system, but for validation purposes will need to perform multiple mass balance calculations. Allocation is only permitted when there is a physical connection towards the bio-based product and is limited to the physical transportation and storage of the bio-based product (e.g. in storage, storage tank, tank car, barge, truck, vessel, and pipeline). It is recommended that verification of allocations are performed and approved by a third party.

When a verified amount of bio-based product has been established using the mass balance calculation within a pre-defined system boundary it could be possible to allocate the bio-based content from between identical products in a percentage up to 100% bio-based content, or bio-based carbon content if the stoichiometric limit permits (in mass balance Method A the products did not have to be the same). It is recommended to clarify in any claims that the degree of allocation does not directly equate to a quantified bio-based content of a product, although any contradiction with analytical methods will harm communication of bio-based product claims. In order to enable the creation of technology drivers and in order to not create barriers for the development of new bio-based components, a limiting factor to the maximum percentage for allocation is introduced. For a chemical that consists of multiple constituents, some which may be bio-based and some which may be fossil based, allocation may only be performed up to the maximum percentage of bio-based content according to the stoichiometric rules for the specific chemical transformation. For example, ethyl acetate, the product of bio-ethanol and fossil derived acetic acid can only be allocated to a maximum percentage of 50% bio-based carbon share. If at any point during the fixed time period bio-ethanol is replaced with fossil derived ethanol, the average indirect bio-based content that



can be allocated to the product will be less than 50%, although at times the direct bio-based carbon content will reach 50%, and sometimes even fall to 0% if no biomass feedstock is being used. Allocation could in theory be used to quote the stoichiometric maximum bio-based content for some batches, and artificially lower claims in others to compensate. The system boundaries must guarantee that the total amount of allocated bio-based carbon content or allocated bio-based content stay within the rolling time interval. It has been decided within CEN/TC 411 that if the bio-based content of products emerging from a biorefinery ever reaches 0% at any point during the pre-defined time interval, those products affected cannot be considered as bio-based.

Allocation should be conducted in regards to the bio-based output from the mass balance calculations using predefined chemical reaction pathways of subsequent chemical reactions and based upon the physical transportation events that are being performed within the physical supply chain of the bio-based product(s).

- Allocation may only be performed up to the amount of bio-based content or bio-based carbon content that has been determined for a specific product.
- As described in **CEN/TC 411/WG 3 document N93**, “*considering that we want to promote technology drivers for bio-based components*”, allocation may only be performed up to the maximum percentage of bio-based content or bio-based carbon content that can be stoichiometrically verified.
- Allocation may not be performed in order to directly transfer the bio-based share from one chemical to another, *e.g.* from ethanol to methanol.
- When a given product, with a given allocated bio-based share, is used as raw material for production of a downstream product, the allocated bio-based share of the reactant may be used as an input for a subsequent mass balance calculation of the final article, *e.g.* from ethylene to polyethylene.
- Allocation is only permitted when there is a proven physical connection within the system boundaries for the bio-based product (*e.g.* storage, storage tank, tank car, barge, truck, vessel, and pipeline).

The example of interlinked production followed by purification given in **CEN/TC 411/WG 3 document N93**, is that of a vegetable oil co-feedstock, introduced to a naphtha cracker for the production of light olefins. It has been adopted here as a case study as well. Full range naphtha contains a number of hydrocarbon components with a boiling range of up to 473 K. The reaction is performed anaerobically with water vapour [Weissermel 1993]. The



yields for the conversion of naphtha and the yields for conversion of vegetable oil in a naphtha cracker may be different for any given reactor and reaction conditions, the numbers used in this example is merely for illustrating the method and is not meant to be used for any other purpose. In this example, 10 tonnes of bio-based vegetable oil is introduced as a bio-based feedstock (Table 5-4). The vegetable oil is added as a co-feed in an otherwise fossil feed. The yields for the conversion of full range naphtha are known, and typically are 20% ethylene, 17% propene, and 11% of butenes and butadiene [Weissermel 1993]. The remaining products include fuel gases and oil residues. The data in Table 5-4 is retained from **CEN/TC 411/WG 3 document N93** and loosely approximates this. The yields for converting vegetable oil in different process conditions are also known [Bezergianni 2009, Doronin 2012]. The yields for the separate feedstock processing methods (naphtha and vegetable oil) may be proven using analysis, preferably ^{14}C measurements for bio-based carbon content (as described in **EN 15440**, **CEN/TS 16640** and **ASTM D6866**). This may even help assign the reaction pathways which might be problematic in an example such as this where two simultaneous reactions are occurring in the same vessel to yield a similar distribution of products.

Table 5-4 Naphtha and vegetable oil cracking mass balance data over a pre-defined time period.

Mass flow	Total mass /kg	Biomass /kg	Fossil /kg
M_{in}	100,000 (100%)	10,000 (100%)	90,000 (100%)
M_{out}			
Ethylene	24,500 (24.5%)	2,000 (20%)	22,500 (25%)
Propylene	19,500 (19.5%)	1,500 (15%)	18,000 (20%)
Butenes	14,700 (14.7%)	1,200 (12%)	13,500 (15%)
Other products	35,600 (35.6%)	5,000 (50%)	30,600 (34%)
M_{loss}	5,700 (5.7%)	300 (3%)	5,400 (6%)

The results of the mass balance need to be close to, or ideally the same as the result achieved from continuous analytical measurement (feedstock variation with time is an issue). Mass balance determination by calculation of the average bio-based content (or bio-based carbon content) within a pre-defined time period based on ethylene gives the result of $\sum M_{bio,in} = 10,000$ kg, $\sum M_{bio,out} = 9,700$ kg (distributed between all the products) and therefore $\sum M_{bio,loss} = 300$ kg by using the biomass mass balance.

Using the total mass balance equation, encompassing all material mass flows puts these results into context, where $\sum M_{in} = 100,000$ kg, $\sum M_{loss} = 5,700$ kg and $\sum M_{out} = 94,300$ kg distributed amongst all the products. Ethylene is produced in a quantity of 24,500 kg over the course of the pre-defined time period. From the mass balance equations, the bio-based content can be determined for ethylene as 8.16%.



$$\frac{\text{Bio, ethylene}}{\text{Total mass, ethylene}} = \frac{2,000 \text{ kg}}{24,500 \text{ kg}} \times 100\% = 8.16 \%$$

For ethylene in this example, allocation may only be performed to the maximum amount of 2,000 kg (8.16% bio-based content on average). The possibility to allocate this portion of bio-based content is specific to ethylene within the pre-defined time period. The stoichiometric maximum bio-based content of the ethylene is 100%, opening up several allocation possibilities. The process is also valid for the other products; an average of 7.69% bio-based propylene can also be reported. The initial feedstock input was 10 wt% biomass, highlighting the difference in each approach to the concept of mass balance.

5.1.4 Mass balance Method C: The determination of the average bio-based content by calculation of fossil carbon savings

The third approach to mass balance describes a method to calculate bio-based carbon, and hence the substitution of fossil carbon in the final product during the production of a product, or indeed an intermediate in subsequent chemical reactions. In this variation of the mass balance concept, mass balances are carried out to quantify the bio-based carbon and the total mass flows during in the production of an article. The mass balance for the total product mass can be calculated according to the familiar equation. To account for bio-based carbon, a mass balance based on the input and output of bio-based carbon is to be established for each step (within the defined system boundaries).

$$\sum M_{bc,in} = \sum M_{bc,out} + \sum M_{bc,loss}$$

$\sum M_{bc,in}$ is the sum of the inputs of total bio-based carbon, by mass (either actual or via certificate).

$\sum M_{bc,out}$ is the sum of the outputs of total bio-based carbon, by mass distributed among the manufactured or semi-finished products (actual or certificate basis).

$\sum M_{bc,loss}$ is the sum of the bio-based carbon, by mass, lost during processing.

A certificate is created for the product based on the calculated mass of bio-based carbon in the final article that communicates the fossil carbon savings resulting from its displacement by bio-based carbon. This avoids deriving fossil savings from calculations based on an alternative feedstock (*i.e.* mass balance Method A), which can be misleading if the conversion of biomass is less efficient than the typical fossil feedstock (hence requiring more biomass feedstock which could result in an overemphasis of bio-based content and promote



inefficient manufacturing technologies). Claims for the final product can only be made up to the maximum stoichiometric contribution of the bio-based raw material in the final product. In this approach, bio-based carbon accounting in combination with fossil carbon savings claims are chosen because bio-based carbon content is standardised terminology and the ^{14}C radiocarbon methodology is established and refers to the physically embedded bio-based carbon content with the sample. Mass balance approaches, on the contrary, can be applied to non-dedicated facilities and therefore may not reflect the actual amount of bio-based carbon physically embedded in the product at a particular time, but overall give a balanced reflection of the process. To claim fossil carbon savings with mass balance Method C and not an alternative and perhaps conflicting bio-based carbon result is beneficial in creating complementary direct and indirect approaches. Although having said that, the product of mass balance Method C will usually be reported here as a percentage of bio-based carbon (total carbon basis) to enhance comparisons between approaches.

As an example of the application of mass balance Method C, a partially bio-based product is produced from a mixture of biomass and fossil derived feedstocks *via* an intermediate compound (Figure 5-6). The initial proof of the bio-based origin of the feedstock can either be made by extending the system boundaries back to the source (*e.g.* a farm or plantation) or by providing proof of bio-based origin at the point of entry into the mass balance system (*e.g.* analytical determination of bio-based carbon content). Information on the properties of the feedstocks and products can be found in the following figure. The bio-based carbon content of waste stream 2 in Figure 5-6 is given as 90%, although it is unlikely that this would be able to be calculated unless it is the result of a reaction and a known by-product, or losses during transport or storage. A realistic allocation of bio-based carbon would be permitted.



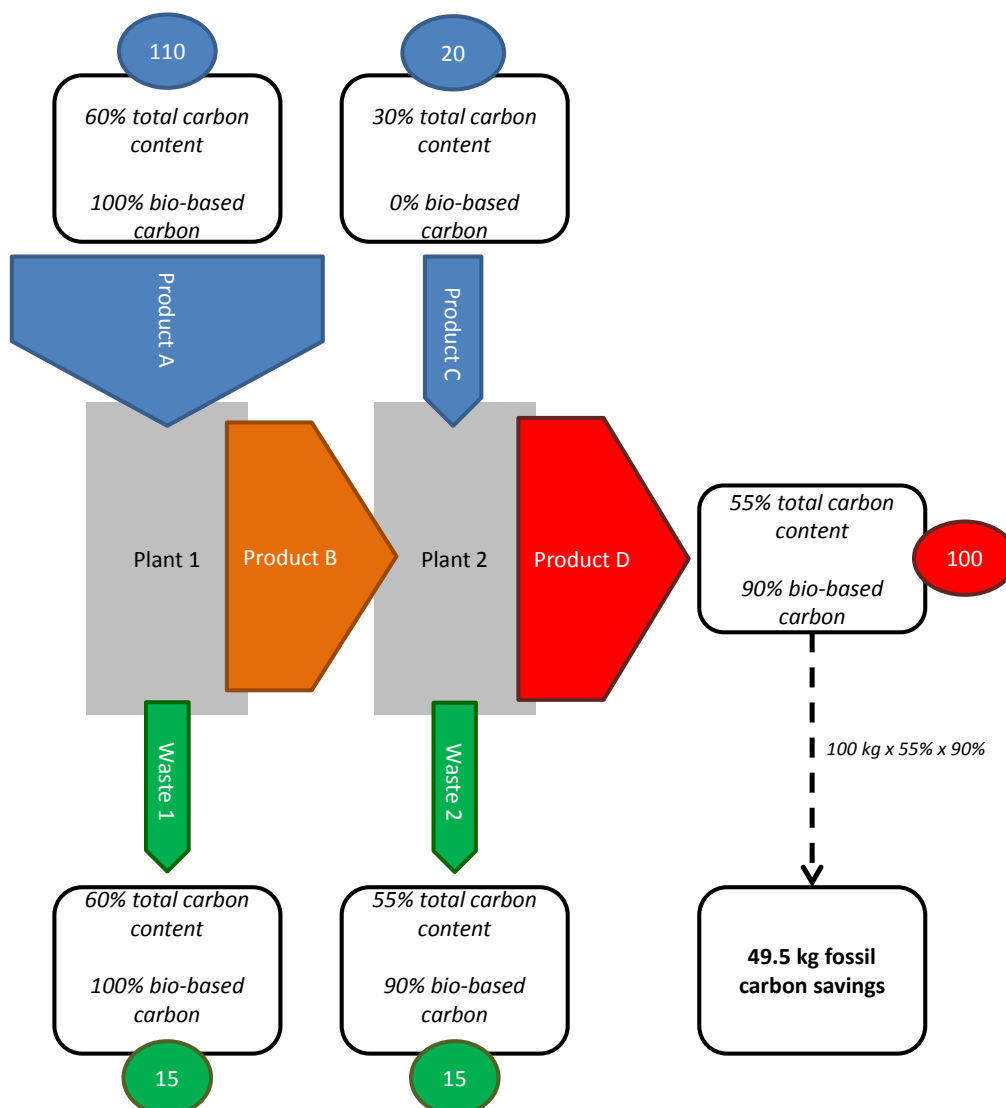


Figure 5-6 Mass balance approach to calculate the amount of bio-based carbon/fossil carbon saved in the global supply chain in a dedicated facility with mass flows described in units of kilograms.

Mass balances for total product mass, bio-based carbon, and total carbon allow the calculation of the bio-based carbon in the final article. Since bio-based carbon displaces the need for fossil based carbon in the production chain, a certificate for the amount of fossil carbon saved in the global supply chain can be issued. In the example above (Figure 5-6), this totals 49.57 kg of fossil carbon savings per 100 kg of product. The bio-based carbon content of the product is 90%, and of the 130 kg of feedstock needed, 85% is biomass. There is no need for a comparison to a previous fossil resource utilising process as in mass balance Method A.



The previous example shows a calculation by the mass balance principle for a dedicated facility. In reality, production facilities, infrastructure and feedstock supply may not be dedicated to bio-based feedstocks. For example, the initial feedstock might be delivered by a pipeline that is used to deliver both bio-based and fossil derived equivalents of the same chemical feedstock. In the example illustrated subsequently, 200 kg of the final product are produced by consecutive conversions in plant 1 and plant 2 (in the pre-defined time interval) from 110 kg of fossil derived feedstock and 110 kg of the equivalent bio-based feedstock (Figure 5-7). Although physical separation is not possible, the 100 kg of the final product (*i.e.* half) produced from the fossil-based feedstock (half of the total initial feedstock) does not warrant a certificate, whereas the other 100 kg of the article produced from the bio-based portion of the feedstock merits a certificate for the amount of fossil carbon saved. This is derived from a virtual separation of the mass balance continued into the final products without being averaged out across all batches of the product. Claims describing the final article can only be made up to the maximum stoichiometric contribution of the raw material found in the final product, and the bio-based carbon lost as waste is not included in the certificate. This is the result of this approach using virtual separation to describe two parallel mass balances, one involving the biomass input and the other not (without attribution). If the bio-based carbon content is averaged by proportioning the result of the mass balance across the entire product 'D' output (Figure 5-7), there is a clear focus on the origin of the article as represented within its actual content and not just how much biomass goes into the process that produces it. Both scenarios, one using allocation to maximise the bio-based content claim of one batch of the product, the other an idealised average across the whole output, do not (and cannot) accurately portray the bio-based carbon content and its fluctuations (including minima and maxima) with time. As for whether one approach is preferable over the other, that would need consultation with business and customers.



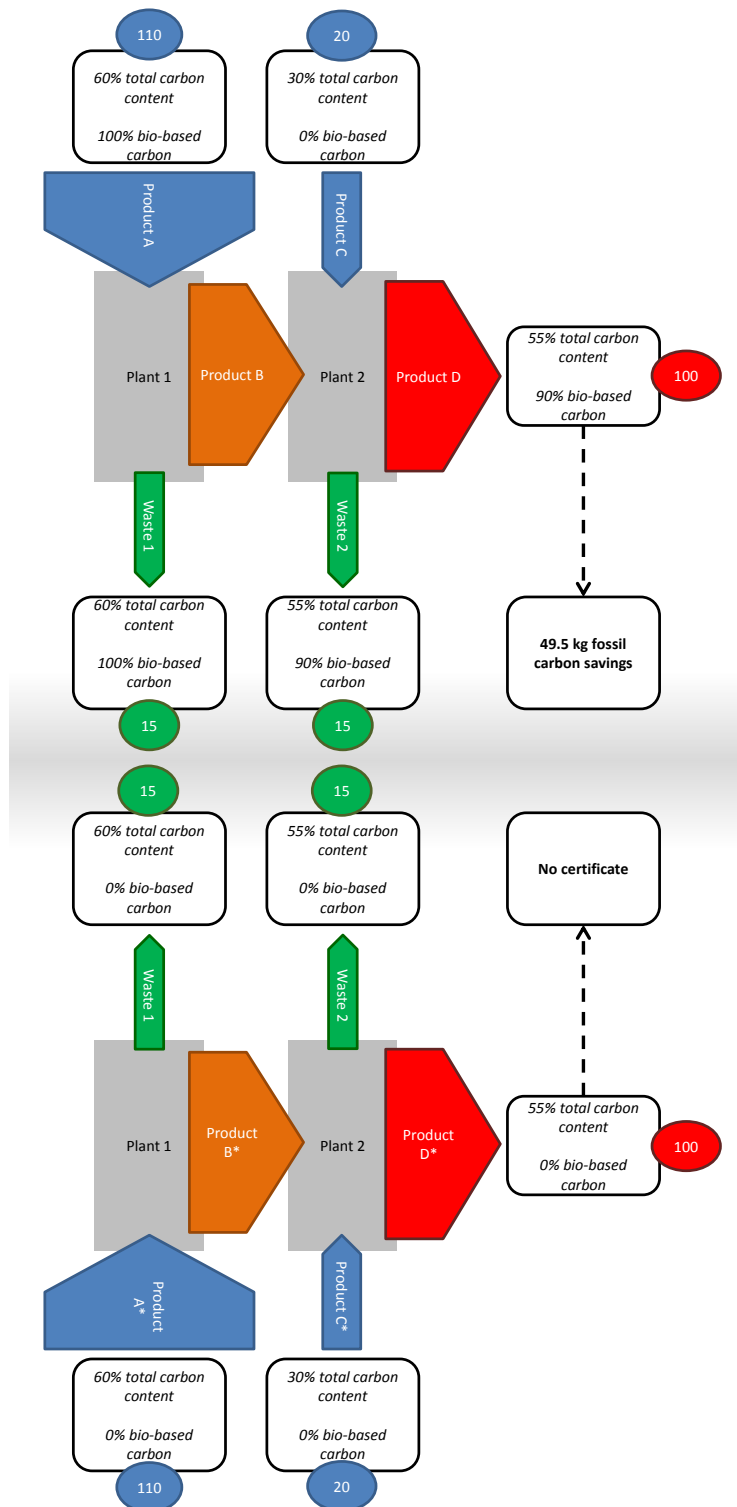


Figure 5-7 Mass balance approach to calculate the amount of bio-based carbon/fossil carbon saved in the global supply chain for the production of product D/D* in a non-dedicated facility with mass flows described in units of kilograms.



In any subsequent reactions, blending, *etc.* involving the final product of the manufacturing process just described, if allocation was used to maximise claims of bio-based content for a portion of the product (Figure 5-7), two separate inventories need to be considered and two separate mass balances need to be carried out to account for both the material conversion and the certificate conversion in the production of any downstream articles. This is because of the two separate certificates that were allocated to the same product, partitioned according to the ratio of biomass and fossil derived feedstocks used (there is no physical separation). The additional mass balances need to be carried out as described previously (Figure 5-8).

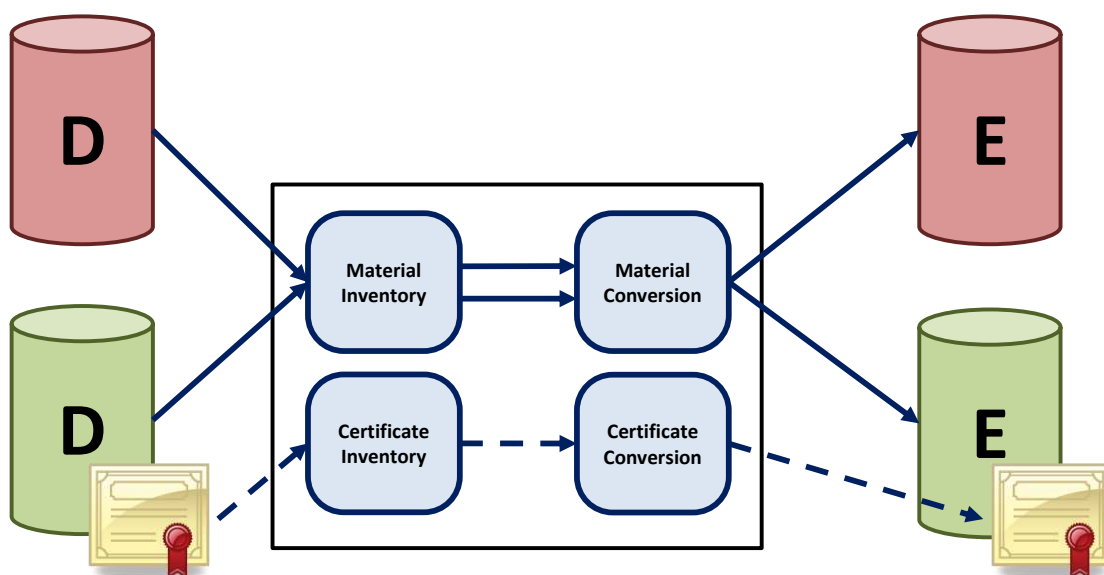


Figure 5-8 An illustration of material and certificate conversion incorporated within the mass balance approach.

5.1.5 Mass balance Method D: Stoichiometrically limited determination of the average or minimum bio-based carbon content and average bio-based content

Atom connectivity Method 1 was designed to consider the feedstocks more than the structure of the final product as a means of determining total bio-based content. Mass balance Method A is also orientated towards the relative amounts of the feedstocks but uses an attribution technique to allocate a total bio-based product. Mass balance Method D shares many principles with these other indirect methods of total bio-based content determination. The feedstocks for the bio-based product are identified. In operations where multiple products are produced the portion of feedstock directly contributing to the nominated target product must be calculated. The production chain must be traced upstream until primary feedstocks are found. The feedstocks must be completely bio-based, completely fossil derived, or



completely mineral. The final category is defined differently to atom connectivity Method 3. Mineral resources are those feedstocks that are not biomass and are not primary petrochemical platform molecules. This definition includes oxygen gas, water, and metal salts such as sodium chloride. When the different feedstocks in their required masses have been identified, the proportion of each incorporated into the product, considering the stoichiometric reaction pathways and losses must be calculated. For synthesis an atomic basis to this calculation is needed. For formulations and assembly of materials where no reactions are occurring a simple mass transfer calculation (incorporating losses) can be used. From the proportions of each feedstock present in the final article the bio-based content can be calculated. A worked example is provided below (Table 5-5). Three calculations have been used to treat the mineral content in different ways. The same calculations apply to bio-based carbon content as well (not shown).

Table 5-5 A demonstration of mass balance Method D.

Feedstock	Mass /kg	Origin	Product incorporation (percentage)	Product incorporation (mass /kg)
A	100	Biomass	40%	40
B	50	Fossil	60%	30
C	25	Fossil	40%	10
D	25	Mineral	80%	20
Sum	200			100
Total bio-based content			40%	
<i>Total bio-based content (ignoring mineral content)</i>			50%	
<i>Total bio-based content (mineral assumed bio-based)</i>			60%	

$$x_{bio}^{mass} = \frac{M_{bio,prod}}{M_{total,prod}} \times 100\% = \frac{40}{(40 + 30 + 10 + 20)} \times 100\% = 40\%$$

$$x_{bio}^{mass,excl.mineral} = \frac{M_{bio,prod}}{(M_{bio,prod} + M_{fossil,prod})} \times 100\% = \frac{40}{(40 + 30 + 10)} \times 100\% = 50\%$$

$$x_{bio,incl.mineral}^{mass} = \frac{(M_{bio,prod} + M_{mineral,prod})}{M_{total,prod}} \times 100\% = \frac{(40 + 20)}{(40 + 30 + 10 + 20)} \times 100\% = 60\%$$

CEN/TC 411/WG 3 document N167 offers the basis of some more general rules that can be used to govern mass balance Method D. The accuracy of the mass depends on stream measurements errors and is dependent on the measurement equipment and correct employment, hence the accuracy varies. To minimise error the facility requires an inventory and balancing every year. The total error of the system can be estimated based on the yearly



balance of the production plant flows. The difference between the real measured values and the calculated values (using the balance sheets) is to be determined. A maximum of 5% error is expected according to [CEN/TC 411/WG 3 document N167](#).

Virtual separation of the process into virtual sub-mass balances is used in mass balance Method D. When biomass is transformed into a product within a production chain in which a fossil resource is also converted into the same product this separation is applicable. The identification of each feedstock as wholly biomass, fossil derived or mineral helps this approach. Sub-dividing of this sort is common in LCA.

5.1.6 The use of the book-and-claim principle for mass balance methods

The mass balance methods are defined for products produced within specific inter-connected system boundaries following consecutive chemical reactions. In order to expand the application of the mass balance methods above, the book-and-claim method can be used ([CEN/TC 411/WG 3 document N93](#)). 'Book-and-claim' is a method to transfer, by means of certificates, a defined product claim from that product at one location to the same product at a different location without any material transport. This method is based on documentation of the characteristic that is transferred (*e.g.* fossil resource saving). In order to establish a book-and-claim system, the following principles need to be considered. These three book-and-claim principles (unit definition, avoidance of double-counting, and quality assurance) are the basis for a book-and-claim system. The book-and-claim system is regarded here as an extension of the mass balance methods presented above. Unlike attribution techniques that are confined within a production facility, 'book-and-claim' does not demand any physical link between the biomass containing product and the fossil derived product to which certification of bio-based content is transferred to. The two products should be chemically identical.

In order to use book-and-claim, a conversion unit needs to be defined. The unit definition depends on the activity and purpose. For the mass balance methods mentioned in the chapters above, following conversion units can be used.

- For biomass allocation, the unit should be the attribution unit (*e.g.* methane equivalent).
- For calculated bio-based content and bio-based carbon content, the unit should be the calculated bio-based content in a defined product. In order to keep a relation between the products, one unit should be created for each defined product.



- For fossil resource savings, the unit should be presented as the mass of fossil resource savings.

The units created and transferred are to be used only once in order to avoid double counting. This avoidance of double counting can only be guaranteed if information is managed in a database at a plant level according to the described procedure and audited by an independent third party. This database allows having a clear overview of the units created and transferred within the system. The complexity and flexibility of the database depends on different factors. The basic objective of this database is to assure that the transferred units are documented in the giving and receiving boundary systems in order to assure that no double counting occurs. In order to have a consistent approach, it is necessary to define clear rules and requirements for the creation, transfer, and use of the units within the book-and-claim system. These rules and requirements are to be applied to any unit that enters or leaves the system. In order to have transparency in the system, it is recommended that these rules are presented in a standard, which also allows certification of the units through third parties. It should be noted, that products receiving 'bio-based attributes' through book-and-claim from another product system (in the defined unit of reference), do not physically incorporate that property, be it bio-based carbon content or another attribute. In turn, bio-based products that have transferred their bio-based attributes to a different product, would not be considered bio-based anymore (despite of an anticipated positive ^{14}C analysis). The transferability of the units shall be regulated and controlled within the book-and-claim system and should be completely documented.

The principle of book-and-claim is already operational in the supply chain of palm oil. GreenPalm operates a book-and-claim supply chain option on behalf of the Roundtable on Sustainable Palm Oil (RSPO) [GreenPalm 2014]. The GreenPalm option allows RSPO certified growers to convert their certified oil into certificates, one tonne of certified crude palm oil or palm kernel oil is equivalent to one certificate. Offers for these certificates are then placed on the 'GreenPalm' market. Product manufacturers who use palm, palm kernel oil or any palm based derivative and fraction in their products then place offers for these certificates, offsetting their physical oil with the equivalent amount of certificates. A claim can then be made that a company or product supports the production of RSPO certified sustainable palm oil. The revenue generated by each certificate is sent back to the RSPO producer who can then reinvest this premium to help tackle the environmental and social issues created by the production of palm oil. No statement of bio-based content is made because it is regarded as a natural product and this is out of the scope of this particular certification scheme.

The principle of trading certificates imparting sustainability or carbon credits does not translate well to the trading of actual physical properties, of which bio-based content can be considered a property (at least in the sense that a carbon isotope ratio is analysed in order to



obtain a value which we then regard as the total bio-based carbon content). An underlying principle of the mass balance approach in combination with book-and-claim is to make use of economies of scale and to avoid transportation burdens to support the growth of a bio-based economy in order to enable a transition from fossil-based to bio-based raw materials in an economic manner. In order to avoid transportation burden in the supply chain of global products, book-and-claim methodologies can be applied to transfer certificates globally amongst same raw materials and products with same CAS number. Composites can be described as the CAS numbers of the individual components, but this means that the certificates apply to separate component materials, including alloys and minerals.

In the simplified example given below, two production facilities located in different regions produce the same final product (identified as having the same CAS number) from the same raw material (again requiring the same CAS number). In the first plant, the incoming raw materials will have no certification. In the second plant, the raw material possesses a certificate. Since the raw materials and products carry the same CAS number, certificates can be transferred from plant to plant. The mass of material must be equal when the certificate is transferred. As the book-and-claim methodology is based on the transfer of a certificate without actual material transfer, inventories need to be maintained at all plants for both certificates and the actual material flows (Figure 5-9).



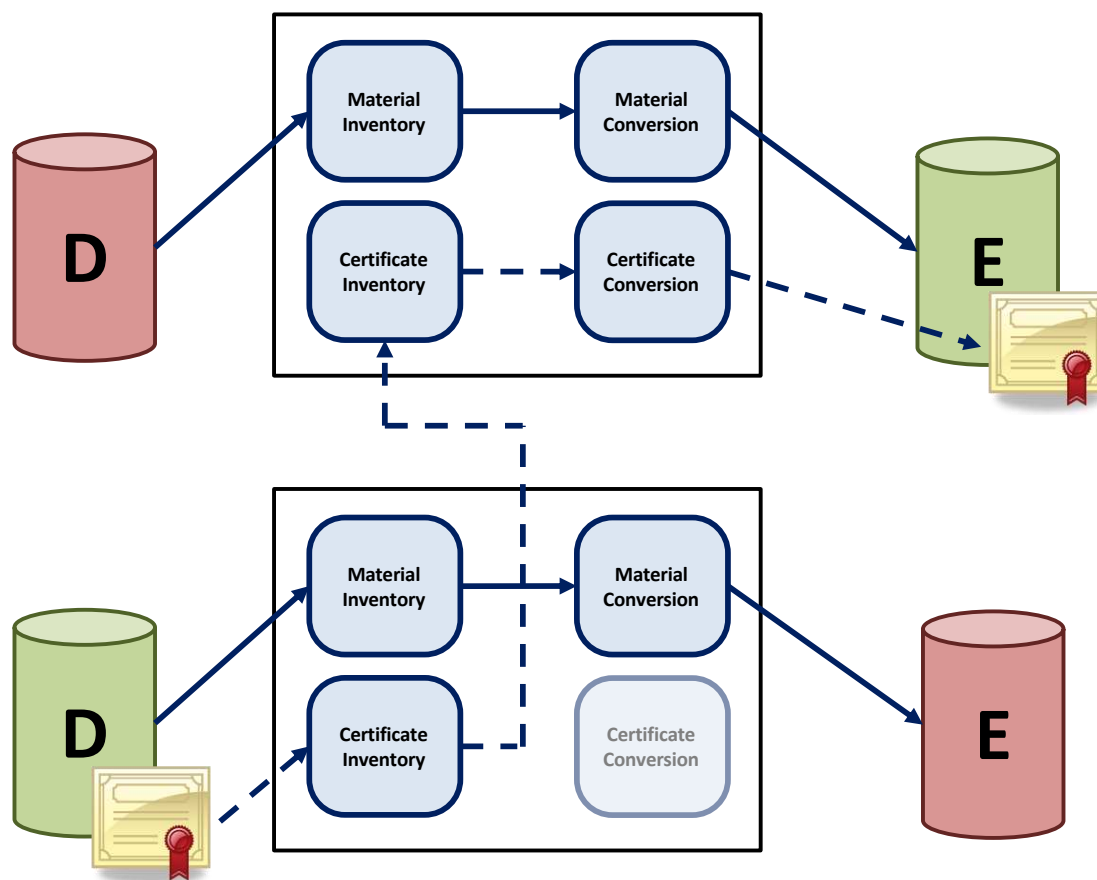


Figure 5-9 A conceptual example of the book-and-claim approach.

In subsequent chemical reactions, conversions need to be taken into account both on a material and a certificate level. Those conversions shall be based on the material balance principle explained previously. It should be noted, that dependent on the chemical nature of the waste, a certain fraction of the certificates will be diverted to waste and will be lost. Furthermore, claims for the final product can only be made up to the maximum stoichiometric contribution of the raw material in the final product.

Book-and-claim transfer of bio-based content (or fossil resource savings) can create ambiguities beyond the contradiction between analytical verification and the claimed bio-based content. If a process contains two parallel streams of an intermediate, as is the case for ethylene in the synthesis of sodium laureth sulphate (Chapter 5.4.1, Figure 5-36) a book-and-claim attribution will surely always be performed to maximise incorporation of the allocated bio-based material. The oligomerisation pathway in this synthesis results in minimal losses of ethylene. The epoxidation suffers 20% material losses [Weissermel 1993]. However it is the latter which has precedent for the use of bio-ethanol, dehydrated to ethylene for the production of bio-based ethylene glycol [Coca-Cola 2014, ICIS 2011]. However to max-



imise a claim of total bio-based content, book-and-claim would be prioritised into the former oligomerisation process. Because products could be claimed as bio-based without any actual measurable bio-based content there is debate as to whether these products fall within the remit of bio-based product standardisation. Book-and-claim will not be a focal point of further discussion.



5.2 Mass balance case study: Platform molecules

In this discussion of platform molecules and their synthesis, two key processes will be examined. Gasification to produce syngas (carbon monoxide and hydrogen) is the first of these, then naphtha cracking to give ethylene. Natural gas reforming is also covered briefly under the second case study, which also produces syngas, and also fermentation as an alternative technology. For each case study the different mass balance methods are calculated for a number of scenarios. Fluctuating biomass feedstock input is not considered as this stage (see Chapter 5.7).

5.2.1 Mass balance case study: Gasification

The gasification of carbon rich feedstocks, notably coal and natural gas, has been an effective method historically of producing carbon monoxide and hydrogen gases [Weissermel 1993]. The water-gas shift reaction can yield more hydrogen gas but at the expense of the carbon monoxide, which is oxidised to carbon dioxide. Alternative biomass feedstocks can be used instead of fossil resources in order to produce these crucial platform molecules. For this mass balance case study the comparison between a typical coal gasification plant [Lee 2007], and a starch feedstock is compared [Calzavara 2005]. A Sankey diagram will be the preferred tool for showing mass balances pictorially for chemical manufacturing processes. In a Sankey diagram arrows are used to represent flows of mass or other quantities. The width of each arrow is proportional to the size of the flow. The Sankey diagrams for both processes are provided below, in which the width of the arrows are proportional to the relative mass flows indicated (Figure 5-10 and Figure 5-11). For every Sankey diagram; blue arrows represent feedstock inputs, orange for intermediates, green arrows represent losses and irrelevant output material, with red arrows reserved for products. The indicated losses are predominately other product streams and included within the losses here of simplicity. The biomass gasification Sankey diagram can be adapted to remove the surplus water of the process from the mass balance (Figure 5-12).



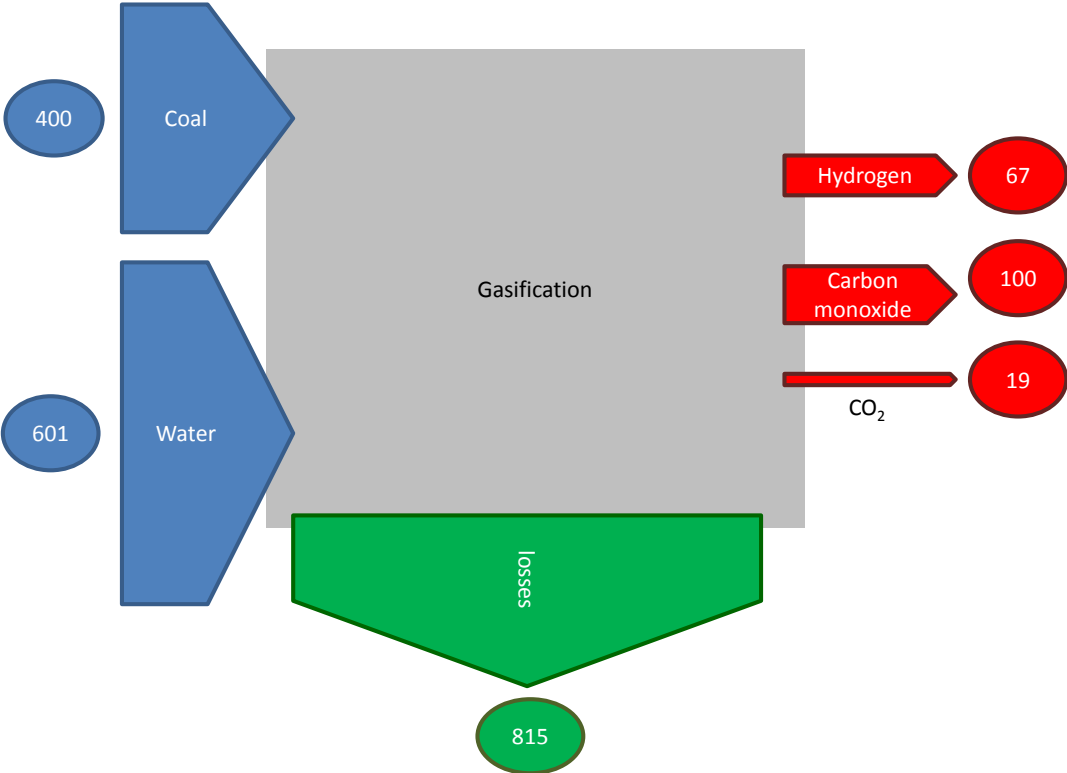


Figure 5-10 A Sankey diagram representing coal gasification.



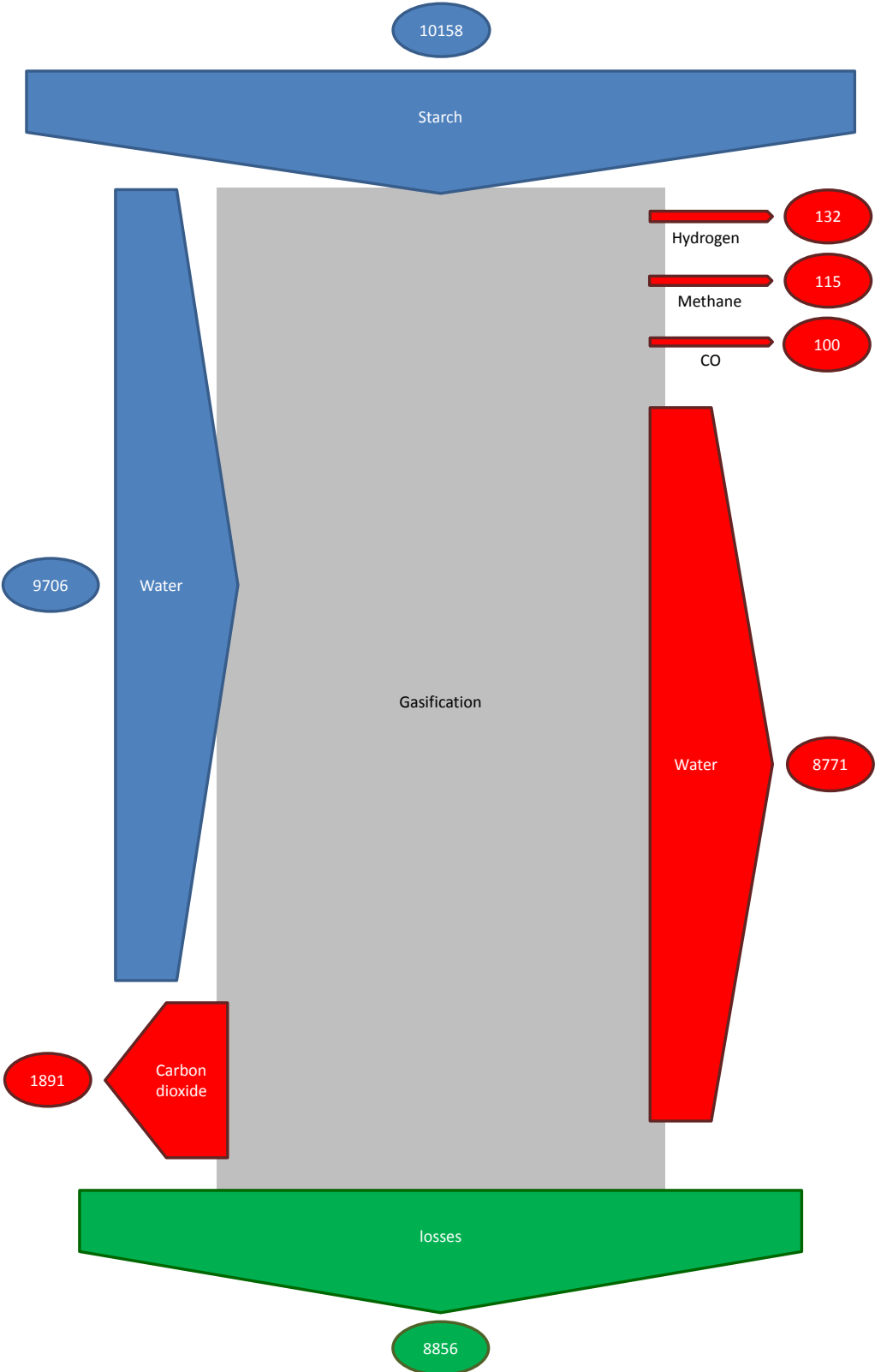


Figure 5-11 A Sankey diagram representing biomass gasification.



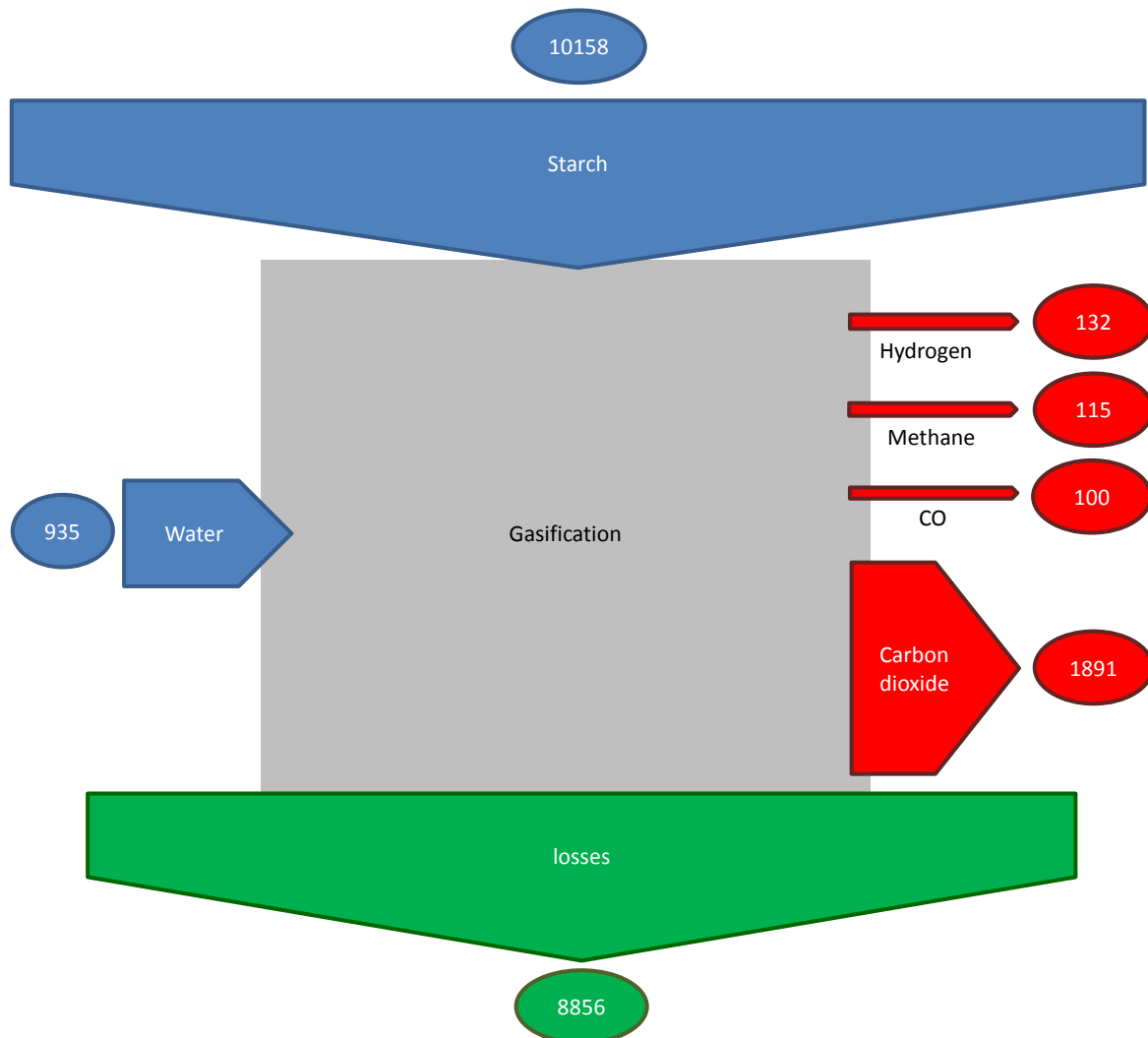


Figure 5-12 A Sankey diagram representing biomass gasification without accounting for the surplus water used in the process.

Mass balance Method A then requires that the feedstock be treated in terms of attribution units. For this the lower heating values of the feedstocks are required. These are listed in the following table (Table 5-6). When coal (400 kg) is transformed into 100 kg carbon monoxide, the number of attribution units attributed to the product is 690 (arrived at by multiplying 400 kg by 1.72 methane equivalents). The amount of starch required as an alternative feedstock to provide an answer of carbon monoxide with 100% bio-based content by this calculation would be only 227 kg. In reality more than 10,000 kg of starch is required to yield the same amount of carbon monoxide, and the bio-based content attributed to the carbon monoxide produced by starch gasification is 4484%. This is not possible (the calculations are presented as Annex B). If complete conversion of the carbon within the starch could be converted into carbon monoxide, then the mass of feedstock required would be 96.7 kg of starch



in order to give 100 kg of carbon monoxide using attribution units. Therefore the completely bio-based product would be designated as containing only 43% bio-based, again unsatisfactory. If only the starch process had ever existed, it would mean the product stream would be considered as 100% bio-based by mass balance Method A, Method B, and Method C. Mass balance Method D recognises a significant mass input is actually water (an inorganic feedstock).

Table 5-6 Energy content data for gasification feedstocks.

Feedstock	Lower heating value /MJkg ⁻¹	Methane equivalent	Relative energy content
Coal	27-31 (average = 29)	1.72	58%
Starch	16.41 [Calzavara 2005]	3.05	33%

The calculations for mass balance Method B are fairly routine for this case study because the only carbon containing feedstock in the gasification of starch to give carbon monoxide is bio-based, and therefore the total bio-based content and the bio-based carbon content of the resulting carbon monoxide is 100%. However if a combined coal-starch feedstock was used, or production switched from one feedstock to the other over the course of the fixed time period of production then the bio-based content would need to be calculated. Both these scenarios can be considered, but it is the final ratio of fossil to biomass feedstock over the fixed time period that ultimately dictates the bio-based content that can be calculated. For example, 320 kg of coal and 2032 kg of starch (thus starch contributing 86% of the total feedstock mass) results in a product containing 20% total bio-based content (Table 9-4).

As a single feedstock (either fossil derived or biomass) gives rise to the products, the calculation is a simple one of proportionality (Figure 5-13). The mass of feedstock required to give rise to a given mass of product is known and so this can be used to calculate the bio-based content of the product. Even if the productivity of starch gasification is unknown, upon part-substitution of coal in favour of starch the resulting change in yield will probably indicate the reaction efficiency (unless non-ideal mixing behaviour occurs). With a single carbon atom in the product (carbon monoxide), bio-based carbon content is the same as total bio-based content for this example, meaning consistency is achieved between this interpretation of mass balance, and atom connectivity and the anticipated analytical ¹⁴C measurements.



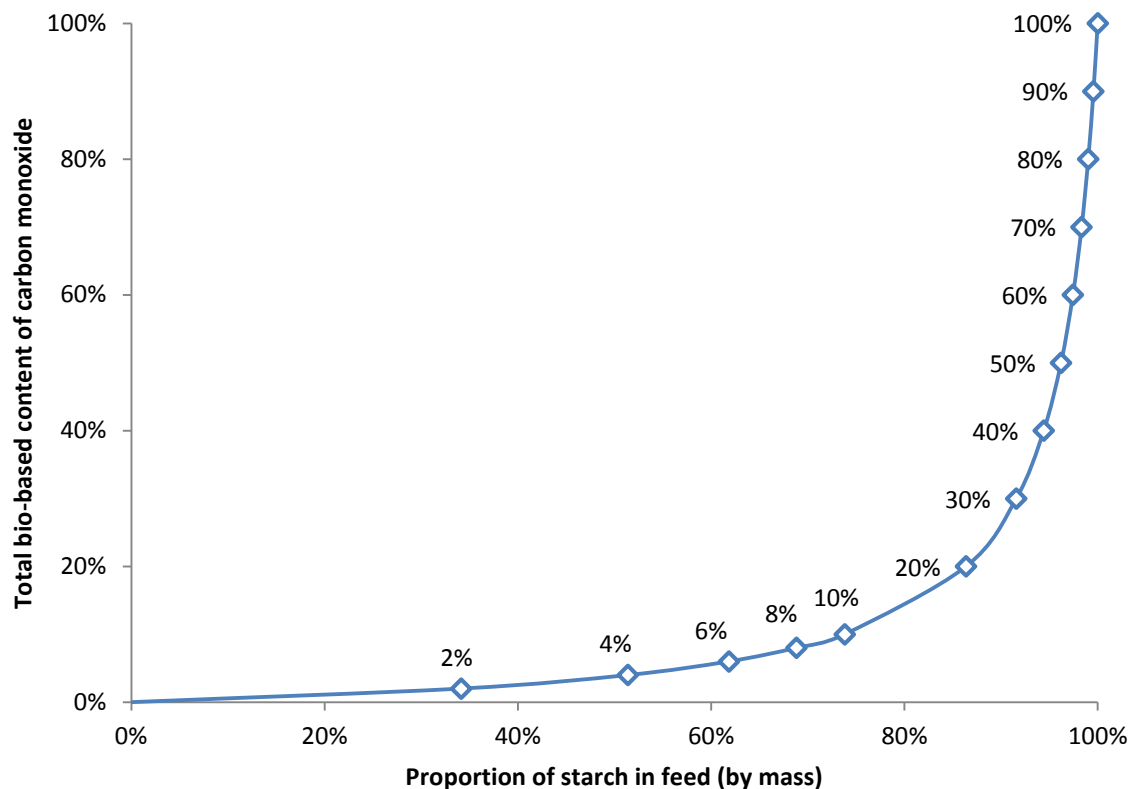


Figure 5-13 The effect on bio-based content by mass balance Method B as the amount of starch is increased in a gasification feedstock.

It is obvious from this analysis that starch is not an efficient feedstock for carbon monoxide production compared to coal. Reporting fossil carbon savings (*à la* mass balance Method C) as the quantity of displaced feedstock and not the amount of biomass in a mixed feedstock might better highlight the excessive losses incurred. This will be explored later. As for the actual rules of mass balance Method C, the bio-based carbon lost as waste is not included in the resulting certificate. Carbon monoxide made from starch gasification would contain only bio-based carbon, translating to a fossil saving of 43 kg per 100 kg of product. To conceptualise this in terms of marketable products, a typical 50 L cylinder of carbon monoxide pressurised to 150 atmospheres will contain approximately 9.5 kg of carbon monoxide (the density of carbon monoxide is 0.19 g/mL at this pressure). This corresponds to 4.1 kg of fossil carbon savings per cylinder, equating to 100% bio-based carbon content, although this specific claim is not declared with mass balance Method C (instead 43 kg per 100 kg of product is claimed, as stated above). It may be more appropriate to use a carbon 'mass for mass' presentation of this result, which would be 1 g/g fossil carbon savings per mass of carbon in this product.



For a hypothetical, non-dedicated facility, in which coal is alternated with starch as a feedstock for gasification, the fossil carbon saving must not be claimed to be higher than the stoichiometric maximum (which happens to be irrelevant for this case study in which 100% bio-based carbon/total bio-based content is feasible). The quantity of carbon monoxide warranting a certificate cannot exceed that made possible by the biomass feedstock, which is easily monitored by the amount of starch entering the manufacturing plant.

Because of losses (less than 1% of the maximum conceivable carbon monoxide yield is obtained by starch gasification) the biomass feedstock input into the process is not related to the bio-based content associated with the product. However displacement of fossil resource demand is made at the feedstock and not the final product (e.g. starch replacing coal). This said, if only for comparison it is worth re-interpreting the principle of mass balance Method C, that being fossil carbon savings, in terms of the feedstock rather than the product. The result would then be attributed to all products arising from that process.

In a gasification plant that creates carbon monoxide from coal, the feedstock (400 kg of coal for every 100 kg of carbon dioxide) can be displaced with starch in variable quantities (Figure 5-13). A significant amount of starch is required to displace the coal, about 25 kg of starch per kilogram of coal. It could be claimed that for every 25 kg of starch introduced into the gasification plant, that a saving of 1 kg of coal per 100 kg of carbon monoxide product is made. In this example the calculation of fossil carbon saving is made easier because coal is mostly carbon, and the values are assumed here to equate (*i.e.* mass of coal equals mass of fossil carbon in feedstock). In Figure 5-14 the increase in what can be claimed as a fossil carbon savings is shown for the product (as in mass balance Method C) and for the process/feedstock as the amount of starch feed is increased. The fossil carbon feedstock saving is much greater than the mass of the final product, which may be confusing when expressed as a mass balance calculation (Figure 5-14). In other processes where the efficiency in converting the feedstock to final products is greater this may not present itself as a problem. By expressing these results as fossil carbon savings (in the product, mass for mass), then the scale will be limited between 0 g/g and 1 g/g fossil carbon savings per mass of carbon, and simplify interpretation. As for fossil carbon savings based on the feedstock, this could be reported relative to the maximum amount of fossil carbon that it is possible to displace from the process, or instead relative to the amount of carbon in the product. The results would be 9.3 g/g and 1.0 g/g respectively for a starch gasification process. The former value would act as a descriptor of the process itself and apply to all products of the bio-refinery (*i.e.* independent of a specific product) whereas the latter is specific to this carbon monoxide product stream and is confined within a range of 0 to 1. The similarity and compatibility to direct radiocarbon isotope analysis means this will be the preferred method of reporting throughout the remainder of this report, especially for comparison between the mass balance approaches.



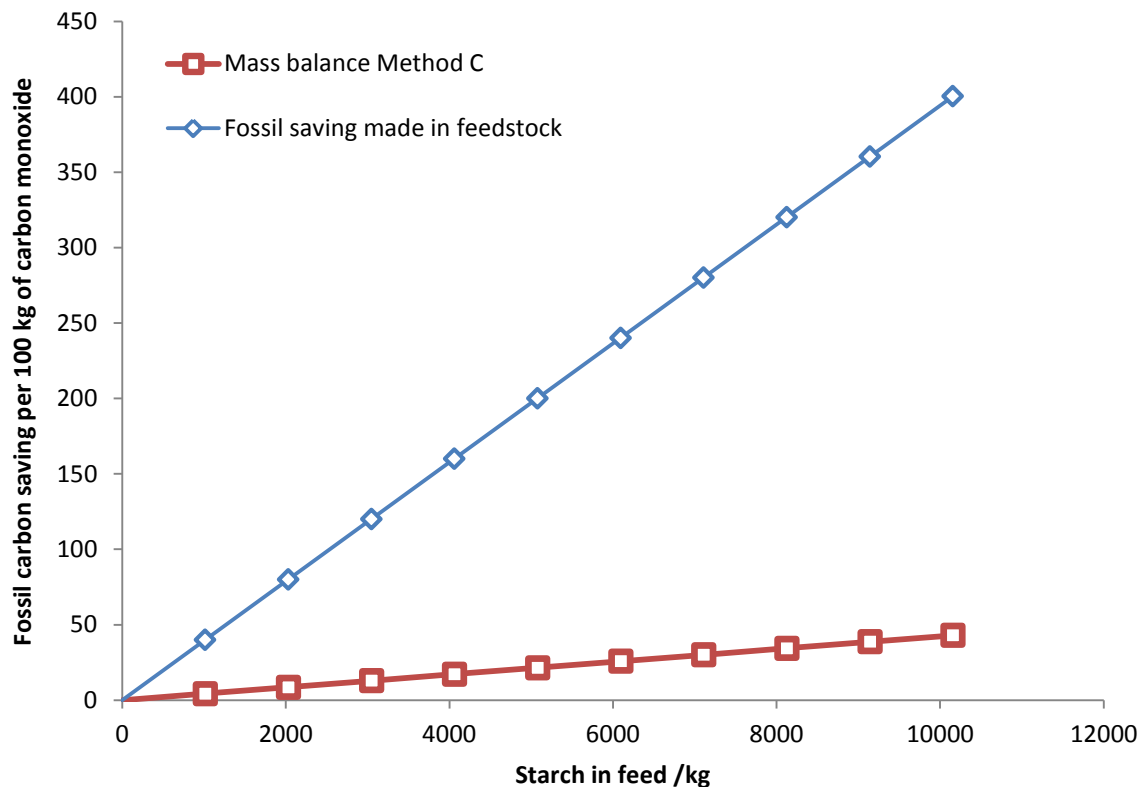


Figure 5-14 The effect on fossil carbon savings as the amount of starch is increased in a gasification feedstock producing 100 kilograms of carbon monoxide.

Total bio-based content can be calculated with Mass balance Method D from the known efficiency of the coal and starch feedstocks. When the input is a mixture of coal and starch, the virtual sub-mass balances are represented by Figure 5-10 and Figure 5-11, weighted appropriately to represent the feedstock ratio. In order to produce an equal amount of carbon monoxide by both routes much more starch is needed than coal because of the poor conversion of the biomass feedstock. In Table 5-7 the virtual fossil resource and biomass sub-mass balances are separated by the dashed line. The mechanism of the gasification of starch is not known from the data available. It has been assumed that the starch is reduced to carbon by pyrolysis and then oxidised to the product. This mirrors process of the coal feedstock, and means the carbon atom in carbon monoxide is starch or coal derived, and the oxygen atom comes from water. In mass balance Method B the distinction is not important, but here the amount of biomass included within the calculations is very dependent upon an understanding of the process. If some, or all, of the oxygen in carbon monoxide was retained from the biomass feedstock the total bio-based content would be calculated to be higher. Removing the water feedstock from the calculation makes the result of 50% much more intuitive and comparable to other mass balance approaches, including bio-based carbon content if calculated with mass balance Method D. Assuming the water is bio-based,



even in the virtual fossil resource stream produces a very high value of total bio-based content.

Table 5-7 Mass balance Method D describing starch and coal gasification to give carbon monoxide.

Feedstock	Mass /kg	Origin	Product incorporation (percentage)	Product incorporation (mass /kg)
Coal	200	Fossil	10.7%	21.5
Water	300	Mineral	9.5%	28.6
Starch	5079	Biomass	0.4%	21.5
Water	4853	Mineral	0.6%	28.6
Sum	10433			100
Total bio-based content			21%	
<i>Total bio-based content (ignoring mineral content)</i>			50%	
<i>Total bio-based content (mineral assumed bio-based)</i>			79%	

5.2.2 Thermocracking of naphtha and its downstream products

Naphtha is a distillation fraction of crude oil [Weissermel 1993]. Further separation can give a less dense 'light naphtha': a mixture of acyclic and cyclic aliphatic hydrocarbons between five to nine carbon atoms in molecular size; as well as a 'heavy naphtha' which contains acyclic and cyclic aliphatic hydrocarbons of between only seven and nine carbon atoms in every molecule [Meyer 1998]. The naphtha is further processed by steam cracking or thermal cracking to give ethylene. It can be expected that a quarter of the naphtha feedstock is converted into ethylene (Table 5-8), although under certain conditions over 30% can be achieved. It is now possible to create bio-based naphtha, and this can be used as a substitute for conventional naphtha in chemical processes [NesteOil 2012]. The product distributions in Table 5-8 are only representative and will vary according to the origin of the feedstock, the refining process, and the exact conditions of the cracking procedure, whether thermal or steam mediated. In a mixed feed process the feedstocks may be prepared with the intention that the fossil and biomass streams are chemically identical, but that may not always be possible and differences in product selectivity caused by the dissimilarity of the feedstocks will be explored in this hypothetical case study to test the robustness of each mass balance approach.



Table 5-8 Naphtha cracking product distribution by mass. Conversion is assumed to be complete.

Product	Conventional naphtha	Bio-based naphtha
Ethylene	25%	31%
Propylene	20%	18%
Butenes	15%	7%
Other products	34%	30%
Losses	6%	14%

The product selectivity of bio-naphtha is not necessarily the same as the conventional feedstock because of chemical composition of the naphtha (a mixture of compounds) will be different [Pyl 2011]. For example, to make 100 kg of ethanol by hydration of ethylene, 251 kg of conventional naphtha is required whereas only 202 kg of bio-naphtha is needed because of their conversions to ethylene are 25% and 31% respectively. The production chain is separated into two virtual sub-mass balances; one for the biomass stream, the other to account for the fossil resource processing (Figure 5-15). Losses can be greater in the conversion of bio-naphtha to platform molecules and so in a bio-refinery scenario efficiency would be less overall when considering all product streams and not just ethylene selectivity (losses in naphtha conversion are included within the 'other products' arrow of the Sankey diagram in Figure 5-15).



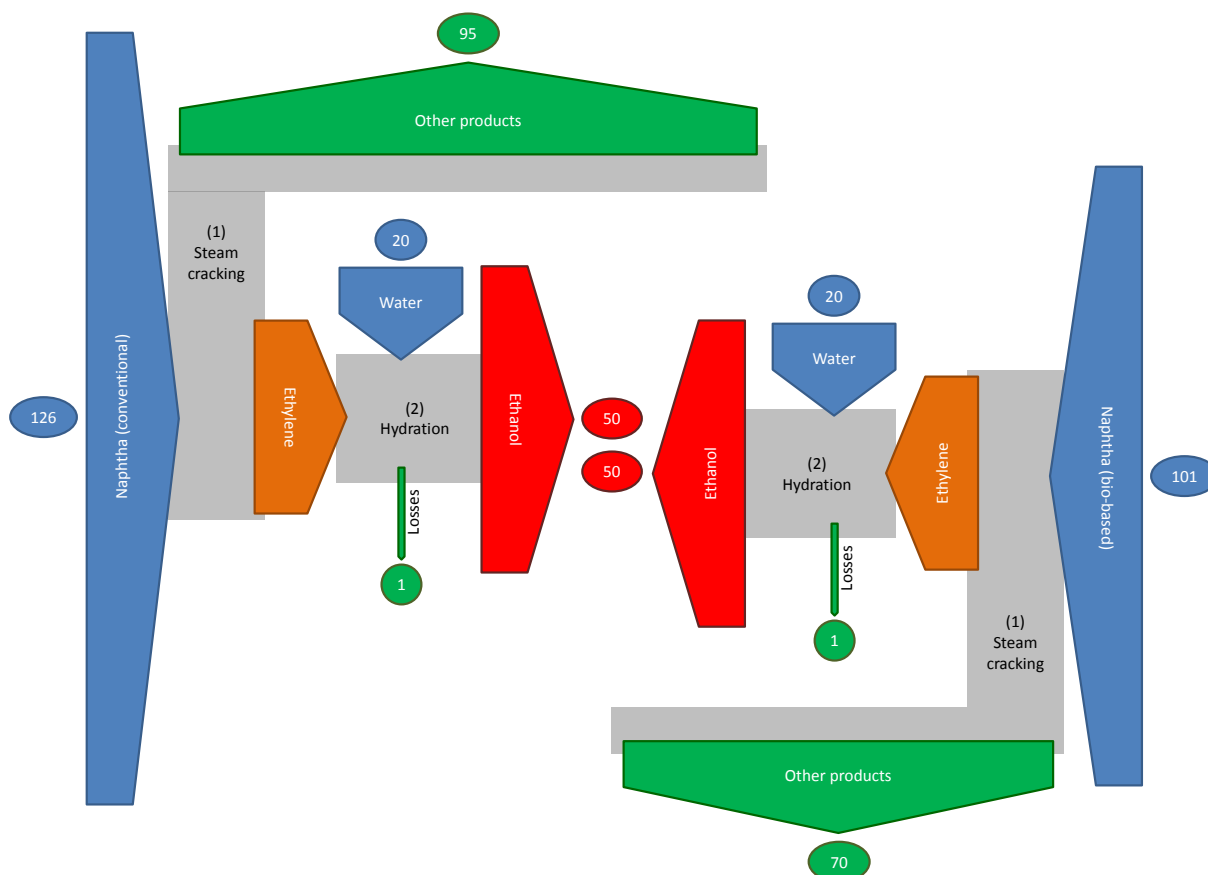


Figure 5-15 A Sankey diagram representing the conversion of both conventional naphtha and bio-naphtha into ethanol by splitting the process into separate virtual fossil and biomass resource sub-streams.

According to the datasheet of lower heating values used for the purposes of mass balance Method A (Table 2-5), naphtha and bio-naphtha are equivalent. In this process, with only one organic feedstock input, the proportion of naphtha replaced by bio-naphtha is the only parameter controlling the calculated bio-based content value for the final product, and equal amounts of both feedstock options would be assumed to create a product of 50% bio-based content. However in reality the differing chemical compositions of bio-naphthas will mean this is untrue. For every kilogram of conventional naphtha substituted, only 0.81 kg of the bio-naphtha described in this assessment is required to replace it to maintain production of ethylene (see Annex B, Table 9-9). Other product streams (propylene, butylene, *etc.*) will vary to compensate. Because less biomass feedstock is needed, the total bio-based content that can be indirectly attributed to the ethanol produced from bio-naphtha is curtailed using mass balance Method A, at 81%. Analytical ^{14}C measurements would be expected to provide an answer of 100% bio-based carbon content if bio-naphtha is the only feedstock. The disparity is quite large and brings the implementation of mass balance Method A as it is conducted here, into question.



The virtual sub-mass balance approach can indicate the relative proportions of each bio-based product stream. When equal amounts of bio-ethylene and fossil derived ethylene are created, the propylene product stream is 42% bio-based and the butenes are 27% bio-based. This is the conclusion arrived at using mass balance Method B. Mass balance Method A, because there is a single feedstock, will by default assign each product with a total bio-based content of 40% (40% being the proportion of bio-naphtha feedstock). There is then the possibility for attribution of this bio-based content to favour a particular product stream (Figure 5-16). Simplifying the case study to just ethylene, propylene, and butenes the mass of the bio-naphtha can be redistributed to favour ethylene (up to 85%). The bio-based content of the other product streams and waste could also be attributed to the ethylene or other products.

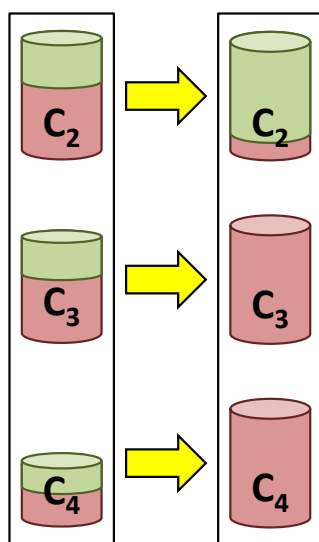


Figure 5-16 Attribution of bio-based content for ethylene (C_2), propylene (C_3) and butenes (C_4) thermoc cracking product streams.

With only one organic feedstock, bio-based content can only be imparted from the naphtha feedstock, the other input being water. Atom connectivity Method 2b will derive a value of total bio-based content in the ethanol product from the bio-based carbon atoms in ethylene. Similarly mass balance Method B must derive the proportion of bio-based content surviving through to the product, *via* ethylene. The advantage of mass balance Method B is that it is applicable across a pre-defined fixed time period, thus accounting for changes in the feedstock origin should they be made. For verification of this at input, analytical measurement would be ideal, but if the feedstock is a fluctuating mixture of bio-based naphtha and conventional naphtha this does not provide a useful indication of the nature of the feedstock generally as it varies over time. However if the conversion of both types of naphtha into ethylene is well understood then this calculation can be derived without analysis of feedstock and intermediates, but this will only apply if the combination of naphtha feedstocks does not



change the expected productivity of the reaction. For example, it is taken to be true, here at least, that conventional naphtha will yield 25% ethylene from cracking processes. If under the same conditions bio-naphtha produces 31% ethylene, then from any mixture of the two feedstocks it is possible to calculate the ideal bio-based content of the intermediate ethylene, as demonstrated in Figure 5-17. The trendline in Figure 5-17 is not linear because of the different selectivity towards ethylene of the two feedstocks. These values translate to the total bio-based content of ethanol downstream, with the atoms introduced by hydration with water adopting the bio-based content of the ethylene (atom connectivity Method 2b). The bio-based carbon content of ethanol is comparable to total bio-based content on a mass percentage basis, with a single feedstock delivering the two carbon atoms that become incorporated into the final product (this is not necessarily true when the carbon atoms of a product originate from different types of feedstocks, fossil and biomass in origin).

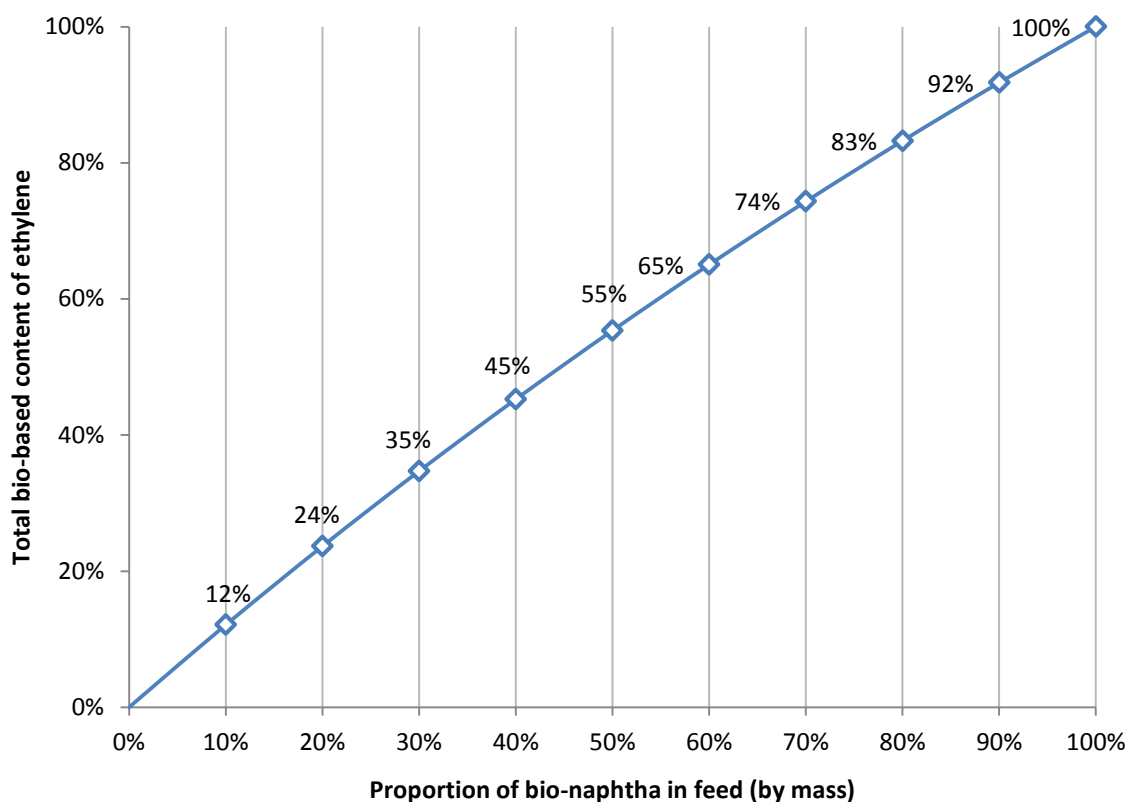


Figure 5-17 The effect on the bio-based content of ethylene as the amount of bio-naphtha is increased in the feedstock according to calculations by mass balance Method B.

When the two sources of naphtha are combined in a process (*i.e.* in a single reactor) and the behaviour of the feedstocks is ideal the virtual sub-mass balances can successfully be calculated (Figure 5-15). Even if only the fossil material flow selectivity is understood, introducing the biomass feedstock will produce a change to the product streams, but the virtual



biomass sub-mass balance can be calculated as the remainder once the fossil stream contribution has been calculated and subtracted from the total. Allocation of average bio-based content would be possible. A problem may arise if the product selectivity is not ideal when the two naphtha feedstocks are used in combination. Reasons for non-ideal behaviour could include auto-catalysis caused by products of the other feedstock, catalyst inhibition caused by the biomass feedstock (or its products) interacting with a catalyst optimised for processing petrochemical materials, or the moisture content of the biomass interfering with chemical processes or temperature regulation within the reaction vessel. A possible example is shown as Figure 5-18. The unpredictable variability of the product selectivity would mean that in order to accurately describe the fossil sub-mass balance and the biomass sub-mass balance as separate virtual material streams, the different product streams would need to be analysed. Radiocarbon analysis would suffice for this example. If the feedstocks fluctuate this would require many analyses and ultimately unreasonable to maintain.

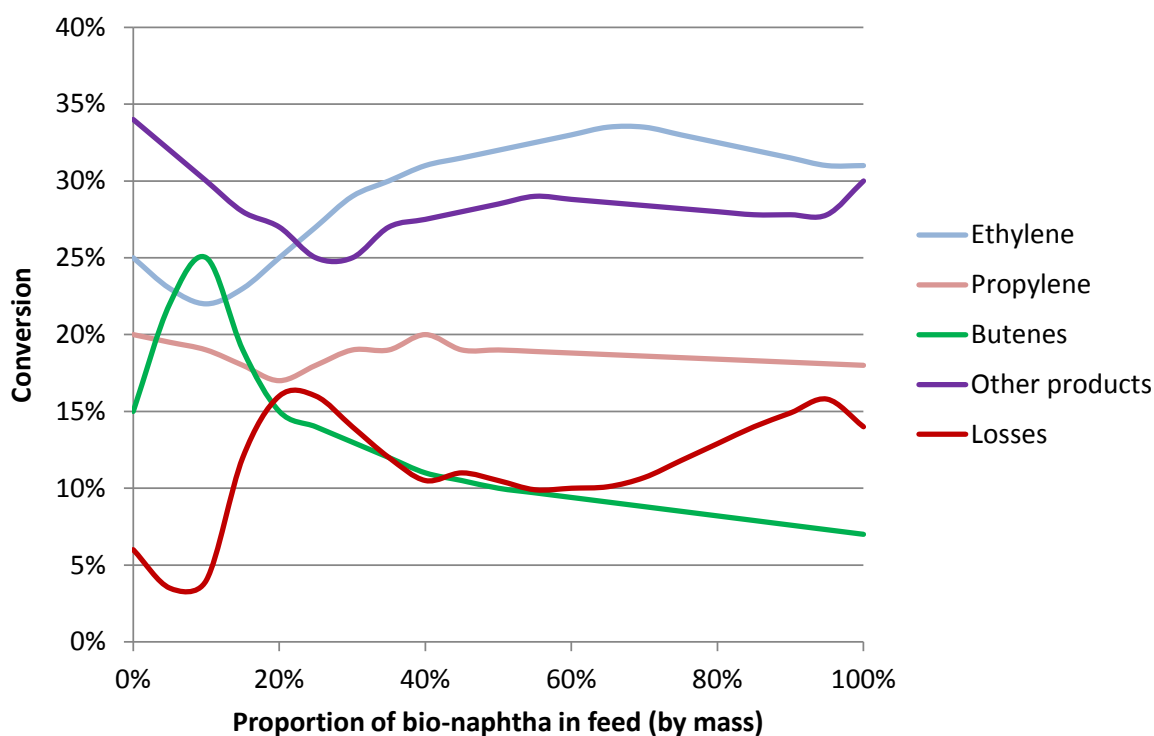


Figure 5-18 A hypothetical example of non-ideal behaviour in a mixed feedstock stream.

To calculate a (worst case scenario) minimum bio-based content the losses would need to be assumed to be 100% bio-based when the mass of the biomass feedstock exceeded the amount of losses. When the biomass feedstock is lower in quantity than the recorded losses all of the bio-based content would be allocated to the waste stream. This would have to be tuned according to any fluctuations of the feedstocks. When several product



streams exist with this apparent non-ideal behaviour when different feedstocks are blended an average bio-based content is not possible without allocating across different products (attribution). Hence mass balance Method A can deal with this scenario, but other approaches would need to rely on complimentary direct analysis. This case study is revisited in Chapter 5.7.3 with further analysis

Mass balance Method C can be used to gain an idea of the fossil carbon savings made by using various proportions of bio-naphtha. Taking ethanol as the final product, the maximum fossil carbon savings are 52.1 kg per 100 kg of product, limited by the stoichiometry of ethanol (C_2H_5OH). The complete fossil carbon saving is proportional to the amount of bio-naphtha in the feed up to the maximum of 202 kg required to produce 100 kg of ethanol, of which 90% is carbon (Figure 5-19). Fossil carbon savings in the feedstock, assuming naphtha has a total carbon content of 90%, can reach 226 kg per 100 kg of product by displacing 251 kg of conventional naphtha. Presenting this value in units of relative mass, 1.0 g/g of feedstock fossil carbon savings per mass of carbon in the original conventional naphtha feedstock (the maximum achievable) is attained, which corresponds to a 4.3 g/g of fossil feedstock carbon savings relative to the carbon content of the product rather than the feedstock (see Annex B, Table 9-11). If the fossil carbon savings for the 50:50 mixed feed (by mass) of conventional naphtha and bio-naphtha are calculated, 28.9 kg of fossil carbon savings are made per 100 kg of product, 2.4 g/g fossil feedstock carbon savings relative to the carbon content of the product.



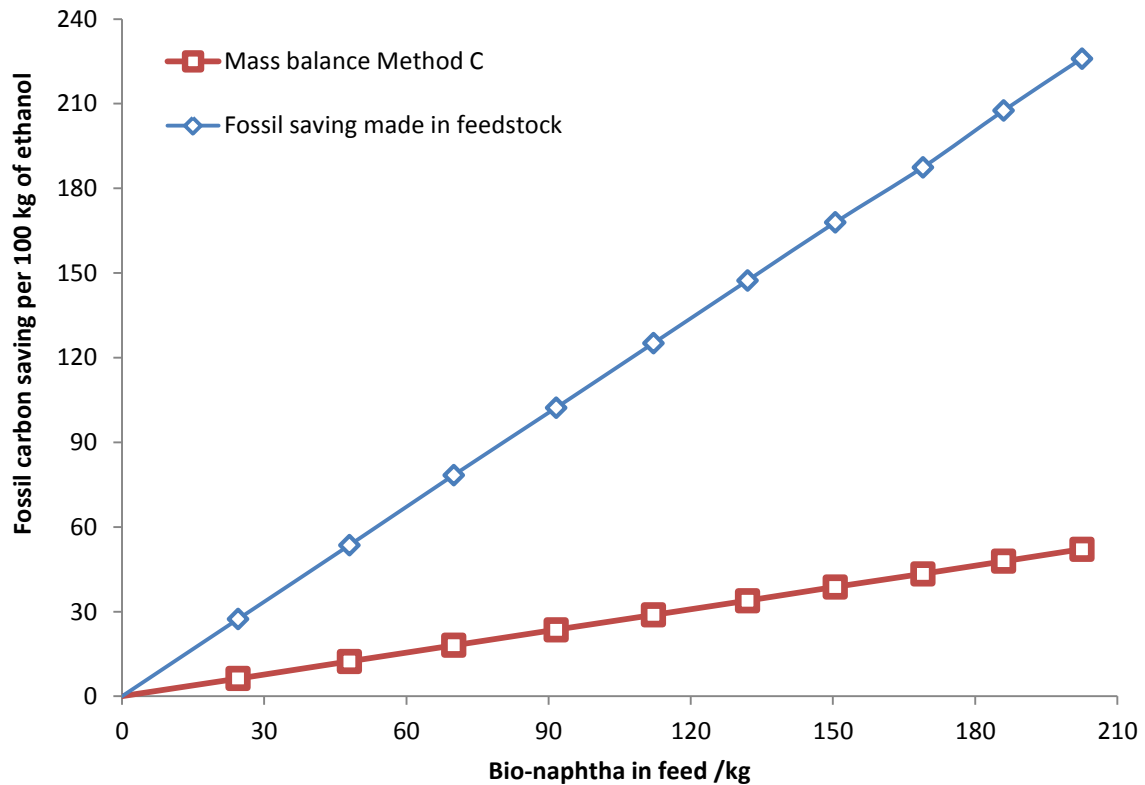


Figure 5-19 Fossil carbon savings based on the final product ethanol (in red) and the feedstock (in blue) per 100 kg of ethanol product manufactured according to mass balance Method C.

Naphtha, *via* ethylene, is the basis of a great number of chemicals, not just ethanol, and for this case study the synthesis of 2-ethoxyethyl acetate will be used as another example (Table 4-15). 2-Ethoxyethyl acetate is partially made from acetic acid, which is obtained through the carbonylation of methanol. As such, the gasification of coal or starch can also play a role in the production of 2-ethoxyethyl acetate. Alternatively fermentation can give acetic acid. The natural gas process will be scrutinised first. In order to make 100 kg of 2-ethoxyethyl acetate (also considering representative losses), 194 kg of conventional naphtha and 26 kg of methane is required, along with water and oxygen inputs (Figure 5-20).



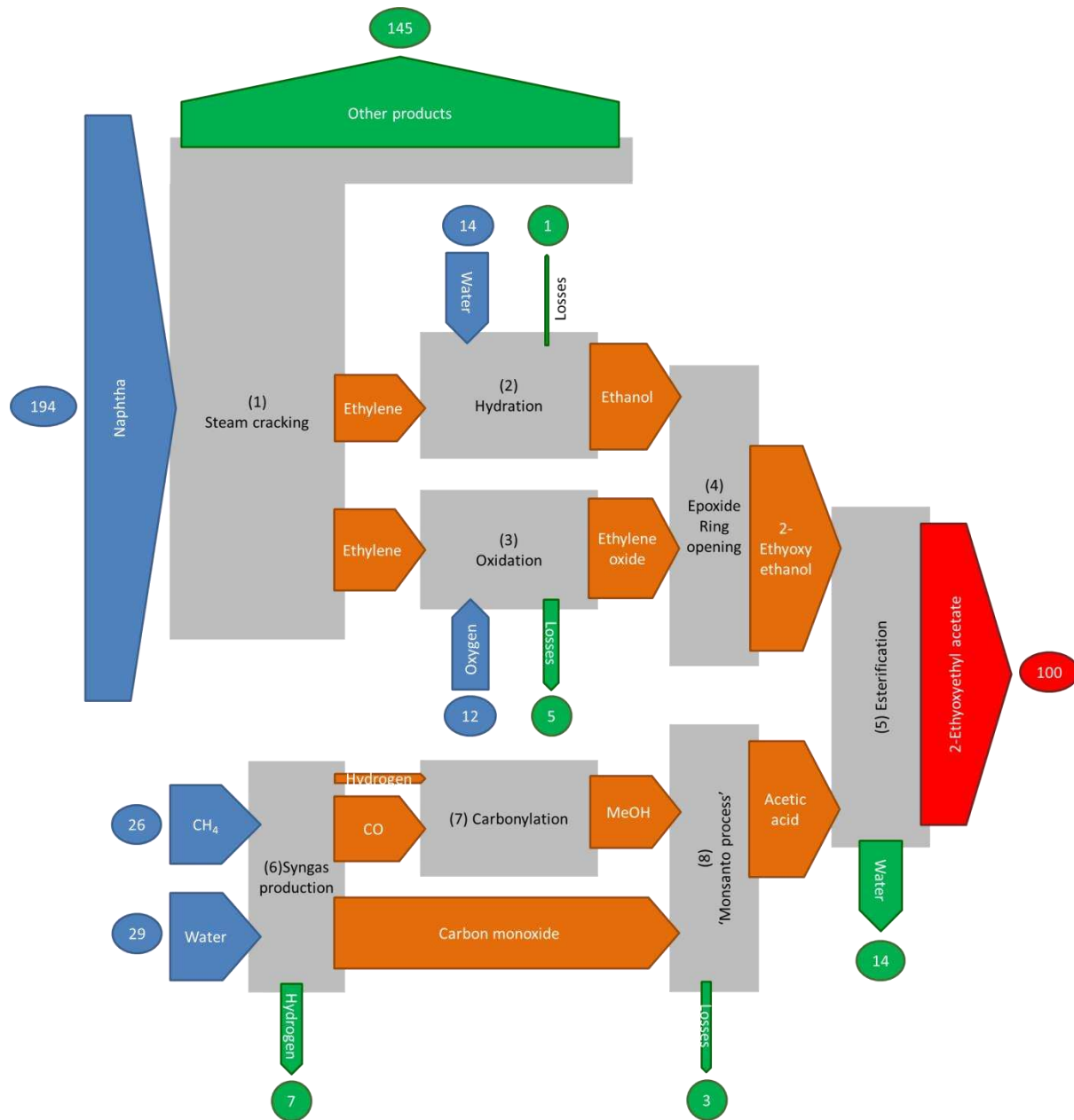


Figure 5-20 A Sankey diagram showing the production of 2-ethoxyethyl acetate from conventional naphtha and natural gas (methane).

The process described in Figure 5-20 will create 245 attribution units for every 100 kg of 2-ethoxyethyl acetate under the rules of mass balance Method A with naphtha (1.13 methane equivalents) and methane (1.00 methane equivalents) the calorific feedstocks (Table 5-9):



$$\begin{aligned} \text{Ethoxyethyl acetate attribution units} &= \sum \text{Input mass} \cdot \text{methane equivalent} \\ &= (1.13 \cdot 194 \text{ kg}) + (1.00 \cdot 26 \text{ kg}) = 245 \text{ kg} \end{aligned}$$

Fully introducing bio-naphtha or bio-methane as a feedstock will produce a product that is considered either 89.5% or 10.5% respectively under mass balance Method A. It is being assumed that there are no differences between the reactivity of conventional naphtha and bio-naphtha, although this was addressed previously as a possibility. Using both biomass feedstocks would obviously result in 100% bio-based content. The calculation for bio-naphtha is given below, with any other combinations of feedstocks in different proportions compared at the end of this case study of mass balance Method A:

$$\begin{aligned} &\text{Mass of biomass feedstock (naphtha)} \Bigg/ \left(\frac{\text{Allocation units}}{\text{Methane equivalents of biomass feedstock (naphtha)}} \right) \\ &= 194 \text{ kg} \Bigg/ \left(\frac{245 \text{ kg}}{1.13} \right) = \frac{194 \text{ kg}}{216 \text{ kg}} = 89.5\% \end{aligned}$$

Table 5-9 Energy content data for the naphtha and natural gas feedstock inputs required to produce 2-ethoxyethyl acetate.

Feedstock	Lower heating value /MJkg ⁻¹	Methane equivalent	Relative energy content
Naphtha	44.3	1.13	88
Methane	50.0	1.00	100

We can also introduce coal or starch gasification as a means of providing the carbon monoxide (and hydrogen) required to make the intermediate acetic acid. For this either 179 kg of coal is required or 4554 kg of starch is needed in order to produce 100 kg of 2-ethoxyethyl acetate. The coal feedstock process is given as Figure 5-21. The scale of the equivalent starch gasification process means it is not possible to show in print as a Sankey diagram, because the amount of starch feedstock and the losses in starch gasification dwarf all the other mass transfer arrows on the Sankey diagram. Remember the gasification of starch has already been presented as Figure 5-12, and this essentially replaces the coal feedstock in Figure 5-21 when starch and naphtha become the two organic feedstocks for 2-ethoxyethyl acetate production.



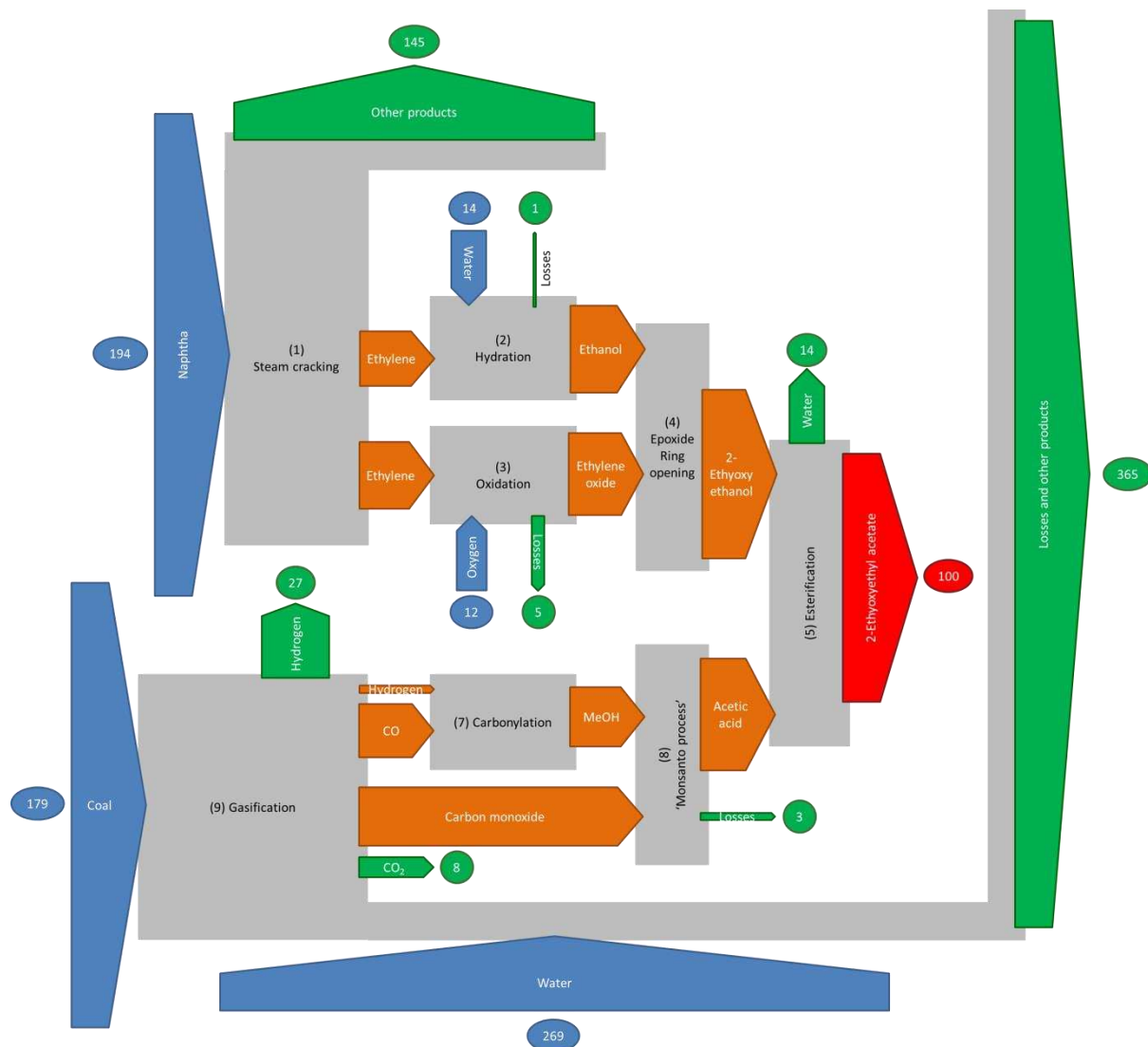


Figure 5-21 A Sankey diagram detailing the combined coal gasification and conventional naphtha cracking process as a means of obtaining 2-ethoxyethyl acetate.

Fermentation to acetic acid directly from carbohydrate could supplant gasification or steam reforming of methane to give carbon monoxide and hydrogen, and also the carbonylation to then give acetic acid. Companies such as Zechem are operating anaerobic fermentation plants to give acetic acid, usually as an intermediate to then give ethanol [Kiff 1983]. This is replacing conventional bio-ethanol production because of the improved carbon efficiency achieved. Stoichiometrically, fermentation to ethanol also creates two equivalents of carbon dioxide but conversion of acetic acid utilises all of the carbon in the carbohydrate. However in practice anaerobic fermentation of cellulose results in a number of products, including acetic acid, but also higher carboxylic acids and some carbon dioxide (Figure 5-22). Not all of the carbohydrate is consumed in the course of the fermentation, contributing to the



reported losses [Khan 1981]. Contemporary processes would be expected to have improved acetic acid yields, but the mass balance shown in Figure 5-22 is suitable as an example case study just for the purpose of testing the necessary bio-based content calculations within each mass balance methodology.

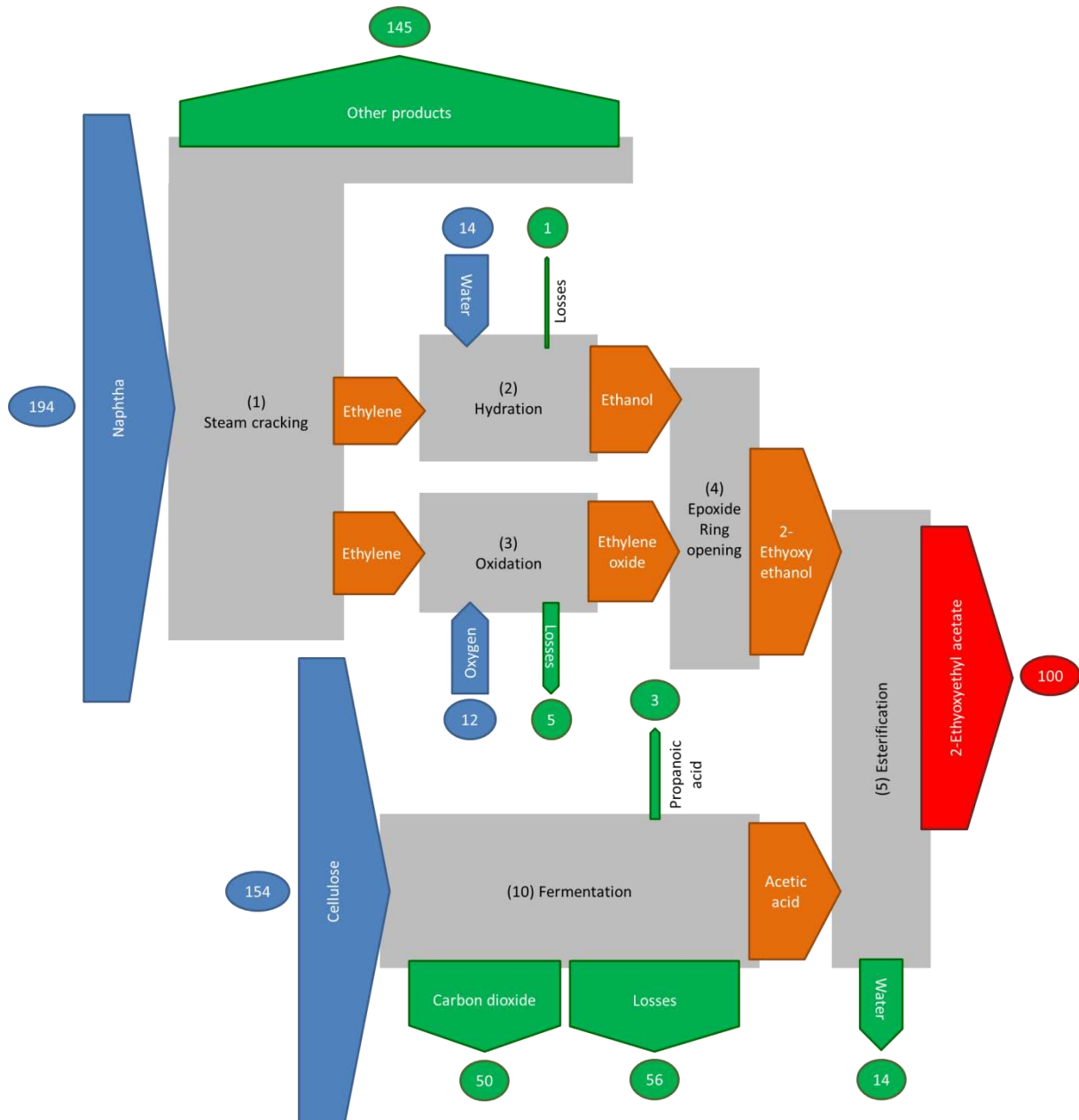


Figure 5-22 Fermentation to acetic acid as part of the manufacture of 2-ethoxyethyl acetate on a Sankey diagram where fossil derived naphtha is another feedstock.



The different methods of producing 2-ethoxyethyl acetate; from natural gas or bio-gas, from coal or starch gasification, and by fermentation, can be combined with either conventional naphtha or bio-based naphtha, in different proportions of fossil and biomass sources, to produce an array of possible calculated total bio-based content values for 2-ethoxyethyl acetate. The amount of naphtha required remains the same for the unchanging production of 2-ethoxyethanol. For these calculations the different naphthas (fossil and bio) are assumed to convert to the same amount of ethylene (25 wt%) after cracking processes. The amount of the second feedstock for the production of the intermediate acetic acid, and the chemical process does change. The different feedstock in each scenario change the allocations units assigned to the product, as does the different lower heating values of the feedstocks. Therefore replacing conventional naphtha with bio-naphtha does not impart the same degree of fossil resource savings across the different synthetic methods for producing 2-ethoxyethyl acetate (Table 5-10). The calculation of allocation units has been renewed for each process rather than basing it on the original process. Had this been the case values of bio-based content would exceed 100% as found for the previous gasification case study. With the same amount of naphtha resulting in different contributions towards the total bio-based content of the product, the methodology (mass balance Method A) would seem to be hindered by inconsistency.

Table 5-10 Total bio-based content by mass balance Method A for different combinations of feedstocks.

	Conventional naphtha	Bio-naphtha	Contribution of bio-naphtha
Natural gas reforming	0.0%	89.5%	(89.5%)
Bio-gas reforming	10.5%	100.0%	(89.5%)
Coal gasification	0.0%	41.4%	(41.4%)
Starch gasification	98.4%	100.0%	(1.6%)
Acetic acid fermentation	67.5%	100.0%	(32.5%)

As the relative proportion of naphtha within the combined mass of the feedstocks increases, the contribution toward total bio-based content that bio-naphtha can make tends to increase, but this is not always the case due to the attribution units of mass balance Method A skewing the contribution of each feedstock (Figure 5-23). It has been assumed that completely bio-based naphtha is being used and not a blend of naphthas, some possibly fossil derived. When a mixture of conventional naphtha and bio-naphtha is used, the contribution of



naphtha to the total bio-based content will linearly fall as a function of the feed ratio (bio-based:fossil derived) from the values in Figure 5-23 assuming the naphtha feedstocks are chemically indistinct.

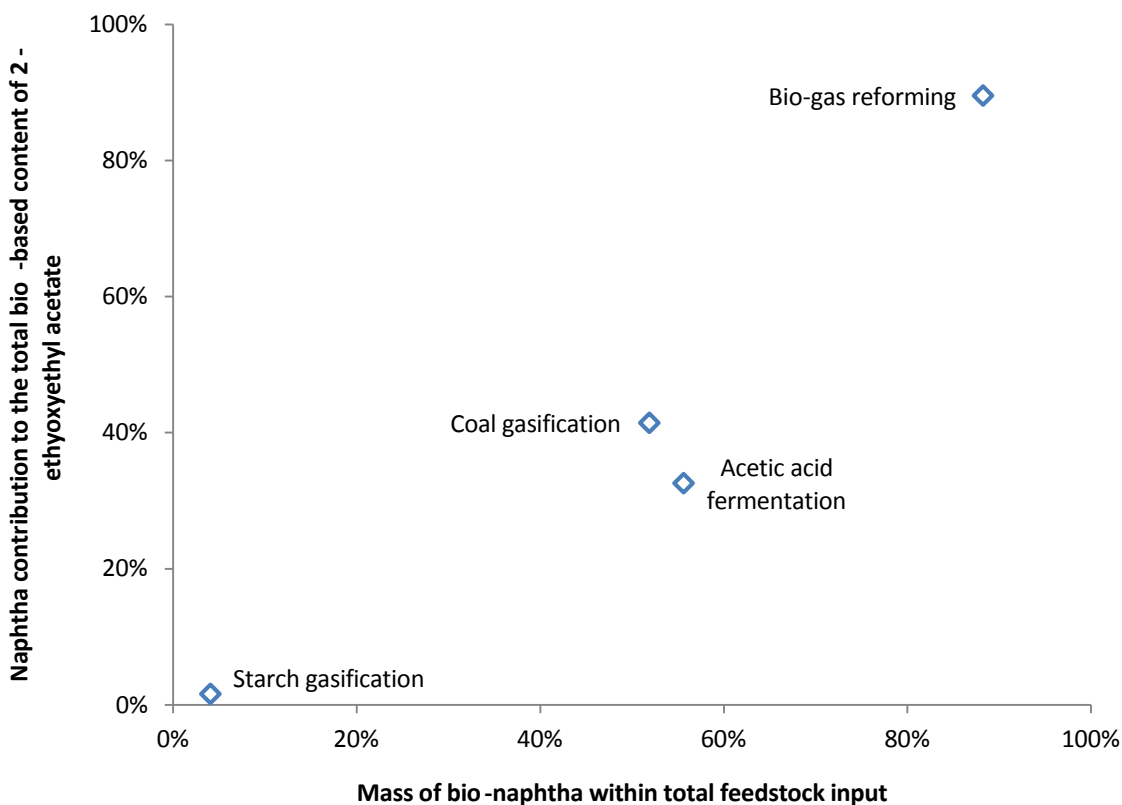
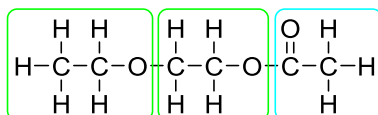


Figure 5-23 Mass balance Method A attributed bio-based content values from the naphtha feedstock onto 2-ethoxyethyl acetate (not the full bio-based content value that also contains a contribution from a second feedstock).

Mass balance Method B can also be used for the indirect determination of bio-based content for the previously discussed case studies. 2-Ethoxyethyl acetate is a three-part molecule in so much as it contains an acetate moiety from acetic acid, a C_2 bridge made from ethylene, and an ethoxy- group derived from ethanol. The latter two portions of the molecule are derived from naphtha, while the acetic acid has been described as having various origins throughout this section. Atom connectivity Method 2b has shown how to allocate bio-based content onto 2-ethoxyethyl acetate (Figure 4-10). This will be useful in working through the calculations necessary for mass balance Method B. Greater detail is reserved for Annex B, here the general conclusions will be presented. The final product, 2-ethoxyethyl acetate, can be broken into the fragments listed above to monitor the total bio-based content and indirect bio-based carbon content for a particular synthesis (Scheme 5-1). Over the course of the pre-defined fixed time period this may differ as the feedstocks are changed, but the time av-



erage composition of the product is easily calculable if the inputs to the process are monitored precisely and virtual sub-mass balances are used for the fossil and biomass flows.



Scheme 5-1 2-Ethoxyethyl acetate sectioned into naphtha derived portions in green and the acetate group highlighted in blue.

The mass of 2-ethoxyethyl acetate derived from naphtha is 67.4% of the total molecular mass (Scheme 5-1), leaving 32.6% that can be derived from natural gas, bio-gas, coal, starch (gasification) or cellulose (fermentation) as previously described. If a natural gas or coal feedstock was being used in combination with a co-feed of conventional naphtha and bio-naphtha to produce 2-ethoxyethyl acetate, then the total bio-based content could vary between 0% and 67.4%. The different case studies employing either fully fossil derived or biomass feedstocks are presented as Table 5-11. The indirect bio-based carbon content is similar in magnitude to the total bio-based content, for the proportion of carbon atoms from a naphtha origin is 66.7% (4 out of 6) and the equivalent total bio-based content is 67.4%. Comparing Table 5-11 back to Table 5-10, there is obviously an improved consistency in using mass balance Method B compared to mass balance Method A. If processes are changed, the allocated bio-based content will vary as biomass is introduced or removed from the feedstocks as would intuitively be expected.

Table 5-11 Total bio-based content by mass balance Method B for different combinations of feedstocks.

	Conventional naphtha	Bio-naphtha	Contribution of bio-naphtha
Natural gas reforming	0.0%	67.4%	(67.4%)
Bio-gas reforming	32.6%	100.0%	(67.4%)
Coal gasification	0.0%	67.4%	(67.4%)
Starch gasification	32.6%	100.0%	(67.4%)
Acetic acid fermentation	32.6%	100.0%	(67.4%)

The carbon content of 2-ethoxyethyl acetate is 54.5 kg per every 100 kg of product. For the purpose of mass balance Method C this is the maximum fossil carbon saving, the



stoichiometric limit. With the 4:2 partition of carbon from naphtha and from the other feedstock, the use of bio-naphtha can create up to 36.4 kg fossil carbon savings per 100 kg of product (Table 5-12). Mass balance Method C provides a consistency that is not achieved with mass balance Method A, and analogous to results with mass balance Method B.

Table 5-12 Fossil carbon savings by mass balance Method C for different combinations of feedstocks for every 100 kg of product.

	Conventional naphtha	Bio-naphtha	Contribution of bio-naphtha
Natural gas reforming	0 kg	36.4 kg	(36.4 kg)
Bio-gas reforming	18.2 kg	54.5 kg	(36.4 kg)
Coal gasification	0 kg	36.4 kg	(36.4 kg)
Starch gasification	18.2 kg	54.5 kg	(36.4 kg)
Acetic acid fermentation	18.2 kg	54.5 kg	(36.4 kg)

The format of the fossil carbon saving declaration can be explored with the range of production methods explored thus far. The fossil carbon savings achieved for 2-ethoxyethyl acetate are straightforward to calculate: replacing naphtha can offer up to 36.4 kg of fossil carbon savings per 100 kg of product (0.67 g/g on a carbon mass basis, 3.2 g/g of fossil feedstock carbon replaced on the basis of the carbon content in 100 kg of the product). Replacing coal or natural gas can give fossil carbon savings of 18.2 kg per 100 kg of product (0.33 g/g on a carbon mass basis). However claiming fossil carbon savings based on the process (or feedstock) rather than the product can be shown to be open to misinterpretation and possible manipulation, despite its advantages in more accurately describing the replacement of fossil derived materials. Taking the example of integrating fermentation acetic acid as an intermediate in the production of 2-ethoxyethyl acetate, making claims on the amount of fossil feedstock carbon saved depends greatly on what process it is said has been replaced. By superseding a natural gas reforming process to give the required acetic acid, in which losses and by-product streams are small, the fossil carbon savings based on the feedstock are similar to what can be claimed when based on the product. However if it is taken that a coal gasification process to yield carbon monoxide has in fact been replaced (in which many other products are made and so carbon utilisation is low), the claims in fossil savings can be raised (Figure 5-24). If it is accounted for that the different products of coal gasification are used in other manufacturing processes then these fossil carbon savings need to be allocated appropriately. Also if large losses are made in the conventional process the calcu-



lated fossil carbon saving is greater than anticipated. It is concluded that claims of fossil savings or bio-based content must be made with reference to the product not the process.

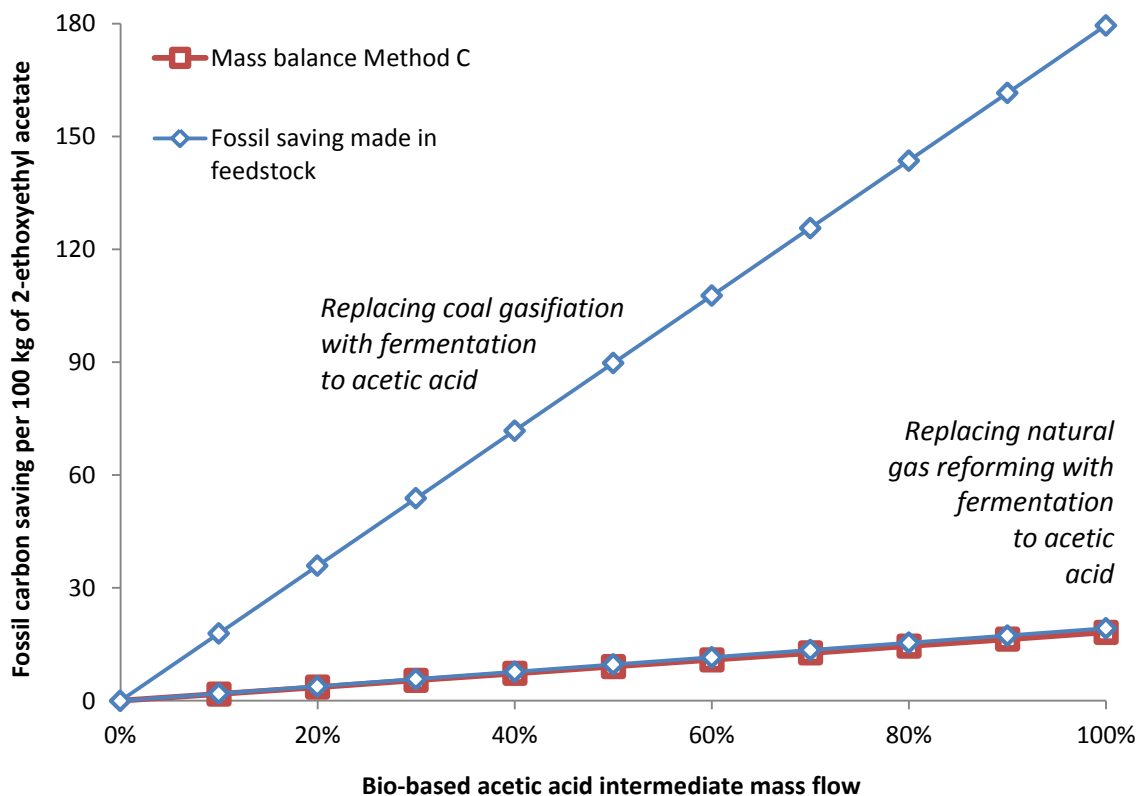


Figure 5-24 Fossil carbon savings based on the final product (in red) and the feedstock (in blue) per 100 kg of 2-ethoxyethyl acetate product relative to two different reference procedures.

Mass balance Method D produces lower values of total bio-based content than mass balance Method B (Table 5-13). Again the different naphthas (fossil and bio) are assumed to convert to the same amount of ethylene (25 wt%) after cracking processes to make the calculations more comparable. The water and oxygen feedstocks limit the bio-based content assignments. Use of acetic acid as a bio-based feedstock increases the maximum threshold of bio-based content because less water derived atoms are incorporated into the final product. Acetic acid can be taken to be the feedstock as fermentation products are assumed to be fully bio-based. If desired the production chain could be followed further upstream to carbohydrate to show the resultant acetic acid is bio-based.



Table 5-13 Total bio-based content by mass balance Method D (including inorganic feedstocks) for different combinations of feedstocks in the production of 2-ethoxyethyl acetate.

	Conventional naphtha	Bio-naphtha	Contribution of bio-naphtha
Natural gas reforming	0.0%	42.5%	(42.5%)
Bio-gas reforming	19.7%	62.2%	(42.5%)
Coal gasification	0.0%	42.5%	(42.5%)
Starch gasification	18.2%	60.6%	(42.5%)
Acetic acid fermentation	32.6%	75.0%	(42.5%)

If the inorganic feedstocks are excluded from calculations, the total bio-based content can reach 100% when the naphtha is bio-based and a renewable feedstock is also used to make the acetic acid intermediate. However, now the contribution of bio-naphtha towards this total is not fixed, as was the case for Mass balance Method A (Table 5-10). This occurs because the different acetic acid producing technologies (syngas, gasification, fermentation) incorporate a different quantity of water derived atoms into the final product, meaning once the mineral content is subtracted from calculations the remaining mass representing the product is process dependent (Figure 5-25).

Table 5-14 Total bio-based content by mass balance Method D (excluding inorganic feedstocks) for different combinations of feedstocks in the production of 2-ethoxyethyl acetate.

	Conventional naphtha	Bio-naphtha	Contribution of bio-naphtha
Natural gas reforming	0.0%	68.3%	(68.3%)
Bio-gas reforming	31.7%	100%	(68.3%)
Coal gasification	0.0%	70.0%	(70.0%)
Starch gasification	30.0%	100.0%	(70.0%)
Acetic acid fermentation	43.4%	100.0%	(56.6%)



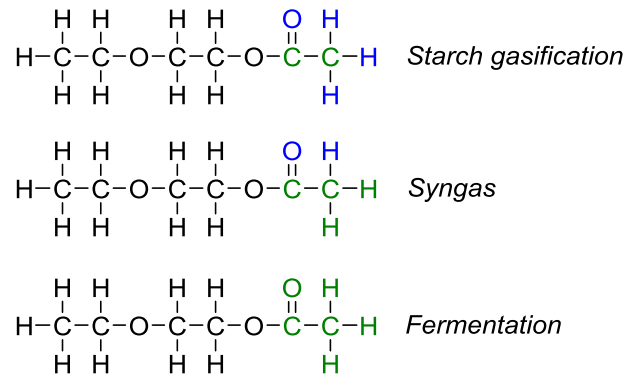


Figure 5-25 Acetyl group atom origins for 2-ethoxyethyl acetate.



5.3 Mass balance case study: Esterification processes for commodity compounds

Esterification is one of the most important transformations to the chemical industry. It has already been encountered in the case study of 2-ethoxyethyl acetate. With the bio-based economy projected to account for an increasing share of European commodity compound manufacturing [EC 2009, BIC 2012], esterification will become even more prominent in order to valorise bio-based platform molecules possessing alcohol and carboxylic acid functional groups [Werpy 2004]. Mass balances for some representative esterification and transesterification reactions now follow. Fluctuating biomass feedstock input is not considered as this stage (see Chapter 5.7).

5.3.1 Ethyl acetate

Ethyl acetate is manufactured with the acid catalysed Fischer esterification of acetic acid with ethanol [Weissermel 1993]. Sometimes ethylene is used instead of ethanol depending on feedstock prices. The equilibrium position of the reaction results in less than 70% conversion and so water can be removed to improve yields or the product continually distilled. The source of ethanol could be from the fermentation of carbohydrate, or more usually from thermal cracking of saturated hydrocarbons, followed by the hydration of the resulting ethylene [Weissermel 1993]. Acetic acid is produced by a carbonylation of methanol following the steam reforming of methane, also covered as part of the 2-ethoxyethyl acetate case study (Figure 5-20). Methane (natural gas) could be replaced by bio-gas from the anaerobic digestion of carbohydrate. Alternatively gasification of carbon containing feedstocks can be used to give syngas (one of many other possibilities), although for the purposes of this assessment this latter process is not considered. Mirroring the production of bio-ethanol, acetic acid fermentation has been commercialised, and is actually used to produce ethanol *via* the reduction of ethyl acetate [Kiff 1983].

Both of the carbon-based feedstocks required in the synthesis of ethyl acetate (ethanol and methane) could be either bio-based or fossil derived, resulting in four permutations (Figure 5-26). The combination of bio-ethanol and fossil-derived acetic acid was suggested by ACDV as an example case study [ACDV 2013]. Further possibilities include blended feedstocks and blended final products of bio-based and fossil origin. The way in which manufacturers declare biomass content using the mass balance principle could therefore present confusion, or at the very least certification may be uninformative in its lack of specificity. This type of blend (two sources of the same chemical mixed together rather than a formulation of different chemicals) may become important for a limited time as a balance between economic competition and the incentives (perhaps even subsidies and green premiums) provided



under the remit of the bio-based economy is found. Eventually it is expected that demand and competition over petroleum feedstocks with the energy sector will lead to mostly wholly bio-based products in the future.

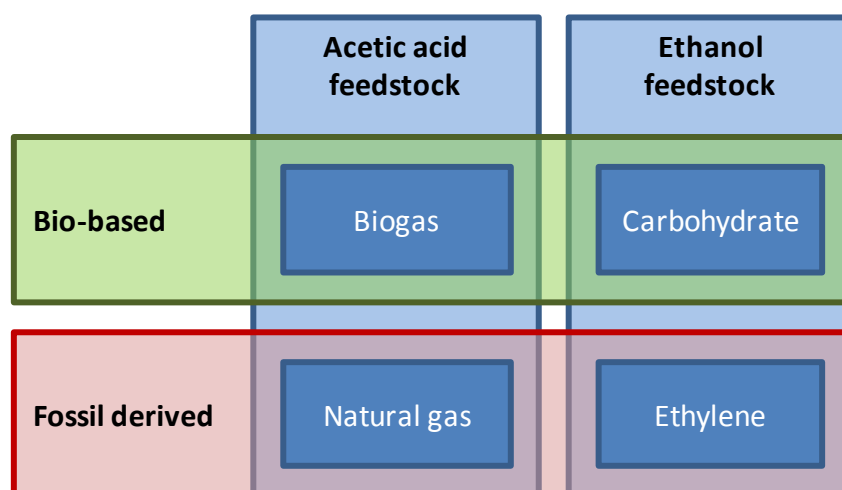
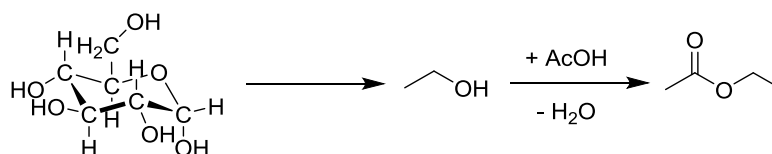


Figure 5-26 Combinations of feedstocks for ethyl acetate manufacturing.

In the ACDV model example, acetic acid is reacted with bio-ethanol to give ethyl acetate. All the atoms belonging to ethanol were considered to be plant-derived and those comprising acetic acid designated as fossil-based (atom connectivity Method 2b). The synthesis liberates water as a by-product (Scheme 5-2). Fermentation of glucose yields 2 molar equivalents of both ethanol and carbon dioxide.



Scheme 5-2 Esterification of bio-ethanol.

The process described in Scheme 5-2 can be represented as a Sankey diagram, and in doing so represents the mass flow of the process (Figure 5-27). If feedstocks are considered as wholly bio-based or petroleum derived we can follow the flow of biomass to some extent. But what might be better is some indication of the flow of renewable and fossil based materials. A modified Sankey diagram in which each material flow is divided into biomass, water, and fossil derived contributions rectifies this, in line with mass balance Method D, but is difficult to comprehend visually (Figure 5-28). Finally a simpler Sankey diagram in which no indication of the processes is made, just the origin of the material, has been developed (Figure 5-29). As with all Sankey diagrams the width of each arrow is proportional to the quantity of each contributing resource (by mass). However this final Sankey diagram is quite



abstract and the first version (Figure 5-27) is better suited to explain the production chain. This style will be used throughout the report as it is important to convey and understand the production chain with its sequences of reactions. References to virtual sub-mass balances are made when appropriate, mostly reserved for Chapter 5.7 when fluctuation is scrutinised in more detail.



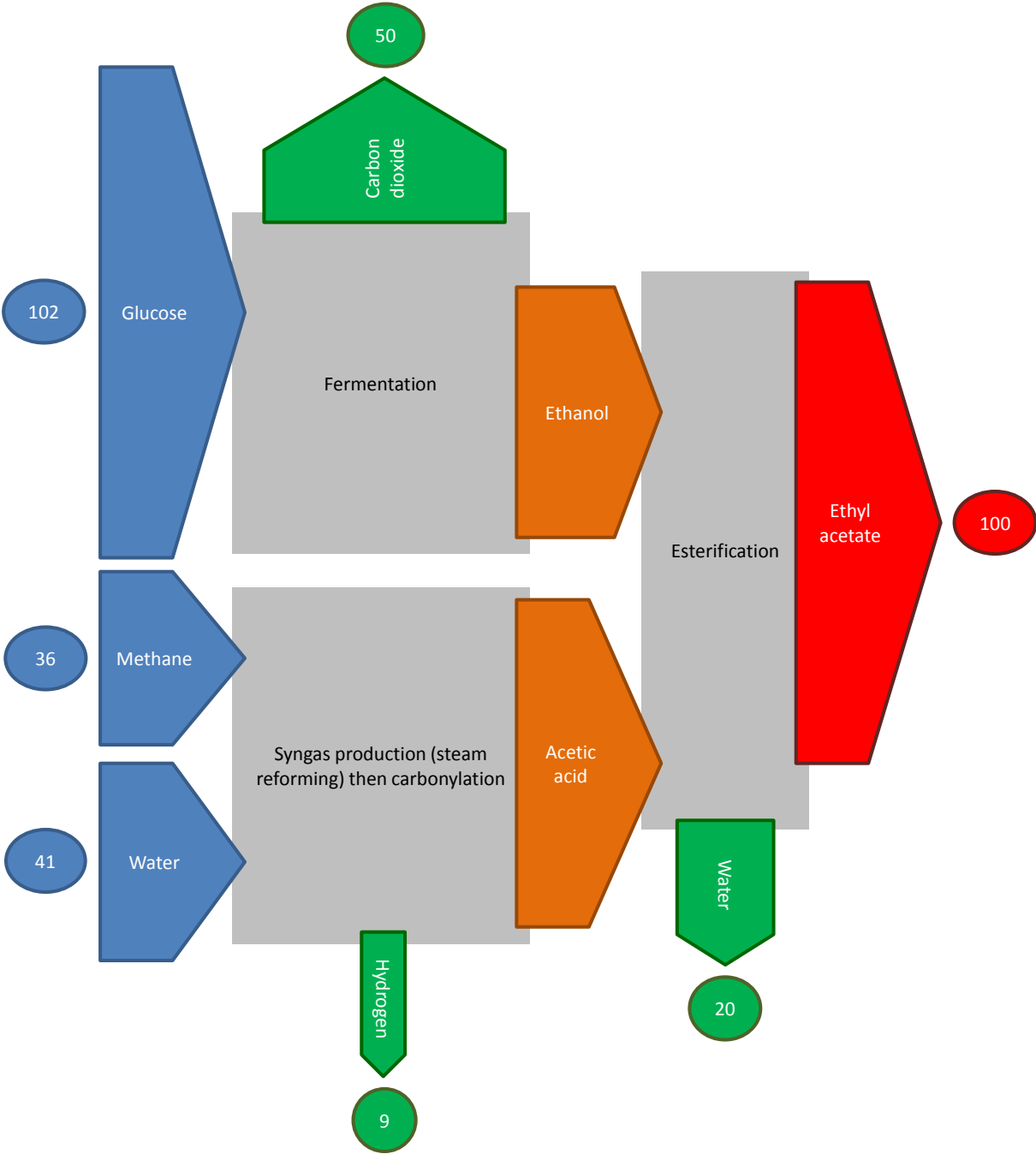


Figure 5-27 A Sankey diagram of the production of partially bio-based ethyl acetate. Numbers refer to relative masses.



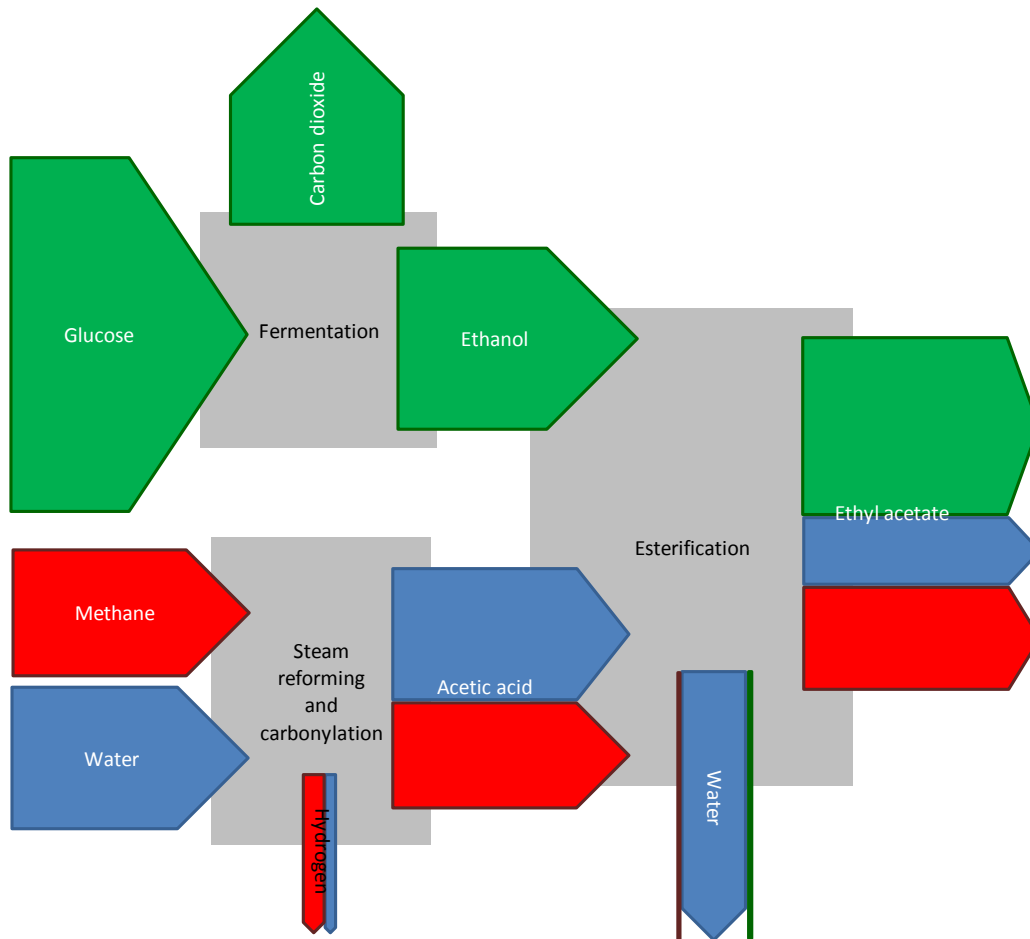


Figure 5-28 A Sankey diagram describing ethyl acetate production while also indicating flows of biomass, atoms from water, and petroleum-derived material. The widths of arrows indicate mass flows. Grey boxes are processes. Green arrows indicate biomass. Blue arrows describe the flow of atoms derived from water. Red arrows indicate fossil based material.



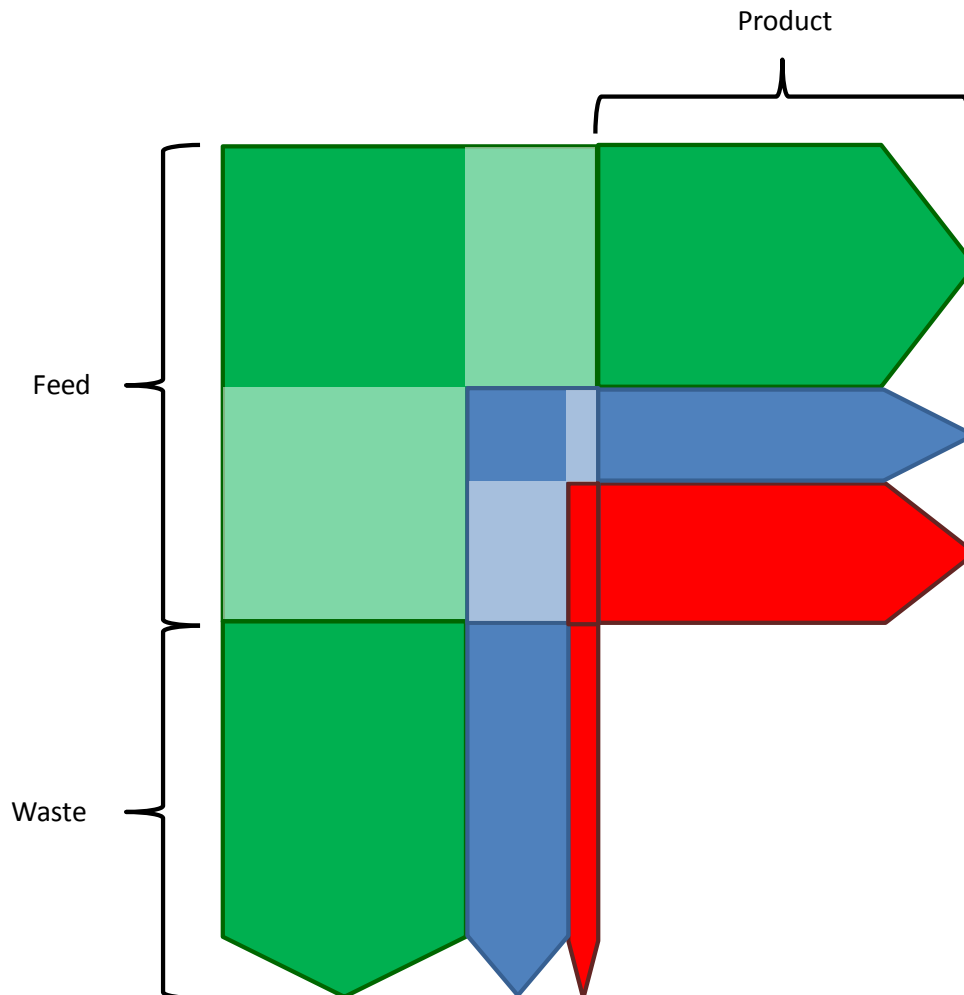


Figure 5-29 Flow of material divided by source. Same key as Figure 5-28. Within the ‘feed’ segment, the areas of the darker coloured boxes are representative of the relative masses of biomass, water, and petroleum derived materials in the feedstocks.

Under the rules of mass balance Method A, ethanol (or bio-ethanol if appropriate) can be taken as the feedstock because both are fully bio-based without ambiguity (**CEN/TC 411/WG 3 document N93**), and Figure 5-27 will become simplified to Figure 5-30. It has a methane equivalents value of 1.853, replacing glucose as a feedstock (3.21 methane equivalents). In order to produce 100 kg of ethyl acetate by bio-ethanol esterification, assuming no losses from the manufacturing processes, the attribution unit system of mass balance Method A will attribute 73% bio-based content to the product. The use of bio-gas instead of methane would contribute a further 27%. The prominence of different feedstocks in terms of how much bio-based content they can attribute to the product is derived from the attribution units awarded to ethyl acetate. For the aforementioned example this is 133 attribution units, but returning to consider glucose as the feedstock and not ethanol this increases this to 364 when recalculated:



$$\begin{aligned} \text{Ethyl acetate allocation units (ethanol feedstock)} &= \sum \text{Input mass} \cdot \text{methane equivalent} \\ &= (52 \text{ kg} \cdot 1.853) + (36 \cdot 1.000) = 133 \text{ kg} \end{aligned}$$

$$\begin{aligned} \text{Ethyl acetate allocation units (glucose feedstock)} &= \sum \text{Input mass} \cdot \text{methane equivalent} \\ &= (102 \text{ kg} \cdot 3.21) + (36 \cdot 1.00) = 364 \text{ kg} \end{aligned}$$

The consequence of this increase in attribution units is that the 36 kg of natural gas used in the process becomes less important. With the contribution of the petrochemical input appearing to diminish, the fossil resource saving (or total bio-based content) attributed to the product increases to 90% (Table 9-29). Of course the mass of fossil derived methane remains constant, as does the mass it contributes as part of the final product. This susceptibility of mass balance Method A is vulnerable to manipulation in order to enhance claims of bio-based content. It would be extremely difficult to harmonise its application to ensure consistency.



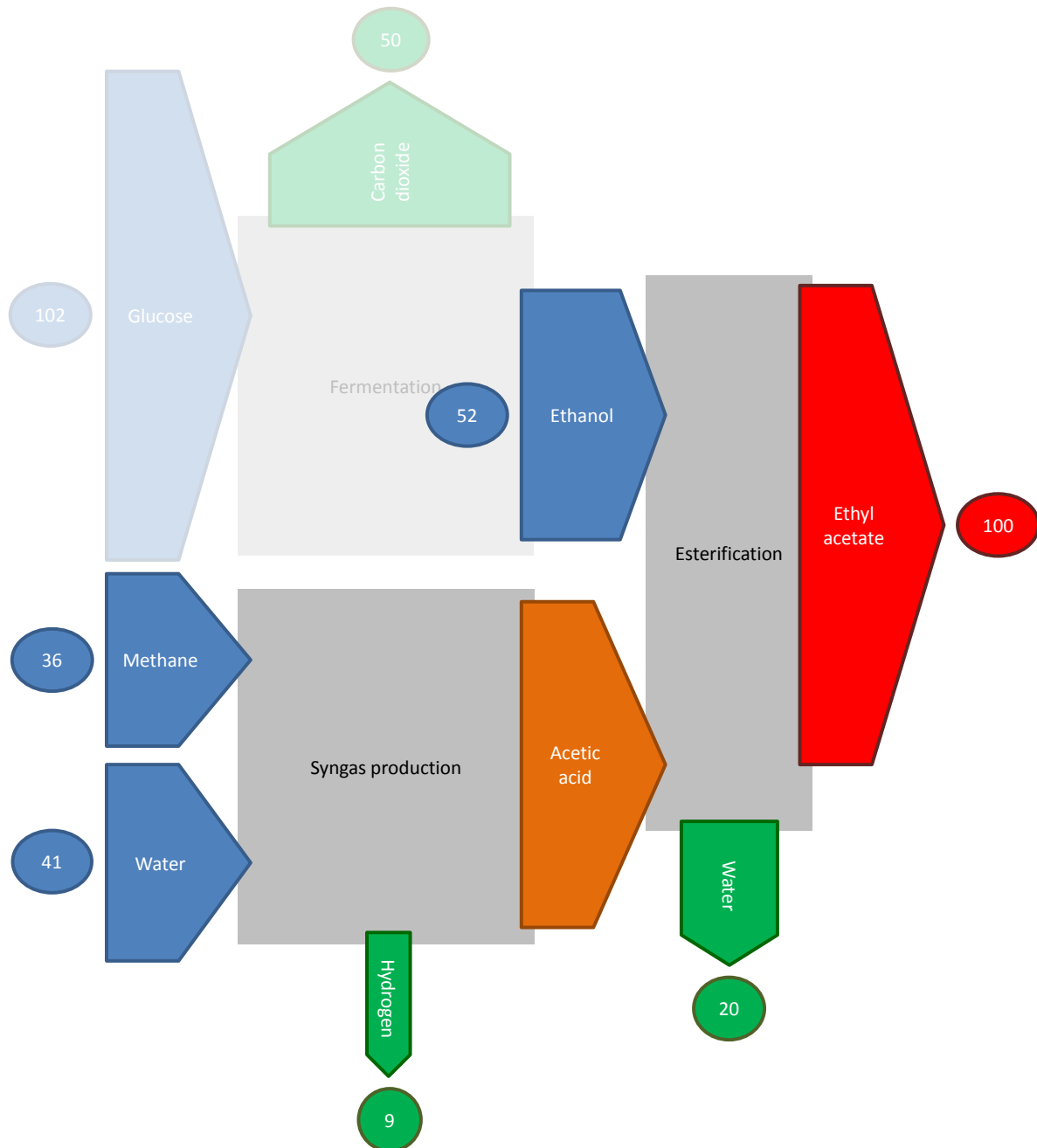


Figure 5-30 A Sankey diagram of the production of partially bio-based ethyl acetate adopting ethanol as one of the feedstocks.

The same synthetic process, combining bio-ethanol and fossil derived acetic acid can be scrutinised by mass balance Method B also. Quite clearly half the carbon atoms (two of four) in ethyl acetate are bio-based and a value of 50% bio-based carbon content is easily arrived at in the absence of fluctuating feedstock input. The total bio-based content can be calculated by following the biomass through the manufacturing steps. Taking either ethanol or glu-

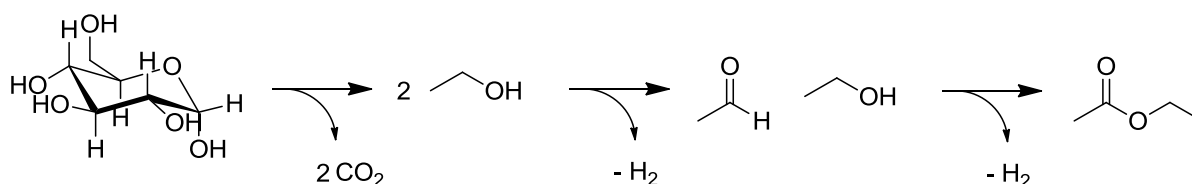


cose as the bio-based feedstock (the end result is unaffected) introduces 52 kg of bio-ethanol for every 100 kg of ethyl acetate produced (Table 5-15). This is split across the desired product and the water liberated during the final esterification, meaning 51 kg of this bio-based material is present in ethyl acetate for every 100 kg (51.1% total bio-based content, consistent with atom connectivity Method 2b, Table 4-37). The water used to create syngas is included as fossil derived content because it is reacted with petrochemical methane and is not part of the biomass flow.

Table 5-15 Mass balance Method B interpretation of the production of ethyl acetate by the esterification of bio-ethanol and acetic acid.

	Total mass /kg	Bio-based content /kg	Fossil derived content /kg
Mass input /kg	130	52	77 (<i>inc. water</i>)
Wastes /kg	30	1	28
Product stream /kg	100	51	49

The bio-based ethyl acetate that is made at present is actually produced not by Fischer esterification, but by a dehydrogenation of ethanol (Scheme 5-3) [Colley 2004]. All of the atoms in the final product originate in the carbohydrate feedstock, and so the product can be considered as wholly bio-based. The entire mass of the feedstock however is not incorporated into the desired product. In terms of atom economy [Trost 1991], this process based on glucose is 49% efficient because of carbon dioxide co-production during fermentation.



Scheme 5-3 Bio-based ethyl acetate by Davy-Sasol method.

If the bio-based ethyl acetate of Scheme 5-3 (50 kg) was combined with conventional ethyl acetate (made from synthetic ethanol and acetic acid, again 50 kg), this blend might produce a more favourable result than the partially bio-based product of Scheme 5-2. Using mass balance Method A it would not, with this blend of feedstock origins and manufacturing processes resulting in final product containing an attributed 59% total bio-based content, whereas the former ACDV model compound is either 72% or 90% bio-based under this approach, as discussed previously. However mass balance Method B (Table 5-16) is capable of delivering a reasonably consistent 50% total or carbon bio-based content, being based on the atoms contained within the product.



Table 5-16 Mass balance Method B interpretation of the production of equal quantities of ethyl acetate produced by the esterification of synthetic ethanol and acetic acid and bio-based ethyl acetate from bio-ethanol via the Davy-Sasol method.

	Total mass /kg	Bio-based content /kg	Fossil derived content /kg
Mass input /kg	117	52	65
Wastes /kg	17	2	15
Product stream /kg	100	50	50

Mass balance Method C is able to offer a bio-based content claim derived from fossil carbon savings. This is 27.3 kg of fossil carbon saved from the final product for every 100 kg of ethyl acetate produced (applicable when the ethyl acetate is considered as 50% bio-carbon content, 0,50 g/g, either because it is made from bio-ethanol and conventional acetic acid or it is blended to that level of bio-based content). As previously reported and summarised by Figure 5-24, by changing what is considered as the original reference process, or what the original feedstock is, the claims of fossil carbon savings on the basis of the feedstock composition will vary. If the claim is that synthetic ethanol is replaced by bio-ethanol in the synthesis of partially bio-based ethyl acetate, then 27.3 kg of fossil carbon is saved (assuming no losses). Changing the original process description to regard naphtha as the feedstock, this value increases to 118 kg because of the low selectivity of naphtha transforming to the intermediate ethylene (Annex B, Table 9-31). This is further evidence that claims of bio-based content must be specific to a given product and not a production chain.

Mass balance Method D is in agreement with mass balance Method B for this case study (Table 5-17). The ACDV ethyl acetate example bio-based product is calculated to be 51% bio-based. Excluding the mineral content has a small effect. The mixture of petrochemical ethyl acetate and the Davy-Sasol 100% bio-based ethyl acetate has also been assessed with mass balance Method D (Table 5-18) and again consistency with mass balance Method B is found. The relationship between total bio-based content calculations from mass balance Method B and Method D is close when the biomass portion of the molecule is not functionalised with mineral resources (*e.g.* oxidation), as is the case here for the bio-ethanol. When the biomass derived intermediates are functionalised mass balance Method B will consider those newly introduced atoms as bio-based through an atom connectivity assignment. This is not the case with mass balance Method D.



Table 5-17 Mass balance Method D applied to the ACDV ethyl acetate case study.

Feedstock	Mass /kg	Origin	Product incorporation (percentage)	Product incorporation (mass /kg)
Ethanol	52	Biomass	97.8%	51.1
Methane	36	Fossil	81.2%	29.6
Water	41	Mineral	47.2%	19.3
Sum	167			100
Total bio-based content			51%	
<i>Total bio-based content (ignoring mineral content)</i>			58%	
<i>Total bio-based content (mineral assumed bio-based)</i>			70%	

Table 5-18 Mass balance Method D applied to a mixture of petrochemical ethyl acetate and bio-based ethyl acetate made by the dehydrogenation of ethanol.

Feedstock	Mass /kg	Origin	Product incorporation (percentage)	Product incorporation (mass /kg)
Ethanol	52	Biomass	95.6%	50.0
Naphtha	66	Fossil	24.3%	15.9
Methane	18	Fossil	81.2%	14.8
Water	31	Mineral	62.9%	19.3
Sum	167			100
Total bio-based content			50%	
<i>Total bio-based content (ignoring mineral content)</i>			62%	
<i>Total bio-based content (mineral assumed bio-based)</i>			69%	

5.3.2 Biodiesel

Mass balances constructed on the basis of deciphering the savings of fossil derived material must work under the presumption that a historical process, or at least the feedstock of that process, has been replaced. Some manufacturing plants do not have this comparison, having always processed biomass with no rival petrochemical facilities. Bio-diesel as a fuel is out of scope for bio-based product mass balance. However a fatty acid methyl ester (FAME) can act as the base oil in lubricants, and their derivatives are used in various applications [Salimon 2010]. This case study is based on coconut oil which is transesterified to make methyl laurate. It is possible to make long chain alcohols from petrochemicals, and by oxidation and esterification convert these intermediates into esters. However it will be assumed here



that the production plant has always processed vegetable oils and no petrochemical feed-stock/fossil carbon has been replaced. The implications of this will now be explored.

Transesterification of vegetable oils (triglycerides) with sodium methoxide produces a FAME product stream and glycerol as a by-product. Excess (fossil derived) methanol has been used in this example (Figure 5-31). Any free acids in the vegetable oil will be neutralised by the basic catalyst. The majority of the product is bio-based (92% bio-based carbon content), with mass balance Method A attributing a 73.5% bio-based content. Mass balance Method A can be used independently of a reference process to compare the new biomass conversion process to a petrochemical route and is therefore applicable (for claims of bio-based content at least) to any process utilising biomass when claiming total bio-based content (to say fossil resource savings is inappropriate here).

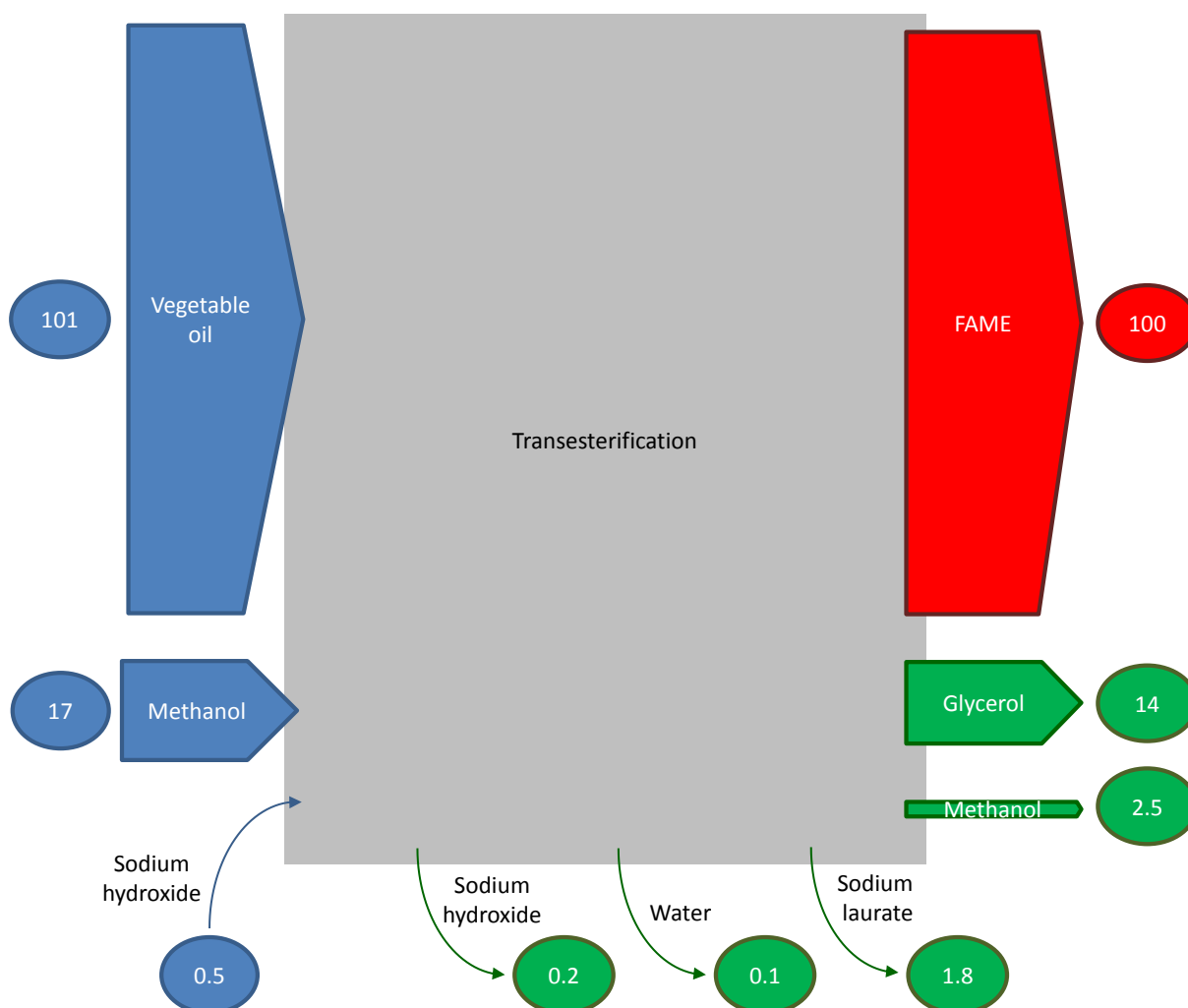


Figure 5-31 A Sankey diagram describing the production of bio-diesel. Mass flows too small to be proportionally represented are displayed as conventional arrows.



Mass balance Method B is consistent with the anticipated analytical bio-based carbon content of 92%. Total bio-based content results are subject to how well the feedstock is understood. Vegetable oils are variable in quality, and ideally waste oils from the food sector will be used as the feedstock. Used vegetable oil will have higher moisture content and a degree of decomposition caused by cooking, especially with regards to free fatty acids caused by hydrolysis of the triglycerides. In this case study a fatty acid content of 5% is assumed, but error is avoided by identifying sodium laurate as a separate output stream. If glycerol (containing hydrogen atoms from methanol) and the other outputs aside from the bio-diesel are calculated to be completely bio-based or wholly fossil derived according to atom connectivity calculations, an error appears to occur, but this is less than 1%: total bio-based content by mass balance Method B is 84.9% but 85.5% by atom connectivity Method 2b. The reason can be illustrated using glycerol. Methanol is fossil derived, as a direct radiocarbon analysis would show, and so its heteroatoms are also considered as fossil derived. Three hydrogen atoms once belonging to molecules of methanol later find themselves chemically bonded to the glycerol by-product. Radiocarbon analysis would show the glycerol is 100% bio-based and so atom connectivity will change the allegiance of those three hydrogen atoms. An attempt has been made to limit the number of atoms changing origin through atom connectivity measurements as part of mass balance Method B, but this cannot be ensured for every case study encountered. The number and character of the chemical bonds formed and broken all have an effect.

Mass balance Method C is hindered by the absence of an analogous petrochemical process. Fossil carbon savings can be claimed of 67.3 kg for every 100kg of product, but no fossil carbon has actually been replaced. This is obviously misleading, and perhaps expressing this result as the quantity of bio-based carbon per 100 kg of product is more appropriate (either way the result equates to 0.92 g/g and should be verifiable by analytical radiocarbon measurements). Claims of fossil carbon saving based on the feedstock will vary according to the fluctuations of the biomass input (the conversion of biomass into the desired product may be less efficient for example and therefore require more feedstock).

Mass balance Method D is in good agreement with mass balance Method B (Table 5-19) and on a carbon basis is consistent with mass balance Method C (Table 5-20). Because this is a single process in which methanol reacts with vegetable oil there is no need to attempt to construct virtual separation of different sub-processes. Taking methanol as a primary feedstock (instead of more correctly using methane and water) does not change the result of the total bio-based content calculation unless this is performed to exclude mineral feedstocks (now 84% bio-based instead of 91%).



Table 5-19 Total bio-based content of methyl laurate as calculated using mass balance Method D.

Feedstock	Mass /kg	Origin	Product incorporation (percentage)	Product incorporation (mass /kg)
Methane	8.7	Fossil	74.9%	6.5
Water	9.8	Mineral	80.9%	7.9
Vegetable oil (triglyceride)	99	Biomass	86.1%	85.5
Vegetable oil (free fatty acid)	1.6	Biomass	0.0%	0.0
NaOH	0.54	Mineral	0.0%	0.0
Sum	120			100
Total bio-based content			86%	
<i>Total bio-based content (ignoring mineral content)</i>			91%	
<i>Total bio-based content (mineral assumed bio-based)</i>			93%	

Table 5-20 Bio-based carbon content of methyl laurate as calculated using mass balance Method D.

Feedstock	Mass /kg	Origin	Product incorporation (percentage)	Product incorporation (mass /kg)
Methane	6.5	Fossil	85.7%	5.6
Water	0.0	Mineral	0.0%	0.0
Vegetable oil (triglyceride)	73	Biomass	92.3%	67.2
Vegetable oil (free fatty acid)	1.2	Biomass	0.0%	0.0
NaOH	0.00	Mineral	0.0%	0.0
Sum	80.6			72.9
Bio-based carbon content			92%	
<i>Bio-based carbon content (ignoring mineral content)</i>			92%	

5.3.3 Polyethylene terephthalate

The manufacturing of poly(ethylene terephthalate) is historically based on the oxidation of fossil derived *p*-xylene and the oxidation of petrochemical ethylene. The intermediate chemicals are esterified to form the desired polymer. At present some poly(ethylene terephthalate) products are partially bio-based. Fermentation of carbohydrates to give bio-ethanol is followed by dehydration to ethylene and subsequent oxidation to ethylene glycol, the diol monomer of poly(ethylene terephthalate) (Table 4-24). Currently in development is the appli-



cation of renewable *p*-xylene to afford wholly bio-based poly(ethylene terephthalate), but this is not considered as part of this case study. The Sankey diagram representing a bio-ethanol to poly(ethylene terephthalate) production plant reveals the use of methanol as an intermediate (Figure 5-32). The esterification of terephthalic acid to give dimethyl terephthalate improves the subsequent polymerisation esterification process. As the methanol is returned at the end of the synthesis it would most likely be recycled.

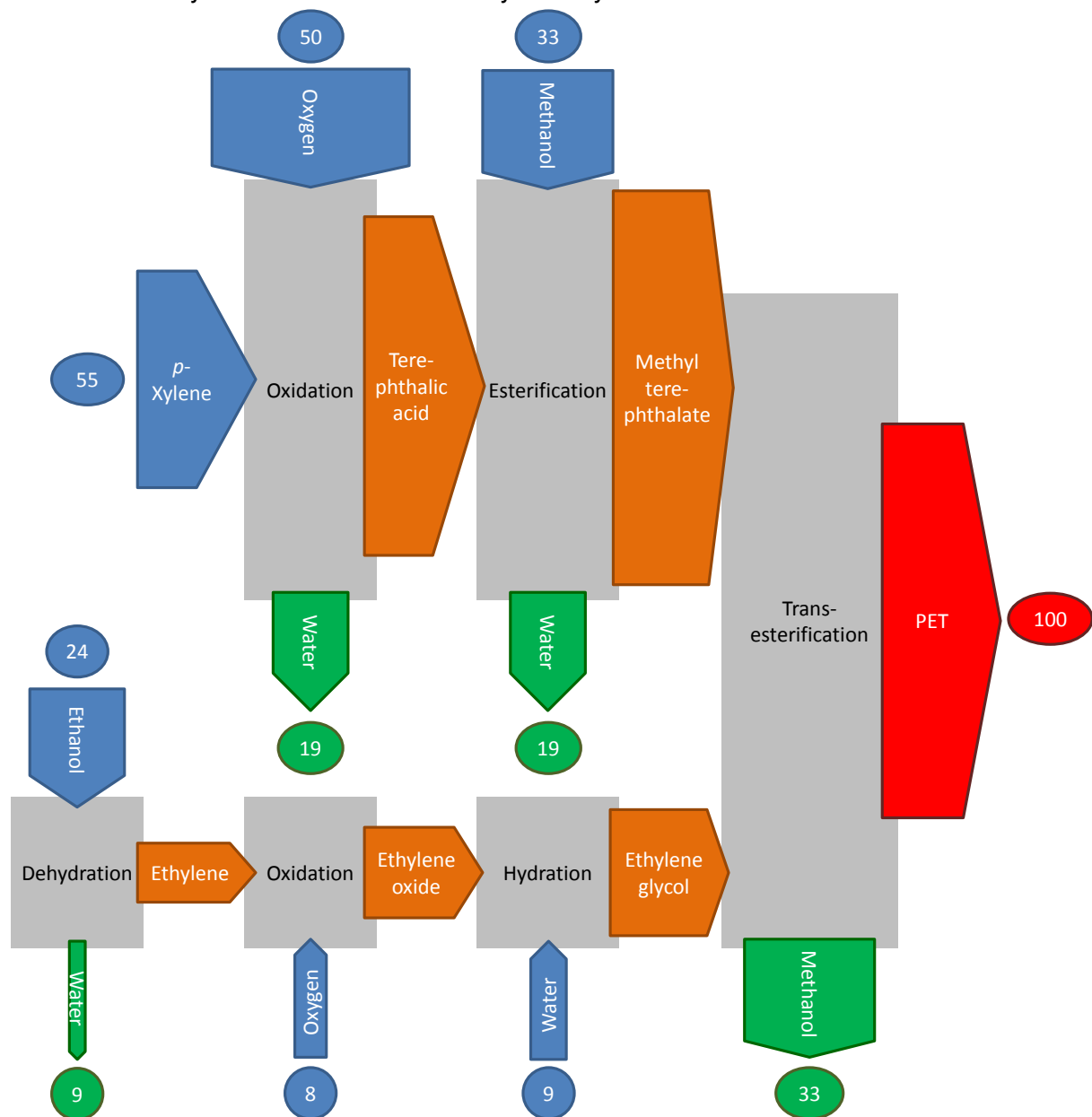


Figure 5-32 The use of bio-ethanol in the production of partially bio-based poly(ethylene terephthalate).



Ethylene may also come from another biomass source, that being bio-naphtha. A 25% selectivity to ethylene is assumed in the cracking of bio-naphtha, meaning that 58 kg is required to contribute to the manufacturing of every 100 kg of poly(ethylene terephthalate) (Figure 5-33). Downstream from ethylene the process remains the same.

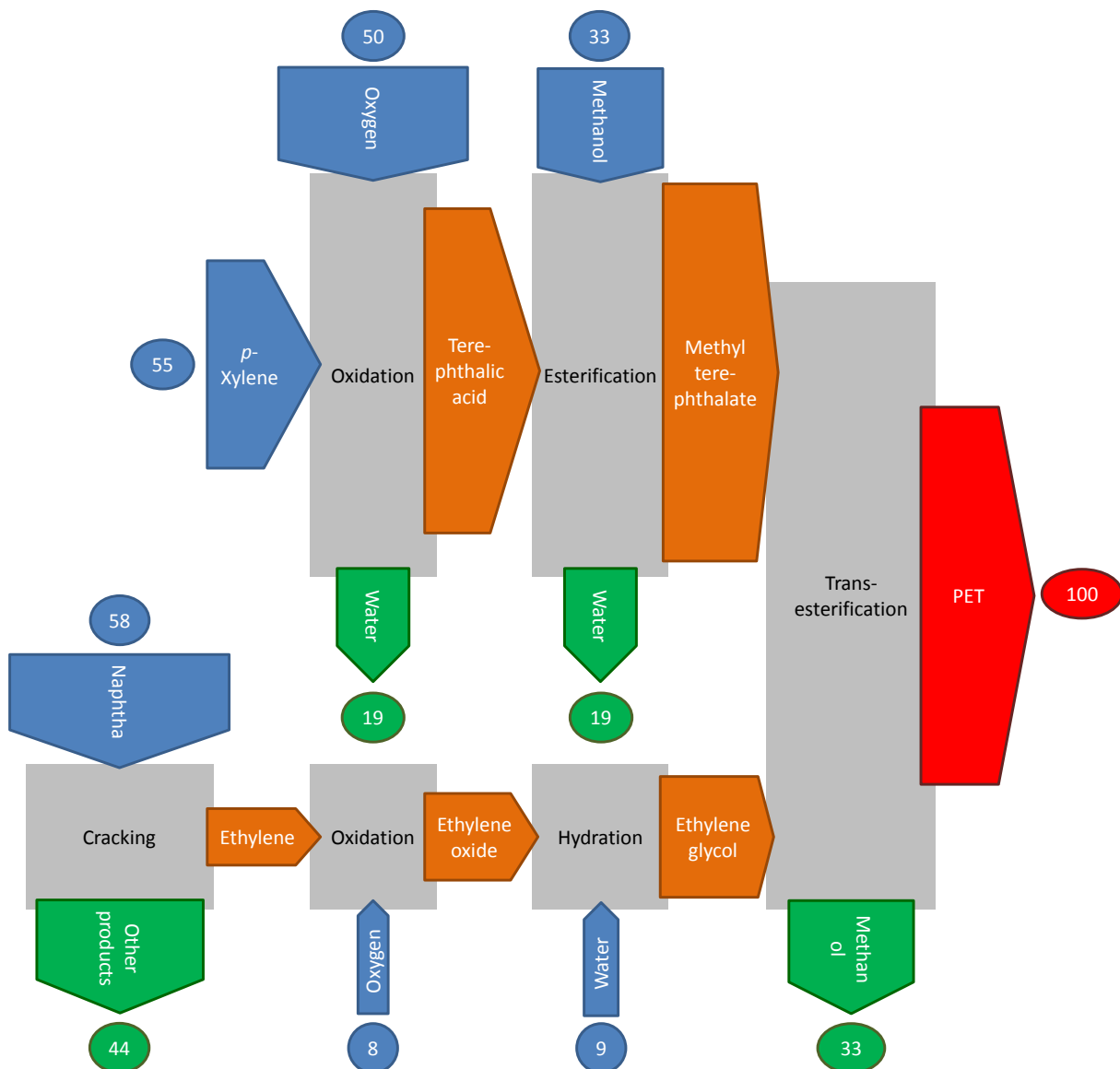


Figure 5-33 A Sankey diagram of poly(ethylene terephthalate) production from naphtha.

As proven in previous case studies, the choice in designation of the feedstock, either bio-ethanol or bio-naphtha in this instance, will affect mass balance Method A. In this case study, the option to recycle the methanol or the decision to remove it as a waste stream also



changes the bio-based content allocated to the product (Table 5-21). The implication of this is that the bio-based content attributed to poly(ethylene terephthalate) can vary between 22% and 49%. It may be that the methanol, as an auxiliary compound, is ignored from calculations, again changing the result.

Table 5-21 Poly(ethylene terephthalate) attribution units and consequent bio-based content claims from mass balance Method A derived from different feedstock and recycling options.

	Bio-ethanol feedstock	Bio-naphtha feedstock
Methanol recycling	122 kg (40%)	134 kg (49%)
Methanol disposal	198 kg (22%)	220 kg (30%)

Returning to mass balance Method B as a means of complementing analytical and atom connectivity methods when feedstocks may change over time, the maximum bio-based carbon that can be introduced into poly(ethylene terephthalate) is 20% (two of every ten carbon atoms). Atom connectivity Method 2b attributes 31% total bio-based content (Table 4-24). In mass balance Method B where the product of interest is partially bio-based, the total bio-based content can be calculated to be the difference between the bio-based content of the combined feedstocks, and the other products and wastes. This is performed in an attempt to minimise the changing of elemental origins through atom connectivity assignments (Table 9-43). The point at which the fossil and biomass material flows interact, and possible conflicts can be caused by atom connectivity, is the final stage of the production chain and so error is minimal following this calculation method. Methanol exiting the process was treated as being wholly petrochemical in line with atom connectivity Method 2b and output of water assigned depending on what feedstock conversion stream it emanated from. This approach has introduced a small discrepancy between mass balance Method B and atom connectivity Method 2b (Figure 5-34). The indirect calculation of bio-based carbon content is proportional with what might be expected from analytical methods.



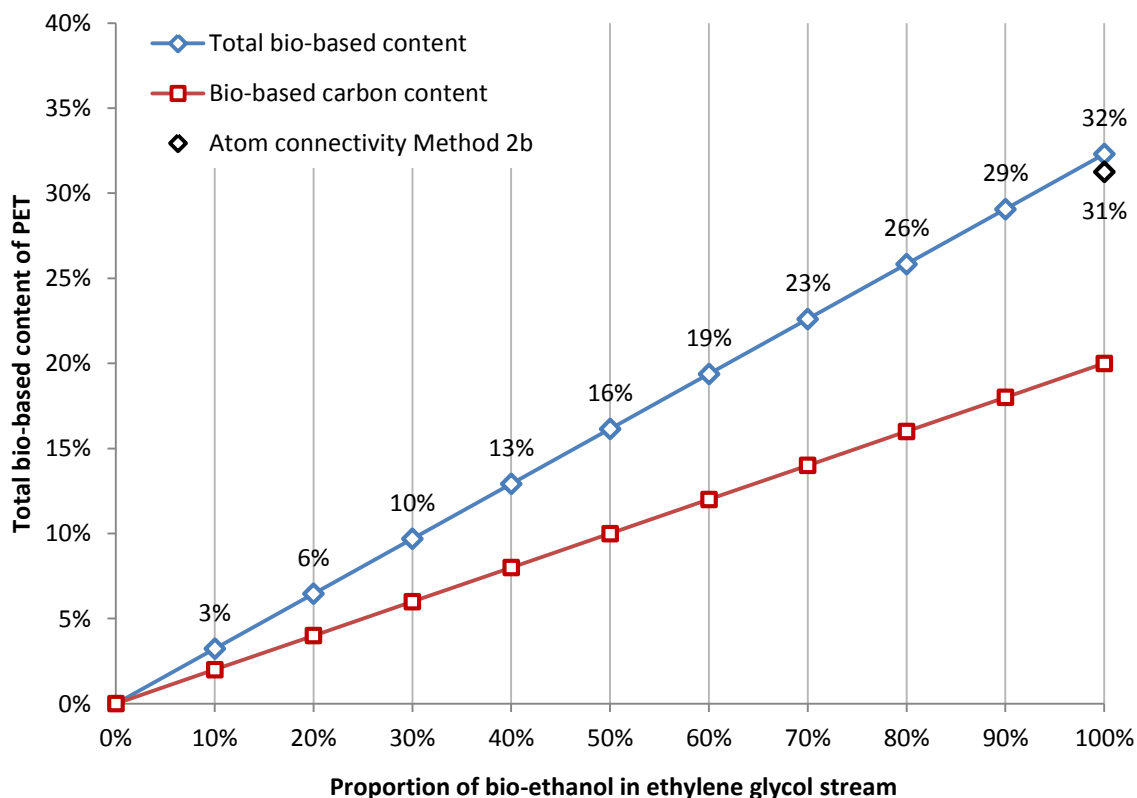


Figure 5-34 Mass balance Method B calculations for variable proportions of bio-ethanol in a process for poly(ethylene terephthalate) production.

The results of calculating a virtual separation of fossil and biomass poly(ethylene terephthalate) product streams shows a linear correlation with the proportion of biomass feedstock used. If a fluctuating amount of synthetic ethanol and bio-ethanol (or conventional naphtha and bio-naphtha) was used as the ethylene glycol process feedstock without losses the calculations in Figure 5-34 would be expected to be a true reflection of the actual process. Uncertainty created by losses, transport, storage, low yields, and other factors relating to the fluctuating biomass input will cause deviations from these idealised results. This topic is presented in Chapter 5.7.

Mass balance Method C is able to return a value of 12.5 kg of fossil carbon savings for every 100 kg of product, corresponding to 0.2 g/g of bio-based carbon as a function of total carbon content. The methanol is considered as feedstock, and as such the amount of carbon in the combined feedstocks is 75 kg when ethanol is regarded as the biomass feedstock, and 115 kg when bio-naphtha is regarded as the biomass feedstock. Applied to the process not the carbon contained within the product, a maximum of 0.17 g/g fossil carbon savings can be made in the process with bio-ethanol, while this increases to 0.46 g/g upon the introduction of bio-naphtha (refer to Annex B, Table 9-45 and Table 9-46).



The total bio-based content of poly(ethylene terephthalate) changes considerably according to the approach used. This is demonstrated with mass balance Method D for the 'plant bottle' example of bio-ethanol used as a feedstock (Table 5-22). Because of the large proportion of oxygen incorporated into the polymer (from the oxidation of *p*-xylene and the intermediate ethylene) much of the product is mineral in origin (approximately 35%). More than half is fossil derived leaving just 15% bio-based content. When excluding mineral feedstocks from the calculation the total bio-based content reaches 22%. This value is close to the bio-based carbon content of 20% (Table 5-23). It is generally the case with mass balance Method D that by removing mineral feedstocks from the calculation the total bio-based content and the bio-based carbon content values converge to a similar value.

Table 5-22 Calculation of total bio-based content according to balance Method D for poly(ethylene terephthalate) made from bio-ethanol.

Feedstock	Mass /kg	Origin	Product incorporation (percentage)	Product incorporation (mass /kg)
Ethanol	24	Biomass	60.9%	14.6
Oxygen	58	Mineral	42.9%	25.0
Water	9.3	Mineral	88.8%	8.3
<i>p</i> -Xylene	55	Fossil	94.3%	52.1
Sum	147			100
Total bio-based content			15%	
<i>Total bio-based content (ignoring mineral content)</i>			22%	
<i>Total bio-based content (mineral assumed bio-based)</i>			48%	

Table 5-23 Mass balance Method D applied for the calculation of bio-based carbon content of poly(ethylene terephthalate).

Feedstock	Mass /kg	Origin	Product incorporation (percentage)	Product incorporation (mass /kg)
Ethanol	12.5	Fossil	100.0%	12.5
Oxygen	0.0	Mineral	0.0%	0.0
Water	0.0	Biomass	0.0%	0.0
<i>p</i> -Xylene	50	Mineral	100.0%	50.0
Sum	62.5			62.5
Bio-based carbon content			20%	
<i>Bio-based carbon content (ignoring mineral content)</i>			20%	



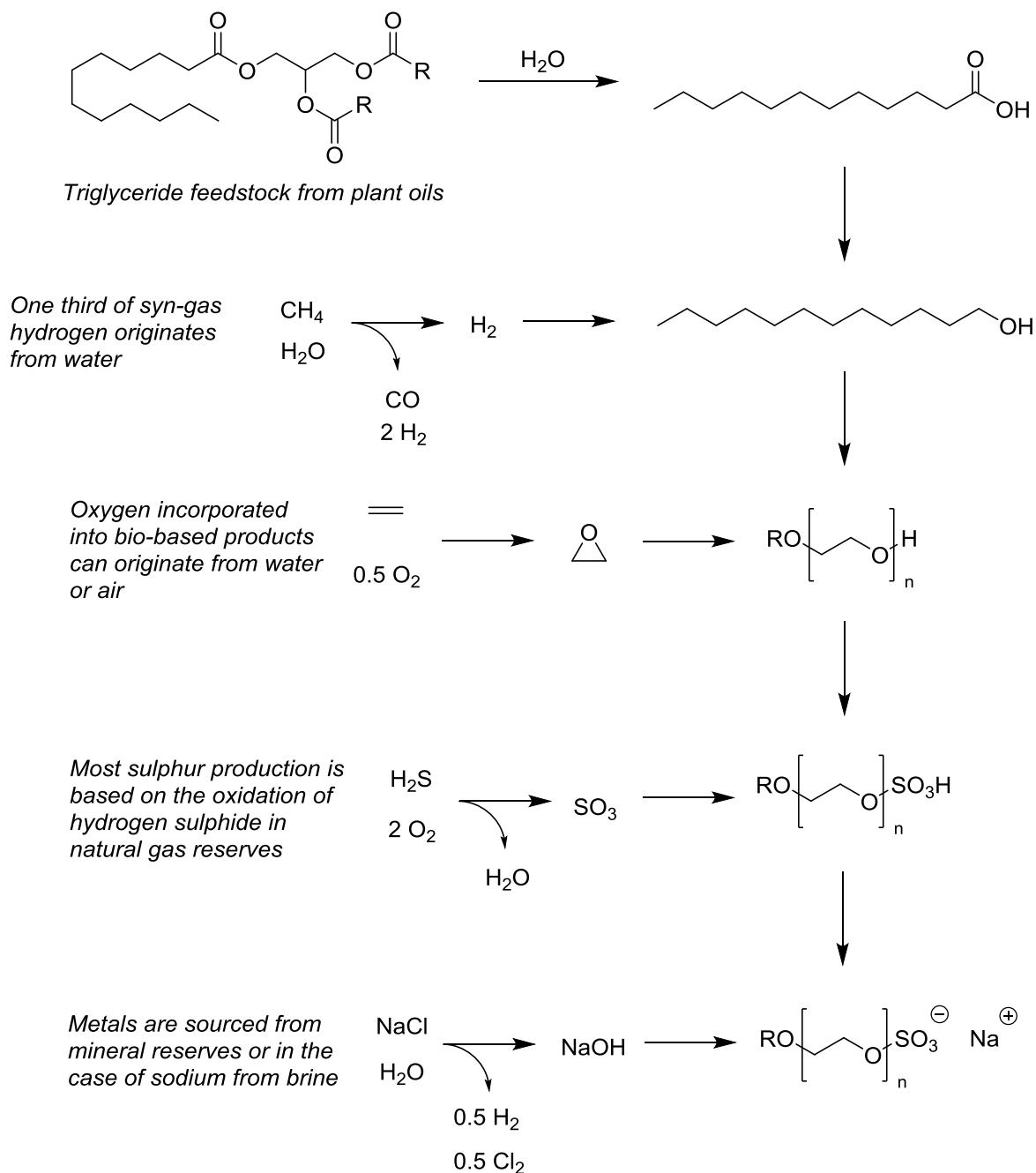
5.4 Mass balance case study: Fine chemical synthesis

The fine chemical sector produces some complex molecules forming part of a large supply chain. The robustness of mass balance approaches can be tested with the examples of sodium laureth sulphate and vanillin. Fluctuating biomass feedstock input is not considered as this stage (see Chapter 5.7).

5.4.1 Sodium laureth sulphate

Sodium laureth sulphate is produced by the method shown in Scheme 5-4. The hydrophobic region can be fatty acid derived, although economically dodecanol from the Ziegler-Natta polymerisation of ethylene is favourable in low value products [Weissermel 1993]. Ethylene is also the other carbon based feedstock required to produce the ethylene glycol oligomeric portion of the surfactant molecule. Ethylene could be bio-based but is likely to be made from naphtha or another fossil derived feedstock. An inorganic sulphate group completes the hydrophilic section.





Scheme 5-4 The synthesis of sodium laureth sulphate from triglycerides.

The likely bio-based product will be synthesised according to Scheme 5-4, producing a poly(ethylene glycol) trimer ($n = 3$). Thus in terms of carbon the product is 67% bio-based. The manufacturing process has been identified as containing ten distinct chemical transformations (Figure 5-35). The primary feedstocks are naphtha and vegetable oil (assumed to be comprised entirely of the triglyceride of lauric acid in order to simplify calculations). Methane



(natural gas) is also required for hydrogen production, as is hydrogen sulphide as a source of sulphur (3.29 methane equivalents). The remaining mass inputs are carbon-free inorganic materials without calorific values so they do not influence mass balance Method A or any mass balance methods based only on carbon such as mass balance Method C.

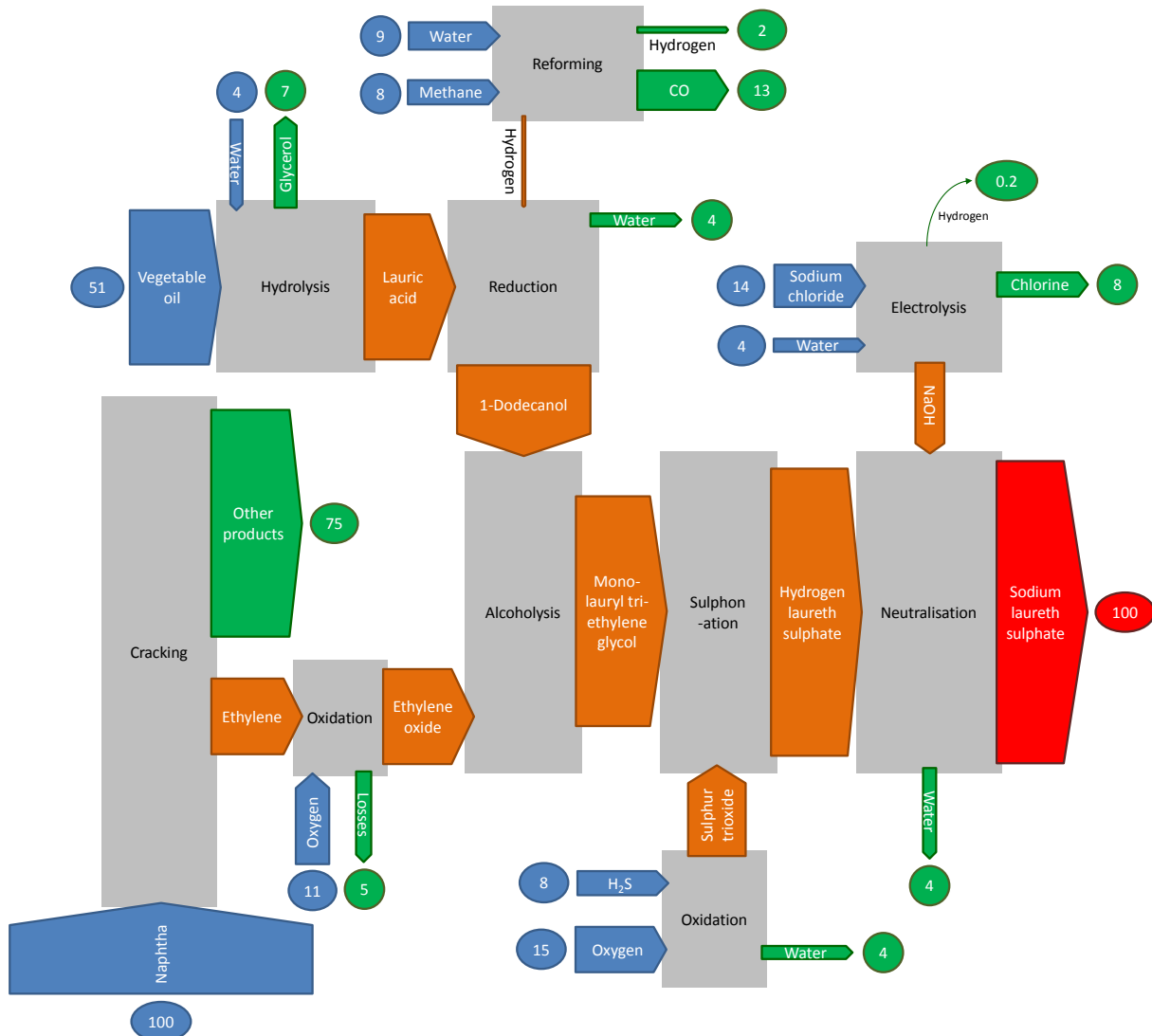


Figure 5-35 A Sankey diagram describing the process of manufacturing the surfactant sodium laureth sulphate containing a triethylene glycol moiety.

According to the calculations of mass balance Method A, 170 kg of vegetable oil for every 100 kg of product would be required to provide 100% bio-based content (more detail is available in Chapter 9.7). Because only 51 kg is used the resulting product is attributed a bio-based content of 30% (Table 9-49). If hydrogen sulphide as a mineral feedstock is ignored in the calculation (meaning only the methane equivalents of natural gas, naphtha, and vegeta-



ble oil are considered), this rises to 34% (Table 9-50). The inconsistency is not uncommon for mass balance Method A, and a well defined protocol for considering inorganic content should be developed for surfactant molecules. Bio-naphtha could contribute up to 54% bio-based content towards the total for sodium laureth sulphate (including hydrogen sulphide in the calculations). Attribution units are derived from the current process and not from a reference petrochemical process. This means the contributions of each feedstock towards the attribution units of the product equal 100% of the maximum fossil resource saving possible. All feedstocks would need to be bio-based to attain 100% fossil resource savings.

When naphtha (to produce ethylene) is the only carbon containing feedstock, 260 kg is required to give 100 kg of sodium laureth sulphate featuring a poly(ethylene glycol trimer) (Figure 5-36). If all of the naphtha was bio-based, and the cracking selectivity towards ethylene remained at 25%, then the total fossil resource saving of the product would be 92%. The presence of hydrogen sulphide, obtained from natural gas deposits, limits the maximum total bio-based content below 100%, even though bio-based carbon would be expected to be 100%. Sulphur can be obtained from other sources, typically mineral deposits [USGS 2014], but even elemental sulphur has a lower heating value (9.163 MJkg^{-1} , 5.46 methane equivalents). Sulphur in biomass is too low in concentration to be a viable resource for general use in the synthesis of bio-based products. Bio-based sulphur may feature in future bio-based products derived from the amino acid cysteine.



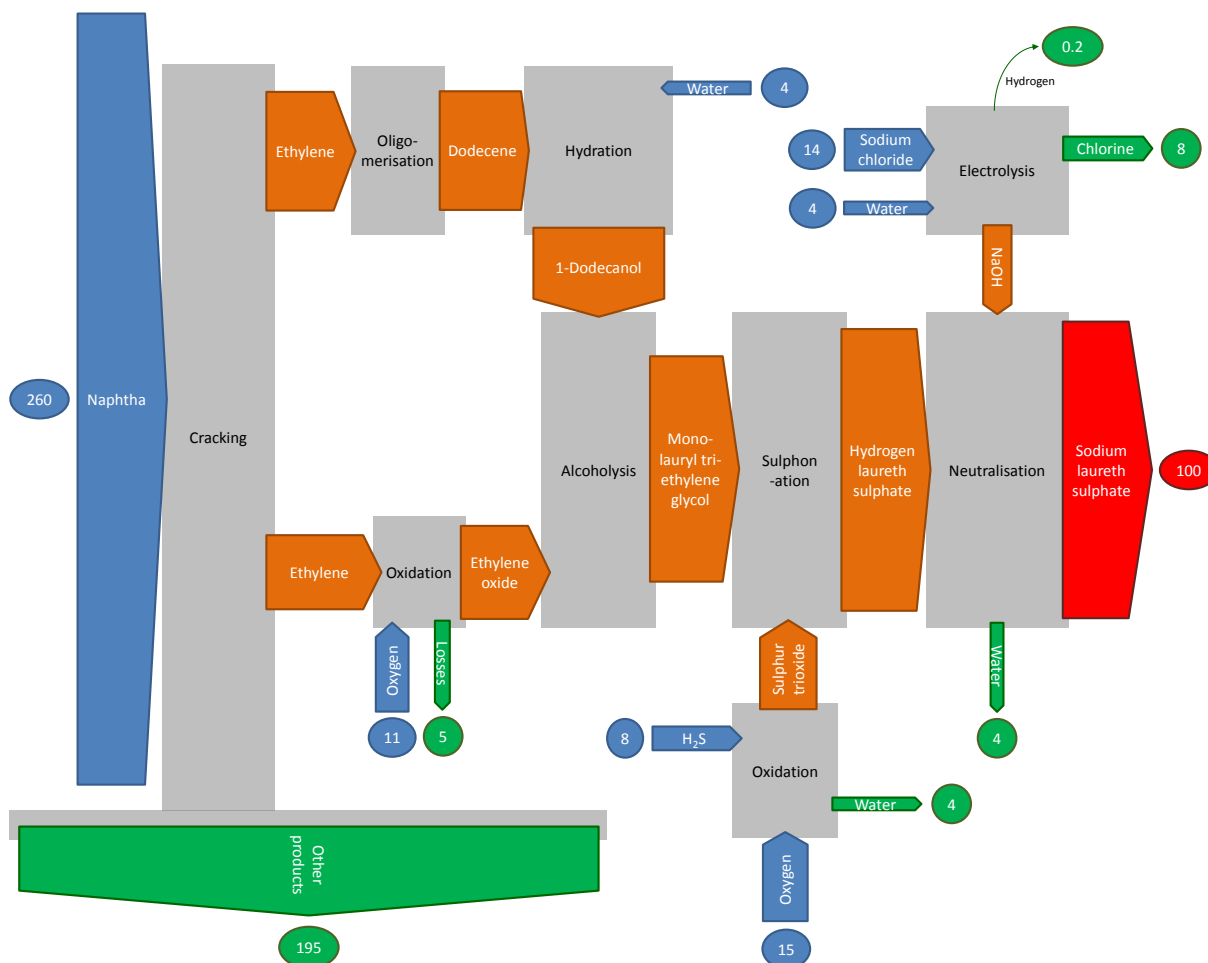


Figure 5-36 A Sankey diagram describing the process of manufacturing the surfactant sodium laureth sulphate from naphtha derived ethylene.

Mass balance Method B can be applied by dividing the input (feedstocks) into bio-based or fossil derived materials, assigning bio-based content through atom connectivity. The same is done for wastes and losses. The difference between these calculations should then equal the calculated bio-based content of the product. This approach has been conducted throughout this work as a kind of verification during these simpler mass balance case studies before the fluctuation of feedstocks is properly addressed. It also helps limit a consequence of atom connectivity; the changing of an element's assigned origin. As of yet it has provided acceptable approximations because even though the desired product tends to be partially bio-based, other outputs are usually completely bio-based or wholly fossil derived. When using mass balance Method B the bio-based content of products (and by-products and losses) should be calculated individually. When the composition of losses is poorly understood atom connectivity is helpful so long as the chemical structure of the final product and the mechanisms of the reactions required to make it are known.



The distribution of bio-based content is now shown overlaid onto the Sankey diagram for the vegetable oil valorisation procedure to give sodium laureth sulphate (Figure 5-37). Those processes directly involving the triglyceride feedstock and its immediate derivatives are considered to be comprised of biomass material flows. The hydrogen does not carry forward its fossil origin because through atom connectivity its chemical bonds with bio-based carbon atoms dictate its association to a feedstock, biomass or otherwise. The result is that the total bio-based content (43%) and bio-based carbon content (67%) values acquired from mass balance Method B are comparable (within 1%) to those of atom connectivity Method 2b (Table 4-45). The slight difference in the calculated total bio-based content can be traced to molecules such as the water eliminated in the hydrogenation of lauric acid, which is assumed to be bio-based although the hydrogen atoms of the water were previously considered to be of fossil origin. Data tables are provided in Annex B (Table 9-52 and Table 9-53).



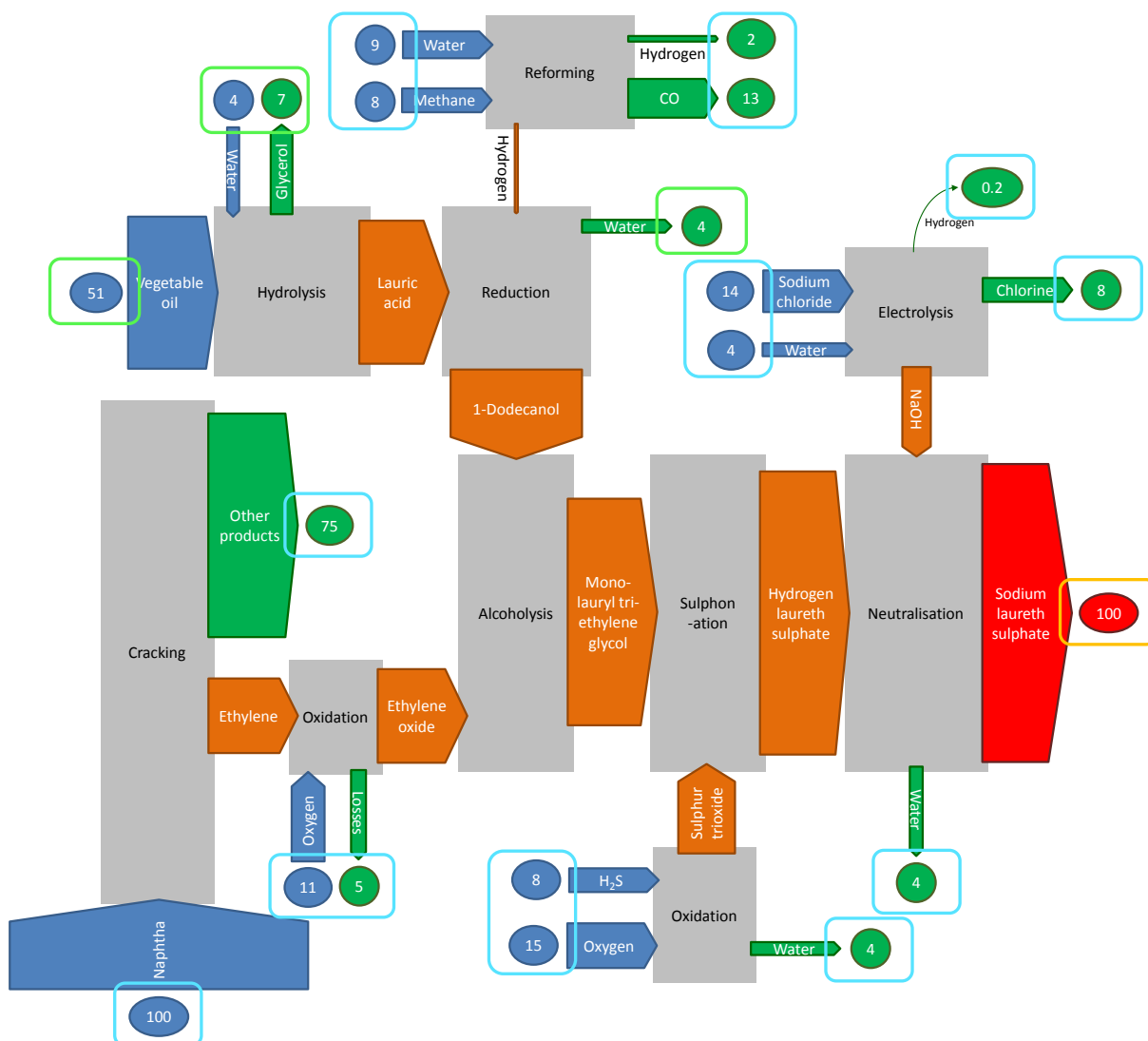


Figure 5-37 The process of manufacturing the surfactant sodium laureth sulphate containing a triethylene glycol moiety from vegetable oil and conventional naphtha with biomass mass flows highlighted in light green and fossil derived mass flows highlighted in light blue and finally the major product being partially bio-based highlighted in light orange.

Depending on the approach adopted, the results of mass balance Method B can be unconvincing. For the alternative scenario in which bio-naphtha is the only carbon containing feedstock (to produce ethylene) either the origin of the feedstocks can be preserved as much as possible (as accounted for by atom connectivity Method 1), or the final product can dictate the atom connectivity assignments as has been the case in previous examples (in line with atom connectivity Method 2b). The inorganic material entering the process (reactions with sulphur trioxide and sodium hydroxide occur) is assigned a petrochemical origin (there is no allowance for mineral feedstocks). They are not chemically bound to any bio-based carbon atoms, or hold any association to biomass until the sulphonation and neutralisation stages.



When the final product is the focus of the calculation, preserving the essence of atom connectivity method 2b, the association to bio-based carbon atoms is established and a total bio-based content of 100% is obtained. Previously during the discussion on atom connectivity it has been recognised that the origin of the poly(ethylene glycol) segment of the molecule will also affect how the sodium sulphate group is treated. If mass balance Method B is applied by attempting to preserve the original fossil origin of the mineral feedstocks a result of 76% total bio-based content for sodium laureth sulphate is obtained. The apportionment of biomass and petrochemical material flows is given as Figure 5-38. This would be the outcome if atom connectivity Method 1 had been used as the basis of the calculations in mass balance Method B instead of atom connectivity Method 2b. A total of 317 kg of the different feedstocks (input material) are required to deliver 100 kg of the product, of which 276 kg is considered to be bio-based, either directly or because it reacts directly with bio-based carbon atoms in an intermediate chemical. Largely because of the selectivity of naphtha cracking, 200 kg of bio-based material is not incorporated into the sodium laureth sulphate product. This means that 76 kg of bio-based material is present in the 100 kg of product. The remainder is accounted for by the sulphur based polar group of sodium laureth sulphate (NaSO_3^-). If a formulation was made between a triglyceride derivative and a separate mineral ingredient the latter would not contribute to the total bio-based content of the product, perhaps making the system inconsistent. Chapter 5.6.3 will explore this further by considering two different processes that utilise the same feedstocks.



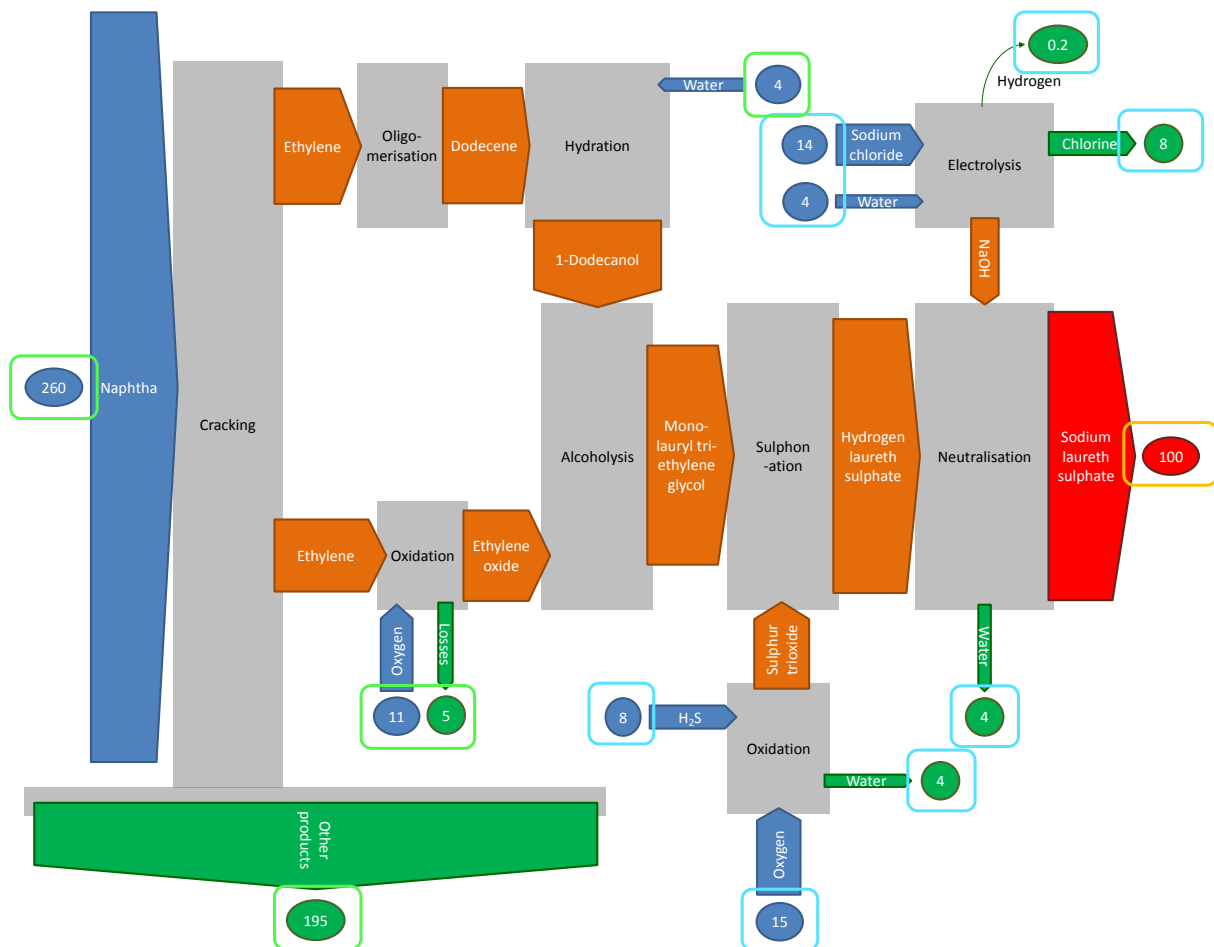


Figure 5-38 The process of manufacturing the surfactant sodium laureth sulphate containing a triethylene glycol moiety from bio-based naphtha with biomass mass flows highlighted in light green and fossil derived mass flows highlighted in light blue and finally the major product being partially bio-based highlighted in light orange.

Fossil carbon savings can be calculated for both processes: one based on triglyceride reduction (Figure 5-35) and an ethylene oligomerisation containing procedure (Figure 5-36). The various claims have been tabulated below (Table 5-24). The claim that is true to the original proposal of mass balance Method C is presented in Table 5-24 as ‘*fossil carbon saving per 100 kg of product*’, which equals either 34.3 kg or 51.4 kg depending on the process utilised for the synthesis of sodium laureth sulphate. As seen before when naphtha has been a feedstock, the amount of carbon in the feedstock is much more than what makes it into the product. The losses of bio-based carbon results in a ‘*fossil feedstock carbon saving per mass of carbon in product*’ of 4.55 g/g, although rather than losses this material will form the basis of other chemical manufacturing processes, and hence this value may be misleading for a number of reasons.



Table 5-24 Different interpretations of fossil carbon savings for sodium laureth sulphate.

Metric	Result	Result
Carbon mass in product: <i>per 100 kg of product</i>	51.4 kg	51.4 kg
Bio-based carbon content	67%	100%
Fossil carbon saving: <i>per 100 kg of product</i>	34.3 kg	51.4 kg
Fossil carbon saving: <i>per mass of carbon in product</i>	0.67 g/g	1.00 g/g
Carbon content of combined feedstocks	133 kg	234 kg
Bio-based carbon content in feedstocks	37.1 kg	234 kg
Fossil feedstock carbon saving: <i>per 100 kg of product</i>	37.1 kg	234 kg
Fossil feedstock carbon saving: <i>per mass of carbon in original feedstock</i>	0.28 g/g	1.00 g/g
Fossil feedstock carbon saving: <i>per mass of carbon in product</i>	0.72 g/g	4.55 g/g

The interpretation of bio-based content by mass balance Method D with its three way division of feedstocks in biomass, fossil resources and mineral materials may act as a barrier for its acceptance. This is demonstrated with sodium laureth sulphate derived from bio-naphtha (Figure 5-36). There is no fossil feedstock and so 100% bio-based content is an obvious conclusion, although because of a large inorganic moiety within the chemical structure this is debatable. Using mass balance Method D, 100% total bio-based content is arrived at when mineral feedstocks are excluded from calculations. However the standard calculation including mineral feedstocks produces an answer of 60% bio-based content (Table 5-25). This might be considered as low given the absence of fossil derived content. It is also in contradiction with the bio-based carbon content of 100% (Table 5-26).



Table 5-25 The total bio-based content of sodium laureth sulphate according to mass balance Method D when made from bio-naphtha.

Feedstock	Mass /kg	Origin	Product incorporation (percentage)	Product incorporation (mass /kg)
Naphtha	260	Biomass	23.1%	60.0
Water	8.6	Mineral	47.2%	4.0
Oxygen	27	Mineral	85.7%	22.8
H ₂ S	8.1	Mineral	94.1%	7.6
NaCl	14	Mineral	39.3%	5.5
Sum	317			100
Total bio-based content			60%	
<i>Total bio-based content (ignoring mineral content)</i>			100%	
<i>Total bio-based content (mineral assumed bio-based)</i>			100%	

Table 5-26 The bio-based carbon content of sodium laureth sulphate according to mass balance Method D when made from bio-naphtha.

Feedstock	Mass /kg	Origin	Product incorporation (percentage)	Product incorporation (mass /kg)
Naphtha	51	Biomass	22.0%	11.3
Water	0.0	Mineral	0.0%	0.0
Oxygen	0.0	Mineral	0.0%	0.0
H ₂ S	0.0	Mineral	0.0%	0.0
NaCl	0.0	Mineral	0.0%	0.0
Sum	51			11.3
Bio-based carbon content			100.0%	
<i>Bio-based carbon content (ignoring mineral content)</i>			100.0%	

The alternative scenario in which sodium laureth sulphate is synthesised from vegetable oil yields different results (Figure 5-35). The total bio-based content is 42% (Table 5-27), but again by removing the mineral feedstocks from the calculation the value rises to meet bio-based carbon calculations (Table 5-28). Fossil derived naphtha used in the hydrophilic poly(ethylene glycol) section of the molecule is responsible for the less than complete bio-based content.



Table 5-27 The total bio-based content of sodium laureth sulphate made from vegetable oil as calculated using mass balance Method D.

Feedstock	Mass /kg	Origin	Product incorporation (percentage)	Product incorporation (mass /kg)
Vegetable oil	51	Biomass	82.3%	41.7
Naphtha	100	Fossil	20.0%	20.0
Methane	7.6	Fossil	4.2%	0.3
Water	17	Mineral	12.0%	2.1
Oxygen	27	Mineral	85.7%	22.8
H ₂ S	8.1	Mineral	94.1%	7.6
NaCl	14	Mineral	39.3%	5.5
Sum	224			100
Total bio-based content			42%	
<i>Total bio-based content (ignoring mineral content)</i>			67%	
<i>Total bio-based content (mineral assumed bio-based)</i>			80%	

Table 5-28 Mass balance Method D applied to triglyceride derived sodium laureth sulphate for the calculation of bio-based carbon content.

Feedstock	Mass /kg	Origin	Product incorporation (percentage)	Product incorporation (mass /kg)
Vegetable oil	37	Biomass	92.3%	34.3
Naphtha	90	Fossil	19.0%	17.1
Methane	5.7	Fossil	0.0%	0.0
Water	0.0	Mineral	0.0%	0.0
Oxygen	0.0	Mineral	0.0%	0.0
H ₂ S	0.0	Mineral	0.0%	0.0
NaCl	0.0	Mineral	0.0%	0.0
Sum	133			51.4
Bio-based carbon content			67%	
<i>Bio-based carbon content (ignoring mineral content)</i>			67%	

It is beneficial to have a quick reminder of the different conclusions of each mass balance approach. This has been summarised as Table 5-29. There is complete agreement between the approaches where bio-based carbon is concerned. For mass balance Method B two interpretations have been explored. The second, as discussed previously, considers the mineral derived sulphate functionality of sodium laureth sulphate as fossil derived regardless of the atom connectivity conclusion (labelled as consistent mineral treatment within Table 5-29). This only has an effect when bio-naphtha provides all the carbon for the product.



When vegetable oils and petrochemical naphtha are the feedstocks the total bio-based content varies, although most often is between 42-43%. This is also reflected by atom connectivity Method 2b (44%, Table 8-194) but not by the ACDV rules of atom connectivity (57%, Table 8-196). This is not because of the nominated origin of the sulphate group depends on the origin of the neighbouring poly(ethylene glycol) segment of the sodium laureth sulphate molecule, because under the rules established by ACDV all atoms aside from carbon, hydrogen, oxygen and nitrogen are considered to be bio-based. The choice of application for mass balance Method D fits the results of other approaches best when mineral feedstocks are included in the calculation, at least when the product is vegetable oil derived. For comparison to bio-based carbon content the mineral feedstock contribution is best removed to make the reported value of total bio-based content a relative assessment between fossil and biomass resource utilisation. Please remember that these mass balance calculations have been made on the maximum biomass input. Fluctuation of feedstocks is addressed later in the chapter, where these assessments act as the virtual biomass sub-mass balances.

Table 5-29 Bio-based content of sodium laureth sulphate products with calculated bio-based carbon values given in brackets.

Mass balance	Vegetable oil derived	Bio-naphtha derived
Method A	30%	92%
Method B	43% (67%)	100% (100%)
(consistent mineral treatment)	43% (67%)	76% (100%)
Method C	(67%)	(100%)
Method D	42% (67%)	60% (100%)
(excluding mineral feedstocks)	67% (67%)	100% (100%)

5.4.2 Vanillin

Natural vanillin is a high value product, and commands a premium price. The market is large enough to accept non-naturally occurring vanillin for broader lower value applications in the food sector. The process designed by Fatiadi *et al.* is used to convert guaiacol into vanillin [Fatiadi 1974]. Because vanillin is not a platform molecule commodity the process used to manufacture it does not need to operate at the levels of mass efficiency typically seen thus far. A significant amount of inorganic by-products are formed, and a large amount of solvent is employed (Table 5-30). The solvent at least would be expected to be recycled, and some unreacted guaiacol can be retrieved in order to be reused. Oxidation by nitric acid will also create a substantial volume of aqueous nitrous waste. The full mass balance data is provided in Table 5-30, and a simplified Sankey diagram is given to improve the resolution of the diagram on the page (Figure 5-39). Solvent and water input in particular has been subtracted from the abbreviated Sankey diagram.



Table 5-30 Full mass balance data for vanillin production from guaiacol.

Material	Flow	Mass /kg
<i>Process 1: Cracking</i>		
Naphtha	In	188
Ethylene	Out (intermediate)	47
Other cracking products	Out	141
<i>Process 2: Olefin oxidation</i>		
Ethylene	In (intermediate)	47
Oxygen	In	27
Acetaldehyde	Out (intermediate)	74
<i>Process 3: Oxidation</i>		
Acetaldehyde	In (intermediate)	74
Nitric acid	In	211
Water	In	300
Glyoxylic acid monohydrate	Out (intermediate)	112
Aqueous waste stream	Out	435
Reaction losses	Out	38
<i>Process 4: Alkylation</i>		
Guaiacol	In	124
Glyoxylic acid monohydrate	In (intermediate)	112
Sodium hydroxide	In	87
Sodium chloride	In	347
Water	In	744
Hydrochloric acid	In	221
Charcoal	In	1
Benzene	In	130
Ethyl acetate	In	1668
4-Hydroxy-3-methoxymandelic acid	Out (intermediate)	129
Guaiacol (unreacted)	Out	5
Hydrogen	Out	2
Water	Out	783
Benzene	Out	130
Ethyl acetate	Out	1668
Inorganic waste	Out	618
Reaction losses	Out	100
<i>Process 5: Decarboxylation</i>		
4-Hydroxy-3-methoxymandelic acid	In (intermediate)	129
Vanillin	Product	100
Carbon dioxide	Out	29



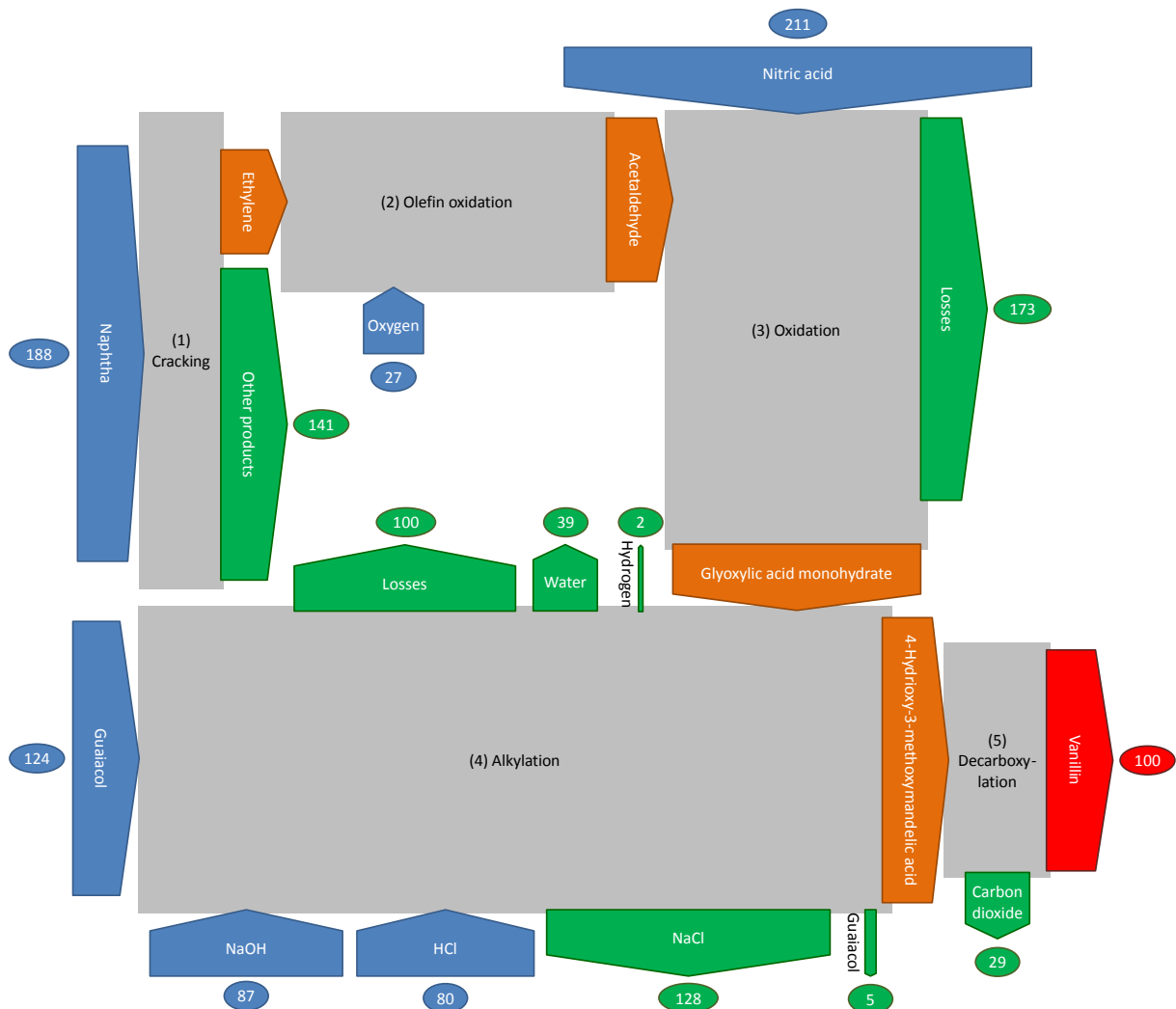


Figure 5-39 A simplified Sankey diagram describing the process used to manufacture synthetic vanillin from guaiacol.

For the purposes of mass balance Method A, only naphtha and guaiacol are of interest as these are the two organic, combustible feedstocks possessing lower heating values and therefore methane equivalents. The 124 kg of guaiacol needed to produce 100 kg of vanillin is enough to impart 47% fossil resource savings. Much of the complexity of the synthesis is circumvented by just considering the two major input feedstocks, only the amount of each needs to be calculated with the mass balance and from there attribution provides the fossil resource saving. Mass balance Method B is much more complicated to implement than in previous case studies because of the number of mixed biomass-petrochemical outputs in addition to the desired product. There is also a large amount of auxiliary material used for solvent extractions and neutralisation. From the structure of guaiacol and vanillin, it is straightforward to deduce that a single carbon atom of a fossil derived origin has been intro-



duced, accompanied by a hydrogen atom and an oxygen atom (Scheme 8-34). The total bio-based content and the bio-based carbon content can then be calculated, as it was in the atom connectivity approaches addressed previously. Figure 5-40 annotates the vanillin process Sankey diagram with the virtual fossil and biomass material flows. The losses in procedure 4 (alkylation) have been proportionally assigned by allocation as 37 kg of bio-based material and 63 kg of fossil derived material. This is inferred from the molar amount of the intermediate 4-hydroxy-3-methoxymandelic acid formed (129 kg, 657 moles) created and the quantity of guaiacol reclaimed (5 kg, 40 moles). Therefore the remaining material from the input of guaiacol (301 moles of the original 998 moles) and glyoxylic acid monohydrate (850 moles of the original 1507 moles) can be allocated proportionally to the losses in this process.

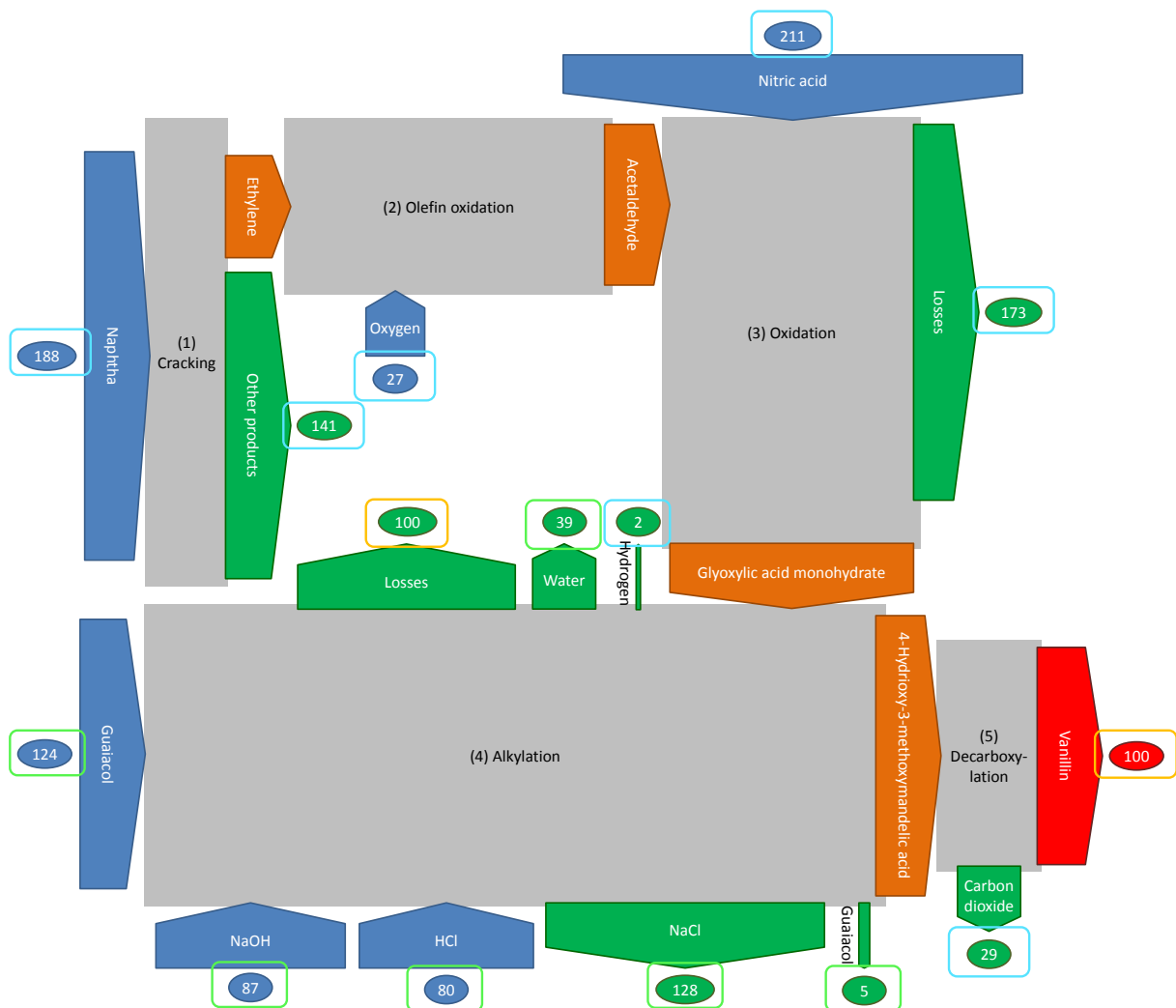


Figure 5-40 The process of manufacturing vanillin from bio-based naphtha with biomass material flows highlighted in light green and fossil derived mass flows highlighted in light blue and finally the partially bio-based outputs highlighted in light orange.



The outcome of mass balance Method B is that the total bio-based content of synthetic vanillin is calculated at 82% (close to the 81% determined by atom connectivity Method 2b) and the bio-based carbon content is calculated to be 88% as analysis should confirm. The estimations applied have not affected the final result to a significant degree, maintaining consistency with atom connectivity acting as a good benchmark.

Finally, fossil carbon savings calculated by mass balance Method C is also applicable. If petrochemical guaiacol is fully substituted in favour of natural guaiacol (124 kg), then 84 kg of fossil carbon will be replaced for every 100 kg of vanillin produced by this method (a third of the carbon contained in all the feedstocks when also considering naphtha). However due to the losses incurred during the process only 63 kg of carbon remains in the 100 kg of vanillin that is produced, and one of every eight atoms is fossil derived, meaning the fossil carbon saving in the product is 55 kg for every 100 kg produced (Figure 5-41).

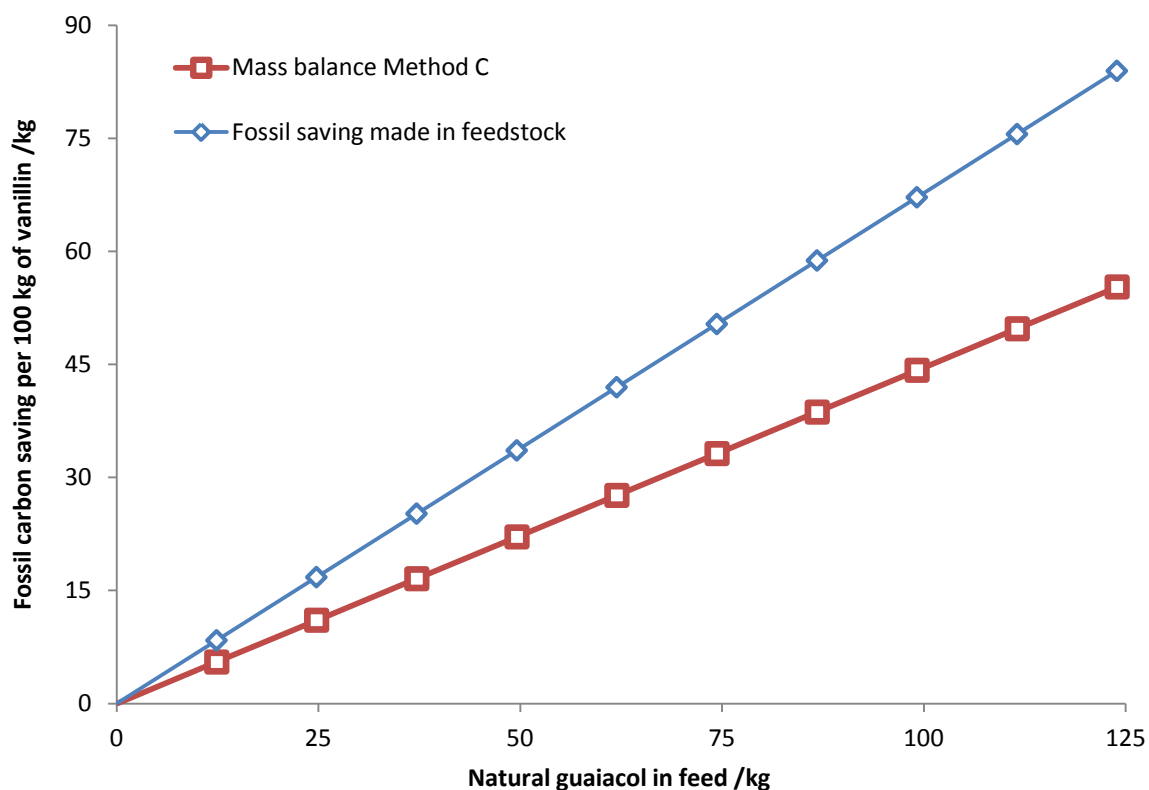


Figure 5-41 The proportion of fossil savings possible by increasing the amount of natural guaiacol in a vanillin production plant up to a maximum of 124 kg for every 100 kg of vanillin produced.

For synthetic vanillin, the value of bio-based content that can be arrived at, by any direct or indirect methodology, will not reach 100% because of the introduction of a fossil derived aldehyde functionality. However certain blends of natural and synthetic petrochemi-



cal vanillin could be formulated to be indistinguishable from synthetic vanillin made from natural guaiacol when analysed using radiocarbon isotope ratios. Because of the scarcity and price of natural vanillin, stable isotope analysis is conducted on samples to confirm its origin (and it is not unheard of for isotope enrichment to be performed in order to deceive customers and the authorities) [Greule 2010]. Natural vanillin is valued above (natural) guaiacol derived vanillin, although both are bio-based products, and stable isotope analysis of hydrogen and carbon atoms can distinguish between the two. When it is possible to produce a synthetic but bio-based chemical that is also isolated from natural sources, the use of stable isotope analysis proves to be a valuable tool. The adoption of stable isotope analysis as a method of verification in bio-based content determination strategies could prove to be an asset. Unfortunately it is only proven for a small number of products and does not give a definitive value of bio-based content.

Mass balance Method D closely approximates mass balance Method B. The vanillin is modified guaiacol, with the addition of a single carbon atom (from naphtha), to which is attached a further hydrogen atom and an oxygen atom (water derived). Ignoring the mineral feedstocks elevates the total bio-based content to 91% (Table 5-31). As shown previously, the calculation of bio-based carbon content is unambiguous and consistent with other approaches (Table 5-32).

Table 5-31 Mass balance Method D for the calculation of total bio-based content of vanillin made from bio-based guaiacol.

Feedstock	Mass /kg	Origin	Product incorporation (percentage)	Product incorporation (mass /kg)
Naphtha	188	Fossil	4.2%	7.9
Oxygen	27	Mineral	0.0%	0.0
Nitric acid	211	Mineral	0.0%	0.0
Water	300	Mineral	3.7%	11.2
Guaiacol	124	Biomass	65.3%	80.9
Sum	850			100
Total bio-based content			81%	
<i>Total bio-based content (ignoring mineral content)</i>			91%	
<i>Total bio-based content (mineral assumed bio-based)</i>			92%	



Table 5-32 Bio-based carbon content of vanillin as calculated by mass balance Method D.

Feedstock	Mass /kg	Origin	Product incorporation (percentage)	Product incorporation (mass /kg)
Naphtha	169	Fossil	4.7%	7.9
Oxygen	0.0	Mineral	0.0%	0.0
Nitric acid	0.0	Mineral	0.0%	0.0
Water	0.0	Mineral	0.0%	0.0
Guaiacol	55.3	Biomass	100%	55.3
Sum	224			63.2
Bio-based carbon content			87.5%	
<i>Bio-based carbon content (ignoring mineral content)</i>			87.5%	



5.5 Mass balance case study: Polymer blends

The mass balance of formulations and blends has not been discussed thus far, but typically the separate ingredients could be treated using the mass balance techniques used up to this point, and then the combination of the ingredients in their respective proportions would just need to be weighted appropriately by summation. A simple mixture can be worked through to exemplify how this would be applied in practice. The following formulation based on six ingredients has a fossil resource saving of at least 46% (mass balance method A), up to 58% total bio-based content (mass balance Method B), with fossil carbon savings of 39 kg within every 100 kg of the formulation (Figure 5-42). The proportions of each ingredient are given in Figure 5-43. These claims would be on a dry basis, even for aqueous solutions due to variability of the moisture content and the dilution making direct analysis difficult ([Open-Bio deliverable report D3.2](#)). More importantly results reported on a dry mass basis are representative of the biomass and fossil resources contained within the product. An example of the calculations required is presented below for mass balance Method A:

Total biobased content (formulation)

$$\begin{aligned} &= \sum \text{Mass of ingredient} \cdot \text{Total biobased content} \\ &= (30 \text{ kg} \cdot 23\%) + (25 \text{ kg} \cdot 72\%) + (15 \text{ kg} \cdot 44\%) + (15 \text{ kg} \cdot 32\%) \\ &\quad + (10 \text{ kg} \cdot 70\%) + (5 \text{ kg} \cdot 52\%) = 46 \text{ kg per } 100 \text{ kg (46\%)} \end{aligned}$$



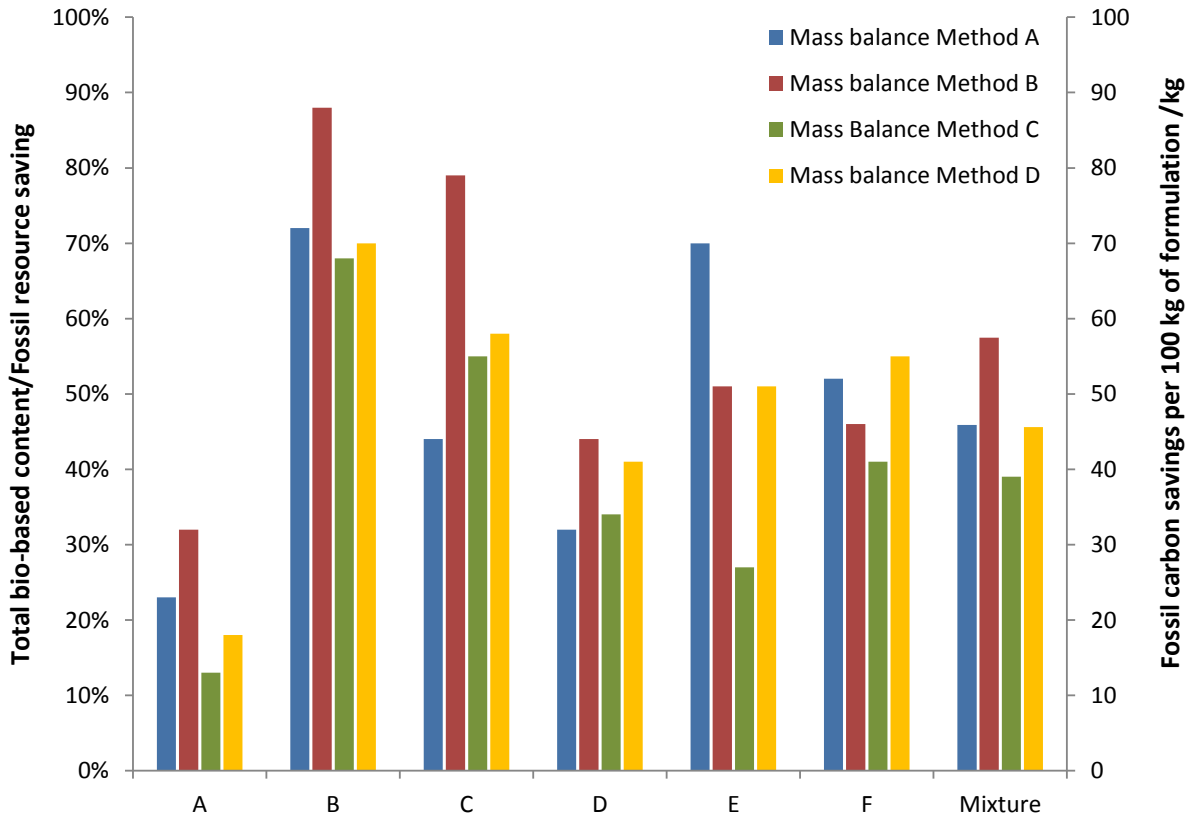


Figure 5-42 A hypothetical formulation of ingredients A to F with the bio-based content and fossil carbon saving indicated for each ingredient and the formulation as a whole.

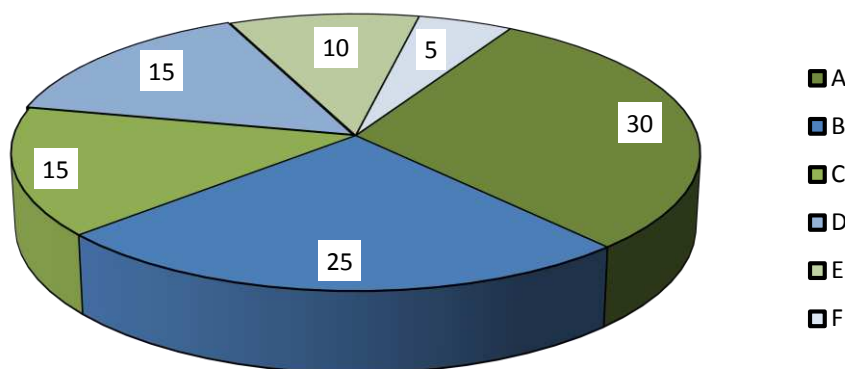


Figure 5-43 The mass given in kilograms of each ingredient in a hypothetical formulation of total mass 100 kg.

In this section of the report types of polymer blend will be examined, and comments offered regarding the calculation of their bio-based content by the different methods. As was the case in Chapter 4, firstly a blend of starch and polyethylene will be discussed as a simple



combination of a bio-based ingredients and a fossil derived component. Then the polymer blend branded as *Ecovio* will be examined [BASF 2014].

5.5.1 Starch polymer blends

First we return to the blended bio-based product of one part starch, three parts poly(ethylene), and a 2:1 starch to glycerol ratio left over from the gelatinisation process, as previously discussed in Chapter 4.8.1. The mass balance of each process required in order to obtain the ingredients can be scrutinised separately. The mass balance applicable to the final article should in effect be the sum of these contributing mass balances, also considering losses during formulation.

The polymerisation of ethylene cracked from naphtha (to produce polyethylene), and vegetable oil transesterification (to produce glycerol) will be familiar from previous case studies (Figure 5-44). For each ingredient, the following contributions towards the total bio-based content can be calculated with mass balance Method A: Starch provides 13.5% of the maximum possible fossil resource saving; glycerol from triglycerides provides up to 19.3%; finally the contribution of poly(ethylene) is a maximum of 60.2% if bio-based in origin. The discrepancy between the mass of each ingredient within the formulation and the contributed bio-based content (according to mass balance Method A) is shown in Figure 5-45, assuming the naphtha used to make the intermediate ethylene is bio-based. The values do not add up to 100% because methanol in the transesterification of triglycerides is another feedstock.



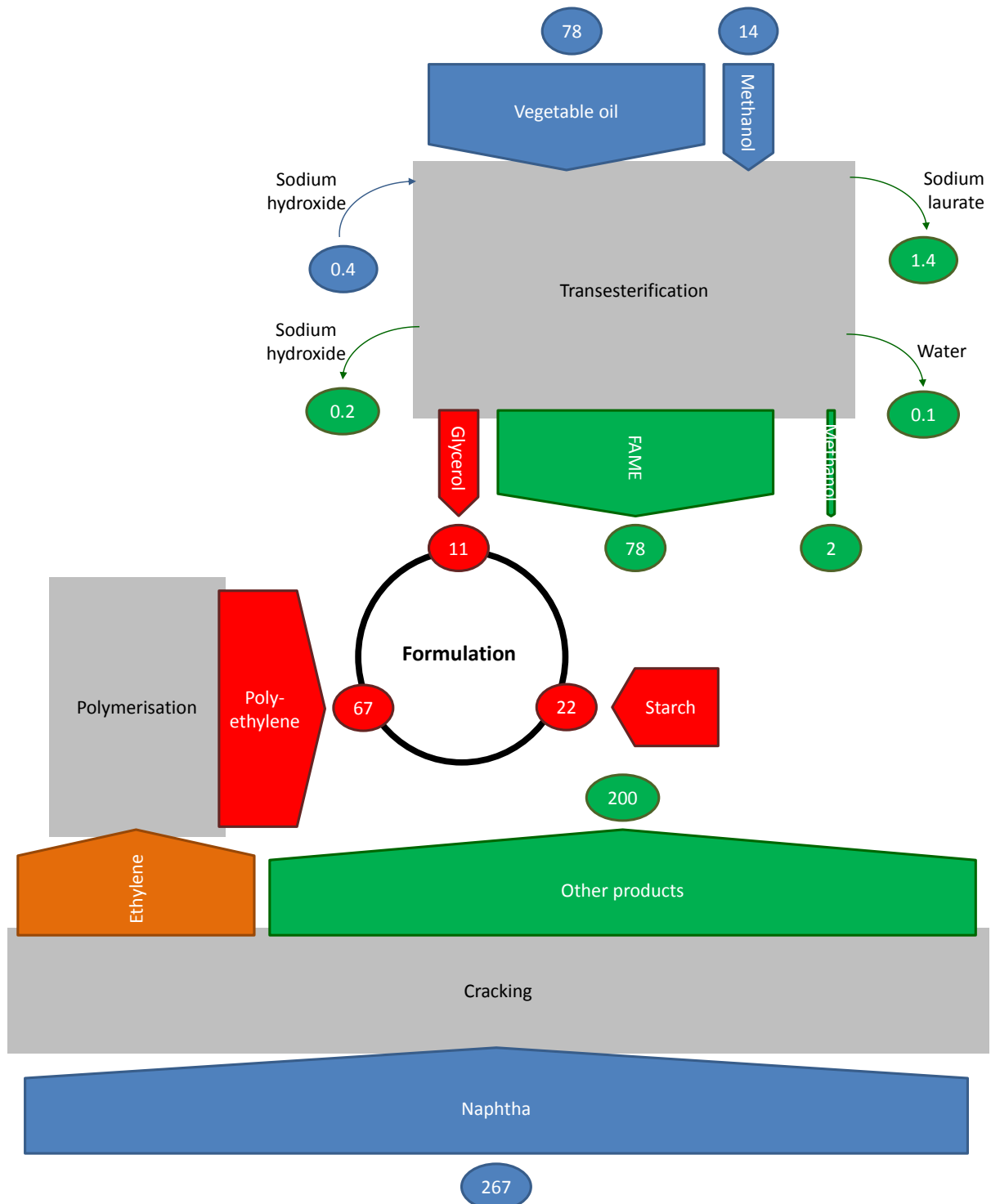


Figure 5-44 A Sankey diagram indicating the processes that combine to give the ingredients of a starch blend plastic material.



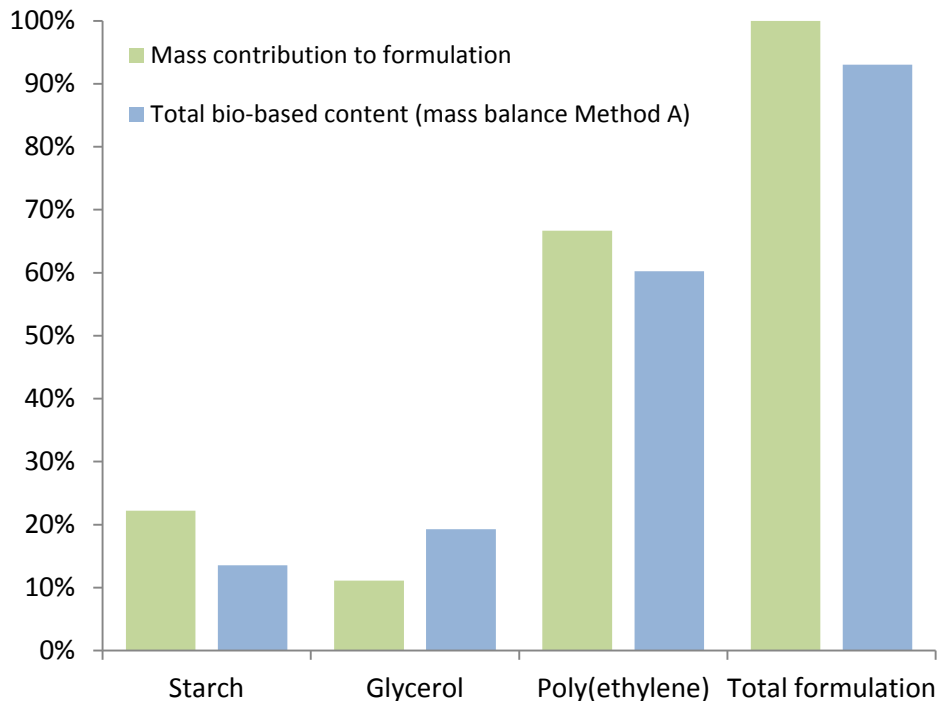


Figure 5-45 The difference between the mass contribution of each bio-based component in a starch polymer blend and the attributed total bio-based content (mass balance Method A) assuming each ingredient is bio-based.

If we consider starch and glycerol as bio-based, but now poly(ethylene) as fossil derived then the formulation of 3:1 poly(ethylene) to starch with 1 equivalent of glycerol for every two equivalents of starch (by mass) is 33% bio-based according to mass balance Method B. The bio-based carbon content of the formulation is 20% (Figure 5-46). These calculations are derived from the formulation ingredients. If looking further upstream, and making an addition of the different manufacturing processes required to make the separate formulation ingredients, the calculated bio-based content of the formulation is no different to the nearest kilogram. Therefore it is proven, at least for this example, that if the formulation ingredients are understood in terms of their molecular structure and origin, the calculation of bio-based content can be arrived at *via* a simpler calculation only considering the formulating stage, which is given in Annex B (Table 9-72 and Table 9-73). If the ingredients already carry certification from a supplier it makes no sense to repeat the full mass balance calculation upstream of the formulation procedure, especially as the data required is unlikely to be readily available to the formulator.



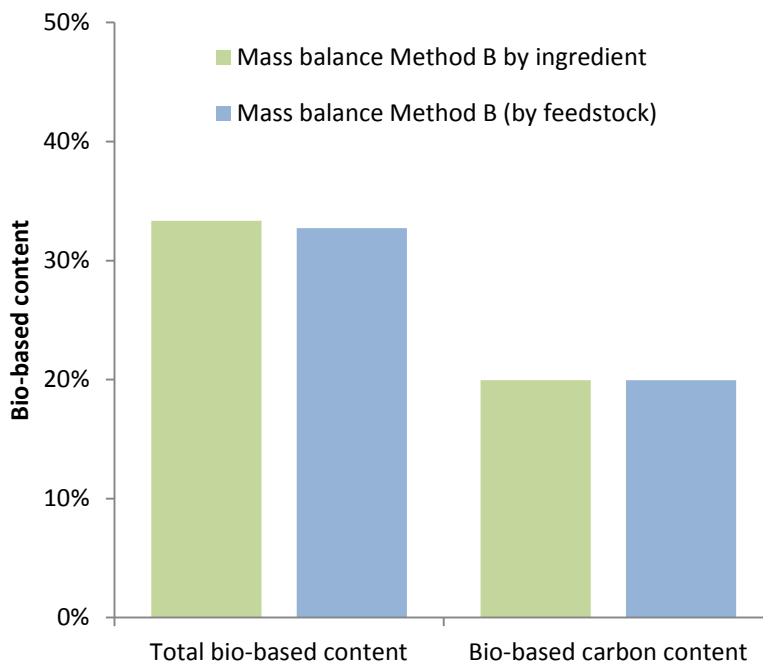


Figure 5-46 Mass balance Method B calculations of bio-based content and bio-based carbon content of a starch blended plastic based on the ingredients contained within the formulation or the original feedstocks.

A calculated 20% bio-based carbon content is also arrived at using mass balance Method C, with 14.2 kg of the carbon in the product assigned as being bio-based (71.3 kg of carbon is present in the formulation when the starch to fossil derived poly(ethylene) ratio is 1:3). Looking back to the respective feedstocks of the formulation ingredients (Figure 5-44), 67.3 kg of the input carbon is bio-based of the total 312 kg of carbon (0.22 g/g feedstock fossil carbon saving) A high value of 0.94 g feedstock fossil carbon savings for every gram contained in the final product is achieved because of the high quantity of feedstock carbon, mostly fossil naphtha, which is not incorporated into the final product because of the 25% selectivity of naphtha cracking towards ethylene.

It was previously shown that the calculation of mass balance Method B can be conducted from the feedstocks or the intermediate ingredients, using atom connectivity. Implementation of mass balance Method D is only suitable when starting calculations from the original feedstocks. This is a limitation for formulators who are likely to purchase intermediate chemicals as ingredients for their products and have a limited understanding of how those ingredients were manufactured. Following the mass balance represented in Figure 5-44, the calculation of total bio-based content with mass balance Method D concurs with mass balance Method B (Table 5-33). The same is true of the calculated bio-based carbon content (Table 5-34).



Table 5-33 Calculation of total bio-based content according to balance Method D for a starch polymer blend.

Feedstock	Mass /kg	Origin	Product incorporation (percentage)	Product incorporation (mass /kg)
Starch	22.2	Biomass	100.0%	22.2
Naphtha	267	Fossil	25.0%	66.7
Vegetable oil	78.4	Biomass	13.7%	10.8
NaOH	0.42	Mineral	0.0%	0.0
Natural gas	6.8	Fossil	2.5%	0.2
Water	7.6	Mineral	2.6%	0.2
Sum	382			100
Total bio-based content			33%	
<i>Total bio-based content (ignoring mineral content)</i>			33%	
<i>Total bio-based content (mineral assumed bio-based)</i>			33%	

Table 5-34 Mass balance Method D applied for the calculation of bio-based carbon content of a starch polymer blend.

Feedstock	Mass /kg	Origin	Product incorporation (percentage)	Product incorporation (mass /kg)
Starch	9.9	Biomass	100.0%	9.9
Naphtha	240	Fossil	23.8%	57.1
Vegetable oil	57.4	Biomass	7.6%	4.3
NaOH	0.0	Mineral	0.0%	0.0
Natural gas	5.1	Fossil	0.0%	0.0
Water	0.0	Mineral	0.0%	0.0
Sum	312			71.3
Bio-based carbon content			20%	
<i>Bio-based carbon content (ignoring mineral content)</i>			20%	

The bands of bio-based content ranges (classes) implemented by certification schemes will put pressure on formulators to meet the minimum levels of bio-based content required for certification. For example, DIN require a minimum of 20% bio-based carbon content (the lowest class), with an intermediate class for products containing between 50% and 85% bio-based content. Finally, if a product contains more than 85% bio-based carbon content the highest certification mark is awarded (Figure 5-47) [DIN CERTO 2014, European Bioplastics 2014]. The amount of starch (and glycerol in a 2:1 ratio) required to make the poly(ethylene)-starch blend meet this requirement of 85% bio-based carbon content can be explored with the different mass balance approaches.





Figure 5-47 The certification mark awarded by DINCERTO for products containing 85% bio-based carbon or more.

The different mass balance approaches report bio-based content in different ways, but it will be assumed that all are valid in proving a bio-based content of 85% (although the DIN certification only permits analytical bio-based carbon measurements at present). By holding the ratio of starch to glycerol at 2:1, the amount of starch needed within every 100 kg of product to attain an 85% total bio-based content for the formulation is quite similar, assuming the poly(ethylene) is fossil derived. A variation range of less than 1 kg of starch for every 100 kg of product is shown in Figure 5-48, an average of 57 kg when calculated by mass balance Method B (calculated on a feedstock basis and an ingredients basis) and Method D. In order to have an analytical bio-based carbon measurement derived from ^{14}C isotope ratios of 85%, the amount of starch needed is anticipated to be 61 kg per 100 kg of product manufactured (calculated with mass balance Method B). Some calculation methods might allow the formulator to reduce bio-based feedstock inputs, however only slightly for this example. Of course significantly changing the proportion of ingredients will change the functionality of the product, and only a certain amount of variation will fall within acceptable limits for the purpose of the intended application.



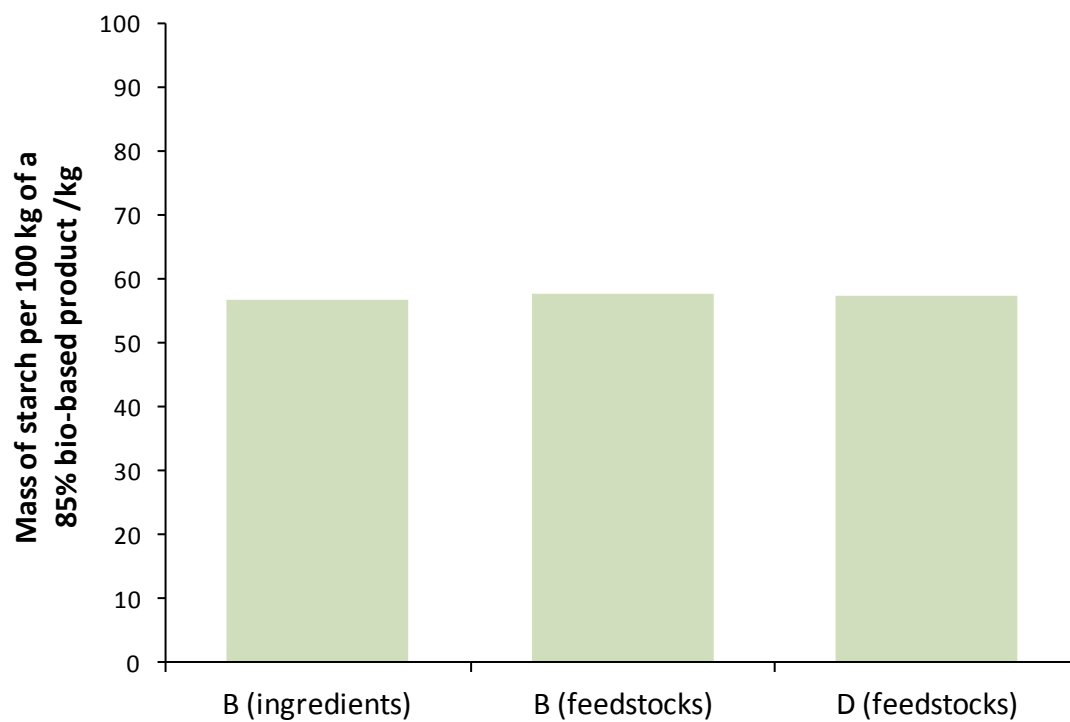


Figure 5-48 The amounts of starch required in 100 kg of a blend with poly(ethylene) to secure a calculated total bio-based content of 85%.

Mass balance Method A has not been included in Figure 5-48. This is because it is actually impossible to produce a blend of glycerol plasticised starch and poly(ethylene) with a bio-based content of 85% with the attribution system used. This is because of the methanol required in the transesterification of triglycerides to produce glycerol. The plasticised starch without any poly(ethylene) is considered to be 82.5% bio-based, even though both components (starch and glycerol) are regarded as bio-based products. This is a hindrance to the adoption of this approach, where certification thresholds for bio-based content cannot be met.

5.5.2 PBAT-PLA blend

As explained previously poly(butylene adipate terephthalate) (PBAT) can be made into a polymer blend with poly(lactic acid) (PLA, Chapter 4.8.2). In this mass balance case study it will also be assumed that the plasticiser acetyl tributyl citrate (ATBC) is also present. A two-part Sankey diagram for the manufacture of such a product is given in Figure 5-49 and Figure 5-50 where the quantity of PBAT is four times the mass of PLA, and the ratio of PLA to ATBC is 10:1. The amount of plasticiser is high in order to observe its influence on total bio-based content.



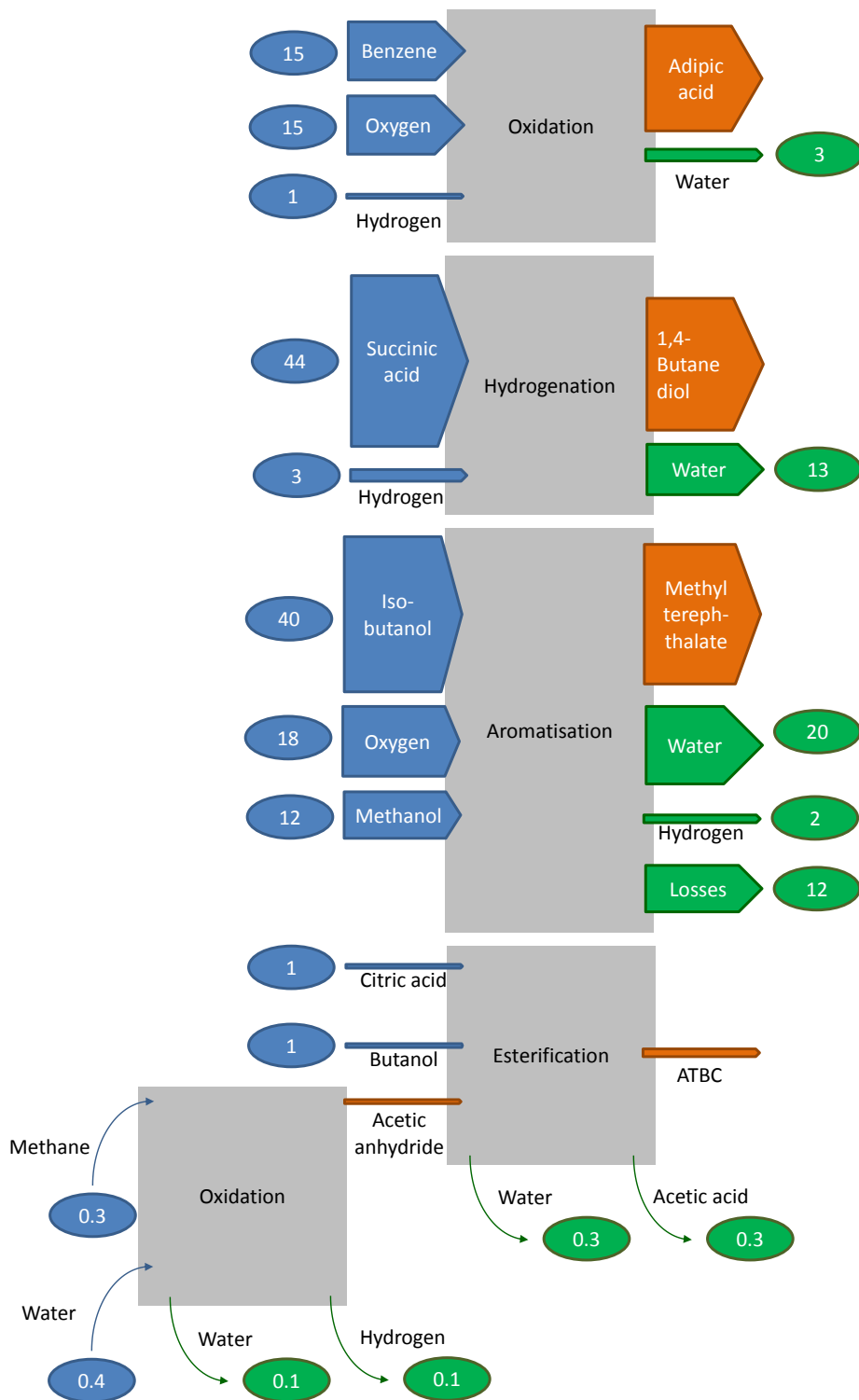


Figure 5-49 The synthesis of monomers and a plasticiser to use in the manufacturing of a blend of poly(lactic acid) and poly(butylene adipate terephthalate) (1:4 mass ratio).



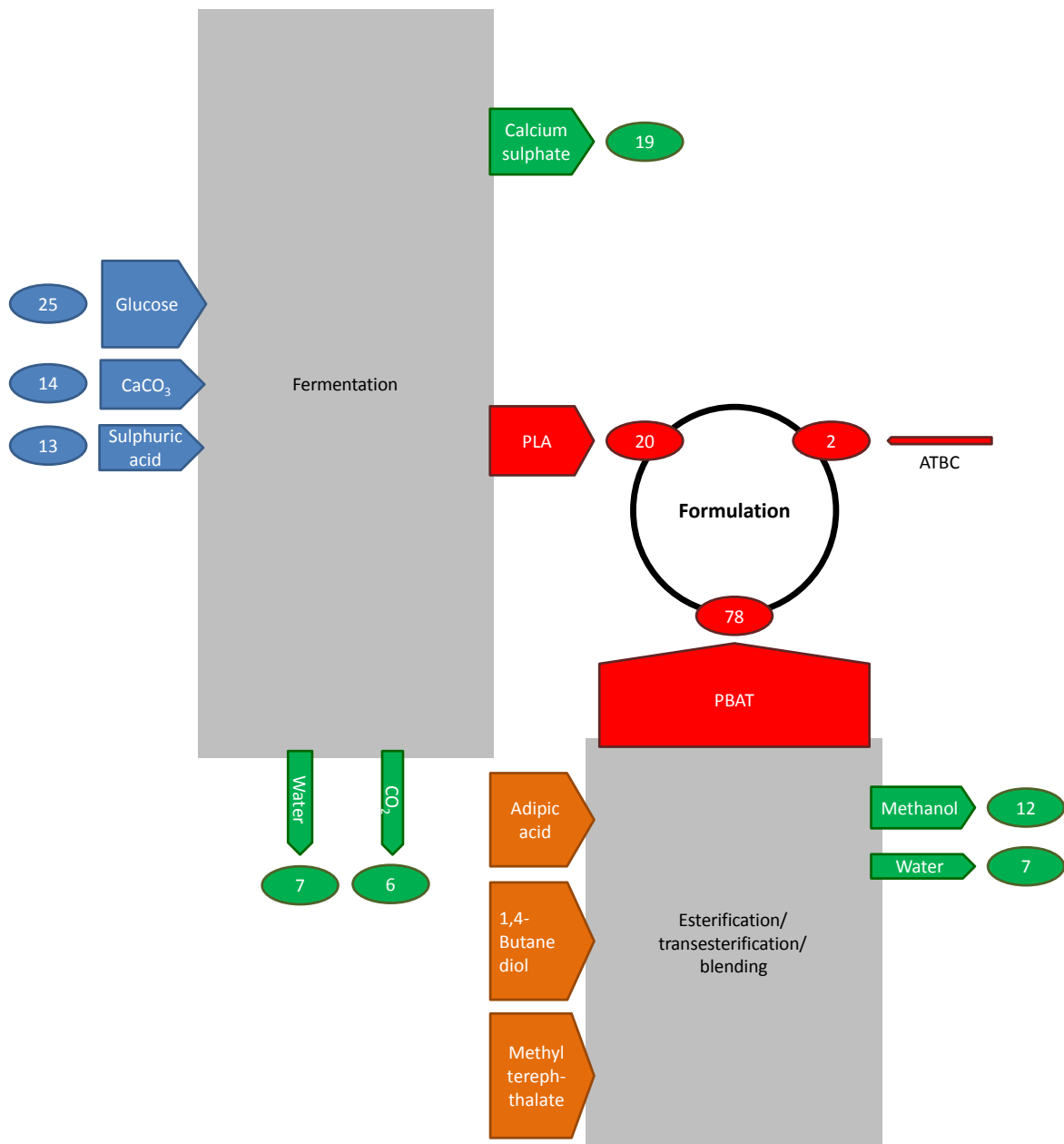


Figure 5-50 A Sankey diagram representing the production of poly(lactic acid) and subsequent formulation to produce a blend of poly(lactic acid) and poly(butylene adipate terephthalate) with a 1:4 mass ratio also containing acetyl tributyl citrate.

The synthesis of ATBC is assumed to be quite efficient with water and acetic acid the chief by-products by mass, although given its minor representation in the final product this is of little consequence. The production of adipic acid from benzene is not very wasteful either, although of course it requires a petroleum derived feedstock. For simplicity the synthesis of dimethyl terephthalic acid is treated in one step from bio-based isobutanol with the preceding fermentation excluded. In fact this part of the process consists of the multiple stages of iso-



butanol dehydration, dimerisation and then aromatisation to give *p*-xylene. This intermediate is then oxidised and the resulting diacid esterified (Scheme 4-13). The total losses of this process are known to exceed 15% of the feedstock mass [Peters 2011]. The synthesis of 1,4-butanediol is achieved through the hydrogenation of succinic acid that has been obtained by fermentation. The production of PLA is tainted with a large amount of calcium sulphate waste, but the actual fermentation of glucose to lactic acid completely utilises all the sugar atoms according just to the stoichiometry of the reaction. The carbon dioxide produced in neutralisation is also significant. Note the methanol liberated in the polymerisation to give PBAT could be recycled into the synthesis of dimethyl terephthalate, although it is indicated as a waste in Figure 5-50. Overall the amounts of the different feedstocks have a combined mass of 202 kg, producing 100 kg of the final product.

To provide a contrast to this scenario, the relative amounts of PLA and PBAT combined in the final product have been reversed in an otherwise analogous description of the manufacturing procedure. As before glucose, succinic acid, isobutanol and citric acid are the bio-based feedstocks. The losses in the synthesis of PBAT (Figure 5-51) are now fairly insignificant compared to those associated with the synthesis of the major component PLA (Figure 5-52). The final product now contains 74 kg of bio-based PLA for every 100 kg that is manufactured.



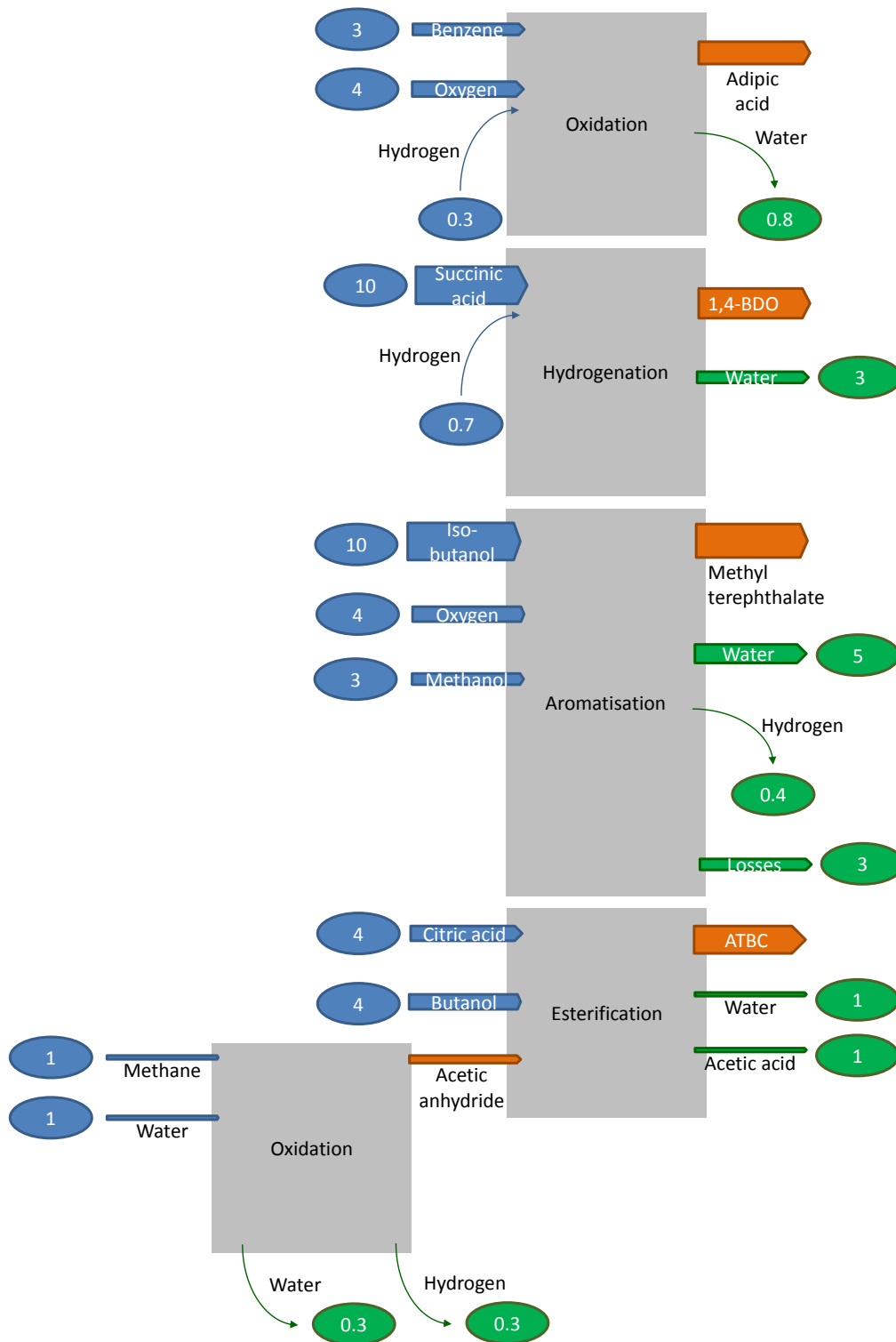


Figure 5-51 The synthesis of monomers and a plasticiser to use in the manufacturing of a blend of poly(lactic acid) and poly(butylene adipate terephthalate) (4:1 mass ratio).



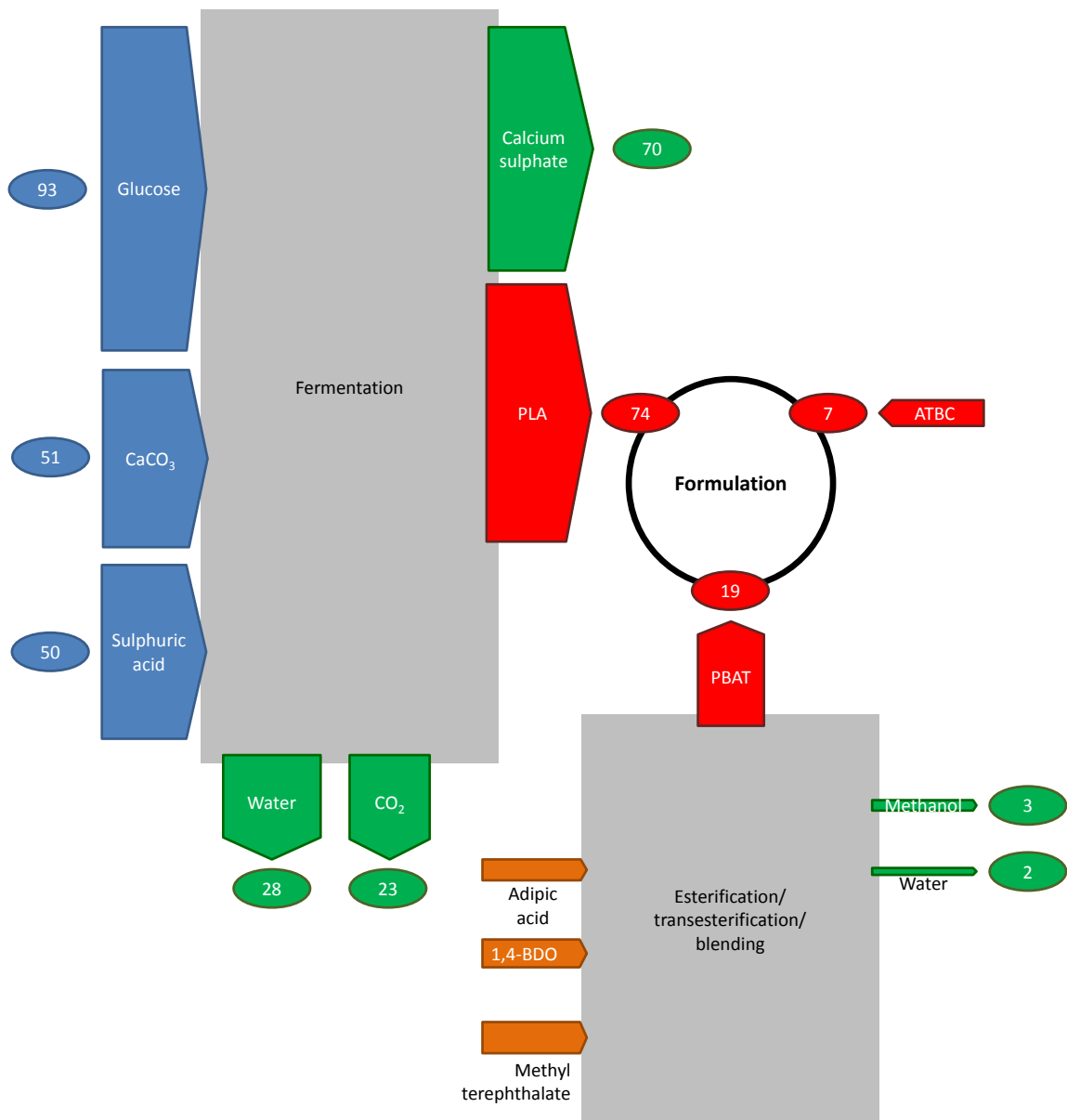


Figure 5-52 A Sankey diagram representing the production of poly(lactic acid) and subsequent formulation to produce a blend of poly(lactic acid) and poly(butylene adipate terephthalate) with a 4:1 mass ratio also containing acetyl tributyl citrate.

The two manufacturing routes to give the different blends of PLA and PBAT can be considered alongside a process utilising conventional petrochemical *p*-xylene instead of bio-based isobutanol. The results of indirect total bio-based content analysis according to mass balance Method A have been tabulated (Table 5-35), and show each composite plastic blend is rich in bio-based content. Considering that isobutanol consists of 20% of the feedstock required (on a mass basis), its influence on bio-based content is perhaps less than expected, but because of the manner in which mass balance Method A is implemented with methane



equivalents, the calorific value of the feedstock has a large influence on the imparted attribution of bio-based content (or fossil resource savings). As the representation of the wholly bio-based poly(lactic acid) is increased within the formulation, displacing the partially bio-based PBAT, the total bio-based content approaches 100%.

Table 5-35 Mass balance Method A conclusions regarding the total bio-based content of poly(lactic acid)-poly(butylene adipate terephthalate) blended products, including when isobutanol is replaced with petrochemical *p*-xylene.

PLA:PBAT (mass ratio)	Bio-based feedstocks				Total bio-based content (mass balance Method A)
	Citric acid	Glucose	Isobutanol	Succinic acid	
1:4	Yes	Yes	Yes	Yes	86.6%
1:4	Yes	Yes	No	Yes	78.4%
4:1	Yes	Yes	Yes	Yes	95.1%

If all the feedstocks were completely bio-based, the division of bio-based content between the feedstock chemicals according to mass balance Method A would appear as shown in Figure 5-53. Glucose (for PLA production) is the most significant feedstock in this regard when PLA is the major component in the final article, while succinic acid is clearly responsible for the most bio-based content imparted when PBAT is the major component. Note the number of attribution units assigned to PBAT changes between the bio-isobutanol route (Table 9-80) and the conventional *p*-xylene process (Table 9-79). The graph in Figure 5-53 does not exactly correspond to the mass of each of these feedstocks required (Figure 5-54).



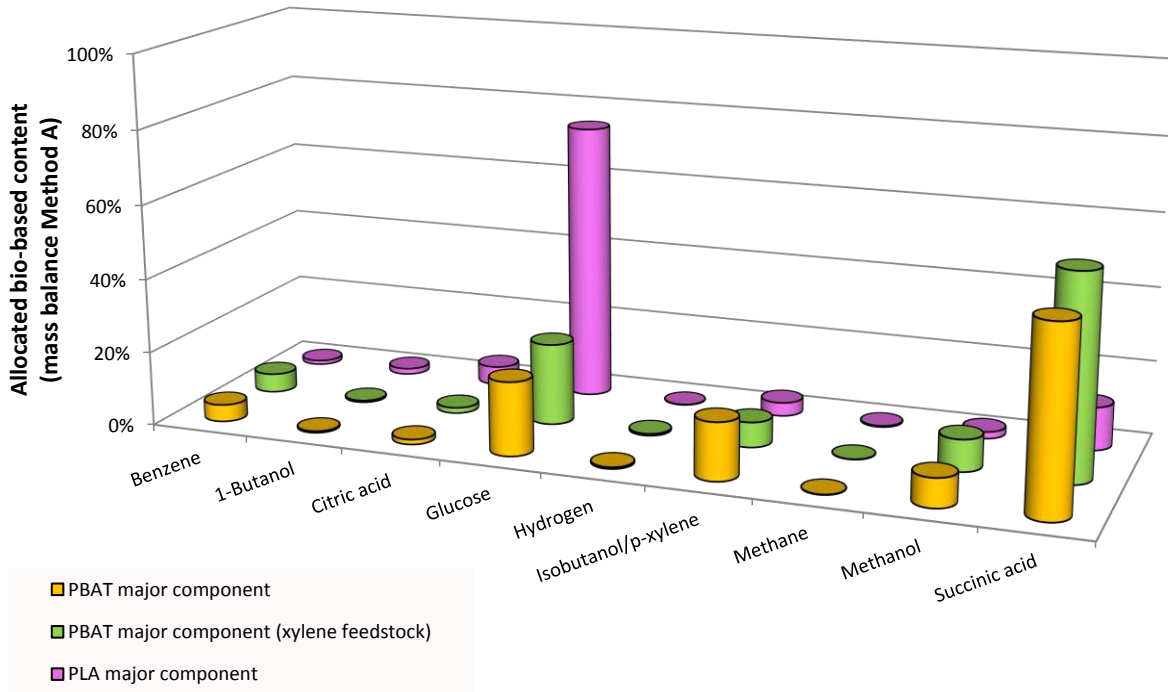


Figure 5-53 The maximum possible contributions by each individual feedstock chemical towards total bio-based content calculated according to mass balance Method A for different polymer blends.

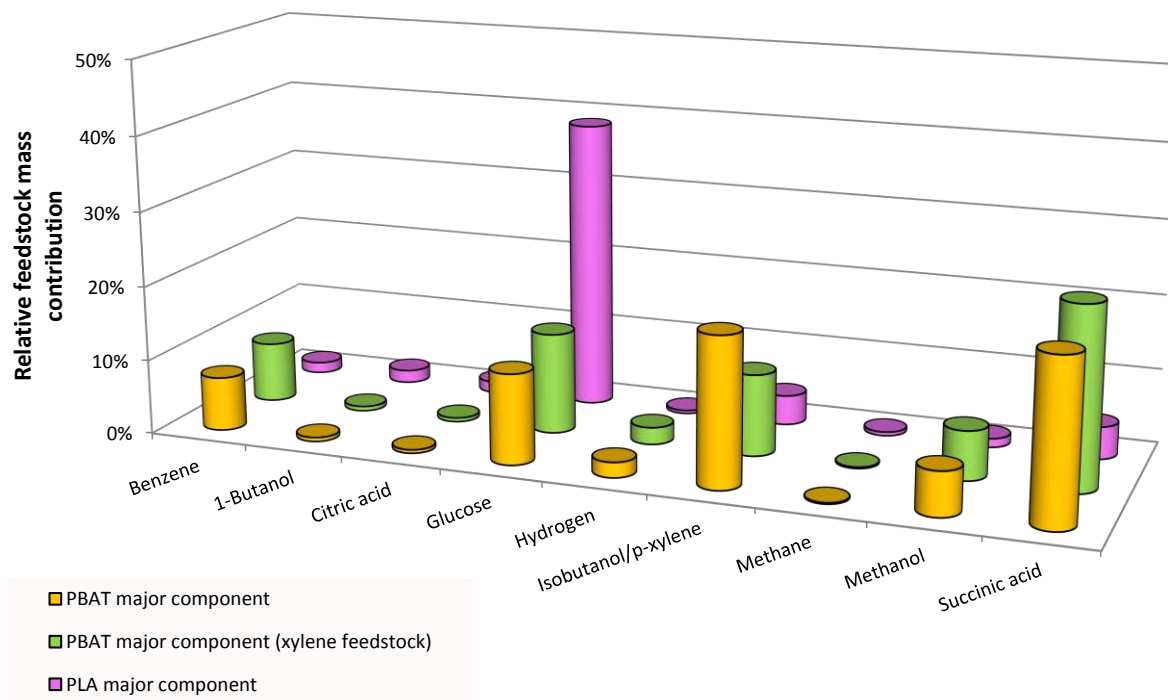


Figure 5-54 The mass contributions by each individual feedstock chemical towards the different blends of poly(lactic acid) and poly(butylene adipate terephthalate).



The (anticipated) total bio-based content as well as values for the expected bio-based carbon content according to mass balance Method B are presented in Table 5-36. The values of bio-based carbon calculated with this mass balance approach are the same as those presented earlier within atom connectivity calculations (Figure 4-56). Total bio-based content values differ (but only slightly) between the purely atom connectivity approach (Method 2b) and this mass balance approach (Method B) due to the conventions adopted for the assignment of heteroatoms as bio-based or fossil derived and how these change during the production chain. For all three entries in Table 5-36 the discrepancy is 1% between values of calculated total bio-based content and those achieved with atom connectivity Method 2b.

Table 5-36 Mass balance Method B applied to the total bio-based content and bio-based carbon content of poly(lactic acid)-poly(butylene adipate terephthalate) blended products in different proportions.

PLA:PBAT (mass ratio)	Bio-based feedstocks				Bio-based content (mass balance Method B)	
	Citric acid	Glucose	Isobutanol	Succinic acid	Total	Carbon
1:4	Yes	Yes	Yes	Yes	78.2%	76.3%
1:4	Yes	Yes	No	Yes	53.9%	46.6%
4:1	Yes	Yes	Yes	Yes	88.7%	88.2%

The communication of fossil carbon saving with mass balance Method C is not dependent on process efficiency, inherent to the mass of fossil derived carbon displaced from each 100 kg of product (on average across the pre-defined manufacturing period). However fossil carbon saving claims based on the quantity of bio-based feedstock will be affected (Table 5-37). Variable efficiency between otherwise identical plants might therefore introduce unwanted variation in claims of fossil carbon savings, and improvements to a process might reduce the amount of bio-based feedstock required to maintain output, and actually harm bio-based content claims. Table 5-37 shows two sets of data, one based on the production chain described previously in which yields and reaction selectivity reduce the carbon efficiency of the process. The other data set refers to a maximum carbon efficiency that would occur if no losses occurred during production. Claims of the mass of fossil carbon displaced from the process are quite different between the two scenarios. Because losses are most significant in the process of converting bio-based isobutanol into *p*-xylene, greater production efficiency will mean the ratio of fossil to biomass feedstocks will increase in favour of fossil resources, which is why claims of fossil savings are made on the basis of the mass of the product. The bio-based carbon content of the final article is 76% (46 kg fossil carbon savings per 100 kg of product) when PBAT is the major component and bio-based isobutanol is a feedstock.



Table 5-37 Fossil carbon savings according to mass balance Method C applied to the manufacture of a 1:4 blend of poly(butylene adipate terephthalate) to poly(lactic acid).

Fossil carbon savings	Stoichiometric analysis (ignoring losses)	Process losses included
Mass of fossil carbon replaced in the product <i>/100 kg of product</i>	46.0 kg	46.0 kg
Mass of fossil carbon displaced from the process <i>/100 kg of product</i>	47.6 kg	55.9 kg
Mass of fossil carbon displaced from the process <i>/proportion of total carbon the in combined feedstocks</i>	0.72 g/g	0.75 g/g
Mass of fossil carbon displaced from the process <i>/relative to the amount of carbon in 100 kg of product</i>	0.79 g/g	0.93 g/g

Mass balance Method D produces a low value of total bio-based content primarily because of the amount of atmospheric oxygen introduced into the bio-based intermediates (Table 5-38). The same issue occurs with poly(ethylene terephthalate) (Table 5-22). With mass balance Method B this oxygen is assigned a biomass origin. The bio-based carbon content is 76% as previously reported (Table 5-39). The three different syngas streams are presented separately in Table 5-38 and Table 5-39.



Table 5-38 Calculation of total bio-based content according to balance Method D for a 1:4 blend of poly(butylene adipate terephthalate) to poly(lactic acid).

Feedstock	Mass /kg	Origin	Product incorporation (percentage)	Product incorporation (mass /kg)
Glucose	24.5	Biomass	80.0%	19.6
Benzene	14.6	Fossil	97.4%	14.2
Oxygen	32.3	Mineral	36.4%	11.9
Succinic acid	44.1	Biomass	71.2%	31.4
Isobutanol	40.4	Biomass	46.2%	18.7
Citric acid	0.9	Biomass	72.9%	0.7
Methane <i>for acetic anhydride production</i>	0.3	Fossil	40.6%	0.1
Methane <i>for 1-butanol production</i>	0.9	Fossil	84.3%	0.8
Methane <i>for hydrogen production</i>	11.0	Fossil	13.7%	1.5
Water <i>for acetic anhydride production</i>	0.4	Mineral	23.6%	0.1
Water <i>for 1-butanol production</i>	1.1	Mineral	26.4%	0.3
Water <i>for hydrogen production</i>	12.3	Mineral	6.1%	0.8
Sum	183			100
Total bio-based content			70%	
Total bio-based content (ignoring mineral content)			81%	
Total bio-based content (mineral assumed bio-based)			83%	



Table 5-39 Mass balance Method D applied for the calculation of bio-based carbon content for a 1:4 blend of poly(butylene adipate terephthalate) to poly(lactic acid).

Feedstock	Mass /kg	Origin	Product incorporation (percentage)	Product incorporation (mass /kg)
Glucose	9.8	Biomass	100.0%	9.8
Benzene	13.4	Fossil	100.0%	13.4
Oxygen	0.0	Mineral	0.0%	0.0
Succinic acid	17.9	Biomass	100.0%	17.9
Isobutanol	26.2	Biomass	68.4%	17.9
Citric acid	0.4	Biomass	100.0%	0.4
Methane <i>for acetic anhydride production</i>	0.2	Fossil	50.0%	0.1
Methane <i>for 1-butanol production</i>	0.7	Fossil	100.0%	0.7
Methane <i>for hydrogen production</i>	8.2	Fossil	0.0%	0.0
Water <i>for acetic anhydride production</i>	0.0	Mineral	0.0%	0.0
Water <i>for 1-butanol production</i>	0.0	Mineral	0.0%	0.0
Water <i>for hydrogen production</i>	0.0	Mineral	0.0%	0.0
Sum	76.9			60.3
Bio-based carbon content			76%	
<i>Bio-based carbon content (ignoring mineral content)</i>			76%	



5.6 Formulation and composite assembly

Without any chemical synthesis, chemicals can be combined (sometimes with losses) to give formulations (often in aqueous solution) or composite materials. Chemicals may be brought in from suppliers and so evidence of the elemental composition and origin may be limited. Generally mass balance is simplified when dealing with formulation or assembly, for now there is no need to account for reaction pathways and the subsequent redistribution of bio-based content by allocation or attribution techniques. However there still remains the possibility of reaching different conclusions of total bio-based content depending on the indirect calculations used and whether losses are incurred. In this section of the report two examples of mixtures; a paint and a wood composite insulation panel, will be scrutinised. These case studies have been reproduced from [CEN/TR 16721](#).

Furthermore an example of two independent processes consisting of both synthesis and formulation, yet both using identical feedstocks and resulting in the same waste streams is also presented. The products, one a cleaning product containing surfactants, the other a composite resin material intended for hardening by curing, would therefore be expected to possess similar total bio-based content despite their chemical dissimilarity. The optimised calculation method by which to obtain this value (by mass balance) will be deduced with a thorough investigation.

5.6.1 Water based paint

Paints are formulated to precise requirements by dissolving pigments and other additives into a solvent. Some paints are solutions in water. The example found in [CEN/TR 16721](#) is one such aqueous paint formulation. The bio-based content of each ingredient was not discussed in the original source material but this is very important with regards to the type and accuracy of subsequent calculations. A total bio-based content of 40% is given (Table 5-40). Despite the stipulation that calculations are performed on a dry mass basis water was included in the mass balance. Here water will be excluded from the amended calculations. A total bio-based content of 57% is calculated on a dry basis.



Table 5-40 The ingredients and their contributions to the bio-based content of a formulated paint product.

Ingredient	Mass /kg	Total content	bio-based	Mass weighted contribution to bio-based content
Water	300	0%		0.0
Biocide	2	0%		0.0
Dispersing agent	5	50%		2.5
Rheological agent	3	80%		2.4
White pigment	150	0%		0.0
Wood filler	120	95%		114.0
Calcium carbonate	120	0%		0.0
Alkyd emulsion	300	94%		282.0
Dry total	700	57%		400.9
Dry w/o inorganics	430	93%		400.9
Total	1000	40%		400.9

If mineral content is excluded from the calculation (*à la* mass balance Method D) the following ingredients are discounted: white pigment (probably titanium dioxide), and calcium carbonate. The remaining mass of the formulation is 430 kg, of which 400.9 kg is regarded as biomass derived. The resulting bio-based content is 93%, considerably higher than the original 40% given in [CEN/TR 16721](#). By excluding the mass of the mineral content the maximum limit of bio-based content is now 100%, and the permissible range of bio-based content (0-100%) should make sense to customers. This case study highlights the importance that the rules of mass balance must be followed. It also demands that those rules are sensible and realistically applicable, as well as being communicated clearly.

5.6.2 Insulation panel

The bio-based content calculation for a wood insulation panel is another example from [CEN/TR 16721](#). The mass ratio of the inputs (wood and a synthetic polyolefin) is 3:1 to give almost 5000 kg of product (Figure 5-55). The final article is cut from this material. The losses are not in the same ratio as the feedstock input (3.07:1) which suggests the losses are analysed, or occur at a point in the production chain before the feedstocks are combined. The total bio-based content of the product is 74.9%. If the losses were not analysed and assumed to represent the ratio of feedstock input the total bio-based content would be allocated at 75.0%. It is also possible that the material that is produced is not uniform in composition. The 74.9% bio-based content is therefore actually an allocated average across the batches of the final article.



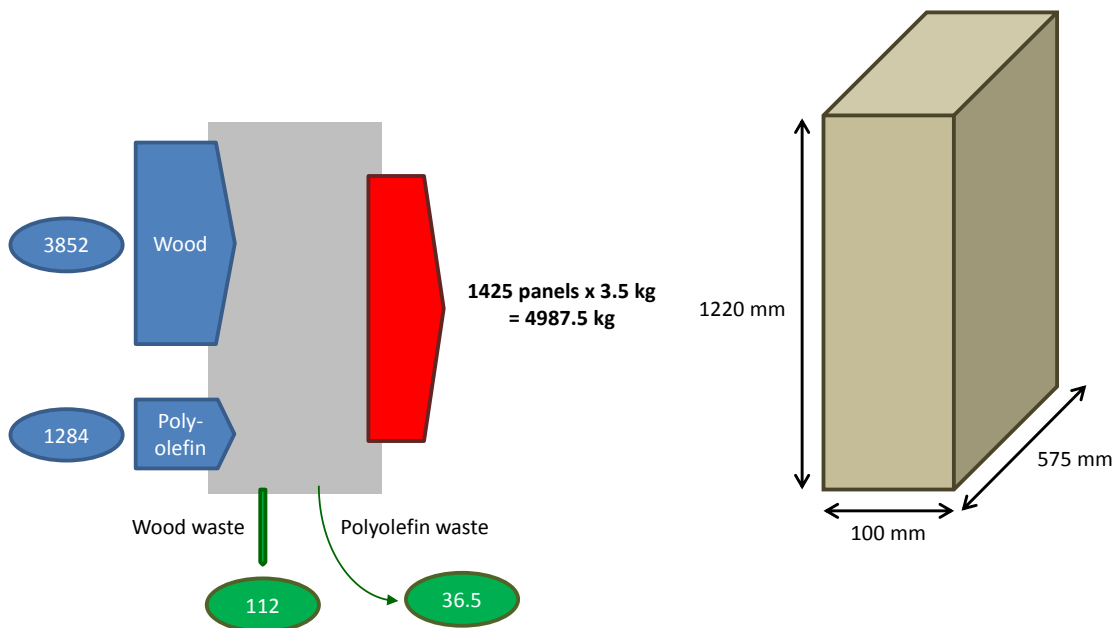


Figure 5-55 A Sankey diagram (left) for the production of an insulation panel (right).

5.6.3 Cleaning product versus composite curing resin

In this case study, the same feedstocks (same chemicals, same mass) are used to produce two completely different formulated products (Table 5-41). The first is a cleaning product, containing two surfactants (sodium laureth sulphate and sodium octadecyl sulphate) and a number of other additives: glycerol, citric acid, limonene and sodium hydroxide (Figure 5-56). The other product is a composite that when cured forms a hardened resin (Figure 5-57) [Coupland 1997]. It consists of sodium sulphate, reactive diols (limonene diol and 1-methyl-1,4-butanediol) and a carbonate derived from vegetable oil. Citric acid is decarboxylated and dehydrated to make the 1-methyl-1,4-butanediol [Rao 1988]. The triglyceride is assumed to consist exclusively of one lauric acid group and two linoleic acid (C_{18} , doubly unsaturated) groups.



Table 5-41 A list of feedstocks needed in order to produce a cleaning product or a resin composite.

Feedstock	Mass /kg
Limonene	16.3
Vegetable oil	41.6
Water	14.1
Naphtha	21.9
Methane	5.0
Oxygen	12.5
Hydrogen sulphide	5.3
Sodium chloride	18.3
Citric acid	12.0
Total	146.9



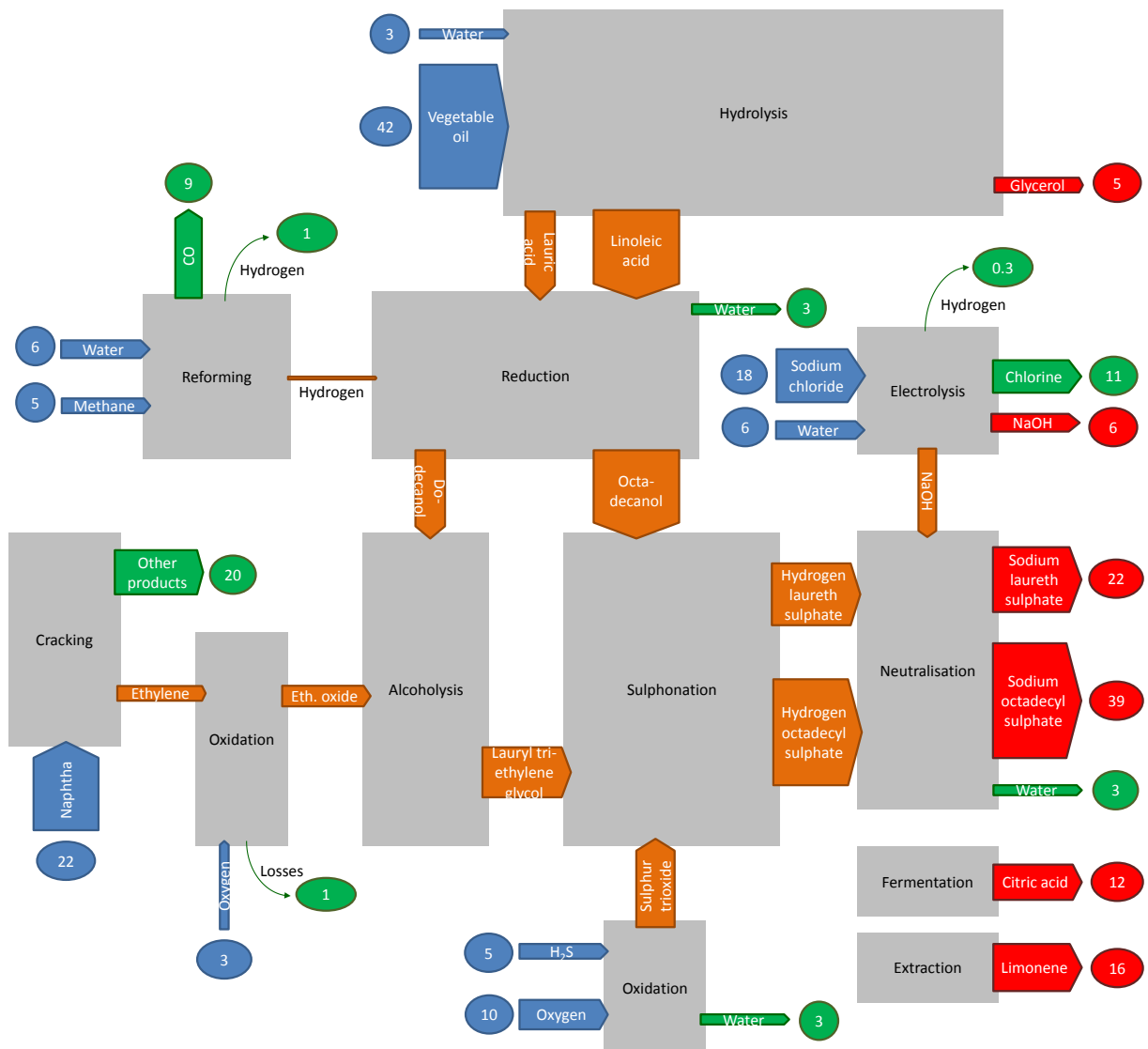


Figure 5-56 A Sankey diagram for the combined synthesis of the ingredients for a cleaning product.



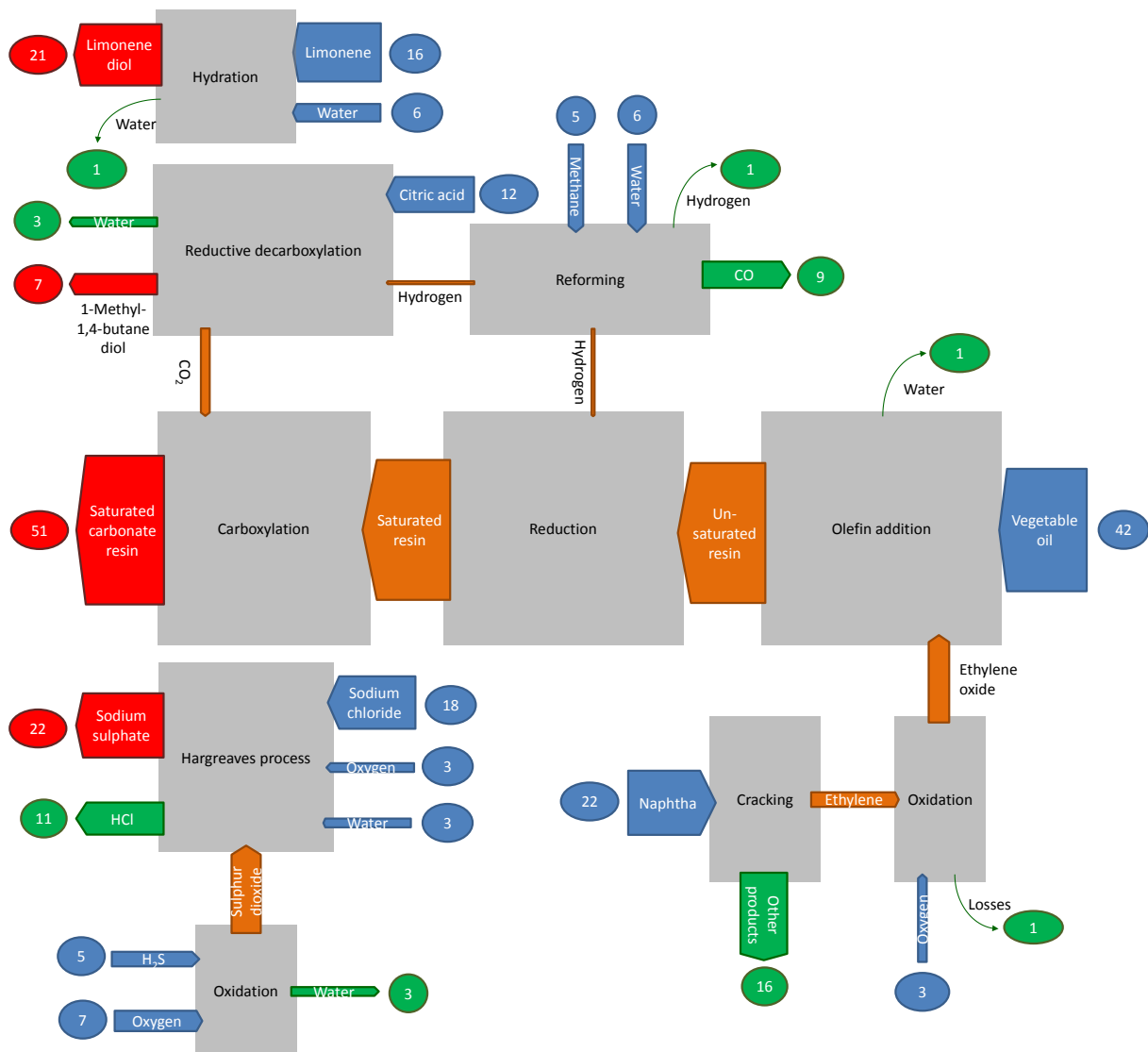
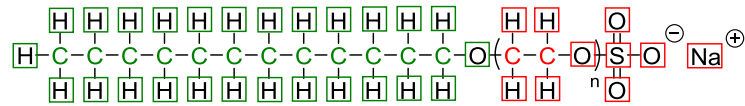


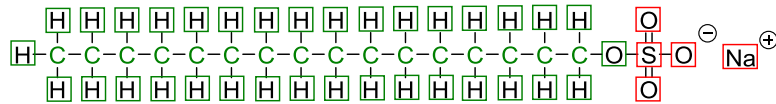
Figure 5-57 A Sankey diagram for the combined synthesis of the ingredients for a resin composite.

The feedstocks will produce 100 kg of either product, and 47 kg of waste. The waste streams are identical except for in the surfactant formulation process chlorine gas and hydrogen gas are by-products, whereas for the resin composite hydrogen chloride (11 kg) is produced. In the former instance the reaction between the gases to give hydrogen chloride (also 11 kg) would equate the waste streams. By consequence, the two formulations, of the same mass, contain the same number and type of atoms. The only difference is the bonding between the atoms and the resulting molecules. The ingredients of the cleaning product (Figure 5-58) and the composite resin (Figure 5-59) follow.

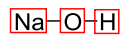




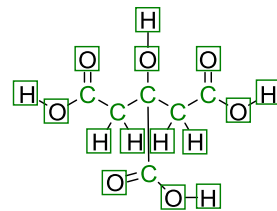
Sodium laureth sulphate (22 wt%)



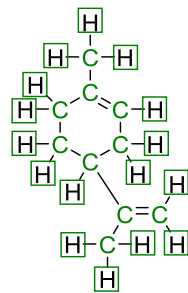
Sodium octadecyl sulphate (39 wt%)



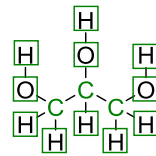
Sodium hydroxide (6 wt%)



Citric acid (12 wt%)



Limonene (16 wt%)



Glycerol (5 wt%)

Figure 5-58 The ingredients of the cleaning product with atom connectivity assignments (Method 2b).



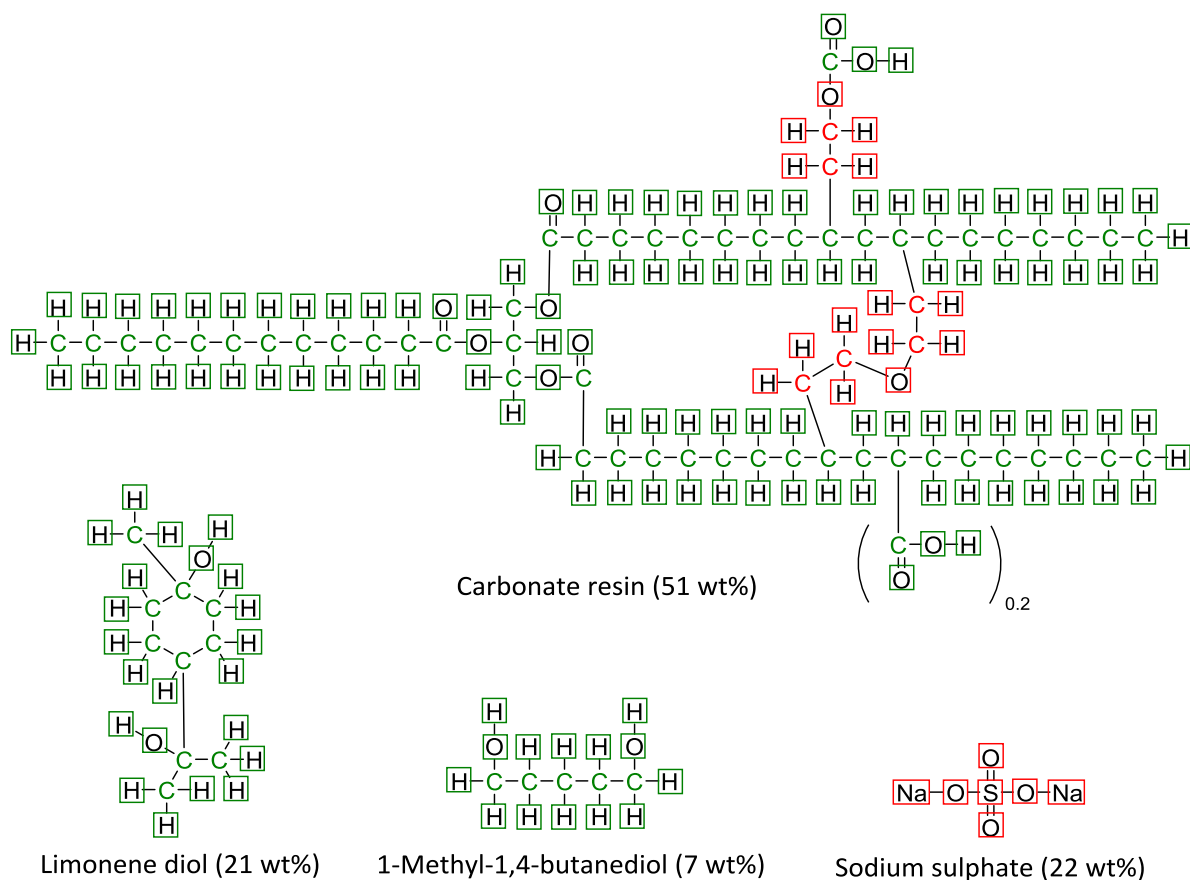


Figure 5-59 The ingredients of the composite curing resin with atom connectivity assignments (Method 2b).

The two products could be considered equally bio-based if the feedstocks are the only consideration. Accordingly mass balance Method A calculates that both products, the cleaning agent and the resin composite, are 75% bio-based. Biomass represents 48% of the feedstock mass, with 18% of fossil resources and 34% mineral input. The bio-based carbon content is 93% for both articles, and as the products of dedicated facilities direct determination of bio-based (carbon) content would be applicable.

Calculations of atom connectivity create a discrepancy between how the products are viewed in terms of their total bio-based content. The results are summarised in the following table (Table 5-42). The disagreement between the two atom connectivity approaches describing the cleaning product is caused by sulphur and sodium, two atoms that are always considered as bio-based under the ACDV rules of atom connectivity when incorporated into an organic molecule. With atom connectivity Method 2b only for the ingredient sodium octadecyl sulphate can its sulphur and sodium atoms be regarded as bio-based. In the composite resin the sulphur and sodium is present as sodium sulphate, an inorganic component of the



formulation and considered as fossil derived under this approach. Both approaches to atom connectivity produce a result of 72% total bio-based content for the composite resin.

Table 5-42 Atom connectivity results of bio-based content for a cleaning product and a composite resin.

Product	Bio-based carbon	Atom connectivity	
		Method 2b	ACDV
Cleaning product	93%	82%	84%
Composite curing resin	93%	72%	72%

Mass balance Method B, deriving its assessment of total bio-based content from atom connectivity (Method 2b) is close to the corresponding atom connectivity assignments shown in Table 5-42. As with previous case studies, there is a small error caused by the limitations of atom connectivity within the mass balance approach (*i.e.* an atom can switch the identity of its assigned origin depending on the closest bonded carbon atom and how that changes during the production chain).

Mass balance Method D is able to produce similar values of total bio-based content for both formulations (Table 5-43). This is the anticipated situation given the many similarities in the feedstocks and composition of each product. However the ingredients and their chemical bonds are not the same in each formulation. Mass balance Method B is dependent on chemical structure and bonding in order to calculate a total bio-based content and so can consider this. When concluding what the most fitting approach is, it should also be remembered that [CEN/TC 411/WG 3 document WI 00411008](#) is recommended as the reference method of total bio-based content determination in business to business communications regarding bio-based products ([CEN/TC 411/WG 5 document WI 00411004](#)). This standard test method, now [prEN 16785](#), is based on the ACDV rules of atom connectivity with direct validation from elemental analysis. Therefore mass balance Method B is better placed to offer compatibility with atom connectivity assignments of total bio-based content. Additionally, [CEN/TR 16721](#) describes mass balance in a similar way to how mass balance Method D is presented in this work but states “*the method based on the material balance ... is easy to implement but requires knowing the bio-based content of the feedstock used*”, perhaps suggesting atom connectivity applied to products at the end of the production chain is not appropriate. Also presented in [CEN/TR 16721](#) are methods for the direct determination of total bio-based content are atom connectivity (ACDV direct approach) and stable isotope analysis. The latter is now recognised as being unable to deliver a judgement of bio-based content on its own, but instead the strength of stable isotope analysis is to help validate claims relating to the origin and sustainability of the biomass feedstock(s) [Zhao 2014]. Thus calculation of total bio-based content will often fall to atom connectivity, and mass balance Method B is best placed to integrate this.



Table 5-43 Mass balance results of bio-based content for a cleaning product and a composite resin.

Product	Bio-based carbon (equivalent to mass balance Method C)	Mass balance		
		Method A	Method B	Method D
Cleaning product	93%	75%	81%	69%
Composite curing resin	93%	75%	71%	67%

The counter argument to the use of mass balance Method B is that it does not represent the actual bio-based content of the product. Errors also accumulate in its calculation, but this could be avoided if only the bio-based carbon is followed through the production chain, and then atom connectivity applied only to the final article and not earlier in the production chain. In this case study mass balance Method B has been shown to give contrasting results for what is essentially (on an atomic level at least) a comparison between equivalent articles. However it must be said that there is greater degree of biomass incorporation into the cleaning product than the composite resin due to the loss in citric acid mass when converted to 1-methyl-1,4-butanediol. This is compensated for with a greater amount of water derived atoms residing in the composite resin. Surprisingly through atom connectivity this is reflected by the results of mass balance Method B to a greater degree than mass balance Method D. Mass balance Method D is a superior approach in terms of attaining consistency between the products but probably unable to be implemented in practice because of lack of data concerning the origin of each feedstock, or maybe even what each original feedstock was. Mass balance method D when calculated by excluding the mineral feedstocks produces a value of total bio-based content of 93.4% for the cleaning product (Table 5-44) and 93.1% for the composite resin (Table 5-45). The two values are quite similar to the bio-based carbon content of 93.1% (which can also be arrived at by using mass balance Method D, Table 5-46 and Table 5-47).



Table 5-44 Total bio-based content of a cleaning formulation according to mass balance Method D.

Feedstock	Mass /kg	Origin	Product incorporation (percentage)	Product incorporation (mass /kg)
Limonene	16.3	Biomass	100.0%	16.3
Vegetable oil	41.6	Biomass	97.0%	40.3
Water	14.1	Mineral	30.6%	4.3
Naphtha	21.9	Fossil	20.0%	4.4
Methane	5.0	Fossil	9.8%	0.5
Oxygen	12.5	Mineral	80.0%	10.0
H ₂ S	5.3	Mineral	94.1%	5.0
Sodium chloride	18.3	Mineral	39.3%	7.2
Citric acid	12.0	Biomass	100.0%	12.0
Sum	146.9			100.0
Total bio-based content			69%	
<i>Total bio-based content (ignoring mineral content)</i>			93%	
<i>Total bio-based content (mineral assumed bio-based)</i>			95%	

Table 5-45 Total bio-based content of a composite curing resin according to mass balance Method D.

Feedstock	Mass /kg	Origin	Product incorporation (percentage)	Product incorporation (mass /kg)
Limonene	16.3	Biomass	100.0%	16.3
Vegetable oil	41.6	Biomass	99.7%	41.5
Water	14.1	Mineral	50.3%	7.1
Naphtha	21.9	Fossil	20.0%	4.4
Methane	5.0	Fossil	10.6%	0.5
Oxygen	12.5	Mineral	73.3%	9.2
H ₂ S	5.3	Mineral	94.1%	5.0
Sodium chloride	18.3	Mineral	39.3%	7.2
Citric acid	12.0	Biomass	74.0%	8.9
Sum	146.9			100.0
Total bio-based content			67%	
<i>Total bio-based content (ignoring mineral content)</i>			93%	
<i>Total bio-based content (mineral assumed bio-based)</i>			95%	



Table 5-46 Bio-based carbon content of a cleaning formulation according to mass balance Method D.

Feedstock	Mass /kg	Origin	Product incorporation (percentage)	Product incorporation (mass /kg)
Limonene	14.4	Biomass	100.0%	14.4
Vegetable oil	31.9	Biomass	100.0%	31.9
Water	0.0	Mineral	0.0%	0.0
Naphtha	19.7	Fossil	19.0%	3.8
Methane	3.8	Fossil	0.0%	0.0
Oxygen	0.0	Mineral	0.0%	0.0
H ₂ S	0.0	Mineral	0.0%	0.0
Sodium chloride	0.0	Mineral	0.0%	0.0
Citric acid	4.5	Biomass	100.0%	4.5
Sum	74.2			54.5
Bio-based carbon content			93%	
<i>Bio-based carbon content (ignoring mineral content)</i>			93%	

Table 5-47 Bio-based carbon content of a composite curing resin as calculated using mass balance Method D.

Feedstock	Mass /kg	Origin	Product incorporation (percentage)	Product incorporation (mass /kg)
Limonene	14.4	Biomass	100.0%	14.4
Vegetable oil	31.9	Biomass	100.0%	31.9
Water	0.0	Mineral	0.0%	0.0
Naphtha	19.7	Fossil	19.0%	3.8
Methane	3.8	Fossil	0.0%	0.0
Oxygen	0.0	Mineral	0.0%	0.0
H ₂ S	0.0	Mineral	0.0%	0.0
Sodium chloride	0.0	Mineral	0.0%	0.0
Citric acid	4.5	Biomass	100.9%	4.5
Sum	74.2			54.5
Bio-based carbon content			93%	
<i>Bio-based carbon content (ignoring mineral content)</i>			93%	

Mass balance Method D can provide various output values for bio-based content, and these are summarised in Table 5-48. A new interpretation is to remove the inorganic ingredients from the mass balance rather than excluding the mineral feedstocks as attempted previously in Chapter 5.6.1. The increase in the calculated total bio-based content is much greater for the composite resin, which is 22 wt% sodium sulphate and now considered 86%



bio-based. By contrast the inorganic content of the cleaning product is only 6 wt% (and 73% bio-based under this approach). The new values of bio-based content represent an increase. The same trend occurs for mass balance Method B, with the total bio-based content of the cleaning product increasing from 81% to 86% and a large increase for the composite resin from 71% to 91% total bio-based content. This is despite the lower incorporation of the biomass feedstocks into the composite resin compared to the cleaning product.

Table 5-48 A summary of mass balance Method D calculations for a cleaning product and a composite resin.

Product	Mass balance Method D				
	<i>Bio-based carbon content</i>	<i>Total bio-based content</i>	<i>Ignoring mineral content</i>	<i>Excluding inorganic ingredients</i>	<i>Mineral assumed bio-based</i>
Cleaning product	93%	69%	93%	73%	95%
Composite curing resin	93%	67%	93%	86%	95%

A clear advantage of mass balance Method B is that it is compatible with the use of intermediates or ingredients that are brought in for formulation. A formulator may have a number of different suppliers for the components of the formulations they produce. These ingredients may not be chemically well defined, but they could be provided with a total bio-based content assigned through an atom connectivity approach. Mass balance Method D cannot deal with this situation as it needs to consider the original feedstocks. If the sodium laureth sulphate was purchased from a supplier for use in creating the cleaning product formulation, accompanying data provided by the supplier will influence a mass balance. The sodium laureth sulphate could be supplied with a statement for total bio-based content at 44% (atom connectivity Method 2b) or 57% (ACDV rules of atom connectivity). The cleaning product will then have a total bio-based content of either 81% or 84% respectively. The original value was 81% using atom connectivity Method 2b as the basis for mass balance Method B, and so no issue arises if the same approach to atom connectivity is used consistently. If mass balance Method D is used as the approach to calculate total bio-based content, the use of sodium laureth sulphate purchased from an external supplier will result in the cleaning product formulation being regarded as 69% or 72% bio-based depending on whether atom connectivity Method 2b was used or the ACDV interpretation. Once again the former atom connectivity technique is more consistent with the mass balance, with less than 1% deviation between the original calculation and now with an ingredient brought in from outside the boundary of the mass balance. In this example mass balance Method D is not too distorted by the combination of atom connectivity and material balance techniques, but this cannot be guaranteed to be a general observation.



5.7 Advantages and limitations of different mass balance approaches

Mass balance offers a means of calculating the distribution of feedstock material across the various outputs of a manufacturing process. The translation of this into an indirect method of bio-based content has been demonstrated for a number of potential bio-based products. When assuming each manufacturing route is an unchanging dedicated process, similarities have been found with other direct and indirect bio-based content approaches. This represents the maximum limit of total bio-based content for each of the case studies. They serve as the virtual biomass sub-mass balance in calculations where exclusively fossil derived products are co-produced. The most important application of mass balance is when the production chain is not served by dedicated biomass feedstocks. Fluctuating biomass feedstocks in non-dedicated facilities produces changing total bio-based content values for the resulting products. Feedstock fluctuation and allocation techniques will be explored after the consistency of the different mass balance approaches has been reviewed based on the accumulated results representative of dedicated facilities.

5.7.1 Inter-methodology comparison

Firstly, both indirect bio-based carbon content (mass balance Method B) and fossil carbon savings (mass balance Method C, expressed as the proportion of bio-based carbon as a function of the total carbon in the product) match the anticipated amount of bio-based carbon that would be found using radiocarbon isotope analysis (Figure 5-60). In Figure 5-60, the example products are methyl laurate (bio-diesel), vanillin, the 1:4 mass ratio of poly(lactic acid) to poly(butylene adipate terephthalate), sodium laureth sulphate containing a fossil derived poly(ethylene glycol) trimer, 2-ethoxyethyl acetate made from bio-naphtha, ethyl acetate (ACDV case study), a starch blend with poly(ethylene) (1:3 mass ratio), carbon monoxide made from a mixed feedstock of coal and starch by gasification (20% bio-based carbon), and finally partially bio-based poly(ethylene terephthalate). Several of the data points in Figure 5-60 overlap.



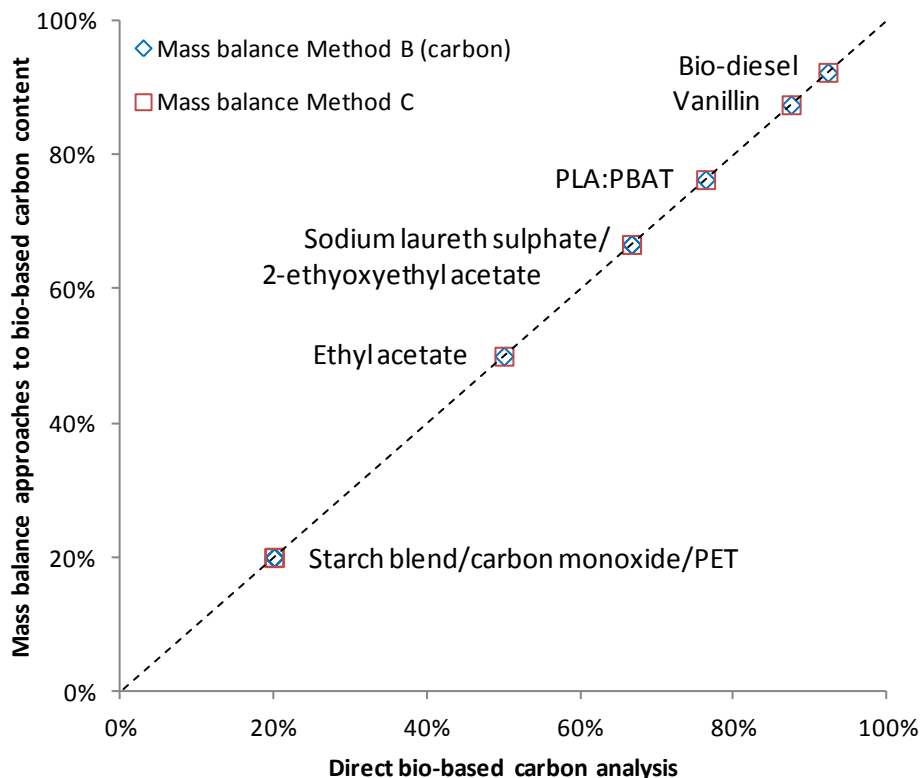


Figure 5-60 The comparison between direct and indirect methods of obtaining bio-based carbon content for various products.

It is also prudent to compare the relationship between atom connectivity Method 2b and mass balance Method A and mass balance Method B as a means of determining total bio-based content (Figure 5-61). An equivalence line is plotted on the graph to indicate when the approaches are in agreement. Solid lines tether different data points representing the same product. The PLA:PBAT blend represents an excess of PBAT (1:4) with bio-based terephthalate. Unlike the comparison of some bio-based carbon content calculations with analytical measurement (Figure 5-60), there are discrepancies, especially with mass balance Method A. The use of mass balance Method B has once again shown consistency with other direct, and in this case indirect, bio-based content approaches. Too much variation in results will not build confidence in this set of declaration tools. Thus mass balance Method A suffers from not being closely linked to the mass of materials, but rather their energy. This mass balance approach would therefore perhaps find more utility in the bio-fuels sector, which is out of the scope defined for bio-based product standards. Also, the designation of the feedstock(s) is often problematic, and with mass balance Method A even changes the result obtained for the total bio-based content; a problem shared with claims of fossil carbon savings when made on the basis of the process and not the product.



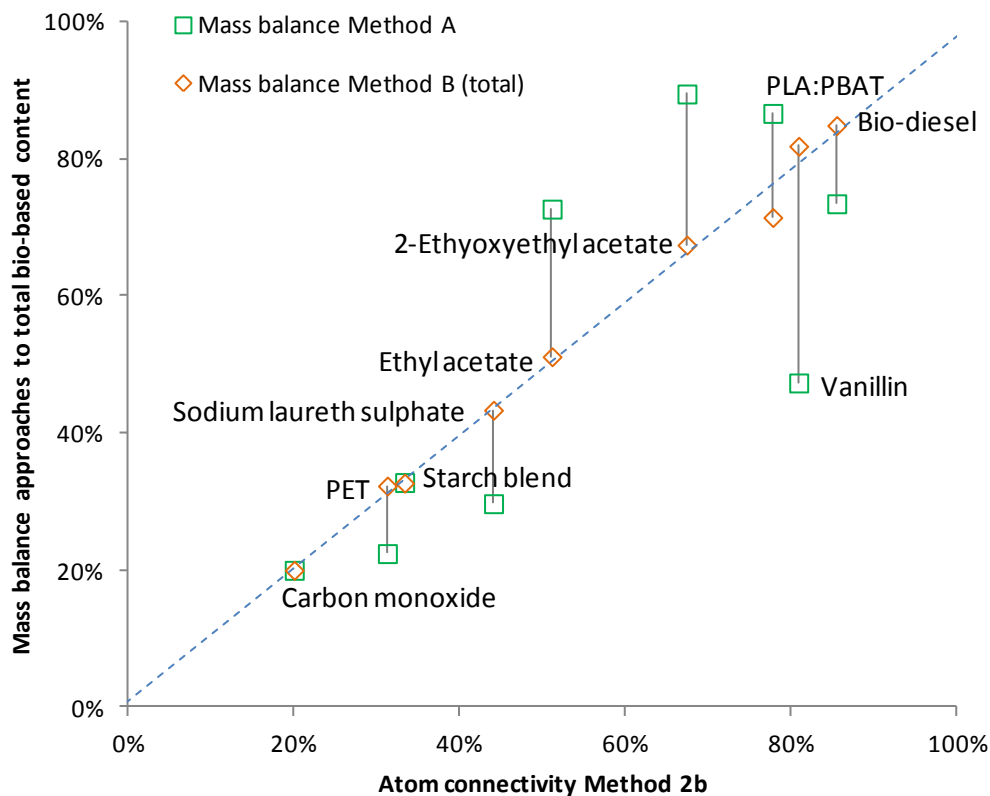


Figure 5-61 The comparison between different indirect mass balance methods of obtaining total bio-based content and atom connectivity Method 2b for various products.

The same basis of comparison, but now with the ACDV approach to atom connectivity, is only different for sodium laureth sulphate (Figure 5-62). For this product the correlation between approaches is worsened; the additional bio-based content automatically allocated with ACDV not recognised in mass balances. However, mass balance Method B is principally derived from atom connectivity Method 2b so a strong similarity is expected in that comparison (Figure 5-61) but not necessarily here (Figure 5-62). Both Figure 5-61 and Figure 5-62 indicate a large discrepancy in the results obtained for vanillin with mass balance Method A compared to the other approaches. This is due to an over-representation of ethylene as a feedstock. Substantial inefficiencies in the process converting naphtha to ethylene (numerous products lines) and then in oxidising ethylene (due to poor yields) are encompassed by mass balance Method A.



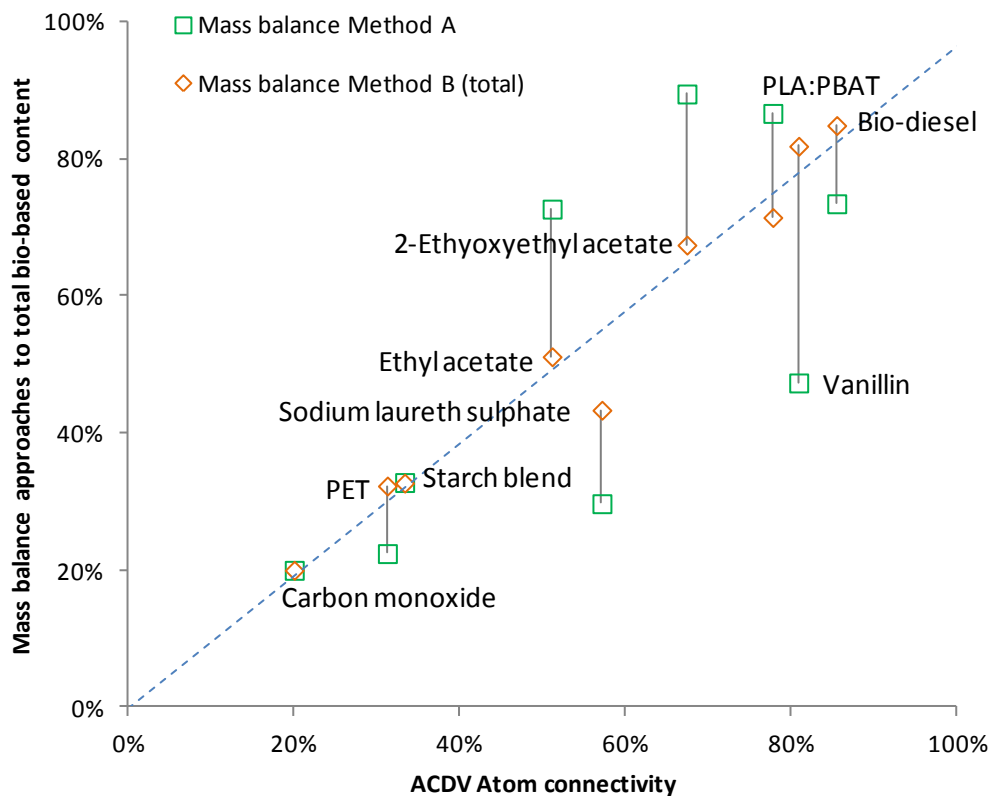


Figure 5-62 The comparison between different indirect mass balance methods of obtaining total bio-based content and atom connectivity according to ACDV calculations for various products.

Mass balance Method B is very similar in its conclusions to the alternative direct methods of bio-based carbon content analysis and atom connectivity for total bio-based content, and may be implemented in an integrated manner in conjunction with the atom connectivity approach. Atom connectivity Method 2b will not reflect changes in the manufacturing process, such as biomass input fluctuation, and so mass balance could help supplement bio-based content claims when the amount of bio-based content can vary.

It has been commented throughout Chapter 5 that the results for total bio-based content reached with mass balance Method D are generally ungenerous. This is not a problem in itself if the approach is applied in an identical way to every product and no other mass balance methods are also in use. The assignment of some of the bio-based product as mineral content also means that if mineral feedstocks are incorporated into the final article the bio-based content cannot reach 100% no matter how much fossil resource is displaced from the production chain. These restrictions are lifted if mineral content is excluded from calculations of total bio-based content. The impact of this is shown as Figure 5-63. When mineral content is ignored the total bio-based content is often similar to the bio-based carbon content. This may simply be a consequence of the case studies chosen in this report, or it may be a more



inherent characteristic of the calculation, increasing the emphasis on the comparison between bio-based carbon and fossil derived carbon when mineral derived elements (notably much of the oxygen and nitrogen) are overlooked. It could be argued that if total bio-based content is similar to the value of bio-based carbon content then what more does a full mass balance offer to the understanding of bio-based content.

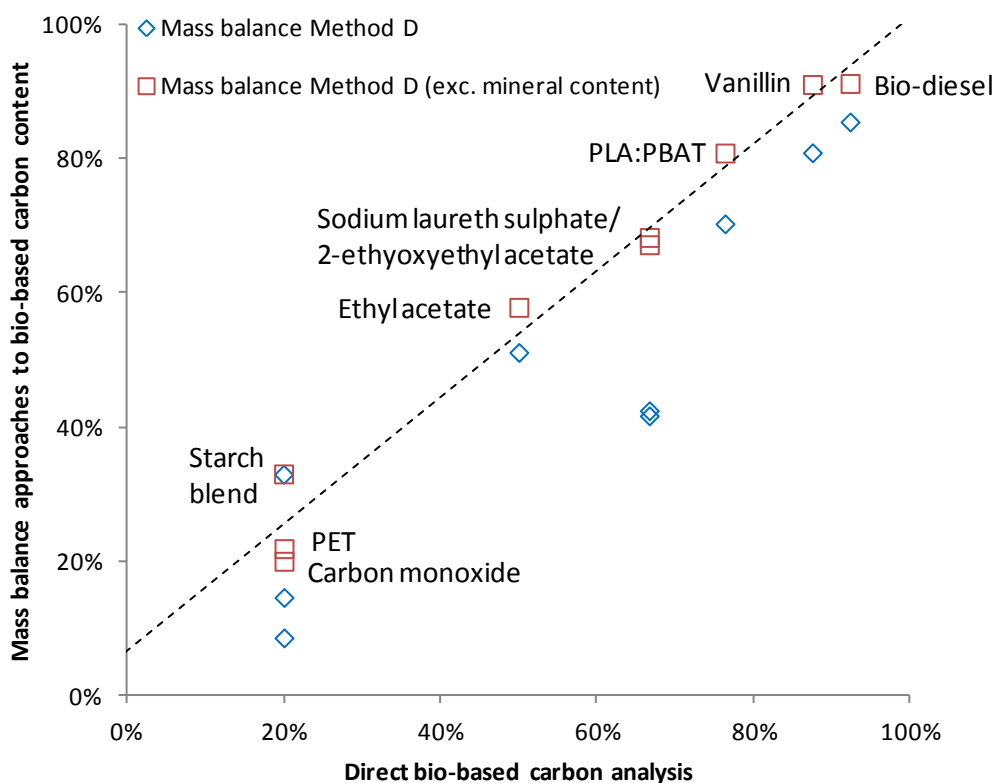


Figure 5-63 The comparison between applications of mass balance Method D and bio-based carbon content.

Atom connectivity Method 2b has served as the primary atom connectivity approach, extended to all heteroatoms without the restrictions of direct analytical validation using elemental analysis. Mass balance Method B has extended this technique and is fully compatible with atom connectivity. In terms of total bio-based content results, sometimes mass balance Method D is more comparable to atom connectivity 2b when mineral content is included, and other times it is more comparable when the mineral content is excluded (Figure 5-64). This depends on whether mineral derived heteroatoms, most often oxygen, are bonded to biomass derived parts of a bio-based product or not. Without atom connectivity incorporated into mass balance Method D it will not necessarily be easy to justify the use of this mass balance approach to bio-based product manufacturers and formulators when many of their input materials could be intermediates supplied with a total bio-based content derived from atom con-



nectivity. When chemicals are produced in dedicated facilities the mass balance is surplus to requirements and so it must be expected that total bio-based content will be described with atom connectivity ([prEN 16785](#)).

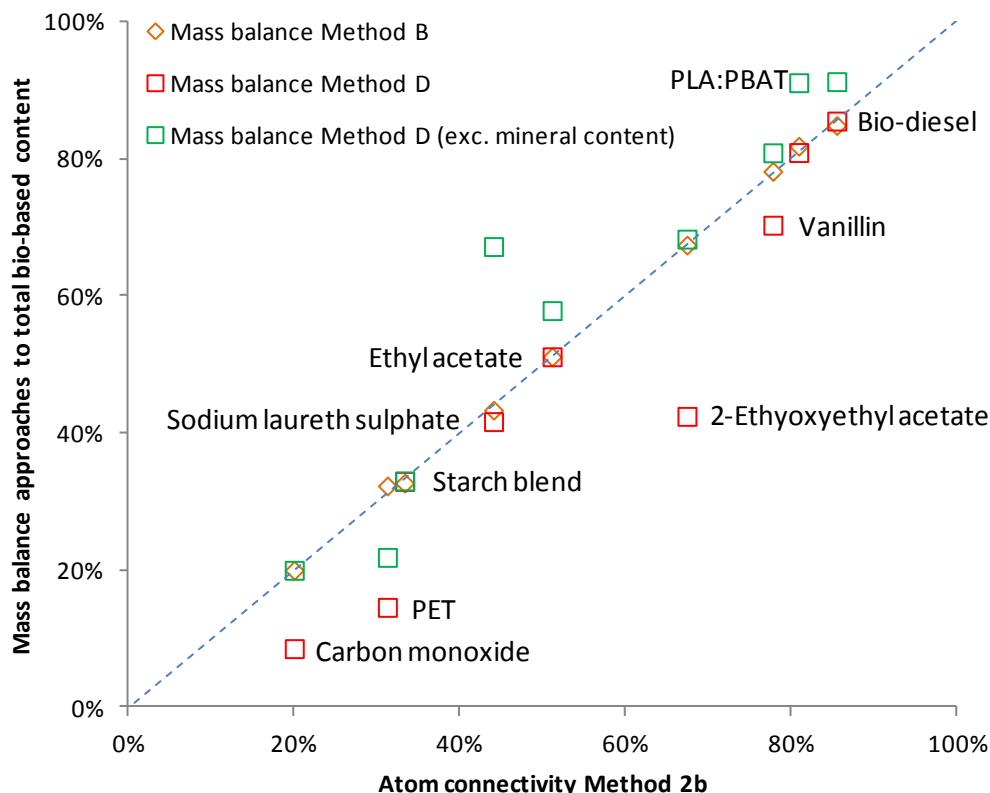


Figure 5-64 A comparison between atom connectivity Method 2b and mass balance Method B and Method D for the indirect calculation of total bio-based content.

Although the examples presented throughout Chapter 5 of this report generally demonstrate successful calculations and conclusions, all the case studies that have been used are largely hypothetical and simplifications of real manufacturing processes. In reality, even the simplest of chemical reactions is complicated on a plant scale, involving many mass transfers. The process diagram for the synthesis of ammonia from hydrogen and nitrogen, a simple reaction on paper, demonstrates this (Figure 5-65) [Jiménez-González 2000]. The volume of material flows are not indicated in Figure 5-65, but the number of events required to transform the feedstock into the product is daunting for someone attempting a mass balance of the process. This could have implications for the accuracy of a mass balance, especially as it must be maintained constantly to reflect the introduction of more or less biomass with time.



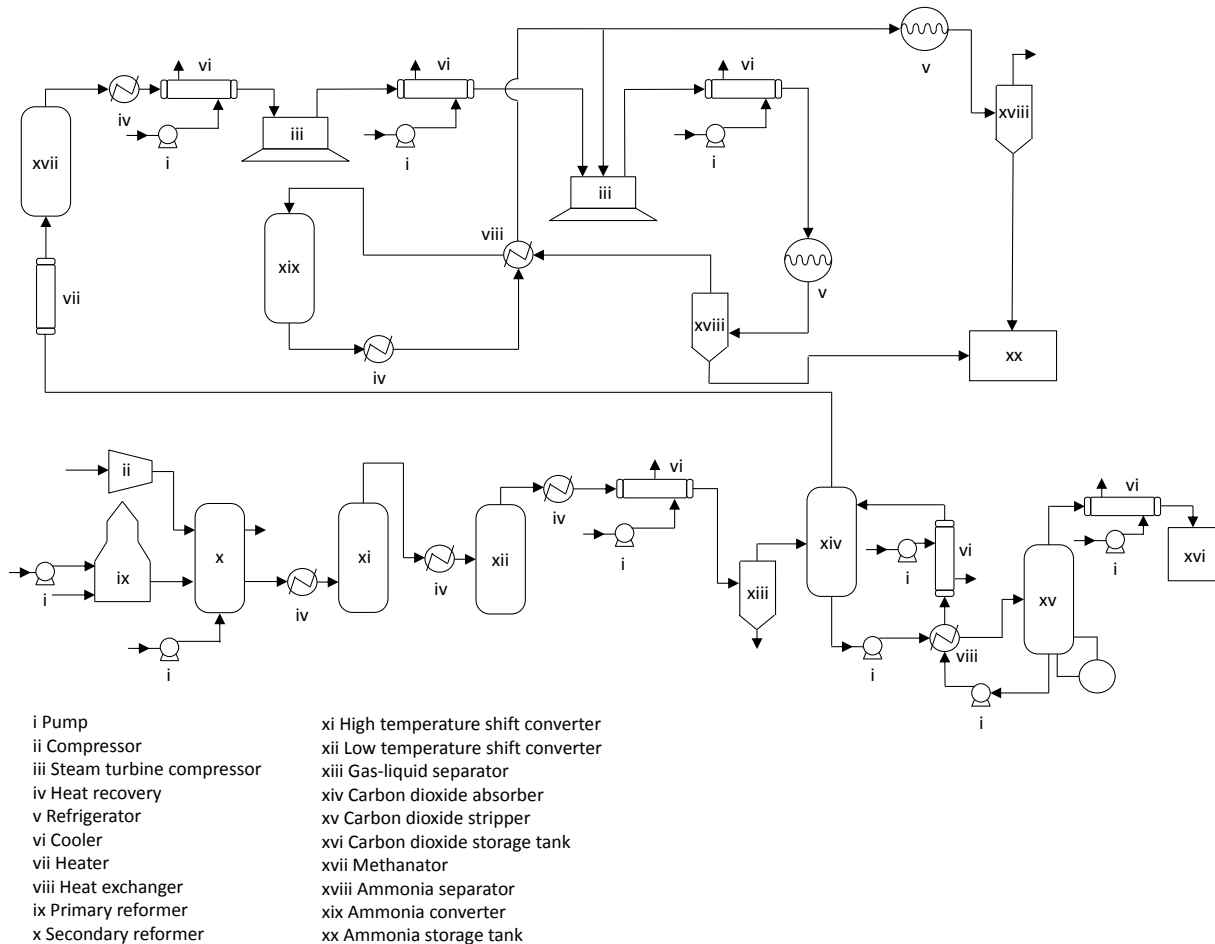


Figure 5-65 An engineering process diagram for the manufacture of ammonia from nitrogen gas and a hydrocarbon hydrogen source including schematic key.

Specific recommendations for the implementation of mass balance for the indirect calculation of total bio-based content will follow, but it is worth reiterating the value of mass balance for calculating the bio-based carbon content of an article. The results presented in this report are unambiguous when applied to bio-based carbon, and for the bio-based based products of non-dedicated facilities, mass balance has a role in the absence of radiocarbon analysis. Other instances also apply when radiocarbon analysis is not accurate, and again mass balance will be helpful. Mass balance Method B tends to take the bio-based carbon of an article for granted and has not been the focal point of discussion. Nevertheless it should be calculated reliably. Mass balance Method D does however provide a robust approach to the calculation of bio-based carbon content. Atom connectivity can be applied to assignments of bio-based carbon content made through mass balance Method D.



5.7.2 Allocation of fluctuating biomass feedstocks: Feedstock variation

It could easily be concluded that indirect methodologies for the determination of total bio-based content are somewhat redundant given the existence of direct analysis. However, analytical measurement is a snapshot of the composition of a product. Depending on feedstock price and availability, manufacturers may adjust the ratio of biomass to petrochemical feedstock entering a given process. If this is the case, then the amount of bio-based carbon in the product will vary across the year, and the timing of analytical measurements will be biased. It was calculated for the gasification to give carbon monoxide that only the final balance between feedstocks is important to determine the average bio-based content (Chapter 5.2.1). Whether feedstocks are used alternately or in combination does not affect calculations based on a pre-defined time period (Table 9-4). However the minimum bio-based content is controlled by the nature of the biomass input fluctuation.

Discussions in [CEN/TC 411/WG 3](#) have resulted in definitions of three product categories dealing with the flexibility of biomass incorporation into these products:

- Category 1: Produced in a dedicated production facility the bio-based content does not vary and can be determined directly without need for the mass balance approach.
- Category 2: The bio-based content varies in a measurable way (using mass balance) and is always greater than zero. The boundaries for this claim "bio-based product" are that it shall be accompanied by statement of the minimum guaranteed bio-based content.
- Category 3: The bio-based content varies and can be zero. These products are not regarded as bio-based products.

The effect of variable feedstock quantities can be further clarified with another hypothetical case study. In this example, 100 kg of a chemical product is manufactured every month. Due to the different chemical compositions of the two feedstocks, if reverting to a single feedstock, 143 kg of biomass, or 111 kg of the conventional fossil derived feedstock would be needed per month. Thus the total quantity of feedstock required will change as the amount of biomass fed into the system changes, as is demonstrated in Figure 5-66. The monthly bio-based content of the product can more than quadruple during the course of the year and so a one-off (direct) analytical measurement of bio-based content will be flawed in this instance. However the average bio-based content can be calculated indirectly using a material balance at 33% (an average of the 12 monthly calculations). If the sum of the total biomass input and the sum of the total petrochemical feedstock input were used to calculate



a single yearly total bio-based content the result is the same. Similarly if it were assumed that the ratio of feedstocks remained the same throughout the year, the average total bio-based content would still remain at 33% (Figure 5-67; key the same as Figure 5-66). This is a significant advantage of the mass balance approach to bio-based content, even though individual monthly batches of the final product will not always approximate the average total bio-based content claimed for the pre-defined manufacturing period. Potentially this could cause problems for downstream formulators using these products. Figure 5-66 shows a minimum total bio-based content value in May of 14% and a maximum of 63% in September. Thus the average total bio-based content of 33% will show a discrepancy of up to 30% compared to the actual total bio-based content. In only five months of the year is the actual total bio-based content within 5% of the average value.

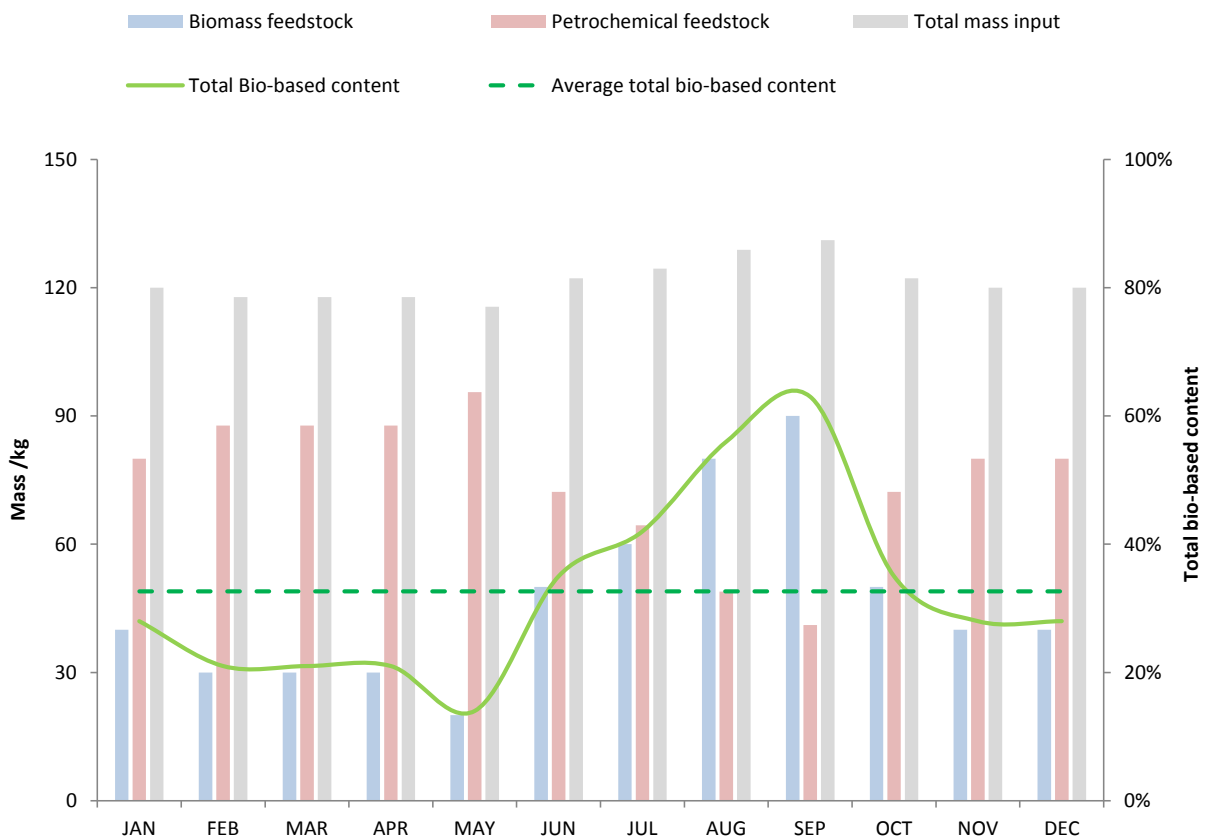


Figure 5-66 An example of how variable feedstocks can change total bio-based content over time.



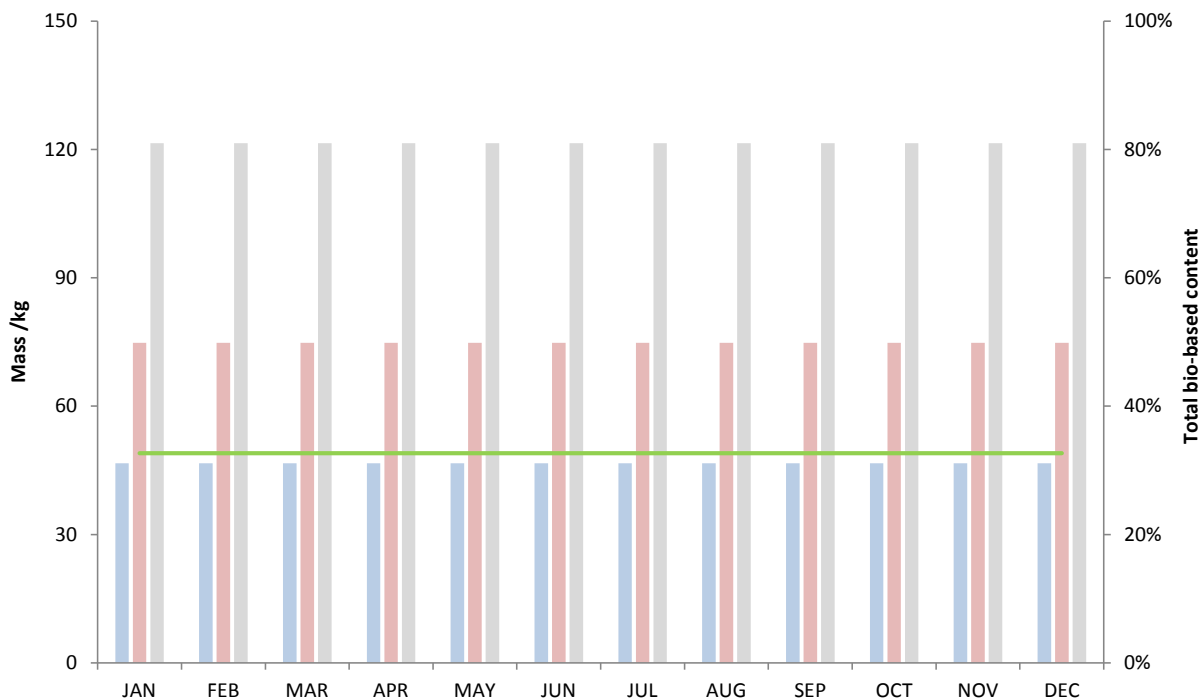


Figure 5-67 A confirmation that fluctuations in biomass input do not change the year average total bio-based content of products compared to this steady state equivalent.

5.7.3 Allocation of fluctuating biomass feedstocks: Integrated production facilities

In the previous section (Chapter 5.7.2) the combination of biomass and fossil feedstocks is ideal and product distributions and their bio-based content can be calculated mathematically from the mass balance. If product selectivity changes in a non-ideal, unpredictable manner the simple calculations seen previously no longer apply. A demonstration of this is given as Figure 5-68 for the case study of naphtha thermoccracking. Due to the differences in chemical structure of conventional naphtha and bio-naphtha the product selectivity is slightly different under the same conditions (Table 5-8). When both feedstocks are used in combination the product distribution may be unexpected. This would be more likely when the biomass feedstock is dissimilar to the fossil feedstock, and the process is optimised for the processing of the conventional fossil resource. Catalyst inhibition, autocatalysis, moisture, feedstock degradation and other effects may cause non-ideal behaviour. When this is the case the bio-based content of each product stream is unknown, and will vary whenever the feedstock ratio is tuned.



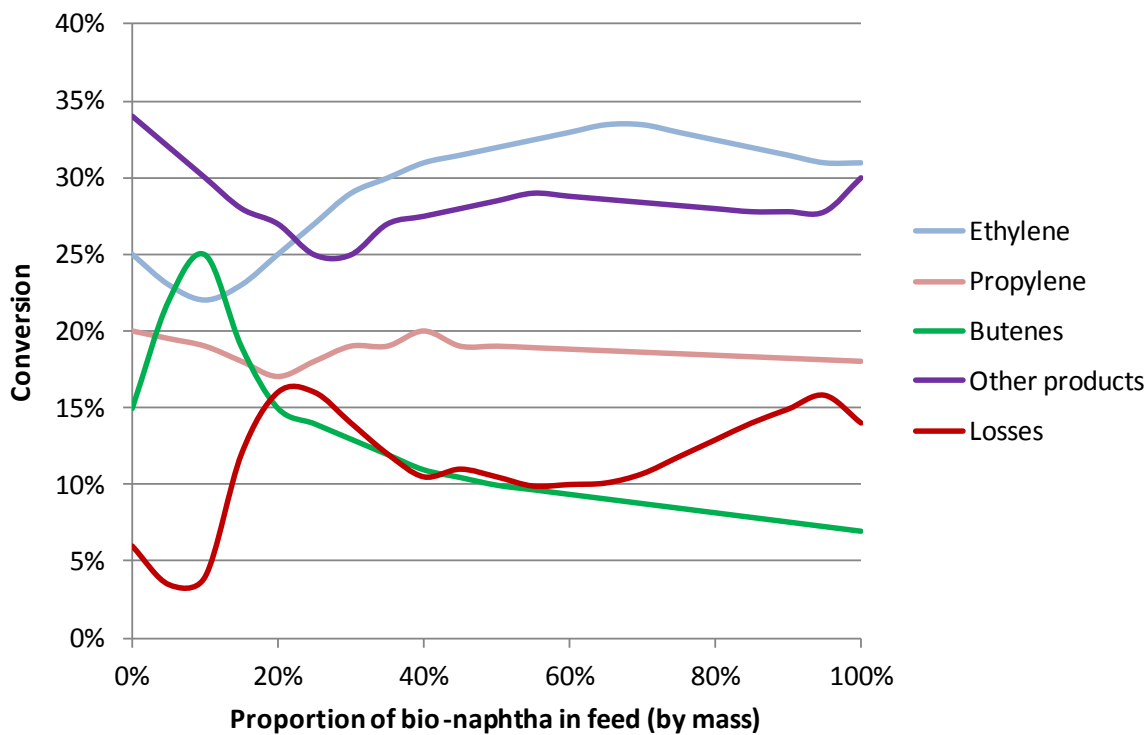


Figure 5-68 A hypothetical example of non-ideal behaviour in a mixed feed thermal cracking process.

With attribution this problem is easily solved. There is no need to consider or preserve the chemical identity of each product stream when attributing bio-based content, even though by looking at Table 5-49 the elevated amounts of ethylene and the depressed quantities of other minor product streams demonstrates the mixed feedstock system is not ideal.

Table 5-49 The non-ideal product selectivity of naphtha feedstocks.

Product	Product distribution (ideal values)			
	0% <i>bio-naphtha</i>	50% <i>bio-naphtha</i>	75% <i>bio-naphtha</i>	100% <i>bio-naphtha</i>
Ethylene	25.0%	32.0% (28.0%)	33.0% (29.5%)	31.0%
Propylene	20.0%	19.0% (19.0%)	18.5% (18.5%)	18.0%
Butenes	15.0%	10.0% (11.0%)	8.5% (9.0%)	7.0%
Other products	34.0%	28.5% (32.0%)	28.2% (31.0%)	30.0%
Losses	6.0%	10.5% (10.0%)	11.8% (12.0%)	14.0%

In order to make a claim of bio-based content *via* allocation as reasonable as possible, and to ensure no over-reporting of bio-based content, when a product stream is greater than ideal behaviour of the dual feedstocks would suggest, the ideal amount of the bio-based product can be considered as having been produced. This is likely to produce an underesti-



mate of total bio-based content. When a product stream is lower in mass than ideal behaviour of the dual feedstocks would suggest, the ideal amount of the fossil derived product can be considered as having been produced. This is also likely to produce an underestimate of total bio-based content. The results of this approach for a production facility using a dedicated amount of 75% bio-naphtha in the feed (Figure 5-69), 50% bio-naphtha (Figure 5-70), and then 75% bio-naphtha for 8 months of the year and wholly petrochemical naphtha for the remaining 4 months (average biomass use is 50%, Figure 5-71).

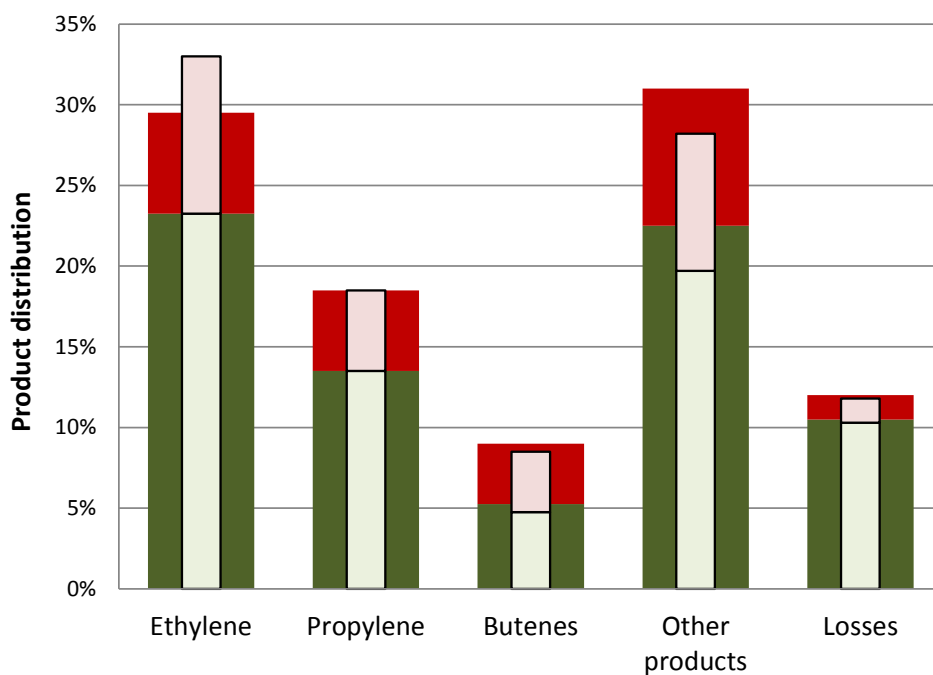


Figure 5-69 Allocated bio-based content of cracked naphtha product streams with 75% bio-naphtha in feedstock. Key: dark green = ideal bio-based portion; dark red = ideal fossil derived content; light green = allocated bio-based content of experimental yield; light red = allocated fossil derived content of experimental yield.



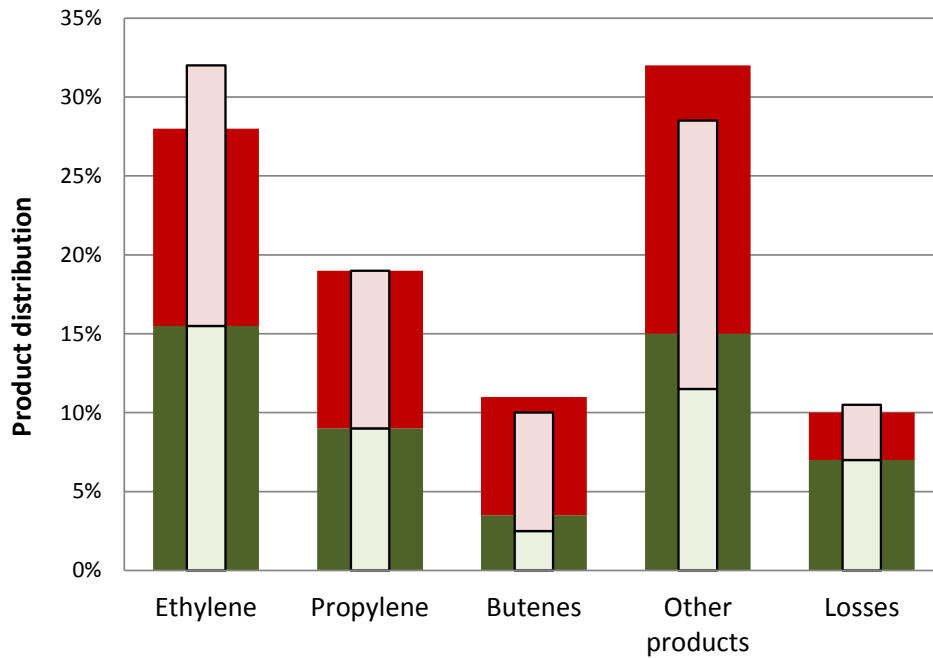


Figure 5-70 Allocated bio-based content of cracked naphtha product streams with 50% bio-naphtha in feedstock. Key as in Figure 5-69.

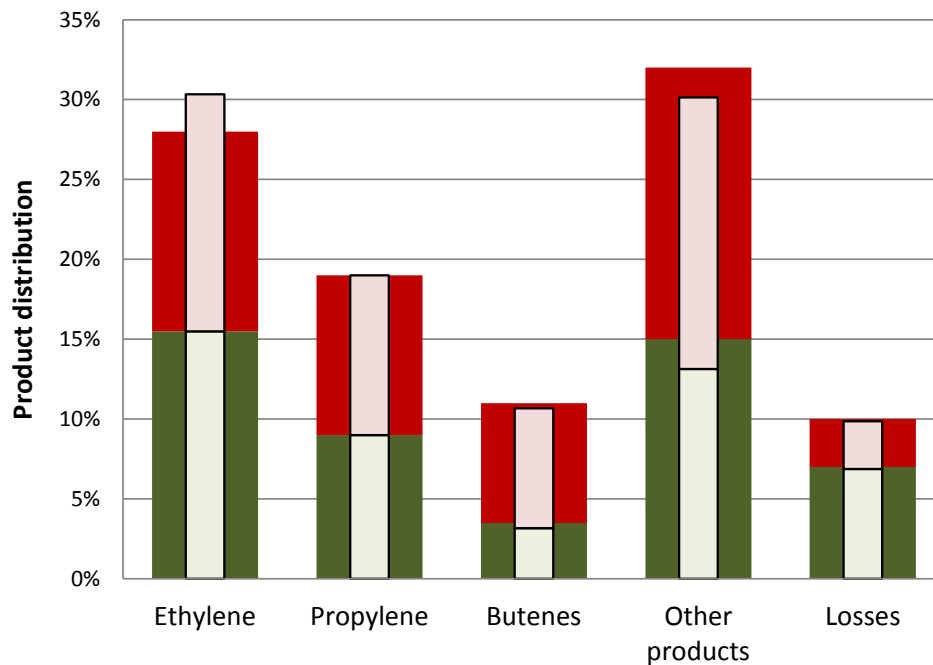


Figure 5-71 Allocated bio-based content of cracked naphtha product streams with a fluctuating bio-naphtha content in the feedstock. Key as in Figure 5-69.



The allocation of bio-based content is not quite equal between the dedicated 50% biomass feedstock process and the fluctuating feedstock scenario utilising the same amount of biomass overall (Figure 5-72). In all cases the quantity of biomass products is lower than the original input, and for the fluctuating feedstock example, the products would fall within category 3 anyway and hence would not be regarded as bio-based. Although this invalidates the mass balance (biomass input \neq biomass output), no bio-based content has been generated artificially. In summary it would seem inappropriate to attempt a mass balance of total bio-based content for production chains in which non-ideal behaviour occurs. If the biomass feedstock does not fluctuate then the products fall within category 1 and should be assessed directly (by analysis) to determine their bio-based content. If the biomass feedstock is in short supply, it may be feasible to stockpile what resource is available to then use at a later date at an input ratio with a known bio-based output distribution. In the meantime a non-bio-based product would be produced. However the storage of biomass can be problematic and this is not an economically attractive option.

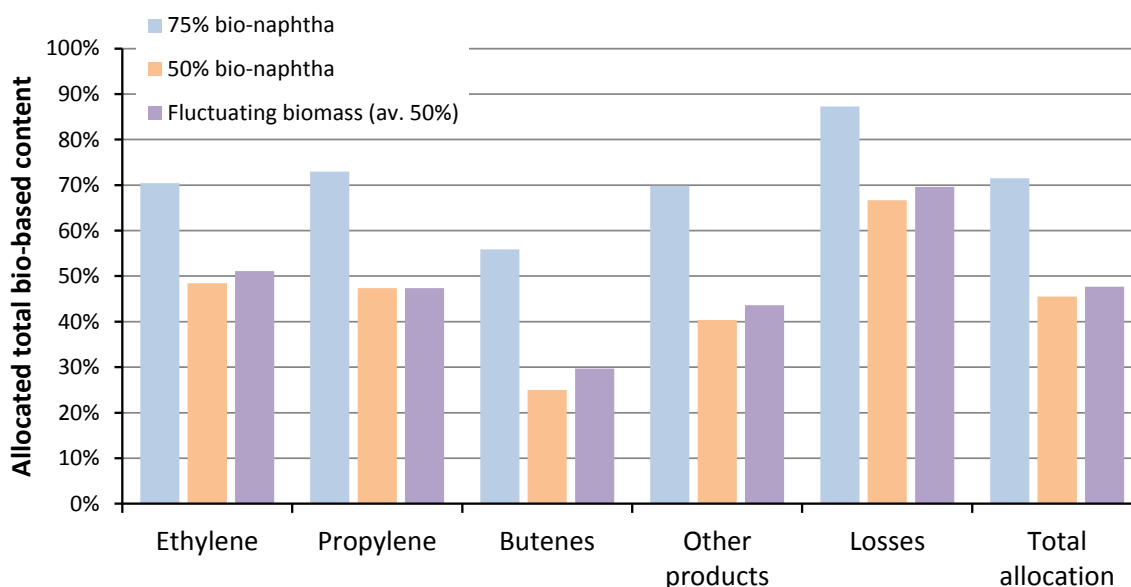


Figure 5-72 The total bio-based content allocated to products of naphtha thermocracking with different biomass feedstock amounts.

5.7.4 Allocation of intermediates and products: Storage and transport

Integrated production facilities may produce parallel streams of a bio-based product or intermediate and a petrochemical equivalent. These may not be physically separated during production. Even if physical separation is enforced, the product or intermediate may then be transported as a single batch anyway. Some of the following scenarios are adapted from



a discussion raised by Jonas Markusson during a meeting of **CEN/TC 411/WG 3** (13th November 2014).

Logistical networks are well established, and must be taken advantage of rather than establish dedicated bio-based product logistics and hinder the growth of the European bio-based economy. Differentiation between batches of a given product for transportation is made on the basis of purity grade and not (bio-based) origin. Therefore it is likely that bio-based products will be combined with conventional chemicals containing no bio-based content. When this occurs with palm oil (sustainable and uncertified material), allocation is used to partition the batch after transportation (**RSPO 2011**). The analogy with mass balance allocation is clear (Figure 5-73). The sustainability certificates must be associated with an equal quantity of palm oil as what originally possessed certification. The combined transportation batch cannot assume a proportional percentage of sustainability (*e.g.* 40% sustainable).



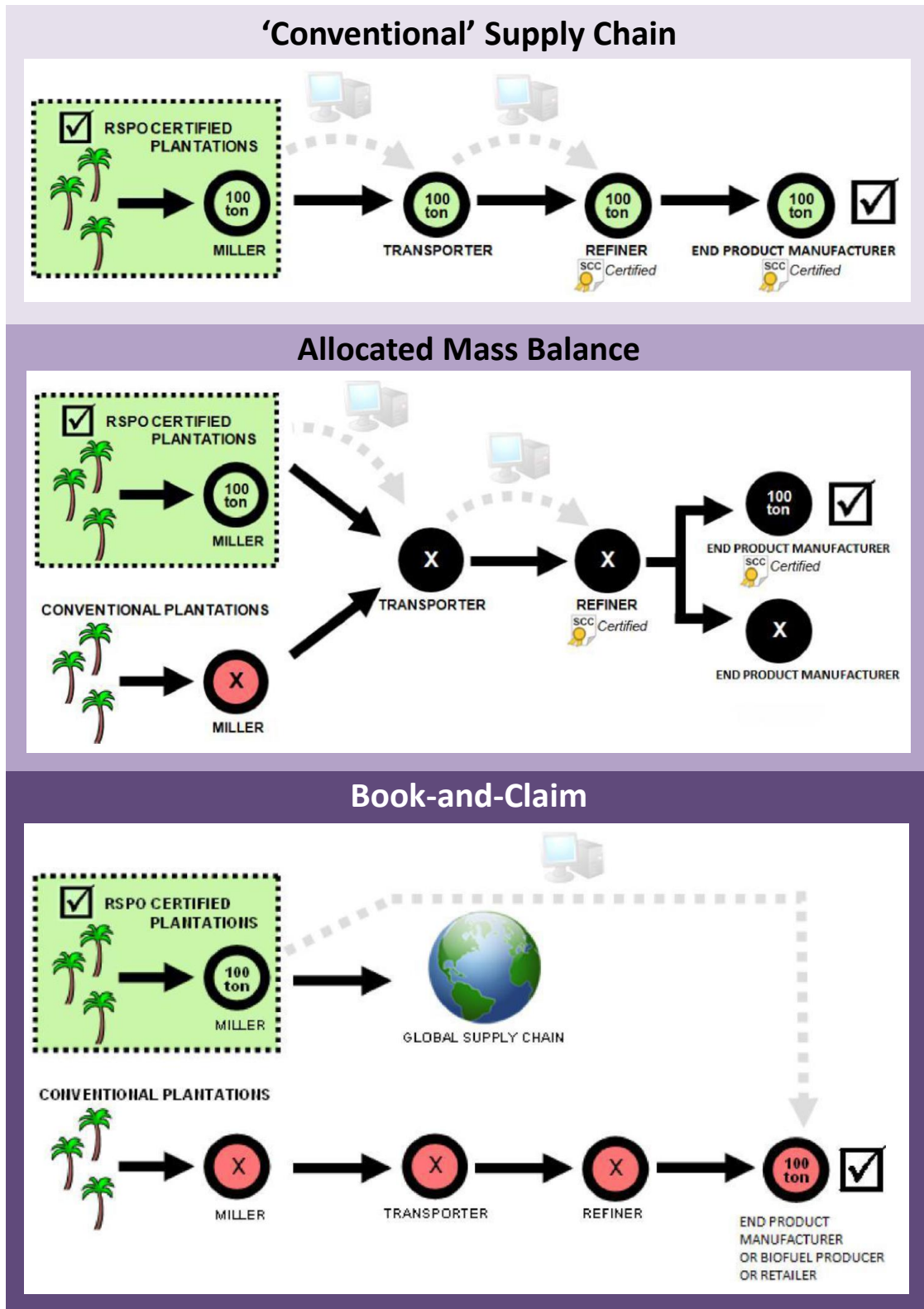


Figure 5-73 Examples of how palm oil sustainability certificates are redistributed after transportation.



It would be possible to allocate a transportation mixture of a bio-based product and an equivalent petrochemical as a product with an intermediate value of bio-based content. If for example an equal quantity of bio-ethylene and fossil derived ethylene (perhaps prior to the synthesis of diethyl ether) were pumped into the same container, the whole batch and subsequent smaller batches could be considered as 50% bio-based. Alternatively, smaller batches could be taken and allocated 100% bio-based content until half the container was emptied. This latter scenario has the greater similarity to palm oil sustainability certification but is less representative of the mixed product. If the bio-ethanol (the precursor to bio-ethylene) had been reacted with the fossil derived ethylene to produce diethyl ether for example, the entire consignment would have a 50% bio-based carbon content (inherent to each molecule) and allocation would make no sense when the product has an analytically verifiable bio-based content. It would be best if the rules regarding allocation did not depend on which order the sequence of processes and reactions occur in.

Taking an example of a solid intermediate, if pellets of a bio-based intermediate are introduced into the conventional product logistic network, the container may contain layers of fossil derived material and the bio-based product depending on how and when they were loaded into the container. Mixing will occur at least to a limited extent but a homogeneous mixture is not expected as it would be for fluids. Imagine 20% of the mass of the consignment is made up of the bio-based product, itself assumed to be 100% bio-based (Figure 5-74). One fifth of the batch could be separated upon delivery and allocated the maximum bio-based content. The remainder would have to be considered 0% bio-based to preserve the mass balance. It is possible that a batch will have none of the bio-based product contained within it and so any of the batches could be 0% bio-based (but not all). On average each batch will be 20% bio-based. If it is possible that a batch can be 0% bio-based in real terms yet is claimed to be >0% bio-based with the use of certificates this is unappealing, and **CEN/TC 411** has warned against the use of this convention (known as category 3 products).



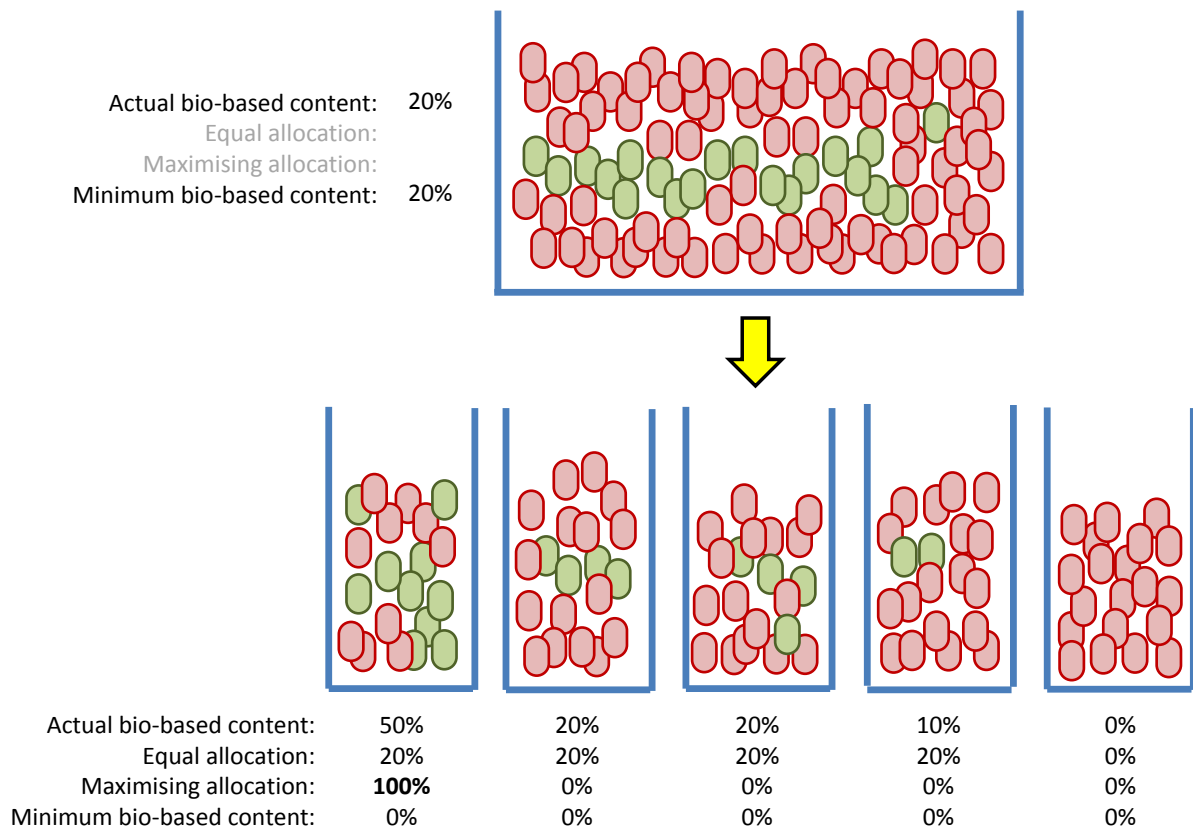


Figure 5-74 A hypothetical situation in which solid pellets are divided into batches, where green indicates the bio-based product and red indicates an identical but fossil derived product.

An alternative version of this situation is presented as Figure 5-75. The transport container now holds 60% bio-based material, 40% fossil derived. It is later split into two equal sized batches. On average a batch will be 60% bio-based, and the minimum is 20%. The minimum is calculated by assuming all the bio-based product ends up in one batch, the quantity of bio-based product relative to the batch size means it cannot be contained in a single batch. Ideally the minimum bio-based content is kept above 0% to ensure it can be regarded as a bio-based product (category 2). The batches sizes could be designed to be unequal so that by allocation one or more batch is 100% bio-based (by allocation) and the others therefore 0% bio-based.



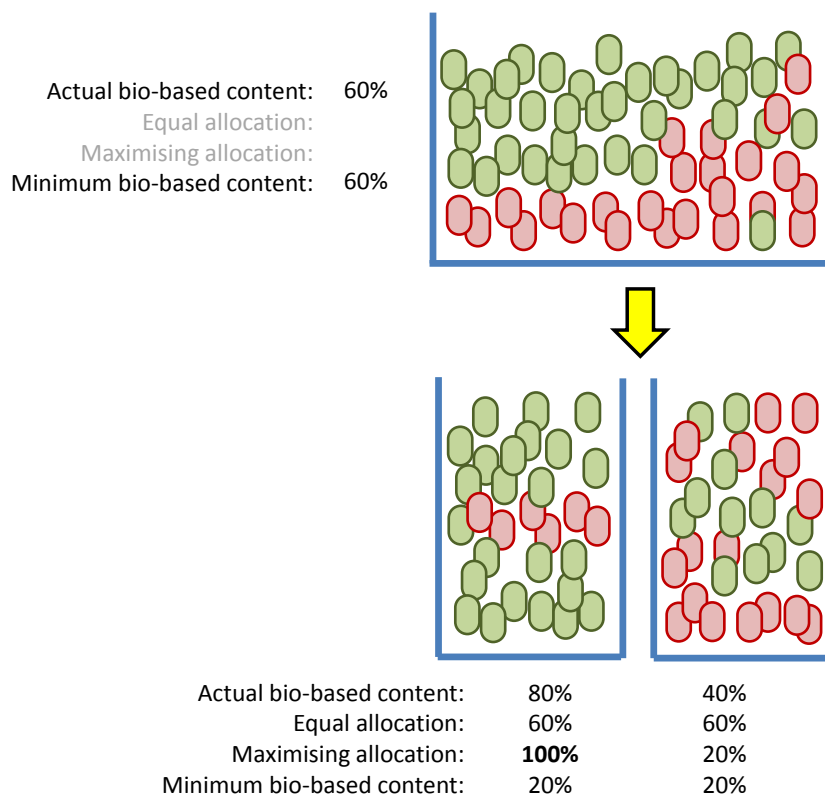


Figure 5-75 A second hypothetical situation in which solid pellets of mixed origin are divided into batches.

5.7.5 Allocation of intermediates and products: Storage and transport with losses

It is possible that losses are incurred during the storage or transport of production intermediates. This is more likely for some chemicals than others, particularly volatile liquids. If one partially bio-based chemical is contained for transport and losses occur no allocation is required. However if a blend of the same bio-based and fossil derived chemical is subject to losses allocation to ensure a minimum bio-based content is applicable. The case study of ethyl acetate can be revisited to explain. As a liquid, a homogeneous solution is assumed to be attained when ethyl acetate of different sources is placed into the same container. During storage or transport 20% losses of ethyl acetate are incurred, as should be calculated with a mass balance (Figure 5-76). A real value would surely be less but exaggerated here to demonstrate the point. The ACDV model ethyl acetate compound is unaffected, with the balance of biomass and petrochemical content fixed within each molecule through chemical bonds. However this is not true of a blend of petrochemical ethyl acetate (0% bio-based content) and ethyl acetate made from bio-ethanol as per the Davy-Sasol process (100% bio-based content, Scheme 5-3) [Colley 2004]. A 20% loss due to evaporation or leaks will not be measured or understood analytically. Mass balance requires that all outputs match the



combined mass of the input materials. In reality losses can be uncontrolled and unmeasured, but a change in mass after storage and transportation will indicate the magnitude of the loss. Even controlled losses, such as losses resulting from the by-products of reaction chemistry cannot necessarily be expected to be analysed and characterised precisely.

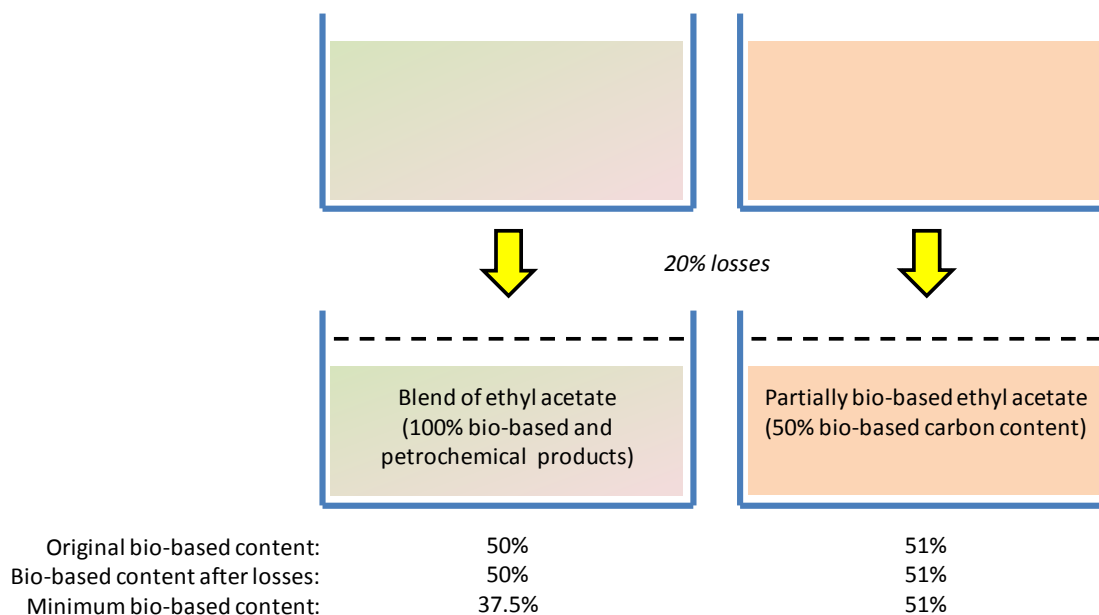


Figure 5-76 A demonstration of the effect of losses incurred during transportation or storage.

The suggested 20% loss during the storage or transportation of the blended ethyl acetate product will almost certainly be a representative mixture of both components. However without analysis of the evaporated solvent, to obtain an absolute minimum bio-based content of the remaining product, the losses will need to be assumed as bio-based (up until the maximum quantity of the bio-based product present is accounted for). If 100 kg of ethyl acetate was present originally then 80kg remains after the losses occur. The absolute minimum total bio-based content of what remains will be 37.5% if the 20 kg loss is assumed to be all bio-based ethyl acetate (meaning 30 kg remains).

The scenario described above is not necessarily realistic, but demonstrates a principle which would be valid for heterogeneous mixtures of solids and mixtures of different liquids of differing volatility within the production chain. In the instance of liquids, the best approach is probably to assume homogeneity and all uncontrolled losses are representative of the original mixture. This rule would help consistency between the two examples shown in Figure 5-76. The following case study extends this discussion of consistency within mass balance allocations.



5.7.6 Allocation of intermediates and products: Changes to storage or transport policy

In the synthesis of partially bio-based poly(ethylene terephthalate), ethylene glycol is made from bio-ethanol and reacted with methyl terephthalate. The process used by the Coca-Cola Corporation for their 'plant bottle' product uses Brazilian bio-ethanol which is converted to ethylene glycol by an Indian operation. Finally the bio-based monomer can be made into the desired polymer (presently done in the UK), and then the plastic material ultimately processed into the final shaped article [Coca-Cola 2014]. Different stages in the production chain occur on different continents (possibly conflicting with the system boundaries defined for the mass balance). With such extensive transport links there is a risk of error within the mass balance calculation.

The example above involves the transport of liquid and solid intermediates. However because the bio-based content of PET is low (up to 20% bio-based carbon) it is not an ideal case study to show variations in calculated bio-based content. A simplified demonstration of the impact of the logistic network is provided with the following case study of adipic acid. Figure 5-77 shows two sources of adipic acid being mixed for transport, while Figure 5-78 shows independent streams (physical separation) of the dimethyl adipate process until transportation for polymer applications.



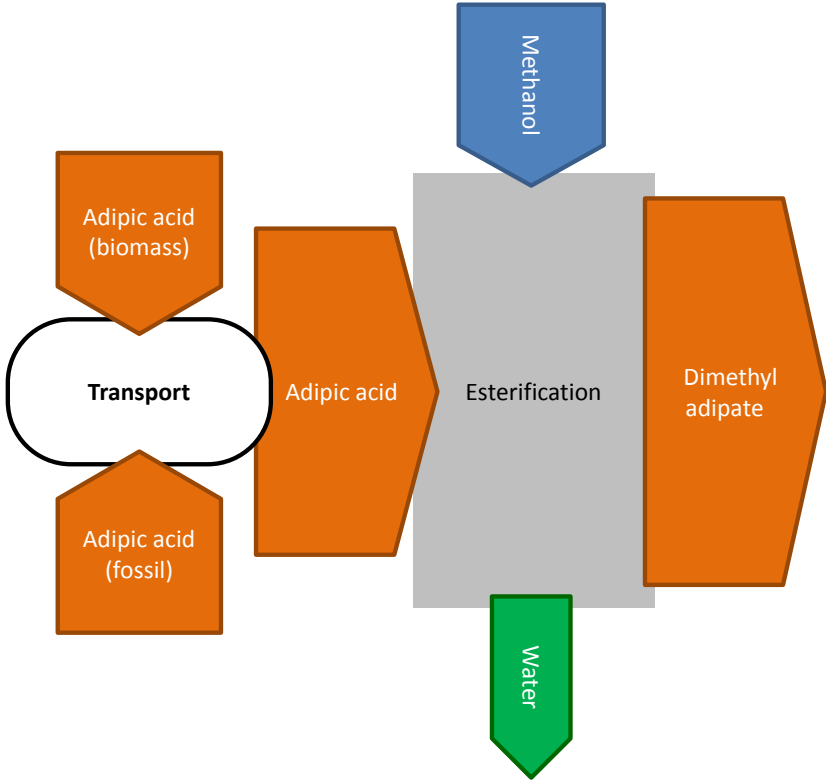


Figure 5-77 A Sankey diagram describing the production of a dimethyl adipate as an intermediate for polymers with mixing of adipic acid early in the production chain.



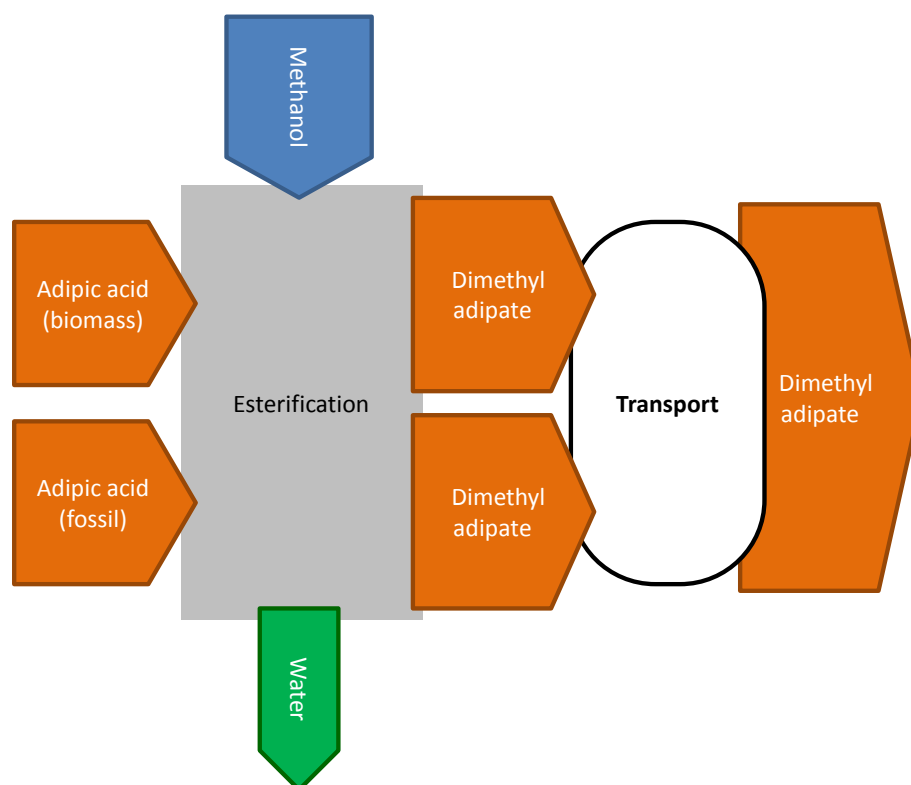


Figure 5-78 A Sankey diagram describing the production of a dimethyl adipate as an intermediate for polymers with mixing of dimethyl adipate late in the production chain.

Adipic acid is a key monomer for polyamides and some polyester products. It can be made from carbohydrate biomass *via* glucaric acid (Scheme 4-15). Most conventionally it is derived from an oxidation of benzene. Figure 5-77 and Figure 5-78 show the esterification of adipic acid (equal contributions of bio-based and fossil derived chemical) with methanol prior to polymerisation. Adipic acid is a solid, and the container may not be mixed homogeneously. Dimethyl adipate is a liquid, and therefore any losses or separation in batches will probably be representative of the mixture's composition of bio-based and fossil derived components.

If losses in transportation or storage are treated as representative (by allocation of the average bio-based content) for liquids, but adopt a worst case scenario for solids, then changes to the logistics network can change the amount of bio-based content the supplier can claim for their product (Table 5-50). This is not consistent, and it would seem that always assuming losses are representative of the batch is the fairest and more rewarding approach, even though the actual bio-based content of the remaining material may be less. The losses in Table 5-50 are over exaggerated, but show a difference between the two approaches.



Table 5-50 Various claims of total bio-based content assuming losses or batch allocation or fluctuating feedstocks in the production of dimethyl adipate.

Event	Minimum bio-based content: worst case scenario (mass balance Method B)	
	Co-transportation of adipic acid	Co-transportation of dimethyl adipate
No transport losses	32%	32%
Losses in transport (10%)	29%	32%
Losses in transport (20%)	24%	32%
Dimethyl adipate split into 2 batches	0% (other batch is 64%)	0% (other batch is 64%)
Alternating feedstock	0%	0%

If after transport the dimethyl adipate is split into two equal batches all the bio-based content can be allocated to one batch, leaving the other to be regarded as 0% bio-based content. The second batch cannot be regarded as a bio-based product even though analytically the bio-based carbon content should be 37.5%. If the feedstock is alternated between biomass and fossil resources then sometimes no biomass will be introduced into the production chain and dimethyl adipate with 0% bio-based content will be produced. This means the dimethyl adipate is a category 3 product and cannot be considered as bio-based.

5.7.7 Allocation of intermediates and products: Production by synthesis

The synthesis of sodium laureth sulphate from ethylene will be used as a case study to apply the findings of Chapter 5.7 thus far. In terms of opportunities for biomass feedstocks, the process operates in two parallel pathways, both amenable to biomass feedstocks. A fatty alcohol is produced in one reaction while the hydrophilic poly(ethylene glycol) moiety is created in the other. The feedstock for both will be ethylene (Figure 5-36 and Figure 5-79). Once the two organic portions of the molecule are reacted together they are further functionalised with a sulphate group.



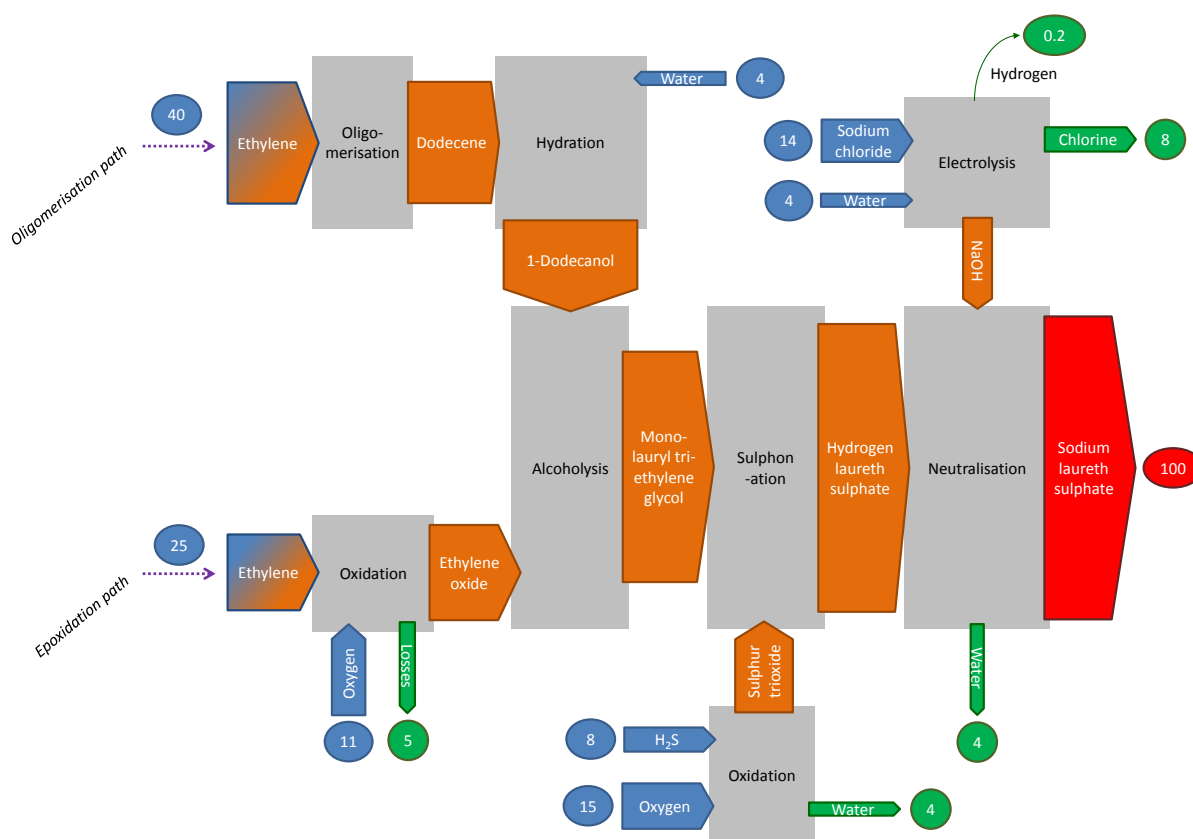


Figure 5-79 A Sankey diagram describing the process of manufacturing the surfactant sodium laureth sulphate from an ethylene intermediate.

This case study will look at various scenarios involving the use of biomass in the different reaction chemistry streams. Mass balance Method D will be used to calculate the mass balance because the identity of the feedstocks is well represented. Every time the same amount of bio-ethanol (66 kg) and petrochemical naphtha (100 kg) is used to produce the intermediate ethylene for the annual production of 100 kg of sodium laureth sulphate. As always the process is considered on a dry mass basis even though the product is made and distributed as an aqueous solution.

The amount of bio-ethanol available is enough to provide a completely bio-based hydrophobic segment of the product molecule (a dodecyl C₁₂ chain). The ethylene produced from the naphtha provides the basis of the hydrophilic portion of the product (poly(ethylene glycol) trimer). These processes will be referred to as the oligomerisation procedure and the epoxidation procedure respectively. To demonstrate, a scenario in which the feedstocks do not fluctuate is presented. The bio-ethylene is fed exclusively into the oligomerisation stream (Figure 5-80). There is no virtual separation of the process because this dedicated facility is combining the biomass and fossil resource derived materials into one chemical product rather than parallel bio-based and petrochemical product streams.



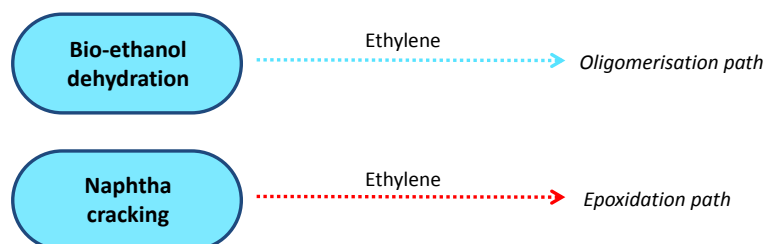


Figure 5-80 The first scenario of sodium laureth sulphate production.

The bio-based content obtained (40%) is slightly less than if vegetable oil had been used as the bio-based feedstock (42%) in what is now the oligomerisation path because of the oxygen atom retained from the triglyceride (Table 5-51). The bio-based carbon content is as expected (Table 5-52). Without fluctuations in the biomass feedstock input direct determination of the bio-based content would be preferable to an indirect mass balance calculation.

Table 5-51 Mass balance Method D calculation of total bio-based content for sodium laureth sulphate produced from a bio-based dodecanol intermediate.

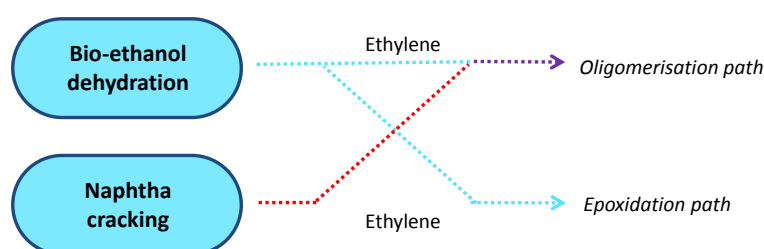
Feedstock	Mass /kg	Origin	Product incorporation (percentage)	Product incorporation (mass /kg)
Ethanol	65.7	Biomass	60.9%	40.0
Naphtha	100.1	Fossil	20.0%	20.0
Water	8.6	Mineral	47.2%	4.0
Oxygen	26.6	Mineral	85.7%	22.8
H ₂ S	8.1	Mineral	94.1%	7.6
NaCl	13.9	Mineral	39.3%	5.5
Sum	223			100
Total bio-based content			40%	
Total bio-based content (ignoring mineral content)			67%	
Total bio-based content (mineral assumed bio-based)			80%	



Table 5-52 Mass balance Method D calculation of bio-based carbon content for sodium laureth sulphate produced from a bio-based dodecanol intermediate.

Feedstock	Mass /kg	Origin	Product incorporation (percentage)	Product incorporation (mass /kg)
Ethanol	34.3	Biomass	100.0%	34.3
Naphtha	90.1	Fossil	19.0%	17.1
Water	0.0	Mineral	0.0%	0.0
Oxygen	0.0	Mineral	0.0%	0.0
H ₂ S	0.0	Mineral	0.0%	0.0
NaCl	0.0	Mineral	0.0%	0.0
Sum	124			51.4
Bio-based carbon content			67%	
<i>Bio-based carbon content (ignoring mineral content)</i>			67%	

The first scenario can be compared to the opposite usage of the biomass feedstock, in which the epoxidation path is prioritised. Because the hydrophilic portion of the product contains half the carbon atoms of the hydrophobic portion, surplus bio-ethylene is diverted into the oligomerisation pathway (Figure 5-81). This time a virtual separation of a fully bio-based product and partially bio-based sodium laureth sulphate could be constructed. There is no 0% bio-based sodium laureth sulphate produced because the feedstocks are assumed not to fluctuate and so the biomass feedstock input is always above zero.

**Figure 5-81** The second scenario of sodium laureth sulphate production.

The bio-based content is lower now even though the same quantities of biomass and fossil feedstocks were used (Table 5-53). This is caused by losses in the production. The epoxidation reaction is not very efficient at 80% yield from ethylene. The bio-based carbon content is 58%, down from 67% (Table 5-54). This is relevant in the context of book-and-claim as well. The use of bio-ethylene for epoxidation is a proven technology [Coca-Cola 2014], used in the production of partially bio-based poly(ethylene terephthalate). The oligomerisation of bio-ethylene is less well developed, although full polymerisation to give poly(ethylene) is known [Moser 2013]. If by book-and-claim 40 kg of petrochemical ethylene could be considered as bio-based through the transfer of certificates, this would equate to



the ethylene obtained from bio-ethanol in this example. A completely petrochemical production facility of sodium laureth sulphate could then assign the certificates to some of the fossil derived ethylene (40 kg from a total of 65 kg). Ultimately the bio-based content accredited to the sodium laureth sulphate would be a maximum of 40% (Table 5-51) or a minimum of 35% (Table 5-53) depending on how the certificates were assigned. This does not seem to be agreeable because the certificates would surely always be used to certify the ethylene of the higher yielding process and not the proven, but less efficient route. Book-and-claim is beyond the scope of indirect bio-based content calculations for this reason amongst others.

Table 5-53 Mass balance Method D calculation of total bio-based content for sodium laureth sulphate produced with a bio-based hydrophilic section.

Feedstock	Mass /kg	Origin	Product incorporation (percentage)	Product incorporation (mass /kg)
Ethanol	65.7	Biomass	53.3%	35.0
Naphtha	100.1	Fossil	25%	25.0
Water	8.6	Mineral	47.2%	4.0
Oxygen	26.6	Mineral	85.7%	22.8
H ₂ S	8.1	Mineral	94.1%	7.6
NaCl	13.9	Mineral	39.3%	5.5
Sum	223			100
Total bio-based content			35%	
<i>Total bio-based content (ignoring mineral content)</i>			58%	
<i>Total bio-based content (mineral assumed bio-based)</i>			75%	

Table 5-54 Mass balance Method D calculation of bio-based carbon content for sodium laureth sulphate produced with a bio-based hydrophilic section.

Feedstock	Mass /kg	Origin	Product incorporation (percentage)	Product incorporation (mass /kg)
Ethanol	34.3	Biomass	87.5%	30.0
Naphtha	90.1	Fossil	23.8%	21.4
Water	0.0	Mineral	0.0%	0.0
Oxygen	0.0	Mineral	0.0%	0.0
H ₂ S	0.0	Mineral	0.0%	0.0
NaCl	0.0	Mineral	0.0%	0.0
Sum	124			51.4
Bio-based carbon content			58%	
<i>Bio-based carbon content (ignoring mineral content)</i>			58%	



The previous scenarios did not consider feedstock fluctuation or the resulting consequence of the possibility for allocation of the total bio-based content. The third scenario addresses biomass feedstock fluctuations when entry of the biomass into the more efficient oligomerisation process stream is prioritised. The variable availability and price of bio-ethanol may mean it is not always possible to have a dedicated bio-based oligomerisation pathway. For the purpose of demonstrating the calculation, a seasonal fluctuation of biomass feedstock input is given in Table 5-55. In reality the fluctuations could be much more frequent. The production scale varies slightly across the year, as may be the case as market demand changes.

Table 5-55 An example of seasonal feedstock input fluctuations with percentage of ethylene contribution also indicated.

Season	Ethanol /kg		Naphtha /kg		Total ethylene /kg
Spring	13.2	52%	30.0	48%	15.5
Summer	26.3	100%	0.0	0%	16.0
Autumn	19.7	71%	20.0	29%	17.0
Winter	6.6	24%	50.0	76%	16.5
Year	65.7	61.5%	100.1	38.5%	65.0

The ethylene demand for the oligomerisation pathway is 61.5% of the total ethylene requirement. On average this is matched over the course of the year by the amount of bio-based ethylene but in some seasons there is not enough (spring and winter in Table 5-55). Therefore the schematic for the production process (with bio-based oligomerisation feedstock prioritised) now looks as shown in Figure 5-82. There will always be some biomass incorporated within the product and so the sodium laureth sulphate is regarded as a category 2 product.

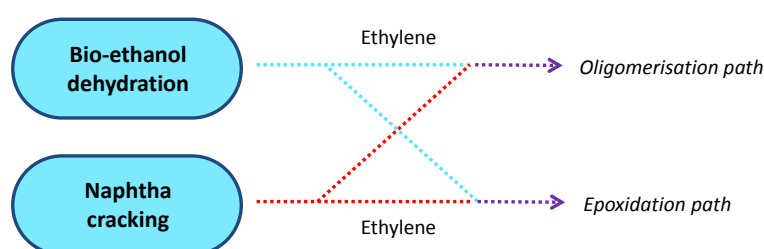


Figure 5-82 The third scenario of sodium laureth sulphate production with biomass feedstock fluctuation.

Virtual separation of the mass balance can be attempted in order to distinguish between sodium laureth sulphate products with different quantities of bio-based content. The four seasons can be treated separately to identify the input of bio-ethylene and fossil derived ethylene into the oligomerisation and epoxidation processes (Table 5-56). This provides the



data for the virtual separation of the biomass and fossil resource sub-mass balances streams. The oligomerisation path leads to 1-dodecanol, and the epoxidation path arrives at ethylene oxide which is reacted with the 1-dodecanol. At this point the virtual separation of biomass and fossil resources into the two sub-mass balances converges into a single linear production chain.

Table 5-56 The division of bio-based ethylene and conventional ethylene whilst prioritising biomass input into oligomerisation in the production of sodium laureth sulphate.

Season	Bio-ethylene /kg		Naphtha derived ethylene /kg	
	<i>Oligomerisation</i>	<i>Epoxidation</i>	<i>Oligomerisation</i>	<i>Epoxidation</i>
Spring	8.0	0.0	1.5	6.0
Summer	9.8	6.2	0.0	0.0
Autumn	10.5	1.5	0.0	5.0
Winter	4.0	0.0	6.2	6.4
Year	32.3	7.7	7.7	17.3

The total bio-based content of the sodium laureth sulphate is 38% (Table 5-57). This is a small decrease from the 40% bio-based content that is achieved when the available biomass input is dedicated to the oligomerisation pathway (Table 5-51). The theoretical maximum of is limited by the stoichiometry of the chemical reaction to 60% (mass balance Method D). This is higher than if a vegetable oil was the biomass feedstock for the oligomerisation pathway because ethylene can be used as a common intermediate in both the oligomerisation and epoxidation processes rather than just contribute to the hydrophobic portion of the product mass. It could be possible therefore with an allocation to assign some of the product as 60% bio-based and other batches with lower bio-based content to compensate. The bio-based carbon content is 64% (Table 5-58) while the maximum is 100%.



Table 5-57 Mass balance Method D calculation of total bio-based content for sodium laureth sulphate when seasonal variation influences the bio-based content and biomass is prioritised into the oligomerisation pathway.

Feedstock	Mass /kg	Origin	Product incorporation (percentage)	Product incorporation (mass /kg)
Ethanol	65.7	Biomass	58.6%	38.5
Naphtha	100.1	Fossil	21.5%	21.6
Water	8.6	Mineral	47.2%	4.0
Oxygen	26.6	Mineral	85.7%	22.8
H ₂ S	8.1	Mineral	94.1%	7.6
NaCl	13.9	Mineral	39.3%	5.5
Sum	223			100
Total bio-based content			38%	
<i>Total bio-based content (ignoring mineral content)</i>			64%	
<i>Total bio-based content (mineral assumed bio-based)</i>			78%	

Table 5-58 Mass balance Method D calculation of bio-based carbon content for sodium laureth sulphate when seasonal variation influences the bio-based content and biomass is prioritised into the oligomerisation pathway.

Feedstock	Mass /kg	Origin	Product incorporation (percentage)	Product incorporation (mass /kg)
Ethanol	34.3	Biomass	%	33.0
Naphtha	90.1	Fossil	%	18.4
Water	0.0	Mineral	0.0%	0.0
Oxygen	0.0	Mineral	0.0%	0.0
H ₂ S	0.0	Mineral	0.0%	0.0
NaCl	0.0	Mineral	0.0%	0.0
Sum	124			51.4
Bio-based carbon content			64%	
<i>Bio-based carbon content (ignoring mineral content)</i>			64%	

For the final scenario, it will now be assumed that the ethylene is transported or stored in a single vessel, so the proportions of bio-based ethylene and the fossil derived ethylene that enter both reaction pathways are equal (Figure 5-83). This is possibly the most likely scenario. Again the seasonal variance of Table 5-55 will be used.



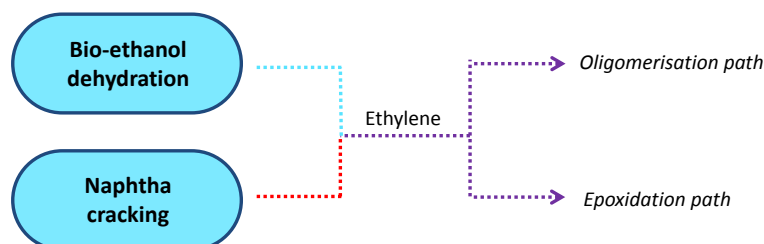


Figure 5-83 The fourth scenario of sodium laureth sulphate production with biomass feedstock fluctuation.

From the proportions of each feedstock the virtual separation of bio-based sodium laureth sulphate and fossil derived is made easy because of the mixing of ethylene. A representative amount of the product can be assigned as the maximum 60% bio-based product (mass balance Method D) and the remainder as the result of the fossil resource sub-stream (Table 5-59). This could be the final allocation of bio-based content or it could be averaged across the output for that year.

Table 5-59 The virtual separation of bio-based ethylene and conventional ethylene for the production of sodium laureth sulphate without prioritisation of biomass input into a specific pathway.

Season	Bio-ethylene /kg		Naphtha derived ethylene /kg	
	<i>Oligomerisation</i>	<i>Epoxidation</i>	<i>Oligomerisation</i>	<i>Epoxidation</i>
Spring	4.9	3.1	4.6	2.9
Summer	9.9	6.2	0.0	0.0
Autumn	7.4	4.6	3.1	1.9
Winter	2.5	1.5	7.7	4.8
Year	24.6	15.4	15.4	9.6

The average total bio-based content varies quite significantly across the year (Figure 5-84). The minimum value is 15% bio-based content, and the maximum in summer when no fossil feedstock is needed is the stoichiometric limit of 60% bio-based content (mass balance Method D). The average total bio-based content is 37% (Table 5-60) and the average bio-based carbon content is 62% (Table 5-61). Mass balances for the individual seasons are included in Annex B (Chapter 9.7).



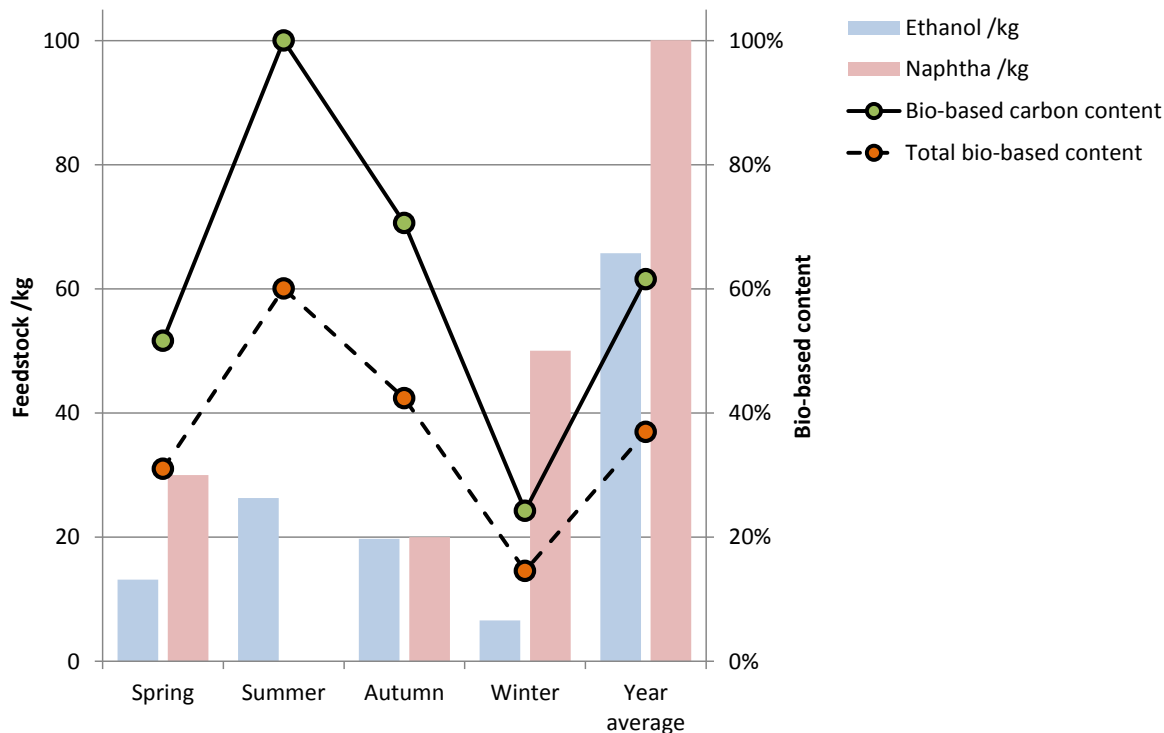


Figure 5-84 The variable bio-based content of sodium laureth sulphate according to mass balance Method D.

Table 5-60 Mass balance Method D calculation of total bio-based content for sodium laureth sulphate when seasonal variation influences the bio-based content.

Feedstock	Mass /kg	Origin	Product incorporation (percentage)	Product incorporation (mass /kg)
Ethanol	65.7	Biomass	56.2%	37.0
Naphtha	100.1	Fossil	23.1%	23.1
Water	8.6	Mineral	47.2%	4.0
Oxygen	26.6	Mineral	85.7%	22.8
H ₂ S	8.1	Mineral	94.1%	7.6
NaCl	13.9	Mineral	39.3%	5.5
Sum	223			100
Total bio-based content			37%	
Total bio-based content (ignoring mineral content)			62%	
Total bio-based content (mineral assumed bio-based)			77%	



Table 5-61 Mass balance Method D calculation of bio-based carbon content for sodium laureth sulphate when seasonal variation influences the bio-based content.

Feedstock	Mass /kg	Origin	Product incorporation (percentage)	Product incorporation (mass /kg)
Ethanol	34.3	Biomass	92.3%	31.6
Naphtha	90.1	Fossil	22.0%	19.8
Water	0.0	Mineral	0.0%	0.0
Oxygen	0.0	Mineral	0.0%	0.0
H ₂ S	0.0	Mineral	0.0%	0.0
NaCl	0.0	Mineral	0.0%	0.0
Sum	124			51.4
Bio-based carbon content			62%	
<i>Bio-based carbon content (ignoring mineral content)</i>			62%	

If the losses incurred during epoxidation were assumed to be all bio-based, the total bio-based content of the sodium laureth sulphate will reduce to an average of 35%. The minimum total bio-based content (in winter) is now just 11% on average. The minimum total bio-based content is a questionable calculation (a debate that continues into Chapter 5.7.8) whereas the average value of total bio-based content would seem to be a more rewarding conclusion for the manufacturers and formulators of bio-based products. Allocation of the maximum bio-based content into an appropriately sized batch could be interpreted as an attempt to artificially add value to an article and is not generally advocated within this report.

From the data generated in this section of the report, the total bio-based content when mineral feedstocks are excluded from the calculation is always equal to the corresponding bio-based carbon content. The pair of results has always been similar for mass balance Method D, but in this example the ethylene intermediate (C₂H₄) is never modified during the production chain in such a way to lose atoms hence the equivalence between the total bio-based content (excluding mineral feedstocks) and bio-based carbon content. This compatibility and comparability could help acceptance of the calculation method, even though the whole mass of the article is not considered. It also makes it more comparable to formulated products containing minerals and other inorganic molecules.

5.7.8 Allocation of intermediates and products: Formulation

If ingredients are obtained from suppliers with validated total bio-based content data provided, in the absence of losses during the formulating process the total bio-based content of the final article can be calculated accurately with a mass balance. Formulation losses and



variable bio-based content of the ingredients will complicate matters but ultimately an average and (usually) a minimum bio-based content can be calculated.

A case study in which two ingredients are combined within a formulation will be used to demonstrate. Imagine the two ingredients are produced in non-dedicated facilities in which the biomass feedstock input is fluctuating. The formulator is provided with the following data from the supplier (Table 5-62). During the formulation procedure 8 kg of material is lost. The waste stream is pumped directly to a water treatment facility and no analysis of this by-product material is feasible. The waste stream could be assumed to be the more biomass rich ingredient (B) to ensure the minimum total bio-based content of the final article is reported accurately. Alternatively it could be allocated fairly between the ingredients based on the amount of each in the formulating process. The results are presented in Table 5-63.

Table 5-62 Data for two ingredients of a formulation made from variable amounts of biomass.

Ingredient	Mass /kg	Total bio-based content (ingredients)		
		Minimum	Year average	Maximum
A	64	0%	35%	50%
B	44	75%	85%	100%

Table 5-63 The total bio-based content of a formulation accounting for the fluctuating feedstocks that created the ingredients.

Scenario	Total bio-based content (formulation)		
	Minimum	Year average	Maximum
Worst case loss scenario	27%	53%	68%
Proportional loss allocation	31%	55%	70%

Not knowing what ingredients contribute to the waste stream is not acceptable for the construction of the mass balance. One component may be volatile and the other not for example, and therefore the proportional loss allocation is not appropriate. However the ingredients may be chemically identical, and simply mixed together to provide enough of an intermediate chemical for production of a bio-based product.

When losses occur and they are attributed to the ingredient with the highest bio-based content (worst case scenario), only if the total bio-based content of the ingredients is known at all times can this be successfully implemented. Although generally true, for this case study it is not an issue because ingredient B is always more bio-based than ingredient A (Table 5-64). A proportional allocation of average total bio-based content is more reliable, but the true minimum bio-based content cannot be calculated in this way (it is an allocation not a material balance). It follows that the minimum and average total bio-based content of the formulation is not dependant on whether it is calculated from an accurate statement from



the supplier regarding the ingredients (Table 5-62), or by using measured values of the total bio-based content of the ingredients (Table 5-64). The maximum possible total bio-based content of the formulation is never attained in this case study because the ingredients never reach their own maximum total bio-based content at the same time within the pre-defined time period (Figure 5-85). Therefore quoting a maximum bio-based content could be considered as misleading.

Table 5-64 Seasonal total bio-based content describing the formulation ingredients.

Season	Total bio-based content	
	<i>Ingredient A</i>	<i>Ingredient B</i>
Spring	50%	75%
Summer	40%	100%
Autumn	50%	90%
Winter	0%	75%
Year average	35%	85%

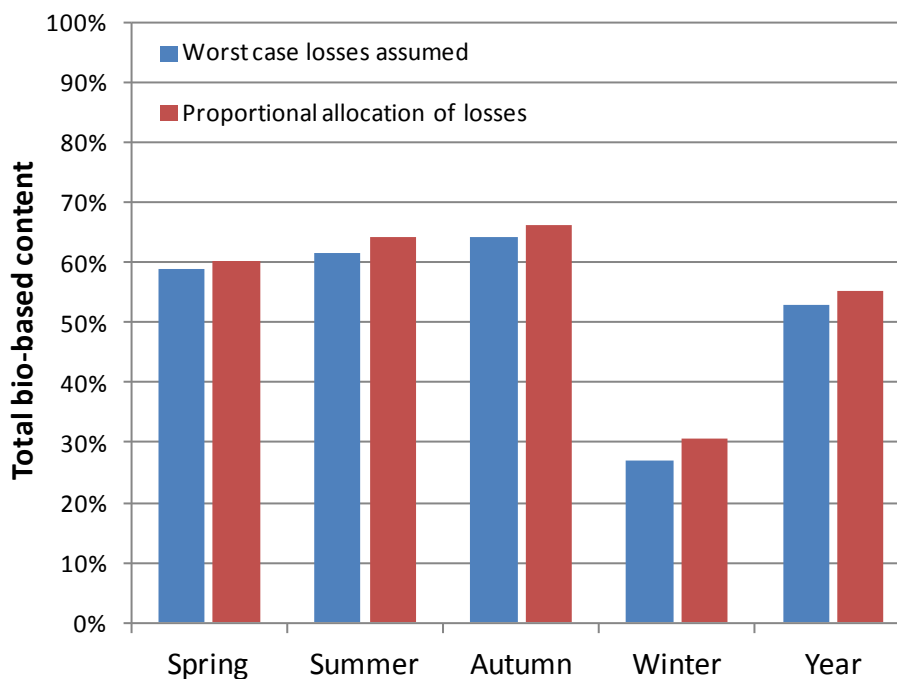


Figure 5-85 The total bio-based content of a formulation calculated by assuming the worst case losses in the production chain or proportional losses.

The formulation may not necessarily be produced to be of a fixed composition if its functionality is uncompromised. The ingredients may be similar and the function of the bio-based product more to do with the shape and structure of the article and not its precise



chemical composition. When this is the case allocation techniques can be employed to provide a claim of total bio-based content. The possible range of total bio-based content values will now change according to the ratio of the ingredients present at a particular time. For this case study, using the total input of both ingredients across the duration of the pre-defined time interval, with proportionally allocated losses, the average will be constant at 55% regardless of intermittent variations in the ratio of ingredients (Table 5-63). So although the minimum value of total bio-based content is a valuable output of the mass balance calculation, when the ingredients come from non-dedicated facilities it is only realistic to achieve a reliable value of the minimum total bio-based content if the composition of the formulation is constant and unchanging, or at least fixed between pre-defined limits. This is in fact true for the majority of products, but for some products, especially those incorporating recycled material, the composition of the formulation could vary over time. The average total bio-based content could be regarded as more reliable because it is steady for a given quantity of feedstocks or ingredients, independent of how they are arranged or varied.

5.7.9 Summary of mass balance

An overview of each mass balance approach is tabulated below (Table 5-65). The intended use of each approach is indicated with a tick (✓) while possible applications are shown with a tick contained within brackets. The definitions relating to system boundaries *etc.* come from [CEN/TC 411/WG 3 document N93](#), now updated to [CEN/TC 411/WG 3 document N110b](#). With mass balance Method B offering the most flexibility with regards to encompassing bio-based carbon and total bio-based content, as well as applicability within Europe and consistency with direct methods of total bio-based content determination, it would seem this is the most logical basis for applying mass balance in bio-based content calculations. However this approach will introduce problematic continuity errors when atom connectivity assignments change throughout the production chain. In practice only small deviations occur, usually when a hydrogen atom is switched from being regarded as bio-based to fossil derived or *vice-versa*.



Table 5-65 Overview of the different mass balance approaches.

Methods involving analytical analysis			Mass balance approaches			
	¹⁴ C isotope analysis	Atom connectivity Method 2b	A	B	C	D
Declaration						
Bio-based carbon content	✓	✓	✗	✓	✗	✓
Total bio-based content	✗	✓	✓	✓	✗	✓
Fossil carbon saving	✗	✗	✗	✗	✓	✗
Type of chemical production						
Dedicated production	✓	✓	(✓) <i>Superfluous to requirements</i>	(✓) <i>Superfluous to requirements</i>	(✓) <i>Superfluous to requirements</i>	✓
Interlinked production	(✓) <i>For verification only</i>	(✓) <i>For verification only</i>	✓	(✓) <i>Only if ideal behaviour observed</i>	✓	(✓) <i>Only if ideal behaviour observed</i>
Complex supply chains	(✓) <i>For verification only</i>	(✓) <i>For verification only</i>	✓	✓	✓	✓
Consecutive chemical reactions	✓	✓	✓	✓	✓	✓



Table 5-65 Continued. Overview of the different mass balance approaches.

Methods involving analytical analysis			Mass balance approaches			
	¹⁴ C isotope analysis	Atom connectivity Method 2b	A	B	C	D
Tracking						
Analytical detection: Final product	✓	✓	✗	✗	✗	✗
Analytical detection: Feedstock input	✗	✗	✓	✓	✓	✓
Book and claim	✗	(✓)	✓	✓	✓	✓
Allocation	✗	✗	✓	(✓) <i>For a carbon mass balance</i>	✓	✓
System boundaries	Product	Product	Connected production sites (including transport).	Limited to the European geographical area. Not applicable for global allocation.	Global production systems including multiple linked sites.	Connected production sites (including transport).
Declaration						
Claims	Bio-based carbon content (product).	Total bio-based content (product).	Fossil resource saving	Average bio-based content.	Fossil carbon savings in global supply chain.	Average bio-based content.



Mass balance Method D will often provide lower than expected values of total bio-based content because mineral content is also considered and separated from bio-based content. However if the mass contribution of mineral feedstocks to the final article are excluded the result of total bio-based content closely approximates the bio-based carbon content, which may help acceptance of the approach, but at the same time makes it less valuable because it offers nothing more to the communication of bio-based content than the bio-based carbon content.

Implementing mass balance Method D will be problematic because the original feedstocks must be identified, and the primary fossil resource conversion facilities are not necessarily linked to bio-refineries. However mass balance Method D offers a robust calculation with which to obtain a value of bio-based carbon content. It is independent of direct bio-based carbon analysis, whereas mass balance Method B in practice is reliant on this the same as atom connectivity techniques are. Even for dedicated production facilities, errors in radiocarbon analysis leave scope for the application of mass balance Method D.

Mass balance Method A and Method C do not contribute anything further to the calculation of bio-based content. Mass balance Method A uses attribution techniques derived from a unit of methane equivalents, while primarily mass balance Method C was used to calculate the quantity of bio-based carbon in a product. Although quite different, they share a common premise within this work that the total bio-based content of an article can be derived from the nature of the feedstock inputs and the process instead of what is contained specifically within the product. Ultimately this was found to be unsatisfactory. When mass balance Method C was used to provide the bio-based carbon of a product (and not a description of the process) it did not offer anything different to other approaches, and is limited to just bio-based carbon content.

Based on the observations made in this report, for the application of mass balance to indirectly calculate the average total bio-based content of a bio-based product, mass balance Method D is well placed to calculate the bio-based carbon content. Then atom connectivity can be applied to the final article. This avoids much of the ambiguity when designating feedstocks and performing atom connectivity through the production chain. Virtual separation of bio-based and fossil derived products helps the assignment of atom connectivity. Atom connectivity shall not be applied to feedstocks or intermediates within the boundary of the mass balance to reduce errors. Intermediates provided by suppliers can use validated total bio-based content values derived from atom connectivity, as was previously explored within the framework of mass balance Method B. Allocation of total bio-based content should be performed to represent the average value for the pre-defined time interval. The minimum total bio-based content can be problematic to calculate depending on the exact circumstance, and allocation up to the stoichiometric limit of the bio-based product for an appropriately sized



batch (to conserve the mass balance) is misleading. The limitations of mass balance in various production scenarios, as previously discussed, are summarised in the following diagram (Figure 5-86).

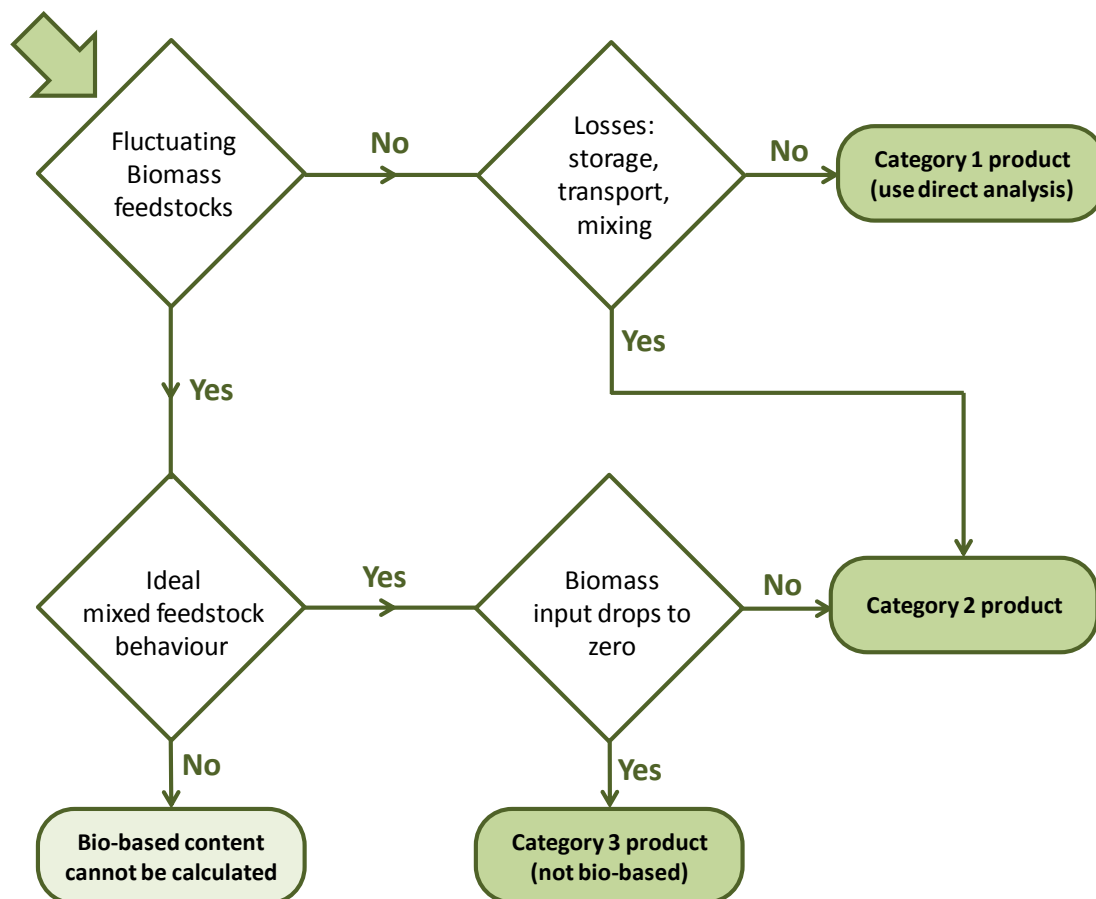


Figure 5-86 A flow diagram representing events in the production chain that determine how mass balance can be applied.

When the biomass feedstock input is not fluctuating, and there are no uncontrolled losses during storage, transport, or formulation, the bio-based content of the product cannot vary and thus it is a category 1 product. Direct analysis of the total bio-based content is applicable for these articles. Stoichiometric reaction losses may still occur but these waste streams can be well understood in terms of their chemical composition, their origin, and therefore their bio-based content. If uncontrolled losses do occur the bio-based content may vary, or it may not be precisely understood. The total bio-based content of the product is allocated and could change over time. Therefore these articles fall within category 2. Despite fluctuating biomass input, if the conversion of the feedstocks is understood and varies predictably according to the proportion of biomass used, as long as the biomass input never falls



to zero the resulting product(s) are also in category 2. If the bio-based content does fall to zero during the pre-defined time interval, a mass balance is obtainable but the product is not regarded as bio-based (category 3). As described in Chapter 5.7.3, if non-ideal behaviour of fluctuating feedstocks is observed a mass balance cannot be calculated, unless mass balance Method A (or an equivalent approach) is used. Even then a total bio-based content for the product cannot be claimed, because attribution of fossil resource savings through specially designed attribution units has no relationship to the actual total bio-based content inherent to the article. Instead terms such as 'fossil resource savings' are used.



6 Indirect bio-based content assessment

Methods for the indirect calculation of total bio-based content are sought after by the manufacturers of bio-based products who use non-dedicated facilities and incorporate variable amounts of biomass into their products. A short survey of bio-based products suggests this is a significant portion of the market (Figure 6-1). The online bio-based product database 'Agrobiobase' (www.agrobiobase.com, search performed on 24/11/2014) was used as the basis of this survey. Seventy five products from relevant sectors were examined. When the bio-based content of the product was quoted in the database as a range of values, or a minimum value, the product was considered as originating from a non-dedicated facility (light blue bars in Figure 6-1). When the name of the bio-based product was not specific (*e.g.* 'fibre') the possibility for fluctuation in the bio-based content was noted (dark blue bars in Figure 6-1; these data also encompass the products definitely originating from non-dedicated facilities). The same reasoning has been applied when the bio-based product is also available as a product or intermediate of the petrochemical industry (*e.g.* acetaldehyde).



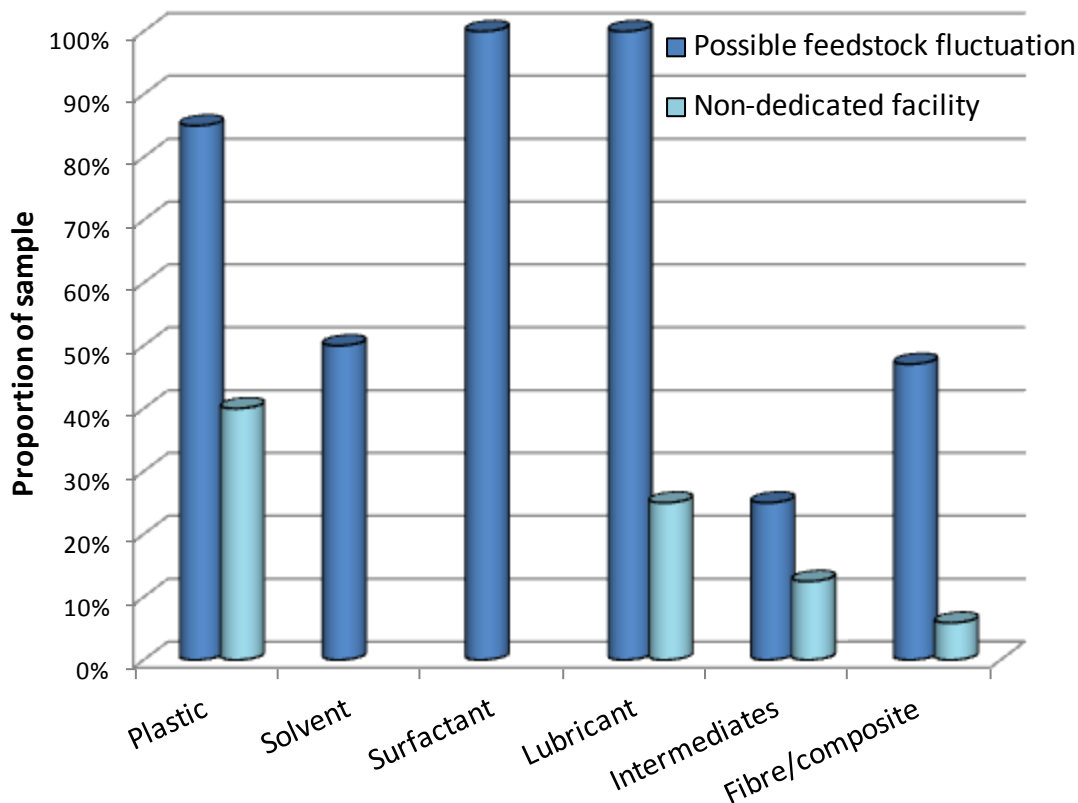


Figure 6-1 Survey of the 'Agrobiobase' online database for products of potentially variable total bio-based content.

Figure 6-1 shows us that bio-based plastic materials are the most likely to be produced in non-dedicated facilities, while lubricant and surfactant formulations have the greatest potential to be produced in this way. Although this analysis is not comprehensive and should not be mistaken for a thorough analysis of the bio-based market, it does indicate a potential demand for mass balance techniques. The following recommendations for the use of mass balance to calculate the total bio-based content are applicable to any bio-based product at any point in the production and supply chain.

6.1 Instructions and guidance for applying mass balance

The technique of mass balance, for the calculation of total bio-based content, can imply a methodology in which the conclusion is not necessarily an accurate reflection of the actual bio-based content of the final article. Instead, it is a tool to account for the biomass input of a complex production chain by distributing an equal mass of bio-based content across the various product streams. This is unsatisfactory when a realistic material balance



is feasible, which makes a calculation of the actual bio-based content possible when the input of biomass is constant and does not fluctuate. Between the extremes of dedicated facilities that produce articles of a fixed bio-based content, and the incomprehensible complexity of interlinked manufacturing plants without known biomass conversions or product selectivity (requiring attribution of fossil resource savings to reach any judgement at all) are circumstances where fluctuating biomass feedstocks and the potential for losses during the production chain mean an allocated total bio-based content can be found. The allocation of a total bio-based content provides a reasonable average value across a pre-defined time interval for a bio-based product of this sort.

A general schematic of a production chain utilising biomass feedstocks is shown in Figure 6-2. There are three stages representing an increasing complexity of the chemical products until the final article is manufactured. The mass balance method is applicable to any of these sectors. Feedstocks can be considered as fossil resources, biomass, and other mineral resources. The latter category includes (but it not limited to) water, oxygen gas, calcium carbonate, sodium chloride and other inorganic compounds.

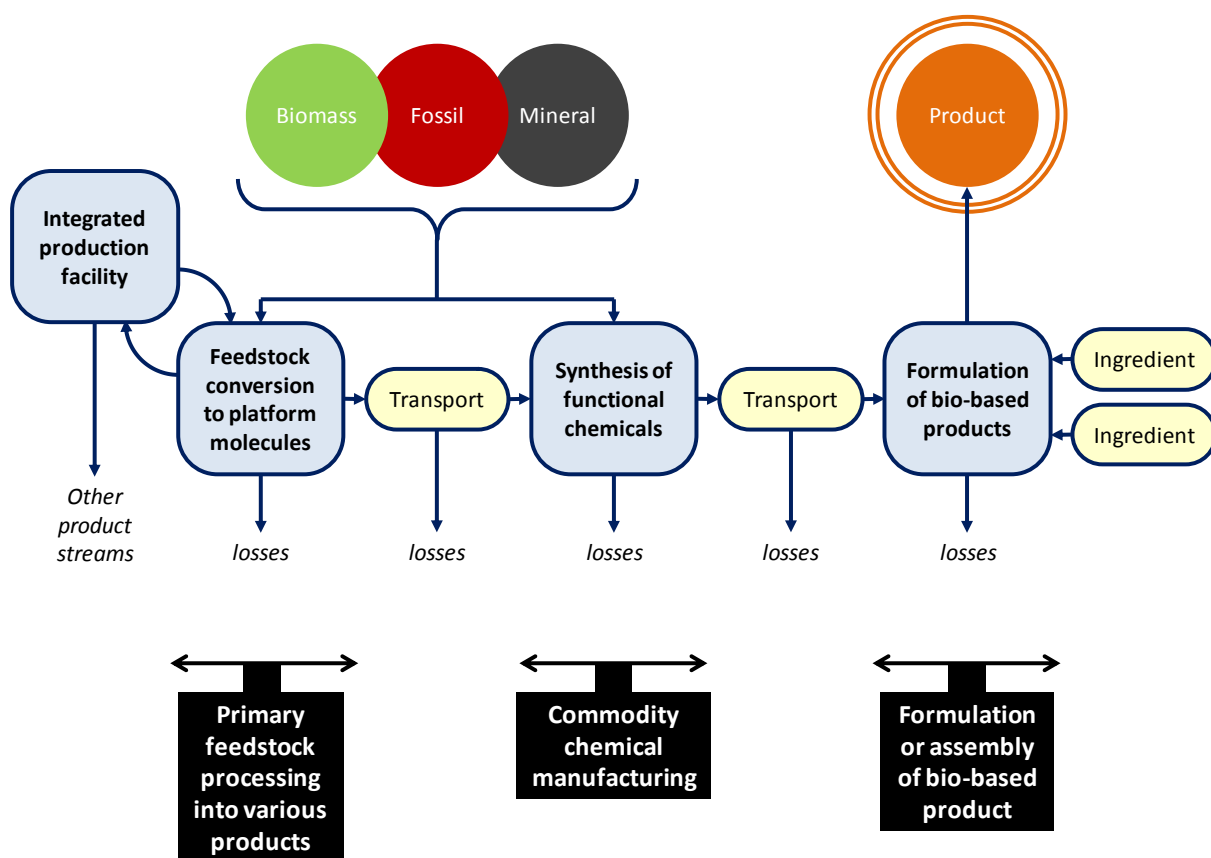


Figure 6-2 A schematic describing the production chain for a bio-based product.



The feedstocks of the production chain are required to produce intermediate platform molecules (carbon monoxide, ethylene, hydrogen, *etc.*). These compounds and the feedstocks may be involved in a number of subsequent product streams within an integrated production facility. The proportion of each feedstock directly relevant to the synthesis of the nominated bio-based product must be deduced by calculation. Additional feedstock is usually required to transform the platform molecules into the components of the final article (plastic monomers for example). Finally a combination of ingredients is required to formulate the final article. Some of these ingredients will be sourced from outside the boundary of the mass balance. Furthermore, transportation or storage of intermediates may be required within the production chain. Losses may occur at any point of the production chain. These can be inevitable stoichiometric losses, such as the water liberated as the by-product of an esterification reaction. Losses may occur due to evaporation of volatile components or leaks during transport. These types of losses are not measured outputs of the production facility but the mass balance demands that the outputs of the production chain equal the feedstock input.

When simultaneous production of fossil and bio-based products is occurring (the same product but different sources), and physical separation of these production pathways is not possible, a virtual separation can be employed (Figure 6-3). This is based on the final quantities of the fossil and biomass derived product, accounting for the stoichiometry of reactions, losses and selectivity.



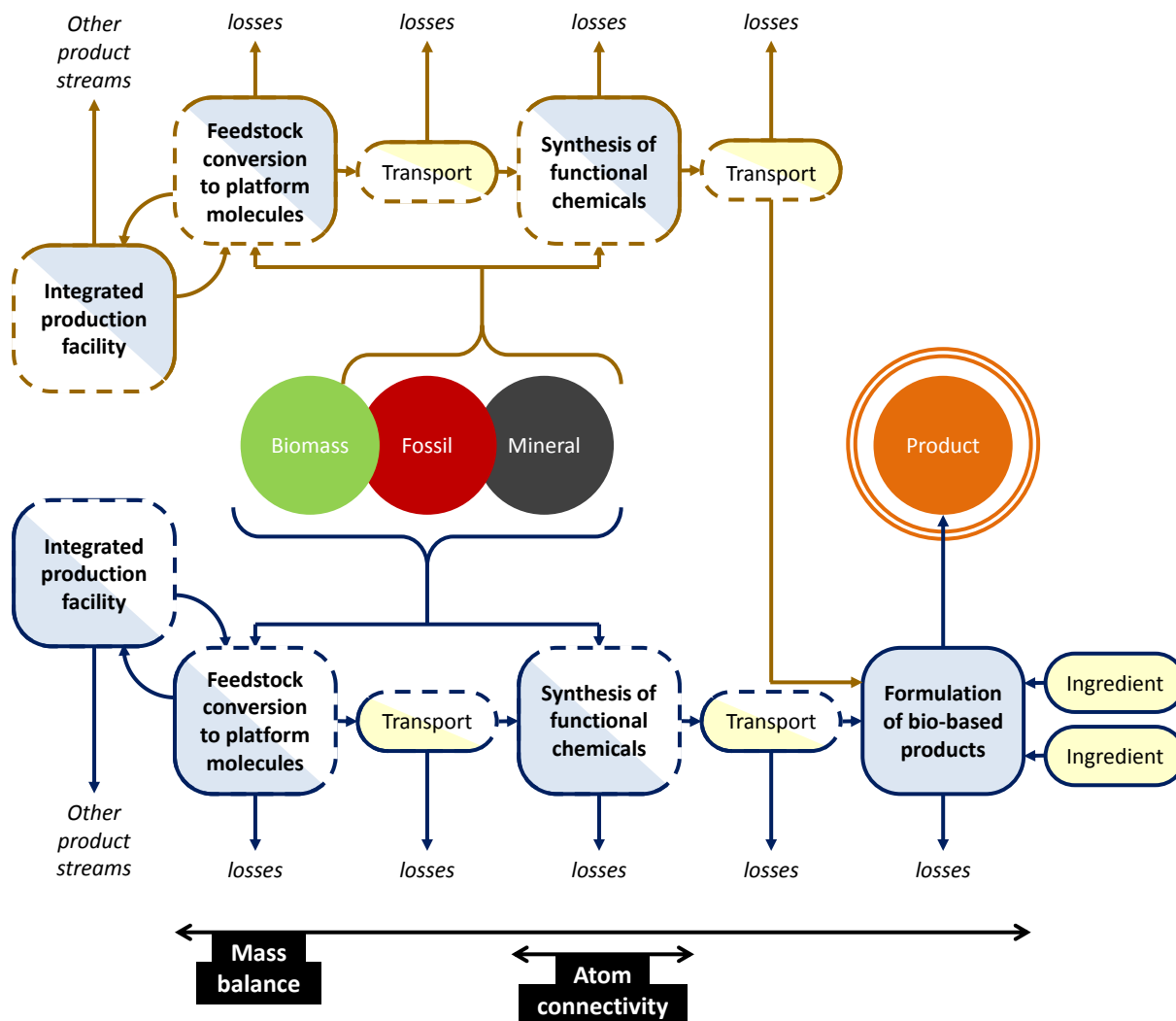


Figure 6-3 A schematic describing the production chain for a bio-based product divided into a virtual biomass processing mass balance (blue) and a virtual fossil sub-mass balance (brown).

The most reliable way of assigning a value of total bio-based content to a bio-based product is to first trace the carbon from feedstock to finished article, recording the flow of total carbon and bio-based carbon. Virtual separation of the mass balance is possible when the final article is a mixture of fossil derived and bio-based chemicals. Partially bio-based intermediates and products are not subject to virtual separation, and are included in the biomass processing sub-mass balance (Figure 6-3). Regardless of whether the biomass feedstock fluctuates (causing the proportion of bio-based material to change periodically within the final article) only the total feedstock use over the pre-defined time interval is required in order to calculate an average bio-based content. When a fluctuation in biomass feedstock causes the bio-based content of the product to change, *e.g.* ethyl acetate made from a mixture of petrochemical ethanol (0% bio-based carbon) and bio-ethanol (50% bio-based carbon) sub-mass



balances describing the production of the ethyl acetate must be virtually separated. A general example is given in Figure 6-4.

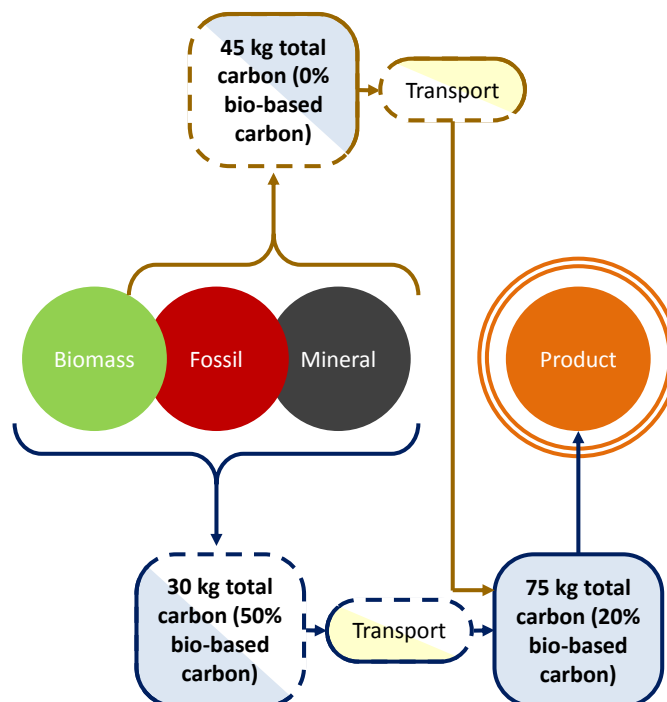


Figure 6-4 An example of virtual separation in a carbon mass balance.

The quantity of bio-based carbon in the final article that is produced over the course of the pre-defined time interval is reported as the average percentage of the total carbon content. The amount of bio-based carbon in the feedstocks is arrived at after dividing all feedstocks into biomass, fossil resources, and mineral resources. Biomass feedstocks shall include (but are not limited to) whole biomass crops and fermentation products (e.g. bio-ethanol). Validation of the identity of biomass feedstocks may need to be provided using radiocarbon analysis. Fossil feedstocks include naphtha, synthetic ethylene, benzene, etc. Mineral feedstocks include water, oxygen and calcium carbonate. Feedstocks should be classifiable as wholly bio-based, or wholly fossil derived, or wholly mineral derived. Chemical feedstocks that are mixtures of fossil and mineral resources could be used directly in the mass balance because the calculation of bio-based carbon content is unaffected. One example is carbon monoxide, produced from the reaction between methane and water. The carbon content in each feedstock (on a dry mass basis) must be known. The incorporation of the feedstock carbon into the final article is calculated with a mass balance (Table 6-1). If no losses occur then 100% of the carbon content of each feedstock is incorporated into the product. Performing the mass balance as demonstrated in Table 6-1 should assist in the identification of the bio-based atoms within the chemical structure of the bio-based product. The chemical reactivity pathways must be understood to designate how much of each feed-



stock is incorporated into the final article. This is crucial for the subsequent application of atom connectivity

Table 6-1 A demonstration of the calculation required to produce a value of bio-based carbon content.

Feedstock	Mass /kg	Origin	Product incorporation (percentage)	Product incorporation (mass /kg)
A	30	Biomass	50%	15
B1	21.4	Fossil	70%	15
C1	20	Mineral	0%	0
B2	64.3	Fossil	70%	45
C2	20	Mineral	0%	0
Sum	155.7			75
Bio-based carbon content			20%	

Losses may be incurred during transportation and storage (Figure 6-5). The mass change must be recorded. When the loss is uncontrolled (*i.e.* not an anticipated and quantifiable by-product of a reaction) and the intermediate is composed of a single chemical it shall be regarded as a representative mixture of the bio-based and fossil derived components. If during a formulation or assembly process losses are also incurred the chemical identify of the waste stream should be identified to permit calculation of the amount of bio-based carbon contained within the final article. If the composition of a waste stream cannot be measured or calculated the mass balance cannot be completed.



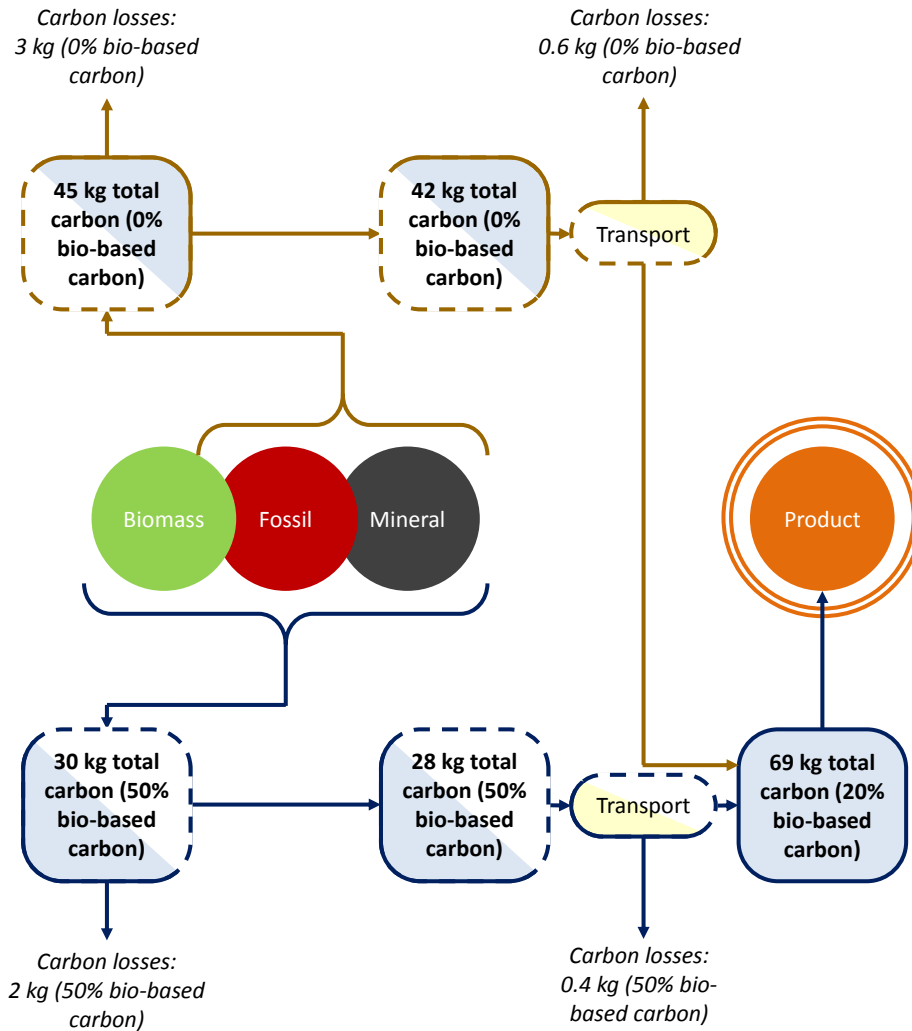


Figure 6-5 An example of virtual separation in a carbon mass balance with proportional losses allocated to each virtual sub-mass balance.

The bio-based carbon content, x_{bc}^{tc} , (expressed as a percentage of the total carbon content), is calculated as follows:

$$x_{bc}^{tc} = \frac{M_{bc,prod}}{M_{tc,prod}} \times 100\%$$

$$M_{bc,prod} = \sum (M_{bc,feed} - M_{bc,losses})$$

$$M_{tc,prod} = \sum (M_{tc,feed} - M_{tc,losses})$$



$M_{bc,prod}$ is the mass of bio-based carbon in the final article.

$M_{tc,prod}$ is the mass of the total carbon in the final article.

$M_{bc,feed}$ is the mass of bio-based carbon in a biomass feedstock.

$M_{tc,feed}$ is the mass of the total carbon in a feedstock.

$M_{bc,losses}$ is the mass of bio-based carbon in a biomass feedstock not incorporated into the final article.

$M_{tc,losses}$ is the mass of the total carbon in a feedstock not incorporated into the final article.

Once the bio-based carbon content of the product is known, atom connectivity can be used to assign it a total bio-based content. The result from the calculation of total bio-based content is completely comparable with those of bio-based products from dedicated facilities ([prEN 16785](#)). The proportion of the final article in the virtual sub-mass balance defining the fossil product stream will be 0% bio-based. The total bio-based content is reported as the average over the pre-defined time interval, allocated equally across all batches of the article. Total bio-based content cannot be attributed to other articles of a different chemical composition. Book-and-claim approaches to transfer the total bio-based content to a petrochemical product of the same chemical composition cannot be used at present.

The approach to atom connectivity adopted here is referred to as atom connectivity Method 2b. In practice it is not possible to validate this methodology because it extends to cover all elements. However as an indirect calculation of total bio-based content analytical validation is not applicable to the scenarios for which mass balance is primarily used. Alternatively the standardised rules of atom connectivity ([prEN 16785](#)), derived from ACDV certification [ACDV 2013], should be used for better consistency across bio-based product standardisation approaches. Atom connectivity is not applied to feedstocks and carried forward through the production chain because when reapplying the rules of atom connectivity after each reaction the assigned origin of atoms can change and the quantity of bio-based material becomes misrepresented, defying the mass balance. Maintaining the atom connectivity assignments of the feedstocks is also problematic because it may not be known exactly how each atom is transferred and distributed during every reaction. Annex A demonstrates the underlying complexity of some routine chemical reactions. This work has shown that ultimately there is no major difference between atom connectivity applied at the beginning of the production chain and the end. The value of total bio-based content is best reported as a per-



centage of the total mass of the product. The claim should be presented as an average allocation of total bio-based content over a pre-defined time interval.



6.2 Applications of calculated total bio-based content

This report has been dedicated to the testing of different indirect calculation methods for the determination of bio-based content on a theoretical basis. A framework for the mass balance approach and recommendations for its use in order to calculate total bio-based content have been proposed. It is important that the results of the mass balance are communicated clearly and are not misleading. It must be compatible with existing standards and declaration tools, as well as those in development. For the purpose of enhancing public and business communication, a reporting template for bio-based products is in development ([CEN/TC 411/WG 5 document WI 00411004](#)). The benefits of how the exact claim regarding the total bio-based content of an article is presented will be discussed briefly in this chapter.

Furthermore it would be hugely valuable if an indirect method of bio-based content could be integrated with, or expanded into, an indirect methodology for the calculation of the renewability of bio-based products (associated with environmental sustainability). A brief link between the outcomes of this report and the forthcoming [Open-Bio deliverable report D3.5](#) concerning indirect renewability assessments for bio-based products has been included here to demonstrate the usefulness of mass balance in this broader context.

6.2.1 Application of (indirect) total bio-based content

There are a number of bio-based product certification schemes already in operation, all using analysis to provide a total organic carbon content to ensure the product is itself organic, and then carbon radioisotope data to derive a bio-based carbon content. The minimum thresholds for these certification schemes do vary slightly, with 20% bio-based carbon content a common cut-off (see Chapter 2.3). The output of an indirect assessment of total bio-based content should be complementary to a statement of analytical bio-based carbon content when both are applicable. The two values should never be contradictory (which will generally be true) or an orthogonal description of bio-based content could be employed to avoid the comparison. The latter was attempted with 'fossil resource savings' (using mass balance Method A). The declaration of 'fossil resource savings' (or 'fossil carbon savings') on the basis of feedstock demand was liable to variation depending on plant efficiency and how the basis of comparison with an alternative petrochemical process was established, thus rendering the value of bio-based carbon content obtained as somewhat subjective and possibly inconsistent with other approaches to bio-based content.

It might be more fitting to develop indirect methods of bio-based content that sit within the concept of functionality, rather than biomass content. An analogy can be drawn from the current trend of using reusable (polypropylene) plastic shopping bags instead of the conven-



tional disposable poly(ethylene) alternative. The products are not equivalent from the perspective that the reusable bag is thicker and larger (meaning a greater mass per unit) and made of a different material. A functionality comparison based on mass is not appropriate, for one bag cannot be compared to one quarter of another. The reusable bag requires almost thirty times the energy to produce as one disposable bag [WSJ 2008], and may be used on more than fifty occasions during the year resulting in a net energy saving benefit. Conversely it must be said that the supposedly reusable bag may only be used once, and therefore represent a detriment to the environment. What must also be considered is that the reusable bag, being larger and able to bear greater loads, may displace two or more conventional disposable bags during each use. Thinking more broadly in terms of other possible case studies, bio-based chemical intermediates may have no preconceived destination product or functionality.

If a bio-based material is used in a product that is meant to replace a different petrochemical product but for the same purpose, the same arguments to that of the reusable shopping bag debate can be used. If 100 kg of a partially bio-based product (say 40% bio-based) is used in an application that would normally require 80 kg of a completely fossil derived product, then in real terms 20 kg of fossil derived feedstock is saved from the manufacturing process. However if the replacement product is only 20% bio-based then no fossil feedstock saving is made. The reuse lifespan of these products must also be considered, for if the partially bio-based product (20% bio-based) functions for 8 months yet the same quantity of the conventional product has a longevity of one year, the demand on fossil derived feedstocks actually increases when using the bio-based product. However if recycling of the bio-based product becomes feasible this extra burden of fossil feedstocks can be negated. It is also important to consider any broader benefits from product substitution, not those just limited to biomass utilisation at the manufacturing stage (*e.g.* biodegradation, toxicity, energy and land use, VOC emissions *etc.*). All these factors will be extremely dependant on the nature and design of the product, and the intended application sector.

It could be possible to virtually ensure a situation never arises in which demand for petrochemical feedstocks increases when using a bio-based product, but this would require the enforcement of a very high minimum total bio-based content. This would leave very little scope for the issues presented above to pose a problem. Conversely this would not be conducive to promoting the bio-based economy and would be contrary to new standards and existing certification schemes which have all established relatively low bio-based (carbon) content thresholds.

Because of the multi-faceted complexity of determining whether the introduction of a bio-based product is indeed of benefit or otherwise, an indirect method of bio-based content determination should not be made solely accountable for providing this information. Total bio-



based content should be reported as the proportion of the article's mass that is formed from biomass. When the bio-based product is a formulation including inorganic ingredients (including water) these should all be excluded from the calculation. If mineral feedstocks are incorporated into organic molecules (*e.g.* sodium laureth sulphate), atom connectivity shall assign any bio-based content appropriately.

Complimentary standards and labelling schemes could, in combination with total bio-based content claims, provide sufficient coverage across the product life cycle to encompass functionality (Figure 6-6). If an indirect total bio-based content assessment covers the use of renewable feedstocks in manufacturing, then (for appropriate product types) EU Ecolabel would offer a means of ensuring a bio-based product is capable of performing as expected in the intended application. This is done at present with verification using relevant standards. EU Ecolabel also covers toxicity, the regulation of hazardous chemical use in manufacturing, atmospheric emissions, and biodegradability (Chapter 2.3.8).



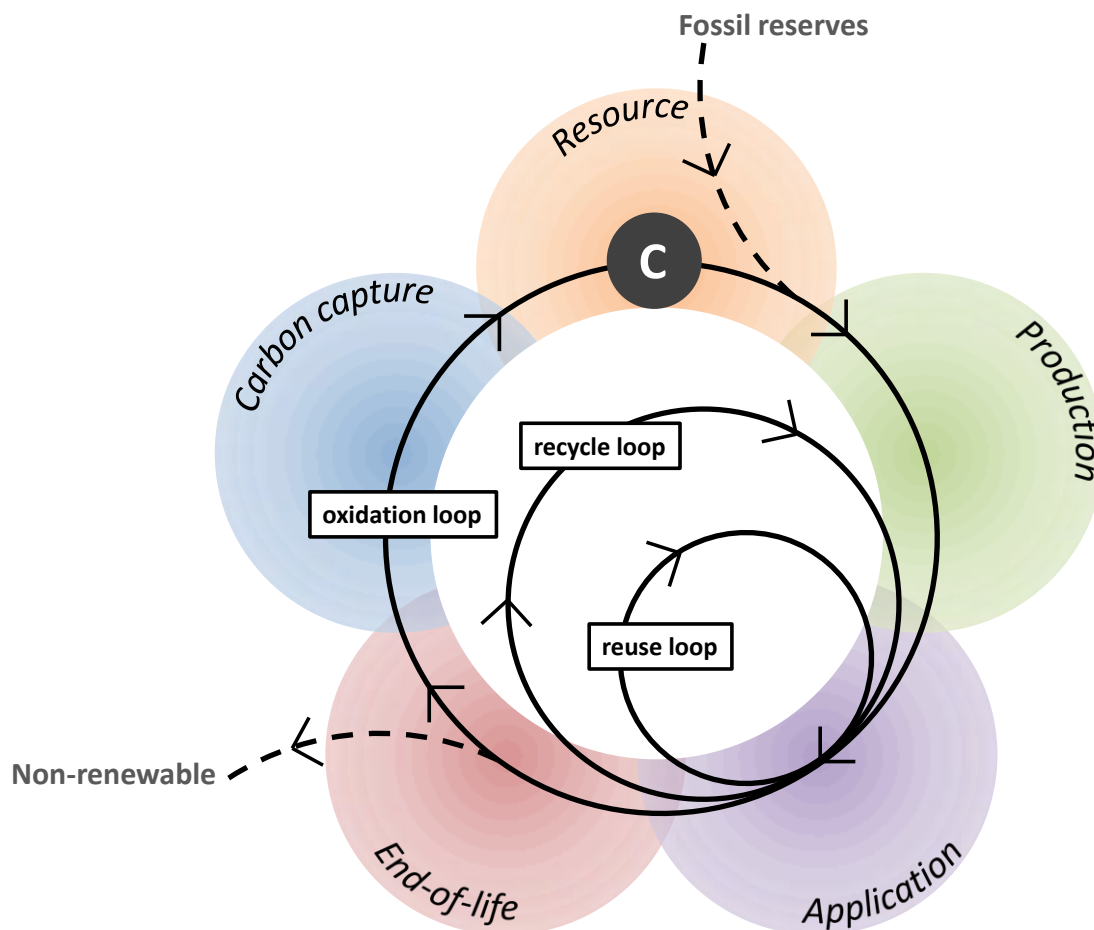


Figure 6-6 An abstract schematic of a life cycle describing a bio-based product but specific to its carbon content. Mass balance for indirect total bio-based content calculations resides within the 'production' segment.

Within the life cycle of a bio-based product, especially in the production chain which has been the focus of this work, other auxiliary substances are required and become associated with the creation of the article. The case study that demonstrates this most graphically is that of vanillin, synthesised from guaiacol using oxidising agents and solvents (Figure 5-39). These auxiliary chemicals, and their by-products, may not actually end up in the final formulation and will likely become waste. This is also a concern for rare metals used as catalysts, many having been identified by the EC as resources at risk [EC 2010]. These considerations have not been addressed here because of the complexity of the issue. If they had been incorporated into calculations of total bio-based products, many articles would have dramatically reduced values of bio-based content. However the amount of solvent used in a process for example is easily varied and not deducible from the composition of the final article. When previously claims of bio-based content were attempted on the basis of material input into the production chain, not the output (*i.e.* the product), with attribution techniques in some cases,



the calculations were inconsistent and not representative of the bio-based product. Advantageous in theory, it is not possible in practice to use mass balance Method A or Method C (as examples) to produce a mass balance and then extend that calculation into a reliable judgement about the renewability of the bio-based product.

6.2.2 Compatibility with future renewability assessments

It should be recognised that bio-based products must be renewable, and not made from unsustainable biomass. This will depend on correctly managed land use, energy sources, and whether any fossil derived auxiliary materials or scarce metals are required in the manufacturing process. These are just some of the many important considerations that lay beyond the scope of this assessment of total bio-based content calculations.

Atoms, as the basis of all chemicals (which are the sum of their atomic parts in this respect) are key to the calculation of bio-based content using atom connectivity methods. Expanding upon this principle, it is possible to follow the lifespan of chemicals on an atomic basis in order to appreciate the renewability of bio-based products. An indirect assessment of total bio-based content should not only be compatible with an indirect method of determining the renewability of a bio-based product, but become one section of a broader methodology covering the entire product life cycle. Definitions for the different aspects of renewability (on an atomic basis) have already been described as part of the Open-Bio project in [Open-Bio deliverable report D3.4](#). When all the atoms in a product adhere to any of these definitions, the definition is then applicable to the molecule and in turn the final article:

Recirculated. Returned to use within a certain timeframe by an anthropogenic process and/or a natural process. Any element that is not returned to use is considered in an ‘uncontrolled’ framework. Recirculated includes the terms renewable, reusable and recyclable.

Renewable. Comes from renewable resources and is returned to use within a certain timeframe by a natural process.

Recyclable. Returned to use within a certain timeframe by an anthropogenic process.

Reusable. Returned to use within a certain timeframe without modification to the parent article or loss of performance.

The pathways of the atoms, whether *renewable* (green route), *recyclable* (blue route), or *reusable* (grey route), are encompassed within the broader definition of *recirculated* when proven to actually occur and not just proposed as feasible on the basis of expected biodeg-



radation character or the presumed recycling infrastructure *etc.* (Figure 6-7). Proof of this sort may have to be achieved using allocation techniques in a similar way to mass balance methods.

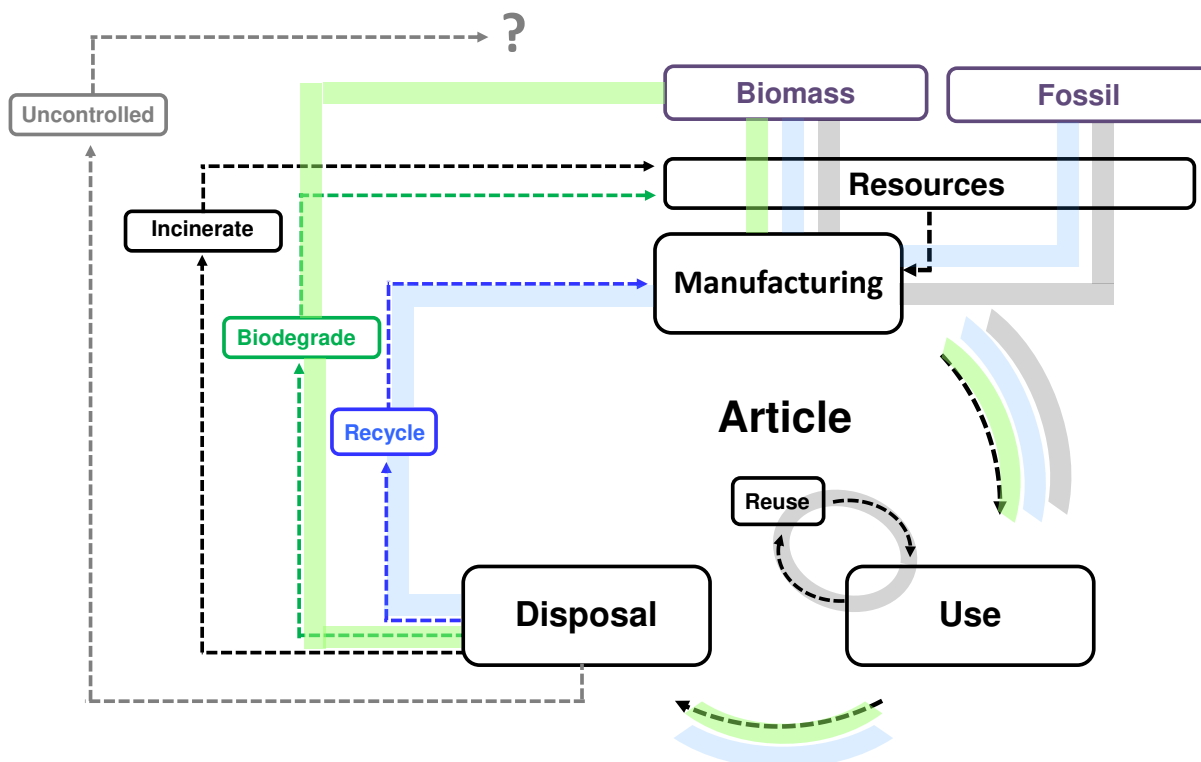


Figure 6-7 Renewability definitions applied pictorially within the context of the life cycle of a bio-based product.

A mass balance describing the conversion of biomass into useful articles is significant in this context, but only a partial representation of bio-based product renewability. An allocation of bio-based content can be calculated by mass balance and/or atom connectivity and extended as the article is used, disposed and renewed into biomass again. Much of the life cycle of bio-based products is not within the controlled environment of the production chain, and so allocation takes on a significant role. Applied to carbon, its association to other elements can be monitored. Photosynthesis regenerates biomass from carbon dioxide and water, and so the focus on carbon is maintained. To track the life cycle events of a bio-based product in a renewability assessment, assistance from standards will be required in order to normalise and validate the approach (Figure 6-8). These include the sustainability of biomass and bio-based products ([NTA 8080](#) and [prEN 16751](#)), minimum bio-based content thresholds and functionality requirements (*e.g.* [CEN/TR 16227](#)). Traceability of biomass and recycled material (*e.g.* [EN 15343](#)), and end of life options for bio-based products ([CEN/TC 411/WG 4 document WI 00411010](#)).



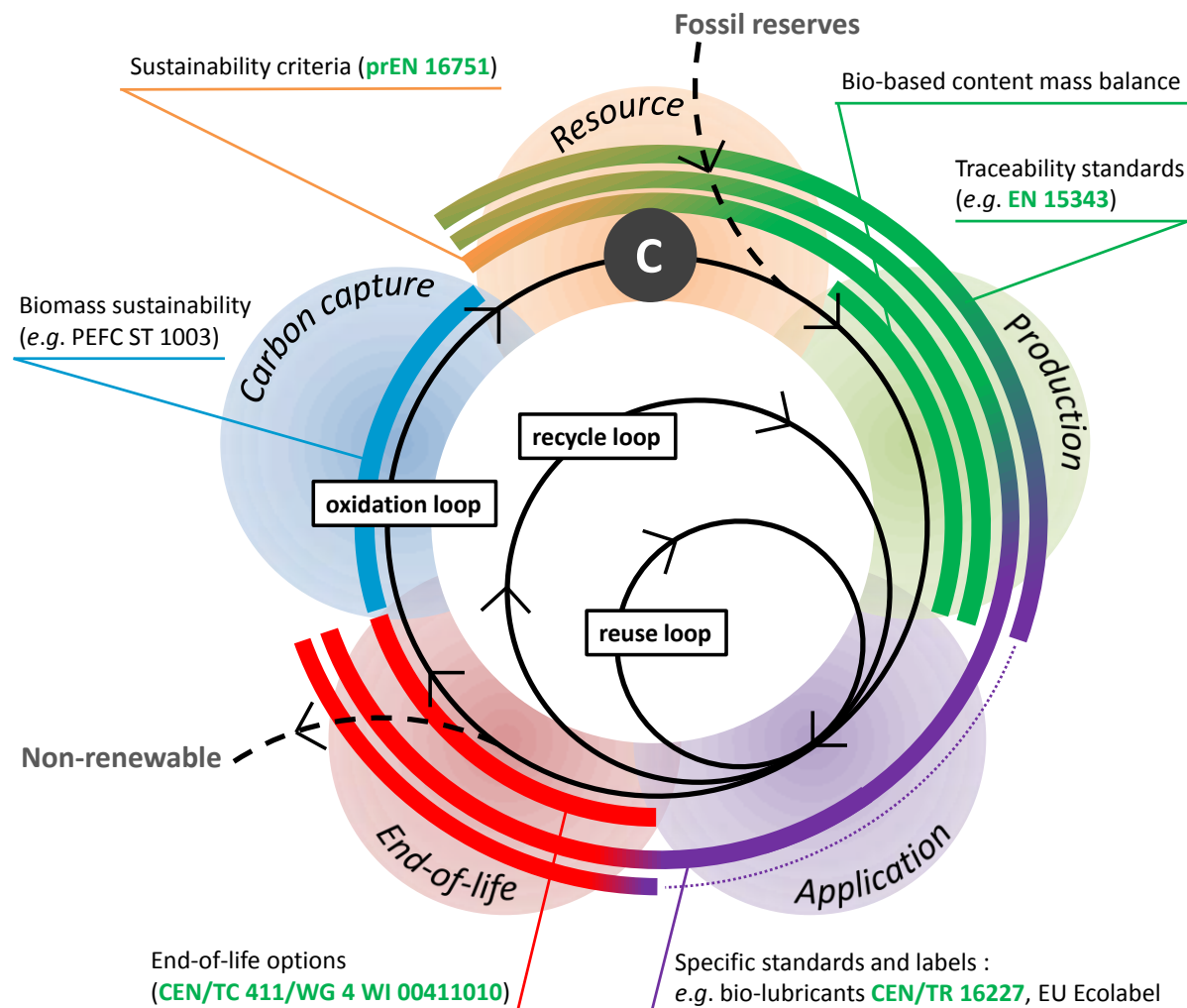


Figure 6-8 A schematic of the life cycle describing a bio-based product specific to its carbon content annotated with complimentary tools and standards and where they apply.

What happens after disposal of an article and linking this to biomass production to complete the cycle and prove the renewability of the bio-based product is where allocation may prove most useful. Sustainable forestry management standards require that “*forest management practices shall safeguard the quantity and quality of the forest resources in the medium and long term by balancing harvesting and growth rates, and by preferring techniques that minimise direct or indirect damage to forest, soil or water resources.*” (**PEFC ST 1003**). If the biomass resource is maintained, and the carbon contained within the bio-based product is liberated through biodegradation, or another resource produced from a managed end-of-life protocol (e.g. anaerobic digestion for bio-gas production) then the carbon balance would indicate that the bio-based product is recirculated. For materials containing recycled content, complementing any bio-based content, additional standards are available to ensure the traceability of this recycled content (**EN 15343**). Hence the mass bal-



ance principle, based on the allocation of (average) total bio-based content, is amenable to the indirect assessment of renewability. The concept will be fully disclosed in **Open-Bio deliverable report D3.5**. The preferred approach to mass balance demonstrated in Chapter 6.1 can likely be extended throughout the life cycle of a bio-based product, retrospectively justifying the decision to derive indirect total bio-based content calculations on a carbon mass balance as its backbone. This is complimented with atom connectivity when appropriate to generate the completed total bio-based content describing the bio-based product.



7 Conclusion

This report has been compiled on behalf of the KBBPPS pre-standardisation project. It is part of an effort to support the development of European standards for bio-based products. The application of standards and certification systems in the European bio-based product industry has positive long-term effects on the overall development of bio-based product markets. The aims of the KBBPPS project (www.bio-based.eu/kbbpps) include the development, harmonisation, and validation of standard test methodologies for the assessment of bio-based products, the demonstration of bio-based carbon content determination and biomass content calculations not solely dependent on radiocarbon analysis, and improving current sample preparation methods, and introducing new fractionation and thermal treatments to enhance bio-based carbon and other bio-based element assessments.

The findings of this report indicate that mass balance combined with atom connectivity can provide the necessary tools to describe total bio-based content. The rules governing how these approaches are applied is very important. The calculation must provide a meaningful result that is horizontally applicable to all types of bio-based product. Mass balance can be implemented in a way that complements direct analysis of bio-based carbon content ([KBBPPS deliverable report D3.2](#) and [KBBPPS deliverable report D3.3](#)) and total bio-based content ([KBBPPS deliverable report D4.4](#)). This is best achieved by applying the mass balance to only the carbon atoms and then generating a calculated result of total bio-based content using atom connectivity. The average, allocated total bio-based content was the most reliable output of the calculation. Other approaches to the calculation of total bio-based content were ruled out because completion of the mass balance could not be guaranteed, or the method of reporting was erroneous or biased.

The subsequent [KBBPPS deliverable report D4.6](#) will further the recommendations of this report concerning indirect total bio-based content, also with analogous judgements on the direct analysis of total bio-based content. With the approach described, the assessment of total bio-based content for bio-based products should be applicable in all circumstances and no longer act as a market barrier.



8 Annex A: Atom connectivity

8.1 Calculated radiocarbon and elemental analysis of chemical products

For reference, the supposed bio-based carbon content (by ^{14}C radioisotope analysis) of the 30 case study chemical products are presented in the following table, as are theoretical CHN elemental analysis data (Table 8-1). This data set is calculated (*i.e.* theoretical values) on the basis of molecular structure, and is not experimental analytical data.

Table 8-1 Bio-based carbon content and elemental analysis data for chemical products of relevance to the ACDV certification scheme.

Category	Name	^{14}C	C	H	N	Rest
<i>Bulk chemicals</i>						
	Acetic acid (<i>syngas</i>)	0%	40%	7%	0%	53%
	Acetic acid (<i>fermentation</i>)	100%				
	Glycerol	100%	39%	9%	0%	52%
	<i>p</i> -Xylene (<i>furan based</i>)	75%	91%	9%	0%	0%
	<i>p</i> -Xylene (<i>fermentation</i>)	100%				
	1,4-Butanediol	100%	53%	11%	0%	36%
	Adipic acid	100%	49%	7%	0%	44%
	2-Ethoxyethyl acetate	33%	55%	9%	0%	36%
	BHT	0%	82%	11%	0%	7%
	ATBC	30%	60%	9%	0%	32%
	Ammonia	n/a	0%	18%	82%	0%
<i>Lubricants</i>						
	Methyl oleate	95%	77%	12%	0%	11%
	Neopentyl glycol distearate	88%	77%	13%	0%	10%
<i>Plastics</i>						
	Polyethylene (<i>petroleum</i>)	0%	86%	14%	0%	0%
	Polyethylene (<i>fermentation</i>)	100%				
	PLA	100%	50%	6%	0%	44%
	PET	20%	63%	4%	0%	33%
	PVAc	50%	56%	7%	0%	37%
	PBAT	36%	63%	7%	9%	30%
	PVAc	50%	56%	7%	0%	37%



Table 8-1 (continued) Bio-based carbon content and elemental analysis data for chemical products of relevance to the ACDV certification scheme.

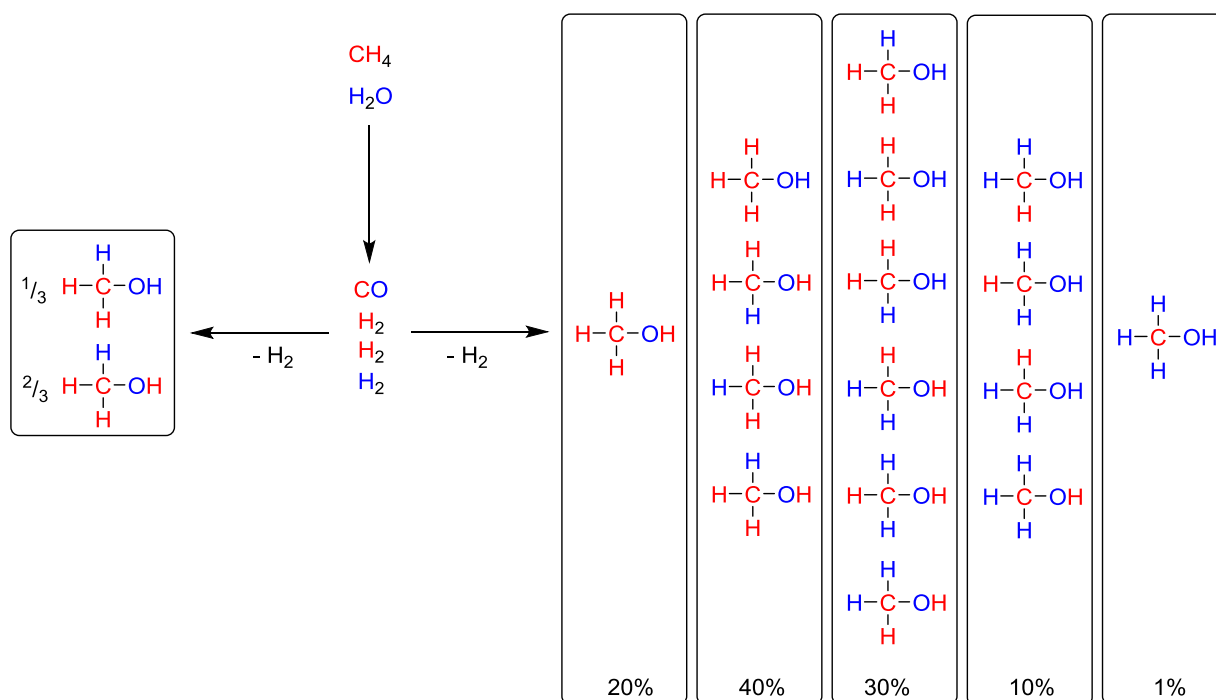
Category	Name	¹⁴ C	C	H	N	Rest
<i>Plastics (continued)</i>						
	PVA	0%	55%	9%	0%	36%
	Polyethyl acrylate (<i>petroleum</i>)	0%				
	Polyethyl acrylate (<i>bio-ethanol</i>)	40%	60%	8%	0%	32%
	Polyethyl acrylate (<i>glycerol</i>)	60%				
	Polyethyl acrylate (<i>fermentation</i>)	100%				
	Polydecyl acrylate (<i>fatty acid</i>)	80%	75%	12%	0%	13%
	Polydecyl acrylate (<i>glycerol</i>)	20%				
	Sodium polyacrylate	100%	38%	3%	0%	58%*
	Polyurethane	53%	68%	8%	4%	20%
<i>Solvents</i>						
	Methanol	0%	37%	13%	0%	50%
	Ethyl acetate	50%	55%	9%	0%	36%
	Ethyl lactate	100%	51%	9%	0%	41%
	Acetone	0%	62%	10%	0%	28%
	2-MeTHF	100%	70%	12%	0%	19%
	NMP	80%	61%	9%	14%	16%
	Dimethyl isosorbide	75%	55%	8%	0%	37%
<i>Surfactants</i>						
	Hydrogen dodecyl sulphate	100%	54%	10%	0%	36%*
	Sodium dodecyl sulphate	100%	50%	9%	0%	41%*
	SLES (short PEG chain)	67%	51%	9%	0%	40%*
	SLES (long PEG chain)	38%	53%	9%	0%	38%*
	Cocamidopropyl betaine	63%	67%	11%	8%	14%
	<i>N</i> -Dodecylpyridinium chloride	71%	72%	11%	5%	12%*
<i>Fine chemicals</i>						
	Aspirin	11%	60%	4%	0%	36%
	Vanillin	88%	63%	5%	0%	32%
	<i>p</i> -Cymenesulphonamide	100%	56%	7%	7%	30%*

*Comprises of contributions beyond oxygen.

The remainder of this annex elaborates on the data presented in *Chapter 4* with full atom assignments according to the different atom connectivity methods of bio-based content. In instances where the production of two products is related they are treated within the same section, otherwise each case study is presented in the order addressed by Table 8-1 above. The origin of the atoms that constitute each chemical product are coloured to represent their source, be it fossil (red), biomass (green), water (blue), the atmospheric gases oxygen and



nitrogen (orange), or mineral (grey). In instances where the positioning of an atom is statistically distributed across two or more possible positions, this is not fully accounted for in this annex. In the case of methanol for example, four hydrogen atoms, one third water derived and the remainder fossil derived, are distributed in the molecule. To be precise, representing the statistical distribution of these hydrogen atoms requires at least five diagrams but a total of 16 can be used, ignoring the equivalence of the three methyl hydrogens (Scheme 8-1, right side reaction pathway). Instead of this exhaustive monitoring of identical atoms from different sources, their origins can be represented by preserving the correct ratio in the smallest number of diagrams (Scheme 8-1, left side reaction pathway). The origin of atoms drawn in black are not specifically represented to save space when this does not have a bearing on the final product.

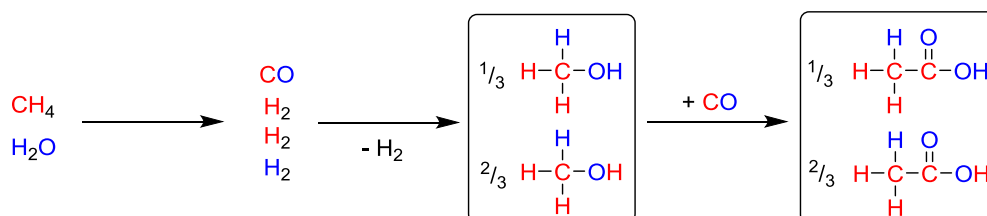


Scheme 8-1 Two methods of displaying the distribution of hydrogen atoms from fossil and water sources in methanol.



8.2 Methanol and acetic acid

The value of syngas lies in the synthesis of methanol and the surplus hydrogen that is created. Acetic acid is produced for industrial applications from the carbonylation of methanol and so for these products the carbon is all fossil based, the oxygen is derived from water, and the hydrogen is a 2:1 molar mixture of fossil and water resources (Scheme 8-2). Hydrogenations are common in industrial organic chemistry and require this hydrogen source. As such the 2:1 mixed origin hydrogen will recur numerous times in the examples contained within this annex.



Scheme 8-2 The synthesis of acetic acid from syngas.

Because the carbon atoms are from natural gas resources, all the other atoms are considered as fossil derived according to atom connectivity methods of indirect bio-based content determination. However the oxygen actually originates in water, as does some of the hydrogen. This inconsistency is shown in Table 8-5, where the so-called bio-based content (actually water-based content or non-petroleum content in this instance) of methanol can be interpreted as 54% of the total mass and 56% for acetic acid (Table 8-10).

Table 8-2 Indirect bio-based content allocation for methanol (Method 1).

Origin	Atom allocation: Method 1						
	C	H	N	O	S	Cl	Na
Fossil	1	4		1			
Plant							
'Bio-based'	0%						



Table 8-3 Indirect bio-based content allocation for methanol (Method 2a).

Origin	Atom allocation: Method 2a						
	C	H	N	O	S	Cl	Na
Fossil	1	4		1			
Plant							
'Bio-based'	0%						

Table 8-4 Indirect bio-based content allocation for methanol (Method 2b).

Origin	Atom allocation: Method 2b						
	C	H	N	O	S	Cl	Na
Fossil	1	4		1			
Plant							
'Bio-based'	0%						

Table 8-5 Indirect bio-based content allocation for methanol (Method 3).

Origin	Atom allocation: Method 3						
	C	H	N	O	S	Cl	Na
Fossil	1	$2\frac{2}{3}$					
Plant							
Water		$\frac{1}{3}$		1			
Air							
Mineral							
'Bio-based'	54%						

Table 8-6 Indirect bio-based content allocation for methanol (ACDV method).

Origin	Atom allocation: ACDV						
	C	H	N	O	S	Cl	Na
Fossil	1	4		1			
Plant							
'Bio-based'	0%						



Table 8-7 Indirect bio-based content allocation for acetic acid from syngas (Method 1).

Origin	Atom allocation: Method 1						
	C	H	N	O	S	Cl	Na
Fossil	2	4		2			
Plant							
'Bio-based'	0%						

Table 8-8 Indirect bio-based content allocation for acetic acid from syngas (Method 2a).

Origin	Atom allocation: Method 2a						
	C	H	N	O	S	Cl	Na
Fossil	2	4		2			
Plant							
'Bio-based'	0%						

Table 8-9 Indirect bio-based content allocation for acetic acid from syngas (Method 2b).

Origin	Atom allocation: Method 2b						
	C	H	N	O	S	Cl	Na
Fossil	2	4		2			
Plant							
'Bio-based'	0%						

Table 8-10 Indirect bio-based content allocation for acetic acid from syngas (Method 3).

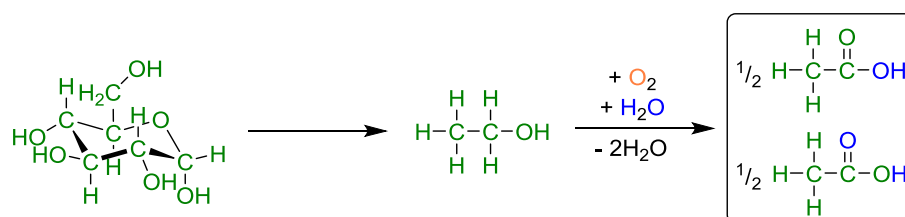
Origin	Atom allocation: Method 3						
	C	H	N	O	S	Cl	Na
Fossil	2	$2\frac{2}{3}$					
Plant							
Water		$\frac{1}{3}$		2			
Air							
Mineral							
'Bio-based'	56%						



Table 8-11 Indirect bio-based content allocation for acetic acid from syngas (ACDV method).

Origin	Atom allocation: ACDV						
	C	H	N	O	S	Cl	Na
Fossil	2	4		2			
Plant							
'Bio-based'	0%						

Food grade acetic acid (*i.e.* vinegar) is made by the bacterial oxidation of bio-ethanol in air (Scheme 8-3). The oxidation mechanism can be simplified to the oxidative dehydrogenation of ethanol to acetaldehyde, followed by addition of water to give an acetal intermediate, which then decomposes to a carboxylic acid in oxidising conditions with another oxidative dehydrogenation. This means that the second oxygen atom introduced into the compound is actually from a water molecule, and not the oxidising air. This does not affect the designation of bio-based content as this oxidation is independent of fossil resources, and atom connectivity is not important because all the carbon atoms are bio-based in origin.

**Scheme 8-3** An alternative synthesis of acetic acid by bio-ethanol oxidation.

This is true of all practical methods of oxidation available for ethanol, and the atom allocation is decided on the basis that water derived elements have been introduced. However, elsewhere in this work fermentation products have been assumed to be entirely bio-based. If this was to be applied here the atom allocation calculations used in Atom Allocation Method 3 would change but the conclusion would remain the same at 100% (Table 8-15).

Table 8-12 Indirect bio-based content allocation for acetic acid produced by fermentation (Method 1).

Origin	Atom allocation: Method 1						
	C	H	N	O	S	Cl	Na
Fossil							
Plant	2	4		2			
'Bio-based'	100%						



Table 8-13 Indirect bio-based content allocation for acetic acid produced by fermentation (Method 2a).

Origin	Atom allocation: Method 2a						
	C	H	N	O	S	Cl	Na
Fossil							
Plant	2	4		2			
'Bio-based'	100%						

Table 8-14 Indirect bio-based content allocation for acetic acid produced by fermentation (Method 2b).

Origin	Atom allocation: Method 2b						
	C	H	N	O	S	Cl	Na
Fossil							
Plant	2	4		2			
'Bio-based'	100%						

Table 8-15 Indirect bio-based content allocation for acetic acid produced by fermentation (Method 3).

Origin	Atom allocation: Method 3						
	C	H	N	O	S	Cl	Na
Fossil							
Plant	2	3		1			
Water		1		1			
Air							
Mineral							
'Bio-based'	100%						

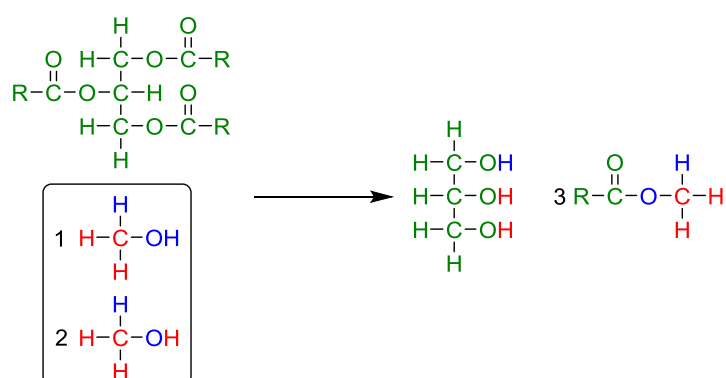
Table 8-16 Indirect bio-based content allocation for acetic acid produced by fermentation (ACDV method).

Origin	Atom allocation: ACDV						
	C	H	N	O	S	Cl	Na
Fossil							
Plant	2	4		2			
'Bio-based'	100%						



8.3 Glycerol and fatty acid methyl esters

Vegetable oils are a valuable, rich source of triglycerides, which can be transesterified to give fatty acid methyl ester (FAME) bio-diesel (Scheme 8-4). The side product of this process is glycerol, which itself is useful commodity compound. The use of methanol made from syngas introduces atoms derived from natural gas and water. This means that biodiesel FAMEs contain one fossil derived carbon atom per molecule.



Scheme 8-4 The synthesis of fatty acid methyl esters (FAMEs) and glycerol from vegetable oil.

The chemical equation in Scheme 8-4 is an ideal description. In reality a variable quantity of sodium hydroxide is used to produce a sodium methoxide reactive intermediate. The sodium hydroxide is a product of brine electrolysis, and so the three hydrogen atoms that are positioned on glycerol in the reaction, through exchange as well as reaction stoichiometry, will be affected by the extra water derived hydrogens made available by the base. In actual fact, the low amount of sodium hydroxide used (~2.5 mol%) means that the statistical 2:1:5 ratio of fossil:water:plant derived hydrogen atoms in each glycerol molecule produced in biodiesel manufacturing is not greatly affected.

Table 8-17 Indirect bio-based content allocation for methyl oleate (Method 1).

Origin	Atom allocation: Method 1						
	C	H	N	O	S	Cl	Na
Fossil	1	3		1			
Plant	18	33		1			
'Bio-based'	90%						



Table 8-18 Indirect bio-based content allocation for methyl oleate (Method 2a).

Origin	Atom allocation: Method 2a						
	C	H	N	O	S	Cl	Na
Fossil	1	3		$\frac{1}{2}$			
Plant	18	33		$1\frac{1}{2}$			
'Bio-based'	92%						

Table 8-19 Indirect bio-based content allocation for methyl oleate (Method 2b).

Origin	Atom allocation: Method 2b						
	C	H	N	O	S	Cl	Na
Fossil	1	3		1			
Plant	18	33		1			
'Bio-based'	90%						

Table 8-20 Indirect bio-based content allocation for methyl oleate (Method 3).

Origin	Atom allocation: Method 3						
	C	H	N	O	S	Cl	Na
Fossil	1	2					
Plant	18	33		1			
Water		1		1			
Air							
Mineral							
'Bio-based'	95%						

Table 8-21 Indirect bio-based content allocation for methyl oleate (ACDV method).

Origin	Atom allocation: ACDV						
	C	H	N	O	S	Cl	Na
Fossil	1	3		1			
Plant	18	33		1			
'Bio-based'	90%						



Table 8-22 Indirect bio-based content allocation for glycerol (Method 1).

Origin	Atom allocation: Method 1						
	C	H	N	O	S	Cl	Na
Fossil		3					
Plant	3	5		3			
'Bio-based'	97%						

Table 8-23 Indirect bio-based content allocation for glycerol (Method 2a).

Origin	Atom allocation: Method 2a						
	C	H	N	O	S	Cl	Na
Fossil							
Plant	3	8		3			
'Bio-based'	100%						

Table 8-24 Indirect bio-based content allocation for glycerol (Method 2b).

Origin	Atom allocation: Method 2b						
	C	H	N	O	S	Cl	Na
Fossil							
Plant	3	8		3			
'Bio-based'	100%						

Table 8-25 Indirect bio-based content allocation for glycerol (Method 3).

Origin	Atom allocation: Method 3						
	C	H	N	O	S	Cl	Na
Fossil		2					
Plant	3	5		3			
Water		1					
Air							
Mineral							
'Bio-based'	98%						



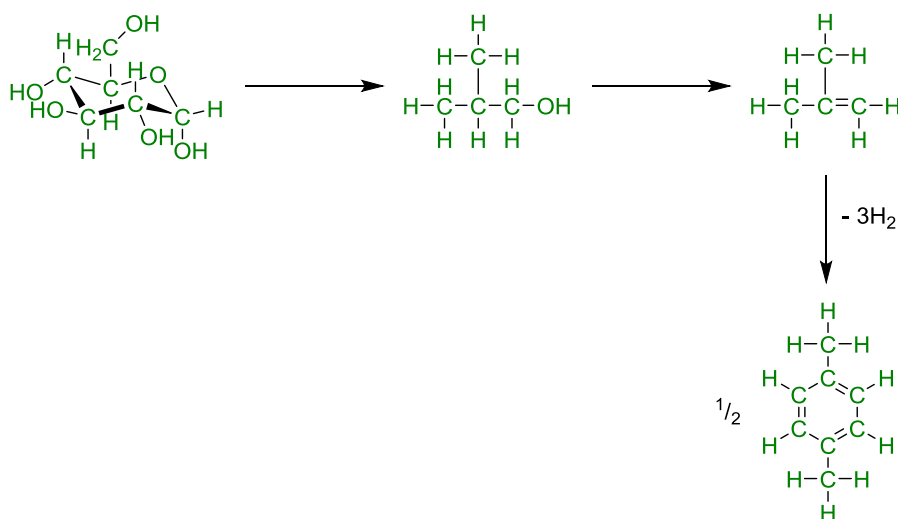
Table 8-26 Indirect bio-based content allocation for glycerol (ACDV method).

Origin	Atom allocation: ACDV						
	C	H	N	O	S	Cl	Na
Fossil							
Plant	3	8		3			
'Bio-based'	100%						



8.4 *p*-Xylene

Bio-based *p*-xylene is a sought-after platform molecule because of its application in PET production. Traditionally distilled from reformed crude oil fractions, several companies are trying different approaches in pursuing a renewable equivalent of this molecule. It is possible to produce liquid aromatics from the catalytic fast pyrolysis of carbohydrate [Karanjkar 2014]. Alternatively sugars can be fermented to isobutanol and dehydrated to isobutene which is used as a precursor to *p*-xylene (Scheme 8-5). The resulting product is completely plant based.



Scheme 8-5 The synthesis of *p*-xylene from isobutanol.

Table 8-27 Indirect bio-based content allocation for *p*-xylene from isobutanol (Method 1).

Origin	Atom allocation: Method 1						
	C	H	N	O	S	Cl	Na
Fossil							
Plant	8	10					
'Bio-based'	100%						



Table 8-28 Indirect bio-based content allocation for *p*-xylene from isobutanol (Method 2a).

Origin	Atom allocation: Method 2a						
	C	H	N	O	S	Cl	Na
Fossil							
Plant	8	10					
'Bio-based'	100%						

Table 8-29 Indirect bio-based content allocation for *p*-xylene from isobutanol (Method 2b).

Origin	Atom allocation: Method 2b						
	C	H	N	O	S	Cl	Na
Fossil							
Plant	8	10					
'Bio-based'	100%						

Table 8-30 Indirect bio-based content allocation for *p*-xylene from isobutanol (Method 3).

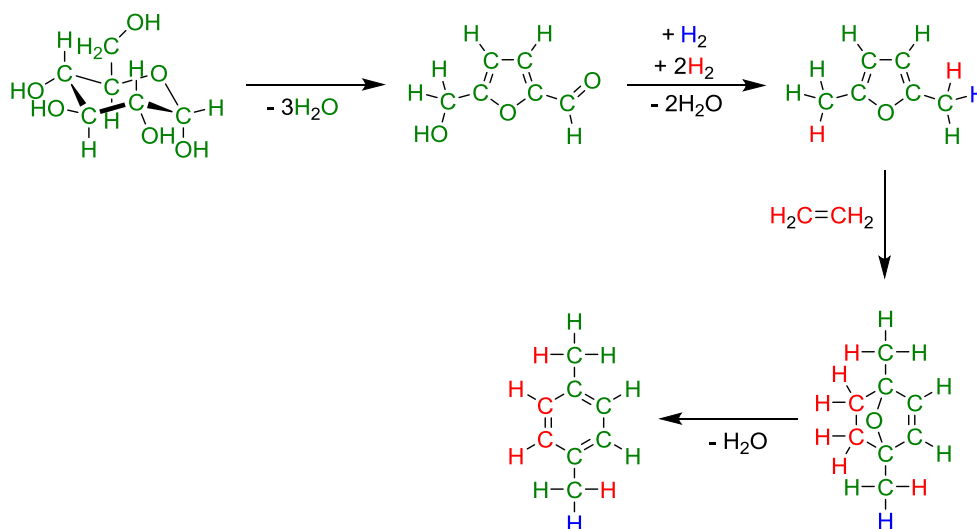
Origin	Atom allocation: Method 3						
	C	H	N	O	S	Cl	Na
Fossil							
Plant	8	10					
Water							
Air							
Mineral							
'Bio-based'	100%						

Table 8-31 Indirect bio-based content allocation for *p*-xylene from isobutanol (ACDV method).

Origin	Atom allocation: ACDV						
	C	H	N	O	S	Cl	Na
Fossil							
Plant	8	10					
'Bio-based'	100%						



Another method of obtaining *p*-xylene is to react ethylene with 2,5-dimethylfuran (Scheme 8-6) [Xiong 2014]. The product is only 75% bio-based with respect to carbon. Hydrogenation of the precursor 5-hydroxymethylfurfural, made by the acid catalysed dehydration of sugar, is another source of non-plant atoms.



Scheme 8-6 The synthesis of *p*-xylene via 2,5-dimethylfuran.

Table 8-32 Indirect bio-based content allocation for *p*-xylene from dimethylfuran (Method 1).

Origin	Atom allocation: Method 1						
	C	H	N	O	S	Cl	Na
Fossil	2	2					
Plant	6	8					
'Bio-based'	76%						

Table 8-33 Indirect bio-based content allocation for *p*-xylene from dimethylfuran (Method 2a).

Origin	Atom allocation: Method 2a						
	C	H	N	O	S	Cl	Na
Fossil	2	2					
Plant	6	8					
'Bio-based'	76%						



Table 8-34 Indirect bio-based content allocation for *p*-xylene from dimethylfuran (Method 2b).

Origin	Atom allocation: Method 2b						
	C	H	N	O	S	Cl	Na
Fossil	2	2					
Plant	6	8					
'Bio-based'	76%						

Table 8-35 Indirect bio-based content allocation for *p*-xylene from dimethylfuran (Method 3).

Origin	Atom allocation: Method 3						
	C	H	N	O	S	Cl	Na
Fossil	2	4					
Plant	6	5					
Water		1					
Air							
Mineral							
'Bio-based'	74%						

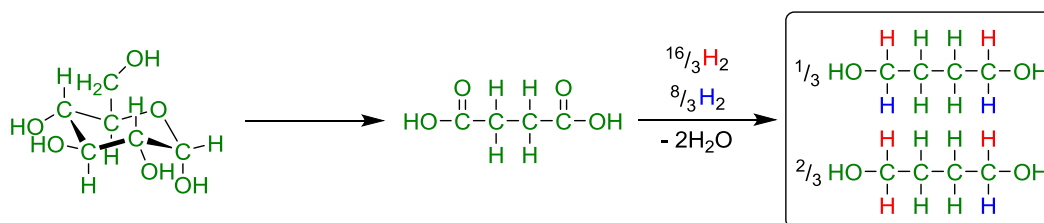
Table 8-36 Indirect bio-based content allocation for *p*-xylene from dimethylfuran (ACDV method).

Origin	Atom allocation: ACDV						
	C	H	N	O	S	Cl	Na
Fossil	2	2					
Plant	6	8					
'Bio-based'	76%						



8.5 1,4-Butanediol

The fermentation product succinic acid can be reduced to give its respective diol, 1,4-butanediol (Scheme 8-7). Because hydrogen is the only other reactant, and this is bound directly to bio-based carbon atoms within 1,4-butanediol after reaction, then atom connectivity methods of indirect bio-based content generally suggest a 100% bio-based products. Atom connectivity Method 1, in which the stated origin of the reactants is used to determine the bio-based content of the final product, calculates a 96% bio-based content based on fossil derived hydrogen gas (Table 8-37). Alternatively a total bio-based content of 97% is calculated when appreciating the water derived content of syngas hydrogen (Table 8-40).



Scheme 8-7 The synthesis of 1,4-butanediol by the hydrogenation of succinic acid.

Table 8-37 Indirect bio-based content allocation for 1,4-butanediol from succinic acid (Method 1).

Origin	Atom allocation: Method 1						
	C	H	N	O	S	Cl	Na
Fossil		4					
Plant	4	6		2			
'Bio-based'	96%						

Table 8-38 Indirect bio-based content allocation for 1,4-butanediol from succinic acid (Method 2a).

Origin	Atom allocation: Method 2a						
	C	H	N	O	S	Cl	Na
Fossil							
Plant	4	10		2			
'Bio-based'	100%						



Table 8-39 Indirect bio-based content allocation for 1,4-butanediol from succinic acid (Method 2b).

Origin	Atom allocation: Method 2b						
	C	H	N	O	S	Cl	Na
Fossil							
Plant	4	10		2			
'Bio-based'	100%						

Table 8-40 Indirect bio-based content allocation for 1,4-butanediol from succinic acid (Method 3).

Origin	Atom allocation: Method 3						
	C	H	N	O	S	Cl	Na
Fossil		$2 \frac{2}{3}$					
Plant	4	6		2			
Water		$1 \frac{1}{3}$					
Air							
Mineral							
'Bio-based'	97%						

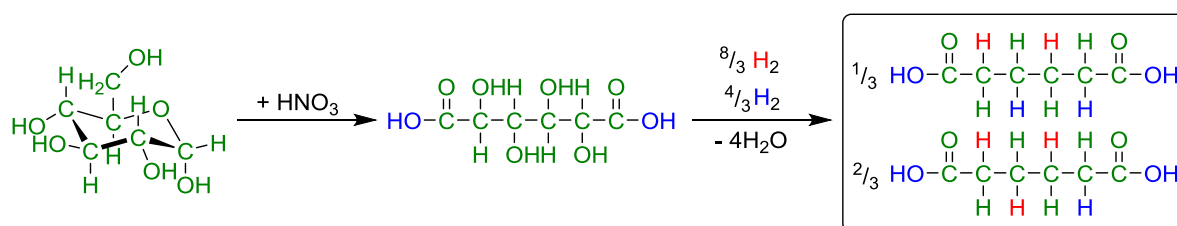
Table 8-41 Indirect bio-based content allocation for 1,4-butanediol from succinic acid (ACDV method).

Origin	Atom allocation: ACDV						
	C	H	N	O	S	Cl	Na
Fossil							
Plant	4	10		2			
'Bio-based'	100%						



8.6 Adipic acid

The oxidation of alcohols and aldehydes by nitric acid does not result in the incorporation of atoms belonging to the nitric acid. Instead its reduction to nitric oxide permits the oxidation, with water attacking an intermediate aldehyde before further elimination of hydrogen [Smith 2007]. This process allows for the chemical synthesis of glucaric acid from glucose, which can then be reduced to adipic acid with hydrogen (Scheme 8-8). As is the case for 1,4-butanediol, hydrogenation means typical atom connectivity methods of indirect bio-based content differ from approaches that extrapolate a value from the origin of the reactants. This is always the case when bio-based functional groups are hydrogenated with traditional petroleum derived syngas hydrogen. Glucaric acid and hydrogen are taken to be the reactants for atom connectivity Method 1.



Scheme 8-8 The synthesis of adipic acid from the oxidation the reduction of glucose.

Table 8-42 Indirect bio-based content allocation for adipic acid synthesised by the oxidation of glucose (Method 1).

Origin	Atom allocation: Method 1						
	C	H	N	O	S	Cl	Na
Fossil		4					
Plant	6	6		4			
'Bio-based'	97%						

Table 8-43 Indirect bio-based content allocation for adipic acid synthesised by the oxidation of glucose (Method 2a).

Origin	Atom allocation: Method 2a						
	C	H	N	O	S	Cl	Na
Fossil							
Plant	6	10		4			
'Bio-based'	100%						



Table 8-44 Indirect bio-based content allocation for adipic acid synthesised by the oxidation of glucose (Method 2b).

Origin	Atom allocation: Method 2b						
	C	H	N	O	S	Cl	Na
Fossil							
Plant	6	10		4			
'Bio-based'	100%						

Table 8-45 Indirect bio-based content allocation for adipic acid synthesised by the oxidation of glucose (Method 3).

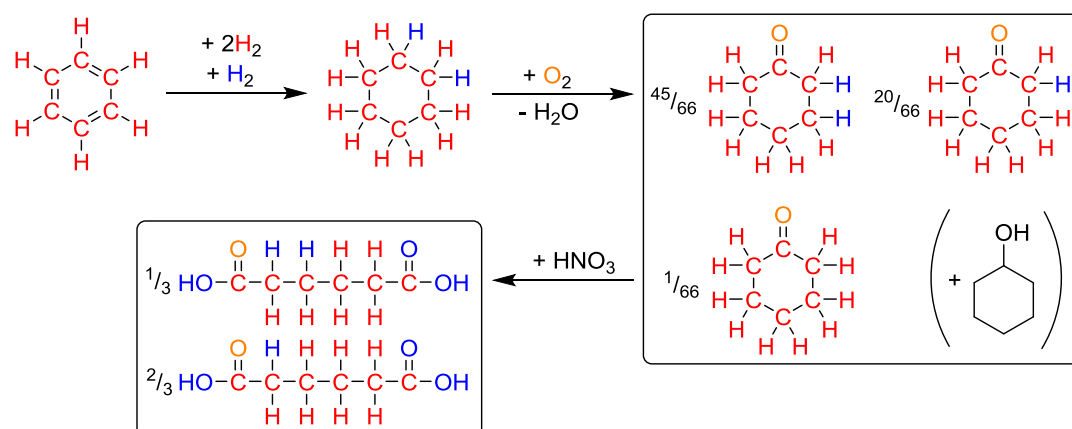
Origin	Atom allocation: Method 3						
	C	H	N	O	S	Cl	Na
Fossil		$2\frac{2}{3}$					
Plant	6	4		2			
Water		$3\frac{1}{3}$		2			
Air							
Mineral							
'Bio-based'	98%						

Table 8-46 Indirect bio-based content allocation for adipic acid synthesised by the oxidation of glucose (ACDV method).

Origin	Atom allocation: ACDV						
	C	H	N	O	S	Cl	Na
Fossil							
Plant	6	10		4			
'Bio-based'	100%						

The traditional method of producing adipic acid was from oxidising animal fat, but that practice has been superseded by a benzene feedstock process, which persists as the main method of adipic acid production globally. Hydrogenation of benzene is followed by oxidation with air, then oxidative carbon-carbon cleavage with nitric acid (Scheme 8-9). Oxygen in acetic acid solution has been used for the second oxidation but product quality is compromised [Weissermel 1993].





Scheme 8-9 Petrochemical feedstock synthesis for adipic acid.

Table 8-47 Indirect bio-based content allocation for adipic acid synthesised from benzene (Method 1).

Origin	Atom allocation: Method 1						
	C	H	N	O	S	Cl	Na
Fossil	6	10		4			
Plant							
'Bio-based'	0%						

Table 8-48 Indirect bio-based content allocation for adipic acid synthesised from benzene (Method 2a).

Origin	Atom allocation: Method 2a						
	C	H	N	O	S	Cl	Na
Fossil	6	10		4			
Plant							
'Bio-based'	0%						

Table 8-49 Indirect bio-based content allocation for adipic acid synthesised from benzene (Method 2b).

Origin	Atom allocation: Method 2b						
	C	H	N	O	S	Cl	Na
Fossil	6	10		4			
Plant							
'Bio-based'	0%						



Table 8-50 Indirect bio-based content allocation for adipic acid synthesised from benzene (Method 3).

Origin	Atom allocation: Method 3						
	C	H	N	O	S	Cl	Na
Fossil	6	6 ² / ₃					
Plant							
Water		3 ¹ / ₃		3			
Air				1			
Mineral							
'Bio-based'	46%						

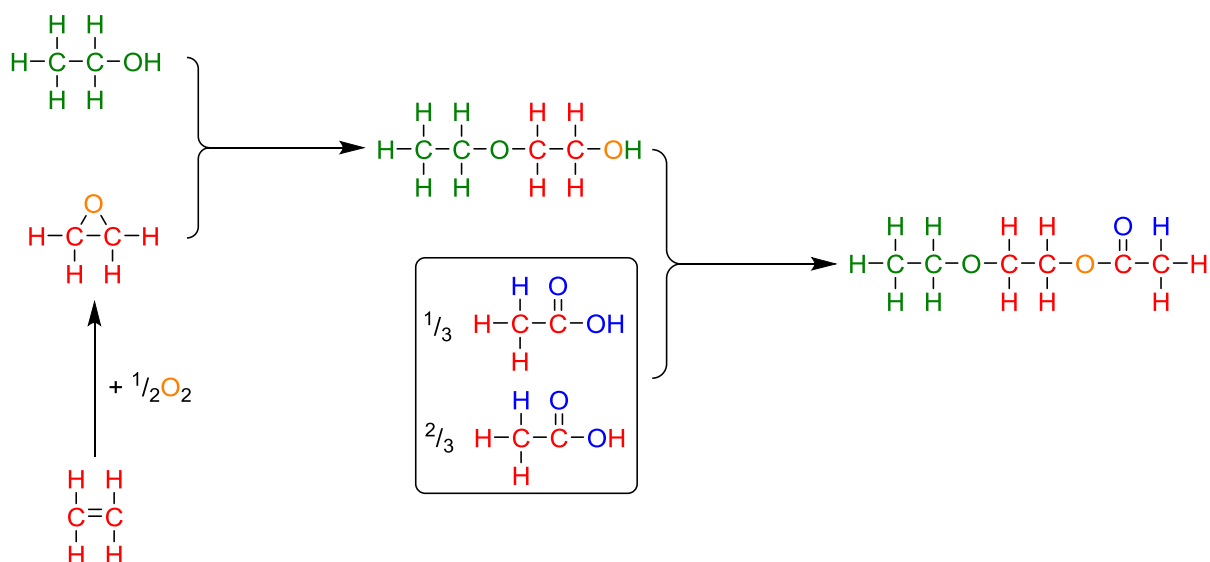
Table 8-51 Indirect bio-based content allocation for adipic acid synthesised from benzene (ACDV method).

Origin	Atom allocation: ACDV						
	C	H	N	O	S	Cl	Na
Fossil	6	10		4			
Plant							
'Bio-based'	0%						



8.7 2-Ethoxyethyl acetate

The synthesis of 2-ethoxyethyl acetate consists of the reaction between ethanol and ethylene oxide (both typically made from ethylene), and the resulting alcohol esterified with acetic acid. Each reactant has 2 carbon atoms, and substituting any of the reactants for its bio-based equivalent would have a similar effect on total bio-based content. Each reactant contributes one oxygen atom to the final product too. Here the impact of using bio-ethanol is examined (Scheme 8-10). The three oxygen atoms come from different resources, but at least two are typically recorded as being fossil derived.



Scheme 8-10 The synthesis of 2-ethoxyethyl acetate using bio-ethanol.

Table 8-52 Indirect bio-based content allocation for 2-ethoxyethyl acetate synthesised from bio-ethanol (Method 1).

Origin	Atom allocation: Method 1						
	C	H	N	O	S	Cl	Na
Fossil	4	7		2			
Plant	2	5		1			
'Bio-based'	34%						



Table 8-53 Indirect bio-based content allocation for 2-ethoxyethyl acetate synthesised from bio-ethanol (Method 2a).

Origin	Atom allocation: Method 2a						
	C	H	N	O	S	Cl	Na
Fossil	4	7		2 ½			
Plant	2	5		½			
'Bio-based'	28%						

Table 8-54 Indirect bio-based content allocation 2-ethoxyethyl acetate synthesised from bio-ethanol (Method 2b).

Origin	Atom allocation: Method 2b						
	C	H	N	O	S	Cl	Na
Fossil	4	7		2			
Plant	2	5		1			
'Bio-based'	34%						

Table 8-55 Indirect bio-based content allocation for 2-ethoxyethyl acetate synthesised from bio-ethanol (Method 3).

Origin	Atom allocation: Method 3						
	C	H	N	O	S	Cl	Na
Fossil	4	6					
Plant	2	5		1			
Water		1		1			
Air				1			
Mineral							
'Bio-based'	59%						



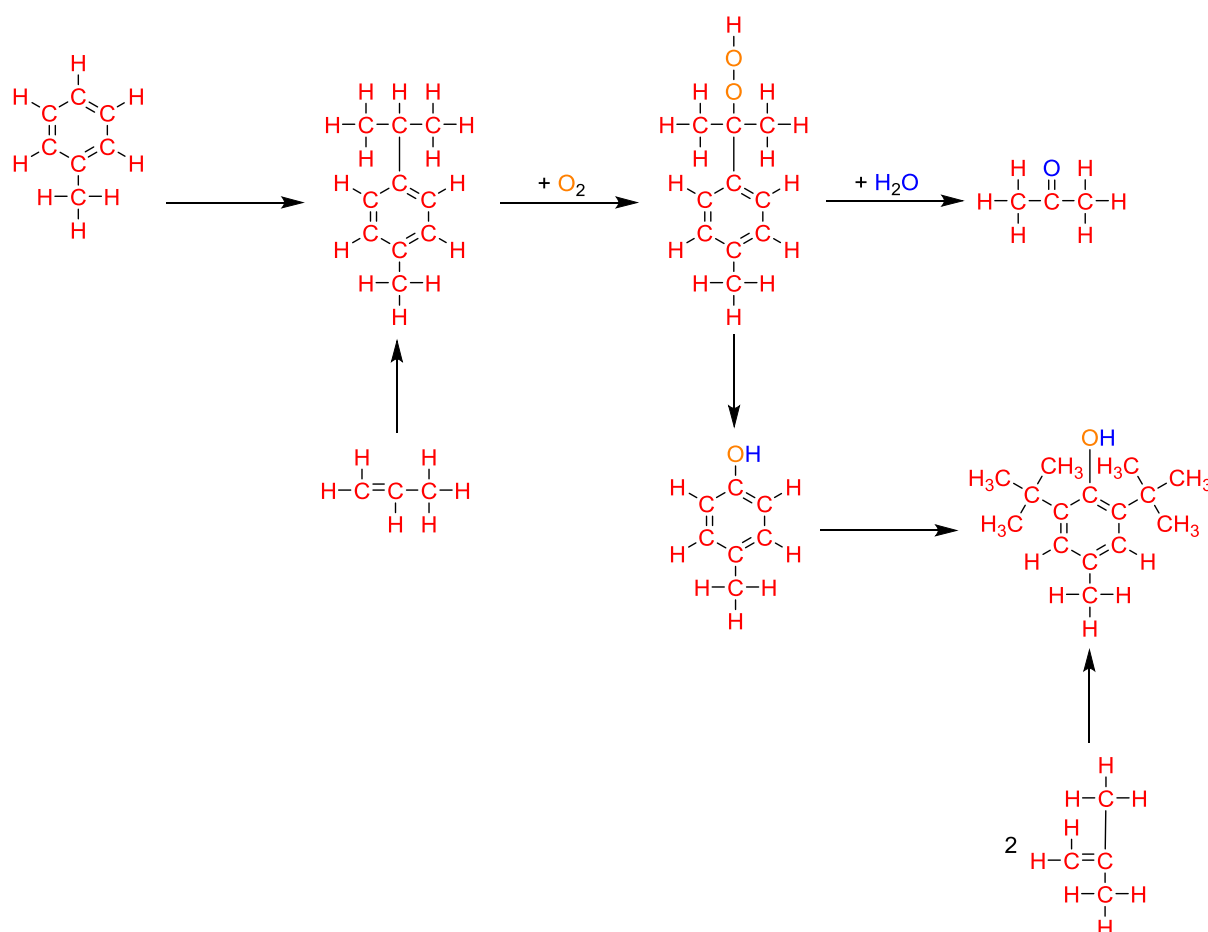
Table 8-56 Indirect bio-based content allocation for 2-ethoxyethyl acetate synthesised from bio-ethanol (ACDV method).

Origin	Atom allocation: ACDV						
	C	H	N	O	S	Cl	Na
Fossil	4	7		2			
Plant	2	5		1			
'Bio-based'	34%						



8.8 Butylated hydroxytoluene and acetone

The cumene process is quite famous as the most prevalent method of obtaining phenol and acetone from benzene and propylene [Weissermel 1993]. The acetone is liberated from the intermediate cumene by peroxidation, then cleavage by water. Substituting benzene for another non-renewable platform molecule, toluene, results in the production of cresol and acetone (*via p-cymene*). Alkylation of the *p*-cresol with isobutene provides the common antioxidant butylated hydroxytoluene (BHT, Scheme 8-11). All the carbon in this molecule is fossil derived and so this product will not attract any interest as a bio-based product, but it is interesting to observe that the acetone co-product contains an oxygen atom sourced from water, and not from molecular oxygen as implied by the oxidative nature of the reaction, which is conducted under air.



Scheme 8-11 The synthesis of butylated hydroxytoluene (BHT) and acetone from toluene.



Table 8-57 Indirect bio-based content allocation for petrochemical butylated hydroxytoluene (Method 1).

Origin	Atom allocation: Method 1						
	C	H	N	O	S	Cl	Na
Fossil	15	24		1			
Plant							
'Bio-based'	0%						

Table 8-58 Indirect bio-based content allocation for petrochemical butylated hydroxytoluene (Method 2a).

Origin	Atom allocation: Method 2a						
	C	H	N	O	S	Cl	Na
Fossil	15	24		1			
Plant							
'Bio-based'	0%						

Table 8-59 Indirect bio-based content allocation for petrochemical butylated hydroxytoluene (Method 2b).

Origin	Atom allocation: Method 2b						
	C	H	N	O	S	Cl	Na
Fossil	15	24		1			
Plant							
'Bio-based'	0%						



Table 8-60 Indirect bio-based content allocation for petrochemical butylated hydroxytoluene (Method 3).

Origin	Atom allocation: Method 3						
	C	H	N	O	S	Cl	Na
Fossil	15	23					
Plant							
Water		1					
Air				1			
Mineral							
'Bio-based'	8%						

Table 8-61 Indirect bio-based content allocation for petrochemical butylated hydroxytoluene (ACDV method).

Origin	Atom allocation: ACDV						
	C	H	N	O	S	Cl	Na
Fossil	15	24		1			
Plant							
'Bio-based'	0%						

Table 8-62 Indirect bio-based content allocation for petrochemical acetone (Method 1).

Origin	Atom allocation: Method 1						
	C	H	N	O	S	Cl	Na
Fossil	3	6		1			
Plant							
'Bio-based'	0%						

Table 8-63 Indirect bio-based content allocation for petrochemical acetone (Method 2a).

Origin	Atom allocation: Method 2a						
	C	H	N	O	S	Cl	Na
Fossil	3	6		1			
Plant							
'Bio-based'	0%						



Table 8-64 Indirect bio-based content allocation for petrochemical acetone (Method 2b).

Origin	Atom allocation: Method 2b						
	C	H	N	O	S	Cl	Na
Fossil	3	6		1			
Plant							
'Bio-based'	0%						

Table 8-65 Indirect bio-based content allocation for petrochemical acetone (Method 3).

Origin	Atom allocation: Method 3						
	C	H	N	O	S	Cl	Na
Fossil	3	6					
Plant							
Water				1			
Air							
Mineral							
'Bio-based'	28%						

Table 8-66 Indirect bio-based content allocation for petrochemical acetone (ACDV method).

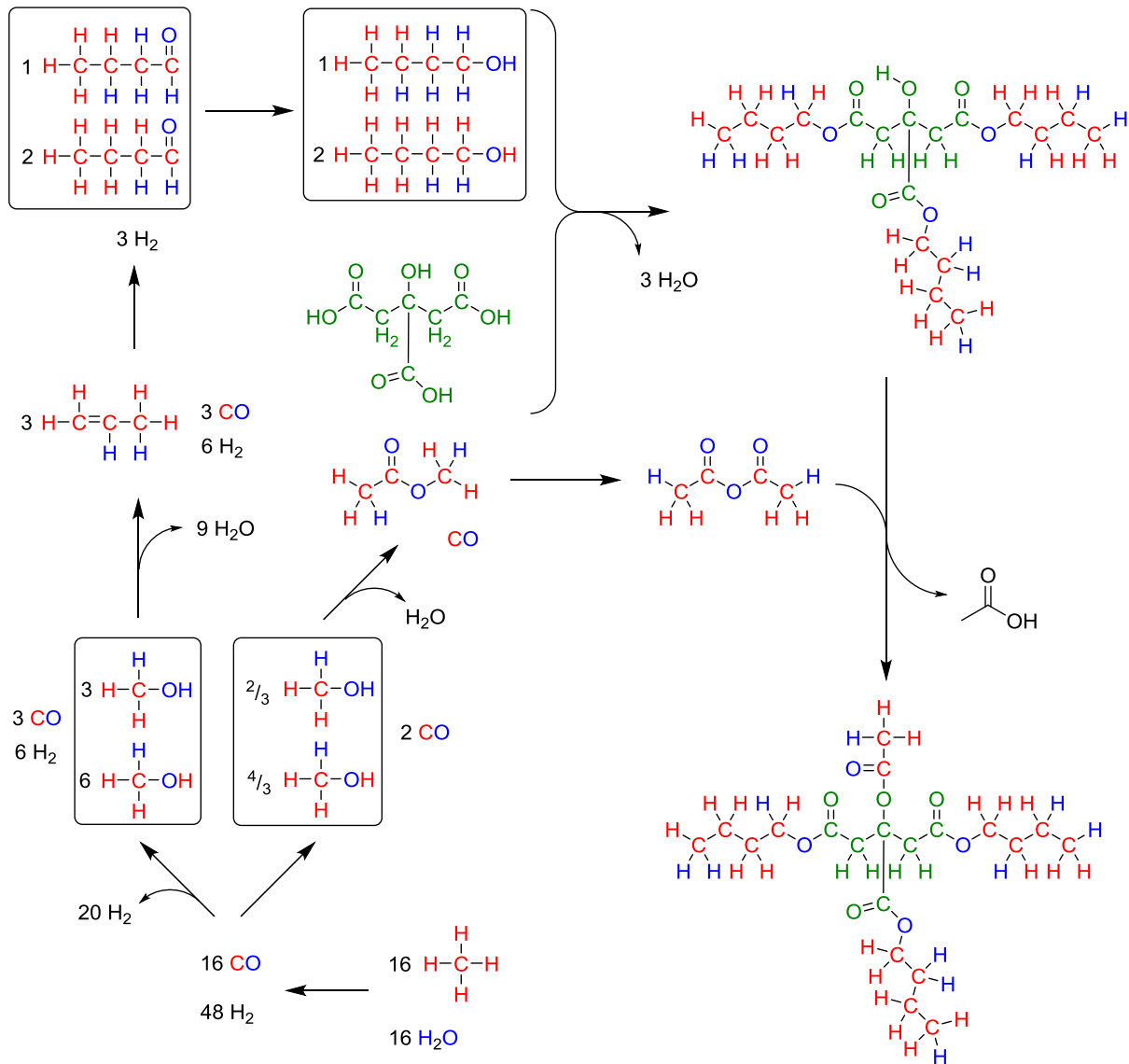
Origin	Atom allocation: ACDV						
	C	H	N	O	S	Cl	Na
Fossil	3	6		1			
Plant							
'Bio-based'	0%						



8.9 Acetyl tributyl citrate

This common plasticiser is synthesised by using esterification chemistry to functionalise citric acid. Although associated with citrus fruits, commercially citric acid is produced specifically by the fermentation of sugars. Thus citric acid is considered as wholly bio-based. Acetyl tributyl citrate is the product of reactions between citric acid, 1-butanol and acetic anhydride. 1-Butanol can now be obtained through fermentation, but the majority share of production is still petrochemical in origin. Acetic anhydride is produced by a series of carbonylations, transforming syngas derived methanol into methyl acetate (a by-product of acetic acid synthesis) and then to acetic anhydride. Both 1-butanol and acetic anhydride are syngas derived and have the usual proportion of fossil and water derived atoms made from this source (Scheme 8-12).





Scheme 8-12 The synthesis of acetyl tributyl citrate (ATBC) from only citric acid and syngas.

Table 8-67 Indirect bio-based content allocation for acetyl tributyl citrate from citric acid and syngas (Method 1).

Origin	Atom allocation: Method 1						
	C	H	N	O	S	Cl	Na
Fossil	20	30		4			
Plant	6	4		4			
'Bio-based'	35%						



Table 8-68 Indirect bio-based content allocation for acetyl tributyl citrate from citric acid and syngas (Method 2a).

Origin	Atom allocation: Method 2a						
	C	H	N	O	S	Cl	Na
Fossil	20	30		3			
Plant	6	4		5			
'Bio-based'	39%						

Table 8-69 Indirect bio-based content allocation for acetyl tributyl citrate from citric acid and syngas (Method 2b).

Origin	Atom allocation: Method 2b						
	C	H	N	O	S	Cl	Na
Fossil	20	30		4			
Plant	6	4		4			
'Bio-based'	35%						

Table 8-70 Indirect bio-based content allocation for acetyl tributyl citrate from citric acid and syngas (Method 3).

Origin	Atom allocation: Method 3						
	C	H	N	O	S	Cl	Na
Fossil	20	20					
Plant	6	4		4			
Water		10		4			
Air							
Mineral							
'Bio-based'	53%						



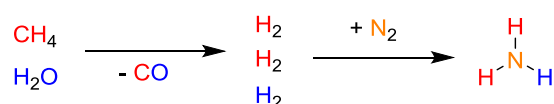
Table 8-71 Indirect bio-based content allocation for acetyl tributyl citrate from citric acid and syngas (ACDV method).

Origin	Atom allocation: ACDV						
	C	H	N	O	S	Cl	Na
Fossil	20	30		4			
Plant	6	4		4			
'Bio-based'	35%						



8.10 Ammonia

Ammonia is not organic, but is the overwhelming majority source of nitrogen for the organic chemical industry. Other viable sources of nitrogen exist; amino acids are the primary alternative. The nitrogen content of crude oil and natural gas is very low, but some petroleum refinery products do contain nitrogen. Pyridine is still obtained from fossil resources, although more complicated analogues are usually synthetic creations requiring ammonia as the nitrogen source. Hydrogen is reacted with nitrogen in the Haber-Bosch process to afford ammonia (Scheme 8-13). Assuming the hydrogen reactant comes from syngas, the familiar 2:1 ratio of fossil to water derived hydrogen is present in ammonia.



Scheme 8-13 The synthesis of ammonia from its constituent elements.

In the absence of carbon, the source of the nitrogen dictates the atom connectivity rules, and accordingly ammonia is treated as derived from air (equivalent to 100% bio-based) in Method 2a and Method 2b. Because it is not plant-based ammonia is regarded as fossil derived in the other atom connectivity methods. The contradiction is a result of the lack of carbon, which is not covered well with the existing rules that focus on organic compounds.

Table 8-72 Indirect bio-based content allocation for ammonia (Method 1).

Origin	Atom allocation: Method 1						
	C	H	N	O	S	Cl	Na
Fossil		3	1				
Plant							
'Bio-based'	0%						

Table 8-73 Indirect bio-based content allocation for ammonia (Method 2a).

Origin	Atom allocation: Method 2a						
	C	H	N	O	S	Cl	Na
Air		3	1				
'Bio-based'	100%						



Table 8-74 Indirect bio-based content allocation for ammonia (Method 2b).

Origin	Atom allocation: Method 2b						
	C	H	N	O	S	Cl	Na
Air		3	1				
'Bio-based'	100%						

Table 8-75 Indirect bio-based content allocation for ammonia (Method 3).

Origin	Atom allocation: Method 3						
	C	H	N	O	S	Cl	Na
Fossil		2					
Plant							
Water		1					
Air			1				
Mineral							
'Bio-based'	88%						

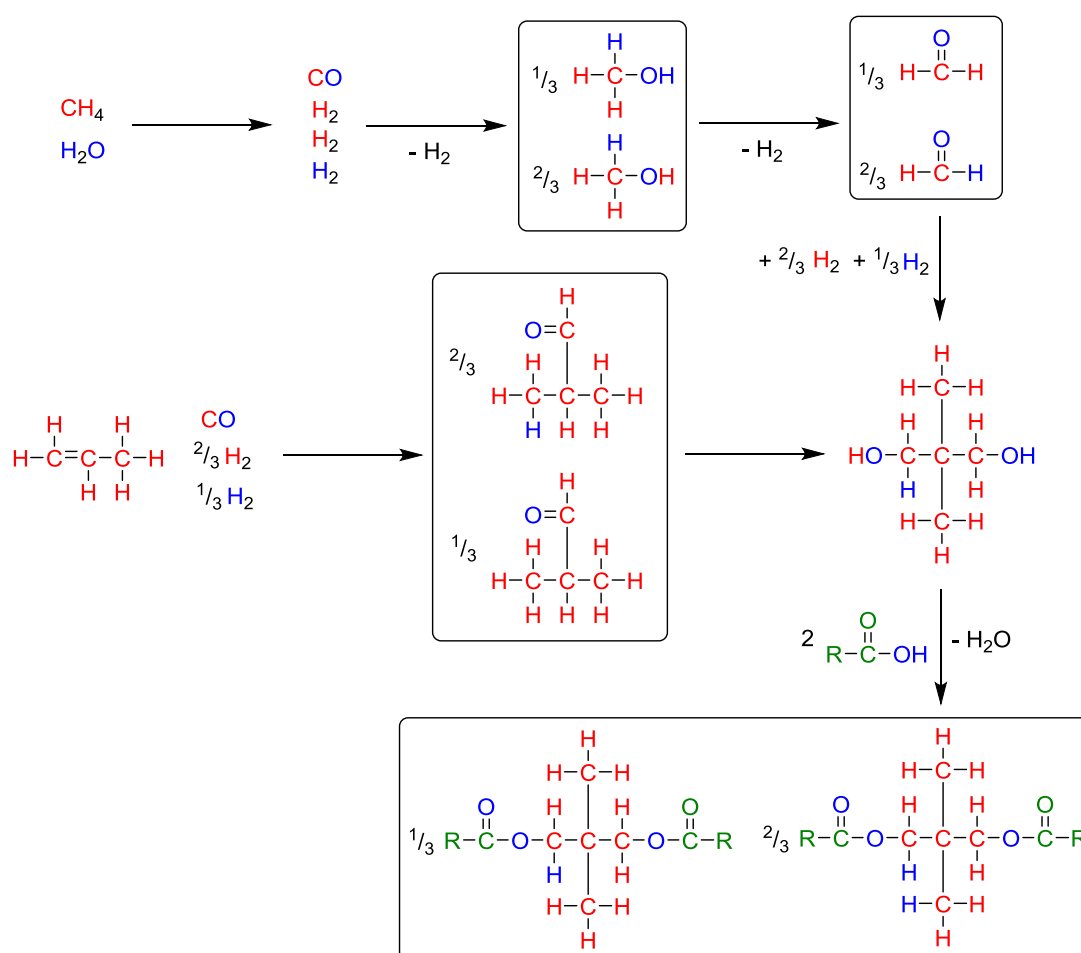
Table 8-76 Indirect bio-based content allocation for ammonia (ACDV method).

Origin	Atom allocation: ACDV						
	C	H	N	O	S	Cl	Na
Fossil		3	1				
Plant							
'Bio-based'	0%						



8.11 Neopentyl glycol distearate

Neopentyl glycol distearate is the diester of a synthetic glycol and bio-based fatty acids. The glycol is formed from hydroformylation and an aldol reaction (Scheme 8-14). The mechanism places a hydrogen atom of a syngas origin as part of one of the hydroxyl groups, but not the other. Thus five hydrogen atoms from a syngas source are present in the final diester. The formation of the fatty acid (triglyceride hydrolysis) results in one plant based oxygen atom and a water derived oxygen atom. These are distributed equally in both positions. The result of this, in terms of the atoms surviving in the final diester, is a 3:1 ratio of water to plant oxygen.



Scheme 8-14 The synthesis of neopentyl glycol distearate from syngas and propene and fatty acids.



Table 8-77 Indirect bio-based content allocation for neopentyl glycol distearate from syngas and propene and fatty acids (Method 1).

Origin	Atom allocation: Method 1						
	C	H	N	O	S	Cl	Na
Fossil	5	10		2			
Plant	36	70		2			
'Bio-based'	84%						

Table 8-78 Indirect bio-based content allocation for neopentyl glycol distearate from syngas and propene and fatty acids (Method 2a).

Origin	Atom allocation: Method 2a						
	C	H	N	O	S	Cl	Na
Fossil	5	10		1			
Plant	36	70		3			
'Bio-based'	87%						

Table 8-79 Indirect bio-based content allocation for neopentyl glycol distearate from syngas and propene and fatty acids (Method 2b).

Origin	Atom allocation: Method 2b						
	C	H	N	O	S	Cl	Na
Fossil	5	10		2			
Plant	36	70		2			
'Bio-based'	84%						



Table 8-80 Indirect bio-based content allocation for neopentyl glycol distearate from syngas and propene and fatty acids (Method 3).

Origin	Atom allocation: Method 3						
	C	H	N	O	S	Cl	Na
Fossil	5	8 ¹ / ₃					
Plant	36	70		1			
Water		1 ² / ₃		3			
Air							
Mineral							
'Bio-based'	89%						

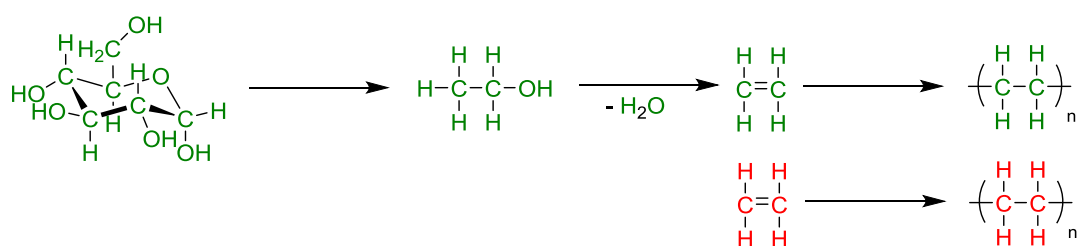
Table 8-81 Indirect bio-based content allocation for neopentyl glycol distearate from syngas and propene and fatty acids (ACDV method).

Origin	Atom allocation: ACDV						
	C	H	N	O	S	Cl	Na
Fossil	5	10		2			
Plant	36	70		2			
'Bio-based'	84%						



8.12 Polyethylene

Bio-ethanol is now being dehydrated to ethylene for polymer applications (Scheme 8-15). No new atoms are introduced and so the product is completely bio-based. By contrast traditionally sourced ethylene is totally fossil derived, produced by the thermal cracking of petroleum.



Scheme 8-15 The synthesis of polyethylene by fermentation or from the cracking of saturated hydrocarbons in fossil resources.

Table 8-82 Indirect bio-based content allocation for polyethylene from petroleum (Method 1).

Origin	Atom allocation: Method 1						
	C	H	N	O	S	Cl	Na
Fossil	2	4					
Plant							
'Bio-based'	0%						

Table 8-83 Indirect bio-based content allocation for polyethylene from petroleum (Method 2a).

Origin	Atom allocation: Method 2a						
	C	H	N	O	S	Cl	Na
Fossil	2	4					
Plant							
'Bio-based'	0%						



Table 8-84 Indirect bio-based content allocation for polyethylene from petroleum (Method 2b).

Origin	Atom allocation: Method 2b						
	C	H	N	O	S	Cl	Na
Fossil	2	4					
Plant							
'Bio-based'	0%						

Table 8-85 Indirect bio-based content allocation for polyethylene from petroleum (Method 3).

Origin	Atom allocation: Method 3						
	C	H	N	O	S	Cl	Na
Fossil	2	4					
Plant							
Water							
Air							
Mineral							
'Bio-based'	0%						

Table 8-86 Indirect bio-based content allocation for polyethylene from petroleum (ACDV method).

Origin	Atom allocation: ACDV						
	C	H	N	O	S	Cl	Na
Fossil	2	4					
Plant							
'Bio-based'	0%						

Table 8-87 Indirect bio-based content allocation for polyethylene from bio-ethanol (Method 1).

Origin	Atom allocation: Method 1						
	C	H	N	O	S	Cl	Na
Fossil							
Plant	2	4					
'Bio-based'	100%						



Table 8-88 Indirect bio-based content allocation for polyethylene from bio-ethanol (Method 2a).

Origin	Atom allocation: Method 2a						
	C	H	N	O	S	Cl	Na
Fossil							
Plant	2	4					
'Bio-based'	100%						

Table 8-89 Indirect bio-based content allocation for polyethylene from bio-ethanol (Method 2b).

Origin	Atom allocation: Method 2b						
	C	H	N	O	S	Cl	Na
Fossil							
Plant	2	4					
'Bio-based'	100%						

Table 8-90 Indirect bio-based content allocation for polyethylene from bio-ethanol (Method 3).

Origin	Atom allocation: Method 3						
	C	H	N	O	S	Cl	Na
Fossil							
Plant	2	4					
Water							
Air							
Mineral							
'Bio-based'	100%						

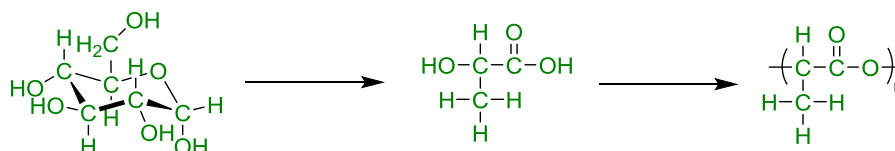
Table 8-91 Indirect bio-based content allocation for polyethylene from bio-ethanol (ACDV method).

Origin	Atom allocation: ACDV						
	C	H	N	O	S	Cl	Na
Fossil							
Plant	2	4					
'Bio-based'	100%						



8.13 Products of lactic acid

Lactic acid is made by fermentation for polylactic acid (PLA). The theoretical glucose consumption is 100%, but in reality about 85% is achieved. Nevertheless all the atoms within PLA are plant-based. The same is not strictly true of lactic acid itself, which is isolated as its calcium salt. The calcium lactate is treated with sulphuric acid (obtained from the reaction between sulphur trioxide and water), and the purified lactic acid dimerised prior to polymerisation (Scheme 8-16). The water derived labile hydrogen atom of lactic acid is lost upon esterification and so has no bearing on the calculations presented below. Similarly the calcium sulphate by-product is unimportant when bio-based content is only being assessed by the atoms contained in the desired product.



Scheme 8-16 The synthesis of polylactic acid by fermentation and polyesterification.

Table 8-92 Indirect bio-based content allocation for polylactic acid (Method 1).

Origin	Atom allocation: Method 1						
	C	H	N	O	S	Cl	Na
Fossil							
Plant	3	4		2			
'Bio-based'	100%						

Table 8-93 Indirect bio-based content allocation for polylactic acid (Method 2a).

Origin	Atom allocation: Method 2a						
	C	H	N	O	S	Cl	Na
Fossil							
Plant	3	4		2			
'Bio-based'	100%						



Table 8-94 Indirect bio-based content allocation for polylactic acid (Method 2b).

Origin	Atom allocation: Method 2b						
	C	H	N	O	S	Cl	Na
Fossil							
Plant	3	4		2			
'Bio-based'	100%						

Table 8-95 Indirect bio-based content allocation for polylactic acid (Method 3).

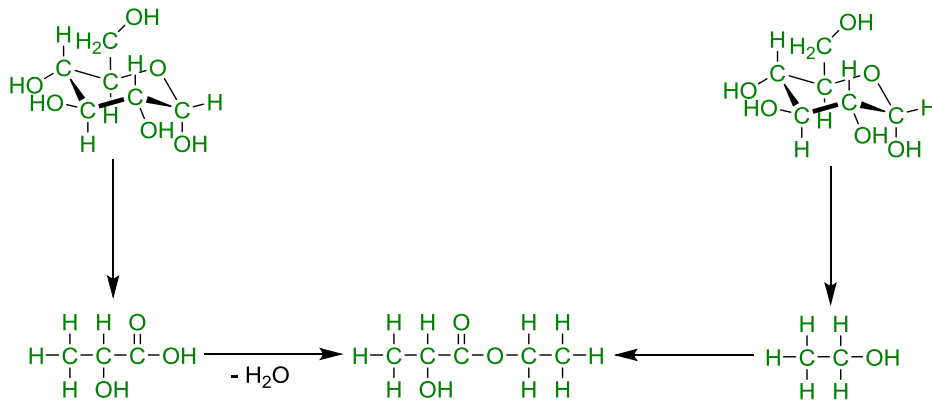
Origin	Atom allocation: Method 3						
	C	H	N	O	S	Cl	Na
Fossil							
Plant	3	4		2			
Water							
Air							
Mineral							
'Bio-based'	100%						

Table 8-96 Indirect bio-based content allocation for polylactic acid (ACDV method).

Origin	Atom allocation: ACDV						
	C	H	N	O	S	Cl	Na
Fossil							
Plant	3	4		2			
'Bio-based'	100%						

Ethyl lactate is produced by esterification of lactic acid and used as a solvent (Scheme 8-17). As both reactants are bio-derived the product is 100% bio-based. All atom connectivity methods are in agreement. All fermentation products are considered to be entirely bio-based, and this must apply to any chemical that results from the reaction between two fermentation products, if only these reactants are involved.





Scheme 8-17 The synthesis of ethyl lactate by fermentation and esterification.

Table 8-97 Indirect bio-based content allocation for ethyl lactate (Method 1).

Origin	Atom allocation: Method 1						
	C	H	N	O	S	Cl	Na
Fossil							
Plant	5	10		3			
'Bio-based'	100%						

Table 8-98 Indirect bio-based content allocation for ethyl lactate (Method 2a).

Origin	Atom allocation: Method 2a						
	C	H	N	O	S	Cl	Na
Fossil							
Plant	5	10		3			
'Bio-based'	100%						

Table 8-99 Indirect bio-based content allocation for ethyl lactate (Method 2b).

Origin	Atom allocation: Method 2b						
	C	H	N	O	S	Cl	Na
Fossil							
Plant	5	10		3			
'Bio-based'	100%						



Table 8-100 Indirect bio-based content allocation for ethyl lactate (Method 3).

Origin	Atom allocation: Method 3						
	C	H	N	O	S	Cl	Na
Fossil							
Plant	5	10		3			
Water							
Air							
Mineral							
'Bio-based'	100%						

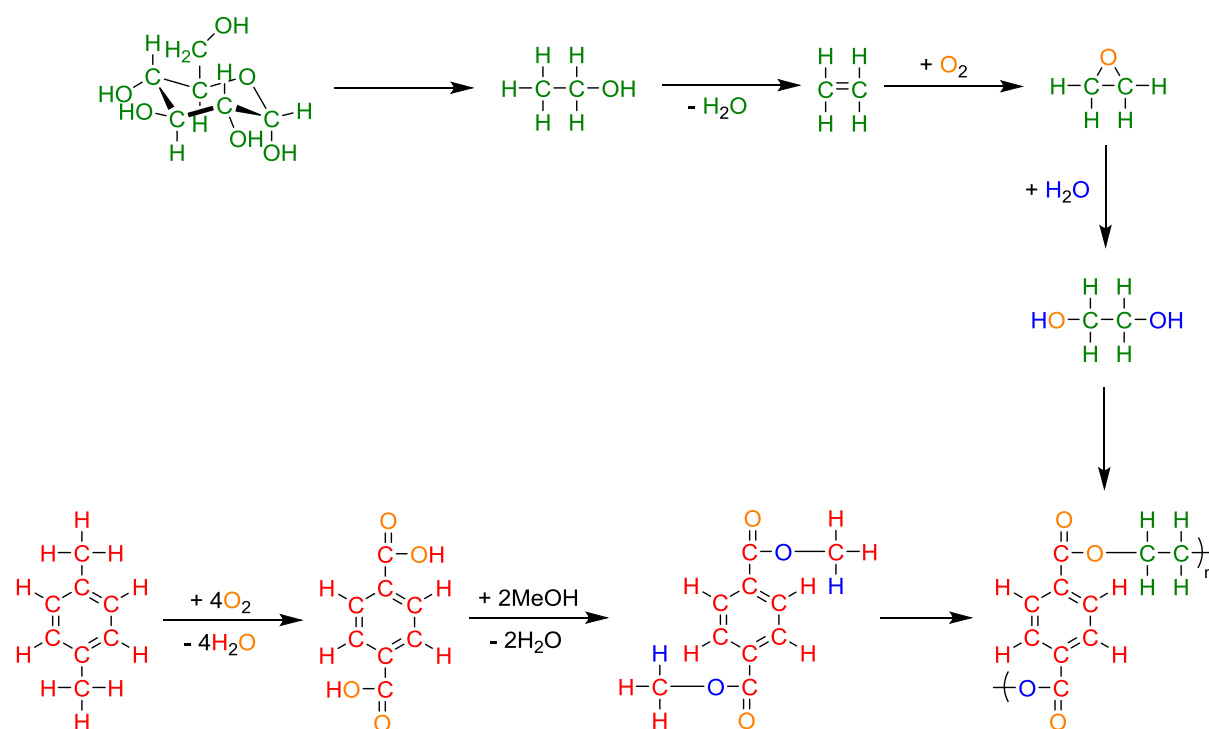
Table 8-101 Indirect bio-based content allocation for ethyl lactate (ACDV method).

Origin	Atom allocation: ACDV						
	C	H	N	O	S	Cl	Na
Fossil							
Plant	5	10		3			
'Bio-based'	100%						



8.14 Terephthalate derived polymers

Polyethylene terephthalate (PET) is presently manufactured as a polymer of fossil derived methyl terephthalate and bio-based ethylene glycol [Coca-Cola 2014]. The *p*-xylene used is oxidised with oxygen, as is the ethylene produced by dehydrating bio-ethanol. An oxygen atom sourced from water is present in the final polymer due to the epoxide opening hydrolysis process (Scheme 8-18). The commercial realisation of this product is accompanied with claims that the product is 30% plant-based material. This claim is understandable by considering the reactants (atom connectivity Method 1, Table 8-102) or the atom connectivity with the bio-based carbon atoms of the ethylene moiety (atom connectivity Method 2b, Table 8-104).



Scheme 8-18 The synthesis of polyethylene terephthalic acid from bio-ethylene and terephthalic acid from fossil based *p*-xylene.



Table 8-102 Indirect bio-based content allocation for polyethylene terephthalic acid from bio-ethylene (Method 1).

Origin	Atom allocation: Method 1						
	C	H	N	O	S	Cl	Na
Fossil	8	4		2			
Plant	2	4		2			
'Bio-based'	31%						

Table 8-103 Indirect bio-based content allocation for polyethylene terephthalic acid from bio-ethylene (Method 2a).

Origin	Atom allocation: Method 2a						
	C	H	N	O	S	Cl	Na
Fossil	8	4		3			
Plant	2	4		1			
'Bio-based'	23%						

Table 8-104 Indirect bio-based content allocation for polyethylene terephthalic acid from bio-ethylene (Method 2b).

Origin	Atom allocation: Method 2b						
	C	H	N	O	S	Cl	Na
Fossil	8	4		2			
Plant	2	4		2			
'Bio-based'	31%						



Table 8-105 Indirect bio-based content allocation for polyethylene terephthalic acid from bio-ethylene (Method 3).

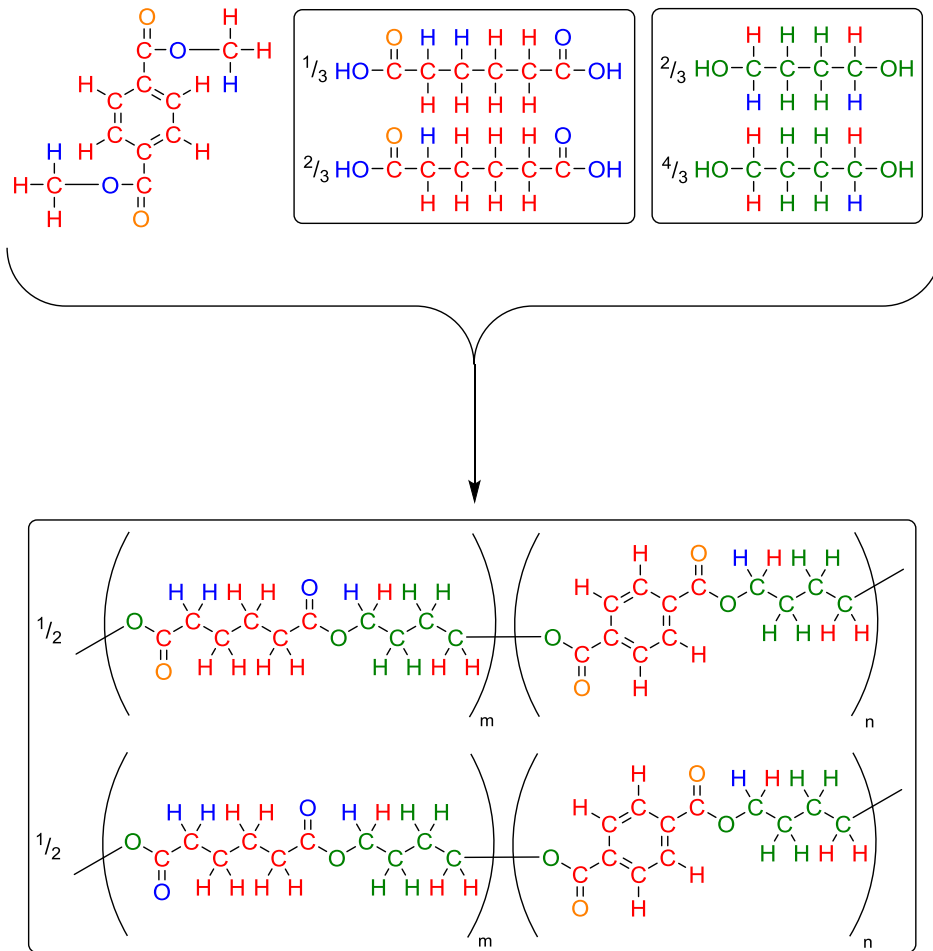
Origin	Atom allocation: Method 3						
	C	H	N	O	S	Cl	Na
Fossil	8	4					
Plant	2	4					
Water				1			
Air				3			
Mineral							
'Bio-based'	48%						

Table 8-106 Indirect bio-based content allocation for polyethylene terephthalic acid from bio-ethylene (ACDV method).

Origin	Atom allocation: ACDV						
	C	H	N	O	S	Cl	Na
Fossil	8	4		2			
Plant	2	4		2			
'Bio-based'	31%						

Terephthalate is also a component in the polymer product *Ecoflex*, that chemical-ly is the co-polymer poly(butylene adipate terephthalate) (the molar diacid monomer ratio is assumed to be 1:1). Its synthesis is based on petrochemical monomers, however develop-ments in the production of bio-based 1,4-butanediol mean it is feasible to produce poly(butylene adipate terephthalate) with the inclusion of some bio-based content (Scheme 8-19). The synthesis of the reactants methyl terephthalate (Scheme 8-18), adipic acid (Scheme 8-9), and 1,4-butanediol (Scheme 8-7), have all been covered previously.





Scheme 8-19 The synthesis of poly(butylene adipate terephthalate) from bio-based 1,4-butanediol and other petrochemical reactants.

Table 8-107 Indirect bio-based content allocation for poly(butylene adipate terephthalate) synthesised from bio-based 1,4-butanediol (Method 1).

Origin	Atom allocation: Method 1						
	C	H	N	O	S	Cl	Na
Fossil	8	12		4			
Plant	14	16		4			
'Bio-based'	42%						



Table 8-108 Indirect bio-based content allocation for poly(butylene adipate terephthalate) synthesised from bio-based 1,4-butanediol (Method 2a).

Origin	Atom allocation: Method 2a						
	C	H	N	O	S	Cl	Na
Fossil	8	12		6			
Plant	14	16		2			
'Bio-based'	34%						

Table 8-109 Indirect bio-based content allocation for poly(butylene adipate terephthalate) synthesised from bio-based 1,4-butanediol (Method 2b).

Origin	Atom allocation: Method 2b						
	C	H	N	O	S	Cl	Na
Fossil	8	12		4			
Plant	14	16		4			
'Bio-based'	42%						

Table 8-110 Indirect bio-based content allocation for poly(butylene adipate terephthalate) synthesised from bio-based 1,4-butanediol (Method 3).

Origin	Atom allocation: Method 3						
	C	H	N	O	S	Cl	Na
Fossil	8	16					
Plant	14	8		4			
Water		4		1.5			
Air				2.5			
Mineral							
'Bio-based'	56%						



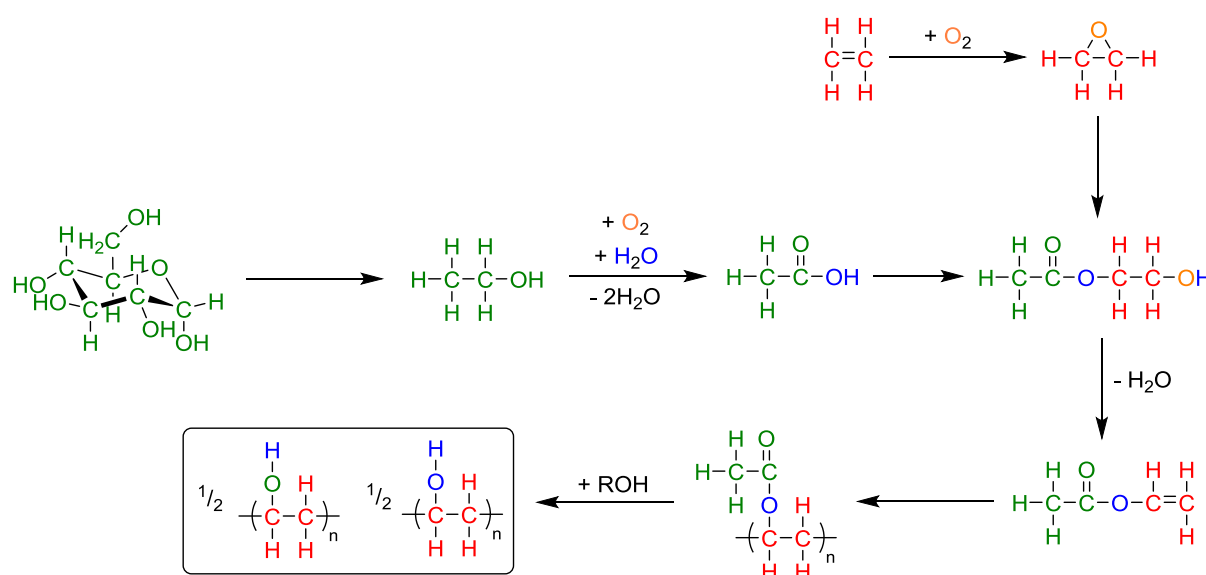
Table 8-111 Indirect bio-based content allocation for poly(butylene adipate terephthalate) synthesised from bio-based 1,4-butanediol (ACDV method).

Origin	Atom allocation: ACDV						
	C	H	N	O	S	Cl	Na
Fossil	8	12		4			
Plant	14	16		4			
'Bio-based'	42%						



8.15 Polyvinyl acetate and polyvinyl alcohol

The synthesis of polyvinyl alcohol is not as straight-forward as polymerising the monomer. The process must be conducted through the ester and then alcoholysis is preferred to hydrolysis. The oxidation of an alcohol, *via* aldehyde and acetal intermediates incorporates a water derived oxygen atom into the resulting carboxylic acid, which may reside at the carbonyl or –OH position because in the intermediate acetal both oxygen atoms are chemically identical. Thus in the final polyvinyl alcohol the oxygen atom is plant based 50% of the time and otherwise water derived (Scheme 8-20). Therefore, contrary to intuition, the oxygen used to oxidised ethanol is not incorporated into acetic acid. Both oxygen atoms present in acetic acid are retained in the intermediate 2-hydroxyethyl acetate, and upon dehydration the oxygen atom previously of the epoxide is lost. The protic hydrogen in PVA is assumed to be water derived, for if ethanol is applied in the alcoholysis, then hydration of ethylene to produce the ethanol would make this so. It is also consistent with the direct hydrolysis of PVAc too, which is convenient in resolving this inconsistency. The oxygen atom in PVA is originally from the acetic acid, and the plant based oxygen atom and the water derived oxygen atom are distributed equally in both positions (carbonyl and hydroxyl).



Scheme 8-20 The synthesis of polyvinyl acetate from the esterification of bio-based acetic acid and alcoholysis to give polyvinyl alcohol.

Atom connectivity bio-based content by Method 1 and Method 2b do not differ for PVAc, as is the case for most chemical products. However this is not the case for PVA. Because all the carbon atoms of PVA are fossil derived there is no means by which to consider any of the other atoms as bio-based by atom connectivity, which is anchored through association with carbon. The addition of non-fossil sourced, non-carbon atoms to ethylene has cre-



ated a discrepancy. It might be decided that because the bio-based carbon content is zero Method 2b is superior to Method 1 as it is agreement with bio-based carbon (as is the ACDV method).

Table 8-112 Indirect bio-based content allocation for polyvinyl acetate made with renewable acetic acid (Method 1).

Origin	Atom allocation: Method 1						
	C	H	N	O	S	Cl	Na
Fossil	2	3					
Plant	2	3		2			
'Bio-based'	69%						

Table 8-113 Indirect bio-based content allocation for polyvinyl acetate made with renewable acetic acid (Method 2a).

Origin	Atom allocation: Method 2a						
	C	H	N	O	S	Cl	Na
Fossil	2	3		$\frac{1}{2}$			
Plant	2	3		$1\frac{1}{2}$			
'Bio-based'	59%						

Table 8-114 Indirect bio-based content allocation for polyvinyl acetate made with renewable acetic acid (Method 2b).

Origin	Atom allocation: Method 2b						
	C	H	N	O	S	Cl	Na
Fossil	2	3					
Plant	2	3		2			
'Bio-based'	69%						



Table 8-115 Indirect bio-based content allocation for polyvinyl acetate made with renewable acetic acid (Method 3).

Origin	Atom allocation: Method 3						
	C	H	N	O	S	Cl	Na
Fossil	2	3					
Plant	2	3		1			
Water				1			
Air							
Mineral							
'Bio-based'	69%						

Table 8-116 Indirect bio-based content allocation for polyvinyl acetate made with renewable acetic acid (ACDV method).

Origin	Atom allocation: ACDV						
	C	H	N	O	S	Cl	Na
Fossil	2	3					
Plant	2	3		2			
'Bio-based'	69%						

Table 8-117 Indirect bio-based content allocation for polyvinyl alcohol (Method 1).

Origin	Atom allocation: Method 1						
	C	H	N	O	S	Cl	Na
Fossil	2	3					
Plant		1		1			
'Bio-based'	39%						

Table 8-118 Indirect bio-based content allocation for polyvinyl alcohol (Method 2a).

Origin	Atom allocation: Method 2a						
	C	H	N	O	S	Cl	Na
Fossil	2	4		1			
Plant							
'Bio-based'	0%						



Table 8-119 Indirect bio-based content allocation for polyvinyl alcohol (Method 2b).

Origin	Atom allocation: Method 2b						
	C	H	N	O	S	Cl	Na
Fossil	2	4		1			
Plant							
'Bio-based'	0%						

Table 8-120 Indirect bio-based content allocation for polyvinyl alcohol (Method 3).

Origin	Atom allocation: Method 3						
	C	H	N	O	S	Cl	Na
Fossil	2	3					
Plant				1/2			
Water		1		1/2			
Air							
Mineral							
'Bio-based'	39%						

Table 8-121 Indirect bio-based content allocation for polyvinyl alcohol (ACDV method).

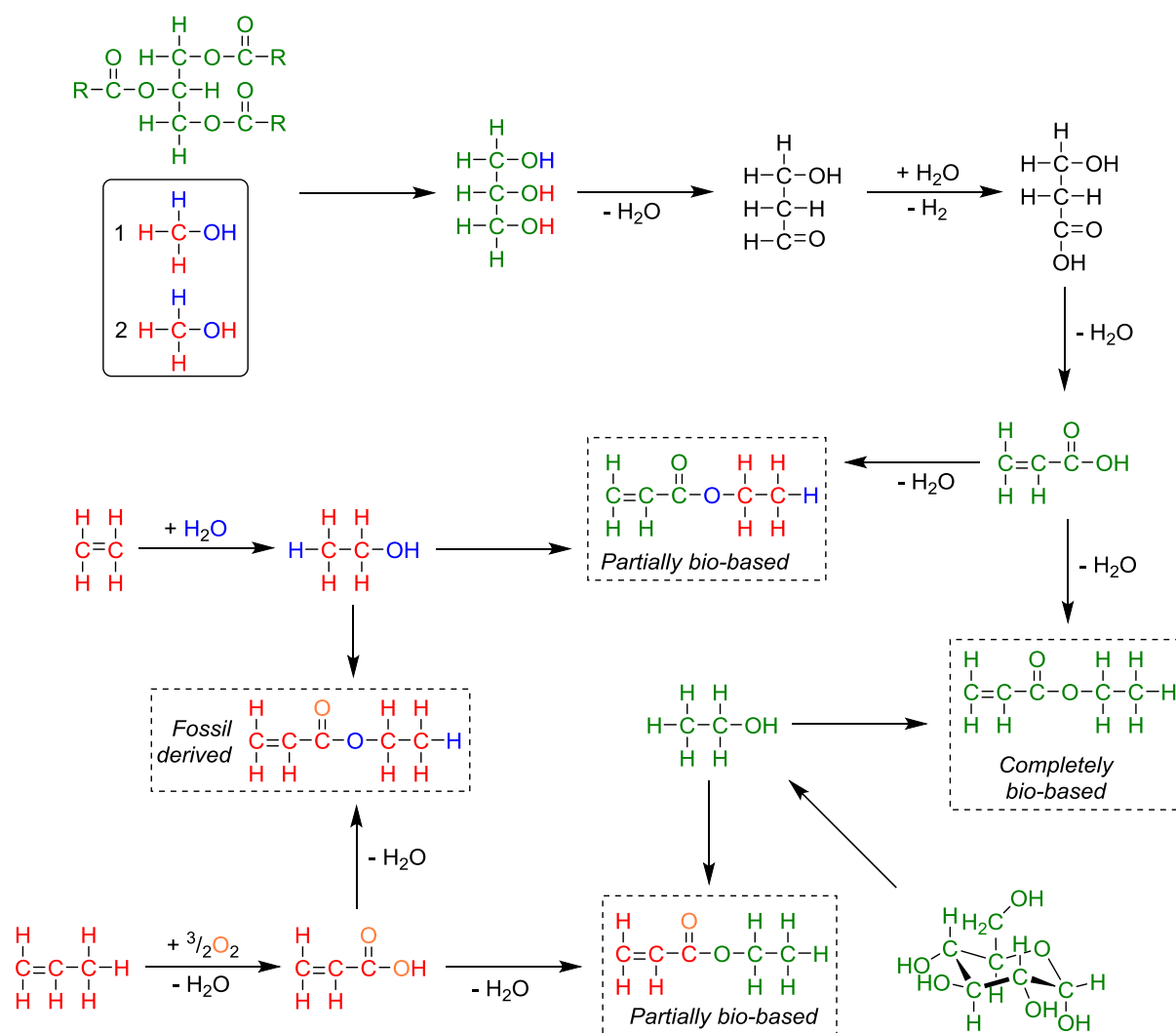
Origin	Atom allocation: ACDV						
	C	H	N	O	S	Cl	Na
Fossil	2	4		1			
Plant							
'Bio-based'	0%						



8.16 Polyacrylate products

Acrylates are abundant polymers but currently produced synthetically from fossil resources. At present there is progress being made in the production of intermediate compounds that could then in turn be used to produce polyacrylates. In the specific instance of polyethyl acrylate, the ethanol used in the esterification with acrylic acid is produced on a large scale from biomass. The prospect of large scale bio-based acrylic acid is still some way off, but the bio-synthesis of 3-hydroxypropanoic acid (3-HPA) from glycerol has been proven [Ashok 2011]. Dehydration to acrylic acid is then feasible. In the diagram below, the four possible combinations of bio-based and fossil derived reactants are presented to give the monomer of polyethyl acrylate (Scheme 8-21). Addition polymerisation of the alkene does not introduce further atoms, or result in the loss of atoms, and so the bio-based content of the monomer is the same as the polymer in this instance.





Scheme 8-21 The possible syntheses of ethyl acrylate from acrylic acid and ethanol (products indicated in dashed boxes).

The chemistry consists of oxidations, hydrations and dehydrations prior to the final esterification but presents few challenges aside from understanding the enzymatic processes. By treating all fermentation products as completely bio-based this difficulty can be circumvented, although an accurate understanding of the true bio-based content, as usually delivered by use of atom connectivity Method 3, is not achieved.



Table 8-122 Indirect bio-based content allocation for fossil derived polyethyl acrylate (Method 1).

Origin	Atom allocation: Method 1						
	C	H	N	O	S	Cl	Na
Fossil	5	8		2			
Plant							
'Bio-based'	0%						

Table 8-123 Indirect bio-based content allocation for fossil derived polyethyl acrylate (Method 2a).

Origin	Atom allocation: Method 2a						
	C	H	N	O	S	Cl	Na
Fossil	5	8		2			
Plant							
'Bio-based'	0%						

Table 8-124 Indirect bio-based content allocation for fossil derived polyethyl acrylate (Method 2b).

Origin	Atom allocation: Method 2b						
	C	H	N	O	S	Cl	Na
Fossil	5	8		2			
Plant							
'Bio-based'	0%						

Table 8-125 Indirect bio-based content allocation for fossil derived polyethyl acrylate (Method 3).

Origin	Atom allocation: Method 3						
	C	H	N	O	S	Cl	Na
Fossil	5	7					
Plant							
Water		1		1			
Air				1			
Mineral							
'Bio-based'	33%						



Table 8-126 Indirect bio-based content allocation for fossil derived polyethyl acrylate (ACDV method).

Origin	Atom allocation: ACDV						
	C	H	N	O	S	Cl	Na
Fossil	5	8		2			
Plant							
'Bio-based'	0%						

Table 8-127 Indirect bio-based content allocation for polyethyl acrylate made with bio-ethanol (Method 1).

Origin	Atom allocation: Method 1						
	C	H	N	O	S	Cl	Na
Fossil	3	3		1			
Plant	2	5		1			
'Bio-based'	45%						

Table 8-128 Indirect bio-based content allocation for polyethyl acrylate made with bio-ethanol (Method 2a).

Origin	Atom allocation: Method 2a						
	C	H	N	O	S	Cl	Na
Fossil	3	3		1 ¹ / ₂			
Plant	2	5		¹ / ₂			
'Bio-based'	37%						

Table 8-129 Indirect bio-based content allocation for polyethyl acrylate made with bio-ethanol (Method 2b).

Origin	Atom allocation: Method 2b						
	C	H	N	O	S	Cl	Na
Fossil	3	3		1			
Plant	2	5		1			
'Bio-based'	45%						



Table 8-130 Indirect bio-based content allocation for polyethyl acrylate made with bio-ethanol (Method 3).

Origin	Atom allocation: Method 3						
	C	H	N	O	S	Cl	Na
Fossil	3	3					
Plant	2	5		1			
Water							
Air				1			
Mineral							
'Bio-based'	61%						

Table 8-131 Indirect bio-based content allocation for polyethyl acrylate made with bio-ethanol (ACDV method).

Origin	Atom allocation: ACDV						
	C	H	N	O	S	Cl	Na
Fossil	3	3		1			
Plant	2	5		1			
'Bio-based'	45%						

Table 8-132 Indirect bio-based content allocation for polyethyl acrylate made from bio-based acrylic acid (Method 1).

Origin	Atom allocation: Method 1						
	C	H	N	O	S	Cl	Na
Fossil	2	5		1			
Plant	3	3		1			
'Bio-based'	55%						



Table 8-133 Indirect bio-based content allocation for polyethyl acrylate made from bio-based acrylic acid (Method 2a).

Origin	Atom allocation: Method 2a						
	C	H	N	O	S	Cl	Na
Fossil	2	5		1/2			
Plant	3	3		1 1/2			
'Bio-based'	63%						

Table 8-134 Indirect bio-based content allocation for polyethyl acrylate made from bio-based acrylic acid (Method 2b).

Origin	Atom allocation: Method 2b						
	C	H	N	O	S	Cl	Na
Fossil	2	5		1			
Plant	3	3		1			
'Bio-based'	55%						

Table 8-135 Indirect bio-based content allocation for polyethyl acrylate made from bio-based acrylic acid (Method 3).

Origin	Atom allocation: Method 3						
	C	H	N	O	S	Cl	Na
Fossil	2	4					
Plant	3	3		1			
Water		1		1			
Air							
Mineral							
'Bio-based'	72%						



Table 8-136 Indirect bio-based content allocation for polyethyl acrylate made from bio-based acrylic acid (ACDV method).

Origin	Atom allocation: ACDV						
	C	H	N	O	S	Cl	Na
Fossil	2	5		1			
Plant	3	3		1			
'Bio-based'	55%						

Table 8-137 Indirect bio-based content allocation for bio-based polyethyl acrylate (Method 1).

Origin	Atom allocation: Method 1						
	C	H	N	O	S	Cl	Na
Fossil							
Plant	5	8		2			
'Bio-based'	100%						

Table 8-138 Indirect bio-based content allocation for bio-based polyethyl acrylate (Method 2a).

Origin	Atom allocation: Method 2a						
	C	H	N	O	S	Cl	Na
Fossil							
Plant	5	8		2			
'Bio-based'	100%						

Table 8-139 Indirect bio-based content allocation for bio-based polyethyl acrylate (Method 2b).

Origin	Atom allocation: Method 2b						
	C	H	N	O	S	Cl	Na
Fossil							
Plant	5	8		2			
'Bio-based'	100%						



Table 8-140 Indirect bio-based content allocation for bio-based polyethyl acrylate (Method 3).

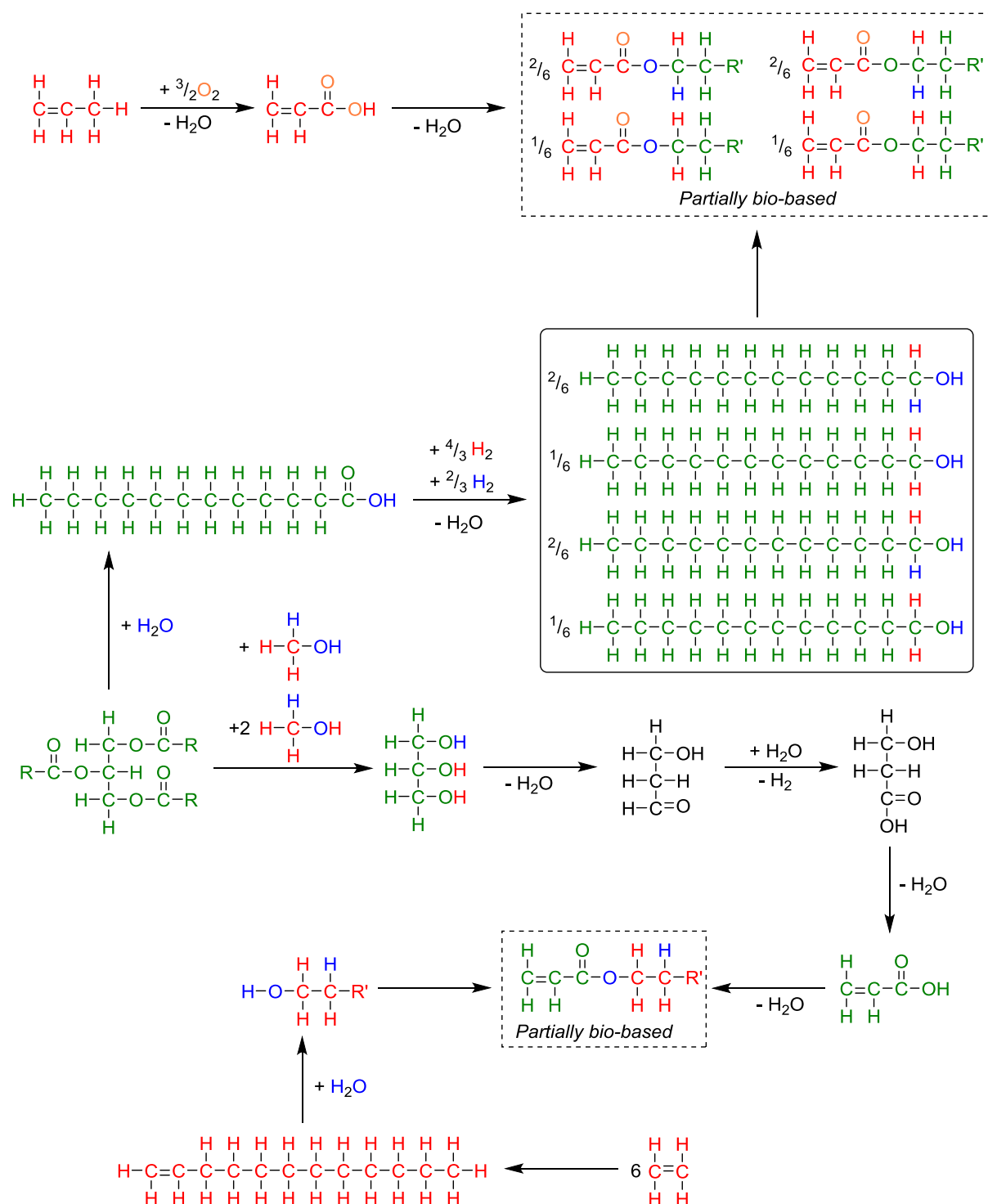
Origin	Atom allocation: Method 3						
	C	H	N	O	S	Cl	Na
Fossil							
Plant	5	8		2			
Water							
Air							
Mineral							
'Bio-based'	100%						

Table 8-141 Indirect bio-based content allocation for bio-based polyethyl acrylate (ACDV method).

Origin	Atom allocation: ACDV						
	C	H	N	O	S	Cl	Na
Fossil							
Plant	5	8		2			
'Bio-based'	100%						

The longer chain version of the same monomer, dodecyl acrylate, could be synthesised from coconut oil (rich in lauric acid triglycerides). The fatty acids could be reduced to form the alcoholic reactant, or the glyceride segment of the feedstock could be used to give the acrylic acid (Scheme 8-22). When biomass is not being used as a feedstock, ethylene is polymerised into various long chain olefins, including dodecene, which is primarily of use in surfactants [Weissermel 1993], but can be hydrated to 1-dodecanol. Acrylic acid is derived from propene [Weissermel 1993]. The standard rules of esterification by the $A_{AC}2$ mechanism have been followed. The oxygen atom in bio-based dodecanol has an equal chance of being water derived or bio-based as a consequence of the hydrolysis of the triglyceride feedstock (proceeding as it does from a symmetrical geminal diol).





Scheme 8-22 Two possible syntheses of dodecyl acrylate from acrylic acid and dodecanol (products indicated in dashed boxes).



Table 8-142 Indirect bio-based content allocation for poly(dodecyl acrylate) made from bio-based acrylic acid (Method 1).

Origin	Atom allocation: Method 1						
	C	H	N	O	S	Cl	Na
Fossil	12	25		1			
Plant	3	3		1			
'Bio-based'	23%						

Table 8-143 Indirect bio-based content allocation for poly(dodecyl acrylate) made from bio-based acrylic acid (Method 2a).

Origin	Atom allocation: Method 2a						
	C	H	N	O	S	Cl	Na
Fossil	12	25		$\frac{1}{2}$			
Plant	3	3		$1\frac{1}{2}$			
'Bio-based'	26%						

Table 8-144 Indirect bio-based content allocation for poly(dodecyl acrylate) made from bio-based acrylic acid (Method 2b).

Origin	Atom allocation: Method 2b						
	C	H	N	O	S	Cl	Na
Fossil	12	25		1			
Plant	3	3		1			
'Bio-based'	23%						



Table 8-145 Indirect bio-based content allocation for poly(dodecyl acrylate) made from bio-based acrylic acid (Method 3).

Origin	Atom allocation: Method 3						
	C	H	N	O	S	Cl	Na
Fossil	12	24					
Plant	3	3		1			
Water		1		1			
Air							
Mineral							
'Bio-based'	30%						

Table 8-146 Indirect bio-based content allocation for poly(dodecyl acrylate) made from bio-based acrylic acid (ACDV method).

Origin	Atom allocation: ACDV						
	C	H	N	O	S	Cl	Na
Fossil	12	25		1			
Plant	3	3		1			
'Bio-based'	23%						

Table 8-147 Indirect bio-based content allocation for poly(dodecyl acrylate) made from vegetable oil components (Method 1).

Origin	Atom allocation: Method 1						
	C	H	N	O	S	Cl	Na
Fossil	3	3		1			
Plant	12	25		1			
'Bio-based'	77%						



Table 8-148 Indirect bio-based content allocation for poly(dodecyl acrylate) made from vegetable oil components (Method 2a).

Origin	Atom allocation: Method 2a						
	C	H	N	O	S	Cl	Na
Fossil	3	3		1 1/2			
Plant	12	25		1/2			
'Bio-based'	74%						

Table 8-149 Indirect bio-based content allocation for poly(dodecyl acrylate) made from vegetable oil components (Method 2b).

Origin	Atom allocation: Method 2b						
	C	H	N	O	S	Cl	Na
Fossil	3	3		1			
Plant	12	25		1			
'Bio-based'	77%						

Table 8-150 Indirect bio-based content allocation for poly(dodecyl acrylate) made from vegetable oil components (Method 3).

Origin	Atom allocation: Method 3						
	C	H	N	O	S	Cl	Na
Fossil	3	4 1/3					
Plant	12	23		1/2			
Water		2/3		1/2			
Air				1			
Mineral							
'Bio-based'	83%						



Table 8-151 Indirect bio-based content allocation for poly(dodecyl acrylate) made from vegetable oil components (ACDV method).

Origin	Atom allocation: ACDV						
	C	H	N	O	S	Cl	Na
Fossil	3	3		1			
Plant	12	25		1			
'Bio-based'	77%						

The sodium salt of poly(acrylic acid) is produced by reacting the polymer with sodium hydroxide (Scheme 8-23). The sodium cation is from a mineral source, but some atom connectivity methods will associate the sodium atom with the bio-based organic part of the molecule. Acrylic acid and poly(acrylic) acid are treated as completely plant derived in origin because of the fermentation to produce the intermediate hydroxyacid. Although all fermentation products will be treated as wholly bio-based, in reality the valorisation of feedstocks by fermentation that are not bio-based themselves will not necessarily produce products that are wholly bio-based.

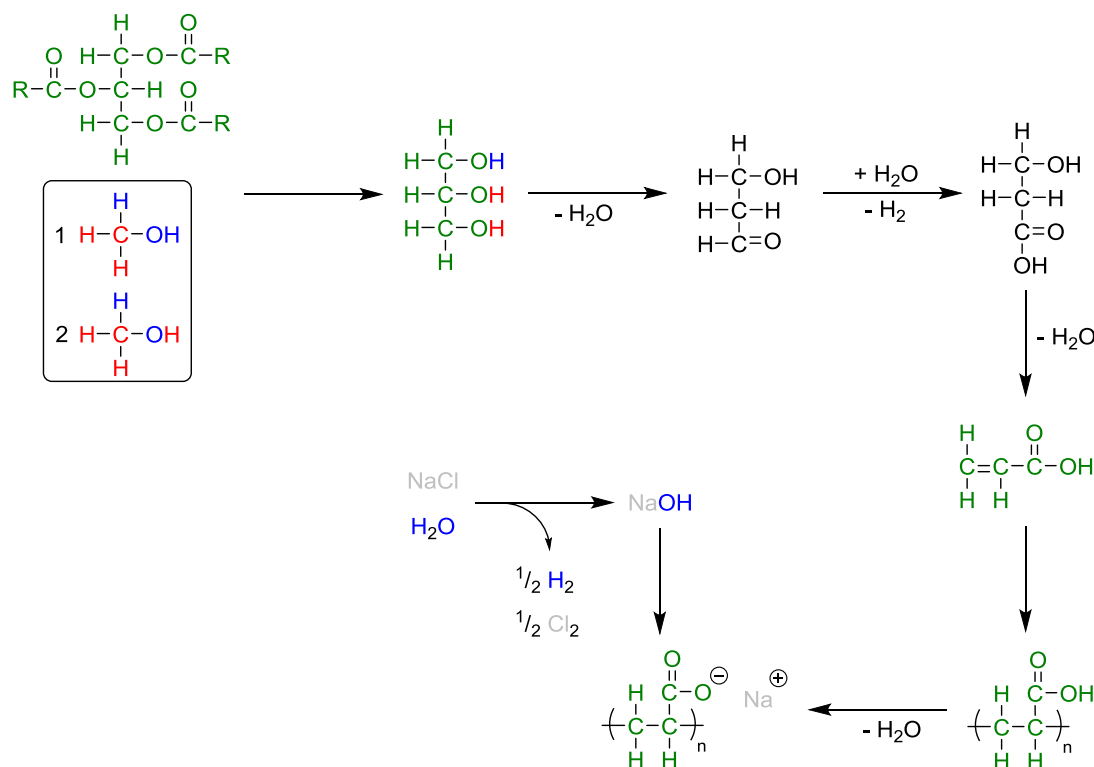
**Scheme 8-23** The synthetic route to poly(sodium acrylate) from biomass.

Table 8-152 Indirect bio-based content allocation for sodium poly(acrylate) made from bio-based acrylic acid (Method 1).

Origin	Atom allocation: Method 1						
	C	H	N	O	S	Cl	Na
Fossil							1
Plant	3	3		2			
'Bio-based'	76%						

Table 8-153 Indirect bio-based content allocation for sodium poly(acrylate) made from bio-based acrylic acid (Method 2a).

Origin	Atom allocation: Method 2a						
	C	H	N	O	S	Cl	Na
Fossil							
Plant	3	3		2			1
'Bio-based'	100%						

Table 8-154 Indirect bio-based content allocation for sodium poly(acrylate) made from bio-based acrylic acid (Method 2b).

Origin	Atom allocation: Method 2b						
	C	H	N	O	S	Cl	Na
Fossil							
Plant	3	3		2			1
'Bio-based'	100%						



Table 8-155 Indirect bio-based content allocation for sodium poly(acrylate) made from bio-based acrylic acid (Method 3).

Origin	Atom allocation: Method 3						
	C	H	N	O	S	Cl	Na
Fossil							
Plant	3	3		2			
Water							
Air							
Mineral							1
'Bio-based'	100%						

Table 8-156 Indirect bio-based content allocation for sodium poly(acrylate) made from bio-based acrylic acid (ACDV method).

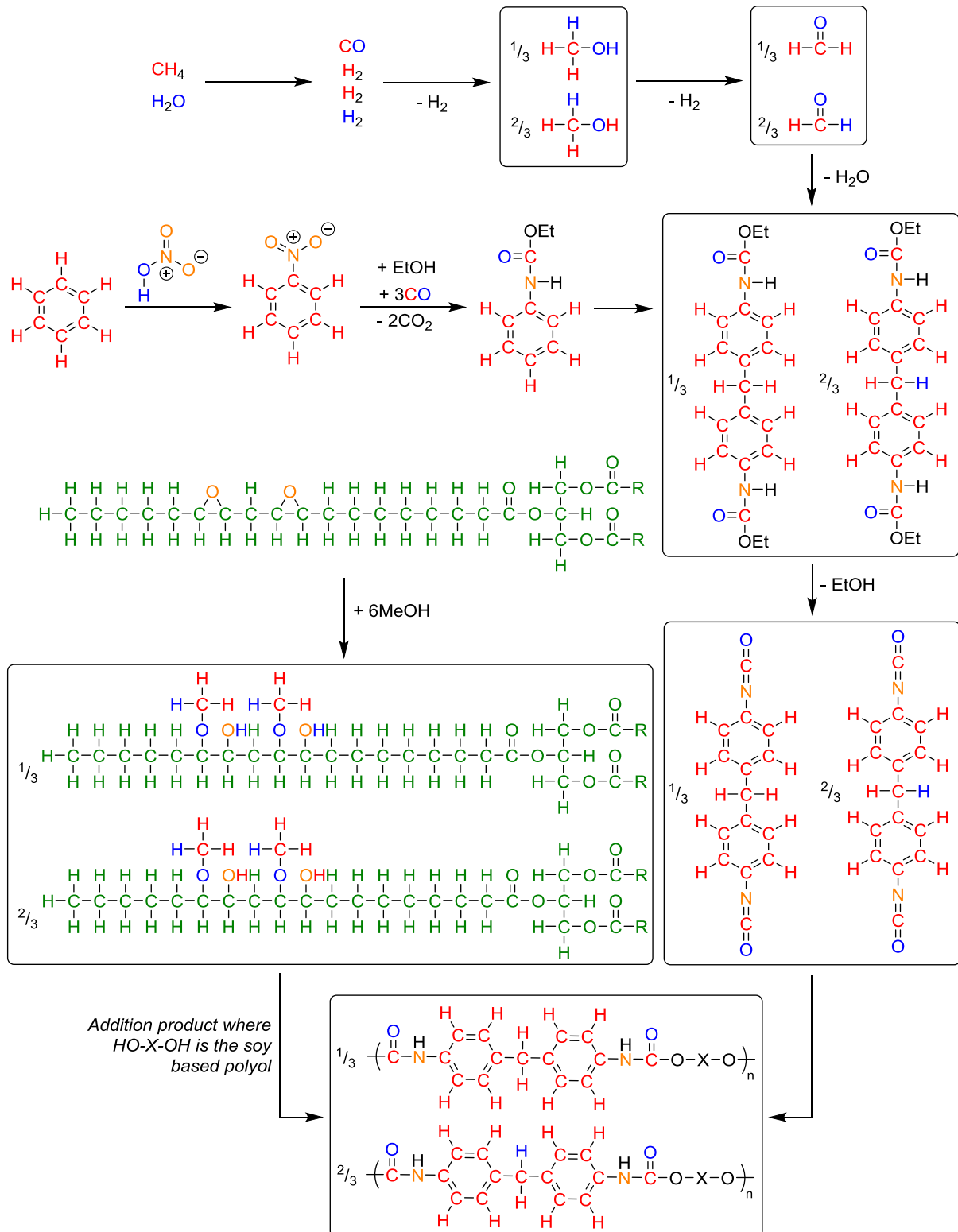
Origin	Atom allocation: ACDV						
	C	H	N	O	S	Cl	Na
Fossil							
Plant	3	3		2			1
'Bio-based'	100%						



8.17 Polyurethane

Polyurethanes are a class of polymer. This example is produced from the fossil derived methylene diphenyl diisocyanate monomer and epoxidised soy oil, which is approximated with the hexa-epoxide of glyceryl trilinoleate (linoleic acid is the most abundance fatty acid group in soy oil) [Turley 2008]. The origin of the atoms in nitric acid has been simplified in the following scheme (Scheme 8-24). The oxygen atoms of nitric originate in both water and atmospheric oxygen, but recycling in the production process makes the allocation difficult to represent. The nitrogen atom is derived from atmospheric nitrogen, and is the only atom of the nitric acid reactant to remain present in the final product.





Scheme 8-24 The synthesis of a polyurethane from epoxidised soy oil.



Table 8-157 Indirect bio-based content allocation for a polyurethane (Method 1).

Origin	Atom allocation: Method 1						
	C	H	N	O	S	Cl	Na
Fossil	51	54	6	12			
Plant	57	98		12			
'Bio-based'	51%						

Table 8-158 Indirect bio-based content allocation for a polyurethane (Method 2a).

Origin	Atom allocation: Method 2a						
	C	H	N	O	S	Cl	Na
Fossil	51	54	6	12			
Plant	57	98		12			
'Bio-based'	51%						

Table 8-159 Indirect bio-based content allocation for a polyurethane (Method 2b).

Origin	Atom allocation: Method 2b						
	C	H	N	O	S	Cl	Na
Fossil	51	54	6	12			
Plant	57	98		12			
'Bio-based'	51%						

Table 8-160 Indirect bio-based content allocation for a polyurethane (Method 3).

Origin	Atom allocation: Method 3						
	C	H	N	O	S	Cl	Na
Fossil	51	44					
Plant	57	98		6			
Water		10		12			
Air			6	6			
Mineral							
'Bio-based'	66%						



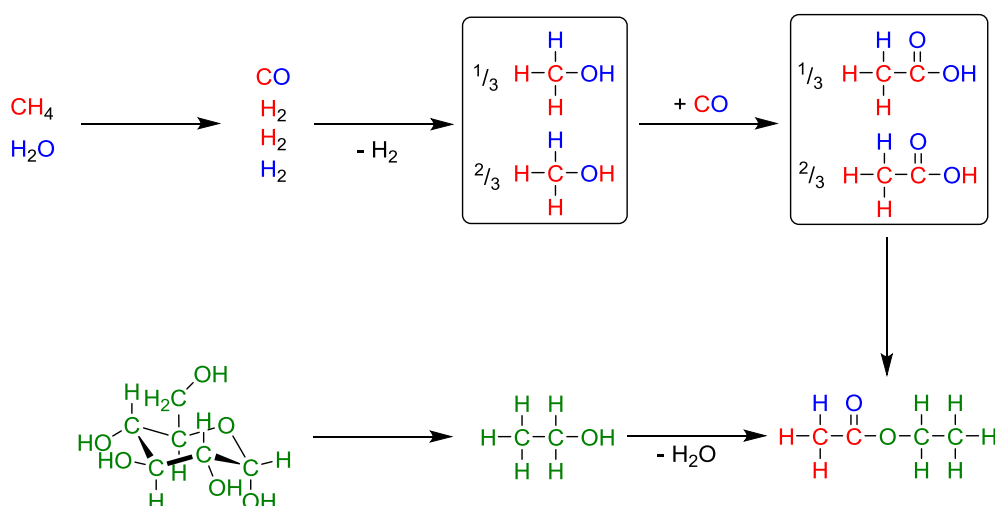
Table 8-161 Indirect bio-based content allocation for a polyurethane (ACDV method).

Origin	Atom allocation: ACDV						
	C	H	N	O	S	Cl	Na
Fossil	51	54	6	12			
Plant	57	98		12			
'Bio-based'	51%						



8.18 Ethyl acetate

The example synthesis used in the ACDV certification documentation is that of ethyl acetate formed from bio-ethanol and acetic acid which is created from syngas (Scheme 8-25). The allocation of bio-based content through the ACDV method ignores the hydrogen atoms that originate in water and assigns a fossil origin to them. In a small molecule such as ethyl acetate, the calculated total bio-based content varies considerably just from the different treatments of hydrogen atoms. However the ACDV method of atom allocation produces a result (51%) very similar to the bio-based carbon content (50%). Including water derived atoms in the total bio-based content allocation produces what might be regarded as an inflated total bio-based content result at 70%.



Scheme 8-25 The synthesis of ethyl acetate from bio-ethanol.

One final consideration is the exact esterification mechanism, of which there are four possibilities (all acid catalysed) [Smith 2007]. The most common is the one assumed to occur here, the bimolecular acyl cleavage ($\text{A}_{\text{AC}2}$) mechanism. This process and its first order equivalent occur through the nucleophilicity of the alcohol, and so one oxygen atom of the ester originates in the alcohol. The oxygen that is displaced from the acid is not necessarily the one drawn schematically as the $-\text{OH}$ group because the acid catalyst protonates the carbonyl in such a way to make two chemically identical leaving groups. This has implications for molecules in which an acid group has oxygen atoms of different sources, although that is not the case here. The alkyl cleavage mechanisms of esterification do not include the oxygen of the alcohol reactant in the final ester product. This mechanism can occur with tertiary alcohols in which a stable carbocation is possible. Allowances must be made for this in particular circumstances, but proving the mechanism is isotope studies is very specialised research not expected for chemical suppliers in order to assign total bio-based content.



Table 8-162 Indirect bio-based content allocation for ethyl acetate from bio-ethanol (Method 1).

Origin	Atom allocation: Method 1						
	C	H	N	O	S	Cl	Na
Fossil	2	3		1			
Plant	2	5		1			
'Bio-based'	51%						

Table 8-163 Indirect bio-based content allocation for ethyl acetate from bio-ethanol (Method 2a).

Origin	Atom allocation: Method 2a						
	C	H	N	O	S	Cl	Na
Fossil	2	3		1 1/2			
Plant	2	5		1/2			
'Bio-based'	42%						

Table 8-164 Indirect bio-based content allocation for ethyl acetate from bio-ethanol (Method 2b).

Origin	Atom allocation: Method 2b						
	C	H	N	O	S	Cl	Na
Fossil	2	3		1			
Plant	2	5		1			
'Bio-based'	51%						

Table 8-165 Indirect bio-based content allocation for ethyl acetate from bio-ethanol (Method 3).

Origin	Atom allocation: Method 3						
	C	H	N	O	S	Cl	Na
Fossil	2	2					
Plant	2	5		1			
Water		1		1			
Air							
Mineral							
'Bio-based'	70%						



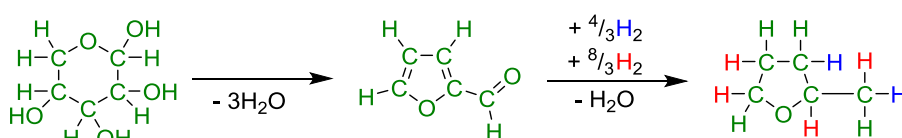
Table 8-166 Indirect bio-based content allocation for ethyl acetate from bio-ethanol (ACDV method).

Origin	Atom allocation: ACDV						
	C	H	N	O	S	Cl	Na
Fossil	2	3		1			
Plant	2	5		1			
'Bio-based'	51%						



8.19 2-Methyltetrahydrofuran

The bio-based solvent 2-methyltetrahydrofuran (2-MeTHF) contains 100% bio-based carbon. Dehydration of pentose sugars (such as xylose) to furfural retains the completely plant based nature of the parent feedstock. The hydrogenation results in the introduction of fossil derived and water derived atoms, although as hydrogen atoms only account for 5% of the mass of the molecule (Scheme 8-26).



Scheme 8-26 The synthesis of 2-methyltetrahydrofuran from furfural.

Table 8-167 Indirect bio-based content allocation for 2-methyltetrahydrofuran (Method 1).

Origin	Atom allocation: Method 1						
	C	H	N	O	S	Cl	Na
Fossil		6					
Plant	5	4		1			
'Bio-based'	93%						

Table 8-168 Indirect bio-based content allocation for 2-methyltetrahydrofuran (Method 2a).

Origin	Atom allocation: Method 2a						
	C	H	N	O	S	Cl	Na
Fossil							
Plant	5	10		1			
'Bio-based'	100%						

Table 8-169 Indirect bio-based content allocation for 2-methyltetrahydrofuran (Method 2b).

Origin	Atom allocation: Method 2b						
	C	H	N	O	S	Cl	Na
Fossil							
Plant	5	10		1			
'Bio-based'	100%						



Table 8-170 Indirect bio-based content allocation for 2-methyltetrahydrofuran (Method 3).

Origin	Atom allocation: Method 3						
	C	H	N	O	S	Cl	Na
Fossil		4					
Plant	5	4		1			
Water		2					
Air							
Mineral							
'Bio-based'	95%						

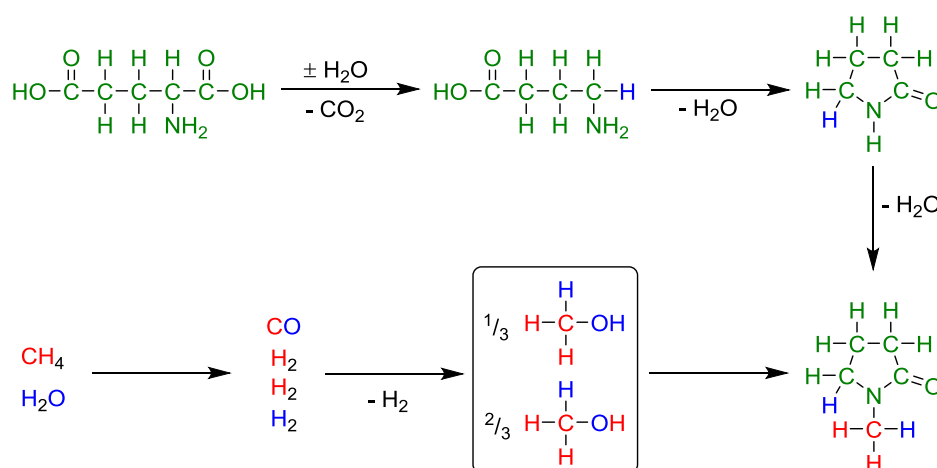
Table 8-171 Indirect bio-based content allocation for 2-methyltetrahydrofuran (ACDV method).

Origin	Atom allocation: ACDV						
	C	H	N	O	S	Cl	Na
Fossil							
Plant	5	10		1			
'Bio-based'	100%						



8.20 N-Methylpyrrolidinone

The synthesis of NMP presented here has been achieved on a lab scale. It is the one example of an amino acid used as a start material in this work. For the scale it is required in the food industry, production of glutamic acid is usually based on fermentation technologies. As such the nitrogen atom is considered as being plant derived, although originally that nitrogen would have been fixed from atmospheric nitrogen. Enzymatic decarboxylation requires water, and so a water derived hydrogen atom is incorporated into the intermediate 3-aminobutyric acid (Scheme 8-27). Syngas is used to make the methanol for alkylation. The actual reaction occurs between bromomethane created *in situ* where the bromide is recycled. This has a bearing on the process metrics but not on the total bio-based content of the product.



Scheme 8-27 The synthesis of *N*-methylpyrrolidinone from glutamic acid.

Table 8-172 Indirect bio-based content allocation for *N*-methylpyrrolidinone from glutamic acid (Method 1).

Origin	Atom allocation: Method 1						
	C	H	N	O	S	Cl	Na
Fossil	1	3					
Plant	4	6	1	1			
'Bio-based'	85%						



Table 8-173 Indirect bio-based content allocation for *N*-methylpyrrolidinone from glutamic acid (Method 2a).

Origin	Atom allocation: Method 2a						
	C	H	N	O	S	Cl	Na
Fossil	1	3	$\frac{1}{3}$				
Plant	4	6	$\frac{2}{3}$	1			
'Bio-based'	80%						

Table 8-174 Indirect bio-based content allocation for *N*-methylpyrrolidinone from glutamic acid (Method 2b).

Origin	Atom allocation: Method 2b						
	C	H	N	O	S	Cl	Na
Fossil	1	3					
Plant	4	6	1	1			
'Bio-based'	85%						

Table 8-175 Indirect bio-based content allocation for *N*-methylpyrrolidinone from glutamic acid (Method 3).

Origin	Atom allocation: Method 3						
	C	H	N	O	S	Cl	Na
Fossil	1	2					
Plant	4	5	1	1			
Water		2					
Air							
Mineral							
'Bio-based'	86%						



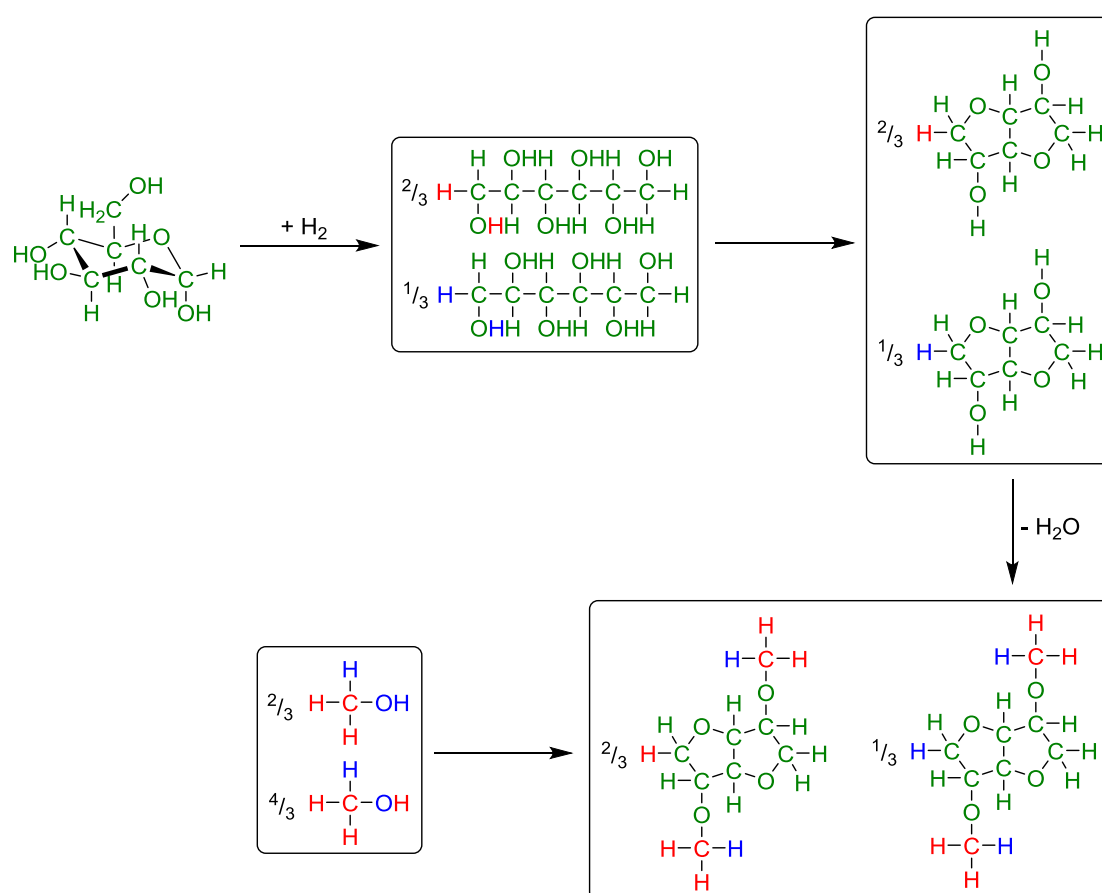
Table 8-176 Indirect bio-based content allocation for *N*-methylpyrrolidinone from glutamic acid (ACDV method).

Origin	Atom allocation: ACDV						
	C	H	N	O	S	Cl	Na
Fossil	1	3					
Plant	4	6	1	1			
'Bio-based'	85%						



8.21 Dimethyl isosorbide

Sorbitol is a reduced sugar that can be made from glucose. It will dehydrate with a double intramolecular nucleophilic substitution to give the bicyclic isosorbide (Scheme 8-28). The resulting bicyclic diol is then alkylated by a derivative of methanol, such as is the case for NMP as described previously. For simplicity methanol is given as the reactant in Scheme 8-28, and the methanol is not bio-based. The final product should be 75% bio-based according to bio-based carbon analysis.



Scheme 8-28 The synthesis of dimethyl isosorbide from sorbitol.



Table 8-177 Indirect bio-based content allocation for dimethyl isosorbide from sorbitol (Method 1).

Origin	Atom allocation: Method 1						
	C	H	N	O	S	Cl	Na
Fossil	2	6					
Plant	6	8		4			
'Bio-based'	83%						

Table 8-178 Indirect bio-based content allocation for dimethyl isosorbide from sorbitol (Method 2a).

Origin	Atom allocation: Method 2a						
	C	H	N	O	S	Cl	Na
Fossil	2	6		1			
Plant	6	8		3			
'Bio-based'	74%						

Table 8-179 Indirect bio-based content allocation for dimethyl isosorbide from sorbitol (Method 2b).

Origin	Atom allocation: Method 2b						
	C	H	N	O	S	Cl	Na
Fossil	2	6					
Plant	6	8		4			
'Bio-based'	83%						

Table 8-180 Indirect bio-based content allocation for dimethyl isosorbide from sorbitol (Method 3).

Origin	Atom allocation: Method 3						
	C	H	N	O	S	Cl	Na
Fossil	2	4 ² / ₃					
Plant	6	7		4			
Water		2 ¹ / ₃					
Air							
Mineral							
'Bio-based'	83%						



Table 8-181 Indirect bio-based content allocation for dimethyl isosorbide from sorbitol (ACDV method).

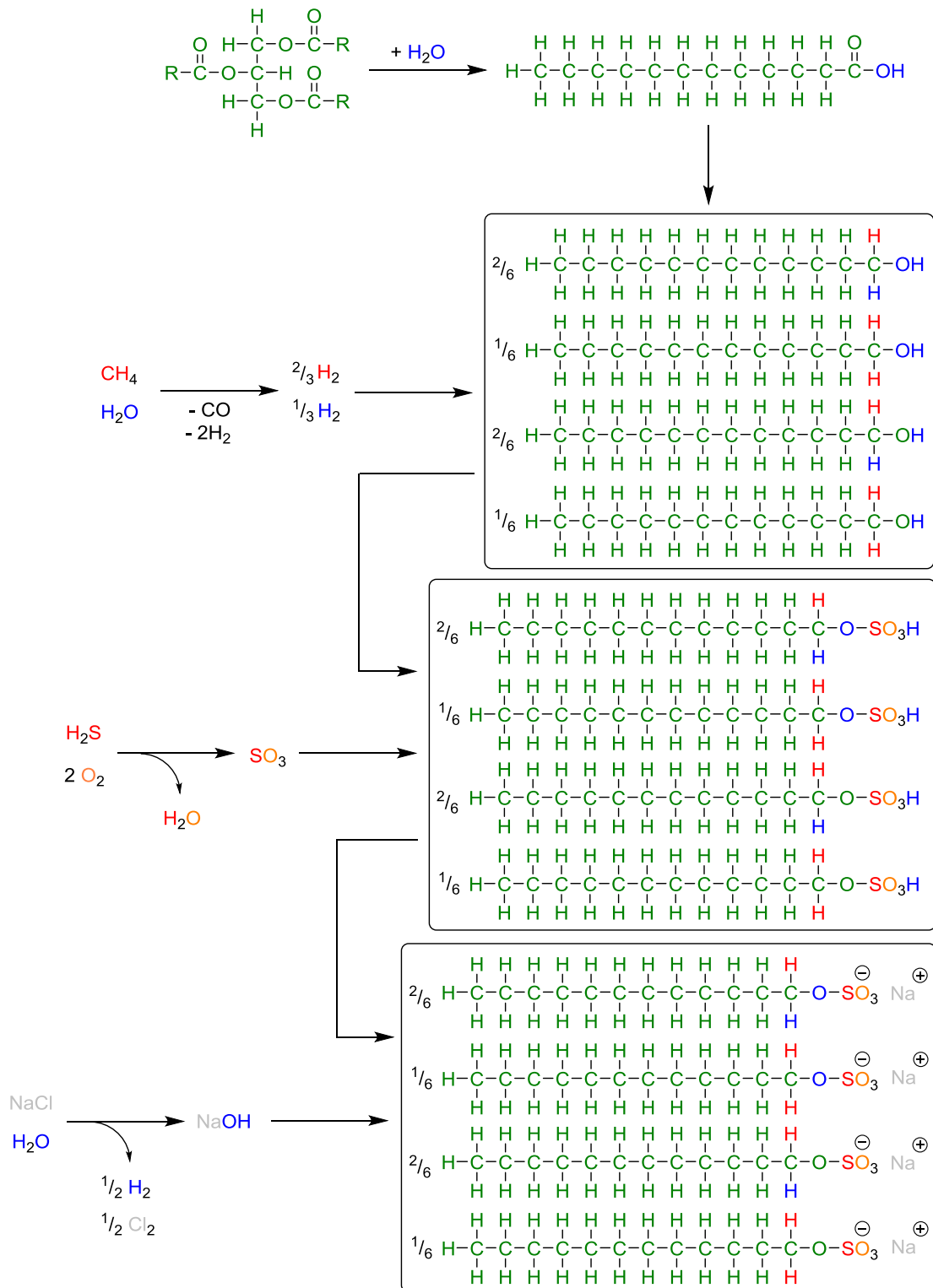
Origin	Atom allocation: ACDV						
	C	H	N	O	S	Cl	Na
Fossil	2	6					
Plant	6	8		4			
'Bio-based'	83%						



8.22 Hydrogen dodecyl sulphate and the sodium salt

The surfactant sodium dodecyl sulphate is mass produced using polymerisation technology which yields 1-dodecene from ethylene. Hydration affords 1-dodecanol. An alternative would be to use coconut oil as a feedstock, which is predominately the triglyceride of lauric (dodecanoic) acid. Reduction of the hydrolysed triglyceride will produce dodecanol, although if produced from coconut oil it will contain other, higher molecular weight alcohols. This will affect any calculations performed by considering an idealised system. The unsaturation present in many fatty acids could be eliminated in the hydrogenation step. The alcohol is functionalised with sulphur trioxide, oxidised from the hydrogen sulphide found in natural gas reserves. This is an addition reaction (Scheme 8-29). Formation of the salt is done with sodium hydroxide.





Scheme 8-29 The synthesis of sodium dodecyl sulphate from vegetable oil via hydrogen dodecyl sulphate.



Table 8-182 Indirect bio-based content allocation for hydrogen dodecyl sulphate (Method 1).

Origin	Atom allocation: Method 1						
	C	H	N	O	S	Cl	Na
Fossil		2		3	1		
Plant	12	24		1			
'Bio-based'	69%						

Table 8-183 Indirect bio-based content allocation for hydrogen dodecyl sulphate (Method 2a).

Origin	Atom allocation: Method 2a						
	C	H	N	O	S	Cl	Na
Fossil							
Plant	12	26		4	1		
'Bio-based'	100%						

Table 8-184 Indirect bio-based content allocation for hydrogen dodecyl sulphate (Method 2b).

Origin	Atom allocation: Method 2b						
	C	H	N	O	S	Cl	Na
Fossil							
Plant	12	26		4	1		
'Bio-based'	100%						

Table 8-185 Indirect bio-based content allocation for hydrogen dodecyl sulphate (Method 3).

Origin	Atom allocation: Method 3						
	C	H	N	O	S	Cl	Na
Fossil		$1\frac{1}{3}$			1		
Plant	12	23		$\frac{1}{2}$			
Water		$1\frac{2}{3}$		$\frac{1}{2}$			
Air				3			
Mineral							
'Bio-based'	88%						



Table 8-186 Indirect bio-based content allocation for hydrogen dodecyl sulphate (ACDV method).

Origin	Atom allocation: ACDV						
	C	H	N	O	S	Cl	Na
Fossil							
Plant	12	26		4	1		
'Bio-based'	100%						

Table 8-187 Indirect bio-based content allocation for sodium dodecyl sulphate from vegetable oil (Method 1).

Origin	Atom allocation: Method 1						
	C	H	N	O	S	Cl	Na
Fossil		2		3	1		1
Plant	12	23		1			
'Bio-based'	64%						

Table 8-188 Indirect bio-based content allocation for sodium dodecyl sulphate from vegetable oil (Method 2a).

Origin	Atom allocation: Method 2a						
	C	H	N	O	S	Cl	Na
Fossil							
Plant	12	25		4	1		1
'Bio-based'	100%						

Table 8-189 Indirect bio-based content allocation for sodium dodecyl sulphate from vegetable oil (Method 2b).

Origin	Atom allocation: Method 2b						
	C	H	N	O	S	Cl	Na
Fossil							
Plant	12	25		4	1		1
'Bio-based'	100%						



Table 8-190 Indirect bio-based content allocation for sodium dodecyl sulphate from vegetable oil (Method 3).

Origin	Atom allocation: Method 3						
	C	H	N	O	S	Cl	Na
Fossil		1 ¹ / ₃			1		
Plant	12	23		¹ / ₂			
Water		² / ₃		¹ / ₂			
Air				3			
Mineral							1
'Bio-based'	87%						

Table 8-191 Indirect bio-based content allocation for sodium dodecyl sulphate from vegetable oil (ACDV method).

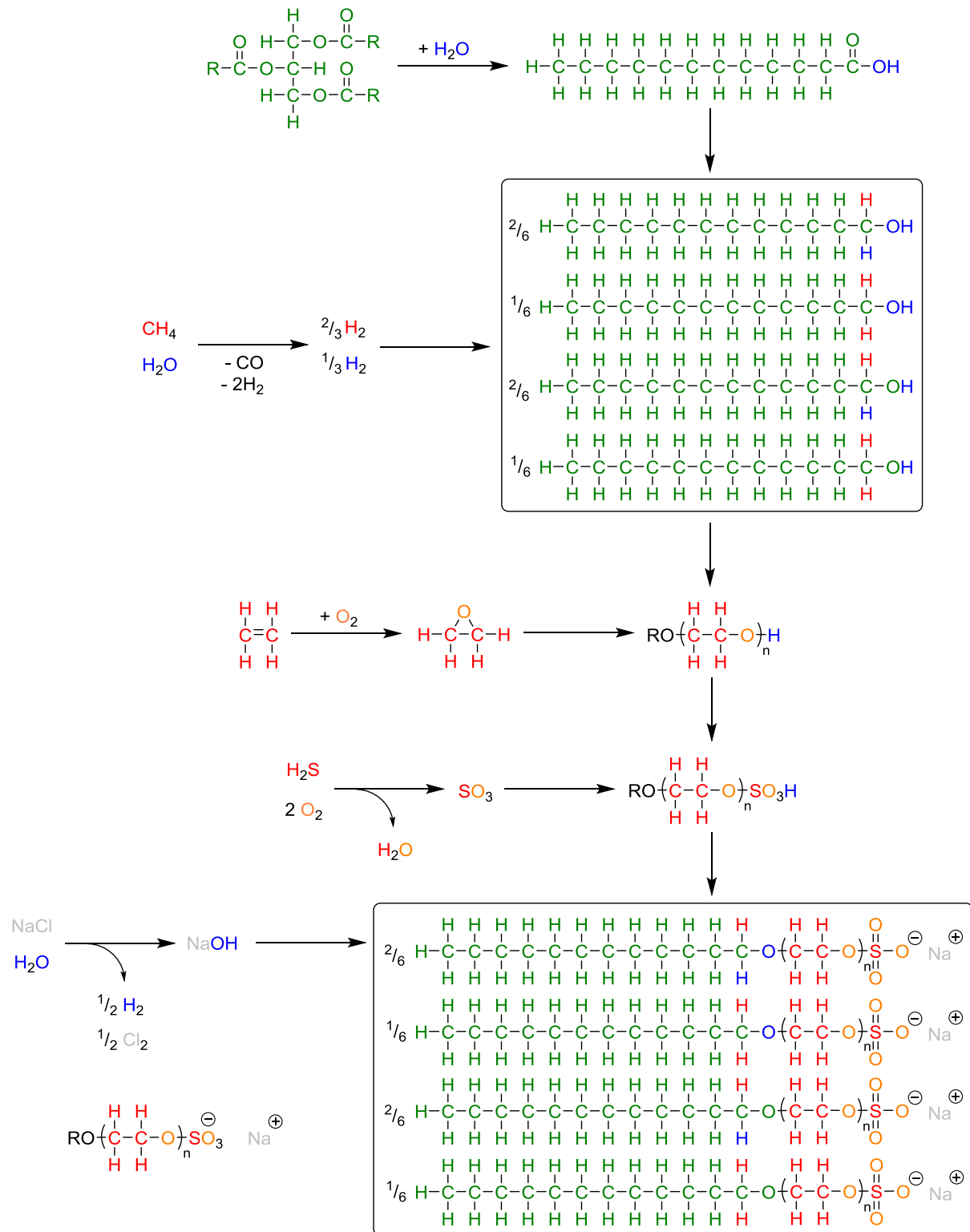
Origin	Atom allocation: ACDV						
	C	H	N	O	S	Cl	Na
Fossil							
Plant	12	25		4	1		1
'Bio-based'	100%						



8.23 Sodium laureth sulphate

Similar to sodium dodecyl sulphate, in sodium laureth sulphate production an addition poly(ethylene glycol) section is introduced to modify the properties of the surfactant. Ethylene oxide is reacted with 1-dodecanol in much the same way that the precursor to polyvinyl acetate is formed. The number of ethylene glycol units is tailored to the application. Addition of sulphur trioxide and salt formation follow to yield the product (Scheme 8-30). The bio-based content is derived from the lipophilic section of the molecule. Bulk production of sodium laureth sulphate is achieved at minimum cost by using the polymerisation of ethylene as the basis of the synthesis. If a plant derived alkyl chain was to be used instead, the natural variation of triglycerides in vegetable oils would modify the product, and probably increase the bio-based content slightly.





Scheme 8-30 The synthesis of sodium laureth sulphate from vegetable oil.



Table 8-192 Indirect bio-based content allocation for sodium laureth sulphate (PEG trimer) from vegetable oil (Method 1).

Origin	Atom allocation: Method 1						
	C	H	N	O	S	Cl	Na
Fossil	6	14		6	1		1
Plant	12	23		1			
'Bio-based'	44%						

Table 8-193 Indirect bio-based content allocation for sodium laureth sulphate (PEG trimer) from vegetable oil (Method 2a).

Origin	Atom allocation: Method 2a						
	C	H	N	O	S	Cl	Na
Fossil	6	12		6 ¹ / ₂	1		1
Plant	12	25		¹ / ₂			
'Bio-based'	42%						

Table 8-194 Indirect bio-based content allocation for sodium laureth sulphate (PEG trimer) from vegetable oil (Method 2b).

Origin	Atom allocation: Method 2b						
	C	H	N	O	S	Cl	Na
Fossil	6	12		6	1		1
Plant	12	25		1			
'Bio-based'	44%						



Table 8-195 Indirect bio-based content allocation for sodium laureth sulphate (PEG trimer) from vegetable oil (Method 3).

Origin	Atom allocation: Method 3						
	C	H	N	O	S	Cl	Na
Fossil	6	13 $\frac{1}{3}$			1		
Plant	12	23		$\frac{1}{2}$			
Water		$\frac{2}{3}$		$\frac{1}{2}$			
Air				6			
Mineral							1
'Bio-based'	70%						

Table 8-196 Indirect bio-based content allocation for sodium laureth sulphate (PEG trimer) from vegetable oil (ACDV method).

Origin	Atom allocation: ACDV						
	C	H	N	O	S	Cl	Na
Fossil	6	12		6			
Plant	12	25		1	1		1
'Bio-based'	57% (51% based only on mass contribution of CHNO atoms)						

Table 8-197 Indirect bio-based content allocation for sodium laureth sulphate (PEG decamer) from vegetable oil (Method 1).

Origin	Atom allocation: Method 1						
	C	H	N	O	S	Cl	Na
Fossil	20	42		13	1		1
Plant	12	23		1			
'Bio-based'	25%						



Table 8-198 Indirect bio-based content allocation for sodium laureth sulphate (PEG decamer) from vegetable oil (Method 2a).

Origin	Atom allocation: Method 2a						
	C	H	N	O	S	Cl	Na
Fossil	20	40		13 ¹ / ₂	1		1
Plant	12	25		¹ / ₂			
'Bio-based'	24%						

Table 8-199 Indirect bio-based content allocation for sodium laureth sulphate (PEG decamer) from vegetable oil (Method 2b).

Origin	Atom allocation: Method 2b						
	C	H	N	O	S	Cl	Na
Fossil	20	40		13	1		1
Plant	12	25		1			
'Bio-based'	25%						

Table 8-200 Indirect bio-based content allocation for sodium laureth sulphate (PEG decamer) from vegetable oil (Method 3).

Origin	Atom allocation: Method 3						
	C	H	N	O	S	Cl	Na
Fossil	20	41 ¹ / ₃			1		
Plant	12	23		¹ / ₂			
Water		² / ₃		¹ / ₂			
Air				13			
Mineral							1
'Bio-based'	56%						



Table 8-201 Indirect bio-based content allocation for sodium laureth sulphate (PEG decamer) from vegetable oil (ACDV method).

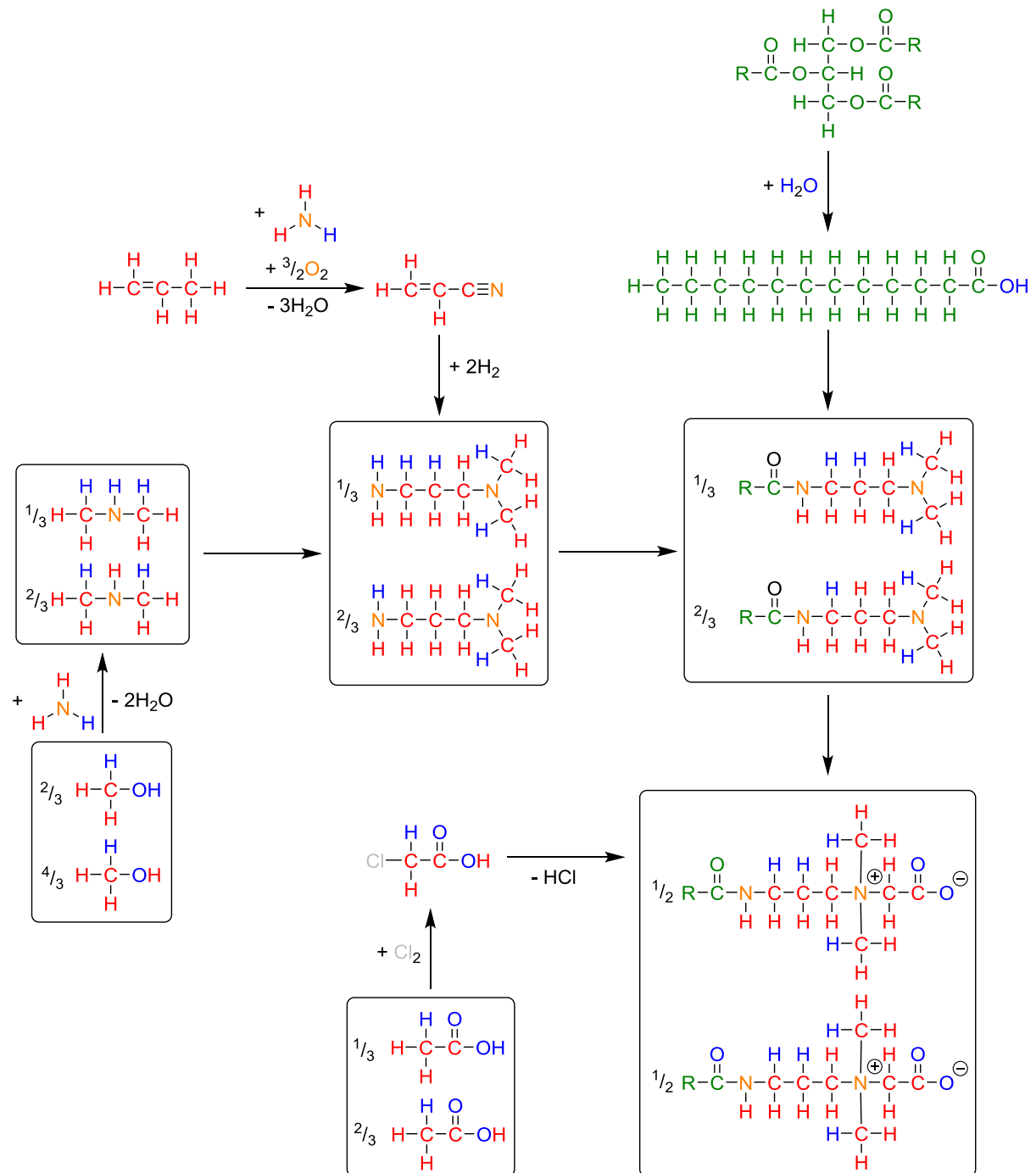
Origin	Atom allocation: ACDV						
	C	H	N	O	S	Cl	Na
Fossil	20	40		13			
Plant	12	25		1	1		1
'Bio-based'	33% (28% based on mass contribution of CHNO atoms)						



8.24 Cocamidopropyl betaine

The amphoteric surfactant cocamidopropyl betaine is also dependant on the lauric acid of coconut oil to impart bio-based content. Amidation with a bifunctional amine gives the amide intermediate; statistically half the molecules will contain an oxygen atom from the original triglyceride, and the rest a water derived oxygen atom according to the $A_{AC}2$ esterification mechanism addressed previously. Quarternarisation with chloroacetic acid gives the final zwitterionic product (Scheme 8-31).





Scheme 8-31 The synthesis of cocamidopropyl betaine from vegetable oil.



Table 8-202 Indirect bio-based content allocation for cocamidopropyl betaine from vegetable oil (Method 1).

Origin	Atom allocation: Method 1						
	C	H	N	O	S	Cl	Na
Fossil	7	15	2	2			
Plant	12	23		1			
'Bio-based'	54%						

Table 8-203 Indirect bio-based content allocation for cocamidopropyl betaine from vegetable oil (Method 2a).

Origin	Atom allocation: Method 2a						
	C	H	N	O	S	Cl	Na
Fossil	7	14 ¹ / ₂	1 ¹ / ₂	2			
Plant	12	23 ¹ / ₂	¹ / ₂	1			
'Bio-based'	56%						

Table 8-204 Indirect bio-based content allocation for cocamidopropyl betaine from vegetable oil (Method 2b).

Origin	Atom allocation: Method 2b						
	C	H	N	O	S	Cl	Na
Fossil	7	15	2	2			
Plant	12	23		1			
'Bio-based'	54%						



Table 8-205 Indirect bio-based content allocation for cocamidopropyl betaine from vegetable oil (Method 3).

Origin	Atom allocation: Method 3						
	C	H	N	O	S	Cl	Na
Fossil	7	11					
Plant	12	23		1/2			
Water		4		2 1/2			
Air			2				
Mineral							
'Bio-based'	72%						

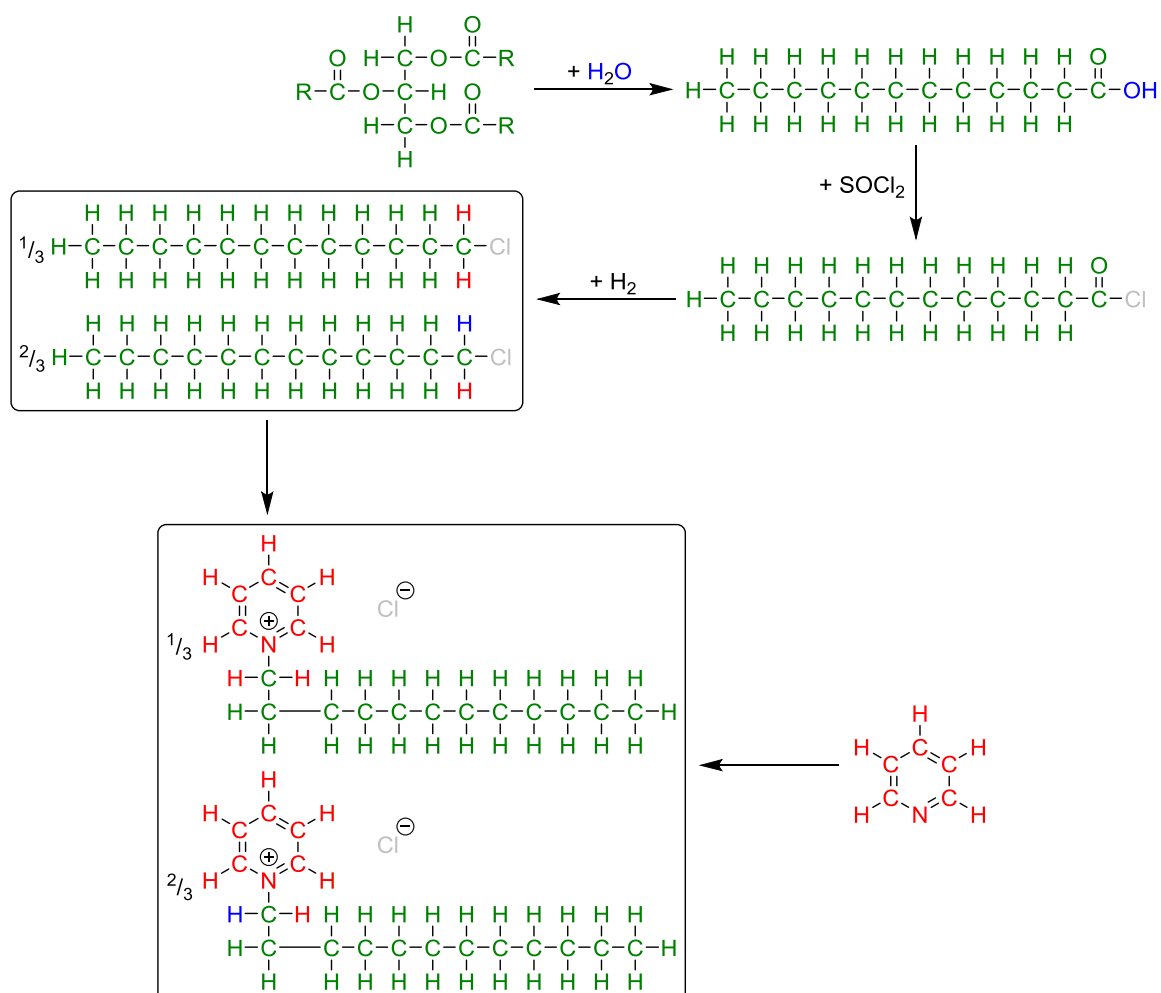
Table 8-206 Indirect bio-based content allocation for cocamidopropyl betaine from vegetable oil (ACDV method).

Origin	Atom allocation: ACDV						
	C	H	N	O	S	Cl	Na
Fossil	7	15	2	2			
Plant	12	23		1			
'Bio-based'	54%						



8.25 *N*-Dodecylpyridinium chloride

Pyridine is still sourced from crude oil in enough quantities to satisfy the global market as it stands. Thus the nitrogen of *N*-dodecylpyridinium chloride is fossil based, which is a rarity given the low quantities of nitrogen available in fossil resources. The fatty alcohol is not synthesised as an intermediate in *N*-dodecylpyridinium chloride production, instead the acyl chloride can be formed from a range of chlorinating reagents and then reduced to its respective chloroalkane. Addition with a variant of the Menshutkin reaction yields the cationic product (Scheme 8-32).



Scheme 8-32 The synthesis of *N*-dodecylpyridinium chloride from pyridine and vegetable oil.



Table 8-207 Indirect bio-based content allocation for *N*-dodecylpyridinium chloride from pyridine and vegetable oil (Method 1).

Origin	Atom allocation: Method 1						
	C	H	N	O	S	Cl	Na
Fossil	5	5	1				
Plant	12	25				1	
'Bio-based'	72%						

Table 8-208 Indirect bio-based content allocation for *N*-dodecylpyridinium chloride from pyridine and vegetable oil (Method 2a).

Origin	Atom allocation: Method 2a						
	C	H	N	O	S	Cl	Na
Fossil	5	5	$\frac{3}{4}$			$\frac{3}{4}$	
Plant	12	25	$\frac{1}{4}$			$\frac{1}{4}$	
'Bio-based'	64%						

Table 8-209 Indirect bio-based content allocation for *N*-dodecylpyridinium chloride from pyridine and vegetable oil (Method 2b).

Origin	Atom allocation: Method 2b						
	C	H	N	O	S	Cl	Na
Fossil	5	5	1			1	
Plant	12	25					
'Bio-based'	60%						



Table 8-210 Indirect bio-based content allocation for *N*-dodecylpyridinium chloride from pyridine and vegetable oil (Method 3).

Origin	Atom allocation: Method 3						
	C	H	N	O	S	Cl	Na
Fossil	5	6 ¹ / ₃	1				
Plant	12	23					
Water		² / ₃					
Air							
Mineral						1	
'Bio-based'	68%						

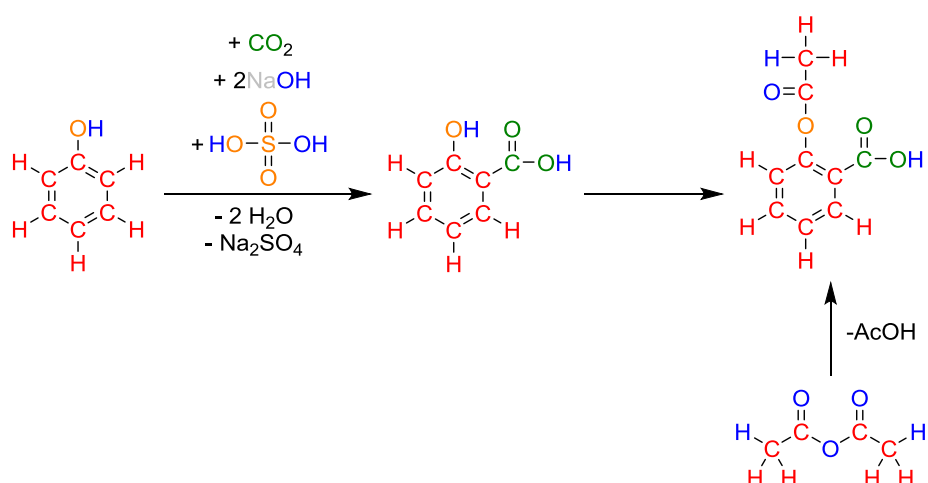
Table 8-211 Indirect bio-based content allocation for *N*-dodecylpyridinium chloride from pyridine and vegetable oil (ACDV method).

Origin	Atom allocation: ACDV						
	C	H	N	O	S	Cl	Na
Fossil	5	5	1				
Plant	12	25				1	
'Bio-based'	72% (65% based on mass contribution of CHNO atoms)						



8.26 Aspirin

Carbon dioxide as a reagent can be sourced from different waste streams. Some are the result of natural processes, or are otherwise bio-based (e.g. fermentation, biomass combustion). It will be presumed for this case study that the carbon dioxide has been captured from the brewing industry, and so is bio-based. Although aspirin is historically derived from salicylic acid as its ester, commercial production is based on the cheaper petroleum feedstock, phenol (Scheme 8-33). Phenol is produced in the same way as was demonstrated for *p*-cresol in the synthesis of BHT described earlier. Acetylation is achieved with acetic anhydride which is made from syngas (precisely, the carbonylation of methyl acetate is required, which in turn is a by-product of acetic acid production involving the carbonylation of methanol).



Scheme 8-33 The synthesis of aspirin from phenol.

Table 8-212 Indirect bio-based content allocation for aspirin from phenol (Method 1).

Origin	Atom allocation: Method 1						
	C	H	N	O	S	Cl	Na
Fossil	8	8		2			
Plant	1			2			
'Bio-based'	24%						



Table 8-213 Indirect bio-based content allocation for aspirin from phenol (Method 2a).

Origin	Atom allocation: Method 2a						
	C	H	N	O	S	Cl	Na
Fossil	8	7		2			
Plant	1	1		2			
'Bio-based'	25%						

Table 8-214 Indirect bio-based content allocation for aspirin from phenol (Method 2b).

Origin	Atom allocation: Method 2b						
	C	H	N	O	S	Cl	Na
Fossil	8	7		2			
Plant	1	1		2			
'Bio-based'	25%						

Table 8-215 Indirect bio-based content allocation for aspirin from phenol (Method 3).

Origin	Atom allocation: Method 3						
	C	H	N	O	S	Cl	Na
Fossil	8	6					
Plant	1			2			
Water		2		1			
Air				1			
Mineral							
'Bio-based'	43%						

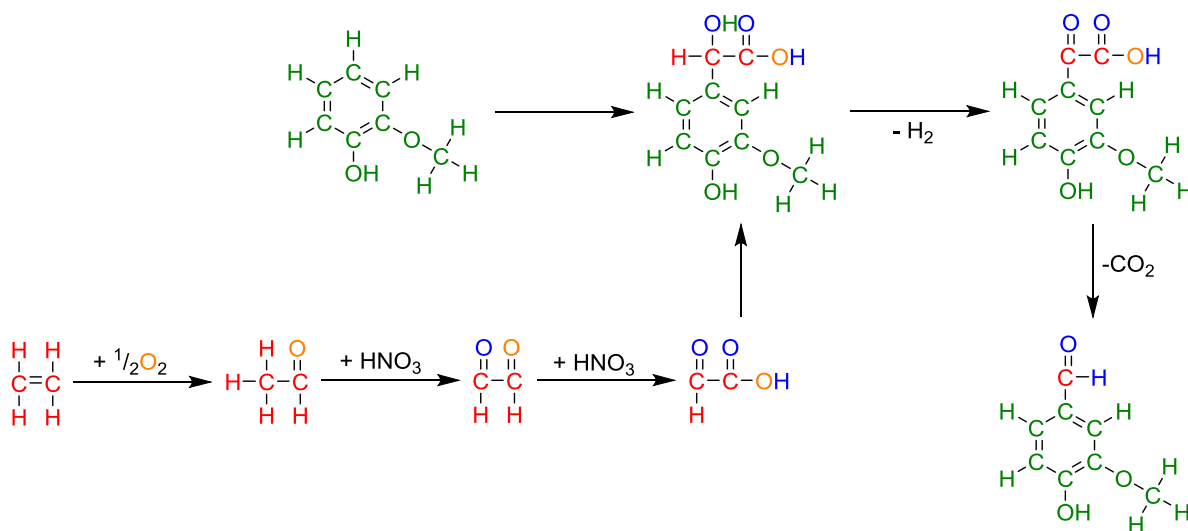
Table 8-216 Indirect bio-based content allocation for aspirin from phenol (ACDV method).

Origin	Atom allocation: ACDV						
	C	H	N	O	S	Cl	Na
Fossil	8	7		2			
Plant	1	1		2			
'Bio-based'	25%						



8.27 Vanillin

Naturally extracted vanillin occupies a minority share of the market. More commonly it is synthesised from the more abundant guaiacol. Guaiacol is generally fossil based but for this exercise it is assumed it has been extracted as a component of wood creosote for example. The reaction between glyoxylic acid and guaiacol is followed by dehydrogenation and decarboxylation to afford vanillin (Scheme 8-34). The glyoxylic acid is the product of oxidation of ethylene: first by molecular oxygen and then by nitric acid, which from previous case studies is known to introduce water derived atoms into the oxidised product.



Scheme 8-34 The synthesis of vanillin from guaiacol.

Table 8-217 Indirect bio-based content allocation for synthetic vanillin (Method 1).

Origin	Atom allocation: Method 1						
	C	H	N	O	S	Cl	Na
Fossil	1	1		1			
Plant	7	7		2			
'Bio-based'	81%						



Table 8-218 Indirect bio-based content allocation for synthetic vanillin (Method 2a).

Origin	Atom allocation: Method 2a						
	C	H	N	O	S	Cl	Na
Fossil	1	1		1			
Plant	7	7		2			
'Bio-based'	81%						

Table 8-219 Indirect bio-based content allocation for synthetic vanillin (Method 2b).

Origin	Atom allocation: Method 2b						
	C	H	N	O	S	Cl	Na
Fossil	1	1		1			
Plant	7	7		2			
'Bio-based'	81%						

Table 8-220 Indirect bio-based content allocation for synthetic vanillin (Method 3).

Origin	Atom allocation: Method 3						
	C	H	N	O	S	Cl	Na
Fossil	1						
Plant	7	7		2			
Water		1		1			
Air							
Mineral							
'Bio-based'	92%						

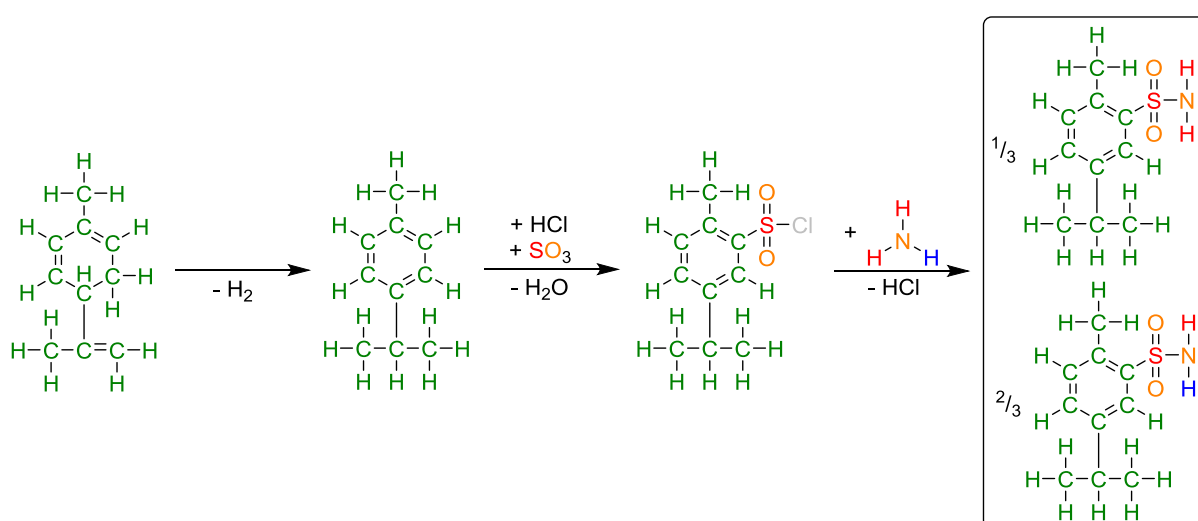
Table 8-221 Indirect bio-based content allocation for synthetic vanillin (ACDV method).

Origin	Atom allocation: ACDV						
	C	H	N	O	S	Cl	Na
Fossil	1	1		1			
Plant	7	7		2			
'Bio-based'	81%						



8.28 *p*-Cymenesulphonamide

p-Cymenesulphonamide is not a commercially available material but serves a purpose in this report to demonstrate how the rules of bio-based content by atom connectivity operate when heteroatoms are bonded to each other and not directly to carbon. Sulphonamides have been made from *p*-cymene, itself a derivative of limonene in the literature before. Limonene is transformed into *p*-cymene through an isomerisation-dehydrogenation process. The arene is then sulphonated before a reaction with ammonia (Scheme 8-35).



Scheme 8-35 The synthesis of *p*-cymenesulphonamide from limonene.

Table 8-222 Indirect bio-based content allocation for *p*-cymenesulphonamide from limonene (Method 1).

Origin	Atom allocation: Method 1						
	C	H	N	O	S	Cl	Na
Fossil		2	1	2	1		
Plant	10	13					
'Bio-based'	63%						



Table 8-223 Indirect bio-based content allocation for *p*-cymenesulphonamide from limonene (Method 2a).

Origin	Atom allocation: Method 2a						
	C	H	N	O	S	Cl	Na
Fossil							
Plant	10	15	1	2	1		
'Bio-based'	100%						

Table 8-224 Indirect bio-based content allocation for *p*-cymenesulphonamide from limonene (Method 2b).

Origin	Atom allocation: Method 2b						
	C	H	N	O	S	Cl	Na
Fossil							
Plant	10	15	1	2	1		
'Bio-based'	100%						

Table 8-225 Indirect bio-based content allocation for *p*-cymenesulphonamide from limonene (Method 3).

Origin	Atom allocation: Method 3						
	C	H	N	O	S	Cl	Na
Fossil		$1\frac{1}{3}$			1		
Plant	10	13					
Water		$\frac{2}{3}$					
Air			1	2			
Mineral							
'Bio-based'							



Table 8-226 Indirect bio-based content allocation for *p*-cymenesulphonamide from limonene (ACDV method).

Origin	Atom allocation: ACDV						
	C	H	N	O	S	Cl	Na
Fossil							
Plant	10	15	1	2	1		
'Bio-based'	100%						



9 Annex B: Mass balance

9.1 Gasification mass balance calculations

For the conversion of either coal or starch into syngas the product distribution changes considerably depending on the feedstock. This means that the processes are not comparable, which will come apparent upon examination of the mass balance calculations. The mass balance data for the gasification of coal (Table 9-1), and starch gasification are tabulated below (Table 9-2) [Calzavara 2005, Lee 2007]. The mass balances are scaled in both instances to offer 100 kg of carbon monoxide, a key chemical intermediate for many products. Carbon monoxide will be the primary product for which a calculation of total bio-based content will be determined.

Table 9-1 Mass balance data for coal gasification.

Mass flow	Substance	Mass /kg
Input	Coal	400
Input	Water	601
Output	Hydrogen	67
Output	Carbon monoxide	100
Output	Carbon dioxide	19
Output	Methane	0
Output	Water	0
Losses	(unknown)	815

Table 9-2 Mass balance data for starch gasification.

Mass flow	Substance	Mass /kg
Input	Starch	10158
Input	Water	9706
Output	Hydrogen	132
Output	Carbon monoxide	100
Output	Carbon dioxide	1891
Output	Methane	115
Output	Water	8771
Losses	(unknown)	8856



9.1.1 Total bio-based content calculation by mass balance Method A

The calculations to accompany the discussion presented in Chapter 5 concerning the application of mass balance Method A to describe the gasification of starch to give carbon monoxide are presented here (Table 9-3). Two sets of calculations were performed; the standard mass balance with attribution units, followed by an adjusted feedstock input for stoichiometric conversion of starch to carbon dioxide (ignoring conversion of starch to carbon dioxide and other products).

Table 9-3 Mass balance equations for the gasification of starch to give carbon monoxide by mass balance Method A.

Metric	Calculation	Result
Mass of coal		400 kg
Methane equivalents (coal)	$\frac{LHV_{methane}}{LHV_{coal}} = \frac{50 \text{ MJ/kg}}{29 \text{ MJ/kg}}$	1.72
Allocation (per 100 kg of carbon monoxide)	$Mass \cdot Methane \text{ equivalents} = 400 \text{ kg} \cdot 1.72$	690 kg
Mass of starch		10158 kg
Methane equivalents (starch)	$\frac{LHV_{methane}}{LHV_{starch}} = \frac{50 \text{ MJ/kg}}{16 \text{ MJ/kg}}$	3.05
Feedstock requirement	$\frac{Allocation}{Methane \text{ equivalents (starch)}} = \frac{690 \text{ kg}}{3.05}$	227 kg
Bio-based content (carbon monoxide)	$\frac{Mass \text{ of starch}}{Feedstock \text{ requirement}} = \frac{10158 \text{ kg}}{227 \text{ kg}}$	4484%
Proportion of starch carbon reaching carbon monoxide	$\frac{moles_{CO} \cdot carbon \text{ atoms}_{CO}}{moles_{starch} \cdot carbon \text{ atoms}_{starch}}$	0.95%
Minimum amount of starch required to produce 100 kg of carbon dioxide	$Mass \text{ of starch} \cdot yield = 10158 \text{ kg} \cdot 0.95\%$	96.7 kg
Total bio-based content (carbon monoxide)	$\frac{Mass \text{ of starch}}{Feedstock \text{ requirement}} = \frac{96.7 \text{ kg}}{227 \text{ kg}}$	43%

9.1.2 Total bio-based content calculation by mass balance Method B

The following calculation is for a manufacturing plant operating a gasification procedure in which over the course of the fixed time period (e.g. 12 months), 100 kg of carbon monoxide was synthesised from 320 kg of coal and 2032 kg of starch (Table 9-4). This results in a product that is 20% bio-based, averaged across the fixed time period. Bio-based carbon content is the same as total bio-based content because the two equivalent product



streams (from biomass and from coal) are equal in terms of the number of carbon atoms present and either fully bio-based or fully fossil derived, resulting in the following calculations (Table 9-4).

Table 9-4 Mass balance equations for the gasification of starch to give carbon monoxide by mass balance Method B.

Metric	Calculation	Result
Mass of coal		320 kg
Conversion factor	$\frac{\text{Mass of product}}{\text{Mass of feedstock}} = \frac{100 \text{ kg}}{400 \text{ kg}}$	0.250
Mass of fossil derived carbon monoxide	$\text{Mass of coal} \cdot \text{Conversion factor}$ $= 320 \text{ kg} \cdot 0.250$	80 kg
Mass of fossil derived carbon atoms	$\frac{\text{Atomic mass}_C}{\text{RMM}_{CO}} \cdot \text{Mass}_{CO} = \frac{12.01 \text{ g} \cdot \text{mol}^{-1}}{28.01 \text{ g} \cdot \text{mol}^{-1}} \cdot 80 \text{ kg}$	34.40 kg
Mass of starch		2032 kg
Conversion factor	$\frac{\text{Mass of product}}{\text{Mass of feedstock}} = \frac{100 \text{ kg}}{10158 \text{ kg}}$	0.00987
Mass of biomass derived carbon monoxide	$\text{Mass of starch} \cdot \text{Conversion factor}$ $= 2032 \text{ kg} \cdot 0.00987$	20 kg
Mass of biomass derived carbon atoms	$\frac{\text{Atomic mass}_C}{\text{RMM}_{CO}} \cdot \text{Mass}_{CO}$ $= \frac{12.01 \text{ g} \cdot \text{mol}^{-1}}{28.01 \text{ g} \cdot \text{mol}^{-1}} \cdot 20 \text{ kg}$	8.60 kg
Total bio-based content (carbon monoxide)	$\frac{\text{Mass of biobased carbon monoxide}}{\text{Total mass of carbon monoxide}}$ $= \frac{20 \text{ kg}}{20 \text{ kg} + 80 \text{ kg}}$	20%
Bio-based carbon content	$\frac{\text{Biobased carbon atoms in carbon monoxide}}{\text{Total carbon atoms in carbon monoxide}}$ $= \frac{8.60 \text{ kg}}{34.4 \text{ kg} + 8.60 \text{ kg}}$	20%

9.1.3 Total bio-based content calculation by mass balance Method C

The calculation needed to arrive at fossil savings is simple enough, but the presentation of the result could be misleading, or be out of context and so become unhelpful to customers. Different expressions of the fossil carbon savings made when starch is used as the sole gasification feedstock (Table 9-5), and when a mixture of starch and coal is used across the pre-defined manufacturing period to give carbon monoxide of 20% total bio-based content as in Table 9-4 (Table 9-6). With only one organic feedstock the majority of the calcula-



tions are a matter of proportionality, with fossil savings proportional to the amount of fossil derived feedstock supplanted. The final calculation in both Table 9-5 and Table 9-6 requires that the savings in fossil derived feedstock carbon are expressed as a fraction relative to the mass of carbon in the product. The resulting values are indicative of the amount of biomass included in the manufacturing process, but need to be partnered with a direct or indirect bio-based (carbon) content to provide a context to these fossil carbon savings.



Table 9-5 Mass balance Method C applied to carbon monoxide made by starch gasification (100% total bio-based content).

Metric	Calculation	Result
Proportion of carbon atom mass in carbon monoxide	$\frac{\text{Atomic mass}_C}{RMM_{CO}} = \frac{12.01 \text{ g} \cdot \text{mol}^{-1}}{28.01 \text{ g} \cdot \text{mol}^{-1}}$	42.9%
Bio-based carbon content		100%
Fossil carbon saving: per 100 kg of product	$\text{Carbon mass} \cdot \text{Biobased carbon content} \cdot 100 \text{ kg} \\ = 42.9\% \cdot 100\% \cdot 100 \text{ kg}$	43 kg
Fossil carbon saving: per mass of carbon in product	$\frac{\text{Fossil carbon saving per 100 kg of product}}{\text{Mass of carbon per 100 kg of product}} \\ = \frac{43 \text{ kg}}{43 \text{ kg}}$	1.0 g/g
Original mass of coal feedstock (per 100 kg of product)		400 kg
Mass of fossil carbon in original feedstock	$\text{Mass of fossil feedstock} \cdot \text{Carbon content} \\ = 400 \text{ kg} \cdot 100\%$	400 kg
Mass of coal replaced		400 kg
Mass of fossil carbon in feedstock	$\text{Mass of fossil feedstock remaining} \\ \cdot \text{Carbon content} = 0 \text{ kg} \cdot 100\%$	0 kg
Fossil feedstock carbon saving: per 100 kg of product	$\text{Mass of fossil carbon in original feedstock} \\ - \text{mass of fossil carbon in feedstock} = 400 - 0$	400 kg
Fossil feedstock carbon saving: per mass of carbon in original feedstock	$1 \\ - \frac{\text{Mass of fossil carbon in feedstock}}{\text{Maximum mass of fossil carbon in feedstock}} \\ = 1 - \frac{0 \text{ kg}}{400 \text{ kg}}$	1.0 g/g
Fossil feedstock carbon saving: per mass of carbon in product	$\frac{\text{Mass of fossil carbon in feedstock replaced}}{\text{Mass of carbon per 100 kg of product}} \\ = \frac{400 \text{ kg}}{43 \text{ kg}}$	9.3 g/g



Table 9-6 Mass balance Method C applied to carbon monoxide made by starch gasification (20% total bio-based content).

Metric	Calculation	Result
Proportion of carbon atom mass in carbon monoxide	$\frac{\text{Atomic mass}_C}{RMM_{CO}} = \frac{12.01 \text{ g} \cdot \text{mol}^{-1}}{28.01 \text{ g} \cdot \text{mol}^{-1}}$	42.9%
Bio-based carbon content		20%
Fossil carbon saving: per 100 kg of product	$\text{Carbon mass} \cdot \text{Biobased carbon content} \cdot 100 \text{ kg}$ $= 42.9\% \cdot 20\% \cdot 100 \text{ kg}$	8.6 kg
Fossil carbon saving: per mass of carbon in product	$\frac{\text{Fossil carbon saving per 100 kg of product}}{\text{Mass of carbon per 100 kg of product}}$ $= \frac{8.6 \text{ kg}}{43 \text{ kg}}$	0.2 g/g
Original mass of coal feedstock (per 100 kg of product)		400 kg
Mass of fossil carbon in original feedstock	$\text{Mass of fossil feedstock} \cdot \text{Carbon content}$ $= 400 \text{ kg} \cdot 100\%$	400 kg
Mass of coal replaced		800 kg
Mass of fossil carbon in feedstock	$\text{Mass of fossil feedstock remaining}$ $\cdot \text{Carbon content}$ $= 320 \text{ kg} \cdot 100\%$	320 kg
Fossil feedstock carbon saving: per 100 kg of product	$= \text{Mass of fossil carbon in original feedstock}$ $- \text{mass of fossil carbon in feedstock}$ $= 400 - 320$	80 kg
Fossil feedstock carbon saving: per mass of carbon in original feedstock	$1 - \frac{\text{Mass of fossil carbon in feedstock}}{\text{Maximum mass of fossil carbon in feedstock}}$ $= 1 - \frac{320 \text{ kg}}{400 \text{ kg}}$	0.2 g/g
Fossil feedstock carbon saving: per mass of carbon in product	$\frac{\text{Mass of fossil carbon in feedstock replaced}}{\text{Mass of carbon per 100 kg of product}}$ $= \frac{80 \text{ kg}}{43 \text{ kg}}$	1.9 g/g



9.2 Naphtha processing mass balance calculations (ethanol synthesis)

The conversion of naphtha to ethanol has been calculated using mass balance methods for two types of naphtha feedstock with different product distributions. Table 9-7 refers to conventional naphtha and Table 9-8 to a bio-naphtha feedstock. Sankey diagrams for both mass balances are presented in Figure 5-15.

Table 9-7 Mass balance data for the conversion of conventional naphtha to ethanol.

Mass flow	Substance	Mass /kg
Input	Naphtha	251
Input	Water	40
Output	Ethanol	100
Output	Propylene	50
Output	Butenes	38
Output	Remaining naphtha stream	100
Losses	(unknown)	2

Table 9-8 Mass balance data for the conversion of bio-naphtha to ethanol.

Mass flow	Substance	Mass /kg
Input	Bio-naphtha	202
Input	Water	40
Output	Ethanol	100
Output	Propylene	37
Output	Butenes	14
Output	Remaining naphtha stream	89
Losses	(unknown)	2

9.2.1 Total bio-based content calculation by mass balance Method A

The calculations to accompany the discussion presented in Chapter 5 concerning the application of mass balance Method A to describe the conversion of naphtha to ethanol are presented here (Table 9-9). The two possible routes; the conventional petrochemical method and the bio-based feedstock, can be found in Figure 5-15. Mass balance Method A fails to account for the differences between naphthas, and so the greater productivity to ethylene (and onto ethanol) of bio-naphtha is actually a disadvantage as it fail to meet the mass input quota required from the designated attribution units. Hence the maximum bio-based content allocated using mass balance Method A when all the feedstock is bio-based is limited to 81%. Employing an equal amount of each feedstock would result in an allocated 45% total bio-based content and not 50% as might be intuitively expected, or the 55% that actually



occurs because of the greater ethylene productivity of bio-naphtha (Table 9-10). To produce 100 kg of ethanol, 112 kg of conventional naphtha and 112 kg of bio-naphtha may be combined.

Table 9-9 Mass balance equations for the conversion of bio-naphtha to ethanol using mass balance Method A.

Metric	Calculation	Result
Mass of fossil derived naphtha		251 kg
Methane equivalents (naphtha)	$\frac{LHV_{methane}}{LHV_{naphtha}} = \frac{50 \text{ MJ/kg}}{44.3 \text{ MJ/kg}}$	1.13
Allocation (per 100 kg of ethanol)	$Mass \cdot \text{Methane equivalents} = 251 \text{ kg} \cdot 1.13$	284 kg
Mass of bio-based naphtha		202 kg
Methane equivalents (bio-based naphtha)	$\frac{LHV_{methane}}{LHV_{naphtha}} = \frac{50 \text{ MJ/kg}}{44.3 \text{ MJ/kg}}$	1.13
Feedstock requirement	$\frac{Allocation}{Methane \text{ equivalents (naphtha)}} = \frac{284 \text{ kg}}{1.13}$	251 kg
Bio-based content (ethanol)	$\frac{Mass \text{ of bionaphtha}}{Feedstock \text{ requirement}} = \frac{202 \text{ kg}}{251 \text{ kg}}$	81%

Table 9-10 Mass balance equations for the conversion of a mixed naphtha feed (1:1 by mass) to ethanol using mass balance Method A.

Metric	Calculation	Result
Mass of bio-based naphtha		112 kg
Methane equivalents (bio-based naphtha)	$\frac{LHV_{methane}}{LHV_{naphtha}} = \frac{50 \text{ MJ/kg}}{44.3 \text{ MJ/kg}}$	1.13
Feedstock requirement	$\frac{Allocation}{Methane \text{ equivalents (naphtha)}} = \frac{284 \text{ kg}}{1.13}$	251 kg
Bio-based content (ethanol)	$\frac{Mass \text{ of bionaphtha}}{Feedstock \text{ requirement}} = \frac{112 \text{ kg}}{251 \text{ kg}}$	45%

9.2.2 Total bio-based content calculation by mass balance Method B

Figure 5-17 has shown the non-linear proportionality between the relative amount of bio-naphtha in the cracking feed and the resulting bio-based content of ethylene and the other products. This is caused by the different productivities and product selectivity of conventional naphtha and bio-naphtha. The amount of ethylene produced from each variety of naphtha equates to the total bio-based content of the product stream, because each naph-



tha (conventional and biomass) is either wholly fossil derived or completely bio-based. The equation required to calculate the amount of bio-based content in the ethylene product stream is as follows, with M representing mass and C representing conversion (yield):

$$\text{Total biobased content} = \frac{(M_{\text{bionaphtha}} \cdot C_{\text{bio-based naphtha}}^{\text{ethylene}})}{\{(M_{\text{bio-naphtha}} \cdot C_{\text{ethylene}}) + (M_{\text{petro-naphtha}} \cdot C_{\text{petro-naphtha}}^{\text{ethylene}})\}}$$

Using Table 5-8 the equation reads thusly:

$$\text{Total biobased content} = \frac{(M_{\text{bionaphtha}} \cdot 0.31)}{\{(M_{\text{bio-naphtha}} \cdot 0.31) + (M_{\text{petro-naphtha}} \cdot 0.25)\}}$$

And when the mass of both varieties of feedstock are the same, the result is 55%:

$$\text{Total biobased content} = \frac{(112 \cdot 0.31)}{\{(112 \cdot 0.31) + (122 \cdot 0.25)\}} = 55\%$$

9.2.3 Total bio-based content calculation by mass balance Method C

Fossil savings have been calculated for the complete displacement of conventional naphtha with bio-naphtha (Table 9-11), and a 50:50 feed, by mass (Table 9-12). In the latter instance the bio-based carbon content of the product is the same as its total bio-based content as calculated in the previous section as 55%.



Table 9-11 Mass balance Method C applied to ethanol made from bio-naphtha.

Metric	Calculation	Result
Proportion of carbon atom mass in ethanol	$\frac{2 \cdot \text{Atomic mass}_C}{RMM_{\text{ethanol}}} = \frac{2 \cdot 12.01 \text{ g} \cdot \text{mol}^{-1}}{46.07 \text{ g} \cdot \text{mol}^{-1}}$	52.1%
Bio-based carbon content		100%
Fossil carbon saving: per 100 kg of product	$\text{Carbon mass} \cdot \text{Biobased carbon content} \cdot 100 \text{ kg}$ $= 52.1\% \cdot 100\% \cdot 100 \text{ kg}$	52.1 kg
Fossil carbon saving: per mass of carbon in product	$\frac{\text{Fossil carbon saving per 100 kg of product}}{\text{Mass of carbon per 100 kg of product}}$ $= \frac{52.1 \text{ kg}}{52.1 \text{ kg}}$	1.0 g/g
Original mass of conventional naphtha feedstock (per 100 kg of product)		251 kg
Mass of fossil carbon in original feedstock	$\text{Mass of fossil feedstock} \cdot \text{Carbon content}$ $= 251 \text{ kg} \cdot 90\%$	226 kg
Mass of conventional naphtha replaced		251 kg
Mass of fossil carbon in feedstock	$\text{Mass of fossil feedstock remaining}$ $\cdot \text{Carbon content} = 0 \text{ kg} \cdot 90\%$	0 kg
Fossil feedstock carbon saving: per 100 kg of product	$\text{Mass of fossil carbon in original feedstock}$ $- \text{mass of fossil carbon in feedstock} = 226 - 0$	226 kg
Fossil feedstock carbon saving: per mass of carbon in original feedstock	1 $-\frac{\text{Mass of fossil carbon in feedstock}}{\text{Maximum mass of fossil carbon in feedstock}}$ $= 1 - \frac{0 \text{ kg}}{226 \text{ kg}}$	1.0 g/g
Fossil feedstock carbon saving: per mass of carbon in product	$\frac{\text{Mass of fossil carbon in feedstock replaced}}{\text{Mass of carbon per 100 kg of product}}$ $= \frac{226 \text{ kg}}{52.1 \text{ kg}}$	4.3 g/g



Table 9-12 Mass balance Method C applied to ethanol made from equal quantities of bio-naphtha and conventional naphtha.

Metric	Calculation	Result
Proportion of carbon atom mass in ethanol	$\frac{2 \cdot \text{Atomic mass}_C}{RMM_{\text{ethanol}}} = \frac{2 \cdot 12.01 \text{ g} \cdot \text{mol}^{-1}}{46.07 \text{ g} \cdot \text{mol}^{-1}}$	52.1%
Bio-based carbon content		55.4%
Fossil carbon saving: per 100 kg of product	$\text{Carbon mass} \cdot \text{Biobased carbon content} \cdot 100 \text{ kg}$ $= 52.1\% \cdot 55.4\% \cdot 100 \text{ kg}$	28.9 kg
Fossil carbon saving: per mass of carbon in product	$\frac{\text{Fossil carbon saving per 100 kg of product}}{\text{Mass of carbon per 100 kg of product}}$ $= \frac{28.9 \text{ kg}}{52.1 \text{ kg}}$	0.55 g/g
Original mass of conventional naphtha feedstock (per 100 kg of product)		251 kg
Mass of fossil carbon in original feedstock	$\text{Mass of fossil feedstock} \cdot \text{Carbon content}$ $= 251 \text{ kg} \cdot 90\%$	226 kg
Mass of conventional naphtha replaced		139 kg
Mass of fossil carbon in feedstock	$\text{Mass of fossil feedstock remaining} \cdot \text{Carbon content} = 112 \text{ kg} \cdot 90\%$	101 kg
Fossil feedstock carbon saving: per 100 kg of product	$\text{Mass of fossil carbon in original feedstock}$ $- \text{mass of fossil carbon in feedstock}$ $= 226 - 101$	125 kg
Fossil feedstock carbon saving: per mass of carbon in original feedstock	$1 - \frac{\text{Mass of fossil carbon in feedstock}}{\text{Maximum mass of fossil carbon in feedstock}}$ $= 1 - \frac{101 \text{ kg}}{226 \text{ kg}}$	0.55 g/g
Fossil feedstock carbon saving: per mass of carbon in product	$\frac{\text{Mass of fossil carbon in feedstock replaced}}{\text{Mass of carbon per 100 kg of product}}$ $= \frac{125 \text{ kg}}{52.1 \text{ kg}}$	2.4 g/g



9.3 Naphtha processing mass balance calculations (2-ethoxyethyl acetate synthesis)

The previous two mass balance case studies can be combined to demonstrate the manufacturing process of 2-ethoxyethyl acetate. Naphtha and natural gas feedstocks can be employed (Table 9-13) or the natural gas replaced with coal (Table 9-14) or starch (Table 9-15) gasification. Alternatively fermentation can yield the acetic acid intermediate (Table 9-16).

Table 9-13 Mass balance data for 2-ethoxyethyl acetate made from naphtha and natural gas.

Mass flow	Substance	Mass /kg
Input	Naphtha	194
Input	Natural gas	26
Input	Water	43
Input	Oxygen	12
Output	2-Ethoxyethyl acetate	100
Output	Hydrogen	7
Output	Water	14
Losses	(combined)	154

Table 9-14 Mass balance data for 2-ethoxyethyl acetate made from naphtha and coal.

Mass flow	Substance	Mass /kg
Input	Naphtha	194
Input	Coal	179
Input	Water	283
Input	Oxygen	12
Output	2-Ethoxyethyl acetate	100
Output	Hydrogen	27
Output	Carbon dioxide	8
Output	Water	14
Losses	(combined)	519



Table 9-15 Mass balance data for 2-ethoxyethyl acetate made from naphtha and starch reforming.

Mass flow	Substance	Mass /kg
Input	Naphtha	194
Input	Starch	4554
Input	Water	433
Input	Oxygen	12
Output	2-Ethoxyethyl acetate	100
Output	Hydrogen	56
Output	Carbon dioxide	848
Output	Methane	51
Output	Water	14
Losses	(combined)	4124

Table 9-16 Mass balance data for 2-ethoxyethyl acetate made from naphtha and fermentation.

Mass flow	Substance	Mass /kg
Input	Naphtha	194
Input	Cellulose	154
Input	Water	14
Input	Oxygen	12
Output	2-Ethoxyethyl acetate	100
Output	Propanoic acid	3
Output	Carbon dioxide	50
Output	Water	14
Losses	(combined)	207

9.3.1 Total bio-based content calculation by mass balance Method A

For the process combining natural gas and naphtha feedstocks (Figure 5-20), either feedstock could be bio-based to any extent. It will be assumed that for the purpose of mass balance Method A that the origin of the feedstock does not change its calorific value or downstream product distribution. Replacing conventional naphtha with bio-naphtha will provide up to 89.5% bio-based content (Table 9-17), with bio-gas offering 10.5% (Table 9-18). Results for mixed source feedstocks would be scaled down appropriately.



Table 9-17 Mass balance equations for the conversion of bio-naphtha (and natural gas) to 2-ethoxyethyl acetate using mass balance Method A.

Metric	Calculation	Result
Mass of fossil derived naphtha		194 kg
Methane equivalents (naphtha)	$\frac{LHV_{methane}}{LHV_{naphtha}} = \frac{50 \text{ MJ/kg}}{44.3 \text{ MJ/kg}}$	1.13
Allocation (per 100 kg of 2-ethoxyethyl acetate)	$\sum \text{Mass} \cdot \text{Methane equivalents}$ $= (194 \text{ kg} \cdot 1.13)$ $+ (26 \text{ kg} \cdot 1.00)$	245 kg
Mass of bio-based naphtha		194 kg
Methane equivalents (bio-based naphtha)	$\frac{LHV_{methane}}{LHV_{naphtha}} = \frac{50 \text{ MJ/kg}}{44.3 \text{ MJ/kg}}$	1.13
Feedstock requirement	$\frac{\text{Allocation}}{\text{Methane equivalents (naphtha)}} = \frac{245 \text{ kg}}{1.13}$	216 kg
Bio-based content (2-ethoxyethyl acetate)	$\frac{\text{Mass of bionaphtha}}{\text{Feedstock requirement}} = \frac{194 \text{ kg}}{216 \text{ kg}}$	89.5%

Table 9-18 Mass balance equations for the conversion of bio-gas (and conventional naphtha) to 2-ethoxyethyl acetate using mass balance Method A.

Metric	Calculation	Result
Mass of fossil derived natural gas		26 kg
Methane equivalents (methane)	$\frac{LHV_{methane}}{LHV_{methane}} = \frac{50 \text{ MJ/kg}}{50 \text{ MJ/kg}}$	1.00
Allocation (per 100 kg of 2-ethoxyethyl acetate)	$\sum \text{Mass} \cdot \text{Methane equivalents}$ $= (194 \text{ kg} \cdot 1.13)$ $+ (26 \text{ kg} \cdot 1.00)$	245 kg
Mass of bio-gas		26 kg
Methane equivalents (bio-based methane)	$\frac{LHV_{methane}}{LHV_{methane}} = \frac{50 \text{ MJ/kg}}{44.3 \text{ MJ/kg}}$	1.00
Feedstock requirement	$\frac{\text{Allocation}}{\text{Methane equivalents (methane)}} = \frac{245 \text{ kg}}{1.00}$	245 kg
Bio-based content (2-ethoxyethyl acetate)	$\frac{\text{Mass of biogas}}{\text{Feedstock requirement}} = \frac{26 \text{ kg}}{245 \text{ kg}}$	10.5%

Using either coal or starch gasification instead of natural gas reforming as a means of obtaining acetic acid for the synthesis of 2-ethoxyethyl acetate will also change the influence of naphtha on the total bio-based content calculated. With coal (of which 179 kg is required)



holding 1.72 methane equivalents, the allocation to 2-ethoxyethyl acetate increases when coal replaced natural gas, from 245 kg to 528 kg of attribution units. This suppresses the amount of bio-based content that the naphtha can impart to 41% (Table 9-19). When starch is used for gasification, the large quantity of feedstock introduced further diminishes the influence of any bio-naphtha (Table 9-20).

Table 9-19 Mass balance equations for the conversion of bio-naphtha (and coal) to 2-ethoxyethyl acetate using mass balance Method A.

Metric	Calculation	Result
Mass of fossil derived naphtha		194 kg
Methane equivalents (naphtha)	$\frac{LHV_{methane}}{LHV_{naphtha}} = \frac{50 \text{ MJ/kg}}{44.3 \text{ MJ/kg}}$	1.13
Allocation (per 100 kg of 2-ethoxyethyl acetate)	$\sum \text{Mass} \cdot \text{Methane equivalents}$ = (194 kg · 1.13) + (179 kg · 1.72)	528 kg
Mass of bio-based naphtha		194 kg
Methane equivalents (bio-based naphtha)	$\frac{LHV_{methane}}{LHV_{naphtha}} = \frac{50 \text{ MJ/kg}}{44.3 \text{ MJ/kg}}$	1.13
Feedstock requirement	$\frac{\text{Allocation}}{\text{Methane equivalents (naphtha)}} = \frac{528 \text{ kg}}{1.13}$	468 kg
Bio-based content (2-ethoxyethyl acetate)	$\frac{\text{Mass of bionaphtha}}{\text{Feedstock requirement}} = \frac{194 \text{ kg}}{468 \text{ kg}}$	41.4%

Table 9-20 Mass balance equations for the conversion of starch and naphtha to 2-ethoxyethyl acetate using mass balance Method A.

Metric	Calculation	Result
Allocation (per 100 kg of 2-ethoxyethyl acetate)	$\sum \text{Mass} \cdot \text{Methane equivalents}$ = (194 kg · 1.13) + (4554 kg · 3.05)	14095 kg
Mass of starch		4554 kg
Methane equivalents (starch)	$\frac{LHV_{methane}}{LHV_{starch}} = \frac{50 \text{ MJ/kg}}{16.4 \text{ MJ/kg}}$	3.05
Feedstock requirement	$\frac{\text{Allocation}}{\text{Methane equivalents (starch)}} = \frac{14095 \text{ kg}}{3.05}$	4626 kg
Bio-based content (2-ethoxyethyl acetate)	$\frac{\text{Mass of starch}}{\text{Feedstock requirement}} = \frac{4554 \text{ kg}}{4626 \text{ kg}}$	98.4%



Finally fermentation can be used to make the acetic acid for the final esterification with 2-ethoxyethanol to give the product. Cellulosic fermentation will introduce 67.5% bio-based content into 2-ethoxyethyl acetate using indirect calculations with mass balance Method A (Table 9-21), but only account for two of the six carbon atoms in every molecule.

Table 9-21 Mass balance equations for the conversion of bio-naphtha (and coal) to 2-ethoxyethyl acetate using mass balance Method A.

Metric	Calculation	Result
Allocation (per 100 kg of 2-ethoxyethyl acetate)	$\sum \text{Mass} \cdot \text{Methane equivalents}$ $= (194 \text{ kg} \cdot 1.13)$ $+ (154 \text{ kg} \cdot 2.94)$	673 kg
Mass of cellulose		154 kg
Methane equivalents (bio-based naphtha)	$\frac{LHV_{\text{methane}}}{LHV_{\text{naphtha}}} = \frac{50 \text{ MJ/kg}}{17 \text{ MJ/kg}}$	2.94
Feedstock requirement	$\frac{\text{Allocation}}{\text{Methane equivalents (naphtha)}} = \frac{673 \text{ kg}}{2.94}$	229 kg
Bio-based content (2-ethoxyethyl acetate)	$\frac{\text{Mass of bionaphtha}}{\text{Feedstock requirement}} = \frac{154 \text{ kg}}{229 \text{ kg}}$	67.5%

9.3.2 Total bio-based content calculation by mass balance Method C

Of the many variants of this case study discussed thus far, three scenarios are presented within the context of mass balance Method C: bio-naphtha replacing conventional naphtha (Table 9-22), when fermentation replaces natural gas (Table 9-23), and fermentation as an alternative to coal gasification (Table 9-24).



Table 9-22 Mass balance Method C applied to 2-ethoxyethyl acetate made from bio-naphtha and natural gas.

Metric	Calculation	Result
Proportion of carbon atom mass in 2-ethoxyethyl acetate	$\frac{6 \cdot \text{Atomic mass}_C}{RMM_{\text{product}}} = \frac{6 \cdot 12.01 \text{ g} \cdot \text{mol}^{-1}}{132.2 \text{ g} \cdot \text{mol}^{-1}}$	54.5%
Bio-based carbon content		66.7%
Fossil carbon saving: per 100 kg of product	$\text{Carbon mass} \cdot \text{Biobased carbon content} \cdot 100 \text{ kg}$ $= 54.5\% \cdot 66.7\% \cdot 100 \text{ kg}$	36.4 kg
Fossil carbon saving: per mass of carbon in product	$\frac{\text{Fossil carbon saving per 100 kg of product}}{\text{Mass of carbon per 100 kg of product}}$ $= \frac{36.4 \text{ kg}}{54.5 \text{ kg}}$	0.67 g/g
Original mass of conventional naphtha feedstock (per 100 kg of product)		194 kg
Mass of natural gas feedstock (per 100 kg of product)		26 kg
Mass of fossil carbon in original feedstock	$\sum \text{Mass of fossil feedstock} \cdot \text{Carbon content}$ $= (194 \text{ kg} \cdot 90\%) + (26 \text{ kg} \cdot 75\%)$	194 kg
Mass of conventional naphtha replaced		194 kg
Mass of fossil carbon in feedstock	$\text{Mass of fossil feedstock remaining} \cdot \text{Carbon content} = 26 \text{ kg} \cdot 75\%$	19.3 kg
Fossil feedstock carbon saving: per 100 kg of product	$\text{Mass of fossil carbon in original feedstock}$ $- \text{mass of fossil carbon in feedstock}$ $= 194 - 19.3$	175 kg
Fossil feedstock carbon saving: per mass of carbon in original feedstock	$1 - \frac{\text{Mass of fossil carbon in feedstock}}{\text{Maximum mass of fossil carbon in feedstock}}$ $= 1 - \frac{19 \text{ kg}}{175 \text{ kg}}$	0.89 g/g
Fossil feedstock carbon saving: per mass of carbon in product	$\frac{\text{Mass of fossil carbon in feedstock replaced}}{\text{Mass of carbon per 100 kg of product}}$ $= \frac{175 \text{ kg}}{54.5 \text{ kg}}$	3.2 g/g



Table 9-23 An interpretation of the synthesis of 2-ethoxyethylacetate using mass balance Method C when fermentation replaces natural gas.

Metric	Calculation	Result
Proportion of carbon atom mass in 2-ethoxyethyl acetate	$\frac{6 \cdot \text{Atomic mass}_C}{RMM_{\text{product}}} = \frac{6 \cdot 12.01 \text{ g} \cdot \text{mol}^{-1}}{132.2 \text{ g} \cdot \text{mol}^{-1}}$	54.5%
Bio-based carbon content		33.3%
Fossil carbon saving: per 100 kg of product	$\text{Carbon mass} \cdot \text{Biobased carbon content} \cdot 100 \text{ kg} \\ = 54.5\% \cdot 33.3\% \cdot 100 \text{ kg}$	18.2 kg
Fossil carbon saving: per mass of carbon in product	$\frac{\text{Fossil carbon saving per 100 kg of product}}{\text{Mass of carbon per 100 kg of product}} \\ = \frac{18.2 \text{ kg}}{54.5 \text{ kg}}$	0.33 g/g
Original mass of conventional naphtha feedstock (per 100 kg of product)		194 kg
Mass of natural gas feedstock (per 100 kg of product)		26 kg
Mass of fossil carbon in original feedstock	$\sum \text{Mass of fossil feedstock} \cdot \text{Carbon content} \\ = (194 \text{ kg} \cdot 90\%) + (26 \text{ kg} \cdot 75\%)$	194 kg
Mass of natural gas replaced		26 kg
Mass of fossil carbon in feedstock	$\text{Mass of fossil feedstock remaining} \\ \cdot \text{Carbon content} = 194 \text{ kg} \cdot 90\%$	174 kg
Fossil feedstock carbon saving: per 100 kg of product	$\text{Mass of fossil carbon in original feedstock} \\ - \text{mass of fossil carbon in feedstock} \\ = 194 - 174$	19 kg
Fossil feedstock carbon saving: per mass of carbon in original feedstock	$1 - \frac{\text{Mass of fossil carbon in feedstock}}{\text{Maximum mass of fossil carbon in feedstock}} \\ = 1 - \frac{174 \text{ kg}}{194 \text{ kg}}$	0.10 g/g
Fossil feedstock carbon saving: per mass of carbon in product	$\frac{\text{Mass of fossil carbon in feedstock replaced}}{\text{Mass of carbon per 100 kg of product}} \\ = \frac{19 \text{ kg}}{54.5 \text{ kg}}$	0.4 g/g



Table 9-24 An interpretation of the synthesis of 2-ethoxyethylacetate using mass balance Method C when fermentation replaces coal gasification.

Metric	Calculation	Result
Proportion of carbon atom mass in 2-ethoxyethyl acetate	$\frac{6 \cdot \text{Atomic mass}_C}{RMM_{\text{product}}} = \frac{6 \cdot 12.01 \text{ g} \cdot \text{mol}^{-1}}{132.2 \text{ g} \cdot \text{mol}^{-1}}$	54.5%
Bio-based carbon content		33.3%
Fossil carbon saving: per 100 kg of product	$\text{Carbon mass} \cdot \text{Biobased carbon content} \cdot 100 \text{ kg}$ $= 54.5\% \cdot 33.3\% \cdot 100 \text{ kg}$	18.2 kg
Fossil carbon saving: per mass of carbon in product	$\frac{\text{Fossil carbon saving per 100 kg of product}}{\text{Mass of carbon per 100 kg of product}}$ $= \frac{18.2 \text{ kg}}{54.5 \text{ kg}}$	0.33 g/g
Original mass of conventional naphtha feedstock (per 100 kg of product)		194 kg
Mass of coal feedstock (per 100 kg of product)		179 kg
Mass of fossil carbon in original feedstock	$\sum \text{Mass of fossil feedstock} \cdot \text{Carbon content}$ $= (194 \text{ kg} \cdot 90\%)$ $+ (179 \text{ kg} \cdot 100\%)$	354 kg
Mass of coal replaced		179 kg
Mass of fossil carbon in feedstock	$\text{Mass of fossil feedstock remaining}$ $\cdot \text{Carbon content} = 194 \text{ kg} \cdot 90\%$	174 kg
Fossil feedstock carbon saving: per 100 kg of product	$\text{Mass of fossil carbon in original feedstock}$ $- \text{mass of fossil carbon in feedstock}$ $= 354 - 174$	179 kg
Fossil feedstock carbon saving: per mass of carbon in original feedstock	$1 - \frac{\text{Mass of fossil carbon in feedstock}}{\text{Maximum mass of fossil carbon in feedstock}}$ $= 1 - \frac{174 \text{ kg}}{354 \text{ kg}}$	0.51 g/g
Fossil feedstock carbon saving: per mass of carbon in product	$\frac{\text{Mass of fossil carbon in feedstock replaced}}{\text{Mass of carbon per 100 kg of product}}$ $= \frac{179 \text{ kg}}{54.5 \text{ kg}}$	3.3 g/g



9.4 Ethyl acetate production mass balance calculations

Two hypothetical processes for making 50% bio-based ethyl acetate have been presented in this work. Firstly the ACDV case study of ethyl acetate made from esterified bio-ethanol (Table 9-25), and then a type of blended product where ethyl acetate made completely from bio-ethanol (Table 9-26), is mixed with conventional ethyl acetate made from non-renewable feedstocks (Table 9-27). Losses during the manufacturing processes have been ignored for this case study, placing a focus on stoichiometry and feedstock selection.

Table 9-25 Mass balance data for partially bio-based ethyl acetate as proposed by ACDV.

Mass flow	Substance	Mass /kg
Input	Glucose	102
Input	Methane	36
Input	Water	41
Output	Ethyl acetate	100
Output	Carbon dioxide	50
Output	Water	20
Output	Hydrogen	9

Table 9-26 Mass balance data for bio-based ethyl acetate made only from bio-ethanol (to be blended with petrochemical ethyl acetate).

Mass flow	Substance	Mass /kg
Input	Ethanol	105
Output	Ethyl acetate	100
Output	Hydrogen	5

Table 9-27 Mass balance data for conventional ethyl acetate made from petrochemical feedstocks (to be blended with wholly bio-based ethyl acetate).

Mass flow	Substance	Mass /kg
Input	Ethanol*	52
Input	Methane	36
Input	Water	41
Output	Ethyl acetate	100
Output	Water	20
Output	Hydrogen	9

*Ethanol would be made from naphtha *via* ethylene. This transformation was covered previously.



9.4.1 Total bio-based content calculation by mass balance Method A

The inconsistency of mass balance Method A depending on how expansive the process is considered to be has been demonstrated. The necessary calculations are presented here in Table 9-28 and

Table 9-29 for different feedstock inputs, be it bio-ethanol or the glucose that is converted into the bio-ethanol. The discrepancy arises in the attribution units.

Table 9-28 Mass balance equations for the conversion of bio-ethanol (and natural gas) to ethyl acetate using mass balance Method A.

Metric	Calculation	Result
Mass of ethanol		52 kg
Methane equivalents (ethanol)	$\frac{LHV_{methane}}{LHV_{ethanol}} = \frac{50 \text{ MJ/kg}}{26.8 \text{ MJ/kg}}$	1.853
Mass of natural gas		36 kg
Methane equivalents (methane)	$\frac{LHV_{methane}}{LHV_{methane}} = \frac{50 \text{ MJ/kg}}{50 \text{ MJ/kg}}$	1.00
Allocation (per 100 kg of ethyl acetate)	$\sum \text{Mass} \cdot \text{Methane equivalents}$ $= (52 \text{ kg} \cdot 1.853)$ $+ (36 \text{ kg} \cdot 1.00)$	133 kg
Feedstock requirement	$\frac{\text{Allocation}}{\text{Methane equivalents (ethanol)}} = \frac{133 \text{ kg}}{1.854}$	71.9 kg
Bio-based content (ethyl acetate)	$\frac{\text{Mass of bioethanol}}{\text{Feedstock requirement}} = \frac{52 \text{ kg}}{71.9 \text{ kg}}$	72.7%



Table 9-29 Mass balance equations for the conversion of bio-ethanol (and natural gas) to ethyl acetate using mass balance Method A beginning with glucose as the fermentation feedstock.

Metric	Calculation	Result
Mass of glucose		102 kg
Methane equivalents (glucose)	$\frac{LHV_{methane}}{LHV_{ethanol}} = \frac{50 \text{ MJ/kg}}{15.6 \text{ MJ/kg}}$	3.21
Mass of natural gas		36 kg
Methane equivalents (methane)	$\frac{LHV_{methane}}{LHV_{methane}} = \frac{50 \text{ MJ/kg}}{50 \text{ MJ/kg}}$	1.00
Allocation (per 100 kg of ethyl acetate)	$\sum \text{Mass} \cdot \text{Methane equivalents}$ $= (102 \text{ kg} \cdot 3.21)$ $+ (36 \text{ kg} \cdot 1.00)$	364 kg
Feedstock requirement	$\frac{\text{Allocation}}{\text{Methane equivalents (ethanol)}} = \frac{364 \text{ kg}}{3.21}$	113 kg
Bio-based content (ethyl acetate)	$\frac{\text{Mass of bioethanol}}{\text{Feedstock requirement}} = \frac{102 \text{ kg}}{113 \text{ kg}}$	90.0%

9.4.2 Total bio-based content calculation by mass balance Method C

The effect of changing opinion on what is considered the feedstock is explored in Table 9-30 and Table 9-31. The original proposal of reporting fossil carbon savings as those savings contained within the product are unchanged regardless of what is considered as the start point of the process. However attempts at reporting fossil carbon savings made in the feedstock option are variable as the feedstock is reconsidered. The mass of fossil carbon replaced in the feedstock for every 100 kg of product made from bio-ethanol is 0.5 g/g when synthetic ethanol is designated as the original feedstock (Table 9-30). When calculations are based on replacing naphtha with biomass feedstocks the fossil carbon saving is 2.17 g/g (Table 9-31).



Table 9-30 Mass balance Method C applied to ethyl acetate made from bio-ethanol and natural gas.

Metric	Calculation	Result
Proportion of carbon atom mass in 2-ethoxyethyl acetate	$\frac{4 \cdot \text{Atomic mass}_C}{RMM_{\text{product}}} = \frac{4 \cdot 12.01 \text{ g} \cdot \text{mol}^{-1}}{88.11 \text{ g} \cdot \text{mol}^{-1}}$	54.5%
Bio-based carbon content		50.0%
Fossil carbon saving: per 100 kg of product	$\text{Carbon mass} \cdot \text{Biobased carbon content} \cdot 100 \text{ kg} \\ = 54.5\% \cdot 50.0\% \cdot 100 \text{ kg}$	27.6 kg
Fossil carbon saving: per mass of carbon in product	$\frac{\text{Fossil carbon saving per 100 kg of product}}{\text{Mass of carbon per 100 kg of product}} \\ = \frac{27.6 \text{ kg}}{54.5 \text{ kg}}$	0.50 g/g
Original mass of synthetic ethanol (per 100 kg of product)		52 kg
Mass of natural gas feedstock (per 100 kg of product)		36 kg
Mass of fossil carbon in original feedstock	$\sum \text{Mass of fossil feedstock} \cdot \text{Carbon content} \\ = (52 \text{ kg} \cdot 54.5\%) \\ + (36 \text{ kg} \cdot 75\%)$	54.5 kg
Mass of synthetic ethanol replaced		52 kg
Mass of fossil carbon in feedstock	$\text{Mass of fossil feedstock remaining} \\ \cdot \text{Carbon content} = 36 \text{ kg} \cdot 75\%$	27.3 kg
Fossil feedstock carbon saving: per 100 kg of product	$\text{Mass of fossil carbon in original feedstock} \\ - \text{mass of fossil carbon in feedstock} \\ = 54.5 \text{ kg} - 27.3 \text{ kg}$	27.3 kg
Fossil feedstock carbon saving: per mass of carbon in original feedstock	$1 - \frac{\text{Mass of fossil carbon in feedstock}}{\text{Maximum mass of fossil carbon in feedstock}} \\ = 1 - \frac{27.3 \text{ kg}}{54.5 \text{ kg}}$	0.50 g/g
Fossil feedstock carbon saving: per mass of carbon in product	$\frac{\text{Mass of fossil carbon in feedstock replaced}}{\text{Mass of carbon per 100 kg of product}} \\ = \frac{27.3 \text{ kg}}{54.5 \text{ kg}}$	0.50 g/g



Table 9-31 Mass balance equations for the conversion of glucose (and natural gas) to ethyl acetate using mass balance Method C by displacing naphtha as a feedstock.

Metric	Calculation	Result
Proportion of carbon atom mass in 2-ethoxyethyl acetate	$\frac{4 \cdot \text{Atomic mass}_C}{RMM_{\text{product}}} = \frac{4 \cdot 12.01 \text{ g} \cdot \text{mol}^{-1}}{88.11 \text{ g} \cdot \text{mol}^{-1}}$	54.5%
Bio-based carbon content		50.0%
Fossil carbon saving: per 100 kg of product	$\text{Carbon mass} \cdot \text{Biobased carbon content} \cdot 100 \text{ kg}$ $= 54.5\% \cdot 50.0\% \cdot 100 \text{ kg}$	27.6 kg
Fossil carbon saving: per mass of carbon in product	$\frac{\text{Fossil carbon saving per 100 kg of product}}{\text{Mass of carbon per 100 kg of product}}$ $= \frac{27.6 \text{ kg}}{54.5 \text{ kg}}$	0.50 g/g
Mass of naphtha (per 100 kg of product)		131 kg
Mass of natural gas feedstock (per 100 kg of product)		36 kg
Mass of fossil carbon in original feedstock (naphtha plus natural gas)	$\sum \text{Mass of fossil feedstock} \cdot \text{Carbon content}$ $= (131 \text{ kg} \cdot 90.0\%)$ $+ (36 \text{ kg} \cdot 75\%)$	145 kg
Mass of naphtha replaced by glucose		131 kg
Mass of fossil carbon in feedstock	$\text{Mass of fossil feedstock remaining}$ $\cdot \text{Carbon content} = 36 \text{ kg} \cdot 75\%$	27.3 kg
Fossil feedstock carbon saving: per 100 kg of product	$\text{Mass of fossil carbon in original feedstock}$ $- \text{mass of fossil carbon in feedstock}$ $= 145 \text{ kg} - 27.3 \text{ kg}$	118 kg
Fossil feedstock carbon saving: per mass of carbon in original feedstock	$1 - \frac{\text{Mass of fossil carbon in feedstock}}{\text{Maximum mass of fossil carbon in feedstock}}$ $= 1 - \frac{27.3 \text{ kg}}{145 \text{ kg}}$	0.81 g/g
Fossil feedstock carbon saving: per mass of carbon in product	$\frac{\text{Mass of fossil carbon in feedstock replaced}}{\text{Mass of carbon per 100 kg of product}}$ $= \frac{118 \text{ kg}}{54.5 \text{ kg}}$	2.17 g/g



9.5 Bio-diesel manufacturing mass balance calculations

Biodiesel is produced in many plants across the world. A typical mass balance is presented in Table 9-32. The coconut oil feedstock has been assumed to be completely based on lauric acid so that the product stream is only methyl laurate. A free fatty acid content of 5% has been assumed, as has a 0.5 molar excess of methanol (making 3.5 equivalents).

Table 9-32 Mass balance data for a biodiesel manufacturing process.

Mass flow	Substance	Mass /kg
Input	Vegetable oil	101
	<i>Glycerol trilaurate</i>	99
	<i>Lauric acid</i>	1.6
Input	Methanol	17
Input	Sodium hydroxide	0.5
Output	Methyl laurate	100
Output	Glycerol	14
Output	Water	0.2
Output	Sodium laurate	1.8
Losses	Sodium hydroxide	0.2
Losses	Excess methanol	2.5

9.5.1 Total bio-based content calculation by mass balance Method A

The calculation of total bio-based content by mass balance Method A shows that the vegetable oil converted into biodiesel retains 73.5% of its total bio-based content using attribution units of methane equivalents (Table 9-33). If bio-methanol were to be used the remaining 26.5% could be allocated to the product.



Table 9-33 Mass balance equations for the production of bio-diesel (FAME) using mass balance Method A.

Metric	Calculation	Result
Mass of vegetable oil		101 kg
Methane equivalents (vegetable oil)	$\frac{LHV_{methane}}{LHV_{ethanol}} = \frac{50 \text{ MJ/kg}}{40.7 \text{ MJ/kg}}$	1.23
Mass of methanol		17 kg
Methane equivalents (methanol)	$\frac{LHV_{methane}}{LHV_{methanol}} = \frac{50 \text{ MJ/kg}}{19.4 \text{ MJ/kg}}$	2.574
Allocation (per 100 kg of FAME)	$\sum \text{Mass} \cdot \text{Methane equivalents}$ $= (101 \text{ kg} \cdot 1.23)$ $+ (17 \text{ kg} \cdot 2.574)$ <i>Allocation</i>	169 kg
Feedstock requirement	$\frac{\text{Methane equivalents (vegetable oil)}}{1.23}$ $= \frac{169 \text{ kg}}{1.23}$	138 kg
Bio-based content (FAME)	$\frac{\text{Mass of vegetable oil}}{\text{Feedstock requirement}} = \frac{101 \text{ kg}}{138 \text{ kg}}$	73.5%

9.5.2 Total bio-based content calculation by mass balance Method B

Total bio-based content (Table 9-34) and bio-based carbon content (Table 9-35) can be attributed to methyl laurate by splitting the mass flows of the manufacturing process into biomass and petrochemical. The final calculation of bio-based content then becomes the mass of biomass divided by the total mass of the product, which is set (as it has been throughout this work) at 100 kg for the pre-defined time interval:

$$\text{Total biobased content} = \frac{84.9 \text{ kg}}{100 \text{ kg}} = 84.9\%$$

$$\text{Biobased carbon content} = \frac{93.2 \text{ kg}}{100 \text{ kg}} = 92.3\%$$



Table 9-34 Biomass and fossil material mass flows during vegetable oil transesterification for the calculation of total bio-based content according to mass balance Method B.

	Total mass /kg	Biomass /kg	Petrochemical mass /kg
Input	119	101	18
Output (excluding product)	19	16	3
Product	100	85	15

Table 9-35 Biomass and fossil material mass flows during vegetable oil transesterification for the calculation of bio-based carbon content according to mass balance Method B.

	Total mass /kg	Biomass /kg	Petrochemical mass /kg
Input	81	74	7
Output (excluding product)	8	7	1
Product	73	67	6

9.5.3 Total bio-based content calculation by mass balance Method C

Mass balance method C suffers in this example as a fossil derived feedstock has not been replaced. There is bio-based content in the product, 67.3 kg for every 100 kg produced (Table 9-36), but no petrochemical feedstock has been replaced. It would also appear strange to be claiming fossil carbon savings for historically plant derived materials such as biodiesel and other oils, or even carbohydrate products.



Table 9-36 Mass balance Method C applied to vegetable oil transesterification.

Metric	Calculation	Result
Proportion of carbon atom mass in methyl laurate	$\frac{13 \cdot \text{Atomic mass}_C}{RMM_{\text{product}}} = \frac{13 \cdot 12.01 \text{ g} \cdot \text{mol}^{-1}}{639.02 \text{ g} \cdot \text{mol}^{-1}}$	72.85%
Bio-based carbon content		92.3%
Fossil carbon saving: per 100 kg of product	$\text{Carbon mass} \cdot \text{Biobased carbon content} \cdot 100 \text{ kg}$ $= 72.85\% \cdot 92.3\% \cdot 100 \text{ kg}$	67.3 kg
Fossil carbon saving: per mass of carbon in product	$\frac{\text{Fossil carbon saving per 100 kg of product}}{\text{Mass of carbon per 100 kg of product}}$ $= \frac{67.3 \text{ kg}}{72.9 \text{ kg}}$	0.92 g/g
Mass of vegetable oil (per 100 kg of product)		101 kg
Mass of methanol feedstock (per 100 kg of product)		17 kg
Mass of fossil feedstock replaced		0 kg
Mass of fossil carbon in feedstock	$\text{Mass of fossil feedstock remaining}$ $\cdot \text{Carbon content} = 17 \text{ kg} \cdot 37\%$	6.5 kg
Fossil feedstock carbon saving: per 100 kg of product	$\text{Mass of fossil carbon in original feedstock}$ $- \text{mass of fossil carbon in feedstock}$ $= 6.5 \text{ kg} - 6.5 \text{ kg}$	0 kg
Fossil feedstock carbon saving: per mass of carbon in original feedstock	$1 - \frac{\text{Mass of fossil carbon in feedstock}}{\text{Maximum mass of fossil carbon in feedstock}}$ $= 1 - \frac{6.5 \text{ kg}}{6.5 \text{ kg}}$	0 g/g
Fossil feedstock carbon saving: per mass of carbon in product	$\frac{\text{Mass of fossil carbon in feedstock replaced}}{\text{Mass of carbon per 100 kg of product}}$ $= \frac{0 \text{ kg}}{72.9 \text{ kg}}$	0 g/g



9.6 Polyethylene terephthalate mass balance calculations

In this case study bio-based poly(ethylene terephthalate) is examined by considering the feedstock as either bio-ethanol (Table 9-37), or upstream bio-naphtha (Table 9-38). The bio-ethanol in the first example could be made from bio-naphtha also, but an origin in fermentation is equally acceptable as it makes no difference to the mass balance. Methanol is used in the intermediate terephthalate ester and later removed. The difference in the mass balance when methanol is considered a waste of the process, and when it is assumed to be recycled will be assessed.

Table 9-37 Mass balance data for partially bio-based poly(ethylene terephthalate) made from bio-ethanol.

Mass flow	Substance	Mass /kg
Input	Ethanol	24
Input	Methanol	33
Input	Oxygen	58
Input	Water	9
Input	<i>p</i> -Xylene	55
Output	PET	100
Output	Water	47
Output	Methanol	33

Table 9-38 Mass balance data for partially bio-based poly(ethylene terephthalate) made from bio-ethanol *via* bio-naphtha.

Mass flow	Substance	Mass /kg
Input	Ethanol	58
Input	Methanol	33
Input	Oxygen	58
Input	Water	9
Input	<i>p</i> -Xylene	55
Output	PET	100
Output	Water	37
Output	Methanol	33
Output	Other cracking products	44



9.6.1 Total bio-based content calculation by mass balance Method A

There are four scenarios addressed by mass balance Method A. These are the different combinations of either bio-ethanol or bio-naphtha regarded as the feedstock, and then both treated with and without methanol recycling within the system boundaries. The attribution units vary as a result, and the indirectly calculated bio-based content can be as low as 22% (Table 9-39), up to 49% (Table 9-42).

Table 9-39 Mass balance Method A applied to partially bio-based poly(ethylene terephthalate) made from bio-ethanol where methanol is treated as a waste.

Metric	Calculation	Result
Mass of ethanol		24 kg
Methane equivalents (ethanol)	$\frac{LHV_{methane}}{LHV_{ethanol}} = \frac{50 \text{ MJ/kg}}{26.8 \text{ MJ/kg}}$	1.853
Mass of <i>p</i> -xylene		55 kg
Methane equivalents (<i>p</i> -xylene)	$\frac{LHV_{methane}}{LHV_{xylene}} = \frac{50 \text{ MJ/kg}}{40.8 \text{ MJ/kg}}$	1.23
Mass of methanol		33 kg
Methane equivalents (methanol)	$\frac{LHV_{methane}}{LHV_{methanol}} = \frac{50 \text{ MJ/kg}}{19.4 \text{ MJ/kg}}$	2.574
Allocation (per 100 kg of PET)	$\sum \text{Mass} \cdot \text{Methane equivalents}$ $= (24 \text{ kg} \cdot 1.853)$ $+ (55 \text{ kg} \cdot 1.23)$ $+ (33 \text{ kg} \cdot 2.574)$	198 kg
Feedstock requirement	$\frac{\text{Allocation}}{\text{Methane equivalents (ethanol)}} = \frac{198 \text{ kg}}{1.853}$	107 kg
Bio-based content (PET)	$\frac{\text{Mass of ethanol}}{\text{Feedstock requirement}} = \frac{24 \text{ kg}}{107 \text{ kg}}$	22.4%



Table 9-40 Mass balance Method A applied to partially bio-based poly(ethylene terephthalate) made from bio-ethanol where methanol is recycled.

Metric	Calculation	Result
Mass of ethanol		24 kg
Methane equivalents (ethanol)	$\frac{LHV_{methane}}{LHV_{ethanol}} = \frac{50 \text{ MJ/kg}}{26.8 \text{ MJ/kg}}$	1.853
Mass of <i>p</i> -xylene		55 kg
Methane equivalents (<i>p</i> -xylene)	$\frac{LHV_{methane}}{LHV_{xylene}} = \frac{50 \text{ MJ/kg}}{40.8 \text{ MJ/kg}}$	1.23
Allocation (per 100 kg of PET)	$\sum \text{Mass} \cdot \text{Methane equivalents}$ = (24 kg · 1.853) + (55 kg · 1.23)	112 kg
Feedstock requirement	$\frac{\text{Allocation}}{\text{Methane equivalents (ethanol)}} = \frac{112 \text{ kg}}{1.853}$	61 kg
Bio-based content (PET)	$\frac{\text{Mass of ethanol}}{\text{Feedstock requirement}} = \frac{24 \text{ kg}}{61 \text{ kg}}$	39.6%

Table 9-41 Mass balance Method A applied to partially bio-based poly(ethylene terephthalate) made from bio-naphtha where methanol is treated as a waste.

Metric	Calculation	Result
Mass of <i>p</i> -xylene		55 kg
Methane equivalents (<i>p</i> -xylene)	$\frac{LHV_{methane}}{LHV_{xylene}} = \frac{50 \text{ MJ/kg}}{40.8 \text{ MJ/kg}}$	1.23
Mass of naphtha		58 kg
Methane equivalents (naphtha)	$\frac{LHV_{methane}}{LHV_{naphtha}} = \frac{50 \text{ MJ/kg}}{44.3 \text{ MJ/kg}}$	1.13
Mass of methanol		33 kg
Methane equivalents (methanol)	$\frac{LHV_{methane}}{LHV_{methanol}} = \frac{50 \text{ MJ/kg}}{19.4 \text{ MJ/kg}}$	2.574
Allocation (per 100 kg of PET)	$\sum \text{Mass} \cdot \text{Methane equivalents}$ = (58 kg · 1.13) + (55 kg · 1.23) + (33 kg · 2.574)	220 kg
Feedstock requirement	$\frac{\text{Allocation}}{\text{Methane equivalents (naphtha)}} = \frac{220 \text{ kg}}{1.13}$	194 kg
Bio-based content (PET)	$\frac{\text{Mass of naphtha}}{\text{Feedstock requirement}} = \frac{58 \text{ kg}}{194 \text{ kg}}$	30.1%



Table 9-42 Mass balance Method A applied to partially bio-based poly(ethylene terephthalate) made from bio-naphtha where methanol is recycled.

Metric	Calculation	Result
Mass of <i>p</i> -xylene		55 kg
Methane equivalents (<i>p</i> -xylene)	$\frac{LHV_{methane}}{LHV_{xylene}} = \frac{50 \text{ MJ/kg}}{40.8 \text{ MJ/kg}}$	1.23
Mass of naphtha		58 kg
Methane equivalents (naphtha)	$\frac{LHV_{methane}}{LHV_{naphtha}} = \frac{50 \text{ MJ/kg}}{44.3 \text{ MJ/kg}}$	1.13
Allocation (per 100 kg of PET)	$\sum \text{Mass} \cdot \text{Methane equivalents}$ = (55 kg · 1.23) + (58 kg · 1.13)	134 kg
Feedstock requirement	$\frac{\text{Allocation}}{\text{Methane equivalents (naphtha)}} = \frac{134 \text{ kg}}{1.13}$	118 kg
Bio-based content (PET)	$\frac{\text{Mass of naphtha}}{\text{Feedstock requirement}} = \frac{58 \text{ kg}}{118 \text{ kg}}$	49.4%

9.6.2 Total bio-based content calculation by mass balance Method B

The designation of the feedstock (either naphtha or ethanol in this case) does not affect mass balance Method B. Bio-ethanol as a feedstock is used here for the calculation of total bio-based content (Table 9-43), and bio-based carbon content (Table 9-44). The results are 32.3% and 20% respectively. The methanol is assumed to be wholly fossil derived as it leaves the plant. Recycling of the methanol does impact the calculations. As for the previous bio-diesel case study, the amount of bio-based material and fossil derived material in the product is arrived at by subtracting the mass flows of the other outputs from the feedstocks.

Table 9-43 Biomass and fossil material mass flows describing poly(ethylene terephthalate) synthesis for the calculation of total bio-based content according to mass balance Method B.

	Total mass /kg	Biomass /kg	Petrochemical mass /kg
Input	180	42	139
Output (excluding product)	80	9	71
Product	100	32	68



Table 9-44 Biomass and fossil material mass flows describing poly(ethylene terephthalate) synthesis for the calculation of bio-based carbon content according to mass balance Method B.

	Total mass /kg	Biomass /kg	Petrochemical mass /kg
Input	75	13	63
Output (excluding product)	13	0	13
Product	63	13	50

9.6.3 Total bio-based content calculation by mass balance Method C

The two PET manufacturing processes (bio-ethanol and bio-naphtha) with methanol included in the calculations have been interpreted using mass balance Method C. The 20% bio-based carbon content of the polymer product corresponds to a 12.5 kg of fossil carbon saved for every 100 kg of product. This corresponds to 0.17 g/g of fossil carbon replaced within the combined feedstocks based on ethanol (Table 9-45), but 0.46 g/g when naphtha is considered the feedstock (Table 9-46).



Table 9-45 Fossil carbon savings in poly(ethylene terephthalate) when bio-ethanol is a feedstock.

Metric	Calculation	Result
Proportion of carbon atom mass in PET	$\frac{10 \cdot \text{Atomic mass}_C}{RMM_{\text{product}}} = \frac{10 \cdot 12.01 \text{ g} \cdot \text{mol}^{-1}}{192.2 \text{ g} \cdot \text{mol}^{-1}}$	62.5%
Bio-based carbon content		20%
Fossil carbon saving: per 100 kg of product	$\text{Carbon mass} \cdot \text{Biobased carbon content} \cdot 100 \text{ kg}$ $= 62.5\% \cdot 20.0\% \cdot 100 \text{ kg}$	12.5 kg
Fossil carbon saving: per mass of carbon in product	$\frac{\text{Fossil carbon saving per 100 kg of product}}{\text{Mass of carbon per 100 kg of product}}$ $= \frac{12.5 \text{ kg}}{62.5 \text{ kg}}$	0.2 g/g
Mass of ethanol feedstock (per 100 kg of product)		24 kg
Mass of <i>p</i> -xylene feedstock (per 100 kg of product)		55 kg
Mass of methanol feedstock (per 100 kg of product)		33 kg
Mass of fossil carbon in original feedstock	$\sum \text{Mass of fossil feedstock} \cdot \text{Carbon content}$ $= (24 \text{ kg} \cdot 52\%) + (55 \text{ kg} \cdot 91\%)$ $+ (33 \text{ kg} \cdot 37\%)$	75.0 kg
Mass of conventional ethanol replaced		24 kg
Mass of fossil carbon in feedstock	$\text{Mass of fossil feedstock remaining} \cdot \text{Carbon content}$	62.5 kg
Fossil feedstock carbon saving: per 100 kg of product	$\text{Mass of fossil carbon in original feedstock}$ $- \text{mass of fossil carbon in feedstock}$ $= 75.0 - 62.5$	12.5 kg
Fossil feedstock carbon saving: per mass of carbon in original feedstock	$1 - \frac{\text{Mass of fossil carbon in feedstock}}{\text{Maximum mass of fossil carbon in feedstock}}$ $= 1 - \frac{62.5 \text{ kg}}{75 \text{ kg}}$	0.17 g/g
Fossil feedstock carbon saving: per mass of carbon in product	$\frac{\text{Mass of fossil carbon in feedstock replaced}}{\text{Mass of carbon per 100 kg of product}}$ $= \frac{12.5 \text{ kg}}{62.5 \text{ kg}}$	0.2 g/g



Table 9-46 Mass balance Method C calculations for a process making poly(ethylene terephthalate) from bio-naphtha.

Metric	Calculation	Result
Proportion of carbon atom mass in PET	$\frac{10 \cdot \text{Atomic mass}_C}{RMM_{\text{product}}} = \frac{10 \cdot 12.01 \text{ g} \cdot \text{mol}^{-1}}{192.2 \text{ g} \cdot \text{mol}^{-1}}$	62.5%
Bio-based carbon content		20%
Fossil carbon saving: per 100 kg of product	$\text{Carbon mass} \cdot \text{Biobased carbon content} \cdot 100 \text{ kg}$ $= 62.5\% \cdot 20.0\% \cdot 100 \text{ kg}$	12.5 kg
Fossil carbon saving: per mass of carbon in product	$\frac{\text{Fossil carbon saving per 100 kg of product}}{\text{Mass of carbon per 100 kg of product}}$ $= \frac{12.5 \text{ kg}}{62.5 \text{ kg}}$	0.2 g/g
Mass of naphtha feedstock (per 100 kg of product)		58 kg
Mass of fossil carbon in original feedstock	$\sum \text{Mass of fossil feedstock} \cdot \text{Carbon content}$ $= (58 \text{ kg} \cdot 90\%) + (55 \text{ kg} \cdot 91\%)$ $+ (33 \text{ kg} \cdot 37\%)$	115.1 kg
Mass of conventional naphtha replaced		58 kg
Mass of fossil carbon in feedstock	$\text{Mass of fossil feedstock remaining}$ $\cdot \text{Carbon content}$	62.5 kg
Fossil feedstock carbon saving: per 100 kg of product	$\text{Mass of fossil carbon in original feedstock}$ $- \text{mass of fossil carbon in feedstock}$ $= 115.1 - 62.5$	52.6 kg
Fossil feedstock carbon saving: per mass of carbon in original feedstock	$1 - \frac{\text{Mass of fossil carbon in feedstock}}{\text{Maximum mass of fossil carbon in feedstock}}$ $= 1 - \frac{62.5 \text{ kg}}{115.1 \text{ kg}}$	0.46 g/g
Fossil feedstock carbon saving: per mass of carbon in product	$\frac{\text{Mass of fossil carbon in feedstock replaced}}{\text{Mass of carbon per 100 kg of product}}$ $= \frac{52.6 \text{ kg}}{62.5 \text{ kg}}$	0.84 g/g



9.7 Sodium laureth sulphate mass balance calculations

Two scenarios have been calculated for the manufacture of sodium laureth sulphate; the use of vegetable oil to incorporate a hydrophobic region into the surfactant, and a single naphtha feedstock. The data for these mass balances have been provided as Table 9-47 and Table 9-48 respectively. The product is the triethylene glycol containing surfactant. The natural product distribution has been ignored for simplicity, although in reality a number of differing oligomers would be produced during the course of the reaction. In addition the use of a vegetable oil would result in a number of different fatty acid derived hydrophobic regions (C₁₂-C₁₈ most commonly), of which, the unsaturated moieties would need to be hydrogenated. This is also ignored for simplicity.

Table 9-47 Mass balance data for sodium laureth sulphate production from vegetable oil.

Mass flow	Substance	Mass /kg
Input	Vegetable oil	51
Input	Naphtha	100
Input	Methane	8
Input	Hydrogen sulphate	8
Input	Oxygen	26
Input	Water	17
Input	Sodium chloride	14
Output	Sodium laureth sulphate	100
Output	Glycerol	7
Output	Carbon monoxide	13
Output	Hydrogen	2
Output	Chlorine	8
Output	Water	12
Output	Naphtha cracking products	75
Losses	Epoxidation losses	5



Table 9-48 Mass balance data for sodium laureth sulphate production from naphtha as the only carbon based feedstock.

Mass flow	Substance	Mass /kg
Input	Naphtha	260
Input	Hydrogen sulphate	8
Input	Oxygen	26
Input	Water	8
Input	Sodium chloride	14
Output	Sodium laureth sulphate	100
Output	Hydrogen	0.2
Output	Chlorine	8
Output	Water	8
Output	Naphtha cracking products	195
Losses	Epoxidation losses	5

9.7.1 Total bio-based content calculation by mass balance Method A

The reliance of hydrogen sulphide as a reactant introduces an inorganic portion into the resulting surfactant molecule. Hydrogen sulphide can be combusted, and hence it can be allocated methane equivalents (Table 9-49). Accordingly, even if bio-naphtha is employed as a feedstock, the bio-based content cannot reach 100% despite all the organic feedstock being derived from biomass. Hydrogen sulphide could be ignored from the calculations, and the contribution to bio-based content of the vegetable oil increases (Table 9-50). A justification for the omission of hydrogen sulphide could be made on the basis that it is inorganic and contains no carbon, fossil derived or otherwise. The feedstock could be taken as the intermediate sulphur trioxide, which as an oxidised material has no discernible lower heating value. However the manner in which to approach this, whatever is decided, should be well defined as part of the methodology.



Table 9-49 Mass balance Method A description of the production of sodium laureth sulphate (SLS) from triglycerides.

Metric	Calculation	Result
Mass of vegetable oil		51 kg
Methane equivalents (vegetable oil)	$\frac{LHV_{methane}}{LHV_{vegetable\ oil}} = \frac{50\text{ MJ/kg}}{40.7\text{ MJ/kg}}$	1.23
Mass of naphtha		100 kg
Methane equivalents (naphtha)	$\frac{LHV_{methane}}{LHV_{naphtha}} = \frac{50\text{ MJ/kg}}{44.3\text{ MJ/kg}}$	1.13
Mass of methane		8 kg
Methane equivalents (methane)	$\frac{LHV_{methane}}{LHV_{methane}} = \frac{50\text{ MJ/kg}}{50\text{ MJ/kg}}$	1.00
Mass of hydrogen sulphide		8 kg
Methane equivalents (hydrogen sulphide)	$\frac{LHV_{methane}}{LHV_{hydrogen\ sulphide}} = \frac{50\text{ MJ/kg}}{15.2\text{ MJ/kg}}$	3.29
Allocation (per 100 kg of SLS)	$\begin{aligned} \sum Mass \cdot Methane\ equivalents \\ &= (51\text{ kg} \cdot 1.23) \\ &+ (100\text{ kg} \cdot 1.13) \\ &+ (8\text{ kg} \cdot 1.00) + (8\text{ kg} \cdot 3.29) \end{aligned}$	210 kg
Feedstock requirement	$\frac{Allocation}{Methane\ equivalents\ (vegetable\ oil)} = \frac{210\text{ kg}}{1.23}$	170 kg
Bio-based content (SLS)	$\frac{Mass\ of\ vegetable\ oil}{Feedstock\ requirement} = \frac{51\text{ kg}}{170\text{ kg}}$	29.7%

Table 9-50 Mass balance Method A description of the production of sodium laureth sulphate (SLS) from triglycerides (excluding hydrogen sulphide from calculations).

Metric	Calculation	Result
Allocation (per 100 kg of SLS)	$\begin{aligned} \sum Mass \cdot Methane\ equivalents \\ &= (51\text{ kg} \cdot 1.23) \\ &+ (100\text{ kg} \cdot 1.13) \\ &+ (8\text{ kg} \cdot 1.00) \end{aligned}$	183 kg
Feedstock requirement	$\frac{Allocation}{Methane\ equivalents\ (vegetable\ oil)} = \frac{183\text{ kg}}{1.23}$	149 kg
Bio-based content (SLS)	$\frac{Mass\ of\ vegetable\ oil}{Feedstock\ requirement} = \frac{51\text{ kg}}{149\text{ kg}}$	34.0%



The vegetable oil feedstock is no longer required if the intermediate dodecanol is made by the polymerisation and subsequent hydration of ethylene. In this scenario naphtha is the only carbon containing feedstock. However due to the input of hydrogen sulphide the total bio-based content allocation can only reach 92% if all the naphtha is bio-based. Mixtures of conventional naphtha and bio-naphtha would result in proportionally lower bio-based content values if they produce the same conversion selectivity to ethylene as has been assumed here (e.g. 1:1 feedstock input gives a 46% bio-based product, 3 parts fossil derived and 1 part bio-based 23%, etc.).

Table 9-51 Mass balance Method A description of the production of sodium laureth sulphate (SLS) from naphtha as the only carbon containing feedstock.

Metric	Calculation	Result
Mass of naphtha		260 kg
Methane equivalents (naphtha)	$\frac{LHV_{methane}}{LHV_{naphtha}} = \frac{50 \text{ MJ/kg}}{40.7 \text{ MJ/kg}}$	1.13
Mass of hydrogen sulphide		8 kg
Methane equivalents (hydrogen sulphide)	$\frac{LHV_{methane}}{LHV_{hydrogen\ sulphide}} = \frac{50 \text{ MJ/kg}}{15.2 \text{ MJ/kg}}$	3.29
Allocation (per 100 kg of SLS)	$\sum \text{Mass} \cdot \text{Methane equivalents}$ $= (260 \text{ kg} \cdot 1.13)$ $+ (8 \text{ kg} \cdot 3.29)$	321 kg
Feedstock requirement	$\frac{\text{Allocation}}{\text{Methane equivalents (naphtha)}} = \frac{321 \text{ kg}}{1.13}$	284 kg
Bio-based content (SLS)	$\frac{\text{Mass of naphtha}}{\text{Feedstock requirement}} = \frac{260 \text{ kg}}{284 \text{ kg}}$	91.7%

9.7.2 Total bio-based content calculation by mass balance Method B

The compounds discussed in Table 4-45 have a bio-based carbon content of 67% and a total bio-based content by atom connectivity (Method 2b) of 44%. By following the mass flows through the process of manufacture the results concur within an error of 1%. Table 9-52 suggests that by subtracting the biomass containing wastes and losses, the product, sodium laureth sulphate from vegetable oil, contains 43% bio-based content. The small difference between this value and that of atom connectivity Method 2b arises from approximations in which outputs aside from the major product are assumed to be either bio-based or fossil derived without mixtures of the two. This is decided according to the major feedstock and the transformations performed on them during the processes. The bio-based carbon content is calculated to be 67% as would also be expected from an analytical measurement (Table 9-53).



Table 9-52 Biomass and fossil material mass flows describing the synthesis of sodium laureth sulphate from vegetable oil for the calculation of total bio-based content according to mass balance Method B.

	Total mass /kg	Biomass /kg	Petrochemical mass /kg
Input	224	55	169
Output (excluding product)	124	12	113
Product	100	43	57

Table 9-53 Bio-based carbon and fossil material mass flows describing the synthesis of sodium laureth sulphate from vegetable oil for the calculation of bio-based carbon content according to mass balance Method B.

	Total mass /kg	Biomass /kg	Petrochemical mass /kg
Input	133	37	96
Output (excluding product)	81	3	79
Product	51	34	17

When bio-naphtha is used as the only organic feedstock to produce ethylene, the total bio-based content does not reach 100% by mass balance Method B if the inorganic content is dealt with separately (this is a change to the rules defined in Chapter 5.1.3). The value of 76% is far from the intuitively anticipated value of 100% bio-based carbon content (Table 9-54). Atom connectivity approaches to indirect bio-based content will allocate 100% bio-based content because all the carbon atoms are themselves bio-based (Table 9-55). Mass balance Method B should be applied in a complimentary manner.

Table 9-54 Biomass and fossil material mass flows describing the synthesis of sodium laureth sulphate for the calculation of total bio-based content according to mass balance Method B for a process without vegetable oil.

	Total mass /kg	Biomass /kg	Petrochemical mass /kg
Input	317	276	42
Output (excluding product)	217	200	17
Product	100	76	24



Table 9-55 Bio-based carbon and fossil material mass flows describing the synthesis of sodium laureth sulphate for the calculation of bio-based carbon content according to mass balance Method B for a process without vegetable oil.

	Total mass /kg	Biomass /kg	Petrochemical mass /kg
Input	234	234	0
Output (excluding product)	183	183	0
Product	51	51	0

9.7.3 Total bio-based content calculation by mass balance Method C

Mass balance Method C reiterates that when vegetable oil is used in conjunction with conventional naphtha, two thirds of the carbon is bio-based, corresponding to fossil carbon savings of 34.3 kg for every 100 kg of sodium laureth sulphate (Table 9-56). Because ethylene can be the basis of the hydrophobic region of the surfactant product, to claim fossil carbon savings is logical, unlike in some instances where there is no analogous petrochemical process. Using bio-naphtha as a feedstock and the origin of all the carbon in sodium laureth sulphate, 51.4 kg for every 100 kg of sodium laureth sulphate of fossil carbon savings can be made, the maximum possible (Table 9-57).



Table 9-56 Fossil carbon savings in sodium laureth sulphate (SLS) when vegetable oil is a feedstock.

Metric	Calculation	Result
Proportion of carbon atom mass in SLS	$\frac{18 \cdot \text{Atomic mass}_C}{RMM_{\text{product}}} = \frac{18 \cdot 12.01 \text{ g} \cdot \text{mol}^{-1}}{420.5 \text{ g} \cdot \text{mol}^{-1}}$	51.4%
Bio-based carbon content		67%
Fossil carbon saving: per 100 kg of product	$\text{Carbon mass} \cdot \text{Biobased carbon content} \cdot 100 \text{ kg}$ $= 51.4\% \cdot 67\% \cdot 100 \text{ kg}$	34.3 kg
Fossil carbon saving: per mass of carbon in product	$\frac{\text{Fossil carbon saving per 100 kg of product}}{\text{Mass of carbon per 100 kg of product}}$ $= \frac{34.3 \text{ kg}}{51.4 \text{ kg}}$	0.67 g/g
Mass of vegetable oil feedstock (per 100 kg of product)		51 kg
Mass of naphtha feedstock (per 100 kg of product)		100 kg
Mass of methane feedstock (per 100 kg of product)		8 kg
Mass of carbon in original feedstock	$\sum \text{Mass of feedstock} \cdot \text{Carbon content}$ $= (51 \text{ kg} \cdot 51\%) + (100 \text{ kg} \cdot 90\%) + (8 \text{ kg} \cdot 75\%)$	132.9 kg
Mass of bio-based vegetable oil		51 kg
Mass of fossil carbon in feedstock	$\text{Mass of fossil feedstock remaining} \cdot \text{Carbon content}$	95.8 kg
Fossil feedstock carbon saving: per 100 kg of product	$\text{Mass of fossil carbon in original feedstock} - \text{mass of fossil carbon in feedstock}$ $= 132.9 - 95.8$	37.1 kg
Fossil feedstock carbon saving: per mass of carbon in original feedstock	$1 - \frac{\text{Mass of fossil carbon in feedstock}}{\text{Maximum mass of fossil carbon in feedstock}}$ $= 1 - \frac{95.8 \text{ kg}}{132.9 \text{ kg}}$	0.28 g/g
Fossil feedstock carbon saving: per mass of carbon in product	$\frac{\text{Mass of fossil carbon in feedstock replaced}}{\text{Mass of carbon per 100 kg of product}}$ $= \frac{37.1 \text{ kg}}{51.4 \text{ kg}}$	0.72 g/g



Table 9-57 Fossil carbon savings in sodium laureth sulphate when bio-naphtha is the only carbon containing feedstock.

Metric	Calculation	Result
Proportion of carbon atom mass in SLS	$\frac{18 \cdot \text{Atomic mass}_C}{RMM_{\text{product}}} = \frac{18 \cdot 12.01 \text{ g} \cdot \text{mol}^{-1}}{420.5 \text{ g} \cdot \text{mol}^{-1}}$	51.4%
Bio-based carbon content		100%
Fossil carbon saving: per 100 kg of product	$\text{Carbon mass} \cdot \text{Biobased carbon content} \cdot 100 \text{ kg}$ $= 51.4\% \cdot 100\% \cdot 100 \text{ kg}$	51.4 kg
Fossil carbon saving: per mass of carbon in product	$\frac{\text{Fossil carbon saving per 100 kg of product}}{\text{Mass of carbon per 100 kg of product}}$ $= \frac{51.4 \text{ kg}}{51.4 \text{ kg}}$	1.00 g/g
Mass of naphtha feedstock (per 100 kg of product)		260 kg
Mass of fossil carbon in feedstock	$\text{Mass of fossil feedstock remaining}$ $\cdot \text{Carbon content}$	0 kg
Fossil feedstock carbon saving: per 100 kg of product	$\text{Mass of fossil carbon in original feedstock}$ $- \text{mass of fossil carbon in feedstock}$ $= (260 \text{ kg} \cdot 90\%) - 0$	234 kg
Fossil feedstock carbon saving: per mass of carbon in original feedstock	$1 - \frac{\text{Mass of fossil carbon in feedstock}}{\text{Maximum mass of fossil carbon in feedstock}}$ $= 1 - \frac{0 \text{ kg}}{234 \text{ kg}}$	1.00 g/g
Fossil feedstock carbon saving: per mass of carbon in product	$\frac{\text{Mass of fossil carbon in feedstock replaced}}{\text{Mass of carbon per 100 kg of product}}$ $= \frac{234 \text{ kg}}{51.4 \text{ kg}}$	4.55 g/g

9.7.4 Total bio-based content calculation by mass balance Method D (seasonal variation)

The calculations for each season from the fourth scenario of Chapter 5.7.7 are presented here. Data for spring (Table 9-58 and Table 9-59), summer (Table 9-60 and Table 9-61), autumn (Table 9-62 and Table 9-63) and winter (Table 9-64 and Table 9-65) contributed to Figure 5-84.



Table 9-58 Spring data for a mass balance Method D calculation of total bio-based content for sodium laureth sulphate when seasonal variation influences the bio-based content.

Feedstock	Mass /kg	Origin	Product incorporation (percentage)	Product incorporation (mass /kg)
Ethanol	13.2	Biomass	56.2%	7.4
Naphtha	30.0	Fossil	23.1%	6.9
Water	2.0	Mineral	47.2%	1.0
Oxygen	6.4	Mineral	85.7%	5.4
H ₂ S	1.9	Mineral	94.1%	1.8
NaCl	3.3	Mineral	39.3%	1.3
Sum	56.8			23.9
Total bio-based content			31%	
<i>Total bio-based content (ignoring mineral content)</i>			52%	
<i>Total bio-based content (mineral assumed bio-based)</i>			71%	

Table 9-59 Spring data for a mass balance Method D calculation of bio-based carbon content for sodium laureth sulphate when seasonal variation influences the bio-based content.

Feedstock	Mass /kg	Origin	Product incorporation (percentage)	Product incorporation (mass /kg)
Ethanol	6.9	Biomass	92.3%	6.3
Naphtha	27.0	Fossil	22.0%	5.9
Water	0.0	Mineral	0.0%	0.0
Oxygen	0.0	Mineral	0.0%	0.0
H ₂ S	0.0	Mineral	0.0%	0.0
NaCl	0.0	Mineral	0.0%	0.0
Sum	33.9			12.3
Bio-based carbon content			52%	
<i>Bio-based carbon content (ignoring mineral content)</i>			52%	



Table 9-60 Summer data for a mass balance Method D calculation of total bio-based content for sodium laureth sulphate when seasonal variation influences the bio-based content.

Feedstock	Mass /kg	Origin	Product incorporation (percentage)	Product incorporation (mass /kg)
Ethanol	26.9	Biomass	56.2%	14.8
Naphtha	0.0	Fossil	0.0%	0.0
Water	2.1	Mineral	47.2%	1.0
Oxygen	6.6	Mineral	85.7%	5.6
H ₂ S	2.0	Mineral	94.1%	1.9
NaCl	3.4	Mineral	39.3%	1.3
Sum	40.4			24.6
Total bio-based content			60%	
<i>Total bio-based content (ignoring mineral content)</i>			100%	
<i>Total bio-based content (mineral assumed bio-based)</i>			100%	

Table 9-61 Summer data for a mass balance Method D calculation of bio-based carbon content for sodium laureth sulphate when seasonal variation influences the bio-based content.

Feedstock	Mass /kg	Origin	Product incorporation (percentage)	Product incorporation (mass /kg)
Ethanol	13.7	Biomass	92.3%	12.7
Naphtha	0.0	Fossil	0.0%	0.0
Water	0.0	Mineral	0.0%	0.0
Oxygen	0.0	Mineral	0.0%	0.0
H ₂ S	0.0	Mineral	0.0%	0.0
NaCl	0.0	Mineral	0.0%	0.0
Sum	13.7			12.7
Bio-based carbon content			100%	
<i>Bio-based carbon content (ignoring mineral content)</i>			100%	



Table 9-62 Autumn data for a mass balance Method D calculation of total bio-based content for sodium laureth sulphate when seasonal variation influences the bio-based content.

Feedstock	Mass /kg	Origin	Product incorporation (percentage)	Product incorporation (mass /kg)
Ethanol	19.7	Biomass	56.2%	11.1
Naphtha	20.1	Fossil	23.1%	4.6
Water	2.2	Mineral	47.2%	1.1
Oxygen	7.0	Mineral	85.7%	6.0
H ₂ S	2.1	Mineral	94.1%	2.0
NaCl	3.6	Mineral	39.3%	1.4
Sum	54.7			26.2
Total bio-based content			42%	
<i>Total bio-based content (ignoring mineral content)</i>			71%	
<i>Total bio-based content (mineral assumed bio-based)</i>			82%	

Table 9-63 Autumn data for a mass balance Method D calculation of bio-based carbon content for sodium laureth sulphate when seasonal variation influences the bio-based content.

Feedstock	Mass /kg	Origin	Product incorporation (percentage)	Product incorporation (mass /kg)
Ethanol	10.2	Biomass	92.3%	9.5
Naphtha	18.0	Fossil	22.0%	4.0
Water	0.0	Mineral	0.0%	0.0
Oxygen	0.0	Mineral	0.0%	0.0
H ₂ S	0.0	Mineral	0.0%	0.0
NaCl	0.0	Mineral	0.0%	0.0
Sum	28.3			13.5
Bio-based carbon content			71%	
<i>Bio-based carbon content (ignoring mineral content)</i>			71%	



Table 9-64 Winter data for a mass balance Method D calculation of total bio-based content for sodium laureth sulphate when seasonal variation influences the bio-based content.

Feedstock	Mass /kg	Origin	Product incorporation (percentage)	Product incorporation (mass /kg)
Ethanol	6.6	Biomass	56.2%	3.7
Naphtha	50.0	Fossil	23.1%	11.5
Water	2.2	Mineral	47.2%	1.0
Oxygen	6.7	Mineral	85.7%	5.8
H ₂ S	2.1	Mineral	94.1%	1.9
NaCl	3.5	Mineral	39.3%	1.4
Sum	71.1			25.4
Total bio-based content			15%	
<i>Total bio-based content (ignoring mineral content)</i>			24%	
<i>Total bio-based content (mineral assumed bio-based)</i>			54%	

Table 9-65 Winter data for a mass balance Method D calculation of bio-based carbon content for sodium laureth sulphate when seasonal variation influences the bio-based content.

Feedstock	Mass /kg	Origin	Product incorporation (percentage)	Product incorporation (mass /kg)
Ethanol	3.4	Biomass	92.3%	3.2
Naphtha	45.0	Fossil	22.0%	9.9
Water	0.0	Mineral	0.0%	0.0
Oxygen	0.0	Mineral	0.0%	0.0
H ₂ S	0.0	Mineral	0.0%	0.0
NaCl	0.0	Mineral	0.0%	0.0
Sum	48.5			13.1
Bio-based carbon content			24%	
<i>Bio-based carbon content (ignoring mineral content)</i>			24%	



9.8 Synthetic vanillin mass balance calculations

The mass flows in the manufacturing of synthetic vanillin from guaiacol were previously given in Table 5-30. Replacing petrochemical guaiacol with the natural equivalent obtained from some essential oils will introduce some bio-based content. Analytical (direct) bio-based carbon content should indicate that seven of the eight carbon atoms per molecule are bio-based (88%). Atom connectivity Method 2b calculates an indirect total bio-based content of 81% (Table 4-50).

9.8.1 Total bio-based content calculation by mass balance Method A

Data for the lower heating value of guaiacol could not be found, and so an approximation was made by using the lower heating value of phenol instead. Any discrepancy will inevitably affect the result of the following calculation. Although not dissimilar masses of both carbon containing feedstocks are used, the final product is predominately guaiacol derived, functionalised with an additional C₁ petrochemical aldehyde group. Much of the naphtha feedstock, once cracked into olefins, is siphoned into other manufacturing processes. A total bio-based content of 47.3% is obtained using the calculations of mass balance Method A (Table 9-66).

Table 9-66 The bio-based content of synthetic vanillin made from guaiacol according to mass balance Method A.

Metric	Calculation	Result
Mass of guaiacol		124 kg
Methane equivalents (guaiacol)	$\frac{LHV_{methane}}{LHV_{vegetable\ oil}} = \frac{50\text{ MJ/kg}}{32.5\text{ MJ/kg}}$	1.54
Mass of naphtha		188 kg
Methane equivalents (naphtha)	$\frac{LHV_{methane}}{LHV_{naphtha}} = \frac{50\text{ MJ/kg}}{40.7\text{ MJ/kg}}$	1.13
Allocation (per 100 kg of vanillin)	$\sum Mass \cdot Methane\ equivalents$ = (124 kg · 1.54) + (188 kg · 1.13)	403 kg
Feedstock requirement	$\frac{Allocation}{Methane\ equivalents\ (guaiacol)} = \frac{403\text{ kg}}{1.54}$	262 kg
Bio-based content (vanillin)	$\frac{Mass\ of\ guaiacol}{Feedstock\ requirement} = \frac{124\text{ kg}}{262\text{ kg}}$	47.3%



9.8.2 Total bio-based content calculation by mass balance Method B

Assigning the distribution of biomass derived material and the petrochemical materials through the synthesis of vanillin is made difficult by the quantities of losses suffered, and the use of both organic and inorganic chemical auxiliaries. Reaction losses can be partitioned (theoretically) into bio-based and fossil derived quantities from the ratio of input material, although this only serves as an estimation. It is possible to calculate the amount of biomass derived material in the vanillin but then the approach relies on reactions stoichiometry and becomes no different to atom connectivity Method 3. Total mass flows (Table 9-67), and carbon mass flows (Table 9-68) are tabulated below. The data describes the whole process and not the simplified approximation of Figure 5-39.

Table 9-67 Biomass and fossil derived material mass flows describing the synthesis vanillin for use in mass balance Method B calculations.

	Total mass /kg	Biomass /kg	Petrochemical mass /kg
Input	4049	1525	2524
Output (excluding product)	3949	1443	2506
Product	100	82	18

Table 9-68 Bio-based carbon and fossil carbon mass balance data for the manufacture of vanillin from guaiacol.

	Total mass /kg	Biomass /kg	Petrochemical mass /kg
Input	1284	85	1199
Output (excluding product)	1221	30	1191
Product	63	55	8

9.8.3 Total bio-based content calculation by mass balance Method C

The calculation of fossil carbon savings upon the substitution of petrochemical guaiacol with natural guaiacol is presented in Table 9-69. Up to 55.3 kg of fossil carbon can be displaced from the product (per 100 kg) in this way. A third of the carbon present in the combined feedstocks is now bio-based.



Table 9-69 Mass balance Method C calculations applied to the synthesis of vanillin.

Metric	Calculation	Result
Proportion of carbon atom mass in vanillin	$\frac{8 \cdot \text{Atomic mass}_C}{RMM_{\text{product}}} = \frac{8 \cdot 12.01 \text{ g} \cdot \text{mol}^{-1}}{152.1 \text{ g} \cdot \text{mol}^{-1}}$	63.2%
Bio-based carbon content		88%
Fossil carbon saving: per 100 kg of product	$\text{Carbon mass} \cdot \text{Biobased carbon content} \cdot 100 \text{ kg}$ $= 63.2\% \cdot 88\% \cdot 100 \text{ kg}$	55.3 kg
Fossil carbon saving: per mass of carbon in product	$\frac{\text{Fossil carbon saving per 100 kg of product}}{\text{Mass of carbon per 100 kg of product}}$ $= \frac{55.3 \text{ kg}}{63.2 \text{ kg}}$	0.88 g/g
Mass of guaiacol feedstock (per 100 kg of product)		124 kg
Mass of naphtha feedstock (per 100 kg of product)		188 kg
Mass of carbon in original feedstock	$\sum \text{Mass of feedstock} \cdot \text{Carbon content}$ $= (124 \text{ kg} \cdot 68\%)$ $+ (188 \text{ kg} \cdot 90\%)$	253 kg
Mass of bio-based guaiacol		124 kg
Mass of fossil carbon in feedstock	$\text{Mass of fossil feedstock remaining}$ $\cdot \text{Carbon content}$	169 kg
Fossil feedstock carbon saving: per 100 kg of product	$\text{Mass of fossil carbon in original feedstock}$ $- \text{mass of fossil carbon in feedstock}$ $= 253 - 169$	84 kg
Fossil feedstock carbon saving: per mass of carbon in original feedstock	$1 - \frac{\text{Mass of fossil carbon in feedstock}}{\text{Maximum mass of fossil carbon in feedstock}}$ $= 1 - \frac{169 \text{ kg}}{253 \text{ kg}}$	0.33 g/g
Fossil feedstock carbon saving: per mass of carbon in product	$\frac{\text{Mass of fossil carbon in feedstock replaced}}{\text{Mass of carbon per 100 kg of product}}$ $= \frac{84 \text{ kg}}{63.2 \text{ kg}}$	1.33 g/g



9.9 Mass balance calculations describing starch polymer blends

In Chapter 5 two scenarios were investigated for a hypothetical blend of glycerol plasticised starch and poly(ethylene). In the first example a typical blend in which poly(ethylene) is the major component, then instances where the different mass balance methods deduce a bio-based content of 85%. The composition of these products is given below (Table 9-70). In all cases a 2:1 ratio of starch to glycerol is maintained. This is combined with poly(ethylene) in the desired quantities, most probably by a hot melt extrusion process. In the following calculations only the primary example is given to avoid extensive repetition.

Table 9-70 Ingredients for blends of starch plasticised with glycerol and poly(ethylene) amounting to 100 kg of product.

Product	Starch	Glycerol	Poly(ethylene)
Primary example	22.2 kg	11.1 kg	66.7 kg
82.5% bio-based (total) <i>according to mass balance Method A</i>	66.7 kg	33.3 kg	0.0 kg
85% bio-based (carbon) <i>according to mass balance Method B</i>	61.3 kg	30.6 kg	8.0 kg
85% bio-based (total) <i>according to mass balance Method B</i>	56.7 kg	28.3 kg	15.0 kg
85% product fossil carbon saving <i>according to mass balance Method C</i>	61.3 kg	30.6 kg	8.1 kg
85% feedstock fossil carbon saving <i>according to mass balance Method C</i>	63.1 kg	31.6 kg	5.4 kg

9.9.1 Total bio-based content calculation by mass balance Method A

The calculation of bio-based content with mass balance Method A for the typical 3:1 poly(ethylene) to starch blend is presented in Table 9-71. Because of the relative volumes of the product stream when vegetable oils are transesterified, glycerol has an elevated representation within the formulation as far as its contribution to bio-based content is concerned: 11% by mass (11.1 kg) but a 19% contribution to bio-based content.



Table 9-71 Mass balance Method A applied to a formulation consisting of 75 wt% of petrochemical poly(ethylene) and plasticised starch.

Metric	Calculation	Result
Mass of starch		22.2 kg
Methane equivalents (starch)	$\frac{LHV_{methane}}{LHV_{starch}} = \frac{50 \text{ MJ/kg}}{16.41 \text{ MJ/kg}}$	3.05
Mass of naphtha		267 kg
Methane equivalents (naphtha)	$\frac{LHV_{methane}}{LHV_{naphtha}} = \frac{50 \text{ MJ/kg}}{40.7 \text{ MJ/kg}}$	1.13
Mass of vegetable oil		78.4 kg
Methane equivalents (vegetable oil)	$\frac{LHV_{methane}}{LHV_{vegetable \text{ oil}}} = \frac{50 \text{ MJ/kg}}{40.7 \text{ MJ/kg}}$	1.23
Mass of methanol		13.5 kg
Methane equivalents (methanol)	$\frac{LHV_{methane}}{LHV_{methanol}} = \frac{50 \text{ MJ/kg}}{19.4 \text{ MJ/kg}}$	2.574
Allocation (per 100 kg of formulation)	$\sum \text{Mass} \cdot \text{Methane equivalents}$ $= (22.2 \text{ kg} \cdot 3.05)$ $+ (267 \text{ kg} \cdot 1.13)$ $+ (78.4 \text{ kg} \cdot 1.23)$ $+ (13.5 \text{ kg} \cdot 2.574)$	500 kg
Feedstock requirement	$\frac{\text{Allocation}}{\text{Methane equivalents (starch)}} = \frac{500 \text{ kg}}{3.05}$	164 kg
Bio-based content (contribution by starch)	$\frac{\text{Mass of starch}}{\text{Feedstock requirement}} = \frac{22.2 \text{ kg}}{164 \text{ kg}}$	13.5%
Feedstock requirement	$\frac{\text{Allocation}}{\text{Methane equivalents (vegetable oil)}}$ $= \frac{500 \text{ kg}}{1.23}$	407 kg
Bio-based content (contribution by glycerol)	$\frac{\text{Mass of vegetable oil}}{\text{Feedstock requirement}} = \frac{78.4 \text{ kg}}{378407 \text{ kg}}$	19.3%
Bio-based content (formulation)		32.8%

9.9.2 Total bio-based content calculation by mass balance Method B

Calculating bio-based content with mass balance Method B (either on the basis of total mass or carbon mass) has been performed on the basis of the ingredients, and also the original feedstocks as a type of reassurance. The total bio-based content is 33.3% when de-



rived from the ingredients (assuming glycerol is entirely bio-based, Table 9-72) and the corresponding bio-based carbon is 20.0% (Table 9-73).

Table 9-72 Biomass and fossil material content in the ingredients of a starch blend (3:1 poly(ethylene) to starch) for the calculation of total bio-based content according to mass balance Method B.

	Total mass /kg	Biomass /kg	Petrochemical mass /kg
Input	100	33.3	67.7
Output (excluding product)	0.0	0.0	0.0
Product	100	33.3	67.7

Table 9-73 Biomass and fossil material content in the ingredients of a starch blend (3:1 poly(ethylene) to starch) for the calculation of bio-based carbon content according to mass balance Method B.

	Total mass /kg	Biomass /kg	Petrochemical mass /kg
Input	71.3	14.2	57.1
Output (excluding product)	0.0	0.0	0.0
Product	71.3	14.2	57.1

When also considering the manufacturing of the individual ingredients, a slight discrepancy occurs, and now the total bio-based content is 32.7% (Table 9-74). This value is 0.6% lower than that arrived at from only considering the feedstocks, and now accounts more correctly for the fossil derived hydrogen atoms in the glycerol. Depending on the convention followed, the assignment of these non-carbon atoms as fossil derived when all the carbon atoms in the molecule are bio-based is not always appropriate. Because the origin of the carbon atoms has been successfully determined there is no change to the calculation of bio-based carbon content, and this should match analytical measurements (Table 9-75).

Table 9-74 Biomass and fossil material mass flows describing the synthesis of the ingredients in a starch blend according to mass balance Method B.

	Total mass /kg	Biomass /kg	Petrochemical mass /kg
Input	381	101	281
Output (excluding product)	281	67.9	213
Product	100	32.7	67.3



Table 9-75 Biomass and fossil material mass flows describing the synthesis of the ingredients in a starch blend according to mass balance Method B.

	Total mass /kg	Biomass /kg	Petrochemical mass /kg
Input	312	67.3	245
Output (excluding product)	241	53.1	188
Product	71.3	14.2	57.1

9.9.3 Total bio-based content calculation by mass balance Method C

Fossil carbon savings have been calculated based on the manufacturing process including feedstocks, although for the format presented in the original approach, only the carbon in the product is relevant and so calculations could be constructed from the ingredients. The fossil carbon saving in the formulation is 14.2 kg (0.2 g/g) for every 100 kg of product. The vegetable oil and starch feedstocks accounts for a similar proportion of the total quantity of carbon in the combined feedstocks (0.22 g/g). Overall, the number of bio-based carbon atoms in the combined feedstocks for every carbon atom in 100 kg of the product is calculated to be 0.94 (Table 9-76). When the amount of starch is increased to secure an 85% bio-based carbon content, this figure rises to more than 4 (given that most the bio-based carbon atoms in the triglyceride feedstock are not incorporated into the final product).



Table 9-76 Mass balance Method C for the calculation of fossil carbon saving in the production of a starch blend with poly(ethylene).

Metric	Calculation	Result
Proportion of carbon atom mass in formulation	$\sum \frac{n \cdot Atomic\ mass_C}{RMM_{ingredient}}$	71.3%
Bio-based carbon content		20%
Fossil carbon saving: per 100 kg of product	$Carbon\ mass \cdot Biobased\ carbon\ content \cdot 100\ kg$ $= 71.3\% \cdot 20\% \cdot 100\ kg$	14.2 kg
Fossil carbon saving: per mass of carbon in product	$\frac{Fossil\ carbon\ saving\ per\ 100\ kg\ of\ product}{Mass\ of\ carbon\ per\ 100\ kg\ of\ product}$ $= \frac{14.2\ kg}{71.3\ kg}$	0.20 g/g
Mass of vegetable oil feedstock (per 100 kg of formulation)		78.4 kg
Mass of naphtha feedstock (per 100 kg of formulation)		267 kg
Mass of starch (per 100 kg of formulation)		22.2 kg
Mass of methanol (per 100 kg of formulation)		13.5 kg
Mass of carbon in original feedstock	$\sum Mass\ of\ feedstock \cdot Carbon\ content$ $= (78.4\ kg \cdot 73\%)$ $+ (267\ kg \cdot 90\%)$ $+ (22.2\ kg \cdot 44\%)$ $+ (13.5\ kg \cdot 37\%)$	312 kg
Mass of bio-based starch		22.2 kg
Mass of bio-based vegetable oil		78.4 kg
Mass of fossil carbon in feedstock	$Mass\ of\ fossil\ feedstock\ remaining$ $\cdot Carbon\ content$	245 kg
Fossil feedstock carbon saving: per 100 kg of product	$Mass\ of\ fossil\ carbon\ in\ original\ feedstock$ $- mass\ of\ fossil\ carbon\ in\ feedstock$ $= 312\ kg - 245\ kg$	67.3 kg
Fossil feedstock carbon saving: per mass of carbon in original feedstock	$1 - \frac{Mass\ of\ fossil\ carbon\ in\ feedstock}{Maximum\ mass\ of\ fossil\ carbon\ in\ feedstock}$ $= 1 - \frac{245\ kg}{312\ kg}$	0.22 g/g
Fossil feedstock carbon saving: per mass of carbon in product	$\frac{Mass\ of\ fossil\ carbon\ in\ feedstock\ replaced}{Mass\ of\ carbon\ per\ 100\ kg\ of\ product}$ $= \frac{67.3\ kg}{71.3\ kg}$	0.94 g/g



9.10 PBAT-PLA mass balance calculations

A blend of poly(lactic acid) (PLA) and poly(butylene adipate terephthalate) (PBAT) has already been commercialised [BASF 2014], in which the PLA portion introduces some bio-based content. In this example, the 1,4-butanediol monomer of PBAT is also bio-based, and in some examples so is the terephthalate moiety of PBAT. The feedstocks required to produce PLA, PBAT and the plasticiser acetyl tributyl citrate (ATBC) in two different blends is given in Table 9-77. The mass proportion of ATBC is one tenth that of PLA in both examples. The feedstocks for the conventional practice in which the terephthalate is fossil derived is also presented (Table 9-78).

Table 9-77 Mass balance data for the manufacture of different blends of poly(lactic acid) and poly(butylene adipate terephthalate) made from bio-based *p*-xylene with the plasticiser acetyl tributyl citrate included.

Mass flow	Substance	Mass /kg	
		PLA:PBAT 1:4	PLA:PBAT 4:1
Input	Benzene	15	3
Input	Oxygen	33	8
Input	Hydrogen	4	1
Input	Succinic acid	44	10
Input	Isobutanol	40	10
Input	Methanol	12	3
Input	Methane	0.31	1
Input	Water	0.35	1
Input	Citric acid	1	4
Input	1-Butanol	1	4
Input	Glucose	25	93
Input	Calcium carbonate	14	51
Input	Sulphuric acid	13	50
Output	ATBC	2	7
Output	PBAT	78	19
Output	PLA	20	74
Output	Water	51	39
Output	Hydrogen	2	0.34
Output	Acetic acid	0.29	1
Output	Carbon dioxide	6	23
Output	Calcium sulphate	19	70
Output	Methanol	12	3
Losses	(bio- <i>p</i> -xylene synthesis)	12	3



Table 9-78 Mass balance data for the manufacture of a poly(lactic acid) and poly(butylene adipate terephthalate) containing fossil derived *p*-xylene blend with the plasticiser acetyl tributyl citrate included.

Mass flow	Substance	Mass /kg
		PLA:PBAT
		1:4
Input	Benzene	15
Input	Oxygen	33
Input	Hydrogen	4
Input	Succinic acid	44
Input	<i>p</i> -Xylene	20
Input	Methanol	12
Input	Methane	0.31
Input	Water	0.35
Input	Citric acid	1
Input	1-Butanol	1
Input	Glucose	25
Input	Calcium carbonate	14
Input	Sulphuric acid	13
Output	ATBC	2
Output	PBAT	78
Output	PLA	20
Output	Water	47
Output	Hydrogen	0.08
Output	Acetic acid	0.29
Output	Carbon dioxide	6
Output	Calcium sulphate	19
Output	Methanol	12

9.10.1 Total bio-based content calculation by mass balance Method A

Three scenarios are covered in this assessment of mass balance Method A. Firstly the majority PBAT product in which fossil derived terephthalate is present is evaluated (Table 9-79). The three bio-based feedstocks are succinic acid (producing 1,4-butanediol), glucose (for fermentation to PLA), and citric acid (esterified to ATBC). The six other feedstocks with calorific values and hence qualifying under mass balance Method A are benzene, hydrogen, *p*-xylene, methanol, methane, 1-butanol.



Table 9-79 Total bio-based content by mass balance Method A for a poly(lactic acid) and poly(butylene adipate terephthalate) blend (1:4 by mass) in which the 1,4-butanediol monomer is bio-based.

Metric	Calculation	Result
Mass of succinic acid		44 kg
Methane equivalents (succinic acid)	$\frac{LHV_{methane}}{LHV_{succinic\ acid}} = \frac{50\text{ MJ/kg}}{11.3\text{ MJ/kg}}$	4.44
Mass of glucose		25 kg
Methane equivalents (glucose)	$\frac{LHV_{methane}}{LHV_{glucose}} = \frac{50\text{ MJ/kg}}{15.6\text{ MJ/kg}}$	3.21
Mass of citric acid		0.94 kg
Methane equivalents (citric acid)	$\frac{LHV_{methane}}{LHV_{citric\ acid}} = \frac{50\text{ MJ/kg}}{8.94\text{ MJ/kg}}$	5.60
	$\sum \text{Mass} \cdot \text{Methane equivalents}$	
	$= (44\text{ kg} \cdot 4.44)$	
	$+ (25\text{ kg} \cdot 3.21)$	
	$+ (0.94\text{ kg} \cdot 5.60)$	
Allocation (per 100 kg of formulation)	$+ (15\text{ kg} \cdot 1.245)$	356 kg
	$+ (4\text{ kg} \cdot 0.417)$	
	$+ (20\text{ kg} \cdot 1.23)$	
	$+ (12\text{ kg} \cdot 2.574)$	
	$+ (0.31\text{ kg} \cdot 1.00)$	
	$+ (1.1\text{ kg} \cdot 1.511)$	
	<i>Allocation</i>	
Feedstock requirement	$\frac{\text{Methane equivalents (succinic acid)}}{4.44} = \frac{356\text{ kg}}{4.44}$	80.2 kg
Bio-based content (contribution by 1,4-butanediol)	$\frac{\text{Mass of succinic acid}}{\text{Feedstock requirement}} = \frac{44\text{ kg}}{80.2\text{ kg}}$	54.9%
Feedstock requirement	$\frac{\text{Allocation}}{\text{Methane equivalents (glucose)}} = \frac{356\text{ kg}}{3.21}$	111 kg
Bio-based content (contribution by PLA)	$\frac{\text{Mass of glucose}}{\text{Feedstock requirement}} = \frac{25\text{ kg}}{111\text{ kg}}$	22.0%
Feedstock requirement	$\frac{\text{Allocation}}{\text{Methane equivalents (citric acid)}} = \frac{356\text{ kg}}{5.60}$	63.7 kg
Bio-based content (contribution by ATBC)	$\frac{\text{Mass of citric acid}}{\text{Feedstock requirement}} = \frac{0.94\text{ kg}}{63.7\text{ kg}}$	1.5%
Bio-based content (composite)		78.4%



Table 9-80 Total bio-based content by mass balance Method A for a poly(lactic acid) and poly(butylene adipate terephthalate) blend (1:4 by mass) in which the 1,4-butanediol and terephthalate monomers are bio-based.

Metric	Calculation	Result
Mass of isobutanol		40 kg
Methane equivalents (isobutanol)	$\frac{LHV_{methane}}{LHV_{citric\ acid}} = \frac{50\text{ MJ/kg}}{32.96\text{ MJ/kg}}$	1.517
Allocation (per 100 kg of formulation)	$\sum Mass \cdot Methane\ equivalents$ $= (40\text{ kg} \cdot 1.517)$ $+ (44\text{ kg} \cdot 4.44)$ $+ (25\text{ kg} \cdot 3.21)$ $+ (0.94\text{ kg} \cdot 5.60)$ $+ (15\text{ kg} \cdot 1.245)$ $+ (4\text{ kg} \cdot 0.417)$ $+ (12\text{ kg} \cdot 2.574)$ $+ (0.31\text{ kg} \cdot 1.00)$ $+ (1.1\text{ kg} \cdot 1.511)$	394 kg
Feedstock requirement	$\frac{Allocation}{Methane\ equivalents\ (isobutanol)} = \frac{394\text{ kg}}{1.517}$	259 kg
Bio-based content (contribution by terephthalic acid)	$\frac{Mass\ of\ isobutanol}{Feedstock\ requirement} = \frac{40\text{ kg}}{259\text{ kg}}$	15.6%
Feedstock requirement	$\frac{Allocation}{Methane\ equivalents\ (succinic\ acid)}$ $= \frac{394\text{ kg}}{4.44}$	88.5 kg
Bio-based content (contribution by 1,4-butanediol)	$\frac{Mass\ of\ succinic\ acid}{Feedstock\ requirement} = \frac{44\text{ kg}}{88.5\text{ kg}}$	49.8%
Feedstock requirement	$\frac{Allocation}{Methane\ equivalents\ (glucose)} = \frac{394\text{ kg}}{3.21}$	123 kg
Bio-based content (contribution by PLA)	$\frac{Mass\ of\ glucose}{Feedstock\ requirement} = \frac{25\text{ kg}}{123\text{ kg}}$	20.0%
Feedstock requirement	$\frac{Allocation}{Methane\ equivalents\ (citric\ acid)} = \frac{394\text{ kg}}{5.60}$	70.3 kg
Bio-based content (contribution by ATBC)	$\frac{Mass\ of\ citric\ acid}{Feedstock\ requirement} = \frac{0.94\text{ kg}}{70.3\text{ kg}}$	1.3%
Bio-based content (composite)		86.6%



Table 9-81 Total bio-based content by mass balance Method A for a poly(lactic acid) and poly(butylene adipate terephthalate) blend (4:1 by mass) in which the 1,4-butanediol and terephthalate monomers are bio-based.

Metric	Calculation	Result
Allocation (per 100 kg of formulation)	$\sum \text{Mass} \cdot \text{Methane equivalents}$ $= (10 \text{ kg} \cdot 1.517)$ $+ (10 \text{ kg} \cdot 4.44)$ $+ (93 \text{ kg} \cdot 3.21)$ $+ (3.5 \text{ kg} \cdot 5.60)$ $+ (3 \text{ kg} \cdot 1.245)$ $+ (1.0 \text{ kg} \cdot 0.417)$ $+ (2.8 \text{ kg} \cdot 2.574)$ $+ (1.2 \text{ kg} \cdot 1.00)$ $+ (4.1 \text{ kg} \cdot 1.511)$	397 kg
Feedstock requirement	$\frac{\text{Allocation}}{\text{Methane equivalents (isobutanol)}} = \frac{397 \text{ kg}}{1.517}$	261 kg
Bio-based content (contribution by terephthalic acid)	$\frac{\text{Mass of isobutanol}}{\text{Feedstock requirement}} = \frac{10 \text{ kg}}{261 \text{ kg}}$	3.65%
Feedstock requirement	$\frac{\text{Allocation}}{\text{Methane equivalents (succinic acid)}} = \frac{397 \text{ kg}}{4.44}$	89.2 kg
Bio-based content (contribution by 1,4-butanediol)	$\frac{\text{Mass of succinic acid}}{\text{Feedstock requirement}} = \frac{10 \text{ kg}}{89.2 \text{ kg}}$	11.7%
Feedstock requirement	$\frac{\text{Allocation}}{\text{Methane equivalents (glucose)}} = \frac{397 \text{ kg}}{3.21}$	124 kg
Bio-based content (contribution by PLA)	$\frac{\text{Mass of glucose}}{\text{Feedstock requirement}} = \frac{93 \text{ kg}}{124 \text{ kg}}$	74.8%
Feedstock requirement	$\frac{\text{Allocation}}{\text{Methane equivalents (citric acid)}} = \frac{397 \text{ kg}}{5.60}$	70.9 kg
Bio-based content (contribution by ATBC)	$\frac{\text{Mass of citric acid}}{\text{Feedstock requirement}} = \frac{3.5 \text{ kg}}{70.9 \text{ kg}}$	5.0%
Bio-based content (composite)		95.1%



9.10.2 Total bio-based content calculation by mass balance Method B

The same three scenarios in the production of the PLA-PBAT blend were scrutinised with mass balance Method B. In each instance the value of bio-based carbon content obtained matched that from Atom connectivity Method 2b (88.2% when PLA is the major component, 76.3% when PLA is the minor component, dropping further to 46.6% when fossil derived *p*-xylene is a feedstock instead of bio-isobutanol). Discrepancy in total bio-based content values from atom connectivity methods and mass balance approaches could exceed 6% as discussed subsequently.

In the first example, where the mass of PBAT is four times that of PLA in the final product (ATBC mass being one tenth that of PLA as always), and the terephthalate ester moiety is derived from petrochemical *p*-xylene, total bio-based content was found to be 53.9% (Table 9-82). Atom connectivity Method 2b calculations give a total bio-based content of 53.2% (Figure 4-57). Calculated bio-based carbon content was 46.6% (Table 9-83).

Table 9-82 Material flows in the production of a poly(lactic acid) blend with poly(butylene adipate terephthalate) (1:4 by mass) for the calculation of total bio-based content according to mass balance Method B in which the terephthalate monomer is fossil derived.

	Total mass /kg	Biomass /kg	Petrochemical mass /kg
Input	182	99	82
Output (excluding product)	82	46	36
Product	100	54	46

Table 9-83 Material flows in the production of a poly(lactic acid) blend with poly(butylene adipate terephthalate) (1:4 by mass) for the calculation of bio-based carbon content according to mass balance Method B in which the terephthalate monomer is fossil derived.

	Total mass /kg	Biomass /kg	Petrochemical mass /kg
Input	66	30	37
Output (excluding product)	6	2	5
Product	60	28	32

When the terephthalate is produced from bio-based isobutanol, bio-based content increases, although the calculated total bio-based content can be as low as 71.5% using mass balance Method B depending on assignment of water by-product streams as bio-based or fossil derived, falling short of the atom connectivity approach in which bio-based carbon



content is calculated to be 77.8% (Figure 4-57). The most accurate application of atom connectivity within mass balance Method B is shown in Table 9-84, and the resulting value of total bio-based content is similar to that obtained with atom connectivity Method 2b. Bio-based carbon mass flows correspond to that expected of an analytical measurement, and concur with atom connectivity Method 2b (Table 9-85).

Table 9-84 Material flows in the production of a poly(lactic acid) blend with poly(butylene adipate terephthalate) (1:4 by mass) for the calculation of total bio-based content according to mass balance Method B in which the terephthalate monomer is bio-based with the mass flows of an analogous process but without losses in the conversion of isobutanol to *p*-xylene given in brackets.

	Total mass /kg	Biomass /kg	Petrochemical mass /kg
Input	202 (189)	158 (145)	44
Output (excluding product)	102 (89)	80 (74)	22
Product	100	78	22

Table 9-85 Material flows in the production of a poly(lactic acid) blend with poly(butylene adipate terephthalate) (1:4 by mass) for the calculation of bio-based carbon content according to mass balance Method B in which the terephthalate monomer is bio-based with the mass flows of an analogous process but without losses in the conversion of isobutanol to *p*-xylene given in brackets.

	Total mass /kg	Biomass /kg	Petrochemical mass /kg
Input	75 (66)	56 (48)	19
Output (excluding product)	15 (6)	10 (2)	5
Product	60	46	14

Changing the ratio of PLA to PBAT so that now the former outweighs the latter by four parts to one, the discrepancy between methods of indirect total bio-based content calculation falls. Poly(lactic acid) being a wholly bio-based product, there is no possibility for the erroneous calculation of total bio-based content caused by attempts to account for the synthesis of a partially bio-based product where heteroatoms may switch their assigned origin. Total bio-based content was calculated at 88.7% with mass balance Method B (Table 9-86). Calculated bio-based carbon content was 88.2% (Table 9-87).



Table 9-86 Material flows in the production of a poly(lactic acid) blend with poly(butylene adipate terephthalate) (4:1 by mass) for the calculation of total bio-based content according to mass balance Method B in which the terephthalate monomer is bio-based.

	Total mass /kg	Biomass /kg	Petrochemical mass /kg
Input	240	223	17
Output (excluding product)	140	134	5
Product	100	89	11

Table 9-87 Material flows in the production of a poly(lactic acid) blend with poly(butylene adipate terephthalate) (4:1 by mass) for the calculation of bio-based carbon content according to mass balance Method B in which the terephthalate monomer is bio-based.

	Total mass /kg	Biomass /kg	Petrochemical mass /kg
Input	63	55	8
Output (excluding product)	10	8	2
Product	53	47	6

9.10.3 Total bio-based content calculation by mass balance Method C

Accountability in the measurement of waste streams can be important for fossil saving claims. As indicated in Table 9-85, the bio-based carbon flow in the process as isobutanol is converted to methyl terephthalate is affected by the losses incurred. Reaction stoichiometry is not always suitable as a basis for mass balance calculations, although for simplicity this is relied on to an extent throughout this work in the absence of actual process data. Table 9-88 and Table 9-89 show the effect of excluding losses from the mass balance. Claims of fossil carbon saving made on the basis of the material contained within the product are not affected, only those claims based on the mass of feedstock. Due to the number of feedstocks in this process these tables displaying the calculations required for mass balance Method C have been shortened.



Table 9-88 Assessment of fossil carbon saving in the production of a poly(lactic acid) blend with poly(butylene adipate terephthalate) (1:4 by mass) made from bio-based 1,4-butanediol and bio-based terephthalate

Metric	Calculation	Result
Proportion of carbon atom mass in formulation	$\sum \frac{n \cdot \text{Atomic mass}_C}{RMM_{\text{ingredient}}}$	60.3%
Bio-based carbon content		76.3%
Fossil carbon saving: per 100 kg of product	$\text{Carbon mass} \cdot \text{Biobased carbon content} \cdot 100 \text{ kg}$ $= 60.3\% \cdot 46\% \cdot 100 \text{ kg}$	46.0 kg
Fossil carbon saving: per mass of carbon in product	$\frac{\text{Fossil carbon saving per 100 kg of product}}{\text{Mass of carbon per 100 kg of product}}$ $= \frac{46.0 \text{ kg}}{60.3 \text{ kg}}$	0.76 g/g
Mass of carbon in original feedstock	$\sum \text{Mass of feedstock} \cdot \text{Carbon content}$	74.8 kg
Mass of fossil carbon in feedstock	$\text{Mass of fossil feedstock remaining} \cdot \text{Carbon content}$	18.9 kg
Fossil feedstock carbon saving: per 100 kg of product	$\text{Mass of fossil carbon in original feedstock}$ $- \text{mass of fossil carbon in feedstock}$ $= 74.8 \text{ kg} - 18.9 \text{ kg}$	55.9 kg
Fossil feedstock carbon saving: per mass of carbon in original feedstock	$1 - \frac{\text{Mass of fossil carbon in feedstock}}{\text{Maximum mass of fossil carbon in feedstock}}$ $= 1 - \frac{18.9 \text{ kg}}{74.8 \text{ kg}}$	0.75 g/g
Fossil feedstock carbon saving: per mass of carbon in product	$\frac{\text{Mass of fossil carbon in feedstock replaced}}{\text{Mass of carbon per 100 kg of product}}$ $= \frac{55.9 \text{ kg}}{60.3 \text{ kg}}$	0.93 g/g



Table 9-89 Assessment of fossil carbon saving in the production of a poly(lactic acid) blend with poly(butylene adipate terephthalate) (1:4 by mass) made from bio-based 1,4-butanediol and bio-based terephthalate by reaction stoichiometry when process losses are ignored.

Metric	Calculation	Result
Proportion of carbon atom mass in formulation	$\sum \frac{n \cdot \text{Atomic mass}_C}{RMM_{\text{ingredient}}}$	60.3%
Bio-based carbon content		76.3%
Fossil carbon saving: per 100 kg of product	$\text{Carbon mass} \cdot \text{Biobased carbon content} \cdot 100 \text{ kg}$ $= 60.3\% \cdot 46\% \cdot 100 \text{ kg}$	46.0 kg
Fossil carbon saving: per mass of carbon in product	$\frac{\text{Fossil carbon saving per 100 kg of product}}{\text{Mass of carbon per 100 kg of product}}$ $= \frac{46.0 \text{ kg}}{60.3 \text{ kg}}$	0.76 g/g
Mass of carbon in original feedstock	$\sum \text{Mass of feedstock} \cdot \text{Carbon content}$	66.5 kg
Mass of fossil carbon in feedstock	$\text{Mass of fossil feedstock remaining} \cdot \text{Carbon content}$	18.9 kg
Fossil feedstock carbon saving: per 100 kg of product	$\text{Mass of fossil carbon in original feedstock}$ $- \text{mass of fossil carbon in feedstock}$ $= 66.5 \text{ kg} - 18.9 \text{ kg}$	47.6 kg
Fossil feedstock carbon saving: per mass of carbon in original feedstock	$1 - \frac{\text{Mass of fossil carbon in feedstock}}{\text{Maximum mass of fossil carbon in feedstock}}$ $= 1 - \frac{18.9 \text{ kg}}{66.5 \text{ kg}}$	0.72 g/g
Fossil feedstock carbon saving: per mass of carbon in product	$\frac{\text{Mass of fossil carbon in feedstock replaced}}{\text{Mass of carbon per 100 kg of product}}$ $= \frac{47.6 \text{ kg}}{60.3 \text{ kg}}$	0.79 g/g



9.11 Cleaning product

The cleaning product made from sodium laureth sulphate, sodium octadecyl sulphate, glycerol, limonene, citric acid, sodium hydroxide was described in Chapter 5.6. Calculations for mass balance Method D and the feedstock quantities were presented during discussions in that chapter. Here the data for mass balance Method A, Method B, and Method C will be presented.

9.11.1 Total bio-based content calculation by mass balance Method A

Mass balance Method A brings together six feedstocks, three of which (vegetable oil, citric acid, and limonene) are bio-based (Table 9-90). The remainder are naphtha, methane, and hydrogen sulphide. A further three are not relevant because they are mineral or inorganic (water, oxygen, sodium chloride) and do not have a lower heating value. The fossil resource saving is 74.5%.



Table 9-90 Total bio-based content by mass balance Method A for a cleaning product formulation.

Metric	Calculation	Result
Mass of vegetable oil		42 kg
Methane equivalents (vegetable oil)	$\frac{LHV_{methane}}{LHV_{vegetable\ oil}} = \frac{50\text{ MJ/kg}}{40.7\text{ MJ/kg}}$	1.23
Mass of methane		5 kg
Methane equivalents (methane)	$\frac{LHV_{methane}}{LHV_{methane}} = \frac{50\text{ MJ/kg}}{50\text{ MJ/kg}}$	1.00
Mass of naphtha		22 kg
Methane equivalents (naphtha)	$\frac{LHV_{methane}}{LHV_{naphtha}} = \frac{50\text{ MJ/kg}}{44.3\text{ MJ/kg}}$	1.13
Mass of hydrogen sulphide		5 kg
Methane equivalents (hydrogen sulphide)	$\frac{LHV_{methane}}{LHV_{hydrogen\ sulphide}} = \frac{50\text{ MJ/kg}}{15.2\text{ MJ/kg}}$	3.29
Mass of citric acid		12 kg
Methane equivalents (citric acid)	$\frac{LHV_{methane}}{LHV_{citric\ acid}} = \frac{50\text{ MJ/kg}}{8.94\text{ MJ/kg}}$	5.60
Mass of limonene		16 kg
Methane equivalents (limonene)	$\frac{LHV_{methane}}{LHV_{limonene}} = \frac{50\text{ MJ/kg}}{41\text{ MJ/kg}}$	1.22
Allocation (per 100 kg of formulation)	$\sum Mass \cdot Methane\ equivalents$ $= (42\text{ kg} \cdot 1.23) + (5\text{ kg} \cdot 1.00)$ $+ (22\text{ kg} \cdot 1.13) + (5\text{ kg} \cdot 3.29)$ $+ (12\text{ kg} \cdot 5.6) + (16\text{ kg} \cdot 1.22)$	185 kg
Feedstock requirement	$\frac{Allocation}{Methane\ equivalents\ (veg\ oil)} = \frac{185\text{ kg}}{1.23}$	151 kg
Bio-based content (contribution by vegetable oil)	$\frac{Mass\ of\ veg\ oil}{Feedstock\ requirement} = \frac{42\text{ kg}}{151\text{ kg}}$	27.6%
Feedstock requirement	$\frac{Allocation}{Methane\ equivalents\ (citric\ acid)} = \frac{185\text{ kg}}{5.60}$	33 kg
Bio-based content (contribution by citric acid)	$\frac{Mass\ of\ glucose}{Feedstock\ requirement} = \frac{12\text{ kg}}{33\text{ kg}}$	36.2%
Feedstock requirement	$\frac{Allocation}{Methane\ equivalents\ (limonene)} = \frac{185\text{ kg}}{1.22}$	152 kg
Bio-based content (contribution by limonene)	$\frac{Mass\ of\ limonene}{Feedstock\ requirement} = \frac{16\text{ kg}}{152\text{ kg}}$	10.7%
Bio-based content (formulation)		74.5%



9.11.2 Total bio-based content calculation by mass balance Method B

The total bio-based content of the cleaning product is 81% (Table 9-91), and its bio-carbon content is 93% (Table 9-92). The bio-based waste streams are all water from fatty acid modifications except the hydrogen and chlorine from the relevant synthesis pathway of sodium octadecyl sulphate (Figure 5-56). Loss of hydrogen and chloride from the production of the intermediate sodium hydroxide is regarded as fossil derived when allocated to the synthesis of sodium laureth sulphate because of reasons of atom connectivity dictating this assignment.

Table 9-91 The calculation of total bio-based content according to mass balance Method B for a cleaning product.

	Total mass /kg	Biomass /kg	Petrochemical mass /kg
Input	147	91	56
Output (excluding product)	47	10	37
Product	100	81	19

Table 9-92 The calculation of bio-based carbon content according to mass balance Method B for a cleaning product.

	Total mass /kg	Biomass /kg	Petrochemical mass /kg
Input	74	51	23
Output (excluding product)	20	0	20
Product	55	51	4

9.11.3 Total bio-based content calculation by mass balance Method C

The bio-based carbon content of the cleaning product is high in the final article but if naphtha is regarded as a feedstock the 25% selectivity to the relevant intermediate ethylene means reporting fossil carbon feedstock savings reduces the apparent bio-based content (Table 9-93).



Table 9-93 Calculation of bio-based carbon metrics for a cleaning product using mass balance Method C.

Metric	Calculation	Result
Proportion of carbon atom mass in formulation	$\sum \frac{n \cdot Atomic\ mass_C}{RMM_{ingredient}}$	54.5%
Bio-based carbon content		93%
Fossil carbon saving: per 100 kg of product	$Carbon\ mass \cdot Biobased\ carbon\ content \cdot 100\ kg$ $= 54.5\% \cdot 93\% \cdot 100\ kg$	50.8 kg
Fossil carbon saving: per mass of carbon in product	$\frac{Fossil\ carbon\ saving\ per\ 100\ kg\ of\ product}{Mass\ of\ carbon\ per\ 100\ kg\ of\ product}$ $= \frac{50.8\ kg}{54.5\ kg}$	0.93 g/g
Mass of carbon in original feedstock	$\sum Mass\ of\ feedstock \cdot Carbon\ content$	74.2 kg
Mass of fossil carbon in feedstock	$Mass\ of\ fossil\ feedstock\ remaining$ $\cdot Carbon\ content$	23.5 kg
Fossil feedstock carbon saving: per 100 kg of product	$Mass\ of\ fossil\ carbon\ in\ original\ feedstock$ $- mass\ of\ fossil\ carbon\ in\ feedstock$ $= 74.2\ kg - 23.5\ kg$	50.8 kg
Fossil feedstock carbon saving: per mass of carbon in original feedstock	$1 - \frac{Mass\ of\ fossil\ carbon\ in\ feedstock}{Maximum\ mass\ of\ fossil\ carbon\ in\ feedstock}$ $= 1 - \frac{23.5\ kg}{74.2\ kg}$	0.68 g/g
Fossil feedstock carbon saving: per mass of carbon in product	$\frac{Mass\ of\ fossil\ carbon\ in\ feedstock\ replaced}{Mass\ of\ carbon\ per\ 100\ kg\ of\ product}$ $= \frac{50.8\ kg}{54.5\ kg}$	0.93 g/g



9.12 Composite curing resin

The composite resin made from a carbonated derivative of a triglyceride, sodium sulphate, limonene diol and 1-methyl-1,4-butanediol was described in Chapter 5.6. The feedstocks are identical to those of the previous example in Chapter 9.11.

9.12.1 Total bio-based content calculation by mass balance Method A

Because the feedstocks are the same as the previous example of the cleaning product formulation (Table 9-90), the conclusion of mass balance Method A is also the same for this composite resin (Table 9-94). A fossil resource saving of 74.5% is calculated.



Table 9-94 Total bio-based content by mass balance Method A for a composite resin.

Metric	Calculation	Result
Mass of vegetable oil		42 kg
Methane equivalents (vegetable oil)	$\frac{LHV_{methane}}{LHV_{vegetable\ oil}} = \frac{50\text{ MJ/kg}}{40.7\text{ MJ/kg}}$	1.23
Mass of methane		5 kg
Methane equivalents (methane)	$\frac{LHV_{methane}}{LHV_{methane}} = \frac{50\text{ MJ/kg}}{50\text{ MJ/kg}}$	1.00
Mass of naphtha		22 kg
Methane equivalents (naphtha)	$\frac{LHV_{methane}}{LHV_{naphtha}} = \frac{50\text{ MJ/kg}}{44.3\text{ MJ/kg}}$	1.13
Mass of hydrogen sulphide		5 kg
Methane equivalents (hydrogen sulphide)	$\frac{LHV_{methane}}{LHV_{hydrogen\ sulphide}} = \frac{50\text{ MJ/kg}}{15.2\text{ MJ/kg}}$	3.29
Mass of citric acid		12 kg
Methane equivalents (citric acid)	$\frac{LHV_{methane}}{LHV_{citric\ acid}} = \frac{50\text{ MJ/kg}}{8.94\text{ MJ/kg}}$	5.60
Mass of limonene		16 kg
Methane equivalents (limonene)	$\frac{LHV_{methane}}{LHV_{limonene}} = \frac{50\text{ MJ/kg}}{41\text{ MJ/kg}}$	1.22
Allocation (per 100 kg of formulation)	$\sum Mass \cdot Methane\ equivalents$ $= (42\text{ kg} \cdot 1.23) + (5\text{ kg} \cdot 1.00)$ $+ (22\text{ kg} \cdot 1.13) + (5\text{ kg} \cdot 3.29)$ $+ (12\text{ kg} \cdot 5.6) + (16\text{ kg} \cdot 1.22)$	185 kg
Feedstock requirement	$\frac{Allocation}{Methane\ equivalents\ (veg\ oil)} = \frac{185\text{ kg}}{1.23}$	151 kg
Bio-based content (contribution by vegetable oil)	$\frac{Mass\ of\ veg\ oil}{Feedstock\ requirement} = \frac{42\text{ kg}}{151\text{ kg}}$	27.6%
Feedstock requirement	$\frac{Allocation}{Methane\ equivalents\ (citric\ acid)} = \frac{185\text{ kg}}{5.60}$	33 kg
Bio-based content (contribution by citric acid)	$\frac{Mass\ of\ glucose}{Feedstock\ requirement} = \frac{12\text{ kg}}{33\text{ kg}}$	36.2%
Feedstock requirement	$\frac{Allocation}{Methane\ equivalents\ (limonene)} = \frac{185\text{ kg}}{1.22}$	152 kg
Bio-based content (contribution by limonene)	$\frac{Mass\ of\ limonene}{Feedstock\ requirement} = \frac{16\text{ kg}}{152\text{ kg}}$	10.7%
Bio-based content (formulation)		74.5%



9.12.2 Total bio-based content calculation by mass balance Method B

Even when the feedstocks for two different products are the same, atom connectivity can vary the reported total bio-based content output. The composite curing resin is 71% bio-based (Table 9-95) compared to the 81% bio-based cleaning product. The bio-based waste streams are water from the processing of limonene and citric acid (Figure 5-57). The bio-based carbon content of 93% is unchanged (Table 9-96).

Table 9-95 The calculation of total bio-based content according to mass balance Method B for a cleaning product.

	Total mass /kg	Biomass /kg	Petrochemical mass /kg
Input	147	76	71
Output (excluding product)	47	5	42
Product	100	71	29

Table 9-96 The calculation of bio-based carbon content according to mass balance Method B for a cleaning product.

	Total mass /kg	Biomass /kg	Petrochemical mass /kg
Input	74	51	23
Output (excluding product)	20	0	20
Product	55	51	4

9.12.3 Total bio-based content calculation by mass balance Method C

The bio-based carbon content of the composite resin is identical to the previous case study of the cleaning product. There is no loss of carbon aside from that belonging to methane (only the hydrogen in the syngas is required) and the other product streams from naphtha cracking not relevant to this production chain. The fossil carbon saving is 51 kg per 100 kg of composite (Table 9-97).



Table 9-97 Fossil carbon savings for a composite curing resin product made from a triglyceride.

Metric	Calculation	Result
Proportion of carbon atom mass in formulation	$\sum \frac{n \cdot \text{Atomic mass}_C}{RMM_{\text{ingredient}}}$	54.5%
Bio-based carbon content		93%
Fossil carbon saving: per 100 kg of product	$\text{Carbon mass} \cdot \text{Biobased carbon content} \cdot 100 \text{ kg}$ $= 54.5\% \cdot 93\% \cdot 100 \text{ kg}$	50.8 kg
Fossil carbon saving: per mass of carbon in product	$\frac{\text{Fossil carbon saving per 100 kg of product}}{\text{Mass of carbon per 100 kg of product}}$ $= \frac{50.8 \text{ kg}}{54.5 \text{ kg}}$	0.93 g/g
Mass of carbon in original feedstock	$\sum \text{Mass of feedstock} \cdot \text{Carbon content}$	74.2 kg
Mass of fossil carbon in feedstock	$\text{Mass of fossil feedstock remaining} \cdot \text{Carbon content}$	23.5 kg
Fossil feedstock carbon saving: per 100 kg of product	$\text{Mass of fossil carbon in original feedstock}$ $- \text{mass of fossil carbon in feedstock}$ $= 74.2 \text{ kg} - 23.5 \text{ kg}$	50.8 kg
Fossil feedstock carbon saving: per mass of carbon in original feedstock	$1 - \frac{\text{Mass of fossil carbon in feedstock}}{\text{Maximum mass of fossil carbon in feedstock}}$ $= 1 - \frac{23.5 \text{ kg}}{74.2 \text{ kg}}$	0.68 g/g
Fossil feedstock carbon saving: per mass of carbon in product	$\frac{\text{Mass of fossil carbon in feedstock replaced}}{\text{Mass of carbon per 100 kg of product}}$ $= \frac{50.8 \text{ kg}}{54.5 \text{ kg}}$	0.93 g/g



10 List of standards and pre-standardisation research reports

- ASTM D6866 USA standard ASTM D6866, *Standard test methods for determining the biobased content of solid, liquid, and gaseous samples using radiocarbon analysis*, 2012.
- CEN/TC 411/WG 3 Working group 3: Bio-based content, part of European standardisation technical committee CEN/TC 411 (Bio-based products). For more information about this working group see <http://www.biobasedeconomy.eu/standardisation/cen-tc411/wg3/> (accessed 07/01/2015) or http://standards.cen.eu/dyn/www/f?p=204:7:0:::FSP_ORG_ID:904047&cs=1056E67484120CF58BEDB2400D49C01D0 (accessed 09/07/2014). Documents of this working group are not publically available.
- CEN/TC 411/WG 4 Working group 4: Sustainability criteria, life cycle analysis and related issues, part of European standardisation technical committee CEN/TC 411 (Bio-based products). For more information about this working group see <http://www.biobasedeconomy.eu/standardisation/cen-tc411/wg4/> (accessed 07/01/2-015) or http://standards.cen.eu/dyn/www/f?p=204:7:0:::FSP_ORG_ID:904048&cs=1287DD74F9A2ACF0D0473C4B34EA944FE (accessed 09/12/2014). Documents of this working group are not publically available.
- CEN/TC 411/WG 5 Working group 5: Certification and declaration tools, part of European standardisation technical committee CEN/TC 411 (Bio-based products). For more information about this working group see <http://www.biobasedeconomy.eu/standardisation/cen-tc411/wg5/> (accessed 07/01/2-015) or http://standards.cen.eu/dyn/www/f?p=CENWEB:7:0:::FSP_ORG_ID:904049&cs=1C2A446481F4873C49B8A733A88E8BCE5 (accessed 09/12/2014). Documents of this working group are not publically available.



CEN/TS 16137	European technical specification CEN/TS 16137, <i>Plastics - Determination of bio-based carbon content</i> , 2011.
CEN/TR 16227	European technical report CEN/TR 16227, <i>Liquid petroleum products - Bio-lubricants - Recommendation for terminology and characterisation of bio-lubricants and bio-based lubricants</i> , 2011.
CEN/TS 16640	European technical specification CEN/TS 16640, <i>Bio-based products. Determination of the bio based carbon content of products using the radiocarbon method</i> , 2014.
CEN/TR 16721	European technical report CEN/TR 16721, <i>Bio-based products - Overview of methods to determine the biobased content</i> , 2014.
EN 15343	EN 15343, 2007, <i>Plastics. Recycled plastics. Plastics recycling traceability and assessment of conformity and recycled content</i> , published January 2008. Refer to http://shop.bsigroup.com/ProductDetail/?pid=000000000030097507 . Accessed 19/08/14.
ISO 13833	ISO 13833, 2013, <i>Stationary source emissions - Determination of the ratio of biomass (biogenic) and fossil-derived carbon dioxide - Radiocarbon sampling and determination</i> .
KBBPPS D3.1	Knowledge Based Bio-Based Products' Pre-Standardization (KBBPPS) project deliverable report D4.1, <i>Overview of current relevant sampling and biogenic carbon standards on global level</i> , J.W. Hooijmans and T. Klymko, 2013.
KBBPPS D3.2	Knowledge Based Bio-Based Products' Pre-Standardization (KBBPPS) project deliverable report D4.2, <i>Bio-based products - Determination of the bio based carbon content of products using the radiocarbon method</i> , 2013.
KBBPPS D3.3	Knowledge Based Bio-Based Products' Pre-Standardization (KBBPPS) project deliverable report D4.1, <i>Verification of the method for total carbon determination (ruggedness test) in-termediate report</i> , J.W. Hooijmans and T. Klymko, 2014.



KBBPPS D4.1	Knowledge Based Bio-Based Products' Pre-Standardization (KBBPPS) project deliverable report D4.1, <i>Thermal treatment study: Assessment study report on novel thermal treatments for biogenic measurement</i> , M. Chanidou, J. Clark, T. Farmer and J. Sherwood, 2014.
KBBPPS D4.3	Knowledge Based Bio-Based Products' Pre-Standardization (KBBPPS) project deliverable report D4.3, <i>Sample Preparation Techniques For Total Biomass Content Determination</i> , J. Clark, T. Farmer and J. Sherwood, 2014. Available to download at http://www.biobasedeconomy.eu/wp-content/plugins/download-monitor/download.php?id=43 .
KBBPPS D4.4	Knowledge Based Bio-Based Products' Pre-Standardization (KBBPPS) project deliverable report D4.4, <i>Direct biomass content assessment</i> , currently in preparation.
KBBPPS D4.6	Knowledge Based Bio-Based Products' Pre-Standardization (KBBPPS) project deliverable report D4.6, <i>Biomass content test method and scheme</i> , currently in preparation.
NTA 8080	Netherlands Technical Agreement (NTA) 8080, <i>Sustainability criteria for biomass for energy purpose</i> , 2010.
Open-Bio D3.2	Open-BIO project deliverable report D3.2, <i>Bio-based content techniques' evaluation</i> , currently in preparation.
Open-Bio D3.4	Open-BIO project deliverable report D3.4, <i>Definitions for renewable elements and renewable molecules</i> , J. H. Clark, T. J. Farmer, L. Moity and J. Sherwood, 2014. Available to download at http://www.biobasedeconomy.eu/research/open-bio/publications .
Open-Bio D3.5	Open-BIO project deliverable report D3.5, <i>Assessment of indirect methodology</i> , currently in preparation.
PAS 600	BSI Standards Publication PAS 600:2013, <i>Bio-based products – Guide to standards and claims</i> , The British Standards Institution, London, 2013.
PEFC ST 1003	Programme for the Endorsement of Forest Certification (PEFC), <i>Sustainable Forest Management</i> , industry standard



PEFC ST 1003, 2010. Also refer to <http://www.pefc.org/certification-services/supply-chain>. Accessed 19/08/14.

prEN 16751

European draft standard prEN 16751, *Bio-based products – sustainability criteria*, 2014.

prEN 16785

European draft standard prEN 16785, *Bio-based products - Determination of the bio-based content using the radiocarbon analysis and elemental analysis*, 2014.

RSPO 2011

Roundtable on sustainable palm oil (RSPO), *Supply chain certification standard*, 2011.



11 References

- 2009/28/EC EU Directive 2009/28/EC of the European Parliament, *on the promotion of the use of energy from renewable sources and amending and subsequently repealing Directives 2001/77/EC and 2003/30/EC*, April 2009. Available at http://eur-lex.europa.eu/legal-content/EN/ALL/;ELX_SESSIONID=yZvqT96DTpflS2ZRLRD7ySG8J2Rz8n6QgvY2pW1QDrPj5P6HKfw2!-1556749933?uri=CELEX:32009L0028, accessed 27/08/14.
- Accium 2012 Press release, “*Vitalea Science and Accium BioSciences Announce Initiation of Two-Way Cooperative Agreement to Cross-Validate Accelerator Mass Spectrometer (AMS) Resources*”, March 2012. Available at <http://www.acciumbio.com/Company-News.html>. Accessed 0/12/14.
- ACDV 2013 ACDV bio-based content analysis certification scheme. Refer to <http://www.chimieduvegetal.com/pageLibre000110dd.asp>. Accessed 22/11/2013.
- Aellig 2011 C. Aellig, C. Girard and I. Hermans, *Angew. Chem. Int. Ed.*, 2011, **50**, 12355.
- Ashok 2011 S. Ashok, S. M. Raj, C. Rathnasingh and S. Park, *Appl. Microbiol. Biotechnol.*, 2011, **90**, 1253.
- Aycock 2007 David F. Aycock, *Org. Process Res. Dev.*, 2007, **11**, 156.
- BASF 2014 Ecovio compostable polymer, produced by BASF. See http://www.plasticsportal.net/wa/plasticsEU~pl_PL/portal/show/content/products/biodegradable_plastics/ecovio for more information, accessed 05/12/14.
- Beardslee 2012 T. Beardslee and S. Picataggio, *Lipid Technology*, 2012, **24**, 223.
- Berryman 2011 E. M. Berryman, J. D. Marshall, T. Rahn, S. P. Cook and M. Litvak, *Rapid Commun. Mass Spectrom.*, 2011, **25**, 2355.



- Bezergianni 2009 S. Bezergianni, S. Voutetakis and A. Kalogianni, *Ind. Eng. Chem. Res.*, 2009, **48**, 8402.
- BIC 2012 *Accelerating innovation and market uptake of bio-based products*, report of the Bio-based Industries Consortium (BIC), 2012.
- Binder 2009 J. B. Binder and R. T. Raines, *J. Am. Chem. Soc.*, 2009, **131**, 1979.
- Biofuels Digest 2013 *BASF produces first commercial volumes of butanediol from renewable raw material*, press release, Biofuels Digest, November 2013. Available at <http://www.biofuelsdigest.com/bdigest/2013/11/28/basf-produces-first-commercial-volumes-of-butanediol-from-renewable-raw-material>. Accessed 08/12/14.
- BioPreferred 2014 USA BioPreferred program, <http://www.biopreferred.gov/aboutus.aspx>. Accessed 16/01/2014.
- Brenna 1997 J. T. Brenna, T. N. Corso, H. J. Tobias and R. J. Caimi, *Mass Spectrometry Reviews*, 1997, **16**, 227.
- Brock 2010 F. Brock, T. Higham, Ditchfield and C. B. Ramsey, *Radio-carbon*, 2010, **52**, 103.
- Calzavara 2005 Y. Calzavara, C. Jousset-Dubien, G. Boissonnet and S. Sarade, *Energy Conversion and Management*, 2005, **46**, 615.
- Cellulac 2014 Cellulac bio-based ethyl lactate information, available at <http://cellulac.co.uk/en/ethyl-lactate>. Accessed 08/12/14.
- Chian 1998 K. S. Chian and L. H. Gan, *Journal of Applied Polymer Science*, 1998, **68**, 509.
- Ciriminna 2014 Rosaria Ciriminna, Cristina Della Pina, Michele Rossi and Mario Pagliaro, *Eur. J. Lipid Sci. Technol.*, 2014, **116**, 1432.
- Clark 2012a J. H. Clark, E. M. Fitzpatrick, D. J. Macquarrie, L. A. Pfaltzgraff and J. Sherwood, *Catalysis Today*, 2012, **190**, 144.
- Clark 2012b J. H. Clark, D. J. Macquarrie and J. Sherwood, *Green Chem.*, 2012, **14**, 90.



- Clark 2013a J. H. Clark, D. J. Macquarrie and J. Sherwood, *Chem. Eur. J.*, 2013, **19**, 5174.
- Clark 2013b J. H. Clark, L. A. Pfaltzgraff, V. L. Budarin, A. J. Hunt, M. Gronnow, A. S. Matharu, D. J. Macquarrie and J. R. Sherwood, *Pure Appl. Chem.*, 2013, **85**, 1625.
- Clark 2013c J. H. Clark, T. J. Farmer, D. J. Macquarrie and J. Sherwood, *Sustainable Chemical Processes*, 2013, **1**:23.
- Coca-Cola 2014 See <http://www.coca-cola.co.uk/faq/environment/transporting-plantbottle-materials-from-brazil.html>. Accessed 02/12/2014.
- Colonna 2011 M. Colonna, C. Berti, M. Fiorini, E. Binassi, M. Mazzacurati, M. Vannini and S. Karanam, *Green Chem.*, 2011, **13**, 2543.
- Colley 2004 S. W. Colley, C. R. Fawcett, C. Rathmell and M. W. M. Tuck, US pat. 6809217, 2004.
- Coltelli 2008 M. –B. Coltelli, I. D. Maggiore, M. Bertoldo, F. Signori, S. Bronco and F. Ciardelli, *Journal of Applied Polymer Science*, 2008, **110**, 1250.
- Coupland 1997 D. Coupland, K. Coupland, D. W. Cowie and D. A. Parker, world patent WO 1997009367, 1997.
- Darden Hood 2014 E-mail communication from Darden Hood of Beta Analytic Inc., 23/09/2014.
- DIN CERTCO 2014 DIN CERTCO certification of bio-based products. For information refer to http://www.dincertco.de/en/dincertco/produkte_leistungen/zerifizierung_produkte/umwelt_1/biobasierte_produkte/biobasierte_produkte_mehr_nachhaltigkeit.html
- Doronin 2012 V. P. Doronin, O. V. Potapenko, P. V. Lipin, T. P. Sorokina and L. A. Buluchevskaya, *Petroleum Chemistry*, 2012, **52**, 392.
- EC 2009 *Taking Bio-based from Promise to Market*, report of the Ad-hoc Advisory Group for Bio-based Products in the framework of the European Commission's Lead Market Initiative, 2009.



- EC 2010 Critical raw materials for the EU, Report of the ad-hoc working group on defining critical raw materials, 2010. Available at http://ec.europa.eu/enterprise/policies/raw-materials/documents/index_en.htm.
- EC Energy 2014 EC Biofuel sustainability certification schemes. See http://ec.europa.eu/energy/renewables/biofuels/sustainability_schemes_en.htm, accessed 02/12/2014.
- Ecolabel 2014 The EU Ecolabel. Information and links to Commission decisions, test reports *etc.* is available at http://ec.europa.eu/environment/ecolabel/index_en.htm. Accessed 19/08/14.
- Ehleringer 1989 J. R. Ehleringer and P. W. Rundel in *Stable Isotopes in Ecological Research*, 1989, Springer-Verlag, New York.
- Erhan 2000 S. Z. Erhan and S. Asadauskas, *Industrial Crops and Products*, 2000, **11**, 277.
- EU M/429 EU mandate, *Mandate addressed to CEN, CENELEC and ETSI for the elaboration of a standardisation programme for bio-based products*, European Commission Enterprise and Industry Directorate-General, Brussels, 10/10/2008. See <http://www.cen.eu/cen/Sectors/Sectors/Biobased/Pages/default.aspx>, accessed 06/12/2013.
- EU M/492 EU mandate, *Mandate addressed to CEN, CENELEC and ETSI for the development of horizontal European standards and other standardisation deliverables for bio-based products*, European Commission Enterprise and Industry Directorate-General, Brussels, 07/03/2011. See <http://www.cen.eu/cen/Sectors/Sectors/Biobased/Pages/default.aspx>, accessed 06/12/2013.
- European Bioplastics 2012 *Fivefold growth of the bioplastics market by 2016*, press release, European Bioplastics, October 2012.
- European Bioplastics 2014 For examples of DINCERTO bio-based content labels refer to <http://en.european-bioplastics.org/standards/labelling/bio-based-label/>, accessed 08/12/14.



- Fatiadi 1974 A. J. Fatiadi and R. Schaffer, *Journal of Research of the National Bureau of Standards, A. Physics and Chemistry*, 1974, **78A**, 411.
- Foley 2012 P. Foley, A. Kermanshahi, E. S. Beach and J. B. Zimmerman, *Chem. Soc. Rev.*, 2012, **41**, 1499.
- Fukaya 1992 M. Fukaya, Y. S. Park and K. Toda, *Journal of Applied Bacteriology*, 1992, **73**, 447.
- Garlotta 2001 D. Garlotta, *Journal of Polymers and the Environment*, 2001, **9**, 63.
- Gorbanev 2012 Y. Y. Gorbanev, S. Kegnæs, C. W. Hanning, T. W. Hansen and A. Riisager, *ACS Catal.*, 2012, **2**, 604.
- GreenPalm 2014 GreenPalm book and claim option. Refer to <http://www.greenpalm.org/>. Accessed 16/04/2014.
- Greule 2010 M. Greule, L. D. Tumino, T. Kronewald, U. Hener, J. Schleucher, A. Mosandl and Frank Keppler, *Eur. Food Res. Technol.*, 2010, **231**, 933.
- Gu 2013 Y. Gu and F. Jérôme, *Chem. Soc. Rev.*, 2013, **42**, 9550.
- Hattori 2010 R. Hattori, K. Yamada, H. Shibata, S. Hirano, O. Tajima and N. Yoshida, *J. Agric. Food Chem.*, 2010, **58**, 7115.
- Hauben 1943 S. S. Hauben and R. S. Siegel, *J. Chem. Educ.*, 1943, **20**, 166.
- Hellborg 2008 R. Hellborg and G. Skog, *Mass Spectrometry Reviews*, 2008, **27**, 398.
- Hermes 2014 The Claus process, technical document. Available at www.hermescatalyst.com/images/stories/pdf/hermes_claus_process.pdf. Accessed 08/12/14.
- Huneault 2012 M. A. Huneault and H. Li, *Journal of Applied Polymer Science*, 2012, **126**, E96.
- ICIS 2010 D. de Guzman, *Germany's Wacker to license bio-based acetic acid process*, press release, March 2010. Comment



- available on <http://www.icis.com/resources/news/2010/03/25/9345966/germany-s-wacker-to-license-bio-based-acetic-acid-process/>. Accessed 27/08/2014.
- ICIS 2011 A. Jagger, *APLA: Brazil's first major petrochemical company makes its mark*, press release, November 2011. <http://www.icis.com/resources/news/2011/11/07/9505415/apla-brazil-s-first-major-petrochemical-company-makes-its-mark/>. Accessed 08/12/14.
- ISCC-plus 2014 ISCC sustainable bio-based product certification, ISCC-PLUS. See <http://www.iscc-system.org/en/iscc-system/iscc-plus/overview-add-ons/>, accessed 02/12/2014.
- Ishida-Fujii 2005 K. Ishida-Fujii, S. Goto, R. Uemura, K. Yamada, M. Sato and N. Yoshida, *Biosci. Biotechnol. Biochem.*, 2005, **69**, 2193.laursen
- Jame 2010 P. Jame, H. Casabianca, M. Batteau, P. Goetinck and V. Salomon, *SOFW Journal*, 2010, **136**, 1.
- Jiménez-González 2000 C. Jiménez-González, S. Kim and M. R. Overcash, *Int. J. LCA*, 2000, **5**, 153.
- Joshi 2005 S. R. Joshi, K. L. Kataria, S. B. Sawant and J. B. Joshi, *Ind. Eng. Chem. Res.*, 2005, **44**, 325.
- Karanjkar 2014 P. U. Karanjkar, R. J. Coolman, G. W. Huber, M. T. Blatnik, S. Almalkie, S. M. de Bruyn Kops, T. J. Mountziaris and W. C. Conner, *AIChE*, 2014, **60**, 1320.
- Kelly 1997 S. Kelly, I. Parker, M. Sharman, J. Dennis and I. Goodall, *Food Chem.*, 1997, **59**, 181.
- Khan 1981 A. W. Khan, D. Wall and L. van den Berg, *Applied and Environmental Microbiology*, 1981, **41**, 1214.
- Kiff 1983 B. W. Kiff and D. J. Schreck, US patent 4421939, 1983.
- Kirsten 1983 W. J. Kirsten in *Organic Elemental Analysis*, Academic Press Inc., New York, 1983.



- Koziet 1995 J. Koziet, A. Rossmann, G. J. Martin and P. Johnson, *Anal. Chim. Acta*, 1995, **302**, 29.
- Lammens 2010 T. M. Lammens, M. C. R. Franssen, E. L. Scott and J. P. M. Sanders, *Green Chem.*, 2010, **12**, 1430.
- Laursen 2013 K. H. Laursen, A. Mihailova, S. D. Kelly, V. N. Epov, S. Bé-rail, J. K. Schjoerring, O. F. X. Donard, E. H. Larsen, N. Pedentchouk, A. D. Marca-Bell, U. Halekoh, J. E. Olesen and S. Husted, *Food Chemistry*, 2013, **141**, 2812.
- Lee 2007 S. Lee in *Handbook of Alternative Fuel Technology*, edited by S. Lee, J. G. Speight and S. K. Loyalka, CRC Press, Boca Raton, 2007.
- Lee 2013 X. Lee, L. Zhang, D. Huang, N. An, F. Yang, W. Jiang and B. Fang, *Analytical Biochemistry*, 2013, **436**, 178.
- M² Polymer Tech. 2014 *History of Super Absorbent Polymer Chemistry*, company website, M² Polymer Technology Inc. Accessed 08-12-14.
- Martin-Luengo 2010 M. A. Martin-Luengo, M. Yates, E. Saez Rojo, D. Huerta Arribas, D. Aguilar and E. Ruiz Hitzky, *Applied Catalysis A: General*, 2010, **387**, 141.
- Martino-Gauchi 2007 G. Martino-Gauchi and R. Teissier, US pat. 7297809, 2007.
- Max 2010 B. Max, J. M. Salgado, N. Rodríguez, S. Cortés, A. Converti and J. M. Domínguez, *Brazilian Journal of Microbiology*, 2010, **41**, 862.
- Meier-Augenstein 1999 W. Meier-Augenstein, *Journal of Chromatography A*, 1999, **842**, 351.
- Meyer 1998 E. Meyer in *Chemistry of Hazardous Materials*, third edition, 1998, Prentice Hall, Upper Saddle River, page 458.
- Moodie 1986 R. B. Moodie and S. N. Richards, *J. Chem. Soc. Perkin Trans.*, 1986, 1833.



- Moser 2013 B. Moser, *Braskem introducing LDPE made from sugarcane ethanol*, *Plastics News*, May 2013. Available at <http://www.plasticsnews.com/article/20130521/NEWS/130529974/braskem-introducing-lpde-made-from-surgarcane-ethanol>. Accessed 08/12/14.
- NesteOil 2012 *Neste Oil adds NExBTL renewable naphtha suitable for producing bioplastics to its corporate customer product range*, press release, 29/10/2012. Available at <http://www.nesteoil.com/default.asp?path=1,41,540,1259,1260,18523,20210>. Accessed 15/07/2014.
- Norton 2006 G. A. Norton and S. L. Devlin, *Bioresource Technology*, 2006, **97**, 2084.
- Norton 2007 G. A. Norton, D. G. Hood and S. L. Devlin, *Bioresource Technology*, 2007, **98**, 1052.
- Oba 2007 Y. Oba and H. Naraoka, *Geochemical Journal*, 2007, **41**, 103.
- Paggiola 2014 G. Paggiola, A. J. Hunt, C. R. McElroy, J. Sherwood and J. H. Clark, *Green Chem.*, 2014, **16**, 2107.
- Panetta 2011 R. J. Panetta and A. H. Jahren, *Rapid Commun. Mass Spectrom.*, 2011, **25**, 1373.
- Perevalov 2006 B. V. Perevalov, S. Kassi, D. Romanini, V. I. Perevalov, S. A. Tashkun and A. Campargue, *Journal of Molecular Spectroscopy*, 2006, **238**, 241.
- Perevalov 2008 B. V. Perevalov, V. I. Perevalov and A. Campargue, *Journal of Quantitative Spectroscopy and Radiative Transfer*, 2008, **109**, 2437.
- Peters 2011 M. W. Peters, J. D. Taylor, M. Jenni, L. E. Manzer and D. E. Henton, US pat. 0087000, 2011.
- Picarro 2014a Cavity ring down spectroscopy applications. Information provided at http://www.picarro.com/applications/food_pharma_and_chemicals/supply_chain_integrity. Accessed 20/08/2014.



- Picarro 2014b For further information on Cavity ring down spectroscopy refer to http://www.picarro.com/products_solutions/isotope_analyzers/13c_combustion_module and http://www.picarro.com/technology/cavity_ring_down_spectroscopy. Accessed 20/08/2014.
- Preston 1992 T. Preston, *Plant Cell and Environment*, 1992, **15**, 1091.
- Prinos 2004 J. Prinos, D. Bikiaris, S. Theologidis and C. Panayiotou, *Polymer Engineering and Science*, 1998, **38**, 954.
- Pyl 2011 S. P. Pyl, C. M. Schietekat, M. –F. Reyniers, R. Abhari, G. B. Marin and K. M. Van Geema, *Chemical Engineering Journal*, 2011 **176-177**, 178.
- Rao 1988 V. N. M. Rao, European pat. 0277562, 1988.
- Rong 2012 C. Rong, X. Ding, Y. Zhu, Y. Li, L. Wang, Y. Qu, X. Ma and Z. Wang, *Carbohydrate Research*, 2012, **350**, 77.
- Roquette 2010 *Roquette, the world leader for isosorbide, is greatly increasing its production capacity*, press release, September 2010. Available at <http://www.roquette.com/news-2010-starch-polyols-food-paper/roquette-the-world-leader-for-isosorbide-is-greatly-increasing-its-production-capacity>. Accessed 08/12/14.
- Rossmann 2007 A. Rossmann, *Food Reviews Int.*, 2001, **17**, 347.
- Salimon 2010 J. Salimon, N. Salih and E. Yousif, *Eur. J. Lipid Sci. Technol.*, 2010, **112**, 519.
- Sánchez 2008 Ó. J. Sánchez and C. A. Cardona, *Bioresource Technology*, 2008, **99**, 5270.
- Santato 2012 A. Santato, D. Bertoldi, M. Perini, F. Camin and R. Larcher, *J. Mass Spectrom.*, 2012, **47**, 1132.
- Schmidt 2004 T. C. Schmidt, L. Zwank, M. Elsner, M. Berg, R. U. Meckenstock and S. B. Haderlein, *Anal. Bioanal. Chem.*, 2004, **378**, 283.



- da Silva 2013 J. da Silva, D. Freire, A. Habert, V. Soares, European Patent application EP 2657324, April 2013.
- SpecialChem 2011 *Coca Cola to Discuss Method of Assessing Bio-carbon from Renewable Resources at BioPlastek*, SpecialChem, 2011. Article available at <http://www.specialchem4polymers.com/resources/latest/displaynews.aspx?id=6158>. Accessed 20/08/2014.
- Smith 2007 M. B. Smith and J. March in *March's Advanced Organic Chemistry*, 6th edition, John Wiley and Sons, Hoboken, 2007.
- Suzuki 2010 Y. Suzuki, F. Akamatsu, R. Nakashita and T. Korenaga, *Chem. Lett.*, 2010, **39**, 998.
- Tan 2010 S. Tan, Ph.D. thesis, *Polyurethane Rigid Foam from Soybean Oil-based Polyol*, University of Minnesota, 2010.
- Trost 1991 B. M. Trost, *Science*, 1991, **254**, 1471.
- Turley 2008 David B. Turley, *Introduction to Chemicals from Biomass*, edited by J. H. Clark and F. E. I. Deswarte, John Wiley and Sons, Chichester, 2008, page 28.
- TÜV SÜD 2013 TÜV SÜD Industrie Service GmbH, Standard CMS 71, Mass balance for the traceability of renewable raw materials (abbreviated: Renewable Resources), 2013.
- University of York 2013 University of York elemental analysis service. See <http://www.york.ac.uk/chemistry/internal/staffinfo/workchem/analytical/chn/>. Accessed 22/11/2013.
- USGS 2014 United States Geological survey (USGS), *Sulphur Statistics and Information*, available at <http://minerals.usgs.gov/minerals/pubs/commodity/sulfur>. Accessed 08/12/14.
- Vinçotte 2013 Vinçotte 'OK Biobased' certification scheme. See <http://www.okcompost.be/en/recognising-ok-environment-logos/ok-biobased/>. Accessed 22/11/2013.



- Weissermel 1993 K. Weissermel and H. –J. Arpe in *Industrial Organic Chemistry*, second edition, Wiley VCH, Weinheim, 1993.
- Werpy 2004 T. Werpy and G. Petersen in *Top Value Added Chemicals From Biomass Volume I: Results of Screening for Potential Candidates from Sugars and Synthesis Gas*, US Department of Energy technical report, 2004.
- Wildes 2002 S. Wildes, *Chem. Health Saf.*, 2002, **9**, 24.
- WSJ 2008 E. Gamerman in *An inconvenient bag*, Wall Street Journal, online edition, 2008. See <http://www.wsj.com/articles/SB122238422541876879>. Accessed 18/08/14.
- Xiong 2014 R. Xiong, S. I. Sandler, D. G. Vlachos and P. J. Dauenhauer, *Green Chem.*, 2014, **16**, 4086.
- Yamada 2007 K. Yamada, N. Yoshida, G. Calderone and C. Guillou, *Rapid Commun. Mass Spectrom.*, 2007, **21**, 1431.
- Zhao 2014 Y. Zhao, B. Zhang, G. Chen, A. Chen, S. Yang and Z. Ye, *Food Chem.*, 2014, **145**, 300.

