

# Efficiency Evaluation of a Novel Supercapattery Stack with a Power Electronic Interface for Energy Storage Systems

P. Kulsangcharoen\*, C. Klumpner\*, X.H. Zhou\*\*, C. Peng\*\*, G.Z. Chen\*\*, M. Rashed\*, G. Asher\*  
Departments of \*Electrical and Electronic Engineering, \*\*Chemical and Environmental Engineering  
Faculty of Engineering, University of Nottingham, UK

## Abstract

The increase of renewable energy generation seen as the only way to ensure clean and sustainable development, is under scrutiny due to its intermittent nature and an insufficient development of complementary technologies such as electrical energy storage. There are quite a few energy storage devices available such as super/ultracapacitors that can address the high specific power applications compared to batteries, but have quite large size for same energy installed. Batteries on the other hand have much higher specific energy but cannot accommodate that easily the requirement to deliver quickly high power. This paper reports on the evaluation of a newly developed device, the supercapattery, that is a single device in which the core material is chemically engineered carbon nanotubes that can store similar amount of energy as a battery but release it faster.

## 1. Introduction

The capability of various electrical energy storage devices in terms of specific energy and power is summarised in Fig. 1. Electrolytic capacitors are known to offer very fast charge/discharge (milliseconds) but the amount of energy they can store is still very low compared to conventional lead-acid batteries, which however need very long charging times (5-10 hours). More advanced batteries such as Li-Ion used largely on laptops, offer the best performance, with high energy densities and charging times down to one hour, but the number of charging/discharging cycles is drastically reduced. Fuel cells are devices that achieve a very high energy density because the electrical energy is converted into chemical components

which are physically separated but the technology has serious limitations in terms of life cycles and cost. Supercapacitors (SCs) are devices that appeared on the market quite recently, and can bridge the gap between capacitors and batteries. The devices currently available on the market are optimised mostly towards offering the increased power capability in the seconds time range, whilst the minutes/tens minutes range, which is relevant to power levelling applications, remains still not covered by a proper device.

Constant power or constant power cycling which is typical for some industrial applications, have been used already to test the SCs power performance [2]-[8]. This method is simply controlling the power level of SCs to be constant during charging/discharging until voltage reaches a given level that triggers the mode to be toggled to the complementary mode (i.e. from charging to discharging and vice versa). The power levels used to charge and discharge the device can be the same or be different depending on the testing condition. Usually, the upper trigger voltage level in this test is chosen to be the maximum that the device can withstand whilst the lower level is selected in agreement with the maximum amount of energy that can be retrieved from the device in an efficient way. If this is half of the rated SC voltage, 75% of the rated energy stored in the SC can be retrieved. It should be noted that in constant power mode, extraction of the energy at reduced voltage levels becomes inefficient (due to  $R \times i^2$ ).

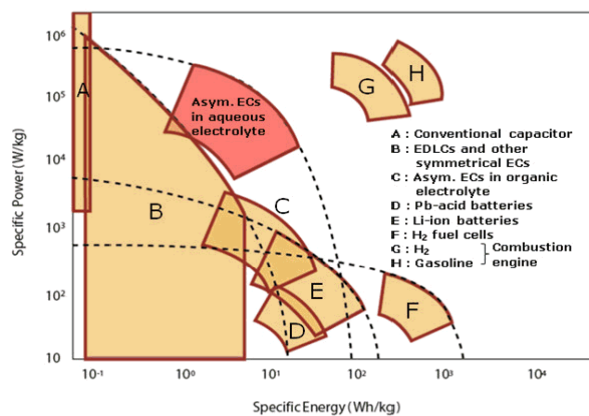

Fig. 1. Ragone plot of various energy storage technologies [1]

It may also increase the cost of the associated power electronics due to the required increase of SC current that has to compensate the decrease of voltage. Since SCs may be charged at highly constant power level as well as discharged, loss and efficiency of SCs should be analysed over a round-trip charge-discharge cycle.

This paper aims at evaluating the efficiency cycle of a newly developed energy storage device at University of Nottingham, the supercapattery, under constant power charge-discharge operation.

## 2. The Supercapattery Technology

At the University of Nottingham, past research led by Prof. George Z. Chen has led to the invention of novel composites of redox active materials and carbon nanotubes [9]. These are known as the third generation energy storage materials. The unit cell made from these nano-composite materials may have a voltage of 1.0-3.0 V, mainly depending on the nature of electrolyte used. The specific capacitance of these materials ranges from 100 to 500 F/g [9]–[10]. Considering that 1.5 V is a technically viable unit cell voltage, it may be calculated that the specific energy (or energy density vs. active material mass) can reach 28-140 kJ/kg (or 8-39 Wh/kg) (vs. both electrodes in a unit cell. For each electrode the energy density would be four times higher). Preliminary results of a 9 cell supercapattery stack demonstrator reported in [9], are illustrated in Fig. 2. The electrode specific capacitance of these materials has reached beyond 5 F/cm<sup>2</sup> (vs. surface area of electrode substrate) in laboratory tests and a cycle life beyond 5000 (1000 cycles ≅ 3 charge/discharge cycles per day for 1 year).

The difference in the chemistry/construction compared to standard SCs can be explained using porous composites of carbon nanotubes and redox materials (referred to as 3<sup>rd</sup> generation materials) as illustrated in Fig. 2, that enhance the charge conduction and penetration. An aqueous electrolyte of potassium chloride (KCl) is used, which has the advantage of being non-flammable and not toxic compared to the electrolyte used in standard SCs. The following chemical reactions take place: At the positive electrode that consists of composite of polypyrrole (PPy) and carbon nanotubes (CNTs) [10]:

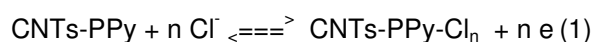

At the negative electrode (activated carbon (C<sub>m</sub>)):

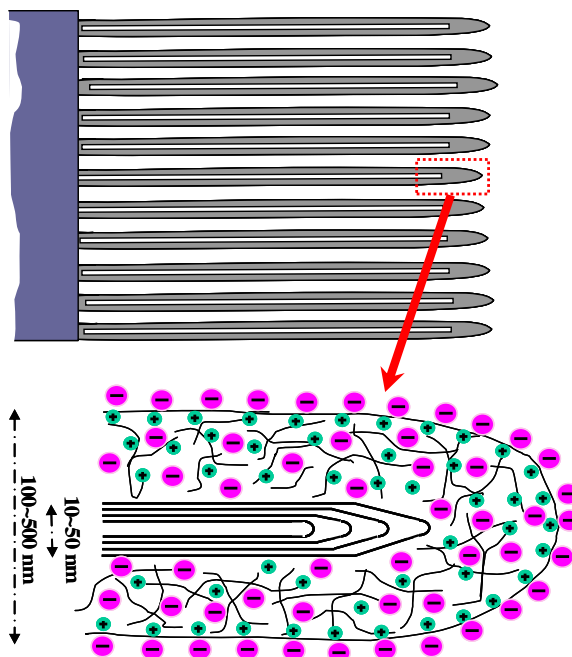
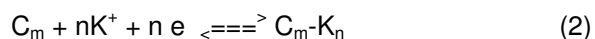

**Fig. 2.** Improved charge conduction and penetration by employing porous composites of carbon nanotubes and redox materials (3<sup>rd</sup> generation) [9]

Both electrode reactions are reversible. The direction to the right corresponds to charging, and to the left to discharging. Please note that these reactions are specifically written for the prototype supercapattery that has been tested in this work. However, it should be mentioned that these reactions also occur in other SCs with the same or similar electrode materials.

## 3. Experimental Setup

### 3.1. Development of the Supercapattery Stack

Since increasing the rated voltage of the supercapattery is essential in obtaining a good system efficiency, the research work has been concentrated in designing and building of a stack using bipolar plates [11], as illustrated in Fig. 3.

Figs. 4 illustrate the step-by-step assembly of the 19-cell supercapattery stack that uses bipolar plates and is tested in this work. The active area is 10 cm by 10 cm but the actual device is slightly larger to allow the mounting of two external plates and bolts that keep the device mechanically rigid and pressurized. After fabrication, the whole stack was sealed with epoxy to avoid the electrolyte from drying, a process which was quite successful, since the device remained stable for more than seven months [12].

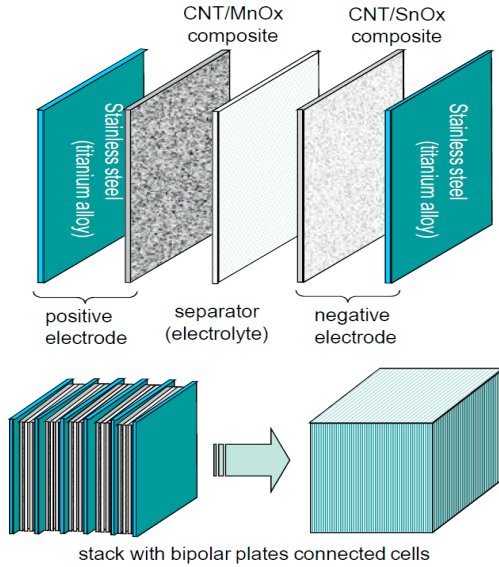

**Fig. 3.** The high voltage stack assembly from individual supercapattery cells [11]

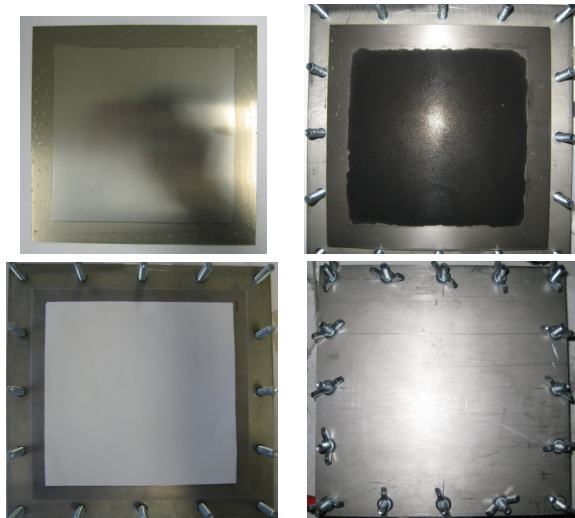
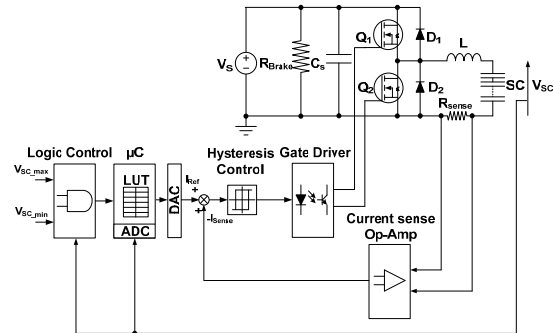

**Fig. 4.** Step-by-step supercapattery stack fabrication process [12]: a) Electrode plate; b) same with printed carbon nanotube mask mounted on the frame; c) separator applied to the plate; d) assembled stack

### 3.2. Development of the Power Electronic Interface

To facilitate the evaluation of the supercapattery stack, a 25V/6A DC/DC converter prototype that can perform various automatic charge/discharge modes, is implemented [13]. Fig. 5 shows the control and the schematic diagram of the automatic charging-discharging system that can operate in constant current, pulse current or in constant power charge/discharge modes. The constant power control requires two feedback

signals: the stack current and voltage. The inductor current signal is sensed by a current shunt resistor and controlled via a Hysteresis current control loop to follow a current reference that is outputted by a microcontroller via a D/A converter using a constant power look-up table algorithm (LUT). The voltage measurement is primarily used to limit the stack voltage between  $V_{SC\_min}$  and  $V_{SC\_max}$ ; reaching one of the limits is forcing the system to toggle from one state (i.e. charging) to its opposite (i.e. discharging). The voltage feedback is also used for determining the reference current from the constant power LUT.

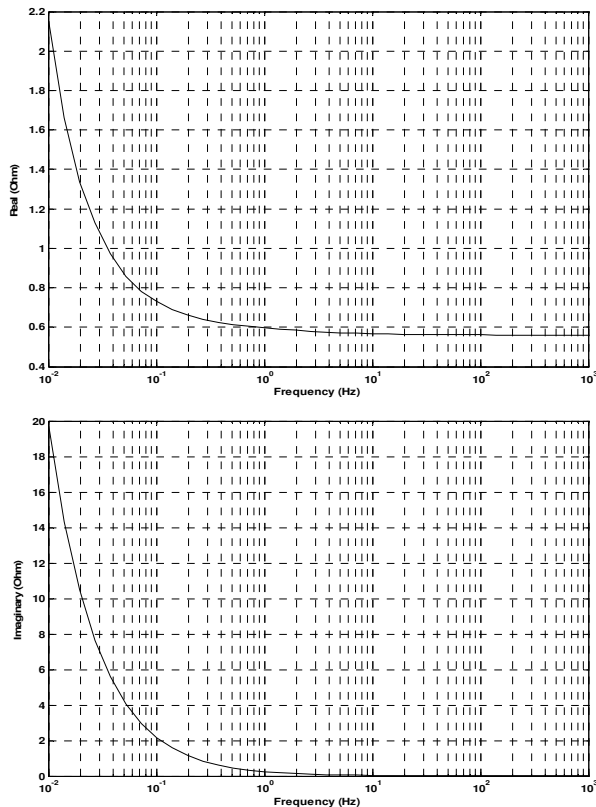

**Fig. 5.** Control block diagram of the test system

## 4. Experimental Evaluation

The experimental evaluation of the supercapattery stack and associated power electronic converter consisted of several tests. First, an impedance spectroscopy test of the supercapattery stack was performed in a frequency range from 10 mHz to 1 kHz in order to determine the real and the imaginary terms of the complex impedance in the frequency domain. The results are shown in Fig. 6. It can be noted that the resistance of the supercapattery stack varies from a maximum of 2.1  $\Omega$  at 10mHz which is the minimum frequency to approx 0.56  $\Omega$  at frequencies above 10Hz. Around 0.3 Hz, which is the corresponding cycle frequency for the tests that have been carried out in this paper, the equivalent series resistance dips below 0.63  $\Omega$ .

Next, a set of higher current/power tests consisting of cycling the supercapattery stack under constant current and constant power charge-discharge mode for a long term have been conducted. The stack voltage, current and their product as performed by the oscilloscope that would represent the instantaneous power processed by the stack have been recorded in each test. Fig. 7 shows a cycling charge-discharge test with the 19-cell supercapattery stack, performed at a constant current level of 6A.



**Fig. 6.** Real and imaginary terms of the complex impedance spectroscopy test conducted on the 19-cell supercapattery stack

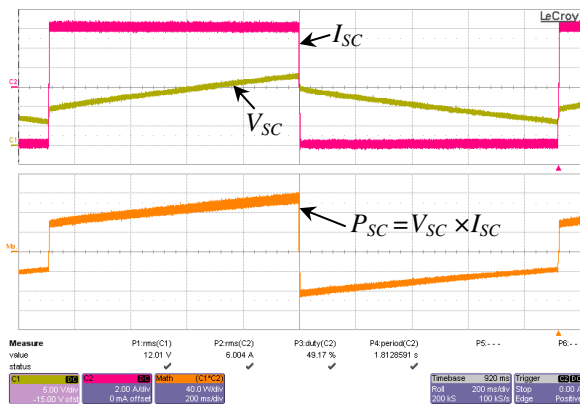

**Fig. 7.** 6 A constant current charge-discharge cyclic test of the 19-cell supercapattery stack

It can be seen that towards the end of the charging mode, the power input in the supercapattery stack reaches 110W. This 6A constant-current cycling test has been conducted continuously for an hour in order to study the impact of losses (expected to be around 22W) on the stack behavior and get an idea about its safe operating ratings. The supercapattery stack temperature has been monitored by thermal imaging to determine if it was overheating. The result after an hour of operation is shown in Fig. 8.

It can be seen that a slightly hot area had developed on the upper plate, around the electrical connections, where a temperature of 33.8°C was reached, which is only slightly higher than the 27°C seen in the middle of the upper plate. It is very likely that slightly higher temperatures may develop inside the stack, but due to its flat and thin shape and quite thick metal end plates that provides good cooling, helps the heat to spread out well and prevents dangerous overheating.

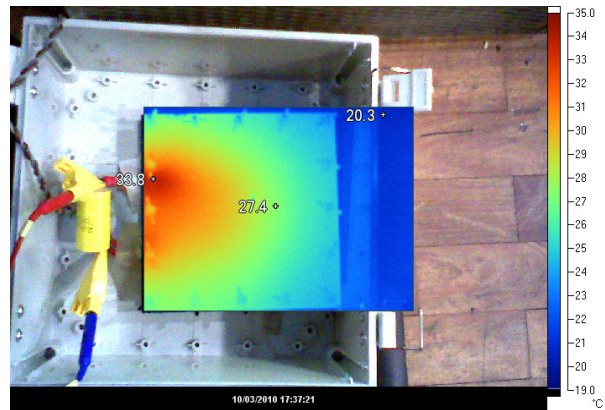

**Fig. 8.** Thermal imaging of the 19-cell supercapattery stack operating for an hour at 6A constant charge-discharge current

Following this test, it has been concluded that operation with a current of up to 6 A, at least for this stage of the work, can be considered as being safe. This limitation will have an implication on the following constant power tests as it will limit the minimum voltage that the device can be discharged to. Fig. 9 show cycling charge-discharge tests using the 19-cell supercapattery stack performed at different constant power level of 40W, 50W and 60W and at different minimum discharge voltages of 12 V, 10 V and 8V. These voltages are relevant since under 12V, the supercapattery stack discharged below 40% of the total stored energy (corresponding to 19V full charged level). Also, as the supercapattery stack voltage decreases, the current increases, affecting both the charge discharge roundtrip efficiency and the cost of the components (switches, inductors) in the associated DC/DC converter, which means that there will always have to be a trade-off between the desire to extract as much of the stored energy as possible and the cost in terms of components and losses, involved in retrieving it. This is why the roundtrip efficiency of the supercapattery stack alone has to be determined. Here two methods were used based on:

- i) direct measurement of the power/energy in and out based on the voltage and current waveforms;
- ii) efficiency estimation based on monitoring the charging ( $P_C$ ) and discharging power ( $P_D$ ) and

the charging dutycycle ( $d$ ), a method developed by the authors in a previous paper [13] that uses:

$$\eta_{duty} = \frac{P_D}{P_C} \left( \frac{1}{d} - 1 \right) \quad (3)$$

The result of an actually larger set of constant power tests that was performed on the supercapattery stack is summarized in Table 1. It can be seen that in general, there is quite good agreement between the two methods, which means that the second one, which is easier to implement, can be used for example in monitoring of stack health in a complex energy storage equipment consisting of a large number of stacks.

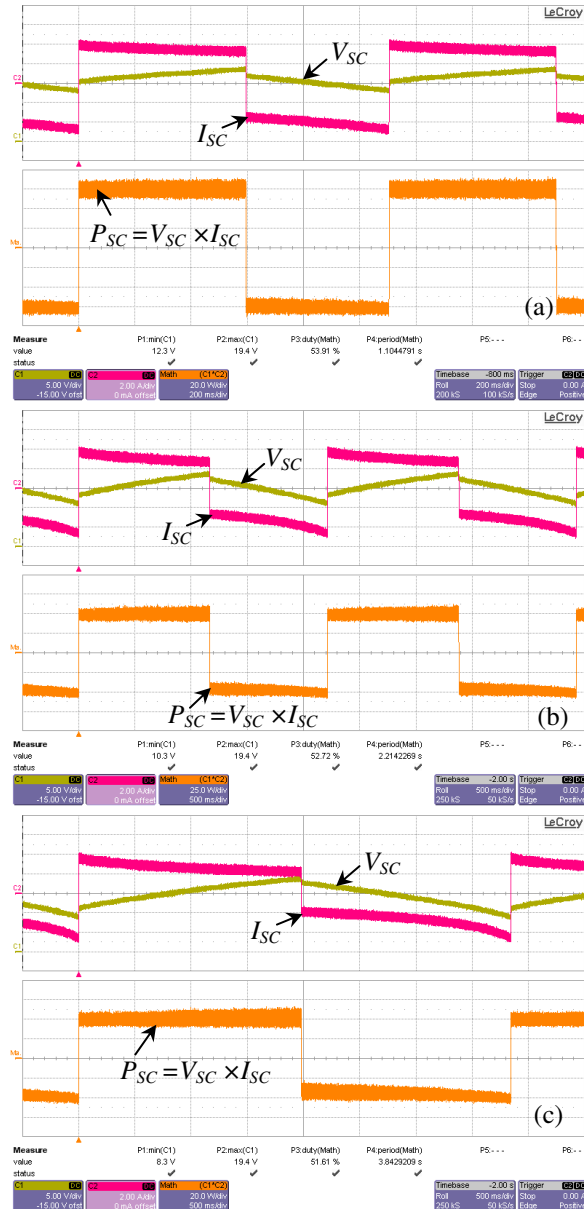

**Fig. 9.** Constant power charge-discharge cyclic tests of the 19-cell supercapattery stack at: a)  $P=60\text{W}$  and  $V_{sc-min}=12\text{V}$ ; b)  $P=50\text{W}$  and  $V_{sc-min}=10\text{V}$ ; c)  $P=40\text{W}$  and  $V_{sc-min}=8\text{V}$

**Table 1.** Comparison of measured roundtrip efficiency vs. estimated one based on charging dutycycle at various power and discharge levels

$P_C$ (W)	$P_D$ (W)	Voltage range (V)	$\eta_{EXP}$ (%)	Duty cycle (%)	$\eta_{duty}$ (%)
40.68	36.23	8-19	83.46	51.61	83.49
45.29	41.83	8-19	83.40	52.6	83.24
40.48	35.90	10-19	85.80	50.72	86.18
45.19	41.74	10-19	85.99	51.77	86.05
49.20	47.77	10-19	86.93	52.76	86.94
59.43	56.16	10-19	83.29	54.45	79.06
40.61	37.05	12-19	89.46	50.47	89.52
45.07	42.95	12-19	90.10	51.46	89.90
49.96	48.64	12-19	88.88	52.33	88.70
59.81	60.38	12-19	86.33	53.41	88.05

A note regarding the slight mismatch between the charging and discharging power in Table 1 is that this was caused by some non-linearities in the circuit such as offsets or interaction between sampling and the switching ripple existent in the measurements of the A/D, D/A convertors.

In general, it can be noted that at high power level, as well as operation at low discharge voltage levels, the efficiency is decreased as Fig. 10 shows, which in constant power tests is caused by the increase of the current in the circuit.

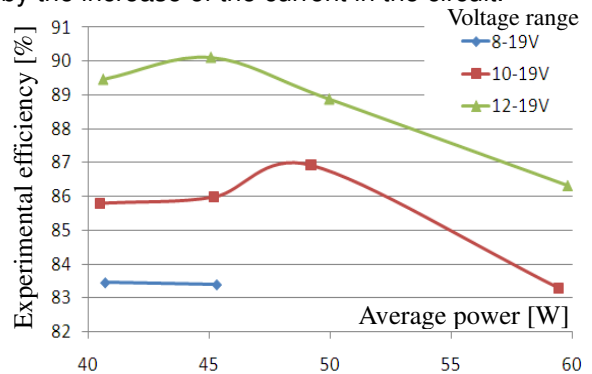

**Fig. 10.** Experimentally determined efficiency vs. power throughput for different voltage ranges

In addition, at low voltage (8-19V range), only two operating points at lower power levels of 40 W and 45W have been tested, which means that the losses are referred to a low power throughput, resulting a lower efficiency. This may also be a potential explanation why the efficiency seems to increase with the power level up to a point, after which it starts to drop (probably due to the losses increasing exponentially with square the current, outpacing the increase of power throughput).

## 5. Conclusions

This paper presented the implementation and efficiency evaluation of a novel energy storage device, the supercapattery, which is a single device in which the core material is chemically engineered carbon nanotubes that can store energy levels comparable to a battery but as fast as a supercapacitor. The technology behind the device is briefly presented, as well as the process to produce the supercapattery stack. This is then evaluated by an impedance spectroscopy test to confirm its equivalent series resistance and capacitance. A DC/DC power converter able to produce continuous cycles of various charge-discharge modes was used to characterize the device at 6 A constant current. Thermal imaging revealed that the temperature build-up remains acceptable facilitated also by the planar shape of the stack. The evaluation concluded by performing a comprehensive set of cyclic charge-discharge tests at different levels of constant power and minimum discharge voltage which were used to experimentally determine the roundtrip efficiency and confirm an earlier efficiency estimation technique proposed by the authors. The results revealed that the roundtrip efficiency of the supercapattery stack changes with the test conditions, but remains at a high enough level to justify the utilization of this technology in power peak levelling applications.

## 6. Acknowledgement

This work is based on a project which was funded by E.ON AG as part of the E.ON International Research Initiative (2007–Energy Storage). Responsibility for the content of this publication lies with the authors.

## 7. Literature

- [1] J.H. Chae, K.C. Ng, G.Z. Chen, "Nanostructured materials for the construction of asymmetrical supercapacitors", Proc. Inst. Mech. Eng. Part A - J. Power Energy, (2010) (DOI: 10.1243/09576509JPE861).
- [2] O. Briat, W. Lajnef, J-M Vinassa, E. Woirgard, "Power cycling tests for accelerated ageing of ultracapacitors," Microelectronics Reliability, no. 46, pp. 1445-1450, 2006.
- [3] P. Kreczanik, C. Martin, P. Venet, G. Clerc, G. Rojat, Y. Zitouni, "Constant power cycling for accelerated ageing of supercapacitors",

Proc.EPE2009, paper #0151, ISBN978-1-4244-4432-8.

- [4] P. J. Mahon, G. L. Paul, S. M. Keshishian and A. M. Vassallo, "Measurement and modelling of the high-power performance of carbon-based supercapacitors," Journal of Power Sources, no. 91, pp. 68-76, 2000.
- [5] R. L. Spyker and R. M. Nelms, "Analysis of Double-Layer Capacitors Supplying Constant Power Loads," IEEE Trans on Aerospace and Electronic Systems, vol. 36, no. 4, pp. 1439-1443, 2000.
- [6] P. Barrade, A. Rufer, "Current Capability and Power Density of Supercapacitors: Considerations on Energy Efficiency," Proc. EPE2003, paper #338, ISBN 90-75815-07-7.
- [7] J. M. Miller, "Electrical and Thermal Performance of the Carbon-carbon Ultracapacitor Under Constant Power Conditions," Proc. IEEE VPPC2007, ISBN 978-0-7803-9760-6, pp. 559-566.
- [8] M. W. Verbrugge, P. Liu, "Analytical Solutions and Experimental Data for Cyclic Voltammetry and Constant-Power Operation of Capacitors Consistent with HEV Applications," Journal of Electrochemical Society, vol. 153, no. 6, pp. A1237-A1245, 2006.
- [9] Chen GZ, "Composites of carbon nanotubes and conducting polymers", Electrochem 2001, Loughborough University, Sept. 2001.
- [10] M. Hughes, G.Z. Chen, M.S.P. Shaffer, D.J. Fray, A.H. Windle, "Composites of Carbon Nanotubes and Polypyrrole for Electrochemical Supercapacitors", Chem. Mater. 14 (2002) 1610-1613.
- [11] G.Z. Chen, "The technical feasibility of large scale electricity storage in supercapacitors", U21 International Conference on Energy Technologies and Policy, University of Birmingham, UK 7–10 Sept 2008.
- [12] X.H. Zhou, C. Peng, G.Z. Chen, "High voltage stacks of aqueous supercapacitors: Materials, fabrication and performance", 217th ECS Meeting, Vancouver, Canada, 25-30 Apr 2010. (accepted)
- [13] P. Kulsangcharoen, C. Klumpner, M. Rashed, G. Asher, "A New Duty Cycle Based Efficiency Estimation Method for a Supercapacitor Stack under Constant Power Operation", Proc. of IET Power Electronics Machines and Drives Conference PEMD'10, paper #0224, Brighton, UK, April 2010, (in press).