

Yeo, Helen (2000) Mycoinsecticides for aphid management: a biorational approach. PhD thesis, University of Nottingham.

**Access from the University of Nottingham repository:**

<http://eprints.nottingham.ac.uk/11603/1/324106.pdf>

**Copyright and reuse:**

The Nottingham ePrints service makes this work by researchers of the University of Nottingham available open access under the following conditions.

This article is made available under the University of Nottingham End User licence and may be reused according to the conditions of the licence. For more details see:  
[http://eprints.nottingham.ac.uk/end\\_user\\_agreement.pdf](http://eprints.nottingham.ac.uk/end_user_agreement.pdf)

**A note on versions:**

The version presented here may differ from the published version or from the version of record. If you wish to cite this item you are advised to consult the publisher's version. Please see the repository url above for details on accessing the published version and note that access may require a subscription.

For more information, please contact [eprints@nottingham.ac.uk](mailto:eprints@nottingham.ac.uk)

**MYCOINSECTICIDES FOR APHID MANAGEMENT :  
A BIORATIONAL APPROACH**

By

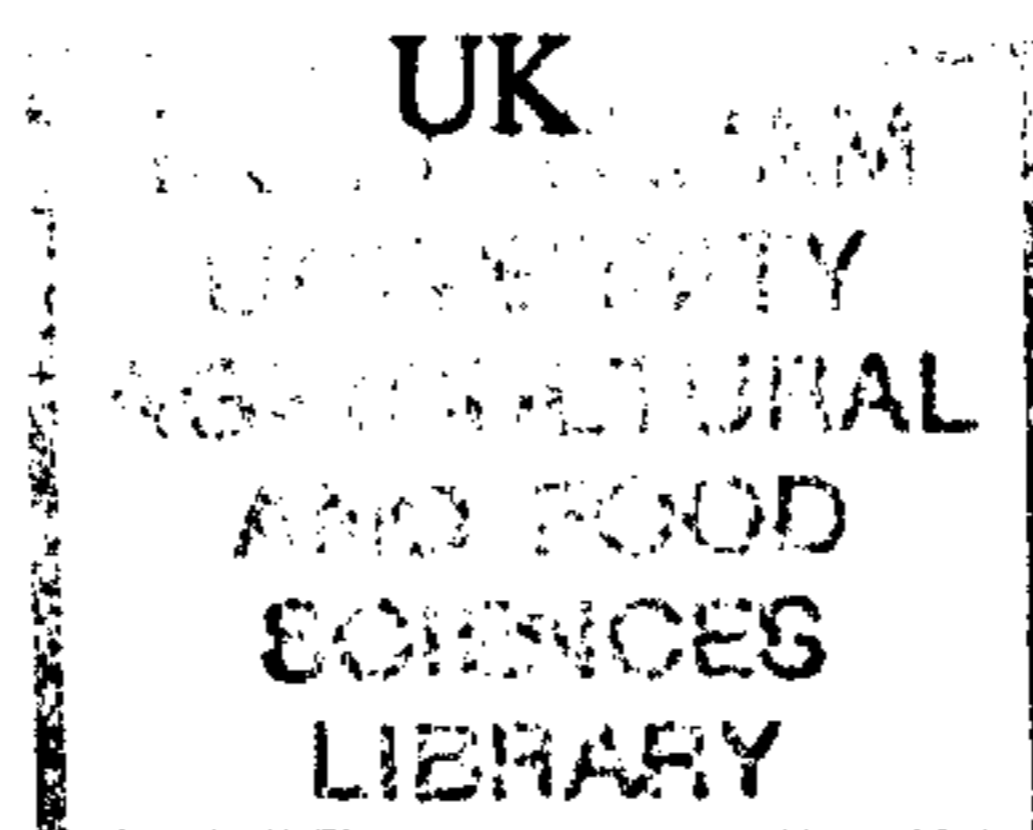
**HELEN YEO**

**B.Sc. (Hons), M.Sc. (Distinction)**

**Thesis submitted to the University of Nottingham for the degree of Doctor of  
Philosophy**

**September 2000**

**Division of Agriculture and Horticulture  
University of Nottingham  
Sutton Bonington Campus  
Loughborough  
Leicestershire  
LE12 5RD**



**BEST COPY**

**AVAILABLE**

Variable print quality

## ACKNOWLEDGMENTS

I am deeply grateful to my supervisors Dr. Judy Pell (IACR-Rothamsted) and Dr. Peter Alderson (University of Nottingham) for their encouragement and support throughout my studies. The University of Nottingham provided funding for this project and Prof. Brian Kerry kindly allowed the work to be undertaken at Rothamsted.

Many thanks to Barry Pye for doing all the spraying (often at the last minute) and for keeping me up to date with the latest gossip. Thanks also to; Suzanne Clark for statistical advice, Dr. Alistair McCartney and Mr. Mike Feather for help with the datalogger, Roger Jenkins for constructing the ventilated psychrometers and Dave Brooks for donating parasitoids. Thanks to Dave Chandler, Tove Steenberg, John Vandenberg and Gisbert Zimmermann for kindly supplying isolates of fungus for this research.

Thanks for support from Albert, Jill and Alan in the glasshouse and insectary, Peter, Nicky and Linda in the photographic department. Thanks to everyone at the farm for the well organised field trials and for bringing visitors on farm tours when I was sunbathing rather than working.

Thanks to all my friends who have supported me along the way including Mike, Helen, Luda and Vibeke for useful discussions, practical advice, and making my long days (and nights) in the lab more bearable. Special thanks to Katie for keeping me sane over the months of writing and making me laugh.

Thankyou to my parents and sister for their love and support throughout everything. Finally, thankyou to Nick for his unfaltering love and belief in me.

## CONTENTS

<b>ACKNOWLEDGEMENTS</b>	i
<b>ABSTRACT</b>	viii
<b>LIST OF FIGURES</b>	x
<b>LIST OF TABLES</b>	xviii
<b>Chapter 1 : INTRODUCTION</b>	1
<b>1.1 Aphids as pests</b>	1
1.1.1 Biology of aphids used in this study	2
1.1.1.1 <i>Rhopalosiphum padi</i>	2
1.1.1.2 <i>Sitobion avenae</i>	3
1.1.1.3 <i>Metopolophium dirhodum</i>	3
1.1.1.4 <i>Aphis fabae</i>	4
1.1.1.5 <i>Acyrtosiphon pisum</i>	4
1.1.1.6 <i>Myzus persicae</i>	4
<b>1.2 Integrated pest management</b>	5
1.2.1 Biological control	6
<b>1.3 Entomopathogenic fungi</b>	7
1.3.1 Fungal taxonomy	7
1.3.2 Morphological and diagnostic characteristics of hyphomycete fungi	10
1.3.2.1 <i>Beauveria bassiana</i>	10
1.3.2.2 <i>Verticillium lecanii</i>	10
1.3.2.3 <i>Metarhizium anisopliae</i>	12
1.3.2.4 <i>Paecilomyces</i> species	12
1.3.3 Fungal infection processes	12
1.3.4 Fungal Epizootiology	14
<b>1.4 Arthropods as aphid biocontrol agents</b>	16
1.4.1 Parasitoids	17
1.4.2. Ladybirds	17
<b>1.5 Hyphomycete fungi as natural aphid biocontrol agents</b>	20
<b>1.6 Mycoinsecticides</b>	21
1.6.1 Historical Background	21
1.6.2 Successful control programmes	22
1.6.2.1 <i>Beauveria bassiana</i>	23
1.6.2.2 <i>Verticillium lecanii</i>	24
1.6.2.3 <i>Metarhizium anisopliae</i>	24
1.6.2.4 <i>Paecilomyces</i>	25
<b>1.7 A biorational approach to selecting mycoinsecticides</b>	25

<b>Chapter 2 : GENERAL MATERIALS AND METHODS</b>	<b>29</b>
<b>2.1 Aphid Cultures</b>	<b>29</b>
2.1.1 Legume Aphids: <i>Acyrtosiphon pisum</i> and <i>Aphis fabae</i>	29
2.1.2 Cereal Aphids: <i>Sitobion avenae</i> , <i>Metopolophium dirhodum</i> and <i>Rhopalosiphum padi</i>	29
2.1.3 <i>Myzus persicae</i>	30
<b>2.2 Production of leaves in water agar</b>	<b>30</b>
<b>2.3 Rearing apterous adult aphids of known age</b>	<b>31</b>
<b>2.4 Culturing the 7-spot ladybird, <i>Coccinella septempunctata</i></b>	<b>32</b>
<b>2.5 Culturing the parasitoid <i>Praon volucre</i></b>	<b>33</b>
<b>2.6 Fungal isolates</b>	<b>34</b>
2.6.1 Collection	34
2.6.2 Storage	36
2.6.3 Subculturing fungi	37
2.6.4 Spore harvesting	37
2.6.5 Preparing suspensions of conidia	38
2.6.6 Spraying fungi	39
<b>2.7 Bioassay assessment</b>	<b>41</b>
<b>2.8 Changing bioassay dishes</b>	<b>41</b>
<b>2.9 Statistical analysis</b>	<b>41</b>
<b>Chapter 3 : DEVELOPMENT OF A STANDARDISED BIOASSAY METHOD FOR SCREENING HYPHOMYCETE FUNGI AGAINST APHIDS</b>	<b>42</b>
<b>3.1 Introduction</b>	<b>42</b>
3.1.1 Inoculating test insects	43
3.1.1.1 Showering conidia	44
3.1.1.2 Topical applications and direct injection of conidia	45
3.1.1.3 Incorporation of conidia into foodstuff and exposure to inoculated surfaces	46
3.1.1.4 Dipping in suspensions of conidia	48
3.1.1.5 Spraying systems	50
3.1.2 Choice of target insect	52
3.1.3 Choice of carrier	54
3.1.4 Post-inoculation incubation and mortality assessment	55

<b>3.2 Materials and Methods</b>	58
3.2.1 Insect and fungus cultures	58
3.2.2 Aphid movement in dishes during spray applications	58
3.2.3 Post-inoculation incubation	59
3.2.4 Aphid population density	61
3.2.5 Effect of carrier on aphid survival	61
3.2.6 Preliminary maximum challenge	62
<b>3.3 Results</b>	63
3.3.1 Aphid movement in dishes during spray applications	63
3.3.2 Post-inoculation incubation	64
3.3.3 Aphid population density	65
3.3.4 Effect of carrier on aphid survival	65
3.3.5 Preliminary maximum challenge	67
<b>3.5 Discussion</b>	68
<b>Chapter 4 - PATHOGENICITY, VIRULENCE AND APHID HOST RANGE</b>	72
<b>4.1 Introduction</b>	72
<b>4.2 Materials and Methods</b>	80
4.2.1 Insect and Fungus Cultures	80
4.2.2 Single-dose isolate selection assays against <i>Aphis fabae</i> with 18 isolates	80
4.2.3 Dose-response assays against <i>Aphis fabae</i> with four selected isolates	81
4.2.3.1 Dose ranges of $1 \times 10^5$ - $1 \times 10^9$ conidia ml <sup>-1</sup>	81
4.2.3.2 Dose ranges of $1 \times 10^6$ - $1 \times 10^8$ conidia ml <sup>-1</sup>	82
4.2.4 Dose-response against <i>A. fabae</i> with isolate HRI 1.72	83
4.2.5 Host range assays against representative cereal aphids, legume aphids and the polyphagous aphid <i>Myzus persicae</i>	83
<b>4.3 Results</b>	85
4.3.1 Single-dose isolate selection assays against <i>Aphis fabae</i> with 18 isolates	85
4.3.2 Dose-response assays against <i>Aphis fabae</i> with four selected isolates	92
4.3.2.1 Dose ranges of $1 \times 10^5$ - $1 \times 10^9$ conidia ml <sup>-1</sup>	92
4.3.2.2 Dose ranges of $1 \times 10^6$ - $1 \times 10^8$ conidia ml <sup>-1</sup>	98
4.3.3 Dose-response against <i>A. fabae</i> with isolate HRI 1.72	101
4.3.4 Host range assays against representative cereal aphids, legume aphids and the polyphagous aphid <i>Myzus persicae</i>	102

<b>4.4 Discussion</b>	107
<b>Chapter 5 - IMPACT OF ABIOTIC FACTORS</b>	114
<b>5.1 Introduction</b>	114
5.1.1 Humidity	114
5.1.2 Temperature	117
5.1.3 Pesticides	121
5.1.4 UV and Solar radiation	124
<b>5.2 Materials and Methods</b>	125
5.2.1 Insect and Fungus Cultures	125
5.2.2 Impact of temperature on <i>in vitro</i> fungal germination	125
5.2.3 Impact of temperature on <i>in vitro</i> fungal colony growth	126
5.2.4 Impact of temperature on pathogenicity of fungi to <i>A. fabae</i> and <i>M. persicae</i>	127
5.2.5 Impact of water availability ( $a_w$ ) on <i>in vitro</i> fungal germination	128
<b>5.3 Results</b>	129
5.3.1 Impact of temperature on <i>in vitro</i> germination of conidia	129
5.3.2 Impact of temperature on <i>in vitro</i> fungal colony growth	131
5.3.3 Impact of temperature on pathogenicity of fungi to <i>A. fabae</i>	133
5.3.4. Impact of water availability ( $a_w$ ) on <i>in vitro</i> fungal germination	136
<b>5.4 Discussion</b>	139
<b>Chapter 6 : INTERACTIONS OF MYCOINSECTICIDES WITH OTHER NATURAL ENEMIES</b>	145
<b>6.1 Introduction</b>	145
6.1.1 Predators	147
6.1.2 Parasitoids	150
6.1.3 Pollinators	155
6.1.4 Microbial Pathogens	155
<b>6.2 Materials and Methods</b>	157
6.2.1 Insect and hyphomycete fungus cultures	157
6.2.1.1 Culturing <i>Erynia neoaphidis</i>	158
6.2.1.2 Inoculating <i>Aphis fabae</i> with <i>Erynia neoaphidis</i>	159
6.2.1.3 Inoculating <i>Coccinella septempunctata</i> and <i>Praon             volucre</i> with hyphomycete fungi	159
6.2.2 Single-dose bioassays against <i>Coccinella septempunctata</i>	160



6.2.3	Single-dose bioassays against the generalist parasitoid, <i>Praon volucre</i>	162
6.2.4	Interactions between hyphomycete fungi, <i>Erynia neoaphidis</i> and <i>A. fabae</i>	164
6.2.4.1	Infection of <i>Aphis fabae</i> with <i>Erynia neoaphidis</i>	164
6.2.4.2	Interactions between hyphomycete isolates and <i>Erynia neoaphidis</i> on <i>A. fabae</i>	164
<b>6.3</b>	<b>Results</b>	166
6.3.1	Single-dose bioassays against <i>Coccinella septempunctata</i>	166
6.3.2	Single-dose bioassays against the generalist parasitoid, <i>Praon volucre</i>	168
6.3.3	Interactions between hyphomycete fungi, <i>Erynia neoaphidis</i> and <i>A. fabae</i>	173
6.3.3.1	Infection of <i>Aphis fabae</i> with <i>Erynia neoaphidis</i>	173
6.3.3.2	Interactions between hyphomycete isolates and <i>Erynia neoaphidis</i> on <i>A. fabae</i>	173
<b>6.4</b>	<b>Discussion</b>	175
<b>Chapter 7 : FIELD EVALUATION OF SELECTED ISOLATES AS POTENTIAL MYCOINSECTICIDES</b>		181
<b>7.1</b>	<b>Introduction</b>	181
7.1.1	Persistence of fungi	181
7.1.2	Climate monitoring	183
7.1.3	Spatial distribution of aphids in crops	185
7.1.4	Temporal distribution of <i>Erynia neoaphidis</i>	185
<b>7.2</b>	<b>Materials and Methods</b>	187
7.2.1	Field trial design	187
7.2.2	Aphid and natural enemy monitoring	191
7.2.3	Climate monitoring	192
7.2.3.1	Macroclimate measurements	192
7.2.3.2	Microclimate measurements	192
7.2.3.1.1	Temperature measurements	192
7.2.3.1.2	Humidity measurements	194
7.2.4	Spray application in field trials	200
7.2.5	Aphid bioassays	201
7.2.5.1	Evaluation of susceptibility of aphids in the field	202
7.2.5.2	Persistence of conidia on leaves	202
<b>7.3</b>	<b>Results</b>	203
7.3.1	Aphid and natural enemy counts	203
7.3.1.1	Wheat 1997	203

7.3.1.2 Wheat 1998	206
7.3.1.3 Beans 1997	208
7.3.1.4 Beans 1998	210
7.3.2 Climate measurements	212
7.3.2.1 Microclimate temperature	212
7.3.2.2 Microclimate humidity	219
7.3.4 Aphid bioassays	224
7.3.4.1 Evaluation of susceptibility of aphids in the field	224
7.3.4.2 Evaluation of persistence on leaves	226
<b>7.4 Discussion</b>	<b>233</b>
<b>Chapter 8 : GENERAL DISCUSSION</b>	<b>240</b>
<b>References</b>	<b>248</b>
<b>Appendices</b>	<b>286</b>

## ABSTRACT

This study considered a novel approach to selecting isolates of Hyphomycete fungi as mycoinsecticides for biological control of aphids in arable crops in the UK. The approach was designed to select isolates which were compatible with both the biotic and abiotic environment.

*Aphis fabae* was chosen as a representative target aphid for bioassays, based on results of preliminary experiments. Eighteen isolates of fungi were screened at a single concentration of  $1 \times 10^8$  conidia ml<sup>-1</sup> against apterous adult *A. fabae*, which were incubated at 23°C. Spray applications were made using an electrostatic rotary atomiser in both laboratory and field experiments. Isolates that originated from aphid hosts were most pathogenic to *A. fabae*. Four isolates were selected for further studies; ARSEF 2879 (*Beauveria bassiana*), HRI 1.72 (*Verticillium lecanii*), Mycotrol strain GHA (*B. bassiana*) and Z11 (*Paecilomyces fumosoroseus*).

Isolate HRI 1.72 was most virulent to *A. fabae* in dose-response assays compared to other isolates; at concentrations of  $1 \times 10^5$  conidia ml<sup>-1</sup> and above, mortality of aphids due to infection by HRI 1.72 was 100%. Isolates of *P. fumosoroseus* and *V. lecanii* were able to grow and germinate better *in vitro* at low temperatures (10 & 15°C), than isolates of *B. bassiana* and *Metarhizium anisopliae*. *Aphis fabae* and *Myzus persicae*, inoculated with isolate HRI 1.72 and incubated at 10°C, succumbed to infection after a significantly shorter period of time compared to other isolates.

*Rhopalosiphum padi* was most resistant to infection by the four isolates compared to five other species of aphid. *Aphis fabae*, *Acyrtosiphon pisum*, *Sitobion avenae*, *Metopolophium dirhodum*, *R. padi* and *M. persicae* were most susceptible to infection by isolate HRI 1.72. Aphids infected with isolates of *V. lecanii* often had fungal sporulation on their legs and died attached to leaves on which they were feeding.

The isolates Mycotrol strain GHA and ARSEF 2879 were pathogenic to the 7-spot ladybird *Coccinella septempunctata* and the generalist parasitoid *Praon volucre*.

The isolates HRI 1.72 and Z11 had very little impact on these natural enemies tested.

When aphids of *A. fabae* were co-inoculated with isolates of Hyphomycete fungi and *Erynia neoaphidis*, most individuals succumbed to infection with *E. neoaphidis*. A significant number of aphids died within 24 hours of inoculation and showed no signs of external sporulation. The potential interactions between these natural enemies in the biocontrol of aphids are discussed.

The spatial and temporal distribution of aphids and their natural enemies, in field bean and wheat crops, was determined in two field seasons (1997 & 1998). Aphids sampled from the field, after application of Hyphomycete fungi in 1998, mostly succumbed to infection with *E. neoaphidis*. Epizootics of *E. neoaphidis* were recorded in both years. Greater numbers of healthy laboratory aphids succumbed to infection with Hyphomycete fungi when they were bioassayed on leaves sampled immediately following spraying (51 - 100%) compared to 24 hours later (8 - 65%). Microclimate recordings showed humidity in both crops was generally >90% overnight and differences were as great as 15% between the top and bottom of crop canopies. Temperature differences were as great as 5 - 7 °C between individual sensors.

The implications of using a biorational approach as part of the development of Hyphomycete fungi as mycoinsecticides for the control of aphids is discussed.

## LIST OF FIGURES

- FIGURE 1.1** Schematic drawings of morphological features of species of Hyphomycete fungi. [Reproduced from Samson, 1981]. 11
- FIGURE 1.2** *Coccinella septempunctata* (the 7-spot ladybird) feeding on *Acyrtosiphon pisum* (the pea aphid). 19
- FIGURE 1.3** Stepwise, biorational selection procedure for Hyphomycete fungi against aphid pests. 28
- FIGURE 2.1** Detail of the APE 80 spray head used to apply suspensions of conidia of fungi to aphids in laboratory and field assays. 40
- FIGURE 3.1** Three holding systems tested for incubating *Aphis fabae* during bioassays. From left to right; a Blackman box with leaves held in moist sponge, a Petri dish with leaves set in water agar and a whole plant held under a lampglass. 60
- FIGURE 3.2** Cumulative proportion of *Aphis fabae* dying on each day having been reared in different systems (on whole plants (IR) or excised leaves in Petri dishes (PR)) and then incubated in three systems (a whole plant (PLANT), excised leaves in Petri dishes (PETRI) or Blackman boxes (BLACK)). 64
- FIGURE 3.3** Cumulative proportion of *Aphis fabae* dying on each day at different population densities (5, 8, 10, 12, 15 or 20 aphids) when incubated on excised leaves set in agar in Petri dishes. 65
- FIGURE 3.4** Cumulative proportion of *Aphis fabae* dying on each day following spraying with water, Tween 80 (0.03%) or left unsprayed at three different population densities; a) 5 aphids, b) 12 aphids or c) 20 aphids per Petri dish. 66
- FIGURE 3.5** Pathogenicity of isolates ARSEF 2859 (*V. lecanii*) and ARSEF 4491 (*P. fumosoroseus*) to *Acyrtosiphon pisum* and *Aphis fabae* aphids. 67
- FIGURE 4.1** Cumulative proportion of *A. fabae* dying due to fungus on each day following inoculation with a single concentration ( $1 \times 10^8$  conidia  $\text{ml}^{-1}$ ) of isolate Mycotech strain GHA in each of four bioassays. 85

- FIGURE 4.2** Cumulative proportion of *A. fabae* dying due to fungus on each day following inoculation with a single concentration ( $1 \times 10^8$  conidia  $\text{ml}^{-1}$ ) of isolates ARSEF 2879 (*B. bassiana*), T195 (*B. bassiana*), T80 (*V. lecanii*), Z4 (*P. fumosoroseus*) and the standard isolate Mycotech strain GHA (*B. bassiana*). 88
- FIGURE 4.3** Cumulative proportion of *A. fabae* dying due to fungus on each day following inoculation with a single concentration ( $1 \times 10^8$  conidia  $\text{ml}^{-1}$ ) of isolates HRI 1.72 (*V. lecanii*), Z43 (*M. anisopliae*), ARSEF 4491 (*P. fumosoroseus*), Z26 (*V. lecanii*) and the standard isolate Mycotech strain GHA (*B. bassiana*). 89
- FIGURE 4.4** Cumulative proportion of *A. fabae* dying due to fungus on each day following inoculation with a single concentration ( $1 \times 10^8$  conidia  $\text{ml}^{-1}$ ) of isolates Z25 (*V. lecanii*), Z11 (*P. fumosoroseus*), ARSEF 2859 (*V. lecanii*), T130 (*M. anisopliae*) and the standard isolate Mycotech GHA (*B. bassiana*). 90
- FIGURE 4.5** Cumulative proportion of *A. fabae* dying due to fungus on each day following inoculation with a single concentration ( $1 \times 10^8$  conidia  $\text{ml}^{-1}$ ) of isolates Z139 (*B. bassiana*), ARSEF 3458 (*P. fumosoroseus*), Z135 (*B. bassiana*), T229 (*P. farinosus*), ARSEF 4461 (*P. fumosoroseus*) and the standard isolate Mycotech strain GHA (*B. bassiana*). 91
- FIGURE 4.6** Proportion of adult *Aphis fabae* dying due to fungus in the first run of a dose response assay with five concentrations ( $\log_{10}$  5.0, 6.0, 7.0, 8.0 & 9.0 conidia  $\text{ml}^{-1}$ ) of isolates Mycotech strain GHA (*B. bassiana*), HRI 1.72 (*V. lecanii*), Z11 (*P. fumosoroseus*) and ARSEF 2879 (*B. bassiana*) 92
- FIGURE 4.7** Cumulative proportion of *Aphis fabae* dying due to fungus on each day following inoculation with five concentrations ( $\log_{10}$  5.0, 6.0, 7.0, 8.0 & 9.0 conidia  $\text{ml}^{-1}$ ) of isolates a) Mycotech strain GHA (*B. bassiana*), b) HRI 1.72 (*V. lecanii*), c) Z11 (*P. fumosoroseus*) and d) ARSEF 2879 (*B. bassiana*). First run of experiment. 94
- FIGURE 4.8** Proportion of adult *Aphis fabae* dying due to fungus in the second run of a dose response assay with five concentrations ( $\log_{10}$  5.0, 6.0, 7.0, 8.0 & 9.0 conidia  $\text{ml}^{-1}$ ) of isolates Mycotech strain GHA (*B. bassiana*), HRI 1.72 (*V. lecanii*), Z11 (*P. fumosoroseus*) and ARSEF 2879 (*B. bassiana*) 95

- FIGURE 4.9** Cumulative proportion of *Aphis fabae* dying of fungus on each day following inoculation with five concentrations ( $\log_{10}$  5.0, 6.0, 7.0, 8.0 & 9.0 conidia  $\text{ml}^{-1}$ ) of isolates a) Mycotech strain GHA (*B. bassiana*), b) HRI 1.72 (*V. lecanii*), c) Z11 (*P. fumosoroseus*), and d) ARSEF 2879 (*B. bassiana*). Second run of experiment. 97
- FIGURE 4.10** Proportion of adult *Aphis fabae* dying due to fungus in a dose response assay after inoculation with five concentrations ( $\log_{10}$  6.0, 6.5, 7.0, 7.5 & 8.0 conidia  $\text{ml}^{-1}$ ) of isolates Mycotech strain GHA (*B. bassiana*), HRI 1.72 (*V. lecanii*), Z11 (*P. fumosoroseus*) and ARSEF 2879 (*B. bassiana*) 98
- FIGURE 4.11** Cumulative proportion of *Aphis fabae* dying due to fungus on each day following inoculation with five concentrations ( $\log_{10}$  6.0, 6.5, 7.0, 7.5 & 8.0 conidia  $\text{ml}^{-1}$ ) of isolates a) Mycotech GHA (*B. bassiana*), b) HRI 1.72 (*V. lecanii*), c) Z11 (*P. fumosoroseus*) and d) ARSEF 2879 (*B. bassiana*). 100
- FIGURE 4.12** Cumulative proportion of *Aphis fabae* dying due to fungus on each day following inoculation with seven concentrations ( $\log_{10}$  2.5, 3.0, 3.5, 4.0, 4.5, 5.0 & 5.5 conidia  $\text{ml}^{-1}$ ) of isolate HRI 1.72 (*V. lecanii*). 101
- FIGURE 4.13** Proportion of *Aphis fabae* dying due to fungus in each replicate (dish) following inoculation at seven concentrations ( $\log_{10}$  2.5, 3.0, 3.5, 4.0, 4.5, 5.0 & 5.5 conidia  $\text{ml}^{-1}$ ) of isolate HRI 1.72 (*V. lecanii*). 102
- FIGURE 4.14** Total proportion of control aphids dying due to causes other than infection with fungus, six days after inoculation with Tween 80 (0.03%), in the first run of a host range experiment. 103
- FIGURE 4.15** : Total proportion of control aphids dying due to causes other than infection with fungus, six days after inoculation with Tween 80 (0.03%), in the second run of a host range experiment. 103
- FIGURE 4.16** Predicted  $\text{LT}_{50}$  values (with standard errors) for "non-stressed" species of aphid in a host range assay following inoculation with a single dose ( $1 \times 10^8$  conidia  $\text{ml}^{-1}$ ) of isolates Mycotech strain GHA (*B. bassiana*), Z11 (*P. fumosoroseus*), HRI 1.72 (*V. lecanii*) and ARSEF 2879 (*B. bassiana*). 104
- FIGURE 4.17** Predicted  $\text{LT}_{50}$  values (with standard errors) for "stressed" species of aphid in a host range assay following inoculation with a single dose ( $1 \times 10^8$  conidia  $\text{ml}^{-1}$ ) of isolates Mycotech strain GHA (*B. bassiana*), Z11 (*P. fumosoroseus*), HRI 1.72 (*V. lecanii*) and ARSEF 2879 (*B. bassiana*). 106

- FIGURE 4.18** apterous adult black bean aphid *Aphis fabae* with characteristic mycelial growth of *Verticillium lecanii* displayed on the legs. 109
- FIGURE 5.1** Cumulative proportion of *A. fabae* and *M. persicae* dying due to fungus on each day following inoculation with a single concentration ( $1 \times 10^8$  conidia ml<sup>-1</sup>) of isolates HRI 1.72 (*V. lecanii*), Z11 (*P. fumosoroseus*) and Mycotech strain GHA (*B. bassiana*) and incubated at a) 10, b) 18 and c) 23°C. 134
- FIGURE 5.2** LT<sub>50</sub> values (with associated standard errors) for *A. fabae* and *M. persicae* dying due to fungus following inoculation with a single concentration ( $1 \times 10^8$  conidia ml<sup>-1</sup>) of isolates HRI 1.72 (*V. lecanii*), Z11 (*P. fumosoroseus*) and Mycotech strain GHA (*B. bassiana*) and incubated at 10, 18 and 23°C. 135
- FIGURE 5.3** Length of germ tubes (with standard errors) produced from conidia of isolates HRI 1.72 (*V. lecanii*), ARSEF 2879 (*B. bassiana*) and Mycotech strain GHA (*B. bassiana*) on media with and without added nutrients. 137
- FIGURE 5.4** Number of germinated conidia (%) of isolates a) HRI 1.72 (*V. lecanii*), b) ARSEF 2879 (*B. bassiana*), c) Z11 (*P. fumosoroseus*) and d) Mycotech strain GHA after 24 hours on media adjusted to give water activities in the range  $a_w$  1.000 - 0.923 with or without added nutrients. 138
- FIGURE 6.1** ARSEF 2879 (*B. bassiana*, left) and Mycotech strain GHA (*B. bassiana*, right) sporulating from adult 7-spot ladybirds *Coccinella septempunctata*. 161
- FIGURE 6.2** Cumulative proportion of *C. septempunctata* dying due to fungus on each day following inoculation with a single concentration ( $1 \times 10^8$  conidia ml<sup>-1</sup>) of isolates Z11 (*P. fumosoroseus*), HRI 1.72 (*V. lecanii*), ARSEF 2879 (*B. bassiana*) and Mycotech strain GHA (*B. bassiana*). 167
- FIGURE 6.3** Cumulative proportion of *P. volucre* (from *S. avenae* hosts) dying due to fungus, in two bioassays, on each day following inoculation with isolates Mycotech strain GHA (*B. bassiana*), Z11 (*P. fumosoroseus*), HRI 1.72 (*V. lecanii*) and ARSEF 2879 (*B. bassiana*). 169
- FIGURE 6.4** Cumulative proportion of *P. volucre* (from *A. pisum* hosts) dying due to fungus, in two bioassays, on each day following inoculation with isolates Mycotech strain GHA (*B. bassiana*), Z11 (*P. fumosoroseus*), HRI 1.72 (*V. lecanii*) and ARSEF 2879 (*B. bassiana*). 170



<b>FIGURE 6.5</b> Cumulative proportion of <i>P. volucre</i> (from <i>A. pisum</i> and <i>S. avenae</i> hosts) dying due to fungus in two bioassays, on each day following inoculation with isolates Mycotech strain GHA ( <i>B. bassiana</i> ), Z11 ( <i>P. fumosoroseus</i> ) and ARSEF 2879 ( <i>B. bassiana</i> ).	171
<b>FIGURE 6.6</b> Cumulative proportion of <i>A. fabae</i> and <i>A. pisum</i> dying due to fungus over a period of four days following inoculation with isolate X4 ( <i>E. neoaphidis</i> ).	173
<b>FIGURE 6.7</b> Cumulative proportion of <i>A. fabae</i> dying due to <i>E. neoaphidis</i> (for treatments E, EH and HE) or a hyphomycete fungus (for treatment H) on each day following inoculation with isolates X4 ( <i>E. neoaphidis</i> ), Mycotech strain GHA ( <i>B. bassiana</i> ), Z11 ( <i>P. fumosoroseus</i> ) or HRI 1.72 ( <i>V. lecanii</i> ) individually or successively.	174
<b>FIGURE 7.1</b> Microclimatic conditions around leaf surfaces in a crop of beans over a 24 hour period in June. [Reproduced from Willmer, 1982].	184
<b>FIGURE 7.2</b> Field experiment plans for spring beans and spring wheat in 1997.	188
<b>FIGURE 7.3</b> Field experiment plans for spring beans in 1998.	189
<b>FIGURE 7.4</b> Field experiment plans for spring wheat in 1998.	190
<b>FIGURE 7.5</b> Campbell 21X datalogger simultaneously recording microclimate in a crop of spring field bean and spring wheat, positioned in the buffer zone between the two crop types during field experiments in 1998.	193
<b>FIGURE 7.6</b> Thermocouple tip taped to a bean leaf in recording position	195
<b>FIGURE 7.7</b> Inverted conical tubes acting as protective covers for thermocouple connectors in the field.	196
<b>FIGURE 7.8</b> Prototype of a ventilated psychrometer built at IACR-Rothamsted showing design details.	197
<b>FIGURE 7.9</b> Ventilated psychrometer mounted on wooden stake in position in field bean crop.	198
<b>FIGURE 7.10</b> Wet and dry bulb thermocouples in a prototype of a ventilated psychrometer built at IACR-Rothamsted.	199

<b>FIGURE 7.11</b> Average number of healthy aphids (all species combined) and aphids infected with <i>E. neoaphidis</i> recorded per plant in a spring wheat crop over the period 05/06/97 - 06/08/97.	204
<b>FIGURE 7.12</b> Distribution of (a) healthy <i>S. avenae</i> , (b) healthy <i>M. dirhodum</i> , and (c) aphids infected with <i>E. neoaphidis</i> at four positions on plants (ear, top, middle and bottom) in a spring wheat crop over the period 05/06/97 - 06/08/97.	205
<b>FIGURE 7.13</b> Average number of healthy aphids (all species combined) recorded per plant in a crop of spring wheat over the period 29/05/98 - 16/07/98.	206
<b>FIGURE 7.14</b> Distribution of (a) healthy <i>S. avenae</i> and (b) healthy <i>M. dirhodum</i> aphids at four positions on plants (ear, top, middle and bottom) in a spring wheat crop over the period 29/05/98 - 16/07/98.	207
<b>FIGURE 7.15</b> Average number of healthy aphids (all species combined) recorded per plant in a spring field bean crop over the period 04/06/97 - 03/07/97.	208
<b>FIGURE 7.16</b> Distribution of (a) healthy <i>A. fabae</i> and (b) healthy <i>A. pisum</i> aphids at three positions on plants (top, middle and bottom) in a spring field bean crop over the period 04/06/97 - 03/07/97	209
<b>FIGURE 7.17</b> Average number of healthy aphids (all species combined) and aphids infected with <i>E. neoaphidis</i> recorded per plant in a spring field bean crop over the period 14/05/98 - 30/06/98	210
<b>FIGURE 7.18</b> Distribution of (a) healthy <i>A. fabae</i> and (b) healthy <i>A. pisum</i> aphids at three positions on plants (top, middle and bottom) in a spring field bean crop over the period 14/05/98 - 30/06/98	211
<b>FIGURE 7.19 (a)</b> Average temperatures of the upper side of leaves at the top and the lower side of leaves at the bottom of a crop of spring wheat during the period 03/07/98 - 09/07/98	213
<b>FIGURE 7.19 (b)</b> Average temperatures of the upper side of leaves at the top and the lower side of leaves at the bottom of a crop of spring wheat during the period 10/07/98 - 16/07/98	214
<b>FIGURE 7.19 (c)</b> Average temperatures of the upper side of leaves at the top and the lower side of leaves at the bottom of a crop of spring wheat during the period 17/07/98 - 22/07/98	215

<b>FIGURE 7.20 (a)</b>	Average temperatures of the upper side of leaves at the top and the lower side of leaves at the bottom of a crop of spring field bean during the period 03/07/98 - 09/07/98.	216
<b>FIGURE 7.20 (b)</b>	Average temperatures of the upper side of leaves at the top and the lower side of leaves at the bottom of a crop of spring field bean during the period 10/07/98 - 16/07/98.	217
<b>FIGURE 7.20 (c)</b>	Average temperatures of the upper side of leaves at the top and the lower side of leaves at the bottom of a crop of spring field bean during the period 17/07/98 - 23/07/98.	218
<b>FIGURE 7.21 (a)</b>	Average relative humidity calculated from wet and dry bulb temperature recordings from three ventilated psychrometers positioned at the top, middle and bottom of a crop of spring field beans during the periods 03/07/98 - 09/07/98.	220
<b>FIGURE 7.21 (b)</b>	Average relative humidity calculated from wet and dry bulb temperature recordings from three ventilated psychrometers positioned at the top, middle and bottom of a crop of spring field beans during the periods 10/07/98 - 16/07/98.	221
<b>FIGURE 7.21 (c)</b>	Average relative humidity calculated from wet and dry bulb temperature recordings from three ventilated psychrometers positioned at the top, middle and bottom of a crop of spring field beans during the periods 17/07/98 - 23/07/98.	222
<b>FIGURE 7.22</b>	Average relative humidity calculated from wet and dry bulb temperature recordings from a single ventilated psychrometer positioned at the top of a crop of spring wheat during the period a) 10/07/98 - 16/07/98 and b) 17/07/98 - 23/07/98.	223
<b>FIGURE 7.23</b>	Mortality of (a) <i>A. fabae</i> and (b) <i>A. pisum</i> aphids sampled from plots in a crop of spring field bean sprayed with suspensions of conidia of isolates Mycotech strain GHA ( <i>B. bassiana</i> ) and HRI 1.72 ( <i>V. lecanii</i> ) at a concentration of $1 \times 10^9$ conidia ml <sup>-1</sup> .	225
<b>FIGURE 7.24</b>	Mortality of <i>A. fabae</i> exposed for 48 hours to leaves which had been removed from plots in a crop of spring field bean immediately following spraying on 19/06/98 with a suspension of Mycotech strain GHA ( <i>B. bassiana</i> ) at a concentration of $1 \times 10^9$ conidia ml <sup>-1</sup> .	226
<b>FIGURE 7.25</b>	Mortality of <i>A. fabae</i> exposed for 48 hours to leaves which had been removed from plots in a crop of spring field bean immediately following spraying with a suspension of Mycotech strain GHA ( <i>B. bassiana</i> ) at a concentration of $1 \times 10^9$ conidia ml <sup>-1</sup> on 07/07/98 and 24 hours later, due to (a) <i>B. bassiana</i> and (b) <i>E. neoaphidis</i> .	227

- FIGURE 7.26** Mortality of *A. fabae* aphids exposed for 48 hours to leaves which had been removed from plots in a crop of spring field bean immediately following spraying with a solution of Tween 80 (0.03%) on 07/07/98 and 24 hours later, due to *E. neoaphidis*. 228
- FIGURE 7.27** Mortality of *S. avenae*, exposed for 48 hours to leaves which had been removed from plots in a crop of spring wheat immediately following spraying with a solution of Tween 80 (0.03%) on 19/06/98, due to a *V. lecanii*-like pathogen 229
- FIGURE 7.28** Mortality of *S. avenae* exposed for 48 hours to leaves which had been removed from plots in a crop of spring wheat immediately following spraying with Mycotech strain GHA (*B. bassiana*) at a concentration of  $1 \times 10^9$  conidia ml<sup>-1</sup> on 19/06/98, due to *B. bassiana* and a *V. lecanii*-like pathogen 229
- FIGURE 7.29** Mortality of *S. avenae* exposed for 48 hours to leaves which had been removed from plots in a crop of spring wheat immediately following spraying with HRI 1.72 (*V. lecanii*) at a concentration of  $1 \times 10^9$  conidia ml<sup>-1</sup> on 19/06/98, due to *B. bassiana* and a *V. lecanii*-like pathogen 230
- FIGURE 7.30** Mortality of *S. avenae* exposed for 48 hours to leaves which had been removed from plots in a crop of spring wheat immediately following spraying with a suspension of Mycotech strain GHA (*B. bassiana*) at a concentration of  $1 \times 10^9$  conidia ml<sup>-1</sup> on 07/07/98 and 24 hours later, due to *B. bassiana* 231
- FIGURE 7.31** Mortality of *S. avenae* exposed for 48 hours to leaves which had been removed from plots in a crop of spring wheat immediately following spraying with a suspension of HRI 1.72 (*V. lecanii*) at a concentration of  $1 \times 10^9$  conidia ml<sup>-1</sup> on 07/07/98 and 24 hours later, due to *V. lecanii* 232
- FIGURE 8.1** Stepwise, biorational selection procedure for Hyphomycete fungi against aphid pests. 247

## LIST OF TABLES

<b>TABLE 2.1</b>	Requirements for producing aphids of known age for each of six different aphid species	32
<b>TABLE 2.2</b>	Culture collection at IACR-Rothamsted (UK) of isolates of the hyphomycete fungi <i>Beauveria bassiana</i> , <i>Metarhizium anisopliae</i> , <i>Verticillium lecanii</i> and <i>Paecilomyces</i> spp. that were selected as likely mycoinsecticide candidates with reported potential against aphids.	35
<b>TABLE 2.3</b>	Calculated number of spores deposited per cm <sup>2</sup> of area sprayed using the APE 80 when different concentrations of fungal suspensions are applied.	39
<b>TABLE 3.1</b>	Movement in a ten minute period of apterous adult aphids of six species in Petri dishes after being held in different controlled environment facilities overnight.	63
<b>TABLE 4.1</b>	Life table analysis of bioassays with 18 isolates of hyphomycete fungi at a single dose ( $1 \times 10^8$ conidia ml <sup>-1</sup> ) against apterous adult <i>A. fabae</i> .	87
<b>TABLE 4.2</b>	Calculated LT <sub>50</sub> values for four isolates of hyphomycete fungi; Mycotech GHA ( <i>B. bassiana</i> ), Z11 ( <i>P. fumosoroseus</i> ), HRI 1.72 ( <i>V. lecanii</i> ) and ARSEF 2879 ( <i>B. bassiana</i> ), screened against adult <i>Aphis fabae</i> in the first run of a dose response assay at concentrations of $1 \times 10^5 - 1 \times 10^9$ conidia ml <sup>-1</sup> .	93
<b>TABLE 4.3</b>	Calculated LT <sub>50</sub> values for four isolates of hyphomycete fungi; Mycotech strain GHA ( <i>B. bassiana</i> ), Z11 ( <i>P. fumosoroseus</i> ), HRI 1.72 ( <i>V. lecanii</i> ) and ARSEF 2879 ( <i>B. bassiana</i> ), assayed against adult <i>Aphis fabae</i> in the second run of a dose response assay at concentrations of $1 \times 10^5 - 1 \times 10^9$ conidia ml <sup>-1</sup> .	96
<b>TABLE 4.4</b>	Calculated LT <sub>50</sub> values for four isolates of hyphomycete fungi; Mycotech GHA ( <i>B. bassiana</i> ), Z11 ( <i>P. fumosoroseus</i> ), HRI 1.72 ( <i>V. lecanii</i> ) and ARSEF 2879 ( <i>B. bassiana</i> ), screened against adult <i>Aphis fabae</i> in a dose response assay at concentrations of $1 \times 10^6 - 1 \times 10^8$ conidia ml <sup>-1</sup> .	99
<b>TABLE 5.1</b>	Time (hours post-inoculation) at which conidia were fixed in an experiment to determine the impact of temperature on <i>in vitro</i> germination of conidia.	126
<b>TABLE 5.2</b>	Results for general linear regression analysis on log <sub>e</sub> time for 50% of conidia to germinate <i>in vitro</i> (GT <sub>50</sub> ) for isolates of <i>V. lecanii</i> , <i>P. fumosoroseus</i> , <i>M. anisopliae</i> and <i>B. bassiana</i> , at four different temperatures (10, 15, 20 and 25°C).	130

<b>TABLE 5.3</b> <i>In vitro</i> colony radial growth rates [Kr ( $\mu\text{m h}^{-1}$ )] for isolates of <i>V. lecanii</i> , <i>B. bassiana</i> , <i>M. anisopliae</i> and <i>Paecilomyces</i> spp. grown at four different temperatures (10, 15, 20 & 25°C).	132
<b>TABLE 5.4</b> Number of conidia that germinated <i>in vitro</i> at $a_w$ 1.00 for isolates HRI 1.72 ( <i>V. lecanii</i> ), Z11 ( <i>P. fumosoroseus</i> ), Mycotech strain GHA ( <i>B. bassiana</i> ) and ARSEF 2879 ( <i>B. bassiana</i> ) in the presence (+) and absence (-) of added nutrients.	136
<b>TABLE 6.1</b> : Treatment application times for <i>E. neoaphidis</i> (E) and each of three hyphomycete (H) isolates; Z11 ( <i>P. fumosoroseus</i> ), HRI 1.72 ( <i>V. lecanii</i> ) and Mycotech strain GHA ( <i>B. bassiana</i> ) applied either alone or in succession to the aphid <i>Aphis fabae</i> .	166

---

## Chapter 1 – INTRODUCTION

---

### 1.1 Aphids as pests

Aphids have a world wide distribution, although the greatest number of species occur in temperate regions, and represent a huge pest problem in agriculture. There are over 4,000 species of aphid (Minks & Harrewijn, 1987) which is relatively few compared to 10,000 species of grasshoppers, 12,000 geometrid moths and 60,000 weevils (Dixon, 1998). However, one in four plants in temperate regions may be infested with aphids.

The success of aphids in colonising host plants has largely been attributed to their ability to reproduce parthenogenetically for much of the year (Dixon, 1998). Parthenogenetic females are able to reproduce without fertilisation, producing numerous offspring. These nymphs may have embryos developing within them when they are born and these embryos may also have embryos. This “telescoping” of generations and viviparity (giving birth to live young) allows aphids to have very high reproductive rates. The high rate of increase of aphid populations, coupled with the fact that aphids are phloem feeding plant bugs has lead to their status as major agricultural crop pests.

The economic damage caused by aphids in agricultural crops is due to direct feeding damage and the transmission of plant viruses. Direct injury of economic importance usually only occurs when aphids reach high numbers. Such outbreaks tend to be sporadic in Britain and Europe but in some years losses in cereals, for example, have exceeded 30% (Kolbe, 1969). More regularly, serious yield losses in cereals in the UK are due to barley yellow dwarf virus (BYDV). This virus is persistent in aphids so once they are infected, they may transmit the virus for life. The most economically important vectors in cereals in the U.K. are the bird-cherry oat aphid *Rhopalosiphum padi* (L.) and the grain aphid *Sitobion avenae* (Fabricus) (Plumb, 1986). On legumes, the black bean aphid, *Aphis fabae* Scopoli, and the pea aphid, *Acyrtosiphon pisum* (Harris), are major pests. It has been suggested that the most important aphid pest world wide is the peach potato aphid *Myzus*

*persicae* (Sulzer) (Mackauer & Way, 1976). It has been reported as a vector of at least 24 viruses of plants and of at least 100 diseases altogether in over 50 different plant families. These families include beans, sugar beet, brassicas and potatoes in the UK (Kennedy, Day & Eastop, 1962).

Current data show that, in wheat and winter barley, over 80% of foliar insecticide applications are made against aphids, representing an area of over 1,900,000 ha (Thomas, Garthwaite & Banham, 1996). As the incidence of BYDV differs over years and regions, farmers usually apply prophylactic sprays against aphid vectors in the autumn. The annual cost of this control is estimated at around £10 million. Similarly, in other crops, a large percentage of the total area treated with insecticides is for aphid control; between autumn 1995 and harvests in 1996, 84.3% of peas, 62.8% of beans and 81.3% of ware potatoes were treated (Thomas *et al.*, 1996).

It is not surprising that with such high use of chemical insecticides, there has been increasing concern over public health and the environment. Additionally, problems of insecticide resistance and secondary pest outbreaks have also become more apparent. It has become more difficult to control *M. persicae*, for example, due to insecticide resistance; in summer 1996 it was not possible to control some populations of *M. persicae* that were present on potato and brassica crops using currently available chemical sprays (Foster & Devonshire, 1996). For these reasons, there is increasing pressure to move towards more sustainable practices in agriculture using environmentally acceptable methods of control for insect pests.

### ***1.1.1 Biology of aphids used in this study***

#### ***1.1.1.1 Rhopalosiphum padi***

Apterous aphids are green mottled yellowish green or olive-green, or dark-olive to greenish black, often with rust-coloured patches around the bases of the siphunculi. Alates have a pale to dark-green abdomen. Aphids are broadly oval and both apterae and alatae are 1.2 - 2.4 mm long.



In Europe, the usual host is the bird-cherry *Prunus padus* and the secondary hosts are various species of Gramineae, including all the major grasses and cereals. The life cycle is heteroecious (host alternating) holocyclic between *P. padus* and Gramineae in Europe but may be anholocyclic on Gramineae if the primary hosts are not available and where winter conditions permit (Blackman & Eastop, 2000). Aphids which have a holocyclic life cycle produce sexual morphs in the autumn which produce eggs for overwintering. Those which adopt an anholocyclic life cycle show permanent, year-round parthenogenesis.

#### *1.1.1.2 Sitobion avenae*

Apterous aphids are yellowish-green or dirty reddish brown and sometimes shiny, with black antennae and black siphunculi. Alatae are similarly coloured but may have distinct dark dorsal intersegmental markings. Aphids are broadly spindle shaped and medium sized; the apterae are 1.3 - 3.3 mm long whilst alatae are 1.6 - 2.9 mm long.

The host plants are numerous species of Gramineae which includes all the cereals and pasture grasses of temperate climates. The life cycle is monoecious holocyclic on these hosts, or anholocyclic where warm winters allow. *Sitobion avenae* is a vector of several viruses including BYDV, bean yellow mosaic, pea mosaic and beet western yellows (Blackman & Eastop, 2000).

#### *1.1.1.3 Metopolophium dirhodum*

Apterous *Metopolophium dirhodum* Walker are green or yellow-green with a darker green longitudinal mid-dorsal stripe. The legs, siphunculi and cauda are pale. The apterae are spindle-shaped and 1.6 - 2.9 mm long whilst alatae are similarly shaped but may be slightly larger at 1.6 - 3.3 mm long.

The primary hosts are wild and cultivated *Rosa* spp. and the secondary hosts are numerous species of cereals and grasses. The aphid is heteroecious holocyclic

between these two hosts, but may overwinter parthenogenetically on grasses in some areas of Europe (Prior, 1976). As well as feeding pressures exerted on host plants, the aphid is a vector of BYDV.

#### *1.1.1.4 Aphis fabae*

Young aphids are matt black in colour but, as they age, may develop white wax markings. Apteræ are 1.5 - 3.1 mm long whilst alatae are 1.3 - 2.6 mm long.

The aphid is heteroecious holocyclic between spindle *Euonymus europaeus* or guelder-rose *Viburnum opulus* and a very wide range of secondary host plants which includes many crops (Blackman & Eastop, 2000). It is a particular pest of beans *Vicia faba*, causing direct feeding damage due to swamping colonies developing on young shoots and other aerial parts of plants. The aphid is also a vector of viruses in sugar beet.

#### *1.1.1.5 Acyrthosiphon pisum*

Aphids are large and green or pink with slender appendages. Apteræ are 2.5 - 4.4 mm long whilst alatae are 2.3 - 4.3 mm long. The life cycle is holocyclic on various leguminous hosts (Blackman & Eastop, 2000). The species *A. pisum* is a complex of races and subspecies and populations of these are known to occur with particular host-plant preferences in Europe (Müller, 1980; Müller & Steiner, 1985).

#### *1.1.1.6 Myzus persicae*

Apterous adults are whitish green, pale-yellow-green, grey-green, mid-green, pink, red or almost black and are uniformly coloured and not shiny. Alatae have a black central dorsal patch on the abdomen. Apteræ and alates are medium sized, 1.2 - 2.1 mm long (Blackman & Eastop, 2000).

The primary host is usually the peach tree *Prunus persica* and the nectarine tree *P. nectarina*. There are a very wide variety of secondary hosts which cover over 40

different plant families and include economically important crops. The life cycle is generally heteroecious holocyclic between *Prunus* and secondary hosts in temperate areas. In warmer climates and when peach is absent as a host, an anholocyclic life cycle is prevalent on secondary hosts (Mackauer & Way, 1976).

*Myzus persicae* is the most important aphid virus vector (Kennedy *et al.*, 1962). Persistent viruses that are transmitted include bean leaf roll, beet western yellows, beet mild yellowing, beet yellow net, pea enation mosaic, potato leaf roll, tobacco vein-distorting, tobacco yellow net and tobacco yellow vein (Blackman & Eastop, 2000).

## **1.2 Integrated pest management**

In integrated pest management (IPM), the reliance on chemical pesticides is reduced by increasing the use of other, sustainable control methods, such as cultural, biological control and host plant resistance, to maintain pest numbers below economically significant levels (Allen, 1980; Hoy & Herzog, 1985).

IPM has been defined as:

*“a pest management system that in the socioeconomic context of farming systems, the associated environment and the population dynamics of the pest species, utilises all suitable techniques and methods in as compatible a manner as possible and maintains the pest population levels below those causing economic injury”* (Smith & Reynolds, 1966).

Aspects of biological control, one of the methods of control that may be used in an IPM programme, are investigated in this thesis. More specifically, the use of entomopathogenic (insect pathogenic) fungi for the biological control of aphids in arable crops in the UK is the basis of this work.

### ***1.2.1 Biological control***

Biological control in general may be defined simply as:

*"the use of living organisms, excluding host plants, as pest control agents"* (Greathead & Waage, 1983) or,

*"the utilisation of natural enemies to reduce damage caused by noxious organisms to tolerable levels"* (Debach & Rosen, 1991).

These natural enemies may be predators, parasites or pathogens of the pest. There are three main methods that are used to achieve biological control defined by Luck (1990) as introduction or classical biological control, augmentation and conservation.

Introduction or classical biological control involves the introduction of exotic natural enemies to permanently reduce a pest, which itself is usually of foreign origin. Augmentation utilises insectary- or laboratory-reared natural enemies to supplement indigenous populations of natural enemies or initiate natural enemy populations for a limited period, e.g. for a growing season. Augmentation has been further divided to cover two types of augmentative biological control; inoculation and inundation (Dent, 1995). In inoculative releases, a small number of the natural enemy are released early in the cropping season with the hope that they reproduce and the population is able to control pests over an extended period of time. Inundation methods rely on releasing large numbers of individuals when natural populations or released populations have not reproduced to high enough numbers to effect control. Pest control in this situation will be by the released individuals themselves rather than by their offspring.

In conservation biological control, important natural enemies are identified and husbanded by appropriate management practices. Appropriate practices may remove negative influences, such as broad spectrum chemical insecticides, and encourage positive activities, such as maintaining physical refuges including

hedgerows and field margins. Indeed, the addition of banks of grass as a physical refuge in cereal fields in the UK has been successful in providing overwintering refuges for predators of aphids and, hence, an important source of predators early in the following season (Thomas, Wratten & Sotherton, 1991).

The first well documented case of biological control was in 1762, when a mynah bird from India was used to control locusts in Mauritius. During the 1880's the vedalia beetle *Rodalia cardinalis* Mulsant demonstrated impressive control of the cottony cushion scale *Icerya purchasi* Maskell on citrus in California. This impressive success led the way to many other successful biological control programmes, such as the control of cassava mealybug *Phenacoccus manihoti* Matile-Ferrero in Africa using the parasitoid *Epidinocarsis lopezi* (De Santis) (Neuenschwander & Herren, 1988). By 1986, there had been 1162 introductions of predators or parasitoids; 25% of these successfully regulated the target pest, 69% provided intermittent or partial control and only 6% failed to provide any control at all (Luck, 1990).

Important groups of biological control agents include arthropod natural enemies, such as ladybirds, parasitoids and predatory beetles and entomopathogenic fungi.

### **1.3 Entomopathogenic fungi**

Entomopathogenic fungi occur naturally and have the ability to cause epizootics which significantly reduce insect host populations (Burgess, 1981). An epizootic is a term which is applied to a disease which affects a large number of animals simultaneously and is similar to that of an epidemic in humans (Holmes, 1979). Over 750 species of fungi from two kingdoms, Chromista and Fungi, have been recorded as entomopathogens (Glare & Milner, 1991).

#### **1.3.1 Fungal taxonomy**

Most of the entomopathogenic fungi are true Fungi in the divisions Chytridiomycota, Zygomycota, Ascomycota and Basidiomycota. The best known

genus in the division Chytridiomycota is *Coelomomyces* which contains mainly aquatic species which produce zoospores (flagellated spores for asexual reproduction) and are entomopathogens of mosquitoes and other Diptera.

Most entomopathogens within the division Zygomycota are in the subdivision Zygomycotina, class Zygomycetes and order Entomophthorales. There are over 200 known species of entomopathogenic fungi in the order Entomophthorales (Glare & Milner, 1991) and naturally occurring epizootics of these fungi occur in many insect species (Hamm, 1980; McCoy, Samson & Boucias, 1988). The most commonly occurring Entomophthoralean fungus infecting aphids in the UK is *Erynia neoaphidis* Remaudière & Hennebert (Dean & Wilding, 1971, 1973; Wilding, 1975; Wilding & Perry, 1980).

The Entomophthorales are characterised by production of forcibly discharged, uninucleate or multinucleate asexual spores known as conidia. In the absence of a suitable host, these conidia may produce secondary or tertiary spores which also have the potential to germinate and infect hosts. Fungi within this order are able to produce resting spores which survive during unfavourable conditions, for example over the winter months. Resting spores can be produced either sexually or asexually. The most common genera include, *Conidiobolus*, *Erynia*, *Entomophaga*, *Zoophthora* and *Neozygites* (Tanada & Kaya, 1993). Most of the Entomophthorales have been recorded from a limited number of hosts and are therefore relatively host specific, such as *E. neoaphidis* which is only recorded from aphids. Others, such as *Zoophthora radicans* (Brefeld) Batko, have been recorded from a wide range of different hosts but individual isolates may only infect insects of a particular species. Aspects of the host range and specificity of these fungi are reviewed by Pell, Eilenberg, Hajek & Steinkraus (in press).

Many important entomopathogens occur in the subdivision Deuteromycotina (also referred to as Fungi Imperfecti) and the artificial class Hyphomycetes. These fungi form asexual conidia and the sexual forms are either unknown or occur rarely, hence the name Fungi Imperfecti. As sexual forms do occur in some species, such as *Cordyceps*, some authors feel that these fungi should be classified within the

division Ascomycota (Goettel, Inglis & Wraight, 2000). However, until this view is formally recognised, the widely accepted classification of the Hyphomycetes in the Deuteromycotina is used in this study. The Deuteromycotina do not produce resting spores and are capable of surviving in soil as conidia (Samson, Evans & Latgé, 1988).

The most prominent genera containing insect pathogens within the class Hyphomycetes are *Beauveria*, *Metarhizium*, *Paecilomyces*, *Verticillium*, *Aschersonia*, *Hirsutella* and *Nomuraea*.

The most studied species of *Beauveria*, the white muscardine fungus, are *B. bassiana* (Balsamo) Vuillemin and *B. brongniartii* (Saccardo) Petch (McCoy *et al.*, 1988).

Within the genus *Paecilomyces*, Samson (1974) recognised 31 species of which the best known entomopathogenic fungi are *P. farinosus* (Holm) Brown & Smith, the yellow muscardine fungus, and *P. fumosoroseus* (Wize) Brown & Smith.

The genus *Verticillium* has been previously referred to as the genus *Cephalosporium* but, more recently, authors have preferred to use *Verticillium* (Hall, 1981a; McCoy *et al.*, 1988). The most researched and well documented pathogen in this genus is *V. lecanii* (Zimmermann) Viegas.

Until very recently, the genus *Metarhizium*, the green muscardine fungus, was based on morphological characters and was reviewed by Tulloch (1976). The genus consisted of the species *Metarhizium anisopliae* (Metschnikoff) Sorokin which had two varieties, *M. anisopliae* var. *majus* (Johnston) Tulloch and *M. anisopliae* var. *anisopliae* Tulloch, and the species *M. flavoviride* Gams & Rozsypal. However, Driver, Milner & Trueman (2000) have reassessed the genus using sequence data and RAPD patterns. They accept three species and eight varieties of *Metarhizium*, of which five are new varieties. The three species are *M. anisopliae*, *M. album* and *M. flavoviride*. The varieties are listed as *M. anisopliae* var. *anisopliae*, *M. anisopliae* var. *majus*, *M. anisopliae* var. *acridum*, *M.*

*anisopliae* var. *lepidiotum*, *M. flavoviride* var. *novazealandicum*, *M. flavoviride* var. *pemphigum*, *M. flavoviride* var. *minus* and *M. flavoviride* var. *flavoviride*. In this thesis, the species *M. anisopliae* is identified not by variety, but by the species name used in the literature cited, as the majority of isolates of *Metarhizium* spp. have yet to be reclassified. One notable exception is a grasshopper and locust pathogen used in the product “Green Muscle™” and reported on widely in literature from the LUBILOSA<sup>1</sup> project. This isolate has been reclassified from *M. flavoviride* to *M. anisopliae* var. *acridum* and any references to this pathogen in this thesis will be made using the most recent taxonomic classification.

The majority of the fungal isolates used in this study are from the species *V. lecanii*, *M. anisopliae*, *B. bassiana* and *Paecilomyces* spp.

### **1.3.2 Morphological and diagnostic characteristics of hyphomycete fungi**

#### **1.3.2.1 *Beauveria bassiana***

Insects that have succumbed to infection with *B. bassiana* have a dusty, white appearance and infection with the pathogen is often referred to as “white muscardine disease” (Tanada & Kaya, 1993). The conidia are usually densely clustered with denticulate (toothed) apical extensions (rachis) bearing one conidium per denticle and conidia are aseptate (Figure 1.1a). Conidia of *B. bassiana* are nearly globose and  $\leq 3.5\mu\text{m}$  diameter whilst conidia of *B. brongniartii* are long, ovoid and cylindrical, with a length of 2.5 - 4.5  $\mu\text{m}$ .

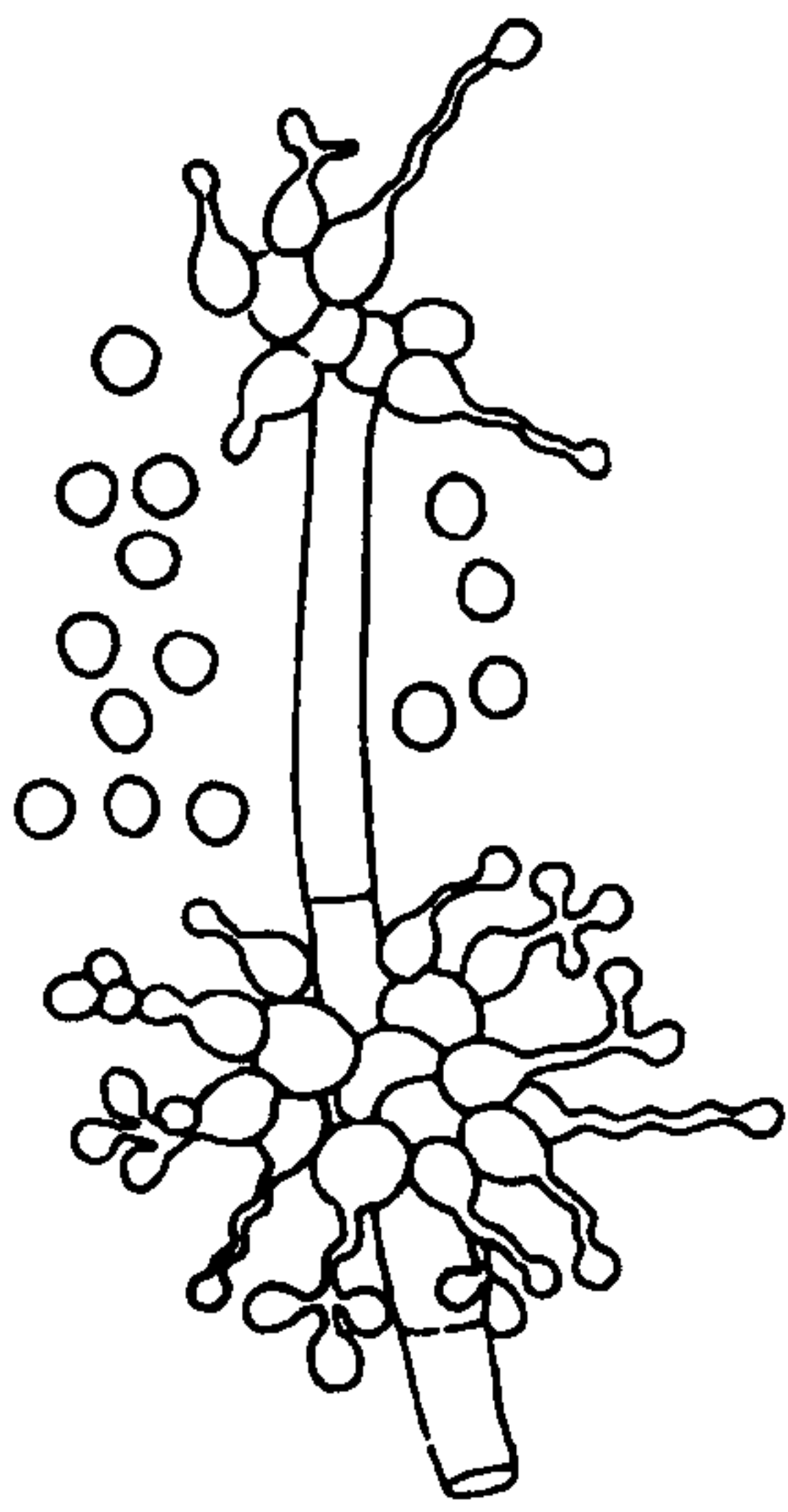
#### **1.3.2.2 *Verticillium lecanii***

*Verticillium lecanii* is known as the “white-halo” fungus because mycelium grow around the edge of infected scale insects. The conidiophores are little differentiated from vegetative hyphae and conidia occur as pairs or singly in whorls on hyphae or apically on short side branches (Figure 1.1b). Conidia are aseptate and borne in

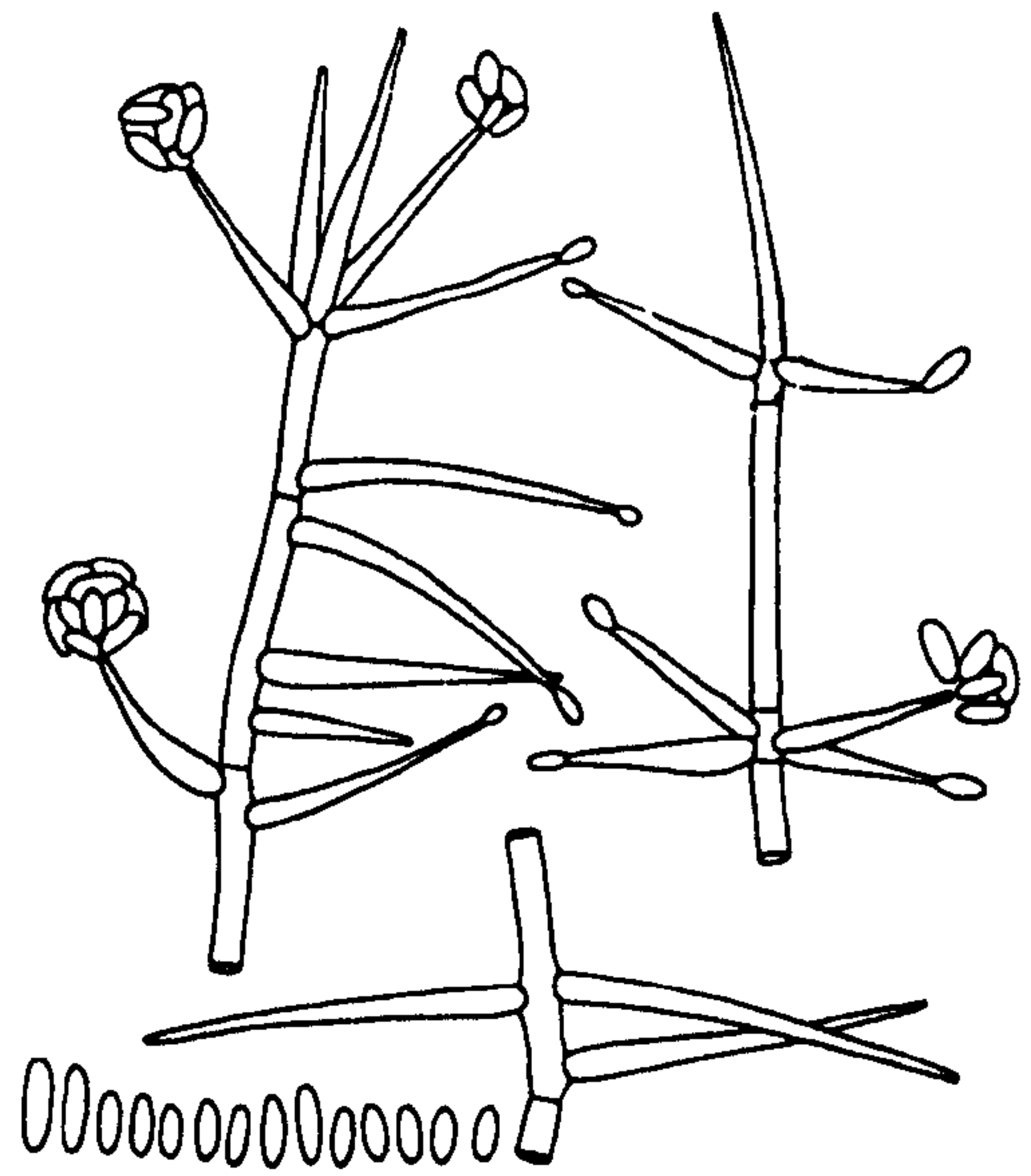
---

<sup>1</sup> Lutte Biologique contre des Locustes et les Sautereaux: an international collaborative research and implementation programme for the biological control of locusts and grasshoppers.

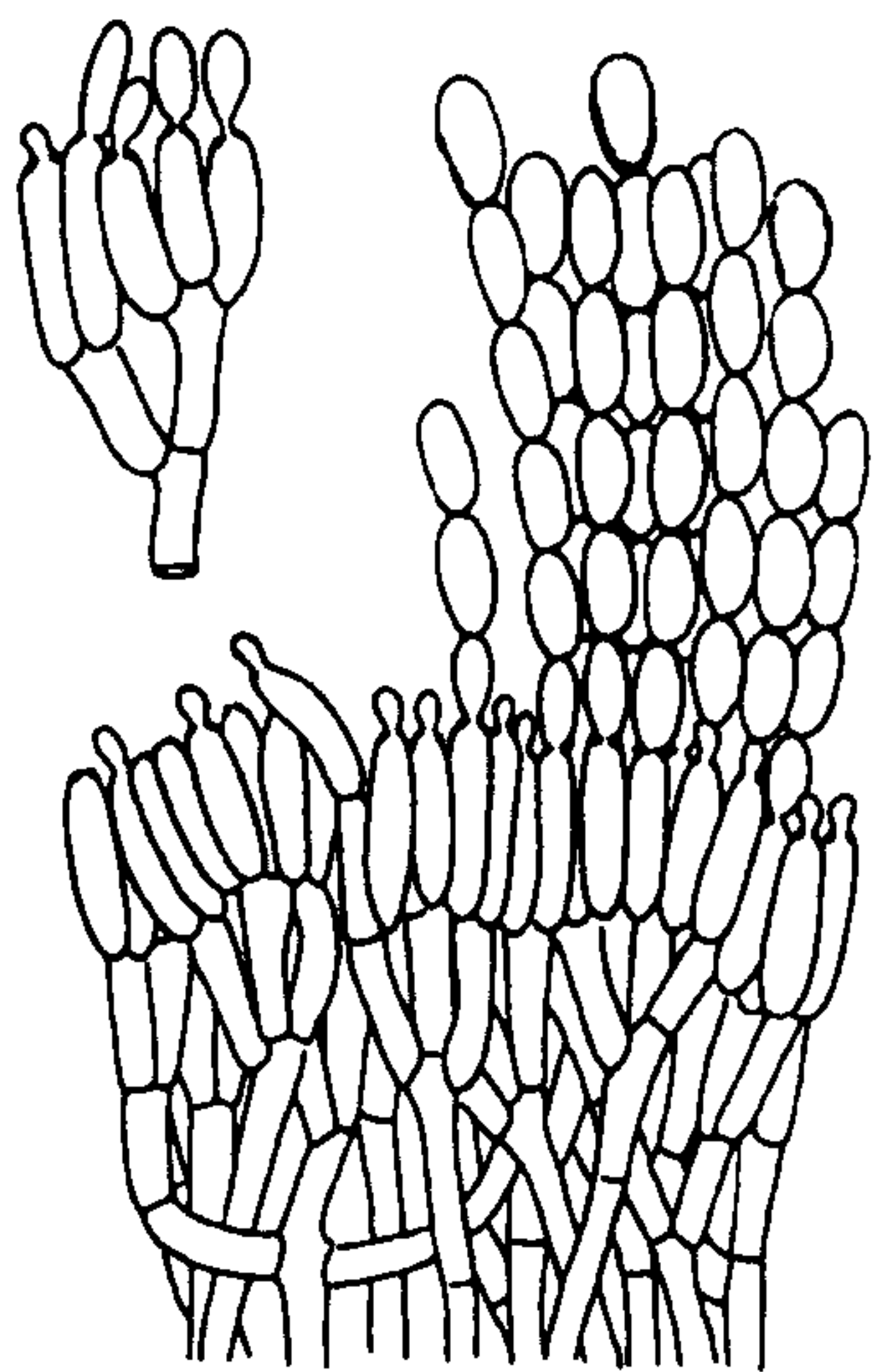




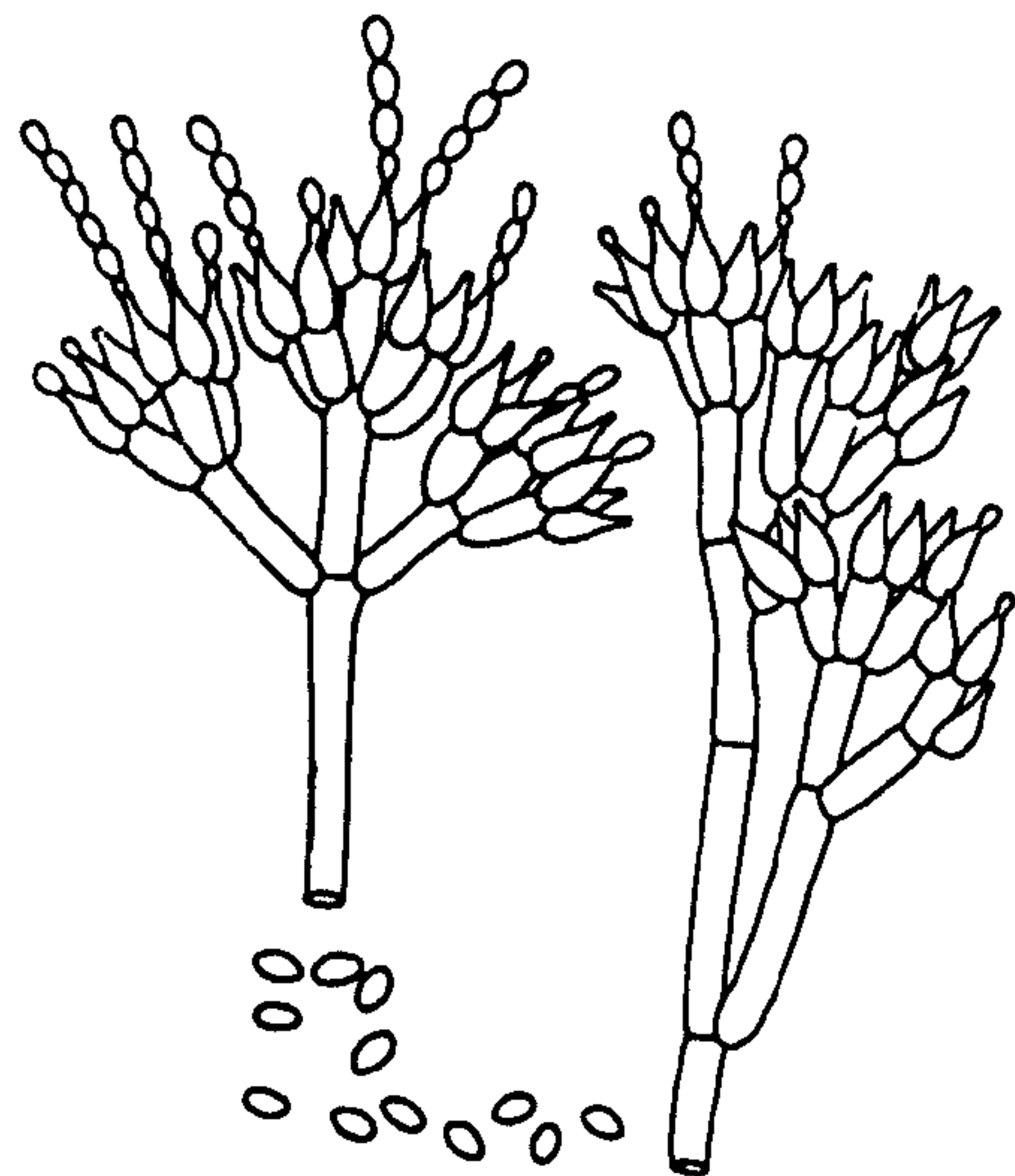
a) *Beauveria bassiana*



b) *Verticillium lecanii*



c) *Metarhizium anisopliae*



d) *Paecilomyces* spp.

**FIGURE 1.1** : Schematic drawings of morphological features of species of Hyphomycete fungi. [Reproduced from Samson, 1981]

slime drops. They range from short ovoid to elongate and cylindrical with a diameter of 1.0 -1.7  $\mu\text{m}$  and length of 2 - 10  $\mu\text{m}$ .

#### *1.3.2.3 Metarhizium anisopliae*

Affected hosts are often densely covered in mycelium. The conidiophores are usually broadly branched and densely intertwined. Conidia are aseptate, cylindrical or ovoid and form chains that are usually arranged in cylindrical columns or a solid mass of parallel chains (Figure 1.1c). Conidia range in colour from bright green to yellow-green, whilst hyphae tend to be white. Conidia of *M. anisopliae* var. *anisopliae* have a cylindrical conidium which is  $\geq 9 \mu\text{m}$  long, often with a slight central narrowing. *Metarhizium anisopliae* var. *majus* have conidia that are morphologically similar to those of *M. anisopliae* var. *anisopliae*, but conidia are larger, generally  $\leq 11 \mu\text{m}$ .

#### *1.3.2.4 Paecilomyces species*

Conidia are born singly or as groups on whorls on branches of conidiophores or on short side branches or in apical whorls (Figure 1.1d). Conidia are aseptate and range from colourless to pigmented but are never black, brown or olive. Conidia of *P. fumosoroseus* are long, ovoid and  $\leq 4 \mu\text{m}$  long. Conidia in mass are rosy-tan to smoky-pink in colour. Conidia of *P. farinosus* are generally short fusoid to lemon shaped and slightly smaller than those of *P. fumosoroseus*,  $\leq 3 \mu\text{m}$  long, coloured white to cream in mass.

### *1.3.3 Fungal infection processes*

Entomopathogenic fungi typically penetrate the insect host through the cuticle, rather than having to be ingested like other microbials. Fungi are therefore the only major pathogens known to infect insects with sucking mouthparts in the orders Hemiptera and Homoptera (Roberts & Humber, 1981). There have been reports of viral infections in aphid populations (Williamson, Von Wechmar & Rybicki, 1989), but these are rare and generally occur within insectary-reared colonies rather than field populations.

Once a conidium lands on the cuticle of an insect it will germinate and form a germ tube as long as temperature and humidity conditions are favourable. However, even under favourable temperature and humidity conditions, some fatty acids on insect cuticles may be fungistatic and fungal development may be inhibited (Smith & Grula, 1982). Cuticular components may also provide a nutritional role for stimulation and growth of the germ tubes of conidia, dependent on the species of fungus. *Beauveria bassiana*, for example, requires both a carbon and nitrogen source for stimulation and growth of the germ tube (Smith & Grula, 1981).

The germ tube then penetrates the insect cuticle. The Hyphomycete fungi demonstrate two methods of penetration; direct penetration of the cuticle by hyphae, as in *V. lecanii* and *B. bassiana* (Hughes & Gillespie, 1985), or the formation of an appressorium which produces a penetration peg such as in *M. anisopliae* (Zacharuk, 1970a,b). Having penetrated the host, the fungus proliferates within the insect haemocoel as cell-walled hyphal bodies (blastospores) or wall-less amoeboid protoplasts. The host is generally killed within three to fourteen days, although this may take longer; the precise time is dependent not only on the intrinsic activity of the fungal isolate, but also on the number of conidia applied, temperature conditions during the incubation period and host defences (Gillespie, 1988).

Some Hyphomycetes may induce death before extensive invasion of host tissues. This type of fungus-induced mortality has been attributed to the production of toxins. Both *M. anisopliae* and *B. bassiana* have been reported as producing an array of toxins (Roberts, 1980). Normally though, as long as there are high humidity conditions following death of the host, the fungus will emerge through the cuticle and sporulate on the cadaver. In many cases, this fungal outgrowth will initially occur at the intersegmental regions of the host where growth may also be most predominant. This provides a local source of inoculum for the infection of other hosts. However, if conditions are unfavourable, then the fungus can remain viable within the mummified cadaver for several months and will produce conidia when favourable conditions return (Ferron, 1981). Conidia may also be produced

within the host cadaver and it has been suggested that they are released when the host cadaver naturally breaks down (P. Shah, pers. comm.).

The Entomophthorales are generally specialised pathogens which are often difficult to culture *in vitro*. The Hyphomycetes, however, are able to infect a wide range of different hosts and are much easier to culture *in vitro*, making them ideal candidates for large scale production. The most successful examples of the use of entomopathogenic fungi for insect pest control have therefore involved fungi from the class Hyphomycetes and inundative biological control. This has generally been achieved by using single or multiple applications of large amounts of inoculum to promote the rapid development of an epizootic, often referred to as the “*mycoinsectide approach*” (Charnley, 1989).

The efficacy of a group of entomopathogenic Hyphomycete fungi against aphid pests and their interaction with other natural enemies and the abiotic environment form the basis of this Ph.D study.

#### ***1.3.4 Fungal epizootiology***

The most common epizootics in aphids are caused by entomophthoralean fungi. An epizootic is an “*unusually large number of cases of disease*” in a host population (Fuxa & Tanada, 1987). Therefore, a very small number of cases of disease may be termed an epizootic if no cases were expected. Long-term monitoring of diseases is important to establish when a disease becomes an epizootic. One way of doing this is to determine when an enzootic disease becomes epizootic. Whilst epizootics are sporadic and characterised by a sudden change in incidence, enzootics are characterised by low levels of disease over a long duration.

The change in prevalence of fungi within host populations, as with diseases in other organisms, relies on susceptibility of the host population to the disease and then efficient transmission within the population through contact between infected

and healthy hosts. All these stages in an epizootic may be affected by environmental and host factors.

Transmission may be either horizontal, from host to host (Canning, 1982), or vertical, from parent to progeny (Fine, 1975). Fungi are generally horizontally transmitted and this has been shown to be important for the transmission of Hyphomycete fungi in insects including aphids (Hall, 1981a), Colorado potato beetle (Long, Groden & Drummond, 2000) and grasshoppers and locusts (Thomas, Wood & Lomer, 1995).

Generally, an epizootic is more likely to develop at high host densities (Watanabe, 1987). High host densities may increase contact between individuals and hence pathogen transmission, as well as increasing individual stress due to crowding which in turn may make insects more susceptible to pathogen infection. In this way, pathogens act in a density-dependent manner, causing mortality in more hosts as host density increases.

Properties of the pathogen population will affect the development of an epizootic. Pathogens must be infective to the host, be able to survive and persist within the host environment and have the capacity to disperse and occur in high enough densities to initiate infection. Entomophthoralean fungi may produce resistant structures, such as resting spores, to persist within the environment but no similar structures are known to occur for the Hyphomycetes. Factors, such as the forcible discharge of conidia of Entomophthorales, ensure local dispersal and other factors, such as wind and rain, increase this dispersal (Hemmati, 1998).

Predators and parasitoids are able to act as carriers or vectors of conidia within host populations (Roy, 1997; Andreadis, 1987). Not only is the direct vectoring potential of a predator or parasitoid important, but the resulting movement of the host species when disturbed may also play an important role in development of an epizootic. Studies on the interactions between *Z. radicans* and two parasitoids, which attack the diamondback moth *Plutella xylostella* (L.), have shown that the presence of a foraging parasitoid increases the level of infection in *P. xylostella* larvae

by causing greater movement of the larvae in the vicinity of infected cadavers (Furlong & Pell, 1996). Similarly, the presence of a foraging ladybird increased the level of infection in pea aphids *A. pisum* by the fungus *E. neoaphidis* (Roy, 1997). Additionally, studies on the movement of aphids mediated by alarm pheromone have been shown to cause greater levels of *V. lecanii* infection within aphid populations (Hockland, Dawson, Griffiths, Marples, Pickett & Woodcock, 1986). Other behaviours, such as grooming, may remove conidia from individual hosts but transmit them to other, healthy hosts. The fungus *M. anisopliae* spread in healthy populations of the termite *Reticulitermes* sp. because of grooming activity between infected and healthy termites (Kramm, West & Rockenbach, 1982).

The environment may be very influential in epizootic development. It has been widely accepted that moisture is the most important environmental factor influencing the course of epizootics in aphid populations. Infection of the pea aphid *A. pisum* has been positively correlated to the average rainfall recorded 12 days prior to observation of the disease (Wilding, 1975). Missonier, Robert & Thoizon (1970) showed that an enzootic of *Entomophthora* sp. was maintained in an aphid population when RH was a minimum of 90% for at least eight hours per day but, to become epizootic, RH had to exceed 90% for ten hours per day and there had to be five hours of rain per day for three days.

Temperature may also affect the progression of disease epizootics. When temperature favours a quick generation time for the host such as aphids, but is above or below the optimum for the fungus, then the aphid population may still increase to damaging numbers. However, if temperature favours the fungus by allowing a short incubation period but reduces the speed of insect development, then an epizootic may develop.

#### **1.4 Arthropods as aphid biocontrol agents**

Arthropod natural enemies of aphids include parasitoids and predators such as lacewings, ladybirds, hoverflies, carabid and staphylinid beetles. In many years, this suite of natural enemies is able to exert enough pressure on aphid populations

to maintain numbers below an economic damage threshold. Two of these natural enemies, the generalist parasitoid *Praon volucre* (Halliday) and the seven-spot ladybird *Coccinella septempunctata* L. were used in this study as representatives of aphid arthropod natural enemies.

#### **1.4.1 Parasitoids**

There have been more than 400 aphid parasitoid species recorded (Stary, 1988) and these are important components of the natural enemy guild which helps control aphids in different crops. The grain aphid *S. avenae*, for example, is parasitised by several aphid parasitoids, particularly from the genus *Aphidius* (Powell, 1982). The parasitoid considered in the current study is the species *P. volucre* which is a generalist parasitoid species, commonly occurring in a range of habitats and attacking a wide range of aphid species.

Adult aphid parasitoids are solitary endoparasitoids which attack their host and lay a single egg within it. On hatching, the larva feeds on the host tissues internally and ultimately causes the death of the host (Polaszek, 1986). The skin of the dead aphid is attached to the substrate by the parasitoid larva and this is then called the aphid "mummy". The parasitoid pupates within the mummy and emerges as an adult, cutting a circular hole in the mummy. In the genus *Praon*, the larva spins a cocoon beneath the empty skin of the aphid in which to pupate.

Parasitoids are able to attack aphids at low densities in the early part of the growing season (Carter, McClean, Watt & Dixon, 1980). The ability of parasitoids to slow down initial aphid population growth rates, reduces the potential aphid population levels and increases the likelihood that other natural enemies will be able to control aphid populations (Wratten & Powell, 1991).

#### **1.4.2 Ladybirds**

The seven-spot ladybird *C. septempunctata* (Figure 1.2) is the most common coccinellid species found in Europe (Majerus, 1994). Both larvae and adults are

voracious aphid predators (Bodenheimer, 1943). Ladybird numbers generally do not synchronise with initial outbreaks of aphids which are recorded early in the season (Coderre, 1988). This has largely been attributed to their slow reproductive rate in comparison to the much faster reproduction rates of aphids.

Ladybirds overwinter in woodlands (Zhou & Carter, 1992) and emerge from these sites in spring to disperse to non-crop habitats in late April (Zhou, Carter & Powell, 1994). Subsequently, ladybirds then move into agricultural crops. Eggs are laid in crops near aphid colonies to coincide with seasonal peaks of aphid availability on host plants (Dixon, 1970; Wratten, 1973; Wright & Laing, 1980). Eggs are generally laid as aphid populations are starting to increase in density and therefore cues, such as the presence of honeydew and/or low aphid density, stimulate oviposition (Hemptinne, Dixon & Coffin, 1992; Evans & Dixon, 1986).

First instar larvae feed on the egg case from which they emerged, before dispersing and foraging in aphid colonies. Pupation takes place within the crop and adults emerge in early June, although developmental times are dependent on both prey availability and temperature. These adults feed until mid to late September. Coccinellids aggregate in areas of high prey density and disperse from those of low density (Honěk, 1985; Coderre, 1988); these aggregations at the population level in areas of high aphid density may be large, even though individuals only respond weakly to aphid density (Ives, Kareiva & Perry, 1993). In mid to late September, adults move to overwintering sites where they remain until spring. There is only one generation of new adults in a season and the majority of new adults need a period of overwintering to reach sexual maturity (Majerus, 1994).

The use of ladybirds in classical and augmentative biological control has been limited by problems with commercially culturing the species (Gurney & Hussey 1970). One of the most successful examples of classical control however, was the release of the vedalia ladybird *R. cardinalis* to control cottony cushion scale *I. purchasi* (Van Emden, 1989). Additionally, very successful programmes of augmentative biological control using the convergent ladybird *Hippodamia convergens* Guerin-Meneville have been instigated in the United States. At the end





**FIGURE 1.2 :** *Coccinella septempunctata* (the 7-spot ladybird) feeding on *Acyrthosiphon pisum* (the pea aphid).

of the breeding season, large numbers of ladybirds move from lowland breeding sites to mountainous regions. These winter groups may comprise millions of individuals which are collected, bottled and stored at temperatures just above freezing. In spring, bottles of ladybirds are sold to growers in niche markets, such as market gardeners and organic farmers (Majerus, 1994). However, as individuals often disperse following release, this control is most effective in contained environments such as the glasshouse.

These arthropod predators are obviously an important component species in the suite of natural enemies that attack aphid pests. It is likely that conservation biological control will prove to be the most useful method of biological control utilising coccinellid predators in agricultural cropping systems.

### **1.5 Hyphomycete fungi as natural aphid biocontrol agents**

*Verticillium lecanii* is the only Hyphomycete fungus to be found naturally causing epizootics in aphid populations and has been recorded from many geographically distinct areas (Milner, 1997). Scale insects in the tropics and semi-tropics are also commonly infected with *V. lecanii*. Other insects, such as thrips, mites and whitefly, are also susceptible. *Verticillium lecanii* has been found infecting aphid species, such as the cardamom aphid *Pentalonia nigronervosa* f. *caladii* van der Goot (Mathew, Venugopal & Saju, 1999), several species of cereal aphid (Ozino, Arzone & Alma, 1988; Feng, Johnson & Kish, 1990a), the peach-potato aphid *M. persicae* (Kish, Majchrowicz & Biever, 1994) and the melon aphid *Aphis gossypii* Glover (Sanchez-Pena, 1993). Only recently, the first record of *V. lecanii* from aphid hosts in South Africa was made from a survey of entomopathogenic fungi in 16 species of aphid (Hatting, Humber, Poprawski & Miller, 1999).

There are fewer reports of *B. bassiana* and *Paecilomyces* spp. naturally infecting aphids and these infections are not recorded as being epizootic in aphid populations. *Beauveria bassiana* has been recorded from the peach potato aphid *M. persicae* (Kish *et al.*, 1994) and six species of cereal aphid, although the majority were from the potato aphid *Macrosiphum euphorbiae* Thomas (Feng *et al.*, 1990a).

Prior to this, there is only one other report of *B. bassiana* infecting an aphid; the pea aphid *A. pisum* (Pavliushin, 1983).

Generally, levels of Hyphomycete infection are low in sampled aphid populations. From thousands of cereal aphids collected in the field, less than 1% were found to have natural infections with *B. bassiana* (Feng & Johnson, 1990). *Beauveria bassiana* was identified from 33 cadavers and *V. lecanii* from 50 cadavers from a total of 10 737 cadavers investigated by Feng *et al.*, (1990a). In comparison, infection levels of *E. neoaphidis* have been recorded as high as 73.5% in cabbage aphid *Brevicoryne brassicae* (L.) (Sivcev, 1992) and 43.9% of sampled cereal aphids (Feng *et al.*, 1990a).

The Hyphomycete fungus *Metarhizium* sp. has only ever been recorded naturally infecting aphids in populations of the lettuce root aphid *Pemphigus bursarius* (= *trehernei*) (L.) in Norfolk, UK (Foster, 1975). The isolates have been treated as an undescribed variety of *M. flavoviride* (Milner, 1997).

## **1.6 Mycoinsecticides**

### ***1.6.1 Historical Background***

Historically, the potential for using fungi as insect biocontrol agents has been known since 1834 when Agostino Bassi infected the silkworm *Bombyx mori* (L.) with *B. bassiana* (Glare & Milner, 1991; Hall & Papierok, 1982). In 1879, Metschnikoff conducted experiments using *M. anisopliae* against larvae of the wheat cockchafer, *Anisoplia austriaca* (Hbst.) and in 1888, Krassilstichik used this fungus against the sugar beet curculio, *Cleonus punctiventris* (Germar.). These were the first recorded practical attempts at using fungi as biological control agents.

Following these first experiments, there were several unsuccessful attempts at introducing fungi into biological control programmes and there was little interest in developing fungi as microbial insecticides (mycoinsecticides). Whilst the

specific requirements for fungal infection of host insects were relatively well understood, the impact of environmental factors on the epizootiology of fungal infections in the field were less well researched. The emphasis in research was focused on other methods of biological control; there was little research conducted from the late nineteenth century (until the 1960's) on basic or applied aspects of using fungi as biological control agents. There has, however, been a resurgence in interest in this area over the past 30 years, largely due to the increase in problems associated with chemicals.

Reports have estimated that the world market for pesticides in 1995 was approximately \$29 billion with biopesticides representing a market share of \$380 million (Menn, 1997). However, the growth rate for biopesticides has been forecast as 10 - 15% for the period 1997 - 2007 (Menn, 1996). The largest share of the biopesticides market is currently based on the bacterium *Bacillus thuringiensis* (Bt) and related products. Most of these have been developed in the United States for the control of cotton pests. The European markets are somewhat different from world markets, with a greater proportion of crop protection efforts devoted to plant pathogens as opposed to insect pests (Butt, Harris & Powell, 1999).

### ***1.6.2 Successful control programmes***

The following reviews are concentrated on the species of fungus investigated in this study rather than microbial pathogens in general for insect pest control. The reports on these pathogens are intended to indicate the crops and pests against which these fungal species have been successful as control agents.

For information on the successful introduction of other fungal pathogens into insect control programmes the reader is referred to Ignoffo & Mandava (1988) and Ferron, Fargues and Riba (1991). Recent developments and future prospects in microbial control of pests in general have been reviewed by Lacey & Goettel (1995), whilst the use of fungal pathogens specifically against aphids has recently been discussed by Milner (1997). Current information on the range of registered

pest control products based on fungi is available in publications by Copping (1998) and Shah & Goettel (1999).

#### 1.6.2.1 *Beauveria bassiana*

*Beauveria bassiana* has been used on a large scale both in China and in the former Soviet Union as a mycoinsecticide. In China, preparations have been used against the European corn borer *Ostrinia nubilalis* Hubner (Chiang & Huffaker, 1976), pine caterpillars such as *Dendrolimus punctatus* Walker and green leafhoppers *Nephotettix* spp. (Charnley, 1989). In the former Soviet Union, *B. bassiana* was developed as the product "Boverin" for large-scale control of the Colorado potato beetle *Leptinotarsa decemlineata* (Say) and to a lesser extent, the codling moth *Cydia pomonella* (L.) (Ferron, 1981). Application of Boverin made with a reduced dosage of chemical insecticides successfully reduced spring populations of *C. pomonella* when summer generations of the moth were treated (Ferron, 1981). Field trials in the former Soviet Union showed that application of Boverin with insecticides provided adequate control of *L. decemlineata* under variable climatic conditions (Ferron, 1981).

The potential of *B. bassiana* for controlling *L. decemlineata* has been evaluated in the United States since 1980 (Ferron *et al.*, 1991). Populations of pupae of *L. decemlineata* were reduced when *B. bassiana* was applied to soil (Watt & Lebrun, 1984). More recently, the Mycotech Corporation in the United States has obtained registration for *B. bassiana* strain GHA for the control of several pests including thrips, aphids, whitefly and mealybugs (Bradley, Lord, Jaronski, Gill, Dreves & Murphy, 1998). Products are used in vegetables and ornamentals under the tradenames Botanigard<sup>®</sup>, Mycotrol<sup>®</sup> and Cornguard<sup>®</sup>. Other companies, such as Natural Plant Protection (NPP) and Troy Biosciences, have *B. bassiana* products aimed at corn borers and a range of soft-bodied coleopteran, heteropteran and homopteran pests (Copping, 1998).

*Beauveria brongniartii* has been used extensively in Switzerland to control swarms of cockchafers *Melolontha melolontha* (L.) (Keller, 1982). *Beauveria brongniartii*

is marketed as the products Ago Biocontrol Beauveria 50 (Ago Biocontrol) and Engerlingspilz (Andermatt Biocontrol AG).

#### 1.6.2.2 *Verticillium lecanii*

An isolate of *V. lecanii* was introduced in 1981 for control of aphids on chrysanthemums as the product "Vertalec<sup>®</sup>" and in 1982, another isolate was introduced as "Mycotal<sup>®</sup>" for the control of whitefly on cucumbers and tomatoes. Despite being temporarily discontinued in 1986 by the original producer Tate and Lyle, both products are still available and now manufactured by Koppert Biological Systems B.V. Vertalec<sup>®</sup> is produced by liquid fermentation as blastospores which are formulated to improve stability and these are applied as a spray diluted to  $10^6$  blastospores  $\text{ml}^{-1}$ . The market has been limited by competition with effective chemical insecticides and the requirement of the fungus for high relative humidity for host infection (Milner & Lutton, 1986). These factors have been suggested to have contributed to the original withdrawal of the product (Charnley, 1989).

#### 1.6.2.3 *Metarhizium anisopliae*

*Metarhizium anisopliae* var. *major* has been used successfully to control the rhinoceros beetle *Oryctes rhinoceros* (L.) in Fiji, Tonga and Western Samoa (Latch & Falloon, 1976). A formulation of conidia of *M. anisopliae* called "Metaquino" was used in Brazil to control the sugarcane spittle bug *Mahanarva posticata* (Stal) (Ferron, 1981). Products are also available for the control of red-headed cockchafer (BioGreen<sup>®</sup> granules, Bio-Care Technology Pty. Limited), vine weevil (BIO 1020, Bayer AG), termites (Bioblast, Ecoscience and Terminex) and a range of lepidopteran, coleopteran, homopteran and orthopteran pests (Ago Biocontrol Metarhizium 50, Ago Biocontrol).

Recently, the isolate IMI 330189 *M. anisopliae* var. *acridum* was registered as the product "Green Muscle" (International Institute of Biological Control) for the control of locusts and grasshoppers (Neethling & Dent, 1998).

conditions of low relative humidity are often suggested to be the negative influence acting on development of the pathogen (James, Schaffer, Croft & Lighthart, 1995). The successful development of epizootics of Entomophthoralean fungi that correlate with periods of rainfall or high relative humidity is thought to indicate that these favourable conditions are needed for a fungal pathogen to infect hosts under field conditions (Wilding, 1975; Missionier *et al.*, 1970).

Whilst the impact of macroclimate on the epizootiology of fungi is well recognised, there has been little research on the influence of the microclimate within the crop canopy, not only on applied mycoinsecticides but also on indigenous entomopathogens. Favourable microclimates within a dense canopy may facilitate a higher level of humidity than that of the ambient air or have areas of suitable temperature or protection from solar radiation for development of fungal pathogens (Fuxa & Tanada, 1987). By identifying areas of the crop that support pest insects and are more suitable for fungal development, it may be possible to target applications of mycoinsecticides to these areas and thus improve the levels of pest control achieved under field conditions.

The aims of this study were to investigate an ecologically sound integrated approach to selecting potential mycoinsecticides based not only on their ability to kill the target host, but also on their ability to do so over the range of abiotic conditions that may be experienced in the field and with little impact on non-target natural enemies. It is this approach that has been termed a biologically rational or "biorational" approach to selecting mycoinsecticides. A useful discussion of the need to adopt a more ecological approach towards developments in IPM is given in Thomas (1999), drawing on examples from the LUBILOSA project and the integration of biological control and host-plant resistance.

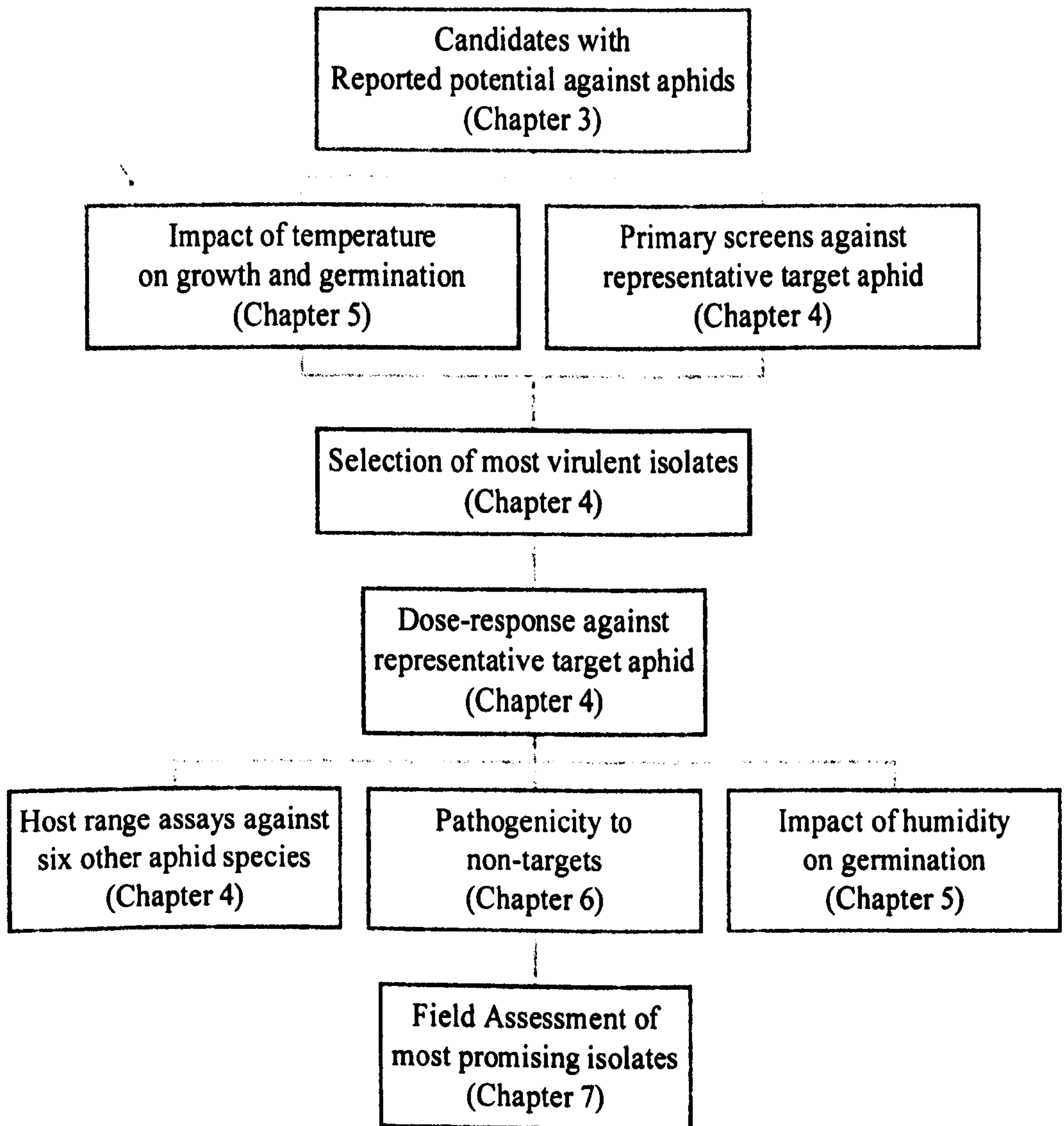
Milner (1997) states that an ideal bioinsecticide against aphids would satisfy the following conditions:

1. cheap to mass produce,
2. easy to store,
3. effective over a wide range of temperature and humidity conditions,
4. provide rapid kill at economical doses,
5. wide host range within aphids,
6. minimal non-target effect especially on parasites and predators of aphids.

Additionally, an ideal bioinsecticide would also be compatible with other cropping practices, including pesticides.

The aim of this Ph.D. study is to investigate the possibility of using selection criteria based on points three to six, as a way of selecting isolates of fungi as potential mycoinsecticides for the control of aphids in arable crops in the UK. The approach taken still emphasises virulence to the host insect as an important aspect of the selection procedure. However, it also takes into account the effect of abiotic factors on the ability of isolates to infect hosts, both under laboratory and field conditions. Additionally, the impact of isolates on representative natural enemies, such as ladybirds, parasitoids and other naturally occurring fungi, is also considered. A plan of the biorational selection procedure indicates how the thesis is structured to answer the aims set out above (Figure 1.3).





**FIGURE 1.3 :** Stepwise, biorational selection procedure for Hyphomycete fungi against aphid pests.

---

## CHAPTER 2: GENERAL MATERIALS AND METHODS

---

### 2.1 Aphid Cultures

All aphid cultures were maintained in the Rothamsted insectary facility in ventilated perspex cages (0.5m<sup>2</sup> x 1m) at a constant temperature of 18°C and a 16 hour photoperiod (16 light: 8 dark). Individual species of aphids were maintained using different methods. None of the aphid cultures originated from single clones.

#### 2.1.1 Legume Aphids: *Acyrtosiphon pisum* and *Aphis fabae*

Pea aphid, *Acyrtosiphon pisum*, and bean aphid, *Aphis fabae*, colonies have been cultured continuously at Rothamsted for at least ten years and seven to eight years respectively. The aphids that were used to establish these colonies were collected from bean crops on Rothamsted farm. Both species of aphid were reared on three to four weeks old dwarf broad bean plants (*Vicia faba*, var. "The Sutton").

Plants in the aphid cultures were changed regularly (at least every seven days) as aphid numbers rapidly increased under insectary conditions. *Acyrtosiphon pisum* were gently dislodged from plants and a small sample (approximately 200 individuals of mixed instar) were transferred to fresh plants. Six to nine pots containing five plants per pot were placed in each cage. *Aphis fabae* were transferred to fresh plants by cutting an infested pair of leaflets or a small growing tip from a plant and placing it on an uninfested plant. Once these leaves wilted, the aphids moved onto the fresh plant. *Aphis fabae* aphids were difficult to move as they did not withdraw their stylets readily from the feeding site so moving infested leaves and allowing aphids to transfer to new leaves ensured the minimal amount of damage to individuals.

#### 2.1.2 Cereal Aphids: *Sitobion avenae*, *Metopolophium dirhodum* and *Rhopalosiphum padi*

The colonies of *S. avenae* and *M. dirhodum* were established from aphids collected on Rothamsted farm (Appendix 1). Both *S. avenae* and *M. dirhodum* were

maintained on one to two weeks old winter wheat plants (*Triticum aestivum* L., cultivar Beaufort). Cultures of both species of aphid were changed weekly by dislodging aphids from plants and transferring a small sample (approximately 200 individuals of mixed instar) to uninfested fresh plants. The population of *S. avenae* was kept high in culture to ensure alate aphids were produced which were subsequently used for producing aphids of known age.

The *R. padi* colony has been cultured continuously for at least six years at Rothamsted. Aphids were maintained on one to two week old barley plants (*Hordeum vulgare* var. "Puffin"). Care was taken when working with *R. padi* as this species tended to contaminate other aphid cultures; as a sanitary measure, *R. padi* were always the last species to be handled. *Rhopalosiphum padi* were generally more waxy than the other cereal aphids so dusting the collecting tray with a light coating of non-perfumed talcum powder made the aphids easier to collect.

### **2.1.3 *Myzus persicae***

The *M. persicae* colony was established from an insecticide susceptible clone (Appendix 1) and was maintained on three to four weeks old Chinese cabbage (*Brassica chinensis* L., var. *pekinensis*, cultivar "Tip Top"). Aphids were transferred in a similar manner to *A. fabae* by placing a small piece of leaf from an infested plant onto a clean, uninfested plant.

## **2.2 Production of leaves in water agar**

The appropriate plant material was chosen for the species of aphid that was being reared. Approximately 10ml of 2% water agar was poured into sterile Petri dishes (9cm diameter; Sterilin, Bibby Sterilin Ltd.) and leaves were embedded into the agar once it had cooled, but had not set, with the upper leaf surface in contact with the agar.

Bean leaves were used as young pairs of leaflets or as older single leaves. *Aphis fabae* tended to move less often on slightly older, single leaves. Wheat and barley

leaves were used as young single leaves or as larger leaves cut into sections. Leaf discs were cut from Chinese cabbage using a large cork borer (number 18, 2.5cm diameter) in preliminary experiments. In later experiments, a single, large disc was cut using a biscuit cutter (6cm diameter). Leaves set in agar as described would generally last for two to three days at 23°C and for five days or more at 10°C, when used to maintain aphids.

### **2.3 Rearing apterous adult aphids of known age**

All aphids of known age were reared in the insectary at 18°C and 16 hour photoperiod. Apterous adult aphids were harvested from the insectary. *Aphis fabae* and *M. persicae* were harvested by cutting bean stems or Chinese cabbage leaves with aphids on and placing the plant parts in large, plastic, ventilated boxes (24 x 24 x 12cm). As the plants wilted over a period of three to four hours, adult aphids moved off the stems or leaves and onto the lid of the box where they were easily picked up individually using a fine camel hair paintbrush. *Metopolophium dirhodum* and *R. padi* were harvested by dislodging aphids from plants. *Acyrtosiphon pisum* were gently sieved through a metal soil sieve (mesh size 12) leaving only adult and fourth instar aphids in the sieve. Alate *S. avenae* were collected from the insectary culture using an electric insect pooter. Alate *S. avenae* were used to produce aphids of known age as apterous adults tended to produce nymphs which gave a mixture of apterous and alate adults; alate aphids produced nymphs which mainly developed as apterous adults.

Adult aphids collected from the insectary were transferred to Petri dishes which contained leaves set in 2% water agar of the appropriate host plant for each aphid species. The number of aphids placed in each dish and the number of dishes used was different for the different species of aphid (Table 2.1). The dishes were inverted and adults were allowed to produce nymphs for 24 hours at 18°C in a 16 hour photoperiod.

Adults were then removed using a fine pair of Storkbill forceps (Watkins and Doncaster) leaving the nymphs that had been produced overnight on the leaves.

Preliminary investigations showed that the number of nymphs produced per adult over 24 hours depended on the species of aphid and the environmental conditions. Generally, the cereal aphids produced fewer nymphs compared to the other aphid species.

**TABLE 2.1** : Requirements for producing aphids of known age for each of six different aphid species

Aphid Species	No. of adults per dish	Number of Petri dishes	No. of nymphs produced	Developmental Period (days)
<i>A. fabae</i> <sup>1</sup>	10 - 12	20	1 500	7 - 8
<i>A. pisum</i> <sup>1</sup>	10 - 12	10	850	7 - 8
<i>S. avenae</i> <sup>2</sup>	15 - 20	20	550	10 - 11
<i>R. padi</i> <sup>1</sup>	10 - 12	20	1 500	7 - 8
<i>M. dirhodum</i> <sup>1</sup>	10 - 12	20	350	10 - 11
<i>M. persicae</i> <sup>1</sup>	10 - 12	20	1 000	7 - 8

<sup>1</sup> Apterous adult aphids

<sup>2</sup> Alate adult aphids

Nymphs were transferred to clean, whole plants in the insectary by peeling leaves from the agar and placing them on clean plants. The developmental period from nymph to adult differed between the aphid species (Table 2.1). Aphids were used as one to three days old adults for experiments (i.e. one to three days after they had started to produce nymphs).

#### **2.4 Culturing the 7-spot ladybird, *Coccinella septempunctata***

Ladybirds were reared in the Rothamsted insectary at a constant temperature of 18°C and a 16 hour photoperiod. Adult ladybirds that had recently emerged and older adults from the previous year were collected from fields around Rothamsted in the summers 1996 - 1999. These adults were placed in insectary cages containing bean plants and *A. pisum* as prey. The older adults were maintained as the breeding colony in the insectary with *A. pisum* as a source of food. The young adults were stored at 4°C for at least one month to simulate a winter hibernation period, necessary for the development of sexual maturity in the females. These

ladybirds were stored in groups of twenty in Petri dishes which contained a small piece of tissue folded in a fan shape to provide gaps that ladybirds could squeeze into. Approximately 20-30 adults were maintained in the insectary for breeding and adults were brought out of cold storage when the colony needed to be supplemented. Adults survived cold storage for up to six months but were generally used up to three months after being stored as the number surviving after this period started to decline.

Eggs were usually laid on plant pots or occasionally on the sides of the cage. Plant pots were removed to prevent cannibalism and eggs on the side of the cage were protected with a Petri dish held in place with adhesive tape. At 18°C, eggs hatched four days after being laid. First instar larvae were fed as a group with a mixture of instars of *A. pisum* in Petri dishes (9cm Petri dish with a 9cm piece of filter paper in the base). Second instar larvae were transferred three to four days later using a camel hair paintbrush, in groups of three or four individuals, to separate Petri dishes. Larvae were maintained in these dishes and fed with *A. pisum* every two days until pupation. Under insectary conditions, developmental time from egg to pupa took 21 - 23 days and a further five to six days before adults emerged from pupae. Young adults were transferred to an insectary cage and maintained in the same way as the breeding colony. They were used for experiments when they were two to four weeks old adults.

## **2.5 Culturing the parasitoid *Praon volucre***

Parasitoids were reared in the Rothamsted insectary at a constant temperature of 18°C and a 16 hour photoperiod. Parasitoids were field collected in 1996 and subsequently have been cultured on *A. pisum* and *S. avenae* (Appendix 1). To set up cultures for this study, approximately 50 "mummies" (cadavers of aphid hosts containing parasitoid larvae) were placed in a cage containing high numbers of either *A. pisum* or *S. avenae*. Emerging adults were allowed to oviposit freely and aphid numbers were supplemented as necessary over a period of two weeks. After approximately one week, most of the adult parasitoids died as there was no source of food provided and many mummies were visible on the aphid host plants. The

culture was changed every two weeks with approximately 50 mummies being returned to fresh plants and aphid colonies. *Praon volucre* is a solitary endoparasitoid so mummies only contained a single larva, making it relatively easy to balance the numbers of emerging adults within the culture.

The male and female sex ratios had to be monitored every three to four months to ensure that the number of males to females was maintained as a 50:50 proportion. This ensured that female parasitoids did not reproduce parthenogenetically as this resulted in all male offspring. Maintaining high numbers of parasitoids in the colony also helped to prevent this.

Parasitoids were harvested for experiments as mummies by gently removing individuals from leaves using a fine pair of Storkbill forceps. Adult parasitoids emerged over the following week. It was too time consuming and difficult to rear more accurately aged individuals for experiments because of the high number of individuals required.

## **2.6 Fungal isolates**

For the purposes of this study, a fungal isolate is defined following the definition of Hawksworth, Kirk, Sutton & Pegler (1995) as "*the first single-spore or pure isolation of a fungus from any place*".

### **2.6.1 Collection**

Isolates were supplied by; the United States Department of Agriculture (USDA) Agricultural Research Service Collection of Entomopathogenic fungi (ARSEF), Ithaca, New York; the Danish Pest Infestation Laboratory, Skovbrynet, Denmark; the Federal Biological Research Centre for Agriculture and Forestry, Darmstadt, Germany and Horticulture Research International (HRI), Wellesbourne, UK. All isolates had reported potential against aphids either in the literature or by personal communication and many were originally isolated from aphids (Table 2.2).

TABLE 2.2 : Culture collection at IACR-Rothamsted (UK) of isolates of the hyphomycete fungi *Beauveria bassiana*, *Metarhizium anisopliae*, *Verticillium lecanii* and *Paecilomyces* spp. that were selected as likely mycoinsecticide candidates with reported potential against aphids.

Species	Isolate	Host or source	Country
<i>B. bassiana</i>	ARSEF2879	<i>Diuraphis noxia</i> (Homoptera: Aphididae)	USA <sup>a</sup>
"	Z195	<i>Sitona lineatus</i> (Coleoptera: Curculionidae)	Denmark <sup>b</sup>
"	Z135	<i>Ips typographus</i> (Coleoptera: Nitidulidae)	Germany <sup>c</sup>
"	Z139	Unknown Product	China <sup>c</sup>
"	GHA <sup>d</sup>	Unknown	Unknown
<i>V. lecanii</i>	ARSEF2859	<i>Sitobion avenae</i> (Homoptera: Aphididae)	USA <sup>a</sup>
"	HRI 1.72	Original single spore isolate Vertalec <sup>e</sup>	
"	T80	<i>Alphitobius diaperinus</i> (Coleoptera: Tenebrionidae) <sup>e</sup>	Denmark <sup>b</sup>
"	T25	<i>Thrips</i> (Thysanoptera: Thripidae)	Germany <sup>c</sup>
"	T26	<i>Synanthedon myopaeformis</i> (Lepidoptera: Sesiidae)	Germany <sup>c</sup>
<i>Acremonium</i> spp.	TT5	<i>Thrips tabaci</i> (Thysanoptera: Thripidae)	Denmark <sup>b</sup>
<i>P. fumosoroseus</i>	ARSEF3458	<i>Myzus persicae</i> (Homoptera: Aphididae)	Unknown <sup>a</sup>
"	ARSEF4461	<i>Diuraphis noxia</i> (Homoptera: Aphididae) <sup>f</sup>	USA <sup>a</sup>
"	ARSEF4491	<i>Bemisia tabaci</i> (Homoptera: Aphididae)	India <sup>a</sup>
"	T314	Soil <sup>g</sup>	Denmark <sup>b</sup>
"	Z4	<i>Cydia pomonella</i> (Lepidoptera: Tortricidae)	Germany <sup>c</sup>
"	Z11	<i>Melolontha melolontha</i> (Coleoptera: Scarabaeidae)	Switzerland <sup>c</sup>
<i>P. farinosus</i>	T229	<i>Physokermes helichrysi</i> (Homoptera: Coccoidea)	Denmark <sup>b</sup>
<i>M. anisopliae</i>	T130	<i>Agrotis segetum</i> (Lepidoptera: Noctuidae)	Denmark <sup>b</sup>
"	Z43	<i>Cydia pomonella</i> (Lepidoptera: Tortricidae)	Austria <sup>c</sup>
"	Z143	<i>Tipula paludosa</i> (Diptera: Tipulidae)	Germany <sup>f</sup>

<sup>a</sup>Obtained from the USDA Agricultural Research Service Collection of Entomopathogenic fungi (ARSEF), Ithaca, New York.

<sup>b</sup>Kindly supplied by Tove Steenberg, Danish Pest Infestation Laboratory, Denmark.

<sup>c</sup>Kindly supplied by Gisbert Zimmermann, Federal Biological Research Centre for Agriculture and Forestry, Institute for Biological Control, Darmstadt, Germany.

<sup>d</sup>Mycotech (Butte, MT) strain GHA isolated from Mycotrol<sup>®</sup>WP, kindly supplied for research purposes by John Vandenberg, USDA ARS, Ithaca, New York.

<sup>e</sup>Strain 449 (original host: *Dreyfusia normanniana* (Homoptera: Adelgidae) from Denmark) passed through *Alphitobius diaperinus* (Coleoptera: Tenebrionidae) larva.

<sup>f</sup>Single spore isolate from formulated ARSEF3699 (original host: *Bemisia tabaci* (Homoptera: Aphididae) from India) passed through *Diuraphis noxia* (Homoptera: Aphididae).

<sup>g</sup>Isolated from soil using *Galleria mellonella* (Lepidoptera: Pyrellidae) larvae as insect bait.

NOTE: numerical coding for all isolates (except ARSEF isolates) is as provided from the donator and has been pre-fixed with a single letter to identify the source



### **2.6.2 Storage**

Isolates were received as mycelial cultures on either sabouraud dextrose agar (SDA) or SDA supplemented with 1% yeast (SDAY) as first subcultures. Mycotech strain GHA was isolated from a sample of the formulated product, Mycotrol<sup>®</sup> WP (kindly supplied by Dr. J. D. Vandenberg), by streaking the powder onto Oatmeal Dodine Agar (ODA) and then subculturing from this onto SDA. ODA is a selective medium for the isolation of hyphomycete fungi (Appendix 2), particularly *Metarhizium* spp. and *Beauveria* spp., and this allowed separation of the fungal strain GHA from the formulation component of Mycotrol<sup>®</sup> WP. All isolates were subsequently stored as a culture collection at IACR-Rothamsted, Harpenden, England.

Fungi were stored at -86°C in cryovials (System 100 Cryogenic vials (1.5ml), Nalgene<sup>®</sup>) in 10% glycerol (v/v) as a cryoprotectant to help prevent the formation of ice crystals during freezing, storage and thawing of cultures. All procedures were carried out in a laminar flow hood using sterile methods. All equipment was sterilised in an autoclave at 121°C and 15 p.s.i. (pressure, in pounds per square inch) for 20 minutes. A cork borer (size 2, diameter 5mm) was used to cut “plugs” of fungus from culture plates. If isolates were received on slopes of media in tubes, a piece of tungsten wire bent at a right angle was used to cut small pieces of fungus in the tube. Two or three plugs of fungus were placed in each vial which contained approximately 1ml of 10% sterile glycerol solution. Tubes were gently shaken to ensure the plugs were covered with the glycerol solution, screwed shut and placed directly in the -86°C freezer.

Vials were stored in a cryobox (System 100 Cryobox, Nalgene<sup>®</sup>) which had a permanent numerical grid system printed on the lid, allowing an inventory to be kept of all vials in storage. Isolates did not lose viability over the duration of the study. Regular subcultures were made and isolates stored to ensure there was always a suitable supply of fungal material for experiments. All fungi used in experiments were either third or fourth subculture from the original sample received at IACR-Rothamsted.

### **2.6.3 Subculturing fungi**

A single vial of each isolate to be subcultured was taken out of the freezer and allowed to defrost at room temperature for at least ten to fifteen minutes. All procedures were carried out aseptically in a laminar flow bench. The plugs of fungus were macerated in the vial, using the solid end of a wire holder to form a suspension. Three or four drops (approximately 0.15ml) of this suspension were pipetted onto each of eight plates of sterile SDA (10ml SDA in 9cm Petri dishes). A sterile inoculation loop (5.05mm diameter, volume = 1/100ml) was used to streak the drops of fungal suspension across the plate. The plates were then sealed with Parafilm (Parafilm<sup>®</sup>M, American National Can.) and stored at 25°C in darkness.

After seven days, the plates were opened in the laminar flow and sterile air was allowed to pass over each plate for approximately 30 seconds before they were re-sealed with Parafilm and placed back in the incubator. Preliminary investigations showed that a small slit made in the Parafilm at this time allowed free exchange of air and encouraged large numbers of conidia to be produced quickly. Conidia were harvested after a further seven days.

### **2.6.4 Spore harvesting**

All procedures were carried out aseptically in a laminar flow bench. In general, conidia harvested from eight culture plates and suspended in 20ml of 0.03% Tween 80 (polyoxyethylenesorbitan, biological detergent, BDH) resulted in a suspension of approximately  $1 \times 10^9$  conidia ml<sup>-1</sup>. The final concentration depended on individual isolate characteristics, such as the quantity of conidia produced and the ease with which these could be harvested and suspended.

Different methods were used for harvesting conidia from the different species of fungus. Conidia of *B. bassiana*, *M. anisopliae* and *Paecilomyces* spp. produced dusty conidia which had hydrophobic cell walls and were therefore difficult to suspend in water alone. *Paecilomyces* spp. had less hydrophobic cell walls than *Beauveria* spp. and *Metarhizium* spp., but they were still difficult to suspend in

water. Conidia of *V. lecanii* had hydrophilic cell walls and were easy to place in aqueous suspension.

Conidia from isolates of *B. bassiana* and *M. anisopliae* were gently scraped into small plastic weigh boats using the flat end of a spatula. Conidia and scrapings were then suspended in approximately 20ml of 0.03% Tween 80 in a 50ml graduated conical tube (50ml centrifuge tubes, BDH). To prepare suspensions of conidia of *V. lecanii* and *Paecilomyces* spp. isolates, 20 - 30ml of 0.03% Tween 80 was pipetted onto plates, distributing the Tween between the number of plates to be scraped. Plates were gently scraped using the flat end of a spatula before pouring conidia and scrapings into a 50ml conical tube.

#### ***2.6.5 Preparing suspensions of conidia***

Once conidia had been harvested using the appropriate method (section 2.6.4), the tubes of suspensions were vortexed using a Gallenkamp Spinmix (Gallenkamp) for approximately two minutes and then placed on a Griffin flask shaker (Griffin & George Ltd.). The suspensions were shaken vigorously for approximately 1½ hours at room temperature to ensure that conidia were well suspended; the hydrophobic conidia of *M. anisopliae* develop in long chains and those of *B. bassiana* develop in dense balls making them difficult to suspend as individual conidia.

Each suspension was filtered through four layers of tight woven muslin placed in a Buchner funnel (10cm diameter). The suspensions were allowed to filter under gravity and the filtrates were placed on ice to prevent germination of conidia. Suspensions were used on the day that they were prepared for isolate selection assays. In subsequent bioassays, suspensions were prepared the day before an experiment and the stock suspension was held overnight on ice in a polystyrene box at 4°C in darkness. No conidia germinated overnight under these conditions and subsequent germination tests indicated that there was no lasting effect on the ability of conidia to germinate.

The concentration of conidia in each suspension was estimated by using an improved Neubauer bright-line haemocytometer (Reichart).

### 2.6.6 Spraying fungi

All spray applications were made using an electrostatically charged rotary atomiser, the APE 80 (Arnold & Pye, 1980), mounted on a modified track sprayer. The APE 80 was originally developed at Rothamsted for tractor boom mounting to apply oil and water-based ultra low volume (ULV) formulations to field crops. In the sprayer head (Figure 2.1), a metal plate is charged with 30 000 V from a high tension (HT) electrode which ionises the plate, giving it a negative charge. A jet unit then applies the fungal suspension or other liquid at a rate of 25ml min<sup>-1</sup> onto the metal plate. A spinning disc surrounds the plate and this runs at 4 500 rotations per minute (rpm), forming droplets of liquid at the edge of the disc. Deflectors are positioned on either side of the sprayer head and are negatively charged. As droplets are formed at the edge of the plate and sprayed outwards, the deflectors push the spray down to accurately maintain the direction of application. This ensures there is no spray drift. Suspensions of conidia of fungi were always applied at 10.41 l ha<sup>-1</sup> with a 1m swath width at a height of 25cm above the spray target. The number of conidia per cm<sup>2</sup> was calculated from this application rate (Table 2.3). Droplets had a volume median diameter (VMD) of 100µm.

**TABLE 2.3 :** Calculated number of spores deposited per cm<sup>2</sup> of area sprayed using the APE 80 when different concentrations of fungal suspensions are applied.

Concentration of spray (conidia ml <sup>-1</sup> )	Number of spores deposited (per cm <sup>2</sup> )
1x10 <sup>2</sup>	0.01
1x10 <sup>3</sup>	0.10
1x10 <sup>4</sup>	1.04
1x10 <sup>5</sup>	10.41
1x10 <sup>6</sup>	104.10
1x10 <sup>7</sup>	1 041
1x10 <sup>8</sup>	10 410
1x10 <sup>9</sup>	104 100

## 2.7 Bioassay assessment

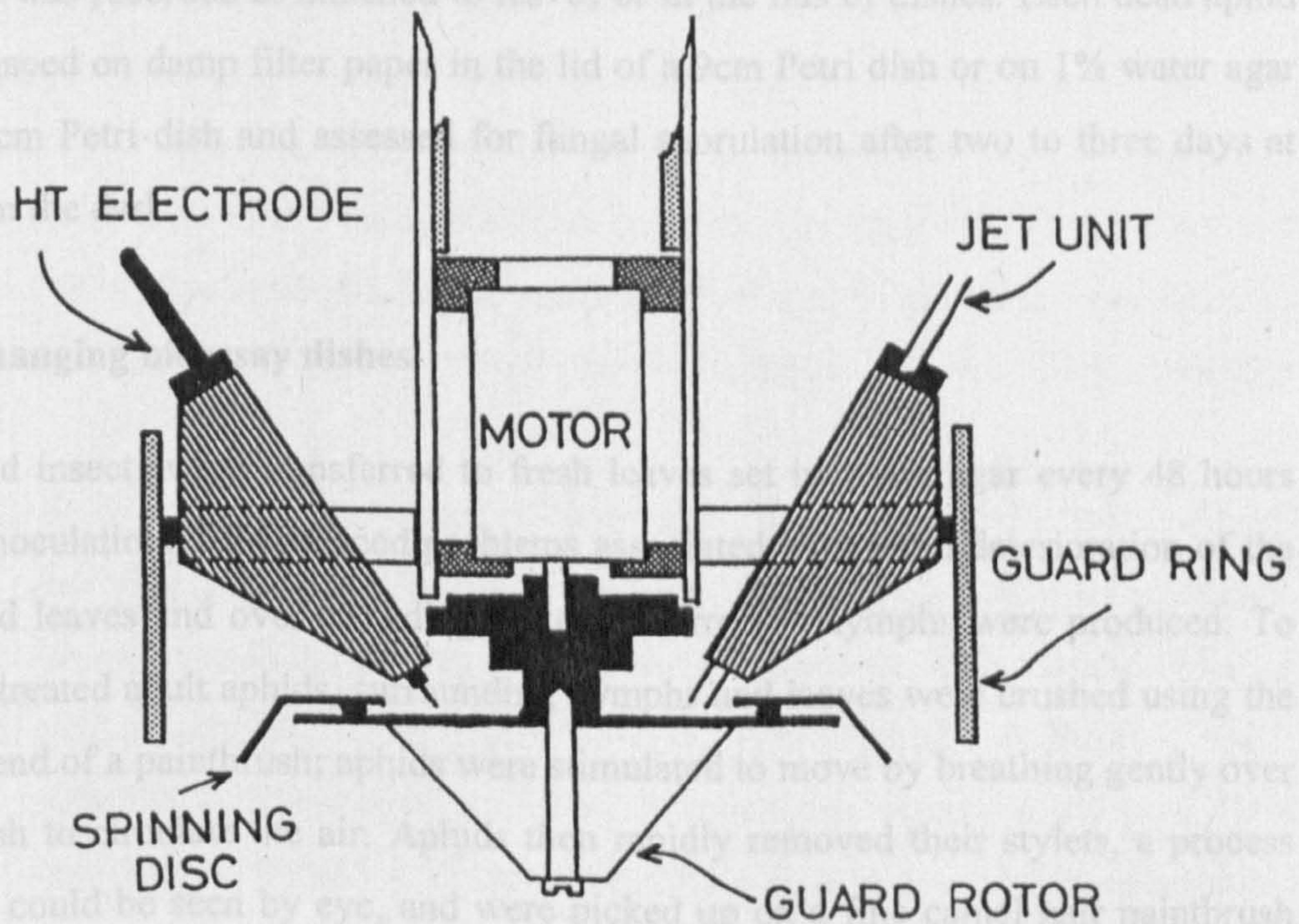
Insects were checked on a daily or twice daily basis throughout the duration of a bioassay. The length of time varied depending on the experiment conducted, for example a bioassay using large concentrations of conidia would be run for a shorter time, as insects succumbed to fungal infection more quickly, than a bioassay using small concentrations of conidia. The number of individuals that died was recorded as well as any missing aphids. Additionally, the position of dead aphids was recorded as attached to leaves or in the lids of dishes. Each dead aphid was placed on damp filter paper in the lid of a 9cm Petri dish or on 1% water agar in a 9cm Petri-dish and assessed for fungal germination after two to three days at 23°C.

## 2.8 Changing bioassay dishes

Treated insects were transferred to fresh bioassay dishes every 48 hours post-inoculation. The bioassay dishes were inverted and the aphids were removed from excised leaves and transferred to fresh bioassay dishes. To move treated aphids to fresh bioassay dishes, the aphids were brushed using the blunt end of a paintbrush. Aphids were removed from the bioassay dishes by moving the dish to clean air. Aphids were removed from the bioassay dishes by moving the dish to clean air. Aphids were removed from the bioassay dishes by moving the dish to clean air. Aphids were removed from the bioassay dishes by moving the dish to clean air.

## 2.9 Statistical analysis

All calculations and analyses were performed in the computer packages, Microsoft<sup>®</sup> Excel 97 and Genstat 5, release 4.1 (Genstat Committee, 1998). All raw data is held at IACR-Rothamsted from whom relevant information can be obtained.



**FIGURE 2.1 :** Detail of the APE 80 spray head used to apply suspensions of conidia of fungi to aphids in laboratory and field assays

## **2.7 Bioassay assessment**

Insects were checked on a daily or twice daily basis throughout the duration of a bioassay. The length of time varied depending on the experiment conducted, for example a bioassay using large concentrations of conidia would be run for a shorter time, as insects succumbed to fungal infection more quickly, than a bioassay using small concentrations of conidia. The number of individuals that died was recorded as well as any missing aphids. Additionally, the position of dead aphids was recorded as attached to leaves or in the lids of dishes. Each dead aphid was placed on damp filter paper in the lid of a 9cm Petri dish or on 1% water agar in a 9cm Petri dish and assessed for fungal sporulation after two to three days at 23°C in the dark.

## **2.8 Changing bioassay dishes**

Treated insects were transferred to fresh leaves set in water agar every 48 hours post-inoculation. This reduced problems associated with rapid deterioration of the excised leaves and over-crowding which occurred as nymphs were produced. To move treated adult aphids, surrounding nymphs and leaves were crushed using the blunt end of a paintbrush; aphids were stimulated to move by breathing gently over the dish to circulate the air. Aphids then rapidly removed their stylets, a process which could be seen by eye, and were picked up on a fine camel hair paintbrush and moved to clean leaves. Fresh filter paper was placed in the lid of the inverted dishes.

## **2.9 Statistical analysis**

All calculations and analyses were performed in the computer packages, Microsoft® Excel 97 and Genstat 5, release 4.1 (Genstat Committee, 1998). All raw data is held at IACR-Rothamsted from whom relevant information can be obtained.

---

## CHAPTER 3 - DEVELOPMENT OF A STANDARDISED BIOASSAY METHOD FOR SCREENING HYPHOMYCETE FUNGI AGAINST APHIDS

---

### 3.1 Introduction

The key biological attribute when selecting isolates of fungi to be developed as mycoinsecticides is their virulence towards the target insect(s) and their limited pathogenicity to non-target organisms. This chapter is aimed at reviewing some of the methods used to determine virulence towards the host. Pathogenicity of fungi to non-target insects will be reviewed in chapter 6. The definitions of pathogenicity and virulence used in this study are those suggested by Prior (1992) in the context of insect pathology as "*the ability to cause disease*" and "*a quantitative measure of the capacity of an individual pathogen genotype to cause infection*" respectively.

Pathogenicity and virulence of entomopathogenic fungi are most often evaluated under controlled conditions in the laboratory using precise bioassay methods. Abiotic factors such as temperature and humidity can cause large variability in the virulence of a pathogen to its host (Doberski, 1981b; Milner & Bourne, 1983; Hsiao, Bidochka & Khachatourians, 1992; Vandenberg, Ramos & Altre, 1998b; Feng, Poprawski, Nowierski & Zeng, 1999). The design of any laboratory bioassay must ensure that the assay is repeatable and reliable. As variability in bioassay results are generally caused by the cumulative differences of many different components of the assay, the only way to achieve repeatable results is to have detailed technical standardisation of every part of the assay (Burges & Thompson, 1971).

The following review is concentrated on the components that are particularly important when designing a bioassay to screen fungal isolates for their pathogenicity and/or virulence to aphid hosts. Relevant bioassays of different fungi against a selected range of other insect hosts will be limited to those with similarities to aphid systems. It is not within the scope of this work to review bioassays using different micro-organisms and the reader is referred to Burges

(1981), Tanada and Kaya (1993) and Navon and Ascher (2000) for reviews of bioassays using other pathogens such as bacteria, viruses and protozoans.

### ***3.1.1 Inoculating test insects***

One of the greatest problems in standardising a bioassay system is administering conidia to target insects in a controlled and repeatable manner. The normal route of fungal penetration is through the cuticle and techniques to achieve inoculation via this route in a standardised manner are often laborious and time-consuming (Hall & Papierok, 1982).

The first tier of testing in a pathogen screening programme is generally to determine the pathogenicity of candidate fungi to the target insects. Inoculation procedures are relatively crude as it is only the ability of fungi to cause disease which is tested at this stage and estimation of the dose received by insects is less important. Insects are often exposed directly to large quantities of conidia which for hyphomycete fungi is usually as dusts or on culture plates (Yokomi & Gottwald, 1988; Jones, Grace & Tamashiro, 1996; Meadow, Shelton & Vandenberg, 1998; Smith, Oduor & Moore, 1998; Mohan, Aruna & Uma, 1999) and for entomomphthoralean fungi as discharged showers of conidia (Milner, 1982; Pell, Wilding, Player & Clark, 1993). This allows a large number of fungal isolates to be screened quickly, using few test insects which may be important when insects cannot be cultured in the laboratory and have to be field collected (Milner, 1992). Some caution must be exercised, however, to ensure that these first tier assays are accurately measuring pathogenicity of the conidia. Jones *et al.* (1996) observed that ticks exposed to conidia of *Metarhizium anisopliae* on culture plates were “*so heavily coated with conidia that they could no longer walk freely*”. Death of host insects in such situations may be due to shock and mechanical damage associated with numerous penetrations of conidia or suffocation because of occlusion of the respiratory apparatus.

Generally, pathogenicity screening is used to identify a limited number of isolates to be tested against the target insect in assays to determine their virulence. These assays require a precise method of inoculating insects with conidia, most often



over a range of different doses to estimate the LD<sub>50</sub> (dose which kills 50% of test insects) values for each isolate. A dose is defined as the accurately measured number of infective propagules a host is exposed to. When test insects are exposed to a known concentration of infective propagules in suspension, but the actual dose received by insects is not quantified, the LC<sub>50</sub> value (concentration that kills 50% of test insects) gives a better estimate of virulence of an isolate. Estimates may also be made of the LT<sub>50</sub> (time for 50% mortality of test insects) for each isolate at specific doses of conidia.

#### *3.1.1.1 Showering conidia*

Direct inoculation of test insects with an accurate dose of conidia of species in the Entomophthorales is very difficult. In contrast to conidia of the Hyphomycetes, conidia of the Entomophthorales cannot easily be suspended in aqueous suspension making inoculation difficult. The Entomophthorales are characterised by the formation of forcibly discharged conidia so bioassays are often developed such that an estimation of dose depends on the time insects are exposed to showers of conidia.

Vandenberg & Soper (1979) showered larvae of the spruce budworm *Choristoneura fumiferana* (Clem.) with spores of *Zoophthora radicans* (= *Entomophthora sphaerosperma*). Larvae were showered with the fungus for different periods of time to regulate the number of conidia to which the insects were exposed. An estimation of the dose of fungus received by larvae was made based on the average number of conidia in a selected area of agar from water agar plates showered before and after larvae were inoculated. Hemmati (1998) exposed *Acyrtosiphon pisum* and *Sitobion avenae* to primary conidia of *Erynia neoaphidis* by showering the aphids for different periods of time in Petri dishes where they were feeding on leaves embedded in water agar. The dose of conidia received by aphids was estimated by counting the conidia deposited on a known area of the water agar adjacent to the aphids.

Wilding (1976) developed a more accurate method for estimating the dose of *Entomophthora* conidia showered onto the aphid *A. pisum*. Aphids were held under

a celluloid sheet that had holes through which conidia could pass but aphids could not escape. By counting the conidia that landed on the celluloid around the aphids, an accurate measurement of the dose could be made. This was the first time a linear relationship between log-dose and probit mortality was reported for *Entomophthora* spp.

Other authors have used similar methods to estimate the dose of *Entomophthora* spp. to which aphids were exposed. Milner & Soper (1981) directly exposed adult spotted alfalfa aphids *Therioaphis trifolii* f. *maculata* to primary conidia of *Entomophthora* spp. by showering aphids in a purpose built bioassay chamber. The dose was estimated from the number of conidia that landed on a coverslip placed beneath the aphids. In a subsequent experiment, Milner (1982) exposed *A. pisum* and bluegreen aphids *Acyrtosiphon kondoi* Shinji to a shower of primary conidia and controlled the dose by the length of exposure time. The dose received was again estimated from counts of conidia on glass slides placed beneath the sporulating fungus used to inoculate aphids. Feng *et al.* (1999) exposed groups of *A. pisum* directly to primary conidia of *Erynia* (=Pandora) *neoaphidis* by showering from mats of mycelia. A coverslip placed beside the aphids for the duration of inoculation allowed the dose to be estimated.

### 3.1.1.2 Topical applications and direct injection of conidia

Topical applications using a micro-applicator are an accurate way of dosing large insects. This method has been used for inoculating insects such as grasshoppers and locusts (Prior, Carey, Abraham, Moore & Bateman, 1995; Bateman, Carey, Batt, Prior, Abraham, Moore, Jenkins & Fenlon, 1996), termites (Jones *et al.*, 1996) and cockroaches (Mohan *et al.*, 1999).

The position of application of fungal conidia may influence the level of mortality achieved. Butt, Ibrahim, Clark and Beckett (1995) found that conidia of *M. anisopliae* applied under the elytra of the cabbage stem flea beetle *Psylloides chrysocephala* (L.) resulted in a lower LT<sub>50</sub> value than when conidia were placed on the exposed parts of the insect body. However, Prior *et al.* (1995) showed that there was no significant difference between placing drops of a suspension of *M.*

*flavoviride* conidia under the thorax or on the mouthparts of desert locust *Shistocerca gregaria* (Forskål). However, it was noted that placing the inoculum under the pronotum gave a quick and consistent kill so this was subsequently chosen as the standard method of inoculation for future bioassays.

Inoculation may be achieved by injecting spores directly into the host. Generally, insects are immobilised and a micro-injector is used to pierce the intersegmental membranes and inject the propagules straight into the haemocoel. The main route of fungal infection is via the cuticle and this may present an important barrier to host infection (Hajek & St. Leger, 1994). This suggests that inoculation by injection of fungal inocula is not an accurate way to test the virulence of entomopathogenic fungi. Several studies have shown that there are differences in susceptibility of hosts to fungal pathogens after topical exposure of conidia, but there were no differences when hosts were injected with fungi (Riba, Katagiri & Kawakami, 1982; Ramoska, Hajek, Ramos & Soper, 1988; Hajek, Butler & Wheeler, 1995). In other studies, the resistance of larvae to fungal infection has been shown to be not solely due to the integumental barrier. Ignoffo, Garcia and Kroha (1982a) showed that *Anticarsia gemmatalis* (Hubner) larvae injected with fungal inocula had similar levels of resistance to infection with inocula that were injected or applied topically and dose-mortality relationships were even demonstrated for injected inocula.

### *3.1.1.3 Incorporation of conidia into foodstuff and exposure to inoculated surfaces*

Inoculum has been presented to test insects incorporated into either bait or foodstuff and/or by exposing them directly to a surface which is often a foodstuff that has been treated with conidia. In any food bait experiment a large amount of infection is through the host cuticle from contact with conidia on the substrate and so it is difficult to dissociate the two different methods of inoculation.

In assays against boll weevils, conidia of *Beauveria bassiana* incorporated into feeding substrates were found to be no less pathogenic than conidia applied directly as conidial sprays (Wright & Chandler, 1992). Isolates of *B. bassiana* were also shown to be pathogenic to the American cockroach *Periplaneta americana*

(L.) when conidia were incorporated into wheat flour as a foodstuff (Mohan *et al.*, 1999). A mortality of 67-100% in cockroaches exposed to the food baits suggested this might be a method that could be developed for cockroach control.

In a bioassay of *B. bassiana* against Colorado potato beetle *Leptinotarsa decemlineata* larvae were allowed to feed for 48 hours on leaves that had been surface treated with conidia of *B. bassiana* (Ignoffo, Garcia, Kroha, Samšináková & Kálalová, 1983). An LC<sub>50</sub> value of  $28.8 \pm 13.9$  conidia/mm<sup>2</sup> was calculated but there was no inhibition of larval feeding or effect on larval body weight. Larvae of various cabbage pests were inoculated with conidia of the mycoinsecticide Boverin (*B. bassiana*) by allowing larvae to feed on treated leaves for 48 or 72 hours (Ignoffo, Garcia, Alyoshina & Lappa, 1979). This gave an inverse relationship between consumption of leaves and Boverin concentration and a typical dose-mortality response. A similar inoculation method was used to bioassay *B. bassiana* and *Nomuraea rileyi* (Farlow) against *Trichoplusia ni* (Hubner) (Ignoffo, Puttler, Hostetter & Dickerson, 1976b; Ignoffo, Garcia, Kroha & Couch, 1982b).

Agudelo & Falcon (1983) compared the infectivity of *Paecilomyces farinosus* conidia and hyphal bodies to the beet armyworm *Spodoptera exigua*. Fourth instar larvae were microfed or topically exposed to conidia and hyphal bodies. Ingested conidia were significantly less pathogenic than topically applied conidia or topically applied or ingested hyphal bodies. The LT<sub>50</sub> for external infection was 4.1 days, compared with 6.3 days when the larvae were microfed. Such an inoculation procedure is more suitable when considering lepidopteran pests such as *S. exigua* whose feeding habit will expose them to conidia both on the exoskeleton and in the gut. Pell *et al.* (1993) inoculated leaf discs with primary conidia of *Z. radicans* and then allowed secondary conidia to be formed overnight. By counting conidia showered onto slides at the same time the leaves were inoculated, the authors were able to quantify the number of spores on each leaf before allowing larvae of the diamondback moth *Plutella xylostella* to walk over and feed on the leaves for 30 minutes. A positive relationship was demonstrated between the dose of conidia and mortality of larvae. Similar methods have been used to evaluate doses of conidia received by aphids (Milner & Soper, 1981).

The pathogenicity of *N. rileyi* to nine species of caterpillar was evaluated by allowing larvae to walk on leaves treated with a known volume of conidia (Puttler, Ignoffo & Hostetter, 1976). Using this method, the authors were able to confirm differences they had noted in the field in larval susceptibility to the fungus. Similarly, the pathogenicity of isolates of *B. bassiana*, *P. farinosus* and *M. anisopliae* to *Scolytus scolytus* (F.) was tested by exposing insects to leaf discs inoculated with an unknown quantity of conidia (Doberski, 1981a).

The relationship between pathogenicity and dose has been more accurately quantified using exposure to treated surfaces as a method of host insect inoculation. Ferron & Robert (1975) obtained a relationship between dose and pathogenicity when they inoculated the bean weevil *Acanthoscelides obtectus* Say by allowing insects to walk over Petri dishes sprayed with *B. bassiana*, *M. anisopliae* or *P. fumosoroseus*. Barson (1977) exposed *S. scolytus* larvae to elm bark which had been treated with suspensions of *B. bassiana*. Although a relationship between pathogenicity and dose was demonstrated, the calculated values of the LD<sub>50</sub> were suggested to be inaccurate because larvae were exposed to conidia for the entire duration of the experiment.

#### 3.1.1.4 Dipping in suspensions of conidia

In many bioassays, the test insects are treated by dipping them in suspensions of conidia at known concentrations and monitoring the numbers of test insects that die and sporulate with fungus. These systems have been reported for various aphid species (Hall, 1976a; Hall & Burges, 1979; Feng & Johnson, 1990; Feng, Johnson & Kish, 1990b; Dorschner, Feng & Baird, 1991; Miranpuri & Khachatourians, 1996). Dipping insects in fungal suspensions has also proved useful as a method for inoculating ticks (Monteiro, Bittencourt, Daemon & Faccini, 1998a; Monteiro, Fiorin, & Correia, 1998b), grasshoppers (Khachatourians, 1992), cockchafers (Keller, Schweizer & Shah, 1999) and whitefly scales (Hall, 1982).

Inoculating test insects by dipping them in suspensions of conidia is not suitable for all insect species. Doberski (1981a) tried inoculating adult elm bark beetles *S. scolytus* by dipping them in suspensions of conidia and noted that many of the

beetles did not survive the treatment. Chandler (1997) tried dosing lettuce root aphid *Pemphigus bursarius* by totally immersing them in suspensions of conidia but all aphids were killed during treatment. However, Hall (1976a) developed a successful bioassay system to investigate the impact of *Verticillium lecanii* on the chrysanthemum aphid *Macrosiphoniella sanborni* (Gillette) which relied on aphids being totally immersed in suspensions of conidia. Feng & Johnson (1990) and Feng *et al.* (1990b) also successfully inoculated several species of cereal aphids using a short immersion period in suspensions of conidia.

There are limitations to using immersion techniques as a method of inoculating insects. Most importantly, the  $LC_{50}$  and  $LT_{50}$  values that are calculated from bioassays using immersion inoculation are likely to be unrealistically low estimates of doses needed to achieve the same kill in the field. Yokomi & Gottwald (1988) compared the efficacy of spray and drench applications of *V. lecanii* against three aphid species, which often attack greenhouse-grown citrus. Aphids were either immersed in suspensions of conidia or sprayed with suspensions (to the point of runoff) with an airbrush. At concentrations of  $1 \times 10^4$  conidia  $ml^{-1}$  the  $LT_{50}$  for the drench treatment was calculated as 9.9 days and for the spray treatment was 12.4 days. Hall (1979) compared the level of *V. lecanii* infection in the chrysanthemum aphid *M. sanborni* when aphids were exposed to conidia by immersion in suspensions of conidia or by allowing the aphids to walk over leaves treated with conidia. Infection from conidia treated leaves was very low compared to that obtained when aphids themselves were treated with conidia.

The differences between laboratory and field estimates of  $LC_{50}$  values were shown by Dorschner *et al.* (1991). The authors tested the virulence of *B. bassiana* to the hop aphid *Phorodon humuli* (Schrank) under controlled laboratory conditions, on potted plants and in the field. In the laboratory bioassay, aphids were treated by immersion in suspensions of conidia and the calculated  $LC_{50}$  was  $1.37 \times 10^5$  conidia  $ml^{-1}$ . In the pot experiments, doses of  $1 \times 10^5$  and  $1 \times 10^7$  conidia  $ml^{-1}$  were applied to potted hop plants, representing the  $LC_{50}$  and  $LC_{95}$  values obtained in the laboratory bioassay. Effective control after four weeks was only achieved with the dose of  $1 \times 10^7$  conidia  $ml^{-1}$  and the  $1 \times 10^5$  conidia  $ml^{-1}$  treatment was not

significantly different from the control at this time. Although these differences were largely attributed to variable relative humidity (RH) in the pot experiment (in the range 50 - 95%), this work demonstrates some inherent problems with extrapolating results from laboratory bioassays to the field situation. Indeed, there were no mycoses or control of target insects observed in the field assay described, although this was suggested to be due to the effects of low humidity and high temperatures.

Sopp, Gillespie and Palmer (1989) applied the *V. lecanii* isolate 1.72 used in the product Vertalec® to Chrysanthemums and found it gave good control of the aphid *Myzus persicae* but not *Aphis gossypii*. The aphids had been shown to be equally susceptible to the fungus using immersion bioassays in the laboratory, with calculated LC<sub>50</sub> values of approximately  $1 \times 10^5$  conidia ml<sup>-1</sup> (Hall, 1976a). However, *M. persicae* is a more active aphid than *A. gossypii* and Sopp *et al.* (1989) suggested that this enhanced mobility meant *M. persicae* came into contact with more conidia than *A. gossypii* when the aphids were treated under field conditions. This demonstrates the need to use application systems in a laboratory bioassay that accurately represent the system used for applying conidia under field conditions. Whilst dipping insects in suspensions of conidia may be a suitable method to test pathogenicity and provide repeatable results, this author suggests that more realistic application methods should be used to test virulence of fungi in the laboratory.

#### 3.1.1.5 Spraying systems

The simplest spraying techniques used in laboratory bioassays, have involved propellant systems such as an artist airbrush (Yokomi & Gottwald, 1988). These systems have proved useful in evaluating the pathogenicity and virulence of hyphomycete fungi to aphids (Miranpuri & Khachatourians, 1995; Askary, Carrière, Bélanger & Brodeur, 1998). Although such equipment may be calibrated to apply a specific volume of spray, like other methods of inoculation, the actual dose received by insects is often not quantified. Additionally, many of these sprays are applied until the point of run-off which exposes insects to very high volumes of conidial suspensions similar to those which they may experience if the dipping

method of inoculation was used (Yokomi & Gottwald, 1988). Aerosol propellants are not always suitable for application of conidia and high mortality has been noted in some aphids treated using such application systems (Chandler, 1997). Other authors have used aerosol spray bottles (Poprawski, Parker & Tsai, 1999) or hand operated spray bottles (Dorschner *et al.*, 1991) to apply fungal inocula to aphids under laboratory conditions.

Many studies have used static sprayers to allow a more accurate dose of fungal conidia to be applied to aphid hosts. The most commonly used static sprayers are the Potter tower (Potter, 1952) and the Burgerjon tower (Burgerjon, 1956), which are both accurately calibrated systems which rely on atomisation to deliver a fine spray with great precision. Poprawski *et al.* (1999) observed that the Burgerjon tower gave the least variable doses (compared to aerosol spray bottles) as a method to inoculate the brown citrus aphid *Toxoptera citricida* (Kirkaldy) with different hyphomycete fungi.

The Potter tower has been used to inoculate various insect hosts with entomopathogenic fungi including whiteflies (Vidal, Lacey & Fargues, 1997b; Meekes, Fransen & van Lenteren, 1996; Wraight, Carruthers, Bradley, Jaronski, Lacey, Wood & Galaini-Wraight, 1998; Lacey, Kirk, Millar, Mercadier & Vidal, 1999) lepidopteran larvae (Feng, Carruthers, Roberts & Robson 1985), coleopteran larvae (Ferron & Robert, 1975) and aphids (Mesquita, Lacey, Mercadier & Leclant, 1996; Chandler, 1997; Poprawski *et al.*, 1999).

Different methods have been developed to estimate the dose of conidia received by test insects inoculated in spray towers. Mesquita *et al.* (1996) used the Potter tower to inoculate the Russian wheat aphid *Diuraphis noxia* (Mordvilko) with an isolate of *P. fumosoroseus*. The tower was calibrated by spraying suspensions of conidia onto Petri dishes containing water agar and counting conidia in a known area. This method allowed a very accurate dose to be applied to aphids. Similar methods have been used to calculate the dose of *B. bassiana* and *P. fumosoroseus* conidia received by *D. noxia* (Vandenberg, 1996) and *P. xylostella* larvae using the Burgerjon spray tower (Vandenberg *et al.*, 1998b). The LC<sub>50</sub> values that were



calculated for these fungi against aphids were found to be lower than other authors had obtained. Vandenberg (1996) suggested that the main reason for this was that the bioassay methods were more accurate and the assay itself was quite sensitive. Chandler (1997) estimated the doses of *M. anisopliae* conidia received by lettuce root aphid *P. bursarius* by macerating recently inoculated aphids and plating out the resulting suspensions onto plates of media. By counting the number of colonies that developed an estimate was made of the dose of conidia received by the aphids. However, as the author notes, this method does not differentiate between infectious conidia and those that were unable to infect.

Various different types of ultra-low volume (ULV) spray application methods have been used to inoculate insects. Puterka, Humber and Poprawski (1994) used an ULV spray application method that consisted of a pressurised spray bottle in a spray chamber to spray pear psylla *Cacopsylla pyricola* (Foerster) nymphs on leaf discs in Petri dishes. Although a ULV spray was used, the leaves were still sprayed to run-off with 200 µl of conidia suspension applied to both adaxial and abaxial surfaces of the leaf. This type of spray application technology has been useful under glasshouse conditions to apply mycoinsecticides to aphids (Sopp *et al.*, 1989) and particularly under field conditions to control locusts in the LUBILOSA programme (Neethling & Dent, 1998; Bateman, 1999).

### **3.1.2 Choice of target insect**

Standardisation of the target host is virtually impossible but there are several points that should be considered when selecting insects to be used in assays. Generally, the host used in bioassays should be that which will be targeted in subsequent field applications. Mycoinsecticides are likely to be targeted at the most susceptible life stage of the host.

Dose-mortality experiments have indicated that there is an age-maturation immune response so that, generally, the early instars are the most susceptible (Boucias, Bradford & Barfield, 1984; Steenberg & Vagn Jenson, 1998; Vandenberg *et al.*, 1998b). However, there are exceptions to this general rule; Feng *et al.*, (1985)

quantified the dose-mortality relationships between three isolates of *B. bassiana* and five instars of the European corn borer *Ostrinia nubilalis*. Characteristically, the first instar was the most susceptible and the fourth instar the most resistant. However, the fifth instar, which was expected to be less susceptible than instars one to four, only had an LC<sub>50</sub> higher than the first instar. It was suggested that the fifth instar period accounts for 40% of the entire larval development period and so is less likely to moult during an inoculation period. Conidia are therefore less likely to be removed with the moulted cuticle than in other instars and so will have a greater chance of germinating and penetrating the host cuticle.

Many entomopathogenic fungi will only infect a particular life stage (Ignoffo & Mandava, 1988) and bioassay procedures should be standardised to ensure that the same life stage is used in each assay. Most bioassays of entomopathogenic fungi against aphids use apterous adults as the target host (Hall, 1976a, 1976b; Yokomi & Gottwald, 1988; Feng *et al.*, 1990b; Vandenberg, 1996). Other assays have been conducted on third instar (Mesquita *et al.*, 1996) or first instar aphids (Milner, 1982). However, if treated aphids moult before conidia attached to the cuticle have germinated, the estimates of values for the LT<sub>50</sub> and LD<sub>50</sub> for early instar aphids may be inaccurate.

There is an effect of age or life stage of aphids on their susceptibility to entomopathogenic fungi. Dromph, Pell, Clark and Eilenberg (in prep.) showed that alate *S. avenae* aphids from two different coloured clones were both more susceptible to *E. neoaphidis* than apterae of the same clones. The susceptibility of adult *A. pisum* to infection with *E. neoaphidis* has been shown to change with the age of aphid. Apterous adults which were three to four days old were found to be more susceptible than one day old or six to seven day old adults (Lizen, Latteur & Oger, 1985). Additionally, alate *A. pisum* in the same study were shown to be up to six times more resistant to fungal infection.

Host insects should be uniform in size although some studies have shown there are no differences between different sized hosts in their susceptibility to entomopathogenic fungi (Mohan *et al.*, 1999). Other factors, such as host sex, may

need to be considered for some insects (Maniania & Odulaja, 1998) but other studies have shown that this is not always an important determinant in host susceptibility (Prior *et al.*, 1995).

### **3.1.3 Choice of carrier**

The carrier used to suspend fungal conidia must be chosen carefully as some are known to have toxic effects on the host insect.

Prior *et al.* (1995) tested nine refined vegetable oils, six unrefined vegetable oils and kerosene as dilutants for various species of hyphomycete fungi in bioassays against the desert locust *S. gregaria*. Mortality of adult locusts twelve days post-treatment with the dilutents alone ranged from 16.7% for coconut and cotton seed oils to 100% for Neem and Kerosene. However, there were no untreated controls held under the bioassay conditions used in this experiment so it is difficult to determine whether a mortality of 16.7% is higher than would be expected for locusts under these conditions. Neem is known to have insecticidal properties and so was unsuitable as a dilutant for this bioassay. Interestingly, the authors also observed that as vegetable oils aged, the control mortality in bioassays increased. To reduce this effect on control mortality, fresh oils were obtained regularly.

Surfactants such as Silwet L-77 (an organo-silicone nonionic surfactant) often cause relatively high mortality in aphids (Imai, Tsuchiya, Morita & Fujimori, 1994; Imai, Tsuchiya & Fujimori; 1995) and other soft-bodied insects (Purcell & Schroeder, 1996). Poprawski *et al.* (1999) noted high mortality in their control group of brown citrus aphid *T. citricida* ( $43.9 \pm 7.5\%$ ) treated with 0.05% Silwet L-77 compared to a blank control (unsprayed) group with lower mortality ( $17.1 \pm 2.3\%$ ). Although this surfactant was used in a maximum challenge pathogenicity assay, Tween 80 at 0.01% was used for multiple dose assays and control mortality was reduced to less than 5%.

Hall (1976a) immersed *M. sanborni*, *Brachycaudus helichrysi* and *M. persicae* in increasing concentrations of Triton X100 or Tween 80 to determine the effect of the surfactants on aphid survival. The percentage of aphids drowning increased

with increasing concentrations of both carriers for *M. sanborni* but *B. helichrysi* and *M. persicae* were not affected, even at concentrations as high as 1% of the wetting agents.

Interestingly, *M. sanborni* was chosen as the host aphid for further bioassays because the other aphids displayed other disadvantages; there was high control mortality of the other aphids as they were restless and reluctant to feed under the bioassay conditions. It was suggested that the low control mortality of *M. sanborni* was more important than the drowning effect. This is a good example of the compromise that has to be made when designing an accurate and repeatable bioassay system.

#### **3.1.4 Post-inoculation incubation and mortality assessment**

Test insects should be incubated under controlled conditions that favour survival of control insects that do not receive any treatment at all or those that are only inoculated with the carrier. Factors such as temperature, humidity and photoperiod can be adjusted to favour fungal germination immediately following inoculation and reverted to optimal conditions for prolonged insect survival. Alternatively, conditions such as temperature may need to be maintained to favour insect survival as long as fungal growth is not adversely affected (Ferron & Robert, 1975).

A good incubation system will be indicated by low control mortality. This has been suggested to be ideally less than 10% for pathogen bioassays (Goettel & Inglis, 1997). As aphids are phloem-feeding insects, they should ideally be maintained on whole plants rather than excised leaves. Chandler (1997) showed that the lettuce root aphid *P. bursarius* was only able to survive on whole living plants and suggested that using excised leaves for bioassay systems would not provide aphids with adequate nutrition. However, there is often a need to compromise on an ideal incubation system because of the number of insects to be screened.

It has been shown that successful infection by a fungus may be influenced by the physiological state of the host. The susceptibility of the spotted alfalfa aphid *T. trifolii* to infection by *Z. radicans* (= *Entomophthora sphaerosperma*) was shown to

be reduced if aphids were starved for a 24 hour period after fungal inoculation (Milner & Soper, 1981). However, other studies have shown that susceptibility of test insects to fungus is not affected by periods of starvation. There was no significant difference in susceptibility of locusts to *M. flavoviride* whether they were fed or starved during the course of a bioassay (Prior *et al.*, 1995).

Mortality assessments should be made on a daily basis and any insects that die should be removed immediately from the assay container. Dead insects must be removed to prevent horizontal transmission of conidia from the sporulating cadavers (Arthurs & Thomas, 1999). The cadavers should be incubated at a warm temperature and a high relative humidity to encourage sporulation of conidia on the host for positive identification.

It is essential that control groups of insects are included in any bioassay, including those of entomopathogenic fungi against insect hosts. Controls may be used to indicate a background level of fungal mortality occurring naturally in host populations. Milner & Soper (1981) used field collected spotted alfalfa aphid *T. trifolii* for bioassays of *Entomophthora* spp. and noted that the frequency of naturally occurring disease was generally very low (<2%) as indicated by control mortality.

In laboratory bioassays there are generally two approaches to interpreting control mortality. Many researchers use the control group of insects solely to prove there is no fungal contamination between treatments. Often in these cases, no details are presented on control mortality other than a statement that there was "*no mortality attributable to fungal infection in control insects*". This is true for assays with cereal aphids (Feng & Johnson, 1990; Feng *et al.*, 1990b; Feng & Johnson, 1991; Vandenberg, 1996), pea aphids (Milner, 1982) and hop aphids (Dorschner *et al.*, 1991), as well as several species of lepidoptera (Vandenberg & Soper, 1979; Ignoffo *et al.*, 1979; Ignoffo *et al.*, 1982a; Vandenberg *et al.*, 1998b). Alternatively, control deaths are used to show how suitable the incubation methods are for a host insect species; a small number of control deaths indicate that conditions in the incubation system do not cause stress in the insect host.

Considering bioassays of entomopathogenic fungi against aphids, the ideal control mortality of less than 10% appears to be a somewhat unrealistic value to obtain in the laboratory. Hayden, Bidochka & Khachatourians (1992) evaluated virulence of several entomopathogenic fungi to *S. avenae* and obtained mortality in control groups between 0 - 10%. Chandler (1992) developed a bioassay against the lettuce root aphid *P. bursarius* which gave a mean control mortality of 11%, although the range of mortality was from 8 - 15%. When the same assay procedure was used for pathogenicity tests on a separate occasion, mortality was as great as 20% (Chandler, 1997).

Other bioassays against aphids have recorded higher values for control mortality. Miranpuri & Khachatourians (1996) had less than 13% control mortality in a bioassay of woolly elm aphid *Eriosoma americanum* Riley. However, this result is dubious as the method of inoculation was different for those aphids treated with fungus (dipped in fungal suspensions) compared to the control aphids (sprayed with water). Under these conditions, any observations made on control mortality are meaningless. In an assay against the Russian wheat aphid *D. noxia*, control mortality was recorded as  $11.67 \pm 5.69\%$  (Mesquita *et al.*, 1996) whilst an assay against the chrysanthemum aphid *M. sanborni* had recorded control mortality of  $16.3 \pm 4.7\%$  (Jackson, Heale & Hall, 1985). A much higher level of control mortality (up to  $37.2 \pm 2.7\%$ ) has been reported in bioassays against *S. avenae* (Miranpuri & Khachatourians, 1995). Whilst a low control mortality indicates a good bioassay system, it would appear that the often quoted level of less than 10% is very difficult to achieve with soft-bodied, phloem-feeding insects such as aphids. Improved rearing, handling and incubation systems should be developed for specific aphid species to ensure as low a control mortality as possible.

The problems of analysing and interpreting control mortality data have become a contentious issue. An exhaustive review of the subject is not intended here, but an overview of some of the more pertinent issues concerning bioassays of entomopathogenic fungi against insects is useful. Many authors use Abbott's formula to remove effects not due to the entomopathogen for insects treated with pathogen by correcting for mortality observed in the control treatment where the

carrier alone is applied (Abbott, 1925). However, this does not allow for sampling variation as the formula fixes the level of control mortality according to a single sample i.e. the single control group of insects assayed for all treatments (Fenlon, 1995). Other methods have been suggested to be more suitable for analysis, such as the maximum likelihood method (Finney, 1971).

Insects treated with fungi may die from the action of toxins produced by the invading fungi and, therefore these insects will not show overt signs of mycosis. These insect deaths are generally classed as "non-fungal" control mortality. Current analysis procedures do not satisfactorily deal with these non-fungal deaths in controls which may potentially be related to the treatments because of toxin effects. IACR statisticians are currently investigating modelling non-fungal deaths more accurately (S. J. Clark, pers. comm.).

## **3.2 Materials and Methods**

### ***3.2.1 Insect and fungus cultures***

All aphid species were reared to apterous adults of known age using methods described in section 2.1. Fungal isolates were cultured as described in section 2.6.3 and fungal suspensions were prepared as described in sections 2.6.4 and 2.6.5. The sprayer system used for all spray applications is described in section 2.6.6.

### ***3.2.2 Aphid movement in dishes during spray applications***

The movement of aphids of the six species detailed in section 2.1 was assessed in Petri dishes to determine if this was an appropriate method for holding test insects during spraying only; systems for post-inoculation incubation are evaluated in section 3.2.3. Five aphids were placed into each of 15 Petri dishes for each aphid species which contained leaves embedded in 2% water agar. Aphids were placed in dishes late in the afternoon, the dishes were then inverted and five dishes were placed overnight in each of a controlled environment (CE) room, insectary cage or a CE cabinet at 18°C and a 16 hour photoperiod. On the following day, all the dishes were moved to the 18°C CE room and were turned the right way up and the

lid removed. Aphids were observed for ten minutes and the time that each individual began moving was recorded; moving was defined as removal of the stylets and walking away from the feeding site. If any aphids were on the lid of the Petri dish at the start of the experiment they were removed before the observation period started and the sample size reduced appropriately.

### ***3.2.3 Post-inoculation incubation***

Three methods of incubating insects following inoculation with candidate fungi were investigated to determine which method resulted in the smallest control mortality of test insects. This experiment was only done with the black bean aphid *A. fabae*.

The three methods for incubating aphids (Figure 3.1) were; i) excised leaves set in 2% water agar in 9cm Petri dishes, ii) a Blackman box (12.5 x 8 x 2cm with a 5.5cm diameter hole covered with muslin), where excised leaves were held in water saturated foam in a ventilated plastic box or iii) a small plant under a lampglass covered with muslin held in place with a metal ring. Five aphids were placed in each incubation system, with five replicates of each system. The different incubation systems were all placed in a CE room at 23°C and a 16 hour photoperiod. Aphids were checked daily for seven days and the number that died or were missing was recorded.





**FIGURE 3.1** : Three holding systems tested for incubating *Aphis fabae* during bioassays. From left to right; a Blackman box with leaves held in moist sponge, a Petri dish with leaves set in water agar and a whole plant held under a lampglass.

### **3.2.4 Aphid population density**

The density of aphids on a leaf set in 2% water agar in a Petri dish affected aphid survival over the duration of a bioassay. This experiment was designed to determine the optimal number of aphids per Petri dish which would result in small control mortality but give results that could be analysed statistically. This experiment was only done with the black bean aphid *A. fabae*.

Aphids were placed on excised bean leaves set in 2% water agar to give densities of 5, 8, 10, 12, 15 and 20 aphids per dish. Five replicates of each aphid density were placed at 23°C in a 16 hour photoperiod. Aphids were checked daily for 15 days and the number of dead and missing aphids recorded. Aphids were moved onto fresh leaves 72 hours after they were placed in the dishes; this simulated a 24 hour settling period prior to spraying and a 48 hour incubation period after spraying. Aphids were subsequently moved to clean leaves every 48 hours.

### **3.2.5 Effect of carrier on aphid survival**

The surfactant Tween 80 was used as a carrier for conidia; a concentration of 0.03% was sufficient to suspend conidia and had no effect on germination of conidia. Tween 80 at a concentration of 0.03% was tested against the aphid *A. fabae* to determine any side effects of the carrier on different populations of the aphid.

Three aphid population densities of 5, 12 or 20 aphids were sprayed with 0.03% Tween 80, distilled water, or were left unsprayed. All aphids were sprayed using methods detailed in section 2.6.6 and were incubated on excised leaves in 2% water agar in Petri dishes at 23°C, in a 16 hour photoperiod. Mortality was assessed daily for eight days and dead aphids were removed. Aphids were moved to clean leaves every 48 hours.

### **3.2.6 Preliminary maximum challenge**

A first tier pathogenicity test was carried out with isolates ARSEF 2859 (*V. lecanii*) and ARSEF 4491 (*P. fumosoroseus*). Twenty-five *A. pisum* and *A. fabae* were allowed to walk on culture plates of conidia for a ten minute exposure period. There were two replicates for *A. pisum* and three replicates for *A. fabae* for each treatment. A single replicate of 25 aphids of each species were allowed to walk in empty Petri dishes for a ten minute period as controls. Following inoculation, aphids were removed and placed in the CE cabinet, at 18°C with a 16 hour photoperiod, on single bean plants in lampglasses covered with cling film. The cling film was replaced with muslin after 24 hours and aphid mortality checked daily for three days. Data were analysed using logistic regression under the general linear regression procedure in Genstat 5.

### 3.3 Results

#### 3.3.1 Aphid movement in dishes during spray applications

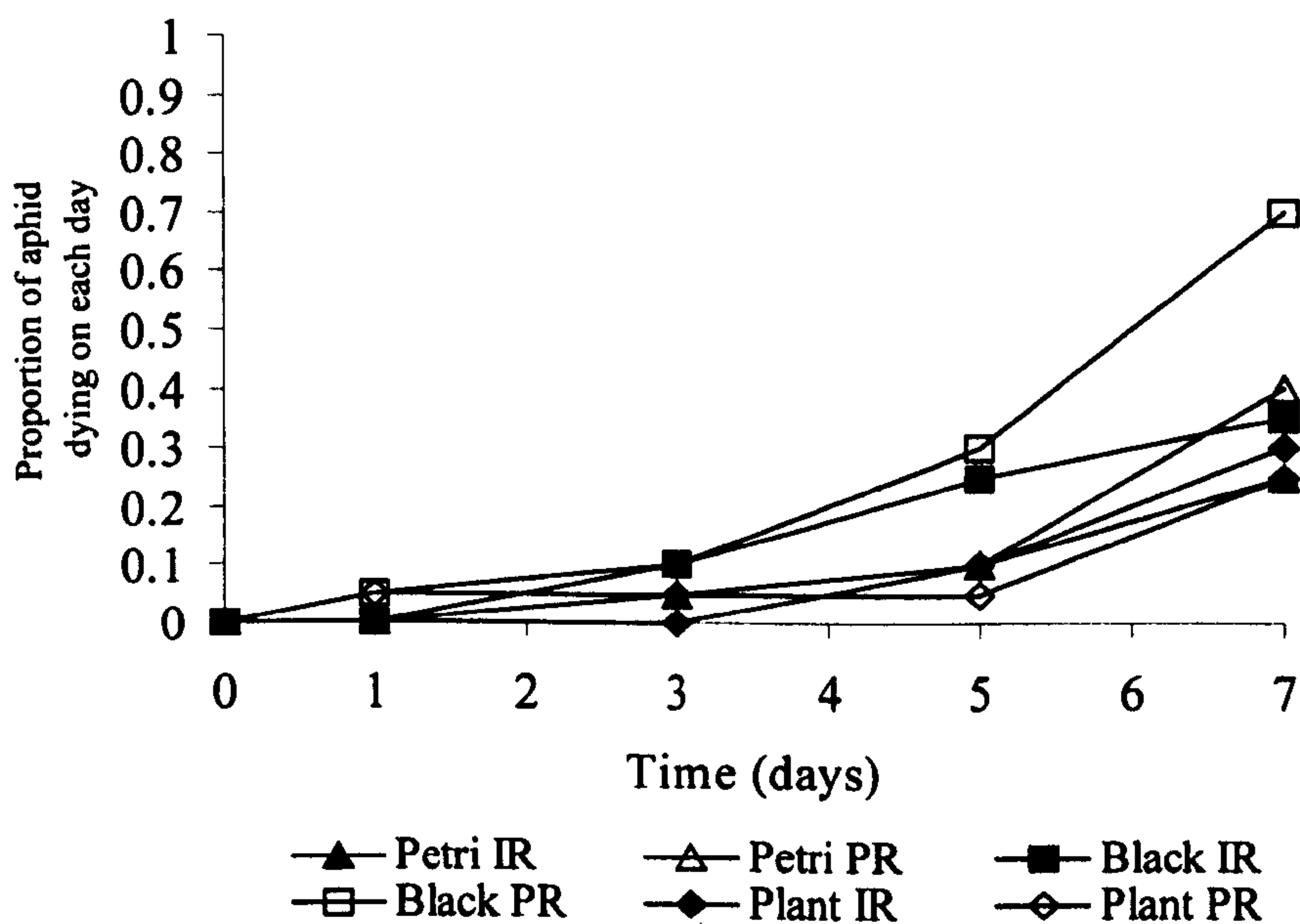
Aphids moved infrequently for all six species that were tested (Table 3.1). The most movement was for *A. pisum* and *M. dirhodum*. Individuals of *A. fabae*, *R. padi* and *M. persicae* did not move over the ten minute recording period.

**TABLE 3.1** : Movement in a ten minute period of apterous adult aphids of six species in Petri dishes after being held in different controlled environment facilities overnight.

Aphid species	Location overnight	Number of aphids moving (%)	Time(s) of first movement (secs)
<i>A. pisum</i>	CE Room	4	375
	Tardis	21	20 - 395
	Insectary	17	35 - 246
<i>S. avenae</i>	CE Room	0	0
	Tardis	0	0
	Insectary	4	77
<i>M. dirhodum</i>	CE Room	12	207 - 347
	Tardis	4	500
	Insectary	4	383
<i>A. fabae</i>	CE Room	0	0
	Tardis	-	-
	Insectary	0	0
<i>R. padi</i>	CE Room	0	0
	Tardis	-	-
	Insectary	0	0
<i>M. persicae</i>	CE Room	0	0
	Tardis	-	-
	Insectary	0	0

### 3.3.2 Post-inoculation incubation

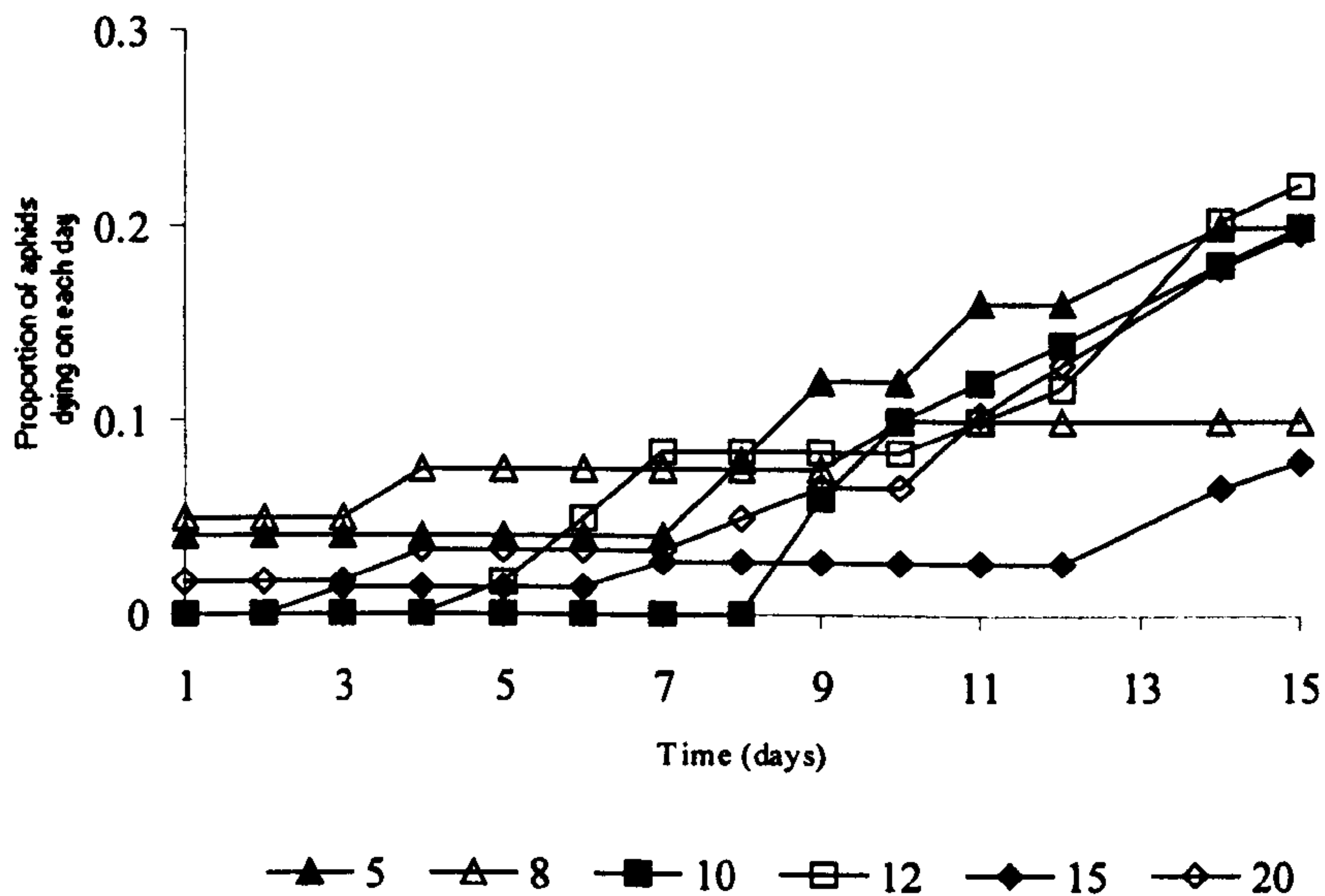
There was less than 10% mortality in all the incubation systems until day three, after which mortality began to increase (Figure 3.2). After seven days, the greatest mortality (70%) occurred in aphids reared in Petri dishes and then incubated in Blackman boxes. The lowest mortality (25%) was for aphids reared in the insectary and then incubated in Petri dishes and those reared in Petri dishes and then incubated on whole plants. Generally, those aphids incubated on whole plants survived better than those in Petri dishes, which in turn survived better than those incubated in Blackman boxes.



**Figure 3.2:** Cumulative proportion of *Aphis fabae* dying on each day having been reared in different systems (on whole plants (IR) or excised leaves in Petri dishes (PR)) and then incubated in three systems (a whole plant (PLANT), excised leaves in Petri dishes (PETRI) or Blackman boxes (BLACK)).

### 3.3.3 Aphid population density

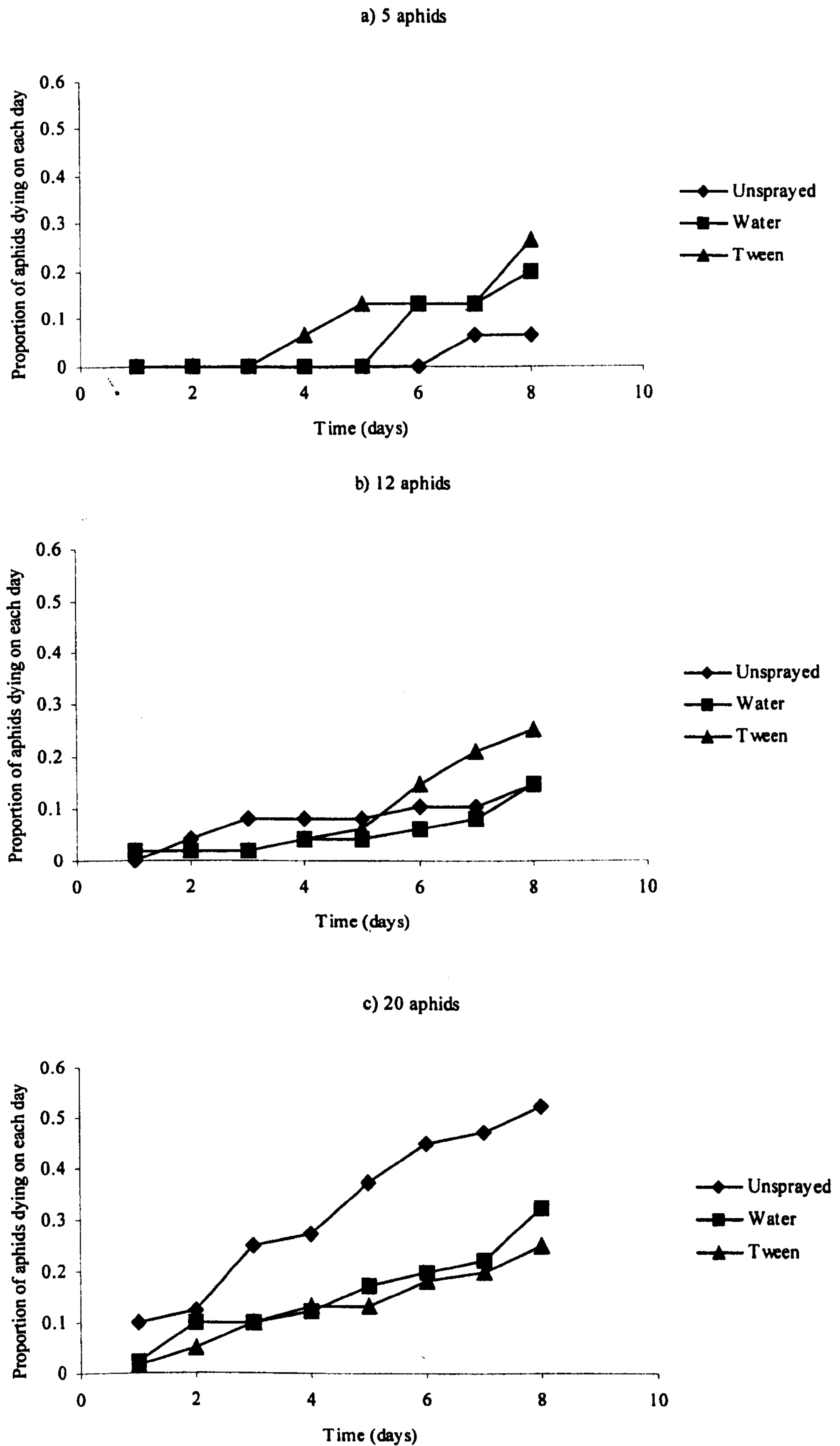
The mortality of aphids at all densities over the first eight days of the assay was less than 10% (Figure 3.3). At the end of the assay (day 15), aphid mortality was below 25% in all treatments, ranging from 8% for those dishes with a density of 15 aphids to 21.7% for those with an aphid density of 12.



**FIGURE 3.3** : Cumulative proportion of *Aphis fabae* dying on each day at different population densities (5, 8, 10, 12, 15 or 20 aphids) when incubated on excised leaves set in agar in Petri dishes.

### 3.3.4 Effect of carrier on aphid survival

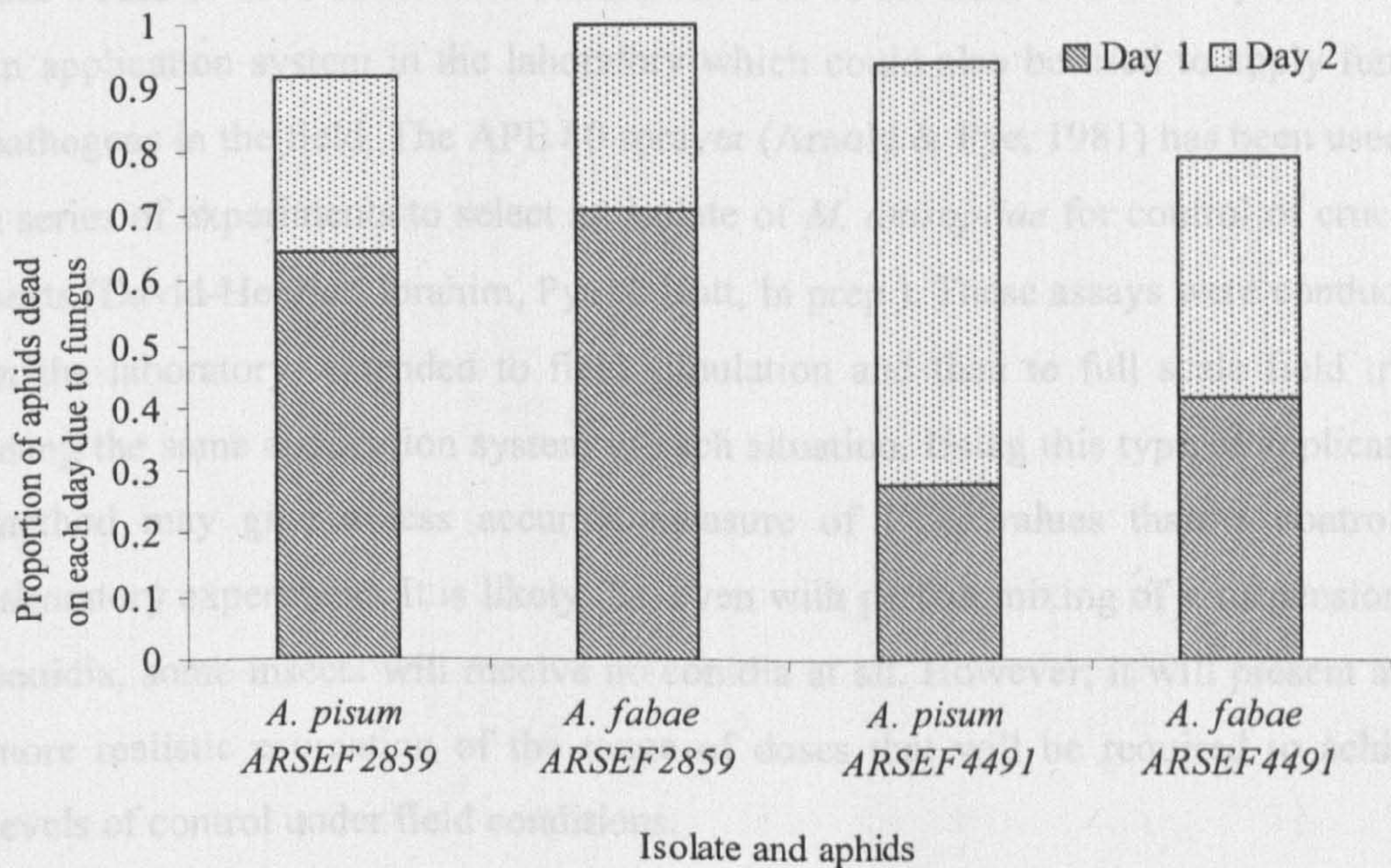
The proportion of aphids that died in populations of 5 or 12 aphids was greatest for those treated with Tween 80 at 0.03%, although this did not exceed 27% for either population (Figure 3.4). However, when the population was increased to 20 aphids per dish the mortality in unsprayed controls increased to 53% and mortality of aphids sprayed with Tween 80 at 0.03% was lower at 25%.



**FIGURE 3.4 :** Cumulative proportion of *Aphis fabae* dying on each day following spraying with water, Tween 80 (0.03%) or left unsprayed at three different population densities; a) 5 aphids, b) 12 aphids or c) 20 aphids per Petri dish.

### 3.3.5 Preliminary maximum challenge

Approximately 80-100% of aphids treated with suspensions of conidia of either isolate had died by 48 hours post-inoculation (Figure 3.5). No assessment of fungal sporulation on cadavers was made. There was no significant difference in the total number of aphids that died over the two days between treatments ( $F_{3,7} = 0.11$ ,  $P = 0.951$ ). There was also no significant difference between isolates ( $F_{1,6} = 4.31$ ,  $P < 0.05$ ) for the number of aphids that died on the two days. Many of the aphids treated with fungus were noted to be so heavily covered with spores that they were unable to walk.



**FIGURE 3.5 :** Pathogenicity of isolates ARSEF 2859 (*V. lecanii*) and ARSEF 4491 (*P. fumosoroseus*) to *Acyrtosiphon pisum* and *Aphis fabae* aphids.



### 3.5 Discussion

Any bioassay system should be designed to ensure that the host insects are exposed to environmental conditions that cause the minimal amount of stress to the insects. This should result in small control mortality and therefore an accurate assessment of pathogenicity and virulence of tested pathogens. Any system can then be adapted to allow for conditions which favour fungal infection, such as periods of high humidity following inoculation for germination of conidia.

Most laboratory bioassays of entomopathogenic fungi against insect hosts use methods of inoculation that are poor representations of the application technique that would be used under field conditions. One of the aims of this study was to use an application system in the laboratory which could also be used to apply fungal pathogens in the field. The APE 80 sprayer (Arnold & Pye, 1981) has been used in a series of experiments to select an isolate of *M. anisopliae* for control of crucifer pests (David-Henriet, Ibrahim, Pye & Butt, In prep.). These assays were conducted in the laboratory, extended to field simulation and then to full scale field trials using the same application system in each situation. Using this type of application method may give a less accurate measure of LC<sub>50</sub> values than a controlled laboratory experiment. It is likely that even with perfect mixing of a suspension of conidia, some insects will receive no conidia at all. However, it will present a far more realistic estimation of the range of doses that will be required to achieve levels of control under field conditions.

The APE 80 was therefore chosen as the inoculation system to test isolates against aphids. As part of a biorational approach it is suggested that isolates which could produce a repeatable level of kill using the same application system to be used under field conditions would be better adapted for use as mycoinsecticides than isolates which are more variable in their ability to infect host insects. However, to ensure reliability and repeatability of the bioassay method, other components of the assay were rigorously standardised.

Apterous adult aphids of known age were used for all assays as previous studies have shown that there may be differences in host susceptibility to fungi depending on host age (Lizen *et al.*, 1985). Additionally, using apterous adults ensured that the host aphids would not moult during the course of the bioassay and in the process shed conidia on the cast exuviae. It has been shown that moulting soon after inoculation reduces susceptibility of insects to fungal infection (Vey & Fargues, 1977; Vandenberg *et al.* 1998b).

Aphids were sprayed in dishes where they were held on excised leaves set in water agar. It would have been more realistic to spray aphids on whole plants or spray plants and then place aphids on them. However, up to 105 replicates were sprayed on some occasions so the Petri dish system was used for ease of handling, storage and assessment. Preliminary investigations indicated that aphids placed on dishes 24 hours prior to spraying did not move when they were inoculated the following day. However, in later experiments it became apparent that insects became stressed after 48 hours in a dish post-inoculation and many would be found drowned in collected water in the lids of dishes. To overcome this, aphids were placed onto leaves in Petri dishes on the morning of the day they were to be sprayed. Most aphids were then settled in a feeding position by the afternoon when sprays were applied. Additionally, a piece of filter paper (5cm diameter) was placed in the lids of dishes which absorbed excess free water and maintained a high humidity.

Aphids were incubated post-inoculation in Petri dishes, even though it was shown that survival was better on whole plants. Aphids were not moved to whole plants after inoculation because; i) it was very time consuming searching for treated aphids, ii) aphids were often lost, so sample sizes had to be reduced and iii) test aphids needed to be moved before the end of the experiment (generally eight days post-inoculation) as plants became over-crowded with nymphs and it became difficult to identify treated adult aphids from newly developed adults and late instar nymphs.

The optimal number of aphids per dish was shown to be 15 for long-term aphid survival (15 days, based on results from aphid population density experiments) but

the length of most bioassays was less than eight days, at which time there was less than 10% aphid mortality for all population densities of aphids. A density of 12 aphids per dish was used for short assays and increased to 15 aphids per dish in assays where the total number of replicates had to be reduced to make the running of the assay technically feasible.

The total sample sizes used were generally between 60 - 90 aphids per treatment. Mathematical calculations have shown the minimum sample size for assays to give a reliable estimate of the LD<sub>50</sub> and LT<sub>50</sub> is 120 individuals. For increased precision, sample sizes of 240 or more individuals are required (Robertson, Smith, Savin & Lavigne, 1984) but this may be an impractical number of insects to handle in a bioassay. Sample sizes as low as 20 aphids per treatment have been used but this dramatically reduces the precision of LT<sub>50</sub> and LD<sub>50</sub> estimates (Hayden *et al.*, 1992). Conclusions drawn from such experiments should be treated with caution. An increase in precision of dose-response assays by increasing replication has been found to be greater than increasing the number of insects from ten to twenty, or increasing the number of doses (Hall, 1976b).

There was high control mortality in initial assays. Some insects died of fungal infection in control treatments in the first two assays, and this appeared to be largely due to contamination with an isolate of *M. anisopliae* which had been applied in a previous un-related experiment. Careful routine cleaning of the sprayer head with Decon 75<sup>®</sup> (detergent), 95% ethyl alcohol and water after every application of fungal suspension, eliminated this type of control mortality. A strict hygiene routine was adopted when spraying; Petri dishes were placed on fresh blue paper towel (Kimberly-Clark<sup>®</sup>) and isolates were applied in an order that ensured no two isolates of the same species were applied sequentially. If there was any contamination between sprays it was easily noticed because subsequent deaths could be confirmed as being caused by a different fungal species when sporulation tests were done.

Preliminary assays were conducted with three aphid species; *S. avenae*, *M. persicae* and *A. fabae*. Generally, *M. persicae* was less susceptible than *S. avenae*

or *A. fabae* to a range of isolates that were tested in these preliminary assays (Appendix 3). Although mortality of *S. avenae* and *A. fabae* to fungal isolates was similar, control mortality in *S. avenae* was higher than that for *A. fabae*. Therefore, *A. fabae* was chosen as the representative target aphid because, of those aphids tested, it showed intermediate susceptibility to fungal isolates and had a low level of control mortality.

Preliminary bioassays of several isolates of fungi against *A. fabae* were carried out using a concentration of  $1 \times 10^6$  conidia  $\text{ml}^{-1}$  but there was little or no kill of test insects. An increased concentration of  $1 \times 10^7$  conidia  $\text{ml}^{-1}$  showed differences between isolates, with some killing large numbers of aphids. However, there was a large amount of variability between assays. A concentration of  $1 \times 10^8$  conidia  $\text{ml}^{-1}$  was finally chosen as a discriminatory dose for bioassays to determine pathogenicity of fungi towards the target aphids. At this dose, variability between assays was reduced; aphids died over a shorter time period and reduced periods of handling were required.

All assays were done at 23°C, which favoured fungal development and reduced the length of bioassays because insects succumbed to fungal infection over a shorter period of time compared to 18°C. In turn, this reduced control mortality of aphids.

By evaluating the different components of the bioassay system, a standardised bioassay for evaluating hyphomycete fungi against aphids was designed and used throughout this study (Appendix 4).

---

## CHAPTER 4 - PATHOGENICITY, VIRULENCE AND APHID HOST RANGE

---

### 4.1 Introduction

Historically, an isolate of *Verticillium lecanii* from the chrysanthemum aphid *Macrosiphoniella sanborni* (isolate reference; 1-72) was produced in the U.K. as the commercial product Vertalec<sup>®</sup> for the control of aphids in glasshouses. There was a large amount of research into many aspects of the pathogenicity and virulence of this specific isolate towards glasshouse aphid pests (Hall, 1976a, 1979, 1980ab, 1982). More recently, there has been interest in using isolates of *Beauveria bassiana* for control of cereal aphids (Feng & Johnson, 1990; Feng *et al.* 1990b; Feng, Poprawski & Khachatourians, 1994). Research has largely been concentrated on the pathogenicity and virulence of isolates towards the Russian wheat aphid *Diuraphis noxia*. This aphid has become a serious pest in the United States since it was first recorded there in 1986 (Stoetzel, 1987). Subsequently, research has expanded into the potential use of other hyphomycete fungi, such as *Paecilomyces fumosoroseus* for the control of cereal aphids (Mesquita *et al.*, 1996; Vandenberg, 1996).

This chapter is aimed specifically at investigating aspects of the pathogenicity and virulence of different species of hyphomycete fungi to a range of aphids under laboratory conditions. The effects of fungi on other organisms such as non-target beneficials is covered in chapter 6 and the impact of microbials at the field level in chapter 7. Evaluating the host range of fungal isolates is important to determine their potential as mycoinsecticides; the more pest species that an isolate of fungus can infect the more marketable it will be as a commercial product, but the greater the risk it may pose to non-target natural enemies.

Within a single species of fungus, there may be differences between isolates in virulence toward a species of host insect or virulence of a single isolate may differ against related species of the host insect (Khachatourians, 1992). The most virulent isolates to a host are generally those that were isolated from individuals of the

same host (Goettel, Poprawski, Vandenberg, Li & Roberts, 1990). Jackson *et al.* (1985) showed that the chrysanthemum aphid *M. sanborni* was most susceptible to isolates of *V. lecanii* originating from aphid hosts compared to isolates from other insect and non-insect hosts. However, an isolate may increase in virulence to a host if it is passaged through that host and reisolated. Hayden *et al.* (1992) found that passage of *Paecilomyces farinosus* through the grain aphid *Sitobion avenae* reduced the LT<sub>50</sub> from 11.1 days to 5.3 days. In comparison, passage of *V. lecanii* through the chrysanthemum aphid *M. sanborni* did not enhance virulence of the fungal isolate (Hall, 1980b).

When assessing virulence between isolates, generally a comparison is made of the dose or concentration of conidia needed to achieve a given level of host mortality, often quoted as the LD<sub>50</sub> or LC<sub>50</sub> respectively. For the purposes of this study, the term dose is defined as the "*exact measured number of infective propagules that a host comes into contact with*" and concentration as "*the number of infectious propagules in a unit amount that is applied to the hosts*".

Hall (1976b) evaluated the virulence of the *V. lecanii* isolate (isolate reference; 1-72) to *M. sanborni* (from which the fungus was originally isolated) and reported an LC<sub>50</sub> of  $2.33 \times 10^5$  conidia ml<sup>-1</sup>. The relative pathogenicity of conidia and blastospores of this *V. lecanii* isolate to *M. sanborni* was also considered. The LC<sub>50</sub> value for aphids that were dipped in suspensions of conidia was given as  $4.85 \times 10^5$  conidia ml<sup>-1</sup> for blastospores and  $1.51 \times 10^5$  conidia ml<sup>-1</sup> for aerially produced conidia, indicating that conidia were over three times more virulent. When aphids were exposed to inocula on treated leaf discs, the LC<sub>50</sub> value was given as  $9 \times 10^6$  conidia ml<sup>-1</sup> for blastospores and  $5.3 \times 10^7$  conidia ml<sup>-1</sup> for conidia. The authors suggested that aphids did not acquire disease as readily from leaf surfaces treated with conidia as they did when they were treated directly. However, this may equally be due to the differences between the methods of inoculation, making it difficult to compare between these treatments. Vandenberg, Jackson and Lacey (1998a) also compared the efficacy of blastospores and aerially produced conidia for an isolate of *P. fumosoroseus* to the Russian wheat aphid *D. noxia* and found

that there was no difference between the two forms of inocula in mortality or average survival time of the aphids.

Hall (1979) suggested that isolates of *V. lecanii* with large conidia (6.7 - 8.4  $\mu\text{m}$  in length) were better able to initiate epizootics compared to isolates with small conidia (3.8 - 6.7  $\mu\text{m}$ ). A large number of isolates were assayed against *M. sanborni* and virtually all killed adults, with greater than 50% mortality recorded (Hall, 1984). Interestingly, the isolates with the greatest epizootic potential (measured as the mortality of aphid progeny) were those with large conidia and a fast *in vitro* growth and germination rate. Similarly, Altre, Vandenberg & Cantone (1999) demonstrated a strong positive correlation between the size of conidia of isolates of *P. fumosoroseus* and the virulence of those isolates to diamondback moth *P. xylostella*. Additionally, conidia which germinated fastest *in vitro* were also the most virulent against *P. xylostella*.

A comparison of characteristics of 18 isolates of *V. lecanii* suggested that the expression of virulence appeared to be related to a fast germination rate, high sporulation, the absence of extracellular amylase activity and relatively high extracellular chitinase production (Jackson *et al.*, 1985). It was noted, however, that there were some important exceptions to this and the authors concluded that virulence may be determined by additive effects of different traits and the absence of one trait was not necessarily detrimental to the virulence of that isolate.

Yokomi and Gottwald (1988) used a detached leaf bioassay to assay three isolates of *V. lecanii* against the spiraea aphid *Aphis citricola* van der Goot, the melon aphid *Aphis gossypii* and the peach-potato aphid *Myzus persicae*. The aphid *M. persicae* was found to be the most susceptible and *A. citricola* the most resistant to the three isolates. In this assay, the most virulent isolates were also those that germinated most quickly *in vitro*.

An aphid derived isolate of *B. bassiana* (isolate reference; SGBB8601) was obtained from a field population of the greenbug *Schizaphis graminum* Rondani in June 1986. The virulence of this isolate was compared to five other *B. bassiana*

isolates from a range of different insect hosts to the Russian wheat aphid *D. noxia* (Feng & Johnson, 1990). The aphid-derived isolate had the lowest LC<sub>50</sub> ( $0.57 \times 10^5$  conidia ml<sup>-1</sup>) and deaths were observed after two days at the highest concentration of  $1 \times 10^7$  conidia ml<sup>-1</sup>. The rate of cumulative mortality increased with increasing concentration of conidia for all isolates and increased more rapidly for the more virulent isolates. At a concentration of  $1 \times 10^7$  conidia ml<sup>-1</sup>, the LT<sub>50</sub> values ranged from  $4.2 \pm 1.5$  days for isolate SGBB8601 to  $8.7 \pm 2.7$  days for an isolate derived from the Homopteran *Deois flavopicta* (Stal). Interestingly, two coleopteran derived isolates were more virulent to aphids than two homopteran isolates. This was suggested to indicate that the host or origin was not a reliable indicator of the virulence of an isolate to a specific host.

Isolate SGBB8601 was then tested alongside an isolate of *V. lecanii* from the Russian wheat aphid *D. noxia* to six species of aphids infesting cereals (Feng *et al.*, 1990b). All the aphids tested were susceptible to infection with both isolates but, overall, the *B. bassiana* isolate was more virulent than the *V. lecanii* isolate. Of the six aphid species, *D. noxia* was the most susceptible and the bird-cherry oat aphid *Rhopalosiphum padi* the least susceptible to fungal infection. As conidial concentration increased, the LT<sub>50</sub> values decreased, but differed significantly between aphid species. The lowest calculated LT<sub>50</sub> values were given for *D. noxia* infected with *B. bassiana* as  $1.6 \pm 3.2$  days at a concentration of  $1 \times 10^8$  conidia ml<sup>-1</sup>. Results could be directly compared with those obtained by Feng & Johnson (1990) as the same methods of host inoculation were used. The LC<sub>50</sub> for isolate SGBB8601 to *D. noxia* was given by Feng *et al.* (1990b) as  $0.82 \times 10^5$  conidia ml<sup>-1</sup> (recorded as  $0.57 \times 10^5$  conidia ml<sup>-1</sup> by Feng & Johnson, 1990) and the LT<sub>50</sub> at a concentration of  $1 \times 10^7$  conidia ml<sup>-1</sup> as  $4.3 \pm 1.6$  days (recorded at the same concentration as  $4.2 \pm 1.5$  days by Feng & Johnson, 1990). Prior to this, other authors had noted high variability between assays in values of the LC<sub>50</sub> and LT<sub>50</sub> (Hall, 1976b). Feng *et al.* (1990b) showed that the assay they developed was both repeatable and reliable in assessing the virulence of different isolates to aphids infesting cereals.



Further studies showed that isolate SGBB8601 was just as virulent to the hop aphid *Phorodon humuli* (Schrank) as to the Russian wheat aphid *D. noxia* (Dorshner *et al.*, 1991). An  $LC_{50}$  of  $1.37 \times 10^5$  conidia  $ml^{-1}$  and an  $LT_{50}$  of 3.09 days at a concentration of  $1 \times 10^8$  conidia  $ml^{-1}$  was obtained when aphids were dipped in suspensions of the fungus. This isolate also caused high mortality (48% in laboratory assays), to the woolly elm aphid *Eriosoma americanum* Riley (Miranpuri & Khachatourians, 1996). However, under field conditions, a *V. lecanii* isolate (ATCC 46578) gave effective control of field populations of *E. americanum* whilst the *B. bassiana* isolate (SGBB8601) had no significant effect on aphids. This indicates that virulence under laboratory conditions to a specific host is not always translated directly to virulence in the field. The authors concluded that *V. lecanii* may have more use as a microbial control agent for this aphid.

Other studies have also found isolates of *V. lecanii* to be more pathogenic to aphids than isolates of *B. bassiana*. Hayden *et al.* (1992) investigated the virulence of several entomopathogenic fungi towards the grain aphid *S. avenae* and found an isolate of *V. lecanii* (ATCC 46578) to be the most pathogenic with an  $LT_{50}$  of 2.4 days compared to *B. bassiana* which had an  $LT_{50}$  of 9.5 days. However, the low sample sizes used (20 aphids for isolates of *B. bassiana* and 40 aphids for isolates of *V. lecanii*) and the high doses of fungi that insects received ( $4 \times 10^3$  to  $7 \times 10^3$  conidia per aphid) suggests that these results should be treated with caution.

The virulence of different isolates of *V. lecanii* and *B. bassiana* towards *S. avenae* was also investigated using a range of different inoculation methods (Miranpuri & Khachatourians, 1995). Again, isolates of *V. lecanii* were generally found to be more virulent than those of *B. bassiana*. The *V. lecanii* isolate (which was also used by Hayden *et al.*, (1992)) had a similar  $LT_{50}$  value compared to previous assays. In this case, the  $LT_{50}$  was between 2.16 and 2.73 days compared to 2.4 days in the previous assay. In comparison, the isolate of *B. bassiana* had  $LT_{50}$  values in the range of 3.0 to 4.6 days. Isolate BBSG8601 (the *B. bassiana* greenbug isolate) had  $LT_{50}$  values in replicates of 4.24 and 3.62 days compared to the  $LT_{50}$  of 5.2 days at the highest dose ( $1 \times 10^8$  conidia  $ml^{-1}$ ) tested by Feng *et al.* (1990b). Both experiments used an immersion method to inoculate test insects so the differences

between the assays were more likely to be related to differences between the populations of host aphids tested. Milner (1982) found that two biotypes of the pea aphid *Acyrtosiphon pisum* differed in their susceptibility to a range of isolates of *Erynia neoaphidis* such that one biotype could be described as resistant to the fungal pathogen. Interestingly, an isolate that originated from the host aphid proved to be non-pathogenic to both the susceptible and resistance biotypes, again suggesting that virulence cannot be predicted from the host from which a fungus is isolated.

The first report of the potential of the species *P. fumosoroseus* for the microbial control of aphids was made by Mesquita *et al.* (1996). The virulence of a whitefly (*Bemisia tabaci* (Grennadius)) derived isolate of *P. fumosoroseus* (ARSEF 3877) was evaluated against the Russian wheat aphid *D. noxia* using a Potter tower to inoculate aphids with different doses of conidia. The LD<sub>50</sub> for this isolate was  $1.78 \times 10^3$  conidia ml<sup>-1</sup>. The shortest LT<sub>50</sub> was 2.06 days at a dose of  $3.74 \times 10^4$  conidia ml<sup>-1</sup>. Although the methods of inoculation were different, the LC<sub>50</sub> value obtained ( $0.57 \times 10^5$  conidia ml<sup>-1</sup>) compared favourably with that obtained previously for other isolates of *B. bassiana* against *D. noxia* ( $0.82 \times 10^5$  conidia ml<sup>-1</sup> (Feng *et al.*, 1990b)).

Vandenberg (1996) developed a standardised assay and evaluated the virulence of a large number of isolates of *B. bassiana* and *P. fumosoroseus* to the Russian wheat aphid *D. noxia*. Initial assays were conducted with two isolates of each species of fungus. Aphids were found to be significantly less susceptible to the *B. bassiana* isolates than the *P. fumosoroseus* isolates, similar to the results of Mesquita *et al.* (1996). One isolate of each species was then chosen as a standard for further assays; the virulence of other isolates of *B. bassiana* and *P. fumosoroseus* was compared to the standards at a dose of  $1 \times 10^5$  conidia ml<sup>-1</sup>. The LT<sub>50</sub> values for isolates of *B. bassiana* ranged from 5.7 to 11.7 days (compared to 8.0 days for the standard) and for isolates of *P. fumosoroseus* from 5.7 to 8.5 days (compared to 7.5 days for the standard). It has been suggested that *P. fumosoroseus* may present the most promising pathogen for development as a mycoinsecticide

against aphids for several reasons including the discovery of these highly virulent isolates (Milner, 1997).

Recently, the first bioassay of *B. bassiana* against the brown citrus aphid *Toxoptera citricidus* was reported (Poprawski *et al.*, 1999). Isolates of *B. bassiana* and the other hyphomycete fungi *P. fumosoroseus* and *Metarhizium anisopliae* were assayed in single-dose assays to select the most promising isolates. Seven isolates (including a standard isolate, *B. bassiana* strain GHA, used as the commercial product Mycotrol<sup>®</sup>, Mycotech, Butte, MT) were then assessed in multiple-dose bioassays to determine the virulence of each isolate towards the aphid host. In this case, aphids were found to be less susceptible to isolates of *P. fumosoroseus* compared to the standard *B. bassiana* isolate, strain GHA, but another isolate of *B. bassiana* and one of *M. anisopliae* were more virulent than the standard.

Few studies have been conducted using isolates of *M. anisopliae* against aphids. Hall (1980a) compared the virulence of a strain of *M. anisopliae* isolated from *Pemphigus bursarius* against the *V. lecanii* isolate 1-72 to the aphid *M. sanborni*. The larger LC<sub>50</sub> values that were found for *M. anisopliae* were suggested to be because the germination of conidia, growth and sporulation rates of *M. anisopliae* were slower than those of *V. lecanii*.

Chandler (1992) evaluated the potential of *M. flavoviride* isolate 99.82 (original host *Pemphigus trehernei* (= *bursarius*)) and two isolates of *V. lecanii*; isolate 1.72 and isolate 19.79 (original host *Trialeurodes vaporariorum* (Westwood) and developed as the product Mycotal<sup>®</sup> against whitefly) to the lettuce root aphid *P. bursarius*. The *M. flavoviride* isolate was found to be more pathogenic to aphids than either of the *V. lecanii* isolates. The author suggested that because these aphids are soil-inhabiting insects, they encounter a wider range of insect pathogens and have therefore been able to develop some type of resistance to infection. This isolate was then assayed with isolates of *B. bassiana*, *P. farinosus* and *M. anisopliae* for pathogenicity toward *P. bursarius* (Chandler, 1997). Of 25 isolates, only isolate 391.93 *M. anisopliae* (original host *P. trehernei*) and ARSEF 321 *V.*

*lecanii* (original host the water lily aphid *Rhopalosiphum nymphaea* (L.)) were able to kill aphids and only the *M. anisopliae* isolate was able to do so consistently. A series of dose-response assays with the *M. anisopliae* isolate resulted in LC<sub>50</sub> values of between  $8.07 \times 10^5$  and  $4.47 \times 10^6$  conidia ml<sup>-1</sup>.

Butt, Ibrahim, Ball and Clark (1994) investigated the pathogenicity of two isolates of *M. anisopliae* to a range of crucifer pests including the peach-potato aphid *M. persicae* and the turnip or mustard aphid *Lipaphis erysimi* (= *Lipaphis pseudobrassicae*) (Kaltenbach). When aphids were immersed in suspensions of conidia at concentrations of  $1 \times 10^7$  or  $1 \times 10^{10}$  conidia ml<sup>-1</sup>, mortality of 100% was recorded for both species of aphid after three days. The earliest deaths were recorded on the day after inoculation.

One of the major restrictions to the uptake of microbial pesticides has been their narrow host range and their requirements for specific environmental conditions. Little research has been done on evaluating the pathogenicity and virulence of fungal isolates to a range of targets with different pest status. An isolate of *V. lecanii* from soil (reference; DAOM 179104) was tested against a variety of insect pests including five aphid species (Harper & Huang, 1986). Aphids were sprayed on plants at a dose of  $2.06 \times 10^7$  conidia ml<sup>-1</sup> and the subsequent reduction in aphid populations was found to be different between the aphid species. There was a significant reduction of the pea aphid *A. pisum* (97%) and the rose-grain aphid *Metopolophium dirhodum* (67%), a sometimes significant reduction of the peach-potato aphid *M. persicae* (54%) and the spotted alfalfa aphid *Therioaphis trifolii* f. *maculata* (75%) and no significant reduction of the bird-cherry oat aphid *R. padi* (32%).

Other studies have shown that an isolate of *V. lecanii* derived from the codling moth (reference 198499) is comparable in virulence to the potato aphid *Macrosiphum euphorbiae* as the commercial product Vertalec® and is also an antagonist of cucumber powdery mildew *Sphaerotheca fuliginea* (Schlechtend : Fr.) Pollaci (Askary *et al.*, 1998). The level of control of powdery mildew was equivalent to that of *Sporothrix flocculosa* Traquair, Shaw and Jarvis, a biological

control agent of greenhouse pathogens. Hall (1980d) first suggested that a single, versatile strain of a fungus could be used for the simultaneous control of arthropod pests and plant diseases. Askary *et al.* (1998) suggest that the development of isolates such as *V. lecanii* strain 198499 on a host may favour the expansion of epizootics to other organisms and facilitate development of such isolates as commercial microbial pesticides.

## **4.2 Materials and Methods**

### ***4.2.1 Insect and Fungus Cultures***

All aphid species were reared using methods described in section 2.1. Fungal isolates were cultured as described in section 2.6.3 and fungal suspensions were prepared as described in sections 2.6.4 and 2.6.5. All spray applications were made using the methods and sprayer system described in section 2.6.6. The general bioassay procedures described in chapter 2 were followed for all experiments unless stated otherwise.

### ***4.2.2 Single-dose isolate selection assays against *Aphis fabae* with 18 isolates***

All isolates could not be assessed at the same time so they were randomly divided into four groups. Each group contained five or six isolates which included a standard isolate, Mycotech strain GHA (*B. bassiana*) which was used in every bioassay. This isolate was chosen as the standard because it had been cultured from the formulated product, Mycotrol<sup>®</sup> WP (Mycotech Corporation, Butte, MT) and so was assumed to be a relatively stable isolate, causing a similar level of host mortality on each occasion. Each group of isolates were screened on a single occasion against the black bean aphid *Aphis fabae*. Aphids were sprayed with suspensions of fungi at a single concentration of  $1 \times 10^8$  conidia ml<sup>-1</sup>. Each treatment was applied to six Petri dishes each containing 12 insects, giving a total of 72 aphids per treatment. Six dishes of insects in each experiment were sprayed with 0.03% Tween 80 as controls. Daily mortality was recorded over a period of

eight days as detailed in section 2.7 and insects were transferred to fresh leaves in water agar every 48 hours post-inoculation as detailed in section 2.8.

The Kaplan-Meier test was used to estimate survival probabilities and plot survival distributions in each bioassay for the standard isolate, Mycotech strain GHA (*B. bassiana*). The points on the curve of the survival distribution give estimates of the proportion of insects that survive to a given period of time. From the Kaplan-Meier estimates, the median survival time can be estimated by linear interpolation. A non-parametric k-sample rank test for censored data (Peto & Peto, 1972) was used to examine differences between bioassays for the standard isolate, Mycotech strain GHA (*B. bassiana*). An uncensored value arises when an insect dies from the treatment and a censored value when an insect survives to the end of the trial.

The  $LT_{50}$ , standard error of the  $LT_{50}$  and 95% confidence intervals were calculated individually for all of the isolates using actuarial clinical life tables analysis (Lee, 1992). The life table method requires a large number of observations so that survival times can be grouped into intervals. The advantage of using the life table technique is that it allows for losses that occur before the end of the experiment that are not due to the treatment, i.e. aphids that have died for another reason. Missing aphids were excluded from all analyses.

#### ***4.2.3 Dose-response assays against Aphis fabae with four selected isolates***

##### ***4.2.3.1 Dose ranges of $1 \times 10^5$ - $1 \times 10^9$ conidia $ml^{-1}$***

A dose-response bioassay was performed with the isolates Mycotech strain GHA (*B. bassiana*), HRI 1.72 (*V. lecanii*), ARSEF 2879 (*B. bassiana*) and Z11 (*P. fumosoroseus*) against *A. fabae*. All four isolates were assayed at the same time and the bioassay was repeated on three occasions. Aphids were sprayed with suspensions of each fungus at concentrations of  $1 \times 10^5$ ,  $1 \times 10^6$ ,  $1 \times 10^7$ ,  $1 \times 10^8$  and  $1 \times 10^9$  conidia  $ml^{-1}$ . Each treatment was applied to five separate Petri dishes, each containing 12 aphids giving a total of 60 aphids per treatment. Five dishes of insects in each experiment were sprayed with 0.03% Tween 80 as controls. Daily

mortality was recorded over a period of 11 days as detailed in section 2.7 and aphids were transferred to fresh leaves every 48 hours post-inoculation as detailed in section 2.8. It was not possible to prepare the highest concentration of suspension of fungus ( $1 \times 10^9 \text{ ml}^{-1}$ ) for isolates HRI 1.72 (*V. lecanii*) and Mycotech strain GHA on the first occasion, so these treatments were excluded for this bioassay.

Data were analysed using the general linear regression procedure with probit analysis in Genstat 5. Using this analysis, the  $LC_{50}$  values and associated 95% confidence limits of the  $LC_{50}$  were calculated for each isolate. The  $LT_{50}$  values, standard error of the  $LT_{50}$  and 95% confidence limits of the  $LT_{50}$  were calculated using the actuarial life tables analysis detailed in section 4.2.2.

#### 4.2.3.2 Dose ranges of $1 \times 10^6$ - $1 \times 10^8$ conidia $\text{ml}^{-1}$

The four selected isolates, Mycotech strain GHA (*B. bassiana*), Z11 (*P. fumosoroseus*), ARSEF 2879 (*B. bassiana*) and HRI 1.72 (*V. lecanii*) were assayed against *A. fabae* over a more precise range of concentrations than those tested in section 4.2.3.1. All four isolates were screened at the same time and the assay was run on one occasion. Aphids were sprayed with suspensions of fungi at concentrations of  $1 \times 10^6$ ,  $1 \times 10^{6.5}$ ,  $1 \times 10^7$ ,  $1 \times 10^{7.5}$  and  $1 \times 10^8$  conidia  $\text{ml}^{-1}$ . Each treatment was applied to four Petri dishes, each containing 15 aphids which gave a total of 60 aphids per treatment. Mortality was recorded over a period of eight days as detailed in section 2.7, with recordings made twice a day on days three, four and five.

Data were analysed using the general linear regression procedure with probit analysis in Genstat 5. Using this analysis, the  $LC_{50}$  values and associated 95% confidence limits were calculated for each isolate. The  $LT_{50}$  values, standard error of the  $LT_{50}$  and 95% confidence limits were calculated for each isolate and concentration combination using actuarial life tables analysis as detailed in section 4.2.2.

#### **4.2.4 Dose-response against *A. fabae* with isolate HRI 1.72**

The isolate HRI 1.72 (*V. lecanii*) was screened alone against *A. fabae* at a range of concentrations to allow an LC<sub>50</sub> to be calculated for this isolate. Aphids were sprayed with suspensions of the fungus at concentrations of  $1 \times 10^2$ ,  $1 \times 10^{2.5}$ ,  $1 \times 10^3$ ,  $1 \times 10^{3.5}$ ,  $1 \times 10^4$ ,  $1 \times 10^{4.5}$ ,  $1 \times 10^5$  and  $1 \times 10^{5.5}$  conidia ml<sup>-1</sup>. Each treatment was applied to six Petri dishes each containing 15 aphids, giving a total of 90 aphids in each treatment. The assay was conducted on a single occasion. Daily mortality was recorded over a period of ten days using methods detailed in section 2.7, with recordings made twice a day except for the first two days when mortality was recorded only once a day. Aphids were transferred to fresh leaves every 48 hours post-inoculation as detailed in section 2.8.

The LT<sub>50</sub> values, standard error of the LT<sub>50</sub> and 95% confidence limits were calculated at each dose using the actuarial life tables analysis detailed in section 4.2.2.

#### **4.2.5 Host range assays against representative cereal aphids, legume aphids and the polyphagous aphid *Myzus persicae***

The four isolates HRI 1.72 (*V. lecanii*), Z11 (*P. fumosoroseus*), ARSEF 2879 (*B. bassiana*) and Mycotech strain GHA (*B. bassiana*) were screened against the six aphid species listed in section 2.1. All four isolates were screened at the same time and the assay was repeated on two occasions. Aphids were sprayed with suspensions of fungi at a single concentration of  $1 \times 10^8$  conidia ml<sup>-1</sup>. Each treatment was applied to three Petri dishes each containing 15 aphids, giving a total of 45 aphids per treatment. Three dishes of aphids for each species were sprayed with 0.03% Tween 80 as controls. Daily aphid mortality was recorded for six days using the methods detailed in section 2.7, with recordings made twice a day, except for days one, two and three in the first experiment where recordings were made only once a day.

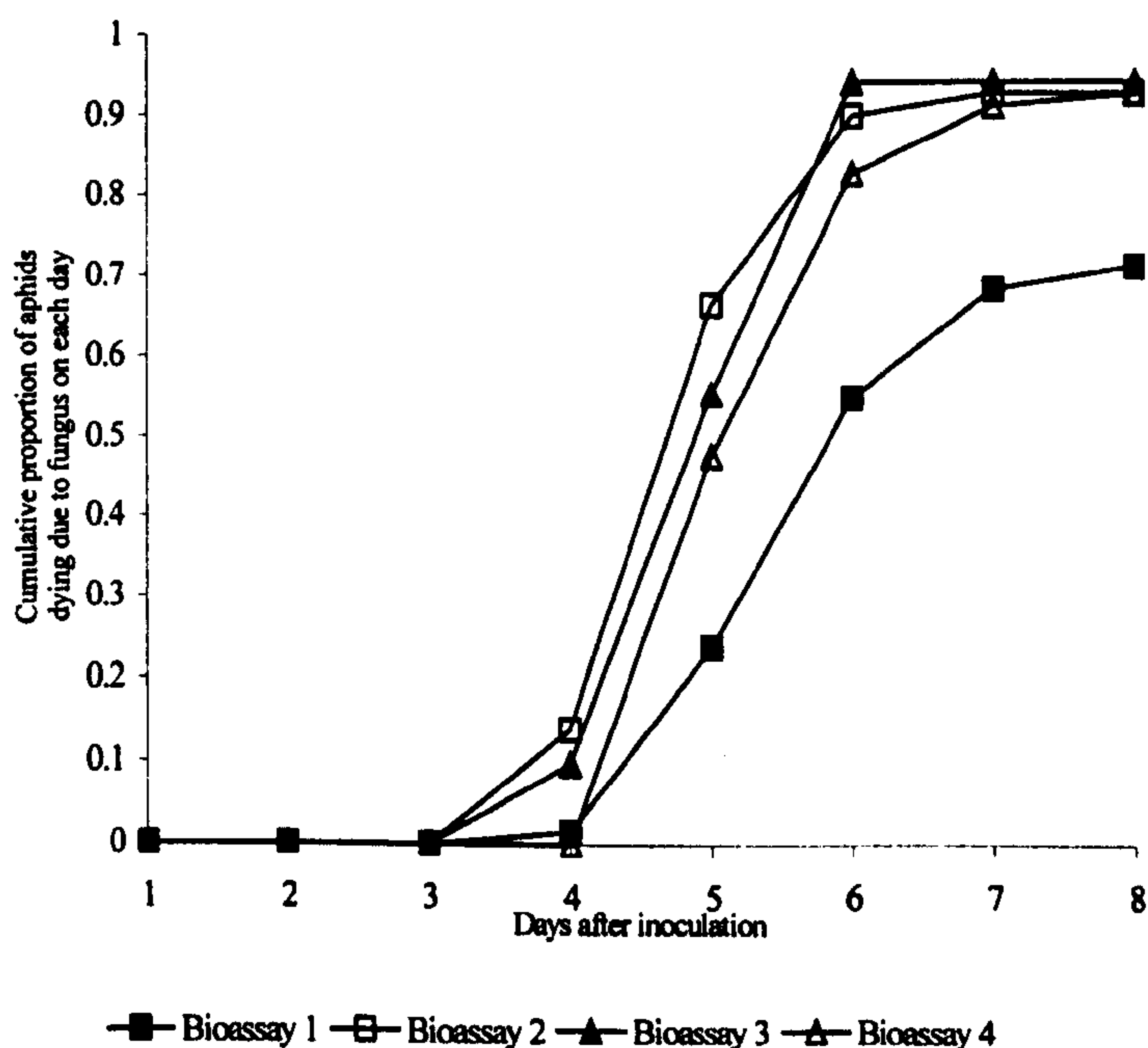


Data for all treatments applied to the aphid *M. dirhodum* were not statistically analysed because 100% non-fungal mortality occurred in the controls. Because of this high mortality, *M. dirhodum* was not used in the second experiment. *Rhopalosiphum padi* were assayed on wheat in the first experiment and whilst the bioassay insects were reared on wheat, the original stock culture was maintained on barley. It was suspected that high control mortality in the bioassay for this species of aphid was due to the change of host plant. Therefore, *R. padi* in the second assay were reared and maintained throughout the assay on barley. The  $LT_{50}$  value for each treatment and aphid combination was calculated for each dish using the actuarial life tables analysis (section 4.2.2). The standard error for the  $LT_{50}$  of each replicate (dish) was weighted by calculating the inverse of the estimate of the variance of the  $LT_{50}$ . The  $LT_{50}$  value was calculated for each dish and therefore had a standard error associated with it. Weighting the data by a function of the standard error meant the analysis took account of differences in the variability around the calculated  $LT_{50}$  values. The weighted data were analysed using the general linear regression procedure in Genstat 5.

## 4.3 Results

### 4.3.1 Single-dose isolate selection assays against *Aphis fabae* with 18 isolates

The non-parametric k-sample rank test indicated a difference between the bioassays in the survivorship of insects treated with the standard isolate Mycotech strain GHA (*B. bassiana* ;  $\chi^2_3 = 48.3$ ,  $P < 0.001$ ). The median values calculated using the Kaplan-Meier survivorship analysis for Mycotech strain GHA (*B. bassiana*) in the four bioassays were 5.7, 4.6, 4.8 and 5.0 days. The differences shown by Mycotech strain GHA (*B. bassiana*) between each of the four bioassays suggested that the bioassays could not be combined in one analysis. In the first run of the bioassay, the pattern of aphid mortality due to isolate Mycotech strain GHA was different to that in the following three bioassays (Figure 4.1). A smaller proportion of aphids died on each day although the first aphid deaths were recorded four days post-inoculation which was similar in all four assays.



**FIGURE 4.1** : Cumulative proportion of *A. fabae* dying due to fungus on each day following inoculation with a single concentration ( $1 \times 10^8$  conidia  $\text{ml}^{-1}$ ) of isolate Mycotech strain GHA in each of four bioassays.

Because of the differences between bioassays in the  $LT_{50}$  values calculated for Mycotech strain GHA, each of the four bioassays were analysed separately using parametric actuarial clinical life table analysis to describe the data (Table 4.1).

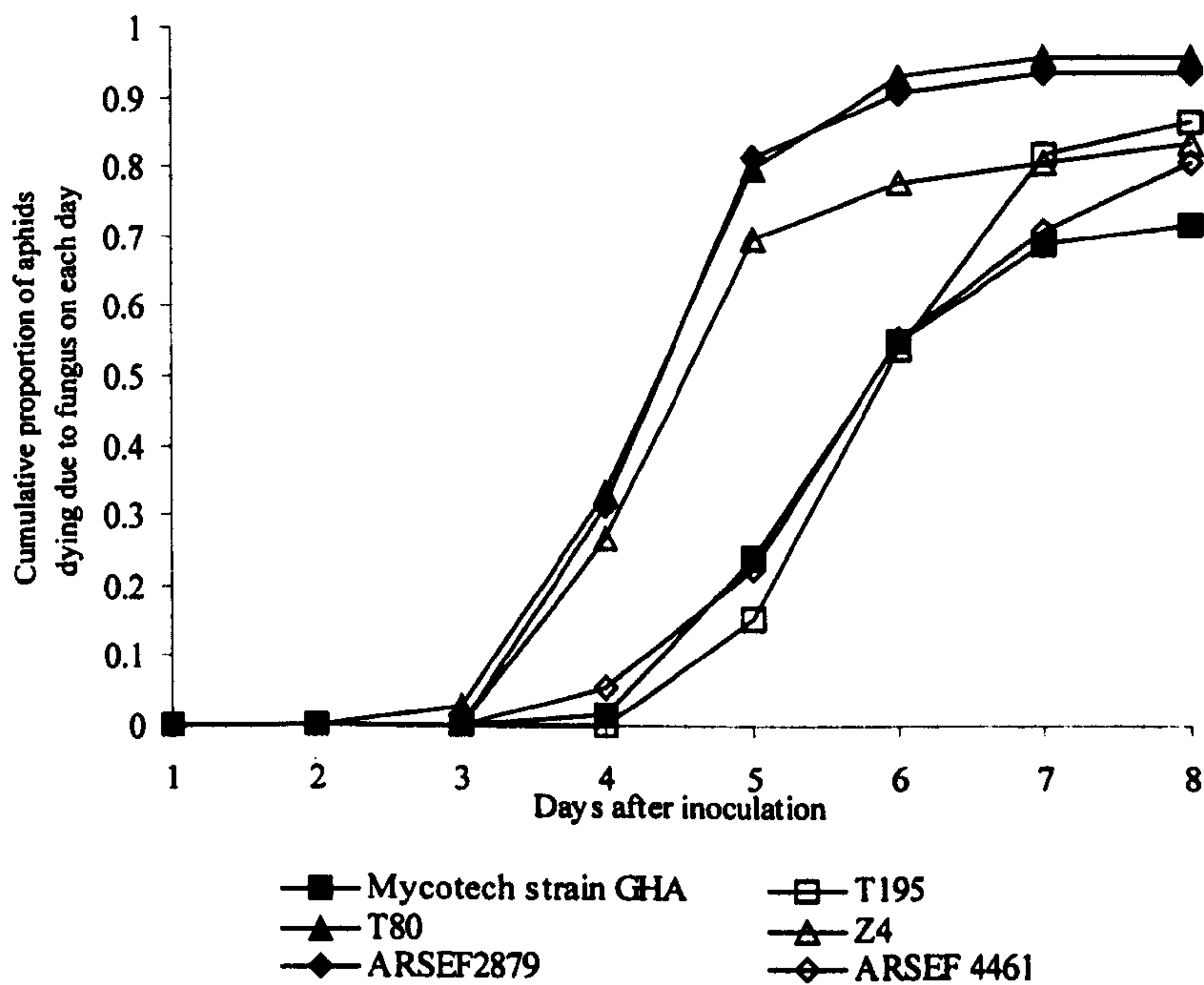
**TABLE 4.1 :**

Life table analysis of bioassays with 18 isolates of hyphomycete fungi at a single dose ( $1 \times 10^8$  conidia  $\text{ml}^{-1}$ ) against apterous adult *A. fabae*.

Bioassay Number	Isolate Reference	LT <sub>50</sub> (days)	±se of LT <sub>50</sub>	± 95% CI of LT <sub>50</sub> (days)	% Infection in aphids <sup>a</sup>
1	T80 ( <i>Verticillium lecanii</i> )	4.32	0.12	0.23	96 (69)
	ARSEF 2879 ( <i>Beauveria bassiana</i> )	4.38	0.12	0.23	96 (74)
	Z4 ( <i>Paecilomyces fumosoroseus</i> )	4.53	0.14	0.26	83 (72)
	Mycotech GHA ( <i>B. bassiana</i> )	5.76	0.18	0.36	72 (67)
	T195 ( <i>B. bassiana</i> )	5.82	0.15	0.29	86 (65)
2	HRI 1.72 ( <i>V. lecanii</i> )	3.31	0.08	0.16	100 (72)
	Z26 ( <i>V. lecanii</i> )	4.53	0.09	0.18	92 (74)
	Mycotech GHA ( <i>B. bassiana</i> )	4.65	0.11	0.21	93 (72)
	ARSEF 4491 ( <i>P. fumosoroseus</i> )	5.06	0.26	0.51	75 (72)
	Z43 ( <i>Metarhizium anisopliae</i> )	5.12	0.17	0.33	96 (71)
3	Z11 ( <i>P. fumosoroseus</i> )	3.69	0.10	0.19	99 (72)
	ARSEF 2859 ( <i>V. lecanii</i> )	3.86	0.10	0.20	96 (71)
	Z25 ( <i>V. lecanii</i> )	4.54	0.09	0.18	92 (60)
	Mycotech GHA ( <i>B. bassiana</i> )	4.85	0.13	0.24	94 (72)
	T130 ( <i>M. anisopliae</i> )	5.55	0.09	0.19	97 (71)
4	Mycotech GHA ( <i>B. bassiana</i> )	4.97	0.12	0.23	93 (71)
	Z139 ( <i>B. bassiana</i> )	5.28	0.18	0.35	81 (70)
	Z135 ( <i>B. bassiana</i> )	5.70	0.23	0.44	88 (72)
	ARSEF 4461 ( <i>P. fumosoroseus</i> )	5.76	0.17	0.33	81 (72)
	ARSEF 3458 ( <i>P. fumosoroseus</i> )	6.82	0.27	0.53	58 (71)
	T229 ( <i>P. farinosus</i> )	-	-	-	46 (71)

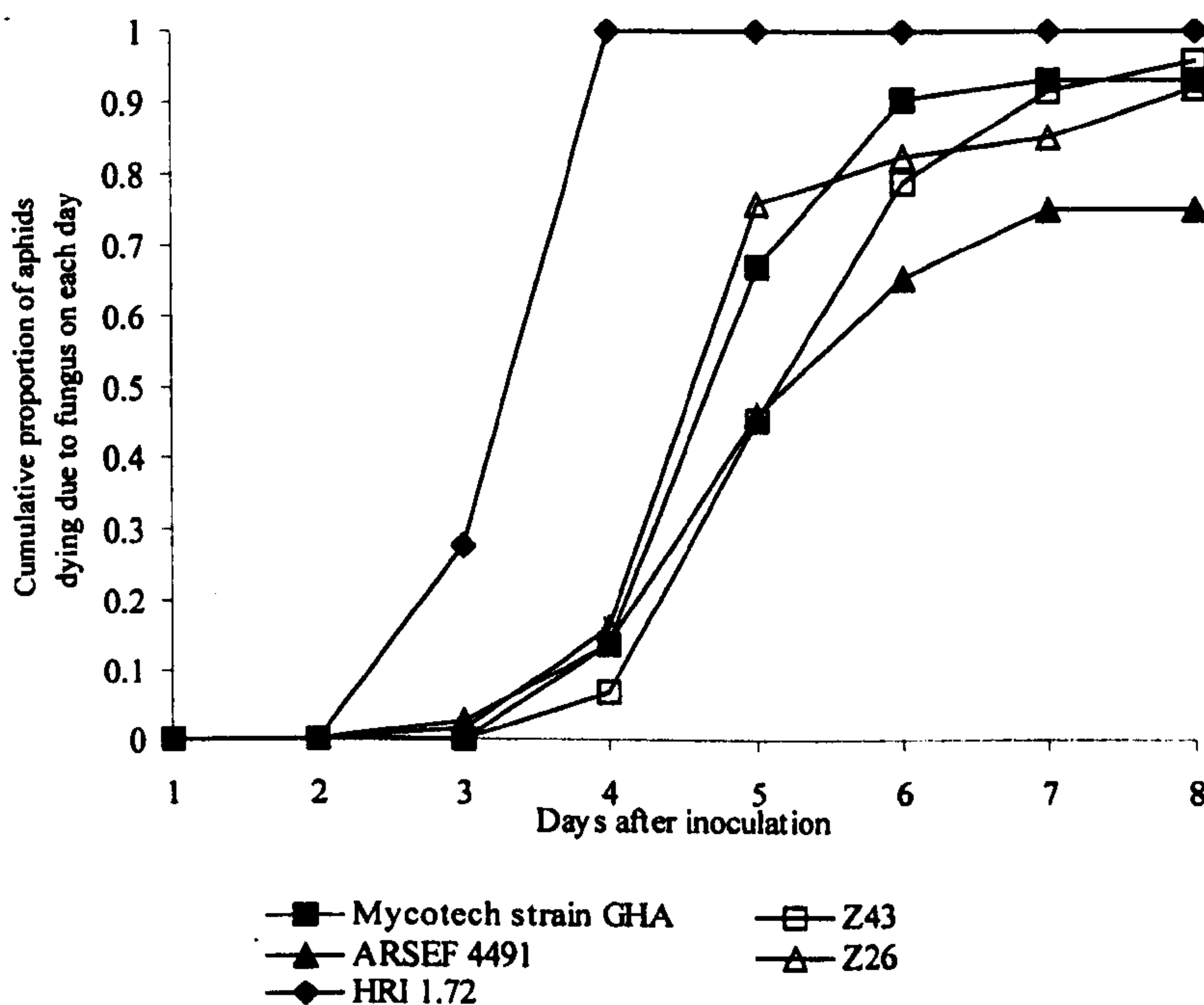
<sup>a</sup> Values in parentheses = n, excluding missing individuals

In the first assay, there was little difference in aphid mortality due to the isolates T80 (*V. lecanii*) and ARSEF 2879 (*B. bassiana*) which killed the highest number of aphids (>95% for both isolates (Table 4.1)) in the shortest times (LT<sub>50</sub> for T80 = 4.32 days; ARSEF 2879 = 4.39 days). Aphid mortality due to the isolates Mycotech strain GHA (*B. bassiana*) and T195 (*B. bassiana*) only started to occur four days after inoculation (Figure 4.2) and more aphids survived in these treatments.



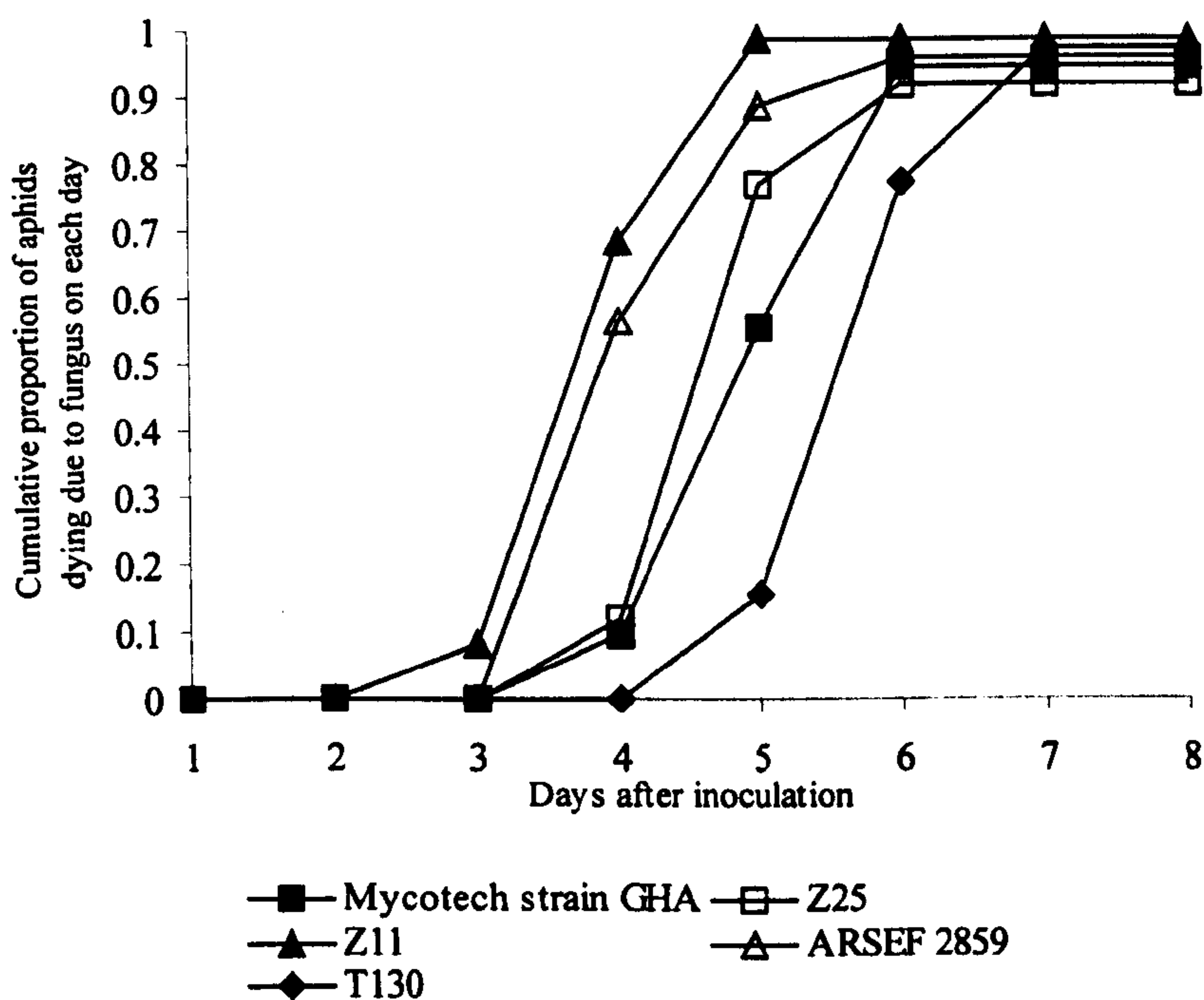
**FIGURE 4.2 :** Cumulative proportion of *A. fabae* dying due to fungus on each day following inoculation with a single concentration ( $1 \times 10^8$  conidia ml<sup>-1</sup>) of isolates ARSEF 2879 (*B. bassiana*), T195 (*B. bassiana*), T80 (*V. lecanii*), Z4 (*P. fumosoroseus*) and the standard isolate Mycotech strain GHA (*B. bassiana*).

In the second assay, aphid mortality due to isolate HRI 1.72 (*V. lecanii*) occurred very quickly following inoculation (Figure 4.3,  $LT_{50} = 3.31$  days) and this was the only isolate in any of the four assays for which 100% of the treated aphids succumbed to fungal infection (Table 4.1). In the second assay, aphid mortality due to isolates Z26 (*V. lecanii*), Z43 (*M. anisopliae*) and Mycotech strain GHA (*B. bassiana*) only started to occur after three to four days and more than 80% of aphids in each treatment succumbed to fungal infection. Aphid mortality due to isolate ARSEF 4491 (*P. fumosoroseus*) was less than for the other isolates (75%).



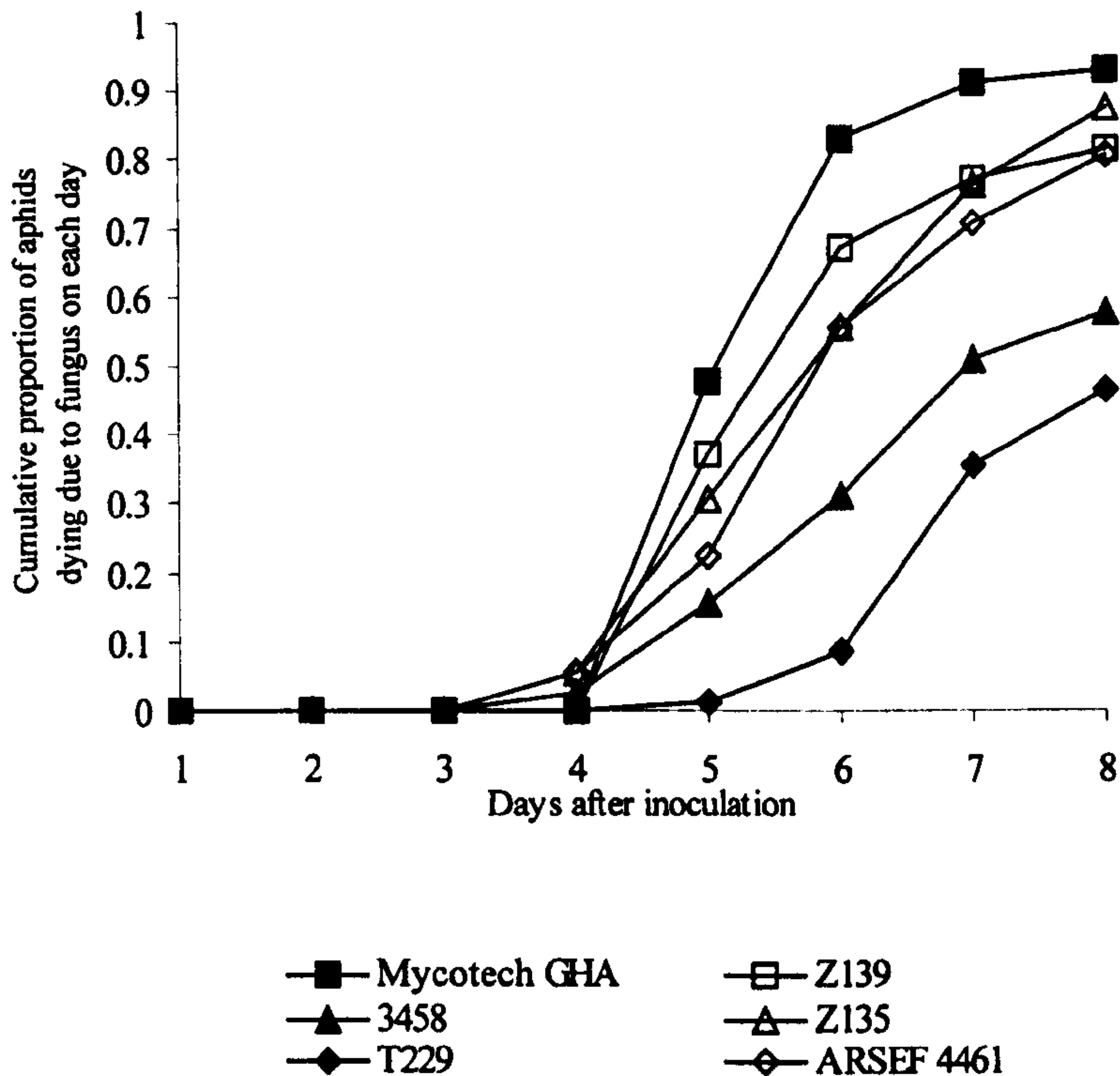
**FIGURE 4.3 :** Cumulative proportion of *A. fabae* dying due to fungus on each day following inoculation with a single concentration ( $1 \times 10^8$  conidia  $ml^{-1}$ ) of isolates HRI 1.72 (*V. lecanii*), Z43 (*M. anisopliae*), ARSEF 4491 (*P. fumosoroseus*), Z26 (*V. lecanii*) and the standard isolate Mycotech strain GHA (*B. bassiana*).

In the third bioassay, aphid mortality due to isolate Z11 (*P. fumosoroseus*) started to occur on day three (Figure 4.4). This isolate also had the lowest  $LT_{50}$  of the isolates screened in this assay ( $LT_{50} = 3.687$  days). There was little difference in the total number of aphids that succumbed to fungal infection between the isolates (Table 4.1). Aphid mortality due to isolate T130 (*M. anisopliae*) occurred more slowly than mortality due to the other isolates ( $LT_{50} = 5.55$  days; Figure 4.4).



**FIGURE 4.4 :** Cumulative proportion of *A. fabae* dying due to fungus on each day following inoculation with a single concentration ( $1 \times 10^8$  conidia  $ml^{-1}$ ) of isolates Z25 (*V. lecanii*), Z11 (*P. fumosoroseus*), ARSEF 2859 (*V. lecanii*), T130 (*M. anisopliae*) and the standard isolate Mycotech GHA (*B. bassiana*).

In the fourth bioassay, total aphid mortality due to the standard isolate Mycotech strain GHA (*B. bassiana*) was large (93%) and occurred more quickly than for the other isolates ( $LT_{50} = 4.97$  days). Aphid mortality due to the isolates, Z139 (*B. bassiana*), ARSEF 4461 (*P. fumosoroseus*) and Z135 (*B. bassiana*), occurred over a similar period of time (Figure 4.5) and the total number of aphids that succumbed to fungal infection was similar for these isolates (Table 4.1).



**FIGURE 4.5 :** Cumulative proportion of *A. fabae* dying due to fungus on each day following inoculation with a single concentration ( $1 \times 10^8$  conidia  $\text{ml}^{-1}$ ) of isolates Z139 (*B. bassiana*), ARSEF 3458 (*P. fumosoroseus*), Z135 (*B. bassiana*), T229 (*P. farinosus*), ARSEF 4461 (*P. fumosoroseus*) and the standard isolate Mycotech strain GHA (*B. bassiana*).

Mortality due to the isolates T229 (*P. farinosus*) and ARSEF 3458 (*P. fumosoroseus*) was small compared to the other isolates and occurred over a longer period of time (Figure 4.5, Table 4.1). An  $\text{LT}_{50}$  value could not be calculated for isolate T229 as only 46.48% of the aphids treated had succumbed to fungal infection by day eight of the assay.

As assays could not be combined, the most effective treatments for each assay were identified as those which had the lowest  $\text{LT}_{50}$  values and caused the highest mortality in treated aphids. The most effective treatments were therefore:

Bioassay 1: T80 (*V. lecanii*) and ARSEF 2879 (*B. bassiana*)

Bioassay 2: HRI 1.72 (*V. lecanii*)

Bioassay 3: Z11 (*P. fumosoroseus*)

Bioassay 4: Mycotech strain GHA (*B. bassiana*)



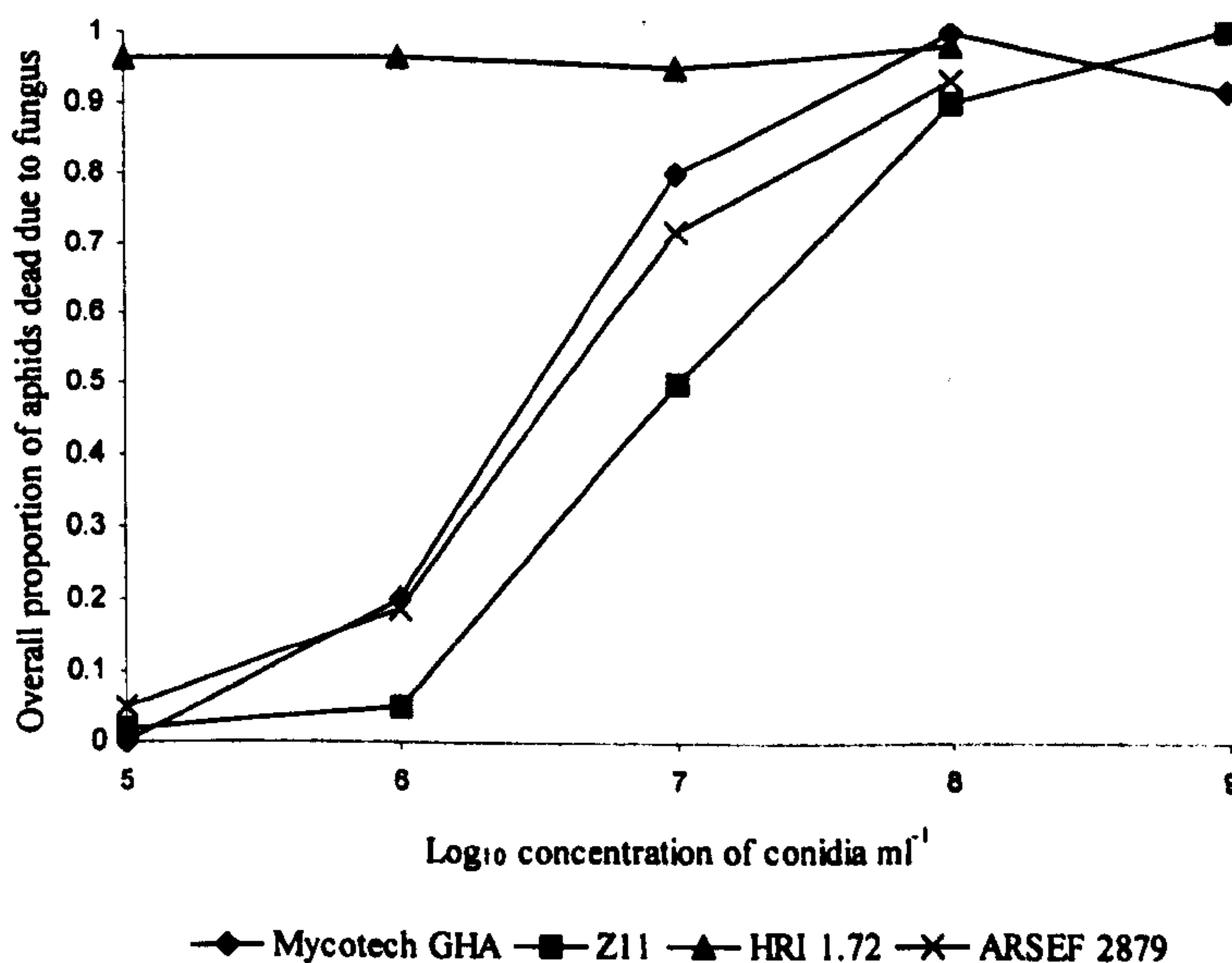
All of these isolates, except for T80 (*V. lecanii*) were taken forward to the next level of testing. Isolate ARSEF 2879 (*B. bassiana*) was chosen from the first assay as it was easier to harvest large numbers of spores from solid culture for this isolate compared to T80 (*V. lecanii*).

#### 4.3.2 Dose-response assays against *Aphis fabae* with four selected isolates

##### 4.3.2.1 Dose ranges of $1 \times 10^5$ - $1 \times 10^9$ conidia $\text{ml}^{-1}$

In the third run of the dose-response assay, there were a large number of deaths in the controls due to fungus (49%). It was suspected that this fungus was *V. lecanii*, from characteristic sporulation on dead aphids and examination of conidia under the microscope. Similar deaths occurred in the applied fungal treatments so the results from this assay were discarded.

In the first assay, isolate HRI 1.72 (*V. lecanii*) was clearly the most effective isolate causing a distinctly different pattern of aphid mortality compared to the other three isolates (Figure 4.6).



**FIGURE 4.6 :** Proportion of adult *Aphis fabae* dying due to fungus in the first run of a dose response assay with five concentrations ( $\log_{10}$  5.0, 6.0, 7.0, 8.0 & 9.0 conidia  $\text{ml}^{-1}$ ) of isolates Mycotech strain GHA (*B. bassiana*), HRI 1.72 (*V. lecanii*), Z11 (*P. fumosoroseus*) and ARSEF 2879 (*B. bassiana*)

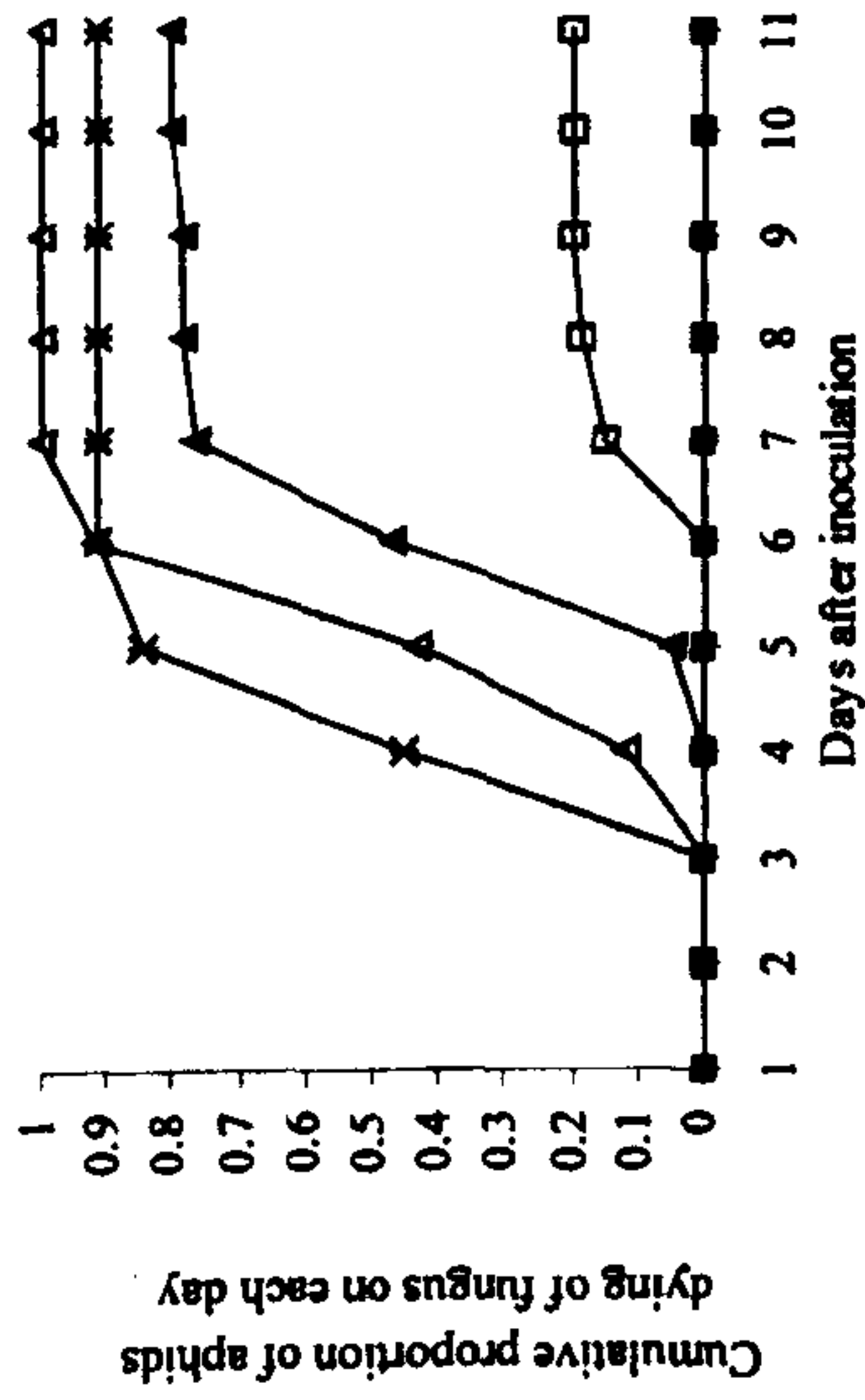
For this reason, HRI 1.72 (*V. lecanii*) was removed from the probit analysis. The results from the general linear regression with probit analysis, indicated that a single line was sufficient to describe the data for the other three isolates ( $F_{1,8} = 108.77$ ,  $P < 0.001$ ). The single line model suggested there was no significant difference between the three isolates in the effect they had on aphids over the range of concentrations of conidia applied; the calculated  $LC_{50}$  for the three isolates was  $5.78 \times 10^6$  conidia  $ml^{-1}$  (95% confidence interval;  $3.33 \times 10^6 - 1.01 \times 10^7$  conidia  $ml^{-1}$ ). Adding an additional description of an individual intercept for each isolate did not describe the data any better ( $F_{2,8} = 1.14$ ,  $P = 0.366$ ) and neither did adding a further description of a different slope for each isolate ( $F_{2,8} = 0.31$ ,  $P = 0.743$ ).

In general, the  $LT_{50}$  values for all isolates (including HRI 1.72 (*V. lecanii*)) decreased with an larger concentrations of conidia (Table 4.2). Aphids treated with a large concentration ( $1 \times 10^8$  conidia  $ml^{-1}$ ) of isolate HRI 1.72 (*V. lecanii*) began to die to fungal infection two days after inoculation compared to the other treatments in which mortality began after three to four days (Figure 4.7).

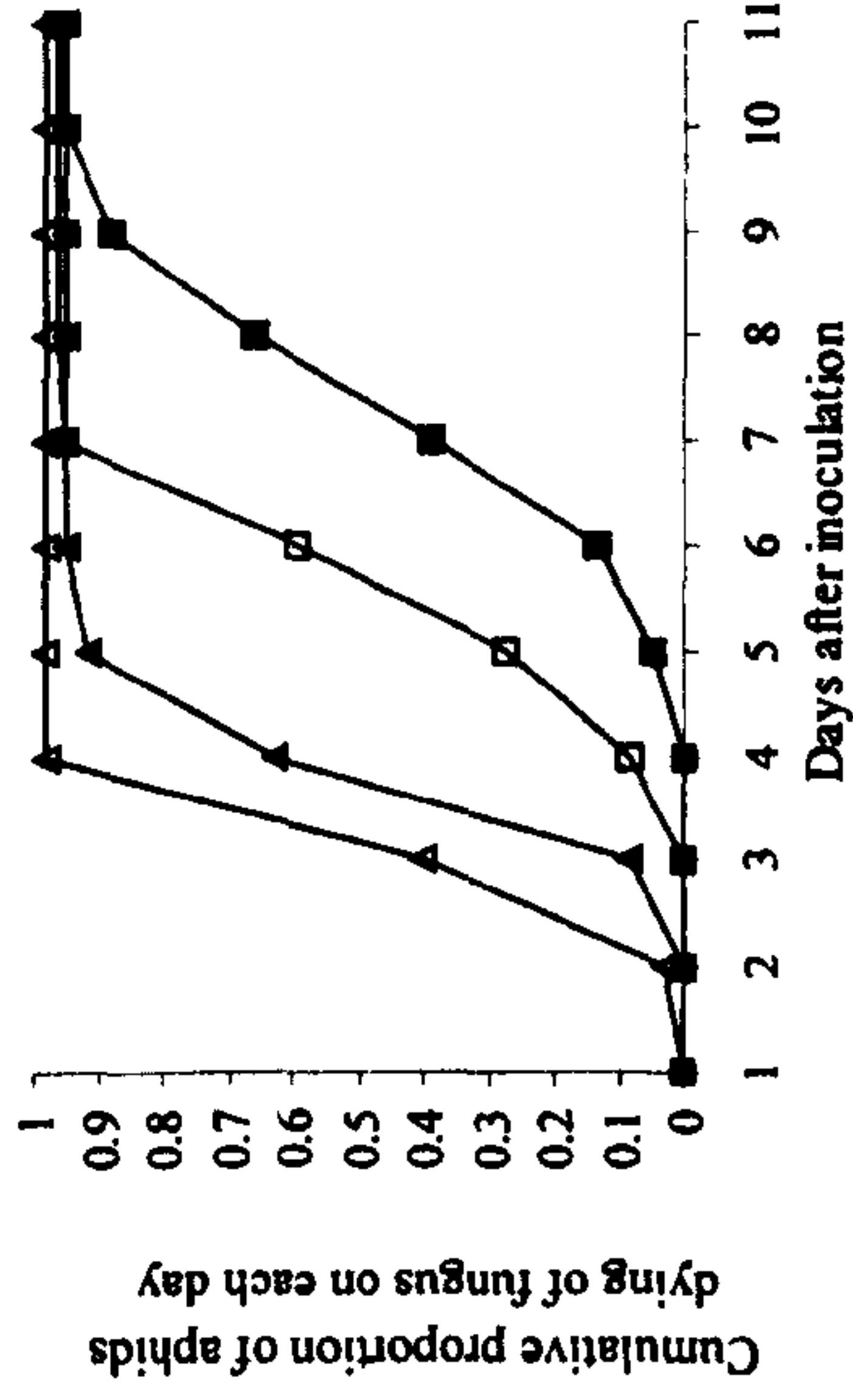
**TABLE 4.2 :** Calculated  $LT_{50}$  values for four isolates of hyphomycete fungi; Mycotech GHA (*B. bassiana*), Z11 (*P. fumosoroseus*), HRI 1.72 (*V. lecanii*) and ARSEF 2879 (*B. bassiana*), screened against adult *Aphis fabae* in the first run of a dose response assay at concentrations of  $1 \times 10^5 - 1 \times 10^9$  conidia  $ml^{-1}$ .

Isolate	Concentration (conidia $ml^{-1}$ )	$LT_{50}$ (days)	se of $LT_{50}$ (days)	$\pm$ 95% CI of $LT_{50}$
Mycotech Strain GHA	$10^5$	*	*	*
	$10^6$	*	*	*
	$10^7$	6.06	0.21	0.41
	$10^8$	5.14	0.13	0.26
	$10^9$	4.03	0.15	0.29
Z11	$10^5$	*	*	*
	$10^6$	*	*	*
	$10^7$	7.98	3.57	6.99
	$10^8$	4.00	0.35	0.68
	$10^9$	3.60	0.08	0.16
HRI 1.72	$10^5$	7.38	0.24	0.46
	$10^6$	5.66	0.20	0.38
	$10^7$	3.71	0.11	0.22
	$10^8$	3.18	0.11	0.21
	$10^9$	-	-	-
ARSEF 2879	$10^5$	*	*	*
	$10^6$	*	*	*
	$10^7$	5.50	0.27	0.53
	$10^8$	4.05	0.13	0.25
	$10^9$	-	-	-

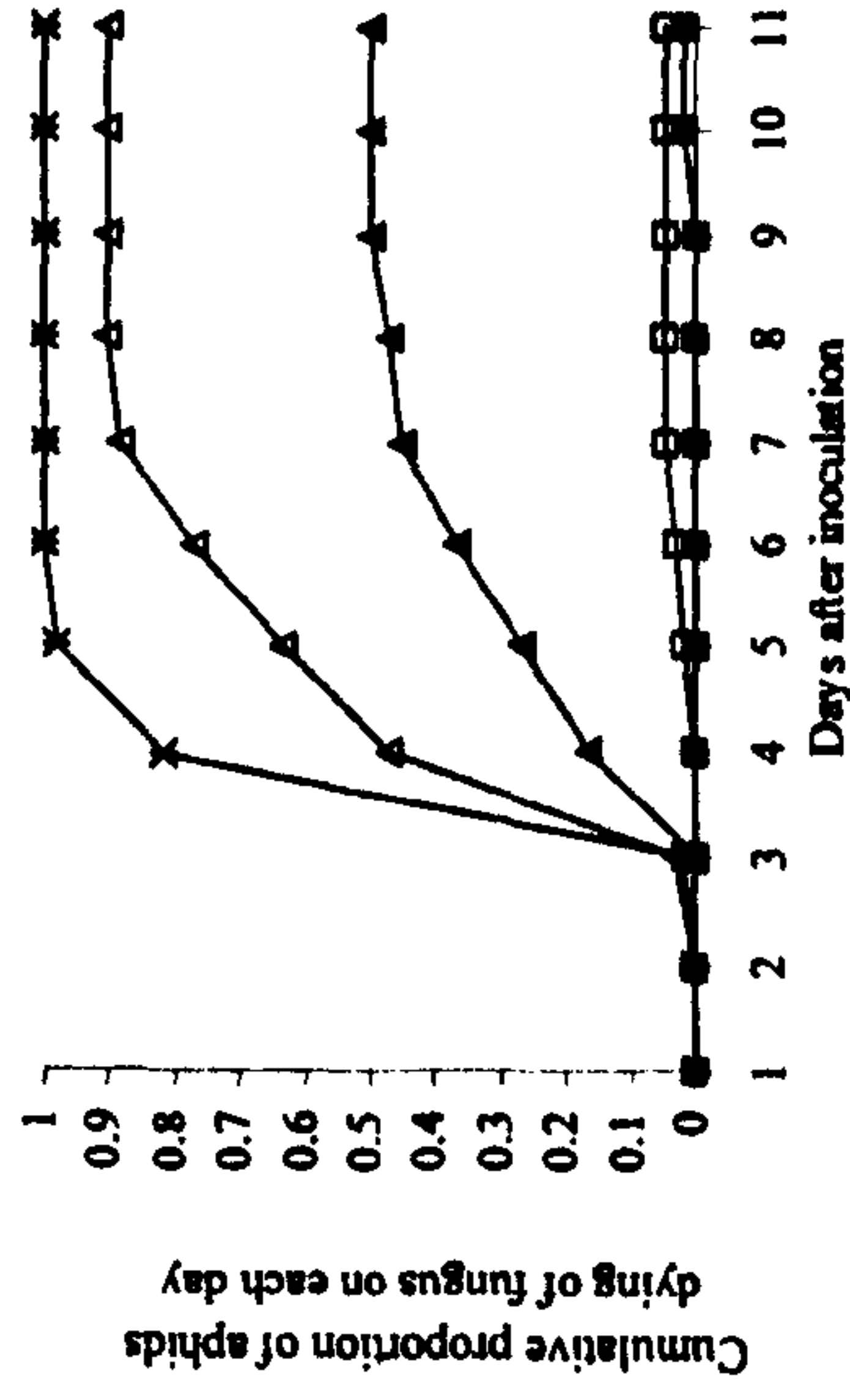
a) Mycotech strain GHA



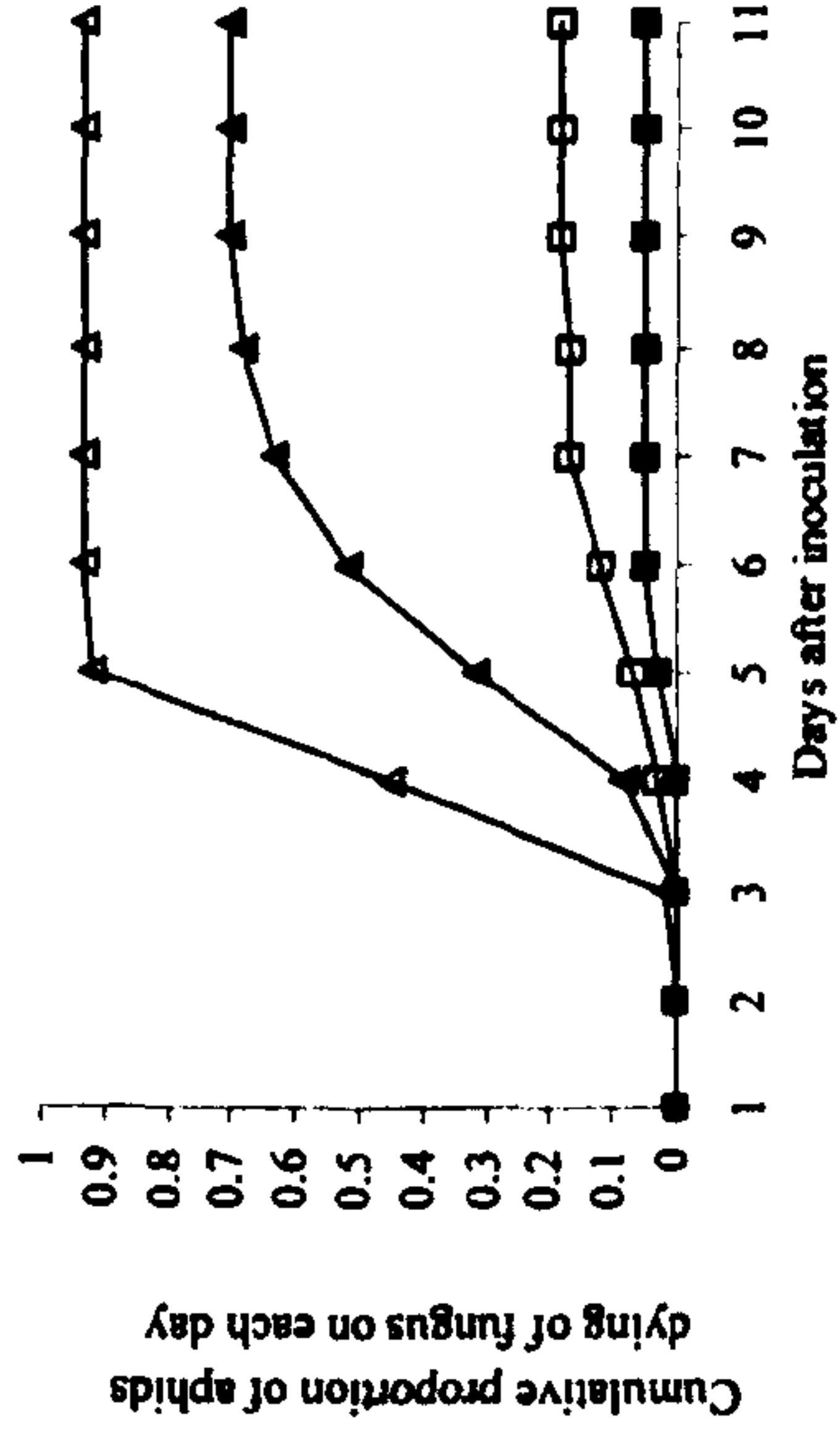
b) HRI 1.72



c) Z11



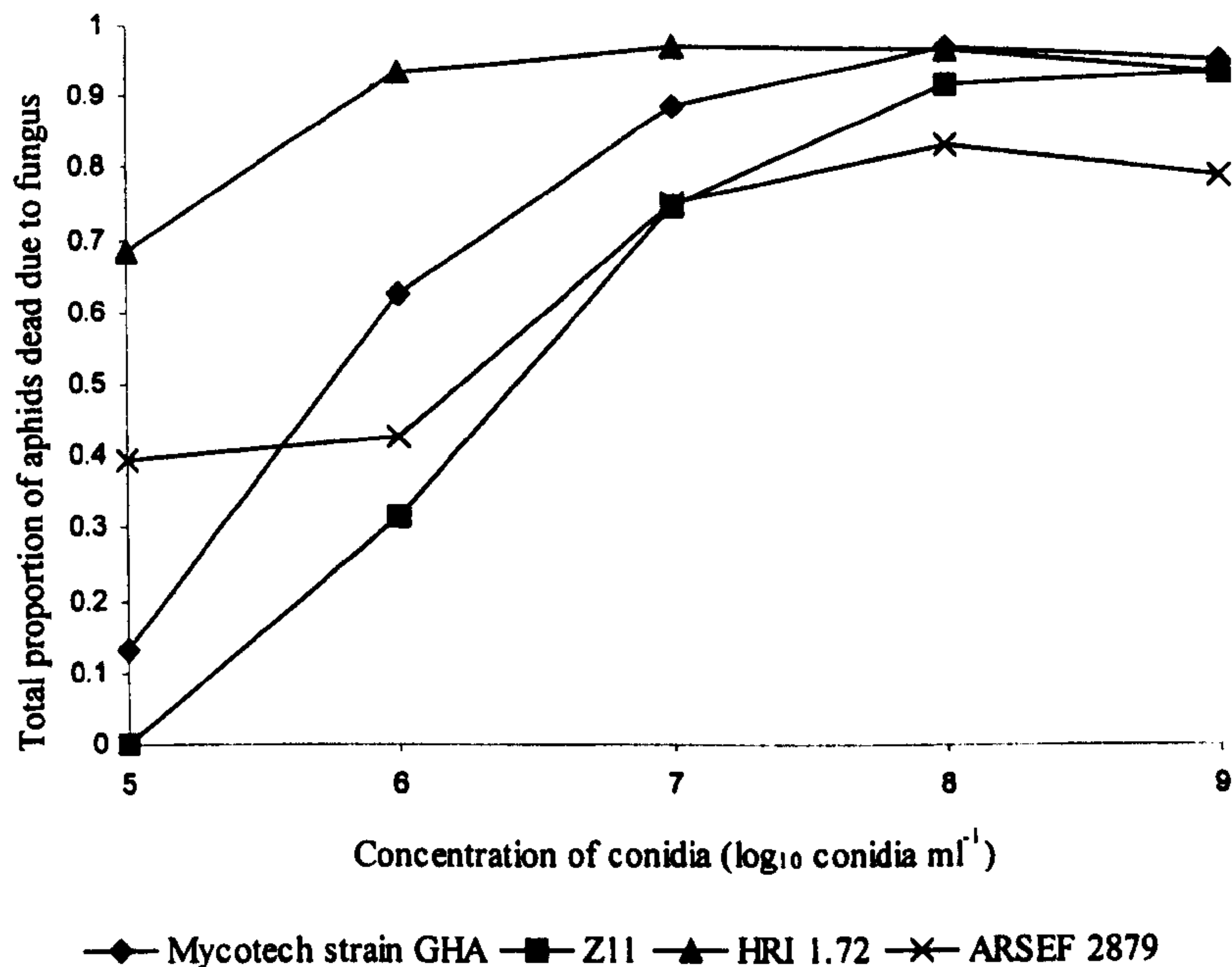
d) ARSEF 2879



—■— 5 —□— 6 —▲— 7 —△— 8 —×— 9 Log<sub>10</sub> conidia ml<sup>-1</sup>

**FIGURE 4.7 :** Cumulative proportion of *Aphis fabae* dying due to fungus on each day following inoculation with five concentrations ( $\log_{10}$  5.0, 6.0, 7.0, 8.0 & 9.0 conidia ml<sup>-1</sup>) of isolates a) Mycotech strain GHA (*B. bassiana*), b) HRI 1.72 (*V. lecanii*), c) Z11 (*P. fumosoroseus*) and d) ARSEF 2879 (*B. bassiana*). First run of experiment.

Data for HRI 1.72 (*V. lecanii*) were also removed from analysis in the second dose-response assay for consistency. Although this isolate was less effective than in the first assay, it still showed a different pattern of kill to the other isolates (Figure 4.8).



**FIGURE 4.8 :** Proportion of adult *Aphis fabae* dying due to fungus in the second run of a dose response assay with five concentrations ( $\log_{10}$  5.0, 6.0, 7.0, 8.0 & 9.0 conidia  $\text{ml}^{-1}$ ) of isolates Mycotech strain GHA (*B. bassiana*), HRI 1.72 (*V. lecanii*), Z11 (*P. fumosoroseus*) and ARSEF 2879 (*B. bassiana*)

The general linear regression with probit analysis indicated that the data for ARSEF 2879 (*B. bassiana*), Z11 (*P. fumosoroseus*) and Mycotech strain GHA (*B. bassiana*) were described by a single line model as adding an additional description of an individual intercept for each isolate did not describe the data any better ( $F_{2,9} = 1.67$ ,  $P = 0.241$ ). However, the addition of a further parameter to the model of an individual slope for each isolate was found to give a better description of the data ( $F_{2,9} = 4.62$ ,  $P = 0.042$ ). This suggested that the isolates had very close, but not exactly the same, intercepts and quite different slopes.

The calculated  $\text{LC}_{50}$  values could only be compared if the model describing the response of aphids to an isolate fitted lines that were either the same or parallel for each isolate. In this assay, the fitted model suggested that the three isolates could not be directly compared. The model suggested that the isolates were acting in a

different way over the range of concentrations of conidia: the  $LT_{50}$  values at any one dose were dependent on the isolate that was applied.

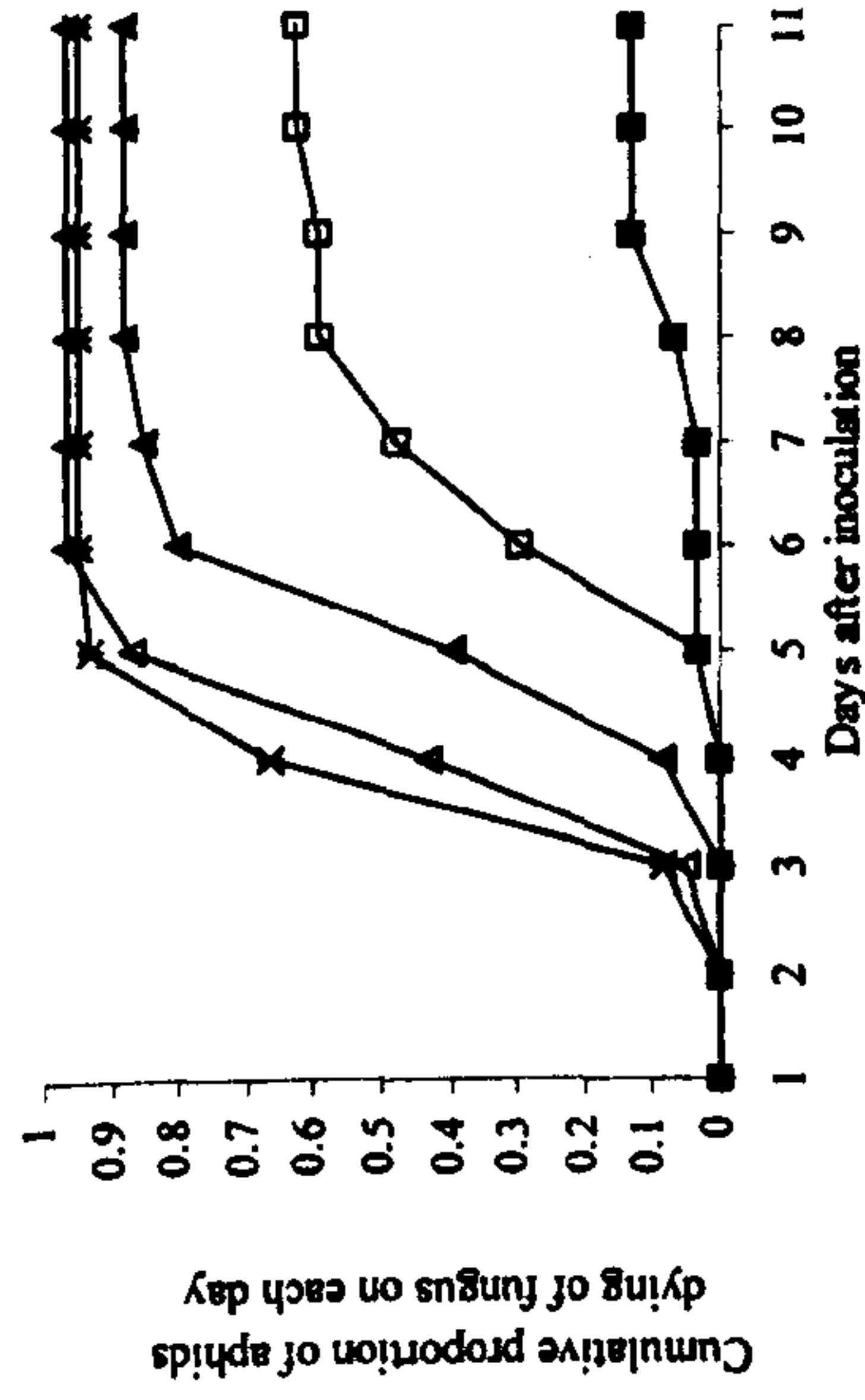
The calculated  $LT_{50}$  values (Table 4.3) generally decreased as the concentration of conidia increased for all isolates including HRI 1.72 (*V. lecanii*). However, the mortality of aphids due to isolate ARSEF 2879 at concentrations of  $1 \times 10^5$  and  $1 \times 10^6$  conidia  $ml^{-1}$  was similar whilst mortality of aphids due to other isolates was less at the smaller concentration.

**TABLE 4.3** : Calculated  $LT_{50}$  values for four isolates of hyphomycete fungi; Mycotech strain GHA (*B. bassiana*), Z11 (*P. fumosoroseus*), HRI 1.72 (*V. lecanii*) and ARSEF 2879 (*B. bassiana*), assayed against adult *Aphis fabae* in the second run of a dose response assay at concentrations of  $1 \times 10^5 - 1 \times 10^9$  conidia  $ml^{-1}$ .

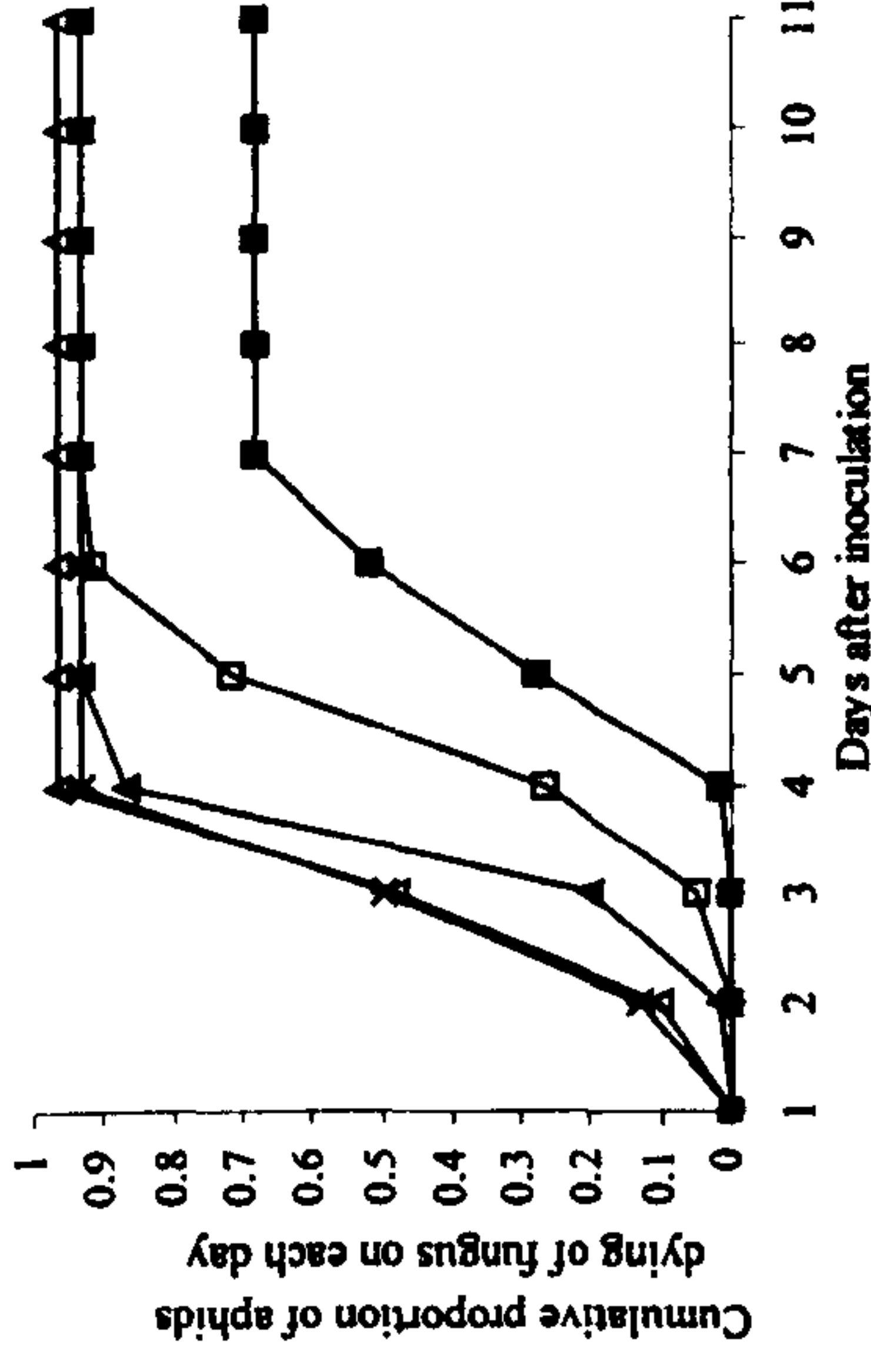
Isolate	Concentration (conidia $ml^{-1}$ )	$LT_{50}$ (days)	se of $LT_{50}$ (days)	$\pm$ 95% CI of $LT_{50}$
Mycotech strain GHA	$10^5$	*	*	*
	$10^6$	6.61	0.28	0.55
	$10^7$	5.14	0.14	0.28
	$10^8$	4.12	0.15	0.28
	$10^9$	3.67	0.11	0.21
Z11	$10^5$	*	*	*
	$10^6$	*	*	*
	$10^7$	5.01	0.29	0.58
	$10^8$	4.16	0.13	0.25
	$10^9$	3.70	0.09	0.18
HRI 1.72	$10^5$	5.27	0.19	0.38
	$10^6$	4.46	0.14	0.27
	$10^7$	3.43	0.09	0.18
	$10^8$	3.00	0.13	0.26
	$10^9$	2.91	0.17	0.33
ARSEF 2879	$10^5$	9.26	0.65	1.28
	$10^6$	9.35	1.45	2.85
	$10^7$	5.23	0.19	0.38
	$10^8$	3.64	0.09	0.18
	$10^9$	3.59	0.09	0.18

Again, isolate HRI 1.72 (*V. lecanii*) was the most effective of the four isolates; aphids began to die due to fungal infection on the second day of the assay and approximately 90% of aphids were dead by day six for all concentrations except  $1 \times 10^5$  conidia  $ml^{-1}$  (Figure 4.9).

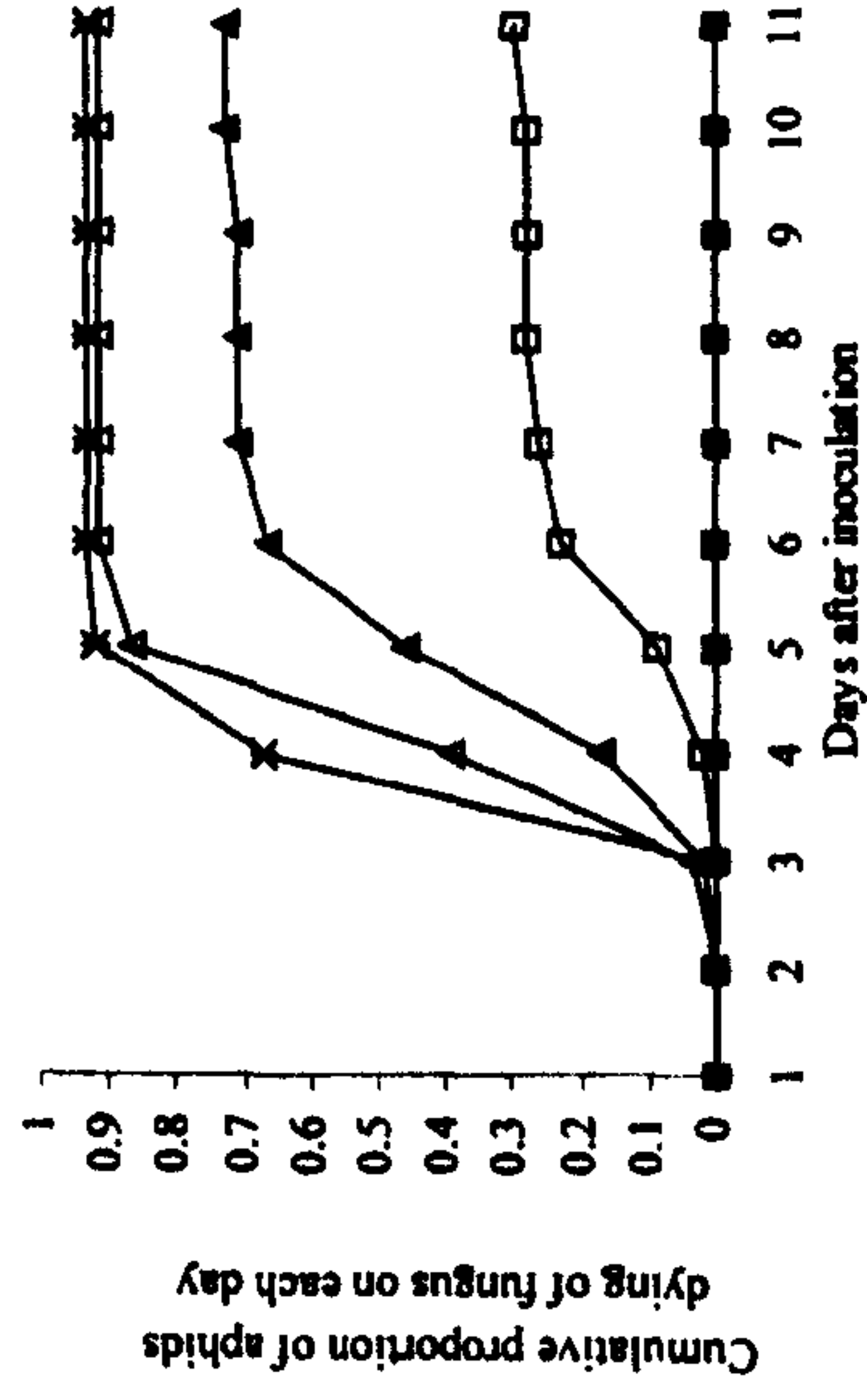
a) Mycotech GHA



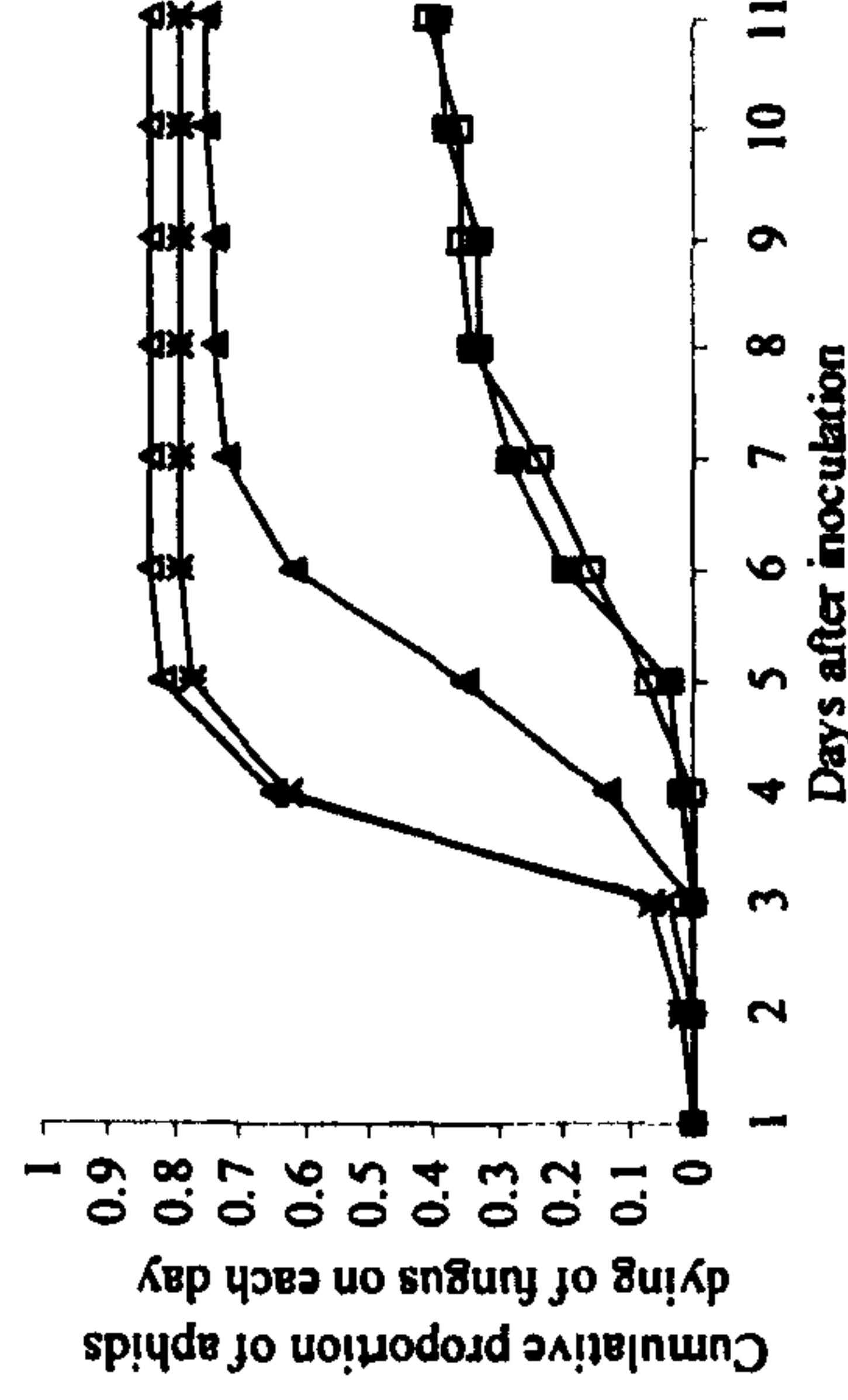
b) HRI 1.72



c) Z11



d) ARSEF 2879



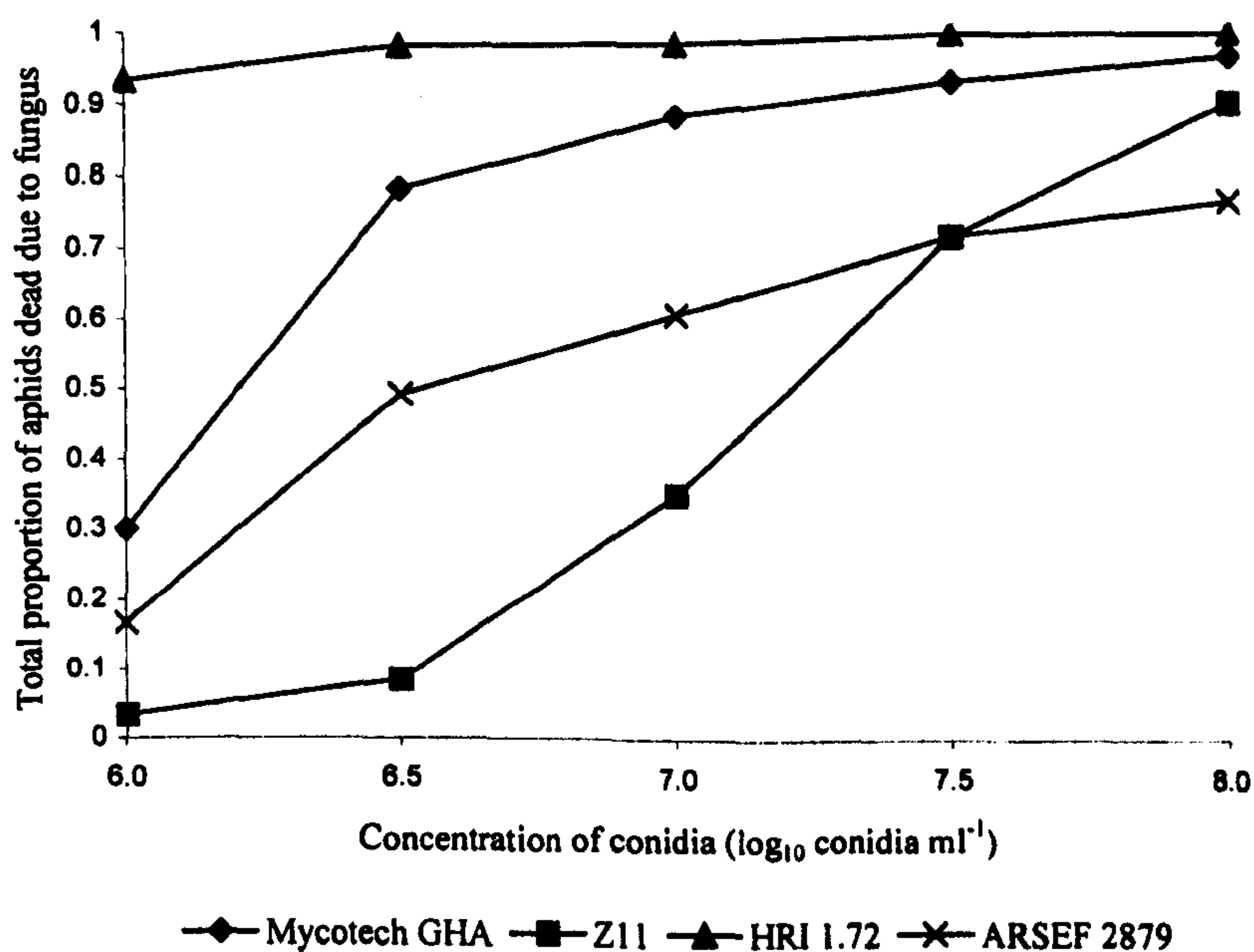
—■— 5 —□— 6 —▲— 7 —△— 8 —×— 9 Log<sub>10</sub> conidia ml<sup>-1</sup>

**FIGURE 4.9 :** Cumulative proportion of *Aphis fabae* dying of fungus on each day following inoculation with five concentrations ( $\log_{10}$  5.0, 6.0, 7.0, 8.0 & 9.0 conidia ml<sup>-1</sup>) of isolates a) Mycotech strain GHA (*B. bassiana*), b) HRI 1.72 (*V. lecanii*), c) Z11 (*P. fumosoroseus*), and d) ARSEF 2879 (*B. bassiana*). Second run of experiment.

Overall, in both runs of the assay, total aphid mortality due to all isolates showed little difference at the two largest concentrations ( $1 \times 10^8$  and  $1 \times 10^9$  conidia  $\text{ml}^{-1}$ ) and aphids succumbed to fungal infection over a similar period of time (Tables 4.2 & 4.3). The mortality of aphids due to each isolate was more variable at concentrations smaller than  $1 \times 10^8$  conidia  $\text{ml}^{-1}$  (Figures 4.7 & 4.9). To calculate more accurate values for the  $\text{LC}_{50}$  and  $\text{LT}_{50}$  of each isolate, an increased range of concentrations were screened between  $1 \times 10^6$  and  $1 \times 10^8$  conidia  $\text{ml}^{-1}$ .

#### 4.3.2.2 Dose ranges of $1 \times 10^6 - 1 \times 10^8$ conidia $\text{ml}^{-1}$

Data for HRI 1.72 (*V. lecanii*) were removed from the analysis; aphid mortality due to this isolate showed a different pattern compared to the other isolates (Figure 4.10).



**FIGURE 4.10** : Proportion of adult *Aphis fabae* dying due to fungus in a dose response assay after inoculation with five concentrations ( $\log_{10}$  6.0, 6.5, 7.0, 7.5 & 8.0 conidia  $\text{ml}^{-1}$ ) of isolates Mycotech strain GHA (*B. bassiana*), HRI 1.72 (*V. lecanii*), Z11 (*P. fumosoroseus*) and ARSEF 2879 (*B. bassiana*)

The general linear regression with probit analysis indicated that a single line was not sufficient to describe the data ( $F_{1,14} = 19.69$ ,  $P < 0.001$ ). Adding an additional description to the data of an individual intercept for each isolate did not describe the data any better ( $F_{2,14} = 13.05$ ,  $P < 0.001$ ). Therefore the best model to describe

the data was with a different slope and intercept for each isolate. The LC<sub>50</sub> values could not be compared between isolates as the fitted model suggested that the isolates were acting in a different way over the range of concentrations of conidia.

In general, for each isolate as concentration of conidia increased, the calculated LT<sub>50</sub> values decreased (Table 4.4).

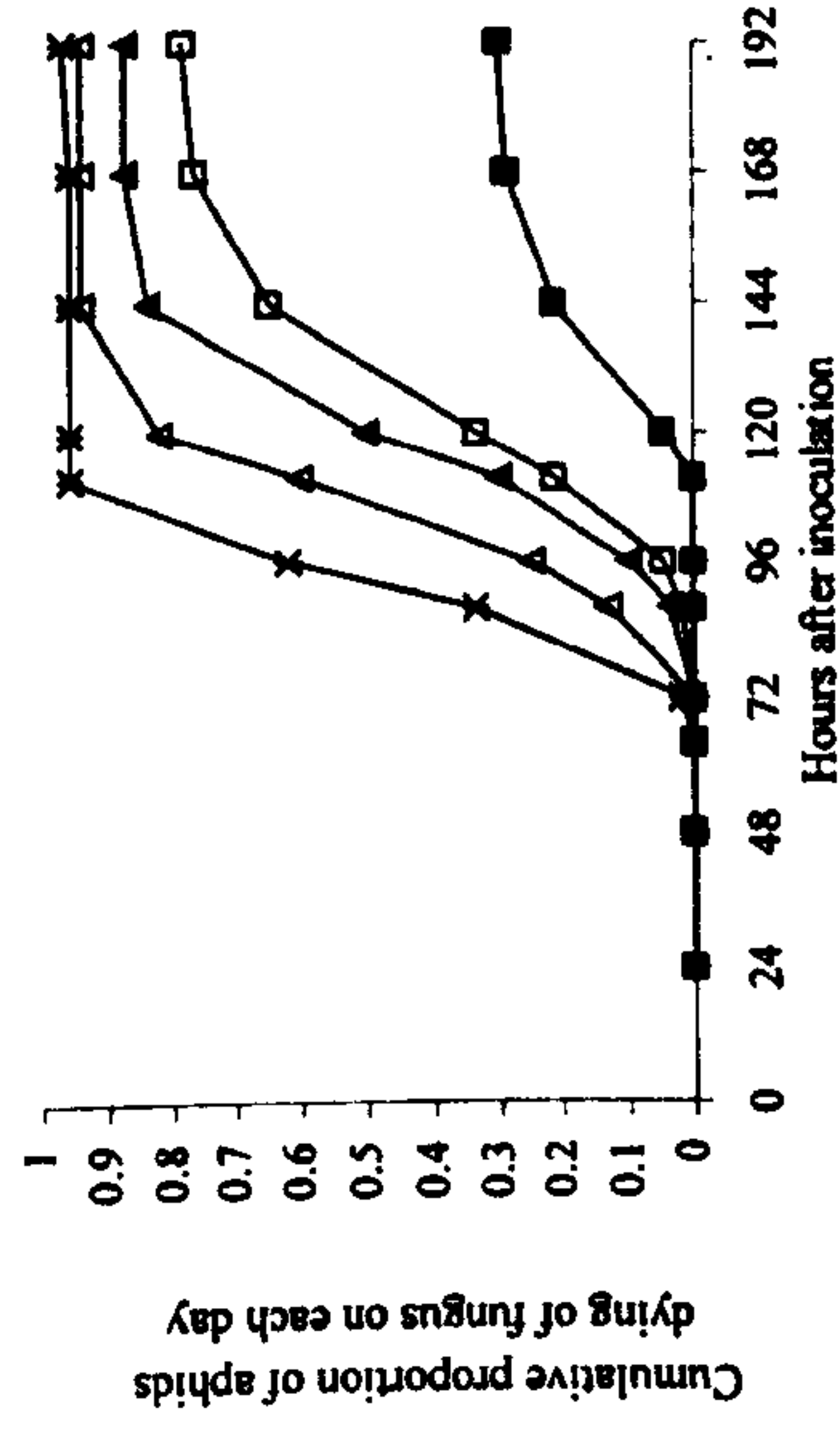
**TABLE 4.4 :** Calculated LT<sub>50</sub> values for four isolates of hyphomycete fungi; Mycotech GHA (*B. bassiana*), Z11 (*P. fumosoroseus*), HRI 1.72 (*V. lecanii*) and ARSEF 2879 (*B. bassiana*), screened against adult *Aphis fabae* in a dose response assay at concentrations of  $1 \times 10^6 - 1 \times 10^8$  conidia ml<sup>-1</sup>.

Isolate	Concentration (conidia ml <sup>-1</sup> )	LT <sub>50</sub> (days)	se of LT <sub>50</sub> (days)	± 95% CI of LT <sub>50</sub>
Mycotech GHA	$1 \times 10^6$	*	*	*
	$1 \times 10^{6.5}$	5.46	0.19	0.38
	$1 \times 10^7$	4.93	0.10	0.19
	$1 \times 10^{7.5}$	4.41	0.11	0.23
	$1 \times 10^8$	3.84	0.07	0.14
Z11	$1 \times 10^6$	*	*	*
	$1 \times 10^{6.5}$	*	*	*
	$1 \times 10^7$	*	*	*
	$1 \times 10^{7.5}$	5.31	0.30	0.58
	$1 \times 10^8$	4.53	0.12	0.24
HRI 1.72	$1 \times 10^6$	5.55	0.17	0.34
	$1 \times 10^{6.5}$	4.37	0.10	0.19
	$1 \times 10^7$	3.95	0.04	0.08
	$1 \times 10^{7.5}$	3.23	0.07	0.14
	$1 \times 10^8$	3.17	0.09	0.17
ARSEF 2879	$1 \times 10^6$	*	*	*
	$1 \times 10^{6.5}$	6.72	0.47	0.92
	$1 \times 10^7$	4.82	0.12	0.24
	$1 \times 10^{7.5}$	3.89	0.06	0.12
	$1 \times 10^8$	3.95	0.07	0.13

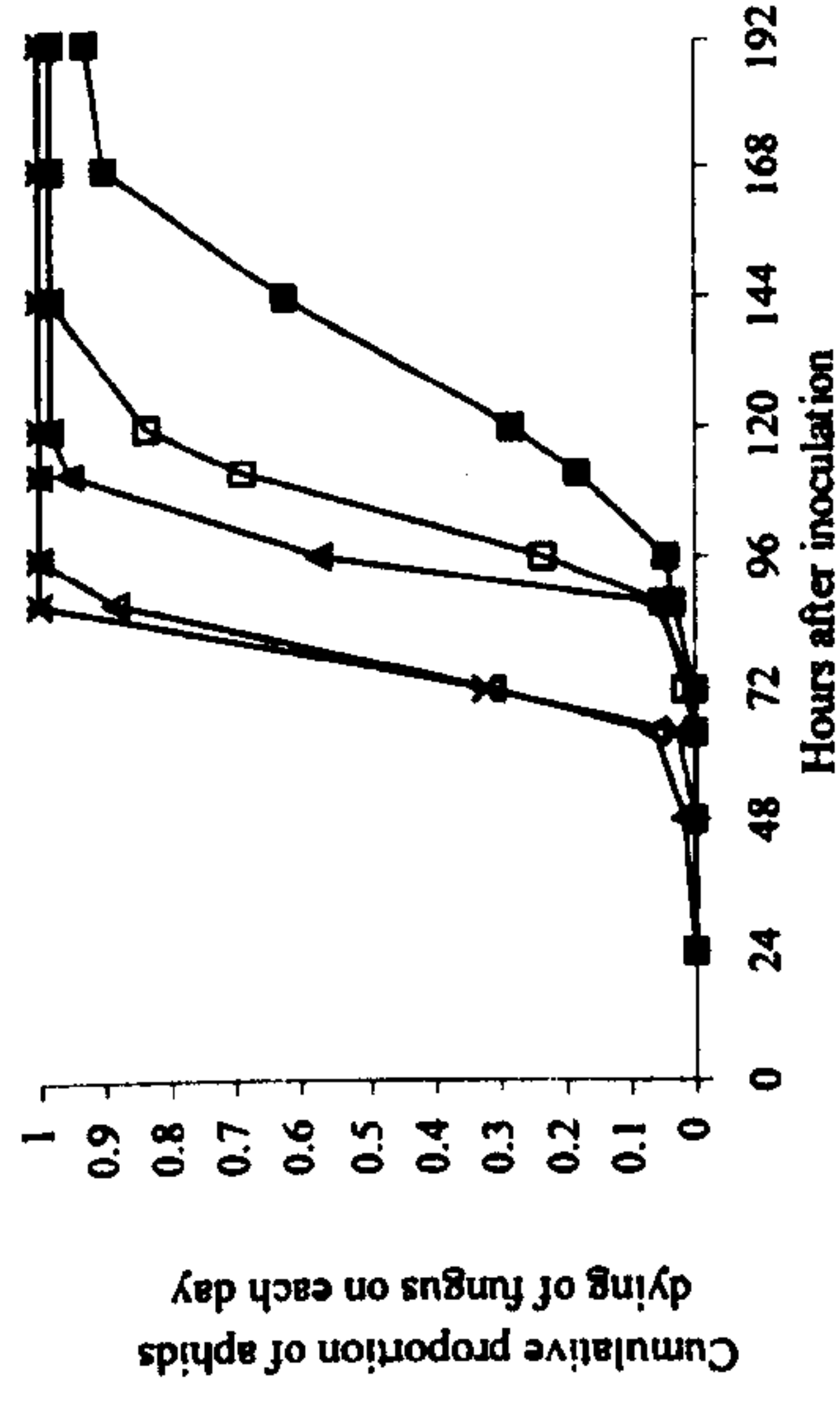
At the larger concentrations of conidia ( $1 \times 10^8$  and  $1 \times 10^{7.5}$ ) mortality of aphids due to isolate HRI 1.72 (*V. lecanii*) started to occur after 48 hours and mortality was greater than 90% for each concentration of conidia after 168 hours (Figure 4.11).



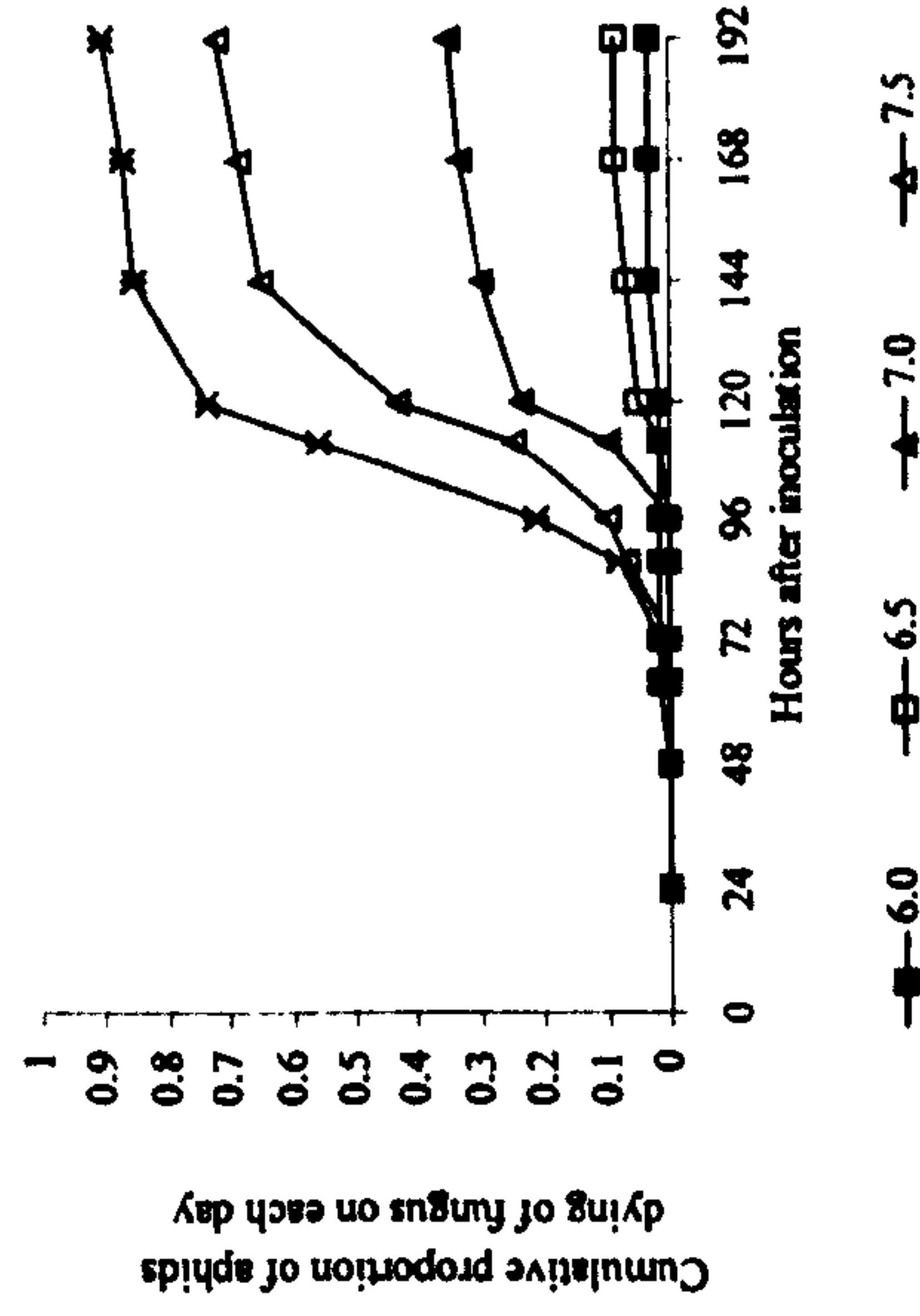
a) Mycotech GHA



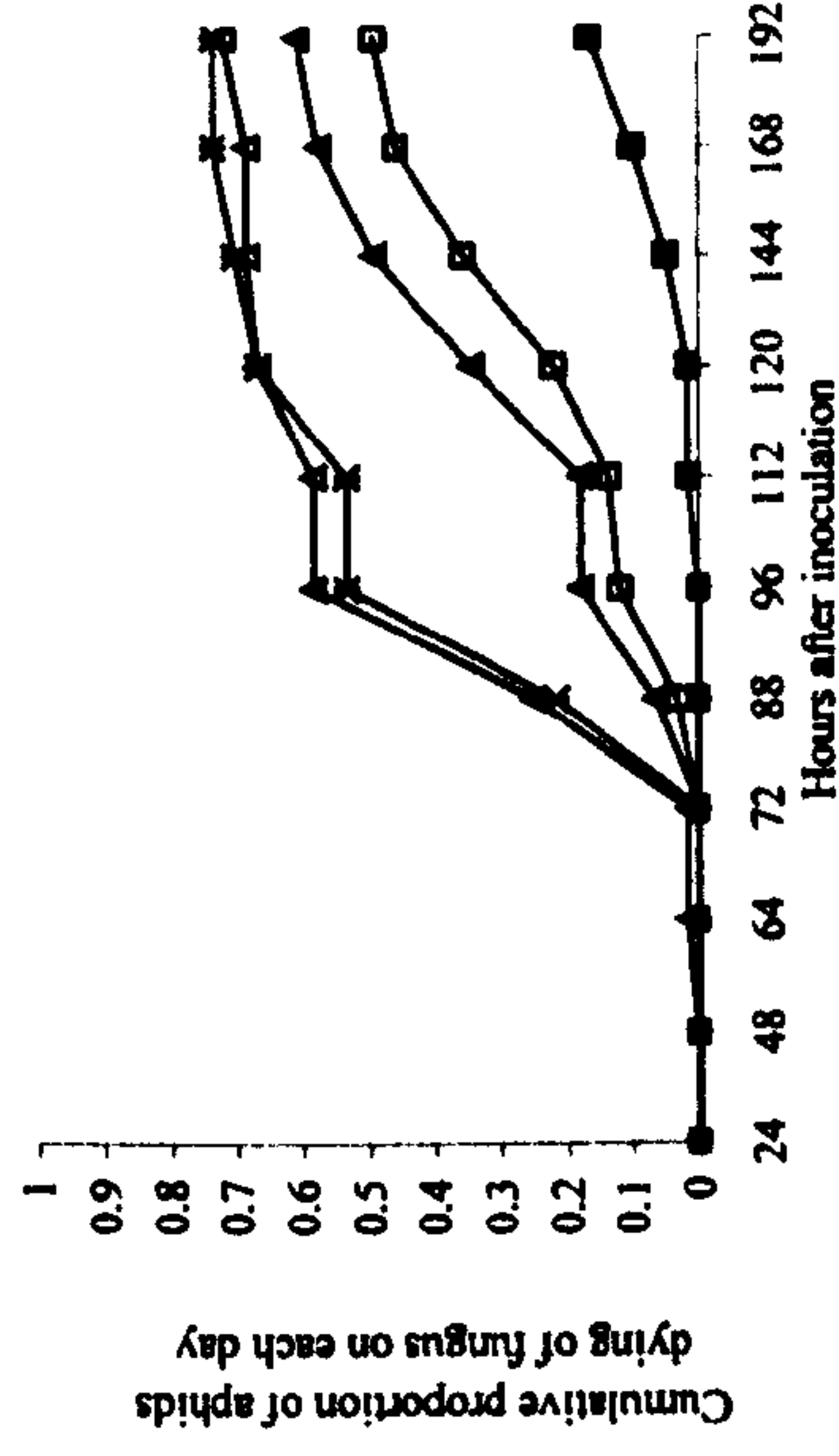
b) HRJ 1.72



c) Z11



d) ARSEF 2879



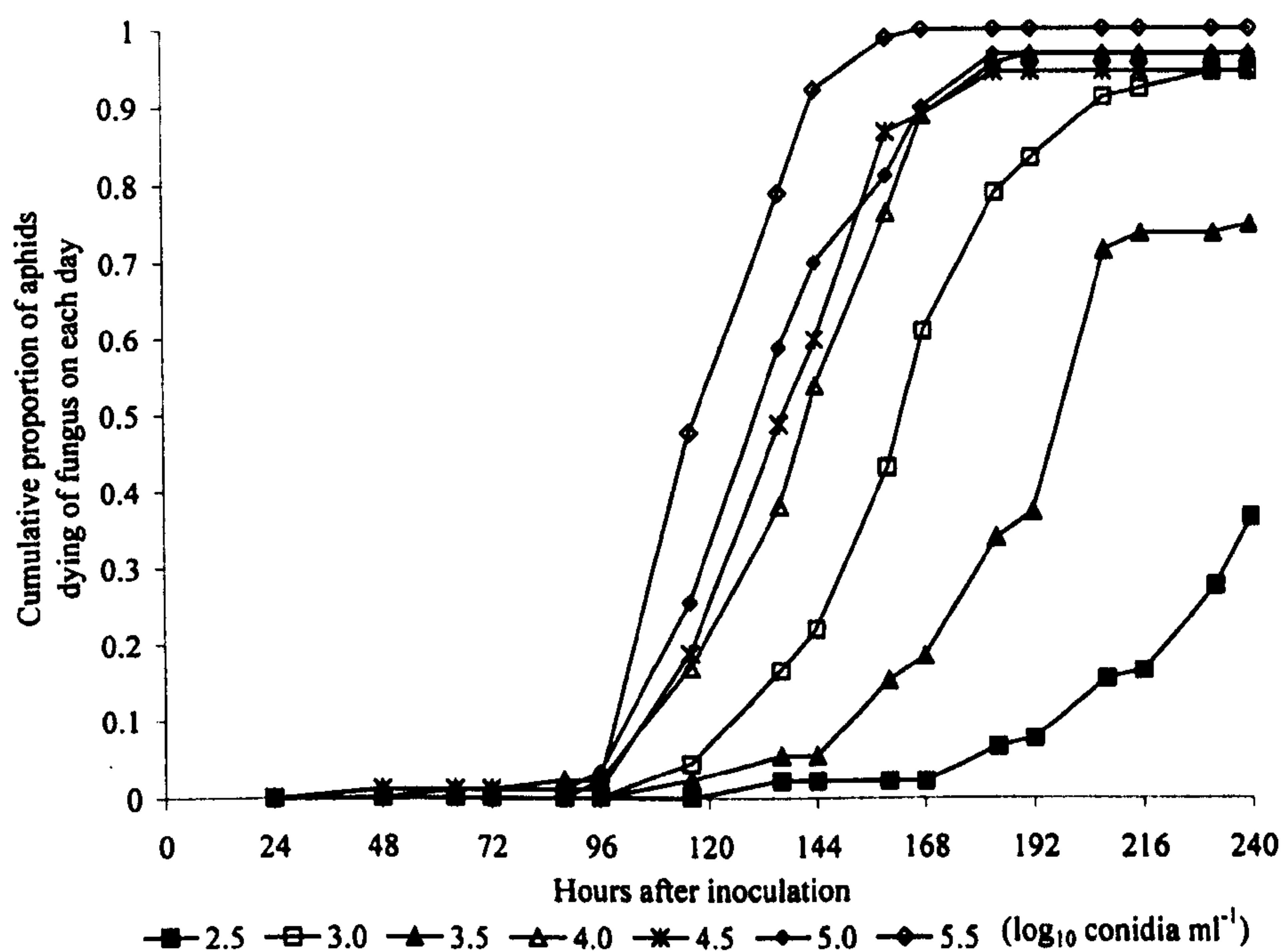
—■— 6.0 —□— 6.5 —▲— 7.0 —\*— 7.5 —x— 8.0 Log<sub>10</sub> conidia ml<sup>-1</sup>

**FIGURE 4.11 :** Cumulative proportion of *Aphis fabae* dying due to fungus on each day following inoculation with five concentrations ( $\log_{10}$  6.0, 6.5, 7.0., 7.5 & 8.0 conidia ml<sup>-1</sup>) of isolates a) Mycotech GHA (*B. bassiana*), b) HRJ 1.72 (*V. lecanii*), c) Z11 (*P. fumosoroseus*) and d) ARSEF 2879 (*B. bassiana*).

Mortality of aphids due to isolate ARSEF 2879 (*B. bassiana*) was not more than 77% of insects treated at any concentration of conidia. Mortality of aphids due to isolate Z11 (*P. fumosoroseus*) was less than 40% of treated insects at concentrations of  $1 \times 10^6$ ,  $1 \times 10^{6.5}$  and  $1 \times 10^7$  conidia  $\text{ml}^{-1}$ . To calculate the  $\text{LC}_{50}$  values for isolate HRI 1.72 (*V. lecanii*), a range of smaller concentrations needed to be investigated.

#### 4.3.3 Dose-response against *A. fabae* with isolate HRI 1.72

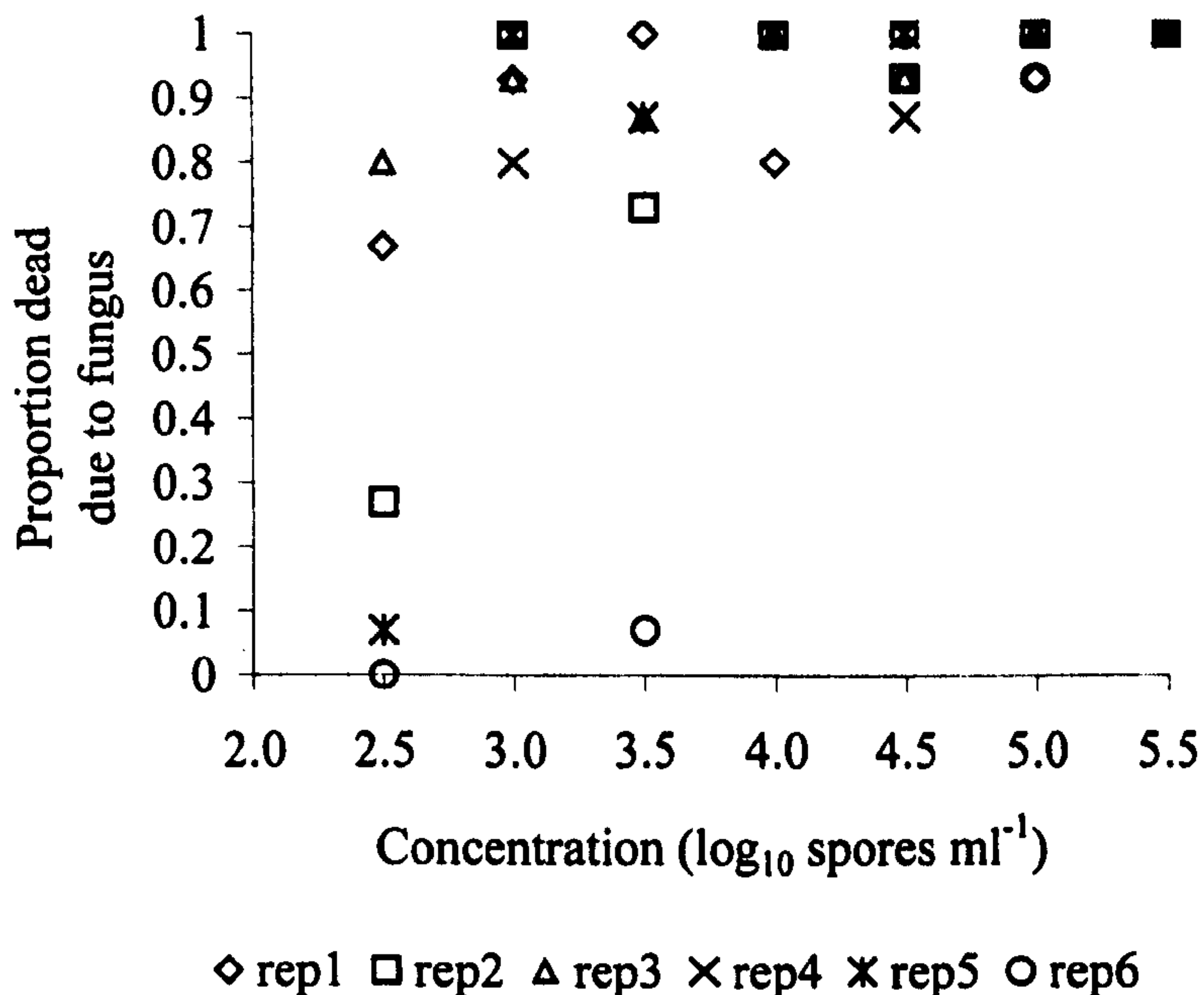
Aphid mortality due to isolate HRI 1.72 (*V. lecanii*) was greater than 90% of aphids treated with concentrations of conidia larger than  $1 \times 10^4$  conidia  $\text{ml}^{-1}$ . Most of this mortality had occurred 144 to 168 hours following inoculation (Figure 4.12).



**FIGURE 4.12** : Cumulative proportion of *Aphis fabae* dying due to fungus on each day following inoculation with seven concentrations ( $\log_{10}$  2.5, 3.0, 3.5, 4.0, 4.5, 5.0 & 5.5 conidia  $\text{ml}^{-1}$ ) of isolate HRI 1.72 (*V. lecanii*).

At the smallest dose of  $1 \times 10^{2.5}$  conidia  $\text{ml}^{-1}$  aphid mortality due to fungus was almost 40% of treated aphids by the end of the experiment. Aphid mortality due to fungus was higher and occurred over a shorter period of time when a concentration of  $1 \times 10^3$  conidia  $\text{ml}^{-1}$  was applied compared to  $1 \times 10^{3.5}$  conidia  $\text{ml}^{-1}$ . The proportion

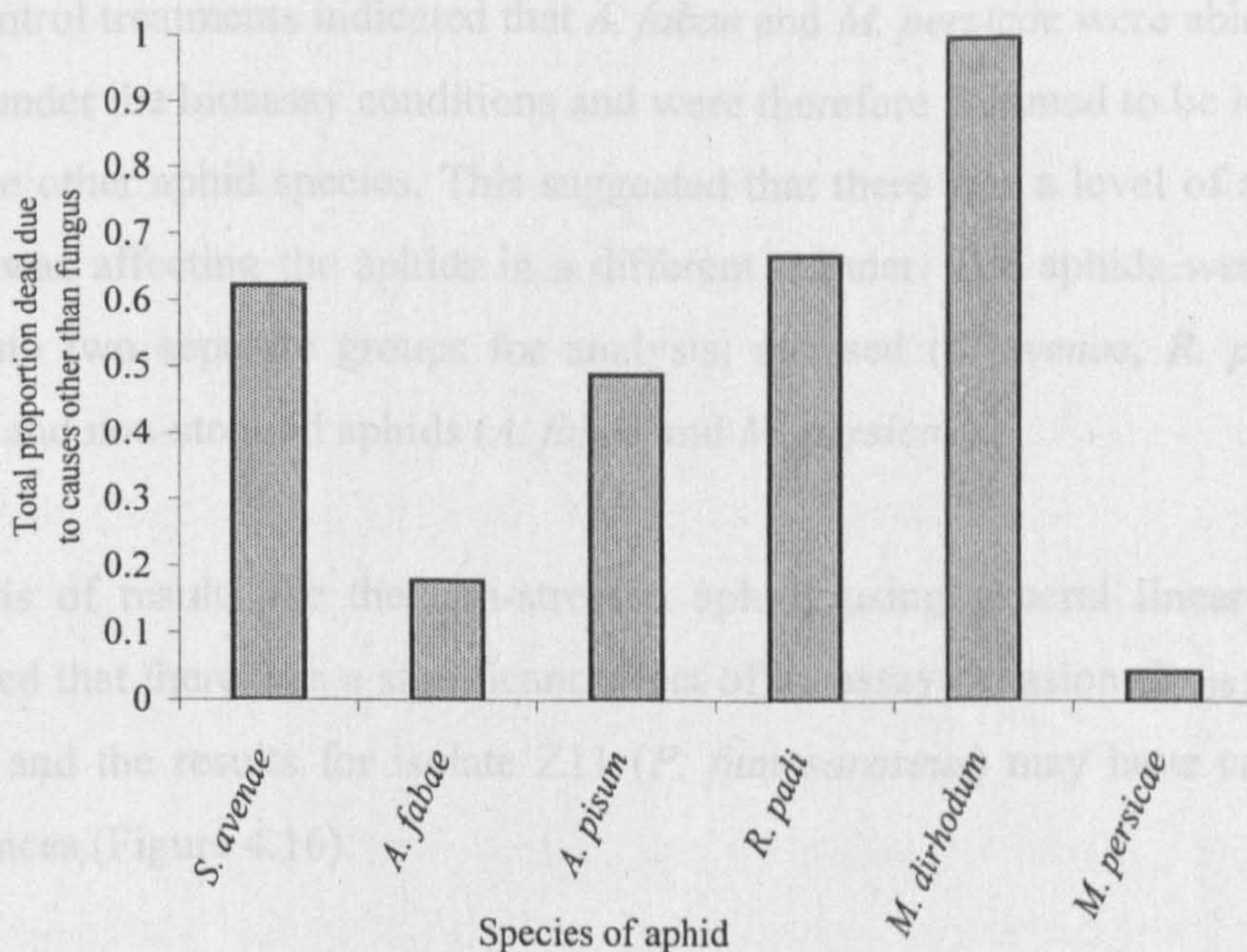
of aphids dead due to fungus in each dish indicated large variability in data points for the concentration of  $1 \times 10^{2.5}$  conidia  $\text{ml}^{-1}$  and an extreme data point for the concentration of  $1 \times 10^{3.5}$  conidia  $\text{ml}^{-1}$  (Figure 4.13). The data were considered to be too variable to perform a formal statistical test to calculate an  $\text{LC}_{50}$  value for this isolate.



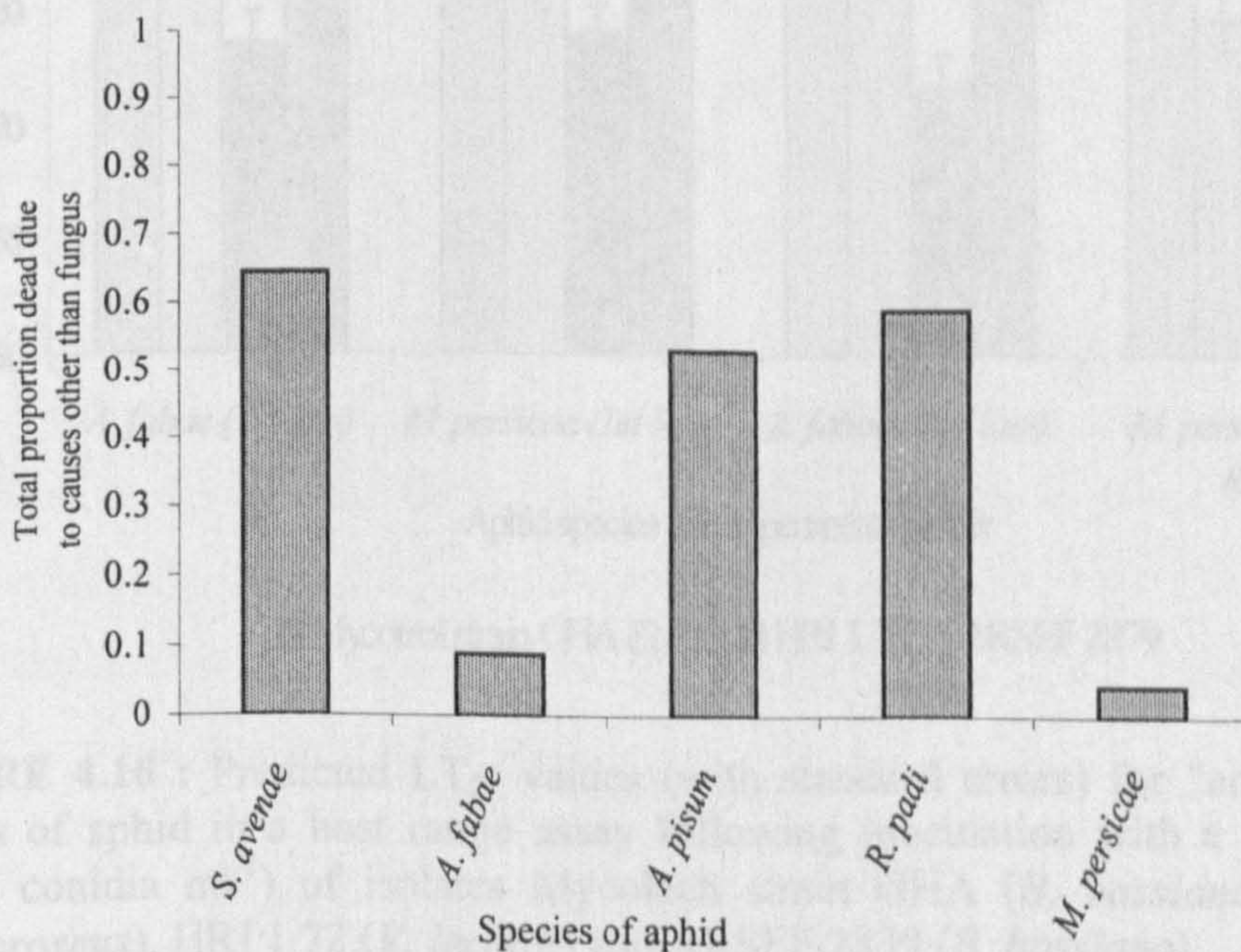
**FIGURE 4.13** : Proportion of *Aphis fabae* dying due to fungus in each replicate (dish) following inoculation at seven concentrations ( $\log_{10}$  2.5, 3.0, 3.5, 4.0, 4.5, 5.0 & 5.5 conidia  $\text{ml}^{-1}$ ) of isolate HRI 1.72 (*V. lecanii*).

#### 4.3.4 Host range assays against representative cereal aphids, legume aphids and the polyphagous aphid *Myzus persicae*

Control mortality was very high, but similar, for three of the six aphid species (*S. avenae*, *R. padi* and *A. pisum*) on the two occasions the host range bioassay was run (Figures 4.14 & 4.15). Mortality in control treatments for *A. fabae* and *M. persicae* was much lower than for the other aphids and never exceeded 20% in either run of the bioassay. *Metopolophium dirhodum* was excluded from the experiment after the first run of the bioassay because there was 100% control mortality on this occasion for this aphid species. However, none of the mortality in any of the control treatments was ever attributable to a fungus treatment (based on sporulation data).



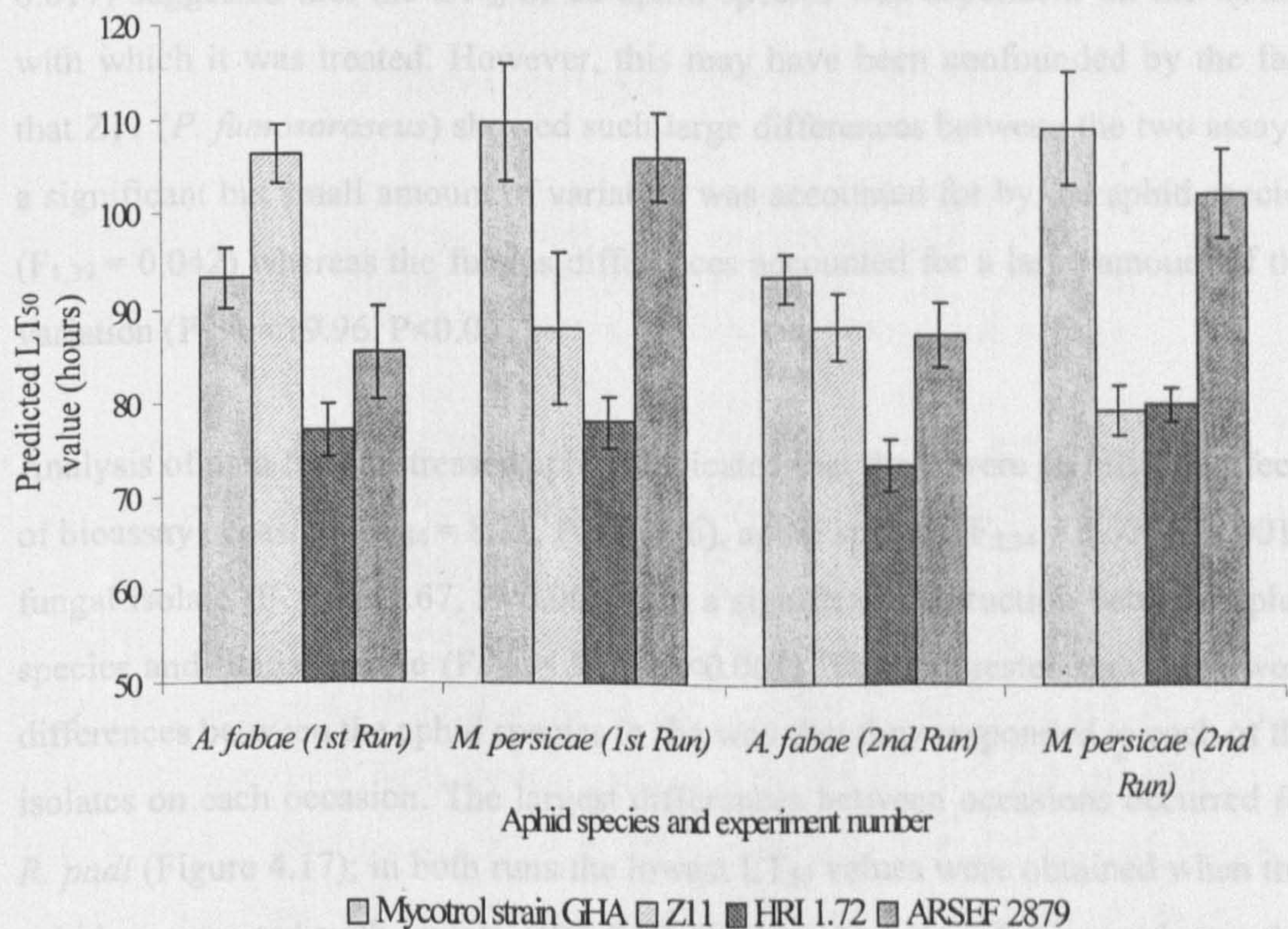
**FIGURE 4.14 :** Total proportion of control aphids dying due to causes other than infection with fungus, six days after inoculation with Tween 80 (0.03%), in the first run of a host range experiment.



**FIGURE 4.15 :** Total proportion of control aphids dying due to causes other than infection with fungus, six days after inoculation with Tween 80 (0.03%), in the second run of a host range experiment.

The control treatments indicated that *A. fabae* and *M. persicae* were able to survive better under the bioassay conditions and were therefore assumed to be less stressed than the other aphid species. This suggested that there was a level of aphid stress which was affecting the aphids in a different manner. The aphids were therefore split into two separate groups for analysis; stressed (*S. avenae*, *R. padi* and *A. pisum*) and non-stressed aphids (*A. fabae* and *M. persicae*).

Analysis of results for the non-stressed aphids using general linear regression indicated that there was a significant effect of bioassay occasion ( $F_{1,39} = 8.80$ ,  $P = 0.005$ ) and the results for isolate Z11 (*P. fumosoroseus*) may have caused these differences (Figure 4.16).

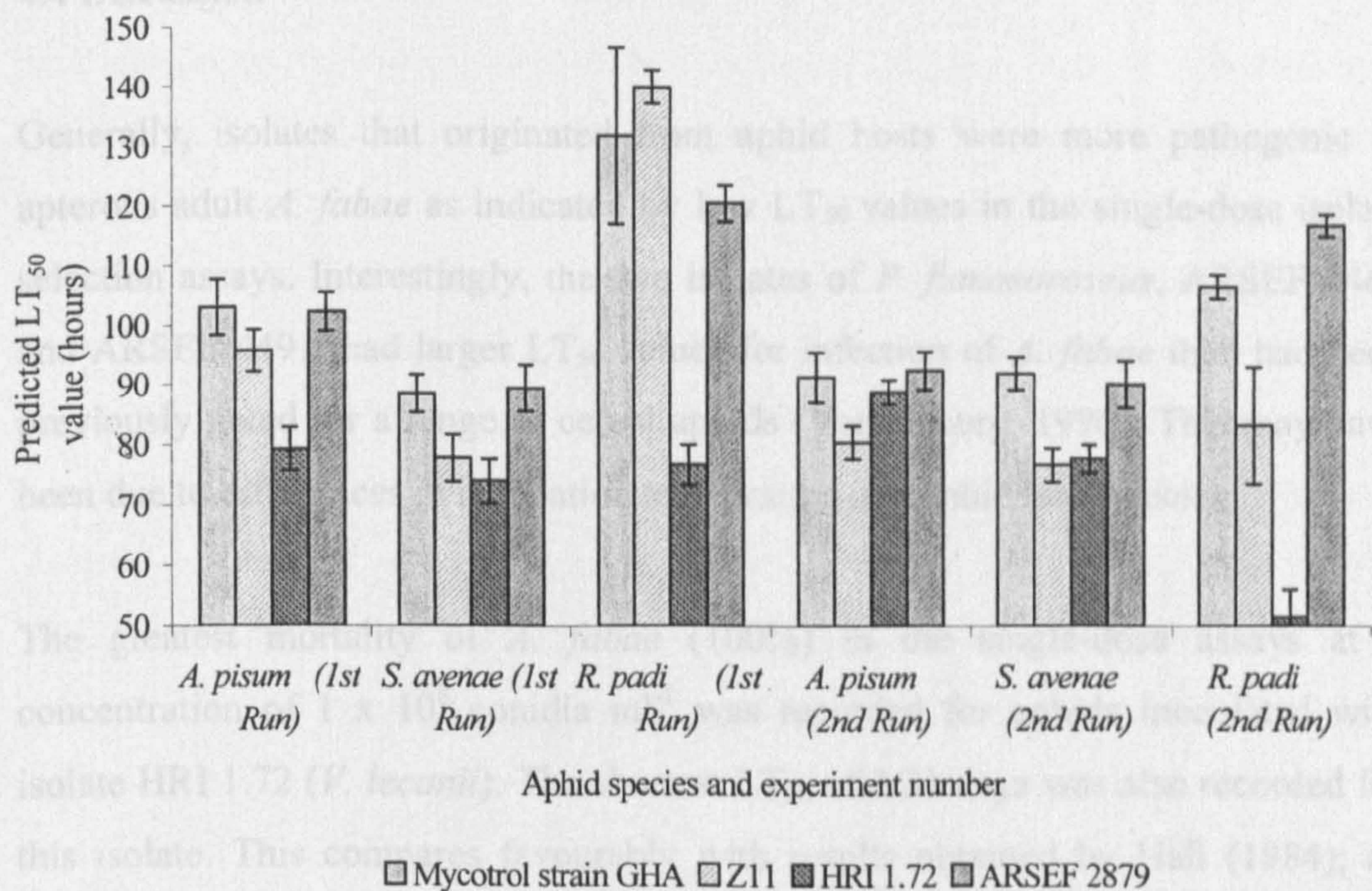


**FIGURE 4.16 :** Predicted  $LT_{50}$  values (with standard errors) for "non-stressed" species of aphid in a host range assay following inoculation with a single dose ( $1 \times 10^8$  conidia  $ml^{-1}$ ) of isolates Mycotech strain GHA (*B. bassiana*), Z11 (*P. fumosoroseus*), HRI 1.72 (*V. lecanii*) and ARSEF 2879 (*B. bassiana*).

Both species of aphid treated with the isolates ARSEF 2879 (*B. bassiana*), Mycotech strain GHA (*B. bassiana*) and HRI 1.72 (*V. lecanii*) had similar  $LT_{50}$  values between the two experiments whereas aphids treated with Z11 (*P. fumosoroseus*) appeared to have much lower  $LT_{50}$  values in the second bioassay. Aphids of both species had the lowest  $LT_{50}$  values when treated with isolate HRI 1.72 (*V. lecanii*) in both experiments. Both species of aphid treated with the isolates Mycotech strain GHA (*B. bassiana*) and ARSEF 2879 (*B. bassiana*) had similar  $LT_{50}$  values but Mycotech strain GHA (*B. bassiana*) appeared to have a slightly higher  $LT_{50}$  compared to ARSEF 2879 (*B. bassiana*) in both bioassays.

A significant interaction between aphid species and fungal isolate ( $F_{3,47} = 4.24$ ,  $P = 0.011$ ) suggested that the  $LT_{50}$  of an aphid species was dependent on the isolate with which it was treated. However, this may have been confounded by the fact that Z11 (*P. fumosoroseus*) showed such large differences between the two assays; a significant but small amount of variation was accounted for by the aphid species ( $F_{1,39} = 0.042$ ) whereas the fungus differences accounted for a large amount of the variation ( $F_{3,39} = 19.96$ ,  $P < 0.001$ ).

Analysis of data for the stressed aphids indicated that there were significant effects of bioassay occasion ( $F_{1,54} = 8.31$ ,  $P = 0.006$ ), aphid species ( $F_{2,54} = 8.57$ ,  $P < 0.001$ ), fungal isolate ( $F_{3,54} = 21.67$ ,  $P < 0.001$ ) and a significant interaction between aphid species and fungal isolate ( $F_{6,54} = 5.09$ ,  $P < 0.001$ ). This suggested that there were differences between the aphid species in the way that they responded to each of the isolates on each occasion. The largest differences between occasions occurred for *R. padi* (Figure 4.17); in both runs the lowest  $LT_{50}$  values were obtained when this aphid was treated with isolate HRI 1.72 (*V. lecanii*) but in the second run, this value was lower than in the first run.



**FIGURE 4.17 :** Predicted  $LT_{50}$  values (with standard errors) for "stressed" species of aphid in a host range assay following inoculation with a single dose ( $1 \times 10^8$  conidia  $ml^{-1}$ ) of isolates Mycotech strain GHA (*B. bassiana*), Z11 (*P. fumosoroseus*), HRI 1.72 (*V. lecanii*) and ARSEF 2879 (*B. bassiana*).

Additionally, *R. padi* had very different  $LT_{50}$  values when treated with Z11 (*P. fumosoroseus*) between the two runs of the bioassay; on the first occasion it was quite high ( $LT_{50} = 140.18 \text{ h} \pm 2.80$ ) but on the second occasion aphids succumbed to the fungus more quickly and the  $LT_{50}$  value was much lower ( $LT_{50} = 83.32 \text{ h} \pm 9.76$ ). The predicted  $LT_{50}$  values for *A. pisum* and *S. avenae* were similar between bioassays when they were treated with each of the isolates; aphids treated with HRI 1.72 (*V. lecanii*) succumbed to fungal infection over the shortest period of time and *S. avenae* succumbed to fungal infection more quickly than *A. pisum*.

Isolate Z11 (*P. fumosoroseus*) was highly variable in the time that it took to kill aphids, both within and between species assayed on different occasions. Isolate HRI 1.72 (*V. lecanii*) consistently killed aphids in the shortest time and also appeared to be less variable than the other isolates, killing aphids that were stressed and non-stressed over similar periods of time.

#### 4.4 Discussion

Generally, isolates that originated from aphid hosts were more pathogenic to apterous adult *A. fabae* as indicated by low LT<sub>50</sub> values in the single-dose isolate selection assays. Interestingly, the two isolates of *P. fumosoroseus*, ARSEF 4461 and ARSEF 4491, had larger LT<sub>50</sub> values for infection of *A. fabae* than had been previously noted for a range of cereal aphids (Vandenberg, 1996). This may have been due to differences in incubation temperature and aphid host species.

The greatest mortality of *A. fabae* (100%) in the single-dose assays at a concentration of  $1 \times 10^8$  conidia ml<sup>-1</sup> was recorded for aphids inoculated with isolate HRI 1.72 (*V. lecanii*). The shortest LT<sub>50</sub> of 3.31 days was also recorded for this isolate. This compares favourably with results obtained by Hall (1984); an LT<sub>50</sub> of 3.1 days was recorded for the chrysanthemum aphid *M. sanborni* inoculated with isolate HRI 1.72 (*V. lecanii*) at a concentration of  $1 \times 10^7$  conidia ml<sup>-1</sup> and an LT<sub>50</sub> of 3.6 days at a concentration of  $1 \times 10^6$  conidia ml<sup>-1</sup>. As the original host of isolate HRI 1.72 was *M. sanborni*, these results would suggest that this fungus is more virulent specifically towards the aphid species from which it was isolated. Other authors have noted similar differences between aphid hosts in susceptibility to the same fungal isolates (Feng *et al.*, 1990b).

Aphids that succumbed to fungal infection with isolates of *V. lecanii* were often observed attached to the leaves on which they had been feeding in Petri dish assays (personal observation). Those aphids which succumbed to infection with isolates of *B. bassiana*, *P. fumosoroseus* or *M. anisopliae* tended to be found in the lids of dishes. It is suggested that this was because they had either actively moved off the leaf surface or had dropped off the leaf and been unable to climb back on. Butt, Beckett and Wilding (1990) noted that there was invasion of the muscle tissues in *A. pisum* after one day of infection with the fungal pathogen *E. neoaphidis*, suggesting that reduced mobility may be associated with this tissue invasion. Roy (1997) showed that *A. pisum* infected with *E. neoaphidis* were unable to recolonise plants after they were dislodged.



Adults of *A. fabae* and other aphid species frequently had fungal growth and sporulation on their legs, one to two days before they died of infection with isolates of *V. lecanii* (Figure 4.18). Similar patterns of mortality were noted for *M. sanborni* treated with *V. lecanii* (Hall, 1976b). Aphids of *A. fabae* infected with *V. lecanii* in the current study were also observed to be more difficult to move into clean dishes; they appeared to be unable to respond to alarm pheromone and had great difficulty walking. Roy (1997) showed that *A. pisum* infected with *E. neoaphidis* were less responsive to alarm pheromone in the later stages of infection. Similarly, when *A. pisum* and *A. fabae* infected with isolate ARSEF 3458 (*P. fumosoroseus*) were exposed to alarm pheromone of healthy aphids, there was a reduced response in the later stages of infection (Redman, 1998). Sporulation on appendages and reduced movement of infected insects may be beneficial in establishing fungus in host populations that could aid in the development of fungal epizootics.

It is likely that infected aphids that drop off plants will effectively be removing fungal inoculum from the aerial environment and therefore reduce the potential for the pathogen to spread in the aphid population. It is suggested that the attachment of cadavers to the host plant could be recorded as an indication of epizootic potential of an isolate.

The relationship between dose of inocula and the infection of host insects has previously been demonstrated (Burgess, 1981). Many studies have shown that  $LT_{50}$  values for aphids treated with entomopathogenic fungi decrease with increasing dose or concentration of inoculum (Poprawski *et al.*, 1999; Chandler, 1997; Mesquita *et al.*, 1996; Vandenberg, 1996; Dorshner *et al.*, 1991; Feng & Johnson, 1990; Feng *et al.*, 1990b). The isolates selected for the dose-response experiment in this study showed a similar pattern of decreasing  $LT_{50}$  values with increasing concentration of conidia. Generally, there was little change in the  $LT_{50}$  value or total mortality of aphids between the concentrations of  $1 \times 10^8$  and  $1 \times 10^9$  conidia



**FIGURE 4.18** : apterous adult black bean aphid *Aphis fabae* with characteristic mycelial growth of *Verticillium lecanii* displayed on the legs.

ml<sup>-1</sup>. A maximum speed of kill was therefore achieved using a concentration of 1 x 10<sup>8</sup> conidia ml<sup>-1</sup> under the conditions of this assay.

Although the relationships between isolates and the concentration of conidia applied were difficult to determine in this study (largely due to the variable nature of isolate Z11 (*P. fumosoroseus*)) it was apparent that the largest mortality in aphids was consistently recorded due to isolate HRI 1.72 (*V. lecanii*). At concentrations of 1 x 10<sup>5</sup> conidia ml<sup>-1</sup> and above, mortality of aphids due to fungal infection was 100% by this isolate. Aphids began to die due to fungal infection only two days post-inoculation. Even at concentrations as low as 1 x 10<sup>2.5</sup> conidia ml<sup>-1</sup>, some aphid mortality due to fungal infection was noted.

There was large variability in the total mortality of aphids due to isolate HRI 1.72 (*V. lecanii*) at low concentrations of 1 x 10<sup>2.5</sup> and 1 x 10<sup>3</sup> conidia ml<sup>-1</sup>. The number of conidia at these concentrations was calculated as 2.01 and 6.36 conidia per dish. At these low densities of conidia there would have been large variability between aphids in the number of conidia that they contacted. When a concentration of 1 x 10<sup>4.5</sup> conidia ml<sup>-1</sup> (= 201.03 conidia per dish) was applied to aphids, the total mortality of aphids due to fungus in replicates became much less variable.

It is likely that many aphids will only be exposed to low concentrations of conidia under field conditions. Isolates selected for field use should exhibit a very high level of virulence to the target host. It may be possible that isolates such as HRI 1.72 (*V. lecanii*) can be applied at much higher concentrations than necessary to achieve high levels of host mortality. This will allow large numbers of conidia to be lost or inactivated by environmental exposure, whilst the high level of virulence will compensate for these losses as only a few conidia will be needed to survive to cause lethal infections within the host population.

Mortality of aphids in control treatments was large for some species of aphid in the host range studies. The cereal aphids, *R. padi*, *M. dirhodum* and *S. avenae*, and the pea aphid *A. pisum* did not survive well on excised leaves. In comparison, mortality in control treatments for the peach-potato aphid *M. persicae* and the bean

aphid *A. fabae* was smaller. *Myzus persicae* is known to feed preferentially on senescing and physiologically old leaves (van Emden, 1969). The changes in excised leaves resemble those of senescing ones, so aphids such as *M. persicae* will be able to survive well on excised leaves (Minks & Harrewijn, 1987). *Aphis fabae* prefers to feed near a vein (Lowe, 1967) and it may be that the phloem pressure on excised leaves is sufficient to sustain aphids in the bioassay system described.

The other aphid species were probably less well adapted to survival on excised leaves; *S. avenae* generally colonises the upper parts of plants, especially the ear. It is likely that the nutritional qualities of the young wheat leaves used in this bioassay were very different to those of a mature wheat plant or a wheat ear. Because of these differences between the aphid species, it was necessary to split the aphid hosts in the host range assays into “stressed” or “non-stressed” species to account for the differences that host plant suitability may have on levels of aphid stress and hence susceptibility to fungal infection.

Both the non-stressed aphid species (*M. persicae* and *A. fabae*) and the stressed aphid species (*M. dirhodum*, *R. padi*, *S. avenae* & *A. pisum*) were most susceptible to isolate HRI 1.72 (*V. lecanii*). Isolate Z11 (*P. fumosoroseus*) was variable in pathogenicity to these aphids between different experiments. In general, *S. avenae* appeared to be more susceptible than *A. pisum* to isolates, but *R. padi* was relatively resistant except to HRI 1.72 (*V. lecanii*). Other studies on the susceptibility of cereal aphids to hyphomycete fungi have found *S. avenae* to be more susceptible to *V. lecanii* and *B. bassiana* than *R. padi* (Feng *et al.*, 1990b), and *R. padi* was found to be the most resistant aphid of six species of cereal aphid tested. The  $LT_{50}$  values were smaller for *S. avenae* inoculated with *V. lecanii* and *B. bassiana* in the current study compared to those found by Feng *et al.* (1990b), which suggests the isolates used in the current study were more virulent than those previously tested.

Studies to date have generally suggested that isolates of *B. bassiana* and *V. lecanii* are better at controlling aphids than isolates from species such as *M. anisopliae*.

Whilst *V. lecanii* and *B. bassiana* are recorded in aphid populations, they are usually found at low levels of infection and are rarely noted to cause epizootics. These infections could be opportunistic and restrained from becoming epizootic by the dependence of these fungi on high humidity for their spread through host populations.

It has been suggested that the lettuce root aphid *P. bursarius* is susceptible to isolates of *M. anisopliae* because the aphids are regularly exposed to other hyphomycete fungi in the root environment (Chandler, 1997). Alternatively, this may represent an example of co-evolution between the host and the pathogen. *Beauveria bassiana* for example, occurs in soil as a ubiquitous saprophyte and mainly infects Lepidopteran, Coleopteran and Hemipteran insects. However, *V. lecanii* infects aphids, scale insects and whiteflies, primarily in tropical and semi-tropical environments (Hall, 1981a). If this pathogen is more prevalent in the aerial environment, then it is possible that aphids may be exposed more regularly to this species compared to other hyphomycetes and therefore develop resistance to the pathogen. This is not the case however, as several isolates of *V. lecanii* have proved to be highly pathogenic to aphids under laboratory conditions and within the field environment (Khalil, Bartos & Landa, 1985).

Because of the wide host range of *B. bassiana* and *M. anisopliae*, it is not easy to quantify fungus-host relationships for these species. Additionally, the host lists for the hyphomycetes in general may represent the focus of research on specific pests and beneficial species of insect and therefore not accurately represent the true host range. Information about isolates, such as origin and host passages, should always be provided in the literature to allow more accurate information on the host range of these fungi to be obtained.

It is currently very difficult to compare results of bioassays of entomopathogenic fungi on aphids because of differences between methods of inoculation, number of subcultures or host passages made, differences between aphid biotypes or populations and differences in post-incubation systems (e.g. temperature, humidity and incubation container). Whilst some of these are inherently difficult to

compensate for, such as differences between populations of the same aphid species, it is suggested that some form of standardisation in other areas of bioassay design would allow for better comparison between results from different researchers.

## **5.1 Introduction**

Environmental factors have a large impact on many aspects of fungal-insect interactions; they may alter host susceptibility to infection, alter the progress of infection both within living and dead hosts, or alter the sporulation on a host and therefore alter the ability of the fungus to spread through host populations. The main abiotic factors that affect entomopathogenic fungi are humidity, temperature and exposure to ultra-violet (UV) radiation. Additionally, chemical pesticides may adversely affect the development and progression of fungal epizootics by inhibition of germination of conidia or vegetative growth, or by reducing the host population.

This section of work is concentrated on evaluating the impact of a range of environmental factors on the ability of isolates of fungus to germinate, grow and infect their aphid hosts. This information will aid in the selection of isolates for further work which will be tolerant of the field environment in which they will be required to operate. Although studies detailed here are concentrated on the impact of temperature and humidity, the potential impact of other abiotic factors is discussed.

### **5.1.1 Humidity**

High relative humidity and/or free water is required by entomopathogenic fungi for germination of conidia and is considered the most critical environmental factor influencing the development of epizootics (Fuxa & Tanada, 1987; Hall & Papierok, 1982; Nordin, Brown & Millstein, 1983). Under field conditions, epizootics of entomophthoralean fungi occur during or after periods of high humidity or rainfall (Hemmati, 1998; Milner & Bourne, 1983; Wilding, 1969). Water saturation or near saturation is needed by many entomophthoralean species for active discharge of their conidia from host cadavers (Glare, Milner & Chilvers, 1986a).

The requirement for long periods of high humidity for effective transmission of *Verticillium lecanii* has been a major constraint to the commercial uptake of Vertalec<sup>®</sup> and Mycotal<sup>®</sup> (Milner & Lutton, 1986); a period of 14 hours at 100% RH and 15 - 20° was required for high levels of infection in aphids by these isolates (Hall, 1981a). At a RH of 97%, both infection and subsequent sporulation of the Vertalec<sup>®</sup> isolate in peach-potato aphid *Myzus persicae* populations was delayed and reduced, whilst at 80% RH no sporulation was detected (Milner & Lutton, 1986). It has been suggested that high humidity is more crucial to the establishment of infection than to subsequent mycelial development occurring on dead cadavers for isolates of *V. lecanii* (Drummond, Heale & Gillespie, 1987). However, under dry conditions, fungi may sporulate inside the host. *Zonocerus variegatus* grasshoppers died from infection by *Metarhizium anisopliae* var. *acridum* in the field in Benin and sporulation occurred on the inside of the cadaver (Lomer, Bateman, Godonou, Kpindou, Shah, Paraïso & Prior, 1993). In this situation, conidia will only become available for transmission to other hosts when the cadaver breaks down and conidia are released (P. Shah, pers. comm.).

High RH is also required for 100% infection of hosts with *V. lecanii* in the peach-potato aphid *M. persicae* (Milner & Lutton, 1986) and the greenhouse whitefly *Trialeurodes vaporariorum* (Ekbohm, 1981). Mortality of 100% was recorded for the bird-cherry oat aphid *Rhopalosiphum padi* inoculated with an isolate of *V. lecanii* when aphids were held at humidities in the range 12 - 100% (Hsiao *et al.*, 1992). However, the experimental methods are questionable for this experiment. It appears that aphids in these assays were placed on excised barley leaves on damp filter paper in Petri dishes and then placed in dessicators over various chemicals to maintain different relative humidities. This would suggest that aphids would still be exposed to a high RH within the Petri dish itself.

The humidity requirements of *Beauveria bassiana* and *M. anisopliae* have been shown to be similar to those of *V. lecanii* with the fastest rate of germination of conidia at 100% RH and inhibition of germination at less than 90% RH (Walstad, Anderson & Stambaugh, 1970). External sporulation of *B. bassiana* and *M. anisopliae* on fungus-killed cadavers also requires humidity of greater than 90% (Walsted *et al.*, 1970; Ramoska, 1984; Ferron, 1977).



The ability of conidia to germinate under low RH conditions can be represented by germination *in vitro* on media adjusted to different water activities which measures the actual availability of water to a conidium. Water activity ( $a_w$ ) is defined as the ratio between the vapour pressure of water in a substrate (P) and vapour pressure of pure water ( $P_o$ ) at the same temperature and pressure. An  $a_w$  value of 1.00 is equivalent to an RH of 100%. Hallsworth and Magan (1999) found the growth of *M. anisopliae* and *Paecilomyces farinosus* was fastest at 0.97 - 0.98 $a_w$  (= 97 - 98% RH). However, growth of *B. bassiana* was fastest when water was freely available at 0.998 $a_w$  (= 99.8% RH).

Although it is difficult to relate data from *in vitro*  $a_w$  studies to field conditions, this may be a quick method for selecting isolates of fungi that are capable of growing at reduced  $a_w$  or tolerating these conditions for short periods of time. These isolates may be better adapted to infect host insects under reduced humidity conditions that may be experienced in the field.

Not all hyphomycete isolates are dependent on high humidity for infection of host insects. Humidity has been shown to have no influence on levels of mortality in the desert locust *Schistocerca gregaria* treated with *M. flavoviride* (Fargues, Ouedraogo, Goettel & Lomer, 1997b). Similarly, an isolate of *M. anisopliae* was able to infect two species of termite at RH as low as 86%, even though it did not germinate below 0.93 $a_w$  in *in vitro* studies (Milner, Staples & Lutton, 1997). It was suggested that the microclimate around the cuticle of the termites was maintained at close to 100% RH, allowing conidia to germinate and penetrate the host cuticle. As the fungus was not able to sporulate on termites killed by fungus it was suggested that the humidity on the cuticle reached that of ambient RH after the host's death. Studies such as these show how critical small changes of microclimate at the host cuticle can be when considering the possibility of secondary cycling of conidia.

There has been interest in manipulating conidia to improve germination at low  $a_w$  by modifying their polyol content. Hallsworth and Magan (1995) showed that conidia containing enhanced levels of glycerol and erythritol were able to germinate on media at 0.887  $a_w$  (*M. anisopliae*), 0.923  $a_w$  (*P. farinosus*) and 0.935

$a_w$  (*B. bassiana*). Manipulation of conidia to allow germination at low water availability may improve pathogenicity under field conditions. Additionally, mutants of *P. farinosus* and *M. anisopliae*, selected for their ability to grow at lower water activities than their parental strains, have been shown to be more virulent against the green leafhopper *Nephotettix virescens* Distant at humidities of 96 and 98% RH (Matewele, Trinci & Gillespie, 1994).

### 5.1.2 Temperature

Temperature acts on the host-pathogen system by influencing germination of conidia and the infection process. Fungal species have different temperature tolerances and these generally fall between 20 - 30°C (Ignoffo & Mandava, 1988).

The optimum temperature for germination of conidia of *Entomophthora* spp. has been recorded between 16 and 27°C (Wilding, 1970, 1981a; Milner & Bourne, 1983). Conidia of *Entomophthora* spp. have been recorded as being discharged at temperatures between 5 and 30°C (Wilding, 1981a; Hemmati, 1998) but the optimum temperature for discharge and growth has been recorded around 20°C (Morgan, Boddy, Clark & Wilding, 1995; Glare *et al.*, 1986a; Wilding, 1971). However, species such as *Neozygites fresenii* (Novakowski) occur in tropical and subtropical environments where average temperatures are higher than 20°C (Keller, 1997; Steinkraus, Kring & Tugwell, 1991) and isolates of *Zoophthora radicans* have been recorded growing *in vitro* at temperatures as high as 30°C (M. J. Furlong, pers. comm.).

Extensive laboratory studies have evaluated the *in vitro* growth and germination of several species of hyphomycete fungi. Species of hyphomycete fungi are able to grow in the temperature range of 5 - 35°C (Hallsworth & Magan, 1999). The optimal constant temperature for growth and germination of isolates of *B. bassiana* is generally about 25°C (Ekesi, Maniania, Ampong-Nyarko, 1999; Hallsworth & Magan, 1999; Sivasankaran, Easwaramoorthy & David, 1998; Ferron, 1981) with a temperature threshold of 35 - 37°C (Fargues, Goettel, Smits, Ouedraogo & Rougier, 1997a; Ouedraogo, Fargues, Goettel & Lomer, 1997).

In comparison, isolates of *M. anisopliae* have been shown to have a higher optimal temperature for *in vitro* growth between 25 - 30°C (Fargues, Maniania, Delmas & Smits, 1992; Walsted *et al.*, 1970) and faster rates of germination than isolates of *B. bassiana* at 25 - 30°C (Hywel-Jones & Gillespie, 1990). However, an isolate of *M. anisopliae* has recently been reported as being able to grow at 40°C (Hallsworth & Magan, 1999). Isolates of *M. flavoviride* and *M. anisopliae* var. *acridum* are able to tolerate very high temperatures. Most isolates of these species are from Acridids and it has been suggested that the thermal tolerance of these pathogens is due to the ability of host grasshoppers to thermoregulate, elevating their body temperature to higher than ambient by intercepting solar radiation (Chappell & Whitman, 1990) and thereby exposing the fungus directly to increased temperatures. Thermal regulation has been shown to be very important in reducing development of *B. bassiana* infections in grasshopper populations under field conditions (Inglis, Johnson & Goettel, 1997) and of *M. anisopliae* var. *acridum* infection in locusts under both laboratory and field conditions (Blanford & Thomas, 1999; Blanford, Thomas & Langewald, 1998).

*Paecilomyces* spp. tend to have a lower temperature optima for growth and germination compared to the other species of hyphomycete, at approximately 20°C (Hallsworth & Magan, 1999). However, the temperature optima for vegetative growth of 37 isolates of *P. fumosoroseus* from a diverse host range was found to be wide ranging from 20 - 30°C (Vidal, Fargues & Lacey, 1997a).

The majority of evidence indicates that optimal temperatures for *in vitro* growth and germination are related to optimal temperatures for *in vivo* host infection. The optimal temperature for *in vitro* growth and germination of an isolate of *B. bassiana* was shown to be 25°C and susceptibility of the sugarcane shoot borer *Chilo infuscatellus* Snellen to this fungus was found to be highest when larvae were held at 25°C after inoculation (Sivasankaran *et al.*, 1998). Ignoffo, Garcia & Hostetter (1976a) showed the optimal temperature for *in vitro* development of *Nomuraea rileyi* was similar to the optimum temperature for germ tube penetration and vegetative growth of the fungus in the velvetbean caterpillar *Anticarsia gemmatalis* (Boucias *et al.*, 1984).

There have been other reports however, that do not show the same correlation between *in vitro* and *in vivo* fungal development related to temperature. The optimal temperature for infection of the variegated grasshopper *Z. variegatus* with *M. flavoviride* has been shown to be higher than that for optimal growth *in vitro* (Thomas & Jenkins, 1997). Maniania and Fargues (1986) assayed ten isolates of *P. fumosoroseus* and six of *N. rileyi* at 20°C and 25°C for infectivity to larvae of *Mamestra brassicae* (L.) and *Spodoptera littoralis* (Boisd.). Higher rates of mortality were recorded for *M. brassicae* exposed to *P. fumosoroseus* at 25 than 20°C but there was no difference when larvae were exposed to *N. rileyi* at the different temperatures. However, mortality of *S. littoralis* was significantly higher to *P. fumosoroseus* at 20°C than at 25°C whilst there was no significant difference for *N. rileyi*. The authors suggested the effect of temperature on the infection process may depend on interactions between the individual host species and fungal isolate.

Similarly, isolates of *M. flavoviride* which had different relative growth rates *in vitro* at 35°C were found to cause equal mortality to the grasshopper *S. gregaria* at this temperature (Ouedraogo *et al.*, 1997). Additionally, an isolate of *B. bassiana* that germinated and grew most rapidly *in vitro* between 25 and 32°C caused the greatest mycosis in the convergent ladybird *Hippodamia convergens* between 10 and 15°C, temperatures at which *in vitro* growth and germination was greatly delayed or inhibited (James, Croft, Schaffer & Lighthart, 1998). The authors suggested that the ladybirds may be able to resist infection because of changes in immunity to pathogen infection at the higher temperatures.

Generally, as temperatures decrease below the optimal for *in vivo* infection, the time taken for insects to succumb to fungal infection increases (Vandenberg *et al.*, 1998b; Boucias *et al.*, 1984; Doberski, 1981b). Often however, there may be a reduction in the rate at which host mortality occurs but the overall total mortality is not significantly different to that achieved at higher temperatures (Ekesi *et al.*, 1999).

Few studies have been conducted to evaluate the effect of temperature on infectivity of fungi to aphids. Studies have mostly been limited to the

*Entomophthorales* (Steinkraus & Slaymaker, 1994; Glare, Milner & Chilvers, 1986b; Milner & Lutton, 1983; Wilding, 1970). Maximum mortality of the bird-cherry oat aphid *R. padi* infected with *V. lecanii* occurred at constant temperatures of 21 and 27°C but there was no mortality due to fungus at 8°C (Hsiao *et al.*, 1992).

Although it is important to study the impact of constant temperatures on fungal growth and infection, temperature will fluctuate under field conditions and these fluctuations may affect the ability of fungi to invade their hosts. Feng *et al.* (1999) investigated the effect of fluctuating temperatures, designed to simulate late-season temperatures, on the infectivity of the fungus *Erynia* (= *Pandora*) *neoaphidis* to the pea aphid *Acyrtosiphon pisum*. The authors suggested that the fungus was more virulent at high temperatures compared to lower fluctuating temperatures; LC<sub>50</sub> values were lower at a constant temperature of 20°C compared to those at lower fluctuating temperatures (5.4°C - 18.9°C with mean temperature of 12.12°C) under 11h and 16h photoperiods. Studies of infection of the migratory grasshopper *Melanoplus sanguinipes* (F.) by *B. bassiana* (Mycotech strain GHA) and *M. flavoviride*, at various combinations of oscillating temperatures with the same mean temperature, showed that there was a decreased rate of grasshopper mortality as the degree of temperature oscillation increased (Inglis, Duke, Kawchuk & Goettel, 1999). This reduced rate of mortality was more pronounced for the isolate of *B. bassiana* than that of *M. flavoviride* although *in vitro* growth studies suggested that both fungi were adversely affected by the larger oscillations in temperature.

Furlong, Pell, Choo & Rahman (1995) inoculated adult *Plutella xylostella* with *Zoophthora radicans* and then incubated the moths at a constant temperature of 18, 20, 23 or 25°C, or at 23°C and then 16°C on an alternating 12h diurnal cycle. Moths succumbed to infection and died within 72 hours of inoculation at the constant temperatures, but at the alternating temperatures, this period was extended to 84 hours. Interestingly, infected adults placed in the field (where temperatures fluctuated between 22.8°C and 15°C), succumbed to infection and died within 96 hours. These results showed how laboratory studies of the effects of alternating

temperatures on infection by fungi may provide a more realistic estimate of the rate of infection under field conditions.

Fargues and Luz (2000) performed an elaborate series of experiments to investigate the effects of several fluctuating humidity and temperature regimes on infection of the hemipteran disease vector *Rhodnius prolixus* Ståhl by the fungus *B. bassiana*. By taking into account the microclimatic measurements of these variables from a range of different habitats, the authors were able to show that temperature was less critical than humidity for infection. However, under favourable humidity regimes, moderate temperatures (20 and 25°C) resulted in higher levels of infection compared to lower temperatures (15°C). By evaluating a range of combinations of environmental factors, the authors suggest that windows of opportunity may be identified for pathogen applications to target the pest best.

### **5.1.3 Pesticides**

If entomopathogenic fungi are to be successfully incorporated into insect pest control programmes, they must be compatible with pesticides that are used in commercial crop protection. Studies have demonstrated inhibition *in vitro* of fungal growth and germination by many pesticides.

The effect of nine fungicides and fourteen insecticides on isolates of *Beauveria* spp. and *Verticillium* spp. showed fungicides such as benomyl, maneb and captan were highly deleterious to fungal growth for most isolates of both genera, even at a tenth of the recommended field rate (Olmert & Kenneth, 1974).

Hall (1981b) found that germination of two isolates of *V. lecanii* was more sensitive to chemicals than growth. In contrast, the growth of a single isolate of *M. anisopliae* was found to be more sensitive to pesticides than germination (Moorhouse, Gillespie, Sellers & Charnley, 1992). Hall (1981b) showed that fungicides such as maneb, fenarimol, captan, imazil and dichlofluarid inhibited germination of conidia of *V. lecanii*, but in contrast to Olmert and Kenneth (1974), benomyl was found to only significantly inhibit germination at recommended and greater doses of fungicides. Mietkiewski, Pell and Clark (1997) found that

benomyl had the most inhibitory effect of several pesticides tested on *in vitro* growth of *B. bassiana* and field studies confirmed this inhibition; significantly fewer wax moth *Galleria melonella* (L.) larvae became infected with *B. bassiana* from soil treated with benomyl compared to untreated soil.

The susceptibility of fungi to different pesticides has been shown to vary between fungal species and between chemicals (Poprawski & Majchrowicz, 1995). Majchrowicz and Poprawski (1993) found that growth of entomophthoralean fungi was generally more adversely affected by fungicides than isolates of the hyphomycetes. However, intraspecific differences between isolates of *V. lecanii* and *M. anisopliae* in susceptibility to pesticides, suggests that it is not only species differences that are important (Olmert & Kenneth, 1974; Moorhouse *et al.*, 1992). Majchrowicz and Poprawski (1993) found the dithiocarbamate derivatives zineb + copper oxychloride together and manozeb alone completely inhibited germination of *Conidiobolus coronatus*, *C. thromboides*, *B. bassiana*, *P. farinosus*, *M. anisopliae* and *V. lecanii*. Hall (1983) showed that whilst germination of conidia of *V. lecanii* on agar was only slightly inhibited by the two chemicals iprodione and carbaryl applied separately, there was much greater inhibition of germination when a mixture of the chemicals was used, suggesting mixtures of pesticides may be more detrimental to fungi than the component pesticides alone.

*In vitro* mycelial growth assays in the laboratory have been suggested to be crude and that the germination of conidia and subsequent host penetration are more important factors in the fungal infection process (Majchrowicz & Poprawski, 1993). Mycelial development occurs mainly within host tissues and as pesticides are less likely to be present here, it is less likely that development of mycelia will be inhibited (Khalil, Shah & Naeem, 1985; Hall, 1981b). Studies of the effect of ten fungicides on the development of *Erynia neoaphidis* (= *Entomophthora aphidis*) on pea aphid *A. pisum* showed that suppression of fungal infection of aphids by the fungicides corresponded with suppression of the germination of conidia *in vitro* (Wilding & Brobyn, 1980).

It is widely accepted that field studies of the effect of pesticides on fungi have not reflected the results obtained in *in vitro* experiments. Hall (1981b) found that

several chemical compounds inhibited germination of *V. lecanii* conidia at doses of 0.1x the recommended field dose and these were all incompatible with the fungus in *in vivo* studies against the aphids *Macrosiphoniella sanborni* and *M. persicae*. However, the chemical fenarimol only impaired the ability of *V. lecanii* to infect aphids when applied simultaneously with the fungus. Similarly, at high doses of *B. bassiana* against the Colorado potato beetle *Leptinotarsa decemlineata*, laboratory studies indicated detrimental effects of the fungicides on fungal infection of the host but there was negligible impact of the fungicides under field conditions (Jaros-Su, Groden & Zhang, 1999). Even when growth of *B. bassiana* was completely inhibited in the laboratory, this inhibition was reduced when the fungus was applied against the Colorado potato beetle in the field (Clark, Casagrande & Wallace, 1982).

There may be synergistic effects of applying fungal pathogens and chemicals together. Chemicals could be used as "stressors" to increase susceptibility to fungal pathogens. Quintela & McCoy (1998) showed that low doses of the insecticide imidacloprid increased the susceptibility of larvae of the weevil *Diaprepes abbreviatus* (L.) to the fungal pathogen *M. anisopliae*. It was suggested that the chemical reduced movement of larvae and, subsequently, reduced the number of conidia removed from the cuticle when contacting the substrate. Boucias (1996) reported similar interactions between *B. bassiana* and imidacloprid against the termite *Reticulitermes flavipes* (Kollar); the chemical prevented termite grooming and hence fewer conidia were removed and mortality due to the fungal pathogen increased.

Potential detrimental effects of host plant chemical defences (allelochemicals) should also be considered. These allelochemicals inhibit a large number of fungal pathogens and it is possible that these could inhibit growth and germination at the plant surface. The alkaloids tomatine and solanine have been shown to inhibit growth and germination of *B. bassiana* and *P. fumosoroseus* (Costa & Gaugler, 1989; Lacey & Mercadier, 1998). It may therefore be very important to consider plant chemicals when resistant plant species or cultivars are utilised in an integrated pest control programme alongside a mycoinsecticide.



#### **5.1.4 UV and Solar radiation**

It is well known that solar radiation and particularly the ultraviolet waveband have detrimental effects on entomopathogenic fungi (Moore, Higgins, & Lomer, 1996; Carruthers, Feng, Ramos & Soper, 1988; Hunt, Moore, Higgins & Prior, 1994). Artificial sunlight is most often used to investigate the effects of solar radiation on deactivation of conidia because of the variability associated with natural sunlight (Zimmermann, 1982; Ignoffo, Hostetter, Sikorowski, Sutter & Brookes, 1977).

Under artificial conditions, the susceptibility of conidia to UV is related to the spectral composition and intensity of light. An isolate of *P. fumosoroseus* was adversely affected by UVA (320 - 400 nm) but UVB (280 - 320 nm and 295 - 320 nm) was more detrimental to the fungus, measured by criteria such as ability to infect larvae of the fall armyworm *Spodoptera frugiperda* (Smith). Primary conidia of *Z. radicans* were very susceptible to artificial UV radiation (peak 365, range 300 - 400 nm) and were unable to cause mycosis after only three minute exposures (Furlong & Pell, 1997). However, exposure of up to four hours to natural temperate summer sunlight had no affect on the ability of conidia to cause mycosis in the diamondback moth *P. xylostella*. This indicates that conidia are able to tolerate less intense solar radiation and may therefore be more protected in shaded areas of crops. Indeed, conidia have been shown to be able to survive longer on abaxial leaf surfaces rather than adaxial which may be related to the differences in exposure to solar radiation (Brobyn, Wilding & Clark, 1985; Carruthers & Haynes, 1986).

Inglis *et al.*, (1997) noted that there was deactivation of conidia by UVB in field trials of *B. bassiana* against grasshoppers. However, the authors suggested that temperature and sunlight influenced the ability of grasshoppers to thermoregulate and that this indirectly had a greater negative impact on *B. bassiana* infection than UVB deactivation of conidia. Thermoregulation in acridids has been shown to reduce disease in controlled environments (Boorstein & Ewald, 1987; Carruthers, Larkin & Firstencel, 1992). Ultraviolet protectants have therefore proved to be useful in formulations of *B. bassiana* to increase survival of conidia in the laboratory and under field conditions (Inglis, Goettel & Johnson, 1995).

## **5.2 Materials and Methods**

### ***5.2.1 Insect and Fungus Cultures***

All aphid species were reared to known-age using methods described in section 2.1. Fungal isolates were cultured as described in section 2.6.3 and fungal suspensions were prepared as described in sections 2.6.4 and 2.6.5. All spray applications were made using the methods and sprayer system described in section 2.6.6. The general bioassay procedures described in chapter 2 were followed for all experiments unless stated otherwise.

### ***5.2.2 Impact of temperature on in vitro fungal germination***

The impact of temperature on *in vitro* germination was evaluated for all isolates listed in section 2.6.1 (except T229 *P. farinosus*). All isolates could not be tested on one occasion so five isolates were screened each time and included a standard isolate, Mycotech strain GHA (*B. bassiana*). Suspensions of conidia were prepared and diluted to give a concentration of  $1 \times 10^6$  conidia ml<sup>-1</sup> the day before the experiment and held overnight on ice in a CE room at 4°C. The following day, 84 plates of SDA (10ml of SDA in 9cm Petri dishes) were inoculated at the centre of the plate, using a Gilson Pipetteman, with 4µl of a suspension of conidia for each isolate. Twenty-one plates for each fungal isolate were placed in a plastic box with wet blue roll and the boxes placed in incubators set at 10, 15, 20 or 25°C. A Tinytalk<sup>®</sup>II miniature temperature datalogger (Radio Spares, UK) was placed in one box in each incubator to record the temperature over the assay period.

At each of the times shown in Table 5.1, three plates for each isolate by temperature combination were fixed by placing a drop of 10% cotton blue in lactophenol and a coverslip on the conidia at the centre of the plate. Plates were stored in sealed plastic bags at 4°C until they could be evaluated. Plates could be kept in this way for six months or longer without contamination. For each replicate (plate), 300 conidia were counted in random fields of view using a Leitx Dialux 20 EB light microscope (magnification x 500) and the number that had germinated

was noted. A conidium was considered to be germinated when the germ tube was at least as long as the diameter of the conidium.

**TABLE 5.1** : Time (hours post-inoculation) at which conidia were fixed in an experiment to determine the impact of temperature on *in vitro* germination of conidia.

	Temperature (°C)			
	10	15	20	25
	0	0	0	0
	12	12	6	6
Time	24	18	9	9
(hours)	36	24	12	12
	48	30	18	18
	72	36	24	24
	96	48	30	30

A measure of time taken for 50% of conidia to germinate (GT<sub>50</sub>) was calculated for each temperature and fungus combination by using general linear regression with modelling of binomial proportions with logits procedure in Genstat 5. The inverse of the variance of each GT<sub>50</sub> was taken to weight the data. The natural logarithm (log<sub>e</sub>) of the GT<sub>50</sub> was calculated to normalise data and the normalised data were analysed using the general linear regression procedure in Genstat 5, taking account for the weight of each GT<sub>50</sub>. Data for the standard isolate Mycotech strain GHA were analysed using this method to determine whether the different runs of the assay could be combined. Data for all isolates were subsequently grouped by fungal species and then analysed using the same analysis.

### ***5.2.3 Impact of temperature on in vitro fungal colony growth***

Isolates were randomly divided into two groups, sub-cultured on successive days and placed in an incubator at 20°C in the dark for four days. Plugs were cut using a sterile cork borer (5mm diameter) from non-sporulating mycelium on plates and a single plug was placed upside down in the centre of a clean plate of medium (22ml of SDA in a 9cm Petri dish). Plates were sealed with parafilm and incubated in the dark at 10, 15, 20 or 25°C. Five replicate plates were prepared for each isolate by temperature combination. Surface radial growth was recorded every two days

using two cardinal diameters previously drawn on the bottom of the dish. Plates were exposed to light during the periods of measurement. The experiment was run for 26 days or until the fungal colony had covered the plate.

The colony radial growth rate (Kr) (Pirt, 1967) was calculated for each isolate at each temperature. Colonies grew in a linear way between days three and twelve post-inoculation and this growth could be described with a linear model ( $y = Kr(t) + b$ ). The increase in colony radius was plotted against time and Kr was calculated by linear regression as the slope of this graph. Colony radial growth rates were used as the main parameter to evaluate the influence of temperature on fungal growth.

#### ***5.2.4 Impact of temperature on pathogenicity of fungi to A. fabae and M. persicae***

Three isolates (HRI 1.72 (*V. lecanii*), Mycotech strain GHA (*B. bassiana*) and Z11 (*P. fumosoroseus*)) were assayed for pathogenicity to the black bean aphid *Aphis fabae* and the peach-potato aphid *M. persicae* at different temperatures. Suspensions of conidia were applied at a single dose of  $1 \times 10^8$  conidia ml<sup>-1</sup>. There were four replicates (Petri dishes) of 15 aphids for each isolate and temperature combination and a control. Following spraying, aphids were incubated in CE rooms at either 10, 18 or 23°C with a 16 hour photoperiod. Aphids were transferred to clean leaves set in water agar, 48 hours post-inoculation. Mortality was recorded twice daily for aphids incubated at 18 and 23°C and once every two to three days at 10°C using methods described in section 2.7. Aphids were transferred to fresh leaves every two days post-inoculation at 18 and 23°C and every seven days at 10°C, as detailed in section 2.8. Dead aphids were placed onto damp filter paper and assessed for fungal sporulation.

The LT<sub>50</sub>, standard error of the LT<sub>50</sub> and 95% confidence intervals for each temperature by aphid by fungus treatment were calculated for each dish using actuarial clinical life tables analysis (section 4.2.2). The inverse of the variance of the LT<sub>50</sub> of each dish was taken to weight the data. The LT<sub>50</sub> values were analysed using the general linear regression procedure in Genstat 5.1 with account taken for

the weights of each  $LT_{50}$  value. The model that described these data best was used to calculate predicted  $LT_{50}$  values with associated standard errors for each aphid by fungus by temperature combination.

### ***5.2.5 Impact of water availability ( $a_w$ ) on in vitro fungal germination***

The impact of low water activity ( $a_w$ ) on *in vitro* germination was determined for the four isolates selected in section 4.3.1. Suspensions of conidia were prepared and diluted to give a concentration of  $1 \times 10^6$  conidia  $ml^{-1}$  using methods described in section 2.6 and  $4\mu l$  of a suspension was applied using a Gilson pipette (Gilson®) at the centre of a 9cm Petri dish containing 10ml of agar.

In the first experiment, the effect of added nutrients on the rate of conidial germination was tested at a single  $a_w$  of 1.000 (=100% RH). Plates of water agar (1.5% w/v, 10ml water agar in 9cm Petri dishes) were prepared with or without added nutrients (1% w/v D-Glucose anhydrous (Fisher Scientific) and 1% yeast extract w/v (Oxoid)). Twelve plates (replicates) were inoculated for each isolate by nutrient combination and plates were placed in sealed plastic boxes and incubated at 24°C in darkness. Three plates were removed at 18, 24, 30 and 43h post-inoculation from each isolate by nutrient combination and were fixed by placing a drop of 10% cotton blue in lactophenol and a coverslip on the conidia at the centre of the plate. For each dish, 100 conidia were counted and the number that had germinated was recorded as detailed in section 5.2.2. Additionally, the length of the germ tubes produced by conidia for isolates HRI 1.72 (*V. lecanii*), Mycotech strain GHA (*B. bassiana*) and ARSEF 2879 (*B. bassiana*) was recorded for 30 conidia of each isolate at 18h post-inoculation.

The second experiment was designed to determine the effect of different  $a_w$  on the germination of conidia. Two types of  $a_w$  media were tested. The first contained 1.5% (w/v) agar-agar and glycerol (Scientific grade for analysis, Fisher Scientific) adjusted, as described by Dallyn and Fox (1980), to give a medium with  $a_w$  ranging from 0.923 - 0.993 (= 92.3 - 99.3% RH). The second was exactly the same as the first except that nutrients were added (1% w/v D-Glucose anhydrous (Fisher Scientific) and 1% yeast extract w/v (Oxoid)). Three plates (replicates) were

inoculated for each isolate by nutrient by  $a_w$  combination and plates were placed in sealed plastic bags with plates of the same  $a_w$  and incubated at 24°C in darkness. All dishes were removed 24h post-inoculation and were fixed by placing a drop of 10% cotton blue in lactophenol and a coverslip on the conidia at the centre of the plate. For each plate, 100 conidia were counted and the number that had germinated was recorded as detailed in section 5.2.2.

## 5.3 Results

### 5.3.1 Impact of temperature on *in vitro* germination of conidia

Rates of germination of conidia for all isolates were faster at the higher temperatures (25 and 20°C) than at the lower temperatures (10 and 15°C). General linear regression analysis of the weighted  $\text{Log}_e\text{GT}_{50}$  values for the standard isolate, Mycotech strain GHA, indicated that the data were best described by a single line model which indicated that germination of conidia was significantly affected by temperature ( $F_{1,10} = 134.86$ ,  $P < 0.001$ ). Adding an additional description of an individual intercept for each isolate in each run of the experiment did not describe the data any better ( $F_{4,10} = 1.12$ ,  $P = 0.401$ ). All runs of the assay could therefore be combined in one analysis. These results suggested that there were significant differences between temperatures in the number of conidia of the standard isolate (Mycotech strain GHA) that germinated, but that germination was not significantly different at each temperature over the different assays.

When isolates were grouped and analysed as individual species, the single line model was sufficient to describe the data for isolates of *P. fumosoroseus* and *M. anisopliae* (Table 5.2), indicating that there were significant differences in the rate of germination of conidia between the different temperatures (*P. fumosoroseus*  $F_{1,16} = 195.84$ ,  $P < 0.001$ ; *M. anisopliae*  $F_{1,5} = 43.11$ ,  $P < 0.001$ ). Adding an additional description of an individual intercept for each isolate did not describe the data any better (*P. fumosoroseus*  $F_{5,16} = 2.62$ ,  $P = 0.065$ ; *M. anisopliae*  $F_{2,5} = 2.33$ ,  $P = 0.193$ ). This would suggest that there was no significant intra-specific differences in the number of conidia that germinated for isolates of *P. fumosoroseus* and *M. anisopliae* over the range of temperatures tested.

**TABLE 5.2 :** Results for general linear regression analysis on  $\log_e$  time for 50% of conidia to germinate *in vitro* (GT<sub>50</sub>) for isolates of *V. lecanii*, *P. fumosoroseus*, *M. anisopliae* and *B. bassiana*, at four different temperatures (10, 15, 20 and 25°C).

Species	Intercept ( $\log_e$ GT <sub>50</sub> )	Standard error of intercept	Slope of line	Standard error of slope
<i>P. fumosoroseus</i>	5.00	0.167	-0.112	0.034
<i>M. anisopliae</i>	5.81	0.446	-0.142	0.024
<i>V. lecanii</i>	4.559	0.226	-0.092	0.036
HRI 1.72	3.758	0.330	-0.073	0.018
ARSEF 2859	4.283	0.812	-0.080	0.044
T80	4.169	0.855	-0.071	0.046
TT5	4.647	0.818	-0.996	0.045
Z25	4.943	0.787	-0.106	0.043
<i>B. bassiana</i>				
Mycotech GHA	4.76	0.167	-0.102	0.009
ARSEF 2879	4.80	0.235	-0.101	0.235
T195	5.27	0.261	-0.112	0.261
Z135	4.20	0.245	-0.083	0.245
Z139	4.50	0.303	-0.087	0.303

Germination of conidia of isolates of *V. lecanii* was significantly affected by temperature ( $F_{1,10} = 105.09$ ,  $P < 0.001$ ). The single line model did not describe the data well, but an additional description of a different intercept for each isolate did describe the data sufficiently ( $F_{4,10} = 4.49$ ,  $P = 0.025$ ). This suggested that the pattern of germination of isolates of *V. lecanii* changed in the same way over the range of temperatures, but that there were significant differences between isolates in their rate of germination at any one temperature. Isolate HRI 1.72 behaved very differently to all the other *V. lecanii* isolates and germinated much more quickly at every temperature tested. When this isolate was removed from the analysis, the data for the remaining isolates could be described by the single line model ( $F_{1,8} = 142.18$ ,  $P < 0.001$ ) as adding an additional description of different intercepts did not account for significantly more of the variability in the data ( $F_{3,8} = 1.29$ ,  $P = 0.342$ ).

Data for isolates of *P. fumosoroseus*, *M. anisopliae* and *V. lecanii* (with HRI 1.72 removed) were grouped by species and analysed using general linear regression to determine whether there were any differences between the species in rate of germination at the different temperatures. The best model to describe the data was

one in which the equation of the line for each species had a separate intercept but a similar slope. There was a significant effect of temperature ( $F_{1,49} = 5324.43$ ,  $P < 0.001$ ) and there was a significant difference between the response of each species at any given temperature ( $F_{3,49} = 558.14$ ,  $P < 0.001$ ) but the pattern of this response was not significantly different over the range of temperatures ( $F_{2,49} = 3.06$ ,  $P = 0.056$ ). However, this value is very close to the arbitrary significance level of 5% so this final result should be treated with some caution.

### **5.3.2 Impact of temperature on in vitro fungal colony growth**

There were inter- and intra-specific differences between isolates in colony growth rates at the four temperatures tested (Table 5.3). Generally, the rate of colony growth for all isolates, regardless of species, was faster at the higher temperatures (20 and 25°C) compared to growth at lower temperatures (10 and 15°C). There were differences between the species of fungus in their growth rates at the lowest temperature (10°C); isolates of *M. anisopliae* had the slowest growth (2.68 - 20.64  $\mu\text{m h}^{-1}$ ) compared to the other species and *P. fumosoroseus* isolates were able to grow the fastest at this temperature (20.31 - 77.90  $\mu\text{m h}^{-1}$ ). Additionally, at 10°C, there was more interspecific variability in colony growth rates for isolates of *P. fumosoroseus* compared to isolates of the other species at this temperature.

At the highest temperature (25°C), isolates of *M. anisopliae* grew faster than isolates of *V. lecanii* or *B. bassiana* and only one isolate of *P. fumosoroseus* (Z11) was recorded as growing faster. A decrease in growth rates at 25°C compared to 20°C was noted for isolates Z25 (*V. lecanii*), Z135 (*B. bassiana*) and T229 (*P. farinosus*).



TABLE 5.3 : *In vitro* colony radial growth rates [Kr ( $\mu\text{m h}^{-1}$ )] for isolates of *V. lecanii*, *B. bassiana*, *M. anisopliae* and *Paecilomyces* spp. grown at four different temperatures (10, 15, 20 & 25°C).

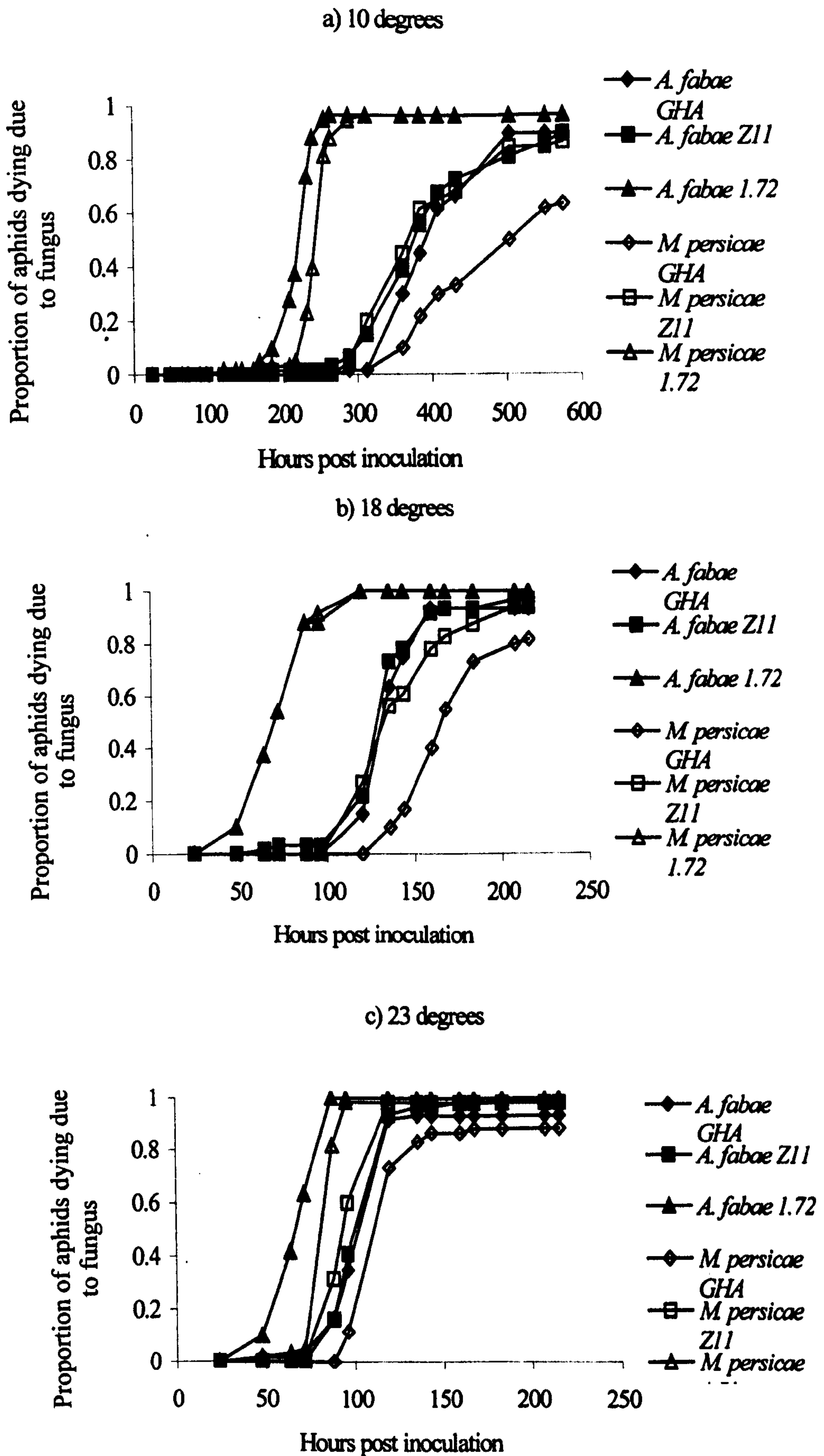
Species	Isolate reference number	Kr ( $\mu\text{m h}^{-1}$ )			
		Temperature ( $^{\circ}\text{C}$ )			
		10	15	20	25
<i>V. lecanii</i>	ARSEF 2859	35.34	63.02	71.32	92.08
	Z25	37.65	71.21	104.84	78.27
	Z26	48.40	88.10	116.37	121.91
	TTS	35.42	53.13	78.93	86.24
	T80	36.61	70.61	95.50	96.80
	HRI 1.72	38.99	65.55	101.79	119.79
<i>B. bassiana</i>	Mycotech strain GHA	17.71	60.49	90.77	92.82
	ARSEF 2879	27.68	44.89	74.03	93.32
	Z135	24.55	65.10	81.18	77.46
	T195	20.28	60.42	85.27	100.41
	Z139	26.04	29.61	40.48	71.73
	Z43	11.01	63.77	106.13	164.25
<i>M. anisopliae</i>	Z143	20.46	63.91	129.17	174.85
	T130	2.68	40.51	120.44	160.12
	ARSEF 3458	56.85	72.55	135.94	144.87
<i>Paecilomyces</i> spp.	ARSEF 4491	24.70	50.22	112.50	143.71
	ARSEF4461	43.68	43.68	121.43	126.27
	Z4	39.58	83.26	111.61	140.10
	Z11	31.77	83.04	133.56	166.96
	T229	77.90	85.19	138.84	130.58
	T314	20.31	71.35	118.23	141.74

### **5.3.3 Impact of temperature on pathogenicity of fungi to *A. fabae***

Generally, mortality occurred more quickly and reached a maximum earlier at the higher temperatures of 18 and 23°C compared to 10°C (Figure 5.1). The first mortality due to fungus occurred 48 hours post-inoculation at 18 and 23°C but not until 120 hours at 10°C. Aphids of both *A. fabae* and *M. persicae* were most susceptible to isolate HRI 1.72 at all three temperatures. Greater than 96% mortality was recorded for aphids treated with this isolate at each temperature. The smallest mortality of aphids was recorded for *M. persicae* treated with isolate Mycotech strain GHA and mortality to this fungus was noted latest at each of the three temperature by isolate combinations.

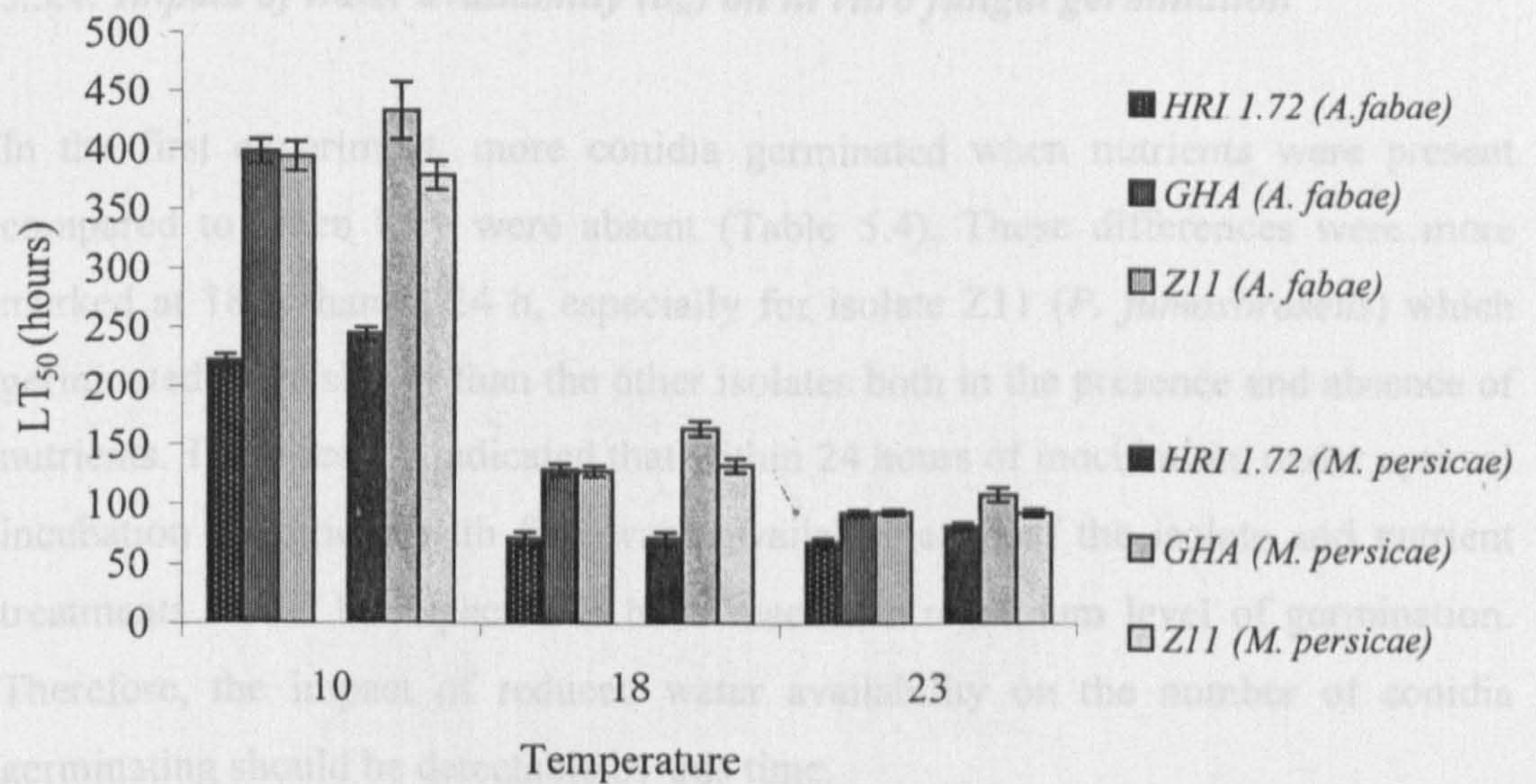
There were significant differences in the  $LT_{50}$  values for the two aphid species ( $F_{1,52} = 12.67$ ,  $P < 0.001$ ). *Aphis fabae* was generally more susceptible than *M. persicae* (Figure 5.2). Having allowed for these differences between aphids, adding an additional description to the model of the effect of temperature accounted for significantly more of the variability in the data ( $F_{2,52} = 1484.05$ ,  $P < 0.001$ ) suggesting that differences between  $LT_{50}$  values were largely caused by the temperature at which the assay was run;  $LT_{50}$  values at the lowest temperature (10°C) were larger than those at 18 or 23°C.

Adding a third description to the model of a different slope for each fungus also accounted for more of the variability in the data ( $F_{2,52} = 213.08$ ,  $P < 0.001$ ). This suggested that, given the differences between aphids and the differences between temperatures, there was a significant effect of fungal isolate on the  $LT_{50}$  values; aphid mortality due to isolate HRI 1.72 occurred more quickly following inoculation compared to the other two isolates.



**FIGURE 5.1** : Cumulative proportion of *A. fabae* and *M. persicae* dying due to fungus on each day following inoculation with a single concentration ( $1 \times 10^8$  conidia  $\text{ml}^{-1}$ ) of isolates HRI 1.72 (*V. lecanii*), Z11 (*P. fumosoroseus*) and Mycotech strain GHA (*B. bassiana*) and incubated at a) 10, b) 18 and c) 23°C.

### 5.3.4 Impact of water availability (a<sub>w</sub>) on in vitro fungal germination



**FIGURE 5.2 :** LT<sub>50</sub> values (with associated standard errors) for *A. fabae* and *M. persicae* dying due to fungus following inoculation with a single concentration ( $1 \times 10^8$  conidia ml<sup>-1</sup>) of isolates HRI 1.72 (*V. lecanii*), Z11 (*P. fumosoroseus*) and Mycotech strain GHA (*B. bassiana*) and incubated at 10, 18 and 23°C.

There was no interaction between aphid species and temperature, suggesting that the two aphid species reacted in a similar way to the fungi at each of the different temperatures ( $F_{2,52} = 2.01$ ,  $P = 0.144$ ). However, there was a significant interaction between aphid species and fungal isolate ( $F_{2,52} = 9.00$ ,  $P < 0.001$ ) which is suggested to be because the LT<sub>50</sub> values for *M. persicae* inoculated with isolate Mycotech strain GHA (*B. bassiana*) were significantly different to those for *A. fabae* inoculated with the same isolate at 18 and 23°C.

There was a significant interaction between temperature and species of fungus ( $F_{4,52} = 90.76$ ,  $P < 0.001$ ) suggesting that the difference between temperatures changed with the species of fungus.

Adding nutrients increased the lengths of germling tubes for isolates HRI 1.72 (*V. lecanii*) and ARSEF 2879 (*B. bassiana*) but had no effect on isolate Mycotech strain GHA (*B. bassiana*).

#### 5.3.4. Impact of water availability ( $a_w$ ) on *in vitro* fungal germination

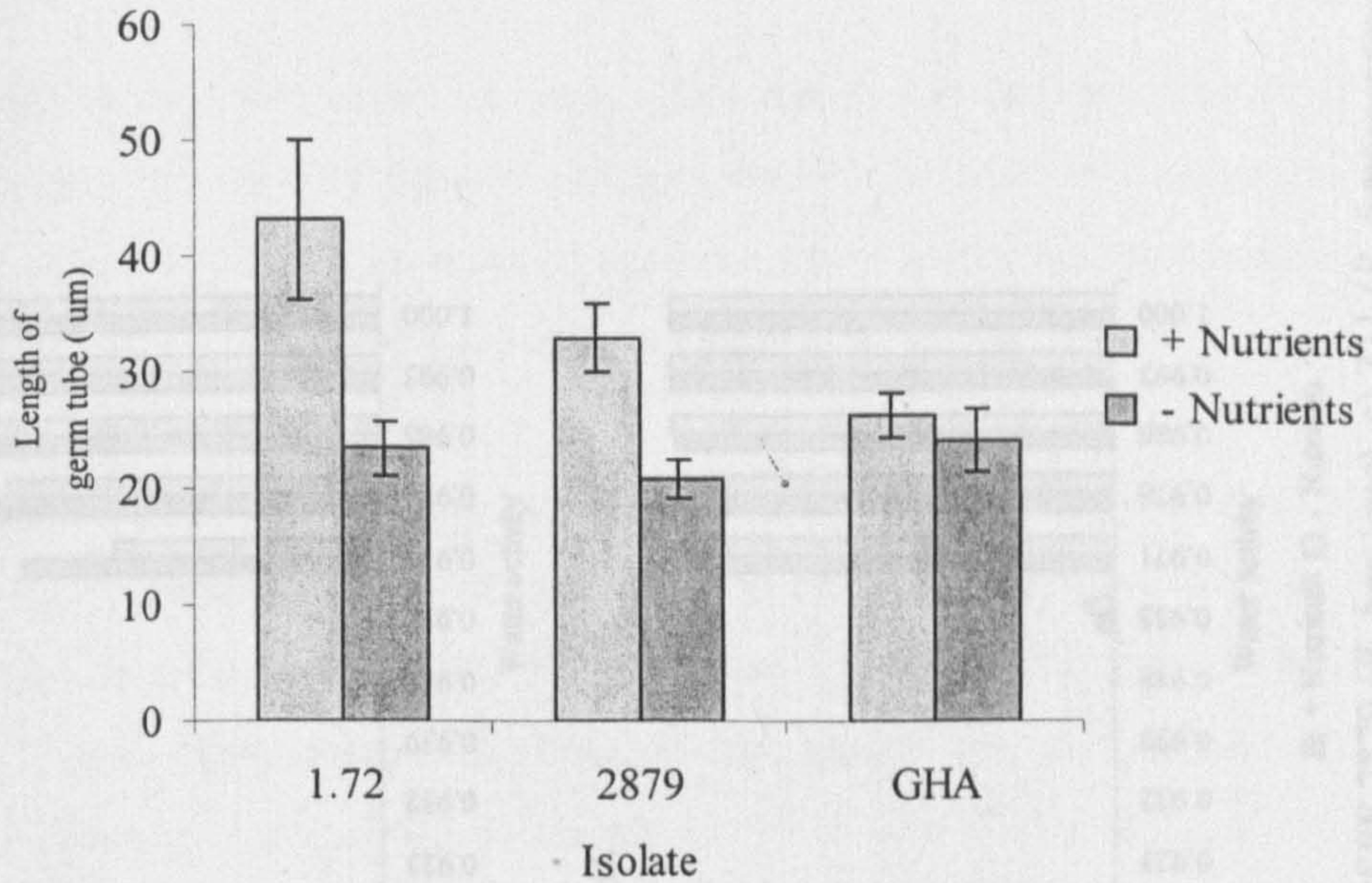
In the first experiment, more conidia germinated when nutrients were present compared to when they were absent (Table 5.4). These differences were more marked at 18 h than at 24 h, especially for isolate Z11 (*P. fumosoroseus*) which germinated more slowly than the other isolates both in the presence and absence of nutrients. These results indicated that within 24 hours of inoculation, under optimal incubation conditions with free water available, each of the isolate and nutrient treatments would be expected to have reached a maximum level of germination. Therefore, the impact of reduced water availability on the number of conidia germinating should be detectable by this time.

**TABLE 5.4** : Number of conidia that germinated *in vitro* at  $a_w$  1.00 for isolates HRI 1.72 (*V. lecanii*), Z11 (*P. fumosoroseus*), Mycotech strain GHA (*B. bassiana*) and ARSEF 2879 (*B. bassiana*) in the presence (+) and absence (-) of added nutrients.

	Number of germinated conidia (%)			
	18h (+)	18h (-)	24h (+)	24h (-)
HRI 1.72	96.33	94.67	*	99.33
Z11	41.33	26.00	94.33	86.33
ARSEF 2879	98.67	89.67	99.00	95.00
Mycotech strain GHA	99.33	97.00	*	100.00

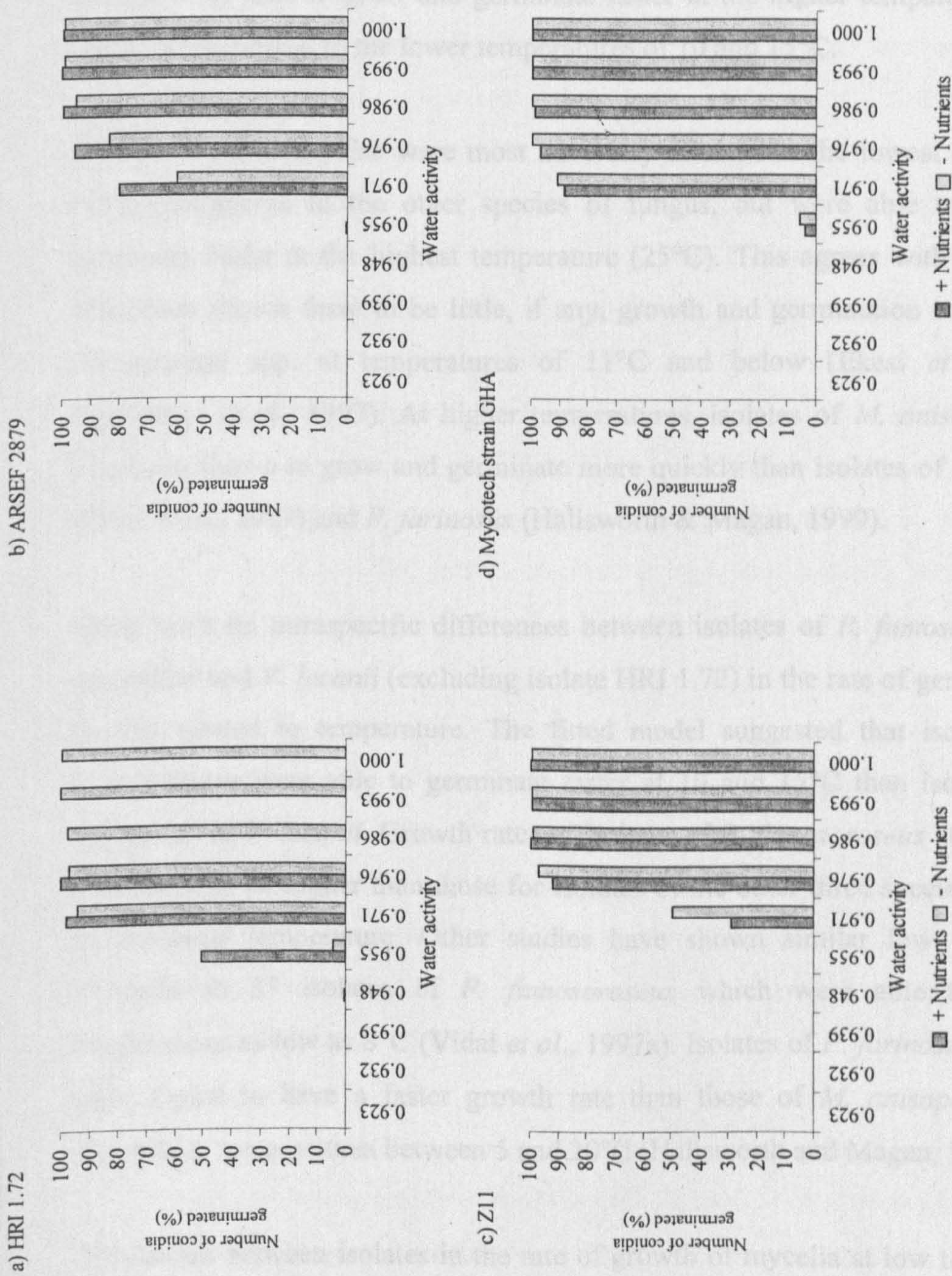
\* indicates that it was not possible to count individual conidia because of dense growth of mycelia

There were differences between isolates in the length of germ tube produced after 18 h growth either in the presence or absence of added nutrients (Figure 5.3). In the absence of added nutrients, germ tube lengths were similar for all three isolates. Adding nutrients increased the length of germ tubes for isolates HRI 1.72 (*V. lecanii*) and ARSEF 2879 (*B. bassiana*) but had no effect on isolate Mycotech strain GHA (*B. bassiana*).



**FIGURE 5.3 :** Average length of germ tubes (with standard errors) produced from conidia of isolates HRI 1.72 (*V. lecanii*), ARSEF 2879 (*B. bassiana*) and Mycotech strain GHA (*B. bassiana*) on media with and without added nutrients.

In the second experiment, when the water availability of agar was reduced, there was a reduction in the number of conidia that germinated for each isolate (Figure 5.4). None of the isolates were able to germinate below 0.955  $a_w$  (= 95.5% RH). A general ANOVA of data for 1.00 - 0.971  $a_w$  indicated that there was no significant effect of adding nutrients on the number of conidia that germinated ( $F_{1,74} = 0.56$ ,  $P = 0.457$ ). Data could not be analysed for  $a_w$  treatments lower than this because of the extreme differences between results at 0.955  $a_w$  and above. There was a significant effect of isolate on the number of conidia that germinated ( $F_{3,74} = 264.89$ ,  $P < 0.001$ ). Germination was reduced or totally inhibited at 0.955  $a_w$  for all isolates except HRI 1.72 (*V. lecanii*) for which approximately 50% of conidia were able to germinate in the presence of added nutrients.



**FIGURE 5.4 :** Number of germinated conidia (%) of isolates a) HRI 1.72 (*V. lecanii*), b) ARSEF 2879 (*B. bassiana*), c) Z11 (*P. fumosoroseus*) and d) Mycotech strain GHA after 24 hours on media adjusted to give water activities in the range  $a_w$  1.000 - 0.923 with or without added nutrients.

## 5.4 Discussion

In this study, there were differences both within and between species of fungus in their *in vitro* rate of growth and germination in relation to temperature. Most isolates were able to grow and germinate faster at the higher temperatures of 20 and 25°C compared to the lower temperatures of 10 and 15°C.

Isolates of *M. anisopliae* were most adversely affected at the lowest temperature (10°C) compared to the other species of fungus, but were able to grow and germinate faster at the highest temperature (25°C). This agrees with other work which has shown there to be little, if any, growth and germination of isolates of *Metarhizium* spp. at temperatures of 11°C and below (Ekesi *et al.*, 1999; Ouedraogo *et al.*, 1997). At higher temperatures, isolates of *M. anisopliae* have also been shown to grow and germinate more quickly than isolates of *B. bassiana* (Ekesi *et al.*, 1999) and *P. farinosus* (Hallsworth & Magan, 1999).

There were no intraspecific differences between isolates of *P. fumosoroseus*, *M. anisopliae* and *V. lecanii* (excluding isolate HRI 1.72) in the rate of germination of conidia related to temperature. The fitted model suggested that isolates of *P. fumosoroseus* were able to germinate faster at 10 and 15°C than isolates of *M. anisopliae* or *V. lecanii*. Growth rates of isolates of *P. fumosoroseus* at 10°C were also found to be higher than those for isolates of the other three species of fungus at the same temperature. Other studies have shown similar low temperature tolerance in 37 isolates of *P. fumosoroseus* which were able to grow at temperatures as low as 8°C (Vidal *et al.*, 1997a). Isolates of *P. farinosus* have also been shown to have a faster growth rate than those of *M. anisopliae* and *B. bassiana* at temperatures between 5 and 20°C (Hallsworth and Magan, 1999).

Differences between isolates in the rate of growth of mycelia at low temperatures is likely to be very important when selecting isolates as potential mycoinsecticides for use in cropping systems. In the current study, isolates of species such as *P. fumosoroseus* and *V. lecanii* that are able to grow and germinate well at temperatures of 10 and 15°C are therefore likely to be better adapted for



development as mycoinsecticides; the average monthly temperatures for May to August at Rothamsted were 11.0 to 15.9°C over the years 1872 - 1969.

It has been suggested that the differences between and within species of fungus in growth of mycelia and germination of conidia related to temperature may be attributed to the geographic origin of the isolate. The effect of temperature on the *in vitro* growth rate of isolates of *P. fumosoroseus* indicated that interspecific variability was partially related to the climate from which the isolates were obtained (Vidal *et al.*, 1997a). Indian isolates were able to grow well at high temperatures (optima of 32 and 35°C) whilst those originating from Europe grew well at low temperatures (optima between 20 and 25°C). Fargues *et al.*, (1992) showed that there was a relationship between the minimum and maximum temperatures for fungal growth and the climatic conditions of the site of origin in a study of isolate from six species of hyphomycete. Isolates from tropical, humid areas (such as isolates of *M. anisopliae*) were able to grow well at high temperatures (35°C) whilst isolates originating from soil insects in temperate areas (such as isolates of *B. bassiana* and *B. brongniartii*) were able to grow at low temperatures (8°C).

However, Ekesi *et al.* (1999) found two isolates of *M. anisopliae* from the same origin had significantly different germination profiles. Fargues *et al.*, (1997a) also found no clear relationship between relative growth rates of isolates of *B. bassiana* at different temperatures and geographical origin. The authors suggest however, that this is not surprising as *B. bassiana* has a very wide host range and is a cosmopolitan, facultative pathogen.

It therefore appears that the geographical origin of an isolate may not be a very reliable indicator of the ability of that isolate to germinate and grow under specific temperature conditions. Although there are generalisations that can be made for different species of fungi based on temperature optima for growth and germination, it is likely that there will be isolates that can tolerate temperatures above and below these optima. Evidence of differences between isolates within a species in their temperature tolerance for growth and germination would suggest that it is not possible to determine the response of an isolate based solely on general trends for

that species or the climate from which it originated. Climatic differences between seasons at any one site may place selection pressures on fungi that are able to grow and germinate under very different abiotic conditions. An isolate collected in a temperate climate in a very hot summer for example, may have a temperature profile closer to that of a tropical isolate, compared to an isolate that is collected at the same site but under cool spring conditions. Mycoinsecticides should not therefore, be chosen simply by matching climatic factors between the site of origin and that of application.

The *in vivo* infection studies at different temperatures in this study showed there was little difference between the  $LT_{50}$  values obtained at 18 and 23°C for either *A. fabae* or *M. persicae* when they were inoculated with fungi. Results of *in vitro* studies showed rates of growth of these isolates only increased slightly between 20 and 25°C so it may be expected that these changes in temperature would have little impact on the rate of aphid mortality if the same relationship existed *in vivo*. The  $LT_{50}$  values for both aphid species inoculated with isolate HRI 1.72 (*V. lecanii*) were significantly smaller at 10°C than those for the other isolates. The *in vitro* germination data suggested that HRI 1.72 (*V. lecanii*) was able to germinate more quickly than the other isolates at this temperature which may also be related to the *in vivo* pathogenicity of this isolate at 10°C. Other studies have suggested that a fast germination rate of conidia (amongst other traits) may be related to the expression of pathogenicity (Jackson *et al.*, 1985). However, differences do occur between *in vitro* and *in vivo* germination of fungal isolates related to temperature (Ouedraogo *et al.*, 1997), suggesting isolates should be selected on the basis of results from both *in vitro* and *in vivo* germination tests.

The *in vitro* germination studies on agar adjusted to different water activities indicated that none of the isolates tested were able to germinate below  $a_w$  0.955 ( $\equiv$  95.5 % RH). This agrees with other studies in which *V. lecanii* has been cited as requiring above 0.93 $a_w$  for conidial germination and mycelial growth (Drummond *et al.*, 1987) and isolates of *B. bassiana*, *M. anisopliae* and *Paecilomyces* spp. have been shown to be unable to germinate below 0.93  $a_w$  (Gillespie & Crawford, 1986). A strain of *V. lecanii* which colonises grain has, however, been recorded as germinating on media with water activity as low as  $a_w$  0.90 (Magan & Lacey,

1984). In the current study, although conidia were recorded as being unable to germinate on media with  $a_w$  0.932 - 0.955, they were noted to have become quite swollen as if water had entered them. Increasing the recording period would establish whether these conidia had the potential to germinate or if germination was totally inhibited at these water activities.

A small number of conidia (0.33%) of the isolate HRI 1.72 (*V. lecanii*) were recorded in the current study as being able to germinate at a water activity as low as  $a_w$  0.948. It is interesting that this isolate was also the most pathogenic *in vivo* to aphid hosts. Similar relationships between germination of conidia at low humidity or water activity and *in vivo* pathogenicity has been reported for isolate HRI 1.72 (Chandler, Heale & Gillespie, 1994), an isolate of *V. lecanii* identified only as isolate "A" (Drummond *et al.*, 1997) and isolates of *M. anisopliae* and *P. farinosus* (Matewele *et al.*, 1994). Additionally, the use of formulations in carriers such as oil has been shown to increase mortality of inoculated insects under low humidity compared to carriers such as Tween (Prior, Jollands & le Patourel, 1988; Bateman, Carey, Moore & Prior, 1993; Ibrahim, Butt, Beckett & Clark, 1999).

Adding nutrients to media had the greatest effect on isolate HRI 1.72, increasing the speed of germination and the length of germ tubes recorded. It is most likely that the increase in length of germ tube was simply because conidia germinated more quickly in the presence of added nutrients and the germ tubes therefore had more time to grow before the recording was made. This does however, suggest that the presence of nutrients, such as those in the host cuticle, may increase the rate of germination of conidia and subsequently, germ tube production. The germination and differentiation of germination structures has previously been shown to be influenced by the insect cuticle (Butt *et al.*, 1995). *In vitro* studies incorporating host cuticle into germination media have also been shown to alter the germination of fungi depending on the host cuticle used (Ibrahim *et al.*, 1999).

Studies have demonstrated that insects may become infected by fungi under low humidity conditions but that external sporulation, and hence epizootic potential, generally occurs at high humidity. Under low humidity conditions, fungi may sporulate inside the host (Lomer *et al.*, 1993). Imagines of the bean weevil

*Acanthoscelides obtectus* Say have been reported as being infected with *B. bassiana* at an ambient RH of 0% but sporulation only occurred at above 92% (Ferron, 1977). The elm bark beetle *Scolytus scolytus* has been infected with *B. bassiana* at ambient humidities as low as 5% (Doberski, 1981b). The chinch bug *Blissus leucopterus* (Say) was also infected at a low RH of 30% with *B. bassiana* but again, sporulation on the host only occurred at higher humidity of 75% RH and above (Ramoska, 1984). It has been suggested that a boundary layer of moist air, similar to that which exists in plants (Waggoner, 1965), surrounds the insect cuticle and that this constant, higher humidity (compared to macroclimatic RH) provides the ideal environment for germination of fungal conidia (Ferron, 1977; Ramoska, 1984).

The impact of pesticides on germination and growth of fungi was not investigated in this study. An M.Sc. student (Nicholas Mantis) at the University of Nottingham investigated the compatibility of isolates ARSEF 2879 (*B. bassiana*), Z11 (*P. fumosoroseus*), HRI 1.72 (*V. lecanii*) and Mycotech strain GHA (*B. bassiana*) with the fungicides Bravo 500 (chlorothalonil), Sportak-Sierra (prochloraz) and Standon (kresoxim-methyl + epiconazole) and the insecticide Toppel (cypermethrin) (Mantis, 2000). At the recommended field rate, the germination of conidia of all isolates was reduced in the fungicide treatments. Additionally, the rate of mycelial growth and the overall number of conidia that were able to germinate was also reduced. The rate of mycelial growth and germination of conidia was not so adversely affected by the insecticide Toppel. At 0.01 x field rate of all chemicals, the percentage germination of conidia of each isolate increased, compared to field rate treatments; the greatest increase was for isolate Z11 (*P. fumosoroseus*). Studies such as these should be included as part of the selection criteria in the biorational approach as isolates that are compatible with commonly used pesticides will be more easily incorporated into IPM programmes of aphid control.

Therefore, part of the selection criteria for isolates that have the potential for use as mycoinsecticides should be based on information from both germination and growth studies under abiotic conditions which prevail at the site of release. Knowledge of germination of conidia will aid in selecting isolates that are able to infect and penetrate hosts quickly under field conditions. An increase in the ability

of conidia to germinate quickly has been associated with increased pathogenicity of an isolate of *M. anisopliae* to the tobacco hornworm *Maduca sexta* (Hassan, Dillon and Charnley, 1989). Also, the ability of an isolate to grow during the incubation period within a host will ultimately dictate the speed of kill achieved with a mycoinsecticide. The idea that microbial control agents will operate in a similar manner to conventional chemical insecticides may place strong pressures on ensuring "knock-down" insect pest control with mycoinsecticides and hence, the selection of isolates that can germinate and grow quickly.

---

## CHAPTER 6 : INTERACTIONS OF MYCOINSECTICIDES WITH OTHER NATURAL ENEMIES

---

### 6.1 Introduction

There are many potentially antagonistic, synergistic and additive interactions that could occur between microbial insecticides and non-target organisms, such as invertebrates and other microbial pathogens, but there is currently an incomplete understanding of these interactions.

Microbial products have been registered and marketed in a similar way to chemical insecticides so there has been a tendency to assess their impact on non-target organisms in a similar manner to chemical insecticides. Most of the literature on interactions between microbial pathogens and non-target organisms therefore relates to direct impact assessments. The reader is referred to Cook, Bruckart, Coulson, Goettel, Humber, Lumsden, Maddox, McManus, Moore, Meyer, Quimby Stack & Vaughn (1996) for a recent review on safety considerations of live organisms introduced for biological control. It has been suggested, however, that long term effects of microbial pathogens are likely to be more important for natural enemies than intermediate, direct mortalities (Flexner, Lighthart & Croft, 1986).

The main risks associated with microbial insecticides have been identified as toxicity, allergenicity and infections in mammals and non-target fauna (Hall & Papierok, 1982). The safety of any microbial agent will be directly linked to its physiological and ecological host range (Goettel, 1994). The physiological host range has been defined as the range of hosts that a pathogen may infect under laboratory conditions, whereas the ecological host range is the range of hosts that will actually be affected under field conditions (Hajek & Butler, 2000). Generally, fungal isolates are most virulent to the host from which they were initially isolated (Goettel *et al.*, 1990). However, some insect species may also be very easy to infect in the laboratory with fungi that are not known to attack them in nature (Goettel, 1994). For this reason, it has been suggested that specificity testing may

only be useful for fungi with narrow ecological host ranges and, if the fungus has a wide ecological host range, testing non-target susceptibility in the laboratory is not a reliable indicator of safety in the field (Goettel, 1994). However, testing pathogens in both the laboratory and field to demonstrate such differences between physiological and ecological host range has been limited (Hajek & Butler, 2000).

A particular species of fungus may be recorded from a very diverse range of hosts; *Beauveria bassiana* has been recorded infecting over 700 species of arthropods (Li, 1988). However, strains or isolates within a species of fungus may show high specificity towards a particular host (Milner, 1982). Potentially, individual isolates of the same fungal species may adversely affect non-target beneficial organisms with varying degrees of pathogenicity to those non-targets. However, the lists of those non-targets that are susceptible to infection by different fungi do not contain information of individual isolates but only of the species of fungus (Goettel *et al.*, 1990).

Additionally, the physiological and ecological host range of an entomopathogenic fungus may be influenced by the biology and ecology of the host and abiotic factors. There may be differences in both the applied pathogen and the hosts, as well as many host-related factors that cause differences between the laboratory and field (Hajek & Butler, 2000; Watson, Jenkins & Thomas, 1999). For example, it has been suggested that fungal pathogens and non-targets may be spatially or temporally separated, that the host may have defensive behaviours such as the ability to thermoregulate to avoid fungal infections (Carruthers *et al.*, 1992; Watson, Mullens & Peterson, 1993; Inglis *et al.*, 1996, 1997) or there may be changes in virulence of spores that are passaged through the host (Aizawa, 1971; Hayden *et al.*, 1992).

The assessment of the hazard that entomopathogens may pose to non-target arthropods normally follows several tiers. In the first tier, individual isolates are screened for pathogenicity to non-target arthropods. These tests are done in the laboratory and potential hosts are exposed to relatively high doses of the pathogen. If the pathogen proves to be virulent, experiments at higher tiers are used to

attempt to simulate realistic exposure under field conditions and assess effects in the field. Such experiments are more effective when semi-field bioassays are combined with full scale field experiments (Danfa & van der Valk, 1999).

Direct impact assessments have been made against several species of natural enemies, including predators, parasitoids and pollinators (Vinson, 1990). Many of these were first tier tests to determine the pathogenicity of microbial control agents to a chosen non-target indicator species; some have been published as standard protocols for laboratory testing of microbial pathogens against specific non-target species (James & Lighthart, 1992). Predicting the ecological host range is somewhat more difficult, particularly with selfperpetuating organisms that function at the tertiary trophic level, such as entomopathogens and predatory insects. The following sections are primarily aimed at reviewing the “safety” aspect of microbial pathogens, specifically focusing on interactions between fungal pathogens and other natural enemies of aphids.

### **6.1.1 Predators**

Testing microbials against predators has involved species of coleoptera, predatory mites and predatory bugs (Magalhaes, Lord, Wraight, Daoust & Roberts, 1988; James & Lighthart, 1994; Poprawski, Legaspi & Parker, 1998; Vinson, 1990). Such studies have largely been designed to look at the direct impact of microbials through contact and/or ingestion of propagules by non-target organisms. The impact of microbial pathogens on predators has been reviewed by Goettel *et al.* (1990) and Vinson (1990).

Coccinellid beetles are very important predators of aphids and many non-target tests of microbial pathogens have involved coccinellids. Second instar larvae of the coccinellid *Serangium parcesetosum* Sicard were found to be more susceptible to conidia of *Beauveria bassiana* than *Paecilomyces fumosoroseus* when they were exposed directly to the conidia (Poprawski *et al.*, 1998). Similarly, adult coccinellid beetles of other species have been found to be susceptible on direct exposure to *B. bassiana* but not to *Zoophthora radicans* conidia (Magalhaes *et al.*,



1988). James and Lighthart (1994) also found that *B. bassiana*, *Metarhizium anisopliae* and *P. fumosoroseus* were pathogenic to first instar larvae of the coccinellid *Hippodamia convergens* but there was no infection in larvae treated with *Nomuraea rileyi*. Haseeb & Murad (1997) showed that although several isolates of *B. bassiana* were highly pathogenic to adults of the coccinellid *Coccinella septempunctata*, some were faster acting than others. Additionally, different isolates showed a range of pathogenicity to several different predators of vegetable pests (Haseeb & Murad, 1998).

Direct exposure to conidia through ingestion has also been investigated for predators. Whilst entomopathogenic fungi generally invade the host through the cuticle without requiring ingestion, there is evidence that some entomopathogenic fungi, such as *B. bassiana*, are able to invade insects with chewing mouthparts via the alimentary canal (Feng *et al.*, 1994). However, it is difficult to determine the contribution that the two methods of infection may have on the infection process in predatory insects. The mortality of *S. parcesetosum* was found to be high when larvae were allowed to feed on whiteflies infected with *B. bassiana* (Poprawski *et al.*, 1998) and larvae of the coccinellid *Cryptolaemus montrousieri* Mulsant were also susceptible to *B. bassiana* when they were fed mealybugs which were treated with the commercial product Boverin<sup>®</sup> (Kiselek, 1975). However, there were no detrimental effects on the predatory mite *Phytoseiulus persimilis* (Athias-Henriot) when it consumed whiteflies infected with *Aschersonia aleyrodis* Webber (Fransen, 1987). Similarly, other studies have shown there may be no detrimental effects of feeding prey infected with bacteria such as *Bacillus thuringiensis* Berliner to predators (Yousten, 1973). Also, protozoan pathogens and nuclear polyhedrosis viruses appear to have little impact on predators (Abbas & Boucias, 1984; Young & Hamm, 1985; Marti & Hamm, 1986).

There may be indirect detrimental effects of predators feeding on prey infected with microbial pathogens. Reductions in food consumption and increased developmental times have been recorded for predators exposed to bacteria (Salama, Zaki & Sharaby, 1982). Similarly, high mortality of larvae of *C. septempunctata* fed with cotton aphids which were infected with the fungus

*Neozygites fresenii* was suggested to be because of the lack of suitability of the prey for the predator (Simelane, 1996).

Other coleopteran species have been used to investigate the non-target effects of fungal pathogens. An isolate of *M. anisopliae* var. *acridum* being developed for use as a mycoinsecticide against grasshoppers and locusts has been tested against various non-target organisms in the Sahel (Danfa & van der Valk, 1999). When two species of predatory tenebrionid beetle were exposed to conidia (either through direct topical applications or through ingestion of infected grasshoppers) there was no significant effect of the pathogen on the predators. Subsequent field studies in Niger showed there was indeed no negative impact of the same isolate on several non-target species including the tenebrionid beetles (Peveling, Attignon, Langewald & Ouambama, 1999).

Studies on several predators in cotton have also shown little impact of a *B. bassiana* based mycoinsecticide treatment in the field (Jaronski, Lord, Rosinska, Bradley, Hoelmer, Simmons, Osterlind, Brown, Staten & Antilla, 1998). Only one predator species out of four that were susceptible to the fungus under laboratory bioassay conditions was actually susceptible in the field. However, other species studied in the laboratory were not present in the field trial so conclusions could not be made about their susceptibility. Additionally, as *B. bassiana* infection was found in all treatments, including the untreated controls, the authors suggest there may have been a natural outbreak of the pathogen, but were unable to differentiate between the applied strain and those isolated from infected predators. There was significant control of whiteflies (the target insects) in plots treated with *B. bassiana*, suggesting that the infections found in untreated controls could equally be due to the applied fungus and to a natural *B. bassiana* epizootic, although the control plots were a considerable distance from the treated plots.

In a similar study, an isolate of *B. bassiana* that was pathogenic in the laboratory to the coccinellid *H. convergens* (James & Lighthart, 1994) was tested under field conditions to determine its pathogenicity to target aphids and non-target predators (James *et al.*, 1995). In contrast to the previous study, larvae of *H. convergens*

were affected in one of two studies at lower concentrations of pathogen than those used in laboratory studies. Differences in larval susceptibility between the two studies were suggested to be due to weather conditions; early in the season the incidence of the predator was reduced by 75-93% even at low concentrations of pathogen, but was not affected later in the season. Similarly, other studies have shown changes in insect susceptibility to a fungal pathogen may be caused by stressful conditions, such as starvation and changes in temperature (Donegan & Lighthart, 1989).

### **6.1.2 Parasitoids**

The competitive interactions between unrelated organisms which share a resource is receiving increasing attention (Hochberg & Lawton, 1990). Host-parasitoid-pathogen interactions may be detrimental or beneficial for the parasitoid and pathogen that interact within the shared host. Hochberg (1991a, 1991b) has defined two potential types of parasitoid and pathogen interaction as, i) intrahost interactions, where the natural enemies interact during their development within the same host and, ii) extrahost interactions, where the parasitoid may transmit the pathogen outside of the host. Modelling theory has suggested that the interactions between pathogens and parasitoids acting simultaneously against the same hosts in a population may result in the elimination of one natural enemy by the competitor in all co-infected hosts, or some intermediate outcome (Hochberg, Hassell & May, 1990). The interactions between specific pathogen groups and parasitoids have been reviewed by Akhurst (1990), Gröner (1990), Goettel *et al.* (1990), Melin & Cozzi (1990) and Brooks (1993).

One of the main detrimental effects that fungi have on parasitoids is to cause premature death of the host before the parasitoid has completed development. The time at which a pathogen infects a parasitised host has been shown to be critical for successful development of the parasitoid in several host-pathogen-parasitoid systems (Brooks, 1993). The parasitoid *Aphidius rhopalosiphi* De Stefani-Perez was adversely affected when the host aphid, *Metopolophium dirhodum*, was infected with the pathogen *Erynia neoaphidis* less than four days after being

parasitised (Powell, Wilding, Brobyn & Clark, 1986). Similarly, when the potato aphid *Macrosiphum euphorbiae* was parasitised by *Aphidius nigripes* Ashmead, only 30.7% of the parasitoids survived if aphids were infected with *V. lecanii* two days after parasitism compared to 89.2% survival if infection occurred four days following parasitism (Askary & Brodeur, 1999). Similar patterns in differences of parasitoid survival have been shown when larvae of the diamondback moth *Plutella xylostella* were parasitised by *Diadegma semiclausum* Hellén or *Cotesia plutellae* Kurdjumov and subsequently infected with the pathogen *Zoophthora radicans*; none of the parasitoids survived if larvae were infected with the fungus four days following parasitism (Furlong & Pell, in press).

The effect of the timing of attack by the parasitoid and pathogen on the successful development of either natural enemy is known as the priority effect (Powell *et al.*, 1986; Fransen & van Lenteren, 1993). A recent study evaluating the priority required by the parasitoid *A. rhopalosiphi* to complete its development in the host *Sitobion avenae*, prior to infection by the fungus *E. neoaphidis*, showed that under certain priority conditions, the competitive outcome of the pathogen-parasitoid interaction was influenced by the resistance of the wheat host plant (Fuentes-Contreras, Pell & Niemeyer, 1998). Resistance to aphids in plants increased the developmental time of the parasitoid but did not change the developmental time of the fungus. When the two natural enemies competed within the same host on a resistant plant and both had a chance to complete their development successfully, the survival of the parasitoid was significantly reduced. Because of the reduced developmental time of the parasitoid on the resistant plant, this natural enemy required a greater advantage (priority effect) to outcompete the fungus than it did on a susceptible plant.

There have been a limited number of reports of the direct pathogenicity of entomopathogenic fungi to adult parasitoids compared to those on the indirect effects. Furlong and Pell (1996) studied parasitoids of *P. xylostella* and found the fungus *Z. radicans* was pathogenic to adult *D. semiclausum*, but not to adult *C. plutellae* when adult wasps were exposed to large numbers of conidia. Poprawski, Mercadier and Wraight (1992) found *Z. radicans* was pathogenic to adults of the

aphid parasitoid *Aphelinus asychis* Walker which were exposed to showers of conidia. Additionally, when mummies were treated with conidia, an average of 20.1% of the emerging adult parasitoids subsequently succumbed to fungal infection. Lacey, Mesquita, Mercadier, Debire, Kazmer & Leclant (1997) showed that adult *A. asychis* were also susceptible to infection by *P. fumosoroseus*. There is also some evidence that parasitoid susceptibility to fungal pathogens depends on the exposure time and hence the dose of conidia received by the parasitoids. Danfa & van der Valk (1999) showed that isolates of *M. anisopliae* and *B. bassiana* caused 100% mortality in two common Sahelian parasitoids which were exposed continuously to conidia on treated paper but, when the exposure time was limited to less than six hours, there was no infection in parasitoids.

There may be direct interactions between entomopathogenic fungi and parasitoid larvae within the same host (Brooks, 1993). Studies of the susceptibility of larvae of the aphid parasitoid *A. nigripes* to the fungus *V. lecanii* showed that developing hyphae of the fungus were able to colonise the host aphid tissues (within which the parasitoid larva was developing) but were then restricted to the periphery of the parasitoid cuticle (Askary & Brodeur, 1999). Similar restrictions to hyphal growth have been reported for parasitoids developing in other aphid hosts (Milner, Lutton & Borne, 1984; Powell *et al.*, 1986). Interestingly, Askary and Brodeur (1999) also found hyphae and blastospores of *V. lecanii* in the gut of parasitoid larvae, suggesting the fungus was consumed with the aphid host tissues by the parasitoid. The authors concluded that there may have been some defensive reaction of the larvae which prevented them becoming infected with the fungus. It has been indicated in other studies that parasitoid larvae may produce antimicrobial compounds which can inhibit fungal development within the host (Führer & Willers, 1986).

There may be indirect or sublethal effects of entomopathogenic fungi on parasitoids that have developed in mycosed hosts (Brooks, 1993). El-Maghraby, Hegab & Yousif-Khalil (1988) found the developmental period of the parasitoid *Microplitis rufiventris* Kok. was increased when parasitised larvae of *Spodoptera littoralis* were infected with *B. thuringiensis* or *B. bassiana*. Lacey *et al.* (1997)

found that under high relative humidity, adult *A. asychis* treated with *P. fumosoroseus* were significantly less active than untreated controls. The authors suggest that reduced searching capacity by affected parasitoids may subsequently reduce the number of aphids parasitised under field conditions. Reductions in host development and other sublethal effects have also been noted in other host-parasitoid-pathogen systems (Hoch, Schopf & Maddox, 2000).

Fungal pathogens may also be detrimental to parasitoids by altering hosts and making them unattractive to ovipositing female parasitoids. Brobyn, Clark and Wilding (1988) showed that the parasitoid *A. rhopalosiphi* could only discriminate between healthy aphids and aphids infected with *E. neoaphidis* once the fungus had heavily colonised the aphid host tissues. Prior to this, the frequency of oviposition attempts was the same as for the controls, suggesting the mechanism for detecting the fungus in the host was only poorly developed. Potentially, the development of parasitoid populations under field conditions may be adversely affected when they competitively interact with entomopathogenic fungi. When the mealybug *Rastrococcus invadens* Williams was treated with the fungus *Hirsutella cryptosclerotium* Fernandez-Garcia, Evans and Samson and the parasitoid *Gyranussoidea tebygi* Noyes, there were increased levels of parasitism when there were longer periods between fungal treatment and parasitoid exposure to mealybug populations (Akalach, Fernandez-Garcia & Moore, 1992). It was suggested that at later stages of fungal infection, parasitoids were able to avoid ovipositing in hosts infected with fungus whilst at early exposures, many would oviposit in hosts which would subsequently die due to fungal infection. Fransen and van Lenteren (1993) also observed ovipositing female *Encarsia formosa* Beltville avoided whitefly hosts that had been infected with the fungus *A. aleyrodis*. When the fungus was applied to parasitised whitefly hosts four days after parasitism had taken place, healthy *E. formosa* adults emerged, demonstrating how the two natural enemies may act synergistically to control whitefly.

Field studies to evaluate the effect of fungal pathogens on natural populations of parasitoids have shown promising results, with little impact of the pathogens on the non-target fauna. A recent study was focused on evaluating the effect of the *B.*

*bassiana* based mycoinsecticide Mycotrol® WP on *Eretmocerus* nr. *californicus* Howard wasps in commercial melons (Jaronski *et al.*, 1998). The parasitoids had been shown to be highly susceptible to the pathogen under laboratory conditions. However, the field application of *B. bassiana* had no significant effect on the rate of parasitism, although parasitoids were less abundant in the *B. bassiana* treated plots than in control plots. The authors suggest that this reduced parasitoid abundance may be due to the reduced numbers of hosts available in plots where whiteflies were controlled with the fungus. They conclude that this study indicates that, under field conditions, the parasitoids were not as severely impacted by *B. bassiana* applications as would have been suggested from laboratory studies. However, the long-term impact of such reduced host availability to parasitoid abundance and survival was not evaluated.

An isolate of *P. fumosoroseus* also had no significant detrimental effect on the parasitoid *A. asychis* when the pathogen and parasitoid were applied in combination against *Diuraphis noxia* (Mesquita, Lacey & Leclant, 1997). There were no differences between the number of mummies and the F1 emergence in the treated parasitoid populations compared to the controls and it was suggested that *A. asychis* and *P. fumosoroseus* had potential to be used together in integrated aphid control. Glasshouse experiments with *P. fumosoroseus* and *E. formosa* supported laboratory experiments that the parasitoid was not susceptible to the fungus and others have demonstrated the capacity for an additive effect of fungus and parasitoids for aphid control (Mesquita *et al.*, 1997).

Results of glasshouse and field testing are therefore very encouraging for the introduction of fungal pathogens into insect pest control programmes. However, as Danfa and van der Valk (1999) observe specifically for *B. bassiana* and *M. anisopliae*, the hymenoptera should remain a priority group to be included in impact assessments when mycoinsecticides are used under field conditions.

### **6.1.3 Pollinators**

Research on the impact of pathogens on pollinators has concentrated on the honeybee, *Apis mellifera* L., mainly because of regulatory requirements for registering microbial insecticides (Neale & Newton, 1999). General reviews of effects of microbial pathogens on bees and other pollinators are given by Goettel *et al.* (1990) and Vinson (1990).

There is much variability in the susceptibility of pollinators to entomopathogenic fungi. Some authors report high levels of pathogenicity to bees (Vandenberg, 1990; Butt *et al.*, 1994; Brinkman, Fuller, Leubke & Hildreth, 1997), whilst others have demonstrated non-susceptibility or reduced susceptibility to doses more realistic of field applications (Cooper, Hornitzky & Medcraft, 1984; Ball, Pye, Carreck, Moore & Bateman, 1994; Butt, Carreck, Ibrahim & Williams, 1998). However, it is widely accepted that safety testing against pollinators is a necessity when assessing non-target impacts of microbial insecticides.

### **6.1.4 Microbial Pathogens**

It is likely that microbial insecticides will interact with other pathogens that occur naturally in the field environment or within mixtures of pathogens which may be introduced together to achieve better control (Heale, 1988). In both of these situations, the potential interactions between pathogens will have important implications for the success of a biological control programme.

Investigations into the interactions between two or more microbial pathogens in the same host has been relatively limited. Competitive interactions between *B. bassiana* and *M. flavoviride* when nymphs of grasshoppers (*Melanoplus sanguinipes*) were co-inoculated with the fungi were found to change under oscillating temperatures (Inglis *et al.*, 1999). Populations of *M. flavoviride* in the haemocoel of nymphs increased relative to *B. bassiana* as the amplitude of the temperature oscillation increased.



Similarly, the competitive interactions between two entomophthoralean fungi, *N. fresenii* and *E. neoaphidis*, were investigated when *Aphis fabae* was co-inoculated with the fungi (Villacarlos, Pell & Steinkraus, in prep.). The development of either fungus was dependent on temperature; at low temperatures, *E. neoaphidis* was more prevalent, whilst at higher temperatures, *N. fresenii* was more common. Competitive interactions have also been observed between isolates of the same species of fungus applied as a mixture for whitefly control (Chandler, Heale & Gillespie, 1993a).

In a more intricate system, the interaction of two microbial pathogens, *B. thuringiensis* and *B. bassiana* and the host/parasitoid system *S. littoralis*/*M. rufiventris* showed that there were direct adverse effects on adult parasitoids when the pathogens were applied together (El-Maghraby *et al.*, 1988). Additionally, applying both pathogens to *S. littoralis* larvae, which had previously been parasitised, resulted in fewer larval deaths compared to single pathogen applications. It was suggested that the parasitoids may be directly affected by toxins or that *B. thuringiensis* caused reduced feeding in the host, making the host unsuitable for development of the parasitoid. Parasitoids died after emergence from the host but there was no record made of cause of death, so it is not possible to determine whether the bacterium or fungus had a greater impact on the emerging parasitoids.

Synergistic interactions between pathogens are not uncommon but often depend on the dose and time of inoculation of the pathogens. When gypsy moth larvae *Lymantria dispar* L. were simultaneously inoculated with gypsy moth nucleopolyhedrosis virus (LdNPV) and the fungus *Entomophaga maimaiga* Humber, Shimazu & Soper, the fungus alone was observed in the majority of cadavers. This was suggested to be solely due to the shorter incubation time of the fungus (Malakar, Elkinton, Hajek & Burand, 1999). However, when sequentially inoculated (so mortality from both pathogens would be expected at the same time) the LD<sub>50</sub> for the LdNPV decreased suggesting that the presence of the fungus enhanced LdNPV replication. Other studies have found similar synergistic interactions between *B. thuringiensis* and nematodes (Koppenhofer & Kaya, 1997),

*B. tenella* Delacroix and the virus *Entomopoxvirus melolonthae* (Ferron & Hurpin, 1974) and *B. thuringiensis* and a microsporidium, *Vairimorpha necatrix* Kramer (Fuxa, 1979).

A recent study used morphological diagnostic methods for the first time to demonstrate the co-prevalence of a fungus (*Strongwellsea castrans* Batko & Weiser), microsporidium (*Cystosporogenes deliaradicae* Larsson, Eilenberg and Bresciani) and bacterium (*B. thuringiensis*) in the cabbage root fly, *Delia radicum* (Eilenberg, Damgaard, Hansen, Pedersen, Bresciani & Larsson, 2000). In this case it was suggested that infection with the fungus may allow an opportunistic infection by the microsporidium as the prevalence of the microsporidium was higher in those individuals infected with *S. castrans* than in uninfected *D. radicum*. It was also suggested that proliferation of the bacterium may take place after oral uptake in insects infected by other pathogens; in this case there were two records of simultaneous infections of *D. radicum* with *B. thuringiensis* and *S. castrans*. Such studies indicate the complexity of multiple pathogen interactions.

The aim of the current study was to evaluate the direct impact of the four selected isolates Mycotech strain GHA (*B. bassiana*), HRI 1.72 (*V. lecanii*), ARSEF 2879 (*B. bassiana*) and Z11 (*P. fumosoroseus*) in laboratory assays against three aphid natural enemies; the 7-spot ladybird *C. septempunctata*, the generalist parasitoid *Praon volucre* and the naturally occurring entomophthoralean fungus *Erynia neoaphidis*.

## **6.2 Materials and Methods**

### **6.2.1 Insect and hyphomycete fungus cultures**

The aphid *A. fabae* and ladybird *C. septempunctata* were reared to known-age using the methods described in sections 2.3 and 2.4. The generalist parasitoid *P. volucre* was reared using methods described in section 2.5. Fungi were cultured and suspensions of conidia prepared using the methods described in section 2.6 and were adjusted to give a final concentration of  $1 \times 10^8$  conidia ml<sup>-1</sup> unless stated

otherwise. All spray applications were made using the methods and sprayer system described in section 2.6.6. The general bioassay procedure described in sections 2.7 and 2.8 was followed for all experiments on aphids unless stated otherwise.

#### 6.2.1.1 Culturing *Erynia neoaphidis*

A single isolate of *E. neoaphidis* (reference X4) was used for all experiments. This isolate was obtained in the mid 1970's from infected *Acyrtosiphon pisum* on lucerne. It has been continually cultured *in vivo* on *A. pisum* at IACR-Rothamsted since this time and is permanently stored in liquid nitrogen.

To produce *A. pisum* cadavers, "mummies" (dried cadavers of aphids infected by *E. neoaphidis*) were placed on a damp piece of tissue paper on a small circular piece of moistened foam (approximately 1 cm diameter) in the lid of a glass tube (4.5cm x 2cm) late in the afternoon. The lids were then placed into a plastic box (17 x 11.5 x 6cm, Stewarts Ltd.) which contained damp tissue paper to maintain a high humidity and held overnight at 10°C in the dark. By the following morning, the mummies had swelled, changed from dark brown to straw coloured and begun to sporulate. Prior to aphid inoculation, mummies were allowed to warm gently in the laboratory to encourage sporulation.

To inoculate *A. pisum* with *E. neoaphidis*, aphids were showered with fungal conidia. A small piece of wide-meshed nylon netting was placed over one end of an open ended glass tube and secured with a rubber band. Approximately 20 - 30 apterous, adult *A. pisum* aphids were placed in the tube. A piece of nylon netting was placed over the lid containing the sporulating mummies and the lid was securely fastened over the aphids. The tubes were then placed over glass slides (76 x 26mm, Chance Propper Ltd.) with the open end facing down and the mummies showering conidia from above, in a plastic box containing damp tissue paper to maintain a high relative humidity. Aphids were inoculated for two to three hours on the laboratory bench. Following inoculation, the slides were stained with cotton blue in lactophenol (10% cotton blue, v/v) and the spores examined under a Dialux 20 compound microscope to confirm that conidia were present and could be

identified as *E. neoaphidis*.

Inoculated aphids were transferred to single bean plants which were enclosed by lamp glasses. The lamp glasses had cling film placed over the top to maintain a high relative humidity and the plants were placed in a CE cabinet at 18°C with a 16 hour photoperiod. After 24 hours, the cling film was replaced with fine meshed muslin which was held in place with metal rings.

Aphids died on the third or fourth day post-inoculation, mostly in the late afternoon, and plants were checked regularly over this period for infected cadavers. Aphids that had died from fungal infection were straw coloured and firm to touch. The cadavers were removed with fine forceps before conidiophores and rhizoids had emerged and placed in drying Petri dishes. The drying dishes were made of Petri dish lids (90mm diameter) which had 80mm holes cut in them which in turn were covered with nylon mesh. Cadavers were placed in one lid and another lid was fastened over them and held securely with masking tape. These drying dishes were placed in the CE cabinet at 18°C and 16 hour photoperiod for 48 hours, after which the cadavers had dried to form hard “mummies”. Mummies were stored for up to six weeks in a glass dessicator at 4°C over 90% aqueous glycerol (v/v) which maintained a 20% relative humidity.

#### *6.2.1.2 Inoculating Aphis fabae with Erynia neoaphidis*

Apterous, adult *A. fabae* were inoculated with *E. neoaphidis* for experiments using the same procedures detailed for inoculation of *A. pisum* when culturing *E. neoaphidis* (section 6.2.1.1).

#### *6.2.1.3 Inoculating Coccinella septempunctata and Praon volucre with hyphomycete fungi*

Adult *C. septempunctata* and mummies of *P. volucre* were inoculated by dipping them for ten seconds in fungal suspensions or Tween 80 (0.03%) as a control. Details of the number of insects treated and number of replicates are given in

sections 6.2.2 and 6.2.3. *Coccinella septempunctata* were dipped in 10ml of each treatment in a 50ml centrifuge tube (BDH), whilst *P. volucre* were dipped in 5ml of each treatment in a 7ml Bijou tube (Sterilin). Treated insects were then tipped into a Büchner funnel lined with filter paper (Whatman No. 41, 90mm diameter) and the excess liquid drawn off under suction. A clean Büchner funnel was used for each isolate. The funnel was rinsed between each replicate with 95% ethyl alcohol and deionised water and a fresh piece of filter paper was placed inside. Control treatments were applied first and fungal treatments were then applied in a random order.

### **6.2.2 Single-dose bioassays against *Coccinella septempunctata***

The four isolates selected in section 4.3.1 were screened against adult *C. septempunctata* at a single dose of  $1 \times 10^8$  conidia  $\text{ml}^{-1}$ . As a limited number of adult coccinellids could be maintained at any one time, only three isolates could be screened on any occasion. To allow for this, a cyclic design of four treatments (all isolates to be used) in four blocks (bioassay occasion) of three plots (isolates to be used on each occasion) was arranged. Using this design, each fungus was replicated three times with each pair of fungi occurring twice.

Adult ladybirds were inoculated using procedures detailed in section 6.2.1.3. Each treatment consisted of three replicates of ten insects. Treated ladybirds were placed onto a small, single bean plant infested with *A. pisum* under a lampglass. Cling film was placed over the top of the lampglasses to maintain a high humidity and they were placed in a 23°C CE room with a photoperiod of 16 hours. The cling film was replaced with muslin after 24 hours.

Mortality in treatments was recorded daily for 21 days (except for bioassay number two when data were not collected on days four and five) and any dead ladybirds removed and placed onto damp filter paper at 23°C for two to three days to check for fungal sporulation (Figure 6.1). Additionally, all dead ladybirds were dissected to confirm the cause of death. The body cavity of those individuals killed by fungus was a solid mass of mycelium compared to non-fungal deaths where the



**FIGURE 6.1 :** ARSEF 2879 (*B. bassiana*, left) and Mycotech strain GHA (*B. bassiana*, right) sporulating from adult 7-spot ladybirds *Coccinella septempunctata*.

body cavity was full of black liquid. Any individuals that showed external sporulation but no dense mass of mycelia in the body cavity were assumed to have died of causes other than fungal infection and to be showing saprophytic fungal growth. *Acyrtosiphon pisum* were regularly added to lampglasses to ensure the ladybirds were fed to satiation.

On each bioassay occasion, a positive control bioassay was run. *Aphis fabae* were inoculated with isolates of fungus which were being used in ladybird assays to confirm the fungus was viable. The standard bioassay methods described in chapter two were used for all aphid assays. Mortality was recorded daily for seven days as described in section 2.8 or until all aphids were dead.

### **6.2.3 Single-dose bioassays against the generalist parasitoid, *Praon volucre***

The four isolates selected in section 4.3.1 were screened against adult *P. volucre* which were reared on either *A. pisum* or *S. avenae* hosts at a single dose of  $1 \times 10^8$  conidia  $\text{ml}^{-1}$ . There was one experiment against parasitoids from *A. pisum* and one against parasitoids from *S. avenae*. Each experiment was repeated on two occasions. An additional experiment was done where parasitoids from different hosts were bioassayed on the same occasion and this was repeated on two occasions.

Mummies were gently removed from leaves using fine forceps (Storkbill forceps, Watkins & Doncaster). Rolling leaves gently lifted the edges of the mummy, allowing the forceps to be slipped under the mummy making it easier to lift it off the leaf intact. By collecting individual mummies in this way, any mummies from which a parasitoid had emerged were identified and excluded from the experiment.

Mummies were inoculated in batches of 50 individuals using the procedures detailed in section 6.2.1.3. Following inoculation, mummies were carefully separated using fine forceps and each mummy was placed in a separate specimen tube (soda glass specimen tube, 50 x 13mm) with the plastic stopper in place. All tubes from one treatment were placed in a sandwich box (17 x 11.5 x 6cm, Stewarts

Ltd.) so that each treatment was kept separate. Boxes were held at 23°C in a 16 hour photoperiod.

On each bioassay occasion, a positive control bioassay was run. *Aphis fabae* were inoculated with isolates of fungus which were being used in parasitoid assays to confirm the fungus was viable. The standard bioassay methods described in chapter two were used for all aphid assays. Mortality was recorded daily for seven days as described in section 2.8 or until all aphids were dead.

Tubes were checked daily for parasitoid emergence and deaths. On emergence, adult parasitoids were sexed and carefully moved to clean tubes away from the aphid mummy from which they had emerged. A small ball of cotton wool was placed in the lid of the tube and 50% honey solution (v/v) was pipetted onto the cotton wool until it was saturated. The stopper was placed back in the tube and the tube placed on its side in a tray. Each tube was numbered sequentially and the date of emergence and sex of the parasitoid were recorded. When parasitoids died, the cadavers were placed onto damp filter paper and held at 23°C for 24 - 48 hours to determine whether sporulation occurred. The date and cause of death were recorded for each parasitoid.

This experiment was run for 14 days after which the majority of parasitoids had emerged. Additionally, preliminary experiments run for 21 days showed that adult parasitoids began to die naturally seven to ten days post-emergence under control conditions. The mummies from which a parasitoid had failed to emerge were dissected under a binocular light microscope and the reason for the non-emergence established. The four categories for non-emergence were: adult parasitoid had emerged before treatment; unsuccessful emergence, i.e. where an adult parasitoid had developed and died before emergence or had become trapped when trying to emerge from the mummy; unsuccessful larval development, i.e. where a larva was found in the mummy which had not successfully developed into an adult parasitoid; and mycosed adult pre-emergence, i.e. the adult parasitoid was found to be mycosed within the mummy on dissection.



Data were adjusted to take account of the recording period; for example a parasitoid may have emerged any time between the recording made on one day and the next so the actual time of emergence was taken as the mid-point between recording times. The results for each assay were used to calculate time from inoculation to emergence, from emergence to death and from inoculation to death. Additionally, these data could be categorised by parasitoid sex and cause of death, i.e. either due to fungus or to other causes. Data were analysed using logistic regression under the general linear regression procedure in Genstat 5.

#### ***6.2.4 Interactions between hyphomycete fungi, Erynia neoaphidis and A. fabae***

##### ***6.2.4.1 Infection of Aphis fabae with Erynia neoaphidis***

An isolate of *E. neoaphidis* (reference X4) was tested against *A. fabae* and *A. pisum* in a maximum challenge experiment to compare susceptibility of the two aphid species to the fungus. Aphids of both species were inoculated with a large number of conidia using the techniques described in section 6.2.1. Aphids were showered with conidia for two to three hours to ensure they were exposed to a large number of conidia. Controls were held under the same conditions but were not exposed to the fungus. There were six replicates of ten aphids for each aphid species and treatment. Aphids were maintained on whole plants under lampglasses and were monitored once a day on the first and second days and then four times on day three and twice on day four. Dead aphids were removed and placed on damp filter paper to identify sporulation due to *E. neoaphidis*.

##### ***6.2.4.2 Interactions between hyphomycete isolates and Erynia neoaphidis on A. fabae***

Three hyphomycete isolates were used in an experiment to determine whether there was any competition between them and *E. neoaphidis* within the same aphid host, *A. fabae*. The hyphomycete isolates used were Z11 (*P. fumosoroseus*), HRI 1.72 (*V. lecanii*) and Mycotech strain GHA (*B. bassiana*). Suspensions of these fungi were prepared the day before the assay and were adjusted to give

concentrations of  $1 \times 10^8$  conidia  $\text{ml}^{-1}$  for HRI 1.72 (*V. lecanii*) and  $1 \times 10^9$  conidia  $\text{ml}^{-1}$  for isolates Mycotech strain GHA (*B. bassiana*) and Z11 (*P. fumosoroseus*). The suspensions were held overnight on ice as detailed in section 2.4.5.

The day before the assay, 64 bioassay dishes containing bean leaves set in 2% water agar were prepared using methods described in section 2.2 and placed at 10°C overnight. An additional 38 Petri dish lids (9cm) were prepared with moistened filter paper (70mm) placed in the lid and six mummies of *E. neoaphidis* arranged evenly on the filter paper. The bottoms of the dishes were placed under the lids and the dishes were inverted and held at 10°C overnight in the dark in containers with wet paper to maintain a high humidity. Bean leaves and stems infested with *A. fabae* were harvested late in the afternoon and placed in ventilated boxes at 18°C overnight to allow aphids to move off the plants.

The next day, 15 aphids were placed in each bioassay dish early in the morning (08.00 hours) and allowed to settle for approximately three hours. Aphids were then inoculated with the hyphomycete fungi by spraying using the standard techniques set out in section 2.6.6 or inoculated with *E. neoaphidis* by placing a lid of sporulating mummies over the dish containing the aphids and showering them with conidia for 2½ hours. There were four treatments; *E. neoaphidis* alone (E), a hyphomycete isolate alone (H), *E. neoaphidis* and then a hyphomycete isolate (EH), and a hyphomycete isolate and then *E. neoaphidis* (HE). Each treatment had a control in which aphids were not exposed to fungus but were held under the same conditions as treated aphids. The timing for treatment applications is shown in Table 6.1.

Aphids were transferred to clean leaves 48 hours after inoculation. Mortality was recorded 24 hours following inoculation and then twice daily for four days. Dead aphids were placed on 1% water agar at 23°C and checked after 24 hours for signs of sporulation. If it was not obvious which fungus was sporulating from an aphid, the cadaver was squashed and stained with a drop of 10% cotton blue in lactophenol to determine which conidia were present.

**TABLE 6.1 :** Treatment application times for *E. neoaphidis* (E) and each of three hyphomycete (H) isolates; Z11 (*P. fumosoroseus*), HRI 1.72 (*V. lecanii*) and Mycotech strain GHA (*B. bassiana*) applied either alone or in succession to the aphid *Aphis fabae*.

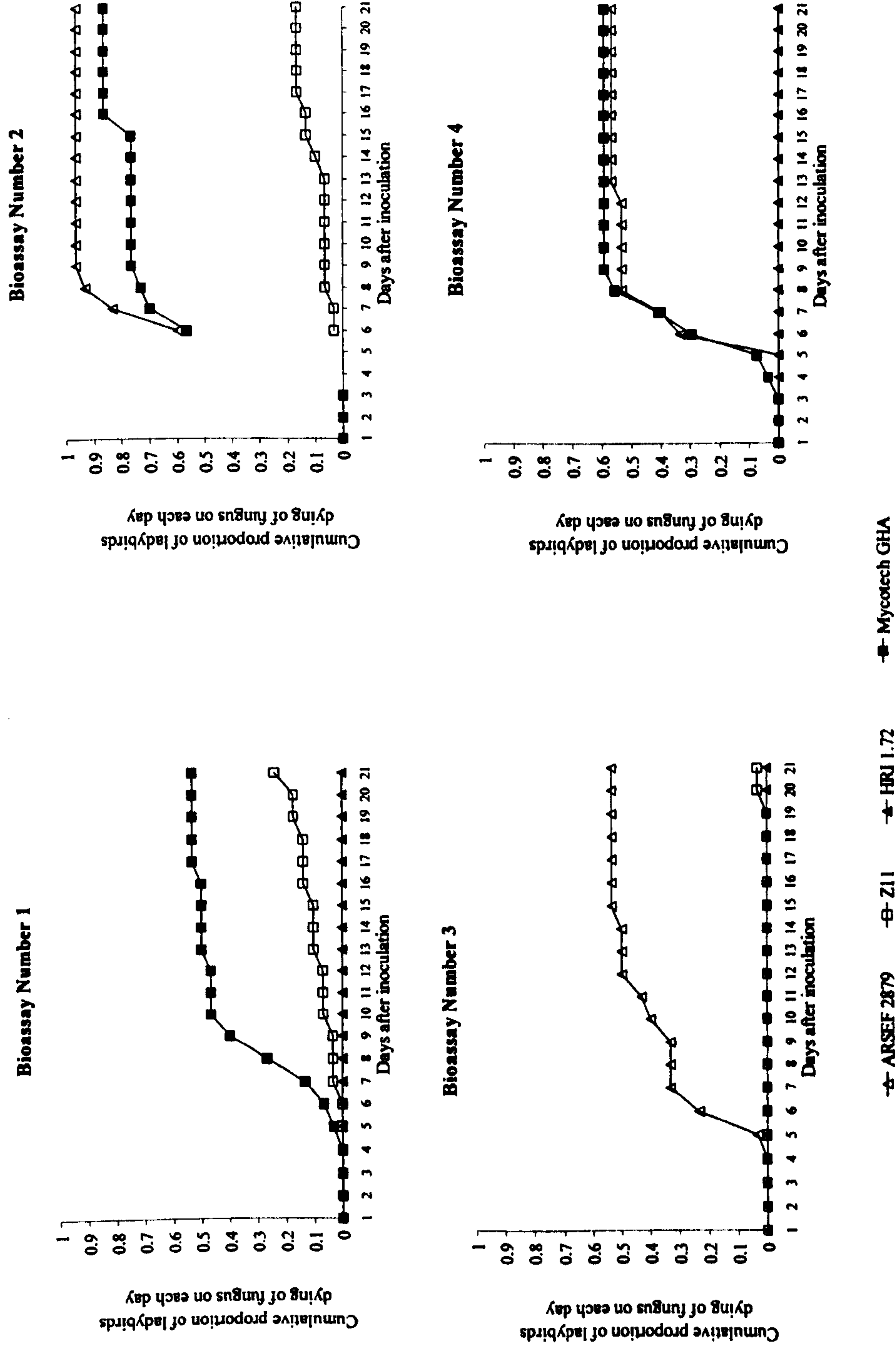
Treatment	Time for H inoculation	Time for E inoculation
E	-	12.30 - 15.00
H	15.30	-
EH	15.30	12.30 - 15.00
HE	11.00	12.30 - 15.00

On the first day there were a large number of non-fungal deaths in some treatments. These non-fungal deaths were analysed using logistic regression under the general linear regression procedure in Genstat 5.

## 6.3 Results

### 6.3.1 Single-dose bioassays against *Coccinella septempunctata*

The isolates Mycotech strain GHA (*B. bassiana*) and ARSEF 2879 (*B. bassiana*) were variable in their pathogenicity to ladybirds between assays which meant assays could not be combined in a single statistical analysis. On each occasion that ladybirds were inoculated with these isolates, more than 50% of the ladybirds succumbed to fungal infection (Figure 6.2). On the two occasions that isolates Mycotech strain GHA (*B. bassiana*) and ARSEF 2879 (*B. bassiana*) were screened in the same assay, they caused a similar percentage of mortality in treated ladybirds. In contrast, isolate Z11 (*P. fumosoroseus*) killed very few ladybirds in all assays (3 - 24% of treated ladybirds) and there was no fungal infection noted in any ladybirds treated on any occasion with isolate HRI 1.72 (*V. lecanii*). The first mortalities in ladybirds treated with fungi occurred three and five days post-inoculation and few individuals succumbed to fungal infection after approximately nine days.



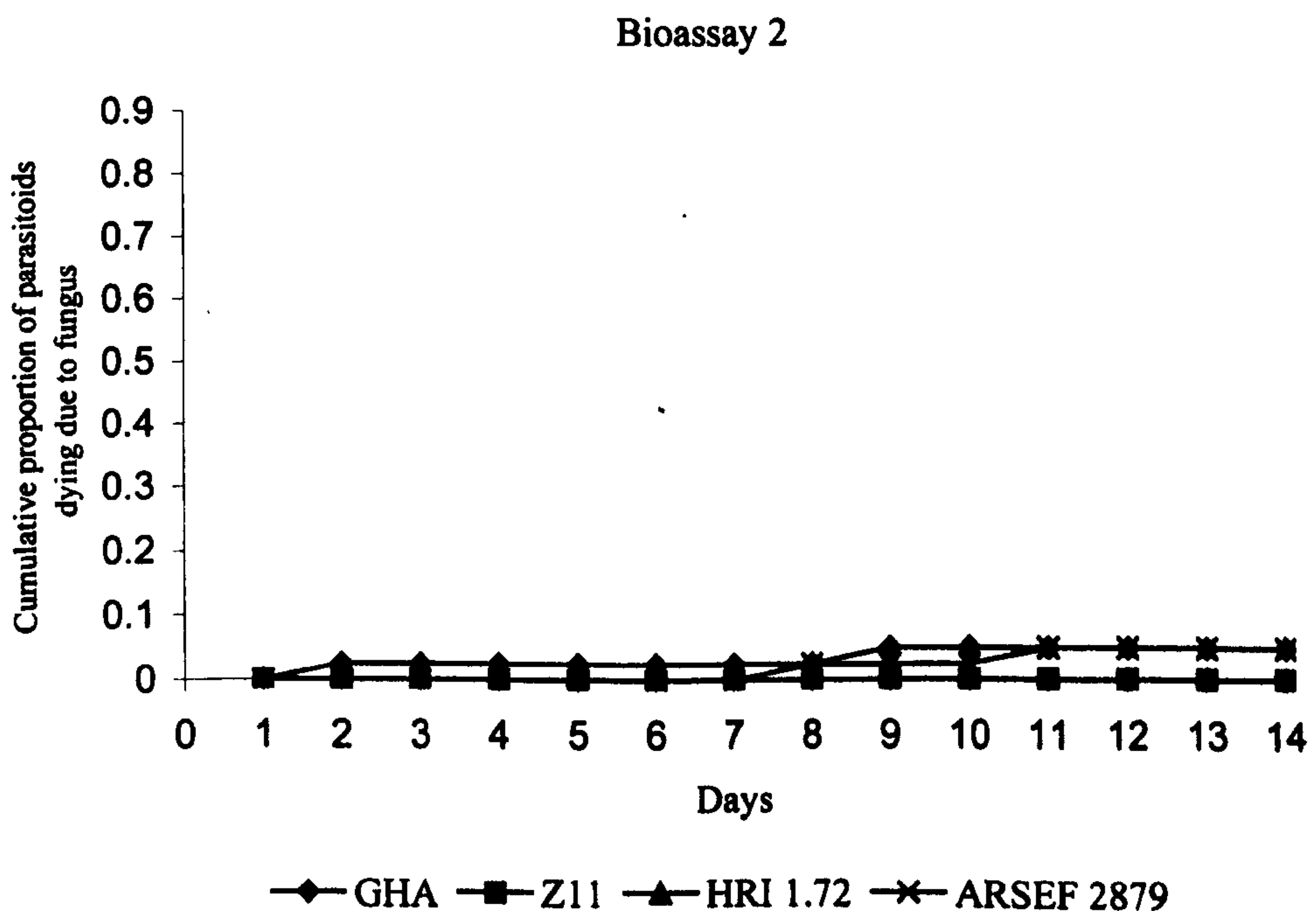
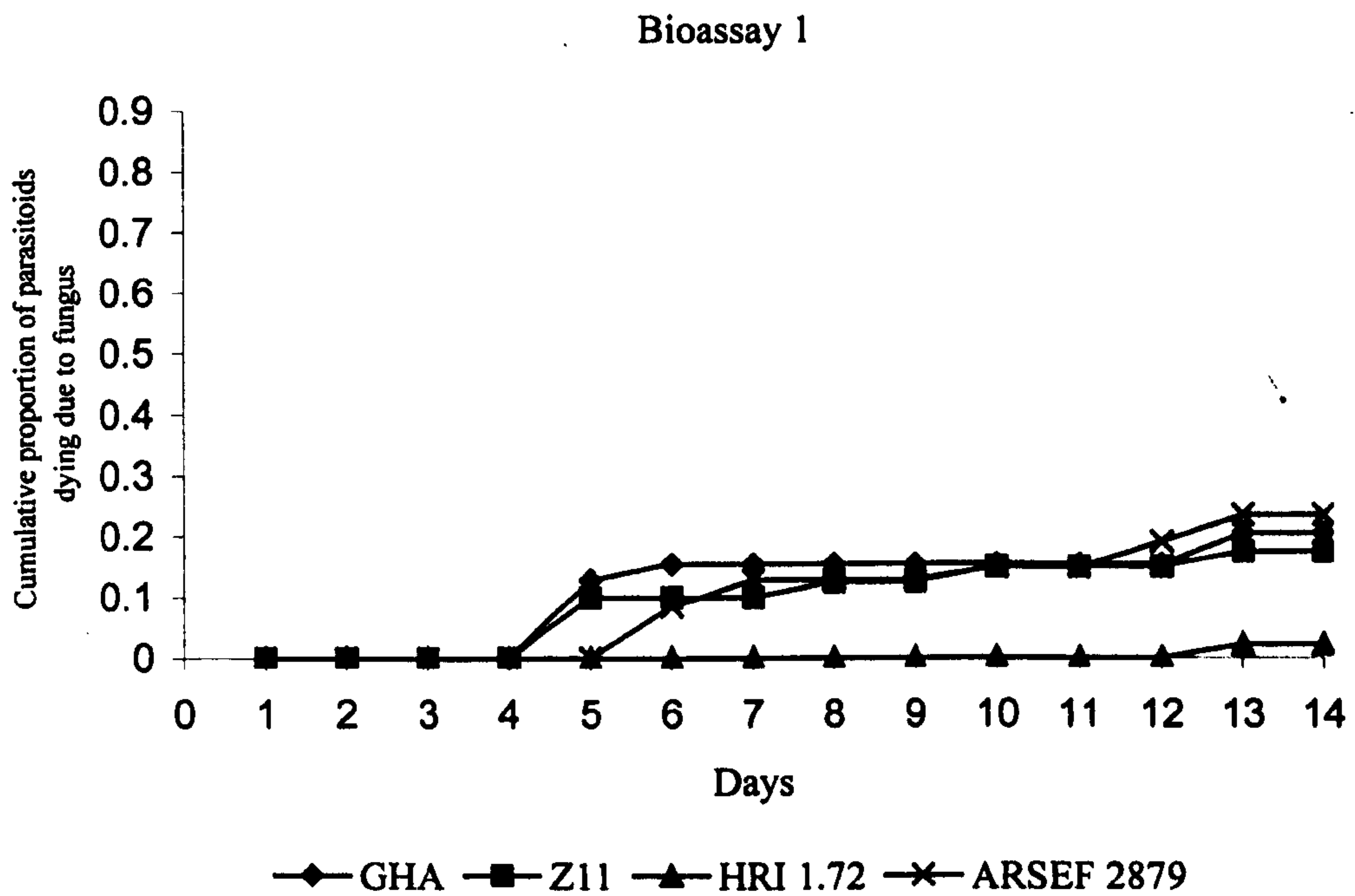
**FIGURE 6.2 :** Cumulative proportion of *C. septempunctata* dying due to fungus on each day following inoculation with a single concentration ( $1 \times 10^8$  conidia  $\text{ml}^{-1}$ ) of isolates Z11 (*P. fumosoroseus*), HRI 1.72 (*V. lecanii*), ARSEF 2879 (*B. bassiana*) and Mycotech strain GHA (*B. bassiana*).

Control mortality was below 23% for all assays except assay number two when it was much higher at 60%. On this occasion, the ladybirds used were slightly younger than in the other assays at two weeks old compared to three to four weeks old. Most of the deaths occurred later in the assay on days 14 - 16. It is possible that these ladybirds were adversely affected by the methods used to dose them during the bioassay, but it is more likely that they were not as fit as those used in other assays and were not able to survive under the bioassay conditions.

*Aphis fabae* inoculated with isolates in positive control bioassays succumbed to infection with the applied fungi and the total mortality for inoculated aphids was never less than 90%.

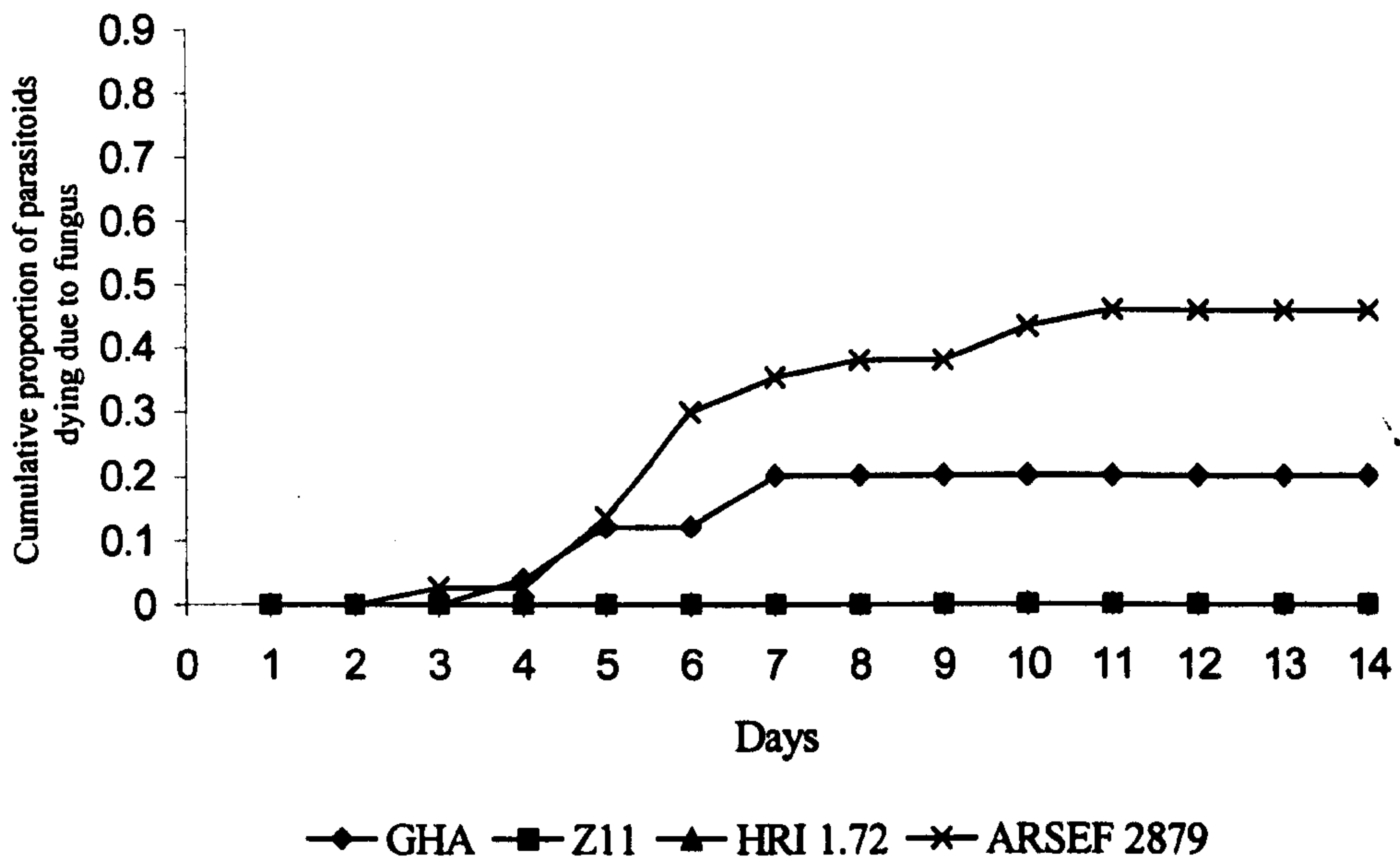
### **6.3.2 Single-dose bioassays against the generalist parasitoid, *Praon volucre***

In the experiments where parasitoids treated were from a single aphid host, the two *B. bassiana* isolates, Mycotech strain GHA and ARSEF 2879 were most pathogenic to adult parasitoids of *P. volucre* that emerged from either *S. avenae* or *A. pisum* hosts (Figures 6.3 and 6.4). Overall, mortality of parasitoids due to fungus appeared to be smaller for those parasitoids emerging from *S. avenae* hosts compared to those emerging from *A. pisum* hosts. When parasitoids from both hosts were used in assays to evaluate these apparent differences, on one occasion the patterns of parasitoid mortality were similar between hosts but, on the other occasion, it appeared that those parasitoids emerging from *A. pisum* hosts were more susceptible to the fungal pathogens than those emerging from *S. avenae* hosts (Figure 6.5).

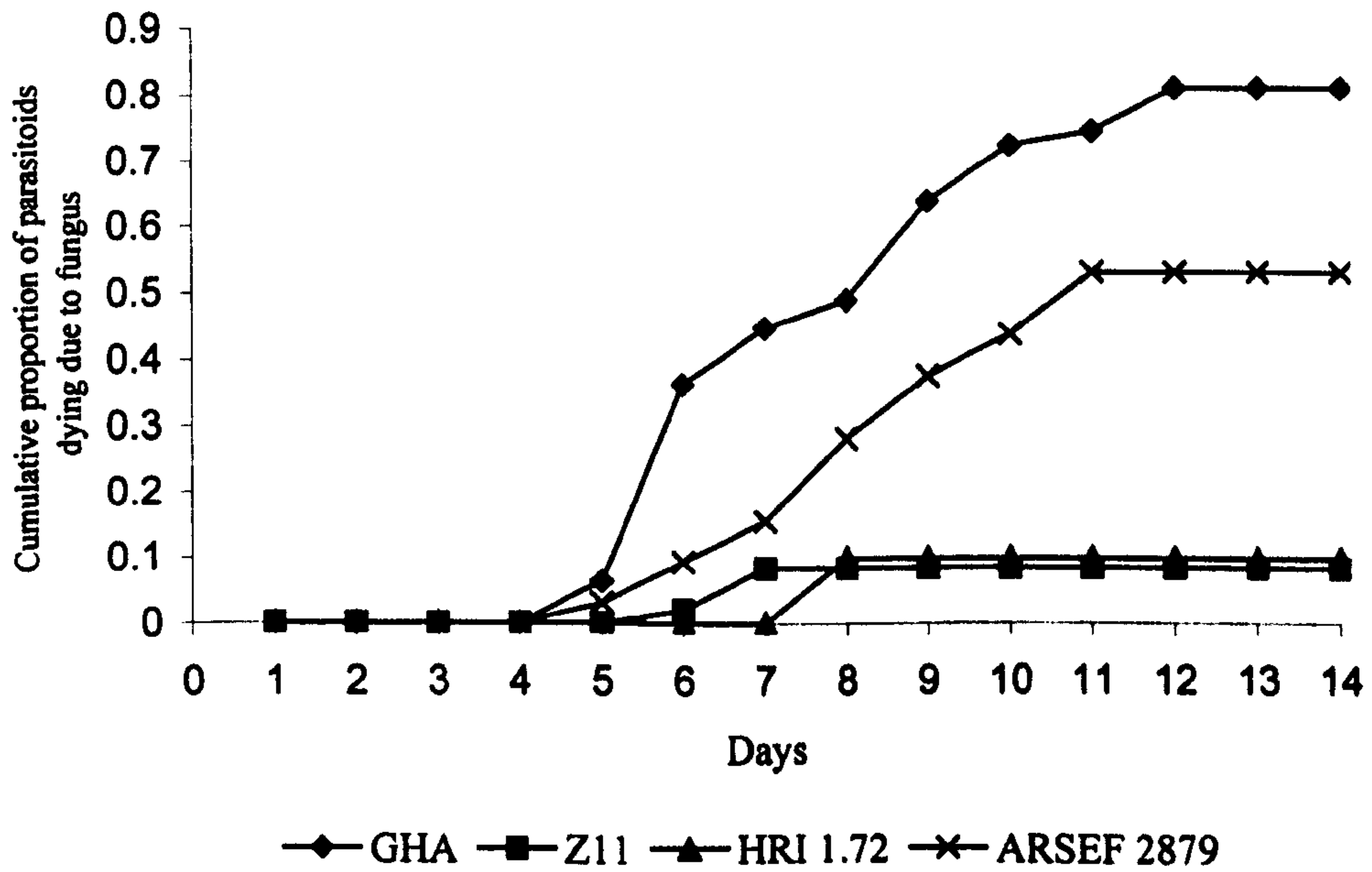


**FIGURE 6.3 :** Cumulative proportion of *P. volucre* (from *S. avenae* hosts) dying due to fungus, in two bioassays, on each day following inoculation with isolates Mycotech strain GHA (*B. bassiana*), Z11 (*P. fumosoroseus*), HRI 1.72 (*V. lecanii*) and ARSEF 2879 (*B. bassiana*).

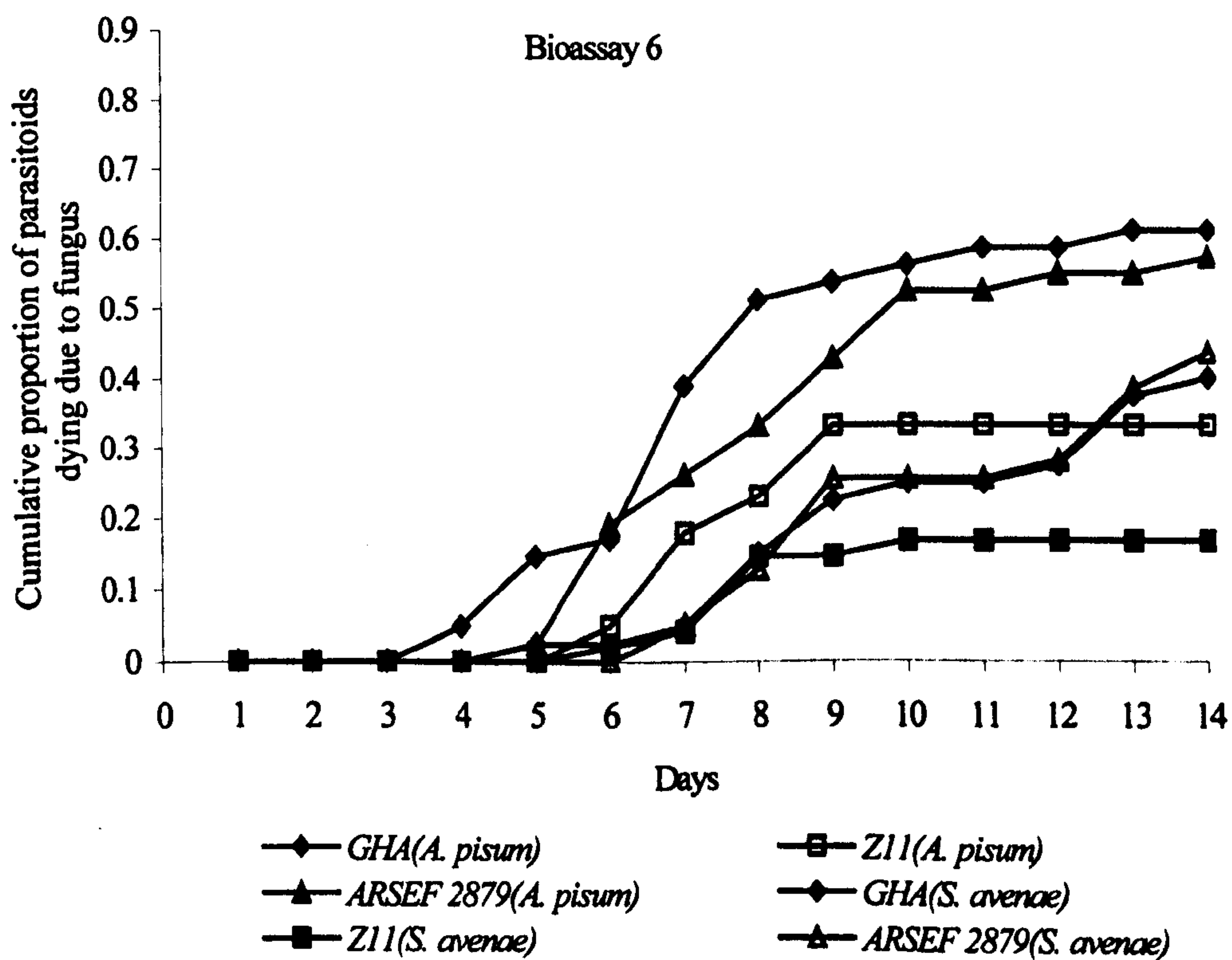
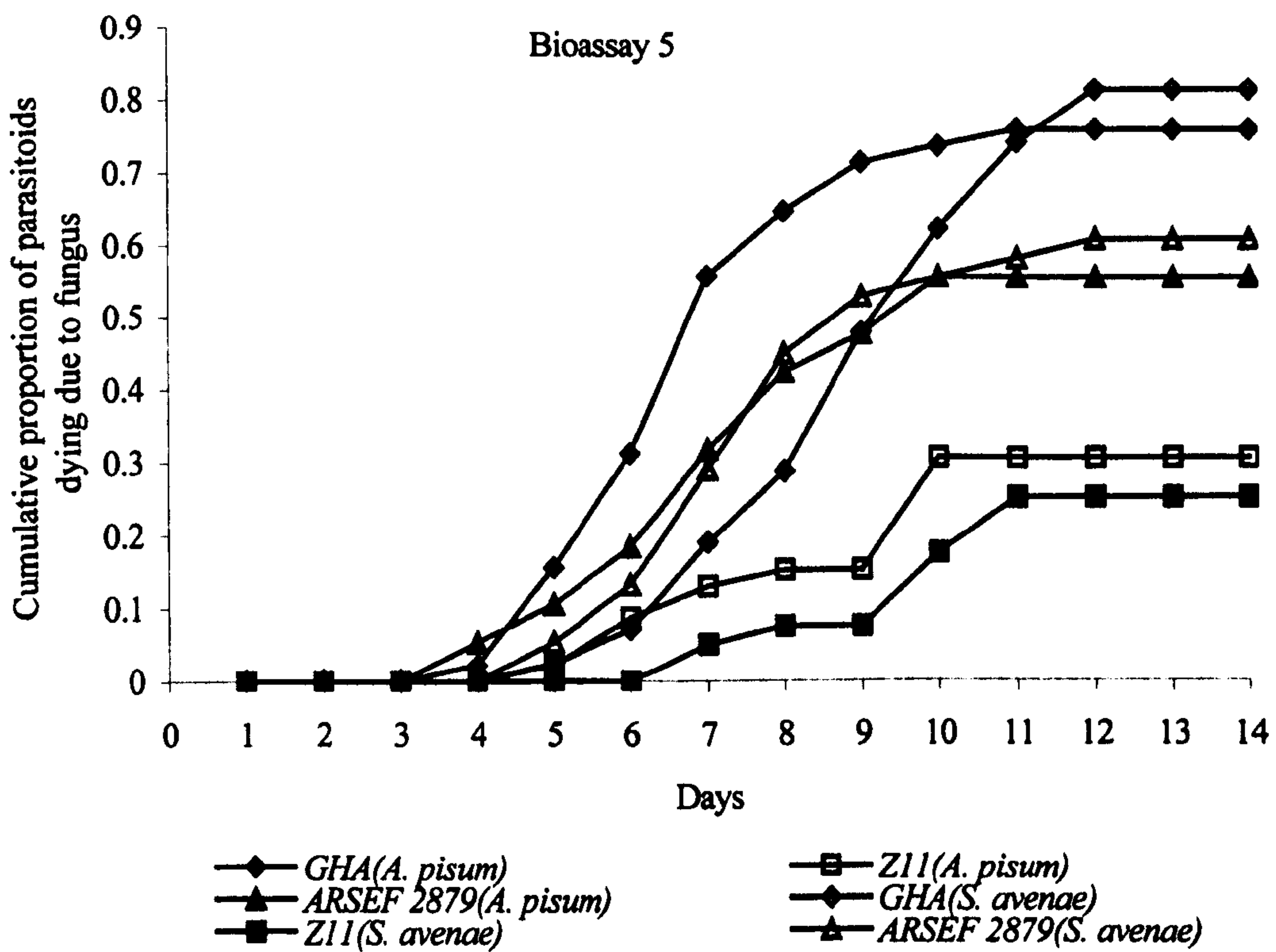
### Bioassay 3



### Bioassay 4



**FIGURE 6.4** : Cumulative proportion of *P. volucre* (from *A. pisum* hosts) dying due to fungus, in two bioassays, on each day following inoculation with isolates Mycotech strain GHA (*B. bassiana*), Z11 (*P. fumosoroseus*), HRI 1.72 (*V. lecanii*) and ARSEF 2879 (*B. bassiana*).



**FIGURE 6.5 :** Cumulative proportion of *P. volucre* (from *A. pisum* and *S. avenae* hosts) dying due to fungus in two bioassays, on each day following inoculation with isolates Mycotech strain GHA (*B. bassiana*), Z11 (*P. fumosoroseus*) and ARSEF 2879 (*B. bassiana*).



There was a significant effect of sex on time from inoculation to emergence for parasitoids from *S. avenae* hosts assayed on their own in one run of the assay (Bioassay 2  $F_{1,205} = 6.97$ ,  $P = 0.009$ ) but not in the other (Bioassay 1  $F_{1,183} = 0.13$ ,  $P = 0.724$ ). This difference was due to female parasitoids having a longer period from inoculation to emergence compared to male parasitoids. There was no effect of treatment in either run of the assay (Bioassay 1  $F_{4,183} = 1.00$ ,  $P = 0.410$ , Bioassay 2  $F_{4,205} = 1.82$ ,  $P = 0.126$ ). When parasitoids from *A. pisum* were assayed on their own, on one occasion there was a significant effect of sex on time to emergence (Bioassay 3  $F_{1,191} = 45.50$ ,  $P < 0.001$ ) which was due to the longer time for inoculation to emergence for female parasitoids. In both runs of the experiment there was also a significant effect of isolate on time to emergence (Bioassay 3  $F_{4,191} = 3.46$ ,  $P = 0.009$ , Bioassay 4  $F_{4,134} = 4.21$ ,  $P = 0.03$ ). There were generally very few females that emerged from aphid mummies so when a significant effect of sex on inoculation to emergence time was noted, it was not possible to do any further analysis due to the unbalanced nature of the data.

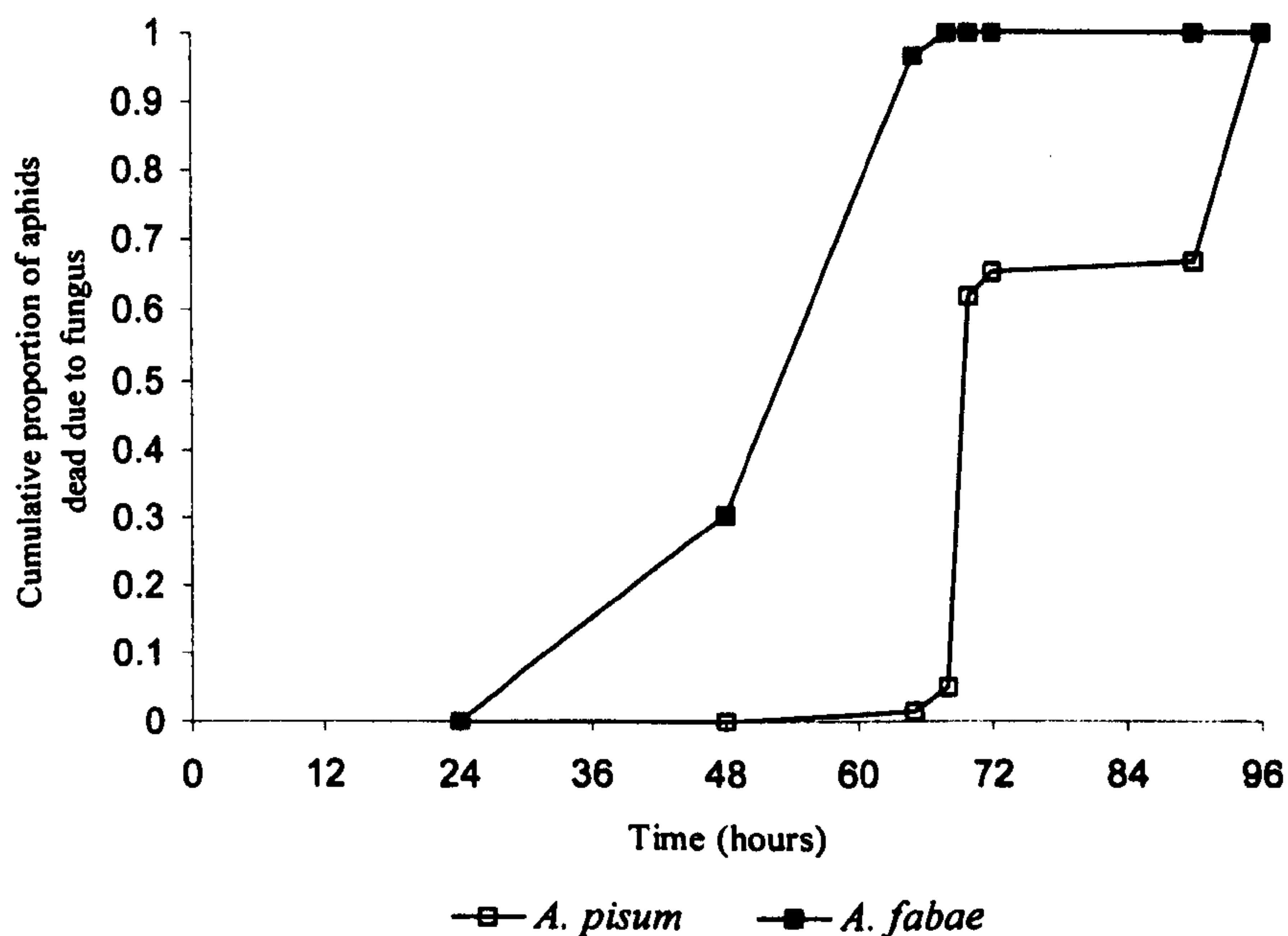
When parasitoids from both hosts were assayed at the same time, there was a significant effect of sex on time from inoculation to emergence in both assays for parasitoids from *A. pisum* (Bioassay 5  $F_{1,164} = 37.21$ ,  $P < 0.001$ , Bioassay 6  $F_{1,157} = 5.80$ ,  $P = 0.017$ ). When parasitoids from *S. avenae* were assayed, there was a significant effect of sex on time from inoculation to emergence on one occasion (Bioassay 6,  $F_{1,163} = 4.59$ ,  $P = 0.034$ ) but not on the other occasion (Bioassay 5,  $F_{1,151} = 0.25$ ,  $P = 0.616$ ).

*Aphis fabae* inoculated with isolates in positive control bioassays succumbed to infection with the applied fungi and the total mortality for inoculated aphids was never less than 90%.

### 6.3.3 Interactions between hyphomycete fungi, *Erynia neoaphidis* and *A. fabae*

#### 6.3.3.1 Infection of *Aphis fabae* with *Erynia neoaphidis*

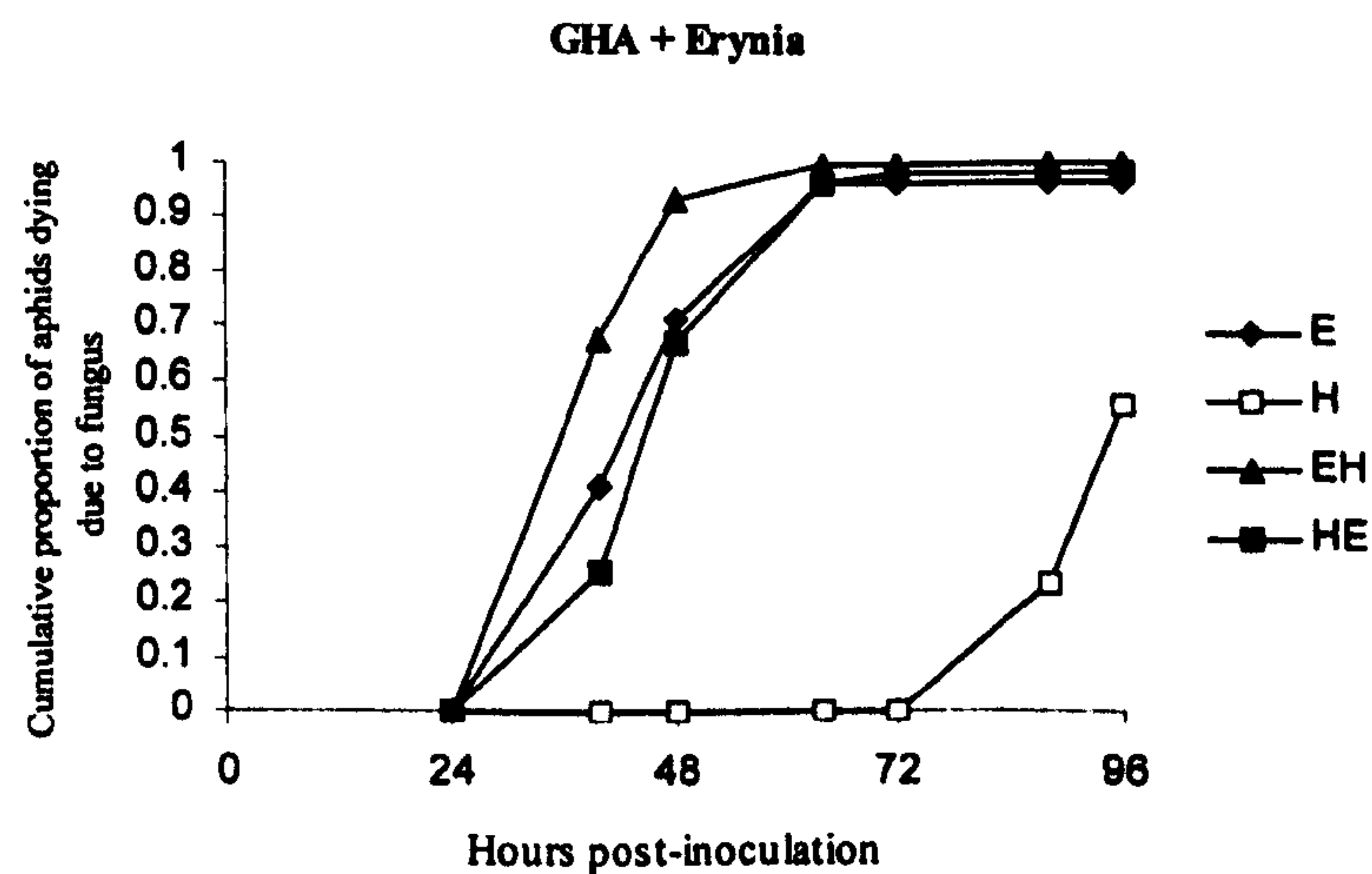
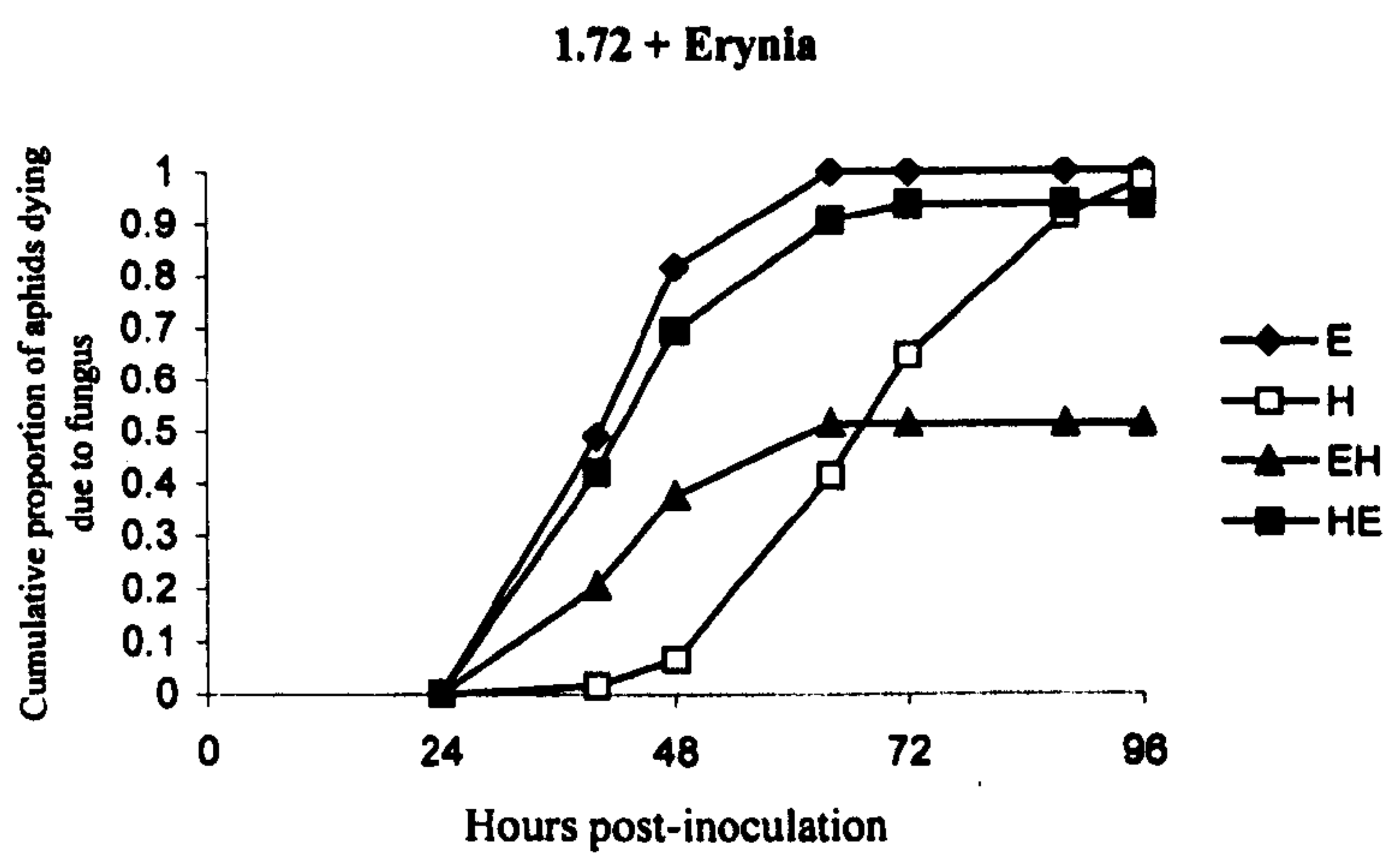
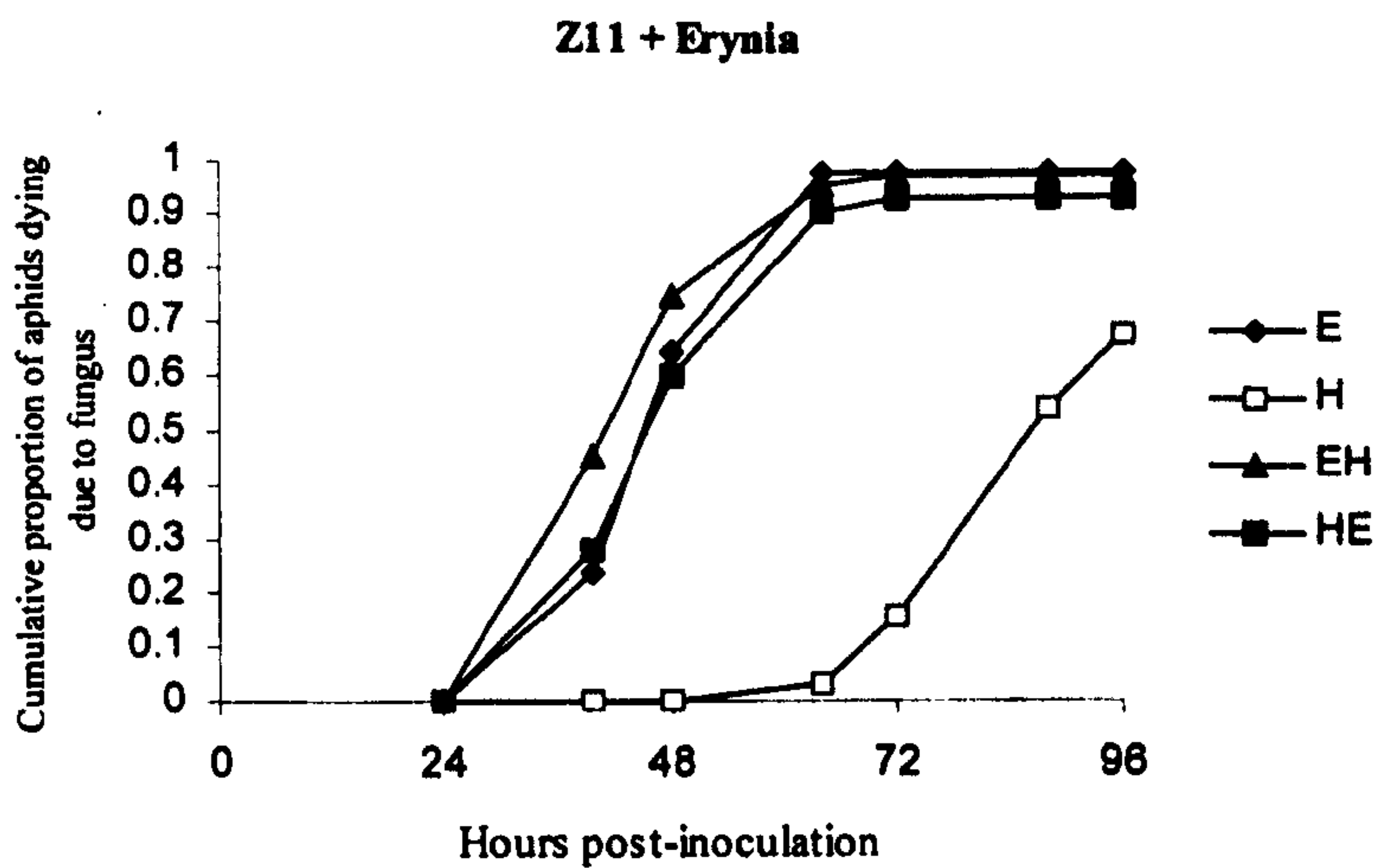
There was 30% mortality of *A. fabae* at 48 hours post-inoculation and, by 65 hours, over 95% of *A. fabae* had succumbed to fungal infection, with 100% mortality by 68 hours (Figure 6.6). The first mortalities of *A. pisum* treated with the fungus occurred after 65 hours with 62% mortality by 70 hours and 100% mortality by 96 hours. At 68 hours post-inoculation, there was 100% mortality of *A. fabae* but only 5% mortality of *A. pisum*. In general, *A. fabae* died three days post-inoculation whilst *A. pisum* died three to four days post-inoculation.



**FIGURE 6.6** : Cumulative proportion of *A. fabae* and *A. pisum* dying due to fungus over a period of four days following inoculation with isolate X4 (*E. neoaphidis*).

#### 6.3.3.2 Interactions between hyphomycete isolates and *Erynia neoaphidis* on *A. fabae*

The majority of aphids succumbed to infection with *E. neoaphidis* (Figure 6.7) when they were dual inoculated (EH and HE treatments) with *E. neoaphidis* and the hyphomycete isolate Mycotech strain GHA (*B. bassiana*) or Z11 (*P. fumosoroseus*). The number of aphids which succumbed to infection with *E.*



**FIGURE 6.7** : Cumulative proportion of *A. fabae* dying due to *E. neoaphidis* (for treatments E, EH and HE) or a hyphomycete fungus (for treatment H) on each day following inoculation with isolates X4 (*E. neoaphidis*), Mycotech strain GHA (*B. bassiana*), Z11 (*P. fumosoroseus*) or HRI 1.72 (*V. lecanii*) individually or successively.

*neoaphidis* in the EH and HE treatments was similar to the number that succumbed to *E. neoaphidis* in the E treatment. When the hyphomycete isolate HRI 1.72 (*V. lecanii*) was applied alone, the pattern of aphid mortality due to the hyphomycete was similar to that of *E. neoaphidis* mortality when the entomophthoralean was applied alone. There appeared to be less mortality due to the entomophthoralean when it was co-inoculated with the hyphomycete HRI 1.72 (*V. lecanii*).

There was no significant difference between the isolates in the patterns between different treatments of the non-fungal deaths that occurred on the first day ( $F_{2,36} = 1.44$ ,  $P = 0.251$ ). When insects were dual inoculated with two fungi (EH or HE), there were significantly more non-fungal deaths compared to those when a single fungus was applied ( $F_{1,36} = 8.03$ ,  $P = 0.008$ ). Considering treatments with a single fungus applied (H and E), there were significantly more deaths occurring in treatment E than H for all isolates ( $F_{3,36} = 15.98$ ,  $P < 0.001$ ). Although there was no significant difference between the order of inoculation with two fungi, i.e. EH or HE ( $F_{1,36} = 3.67$ ,  $P = 0.063$ ), there was slight evidence (indicated by a P value close to the arbitrary significance level of  $P = 0.05$ ) that there could be differences between isolates and this may have been due to isolate Mycotech strain GHA where there were fewer mortalities in the HE treatment compared to the EH treatment.

## 6.4 Discussion

The hyphomycete isolates ARSEF 2879 (*B. bassiana*) and Mycotech strain GHA (*B. bassiana*) were shown to be pathogenic to the natural enemies *C. septempunctata* and *P. volucre* in first tier pathogenicity tests under laboratory conditions. This physiological susceptibility may not reflect the ecological susceptibility of the beneficial insect species, but the results can be used as an indication of the potential effects of the pathogens on natural enemies under field conditions.

In line with other studies, *B. bassiana* was found to be pathogenic to ladybirds. *Beauveria bassiana* is one of the few pathogens that is noted as causing epizootics

in natural enemies, such as staphylinid beetles (Steenberg, Langer & Esbjerg, 1995), and has been recorded from sixteen genera of coccinellids (Goettel *et al.*, 1990). This pathogen has been identified as a major mortality factor in overwintering coccinellids (Hodek, 1973; Mills, 1981) and it is therefore not surprising that *B. bassiana* was often particularly pathogenic towards coccinellids in the laboratory. It has been suggested that increased use of mycoinsecticides may increase the level of overwintering mortality in many hibernating non-target insects (Flexner *et al.*, 1986). Coleopteran species are therefore very important organisms for use in evaluations of the side-effects of microbial pathogens on non-targets.

Ladybirds treated with isolate ÅRSEF 2879 (*B. bassiana*) often died at the top of the lampglass, attached to the muslin by their legs and were noted to sporulate in this position. Fungus-mediated behavioural changes, such as the behaviour of grasshoppers infected with *Entomophaga* (= *Empusa*) *grylli* (Fresenius) Batko which climb to the top of vegetation prior to death, assist in aerial dispersal of fungal conidia (Skaife, 1925; Glare & Milner, 1991). In the current study, spread of conidia to other ladybirds in such a way would be detrimental to the natural enemy. However, it could be beneficial to the pathogen by allowing it to survive a reduction in an aphid host population, for example at the end of the growing season, by providing an alternative host. Additionally, the large number of conidia produced on a ladybird cadaver may be beneficial for spread of the pathogen within an aphid population. This would however, rely on the pathogen being able to cause an epizootic in the host population, similar to those associated with entomophthoralean fungi.

When ladybirds were treated with isolate HRI 1.72, some of the *A. pisum* aphids that were supplied as a source of food were noted to succumb to infection with the fungus. Ladybirds are able to vector conidia of *E. neoaphidis* to healthy aphids (Roy, 1997). Vectoring of fungi has also been shown for parasitoids (Nemeye, Moore & Prior, 1990), mites (Schable, 1982) and bees (Butt *et al.*, 1998). Roy (1997) showed that the presence of a foraging 7-spot ladybird *C. septempunctata* on populations of the pea aphid *A. pisum* resulted in significantly more aphids

becoming infected with the pathogen *E. neoaphidis* than in the absence of a foraging ladybird. Thus, beneficials may play an important role in the dissemination of pathogens to populations of the host which are distanced both spatially and temporally. However, the dissemination of pathogens often has a profound negative effect on populations of beneficials involved. This negative effect may be a lethal or sublethal effect, such as a reduction in reproductive rate and/or development time of beneficials. It appears that, in the current study, the predator was able to vector the hyphomycete isolate HRI 1.72 to healthy aphids but was not adversely affected in the process. However, vectoring was not directly observed and further studies are needed to confirm these observations.

The parasitoids used in experiments were at a, theoretically, resistant stage of their life cycle with respect to pathogen infections; it has been shown that exposure to a pathogen late in the development of the larval parasitoid, compared to earlier exposures, results in the parasitoid developing successfully (Brooks, 1993; Askary & Brodeur, 1999). Isolates ARSEF 2879 (*B. bassiana*) and Mycotech strain GHA (*B. bassiana*) were pathogenic to emerging adult *P. volucre* but there was variability between assays in the degree of pathogenicity. This may have been because the actual dose of conidia received by a parasitoid was not accurately measured; if a parasitoid emerged shortly after a recording had been made it was in contact with a mummy case covered with conidia for a longer period compared to a parasitoid that emerged shortly before the next recording was made.

Generally, female parasitoids took longer to emerge than male parasitoids and therefore, under field conditions, may be exposed to fewer viable conidia on the external surface of the mummy, as factors such as exposure to UV radiation will inactivate many conidia on the parasitoid mummy. Mummies which contained parasitoids which did not emerge over the course of the experiment were dissected but the larvae or adult parasitoids were never found to be infected with a fungal pathogen. This suggests that adult parasitoids were infected with fungi on emergence from the mummy rather than inside the host.

Interestingly there was also a significant effect of fungal treatment on some occasions (data not shown), with parasitoids emerging earlier when they were

treated with isolate Mycotech strain GHA (*B. bassiana*). The larval period of parasitoids in virus infected hosts has been observed as being shorter (Beegle & Oatman, 1975) or longer (Hotchkin & Kaya, 1983) than in non-infected hosts. However, in the current study it is an adult emergence time rather than a larval development time that was considered. It is possible that conidia of isolate Mycotech strain GHA produced mycelia which were able to penetrate the mummy and adult parasitoids reacted to this invasion, and subsequent possible decline in food or environmental quality, by emerging more quickly. Further work is necessary to confirm the observations reported in these experiments. It would be interesting to use microscopic techniques to determine whether conidia do germinate on the mummy surface and if so, whether this differs between isolates of fungus and between different parasitoid hosts.

The isolates HRI 1.72 (*V. lecanii*) and Z11 (*P. fumosoroseus*) were found to have very little impact on *C. septempunctata* and *P. volucre*, with few individuals succumbing to fungal infection. Although these experiments only evaluated the physiological host range it does not seem unreasonable to suggest that these isolates are also likely to have little impact on these natural enemies under field conditions. Mycoinsecticides that have an adverse impact on natural enemies should be carefully evaluated to determine if spatial or temporal separation of the applied fungi and other natural enemies will reduce the potential negative impact on non-targets (Fransen & van Lenteren, 1993).

It is likely that parasitoids came into contact with conidia on emergence from the mummy. Potentially, these parasitoids could vector conidia within and between aphid populations. The parasitoid *Heterospilus prosopidis* has been shown to carry conidia of plant pathogens which may remain viable on the parasitoid for at least 10 days (Nemeye *et al.*, 1990). Other studies showed that parasitoids were unable to vector certain microsporidia (Hoch *et al.*, 2000). However, parasitoids exposed to fungus have been shown to significantly increase fungal infection in host populations of the grain aphid *S. avenae* (Fuentes-Contreras *et al.*, 1998) and the diamondback moth *P. xylostella* (Furlong & Pell, 1996). It is suggested that

parasitoids increase mobility of the host and therefore the likelihood that hosts may contact conidia, hence increasing fungal infection in the host population.

It is also possible that parasitoids have a detrimental effect on fungal pathogens. Furlong and Pell (In press) studied the infection of *P. xylostella* larvae with the pathogen *Z. radicans* after larvae had been parasitised with either of the parasitoids *Cotesia plutellae* or *Diadegma semiclausum*. When larvae were infected with the pathogen three days after being parasitised, there was a significant reduction in the number of conidia produced per cadaver.

In the current study, when aphids were dual inoculated with large doses of fungal pathogens from different orders, namely a hyphomycete and an entomophthoralean, the hyphomycete was generally unable to develop successfully and insects succumbed to infection with the entomophthoralean *E. neoaphidis*. Large numbers of conidia of both pathogens were used in this study, so further studies should investigate whether there is an interaction between the dose of conidia received and the outcome of dual inoculation with a hyphomycete and entomophthoralean fungus. The development of *E. neoaphidis* and the different isolates of hyphomycete fungi used in this study is dependent on temperature conditions. It would be interesting to determine if relationships between the two fungi change when the hosts are exposed to fluctuating temperatures more realistic of field conditions.

It is probable that the two pathogens were not directly competing within the aphid host in these studies because of the shorter incubation time required for *E. neoaphidis*. To investigate the direct competitive interactions between these two fungi, the hyphomycete isolates would need to be applied first and then the *E. neoaphidis* the following day. Additionally, histological studies would reveal whether both conidia types are able to germinate in the presence of each other on the host cuticle.

The fact that many aphids died within 24 hours of being inoculated with fungi, but did not show any signs of fungal sporulation, was interesting. The results suggest



that this mortality was largely due to *E. neoaphidis*, but was enhanced by the presence of a hyphomycete fungus. It is most likely that the large number of conidia applied to insects resulted in massive puncturing of the host cuticle by fungal mycelia and, hence, premature host death. This situation is potentially beneficial for a commercial mycoinsecticide as the host population is reduced quickly. However, it may be detrimental for both a naturally occurring entomophthoralean fungus and an applied hyphomycete fungus as a reduction in inoculum may correspondingly reduce the opportunity for the fungus to reach epizootic levels within a host population.

It has been stated that the physiological host range may not directly reflect the ecological host range of an entomopathogenic fungus and that insects may be infected under laboratory conditions when they would not become infected in the field (Goettel, 1994). Whilst this is true, the biorational approach used in the current study allows selection of isolates that are pathogenic to the host insect but have limited, if any, detrimental impact on non-target natural enemies. Selection of isolates of hyphomycete fungi for insect pest control that are relatively innocuous to non-targets under maximum challenge conditions in the laboratory (physiological host range) can only serve to reduce the potential impact of large quantities of hyphomycete fungi, applied as mycoinsecticides, to natural enemy populations.

---

## Chapter 7 - FIELD EVALUATION OF SELECTED ISOLATES AS POTENTIAL MYCOINSECTICIDES

---

### 7.1 Introduction

The objectives of the field trials were to determine (i) the persistence and distribution of isolates selected sprayed in the field in two contrasting canopy types (spring wheat and spring beans) in relation to microclimatic conditions, (ii) the temporal and spatial distribution of aphids and their natural enemies within these crops, particularly the entomophthoralean fungus *Erynia neoaphidis* and (iii) the effect of the applied mycoinsecticides on aphids from each of the different crops.

#### 7.1.1 Persistence of fungi

The successful outcome of a mycoinsecticide applied to an insect host population (i.e. host population reduction or extinction) will depend on factors such as the innate susceptibility of the insect to the microbial pathogen, the degree of exposure to the pathogen and environmental conditions. Laboratory assays are most often used to indicate the susceptibility of different insect hosts (see chapters three and four). Additionally, the effects of environmental conditions, representative of those that a pathogen may be exposed to under field conditions, are usually assessed under laboratory *in vitro* and *in vivo* studies (chapter five).

The degree of exposure of the host to the pathogen, depends on the likelihood that the insect will come into contact with the microbe. For entomopathogenic fungi in the aerial environment, this is dependent on factors such as the persistence of the microbial agent, its distribution within the canopy and the behaviour and morphology of the insect. Part of the biorational approach described in this study was to assess the potential for targeting fungal sprays to specific areas within the crop canopy. It was hoped that this would not only improve the persistence of the agent applied, but also target areas where large numbers of hosts were most common to improve contact between the fungus and the aphid population.

The stability and persistence of entomopathogenic fungi within the field environment are influenced by sunlight (UV component), humidity or free water availability and temperature (McCoy *et al.*, 1988). Additionally, the physical effect of rainfall and the chemical influences of substrate also influence persistence of conidia. It is, however, difficult to separate the impact of these different, environmental influences on the persistence of conidia of fungi and results should be treated on a case by case basis.

Some of the effects of UV on conidia of fungi under laboratory conditions have been discussed in chapter five, so the following review is concentrated on the effects of UV on conidia at the plant surface, mainly under field conditions. The persistence of conidia of *Beauveria bassiana* on soybean foliage was reduced under solar radiation with a half life of 4.2 days. Conidia of *Nomuraea rileyi* had a half life of only two to three days (Gardner, Sutton & Noblet, 1977). Exposure to direct sunlight on the upper surface of cabbage or pigeon bean plants reduced the half-life of *N. rileyi* to 3.6 hours (Fargues, Rougier, Goujet & Itier, 1988). The half life of conidia of both *B. bassiana* and *Metarhizium anisopliae* applied to cowpea *Vigna unguiculata* (L.) was generally one to two days on exposure to full sunlight outdoors (Daoust & Pereira, 1986). Conidia exposed to full sunlight were not viable after a week whilst those protected from sunlight were able to survive for three weeks or more. Similarly, exposure to sunlight in the field in Israel resulted in 100% mortality of primary conidia of *Zoophthora* (= *Erynia*) *radicans* in less than 24 hours (Uziel & Schtienberg, 1993) and in the Cameron Highlands, the ability of conidia to infect the diamondback moth *Plutella xylostella* was dramatically reduced after 24 hours of field exposure (Furlong & Pell, 1997). It was suggested that exposure to sunlight was the major factor limiting the persistence of conidia of this pathogen in the field. Exposure to ultraviolet radiation was also suggested to be the main factor causing the decline in number of conidia of *B. bassiana* after application to crested wheat grass and alfalfa plots in Canada (Inglis, Goettel & Johnson, 1993).

The impact of rainfall on the foliar persistence of plant pathogenic fungi is well documented (Fitt, McCartney & Walklate, 1989) but there have been fewer studies of the impact of rainfall on entomopathogenic fungi (Morgan, 1994; Furlong & Pell,

1997; Pell, Tydeman & McCartney, 1998). Rainfall has been shown to reduce significantly the number of airborne conidia of *N. rileyi* (Kish & Allen, 1978) and similar results have been shown for *B. bassiana* (Gardner *et al.*, 1977) and *V. lecanii* (Hall, 1981a). A range of intensities of simulated rainfall removed the majority of conidia of *B. bassiana* from potato *Solanum tuberosum* (L.) within the first 15 minutes of exposure (Inglis, Ivie, Duke & Goettel, 2000), but there was no difference between different intensities in the total number of conidia that were removed. However, Inglis, Johnson and Goettel (1995) showed that there was a reduction of only 28% and 35% of conidia of *B. bassiana* from alfalfa and wheat respectively when leaves were exposed to 26.7 mm h<sup>-1</sup> of simulated rain for 30 minutes. Increasing the exposure time to an hour though, reduced the number of conidia remaining on wheat but not on alfalfa, although these differences were not significant.

### **7.1.2 Climate monitoring**

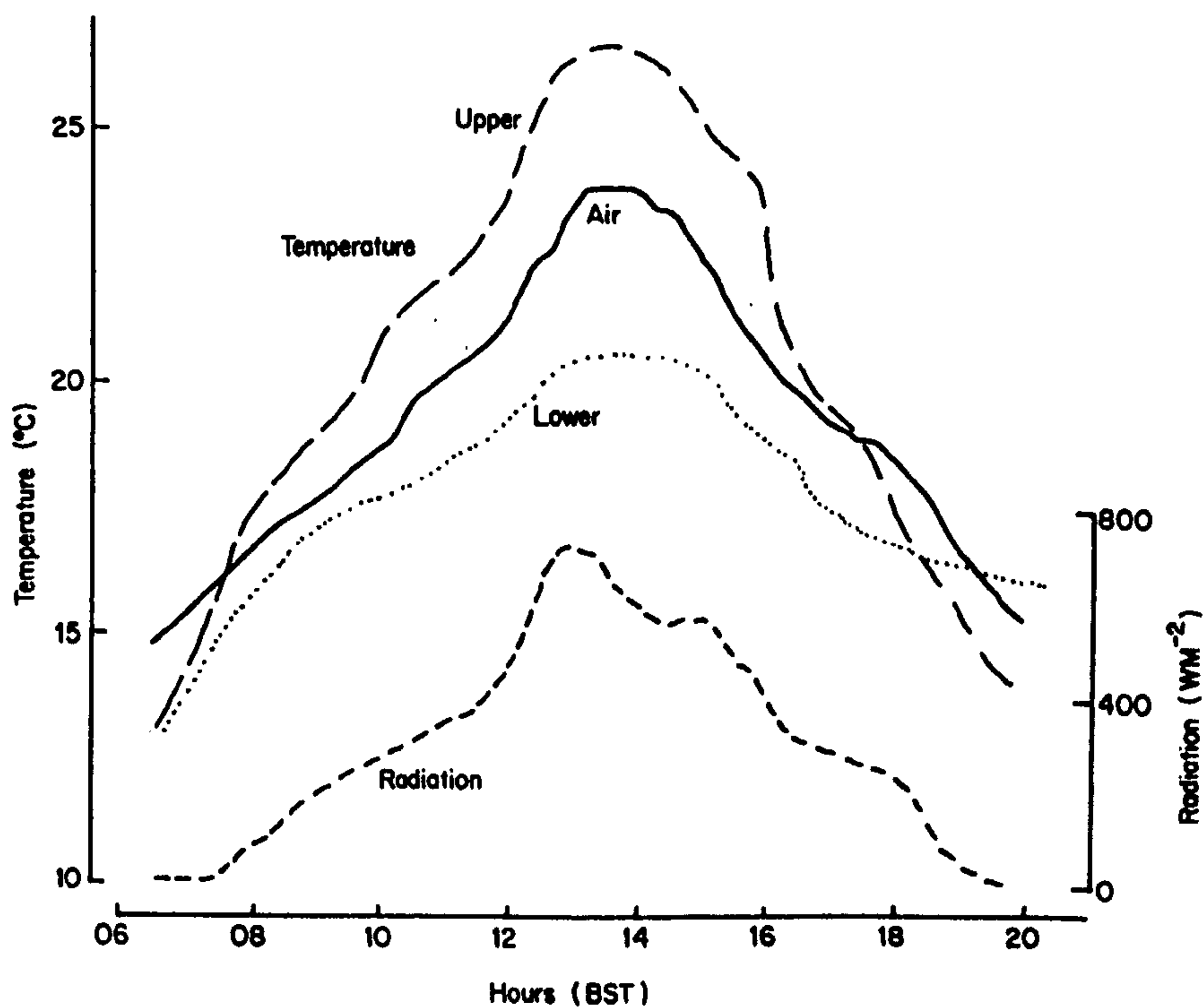
Whilst macroclimatic conditions may give an indication of the environmental conditions to which a pathogen is exposed, it is the microclimate which is likely to have the greatest impact both on applied pathogens and their insect hosts.

Microclimatology is the study of "*the climate in the boundary layer of the atmosphere where factors such as temperature and humidity can change dramatically in a distance of a few cm and where plants and animals can modify the climate in which they and other organisms live*" (Unwin, 1980). Because the scale of measurement is often very small, any microclimatic figures quoted can only be representative of the situation under which those measurements were made.

The most important microclimatic factors likely to affect pathogens in the field will be temperature, humidity and exposure to UV light. It is not intended to give an exhaustive review of the measurement and influence of these microclimatic factors on the biotic environment, rather to highlight some of the more important facts relevant to the current field trials. For reviews of specific aspects of microclimate, the reader is referred to Unwin & Corbet (1991) and Willmer (1986) for discussion

of the influence of microclimate on insects, to Jones (1983) for details of the influence of microclimate on plants and to Monteith & Unsworth (1990) for the principles of environmental measurements.

The microclimate around leaves within a crop canopy may be very variable over the course of a day (Figure 7.1). Generally, the upper (adaxial) leaf surface is warmer and the lower (abaxial) surface cooler during daylight and this depends largely on radiation levels (Willmer, 1986). Also, leaves are often warmer than the surrounding air in cold weather and cooler than the surrounding air in hot weather (Gates, 1965). The effects seen at the level of the individual leaf will contribute to the microclimate of larger elements of vegetation, such as the total stand of crop vegetation.



**FIGURE 7.1** : Microclimatic conditions around leaf surfaces in a crop of beans over a 24 hour period in June. [Reproduced from Willmer, 1986].

For a dense stand of vegetation, such as a crop of field beans, the largest changes in microclimate will be experienced at the top of the crop or the "active surface". Although aphids are often found in the growing points of plants for nutritional reasons, they also settle in areas of a crop where the microclimate is more stable as they are immobile whilst in their feeding positions. This is one reason why aphids are often found on the lower surfaces of leaves compared to the upper surfaces.

### **7.1.3 Spatial distribution of aphids in crops**

Aphids show differences in preference for feeding sites. In cereal crops, individuals of the grain aphid *Sitobion avenae* generally colonise the upper part of the plant, particularly the ears (Klingauf, 1987). In a field experiment, when peak numbers of aphids were recorded in wheat, the rose-grain aphid *Metopolophium dirhodum* and *S. avenae* were distributed differently over individual plants (Wratten, 1978). *Metopolophium dirhodum* was found on the flag leaf (36%), leaf 2 (49%) and leaf 3 (15%), whilst *S. avenae* was found in the ear (89%), flag leaf (5%), leaf 2 (4%) and leaf 3 (2%). Holmes (1988) showed that, whilst *S. avenae* are found mainly in the ear, they do move from the plant on which they were born during their development. This occurred even in small colonies and so was suggested not to be a response to crowding on individual plants.

The black bean aphid *Aphis fabae* characteristically forms compact apical colonies as do pea aphids *Acyrtosiphon pisum* (Lowe, 1971). Kennedy, Booth and Ibbotson (1950) showed that aphids of *A. fabae* preferred young or early senescent leaves of sugar beet compared to mature leaves. Lowe (1967) found that aphids of *A. fabae* that settled on the abaxial surface of leaves fed only on veins, ignoring the lamina and margins. Aphids of *A. pisum* preferred leaves to stems of bean plants, with between 86 - 98% of aphids tested selecting leaves (Lowe & Taylor, 1964).

Aphids are generally found on lower compared to upper surfaces (Trumble, 1982). *Aphis fabae* has been reported as feeding only on the underside of sweet pea (Hull, 1964) but on either surface of beans (Dixon & Wratten, 1971). *Acyrtosiphon pisum* has been recorded as feeding on leaf undersides (Hull, 1964). Whilst *R. padi* preferentially select the lower side of leaves, *M. dirhodum* is often found on upper and lower leaf surfaces (Klingauf, 1987).

### **7.1.4 Temporal distribution of *Erynia neoaphidis***

The entomopathogenic fungus, *Erynia neoaphidis*, has often been recorded in cereal aphids (Dean & Wilding, 1973; Roy, 1997) and in bean aphids (Wilding, 1975; Wilding & Perry, 1980). In some years, natural epizootics of the fungus may

control aphid populations. Wilding (1975) reported that *Erynia neoaphidis* (= *Entomophthora aphidis*) occurring with two other *Entomophthora* spp. was able to cause 83% mortality in the host, *A. pisum*.

Epizootics are generally recorded in July and early August (Way, 1967; Dean & Wilding, 1971, 1973; Wilding, 1975). However, this is often after aphid populations have reached damaging densities on crops. The late development of epizootics is suggested to be due to low infection in early, low density populations of aphids migrating into crops. The probability of an aphid being infected by the overwintering forms of Entomophthoralean fungi is thought to be relatively low (Gustafsson, 1969). Only once aphids reach high densities do disease epizootics increase to a level which has the potential to cause a decline in aphid numbers.

*Erynia neoaphidis* requires a high relative humidity (90 - 100%) during the initial stages of infection (Wilding, 1969) and saturated air is necessary for the pathogen to discharge conidia (Yendol, 1968). Aphids infected with *E. neoaphidis* in the field die just prior to dusk, enabling the fungus to sporulate under warm, humid conditions (Glare & Milner, 1991). *Erynia neoaphidis* failed to spread in populations of *A. fabae* in field beans *Vicia faba* during two warm, dry seasons but was able to spread rapidly in cool, moist seasons (Wilding, 1981b). It is accepted that a high relative humidity exceeding 90% and an adequate temperature above a threshold of about 20°C are the ideal conditions for the development of an epizootic (Wilding & Perry, 1980; Wilding, 1981a). Therefore, conditions under which an epizootic of *E. neoaphidis* develops, are likely to be similar to those required by Hyphomycete fungi for host infection, i.e. high relative humidity and a warm temperature.

Temperatures of 10, 15 and 20°C have been shown to have no effect on the infectivity of primary conidia of *E. neoaphidis* for the blue green aphid *Acyrtosiphon kondoi* when moisture was not limiting (Milner & Bourne, 1983). However, temperature did affect the rate of disease development and, alongside leaf wetness, the number of primary conidia available to infect new hosts. As temperature has an impact both on the development of the host population and the

fungus population, its effect on the prevalence of *E. neoaphidis* and other pathogens is difficult to determine (Fuxa & Tanada, 1987). If temperatures favour a short incubation time for the fungus, but retard insect development, then it is possible that an epizootic of the fungus will develop.

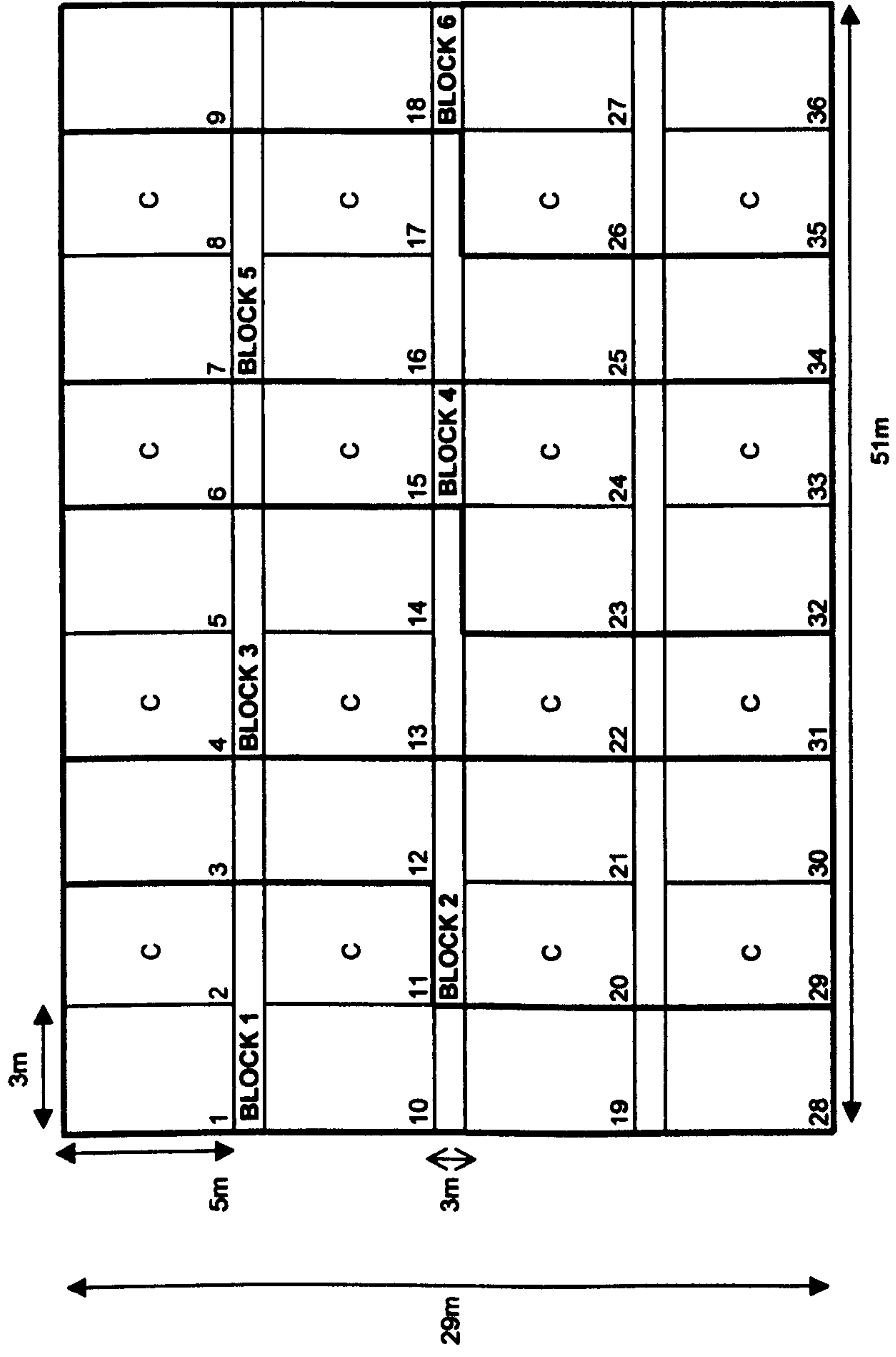
## **7.2 Materials and Methods**

### **7.2.1 Field trial design**

Field trials were set up on Rothamsted Farm in 1997 and 1998 on the Long Hoos fields in the same plots in both years. In each year, crops of spring field bean *V. faba* and spring wheat *Triticum aestivum* (L.) were planted (Appendix 5). The crops were adjacent to each other and were rotated over the two years, with 36 plots (5m x 3m) arranged in a 6 x 6 randomised block with un-drilled side paths (0.5m and 3m) between plots (Figures 7.2, 7.3 & 7.4). Treatments were only applied in blocks one to three, and blocks four, five and six were maintained for additional experiments as required. Plots were marked with a single fibre glass cane at one corner of the plot. Standard farm operations were applied to both crops except there were no insecticides or fungicides applied in 1997 and in 1998 one spray of Carbendazim was made against chocolate spot in the beans early in the season before any mycoinsecticide applications were made or *E. neoaphidis* was recorded in the crop.

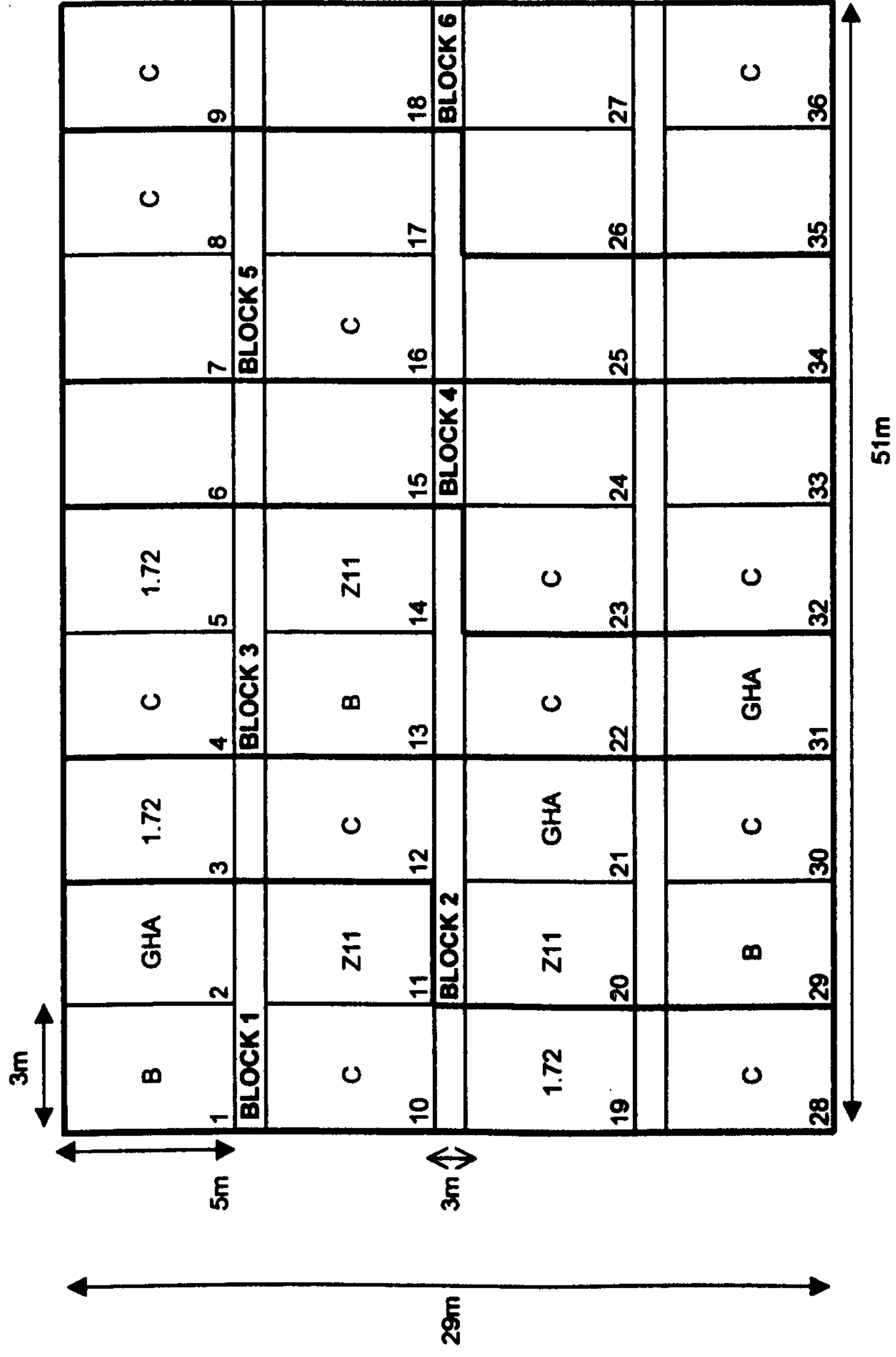
Plants were divided into three equal parts for recording purposes, defined as the (i) top, which in wheat, prior to ear formation, contained the flag leaf and for beans included the growing point, (ii) middle which included the second leaf in the wheat and (iii) bottom which included the third leaf and stem below in the wheat. For wheat, the “top” category was split into the top and the ear, once the ears had formed. The other sections of the plant assigned to the categories remained constant throughout the season.





C = Natural population monitoring plot  
 B = Blank formulation of Tween 80 (0.03%)  
 GHA = Mycotech strain GHA (*B. bassiana*) spray application  
 1.72 = HRI 1.72 (*V. lecanii*) spray application  
 Z11 = Z11 (*P. fumosoroseus*) spray application

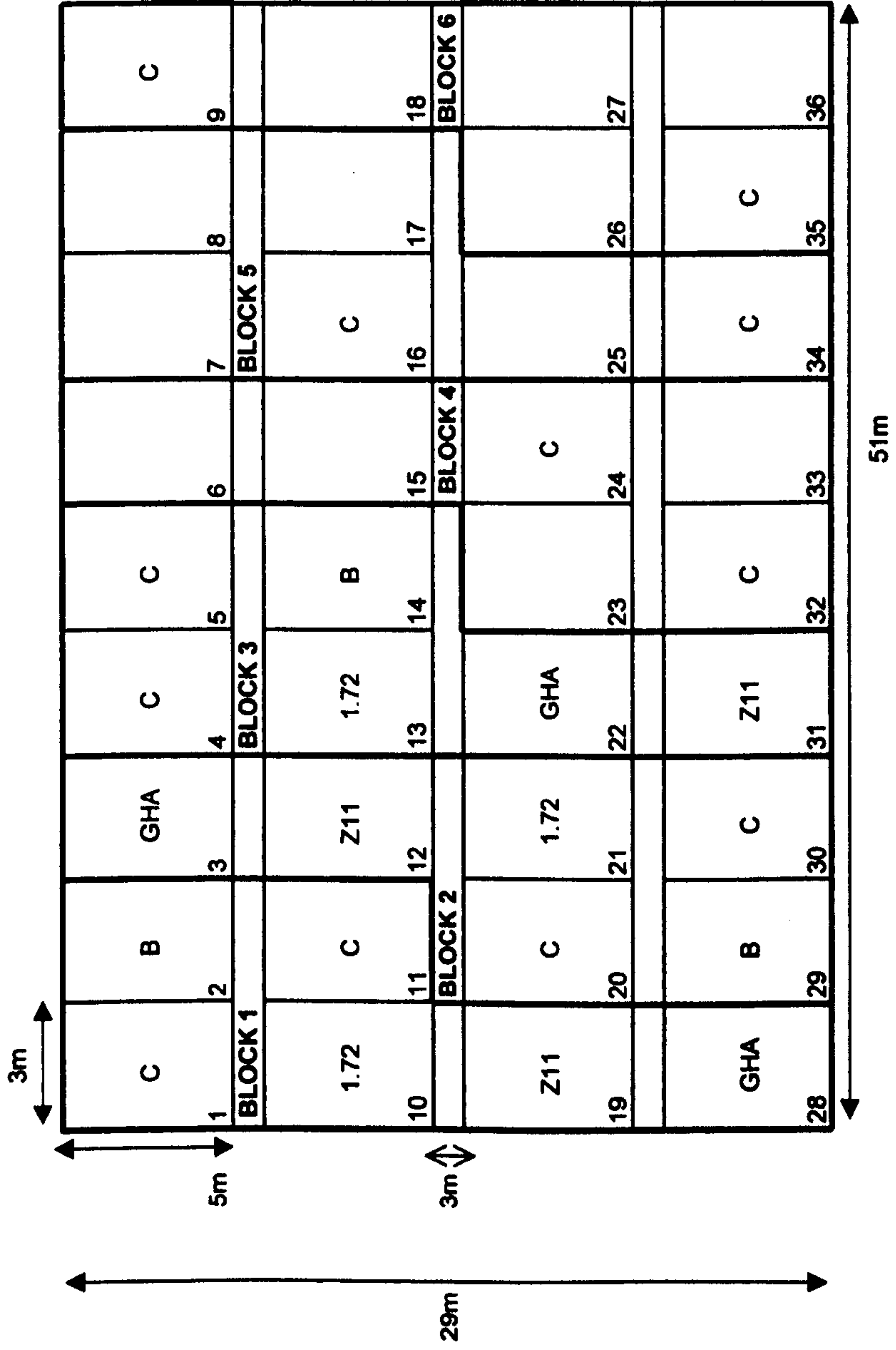
**FIGURE 7.2 : Field experiment plans for spring beans and spring wheat in 1997.**



C = Natural population monitoring plot  
 B = Blank formulation of Tween 80 (0.03%)

GHA = Mycotech strain GHA (*B. bassiana*) spray application  
 1.72 = HRI 1.72 (*V. lecanii*) spray application  
 Z11 = Z11 (*P. fumosoroseus*) spray application

FIGURE 7.3 : Field experiment plans for spring beans in 1998.



C = Natural population monitoring plot  
 B = Blank formulation of Tween 80 (0.03%)  
 GHA = Mycotech strain GHA (*B. bassiana*) spray application  
 1.72 = HRI 1.72 (*V. lecanii*) spray application  
 Z11 = Z11 (*P. fumosoroseus*) spray application

**FIGURE 7.4 : Field experiment plans for spring wheat in 1998.**

### **7.2.2 Aphid and natural enemy monitoring**

The crops were monitored regularly and counts of aphids and natural enemies were made as soon as the first individuals were noted. Counts were made approximately every two weeks in twelve plots in each year, until aphid populations crashed (Figures 7.2, 7.3 & 7.4, plots marked "C"). The recording period in 1997 was from 5<sup>th</sup> June to 6<sup>th</sup> August and in 1998 from 29<sup>th</sup> May to 16<sup>th</sup> July. Counts were made on 20 main stems of bean plants and 20 tillers of wheat in each plot, from plants in a 1m<sup>2</sup> area in the centre of each plot. Therefore, a maximum number of 240 plants were assessed for each recording date. When numbers of aphids became very large, the number of plants assessed was reduced according to the time taken to assess the two crops.

Records were made at each of the three positions (top, middle and bottom) on a plant using the following categories:

- Aphids : species (alate, aptera or nymph)
- Ladybirds : species (adult, larva or egg batch)
- Parasitoids : adult or mummy
- Lacewings : adult, larva or egg
- Hoverflies : adult or larva
- Fungi : species

The species of entomophthoralean fungi infecting aphids in the field were identified *in situ* and by regularly sampling aphid cadavers. The cadavers were placed on damp filter paper in the bottom of a Petri dish and conidia were showered from them onto glass slides in the laboratory. The slides were stained with 10 % cotton blue in lactophenol and the species of fungus identified.

The average number of aphids per plant for all plots at one recording position was calculated for each crop type. The log<sub>10</sub> values of these counts (plus one to allow for logs of zero to be calculated) were taken to transform data to show on the same graphical scale and not for analysis purposes. Natural enemy counts were very small and so were expressed as the number in a 1 m<sup>2</sup> area of crop.

### **7.2.3 Climate monitoring**

#### **7.2.3.1 Macroclimate measurements**

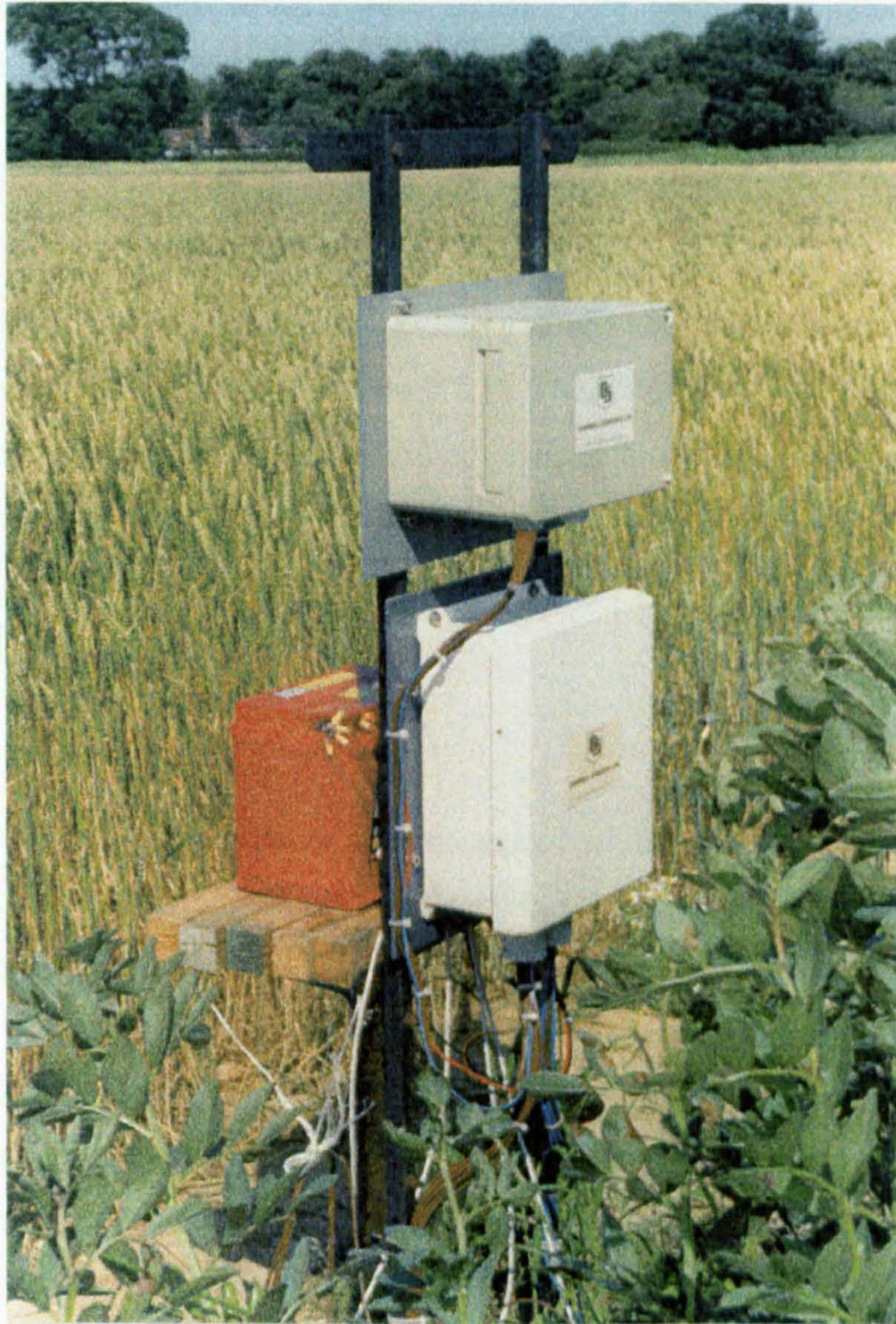
Data from the IACR-Rothamsted meteorological station were obtained for the periods when field trials were carried out. Measurements were made on a daily basis and included maximum and minimum temperatures ( $^{\circ}\text{C}$ ), rainfall (mm), sun (hours), dry bulb and wet bulb temperatures ( $^{\circ}\text{C}$ ) and wind speed ( $\text{ms}^{-1}$ ).

#### **7.2.3.2 Microclimate measurements**

In the 1998 field season, the microclimate of both crops was recorded over the period 26<sup>th</sup> June to 27<sup>th</sup> July, using a Campbell Scientific 21X data logger. Data were multiplexed through a Campbell Scientific AM416 multiplexer because of the high number of inputs to the logger. Measurements were made every 60 seconds and the average values computed within the logger and stored every 30 minutes (Appendix 6). Data were downloaded from the logger to a portable storage module in the field and subsequently downloaded to a PC in the laboratory, using Campbell software, and exported into Excel 97 spreadsheets. Power was supplied to the datalogger using a rechargeable leisure battery (BSX Powerdrive, type 678A, 75 amp) which was charged on mains electricity every six days in the laboratory. The datalogger was positioned in the buffer zone between the two crops so that measurements could be taken simultaneously in both crops (Figure 7.5). Sensors were placed so that measurements were made at random positions within a 4 m radius of the datalogger.

##### **7.2.3.1.1 Temperature measurements**

Temperature was measured using type T copper/copper-nickel thermocouples with welded tips and polytetrafluoroethylene insulation (RS components Ltd.). The thermocouples were connected to type T thermocouple extension wire using miniature type T thermocouple connectors and the wire was attached directly to the datalogger.



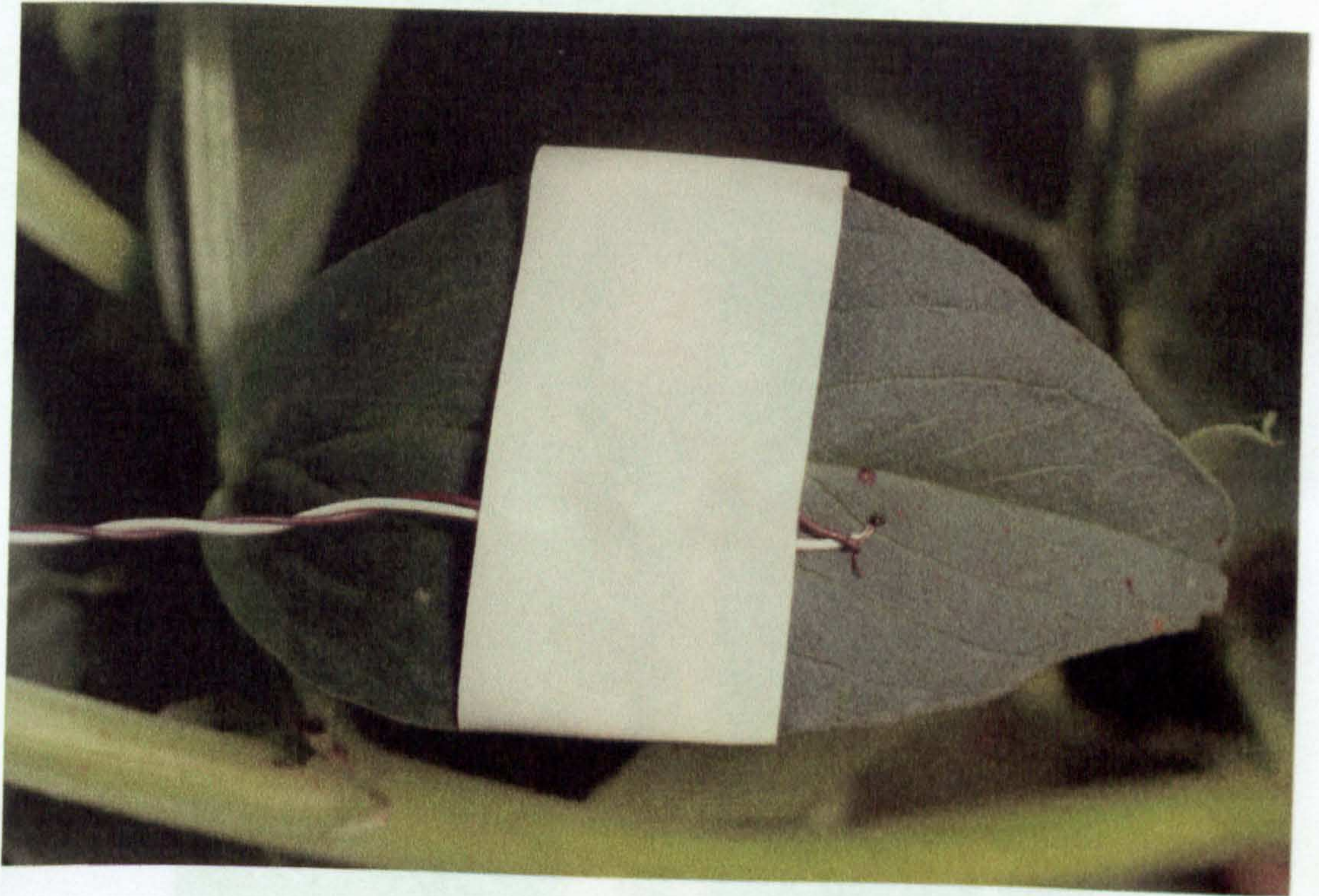
**FIGURE 7.5 :** Campbell 21X datalogger simultaneously recording microclimate in a crop of spring field bean and spring wheat, positioned in the buffer zone between the two crop types during field experiments in 1998.

Thermocouples were attached to leaves using electricians' tape so that the thermocouple was touching the leaf (Figure 7.6). The thermocouple connectors were held in inverted conical tubes using a rubber bung to secure the wires (Figure 7.7) in order to protect the connectors from damp conditions which could cause rusting and hence inaccurate measurements. The tubes were attached to plastic stakes within each of the crops.

A pair of thermocouples were positioned with one on the adaxial surface of a leaf and one on the abaxial surface of a separate leaf. Pairs of thermocouples were positioned in this way at the top, middle and bottom of the wheat and bean crops (positions were as defined in section 7.2.1). There were two pairs of thermocouples at the top and middle of the crop and one pair at the bottom. Thermocouples were checked regularly in the field and if the welded tip of a thermocouple broke it was replaced with a new thermocouple.

#### 7.2.3.1.2 Humidity measurements

Wet and dry bulb temperatures were measured within the wheat and bean canopies using six ventilated (aspirated) psychrometers which were designed and built at IACR-Rothamsted (Figure 7.8). Psychrometers were mounted on wooden stakes in the field (Figure 7.9) at three heights within each crop at (a) the bottom (75cm from soil surface), (b) the middle (halfway between the canopy surface and the bottom psychrometer) and (c) the top (level with the top of the crop canopy). Each psychrometer contained two thermocouples, one of which measured air temperature whilst the other was covered by cloth and a water-soaked wick which gave a temperature lowered by evaporative cooling (Figure 7.10). The difference between these two temperatures gave the wet bulb depression. The air flow across the wet bulb needed to be above  $3 \text{ ms}^{-1}$ , a critical value below which the wet bulb depression may be inaccurate, so the netting and fans on the psychrometers were regularly cleaned to maintain a satisfactory air flow. Psychrometers were disconnected from the battery supply and the netting was dusted with a stiff brush to removed debris. The fans were cleaned carefully with cotton buds and water. The water reservoir for the wet wick was checked weekly and filled with distilled

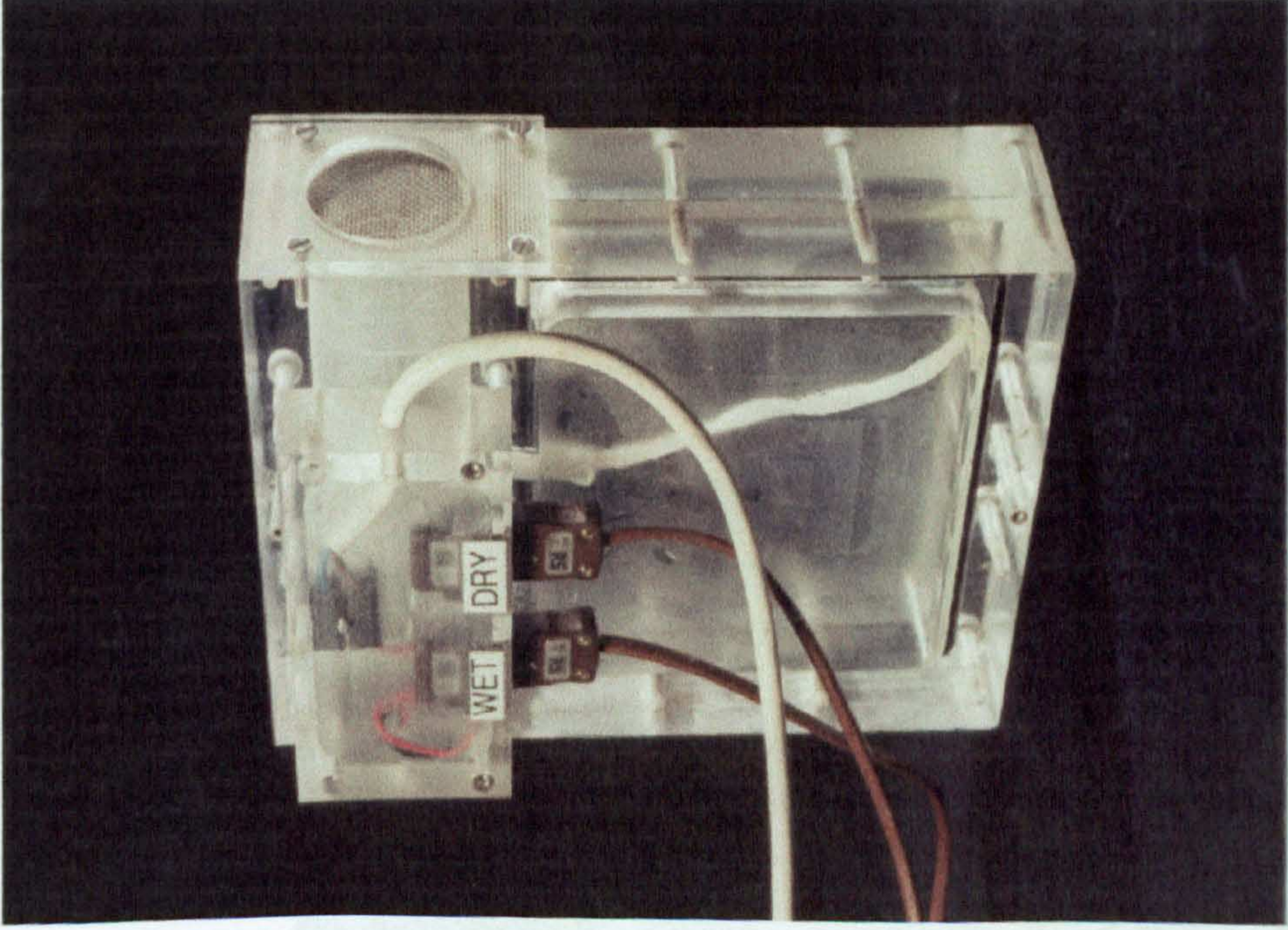
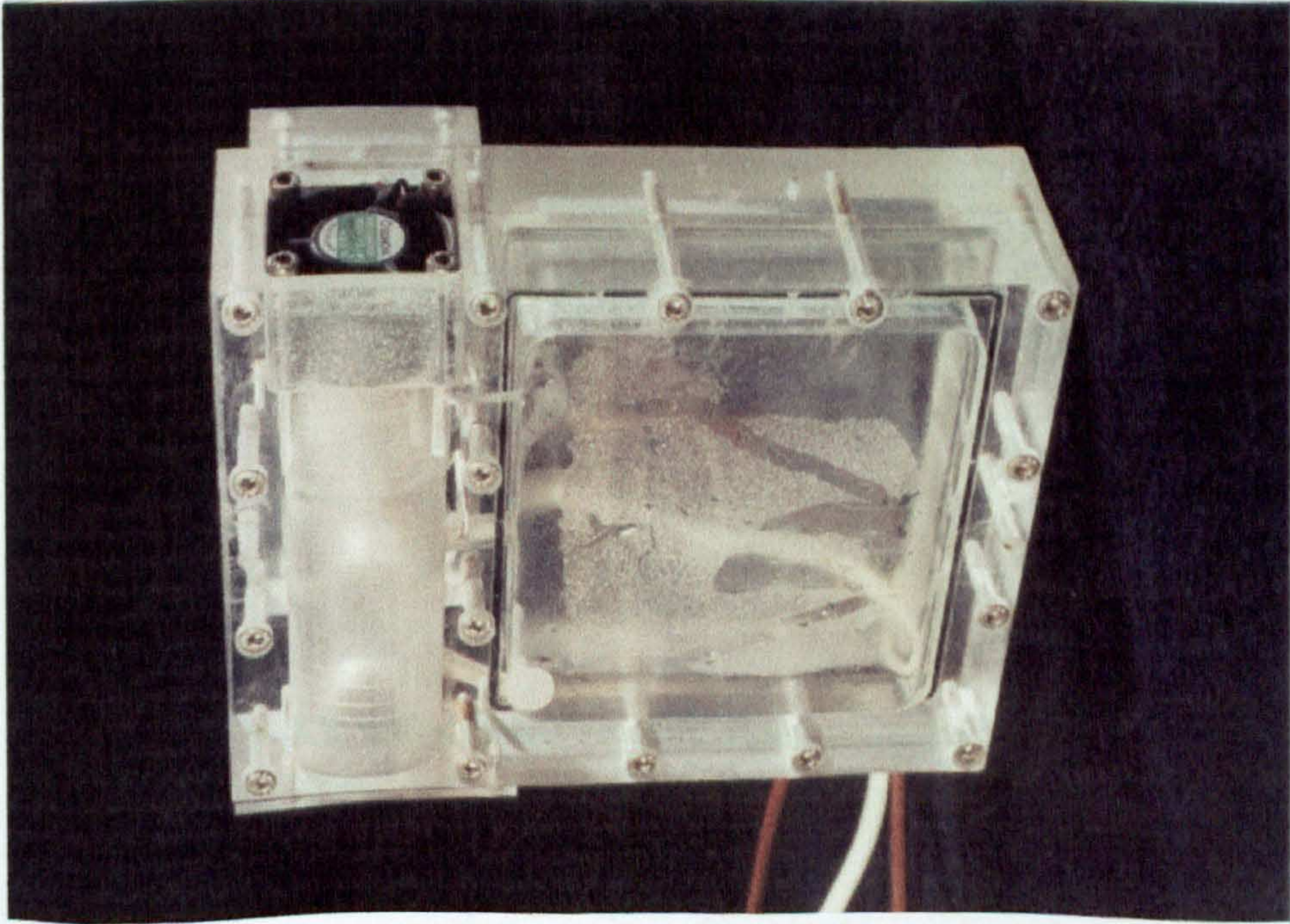


**FIGURE 7.6 :** Thermocouple tip taped to a bean leaf in recording position

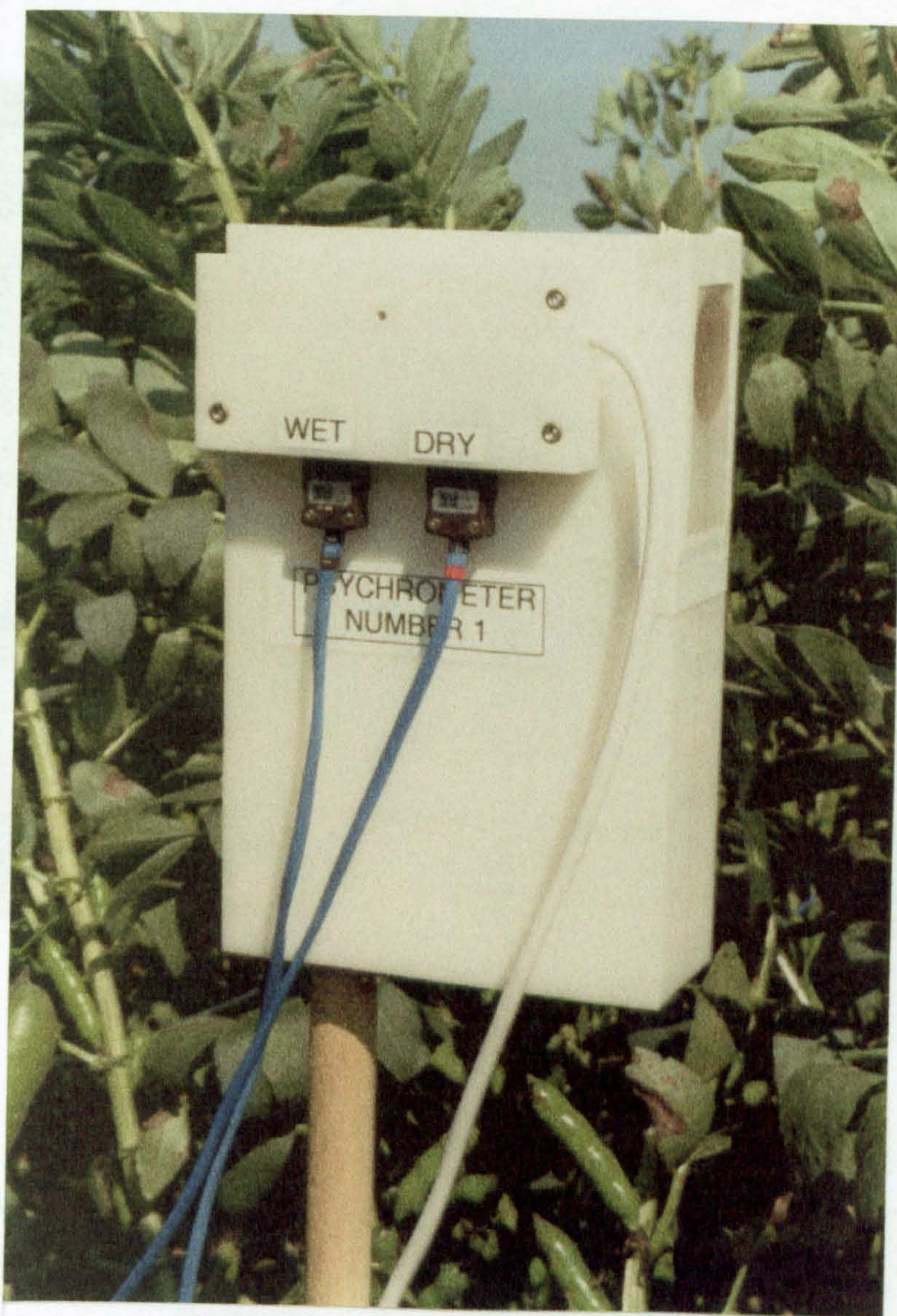




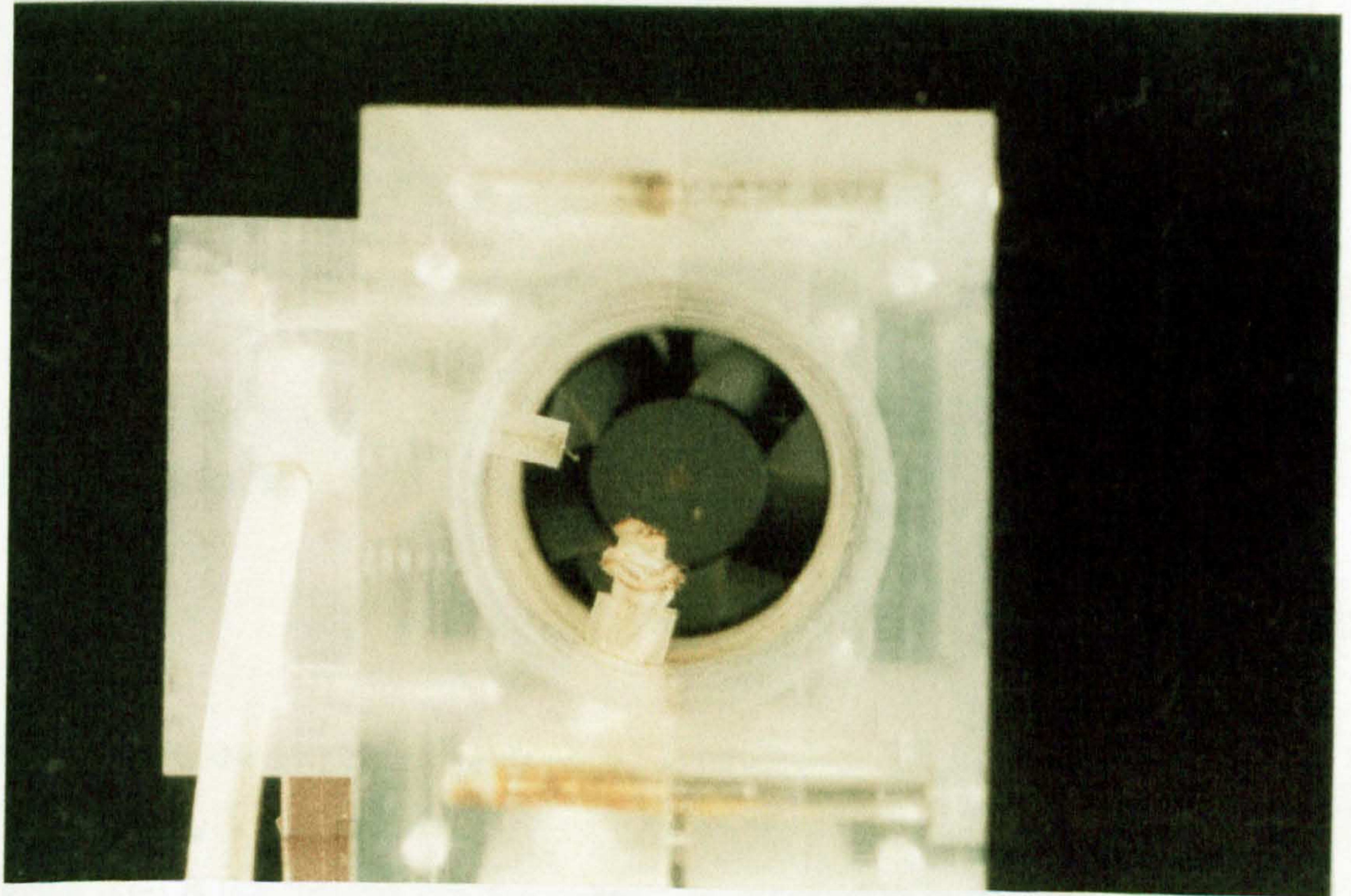
**FIGURE 7.7 :** Inverted conical tubes acting as protective covers for thermocouple connectors in the field.



**FIGURE 7.8 :** Prototype of a ventilated psychrometer built at IACR-Rothamsted showing design details.



**FIGURE 7.9 :** Ventilated psychrometer mounted on wooden stake in position in field bean crop.



**FIGURE 7.10** : Wet and dry bulb thermocouples in a prototype of a ventilated psychrometer built at IACR-Rothamsted.

water which had a few drops of sodium hypochlorite added to reduce the incidence of algal growth in the reservoir.

Relative humidity was calculated from the measurements of wet and dry bulb temperature using the following sets of equations. Firstly, it was necessary to calculate the saturation vapour pressure (vapour pressure of water saturated air) which is a function of temperature. Saturation vapour pressure ( $e_s$ ) at temperature  $t$  (degrees Kelvin,  $^{\circ}\text{C} + 273$ ) can be calculated as follows (Unwin, 1980):

$$\text{Log}_{10} e_s = 9.24349 - \frac{2305}{t} - \frac{500}{t^2} - \frac{100\,000}{t^3}$$

From this, the vapour pressure ( $e$ ) at temperature  $t$  can be calculated from the following formula:

$$e = e_{s(w)} - 0.66 (T_d - T_w)$$

Where,  $T_d$  is the air (dry bulb) temperature (in  $^{\circ}\text{C}$ ),  $T_w$  is wet bulb temperature (in  $^{\circ}\text{C}$ ) and  $e_{s(w)}$  is the saturation vapour pressure at the wet bulb temperature. The value 0.66 is the "psychrometer constant" for a ventilated psychrometer. Relative humidity can then be calculated as follows:

$$\text{RH (\%)} = \frac{e \times 100}{e_{s(d)}}$$

Where  $e_{s(d)}$  is the saturation vapour pressure at the air temperature ( $T_d$ ).

#### ***7.2.4. Spray application in field trials***

All suspensions of conidia were applied to field plots using a hand held version of the APE80 sprayer detailed in section 2.6.6. The application rate of  $10.4 \text{ l ha}^{-1}$  was identical to that used in laboratory experiments with 24 ml of liquid applied per minute. To spray three plots of 5 x 3 m in one crop, approximately 70 ml of each

suspension of conidia was required. This allowed approximately 20 ml which could be run through the sprayer on the approach to the plot and on the way out the other side of the plot. Therefore, at least 140 ml of a suspension of each fungus was needed to spray three replicate plots within each crop type, with depositions of approximately  $1.56 \times 10^{10}$  conidia per plot.

A germination test was carried out for each suspension of conidia to check the viability of conidia; the percentage of conidia that germinated on SDA after 24 hours at 20°C was recorded. Additionally, three water agar plates (1% water agar in a 9cm Petri dish) were placed in each plot to be sprayed with suspensions of conidia. The plates were balanced on plastic rods and secured with a piece of reusable adhesive (Bluetack<sup>®</sup>) so that the surface of the agar was facing upwards. The dishes were placed at random positions within the plot but so that the dishes were level with the top of the canopy. After sprays had been applied, the dishes were incubated at 20°C for 24 hours and the number of conidia that germinated was recorded. This gave a measure of viability of conidia and also acted as a check to ensure that conidia were deposited evenly in the crop.

Spray applications were made on 19/06/98 and 07/07/98. On both occasions the wind speed was less than 5 m.p.h., which was necessary to reduce spray drift, and the sprays were applied in the late afternoon at approximately 17.00 hours. On both occasions, applications of Mycotech strain GHA (*B. bassiana*) were made to plots in the beans and wheat (plots labelled "GHA" in Figures 7.3 & 7.4), applications of HRI 1.72 (*V. lecanii*) were made in the wheat crop only (plots labelled "1.72" in Figure 7.4) and Tween 80 (0.03%) as a control was applied to both crops (plots labelled "B" in Figures 7.3 & 7.4). HRI 1.72 was not applied to beans because there was only sufficient inoculum to make applications in one crop.

### **7.2.5 Aphid bioassays**

Aphids of *A. fabae* and *S. avenae* were reared to known-age using the methods described in section 2.3. Fungi were cultured using the methods described in section 2.6 except that at least 100 plates were prepared for each isolate for each spray date. Suspensions of conidia were prepared on the day which they were

sprayed using the methods described in section 2.6 and the appropriate quantities to give a volume of approximately 150 ml of suspension of conidia. These suspensions were adjusted to give a final concentration of  $1 \times 10^9$  conidia ml<sup>-1</sup>.

#### *7.2.5.1 Evaluation of susceptibility of aphids in the field*

This experiment was carried out on one occasion only, for the spray on 19/06/98. Counts of the number of aphids and natural enemies in blank formulation plots (i.e. those to be treated with Tween only) and the treatment plots were made three days prior to the spray application, using the methods detailed in section 7.2.2. The same plots were assessed seven days after sprays had been applied.

A sample of aphids of *A. fabae* and *A. pisum* were removed from each plot, immediately following spray applications. Ten aphids of each species were taken from leaves at the top of the crop and ten from the middle, but none were sampled from the bottom of the crop as leaves in this area had started to senesce and very few aphids were found there. The aphids were placed on clean bean leaves set in 2% water agar in 9cm Petri dishes and incubated using the standard methods detailed in section 2.8. Mortality was recorded daily for 10 days as described in section 2.7. When aphids died of fungal infection, the pathogen was identified by (i) showering conidia over glass slides and staining with 10% cotton blue in lactophenol if the fungus was suspected to be an entomophthoralean, or (ii) crushing the insect in a drop of 10% cotton blue in lactophenol under a coverslip if the pathogen was suspected to be a Hyphomycete fungus. Results from this assessment were used to determine the number of aphids that received a lethal dose of conidia directly from the spray application in the field. The same assessments were not made in the wheat crop as aphid numbers were very low.

#### *7.2.5.2 Persistence of conidia on leaves*

This experiment was carried out on both occasions that spray applications were made. Leaves were collected immediately following spray applications from all treated plots and blank control plots and carefully placed in labelled plastic bags. Two sets of leaves were picked from the top, middle and bottom of both the wheat

and bean crops. Leaves were set in 2% water agar in 9cm Petri dishes in the laboratory. Bean leaves were used as a pair of leaflets if they were small (i.e. could fit in a 9cm Petri dish), or as single leaves if they were larger. Each wheat leaf was cut into a maximum of three sections to fit into the Petri dishes. All leaves were embedded in agar with the lower (abaxial) surface facing upwards to represent the normal feeding site for aphids. Ten healthy, apterous adult *A. fabae* reared in the insectary to known-age were placed into each dish of bean leaves and incubated at 23°C for 48 hours, after which the aphids were transferred to clean leaves using the methods detailed in section 2.8. Similarly, ten healthy apterous adult aphids of *S. avenae* reared in the insectary to known-age were placed into each dish of wheat leaves and incubated in the same way. Mortality was recorded daily using the methods detailed in section 2.7 for nine to ten days.

On the second spray date (07/07/98), an additional sample of leaves was collected 24 hours post-application, and aphids were assayed using the methods detailed above.

## **7.3 Results**

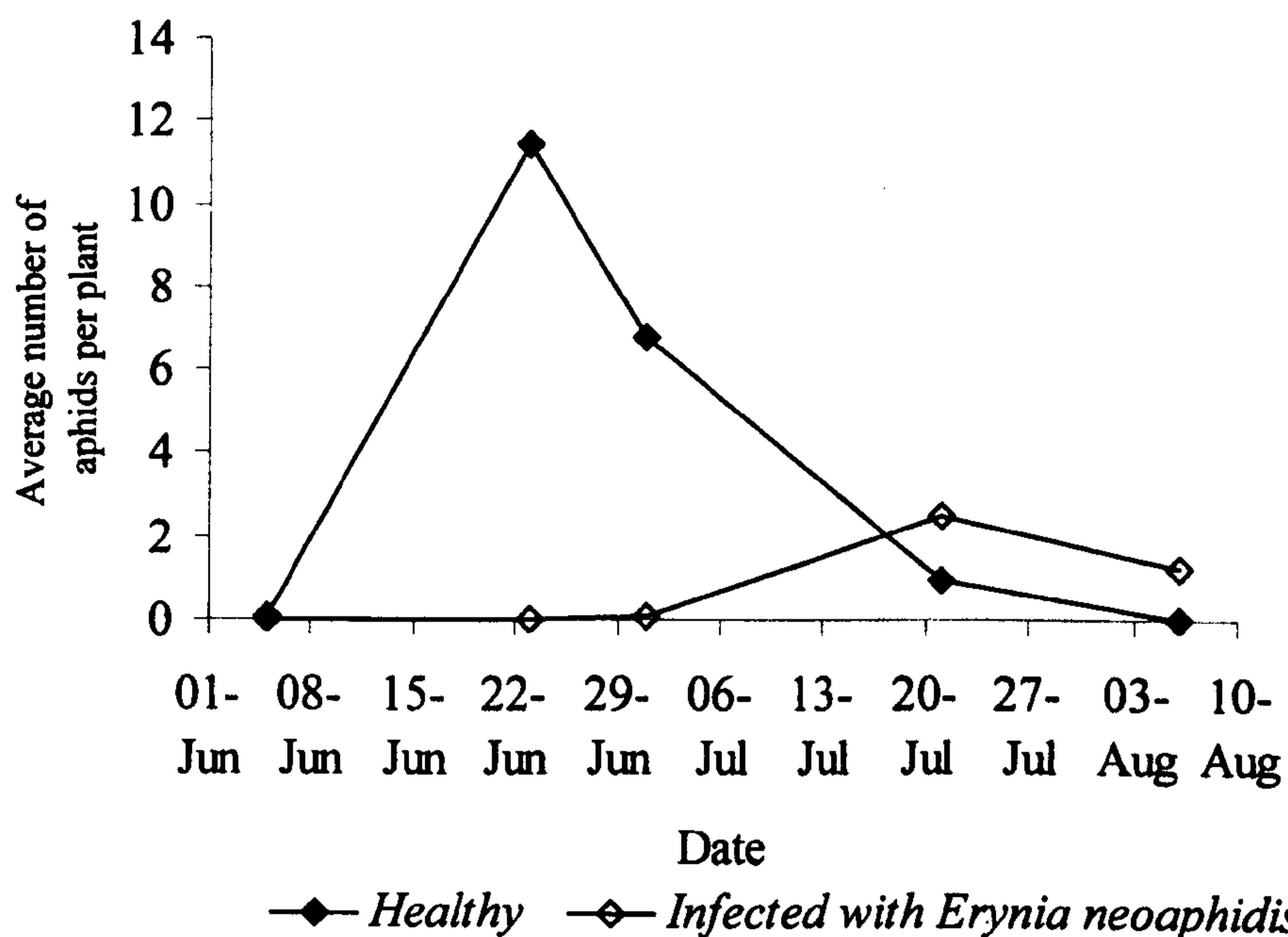
### ***7.3.1 Aphid and natural enemy counts***

#### ***7.3.1.1 Wheat 1997***

In 1997, the first aphids were recorded in the wheat crop at the beginning of June with numbers peaking later than month and decreasing to very few individuals by the beginning of August (Figure 7.11).

The majority of the aphids recorded were *M. dirhodum* with fewer *S. avenae* (Appendix 7). The majority of *S. avenae* were recorded in the ear and at the top (including the flag leaf) of plants with fewer aphids at the middle and the bottom (Figure 7.12a). In comparison, very few aphids of *M. dirhodum* were recorded in the ear and individuals were evenly distributed between the top, middle and bottom of the crop (Figure 7.12b).

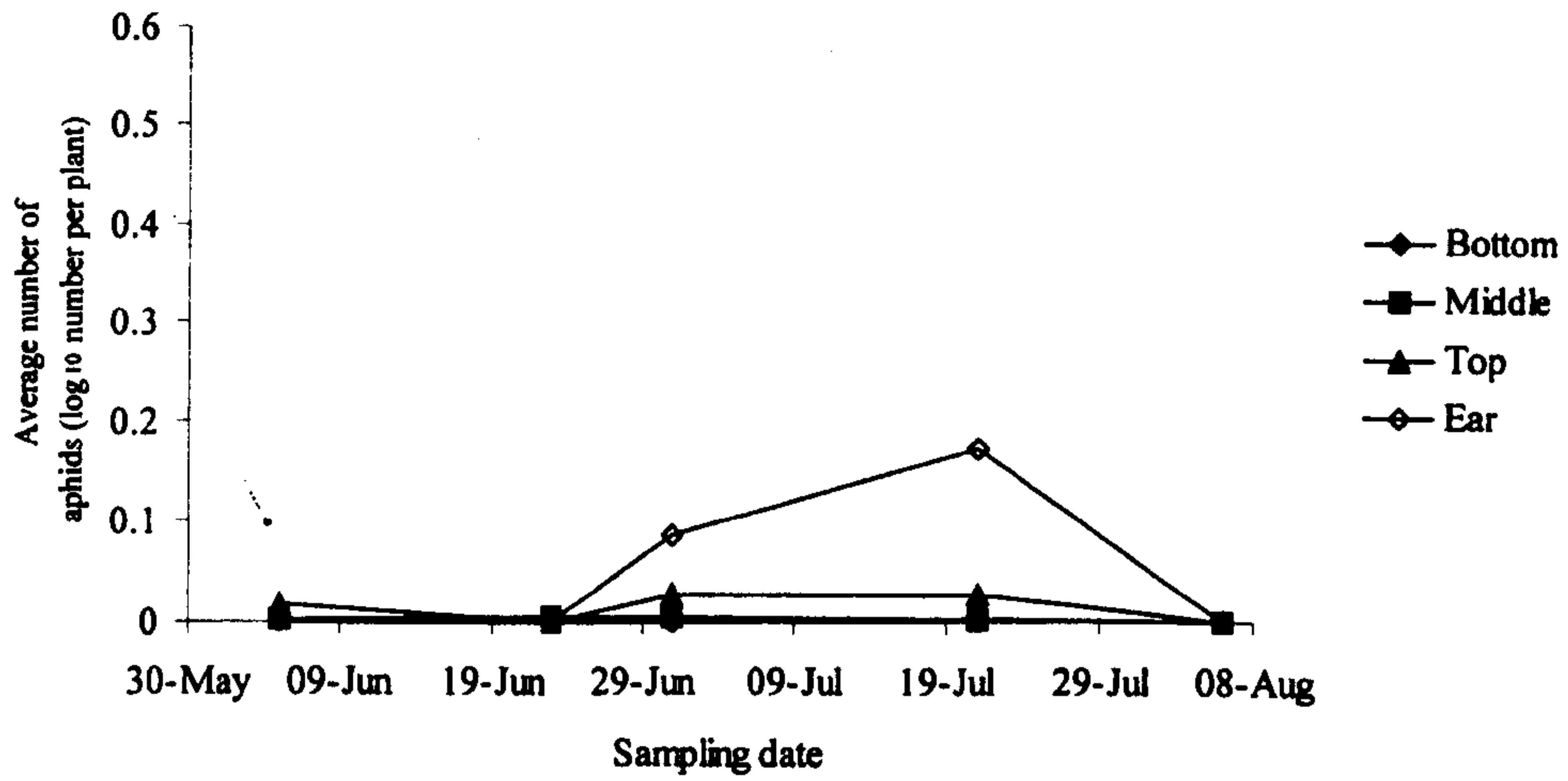




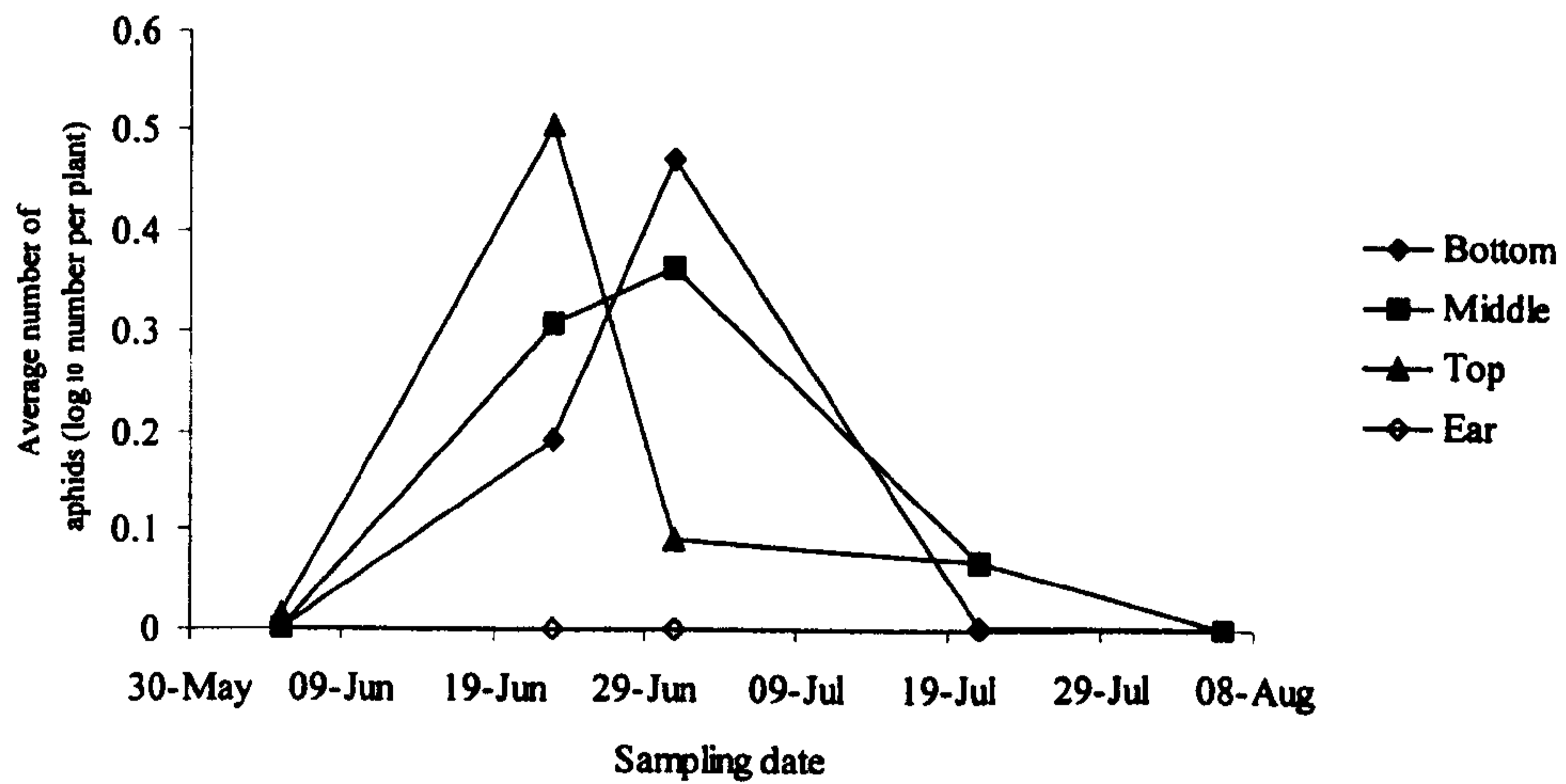
**FIGURE 7.11** : Average number of healthy aphids (all species combined) and aphids infected with *E. neoaphidis* recorded per plant in a spring wheat crop over the period 05/06/97 - 06/08/97.

Sporulating aphids infected with *E. neoaphidis* were noted on plants from the beginning of July, at around the same time that healthy aphid numbers peaked (Figure 7.12c). The biggest number of infected aphids was recorded as the number of healthy aphids started to decrease. Infected aphids were distributed relatively evenly between the four recording positions (Figure 7.12c). Although few ladybirds were recorded on the plants selected for monitoring, there were large numbers of ladybirds present in the crop from the middle of June to the end of the recording period.

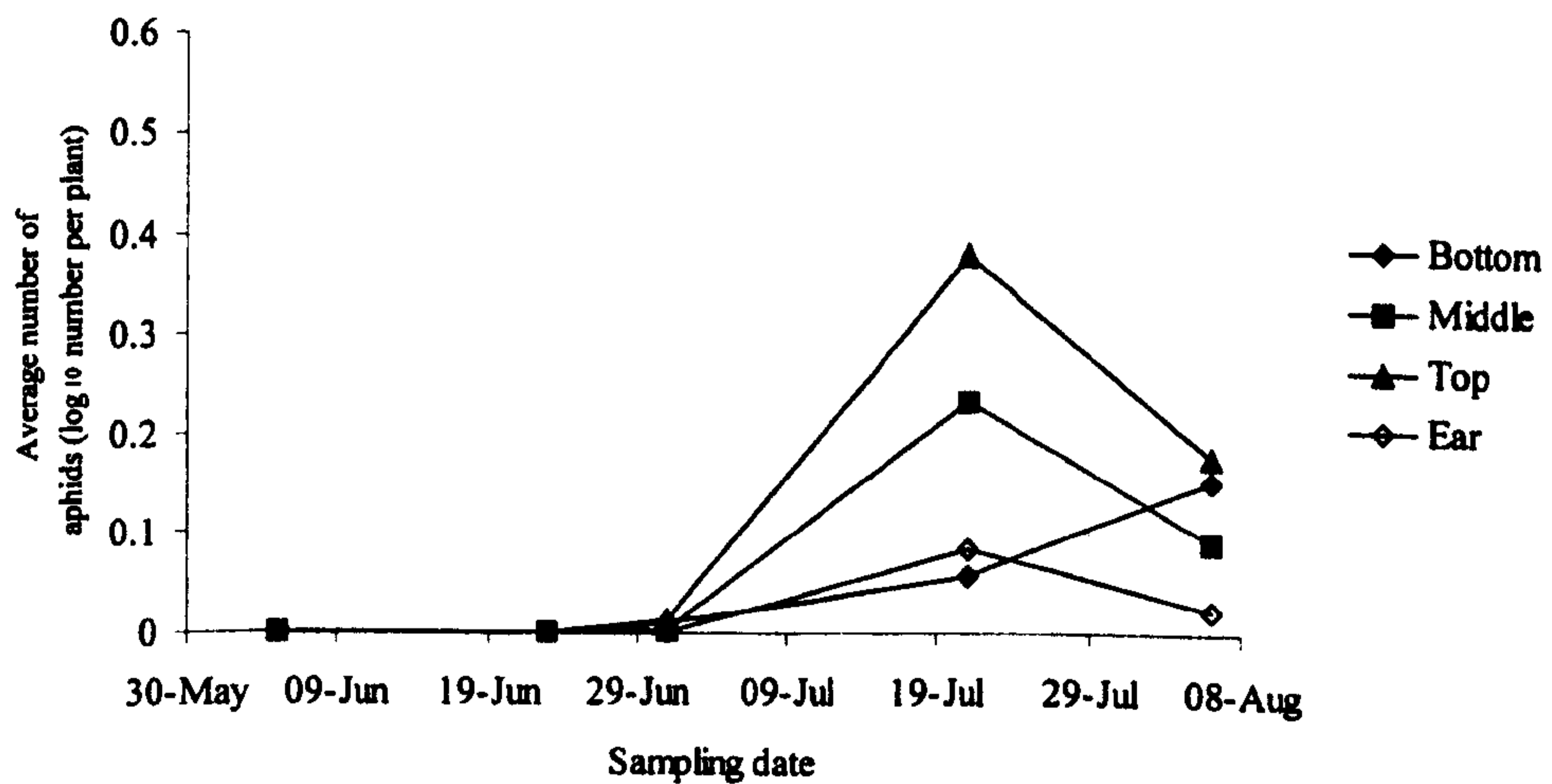
(a) healthy *S. avenae*



(b) healthy *M. dirhodum*



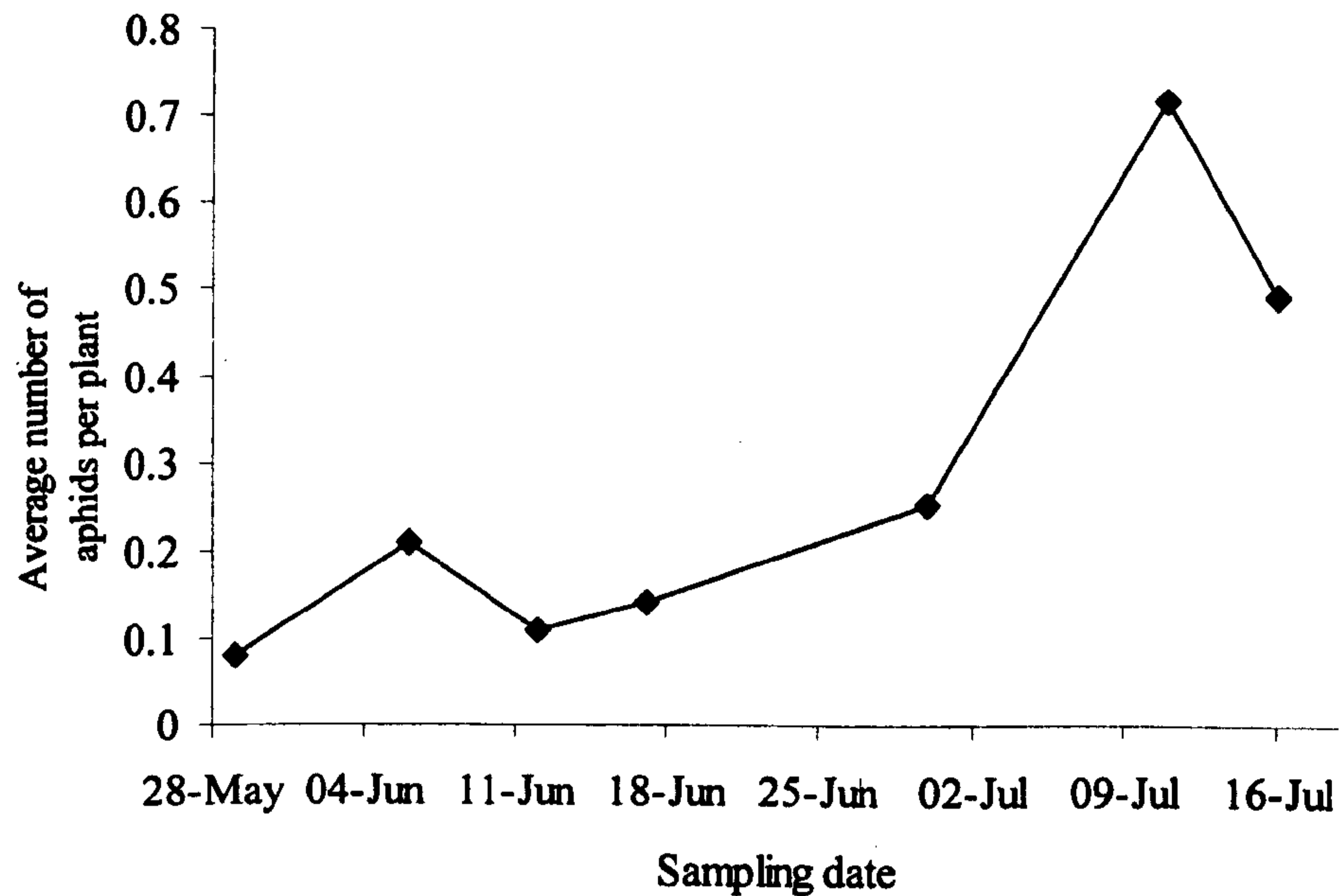
(c) aphids infected with *E. neoaphidis*



**FIGURE 7.12** : Distribution of (a) healthy *S. avenae*, (b) healthy *M. dirhodum*, and (c) aphids infected with *E. neoaphidis* at four positions on plants (ear, top, middle and bottom) in a spring wheat crop over the period 05/06/97 - 06/08/97.

### 7.3.1.2 Wheat 1998

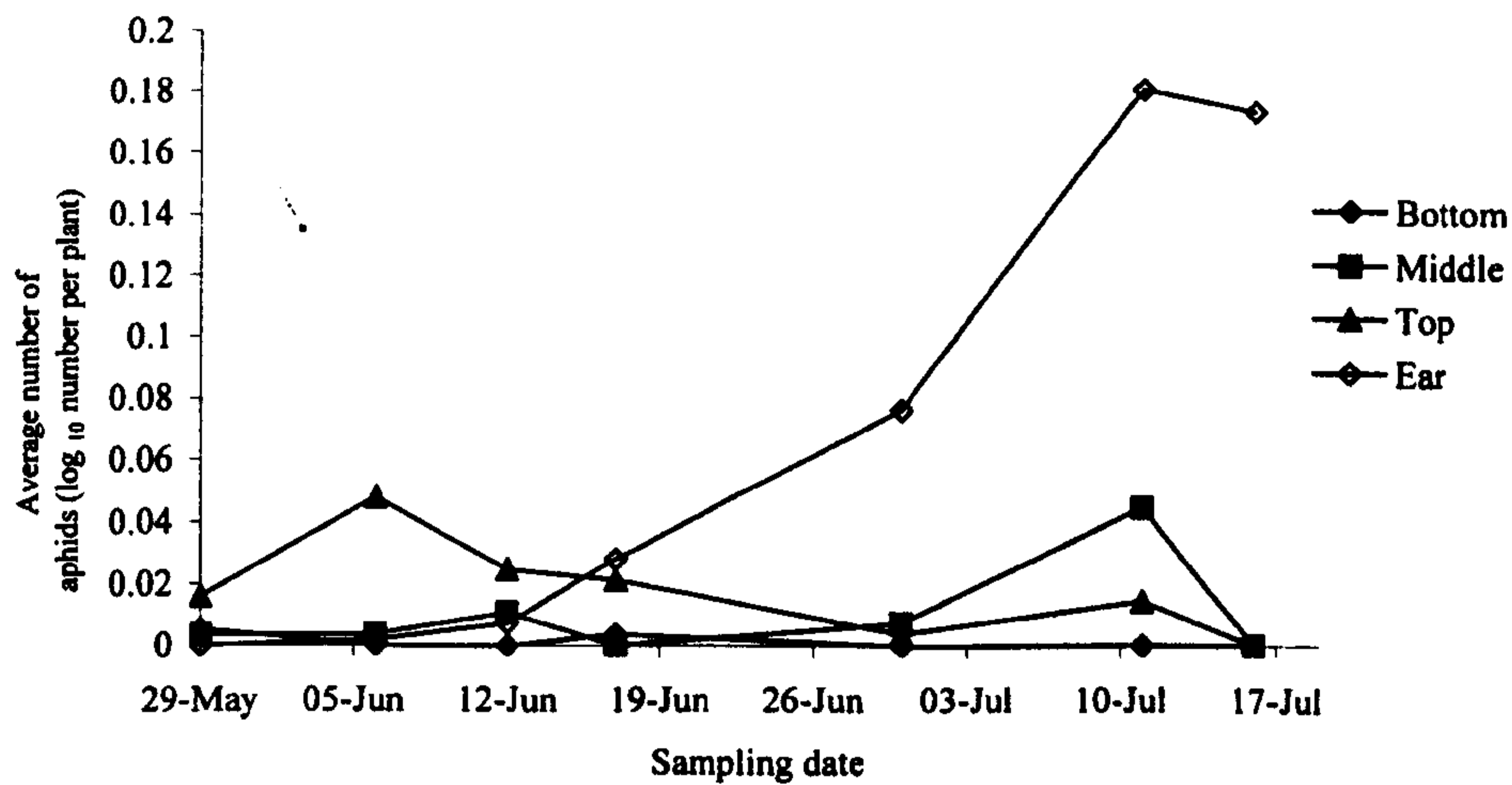
In 1998, the first aphids were recorded at approximately the same time as in 1997, i.e. at the end of May (Figure 7.13). Numbers increased slightly in late June and then started to decrease by the middle of July. The number of aphids recorded was much smaller than in 1997 and there were generally more aphids of *S. avenae* present than *M. dirhodum* (Appendix 7).



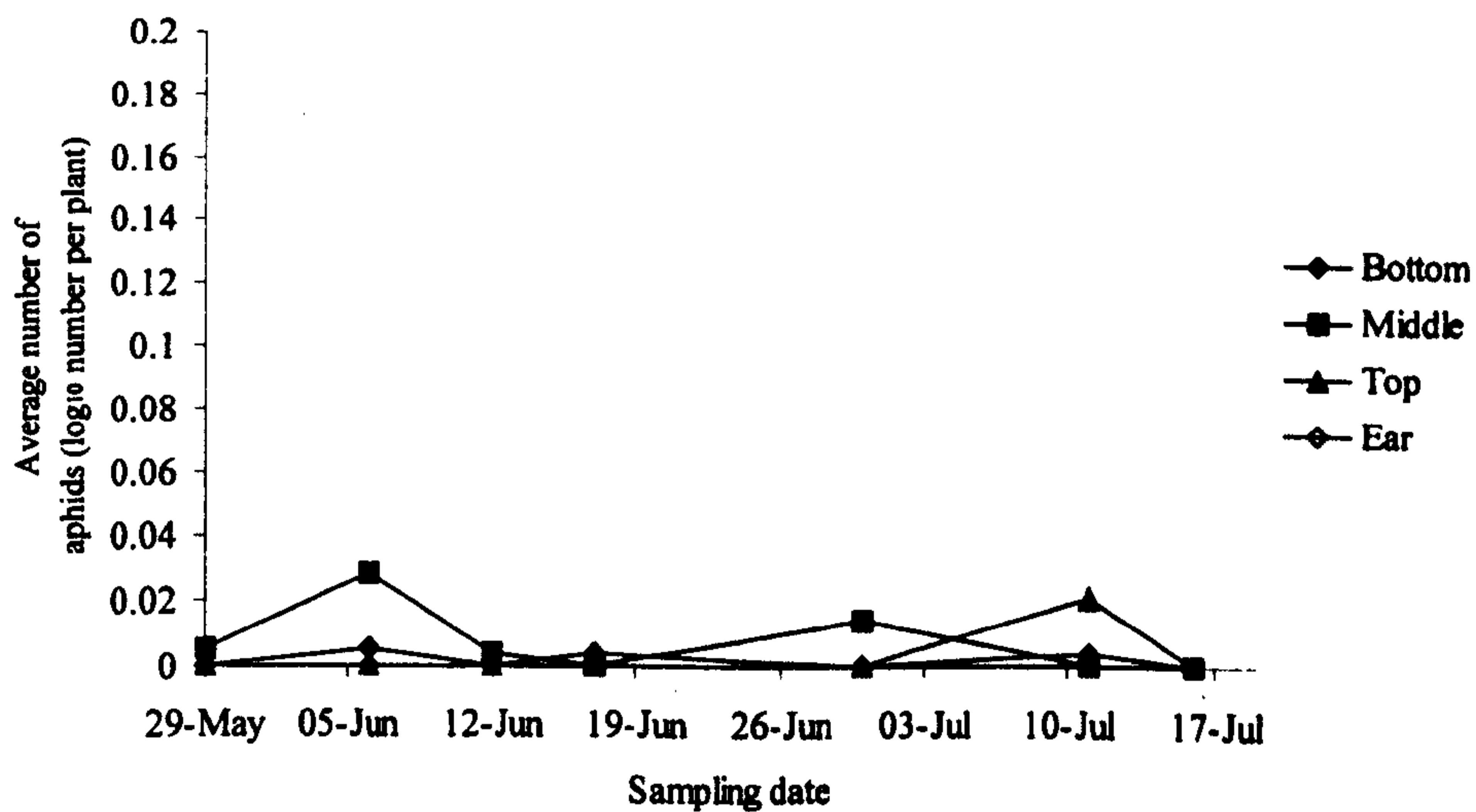
**FIGURE 7.13** : Average number of healthy aphids (all species combined) recorded per plant in a crop of spring wheat over the period 29/05/98 - 16/07/98.

Although there were smaller numbers of aphids recorded, the majority of *S. avenae* were found in the upper regions of the crop and aphids of *M. dirhodum* were found mostly in the middle of the crop (Figure 7.14).

(a) healthy *S. avenae*



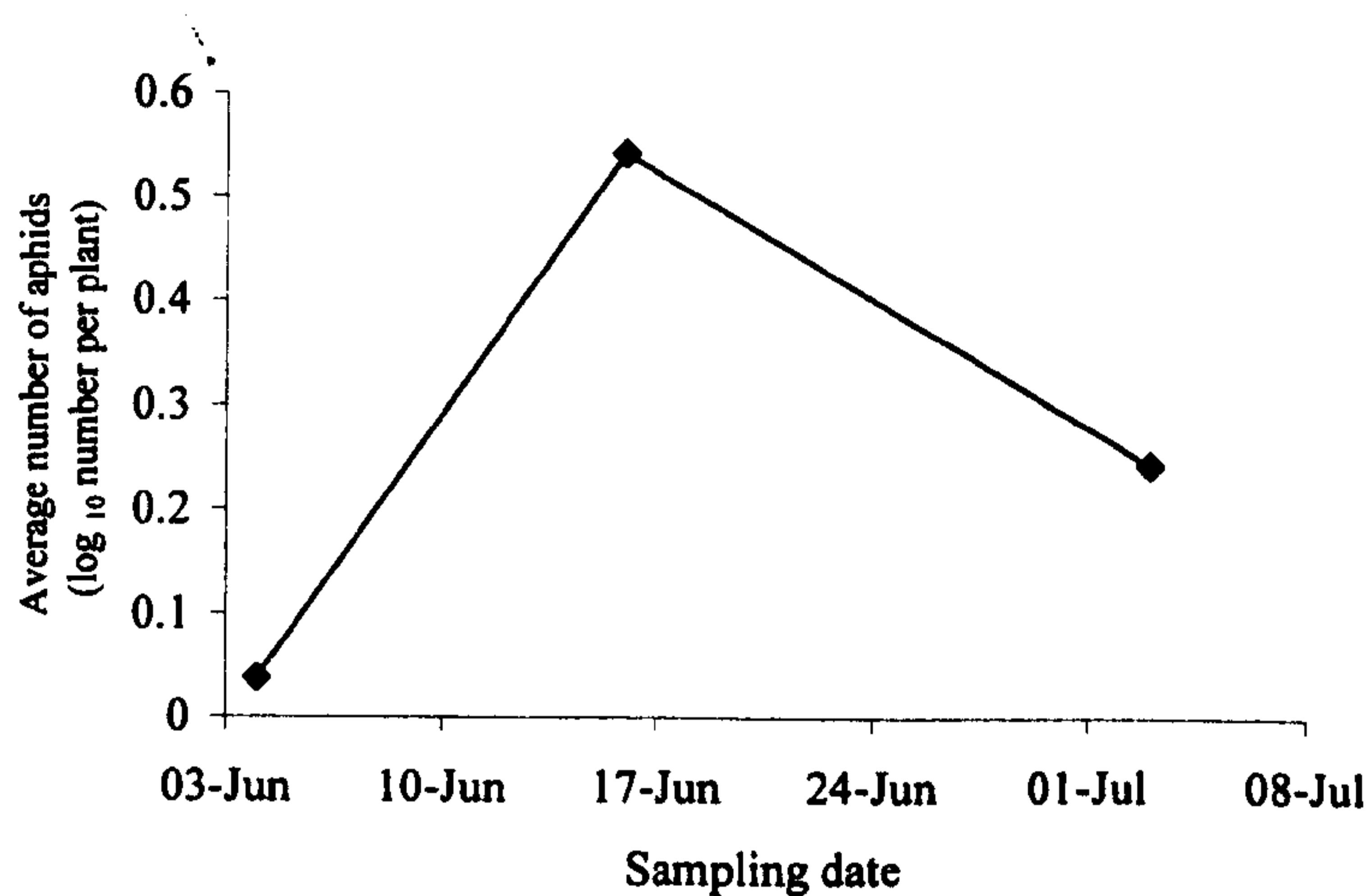
(b) healthy *M. dirhodum*



**FIGURE 7.14** : Distribution of (a) healthy *S. avenae* and (b) healthy *M. dirhodum* aphids at four positions on plants (ear, top, middle and bottom) in a spring wheat crop over the period 29/05/98 - 16/07/98.

### 7.3.1.3 Beans 1997

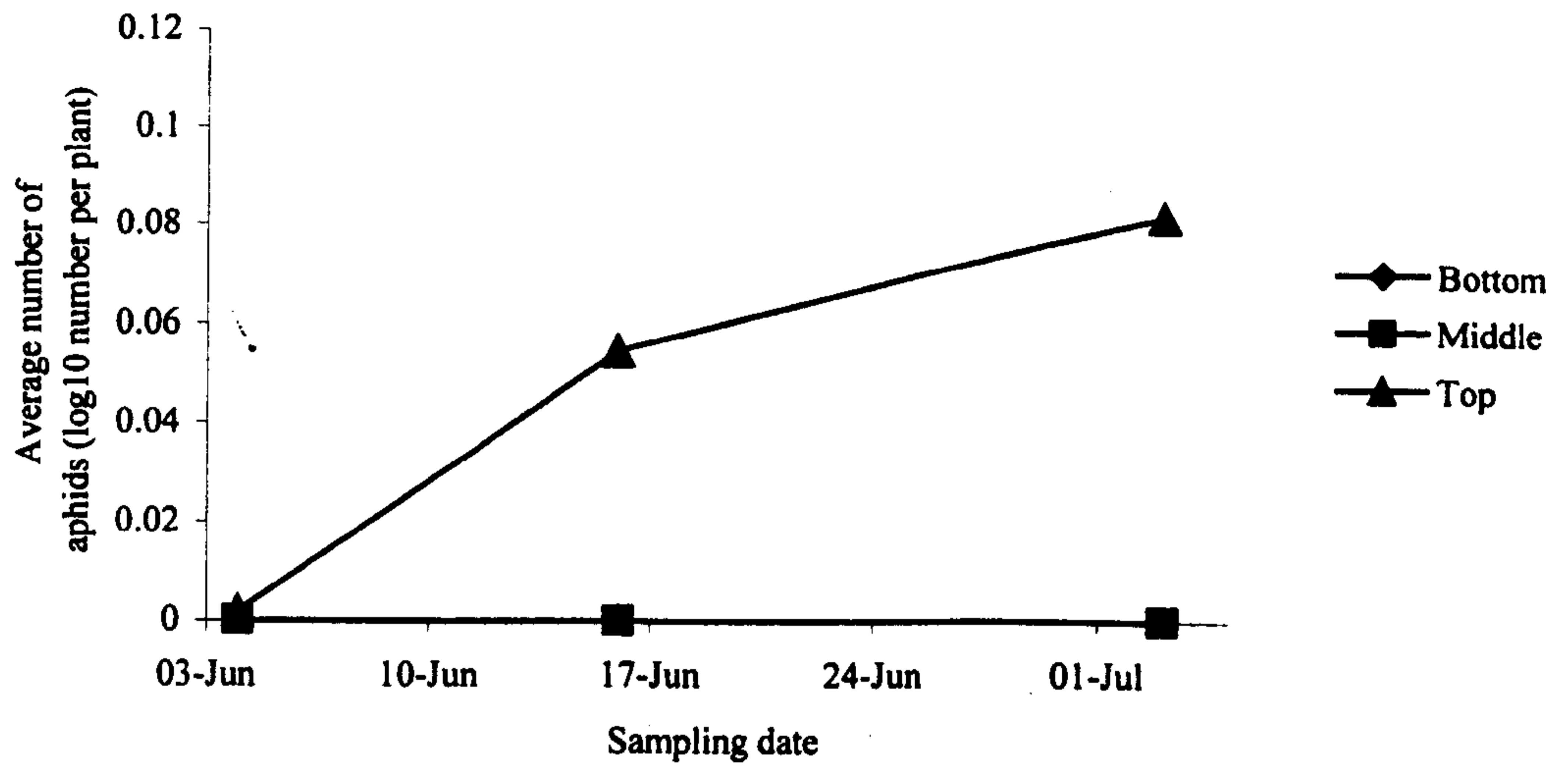
In 1997 there were very few aphids recorded in the bean crop (Figure 7.15). The first aphids were noted at the beginning of June with numbers peaking around the middle of June and then decreasing at the beginning of July. There were more individuals of *A. pisum* recorded than *A. fabae* (Appendix 8).



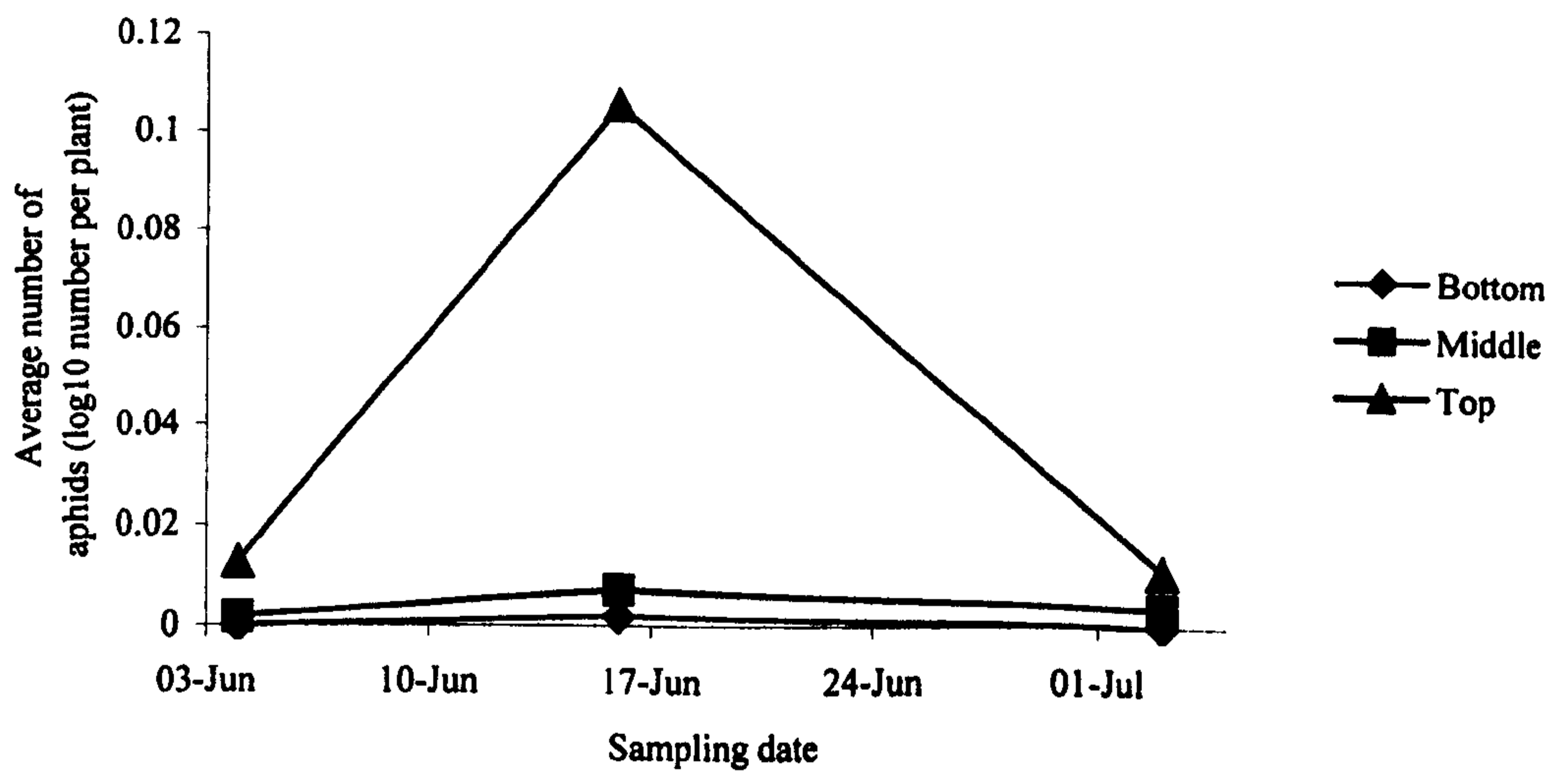
**FIGURE 7.15** : Average number of healthy aphids (all species combined) recorded per plant in a spring field bean crop over the period 04/06/97 - 03/07/97.

The majority of individuals of both species were recorded at the top of the plants with only a few *A. pisum* being recorded in the lower regions (Figure 7.16). Very few natural enemies were present in the crop and no *E. neoaphidis* was recorded.

(a) healthy *A. fabae*



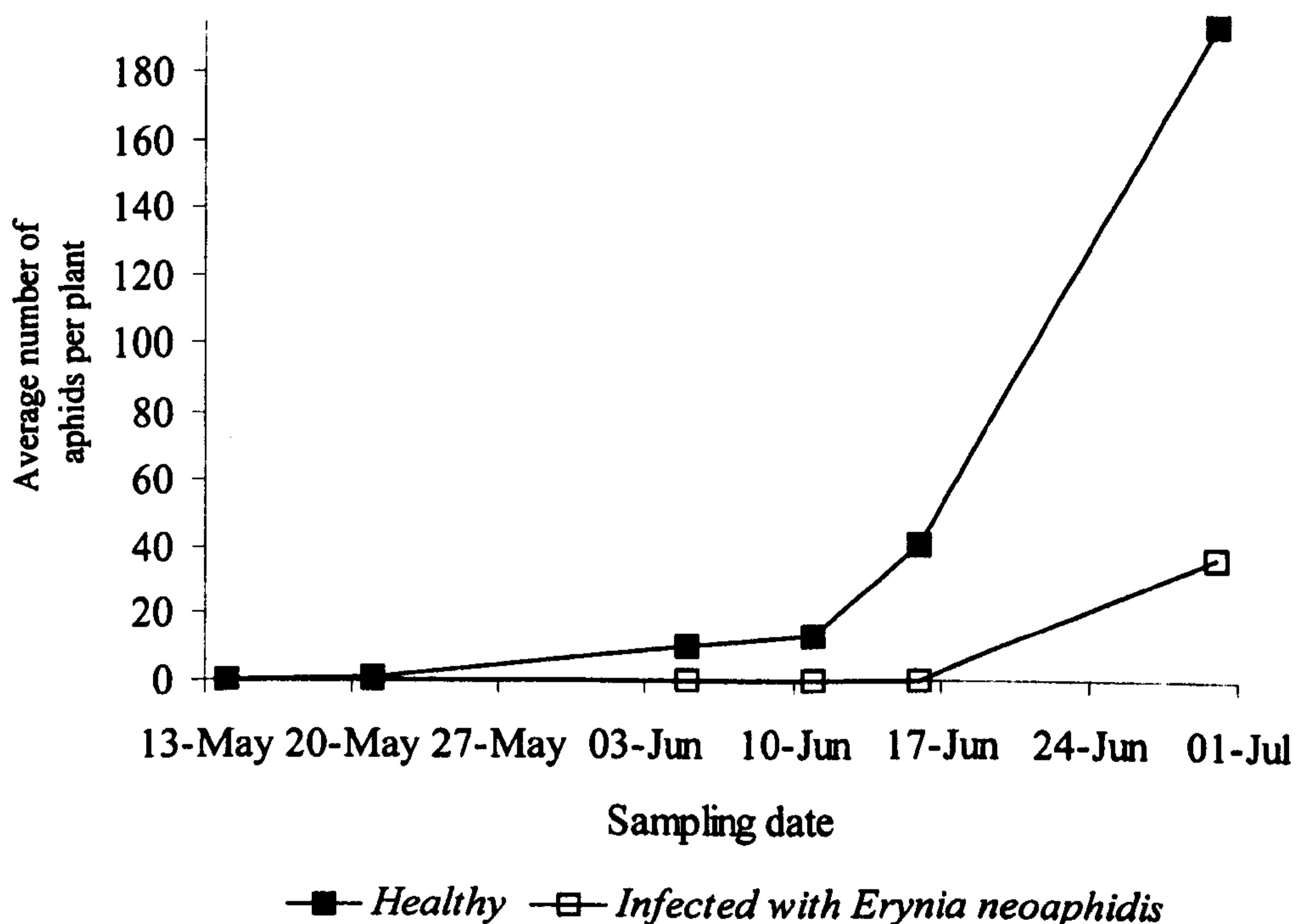
(b) healthy *A. pisum*



**FIGURE 7.16** : Distribution of (a) healthy *A. fabae* and (b) healthy *A. pisum* aphids at three positions on plants (top, middle and bottom) in a spring field bean crop over the period 04/06/97 - 03/07/97

### 7.3.1.4 Beans 1998

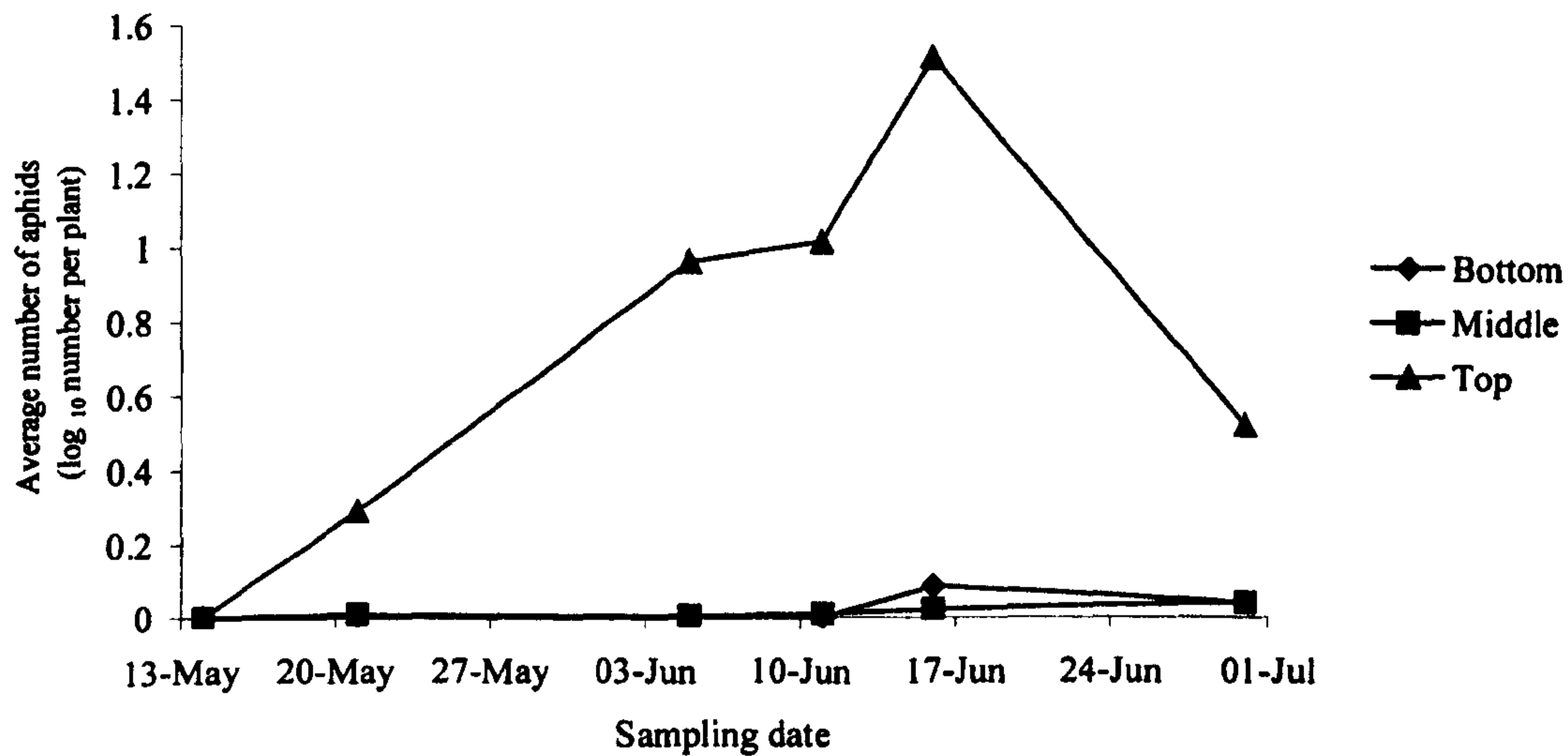
In 1998 there were a very large number of aphids recorded in the beans (Appendix 8). The first aphids were recorded in the middle of May with numbers increasing quickly around the middle of June (Figure 7.17). There were large numbers of *A. pisum* present compared to 1997 and very large numbers of *A. fabae* (Appendix 8). By the beginning of July, shortly after the last recording date, it was not possible to count individual aphids of *A. fabae* as colonies had become very dense, even causing the collapse of some plants within the the crop.



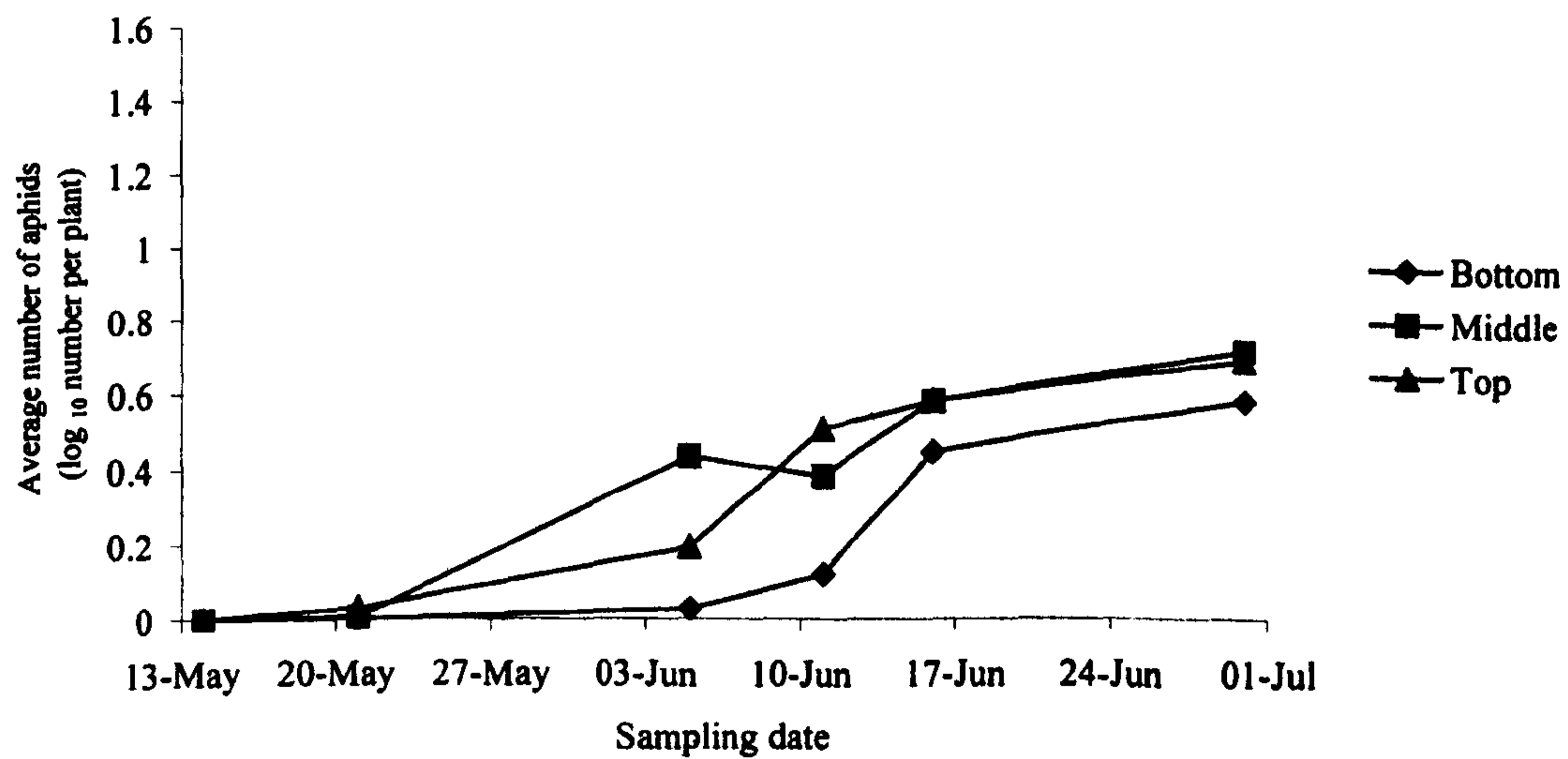
**FIGURE 7.17** : Average number of healthy aphids (all species combined) and aphids infected with *E. neoaphidis* recorded per plant in a spring field bean crop over the period 14/05/98 - 30/06/98

The largest number of *A. fabae* was recorded at the top of the crop throughout the season, but numbers also increased at the middle and bottom of the crop later in the season (Figure 7.18a). In comparison to 1997, *A. pisum* were found to be distributed evenly between the three regions of the plant and for several of the sampling dates, there were more individuals recorded in the middle of the crop than the top and bottom (Figure 7.18b).

(a) healthy *A. fabae*



(b) healthy *A. pisum*



**FIGURE 7.18** : Distribution of (a) healthy *A. fabae* and (b) healthy *A. pisum* aphids at three positions on plants (top, middle and bottom) in a spring field bean crop over the period 14/05/98 - 30/06/98



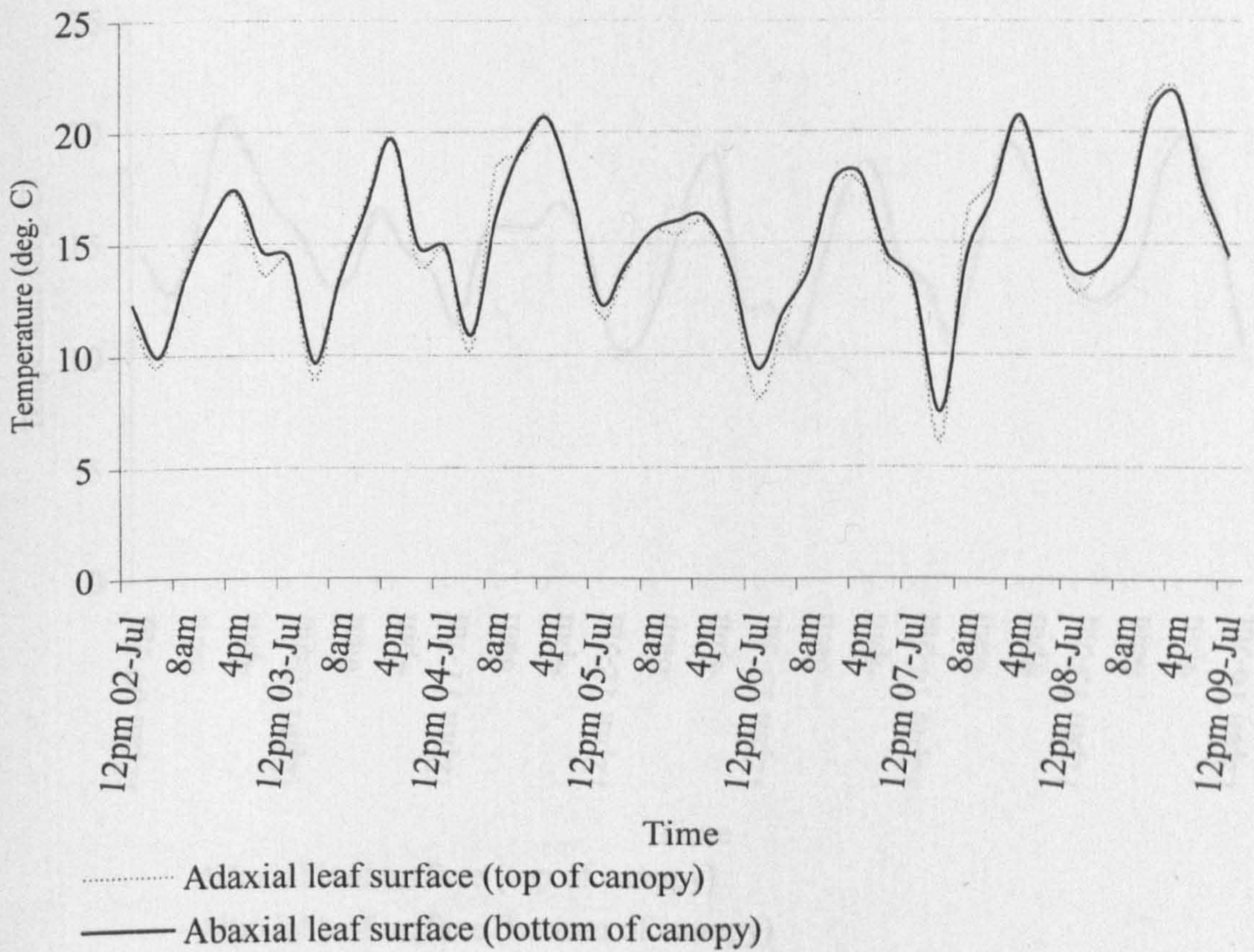
Aphids infected with *E. neoaphidis* were first noted in the middle of June and numbers of infected aphids rapidly increased over the following two week period (Appendix 8). Although formal recording ceased on 30/06/97, a large epizootic of *E. neoaphidis* had established and within two weeks, there were very few live aphids left in the crop.

### **7.3.2 Climate measurements**

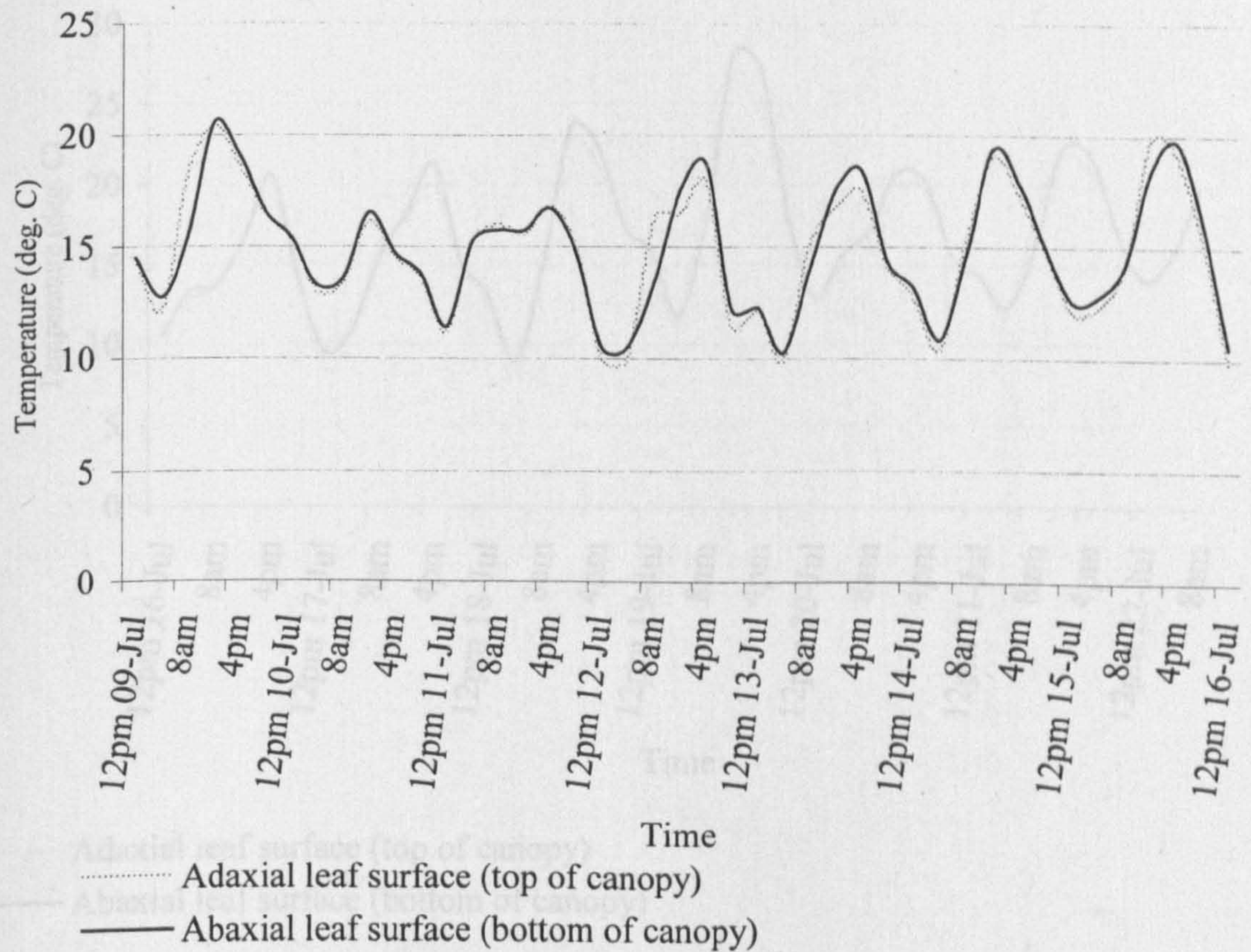
#### **7.3.2.1 Microclimate temperature**

There were only very small differences between the different temperature measurements made at the three positions within both of the crops. The biggest differences occurred between the adaxial leaf surfaces at the top of the canopy and the abaxial leaf surfaces at the bottom of the canopy for both crops (Figures 7.19 & 7.20). However, during the hottest and coolest times of the day, the differences could be as much as 2°C between these positions within the crop canopy. Generally, during daytime the highest temperatures were recorded for the upper surface of leaves at the top of the crop whilst, during the night, the lower surfaces at the bottom of the canopy were warmest.

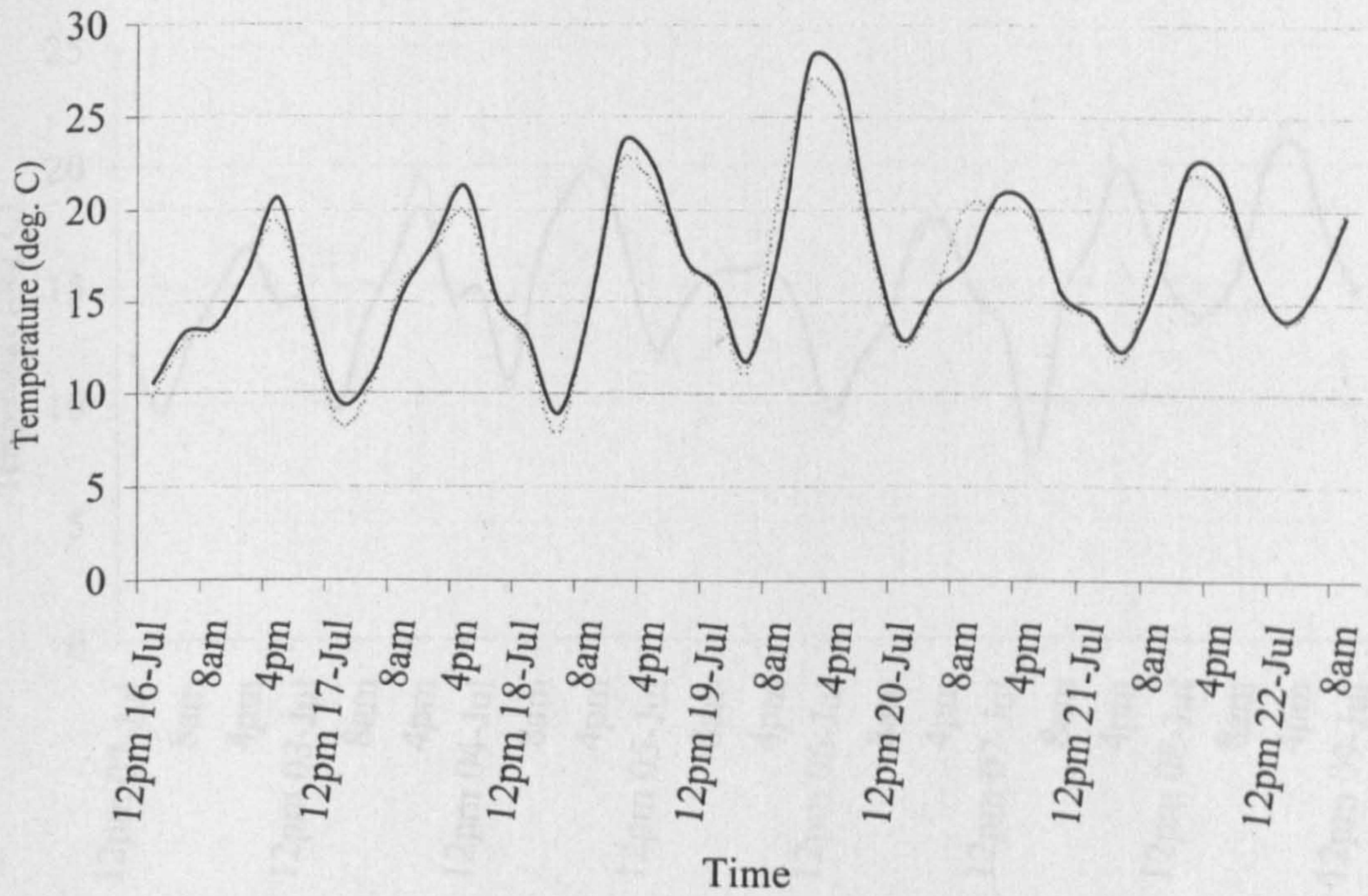
There were large differences in temperature between replicates at the different positions within the crop canopies with differences being in the region of 5 to 7°C for some recording periods. Higher temperatures were associated with leaves that were in direct sunlight whilst lower temperatures occurred when leaves were shaded, which often occurred in the lower parts of the canopy. The average temperature for the replicate thermocouples held at the top and middle of the crops gave a more accurate measurement of temperatures across a range of leaves at each height.



**FIGURE 7.19 (a) :** Average temperatures of the upper side of leaves at the top and the lower side of leaves at the bottom of a crop of spring wheat during the period 03/07/98 - 09/07/98

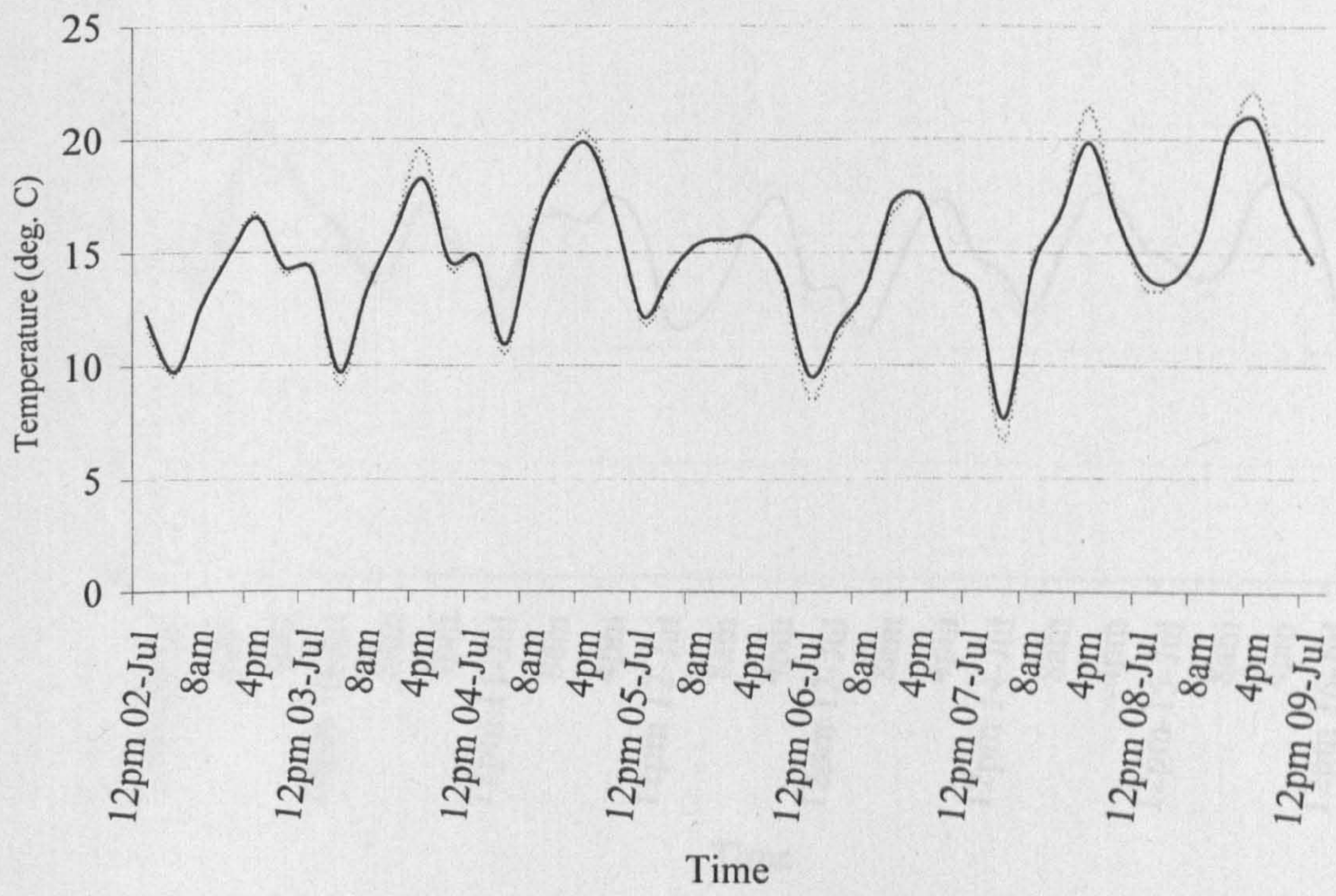


**FIGURE 7.19 (b) :** Average temperatures of the upper side of leaves at the top and the lower side of leaves at the bottom of a crop of spring wheat during the period 10/07/98 - 16/07/98



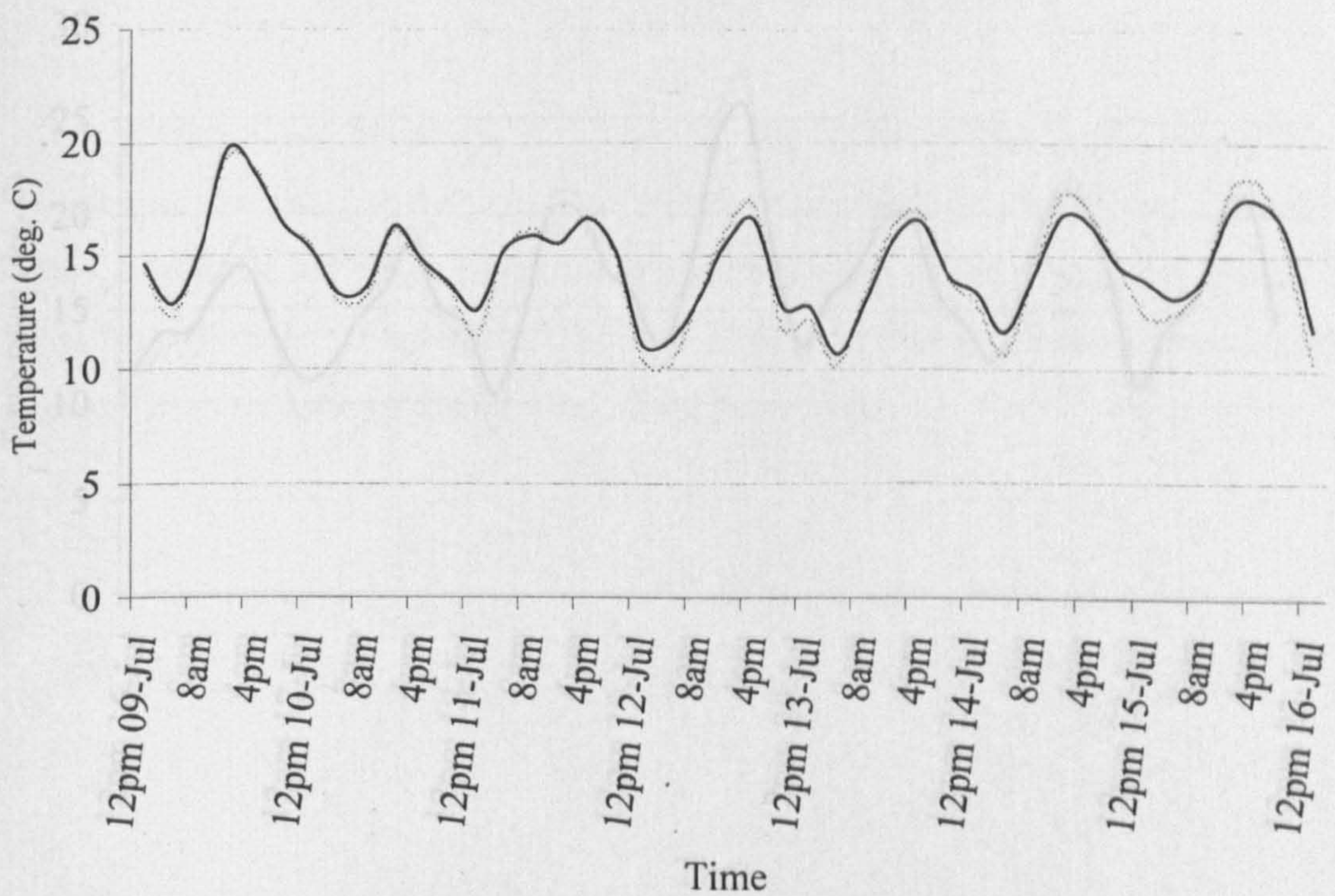
..... Adaxial leaf surface (top of canopy)  
 — Abaxial leaf surface (bottom of canopy)

**FIGURE 7.19 (c) :** Average temperatures of the upper side of leaves at the top and the lower side of leaves at the bottom of a crop of spring wheat during the period 17/07/98 - 22/07/98



..... Adaxial leaf surface (top of canopy)  
 — Abaxial leaf surface (bottom of canopy)

**FIGURE 7.20 (a) :** Average temperatures of the upper side of leaves at the top and the lower side of leaves at the bottom of a crop of spring field bean during the period 03/07/98 - 09/07/98.

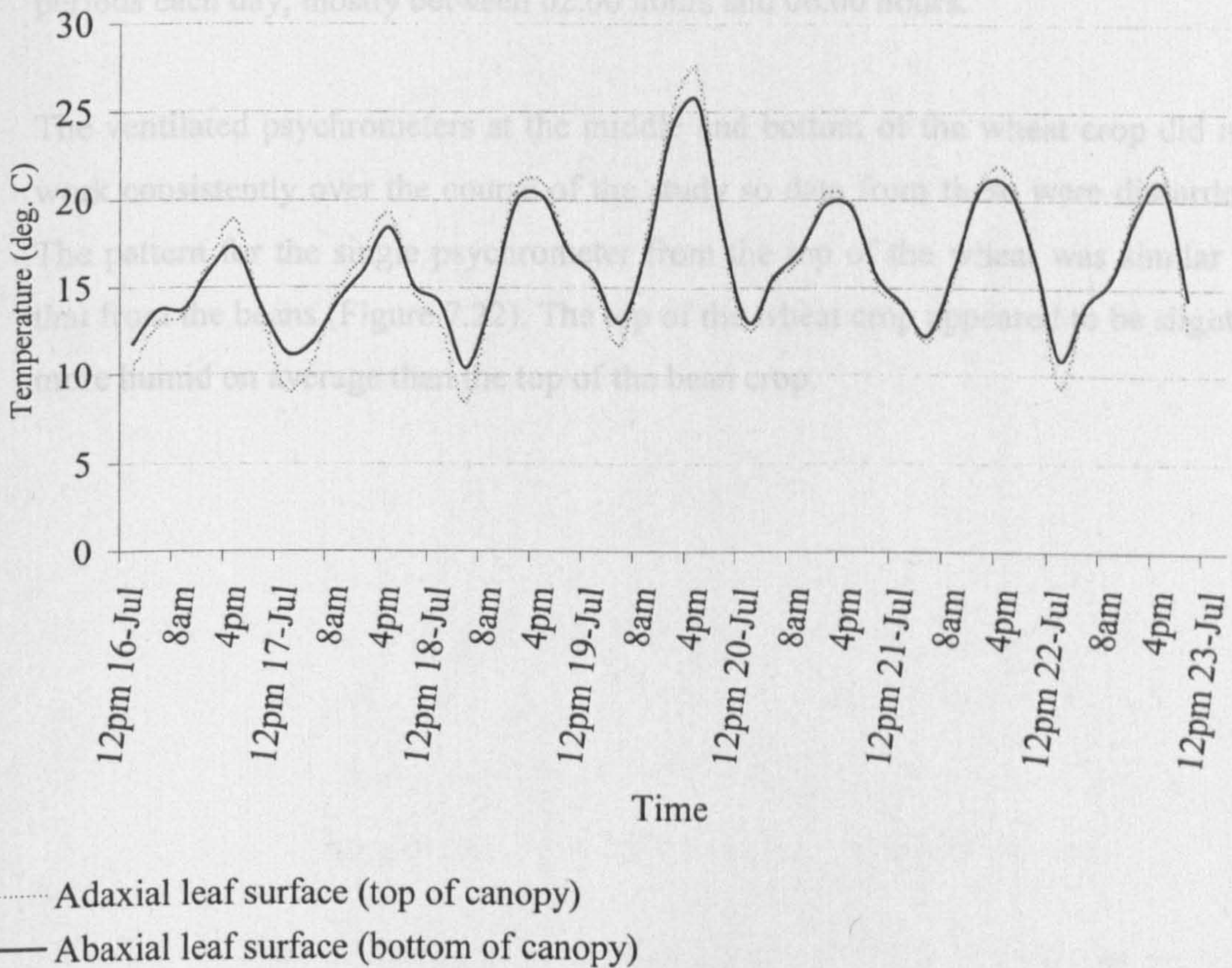


..... Adaxial leaf surface (top of canopy)  
 — Abaxial leaf surface (bottom of canopy)

**FIGURE 7.20 (b) :** Average temperatures of the upper side of leaves at the top and the lower side of leaves at the bottom of a crop of spring field bean during the period 10/07/98 - 16/07/98.

### 7.3.2.2 Microclimate humidity

Data for the three psychrometers in the bean crop indicated that humidity was consistently higher at the bottom of the crop than at the top of the crop (Figure 7.21a,b,c). From midday to early afternoon, there was as much as 15% difference between the humidity at the bottom and the top of the canopy, with humidity consistently lower at the top of the canopy. The highest humidity was generally recorded between midnight and 05.00 hours; but only exceeded 90% RH for short periods each day, mostly between 02.00 hours and 06.00 hours.



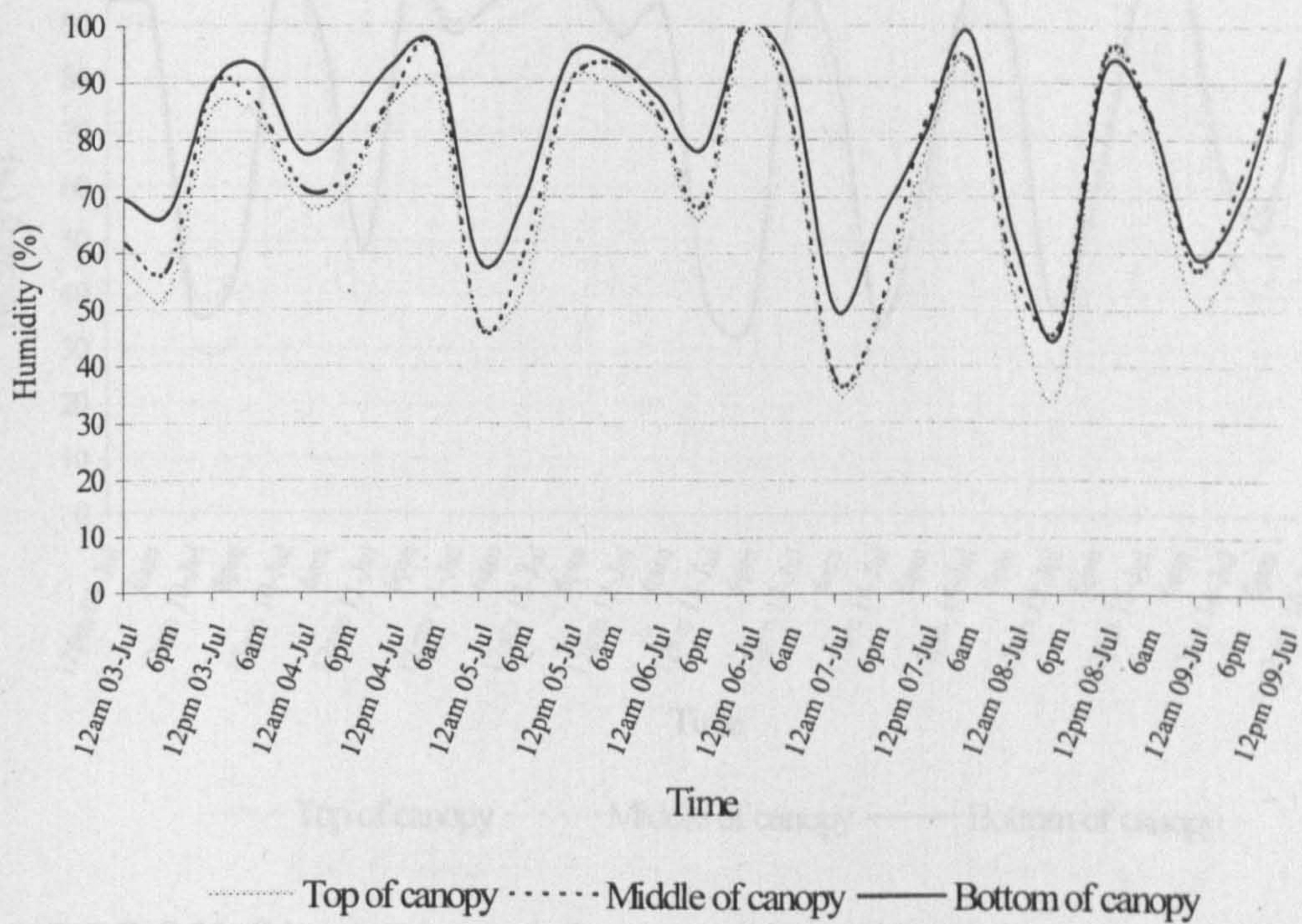
**FIGURE 7.20 (c) :** Average temperatures of the upper side of leaves at the top and the lower side of leaves at the bottom of a crop of spring field bean during the period 17/07/98 - 23/07/98.

### *7.3.2.2 Microclimate humidity*

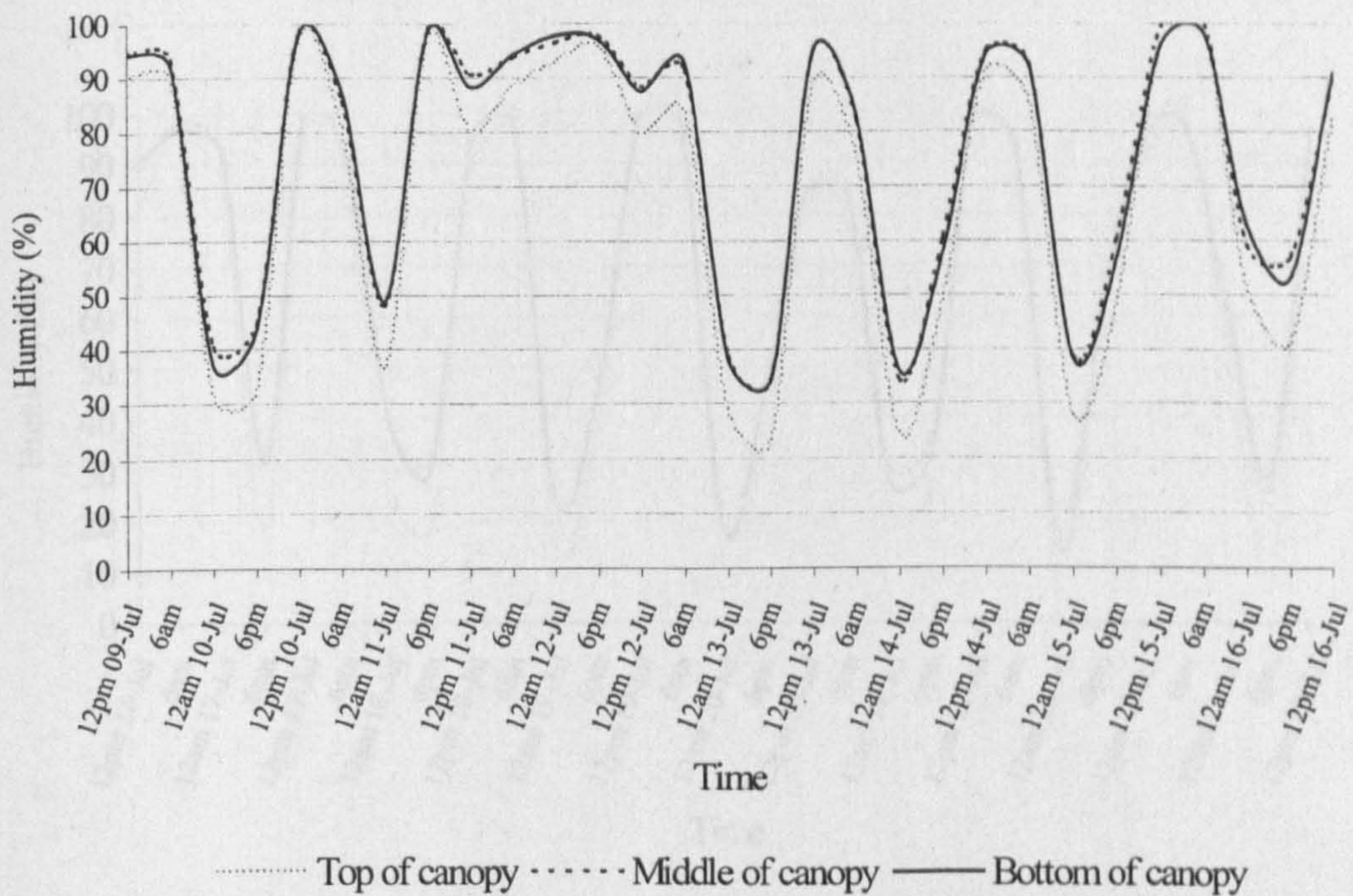
Data for the three psychrometers in the bean crop indicated that humidity was consistently higher at the bottom of the crop than at the top of the crop (Figure 7.21a,b,c). From midday to early afternoon, there was as much as 15% difference between the humidity at the bottom and the top of the canopy, with humidity consistently lower at the top of the canopy. The highest humidity was generally recorded between midnight and 05.00 hours, but only exceeded 90% RH for short periods each day, mostly between 02.00 hours and 06.00 hours.

The ventilated psychrometers at the middle and bottom of the wheat crop did not work consistently over the course of the study so data from these were discarded. The pattern for the single psychrometer from the top of the wheat was similar to that from the beans (Figure 7.22). The top of the wheat crop appeared to be slightly more humid on average than the top of the bean crop.



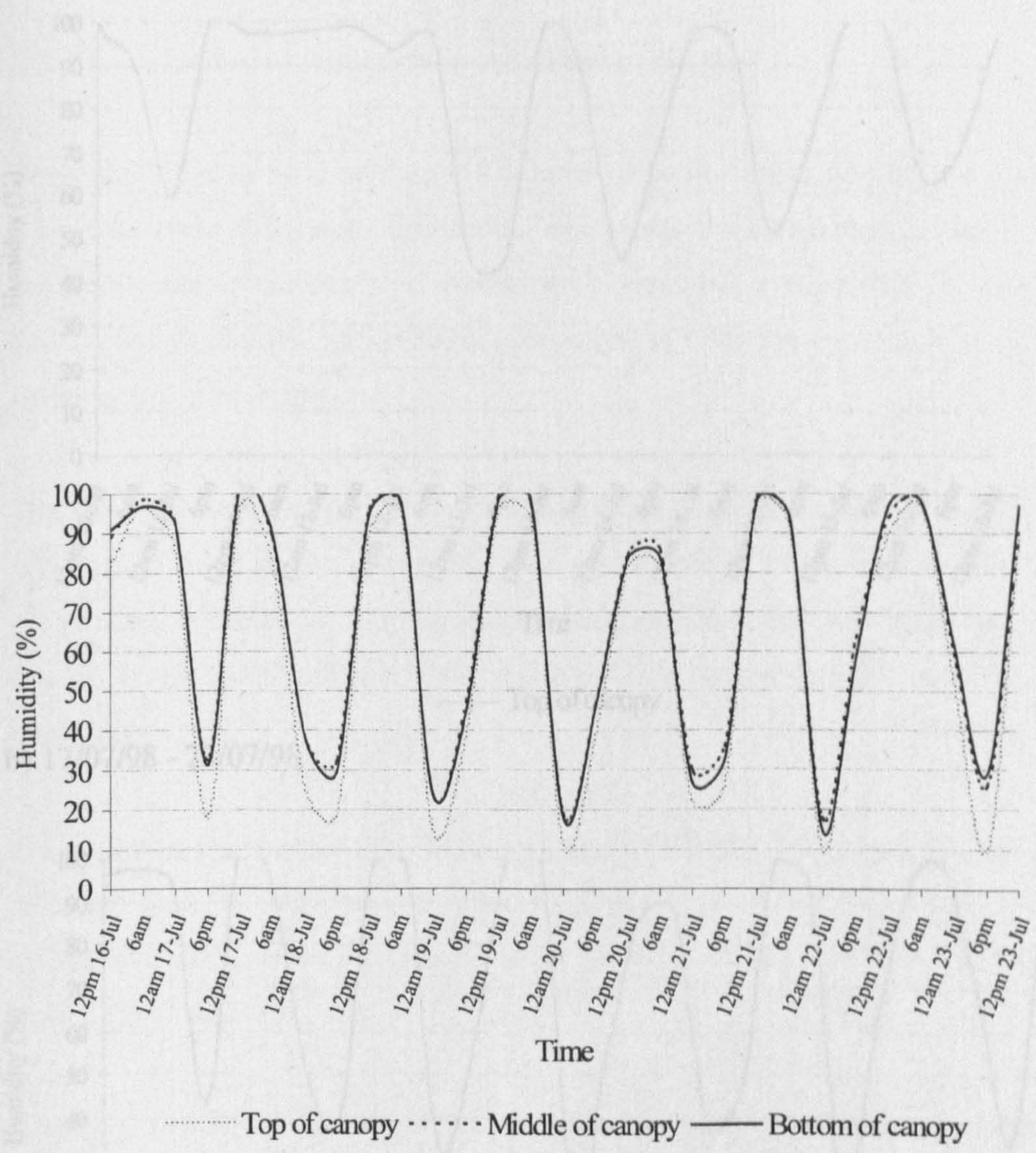


**FIGURE 7.21 (a) :** Average relative humidity calculated from wet and dry bulb temperature recordings from three ventilated psychrometers positioned at the top, middle and bottom of a crop of spring field beans during the periods 03/07/98 - 09/07/98.



**FIGURE 7.21 (b) :** Average relative humidity calculated from wet and dry bulb temperature recordings from three ventilated psychrometers positioned at the top, middle and bottom of a crop of spring field beans during the periods 10/07/98 - 16/07/98.

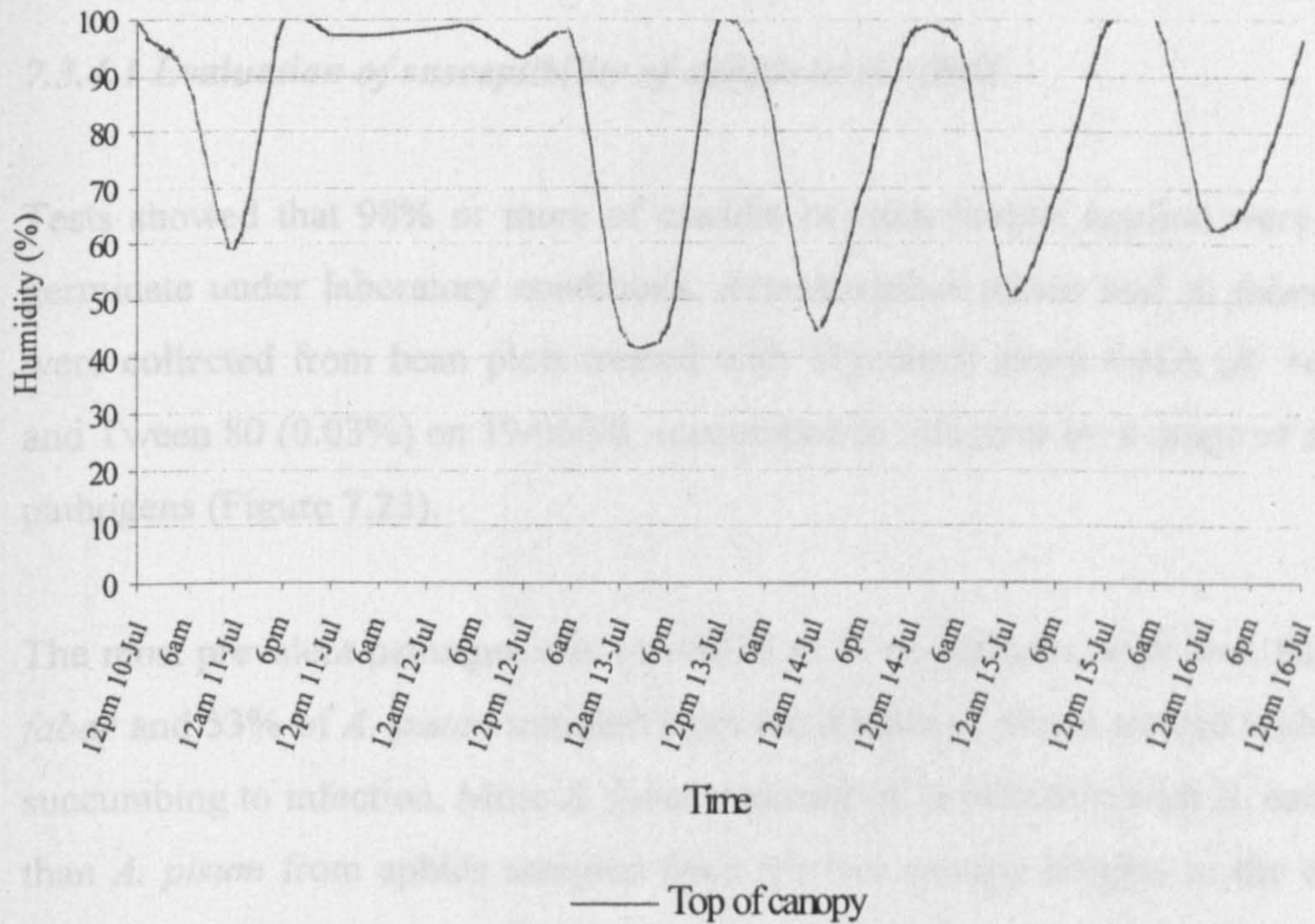
a) 17/07/98 - 16/07/98



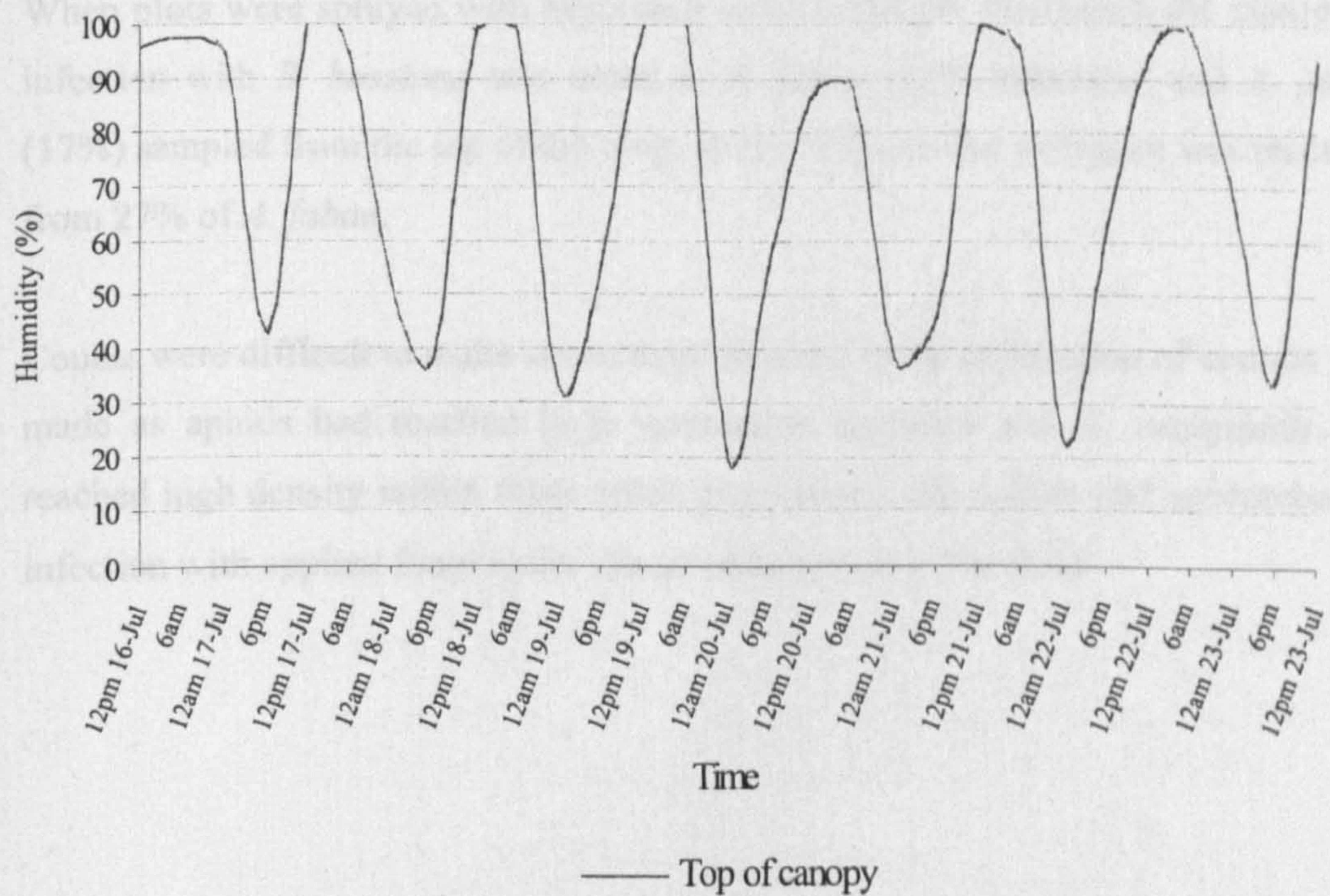
**FIGURE 7.21 (c) :** Average relative humidity calculated from wet and dry bulb temperature recordings from three ventilated psychrometers positioned at the top, middle and bottom of a crop of spring field beans during the periods 17/07/98 - 23/07/98.

**FIGURE 7.22 :** Average relative humidity calculated from wet and dry bulb temperature recordings from a single ventilated psychrometer positioned at the top of a crop of spring wheat during the period a) 15/07/98 - 16/07/98 and b) 17/07/98 - 23/07/98.

a) 10/07/98 - 16/07/98



b) 17/07/98 - 23/07/98



**FIGURE 7.22** : Average relative humidity calculated from wet and dry bulb temperature recordings from a single ventilated psychrometer positioned at the top of a crop of spring wheat during the period a) 10/07/98 - 16/07/98 and b) 17/07/98 - 23/07/98.

### 7.3.4 Aphid bioassays

#### 7.3.4.1 Evaluation of susceptibility of aphids in the field

Tests showed that 98% or more of conidia of each fungus applied were able to germinate under laboratory conditions. *Acyrtosiphon pisum* and *A. fabae* which were collected from bean plots treated with Mycotech strain GHA (*B. bassiana*) and Tween 80 (0.03%) on 19/06/98, succumbed to infection by a range of different pathogens (Figure 7.23).

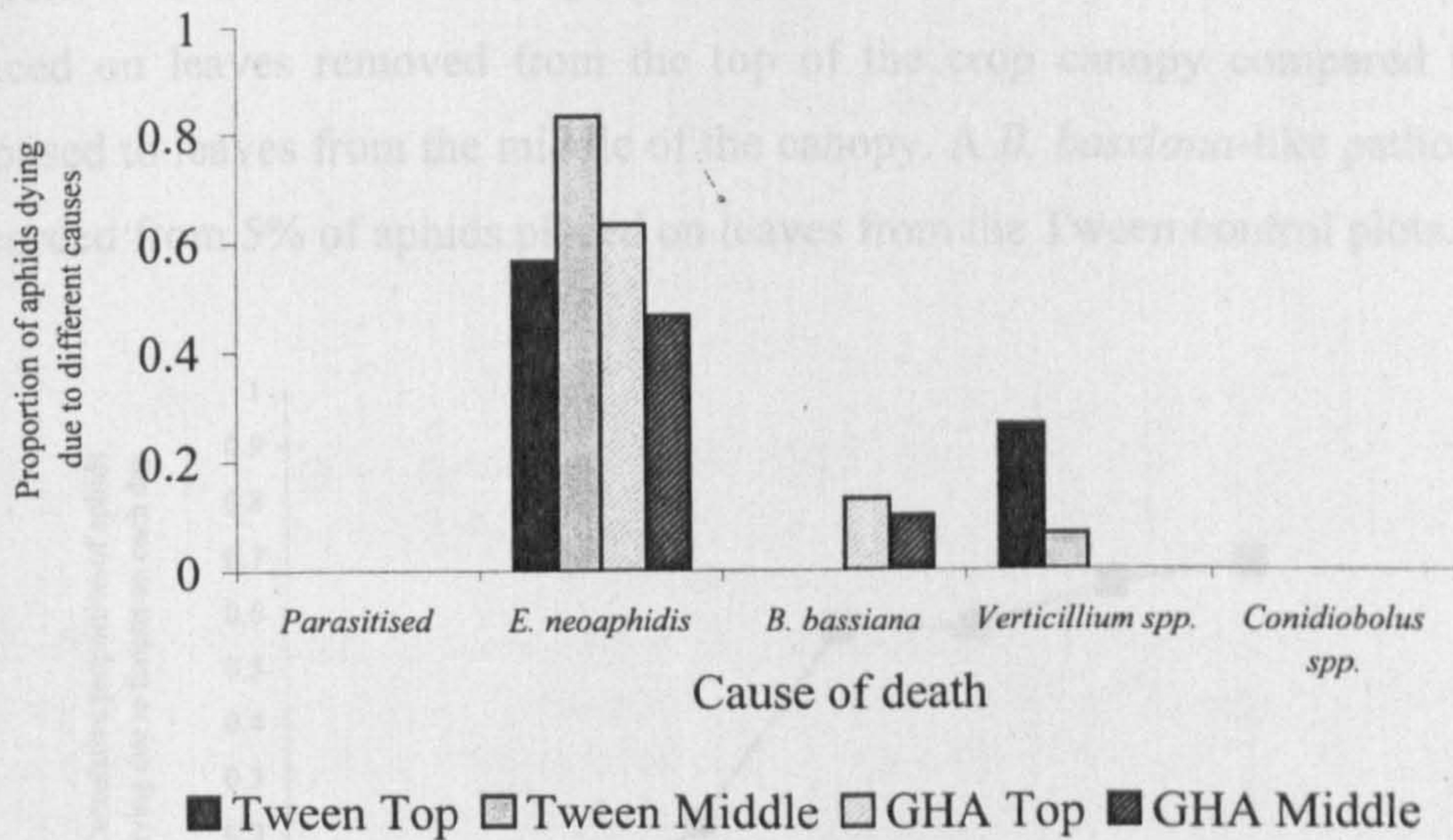
The most prevalent pathogen was identified as *E. neoaphidis*, with over 83% of *A. fabae* and 53% of *A. pisum* sampled from the middle of plants treated with Tween succumbing to infection. More *A. fabae* succumbed to infection with *E. neoaphidis* than *A. pisum* from aphids sampled from the two canopy heights in the different treatments.

When plots were sprayed with Mycotech strain GHA (*B. bassiana*), the maximum infection with *B. bassiana* was noted in *A. fabae* (13% infection) and *A. pisum* (17%) sampled from the top of the crop. A *Verticillium*-like pathogen was recorded from 27% of *A. fabae*.

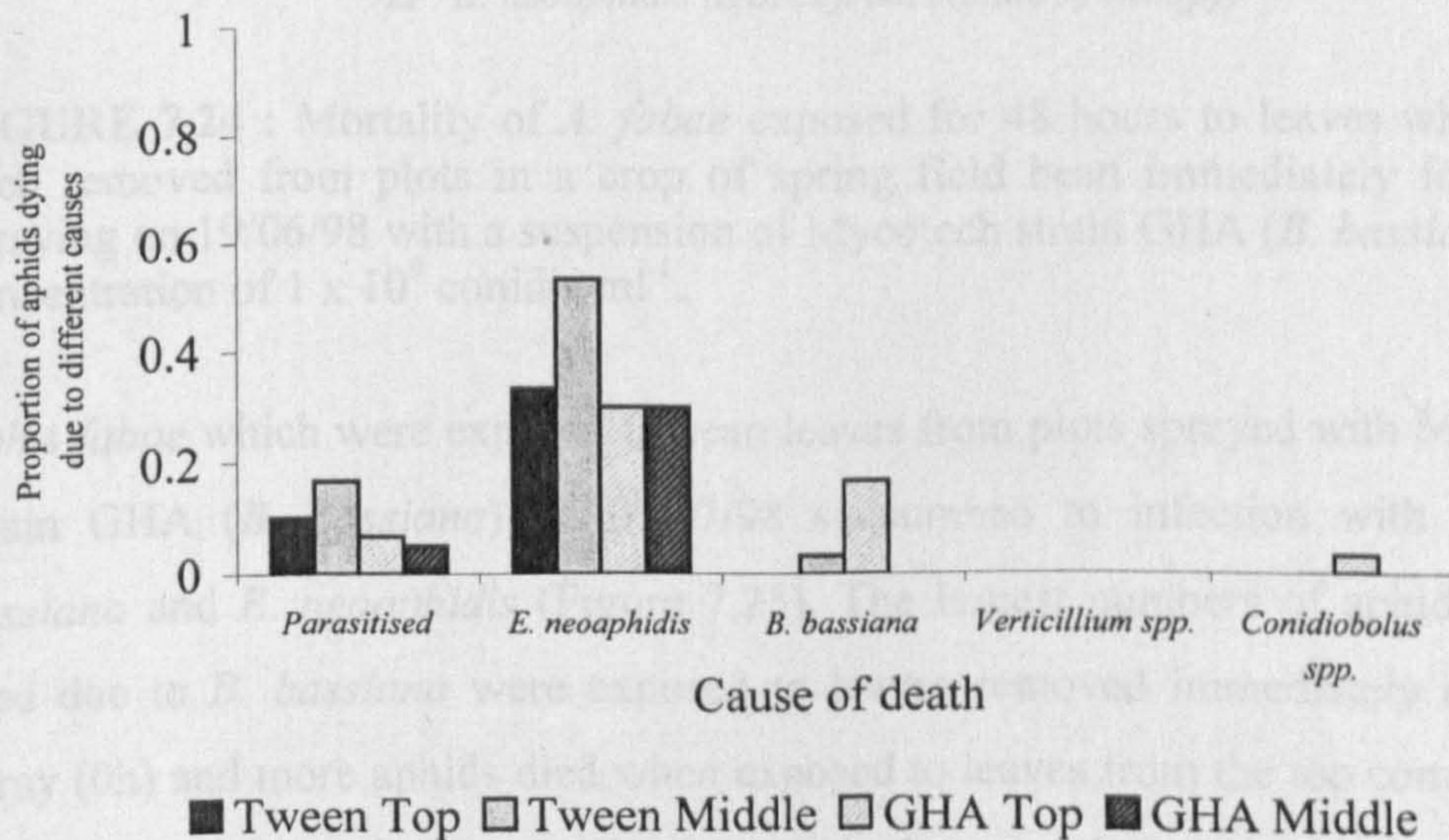
Counts were difficult to make seven days after the spray application of conidia was made as aphids had reached large population densities and *E. neoaphidis* had reached high density within those aphid populations. No aphids had succumbed to infection with applied fungi under casual observation in the field.

7.3.4.2 Evaluation of persistence on leaves

(a) *A. fabae*



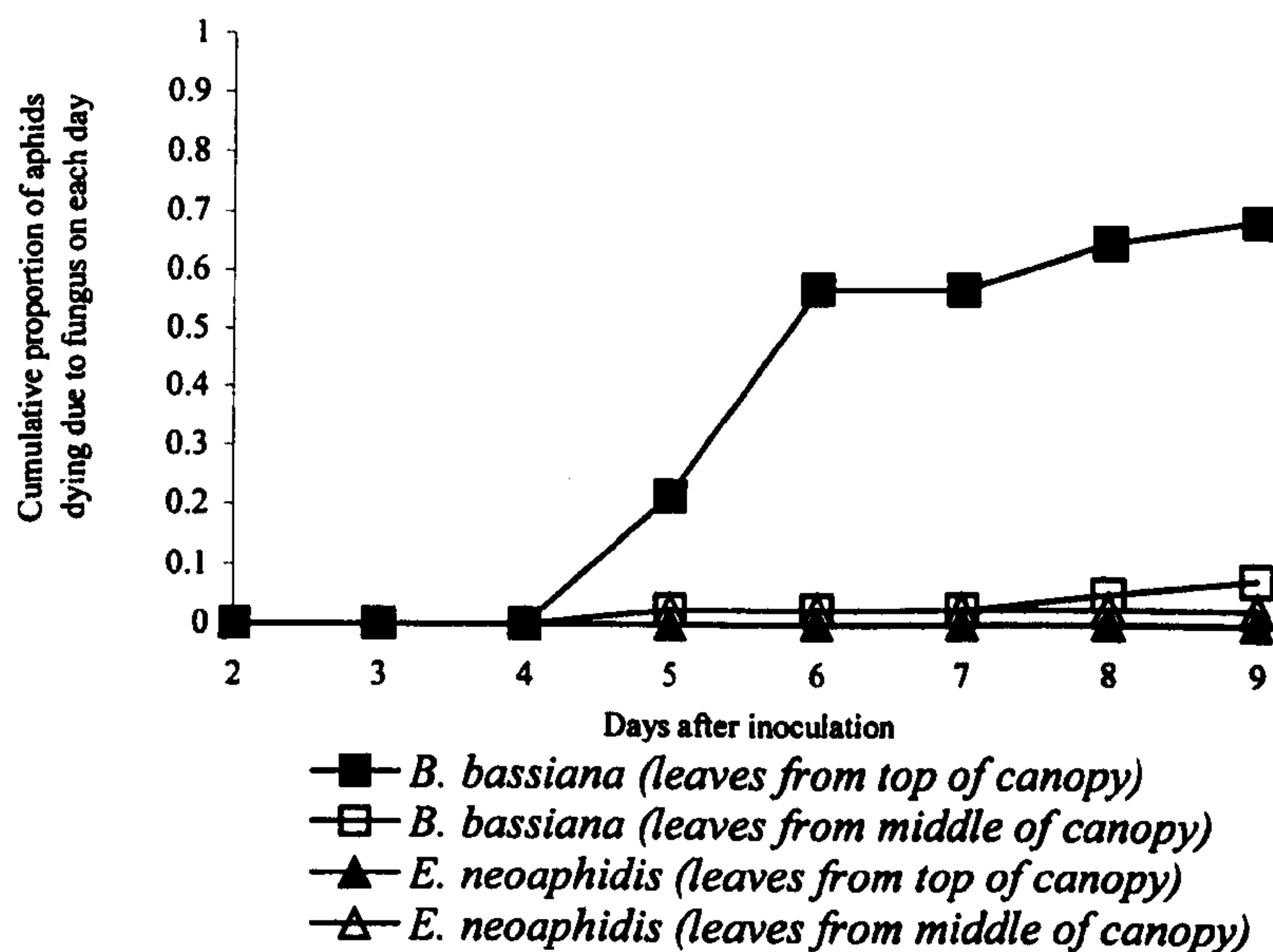
(b) *A. pisum*



**FIGURE 7.23 :** Mortality of (a) *A. fabae* and (b) *A. pisum* aphids sampled from plots in a crop of spring field bean sprayed with suspensions of conidia of isolates Mycotech strain GHA (*B. bassiana*) and HRI 1.72 (*V. lecanii*) at a concentration of  $1 \times 10^9$  conidia  $ml^{-1}$ .

### 7.3.4.2 Evaluation of persistence on leaves

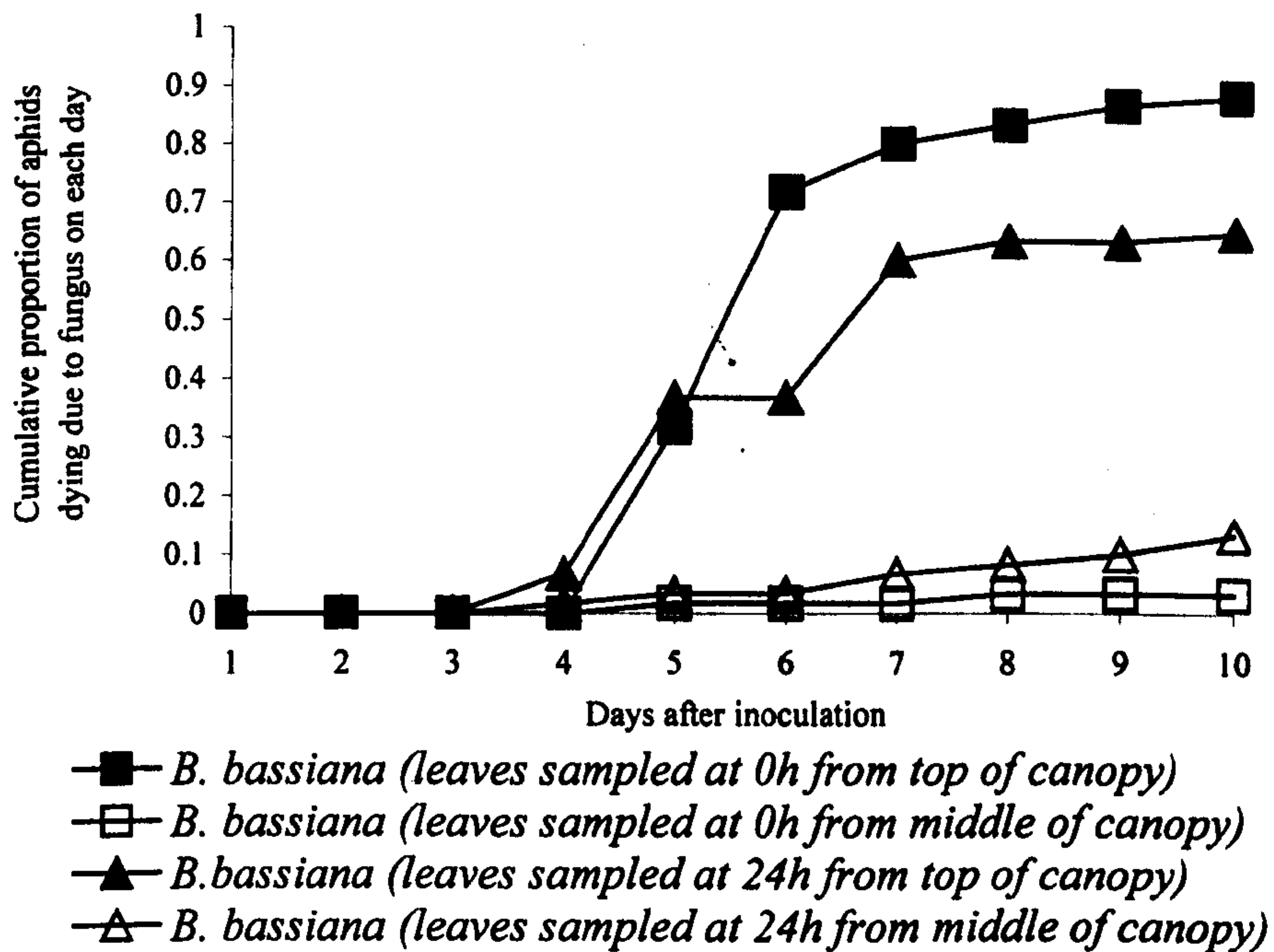
*Aphis fabae* which were exposed to bean leaves sampled immediately from plots sprayed with Mycotech strain GHA (*B. bassiana*) on 19/06/98 succumbed to infection with *B. bassiana* (Figure 7.24). More aphids died of *B. bassiana* when placed on leaves removed from the top of the crop canopy compared to those exposed to leaves from the middle of the canopy. A *B. bassiana*-like pathogen was recorded from 5% of aphids placed on leaves from the Tween control plots.



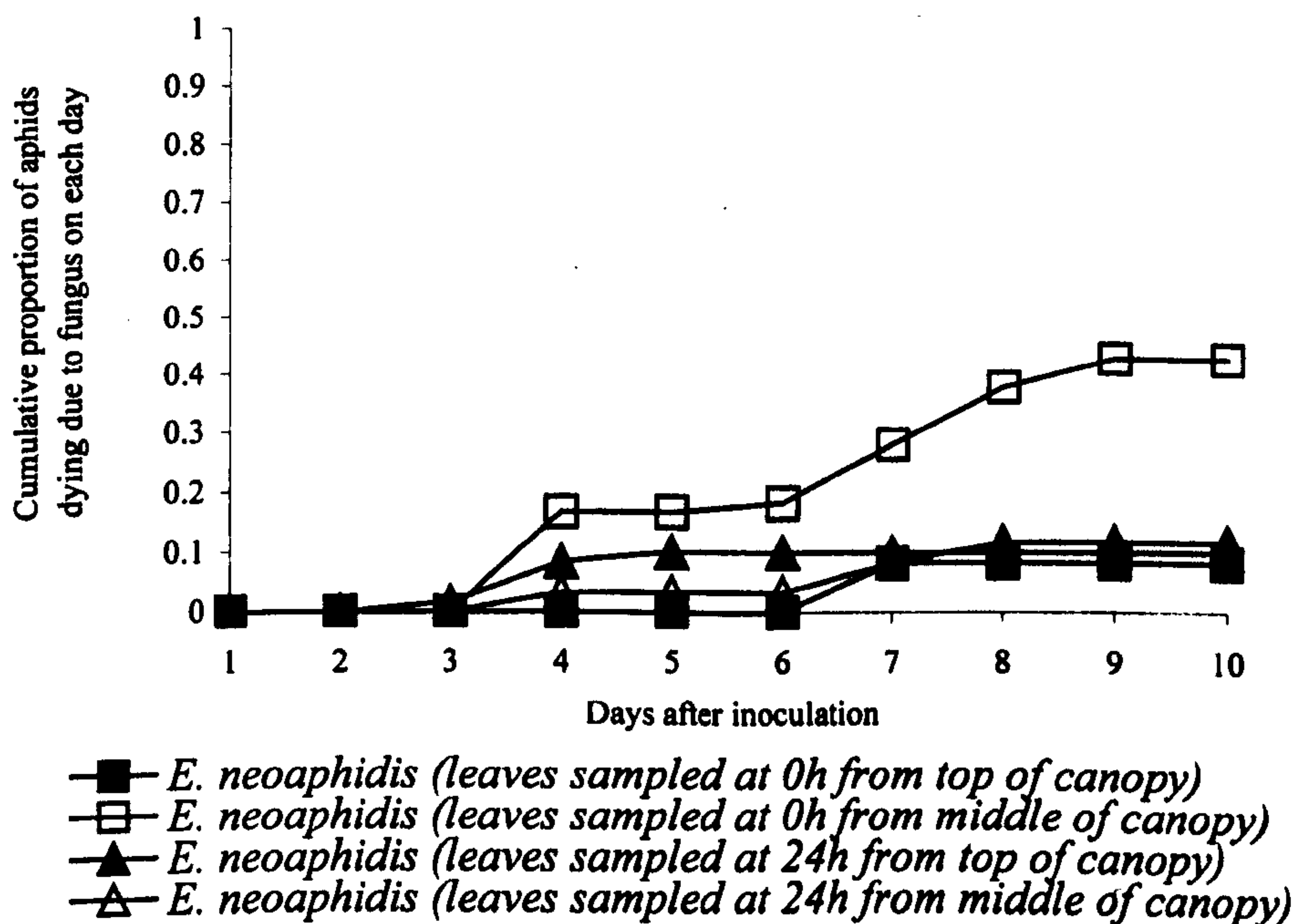
**FIGURE 7.24** : Mortality of *A. fabae* exposed for 48 hours to leaves which had been removed from plots in a crop of spring field bean immediately following spraying on 19/06/98 with a suspension of Mycotech strain GHA (*B. bassiana*) at a concentration of  $1 \times 10^9$  conidia ml<sup>-1</sup>.

*Aphis fabae* which were exposed to bean leaves from plots sprayed with Mycotech strain GHA (*B. bassiana*) on 07/07/98 succumbed to infection with both *B. bassiana* and *E. neoaphidis* (Figure 7.25). The largest numbers of aphids which died due to *B. bassiana* were exposed to leaves removed immediately after the spray (0h) and more aphids died when exposed to leaves from the top compared to the middle of the crop. The number of aphids that were infected with fungi, when exposed to leaves only 24 hours after the spray had been applied, was reduced for leaves sampled from the top of the canopy but slightly increased for those sampled

(a) *B. bassiana* infection



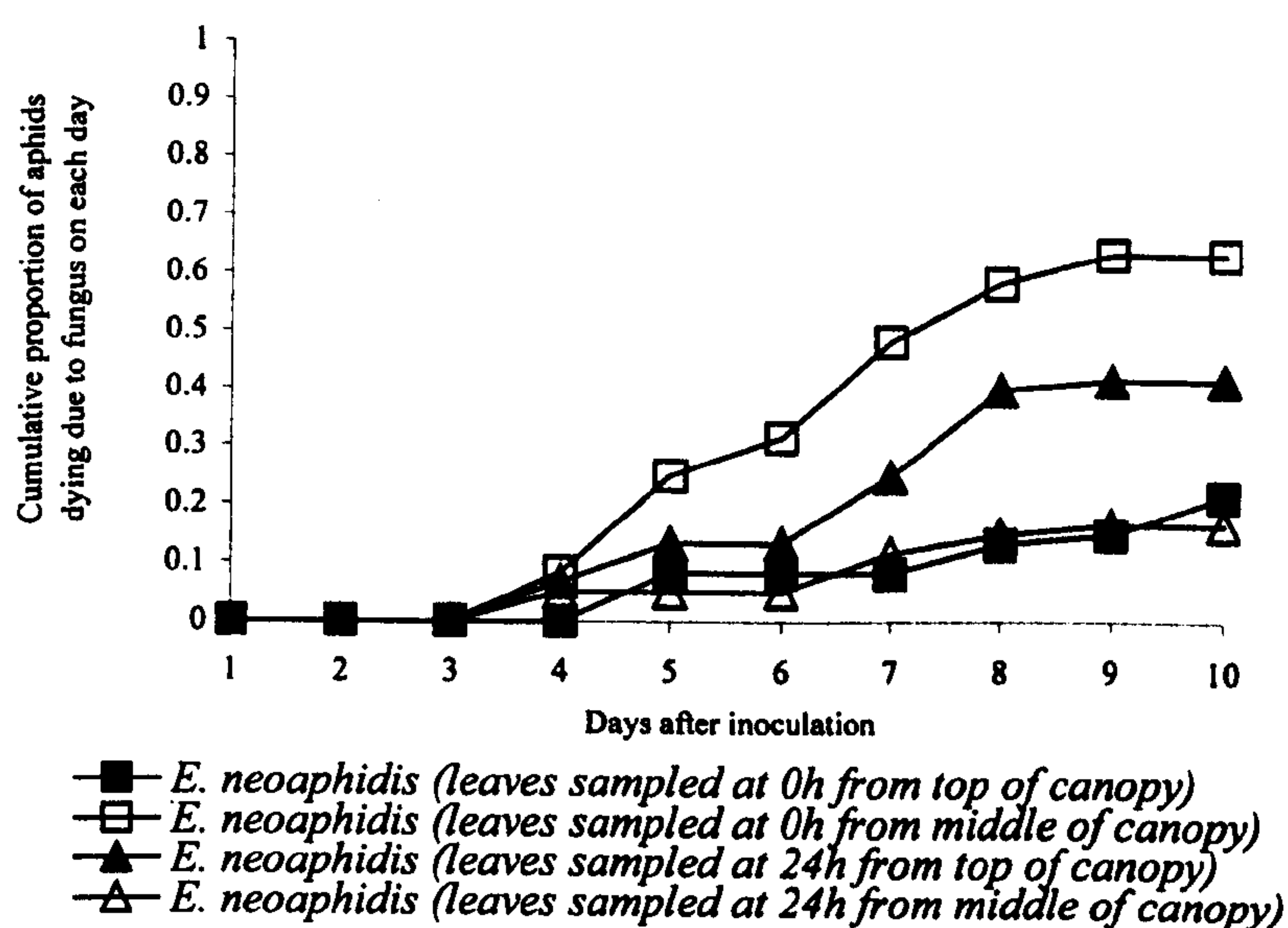
(b) *E. neoaphidis* infection



**FIGURE 7.25 :** Mortality of *A. fabae* exposed for 48 hours to leaves which had been removed from plots in a crop of spring field bean immediately following spraying with a suspension of Mycotech strain GHA (*B. bassiana*) at a concentration of  $1 \times 10^9$  conidia  $\text{ml}^{-1}$  on 07/07/98 and 24 hours later, due to (a) *B. bassiana* and (b) *E. neoaphidis*.

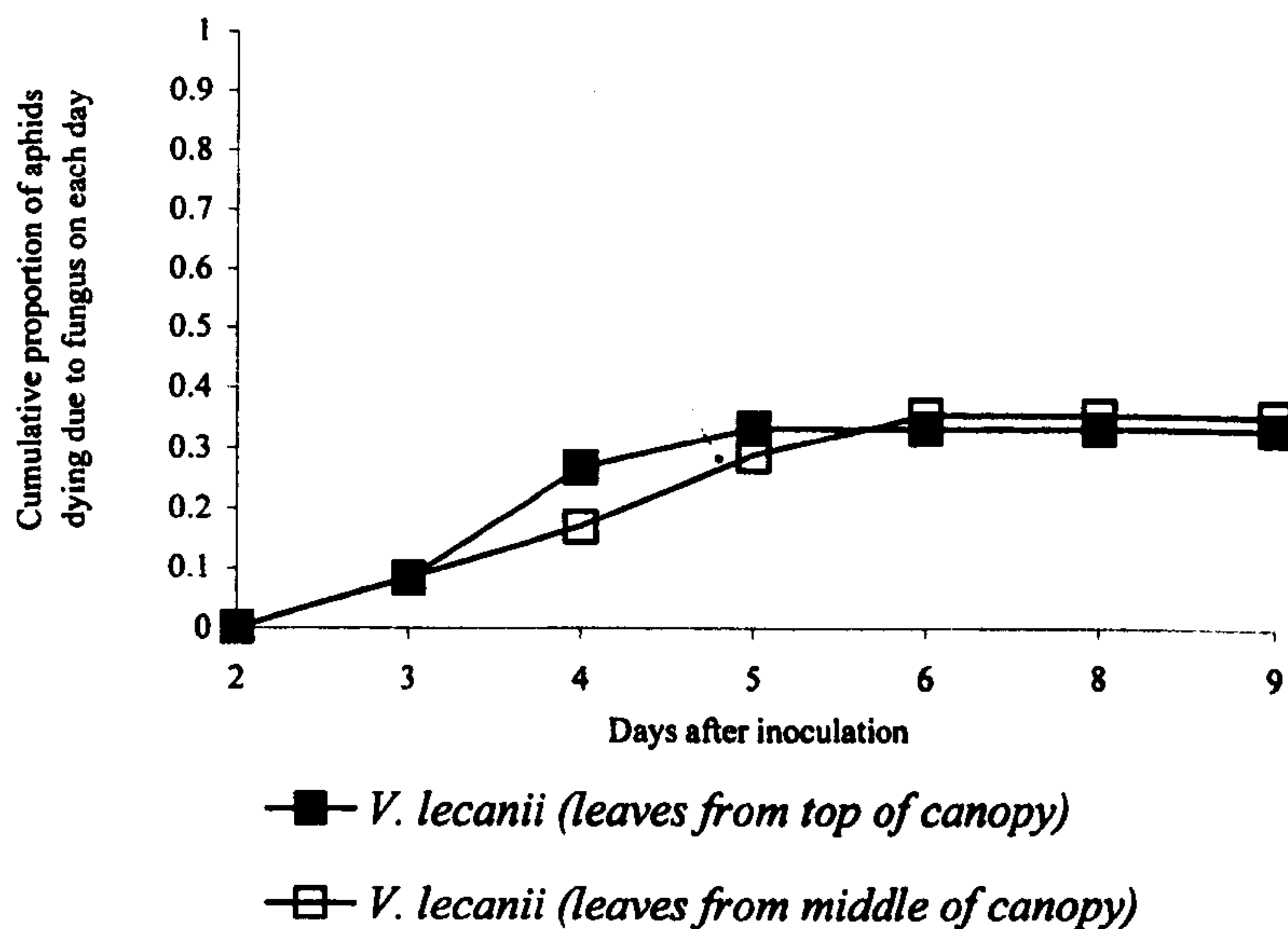


from the bottom of the canopy. The largest number of aphids died due to *E. neoaphidis* when exposed to leaves sampled immediately following spraying from the middle of the crop. There were similar numbers of aphids succumbing to infection with *E. neoaphidis* when exposed to leaves from the other areas of the crop at either 0h or 24h following spraying (Figure 7.26). A large number of aphids (43%) exposed to leaves from Tween treated plots succumbed to infection with *E. neoaphidis*.

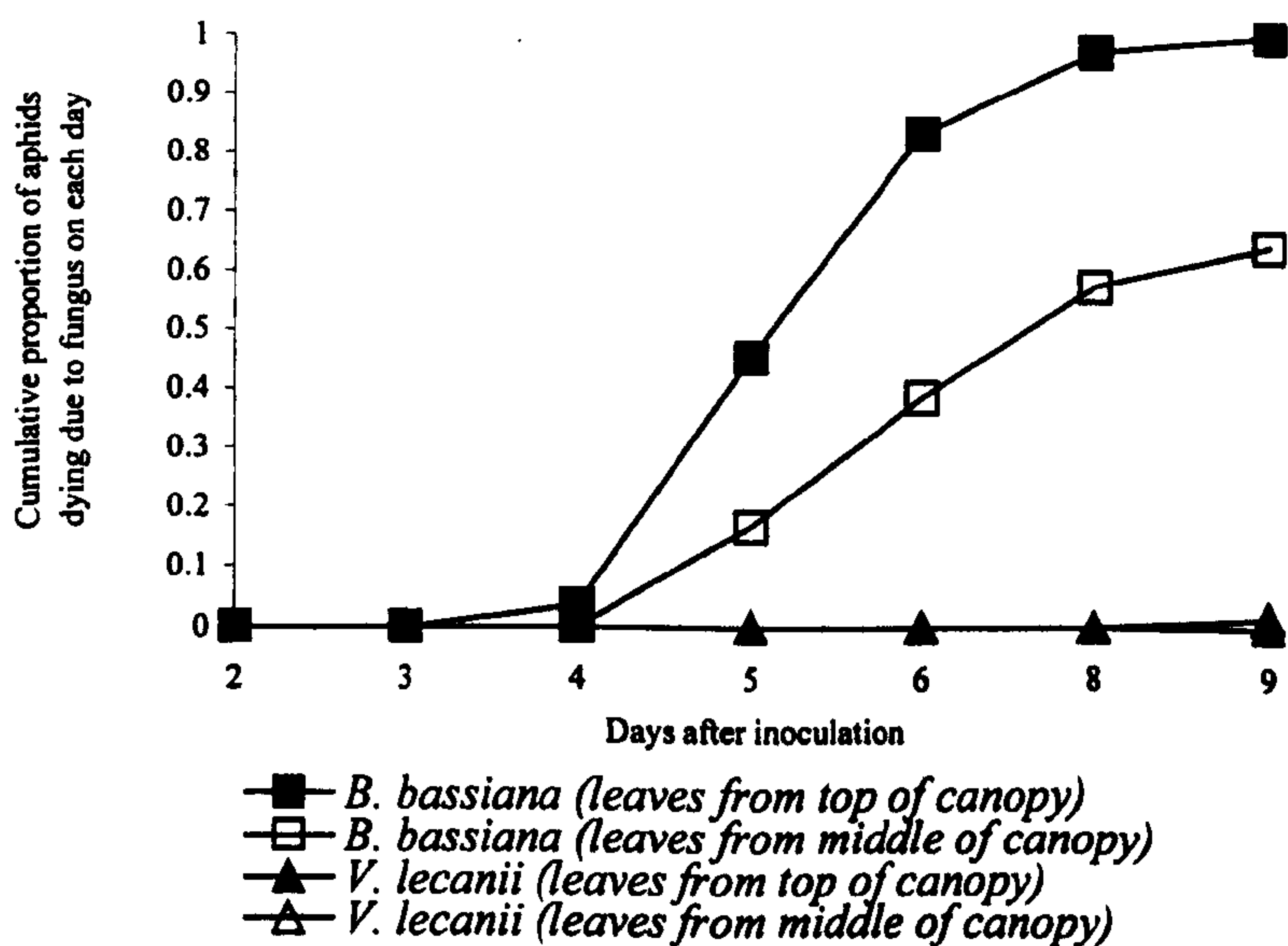


**Figure 7.26 :** Mortality of *A. fabae* aphids exposed for 48 hours to leaves which had been removed from plots in a crop of spring field bean immediately following spraying with a solution of Tween 80 (0.03%) on 07/07/98 and 24 hours later, due to *E. neoaphidis*.

*Sitobion avenae* exposed to wheat leaves from plots immediately following spraying with Tween on 19/06/98 succumbed to infection with a *V. lecanii*-like fungus (Figure 7.27). Similar numbers of aphids succumbed to fungal infection when exposed to leaves removed either from the middle or the top of the crop. When *S. avenae* were exposed to wheat leaves from plots immediately following spraying with isolate Mycotech strain GHA (*B. bassiana*) on 19/06/98, approximately 100% of the aphids exposed to leaves from the top of the crop and 60% of aphids exposed to leaves from the middle of the crop succumbed to infection with *B. bassiana* (Figure 7.28).

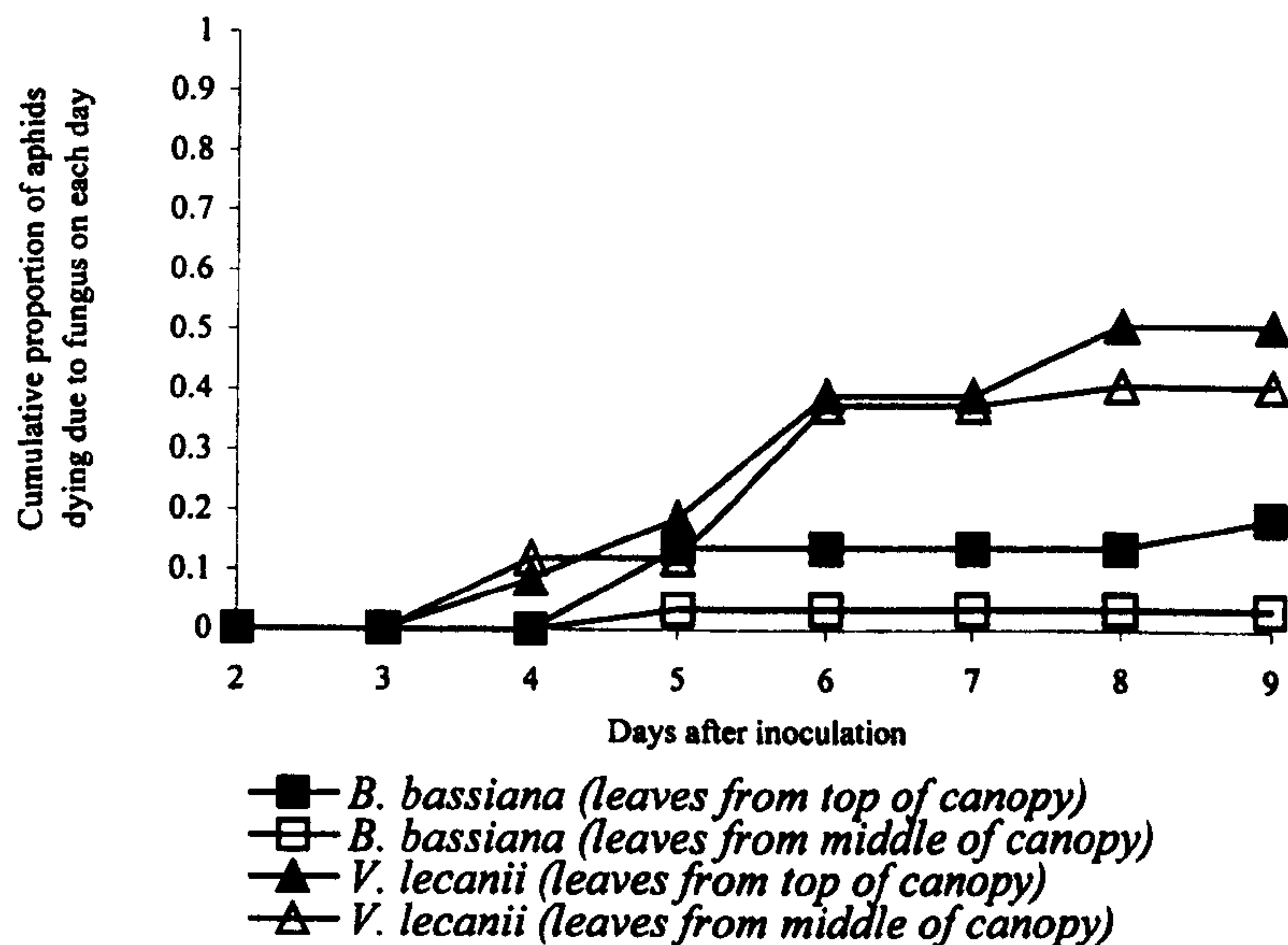


**FIGURE 7.27 :** Mortality of *S. avenae*, exposed for 48 hours to leaves which had been removed from plots in a crop of spring wheat immediately following spraying with a solution of Tween 80 (0.03%) on 19/06/98, due to a *V. lecanii*-like pathogen



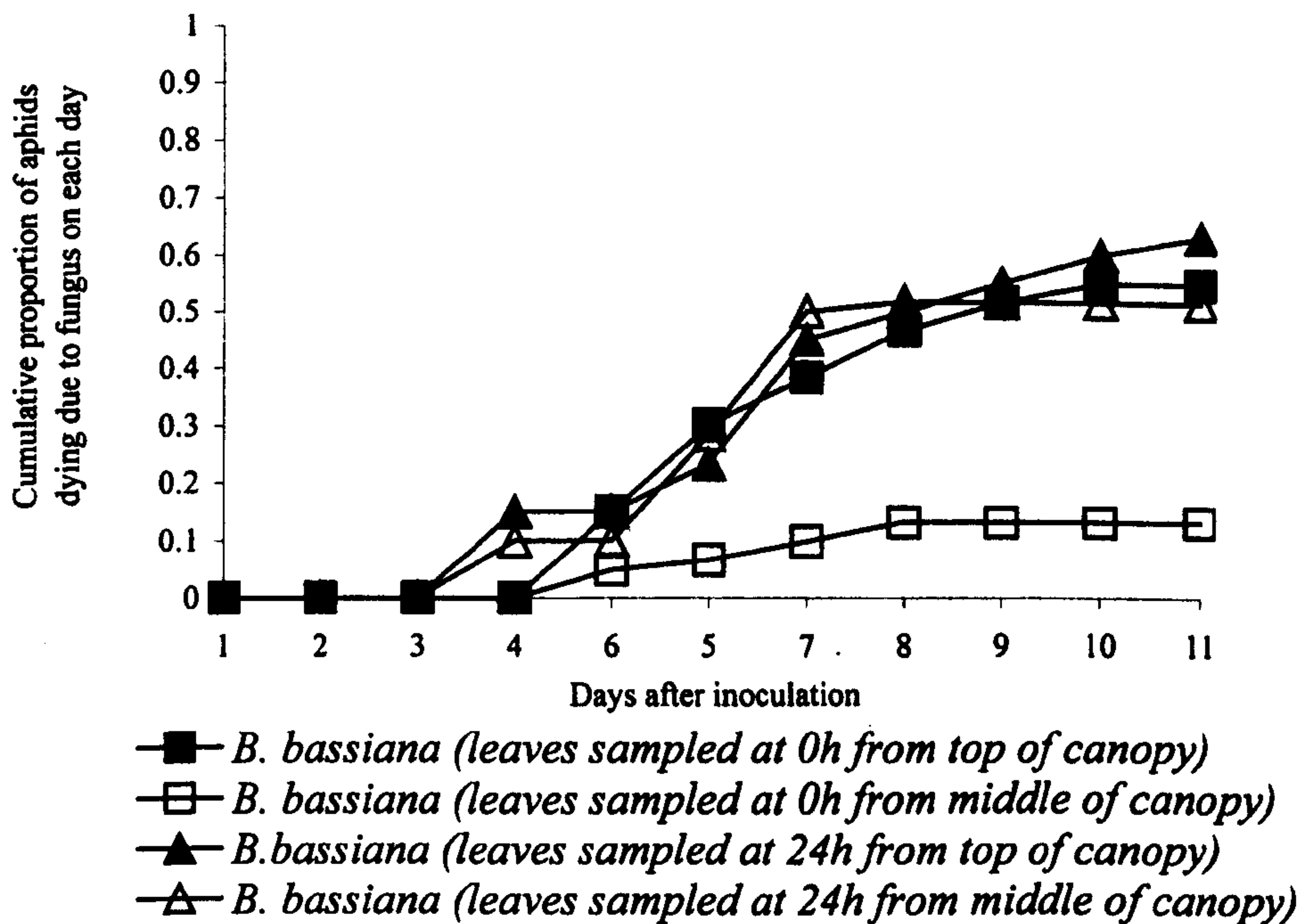
**FIGURE 7.28 :** Mortality of *S. avenae* exposed for 48 hours to leaves which had been removed from plots in a crop of spring wheat immediately following spraying with Mycotech strain GHA (*B. bassiana*) at a concentration of  $1 \times 10^9$  conidia  $\text{ml}^{-1}$  on 19/06/98, due to *B. bassiana* and a *V. lecanii*-like pathogen

Aphids exposed to leaves from plots sprayed with isolate HRI 1.72 (*V. lecanii*) mainly succumbed to infection with *V. lecanii*, with more aphids dying from the fungus when exposed to leaves from the top of the crop compared to the middle (Figure 7.29). However, approximately 20% of aphids exposed to leaves from the top of the crop also succumbed to infection with a *B. bassiana*-like pathogen.



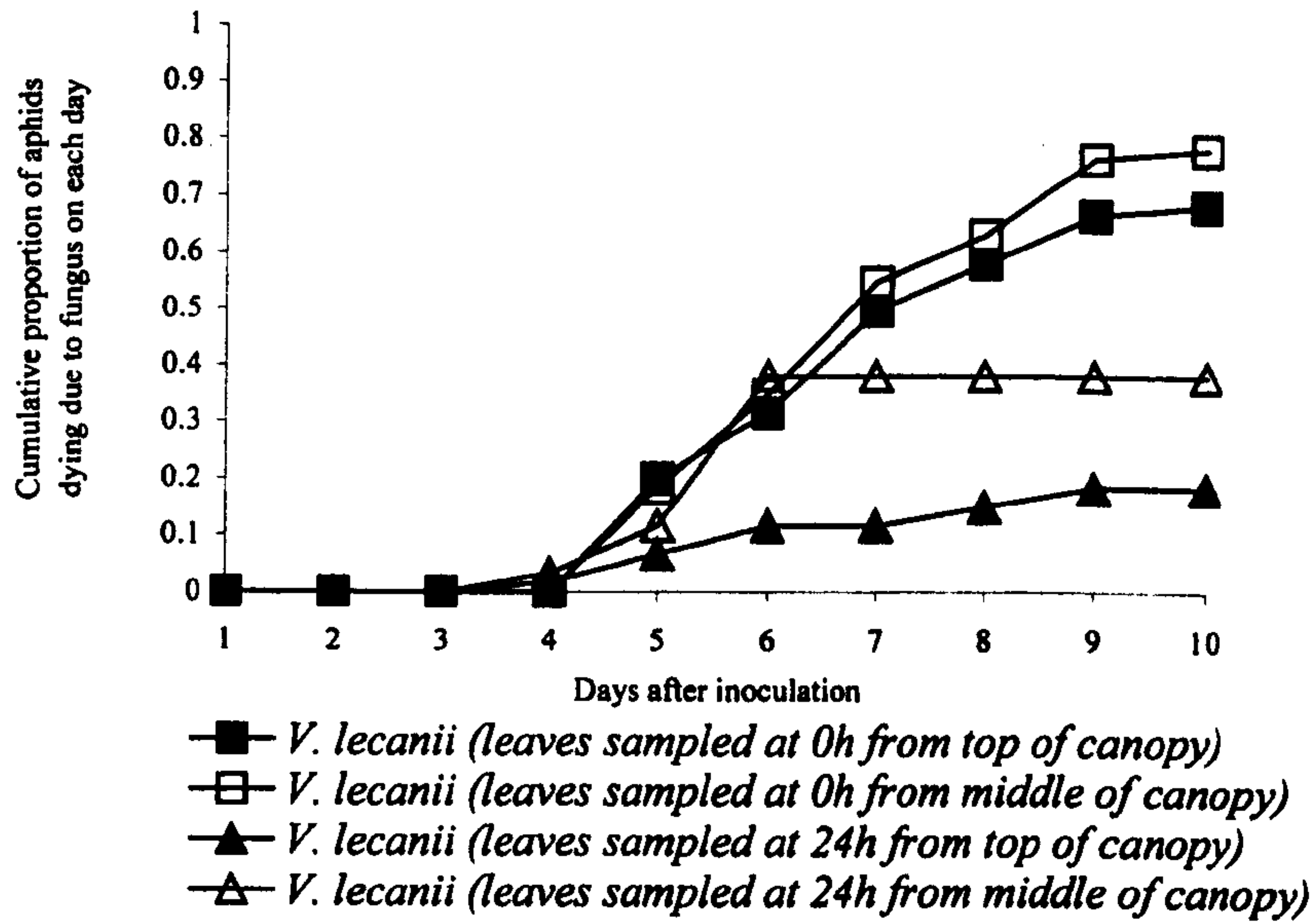
**FIGURE 7.29** : Mortality of *S. avenae* exposed for 48 hours to leaves which had been removed from plots in a crop of spring wheat immediately following spraying with HRI 1.72 (*V. lecanii*) at a concentration of  $1 \times 10^9$  conidia ml<sup>-1</sup> on 19/06/98, due to *B. bassiana* and a *V. lecanii*-like pathogen

*Sitobion avenae* exposed to leaves from plots of wheat sprayed with Tween 80 (0.03%) on 07/07/98 did not succumb to any infections over the course of the assays, regardless of whether leaves had been removed immediately following spraying or 24 hours later. *Sitobion avenae* exposed to wheat leaves removed from plots sprayed with Mycotech strain GHA (*B. bassiana*) succumbed to infection with *B. bassiana* (Figure 7.30). More aphids died of *B. bassiana* when they were exposed to leaves from the top of the canopy, compared to the middle, when leaves were sampled both immediately after spraying and 24 hours later. However, more aphids succumbed to infection with *B. bassiana* when exposed to leaves from the middle of the canopy 24 hours after spraying compared to immediately following spraying.



**FIGURE 7.30** : Mortality of *S. avenae* exposed for 48 hours to leaves which had been removed from plots in a crop of spring wheat immediately following spraying with a suspension of Mycotech strain GHA (*B. bassiana*) at a concentration of  $1 \times 10^9$  conidia  $\text{ml}^{-1}$  on 07/07/98 and 24 hours later, due to *B. bassiana*

*Sitobion avenae* exposed to wheat leaves from plots sprayed with isolate HRI 1.72 (*V. lecanii*) succumbed to infection with *V. lecanii* (Figure 7.31). More aphids died when exposed to leaves removed immediately after the spray application than 24 hours later. More aphids succumbed to infection with *V. lecanii* when exposed to leaves from the middle of the crop compared to the top, at each of the times at which the leaves were sampled. However, a smaller numbers of aphids succumbed to infection with *V. lecanii* when exposed to leaves sampled after 24 hours compared to those from leaves sampled immediately following spraying. The number of aphids succumbing to infection with *V. lecanii* when exposed to leaves from the middle of the crop decreased by 40% from the sample time of 0h compared to that of 24h, whilst the number succumbing to infection when exposed to leaves from the top of the crop decreased by 60% between the two sampling times.



**FIGURE 7.31** : Mortality of *S. avenae* exposed for 48 hours to leaves which had been removed from plots in a crop of spring wheat immediately following spraying with a suspension of HRI 1.72 (*V. lecanii*) at a concentration of  $1 \times 10^9$  conidia ml<sup>-1</sup> on 07/07/98 and 24 hours later, due to *V. lecanii*

## 7.4 Discussion

The temporal and spatial distribution of aphids and their natural enemies was determined over two field seasons in crops of field beans and wheat. Aphid numbers reached high levels in wheat in 1997 and in beans in 1998. In both years, the number of aphids increased in the last two weeks of June and reached a peak in the first two weeks of August, before decreasing dramatically just prior to harvest. The number of aphid cadavers identified with infection by the natural enemy *E. neoaphidis* reached a peak as aphid numbers began to decline. Large numbers of aphids sampled after spray applications on 19/06/98 in bean crops succumbed to infection with *E. neoaphidis* suggesting that this fungus was more prevalent than field counts on 16/06/98 had suggested. Parasitoid numbers in beans in 1998 also increased as aphid numbers increased (data not shown). Whether aphid numbers decreased in either year because of the impact of natural enemies is difficult to determine as aphid populations naturally decrease prior to harvest when plants become unsuitable hosts.

The spatial distribution of aphids over individual wheat plants was similar between the two years and agrees with distribution patterns of cereal aphids found by other authors (Dean & Luuring, 1970). There was a general increase in numbers of *S. avenae* recorded in the lower regions of the crop as the population density of this species increased in the ear. At high infestation levels, interspecific competition within *S. avenae* populations has been reported to cause a general movement of aphids of this species to lower regions of the plant (Chongrattanameteekul, Foster & Araya, 1991). These temporal and spatial patterns of distribution of aphids within a crop are important considerations for targeting mycoinsecticide sprays.

In the bean crop, when aphid numbers were low in 1997, both *A. fabae* and *A. pisum* were distributed mainly at the top of the plants. However, although both species of aphid were distributed at the top of the crop in the early part of the 1998 field season, when high densities of *A. fabae* developed, *A. pisum* became more frequent in the middle of the crop. It is possible that there was direct competition between the two aphid species at the top of the plants forcing *A. pisum* to occupy lower areas. *Aphis fabae* changes feeding position from stems to leaves in the

presence of *A. pisum* and from the upperside to the underside of leaves (Lowe, 1967; Salyk & Sullivan, 1982). It is possible that one species of aphid in the current study was affecting the behaviour of the other, but in contrast to previous studies, it appeared that *A. pisum* was the species that changed feeding position rather than *A. fabae*.

Alternatively, the reduction in numbers of *A. pisum* at the top of the crop could be explained by competitive interactions. When two species share a natural enemy, an increase in abundance of one species may increase abundance of the shared natural enemy and therefore increase predation of the second species. These types of interaction between two species have been termed "apparent competition" (Holt, 1977). The population growth of one species is reduced as the population growth of the other species increases, similar to changes noted in classic interspecific competition. Apparent competition has been shown in populations of the nettle aphid *Microlophium carnosum* (Buckton) and the bird-cherry oat aphid *Rhopalosiphum padi* (Müller & Godfray, 1997). An increase in populations of *R. padi* caused a decrease in adjacent populations of *M. carnosum* because of increased predation by coccinellids which were attracted into the area by the large populations of *R. padi*.

It is possible that apparent competition was causing a decrease in numbers of *A. pisum* at the top of the bean crop if the increased populations of *A. fabae* attracted a shared natural enemy. There was an increase in the number of parasitoids, predators and pathogens (especially *E. neoaphidis*) as the populations of *A. fabae* increased (data not shown for predators and pathogens). Any of these shared natural enemies could have caused a reduction of *A. pisum* in the upper crop regions. Alternatively, another factor such as plant quality or a combination of competitive interactions may have caused these changes in aphid distribution.

More *A. fabae* succumbed to infection with *E. neoaphidis* than *A. pisum* when aphids were sampled from populations in the field after spray applications (personal observation, data not shown). It is possible that the isolate of *E. neoaphidis* in the field was more virulent against *A. fabae* than *A. pisum*. Variability in susceptibility to different isolates of *E. neoaphidis* has been

demonstrated previously in aphids (Milner & Soper, 1981). Alternatively, because *A. fabae* had formed dense colonies by the time aphids were sampled, the pathogen may have been able to spread more readily to new hosts within populations of *A. fabae* compared to *A. pisum* which were distributed more sparsely. These results show that applied Hyphomycete fungi and *E. neoaphidis* may potentially interact within the field environment. Investigations reported in chapter five suggest that, under such conditions, *E. neoaphidis* would be more aggressive. Indeed, when bean leaves from the field which were sprayed with suspensions of conidia were assayed against healthy aphids, a large number of aphids in some samples succumbed to infection with *E. neoaphidis* rather than the applied Hyphomycete fungus.

It is difficult to determine whether the *V. lecanii*-like and *B. bassiana*-like fungi noted in aphids that were exposed to leaves from control plots on 19/06/98 were due to spray drift or were other pathogens occurring in the field. All spray applications were made when wind speeds were less than 5 m.p.h which should have prevented any spray drift. Additionally, one of the benefits of using an electrostatic sprayer is that charged particles are attracted directly to the crop plant. Molecular techniques could be used to determine whether fungi such as those described above are applied isolates or other isolates occurring naturally. Such techniques will be useful for evaluating persistence of applied fungi and tracking the development of epizootics within host populations.

Persistence studies, using assays of field collected leaves against healthy aphids, indicated that there was generally more inoculum at the top of the canopy compared to the lower regions immediately following spray applications of conidia of *B. bassiana* and *V. lecanii* in the two crops. This type of bioassay method has been used for both Hyphomycete and entomophthoralean fungi (Brobyn *et al.*, 1985; Vandenberg, Shelton, Wilsey & Ramos, 1998c) and is useful for detecting not only viable conidia but other infectious inocula such as hyphae (Goettel *et al.*, 2000). Conidia did not persist for long periods as, after only 24 hours, fewer aphids were infected when exposed to leaves sampled from the field compared to leaves sampled immediately following spraying. However, leaves were not sampled at any later times and this would have been useful to have determined whether



inocula could persist for longer periods of time. Inocula of *B. bassiana* and *V. lecanii* have been recorded as persisting in the field and under glasshouse conditions for periods of 28 and 39 days respectively (Hall, 1980c; James *et al.*, 1995).

However, conidia have also been reported to survive for shorter periods under field conditions. Survival of *B. bassiana* on the upper surfaces of foliage in Southern California was very limited; survival of conidia only had a half-life of 1.7 days on melon and 1 day on broccoli (Jaronski & Goettel, 1997). Survival on the undersides of leaves was greater than on the upper surfaces with a half-life of 5 - 9 days on melon leaves. The rate of decay is affected by both the plant species and location within the canopy; a dense canopy of alfalfa gave better protection for conidia from solar radiation than that of wheatgrass (Inglis *et al.*, 1993). In targeting mycoinsecticides, applications should be maximised at the top of the crop, to inoculate directly the insects that are distributed there, but also penetrate lower into the crop to favour survival and expose insects to residual inoculum. The electrostatic sprayer gives an even coverage of both surfaces of leaves at different heights in the crop. Applications of *M. anisopliae* to control the mustard beetle *Phaedon cochleariae* (F.) under field conditions resulted in higher mortality of beetles when applications were made using an electrostatic sprayer compared to a hydraulic sprayer (Inyang, McCartney, Oyejola, Ibrahim, Pye, Archer & Butt, 2000).

Humidity recordings were of ambient RH in the air surrounding leaves, rather than the humidity of leaf surfaces themselves. The highest humidities were recorded during the night when temperatures were at their lowest. For example, between 12.00pm and 6.00am, the average temperature of bean leaves over the recording period 3<sup>rd</sup> July to 23<sup>rd</sup> July was 11.87°C for the upper leaf surface at the top of the canopy and 12.48°C for the lower leaf surface at the bottom of the canopy. Isolates for use in temperate fields in the summer should, therefore, be selected using the biorational approach based on their temperature tolerance to a range of temperatures around these low values. Isolates selected in this way may then be able to germinate and grow at temperatures that are associated with ideal humidity conditions in the field.

When spray applications were made in the field on 07/07/98, the recorded humidity of the field bean crop was above 97% between 21.30 hours and 04.30 hours (Appendix 9). During this period, the maximum temperature was recorded as 10.29°C and the minimum as 7.45°C (Appendix 10). Data from *in vivo* experiments reported in chapter 5 suggest that at 100% RH and 10°C, the LT<sub>50</sub> values for aphids treated with isolate HRI 1.72 were 221.72 hours for *A. fabae* and 244.12 hours for *M. persicae*. This would suggest that under these field conditions, the progression of disease may have been slow.

It is important to determine whether germination and penetration of conidia can be achieved under such conditions in the field as this will influence the ability of fungi to cause infection in host populations. Theoretically, the pattern of germination for isolates under the field conditions described above may be calculated using the equations derived in chapter five for *in vitro* germination of conidia of each isolate. The calculated GT<sub>50</sub> values for HRI 1.72 using this equation would be 42.11 hours and 42.32 hours under the maximum and minimum temperatures recorded in the field. It is therefore possible that some conidia of HRI 1.72 that came into contact with hosts overnight would be able to germinate under the microclimatic conditions recorded in the field.

However, it is not advisable to extrapolate results from laboratory studies to represent what may occur under field conditions. Observation of the development of conidia on host cuticle under field conditions in relation to temperature and humidity regimes would provide evidence of the actual ability of conidia to germinate and penetrate during short periods of optimal conditions. Conidia of *V. lecanii* were able to germinate at 70% RH on leaves but showed poor infection of aphids (Burgess, 2000). However, when RH was maintained at 95% for 15 to 18 hours, alternating with 40 or 70% RH, fungal growth, sporulation and aphid infection was increased.

Conidia are generally not exposed to a constant regime of temperature and humidity. The microclimate records from the current study indicate how dramatic the differences in both environmental factors can be even over the period of one day. The impact of fluctuating temperature and humidity regimes on germination,

growth and virulence of pathogens have been discussed in chapter five.

The results of the field experiments provide evidence that in temperate cropping systems aphid natural enemies may occur when Hyphomycete fungi are applied. Some of these natural enemies may therefore be exposed for long periods of time to conidia; individual seven-spot ladybirds *C. septempunctata* were often noted to remain in crop areas in the field for two weeks or more (personal observation). However, spray applications were made quite late in the growing season when aphids had reached high numbers. For population suppression in commercial crops sprays are more likely to be applied earlier in the season when host populations are beginning to increase in numbers but before significant damage to the crop. Results from natural enemy monitoring would suggest that earlier applications may impact on fewer natural enemies. It is difficult to determine what the potential impact would be on natural enemies, as previous studies have indicated that non-target susceptibility may be related to weather conditions during exposure in the field (James *et al.*, 1995). Issues surrounding the impact of applied microbial pathogens on non-target organisms are discussed in chapter six.

It was not possible to determine whether the applied Hyphomycete fungi reduced aphid populations as a natural epizootic of *E. neoaphidis* was present and appeared to cause the decrease in host aphid populations shortly after sprays were applied in the beans. In a similar study, a single spray of blastospores of *V. lecanii* also applied in late June failed to control *A. fabae* on broad beans (Khalil *et al.*, 1985). The authors suggest that low humidities (40-60% RH) were not suitable for fungal development, but it is not clear over what periods this humidity was recorded i.e. daily or hourly for example. As the results in this chapter show, the mean daily humidity may be low but an RH of 100% may be reached on the microclimate scale and maintained for a reasonable period of time every night in wheat and bean crops.

The field experiments described in this chapter were designed to demonstrate that isolates selected using the biorational approach were able to demonstrate some level of aphid control under field conditions. For a number of reasons, highlighted previously, this was not fully achieved in these trials. It may be more useful to use

field simulation studies as a method to evaluate the performance of selected isolates under field conditions, before a full scale field trial is undertaken. The potential of isolates of *M. anisopliae* for the control of crucifer pests was evaluated using this method (David-Henriet *et al.*, In Press). The infectivity of a promising isolate of *M. anisopliae* was reduced (compared to that achieved in the laboratory) under field simulation conditions and this infectivity was reduced more in full field trials. Using a method such as this in the biorational approach would allow a large number of isolates to be screened in field simulation assays and would increase the likelihood that an isolate selected for further trials would be effective under field conditions.

---

## Chapter 8 - GENERAL DISCUSSION

---

The isolates obtained for this study from international culture collections all had reported potential against aphids. However, first tier tests against the black bean aphid *Aphis fabae* and subsequent dose-response studies identified differences in pathogenicity between isolates. There have been few reports using *A. fabae* as a target aphid for bioassay studies of entomopathogenic fungi (Zayed & Zebitz, 1997). The current study indicated that *A. fabae* was a useful representative target for the selection of fungal isolates for the biocontrol of aphids. *Aphis fabae* survived on excised leaves and, as these aphids normally form dense colonies on plants, they were not stressed when forced to occupy a small area of leaf together.

Host range studies against several aphid species, using the isolates selected in first tier tests, indicated that the bird cherry oat aphid *Rhopalosiphon padi* was more resistant to infection (indicated by large  $LT_{50}$  values) compared to other aphid species. This may have been due to stress from being maintained on excised leaves. Further studies using whole plants as an incubation system would confirm whether this was a factor influencing patterns of aphid mortality. *Rhopalosiphum padi* was also the most resistant of several species of aphid inoculated with Hyphomycete isolates (Feng *et al.*, 1990b) and *Erynia neoaphidis* (P. Shah, pers. comm.). In both of these studies, aphids were reportedly not stressed, suggesting that susceptibility to infection was related to another, unknown, factor. The mechanism(s) of this resistance to infection require further investigation.

Aphids used in assays of entomopathogenic fungi are generally from laboratory cultures. These cultures often originate from single clones or from a small sample of field collected aphids. The potential differences between clones or biotypes of aphids needs to be studied to determine whether populations of aphids differ in susceptibility to isolates of fungi. For example, Milner (1982) found that biotypes of *Acyrtosiphon pisum* may differ in susceptibility to *E. neoaphidis*, so that one biotype may be described as resistant. It will be essential in the development of mycoinsecticides to determine the impact of isolates of Hyphomycete fungi to genetically diverse populations of aphids that may be present in crops.

When *A. fabae* and *Myzus persicae* were inoculated with isolate HRI 1.72 and incubated at 10°C, LT<sub>50</sub> values of between nine and ten days were recorded for these aphids respectively. Although aphid numbers would be increasing at a slow rate under these conditions, this may not represent an acceptable speed of kill for a mycoinsecticide under field conditions. However, although the immediate "knockdown" effect of mycoinsecticides may not be comparable with that of chemical insecticides, the mycoinsecticides may provide better long term control of insect pests. Trials in Niger showed that the reduction in a grasshopper population after spray application of an isolate of *Metarhizium anisopliae* was similar to that achieved with an organophosphate insecticide (Langewald, Ouambama, Mamadou, Peveling, Stolz, Bateman, Attignon, Blanford, Arthurs & Lomer, 1999). However, grasshopper populations recovered in plots sprayed with insecticide within 16 days, whilst populations in plots sprayed with the fungus remained lower as grasshoppers were exposed to conidia which remained infective for three weeks after spraying.

In addition, sublethal effects or changes in host behaviour due to infection with fungi may reduce the damage by aphids to a crop. Changes in host behaviour or sublethal effects may be just as useful in crop protection as the death of the host. For example, *M. flavoviride* infection reduced feeding and flying in desert locusts (Seyoum, Moore & Charnely, 1995) and *Beauveria bassiana* infection in Colorado potato beetle reduced fecundity of surviving individuals (Fargues, Delmas, Auge & Lebrun, 1991). In comparison, infection with *B. bassiana* did not significantly affect the rate of nymph production by adult *D. noxia* (Wang & Knudsen, 1993). However, if infection with a fungus had sublethal effects on aphids which inhibited feeding, an immediate "knock-down" of pests would not be such an important feature of a mycoinsecticide.

Molecular techniques, such as genetic recombination, present exciting opportunities to enhance the virulence of fungi, with much of the work to date concentrated on *M. anisopliae* (St. Leger, Frank, Roberts & Staples, 1992a; St. Leger, Staples & Roberts, 1992b). Many Hyphomycete fungi have considerable natural genetic variation (such as *M. anisopliae*) and this could be of benefit for

establishing "genetic fingerprints" of isolates. This is important for patenting and registration of isolates as mycoinsecticides, as well as monitoring of non-target effects. Additionally, such fingerprints may provide a very powerful tool to "track" isolate movement within host populations and allow accurate models of epizootic development. A useful review of areas of opportunity for using molecular techniques to improve mycoinsecticides is given by Charnley, Cobb & Clarkson (1997).

Many biopesticides were rushed onto the pesticide markets in the 1980s during a period when concerns over pesticides and public health were high profile issues. This meant some of these products were available before predictable efficiency and cost effectiveness had been developed. Biopesticides were "fast tracked" through registration processes and, although this had the advantage of costing less, and requiring fewer toxicology tests than conventional chemicals, there were disadvantages; a lot of companies were not ready to effectively produce, market, support or sell products. The historical failure under field conditions of the *V. lecanii* product Vertalec<sup>®</sup> may simply have been because there had been little research into mycoinsecticides and problems with using these products in the field were not understood at this time. Both Vertalec<sup>®</sup> and Mycotal<sup>®</sup> are still commercially available and are very successful control agents used in glasshouses.

The success of companies, such as the Mycotech Corporation in the United States, has shown that with increased knowledge of the biology of fungi and improved application technology, products based on entomopathogenic fungi are successfully entering markets in a wide range of agricultural and horticultural crops. However, the success of many of these products as mycoinsecticides relies on their ability to control a wide range of pest species. The disadvantage of this is that non-target beneficials may be adversely affected although, to date, there have been no reports of adverse effects of field applications on beneficials (Cory & Myers, 2000).

The increasing problems of negative indirect and non-target effects of biological control are receiving increasing attention (Cory & Myers, 2000). As yet, however,

there is no evidence that inundative release of insect pathogens has resulted in long-term negative effects on non-targets or even that pathogens applied in this way have established. However, there has been little research in this area and it is essential that studies are made of any negative effects of mycoinsecticide applications. The potential genetic changes that may occur in inundation releases need to be assessed. Whilst the ability of isolates to adapt and avoid host resistance are beneficial, there may also be problems of isolates adapting to infect non-target organisms. Changes in fungi have been noted after *in vivo* and *in vitro* passages, such as changes in virulence (Daoust & Roberts, 1982; Morrow, Boucias & Heath, 1989; Hayden *et al.*, 1992) and changes in sporulation, growth rate and morphology (Hall, 1980b). It is unclear whether these changes are due to phenotypic plasticity, genetic variation within a population and/or genetic changes (Watson *et al.*, 1999).

Physiological host range studies showed that isolates of *P. fumosoroseus* and *V. lecanii* were the least pathogenic of the isolates tested to the 7-spot ladybird *Coccinella septempunctata* and the generalist parasitoid *Praon volucre*. Ecological host range studies are required to confirm whether the negative impact of *B. bassiana* isolates on these natural enemies noted under laboratory conditions extends to the field situation. Isolates, which have little or no impact on a natural enemy in a maximum challenge experiment under laboratory conditions, are unlikely to infect similar targets in the field environment. It is these isolates that would be identified using the biorational approach as well as those with a wide physiological host range. The impact of potential mycoinsecticides on non-target, beneficial insects should be a major consideration during the selection process, rather than in "side-effect" testing once an isolate is under development.

The host cuticle is one level at which specificity is determined (Hall & Papierok, 1982). Differences in adhesion and germination of conidia on host cuticle have been related to pathogenicity (Butt *et al.*, 1995) and host cuticle incorporated into media has been shown to influence germination of conidia (Butt *et al.*, 1999). Methods such as this could provide a way of indicating the potential host range of isolates in first tier pathogenicity tests. This would allow a large number of hosts,



including a range of non-target organisms, to be screened in *in vitro* tests. The potential impact of fungi on non-target species that would normally be excluded from bioassays, because of difficulty with rearing procedures or post-inoculation incubation, could then be investigated. Host cuticle germination studies, such as these, could be included in the biorational selection procedure, preceding *in vivo* studies on a more limited number of non-target natural enemies.

It was not within the scope of this thesis to evaluate the mass production or formulation of the isolates that were selected as potential mycoinsecticides. Efficient mass production systems and technologies exist for only a few species of fungus. The greatest achievements have been for *B. bassiana* (Feng *et al.*, 1994) and full commercial-scale production of this fungus has been achieved most notably by the Mycotech Corporation of Butte, MT. Wraight & Carruthers (1999) provide a useful review of the most recent advances in the development of mass production technologies. The suitability of isolates for mass production was not used as a specific criterion in the biorational selection procedure but three isolates were dropped from the study during first tier pathogenicity assays because it was difficult to obtain large numbers of conidia from culture plates of these isolates.

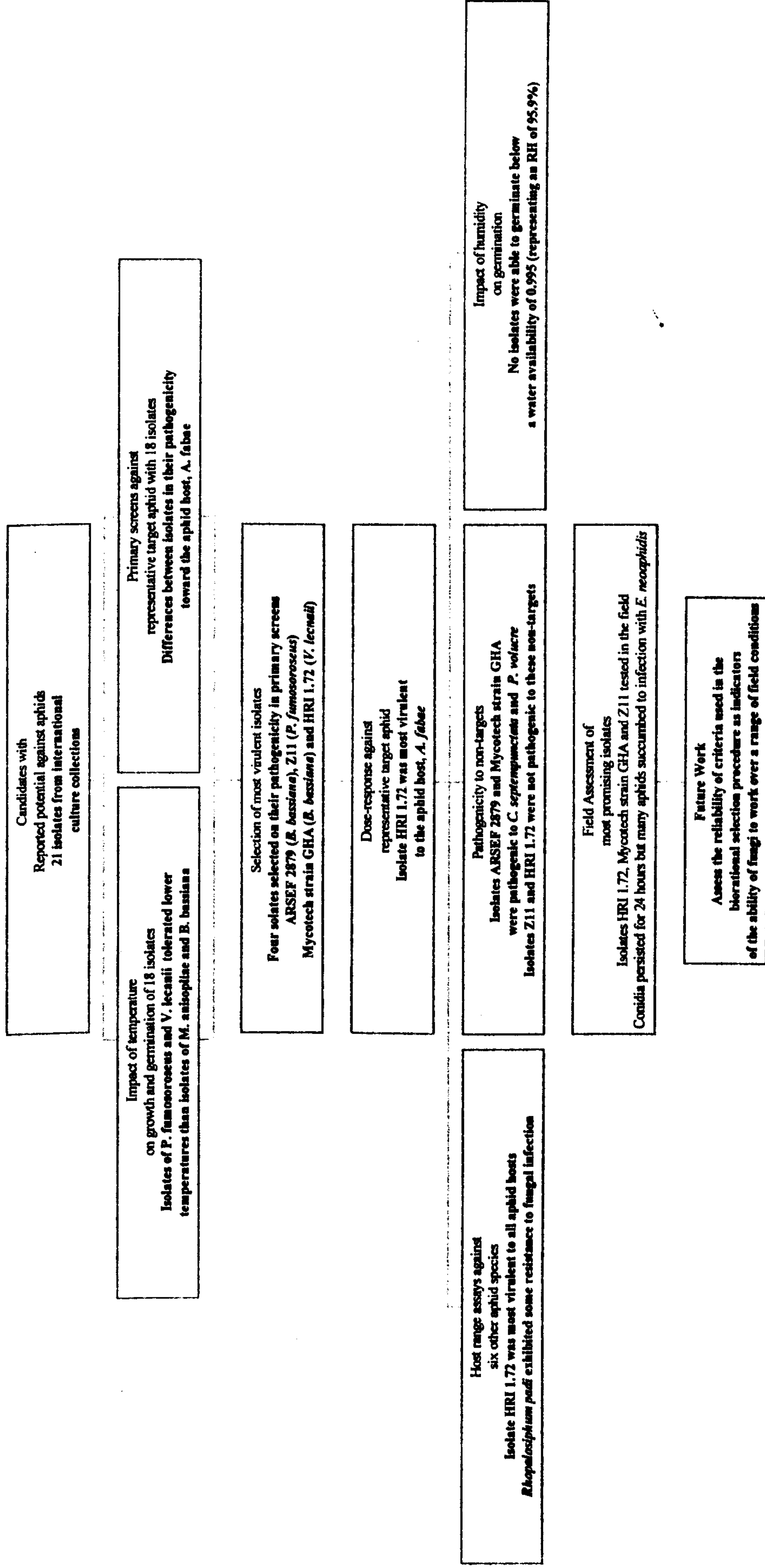
The success of any mycoinsecticide may also depend on the development of an appropriate delivery system (Bateman, 1998). Formulations of fungi in oil may allow them to operate under ambient conditions of very low humidity, such as desert conditions (Bateman *et al.*, 1993). Some studies have shown that formulation does not always improve field activity (Bull, 1978; Couch & Ignoffo, 1981), although to maximise application efficiency, storage and shelf life and allow a microbial to operate over a wide range of environmental conditions, it is likely that some type of formulation will be necessary (Jones, Cherry & Grzywacz, 1997). More detail on the issues surrounding the formulation of biopesticides in general is discussed in Burges (1998). It would be useful to determine to what extent formulation and application technology could increase the effectiveness of isolates; this could compensate for isolates that are adversely affected by humidity but in all other respects would be selected in the biorational approach.

Currently, mycoinsecticides are still limited to niche markets, although research and development of mycoinsecticides for the control of Russian wheat aphid, Colorado potato beetle and grasshoppers and locusts have shown that the opportunity exists to use these products over a wide range of cropping systems. Mycoinsecticides may also be useful in organic farming and high value vegetable crops. However, these markets may be highly competitive and it may, therefore, be better to focus on the green credentials of mycoinsecticides, for use in environmentally sensitive areas and as a tool for resistance management. As pressure from the government and public is increased to farm in a more environmentally acceptable way, mycoinsecticides may become more acceptable and growers may become prepared to accept some of the limitations of using mycoinsecticides.

Mycoinsecticides are often viewed as operating in a similar way to chemical insecticides and research has reflected this by focusing largely on the "knockdown" impact of isolates of fungus on host insects. Ideally, these biopesticides should represent one part of an IPM programme and should not be developed with a view to replacing chemical insecticides in a control programme. As there is an increasing need to assess more long-term solutions for insect pest control, there are increasing opportunities for development of mycoinsecticides as pest management tools.

In conclusion, the biorational approach described in this study allowed selection of isolates of fungi for the biocontrol of aphids in arable crops that were not only pathogenic to host aphids, but non-pathogenic to non-target organisms and had the ability to operate over a wide range of environmental conditions (Figure 8.1). The most promising isolate identified in the selection procedure was HRI 1.72 (*V. lecanii*), from the original single spore isolate developed as the product Vertalec®. Isolates of *P. fumosoroseus* and *V. lecanii* were identified as potentially more useful species for development as mycoinsecticides, compared to *M. anisopliae* and *B. bassiana*. This was largely because isolates of *P. fumosoroseus* and *V. lecanii* were more host specific, but also because they were able to operate over a range of environmental conditions.

Future research should be aimed at determining to what extent these selection criteria relate to the ability of isolates of fungi to operate under field conditions. This would determine how useful the criteria are for selecting isolates of fungi for aphid control and how useful the "semi-field" bioassay approach is compared to more precise laboratory bioassay methods. Whilst screening for more virulent isolates of fungus will continue, it is likely that the biggest advances will be made with development of new application and formulation technologies. The emphasis of an isolate selection procedure should therefore shift from isolate pathogenicity to target insects to assessment of factors that make the mycoinsecticide more ecologically sound. The biorational approach has been shown to be a useful method for selection of isolates. Although infection of aphids with isolates such as HRI 1.72 may be adversely affected by low humidity, constraints such as these may be overcome by formulation. Ultimately, using a biorational approach, such as that described in this study, will result in selection of potential mycoinsecticides which are likely to provide predictable and reliable biological control of aphid pests as part of an IPM programme.



**FIGURE 8.1 : Stepwise, biorational selection procedure for Hyphomycete fungi against aphid pests.**

## REFERENCES

- ABBAS, M. S. T. & BOUCIAS, D. G. (1984).** Interaction between nuclear polyhedrosis virus-infected *Anticarsia gemmatalis* (Lepidoptera : Noctuidae) larvae and predator *Podisus maculiventris* (Say) (Hemiptera : Pentatomidae). *Environmental Entomology* 13 : 599 - 602.
- ABBOT, W. S. (1925).** A method of computing the effectiveness of an insecticide. *Journal of Economic Entomology* 18 : 265 - 267.
- AGUDELO, F. & FALCON, L. A. (1983).** Mass production, infectivity, and field application studies with the entomogenous fungus *Paecilomyces farinosus*. *Journal of Invertebrate Pathology* 42 : 124 - 132.
- AIZAWA, A. (1971).** Strain improvement and preservation of virulence. In: *Microbial Control of Insects and Mites*. Eds. H. D. Burges & N. W. Hussey. Academic Press, London & New York. Pp 655 - 672.
- AKALACH, M., FERNANDEZ-GARCIA, E. & MOORE, D. (1992).** Interaction between *Rastrococcus invadens* [Hom.: Pseudococcidae] and two natural enemies. *Entomophaga* 37 : 99- 106.
- AKHURST, R. J. (1990).** Safety to nontarget invertebrates of nematodes of economically important pests. In: *Safety of Microbial Insecticides*. Eds. M. Laird, L. A. Lacey & E. W. Davidson. CRC Press, Boca Raton, Florida. Pp 233 - 240.
- ALLEN, G. E. (1980).** Integrated Pest Management : A special issue. *Bioscience* 30 : 655 - 701.
- ALTRE, J. A., VANDENBERG, J. D. & CANTONE, F. A. (1999).** Pathogenicity of *Paecilomyces fumosoroseus* isolates to diamondback moth, *Plutella xylostella* : correlation with spore size, germination speed, and attachment to cuticle. *Journal of Invertebrate Pathology* 73 : 332 - 338.
- ANDREADIS, T. A. (1987).** Transmission. In : *Epizootiology of insect diseases*. Eds. J. R. Fuxa & Y. Tanada. John Wiley & Sons, New York. Pp. 159 - 176.
- ARNOLD, A. J. & PYE, B. J. (1981).** Electrostatic spraying crops with the APE 80. *BCPC Monographs* 24 : 109 - 117.
- ARNOLD, A. J. & PYE, B. J. (1980).** Spray application with charged rotary atomisers. *BCPC Application Symposium. Spraying Systems for the 1980s*. Monograph No. 24 : 109 - 117.
- ARTHURS, S. P. & THOMAS, M. B. (1999).** Factors affecting horizontal transmission of entomopathogenic fungi in locusts and grasshoppers. *Aspects of Applied Biology* 53 : 89 - 97.

- ASKARY, H. & BRODEUR, J. (1999).** Susceptibility of larval stages of the aphid parasitoid *Aphidius nigripes* to the entomopathogenic fungus *Verticillium lecanii*. *Journal of Invertebrate Pathology* 73 : 129 - 132.
- ASKARY, H., CARRIÈRE, Y., BÉLANGER, R. R. & BRODEUR, J. (1998).** Pathogenicity of the fungus *Verticillium lecanii* to aphids and powdery mildew. *Biocontrol Science and Technology* 8 : 23 - 32.
- BALL, B. V., PYE, B. J., CARRECK, N. L., MOORE, D. & BATEMAN, R. P. (1994).** Laboratory testing of a mycopesticide on non-target organisms: the effects of an oil formulation of *Metarhizium anisopliae* applied to *Apis mellifera*. *Biocontrol Science and Technology* 4 : 289 - 296.
- BARSON, G. (1977).** Laboratory evaluation of *Beauveria bassiana* as a pathogen of the large elm bark beetle, *Scolytus scolytus*. *Journal of Invertebrate Pathology* 29 : 361 - 366.
- BATEMAN, R. (1999).** Delivery systems and protocols for biopesticides. In: *Biopesticides: Use and Delivery*. Eds. F. R. Hall & J. J. Menn. Humana Press Inc., Totowa, New Jersey. Pp 509 - 528.
- BATEMAN, R. P. (1998).** Delivery systems and protocols for biopesticides. Chapter 27. In : *Biopesticides : Use and Delivery*. Eds. F. R. Hall & J. Menn. Humana Press, Totowa, USA. Pp. 509 - 528.
- BATEMAN, R., CAREY, M., BATT, D., PRIOR, C., ABRAHAM, Y., MOORE, D., JENKINS, N. & FENLON, J. (1996).** Screening for virulent isolates of Entomopathogenic fungi against the Desert locust, *Shistocerca gregaria* (Forskål). *Biocontrol Science and Technology* 6 : 549 - 560.
- BATEMAN, R. P., CAREY, M., MOORE, D. & PRIOR, C. (1993).** The enhanced infectivity of *Metarhizium flavoviride* in oil formulations to desert locusts at low humidities. *Annals of Applied Biology* 122 : 145 - 152.
- BEEGLE, C. C. & OATMAN, E. R. (1975).** Effect of a nuclear polyhedrosis virus on the relationship between *Trichoplusia ni* (Lepidoptera: Noctuidae) and the parasite, *Hyposoter exiguae* (Hymenoptera: Ichneumonidae). *Journal of Invertebrate Pathology* 25 : 59 - 71.
- BLACKMAN, R. L. & EASTOP, V. F. (2000).** *Aphids on the World's Crops. An Identification and Information Guide*. 2<sup>nd</sup> Edition. John Wiley & Sons Ltd. Chichester, England. 446 pp.
- BLANFORD, S. & THOMAS, M. B. (1999).** Role of thermal biology in disease dynamics. *Aspects of Applied Biology* 53 : 73 - 82.
- BLANFORD, S., THOMAS, M. B. & LANGEWALD, J. (1998).** Behavioural fever in the Senegalese grasshopper, *Oedaleus senegalensis*, and its

implications for biological control using pathogens. *Ecological Entomology* 23 : 9 - 14.

**BODENHEIMER, F. S. (1943).** Studies of the life history and ecology of Coccinellidae. *Bulletin of the Society of Fouad Entomology* 27 : 1 - 28.

**BOORSTEIN, S. M. & EWALD, P. W. (1987).** Costs and benefits of behavioural fever in *Melanoplus sanguinipes* infected by *Nosema acridophagus*. *Physiological Zoology* 60 : 586 - 595.

**BOUCIAS, D. G. (1996).** Imidacloprid - Chemical synergist for microbial control agents of termites. *Abstracts of Papers of the American Chemical Society*. 212 : 19.

**BOUCIAS, D. G., BRADFORD, D. L. & BARFIELD, C. S. (1984).** Susceptibility of the velvetbean caterpillar and soybean looper (Lepidoptera: Noctuidae) to *Nomuraea rileyi*: effects of pathotype, dosage, temperature and host age. *Journal of Economic Entomology* 77 : 247 - 253.

**BRADLEY, C. A., LORD, J. C., JARONSKI, S. T., GILL, S. A., DREVES, A. J. & MURPHY, B. C. (1998).** Mycoinsecticides in thrips management. In : *Proceedings Brighton Crop Protection Conference - Pests & Diseases*. Pp. 177 - 182.

**BRINKMAN, M. A., FULLER, B. W., LEUBKE, K. G. & HILDRETH, M. B. (1997).** Susceptibility of adult alfalfa leafcutting bees (Hymenoptera: Megachilidae) to *Beauveria bassiana* infection. *Journal of Agricultural Entomology* 14 : 393 - 397.

**BROBYN, P. J., CLARK, S. J. & WILDING, N. (1988).** The effect of fungus infection of *Metopolophium dirhodum* [Hom.: Aphididae] on the oviposition behaviour of the aphid parasitoid *Aphidius rhopalosiphi* [Hym.: Aphididae]. *Entomophaga* 33 : 333 - 338.

**BROBYN, P. J., WILDING, N. & CLARK, S. J. (1985).** The persistence of infectivity of conidia of the aphid pathogen *Erynia neoaphidis* on leaves in the field. *Annals of Applied Biology* 107 : 365 - 376.

**BROOKS, W. M. (1993).** Host-parasitoid-pathogen interactions. In: *Parasites and Pathogens of Insects. Volume 2: Pathogens*. Eds. N. E. Beckage, S. N. Thompson & B. A. Federici. Academic Press Inc. San Diego, California. Pp 231 - 272.

**BULL, D. L. (1978).** Formulation of microbial insecticides : Microencapsulation and adjuvants. *Miscellaneous Publications of the Entomological Society of America* : 10 : 11 - 20.

**BURGERJON, A. (1956).** Pulvérisation et poudrage au laboratoire par des préparations pathogènes insecticides. *Annals of Epiphytology* 4 : 677 - 688.

- BURGES, H. D. (2000).** Techniques for testing microbials for control of arthropod pests in greenhouses. In : *Field Manual of Techniques in Invertebrate Pathology*. Eds. L. A. Lacey & H. K. Kaya. Kluwer Academic Publishers, Dordrecht, The Netherlands. Pp 505 - 526.
- BURGES, H. D. (1998).** Formulation of Mycoinsecticides. In : *Formulation of Microbial Biopesticides, Beneficial Microorganisms, Nematodes and Seed treatments*. Ed. H. D. Burges. Kluwer Academic Publishers, Dordrecht, The Netherlands. Pp. 131 - 185.
- BURGES, H. D. (1981).** *Microbial Control of Pests and Plant Diseases 1970 - 1980*. Academic Press Ltd. London, New York. Pp. 949.
- BURGES, H. D. & THOMPSON, E. M. (1971).** Standardization and assay of microbial insecticides. In: *Microbial control of insects and mites*. Eds. H. D. Burges & N. W. Hussey. Academic Press, London & New York. Pp. 591 - 622.
- BUTT, T. M., BECKETT, A. & WILDING, N. (1990).** A histological study of the invasive and developmental processes of the aphid pathogen *Erynia neoaphidis* (Zygomycotina : Entomophthorales) in the pea aphid *Acyrtosiphon pisum*. *Canadian Journal of Botany* 68 : 2153 - 2163.
- BUTT, T. M., CARRECK, N. L., IBRAHIM, L. & WILLIAMS, I. H. (1998).** Honey-bee-mediated infection of pollen beetle (*Meligethes aeneus* Fab.) by the insect-pathogenic fungus, *Metarhizium anisopliae*. *Biocontrol Science and Technology* 8 : 533 - 538.
- BUTT, T. M. & GOETTEL, M. S. (2000).** Bioassays of entomogenous fungi. In : *Bioassays of Entomopathogenic microbes and nematodes*. Eds. A. Navon & K. R. S. Ascher. CABI Publishing. Pp. 141 - 193.
- BUTT, T. M., HARRIS, J. G. & POWELL, K. A. (1999).** Microbial pesticides. The European scene. In : *Biopesticides. Use and Delivery*. Eds. F. R. Hall & J. J. Menn. Humana Press, Totowa, New Jersey. Pp. 23 - 44.
- BUTT, T. M., IBRAHIM, L., BALL, B. V. & CLARK, S. J. (1994).** Pathogenicity of the entomogenous fungi *Metarhizium anisopliae* and *Beauveria bassiana* against crucifer pests and the honey bee. *Biocontrol Science and Technology* 4 : 207 - 214.
- BUTT, T. M., IBRAHIM, L., CLARK, S. J. & BECKETT, A. (1995).** The germination behaviour of *Metarhizium anisopliae* on the surface of aphid and flea beetle cuticles. *Mycological Research* 99 : 945 - 950.
- CANNING, E. U. (1982).** An evaluation of protozoal characteristics in relation to biological control of pests. *Parasitology* 84 : 119 - 149.
- CARRUTHERS, R. I., FENG, Z., RAMOS, M. E. & SOPER, R. S. (1988).** The effect of solar radiation on the survival of *Entomophaga grylli*



(Entomophthorales: Entomophthoraceae) conidia. *Journal of Invertebrate Pathology* 52 : 154 - 162.

**CARRUTHERS, R. I. & HAYNES, D. L. (1986).** Temperature, moisture and habitat effects on *Entomophthora muscae* (Entomophthorales : Entomophthoraceae) conidial germination and survival in the onion agroecosystem. *Environmental Entomology* 15 : 1154 - 1160.

**CARRUTHERS, R. I., LARKIN, T. S. & FIRSTENCEL, H. (1992).** Influence of thermal ecology on the mycosis of a rangeland grasshopper. *Ecology* 73 : 190 - 204.

**CARTER, N., McCLEAN, I. F. G., WATT, A. D. & DIXON, A. F. G. (1980).** Cereal aphids : a case study and review. *Applied Biology* 5 : 271 - 348.

**CHANDLER, D. (1997).** Selection of an isolate of the insect pathogenic fungus *Metarhizium anisopliae* virulent to the Lettuce Root Aphid, *Pemphigus bursarius*. *Biocontrol Science and Technology* 7 : 95 - 104.

**CHANDLER, D. (1992).** The potential of entomopathogenic fungi to control the lettuce root aphid *Pemphigus bursarius*. *Phytoparasitica* 20 (Suppl.): 11 - 15.

**CHANDLER, D., HEALE, J. B. & GILLESPIE, A. T. (1993a).** Competitive interaction between strains of *Verticillium lecanii* on two insect hosts. *Annals of Applied Biology* 122 : 435 - 440.

**CHANDLER, D., HEALE, J. B. & GILLESPIE, A. T. (1993b).** Germination of the entomopathogenic fungus *Verticillium lecanii* on scales of the glasshouse whitefly *Trialeurodes vaporariorum*. *Biocontrol Science and Technology* 3 : 161 - 164.

**CHANDLER, D., HEALE, J. B. & GILLESPIE, A. T. (1994).** Effect of osmotic potential on the germination of conidia and colony growth of *Verticillium lecanii*. *Mycological Research* 98 : 384 - 388.

**CHAPPEL, M. A. & WHITMAN, D. W. (1990).** Grasshopper thermoregulation. In: *Biology of Grasshoppers*. Eds. R. F. Chapman and A. Joern. Wiley Interscience, New York. Pp. 143 - 172.

**CHARNLEY, A. K. (1989).** Mycoinsecticides : Present use and future prospects. *Progress and Prospects in Insect Control*. BCPC Monograph No. 43. British Crop Protection Council. Pp 165 - 181.

**CHARNLEY, A. K., COBB, B. & CLARKSON, J. M. (1997).** Towards the improvement of fungal insecticides. In : *Microbial Insecticides : Novelty or Necessity*. British Crop Protection Council Symposium Proceedings No. 68. British Crop Protection Council. Pp 115 - 126.

- CHIANG, H. C. & HUFFAKER, C. B. (1976).** Insect pathology and microbial control of insects in the People's Republic of China. In: *Proceedings 1<sup>st</sup> International Colloquium on Invertebrate Pathology*. Queen's University Press, Kingston, Canada. PP 42 - 46.
- CHONGRATTANAMETEEKUL, W., FOSTER, J. E. & ARAYA, J. E. (1991).** Biological interactions between the cereal aphids *Rhopalosiphum padi* (L.) and *Sitobion avenae* (F.) (Hom., Aphididae) on wheat. *Journal of Applied Entomology* 111 : 249 - 253.
- CLARK, R. A., CASAGRANDE, R. A. & WALLACE, D. B. (1982).** Influence of pesticides on *Beauveria bassiana*, a pathogen of the Colorado potato beetle. *Environmental Entomology* 11: 67 - 70.
- CODERRE, D. (1988).** The numerical response of predators to aphid availability in maize : Why coccinellids fail? In : *Ecology and Effectiveness of Aphidophaga*. Eds. E. Niemczyk & A. F. G. Dixon. SPB Academic Publishing, The Hague.
- COOK, R. J., BRUCKART, W. L., COULSON, J. R., GOETTEL, M. S., HUMBER, R. A., LUMSDEN, R. D., MADDOX, J. V., McMANUS, M. L., MOORE, L., MEYER, S. F., QUIMBY, P. C. Jr., STACK, J. P. & VAUGHN, J. L. (1996).** Safety of microorganisms intended for pest and plant disease control : a framework for scientific evaluation. *Biological Control* 7 : 333 - 351.
- COOPER, R., HORNITZKY, M. & MEDCRAFT, B. E. (1984).** Non-susceptibility of *Apis mellifera* to *Culicinomyces clavisporus*. *Journal of the Australian Entomological Society* 23 : 173 - 174.
- COPPING, L. G. (1998).** *The Biopesticide Manual*. 1<sup>st</sup> Edition. British Crop Protection Council. 333 pp.
- CORY, J. S. & MYERS, J. H. (2000).** Direct and indirect ecological effects of biological control. *Trends in Ecology and Evolution* 15 : 137 - 139.
- COSTA, S. D. & GAUGLER, R. R. (1989).** Sensitivity of *Beauveria bassiana* to solanine and tomatine : plant defensive chemicals inhibit an insect pathogen. *Journal of Chemical Ecology* 15 : 697 - 706.
- COUCH, T. L. & IGNOFFO, C. M. (1981).** Formulation of insect pathogens. In : *Microbial Control of Pests and Plant diseases 1970 - 1980*. Ed. H. D. Burges. Academic Press, London. Pp. 621 - 634.
- DALLYN, H. & FOX, A. (1980).** Spoilage of materials of reduced water activity by xerophilic fungi. In: *Microbial Growth and Survival in Extremes of Environment*. Eds. G. H. Gould & J. E. L. Corry. *The Society for Applied Bacteriology*. Technical Series No. 15. Academic Press, New York. Pp. 129 - 139.

- DANFA, A. & VAN DER VALK, H. C. H. G. (1999).** Laboratory testing of *Metarhizium* spp. and *Beauveria bassiana* on Sahelian non-target arthropods. *Biocontrol Science and Technology* 9 : 187 - 198.
- DAOUST, R. A. & ROBERTS, D. W. (1982).** Virulence of natural and insect-passaged strains of *Metarhizium anisopliae* to mosquito larvae. *Journal of Invertebrate Pathology* 40 : 107 - 117.
- DAOUST, R. A. & PEREIRA, R. M. (1986).** Stability of entomopathogenic fungi *Beauveria bassiana* and *Metarhizium anisopliae* on beetle-attracting tubers and cowpea foliage in Brazil. *Environmental Entomology* 15 : 1237 - 1243.
- DAVID-HENRIET, A. I., IBRAHIM, L., PYE, B. J. & BUTT, T. M. (In Prep.).** Isolate selection and formulation of the entomogenous fungus *Metarhizium anisopliae* for the control of crucifer pests.
- DEAN, G. J. & LUURING, B. B. (1970).** Distribution of aphids in cereal crops. *Annals of Applied Biology* 66 : 485 - 496.
- DEAN, G. J. W. & WILDING, N. (1971).** *Entomophthora* infecting the cereal aphids *Metopolophium dirhodum* and *Sitobion avenae*. *Journal of Invertebrate Pathology* 18 : 169 - 176.
- DEAN, G. J. W. & WILDING, N. (1973).** Infection of cereal aphids by the fungus *Entomophthora*. *Annals of Applied Biology* 74 : 133 - 138.
- DEBACH, P. & ROSEN, D. (1991).** *Biological Control by Natural Enemies*. 2<sup>nd</sup> Edition. Cambridge University Press. 440 pp.
- DENT, D. (1995).** *Integrated Pest Management*. Chapman & Hall, London. 356 pp.
- DIXON, A. F. G. (1970).** Factors limiting the effectiveness of the coccinellid beetle *Adalia bipunctata* (L.) as a predator of the sycamore aphid, *Drepanosiphum platanoides* (Schr.). *Journal of Animal Ecology* 39 : 739 - 751.
- DIXON, A. F. G. (1998).** *Aphid Ecology*. 2<sup>nd</sup> Edition. Chapman & Hall, London. 300 pp.
- DIXON, A. F. G. & WRATTEN, S. D. (1971).** Laboratory studies on aggregation, size and fecundity in the black bean aphid, *Aphis fabae* Scop. *Bulletin of Entomological Research* 61 : 97 - 111.
- DOBERSKI, J. W. (1981a).** Comparative laboratory studies on three fungal pathogens of the Elm bark beetle *Scolytus scolytus* : Pathogenicity of *Beauveria bassiana*, *Metarhizium anisopliae* and *Paecilomyces farinosus* to larvae and adults of *S. scolytus*. *Journal of Invertebrate Pathology* 37 : 188 - 194.

- DOBERSKI, J. W. (1981b).** Comparative laboratory studies on three fungal pathogens of the Elm bark beetle *Scolytus scolytus* : Effect of temperature and humidity on infection by *Beauveria bassiana*, *Metarhizium anisopliae* and *Paecilomyces farinosus*. *Journal of Invertebrate Pathology* 37 : 195 - 200.
- DONEGAN, K. & LIGHTHART, B. (1989).** Effect of several stress factors on the susceptibility of the predatory insect, *Chrysoperla carnea* (Neuroptera : Chrysopidae), to the fungal pathogen *Beauveria bassiana*. *Journal of Invertebrate Pathology* 54 : 79 - 84.
- DORSCHNER, K. W., FENG, M. & BAIRD, C. R. (1991).** Virulence of an aphid-derived isolate of *Beauveria bassiana* (Fungi : Hyphomycetes) to the hop aphid, *Phorodon humuli* (Homoptera : Aphididae). *Environmental Entomology* 20 : 690 - 693.
- DRIVER, F., MILNER, R. J. & TRUEMAN, J. W. H. (2000).** A taxonomic revision of *Metarhizium* based on phylogenetic analysis of rDNA sequence data. *Mycological Research* 104 : 134 - 150.
- DROMPH, K., PELL, J. K., CLARK, S. J. & EILENBERG, J. (In Prep.).** Effect of biotic and abiotic factors on infection of *Sitobion avenae* with *Erynia neoaphidis*.
- DRUMMOND, J., HEALE, J. B. & GILLESPIE, A. T. (1987).** Germination and effect of reduced humidity on expression of pathogenicity in *Verticillium lecanii* against the glasshouse whitefly *Trialeurodes vaporariorum*. *Annals of Applied Biology* 111 : 193 - 201.
- EILENBERG, J., DAMGAARD, P. H., HANSEN, B. M., PEDERSEN, J. C., BRESCIANI, J. & LARSSON, R. (2000).** Natural coprevalence of *Strongwellsea castrans*, *Cystosporogenes deliaradicae* and *Bacillus thuringiensis* in the host *Delia radicum*. *Journal of Invertebrate Pathology* 75 : 69 - 75.
- EKBOM, B. S. (1981).** Humidity requirements and storage of the entomopathogenic fungus *Verticillium lecanii* for use in greenhouse. *Annales Entomologici Fennici* 47 : 61 - 62.
- EKESI, S., MANIANIA, N. K. & AMPONG-NYARKO, K. (1999).** Effect of temperature on germination, radial growth and virulence of *Metarhizium anisopliae* and *Beauveria bassiana* on *Megalurothrips sjostedti*. *Biocontrol Science and Technology* 9 : 177 - 185.
- EL-MAGHRABY, M. M. A., HEGAB, A. & YOUSIF-KHALIL, S. I. (1988).** Interactions between *Bacillus thuringiensis* Berl., *Beauveria bassiana* (Bals.) Vuill. and the host/parasitoid system *Spodoptera littoralis* (Boisd.)/*Microplitis rufiventris* Kok. *Journal of Applied Entomology* 106 : 417 - 421.

- EVANS, E. W. & DIXON, A. F. G. (1986).** Cues for oviposition by ladybird beetles (*Coccinellidae*) : Response to aphids. *Journal of Animal Ecology* 55 : 1027 - 1034.
- EVANS, H. C. (1989).** Mycopathogens of insects of epigeal and aerial habitats. In: *Insect-Fungus Interactions*. Eds. N. Wilding, N. M. Collins, P. M. Hammond & J. F. Webber Jr. pp 205 - 238. Academic Press, London.
- FARGUES, J., DELMAS, J. C., AUGE, J. & LEBRUN, R. A. (1991).** Fecundity and egg fertility in the adult Colorado beetle (*Leptinotarsa decemlineata*) surviving infection by the fungus *Beauveria bassiana*. *Entomologia Experimentalis et Applicata* 61 : 45 - 51.
- FARGUES, J., GOETTEL, M. S., SMITS, N., OUEDRAOGO, A. & ROUGIER, M. (1997a).** Effect of temperature on vegetative growth of *Beauveria bassiana* isolates from different origins. *Mycologia* 89 : 383 - 392.
- FARGUES, J. & LUZ, C. (2000).** Effects of fluctuating moisture and temperature regimes on the infection potential of *Beauveria bassiana* for *Rhodnius prolixus*. *Journal of Invertebrate Pathology* 75 : 202 - 211.
- FARGUES, J., MANIANIA, N. K., DELMAS, J. C. & SMITS, N. (1992).** Influence de la température sur la croissance *in vitro* d'hyphomycètes entomopathogènes. *Agronomie* 12 : 557 - 564.
- FARGUES, J., OUEDRAOGO, A., GOETTEL, M. S. & LOMER, C. J. (1997b).** Effects of temperature, humidity and inoculation method on susceptibility of *Schistocerca gregaria* to *Metarhizium flavoviride*. *Biocontrol Science and Technology* 7 : 345 - 356.
- FARGUES, J., ROUGIER, M., GOUJET, R. & ITIER, B. (1988).** Effet du rayonnement solaire sur la persistance des conidospores de l'hyphomycète entomopathogène *Nomuraea rileyi* à la surface d'un couvert végétal. *Entomophaga* 33 : 357 - 370.
- FENG, Z., CARRUTHERS, R. I. ROBERTS, D. W. & ROBSON, D. S. (1985).** Age-specific dose-mortality effects of *Beauveria bassiana* (Deuteromycotina : Hyphomycetes) on the European Corn Borer, *Ostrinia nubilalis* (Lepidoptera : Pyralidae). *Journal of Invertebrate Pathology* 46 : 259 - 264.
- FENG, M. & JOHNSON, J. B. (1990).** Relative virulence of six isolates of *Beauveria bassiana* on *Diuraphis noxia* (Homoptera : Aphididae). *Environmental Entomology* 19 : 785 - 790.
- FENG, M. & JOHNSON, J. B. (1991).** Bioassay of four entomophthoralean fungi (Entomophthorales) against *Diuraphis noxia* and *Metopolophium dirhodum* (Homoptera : Aphididae). *Environmental Entomology* 20 : 338 - 345.

- FENG, M. G., JOHNSON, J. B. & KISH, L. P. (1990a).** Survey of entomopathogenic fungi naturally infecting cereal aphids (Homoptera : Aphididae) of irrigated grain crops in southwestern Idaho. *Environmental Entomology* 19 : 1534 - 1542.
- FENG, M., JOHNSON, J. B. & KISH, L. P. (1990b).** Virulence of *Verticillium lecanii* and an aphid-derived isolate of *Beauveria bassiana* (Fungi : Hyphomycetes) for six species of cereal-infesting aphids (Homoptera : Aphididae). *Environmental Entomology* 19 : 815 - 820.
- FENG, M. G. T., POPRAWSKI, T. J. & KHACHATOURIANS, G. G. (1994).** Production, formulation and application of the entomopathogenic fungus *Beauveria bassiana* for insect control: current status. *Biocontrol Science and Technology* 4 : 3 - 34.
- FENG, M. G., POPRAWSKI, T. J., NOWIERSKI, R. M. & ZENG, Z. (1999).** Infectivity of *Pandora neoaphidis* (Zygomycetes: Entomophthorales) to *Acythosiphon pisum* (Hom., Aphididae) in response to varying temperature and photoperiod regimes. *Journal of Applied Entomology* 123: 29 - 35.
- FENLON, J. S. (1995).** It's time to bury Abbott! In: *Abstracts of the 28<sup>th</sup> Annual Meeting of the Society for Invertebrate Pathology*, Cornell University, Ithaca, New York. 16 - 21 July, 1995. P. 18
- FERRON, P. (1977).** Influence of relative humidity on the development of fungal infection caused by *Beauveria bassiana* (Fungi imperfecti) in imagines of *Acanthoscelides obtectus*. *Entomophaga* 22 : 393 - 396.
- FERRON, P. (1981).** Pest control by the fungi *Beauveria* and *Metarhizium*. In: *Microbial Control of Pests and Plant Diseases 1970 - 1980*. Ed. H. D. Burges. Academic Press. Pp. 465 - 482.
- FERRON, P., FARGUES, J. & RIBA, G. (1991).** Fungi as microbial insecticides against pests. In : *Handbook of Applied Mycology - Humans, Animals and Insects. Volume 2*. Eds. D. K. Arora, L. Ajello & K. G. Mukerji. Marcel Dekker Inc., New York, Basel, Hong Kong. Pp. 655 - 706.
- FERRON, P. & HURPIN, P. (1974).** Effects of simultaneous or successive contamination by *Beauveria tenella* and by *Entomopoxvirus melolonthae* of *Melolontha melolontha* larvae (Coleoptera: Scarabaeidae). *Annales de la Societe Entomologique de France* 10 : 771 - 779.
- FERRON, P. & ROBERT, P. H. (1975).** Virulence of Entomopathogenic fungi (Fungi imperfecti) for the adults of *Acanthoscelides obtectus* (Coleoptera : Bruchidae). *Journal of Invertebrate Pathology* 25 : 379 - 388.
- FINE, P. E. M. (1975).** Vectors and vertical transmission : An epidemiologic perspective. *Annals of the New York Academy of Science* 266 : 173 - 194.

- FINNEY, D. J. (1971).** *Probit Analysis*. 3<sup>rd</sup> Edition. Cambridge University Press. 333 pp.
- FITT, B. D. L., McCARTNEY, H. A. & WALKLATE, P. J. (1989).** The role of rain in dispersal of pathogen inoculum. *Annual Review of Phytopathology* 27 : 241 - 270.
- FLEXNER, J. L., LIGHTHART, B. & CROFT, B. A. (1986).** The effects of microbial pesticides on non-target, beneficial arthropods. *Agriculture, Ecosystems and Environment* 16 : 203 - 254.
- FOSTER, S. J. & DEVONSHIRE, A. L. (1996).** The continuing threat of insecticide resistance. *Beet Review* 64 : 15 - 17.
- FOSTER, W. A. (1975).** Life history and population biology of an intertidal aphid, *Pemphigus trehernei* Foster. *Transactions of the Royal Entomological Society* 127 : 192 - 207.
- FRANSEN, J. J. (1987).** *Aschersonia aleyrodis* as a microbial control agent of greenhouse whitefly. *PhD Thesis*. University of Wageningen, Netherlands.
- FRANSEN, J. J. & van LENTEREN, J. C. (1993).** Host selection and survival of the parasitoid *Encarsia formosa* on greenhouse whitefly, *Trialeturodes vaporariorum*, in the presence of hosts infected with the fungus *Aschersonia aleyrodis*. *Entomologia Experimentalis et Applicata* 69 : 239 - 249.
- FUENTES-CONTRERAS, E., PELL, J. K. & NIEMEYER, H. M. (1998).** Influence of plant resistance at the third trophic level : interactions between parasitoids and entomopathogenic fungi of cereal aphids. *Oecologia* 17 : 426 - 432.
- FÜHRER, E. & WILLERS, D. (1986).** The anal secretion of the endoparasitic larva *Pimpla turionellae* : sites of production and effects. *Journal of Insect Physiology* 32 : 361 - 367.
- FURLONG, M. J., PELL, J. K., CHOO, O. P. & RAHMAN, S. A. (1995).** Field and laboratory evaluation of a sex pheromone trap for the autodissemination of the fungal entomopathogen *Zoophthora radicans* (Entomophthorales) by the diamond-back moth, *Plutella xylostella* (Lepidoptera: Yponomeutidae). *Bulletin of Entomological Research* 85 : 331 - 337.
- FURLONG, M. J. & PELL, J. K. (1996).** Interactions between the fungal entomopathogen *Zoophthora radicans* Brefeld (Entomophthorales) and two hymenopteran parasitoids attacking the diamondback moth, *Plutella xylostella* L. *Journal of Invertebrate Pathology* 68 : 15 - 21.

- FURLONG, M. J. & PELL, J. K. (1997).** The influence of environmental factors on the persistence of *Zoophthora radicans* conidia. *Journal of Invertebrate Pathology* 69 : 223 - 233.
- FURLONG, M. J. & PELL, J. K. (In Press).** Conflicts between a fungal entomopathogen, *Zoophthora radicans*, and two larval parasitoids of the diamondback moth.
- FUXA, J. R. (1979).** Interactions of the microsporidium *Vairimorpha necatrix* with bacterium, virus, and fungus in *Heliothis zea*. *Journal of Invertebrate Pathology* 33 : 316 - 323.
- FUXA, J. R. & TANADA, Y. (1987).** *Epizootiology of insect diseases*. Eds. John Wiley & Sons, New York.
- GARDNER, W. A., SUTTON, R. M. & NOBLET, R. (1977).** Persistence of *Beauveria bassiana*, *Nomuraea rileyi* and *Nosema necatrix* on soybean foliage. *Environmental Entomology* 6 : 616 - 618.
- GATES, D. M. (1965).** Heat transfer in plants. *Scientific American* 123 : 76 - 84.
- GENSTAT 5 COMMITTEE (1998).** Genstat 5 Release 4.1. Reference summary. Lawes Agricultural Trust (Rothamsted Experimental Station).
- GILLESPIE, A. T. & CRAWFORD, E. (1986).** Effect of water activity on conidial germination and mycelial growth of *Beauveria bassiana*, *Metarhizium anisopliae*, *Paecilomyces* spp. and *Verticillium lecanii*. In: *Fundamental and Applied Aspects of Invertebrate Pathology, Proceedings of the Fourth International Colloquium of Invertebrate Pathology*. Eds. R. A. Samson, J. M. Vlak & D. Peters. Foundation of the Fourth International Colloquium of Invertebrate Pathology, Wageningen, Netherlands. P. 254.
- GILLESPIE, A. T. (1988).** Use of fungi to control pests of agricultural importance. In : *Fungi in Biological Control Systems*. Ed. M. N. Burge. Manchester University Press. Pp. 37 - 60.
- GLARE, T. R. & MILNER, R. J. (1991).** Ecology of Entomopathogenic fungi. In: *Handbook of Applied Mycology. Humans, Animals & Insects, Volume 2*. Eds. D. K. Arora, L. Ajello & K. G. Mukerji. Marcel Dekker Inc., New York, Basel, Hong Kong. Pp. 556 - 562.
- GLARE, T. R., MILNER, R. & CHILVERS, G. A. (1986a).** The effect of environmental factors on the production, discharge and germination of primary conidia of *Zoophthora phalloides* Batko. *Journal of Invertebrate Pathology* 48 : 275 - 283.
- GLARE, T. R., MILNER, R. & CHILVERS, G. A. (1986b).** Influence of temperature on the mortality of *Myzus persicae* (Sulzer) due to the fungal pathogen *Zoophthora phalloides* Batko. *Journal of the Australian Entomological Society* 25 : 63 - 64.



- GOETTEL, M. S. (1994).** Host range and specificity in relation to safety of exotic fungi. In: *Vlth International Colloquium on Invertebrate Pathology and Microbial Control, XXVII<sup>th</sup> Annual Meeting of the Society for Invertebrate Pathology*, Montpellier, France, 28 August - 2 September, 1994. pp. 325 - 329.
- GOETTEL, M. S. & INGLIS, G. D. (1997).** Fungi : Hyphomycetes. In : *Manual of Techniques in Insect Pathology*. Ed. L. A. Lacey. Academic Press Inc. Pp 213 - 249.
- GOETTEL, M. S., INGLIS, G. D. & WRAIGHT, S. P. (2000).** Fungi. Chapter IV-4. In : *Field Manual of Techniques in Invertebrate Pathology*. Eds. L. A. Lacey & H. K. Kaya. Kluwer Academic Publishers, Dordrecht, The Netherlands. Pp. 255 - 282.
- GOETTEL, M. S., POPRAWSKI, T. J., VANDENBERG, J. D., LI, Z. & ROBERTS, D. W. (1990).** Safety to nontarget invertebrates of fungal biocontrol agents. In: *Safety of Microbial Insecticides*. Eds. M. Laird, L. A. Lacey & E. W. Davidson. CRC Press, Boca Raton, Florida. Pp. 209 - 231.
- GREATHEAD, D. J. & WAAGE, J. K. (1983).** *Opportunities for Biological Control of Agricultural Pests in Developing Countries*. World Bank, Washington, DC, USA. 44 pp.
- GRÖNER, A. (1990).** Safety to nontarget invertebrates of baculoviruses. In: *Safety of Microbial Insecticides*. Eds. M. Laird, L. A. Lacey & E. W. Davidson. CRC Press, Boca Raton, Florida. Pp. 135 - 147.
- GURNEY, B. & HUSSEY, N. W. (1970).** Evaluation of some coccinellid species for the biological control of aphids in protective cropping. *Annals of Applied Biology* 65 : 451 - 458.
- GUSTAFSSON, M. (1969).** On species of the genus *Entomophthora* Fres. in Sweden. III. Possibility of use in biological control. *Lantbrukshögskolans annaler* 35 : 235 - 274.
- HAJEK, A. E. & BUTLER, L. (2000).** Predicting the host range of entomopathogenic fungi. In: *Nontarget Effects of Biological Control*. Eds. P. A. Follett & J. J. Duan. Kluwer Academic Press, Dordrecht, The Netherlands. Pp 263 - 276.
- HAJEK, A. E., BUTLER, L. & WHEELER, M. M. (1995).** Laboratory bioassays testing the host range of the Gypsy moth fungal pathogen *Entomophaga maimaiga*. *Biological Control* 5 : 530 - 544.
- HAJEK, A. E. & St LEGER, R. J. (1994).** Interactions between fungal pathogens and insect hosts. *Annual Review of Entomology* 39 : 293 - 322.

- HALL, R. A. (1976a).** A bioassay of the pathogenicity of *Verticillium lecanii* conidiospores on the aphid, *Macrosiphoniella sanborni*. *Journal of Invertebrate Pathology* 27 : 41 - 48.
- HALL, R. A. (1976b).** *Verticillium lecanii* on the aphid *Macrosiphoniella sanborni*. *Journal of Invertebrate Pathology* 28 : 389 - 391.
- HALL, R. A. (1979).** Pathogenicity of *Verticillium lecanii* conidia and blastospores against the aphid, *Macrosiphoniella sanborni*. *Entomophaga* 24 : 191 - 198.
- HALL, R. A. (1980a).** Comparison of laboratory infection of aphids by *Metarhizium anisopliae* and *Verticillium lecanii*. *Annals of Applied Biology* 95 : 159 - 162.
- HALL, R. A. (1980b).** Effect of repeated subculturing on agar and passaging through an insect host on pathogenicity, morphology, and growth rate of *Verticillium lecanii*. *Journal of Invertebrate Pathology* 36 : 216 - 222.
- HALL, R. A. (1980c).** Effect of relative humidity on survival of washed and unwashed conidiospores of *Verticillium lecanii*. *Acta Oecologica Oecologia Applicata* 1 : 265 - 274.
- HALL, R. A. (1980d).** Laboratory infection of insects by *Verticillium lecanii* strains isolated from phytopathogenic fungi. *Transactions of the British Mycological Society* 74 : 445 - 446.
- HALL, R. A. (1981a).** The fungus *Verticillium lecanii*, as a microbial insecticide against aphids and scales. In: *Microbial Control of Pests and Plant Diseases 1970 - 1980*. Ed. H. D. Burges. Academic Press, London. Pp. 483 - 498.
- HALL, R. A. (1981b).** Laboratory studies on the effects of fungicides, acaricides and insecticides on the entomopathogenic fungus, *Verticillium lecanii*. *Entomologia Experimentalis et Applicata* 29 : 39 - 48.
- HALL, R. A. (1982).** Control of whitefly, *Trialeurodes vaporariorum* and cotton aphid, *Aphis gossypii* in glasshouses by two isolates of the fungus *Verticillium lecanii*. *Annals of Applied Biology* 101 : 1 - 11.
- HALL, R. A. (1983).** Synergistic inhibitory action of preparations of Iprodione and Carbaryl on germination of conidia of *Verticillium lecanii*. *Journal of Invertebrate Pathology* 42 : 384 - 386.
- HALL, R. A. (1984).** Epizootic potential for aphids of different isolates of the fungus *Verticillium lecanii*. *Entomophaga* 29 : 311 - 321.
- HALL, R. A. & BURGESS, H. D. (1979).** Control of aphids in glasshouses with the fungus, *Verticillium lecanii*. *Annals of Applied Biology* 93 : 235 - 246.

- HALL, R. A. & PAPIEROK, B. (1982).** Fungi as biological control agents of arthropods of agricultural and medical importance. *Parasitology* 84 : 205 - 240.
- HALLSWORTH, J. E. & MAGAN, N. (1995).** Manipulation of intracellular glycerol and erythritol enhances germination of conidia at low water availability. *Microbiology* 141 : 1109 - 1115.
- HALLSWORTH, J. E. & MAGAN, N. (1999).** Water and temperature relations of growth of the entomogenous fungi *Beauveria bassiana*, *Metarhizium anisopliae* and *Paecilomyces farinosus*. *Journal of Invertebrate Pathology* 74 : 261 - 266.
- HAMM, J. J. (1980).** Epizootics of *Entomophthora aulicae* in lepidopterous pests of sorghum. *Journal of Invertebrate Pathology* 36 : 60 - 63.
- HARPER, A. M. & HUANG, H. C. (1986).** Evaluation of the entomophagous fungus *Verticillium lecanii* (Moniliales : Moniliaceae) as a control agent for insects. *Environmental Entomology* 15 : 281 - 284.
- HASEEB, M. & MURAD, H. (1997).** Susceptibility of the predator, *Coccinella septempunctata* to the entomogenous fungus, *Beauveria bassiana*. *Annals of Plant Protection Sciences* 5 : 188 - 190.
- HASEEB, M. & MURAD, H. (1998).** Pathogenicity of the entomogenous fungus, *Beauveria bassiana* (Bals.) Vuill. to insect predators. *International Pest Control* 40 : 50 - 51.
- HASSAN, A. E. M., DILLON, R. J. & CHARNLEY, A. K. (1989).** Influence of accelerated germination of conidia on the pathogenicity of *Metarhizium anisopliae* for *Manduca sexta*. *Journal of Invertebrate Pathology* 54 : 277 - 279.
- HATTING, J. L., HUMBER, R. A., POPRAWSKI, T. J. & MILLER, R. M. (1999).** A survey of fungal pathogens of aphids from South Africa, with special reference to cereal aphids. *Biological Control* 16 : 1 - 12.
- HAWKSWORTH, D. L., KIRK, P. M., SUTTON, B. C. & PEGLER, D. N. (1995).** *Ainsworth & Bisby's dictionary of the fungi*. 8<sup>th</sup> Edn. CAB International. 616 pp.
- HAYDEN, T. P., BIDOCHKA, M. J. & KHACHATOURIANS, G. G. (1992).** Entomopathogenicity of several fungi toward the English grain aphid (Homoptera: Aphididae) and enhancement of virulence with host passage of *Paecilomyces farinosus*. *Journal of Economic Entomology* 85 : 58 - 64.
- HEALE, J. B. (1988).** The potential impact of fungal genetics and molecular biology on biological control, with particular reference to entomopathogens. In: *Fungi in Biological Control Systems*. Ed. M. N. Burge. Manchester University Press. Pp. 211 - 234.

- HEMMATI, F. (1998).** Aerial dispersal of the entomopathogenic fungus *Erynia neoaphidis*. *PhD Thesis*. University of Reading, UK. 187 pp.
- HEMPTINNE, J. L., DIXON, A. F. G. & COFFIN, J. (1992).** Attack strategy of ladybird beetles (Coccinellidae) : Factors shaping their numerical response. *Oecologia* 90 : 238 - 245.
- HOCH, G., SCHOPF, A. & MADDOX, J. V. (2000).** Interactions between an entomopathogenic microsporidium and the endoparasitoid *Glyptapanteles liparidis* within their host, the gypsy moth larva. *Journal of Invertebrate Pathology* 75 : 59 - 68.
- HOCHBERG, M. E. (1991a).** Intra-host interactions between a braconid endoparasitoid, *Apanteles glomeratus*, and a baculovirus for larvae of *Pieris brassicae*. *Journal of Animal Ecology* 60 : 51 - 63.
- HOCHBERG, M. E. (1991b).** Extra-host interactions between a braconid endoparasitoid, *Apanteles glomeratus*, and a baculovirus for larvae of *Pieris brassicae*. *Journal of Animal Ecology* 60 : 65 - 77.
- HOCHBERG, M. E., HASSELL, M. P. & MAY, R. M. (1990).** The dynamics of host-parasitoid-pathogen interactions. *American Naturalist* 135 : 74 - 94.
- HOCHBERG, M. E. & LAWTON, J. H. (1990).** Competition between kingdoms. *Trends in Ecology and Evolution* 5 : 367 - 371.
- HOCKLAND, S. H., DAWSON, G. W., GRIFFITHS, D. C., MARPLES, B., PICKETT, J. A. & WOODCOCK, C. M. (1986).** The use of aphid alarm pheromone (E)- $\beta$ -farnesene to increase the effectiveness of the entomophilic fungus *Verticillium lecanii* in controlling aphids on chrysanthemums under glass. In : *Fundamental and Applied Aspects of Invertebrate Pathology*. Eds. R. A. Samson, J. M. Vlcek, and R. Peters, pp. 252. The Netherlands Society of Invertebrate Pathology.
- HODEK, I. (1973).** *Biology of Coccinellidae*. Junk, The Hague. Academia: Prague. 346 pp.
- HOLMES, P. R. (1988).** Mobility of apterous grain aphids *Sitobion avenae* within wheat fields. *Entomologia Experimentalis et Applicata* 46 : 275 - 279.
- HOLMES, S. (1979).** *Henderson's Dictionary of Biological Terms*. 9<sup>th</sup> Edn. Longman, New York & London. 510 pp.
- HOLT, R. D. (1977).** Predation, apparent competition and the structure of prey communities. *Theoretical Population Biology* 12 : 197 - 229.
- HONĚK, A. (1985).** Activity and predation of *Coccinella septempunctata* adults in the field (Col., Coccinellidae). *Zeitschrift für Angewandte Entomologie* 100 : 399 - 409.

- HOTCHKIN, P. G. & KAYA, H. K. (1983).** Interactions between two baculoviruses and several insect parasites. *Canadian Entomologist* 115 : 841 - 846.
- HOY, M. A. & HERZOG, D. G. (1985).** *Biological Control in Agricultural IPM systems*. Academic Press. Orlando, Florida. 589 pp.
- HSIAO, W. -F., BIDOCHKA, M. J. & KHACHATOURIANS, G. G. (1992).** Effect of temperature and relative humidity on the virulence of the entomopathogenic fungus *Verticillium lecanii*, toward the oat-bird cherry aphid, *Rhopalosiphum padi* (Hom., Aphididae). *Journal of Applied Entomology* 114 : 484 - 490.
- HUGHES, J. C. & GILLESPIE, A. T. (1985).** Germination and penetration of the aphid *Macrosiphoniella sanborni* by two strains of *Verticillium lecanii*. *Proceedings, XVIIIth Annual Meeting of the Society for Invertebrate Pathology*, Sault Ste Marie, p. 28.
- HULL, R. (1964).** Some observations of *Acyrtosiphon pisum* (Harris) and *Aphis fabae* Scop. colonising sweet peas. *Entomologia Experimentalis et Applicata* 7 : 195 - 204.
- HUNT, T. R., MOORE, D., HIGGINS, P. M. & PRIOR, C. (1994).** Effect of sunscreens, irradiance and resting periods on the germination of *Metarhizium flavoviride* conidia. *Entomophaga* 39 : 313 - 322.
- HYWEL-JONES, N. L. & GILLESPIE, A. T. (1990).** Effect of temperature on spore germination in *Metarhizium anisopliae* and *Beauveria bassiana*. *Mycological Research* 94 : 389 - 392.
- IBRAHIM, L., BUTT, T. M., BECKETT, A. & CLARK, S. J. (1999).** The germination of oil-formulated conidia of the insect pathogen, *Metarhizium anisopliae*. *Mycological Research* 103 : 901 - 907.
- IGNOFFO, C. M., GARCIA, C., ALYOSHINA, O. A. & LAPPA, N. V. (1979).** Laboratory and field studies with Boverin: a mycoinsecticidal preparation of *Beauveria bassiana* produced in the Soviet Union. *Journal of Economic Entomology* 72 : 562 - 565.
- IGNOFFO, C. M., GARCIA, C. & HOSTETTER, D. L. (1976a).** Effects of temperature on growth and sporulation of the entomopathogenic fungus *Nomuraea rileyi*. *Environmental Entomology* 5 : 935 - 936.
- IGNOFFO, C. M., GARCIA, C. & KROHA, M. (1982a).** Susceptibility of larvae of *Trichoplusia ni* and *Anticarsia gemmatalis* to intrahemocoelic injections of conidia and blastospores of *Nomuraea rileyi*. *Journal of Invertebrate Pathology* 39 : 198 - 202.

- IGNOFFO, C. M., GARCIA, C., KROHA, M. & COUCH, T. L. (1982b).** Use of larvae of *Trichoplusia ni* to bioassay conidia of *Beauveria bassiana*. *Journal of Economic Entomology* 75 : 275 - 276.
- IGNOFFO, C. M., GARCIA, C., KROHA, M., SAMŠINÁKOVÁ, A. & KÁLALOVÁ, S. (1983).** A leaf surface treatment bioassay for determining the activity of conidia of *Beauveria bassiana* against *Leptinotarsa decemlineata*. *Journal of Invertebrate Pathology* 41 : 385 - 386.
- IGNOFFO, C. M., HOSTETTER, D. L., SIKOROWSKI, P. P., SUTTER, G. & BROOKES, W. M. (1977).** Inactivation of representative species of entomopathogenic viruses, a bacterium, fungus and protozoan by an ultraviolet light source. *Environmental Entomology* 6 : 411 - 415.
- IGNOFFO, C. M. & MANDAVA, N. B. (1988).** *Handbook of Natural Pesticides. Volume V. Microbial Insecticides. Part A, Entomogenous Protozoa and Fungi.* CRC Press Inc. Boca Raton, Florida. 243 pp.
- IGNOFFO, C. M., PUTTLER, B., HOSTETTER, D. L. & DICKERSON, W. A. (1976b).** Susceptibility of the cabbage looper, *Trichoplusia ni*, and the velvetbean caterpillar, *Anticarsia gemmatilis*, to several isolates of the entomopathogenic fungus *Nomuraea rileyi*. *Journal of Invertebrate Pathology* 28 : 259 - 262.
- IMAI, T., TSUCHIYA, S. & FUJIMORI, T. (1995).** Aphicidal effects of Silwet L-77, organosilicone nonionic surfactant. *Applied Entomology and Zoology* 30 : 380 - 382.
- IMAI, T., TSUCHIYA, S., MORITA, K. & FUJIMORI, T. (1994).** Surface tension-dependent surfactant toxicity on the green peach aphid, *Myzus persicae* (Sulzer) (Hemiptera: aphididae). *Applied Entomology and Zoology* 29 : 389 - 393.
- INGLIS, G. D., DUKE, G. M., KAWCHUK, L. M. & GOETTEL, M. S. (1999).** Influence of oscillating temperatures on the competitive infection and colonisation of the migratory grasshopper by *Beauveria bassiana* and *Metarhizium flavoviride*. *Biological Control* 14 : 111 - 120.
- INGLIS, G. D., GOETTEL, M. S. & JOHNSON, D. L. (1993).** Persistence of the entomopathogenic fungus, *Beauveria bassiana*, on phylloplanes of crested wheatgrass and alfalfa. *Biological Control* 3 : 258 - 270.
- INGLIS, G. D., GOETTEL, M. S. & JOHNSON, D. L. (1995).** Influence of ultraviolet light protectants on the persistence of the entomopathogenic fungus, *Beauveria bassiana*. *Biological Control* 5 : 581 - 590.
- INGLIS, G. D., IVIE, T. J., DUKE, G. M. & GOETTEL, M. S. (2000).** Influence of rain and conidial formulation on persistence of *Beauveria bassiana* on potato leaves and Colorado potato beetle larvae. *Biological Control* 18 : 55 - 64.

- INGLIS, G. D., JOHNSON, D. L. & GOETTEL, M. S. (1995).** Effects of simulated rain on the persistence of *Beauveria bassiana* conidia on leaves of alfalfa and wheat. *Biocontrol Science and Technology* 5 : 365 - 369.
- INGLIS, G. D., JOHNSON, D. L. & GOETTEL, M. S. (1996).** Effects of temperature and thermoregulation on mycosis by *Beauveria bassiana* in grasshoppers. *Biological Control* 7 : 131 - 139.
- INGLIS, G. D., JOHNSON, D. L. & GOETTEL, M. S. (1997).** Effects of temperature and sunlight on mycosis (*Beauveria bassiana*) (Hyphomycetes : Symptodulosporae) of grasshoppers under field conditions. *Environmental Entomology* 26 : 400 - 409.
- INYANG, E. N., McCARTNEY, H. A., OYEJOLA, B., IBRAHIM, L., PYE, B. J., ARCHER, S. A. & BUTT, T. M. (2000).** Effect of formulation, application and rain on the persistence of the entomogenous fungus *Metarhizium anisopliae* on oilseed rape. *Mycological Research* 104 : 653 - 661.
- IVES, A. R., KAREIVA, P. & PERRY, R. (1993).** Response of a predator to variation in prey density at three hierarchical scales : Ladybirds feeding on aphids. *Ecology* 74 : 1929 - 1938.
- JACKSON, C. W., HEALE, J. B. & HALL, R. A. (1985).** Traits associated with virulence to the aphid *Macrosiphoniella sanborni* in eighteen isolates of *Verticillium lecanii*. *Annals of Applied Biology* 106 : 39 - 48.
- JAMES, R. R., CROFT, B. A., SHAFFER, B. T. & LIGHTHART, B. (1998).** Impact of temperature and humidity on host-pathogen interactions between *Beauveria bassiana* and a coccinellid. *Environmental Entomology* 27 : 1506 - 1513.
- JAMES, R. R. & LIGHTHART, B. (1992).** Protocol for testing the effects of fungal pesticides on nontarget beetles using *Hippodamia convergens* (Coleoptera : Coccinellidae). *Technical Report*. U.S. Environmental Protection Agency, Environmental Research Laboratory, Corvallis, Oregon. 26 pp.
- JAMES, R. R. & LIGHTHART, B. (1994).** Susceptibility of the convergent lady beetle (Coleoptera : Coccinellidae) to four entomogenous fungi. *Environmental Entomology* 23 : 190 - 192.
- JAMES, R. R., SCHAFFER, B. T., CROFT, B. & LIGHTHART, B. (1995).** Field evaluation of *Beauveria bassiana* : its persistence and effects on the pea aphid and a non-target coccinellid in alfalfa. *Biocontrol Science and Technology* 5 : 425 - 437.
- JARONSKI, S. T. & GOETTEL, M. S. (1997).** Development of *Beauveria bassiana* for control of grasshoppers and locusts. *Memoirs of the Entomological Society of Canada* 171 : 225 - 237.

- JARONSKI, S. T., LORD, J., ROSINSKA, J., BRADLEY, C., HOELMER, K., SIMMONS, G., OSTERLIND, R., BROWN, C., STATEN, R. & ANTILLA, L. (1998).** Effect of a *Beauveria bassiana*-based mycoinsecticide on beneficial insects under field conditions. *The 1998 Brighton Conference - Pests and Diseases*. Pp. 651 - 656.
- JAROS-SU, J., GRODEN, E. & ZHANG, J. (1999).** Effects of selected fungicides and the timing of fungicide application on *Beauveria bassiana* induced mortality of the Colorado potato beetle (Coleoptera : Chrysomelidae). *Biological Control* 15 : 259 - 269.
- JONES, H. G. (1983).** *Plants and Microclimate*. Cambridge University Press, Cambridge. 323 pp.
- JONES, K. A., CHERRY, A. J. & GRZYWACZ, D. (1997).** Formulation : Is it an excuse for poor application? In : *Microbial Insecticides : Novelty or Necessity?* BCPC Symposium Proceedings No. 68. British Crop Protection Council. Pp. 173 - 180.
- JONES, W. E., GRACE, J. K. & TAMASHIRO, M. (1996).** Virulence of seven isolates of *Beauveria bassiana* and *Metarhizium anisopliae* to *Coptotermes formosanus* (Isoptera : Rhinotermitidae). *Environmental Entomology* 25 : 481 - 487.
- KELLER, S. (1982).** On the importance of fungal diseases in the regulation of cockchafer populations. *Mitteilungen der Schweizerischen Entomologischen* 17 : 124 - 133.
- KELLER, S. (1997).** The genus *Neozygites* (Zygomycetes : Entomophthorales) with special reference to species found in tropical regions. *Sydowia* 49 : 118 - 146.
- KELLER, S., SCHWEIZER, C. & SHAH, P. (1999).** Differential susceptibility of two *Melolontha* populations to infections by the fungus *Beauveria brongniartii*. *Biocontrol Science and Technology* 9 : 441 - 446.
- KENNEDY, J. S., BOOTH, C. O. & IBBOTSON, A. (1950).** The distribution of aphid infestation in relation to leaf age. I. *Myzus persicae* Sulz. and *Aphis fabae* Scop. on spindle trees and sugar beets. *Annals of Applied Biology* 37 : 659 - 679.
- KENNEDY, J. S., DAY, M. F. & EASTOP, V. F. (1962).** *A Conspectus of Aphids as Vectors of Plant Viruses*. Commonwealth Institute of Entomology, London. Pp 114.
- KHACHATOURIANS, G. G. (1992).** Virulence of five *Beauveria* strains, *Paecilomyces farinosus*, and *Verticillium lecanii* against the migratory grasshopper, *Melanoplus sanguinipes*. *Journal of Invertebrate Pathology* 59 : 212 - 214.



- KHALIL, S. K., BARTOS, J. & LANDA, Z. (1985).** Effectiveness of *Verticillium lecanii* to reduce populations of aphids under glasshouse and field conditions. *Agriculture, Ecosystems and Environment* 12 : 151 - 156.
- KHALIL, S. K., SHAH, M. A. & NAEEM, M. (1985).** Laboratory studies on the compatibility of the entomopathogenic fungus *Verticillium lecanii* with certain pesticides. *Agriculture, Ecosystems and Environment* 13 : 329 - 334.
- KISELEK, E. V. (1975).** The effect of biopreparations on insect enemies. *Zashchita Rastenii* 12: 23.
- KISH, L. P. & ALLEN, G. E. (1978).** The biology and ecology of *Nomuraea rileyi* and a program for predicting its incidence on *Anticarsia gemmatilis* in soybean. *Bulletin, Florida Agricultural Experiment Stations*. No. 795. 48 pp.
- KISH, L. P., MAJCHROWICZ, I. & BIEVER, K. D. (1994).** Prevalence of natural fungal mortality of green peach aphid (Homoptera : Aphididae) on potatoes and nonsolonaceous hosts in Washington and Idaho. *Environmental Entomology* 23 : 1326 - 1330.
- KLINGAUF, F. A. (1987).** Feeding, adaptation and excretion. In: *Aphids. Their Biology, Natural Enemies and Control. Vol 2A*. Eds. A. K. Minks & P. Harrewign. Elsevier, Amsterdam. Pp. 225 - 253.
- KOLBE, W. (1969).** Studies on the occurrence of different aphid species as the cause of cereal yield and quality losses. *Pflanzenschutz-Nachrichten Bayer* 22 : 171 - 204.
- KOPPENHOFER, A. M. & KAYA, H. K. (1997)** Additive and synergistic interaction between entomopathogenic nematodes and *Bacillus thuringiensis* for scarab grub control. *Biological Control* 8 : 131 - 137.
- KRAMM, K. R., WEST, D. F. & ROCKENBACH, P. G. (1982).** Termite pathogens : Transfer of the entomopathogen *Metarhizium anisopliae* between *Reticulitermes* sp. termites. *Journal of Invertebrate Pathology* 40 : 1 - 6.
- LACEY, L. M. & GOETTEL, M. S. (1995).** Current developments in microbial control of insect pests and prospects for the early 21<sup>st</sup> century. *Entomophaga* 40 : 3 - 27.
- LACEY, L. A., KIRK, A. A., MILLAR, L., MERCADIER, G. & VIDAL, C. (1999).** Ovicidal and larvicidal activity of conidia and blastospores of *Paecilomyces fumosoroseus* (Deuteromycotina: hyphomycetes) against *Bemisia argentifolii* (Homoptera: aleyrodidae) with a description of a bioassay system allowing prolonged survival of control insects. *Biocontrol Science and Technology* 9 : 9 - 18.

- LACEY, L. A. & MERCADIER, G. (1998).** The effect of selected allelochemicals on germination of conidia and blastospores and mycelial growth of the entomopathogenic fungus, *Paecilomyces fumosoroseus* (Deuteromycotina : Hyphomycetes). *Mycopathologia* 142 : 17 - 25.
- LACEY, L. A., MESQUITA, A. M., MERCADIER, G., DEBIRE, R., KAZMER, D. J. & LECLANT, F. (1997).** Acute and sublethal activity of the entomopathogenic fungus *Paecilomyces fumosoroseus* (Deuteromycotina : Hyphomycetes) on adult *Aphelinus asychis* (Hymenoptera : Aphelinidae). *Environmental Entomology* 26 : 1452 - 1460.
- LATCH, G. C. M. & FALLOON, R. E. (1976).** Studies on the use of *Metarhizium anisopliae* to control *Oryctes rhinoceros*. *Entomophaga* 21 : 39 - 48.
- LANGEWALD, J., OUAMBAMA, Z., MAMADOU, A., PEVELING, R., STOLZ, I., BATEMAN, R., ATTIGNON, S., BLANFORD, S., ARTHURS, S. & LOMER, C. (1999).** Comparison of an organophosphate insecticide with a mycoinsecticide for the control of *Oedaleus senegalensis* (Orthoptera : Acrididae) and other Sahelian grasshoppers at an operational scale. *Biocontrol Science and Technology* 9 : 199 - 214.
- LEE, E. T. (1992).** Non parametric methods of estimating survival functions. In : *Statistical Methods for Survival Data Analysis*. Wiley, New York. Pp. 86 - 92.
- LI, Z. (1988).** A list of insect hosts of *Beauveria bassiana*. In: *Study and Application of Entomogenous Fungi in China*. Eds. Y. W. Li, Z. Z. Li, Z. Q. Liang, J. W. Wu, Z. K. Wu & Q. F. Xi. Academic Press, Beijing, PRC. Pp 10 - 14.
- LIZEN, E., LATTEUR, G. & OGER, R. (1985).** Sensibilité á l'infection par l'Entomophthorale *Erynia neoaphidis* REMAUD. et HENN. du puceron *Acyrtosiphon pisum* (HARRIS) selon sa forme, son stade et son âge. *Parasitica* 41 : 163 - 170.
- LOMER, C. J., BATEMAN, R. P., GODONOU, I., KPINDOU, D., SHAH, P. A., PARAÍSO, A. & PRIOR, C. (1993).** Field infection of *Zonocerus variegatus* following application of an oil-based formulation of *Metarhizium flavoviride* conidia. *Biocontrol Science and Technology* 3 : 337 - 346.
- LONG, D. W., GRODEN, E. & DRUMMOND, F. (2000).** Horizontal transmission of *Beauveria bassiana* (Bals.) Vuill. *Agricultural and Forest Entomology* 2 : 11 - 17.
- LOWE, H. J. B. (1967).** Interspecific differences in the biology of aphids (Homoptera) (Aphididae) on leaves of *Vicia faba*. *Entomologia Experimentalis et Applicata* 10 : 347 - 357.

- LOWE, H. J. B. (1971).** Relationship of the movements of aphids over the host-plant to their spatial distribution. *Bulletin of Entomological Research* 60 : 599 - 605.
- LOWE, H. J. B. & TAYLOR, L. R. (1964).** Population parameters, wing production and behaviour in red and green *Acyrtosiphon pisum* (Harris) (Hom : Aphidiae). *Entomologia Experimentalis et Applicata* 7 : 287 - 295.
- LUCK, R. F. (1990).** Evaluation of natural enemies for biological control : A behavioural approach. *Trends in Ecology and Evolution* 5 : 196 - 199.
- MACKAUER, M. & WAY, M. J. (1976).** *Myzus persicae* Sulz., an aphid of world importance. In : *Studies in Biological Control*. Ed. V. L. Delucchi. Cambridge University Press. Pp 51 - 119.
- MAGALHAES, B. P., LORD, J. C., WRAIGHT, S. P., DAOUST, R. A. & ROBERTS, D. W. (1988).** Pathogenicity of *Beauveria bassiana* and *Zoophthora radicans* to the coccinellid predators *Coleomegilla maculata* and *Eriopsis connexa*. *Journal of Invertebrate Pathology* 52 : 471 - 473.
- MAGAN, N. & LACEY, J. (1984).** Effect of temperature and pH on water relations of field and storage fungi. *Transactions of the British Mycological Society* 82 : 71 - 81.
- MAJCHROWICZ, I. & POPRAWSKI, T. J. (1993).** Effects *in vitro* of nine fungicides on growth of Entomopathogenic fungi. *Biocontrol Science and Technology* 3 : 321 - 336.
- MAJERUS, M. E. N. (1994).** *Ladybirds*. Harper Collins Publishers, London. 367 pp.
- MALAKAR, R., ELKINTON, J. S., HAJEK, A. E. & BURAND, J. P. (1999).** Within-host interactions of *Lymantria dispar* (Lepidoptera: Lymantriidae) nucleopolyhedrosis virus and *Entomophaga maimaiga* (Zygomycetes: Entomophthorales). *Journal of Invertebrate Pathology* 73 : 91 - 100.
- MANIANIA & FARGUES (1986).** Infectivity of *Paecilomyces fumosoroseus* and *Nomuraea rileyi* to larvae of *Mamestra brassicae* and *Spodoptera littoralis* at two temperatures. In : *Fundamental and Applied Aspects of Invertebrate Pathology*. Eds. R. A. Samson, J. M. Vlak & D. Peters. Fourth International Colloquium of Invertebrate Pathology. Wageningen. P 251.
- MANIANIA, N. K. & ODULAJA, A. (1998).** Effect of species, age and sex of tsetse on response to infection by *Metarhizium anisopliae*. *Biocontrol* 43 : 311 - 323.
- MANTIS, N. (2000).** Laboratory studies on the effects of four commercially used agrochemicals on the germination and growth of the entomopathogenic fungi *Verticillium lecanii*, *Paecilomyces fumosoroseus* and *Beauveria bassiana*. *M.Sc. Thesis*. University of Nottingham. 64 pp.

- MARTI, O. G. Jr. & HAMM, J. J. (1986).** Effect of *Vairimorpha* sp. on the survival of adult *Calleida decora* in the laboratory. *Journal of Agricultural Entomology* 3 : 242 - 248.
- MATEWELE, P., TRINCI, A. P. J. & GILLESPIE, A. T. (1994).** Mutants of entomopathogenic fungi that germinate and grow at reduced water activities and reduced relative humidities are more virulent to *Nephotettix virescens* (green leafhopper) than the parental strains. *Mycological Research* 98 : 1329 - 1333.
- MATHEW, M. J., VENUGOPAL, M. N. & SAJU, K. A. (1999).** First record of some entomogenous fungi on cardamon aphid, *Pentalonia nigronervosa* f. *caladii* van der Goot (Homoptera : Aphididae). *Insect Environment* 4 : 147 - 148.
- McCOY, C. W., SAMSON, R. A. & BOUCIAS, D. G. (1988).** Entomogenous fungi. In: *Handbook of Natural Pesticides. Vol 5, Microbial Insecticides, Part A, Entomogenous Protozoa and Fungi*. Eds. C. M. Ignoffo & N. B. Mandava. CRC Press, Inc., Boca Raton, Florida, USA. Pp. 151 - 236.
- MEADOW, R., SHELTON, A. M. & VANDENBERG, J. D. (1998).** Autodissemination of *Beauveria bassiana* for microbial control of the cabbage root fly in sustainable agriculture. *Bulletin IOBC wprs* 21: 37-40.
- MEEKES, E. T. M., FRANSEN, J. J. & van LENTEREN, J. C. (1996).** Pathogenicity of entomopathogenic fungi of the genus *Aschersonia* against whitefly. *Bulletin IOBC wprs* 19: 191 - 194.
- MELIN, B. E. & COZZI, E. M. (1990).** Safety to nontarget invertebrates of lepidopteran strains of *Bacillus thuringiensis* and their  $\beta$ -exotoxins. In: *Safety of Microbial Insecticides*. Eds. M. Laird, L. A. Lacey & E. W. Davidson. CRC Press, Boca Raton, Florida. Pp. 149 - 167.
- MENN, J. J. (1996).** Biopesticides : Has their time come? *Journal of Environmental Science and Health B* 31 : 383 - 389.
- MENN, J. J. (1997).** Biopesticides - are they relevant? In : *Focus on Biopesticides*. The Royal Society of Chemistry. Pp 1 - 2.
- MESQUITA, A. L. M., LACEY, L. A. & LECLANT, F. (1997).** Individual and combined effects of the fungus, *Paecilomyces fumosoroseus* and parasitoid, *Aphelinus asychis* Walker (Hym., Aphelinidae) on confined populations of Russian wheat aphid, *Diuraphis noxia* (Mordvilko) (Hom., Aphididae) under field conditions. *Journal of Applied Entomology* 121 : 155 - 163.
- MESQUITA, A. L. M., LACEY, L. A., MERCADIER, G. & LECLANT, F. (1996).** Entomopathogenic activity of a whitefly-derived isolate of *Paecilomyces fumosoroseus* (Deuteromycotina: hyphomycetes) against the Russian wheat aphid, *Diuraphis noxia* (Homoptera: Sternorrhyncha:

aphididae) with the description of an effective bioassay method. *European Journal of Entomology* 93 : 69 - 75.

- MIETKIEWSKI, R. T., PELL, J. K. & CLARK, S. J. (1997).** Influence of pesticide used on the natural occurrence of Entomopathogenic fungi in arable soils in the UK : Field and laboratory comparisons. *Biocontrol Science and Technology* 7 : 565 - 575.
- MILLS, N. J. (1981).** The mortality and fat content of *Adalia bipunctata* during hibernation. *Entomologia Experimentalis et Applicata* 30 : 265 - 268.
- MILNER, R. J. (1982).** On the occurrence of pea aphids, *Acyrtosiphon pisum*, resistant to isolates of the fungal pathogen *Erynia neoaphidis*. *Entomologia Experimentalis et Applicata* 32 : 23 - 27.
- MILNER, R. J. (1992).** Selection and characterisation of strains of *Metarhizium anisopliae* for control of soil insects in Australia. In: *Biological Control of Locusts and Grasshoppers*. Eds. C. J. Lomer & C. Prior. C.A.B. International. Pp. 200 - 207.
- MILNER, R. J. (1997).** Prospects for biopesticides for aphid control. *Entomophaga* 42 : 227 - 239.
- MILNER, R. J. & BOURNE, J. (1983).** Influence of temperature and duration of leaf wetness on infection of *Acyrtosiphon kondoi* with *Erynia neoaphidis*. *Annals of Applied Biology* 102 : 19 - 27.
- MILNER, R. J. & LUTTON, G. G. (1983).** Effect of temperature on *Zoophthora radicans* (Brefeld) Batko : an introduced microbial control agent of the spotted alfalfa aphid, *Therioaphis trifolii* (Monell) f. *maculata*. *Journal of the Australian Entomological Society* 22 : 167 - 173.
- MILNER, R. J. & LUTTON, G. G. (1986).** Dependence of *Verticillium lecanii* (Fungi : Hyphomycetes) on high humidities for infection and sporulation using *Myzus persicae* (Homoptera : Aphididae) as host. *Environmental Entomology* 15 : 380 - 382.
- MILNER, R. J., LUTTON, G. G. & BOURNE, J. (1984).** A laboratory study of the interaction between aphids, fungal pathogens and parasites. In: *Proceedings of the 4<sup>th</sup> Australian Applied Entomology Research Conference*. Eds. P. Bailey & D. Swincer. Adelaide. Pp 375 - 381.
- MILNER, R. J. & SOPER, R. S. (1981).** Bioassay of *Entomophthora* against the spotted alfalfa aphid *Therioaphis trifolii* f. *maculata*. *Journal of Invertebrate Pathology* 37 : 168 - 173.
- MILNER, R. J., STAPLES, J. A. & LUTTON, G. G. (1997).** The effect of humidity on germination and infection of termites by the hyphomycete, *Metarhizium anisopliae*. *Journal of Invertebrate Pathology* 69 : 64 - 69.

- MINKS, A. K. & HARREWIJN, P. (1987).** *Aphids. Their Biology, Natural Enemies and Control*. Volume A. Elsevier, Amsterdam.
- MIRANPURI, G. S. & KHACHATOURIANS, G. G. (1995).** Entomopathogenicity of *Beauveria bassiana* (Balsamo) Vuillemin and *Verticillium lecanii* (Zimmerman) toward english grain aphid, *Sitobion avenae* (Fab.) (Homoptera: aphididae). *Journal of Insect Science* 8 : 34 - 39.
- MIRANPURI, G. S. & KHACHATOURIANS, G. G. (1996).** Bionomics and fungal control of woolly elm aphid, *Eriosoma americanum* (Riley) (Eriosomatidae : Homoptera) on Saskatoon berry, *Amelanchier alnifolia*. *Journal of Insect Science* 9 : 33 - 37.
- MISSONIER, J., ROBERT, Y. & THOIZON, G. (1970).** Circonstances épidémiologiques semblant favoriser le développement des mycoses à Entomophthorales chez trois aphides, *Aphis fabae* Scop., *Capitophorus horni* Börner et *Myzus persicae* Sulz. *Entomophaga* 15 : 169 - 190.
- MOHAN, C. H. M, ARUNA, K. L. & UMA, K. D. (1999).** Laboratory evaluation of the pathogenicity of three isolates of the entomopathogenic fungus *Beauveria bassiana* (Bals.) Vuillemin on the American Cockroach (*Periplaneta americana*). *Biocontrol Science and Technology* 9 : 29 - 33.
- MONTEIRO, S. G., BITTENCOURT, V. R. E. P., DAEMON, E. & FACCINI, J. L. H. (1998a).** Pathogenicity under laboratory conditions of the fungus *Beauveria bassiana* and *Metarhizium anisopliae* on larvae of the tick *Rhipicephalus sanguineus* (Acari: Ixodidae). *Revista Brasileira de Parasitologia Veterinaria* 7 : 113 - 116.
- MONTEIRO, A. C., FIORIN, A. C. & CORREIA, A. C. B. (1998b).** Pathogenicity of isolates of *Metarhizium anisopliae* (Metsch.) Sorokin towards the cattle tick *Boophilus microplus* (Con.) (Acari: Ixodidae) under laboratory conditions. *Revista de Microbiologia* 29 : 109 - 112.
- MONTEITH, J. L. & UNSWORTH, M. H. (1990).** *Principles of Environmental Physics*. 2<sup>nd</sup> Edn. Edward Arnold, London. 291 pp.
- MOORE, D., HIGGINS, P. M. & LOMER, C. J. (1996).** Effects of simulated and natural sunlight on the germination of conidia of *Metarhizium flavoviride* Gams and Rozsypal and interactions with temperature. *Biocontrol Science and Technology* 6 : 63 - 76.
- MOORHOUSE, E. R., GILLESPIE, A. T., SELLERS, E. K. & CHARNLEY, A. K. (1992).** Influences of fungicides and insecticides on the entomogenous fungus *Metarhizium anisopliae*, a pathogen of the vine weevil, *Otiorhynchus sulcatus*. *Biocontrol Science and Technology* 2 : 49 - 58.

- MORGAN, L. W. (1994).** Survival, germination responses and infectivity of conidia of *Erynia neoaphidis* (Zygomycetes : Entomophthorales). *Ph.D. thesis*, University of Wales, Cardiff.
- MORGAN, L. W., BODDY, L., CLARK, S. J. & WILDING, N. (1995).** Influence of temperature on germination of primary and secondary conidia of *Erynia neoaphidis* (Zygomycetes : Entomophthorales). *Journal of Invertebrate Pathology* 65 : 132 - 138.
- MORROW, B. J., BOUCIAS, D. G. & HEATH, M. A. (1989).** Loss of virulence in an isolate of an entomopathogenic fungus, *Nomuraea rileyi*, after serial *in vitro* passage. *Journal of Economic Entomology* 82 : 404 - 407.
- MÜLLER, C. B. & GODFRAY, H. C. J. (1997).** Apparent competition between two aphid species. *Journal of Animal Ecology* 66 : 57 - 64.
- MÜLLER, F. P. (1980).** Host plants, generation sequence and reproductive isolation of infraspecific forms of *Acyrtosiphon pisum*. *Entomologia Experimentalis et Applicata* 28 : 145 - 157.
- MÜLLER, F. P. & STEINER, H. (1985).** The problem of *Acyrtosiphon pisum* (Homoptera : Aphididae). *Zeitschrift für Angewandte Zoologie* 72 : 317 - 334.
- NAVON, A. & ASCHER, K. R. S. (2000).** *Bioassays of Entomopathogenic Microbes and Nematodes*. CABI Publishing, Wallingford. 324 pp.
- NEALE, M. & NEWTON, P. (1999).** Registration/Regulatory requirements in Europe. In : *Biopesticides. Use and Delivery*. Eds. F. R. Hall & J. J. Mann. Humana Press, Totowa, New Jersey. Pp . 453 - 471.
- NEETHLING, D. C. & DENT, D. R. (1998).** *Metarhizium anisopliae*, isolate IMI 330189: A mycoinsecticide for locust and grasshopper control. In : *Proceedings Brighton Crop Protection Conference - Pests & Diseases*. pp 37 - 42.
- NEMEYE, P. S., MOORE, D. & PRIOR, C. (1990).** Potential of the parasitoid *Heterospilus prosopidis* (Hymenoptera : Braconidae) as a vector of plant-pathogenic *Colletotrichum* spp. *Annals of Applied Biology* 116 : 11 - 19.
- NEUENSCHWANDER, P. & HERREN, H. R. (1988).** Biological control of the cassava mealybug, *Phenacoccus manihoti*, by the exotic parasitoid *Epidinocarsis lopezi* in Africa. *Philosophical Transactions of the Royal Society of London B* 318 : 319 - 333.
- NORDIN, G. L., BROWN, G. C. & MILLSTEIN, J. A. (1983).** Epizootic phenology of *Erynia* disease of the alfalfa weevil, *Hypera postica* (Gyllenhal) (Coleoptera : Curculionidae), in central Kentucky. *Environmental Entomology* 12 : 1350 - 1355.

- OLMERT, I. & KENNETH, R. G. (1974).** Sensitivity of the entomopathogenic fungi, *Beauveria bassiana*, *Verticillium lecanii*, and *Verticillium* sp. to fungicides and insecticides. *Environmental Entomology* 3 : 33 - 38.
- OUEDRAOGO, A., FARGUES, J., GOETTEL, M. S. & LOMER, C. J. (1997).** Effect of temperature on vegetative growth among isolates of *Metarhizium anisopliae* and *M. flavoviride*. *Mycopathologia* 137 : 37 - 43.
- OZINO, O. I., ARZONE, A. & ALMA, A. (1988).** Entomogenous fungi of *Sitobion avenae* (F.) in Piedmont cereal crops. *Redia* 71 : 173 - 183.
- PAVLIUSHIN, V. A. (1983).** White muscardine disease of the pea aphid. In: *Sistematika i eklogiia tlei vrediteli rastenii: tezis dokladov i mezhreshpublikanskogo afidologicheskogo simpoziuma. Zinatne*. Ed. A. A. Rupaïd. Pp. 52 - 53. (In Russian).
- PELL, J. K., EILENBERG, J., HAJEK, A. E. & STEINKRAUS, D. C. (In Press).** Exploring the potential of Entomophthorales in pest management. In: *Use of Fungi in the Control of Pests, Weeds and Diseases*. CABI Publishing.
- PELL, J. K., TYDEMAN, C. & McCARTNEY, A. (1998).** Impact of rainfall on the persistence and transmission of *Erynia neoaphidis*. *IOBC/WPRS Bulletin* 21 : 49.
- PELL, J. K., WILDING, N., PLAYER, A. L. & CLARK, S. J. (1993).** Selection of an isolate of *Zoophthora radicans* (Zygomycetes : Entomophthorales) for biocontrol of the diamondback moth *Plutella xylostella* (Lepidoptera : Yponomeutidae). *Journal of Invertebrate Pathology* 61 : 75 - 80.
- PETO, R. & PETO, J. (1972).** Asymptotically efficient rank invariant test procedures (with discussion). *Journal of the Royal Statistical Society Series A*. 135 : 185 - 198.
- PEVELING, R., ATTIGNON, S., LANGEWALD, J. & OUAMBAMA, Z. (1999).** An assessment of the impact of biological and chemical grasshopper control agents on ground-dwelling arthropods in Niger, based on presence/absence sampling. *Crop Protection* 18 : 323 - 339.
- PIRT, S. J. (1967).** A kinetic study of the mode of growth of surface colonies on bacteria and fungi. *Journal of General Microbiology* 47 : 181 - 197.
- PLUMB, R. T. (1986).** A rational approach to the control of barley yellow dwarf virus. *Journal of the Royal Agricultural Society of England* 147 : 162 - 171.
- POLASZEK, A. (1986).** The effects of two species of hymenopterous parasitoid on the reproductive system of pea aphid, *Acyrtosiphon pisum*. *Entomologia Experimentalis et Applicata* 40 : 285 - 292.



- POPRAWSKI, T. J., LEGASPI, J. C. & PARKER, P. E. (1998).** Influence of entomopathogenic fungi on *Serangium parcesetosum* (Coleoptera : Coccinellidae), an important predator of whiteflies (Homoptera : Aleyrodidae). *Environmental Entomology* 27 : 785 - 795.
- POPRAWSKI, T. J. & MAJCHROWICZ, I. (1995).** Effects of herbicides on *in vitro* vegetative growth and sporulation of entomopathogenic fungi. *Crop Protection* 14 : 81 - 87.
- POPROWSKI, T. J., MERCADIER, G. & WRAIGHT, S. P. (1992).** Interactions between *Diuraphis noxia*, *Zoophthora radicans* and *Aphelinus asychis* : preliminary results of laboratory studies. In: *Proceedings; 5<sup>th</sup> Annual Russian Wheat Aphid Conference*, 26 - 28 January, 1992. Ft. Worth, Texas. Pp. 180 - 188.
- POPRAWSKI, T. J., PARKER, P. E. & TSAI, J. H. (1999).** Laboratory and field evaluation of hyphomycete insect pathogenic fungi for control of brown citrus aphid (Homoptera: aphididae). *Environmental Entomology* 28 : 315 - 321
- POTTER, C. (1952).** An improved apparatus for applying direct sprays and surface films with data on the electrostatic charge on atomised spray fluids. *Annals of Applied Biology* 39 : 1 - 28.
- POWELL, W. (1982).** The identification of hymenopterous parasitoids attacking cereal aphids in Britain. *Systematic Entomology* 8 : 179 - 188.
- POWELL, W., WILDING, N., BROBYN, P. J. & CLARK, S. J. (1986).** Interference between parasitoids (Hym.: Aphididae) and fungi (*Entomophthorales*) attacking cereal aphids. *Entomophaga* 31 : 293 - 302.
- PRIOR, C. (1992).** Discovery and characterisation of fungal pathogens for locust and grasshopper control. In: *Biological Control of Locusts and Grasshoppers*. Eds. C. J. Lomer & C. Prior. C.A.B. International. Pp. 159 - 180.
- PRIOR, C., CAREY, M., ABRAHAM, Y. J., MOORE, D. & BATEMAN, R. P. (1995).** Development of a bioassay method for the selection of entomopathogenic fungi virulent to the desert locust, *Shistocerca gregaria* (Forskål). *Journal of Applied Entomology* 119 : 567 - 573.
- PRIOR, C., JOLLANDS, P. & LE PATOUREL, G. (1988).** Infectivity of oil and water formulations of *Beauveria bassiana* (Deuteromycotina: Hyphomycetes) to the cocoa weevil pest *Pantorhytes plutus* (Coleoptera: Curculionidae). *Journal of Invertebrate Pathology* 52 : 66 - 72.
- PRIOR, R. N. B. (1976).** Keys to the British species of *Metopolophium* (Aphididae) with one new species. *Systematic Entomology* 1 : 271 - 279.

- PURCELL, M. F. & SCHROEDER, W. J. (1996).** Effect of Silwet L-77 and diazinon on three tephritid fruit flies (Diptera: Tephritidae) and associated endoparasitoids. *Journal of Economic Entomology* 89 : 1566 - 1570.
- PUTERKA, G. J., HUMBER, R. A. & POPRAWSKI, T. J. (1994).** Virulence of fungal pathogens (Imperfect Fungi: hyphomycetes) to pear psylla (Homoptera: psyllidae). *Environmental Entomology* 23 : 514 - 520.
- PUTTLER, B., IGNOFFO, C. M. & HOSTETTER, D. L. (1976).** Relative susceptibility of nine caterpillar species to the fungus *Nomuraea rileyi*. *Journal of Invertebrate Pathology* 27 : 269 - 270.
- QUINTELA, E. D. & McCOY, C. W. (1998).** Conidia attachment of *Metarhizium anisopliae* and *Beauveria bassiana* to the larval cuticle of *Diaprepes abbreviatus* (Coleoptera : Curculionidae) treated with Imidacloprid. *Journal of Invertebrate Pathology* 72 : 220 - 230.
- RAMOSKA, W. A. (1984).** The influence of relative humidity on *Beauveria bassiana* infectivity and replication in the chinch bug, *Blissus leucopterus*. *Journal of Invertebrate Pathology* 43 : 389 - 394.
- RAMOSKA, W. A., HAJEK, A. E., RAMOS, M. E. & SOPER, R. S. (1988).** Infection of grasshoppers (Orthoptera: Acrididae) by members of the *Entomophaga grylli* species complex (Zygomycetes: Entomophthorales). *Journal of Invertebrate Pathology* 52 : 309 - 313.
- REDMAN, E. (1998).** The effect of *Paecilomyces fumosoroseus* on the ability of aphids to respond to alarm pheromone. *B.Sc. Thesis*. University of Nottingham. 55 pp.
- RIBA, G., KATAGIRI, K. & KAWAKAMI, K. (1982).** Preliminary studies on the susceptibility of the silkworm, *Bombyx mori* (Lepidoptera: Bombycidae), to some entomogenous Hyphomycetes. *Applied Entomology and Zoology* 17 : 238 - 243.
- ROBERTS, D. W. (1980).** Toxins of entomopathogenic fungi. In: *Microbial Control of Insects, Mites and Plant diseases, Vol 2*. Ed. H. D. Burges. Academic Press, New York. Pp. 441 - 463.
- ROBERTS, D. W. & HUMBER, R. A. (1981).** Entomogenous fungi. In : *Biology of Conidial Fungi*. Vol 2. Eds. G. T. Cole & B. Kendrick. Academic Press, New York. Pp. 201 - 236.
- ROBERTSON, J. L., SMITH, K. C., SAVIN, N. E. & LAVIGNE, R. J. (1984).** Effects of dose selection and sample size on the precision of lethal dose estimates in dose-mortality regression. *Journal of Economic Entomology* 77 : 833 - 837.

- ROY, H. E. (1997).** Interactions between aphid predators and the entomopathogenic fungus *Erynia neoaphidis*. PhD Thesis. University of Nottingham, United Kingdom. 206 pp.
- SALAMA, H. S., ZAKI, F. N. & SHARABY, A. F. (1982).** Effect of *Bacillus thuringiensis* Berl. on parasites and predators of the cotton leafworm *Spodoptera littoralis* (Boisd.). *Zeitschrift fuer Angewandte Entomologie* 94 : 498 - 504.
- SALYK, R. P. & SULLIVAN, D. J. (1982).** Comparative feeding behaviour of two aphid species : bean aphid (*Aphis fabae* Scopoli) and pea aphid (*Acyrtosiphon pisum* (Harris)) (Homoptera : Aphididae). *New York Entomological Society*. Volume XC. Number 2, pp. 87 - 93.
- SAMSON, R. A. (1974).** *Paecilomyces* and some allied hyphomycetes. *Studies in Mycology* 6 : 1 - 119.
- SAMSON, R. A., EVANS, H. C. & LATGÉ, J. P. (1988).** *Atlas of Entomopathogenic Fungi*. Springer-Verlag, Berlin.
- SAMUELS, K. D. Z, HEALE, J. B. & LLEWELLYN, M. (1989).** Characteristics relating to the pathogenicity of *Metarhizium anisopliae* toward *Nilaparvata lugens*. *Journal of Invertebrate Pathology* 53 : 25 - 31.
- SANCHEZ-PENA, S. R. (1993).** Entomogenous fungi associated with the cotton aphid in the Texas high plains. *Southwestern Entomologist* 18 : 69 - 71.
- SCHABLE, H. G. (1982).** Phoretic mites as carriers of Entomopathogenic fungi. *Journal of Invertebrate Pathology* 39 : 410 - 412.
- SEYOUM, E., MOORE, D. & CHARNLEY, A. K. (1995).** Reduction in flight activity and food consumption by the desert locust, *Schistocerca gregaria*, after infection with *Metarhizium flavoviride*. *Journal of Applied Entomology* 118 : 310 - 315.
- SHAH, P. A. & GOETTEL, M. S. (1999).** *Directory of Microbial Control Products and Services*. Microbial Control Division, Society for Invertebrate Pathology. 31 pp.
- SIMELANE, D. O. (1996).** Effect of a diet of *Neozygites fresenii*-infected cotton aphids on predation by and development of *Coccinella septempunctata* L. M.Sc. Thesis, University of Arkansas.
- SIVASANKARAN, P., EASWARAMOORTHY, E. & DAVID, H. (1998).** Influence of temperature and relative humidity on the growth, sporulation and pathogenicity of *Beauveria* nr. *bassiana*. *Journal of Biological Control* 12 : 71 - 75.
- SIVCEC, I. (1992).** Seasonal dynamics and density of the entomogenous fungi of the cabbage aphid (*Brevicoryne brassicae* L.). *Zastita Bilja* 43 : 181 - 195.

- SKAIFE, S. H. (1925).** The locust fungus *Empusa gryllii* and its effect on its host. *South African Journal of Science* 22 : 298 - 308.
- SMITH, R. F. & REYNOLDS, H. T. (1966).** Principles, definitions and scope of integrated pest control. *Proceedings of FAO (United Nations Food and Agriculture Organisation) Symposium on Integrated Pest Control* 1 : 11 - 17.
- SMITH, R. J. & GRULA, E. A. (1982).** Toxic compounds on the larval surface of the corn earworm (*Heliothis zea*) and their effects on germination and growth of *Beauveria bassiana*. *Journal of Invertebrate Pathology* 39 : 15 - 22.
- SMITH, R. J. & GRULA, E. A. (1981).** Nutritional requirements for conidial germination and hyphal growth of *Beauveria bassiana*. *Journal of Invertebrate Pathology* 37 : 222 - 230.
- SMITH, S. M., ODUOR, G. I. & MOORE, D. (1998).** Preliminary investigations into the potential of entomopathogenic fungi for the control of pests of stored maize. *Bulletin IOBC wprs* 21 : 53-60.
- SOPP, P. I., GILLESPIE, A. T. & PALMER, A. (1989).** Application of *Verticillium lecanii* for the control of *Aphis gossypii* by a low-volume electrostatic rotary atomiser and a high-volume hydraulic sprayer. *Entomophaga* 34 : 417 - 428.
- ST. LEGER, R. J., FRANK, D. C., ROBERTS, D. W. & STAPLES, R. C. (1992a).** Molecular cloning and regulatory analysis on the cuticle-degrading protease structural gene from the entomopathogenic fungus *Metarhizium anisopliae*. *European Journal of Biochemistry* 204 : 991 - 1001.
- ST. LEGER, R. J., STAPLES, R. C. & ROBERTS, D. W. (1992).** Cloning and regulatory analysis of starvation-stress gene, *ssgA*, encoding a hydrophobin-like protein from the entomopathogenic fungus *Metarhizium anisopliae*. *Gene* 120 : 119 - 124.
- STARÝ, P. (1988).** Aphidiidae. In: *Aphids. Their Biology, Natural Enemies and Control. World Crop Pests*. Vol 2B. Eds. A. K. Minks & P. J. Harrewijn. Elsevier, Amsterdam. Pp. 171 - 184.
- STEENBERG, T. & VAGN JENSON, K. M. (1998).** Entomopathogenic fungi for control of German cockroach (*Blattella germanica*) and other synanthropic cockroaches. *Bulletin IOBC wprs* 21: 145 - 150.
- STEENBERG, T., LANGER, V. & ESBJERG, P. (1995).** Entomopathogenic fungi in predatory beetles (COL.: CARABIDAE AND STAPHYLINIDAE) from agricultural fields. *Entomophaga* 40 : 77 - 85.

- STEINKRAUS, D. C., KRING, T. J. & TUGWELL, N. P. (1991).** *Neozygites fresenii* in *Aphis gossypii* on cotton. *Southwestern Entomologist* 16 : 118 - 122.
- STEINKRAUS, D. C. & SLAYMAKER, P. H. (1994).** Effect of temperature and humidity on formation, germination, and infectivity of conidia of *Neozygites fresenii* (Zygomycetes : Neozygitaceae) from *Aphis gossypii* (Homoptera : Aphididae). *Journal of Invertebrate Pathology* 64 : 130 - 137.
- STOETZEL, M. B. (1987).** Information and identification of *Diuraphis noxia* (Homoptera : Aphididae) and other aphid species colonizing leaves of wheat and barley in the United States. *Journal of Economic Entomology* 80 : 696 - 704.
- TANADA, Y. & KAYA, H. K. (1993).** *Insect pathology*. Academic Press Ltd. London. 666 pp.
- THOMAS, M. B. (1999).** Ecological approaches and the development of "truly integrated" pest management. *Proceedings of the National Academy of Sciences USA* 96 : 5944 - 5951.
- THOMAS, M. B. & JENKINS, N. E. (1997).** Effects of temperature on growth of *Metarhizium flavoviride* and virulence to the variegated grasshopper, *Zonocerus variegatus*. *Mycological Research* 101 : 1469 - 1474.
- THOMAS, M. B. & WOOD, S. N. (1997).** Fungal ecology and its application to the practical use of mycoinsecticides. In : *Microbial Insecticides : Novelty or Necessity*. British Crop Protection Council Symposium Proceedings No. 68. British Crop Protection Council. Pp 63 - 72.
- THOMAS, M. B., WOOD, S. N. & LOMER, C. J. (1995).** Biological control of locust and grasshoppers using a fungal pathogen : the importance of secondary cycling. *Proceedings of the Royal Society of London B* 259 : 265 - 270.
- THOMAS, M. B., WRATTEN, S. D. & SOTHERTON, N. W. (1991).** Creation of island habitats in farmland to manipulate populations of beneficial arthropods: predator densities and emigration. *Journal of Applied Ecology* 28 : 906 - 917.
- THOMAS, M. R., GARTHWAITE, D. G. & BANHAM, A. R. (1996).** *Pesticide Usage Survey Report 141 : Arable Farm Crops in Great Britain 1996*. Ministry of Agriculture, Fisheries and Food, London. 97 pp.
- TRUMBLE, J. T. (1982).** Within-plant distribution and sampling of aphids (Homoptera : Aphididae) on broccoli in Southern California. *Journal of Economic Entomology* 75 : 587 - 592.
- TULLOCH, M. (1976).** The genus *Metarhizium*. *Transactions of the British Mycological Society* 66 : 407 - 411.

- UNWIN, D. M. (1980).** *Microclimate Measurement for Ecologists*. Academic Press Inc., (London) Ltd. 97 pp.
- UNWIN, D. M. & CORBET, S. A. (1991).** *Insects, Plants and Microclimate*. Richmond Publishing Co. Ltd, England.
- UZIEL, U. & SHTIENBERG, D. (1993).** Effect of meteorological variates on persistence of primary conidia and capilliconidia of *Erynia radicans* (Zygomycotina : Entomophthorales) under natural conditions. *Annals of Applied Biology* 122 : 441 - 450.
- VAN EMDEN, H. F. (1969).** The differing reactions of *Brevicoryne brassicae* and *Myzus persicae* to leaf age, turgidity and soluble nitrogen in brassicas. *Annals of Applied Biology* 63 : 324 - 326.
- VAN EMDEN, H. F. (1989).** *Pest Control*. 2<sup>nd</sup> Edition. Edward Arnold, London. 117 pp.
- VANDENBERG, J. D. (1990).** Safety of four entomopathogens for caged adult honey bees (Hymenoptera: Apidae). *Journal of Economic Entomology* 83 : 755 - 759.
- VANDENBERG, J. D. (1996).** Standardised bioassay and screening of *Beauveria bassiana* and *Paecilomyces fumosoroseus* against the Russian wheat aphid (Homoptera: Aphididae). *Journal of Economic Entomology* 89 : 1418 - 1423.
- VANDENBERG, J. D., JACKSON, M. A. & LACEY, L. A. (1998a).** Relative efficacy of blastospores and aerial conidia of *Paecilomyces fumosoroseus* against the Russian wheat aphid. *Journal of Invertebrate Pathology* 72 : 181 - 183.
- VANDENBERG, J. D., RAMOS, M. & ALTRE, J. A. (1998b).** Dose-response and age- and temperature-related susceptibility of the diamondback moth (Lepidoptera: Plutellidae) to two isolates of *Beauveria bassiana* (Hyphomycetes: Moniliaceae). *Environmental Entomology* 27: 1017 - 1021.
- VANDENBERG, J. D., SHELTON, A. M., WILSEY, W. T. & RAMOS, M. (1998c).** Assessment of *Beauveria bassiana* sprays for control of diamondback moth (Lepidoptera : Plutellidae) on crucifers. *Journal of Economic Entomology* 91 : 624 - 630.
- VANDENBERG, J. D. & SOPER, R. S. (1979).** A bioassay technique for *Entomophthora sphaerosperma* on the spruce budworm, *Choristoneura fumiferana*. *Journal of Invertebrate Pathology* 33 : 148 - 154.
- VEY, A. & FARGUES, J. (1977).** Histological and ultrastructural studies of *Beauveria bassiana* infection in *Leptinotarsa decemlineata* larvae during ecdysis. *Journal of Invertebrate Pathology* 30: 207 - 215.

- VIDAL, C., FARGUES, J. & LACEY, L. A. (1997).** Intraspecific variability of *Paecilomyces fumosoroseus* : Effect of temperature on vegetative growth. *Journal of Invertebrate Pathology* 70 : 18 - 26.
- VIDAL, C., LACEY, L. A. & FARGUES, J. (1997).** Pathogenicity of *Paecilomyces fumosoroseus* (Deuteromycotina: Hyphomycetes) against *Bemisia argentifolii* (Homoptera: Aleyrodidae) with a description of a bioassay method. *Journal of Economic Entomology* 90 : 765 - 772.
- VILLACARLOS, L. T., PELL, J. K. & STEINKRAUS, D. S. (in prep.).** Mixed infections of *Neozygites fresenii* and *Erynia neoaphidis*.
- VINSON, S. B. (1990).** Potential impact of microbial insecticides on beneficial arthropods in the terrestrial environment. In: *Safety of Microbial Insecticides*. Eds. M. Laird, L. A. Lacey & E. W. Davidson. C.R.C. Press Inc. Boca Raton, Florida. Pp. 209 - 231.
- WAGGONER, P. E. (1965).** Microclimate and plant disease. *Annual Review of Phytopathology* 3 : 103 - 126.
- WALSTAD, J. D., ANDERSON, R. F. & STAMBAUGH, W. J. (1970).** Effects of environmental conditions on two species of muscardine fungi (*Beauveria bassiana* and *Metarhizium anisopliae*). *Journal of Invertebrate Pathology* 16 : 221 - 226.
- WATANABE, H. (1987).** The host population. In : *Epizootiology of insect diseases*. Eds. J. R. Fuxa & Y. Tanada. John Wiley & Sons, New York. Pp. 71 - 112.
- WATSON, D. W., MULLENS, B. A. & PETERSON, J. J. (1993).** Behavioural fever response of *Musca domestica* (Diptera : Muscidae) to infection by *Entomophthora muscae* (Zygomycetes: Entomophthorales). *Journal of Invertebrate Pathology* 61 : 10 - 16.
- WATSON, E., JENKINS, N. E. & THOMAS, M. B. (1999).** Variability and adaptability in mitosporic fungi selected for biocontrol of insect pests. *Aspects of Applied Biology* 53 : 113 - 118.
- WATT, B. A. & LEBRUN, R. A. (1984).** Soil effects of *Beauveria bassiana* on pupal populations of the Colorado potato beetle. *Environmental Entomology* 13 : 15 - 18.
- WAY, M. J. (1967).** The nature and causes of annual fluctuations in numbers of *Aphis fabae* Scop. on field beans (*Vicia faba*). *Annals of Applied Biology* 59 : 175 - 188.
- WILDING, N. (1969).** Effect of humidity on the sporulation of *Entomophthora aphidis* and *Entomophthora thaxteriana*. *Transactions of the British Mycological Society* 53 : 126 - 130.

- WILDING, N. (1970).** The effect of temperature on the infectivity and incubation periods of the fungi *Entomophthora aphidis* and *E. thaxteriana* for the pea aphid *Acyrtosiphon pisum*. *Proceedings of the 4<sup>th</sup> International Colloquium Insect Pathology*, College Park, Maryland. Pp 84 - 88.
- WILDING, N. (1971).** Discharge of conidia of *Entomophthora thaxteriana* Petch from the pea aphid *Acyrtosiphon pisum* Harris. *Journal of General Microbiology* 69 : 417 - 422.
- WILDING, N. (1975).** *Entomophthora* species infecting pea aphids. *Transactions of the Royal Entomological Society* 127 : 171 - 183.
- WILDING (1976).** Determination of the infectivity of *Entomophthora* spp. In: "*Proceedings of the first International Colloquium on Invertebrate Pathology*". Kingston, Ontario. Pp. 296 - 300.
- WILDING, N. (1981a).** Pest control by Entomophthorales. In: *Microbial Control of Pests and Plant Diseases 1970 - 1980*. Ed. H. D. Burges. Academic Press. Pp. 465 - 482.
- WILDING, N. (1981b).** The effect of introducing aphid-pathogenic Entomophthoraceae into field populations of *Aphis fabae*. *Annals of Applied Biology* 99 : 11 - 23.
- WILDING, N. & BROBYN, P. J. (1980).** Effects of fungicides on development of *Entomophthora aphidis*. *Transactions of the British Mycological Society* 75 : 297 - 302.
- WILDING, N. & PERRY, J. N. (1980).** Studies on *Entomophthora* in populations of *Aphis fabae* on field beans. *Annals of Applied Biology* 94 : 367 - 378.
- WILLIAMSON, C., VON WECHMAR, M. B. & RYBICKI, E. P. (1989).** Further characterization of *Rhopalosiphon padi* picorna-like virus of aphids and comparison of isolates from South Africa and Illinois. *Journal of Invertebrate Pathology* 53 : 85 - 96.
- WILLMER, P. (1986).** Microclimatic effects on insects at the plant surface. In: *Insects and the Plant Surface*. Eds. B. Juniper & R. Southwood. Edward Arnold Ltd., London. Pp. 65 - 80.
- WRAIGHT, S. P. & CARRUTHERS, R. I. (1999).** Production, delivery, and use of mycoinsecticides for control of insect pests on field crops. In: *Methods in Biotechnology, vol 5: Biopesticides: Used and Delivery*. Eds. F. R. Hall & J. J. Menn, pp. 233-269. Humana Press Inc., Totowa, New Jersey.
- WRAIGHT, S. P., CARRUTHERS, R. I., BRADLEY, C. A., JARONSKI, S. T., LACEY, L. A., WOOD, P. & GALAINI-WRAIGHT, S. (1998).** Pathogenicity of the entomopathogenic fungi *Paecilomyces* spp. and



- Beauveria bassiana* against the silverleaf whitefly, *Bemisia argentifolii*. *Journal of Invertebrate Pathology* 71 : 217 - 226.
- WRATTEN, S. D. (1973).** The effectiveness of the coccinellid beetle *Adalia bipunctata* (L.) as a predator of the lime aphid, *Eucallipterus tiliae* L. *Journal of Animal Ecology* 42 : 785 - 802.
- WRATTEN, S. D. (1978).** Effects of feeding position of the aphids *Sitobion avenae* and *Metopolophium dirhodum* on wheat yield and quality. *Annals of Applied Biology* 90 : 11 - 20.
- WRATTEN, S. D. & POWELL, W. (1991).** Cereal aphids and their natural enemies. In : *The Ecology of Temperate Cereal Aphids*. 32<sup>nd</sup> Symposium of The British Ecological Society. Eds. L. G. Fairbank, N. Carter, J. F. Darbyshire & G. R. Potts. Pp. 233 - 257. Blackwell, Oxford.
- WRIGHT, E. D. & LAING, J. E. (1980).** Numerical response of coccinellids to aphids in corn in southern Ontario. *Canadian Entomologist* 112 : 977 - 988.
- WRIGHT, J. E. & CHANDLER, L. D. (1992).** Development of a biorational mycoinsecticide: *Beauveria bassiana* conidial formulation and its application against Boll weevil populations (Coleoptera: Curculionidae). *Journal of Economic Entomology* 85 : 1130 - 1135.
- YENDOL, G. W. (1968).** Factors affecting germination of *Entomophthora* conidia. *Journal of Invertebrate Pathology* 10 : 116 - 211.
- YOKAMI, R. K. & GOTTWALD, T. R. (1988).** Virulence of *Verticillium lecanii* isolates in aphids determined by detached-leaf bioassay. *Journal of Invertebrate Pathology* 51 : 250 - 258.
- YOUNG, O. P. & HAMM, J. J. (1985).** The compatibility of two fall armyworm pathogens with a predaceous beetle, *Calosoma sayi* (Coleoptera : Carabidae). *Journal of Entomological Science*. 20 : 212 - 218.
- YOUSTEN, A. A. (1973).** Effect of the *Bacillus thuringiensis* delta-endotoxin on an insect predator which has consumed intoxicated cabbage looper larvae. *Journal of Invertebrate Pathology* 21 : 312 - 314.
- ZACHARUK, R. Y. (1970a).** Fine structure of *Metarhizium anisopliae* infecting three species of larval Elateridae (Coleoptera) I. Dormant and germinating conidia. *Journal of Invertebrate Pathology* 15 : 63 - 80.
- ZACHARUK, R. Y. (1970b).** Fine structure of *Metarhizium anisopliae* infecting three species of larval Elateridae (Coleoptera) II. Conidial germ tubes and appressoria. *Journal of Invertebrate Pathology* 15 : 81 - 91.
- ZAYED, A. & ZEBITZ C. P. W. (1997).** Enzyme banding patterns of *Verticillium lecanii* (Zimm.) isolates of different virulence against *Aphis fabae* (Scop.) and

*Aphis gossypii* Glov. (Homoptera : Aphididae). *Mitteilung-Deutschen Gesellschaft für allgemeine und Angewandte Entomologie* 11 : 579 – 582.

**ZHOU, X. & CARTER, N. (1992).** The ecology of coccinellids on farmland. *Aspects of Applied Biology* 31 : 133 - 138.

**ZHOU, X., CARTER, N. & POWELL, W. (1994).** Seasonal distribution and aerial movement of adult coccinellids on farmland. *Biocontrol Science and Technology* 4 : 167 - 175.

**ZIMMERMANN, G. (1982).** Effect of high temperatures and artificial sunlight on the viability of conidia of *Metarhizium anisopliae*. *Journal of Invertebrate Pathology* 40: 36 - 40.

## **Appendix 1 : Origin of insect cultures**

### *Metopolophium dirhodum*

Set up in the summer of 1995 using approximately 120 individuals collected from winter wheat and rye grass at Road Piece, Rothamsted farm

### *Sitobion avenae*

Set up using green morphs only (although they changed colour once in culture for a while) during the summer of 1996. Approximately 200 from Sawyers 3 (from winter wheat), approximately 150 from Pasteurs (from winter wheat) and approximately 220 from Great Harpenden 1 (from spring wheat) were collected.

### *Aphis fabae*

Continuously cultured at IACR-Rothamsted for at least 8 years. The culture was set up from aphids collected on the Rothamsted farm.

### *Acyrtosiphon pisum* and *Rhopalosiphum padi*

Continuously cultured at IACR-Rothamsted for at least 10 years. The culture was set up from aphids collected on the Rothamsted farm.

### *Myzus persicae*

Set up originally from an insecticide susceptible clone (reference US1L). Aphids were collected from a sugar beet crop in 1974 in Cambridge.

### *Praon volucre* / *Sitobion avenae*

Set up during the summer of 1996 with approximately 90 females and 50 males collected from cereal crops on Road Piece, Rothamsted Farm. The most likely host was *S. avenae* with possibly a small percentage of *M. dirhodum*. *Praon volucre* on *A. pisum* was set up by sub-culturing the *P. volucre* from *S. avenae* once it was well established.

**Appendix 2 : Oatmeal Dodine Agar - Selective medium for isolation of *Beauveria* spp. and *Metarhizium* spp.**

*Ingredients: 500ml batch*

17.5g Oatmeal agar

2.5g Bacto agar

0.45g Cyprex 65WP (Dodine - *N*-dodecylguanidine)

2.5mg Crystal Violet (Hopkin & Williams)

2ml Antibiotic Stock solution

*Crystal Violet stock solution*

0.1g crystal violet

200ml sterile distilled water

Store in the dark in a refrigerator

*Antibiotic Stock solution*

4g Penicillin G (Sigma)

10.0g Streptomycin sulphate (Sigma)

40.0ml Sterile distilled water

*Protocol*

1. Weigh out Oatmeal agar and agar-agar
2. Make a smooth slurry in a duran by adding the 500ml of water slowly and shaking vigorously
3. Add Cyprex and 5ml of the crystal violet solution
4. Autoclave at 121°C and 15 p.s.i. for 20 minutes
5. Allow medium to cool to 50 - 55°C in a waterbath and add 2ml of antibiotic stock solution under sterile conditions
6. Swirl flask well to distribute antibiotics and pour medium into plates

This amount of ODA should give 20 plates (9cm Petri dishes)

**Appendix 3** : number of aphids dying due to fungus (%) in four preliminary bioassays against *S. avenae*, *A. fabae* and *M. persicae*.

	<i>M. persicae</i>	<i>A. fabae</i>	<i>S. avenae</i>
Control	0	2	4
2879 ( <i>B. bassiana</i> )	17	58	70
3458 ( <i>P. fumosoroseus</i> )	8	41	58
T130 ( <i>M. anisopliae</i> )	10	36	60
T80 ( <i>V. lecanii</i> )	52	53	85
Control	0	0	0
T314 ( <i>P. fumosoroseus</i> )	43	34	85
Z143 ( <i>M. anisopliae</i> )	7	3	48
Z25 ( <i>V. lecanii</i> )	20	58	84
Control	0	0	0
T195 ( <i>B. bassiana</i> )	7	21	33
Mycotech strain GHA ( <i>B. bassiana</i> )	0	2	3
Z43 ( <i>M. anisopliae</i> )	31	12	60
2859 ( <i>V. lecanii</i> )	35	83	58
Control	0	0	0
Z25 ( <i>V. lecanii</i> )	13	78	82
2879 ( <i>B. bassiana</i> )	7	66	58
Mycotech strain GHA ( <i>B. bassiana</i> )	32	90	72
3458 ( <i>P. fumosoroseus</i> )	0	3	2
4491 ( <i>P. fumosoroseus</i> )	28	77	64

## **Appendix 4 : Standardised bioassay method**

### ***Day 1***

1) Place apterous adult aphids (or alates of *Sitobion avenae*) on excised leaves set in water agar using the appropriate number of aphids to obtain the required number of nymphs as detailed in section 2.3.

### ***Day 2***

1) Remove adult aphids from dishes and move nymphs to an insectary or other CE facility at 18°C and 16 hour photoperiod (16 hours light : 8 hours dark).

### ***Day 10***

1) Prepare bioassay dishes of leaves in water agar using methods detailed in section 2.2.

2) Prepare fungal suspensions using methods in section 2.6.5.

### ***Day 11***

1) Place aphids on leaves in bioassay dishes in the early morning with 12 or 15 aphids per dish (depending on the bioassay requirements) and allow to settle for approximately four or five hours.

2) Spray with fungal suspensions in the late afternoon, using methods detailed in section 2.6.6.

3) Place inverted dishes at 23°C (or other temperature required) and 16 hour photoperiod (16 hours light : 8 hours dark).

4) Monitor daily mortality of aphids using assessment procedures in section 2.7. Move aphids to fresh leaves in clean dishes every 48 hours using the methods detailed in section 2.8.

**Appendix 5 : Standard practices for cropping on the IACR-Rothamsted Farm (applied to experimental plots).**

Crop	Drilling Date	Variety	Depth	Rate	Row Spacing
Beans	13-3-1997	Sirrocco	10-20 cm	20 seeds m <sup>2</sup>	-
	21-3-1998	Alfred	10-20 cm	20 seeds m <sup>2</sup>	-
Wheat	13-3-1997	Chablis	2-4 cm	400 seeds m <sup>2</sup>	12.5 cm
	21-3-1998	Axona	2-4 cm	400 seeds m <sup>2</sup>	12.5 cm

Range of pesticides used on crops of wheat and field bean on the IACR-Rothamsted Farm (only applied to non-experimental plots).

Crop	Pesticide Applications
Beans	<i>Herbicides:</i> propaquizafop, bentazone <i>Fungicides:</i> chlorothalonil, carbendazim <i>Insecticides:</i> pirimicarb
Wheat	<i>Herbicides:</i> clodinafop <i>Fungicides:</i> mixtures of epoxiconazole, tebuconazole, flusilazole, cyprodinil, fenpropidin, fenpropimorph, quinoxifen <i>Insecticides:</i> pirimicarb <i>Growth Regulators:</i> chlormequat

**Appendix 6 : Data logger program for Campbell Scientific 21X datalogger attached to a Campbell Scientific AM416 Multiplexer.**

**\*1**  
**01:60**            **Set datalogger to record measurements every 60 seconds**

**01:P17**            **Measure Panel Temperature**  
**01:1**            **Input storage location for panel temperature**

**02:P20**            **Activate Multiplexer Set Port**  
**01:1**            **Set High (activate)**  
**02:1**            **Port Number**

**03:P87**            **Begin Measurement Loop**  
**01:1**            **Delay (0 = no delay between passes of loop)**  
**02:16**            **Loop count (16 passes through sets of 2 thermocouples)**

**03:P90**            **Step Loop Index**  
**01:2**            **Step index of 2**

**05:P22**            **Clock Pulse Excitation with delay**  
**01:1**            **Excitation channel**  
**02:1**            **Delay time for excitation (units = 0.01 seconds)**  
**03:0**            **Delay after Excitation**  
**04:5000**            **mV of Excitation**

**06:P14**            **Measure Thermocouple**  
**01:2**            **2 repetitions (input channels to datalogger)**  
**02:1**            **Range code (5mV slow)**  
**03:1**            **Input channel of thermocouple**  
**04:1**            **Thermocouple type T**  
**05:1**            **Reference temperature is stored in location 1**  
**06:2 - -**            **Store thermocouple temperature in location 2 (- - indicates that the location needs to be indexed)**

**07:1**            **Multiplier of 1 (°C)**  
**08:0**            **Offset of zero**

**07:P95**            **End measurement loop**

**08:P20**            **Deactivate multiplexer Set Port**  
**01:1**            **Set low**  
**02:1**            **Control port number**

**09:P92**            **If Time**  
**01:0**            **0 minutes in the interval (mins)**  
**02:30**            **30 minute interval**  
**03:10**            **Set output flag (Flag 0)**

**10:P77**            **Output time**  
**01:10**            **Store hour and minute**



**11:P71 Average**

01:32 Number of repetitions

02:2 Source of Thermocouple temperatures to be averaged, input storage location 2

**12:P92 If Time**

01:0 0 minutes into the interval

02:1440 1440 minute interval (1 day)

03:10 Set output flag (Flag 0)

**13:P77 Output time**

01:110 Store day, hour and minute

**14:P73 Maximise Instruction**

01:32 32 repetitions

02:10 Output the time at which the maximum occurs in hours and minutes

03:2 Location to maximise = thermocouple temperature

**15:P74 Minimise Instruction**

01:32 32 repetitions

02:10 Output the time at which the minimum occurs in hours and minutes

03:2 Location to minimise = thermocouple temperature

## Appendix 7 : Aphid Counts - Wheat

Counts for 1997 - on 240 plants on each occasion

Species	05/06	23/06	01/07	21/07	06/08
<i>S. avenae</i>	11	1	71	137	0
<i>M. dirhodum</i>	8	610	1543	85	0
<i>R. padi</i>	0	0	0	1	0
Aphids infected with <i>E. neoaphidis</i>	0	0	15	592	291

Counts for 1998 - on 240 plants for the first two sampling dates and then on 120 for the remainder

Species	29/05	06/06	12/06	17/06	30/06	11/07	16/07
<i>S. avenae</i>	14	31	21	15	26	79	59
<i>M. dirhodum</i>	3	19	1	1	4	7	0
<i>R. padi</i>	0	0	0	1	0	0	0
Aphids infected with <i>E. neoaphidis</i>	0	0	0	0	0	0	0

## Appendix 8 : Aphid counts - Beans

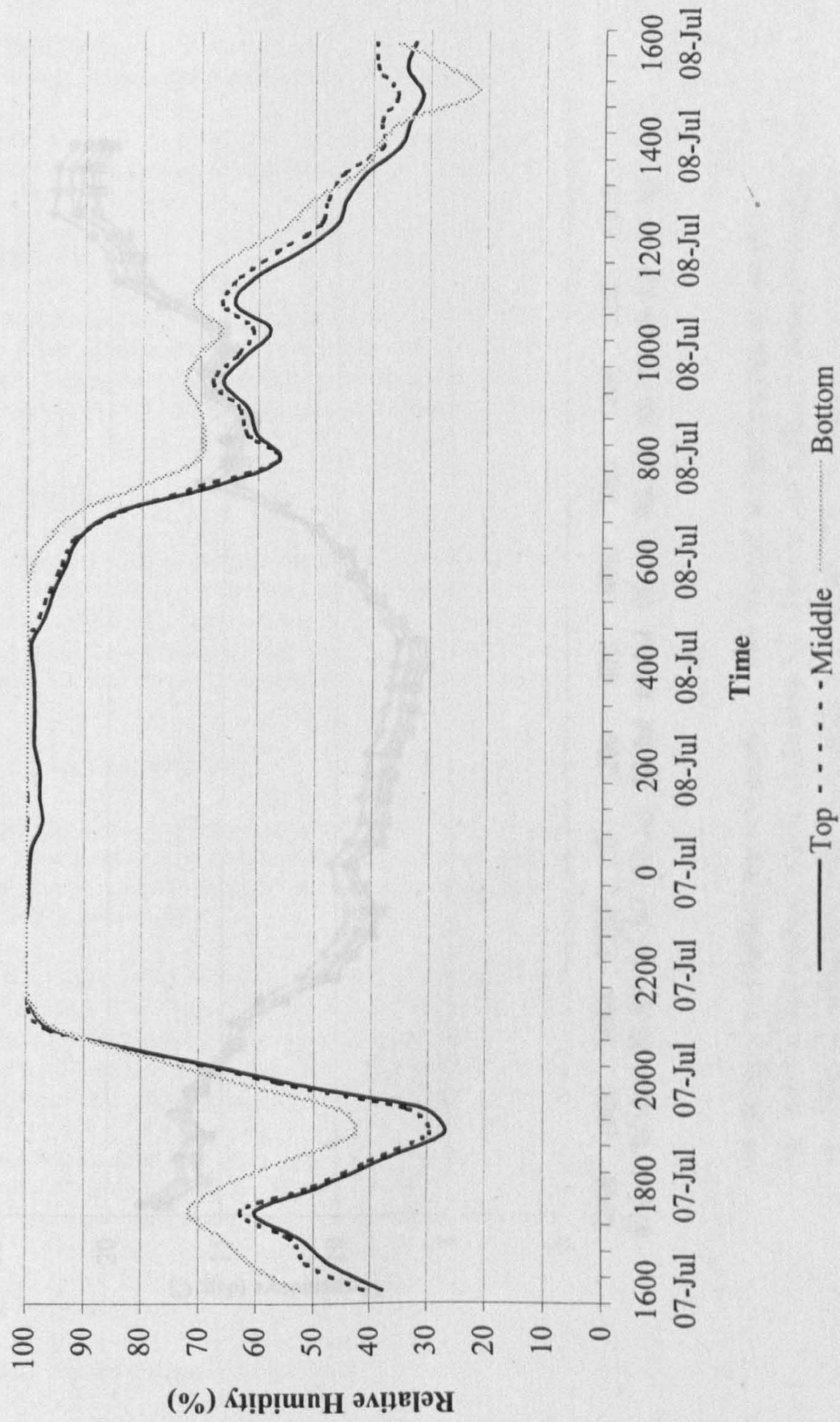
Counts for 1997 - on 240 plants

Species	04/06	16/06	03/07
<i>A. fabae</i>	1	32	50
<i>A. pisum</i> (green morph)	8	65	6
<i>A. pisum</i> (pink morph)	0	33	2
Aphids infected with <i>E. neoaphidis</i>	0	0	0

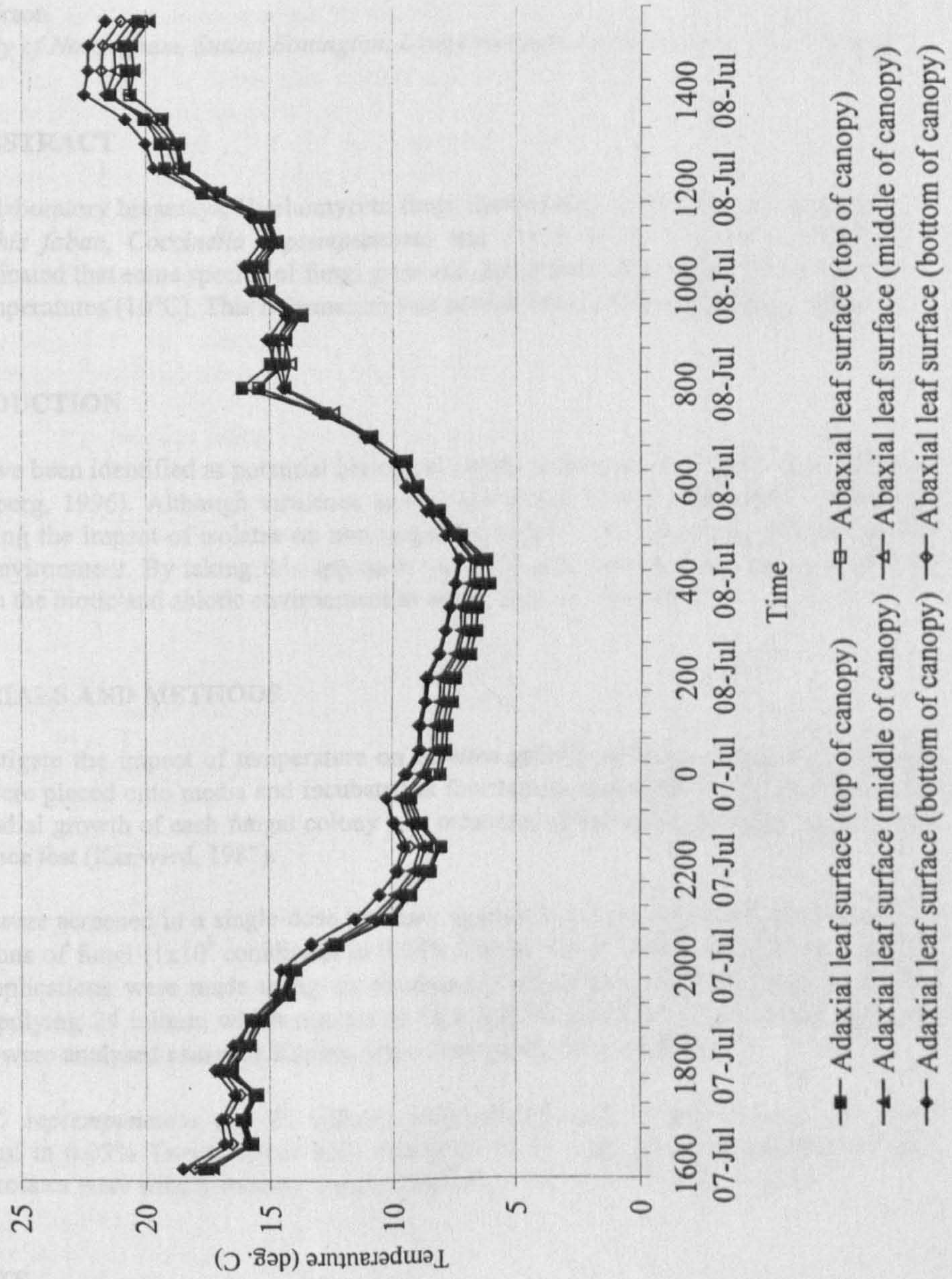
Counts for 1998 - on a reduced number of plants (shown in parentheses) due to the extremely large number of aphids that were present in this year.

Species	14/05 (80)	21/05 (240)	05/06 (140)	11/06 (40)	16/06 (55)	30/06 (10)
<i>A. fabae</i>	0	230	1132	373	1721	1825
<i>A. pisum</i>	0	20	328	175	502	109
Aphids infected with <i>E. neoaphidis</i>	0	0	0	0	4	370

**Appendix 9 :** Average relative humidity calculated from wet and dry bulb temperature recordings from three ventilated psychrometers positioned at the top, middle and bottom of a crop of spring field beans in the period 07/07/98 - 08/07/98.



**Appendix 10 : Average temperatures of the upper and lower side of leaves at the top, middle and bottom of spring field bean in the period 07/07/98 - 08/07/98.**



**A biorational approach to selecting mycoinsecticides for aphid management**

H Yeo, J K Pell, B J Pye

*IACR-Rothamsted, Harpenden, Hertfordshire, AL5 2JQ, UK*

P G Alderson

*University of Nottingham, Sutton Bonington, Loughborough, Leicestershire, LE12 5RD, UK*

**ABSTRACT**

In laboratory bioassays, Hyphomycete fungi showed differential virulence against *Aphis fabae*, *Coccinella septempunctata* and *Praon volucre*. *In vitro* studies indicated that some species of fungi grew and germinated better than others at low temperatures (10°C). This information was used to select isolates for field testing.

**INTRODUCTION**

Fungi have been identified as potential biological control agents against aphids in arable crops (Vandenberg, 1996). Although virulence against the target insect is important, we are also considering the impact of isolates on non-target beneficials and isolate interactions with the abiotic environment. By taking this approach we will select isolates that will be compatible with both the biotic and abiotic environment in which they will be used.

**MATERIALS AND METHODS**

To investigate the impact of temperature on *in vitro* growth of fungi, single plugs of each isolate were placed onto media and incubated at four temperatures; 10, 15, 20 and 25°C. The rate of radial growth of each fungal colony was measured. Data were analysed using an ante-dependence test (Kenward, 1987).

Isolates were screened in a single-dose bioassay against *A. fabae*. Aphids were sprayed with suspensions of fungi ( $1 \times 10^8$  conidia/ml in 0.03% Tween 80) or Tween (0.03%) as a control. Spray applications were made using an electrostatic rotary atomiser on a track sprayer at 0.4m/s applying 24 ml/min which equates to 10.4 litre/ha. Mortalities were monitored daily and data were analysed using the Kaplan-Meier method for survival data.

Adult *C. septempunctata* and *P. volucre* were treated with fungal suspensions ( $1 \times 10^8$  conidia/ml in 0.03% Tween 80) or with Tween 80 (0.03%) and daily mortalities recorded. Fungal isolates were simultaneously screened against *A. fabae* as a positive control.

**RESULTS**

There was a significant difference in the radial growth of all isolates at each temperature after

the first 2-4 days of growth ( $P < 0.001$ ). Trends suggested that *Paecilomyces fumosoroseus* isolates were the most tolerant to the range of temperatures. Preliminary results from *in vitro* germination experiments showed similar trends.

The total number of aphids treated which were killed by fungus in bioassays ranged from 53% for isolate T229 (*Paecilomyces farinosus*) to 100% for isolate 1.72 (*Verticillium lecanii*). The isolates which resulted in the lowest median survival time (MST) of aphids were selected from each bioassay. These isolates were; 1.72 (*V. lecanii*; MST=3.7 days), 2879 (*Beauveria bassiana*; MST=4.4 days), Z11 (*P. fumosoroseus*; MST=3.7 days) and 'Mycotech' *B. bassiana* strain GHA (MST=5.0 days). Subsequent field testing was conducted with isolates 1.72 *V. lecanii* and 'Mycotech' *B. bassiana* strain GHA.

In bioassays, there were large differences between isolates in their virulence towards *C. septempunctata* (Table 1). The percentage of adult *P. volucre* emerging from treated mummies was 76% for controls and 85% for treated mummies. However, 73% of those insects that emerged from treated mummies succumbed to fungal infection.

Table 1. Virulence of seven isolates in bioassays against *C. septempunctata* and corresponding virulence against *A. fabae*.

Fungal Isolate	Infection (%)	
	<i>C. septempunctata</i> (n=30)	<i>A. fabae</i> (n=72)
GHA ( <i>B. bassiana</i> )	21	75
"	20	94
"	90	92
T195 ( <i>B. bassiana</i> )	71	79
T130 ( <i>Metarhizium anisopliae</i> )	100	96
2859 ( <i>V. lecanii</i> )	7	94
Z4 ( <i>P. fumosoroseus</i> )	3	78
T229 ( <i>P. farinosus</i> )	3	26
T80 ( <i>V. lecanii</i> )	0	92

#### ACKNOWLEDGEMENTS

Funding provided by: University of Nottingham (H Yeo) and MAFF (J K Pell). IACR-Rothamsted receives grant-aided support from BBSRC. Isolates donated by: T Steenberg, J D Vandenberg, G Zimmermann and D Chandler. Statistics advice: S J Clark and D Murray.

#### REFERENCES

- Kenward M G (1987). A method for comparing profiles of repeated measures. *Applied Statistics* 36, 296-308.
- Vandenberg J D (1996). Standardised bioassay and screening of *Beauveria bassiana* and *Paecilomyces fumosoroseus* (Deuteromycotina: Hyphomycetes) against the Russian wheat aphid (Homoptera: Aphididae). *Journal of Economic Entomology* 89, 1418-1423.