



Tizani, Walid and Pitrakkos, Theodoros (2015)
Performance of T-stub to CFT joints using blind bolts
with headed anchors. *Journal of Structural Engineering*,
141 (10). 04015001. ISSN 0733-9445

Access from the University of Nottingham repository:

http://eprints.nottingham.ac.uk/34015/1/2015_TizaniPitrakkos_PerformanceTStubToCFTUsingBlindBoltsHeadedAnchor_ASCE_JSE_Jan15_s.pdf

Copyright and reuse:

The Nottingham ePrints service makes this work by researchers of the University of Nottingham available open access under the following conditions.

This article is made available under the Creative Commons Attribution licence and may be reused according to the conditions of the licence. For more details see:
<http://creativecommons.org/licenses/by/2.5/>

A note on versions:

The version presented here may differ from the published version or from the version of record. If you wish to cite this item you are advised to consult the publisher's version. Please see the repository url above for details on accessing the published version and note that access may require a subscription.

For more information, please contact eprints@nottingham.ac.uk

Performance of T-Stub to CFT Joints Using Blind Bolts with Headed Anchors

Walid Tizani¹ and Theodoros Pitrakos²

Abstract: This paper assesses the performance of a newly developed blind bolt, intended for use in constructing bolted moment-resisting connections to concrete-filled tubular steel profiles. A total of ten connection tests are reported, with each configuration having been subjected to a predominantly tensile force in a representation of the tension region of a typical moment connection. The test variables included type of fastener, addition of concrete to the tube, strength of the concrete, spacing among bolts, and bolt class. On the basis of deformability response, the benefits of filling the tubular member with concrete are highlighted. The favorable performance that results from using a relatively, high-grade concrete infill is also highlighted. The addition of a concrete infill to the tube stiffens and strengthens the otherwise relatively flexible tube walls, enhancing overall connection behavior in terms of stiffness, strength, and ductility. The performance of connections to concrete-filled tubular steel profiles using blind bolts with headed anchors is shown to be suitable for moment-resisting construction. DOI: 10.1061/(ASCE)ST.1943-541X.0001169. This work is made available under the terms of the Creative Commons Attribution 4.0 International license, <http://creativecommons.org/licenses/by/4.0/>.

Author keywords: Blind bolt; Headed anchorage; T-stub; Concrete-filled tube; Moment connections; Metal and composite structures.

Introduction

The application of tubular profiles as columns in multistory steel construction is attractive for architectural reasons and because of their favorable properties, such as a high strength-to-weight ratio. Structural steel tubular sections, whether they are circular, square, or rectangular, are inherently more efficient as compression members than any other structural steel section (e.g., I or H) because of their geometric shape (Yeomans 2001). However, their use may be limited because of more difficult connections relative to open sections. Early attempts at solving the connection problem included fully welding the connection, which, in countries such as the United Kingdom, is not an attractive solution because on-site welding can have a negative impact on the construction program and there are concerns about the quality achieved by such procedures. The preferred method of making a connection on site is bolting, which is characterized by speed and ease of construction. However, the use of standard dowel bolts, the principal alternative to welding for open sections, is frequently impossible in the case of tubular members because it requires access to the inside of the tube to facilitate tightening.

One way of overcoming this problem is to use connections that are welded to the column in the workshop and then bolted to the beam on site (Fig. 1). This approach is relatively simple and commonly adopted today, but the connections are usually considered to be shear (nonmoment), the method requires supplementary steelwork and welding, and the column weld components are often

prone to damage during transit to the site. As an alternative, conventional bolts have on occasion been applied to tubular columns using fabricated side-face access slots to allow tightening and by through bolting via welded spacer tubes (Corus 1997). However, the construction of these connections is difficult in the case of four-way beams (i.e., multiplanar joints).

The stud technique is another method that has been used to produce connections to tubular profiles (Jaspart and Weynand 2001; Maquoi et al. 1984). It involves welding threaded studs onto the face of the tubular column, allowing a bolted connection with an open-section beam to be established. As with the connections presented in Fig. 1, the drawback of this method is that the studs are welded onto the tube face in the fabrication workshop, and thus special care is needed to prevent damage during transportation. Connections to tubes are also achievable via a “reverse channel” method, in which the flanges of a channel are welded to the tube to allow the connection to be formed.

For tubular column frames to be erected in the same manner with open-section frames, modern advances in bolting technology have been concerned with developing a system that allows connections to be formed from one (accessible) side only. The need to make mechanical connections from one side only has actually arisen in a number of engineering fields and has resulted in the development of several types of so-called blind bolts. In structural engineering, commercially available blind bolts include Flowdrill (Flowdrill B.V., AK Houten, Netherlands), Hollo-bolt and Lindibolt (Lindapter International, Bradford, U.K.), Molabolt (Advanced Bolting Solutions, Leicester, U.K.), Huck Bolt (Huck International, Waco, Texas), Ajax Oneside (Ajax Engineered Fasteners, Victoria, Australia), and the Blind Bolt (The Blind Bolt Company, Worcester, U.K.).

It is possible to design nominally pinned connections (intended primarily to transfer vertical shear) to tubular columns using blind bolts, such as the Hollo-bolt and Flowdrill fasteners. The capacities of the bolts and the tube face have been shown to be sufficient to withstand the shear load as well as the limited tensile loads arising from structural integrity requirements. Indeed, guides for the design of connections of this sort have been available for a

¹Associate Professor, Dept. of Civil Engineering, Univ. of Nottingham, Nottingham NG7 2RD, U.K. (corresponding author). E-mail: walid.tizani@nottingham.ac.uk

²Research Fellow, Dept. of Civil Engineering, Univ. of Nottingham, Nottingham NG7 2RD, U.K. E-mail: theodoros.pitrakos@nottingham.ac.uk

Note. This manuscript was submitted on October 11, 2013; approved on August 8, 2014; published online on January 6, 2015. Discussion period open until June 6, 2015; separate discussions must be submitted for individual papers. This paper is part of the *Journal of Structural Engineering*, © ASCE, ISSN 0733-9445/04015001(11)/\$25.00.

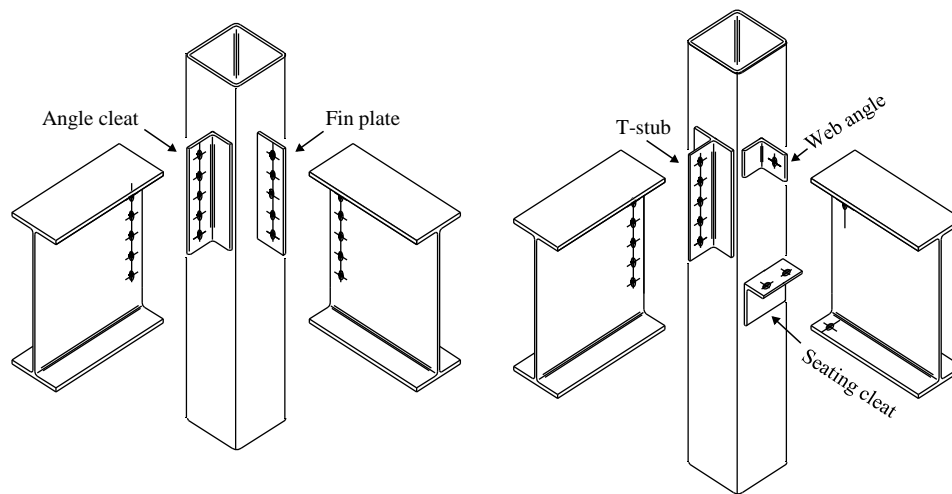

Fig. 1. Typical connections between open and tubular profiles

number of years [British Steel 1997; Steel Construction Institute and British Constructional Steelwork Association (SCI/BCSA) 2002, 2011]. Up to date, however, there is no viable, blind bolted moment connection being applied in practice which limits the application of tubular profiles as columns in steel structures. This is because such fasteners do not have sufficient stiffness, relative to that of the connecting beam to classify the connection as moment-resisting.

For this reason, research at the University of Nottingham has been ongoing to develop a new blind bolt suitable for moment-resisting connections in steel-framed buildings. The response of the tube face—when subjected to moments from a connection fastened with a blind bolt of such stiffness—is also under investigation. This research has resulted in a modification of the Lindapter Hollo-bolt (HB) allowing it to generate sufficient axial stiffness for a moment-resisting connection (Pitrakkos and Tizani 2013; Tizani et al. 2013; Tizani and Ridley-Ellis 2003). The new blind bolt, the Extended Hollo-bolt (EHB) was designed specifically for connections to concrete-filled tubular (CFT) columns. The EHB fastening system is primarily distinguished from that of the standard HB by its longer (extended) internal bolt shank, which includes a headed anchor that is threaded onto its end to provide mechanical anchorage. The proposed connection technology is shown in Fig. 2. This research aimed at developing a fundamental understanding of the connection behavior of a group of fasteners when subjected to direct tension.

Presented here are the results of double-sided joint tests carried out to confirm the monotonic tensile response of this original connection technology. Initially, the program concentrated on ascertaining the benefits of filling the tubular column with concrete, with tests performed on unfilled and concrete-filled tubes to allow

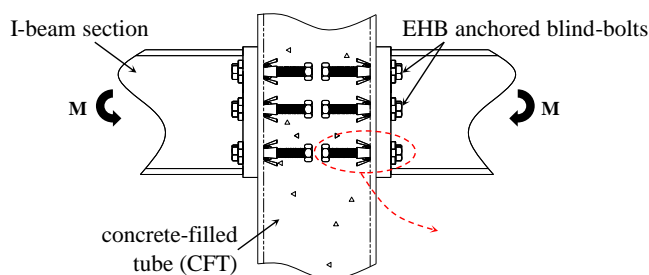

Fig. 2. Blind bolted connections to CFT using the EHB blind bolt

for comparison. For evaluation purposes, the deformability performance of standard HB and conventional bolted connections was then compared with that of EHB connections. To understand the influence of the key joint parameters, this paper investigates a variation in the strength of the concrete infill, the strength of the internal bolt, and the distance between connecting bolts (i.e., horizontal and vertical bolt spacing). The results are discussed with a focus on joint stiffness, strength, ductility, and failure mode. Also provided is an analysis of the interaction between blind bolts and tubular profiles under applied tension, and conclusions regarding the behavior of a group of EHB fasteners compared with conventional bolting systems.

Experimental Details

Test Matrix and Setup

The experimental program consisted of ten connection tests, with each configuration subjected to a monotonic tensile load. The objectives of the tests were (1) to establish the influence on connection behaviour when the tube is filled with concrete; (2) to compare the tensile performance of various blind bolted connections to that of conventional bolted connections; and (3) to investigate the connection behavior of anchored blind bolted connections by varying the principal joint parameters.

The testing matrix is summarized in Table 1, which outlines specimen index alongside the test variables. The test variables included type of fastener, addition of a concrete tube infill, strength of the concrete infill, spacing among bolts, and the class of connecting blind bolts. The test setup and the different configurations that were tested are shown schematically in Figs. 3 and 4, respectively.

The experimental setup simulated the idealized tension region of a typical connection designed to resist bending forces, with the critical force being the component of force acting at 90° to the tube face. Each specimen represented a double-sided joint constructed with T-stub sections and a total of eight bolts. The connections to the tube member were formed on opposite faces, with four bolts used on each face. The connections fastened with conventional bolt-nut-washer systems were designated “Type M” and were tested in combination with unfilled [Fig. 4(a)] (Barnett 2001) and CFT [Fig. 4(b)] (Ellison and Tizani 2004) sections. The connections fastened using the Hollo-bolt blind bolt were designated

Table 1. Test Matrix

Specimen index	Bolt batch	Gauge (mm)	Pitch (mm)	SHS section (width × thickness)	Concrete grade	f_{cu}^a (N/mm ²)
Type HB (without concrete)						
HB-8.8A-G90-P100-SHS10	8.8/A	90	100	200 × 10	N/A	N/A
Type HB (concrete-filled)						
HB-8.8A-G120-P100-SHS10-C50	8.8/A	120	100	200 × 10	C50	57.0
Type M (without concrete)						
M-8.8B-G120-P100-SHS10	8.8/B	120	100	200 × 10	N/A	N/A
Type M (concrete-filled)						
M-8.8B-G120-P100-SHS10-C50	8.8/B	120	100	200 × 10	C50	57.0
Type EHB (concrete-filled)						
EHB-8.8C-G120-P100-SHS10-C50	8.8/C	120	100	200 × 10	C50	53.0
EHB-8.8D-G120-P100-SHS10-C40	8.8/D	120	100	200 × 10	C40	43.5
EHB-8.8D-G120-P100-SHS10-C30	8.8/D	120	100	200 × 10	C30	34.0
EHB-8.8D-G90-P100-SHS10-C40	8.8/D	90	100	200 × 10	C40	43.0
EHB-8.8D-G120-P140-SHS10-C40	8.8/D	120	140	200 × 10	C40	46.5
EHB-10.9E-G90-P140-SHS10-C40	10.9/E	90	140	200 × 10	C40	46.0

^aCompressive cube strength of concrete infill on day of testing.

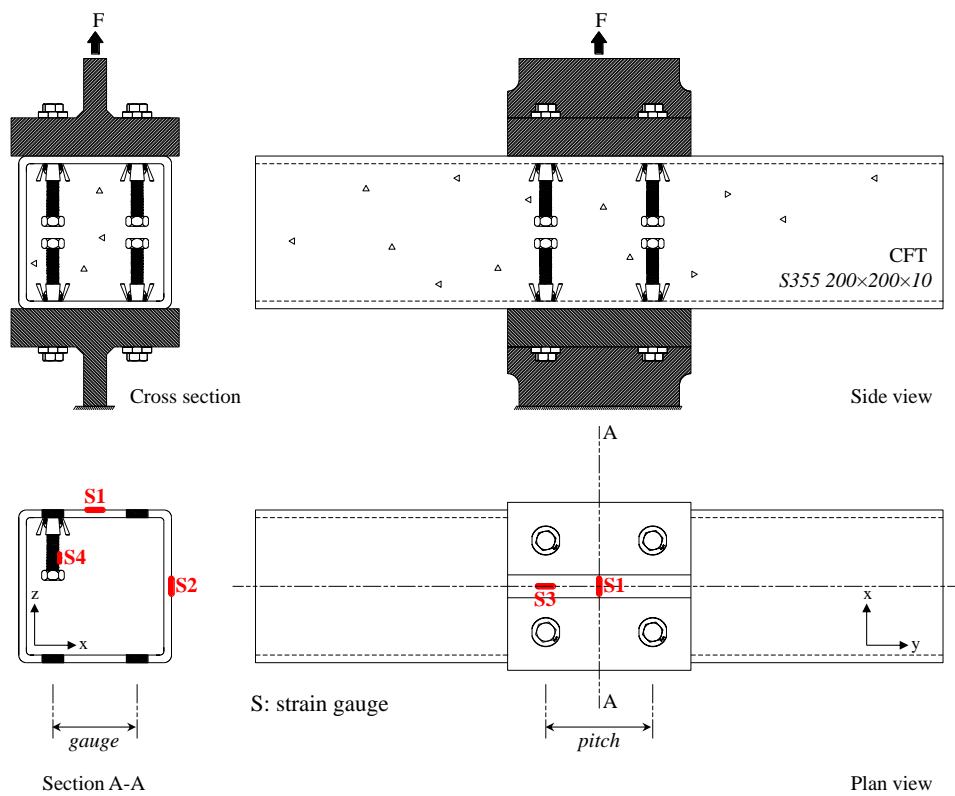

Fig. 3. Test setup

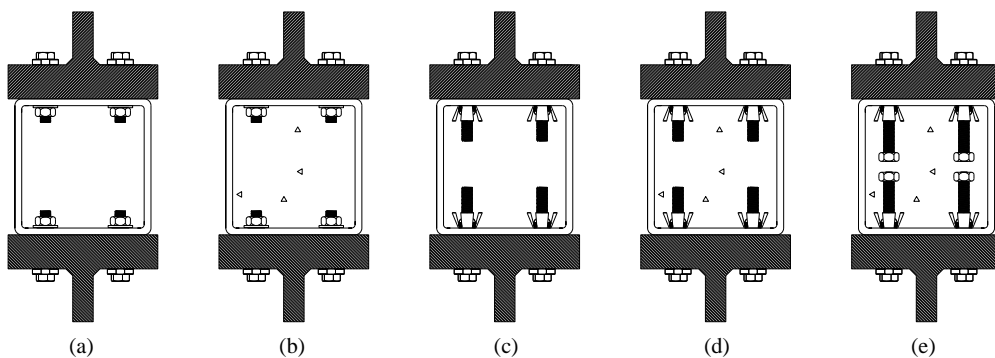

Fig. 4. Double-sided joint configurations

Fig. 5. Connection specimen ready for testing

“Type HB” and were also tested in combination with unfilled [Fig. 4(c)] (Barnett 2001) and CFT members [Fig. 4(d)] (Ellison and Tizani 2004). “Type EHB” used Extended Hollo-bolt blind bolts connected to CFT sections [Fig. 4(e)].

All connecting bolts were tightened using a handheld torque wrench. Except those of property class 10.9 (designated Batch E), all test bolts were fastened at a tightening torque of 190 Nm. Property class 10.9 bolts were tightened at 300 Nm. All test connections had a tube width-to-thickness ratio (b_o/t_o) of 20 and a T-stub width-to-tube width ratio (b_p/b_o) of 1.1. The upper and lower T-stub sections, which had a 50-mm-thick flange, were designed as such to eliminate prying forces, allowing for an exclusive evaluation of interaction performance between the fastening system and the tube member.

To ensure that tube wall deformation was not affected by the open-end conditions, tube member length was arbitrarily selected to be 900 mm. The joint was formed in the center of the length, which provided a distance of at least twice the tube width (i.e., $2b_o$) on either side of the joint. This was deemed suitable in terms of distributing the applied load without interference from the ends of the tube. To examine the effect of bending moment on the deflection of the tube face, and to investigate the performance of a group of EHB fasteners, the spacing between connection bolts was varied within practical ranges. The bolt gauge, which is defined as the transverse distance among bolt centerlines, varied from 90 to 120 mm. The bolt pitch, which is defined as the vertical distance between bolt rows, varied from 100 to 140 mm.

Connection tests were conducted under displacement control, using a 2-MN-capacity testing machine. The moveable crosshead was located on the upper side of the setup and the lower T-stub was fixed into position to allow the application of monotonic increasing load. Additional test instrumentation included displacement transducers and strain gauges, with the latter used on a limited number of EHB specimens only. Displacement transducers were used to monitor the displacement of the connected T-stubs relative to the tube face. Strain gauges were employed to measure strain along different directions in the underlying surface of the test part, with gauges mounted on the tube walls and on the embedded bolt shank. In particular, three strain gauges were mounted on the tube walls (S1, S2, and S3 in Fig. 3) and one on the bolt shank as close as possible to the end anchor (S4 in Fig. 3). The S1 and S3 gauges monitored the bending strain on the tube face in the x - and

Table 2. Bolt Properties

Bolt batch	d_b (mm)	Property class	Shank length (mm)	f_{ub}^a (N/mm ²)
A	16	8.8	120	776
B	16	8.8	120	804
C	16	8.8	150	955
D	16	8.8	150	909
E	16	10.9	150	1,118

^aUltimate tensile strength.

y -directions, respectively; S2 measured the axial strain on the tube side wall in the z -direction (at the mid-depth of the tube). Finally, S4 recorded the axial strain in the bolt shank in the z -direction, representing the development of mechanical anchorage due to resistance from the end anchor head. An actual connection specimen ready for testing is shown in Fig. 5.

Material Properties

The primary mechanical and geometrical properties of the different bolt groups used in the connection tests are summarized in Table 2, with each group being labeled with an alphabetic character to distinguish among the several bolt batches. All bolt shanks had a nominal (major) diameter of 16 mm. The bolts used to assemble the HB and M joint types had a total shank length of 120 mm, whereas the bolts used in the EHB joint types had a total shank length of 150 mm. The nominal grade and actual strength of concrete on the day of testing—for the CFT connections—are included in the test matrix in Table 1 next to the specimen indexes. The age of concrete was typically seven days on the day of testing.

Test Results and Analysis

Application of Concrete Infill

To determine whether a concrete tube infill influences joint performance, connection tests were performed on unfilled and CFT joints for Type HB and Type M. The test results are graphed together for both configurations (i.e., without concrete and CFT) in Fig. 6 for Type HB and in Fig. 7 for Type M. The results are shown as

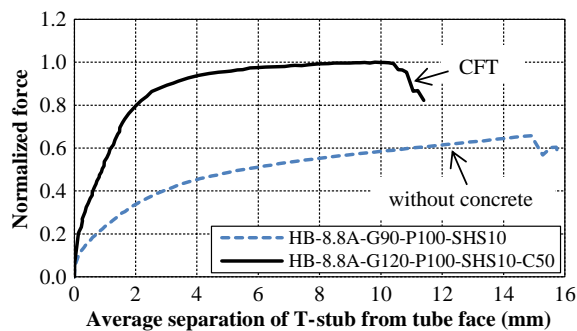

Fig. 6. Joint Type HB (unfilled tube and CFT)

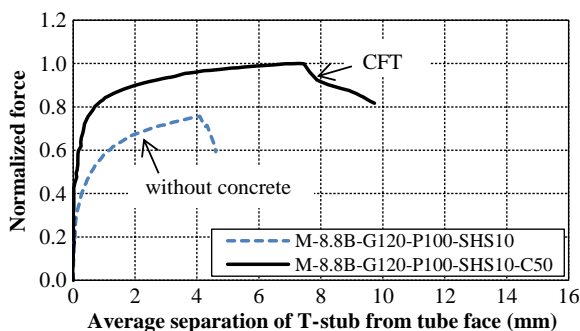

Fig. 7. Joint Type M (unfilled tube and CFT)

normalized applied force versus average T-stub separation relative to the tube face.

The performance of the unfilled and CFT connections was exceptionally dissimilar in terms of stiffness, strength, ductility, and ultimate failure mode. For both tested joint types (i.e., HB and M), enhanced connection performance resulted when the tube was filled with concrete. Regarding connection stiffness, the force-separation curves achieved by the connections to CFT sections were significantly stiffer in comparison to those achieved by the unfilled connections. Connection ductility also increased for CFT connections with standard bolts (Type M). With respect to strength, the concrete infill increased the joint's overall capacity. The strength of Type HB (CFT) increased by 50%, and the achievable strength of Type M (CFT) was higher by approximately 30% than that of the equivalent unfilled configuration.

The source of this additional strength was borne out by the failure modes observed during the tests. For example, the Type HB (without concrete) joint was seen to ultimately fail by the standard Hollo-bolt being pulled through the bolt hole in the tube because of the widening action of the conical expanded sleeve and the shearing off of the sleeve legs. The tests done on connections with standard bolts to unfilled tubes ultimately failed because of the stripping of the bolt threads, which occurred from secondary bending induced by excessive tube deformation. Indeed, for both configurations, local to the connection region, the walls of the unfilled tube underwent considerable deformation (Fig. 8).

In contrast, the ultimate failure mode of the joints with CFT sections was bolt shank fracture accompanied by negligible tube deformation (Fig. 9). Therefore, the enhanced connection behavior in the CFT case was attributed not just to the ability of the concrete to resist deformation of the tube walls; the tube infill also provided a favorable form of resistance by anchoring the connecting bolts. The concrete-bolt interaction improved the axial stiffness and strength of the connecting bolts, permitting their full tensile

Fig. 8. Connections to unfilled tube

capacity to develop. The difference in response to applied force between unfilled and concrete-filled tubes is illustrated in Fig. 10, which highlights the desirable effects provided by the concrete as established for the tested configurations.

Connection Behavior with the Modified Blind Bolt

The performance of connections made with the standard Hollo-bolt was seen to be improved by the addition of a concrete infill, exhibiting equivalent strength and comparable ductility to those of the standard bolt connections. Similar to the conventional configuration (i.e., Type M), the strength of the connections to CFT made with Hollo-bolts was ultimately controlled by the capacity of their internal bolts. However, their connection stiffness was lower than that of the standard bolts. This is because the Hollo-bolt remained susceptible to being partially pulled through the hole prior to the development of the tensile capacity.

The lower tensile stiffness of connections made with the Hollo-bolt, even to tubes subsequently filled with concrete, means that the standard Hollo-bolt remains unsuitable for use in moment-resisting connections for the majority of configurations. However, recognizing the benefits gained by filling the tube with concrete (i.e., stiffening of tube walls and connecting bolts), a new blind bolt was designed for optimum interaction with the infill to achieve behavior comparable to that of conventional bolts. This new blind bolt—the Extended Hollo-bolt (EHB)—achieved optimum performance by maximizing mechanical anchorage within the readily available material. The EHB is a modified version of the standard Hollo-bolt, involving an extended internal, fully threaded bolt shank combined with an anchor head threaded onto its end—hence, “Extended.”

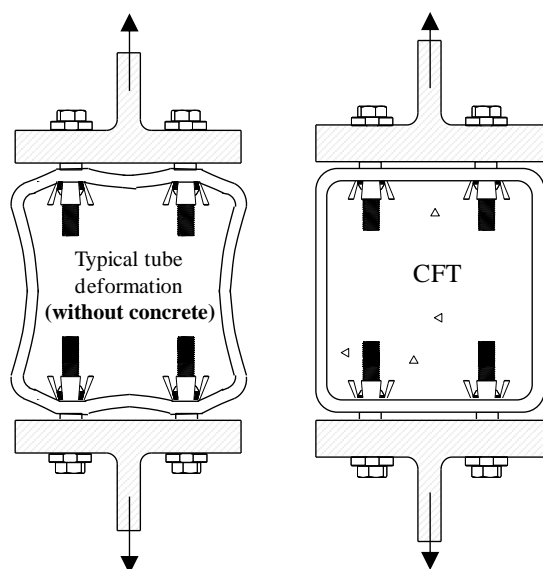
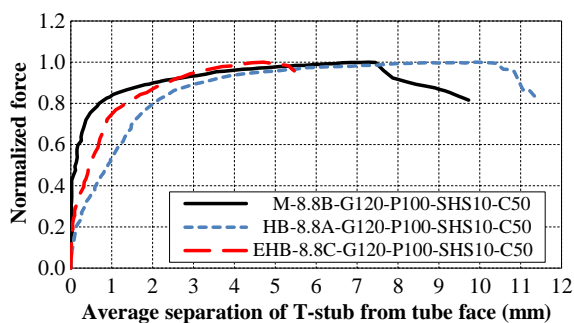
Fig. 9. Bending of tube walls for CFT**Fig. 10.** Transition of failure mode when CFT used**Fig. 11.** Force-separation curves for connections to CFT using M, HB, and EHB**Table 3.** Summary of Test Failure Loads

Specimen index	Failure load (kN)
Type HB (without concrete)	
HB-8.8A-G90-P100-SHS10	352.4
Type HB (concrete-filled)	
HB-8.8A-G120-P100-SHS10-C50	536.3
Type M (without concrete)	
M-8.8B-G120-P100-SHS10	368.7
Type M (concrete-filled)	
M-8.8B-G120-P100-SHS10-C50	487.5
Type EHB (concrete-filled)	
EHB-8.8C-G120-P100-SHS10-C50	621.0
EHB-8.8D-G120-P100-SHS10-C40	542.7
EHB-8.8D-G120-P100-SHS10-C30	609.7
EHB-8.8D-G90-P100-SHS10-C40	529.6
EHB-8.8D-G120-P140-SHS10-C40	555.1
EHB-10.9E-G90-P140-SHS10-C40	642.8

Fig. 11 presents the force-separation curves for connections to CFT made with (1) conventional bolts, (2) Hollo-bolts, and (3) EHBs. The results are shown in a normalized form, where the applied force for each connection is normalized relative to the maximum force reached in the tests (Table 3 lists actual failure loads). The results show all three connections to have an equivalent strength (equal to 1.0), which effectively equates with the strength of the connecting bolts because the ultimate failure mode for all tests was bolt fracture. As anticipated, the conventional connections exhibited the highest stiffness and the response of the joint formed using the EHB showed a favorable deviation toward the conventional data (i.e., Type M).

Knowing that the level of axial stiffness in conventional bolts is suitable for use in moment connections, achieving such stiffness characteristics indicates the suitability of the novel fastener in moment-resisting construction. The improved characteristics of EHB-anchored blind bolts are highlighted in Fig. 11, demonstrating that the axial stiffness of EHB is indeed improved by the modifications, although at the expense of some ductility. Fig. 11 shows

that the ability of the EHB connection to absorb deformation is reduced compared to the other configurations. But, overall, the connection performance using EHBs is comparable to conventional bolting systems and therefore can be considered suitable for moment-resisting applications.

The remainder of this paper concerns the tests done on connections to CFT using the headed anchored EHB blind bolts, where a variation in the primary joint parameters was investigated to further understand connection behavior.

Compressive Strength of Encased Concrete

Normalized Force-Separation Curves

Three double-sided CFT joints made with EHBs, involving different concrete grades, were tested to assess the influence of concrete strength on connection behavior. The normalized force-separation curves for the tested connections are shown in Fig. 12. The joints exhibited an equivalent strength, with all three ultimately failing as a result of bolt fracture. However, the joint that had the highest concrete strength (grade C50) exhibited the most enhanced properties.

For a clearer interpretation of the test results, the data were analyzed in terms of yield (δ^y) and ultimate (δ^u) separation, as shown in Fig. 13, with δ^y and δ^u determined at normalized force levels of 0.8 and 1.0, respectively. The ratio of 0.8 was selected based on the ratio of yield to ultimate strength, which is equal to 0.8 for bolts of property class 8.8. A consistent pattern was found in the data: increasing the concrete strength reduced both the yield and the ultimate separation. To emphasize this observation, the yield separation is shown further normalized in Fig. 14. A reduction in δ^y of 30% was found for the highest concrete grade (C50); however, negligible improvement was seen in increasing the strength from C30 to C40.

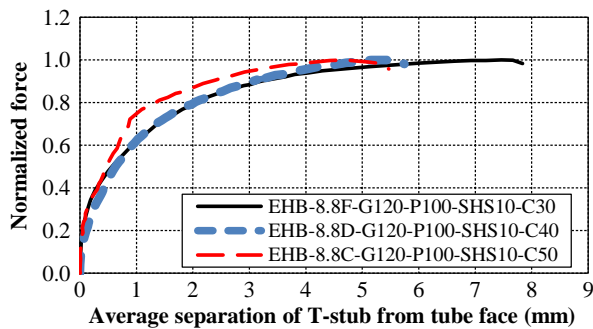

Fig. 12. Force-separation curves for EHB connections to CFT for various concrete strengths

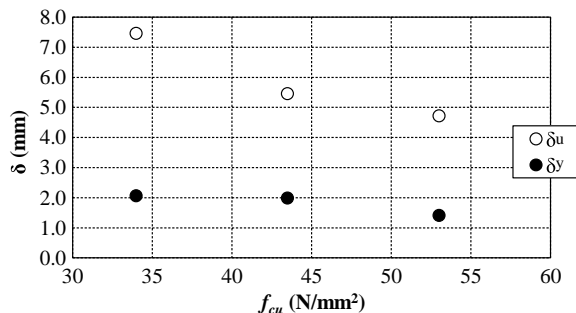

Fig. 13. Yield and ultimate separation versus concrete strength

Having defined the yield and ultimate separation, it was then possible to evaluate the ductility of the tested connections. Here, ductility was assessed on the basis of deformation capacity (δ^{cd}), determined by the algebraic difference between ultimate and yield separation. The normalized δ^{cd} is plotted in Fig. 15, showing that ductility of the double-sided joints decreased with an increase in concrete strength. But it was not seen to be affected for concrete grades of C40 to C50.

Development of Mechanical Anchorage

Comparing the response of the HB connections with that of the EHB connections showed that the development of mechanical anchorage—from the interaction between the EHB end anchor head and the concrete infill—provides additional resistance to bolt pullout. To assess this bearing action for different concrete strengths, axial bolt strain (along the z -direction) was monitored close to the anchor using the S4 strain gauge, as shown in Fig. 3. Dimensionless strain at this position indicated the development of bearing stress acting on the concrete in front of the end anchor head; hence, the relation to development of mechanical anchorage. Strain at this location was recorded for two specimens—index EHB-8.8D-G120-P100-SHS10-C40 and index EHB-8.8D-G120-P100-SHS10-C30—to compare anchorage development when a variation in grades C30 and C40 are considered.

The strain versus the applied (normalized) force is presented in Fig. 16, where it is identified that the development of anchorage in the C40 specimen is superior to that in the specimen of grade C30. Anchorage in the higher-strength concrete developed up to failure (evidenced by an increase in strain with an increase in applied force), whereas it no longer developed in the lower-strength concrete beyond a normalized force of approximately 0.8 (evidenced by the constant strain beyond 0.8). Because the measurement of greater strain demonstrates higher resistance, Fig. 16 reveals that an increase in the compressive strength of concrete can enhance

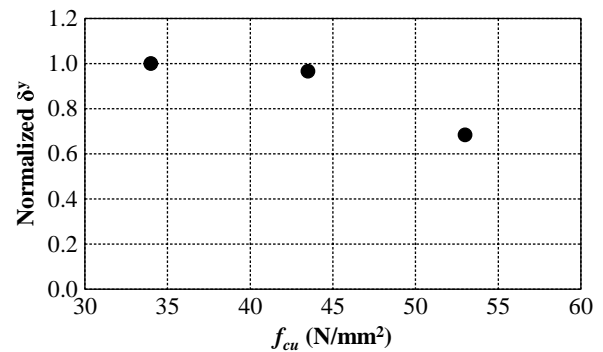

Fig. 14. Normalized yield separation versus concrete strength

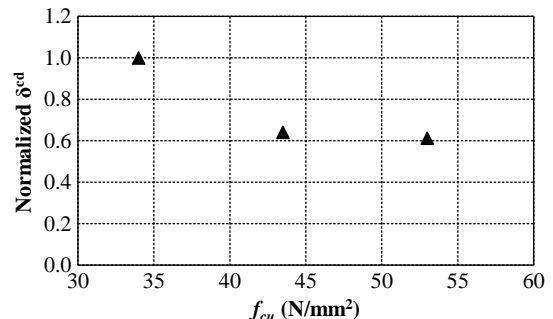

Fig. 15. Normalized deformation capacity

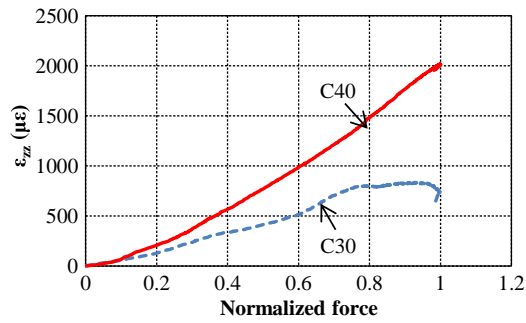

Fig. 16. Strain in bolt due to anchorage development (using strain gauge S4)

the EHB's anchorage characteristics (comprising bond and bearing resistance) and thus improve overall performance of the connector.

This observation can be further linked with the force-separation curves, shown in Fig. 12, where the specimen with grade C30 exhibits the largest ultimate separation, δ^u . As anchorage no longer developed in the C30 specimen, local concrete in front of the anchor was crushing, reducing the resistance to pullout and allowing the bolt to displace. This concrete crushing was not observed when a higher-strength concrete was used—hence, the measurement of the largest global separation (δ^u) for the joint with the C30 concrete. Equally, because of the way in which ductility (δ^{cd}) was calculated, this explains the increased ductility for the C30 specimen compared to the C40 and C50 specimens.

Bending and Axial Strain on CFT Walls

To evaluate the tube–concrete interaction, the face and side wall of the CFT were instrumented with strain gauges for two specimens of different concrete strengths (C30 and C40). The corresponding specimen indexes were EHB-8.8D-G120-P100-SHS10-C40 and EHB-8.8D-G120-P100-SHS10-C30. Bending strain on the tube

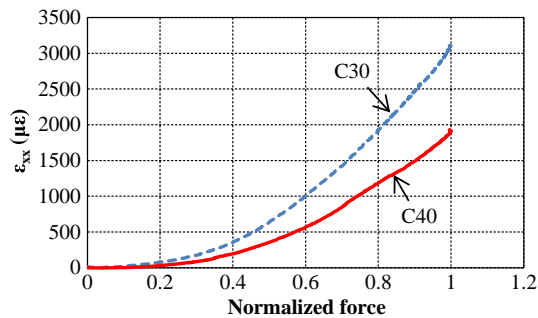

Fig. 17. Bending strain on tube face (using strain gauge S1)

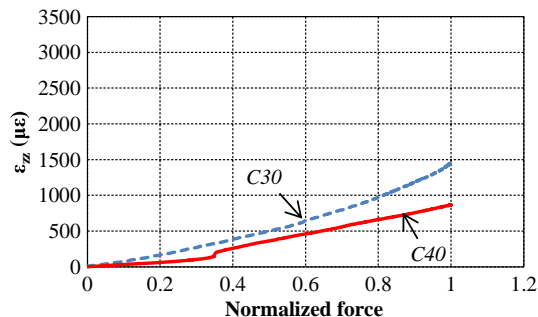

Fig. 18. Axial strain on tube side wall (using strain gauge S2)

face (along x in the center of connection) was monitored using S1 whereas axial strain on the tube side wall (along z mid-depth of the tube) was measured using S2 (Fig. 3).

The results are shown in Figs. 17 and 18 for both concrete grades, charted against the applied (normalized) force. The tensile strain on the tube walls—at the specified locations—is shown to be consistently smaller for the CFT with the higher-strength concrete. To indicate the relationship between recorded strain and concrete strength, the primary strain readings are charted against concrete strength in Figs. 19 and 20. The figures show the yield (ϵ^y) and ultimate (ϵ^u) strain corresponding to the strain at normalized force levels of 0.8 and 1.0, respectively. As shown, the strain profile decreases considerably with an increase in concrete strength, demonstrating a favorable distribution of the applied load for connections to CFT with higher-strength concrete.

Influence of Bolt Gauge

Normalized Force-Separation Curves

Two double-sided CFT joints, constructed using EHBs, were tested to assess the influence of bolt gauge on connection behavior. One specimen had a bolt gauge of 90 mm; the other had a bolt gauge of 120 mm. The corresponding specimen indexes were EHB-8.8D-G90-P100-SHS10-C40 and EHB-8.8D-G120-P100-SHS10-C40. The adopted bolt gauges equated with the minimum and maximum achievable distances relative to the size of the tube used in the connection tests.

The normalized force-separation curves for the tested joints are shown in Fig. 21. The yield and ultimate separation, including the deformation capacity, are charted together against the bolt gauge in Fig. 22, which shows the yield and ultimate separation determined as previously, at normalized force levels of 0.8 and 1.0, respectively. Overall, the connections behaved very similar to each other,

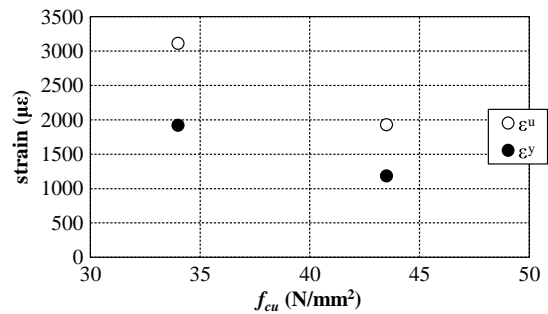

Fig. 19. Bending strain on tube face at yield and ultimate force levels (using strain gauge S1)

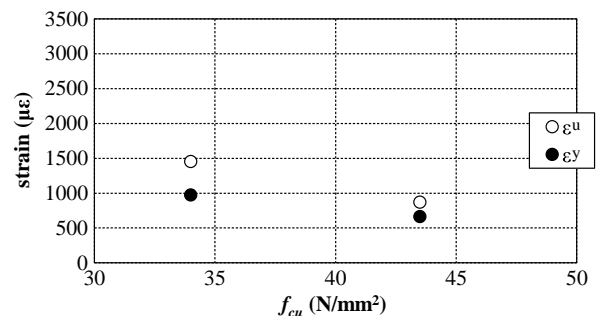

Fig. 20. Axial strain on tube side wall at yield and ultimate force levels (using strain gauge S2)

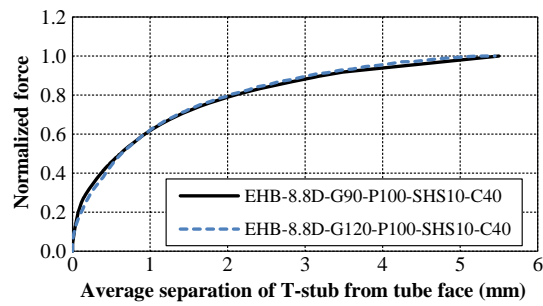

Fig. 21. Force-separation curves for EHB connections to CFT with different bolt gauges

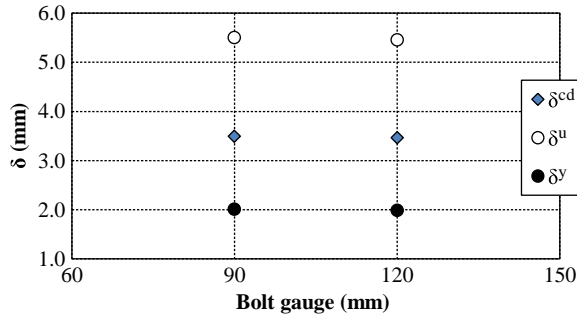

Fig. 22. Effect of bolt gauge on characteristics of EHB connections to CFT

exhibiting an equivalent stiffness, strength, ductility, and failure mode. Both configurations ultimately failed because of bolt fracture, which confirms that the capacity of the original connection is not compromised by group action for bolts approaching the tube side walls and for bolts placed relatively close to each other. Although it was initially anticipated that the shorter bolt gauge would result in a less stiff configuration, such an outcome was not observed in the tests. This is because the stiffening effect was already provided by the concrete infill, surpassing the influence of variations in bolt gauge.

Bending Strain on the Tube Face

To further investigate the variation in bolt gauge, strain was monitored on the face of the CFT at the center of the bolt gauge (i.e., at the centerline of the bolt row). The results obtained by the strain gauge used in the bending strain configuration (S3 in Fig. 3) are shown in Fig. 23. The bending strain varied slightly at the ultimate

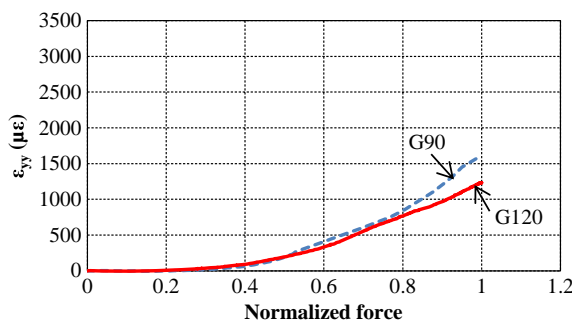

Fig. 23. Bending strain on tube face in center of bolt row (using strain gauge S3)

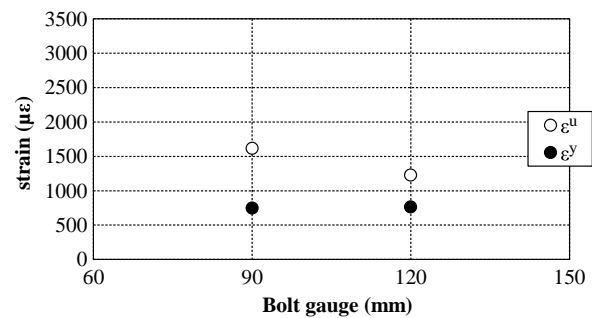

Fig. 24. Bending strain on tube face at yield and ultimate force levels (using strain gauge S3)

state, but was very comparable from zero force up to yield force (0.8). Greater strain was measured on the face of the CFT which had the shortest bolt gauge. Fig. 24 depicts the values of yield and ultimate strain, charted against the varying bolt gauges, as determined at the normalized force levels of 0.8 and 1.0, respectively. Thus, further experimental evidence suggests that the particular variation in bolt gauge does not significantly influence the characteristics of the studied joint configuration.

Influence of Bolt Pitch

Two double-sided CFT joints, formed using EHBs, were tested to assess the influence of bolt pitch on connection behavior. One specimen had a bolt pitch of 100 mm and the other had a bolt pitch of 140 mm. The corresponding specimen indexes were EHB-8.8D-G120-P100-SHS10-C40 and EHB-8.8D-G120-P140-SHS10-C40. Considering tube size, the bolt pitches were selected based on practical distances commonly used in the design of moment connections.

Fig. 25 presents the normalized force-separation curves for the connection tests. Initially, the connection with the longer bolt pitch performed better than the one with the shorter pitch. However, beyond the level of yield force (0.8), the performance of the connections was very comparable, ultimately achieving an equivalent strength. Both joints failed because of bolt fracture.

For a closer examination of joint performance, Fig. 26 graphs the test results with respect to yield (δ^y) and ultimate separation (δ^u); joint ductility (δ^{cd}) was established similarly to the previous analysis, where δ^y was determined at a normalized force of 0.8 and δ^u at a normalized force of 1.0. Fig. 26 shows that the longer bolt pitch decreases the separation between the connecting members at the yielding force of the joint (evidenced by the reduction in δ^y).

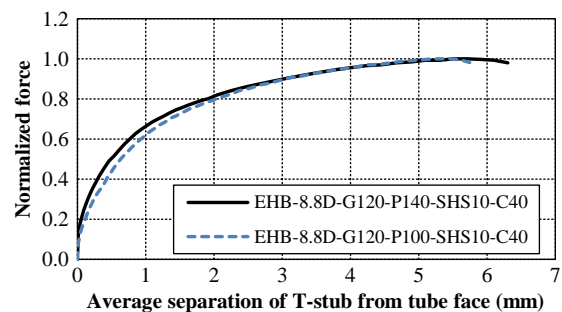

Fig. 25. Force-separation curves for EHB connections to CFT with different bolt pitch

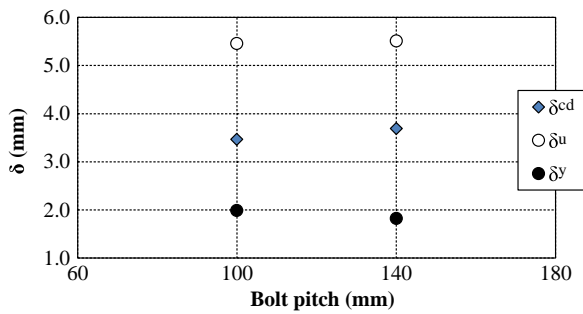

Fig. 26. Effect of bolt pitch on EHB connections to CFT

It also increases the deformation capacity of the connection (evidenced by the increase in δ^{cd}).

Influence of Bolt Class

Bolts of property class 8.8 and 10.9 are most commonly applied in structural connections. The responses of EHB connections to CFT using these two property classes are compared in Fig. 27, where the applied force is shown normalized relative to the maximum force that was reached in the connection test which made use of grade-8.8 bolts. The corresponding specimen indexes were EHB-8.8D-G120-P140-SHS10-C40 and EHB-10.9E-G90-P140-SHS10-C40. Despite the different bolt gauges between the specimens, the comparison was considered valid because the variation in bolt gauge did not affect the characteristics of the joint (see the section “Influence of Bolt Gauge”) and the other primary joint parameters were not varied.

The response of the connection with grade-10.9 bolts was notably improved in comparison to that with grade-8.8 bolts in terms of stiffness and strength. Both joints ultimately failed because of bolt fracture. Assuming that the connection would develop the full tensile capacity of the grade-10.9 bolts, it was expected that the strength of the joint using these bolts would be higher. Indeed, the connection achieved the full capacity of the bolts and allowed for an increase of nearly 20% in capacity compared to the joint with grade-8.8 bolts. The theoretical ratio of the nominal strength of grade-10.9 bolts to that of grade-8.8 bolts is equal to 1.25 (1,000/800). The actual strength ratio measured for the bolts used in the tests was 1.23 (1,118/909). This is analogous to the increased capacity in Fig. 27, demonstrating consistency in the test results.

The enhanced stiffness of the connections that used bolts of property class 10.9 was attributed to the increased torque applied at their tightening stage (300 Nm instead of 190 Nm), which provided a higher clamping force between joint members that did not

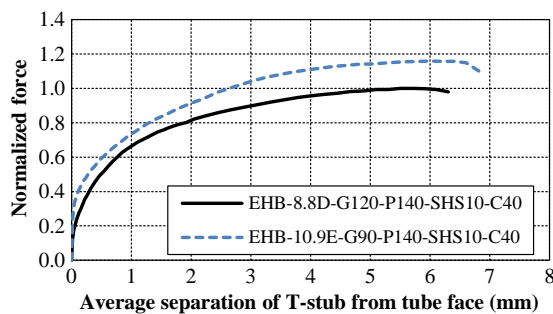

Fig. 27. Force-separation curves for EHB connections to CFT using bolts of different property class

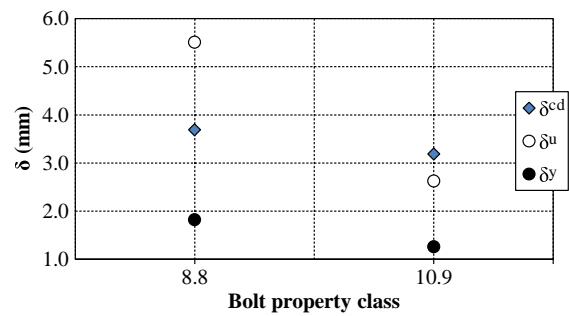

Fig. 28. Influence of bolt grade on characteristics of EHB connections to CFT

permit their separation at the early stages of loading. To highlight the influence of bolt property class, in Fig. 28 the yield (δ^y) and ultimate (δ^u) separation of the grade-8.8 connection is charted alongside the separation of the grade-10.9 connection at the same normalized force levels (0.8 and 1.0). The EHBs with internal grade-10.9 bolts resulted in much less separation at the corresponding forces.

The deformation capacity (δ^{cd}) is also shown in Fig. 28. To allow for a reasonable comparison of ductility, however, δ^{cd} for the grade-10.9 connection was established based on a yield separation determined at 0.9 of the maximum force reached in the test. The ratio of 0.9 was selected based on the ratio of bolt nominal yield to ultimate strength, which was equal to 0.9 for 10.9-grade bolts. It was identified that the ductility capacity of connections to CFT using EHBs with internal grade-10.9 bolts decreased compared to those with grade-8.8 bolts. This is because of the brittle mechanical properties of high-strength bolts (e.g., property class 10.9).

Conclusions

Blind bolts have been developed to provide construction efficient connections to members where access is restricted to one side. The application of the technology in structural beam-to-column connections, however, is currently limited to simple construction when tubular columns are utilized. This paper has introduced an original blind bolt—termed the Extended Holo-bolt (EHB)—designed for application in moment-resisting connections to tubular sections.

An experimental program, comprising ten monotonic connection tests, was described and the force-separation curves achieved were assessed. The tests implemented a setup that simulated the tension zone of typical moment connections, which allowed direct evaluation of the axial stiffness and strength of the connector. Using different fastening systems, connections were made to unfilled tubular and concrete-filled tubular (CFT) sections. The different fastening systems included conventional bolts, standard Holo-bolts, and original EHBs.

The joints formed without concrete were unable to develop the full tensile capacity of the connecting bolts. Indeed, the response of the conventional bolted connections to the unfilled tubes was seen to be heavily influenced by the flexibility of the tube walls. Consequently, connection performance was not limited by the performance of the bolts themselves.

A concrete infill to the tube (after bolting) improved the response of connections made with standard bolts and the Holo-bolt. The following benefits were identified:

- Overall connection stiffness and strength were enhanced;
- Bending and deformation of the tube were reduced; and

- Axial stiffness and fastener strength, were improved, allowing the full capacity of the connecting bolts to develop and thus altering the failure mode from bolt pullout or shearing of expanding sleeves to bolt shank failure.

Considering these benefits, the EHB was proposed as a way of devising a fastener with an axial stiffness equivalent to that of conventional bolts. Introduced as an evolution of the standard Hollo-bolt, the improved mechanics of this modified blind bolt were achieved by optimum interaction of its anchorage system with the concrete infill. This mechanical anchorage is practically provided by extending the internal bolt shank to accommodate an anchor head that is threaded onto its end.

The group performance of EHBs was investigated with respect to several salient connection properties and geometric parameters. The influence of concrete strength, internal bolt class, and various distances between bolts was examined. The total strength of the connection remained constant (i.e., equal to the sum of the individual bolts), confirming that bolt group action does not compromise the strength of the proposed fastening system when it is controlled by bolt strength. Certain test variables, however, did influence the stiffness and ductility of the tested joints. In terms of stiffness, an increase in the compressive strength of the concrete infill to the tube had the most favorable effect on connection behavior. Using an infill of higher strength was also seen to alleviate the applied stress transferred onto the tube walls. As anticipated, a change in bolt property class (from 8.8 to 10.9) also enhanced the stiffness of the connection, but this was at the expense of reduced ductility due to the brittle properties of high-strength bolts.

The paper has provided analysis on the performance of original blind bolted connections to tubular sections. It has developed the understanding of the blind bolt and tube interaction behavior, including the effects that primary variables have on the behavior of the proposed connection technology. The use of CFT, combined with headed anchored blind bolts, was shown to result in behavior comparable to that exhibited by conventional bolting systems, demonstrating its suitability in bolted moment-resisting connections to tubular sections. Overall, it can be concluded that moment-resisting connections with semirigid or rigid behavior can be achieved using extended and anchor-headed blind bolts connected to CFT columns. The development of sophisticated numerical models is the subject of current work in view of further parametric and design-oriented studies.

Acknowledgments

The authors wish to acknowledge TATA Steel (formally Corus), the Institution of Structural Engineers (IStructE), London, U.K., and Lindapter International, Bradford, for supporting this research. Gratitude is due to the following individuals: Mr. Trevor Mustard of TATA Steel and Mr. Neil F. Gill of Lindapter International.

References

- Barnett, T. (2001). "The behaviour of a blind bolt for moment resisting connections in hollow steel sections." Ph.D. thesis, Univ. of Nottingham, Nottingham, U.K.
- British Steel. (1997). "SHS jointing: Flowdrill & Hollobolt. Publication TD 384, British steel Plc".
- Corus. (1997). "SHS jointing." Corus Tubes, Structural and Conveyance Business, (http://www.tatasteeleurope.com/file_source/StaticFiles/Business_Units/Corus_Tubes/CT46-SHS%20Jointing%2014-06-06.pdf) (Mar. 1, 2013).
- Ellison, S., and Tizani, W. (2004). "Behaviour of blind bolted connections to concrete filled hollow sections." *Struct. Eng.*, 82(22), 16–17.
- Jaspert, J. P., and Weynand, K. (2001). "Extension of the component method to joints in tubular construction." *Proc., 9th Int. Symp. and Euroconference on Tubular Structures, Tubular Structures IX*, R. Puthli and S. Herion, eds., A. A. Balkema, Rotterdam, Netherlands, 517–523.
- Maquoi, R., Naveau, X., and Rondal, J. (1984). "Beam-column welded stud connections." *J. Constr. Steel Res.*, 4(1), 3–26.
- Pitakkos, T., and Tizani, W. (2013). "Experimental behaviour of a novel anchored blind-bolt in tension." *Eng. Struct.*, 49, 905–919.
- Steel Construction Institute and British Constructional Steelwork Association (SCI/BCSA). (2002). "Joints in steel construction: Simple connections." *Publication 212*, Ascot, Berkshire, U.K.
- Steel Construction Institute and British Constructional Steelwork Association (SCI/BCSA). (2011). "Joints in steel construction: Simple joints to Eurocode 3." *Publication 358*, Ascot, Berkshire, U.K.
- Tizani, W., Al-Mughairi, A., Owen, J. S., and Pitakkos, T. (2013). "Rotational stiffness of a blind-bolted connection to concrete-filled tubes using modified Hollo-bolt." *J. Constr. Steel Res.*, 80, 317–331.
- Tizani, W., and Ridley-Ellis, D. J. (2003). "The performance of a new blind-bolt for moment-resisting connections." *Tubular Structures X: Proc., 10th Int. Symp. on Tubular Structures*, M. A. Jaurietta, A. Alonso, and J. A. Chica, eds., A. A. Balkema, Rotterdam, Netherlands, 395–400.
- Yeomans, N. F. (2001). "I-Beam to rectangular hollow section column T-connections." *Tubular Structures IX: Proc., 9th Int. Symp. and Euroconf. on Tubular Structures*, A. A. Balkema, Rotterdam, Netherlands, 119–126.