

**SECOND EUROPEAN CONFERENCE ON EARTHQUAKE ENGINEERING  
AND SEISMOLOGY, ISTANBUL AUG. 25-29, 2014****SEISMIC BEHAVIOR OF BEAM-TO-COLUMN DOWEL  
CONNECTIONS: NUMERICAL ANALYSIS VS EXPERIMENTAL TEST**

Gennaro MAGLIULO<sup>1</sup>, Marianna ERCOLINO<sup>2</sup>, Maddalena CIMMINO<sup>3</sup>, Vittorio CAPOZZI<sup>4</sup>, Gaetano MANFREDI<sup>5</sup>

**ABSTRACT**

The high vulnerability of precast structures during seismic events is mainly related to the poor performance of the connection systems, among which the beam-to-column connections. The dowel typology is largely used in Europe and a detailed study is required in order to understand its seismic response. The behavior of dowel beam-to-column connections is influenced by a lot of parameters and it can be analyzed through numerical analyses.

In this work a FEM model of a typical dowel connection is provided; it is validated by experimental evidences and it is used for several parametric analyses in order to investigate the influence of different parameters on the connection behavior in terms of strength and failure mechanism.

**INTRODUCTION**

The global structural response of concrete precast buildings is largely influenced by the performance of few elements (columns) and of the connections between structural elements and between structural and non-structural components. Recent violent seismic events in Europe, which involve industrial areas and precast structures, cause the most of damage to the connection systems (Magliulo et al., 2013), among which the beam-to-column connections.

One of the most common beam-to-column connections with mechanical devices for shear loads is the dowel system. It generally consists of one or more steel dowels, embedded in the column and inserted in a beam hole, filled with mortar (Fig. 1). The connection behavior is influenced by the behavior of different materials (concrete and steel), by the established contacts between elements (e.g. column concrete-to-dowel and mortar-to-dowel contacts) as well as by the behavior of the jointed structural elements themselves (e.g. rotational capacity of beam and column).

---

<sup>1</sup> Assistant Professor, University of Naples Federico II, Naples, [gmagliul@unina.it](mailto:gmagliul@unina.it)

<sup>2</sup> Ph.D, University of Naples Federico II, Naples, [marianna.ercolino@unina.it](mailto:marianna.ercolino@unina.it)

<sup>3</sup> Ph.D student, University of Naples Federico II, Naples, [maddalena.cimmino@unina.it](mailto:maddalena.cimmino@unina.it)

<sup>4</sup> Ph.D, University of Naples Federico II, Naples, [vittorio.capozzi@unina.it](mailto:vittorio.capozzi@unina.it)

<sup>5</sup> Full Professor, University of Naples Federico II, Naples, [gamanfre@unina.it](mailto:gamanfre@unina.it)

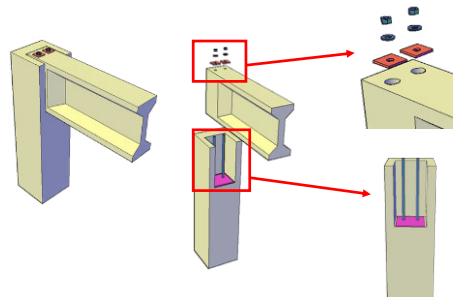

Figure 1. Beam-to-column dowel connection

Numerical models of precast structures usually implement this kind of connection as a fixed hinge between the elements (Magliulo et al., 2014c), assuming the connection strong enough to avoid its failure during the ground motion. In Ercolino (2010) the connection response is investigated and a more detailed model is implemented in the OpenSees software (McKenna and Fenves, 2013) in which beam-to-column connections are modeled as non-linear shear plastic hinges so that connection failure can be caught. In Zoubek et al. (2013) a numerical tool is presented, based on the ABAQUS FEA software (Corp., 2010), in order to model the seismic behavior of a beam-to-column dowel connection with some specific and not generalizable features.

This paper presents a non-linear three-dimensional model of a beam-to-column dowel connection, calibrated on the results of an experimental monotonic test. The characteristics of the tested connection and of the FEM model are described in order to demonstrate the capability of the model in describing the behavior of a large range of precast structures connections.

## EXPERIMENTAL MONOTONIC TEST: SETUP AND RESULTS

An experimental campaign on beam-to-column dowel connections was performed in the Laboratory of the Department of Structures for Engineering and Architecture (University of Naples Federico II), supported by the Italian Department of Civil Protection (national project DPC-ReLUIIS 2010-2013) and by ASSOBETON (Italian Association of Precast Industries). The campaign provided monotonic (Magliulo et al., 2014a) and cyclic (Magliulo et al., 2014b) tests on different connection typologies. In this paper the reference experimental test is a monotonic test on a dowel connection between an external column and a roof beam. The specimen (Fig. 2) consists of two concrete vertical lateral blocks (height: 1.0m, cross section dimensions: 60cmx60cm) and a concrete horizontal element (length: 2.10m, cross section dimensions: 60cmx60cm). The connection is provided for one side of the horizontal element by means of two steel dowels (27mm diameter treaded bar –  $f_{tb}=800\text{N/mm}^2$ ) embedded in the column and inserted in two beam holes, filled with high strength grout (Fig. 3). The dowels are fixed on the top of the horizontal element by means of steel plates, nuts and washers (Fig. 4) A neoprene bearing pad (15cmx60cmx1cm) is inserted between the beam and the column, while, on the other end of the beam, two teflon sheets are placed between the beam and the column, in order to avoid undesirable and out of control frictional resistances. All the elements are designed according to the current European code provisions.



Figure 2. Experimental setup of a monotonic shear test on a beam-to-column dowel connection



Figure 3. Cast of grout in the beam holes



Figure 4. Dowels restrained at the top of the beam by means of steel plate, nut and washer

The vertical load (450kN) is provided by a vertical jack connected to the beam and an hydraulic actuator provides the horizontal load to the specimen, pulling the beam towards a steel reaction wall (see Fig. 2), in order to obtain a force-displacement curve up to failure.

The force-displacement curve (dashed blue line) of the experimental test is reported in Fig. 5 along with the “elaborated” curve (solid red line), obtained removing the setup unwanted frictional strength (e.g. the frictional strength of the teflon sheets). The force is the horizontal action recorded by the horizontal actuator and the displacement is the relative displacement between the beam and the column. Removing the setup unwanted frictional strength from the recorded results, the maximum shear strength becomes 161.76kN when the horizontal displacement is equal to 0.83 mm. The curve shows a brittle behavior of the connection: after the achievement of the maximum strength, a significant strength decay is recorded without any ductile reserve of the connection.

According to Vintzeleou and Tassios (1986), given the direction of the applied load (Fig. 6) and the geometrical features of the connection system, the failure mechanism should be predicted. Since the column concrete covers (Fig. 7) are smaller than 6-7 times the dowel diameter, a concrete failure is expected due to the tensile stresses in the cover. Moreover, since the frontal cover is larger than the lateral one, the collapse should start at the lateral cover. The described prevision corresponds to the experimental evidence: the first crack forms at the lateral cover in the column (Fig. 8a), corresponding to the peak strength of the force-displacement curve, i.e. to the failure mechanism of the connection. After this point, increasing the horizontal displacement, the cracks also propagate in the frontal concrete cover (Fig. 8b).

The collapse mechanism of the connection is also confirmed by the records of the installed instrumentations (Fig. 9): when the force achieves the maximum value ( $t=560$  sec) a sudden increase of strains is recorded by the strain gauge on the lateral cover of the column (SV2 in Fig. 10) and by the strain gauge on the upper stirrup in the column normal to the crack (Y1 in Fig. 10).

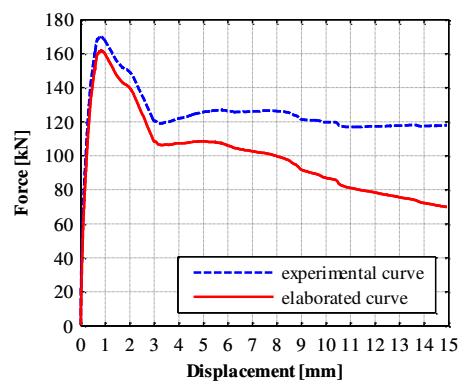

Figure 5. Force-displacement curve of the monotonic test (dashed blue line) and “elaborated” curve (solid red line)

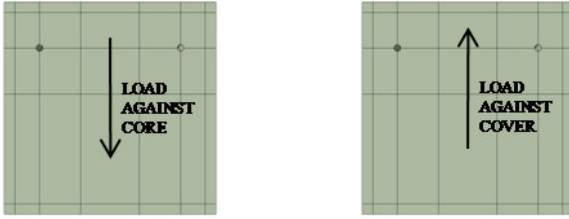

Figure 6. Loading conditions



Figure 7. Frontal cover and lateral cover



(a)



(b)

Figure 8. Phases of connection collapse: (a) first crack during the test and (b) final step of the test

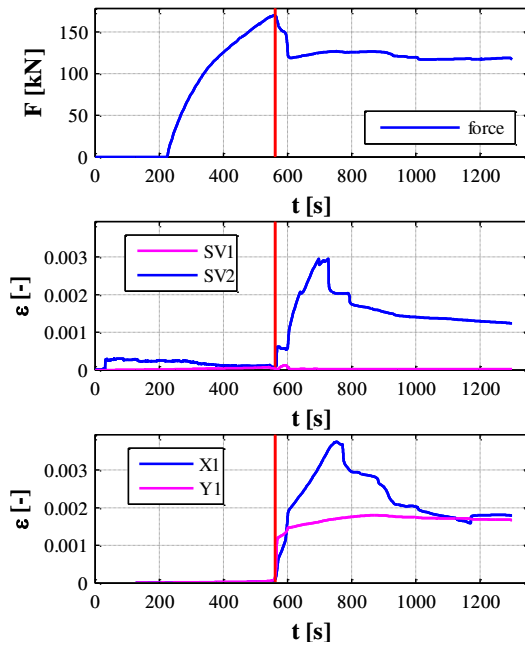

Figure 9. Instrumentations records. From the top: force of the actuator, deformations of the concrete and deformations of the upper stirrup in the column

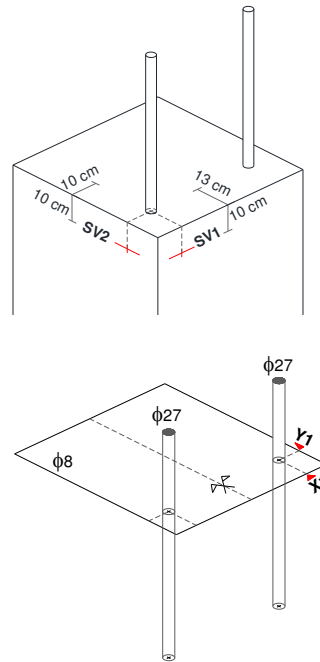

Figure 10. Geometrical layout of the column instrumentations

## NUMERICAL MODELING OF THE TESTED DOWEL CONNECTION

An innovative numerical model of the tested specimen is provided by means of the software ABAQUS (Corp., 2010). The model (Fig. 11) consists of four main parts: the concrete elements (beam and column), the steel elements (reinforcement and dowels), the contact surface (neoprene pad) and the interactions between materials.

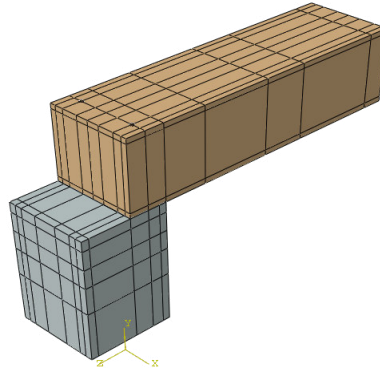

Figure 11. FEM model of the dowel connection by ABAQUS (Corp., 2010)

The concrete elements (beam and column) are modeled as three-dimensional deformable elements, using a specific tool from ABAQUS library which is recommended for analysis with contact problems and large deformations, i.e. C3D8R element.

For the column and the beam a smeared crack concrete model is assumed (Rashid, 1968). This model is included in the ABAQUS/Standard library for reinforced concrete structures. It is suitable to reproduce cracking in tension and crushing in compression under monotonic deformation and low confining pressures (i.e. less than four or five times the maximum value of uniaxial compressive strength). The implementation of the numerical model needs the complete definition of concrete behavior in terms of elastic and inelastic response under compression and tension stresses (Fig. 12) and of the failure surface shape, using ABAQUS tools (Systèmes, 2008) and the experimental mechanical characteristics of the concrete.

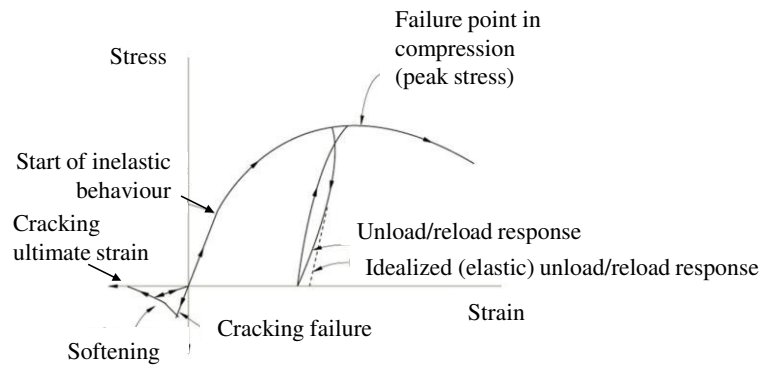

Figure 12. Mechanical behavior of the smeared crack concrete model (Systèmes, 2008)

In order to define the mechanical characteristics of the concrete material, uniaxial compression tests were performed on ten cubic specimens taken from the beam and column cast. Computed the mean cubic compressive strength ( $R_{cm}=49.91\text{N/mm}^2$ ), the other properties of the unconfined concrete are evaluated according to the Eurocode 2 (CEN, 2004) and reported in Table 1 in terms of: characteristic cylinder compressive strength of the concrete at 28 days ( $f_{ck}$ ), mean value of the concrete cylinder compressive strength ( $f_{cm}$ ), mean value of axial tensile strength of the concrete ( $f_{ctm}$ ), compressive strain in the concrete at the peak stress ( $\varepsilon_{c0}$ ) and ultimate compressive strain in the concrete ( $\varepsilon_{cu}$ ).

Table 1. Unconfined concrete mechanical properties

$R_{ck}$	$f_{ck}$	$f_{cm}$	$f_{ctm}$	$E_{cm}$	$\varepsilon_{c0}$	$\varepsilon_{cu}$
[N/mm <sup>2</sup> ]	[N/mm <sup>2</sup> ]	[N/mm <sup>2</sup> ]	[N/mm <sup>2</sup> ]	[N/mm <sup>2</sup> ]	[-]	[-]
49.91	33.62	41.62	3.12	33744	0.002	0.0035

In the model of tested beam and column, the reinforcement is modeled in ABAQUS (Corp., 2010) with a discrete technique: truss elements are created and a perfect correspondence of

deformations with the concrete is assumed. The steel dowels are modeled as three-dimensional elements and interface elements are defined in order to take into account the bond slip phenomena.

For both the reinforcement rebars and the dowels, experimental tensile tests were performed. Concerning the reinforcement, for each diameter used in the setup an equivalent bilinear behavior is implemented in ABAQUS, defining the Young and Poisson modulus, the mean value of experimental stresses and strains for yielding and ultimate point. Concerning the dowels, ABAQUS needs the definition of an “effective” behavior, obtained on the basis of experimental values of stress and strain, which takes into account the reduction of section area and the local elongation of steel specimen during the tests. Fig. 13 shows the experimental curve (blue curve in Fig. 13) and the effective curve (red curve in Fig. 13). Fig. 14 shows the experimental curves for the reinforcement bar with the cross section diameter equal to 8mm: for the other diameters, experimental tests confirm the same mechanical properties.

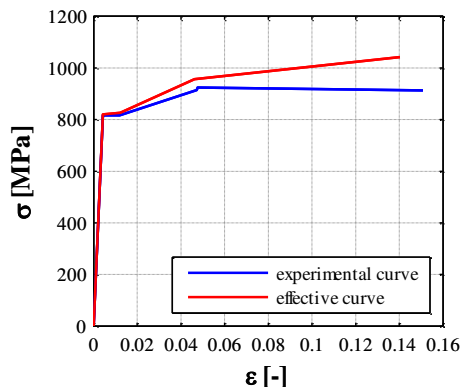

Figure 13. Stress-strain relationships for steel dowel: experimental curve (blue curve) and effective curve (red curve)

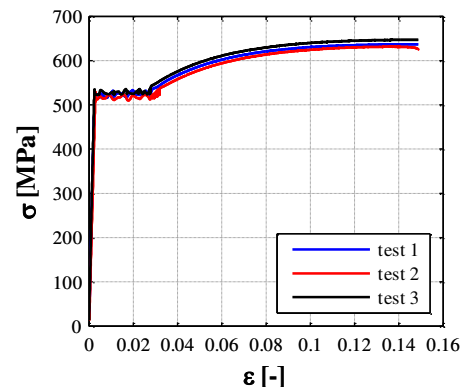

Figure 14. Experimental stress-strain relationships for steel reinforcement ( $\phi=8\text{mm}$ )

Three contact surfaces are defined in the investigated dowel connection: the neoprene-concrete contact surface, the interaction between steel dowels and concrete/grout, and between steel reinforcement and concrete.

In the described finite element model the interaction between concrete and neoprene is introduced as a purely frictional interaction and the neoprene-concrete friction coefficient is calculated according to the formulas reported in Magliulo et al. (2011). The obtained value is equal to 0.122.

The interaction between dowel and concrete/grout is modeled by an interface element of the ABAQUS software, called “cohesive element” and its behavior is defined in terms of local bond stress-slip relationship (Fig. 15). The simplified model, derived from Eligehausen et al. (1986) (Fig. 16), consists of a linear increasing branch and a softening branch, that starts at the damage beginning.

Finally, the interaction between concrete and reinforcement rebar is modeled considering the perfect adhesion.

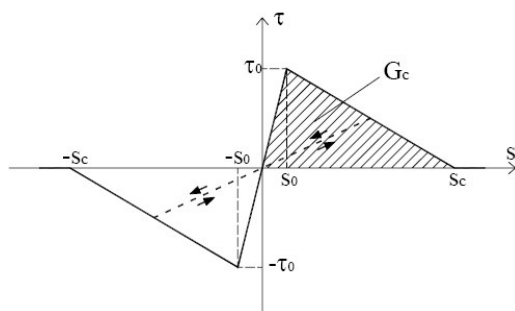

Figure 15. Adopted analytical model for cohesive interface elements

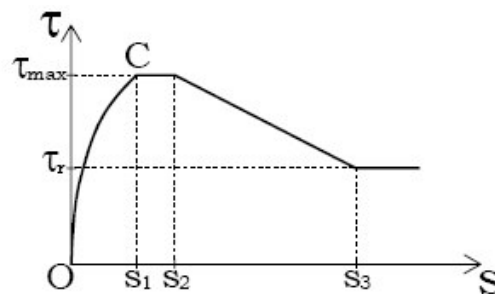

Figure 16. Bond-stresses versus slip for the deformed bar – confined concrete contact behavior according to the Eligehausen model (Eligehausen et al., 1986)

Two loads are imposed to the model: the vertical load and the seismic load. The vertical load corresponds to the constant vertical pressure imposed during the monotonic test, distributed on a

portion of the beam (60cm x 50cm). In order to apply the horizontal forces, the increasing horizontal displacement history provided during the test is applied to the beam. The versus of the displacement is assumed equal to the experimental one, so that the load is applied against the column cover (see Fig. 2 and Fig. 7).

## COMPARISON BETWEEN NUMERICAL ANALYSIS AND EXPERIMENTAL TEST

The results of the numerical analysis are compared with those obtained from the experimental shear test. Fig. 17 shows the force-displacement experimental curve (red line) along with the corresponding curve obtained from the FEM analysis (blue solid line). The experimental curve, shown in Fig. 5 (red line), is reported until the strength degradation is equal to 20%, since smaller values of forces are not significant in defining the connection behavior. The force shown by the numerical curve is the total shear in the column and the displacement is the relative displacement between the beam and the column. The comparison shows a good fitting in terms of maximum strength and initial stiffness: the maximum shear strength obtained by the numerical model is equal to 160.92kN, while the actual value obtained by the shear test is equal to 161.9kN, with a difference equal to 0.52%.

The post-peak behavior is not recorded during the analysis because of convergence problems. This problem does not influence the validation of the model, since the connection has a brittle behavior and the last step of the numerical analysis corresponds to the attainment of the failure mechanism in the concrete. As a consequence of above, the model can be considered suitable, since it is able to catch the two main parameters of the actual behavior: the initial stiffness and the maximum strength of the dowel connection.

The reliability of the numerical model is also confirmed in terms of failure mode. The side splitting of the concrete, i.e. the failure of the lateral cover, is recorded in the model, as evidenced in the experimental test. Fig. 18 shows the stress distribution in the column at the failure step, evidencing that the concrete tensile strength (red color) is reached in the fibers of the lateral cover. A good matching is also found in terms of concrete strains: at the failure step, corresponding to the maximum strength of the connection, the strains recorded by the installed instrumentation are very close to the values estimated by the proposed numerical model (Table 2 and Table 3).

The numerical model is also able to catch the experimental depth of plastic hinges in the dowels for both beam and column: Fig. 20 shows dowel deformation, assumed positive in tension and negative in compression. The higher deformations are recorded at a depth of 3 cm in the column and in the beam; this value of depth corresponds to the experimental evidence, i.e. to the depth at which the dowel appears deformed during the inspection of the specimen after the monotonic test (Fig. 21).

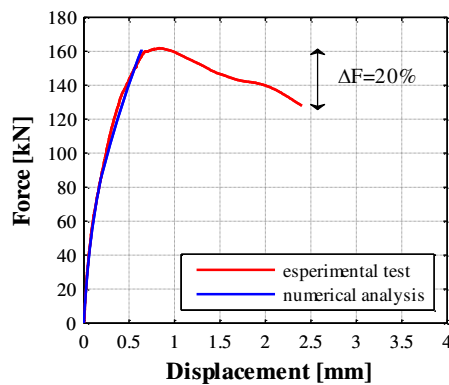

Figure 17. Comparison numerical analysis (blue line) vs experimental test (red line) in terms of force-displacement curve

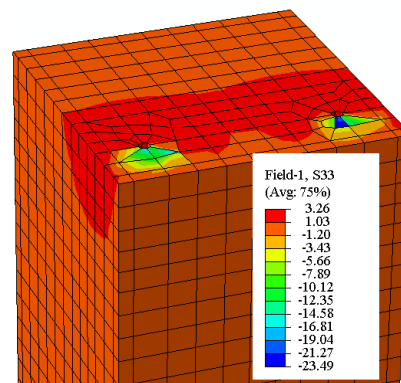

Figure 18. Column stress distribution at the failure step resulting from the numerical model

Table 2. Numerical versus experimental strains of the column frontal and lateral cover (Fig. 7)

SV1		SV2	
$\epsilon_{c,num}$	$\epsilon_{c,exp}$	$\epsilon_{c,num}$	$\epsilon_{c,exp}$
0.0033%	0.0038%	0.0099%	0.0082%

Table 3. Numerical versus experimental strains of the column top surface (Fig. 19)

	S1	S2	S3	S4
$\epsilon_{c,num}$	-0.016%	0.003%	0.012%	0.073%
$\epsilon_{c,exp}$	-0.011%	0.0008%	0.010%	0.097%

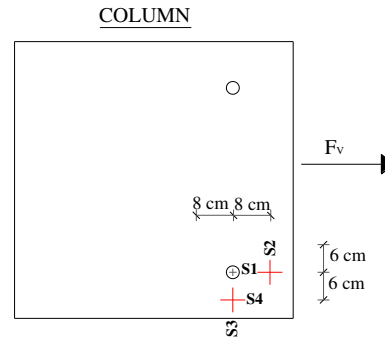

Figure 19. Layout of the strain gauges on the column top surface

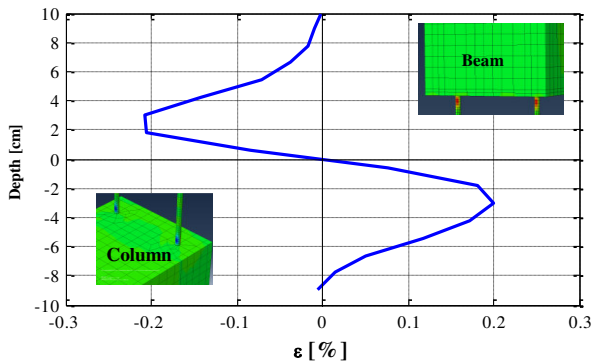

Figure 20. Deformation of the dowel at the failure step versus the beam and column depth



Figure 21. Measurement of the plastic hinge depth in the steel dowel after the monotonic test

## PARAMETRIC STUDY

An extensive parametric study is carried out in order to investigate the main parameters which influence the shear strength of the dowel connection. The case studies are defined considering three variables: the dowel diameter, the size of the frontal concrete cover and the size of the lateral concrete cover (Fig. 7). All the connections are implemented by the ABAQUS software, according to the proposed numerical model and horizontal loads are applied both against the column concrete core and against the column concrete cover in order to obtain force-displacement curve up to the failure. Moreover, it is possible to export the results in terms of stress level in the concrete cover (the lateral or the frontal one) and in the dowels so that the failure mechanism is identified.

The first set of case studies, which correspond to six numerical models in the ABAQUS software, investigates the influence on the connection shear strength of the dowel diameter, ranging from 14mm to 24mm. In these case studies constant values of lateral ( $c_L=100\text{mm}$ ) and frontal cover ( $c_F=130\text{mm}$ ) are assumed.

If the force is applied against the concrete core, the numerical models achieve the failure for the yielding of the steel dowel and the crushing of surrounding concrete (only for small values of dowel diameter, i.e. M14) or for the splitting of lateral concrete cover. The frontal cover always exhibits a low stress level. The force-displacement numerical curves of the six analyzed cases are reported in Fig. 22. The first evidence is the increasing of strength and stiffness with the dowel diameter.

If the force is applied against the concrete cover, in all the considered cases the connection failure is caused by the lateral cover splitting and the frontal cover always exhibits low tensile stresses. For this loading condition, the strength on average decreases of the 15% with respect to the case of load applied against the concrete core (Fig. 23).



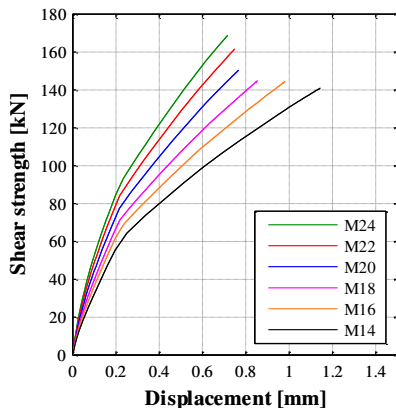

Figure 22. Shear force against the concrete core: force-displacement curves varying the dowels diameter

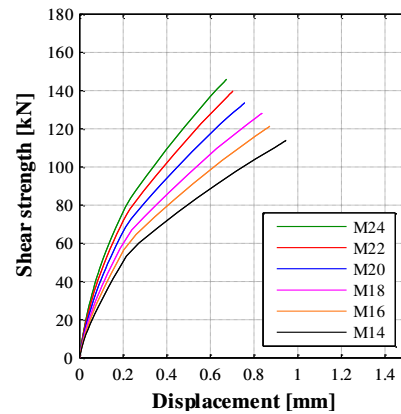

Figure 23. Shear force against the concrete cover: force-displacement curves varying the dowels diameter

The set of numerical analyses that investigates the frontal cover influence are reported in the following. The reference connection has a constant dowel diameter (M27) and a constant value of lateral cover ( $c_L=100\text{mm}$ ). It follows that the ratio between the lateral cover and the dowel diameter is constant and much lower than 6 so that concrete splitting is expected (Vintzeleou and Tassios, 1986).

If the horizontal force acts against the concrete core, the connection failure always occurs for side splitting of the column concrete. For this loading condition, the frontal cover does not significantly influence the connection strength that varies of the 12% (Fig. 24).

If the horizontal force acts against the concrete cover, the connection failure always occurs when the concrete reaches the tensile strength in the lateral cover, unless in the case the frontal cover  $c_F$  is equal to 50mm. In this case the bottom and the side splitting contemporaneously occur and the connection strength is very low (Fig. 25). As expected, the tensile stresses in the frontal cover decrease at the increasing of the frontal cover and, for values of  $c_F$  larger than 100 mm, the connection strength reaches an almost constant value, which is related to the side splitting.

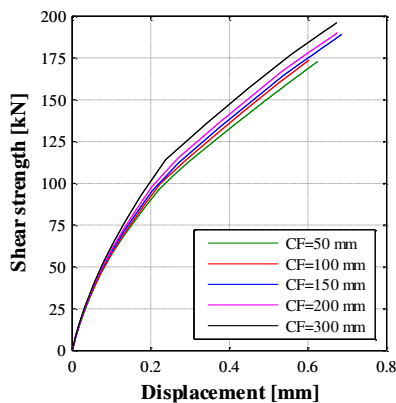

Figure 24. Shear force against the concrete core: force-displacement curves varying the frontal cover

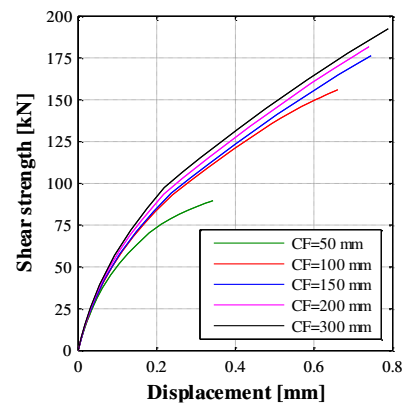

Figure 25. Shear force against the concrete cover: force-displacement curves varying the frontal cover

A third set of numerical analyses is performed varying the lateral cover, assigning a constant dowel diameter (M27) and a constant frontal cover ( $c_F=130\text{ mm}$ ).

When the horizontal force acts against the concrete core, for the lateral cover  $c_L=50\text{ mm}$  the connection failure is due to the side splitting. For greater lateral covers, the connection failure is still due to the side splitting, but the stress in the dowel increases. The increase of the lateral cover leads to a better confining effect, so that the connection shows a higher shear strength (Fig. 26).

When the horizontal force acts against the concrete cover, the connection failure is due to the concrete side splitting for all the analyzed cases ( $c_L=50\text{ mm}$ ,  $100\text{ mm}$ ,  $200\text{ mm}$ ) whereas the frontal cover always exhibits low compressive stresses. As the lateral cover increases, the stress of the dowel at the failure also increases: for this loading condition, the shear strength as well as the failure displacement are highly influenced by the lateral cover depth (Fig. 27).

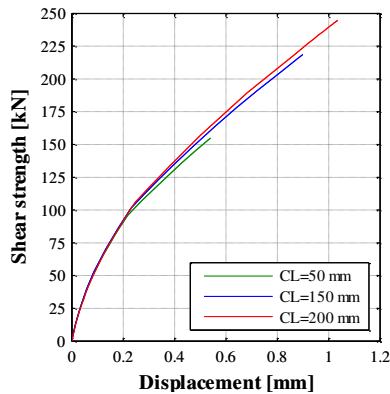

Figure 26. Shear force against the concrete core: force-displacement curves varying the lateral cover

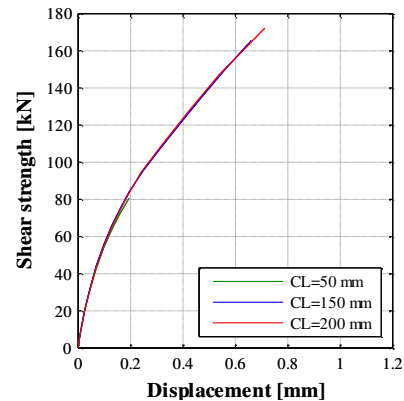

Figure 27. Shear force against the concrete cover: force-displacement curves varying the lateral cover

## CONCLUSIONS

The presented paper investigates the response of dowel beam-to-column connections, typical of European precast industrial buildings, by means of a FEM model of this connection, validated by experimental test results. The reference test is a shear monotonic test on a dowel beam-to-column connection. The results of the test confirm the expected behavior of this kind of connection under horizontal load, showing a brittle splitting failure in the concrete lateral cover of the column.

The numerical model of the connection is presented in details and compared with the results of the monotonic test, showing a good agreement in terms of maximum strength, failure mechanism and local stresses.

An extensive parametric study is performed in order to discuss the influence of some geometrical characteristics of the investigated connection on its shear strength: the case studies are obtained varying the dowel diameter as well as the frontal and later concrete cover in the column. The results of all the case studies show the sensitivity of the model to the parameters variation in terms of strength and of failure mechanism. It is confirmed that, if the lateral and the frontal covers are lower than 6-7 times the dowel diameter, the failure involves the concrete splitting, both in the case of force acting against the concrete core and in the case of force acting against the concrete cover. Furthermore, if the lateral cover is equal or lower than the frontal cover, the side splitting occurs; otherwise, only in the case of force acting against the concrete cover, the failure also involves the bottom splitting.

## ACKNOWLEDGEMENTS

This research was partially funded by the Italian Department of Civil Protection within the national project DPC - ReLUIS 2014 – WP2 and by ASSOBTEN (Italian Association of Precast Industries).

## REFERENCES

- Biondini F, Dal Lago B, Toniolo G (2013) "Role of wall panel connections on the seismic performance of precast structures," *Bulletin of Earthquake Engineering* 11(4): 1061-1081.
- CEN (2004) "Eurocode 2: Design of concrete structures - Part 1-1: General rules and rules for buildings," Brussels, Belgium. .
- Corp. DSS (2010) "Abaqus/CAE 6.10-1," Providence.
- D'Ambrisi A, Mezzi M (2005) "A probabilistic approach for estimating the seismic response of elasto-plastic SDOF systems," *Earthquake Engineering & Structural Dynamics* 34(14): 1737-1753.

- D'Ambrisi A, Mezzi M (2009) "Probabilistic estimate of seismic response design values of RC frames," *Earthquake Engineering & Structural Dynamics* 38(15): 1709-1727.
- Eligehausen R, Popov EP, Bertero VV (1986) "Local bond stress-slip relationships of deformed bars under generalized excitation," *University of California*: 169.
- Ercolino M (2010) "Inelastic seismic response and risk analysis of one-storey precast buildings," *Graduation Thesis*.
- Magliulo G, Capozzi V, Fabbrocino G, Manfredi G (2011) "Neoprene-concrete friction relationships for seismic assessment of existing precast buildings," *Engineering Structures* 33(2): 532-538.
- Magliulo G, Capozzi V, Manfredi G (2014a) "Experimental shear test on beam-column pin connections of precast structures," *Earthquake Engineering & Structural Dynamics (under review)*.
- Magliulo G, Ercolino M, Cimmino M, Capozzi V, Manfredi G (2014b) "Cyclic shear test on dowel beam-column connections," *Earthquakes and Structures (under review)*.
- Magliulo G, Ercolino M, Manfredi G (2014c) "Influence of cladding panels on the first period of one-story precast buildings," *Bulletin of Earthquake Engineering (under review)*.
- Magliulo G, Ercolino M, Petrone C, Coppola O, Manfredi G (2013) "Emilia Earthquake: the Seismic Performance of Precast RC Buildings" *Earthquake Spectra*.
- Magliulo G, Fabbrocino G, Manfredi G (2008) "Seismic assessment of existing precast industrial buildings using static and dynamic nonlinear analyses," *Engineering Structures* 30(9): 2580-2588.
- McKenna F, Fenves GL (2013) "OpenSees Manual <http://opensees.berkeley.edu>." Pacific Earthquake Engineering Research Center.
- Rashid YR (1968) "Analysis of reinforced concrete pressure vessels," *Nuclear Engineering and Design* 7: 334-344.
- Systèmes D (2008) "Abaqus Scripting User's Manual," Providence, RI, USA.
- Vintzeleou EN, Tassios TP (1986) "Mathematical-Models for Dowel Action under Monotonic and Cyclic Conditions," *Magazine of Concrete Research* 38(134): 13-22.
- Zoubek B, Isakovic T, Fahjan Y, Fischinger M (2013) "Cyclic failure analysis of the beam-to-column dowel connections in precast industrial buildings," *Engineering Structures* 52(0): 179-191.