

The use of agrochemicals in developing countries has increased greatly in recent years and those used in greatest quantities, insecticides and herbicides, tend to have the most severe side-effects on the environment. Following UNCED 1992 and its adoption of Agenda 21, there is now a requirement for all countries to carry out pesticide impact monitoring and assessment to counter environmental degradation. The recent UNCED Summit 2002 has set targets to step up the implementation of this commitment.

Ecological Monitoring Methods for the Assessment of Pesticide Impact in the Tropics aims to assist developing countries build their capability in ecotoxicological monitoring. It harnesses the knowledge of pesticide impact and monitoring specialists to provide guidance on the measurement, analysis and interpretation of change in animal populations and key soil functions.

This handbook will be of primary interest to those in government, development agencies, donors and non-government organizations who carry responsibility for the environment, agriculture and public health. Academics and students of ecotoxicology in developing countries should find both the specialist chapters and the field methodology useful.

ECOLOGICAL MONITORING METHODS
FOR THE ASSESSMENT OF PESTICIDE IMPACT IN THE TROPICS HANDBOOK



ECOLOGICAL MONITORING METHODS

FOR THE ASSESSMENT OF PESTICIDE IMPACT IN THE TROPICS

Edited by

Ian F. Grant and Colin C. D. Tingle



ECOLOGICAL MONITORING METHODS

FOR THE ASSESSMENT OF PESTICIDE
IMPACT IN THE TROPICS

Edited by

Ian F. Grant and Colin C. D. Tingle

DFID Department for
International
Development



© The University of Greenwich 2002

The Natural Resources Institute (NRI) of the University of Greenwich is an internationally recognized centre of expertise in research and consultancy in the environment and natural resources sector. The Institute carries out research and development and training to promote efficient management and use of renewable natural resources in support of sustainable livelihoods.

Short extracts of this publication may be reproduced in any non-advertising, non-profit-making context provided that the source is acknowledged as follows:

GRANT, I.F. and TINGLE, C.C.D. (eds) (2002) *Ecological Monitoring Methods for the Assessment of Pesticide Impact in the Tropics*. Chatham, UK: Natural Resources Institute.

Permission for commercial reproduction should be sought from the Managing Editor, University of Greenwich at Medway, Central Avenue, Chatham Maritime, Kent ME4 4TB, United Kingdom.

Production of this publication was funded by the United Kingdom's Department for International Development (DFID), the Natural Resources Institute (NRI) and the Technical Centre for Agricultural and Rural Cooperation (CTA). They can accept no responsibility for any information provided or views expressed in this publication.

The Technical Centre for Agricultural and Rural Cooperation (CTA) was established in 1983 under the Lomé Convention between the ACP (African, Caribbean and Pacific) Group of States and the European Union Member States. Since 2000 it has operated within the framework of the ACP-EC Cotonou Agreement.

CTA's tasks are to develop and provide services that improve access to information for agricultural and rural development, and to strengthen the capacity of ACP countries to produce, acquire, exchange and utilize information in this area. CTA's programmes are organized around four principal themes: developing information management and partnership strategies needed for policy formulation and implementation; promoting contact and exchange of experience; providing ACP partners with information on demand; and strengthening their information and communication capacities.

CTA, Postbus 380, 6700 AJ Wageningen, The Netherlands.

Further information and copies of this publication can be obtained by e-mail from www.nri.org
Please quote **PES3**.



Copies are also available from: Practical Action Publishing, Schumaker Centre for Technology & Development, Boughton-on-Dunsmore, Rugby, Warcs CV23 9QZ, UK. Tel: +44 (0) 1926 634501. Fax: +44 (0) 1926 634502
eMail: publishinginfo@practicalaction.org.uk.

Natural Resources Institute
ISBN: 0 85954 543-1

University of Greenwich, a registered charity and company limited by guarantee, registered in England (Reg. No. 986729).
Registered Office: Old Royal Naval College, Park Row, Greenwich, London SE10 9LS.

CONTENTS

Preface	xi
Acknowledgements	xii
Introduction	1
How to use this handbook	3
I Planning and programme design for ecotoxicological monitoring	5
<i>Colin C.D. Tingle and Ian F. Grant</i>	
Screening pest control programmes	5
Planning phase	7
Risk assessment	8
Fieldwork or implementation phase	14
Study design	14
Site selection	15
Analysis and assessment phase	17
Presentation of results	21
Interpretation of results and drawing of conclusions	27
References	27
Worked example – Effects of locust control operations using barrier-sprayed IGRs on non-target terrestrial invertebrates in Madagascar	30
<i>Observation</i>	30
<i>Problem</i>	30
<i>Desk assessment – risk</i>	30
<i>Hypothesis</i>	31
<i>Fieldwork – programme design</i>	31
<i>Fieldwork – study sites</i>	31
<i>Fieldwork – treatment</i>	33
<i>Fieldwork – sampling method</i>	35
<i>Sample processing</i>	36
<i>Data storage and processing</i>	36
<i>Data analysis</i>	38
Output – results from the ecotoxicological monitoring studies on invertebrates and their interpretation	43
<i>Overall conclusions from the study</i>	52
2 Basic statistical issues and methods	53
<i>John Sherington and Ian F. Grant</i>	
Introduction	53
Study design	53
Basic statistical concepts	54
More on study design	57
Blocking	59
Sampling	60
Data management	62
Estimation, precision and statistical tests	62
Sample size	64

	Trends and relationships	66
	Association between categories	67
	Analysis of variance	68
	References	69
	Summary of basic methods	70
	Worked example – One-way analysis of variance	71
	Worksheets for useful statistics	75
	<i>Random sampling</i>	75
	<i>Random treatment allocation</i>	77
	<i>Calculation of standard deviation (SD)</i>	78
	<i>Mann-Whitney U-test for comparing two samples</i>	79
	<i>Student's t-test for comparing two samples</i>	80
	<i>Correlation and linear regression</i>	81
	<i>Spearman's rank correlation</i>	83
	<i>Chi-squared test for contingency tables</i>	84
	Appendix Statistical tables	85
3	Precautions in the use and handling of pesticides and chemical reagents	89
	<i>John R. Cox</i>	
	Introduction	89
	Solvents	89
	Acids	90
	General reagents	90
	Protective clothing	91
	Further reading	94
4	Pesticide application: mastering and monitoring	95
	<i>Hans Dobson and William King</i>	
	Introduction	95
	Pesticide formulations	95
	Application equipment	97
	Sprayer calibration	101
	Spray application	106
	Spray droplet deposition	107
	Monitoring spray deposition	109
	Methods for sampling, counting and measuring the size of the droplets	111
	<i>Paper and card-based surfaces: oil and water-sensitive papers</i>	111
	<i>Paper and card-based surfaces: white card</i>	112
	<i>Magnesium oxide-coated slides</i>	112
	<i>Fibre samplers</i>	113
	References	114
5	Environmental parameters	115
	<i>Ian F. Grant</i>	
	Introduction	115
	Study design	115
	Meteorological measurements	117
	<i>Wind</i>	117
	<i>Rainfall</i>	117
	<i>Temperature</i>	117

	<i>Relative humidity</i>	118
	Other physical and physico-chemical measurements	118
	<i>Water temperature</i>	118
	<i>Dissolved oxygen</i>	119
	<i>pH</i>	120
	<i>Light and shade</i>	120
	<i>Turbidity/underwater light</i>	120
	<i>Turbidity/suspended solids</i>	121
	<i>Conductivity</i>	121
	<i>Current velocity</i>	121
	<i>Classification of aquatic substrates</i>	122
	<i>Estimating vegetative cover</i>	122
	<i>Soil texture</i>	123
	<i>Soil moisture</i>	123
	<i>Soil water-holding capacity</i>	124
	Recording devices	124
	References	124
6	Sampling for pesticide residue analysis	125
	<i>John R. Cox</i>	
	Introduction	125
	Properties of pesticides	126
	Study design	130
	The prevention of sample contamination	135
	Sampling techniques	138
	<i>Soil sampling</i>	138
	<i>Water sampling</i>	138
	<i>Sediment sampling</i>	140
	<i>Vegetation sampling</i>	140
	<i>Tissue sampling</i>	141
	<i>Vertebrate/invertebrate sampling</i>	142
	Data collection and recording	143
	Data presentation and interpretation	144
	Sample size and the lower limit of determination	144
	Residue calculation	145
	Other considerations	146
	References	147
7	Soil processes	149
	<i>Ian F. Grant</i>	
	Introduction	149
	Study design	150
	Sampling techniques	152
	<i>Soil nitrification</i>	152
	<i>Biological nitrogen-fixation</i>	153
	<i>Soil respiration</i>	153
	<i>Soil texture, moisture and water-holding capacity</i>	154
	<i>Earthworm populations and activity</i>	154
	<i>Litter bags</i>	155

	<i>Soil algae</i>	156
	References	156
8	Terrestrial invertebrates	159
	<i>Colin C.D. Tingle</i>	
	Introduction	159
	Study design	160
	Sampling techniques	165
	Epigeal invertebrates	165
	<i>Pitfall trap</i>	165
	<i>Food baits</i>	166
	<i>Other methods</i>	167
	Vegetation-dwellers	167
	<i>Sweep netting</i>	167
	<i>Other methods</i>	168
	<i>Flying insects</i>	168
	<i>Malaise trap</i>	168
	<i>Water trap</i>	168
	<i>Transect counts</i>	169
	<i>Honeybee activity at hives</i>	169
	Other methods	170
	Arboreal invertebrates	170
	<i>Funnel or sheet trap</i>	170
	<i>Trunk trap</i>	170
	<i>Direct collection</i>	171
	Soil invertebrates	171
	<i>Soil cores</i>	171
	<i>Litter bags</i>	172
	<i>Termite colony health assessment</i>	172
	<i>Other methods</i>	173
	Collecting terrestrial invertebrates for residue analysis	173
	Data processing	173
	Mounting techniques for storage and identification of invertebrates	176
	Labelling of collected invertebrate specimens	178
	Useful contacts	179
	References	179
9	Aquatic invertebrates	183
	<i>Ian F. Grant</i>	
	Introduction	183
	Study design	183
	Sampling strategy	186
	Sampling techniques	188
	Qualitative methods	188
	<i>Heel or kick sampling</i>	188
	<i>Sampling surface-dwellers</i>	188
	<i>Artificial substrates</i>	188
	<i>Sweep net sampling</i>	189
	<i>Aquatic weeds and roots</i>	189

	Quantitative methods	189
	<i>Cylinder or box sampling</i>	189
	<i>Invertebrate drift sampling</i>	190
	<i>Plankton sampling</i>	191
	<i>Emergence traps</i>	191
	<i>Grab sampling</i>	192
	<i>Physico-chemical methods</i>	192
	Sample processing	193
	References	193
10	Fish	195
	<i>Bernadette McCarton</i>	
	Introduction	195
	Study design	195
	Sampling techniques	198
	<i>Sampling local catches</i>	198
	<i>Capture programmes</i>	199
	<i>Seine netting</i>	201
	<i>Gill netting</i>	203
	<i>Trapping</i>	203
	<i>Hooks</i>	205
	<i>Spears</i>	205
	<i>Dewatering and associated methods (e.g. fishing by hand)</i>	206
	<i>Poisoning</i>	206
	<i>Electric fishing</i>	207
	Measurements	207
	Sample processing for residue analysis	208
	Sample processing for population parameter estimation	209
	Laboratory techniques and data analyses	209
	References	211
11	Amphibians and reptiles	213
	<i>Michael R.K. Lambert</i>	
	Introduction	213
	Objectives	214
	Study design	215
	Inventory, monitoring and sampling techniques	218
	<i>Complete species inventorying</i>	218
	<i>Visual encounter surveying</i>	218
	<i>Quadrat block sampling</i>	219
	<i>Transect block sampling</i>	220
	<i>Patch sampling</i>	221
	<i>Quantitative sampling of amphibian larvae (and aquatic reptiles)</i>	221
	<i>Breeding site surveying for amphibians</i>	222
	<i>Additional methods for amphibians</i>	222
	<i>Additional methods for reptiles</i>	223
	Taxonomy	223
	Diversity assessment	224
	Labelling	226
	Bioindicators	226
	References	227

12	Birds	229
	<i>Robert J. Douthwaite and Charles F. Dewhurst</i>	
	Introduction	229
	Effects of pesticide treatments on birds	229
	Study design	230
	Sampling methods	233
	Population size	233
	<i>Timed point counts (sometimes called point counts)</i>	233
	<i>Fixed strip transect counts</i>	234
	<i>Territory mapping</i>	235
	Other methods for estimating abundance	237
	<i>Nest density</i>	237
	<i>Feeding behaviour and diet</i>	239
	References	240
	Appendix Examples of species and activity codes	242
13	Small mammals and bats	243
	<i>Andrew N. McWilliam</i>	
	Introduction	243
	Pesticide effects	244
	Study design	244
	Monitoring methods	245
	<i>Grids</i>	245
	<i>Trap lines</i>	247
	Practical issues	247
	Animal handling	248
	Biochemical and residue analysis	250
	Survey methods for bats	250
	<i>Bat detectors</i>	251
	<i>Transects</i>	252
	<i>Sampling and experimental design</i>	252
	Residue analysis for bats	252
	References	253
	Glossary	255
	Abbreviations	266

METHOD SHEETS

Pesticide application: mastering and monitoring

Measuring droplets and deriving VMD and NMD

Measuring swath width of ULV sprayers

Collection technique for measuring sprayer flow rate

The loss technique for flow rate measurement

Calibration of ULV sprayers

Calibration of high-volume sprayers

Making magnesium oxide-coated slides

Use of fibre drift samplers

Use of rotary magnesium oxide sampler

Environmental parameters

Meteorological methods; temperature; humidity; rainfall; wind speed

Physico-chemical measurements in water

Turbidity

Measurement of current

Classification of aquatic substrates

Vegetative cover and shade

Soil texture

Soil moisture, water-holding capacity, soil pH

Sampling for pesticide residue analysis

Sampling soil for residues

Sampling water for residues

Sampling sediment for residues

Sampling terrestrial vegetation for residues

Sampling aquatic vegetation for residues

Sampling fish for residues

Sampling birds and small mammals for residues

Sampling amphibians and reptiles for residues

Sampling invertebrates for residues

Soil processes

Soil nitrification

Soil respiration (long-term *in situ*)

Soil respiration (semi-continuous)

Earthworm activity estimation

Earthworm population estimation

Soil algal cover

Litter bags (microbial decomposition)

Terrestrial invertebrates

Sweep netting

Pitfall trapping

Food baiting for ants

Baiting for termites

Malaise trapping

Water traps

Butterfly transects

Trunk trapping

Funnel or sheet traps

Soil cores

Litter bags for soil fauna

Flotation for extraction of invertebrates from soil cores

Tulgren funnels for extraction of invertebrates from soil cores

Termite colony health assesment

Aquatic invertebrates

Heel sampling

Artificial substrates

Sweep net (aquatic)

Cylinder or box sampling
Drift sampling
Plankton sampling
Emergence traps
Grab sampling

Fish

Sampling catch from local fisherfolk
Seining
Gill netting
Trapping (e.g. box traps)
Spearing
Hooking
Physico-chemical measurements
Lengths and weights
Gonad condition
Fecundity analysis
Analysis of stomach contents
Collection of scales, otoliths and bones for ageing
Preservation of fish for reference and identification

Amphibians and reptiles

Visual encounter surveying (amphibians and reptiles)
Quadrat and transect block microhabitat sampling (amphibians and certain reptiles)
Patch sampling (amphibians and fossorial reptiles)
Complete species inventorying (amphibians and reptiles)
Breeding site surveying (amphibians)
Quantitative sampling of amphibian larvae (and aquatic reptiles) – pond seining
Quantitative sampling of amphibian larvae (and aquatic reptiles) – dipnetting
Quantitative sampling of amphibian larvae (and aquatic reptiles) – trapping

Birds

General reminder
Bird shapes
Timed point counts
Transect counts
Territory mapping
Nest density
Feeding behaviour and diet assessment

Small mammals and bats

Line trapping
Grid trapping
Bat survey

PREFACE

The tenth anniversary of the United Nations Conference on Environment and Development (UNCED) has just passed. Agenda 21, which sets out comprehensive strategies and programmes to counter environmental degradation and promote sustainable development, was adopted as a legal document by the Conference on 13 June 1992. Strategies for agriculture and health advocate the use of target-specific and readily degradable pesticides or the use of biological control agents as an alternative to the use of toxic pesticides. The vast majority of countries around the world are signatories to this agreement and thus committed to developing policies that minimize adverse pesticide impacts. Legislation governing pesticide use and mandatory environmental assessment is well established in most countries, although implementation is often an uphill struggle in the face of food shortages and disease outbreaks.

Agenda 21 also calls for appropriate environmental impact assessment (EIA) of projects likely to have a significant impact on the environment and it stresses the need for national capacity in toxicity testing, exposure analysis and risk assessment, all of which require considerable investment in resources and training. We hope that this handbook will help developing countries to develop their capacity in ecotoxicological monitoring and enable them to meet their commitments under Agenda 21.

It will also be of value to students undertaking higher education courses in natural resource management, applied ecology, ecotoxicology and other related disciplines.

ACKNOWLEDGEMENTS

This book is the product of nearly two decades of research, development and application. The editors would like to thank those directly involved with its production including the authors, the fund managers Simon Eden-Green of DFID's Crop Protection Programme and Jeremy Stickings of DFID's Advisory and Support Services Contract, and the publications team Valerie Howe, Andrew Beatson and Pete Birkett (Medway Publications Unit, University of Greenwich at Medway) for their support and hard work in the design and production. The excellent illustrations were provided by Sasha Lauer and Pete Birkett. Photographs used on the cover and on the Method Sheets were supplied by Colin Tingle, Ian Grant, Bryn Bettany and Bernadette McCarton. "The support from FAO, CTA and PAN-UK in funding and facilitating the reprint of this Handbook is gratefully acknowledged." We are grateful to the PB Group, Sittingbourne, Kent for producing and reprinting the manual.

One of our contributing authors, Mike Lambert died on 18 July 2004 aged 62 after a two year fight against plasmacytoma. Mike was a widely travelled and experienced herpetologist who championed the user of 'herps' as indicators of environmental health. His contribution to this publication will be one of many legacies to environmental field workers in many parts of the world."

Many people were involved indirectly through assistance provided at project level, including staff from government ministries, departments, universities and aid agencies. To them, who number in excess of one hundred, this is a collective thank you.

INTRODUCTION

The use of agrochemicals to increase food production in developing countries has intensified over recent decades. Industrial crops, such as cotton are also dependent on high inputs of fertilizers and pesticides to maintain or increase yields. Applied appropriately and judiciously, pesticides can assist in the control of plant and animal pests and help to alleviate human and livestock disease. Current trends show that the market for insecticides and herbicides in developing countries is growing and that they outstrip sales and use of fungicides, acaricides, nematicides and rodenticides. Apart from being used in the greatest quantities, insecticides and herbicides tend to have the most severe side-effects on the environment.

The amount of pesticide that actually reaches its target is frequently small, and much ends up as a contaminant in the environment. The environmental problems that can emerge from pesticide use and misuse include contamination of food and water, and adverse effects on non-target organisms and ecosystem function. The behaviour of pesticides and their environmental impact in agricultural and other ecosystems has mainly been studied in temperate countries. This implies that risk predictions based on temperate agricultural conditions are not altogether reliable when applied to other climatic zones and/or to biomes that are home to much of the world's biodiversity.

Ecotoxicology is a relatively new discipline that is itself a combination of at least three other disciplines: chemistry, toxicology and ecology. The science of ecotoxicology is not yet sufficiently developed to allow predictions of hazard and risk with the accuracy that we would like, particularly when answers are being sought under variable operational and environmental conditions. Nonetheless, methodological frameworks and databases have evolved that enable well researched risk assessments to be made, and it is environmental monitoring that underpins environmental assessment through the provision and strengthening of case study material.

Risk assessments are a tool to aid decision-making. They are used to present the available information about an intervention in a rational and communicable way that facilitates the decision-making process. A risk assessment is a predictive exercise about a change or an intervention (such as pesticide use) that is based on scientific data, judgements and assumptions. An assessment identifies significant hazards and estimates the likelihood of harm to individuals or the environment that might arise from those hazards. It also enables decisions to be made about ways to reduce or eliminate certain risks (risk management). Decision-makers and the public would wish to be presented with more precise information, but in many situations such information simply does not exist. The aim of a risk assessment is to determine as objectively as possible from the limited factual information available, the least damaging and reasonable option that will bring the benefits sought. It is where the balance of risk against benefit must be ascertained.

The primary purpose of this handbook is to strengthen the capacity of local and regional institutions to undertake meaningful monitoring and assessments of development interventions that involve significant pesticide usage. The transfer of appropriate methods and techniques for ecological monitoring enables institutions to undertake research, to assume more control and judgement over local pesticide use and to provide decision-makers in agricultural, natural resource, public health and environmental sectors with the tools and advice to resolve management questions. This handbook can assist staff in ministries, departments, district offices and NGOs to understand the rudiments and practice of pesticide impact monitoring and assessment. For operational purposes it is intended for use by field officers and assistants, but it will also be useful to managers and as an educational tool for students of ecotoxicology, ecology and natural resource management. This handbook is an aid to capacity building, but it will not enable ecotoxicological studies to be carried out entirely unassisted.

Specialist input will generally be necessary for planning and designing a pesticide monitoring programme, as well as for the interpretation of the data sets collected.

The handbook has been developed by researchers with extensive field experience of pesticide impact monitoring in tropical countries, where constraints of budget, remote working areas, electrical power and portability have driven the development of 'appropriate' methodologies. The result is a collection of robust ecological methods based on inexpensive equipment for the detection and measurement of change in population structure and ecosystem functions that are appropriate for use in tropical and sub-tropical biomes under various degrees of management (wild to cultivated). Methods requiring relatively sophisticated equipment are only mentioned in outline together with a bibliographic reference: method sheets for such study methods are not provided on the assumption that such methods will rarely be used without outside help.

Please note that although pesticides can have adverse impacts on plants, methods for monitoring vegetation are not covered in this handbook. The impact of pesticides on plants is a rather neglected area, but interested readers are directed to the following books which give the topic (especially in relation to herbicides) some coverage: Brown (1978) and Greaves *et al.* (1988). Ecological census methodologies for plants are given by Bullock (1996).

The methods provided in this handbook are by no means exhaustive. A selection of useful, generic methods are provided that fit the criteria outlined above. These will need to be adapted to local conditions and to specific constraints, including budgetary and logistical considerations. Of all the operational difficulties foreseen and discussed, the lack of taxonomic expertise is the hardest to overcome and so we have suggested ways of tackling initial difficulties, and then where and how to seek help later with faunal identifications.

REFERENCES

BROWN, A.W.A. (1978) *Ecology of Pesticides*. New York: Wiley-Interscience.

BULLOCK, J. (1996) Plants. pp. 111–137 In: *Ecological Census Techniques. A Handbook*. Sutherland, W. J. (ed.). Cambridge: Cambridge University Press.

GREAVES, M.P., SMITH, B.D. and GRIEG-SMITH, P.W. (eds) (1988) *Field Methods for the Study of Environmental Effects of Pesticides. BCPC Monograph*, No. 40. Thornton Heath: British Crop Protection Council.

HOW TO USE THIS HANDBOOK

The primary purpose of this handbook is to assist staff in national and local institutions to understand the rudiments and practice of pesticide impact monitoring and assessment. However, pesticide impact assessment is complex and this handbook cannot hope to provide the comprehensive instruction in the disciplines that the assessments must draw upon. The handbook should be used as an aid to undertaking focused monitoring and assessments of development interventions that involve significant pesticide usage. The book will not provide adequate information to allow all institutions/groups to undertake all aspects of a pesticide impact monitoring programme without technical assistance. Aspects of programme planning, design, data analysis and interpretation will require guidance from qualified technical personnel to ensure secure recommendations.

The handbook is laid out in such a way as to guide the reader through the steps necessary to plan and design an environmental monitoring programme with the aims of:

- assessing pesticide impacts
- selecting ecological processes or wildlife groups to monitor
- selecting appropriate sampling or monitoring methods
- processing and analysing the data collected
- interpreting the information.

The first chapter outlines the preparatory stages necessary for planning and designing an environmental monitoring programme. The desk assessment outlines the type of background data that it is necessary to collect in order to decide which faunal groups are most at risk and should, therefore, be monitored. The various tables which follow will also assist with this decision. Once key fauna and/or processes have been identified, it will then be necessary to consult the appropriate chapter(s) to decide which sampling or monitoring methods to use in order to collect the most appropriate data for the key groups or processes. It may be advantageous to monitor several groups or processes, in which case it will be necessary to consult several chapters.

Once the non-target organisms and appropriate methods for their monitoring have been identified, it will be necessary to go on to chapter 2 on 'Basic Statistical Issues and Methods'. This chapter outlines key elements of experimental design that are needed to ensure appropriate collection and management of data that will provide a statistically valid assessment of a hypothesis. Consultation with a statistician/biometrician at a local college or university is highly recommended at this stage as it will minimize the danger of collecting inappropriate data.

Reading through the Worked Example will also help by taking you through the process from data collection, processing and analysis through to interpretation of the results.

Each chapter outlines the sampling or monitoring methodologies that are most appropriate for the particular faunal group by habitat and pesticide type, application mode and for assessing impacts by pesticide group. Important considerations in the choice of techniques include the availability of equipment: will this be available locally, or can it be made locally? Are the staff numbers needed for the particular method available? Do those staff have the necessary skills or will outside experts need to be called in? Are laboratories necessary to carry out processing of any samples collected and, if so, are these available? Questions such as these should be carefully considered at this stage.

The method sheets for individual field monitoring or sampling techniques need to be read through carefully during the planning phase of the monitoring programme. They outline factors that are necessary to consider

both in preparation for the technique and its implementation. The method sheets are printed on durable, waterproof paper as it is intended that they are taken to the field as an *aide-memoire*. Check the *Don't Forget* section before departure on field visits.

Other than skills in environmental assessment and ecotoxicology, the most likely area where trained staff will be required at some stage is that of taxonomy. In many cases, experts on particular taxa will be required to provide or check the identification of the biota. Such assistance should be relatively easy to find for both mammals and birds from members of local (or national) wildlife groups, NGOs and departments responsible for parks and wildlife. Local or national universities/museums can provide or suggest experts in the taxonomy of insects, spiders, fish and aquatic invertebrates, amphibians and reptiles and general invertebrate zoology.

Note: If going to the field for extended field visits to carry out monitoring using more than one sample method, it is recommended that the whole handbook is taken along, not just the method sheets. This will help in making decisions on sample site selection, sample processing, data collection, sample preservation and storage, etc.

Suggestions for effective presentation of data and results is provided in the section of chapter I on the 'Analysis and Assessment Phase'. These should be considered carefully as they may influence your selection of methods. This is followed, at the end of chapter I, by a Worked Example which should be read again before data analysis and presentation begins.

NB: Since original publication, a number of the authors involved in writing the handbook and methods sheets have moved from NRI. Their updated contact details are included as footnotes to chapters, wherever this is possible. Many of the chapter authors are now part of the NR Group and can be contacted via the group website (www.thengroup.net).

PLANNING AND PROGRAMME DESIGN FOR ECOTOXICOLOGICAL MONITORING

Colin C.D. Tingle¹ and Ian F. Grant²

Natural Resources Institute, University of Greenwich at Medway, Central Avenue,
Chatham Maritime, Kent ME4 4TB, UK

Ecotoxicological monitoring and assessment is a skilled job, involving knowledge and consideration of a complex of issues. As a result, it is usually time consuming, often involves a team of people, a range of equipment and materials and costs that can escalate rapidly. Setting clear and rational objectives before the start of fieldwork will constrain costs and aid the production of robust scientific results. At an early stage, decisions need to be made on what *must* be done, what *can* be done, what assistance is required, and what work is non-essential. This is done by *screening* the proposed pesticide application programme or other pesticide release or contamination incident. Pest control programmes are the most likely source of pesticide release requiring environmental monitoring. However, accidental spillage or other pesticide contamination incidents are dealt with following the same broad principles outlined below.

This chapter outlines all the stages needed to plan and design a monitoring programme to assess the impact of pesticide use in the tropics. It deals systematically with the issues which need consideration. The emphasis is on designing fieldwork, but it also gives guidance to aid in risk assessment; determining whether monitoring is necessary; which fauna (if any) should be monitored; presentation of results; and ends with a worked example to take the reader through the process from start to finish.

SCREENING PEST CONTROL PROGRAMMES

Screening aims to make the hazards and risks of using pesticides explicit: to identify the species, resources or systems exposed and to assess the magnitude, duration and significance of the hazard to each. It relies upon an understanding of the chemical treatment proposed (i.e. timing, dose rate, scale), the nature of the chemical involved, background ecotoxicological studies and on the biota exposed within the context of their ecology. Some risks will be quantifiable (see 'Risk Assessment', page 8), others not, and the final assessment will inevitably be subjective. However, objectivity should be sought as much as possible and subjective elements acknowledged as such. The level of objectivity can be increased through an assessment based on biological, social and economic criteria. A desk study, technical consultancy advice, and a visit to the spray treatment area will be necessary to complete the screening process.

Judging the significance of possible adverse impacts on a wide range of organisms and ecological processes is dealt with below in the section 'Risk Assessment'. In general, the need to monitor pesticide use will be made on the basis of where the pesticide is going to be used. Various types of areas may be subject to pesticide application. Any internationally designated areas will be subject to legislation at national level and interventions may require an environmental impact assessment (EIA). Unprotected environmentally sensitive areas (ESAs) may be subject to pesticide intervention without the need for an EIA, but environmental monitoring of non-targets would be important in any such area. Scientific or strict nature reserves, national parks, natural monuments and tribal peoples reserves should also be largely free from toxic chemical use, but other nationally designated areas may still be treated with pesticides. As with internationally designated areas, the need for monitoring would be

¹ Contact address: 9 Norman Avenue, Henley-on-Thames, Oxon RG9 1SG, UK. tc09@gn.apc.org/colin.tingle@thenrgroup.net

² Contact address: Cybister Environmental Protection, Oak House, South Street, Boughton, Kent ME13 9PE, UK. ian.grant@cybister.plus.com

determined by an EIA in any such area subject to national legislation. Unclassified and undesignated areas, whether forests, wetlands or agricultural lands, are much the most likely habitats to be treated with pesticides. The need to monitor pesticide application in such areas must be examined on a case by case basis but, in general, monitoring should be undertaken unless the risk to wildlife and the environment can be shown to be negligible.

Where pesticides are to be used in an area where no EIA is required under national legislation, the decision to monitor a particular pesticide intervention needs to take account of multiple factors. Table 1.1 outlines some of these. Ecological monitoring is essential where populations and key ecological processes are placed at significant risk from pesticide interventions. Thus situations where critically endangered to rare populations (Table 1.1), keystone species or ecological functions are at risk would be monitored. There are few situations where it is absolutely safe to say that monitoring is unnecessary, even when species are abundant, for there may be cultural

Table 1.1 Factors for consideration in assessing the need to monitor potential impacts on wildlife

Species/resources exposed				Potential impact
Population status ¹	Ecological importance	Cultural importance	Economic importance	
Critically endangered <i>facing an extremely high risk of extinction in the wild in the immediate future</i>	Keystone species <i>important to the ecology of many other species OR crucial to key ecological processes</i>	'Flagship' <i>species which are well known and of high cultural importance</i>	Imperative	Extinction
Endangered <i>facing a high risk of extinction in the wild in the near future</i>	Significant <i>important to a number of other species OR to ecological functions</i>	Valued <i>important to some aspect of human culture</i>	High	Population decline
Vulnerable <i>likely to move into the 'Endangered' category in the medium-term future</i>	Unimportant <i>loss insignificant to species composition of the habitat and to ecological functions</i>	Unimportant <i>of no significance to any major cultural group</i>	Moderate	Adult deaths Immature deaths Breeding failure
Near-threatened <i>close to qualifying as 'Vulnerable'</i>	Unknown		Low	Health impairment Growth retarded
Rare <i>not at present vulnerable, but with small world populations, therefore, at risk</i>				Physiological change Behavioural change
Unthreatened <i>at no risk of extinction in the medium term</i>				
Abundant <i>widespread and common</i>				

¹Definitions of proposed IUCN population status categories.

and economic factors of local significance to be considered. Decision-making then becomes more reliant on the outcome of the risk assessment, a predictive tool described later in the chapter.

Where people may come into direct contact with pesticides, monitoring effects on human health is normally essential. Human health effects of pesticides are beyond the scope of this handbook. The methodologies used by LOCUSTOX to determine exposure of spray operators and others involved in locust control operations are available (Mullie *et al.*, 1998; Dossou and Mullie, 1998). The Food and Agriculture Organization of the United Nations (FAO) also provides excellent guidelines on this (van der Valk & Everts, 2003).

Environmental monitoring, stakeholder consultation and policy formulation

Given the commitment made by all UN countries under Agenda 21 to the use of more environmentally benign pest control (UNCED, 1992), continued review of environmental impacts of pesticides should become 'the norm'. This should then feed into the review and development of policies relating to pesticide use. However, policy-making will require more than just scientific data in order to be successful. Thus, when screening any large-scale pesticide use, a wide range of interested parties (or 'stakeholders') should be involved in discussions to help define the scope of the study, and specifically address the issues of concern, species to be studied and measures of impact (i.e. impact indicators).

The general aim of any fieldwork should be to clarify areas of uncertainty unresolved by the hazard assessment and to ensure any mitigation measures are effective. The results of any fieldwork should be used to help guide future policy on the pest control being monitored. In the past, monitoring has tended to tackle scientific issues alone, rather than including socio-economic concerns. The result has often been that scientists and other stakeholders have talked past each other, to the dissatisfaction of both. It is, therefore, recommended that a stakeholder consultation process be initiated early in the planning of any pesticide impact monitoring project. Any NGOs, government departments, local bodies, farmers groups or unions and other individuals or organizations should be included, so that a wide range of opinion is represented. In this way, the formulation of future policy is less likely to be flawed or unrepresentative.

Detailing the process of stakeholder consultation is beyond the scope of this handbook, but managers of any environmental monitoring programme should be aware that it is an important part of bringing results into a policy context (Royal Society, 1997). Social scientists can provide guidance on stakeholder analysis.

PLANNING PHASE

Analysing the situation

The first step is to outline and describe the (potential) problem. A wide range of factors need to be considered at this stage. The flow diagram and the guidance given below will aid the analysis of your situation and the specific pesticide problem. The flow diagram is a useful tool for defining the process (Figure 1.1): in the example, the *observation* is that an organophosphate insecticide is to be sprayed over or close to water to control a pest. It shows that questions are to be asked about the type of organophosphate, the application parameters, proposed spray dates and the type of water body at risk. A consideration here would be whether the water body has special conservation or economic value. The perceived *problem* will be whether the organophosphate will find its way to the water body and if so, will it result in an adverse affect on invertebrates and/or fish and will it have indirect effects higher up the food chain?

Desk assessment

Before organizing any programme of fieldwork, it is advisable to carry out a desk assessment, which will involve the collection of available relevant baseline data from bibliographic sources and local institutions. This data should include relevant aspects of:

- the ecology of the area, including lists of endemic, rare and protected species
- the ecotoxicology of the pesticide in the same or similar type of environments
- the physico-chemical and other properties of the pesticide and its formulation, including its water/oil solubility, persistence, and its tendency to bioaccumulate in soil, water, plant or animal tissues.

An analysis of these data during the desk assessment defines, through a short screening process, the likely *risks* and *hazards* of the pesticide used to key beneficial and other non-target organisms, including humans. This assessment determines whether a monitoring programme is necessary, and if so, what primary (new field) data need to be collected.

Formulating hypotheses

The next step is to formulate an hypothesis related to your knowledge about the possible impact of the pesticide or pesticides. It would probably state a relationship between the pesticide and its perceived impact like the one given in Figure 1.1. This *hypothesis* is now turned upside down to produce the *null hypothesis* or the opposite statement to the hypothesis, i.e. that no relationship exists between the specific variables under evaluation. In order to minimize any of our own possible biases, scientific rigour tells us that our work will be of a better quality if we attempt to disprove the null hypothesis rather than proving our proposed hypothesis. If the desk assessment of the impact defines more than one problem, a number of null hypotheses may be needed but it is important to keep them all clear and concise, or more information may be collected than is necessary, leading to wastage of time and resources.

Before planning the fieldwork, double check your analysis of the problems so far; it may save you collecting information which is later of no use.

RISK ASSESSMENT

Risk of an adverse impact of pesticides is a function of the toxicity of the particular pesticide (active ingredient and/or chemicals used in its formulation) and the exposure to it of any environmental compartment of interest, including wildlife or humans. The desk assessment stage is the appropriate time to determine which faunal group or ecological process, function or indicator is most at risk from a particular spray operation, trial or programme. It is through this process that you will decide which chapter or chapters from the handbook you will need to consult in detail, in order to sort out your monitoring/sampling programme.

Quantitative risk assessment (QRA) has been developed to produce objective and numerical evaluations of the risk associated with a variety of activities. Using such QRAs, activities can be quantitatively compared for the risk they pose. Despite the effort that has gone in to developing QRAs, there is no consensus over standardization of criteria and what the numbers mean. This handbook will, therefore, deal with risk in a qualitative rather than quantitative manner. We do not dismiss the utility of some quantitative assessments of risk in certain circumstances, but prioritize the understanding of broader issues surrounding risk assessment.

Assessment of the impact of pesticides in the tropics is a neglected area in ecotoxicology. Most of the scientific work has been carried out in temperate areas and thus most of the data is based on pesticide fate and environmental effects under temperate conditions. However, tropical conditions specifically affect the risk

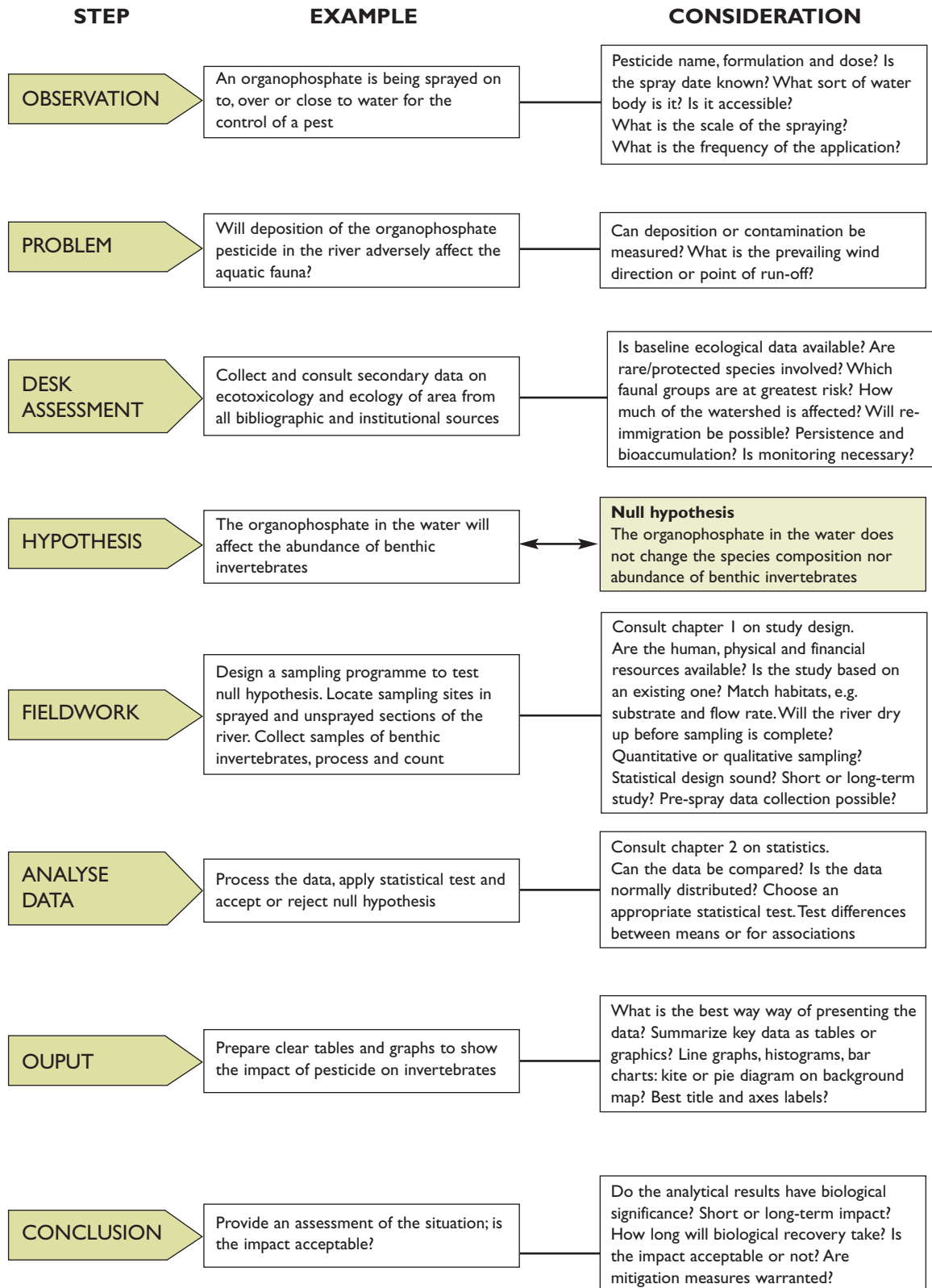

Figure 1.1: Example of a stepwise development for an aquatic monitoring programme

presented by most pesticides. There may be considerable changes to the risk from a given pesticide used in the tropics when compared to its environmental risks in temperate ecosystems. No generalized guide to pesticide risk assessment in the tropics has been proposed, but a number of projects have dealt with the environmental impact of pesticides in the tropics and considered the issue of risk assessment. Fauna of arid environments have received special attention (Everts, 1997) and the FAO LOCUSTOX project in Senegal has addressed many of the issues relevant to pesticide risk assessment in the tropics. Consultation of the LOCUSTOX reports (see 'Further Reading', page 29) is strongly recommended.

The first consideration in risk assessment should be the intrinsic toxicity of the pesticide itself to non-target organisms. The desk assessment should, therefore, aim to gather as much information as possible on the acute and chronic toxicity of the particular pesticide to non-target organisms that may be exposed. The LD_{50} is the classic measure of acute toxicity. It is defined as the dose (usually given as milligrams of technical/undiluted pesticide active ingredient per kilogram), for a given route of exposure, required to kill 50% of the test population of a particular organism. It is usually measured over a short period of time, e.g. 24–96 h. LD_{50} values generally vary widely according to many factors, such as route of exposure (e.g. oral, dermal, inhalation) between different organisms of interest (sometimes even when quite closely related). They also vary between (and sometimes within) pesticide groups. Generalized risks to various faunal groups and ecological processes associated with acute toxicity for each of the major groups of pesticides are given in Table 1.2. This table addresses the risk of mortality and also takes into account issues like persistence, but does not address sub-lethal effects. Table 1.3 addresses the presence and abundance of the different fauna in the different habitats and thus those at risk of exposure to pesticides applied within the habitat. Table 1.4 addresses the risk of exposure to a pesticide based on its method of application. The tables cannot be precise because they deal with groupings of pesticides, whose effects can be wide ranging and variable. However, they serve as a useful first step guide that can be built on with more information about the actual pesticide, particular area to be treated and the specific application methods and faunal groups when these are available. As much specific information as possible should be sought on the characteristics of the individual pesticide of interest, as well as on its proposed use which in turn will affect the exposure of particular faunal groups.

The dose that a non-target organism receives in the field is rarely known because the exposure is often indirect. It is possible to estimate the concentration of a pesticide in air, soil or water and on plant or other surfaces during spraying. This information helps to interpret an observed response (causality) by particular non-target groups and, from knowledge of the concentration-response characteristics and the proposed application rates, aids in the prediction of the likelihood of such impacts occurring again. The likely field concentration is clearly very important and must, in some way, be accounted for when assessing 'toxicity', even if this is done crudely. The typical response of organisms to pesticide exposure is generally described by an asymptotic curve³ (see Figure 1.2), but the precise form of this relationship varies between pesticides, species and field conditions including:

- temperature
- humidity
- light intensity
- interaction with other chemicals.

These factors will affect the toxicity of individual pesticides differently and thus need to be taken into account in assessing which pesticides at what dose will be toxic to which organisms. In general, if acute toxicity (Table 1.2) is considered moderately high or higher, then that group should be studied and monitored. Monitoring of a potentially sensitive faunal group may not be necessary if additional information (e.g. rapid degradation under high temperature or high light intensity) indicates that the particular pesticide will no longer be likely to pose a high risk to the non-target group.

³Sigmoid or S-shaped curve where below a minimum threshold concentration there is no measurable adverse effect and at all concentrations above a certain maximum all members of a specific group are affected.

Table 1.2 Risk of acute toxicity

Pesticide group	Aquatic invertebrates	Amphibians/ chelonians	Fish	Soil processes	Terrestrial invertebrates	Lizards	Birds	Mammals
Organochlorine	+++	++	++	++	+ – +++	++	+ – ++	++
Organophosphate	++ – +++	0 – +++	+ – +++	++ – +++	+++	0 – +++	+ – +++	+ – +++
Carbamate	+++	+ – +++	+++	0 – ++	+++	?	0 – +++	+ – +++
Pyrethroid	+++	+++	+++	++ – +++	+++	++ – +++	0 – +	+
Insect growth regulator (IGR)	+++	0	+	+ – +++	+ – +++	0?	0	0
Phenyl pyrazoles	+++	+++	++ – +++	++ – +++	+ – +++	+++	0 – +++	++
Biologicals	+ – +++	0	0	+ – ++	++ – +++	0	0	0
Herbicide	0 – ++	+ – +++	0 – +++	+ – ++	0 – ++	0 – ++	0 – +	0 – +
Fungicide	0 – +	+ – ++	+ – +++	+ – ++	0 – ++	?	0 – ++	0 – +

Key to scales for Tables 1.2 – 1.4 The scale used in these tables is subjective (deliberately so) and only aims to provide guidance as to the extent of risk of a negative impact.

- 0 = No risk
- + = Low risk
- ++ = Moderate risk
- +++ = High risk
- ? = Risk unknown

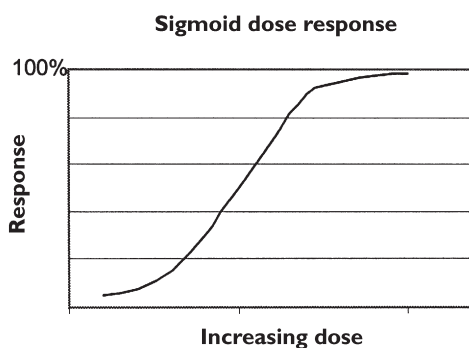

Figure 1.2: Asymptotic curve demonstrating response of organisms to pesticide exposure

However, acute toxicity and lethal effects only provide us with a part of the information on potential non-target effects. Sub-lethal, chronic or delayed effects, which are not accounted for in LD₅₀ studies, can be very important in terms of their ability to disrupt ecological processes. For instance, a pesticide that slows down the developmental rate of an organism, alters its fecundity or changes its feeding behaviour can have just as large an impact on the population size or viability in the longer term as can mortality. A well-known example of this is the impact of DDT on birds of prey. Although rarely reaching lethal levels in birds of prey, DDT can affect the population of some species through the effects of its metabolite, DDE, which disrupts calcium metabolism in birds and leads to eggshell thinning and consequent breeding failure. Thus, wherever possible, information on sub-lethal or chronic effects of the pesticide should also be taken into account in deciding whether or not monitoring is necessary.

Of course, a chemical will only be toxic to a particular group of organisms if the organisms are exposed to it. Exposure to a pesticide is dependent on:

- where the pesticide is applied (habitat)
- over what area
- application method
- timing – season and time of day
- frequency of application
- fate
- persistence
- mode of action
- bioavailability (i.e. the ability of susceptible organisms to pick up a given pesticide from contaminated surfaces, e.g. leaves).

The *habitat* type subjected to pesticide application is the first consideration in assessing risk of exposure to the pesticide (Table 1.3). For example, if a woodland is to be sprayed then terrestrial invertebrates, lizards, birds and mammals are all at risk of exposure as they are all likely to be present in this habitat.

However, as with toxicity, risk of exposure to organisms in a given habitat is modified by other factors such as the *application method* (Table 1.4). For example, ultra-low volume (ULV) application results in very small droplets (see chapter 4) that tend to be attracted to upright surfaces. Thus upright vegetation tends to get high ‘exposure’ to any pesticide sprayed at ULV. This means that faunal groups associated with vegetation are most exposed. If a woodland is sprayed from the air by ULV application, then fauna in the tree canopy are most at risk of exposure, e.g. canopy-dwelling invertebrates, canopy-feeding reptiles and birds, and possibly canopy-inhabiting or visiting mammals.

The *scale* of spray operations is also important in terms of acute impacts and population recovery. Large-scale operations will expose more habitats, affecting more species and also the ability of organisms to re-invade a sprayed area. Thus, total area sprayed and varieties of technique, such as barrier spraying or other discriminative methods that reduce area-wide exposure, are important to consider in determining which faunal groups will be

Table 1.3 Fauna and processes at risk by habitat type

Habitat	Aquatic invertebrates	Amphibians/ chelonians	Fish	Soil processes	Terrestrial invertebrates	Lizards	Birds	Mammals
Forest/woodland	+ ¹	+– +++	0 ¹	+ – +++	+++	+++	+++	+++
Orchards/ plantations	0 ¹	++	0 ¹	++	+++	++	++	++
Grassland	0 ¹	+	0 ¹	+++	+++	+++	++	+++
Wetland	+++	+++	+++	0 – +	+	+	+++	+++
Rivers	+++	+++	+++	0 – +	0	0	++	+++
Riverine forest	+++	+++	++	++	+++	+++	+++	+++
Crops	0 ²	+ ²	0 ²	+++	+++	+	+++	++

¹ Unless there are seasonal streams, ponds or swamps, in which case + – +++.

² Except in specific situations, e.g. paddy rice production, where risks to aquatic fauna will be high.

at risk. However, such discriminative spraying will require modifications to any non-target monitoring programme as well. In these situations even more care and thought needs to go into the design of the monitoring programme to ensure meaningful results (see Worked Example, page 30 et seq.).

Timing of application can also influence the risk of exposure for various organisms, depending on the chemical, its persistence and its fate (see below). A highly acutely toxic contact pesticide, for example, may present a risk to different organisms depending on what time of day spraying takes place. Night spraying may affect different groups from daytime spraying. The time of year when spraying takes place will also influence the fauna at risk. Faunal composition of tropical areas is often highly seasonal. This is particularly true for invertebrates (where even a few weeks can make a difference to the abundance and species composition of the fauna present in a given habitat), but the presence of birds and reptiles can also be highly seasonal. *Frequency of application* also affects the likelihood of exposure: the higher the frequency, the greater the risk.

The *fate* of a pesticide refers to its mode of dissipation, transport and degradation in the environment. Volatile pesticides will be dissipated more rapidly from surfaces than non-volatile compounds, particularly in tropical climates. Most can be transported in running water; some will bind tightly to surface soil or leach into groundwater depending on the properties of both the pesticide and the soil. Exposure of organisms will also be determined by factors such as these. Basic pesticide characteristics (physico-chemistry) and some environmental fate data can be found in agrochemical handbooks, from which it is possible to determine those non-target groups or processes that are most at risk.

Exposure of organisms is significantly affected by the *persistence* of a pesticide, i.e. the length of time during which a pesticide remains active within the environment. For example, organochlorines tend to be far more persistent in soil and on surfaces (leaves, tree bark, etc.) than carbamates, which are much more soluble in water and readily susceptible to microbial breakdown. The receiving environment is an important consideration. Diflubenzuron, a benzoyl phenyl urea IGR, when applied to vegetation binds strongly to the leaf cuticle and often persists for 4–16 weeks after a single application. In soil or water, it degrades rapidly, with a half-life of only 2–8 days. There is no simple way of presenting data on persistence and exposure in a table because the influence of environmental

Table 1.4 Risk by application method (assuming pesticide toxic to group)

Application method	Aquatic invertebrates	Amphibians/ chelonians	Fish	Soil processes	Terrestrial invertebrates	Reptiles	Birds	Mammals
Aerial – exhaust	+++	+++	+++	++	+++	+++	+++	+++
Aerial – ULV	+++	+++	++	++	+++	++	+++	+++
Ground – conventional	++	++	++	+++	+++	+++	++	++
Ground – ULV	+	++	+	++	+++	++	++	+++
Fogging	++	+++	++	++	+++	+++	+++	+++
Dusting	+	+++	+	+++	+++	+++	++	+++
Baiting	+	+ – +++	+	+	+ – ++	++	++	++
Granules	0 – +	++	0 – +	+++	++	+++	+++	+++
Dips/pour-ons	+ ¹	0 ¹	0 ¹	++	++	0	0 – ++	0 – +

¹ Except where dip tanks are close to static and running water (tank flushing increases risk to aquatic fauna).

variables is so great. Organochlorines may be more persistent in the environment than many others, being bound in lipid or tightly bound to organic matter in the soil, but this can also mean that they are not bioavailable (see below) and so direct exposure may be reduced in these states.

The hazard from pesticides to species, groups and ecological processes is also affected by their *mode of action*. Some pesticides act on contact with the organism, passing through an insect cuticle or an animal's skin. Others act as stomach poisons and only have an effect when consumed as part of normal feeding. Some classes of insecticide interfere with metabolism or nerve transmission, while others, typically rodenticides, affect blood clotting in birds and mammals. Some IGRs affect chitin production and act only on animals with a chitinous cuticle and are thus regarded as non-toxic to higher animals. However, a wide range of invertebrates are affected, but usually only whilst immature. Such factors are important to consider whilst assessing which non-target groups or processes require monitoring.

Bioavailability refers to the extent to which organisms have access to poisons within their environment and to which they are physically exposed. The bioavailability of a pesticide depends on its physico-chemical properties (especially water/oil solubility), mode of action, persistence, fate and a range of other factors, including the nature of substrates and climatic conditions. Knowledge of pesticide behaviour in the environment is thus crucial for the prediction of risk. For example, the organophosphate insecticide parathion has a high acute toxicity (low LD₅₀ value) to a wide range of arthropods and other organisms. However, when applied to soil at the same application rate and using the same formulation, it has very different effects on the carabid beetle *Poecilus cupreus* depending on whether the soil is sandy or loamy. On sand, beetle mortality is around 95%, whereas on loamy soils it is about 3% (Heimbach *et al.*, 1992). The exact mechanism by which this difference in toxicity is manifested remains to be determined, but it may be due to rapid absorption of the insecticide on to organic matter in the loamy soils. Whatever the reason, the parathion is not bioavailable to the beetles on the loam soil and thus does not exhibit its normal toxicity.

FIELDWORK OR IMPLEMENTATION PHASE

The first step with implementation of a monitoring programme is to design a sampling programme. The programme must collect data in a fair and unbiased way on faunal groups or processes that were identified as important during the risk assessment. The sampling method selection is critical, as it determines the type, quantity and quality of data used in the analysis of impacts. Logistical factors need to be taken into account at this stage. Decide who is available and competent to collect the data; what are the equipment, transport and fuel requirements; when and where the work will take place; and whether it is necessary to base the study on an existing one. In the latter case you may be comparing impact with a previous year or looking for ecosystem recovery, in which case the collection of comparable data will be important. The chapters and methods sheets in this handbook should help with decisions about design and technique and provide details for carrying out the selected method in the field.

Field-collected data can be difficult to interpret, due to uncontrolled conditions and natural variability of field populations (see Figure 1.5). As a result, it may be valuable (where possible) to carry out laboratory tests and/or semi-field tests to accompany field monitoring. Such experimental work can help researchers to understand the results of field monitoring and elucidate cause and effect factors. Such laboratory and semi-field testing is not included in this handbook, but is described elsewhere (Barrett *et al.*, 1994; Lynch, 1995). The LOCUSTOX reports also describe such supporting laboratory work for field studies. (see page 29).

STUDY DESIGN

At this stage it is necessary to assemble maps, operational and biological information on the ecosystem that is relevant to the study. The locations to be sprayed can be identified from the information provided by the plant protection, public health departments, farmers or contracted companies involved, and from that, habitats at risk can be identified. Field trips will be necessary to determine them in detail. Knowledge of environmental variables

such as local climate statistics, seasonal leaf fall or river flow, and the life histories of sensitive species, pollination periods, etc., from the desk assessment phase, are compiled along with information on the extent of the operation and the spraying statistics. These facts are then used to determine the best sampling strategies, including the positioning of *comparable* untreated areas and optimal timing of the monitoring for key groups of organisms. Even the best-laid plans can become undone: a last minute change of spray date is not an uncommon occurrence. A 4-week pre-spray study in all areas (treated and untreated) is the general recommended minimum. If impact severely reduces populations or ecological functions, be prepared to repeat the monitoring of affected species in the same season one year or more later.

SITE SELECTION

Sample site selection is a vitally important part of any monitoring or sampling programme for pesticide impact assessment. Data collected through careful and meticulous sampling can be completely useless if the sites sampled have been chosen inappropriately. Thinking through the issues involved, and giving yourself adequate time to prepare, will reduce the likelihood of this happening.

The aim in any experiment or comparative study should be to minimize inherent variation that could affect the outcome of the study. In both natural and managed environments many independent variables may be at work. Where these cannot be controlled, it is important to pair, match or stratify experimental/sample sites to minimize variation. Guidance on site selection begins below, but every chapter will indicate special issues important to their group/subject of interest, and give details where necessary. Statistical considerations (including stratification of sampling) are dealt with in chapter 2.

Terrestrial environment

The first stage in selecting sampling sites is to determine which habitat is going to be treated with pesticide and select an area of similar habitat as an untreated comparison. Matching of treated and untreated areas should be done as carefully as possible, taking into account details such as heterogeneity within the habitat and then trying to ensure that both the treated and untreated areas are compatible in these respects. For example, if the habitat to be treated is savanna woodland, then it should be matched with an untreated area of savanna woodland dominated by the same tree species or containing a similar mix of the species as found in the area to be treated. The topography should be similar, as should other features such as ground-cover vegetation, canopy cover and geology. It is also important that the elevation (height above sea level) is similar, as this can affect species composition of faunal communities.

In an agro-ecosystem there is a good chance that a traditional experimental design can be adopted, e.g. randomization, blocking, etc. (see chapter 2). In this event, much of the information below will not be directly relevant. However, if a classic agricultural experimental design is inappropriate, as it often is in relatively unmanaged environments, then it will be necessary to adopt a 'monitoring-type' protocol. This involves repeated observations and/or measurements that check whether that which is under study conforms to a given standard (in the case of ecotoxicology, a population level, relative abundance or species composition of fauna statistically indistinguishable from that in the unsprayed study area). The goal for the design of a monitoring protocol is that like is compared with like and that uncontrolled variation is kept to a minimum.

Scale

The scale of the pesticide application operation under investigation is a key determinant of sample site selection. There is little value in undertaking a sampling programme over an area of a few hundred square metres, if the application of pesticide will cover tens, hundreds or thousands of square kilometres, as the diversity of habitat types will most likely increase as a function of the area treated. The scale of the treatment will govern such factors as the proportion of a susceptible population or community that is likely to be affected and the ability

of the fauna to re-invade an affected area. Sample sites are selected to reflect the scale and biotic diversity of a treated area and to ensure that sites in sprayed and unsprayed areas cover a similar area of matched habitat.

Homogeneity of habitat

Few habitats are homogeneous. Areas to be treated with pesticide should be examined and classified and then matched with sites of similar heterogeneity in the unsprayed area. For example, an apparently homogeneous area of savanna grassland may actually comprise a diversity of grass, shrub and trees species (see Worked Example, page 30). The species composition should be 'matched' (a relative term here) to delimit comparable sample sites in sprayed and unsprayed areas. This habitat characterization should be applied to density of ground cover, density and species composition of trees, shrubs and bushes, areas of bare soil, moist depressions and water resources within the grassland, etc.

Local conditions and microclimate are also factors that influence the choice of sample site placement. Microclimate is particularly significant with regard to microbial processes and soil invertebrate behaviour. It is, therefore, important to match sample sites with regard to factors that influence the microclimate.

Subject/group of interest

Sample sites should be selected or extended to allow ecological data to be collected on sensitive, keystone and bioindicator species or processes that were indicated as important in the screening process and desk study. Also, the spread of sample sites should be matched to the biology and ecology of the chosen group, to help interpret any changes seen in the population or species composition. For example, if bee-eaters are of interest, study sites should be selected which contain a reasonable concentration of prey and suitable perches from which the birds hunt. The sample sites should also be far enough apart to ensure that different family groups are monitored on each occasion.

Influence of application technique

Table 1.4 shows how application technique can affect the fauna and/or ecological processes at risk and may affect decisions made about the choice of sampling sites. If selective or discriminative pesticide application techniques are being used (see chapter 4), this will further affect sampling design, sites and workload. These types of applications are used primarily in large-scale interventions as with the control of locust, armyworm, quelea and tsetse fly, where only a part of a particular area or habitat is treated. In such cases, the randomized placement of sampling sites within the habitat will not necessarily provide data that can be usefully interpreted. For example, with barrier spraying for locust control, sample sites should be stratified within the sprayed area to take account of different concentrations of the insecticide within barriers and at different distances from the barriers within the inter-barrier spaces (see Tingle, 1996; Worked Example, page 35–36). In a situation like this, sample site placement in the unsprayed area can be different from that in the sprayed area, although care still needs to be taken in accounting for habitat heterogeneity.

Aquatic environment

The first step is to establish the boundaries of the spraying programme from the authority (or contractor) carrying out the pesticide application operations. These boundaries are superimposed over a map to identify any wetland areas, streams, rivers and waterholes that might require biological monitoring. The strategy for site selection in static and running waters depends upon the scale of the pesticide application intervention, the extent and designation (e.g. conservation area, protected area, national park) of the aquatic environments and the resources available to monitor them. The primary aim is to establish the population variation at unsprayed and sprayed sites for statistical comparison at intervals after pesticide application to, or nearby, water. Keeping biotic variation to a minimum at the outset requires the matching of sampling sites with respect to substrate, flow rate and depth, a task that is hampered by accessibility and the scale of pesticide applications. For rivers and streams, the ideal situation is to find two or three matched stations above the source of contamination and, at a minimum, the same below. Most hydrobiologists choose more stations downstream to determine the distance at which recovery from

adverse effects may occur. Unless working in large wetland areas such as swamps, deltas or floodplains, it is not usually possible to sample discrete 'treatment' areas, i.e. to be assured that sprayed and unsprayed sites are far enough apart to be isolated from each other. Ponds and small lakes might be found in treated and unsprayed areas but their natural condition, or the uses to which they are put, may reduce their chemical and biological similarity.

Scale

Large-scale pesticide interventions can result in a whole watershed being sprayed, in which case comparable sites must be found in another, adjacent watershed. Effects of scale frequently impose the acceptance of sub-optimal sampling stations:

- when sites upstream of spraying are miles from the last downstream stations
- when an adjacent watershed is needed for comparison

In practice this means that site characteristics (substrate, vegetation, flow rate, water chemistry, etc.) upstream will not match those downstream, with the result that variation in species and communities between sample sites also increases.

Homogeneity of habitat

Invertebrate species in shallow running water are usually sampled at riffle sites, where substrate, flow and depth are fairly uniform, species are rich and access is easy. Lower downstream, depth increases, substrates contain more sediment, and access often deteriorates. It is normally possible to find depositing substrates upstream – in deeper, slow moving water away from main channel flow – and, occasionally, shallower stretches downstream, perhaps at confluences in tributaries. By employing this stratified sampling, the statistics and power of compared data are improved. The same principles are applied to the sampling of fish: seining of pools or riffle sections to obtain comparable samples. In deep rivers and static water, substrate type remains important but other techniques such as artificial substrates may be used to give some standardization of the habitat sampled. Seasonal changes in site characteristics such as the growth of submerged macrophytes and floating weeds may complicate the choice of sampling sites. Applying the rule of matched sites and seasons will accommodate shifts in habitat properties and allow for more robust comparisons.

Size of sampling stations and stratified sampling techniques are discussed in the relevant chapters of the book.

Species of special interest such as bioindicators of hazard, those with low reproductive capacity or of conservation interest can be singled out and sampled appropriately if routine sampling excludes their habitat (e.g. plankton, tube-dwelling species or those living under rocks).

ANALYSIS AND ASSESSMENT PHASE

Natural variation is a significant cause of population and functional change that can confuse the interpretation of pesticide impacts. Once the reason for an observed effect is attributed to pesticide (i.e. the null hypothesis was disproved), the problem then becomes one of deciding the relative importance of the effect. Pesticides cause a range of effects on living organisms and processes. This handbook concerns itself mainly with detecting effects on species abundance and richness, and community structure and function, as the effects are more tangible and readily discernible than those on behaviour and reproduction, which are usually more subtle, difficult and expensive to detect.

Common responses of organisms and biological systems to conventional chemical pesticides can be loosely classified as *positive* or *negative* and *reversible* or *permanent* (non-recoverable or irreversible). Responses may be direct or indirect results of pesticide use, and they are dynamic, i.e. related to time.

A positive response may be an increase in numbers or density compared with a control or pre-spray situation: for a process it would be termed stimulation. An example is an increase in algal populations in pools following an application of insecticide to control mosquito larvae. The chemical temporarily removes grazing pressure on algae from aquatic invertebrates allowing algal biomass (and hence chlorophyll a concentration) to increase (Figure 1.3). An example for a process would be the initial stimulation of soil respiration after the application of pesticide, caused by the release of nutrients from killed and decaying micro-organisms being utilized by others. Negative reactions would be characterized by a population decline, such as the large fish kills or reduced abundance of microcrustacea associated with pesticides used to control blackflies and mosquitoes (Figure 1.3), and for a process by an inhibition, like that caused in litter degradation rates by DDT (Figure 1.4).

To assess the importance of the impact of a pesticide on a population or ecological process, it is necessary to have data on the natural variation of that population or process against which to interpret effects (Figure 1.5). Knowing the type and even severity of a biological response does not help us to decide whether it is of any

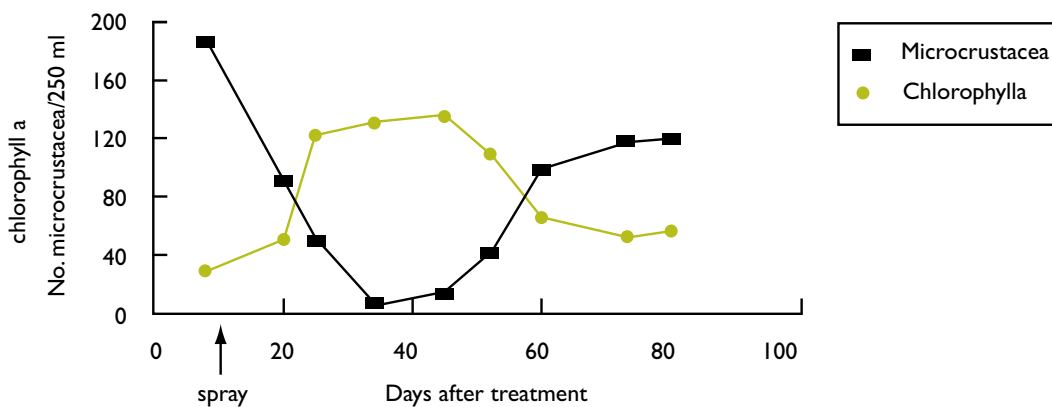

Figure 1.3: Effects of mosquito control on algae and microcrustacea in shallow ponds

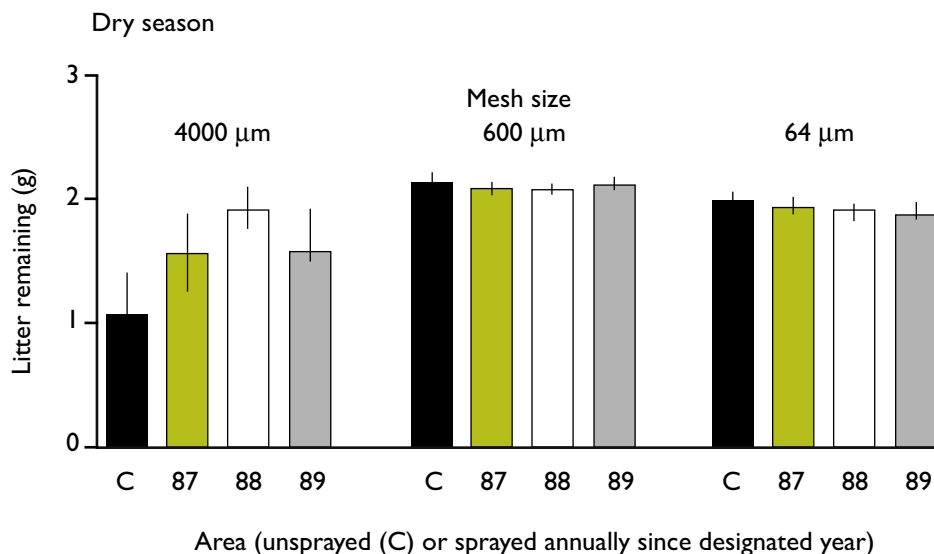

Figure 1.4: Leaf litter remaining in nylon mesh bags (g ± SE) after 6 months burial in soils exposed to DDT spraying

ecological consequence. The statistical difference between one or more bird densities in treated and untreated areas may be significant but whether it is biologically inconsequential, acceptable or critical must be determined using some ecological yardsticks. If a monitoring period is sufficiently long, the time that it takes for a population or function to recover from the (usually) negative response will provide an indication of just what is acceptable damage. For soil microbes and micro-arthropods, the speed of recovery will be quicker than for larger invertebrates, fish and birds, whose life cycles are longer. If a riverine prawn population is decimated by a pyrethroid insecticide and the recovery period is measured in years because of the prawns reproductive capacity, then the impact is certainly unacceptable (but conditions apply!). If canopy-dwelling beetles recover from huge knock-down by pyrethroid aerosols and their populations revert quickly to pre-spray levels through immigration and recovery from the toxic effect, then this response may be insignificant, provided it is not repeated too often. The speed of biological recovery will be related to pesticide dose, application frequency, persistence, the area treated and the untreated area remaining from which re-colonization may occur, the sensitivity or vulnerability of the non-target species and other factors, such as their life cycle and reproductive rate mentioned above.

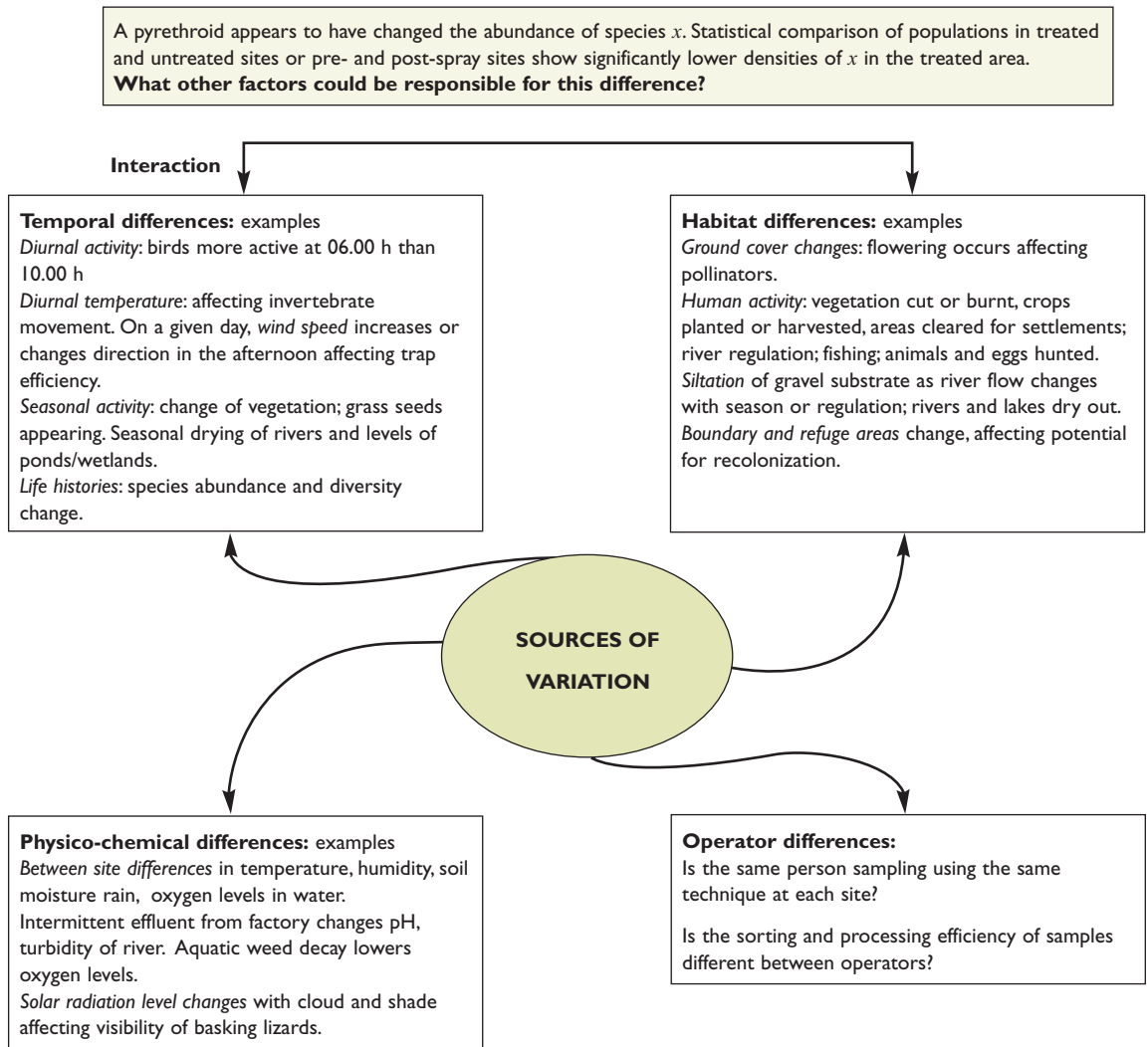

Figure 1.5: Sources of variation in abundance of fauna sampled

A suitable starting position for evaluating negative pesticide responses is to ask whether the application of pesticide was/is justified from a crop, livestock or public health standpoint. Powerful development arguments may be made in support of their use for ensuring food security (e.g. locust emergencies), protecting public health (e.g. malaria outbreaks), maintaining livelihoods (e.g. controlling animal trypanosomiasis to allow use of draught animals) and quality of life (often economic). If the premise for judicious pesticide use is acceptable then conclusions about the biological response to a pesticide can be drawn from its degree of divergence from the natural response of biological systems to natural perturbations, such as drought, fire, flood, seasonal drying of ponds and watercourses, or elephant damage. Provided biological responses to pesticides are no more severe than those occurring naturally then, with some exceptions, they may be found acceptable. In the extreme, does a statistically significant, numerical reduction of 40% in ground beetle abundance from pesticide use compare with their devastation by annual savanna fires (80–95%), or a 5% pesticide-induced mortality of bream in an ox-bow lake compare with mass mortality when the lake dries up? However, if pesticide impacts occur in addition to such 'natural variation', then impacts may be of importance even if relatively minor by comparison with the population change caused by the natural factor. Many responses will fall within similar scenarios, but obvious exceptions will be where the diversity of protected areas or endangered species is threatened, although early action to modify the development plan (at the desk assessment stage or earlier) should normally mitigate the threats.

Crop environments are no less extreme, where wide variations in soil parameters such as temperature and moisture are normal and frequently cause depressions of 10–90% in key functions like nitrification, ammonification and respiration. A measure against which to assess soil microbial responses to pesticides was developed by Domsch *et al.* (1983) after analysing the responses of organisms and processes to natural stress in soils (Figure 1.6). Using the time required for recovery of microbial populations after experiencing natural stress, up to 30 days was deemed necessary to recover from a 90% depression of activity. Recovery time was thus used as an ecological 'yardstick' of pesticide stress, 30–60 days being regarded as 'tolerable' and more than 60 days as 'critical'. Recovery time from natural and pesticide stress in semi-arid soils may be more variable depending upon the season.

Equivalent yardsticks for macro-invertebrate and vertebrate responses to pesticides can be developed and applied in the same way but at a much more specific level; usually that of species. Because of their lower reproductive rates (compared with micro-organisms), the period required for recovery increases, from days and months to years and so yardsticks based on duration of an effect can only be achieved through access to published long-term data, of which there are few, or a long-term commitment to field monitoring, which is

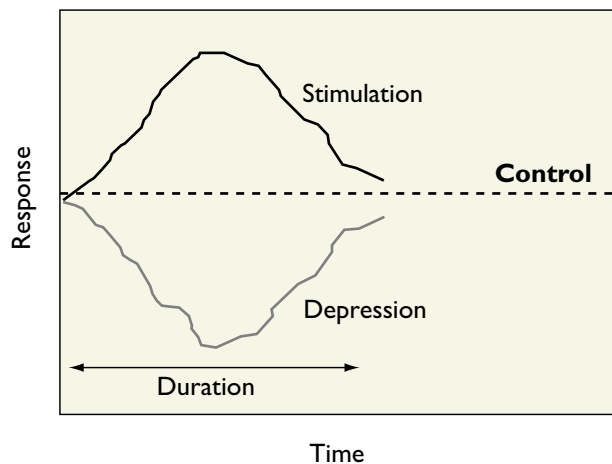

Figure 1.6: Reversible soil responses (after Domsch *et al.*, 1983)

expensive. The recovery period is also more dependent upon the magnitude of the initial population depression, so the recovery period for a species that reproduces once a year will be longer if 70% as opposed to 10% are killed. Other factors affecting the rate of recovery include the mobility of a species, species interactions, such as predator and prey relationships, etc. A shrimp is far less mobile than a dragonfly larva, which has an adult stage that can fly upstream to recolonize a depleted area. As species respond differently to pesticides, recovery of a predator may be delayed if its prey was more susceptible. Lastly, recovery at the population or community level (groups of species that coexist) may not tell the whole story for there are likely to be longer-term changes in their biological interactions that may affect the structure or functions of assemblages. What becomes increasingly important in large-scale use of pesticides is the area of land or watershed in which fauna are affected, because of the reduced chances of subsequent immigration and speed of re-colonization (Grant, 1989).

In the final analysis, acceptability of an adverse pesticide impact becomes an issue of balancing costs with benefits. Thus the extent of negative biological effects must be balanced with factors such as operator and consumer safety, economics, comparison with alternatives and the weight of public opinion (Greig-Smith, 1992; Grant, 2001; McWilliam and Tingle, 2002).

PRESENTATION OF RESULTS

Having invested a lot of effort to analyse and evaluate the information from the bibliographic and field data collected, it is essential to present the resulting information in a meaningful and useful way. Summaries of data in tabular or graphic form are the easiest way of enabling the reader to understand the salient points, trends or predictions that you wish to bring out from the impact studies. The guiding principles for their preparation are relevance and clarity: there is no value in graphing all the data if a quarter of it tells the full story, so concentrate on those pieces of information which show the impact or achievement of the goal (e.g. refutation of the null hypothesis).

The cardinal rule for tables is a simple, logical design. An enormous amount of data is collected during fieldwork so it is worthwhile organizing its assembly right from the start. Clearly and descriptively labelled columns and rows are ordered to allow eventual summaries of data, such as the mean number of different invertebrates caught in sweep net samples on a particular date (see Figure 1.21 in Worked Example, page 39).

For a report, the summary data should be presented to allow comparisons and show relationships, while avoiding columns of data that can be calculated from other columns and tables that exceed one A4 page. Most tables have a number and title, a box heading to identify columns and a stub heading to identify rows and fields that contain the data (Table 1.5). A disadvantage with tabular information is that it is not easy to get an immediate impression of change, particularly if numerical changes are within the same orders of magnitude. Graphic illustrations allow the viewer to grasp this type of change very readily.

Illustrations (line graphs, bar charts, pie diagrams, etc.) convey information on change and trends very effectively. Only choose ones that are relevant to your data and findings and do not duplicate data presented in a table. It is worth remembering that illustrations are often reduced for publication so draw them large with legible points and lettering. Access to a spreadsheet and graphic software package such as Microsoft Excel is useful for creating illustrations (below) but is not at all essential.

Histograms and bar charts are simple illustrations that present discrete data very clearly. Bar charts are ideal for showing the frequency or occurrence of something in a category, such as the numbers of insects caught on sticky traps by insect group (Figure 1.7). Histograms do the same but the horizontal axis is linked as in time, 1987:1989:1994:1997, or space, as with metres along a transect line (Figure 1.8).

Table 1.5 Deltamethrin deposition at two monitoring sites

Monitoring site (Spray cycle number)	Number of samples	Deposit level (mg DTM m ⁻²)			
		mean	SD	minimum	maximum
Beehive transect					
(2)	8	21.5	2.0	18.0	23.8
(3)	4	16.3	1.5	14.0	17.0
(4)	6	5.6	0.4	5.3	6.2
(5)	5	0.89	0.2	0.6	1.0
Lizard transect					
(91)	14	5.8	1.0	4.2	7.4
(2)	16	5.5	1.2	3.4	7.8
(3)	6	9.5	1.5	7.3	11.0
(4)	6	6.5	0.3	6.1	6.9
(5)	6	1.1	0.7	0.6	2.4

There are useful variants of the bar chart: *multiple bar charts* may show up to four bars depicting four treatments or pesticide type per category (Figure 1.9) or *composite bar charts* that show different information on one bar, such as river substrate broken down into percentage pebbles, gravel, sand and silt (Figure 1.10) for one sampling station.

Impacts involving change over time can be effectively presented using *reverse bar graphs*, where negative responses or reductions in populations are drawn below the axis (Figure 1.11). All bar graphs are easily coloured to distinguish between categories or classes of events.

Line graphs are used to show continuous data such as temperature, pesticide concentration, population numbers and rates, (e.g. respiration rate of soil) over a continuous period of time or space. The line drawn through the points shows the high and low values and, therefore, the trends at a glance and provided clarity is not sacrificed, several curves can be drawn on one graph to provide comparative figures, so the untreated, sprayed, and rainfall data can be juxtaposed to illustrate an argument (Figure 1.12; Figures 1.26–1.33 from Worked Example, pages 46–51). When the relationships between measurements or variables are to be shown, a *scattergraph* is a useful tool (Figure 1.13). The x-axis is used to plot the independent variable (e.g. DDT concentration) and the y-axis the dependent variable (e.g. eggshell thickness). A line can be fitted by eye (or regression) to the points and drawn in to show the trend of increasing thinning with pesticide concentration in the egg.

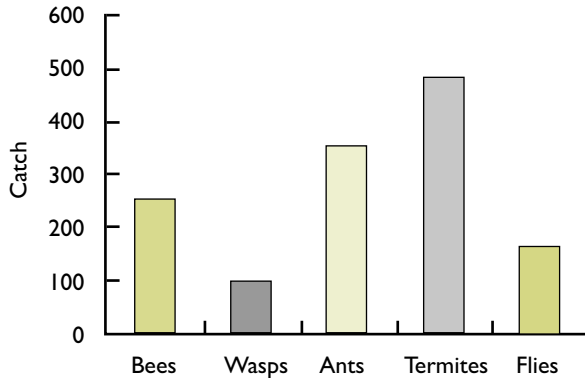

Figure I.7: Bar chart: numbers of insects on sticky traps

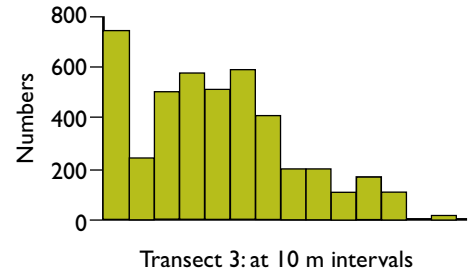

Figure I.8: Histogram: distribution of midges along a transect

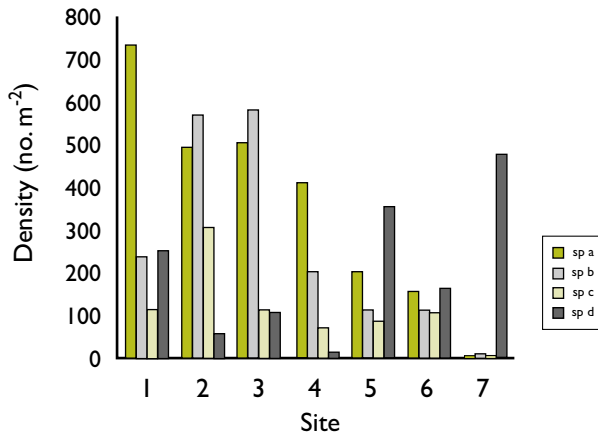

Figure I.9: Multiple bar chart: density of four nocturnal species at seven sites

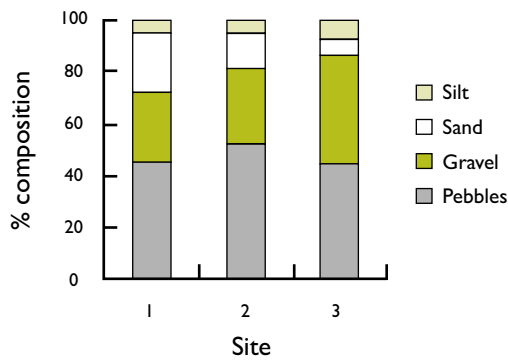

Figure I.10: Composite bar chart: composition of substrates at three sites

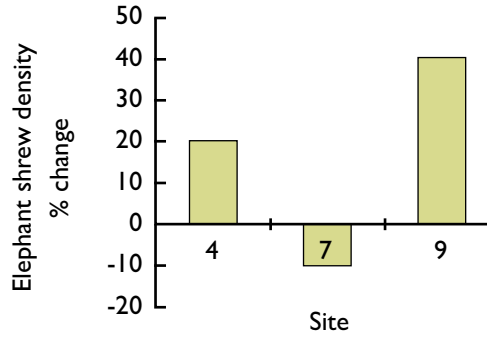

Figure 1.11: Reverse bar graph: change in shrew density

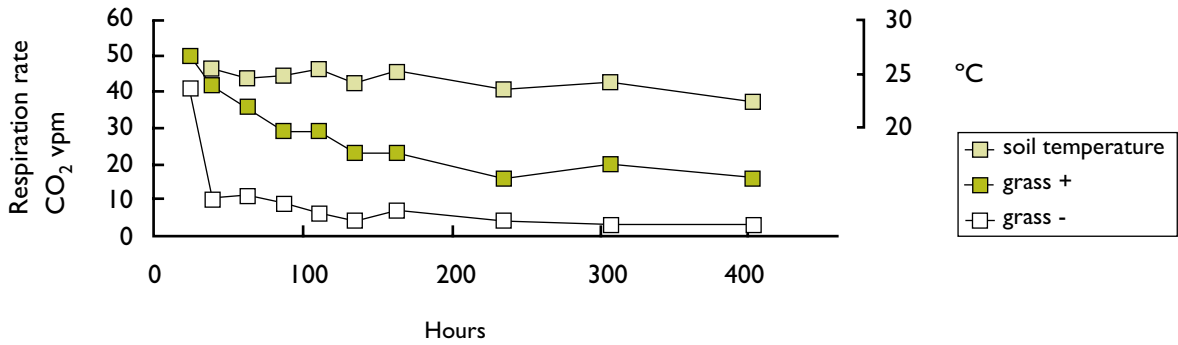

Figure 1.12: Line graph: effect of grass amendments on soil respiration

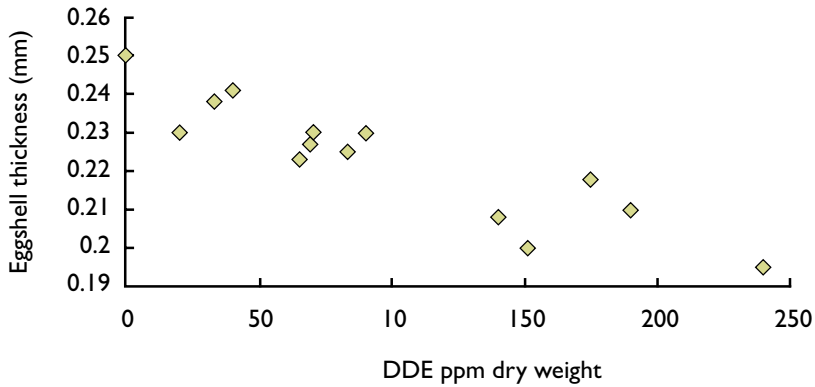

Figure 1.13: Scattergraph: eggshell thickness and DDE residue

A useful way of showing relative percentages or numbers of a small number of groups, such as the numbers of fish by feeding habit, is to express them as a *pie diagram*, where the area of each category is proportional to the number (Figure 1.14). The formula

$$\text{angle} = \frac{\text{number in category}}{\text{total number in sample}} \times 360$$

calculates the angle at which each category needs to be drawn. It is also possible to draw the circle so that its area is proportional to the total number of individuals, in which case the radius is calculated from:

$$r \text{ (radius in cm)} = \sqrt{\frac{\text{total number of individuals}}{3.142}}$$

having selected an appropriate scale such as 1 cm² = 100 individuals. In this way pie diagrams representing different months or sites can be seen to increase in size if the numbers increase. Biomass can be expressed in the same way. Use of a computer package including a chart programme (such as Microsoft Excel) is recommended to generate pie diagrams.

A *kite diagram* is a frequency polygon plotted as a mirror image of itself and where abundance is proportional to the vertical distance between the two lines. It is a good way of showing the results of transect data where the horizontal axis represents distance and the vertical axis the number of species. Other relevant information can also be superimposed, such as the moisture graph in Figure 1.15.

For pesticide impact work, kite diagrams can demonstrate change in species abundance across space (distances) or time (e.g. months). The first step is to prepare a table, e.g. of taxa against distance in metres, filling in the fields with the numbers of each taxa (Table 1.6).

The y-axis of the kite (**Note:** no illustration given for this example), representing species numbers, is placed perpendicularly and to the left of the x-axis, which represents distance and joins the y-axis at zero. One kite is prepared per species. For each species at each distance (sampling point), two dots are drawn above and below the x-axis (and equidistant from the axis). When all the data are plotted, the dots are joined up to form the kite.

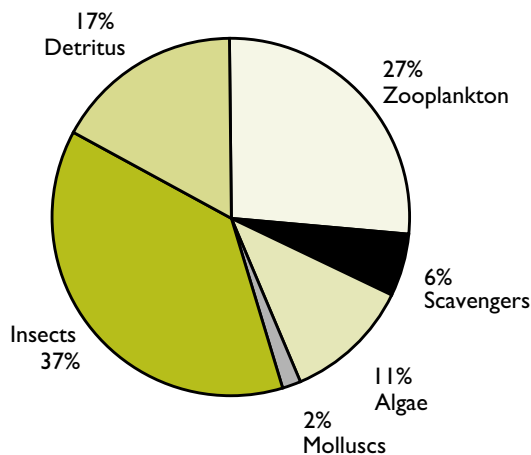

Figure 1.14: Pie diagram: feeding habits of fish at site 3

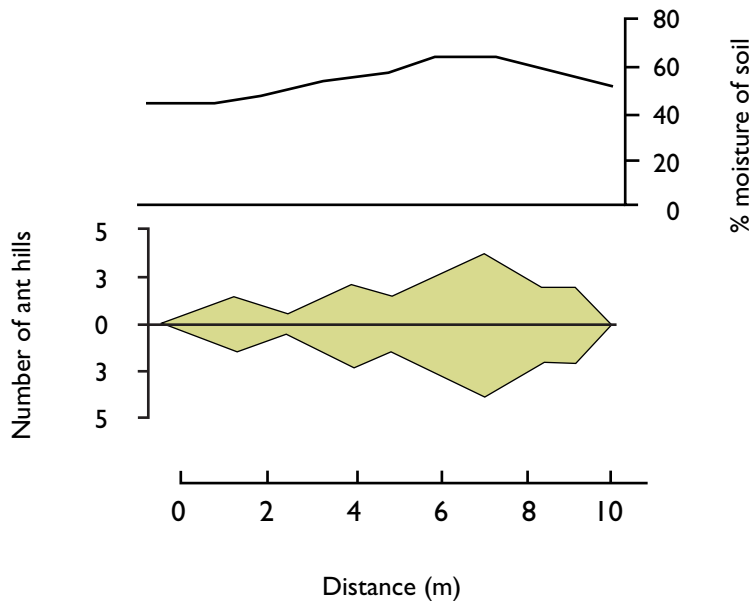

Figure 1.15: Kite diagram of the abundance of ant hills along a transect

Table 1.6 Taxa against distance (m)

Taxon	10	20	30	40	50	60	70
sp. a	734	494	512	415	203	160	2
sp. b	239	573	580	199	110	112	11
sp. c	110	308	113	70	90	109	5
sp. d	254	54	107	16	357	165	482

Additional information such as soil moisture can also be plotted, especially where the distribution or numbers of species is a function of moisture.

A good way of showing orientated data such as the deposition of droplets in relation to wind direction is to use a *radial diagram*. Figure 1.16 uses compass points for direction and thickness of bars attached to the bearings to represent the densities of droplets (could also be species number or diversity) settling out at distances from their source.

There are other types of illustrations that have not been mentioned, including photographic evidence of an impact (post-spray mortalities of fish and birds) that have good visual impact. All graphic illustrations should have a title, a legend if more than one category of information is shown, and axes uncluttered with scale points. If variability of points is indicated, say in the legend or title whether it represents mean \pm standard deviation (SD) or standard error (SE) or 95% confidence limits, etc.

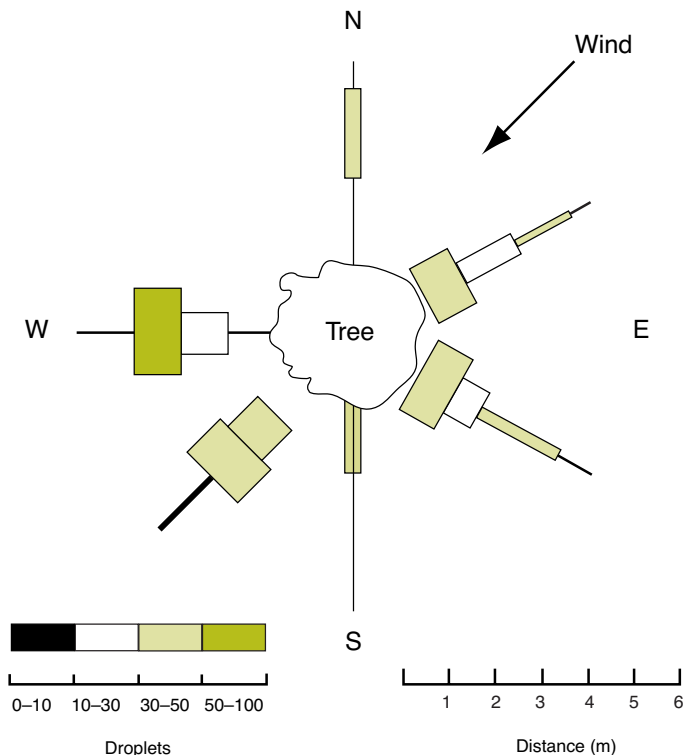

Figure I.16: Radial diagram of droplet deposition around a tree sprayed from the north-west

INTERPRETATION OF RESULTS AND DRAWING OF CONCLUSIONS

The interpretation of the results from field monitoring of pesticide impact on the environment and/or non-target organisms is a complex and skilled business, which benefits from experience. Some aspects have already been considered on pages 17–18. However, consultation with an experienced ecotoxicologist is strongly recommended at this stage. It is impossible to run through the interpretation of all possible results from an ecotoxicological study in the tropics, but a worked example is provided below to highlight the general procedures and illustrate specific instances of result interpretation from specific monitoring outcomes, with reasons for the interpretation. Readers are also referred to the LOCUSTOX study reports (see ‘Further Reading’, page 29) and the interpretations they provide from the data collected.

Determining the acceptability of a particular pesticide impact is also far from simple. This is briefly considered on pages 19–21. Again, expert assistance is recommended for this.

Appropriate conclusions will only be drawn from a study if the results are accurately interpreted within the context of the ecology of the habitat under examination. The worked example illustrates this for the specific case it examines.

REFERENCES

BARRETT, K.L., GRANDY, N., HARRISON, E.G., HASSAN, S. and OOMEN, P. (1994) Guidance document on regulatory testing procedures for pesticides with non-target arthropods. In: *Workshop on European Standard Characteristics of Beneficials Regulatory Testing (ESCORT)*, 28–30 March 1994. Brussels: SETAC-Europe.

DOMSCH, K.H., JAGNOW, G. and ANDERSON, T.-H. (1983) An ecological concept for the assessment of side effects of agrochemicals on soil micro-organisms. *Residue Reviews*, **86**: 65–105.

DOSSOU, N. and MULLIE, W.C. (1998) Individual exposure of pesticide workers to organophosphates in four regions of Senegal (1988–1995). pp. 1–18. In: *Environmental Side-effects of Locust and Grasshopper Control*. Volume 3. LOCUSTOX Project – GCP/SEN/041/NET. Everts, J.W., Mbaye, D., Barry, O. and Mullie, W. (eds). Dakar: Food and Agriculture Organization of the United Nations.

EVERTS, J.W. (1997) Ecotoxicology for risk assessment in arid zones: some key issues. *Archives of Environmental and Contamination Toxicology*, **32**: 1–10.

GRANT, I.F. (1989) Monitoring insecticide side-effects in large-scale treatment programmes: tsetse spraying in Africa. In: *Pesticides and Non-target Invertebrates*. Jepson, P.C. (ed.). Andover, UK: Intercept.

GRANT, I.F. (2001) Insecticides for tsetse and trypanosomiasis control: Is the environmental risk acceptable? *Trends in Parasitology*, **17** (1): 10–14.

GREIG-SMITH, P.W. (1992) The acceptability of pesticide effects on non-target arthropods. pp. 121–132. In: *Interpretation of Pesticide Effects on Beneficial Arthropods. Aspects of Applied Biology 31*. Brown, R.A., Jepson, P.C. and Sotherton, N.W. (eds). Wellesbourne, UK: Association of Applied Biologists, Horticultural Research International.

HEIMBACH, U., ABEL, C., SIEBERS, J. and WEHLING, A. (1992) Influence of different soils on the effects of pesticides on carabids and spiders. pp. 49–59. In: *Interpretation of Pesticide Effects on Beneficial Arthropods. Aspects of Applied Biology 31*. Brown, R.A., Jepson, P.C. and Sotherton, N.W. (eds). Wellesbourne, UK: Association of Applied Biologists, Horticultural Research International.

LYNCH, M.R. (ed.) (1995) *Procedures for Assessing the Environmental Fate and Ecotoxicity of Pesticides*. Brussels: SETAC-Europe.

MULLIE, W.C., ANDREASEN, J., ABIOLA, F.A., DIATTA, F. and VAN DER VALK, H. (1998) Blood cholinesterase levels in crop protection workers after routine spraying operations with organophosphate insecticides in Senegal. pp. 170–189. In: *Environmental Side-effects of Locust and Grasshopper Control*. Volume 2. LOCUSTOX Project – GCP/SEN/041/NET. Everts, J.W., Mbaye, D., Barry, O. and Mullie, W. (eds). Dakar: Food and Agriculture Organization of the United Nations.

ROYAL SOCIETY (1997) *Science, Policy and Risk*. A discussion meeting held at the Royal Society, 18 March 1997. *Science in Society Series*. London: Royal Society.

TINGLE, C.C.D. (1996) Sprayed barriers of diflubenzuron for control of the migratory locust (*Locusta migratoria capito* (Sauss)). [Orthoptera: Acrididae] in Madagascar: short-term impact on relative abundance of terrestrial non-target invertebrates. *Crop Protection*, **15** (6): 579–592.

UNCED (1992). *Agenda 21*. New York: United Nations General Assembly.

VAN DER VALK, H., EVERTS, J.W. (2003) *Safety and Environmental Precautions*. Desert Locust Guidelines 6: First edition. Food and Agriculture Organization of the United Nations, Rome.
http://www.fao.org/ag/locusts/common/ecg/347_en_DLG6e.pdf

FURTHER READING

DOUTHWAITE, R.J. and TINGLE C.C.D. (eds) 1994. *DDT in the Tropics. The Impacts on Wildlife in Zimbabwe of Ground-spraying for Tsetse Fly Control*. Chatham, UK: Natural Resources Institute.

EVERTS, J.W. and BA, L. (eds) (1997) *Environmental Side-effects of Locust and Grasshopper Control*. Volume 1. LOCUSTOX Project – GCP/SEN/041/NET. Dakar: Food and Agriculture Organization of the United Nations.

EVERTS, J.W., MBAYE, D., BARRY, O. and MULLIE, W. (eds) (1998a) *Environmental Side-effects of Locust and Grasshopper Control*. Volume 2. LOCUSTOX Project – GCP/SEN/041/NET. Dakar: Food and Agriculture Organization of the United Nations.

EVERTS, J.W., MBAYE, D., BARRY, O. and MULLIE, W. (eds) (1998b) *Environmental Side-effects of Locust and Grasshopper Control*. Volume 3. LOCUSTOX Project – GCP/SEN/041/NET. Dakar: Food and Agriculture Organization of the United Nations.

MARONI, M and FAIT, A. (1993) Health effects in man from long-term exposure to pesticides. A review of the 1975–1991 literature. *Toxicology*, **78**:1–100.

VISENTIN, S. and FAIT, A. (2002) The IPCS/WHO project on the epidemiological surveillance of acute pesticide poisonings. *Pesticide Safety News*, **5** (3): 1.

USEPA (1992) Framework for Ecological Risk Assessment. EPA/630/R-92/001. Washington DC: USEPA. (unpublished)

Websites on pesticides and human health

www.epa.gov/ebtpages/humanhealth.html

www.epa.gov/pesticides

www.who.int/ctd/whopes/index.html

www.intox.org

WORKED EXAMPLE

EFFECTS OF LOCUST CONTROL OPERATIONS USING BARRIER-SPRAYED IGRS ON NON-TARGET TERRESTRIAL INVERTEBRATES IN MADAGASCAR

This example describes ecotoxicological monitoring of operational scale field trials using the insect growth regulator (IGR) diflubenzuron, which was barrier-sprayed for locust control in south-western Madagascar. The case study is more complex than a standard ‘sprayed versus unsprayed’ comparison. However, spray monitoring will rarely be ‘standard’ and this case study will be described step by step, with the aim of illustrating some of the problems that will have to be faced when carrying out any ecotoxicological monitoring programme. The steps used are those as shown in Figure 1.1. The desk study, planning and design phases of the project will only be given in brief, but emphasizing the points which needed to be taken into account in deciding what to monitor and how.

Barrier spraying is a technique that uses persistent, stomach-acting insecticides applied in swaths between 50 m and 150 m wide, termed barriers. Unsprayed areas between 300 m and 2000 m wide, termed inter-barrier spaces, are then left between spray barriers. The technique is very effective for controlling immature stages of locusts, known as hoppers. The hoppers walk through one or more spray barriers and eat enough insecticide-treated vegetation to kill them. However, as only about 10% or less of a sprayed area actually receives insecticide, the technique is (theoretically at least) relatively environmentally friendly. In order to test this, an assessment was made of the impact on the relative abundance of a variety of non-target terrestrial invertebrates of barriers approximately 50 m wide, spaced at 500–600 m. Sampling began before spraying and continued immediately following spraying and the extent and duration of any impacts detected within the year of spraying were evaluated. For full details see Tingle (1996).

Observation

Operational scale field trials are planned to test the efficacy of barrier-sprayed IGRs for control of locusts. The trials take place in south-western Madagascar. See below for details of application rates, dose, etc.

Problem

Will the IGRs adversely affect wildlife in the savanna grasslands that will be treated, despite the fact that barrier spraying is specifically designed to minimize environmental impact? Will the insecticide affect ecological processes and functioning within the treated savanna and thus undermine sustainable use of the grasslands?

Considerations relating to pesticide deposition and contamination from the operation are discussed below under ‘Fieldwork Treatment’ (page 33) and ‘Overall Conclusions’ (page 52).

Desk assessment – risk

A desk assessment was carried out to look at the risks to the environment and wildlife. For this particular project, the desk assessment took the form of an environmental impact assessment (EIA) and was fairly comprehensive and thorough. Key factors arising from the desk study were as follows.

- Madagascar is an island of global importance for biodiversity. There is a high degree of endemism within the fauna and the island’s wildlife thus has high conservation value on a global level. Relatively little is known about the fauna and ecology of the savanna grasslands of south-western Madagascar.
- The main faunal group at risk appeared to be terrestrial invertebrates. The main group at risk within the terrestrial invertebrates is the mandibulate herbivores.

- Diflubenzuron is a benzoyl urea IGR, which acts by inhibiting chitin synthesis. This mode of action means that the primary risk is to immature invertebrates, whose moulting processes are disrupted by the insecticide. There is also evidence that this IGR can affect egg viability within adult female insects. Both these factors tend to lead to delayed effects at a population level.
- A sampling method was required which could collect data on a wide range of terrestrial invertebrates, but particularly those most at risk from ULV ground-sprayed IGR. Ultra-low-volume application generally leads to contamination of vegetation, thus sweep netting was selected as a sampling method that collects a wide range of vegetation-dwelling and visiting invertebrates.

Hypothesis

The barrier-sprayed IGR will reduce the relative abundance (and thus population) of mandibulate herbivores within the grassland, both within and between the spray barriers. The resulting null hypothesis is thus that *barrier-sprayed diflubenzuron will not affect the relative abundance of vegetation-dwelling invertebrates*.

Fieldwork – programme design

A quantitative study was required to examine the relative abundance of vegetation-dwelling and visiting terrestrial invertebrates using sweep net sampling. Most of the factors taken into account in the design are mentioned below, where the study sites are described, sampling method outlined, etc. The programme was originally designed to monitor ground-sprayed barriers at Beamalo (see below). Because of the need for the trial to be conducted on particular nymphal stages of the locust (as a requirement of the efficacy studies), time was very constrained and only one pre-spray sample could be taken (which is far less than recommended for this type of study, see page 15). However, the success of the first trial in controlling locust hopper bands led to the requirement for a still larger field trial the following year. Due to indications of adverse effects of the IGR on some non-target invertebrates from the first year's ecotoxicological monitoring (see below), it was decided that the second year's trial required further non-target monitoring studies to accompany the efficacy trials. Thus, two study sites were used in consecutive years. However, spray dates were very different (**not** something which would generally be recommended for a comparative study, but which was, in this case study, unavoidable for logistical and financial reasons).

Fieldwork – study sites

Two sites were used for non-target impact studies (Figure 1.17), both containing matched sprayed and unsprayed areas. The first was just outside the village of Beamalo near Bekily (24°08'S; 44°15'E) about 200 km south-east of Tulear. The habitat is savanna grassland comprising a mixture of grass species (including *Cynodon dactylon*, *Eragrostis ?pyramidalis*, *Enneapogon cenchroides*, *Aristida ?mahafalaiensis*, *Heteropogon contortus*, *Panicum pseudovoeltzkowii*, *Digitaria* sp., *Loudetia* sp. and *Hyparrhenia* sp). The area is dotted with trees, principally *Poupartia caffra* [Anacardiaceae] and *Maytenus (Gymnosporia) linearis* [Celastraceae] and bushes (*Flacourtia ramontchi* [Flacourtiaceae], and *Acacia* spp. [Leguminosae]). Crops were grown on small plots scattered over the study area, mainly comprising maize, cassava, groundnut, beans, sweet potato and melon.

The second site was near the village of Andranovorindrengataka in the vicinity of Antanimieva, approximately 100 km north of Tulear. The habitat is also savanna grassland, dominated by the grasses *Heteropogon contortus* and *Hyparrhenia rufa*. The area is sparsely dotted with trees and bushes, the most common species being *Poupartia caffra*, *Tamarindus indica* [Leguminosae], *Stereospermum variabile* [Bignoniaceae] and *Ziziphus jujuba* [Rhamnaceae]. The vegetation was reasonably homogeneous and cover was generally fairly dense, although it did vary between 10% and 100%. The height of the vegetation also varied widely, between 10 cm and 230 cm, but where *H. contortus* dominated (the greatest part of the area), it was mainly between 60 cm and 80 cm. Some

¹ A ? before a species name indicates that this species could not be identified with certainty.

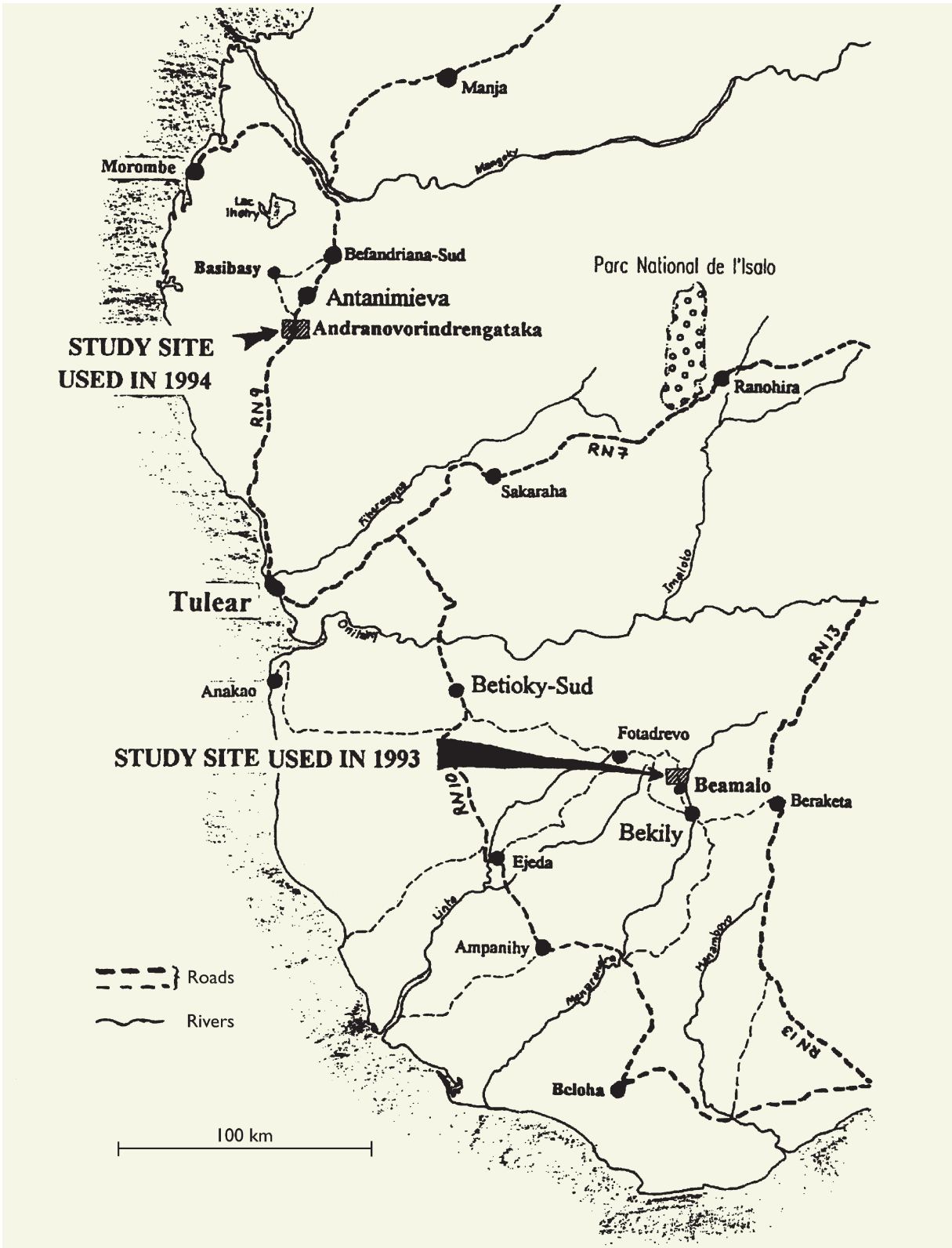

Figure I.17: Location of study sites in south-western Madagascar

crops were also grown in relatively small plots scattered over the whole area. Cotton, maize, cassava and groundnut were the most frequently grown crops.

Fieldwork – treatment

Both study sites were explored to identify relatively homogeneous areas that were large enough to establish an unsprayed site and match it with a similar area that would be sprayed with the IGR. At both Beamalo and Antanimieva, an unsprayed ‘U’ and a sprayed ‘S’ area were marked out and the vegetation characterized (see above). There was a buffer zone approximately 1 km wide between the unsprayed and ‘sprayed’ areas at Beamalo, whilst at Antanimieva the buffer zone was approximately 500 m at its narrowest point, increasing to over 1 km at its widest (Figure I.18). The ‘sprayed’ parts of the two study areas were sprayed in the same way, but with

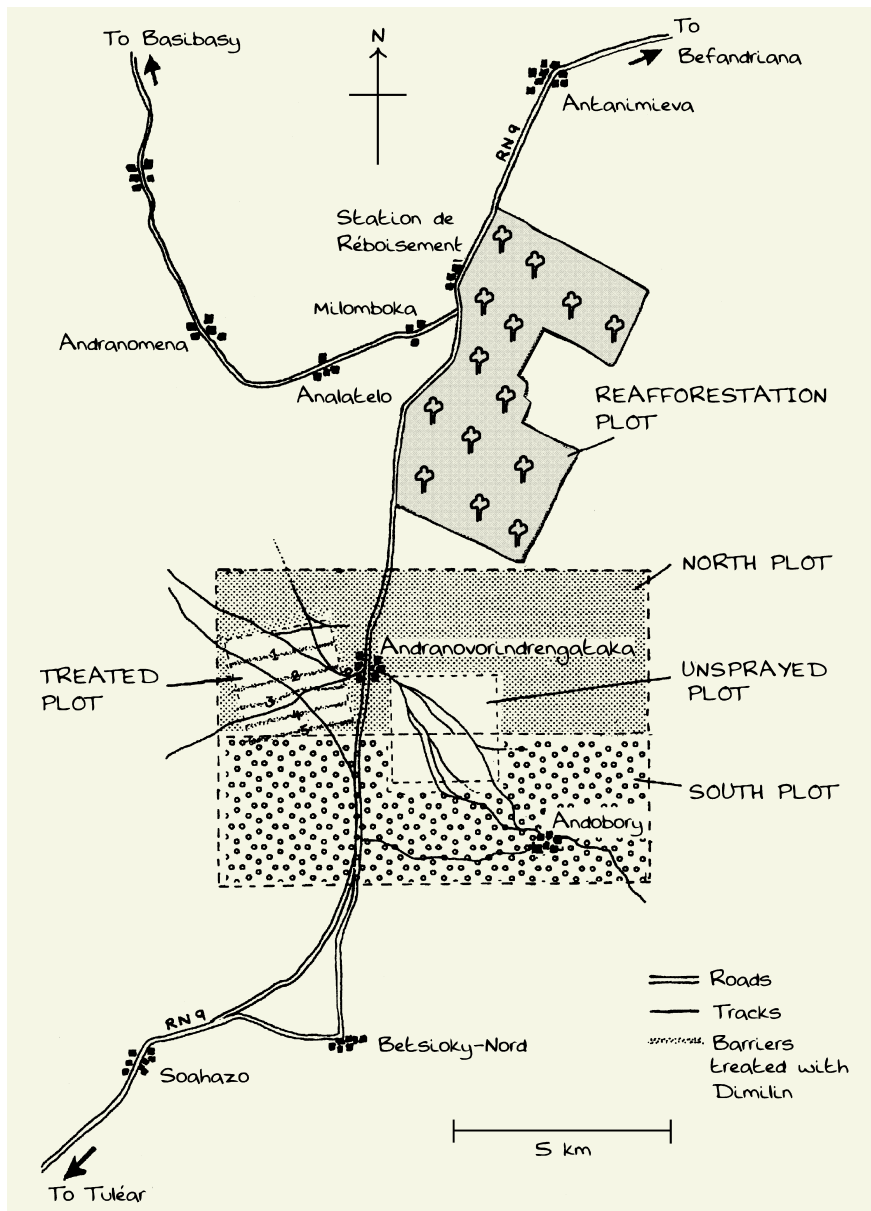

Figure I.18: Sketch map of Antanimieva study site

slight differences in barrier spacing and number. In both cases, diflubenzuron, supplied as a 45% oil-based formulation (Dimilin ODC 45), was diluted in diesel (ratio 1:3, Dimilin:diesel) and sprayed at a dosage of approximately 93 g a.i. ha⁻¹ using hand-held Micro-Ulva, spinning disc sprayers. The disc rotational speed was 8500–10,000 rpm with a nominal flow rate of 75 ml min⁻¹ and the nominal walking speed of the spray team was 1.25 m s⁻¹.

The spraying carried out at Beamalo covered approximately 20 km². Eight barriers were sprayed, each nominally 50 m wide and spaced at approximately 600 m. The actual volume applied was 833 ml ha⁻¹ within the barriers, which gave an overall dosage for the sprayed area of approximately 7.8 g a.i. ha⁻¹. Spraying was carried out over 3 days between 14 and 16 February 1993.

The spraying at Antanimieva covered approximately 5 km², with five barriers each nominally 50 m wide separated by 500 m wide inter-barrier spaces. The actual dose within the barriers was 90 g a.i. ha⁻¹ (approximately), giving an overall dose for the 'sprayed' area of 9 g a.i. ha⁻¹. Spraying was carried out on 26 April 1994.

No sampling for residue analysis was carried out during this study, because of logistical and budgetary constraints. However, spray deposition and distribution was measured during the spray operation at Antanimieva using a combination of oil-sensitive papers and magnesium oxide slides. A summary of the data is shown in Figure 1.19. This clearly shows that most pesticide droplets fall within the barrier, but although droplet number and volume decline rapidly downwind of the barrier some contamination of the inter-barrier space (particularly the first 50 m) does occur.

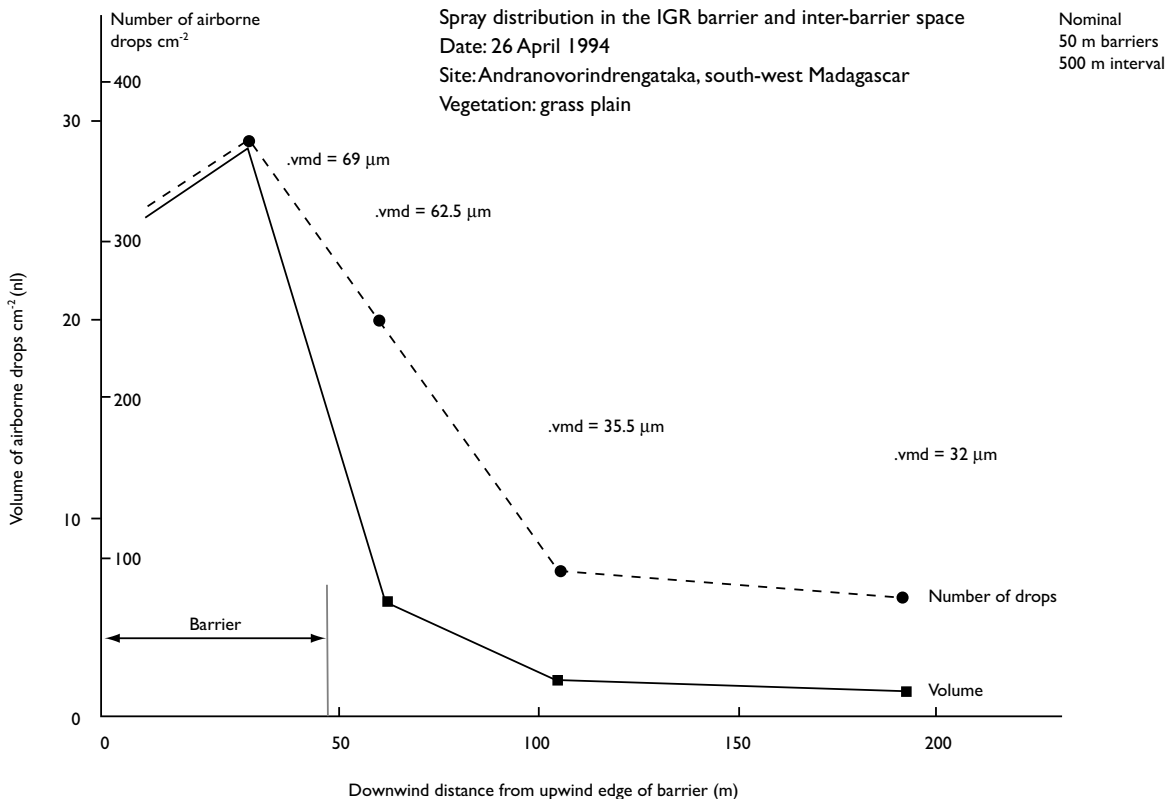

Figure 1.19: Spray distribution recorded from magnesium oxide slides and oil-sensitive papers at the Antanimieva study site in 1994

Fieldwork – sampling method

As the desk study showed that mandibulate herbivores were at the highest risk from IGR barrier spraying, a variety of sampling and monitoring methods were used to sample these invertebrates. Financial, vehicle and personnel constraints limited how much could be done, but sweep netting, Malaise trapping, butterfly transects and yellow water traps were all tried. The latter method was dropped, as catches in the grassland habitat were low. The number of traps available (only two) limited Malaise trapping. This method gave some interesting qualitative data on flying insects, but personnel constraints meant that there was limited time for sorting catches. Only the results from sweep netting are considered further here, as this method gave valuable, quantitative data on a wide range of fauna.

Sweep netting was used to sample the invertebrate fauna inhabiting or visiting the ground-cover vegetation, i.e. the fauna most directly at risk from barrier spraying. The technique used was identical in both years, to allow direct comparison of results. Two samplers paced out a transect of 50 m, in opposite directions, from a single starting point. Both then took three paces to the right (to avoid the area already disturbed), before walking back to the starting point at a slow, steady pace, sweeping a butterfly net (Watkins and Doncaster® standard kite net) from side to side through the vegetation as they went (see chapter 8 and method sheet on sweep netting). The catch was then emptied from the net (see below). Only the central part of each area was used, a 300 m wide band was left as a buffer zone around the edge of the two plots. All sweep netting was carried out between 08.00 h and 12.30 h.

The sample site was selected by randomization before going out to the field, as follows. A random number generator on an electronic calculator generated numbers which were used to define the coordinates of each sampling point. The first number gave the distance to be travelled into the unsprayed area from the most north-easterly point in a westerly direction. The second number gave the distance to be travelled from that point southwards into the plot. This was done repeatedly to select the number of sampling points required. To select sampling points in the barrier-sprayed area, the barrier or inter-barrier space to be sampled was determined by pulling a number from a bag or bowl (the correct number of labelled strips of paper were marked up, put into the bag or bowl, shaken and then selected at random by feel). The distance along the barrier (or at the appropriate distance from the barrier within the inter-barrier space) was then determined using a random number generator on an electronic calculator. **Note:** Sampling in the inter-barrier spaces was **only** carried out on the downwind side of the barrier and the distance from the barrier was measured from the downwind side. This is because pesticide contamination into the inter-barrier space would only occur where droplets of the IGR drifted downwind.

The study period was limited by logistical constraints. In 1993, the budget only allowed for a 6-week visit to Madagascar for one ecotoxicologist. This is generally an unacceptably short period for an ecotoxicological study (see page 15), particularly as study site selection also had to be fitted within this period. As a result, pre-spray data was extremely limited at this site. However, a local postgraduate was trained by the ecotoxicologist during his visit and was able to extend post-spray data collection to 2 months.

At Beamalo, sampling started the day before spraying. Sweep net transects were sampled at seven sites in the area to be sprayed (hereafter called 'sprayed' area) and five in the unsprayed area. The first five samples were carried out in the 'sprayed' plot, followed by all the samples from the unsprayed plot, finishing with the final two samples in the 'sprayed' plot. Sample sites were selected at random (see above). Following spraying, sampling in the unsprayed area was exactly as before, but in the sprayed area, samples were only taken within spray barriers. The barrier and position of sampling site within it were selected at random. Sampling continued for 2 months after spraying.

In 1994, a longer-term study was instigated with an acceptable pre-spray monitoring period. Other logistical and financial constraints still limited the sampling programme. Staff trained in 1993 were unavailable for work in 1994;

thus further staff had to be trained to carry out the monitoring and sampling programme. Three full-time staff were employed in sweep net sampling and sample processing, and butterfly transect counts. Only sweep netting is considered further here (see above).

At Antanimieva, sampling started 6 weeks before spraying within the north and south plots on the 16 March 1994 and moved to the smaller 'sprayed' and unsprayed plots 6 days before spraying (Figure 1.18).² Two pre-spray samples were taken within these smaller plots. In all cases, the first three samples were taken within the unsprayed plot, followed by all those within the 'sprayed' plot and finishing with the final two samples from the unsprayed plot. Before spraying, all sample sites were selected at random. Following spraying, the same sampling programme was maintained within the unsprayed plot, but within the sprayed plot, transects were swept at five sites within the middle of the spray barriers (barriers 2–4 only), whilst transects were swept at three sites 150 m from the barrier and at three sites within the middle of the inter-barrier spaces (i.e. 250 m from the barriers). Only inter-barrier spaces 1, 2 and 3 were used. Barriers, inter-barrier spaces and position of sampling site within these were selected at random. The first post-spray sample was taken 7 days after spraying and sampling continued at approximately weekly intervals until 20 June and thereafter at approximately 2-weekly intervals until 27 July 1994.

Sample processing

The net containing the catch was placed in a plastic bag and the fauna caught was 'knocked-down' with a short blast of pyrethroid insecticide from a standard, household insecticide aerosol (CO₂ propelled). The catch was then transferred to a plastic bag marked with the details of time, place and sampler. Samples were then returned to the laboratory. Samples were emptied into large, white plastic trays and all invertebrates sorted from debris (vegetation, etc.). All invertebrates were transferred into Petri dishes of 70% alcohol and examined under a binocular microscope. All fauna were sorted and counted. Where possible, taxa were sorted to species or morphospecies (i.e. genus or family plus a letter or number). All invertebrates were identified at least to order. A reference collection was established to aid sorting and identification and to ensure that 'morphospecies' were given the correct number or letter on each occasion and that no confusion could arise. Over 400 species of invertebrates were collected.

Data from each sample were recorded on a sheet of paper marked with the sample number and sample date, as the sample was processed. A list of taxa was compiled down one side and the numbers of each taxon caught written against this list (Figure 1.20).

Data storage and processing

All data were stored on Excel spreadsheets (although any suitable spreadsheet programme can be used). Initially, workbooks were compiled for each sample date, with separate sheets kept for the different treatment areas. Data for each 50 m transect, i.e. samples a and b were then pooled (see example sheet in Figure 1.21).

A new spreadsheet was then compiled containing the means for each taxon from the above spreadsheets, with taxon written down the first column and the means for each treatment area and for each sample date written in rows (Figure 1.22).

A third series of spreadsheets was created to export the data into a statistical analysis package in order to carry out an Analysis of Variance (ANOVA) – see chapter 2 on statistics. The example given is for export into Genstat (Figure 1.23). Different statistical packages require the data to be provided in different formats, so it is important

²This was done because originally the spray trial was to have been conducted from the air. However, due to perceived lack of adequate density of the appropriate stage of locust nymphs, the scale of the trial was reduced considerably just before spraying – hence the final study plots were considerably smaller than the original north and south plots. Had plans not been changed, the entire south plot would have been barrier-sprayed with diflubenzuron from the air.

ANTANIMIEVA 08/07/94
WI (150) 2a¹

<u>ARANEAE</u>	♂ ²	♀ ²	J ²
Tibellus 1	---	---	1
Hyponingia A	---	---	1
Araneidae	---	---	1
<u>PSOCOPTERA</u>	---	---	IIII J IIII
<u>ORTHOPTERA</u>	Larvae	Adults	
Gryllidae A	IIII		
Calectonepsus decisa	---	---	II
<u>HOMOPTERA</u>			
Cicadellidae 13	---	---	1
Membridae A	---	---	1
<u>HETEROPTERA</u>			
Reduviidae A	---	---	III
Lyphidostominae	---	---	1
<u>THYSANOPTERA</u>			1
<u>DIPTERA</u>			
Pipunculidae	---	---	II
Cyeborhapha	---	---	1
Nematocera	---	---	1
<u>LEPIDOPTERA</u>			
Larvae	---	---	1
Papillon de nuit	---	---	1
<u>HYMENOPTERA</u>			
Israconidae A	---	---	1
Ycolidea	---	---	1

¹Sample from sweep net transect 2a taken 150 m into interbarrier space on 8 July 1994

²♂ = male; ♀ = female; J = juvenile.

Figure 1.20: Example of data recording as sample processed

ANTANIMIEVA 08/07/94
WI (150) 2b¹

<u>ARANEAE</u>	σ^2	η^2	J^2
Hyposinga 5	—	—	—
Hyposinga indet	—	—	—
Psecitia sp	—	—	—
Hyposinga 1	—	—	—
Araneae. indet	—	—	—
<u>PSOCOPTERA</u> — — — — — 1			
<u>ORTHOPTERA</u>			
	Larvae	Adults	
Gryllidae A	— — — — — IIII	— — — — —	— — — — — 1
<u>HETEROPTERA</u>			
Reduviidae A	— — — — —	— — — — —	— — — — — II
<u>HYMENOPTERA</u>			
Geolidae	— — — — —	— — — — —	— — — — — 1

¹Sample from sweep net transect 2b taken 150 m into interbarrier space on 8 July 1994

² σ = male; η = female; J = juvenile.

Figure 1.20: cont.

to check the form in which the package you use needs the data input. Once you have learnt this, prepare the data for export in the appropriate format.

From the spreadsheet in Figure 1.22, the data were compiled into a form to create graphs for individual taxa of mean number against time (Figure 1.24). Graphs were then plotted as Excel charts from these spreadsheets (see Figures 1.26–1.33).

Data analysis

Statistical analysis was only carried out on those invertebrates which occurred in sufficient numbers to warrant it (i.e. means of >10 per site). The numbers of individuals of each taxon caught in the two samples taken at each sampling site were pooled to avoid any influence of sampler bias on analysis. Data were then subjected to two forms of ANOVA, using pooled samples as pseudoreplicates (see chapter 2). There were no true replicates, as

Sweep net transects Antanimieva 8.7.94 Interbarrier space 150 m from barrier										
	WI(150)1a	WI(150)1b	WI(150)2a	WI(150)2b	WI(150)3a	WI(150)3b	Total	Mean	S.D.	S.E.
Araneae	1	1	3	5	0	2	12	2	1.79	0.73
male spiders	0	0	1	0	0	1	2	0.33	0.52	0.21
female spiders	0	0	0	0	0	0	0	0	0	0
spiderlings	1	1	2	0	0	1	5	0.83	0.75	0.31
Araneidae	0	0	2	0	0	1	3	0.5	0.84	0.34
A	0	0	0	0	0	0	0	0	0	0
Araneidae A male	0	0	0	0	0	0	0	0	0	0
Araneidae A female	0	0	0	0	0	0	0	0	0	0
Araneidae A juvenile	0	0	0	0	0	0	0	0	0	0
B	0	0	0	0	0	0	0	0	0	0
Araneidae B male	0	0	0	0	0	0	0	0	0	0
Araneidae B female	0	0	0	0	0	0	0	0	0	0
Araneidae B juvenile	0	0	0	0	0	0	0	0	0	0
C	0	0	0	0	0	0	0	0	0	0
Araneidae C male	0	0	0	0	0	0	0	0	0	0
Araneidae C female	0	0	0	0	0	0	0	0	0	0
Araneidae C juvenile	0	0	0	0	0	0	0	0	0	0
Araneus sp.1	0	0	0	0	0	0	0	0	0	0
Araneus sp.2	0	0	0	0	0	0	0	0	0	0
Hyposinga sp.1	0	0	1	1	0	0	2	0.33	0.52	0.21
Hyposinga sp.1 male	0	0	0	0	0	0	0	0	0	0
Hyposinga sp.1 female	0	0	0	1	0	0	1	0.17	0.41	0.17
Hyposinga sp.1 juv.	0	0	1	0	0	0	1	0.17	0.41	0.17
Hyposinga sp.2	0	0	0	0	0	0	0	0	0	0
Hyposinga sp.3	0	0	0	0	0	0	0	0	0	0
Hyposinga sp.3 male	0	0	0	0	0	0	0	0	0	0
Hyposinga sp.3 female	0	0	0	0	0	0	0	0	0	0
Hyposinga sp.3 juv.	0	0	0	0	0	0	0	0	0	0
Hyposinga sp.4	0	0	0	0	0	0	0	0	0	0
Hyposinga sp.5	0	0	0	1	0	1	2	0.33	0.52	0.21
Hyposinga sp.5 male	0	0	0	0	0	0	0	0	0	0
Hyposinga sp.5 female	0	0	0	0	0	0	0	0	0	0
Hyposinga sp.5 juv.	0	0	0	1	0	1	2	0.33	0.52	0.21
Argiopidae	0	0	0	0	0	0	0	0	0	0
Argiope sp.	0	0	0	0	0	0	0	0	0	0
Oxyopidae	0	0	0	1	0	0	1	0.17	0.41	0.17
A	0	0	0	0	0	0	0	0	0	0
B	0	0	0	0	0	0	0	0	0	0
Peucetia sp.1	0	0	0	1	0	0	1	0.17	0.41	0.17
Thomisidae	0	1	0	0	0	0	1	0.17	0.41	0.17
Thomisus sp.1	0	0	0	0	0	0	0	0	0	0
Thomisus sp.2	0	0	0	0	0	0	0	0	0	0
Philodromidae	0	0	1	0	0	0	1	0.17	0.41	0.17
Tibellus sp.1	0	0	1	0	0	0	1	0.17	0.41	0.17
Tibellus sp.1 male	0	0	1	0	0	0	1	0.17	0.41	0.17
Tibellus sp.1 female	0	0	0	0	0	0	0	0	0	0
Tibellus sp.1 juv.	0	0	0	0	0	0	0	0	0	0

Figure 1.21: Section of spreadsheet showing raw data, totals, means and standard errors for samples from one treatment area on one sample date

Results from sweep net samples, Antanimieva 1994 - Numbers caught of selected species							
Sample date and site	8.7.94 U	8.7.94 150	8.7.94 250	8.7.94 S	27.7.94 U	27.7.94 150	27.7.94 250
	Geo. mean	Geo. Mean	Geo. mean	Geo. mean	Geo. mean	Geo.mean	Geo. mean
Araneae	4.14	3.33	3.33	2.89	8.44	8.86	3.38
Araneae juvenile	1.40	1.62	2.78	1.76		3.82	0.82
Araneidae	0.78	0.82	0.71	0.52	2.29	2.30	0.59
<i>Hyposinga</i> sp. indet. (1+2)	0.64	1.00	0.44	0.32	1.00	1.29	0.00
Araneidae indet. (Hyp.2+4)	0.00	0.00	0.00	0.00	0.32		
Oxyopidae	0.52	0.26	0.26	0.15	0.52	0.00	0.00
<i>Oxyopes</i> sp.1(A+B)	0.32	0.00	0.00	0.00	0.25	0.00	0.00
<i>Peucetia</i> sp.1	0.15	0.26	0.26	0.15	0.00	0.00	0.00
Thomisidae	0.15	0.26	0.26	0.00	0.15	0.26	0.26
Salticidae	1.94	0.59	0.59	1.00	3.64	2.63	1.52
Salticidae sp. indet. (A+B)	1.64	0.59	0.00	1.00	3.13	2.00	1.52
<i>Heliophanus hamifer</i> (inc.)	0.43	0.00	0.00	0.00	0.32	0.59	0.00
Clubionidae indet.	0.00	0.00	0.00	0.15	0.00	0.26	0.00
Theridiidae	0.00	0.00	0.00	0.00	0.32	0.59	0.59
Isoptera	0.15	0.44	0.00	0.00	0.00	0.26	0.00
Gryllidae	8.15	9.91	10.04	4.55	7.50	7.32	11.49
<i>Oecanthus</i> sp. (A)	8.15	9.91	10.04	4.55	7.34	7.32	11.49
Tettigoniidae	0.15	0.00	1.29	0.00	0.00	0.26	1.29
Tetrigidae	0.00	0.00	0.00	0.00	0.00	0.00	0.00
Acrididae	1.35	2.17	2.00	2.68	1.49	10.27	3.31
Non-target grasshoppers	1.17	1.52	1.62	2.73	1.30	9.46	2.42
<i>Leptacris hova</i>	0.32	0.00	0.00	0.00	0.52	0.26	0.00
<i>Gelastorhinus edax</i> (inc. A)	0.15	0.00	0.00	0.00	0.00	0.00	0.00
<i>Acrida madecassa</i> (inc. A)	0.15	0.00	0.00	0.00	0.15	0.26	0.00
<i>Locusta migratoria</i>	0.00	0.26	0.26	0.25	0.00	0.26	0.00
<i>Oedaleus virgula</i>	0.00	0.00	0.00	0.00	0.00	0.00	0.00
<i>Acorypha decisa</i>	0.15	1.52	1.62	2.52	0.64	8.50	2.42
Psocoptera	10.27	25.25	29.76	28.18	8.32	8.44	14.98
Heteroptera	1.17	3.79	3.16	0.74	0.64	0.82	1.29
?nymph indet.	0.52	0.26	0.26	0.25	0.00	0.26	0.59
Lygaeidae	0.15	0.59	1.76	0.32	0.15	0.00	0.26
<i>Pachygrontha</i> sp. indet. (A)	0.00	0.00	0.00	0.00	0.00	0.00	0.00
<i>Paromius gracilis</i>	0.00	0.00	0.00	0.15	0.00	0.00	0.00
<i>Nysius</i> sp.1	0.00	0.00	0.26	0.15	0.00	0.00	0.00
Berytidae	0.00	0.00	0.00	0.15	0.00	0.00	0.00
<i>Metacanthus</i> sp.1	0.00	0.00	0.00	0.00	0.00	0.00	0.00
Miridae	0.00	0.00	0.00	0.00	0.15	0.44	0.00
<i>Trigonotylus</i> sp. indet. (A)	0.00	0.00	0.00	0.00	0.00	0.00	0.00
<i>Creontiades palidus</i> (C)	0.00	0.00	0.00	0.00	0.00	0.44	0.00
Nabidae	0.00	0.00	0.00	0.00	0.15	0.00	0.00
<i>Tropiconabis capsiformis</i>	0.00	0.00	0.00	0.00	0.15	0.00	0.00
Alydidae	0.00	0.00	0.00	0.00	0.15	0.26	0.00
<i>Tenosius proletarius</i> (Rec)	0.00	2.30	0.00	0.00	0.15	0.26	0.00
Pentatomoidea	0.00	0.26	0.44	0.00	0.00	0.00	0.59
Aphididae	0.32	0.26	0.26	0.43	0.15	0.00	0.00
Cicadellidae	1.79	1.29	6.66	4.59	2.10	4.77	3.38

Figure I.22: Section of spreadsheet compiled to show means from different treatment areas and sample dates for each taxon from sheet in Figure I.21

sample	dat ¹	treatment ²	Araneae	Ntgs ³	Locusta	Heterop	Cicadell
1	1	1	17	6	0	10	6
1	1	1	19	10	0	78	20
1	1	1	32	12	0	66	6
1	1	1	53	50	5	86	41
1	1	1	11	32	1	13	91
1	2	2	13	6	0	7	9
1	2	2	3	4	0	33	7
1	2	2	11	9	1	1	11
1	2	2	13	8	0	16	21
1	2	2	15	29	0	51	62
11	1	1	28	1	0	40	10
11	1	1	19	1	0	16	48
11	1	1	24	9	1	33	22
11	1	1	45	19	0	34	36
11	1	1	45	9	3	11	13
11	2	2	6	4	0	9	22
11	2	2	0	0	85	4	1
11	2	2	6	1	0	10	19
11	2	2	32	5	0	227	28
11	2	2	15	6	1	25	11
33	1	1	17	2	0	24	12
33	1	1	20	1	0	62	17
33	1	1	45	16	2	43	35
33	1	1	59	5	0	97	113
33	1	1	53	38	0	45	126
33	2	2	17	3	0	28	25
33	2	2	10	0	2	14	7
33	2	2	16	2	0	18	20
33	2	2	19	6	1	24	12
33	2	2	30	28	0	7	10
52	3	3	30	2	0	63	24
52	3	3	53	5	1	29	21
52	3	3	28	3	2	16	17
52	3	3	29	5	0	45	23
52	5	5	55	12	0	84	26
52	5	5	13	5	0	13	24
52	5	5	126	12	0	249	56
52	6	6	52	1	1	66	38
52	6	6	84	6	0	60	21
52	6	6	57	10	1	123	25
52	7	7	14	4	4	23	23
52	7	7	24	3	1	42	17
52	7	7	110	6	2	105	24
52	7	7	79	3	0	69	44
52	7	7	117	19	0	116	23
59	3	3	80	31	0	48	154
59	3	3	26	6	11	32	34
59	3	3	27	5	0	40	2
59	3	3	16	3	1	43	15
59	3	3	37	5	1	17	23
59	5	5	19	4	2	29	18
59	5	5	136	25	0	251	20
59	5	5	98	5	0	279	24
59	6	6	27	6	1	40	16
59	6	6	21	1	0	45	13
59	6	6	74	4	2	219	12
59	7	7	73	2	0	85	29
59	7	7	108	9	0	135	38
59	7	7	27	8	1	45	13
59	7	7	121	5	0	90	15
59	7	7	60	6	3	99	55
66	3	3	4	1	0	2	12
66	3	3	31	40	0	16	59
66	3	3	7	2	1	5	33
66	3	3	27	1	0	38	18
66	3	3	46	1	0	12	29
66	5	5	32	18	1	39	32

¹ Sample date code 1 = 16.3.94, 11 = 27.3.94, etc. **Note:** Not all data exported shown. One code number per day from start.

² Treatment code 1 = south, 2 = north, 3 = unsprayed, 4 = pre-spray, 5 = 150 m into inter-barrier space, 6 = 250 m into inter-barrier space, 7 = within spray barrier.

³ Ntgs = non-target grasshoppers.

Figure 1.23: Example sheet showing export of data into Genstat for statistical analysis

Numbers of selected invertebrates caught in different treatments over time: to plot as line graphs
 Sweep net catches, Antanimieva 1994
 NB. GEOMETRIC MEANS FROM POOLED DATA FOR a&b TRANSECTS FOR EACH SAMPLE SITE

Non-target grasshoppers		14.2	21.2	27.2	11.3	16.3	20.3	27.3	31.3	13.4	21.4	26.4	2.5	9.5	16.5	25.5	6.6	13.6	20.6	8.7	27.7	
Date																						
South					16.59	5.03	6.51															
North					8.887	2.35	3.76															
unsprayed											3.92	8.672	3.79	6.97	3.34	2.25	3.28	4.04	2.4	1.17	1.3	
pre-spray											6.8	6.607										
150m													9.05	8.21	5.58	6.42	3.04	3.22	2.63	1.52	9.46	
250m													4.36	3.12	3.12	2.42	5.87	2.63	3	1.62	2.42	
within barrier													4.24	5.47	2.2	1	4.39	2.87	3.28	2.73	2.99	
<i>Leptacris hova</i>																						
Date		14.2	21.2	27.2	11.3	16.3	20.3	27.3	31.3	13.4	21.4	26.4	2.5	9.5	16.5	25.5	6.6	13.6	20.6	8.7	27.7	
South					0.644	0.15	0.15															
North					2.022	0.15	0.58															
unsprayed											0.82	0.644	0.32	1.64	0.15	0.15	0.32	0.43	0.32	0.32	0.52	
pre-spray											0.55	0										
150m													0.26	0.44	0	0.26	0	0	0	0	0	0.26
250m													0.44	0.44	0.26	0	0	0	0	0	0	0
within barrier													0.15	0	0.15	0	0	0	0	0	0	0
<i>Gelastorhinus edax</i>																						
Date		14.2	21.2	27.2	11.3	16.3	20.3	27.3	31.3	13.4	21.4	26.4	2.5	9.5	16.5	25.5	6.6	13.6	20.6	8.7	27.7	
South					0	0	0.15	0.32														
North					0	0	0.32	0														
unsprayed											0	0	0.25	0.43	0.15	0.78	0.25	0	0	0.15	0	
pre-spray											0.15	0										
150m													0	0.59	0	0	0	0	0	0	0	0
250m													0	0	0.26	0	0.44	0	0	0	0	0
within barrier													0	0.25	0	0	0.15	0	0	0	0	0

Figure 1.24: Section of spreadsheet showing compiled data in a form that can be used to create graphs of mean number against time for individual taxa

all samples came from just one treated and one control plot. Thus statistical analysis can detect differences between the areas, but does not inherently prove that any differences result from spraying. This is not ideal, but will often be the case for monitoring studies, particularly where large-scale spray programmes are under investigation as it is often impossible to set up true replicates due to the size of treated areas (see above and chapter 2).

A two-way ANOVA was performed on transformed data ($\text{Log}(x+1)$) for each selected species, to detect evidence of an interaction between treatment and time. The output from the ANOVA package in Genstat is shown in Figure 1.25. This is in the form of an ANOVA table. From this table it is possible to determine which treatment effects were significant and which were not. A significant interaction between treatment and time would indicate that changes over time are not consistent between treatments and thus indicate that spraying was affecting abundance. Where no significant interaction exists, a significant 'main effect' of treatment could reflect inherent differences between treatment areas or a genuine effect of spraying.

The Beamalo data set included all sample dates, as there was only one pre-spray sample. The data for Antanimieva were divided into three groups and analysed separately: (i) the pre-spray samples taken within the north and south plots; (ii) the pre-spray samples taken within the 'sprayed' and unsprayed plots; (iii) the post-spray samples taken within the sprayed and unsprayed plots. A simple (one-way) ANOVA was also performed to examine differences between treatments for each sample date, where a significant interaction between time and treatment was detected.

Note: Where long time-series of data are analysed in this way, it is necessary to break down the data into sections that are analysed separately. Certainly where there are more than 10 points in a time-series, this needs to be done to prevent variation over time from obscuring interactions between time and treatment. Thus, if a time-series of data covers 15 sampling dates, this would be best broken down into two blocks of seven dates. Indeed, if inter-sample intervals change, so extending the time-series, then further sub-division of the data prior to analysis may be necessary. This is a complicated and potentially subjective issue and one best discussed with a statistician for each individual study.

The results from the ANOVA tables for each species can then be used to display the range of statistically significant results and their level of significance in a single table (see Table 1.7).

OUTPUT – RESULTS FROM THE ECOTOXICOLOGICAL MONITORING STUDIES ON INVERTEBRATES AND THEIR INTERPRETATION

The output from the Genstat statistical package for analysis of variance is a series of ANOVA tables (see Figure 1.25 for an example). The statistical significance between treatments for particular faunal groups of interest was then compiled into further tables (Table 1.7 as an example). This allows the significance of different tests at different times (e.g. pre-spray, post-spray) for different faunal groups to be seen at a glance. However, the results are more easily interpreted when data for different faunal groups are presented as line graphs. Examples are given below (Figures 1.26–1.33).

The following descriptions relate to the graphs below. Groups have been selected (non-target grasshoppers at Beamalo and caterpillars at Antanimieva) to show examples of typical adverse impacts of insecticides, whilst the third group (booklice at Antanimieva) shows a typical example where no effect of the insecticide can be seen.

Different aspects of interpretation are shown on different figures, e.g. Figures 1.26–1.28 all relate to non-target grasshoppers at Beamalo; Figures 1.29–1.32 all relate to caterpillars at Antanimieva; Figure 1.33 relates to booklice (Psocoptera) at Antanimieva.

Fri Jul 8 1994 05:49:22 AM

Page 1

Analysis of Variance for LOG(PRETRE.Ntgs+1)

Source of variation	Sum of Squares	d.f.	Mean square	F-ratio	Sig. level ¹
MAIN EFFECTS	.5915411	2	.2957706	.389	.6839 n.s.
PRETRE.sample_dat	.5308338	1	.5308338	.698	.4244 n.s.
PRETRE.Treatment	.0607073	1	.0607073	.080	.7841 n.s.
2-FACTOR INTERACTIONS	.6136511	1	.6136511	.807	.3917
PRETRE.samPRETRE.Tre	.6136511	1	.6136511	.807	.3917 n.s.
RESIDUAL	12.160170	16	.7600106		
TOTAL (CORR.)	13.365362	19			

0 missing values have been excluded.

Fri Jul 8 1994 09:59:33 PM

Page 1

Analysis of Variance for LOG(POSTTRE.Lep_larvae+1)

Source of variation	Sum of Squares	d.f.	Mean square	F-ratio	Sig. level ¹
MAIN EFFECTS	57.083367	2	28.541683	38.962	.0000 ***
TINGL.time	1.689118	1	1.689118	2.306	.1322
TINGL.trt	55.394248	1	55.394248	75.619	.0000 ***
2-FACTOR INTERACTIONS	14.428154	1	14.428154	19.696	.0000
TINGL.timeTINGL.trt	14.428154	1	14.428154	19.696	.0000 ***
RESIDUAL	70.324680	96	.7325487		
TOTAL (CORR.)	141.83620	99			

0 missing values have been excluded.

¹ n.s = not significant; * = significant; ** = highly significant; *** = very highly significant.

Figure 1.25: Examples of output tables from two-way ANOVA in Genstat for pre-spray data for non-target grasshoppers (Ntgs) and post-spray data for caterpillars (Lep. larvae) at Antanimieva

Non-target grasshoppers caught using sweep nets at Beamalo 1993

Sweep netting is a technique that captures vegetation-dwelling or visiting invertebrates. Catches are affected by vegetation type, vegetation density, speed and strength of sweeps, height of sweep through vegetation, climatic conditions (temperature, relative humidity, light intensity), time of day, season, etc. All these need to be standardized to avoid bias in the results.

Interpretation of the results also requires knowledge of the biology and ecology of the taxa caught, e.g. feeding habits, mobility, life cycle, activity periods (diurnal and seasonal), etc.

- 1 Examine pre-spray data for both treatment areas (Figure 1.26). **Note:** 'Within barrier' is the sprayed area.

Examine statistics (see Table 1.7). In this case, there is no significant difference between treatments. Thus, despite the appearance from the graph that there are more non-target grasshoppers in the sprayed area than the unsprayed area before spraying, in fact, statistically the numbers in both areas are effectively the same. The fact that there is only one pre-spray data point leads to low confidence in being able to detect significant differences due to spraying.

- 2 Examine patterns of change in relative abundance over time for each of the treatments post-spray (Figure 1.27).

From Table 1.7, there is a very highly significant treatment vs. time interaction and a significant main effect of treatment. The simple ANOVA also shows that the differences in the numbers caught at one of the sample dates is very highly significant, the differences at two sample dates are highly significant and the differences at a number of the sample dates are significant.

The graph (Figure 1.27) shows that the change in direction of the lines occurs immediately after spraying and is thus likely to be caused by spraying. However, as there are no 'true' replicates, this cannot be proven from the data available.

- 3 Why do numbers caught in the unsprayed area decline after 23 March, whilst apparently increasing in the sprayed area (Figure 1.28)?

This is a methodological aberration. Most grasshoppers mature from nymphs to adults during March. This involves fledging into winged forms that can fly. Flying grasshoppers are much more difficult to catch in a sweep net than immature hoppers, thus fewer are caught. This is what causes the decline in numbers caught in the graph at 3. However, it does not show any evidence that overall relative abundance of grasshoppers declines, merely that numbers caught with a sweep net decline. The numbers of grasshoppers caught in the sprayed area during this period do not actually increase statistically. However, nymphs fledging to adults in the sprayed area may have been affected by the IGR and may not fly so effectively, making them easier to catch than those in the unsprayed area.

Conclusion relating to non-target grasshoppers at Beamalo

Despite the lack of pre-spray data, the patterns of change in numbers of grasshoppers caught in a sweep net suggest a pronounced adverse impact of barrier-sprayed Dimilin on non-target grasshoppers. This is not surprising as grasshoppers are closely related to the target locusts; they are mandibulate herbivores and thus in the same feeding niche as the locusts. It is only the immatures that are susceptible to the IGR, whereas adults are not.

The statistics show that the effects seen in the graphs are real. However, the cause of the differences in relative abundance between treatments cannot be proven from this data. A methodological anomaly accounts for the decline in catches of grasshoppers in the unsprayed area as time goes on. It is thus difficult to estimate the duration of the adverse effect of spraying on relative abundance of grasshoppers, but it seems to last at least 1 month.

Table 1.7 Statistical significance of ANOVAs on relative abundance of selected non-target fauna in different treatment areas for the Beamalo and Antanimieva study sites

		BEAMALO 1993						
		2-way ANOVA		1-way ANOVA				
		Interaction	pre-treatment	post-treatment (duration in weeks)				
		time vs. treatment	<1 week	<1 week	2 weeks	3 weeks	+	
Taxon								
Booklice (Psocoptera)	n.s.							
Non-target grasshoppers	**	n.s.	***	**	*			
Lepidoptera (larvae)	n.s.							

		ANTANIMIEVA 1994							
		pre-treatment			post-treatment				
		2-way ANOVA		1-way ANOVA	2-way ANOVA		1-way ANOVA (duration in weeks)		
		main effect		main effect					
		Interaction	treatment	< 1 week	Interaction	treatment	< 1 week	2 weeks	3 weeks +
Taxon									
Booklice (Psocoptera)	n.s.	n.s.			n.s.	n.s.			
Non-target grasshoppers	n.s.	n.s.			n.s.	n.s.			
Lepidoptera (larvae)	*		*	***		*	**	***	

Two-way ANOVA and simple ANOVA for individual sample dates both pre- and post-treatment with duration of differences between treatments for each level of significance (* $P < 0.05$; ** $P < 0.01$; *** $P < 0.001$).

Barrier-spraying with Dimilin

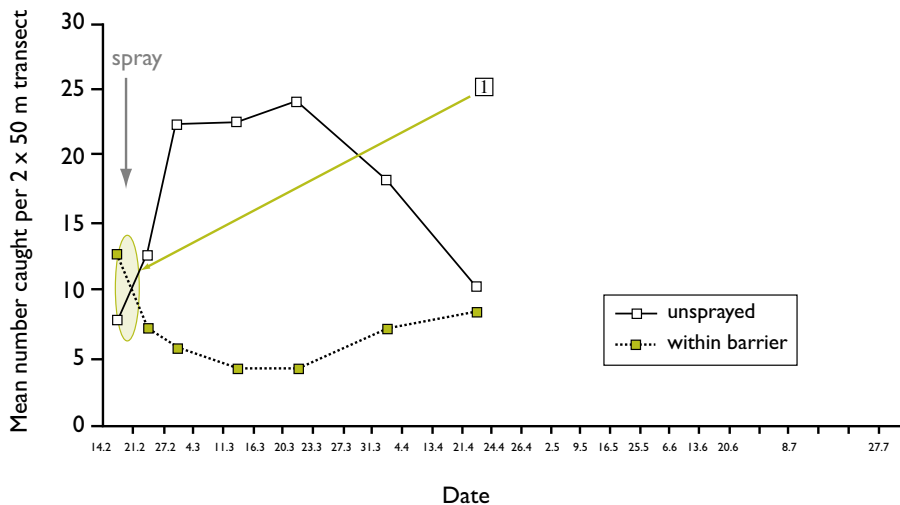

Figure 1.26: Pre-spray data for non-target grasshoppers in both treatment areas at Beamalo 1993

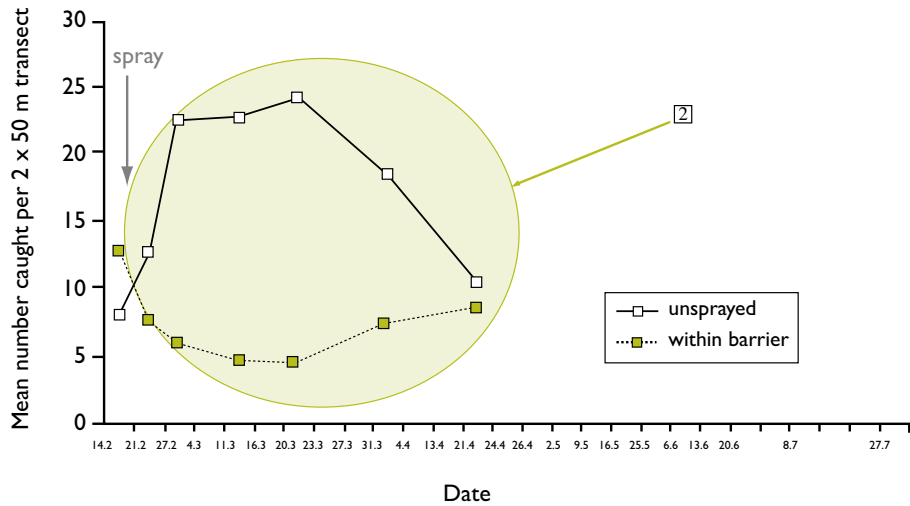

Figure 1.27 Change in relative abundance of non-target grasshoppers for each of the treatments post-spray at Beamalo 1993

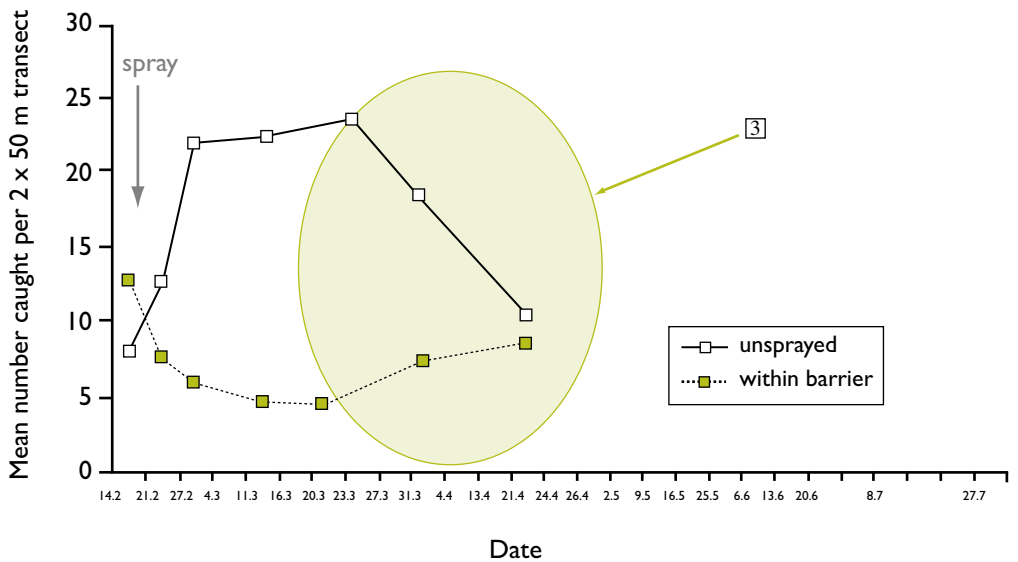

Figure 1.28 Changes in numbers of non-target grasshoppers caught in both treatment areas at Beamalo 1993

Caterpillars caught using sweep nets at Antanimieva 1994

1 Examine pre-spray data for both treatment areas (Figure 1.29).

The statistics show a significant interaction between treatment and time and a significant main effect of treatment (see Table 1.7). This indicates relatively high natural variation in catches of caterpillars between areas. The fact that there are five pre-spray data points gives us reasonably high confidence in pre-spray results. However, the statistically significant differences before spraying reduce our confidence in post-spray differences being attributable to spraying.

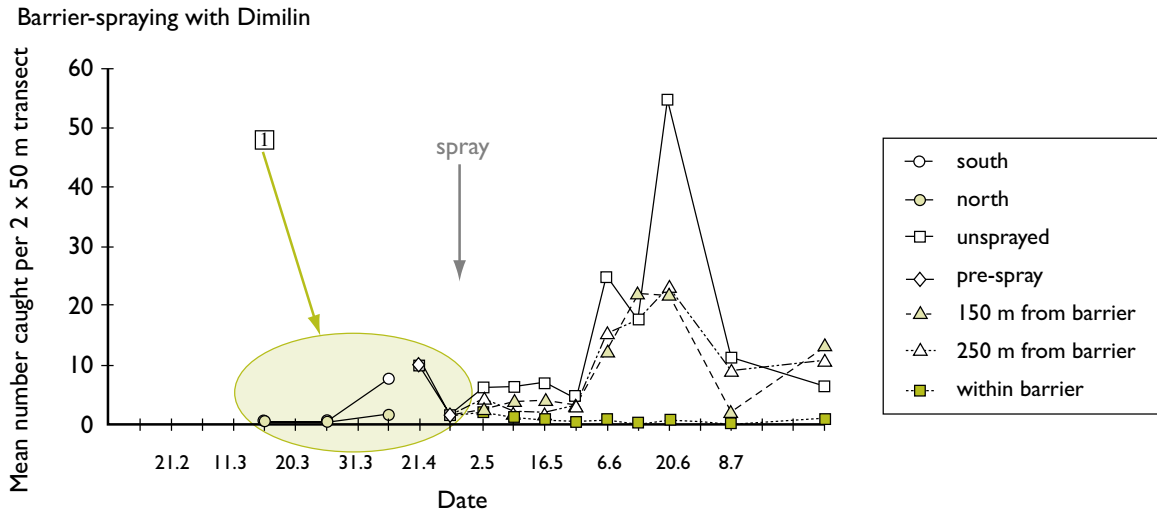

Figure 1.29 Pre-spray data for caterpillars at both treatment areas at Antanimieva 1994

- 2] Examine patterns of change in relative abundance over time for each of the treatments post-spray (Figure 1.24).

The statistics show that there is a highly significant treatment vs. time interaction and a very highly significant main effect of treatment (Table 1.7).

From the graph (Figure 1.30) it can be seen that throughout May the difference in mean number of caterpillars caught between treatment areas is within the limits of natural variation seen before spraying. Although numbers in the spray barrier appear to decline, we cannot be confident from the statistics that this is a 'real' effect due to spraying.

- 2a] The change in direction of the lines which occurs approximately 1 month after spraying, shows that numbers caught in the unsprayed area suddenly increase (Figure 1.31). This is probably due to a seasonal effect, whereby more eggs hatch into caterpillars around this time. Numbers of caterpillars caught in the inter-barrier spaces also increase at this time and follow a similar pattern of change over time as do numbers caught in the unsprayed area although without the high peak in numbers on 20 June.
- 2b] Numbers caught within the spray barriers decrease to zero and remain extremely low for at least 3 months (Figure 1.31). As catches in the inter-barrier spaces and within barriers come from the same study plot, it is very likely that the reduction in numbers caught within spray barriers is caused by spraying.
- 3] The decline in numbers of caterpillars caught in the unsprayed area towards the end of June/beginning of July is due to caterpillars pupating and metamorphosing into adults (Figure 1.32). Thus as part of the natural life cycle of these insects, the number of caterpillars present will decline.

Conclusion for caterpillars at Antanimieva

Despite the statistically significant pre-spray differences, the patterns of change in numbers of caterpillars caught in sweep net samples suggest quite a severe adverse impact of barrier-sprayed Dimilin on non-target caterpillars. This is not surprising as caterpillars are mandibulate herbivores and thus in the same feeding niche as the target locusts. Also, as immatures, they are susceptible to the IGR, whereas adults would not be. The statistics show

that the differences between treatments post-spray are real and that there is a highly significant time vs. treatment interaction. The decline in catches of caterpillars in the unsprayed area as time goes on is due to a natural phase in the life cycle as metamorphosis to adults occurs. The duration of the adverse effect of spraying on relative abundance of caterpillars is at least 3 months. The inter-barrier spaces act as a true unsprayed refuge for the caterpillars and there seems to be as little impact of spraying 150 m into the inter-barrier space as there is in the middle of the inter-barrier space.

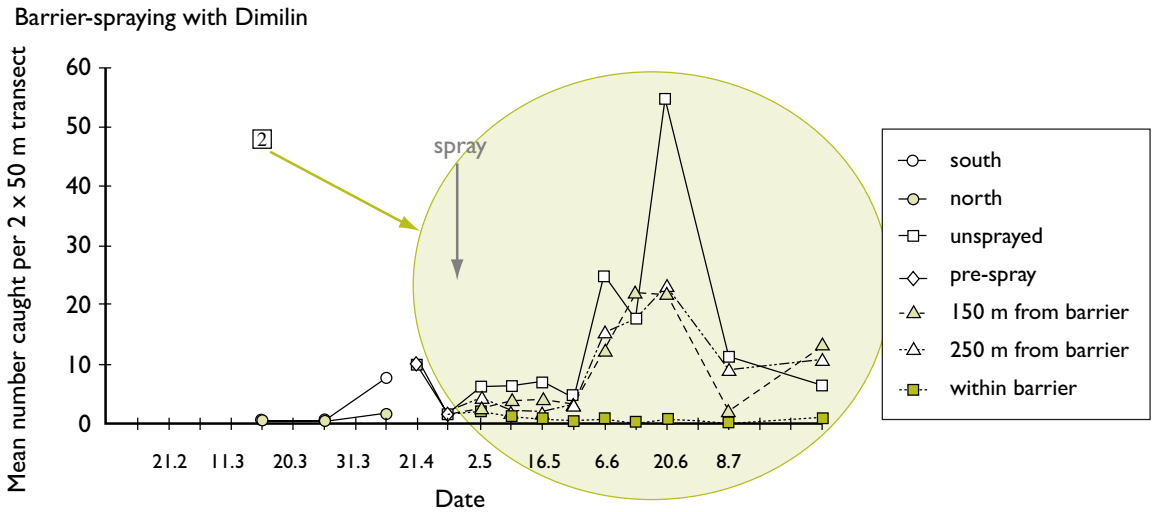

Figure 1.30 Change in relative abundance of caterpillars over time for each of the treatments post-spray at Antanimieva 1994

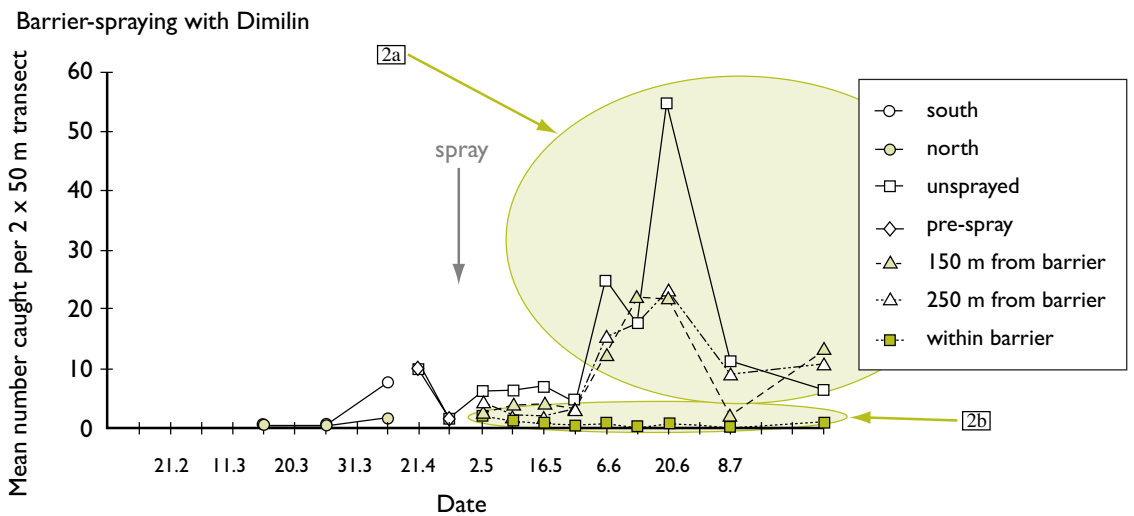

Figure 1.31 Change in relative abundance of caterpillars over time for each of the treatments post-spray at Antanimieva 1994

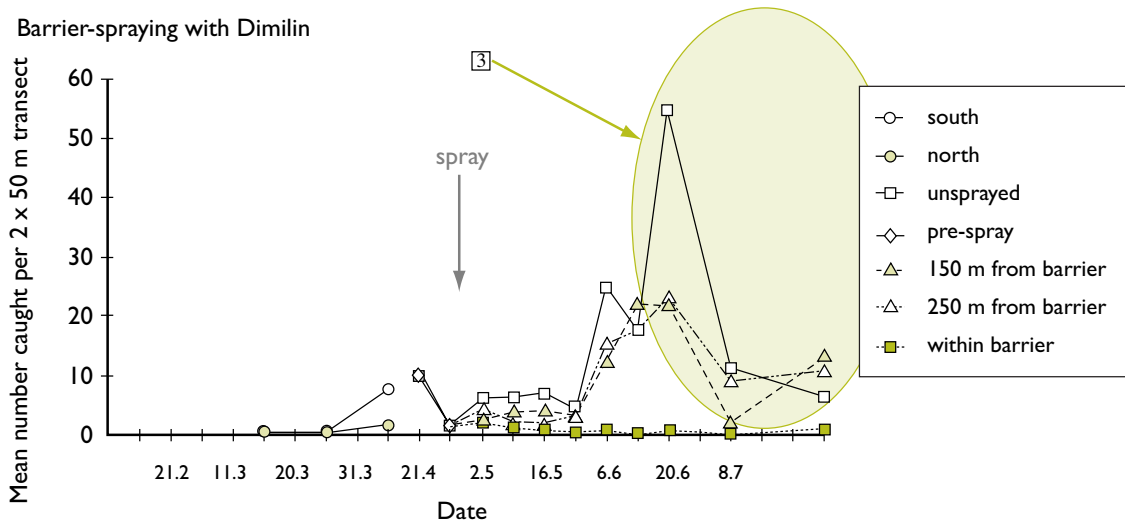

Figure 1.32 Change in relative abundance of caterpillars over time for each of the treatments post-spray at Antanimieva 1994

Booklice caught using sweep nets at Antanimieva 1994

- 1 Examine pre-spray data for both treatment areas (Figure 1.33).

Examine statistics (Table 1.7). Is there a significant difference in relative abundance between treatments?

In this case, there are no statistically significant results.

Natural variation in catches of booklice between areas appears low. The fact that there are five pre-spray data points gives us reasonably high confidence in the pre-spray results.

- 2 Examine patterns of change in relative abundance over time for each of the treatments post-spray (Figure 1.33).

Does the relative abundance follow a similar pattern over time for different treatments?

Statistics will verify whether any apparent differences are real. If there is a significant treatment vs. time interaction, then there are real differences in the patterns of change in relative abundance between treatments.

In this case, there are no statistically significant results. The graph shows that all treatment areas (unsprayed, within barrier and inter-barrier spaces) show similar changes in direction of the lines over time. There are no apparent differences between treatments.

- 3 The decline in numbers of booklice caught in all areas towards the end of June/beginning of July will be due to natural seasonal changes in abundance. The fact that numbers caught at 250 m from the barrier in the inter-barrier space never reach the same peak of abundance as the other treatment areas and decline slightly earlier will probably be due to natural variation. The statistics do not indicate any evidence of a real difference. Biologically, any such difference would also be difficult to explain.

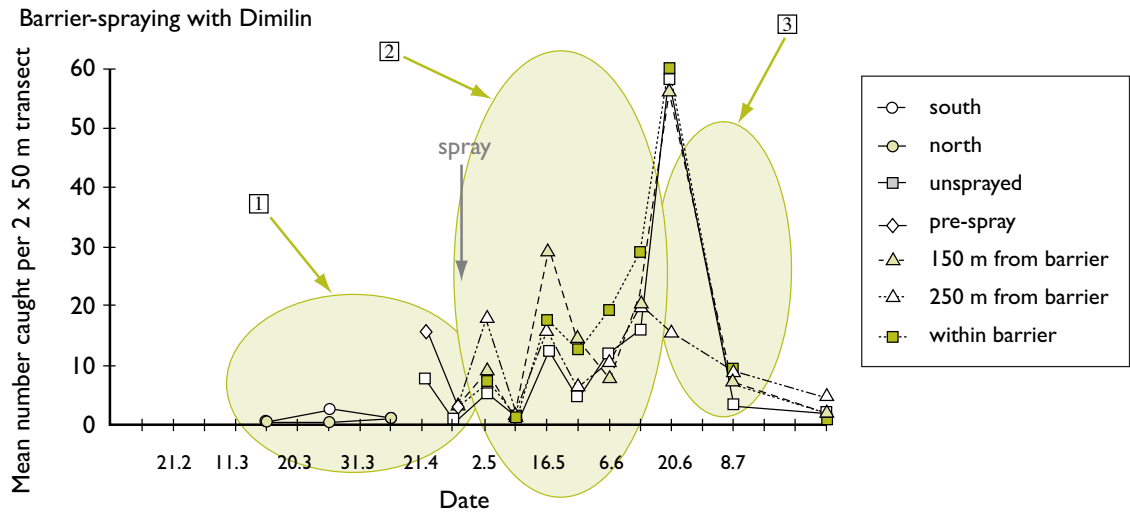

Figure 1.33 Pre-spray data for booklice at both treatment areas at Antanimieva 1994

Conclusion for booklice at Antanimieva

There is no effect of barrier spraying with diflubenzuron on non-target booklice, when spraying occurs in mid-April.

Findings from the study as a whole

Of the 350 species caught during the study, only a very few showed statistically significant differences between the sprayed and unsprayed areas at either of the two study sites. Indeed, the two examples presented above (non-target grasshoppers at Beamalo and caterpillars at Antanimieva) were the only taxa that showed clear and severe adverse effects from the IGR within the spray barriers. Interestingly, both these groups **only** showed evidence of adverse impacts at one of the study sites. As can be seen from Table 1.7, there were no significant differences in the relative abundance of non-target grasshoppers between treatment areas at Antanimieva. There are a number of reasons for this. Firstly, the species composition of grasshoppers at the two sites was different. Seven species were caught at Beamalo in 1993, whilst 14 were caught in the Antanimieva study area in 1994. There were species common to both sites, but the different species may have had different responses to the IGR. Also (and probably more importantly) the difference in spray date may have been significant. At the time of spraying at Beamalo in 1993, a high proportion of the grasshoppers were nymphs (immatures susceptible to the IGR), whilst the late spraying at Antanimieva in 1994 came at a time when the majority of the nymphs had already fledged to adulthood (see above). As adults are not directly susceptible to lethal effects from the IGR, it is biologically understandable that spraying did not result in differences in relative abundance.

Similarly, caterpillars at Beamalo showed no significant differences in relative abundance between treatment areas after spraying with the IGR. The reasons for this may be differences in species composition. The caterpillars caught at Beamalo came from a number of different families and species. This was also true at Antanimieva during the corresponding period. However, in late May and early June, the caterpillar catch at Antanimieva became dominated by one species of noctuid moth, *Mythimna circulus*. This species was undoubtedly affected by the spraying. Too few individuals of each of the other taxa were caught to be certain whether they were adversely affected or not.

Other taxa showing indications of adverse impacts of barrier-sprayed diflubenzuron at one of the study sites were spiders, crickets and parasitic braconid wasps. The findings were, however, inconclusive for all these taxa.

Overall conclusions from the study

The vast majority of terrestrial invertebrates sampled appeared unaffected by barrier spraying with diflubenzuron. However, at least two groups of mandibulate herbivores – non-target grasshoppers and caterpillars – showed a very highly significant decline in relative abundance within spray barriers following spraying. The effect appeared to last at least 1 month for grasshoppers and for several months for caterpillars. Several other groups of invertebrates – spiders, crickets and braconid wasps – may also have been affected temporarily.

Inter-barrier spaces of 500 m were shown to act as true unsprayed refugia for caterpillars and undoubtedly led to reduced environmental impacts by comparison with cover spraying.

Monitoring of droplet deposition showed that the number of drops falling to the ground decreased to about 30% of droplets falling within the barrier about 100 m downwind of the upwind edge of the barrier, whilst the volume mean diameter of the droplets also decreased to about 30% of that within the barrier (Figure 1.19). Assuming 100% kill of caterpillars within the barriers, a worst case estimate would suggest a decline of about 27% in the population across the sprayed area as a whole. This is unlikely to be ecologically significant, but insufficient is known about the importance of *M. circulus* in this habitat to be certain. *Mythimna circulus* is endemic to Madagascar and thus of value from a conservation point of view. The caterpillars may provide an important food source for a variety of birds and this deserves further attention if widespread use of IGR barriers begins.

The acceptability of the findings of adverse impacts on non-target grasshoppers and on *Mythimna circulus* larvae is unclear without a greater depth of knowledge of the ecology of the savanna grasslands of Madagascar. The effects on individual species of grasshopper were not examined at Beamalo in 1993. The dominant grasshopper species was *Oedaleus virgula*, but although this is the most likely species to have declined significantly others may have been involved as well. *Oedaleus virgula* is a Malagasy endemic, but it is also a pest. *Mythimna circulus* is also an endemic, but its importance in the food chain and in the ecology of the grasslands is unknown. Neither are known to be within any of the IUCN population status categories (see Table 1.1, page 6) and both species seem to be widespread and abundant.

The recommendations from the study would be that IGR barrier spraying be used in preference to cover-sprayed organophosphate insecticides, which are known to affect a variety of invertebrates and cause bird mortalities as well. They are also more toxic to spray operators. Further use of IGR barrier spraying should be accompanied by ecotoxicological monitoring studies, until their impact on caterpillars, grasshoppers and vertebrates which prey on them is better understood. Birds that may prey on caterpillars and/or grasshoppers should also be monitored.

Decision-makers would need to balance the costs of this control method with stakeholder views on the technique and with the environmental benefits and drawbacks of this method of locust control.

John Sherington¹ and Ian F. Grant²

Natural Resources Institute, University of Greenwich at Medway, Central Avenue,
Chatham Maritime, Kent ME4 4TB, UK

INTRODUCTION

Ecotoxicological research involves the collection and analysis of data such as the abundance of insects or reptiles, levels of pesticide residues, diurnal temperatures, speed of a biological process and the extent of vegetative cover. Such quantitative information is used in pesticide impact work to make objective and unbiased comparisons between different situations or different times. Also, in some research, relationships between different measurements are of interest.

However, one factor common to all data in biological science is the natural variation that exists. For example, if two similar areas of a crop are both managed in an identical fashion, they are unlikely to have exactly the same number of insects present afterwards. Other, 'random' or unknown factors also contribute to the insect abundance.

Statistical methods assist the interpretation of such quantitative information in the presence of random variation. The analysis of data depends on the design of the experiment or survey which produces the data. For valid conclusions to be drawn from data, it is essential that the study is designed carefully in order to meet its objectives. Statistics has an important role to play here. This chapter starts by introducing some basic ideas on study design and statistical concepts before discussing more detailed issues and presenting some simple methods.

But first, a word of caution. Before going to the field to collect data, discuss your objectives and the biometric techniques available to you with a statistician. Most researchers rely on the use of PC/Mac-based software to analyse their data: it is rare to see hand calculation of anything but the most basic statistics as it is hugely time consuming. Although it is relatively easy to use statistical packages it is also easy to misinterpret the result. Test your study design, assumptions and interpretation on a biometrician. It is also worth remembering that initial data analysis employing a few means and variances and a couple of basic graphs can usually give a good indication about likely inference!

STUDY DESIGN

One important distinction is that between an experiment and a survey. In an experiment, the researcher holds most factors constant, varying only one or two factors at a time. Therefore, any consistent effects caused by varying a factor can be confidently attributed to that factor. For example, if a researcher sprays 10 randomly selected plots within a given area with a particular fungicide, leaving 10 other randomly selected plots in the same area unsprayed, and **all** other conditions are identical, then any differences in, say, severity of attack by a particular pathogen between sprayed and unsprayed areas can be attributed to the effect of spraying. This constitutes a field experiment.

¹Address for correspondence: Pfizer Global Research & Development, Sandwich, CT13 9NJ, UK. john.sherington@pfizer.com

²Contact address: Cybister Environmental Protection, Oak House, South Street, Boughton, Kent ME13 9PE, UK. ian.grant@cybister.plus.com

Surveys, on the other hand, do not give such strong ‘cause and effect’ conclusions. If some farmers sprayed their crops and others did not and the researcher periodically visits different farms to monitor the severity of attack by a particular pathogen, then the difference between sprayed and unsprayed areas may be difficult to interpret. Maybe another factor ‘caused’ some farmers to spray their crops, e.g. an outbreak of a disease related to change of fungicide in a previous season. In a survey situation, such things are uncontrolled.

Objectives

All studies should set clear objectives before being carried out. From a statistical viewpoint, the following questions are usually relevant.

- What are the main comparisons to be made or what relationships are of interest?
- What data will be collected and how?
- Will the researcher impose experimental conditions, or just measure (survey) what already exists?
- What are the basic ‘experimental/survey units’?
- How will replication be achieved? If no replication is possible, how useful will the results be?

One useful technique when a study is being planned is to include in the plan an outline of how the results will be analysed and presented. If it is not known how some of the data will be used, then it is probably not worth collecting that data.

Do not attempt to cover too much in one study. It is tempting to try and measure a large number of variables in a large number of situations. It can often be better to measure a limited number of variables in a restricted set of circumstances. This will give good information on a narrow situation compared with vague information over a broader range of situations. The precision obtained with different sample sizes is discussed later. It is always necessary to set realistic objectives which can reasonably be achieved with the available resources. By trying to do too much, there is always the danger of achieving nothing very useful.

Before proceeding further, the next section will introduce some basic statistical concepts needed for understanding and using the tests and techniques presented.

BASIC STATISTICAL CONCEPTS

In general, a set of data will have a one or more *variables* or measurements (e.g. number of fly larvae, amount of pesticide residue, etc.) recorded for each of a number of *units* (e.g. plots, quadrats, sample points, etc.). Variables may be measured on a continuous scale (e.g. pesticide concentration), as a count (e.g. number of insect species captured or number of pied kingfishers seen), or as categories (e.g. soil type: sand, clay, etc.). Depending on the objectives for any particular analysis, some variables may be considered as *response* variables, i.e. they are the main variable(s) of interest and are affected by other, *explanatory*, variables. For example, thickness of bird eggshell (continuous, response variable) may be affected by pesticide residue (continuous, explanatory variable) and habitat (categorical, explanatory variable). In a different analysis, level of pesticide residue may be considered as a response variable, affected by other factors such as climate.

When presenting results of a study, you will usually wish to summarize the data in some form. For numeric data such as numbers of mammals trapped, or numbers of dead fish, the obvious single summary is the *mean* which gives an average value. However, for some data, particularly if it has a skewed distribution (discussed below), the *median* may be useful.

- The *mean* is the average, i.e. the total of all the values divided by the number of values.
- The *median* is the value such that half of the data values are higher than the median and half are lower than the median.
- The *mode* is the number occurring the most times.

Two artificial data sets demonstrate these statistics (Table 2.1). Set 1 data comes from a symmetric distribution, set 2 comes from a skewed distribution. The median (7) is the same for both data sets (two data points are less than 7, two are greater). The mean is very high for set 2, which has one large value. This mean is not a good intuitive ‘average’, as it is much larger than four out of the five values. The median is particularly useful for skewed distributions such as counts of insects/reptiles/birds.

The differences between the two data sets in Table 2.1 are related to the data having different *distributions*.

The distribution of data can be displayed in a histogram. Examples of two different histograms are shown in Figure 2.1.

Figure 2.1a shows a symmetric distribution. Data such as this can often be represented mathematically by the so-called ‘Normal’ distribution (sometimes called a Gaussian distribution). Some standard statistical procedures and interpretation assume such a distribution.

Table 2.1 Artificial data for insect counts

Sample	Set 1	Set 2
1	12	12
2	0	0
3	13	88
4	7	7
5	3	3
Mean	7	22
Median	7	7

a) Symmetric distribution

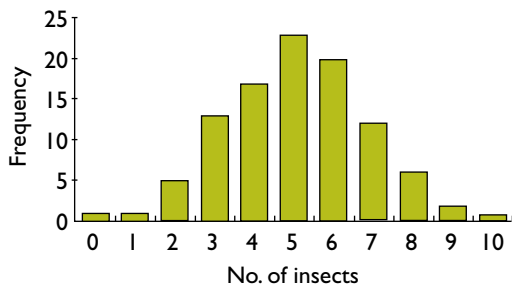

b) Skewed distribution

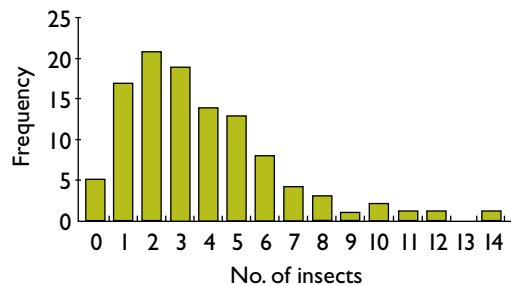

Figure 2.1: Examples of symmetric (a) and skewed (b) distributions

Skewed distributions (Figure 2.1b) frequently arise with insect count data. Sometimes, transforming the data by using $\log(\text{count} + 1)$ or $\sqrt{\text{count}}$ can result in a less skewed distribution. This can allow valid application of some statistical procedures but makes presentation of results more awkward. More will be said about transformation of data later.

Both diagrams above show another important feature of data – its variability. In Figure 2.1a, the observed counts vary from 0 to 10. Different sets of data may show different amounts of variation. One of the important roles of statistical analysis is to quantify this variation.

The simplest measure of the amount of variation has already been demonstrated in the previous paragraph. This is the range of the data, i.e. the difference between the largest and smallest values. This was 10 (0 to 10) in Figure 2.1a and 14 in Figure 2.1b. However, the range is not very flexible and can also be greatly influenced by a single unusual value.

The most useful measure of random variation is the *standard deviation* (SD). This is demonstrated in Table 2.2. The formula for a standard deviation is:

$$SD = \sqrt{\frac{\sum (x - \text{mean})^2}{n - 1}}$$

where x is a data value, n is the number of sample units and \sum is the sign for summation. A different and easier method of calculation is given in the method sheet and most pocket calculators and all spreadsheets will do the calculation for you. The standard deviation is measured in the same units as the original data.

Note that both data sets in Table 2.2 have the same mean residue (12.0 mg kg⁻¹). Data set 1 has much less variability than set 2. This is shown simply by the range, which is 0.5 (12.2–11.7) for set 1 and 5.4 (14.7–9.3) for set 2. The respective standard deviations are 0.23 and 2.28. By both criteria, data set 2 has about 10 times the variability of set 1.

The standard deviation has a useful interpretation in the case of the Normal distribution. In this case, the interval between (mean - SD) and (mean + SD) should contain about 67% of the data points. Similarly, mean \pm 2.SD should contain about 95% of the observations. These interpretations are derived from tables which give the proportion (p) of units within a given range (mean \pm z.SD), for different values of z or p .

Table 2.2 Calculation of standard deviation (SD) for two artificial data sets ($n = 5$)

Sample	Set 1			Set 2		
	Residue mg kg ⁻¹ (x)	$x - \text{mean}$	$(x - \text{mean})^2$	Residue mg kg ⁻¹ (x)	$x - \text{mean}$	$(x - \text{mean})^2$
1	11.7	-0.3	.09	9.3	-2.7	7.29
2	12.1	0.1	.01	14.7	2.7	7.29
3	12.2	0.2	.04	13.8	1.8	3.24
4	11.8	-0.2	.04	10.3	-1.7	2.89
5	12.2	0.2	.04	11.9	-0.1	0.01
Mean	12.0			12.0		
Total (Σ)	60.0		.22	60.0		20.72
SD			.23			2.28

Note: These interpretations do not apply for skewed distributions. With such data other methods may be needed or the data might be transformed (e.g. by using $\log(x + 1)$ or \sqrt{x}) to give a symmetric distribution.

The mean (or median) and the standard deviation are often the two most useful summaries of a set of data, measuring respectively the average size and the amount of variation. As a routine, it is good practice to calculate these summary statistics and plot histograms and graphs of the data.

MORE ON STUDY DESIGN

Frequently a study will wish to compare two or more situations. These may be a comparison between sprayed and unsprayed areas or between a number of different vegetation types or between different times. Sometimes a number of different comparisons may be of interest. One frequently used technique is, for example, when comparing sprayed and unsprayed areas, to take measurements in both areas both before and after spraying. Then the change caused by spraying can be separated from a change over time.

For all comparisons of this sort, two statistical criteria are essential: replication and randomization.

Replication

In order to get reliable conclusions on cause and effect from a study, measurements are usually made on a number of experimental or survey units. This is known as *replication* and underlies much statistical analysis for comparative studies. Simply measuring one experimental unit (e.g. one sprayed area) will not give information which can be generalized. In many ecological studies, this issue can become complex and is related to the definition of experimental/survey units. An example will demonstrate the issue.

You wish to determine the effect of a spray on the abundance of a particular invertebrate species. An inexperienced researcher may propose to have one sprayed area and one unsprayed ('control') area. (In statistical jargon there are two 'treatments' – sprayed and unsprayed.) In each area, insect numbers will be counted at 10 sample points. This is shown in Figure 2.2a.

While there are now 10 insect counts from sprayed vegetation and 10 for unsprayed vegetation, this is *not* genuine replication. It is a form of pseudo-replication. A diagnostic statistical analysis is not appropriate for this experiment as there is no replication of sprayed and unsprayed areas. Any comparison of sprayed areas vs. unsprayed samples only tell us the difference between one area which happened to be sprayed and another

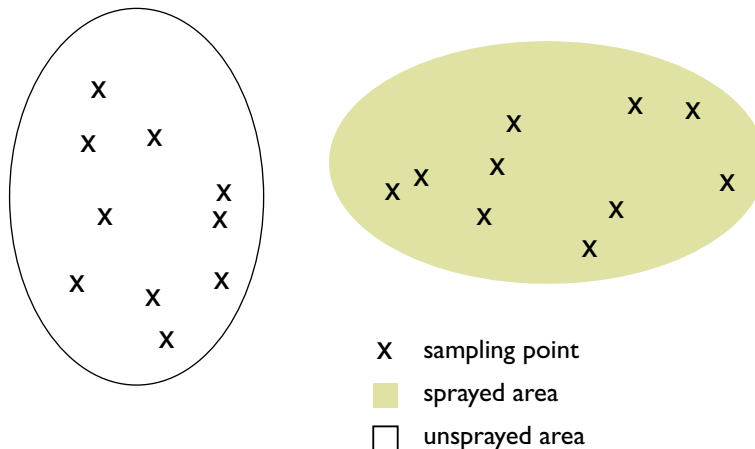

Figure 2.2a: An unreplicated experiment

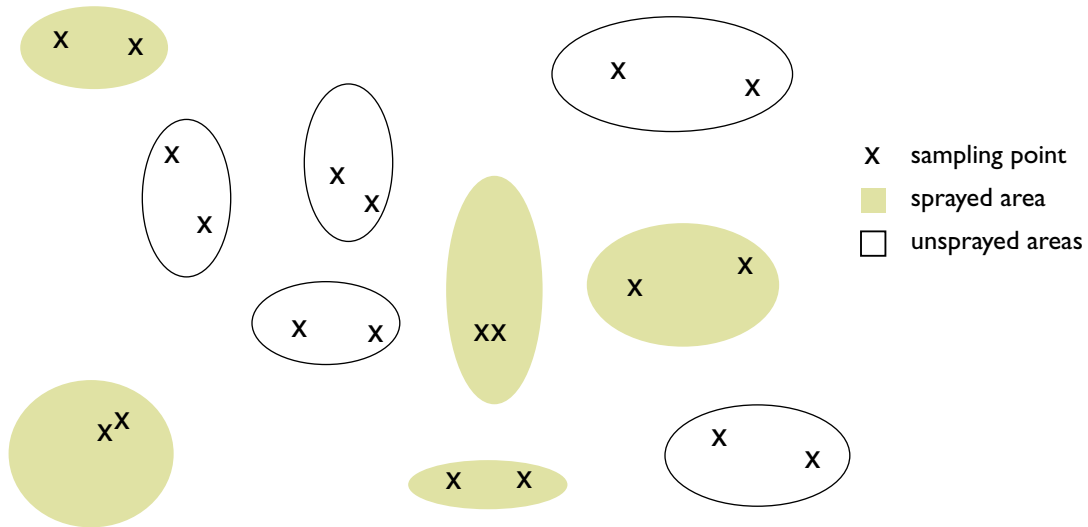

Figure 2.2b: An experiment with five replicates per treatment and two samples per experimental unit

which happened not to have been sprayed: maybe the two areas would have had different insect numbers even without the experiment.

To achieve genuine replication, *a number of sprayed areas need to be compared with a number of unsprayed areas.* Figure 2.2b shows, diagrammatically, such an experiment with five areas ('experimental units') for each treatment and two sample points per area. These 'units' may be plots in one field or they may be different farms.

Again, there are 10 sample points for the sprayed areas and 10 for the unsprayed areas, but in this case there is genuine replication. There are five replicates ('experimental units') of each 'treatment' with two samples in each unit. Data from this must be reduced to one data point per experimental unit (by calculating mean or total per unit) before any formal statistical analysis. **Note:** For a realistic experiment the sample size would be increased.

A formal definition of an experimental unit is: a division of the experimental area such that any two units can receive different treatments. A similar concept applies in surveys. Basically, 'units' in a survey should be independent, i.e. what occurs in one unit should not be related to what occurs in another.

Regardless of the application, all researchers want to know how many replicates should be used. **There is no simple answer to this question.** The decision depends on many factors, but some of the most important are:

- variability of experimental units
- treatment structure
- size of the effect that is important
- available resources.

Incorrect specification of experimental or survey units leads to the problem of *pseudo-replication*. Pseudo-replication can occur either in space or time.

Pseudo-replication

The philosophy of statistical comparisons is based on comparing the between-treatment variability (sprayed/unsprayed in this case) with the random variation between units within treatments. This will determine

whether the observed effect is likely to have been a chance occurrence (due to random variation) or is large enough to be a genuine effect. If the random variation is measured on the wrong basis, then the conclusions will be misleading.

In Figure 2.2b above, there are two levels of variation:

- (i) pooled estimate of the within-treatment variability (from 5 units/treatment)
- (ii) variation between the two samples within each experimental unit.

To draw conclusions about the effect of spraying, the mean difference between sprayed and unsprayed areas would be compared with the random variation measured in (i) above.

For the experiment in Figure 2.2a above, where there is no replication of areas, the component of variation (i) above cannot be measured. Therefore, valid statistical comparisons of the effect of spraying between sprayed and unsprayed areas cannot be made from this experiment. It is possible to use statistics to determine whether differences between the areas are significant but **not** that any differences are due to spraying. Component (ii) contains no information about area variability and will generally underestimate the random variation between areas and give spuriously precise results. (See sections on 'Sampling', page 60, and 'Estimation, Precision and Statistical Tests', page 62.) **Note:** If treatment areas are very large (tens, hundreds or thousands of square kilometres), then true replication may be impossible, particularly in a survey situation. Statistics can be used to ascertain the significance of any differences in particular data between treatment areas, but other supporting data (e.g residue data) will be needed to infer conclusions on the effect of sprays.

Randomization of treatments

Figure 2.2b can also be used to demonstrate randomization. In order to achieve an impartial comparison, the allocation of treatments to areas should be done at random. This may be achieved either by using random number tables (see method sheet on random numbers), by drawing lots or by generating random numbers with a suitable pocket calculator.

In many instances it can be useful to restrict randomization in order to increase precision and ensure a more balanced design. For example, with two treatments, the experimental units could be paired so that two units within a pair are as similar as possible. Then two treatments are randomly allocated to units within each pair. With more treatments, a technique known as a 'blocking' is used.

BLOCKING

The primary idea of blocking is that identification of homogeneous regions allows more precise comparison of treatments through the elimination of the large differences between units in different blocks. The experimental units would be grouped in 'blocks' of similar units, with each treatment occurring once in each block. Information from blocked experiments is predominately based on the comparisons that can be made between treatment observations in the same block. It follows that blocking is not a technique that is easily managed when pesticides are sprayed over large areas because of the risk of spray drift into adjacent blocks and the increasing heterogeneity over large areas. If two treatments do not occur together in a block, then it will still be possible to make a valid comparison between the two treatments if each occurs in a block with a common third treatment. When patterns of likely variation among units are identified, the units are grouped into blocks of similar units. Units within a block should be as near homogeneous as possible. Typically blocking is used in field, glasshouse or some laboratory experiments, where units are close together in space.

There are two important decisions to be made in arriving at an appropriate and effective blocking technique.

- The selection of the source of the variability to be used as the basis for blocking.
- The selection of block shape and orientation.

An ideal source of variation to use as the basis for blocking is one that is large and highly predictable, such as soil heterogeneity where the behaviour of the pesticide is the primary character of interest, or gradient in a field where a study of soil respiration will be related to water tension. After identifying the specific source of variability to be used as the basis for blocking, the size and shape of the blocks must be selected to maximize variability between blocks. Any book on agricultural research will describe blocking procedures that can be used in small-scale pesticide experiments.

SAMPLING

Sampling is used when it is unnecessary, impossible or too expensive to measure everything. Therefore, just a small fraction of the material is measured.

In Figure 2.2b above, it was too difficult to measure the whole area for each experimental unit, so two sample points were taken in each unit. Similarly, in Figure 2.2a there were 10 samples per area.

Individual samples may be taken at points in an area of land, in quadrats, transects or at other relevant features (e.g. trees).

The important thing is to avoid bias but this is almost impossible to do subjectively. The overriding principle for selection of a simple sample is that every unit should have the same chance of being selected. Where this proves impossible, then the target population (and related objectives) may have to be redefined, e.g. areas less than 1 km from a road, or trees less than 100 m from a track.

Random sampling

Random selection of samples is the ideal at which to aim. For this to be done, there needs to be a 'list' (at least conceptually) of all possible units. Random numbers are then selected to ascertain which particular units will be measured. For example, in a forest, each tree could, theoretically, be given a number. By selecting random numbers, a random sample of trees could be obtained. Similarly, in an area of land, each possible point can be given co-ordinates in two dimensions. Selecting two random numbers will then select a random point.

In practice, purely random schemes can be difficult to implement, e.g. how can you ascertain which tree is number 123? However, if the population was 'trees within 10 m of a track', it might be possible to ascertain which tree is number 13.

Random numbers can be obtained from suitable tables (see method sheet on random numbers) and many calculators and computers can produce sequences of random numbers as well. In desperation, the last digit of telephone numbers in a directory can be used as random digits between 0 and 9! (The first digits are usually **not** random.)

To randomly allocate treatments in an experiment, it is straightforward to make 'cards' for the different treatments and draw lots for each unit or to roll dice.

Systematic sampling

In situations where fully random sampling is impossible or too difficult, systematic sampling can provide a practical alternative. With such sampling, a random starting point is selected and then samples taken at regular intervals. To sample fauna in a stream, samples may be taken every 100 m. To sample trees, every tenth tree of a given species may be selected as the researcher follows a path. However, in this case, the population has been implicitly defined as 'trees next to a path' which may not be representative of all trees.

Stratified sampling

Stratified sampling is useful when the population can be divided into sub-populations or strata. Then a separate sample is taken from each stratum. This has two main advantages:

- it ensures that each stratum of the population is properly represented in the sample
- it can be more efficient, statistically, for estimating population parameters.

Different proportions or sample sizes can be taken from each stratum, though a more complex analysis involving different weights for different strata may be needed in this case. For example, an hydrobiologist might be interested in assessing the aquatic insect population of a river bed. There may be a number of different habitats (e.g. gravel, sand, silt) at the sample site. The area could be stratified according to habitat, with samples taken from each habitat in proportion to the habitat type. For example, if the river bed at one site is composed of 25% weeds on pebbles, 50% gravel and 25% mud, then, if eight samples are to be taken, make sure four are in gravel and two in each of the other substrates. The results of the samples could then be combined to give an overall estimate for the area. Alternatively, comparisons between either the gravel and mud habitats may be made.

Multi-stage sampling

Multi-stage sampling is often carried out for administrative convenience even though it is less efficient in narrow statistical terms than simple random sampling. An example will demonstrate the ideas.

In a survey of farms, it may be too expensive or time consuming to visit farms scattered over a wide area. Also, a suitable list of farms may not exist. The first stage is to randomly select a number of districts. At the second stage, villages are randomly selected within the chosen districts. At the third stage, a random selection of farms is made in each of the selected villages. The advantage of this three-stage scheme is that it will reduce the amount of travel required and it may be easier to obtain lists of farms for selected villages than for the whole population.

Note that if the example was altered slightly so that the districts were purposefully chosen as being of particular interest, e.g. high risk areas, then the population has been implicitly redefined as being the nominated districts rather than the whole country. Now there is a two-stage sampling scheme to study the deliberately selected districts.

Sub-sampling

Sub-sampling is used when it is impossible or unnecessary to measure the entire sampling unit or experimental unit. Samples are taken from each basic unit in order to estimate the mean for the whole unit. (This can be considered as an example of multi-stage sampling.) For example, rather than measure biomass of an entire field, a number of randomly selected quadrats may be measured to estimate biomass per square metre. To estimate pesticide residue in a crop, a few plants may be selected and analysed. In this context, sub-sampling is just another level in a multi-stage scheme. The later section on sub-sampling gives more details (see page 65).

DATA MANAGEMENT

Many projects invest large amounts of time and money into all the previous activities described in this chapter and ignore this one. Without good quality data, a survey or monitoring programme can be rendered useless.

A database such as Excel or Access should be used to manage and store the data; this is particularly important if the data are to be distributed to other sites within the country and internationally. A simple, but often neglected safeguard is to ensure that **master copies of the database are held at one site, and no other site should be able to change these copies.**

ESTIMATION, PRECISION AND STATISTICAL TESTS

Statistics is the science of dealing with variability and uncertainty. For straightforward experiments and surveys, the mean of the data in the study is used to estimate the 'true' mean. However, random variation and sampling variability means that if a survey or experiment was repeated a number of times, slightly different estimates of means or percentages would arise on each occasion.

Therefore, it is useful to predict how precisely the sample will estimate the 'true' value. The most useful method for doing this is to calculate the *standard error* (SE) of the estimate (e.g. mean) which can then be interpreted with the aid of a *confidence interval*.

In the simple case of using a mean from a simple sample or experiment, the standard error of the mean is estimated by:

$$SE = \frac{SD}{\sqrt{n}}$$

where SD is the standard deviation of the data and n is the number of experimental units used to estimate the mean.

Comparison of two means

To compare two means, the difference between the means can be easily calculated and estimates the 'true' difference. The standard error of the difference (SED) is given by:

$$SED = SD \times \sqrt{\frac{1}{n_1} + \frac{1}{n_2}}$$

where n_1 and n_2 are the number of experimental units used for the two means. SD is now the average ('pooled') standard deviation (equal to the square root of the residual mean square from an analysis of variance. see page 68).

Confidence intervals

Confidence intervals can be used when comparing two groups (e.g. treatments) each with an estimated mean. The difference between the means can be simply estimated as:

$$\text{difference} = \text{mean 1} - \text{mean 2}$$

For data with an approximately 'Normal' distribution, a 95% confidence interval for the difference is given by:

$$\text{difference} \pm t.SED$$

where t is taken from statistical tables (and depends on the ‘degrees of freedom’ used when estimating the standard deviation). For large experiments or surveys (at least 25 units), t is approximately 2. For smaller samples, t will be larger.

For example, if a large experiment (>30 samples) gave mean numbers of mayfly nymphs for two sites in a river as 10.12 and 11.20 with an SED of 0.22, then the 95% confidence interval for the difference between the two means would be approximately $1.08 \pm 2 \times 0.22 = 0.64$ to 1.52. **Note:** Count data like these are often non-Normal and must be transformed before applying statistical tests: see transformation of data in next section (page 64).

In a case like this it can be said that the difference between numbers of mayfly nymphs at the two sites is statistically significant (at the 5% level) because the 95% confidence interval does not contain zero. This concept of statistical significance should not be confused with practical importance or biological meaning. Statistical significance of a difference simply implies that the difference between two means is greater than would be expected by chance alone and is, therefore, ‘genuine’.

Probabilities (*P*-values)

Many statistical computer packages will give significance probabilities. A probability is a number between 0 and 1 which measures the chance of something occurring. It is also sometimes expressed as a percentage. A probability of 1 (100%) implies absolute inevitability – the thing is certain to occur. A probability of 0 implies total impossibility. A probability of 0.5 (50%) means that something has an equal chance of occurring as not occurring, e.g. a tossed coin has a probability of 0.5 of showing heads.

The significance probability arising from a statistical test has a rather complex precise interpretation. Basically, the smaller the probability, the more evidence there is of genuine differences or effects. A probability of 0.05 corresponds to the old-fashioned notion of ‘significant at the 5% level’. If a difference between two treatment means has, for example, a significance probability of 0.013 (1.3%), the exact interpretation is as follows.

If there was no ‘true’ difference between treatments, then a result like the one obtained would occur in fewer than 1.3% of experiments.

Therefore, the smaller the probability, the less likely there is **not** to be a genuine difference (the more likely there is to be a genuine difference).

The smaller the standard error, the more precisely the experimental difference estimates the ‘true’ difference. From the formula above, it can be seen that the larger the sample sizes (n_1, n_2, \dots), the smaller the standard error and the better the precision. It is worth noting here that there is a practical limit on sample size: it is a waste of resources to be so precise as to be able to detect differences too small to be of any practical significance or biological meaning.

Warning All these statements depend on the following.

- i) The experimental/survey units being correctly defined and, therefore, both the amount of random variation and the corresponding degree of replication being correct. Basically, there should be one data point per experimental unit. If data come from sub-samples of the unit or repeated measurements over time of the same unit, then more complex multi-level analyses need to be considered. It is usually possible to use a summary statistic (e.g. mean or total) to reduce the analysis to a conventional single-level. This type of approach will usually suffice for any analyses where a variance estimate is not required.
- ii) Data having (approximately) a ‘Normal’ or symmetric distribution.

iii) The standard deviation being similar for all treatments.

If the assumptions (ii) and (iii) above are not true, there are five options:

- transform the data
- use generalized linear modelling (logistic and log-linear, etc.)
- use numerical tests, such as permutation tests or bootstrapping
- use a non-parametric test (less powerful)
- do not carry out a formal analysis but rely on basic statistics and graphical methods.

Examples of two of these approaches are given in the method sheets, i.e. transformation at the beginning of Student's *t*-test, and Mann-Whitney U-test for non-parametric example.

Transformation of data

It may be possible to transform the data to give a symmetric distribution (transformation is usually justified on the grounds that it restores the constant variance assumption, which is more important than normality). This is frequently necessary with data on counts of terrestrial and aquatic animals.

It is often true that if a measurement, e.g. a count, has a skewed distribution, then $\sqrt{\text{count}}$ or $\log(1+\text{count})$ may have a symmetric distribution. Standard, parametric statistical analysis can then be done on this basis. However, this gives problems with the presentation of results. It will usually be necessary to 'back-transform' means to return them to the original units of measurement. Back-transformation cannot be applied to standard errors, but can be used for confidence limits. A $\log(x+1)$ transformation must be used when there are zero counts.

Non-parametric tests

Non-parametric tests are useful in that they make no assumptions (or only very weak assumptions) about the data. They do not require assumptions (ii) and (iii) above regarding symmetric distributions and constant standard deviations. Many non-parametric tests rely on sorting the data in order of magnitude and only use the resulting ranking. To rank data, the lowest value is given the rank 1, the next value has a rank 2, etc. Tied values need to be considered and given an average rank, e.g. if there are two values as third and fourth, they are both given a rank of 3.5. The major drawback of non-parametric tests is that they only exist for relatively simple situations, cannot be generalized and lose power through ranking of data, which discards information.

For comparing two groups, the *Mann-Whitney U-test* is used (Sprent, 1989). Here all the data are sorted and given ranks to see whether those from one group tend to be lower than those from the other group. The sum of the ranks from the lower group is compared with tabulated values and if this sum is smaller than the tabulated value, then the two groups are shown to be significantly different (see method sheet).

SAMPLE SIZE

The previous section discussed how precision is related to random variation and the size of the sample. This means that if you know in advance what the random variation (standard deviation) is likely to be, you can predict the precision of your results for a given sample size.

For example, the mean of 20 samples of a pesticide residue in fish liver was $5 \mu\text{g kg}^{-1}$, with a variance of 6.27. The 95% confidence interval of the mean would be 3.9 to $6.1 \mu\text{g kg}^{-1}$ ($2SE = 2SD/\sqrt{n} = 1.12$). Similarly a mean of 100 samples would have a 95% confidence interval of 4.5 to $5.5 \mu\text{g kg}^{-1}$. Depending on how much precision is needed, an appropriate sample size can be estimated. More exact methods of determining sample size are given in many statistics text books (e.g. Mead *et al.*, 1993).

The degree of precision required will depend on the objectives of the study (and, realistically, the resources available). If only large effects (e.g. a 50% reduction in insect numbers) need to be detected, then low precision will be acceptable and a small study may suffice to detect this. On the other hand, if very small differences are important, then a precise (and possibly a large and expensive) study will be necessary.

More on sub-sampling

As stated earlier, sub-sampling is used when it is impossible or unnecessary to measure the entire sampling unit or experimental unit. Samples are taken from each basic unit in order to estimate the mean for the whole unit.

This distinction is of critical importance for statistical analysis. All variance estimates, standard errors, etc., must be based on experimental units and not on sub-units. If data are recorded on a sub-unit or sub-sample basis, the data must be summarized to values (e.g. means or totals) on an experimental unit basis before any analysis (or before more complex statistical modelling is used).

Statistical analyses should be based on the value for the basic sampling or experimental unit and **not** on the individual sub-sample data. Therefore, data from sub-samples need to be averaged to give one value per experimental unit for statistical analysis. The question often arises of how many sub-samples are necessary?

To answer this, it is necessary to know about random variation at two levels: the experimental unit level and sub-samples within an experimental unit.

The variance per experimental unit, s^2 depends on these two levels of variation and the number of sub-samples as follows:

$$s^2 = Var_u + Var_s/n_s$$

where:

Var_u is the variance between units if the true value for the whole unit is known

Var_s is the variance between sub-samples within a unit

n_s is the number of sub-samples per unit.

Note: In the formula for s^2 , if n_s becomes infinite (i.e. the whole unit value is known exactly) then $s^2 = Var_u$.

The benefit of intensive sub-sampling depends on the relative sizes of the two variances Var_u and Var_s . If the variation between sub-samples is small compared to the variation between units, there is little benefit in increasing the numbers of sub-samples. On the other hand, if the sub-sample variation is large compared with the unit to unit variation, then increasing the number of sub-samples can have a major effect on the overall variance.

The optimum number of sub-samples will also depend on the relative costs of sub-samples and experimental units. If sub-sampling is cheap compared to paying for additional units, then increasing sub-sampling may be cost-effective. This will be the case when travel to a remote area is expensive, but taking sub-samples when you are there has little extra cost. On the other hand, if the actual sub-sample measurement is expensive relative to the cost of the units, then more than one sub-sample may not be worthwhile. This can occur with expensive laboratory determination on plants where it would be better to have as many plants as possible with only one laboratory analysis per plant.

If costs are ignored and the total number of measurements allowed is fixed, then the theoretical optimum strategy is to have as many experimental units as possible with one sub-sample per unit.

To estimate Var_u and Var_s , it is necessary to have data recorded on a sub-sample basis with more than one sub-sample per unit. When the two variances are known (or estimated) and the relative costs of sub-samples and units are known, an optimum sub-sampling strategy can be devised.

Bulk samples

In some cases it may be suggested that combining a number of samples together to form a bulk sample for analysis is necessary. This can be a harmful practice if it destroys the replication which was built in to an experiment or sampling scheme. However, if sub-samples are bulked, this will generally have no detrimental effect on the statistical analysis, since some averaging of sub-samples will be necessary anyway. Soil and water are frequently bulked and sub-sampled to determine, for example, pesticide residues or plankton density.

TRENDS AND RELATIONSHIPS

Another common use of statistics in research is to study relationships or trends. For example, the action of a particular enzyme or insecticide might be related to temperature, or a pesticide residue may degrade over time. The first step in handling data for such purposes is to draw a graph (scatter plot). Such a graph will allow us to see if there is an obvious relationship between the two variables.

The simplest mathematical form for a relationship between two variables, X and Y , is a straight line (see Figure 2.3). The formula for this is:

$$Y = a + bX$$

where the parameters a and b will usually be estimated from data using *linear regression*.

The relationship given in Figure 2.3 relates eggshell thickness of African goshawk to the level of DDE residues in the egg and is given by:

$$\text{shell thickness (mm)} = 0.24 + (-0.00018 \times \text{DDE}).$$

In this example, b (called the regression coefficient or slope) has the value of -0.00018 . This shows that an increase of 100 ppm DDE content in eggs gives rise to a 0.018 mm decrease in shell thickness. The parameter, a (called the constant or intercept) which has the value of 0.24, is the (theoretical) eggshell thickness when the DDE residue in the egg is zero. The whole equation gives sensible results over the range of the data which allows us to predict eggshell thickness for a given DDE residue level in the egg (or vice versa) by reading off from the straight line graph. For example, a DDE level of 100 ppm dry weight will likely result in a shell thickness of approximately 0.22 mm; at a DDE level of 50 ppm, a shell thickness of approximately 0.23 mm will result.

The calculation of the regression coefficient is shown on the method sheet on correlation and linear regression.

Standard errors can be calculated for the estimated regression coefficients and used to determine confidence intervals for predicted values.

Before fitting a straight line to data, drawing a graph will show whether this is a sensible procedure, i.e. is likely to produce a good fit. If the relationship is more complicated than a simple straight line, more complex relationships can be fitted (modelled) using non-linear regression.

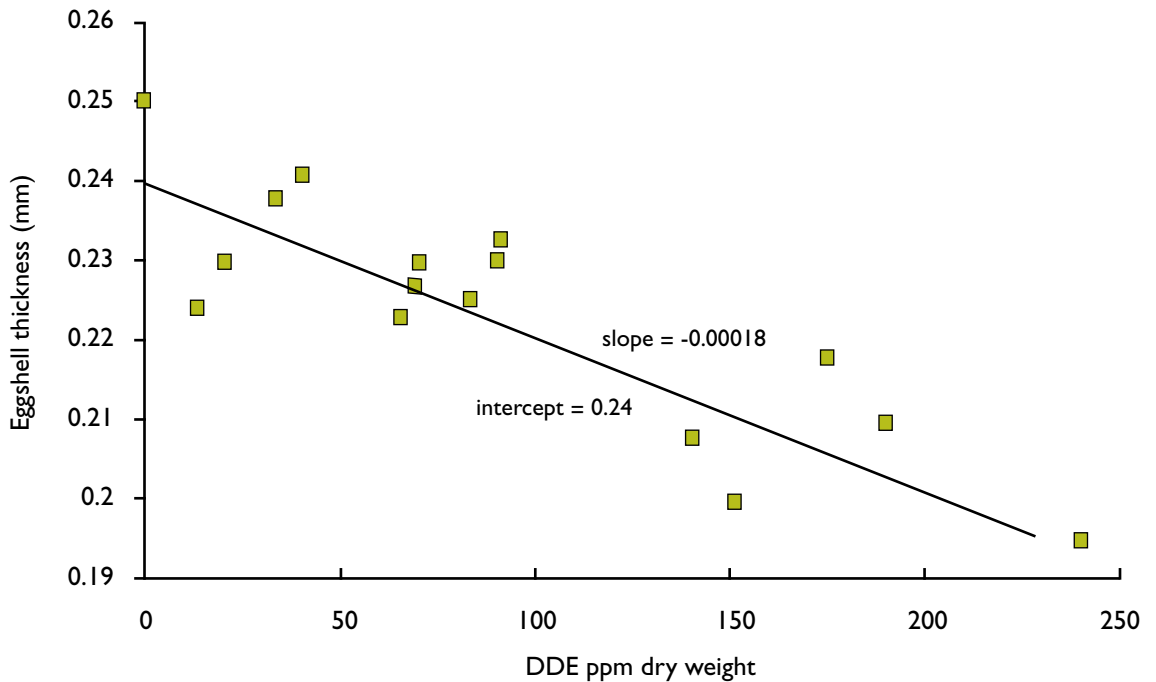

Figure 2.3: Relationship between eggshell thickness of African goshawk and level of DDE residue in eggs

One of the assumptions of regression analysis (in common with many other simple analyses) is that the observations are statistically independent of each other. Particular care is needed when trends over time are examined. For example, if the same sample is measured every week, the result one week will depend on the previous week's result. A simple regression analysis with, say 10 samples each measured on eight occasions, might give misleading results.

The *correlation* between two variables measures the degree of (linear) association between them. The linear correlation coefficient, r , has a value between -1 and $+1$. A value of zero implies that there is no linear relationship between the variables; values of $+1$ and -1 indicate perfect positive and negative association respectively. In other words, all the data will lie exactly on a straight line through the data. (A negative association is one where an increase in one variable, e.g. DDE, is associated with a decrease in the other variable, e.g. shell thickness.)

Non-parametric correlation

The above (Pearson) correlation coefficient assumes a linear relationship and, for significance tests, assumes a bivariate Normal distribution, i.e. for significance tests, joint normality of the two variables is required. An alternative, which does not require these assumptions, is Spearman's rank correlation coefficient. This can be calculated by changing data to ranks (i.e. 1st, 2nd, 3rd highest, etc.) for each variable and calculating the Pearson correlation coefficient on this data. An alternative method of calculation (when there are no ties) is given on the Method Sheet. The value of the Spearman rank correlation can then be tested against tables to give its significance.

ASSOCIATION BETWEEN CATEGORIES

Frequently in ecological studies, observations are based on categories rather than numeric values. Often the objective of an analysis is to determine whether there is an association between two categorical variables. In the

following examples, a number of lizard perches were examined. They were categorized as being above or below 3 m. They were also categorized according to the ground spraying regime applied in the area (i.e. no sprays, two sprays, or more than two sprays). In this study, ground spraying covered trees up to 3 m above the ground – hence the categorization of perch heights. The data are given in Table 2.3 below.

The shaded area of the table contains the basic data in a *contingency table* – in this case a 3 x 2 table (3 rows x 2 columns). It is important in a contingency table that each unit occurs once and only once. In this example, 428 perches were recorded and each perch falls in one of the six shaded cells of the table.

Table 2.3 Comparison of lizard perches above and below 3 m in sprayed and unsprayed areas

Number of sprays	Total number of lizard perches	Number of perches < 3 m	Number of perches ≥ 3 m	Percentage of perches ≥ 3 m
None	197	190	7	3.6
Two	105	99	6	5.7
More than two	126	110	16	12.7
Total	428	399	29	6.8

A chi-squared test (χ^2 test) is used to test whether there is an association between perch height and spraying frequency. Details of this are given in the method sheet. The calculations rely on comparing the observed values with values which would be expected if there was no association. For example, if there was no association, 6.8% of perches would be expected to be ≥ 3 m, irrespective of spraying regime. Therefore, with no spraying, we would expect 6.8% of the 197 perches (13.3 perches) to be higher than 3 m. This compares with the actual observed value of 7. The χ^2 value is calculated as:

$$\chi^2 = \sum \frac{(\text{Observed} - \text{Expected})^2}{\text{Expected}}$$

where the values are summed over all cells in the table. For the data from Table 2.3, the value of χ^2 works out as 10.5. This is compared with critical values from χ^2 tables. The degrees of freedom (d.f.) are calculated as $(r-1) \times (c-1)$ where r and c are the number of rows and columns respectively. In the current example, $r = 3$ and $c = 2$, giving d.f. = 2. The relevant value from tables (see page 85) at the 5% significance level is 5.99. Since our calculated value (10.5) is larger than this tabulated value, the observed values differ significantly from the expected values, and so there is good evidence that the perch height is affected by the spraying frequency.

ANALYSIS OF VARIANCE

This is one of the most widely used methods for testing for significant differences between several (more than two) populations. Analysis of variance determines how much of the variation is due to population differences between treatment areas and how much is due to random variation. It can be used where an experiment or survey has been specifically designed to make a comparison of the effects of these treatments. The method can only be used with normally distributed variables, based on independent observations and variances from samples in different treatments must be equal.

The simplest analysis of variance or ANOVA comes from completely randomized experimental designs, but a whole range of more complex experimental designs are possible involving, for example, blocking (see page 59) or several factors as well as treatments (see chapter 1, Worked Example). The use of ANOVA is best demonstrated through another worked example (see page 71).

REFERENCES

MEAD, R., CURNOW, R.N. and HASTED, A. (1993) *Statistical Methods in Agriculture and Experimental Biology*. Second Edition. London: Chapman and Hall.

NEAVE, H.R. (1981) *Elementary Statistical Tables*. London: George Allen and Unwin.

PEARSON, E.S and HARTLEY, H.O. (1966) *Biometrika Tables for Statisticians*. Cambridge: Cambridge University Press.

SPRENT, P. (1989) *Applied Nonparametric Statistical Methods*. London: Chapman and Hall.

FURTHER READING

CAMPBELL, R.C. (1974) *Statistics for Biologists*. Second edition. Cambridge: Cambridge University Press.

Web help and booklets

<http://www.rdg.ac.uk/ssc/dfid/booklets.html>

A series of booklets aimed at all areas of quantitative analysis in natural resources, funded by the Department for International Development (DFID), UK and authored by the Applied Statistics Department of the University of Reading, UK. Hard copies are available free of charge from the department.

<http://www.statsoft.com/textbook/stathome.html>

This is an electronic statistical textbook giving a detailed coverage.

<http://www.stat.ufl.edu/vlib/statistics.html>

World-wide list of statistical departments.

SUMMARY OF BASIC METHODS

Analysis required	Parametric ¹	Non-parametric
Comparison of two groups	Student's <i>t</i> -test (see page 80) ²	Mann-Whitney U-test (see page 79) ²
Comparison of paired samples	Paired <i>t</i> -test ³	Wilcoxon test ³
Comparison of more than two groups	Analysis of variance (see pages 71–74) ²	Kruskal-Wallis test ³
Comparison of more than two groups (in blocks)	Analysis of variance ³	Friedman's test ³
Experiment with factorial treatment structure (possibly unbalanced)	Analysis of variance (see pages 36–44) ⁴	None
Experiment/survey with additional explanatory variables	Analysis of covariance ³	None
Contingency table	Log-linear models ³	Chi-squared (see page 84) ²
Relationship between two variables	Linear regression ² and correlation (see pages 81–82) ² Non-linear regression ³	Spearman's rank correlation (see page 83) ² Kendall's Tau ³
Relationship between one variable and two or more other variables	Multiple regression ³	None

¹ Since most of the parametric procedures listed here (*t*-tests, analysis of variance, linear and multiple regression and analysis of covariance) are all types of general linear model (GLM), such models give a unified, powerful approach to analysing data. They do, however, require a number of assumptions which may not always be met.

² These methods are described in this chapter.

³ See the references for descriptions of the other methods.

⁴ An example of two-way analysis of variance is given in the Worked Example of chapter 1.

WORKED EXAMPLE

ONE-WAY ANALYSIS OF VARIANCE

The development of an hypothesis about the likely impact of an organophosphate insecticide used near a stream was outlined in chapter 1, Figure 1.1. The null hypothesis was that the organophosphate does not change the abundance of benthic invertebrates in a stream. Let us assume that a monitoring exercise was designed that collected five quantitative samples (cylinder samples of 0.05 m²) at four sites along the course of the Mahaddi river. One of the sites (Site 1) was above the source of pollution, one was immediately below (e.g. the Impact Zone in Figure 9, see chapter 9), and two more (Sites 3 and 4) were further downstream in the Recovery Zone. All were sampled on the same day.

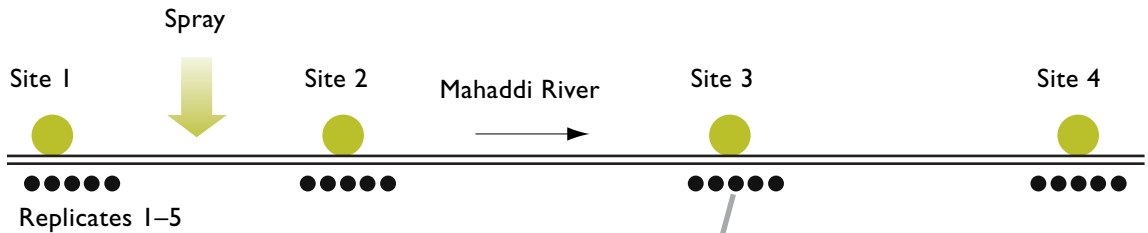

The samples were sorted, identified and counted and the results were tabulated. Species sensitive to organophosphates were identified in the desktop study. These included the mayflies (Ephemeroptera). A look at the counts and mean densities of a species from the mayfly family Baetidae indicated that: (i) the species (*Centroptilum* sp. a) was contagiously distributed in the substrate; and (ii) their abundance declined downstream of the predicted contamination.

Counts of *Centroptilum* sp.a nymphs from five samples (replicates) at four sampling stations (sites)

Site	Description	Count 1	Count 2	Count 3	Count 4	Count 5	Mean	Variance
1	Above pollution	102	93	21	223	69	101.6	5592
2	Below pollution	10	13	15	25	48	22.2	239
3	Further downstream	60	33	14	51	15	34.6	431
4	Further downstream	92	14	23	19	88	47.2	1538

Note: All variances > means, indicating the spatial dispersion is contagious.

Summary	Statistics
Mean	51.4
Median	29.0
Variance	2609.0

Centroptilum sp. a was singled out for a statistical test, a one-way analysis of variance (ANOVA), to accept or reject the null hypothesis. Use of this parametric test assumes that the samples are drawn from the same normally distributed population: a look at the counts above already suggests clumping (likely contagious distribution). Thus the counts must be transformed to normalize the distribution and establish the independence

of the variance from the mean. Logarithmic transformations are normally suitable for small samples from a contagious distribution. (As there is no log of zero, samples containing zero counts are transformed using $\log(x+1)$, a variant that must be applied to all counts.)

Log₁₀ transformed counts of *Centroptilum* sp. a nymphs

Site	Description	Count 1	Count 2	Count 3	Count 4	Count 5	Mean	Variance
1	Above pollution	2.0086	1.9685	1.3222	2.3483	1.8389	1.890	0.139
2	Below pollution	1	1.1139	1.1761	1.3979	1.6812	1.274	0.073
3	Further downstream	1.7785	1.5185	1.1461	1.7076	1.1761	1.465	0.086
4	Further downstream	1.9638	1.1461	1.3617	1.2788	1.9445	1.539	0.150

Note: All variances > means.

Summary Statistics

Mean	1.544
Median	1.458
Variance	0.148

A relationship between the mean and variance in the untransformed counts is clear (right). Despite the fact that there are only four points, the independence of the mean and variance is indicated in the plot of transformed counts (below) and the adequacy of the transformation is therefore accepted. (Non-parametric tests can be applied where these statistics are not independent.)

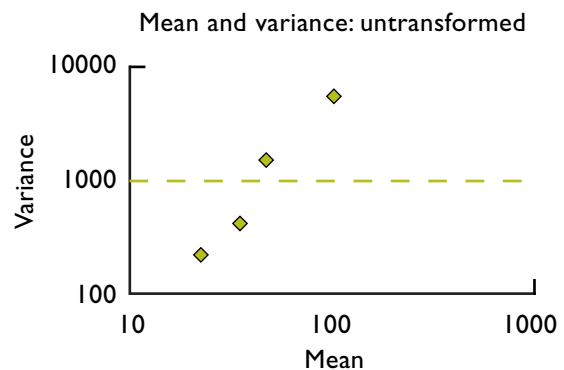
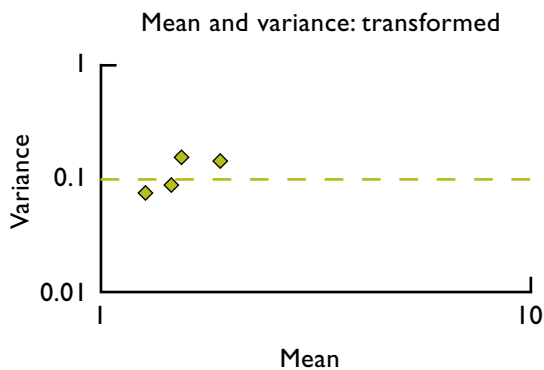

The values from the table of transformed counts may now be entered into a statistical software package to compute the analysis of variance table. The form of data entry in arrays is rather variable between packages: there is no standard design.

The way the above data was entered into Genstat is shown below. Only the *site* and *transformed* count data were used in the ANOVA. The *y* variate was transformed counts of *Centroptilum* sp. a and the treatments were the *Sites*.

The analysis of variance can be calculated by hand but it is very time consuming and particularly daunting for large data arrays. Most people use specialized computer software.

Manual ANOVAR

Site	Counts 1,2,3,4,5, etc	Number of counts	Total	Mean
1		n_1	T1	x_1
2		n_2	T2	x_2
3		n_3	T3	x_3
4		n_4	T4	x_4
Total		$n = \sum n_i$	$\sum T_i = \sum x$	$\bar{x} = \frac{\sum x}{N}$

Total Sum of Squares (SS): overall mean

$$S_t = \sum(x - \bar{x})^2 = \sum(x^2) - \frac{(\sum x)^2}{N}$$

SS between samples

$$S_2 = \sum \left[\frac{(T_i^2)}{n_i} - \frac{(\sum x)^2}{N} \right] = \left[\frac{T_1^2}{n_1} + \frac{T_2^2}{n_2} + \dots + \frac{T_i^2}{n_i} \right] - \frac{(\sum x)^2}{N}$$

SS: Residual variation

$$= \sum \left[\sum(x_i^2) - \frac{(T_i^2)}{n_i} \right]$$

Mean square:

between samples **residual** *F*-test (*v.r.*)

$$S_2^2 = \frac{S_2}{i-1} \qquad S_2^2 = \frac{S_2}{N-i} \qquad F = \frac{S_2^2}{S_1^2}$$

i = number of sites (4)
n = number of counts (5)
N = total number of counts (20)

Data Entry into Software Program

Site	Count	Transformed
1	102	2.0086
1	93	1.96848
1	21	1.32222
1	223	2.34830
1	69	1.83885
2	10	1.00000
2	13	1.11394
2	15	1.17609
2	25	1.39794
2	48	1.68124
3	60	1.77815
3	33	1.51851
3	14	1.14613
3	51	1.70757
3	15	1.17609
4	92	1.96379
4	14	1.14613
4	23	1.36173
4	19	1.27875
4	88	1.94448

Analysis of variance: one-way, no blocking

Source of variation	d.f.	Sum of Squares	Mean square	<i>v.r.</i>	<i>F</i> prob.
Between sites	3	1.0201	0.3400	3.04	0.05
Between samples (residual)	16	1.7898	0.1119		
Total	19	2.8098			

d.f.= degrees of freedom; *v.r.*= variance ratio; *F* prob = probability of the *F* statistic.

The ANOVA of the observations of *Centroptilum* numbers at sites along the river is shown above. The estimates of variance (mean squares) are tested using the variance-ratio test (F -test) to establish whether the random samples of *Centroptilum* at each site come from the same normally distributed populations (same means and variance). If the variances are significantly different then the probability is that they do not and the inference is that insecticide pollution of the water is probably the cause. The column F prob. gives the probability of the calculated $vr.$ of 3.04 occurring by chance. In this case the probability P is equal to 0.05, meaning that there is a 1 in 20 or 5% chance that the difference in population means could have occurred by chance. Thus, there is a statistically significant difference in the abundance of *Centroptilum* sp. a between sample sites. The null hypothesis that the organophosphate insecticide in the water does not affect the abundance of the mayfly is rejected. Higher levels of significance such as $P < 0.01$ or $P < 0.001$ would increase the chances to 1 in 100 and 1 in 1000 respectively, and strengthen the decision that the organophosphate was causing the impact. (By this stage one has accepted that there were no other sources of pollution along this stretch of river.)

In the manual ANOVA, the tabulated value of F at various levels of probability (P) is looked up in a table (e.g. Pearson and Hartley, 1966). The degrees of freedom (ν_1) between sites is 3, and (ν_2), between samples, is 16. The tabulated figure is compared with the calculated value ($vr.$) If the tabulated figure is less than the calculated figure, the null hypothesis is rejected at the tabulated level of significance.

The conclusions to be drawn from this monitoring and those from a later time-series (as you would be interested in the longevity of impact) would draw on the statistical analyses to report with confidence on:

- the observed impacts
- the speed of recovery
- the overall biological significance of the insecticide use

This information and data would help you speculate on whether the observed impact(s) is acceptable or not.

WORKSHEETS FOR USEFUL STATISTICS

Random sampling

These methods are based on using random number tables. Similar methods are used if random numbers are generated by a calculator or computer. The example uses the table opposite and starts at the top left-hand corner of the random number tables.

In practice, a haphazard starting point would be selected.

To select random co-ordinates within an area, pairs of random numbers can be chosen.

Different methods	Example
<p>1. To select a sample from a population with up to 100 units, simply select digits in pairs (with 00 = 100), ignoring any number which is too large. To select a sample from a population with up to 1000 units, select the digits three at a time to give the required sample.</p>	<p>To select a sample of 10 units from a population of 65, take digits in pairs, ignoring numbers > 66.</p> <p>Sequence is 3 2 1 6 6 4 3 5 6 9 0 3 1 5 2 2 8 1 6 5 6 8 1 7 7 8 9 0 6 0 9 4 ...</p> <p>Units sampled are 32, 16, 64, 35, (ignore 69), 3, 15, 22, (ignore 81), 65, (ignore 68), 17, 60.</p>
<p>2. To avoid 'wasting' too many digits, the method in 1 above can be modified.</p> <p>If the population size is less than 200, a selection of between 201 and 400 can be converted to a number between 1 and 200 by the subtraction of 200. Similarly for selections between 401 and 600; or 601 and 800; or 801 and 1000.</p> <p>If the population size is less than 300, selections between 301 and 600 or between 601 and 900 can be converted to a number between 1 and 300 by subtraction of 300 or 600 (selections between 901 and 1000 are ignored).</p>	<p>To select a sample from a population of 175, the maximum round number, e.g. 200 (or 400, 600 or 800) can be subtracted from triples greater than 200.</p> <p>Triples in sequence are 321 664 356 903 152 281 656 817 789 060 944 ...</p> <p>Units sampled are 121 64 156 103 152 81 56 17 (ignore 789/189) 60 144 ...</p>

Tip: Copy methods of 'Random Sampling' and 'Random Treatment Allocation' to right-hand side of book if you will be using a random number table in the field.

Table of random numbers (first two rows made consistent with example overleaf)

3	2	1	6	6	4	3	5	6	9
0	3	1	5	2	2	8	1	6	5
6	8	1	7	7	8	9	0	6	0
9	4	2	5	0	6	4	6	9	5
8	6	6	1	8	6	7	2	0	9
9	0	2	0	6	3	1	1	3	5
8	4	1	0	4	9	4	7	0	2
3	5	2	4	5	0	0	0	4	0
8	5	4	3	2	1	2	2	3	6
6	0	6	1	8	7	0	9	2	8
6	8	0	8	4	1	0	0	2	2
0	2	2	1	0	7	1	7	0	1
0	5	9	6	4	1	9	0	2	5
2	0	4	5	8	7	2	1	5	7
2	3	1	0	0	7	2	1	8	4
6	4	7	5	6	3	5	0	1	1
8	9	4	5	8	5	6	0	9	8
3	1	4	1	0	5	4	5	1	3
4	6	8	1	7	3	1	1	1	7
5	1	1	7	4	6	1	9	2	7
8	0	6	8	1	8	9	2	9	4
5	4	8	5	1	2	9	2	0	6
9	5	9	1	5	6	5	7	6	8
6	1	0	8	0	5	3	1	2	3
7	4	5	1	8	9	5	2	4	1
7	8	5	2	2	9	3	3	0	6
2	6	0	7	7	7	6	2	8	3
0	3	6	3	0	5	9	8	6	1
7	8	7	2	0	6	8	4	6	7
5	2	7	4	1	6	9	6	1	1
3	9	2	2	7	9	8	2	3	4
6	6	7	8	2	6	0	7	4	5
8	5	6	1	2	8	9	5	6	8
7	6	8	0	4	0	9	8	9	7
3	6	4	8	0	7	9	0	6	6
9	3	0	4	3	4	8	1	7	7
3	2	4	7	8	1	6	8	2	3
5	2	7	0	7	3	6	3	9	9
3	2	8	6	6	3	6	7	5	2
7	7	3	5	7	6	1	5	5	9
6	9	0	5	5	3	0	7	2	5
2	5	4	9	3	3	7	3	4	9
7	3	1	0	6	3	1	5	1	2
9	3	0	4	8	5	4	9	6	7
3	5	9	5	8	3	9	3	9	0
5	3	6	0	8	0	8	5	7	1
8	6	9	2	1	5	4	4	8	7
5	3	0	4	7	9	9	7	4	5
1	8	4	2	6	9	0	1	1	1
8	9	3	8	7	9	5	2	3	1
5	8	3	6	7	1	6	6	7	4
3	3	4	8	3	8	3	2	1	2

Random treatment allocation

The first two methods below are based on using random number tables. Similar methods are used if random numbers are generated by a calculator or computer. The examples start in the top left-hand corner of the random number tables given in the method for 'Random Sampling'.

In practice, a haphazard starting point would be selected.

Different methods	Example																				
<p>1. If random allocation of eight treatments is required, take the random digits one at a time, ignoring 0 and 9 and any repeats.</p>	<p>Sequence is 3 2 1 6 6 4 3 5 6 9 0 3 1 5 2 2 8 ; 1 Allocation is 3 2 1 6 - 4 - 5 - - - - - 8 7; 1</p> <p>(The - indicates that the digit is ignored because it is a repeat of a treatment already selected or is 0 or 9. The 7 at the end can be selected since it is the only remaining treatment.)</p>																				
<p>2. If random allocation of, for example, three treatments is required, the method 1 above can be modified to avoid 'wasting' too many digits. Digits 1, 2 and 3 give treatment 1; 4, 5 and 6 give treatment 2; 7, 8 and 9 give treatment 3 and 0 is ignored. Note that an equal number of digits must be allocated to each treatment.</p>	<p>Sequence is 3 2 1 6 ; 6 4 3 ; 5 6 9 ; 0 3 1 5 ; Allocation is 1 - - 2 3; 2 - 1 3; 2 - 3 1; - 1 - 2 3;</p> <p>(The - indicates that the digit is ignored because it is a repeat of a treatment already selected or is 0. The last treatment in each group can be selected without random numbers since it is the only remaining treatment.)</p>																				
<p>3. This method allocates n treatments using a computer spreadsheet (or a calculator). Generate n random numbers in column 1 with another column with the numbers 1...n. Sort both columns and the numbers 1...n will then be in a random order.</p>	<p>To allocate five treatments, the following five random numbers were generated:</p> <table style="margin-left: 20px;"> <tr> <td>.321</td> <td>.166</td> <td>.435</td> <td>.690</td> <td>.315</td> </tr> <tr> <td>1</td> <td>2</td> <td>3</td> <td>4</td> <td>5</td> </tr> </table> <p>Sorting gives:</p> <table style="margin-left: 20px;"> <tr> <td>.166</td> <td>.315</td> <td>.321</td> <td>.435</td> <td>.690</td> </tr> <tr> <td>2</td> <td>5</td> <td>1</td> <td>3</td> <td>4</td> </tr> </table> <p>with the last row giving the order of allocation of treatments to units.</p>	.321	.166	.435	.690	.315	1	2	3	4	5	.166	.315	.321	.435	.690	2	5	1	3	4
.321	.166	.435	.690	.315																	
1	2	3	4	5																	
.166	.315	.321	.435	.690																	
2	5	1	3	4																	

Calculation of standard deviation (SD)

The standard deviation is a measure of random variation. Many scientific calculators will calculate this statistic without going through the steps below. (The relevant button on a calculator may be labelled by s or $s_{(n-1)}$ or $SD_{(n-1)}$.)

The data are the number of Lepidoptera larvae sampled (at nine sites)

Site	Number of larvae	Site	Number of larvae
A	13	F	68
B	13	G	86
C	10	H	6
D	9	I	44
E	45		

The formula for the standard deviation is:

$$SD = \sqrt{\frac{\sum (x - \text{mean})^2}{n-1}}$$

where x is a data value, n is the number of units and \sum is the sign for summation (adding). An alternative formula which can be more easily calculated is:

$$SD = \sqrt{\frac{\sum x^2 - \frac{(\sum x)^2}{n}}{n-1}}$$

Below is shown calculation of SD using the second formula.

Method	Example
1. Calculate $\sum x$ ($= \alpha$)	$13 + 13 + 10 + \dots + 44 = 294$
2. Calculate $\sum x^2$ ($= \beta$)	$13^2 + 13^2 + 10^2 + \dots + 44^2 =$ $169 + 169 + 100 + \dots + 1936 = 16536$
3. Calculate $\beta - \frac{\alpha^2}{n}$ ($= \gamma$)	$16536 - \frac{294 \times 294}{9} = 6932$
4. Calculate Variance $= \frac{\gamma}{n-1}$	$\frac{6932}{8} = 866.5$
4. Calculate SD $= \sqrt{\text{Variance}}$	$\sqrt{866.5} = 29.4$

Mann-Whitney U-test for comparing two samples

The following data are the number of Lepidoptera larvae from nine unsprayed and seven sprayed sites. These data do not meet the assumptions needed to use a standard parametric statistical test, e.g. the variance of the samples for the two treatments is different.

Sprayed	10	2	10	1	0	4	7		
Unsprayed	13	13	10	9	45	68	86	6	44

Method	Example
1. Sort all the data, marking (underlining) those from sprayed sites.	<u>0</u> <u>1</u> <u>2</u> <u>4</u> <u>6</u> <u>7</u> <u>9</u> <u>10</u> <u>10</u> <u>10</u> 13 13 44 45 68 86
2. Attach ranks to the data (i.e. 1st, 2nd, 3rd, etc.) allowing for ties.	<u>1</u> <u>2</u> <u>3</u> <u>4</u> <u>5</u> <u>6</u> <u>7</u> <u>9</u> <u>9</u> <u>9</u> 11 11 13 14 15 16
3. Sum the underlined ranks (= S).	1 + 2 + 3 + 4 + 6 + 9 + 9 = 34
4. Calculate $U_1 = S - (\frac{1}{2} \times n_1 \times (n_1 + 1))$ where n_1 is the sample size for the underlined (sprayed) sample.	$U_1 = 34 - \frac{1}{2} (7 \times 8) = 34 - 28 = 6$
5. Determine U as the smaller of U_1 and $(n_1 \times n_2) - U_1$ (where n_2 is the sample size for the non-underlined sample).	$U_1 = 6$ and $(n_1 \times n_2) - U_1 = (7 \times 9) - 6 = 57$ therefore, $U = 6$
6. Compare value with tables (see page 86).	The tabulated values for $n_1 = 7$ and $n_2 = 9$ is 12 (5% significance level). The calculated value, $U = 6$, is less than this, showing a significant difference between the two groups ($P < 0.05$).
7. Interpret results.	There is statistically significant difference between the abundance of Lepidoptera larvae in sprayed and unsprayed sites, with fewer caught in the sprayed sites.

Student's *t*-test for comparing two samples

The following example data are the same as the data used for the Mann-Whitney U-test, except the data are transformed using $\log_e(1 + \text{number of larvae})$ in order to give similar standard deviations for the two groups and symmetric distributions, e.g. a count of 10 larvae is transformed to $\log_e(1 + 10) = \log_e(11) = 2.40$.

Counts	Sprayed	10	2	10	1	0	4	7	
	Unsprayed	13	13	10	9	45	68	86	6
Transformed counts	Sprayed	2.40	1.10	2.40	0.69	0.00	1.61	2.08	
	Unsprayed	2.64	2.64	2.40	2.30	3.83	4.23	4.47	1.95

Method	Example
1. Calculate the means (m_1 and m_2) and standard deviations (SD_1 and SD_2) for each group.	$m_1 = 1.47$; $SD_1 = 0.915$; $n_1 = 7$ $m_2 = 3.14$; $SD_2 = 0.939$; $n_2 = 9$
2. Calculate the average standard deviation. $SD = \sqrt{\frac{((n_1-1) \times SD_1^2) + ((n_2-1) \times SD_2^2)}{n_1 + n_2 - 2}}$	$SD = \sqrt{\frac{(6 \times 0.915^2) + (8 \times 0.939^2)}{14}} = 0.929$
3. Calculate the difference between the two means ($m_1 - m_2$).	Difference = $1.47 - 3.14 = -1.67$
4. Calculate the standard error for the difference $SED = SD \times \sqrt{\frac{1}{n_1} + \frac{1}{n_2}}$	$SED = 0.929 \times \sqrt{\frac{1}{7} + \frac{1}{9}} = 0.468$
5. Calculate $t = \frac{m_1 - m_2}{SED}$ and (ignoring any minus sign) compare with the tabulated value, $t_{0.05}$, for $(n_1 + n_2 - 2)$ d.f. (see page 85)	$t = \frac{-1.67}{0.468} = 3.57$ (ignoring the minus sign) This is larger than the tabulated value for 14 d.f. ($t_{0.05} = 2.14$; $t_{0.01} = 2.98$), therefore, the difference is statistically significant ($P < 0.01$).
6. Interpret results with the aid of a confidence interval (difference $\pm t_{0.05} \times SED$)	A 95% confidence interval for the 'true' difference is $-1.67 \pm (2.14 \times 0.468)$, i.e. -2.67 to -0.67 . Therefore, the number of larvae on the sprayed sites is about $1.67 \pm 1.00^*$ (on a log scale) lower than the number on the unsprayed sites.

*Interpreting this figure when transformed back to the original scale is rather awkward, but the means of 1.47 and 3.14 can be transformed back to 3.3 and 22.1 larvae, respectively. Their confidence intervals can also be 'back-transformed'.

Correlation and linear regression

The correlation coefficient, r , measures the linear association between two variables. Many scientific calculators will calculate this statistic without going through the steps below. Linear regression estimates the 'best' straight line ($Y = a + bX$) which describes the relationship.

The data are from a study of the relationship between the level of DDE in birds' eggs and the thickness of their eggshells (see page 67).

DDE residue level (X) (ppm dry weight)	0	10	20	33	40	65	69	70	83	90	91	140	151	175	190	240
Shell thickness (mm) (Y)	.25	.225	0.23	0.238	0.241	0.223	0.227	0.23	0.225	0.23	0.233	0.208	0.2	0.218	0.21	0.195

There are PC-based programmes and calculators that can short-circuit the need for manual calculation. The columns of basic statistics below were produced on MS Excel.

Method

Least squares

1. Draw a graph of the data to check if the assumption of a straight line is reasonable.
2. Calculate the means of X and Y ; the deviations from the mean

$$x = X - \bar{X} \quad y = Y - \bar{Y}$$

and the squares and cross products of the deviations (x^2 , y^2 and xy).

	DDE	m m	Deviation from means		Square of deviates		Product of deviates
	X	Y	x	y	x^2	y^2	xy
	0	0.250	-91.6875	0.0260625	8406.597656	0.000679254	-2.389605469
	10	0.225	-81.6875	0.0010625	6672.847656	1.12891E-06	-0.086792969
	20	0.230	-71.6875	0.0060625	5139.097656	3.67539E-05	-0.434605469
	33	0.238	-58.6875	0.0140625	3444.222656	0.000197754	-0.825292969
	40	0.241	-51.6875	0.0170625	2671.597656	0.000291129	-0.881917969
	65	0.223	-26.6875	-0.0009375	712.2226563	8.78906E-07	0.025019531
	69	0.227	-22.6875	0.0030625	514.7226563	9.37891E-06	-0.069480469
	70	0.230	-21.6875	0.0060625	470.3476563	3.67539E-05	-0.131480469
	83	0.225	-8.6875	0.0010625	75.47265625	1.12891E-06	-0.009230469
	90	0.230	-1.6875	0.0060625	2.84765625	3.67539E-05	-0.010230469
	91	0.233	-0.6875	0.0090625	0.47265625	8.21289E-05	-0.006230469
	140	0.208	48.3125	-0.0159375	2334.097656	0.000254004	-0.769980469
	151	0.200	59.3125	-0.0239375	3517.972656	0.000573004	-1.419792969
	175	0.218	83.3125	-0.0059375	6940.972656	3.52539E-05	-0.494667969
	190	0.210	98.3125	-0.0139375	9665.347656	0.000194254	-1.370230469
	240	0.195	148.3125	-0.0289375	21996.59766	0.000837379	-4.291792969
Sum	1467	3.583			72565.4375	0.003266938	-13.1663125
Mean	91.6875	0.224					
square root					269.379732	0.057157677	

3. Compute b (the slope)

$$b = \frac{\sum_{i=1}^n (X_i - \bar{X})(Y_i - \bar{Y})}{\sum_{i=1}^n (X_i - \bar{X})^2} = \frac{\sum xy}{\sum x^2} = \frac{-13.1663125}{72565.4375} = -0.0001814$$

4. Compute a (intercept) from $Y = a + b.X$ $\left\{ \begin{array}{l} a = Y - (b \times X) \\ a = 0.2239375 - (-0.0001814 * 91.6875) \end{array} \right\} = 0.24$
(See Figure 2.3.)

5. Compute the simple linear correlation coefficient r using the formula

$$r = \frac{(\sum xy)}{(\sqrt{\sum x^2}) \times (\sqrt{\sum y^2})}$$

$$\{r = (13.1663125 / 269.379732 * 0.057157677) = -0.855\}$$

The r value of -0.86 being close to -1 implies that DDE residues in eggs and shell thickness of African goshawk eggs is strongly and negatively correlated – the higher the residue level, the thinner the eggshell.

Spearman's rank correlation

Spearman's rank correlation coefficient does not require the assumption of normality, which is needed for valid significance tests for the parametric Pearson correlation coefficient. The method given below for calculation of Spearman's rank correlation coefficient uses some of the data for DDE residue levels and African goshawk eggshell thickness used before (see Correlation and Linear Regression worksheet and page 81).

Data: Correlation between DDE in African goshawk eggs and eggshell thickness.

DDE (<i>X</i>) (ppm) in eggs	0	20	40	70	90	140	190
Shell thickness (<i>Y</i>) (mm) of eggs	0.250	0.230	0.241	0.230	0.230	0.208	0.210

Method	Example																																																										
1. Separately rank the <i>X</i> and <i>Y</i> variables.	<table border="1"> <thead> <tr> <th colspan="2">DDE</th> <th colspan="2">mm</th> <th rowspan="2"><i>d</i></th> <th rowspan="2"><i>d</i>²</th> </tr> <tr> <th><i>X</i></th> <th>Rank</th> <th><i>Y</i></th> <th>Rank</th> </tr> </thead> <tbody> <tr><td>0</td><td>1</td><td>0.250</td><td>1</td><td>0</td><td>0</td></tr> <tr><td>20</td><td>2</td><td>0.230</td><td>4</td><td>-2</td><td>4</td></tr> <tr><td>40</td><td>3</td><td>0.241</td><td>2</td><td>1</td><td>2</td></tr> <tr><td>70</td><td>4</td><td>0.230</td><td>4</td><td>0</td><td>0</td></tr> <tr><td>90</td><td>5</td><td>0.230</td><td>4</td><td>1</td><td>1</td></tr> <tr><td>140</td><td>6</td><td>0.208</td><td>7</td><td>-1</td><td>1</td></tr> <tr><td>190</td><td>7</td><td>0.210</td><td>6</td><td>1</td><td>1</td></tr> <tr> <td colspan="4"></td> <td>Sum</td> <td>T = 9</td> </tr> </tbody> </table>	DDE		mm		<i>d</i>	<i>d</i> ²	<i>X</i>	Rank	<i>Y</i>	Rank	0	1	0.250	1	0	0	20	2	0.230	4	-2	4	40	3	0.241	2	1	2	70	4	0.230	4	0	0	90	5	0.230	4	1	1	140	6	0.208	7	-1	1	190	7	0.210	6	1	1					Sum	T = 9
DDE		mm		<i>d</i>	<i>d</i> ²																																																						
<i>X</i>	Rank	<i>Y</i>	Rank																																																								
0	1	0.250	1	0	0																																																						
20	2	0.230	4	-2	4																																																						
40	3	0.241	2	1	2																																																						
70	4	0.230	4	0	0																																																						
90	5	0.230	4	1	1																																																						
140	6	0.208	7	-1	1																																																						
190	7	0.210	6	1	1																																																						
				Sum	T = 9																																																						
3. Calculate the sum of <i>d</i> ² , $T = \sum d^2$																																																											
4. Calculate Spearman's correlation	$r = 1 - \frac{6 \times 9}{7^3 - 7} = 0.84$																																																										
5. Compare with correlation coefficient values in tables and interpret results.	Coefficient = 0.786 for <i>P</i> = 0.05 = 0.929 for <i>P</i> = 0.01 (Number of pairs = 7) Significant at 5% level																																																										

Chi-squared test for contingency tables

The data for this example are from a study of the effect of ground spraying (up to 3 m) on the height of lizard perches (see Table 2.3)

Number of sprays	Total number of lizard perches	Number of perches < 3 m	Number of perches ≥ 3 m	Percentage of perches ≥ 3 m
None	197	190	7	3.6
Two	105	99	6	5.7
More than two	126	110	16	12.7
Total	428	399	29	6.8

The main data are a 3 × 2 contingency table for three spraying frequencies and two heights, giving six 'cells' with observed values in the shaded area of the table.

The formula for a chi-squared (χ^2) test is, $\chi^2 = \sum \frac{(\text{Observed} - \text{Expected})^2}{\text{Expected}}$

where the expected values are calculated assuming there is no effect of number of sprays, and values are summed over the six cells.

Method	Example						
1. Calculate expected value for each cell as $\text{Expected} = \frac{\text{Row total} \times \text{Column total}}{\text{Overall total}}$	Expected value, e.g. No spray, ≥3 m $= 197 \times 29/428 = 13.3$ (= 6.8% of 197) Values for the six cells are <table style="margin-left: 20px;"> <tr><td>183.7</td><td>13.3</td></tr> <tr><td>97.9</td><td>7.1</td></tr> <tr><td>117.5</td><td>8.5</td></tr> </table>	183.7	13.3	97.9	7.1	117.5	8.5
183.7	13.3						
97.9	7.1						
117.5	8.5						
2. Calculate (Observed - Expected) for each cell.	Values for the six cells are <table style="margin-left: 20px;"> <tr><td>6.3</td><td>-6.3</td></tr> <tr><td>1.1</td><td>-1.1</td></tr> <tr><td>-7.5</td><td>7.5</td></tr> </table>	6.3	-6.3	1.1	-1.1	-7.5	7.5
6.3	-6.3						
1.1	-1.1						
-7.5	7.5						
3. Calculate $\chi^2 = \sum \frac{(\text{Observed} - \text{Expected})^2}{\text{Expected}}$	$\chi^2 = 6.3^2/183.7 + (-6.3)^2/13.3 + 1.1^2/97.9 + (-1.1)^2/7.1 + (-7.5)^2/117.5 + 7.5^2/8.5$ $= 10.5$						
4. Compare calculated χ^2 with value from tables (see page 85) (with $(r - 1) \times (c - 1)$ degrees of freedom, where r and c are the number of rows and columns respectively.	Value from table for 2 d.f. (= $(3-1) \times (2-1)$) at the 5% probability level is $\chi^2_{0.05} = 5.99$; $\chi^2_{0.01} = 9.21$ The calculated value of 10.5 is larger than these, therefore, the association between perch height and number of sprays is statistically significant ($P < 0.01$).						
5. Interpret results.	The proportion of lizard perches above 3 m increases with increased number of sprays.						

APPENDIX STATISTICAL TABLES

Student's <i>t</i> -test and Chi-squared					Pearson's and Spearman's correlation coefficients				
Degrees of Freedom	Student's <i>t</i> -test		Chi-squared		Number of pairs	Pearson's (Normal)		Spearman's (ranks)	
	<i>P</i> = 0.05	<i>P</i> = 0.01	<i>P</i> = 0.05	<i>P</i> = 0.01		<i>P</i> = 0.05	<i>P</i> = 0.01	<i>P</i> = 0.05	<i>P</i> = 0.01
1	12.71	63.66	3.84	6.63	1	-	-	-	-
2	4.30	9.92	5.99	9.21	2	-	-	-	-
3	3.18	5.84	7.81	11.34	3	0.997	1.000	-	-
4	2.78	4.60	9.49	13.28	4	0.950	0.990	-	-
5	2.57	4.03	11.07	15.09	5	0.878	0.959	1.000	-
6	2.45	3.71	12.59	16.81	6	0.811	0.917	0.886	1.000
7	2.36	3.50	14.07	18.48	7	0.756	0.875	0.786	0.929
8	2.31	3.36	15.51	20.09	8	0.707	0.834	0.738	0.881
9	2.26	3.25	16.92	21.67	9	0.666	0.798	0.700	0.833
10	2.23	3.17	18.31	23.21	10	0.632	0.765	0.649	0.794
11	2.20	3.11	19.68	24.73	11	0.602	0.735	0.618	0.755
12	2.18	3.05	21.03	26.22	12	0.576	0.708	0.587	0.727
13	2.16	3.01	22.36	27.69	13	0.553	0.684	0.560	0.703
14	2.14	2.98	23.68	29.14	14	0.532	0.661	0.539	0.679
15	2.13	2.95	25.00	30.58	15	0.514	0.641	0.521	0.654
16	2.12	2.92	26.30	32.00	16	0.497	0.623	0.503	0.635
17	2.11	2.90	27.59	33.41	17	0.482	0.606	0.488	0.618
18	2.10	2.88	28.87	34.81	18	0.468	0.590	0.472	0.600
19	2.09	2.86	30.14	36.19	19	0.456	0.575	0.460	0.584
20	2.09	2.85	31.41	37.57	20	0.444	0.561	0.447	0.570
25	2.06	2.79	37.65	44.31	25	0.396	0.505	0.398	0.511
30	2.04	2.75	43.77	50.89	30	0.361	0.463	0.362	0.467
35	2.03	2.72	49.80	57.34	35	0.334	0.430	0.335	0.433
40	2.02	2.70	55.76	63.69	40	0.312	0.403	0.313	0.405
45	2.01	2.69	61.66	69.96	45	0.294	0.380	0.295	0.382
50	2.01	2.68	67.50	76.15	50	0.279	0.361	0.279	0.363
60	2.00	2.66	79.08	88.38	60	0.254	0.330	0.255	0.331
70	1.99	2.65	90.53	100.43	70	0.235	0.306	0.234	0.307
80	1.99	2.64	101.88	112.33	80	0.220	0.286	0.220	0.287
90	1.99	2.63	113.15	124.12	90	0.207	0.270	0.207	0.271
100	1.98	2.63	124.34	135.81	100	0.197	0.257	0.197	0.257

Mann-Whitney U-test Critical values of U for two-tailed test at $P = 0.05$

$n_1 \backslash n_2$	2	3	4	5	6	7	8	9	10	11	12	13	14	15	16	17	18	19	20
2	-																		
3	-	-																	
4	-	-	0																
5	-	0	1	2															
6	-	1	2	3	5														
7	-	1	3	5	6	8													
8	0	2	4	6	8	10	13												
9	0	2	4	7	10	12	15	17											
10	0	3	5	8	11	14	17	20	23										
11	0	3	6	9	13	16	19	23	26	30									
12	1	4	7	11	14	18	22	26	29	33	37								
13	1	4	8	12	16	20	24	28	33	37	41	45							
14	1	5	9	13	17	22	26	31	36	40	45	50	55						
15	1	5	10	14	19	24	29	34	39	44	49	54	59	64					
16	1	6	11	15	21	26	31	37	42	47	53	59	64	70	75				
17	2	6	11	17	22	28	34	39	45	51	57	63	69	75	81	87			
18	2	7	12	18	24	30	36	42	48	55	61	67	74	80	86	93	99		
19	2	7	13	19	25	32	38	45	52	58	65	72	78	85	92	99	106	113	
20	2	8	14	20	27	34	41	48	55	62	69	76	83	90	98	105	112	119	127

More random numbers

32	16	64	35	69	03	15	22	81	65	68	17	78	90	60	94	40	76	43	95
91	50	53	94	09	37	29	05	22	93	05	60	72	05	38	90	10	61	94	32
65	95	52	85	98	07	35	64	52	51	53	49	15	32	51	88	19	55	49	63
75	93	67	49	81	22	25	02	92	67	10	96	99	41	96	49	00	80	22	42
08	89	85	92	89	95	91	80	61	03	98	71	58	72	88	67	86	10	26	91
73	77	19	68	49	28	48	95	41	65	85	60	38	29	57	07	97	20	71	05
54	52	88	27	05	55	24	78	18	00	71	97	62	87	56	65	83	74	79	30
32	56	68	15	73	94	09	87	75	19	65	64	18	66	56	40	01	06	03	13
10	16	17	75	21	35	37	71	75	87	92	74	37	86	89	71	51	07	12	48
14	52	25	25	76	97	65	42	85	30	36	65	01	69	47	94	66	96	52	38
01	66	16	63	70	33	50	56	09	72	67	15	52	16	81	20	56	89	12	75
54	72	11	99	30	66	76	39	67	91	71	79	37	98	09	49	04	12	25	64
88	91	00	32	88	51	43	47	88	76	16	99	52	19	93	41	41	99	45	11
44	79	42	77	67	66	56	99	59	78	70	56	36	55	66	57	70	35	98	70
06	85	29	90	78	98	28	83	80	55	24	27	74	59	91	78	75	38	72	96
13	31	19	57	99	41	50	65	98	88	13	20	46	29	27	38	85	77	37	85
98	09	10	19	84	71	24	93	50	75	98	40	93	07	82	59	29	23	63	47
30	72	27	90	46	16	19	49	78	64	21	70	48	27	28	35	56	95	21	03
81	29	07	44	83	84	49	19	80	60	44	07	70	87	65	42	52	42	36	47
18	07	57	28	84	66	33	38	25	55	43	49	65	43	93	38	18	84	87	57
11	08	62	67	82	76	25	03	07	95	43	67	14	96	03	14	67	75	07	09
77	12	29	40	97	49	87	67	85	64	43	64	80	07	12	64	79	20	85	63
60	53	30	65	32	62	92	48	58	91	58	40	55	67	95	53	80	70	41	93
28	27	39	92	53	90	19	51	29	42	01	81	65	84	15	09	89	74	39	19
23	44	27	43	50	65	38	27	16	21	37	93	38	12	77	61	96	85	35	96
51	07	07	81	76	50	45	82	59	46	33	76	31	53	78	44	12	91	29	67
11	06	88	60	66	01	39	56	79	05	40	82	21	18	14	50	52	97	95	86
64	27	45	41	52	28	08	84	39	68	19	48	75	21	32	01	12	16	81	29
76	54	43	10	62	21	13	44	54	70	68	37	82	11	21	93	62	69	37	21
84	61	38	04	24	52	36	39	29	21	41	93	63	29	80	93	58	01	72	82
46	97	95	66	45	31	85	84	39	69	18	28	56	78	93	40	70	74	95	14
26	19	31	32	19	18	17	63	39	83	38	52	96	02	37	20	34	61	44	28
63	10	28	91	13	63	70	24	36	57	34	80	61	53	46	93	26	97	46	66
92	37	36	03	76	95	79	61	88	16	76	04	19	63	74	18	66	06	32	89
42	57	03	10	49	11	55	90	70	35	87	65	56	68	66	52	58	81	38	69
96	50	43	59	93	93	92	27	82	31	21	37	14	23	81	88	57	15	08	02
42	89	92	36	24	25	12	82	21	55	57	37	02	60	82	06	77	54	46	52
81	10	56	32	80	92	77	17	04	32	30	70	31	11	36	72	41	95	31	43
44	98	08	74	01	81	09	19	64	89	26	46	35	49	37	06	74	97	28	13
61	70	28	08	33	37	25	84	05	11	61	47	11	88	91	06	43	90	18	43
50	34	51	74	66	01	38	54	29	57	94	10	56	75	84	89	46	02	92	94
68	39	16	74	07	90	34	74	30	07	80	85	35	16	70	21	56	52	15	40
83	83	71	56	68	35	60	56	72	23	01	44	36	91	90	70	23	59	93	34
19	87	48	22	22	49	58	81	34	37	98	91	78	76	78	17	29	79	95	15
15	14	38	88	65	19	55	45	52	43	53	58	17	31	48	89	16	42	19	70
86	25	00	02	58	30	63	71	24	76	07	38	82	76	23	98	67	15	59	75
88	79	26	35	86	77	87	96	28	91	83	18	48	29	08	31	70	25	03	14
90	36	89	63	85	05	03	62	07	10	32	03	32	96	52	66	42	07	52	11
68	87	14	67	13	02	89	03	65	36	02	58	22	09	19	95	37	80	50	80
00	76	77	35	85	12	01	72	53	40	03	71	54	07	97	78	23	37	88	08

John R. Cox¹

Natural Resources Institute, University of Greenwich at Medway, Central Avenue,
Chatham Maritime, Kent ME4 4TB, UK

INTRODUCTION

Chapters in this handbook deal with techniques for the assessment of the impact of pesticides on wildlife and other biological components of the environment and mention the use of various chemicals for the cleaning of sampling equipment or for the preservation of collected samples. It should be remembered that most pesticides and many of these chemicals are hazardous materials and should be treated as such. This chapter provides basic advice on the properties of the listed chemicals (Table 3.1) and on procedures for their safe use, as well as for

Table 3.1 Non-pesticide chemicals suggested for use in this handbook

Solvents	Acids	General reagents
Ethanol	Nitric	Mercuric chloride
Acetone	Acetic	Formalin (formaldehyde solution)
Xylene	Picric	Lactophenol
Methanol		Glycerol
		Silica gel
		Gilson's fluid

handling pesticides or pesticide-contaminated materials.

Some of these reagents are used singly or as mixtures to prepare named reagents, e.g. Gilson's fluid. When handling these chemicals (or any others), always wear a laboratory coat, overalls or other protective clothing and **do not eat, drink or smoke**.

SOLVENTS

- Ethanol, methanol, acetone and xylene are all flammable materials and should be kept away from naked flames or other sources of vapour ignition. **Do not smoke when handling these materials.**
- The vapour from these solvents can be harmful and should not be inhaled. Operations using solvent should be undertaken in well-ventilated areas or outdoors. Note, that particular care should be taken when using **xylene**, which is a potential carcinogen.
- Spillage on to the skin should be avoided; wear solvent-resistant (nitrile rubber) gloves when handling solvents. Xylene is particularly harmful when absorbed through the skin and any affected areas should be immediately and thoroughly washed with soap and water.
- If solvent vapour affects the eyes, or if the eyes are splashed with solvent, irrigate well with water. Seek medical attention in cases of splashing.

¹Contact address: 42 Boughton Lane, Maidstone, Kent ME15 9QR, UK. john_coxuk@btopenworld.com

WARNING

Ethanol and methanol have well known properties of intoxication and in their concentrated form can be particularly harmful. Keep ethanol and methanol locked away to prevent misuse.

ACIDS

- Acetic and nitric acids are liquids: glacial acetic acid is normally greater than 99% pure; concentrated nitric acid is normally 68–72%.
- They are both corrosive and can cause burns to the skin; always use acid-resistant gloves (nitrile rubber) when handling these materials. The eyes are particularly susceptible to damage if splashed; protective glasses should be worn wherever possible.
- **Picric acid is a solid which must be kept moist at all times; it can be explosive if dry.**
- Picric acid solution is also corrosive, harmful to the eyes and is absorbed through the skin. Always wear nitrile gloves when handling this substance and wear protective glasses/goggles.
- With all acids, any affected skin should be immediately and thoroughly washed with water. Affected clothing should be removed and soaked in water.
- The vapour from acetic and nitric acids is an irritant and exposure can damage the respiratory system; only use in a well-ventilated area or outdoors.
- If any acid is inadvertently swallowed, large quantities of water should be drunk and medical attention sought immediately.
- Acid spillages on work surfaces should be carefully treated with large quantities of water; mixing with soil/sand can also help containment. Large spills of acid can be neutralized by the addition of solid, powdered sodium carbonate.
- When preparing dilute acid solutions, **always** add acid to water, **never** water to acid.

GENERAL REAGENTS**Formaldehyde solution**

- Formaldehyde solution (formalin) usually contains 37–41% formaldehyde and 11–14% methanol. The solution is flammable and the vapour is an irritant to the eyes and to the respiratory system. Spillage on to the skin should be treated with running water; if the eyes are affected by vapour, they should be irrigated with water. Formaldehyde solution should only be used in a well-ventilated area. Be careful **not** to directly inhale the vapour. It is also a human carcinogen and thus great care should be taken when using it.
- If any formaldehyde solution is swallowed, large quantities of water should be drunk and medical attention sought.
- The solution can irritate the skin on which it has a hardening effect. Solvent-resistant gloves (nitrile rubber) should be worn when handling the solution.

Gilson's Fluid

Gilson's fluid is made with 100 ml 80% ethanol, 880 ml distilled water, 15 ml 80% nitric acid, 18 ml glacial acetic acid and 20 g mercuric chloride. Take care in the preparation of this reagent as it is corrosive, toxic and an irritant; the properties of the individual chemicals used in its preparation are considered elsewhere in this chapter.

Mercuric chloride

- **Mercuric salts are poisonous** and should be treated with great care. Skin and eye contamination should be avoided and affected areas immediately washed with running water. Care should be taken to avoid breathing any fine dust from the dry material.
- If any mercuric salt solution is swallowed, large quantities of water should be drunk and medical attention sought urgently.
- Disposal of solid waste material in the field, e.g. by burial, should be avoided wherever possible; mercury and salts of mercury should always be disposed of through recognized contractors.

Silica gel

- Silica gel is relatively safe to handle but do not do so with wet hands; inhalation of any dust should also be avoided. The wearing of a face mask is recommended.

Glycerol

- Glycerol is a relatively harmless compound but as with all chemicals, care should be taken to avoid skin contact or ingestion of this substance.

Lactophenol

- Lactophenol is a toxic compound and should be handled with extreme care. Use in a well-ventilated area and wear disposable gloves when handling the material.

PROTECTIVE CLOTHING

General

In the introduction to this section, it was stressed that when handling the listed chemicals, a laboratory coat, overalls or other protective clothing should be worn. Solvent and acid-resistant gloves (nitrile rubber gloves can be used for both types of material) are also recommended when handling these materials **Face masks are sometimes used but it must be remembered that most masks are only dust or particle masks (Figure 3.1); they have little effect in preventing inhalation of solvent or acid vapour.** To give protection against solvents or pesticide fumes, special filtered masks or respirators must be worn (Figure 3.2); different

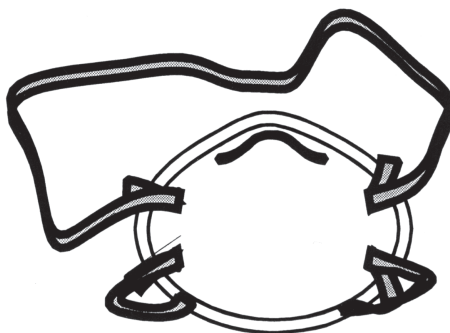

Figure 3.1: Face mask



Figure 3.2: Respirator

companies have different specifications/mask model numbers so it is difficult to give specific recommendations. Most suppliers have detailed catalogues listing specific masks for specific uses, which will provide the necessary information. Where the catalogues are not available, the companies will normally provide the necessary information by telephone/fax.

Pesticides

During ecotoxicological monitoring exercises, it may be necessary for sampling to be carried out in freshly sprayed areas or even where spraying is in progress; in this case the re-entry period should be established. This is the time interval that should elapse between application and entering a treated area and is the interval during which the bulk of pesticide deposits on the crop are absorbed or otherwise removed from plant surfaces. **The re-entry period should not be confused with the harvesting interval, which is the period between pesticide application and when the crop is safe to handle and eat. Re-entry periods may be specified by the product manufacturer but in most cases vary from 1 to 3 days.**

In practice, the length of the re-entry period is subject to many variables such as the nature and toxicity of the product, its application rate, weather conditions and the nature of the crop treated. If entry is required to a sprayed area before the time limit specified by the re-entry period has elapsed, then appropriate protective clothing should be worn. The type of protective clothing required will depend on the toxicity and mode of action of the pesticide applied. In some cases an overall and gloves may be all that is needed, in other cases additional head, face and respiratory protection may be essential. Label information supplied with the pesticide will generally specify the level of protection required. In tropical countries, wearing protective clothing can be unpleasant because of heat fatigue. The use of cotton suits made to the GIFAP (now CropLife International) design is recommended except where the protective clothing is going to get particularly wet (in which case pesticide will soak through on to the skin) and where Tyvek®-type suits should be worn (Figure 3.3). **When wearing protective clothing rubber boots should always be worn with the trouser legs worn over the rubber boot, and not tucked in as sometimes observed.**

Note: When in doubt, and professional advice is not readily available, the individual should always err on the side of caution and wear more protective clothing rather than less.



Figure 3.3: Spray application monitoring and ecotoxicology personnel wearing Tyvek® suits and preparing to work in a recently sprayed area

Cleaning and maintenance of protective clothing

Protective clothing worn in the field requires regular washing to minimize the build-up of residues which may cause sample cross-contamination or, in extreme cases, bodily contamination and possibly illness. In addition, the regular inspection and maintenance of protective clothing is essential for personal protection. It is **recommended** that as a routine, the items of protective clothing that can be washed without special facilities (e.g. boots, gloves, face shields, etc.) are washed before leaving the sample site with the rinsings disposed of at that site. **On no account should any operator conducting sampling be allowed to enter a vehicle without removing overalls, boots and gloves.** Used overalls should be placed within a polyethylene bag after removal to prevent any contamination of the vehicle. It is further **recommended** that where potentially contaminated items are being disposed of, that they be damaged/destroyed to remove the temptation for others to take them for their own use or so that children do not find them and play with them.

Cotton suits/overalls

Cotton suits should be washed in warm water containing a strong detergent and then rinsed in clean water. In cases where the level of contamination is suspected to be high, the warm water/detergent wash should be repeated. The person doing the washing should wear nitrile rubber gloves during the washing process. The washing solutions produced should preferably be disposed of in a pit dug 30–40 cm deep and away from any watercourses or wells.

Note that Tyvek® suits are meant to be disposable and should be destroyed after use. In some cases, depending upon the degree of contamination and the nature of the pesticide, it may be possible to re-use the suit once or twice. In field sampling, however, the suit will have been worn when entering a recently treated area and when the residues of pesticide will have been at their highest. In view of this, there is a significant risk of sample cross-contamination and despite the cost implications, it is **recommended** for field sampling that a fresh suit be worn for each day's sampling and certainly when visiting different sample areas. Contaminated suits should be disposed of by burning on a hot fire; stand clear of the fire and take care not to breathe in any vapours produced by the fire (wear a respirator if possible).

Gloves

Except in the most extreme cases where high contamination levels are anticipated and where heavy duty gloves will be worn, individuals involved in sampling within pesticide-contaminated areas will normally wear lightweight disposable gloves (latex or nitrile). After use these should be collected in a bag and returned to the operational base for appropriate disposal (burial or burning). To minimize the risk to any other individual, it is **recommended** that disposable gloves be water/detergent-washed before removal and that the gloves then be cut such that they cannot be re-used by any other individual. Heavy duty gloves should also be cleaned by water/detergent-washing before leaving the sample site with the washings disposed of in a shallow pit and then covered over.

Rubber boots

Rubber boots should be removed, washed down with water/detergent and scrubbed clean before leaving the sampling site (this prevents the movement of pesticide from the treated area into vehicle, etc.). The washings should be disposed of at the sample site; dig a small pit, pour in the washings and then cover over with soil. The boots should be inspected for damage after cleaning; any tears or holes may enable contamination of the feet and such damaged boots should be replaced.

Face masks

Disposable face masks (for use against dust and slight vapours, depending on design) should be viewed as single use and not re-used. The mask should be disposed of by burning or burial after being cut in half. If face shields are worn, these should be washed down with water/detergent before leaving the site and the washings disposed of in a shallow pit (see above).

Respirators

If respirators have been worn, the cartridges need to be removed and the mask washed with water/detergent and then rinsed with clean water before leaving the site. The cartridges in the mask will have a specified life of (x) hours (see the manufacturer's literature provided with the cartridges). If this time period has been reached then the cartridge should be disposed of and replaced with a fresh one if the respirator is required for another site or for the next day. Opened respirator cartridges have a reduced life span and should be regularly changed even if they have not been used. The best approach is not to open and insert a cartridge into the respirator until immediately before it is required for use. The used cartridges should be returned to base for appropriate disposal; where suitable facilities are not available, the used cartridges can be buried in a hole at least 50 cm deep.

FURTHER READING

GIFAP/CropLife International Guidelines and Technical Monographs. Available from CropLife International, Avenue Louise 143 – B1050 Brussels. A list of guidelines and monographs can be obtained by post, e-mail (info@gcpf.org) or by visiting the CropLife International web page (www.gcpf.org).

Product Data Safety Sheets are provided by suppliers with all chemical materials. These should be read and retained for further reference.

PESTICIDE APPLICATION: MASTERING AND MONITORING

4

Hans Dobson and William King'

Natural Resources Institute, University of Greenwich at Medway, Central Avenue,
Chatham Maritime, Kent ME4 4TB, UK H.M.Dobson@gre.ac.uk

INTRODUCTION

Good management of pesticides can improve their efficacy and reduce negative environmental impacts. Pesticide management issues range from packaging, labelling, transportation, storage, handling, mixing/filling through to application, cleaning and disposal of washings and containers. Many of these issues fall outside the scope of this handbook and this chapter will concentrate on the processes of applying pesticides, together with methods of monitoring in order to provide essential feedback on their fate in the environment. The main focus is the spraying of liquid formulations.

Once a pesticide has been chosen – preferably a product and formulation that is as specific to the pest as possible – the aim is to reach the pest location with a quantity of active ingredient just sufficient to kill it. Excessive dosing and inaccurate spraying is more likely to result in negative environmental impacts. Hence, it is important to meter and regulate the quantity applied to achieve the recommended dose; to conduct the application in such a way as to maximize uniformity of deposit, to present the active ingredient in the right sized spray droplets (or granule/dust particles), to direct the pesticide towards the target location if possible and to apply it under the right meteorological conditions to ensure that there are not excessive losses from the area through drift, volatilization, leaching, etc.

Accurate application is a difficult task requiring continuous attention to equipment settings, weather conditions, and dynamic variables such as sprayer speed, height and track spacing. Perfect application is an infrequent event. Variable deposition uniformity can produce heavy localized over- and under-dosing and drifting pesticide aerosols that are too small to be seen with the naked eye can still cause serious negative environmental impact. This is why it is important to have tools to monitor the fate of pesticides inside and outside the target area. These tools are the 'eyes' of the pesticide applicator, since in practice the fate of the pesticide is not immediately apparent.

The ability to characterize the fate of the spray, such as how much is deposited where and how much is lost from the target area, will also assist in determining whether any observed non-target impacts are a result of the product *per se* or some other application parameter that could be modified in subsequent operations.

PESTICIDE FORMULATIONS

In most pest management activities, relatively small amounts of pesticide active ingredient have to be dispersed uniformly over a wide area, e.g. in the application of herbicide to vegetation or the application of insecticide to the leaf canopy of a field crop. To enable this active ingredient to be evenly distributed over the target by application equipment and to present it in a way that is most likely to control the target pest, it is usually made up into a formulation. This process involves combining the active ingredient with various inert liquid or solid carriers, together with other materials which confer useful properties such as improving shelf-life, assisting dispersal when mixed with water or preventing clumping (granules). The type of formulation can affect a product's toxicity, its persistence in the environment and its rate of release from the deposition site.

¹Contact address: Omega, Mill Lane, Hartlip, Sittingbourne, Kent ME9 7TB, UK. wk5346@yahoo.co.uk

Units of concentration

The amount of active ingredient in a formulation, in relation to the amount of other components of the formulation, may be given in a number of ways. For solids it is usually expressed as the percentage by weight (% w/w) or as grams per 100 g. For liquids a number of alternatives are used:

- percentage by weight, % w/w
- g in 100 g
- percentage by volume, % w/v
- g in 100 cm³
- g per litre, g l⁻¹

In liquids with a specific gravity of 1.0, w/w and w/v are identical, but this is unusual and it is normally essential to distinguish between the two terms. For example, a 98% w/v formulation of fenitrothion contains over 1.2 kg of active ingredient per litre. For this reason, g l⁻¹ is preferred as being less likely to lead to confusion.

Types of formulation

Solutions

Most pesticides are insoluble in water, and organic solvents are required to dissolve them. Such solvents should be available as bulk chemicals, be safe to use, should not attack the insecticide, container or spray gear and should dissolve high concentrations of the insecticide. The most commonly used solvents are aromatic hydrocarbons.

Solutions of pesticides are the simplest type of formulation, e.g. endosulfan 25% ultra-low-volume (ULV) formulation. Concentrations usually range from 200 g l⁻¹ to 500 g l⁻¹. In addition to the active ingredient and the solvent, formulations may also contain low volatility oils to reduce spray droplet evaporation, and stabilizers to prevent chemical decomposition. Solutions are usually used at low-volume (50–200 l ha⁻¹) or ULV rates of application (0.5–3.0 l ha⁻¹). For cost and safety reasons they are not used at higher rates.

Emulsifiable concentrates

Emulsifiable concentrates (ECs) consist of an active ingredient dissolved in a solvent together with emulsifying agents (detergent-like materials). These allow the insecticide to form a milky opaque liquid emulsion when added to water, consisting of very small droplets of insecticide solution held in suspension in the water. In poor formulations these droplets may move up or down to form a separate layer (creasing) or they may coalesce to give an oil layer (breaking). Emulsifiable concentrates are normally diluted with water to form 1–5% solutions which are applied at medium or high-volume application rates (>200 l ha⁻¹), although current trends are towards reducing volumes.

Water dispersible powders or wettable powders

Wettable powders (WPs) contain fine particles of solid insecticide, or particles of an absorbant inorganic carrier (e.g. talc) which can hold a liquid active ingredient, plus surface active agents (surfactants) which promote wetting and dispersal in water. Wettable powders may contain up to 85% active ingredient. Particle size must be small enough to keep sedimentation rate in the spray tank at an acceptable level, and WPs should not 'cake' (stick together in lumps) in storage. They are applied at similar rates and concentrations to ECs.

Other formulations

Other formulations have been developed for specific uses, e.g. water miscible liquids, flowable suspensions, dusts, granules, aerosols, fumigants and capsules.

Formulation specification

The World Health Organization (WHO, 1992) and the Food and Agriculture Organization of the United Nations (FAO, undated) have published specifications for insecticide formulations covering the type and quantity of active ingredient, physical properties, stability considerations, and so on. These specifications are designed to ensure that purchasers of insecticides get value for money and, very importantly, get consistency in formulation characteristics. However, it should be remembered that two formulations meeting the same specification may not be identical in all their components, as the precise type of emulsifier, solvent, wetter, etc., may vary according to availability or cost.

Field observations on formulation quality

The resources of a well-equipped pesticide laboratory are essential for the kind of analysis needed to determine whether or not a particular pesticide sample meets specification requirements. However, it is possible to conduct a few simple tests in the field before using a batch of pesticide and, since pesticides can deteriorate under poor transport or storage conditions, it is worth doing these tests to avoid difficulties during application or poor results following the application.

Solution formulations should be examined to ensure that the active ingredient has not come out of solution; ECs should emulsify easily in water and, if a creamy layer forms, it should form slowly and should easily re-emulsify on agitation. Wettable powders should not be lumpy or contain coarse particles, and should wet easily and not settle out or flocculate (form lumps in the spray mix). Some examples of unacceptable effects are crystallized deposits on sprayer nozzles, corrosion of sprayer parts, and breakdown of containers and container linings.

Formulation compatibility

Occasionally it may be desirable to apply two pesticides at the same time, as a mixture. Manufacturers sometimes supply mixed formulations (e.g. carbaryl-endosulfan and endosulfan-triazophos are mixtures sometimes used in crop spraying), and where these are available there should be no problems. It is usually satisfactory to mix two different insecticides with the same formulation, e.g. two WPs or two ECs. However, small quantities should always be mixed to confirm compatibility before making a large batch of spray solution. Problems are more likely to arise when two different formulations are mixed, e.g. a water dispersible powder (WDP) and an EC. Generally this practice is not recommended, but if it is necessary, remember to try it on a small quantity first. If it worked with one batch of chemicals it cannot be assumed that it will work with other batches; changes in formulation components (already referred to above) may affect the compatibility of the formulations. Some insecticides interact with each other in a way that adversely affects their biological performance. If this happens they are said to be incompatible.

APPLICATION EQUIPMENT

Spray nozzles

Hydraulic energy nozzles

Hydraulic energy nozzles are so designed that when liquid is forced under pressure through the nozzle opening, or orifice, a very thin sheet of liquid is formed which breaks up to give droplets of different sizes. Generally, the droplet spectrum from hydraulic nozzles ranges from a volume median diameter (VMD) of 200 μm to 400 μm . Higher liquid pressures produce smaller droplets. Hydraulic nozzles are common because of their simple construction and low price and are most often found on tractor booms and on lever-operated knapsack sprayers. One important feature of hydraulic nozzles is that they impart a velocity to spray droplets that can

assist their transport and deposition. Hydraulic nozzles generally consist of a body, cap, filter and nozzle tip. The cap screws on to the nozzle body, holding the tip and filter in position. Nozzles are not always fitted with filters, but as spray liquid can be contaminated with dirt that can block, and perhaps damage, the tip, filters are preferable. Nozzle tips can be made of brass, plastic, stainless steel or ceramic material. Brass or plastic is more commonly used for the nozzle body and cap. Both brass and plastic, when used for the nozzle tip, can be susceptible to abrasion, and are fairly easily damaged unlike stainless steel and ceramic tips which are more able to withstand damage, but are much more costly.

Various types of hydraulic nozzle are in common use.

Deflector nozzle

The deflector nozzle (Figure 4.1), sometimes called an impact anvil or flooding nozzle, has a relatively large orifice through which liquid passes to impact at high speed on to a smooth surface in front of the orifice outlet. The liquid is deflected at an angle to produce a fan pattern. The droplets produced have a large size range. This type of nozzle is most often used at low pressure and at high-volume rates of application to produce large droplets (unlikely to drift) for herbicide application. The large orifice reduces the incidence of blockages although there are some deflector nozzles (designed for low-volume applications) that have small orifices.

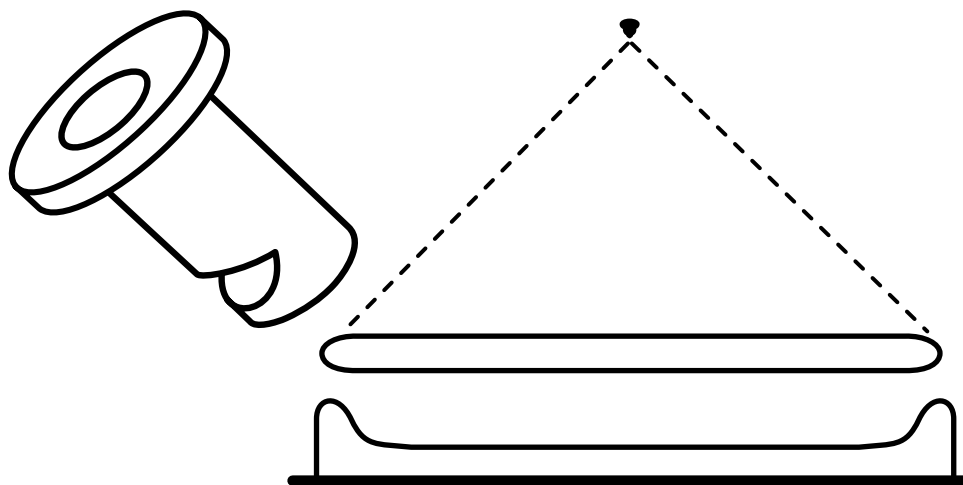

Diagram courtesy of Zeneca

Figure 4.1: Deflector nozzle

Fan nozzle

Fan nozzles are shaped so that as the spray liquid emerges from the orifice it forms a flat sheet that then disintegrates into droplets. Generally, the wider the angle of the liquid sheet, the smaller the droplet size. The spray pattern usually has a smaller deposit at the edges due to the shape of the orifice, but special 'even flat fan nozzles' are available that produce a more uniform spray pattern (Figure 4.2). When using normal fan nozzles on a boom, it is important to make sure that they all have the same spray angle and that their spray emissions overlap slightly to make up for the reduced deposition at the edges of the fan. In this way, a more uniform deposition is achieved. Each individual 'fan' should be set so that its long axis is around 5° offset from the axis of the boom to ensure that interference and coalescence do not occur at the overlapping areas. Fan nozzles are the most suitable for spraying 'flat' surfaces such as soil or walls. The even flat fan nozzle is used in 'band spraying', e.g. where a single nozzle applies a discrete strip of herbicide between the rows of a crop.

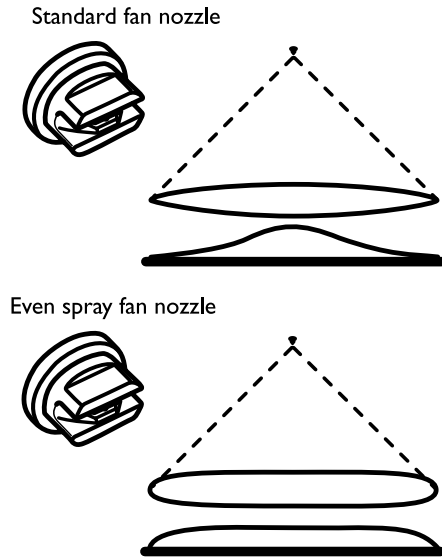

Diagram courtesy of Zeneca

Figure 4.2: Flat fan nozzle

Cone nozzle

The internal construction of a cone nozzle causes liquid to be forced through angled slots in a swirl plate, imparting a circular motion to the liquid in the swirl chamber (Figure 4.3). The liquid then passes out through the circular nozzle orifice. If the slots are cut only at the edge of the swirl plate, a hollow cone spray pattern is formed. If liquid also passes through the centre of the swirl plate a solid cone is formed, usually giving larger droplets than the hollow cone.

The higher the operating pressure the greater the nozzle output and the smaller the droplets produced. It is possible to use any combination of orifice size and number and size of slots in the swirl plate to give a wide range of outputs, droplet sizes and spray angles. Cone nozzles produce a multi-directional spray, which gives better coverage of a complex target, such as foliage, than a fan nozzle. Cone nozzles are rarely used for spraying 'flat' surfaces, such as walls, since their deposit is greatest at the edges and overlapping of deposits cannot be used as a means of achieving a more uniform deposit.

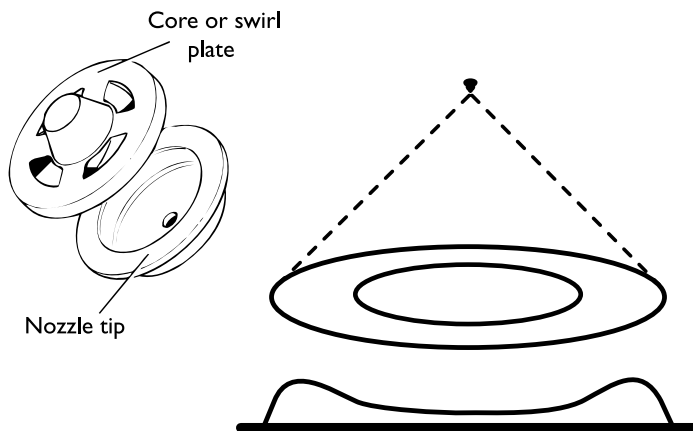

Diagram courtesy of Zeneca

Figure 4.3: Cone nozzle

Solid stream (jet) nozzle

This type of nozzle has no swirl chamber and produces a solid stream of liquid rather than droplets. It is used mainly for spot applications of herbicides and for application of pesticides to water courses or irrigation channels.

Miscellaneous

Other types of hydraulic energy nozzles are available, including variable spray nozzles (typically found on small hand sprayers used by amateur gardeners) and air induction nozzles used to produce droplets with air inclusions. Although lighter than pure liquid droplets, the large spray droplets from these types of nozzle have been shown to drift less.

Gaseous energy nozzles

Air-shear nozzles

Liquid is released from a pipe or tube into a blast of air that breaks the liquid into droplets through the shearing action of the air stream. Air-shear nozzles are often used on knapsack mist blowers and on large vehicle-mounted airblast sprayers. The spray liquid can be introduced into the air stream either inside or outside the airblast tube. The simplest form of gaseous energy nozzle is found in the 'Flit gun' where air passing over a siphon tube creates a negative pressure (known as the venturi effect), causing liquid to be drawn up from the reservoir and sheared into droplets.

Faster airblasts produce smaller droplets. The venturi effect also applies when the liquid outlet orifice is located within the nozzle body, but here the flow of liquid to the nozzle is more commonly controlled by means of restrictors. This type of nozzle is usually fitted to motorized knapsack mistblowers. Droplet size is governed by the air/liquid flow rate ratio. An increase in the liquid flow rate or a reduction in airblast causes the formation of larger droplets, while decreasing the liquid flow or increasing the air flow produces smaller droplets. Motorized knapsack mistblowers maintain a constant air flow, which means that droplet size is governed by liquid flow rate.

Thermal energy nozzles

This type of nozzle works on much the same principle as the gaseous energy nozzle. The liquid supply orifice lies within the airblast pipe, but the air or gas flowing across the orifice is hot, above 500 °C. The spray liquid is formed into droplets by the shearing effect of the gas stream, and is then vaporized by the heat of the gas. The vapour is carried into the atmosphere in the gas stream and condenses on contact with cooler air, forming a fog of extremely small droplets, generally less than 15 µm in diameter. With this type of nozzle the liquid flow rate must not be too high otherwise full vaporization will not occur.

The exhaust nozzle sprayer is a type of air-shear nozzle with the airblast provided by the exhaust gases from the spray vehicle. It is possible to get small droplets (VMD 40–200 µm) with this type of sprayer, but the droplet spectrum is still quite broad so this type of atomizer is not efficient for ULV spraying.

Rotary atomizers (spinning discs, cups and cages)

In this type of nozzle, spray liquid is fed on to a rotating surface, usually near to the centre, and spreads to the edge by centrifugal force. At the edge, at low flow rates, the liquid is thrown off the surface as single droplets or, at higher flow rates, as long curved threads or ligaments, which break down into individual droplets because of surface tension. The rotating surface of the centrifugal nozzle can be a flat disc or cup-shaped surface, or a spinning cage or basket. Droplet size is determined by the rate of liquid flow and the speed of rotation of the

nozzle surface, i.e. the faster the rotation, the smaller the droplets. Droplets produced by a single combination of flow rate and rotation speed lie within a narrow size range. Some discs are constructed with a grooved inner surface to improve control of the flow of liquid over the disc surface, and a toothed edge to provide issuing points and improve uniformity of droplet size in the droplet spectrum. Other rotary atomizers have spinning cages, or spinning cylinders and although their droplet spectrum is often not as good as spinning discs, they can cope with higher flow rates and can be more robust (strong and reliable) in the field than discs. Rotary atomizers are widely used for ULV pesticide application, both from ground-based equipment and from aerial sprayers.

SPRAYER CALIBRATION

Calibration is the process of adjustment of the sprayer components and its manner of use to achieve the desired output level safely and efficiently. It is necessary with all types of application equipment and all classes of pesticide. The principles of calibration are exactly the same for portable, vehicle and aircraft sprayers. If calibration is not carried out, the amount of active ingredient applied (the dose) may be too high, which is wasteful and expensive and may lead to unacceptable residue levels in produce or negative environmental impact. The dose could also be too low and fail to control the target pest. In addition, the deposit may not be uniform and result in localized over-dosing and under-dosing with ensuing patchy efficacy and an increased likelihood of non-target impact. Re-treatment may then be required; a costly and time-consuming repeat that adds a further pesticide burden to the target area. Failure to calibrate sprayers correctly may also result in much of the applied pesticide missing the target, presenting an off-target hazard to the user, the environment and the public.

Calibration is often neglected (usually due to a poor understanding of the reasons for it and the methods to use) or relegated to a low priority when urgent control operations are required. There are no hard and fast rules about frequency of calibration, but the more frequent the better. As a retrospective check on calibration, sufficient records of spraying should be kept so that the volume application rates and active ingredient dose rates can be calculated at the end of each day or week by dividing volumes and quantities of pesticide used by the area sprayed.

The potential for harm from pesticide applications can be minimized providing a number of calibration factors are considered before the start of each spraying operation. There are three important factors in calibration: droplet size, emission height and active ingredient dose rate.

Droplet size

The diameter of droplets is usually measured in micrometres or 'microns', written μm . A micrometre is 1 millionth of a metre (0.000001 m). A 100 μm diameter droplet can be seen by the naked eye; smaller droplets are difficult to see. The size of a droplet is important because it determines the following.

- The volume of pesticide in the droplet and, therefore, the amount of active ingredient it contains. There is a cubic relationship between droplet diameter and its volume. For example, if we halve the diameter of droplets in a spray cloud, we reduce each individual droplet's volume (and quantity of active ingredient) by a factor of 8.
- The number of droplets produced by a given volume of liquid. There is a corresponding inverse cubic relationship between the size of droplets in a spray cloud and the number produced from a given volume of spray liquid. For example, if we halve the diameter of droplets in a spray cloud, we increase the number of droplets by a factor of 8. The distance between deposited droplets will be less so the likelihood of deposition on, or encounter by, an insect pest is increased.
- The behaviour of the droplet in terms of where it is carried to and where/whether it is deposited.

We can adjust the size of droplets produced by most sprayers. It is essential to check that the sprayer is adjusted to produce the size of droplet that will give a good distribution of spray over the target area and give effective

pest control. Optimal droplet sizes for different targets are not well researched but examples of current thinking on best practice are as follows.

- A narrow range between 15 μm and 30 μm for insects such as mosquitoes and tsetse flies, either flying or resting in vegetation. Droplets of this size must be released under inversion conditions so that they drift for long periods without being carried upwards by convection. Foggers and some rotary atomizers can be used to produce these droplet sizes.
- A narrow range of 50–100 μm diameter for ULV migrant pest control, e.g. locusts, grasshoppers or armyworm, to provide good dispersal over the target area. Such a narrow range of small droplets can only be effectively produced by rotary atomizers.
- A broader mid-size range of 150–300 μm for water-based insecticidal and fungicidal sprays. They are a good compromise in that they are small enough to provide some localized drifting and mixing of the spray cloud after its emission velocity has dissipated without being so small as to evaporate quickly or produce excessive drift out of the area. They are generally produced by hydraulic or gaseous energy nozzles.
- Larger droplets in the size range 250–400 μm for water-based herbicide application. These fall quickly and reduce the chances of damage from drift on to other crops or surrounding vegetation. These are generally produced by deflector nozzles or fan nozzles at lower pressures. Excessively coarse sprays should, however, be avoided as large droplets bounce or shatter on impact and are not retained by weed leaves.

It should be remembered that no commercially available field sprayer is capable of producing droplets all of the same diameter – there is always a range of sizes known as the droplet spectrum. This is often shown diagrammatically by a histogram giving the percentage of droplets in different diameter size classes. Measuring the droplet size of emitted spray is difficult, and manufacturer's graphs or illustrations of the spectra produced by their equipment may not be accurate. Most quoted figures are for water, which does not necessarily give the same droplet spectrum as a pesticide formulation.

For droplet spectra, two types of median are often used to describe the range of droplet sizes. The volume median diameter (VMD) is the diameter such that half the total spray volume is in smaller droplets and half is in larger ones, and the number median diameter (NMD) is the diameter such that half the total number of droplets present have a smaller diameter and half of them have a larger diameter (see Figure 4.4).

The ratio of VMD and NMD (often termed the 'R' ratio) gives a crude measure of the homogeneity or uniformity of the droplet spectrum; the nearer it is to 1.0, the more uniform the droplet spectrum. The larger the value of R, the wider the range of droplet sizes.

Typical values for the 'R' ratio are:

- hydraulic nozzle, e.g. lever-operated knapsack sprayers – 2.7
- spinning disc sprayer, e.g. the ULVA or Herbi – 1.5
- spinning cage sprayer, e.g. Micronair sprayers – 1.9
- airblast nozzle, e.g. motorized mistblower sprayers – 2.3

Measuring droplet size

Laser analysis equipment can determine droplet sizes of airborne spray and image analysis equipment exists for measuring deposited spray. Both are expensive. Magnesium oxide-coated slides or other calibrated collecting surfaces can be used to derive the size of droplets and the VMD and NMD of their spectrum. It should be remembered that this will give the size of deposited spray, but not emitted spray.

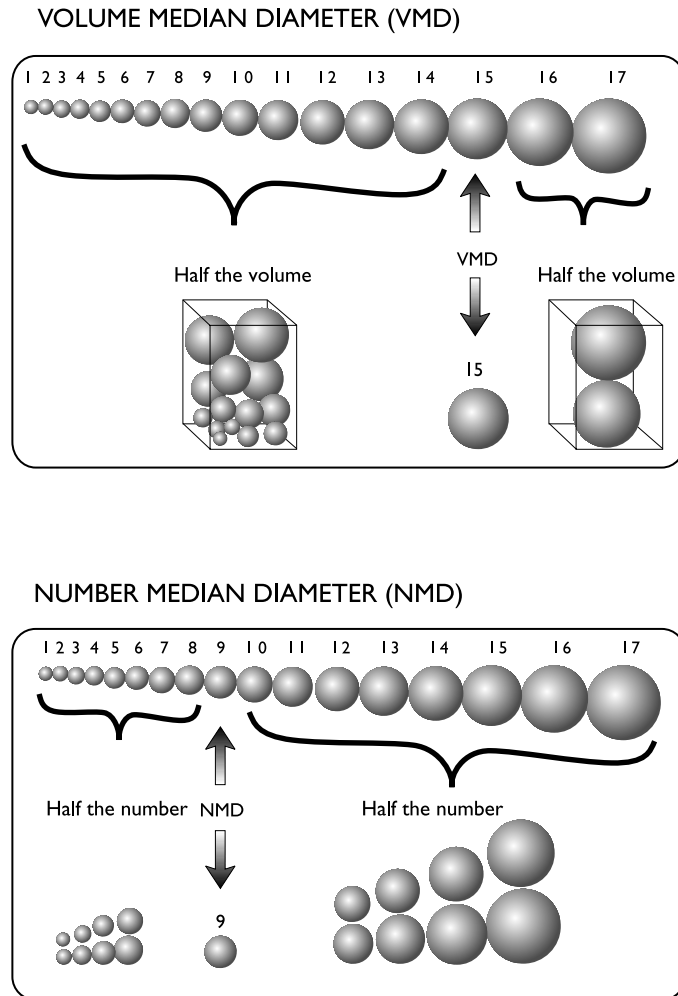

Figure 4.4: Volume median diameter and number median diameter

In practice, rather than measuring each droplet individually, it is more convenient (albeit slightly less accurate) to sort droplets into size classes, e.g. a droplet may fall between class limits of 50 μm and 71 μm . The Porton graticule (see method sheet) has a very fine scale etched on to a plain lens which fits into a microscope eyepiece. Its surface is marked into size classes, and each size class limit is bigger than the adjacent one by a factor of 1.414 (which is the square root of 2, so the graticule is said to have a root 2 progression). For example, a size class may span diameters from 75 μm to 106 μm , so all droplets within these limits (say 83, 90 or 106 μm) would be allocated to this class, whereas droplets of diameter 107 μm would fall into the next larger class.

Emission height

The height at which spray droplets are released will influence the swath width, i.e. the distance from the sprayer over which there is a significant deposit, as well as the proportion of the spray which deposits in the target area. In general, the greater the emission height, the wider the swath. If the emission point is too high, there is a risk that the droplets will not come down in the intended target area – they will represent a drift hazard. High-

volume spraying usually relies on the initial velocity of the emitted spray to carry it to its intended target – a process known as placement spraying. As a result, if emission height is too great, the velocity will have dissipated before the spray reaches the target and the influence of wind will begin to dominate. In contrast, ULV sprays have little initial velocity and the technique relies on the wind to disperse the spray over the target area – a process known as drift spraying. This makes ULV spraying very sensitive to emission height, e.g. a hand-held ULV sprayer with an emission height of around 1 m, can give a swath width of around 25 m compared with an aircraft flying at 10 m height which might have a swath width of 250 m. The method sheet gives a procedure for checking swath widths from ULV sprayers to help operators better understand the characteristics of downwind deposits that are not visible to the naked eye.

Dose of pesticide

This is the quantity of active ingredient (toxic component of the spray liquid) applied per hectare or other unit of area. The pesticide manufacturer will usually provide a recommended dose for each particular pesticide/crop combination for which the product is registered. These are based on the results of efficacy trials carried out during the registration process. Some operators modify these rates based on their own field trials or personal experience. Recommendations for some EC formulations are in the form of volume of concentrated pesticide per hectare (see later for methods of calculating settings for these different types of recommendation).

Whichever dose is required, the method of regulating it in spraying is not direct since liquids, not solids, are being applied. In order to achieve the desired dose, two separate factors must be taken into account, namely formulation concentration (quantity of active ingredient per litre of spray liquid) and volume application rate (VAR) – the volume of spray liquid applied per hectare.

Spray liquid concentration

Ultra-low-volume formulations are supplied ready to spray and the concentration is stated on the pesticide label. However, pesticides designed for high-volume spraying are supplied in concentrated formulations which are mixed with water before spraying. This mixing process is an important step in that it determines the concentration of active ingredient in the spray liquid and will, therefore, need to be regulated in conjunction with VAR in order to achieve the desired dose. Some manufacturers provide calibration recommendations in the form of advice on how much concentrate to mix with 10 litres (or other quantity) of water.

Volume application rate

After recommending a spray tank mix concentration, the application advice might then be to spray to cover the crop foliage or it might go further with advice on recommended volume application rate (VAR) for a particular crop. For example, some manufacturers recommend a VAR for knapsack sprayers on cotton of 200 l ha⁻¹, but it is difficult in practice to get down as low as this. For ULV spraying, the required VAR is sometimes given on the pesticide label, but where it is not, it can be calculated from the recommended dose and the concentration of the ULV formulation.

Even where there is no recommended VAR for a particular operation, it is a good idea for operators to set one for themselves – there is no other way to keep dose consistent. If the operator is not sure of what VAR to use, he can do a dummy spraying of his target with water in a way which he considers satisfactory, and measure the actual VAR which he is using. Sprayer settings can then be based on this VAR and future operations conducted in such a way as to replicate it.

Once the required VAR to achieve the recommended dose is known, the sprayer settings and application parameters to achieve this VAR (and dose) must in turn be determined. The VAR is dependent on three spraying variables, i.e. track spacing, forward speed and flow rate.

Factors affecting the volume application rate

Track spacing

The track spacing is the distance between successive passes of the sprayer, either on the ground or in the air. In row crops treated with portable sprayers, the track spacing is usually a set number of rows. In open crops, such as cereals or grassland, sprayed by tractor or by air, it is measured in metres. Its value is important when calculating and regulating VAR and dose. In high-volume placement spraying, the spray is ideally deposited immediately below the nozzles so the swath width will be almost identical to the track spacing used. However, in ULV spraying, the drifting spray does not deposit uniformly over the swath width: the deposit starts low, builds up to maximum some short distance downwind of the sprayer, then decreases gradually over increasing distance from the sprayer. This long 'tail' contains a significant quantity of pesticide, but is not necessarily sufficient to control the target pest. To compensate for this and to achieve a more uniform deposit over the target area, the individual swaths are deliberately overlapped by making the track spacing much less than the swath width – usually between a half and a third of the swath width. The cumulative deposit from these overlapped swaths is much more uniform (see Figure 4.5) and, if the sprayer has been calibrated properly, will constitute a sufficient dose to control the pest.

The track spacing has practical constraints on it. It may be pre-determined within narrow limits, e.g. by the width of a tractor boom or the number of rows an operator can comfortably spray. In ULV spraying, it will be determined by wind strength and how far it can carry the spray.

Sprayer forward speed

The forward speed is mainly determined by the speed at which the sprayer can move. This should be a speed which can be maintained comfortably and safely, e.g. the speed a man can comfortably walk is around 1.5 m s^{-1} or 5 km h^{-1} , the speed a vehicle can safely drive over rough ground is typically $7\text{--}10 \text{ km h}^{-1}$, and a spray aircraft's normal flying speed is usually between 140 km h^{-1} and 200 km h^{-1} . The speed of the sprayer should be checked using a marked out distance and a stop-watch before making calculations. For aircraft, the pilot can be consulted to check at what speed he normally flies while spraying.

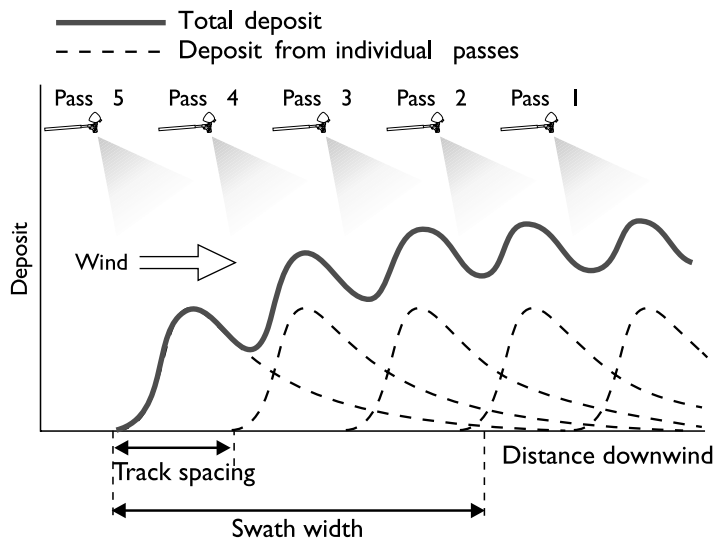

Figure 4.5: Building up a relatively uniform total deposit from ULV swaths

Flow rate

The flow rate is usually the easiest of the factors to adjust, and is set so that when using the chosen track spacing and forward speed, the correct VAR (and dose) is applied.

There are various methods of calculating sprayer settings so that, with the forward speed and track spacing of the spraying operation, the correct volume and dose of pesticide are applied. Some of the differences between these methods are due to the fact that water-based spraying has to cope with the additional step of appropriate dilution of the concentrate, others are due to the different forms that calibration advice takes on the pesticide label. Procedures for most of the commonly encountered challenges facing sprayer operators are given in the method sheets. Flow rate checks must be done with the insecticide formulation itself since water, diesel fuel and even different pesticides have different viscosities (a measure of the 'thickness' of the liquid) and surface tensions and will all have different flow rates. The general principles of measuring flow rate are the same for all types of sprayer. However, aircraft may either be easier (if they have an electronic flow meter) or more difficult (if they have a windmill-driven pesticide pump).

Some sprayers work in a way which allows the operator to collect and measure the liquid emitted over a given time, e.g. 'the collection technique' can be used with a knapsack sprayer and with a spinning disc sprayer with the disc stationary. It is more difficult with some other sprayers, e.g. an airblast sprayer, since the spray comes out together with the airblast and cannot easily be collected. In these cases, the easiest method is to measure the amount missing from the tank after a given time, i.e. the 'loss technique'.

Methods for adjusting the flow rate vary from sprayer to sprayer. Adjustments may be made by fitting a different restrictor or nozzle, altering a needle valve setting or changing the insecticide pump pressure. Consult the manufacturers' manuals for exact details.

Dose rate instructions

Dose rates are usually given on the pesticide label and can be expressed in one of several ways.

- Active ingredient dose: the weight of active ingredient per hectare is given. For example, a label may say 'use 400 grams of active ingredient per hectare (400 g a.i. ha⁻¹)'. This type of dose instruction is not very common for water-based sprays since most farmers and operators find it difficult to convert to a usable recommendation.
- Concentrate dose: the volume (or weight) of concentrated pesticide which should be applied per hectare is given. For example, 'use 1 litre of pesticide per hectare (1 l ha⁻¹)'. This is somewhat easier to understand but calculations are required to work out how much pesticide and water to mix together.
- Tank dose: the volume (or weight) of concentrated pesticide to add per 10 litres of water (which is the volume held by some knapsack sprayers). For example, 'use 20 ml of pesticide per 10 litres of water (20 ml 10 l⁻¹)'. This 'tank dose' is the simplest method of recommending a dose, although basic calculations are still required for tanks of more or less than 10 litres.

When a tank dose is given, some labels also state the area which must be covered by each knapsack load, or a guide volume to be applied over a given area, the VAR. The tank dose method assumes a certain VAR and the dose of active ingredient per area is only correct at this VAR.

SPRAY APPLICATION

Basic guidelines for sprayer operators with regard to their targets (i.e. pests, crops, surfaces) and environmental conditions are summarized below. From a monitoring perspective, they can serve as compliance checks (safety and technical checks) and assist with the development of designs for biological monitoring.

Target characteristics and weather

The sprayer operator needs to be aware of any crop conditions that may influence the spray operation. For example, if the leaf area of the crop seems to be greater than a typical crop of that type, he may decide to increase the VAR used. If pests/diseases are only affecting part of the crop, e.g. the tops of all plants, or discrete patches of plants, then the operator might decide to stratify the spray (spray just one layer) or spot spray (spray only the affected patches). In a similar way, the operator should make efforts to target the pesticide properly, e.g. using upwardly directed spray for pests which are mainly on the underside of leaves.

The sprayer operator also needs to consider various weather factors carefully.

Rainfall

Check the product label to see if there are any recommendations regarding rainfall. Never spray if rain is falling or is likely to fall soon, because the rain may wash off some of the pesticide from the vegetation. Guidance on the application of pesticides which are easily washed from plant surfaces by rainfall, or which require a specific period to be absorbed by the plant, will be given on the product label.

Wind

It is important to understand the influence of wind on the particular type of spraying being carried out. Spraying should not be carried out when there is no wind because on hot, still days, convection currents may carry spray in unpredictable directions, including towards the operator. This applies equally to ULV and high-volume spraying. Minimum wind speeds for both types of spraying are a light breeze of 1–2 m s⁻¹. However, the upper wind speed limits vary a lot between these two spraying techniques. Generally, high-volume spraying should not be carried out in winds of more than 3 m s⁻¹ otherwise there may be uncontrolled and possibly hazardous drift. In contrast, ULV spraying depends on the wind to disperse the spray and can be carried out at wind speeds up to 10 m s⁻¹ (when dust and leaves may be seen blowing around – see Beaufort Scale on method sheet for meteorological methods) provided allowance is made for the wider swath width at higher wind speeds. Spraying should always begin at the downwind edge of the field so that any drift is carried away from the operator as he moves upwind into clean vegetation (or clean air in the case of aircraft).

Sunlight

Bright sunlight may cause pesticide droplets to scorch the leaf. Again the label should be checked to see if recommendations are made against spraying in bright sunlight. Never spray when hot air is rising from the ground (convection) caused by the sun heating up the ground and the air in contact with it. Convection usually occurs on hot afternoons but may also occur in the late morning. It can be detected by frequent variations in wind strength and direction. The best time for spraying is usually between 08.00 h and 11.00 h. Effective spraying may be possible before 08.00 h if the wind direction is consistent and it may also be possible to spray effectively after 11.00 h when it is overcast and relatively cool (less than about 30 °C). Spraying may also be carried out after 16.00 h in the afternoon if it has cooled down sufficiently and there is still a consistent wind direction.

SPRAY DROPLET DEPOSITION

There are several factors involved in the deposition process. Understanding them enables sprayer operators to achieve better biological efficacy and to reduce the risk of negative environmental impact. The nature and location of deposition is heavily influenced by droplet size. No commercially available field sprayer is capable of producing droplets of uniform diameter – there is always a range of sizes known as the droplet spectrum. As we saw earlier, the diameter of a droplet is important because it determines the volume/weight of pesticide in the droplet, the number of droplets produced per litre and the behaviour and fate of the droplets.

Droplet behaviour

Droplet transport

There are several factors that influence the transport of droplets after they have been emitted but before they have a chance to deposit.

Initial velocity of the droplet

The process of spray atomization by a nozzle gives droplets an initial velocity that gradually decreases as they are slowed by the drag of air on their relatively high surface area. Drag is initially less dominant with larger droplets and they retain their initial inertia for longer, after which the influence of gravity becomes predominant. With larger droplets, the velocity imparted during the process of atomization can be significant, and velocities of up to 20 m s^{-1} from hydraulic nozzles may be capable of achieving the complete transportation process from the sprayer on to nearby leaves. To achieve spray cover on trees using small droplets, they need to be carried by a stream of air, and the distance they travel is dictated by how far the stream of air goes before it is dispersed by mixing with stationary air.

Wind speed

Wind speed (u), fall velocity (v), and the height of emission (h) affect the downwind displacement (s) of spray droplets according to the equation $s = hu/v$ (Johnstone, 1971). But while this simple relationship can give an approximation of the overall spray cloud movement and hence the swath width, the actual spread of distances will be greater because of air turbulence (described below). For small droplets, whose fall velocity is much lower than the prevailing wind speed (see below), the wind speed dominates their movement. For large droplets, it is gravity which dominates. This is why herbicides are applied as sprays containing large droplets; the effect is to minimize drift on to adjoining vegetation. Wind speed also has an important effect on droplet deposition by inertial impaction, which is also described below.

Turbulence

As air moves across the ground or over the top of vegetation, it is affected by the drag caused by the roughness of the surface, causing different parts of the air flow to move in different directions. These are termed turbulence effects, and they rotate and mix the air so that airborne droplets move in a way that adds an extra vertical component to the processes involved in spray dispersal. Turbulence is more pronounced at higher wind speeds and over rougher surfaces. These conditions might be expected to increase the component of downwind drift when small droplets are used. However, there is evidence that in some cases, turbulence assists deposition on vegetation to such an extent that spray drift is reduced.

Deposition

The process of deposition of a spray droplet on a natural surface or on an artificial sampling surface can be influenced principally by three processes, i.e. inertial impaction, sedimentation and electrostatic effects, of which inertial impaction and sedimentation are the most important. Their relative importance is dependent on droplet size, wind speed and the dimensions of the target.

Sedimentation

All droplets are heavier than air and (unless they evaporate) will eventually fall to the ground. However, some fall much more quickly than others. The speed at which droplets fall in still air is called their terminal fall velocity, and for all droplets is controlled by a balance between the forces of gravity and those of turbulent drag as they

move down through the air. Droplet diameter has a marked effect on this fall velocity; small droplets fall much more slowly than large droplets as shown in Table 4.1.

Ideally, all falling droplets would be deposited on to the intended target, whether it be vegetation or insect pests, giving a sedimentation collection efficiency of 100. However, four processes dictate that perfect transfer is rarely achieved:

- cross winds will give a horizontal component to the trajectory of spray droplets, resulting in deposition being displaced downwind, possibly off-target
- turbulence, as mentioned above, resulting from moving air passing over a more or less rough surface, will impart a vertical as well as horizontal component to the droplet's motion, meaning that some droplets are brought down more quickly and others supported for longer in the cross wind
- droplets often bounce off surfaces if they are too large or too small due to the elastic properties of their surface tension
- larger droplets often coalesce after deposition, then run off vegetation and drip on to the soil below. Droplet retention by the target can also be affected by the surface of the target itself, which may be waxy or difficult to 'wet', or not held in a horizontal position.

Table 4.1 Effect of droplet size on fall velocity

Diameter of droplets (μm)	Terminal velocity (cm s^{-1})	Time to fall 1.0 m (s)
300	115	0.8
100	27.8	3.6
50	7.3	13.7
20	1.2	83.3

Inertial impaction

When a droplet travelling towards a vertical surface continues its flight and hits the target in its path due to its kinetic energy, it is termed 'inertial impaction'. This is not achieved by all droplets, as some are carried around the target by air flow. When this occurs the droplets are said to have a collection efficiency of less than 100%. It is particularly important to consider collection efficiency for small droplets as these may have a collection efficiency of less than 1% for large targets at low wind speeds. The likelihood of impaction is increased with increased droplet size, increased speed relative to the target and decreased target size. Figure 4.6 illustrates these trends.

MONITORING SPRAY DEPOSITION

There are several reasons why we might want to sample spray:

- training – understanding the principles involved in spray application
- assessing the capabilities of new types of sprayers or new techniques
- quality control of existing operations – perhaps investigating control failures
- ecotoxicological monitoring – assessing the actual amount of spray depositing in a given area.

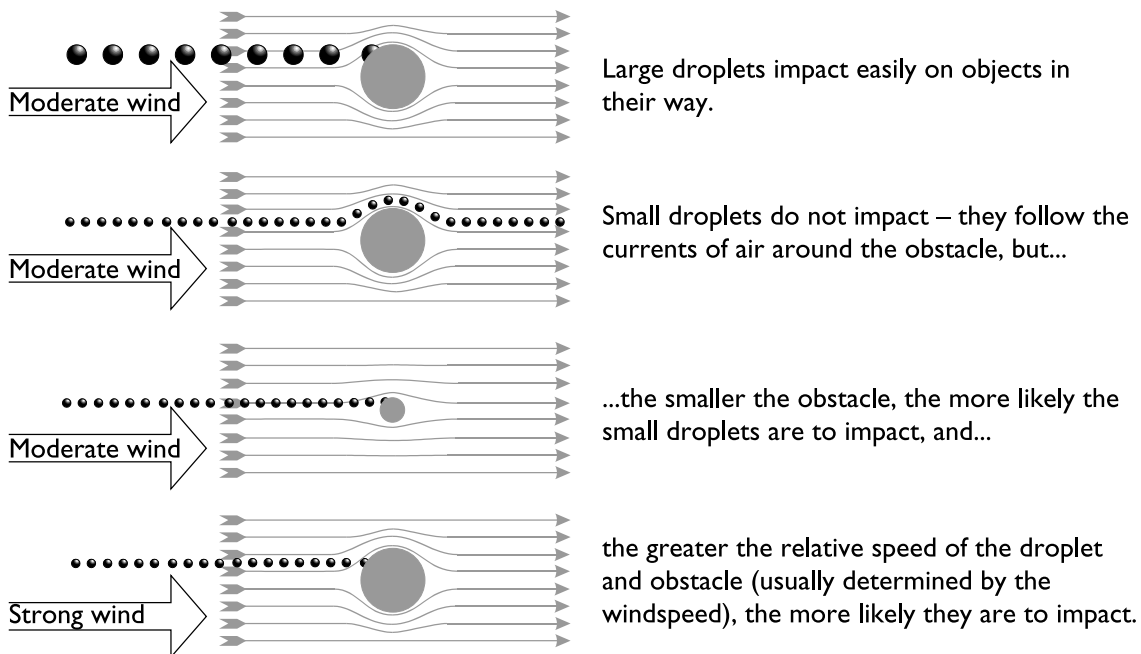

Figure 4.6: Factors affecting inertial impaction of droplets

The droplets might either need to be sampled on surfaces, i.e. deposition, since this indicates how much pesticide actually remains in the area of interest, or alternatively in the air, i.e. flux, since droplets in the air can still impact on and affect target and non-target species even if they would not normally deposit on surfaces in the target area.

There are three main factors of interest during spray sampling:

- number of droplets
- the size of these droplets, which, together with their number, gives volume and amount of active ingredient; these first two factors are combined when fluorimetric, colorimetric or pesticide residue analysis are used as the analysis method
- distribution of these droplets inside and outside the target area.

When sampling agricultural sprays, it is preferable to use the target itself as the sampling surface because both deposition and retention on leaves or other plant surfaces, may be different from those on artificial spray targets. However, as this is not always possible or convenient (see below), artificial samplers are useful in making comparisons of deposition or flux from spraying operations using different parameters.

Care is needed with the choice of sampling equipment and methods, as the properties of the droplets (velocity, density and diameter), and the dimensions of the target greatly influence the chance of impaction and retention. In general, larger droplets are easier to sample and smaller ones are more elusive. For example, artificial spray sampling surfaces held horizontally within or above the crop can be satisfactory for sampling large sedimenting droplets, but would be of little use for sampling the fine sprays used in ULV spraying (or drift from conventional spraying) because of the low collection efficiency of horizontal surfaces for small windborne droplets. Strands of yarn, such as wool or synthetic material possessing numerous fine filaments protruding from their surface, have a high collection efficiency for all but extremely small droplets, and have been successfully used to monitor spray

drift (Cooper *et al.*, 1996) (see method sheet for procedure). Sampling efficiency can also be improved by increasing the relative velocity of the droplet and the sampling surface. Some types of equipment for sampling small spray droplets, such as cascade impactors and rotary samplers, increase the relative velocity in this way to increase collection efficiency by inertial impaction.

METHODS FOR SAMPLING, COUNTING AND MEASURING THE SIZE OF THE DROPLETS

In contrast to colorimetric or residue analysis methods, most physical methods of droplet sampling are less elaborate and, therefore, often cheaper and more convenient. They do not rely on the availability of clean water or solvent to wash deposits from leaves prior to measurement and the equipment is relatively unsophisticated, although a microscope may be needed in some cases. Use of artificial surfaces reveals the location of the actual spray deposit on the leaves and whether the spray is distributed evenly, or in patches, at the edges or over the whole surface, whether on upper or lower leaf surface, etc. This more complete picture of spray distribution may be important if a particular non-target organism is usually found in a particular location. The number of droplets per square centimetre, often referred to as droplet density, can also be important. The same quantity of spray on a leaf can perform differently according to distribution. In contrast, chemical methods of spray sampling reveal the mass and volume of spray on a leaf, but they give no indication of the size and distribution of droplets deposited.

A number of surfaces can be used for collecting spray droplets. Natural surfaces such as leaves and insects can be used but the droplets usually spread quickly and may be difficult to see. For this reason, artificial surfaces, such as sampling papers, are usually used as a substitute, despite the fact that their surface properties may cause droplets to deposit differently from the way they would have deposited on a leaf, insect or crop. For example, hairy nettle leaves collect and retain herbicide droplets better than many artificial targets, so use of artificial targets would tend to under-estimate leaf deposition. The opposite would be true of cabbage leaves, which have a waxy surface which is difficult to wet, and from which spray droplets roll off easily. The more absorptive nature of artificial surfaces could retain more spray droplets than the equivalent area of cabbage leaves and the amount of spray deposited on the crop would be over-estimated.

Paper and card-based surfaces: oil and water-sensitive papers

Oil-sensitive papers react with any oil or solvent in the formulation to produce a dark mark or stain at the point where the droplet impacted. They are particularly useful for sampling ULV formulations. However, not all formulations make an easily visible or permanent mark on all types of oil-sensitive paper; this should be tested before sampling. Some inkless chart recorder papers with micro-encapsulated surfaces show up oil-based spray deposits because the upper waxy layer is dissolved by the spray, revealing the darker backing paper and leaving visible marks. While these marks may show clearly at first, they sometimes fade quite quickly and, in some cases, small droplets do not show up satisfactorily since their volume is insufficient to dissolve a complete hole through the wax layer.

Water-sensitive paper is made by coating or impregnating white paper or card with a yellow dye or pH indicator that changes from yellow to blue in the presence of water. It is useful for sampling water-based sprays but the papers are easily affected by moisture on the hands or on the crop, so when the temperature is high, gloves may need to be worn to prevent sweat marking the papers.

Oil and water-sensitive papers can be purchased in packs of 50 or more. Each paper measures approximately 5 cm x 8 cm and for flux-sampling these can be cut into strips of about 1 cm x 8 cm and stuck with pins or gum to a cane or pole in a vertical position, at a height relevant to the object of the exercise. The sensitive side of the paper should face the wind. For estimating deposition on soil, place papers at ground level and for deposition

on crops or tree canopy, staple papers to leaves at various heights. Little rafts with horizontal papers can be floated on water to estimate deposition on ponds. How many to use is usually determined by various factors such as the scale of the spray operation, the logistics of travel to sites that are being monitored and the period before the stain begins to fade.

Droplet marks or stains can be counted using a magnifying lens. It is important to take several counts from each sampling card and to take them at random to avoid bias, otherwise an unrepresentative result will be obtained. If droplet size is required, a microscope fitted with a special graticule can be used, as for magnesium oxide slides.

Limitations As with all spray deposition assessment techniques, it is wise to test the sampling methods using the actual spray formulation before use. The use of water-sensitive papers is restricted when dew or high humidity is present since they make it impossible to distinguish stains made by spray droplets from background moisture.

Processing Counting and measuring between 5 and 10 papers per site should provide a reasonable estimate of deposition. It is advisable to count and measure the droplets within 2 h of deposition to reduce the risk of fading. If droplet diameter is required, spread factors must be calculated (see page 113). Sampling surfaces can also be analysed automatically by image analysis equipment if available. When there are so many deposited droplets that they have coalesced – often the case in high-volume spraying – it is not possible to count or measure individual droplets. In this case, the only parameter measurable is percentage area cover, a task which is possible by manual means, but is much easier using an image analyser.

Resulting data Number of droplets per square centimetre, size distribution of droplets and volume/mass deposited.

Equipment Commercially available papers, magnifying glass or microscope and graticule.

Staff required 2 to set, collect and count the papers.

Paper and card-based surfaces: white card

Kromokote, chromlux or unexposed, fixed photographic paper can be used in conjunction with a spray formulation to which coloured dye has been added. The spray droplets show up as coloured spots on the white paper. Dye-based techniques are useful in field trials, but are not always acceptable to commercial operators because they can contaminate or stain their machinery, particularly those dyes which are not water soluble and so not easily washed off. Card is used in the same way as oil and water-sensitive papers.

Magnesium oxide-coated slides

Magnesium oxide (MgO) is a unique surface for which the relationship between droplet diameter and the size of the hole or crater left in the surface made as the droplet impacts with the surface, is well established (May, 1950). The crater diameter has been found to be 1.33 times the droplet diameter for 10–15 μm droplets, 1.25 for 15–20 μm droplets and 1.16 for 20–200 μm droplets, provided that the thickness of the oxide is greater than the droplet diameter. This relationship is independent of droplet composition, unlike the other sampling surfaces mentioned above. For this reason, magnesium oxide-coated surfaces are commonly used for accurate physical assessment of sprays. Magnesium oxide-coated slides can be used to determine the spray quality produced by a sprayer, i.e. the droplet size distribution or droplet spectrum.

Slides are made by allowing magnesium oxide smoke from a piece of burning magnesium ribbon (about 20 cm) to condense on the underside of a glass microscope slide. The method sheet gives the procedure for making such slides. The slides should be prepared the day before use, as droplets enter the oxide layer more cleanly after the surface has matured for several hours. However, if they are too old, a crust forms on the surface which limits droplet entry. Unused slides should be discarded after 3–4 days. After exposure to spray, slides can be retained for several months without deterioration. The slides should be handled by the ends that are not coated with magnesium oxide.

The prepared slides are normally placed in a rotary sampler that is fixed to a pole with adhesive tape about 1.5 m above ground. The magnesium oxide layer faces the same direction as the rotation direction of the unit when

operational. The rotor is battery-powered. Magnesium oxide-coated slides can also be placed on the ground or fixed to a cane as described for paper and card-based samplers.

To determine the diameters of the slide craters, the slides are placed on a microscope stage illuminated from below, and measured using a calibrated graticule such as the Porton graticule fitted in the eyepiece of the microscope (see the method sheet on measuring droplets and deriving VMD and NMD).

Limitations Magnesium oxide-coated surfaces are fragile and easily damaged by being touched, so they have to be handled carefully. Special slotted boxes are needed to store magnesium oxide-coated slides and prevent damage in transit. Some users have reported interference from dew drops with early morning use. The scale of use is normally determined by the number of samplers available and the area to be monitored.

Processing Magnesium oxide-coated slides can be analysed automatically using computer-based image analysis systems that can count and size droplets rapidly, but they are relatively expensive.

Equipment Sampler and battery unit, slide box, magnesium ribbon, 6 mm slides, anemometer and microscope.

Staff required 2 or more, as slides must be made, set, collected and analysed.

Determination of the spread factor of artificial sampling surfaces

Card or sensitive paper samplers have been used extensively to monitor spray deposition and to characterize spray quality. However, if the diameter of the droplets sampled is needed, perhaps to calculate the volume of spray deposited, the spread factor of the spray droplets on that particular surface must be determined. The spread factor on paper varies greatly with droplet size, so it is necessary to compare a range of actual droplet diameters with the stain size made by each on the surface. To establish the spread factor, the actual droplet diameter is needed, and it is convenient to use the known properties of magnesium oxide to determine this by simultaneously exposing both the test surface and magnesium oxide-coated slides to a mono-disperse spray from a suitable laboratory droplet generator. The magnesium oxide-coated slide is used to determine the actual droplet diameter, which is then compared with the stain diameter on the test surface. This permits the spread factor for that particular droplet size to be found. The procedure is then repeated for a range of droplet sizes. The data analysis can be achieved either graphically (plotting droplet diameter against stain diameter) or, using a calculator or computer, by mathematical regression. When the relationship between stain diameter and droplet diameter has been established for a range of droplet sizes, the paper can be used for sizing droplets of that spray type.

Fibre samplers

Fibre samplers, such as knitting wool, provide an easy and efficient means of sampling very small drifting droplets in the field. Insecticide trapped on the wool is extracted and analysed or, if a fluorescent dye has been added to the formulation, estimated using a fluorimeter. No power supply is required and the basic material, knitting wool, is readily and widely available and of a consistent standard. Each sampler consists of a wool strand, approximately 1.25 m long, with an elastic band attached at one end. A small loop is tied at the other end. A 1 m section of the sampler is indicated by knots tied in the strand. Each sampler is stored in a self-sealing plastic bag.

Limitations Extreme care is required not to contaminate the wool through handling.

Resulting data For example, μg pesticide per metre of fibre or other quantitative data on flux of drifting spray.

Equipment Knitting wool, surgical gloves, hooks, poles and aluminium foil. The analytical laboratory will do the rest.

Staff required 2.

Interpreting the data

There are several points to be recognized.

- It is essential to remember that most artificial samplers are intended to mimic a natural sampling surface, i.e. soil, vegetation or insect. However, artificial collecting surfaces do not necessarily collect droplets in the

same way as natural targets so the number and volume of spray determined from samplers may only be a rough guide to what is happening on real surfaces.

- There is enormous variation in spray distribution as a result of varying weather conditions, terrain, vegetation, sprayer output and operator performance, and the number of spray samples taken is usually far too small to represent this large variation. The spray data obtained from these sources can only be a guide to actual spray distribution.
- As a consequence of droplet behaviour in relation to size, the droplet spectrum collected close to the sprayer is almost always larger than that found further downwind. This might be due to evaporation after emission, or the 'sorting' of spray, i.e. the large droplets tend to deposit most easily and the smaller ones tend to be carried out of the sampling area. The only real way to get a true measure of droplet spectrum is to sample next to the atomizer, but this is difficult without saturating the sampling surface.
- If sampling surfaces are saturated with spray droplets a true figure for deposited volume and dose cannot be calculated, nor can a droplet size. The best one can estimate is 'more than a certain figure', or the parameter of percentage area cover can be used as a relative level of deposit.
- If samplers are placed vertically on artificial supports, the data give an indication of how much spray was passing that point, in other words, the spray flux is determined rather than spray deposit. However, use of static artificial surfaces in vertical orientation is likely to over-estimate droplet size and under-estimate drifting spray since the small droplets are less likely to be caught. Correction factors are required to compensate for the flux. Data are available on ribbon collection efficiencies for different wind speeds, droplet sizes and ribbon widths (May and Clifford, 1967) and corrected data on flux can be extrapolated to the amount that would have been deposited if there had been a natural surface there.
- If rotary samplers are used, the interpretation is more complex and requires several calculation steps (Cooper *et al.*, 1987).

REFERENCES

COOPER, J.F., DOBSON, H.M. and JOHNSTONE, D.R. (1987) A rotary sampler for coarse aerosol sampling: sampling rate and impaction efficiency connectors to give a good estimate of airborne drops. pp. 37–40. In: *Proceedings First Conference, Aerosol Society, Loughborough*.

COOPER, J.F., SMITH, D.N. and DOBSON, H.M. (1996) An evaluation of two field samplers for monitoring spray drift. *Grop Protection*, **15** (3).

FAO (undated) http://www.fao.org/WAICENT/FAOINFO/AGRICULT/AGP/AGPP/Pesticid/Specs/pes_alp1.html.

JOHNSTONE, D.R. (1971) Droplet size for low and ultra-low volume aerial spraying. *Cotton Growing Review*, **48**: 218–233.

MAY, K.R. (1950) The measurement of airborne droplets by the magnesium oxide method. *Journal of Scientific Instrumentation*, **27**: 128–130.

MAY, K.R. and CLIFFORD, R. (1967) The impaction of aerosol particles on cylinders, spheres, ribbons and discs. *Annals of Occupational Hygiene*, **10**: 83–95.

WHO (1992) *WHO Hazard Classification*. WHO/PCS/92.14. Geneva: World Health Organization.

FURTHER READING

MATTHEWS, G.A. (2000) *Pesticide Application Methods*. Third edition. Ames: CRC Press.

ENVIRONMENTAL PARAMETERS

Ian F. Grant¹

Natural Resources Institute, University of Greenwich at Medway, Central Avenue,
Chatham Maritime, Kent ME4 4TB, UK

INTRODUCTION

Environmental parameters² influence the distribution, abundance and activity of animals and plants. Local meteorological conditions such as air temperature, rainfall or sunlight may affect the behaviour of terrestrial organisms, and water current, dissolved oxygen, suspended material and river bed topography may influence aquatic species.

Pesticides also behave differently under varying environmental conditions and information about soil type, soil moisture, the pH of water and the type of sediment are also instructive in pesticide impact assessment. The bioavailability of an insecticide is an expression of likely exposure of an organism to the toxin. A sandy soil will not bind (immobilize) some types of insecticide as well as clay soils, leaving organisms inhabiting sandy soils at greater risk. Soil moisture and pH can greatly modify the degradation rate of pesticides and, therefore, their persistence and bioavailability in the environment. The measurement of environmental parameters, therefore, becomes an integral part of any study design where the intention is to observe change in species, populations, activities or function as an outcome of pesticide use.

Field techniques for measuring a range of physical and physico-chemical parameters in air, water and soil are provided below. Environmental factors that primarily affect the abundance of plants, such as the concentration of the nutrients nitrogen, phosphorus and potassium in soils and water, are not described. The reason is that the wet chemistry involved is hard to manage in the field, at least for sustained periods. Plant nutrients also have little direct impact on fauna – the principal focus of this handbook.

The methods described are all fairly robust, reliable, cheap and practical to use. When it is not practical to visit sample sites daily because of the travelling distances involved, data loggers may be needed and, in long-term studies, a portable computer on to which data can be transferred. These items are expensive and under some circumstances it may be more cost-effective to employ field staff to reside at distant sample sites. The methods described have been tried and tested by all of the handbook's contributing authors, mostly for daily use and over periods of months to years. You will always lose some data: losses are minimized by forward planning (e.g. consumables or manpower scheduling) and by keeping fixed equipment out of sight of people and large mammals, protected from the latter by a wire fence if necessary. Biometricians can accommodate some gaps in the data sets but this is best avoided if at all possible!

STUDY DESIGN

Table 5.1 provides an indication of the environmental parameters that are important to integrate into study designs. Some are more or less essential (●) while others are optional (○). Many of the parameters, like the meteorological conditions, are measured on a semi-continuous basis, perhaps every 30 min. Others are sampled

¹Contact address: Cybister Environmental Protection, Oak House, South Street, Boughton, Kent ME13 9PE, UK. ian.grant@cybister.plus.com

²Factors or variables.

less regularly (e.g. conductivity and turbidity of water) or only once to establish a baseline (soil texture and water-holding capacity). It may be necessary to consider the influence of daily and season variations on biota, in which case both day and night-time readings of temperature and dissolved oxygen in shallow pools and lagoons will be required, accommodating wet and dry seasons as necessary. In practice, sampling intervals and periods will be constrained by the level of technology employed; a data logger can sample wind speed, relative humidity and temperature every 30 min; a maximum-minimum thermometer is read once a day.

The placement of meteorological equipment is mentioned in relevant sections below. Its importance relates to the compatibility of records with those of government meteorological survey and between stations established at sprayed and unsprayed sites, that can be hundreds of kilometres apart in some instances. Relatively simple precautions are necessary to ensure standardization of procedure and avoid the effect of buildings, tree stands and direct sunlight on parameters such as wind speed, wind direction, temperature and rainfall. When monitoring sites are further than 10–20 km apart, it may be necessary to set up more than one meteorological station, which has implications for resource management and frequency of reading. It may still be more cost-effective to have parameters read manually at fixed times of day rather than purchase expensive and vulnerable data logging equipment.

Table 5.1 Indicative measurements by study group/type

Parameter	Indicative measurements by study group/type													
	Air/water temperature	% RH	Wind	Rain	DO/SS/UL	Current substrate	Soil texture	Soil WHC	Soil moisture	pH	Conductivity	Cover	Shade	
Study														
Application technology	●	○	●	●										
Pesticide residues	●	●	●	●			●			○		○	●	
Soil processes	●	●	○	●			●	●	●	●		●		
Terrestrial invertebrates	●	●	●	●								●		
Aquatic invertebrates	●		●	●	●	●				●	●	●		
Fish	●		○	●	●	●				●	●	●		
Reptiles	●	●	●	●								●	●	
Amphibia	●	●	●	●						●		●	●	
Birds	●	●	●	●								●	○	
Small mammals	●	●	●	●					○			●	○	

Key: RH = relative humidity; DO = dissolved oxygen; SS = suspended solids/turbidity; WHC = water-holding capacity; UL = underwater light (Secchi disk); ● required; ○ optional.

METEOROLOGICAL MEASUREMENTS

Wind

Wind speed and direction provide useful information for predicting the heading of migratory pests, the direction of bird song, the distance and direction of travel of insecticide droplets, and the evaporation rates and residence times of pesticide residues on surfaces, etc. Wind speed and direction are best measured semi-continuously, and especially when pesticide application on a large scale is being monitored. This involves the use of costly anemometers, wind vanes and a data logger (totalling approximately US\$ 2500, but this price represents only a fraction of the operational cost of the application). Direction can be inexpensively but crudely measured using a wind vane or windsock and a compass. Wind speed is readily measured using proprietary plastic gauges that use air pressure to raise a small plastic ball in a calibrated tube, or to rotate hemispherical cups fixed to a spindle of a calibrated anemometer.

Limitations Cost is a limitation in the first instance. All the methods require good placement of the measuring instruments, bearing in mind that obstacles to wind passage, huts, woods, paths and vegetation, will affect both wind speed and direction. It is preferable to stand or place instrumentation in a wide open space and to remember that mounting instrumentation on a mast to clear an obstacle will produce measurements representative of that height. Meteorological equipment left in the open for long periods is vulnerable to theft and interference by animals. Long-term installations should be protected by a tall wire fence, although that is no guarantee against elephant or baboon damage.

Processing Hand-held gauges are read directly. Data loggers will also read out directly or use software to compile averages and other statistics.

Resulting data Speed in m s^{-1} . Data can be represented in tabular or graphic form.

Sampling period Collect data over the entire monitoring period. Electronic data loggers can be set to record every 20 min. Manual intervals (wind gauge) should be used twice a day at the same time of day.

Equipment Anemometer or wind gauge, data logger, laptop computer, compass and wind vane.

Staff required 1.

Rainfall

Rain gauges of various designs provide data that are fundamental for the interpretation and comparison of biological and chemical information. Rain determines the growth of vegetation, soil microbial activity, the presence and behaviour of non-target organisms, pesticide dissipation, movement and degradation. Any container like a coffee can (flat bottom, straight sides) can be used to estimate rainfall. Rain gauges can be purchased or made from a funnel suspended over a graduated cylinder. For long-term, unattended use, a tipping bucket can compute rainfall using a mechanical counter or an electrical signal to a data logger. The height of water in the can or gauge is read off against a precipitation curve that takes account of the area of the opening and converts it to millimetres per unit of time.

Limitations Positioning of the gauge is important to reduce the effects of rain shadow (from buildings, trees, tall grass, etc.), splashing and evaporation, which is rapid in hot climates, especially at the beginning and end of a wet season. A tenth of a millimetre of rain will evaporate quickly if the gauge is not insulated or attended regularly.

Resulting data Millimetres of rain per day/month, etc., that is best represented as a histogram with time on the x-axis.

Sampling period Collect data over the entire monitoring period. Check and empty gauges daily (as necessary).

Equipment Coffee can, funnel and volumetric cylinder (rain gauge), or tipping bucket.

Staff required 1.

Temperature

The temperature of air, water and soil is highly significant in terms of the distribution, behaviour and activity of biota and pesticides. Higher temperatures generally increase animal activity and this has implications for activity-based trapping techniques (e.g. pitfall traps) and the risk of contact with airborne droplets and surface deposits

of pesticides. Temperature inversions at dusk and dawn affect the behaviour (dispersion) of pesticide droplets, while ambient temperatures affect significantly the toxicity of pesticides to most organisms – higher temperatures more commonly increasing toxicity, but lower temperatures increasing the toxicity of many pyrethroids. Pesticide degradation rates and persistence are markedly affected by temperature.

Mercury in glass thermometers provide an accurate way of measuring air, water and soil temperatures. Maximum-minimum thermometers are particularly useful for ecological impact assessment as they are cheap, robust tools that are easily reset for daily recording. Hand-held, electronic temperature sensors are also good but expensive and require long-life batteries. Most portable meters available for determination of pH, oxygen and conductivity have integral temperature sensors that can read out separately from the main function. Meteorological data loggers will have an input for a thermistor or thermocouple.

Limitations Protect thermistors and the bulb of mercury thermometers from direct sunlight when measuring air temperature (best to provide a wooden or polystyrene screen).

Processing None except basic statistics (averaging, range, maximum-minimum).

Resulting data °C. Line graphs (x axis for time) or tables as appropriate.

Sampling period Collect data over the entire monitoring period – setting data loggers to record every 20 min. Manual readings should be taken at dawn, midday and dusk.

Equipment Thermometers, maximum–minimum thermometers or electronic devices employing thermistors.

Staff required 1.

Relative humidity

The speed with which many biota dehydrate is related to the humidity or moisture content of the surrounding air. They lose water very quickly by evaporation through the skin and cuticle when the humidity is low, and the process is aggravated by high ambient temperature and wind speeds. Many species are inactive in dry conditions and small amounts of shade or cover can significantly affect the degree of animal activity, especially above ground. Local conditions influence soil moisture and microbial activity, such that the rate of biological degradation of pesticide is accelerated in more moist areas. Pesticides which 'knock-down' invertebrates (e.g. pyrethroids) often also cause spiracles to open, subjecting them to a risk of desiccation at low relative humidity.

The best instrument with which to measure humidity is the whirling hygrometer as it is fast, accurate and cheaper than electronic humidity probes. The measurement is based on the differential between two thermometers, one of which has a mercury bulb that is kept wet by a wick in a water reservoir, the other not. When the hygrometer is spun around in air (like a football rattle), the water in the wick evaporates as a function of humidity and cools the bulb. The lower the humidity the greater the cooling and the difference in bulb temperature of the two thermometers is used to calculate the relative humidity.

Limitations Microhabitat differences can affect percentage relative humidity.

Processing Differences in temperature are converted to relative humidity using the tables provided with the instrument.

Resulting data Percentage relative humidity plotted against time or as a radial plot for a spatial representation.

Sampling period Take a reading at the same time of day throughout the monitoring period. Set a data logger to record relative humidity every hour.

Equipment Whirling hygrometer.

Staff required 1.

OTHER PHYSICAL AND PHYSICO-CHEMICAL MEASUREMENTS

Water temperature

See general points under 'Temperature' above.

Water temperature can vary widely over 24 h. In the dry season, shallow water bodies, swamp and lagoons can cool by 10 °C between dusk and dawn and shallow, slow moving rivers may do likewise. The physiological activity

of fish and invertebrates is very different at the extremes of the range, and biological sampling procedures should take account of it. At the high end, fish and invertebrates are under more natural stress in shallow water due to increased respiration, lowered dissolved oxygen levels and increased toxicity of many pesticides. In deeper rivers, pools and lakes, the temperature extremes are narrower and the dilution factor ameliorates the acute toxicity of deposited pesticide (not for surface-dwelling invertebrates).

Mercury in glass or electronic thermometers are easily used from the shore, while wading or from boats. A weighted thermistor or thermocouple attached to a cable is useful for measuring at depths. Dissolved oxygen electrodes have integral thermometers and generally longer cables.

Limitations Depth of measurement. The length of cable may constrain deep measurements.

Resulting data Average daily temperature, which may be plotted as a line graph over time.

Sampling period Every time a fish or invertebrate sample is taken in a water body. Data loggers can be set to record temperature every 20 min.

Equipment Glass or electronic thermometer, or thermistor/thermocouple attached to oxygen or conductivity electrodes.

Staff required 1.

Dissolved oxygen

The amount of dissolved oxygen in water is in a constant state of flux. This is a natural result of the influences of water temperature, plant photosynthesis and respiration and organic matter breakdown. Organic pollution and nutrient enrichment increase the exposure of aquatic organisms to a much larger range of oxygen concentrations, and the potential impact can be limiting to a huge range of species as most require, and are sensitive to, dissolved oxygen. Under these conditions it is not unusual to see daily fluctuations ranging from the severely limiting (5–10% saturation) to supersaturation (150% saturation), which can also be limiting. Dissolved oxygen in water is one of the key parameters that aquatic ecotoxicologists need to measure. The physiological stress induced from exposure to pesticides combined with that from low dissolved oxygen levels can be fatal for aquatic organisms.

Measurement of dissolved oxygen in water is relatively straightforward with a portable oxygen meter. A calibrated oxygen electrode is moved slowly in water to produce a reading in ppm of oxygen after 1–2 min. Meters and electrodes are fairly expensive and require good maintenance and long-life batteries, but the alternative (the more accurate Winkler method) is time-consuming wet chemistry, and unsuitable for sustained periods in the field.

Limitations Electrodes are delicate and require calibration every 1–2 days, although for most field purposes, water-saturated air is sufficient to check the calibration. Most meters have automatic temperature compensation but it may be necessary to correct for temperature and pressure with older models. Semi-continuous logging of data is not that practical over long periods: water must move over the electrode tip and continuous immersion in water encourages algal and bacterial growth on the membrane. Devise a schedule of visits to sample sites to ensure that measurements are made at approximately the same time of day at each visit (to accommodate photosynthetic activity). This becomes difficult when large distances need to be covered on land or lake.

Processing None, although older meters may not automatically compensate for temperature and pressure in calculation of percentage saturation with oxygen.

Resulting data ppm oxygen and percentage oxygen saturation.

Sampling period Take readings when sampling aquatic habitats. It is also useful to know hourly dissolved oxygen over a 24 h period. Set data loggers to record every 20 min.

Equipment Portable oxygen meter, temperature compensating electrode and cable.

Staff required 1.

pH

The acidity and alkalinity of soil and water can be estimated from a pH scale. In the case of soil, an aqueous slurry or extraction is prepared before measurement. Soil pH may change slightly with season, leaf-fall, leaching and cropping practices. The pH of water may fluctuate considerably as photosynthetic activity removes carbon dioxide from water and shifts the carbonate-bicarbonate equilibrium. The real significance of pH in soils is its effect on plant nutrient availability but for ecotoxicology, the pH of water and soil can influence the toxicity of pesticides and their rate of degradation.

Colorimetric and electrometric methods are used to measure pH. The latter is more sensitive and involves immersing two electrodes (a pH and a reference), or a combined electrode, in a soil solution or water and reading the pH from a meter within 1–2 min. The less accurate but much cheaper colorimetric method involves the use of colour indicators or, more conveniently, pH papers, that are dipped into the solution and read from a colour chart.

Limitations pH electrodes are delicate and easily broken in the field. Always carry spares of both electrodes and batteries. They also need regular (daily) calibration, which requires carrying 2–3 buffer solutions and distilled water. pH papers are subject to operator influences, colour perception, etc.

Processing Equal volumes of distilled water and soil are stirred for a few minutes before immersing the electrodes or dipping the indicator paper.

Resulting data pH units – to 0.01 with an electrode and within 0.5 of a unit with narrow range paper.

Sampling period Take readings when sampling aquatic habitats.

Equipment pH and reference electrodes, pH meter and buffers, and/or pH indicator paper.

Staff required 1.

Light and shade

In the context of this handbook, light and shade measurements are primarily used to classify terrestrial habitats or describe diurnal and seasonal change. It is the influence of light and shade on animal activity and behaviour that concerns us more than aspects of plant growth and photosynthesis, because population measurements of fauna can become distorted as behaviour changes in response to light. Gradations of light intensity, from full sunlight to deep shade, can also affect persistence of pesticides on surfaces like vegetation and soil, as UV radiation begins to degrade organic compounds.

There is a range of light meters available with sensors designed for the measurement of various types of radiation (e.g. photon irradiance, energy flux, and lux). For simple comparison and recording of light levels in different habitats, a meter with arbitrary units is sufficient, but access to a PAR (photosynthetically active radiation) or lux meter will also suffice for the purpose. Many ecologists take note of the light conditions along transects as they walk, using gradations from full sunlight to full shade to record the conditions when they observed species of insects, reptiles or birds. Combining light measurement with a percentage of vegetation cover (where relevant) is also useful. The cover afforded to ground fauna by a woodland canopy or a riverine sampling site can be estimated crudely by holding up a small quadrat and noting the percentage of clear sky, cloud, canopy, etc. No method sheet is provided for light readings.

Limitations None provided the output is to be used for comparative purposes.

Processing None.

Resulting data Light units or estimated gradations of light/cover can be plotted or tabulated.

Equipment Light meter and sensor, and small quadrat.

Staff required 1.

Turbidity/underwater light

Light penetration into water is sometimes measured in relation to production and behaviour of phytoplankton and fish and to estimate reduction of light caused by floating weed infestations. A Secchi disc is a simple

apparatus used widely for this purpose. The black and white disc is lowered into the water until it just disappears from view and the depth is noted from the line supporting it. It is then lowered further and raised until it becomes visible, to provide a further reading. Comparative measurements over time are easily made and readings can be converted to euphotic zone depth if required (factors can be found in limnology textbooks). (Look under turbidity in method sheet on physico-chemical measurements in water.)

Limitations User variability, changes in ambient light conditions and surface disturbances (ripples, waves) reduce precision and accuracy.

Resulting data In centimetres or metres. Data can easily be graphed as histograms.

Sampling period Take a reading when sampling ponds, lakes and lagoons.

Equipment Secchi disc, and weight and line.

Staff required 1.

Turbidity/suspended solids

Suspended inorganic and organic matter can affect the availability of pesticides in water. Many pesticides bind quite strongly to suspended particulate matter and will be removed downstream of a contaminated area fairly quickly. Turbid rivers give high degrees of protection to local fauna and dilution downstream may mitigate some of the toxic effects, even for filter feeding species. Suspended solids also reduce light penetration into water, affecting phytoplankton, the visibility of aquatic fauna and sometimes the viability of fish eggs. Turbidity meters and solids monitors are expensive. The simplest, reliable field method is a gravimetric determination, requiring a representative sample of water that is passed through a weighed filter paper, which is then oven or sun-dried and reweighed. A Secchi disc can also be used to estimate turbidity providing the depth of water is sufficient to allow its disappearance from view.

Limitations Very turbid water will take a long time to filter without a vacuum pump.

Processing None.

Resulting data Data can be readily plotted or tabulated (in ppm).

Sampling period Sample water to determine suspended solids one or twice a month.

Equipment Plastic graduated cylinder, Hartley or Buchner funnel and flask, filter papers and portable balance (if laboratory too far away).

Staff required 1.

Conductivity

Conductivity of water is a parameter that does not vary greatly under natural conditions, with the exception of estuarine conditions and where saline intrusion into lakes occurs. The ionic concentration of materials dissolved in water is measured with a probe and the conductivity is read from a hand-held meter. Conductivity has little relevance to pesticide impact assessment except where saline intrusion into water bodies occurs intermittently, as it may affect the physiology and distribution of fauna.

Limitations None – the probes are robust and stable.

Processing None.

Resulting data Outputs in ohm^{-1} or Siemens cm^{-1} .

Sampling period Take a reading when sampling aquatic habitats, particularly if they are subject to saline intrusion.

Equipment Conductivity meter and probe.

Staff required 1.

Current velocity

Current changes with season, slope and interventions such as dam releases. Water velocity has a profound effect on physico-chemistry, the composition of a river bed (sand, silt) and the ability of invertebrates to keep a foothold, respire and feed. Aquatic invertebrates are particularly sensitive to pesticides and may drift downstream to avoid them. It is important to be able to distinguish between population change due to pollution from other causes such as a change in current. Variable flow can have a far greater impact on benthic populations than low level pesticide

contamination. Flow measurement is also useful to match monitoring sites within and between reaches of a river. Three methods that are very straightforward are commonly used.

- Timing of a float, often a fruit like an orange, over a known distance. Its advantage is that it is quick, can be repeated to achieve an average and requires no equipment except a watch and a floating object. Most of the float should be submerged and the float should be timed over a reasonable distance, e.g. 10–20 m.
- Use of a Gessner tube, using the time taken for water to inflate a bag.
- A propeller-based flow meter is much more accurate and is often used when differences in speed at various depths (vertical profile) are required. Propeller systems can be used to measure flow through aquatic drift nets although they must be custom made to fit the net.

Limitations The float technique is imprecise because of obstructions in the river, the effect of strong wind, and problems arising from main and peripheral flow in streams – the float takes its own path. Gessner tubes may not be commercially available in some countries but can be fabricated easily enough. Propeller-based systems are expensive (US\$1500).

Processing None.

Resulting data Output in m s^{-1} .

Sampling period Sample flow whenever setting a drift trap and check flows at sample sites every 2 weeks, or more frequently after rain or when streams are drying out.

Equipment Stop-watch, tape measure, and float or Gessner tube.

Staff required 1.

Classification of aquatic substrates

Aquatic invertebrates are associated with certain types of substratum. Some species prefer mud, others gravel or rocks. Substratum is thus another factor that controls the distribution and range of benthic invertebrates and for the purposes of surveillance and monitoring, we need to try and match sampling sites as closely as possible. Methods for classifying substrates can be rapid or lengthy depending on the goal. For the siting of sampling stations, a rapid analysis based on visual estimates will normally suffice, using a percentage scale to characterize the area covered by rocks, pebbles, gravel and sand, silt and mud, emergent or rooted vegetation. Over long reaches of river matching of sample sites is often difficult, as rivers begin to deposit sediment when the slope declines and in the slack of bends. Current velocity is closely related to the substratum and these two parameters are fundamental for site characterization. The more exacting method of classification that uses particle size analysis and settling characteristics of silt and clay is not a practical option in the field but a method to separate broader substrate types is included in the method sheet. A series of sieves and a tape measure is all that is required to classify substrate (Table 5.2).

Estimating vegetative cover

The importance of the positioning of terrestrial sample sites used for comparative studies of fauna is an argument that is vigorously exercised throughout this handbook. Visual estimates of the vegetative/ground cover are an aid for the siting of sampling stations, traps and survey lines. Ecologists carry pictures of habitat type in their minds (also now, digital camera images) when surveying for sites that can be up to hundreds of kilometres apart. They will be looking for similarities in plant biomass, plant cover, height, and species distribution which can be characterized rapidly by visual surveys of cover – in anything from small plots to large study areas. The ultimate test of well-matched sites will of course be the variation in faunal population data, but the efficiency of testing is improved by applying baseline knowledge of plant cover.

The simplest method of site survey is to rank species of vegetation as abundant, frequent, occasional or rare. Dominant vegetation is often used as a fifth descriptor of the habitat, e.g. *miombo* woodland or *Cynodon* grassland. As these rankings are open to interpretation it is useful to define percentages to them for all observers to work to. For

Table 5.2 Substrate categories and their particle size

Name	Size range	US standard mesh number
Clay	<3.9 μm	
Silt	3.9–63 μm	
Fine sand	0.02–0.25 mm	120
Medium sand	0.25–0.5 mm	60
Coarse sand	0.5–1.0 mm	35
Gravel	2–16 mm	10–5
Pebble	16–64 mm	
Rocks	64–256 mm	
Boulder	>256 mm	

example, the Braun-Blanquet scale assigns percentage cover to the rankings. More detail and quantification can be provided by the use of quadrats but at this level of information retrieval, time might be better invested in surveying the animal populations for indications of similarity and abundance. The reader is referred to the book by Grieg-Smith (1983) for quadrat sampling and other vegetation survey methods.

Limitations The subjective interpretation of cover can often lead to inaccuracies and inequalities in the data. The error between operators is hard to quantify and so variation is best reduced if the same individual or team is responsible for all the survey work. Ranked data can be used in non-parametric (statistical) tests but their discriminative power is poor. These drawbacks are compensated for by survey speed.

Processing Ranking of data.

Resulting data Area maps with histograms or area plots showing cover.

Sampling period Normally once, at the time of siting areas for monitoring, but it may need to be repeated if survey periods extend over different seasons.

Staff required: 2.

Soil texture

Choosing comparable sites for the measurement of soil microbial processes, soil invertebrate activity, pesticide residues in soil, etc., requires the assessment of soil texture. Laboratory methods are not feasible in remote areas but a ready guide to soil texture can be obtained from the feel of a soil. It takes some practice but is surprisingly accurate and only requires a trowel and water.

Limitation The only limitation is inexperience which can be overcome by using the technique against soils of known mineral composition (standard soils). No equipment or data processing is necessary. If you can find a soil testing laboratory to assess particle size, the method sheet provides a soil classification based on percentage sand, silt and clay.

Sampling period Normally once, at the time of site selection.

Staff required 1.

Soil moisture

Why is it necessary to measure soil moisture. The methods described for field estimation of soil moisture and water-holding capacity are crude compared with laboratory techniques but sensitive enough to provide standardization of field experiments designed to estimate nitrification or respiration. Moisture is determined by

weighing freshly dug soil before and after drying and expressing the difference as a percentage of dry soil weight (a quirk of soil science).

Limitations Soil moisture varies with soil type (texture, mineral and organic matter content), vegetative cover (shade and evapo-transpiration) and climatic conditions such as the time of day, cloud cover, rainfall and wind speed.

Processing None.

Resulting data A percentage of water in soil (dry weight).

Sampling period Up to 12 h if sun-drying the soil.

Equipment Portable balance and 2 mm sieve if determining in the field, polythene bags and Petri dishes.

Staff required 1.

Soil water-holding capacity

Water-holding capacity is used to describe water available for plant growth. The term is not synonymous with field capacity, which describes the water-holding capacity after water has ceased to move downwards in the soil under gravity. For the purposes of estimating soil nitrification, where prepared (sieved) soils are used, the first water-holding capacity method (1) is satisfactory. The methods (2) are simple to perform and rely on basic equipment.

Limitations Because it is rarely possible to completely dry soils in the field, it is advisable to check their moisture content by oven-drying a few samples on return to the laboratory. Quantitative measures of field capacity require laboratory-based techniques.

Resulting data Weight or percentage of retained water.

Sampling period 1 day is sufficient.

Equipment Balance or portable balance (in the field) and filter papers.

Staff required 1.

RECORDING DEVICES

Data loggers have revolutionized the monitoring of environmental parameters. They have become more manageable (hand-held), reliable and versatile: storage capacity and connectivity has improved and real-time telemetric links and downloads are possible. They remain expensive, however, and are vulnerable to theft, as they are often left in remote places for long periods of time. Even small, hand-held meters have storage capacity for hundreds of readings and many are multi-functional, allowing programming of inputs from temperature, oxygen, conductivity, pH and humidity probes. Data loggers are ideal for long-term meteorological monitoring, although the risk of losing large data sets increases unless data can be downloaded regularly through visits or by telephone. The major constraint to remote use is battery power.

Limitations Major cost and risks of damage and theft to unattended devices.

Processing Processing is easy; ample programmable and statistical functionality.

REFERENCES

GRIEG-SMITH, P. (1983) *Quantitative Plant Ecology*. Oxford: Blackwell Scientific Publications.

FURTHER READING

DOBERSKI, J. and BRODIE, I. (1991) *Techniques in Ecology and Environmental Science. Set A Terrestrial Organisms and Habitats. Set B, Aquatic Organisms and Habitats, Data Collection and Analysis*. Cambridge: Daniels Publishing.

SUTHERLAND, W.J. (1996) *Ecological Census Techniques: A Handbook*. Cambridge: Cambridge University Press.

John R. Cox¹

Natural Resources Institute, University of Greenwich at Medway, Central Avenue,
Chatham Maritime, Kent ME4 4TB, UK

INTRODUCTION

Pesticides used in agriculture, public health and agricultural pest control programmes can enter the environment in a number of ways depending upon the method and proficiency of application, as a result of accidents or through the unauthorized dumping of unwanted pesticide products or their containers.

Pesticide residues are the deposits of pesticide active ingredient (a.i.), its metabolites or breakdown products present in some component of the environment after its application, spillage or dumping. Residue analysis provides a measure of the nature and level of any chemical contamination within the environment and of its persistence. It is often difficult to correlate pesticide residues in the environment with effects on fauna and/or ecological processes. They can, however, show whether an animal or site has been exposed to chemicals and identify the potential for future problems. Selected sampling programmes can be used to:

- investigate residual levels of pesticide in the environment, their movement and their relative rates of degradation
- identify contaminated areas and/or sources of contamination
- examine the uptake of pesticide by food chain components
- determine whether pesticides were a cause of mortality.

All pesticides are subject to degradation and/or metabolism once released into the environment. The rates of degradation and dissipation vary greatly from pesticide to pesticide and situation to situation. The object of residue analysis is to indicate the residues present at the time of sampling and every precaution must be taken to ensure that the sample arriving at the laboratory has not been allowed to deteriorate in such a way that the results are meaningless. Some losses of and/or changes in the chemicals are inevitable and these will vary depending upon the conditions and the nature of the pesticides present. When sampling for residue analysis, the aim is to minimize these losses and thus maximize the correlation between the result obtained from the sample taken and the residue level actually present at the sample site.

The difficulties of sampling biotic and abiotic materials for pesticide residues in tropical countries are exacerbated in areas remote from suitable storage facilities or from the analytical laboratories themselves. Any delay in preserving the sample or extracting the pesticide residues means that there is an increased risk of degradation of any residues present, with a corresponding increase in the uncertainty regarding the analytical results and their interpretation. If analysis of shorter lived compounds (such as organophosphates or carbamates) is required, then the risk of loss is great. However, with some pesticides (particularly the more persistent chlorinated pesticides and some herbicides), the risks of loss are less. The rate of loss for all types of compounds is greater under tropical rather than temperate conditions.

¹Contact address: 42 Boughton Lane, Maidstone, Kent ME15 9QP, UK. john_coxuk@btopenworld.com

PROPERTIES OF PESTICIDES

Knowledge of the properties and characteristics of pesticides is vital in developing a sampling plan for residue analysis. Although it is difficult (and risky!) to generalize, the following briefly outlines the relevant environmental characteristics of the various pesticide classes.

After each of the following sections, a brief summary of reported data (from *The Pesticide Manual* and *EXTOXNET* files – see suggested ‘Further Reading’ on page 147) on water solubility, stability of residues in soil and on mammalian metabolism/excretion of residues is given for examples of each of the classes. This will give some idea of the general characteristics of the class and of the potential variation in environmental persistence. It is difficult to make any general statements on interpretation of this data as the individual compounds are so markedly different. However, increased water solubility indicates the *potential* for greater movement/leaching from the soil (although the type of soil in the treatment area is important in such considerations, e.g. clay soils are more retentive than sandy soils). Soils with a high organic matter content are also more retentive to certain residues. The half-life data (i.e. the times taken for half of the active ingredient to have been lost through degradation or dissipation) is a useful indicator of likely persistence and will help shape, particularly with regard to time scales, any proposed sampling programme. The significance of known metabolites/breakdown products should also be taken into account.

Organochlorines

Mobility of organochlorines in soil is generally limited, although it is greater in sandy soil. They tend to be bound in clay soils with limited leaching. Residues of the parent compound or metabolites can be found in soil, sediment, vegetable samples and in vertebrates/invertebrates for extended periods. Their solubility in water is low, although residues can be detected in water where there is extreme contamination and, particularly, on suspended matter in water.

Examples of water solubility, persistence in soil and mammalian excretion are given below.

- **lindane (gamma isomer of benzene hexachloride)**
Water solubility: 7.3 mg l⁻¹ (25 °C), 12 mg l⁻¹ (35 °C). Half-life of 15 months (temperate) when incorporated into the soil; much shorter if sprayed on the soil surface. Shows a low soil affinity and may be mobile in certain soil types. Fairly readily metabolized by animals to pentachlorocyclohexane, 1,2,4-trichlorobenzene and isomeric trichlorophenols and excreted as glucuronic acid derivatives. Other isomers of benzene hexachloride can be more persistent.
- **dieldrin**
Water solubility: 0.19 mg l⁻¹ (25 °C). Persistent in soil under temperate conditions; at average application rates (3.1–5.6 kg ha⁻¹), it is estimated that roughly 95% will disappear in 12.8 years on average. In bright sunlight, photo-dieldrin can be formed, which is a more toxic product. Some accumulation of dieldrin occurs in animal tissue, particularly fat; dieldrin is very slowly metabolized to water-soluble products which are excreted from the body.
- **DDT (p-p' isomer)**
Practically insoluble in water. Reported half-lives are 28 days (river water) and 56 days (lake water). Residues are lost by volatilization, photodegradation, adsorption on particulate matter and sedimentation. In soil, DDT is chemically and microbially degraded. In temperate climates, a half-life of 2–15 years is reported; under tropical conditions, the half-life is 5–12 months. In the tropics, initial dissipation is rapid, through volatilization. Metabolized (very slowly) to a range of saturated and unsaturated products by progressive dechlorination. Residues accumulate in fatty tissues and are excreted in milk.

- **heptachlor**

Water solubility is low: 0.056 mg l⁻¹ (25–29 °C). Heptachlor is rapidly hydrolyzed in water with the product then converted to the epoxide. Loss from water by volatilization, photodegradation and sedimentation. Persistent in soil with a reported half-life of 250 days; substantial variation reported depending on soil type. In soil, it undergoes hydrolysis and then microbial epoxidation. Half-life in soil (temperate climate) is 9–10 months at agricultural rates of application. In animals, heptachlor metabolizes to the epoxide which can be found in most body organs but it particularly accumulates in body fat.

- **endosulfan**

Water solubility: 0.32–0.33 mg l⁻¹ (22 °C). Stable to sunlight. In neutral river water, residues will disappear in approximately 4 weeks; persistence extended under acidic conditions and substantially so (5 months) under basic conditions. Half-life in soil is 30–70 days and the main metabolite is endosulfan sulphate which is degraded more slowly and is thus an important metabolite. The soil half-life for total endosulfan (both isomers plus sulphate metabolite) is 5–8 months. Endosulfan sulphate again is the primary metabolite on plants; plant half-life is 3–7 days (varies with species). Rapidly metabolized and excreted by mammals.

Note: With the organochlorine pesticides there is substantial variation in the published data for soil half-lives with some authors quoting periods of years instead of months. These materials can be extremely persistent under certain conditions, particularly in temperate climates from where much of the available data is obtained. Under tropical conditions, however, persistence can be substantially reduced. The data presented above although from reputable published sources should be regarded as merely a guide.

Organophosphates

Organophosphates have a fairly limited environmental persistence and residues in living specimens generally are not detected, or only as metabolites in specific cases.

Water solubility is variable but higher than with the organochlorines; residues generally break down quite quickly in water (hydrolysis) and are not generally detected except where the contamination is quite recent. Soil residues are similarly short-lived. Residues are probably only of interest for 5–15 days after spraying unless in shaded areas or where the concentrations applied are high.

Examples of water solubility, persistence in soil and mammalian excretion are given below.

- **fenitrothion**

Water solubility: 21 mg l⁻¹ at 20 °C. Half-life in soil is 12–28 days, less in submerged conditions (4–20 days). Rapid mammalian metabolism and excretion. The most important metabolites are dimethylfenitrooxon and 3-methyl-4-nitrophenol. Plant metabolism to similar products (and their decomposition products) with a half-life of the parent compound of about 4 days.

- **fenthion**

Water solubility: 4.2 mg l⁻¹ at 20 °C. Rapid degradation in soil and water (half-life is approximately 1 day). Elimination of residues in mammals by excretion of hydrolysis products. Major metabolites are fenthion sulfoxide and sulfone and their oxygen analogues. Further degradation of these metabolites to the corresponding phenols can occur. Similar degradation pattern occurs on plants.

Carbamates

Residues of parent compounds are generally not environmentally persistent; metabolites are rapidly excreted by vertebrates. Water solubility is moderate; greater for the metabolites. Most carbamates are relatively stable in water of neutral pH. Stability and mobility in soil varies between compounds. Environmental residues are

probably only of interest for 10–20 days after spraying, although in certain soils and in water, extended monitoring may be required.

Examples of water solubility, persistence in soil and mammalian excretion are given below.

- **aldicarb**
Water solubility: 4.93 g l⁻¹ at 20 °C. Residues are oxidized in soil but residues are persistent and effective for approximately 10 weeks. Aldicarb is toxic to mammals but sub-lethal doses are metabolized rapidly with over 90% excreted in 3–4 days. Major metabolites are the sulfoxide and sulfone. In plants the metabolism pattern is similar but the sulfoxide has a systemic action and is 10–20 times more active as a cholinesterase inhibitor than the parent compound.
- **carbaryl**
Water solubility: 120 mg l⁻¹ at 20 °C. In soil under aerobic conditions, 1 ppm carbaryl is degraded with a half-life of 7–14 days in a sandy loam and 14–28 days in a clay loam. In mammals, carbaryl does not accumulate and is rapidly metabolized to non-toxic substances, particularly 1-naphthol, and excreted.
- **propoxur**
Water solubility: 1.9 g l⁻¹ at 20 °C. Mobility in soil is high although degradation is rapid in different soils. In mammals, metabolism, principally to 2-hydroxyphenyl-N-methylcarbamate and 2-isopropoxyphenol, and excretion in the urine, is rapid.

Pyrethroids

Pyrethroid insecticides are generally non-persistent in the environment, being rapidly degraded in the presence of strong sunlight. Residues are probably only of interest for 5–7 days after spraying, unless in shaded areas and where the concentrations applied are particularly high. Proper and accurate detection of residues requires a specialist laboratory.

Examples of water solubility, persistence in soil and mammalian excretion data are given below.

- **cypermethrin**
Water solubility: 0.004 mg l⁻¹ at 20 °C. In river water, rapid degradation is reported (a half-life of approximately 5 days). In soil, it is fairly persistent; degrades by hydrolysis (approximately 16 weeks). Mammalian metabolism/excretion is similar to that for deltamethrin (see below).
- **permethrin**
Water solubility: 0.2 mg l⁻¹ at 20 °C. Rapidly degraded in soil and water. In mammals, elimination is by hydrolysis, hydroxylation and elimination as glucoside conjugate. In the rat, an orally administered dose is completely eliminated within 12 days. The metabolism of the trans isomer is more rapid than that of the cis isomer.
- **deltamethrin**
Water solubility: <0.2 µg l⁻¹ at 25 °C. In soil, it is microbially degraded in 1–2 weeks. Residues strongly bound in the soil with little risk of leaching. In rats, it is virtually eliminated from the body within 8 days with extensive metabolism occurring.

Insect growth regulators

Benzoyl urea IGRs generally act by inhibition of chitin synthesis and moulting, thus interfering with the formation of the insect cuticle. They are increasingly used for the control of leaf-eating insects (mandibulate herbivores) in forestry, ornamentals and fruit. Their low water solubility and adsorption by soil reduces their environmental

impact and in general use, residues are only likely to be detected in soil. There may be some, limited non-target effects in treated areas.

There are also IGRs which act as juvenile hormone mimics, disrupting or preventing maturation of immature invertebrates.

- **diflubenzuron – benzoyl urea IGR**

Water solubility is low: 0.08 mg l⁻¹ at 20 °C (pH 5.5). Diflubenzuron is strongly bound to the soil/humic acid complex and is virtually immobile. Stable to sunlight. Non-systemic and not metabolized in plants. In mammals, excretion of ingested diflubenzuron is quite rapid, partly as the parent compound but also as hydrolyated metabolites.

- **teflubenzuron – benzoyl urea IGR**

Water solubility is low: 0.019 mg l⁻¹ at 23 °C. Half-life in soil varies from 2 to 12 weeks depending upon soil type and conditions with microbial degradation to 3,5-dichloro-2,4-difluorophenylurea. Almost no uptake or metabolism by plants. In mammals (rats), teflubenzuron and metabolites are rapidly excreted in the faeces and urine.

- **triflumuron – benzoyl urea IGR**

Water solubility is low: 0.025 mg l⁻¹ at 20 °C. Half-life data in soil are not available but the half-life is reported to be fairly rapid; no accumulation of residues has been detected where application to soil is repeated over a period of 3 years. After application at normal rates, no residues could be detected after a few months. In mammals (rats), metabolized residues are excreted quite rapidly.

- **methoprene – terpenoid IGR (juvenile hormone mimic)**

Water solubility is low: 1.4 mg l⁻¹ at 20 °C. Rapidly degraded in soil with a half-life of ±10 days. In plants, it is degraded through ester hydrolysis. In mammals, it is metabolized with cholesterol as one of the secondary metabolites.

- **fenoxy carb – bridged diphenyl carbamate IGR (juvenile hormone analogue)**

Water solubility: 6 mg l⁻¹ at 20 °C. Shows low mobility in soil and relatively rapid breakdown in soil and water. Does not bioaccumulate. Rapidly metabolized in plants.

Herbicides

Although of relatively low acute toxicity to most animals, herbicides can indirectly affect a variety of species through the removal of vegetative cover. Environmental persistence of the herbicides varies; some are readily absorbed by and degraded in soil (e.g. paraquat) whilst others are more persistent and, with relatively high water solubilities, considered to be quite mobile (e.g. triazine materials). Residues transferring (leaching) to waterways is a recognized problem. Residues in wildlife are generally transient with rapid metabolism and excretion.

The significance of residues depends upon the applied material e.g. with 2,4-D, residues decline quite quickly with a half-life of <7 days in soil; with the triazine herbicides or with products such as linuron/diuron, persistence is considerably greater and residues can be present for months. The persistence of sulphonyl urea herbicides varies although at the extremely low rates they are applied under normal use, the residues present are particularly low and the analysis can be difficult.

Examples of water solubility, persistence in soil and mammalian excretion are given below.

- **2-4-D**

Water solubility: 46 mg l⁻¹ at 25 °C; 311 mg l⁻¹ at 25 °C (pH 1.0). Rapidly degraded in soils (by microbial activity; half-life <7 days). Rapidly eliminated from mammals (as parent compound), often within 24 h. Maximum organ concentration is reached in approximately 12 h.

- **atrazine**
Water solubility: 33 mg l⁻¹ at 20 °C. In water, it has an extended half-life (e.g. 100→200 days in groundwater). In soil, the half-life is 35–50 days; longer under dry, cold conditions. The major metabolites are desethylatrazine and hydroxyatrazine. In mammals, rapid and complete metabolism of ingested residues is primarily by oxidative dealkylation of the amino groups.
- **linuron**
Water solubility: 81 mg l⁻¹ at 25 °C. In soil, degraded microbially with a half-life of 2–5 months.
- **chlorsulfuron**
Water solubility: 27.9 g l⁻¹ at 25 °C (pH 7.0). Hydrolyzed in soil in 4–6 weeks; hydrolysis is more rapid in moist conditions, at raised temperatures and in the presence of a high moisture content. Further breakdown is microbial.

Fungicides

Some fungicides can have adverse environmental effects but, although they are used extensively in the field for cereal production, their use patterns suggest limited scope for environmental contamination except as the result of disposal (e.g. from large-scale dip treatment operations) or accidental contamination (spillage, etc.).

Water solubility and stability are variable; some fungicide residues can be detected in water for periods of days through to months.

Examples of water solubility, persistence in soil and mammalian excretion (where available) are given below.

- **carbendazim**
Water solubility: 8 mg l⁻¹ at pH 7; 29 mg l⁻¹ at pH 4.0 (24 °C); water half-life of 2–25 months under aerobic and anaerobic conditions. In soil, it is microbially degraded with a half-life of 3–12 months. It is rapidly metabolized and excreted by mammals.
- **chlorothalonil**
Water solubility: 0.9 mg l⁻¹ at 25 °C. Soil residues are degraded fairly rapidly, 5–36 days under aerobic/anaerobic conditions, much quicker (hours to days) under flooded conditions. Soil residues are not considered to be mobile. Residues are largely unabsorbed by mammals.
- **metalaxyl**
Water solubility: 8.4 g l⁻¹ (22 °C), residual activity in soil is approximately 70–90 days.

Soil fumigants

Materials such as methyl bromide (use now heavily restricted under the Montreal Protocol) and 1,3-dichloropropene are examples of materials used as soil fumigants. Under controlled use, soil fumigants do not pose a substantial environmental problem unless they are allowed to contaminate watercourses (methyl bromide is highly soluble in water, 13.4 g l⁻¹ at 25 °C, 1,3-dichloropropene is less soluble, 2 g l⁻¹ at 20 °C). The materials are volatile and dissipate to atmosphere on aeration of the soil.

STUDY DESIGN

The construction of a comprehensive residue sampling programme is a huge subject and beyond the scope of this text. It is not possible to define a sampling regime for all circumstances and the local conditions will need to be taken into account in each case. However, the following section summarizes the key points to bear in mind when taking and preserving environmental samples.

Residue analysis might be considered as part of an environmental assessment for:

- planned pesticide application
- accidental localized spillage
- major site contamination
- long-term pesticide application or exposure
- unexplained wildlife mortality.

The nature of the sampling exercise and the collection of the samples themselves requires careful thought and planning. Samples taken in the wrong way or without due care can be misleading, resulting in incomplete or wrongly directed conclusions.

General information on the properties and relative persistence of the different pesticide groups (see pp.126–130) and their methods of application will help the investigator to determine the samples which need to be taken, e.g. whether the pesticides used and the area and method of treatment will potentially affect biotic or abiotic factors (or both) and help in the development of an appropriate residue sampling programme.

The exact nature of the study and the material of interest (soil, vegetation, insects, animal tissues, etc.) defines the way in which the samples are taken and preserved prior to analysis. Chapters 7–13 of this handbook consider specific faunal components of the ecosystem or ecosystem processes and include notes on the collection and preservation of samples for pesticide residue analysis, together with some guidance on the potential problems in the interpretation of residue data. There are a few general principles that are applicable to all types of sample and these are discussed below.

Appraisal studies can be either single sampling missions or more structured, e.g. an immediate assessment followed by further, periodic sampling (surveillance) visits. In general, the latter will provide the most useful results to help interpret monitoring studies on fauna, however, it will also significantly increase the costs. The type of study will often reflect the nature of the pesticides used and whether these are likely to be persistent or relatively short-lived. Treatment histories for the area, where available, will be helpful in identifying survey sites and in data assessment.

Background residues

Before proceeding with studies involving the application of pesticides, it is worthwhile establishing baseline data by screening for background pesticide levels. Where pesticide use has not been recent, the only residues likely to be detected will be of the more persistent organochlorine materials, benzoyl urea insect growth regulators (IGRs), phenyl pyrazoles and their metabolites or certain herbicides. These residues may be found in the soil, groundwater or the sediment of waterways. Residues may also be found in vertebrates/invertebrates associated with the treated area, through direct contact or food chain effects.

Planned pesticide application

Intense spray operations for the control of major pests such as locusts, African armyworm, tsetse fly or quelea, can result in broad off-target spray deposition and may warrant a detailed assessment (see chapter 4).

Sampling for the purposes of residue analysis will, in most cases, only involve surviving non-target species and samples of vegetation, soil and, perhaps, surface water or sediment. The analysis of vertebrates or invertebrates killed by direct spray application is generally not meaningful. Residue analysis will only determine the residue present in the body at the time of analysis and interpretation of the significance of that residue is not straightforward.

Where the details of the spray operations are precisely known, and particularly when samples can be obtained immediately before and immediately after application, then sampling for residue analysis can be used to estimate:

- rates of pesticide adsorption or degradation by vegetation and by fauna
- the rate of adsorption by, and movement through, soil
- the rate of loss from soil
- the rate of transfer to groundwater.

Where the pesticide is a relatively non-persistent material (such as an organophosphate, carbamate or pyrethroid), residues are likely to decrease quite quickly, depending upon climatic conditions, and sampling should commence immediately after spraying and then at short intervals thereafter. The half-life of any pesticide will be significantly reduced where it is hot and humid, where they are exposed to direct, bright sunlight or to high microbial populations. The persistence of even some of the more stable pesticides (such as the organochlorines) will be less under tropical climates than in temperate conditions. Sampling programmes must take account of these factors.

Methods of application

The method and precision of application (and the purpose of the pest control operation) usually determines the quantity of pesticide applied and its overall distribution (see chapter 4 on pesticide application). Poor application can result in over-spraying of an area (i.e. an excessive dose), excessive spray drift, or poor targeting with scope for greater non-target contamination.

The types of field treatment used are briefly reviewed in the following paragraphs.

Spray operations

Spray operations refer to the distribution of a pesticide solution or suspension through a nozzle system producing a fine spray of droplets of a controlled or variable size. The size of the droplet, which depends upon the nature of the equipment used and the target pest, generally controls the rate at which the droplet settles; larger droplets settle more quickly than small droplets. Smaller droplets are more likely to drift from the target area, particularly when applied in windy conditions or where there are thermal currents. Application systems can be *high volume*, using a pesticide concentrate that has been diluted with water, or *ultra-low-volume* (ULV) where the concentrated pesticide is dispersed as a fine mist, without any dilution. The former generally result in larger droplets, the latter in smaller droplets. In between these extremes lie a range of modified techniques producing different droplet spectra (see chapter 4).

The purpose of the operation will determine the way in which the pesticide is applied. For example, spray operations where the objective is to drench the target (e.g. certain quelea control techniques) will use coarser droplet sizes and heavy dose rates. Where the target is a smaller flying target, a finer droplet size may be more appropriate although this approach can be used for quelea where a ULV formulation is sometimes used. The capacity for small droplets to drift can be used deliberately to deposit the spray downwind on to the target, but can also result from poor application practice. The height from which the pesticide is applied can also be a factor (i.e. ground or aerial spraying). In all these situations, the extent of pesticide drift determines the frequency of sampling and the extent of the sample area.

Where pesticides have been applied by ULV, and where the droplets are much smaller, residues are likely to be more widespread and to adhere to vegetation (trees, shrubs or grass) with a much smaller proportion reaching the soil. Vegetative cover (unless absent) will thus generally form the primary focus of the sampling programme.

Where pesticides have been applied in aqueous solution at high volume, whatever the target, a larger proportion of the spray solution will reach the ground. Soil and covering vegetation should show, at least initially, the highest residues and should form the primary focus of the sampling programme. The secondary focus for samples will be those species living in the soil/vegetative cover and higher species which may accumulate residues through food chain effects.

Dust treatments

Field dust treatments (e.g. those used in locust control operations) involve the dispersion of a dilute dust (a fine powder formulation generally containing 0.5–2% a.i.) with a vehicle-mounted power sprayer. Application by hand may also be conducted where facilities are limited. Such treatments can involve high levels of application with a clearly visible dust deposit; smaller quantities can drift away from the target site and non-target effects are possible. A range of pesticides can be used, some of which are persistent, e.g. hexachlorocyclohexane (HCH, also known as benzene hexachloride, BHC). Residues of these materials can be detected for extended periods and are most likely to be detected by sampling soil, vegetation and vertebrates/invertebrates coming into contact with treated soil or vegetation.

Dip treatments

Dip treatments are generally used in veterinary medicine or for post-harvest protection of fruits. With dip systems a solution, or suspension, of pesticide is prepared into which the animal or fruit is immersed. The scale of the operation depends upon the quantity and size of the material to be treated. Depending upon where the operation is performed, there can be localized contamination, from splashing or run-off. More significant is localized contamination that can arise at the site of disposal of the pesticide used, particularly where this is effected by tipping on to open ground, draining into a stream or into a soil pit. Subsequent leaching or disturbance of the site can spread the contamination further. Where the site is adjacent to a watercourse, or where treated animals may enter the water, broader, downstream contamination can occur. There is also a slight possibility of contamination of dung from dip use (see pour-ons). Sampling for residues should thus concentrate on water (although contamination is generally transient), sediment, aquatic vegetation, fish and molluscs collected downstream of the contamination site. Sampling of dung fauna may also be informative.

Granule application

Granular pesticide formulations can fulfil two distinct functions. The first is where the active ingredient is particularly toxic and where there is a risk to the operator associated with its use as a dust or as a dilute spray. In such a case, the product is formulated as a heavier granule substantially reducing the risk from movement of the dust and small particles or droplets.

The second covers those active ingredients formulated as a granule with a slow-release mechanism, such that the release of the active ingredient from the granule can be controlled to give an extended active control period.

Granules are generally used as a treatment against soil pests such as nematodes, slugs, cut worms or termites and are distributed around the base of plants or susceptible structures. Sometimes the granule or capsule is deposited on the ground or, more often, it is incorporated into the soil to protect it from disturbance. This also provides protection for non-target species. Environmental contamination is thus localized, but there is a deliberate intention for the soil in the vicinity of the granules/capsules to carry a residue of the active ingredient. The persistence of the residue depends upon the active ingredient and the characteristics of the granule. Some localized contamination of surface water may occur where granules are spread near to irrigation ditches, small streams, ponds etc. This can be through direct broadcast, or from run-off after heavy rain. Underground water will only become contaminated in extreme cases or where the water table is particularly high. Some localized effects on non-target soil-dwelling species and on higher species through food chain effects, may be observed.

Also, birds are particularly susceptible to eating granules and can suffer acute or chronic effects as may occur following improper use or poor incorporation into soil.

Baits

Baits are generally used against infestations of specific pests and are only infrequently used in open areas. The commonest form of bait is either compound blocks or treated cereal feeds used for the control of rats and mice. On rare occasions they may be used in plantations but generally they are used to control infestations in domestic premises, factories or warehouses. As such, their release is controlled and because of the nature of the pesticides used in the baits, there is only limited scope for environmental contamination.

However, insecticidal baits (generally insecticide-treated bran) are sometimes used for the control of locust and grasshopper species and for certain ants and termite pests. These baits have the potential for uptake by non-target species and so are generally used in areas where such risks are minimal (e.g. desert areas). The potential for environmental contamination is limited, although in areas where the bait is laid in strips or broadcast there will be localized contamination. Residues will mainly be detected in soil where the bait has become incorporated with time and in soil-dwelling species; residues in vegetation will be unlikely.

Fogging

The application of pesticides by fogging is now rarely practised in the field and is a technique generally restricted to warehouse use where a very fine mist of pesticide in oil is generated by blowing an oil/pesticide mixture across a hot exhaust nozzle. The technique is more akin to a fumigation and although used occasionally to treat dense forest canopies, plantation crops or orchards, there is significant drift of the fine pesticidal mist and its range of application is limited. If fogging has been used, then significant residues are more likely to be found on vegetation than in the soil. Water contamination will only occur if the fogging has been performed close to an open water body.

Pour-ons

Pour-ons are insecticides (generally synthetic pyrethroid compounds) used for veterinary purposes that are applied along the backs of cattle for the control of biting/sucking flies. They are being increasingly used in areas of Africa where the tsetse fly is prevalent. Contamination of the ground from direct run-off of the insecticide is likely to be minimal, although this could become significant should recently treated cattle be exposed to heavy rain. Similarly, waterways could be contaminated should treated cattle enter rivers or streams to drink. Residues of these materials have been detected in the faeces of cattle at low levels, although these residues may be significant to species such as the dung beetle which feeds on cow dung (Vale and Grant, 2002). The most appropriate samples for analysis will be cow (or other stock animal) dung (both fresh and aged material) and beetles found in and adjacent to the treatment area. The analysis of soil samples is not likely to be productive.

Accidental localized spillage

Spillages generally affect a relatively small area, although the concentration of the spilled product is generally far higher than that of a diluted spray, and thus consequences may be of prime importance to local communities and wildlife.

In selecting appropriate samples for analysis the following factors should be considered.

- Is the contaminated area contained in any way by natural or constructed barriers?
- Is the contaminated area fenced off or can fencing be erected?

- What pesticides were involved in the spillage, what were the quantities involved and how where they formulated?
- If the spillage is on open, natural ground, what is the soil structure like (sandy/clay)?
- How far is the spillage from open watercourses or known underground streams or springs?
- If the area is not fenced, do grazing animals have access to it?
- Which indicator species exist naturally in the area?

The answers to these questions will help to define the types of samples to take.

When examining the focal point of the contamination, protective clothing should be worn (see chapter 3 on safety/precautions). With major incidents, preliminary residue analysis of soil/ground samples should be undertaken as a matter of urgency to define the extent of the main contamination and the nature and concentration of the residues. This will define the safe working areas and help in defining the assessment plan.

Major site contamination

Where the release of pesticide into the environment is major, the chances of broader contamination through soil migration and leaching are significantly greater, particularly where the product is formulated as a water-miscible material and where the formulating agents assist the spread of the material. The implications of a major site contamination (e.g. from an industrial manufacturing or formulating plant or from a large pesticide store that has been destroyed in some way) will generally be long lasting, with a greater reservoir of material available for dispersion. This poses considerable problems for effective site decontamination. The environmental implications can be immense and the scale of any assessment exercise proportionately high.

The considerations outlined above for localized spillages are equally applicable to major incidents. The problem of personal contamination can be significantly greater and the requirement to wear protective clothing, at least until the preliminary analytical findings have been considered, is particularly important.

Unexplained wildlife mortality

The cause of wildlife mortality may be revealed from post-mortem analysis of tissues for residues. Samples should be collected and transferred as quickly as possible to the analytical laboratory. Where delays in transportation are likely, the use of formalin (see below) can be helpful.

Acetylcholinesterase measurements in warm-blooded animals are useful indicators of exposure to organophosphorus and carbamate pesticides and these measurements can be carried out in the field using blood samples taken from the animal. Portable kits are commercially available from veterinary suppliers. Samples of brain tissue require deep-freezing and specialist handling and interpretation.

Samples taken from the habitat of the dead specimens will also be of some use, although the point of ingestion or absorption may have been some time/distance from the point of death, depending on the pesticide and animal in question.

THE PREVENTION OF SAMPLE CONTAMINATION

The physico-chemical properties of individual pesticides affect their behaviour in the environment and their fate. Sampling for residues must take this into account.

Personal protection

There may be some risk of personal contamination when entering a heavily treated or contaminated area. A good precautionary measure is to wear protective clothing and masks if the spraying has been within 24 h of entry. Even after that period, gloves should be worn when collecting samples and bare skin should ideally be covered; do not enter a contaminated area with bare feet. Also remember that gloves and clothing can become contaminated which can then contaminate the samples being collected; wear clean, disposable gloves for each sample. Clothing used during sampling in a contaminated area should be washed as soon as possible using hot water containing detergent (see chapter 3). If going from a pesticide-contaminated to an area contaminated with a different pesticide, an unsprayed or uncontaminated area, protective clothing should be changed.

Sample selection

Each of the component parts of the process of collecting samples for residue analysis, i.e. the nature of the samples and their selection criteria, their location, quantity and preservation, is critical and the analysis will be meaningless if the sample is not representative or if it has been compromised in any way, e.g. if it becomes contaminated during or after sampling or it is allowed to deteriorate through exposure to light, high temperatures, etc.

The nature of the sampling will be directed by the objectives of the exercise. A proper plan for the area and the material to be sampled must be properly established and clearly defined beforehand. Wherever possible, an appropriate, statistically based, sampling scheme should be adopted (see chapter 2). The sampling points **must** be established and marked in such a way that they can be re-visited should further samples be needed to confirm or extend earlier findings.

Sample containers and the prevention of contamination

All sample containers must be clean (internally and externally). New containers are preferred; if containers are to be re-used they should be thoroughly washed with high purity solvent (hexane or acetone) between use. Glass, teflon or aluminium extrusion containers are preferred. Solid samples may be wrapped in aluminium foil and placed in polyethylene or polypropylene bags/containers. **Poly-vinyl chloride (PVC) materials are not to be used as these can be a source of sample contamination.** Filter or blotting paper may be needed to wrap vegetation samples. Sample containers or packing materials used in sample collection or transportation must not come into contact with pesticides of any description and must be stored away from any source of pesticides. Similarly any other materials used during sampling (shovels, trowels, augers, nets, etc.) must be clean and not exposed to any pesticides. Disposable gloves worn during sampling or sub-sampling should be used only once and not re-used.

Tools used during sampling (soil corers, shovels or knives) should be cleaned after use. Washing with water (or water plus detergent) followed by rinsing with acetone is the most effective. Failing this, the tool should be washed with acetone, using a clean acetone-soaked cloth or similar (wear solvent-resistant gloves when handling acetone).

Individuals collecting samples should themselves be clean and have not been involved in spraying operations before sampling unless they have washed and completely changed their clothes. Clothes worn during sampling should not have been worn for any process of pesticide application or previous visits to pesticide-contaminated areas, even if it was some time (e.g. days) before sampling.

All sample containers must be adequately and effectively labelled. Two types of labelling should be used, internally (with a pencil on paper) and externally with all relevant details with permanent marker pen. Samples can be individually and uniquely coded with details of the codes appearing on a separate sheet, a copy of which should accompany the samples at all times.

Sample preservation and pesticide degradation

Pesticide residues in the samples collected can degrade through biological and chemical processes and at a rate dependent on the nature of the pesticides present. Chlorinated pesticides (such as aldrin, lindane or DDT) will deteriorate relatively slowly, but organophosphorus or carbamate materials (such as fenitrothion or carbaryl) degrade at a much faster rate. In hot, damp conditions, degradation will be much faster, even for the chlorinated materials, thus it is important that the samples are transported without delay to the analytical laboratory. Where this is not possible, the samples must be treated in such a way as to minimize the risk (and rate) of deterioration.

Field samples should generally be placed in a cool-box held at 4–8 °C after collection. The rate of pesticide degradation is reduced at lower temperatures. They should be transferred to a refrigerator immediately on return to base. With most samples for residue analysis, it is recommended that the sample should be deep-frozen unless the sample can be analysed (or extracted) within 24–36 h. Tissue samples, or samples of high moisture content (bird or animal tissue, fish, vegetation, etc.) should not be frozen unless:

- storage before shipment to the laboratory is going to be 2–3 days or longer. This period can vary considerably depending upon the nature of the sample and the chemical nature of the residues.
- it can be guaranteed that the sample, once frozen, can be transported to the analytical laboratory without being allowed to thaw.

Where samples are not frozen, alternative arrangements should be made as described later in the individual method sheets. These alternative procedures are not 100% effective in countering degradation processes and some pesticide loss will still occur. The procedures will, however, reduce the rate of deterioration during transfer to the laboratory or to suitable storage facilities.

Where the identity of the pesticide(s) in the analytical sample is known, field recovery ('spiked', see below) samples can be prepared and then subjected to the same delays, conditions of storage and transportation as the actual field samples. Analysis of these 'spiked' samples, in parallel with the samples themselves, will provide an indicator of the rate and extent to which pesticide degradation has occurred in the samples. **Spiked' samples should, therefore, be prepared wherever possible.**

Field recovery samples are prepared by adding known quantities of the pesticide to untreated material of a similar nature (from another source if all the local material is thought to be contaminated) or to further samples of the contaminated field material (i.e. increasing the residue burden). Pesticide(s), generally in organic solvent or as the formulated material, can be prepared by the collaborating analytical laboratory for field application using a simple pipette or hypodermic syringe. Detailed advice/instructions should be obtained from the laboratory together with storage and safety instructions for the pesticide(s) in question.

Transportation to the analytical laboratory

It is important that the samples be delivered to the laboratory conducting the analysis at the earliest opportunity. It is equally important that the laboratory should be advised exactly when to expect the samples so that they are adequately prepared. Such notification (particularly where the laboratory is remote and the samples are being transported by air and/or a courier rather than directly by hand), can prevent unnecessary delay and potentially a further loss in the sample residues. This is particularly important where international travel is involved. Adequate information provided to the recipient laboratory can often expedite customs clearance and sample delivery.

SAMPLING TECHNIQUES

Soil sampling

This will generally begin with the examination of a soil profile. Residues in initial samples are normally confined to the top 5 cm (mainly in the top 1 cm, but this can vary with soil structure). With time after application, downward movement of the pesticide may be observed, particularly where there has been heavy rainfall and the soil is of a fine, sandy texture (see chapter 5). With organophosphorus pesticides, it is likely that the relatively short persistence will not allow time for any significant soil dispersion of residues.

The nature of the soil sample will reflect either the need to monitor for vertical pesticide movement or to determine what pesticides are present and at what concentration. In the former case a depth profile will have to be collected. In the latter case, a large grab sample (to perhaps one spade depth) and appropriately mixed, is generally adequate. To take a depth profile sample, a soil auger or other tool capable of taking a soil core is normally required. The core is cut at selected depths and these sub-samples separately packaged for analysis. In the absence of a suitable tool, and as long as the soil is reasonably firm and does not crumble, a depth profile can be obtained using a clean spade. To do this dig a hole in the soil to the depth of the spade, with one vertical edge and with a clear area in front of the spade to facilitate its removal with soil on the blade. Once this hole has been prepared, the spade is inserted vertically into the soil at a distance of 5–7 cm behind the vertical edge of the hole and a slice of soil removed. This soil slice can then be cut to give the desired soil profile.

Soil samples should always be carefully screened to remove stones, leaves and other vegetable material.

The importance of cleaning any tools used in sampling was stressed earlier in the text; use water containing detergent as the primary wash and follow this with an acetone rinse. Allow the tool to dry before re-use. Where detergent/water is not readily available, wipe or brush the tool and then thoroughly clean using acetone. **Limitations** There can be rapid loss of pesticide from the top few centimetres of soil under extremely hot conditions and shallow sampling can miss significant residues.

Processing Samples require an analytical laboratory with significant resources to allow the extraction of residues and then processing to remove interfering co-extractives prior to analysis by gas liquid chromatography (GLC) and high performance liquid chromatography (HPLC).

Resulting data Identity of the pesticide(s) present and concentration. Soil profile data can help to determine the persistence of the pesticide(s) present and the rate of leaching (which is dependent on soil type and organic matter content).

Number of samples Depends upon size of the sampling area and the statistical sampling pattern. A minimum of five cores should be bulked for a composite sample and a minimum of two replicate samples taken from the bulk for analysis.

Sampling period Immediately after treatment or after contamination has been detected and then at intervals of 2–3 months (chlorinated pesticides) or 5–14 days (other classes of pesticide). Rainy and dry season samples should be collected wherever possible for comparison.

Equipment Sampling scoop (trowel or spade) or soil auger (corer), glass or aluminium sample containers, cleaning materials (for sampling tools), labels and cold-box. A soil cover can be made from metal (steel) tubing.

Staff required 1 or 2 depending upon sample numbers.

Water sampling

Water, particularly from any over-sprayed watercourses, will only tend to show pesticide residues for a short time after application. There are some exceptions, but generally even where the solubility is reasonably high or where rates of degradation are low, the pesticide often absorbs on to sediment or other organic matter and is removed from aqueous solution. With some pesticide formulations the residue may form a surface film rather than being dispersed.

Water samples often contain suspended matter. In most cases, the suspended matter can contain a significantly higher pesticide residue than the water itself and its inclusion should be carefully considered. For many purposes, the water and suspended matter are often considered together although for others, there will be merit in separating them, by filtration, for separate analysis. Suspended matter can also pose difficulties for the analyst and separation may be a practical necessity. Where the components are analysed separately, the values can then either be considered in isolation or together.

The process of water collection requires thorough consideration, and the starting point is the question “why is the sample being taken?”. The answer to this question will help to identify the correct sampling point. Additional considerations are:

- Is the sample to be taken from close to the shore or further out in the river/lake? If the latter, a boat may be needed.
- At what depth is the sample to be taken – at surface level, sub-surface or mid-water? (There can be differences depending on temperature, whether there are surface water films from pollutants or decaying vegetation or whether sediment is present at particular depths.) This will affect the sampling apparatus used and details of the methodology.
- Are streams entering a river or lake to be sampled and the results compared with samples from elsewhere in the river or lake, e.g. above the point of entrance of the stream?

Water analysis (Barcelo, 1991) is difficult in that if the laboratory extraction of the sample is significantly delayed, any residues present can degrade or be absorbed on to the walls of the sample container. There is thus a need to keep the sample chilled and to transport it to the laboratory as soon as possible. Alternative methods exist whereby the sample can be extracted in the field, using solid phase extraction (SPE) technology (International Sorbent Technology, 1995; Font *et al.*, 1993; Albanbis and Hela, 1993; Hendriks, 1993; Land, 1994) assuming there is access to some basic equipment (for further information refer to manufacturers’ specifications or specific procedures published in the scientific press). Samples extracted in this way are more stable than in solution, although to ensure reliable analysis, they should again be transported to the laboratory as soon as possible after extraction. The volume of water required for analysis varies with the analytical sensitivity of individual pesticides and the method of extraction. Volumes used are commonly in the range of 0.5–2 litres.

The data may indicate a contamination. Significance can only be determined by follow-up monitoring to see whether residues remain or have spread, e.g. further down a river or across more wells/boreholes accessing the same aquifer at the same depth.

Containers used to carry/store water samples for residue analysis should be washed with clean water, followed by an acetone rinse and then allowed to dry before re-use.

Limitations Water residues can be transient in nature depending upon water flow, rains, etc. Different analytical techniques are required if the samples are to be analysed for a range of pesticides representing different chemical groups/characteristics. The levels of analytical sensitivity are also significantly different.

Processing Analysis by GLC and HPLC after extraction of the residues from the water into an appropriate organic solvent and concentration of the resultant extract.

Resulting data The identity of the pesticide and or metabolites and approximate concentration.

Number of samples Each identified collection point should be sampled in duplicate (minimum).

Sampling period Immediately after treatment or when contamination is suspected. Routinely during the wet and dry seasons (twice for each season).

Equipment A sampling device for surface water sampling can be made from a locally available 0.75–1 litre with a screw-top glass bottle (thoroughly cleaned with soap and water and rinsed with acetone). The metal cage to contain it should also be possible to construct (or adapt) from locally available materials (see illustration on the

method sheet). A device for sampling from a defined depth can also be made from a similar glass bottle, a rubber or cork bung to fit the bottle neck, a wooden, bamboo or metal pole and thick wire or thin metal (see method sheet for design). Clean glass containers with teflon caps for the water samples, labels, cold-box, map and/or global positioning system (GPS).

Staff required 1 (2 preferable).

Sediment sampling

Sediment samples can be difficult to collect but are important in a residue sampling exercise. *Bottom sediment* is generally found in stagnant water or, in rivers and streams, away from fast-flowing currents and must be sampled using an appropriate device dependent upon the depth of the water. Commercial 'grab-sampling' devices are available but can be relatively expensive and are not always convenient for transportation; a scoop or other container tied to a pole, or similar, can be effective in relatively shallow water (see method sheet).

Suspended solids in flowing water can be collected by filtering the water. Relatively large volumes of water need to be filtered to get a meaningful sediment sample and this can be both tedious and time consuming. The use of portable vacuum pumps where available, and Buchner flask filtration systems, can considerably speed up this process.

Limitations It is difficult to access samples away from the river/lake bank without a boat; restrictions on sampling in deep water.

Processing Samples require an analytical laboratory with significant resources to allow the extraction of residues from tissue and then processing to remove interfering tissue co-extractives before analysis by GLC and HPLC.

Resulting data The identity of the pesticides or metabolites and an indication of the approximate concentration for such residues.

Number of samples At least two replicate samples from each identified collection point.

Sampling period Immediately after pesticide use or when contamination is first detected. Frequency of sampling is dependent upon pesticide type; 2–3 months for chlorinated materials, 1–2 weeks for other pesticide classes.

Equipment A suitable sampling device can be made from a small locally available metal pot or dish (e.g. empty baked bean can cut to a height of 6 cm) attached to pole 2–3 m long. Glass or aluminium sample containers, waterproof boots or waders, labels and cleaning materials (for sampling device).

Staff required 1 or 2 depending upon sample numbers.

Vegetation sampling

Vegetation will often show the highest deposits from spraying, dusting or other operations (apart from in desert situations) and is a good indicator of likely rates of ingestion of residues by grazing animals or vertebrates/invertebrates that live in/on such vegetation. Care should be taken in handling sprayed vegetation samples as initial residues will be surface deposits and easily dislodged by hand. Depending on the nature of the pesticide, there may be little long-term adsorption of residues by the leaf and residues may stay as surface residues (but not so easily dislodged) until they degrade by exposure to sunlight/rainfall; some residues will be washed off and fall to the soil immediately below.

Vegetative samples can pose particular problems. If they are kept in sealed polyethylene bags or glass jars, they quickly lose moisture which condenses as free water, altering the nature of the sample and, where the sample cannot be refrigerated, lead to the rapid development of moulds which can promote microbial degradation of pesticides and, in extreme cases, pose a health hazard to the handler. These conditions should be avoided wherever possible.

Depending upon the nature of the vegetation (size, shape, etc.), one useful method is to enclose the sample in clean filter paper or blotting paper and to put the wrapped sample inside a clean, paper envelope. The addition of a small sachet of silica gel to the envelope, which is then sealed, helps to reduce the moisture content of the

system. Where filter or blotting paper is not available, paper towels or tissue can be used. However, samples of these should be provided to the analytical laboratory to check for possible co-extractives which could interfere with the analysis. Wherever possible, analytical checks on the suitability of the material should be completed before sampling commences. Again, rapid transportation to the analytical laboratory is recommended.

Limitations Substantial variation may be detected in surface residues on vegetation depending on the nature of the application method.

Processing Samples require an analytical laboratory with significant resources to allow the extraction of residues from tissue and then processing to remove interfering tissue co-extractives before analysis by GLC and HPLC.

Resulting data The data will identify the pesticide involved and its concentration at the time of collection.

Number of samples Dependent upon the size of the treated area, nature of the treatment and nature and density of the vegetative cover. As a rule, it is better to collect too many samples than too few; it is easier to throw some samples away once preliminary results have been obtained than to regret that vital additional information is missing. Fewer than 25 samples will rarely be adequate.

Sampling period Samples should be collected before, immediately after treatment and then again at 7-day intervals.

Equipment Scissors, blotting paper or filter paper, paper envelopes, labels, silica gel, disposable gloves and a cold-box.

Staff required 1 or 2 depending upon sample numbers.

Tissue sampling

In the field and where immediate access to chilled storage (3–5 °C) is not practicable, whole body or muscle tissue, organs and viscera from fish, birds, amphibians, reptiles or small mammals (see individual chapters for capture methods) can best be preserved in dilute (8–9%) formalin solution. Deep-freezing should be avoided unless the sample is guaranteed to stay frozen until it reaches the analytical laboratory; freezing/thawing/re-freezing can promote enzymatic and bacteriological breakdown of residues and invalidate the analytical results. The use of formalin may affect some organophosphorus pesticides and, where possible, this should be clarified in advance of sampling. Body lipids are not, generally, soluble in formalin; where this appears to be a problem, separate analysis of the specimen and of the formalin (residue and lipid content) can be undertaken, although this is rare.

The formalin solution should be prepared by diluting a commercial solution (generally at a concentration of 40–45%) in a ratio of *one part formalin solution to four parts distilled (or de-ionized) water*. Wherever possible, this should be carried out in a fume cupboard (see chapter 3 on safety). Where this is impossible, it should be done outside or in a well-ventilated area. Plastic or rubber gloves and safety glasses or goggles should be worn during this process. A face mask would also be helpful and although conventional masks give little protection against solvent vapours, there is some temporary relief.

The diluted solution should preferably be stored in a *clean* glass container (although aluminium or other metal containers can also be used). Ensure that the container screw-cap is lined with teflon or aluminium foil. Where possible, a sample of the formalin solution should be analysed by an analytical laboratory before it is used in the field or, if necessary, after, to ensure that there are no interfering contaminants which could affect the analysis. Also, in cases where the identity of the pesticide(s) in the field samples is known, or the analysis is targeted against specific pesticides, then an experienced pesticide chemist should be consulted to check whether formalin is known to affect those compounds.

Limitations With chlorinated residues it cannot always be determined whether the residues detected are from recent or past exposure.

Processing Samples require an analytical laboratory with significant resources to allow the extraction of residues from the tissue and then processing to remove interfering tissue co-extractives before analysis by GLC and HPLC.

Resulting data The identification and quantification of pesticide detected in live or dead collected samples. Data

provides information on the rate of uptake by different species, tolerance to pesticide, and comparison with published environmental/toxicological data.

Number of samples Depends upon the extent of the sampling area, number of relevant species to be sampled and whether whole samples or dissected samples are to be considered (e.g. analysis of specific body organs). Generally, fewer than five samples of a given species will not give representative results.

Sampling period Sampling should commence immediately after pesticide application or when contamination is first detected and then at intervals to be decided once the identity of the contaminant is known. For example, if the contaminant is a chlorinated pesticide then sampling at intervals of 2–3 months may be appropriate. For other classes of pesticide, the sampling interval will be significantly reduced (days or weeks).

Equipment Sample containers (glass), formalin solution, disposable gloves, forceps, cold-box and labels.

Staff required 1 or 2 depending upon sample numbers.

Vertebrate/invertebrate sampling

Fauna from treated areas should be collected as described in chapters 8–13. Although the collection of samples at periodic intervals after application will give some indication of residue accumulation or the rate of loss/metabolism of any ingested pesticide, this is not always the case with field samples and the data will need careful assessment. Specimens collected from recently sprayed areas may be contaminated on their outer surfaces through contact with treated surroundings and they should be washed/brushed (to remove adhering soil or other material).

Invertebrates such as worms can deteriorate rapidly if not kept in a suitable medium. Unless metabolism of possible ingested pesticides is a problem (see guide to pesticides earlier in this chapter), the specimens may best be preserved alive until immediately before transfer to the analytical laboratory. Storage at reduced temperature (refrigerator, 5 °C) is also required. The specimens can, alternatively, be kept in formalin as described above for tissue samples.

Insects are best preserved dry and intact in ventilated jars or bottles. In cases where extreme delay before analysis is likely, or where the samples are considered likely to deteriorate, formalin preservation can be used.

Limitations With chlorinated residues it cannot always be determined whether the residues detected are from recent or past exposure.

Processing Samples require an analytical laboratory with significant resources to allow the extraction of residues from the tissue and then processing to remove interfering tissue co-extractives before analysis by GLC and HPLC.

Resulting data The identification and quantification of pesticide detected in live or dead collected samples. Provides information on the rate of uptake by different species, tolerance to pesticide, and comparison with published environmental/toxicological data.

Number of samples Depends upon the extent of the sampling area, number of relevant species to be sampled and whether whole samples or dissected samples are to be considered (e.g. analysis of specific body organs). Fewer than five samples per species will rarely be adequate.

Sampling period Sampling should commence immediately after pesticide application or when contamination is first detected and then at intervals to be decided once the identity of the contaminant is known. For example, if the contaminant is a chlorinated pesticide then sampling at intervals of 2–3 months may be appropriate. For other classes of pesticide, the sampling interval will be significantly reduced (days or weeks).

Equipment Sample containers (glass with aluminium-lined lids), formalin solution, disposable gloves, forceps, cold-box and labels.

Staff required 1 or 2 depending upon sample numbers.

DATA COLLECTION AND RECORDING

Whenever carrying out field sampling, it is extremely important to record carefully all the information about sample sites and number at the time of sampling. It is essential to take an additional data sheet along to the field with you.

The format for the data sheet depends on what type of sampling is being conducted. The minimum requirement is for all necessary data to define the sample, and where and when it was collected. However, the researcher may wish to collect supplementary information on, for example, weather conditions at the time or any unusual observations in the sampling area (Figure 6.1). This type of information could be useful in interpreting the results obtained from the sampling/analysis and can only be properly defined at the time of sampling. Never try to remember what the conditions were or any other factors after several weeks or months, as this can be misleading.

Thus there is no perfect model for the data sheet; you develop it for your specific purpose. You do not want an over complicated sheet but you do want to collect all of the necessary information. An example of a completed basic data sheet with a few initial entries is given below. Think what extra information you may need.

A blank data sheet is provided along with the method sheets, to be photocopied and taken out to the field.

Date	Sample type	Site reference	GPS coordinates	Sample code	Weather conditions	Other comments or observations
20.6.02	Soil	1. Farm of Mr Ngata; Area 1	N12.23.41 W87.01.91	SS1	Dry, 28 °C	Fallow field, no recent disturbance
20.6.02	Soil	Farm of Mr Ngata; Area 2	N12.23.42 W87.01.88	SS2	Dry, 28 °C	As above
20.6.02	Soil	Farm of Mr Ngata; Area 3	N12.23.42 W87.01.84	SS3	Dry, 28 °C	As above
20.6.02	Soil	2. Farm of Mr Mwangi; Area 1	N12.22.81 W87.00.34	SS4	Rain, 26 °C	Cultivated soil
20.6.02	Soil	Farm of Mr Mwangi; Area 2	N12.22.81 W87.00.88	SS5	Rain, 26 °C	Cultivated soil
20.6.02	Fish	3. Stream adjacent to site 2	N12.22.81 W87.00.22	F1	Rain, 26 °C	Shallow (30–100 cm), slow moving, little vegetation
20.6.02	Fish	As above	N12.22.81 W87.00.22	F2	Rain, 26 °C	As above
20.6.02	Fish	As above	N12.22.81 W87.00.22	F3	Rain, 26 °C	As above

Figure 6.1: Example sample data sheet: pesticide residue sampling

DATA PRESENTATION AND INTERPRETATION

Data interpretation is critically important. The care taken in sample selection, preservation, transportation and analysis can be wasted if the analytical findings are not properly understood or if they are misinterpreted. It is essential that the worker fully understands both the way in which the results are expressed and their significance. In cases of doubt, the analytical laboratory should be asked to explain the findings; most laboratories will be pleased to help.

It is worthwhile, however, to consider briefly the basic ways in which the analytical data may be presented; this will, in part, depend on what has been requested from the laboratory.

Data are generally expressed as milligrams of pesticide per kilogram of analytical substrate (mg kg^{-1}) for solid materials or milligrams of pesticide per litre (mg l^{-1}) for residues in a liquid medium. These terms both equate to one part per million (ppm), an expression commonly used in the past but now less so, in favour of the above 'comparative units' which give a real, quantitative value. Residues can be expressed as decimal fractions of these comparative units, e.g. a residue of 0.001 mg kg^{-1} , or it could also, correctly, be expressed as $1 \mu\text{g kg}^{-1}$. With increasingly sensitive analytical methods being used, residues at this level (and below in some cases) are increasingly being quoted. For reference, commonly used units include:

- one part per million in a solid material can be written as either 1 mg kg^{-1} , $1 \mu\text{g g}^{-1}$ or 1 ng mg^{-1} ; all these terms are equivalent to each other
- one part per million in an aqueous medium can be written as either 1 mg l^{-1} , $1 \mu\text{g ml}^{-1}$ or $1 \text{ ng } \mu\text{l}^{-1}$
- aqueous pesticide residues, however, are generally low and are often expressed in terms of $\mu\text{g l}^{-1}$ which is one part in one thousand million or ng l^{-1} or part per billion.

These expressions can be confusing and it is essential that the recipient of the data is comfortable with the terms and the units and can manipulate the data without error.

The relationship within the terms is one of quantity (mass) of pesticide compared to the quantity (mass) or volume of sample from which it derived. With aqueous samples, extraction volumes can actually be 1 litre (or sometimes less and in the range of 200–500 ml water), but with solid materials, the quantity analysed (and particularly with small specimens) can range between 5 g (sometimes less) and 50 g. The calculation, however, converts the data to represent (x) mg kg^{-1} .

Residue data can also be expressed as the total weight of pesticide detected in the sample and in some situations this may be a more useful form of data expression. For example, following a spray operation in a given area, it may be useful to look at pesticide deposition on the surface of leaves thought to be contaminated by spray or spray drift. In such a case, the total burden of pesticide (normally in μg) may be more important than the concentration of the contaminant expressed in mg kg^{-1} . Similarly the burden of pesticide in a recently contaminated vertebrate or invertebrate sample (where metabolism and distribution of residues in the body may not have occurred) may be more usefully expressed as the total weight of pesticide rather than in mg kg^{-1} .

SAMPLE SIZE AND THE LOWER LIMIT OF DETERMINATION

Despite the sensitivity of modern analytical equipment and whatever the expertise of the analyst, the sample size must be of a minimum quantity to allow effective analysis whilst retaining a portion of the sample for subsequent analysis (in cases of doubt over the original analysis or should an accident happen to the original analytical portion). This, however, is not always possible. A minimum sample size is also necessary to allow a reasonable *lower limit of determination* (LoD) to be achieved. This term is important and its derivation must be clear. The

LoD is the lowest residue that can be determined by the analytical procedure in use, as determined during laboratory validation of the analytical procedure. The magnitude of the LoD varies with a number of factors, including the nature of the pesticide but the most critical factor is the sample size. If the sample size is, e.g. 10 g, then the LoD for pesticide x in this sample will be 10 times lower than the LoD that could be achieved with a 1 g sample analysed for the same pesticide. This becomes important in environmental analysis where often, and because of the small sample sizes encountered, the whole sample is analysed. Because the samples vary in weight, in practice, a whole range of LoDs may be expected. This is often a source of confusion and the reasons for a range of LoDs is one of the commonest questions received by laboratories conducting environmental analysis.

Consideration of the implications of the LoD raises two key issues which should be considered in advance of the analysis and reviewed with the analytical laboratory.

- What is the appropriate LoD for the samples in question?
- Can the appropriate LoD actually be achieved knowing the likely sample sizes?

It is also worth bearing in mind that every analysis undertaken contains an element of error, despite all the precautions that are taken. This level of error is minimized by the laboratory and is generally kept within defined limits. With small samples, there is an increased risk of error, particularly where the final sample extract for analysis needs to be concentrated to very small volumes before analysis; errors can become magnified and data from small samples need to be considered with this in mind. The data are still meaningful but statistically, the confidence level is less.

RESIDUE CALCULATION

With 'solid' samples, the analytical laboratory will need to know how the residues are to be expressed, e.g. an assessment of the total pesticide deposit as a weight, in mg kg^{-1} and based on whole body weight, or based on the material dry weight or calculated as a residue in the lipid portion of the sample. If necessary the laboratory can provide all of this data but the analytical charge may be higher as this entails additional laboratory work and not just a recalculation of the basic data:

- for data expressed on a *wet weight* (fresh) basis, the weight of the sample on receipt is used
- for data expressed on sample *dry weight* (e.g. soil residue data are often expressed on a dry weight basis for ease of data comparison), the moisture content of the sample must be determined
- for data expressed as a residue *in the lipid*, the fat content of the material must be determined.

To determine moisture and fat content, portions of the sample or of the sample extract must be made available. In cases where the sample is particularly small, it may not always be possible to sacrifice material for these other tests, or material can be sacrificed at the risk of increased analytical error and a higher LoD (see above). This needs to be considered and, again, discussed with the analytical laboratory.

Where residues are originally calculated on a fresh weight basis and then re-calculated, using a factor, to allow for moisture or fat content, the figures can change quite dramatically, particularly where the factor is large. Although this procedure is common, an element of distortion of the values can sometimes occur, particularly where the residue is low and where the results have been rounded-up to one or two decimal places. This can inflate the residue to a level higher than that actually present and could create difficulties in data interpretation for the unwary. However, if the user of the data is aware of the potential problems that can arise, any misinterpretation of the data can be avoided.

A further problem to be aware of is that of summing residues where a pesticide may exist in isomeric form and where metabolites may also be present, or should be analysed for, with the residue being expressed as a total; the analysis of DDT is a good example.

DDT formulations contain the p'p and o'p isomers and both need to be determined. In addition, the two main metabolites – DDE and DDD (sometimes called TDE) – are also commonly determined. Both of these compounds can be produced from the p'p and o'p isomers of DDT and the analysis can include, therefore, six components (although some analysts tend to ignore o'p DDE and o'p DDD because their levels are usually insignificant).

The following example (Table 6.1) illustrates the problem when considering residues below the LoD. In this example, a moisture content of 35% and a lipid level of 9% is assumed.

A key question is should the total DDT value be the sum of the LoDs, the highest recorded LoD or a compromise value? A case could be made for each of these approaches and different authors' treatments of the subject vary. In most cases, it is probably best to present the individual data for each component.

Also, remember that the LoD value may already reflect a rounding-up (say the reported value of 0.02 reflected a calculated lower level or trace residue of 0.015 mg kg⁻¹, rounded-up to an agreed LoD, or lower reporting level of 0.02).

Table 6.1 Residues below the LoD

	Residue (mg kg ⁻¹) expressed on		
	wet weight	dry weight	in lipid
p'p DDT	<0.02	<0.03	0.22
o'p DDT	<0.02	<0.03	<0.22
p'p DDE	<0.01	<0.02	<0.11
o'p DDE	<0.01	<0.02	<0.11
p'p DDD	<0.02	<0.03	<0.22
o'p DDD	<0.02	<0.03	<0.22
Total DDT	<0.10	<0.16	<1.10

OTHER CONSIDERATIONS

The analyst needs to be sure that the moisture or lipid content of the sample has not changed unduly since collection in the field. If the moisture content has fallen, the determined residue value will be higher than its original level.

This is a real problem with certain samples, particularly when as explained earlier, moisture is a factor in the degradation of pesticides and the procedure recommended, e.g. leaf/vegetation samples, is to allow them to partially dry in the presence of adsorbent paper and silica gel. Calculation of the total pesticide deposit is not affected, but the expression of residues in mg kg⁻¹ will certainly be made more difficult. To get around this problem, the initial sample weight needs to be determined, either in the field using a pocket, portable balance or on return to base, and the observed weights provided to the analytical laboratory.

Tissue samples stored in formalin can also be affected. Although lipid content will not be affected by the formalin, the moisture content may be. Wherever possible, the fresh tissue weights should be recorded after sampling and provided to the laboratory. Sample dry weight can then be determined, allowing for calculation of the moisture content.

REFERENCES

ALBANBIS, T.A. and HELA, D.G. (1993) Multi-residue pesticide analysis in environmental water samples using solid-phase extraction discs and gas chromatography with flame thermionic and mass-selective detection. *Journal of Chromatography*, **707**: 283–392.

BARCELO, D. (1991) Occurrence, handling and chromatographic determination of pesticides in the aquatic environment. *Analyst*, **116**.

EXTOXNET: *Extension Toxicology Network, a Pesticide Information Project of Co-operative Extension Offices of Cornell University, Oregon State University, the University of Idaho and the University of California at Davis and the Institute for Environmental Toxicology, Michigan State University.* Data on individual pesticides available on-line via the Internet.

FONT, G., MAÑES, J., MOLTÓ, J.C. and PICÓ, Y. (1993) Solid phase extraction in multi-residue pesticide analysis of water. *Journal of Chromatography*, **642**: 135–161.

HENDRIKS, R.E. (1993) Extraction of organochlorine pesticides from surface water using an extraction disk. *LC/GC International*, **6** (5): 296–298.

INTERNATIONAL SORBENT TECHNOLOGY (1995) *A Guide to Method Development in Solid Phase Extraction of Water Samples Using Isolute® ENV+™ SPE Columns.* International Sorbent Technology.

LAND, C.J. (1994) Solid phase extraction of triazines from environmental water samples using aromatic sulfonic acid. *LC/GC International*, **7** (4): 215–218.

VALE, G.A. and GRANT, I.F. (2002) Modelled impact of insecticide-contaminated dung on the abundance and distribution of dung fauna. *Bulletin of Entomological Research*, **92**: 251–263.

FURTHER READING

BCPC/RSC *The Pesticide Manual. A World Compendium.* Cambridge: British Crop Protection Council/Royal Society of Chemistry.

(This book is essential for the determination of chemical and physical properties of pesticides.)

EPA *Individual Methods for the Sampling and Analysis of Pesticides.* (Available from the Environmental Protection Agency of the United States of America.)

GUNTHER, F.A. (ed.) *Residue Reviews.* Berlin: Springer-Verlag. (Reviews of environmental contamination and toxicology.)

Ian F. Grant¹

Natural Resources Institute, University of Greenwich at Medway, Central Avenue,
Chatham Maritime, Kent ME4 4TB, UK

INTRODUCTION

Many kinds of organisms live in the soil: algae, protozoa, fungi, bacteria, nematodes, worms, mites and a range of insects. Their composition, number and activity varies widely between biome and with seasons, which gives rise to marked changes during the climatic extremes of tropical and sub-tropical biomes. The algae have a production function in soil – carbon-fixation and in some cases, biological nitrogen-fixation – that is important in semi-arid soils and lowland rice fields. The majority of soil organisms live by consuming and decomposing organic material. In this way, soil organisms are responsible for maintaining the natural fertility of soils through processes that cycle plant nutrients and facilitate the flow of energy.

Pesticides can be applied directly to soils for the control of crop pests such as weeds, nematodes and insects or be deposited on soil as an indirect result of crop foliar or forest canopy spraying. A significant proportion (50% is not unusual) of chemical pesticides applied for the control of crop, forest, livestock and public health pests ends up in the soil, and their active ingredients put soil organisms and the processes that they perform at potential risk. Some processes accomplished by soil organisms are easily measured; often more easily than quantification of the actual organisms responsible. This can be very useful in pesticide impact assessment where a process, such as leaf litter breakdown, is studied rather than the complex range of organisms responsible for it.

Mineralization of organic matter, nitrogen transformations and biological nitrogen-fixation are key soil processes in both moist and dry tropical ecosystems. In naturally infertile ecosystems their role in maintaining productivity is prominent. The bacteria responsible for soil nitrification – the conversion of ammonium to nitrate – are slow to grow and are very sensitive to pesticides. Any inhibition of nitrification is indicative of stress in the dynamic equilibrium of nitrogen in the soil, and as nitrification is essentially an aerobic process occurring in the upper soil horizon where pesticides are held, the process is considered as key.

Biological nitrogen-fixation has a conspicuous role in the nitrogen economy of impoverished soils. Nitrogen-fixing algae and bacteria supplement soil nitrogen through the process of using (fixing) nitrogen in the air to make cell proteins that, on decay of the organisms, release the nitrogen into the soil. Nitrogen-fixing algae (Cyanobacteria) are common in flooded rice fields, shallow pools or as encrustations on soils, the bases of trees and under rocks. Herbicides and some insecticides are known to influence the growth and nitrogen-fixing activity of these organisms but current knowledge of such impacts in tropical regions is very limited. Pesticides may also affect nitrogen-fixing bacteria that are symbiotically associated with legumes (*Rhizobium* spp.) and free-living soil diazotrophes, but the fact that they are associated with the rhizosphere provides them with considerable protection from indirect contamination, although not from soil sterilants and nematocides. Algae are also useful in binding soils and protecting them from wind and splash erosion and thus help to increase soil stability.

Decomposition of crop residues and leaf litter results in the release of nutrients and energy that is critical for the maintenance of soil fertility and productivity in tropical ecosystems. The process is achieved through the

¹Contact address: Cybister Environmental Protection, Oak House, South Street, Boughton, Kent ME13 9PE, UK. ian.grant@cybister.plus.com

cutting and shredding action of fauna and the subsequent breakdown and mineralization of organic matter by fungi and bacteria to chemical elements. Pesticide effects on soil micro-organisms and their activity are widely reported but generally short-lived in temperate climates. However, small deficits in soil nitrogen budgets can be expected to have greater impact in nitrogen-limited environments such as infertile savanna grasslands and woodlands. By using pesticides as a source of energy for growth, micro-organisms also play an important role in the breakdown of pesticides, some of which are more resistant to decomposition than others.

Breakdown of organic matter by soil organisms is accompanied by the uptake of oxygen and production of carbon dioxide as soil microbes and soil fauna respire. Soil respiration is a useful indicator of pesticide impact on organic matter breakdown. However, the fact that many types of microbe are involved in the process has the effect of reducing the sensitivity of respiration as an indicator, because microbes not affected by pesticides continue to metabolize. Respiration is readily measured in the field as carbon dioxide release.

In the process of consuming large quantities of soil to extract its nutritive value, earthworms are responsible for considerable soil mixing, breakdown of organic matter and release of nutrients that collectively help to maintain soil fertility. They are also an important part of the food chain for birds and represent a useful bioindicator of soil pesticide contamination and a measure of risk to their predators, especially birds. Although not present in all soils, the estimation of earthworm populations or their casting activity is an indirect way of detecting perturbations of soil processes. Termites frequently occupy a similar role in some tropical ecosystems where earthworms are absent (see also chapter 8).

Soil processes are affected by a number of environmental variables such as soil texture, moisture content and pH. Most soils have a pH in the range 4–8. Humid forest soils tend to be acid (pH 4–6) and semi-arid grassland soils neutral to alkaline (pH 7–8). In the context of this chapter, the importance of soil pH is in determining the solubility of soil minerals and nutrients that affect soil microbial processes and in influencing the toxicity of pesticides to soil organisms. Soil texture refers to the proportions by weight of sand, silt and clay that, together with organic matter content, influence water-holding capacity, leaching and nutrient storage capacity (see chapter 5). As these parameters not only control the dynamics of soil processes but also the availability, degradation rate and persistence of pesticides, the measurement of soil texture, moisture and pH is essential for the interpretation of pesticide impact on soil processes.

Other factors affecting toxicity, movement and persistence of pesticides in tropical soils are rainfall and leaching, sunlight, temperature and wind speed. For this reason a record of site meteorological conditions should be kept during monitoring periods (see chapter 5).

This chapter provides a selection of cost-effective methods for the measurement of key soil processes at risk from pesticide use and also some guidance on their selection, application and operation in a monitoring protocol.

Useful reference works on the impacts of pesticides on soil micro-organisms and soil microbial processes are Domsch *et al.* (1983) and Sommerville and Greaves (1987). A comprehensive collection of chemical and microbiological methods is provided by Weaver *et al.* (1994) and the *Tropical Soil Biology and Fertility* handbook (Anderson and Ingram, 1993), although these have demanding requirements for laboratory facilities and technical expertise. Doberski and Brodie (1991) have compiled a useful series of appropriate techniques for terrestrial habitats.

STUDY DESIGN

Let us assume the aim of the pesticide impact study is to identify biologically significant changes in soil processes that are attributable to the action of the pesticide. The strategy to achieve this requires planning to ensure that appropriate processes are monitored, and the techniques are feasible and applied in a way that allows valid statistical comparison of data. This section should help with those decisions.

Consider from what you know of the specific pesticide, dose, application method, the soil type and the likelihood of soil contamination just what processes may be affected. Aerial spraying is less likely to contaminate soil where vegetation is dense (e.g. forest) than in open woodland or grassland. Dusting, particularly in open and crop areas, is likely to contaminate soil. Remember that dose rates in crop areas are usually much heavier (10–100 more) than those used in less managed environments as, for example, with control of tsetse fly, locust and armyworm (but there are exceptions to this generalization). Table 7.1 should help reduce monitoring choices based on the relative sensitivity of organisms.

Table 7.1 Indicative soil populations and processes by pesticide and soil type

Pesticide type	Soil type	Indicative sensitivity	Useful methods
Fumigants/sterilants	All	All soil faunal and floral populations and processes	SN, SR, EP, SA, LB,
Fungicides	All	Fungal populations, symbiotic nitrogen-fixation	LB
Organochlorines	All	Earthworm populations, litter breakdown, nitrification, micro-arthropods	SN, EP, LB
Organophosphates	Sandy, low organic matter	Nitrification	SN, EP
Carbamates	n/a	None indicated at recommended doses	
Pyrethroids	Low organic matter	Nitrification	SN
Insect growth regulators	Sandy, infertile	Soil micro-arthropods	Chapter 8
Nematocides	All	Litter degradation, respiration, nitrification	SR, SN, LB
Herbicides	Infertile	Algal populations and nitrogen-fixation (fungal populations for atrazine)	SA
Phenyl pyrazoles (fipronil in particular)	All	Soil fertility through action on soil termites, litter breakdown	LB

SN = soil nitrification; SR = soil respiration; EP = earthworm populations; SA = soil algae; LB = litter bags.

Then consider the habitat sensitivity.

- Established agro-ecosystems are fairly robust but any use of persistent chemicals, e.g. organochlorines, nematocides and soil sterilants would indicate monitoring of all processes except biological nitrogen-fixation.
- Relatively unmanaged areas such as woodland and grassland savannas, sub-humid and humid forest are at relatively low risk from migrant pest control (locust, quelea, armyworm), grasshopper, forest pest and public health control measures, provided recommended dose rates are adhered to. For these categories of pests, recommended rates are frequently exceeded as an insurance speculation against the high costs of repeating operations in remote areas. Monitoring of nitrification is the minimum requirement; suspected overdosing requires, in addition, respiration and litter breakdown measurements.
- Despite the above, soils low in organic matter and natural fertility plus those in areas with short growing seasons are at greater risk; monitoring of nitrification, biological nitrogen-fixation and litter breakdown is indicated. Included in this category are the aridisols, ultisols, alfisols and oxisols.

- Land with conservation designations has a high political profile and may require monitoring in accordance with national requirements.

Soil and pesticide properties greatly influence the behaviour, availability and subsequent toxicity of pesticides to soil microbiota and their functions. Thus, pesticides applied to soils with low clay or organic matter content may initially be more biologically active because of diminished binding and adsorption on to organic and clay mineral particles, while a relatively volatile pesticide is likely to evaporate quickly from soil surfaces. Persistent pesticides might be expected to have longer-term effects on some microflora. So some generalizations about the risks to, and sensitivities of, populations and functions are possible but the relative scarcity of field and bioassay data makes predictions for aiding study design rather insecure.

Since the distribution of pesticides in soil is far from uniform and the natural variability of soil populations and processes is high, *in situ* monitoring of pesticide perturbations of soil functions is often impeded by unmanageable sample replication, particularly in uncultivated areas. A compromise is to prepare and deliberately expose native soil to the pesticides in areas where pesticide contamination is anticipated (between crop rows, under the path of helicopters, downwind of aerosol droplet generators, etc.) and then incubate them under field conditions. Methods for nitrification and respiration measurement are given to deal with these conditions.

Change in a population state or the rate of a soil process must be identified and then distinguished as either an outcome of pesticide use or natural variation. A sound experimental design is required at the outset of monitoring to achieve this goal or the data collected may not stand up to statistical scrutiny; chapter 2 is obligatory reading in this respect. It is equally important to select sample and replicate sites in control and treated areas that are matched in terms of soil and vegetation type. At the microhabitat level, for *in situ* assays such as respiration or worm casting activity, soil moisture, shade and ground cover should be compatible.

Microbial growth and activity are limited by soil water and temperature. Comparisons of microbially mediated processes must, therefore, take account of soil moisture. Any conclusions drawn from procedures used to establish the rate of any process measured at different moisture levels or temperature are invalid. Field methods for estimating soil moisture and water-holding capacity are provided in chapter 5. Make a habit of noting down the prevailing air and soil temperature, sun and shade at each study site.

In dry areas, soil activity may be arrested in the dry season with the result that some processes, such as litter breakdown, may take months to complete. The same process in the wet season may be completed within weeks. These are seasonal design considerations for the monitoring protocols, i.e. long time frames may be necessary and collection of pre-spray data (always recommended if affordable), may be impossible if phasing of spraying and post-spray monitoring crosses seasons. Under these circumstances, monitoring at the control (untreated) site will identify the natural variations of activity. The time-scale of post-spray sampling will depend upon the bioavailability and persistence of the pesticide in the soil. A 30-day period should suffice for *in situ* measurements of respiration. Dry season spraying (e.g. for tsetse fly control) will delay the retrieval period of litter bags and force the use of *in vitro* techniques for nitrification and respiration.

Maps (1:50000) and a four-wheel drive vehicle are prerequisites for locating and maintaining sampling sites in woodlands and grasslands in all seasons. It is not always advisable to sample just off a track: explore widely but within sensible limits and in reach of the camp or laboratory.

SAMPLING TECHNIQUES

Soil nitrification

This method indirectly measures pesticide impact on nitrifying organisms that are responsible for the transformation (oxidation) of ammonium to nitrite and nitrate. The criterion for the measure is any observed

delay in the build up of nitrate and is arrived at using a nitrate electrode to determine $\text{NO}_3\text{-N}$ in water-extracted soil samples. The electrode, which measures nitrate ions, is similar to a pH electrode in size and use. The field test is not performed *in situ* but on prepared soils amended with ammonium-N before exposure to the pesticide and subsequent incubation at field temperatures. The method sheet is designed for undertaking the whole, long-term procedure (40–50 days) in the field. However, the procedure can be started in the field and continued under standard incubation conditions in the laboratory if the establishment of a field laboratory is not practicable.

An estimate of dosage received by the soil is obtained from standard magnesium oxide slides (see Matthews, 2000) or water/oil-sensitive papers placed at ground level (see chapter 4). The most accurate but expensive procedure is to analyse the residue content in samples of exposed soil (see chapter 6); it is not practicable on a routine basis.

Limitations Ion-specific electrodes are fairly expensive and not particularly robust. A pH or millivolt meter is also required. The procedure is fairly demanding and requires attention to detail. The assistance of a chemist may be required.

Processing Simple aqueous soil extractions of nitrate. It is important to replenish soil water content and air inside the sample containers daily. Use deionized water if available for re-wetting and extraction of nitrate (0.25M K_2SO_4 may extract more from some soils).

Resulting data A graphic representation of nitrate concentration vs. time is a simple and effective way to show a depression of activity. Nitrate concentration is usually expressed as $\mu\text{g NO}_3\text{-N g dry weight soil}^{-1}$. The ecological importance of depressions in activity caused by pesticides is normally gauged against those observed under conditions of natural stress (e.g. drought or waterlogging). A 90% depression of nitrification for up to 30 days may be regarded as not ecologically significant. Longer periods, particularly in semi-arid climates, may not be tolerable, as the seasonal activity is restricted by rainfall.

Sampling period Sampling period depends upon temperature and moisture but 2 months would be a useful average to use for planning.

Equipment Nitrate electrode, reference electrode, millivolt meter or pH meter.

Staff required 1.

Biological nitrogen-fixation

Field methods for the indirect measurement of biological nitrogen-fixation are available (Holfeld *et al.*, 1979; Grant, 1986, 1988), but the difficulties of accessing portable gas chromatographs and clean acetylene in many tropical countries restrict measurements. Yatazawa *et al.* (1984) provide plans to build a suitable portable gas chromatograph. Alternatively, gas samples in vacutainers may be brought back to the laboratory for measurement on a gas chromatograph. It is recommended that the advice and support of a local soil microbiology/agronomy laboratory is sought for planning acetylene reduction assays. No methods sheets are provided as specialist assistance will be required and the reader is recommended to see Robertson *et al.* (1999) for field techniques for soil and Grant (1986) for water.

Soil respiration

Plant roots, soil macro- and micro-fauna and the soil microbial biomass all contribute to soil respiration. The *in situ* measurement of changes in respiration rates are, therefore, not as straightforward to interpret as using dug soils, which may be prepared in a way to standardize some of these variables. *In situ* respiration techniques trap or continuously measure carbon dioxide released from an enclosed area of soil so care must be taken to match the vegetation types and their spatial distribution between areas compared, and to sample between plant stands. It is also advisable to dig up the soil below an enclosure, after measurement, to measure the percentage soil moisture (see method sheet) and to gauge the extent of any root mass or earthworm populations that might skew respiration rates between sites. The most appropriate time to measure respiration *in situ* is when soils are moist or wet, as there is little microbial activity and respiration in the dry season.

The use of prepared soils largely overcomes the difficulties of root and invertebrate contributions to soil respiration, and because soil moisture significantly affects respiration, this too may be standardized. Soils are pushed through a sieve to remove roots and macro-invertebrates before being amended with organic matter (if necessary) and water. They are subsequently exposed *in situ* to pesticide and monitored over a period of 30–40 days or more (tropical conditions). The organic matter amendment may be local dried grass either pushed through or milled to pass a 0.5 mm sieve.

Limitations *In situ* respiration is most conveniently measured with a portable infra-red gas analyser (e.g. Grant, 1990), but the capital cost is high. Draeger tubes are a less expensive alternative but their availability may be restricted. A classic titrimetric method for long-term *in situ* rates involving carbon dioxide absorption by alkali is, therefore, provided (attributable to Anderson, 1982). *In vitro* (prepared soils) estimates of respiration provide standardized test conditions and a powerful tool for comparing pesticide impacts but respiration rates cannot be translated to field rates. The equipment necessary is relatively inexpensive and robust but the gas analysis tubes are not reusable.

Resulting data Graphic representation of the rates of respiration expressed in relation to either soil dry weight or area is useful to determine and demonstrate any depression of respiratory activity related to pesticides. Examples of outputs may be ml CO₂ g dry weight soil⁻¹ h⁻¹ or mg CO₂ m⁻² h⁻¹. Plotting the soil temperature and moisture on the same graph is also helpful in assessing causes of rates of change in respiration as small fluctuations in either greatly affect microbial activity. Follow the guidelines given under the *Soil Nitrification* section for an interpretation of the ecological significance of depressions of respiration. The use of *in vitro* techniques during the dry season (i.e. on dry soils) is questionable, because if soils are not wetted to stimulate activity, pesticides would be denatured or dissipated by UV light, heat and volatilization, reducing their toxicity by the time it rained. However, spraying normally accompanies vegetation growth after rains: tsetse fly control is the exception as tsetse feed on animals.

Sampling period Typically up to 1 month or more, sampling CO₂ at about six intervals during the month. *In vitro* techniques can be used in any season – *in situ* sampling may be limited to the wet season. Soils in some regions may remain moist enough in the dry season to support microbial activity. *In situ* measurements are made before and after spraying or soil treatment.

Equipment Infra-red gas analyser or Draeger tubes, or simple titration glassware and reagents.

Staff required 1.

Soil texture, moisture and water-holding capacity

See chapter 5 for methods and discussion.

Earthworm populations and activity

Methods for estimating relative earthworm abundance in soils are simple and robust, relying on either hand searching of dug soil or applying an irritant to the soil that causes earthworms to surface, where they are collected or counted. Hand sorting of worms from soil, although tedious, is generally more effective than the drench technique that uses irritants such as formalin and detergent. Both methods rely on marking out sites in treated and untreated areas to either dig/core sample or drench with irritant. Coring and digging small pits are convenient as soils can be transported to a laboratory for hand sorting while drenching requires staying in the field for a day or more.

Limitations Earthworm distribution is affected by soil conditions, moisture, organic matter content and a number of replicate samples may be needed to estimate populations. It is important to match soil type and texture in areas chosen for sprayed/unsprayed monitoring. In the dry season, more drench (irritant) needs to be applied to expel the worms from deeper layers.

Processing Easy but tedious sorting of soils by eye using forceps. Using a drench, worm collections are easy but vegetation can obscure surfacing worms and the irritants can affect human skin (especially formalin) so nitrile/rubber gloves must be worn (see chapter 3). The taxonomy of worms is a job for a specialist – at least at the outset.

Sampling period Estimate earthworm populations every 10–14 days but using a different transect across the area each time as the drench is persistent and will affect the behaviour of the worms.

Equipment Soil corer, trowel or spade.

Staff required Heavy fieldwork is best done with 2 people.

Earthworm activity (feeding and burrowing) is determined by counting surface worm casts or recording the rate of casting. Some casts are distinctive enough to separate one species from another, increasing the information value of the technique. Specialist taxonomic help will be needed initially. The techniques described are based on observations and counts of casting activity at random points along a transect or inside quadrats thrown in treated and untreated areas. Remember to note the weather at the time of sampling and determine the soil pH and percentage soil moisture, as these parameters affect the distribution of worms.

Limitations Not all soils will contain earthworms at high enough densities to count or observe casting, but in moist soils that contain sufficient organic matter as food, the techniques are reliable. Wet season rain can destroy casts.

Processing None.

Resulting data Numerical counts of casting, perhaps by species.

Sampling period The counts are made at intervals of 2 days to 1 week in the wet season. Activity will be curtailed or reduced in the dry season (unless irrigated). Pre- and post-spray estimates should be made of both earthworm populations and activity.

Equipment No special equipment required.

Staff required 1, but 2 people will speed up the layout of transects.

Old but useful general references for earthworm biology and population estimation are Madge (1969) and Edwards and Lofty (1972).

(For methods to determine the abundance/activity of other soil invertebrates, see chapter 8.)

Litter bags

Litter bags are used to gauge the rate of organic matter (leaf or root litter) decomposition in or on the surface of soils by the soil decomposer community. As decomposition is effected by the soil fauna, microflora and associated soil enzymes, their relative contributions are crudely distinguished by burying a known weight of litter in bags of differing size mesh, which restricts the size of organisms that can enter the bag. After a period of time in the ground, from a few months to 2 years – depending upon decomposer activity – the residue is weighed. Use of the bags to determine the invertebrate decomposer role is described in chapter 8. Microbial action is gauged from the use of very small aperture mesh (10–60 μm) but remember microbes also contribute to breakdown in the bags designed to exclude invertebrate groups (e.g. 600 μm , 1 mm and 4 mm meshes). In these larger mesh bags, invertebrates chew up organic matter leaving it open to accelerated breakdown by micro-organisms. Fallen leaves provide an ideal source of litter. Litter should be air or oven-dried (60 °C) before being buried because variations in litter moisture affect initial decomposition rates.

Limitations A lot of bags, perhaps 250 or more, are required to estimate litter processing in a quantitative fashion and their production is labour-intensive. Once buried, they can be hard to locate and so detailed site maps, markers and photographs are necessary. A hand-held global positioning system (GPS) is useful for locating markers in remote areas. Very fine mesh bags can trap air, resisting its displacement with water for a short period. Litter bags exposed on the surface of the soil should be tethered to reduce the likelihood of being washed away in storms or being removed by wildlife. Fine mesh can be holed by termites and ants. Nylon mesh can be difficult to source in some countries and is time consuming to sew.

Processing Care must be taken not to lose bag contents when removing bags from the soil (some bags may be holed). Bags placed vertically in the soil are less vulnerable to losses at removal. Sieves are needed to separate soil particles from remaining debris; it is inevitable that some organic matter will be lost. Reducing the period of burial can reduce these losses.

Resulting data Dry weights of litter remaining or percentage loss can be graphically represented for bags buried in treated and untreated areas.

Sampling period This depends upon the distribution of rainfall and soil type. One wet season of perhaps 3 months or more should be sufficient – a single dry season may not be sufficient as soil microbial activity is negligible.

Equipment Spade, trowel, wire, tape measure and litter bags.

Staff required 2.

Soil algae

In the wet season or shortly after rains, the presence of algal growth on soils is obvious from the soil's green colour. On sandy soils they are less obvious as soil moisture loss is rapid and the algae may appear much darker and encrusted. Any uncertainty can be resolved by wetting a sample for a day or more and smearing a microscope slide with a thin layer of the soil sample before examining it under a high power microscope. The help of a soil microbiologist or phycologist will be necessary if you have never closely observed algae before. A simple belt quadrat technique to assess algal cover is described which only requires the estimation of algal cover within a quadrat placed at intervals along several transect lines.

Limitations The only real limitations of the belt quadrat technique are statistical, and concern the need for random stratified sampling of an area (see chapter 2).

Processing No processing is required as the method is based on visual observation.

Resulting data The quadrat data are used to determine algal cover and a histogram or area diagram can be used to present it.

Sampling period The impacts of herbicides or insecticides on algal grazers should be evident using weekly samples over the period of a month.

Equipment A compound microscope to confirm the presence (and species if interested in taxonomy) of algae, quadrat, string and tape measure.

Staff required 1.

REFERENCES

ANDERSON, J.P.E. (1982) Soil respiration. In: *Methods of Soil Analysis Part II. Chemical and Microbiological Properties*. *Agronomy Monograph*, No. 9. Madison, Wisconsin: Soil Science Society of America.

GRANT, I.F. (1986) Modifications and field testing of a portable gas chromatograph for *in situ* acetylene reduction activity assay of tropical soils. *Plant and Soil*, **95**: 435–439.

GRANT, I.F. (1988) Appropriate technology for monitoring environmental effects of insecticides in the tropics. In: *Field Methods for the Study of Environmental Effects of Pesticides*. Greaves, M. P., Smith, B. D. and Greig-Smith, P. W. (eds). *BCPC Monograph*, No. 40. Thornton Heath: British Crop Protection Council.

GRANT, I.F. (1990) Key soil processes. In: *Environmental Effects of Chemical Locust and Grasshopper Control*. Everts, J. W. (ed.). ELCO/SEN/003/NET. Rome: Food and Agriculture Organization of the United Nations.

HOLFELD, H.S., MALLARD, C.S. and LARUE, T.A. (1979) Portable gas chromatograph. *Plant and Soil*, **52**: 595–598.

MATTHEWS, G.A. (2000) *Pesticide Application Methods*. Ames: CRC Press.

ROBERTSON, P.G., COLEMAN, D.C., BLEDSOE, C.S. and SOLLINS, P. (eds) (1999) *Standard Soil Methods for Long-term Ecological Research*. Oxford: Oxford University Press.

WEAVER, R.W., ANGLE, S., BOTTOMLEY, P., BEZDICEK, D., SMITH, S., TABATABAI, A. and WOLLUM, A. (1994) *Methods of Soil Analysis Pt II. Microbiological and Biochemical Properties*, No. 5. Madison: Soil Science Society of America.

YATAZAWA, M., SASAKAWA, H. and IHOKURA, K. (1984) An improved portable gas chromatograph for the measurement of nitrogen-fixing activity. *Soil Science and Plant Nutrition*, **30**: 503–508.

FURTHER READING

ANDERSON, J.M. and INGRAM, J.S.I. (eds) (1993) *Tropical Soil Biology and Fertility: A Handbook of Methods*. Wallingford, UK: CAB International.

DOBERSKI, J. and BRODIE, I. (1991) *Techniques in Ecology and Environmental Science. Set A Terrestrial Organisms and Habitats*. Cambridge: Daniels Publishing.

DOMSCH, K.H., JAGNOW, G. and ANDERSON, T.-H. (1983) An ecological concept for the assessment of side-effects of agrochemicals on soil micro-organisms. *Residue Reviews*, **86**: 65–105.

EDWARDS, C.A. and LOFTY, J.R. (1972) *Biology of Earthworms*. London: Chapman and Hall.

MADGE, D.S. (1969) Field and laboratory studies on the activities of two species of tropical earthworms. *Pedobiologia*, **9**: 188–214.

SOMMERVILLE, L. and GREAVES, M.P. (eds) (1987) *Pesticide Effects on Soil Microflora*. London: Taylor and Francis.

TERRESTRIAL INVERTEBRATES

Colin C. D. Tingle¹

Natural Resources Institute, University of Greenwich at Medway, Central Avenue,
Chatham Maritime, Kent ME4 4TB, UK

INTRODUCTION

Invertebrates occupy a large array of ecological niches within the terrestrial environment. They are a highly successful group of animals, which makes many important contributions to the functioning of the living world. Some are involved in the decomposition process leading to the recycling of nutrients; some with pollination of flowering plants; many are herbivorous and these have a major impact on plant biomass and survival; whilst others play important roles through the regulation of animal populations, as parasites or predators. In turn, invertebrates provide an important food source for many amphibians and reptiles, birds and some mammals (see chapters 11, 12 and 13). Some invertebrates (particularly insects) are highly mobile and only transient occupants of a particular habitat or area, whilst others may be sedentary, with small home ranges and key roles in the ecology of that range. Many invertebrates show strong seasonality in their occurrence and abundance and even great variation in their activity on a daily basis. Because of this ecological diversity, different techniques are needed to sample those living in different habitats and within different strata of the same habitat. No single method of sampling will be efficient at capturing the entire range of invertebrate fauna within a given area. Thus, methods must be chosen which target the taxa of interest or, if general collections are required, then the use of a number of different techniques simultaneously may be required.

Terrestrial invertebrates are often directly exposed to pesticides, as they live in a number of habitats which are deliberately sprayed to control insect pests, fungi or weeds or to protect human beings from disease vectors. Others are directly exposed by deposition of insecticide sprays which miss their target, e.g. soil-dwelling invertebrates in sprayed forests. In either case, exposure may be through contact or ingestion. Other invertebrates may be indirectly affected through the removal or reduction of food sources, be they vegetable, fungal or animal. Insecticides are designed specifically to kill insects and thus most invertebrates are sensitive to these chemicals. Sensitivity to other pesticides varies, but some herbicides and fungicides are also directly and highly toxic to this group of organisms.

The assessment of pesticide impact on terrestrial invertebrates generally relies on some quantification of population levels, relative abundance and/or species composition in sprayed areas and a statistical comparison with the same criteria in unsprayed areas. In some cases the collection of invertebrates for residue analysis can be helpful and direct mortality assessment (cadaver counts) can also be useful in determining the effects of some insecticides. To be done thoroughly, the scientific assessment requires a substantial input of time and resources. The reliability of the results of any study on pesticide impacts will be greater, the more that is known about the ecology of the area to be treated. Thus, where possible, trials should be sited in areas where data have already been accumulated on invertebrate abundance, and/or species composition, diversity and the role of invertebrates in the ecosystem and its functioning.² In practice, this will rarely occur as the biology and ecology of the invertebrate fauna of many tropical habitats are often poorly known or completely unstudied. Thus some study

¹Contact address: 9 Norman Avenue, Henley-on-Thames, Oxon. RG9 1SG UK. tc09@gn.apc.org/colin.tingle@thenrgroup.net

²Data on previous use of pesticides or other contaminants in the area should also be sought and documented so that results are correctly interpreted.

of the ecology of the site will usually need to be carried out in conjunction with the ecotoxicological assessment. Invertebrates are particularly prone to large natural variation in abundance both in time and space. This makes them one of the most difficult groups of animals to study quantitatively in the field. Long-term (3–5 years) or repeated short-term (minimum 2–3 months each year for 3–5 years) studies are preferable, because the results of a single, short-term study will be difficult to interpret.

The aim of this chapter is to describe some of those sampling methods for invertebrates which are useful in the assessment of pesticide impact work and to provide guidelines for the selection of appropriate techniques for use in different situations.

STUDY DESIGN

Pesticide impact on non-target invertebrates is best assessed using a replicated experimental design (see chapter 2). Details are given by Southerton *et al.* (1988) for designs used in agro-ecosystems. However, large-scale applications of pesticides often take place in non-crop situations, and pesticide impact studies then have to be done as monitoring exercises. In these situations, true replication is impossible. Drawing inferences about cause and effect is much more difficult in this type of situation (Eberhardt and Thomas, 1991) and real care is necessary to avoid collecting data which will prove impossible to analyse and interpret (see chapter 2).

However the study is structured, be it a standard, replicated experiment or a monitoring exercise, several basic features should be incorporated into the design.

- At least 1 month's worth of pre-spray data are required on invertebrate abundance in the trial site and a year's data would be preferable.
- Invertebrate abundance often follows seasonal patterns. Thus a comparison of relative abundance of a given invertebrate taxon between different months may be highly misleading. Similarly, year to year variation of some invertebrates can be very high. Account should be taken of this when designing the study to ensure meaningful results.
- Part (or parts) of the study area should be left unsprayed throughout the study, as a control.
- Plot size must be appropriate for the scale of pesticide applications and activity of invertebrate groups of interest. For example, darkling beetles (Tenebrionidae) may cover distances of 400 m during foraging excursions and thus require very large plot sizes; whereas some springtails (Collembola: Isotomidae) may cover only 5 m. **Note:** There are some situations in which discriminative spray applications are used, e.g. ground-spraying against tsetse fly or barrier treatment against locust, where reinvasion is an inevitable process and an important factor in judging the impact of spraying.
- Pesticide-treated and untreated sites or plots should be sufficiently distant to prevent unintended contamination of the untreated area and to prevent invasion of the treated area by fauna from the untreated area which could confound the results.
- Replication or (where unavoidable) pseudoreplication (see chapter 2) should be adequate for statistical tests to have the power to demonstrate effects above the level of natural variation for the study area. Wherever possible, the use of several unsprayed sites for comparison with the spray impacted site will improve the reliability of findings (Underwood, 1994).
- Selection of sample sites for a monitoring exercise must use a stratified system (see chapter 2), leading to 'matching' of sites across treatment areas, unless work is carried out in a homogeneous study area or unless heterogeneity is so widespread that different sample sites represent a similar diversity of habitat types.

- As much data about the environmental conditions of the study area and individual sample sites should be recorded as possible, e.g. temperature, humidity, soil type, vegetation, distance from field boundaries or other habitat features, etc.
- People living in or near areas selected as study sites for pesticide impact assessment should always be consulted at an early stage. If trials are within farmers fields, then this will inevitably happen, however, if study sites are natural or semi-natural savanna, woodland or forest areas, local people can still provide an enormous wealth of information and should be consulted and involved in the process of setting up the sampling programme. Equipment used for marking out study sites and for sampling invertebrates may be attractive to local people. If they have not been informed of trials, equipment may be moved, stolen or damaged. Consultation and involvement of people living in or using the study area will minimize these types of problems and lead to lower costs, less frustration and more reliable results.
- Design of the study must be in proportion to the resources available. Thus if staff numbers are limiting some methods of sampling for invertebrates (see 'Sampling Techniques' for details, page 165) may be inappropriate. Similarly, if transport is limiting, this will have to be taken into account in determining the practical feasibility of using certain sampling methods.

Design of the study and selection of sampling methods will be affected by the type of pesticide under investigation, the ecosystem in which it is to be applied, the application method and the taxonomic ability of the staff involved or outside expertise available. Table 8.1 is a generalized scheme which gives guidance in selecting sampling methods appropriate to particular situations. More detailed information to aid in the selection process is given below.

Which pesticide?

Different classes of pesticides have different modes of action and each individual pesticide affects different fauna to a differing extent or not at all. The characteristics of the individual pesticide will be important in determining the methods used in evaluating environmental impact. Wherever possible, specific information relating to the chemical should be used in deciding the scope of the environmental monitoring. The overview below provides a synopsis of the main features of the major pesticide groups, which may help in an initial selection of sampling methods for invertebrates appropriate to particular situations. Assuming recommended dose rates are followed, the broad groupings of pesticides give clues to the type of sampling which will be necessary.

Organochlorines	<p>Measurement of residue levels in selected invertebrates (particularly those important as vertebrate prey) from sprayed and unsprayed areas.</p> <p>Species composition of non-target groups and similarity between sprayed and unsprayed sites (e.g. Sorensen's Index (QS)).</p> <p>Diversity and species richness (see page 00).</p> <p>Relative abundance of indicator groups, particularly predatory mites (Acari: Mesostigmata), springtails (Collembola: Isotomidae) and parasitic wasps (Hymenoptera).</p>
Organophosphates	<p>Acute effects on bees (Hymenoptera: Apoidea) and effects on production of new queens.</p> <p>Relative abundance of bees and wasps (Hymenoptera), certain beetles (Coleoptera: ground beetles [Carabidae], soldier beetles [Cantharidae] and ladybirds [Coccinellidae]), jumping spiders (Araneae: Salticidae), Collembola and predatory mites (Acari: Prostigmata, Mesostigmata).</p> <p>Species composition and diversity of faunal assemblages (particularly spiders [Araneae]).</p>

Table 8.1 Matrix for determination of suitable sampling techniques

Sampling method	Non-target fauna of interest										Habitat										Pesticide										Application method						Technical knowledge	
	Bees	FI	VD	AI	EI	SI	IR	FC	P/S	W/F	O/P	WL	OC	OP	Ca	Py	IGR	Bio	H	F	PP	Kn	Tr	ULV	Fog	Aer	G/Sd	B	D/PO	Ent	Non Tax							
Pitfall traps					●	○		●	●	●	●		●	●	●	●	●	●	●	●	●	●	●	○	○	○	○	○	○	○	○	○						
Quadrats			○		●	○		●	●	●	●	●	●	●	●	●	●	●	●	●	●	●	●	●	○	○	○	○	○	○	○	○						
Cryptozoa boards					●	○		●	●	●	●	○	●	●	●	●	●	●	●	●	●	●	●	○	○	○	○	○	○	○	○	○						
Food baits	○	○		●	●	○		●	●	●	●	●	●	●	●	●	●	●	●	●	●	●	○	○	○	○	○	○	○	○	○	○						
D-Vac/ suction sampler	○	○		○	●			●	●	●	●	●	●	●	●	●	●	●	●	●	●	○	○	○	○	○	○	○	○	○	○	○						
Sweep net	○	○		○	●			●	●	●	●	●	●	●	●	●	●	●	●	●	●	○	○	○	○	○	○	○	○	○	○	○						
Malaise trap	○	○		○	●			●	●	●	●	●	●	●	●	●	●	●	●	●	●	○	○	○	○	○	○	○	○	○	○	○						
Yellow water trap	○	○		○	●			●	●	●	●	●	●	●	●	●	●	●	●	●	●	○	○	○	○	○	○	○	○	○	○	○						
Light trap					●			●	●	●	●	●	●	●	●	●	●	●	●	●	●	○	○	○	○	○	○	○	○	○	○	○						
Hive counts/observation	●							●	○	○	○	○	○	○	○	○	○	○	○	○	○	○	○	○	○	○	○	○	○	○	○	○						
Lure/pheromone traps				●	●			○	○	○	○	○	○	○	○	○	○	○	○	○	○	○	○	○	○	○	○	○	○	○	○	○	○					
Beating				○	○			○	○	○	○	○	○	○	○	○	○	○	○	○	○	○	○	○	○	○	○	○	○	○	○	○	○					
Funnel traps	○	○		○	●			○	○	○	○	○	○	○	○	○	○	○	○	○	○	○	○	○	○	○	○	○	○	○	○	○	○					
Sheet traps				●	●			○	○	○	○	○	○	○	○	○	○	○	○	○	○	○	○	○	○	○	○	○	○	○	○	○	○					
Trunk traps				●	○			○	○	○	○	○	○	○	○	○	○	○	○	○	○	○	○	○	○	○	○	○	○	○	○	○	○					
Soil cores						●		○	○	○	○	○	○	○	○	○	○	○	○	○	○	○	○	○	○	○	○	○	○	○	○	○	○					
Litter bags					●			○	○	○	○	○	○	○	○	○	○	○	○	○	○	○	○	○	○	○	○	○	○	○	○	○	○					
Monolith samples					●			○	○	○	○	○	○	○	○	○	○	○	○	○	○	○	○	○	○	○	○	○	○	○	○	○	○					
Formalin drench					●			○	○	○	○	○	○	○	○	○	○	○	○	○	○	○	○	○	○	○	○	○	○	○	○	○	○					
Direct collection				○	○			○	○	○	○	○	○	○	○	○	○	○	○	○	○	○	○	○	○	○	○	○	○	○	○	○	○					
Termite colony health					●			○	○	○	○	○	○	○	○	○	○	○	○	○	○	○	○	○	○	○	○	○	○	○	○	○	○	○				

FI = Flying insects
 VD = Vegetation dwellers
 AI = Arboreal invertebrates
 EI = Epigeal invertebrates
 SI = Soil invertebrates
 IR = Insecticide residues

FC = Field crops
 P/S = Pasture/savanna
 W/F = Woodland/forest
 O/P = Orchards/plantations
 WL = Wetlands

OC = Organochlorine
 OP = Organophosphate
 Ca = Carbamate
 Py = Pyrethroid
 IGR = Insect growth regulator
 Bio = Biologicals (e.g. Bt)
 H = Herbicide
 F = Fungicide
 PP = Phenyl pyrazole

Kn = Knapsack sprayer
 Tr = Tractor/vehicle-mounted sprayer
 ULV = Ultra-low-volume
 Fog = Fogging
 Aer = Aerial application
 G/Sd = Granules/seed dressing
 B = Baits
 D/PO = Dips/pour-ons

Ent = Entomologist
 Non = Non-specialist
 (with some biological training)
 Tax = Taxonomic assistance required

● Appropriate method
 ○ Less suitable but can still give useful results
 □ Not applicable

Carbamates	Acute toxicity to bees. Relative abundance of ants (Formicidae) and other Hymenoptera, predatory mites (Acari: Prostigmata) and ground beetles (Carabidae). Species composition and diversity.
Pyrethroids	Relative abundance of spiders (Araneae) (particularly money spiders [Linyphiidae]), parasitic Hymenoptera, silverfish (Thysanura), leaf beetles (Chrysomelidae) and Formicidae. Species composition and diversity.
Phenyl pyrazoles	Termites (Isoptera) via assessment of colony health and/or termite activity. Acute toxicity to bees. Relative abundance of Acari, Araneae, earwigs (Dermaptera), certain grasshoppers, crickets and relatives (Orthoptera), Coleoptera (certain Carabidae, certain weevils [Curculionidae], certain Tenebrionidae), robber flies, big headed and other flies (Diptera [Asilidae, Pipunculidae, Muscidae]), Hymenoptera (Apoidea, Chalcidoidea, Scelionidae, Sphecidae, Tiphidae, Braconidae, Formicidae). Diversity and species composition.
Insect growth regulators	Relative abundance of orb web, lynx and jumping spiders (Araneidae, certain Oxyopidae, certain Salticidae) and predatory mites (Acari), Orthoptera, lacewings, ant lions and their relatives (Neuroptera), Coleoptera (Tenebrionidae, Curculionidae, Chrysomelidae, Coccinellidae), butterflies and moths (Lepidoptera) and Hymenoptera (Braconidae). Species composition, faunal similarity (QS), diversity (particularly mandibulate herbivores) and species richness (Araneae).
Biologicals	Relative abundance, diversity and species composition (particularly macrolepidoptera, Orthoptera and parasitic Hymenoptera).
Herbicides	Relative abundance of Collembola, Acari, earthworms (Annelida: Oligochaeta), nematodes (Nematoda), honeybees (Apidae) and Carabidae. Secondary effects on soil fauna (see below) and vegetation-dwelling fauna (see below) caused by reductions in vegetation.
Fungicides	Relative abundance of parasitic Hymenoptera (particularly Chalcidoidea), predatory bugs (Hemiptera), mesostigmatic and other Acari. Also Annelida (earthworms and pot worms [Enchytraeidae]).

Where is it used?

The composition of invertebrate faunal assemblages varies with biome, thus different non-target invertebrates may be affected by the application of the same pesticide in different habitat types. As a broad guideline, the following key invertebrate groups are likely to be at risk when the following types of habitat are subjected to pesticide application.

Agro-ecosystem	Beneficial invertebrates – bees, parasitic Hymenoptera and Diptera, predatory Coleoptera, predatory Diptera and Neuroptera, predatory Acari and Araneae. Detritivores and recyclers – Annelida, millipedes (Diplopoda), Acari, Coleoptera and Diptera.
----------------	---

Woodland/forest	Invertebrate faunal diversity. Detritivores and recyclers – Annelida, woodlice (Isopoda), Diplopoda, Coleoptera, cockroaches (Blattodea), Isoptera and Formicidae. Pollinators – Diptera, Hymenoptera. Invertebrates important as food for higher animals – Lepidoptera, Formicidae and Isoptera.
Pasture/savanna	Diversity. Primary consumers – Orthoptera, Coleoptera, Lepidoptera. Detritivores – Isoptera, dung beetles (Scarabaeidae) and Formicidae.
Orchards/plantations	Pollinators – Diptera, Hymenoptera (bees in particular). Beneficial invertebrates – parasitic Hymenoptera and Diptera, predatory Coleoptera, predatory Diptera and Neuroptera, predatory Acari and Araneae.

Application method

The method of pesticide application can also have a major influence on the fauna affected (due to differences in formulation, drop size, drift and pesticide fate) and thus on the sampling methods needed to appraise effects.

High-volume from knapsack or tractor	Fauna on ground cover vegetation (Araneae, Acari, praying mantids [Mantodea], Orthoptera, book and bark lice [Psocoptera], Hemiptera, Thrips [Thysanoptera], Neuroptera, Coleoptera, Diptera, Lepidoptera [larvae] and Hymenoptera); soil surface (Diplopoda, centipedes [Chilopoda], Pauropoda, Araneae, Acari, harvestmen [Opiliones], pseudoscorpions [Chelonethi]; sun spiders [Solifugae]; scorpions [Scorpiones], false scorpions [Amblypygi], Thysanura, Collembola, Blattodea; Dermaptera; Hemiptera; Isoptera; web spinners [Embiidina]; Orthoptera, Coleoptera and Hymenoptera); and within the soil (Annelida, Nematoda, Isopoda, Diplopoda, Chilopoda, Symphyla, Acari, Chelonethi, Collembola, Hemiptera, Isoptera, Embiidina, Coleoptera, Diptera and Hymenoptera).
Ultra-low-volume (ULV)	Fauna associated with low growing but upright vegetation (see above) or, if aerially applied, with the vegetation canopy (those listed above as vegetation-dwelling plus stick insects [Phasmatodea]), arboreal invertebrates (particularly Araneae, Acari, Chelonethi, Collembola, Psocoptera, Blattodea, Mantodea, Orthoptera, Hemiptera, Thysanoptera, Coleoptera, Diptera, Lepidoptera and Hymenoptera), vegetation-dwelling invertebrates and flying insects (Orthoptera, Thysanoptera, Neuroptera, Coleoptera, Diptera, Lepidoptera and Hymenoptera). Epigeal fauna only if little or no vegetation cover.
Fogging	Canopy invertebrates, flying insects, arboreal invertebrates and (to a lesser extent) epigeal fauna.
Aerial	See fogging/ULV.
Granules/seed dressing	Epigeal and soil-dwelling invertebrates.
Baits	Epigeal invertebrates and scavengers (e.g. Formicidae).
Pour-ons	Biting flies (Diptera [Tabanidae, Hypoboscidae, etc.]); detritivorous Coleoptera (Scarabaeoidea, Tenebrionidae) and Diptera (Muscidae); Isoptera (particularly Termitidae); and dung-dwelling Coleoptera (Histeridae) and Diptera (particularly larvae).
Dips	Diptera (Tabanidae, Hypoboscidae, etc.).

Technical expertise

Many of the sampling techniques described below will catch a wide variety of insects or other invertebrates. The taxonomic expertise of the staff involved in the work will govern how much information can be gained from the samples. Almost any work on pesticide impacts on invertebrates will involve some basic taxonomy. Generally, individual species will be affected differently by a given pesticide and thus adverse impacts will often only be detectable if fauna are identified to species. Wherever possible an entomologist or invertebrate zoologist should be involved in the work. For the non-entomological biologist, many methods will allow assessments to be made of biomass, overall numbers and, possibly with the aid of a key, separation of the catch into orders. If further division is required, then fauna which look identical may be grouped as a 'morphospecies', given a number or a letter to distinguish them and counted separately. A reference collection should be established during sorting of samples, so that different groups are not confused and standard records are kept. Quick sketches and notes on major features will aid separation of different taxa found. Reference specimens may then be sent to specialist taxonomists for further identification. Such taxonomists can be contacted through your local or national natural history museum, biology department of your local university, via local or national wildlife groups, via the government's Wildlife and National Parks Department, Environment Department or Conservation Department. If no assistance can be found through any of these routes, then contact the Natural History Museum, London or, for southern African fauna, the Transvaal Museum, Department of Invertebrates (see <http://www.nfi.co.za/coleoptera/identfees.html>).

SAMPLING TECHNIQUES

EPIGEAL INVERTEBRATES

Pitfall trap

Pitfall traps provide a good technique for collecting data on the presence and absence and/or relative abundance of a wide range of surface active invertebrates. Animals fall into a container, set flush with the soil surface. With careful sorting and appropriate taxonomic evaluation, data can be collected on fauna ranging from microscopic mites to large scorpions and beetles. Pitfall traps are widely used, but do have limitations which must be taken into account when interpreting results (Adis, 1979).

Pitfall trapping is suitable for fieldwork in isolated areas, as a variety of containers can be adapted for use as traps (see below), provided the same size and type of container is used throughout a given study. Ideally, a standard pitfall trap should be used (Adis, 1979), but none has yet been agreed. The container should be placed in a sleeve, set permanently in the soil (see method sheet). This will minimize disturbance when emptying and resetting traps. At least 30 traps per treatment area (e.g. 30 in the sprayed area and 30 in the unsprayed area) will be necessary and their arrangement will depend on where they are used and the type of spray operation under study. However, they are generally best placed in a line or grid, with not less than 2 m between traps. The same preservative *must* be used throughout a given study; formalin is probably most readily available, but picric acid solution is the favoured choice.

Limitations Many factors influence the catch, e.g. climatic conditions, vegetation, ground-surface irregularities, trap diameter, shape and form of the trap, killing or preserving agents, whether the trap is covered or not, species selectivity, number and arrangement of traps, material from which the trap is made, time after traps are set, trampling around traps, etc., and great care is required in standardization of these factors in a given study. Pitfall trap catches actually measure 'activity abundance' and provide no absolute measure of population.

Processing Trap contents should be strained from the formalin or other preservative and poured into a petri dish (or similar). Invertebrates should be sorted from debris using forceps, a paintbrush, pipettes, etc. Use a magnifying glass or binocular microscope to sort smaller invertebrates, if available.

Resulting data Numbers of individuals can be sorted into species or morphospecies and counted to give data on relative abundance and faunal composition and/or diversity. Catches can be weighed³ or measured (Rogers *et al.*, 1977) to calculate biomass.

Fauna sampled Most epigeal invertebrates, but certain carabid beetles are particularly susceptible, whilst other species avoid these traps or easily escape. They are also not suitable for trapping certain types of spiders.

Sampling period Traps may be emptied daily, weekly or monthly.

Equipment Traps can easily be made using locally available materials, e.g. jam jars, yoghurt pots, plastic cups or plastic milk bottles. Where possible, traps should be glass or plastic, 6 cm diameter and not less than 12 cm deep. Traps, marker flags and trap covers should all be made in advance.

Staff required 1 (preferably 2). More staff may be required to sort catches, depending on trap numbers; 3–5 staff ideal.

Food baits

Food baits can be used to collect data on relative abundance or activity of a number of invertebrate groups. Suitable foodstuffs or other attractants are left out in appropriate places and monitored regularly to count and identify the fauna attracted (Southwood, 1966). Depending on the objectives of the study, a large range of data can be collected, e.g. time taken to find baits, rate of bait removal, numbers of individuals attending baits, number of species at baits, etc. Baits and traps containing them tend to be highly species-specific and details of a wide variety are given in Southwood (1966). Here, just two examples are given, for termites and for ants.

It is notoriously difficult to estimate populations of ants and termites, but some measure of their foraging activity (and thus colony health) can be made using food baits.

For termites, a variety of wooden or card baits may be used, depending on the termite species of interest and the duration of the trial (French and Robinson, 1981). The baits should be placed on the ground in a grid of at least 10 baits per site. There may be 5–10 sites per treatment area.

Limitations Baits provide a relative measure of activity abundance *only* and are influenced by many other factors, such as temperature, time of day, season, rainfall, soil type, vegetation, presence of other food sources, proximity to termite mounds or nests, etc.

Processing Baits should be examined *in situ*, lifted and replaced as originally set. Any termites feeding on baits should be counted and collected for identification.

Resulting data Several criteria can be noted: any termite runs coming into contact with baits can be taken as evidence of termite activity in the vicinity; attack on baits (i.e. evidence of feeding on the bait); damage to bait (e.g. proportion of area of bait eaten). Baits should be taken back to the laboratory and weighed at the end of the sampling period. Loss of weight can then be used as quantitative data.

Fauna sampled Termites.

Sampling period Baits should be left for several weeks before monitoring and then visited weekly (wet season) or monthly (dry season).

Equipment Locally available materials can be used as baits, e.g. toilet rolls, cardboard or soft-wood boards or pegs. These should be cut to size and weighed individually before they are needed. Marker flags should also be made up in advance.

Staff required 1 (preferably 2).

For ants, a variety of food baits can be used either singly or together, depending on the species of interest (Murphy and Croft, 1990; Tingle, 1993). Peanut butter, fish paste, breakfast cereal, grain, honey, and/or moribund insects can all be used. As with termite baits, grids of at least 10 baits per site should be used, preferably with five or more replicates or pseudoreplicates per treatment area. Baits should be covered with coarse mesh wire to prevent squirrels, birds and other animals from robbing them. If possible, records of numbers of ant nests and their distance from baits would aid interpretation of results.

³Dry weight is usually required for comparison with other biomass data, thus animals should be oven-dried to constant weight

Limitations The numbers and species of ant attracted will depend on the baits used, time of day, temperature, rainfall, season, vegetation, availability of other food and proximity of nests. The results provide an estimate of foraging activity and abundance of some ant species only.

Processing Count ants at baits and estimate quantity of remaining bait *in situ*.

Resulting data The number of species on baits, number of individuals of each species, percentage of bait remaining, time taken to find bait dishes.

Fauna sampled Ants.

Sampling period Baits are best visited on a regular basis, beginning 1 h after setting and continuing at regular intervals (e.g. 3 h, 6 h, 9 h, 24 h) for at least 1 day.

Equipment A marker flag and wire mesh covers for bait dishes should be made up in advance. Baits can be made up from locally available sources. Any dish may be used (but all treatment area dishes *must* be the same). Take transparent polythene and clothes pegs to the field to cover traps if raining.

Staff required 1 (2 preferable).

Other methods

Quadrats (Critchley *et al.*, 1980); Cryptozoa boards (Sutton, 1972); food baiting for flies (Stubbs and Chandler, 1978), cockroaches, crickets and beetles (Southwood, 1966); direct counts (Ausden, 1996). See also tethered litterbags below. See also termite colony health assessment below.

VEGETATION-DWELLERS

Sweep netting

Sweep netting requires little equipment and always catches a wide range of vegetation-dwelling and visiting fauna. Samples are taken along fixed transects and should be carried out at the same time of day in a given study. Night sweeping is beneficial for trapping some groups, e.g. grasshoppers. The position of the transect should be selected randomly or using stratification (depending on the habitat). During sampling the operator walks at a constant, steady speed, repeatedly sweeping the net from side to side (to cover an area of ± 1 m on either side) over a fixed distance, e.g. 50 m. This distance can be varied, depending on the vegetation and the invertebrate species of interest. A minimum of 10 transects per treatment area should be sampled.

Sweep netting can also be used on bushes and trees. In this case, either the time spent sweeping or number of sweeps made should be standardized. Up to 3 min is an appropriate length of time to sweep per sample, or 70–100 sweeps.

Limitations The fauna caught in sweep nets is influenced by vegetation type, height of sweep, vigour of sweep, number of sweeps, speed of walk, temperature, rainfall, wind speed, light intensity, time of day, and season. All these must be standardized within a given study. This method produces data on relative abundance only.

Processing Anaesthetize or kill fauna and sort from debris on a white tray, count and identify. Weigh if biomass estimates required (preferably oven-dried).

Resulting data Numbers of invertebrates, biomass and species composition.

Fauna sampled A wide range, particularly Araneae, Orthoptera, Mantodea, Hemiptera, Lepidoptera (particularly larvae), Diptera, Hymenoptera and certain Coleoptera.

Sampling period Preferably weekly, at set time of day (e.g. 09.00–12.00 h).

Equipment Sweep nets can be bought or made from locally available materials. Marker flags should be made up in advance. Pyrethroid insecticide spray may be used to knock-down invertebrates.

Staff required 1. Additional staff will be needed to sort, identify and count the catch; 3–5 staff ideal.

Other methods

Suction samplers, e.g. Dvac (Southwood, 1966) and other suction devices (Stewart and Wright, 1995); vegetation beating (Southwood, 1966; Ausden, 1996); photoeclector (Törmälä, 1982); and sugaring for moths (Ausden, 1996). See also transect counts below.

FLYING INSECTS

Malaise trap

Malaise traps are useful for making general collections of flying insects. Hymenoptera and Diptera are particularly vulnerable to this technique, Hemiptera, Lepidoptera, Orthoptera and Coleoptera to a lesser extent. Standardization of Malaise trap catches is extremely difficult (Grant, 1989) and initial setting of the trap is a question of trial and error to attain highest possible numbers of insects in a given time period. Traps are best set close to trees or bushes if possible, with the tallest end pointing towards the sun. Care should be taken to make sure that the surfaces are as taut as possible and that the material, particularly the middle wall, reaches the ground. The collection bottle should be angled to allow easy access for insects from the top of the trap into the jar. The jar should be charged with 70% alcohol. Traps may be left for 1 day or up to 1 month before emptying, though if left for longer periods it is advisable to check the traps regularly to ensure collection jars have not dried out, traps have not been damaged or collapsed, spiders have not built webs over the entrance to the collection jar, etc. Several traps will be necessary for each treatment and as many should be used as can be emptied and catches sorted within the time scale of the study.

Limitations Catch is dependent on vegetation type of habitat, temperature, wind direction and speed, light intensity, rainfall, season, and colour and size of the trap. Malaise traps are large and conspicuous and may be damaged or removed by animals or people. Sample processing is very time consuming. They measure activity abundance.

Processing Collection bottles containing trapped fauna should be removed from the trap and replaced with fresh ones. Back at the laboratory, fauna should be strained from the alcohol, transferred to a Petri dish (or similar) and sorted, counted and identified as appropriate.

Resulting data Species composition, relative abundance and biomass.

Fauna sampled Mainly flies (Diptera), Lepidoptera and Hymenoptera, with some Coleoptera, some Orthoptera and some Hemiptera.

Sampling period Empty traps every 5–10 days. The period between trap emptying should be kept constant to allow comparable catches. Traps should be emptied at the same time of day on each occasion. Avoid use during heavy rains in the wet season.

Equipment Traps can be made from locally available material (cotton mosquito netting or 'Nitex') of an appropriate colour. The roof of the trap should be of white material. The collection unit can usually also be constructed from locally available plastic jars (see method sheet). Marker flags should be made in advance. Alcohol (or other preservative) should be available locally. A GPS is useful to mark (and hence map) the position of individual traps.

Staff required 2. More staff may be necessary to sort and identify the catch; 3–5 staff ideal.

Water trap

Water traps consist of a coloured dish containing water, to which many flying insects are attracted. The dish is usually placed on the ground or, where vegetation is high, may be placed on a stand. Insects enter the trap and drown. Different coloured traps attract different groups of insects (e.g. yellow for dipteran flies, aphids, some beetles and chalcidoid wasps). Red, blue and green traps are less effective, particularly for Diptera. At least 10 traps should be used for each treatment area, but the more that can be processed then the more reliable will be the result. The same size, colour and type of trap should be used for the different treatment areas and they should be set at a standard height above the vegetation; highest numbers will be caught if the trap is set just

above the level of the surrounding vegetation. They should be filled to 1 cm from the top with water and a few drops of detergent should be added to reduce surface tension. Traps should be checked regularly and frequently.

Limitations Catch is dependent on vegetation type, temperature, wind speed, light intensity, rainfall, season, colour of trap and height of the trap above vegetation. They measure activity abundance.

Processing Trapped fauna can be removed with a nylon mesh sieve on a handle, or by pouring the contents through a small piece of muslin or nylon mesh (Noyes, 1982). They may then be transferred to a white tray (or similar) for sorting, counting and identification.

Resulting data Species composition, relative abundance and biomass.

Fauna sampled Mainly aphids (Homoptera: Aphididae), flies (Diptera), Hymenoptera, some Coleoptera, and some Lepidoptera.

Sampling period Empty traps daily. Avoid use during heavy rains in the wet season.

Equipment Traps can be adapted from locally available bowls or dishes, painted the appropriate colour. Marker flags should be made in advance. Detergent should be available locally.

Staff required 1. More staff may be needed to sort, identify and count the catch; 2–3 staff ideal.

Transect counts

A set route is walked and all fauna of interest are identified and counted within a set distance (or area) to either side and in front of the recorder. Transect counts can be used for Lepidoptera, Odonata, Orthoptera, Araneae (spider web counts) and less commonly Hymenoptera, Diptera and Coleoptera. Transects may be quite long depending on fauna (up to 2 km) and are divided into sections representing different microhabitats. Data for each sub-section should be recorded separately. Transects should be walked regularly, at least once a week. The procedure varies depending on the invertebrates of interest, and the following is suitable for butterflies only (Pollard, 1977).

The transect should be walked at a steady, slow pace and all insects seen within an imaginary ‘box’ extending 5 m in front, 5 m high and 2.5 m to either side should be recorded. Any insects which cannot be positively identified on sight, should be caught and identified. If they cannot be caught, the record should be ignored. Temperature, wind speed and sunshine should be recorded at the beginning and end of the transect and more frequently if possible. The length of the transect (and any sub-sections) should also be noted.

Limitations This method is subject to many variables and provides only a relative estimate of abundance. Transects must be carefully matched in terms of habitat, vegetation type, microclimate, length, etc. The transects must always be walked at the same time of day (see ‘Sampling Period’).

Processing A prior knowledge of the fauna to be sampled is necessary, so that identification can be made speedily and accurately *in situ*.

Resulting data Counts of numbers of invertebrate of interest seen.

Fauna sampled Butterflies (similar but slightly different methods for grasshoppers, dragonflies, etc.).

Sampling period Walk transects at least once a week. Wherever possible, transects in sprayed and unsprayed areas should be walked on the same morning or afternoon and in similar climatic conditions. The time of day at which transects are walked should be kept as consistent as possible. Pre-spray monitoring should be for at least 4 weeks and post-spray for at least the first, third and sixth months (more frequently where possible).

Equipment Record sheets should be made up or photocopied in advance (see example after method sheet). A butterfly net can be made from locally available materials or purchased. Sample vials and a thermometer will have to be purchased. Marker flags should be made up in advance.

Staff required 1 or 2 (but do not change the number of people used once sampling has begun). If 2 people, one calls out sitings while the other records data and must not contribute to sitings.

Honeybee activity at hives

Impacts of pesticides on honeybees can best be measured by quantification of activity and/or swarm size and comb production. Artificial hives may be constructed or natural hives monitored. The numbers of bees entering and

leaving hives should be recorded during a set period (e.g. 3 min). Such worker bee activity should be monitored each hour over a standardized period (e.g. 09.00–12.00 h), over a number of days before and after spraying. Bee deaths can be monitored by collecting bees falling from hive entrances for several days before and after spraying. Hive desertion should also be monitored. No method sheet is provided for this technique and an apiculturist or other bee specialist are best consulted. The swarm can be weighed after smoking and comb production estimated by direct observation (Douthwaite *et al.*, 1988). As many hives should be monitored as possible, but a minimum of 10 per treatment area is required.

Other methods

Suction traps, lure traps (Southwood, 1966); light traps (Butler and Kondo, 1991); sugaring for moths (Ausden, 1996); window traps (Chapman and Kinghorn, 1955); wind-orientated traps (Vogt *et al.*, 1985); transect methods for grasshoppers (FAO, 1994); and dragonflies (Brooks, 1993).

ARBOREAL INVERTEBRATES

Funnel or sheet trap

Funnels or sheets can be laid out on the woodland floor to catch invertebrates which fall from the canopy, 'knocked-down' by aerially applied insecticide (Grant, 1989). The traps should be reasonably large ($\pm 2 \text{ m} \times 2 \text{ m}$). Smaller sheets or funnels can be adapted to measure knock-down around sprayed tree trunks (Lambert *et al.*, 1991). Sample trees should be matched by species, girth and surrounding woodland type. This gives a good guide to fauna suffering acute effects of insecticide applications. If paired sheets, one of which is impregnated with insecticide, are used, estimates of recovery of fauna suffering knock-down can be made. Standardization is achieved by recording fauna in collectors at set times, preferably at first light to avoid predation of catch.

Limitations Catch is dependent on habitat, temperature, rainfall, wind speed, predation from unattended traps, and recovery rate from knock-down. This is **not** a quantitative method. Sheets are prone to inversion by wind and rocks or other heavy objects should be used to anchor the sheet down.

Processing Remove fauna from sheet or funnel *in situ*, using forceps, pooter, paintbrush, etc.

Resulting data Species composition of susceptible fauna.

Fauna sampled A wide variety of invertebrates, depending on habitat sampled.

Sampling period Twice daily (or more frequently, if possible), starting as soon after spraying as possible. Pre-spray sampling at set time daily.

Equipment Traps can be easily made from locally available materials, e.g. cotton, linen or nylon bed sheets. Support poles can be fashioned on site (provided there are trees nearby).

Staff required 2 (minimum).

Trunk trap

These traps are useful in assessing faunal composition and relative abundance of invertebrates which inhabit or regularly move up and down tree trunks. They work best on trunks which are relatively smooth, but can be adapted to any surface. Design for a simple trap is given by Moeed and Meads (1983), which can be adapted for use with different materials readily available in developing countries, if necessary. Sample trees should be matched by species, girth and surrounding woodland type. Traps should be set at a standard height above the ground (e.g. 1 m). Collecting vessels should be charged with 70% alcohol or formalin and may be left for up to a week before emptying. Moeed and Meads' trap has a removable collecting tray, but if such traps are not available a simple hand pump can be adapted to empty the trap (see method sheet).

Limitations Dependent on tree species, girth, bark type, season, woodland type. Gives relative abundance only. Dependent on activity.

Processing Extract fauna from trap using forceps and vacuum pump. Sort, count and identify fauna in white tray or Petri dishes.

Resulting data Species composition, numbers and biomass.

Fauna sampled A variety of invertebrates including Acari, Araneae, Chelonethi, Collembola, Thysanura, Psocoptera, Thysanoptera, Coleoptera, Orthoptera, Hemiptera, Hymenoptera, Mantodea and Blattodea.

Sampling period Empty traps weekly.

Equipment Marker flags or paint, traps can be made from locally available plastic boxes and heavy gauge plastic sheets. Sample pots have to be purchased. A suction pump will also have to be adapted using locally available materials, but will require the purchase of a basic pump of some type.

Staff required 2. Additional staff may be needed to sort, identify and count catch; 3 or more staff ideal.

Direct collection

Direct removal of invertebrates using an aspirator (pooter) or forceps can also be used in sampling trunk-dwellers (Ausden, 1996). Collection should be carried out for a set period of time (e.g. 5–20 min, depending on the fauna of interest and the tree and habitat type).

Other methods

Beating (Ausden, 1996); adapted Dvac (Lambert *et al.*, 1991); canopy sampling (Basset *et al.*, 1997). **Note:** Canopy fogging techniques are **not** recommended for pesticide impact studies.

SOIL INVERTEBRATES

Soil cores

Absolute population measures can be made by extracting invertebrates from soil cores. To make comparisons of numbers, diversity or biomass of fauna from different areas, soil type should be the same as should the volume of soil taken and the depth to which the core is taken. Cores can be taken using a spade, trowel, auger, steel tube or other digging implement. In general, pesticides will not normally penetrate far down into the soil horizon, so it is rarely useful to take cores down to deeper than 10 cm and usually 5 cm will be adequate to assess any impact of a pesticide on soil fauna. Small cores (up to 10 cm diameter) can be subjected to Tulgren funnel extraction or flotation extraction, whilst larger cores can be hand-sorted to extract macro-invertebrates. Flotation and sieving can yield information on virtually all fauna present in a core (including immobile stages, e.g. eggs and pupae). Tulgrens provide a more limited yield, requiring movement by fauna and generally do not provide useful data on nematodes, annelids and many of the more delicate Acarina and insects.

Limitations Fauna sampled and numbers obtained are dependent on soil type, season, time of day, weather conditions, volume of core, depth to which core is taken, and surface vegetation.

Processing Cores may either be broken up in a white tray and sorted by hand (to extract macro-fauna) or fauna extracted from cores using Tulgren funnels (see method sheet) or flotation techniques (see method sheet). Sort, count and identify fauna in Petri dishes. Mount micro-invertebrates on microscope slides for examination and identification.

Resulting data Species composition, numbers of individual species or taxa and biomass.

Fauna sampled A variety of invertebrates including Annelida, Nematoda, Myriapoda (Diplopoda, Chilopoda, Pauropoda and Symphyla), Isopoda, (Chelonethi), Acari, Collembola, Thysanura, Araneae, Isoptera, Psocoptera, Thysanoptera, Coleoptera, Orthoptera, Hemiptera, Hymenoptera and Blattodea.

Sampling period Take cores weekly (for 3–4 weeks pre-spray) and weekly for the first month post-spray, then monthly for the following 3–6 months. Where Tulgren extraction is used, funnels should be left in full sun for at least 5 days.

Equipment A soil corer can be made from locally available metal tubing. Alternatively, a spade or trowel can be used to take a fixed volume of soil. All the equipment necessary for flotation extraction of invertebrates can be adapted from locally available materials. Tulgren funnels can be made using metal or enamelled funnels (providing these can be bought locally), but the size *must* be standardized. A rack to hold the Tulgrens can be made from

wood or scrap metal and where no laboratory or electricity is available, the rack of Tulgrens can be left in full sunshine. In the dry season in the tropics, the high temperature and low humidity will generally allow reasonable extraction of invertebrates.

Staff required 1 (preferably 2). Additional staff will be needed to sort, identify and count the catch; 3–5 staff ideal.

Litter bags

Leaf litter bags can be used to sample soil invertebrates (particularly micro-fauna), but provide a relative measure of abundance only. Bags of different mesh size can be used to allow access to, or exclude a particular size range of invertebrates. Mesh sizes of around 4 mm will generally allow access to any soil-dwelling invertebrates; mesh of around 600 μm will allow access to nematodes, Collembola and mites but exclude macro-invertebrates, whilst mesh sizes below 60 μm will exclude all but the smallest micro-invertebrates. If bags are filled with a known weight and/or area of dry leaf material, then removal and decomposition can be assessed quantitatively as well. Leaf material used must be the same for each bag and each treatment area. If macro-invertebrates are of interest, large numbers of bags are needed in each treatment area, with a minimum of 50 of each mesh size. Bags may be tethered on the soil surface or buried in soil. Any depth can be used (provided it is standard for all treatment areas), but between 10 cm and 15 cm is recommended (maximum 30 cm). Different fauna are likely to occur in different seasons and thus time of burial and retrieval are important. Invertebrate density is likely to be higher during the rainy season, but bags should be left buried or tethered for a minimum of 1 month regardless of season. On retrieval, each bag should be immediately transferred to a separate plastic bag or plastic box. All soil and debris should be knocked from the bags and collected. This material may then be subjected to flotation extraction (Murphy, 1962) (see also method sheet) and sieving to remove and collect invertebrates present.

Limitations The fauna sampled is dependent on soil type, leaf litter presence and depth, season and woodland type. This method gives relative abundance only. It is dependent on the activity of organisms. The fauna extracted will depend on sample processing (which should thus be standardized).

Processing Extract fauna from litter in bags using hand sorting/flotation. Sort, count and identify fauna in a white tray or Petri dishes (mount micro-fauna on glass microscope slides and view under a high power microscope).

Resulting data Species composition, numbers and biomass.

Fauna sampled A variety of invertebrates including Annelida, Nematoda, Myriapoda, Isopoda, Cheloni, Acari, Collembola, Thysanura, Araneae, Isoptera, Psocoptera, Thysanoptera, Mantodea, Blattodea, Orthoptera, Hemiptera, Coleoptera and Hymenoptera.

Sampling period Length of time before collection depends on whether sampling invertebrates is combined with observing litter decomposition. If so, see chapter 7 on soil processes for timings. If only used for invertebrate samples then: tethered bags: wet season – leave in place for a minimum of 4 weeks pre-spray; replace bags at time of spraying and leave in place for a minimum of 4 weeks (maximum 2 months); dry season – leave in place for a minimum of 4 weeks pre-spray; replace bags at spray time and leave in place for a minimum of 4 weeks, maximum 3 months. Buried bags: wet season – leave in place for a minimum of 4 weeks pre-spray; replace bags at time of spraying and leave in place for a minimum of 4 weeks (maximum 3 months); dry season – leave in place for a minimum of 4 weeks pre-spray (maximum 6 months).

Equipment Litter bags can be made if nylon or plastic mesh material is available locally. Leaf litter can be collected locally, so long as leaf type is kept standard. Maps to mark positions of bags or GPS to note position of bags and markers.

Staff required 1 (preferably 2). Additional staff will be needed to sort, identify and count the catch; 3–5 staff ideal.

Termite colony health assessment

Measuring the relative abundance of social insects like termites and ants is notoriously problematic. However, the only way in which a pesticide can have a significant effect on these insects is if the health of the colony is affected. The death of individual workers is largely irrelevant, unless catastrophically large in extent. The colony health of mound-building termites can be assessed by monitoring the length of time taken for workers to repair any damage to the termitarium. The mound and its structure are crucial to maintaining a healthy colony (through

temperature regulation and protecting the colony from predators or other enemies, and from rain, wind, etc.), and thus any damage to the mound will be a priority for repair by the colony's workers. A healthy colony will rapidly mobilize workers to go to the scene of any damage and instigate repair.

Inflicting deliberate damage on a pre-determined number of termite mounds and recording the length of time taken for the colony to repair the damage is thus a useful tool in assessing the relative colony health. The technique is simple, quick and does not require taxonomic expertise. The larger the number of mounds that can be included, the better (depending on the size of the study area and of the mounds). In general, between 50 and 100 mounds is ideal (but for the larger Macrotermitinae, where mound density will generally be lower, 30 mounds may be adequate). The methodology can be adapted to the time available within the study and/or the persistence of the active ingredient (a.i.) (see method sheet).

Limitations To date, this method has only been tested on mound-building termites. It is dependent on season and species. It gives a relative measure only.

Processing Specimens should be taken from each mound of differing appearance, for identification.

Resulting data Termite species (following identification by termite specialist); time taken to repair damage inflicted on the mound.

Fauna sampled Any mound-building termite species.

Sampling period Either daily for first 10 days, followed by weekly for next 3 months, followed by monthly for next 6 months; or weekly for first 8 weeks, followed by monthly for next 9 months.

Equipment All necessary equipment can be purchased locally or made from local materials.

Staff required 1–2.

Other methods

Monolith sampling (Anderson and Ingram, 1989); formalin drenching for earthworms (Southwood, 1996).

COLLECTING TERRESTRIAL INVERTEBRATES FOR RESIDUE ANALYSIS

Any of the methods described above which result in a dry sample can be used to collect invertebrates for residue analysis or the animals can be collected directly using an aspirator or forceps. Residue analysis is expensive and great care should be taken with sampling to prevent cross-contamination and other errors outlined in chapter 6 which will lead to spurious results. Attempts to relate residue levels to population effect is often disappointing because of the variability of residues and it is important to follow methods in chapter 6 meticulously to avoid this. Collecting implements should be **absolutely** clean before sampling begins and different ones used for samples from different treatment areas, or they should be washed in acetone between samples. Fauna should be collected into aluminium canisters or vials and *frozen* or kept in *10% formalin* solution until residue analysis can be undertaken. Vials should have aluminium lids *without* plastic inserts, and should be clearly labelled (see chapter 6). Advice from an experienced pesticide chemist should be sought.

DATA PROCESSING

Most of the data collected using the methods described in this chapter will be in the form of counts and will be estimates of relative abundance, e.g. numbers of ladybird beetle sp. g caught in a sweep net sample, numbers of the spider *Habrocestum risicalli* caught in pitfall trap S4, etc. Processing data of this kind for analysis is covered in several places within the handbook (see chapter 1, Worked Example; chapter 2).

However, several of the methods can also provide data on the species present at a particular site, in a particular trap or sample, i.e. species composition. From this, other data can be compiled on species richness, species diversity and species similarity between traps, samples or sites. Comparisons of these data can be made if the

data are processed in a suitable way. It is often then possible to test differences in species richness or diversity statistically.

Similarity

There are a number of indices, which describe the similarity in species composition between samples or sites. Sørensen's Quotient (QS) is given by the formula:

$$QS = \frac{.2j}{(a + b)} \times 100$$

where j = the number of species common to both samples
 a = the number of species recorded in sample A
 b = the number of species recorded in sample B

Sørensen's Quotient increases as the number of species common to both samples increases and reaches 100% similarity when all species are common to both samples. Sørensen's Quotient is dependent on sample size and thus of limited value.

Mountford's Index overcomes this problem and is given by:

$$e^{aj} + e^{bj} = I = e^{(a + b - j)I}$$

where a , b and j are as above.

I is obtained by interpolating within the table of exponentials, using the following expression as an approximation to I :

$$\frac{2j}{2ab - (a + b)j}$$

From here, it is possible to classify sites based on a hierarchical comparison of their indices of similarity. The sites are first compiled into a coincidence table (see Table 8.2) which has sites as both column and row headings and then the value of the similarity index between each pairing placed in the appropriate box in the table.

These two sites are then grouped together and indices of similarity calculated between this group and each of the remaining sites. A reduced coincidence table is then compiled. The pair with the next highest index of similarity selected and the procedure of combining sites and re-evaluating indices repeated.

The sites are then plotted on a graph of similarity producing a cluster arrangement (see Figure 8.1).

Diversity

There are a number of indices used to measure (or, strictly speaking, summarize) the diversity of fauna found at any given site in any particular habitat. All have drawbacks and none are perfect descriptions of species diversity. One of the most common and widely used is the Shannon-Wiener function (H'). The method of calculating this index is given in chapter 11, page 224.

Table 8.2 Coincidence table giving species similarity for 10 DDT sprayed and 10 unsprayed sites in savanna woodland based on Sørensen's Quotient of similarity applied to pitfall trap catches of invertebrates

	U1	U2	U3	U4	U5	U6	U7	U8	U9	U10	S1	S2	S3	S4	S5	S6	S7	S8	S9	S10
U1																				
U2	50.7																			
U3	45	44.9																		
U4	41.1	39.6	37.3																	
U5	44.2	44.8	50.3	36.9																
U6	39.6	41.3	37.2	37	38.8															
U7	35.1	33.9	32.9	35	33.3	31.9														
U8	40.6	40.2	37.9	52.8	38.9	39.9	34.2													
U9	36.1	41	33.3	37.2	42.1	38.1	33.7	40												
U10	40.5	40.2	38.7	39.4	39.4	52	32.8	41.1	38.4											
S1	38.9	40.7	40.2	43.1	39.3	38.3	32.5	38.4	37.8	40										
S2	39.6	40	38.8	41.9	37.9	37.9	33	40.1	39.2	37.8	46.2									
S3	31.9	32.7	29.8	34.2	32	31.9	32.8	33.2	26.4	30.5	33.2	31.6								
S4	30.5	33.1	33.7	36.2	33.8	34.3	28.2	31.8	34.7	32.6	35.2	33.2	42.6							
S5	34.6	36	32.2	35.3	36.8	30.7	41.7	33.3	36.3	35.8	31	34	36.2	34.2						
S6	31.1	35.5	31	31.2	34.2	32.2	42.1	34.8	32.9	36.7	35.9	31.6	35.8	35.9	44.9					
S7	33.7	36.1	35.4	33.5	29.7	32.4	23.2	36.9	30.9	33	33.9	32.7	41.5	44.6	33.9	34.1				
S8	32.3	30.6	32.1	33.9	31.7	35.1	22	32.8	35.7	32.1	36.5	34.9	40.8	43.9	36.6	35.7	56.5			
S9	31.3	31.7	36.6	34.4	36	32.5	27.7	36.4	37	33.4	31.4	32	41.9	44.2	34.2	33.9	47.9	48.6		
S10	34.5	33.6	30.8	36.7	35.4	35.6	41.3	34.1	31.9	35.1	35	31.5	36.3	35.4	49	44.2	35.8	36.4	37	

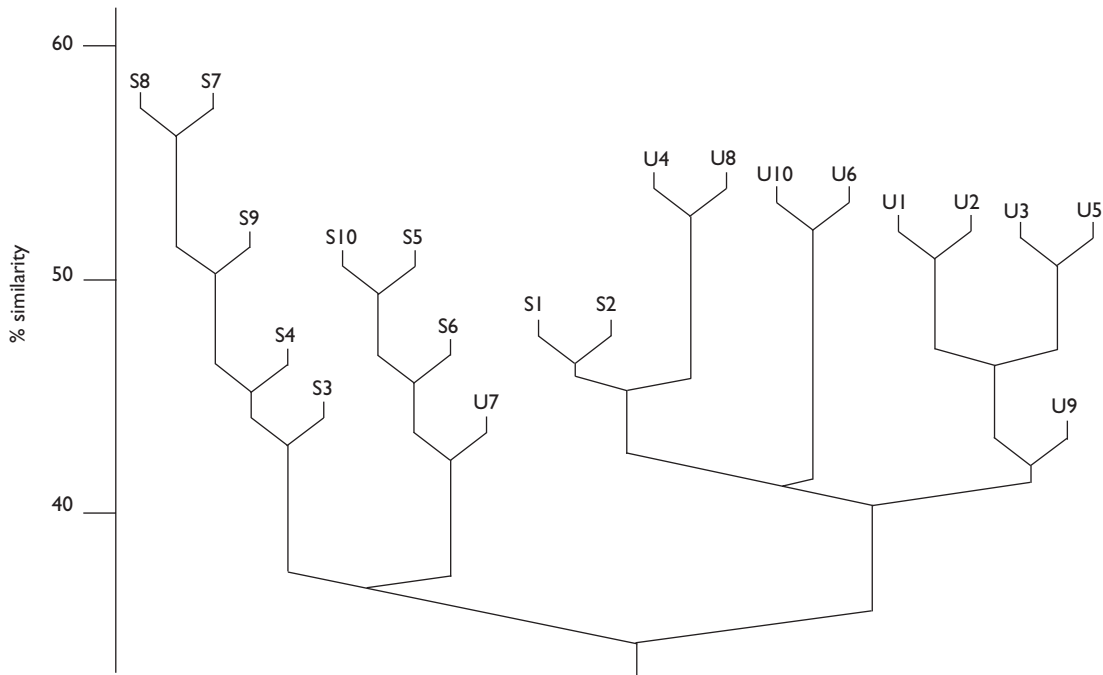

Figure 8.1: Dendrogram of species similarity of invertebrates caught in pitfall traps in two different treatment areas in Zimbabwe. Hierarchical classification of sample sites according to Sørensen's Quotient of similarity. U1–U10 unsprayed; S1– S10 sprayed with DDT.

MOUNTING TECHNIQUES FOR STORAGE AND IDENTIFICATION OF INVERTEBRATES

The majority of invertebrates caught using the methods outlined above may be stored in 70% alcohol in stoppered, labelled, glass or plastic vials. However, some groups need mounting dry to display adequately the taxonomic features needed for their identification.

Butterflies and moths, for example, should be pinned on setting boards, with the wings spread for display. Larger beetles (>1 cm) should be pinned through the right elytron, with legs and antennae displayed, where possible. Smaller beetles should be mounted on card points, using Coleoptera gum, again displaying legs and antennae if possible. Orthoptera should be pinned, with legs and one or both pairs of wings displayed. Larger Diptera and Hymenoptera should be pinned through the thorax with wings on one or both sides of the body displayed (Figure 8.2). In some cases, side pinning is necessary, for Diptera in particular (see Figure 8.3). Small Diptera and Hymenoptera (e.g. Chalcidoidea) may be micro-pinned (see Figure 8.4), or gummed on to card points (Figure 8.5) or cards. The smallest Diptera and Hymenoptera may need to be mounted on microscope slides (Figure 8.6). Mites and Collembola should generally be mounted in lactophenol on microscope slides.

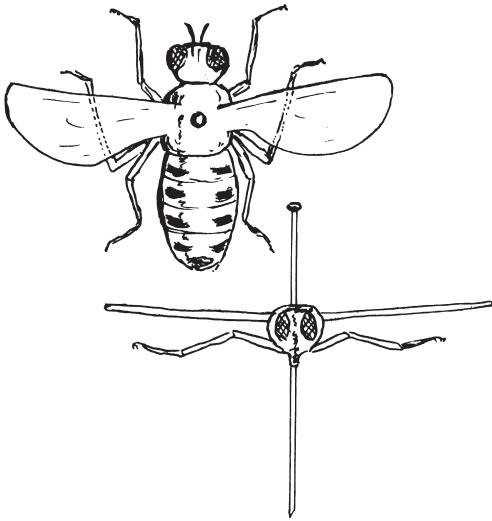

Figure 8.2: Setting of large Lepidoptera, Diptera and Hymenoptera, etc.

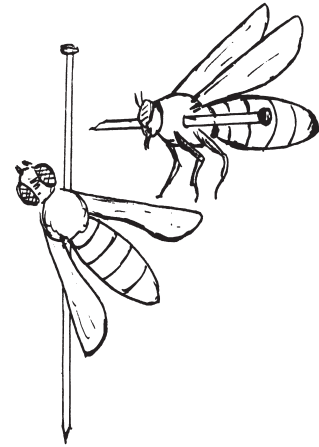

Figure 8.3: Side pinning

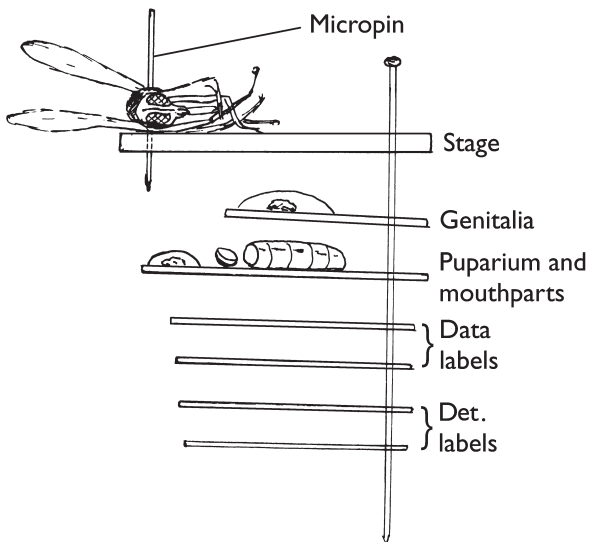

Figure 8.4: Staging for microlepidoptera, small Diptera, Coleoptera and Hymenoptera

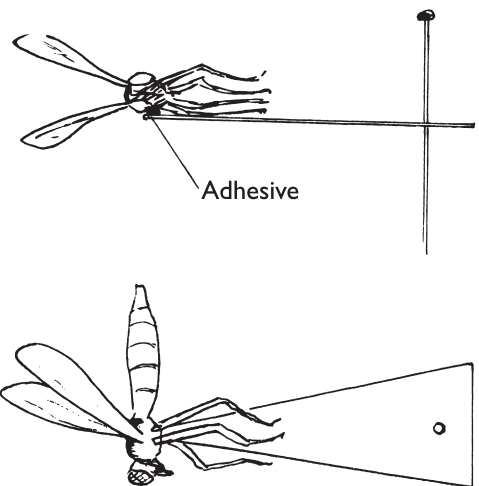

Figure 8.5: Card pointing for small Coleoptera, Diptera, etc.

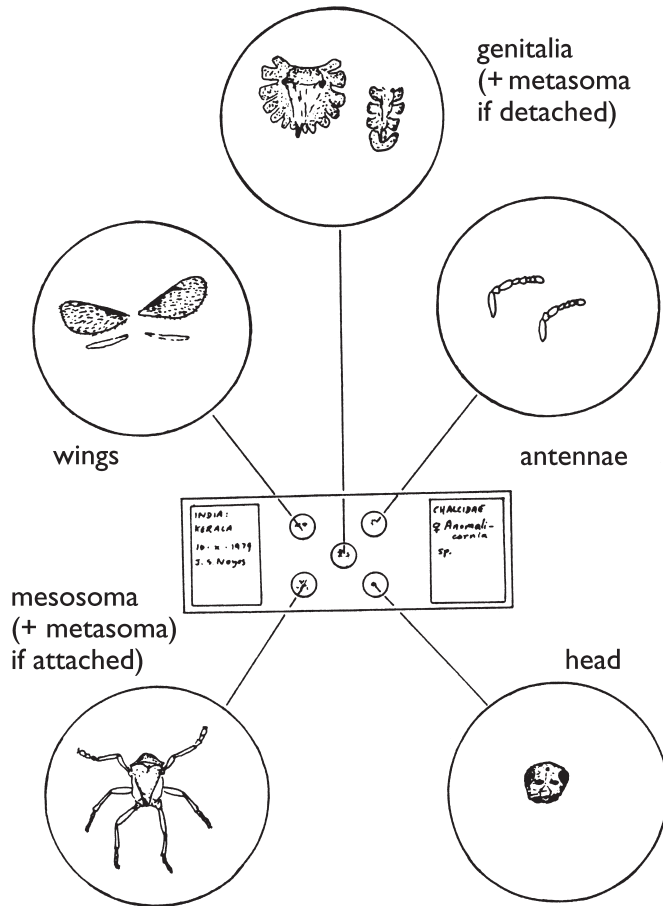

Figure 8.6: Standard arrangement for mounted body parts of small chalcid wasps on a microscope slide

(Reproduced from *The Hymenopterist's Handbook. The Amateur Entomologist 7* (1986) Betts, C. (ed.), published by The Amateur Entomologist's Society, Hanworth, UK.)

LABELLING OF COLLECTED INVERTEBRATE SPECIMENS

Adequate labelling of collected invertebrate material is extremely important. Any invertebrates collected should be placed immediately in a container with a label stating date of capture (or date of emergence, if bred), location (preferably with latitude and longitude), altitude, habitat, method of capture, host or host plant (if bred) and the name of the collector.

An additional label should be prepared with the name of the invertebrate written on it, along with the name of the person who identified it and the date. Both labels should be written in pencil or in indelible ink.

Ampoza, Tulear District, Madagascar

S32° 43' E44° 56' 623 m

Sweep net in *Heteropogon contortus* dominated grassland
C.C.D. Tingle 21 i 1999

Example of a data label

Pelopidas methias

Lepidoptera: Hesperidae

Det. D. Lees 14 viii 1999

Example of a determination label

USEFUL CONTACTS

The Curator, Invertebrate Collections, Natural History Museum, Cromwell Road, London SW7 5BD, UK.

Watkins and Docaster, Entomological equipment and supplies, P O Box 5, Cranbrook, Kent TN18 5EZ, UK.

REFERENCES

- ADIS, J. (1979) Problems of interpreting arthropod sampling with pitfall traps. *Zoologische Anzeiger, Jena*, **202**(3/4): 177–184.
- ANDERSON, J.M. and INGRAM, J.S.I. (eds) (1989) *Tropical Soil Biology and Fertility: A Handbook of Methods*. Wallingford, UK: CAB International.
- AUSDEN, M. (1996) Invertebrates. pp. 139–177. In: *Ecological Census Techniques. A Handbook*. Sutherland, W. J. (ed.). Cambridge: Cambridge University Press.
- BASSET, Y., SPRINGATE, N.D., ABERLENC, H.P. and DELVARE, G. (1997) A review of methods for sampling arthropods in tree canopies. In: *Canopy Arthropods*. Stork, N.E., Adis, J. and Didham, R.K. (eds). London: Chapman and Hall.
- BROOKS, S. J. (1993) Review of a method to monitor adult dragonfly populations. *Journal of the British Dragonfly Society*, **9**(1): 1–4.
- BUTLER, L. and KONDO, V. (1991) Macrolepidopterous moths collected by blacklight trap at Cooper's Rock State Forest, West Virginia: A baseline study. *Bulletin*, No. 705. West Virginia University, Agricultural and Forestry Experiment Station.
- CHAPMAN, J.A. and KINGHORN, J. M. (1955) Window flight trap for insects. *Canadian Entomologist*, **87**: 46–47.
- CRITCHLEY, B.R., COOK, A.G., CRITCHLEY, U., PERFECT, T.J. and RUSSELL-SMITH, A. (1980) The effects of crop protection with DDT on some elements of the subterranean and surface active arthropod fauna of a cultivated forest soil in the humid tropics. *Pedobiology*, **20**: 31–38.
- DOUTHWAITE, R. J., MAHMOUD, D.A. and ABDISALAM, S.T. (1988) Effects of drift sprays of endosulfan applied for tsetse fly control on honeybees (*Apis mellifera* L.) in Somalia. *Journal of Agricultural Research*, **27** (1): 40–48.
- EBERHARDT, L.L. and THOMAS, J.M. (1991) Designing environmental field studies. *Ecological Monographs*, **61** (1): 53–73.
- FAO (1994) *The Desert Locust Guidelines II. Survey*. D1/T3375/E/1/4.94/500. Rome: Food and Agriculture Organization of the United Nations.
- FRENCH, J.R.J. and ROBINSON, P.J. (1981) Baits for aggregating large numbers of subterranean termites. *Journal of the Australian Entomological Society*, **20**: 75–76.
- GRANT, I.F. (1989) Monitoring insecticide side-effects in large-scale treatment programmes: tsetse spraying in Africa. pp 43–69. In: *Pesticides and Non-target Invertebrates*. Jepson, P. C. (ed.). Andover, UK: Intercept.

- LAMBERT, M.R.K., GRANT, I.F., SMITH, C.L., TINGLE, C.C.D. and DOUTHWAITE, R.J. (1991) Effects of deltamethrin ground-spraying on non-target wildlife. Environmental impact assessment of ground-spraying operations against Tsetse flies in Zimbabwe. *Technical Report*, No. 1. Chatham, UK: Natural Resources Institute.
- MOEED, A. and MEADS, M.J. (1983) Invertebrate fauna of 4 tree species in the Orongorongo Valley, New Zealand, as revealed by trunk traps. *New Zealand Journal of Ecology*, **6**: 39–53.
- MURPHY, P.W. (ed.) (1962) *Progress in Soil Zoology*. London: Butterworths.
- MURPHY, C. F. and CROFT, B.A. (1990) Forest ant composition and foraging following aerial spraying of carbaryl to suppress Western Spruce Budworm. *Canadian Entomologist*, **122**: 595–606.
- NOYES, J.S. (1982) Collecting and preserving chalcid wasps (Hymenoptera: Chalcidoidea). *Journal of Natural History*, **16**: 315–334.
- POLLARD, E. (1977) A method for assessing changes in the abundance of butterflies. *Biological Conservation*, **12**: 115–134.
- ROGERS, L.E., BUSCHBOM, R.L. and WATSON, C.R. (1977) Length-weight relationships of shrub-steppe invertebrates. *Annals of the Entomological Society of America*, **70**: 51–53.
- SOUTHERTON, N.W., JEPSON, P.C. and PULLEN, A.J. (1988) Criteria for the design, execution and analysis of terrestrial non-target invertebrate field tests. pp. 183–190. In: *Field Methods for the Study of Environmental Effects of Pesticides*. Greaves, M. P., Smith, B. D. and Greig-Smith, P.W. (eds). *BCPC Monograph*, No. 40. Thornton Heath: British Crop Protection Council.
- SOUTHWOOD, T.R.E. (1966) *Ecological Methods*. London: Chapman and Hall.
- STEWART, A.J.A. and WRIGHT, A.F. (1995) A new inexpensive suction apparatus for sampling arthropods in grassland. *Ecological Entomology*, **20**: 98–102.
- STUBBS, A. and CHANDLER, P. (1978) *A Dipterists Handbook*. *The Amateur Entomologist*, Volume 15. Hanworth, UK: The Amateur Entomologist Society.
- SUTTON, S.L. (1972) *Woodlice. Invertebrate Types Series*. Oxford: Pergamon Press.
- TÖRMÄLÄ, T. (1982) Evaluation of five methods of sampling field layer arthropods, particularly the leafhopper community, in grassland. *Annales Entomologici Fennici*, **84**: 1–16.
- TINGLE, C.C.D. (1993) Bait location by ground-foraging ants (Hymenoptera: Formicidae) in mopane woodland selectively sprayed to control tsetse fly (Diptera: Glossinidae) in Zimbabwe. *Bulletin of Entomological Research*, **83** (2): 259–265.
- UNDERWOOD, A.J. (1994) On beyond BACI: Sampling designs that might reliably detect environmental disturbances. *Ecological Applications*, **41** (1): 3–15.
- VOGT, W. G., RUNKO, S. and STARICK, N.T. (1985) A wind orientated fly trap for quantitative sampling of adult *Musca vestustissima* Walker. *Journal of the Australian Entomological Society*, **24**: 223–227.

FURTHER READING

BETTS, C. (ed.) (1986) *The Hymenopterist's Handbook. The Amateur Entomologist*, Volume 7. Hanworth, UK: The Amateur Entomologist Society.

BROWN, R.A., JEPSON, P.C. and SOTHERTON, N.W. (1992) *Aspects of Applied Biology 31, Interpretation of Pesticide Effects on Beneficial Arthropods*. Wellesbourne, UK: Association of Applied Biologists, Horticultural Research Institute.

DOUTHWAITE, R.J. and TINGLE, C.C.D. (eds) (1994) *DDT in the Tropics: The Impact on Wildlife in Zimbabwe of Ground-spraying for Tsetse Fly Control*. Chatham, UK: Natural Resources Institute.

GREAVES, M.P., SMITH, B.D. and GREIG-SMITH, P.W. (eds) (1988) *Field Methods for the Study of Environmental Effects of Pesticides. BCPC Monograph*, No. 40. Thornton Heath: British Crop Protection Council.

JEPSON, P.C. (ed.) (1989) *Pesticides and Non-target Invertebrates*. Andover, UK: Intercept.

WALLWORK, J.A. (1976) *The Distribution and Diversity of Soil Fauna*. London: Academic Press.

AQUATIC INVERTEBRATES

Ian F. Grant¹

Natural Resources Institute, University of Greenwich at Medway, Central Avenue,
Chatham Maritime, Kent ME4 4TB, UK

INTRODUCTION

Aquatic invertebrates are important constituents of aquatic ecosystems, providing exploitable resources for fish and humans (e.g. crabs, shrimps and molluscs) and vital functions such as the decomposition of organic debris and release of plant nutrients. The term aquatic invertebrates includes the floating plankton, swimming nekton, organisms associated with plants (periphyton) and sediments (benthos) and the surface-dwelling neuston.

Aquatic organisms are exposed to the effects of agrochemicals in two ways: through the direct and deliberate application to water, such as the introduction of pesticides to control weeds or the vectors of disease-causing organisms (blackfly, snails, mosquitoes, etc.) and through indirect means, such as spray-drift deposition or run-off from riparian land. Laboratory and field studies show that aquatic invertebrates are at risk from virtually all groups of synthetic and natural insecticides. Their response to exposure *in vivo* is quite variable as it is related to the physical, chemical and biotic characteristics of their environment, but in general, aquatic invertebrates (including surface-dwelling species) are remarkably sensitive to insecticides. Being a high-risk group to low level pesticide exposure, they require a considerable degree of surveillance and monitoring; but their sensitivity can be used to provide a proxy measure of insecticide contamination of lotic (flowing) and lentic (still) waters, as bioindicators.

A selection of simple, low-cost and robust sampling techniques are given in this chapter that will enable biological monitoring of streams, rivers, swamps, lagoons, pools and lakes. The aim of the biological monitoring is to gather information about the relative abundance and composition of invertebrates over space and time from which decisions about potential agrochemical impacts can be deduced. This does not mean studying and collecting unmanageable amounts of data on all species – a frequent temptation – but rather focusing on key species or functions that are at risk. The techniques described below are a few of many but they have broad application and proved their worth in collecting qualitative and quantitative biological data from diverse aquatic habitats.

No single method will suffice to sample the diversity of species colonizing a body of water but it is rare that monitoring all the invertebrates within the biome is necessary for impact studies. Biological surveillance and monitoring should be accompanied by some basic aquatic physico-chemical monitoring, such as water pH, temperature, oxygen concentration and conductivity, as these parameters invariably help to interpret and discriminate change resulting from natural variation and agrochemical impact (see chapter 5).

STUDY DESIGN

The first step is to describe the observed or expected problem. For example, the regional plant protection service is intending to spray an area close to a wetland site to control a specific pest and this operation could lead to contamination of the river or lagoon by spray-drift of aerosol droplets. The planning strategy is to list the possible effects of such an action, form a testable hypothesis (null) and consider what variables might either

¹Contact address: Cybister Environmental Protection, Oak House, South Street, Boughton, Kent ME13 9PE, UK. ian.grant@cybisterplus.com

hinder the testing of the hypothesis or complicate the interpretation of your results. Figure 1.1 in chapter 1 gives an example. Potential impact is determined from a desk study, i.e. from knowledge of a pesticide's formulation, dose, method and scale of application, persistence, ecotoxicology and physico-chemical properties. An hypothesis about the potential impact is made and a sampling strategy is then devised that will collect the organisms indicated to be at risk. Many field studies are invalidated by poor design and insufficient sampling but some of the pitfalls can be avoided by adhering to sound statistical principles and the guidelines provided below. The classic texts of Southwood (1996) and Elliot (1971) provide a range of ecological and statistical methods for hydrobiology.

Table 9.1 lists the aquatic invertebrate groups most susceptible to pesticides. However, as the dose and frequency of pesticide application vary with the type of pest control measure and also because pesticide bioavailability and toxicity to organisms is related to environmental factors, the list is only indicative. Many more groups and species are at risk from pesticides applied directly to water.

Table 9.1 Aquatic invertebrate groups sensitive to pesticide contamination

Pesticide type	Indirect contamination	Direct contamination
Organochlorines	Crustacea, Ephemeroptera and Plecoptera	All zooplankton and benthos at risk
Organophosphates	Surface-dwelling Heteroptera, Coleoptera (particularly dytiscids), Ephemeroptera and Trichoptera	Plus Cladocera, Amphipoda and Diptera
Carbamates	Crustacea, Ephemeroptera, Trichoptera, Odonata and Zygoptera	All zooplankton and benthos at risk
Pyrethroids	Crustacea, Coleoptera, Heteroptera, Trichoptera, Ephemeroptera, Odonata and Zygoptera	Plus all benthos except Mollusca
Insect growth regulators	Macrocrustacea, zooplankton and other arthropods	All arthropods
Phenyl pyrazoles	Micro- and macrocrustacea, bivalve molluscs, filter feeders	All arthropods
Molluscicides	n/a	All benthos at some risk
Herbicides	Phytoplankton and invertebrate population shifts	Risk through oxygen deprivation (decaying plants)

The methods employed to sample these and other organisms are general collection techniques, i.e. they do not target specific groups and invertebrates, This versatility helps in observing wider population and behavioural change.

Flowing water

By way of example, a plant protection department will aerial spray 16 km² of grassland that borders a river. Having concluded from the desk study that the risk of spray-drift to the river is significant and that an impact on benthic invertebrates is very likely, the (null) hypothesis, that the organophosphate will not change the type or abundance of benthic invertebrates, must now be tested. Access permitting, choose the sampling sites so that substrate type, flow rate and rooted or emergent vegetation appear well matched. Look for riffle sections, i.e. shallow areas of turbulent flow over small rocks or gravel, when scouting the river as these are often the most productive areas, home to many 'sensitive' invertebrates (stoneflies, mayflies and crustaceans) and are easy to sample (see also 'Site Selection' in chapter 1, page 15).

Select at least two sites well upstream (e.g. 10 km) of the treated area to act as an unsprayed area (control), two or more in the target area and two well downstream of it, from which information on the extent of any effects may be gathered. There are no hard and fast rules about siting sampling stations and compromises from the ideal are the norm. Avoid sites likely to provide confounding data, such as just downstream of a village, clothes washing sites, abattoirs and industrial effluent, crops areas subject to localized pesticide application, etc. (Figure 9.1).

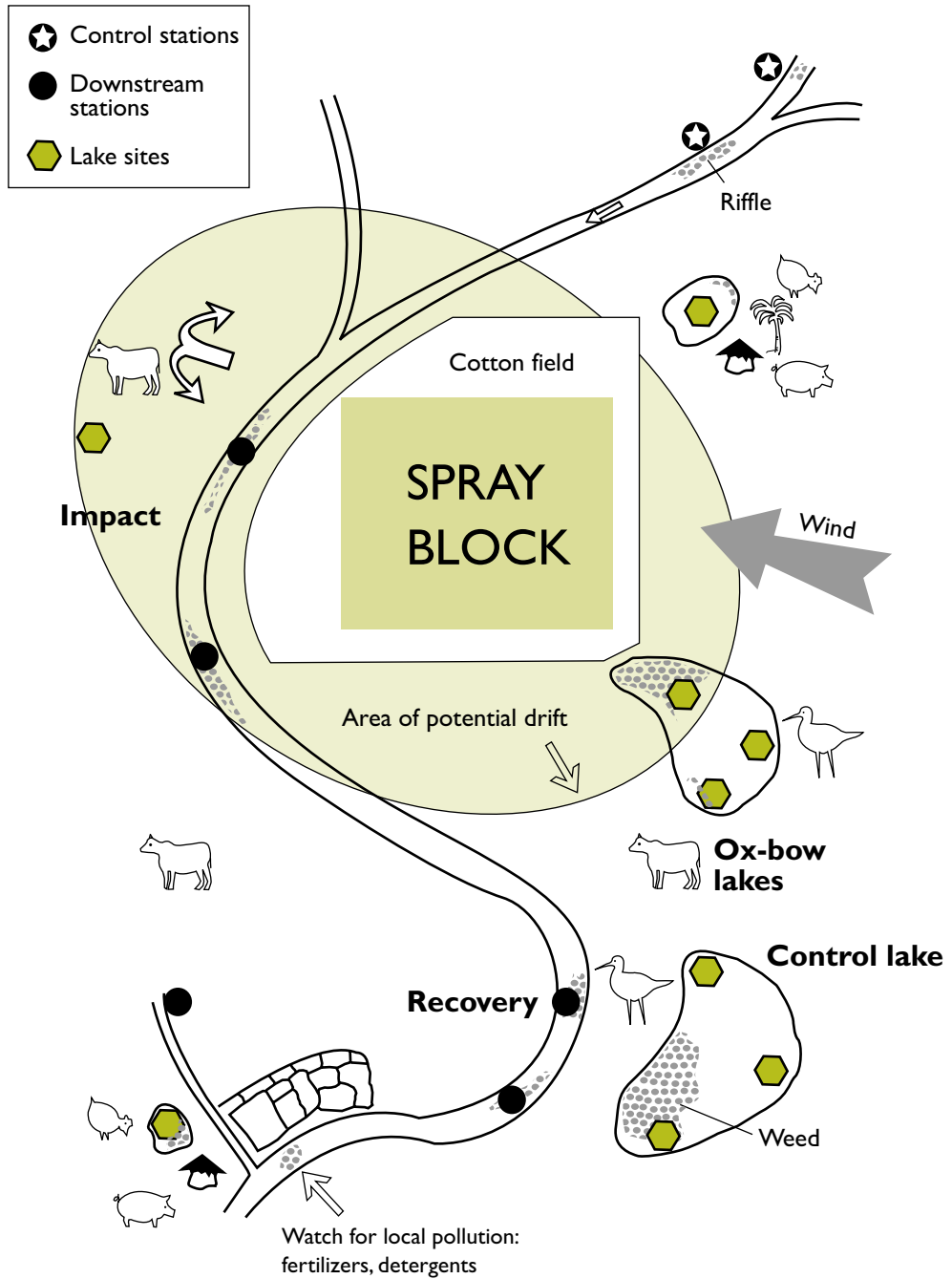

Figure 9.1: Potential lake and riverine sampling sites

Still water

Identification of population change as the means to assess the impact of pesticides on lentic biota is complicated by a usual lack of well defined treated and untreated areas of water. Change must be assessed from a before- and after-pesticide study and unless there are nearby water bodies of a comparable biological structure, distinguishing small, potential effects from natural variation is perplexing. Also, ponds, small lagoons and lakes are regarded, statistically, as one site, even though many replicate samples at more than one location across the lake may be taken (see 'Pseudo-replication' in chapter 2, page 58) and cause and effect reasoning may produce false positives.

Whether sampling flowing or static water, scout for possible sampling stations well in advance of monitoring to allow time to walk or boat to the banks and match site characteristics, access points and the uses to which the water is being put (effluent, irrigation, fish pools, etc.). Avoid choosing obvious access points such as fords or road bridges as sampling stations as they also provide easy access to local people for washing, playing, fishing, etc.

SAMPLING STRATEGY

A decision must be made about the level of data collection required, as this will affect the information value of the data and the reliability of any impact assessment. Qualitative methods provide species lists. They are useful for general collecting and assembly of baseline information on fauna. It is a mistake to think they are not time consuming, as 10 samples per site might be required to retrieve 80% of the species present and the taxonomic effort expended in sorting and identification is enormous. However, they are useful for post-spray recovery studies, where the objective is to determine survival of sensitive species affected or eliminated by pesticide use. Collecting data for comparing relative abundance or absolute numbers of species over space and time requires quantitative techniques and increased effort. Quantitative techniques are normally employed for pesticide impact studies, where identification of the degree of population change is frequently the objective. Obtaining reliable estimates of species abundance requires uniform, replicated sampling and some knowledge of species distribution and statistics. Table 9.2 shows a range of techniques that can be used to collect qualitative and quantitative information on aquatic biota. Their merits and limitations are discussed briefly in the 'Sampling Techniques' section and their use is described in the method sheets.

The following considerations apply to both lotic and lentic environments.

- Try to sample the same substrate type when taking replicate samples at a site. If the swamp bottom is 50% sand and 50% vegetation, stratify the samples and take half the samples from each habitat. The size of the sampling station should be large enough to allow enough replicate samples to be taken without trampling or otherwise disturbing the substrate to be sampled in the process.
- Think about the best sampling method for retrieving the information you require to meet your objectives, including the number of replicates required for statistical analysis: in practice, the latter is often a compromise between the optimal number (on the method sheets) and the time or resources available for processing. Too few replicate samples (<4) could render quantitative work on some species useless.
- Consider the way the pesticide is reaching the water and choose the most appropriate sampling method to measure the organisms most at risk, e.g. surface-dwelling organisms are at more risk from aerosol droplets than from surface run-off.
- Do not attempt to compare riffle sections with pools, weedbeds with clean gravel substrates, wet season with dry season data or sites just up and downstream of a confluence.
- Try to begin sampling at least 1–2 months before the chemical intervention. Sampling frequency is determined by logistical and environmental factors such as manpower, period of river flow, longevity of temporary pools, life cycle length, emergence periods, weather, etc. Sampling at 2-week intervals is a

reasonable goal for an intensive (short-term) study. Post-spray monitoring to determine whether recovery from identified impacts has occurred should continue, ideally, until full recovery is demonstrated; in practice this is rarely achieved, largely because of cost and natural variability of populations.

- With pre and post studies that lack a proper unsprayed control, try to find archive information that provides details of seasonal change in previous years.

Mesh sizes

Methods that employ nets to trap benthic invertebrates, such as sweep nets, cylinder and drift samplers, rely on the mesh size (aperture) to retain organisms of interest. Smaller organisms such as tubificid worms and first instar chironomid larvae may pass through nets with apertures >250 µm. Mesh of this size will clog up quickly when the substrate is disturbed (kick and cylinder sampling) or if samplers are left in place for long periods (drift sampling). A compromise is normally necessary: use larger mesh and anticipate losing some smaller organisms or reduce the mesh size and sample for shorter periods. A good aperture size for general collection of macro-invertebrates is 400 µm. Nylon mesh is much more durable than widely available muslin or mosquito netting, and whose apertures tend to be variable and closer to 1000 µm. Reduce the mesh size if you wish to make a special study of smaller species life stages.

Table 9.2 Aquatic sampling techniques: indicative

Method	Non-target biota					Habitat type			Pesticide
	Benthos	Surface-dwellers	Plankton	Algae	Epiphytic	Flowing	Static	Ephemeral	All
Qualitative									
Heel/kick	●					●		●	●
Drift	●	▲	○						●
Artificial substrate	●			●		●	●	●	●
Sweep net	●	●			●		●	●	●
Plant stems/roots					●	▲	●	●	●
Quantitative									
Cylinder/surber	●					●		●	●
Emergence	●					●	●	●	●
Plankton net			●	●			●	●	●
Grab	●						●	●	●
Artificial substrate	●			●	●	●	●	●	●
Drift	●	▲	○			●			●

● = best; ▲ = second best; ○ = possible if zooplankton retaining mesh size used.

SAMPLING TECHNIQUES

QUALITATIVE METHODS

Heel or kick sampling

This simple method for sampling benthic invertebrates in streams and rivers is excellent for general collecting and only requires a pond net. When replicated in rich habitats, the method can provide an impressive collection of fauna that may be ranked and subjected to non-parametric analysis – but at best it is only semi-quantitative. A pond or hand net (see method sheet) is held downstream of the operator, who grinds or tramples the substrate for a fixed period with boot heels to dislodge organisms which are swept into the net by the current. Heel sampling while walking backwards for a short distance will obtain larger samples. The method is suitable for general collecting of benthic invertebrates in sand, gravel and pebble substrates, but not large rocks or bedrock. There is rarely enough current over depositing substrates to use the method effectively and so tubificids (tube-dwelling worms) and other sediment dwellers (in-fauna) cannot be collected properly by this method. The frequency of sampling will be synchronized with spraying events and their severity: typically visit all sites every 10 days before spraying, then immediately after spraying and 3, 5, 10 and 20 days thereafter.

Limitations Qualitative; semi-quantitative at best. Cannot be used effectively in rivers deeper than the net height.

Processing Organisms are separated by eye from the debris using forceps and Pasteur pipettes and sorted into groups for counting. See section on page 193.

Resulting data Information on organisms are ranked at the family, genus or species level according to their relative abundance, e.g. 0–2 rare; 3–10 occasional; 11–50 frequent; 50–100 abundant. Set your own scale.

Sampling period 2 min.

Equipment Hand net and screw-cap bottles, glass jars or plastic containers.

Staff required 1.

Sampling surface-dwellers

Surface-living invertebrates such as the beetle families Gyrinidae, Veliidae, Hydrometridae and Gerridae are hard to sample. Counting the number of whirligig beetles in part of a river has little meaning as their sudden absence or appearance could be interpreted in many ways. A surface-breaking drift net is a fairly effective tool for trapping surface-dwellers affected by insecticides, whether from aerosol spray-drift or deliberate introductions to streams. The net traps disoriented or dead organisms and gives a wide picture of how a stretch of river is being affected by a toxin. With some types of pesticide application, terrestrial invertebrates in overhanging trees fall into the river too, and this increases the burden of processing. Other groups that are hard to sample such as backswimmers and water boatmen are also trapped. The drift net technique will provide no comparable data at control sites.

Drift nets (see below and method sheet) are staked to sample the top few centimetres of river instead of the main channel flow but otherwise the siting, periodicity of sampling and processing are no different from the sampling of invertebrate drift.

Limitations With only one net in each of the treated or untreated stretches of river, the method has no quantitative application.

Processing and resulting data As for heel samples.

Sampling period Between 1 h and 4 h after a spray event, depending upon how clogged the net becomes.

Equipment Drift net, flow meter and stakes to secure net.

Staff required 1 or 2.

Artificial substrates

Bedrock, sand, lake mud and weed beds can be difficult to sample with nets, especially in static water. Artificial substrates provide surfaces upon which organisms can alight and eventually colonize. Provided that sufficient colonization time is available, stones, tiles, bricks, plastic balls and tubes are all suitable materials to place in water,

either in a mesh bag or box on the bottom or suspended in water. After 2 weeks or more in water they may be removed, examined, washed in a bucket and replaced for another period. The interval spent submerged should be uniform at and between sites. About 4–8 artificial substrate samplers per site should provide enough information for statistical purposes. If the substrate sits on a fine mesh net that can be pulled over the sampler on retrieval, a quantitative result, relating numbers to surface area of substrate, can be achieved.

Limitations If the substrate presented is of uniform area, a semi-quantitative result is obtained that is useful for between site comparisons, *but the fauna sampled may not reflect the structure of the normal community of the underlying substrate.*

Processing The bucket washings are sieved and the contents sorted into groups using a white tray. Preserve for identification and counting. See section on page 193.

Resulting data Number of organisms per unit area.

Sampling period Minimum of 2 weeks.

Equipment Wire mesh and stones or other suitable substrate.

Staff required 2 is most efficient.

Sweep net sampling

Sweep nets can be used to sample qualitatively fauna associated with plant stems and roots of submerged and emergent vegetation (e.g. papyrus and *Vossia* stands), the roots of floating vegetation (e.g. *Eichhornia crassipes*, water hyacinth) or whole floating plants (*Salvinia*, *Piscia*).

Limitations The data collected are normally hard to rank and analyse statistically, but despite these limitations, the method provides information on species richness and can detect changes in relative abundance, e.g. the sudden absence of a shrimp or mayfly nymph that may be biologically significant. When used to sweep up whole plants such as *Salvinia*, the fauna may be related to the wet or dry weight of vegetation. A triangular pond net is useful for timed foraging in amongst weed beds and the rhizomes of papyrus and other grasses.

Processing Sweep net samples are processed in the same way as for heel samples.

Resulting data Data are normally expressed in catch per unit effort, such as the number of shrimp caught in a 3-min sweep of plant roots.

Sampling period 2–5 min.

Equipment Sweep net – these are easily fabricated locally – and collecting bottles.

Staff required 1.

Aquatic weeds and roots

Rooted vegetation provides a relatively stable substrate for invertebrate colonization. Trichoptera, Ephemeroptera, Chironomidae, Ostracoda, Isopoda and simuliids may be qualitatively sampled by cutting weed mats but comparing densities of organisms between sites is not straightforward, given the sampling difficulties and variation. It is probably as useful and faster to employ timed sweep netting of rooted vegetation or the roots of floating weeds rather than attempt semi-quantitation using dry weight or weed area.

QUANTITATIVE METHODS

Cylinder or box sampling

Quantitative information on benthic fauna inhabiting stream and river beds can be obtained using a cylinder or box which encloses a known area of stream bed (0.05 m² is a practical size but smaller is workable where the substrate is gravel or pebble). Compared with a box sampler, which is not easily rotated in stony substrates, the cylinder is more versatile and can be used in soft and stony substrates. Both are of limited use on bedrock, although a foam rubber skirt fitted on the bottom of the sampler can seal off the area of smooth rock to be sampled. The cylinder is driven into the substrate to a depth of about 5 cm. Water passing through the meshed entrance, which faces upstream, washes the animals displaced within the enclosed area into a net tied to the downstream exit (see method sheet). The ideal number of samples taken at any one site is 4–8.

Limitations Stream depth cannot be greater than the height of the samplers (30–40 cm) and they cannot sample large rocks. A Surber sampler can be used in the same way but it has disadvantages: the quadrat only rests on the substrate, sampling is a two person job, and it is effective at a lesser water depth (10 cm).

Processing Organisms are sorted on a white tray into groups and stored in alcohol while awaiting identification. See section on page 193.

Resulting data To maximize the information returned from quantitative samples, organisms are normally identified, where possible, to species. The mean, standard deviation or confidence limits of the mean number of a group or species are presented graphically against, for example, time or site number.

Sampling period A typical sampling frequency would be every 2–3 days immediately after spraying, and weekly or biweekly later on. The frequency will depend upon the severity of the response – the more severe then the greater the frequency. In small streams the number and frequency of samples may be determined also by the surface area of substrate available – the exact same area should not be sampled more than once every 2 weeks, allowing time for recolonization.

Equipment A cylinder, metal box and nets can be fabricated locally. Catering size coffee cans or plastic pipes can also be utilized.

Staff required The ideal number of staff required for all quantitative sampling techniques is 2.

Invertebrate drift sampling

Invertebrates in streams and rivers periodically drift downstream. The largest number of animals normally drift at night, just after dark, but during periods of heavy rain or drought, drift densities soar. Insecticides may cause sensitive species to drift in huge numbers and for many hours after they contact water. The response may be orders of magnitude greater than normal drift densities and can be used as a biological indicator of contamination of water, even at very low concentrations of chemical.

Ideally, drift nets are located above and below the site of pesticide application. Chemical aerosols are often carried considerable distances by prevailing winds and remain airborne for some days. Upstream ‘control’ drift sites should, therefore, be 10 km or more from the nearest site of chemical application. Two or three well-spaced, downstream, drift net sites are preferable to one but access or stream length/depth often determines the number. Methods of measuring current for the estimation of drift density are provided in chapter 5.

In fast flowing streams and during the wet season, nets quickly clog up with debris. Larger mesh sizes will reduce clogging but decrease the catch of smaller organisms. The simplest solution to clogging is to empty nets frequently.

Limitations Although drift can be quantified easily, drift density cannot be reliably related to production or standing populations of benthic invertebrates. This is a consideration if time or manpower is a constraint: it may be worth considering using quantitative population estimates and fewer drift nets. Some invertebrates tend to drift more than others and so the technique is selective.

Processing The samples are washed in a sieve (same aperture size as net mesh) and placed on a white tray. Invertebrates are sorted into groups, preserved in alcohol (70%) or formalin (4%) and later identified and counted. See section on page 193.

Resulting data Drift density is calculated using the area of mouth (or partial area if the net was not completely submerged), the flow rate and numbers of animals caught in a known time. Graphic presentations are very effective at communicating the results.

Sampling period Following insecticide contamination of water, invertebrates may clog downstream nets within 30–60 min. Nets should be observed to ensure water is not ‘backing-up’ at the mouth of the sampler otherwise drifting organisms will be deflected away from the mouth of the net. Under normal conditions, 24 h is a convenient sampling interval as it covers the natural photoperiod to which many invertebrates respond. During or after insecticide use, the frequency of sampling is determined by the amount of material collecting in the net. Samples are taken until the downstream drift density once more approximates that upstream of the contamination.

Equipment Drift nets, preferably with collection bottle attached, stakes, current meter and sample bottles.
Staff required 2 is ideal.

Plankton sampling

Phytoplankton and zooplankton densities may change markedly in response to the application of insecticides, herbicides and fertilizers near lakes, ponds, swamps and rivers. In rivers and oligotrophic standing water, plankton normally needs to be collected with a net that is hauled vertically (deep water) or horizontally to concentrate their numbers sufficiently for counting. As nutrient levels increase, as in river pools, ox-bow lakes and eutrophic waters, plankton becomes more abundant and may, in the absence of a net, be sampled with a wide-mouth bottle.

Sampling strategies for rivers will be similar to those for benthic invertebrates, i.e. sites upstream and downstream of the perturbed area would be sampled as 'unsprayed' control and treated areas. Where whole ponds and lakes are affected by some form of agrochemical intervention, an unaffected water body might act as a control site, or if the intervention is deliberate (e.g. mosquito, snail or weed control) or the timing known (e.g. aerial tsetse control), then pre-treatment data can be gathered. Difficulties in interpretation of post-spray data in standing water are eased if the natural variation of plankton abundance is known from a matched control site, but in practice, these are hard to find.

Limitations Oscillations in plankton densities occur regularly and in response to changing water temperature and light. Direct and indirect effects of agrochemicals on crustaceans, rotifers, diatoms, and green and blue-green algae are not easy to determine, especially when the timing of the intervention is unknown, e.g. run-off of chemical occurring over an extended period or when the deposition of chemical on a water body is low (as with spray-drift). Sorting plankton to main taxonomic groupings is easily achieved. Where species *x* of a group is clearly affected by a chemical, seek specialist help with identification.

Processing If the water sampled was green or the collecting bottle was teeming with zooplankton before preservation, it is likely that sub-sampling or dilution is necessary to reduce the number of organisms prior to counting. Alternatively, a haemocytometer can be used to count phytoplankton in a small volume of water without the need for dilution. Other specialized counting chambers are available for counting low density populations (e.g. Sedgewick-Rafter chamber), but a small Petri dish standing on graph paper will normally suffice, provided wind and heat do not circulate the contents. Zooplankton can be removed from a phytoplankton sample by sieving through fine nylon mesh or muslin. Zooplankton and rotifers are easily counted in a Petri dish sitting on graph paper.

Resulting data Calculate serial dilutions before expressing abundance as numbers (or biomass) per unit volume of water.

Sampling period In ponds and lagoons, the length or depth of the haul determines the sampling period. A 10 m haul is sufficient where plankton are abundant.

Equipment Microscope, counting chamber, Petri dishes, plankton net and bottles.

Staff required 1.

Emergence traps

Insect emergence from water can be assessed with emergence traps. Emergence is not a proxy measure of population density but it is indicative of insecticide impact on a crucial phase in an insect's life cycle. The dynamics of emergence are a function of life history, temperature, light and wind and as these are so variable a large number of traps (5–10) must be deployed to reduce sampling errors. Emergence samplers are useful for quantifying the effects of insect growth regulators and microbial insecticides on insect metamorphosis or nymphal development, where cylinder or other sampling techniques cannot. The traps are set just below the water surface to prevent non-emerging insects from flying inside. In theory, they sample a known area of substrate but riverine traps may not because of the current. Insects that emerge by crawling up emergent plants (e.g. Odonata – dragonflies and damselflies) are generally not sampled, but the method is more efficient for

chironomids and other Nematocera. Traps can be used in shallow littoral regions of still waters or they can be floated on a lake surface. Mundie (1971) reviewed trap construction and use.

Limitations The numbers of emerging insects can be very low at certain times of year and consideration should be given to the value of using the method when low trap catches can seriously reduce the power of the statistical comparison. Traps must be anchored in the wet season.

Processing Traps are emptied periodically and the contents sorted on a white tray. See section on page 193.

Resulting data The density of insects is expressed as numbers of species or groups per unit area (m^2).

Sampling period Two weeks before and after treatments are administered (minimum) but the traps should be emptied every 2–3 days and the formalin recharged.

Equipment Emergence traps, formalin and sample bottles.

Staff required 1.

Grab sampling

In general, sediment-dwelling invertebrates are better protected from incidental pesticide deposition into water bodies than plankton and nekton, as adsorption of chemicals on to the sediment reduces their immediate biological availability and toxicity. Impact assessment and biological monitoring of tubicolous worms (e.g. Tubificidae) and molluscs is not, therefore, commonplace. Where in-fauna are exposed to high concentrations of insecticide, however, such as during the control of the vectors of onchocerciasis, schistosomiasis and malaria, there is good reason to monitor populations of target (e.g. snails) and non-target organisms by sampling the sediment. Assessment of the indirect impacts of dense floating weed (reduced light penetration), weed cutting and herbicide use (deoxygenation/algal growth) on the range and abundance of in-fauna also requires quantitative methodology.

Sediment-dwelling organisms are easily sampled in lakes and rivers by use of grabs, which gouge out a small area of mud using sprung or weighted jaws. (In very shallow swamps, *dambos* and rice fields, a piece of plastic drainpipe may be quicker to use as a coring device.) The Eckman grab is ideal for use in rivers and inshore areas of lakes, where the water is a few feet deep and can be waded. At depths greater than that, a small Petersen grab operated from a boat or canoe is recommended.

Limitations and processing Separation of in-fauna from organic debris and mud is tiresome, and flushing sediment through a sieve series (e.g. 5 mm, 2 mm, 750 μm and 400 μm) is a necessary preliminary step to sorting and counting organisms on white trays. (See 'Sample Processing' on page 193.) Some substrates are not suitable for grab sampling, e.g. sand, rock and stony aggregates.

Resulting data The results are expressed as numbers of species or groups per unit area (m^2).

Sampling period Take samples at least every 3 days after spraying for up to a month after last spray.

Equipment For shallow (wading height) water use an Eckman grab: in deeper water, a boat and a Ponar or Petersen grab are required. These are all relatively expensive.

Staff required 2.

Physico-chemical methods

Measurements of basic parameters such as the water temperature, oxygen concentration, pH, conductivity, turbidity and flow rate (current) are very useful in aiding the interpretation of biological data. For example, dissolved oxygen levels may differ markedly between pools or up and downstream of a non-pesticide source of pollution and would, if undetected, influence the assessment of the pesticide impact on the fauna. Physico-chemical measurements should be made at the time of biological sampling and recorded in a notebook. Descriptions and method sheets for these techniques are given in chapter 5.

SAMPLE PROCESSING

Sorting invertebrate samples is a time consuming and tedious process. After rinsing samples collected in the field through sieves to remove mud, sand and preservative, there is no real substitute for hand sorting invertebrates on white trays in natural light. Backwash the sieve contents on to a tray that is divided into roughly equal segments (c. 6 cm x 6 cm) with a black permanent marker pen and sort like organisms into vials containing preservative using forceps and Pasteur pipettes. When sorting samples in water on a white background, most biologists find it more efficient to focus on groups of organisms, picking up, for example, shrimps first, then mayflies, then worms, etc., rather than sorting all individuals in one pass. Occasional lifting of a corner of the tray to create water movement helps to reveal specimens against a background of sand or sediment. Place a label (pencil on paper) showing the date, sample site and other pertinent information inside the vial. If samples can be sorted fresh in the field, separation is aided by invertebrate movement. Preserve the collections with 70% alcohol and prepare a reference collection of specimens that can be used to identify all others, whether by taxonomic name or, at least initially as morphospecies, by a distinguishing code (sp A, B, etc.). Ensure vial cap seals are not perished as loss of alcohol by evaporation will quickly ruin the collection. Taxonomic knowledge speeds up sample processing but a team of unskilled 'sorters' can be separating like species within a few days given basic, initial guidance. A low-power dissecting microscope, taxonomic keys and the help of specialists will be required to identify the reference specimens and enumerate the samples collected. All enumerations should be recorded in pencil in a notebook. Assistance with the identity of specimens is normally available from national museums, university departments and agricultural colleges, and there are a number of international specialists in aquatic groups who may be willing to assist (contact curators of national museums).

REFERENCES

- BRODIE, I. and DOBERSKI, J. (1991) *Techniques in Ecology and Environmental Science. Set B, Aquatic Organisms and Habitats, Data Collection and Analysis*. Cambridge: Daniels Publishing.
- ELLIOTT, J.M. (1971) *Some Methods for the Statistical Analysis of Samples of Benthic Invertebrates*. *Scientific Publications*, No. 27. Ambleside, UK: Freshwater Biological Association.
- GRANT, I.F. (1989) Monitoring insecticide side-effects in large-scale treatment programmes: Tsetse spraying in Africa. pp. 43–59. In: *Pesticides and Non-target Invertebrates*. Jepson P. C. (ed.). Andover, UK: Intercept.
- HYNES, H.B.N. (1970) *The Ecology of Running Waters*. Liverpool: Liverpool University Press.
- MUNDIE, J.H. (1971) Techniques for sampling emerging aquatic insects. In: *A Manual of Methods for the Assessment of Secondary Production in Freshwaters*. Edmondson, W.T. and Winberg, G. G. (eds). *IBP Handbook*, No. 17. Oxford: Blackwell Science.
- SMITH, V. and QUIGLEY, M. (1986) *Invertebrates of Streams and Rivers*. Oxford: Blackwell Science.
- SOUTHWOOD, T.R.E. (1966) *Ecological Methods with Particular Reference to Study of Insect Populations*. London: Methuen. (Further impressions by Chapman and Hall.)

Bernadette McCarton

Aquaterre, 45 Park Drive, Market Harborough, LE16 7BB bernie@mccarton.net

INTRODUCTION

Assessment of pesticide impact on fishes is based, largely, on recording the species present and estimating the numbers of fish, in comparison with a similar or baseline site where no pesticide is present. Acute effects of pesticides may result in fish kills that can be readily monitored, but prolonged or chronic exposure of fish to low levels of pesticides often gives rise to changes in the populations of fish that are more difficult to assess, particularly if monitoring was not undertaken before pesticide treatment. The difficulty is in actually counting live fish, as underwater observations are expensive and in many situations impossible because of poor visibility and risks to observers. Pesticide treatment often occurs before the assessment of impact is made and it is then necessary to compare treated waters with untreated and often unrelated water bodies. Most studies of pesticide effects have shown that fish are either killed soon after application or they survive, in which case their metabolism or behaviour may be altered, increasing their susceptibility to predation, disease or capture. Other, indirect effects of the pesticide on fish, such as a reduction in availability of an invertebrate diet, may also lead to a decline in fish populations and change in community structures.

Most practical assessments involve capturing and, if necessary, killing a sample of fishes. This chapter provides some practical methods for assessing impacts of pesticides on fish communities and species.

Before designing an impact study it is important in such cases to determine exactly how contamination is occurring as it is likely to be through occasional accidents, rather than regular contamination. For example, health programmes aimed at eradicating mosquitoes by spraying the interior walls of houses are unlikely to affect fish directly. Fish are only likely to be affected by these operations through the secondary introduction of the pesticide to watercourses by cleaning and discarding waste water carelessly, or by spray teams using local water bodies for washing equipment.

Aerial spraying activities, provided they take place well away from watercourses are unlikely to lead to high levels of contamination. The impact is likely to be a one-off event unless aerial spraying is repeated regularly.

The use of pesticides in agriculture and forestry can have serious consequences for fish, as pesticides from run-off and drainage from irrigation canals can flow directly or indirectly into nearby waterways leading to high levels of contamination.

STUDY DESIGN

The design of a monitoring study to assess pesticide impact is dictated by the objectives of the study, which, as a rule, are formulated in response to the pesticide being investigated. If the substance is known it may be possible to predict the effects from previous laboratory and field studies (Muirhead-Thomson, 1971; Hurst *et al.*, 1991), although field studies of pesticide impacts on fish are very scarce. The majority of pesticides that are toxic to fish can be classified into the following groups: organochlorines, organophosphates, carbamates, pyrethroids, phenyl pyrazoles, herbicides and fungicides. In terms of study design, the important division is between studies of the effects of organochlorines, which have chronic effects and studies of the effects of any of the other major

insecticide groups, which cause immediate mortality. For each of the pesticide groups the characteristic effects which influence study design are outlined below.

Organochlorines, such as DDT (DDD and DDE), chlordane, heptachlor, aldrin and dieldrin, are acutely toxic to fish at high doses. Acute exposure causes suffocation due to interference with oxygen uptake by the gills, but normally fish exhibit only chronic effects. In the absence of direct fish kills, the study design must provide for the collection of data relevant to analysis of population dynamics. This requires measurement of length and/or weight, and preferably age, for an adequate sample size.

Organochlorines can also accumulate in the lipid tissues of fish, such as the brain and gonads, leading to biomagnification, and thus the most significant effects are likely to occur in fish high in the food chain. The species to be studied should be at the top of the food chain, provided sufficient numbers can be sampled, e.g. tigerfish (*Hydrocynus forskahlii*), African pike (*Hepsetus odoe*) and piscivorous catfishes (*Clarias gariepinus* and *Heterobranchus longifilis*).

DDT has also been shown to cause a decline in the number of eggs produced and mortalities at the egg and larval stages of some fishes (Burdick *et al.*, 1964; Sukla and Pandey, 1985). A study assessing the effects of organochlorines should be designed to include selected egg counts of sampled fish.

Disturbances in nerve transmission (Niemi and Webb, 1980) may cause erratic behaviour that can lead to increased predation and ease of capture by people fishing and thus indirect fish mortalities. Such indirect effects are not readily assessed, unless monitoring during and immediately after spraying is possible. The varying susceptibility of different species to fishing gears exacerbates the problem of measuring changes in catches caused by the pesticide.

Organophosphates, carbamates and pyrethroids are often extremely toxic to fish in the laboratory, but in the field their effects are often attenuated by environmental parameters, e.g. binding of some pyrethroids to suspended colloids or dissolved organic carbon in water reduces bioavailability to fish. These three groups of pesticides are non-persistent and generally do not accumulate in tissues. Death is caused by the substance interfering with nerve transmission producing nerve tremors, muscle weakness and laboured respiration due to the reduced and eventual total lack of activity of control centres in the brain (Metcalf, 1981). In assessing the impact of pollution from pesticides within these three groups, the study must generally be designed either to monitor fish kills, or to assess total biomass within a short time of the suspected contamination. It is possible with some pesticides to assess the acetylcholinesterase (AChE) as an indicator of pesticide impact (Antwi, 1987). This involves complicated laboratory techniques that should only be attempted by specialists.

The phenyl pyrazole insecticide, fipronil, shows quite varied acute toxicity to fish, depending on the species. Thus results from laboratory tests on standard species may not reflect toxicity to other species in the field. This insecticide has also been shown to bioaccumulate in fish. Studies of sub-lethal effects may thus be required when examining the impact of this insecticide.

Some herbicides like paraquat, diquat, 2,4-dichlorophenoxyacetic acid (2,4-D) and 2,4,5-T, classified as heterocyclics and chlorinated phenoxy compounds, can have significant effects on fish. The former group of chemicals disrupts photosynthesis of plants, whereas the latter mimics growth hormones causing chaotic growth. Herbicides used in irrigation canals, paddy fields and to clear aquatic weeds from clogged reservoirs and lakes have direct and indirect effects on fish. For example, diquat, depending on concentration, is directly toxic to some fish whereas many are tolerant of paraquat, whose indirect effect is exerted through a reduction of dissolved oxygen in the water, caused by decay of aquatic vegetation.

In selecting study sites, it is important to develop an understanding of the catchment areas of lakes and rivers and the connections between water bodies, as small streams can carry pesticides from isolated upstream areas down to more important water bodies where fish abound. Programmes of pest control for public health, agriculture or forestry involve different spray techniques and chemicals, each of which can influence site selection, duration and timing of monitoring.

Such *ad hoc* contamination that may occur in the process of spraying houses, for instance when spraying walls to kill mosquitoes, is difficult to monitor. However, one-off sampling of the whole fish population at key sites can be successful.

Where a fish kill is suspected, as in the case of aerial spraying programmes, sampling and monitoring of fish should be undertaken during and shortly after the event. If the initial sampling does not show the fish population has suffered, prolonged survey effort is unlikely to provide conclusive evidence of any impact.

The use of pesticides in agriculture and forestry may cause contamination over a prolonged period and the study must be designed over a lengthy period and extend beyond the time when pesticide usage abates.

In some cases spray programmes are focused on water bodies, as in the spraying of rivers to eliminate blackfly larvae (*Simulium* spp.) in the control of river blindness. It is widely accepted in this case, that the health benefits outweigh environmental costs. However, monitoring the effects on fish can help to quantify any short-term environmental impact and indicate any longer-term effects which may affect the environmental services provided by the waterway under treatment. Measures can then be taken to mitigate more serious environmental consequences, e.g. substituting alternative insecticides for direct spraying or replacing chemicals with biological control to minimize non-target impacts.

General considerations on how to plan and undertake the survey

- The type and dose rate of the pesticide to be sprayed determines whether activities should focus on immediate effects like expected fish kills (as in the case of high doses of organophosphates, carbamates and pyrethroids) or longer-term effects on catch, biomass, community composition, or on population parameters such as growth, mortality, recruitment, production and fecundity of fish species found in the contaminated waters (as with organochlorines).
- Before and after treatment comparisons at the same site are preferable to comparisons between different sprayed and unsprayed areas, because environmental differences cannot be completely eliminated in the interpretation of results from the latter. However, this will not usually be achieved, as monitoring of impact is unfortunately often not initiated until after pesticide pollution has occurred. Comparing treated and untreated sites, therefore, is often the only option.
- 'Control data', i.e. data from an unsprayed area (before treatment) should be collected if natural variations in community structure, growth, mortality or recruitment of particular species are to be accounted for.
- Physical features of potential sampling sites should be assessed by field visits including: estimations of water flow and direction (as this determines the movement of fish and the dispersion of the pesticide); areas likely to be fished (which will affect the number of species sampled); the depth and slope of banks (affects the size of fish and species present and the fishing methods to be used); nature of the substrate or bottom and coverage of aquatic vegetation (both of these can determine the abundance of different species and the influence of resident animals, such as crocodiles or hippopotamuses, which, if they are present, can cause severe damage to fleets of nets).
- The connectivity of potential sampling sites is a prime consideration, as pesticides can contaminate areas that may have been selected as unsprayed controls. Dispersion through river systems or large lakes can affect the interpretation of the results of the studies. Separate distributaries or tributaries of larger rivers that flow

through or respectively drain similar terrain are ideal, provided flooding does not cause them to unite. Treated waters should not flow into untreated water that is sampled as a contrast, but untreated water further up the catchment may form suitable comparisons. Inlets along the shores of lakes are useful sampling sites, if run-off from the surrounding areas does not flow into both pesticide contaminated and uncontaminated water. This may mean that there is considerable distance between sites.

- The practicalities of sampling need to be taken into account: the proximity of pesticide contaminated and uncontaminated sites; transport considerations (by boat or land vehicle); camping facilities for monitoring sites continuously if fish kills are likely; access to the sites (tracks, roads or by water); and the suitability of different fishing methods, as the same techniques must be employed in both sprayed and unsprayed areas, e.g. an ideal seining beach and clear water at one site is no use if the other site has obstacles such as logs or standing trees that will impede drawing the seine net to the shore.
- When choosing sampling sites, fishing activities of local people should be documented, as this could have a significant effect on the results. For example, if a sprayed area is not fished by locals there may be a healthier population of fish, whereas in the unsprayed area where intensive local fishing occurs, catches may be smaller, hence the pesticide may decrease catches but the effects of fishing may be greater. The observed result will then show little or no effect of the pesticide. Fishing activity records can thus help in the interpretation of results. The presence of people fishing may be an advantage if the survey team is unsuccessful at catching fish: switching to sampling from the existing fishery may be the best way of obtaining information.
- Supporting information about rainfall, river flow rates or discharge, water turbidity, temperature, pH and conductivity need to be gathered in order to match sampling sites (see chapter 5).

SAMPLING TECHNIQUES

The sampling methods for fish depend primarily on the size of the water body affected by pesticide pollution. For small streams or pools, it is possible to sample the entire water body efficiently using either seine netting, dewatering (as is common in Asia) or, as a last resort, poisoning with rotenone or other toxic plant extracts. These methods should only be adopted if high mortality through desiccation is a normal event in the streams concerned, otherwise the sampling will have an effect on the fish population confounding assessment of pollution impacts.

The impact assessment generally takes the form of capture and/or sampling measurements on the fish followed by laboratory or numerical analyses. The sampling and measurements of fish are the same for many techniques of analysis. The capture of fish can either be undertaken by the investigators or by sampling local fisherfolk catches.

Sampling local catches

This is appropriate where the study area includes large water bodies and/or fast flowing rivers, where local capture methods are efficient and reduce the burden of work for ecotoxicological staff. Design of the survey for sampling catches depends on the fishery, but essentially it should take into account:

- that waters may be characterized by multiple species stocks
- variability of fishing methods and fisheries
- settlements of fishing communities along the water body
- variations in the type and size of fishing gears
- variations in the type of fishing vessels and in the mechanization/propulsion of the vessels
- variations in fishing times
- variations in landing times and places
- diversity of fishing skills.

In order to do this, it is necessary to divide the area into similar sampling units using stratification (Bazigos, 1974; see also chapter 2). The aim of stratification is to divide the water body into relatively similar (homogeneous) ecological systems (this is the first or primary level of stratification), and then to divide fish landing centres by size within the primary strata and finally, to stratify fishing vessels by type and fishing methods within the primary strata. It is clear that a great deal of information is needed about the fisheries operating in the waters to be treated in order to plan sampling catches. The considerations mentioned above may differ between the pesticide treated and untreated areas, making the interpretation of results of impact surveys much more difficult. If this is the case, then any amount of stratification may not minimize inherent variations to an acceptable level and this variation may outweigh or mask the effects of pesticides.

If sampling the local fishery is appropriate, it is important that in sampling catches, investigators are aware of the details of capture methods: fishing intensity (fishing effort), best measured in days or hours of fishing activity per piece of gear; full description of the use of fishing gears throughout the fishing period; dimensions of the gear (in case varying sizes of net or trap are used); whether used by day or night or both; area fished and locations to verify whether the water has been pesticide contaminated or not. In addition to these considerations, sampling local catches must be carried out in the same manner each time. Catches should be well mixed and fish selected randomly. If large catches are encountered, these should be stratified by species and size (Bazigos, 1974). Later once the fish have been dissected, it is possible to stratify by sex (this is not always possible at the sampling stage, as many fishes do not show distinct visual sexual dimorphism. All the above points are important to ensure comparisons from catch data from sprayed and unsprayed areas are valid.

Capture programmes

By far the best way of controlling factors influencing the capture of fish is for investigators to establish their own sampling programme. When considering the methods of capture, it is important to take local advice about the best ways to catch fish in the locality, but it is also critical to consider what species and size of fish each type of gear is likely to catch. Reading any publications from the local fisheries department about recent catches can be extremely useful in this regard. The size and species of fish caught by different gears are known as the selection characteristics of fishing gear and the aim is to choose gears that select fish in as near random a fashion as possible. The selectivity of gears depends primarily on the method of use and the mesh size of netting. If gear is passive, i.e. the net or trap is set in one place and fish are simply caught by encountering the mesh, then fish of a certain size are caught. Those that are smaller can pass through the mesh and those larger can back away. Normally fish are 'gilled', the mesh of the net getting caught behind the gill flaps (opercula). However, fish species vary widely in shape and they can often be caught by other protruding parts, such as spines, teeth, scales or simply the breadth of the body. For passive gears like gill nets, the size distribution of fish caught is generally in the form of a narrow normal distribution (see chapter 2). This means by using nets of varying mesh sizes, the distribution can be broadened to approximate the distribution of the population being sampled (Figure 10.1).

When fishing gear is used actively to catch fish, the selection characteristics of each capture method are different. Most important in this group of gears are the surrounding or seine nets. As the name suggests, in seining, an area of water is surrounded, the net circle or fence is slowly closed, and all fish larger (in girth) than the mesh size are caught. Some fish escape if the net does not encompass the whole area or depth of water, others may leap with fright from the circle. This method, however, is relatively efficient, and sampling of fish larger than the mesh closely reflects the distribution of fish in the population (Figure 10.2).

Fishing by hooks, spears and traps samples fish in less predictable ways, depending on the size and species concerned. However, it is important to consider these methods of fishing because in certain areas, these may be the best methods. For example, catfishes, like *Carias gariepinus*, or snakeheads, e.g. *Channa punctatus*, are readily caught at night by hooks and longlines. If attempts are made to catch these species by netting, they burrow into the mud and sand on the river bed. Traps may be the most efficient way to catch fish species moving up small streams, as they are robust and can be used to block completely the path of migrating fish (Figure 10.3).

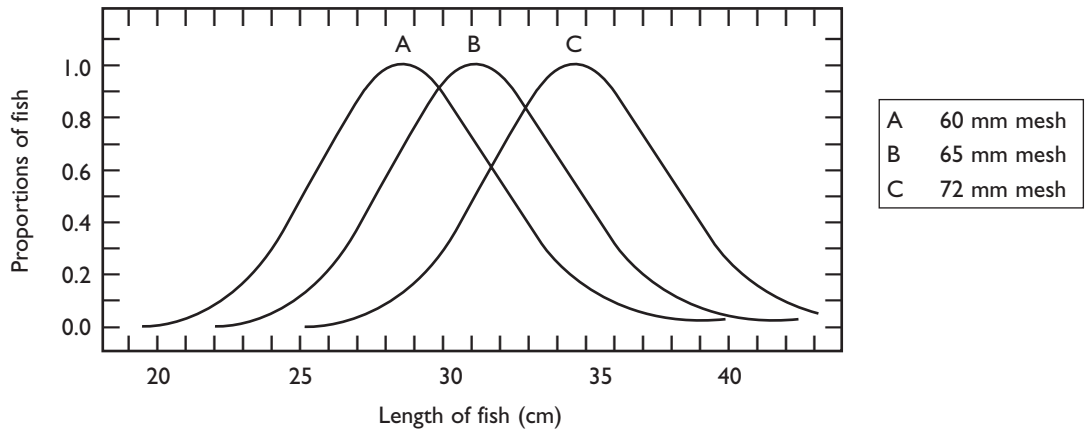

Figure 10.1: The selectivity of three different mesh sizes of gill nets

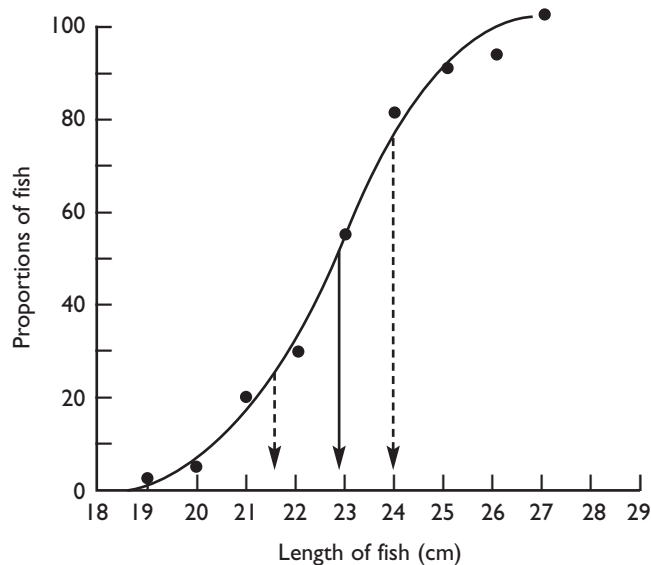

Figure 10.2: Selectivity of seine nets

In many regions of the world, an impressive variety of fishing gears and practices can be found. Some gears are peculiar to a locality and may only be appropriate for catching one or two species. As a rule these types of gear should not be used by survey teams as it is often difficult to estimate their selection characteristics and the levels of skill and experience in operating them may significantly affect the rate of fish capture.

With a combination of fishing gears, most fish species can be caught and, with systematic sampling through the year carried out simultaneously in treated and untreated waters, biases of selectivity of fishing gears can be minimized. In order to choose the best gear in different water bodies, a summary of the suitability of the main types is given below.

The preferred method of sampling, if fishing is undertaken by the survey team themselves, is by netting using seine and gill nets. Sampling must be done by multi-mesh size netting to avoid sampling selectivity. Some trapping and use of hooks can increase the species sampled. Poisoning, dewatering or electric fishing should only be considered in the circumstances described earlier (page 198).

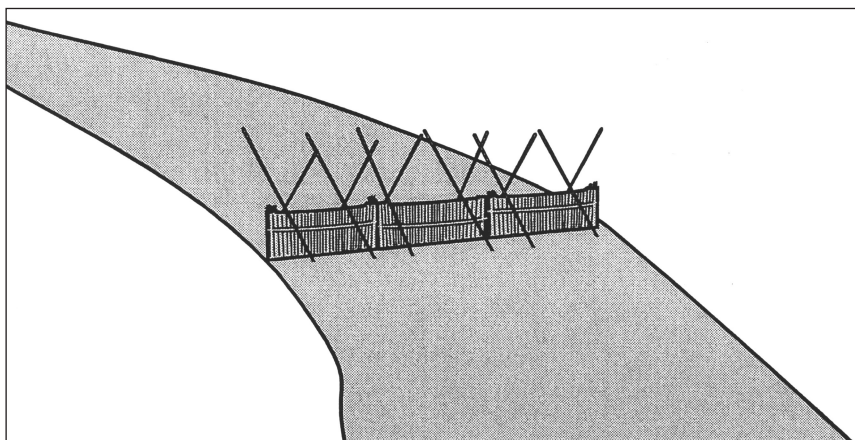

Figure 10.3: Fish traps set across a river

If studies are to show differences attributable to the impact of the pesticide, the importance of the careful selection of sampling sites cannot be overstressed. Before and after spraying comparisons at the same sites are by far the best, and by sampling for a year before spraying, seasonal effects are accounted for. However, contemporary sampling of environmentally matched sites is normally the basis for comparison. Characteristics of the sites that need to be matched are: depth and area of water, nature of bottom and slope of banks, plant cover of the water and surrounding banks, current speed, marginal vegetation and physico-chemical factors such as pH, oxygen, temperature, conductivity and turbidity.

The most useful sampling methods, measurements and analyses depend primarily on the time allowed for the survey. A variety of fishing methods should be carried out if time permits, as bias from netting may only be established during the analysis. The number of measurements taken should be maximized, as once sampling is underway, it is economical to make as many collections as possible of scales or otoliths, tissue preservation for residue analysis, fish eggs and lastly stomach contents. Focusing on a small number of species that are most likely to show the effects of pesticide is recommended, even if time may not initially be available for the analyses. Advice from trained personnel should be sought for complicated techniques, such as estimation of growth and mortality parameters and advanced statistical methods.

Seine netting

Seine netting involves surrounding an area of water, in a bay of a large water body, across a river, or even in the middle of a river or lake. It is better to block off the area with smaller mesh nets (0.5 cm), called stop nets, as these allow fish that escape the seine net to be caught by the stop nets (Figure 10.4). Seining, by dragging the net over the whole area that is blocked off, should be carried out several times, usually until no more fish are caught. Seining is best with netting as it is easier to use, although fencing can be useful where robust blocking is needed, e.g. in fast flowing waters. The method is ideal for small pools where the whole area can be fished, but can be used in large rivers and lakes, preferably from the shores where catches can be landed easily (Figure 10.5). Seine nets come in a range of lengths and sizes (0.5–20 cm mesh) and should be selected according to the water body to be fished. Most fish species can be caught depending on mesh size. Where possible (i.e. in reasonably shallow water) the net should be 1.5 times the depth of the water. As a rule of thumb, 2 people may be able to haul a 50 m long net and about 8 people would be required to haul a 200 m long net.

Limitations Seining is selective up to a certain size of fish as explained earlier, but small mesh sizes (<2.5 cm) are more efficient, although very small meshes (<1 cm) can be difficult to drag through the water. Catches can be affected by the skill of the labourers; obstacles such as trees, large rocks, irregular water depths and shoreline across the area covered can allow fish to escape as the water is effectively swept by the netting. Seining is an

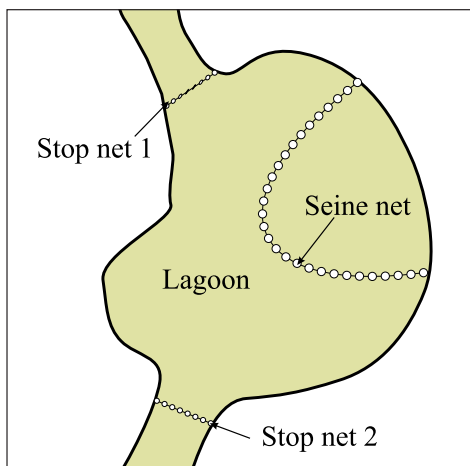

Figure 10.4: Stop nets set in a lagoon selected for seining

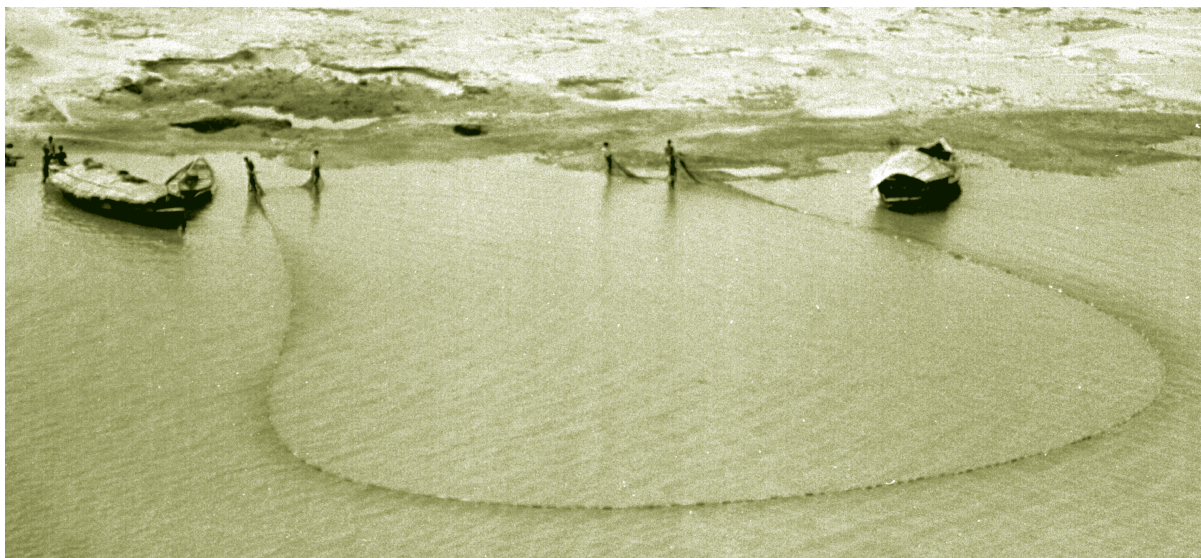

Figure 10.5: Seine net being hauled in to the shore

active fishing method and, therefore, time consuming, employing labourers for part or all of the day. The larger the net, the more costly and the greater the labour requirement. Seining is inappropriate in waters containing obstacles such as trees, large rocks, etc., and cannot be used in fast flowing water.

Processing Fish should be sorted by species from each haul (seine catch) and kept alive in buckets of water or kept on ice in a cool-box. Fish should be weighed and their lengths measured (see section on 'Measurements' below, page 207).

Resulting data Biomass (expressed in grams/kilograms per square metre or per cubic metre – if the average water depth of the area fished is measured) can be estimated if the area fished is calculated and continually seined until no more fish are caught. Species composition by weight and number can be assessed. Catch per unit effort (CPUE) by species or in total using the number of hauls as the units of effort. Individual fish lengths and weights can be used to calculate growth and mortality equations.

Sampling period Daytime; seining at night is possible, but less reliable. Sampling frequency depends upon the efficiency of netting and the sampling sites. One good sampling, comprising a wide variety of species and a wide

length range of important species, is better than small monthly samples. Fishing over consecutive days for one sample is appropriate if the site can take such fishing pressure (this is likely if the fishing site is on a large lake or, for example, a stream site is connected to a larger river). Sampling may be possible on a monthly basis throughout the year (as on a lake) or for only 2 or 3 months as in the case of a stream.

Equipment Seine nets will either be available locally or can be adapted from locally available nets, and similarly with stop nets. String can be used for measuring areas and depths. Cool-boxes and ice are needed to store samples.

Staff required At least 4 (depending upon the length of the seine net).

Gill netting

Gill netting involves positioning straight panels of nets (fleets) of gradually increasing sizes, e.g. mesh sizes at about 1 cm intervals are best, within a water body. Fish that encounter the net and are too large to pass through the mesh are caught by their gill flaps or other protruding parts, like spines. By using a range of mesh sizes (e.g. 1–10 cm), a random sample of fish between the size limits determined by the smallest and largest meshes are caught. By setting a fleet of gill nets across a river, most fish moving upstream or downstream can be sampled. Alternatively, in small areas of water, nets can be used individually. Gill netting is a versatile method and suitable for small and large water bodies, in moving water set along the banks and in slow and still water set from the banks to the middle, in series or separate. Gill nets are not suitable for use in fast flowing water. A barrier of netting can be set from the surface to the bottom of the water so covering both shallow and deeper waters. Individual nets or fleets of nets can be set at different water depths by using weights and floats (Figure 10.6).

Limitations Gill nets select fish by size depending upon the mesh sizes; catches are affected by the positions of nets in relation to the shoreline, water currents and depth of water; small lengths of netting may not sample fish efficiently in large water bodies; removing fish from gill nets can take time, especially if spines or teeth are thoroughly tangled. Relatively inactive fish and bottom-dwellers are far less susceptible to capture. Other animals often become entangled in the nets and may die. All efforts should be made to avoid this.

Processing Fish should be removed from the netting and stored separately by net or by fleet on ice or in buckets.

Resulting data As with seining, except that biomass cannot be estimated by gill netting. CPUE is calculated as the net length x time for which the net is set.

Fauna sampled Most fish species (those resident in fast flowing water, such as catlets, e.g. *Leptoglanis rotundiceps* and *Chiloglanis neumanni*, may escape capture and large fish usually in deep water may not be sampled effectively, e.g. *Hydrocynus farskahlilii*). Species caught depend on mesh sizes used.

Sampling period During the night and/or day – 12 h between checking nets. Several days and nights fishing maybe necessary to acquire enough fish for a suitable sample as passive methods are less efficient than active methods like seining (increasing the number of nets set can be done if the manpower for checking and processing the catch is also increased). Monthly sampling for the duration of the project is recommended if the sites retain sufficient water for setting nets.

Equipment Gill nets should be available locally or adapted from locally available nets. Other materials, such as floats, sinkers, etc., can be made from locally available materials. Access to a boat will usually be necessary. A cool-box with ice will be needed to store the samples.

Staff required 1 boat handler and 2 others to set nets.

Trapping

This is one of the most versatile methods of sampling or censusing fish. Traps can be used in a variety of habitats from relatively fast flowing rivers to still water (including wetlands dominated by vegetation or open estuaries). Traps can take a variety of forms. Using fixed and unbaited traps, the method is similar to using gill nets but, being rigid, traps have the advantage of robustness in a current. Baited and spring traps act similarly to hooks, in that they possess an attractant which influences the size and species that will be caught. For example, if bait such as rice bran is used, herbivorous and omnivorous fishes will be attracted to the trap, whereas if fish flesh or meat is used, predatory and scavenger species will be attracted. The size of trap openings affects the selectivity for size

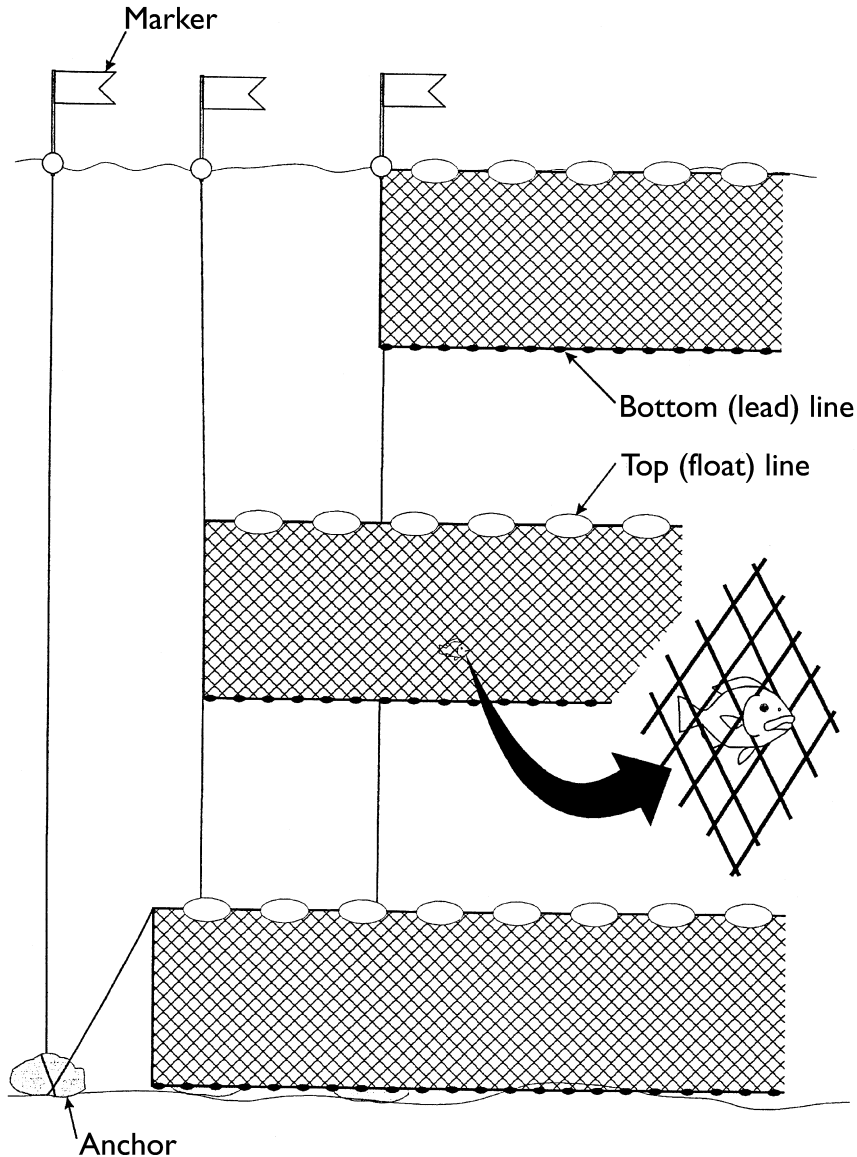

Figure 10.6: Nets can be set at different water depths by using weights and floats

(similar to the mesh of gill nets). Species selectivity can depend on movement and behaviour as well as different baits. Fish migrating during the darker phases of the moon can be targeted by setting traps during these times at strategic places in the river. Places where the river narrows are better, as more complete coverage can be attained. Trap type and construction, sampling location and set time must all be carefully standardized to avoid biases, as all affect trapping success.

Limitations Catches are affected by the design of traps, opening size, baits and position where traps are set. Even for a given species, trapability is influenced by season, sex, age and habitat. Skill is needed to employ traps effectively. Trapping usually does not provide adequate catches to give usable data unless combined with other methods (see below).

Processing Fish should be sorted by species and by trap type and stored in buckets or on ice. Lengths and weights can be measured (see below).

Resulting data Good information on migration and breeding activity is possible with strategic trapping. It is usually necessary to combine trapping with other capture methods, but in certain situations traps can give good data on relative abundance, particularly at species level; it depends a lot on the comparability of sites. Growth and mortality assessments may be incomplete if trapping is not possible throughout the seasons, e.g. in rivers subject to flash floods.

Fauna sampled Most species, particularly migrants, as long as a wide variety of traps and baits are used.

Sampling period During the night and/or day; 12 h or less between checking traps (once traps have caught a lot of fish they are less effective). Trapping during 2 or 3 consecutive days may be necessary to obtain good samples, particularly if water levels are rising or falling rapidly. If possible, 2–3 months data should be obtained, especially when migratory species are important to the study.

Equipment Use locally available traps, as these will have been developed to suit local conditions and fish. Baits should also be based on those used by local fisherfolk. A cool-box with ice is also required (see above).

Staff required At least 2. More will be needed when using a large number of traps.

Hooks

Baited hooks set singly on a line or in multiples down a line can be excellent for sampling predatory fish, such as catfish (*Clarias gariepinus* and *Heterobranchus longifilis*) or tigerfish (*Hydrocynus forskahlii*). It is a cheap method and particularly useful in habitats that are difficult to sample using other techniques. However, capture rates on hooks are difficult to predict and depend upon habitat characteristics as well as bait used. Bait type *must* be carefully standardized to allow meaningful comparison of catches from different areas. Local knowledge about where, when and how to set hooks can be extremely valuable. Active fishing with hooks and line is generally better carried out by local people as they will be familiar with the water and the species likely to be caught. Hooks set on a longline can be useful in fast flowing water.

Limitations Highly selective for size and species, but varying the sizes of hooks can reduce the selectivity of fish based on mouth size, and varying bait can attract different species. Active fishing using hooks and line is time consuming and dependent on the skill of the fisher. The chief disadvantage is that fish are inevitably damaged (although the use of barbless hooks can reduce this) and subject to considerable stress.

Processing Fish should be sorted by species and hook sizes and stored in buckets, bags or on ice in a cool-box. Fish lengths and weights can be measured.

Resulting data Data concerning relative abundance, species composition and growth and mortality of certain species can be obtained, particularly maximum size and longevity. These data cannot be used in isolation, but together with those from the main fishing methods (seining and gill netting).

Fauna sampled Mainly predatory species.

Sampling period Longlines are best set at night (checked in the early morning), and active fishing is best done during the day. Sampling usually augments data gathered using other methods so 1–2 monthly samples are adequate. These are best gathered when water levels are rising and falling.

Equipment Hooks of varying sizes, baits, monofilament line, rod and line (if active fishing), should all be based on locally available and used types. Cool-box with ice is also required (see above).

Staff required 2 for longlines and 1 for active fishing.

Spears

These are suitable for use in fast flowing water as well as still water, but in both circumstances the water needs to be clear to spot fish. Using any kind of spear or harpoon is dependent upon the expertise of the fisher and should be carried out by the same person each time. The shape of the target fish is important as the use of spears favours dorso-ventrally flattened or rounded fishes, e.g. catfishes. Laterally flattened fishes, like breams or tilapias, are more difficult to catch. Spear fishing is not recommended for efficient sampling unless carried out by local people, and particular species are targeted.

Limitations Spear fishing is time consuming and dependent on the skill of the operator. Very selective (depending on the shape of the fish and species).

Processing Fish should be sorted by species and stored in buckets, bags or on ice in a cool-box. Fish lengths and weights can be measured (see below).

Resulting data Growth and mortality cannot be assessed using data from speared fish alone, but useful information on relative abundance, species composition and maximum size and longevity can be gained.

Fauna sampled Mainly suitable for catfishes and snakeheads.

Sampling period Best carried out during the daytime, although some fish by night, mesmerizing fish with flash lamps. Usually carried out once or twice during rising and falling water levels.

Equipment Spears/harpoons should be available locally or made to local designs. Cool-box with ice is also required (see above).

Staff required 1.

Dewatering and associated methods (e.g. fishing by hand)

These are ideal for small shallow water bodies, but can only be recommended if desiccation of the area is likely. Also dewatering is suitable in dammed shallow waters of larger bodies. This method of fishing is very common at the end of the rains in Asia when floodplains are draining. Pumps are used to transfer water from the area being fished. After sifting through the mud with hands and small nets, the water is allowed to flow back into the fished area. Dewatering is relatively unselective, as most fish in the area are caught, but some species can burrow into the river bed and escape capture. These methods are often only appropriate for one-off sampling, as they can affect the following year's sampling. Predation from birds and crocodiles can be a problem during collection. The methods are labour intensive for fishing and follow-up measurements, as catches tend to be very large.

Limitations Suitable for shallow water, or water bodies that can be easily dammed. Labour intensive as many people are needed to dam an area, and to retrieve and process all the fish from the area dewatered.

Processing All fish should be collected, stored as with other methods or measured at the sampling site. Fish should be sorted by species and weighed (usually the total weights are estimated by weighing large numbers of fish combined, then counting and weighing three samples of fish).

Resulting data Ideal for biomass estimates. This method usually yields large samples that are perfect for growth and mortality estimations.

Fauna sampled All species.

Sampling period Dewatering is only suitable for daytime fishing. This is usually a method used once in the season, when water levels are low, but before the main body of water dries out completely.

Equipment Long lengths of fine mesh netting or fencing for seining and for blocking, a pump to remove water, a variety of smaller nets (such as lift nets, cast nets), storage vessels (bowls, buckets and plastic bags), permanent marker pens, and cool-boxes with ice.

Staff required A large number for collecting and sorting fish and several people for weighing. The number of staff depends on the size of the area sampled but about 6–8 people are needed to deal with 20 m².

Poisoning

The use of poison (usually rotenone, although local plants with toxic properties can be useful too) is sometimes appropriate for sampling small pools and streams. Poisoning kills all sizes and species (higher doses may be needed for larger fish). Poisoning is relatively quick, but collection and sample processing is time consuming.

Limitations Not suitable for flowing water as the poison is diluted and carried downstream. It is not suitable for large water bodies.

Processing All fish should be collected using hand nets and by seining and stored as with other methods or measured at the sampling site.

Resulting data Ideal for biomass estimates, fish should be sorted by species and weighed (if the quantity of fish caught is large, total weights can be estimated by weighing large numbers of fish combined, then counting and weighing three samples of fish). Growth and mortality estimates can be assessed as samples are usually large.

Fauna sampled All species.

Sampling period This method can only be used in the daytime. Poisoning can only be carried out once, after the wet season, when water levels are sufficiently low to allow efficient collection of all the fish.

Equipment Fine mesh stop netting or fencing, seine net and/or hand nets for collecting fish, should be available locally or can be adapted from local materials. Cool-boxes with ice are also required (see above).

Staff required At least 4 for collecting and sorting fish and 2 for sample processing depending on the area of water poisoned. The larger the number of staff, the larger the area that can be sampled.

Electric fishing

Electrofishing can be used for one-off sampling, but is not particularly suitable in flowing waters. It involves passing an electric current through the water via electrodes, which stuns the fish. It can only be used in situations with electrical supplies or where a generator can be used and in water where the conductivity is high enough (at least 100 μS for small equipment). Electric fishing can be selective depending upon the power and transmission radius of the equipment, and the area sampled is difficult to estimate (Cowx and Lamaque, 1990). The equipment is expensive and can be dangerous if used by inexperienced investigators (people have been killed when electrofishing). This method is not suitable for all species, some fish are not necessarily stunned and some escape by sinking to the bottom, so seining the area is also necessary. Electric fishing is suitable for daytime fishing only, but is not recommended if other methods such as seining or gill netting are suitable and should only be attempted by trained and experienced fish biologists. As a result, no details are provided here and no method sheet is given (but see Perrow *et al.*, 1996).

For all the above methods, supporting information about the water body should be collected while at the sampling site. While collecting fish and packing gears, time is usually available for one member of the team to measure water depth, temperature, turbidity, oxygen, pH and conductivity (see chapter 5). Collection of phytoplankton and zooplankton using trawl nets can give an indication of the natural productivity of the waters, which will in turn influence the fish yield. Sampling before spray treatment gives better information than during or after treatment, as plankton can also be affected by pesticides (see chapter 9).

MEASUREMENTS

Fish should be sorted into different species and any unknown species preserved for identification. The basic measurements required are fish numbers per species, lengths and weights. The most useful length is the standard length, from the tip of the snout or lips to the end of the caudal peduncle (Figure 10.7). The total length is from the tip of the snout to the end of the caudal fin, with lobes extended to their greatest length. The fork length is from the tip of the snout to the centre position between the lobes of the caudal fin (Figure 10.7). Since tail fins are often damaged, the total and fork lengths are less precise than the standard length. However, it is quick and easy to record all three lengths at the same time and this allows comparisons with other studies to be made. Along with the length, the weight of each fish can show the effects of pesticide on the condition of fish and weights can be summed to evaluate differences in the catches from sprayed and unsprayed areas.

As well as lengths and weights, it is usually possible to slit the fish from anus to 'chin' and make a note of the sex and reproductive status. Sex is easily determined if the fish is mature, as eggs can be seen in the ovaries of females and milt in the gonads of males (usually white, milky fluid). When fish are young, gonads of females and males are very similar. It is, however, important to note that they are immature, as some pesticides can affect the reproductive activity of fish. The stages of reproduction are usually classified as resting, developing (or maturation), ripe (or reproduction) or spent, with some intermediate stages. The method sheet detailing reproduction summarizes a simple coding system for assessing the stages of spawning. In order to assess the impact of pesticides on the fecundity of fishes, eggs from females in ripe condition should be weighed and preserved, so that they can be counted later. The best preserving fluid for fish eggs is Gilson's fluid, but extreme care should be taken while handling the ingredients (see chapter 3). Gilson's fluid is made with 100 ml 80%

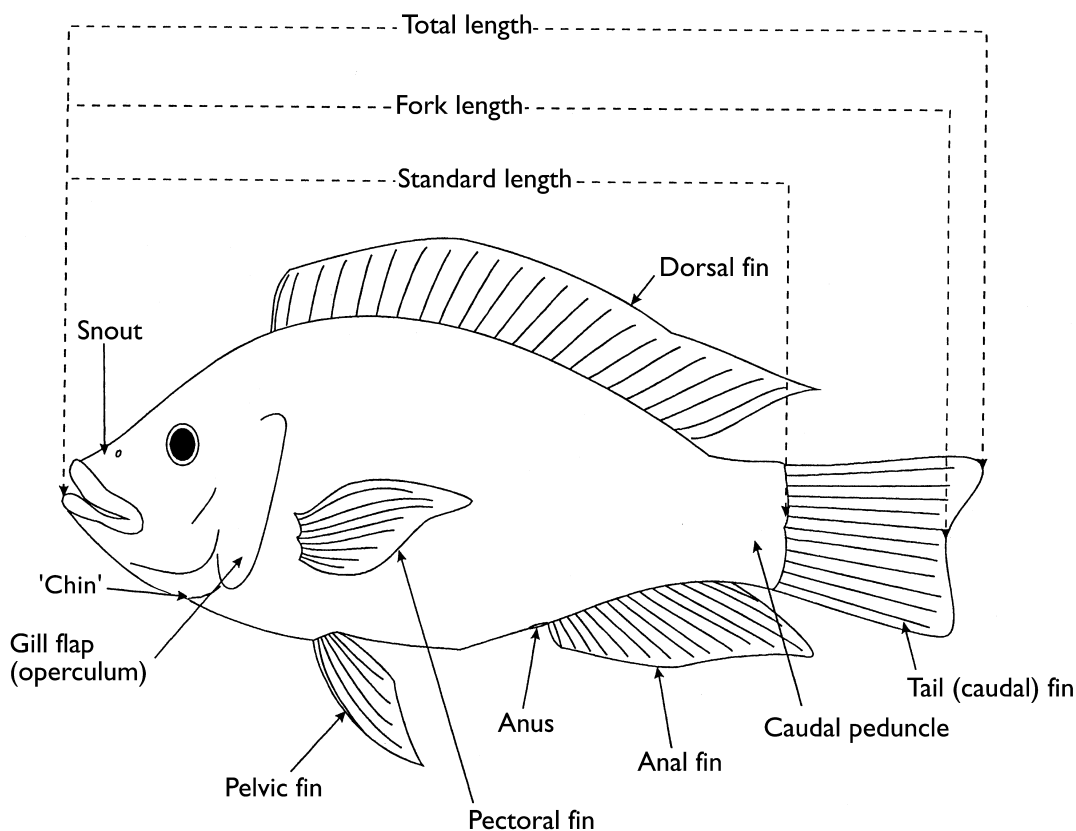

Figure 10.7: Measurement of fish length

alcohol, 880 ml distilled water, 15 ml 80% nitric acid, 18 ml glacial acetic acid and 20 g mercuric chloride. It should be prepared in a laboratory before going to the field and kept in a secure glass bottle. Alternatively preserving in 4–5% formalin (dilution of 1 part formaldehyde solution in 8–10 parts distilled water) is acceptable, but the eggs become very hard and difficult to separate if left for a long time in formalin. Care should also be taken when mixing and handling formalin (see chapter 3). Samples of the preserving fluids should be kept for residue analysis.

The collection of stomach contents to discern the food of different species is very useful, particularly if it is suspected that pesticide reduces the food supply for certain fish species. Changes in feeding patterns and food in the treated areas may also be observed. Both preservation of eggs and stomach contents can take time in the field, particularly if these studies are matters of interest, rather than impacts of particular concern. By selecting a few key species for these studies, it is possible to quickly carry out the preservation and complete the basic measurements on large numbers of fish.

SAMPLE PROCESSING FOR RESIDUE ANALYSIS

One important task to be undertaken in the field is the collection of fish tissue to assess the levels of pesticide residue in them. Organochlorine residues tend to accumulate in fatty tissues, such as gonads, brains, adipose tissues in the gut and liver, so it is these that are generally preserved for analysis. If an objective of the investigation is to evaluate the risks to human health, then fish flesh (or in the case of small fish, the whole body) should be analysed for residues. Preserving in 5–10% formalin (dilution of 1 part formaldehyde solution to 4–8 parts distilled water) is acceptable for tissue samples for most analysis of residues of organochlorine pesticides.

Samples of the formalin should be kept for residue analysis as these may show background levels of pesticide (see method sheet on sampling fish for residues). Pesticides from the organophosphate, carbamate and pyrethroid groups do not tend to bioaccumulate and so residue analysis is not normally undertaken for these. However, in some circumstances, residues of metabolites may be detected and indicate the time of contamination. In general, fish killed by these types of pesticide do not show the threshold residue levels that are fatal and residue analysis is expensive and thus best avoided in these cases.

SAMPLE PROCESSING FOR POPULATION PARAMETER ESTIMATION

In order to carry out growth, mortality and production estimates from ageing fish, scales, otoliths (ear bones) or bony parts, such as spines or vertebrae, need to be collected in the field. Scales are the easiest to obtain, although otoliths are considered best for the most precise ageing as daily rings on the sectioned otoliths can be identified. If it can be established when checks (discontinuities in the ring formations on scales) are formed, by sampling each month for a year or more, then ageing from scales is perfectly acceptable. Since otoliths have to be dissected out of the fishes head, which can in some species be encased in bony plates, time in the field for this operation may not be available. Vertebrae collection can also be a slow task in the field. If ageing can be carried out later in the investigation then collection of scales from each fish is an efficient use of field time. Usually 4 or 5 are needed, including a key scale, i.e. the same scale from each fish of a species, see Figure 10.8. Bony parts are usually dried, and all the connective tissue removed, before being stored in small labelled envelopes until required.

A reference collection of fish species from the waters in the study areas is useful. Collection and preservation of a few individuals of each species sampled can quickly and easily be done during fieldwork. For preserving, use 5–10% formalin or 70% ethanol, after 5 days in formalin.

LABORATORY TECHNIQUES AND DATA ANALYSES

The simplest of all data analyses is comparing numbers or weights of fish from each area, on a monthly, seasonal or annual basis. The data must first be standardized for sampling or fishing effort. If fishing varied between the treatment and control areas, catches can be expressed on a CPUE basis (e.g. weights or numbers of fish caught (by local people or study team in an hour, a day or 24-h period). Samples from local peoples' catches must be

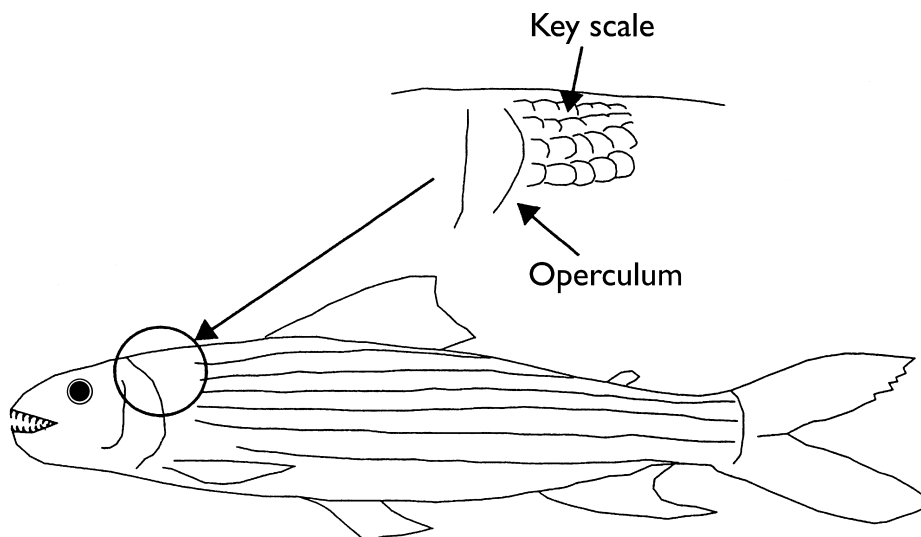

Figure 10.8: Key scales are used in ageing fish

the same proportions of the catch from each area, or multiplied to estimate the whole catch. Catch and effort data can only be used if the fishing intensities of each area are similar. Large differences in effort can influence the amounts of fish caught (catch and effort are not linearly related when effort is very low or high), and also the presence or absence of less common species (Cowx, 1991). Comparisons of catch (or catch/effort) data can be investigated using paired *t*-tests, analysis of variance (see chapter 2) and a subsequent test for differences, like least significant differences. The same comparisons can be made on individual species, although it is unlikely that all species will be compared in this way. Community differences, i.e. differences in species composition can often be visually discerned, some less common or vulnerable species may have disappeared from the sprayed area. If the impact at community level is important in the studies, analysis of the data using cluster analysis or multiple discriminate analysis may be necessary. Consultation with a statistician is recommended for these procedures.

If poisoning or sequential seining was carried out in enclosed or isolated areas, then estimations of fish biomass (ichthyomass) can be made. Several areas of water should be assessed, varying in size, but paired between sprayed and unsprayed waters, as biomass is influenced by area and volume of water, varying considerably in small areas.

From length measurements, length/frequency distributions can be appraised. Pesticides can affect smaller fish more severely than larger ones. By comparing length distributions of fish caught at the same time (usually during the same month) between sprayed and unsprayed areas, such effects may be apparent. There will be changes in length distributions from month to month, as fish grow, get caught, die or migrate to other areas. If the waters sampled are similar in sprayed and unsprayed areas, then differences in the changing distributions can show the effects of spraying. For example, effects on recruitment of young fish can be shown by the absence of smaller fish in the samples from sprayed waters and presence of a peak in the distributions of lengths of fish from the untreated area. Length/frequency distributions can be used to assess growth, mortality and recruitment using specially designed computer programs to estimate these parameters. Details of these analyses are available in Hilborn and Walters (1992) and should only be used by trained personnel and in consultation with a fisheries scientist. These techniques use mathematical modelling and estimate parameters of the models that reflect the dynamics of the population. Comparisons of growth parameters can be assessed by using multiple estimates of the parameter, from different samples from the same sampling sites, during the same time period, or by using the range of parameter values that are equally suitable for the length distributions. These are really a form of pseudo-replication (see chapter 2). If sampling was possible at a number of sites within and outside a number of treated and untreated areas, then these can be considered replicates. Analysis of variance and follow-up statistical tests (see chapter 2; Sokal and Rohlf, 1969; Steel and Torrie, 1980) can be used to evaluate differences in growth parameters. Advice should be sought if the use of such methods is attempted.

Ageing of fish from scales or bony parts should be carried out by trained personnel (methods are documented in Bagenal, 1978). From the length at age data, growth, mortality and production can be estimated, again using modelling techniques. These methods are covered in Bagenal (1978), Gulland (1983) and Pitcher and Hart (1982). Differences among many of the parameters estimated using these techniques cannot easily be analysed using standard statistical methods. Advice should be sought if such methods are tackled.

Fecundity studies involve counting eggs, by sub-sampling each ovary or pair of ovaries from each fish. The eggs should be carefully washed to remove the Gilson's fluid or formalin to make handling easier (see chapter 3). Sub-sampling can be carried out by weight, i.e. weighing all the eggs, taking at least three sub-samples, weighing them and counting the eggs in the sub-samples, then calculating from the number of eggs per gram, the number of eggs in the ovaries. Alternatively by immersing the eggs in water in a measuring cylinder, sub-samples of eggs taken are counted and then the volume they occupy measured, as with all the eggs. Calculation of the number of eggs in the whole ovaries can then be made, as in the case of weighing (further details of these and other methods are given in Bagenal, 1978). Eggs may be kept for residue analysis. A sample of the preserving solution should also be sent as a 'blank' (see chapter 6).

The identification of food items from the preserved stomach contents can be done by eye, or with the aid of a microscope. Consultation with a specialist is usually necessary if taxa need to be identified to species level. Classification of food items into groups is generally considered appropriate. The groups may include: terrestrial plants, aquatic plants, phytoplankton, zooplankton, benthic invertebrates, larger invertebrates, e.g. bivalves and gastropods, terrestrial and aquatic insects, fish (either whole or parts, like fins), and inert material (sand and mud). The quantities of food items in terms of percentage by volume in each stomach and percentage occurrence in the species (number of fish that consumed a particular food as a percentage of all the fish of that species sampled) can be compared using analysis of variance (see chapter 2). By analysing stomach contents, fish species that are most susceptible to the impacts of pesticides through the food chain can be identified, e.g. piscivorous fish and bottom-feeders. In addition, the indirect effects of pesticides on fish, such as the elimination or reduction of various food items, like invertebrates, can be determined. Changes in diet and periods of starvation, noted from the stomach contents, can indicate these effects.

Pesticide residue analysis can be carried out on fish tissue in the same ways as with other animal tissues. See chapter 6 for tissue sampling techniques for residue analysis.

REFERENCES

ANTWI, L.A.K. (1987) Fish head acetylcholinesterase activity after aerial application of temephos in two rivers in Burkina Faso, West Africa. *Bulletin of Environmental Contamination and Toxicology*, **38**: 461–466.

BAGENAL, T.B. (ed.) (1978) *Methods for Assessment of Fish Production in Fresh Waters*. Third edition. *IBP Handbook*, No. 3. Oxford: Blackwell Science.

BAZIGOS, G. (1974) The design of fisheries statistical surveys-inland waters. *FAO Fisheries Technical Paper*, No. 133. Rome: Food and Agriculture Organization of the United Nations.

BURDICK, G.E., HARRIS, E.J., DEAN, H.J., COLBY, T.M., SKEA, J. and COLBY, D. (1964) The accumulation of DDT in the lake trout and the effect on the reproduction. *Transactions of the American Fisheries Society*, **93**: 127–136.

COWX, I.G. (ed.) (1991) *Catch Effort Sampling Strategies: Their Application in Freshwater Fisheries Management*. Oxford: Fishing News Books/Blackwell Science.

COWX, I.G. and LAMARQUE, P. (1990) *Fishing with Electricity: Applications in Freshwater Fisheries Management*. Oxford: Fishing News Books/Blackwell Science.

GULLAND, J.A. (1983) *Fish Stock Assessment: A Manual of Basic Methods*. *FAO/Wiley Series on Food and Agriculture*. Volume 1. New York: John Wiley.

HILBORN, R. and WALTERS, C.J. (1992) *Quantitative Fisheries Stock Assessment: Choice, Dynamics and Uncertainty*. New York: Chapman and Hall.

HURST, P., HAY, A. and DUDLEY, N. (1991) *The Pesticide Handbook*. London: Journeyman Press.

METCALF, R.L. (1981) Insect control technology. pp. 413–485. In: *Encyclopedia of Chemical Technology*. Volume 13. New York: Wiley-Interscience.

MUIRHEAD-THOMSON, R.C. (1971) *Pesticides and Freshwater Fauna*. London: Academic Press.

NIEMI, W.D. and WEBB, G.D. (1980) DDT and sodium transport in the eel electroplaque. *Pesticide Biochemistry and Physiology*, **14**: 170–177.

NIKOLSKY, G.V. (1963) *The Ecology of Fishes*. London: Academic Press.

PERROW, M.R., COTE, I.M. and EVANS, M. (1996) Fish. pp. 178–204. In: *Ecological Census Techniques: A Handbook*. Sutherland, W. J. (ed.). Cambridge: Cambridge University Press.

PITCHER, T.J. and HART, P.J.B. (1982) *Fisheries Ecology*. London: Croom Helm.

STEEL, R.G.D. and TORRIE, J.H. (1980) *Principles and Procedures of Statistics – A Biometrical Approach*. Second edition. Tokyo: McGraw-Hill Kogakusha.

SOKAL, R.R. and ROHLF, F.J. (1969) *Biometry: The Principles and Practice of Statistics in Biological Research*. San Francisco: W. H. Freeman.

SUKLA, L. and PANDEY, A.K. (1985) Effects of two commonly used insecticides on the ovarian histophysiology in the Teleost *Sarotherodon mossambicus*. *Pesticides (Bombay)*, **19**: 45–48.

FURTHER READING

DOUTHWAITE, R.J. and TINGLE, C.C.D. (eds) (1994) *DDT in the Tropics: The Impact on Wildlife in Zimbabwe of Ground-spraying for Tsetse Fly Control*. Chatham, UK: Natural Resources Institute.

HILSENHOFF, W. (1966) Effects of diquat on aquatic insects and related animals. *Journal of Economic Entomology*, **59**: 1520–1521.

LAWS, E. A. (1993) *Aquatic Pollution: An Introductory Text*. Second edition. New York: John Wiley.

MUIRHEAD-THOMSON, R.C. (1987) *Pesticide Impact on Stream Fauna with Special Reference to Macroinvertebrates*. New York: Cambridge University Press.

ROBBINS, R. (1991) *Poisoned Harvest: A Consumer's Guide to Pesticide Use and Abuse*. London: Victor Gollancz Ltd.

AMPHIBIANS AND REPTILES

Michael R. K. Lambert¹

Natural Resources Institute, University of Greenwich at Medway, Central Avenue,
Chatham Maritime, Kent ME4 4TB, UK

INTRODUCTION

Amphibians and reptiles are especially abundant in the world's tropical, sub-tropical and warm temperate regions. They are cold-blooded, or ectothermic, vertebrates, with an internal body temperature primarily dependent upon external warmth.

Amphibians are present in damp wetland habitats, occurring at the edges of ponds and streams, and have both aquatic and terrestrial life stages. Adults breed in water during seasonal rains, the eggs laid as spawn hatching into larvae (tadpoles), which are able to swim and feed initially on algae and later carrion. Some species (e.g. African clawed frog) depend on water throughout the year; others are inactive during dry periods. Invertebrates constitute amphibians' main prey. Amphibians are especially numerous in tropical rainforests.

Certain reptiles, such as crocodylians, freshwater chelonians (turtles and terrapins) and some snake and monitor lizard species, are also associated with water and damp habitats in the tropics and sub-tropics. All are predators, feeding primarily on fish, but also taking carrion. Freshwater chelonians additionally feed on invertebrate species such as crustacea, as well as fish.

Most species of reptile are terrestrial, and abundant in a wide range of habitats. Geckos and certain skink and agamid species inhabit rocks and trees, while others are ground-dwelling. Most lizard species prey on invertebrates, but monitors, for example, scavenge a wide range of prey and, like crocodylians, include carrion. Snakes depend mainly on lizards, anurans (frogs and toads) and other small vertebrates. Like their lizard prey, they are often found in dry, sandy regions, in savanna woodland, as well as in damp habitats and tropical rainforests. Surviving in arid conditions, lizards especially maintain activity during the dry seasons of the year. Tortoises are mostly herbivorous, seeking refuge in vegetation.

Amphibians and such insectivorous reptiles as lizards have an important function in linking invertebrates with more advanced vertebrates higher up the food chain. Not only do they constitute a food resource for such organisms, but they are a means by which chemical residues, especially residues of organochlorine pesticides taken in with contaminated prey, can enter food chains. Through bioconcentration, some of these chemicals find a way into the environment generally and, on occasion, into man. Lipid soluble pesticides tend to become sequestered in the body fat of reptiles. Their ectothermy additionally renders them dependent upon temperature for metabolizing pesticide residues, and a poor ability to do so results in accumulation in body tissues. Amphibians have a soft permeable skin and larval gill membranes, highly vascularized and allowing the entry of chemical contaminants. In contrast to birds and certain epigeal insects, both amphibians and reptiles also have a limited capacity for emigration and recolonization, or to adapt to rapid changes in habitat. With this range of characters they are, therefore, good indicators of the quality of terrestrial habitats, and residue loads are biomarkers of the level of contaminants entering food chains, and hence the environment generally.

¹Contact address: MRKL is deceased. Please contact one of the editors.

Amphibians and reptiles take up pesticides in a number of ways.

- Inhalation: near areas of contamination, pesticides may be taken up during breathing through the lungs, especially in reptiles.
- Contact: after treatment, pesticides may be taken up by amphibians, particularly through larval gill membranes and their permeable skin; reptiles have scaly skins and do not have aquatic larvae, and so pesticides are not taken up as readily by this means.
- Ingestion: both amphibians and insectivorous reptiles can take in pesticides through the ingestion of invertebrate prey which is contaminated, either with pesticide particles adhering to the cuticle or, in the case of species higher up the food chain, through prey with residues sequestered in body fat.

Where there are pesticide control campaigns, amphibians and reptiles can come into direct contact with pesticides as non-target organisms in treated habitats or in areas of spray drift. Amphibians in open water bodies may also be exposed to pesticides due to run-off from adjacent agricultural land on which chemicals are used to control crop pests.

The aim of this chapter is to describe techniques for monitoring amphibian and reptile populations, depending on species and habitat, which have use in pesticide impact assessment work.

OBJECTIVES

There are three main objectives for monitoring amphibian and reptile populations.

- To assess the direct effects of pesticide application and run-off on species and herpetofaunal diversity from the observation of living animals and collection of any specimens killed by pesticides (see chapter 6 on analysis for residues in the laboratory). Selected species are identified for use as bioindicators.
- To assess the indirect effects of pesticide treatment on a range of amphibian and reptile species through the effect on their mainly invertebrate prey, including ingestion of contaminated prey resulting in poisoning (collection of specimens for laboratory residue analysis), and on vegetation (in the case of herbicides) that provides refuge and also a harbour for prey.
- To collect and preserve specimens in the field – voucher specimens – for identification in the case of biodiversity studies, preserved material for gut content and residue analysis (organochlorines) in the laboratory, and living material for cholinesterase testing (mainly organophosphates) in the laboratory.

The method of monitoring the impact of pesticides on amphibian and reptile populations will depend on the pesticide type and formulation, the method of application, the receiving habitat and species involved, and the impact on herpetofaunal diversity (many species) or on bioindicator species (one or two). An estimate of population changes resulting from exposure is required: this may be an estimate of species diversity (richness and composition – percentage frequency), a population estimate (absolute numbers in an area), relative abundance (comparison of relative densities), or a measure of density (numbers per unit area).

Amphibian and reptile activity varies at different times of the year, and populations fluctuate seasonally. Some amphibians depend on seasonal rains for breeding, and most species are inactive during dry or cool periods of the year: certain reptile species may be active throughout the year, or less active during cooler or drier periods and breeding only at specific times of the year.

Effects of pesticide treatment may be compared *before* and *after* treatment, and in relation to time since treatment took place, in *treated* and *untreated areas*.

Sample collections are required for the following.

- Voucher specimens in biodiversity studies, preserved for later identification purposes.
- Analysis for organochlorine residues in the laboratory: specimens are preserved in formalin or deep frozen (see chapter 6). Residue levels are expressed as parts per million or mg kg^{-1} ($\mu\text{g g}^{-1}$) wet or dry body weight, or total lipid. Wet weight is the standard, and useful for estimating the level of residues entering food chains since predators usually ingest fresh prey; dry weight is used for comparing levels with those in other materials, e.g. soil and leaf litter, reflecting atmospheric and environmental levels generally. Lipid levels for determine effects on physiological processes of amphibians and reptiles themselves.
- Live samples of amphibians and reptiles especially lizards, are taken to the laboratory and maintained alive in cages for cholinesterase testing in the case of chemicals such as organophosphates.
- In the case of animals showing signs of acute poisoning, where the cause of morbidity is unknown, samples are killed immediately for biopsy and residue analysis.

STUDY DESIGN

The various techniques for the measurement of population differences in applied ecological studies still require standardization, and a useful work by Heyer *et al.* (1994) includes a description of the different methods for standardized monitoring of amphibian populations in particular, but also certain forms of reptile. Different sampling techniques may yield quite different results. Estimates of population size and density may be limited by differences in activity and behaviour of many species. Problems arise from the limitations of the survey techniques and replication of sites (see chapter 2).

Which pesticide?

Organochlorines

Organochlorines have both chronic and acute effects especially on amphibians, in particular dieldrin and its metabolites and BHC isomers. Residues accumulate and levels are measured from analysis in the laboratory of amphibian and reptile samples from sprayed and unsprayed areas. Organochlorines can have indirect effects on lizards through contamination and a reduction of invertebrate populations.

Organophosphates

Organophosphates, parathion in particular, can have acute effects on certain amphibians. Chlorpyrifos sprayed against locusts has caused death of lizards. Measurement of residue levels in amphibians and reptiles from sprayed and unsprayed areas may help to determine cause of death. Alternatively, the estimation of acetylcholinesterase levels can provide evidence of pesticide impact. Both are expensive and interpretation of resulting data is difficult. The latter procedure is specialized and also requires liquid nitrogen in the field and expensive test kits that are not readily available. Organophosphates may have indirect effects on lizards through contamination and a reduction of invertebrate prey populations.

Carbamates

Carbamates, e.g. bendiocarb, have been observed to affect lizards and probably also have indirect effects on lizards, through a reduction of the invertebrate population.

Pyrethroids

Pyrethroids are not very persistent in the environment but have acute effects on certain amphibians, especially the larvae. They may also have indirect effects on lizards through a reduction of invertebrate prey populations.

Insect growth regulators and biologicals

Insect growth regulators and biologicals have little or no direct effect on amphibians and reptiles; indirect effects through impact on prey have been indicated.

Herbicides

Herbicides have little known effects if any, but paraquat has been recorded to cause running eyes in tortoises. They can have an indirect effect on species through the removal of vegetation providing refuge and a harbour for invertebrate prey.

Where is it used?

- Agro-ecosystems: few amphibian and reptile species occur in agriculturally developed areas and so diversity is low; larval and adult frogs are found by irrigation channels and may be affected by run-off in paddy fields.
- Woodland/forest: amphibian and reptile faunal diversities are determined since they may be affected by pesticides; numbers of both arboreal and fossorial forms of both groups occurring in savanna woodland are determined, amphibians occur especially in tropical rainforests.
- Pasture/savanna: amphibian and reptile faunal diversities are determined, as in woodland/forest; numbers of surface-dwelling forms with burrow refuges are determined, especially lizards, snakes and tortoises, and certain toad species in adult terrestrial phase.

Application method

- Knapsack or tractor: such methods of application affect fauna on trees and shrubs, soil surface and soil.
- Ultra-low-volume: fauna on shrub vegetation and the ground surface are affected; if aerially applied, canopy and arboreal amphibians and arboreal reptiles are specifically affected.
- Fogging: canopy and arboreal amphibians are affected, together with arboreal reptiles.
- Aerial: fauna are affected as for ultra-low-volume and fogging treatments.
- Granules/seed dressing: such applications may affect fossorial amphibians and reptiles.

All methods may have indirect consequences through contamination and disappearance of invertebrate prey.

Measurement of pesticide residues in amphibians and reptiles

Residue levels in amphibians and reptiles are generally expressed as mg kg^{-1} or $\mu\text{g g}^{-1}$ (parts per million).

Wet weight

Residue levels are conventionally given as fresh (wet) weight. This measure is relevant to amphibians and reptiles for comparison with other organisms, and because they are prey of organisms higher up the food chain. Ingested intact or as large fleshy morsels, residue levels in such food material calculated as whole body wet weight provide information on pesticide levels entering the food chain. Amphibians and reptiles form a link in the food chain with invertebrate species, upon which they prey and which may be contaminated, and predators higher-up the

food chain that prey on them in turn. Wet weight residue levels are also more useful for comparing amphibian levels with those in their aquatic environment.

Dry weight

Residue levels in materials like soil and leaf litter are given in dry weight. In order that levels in amphibian and lizard species can be compared directly, whole body dry weight is used. This allows the groups' levels to be placed in perspective by comparing them with baseline levels of materials in their habitats, with which they are closely associated, and which reflect environmental levels generally. Elevated levels in amphibians and reptiles are likely to indicate that the source of uptake is from contaminated prey.

Lipid

Residue levels in relation to body lipid provide information on the pesticide effects, on the physiology of the organisms themselves. Residues are sequestered in body fat, and levels are usually negatively correlated with percentage fat content, that is high residue levels (expressed as mg kg⁻¹ lipid) correspond with low percentages of fat and vice versa. Fat is combusted during lean times of the year when the intake of food is at a low level. Residue levels then increase, and may cause chronic physiological or behavioural disorders, and even death when a lethal level is reached.

Population change

The treatment of areas with pesticides may reduce the population, or even result in the complete disappearance of amphibians and reptiles over a period of time. This is important for biodiversity studies. Alternatively, applications may give rise to a patchy distribution, the surveying of which presents its own problems (Swingland and Shorrocks, 1990). Populations are monitored for the extent of decline or rate of recovery. Halting spraying in an area may result in localization of populations at the start of recovery or re-immigration from adjacent untreated areas.

Distribution change

Reptiles may be repelled from areas with high levels of pesticide contamination. Species inhabiting tree canopies in forests, such as tree frogs, and certain snake and lizard species, for example, may be particularly susceptible to aerial spraying. Perch heights selected by amphibians and reptiles may be influenced by the technique used and target application of pesticide spraying in savanna woodland.

Percentage of habitat occupied

Amphibians and reptiles may depend upon certain habitat units such as trees or rocks. Recording the proportion of these units occupied provides a standardized technique of equal-effort monitoring that is independent of density.

Stage, maturity/age and sex

Pesticide contamination may affect growth and development in amphibians, resulting in deformed or otherwise abnormal animals, and can hinder or prevent larval stages from undergoing metamorphosis to become immature adults. Age and state of maturity, and if possible sex of adult amphibians (presence of nuptial pads in male anurans) are also recorded, especially in selected bioindicator species, to establish whether ratios change after treatment. Poisoning from ingested pesticide residues can also reduce longevity, and this may affect age structure in both amphibians and reptiles. Likewise, in lizards especially among reptiles which tend to go through three phases, i.e. hatchlings or juveniles during their first year, immature or sub-adult in the second, and adults from the third year on, poisoning may affect age structure. It is especially important in selected bioindicator species

to determine the sex of adult lizards if possible (males are often differently and more brightly coloured than females).

INVENTORY, MONITORING AND SAMPLING TECHNIQUES

An estimate of species richness is required for an assessment of biodiversity. Amphibians and reptiles can be observed or collected during searches, and there are several well established methods for surveying and monitoring amphibian and reptile populations in the field. However, amphibians depend on water and damp habitats far more than reptiles, except for crocodiles, turtles and certain monitor and snake species. Most lizard species occupy arid or semi-arid habitats, which may lack amphibians, or in which amphibians are inactive except during periods of rain.

The techniques that follow are applicable either for both amphibians and reptiles, or for one group or another (Table 11.1). Techniques for amphibian surveying are treated separately from those for reptiles (lizards in particular) within the description of each methodology.

Table 11.1 Sampling techniques

Method	Non-target herpetofauna			Habitat								
	Reptile	Amph larvae	Amph adult	Terrestrial				Aquatic				
Woodland				Forest	Savanna	Agro-eco	Woodland	Forest	Savanna	Agro-eco		
Inventory	●	●	●	●	●	●	●	●	●	●	●	●
Visual survey	●		●	●	●	●	●	●	●	●	●	●
Block sampling	●		●	●	●	●	●	●	●	●	●	●
Patch sampling	●		●	●	●	●	●		●	●	●	●
Breeding survey		●	●		●		●		●	●		●
Quantitative	●		●					●	●	●		

Complete species inventorying

The aim in preparing a complete species inventory is to record all possible species in a habitat. It, therefore, constitutes a baseline study before pesticide treatment in an area, and provides information on species richness. It involves two parts: visual encounter surveying and microhabitat searching (see also under quadrats and transects). The making of inventories is extremely time consuming and not a normal objective in pesticide impact work.

Visual encounter surveying

Visual encounter surveys are the simplest kind of survey, and useful for determining herpetofaunal diversity in relation to number and frequency of pesticide applications in an area, and for comparing diversity before and after treatment or in treated and untreated areas. A measure of relative density is provided by the numbers sighted per unit of time, usually 1 h in relation to the number of observers (sightings frequency is expressed as numbers per man-hour), but several replicate surveys are required for statistical comparison. During visual

encounter surveys, and depending on the ecology of species involved, the number and species of amphibian or reptile are recorded while one or more observers walk through an area or habitat for a measured period of time (timed searches). The path or paths taken by one or several observers can be a randomized zig-zag or straight line, or designed paths within a quadrat. These allow a faunal list to be compiled, with frequency of sightings in an assemblage (for species composition), and an estimate of relative abundance (numbers per man-hour) that is an expression of relative density. Actual density cannot be determined since only a proportion of individuals of a species is seen, and some species are fossorial and, therefore, under cover (these species are monitored using microhabitat searches).

For most amphibian surveys of this kind, searching is done at night using a wide-beamed spotlight, as the eyes of most forms reflect light, e.g. tree frogs at heights on forest trees in terrestrial habitats, or on banks and in water for rivers and other large water bodies. Weather conditions (air temperature, cloud cover, rain, etc.) should be recorded before and after surveys. For most diurnal species of lizard, such as lacertids, skinks and agamids, in terrestrial habitats, surveys are made during the day. For nocturnal lizards such as geckos (and especially forms whose eyes reflect light, e.g. turtles and crocodiles in large water bodies), surveys are made at night using a wide-beamed spotlight. Weather conditions (air temperature, cloud cover, etc.) should be recorded before and after surveys.

Limitations Only a proportion of the individuals of species seen on open ground, or those resting exposed and visually unimpeded by vegetation; activity varies with time of day, temperature and other seasonal weather conditions. Replicate surveys are required for purposes of comparison.

Resulting data Relative abundance (percentage species composition); sightings frequency (numbers per man-hour) reflecting relative density. Species richness and diversity within an assemblage.

Fauna sampled Active adults of most anuran (and lizard) species.

Sampling period Day and/or night, depends on species, or range of species or animal group's activity and behaviour.

Equipment Watches or stop-watches, digitometers, wide-beam spotlight (at night), thermometer or whirling hygrometer (see chapter 5) must be purchased. Plastic bags can be bought locally. Metal screw-lid aluminium (purchased) or glass containers (jam jars bought locally) are required for the preservative solution (45% formalin for dilution to 8–10% can be bought at a local hospital).

Staff required 2 or more observers; searching time (man-hours) increased, and hence numbers of animals sighted, in a specific time period (1 man-hour for fewer than 10 species, say; 5 man-hours for more than 10 and several observers).

Quadrat block sampling

This is a useful method to determine species present (richness and composition), and both their relative abundances and area density, where there has been pesticide spraying at ground level. The method applies especially for wooded areas with deep ground litter and a carpet layer of vegetation obscuring species, and rendering visual encounter surveys for certain species of amphibians and fossorial form of reptiles difficult or impossible. The method enables the determination of species present and composition, and area density (e.g. numbers per hectare). It involves thorough searching for amphibians and/or reptiles inside a series of square blocks that have been randomly selected within a matched habitat. One side of the habitat can be marked off, and the location of squares chosen (distance from one end) on the basis of random numbers given in a table. With approximate density of animals estimated beforehand, the size of squares chosen depends on vegetation quality and quantity. Depending on habitat type, microhabitat searches in woodland may involve turning stones, raking through leaf litter, probing holes and crevices with sticks, splitting or dismantling old and rotten logs, removal of epiphytes, etc., and recording time spent searching (area covered depends on number of animals recorded in relation to vegetation cover, quality and quantity). Searching need not continue when no further species are recorded; alternatively, a time limit of one or more man-hours is made, depending on number of species and individuals found, number of searchers and habitat type (1 man-hour with few individuals of species; 5 man-hours with 10 or more species and several observers involved).

Limitations Mainly for use in woodland or similar habitat containing inactive amphibians and/or fossorial reptiles.
Resulting data Relative abundance (percentage species composition); sightings frequency (numbers per man-hour) reflecting relative density when timed microhabitat searches are made. Species richness and diversity within an assemblage.

Fauna sampled Primarily yields both active and inactive species, fossorial species, or individuals of species seeking the refuge of vegetation.

Sampling period Day or night, provided the exact time of the start of the search, air temperature and other weather conditions are recorded, but easier during daylight hours with clear visibility.

Equipment Watch or stop-watch, compass, digitometer, thermometer or whirling hygrometer and altimeter must be purchased. Machetes, vegetable rakes and plastic bags can be bought locally. Metal screw-lid aluminium (purchased) or glass containers (jam jars can be bought locally) are required for the preservative solution (45% formalin for dilution to 8–10% can be bought at a local hospital).

Staff required 2 or more observers; searching time (man-hours) increased, and hence numbers of animals sighted in a specific time period (1 man-hour for fewer than 10 species, say; 5 man-hours for more than 10 and several observers).

Transect block sampling

Transects, as an alternative to quadrats, utilize a similar microhabitat searching procedure, and depending on habitat type, may involve turning stones, raking through leaf litter, probing holes and crevices with sticks, splitting or dismantling of old and rotten logs, removal of epiphytes, etc., recording time spent searching (area covered depends on number of animals recorded, in relation to vegetation cover, quality and quantity). As for quadrats searching need not continue when no further species are recorded; alternatively, a time limit of one or more man-hours is made, depending on number of species and individuals found, number of searchers and habitat type. Transects can be laid out as strips to determine amphibian or reptile population clines over a distance of continuously changing habitat, or in relation to increasing or declining levels of pesticide usage. Blocks at a distance from one end of sections along the transect are selected for intensive searching by random numbers in a table. The method enables determination of species present and composition, and area density (e.g. numbers per hectare) along the transect. Density from visual transects is still only relative density (e.g. numbers per hectare), for a proportion of animals will be in their refuges and not active and not, therefore, counted. If walked, or otherwise travelled, transects are also timed, then relative abundance as sighting frequency (numbers per man-hour) will also be obtained, and can be used as a check from statistical correlation with area density.

Limitations Mainly for use in woodland or similar habitat containing inactive amphibians and/or fossorial reptiles.

Resulting data Relative abundance (percentage species composition); sightings frequency (numbers per man-hour) reflecting relative density if timed microhabitat searches are made. Species richness and diversity within an assemblage.

Fauna sampled Primarily yields both active and inactive species, fossorial species, or individuals of species seeking the refuge of vegetation.

Sampling period Day or night, provided the exact time of the start of the search, air temperature and other weather conditions are recorded, but easier during daylight hours with clear visibility.

Equipment Watch or stop-watch, compass, digitometer, thermometer or whirling hygrometer and altimeter must be purchased. Machetes, vegetable rakes and plastic bags can be bought locally. Linen bags can be made locally. Metal screw-lid aluminium (purchased) or glass jars are required for the preservative solution (45% formalin for dilution to 8–10% can be bought at a local hospital).

Staff required 2 or more observers; searching time (man-hours) increased, and hence number of animals sighted in a specific time period (1 man-hour for fewer than 10 species, say; 5 man-hours for more than 10 and several observers).

Patch sampling

High densities of amphibians and certain reptile species are often associated with specific microhabitats or patches in an area. Patches are selected randomly within an area of uniform widespread pesticide application for comparison with those in similar untreated, or less treated, habitats. One side of the area is measured along a straight line, and patches are selected at distances perpendicular from points on a straight line at a set distance apart using random numbers from a table. Material making up the patch is removed or broken up, e.g. turn over rocks, separate out logs or cut down bush; record the numbers of each species sampled, ensuring that all of the animals associated with each patch are included. The method is used to determine the number, relative abundance and densities of species in the overall area.

Limitations Mainly for use in woodland or similar habitat containing inactive amphibians and/or fossorial reptiles.

Resulting data Relative abundance (percentage species composition); sightings frequency (numbers per man-hour) reflecting relative density if timed microhabitat searches are made. Species richness and diversity within an assemblage.

Fauna sampled Primarily yields fossorial species, or individuals of species seeking the refuge of specific vegetation or ground cover type.

Sampling period Day or night, provided the exact time of the start of the search, air temperature and other weather conditions are recorded, but easier during daylight hours with clear visibility.

Equipment Watch or stop-watch, compass, digitometer, thermometer or whirling hygrometer and altimeter must be purchased. Machetes, vegetable rakes and plastic bags can be bought locally. Metal screw-lid aluminium (purchased) or glass containers (jam jars can be bought locally) are required for the preservative solution (45% formalin for dilution to 8–10% can be bought at a local hospital).

Staff required 2 or more observers; searching time (man-hours) increased, and hence number of animals sighted in a specific time period (1 man-hour for fewer than 10 species, say; 5 man-hours for more than 10 and several observers).

Quantitative sampling of amphibian larvae (and aquatic reptiles)

Sampling methods, mainly for counting amphibian larvae, in pools and lakes, and slow-moving streams include seining, dipnetting and trapping, and enclosure sampling in known volumes of water. The relative merits of funnel-ended cylinder trapping vis-à-vis sweep netting and torch-surveying have been discussed by Griffiths (1985). The number of larval and/or adult amphibians caught are recorded in relation to the size of the pond (in the case of seining), number of net-dips or trap, or volumes of water sampled. A net is used to sample all microhabitats in a pond, which may include open water, under weed, edge of bank or in soft surface mud at the bottom of the water body.

The methods are used to obtain amphibian larval species richness, density and population size of amphibians, in relation to pesticide run-off from surrounding land.

Limitations Applicable in mainly open still water (pools, lakes or slow-moving streams); yields mainly tadpoles.

Resulting data Relative abundance (percentage species composition); tadpole density in relation to the size of the pond or volume of water; frequency (numbers per trap over a set time period, e.g. 24 h) reflecting relative density. Species richness and diversity within an assemblage.

Fauna sampled Tadpoles of water-associated anuran species.

Sampling period Day or night, provided the exact time of the start of the search, air temperature and other weather conditions are recorded, but easier during daylight hours with clear visibility. The activity of tadpoles may vary between day and night.

Equipment Thermometers, waders or hip boots, and long-handled dipnets and headlamps need to be purchased. Many of the net types, etc., could probably be made locally. Plastic bags and spare batteries can be bought locally, as can certain other items like notebooks, etc. Metal screw-lid aluminium (purchased) or glass containers (jam

jars can be bought locally) are required for the preservative solution (45% formalin for dilution to 8–10% can be bought at a local hospital).

Staff required 1 observer with 1–2 assistants.

Breeding site surveying for amphibians

Amphibians congregate, often during season rains, at sites adjacent to water to breed. Adults are counted along visual or aural transects. Larvae are present in water for longer periods than the adults. The surveys are mainly conducted in relation to long-term monitoring of populations of amphibians and reptiles in areas or regions where pesticides have been applied, or where water in breeding sites is known to be contaminated from surface run-off.

Limitations Applicable along edges of open pools, and shorelines of lakes or streams; yields adult anurans.

Resulting data Relative abundance (percentage species composition); sightings frequency (numbers per man-hour) reflecting relative density. Species richness and diversity within an assemblage.

Fauna sampled Adult anurans of water-associated species.

Sampling period Day or night, provided the exact time of the start of the search, air temperature and other weather conditions are recorded, but easier during daylight hours with clear visibility. Some anurans are only active at night.

Equipment Watch or stop-watch, thermometer or whirling hygrometer must be purchased. Waders or hip boots and wet suits (if needed), and long-handled dipnets and headlamps also need to be purchased, but the last could be made locally. Plastic bags and spare batteries can be bought locally, as can certain other items like notebooks, etc. Metal screw-lid aluminium (purchased) or glass containers (e.g. jam jars) are required for the preservative solution (45% formalin for dilution to 8–10% can be bought at a local hospital).

Staff required 2 or more observers; searching time (man-hours) increased, and hence number of animals sighted, in a specific time period (1 man-hour for fewer than 10 species, say; 5 man-hours for more than 10 and several observers).

Additional methods for amphibians

Specific methods of sampling amphibians are described by Heyer *et al.* (1994), which are more suitable for specialist application. These include:

- straight-line drift fences and pitfall traps as surface barriers, under the supervision of a herpetologist, directing ground-dwelling species enter pit-fall or funnel traps (used primarily for inventorying and long-term monitoring of populations of adult amphibians over a period of, for example, several months or seasons in areas or regions where pesticides have been applied)
- drift fences encircling amphibian breeding ponds act as surface barriers, under the supervision of a herpetologist, like the previous technique, but used to monitor amphibians as they enter and leave sites, and conducted in relation to long-term changes from pesticide application in an area
- audio strip transects for many frog species that have characteristic calls; calls are recorded with a tape recorder, after recognition of the species making them, to estimate the relative abundance of calling males, and thus of all adults (after determining sex ratios from ground studies), species composition, and breeding site use and phenology
- artificial ponds, which are placed in an area long enough for amphibians to find them (useful for frog diversity assessment and larval abundance)
- artificial cover, in which flat planks of wood or sheets of corrugated iron are placed on the ground for species to seek refuge under (useful for estimating populations of certain amphibian species)

- light trapping, after darkness is useful for long-term population monitoring of species that seek insect prey attracted to light, e.g. toads during the terrestrial phase in relation to widespread application of pesticides over a number of years; animals are recorded at, say, 30 or 60 min intervals, depending on numbers, for 2–4 h after sunset)
- automatic acoustic monitoring of frog calls (useful for determining male populations, and thus adult numbers)
- radio tracking with transmitters and receivers (used to investigate habitat use by amphibians outside the breeding season)
- radioactive tag tracking used to locate tagged individuals in relation to movement
- geographical information system (GIS) and remote sensing techniques used for determining habitat associated with species at known densities.

Additional methods for reptiles

Specific methods of sampling reptiles (e.g. O'Shea, 1992), which are more suitable for specialist application, include:

- artificial cover in which flat planks of wood or sheets of corrugated iron are placed on the ground for species to seek refuge under (useful for estimating populations of certain lacertid, gecko, skink and snake species)
- tracking threads in which a reel of cotton is attached to the animal and paid out as the animal moves through its habitat (has been used successfully for recording tortoise movements under supervision of an herpetologist)
- straight-line drift fences and pitfall traps, as surface barriers, under the supervision of an herpetologist, directing ground-dwelling species into pit-fall or funnel traps (used primarily for inventorying and long-term monitoring of reptile populations over a period of, for example, several months or seasons, in areas or regions where pesticides have been applied)
- quantitative sampling of aquatic reptiles using seine nets for turtles (numbers caught are recorded in relation to the size of pond, and thus density from indirect effects due to pesticide run-off from surrounding land)
- light trapping, after darkness (useful for monitoring such species as geckos, seen on adjacent even, pale-coloured surfaces seeking insect food attracted to light). Animals are recorded at, say, 30 or 60 min intervals (depends on numbers) for 2-4 h after sunset in relation to long-term changes in population numbers with widespread application of pesticides in an area over a number of years
- radio tracking with the use of transmitters and receivers (used to investigate habitat use by snakes)
- radioactive tag tracking used to locate tagged individuals in relation to movement
- GIS and remote sensing techniques used for determining habitat associated with species at known densities.

TAXONOMY

To determine species richness (composition and frequency), some basic taxonomy will be involved. In the absence of a specialist herpetologist with local knowledge of the fauna, a field guide with identification key is useful, although some skill is still required to work through the key. Field guides for amphibians and reptiles do not exist throughout the world, so a specific example cannot be cited that covers all tropical, sub-tropical and warm temperate areas. Specimens of uncertain species can be collected, labelled, preserved and taken to a museum specialist to confirm identification.

DIVERSITY ASSESSMENT

Herpetofaunal diversity can be reduced by blanket aerial spraying of habitat with pesticides, especially forests. Quantitative sampling will provide information on diversity (the number of species present in a sample of certain size). The formula most commonly adopted is the Index of Diversity using the Shannon-Weiner function (H'). The formula is given by:

$$H' = \sum_{i=1}^s p_i \log_e p_i$$

in which p_i is the proportion of individuals for the i th species out of the total number of individuals (i.e. the number of individuals of a species divided by total number of individuals recorded in sample), while $\log_e p_i$ is usually the natural logarithm (\log_e) of p_i .

The following case studies are based on actual observations.

Amphibians

Table 11.2 Diversity of rainforest species compared in primary and adjacent man-managed (including pesticide exposure) secondary forest (Peninsular Malaysia, March 1995)

Species counted	Primary rainforest			Secondary rainforest		
	No.	p_i	$p_i \cdot n p_i$	No.	p_i	$p_i \cdot n p_i$
1	13	0.200	-0.322	25	0.338	-0.367
2	9	0.138	-0.274	13	0.176	-0.306
3	9	0.138	-0.274	11	0.149	-0.283
4	7	0.108	-0.240	8	0.108	-0.240
5	4	0.062	-0.172	5	0.068	-0.182
6	3	0.046	-0.142	5	0.068	-0.182
7	3	0.046	-0.142	2	0.027	-0.096
8	2	0.031	-0.107	2	0.027	-0.096
9	2	0.031	-0.107	2	0.027	-0.096
10	2	0.031	-0.107	2	0.027	-0.096
11	2	0.031	-0.107			
12	2	0.031	-0.107			
13	2	0.031	-0.107			
14	1	0.015	-0.064			
15	1	0.015	-0.064			
16	1	0.015	-0.064			
17	1	0.015	-0.064			
18	1	0.015	-0.064			
Totals	65	(1.000)	-2.528	74	(1.000)	-1.906

Worked example

p_i is the proportion of the number of a species (i) of amphibian out of the total, i.e. there are 13 (= l) of the first species in primary forest out of a total of 65 amphibians recorded. Then $p_i = 13/65 = 0.200$, and $p_i \times \log_e p_i = -0.322$; $\sum p_i \log_e p_i$ (the sum of $p_i \log_e p_i$ for all 18 species) = -2.528, and thus $H' = 2.528$. Note that the total of p_i equals 1, and provides a check that there are no calculation errors. Index of Diversity using the Shannon-Wiener function (H') is usually between 1 and 3 (below 1 is low diversity; above 2 is high).

Thus, 65 individuals contained 18 species in primary rainforest (Shannon-Wiener function H' is 2.528), while 74 contained 10 species ($H' = 1.906$) in adjacent secondary forest. Amphibian diversity was, therefore, greater in primary forest, and this can be confirmed statistically ($t = 4.33$, 139 d.f., $P < 0.001$) using a test described by Magurran (1988).

Reptiles

Table 11.3 Diversity of woodland savanna species compared in an unpopulated tributary valley (Tug Gabibta) exposed to pesticide run-off and the main river valley (Tug Marodijeh) with human habitation (Hargeisa, Somaliland, March 1993)

Species counted	Tributary valley			Main inhabited valley		
	No.	p_i	$p_i^n p_i$	No.	p_i	$p_i^n p_i$
1	31	0.323	-0.365	58	0.574	-0.319
2	26	0.271	-0.354	11	0.109	-0.241
3	13	0.135	-0.271	8	0.079	-0.201
4	6	0.063	-0.173	7	0.069	-0.185
5	2	0.021	-0.081	4	0.040	-0.128
6	2	0.021	-0.081	3	0.030	-0.104
7	2	0.021	-0.081	2	0.020	-0.078
8	2	0.021	-0.081	2	0.020	-0.078
9	2	0.021	-0.081	2	0.020	-0.078
10	1	0.010	-0.048	1	0.010	-0.046
11	1	0.010	-0.048	1	0.010	-0.046
12	1	0.010	-0.048	1	0.010	-0.046
13	1	0.010	-0.048	1	0.010	-0.046
14	1	0.010	-0.048			
15	1	0.010	-0.048			
16	1	0.010	-0.048			
17	1	0.010	-0.048			
18	1	0.010	-0.048			
19	1	0.010	-0.048			
Totals	96	(1.000)	-2.048	101	(1.000)	-1.596

In the same way as for rainforest amphibians, 96 individuals contained 19 species in the tributary valley (Shannon-Wiener function H' is 2.048), while 101 contained 13 ($H' = 1.596$) in the town main valley. Diversity was, therefore, greater in the unpopulated tributary valley, and was confirmed statistically ($t = 2.52$, 195 d.f., $P < 0.01$).

LABELLING

Specimens of uncertain species should be collected (Simmons, 1987) and preserved for purposes of identification, with information on distribution. The specimens must be carefully labelled giving at least:

- date of capture
- exact locality (preferably with coordinates using GPS)
- name of collector
- basic habitat information if possible (e.g. rocks, on tree, in water, by human dwellings).

The label should be of parchment, cloth or white plastic, which can be written on, and attached securely by cotton thread to the hind limb of the animal, or neck region of snakes and legless lizards. Information on the label should be written in pencil or permanent marker pen.

BIOINDICATORS

Amphibians, and especially lizards among reptiles, possess qualities that render them useful as bioindicator organisms.

Amphibians

Frogs, toads and other amphibians have both aquatic and terrestrial life stages that expose them to pollutants in either or both habitats. Chemicals are rapidly absorbed through the gelatinous outer layer of their eggs, larval gill membranes and larval and adult skin. Skeletal growth defects caused by contaminants are soon detected in the rapidly developing larvae (tadpoles). Both amphibians and reptiles are primitive vertebrates, with simple enzyme systems, and they are unable to detoxify chemical residues that as invertebrate predators they take in with contaminated prey. Cold-bloodedness or ectothermy results in a poor ability to metabolize chemical residues, and results in the accumulation of pesticides such as organochlorines, especially in fat, and also in the liver and other body tissues (including the brain) at readily detectable levels. Residue levels rise, until eventually a lethal level is reached, especially when fat is combusted during lean periods of the year.

High residue levels in turn present a hazard to predators higher up the food chain that ingest them (many amphibian species constitute a food resource for raptorial birds and other vertebrate predators in aquatic and terrestrial ecosystems). With increasing residue burdens, chronic effects become evident and amphibians, like many lizards also, show changes in behaviour and physiology and may not be able to respond and avoid exposure to toxic conditions during aestivation or hibernation. Being active, and visually and vocally conspicuous (especially at breeding ponds), population monitoring is facilitated in the field. Amphibians are also experimentally versatile in the laboratory and field.

Lizards and other reptiles

Lizards particularly among reptiles share many characteristics as pollution bioindicators with amphibians, but unlike most amphibian species, especially in the tropics, they occur in arid habitats and are generally active during both dry and wet seasons of the year. Lizards are relatively immobile with poor powers of emigration, and, therefore, numbers respond to habitat changes, including chemical contamination. Diurnal species especially are also active and visually conspicuous, enabling population monitoring in the field. Like amphibians, lizards are insectivorous and take in pesticides with contaminated prey and, as a food resource, form an important link in

food chains between invertebrates and raptorial birds and other vertebrate predators in terrestrial ecosystems. With intra- and inter-specific competition for food and refuges (many lizards in particular are also territorial), their behaviour and physiology are likely to reflect differences between species due to pollutants. Lizards are also versatile experimental animals in the laboratory and field.

REFERENCES

- GRIFFITHS, R.A. (1985) A simple funnel trap for studying newt populations and an evaluation of trap behaviour in smooth and palmate newts, *Triturus vulgaris* and *T. helveticus*. *Herpetological Journal*, 1(1): 5–10.
- HEYER, W.R., DONNELLY, M.A., MCDIARMID, R.W., HAYEK, L.-A.C. and FOSTER, M.S. (eds) (1994) *Measuring and Monitoring Biological Diversity. Standard Methods for Amphibians*. Washington DC: Smithsonian Institution Press.
- MAGURRAN, A.E. (1988) *Ecological Diversity and Its Measurement*. London: Croom Helm.
- O'SHEA, M. (1992) *Expedition Field Techniques: Reptiles and Amphibians*. London: Royal Geographical Society.
- SIMMONS, J.E. (1987) Herpetological collecting and collections management. *Herpetological Circular*, No. 16: 1–70. Ithaca: Society for the Study of Amphibians and Reptiles.
- SWINGLAND, I.R. and SHORROCKS, B. (eds) (1990) *Living in a Patchy Environment*. Oxford: Oxford University Press.

FURTHER READING

- CAMPBELL, H.W. and CHRISTMAN, S.P. (1982) Field techniques for herpetofaunal community analysis. pp. 193–200. In: *Herpetological Communities*. Scott, N.J. (ed.). *Wildlife Research Report*, No. 13. Washington DC: US Fish and Wildlife Service.
- FERNER, J.W. (1979) A review of marking techniques for amphibians and reptiles. *Herpetological Circular*, No. 9: 1–42. Ithaca: Society for the Study of Amphibians and Reptiles.
- HALLIDAY, T.R. and ADLER, K. (eds) (1986) *The Encyclopaedia of Reptiles and Amphibians*. Oxford: Equinox.
- PISANI, G.R. (1973) A guide to preservation techniques for amphibians and reptiles. *Herpetological Circular*, No. 1: 1–22. Ithaca: Society for the Study of Amphibians and Reptiles.
- SPAWLS, S. (1988) Making a herpetological collecting trip to Africa. *British Herpetological Society Bulletin*, No. 24: 22–31.
- SWINGLAND, I.R. (1978) Marking reptiles. pp. 119–132. In: *Animal Marking*. Stonehouse, B. (ed.). London: Macmillan.
- WISE, M.A. (1994) Techniques for the capture and restraint of captive crocodylians. pp. 401–405. In: *Captive Management and Conservation of Amphibians and Reptiles*. Murphy, J.B., Adler, K. and Collins, J.T. (eds). *Contributions to Herpetology*, No. 11. Ithaca: Society for the Study of Amphibians and Reptiles.

Robert J. Douthwaite

Holly Oast, Hode Lane, Bridge, Canterbury, Kent CT4 5DH, UK
bobdouthwaite@onetel.com/bob.douthwaite@thenrgroup.net

Charles F. Dewhurst¹

Natural Resources Institute, University of Greenwich at Medway, Central Avenue,
Chatham Maritime, Kent ME4 4TB, UK

INTRODUCTION

With over 9000 species, birds are one of the most diverse and evolutionarily successful groups. They occupy almost every habitat on earth, often occurring in large numbers and in a great variety of forms, especially in the tropics. They range in size from the tiny bee hummingbird (*Mellisuga helenae*) of Central America, weighing just 2.0 g, to the ostrich (*Struthio camelus*) of Africa, weighing up to 130 kg. They are probably one of the easiest groups of animals to census, popular to study and are undoubtedly one of the most frequently observed and monitored of all taxa. While many species are sedentary, the power of flight enables others to exploit seasonal changes in food supply and migrate with extraordinary accuracy over thousands of miles each year.

Such attributes have given birds a special place in many human cultures and their fate, in the face of agricultural and industrial intensification, is of widespread concern. As a result, much research has been undertaken into the effects of agrochemical use on their populations. This has shown that birds are often at risk, either directly or indirectly from pesticide spray treatments, but that robust, low cost methodologies can be applied to monitor and assess the impact of pesticide applications in some cases. Indeed, this work has also demonstrated that some birds are good indicator species, revealing effects of pesticide spraying in their invertebrate or fish prey that would not otherwise have been detected. For example, changes in feeding rate, success and diet of pied kingfishers (*Ceryle rudis*) and little bee-eaters (*Merops pusillus*) showed that their prey – small fish and day-flying insects respectively – had been affected by spray treatments.

This aim of this chapter is to help the managers of agricultural projects or programmes, vector control programmes, plant protection divisions or wildlife and environment departments to decide which birds, if any, should be monitored during pesticide spray programmes, using which techniques, and to provide guidance on suitable methods for detecting pesticide effects on bird populations. Simple, low cost monitoring methodologies are described.

EFFECTS OF PESTICIDE TREATMENTS ON BIRDS

Pesticides may have direct and/or indirect effects on birds, with either lethal or sub-lethal consequences. Avicides (e.g. fenthion) are, of course, intended to kill bird species which are pests, such as quelea (*Quelea quelea*). However, routine pesticide spraying operations (for crop, forest or human health pests) will also kill non-target bird species as well, including birds of prey.

¹ Contact address: Ellanore House, Ellanore Lane, West Wittering, Chichester, West Sussex PO20 8AN, UK. OR Senior Entomologist, PNG Oil Palm Research Association Inc., Dami Research Station, PO Box 97, KIMBE, West New Britain 621, Papua New Guinea
charles.dewhurst@pngopra.org.pg

Insecticides and acaricides primarily affect bird populations by reducing the availability of their arthropod prey, but the consumption of contaminated prey (e.g. ants contaminated with DDT, locusts contaminated with fenitrothion) may cause the deaths of insectivorous birds through acute poisoning or cause sub-lethal effects which will affect their behaviour or breeding success. Reduced abundance and/or availability of insect prey (see chapter 8) will result in lower feeding rates, loss of condition, breeding failure and, therefore, population decline. In addition, many insecticides are harmful to fish and thus piscivorous birds may also be at risk. The risk to granivorous species is generally lower although many species feed on insects (insectivorous) during the breeding season. Poisoning may occur when seeds dressed with insecticides are eaten. DDT, where it remains in use, presents a unique risk. The residues of this insecticide accumulate in birds of prey and cause eggshell thinning, which in turn will lead to breeding failure and ultimately population decline.

Herbicides may affect bird populations by reducing the availability of seeds for granivorous species; by reducing invertebrate abundance by the removal of the plants that the invertebrates depend upon for food or habitat; and by reducing cover for ground-nesting species. Such effects are becoming increasingly well documented and are of particular concern as herbicide use is rapidly increasing in many countries.

Impact indicators in bird studies will be the degrees of change to one or more of the following:

- feeding and diet
- condition
- behaviour
- breeding success
- numbers (relative abundance).

STUDY DESIGN

Having determined the scope of the proposed monitoring programme (see chapter 1), the manager should design the study and identify the resources needed, constantly bearing in mind the time available for any monitoring according to the needs of the proposed spray programmes.

Resources

The location, scale and duration of the spraying operation will determine the resources required to:

- replicate observations
- calculate the time required to collect data on pre-treatment or baseline conditions
- determine sample size
- estimate the duration of the environmental risk, and hence the available time for an effective sampling period.

Although some bird species are easy to identify and count, generally there will be a need to employ a trained field biologist with previous ornithological experience to carry out the studies described below.

Study species

Common, conspicuous, and sedentary species can be monitored with fewer resources than rare, secretive or migrant species. Indeed, it is usually impractical to attempt to monitor migratory species, and work on rare, secretive species will require the services of a professional ornithologist.

Study areas

At least *two* study plots should be chosen in the sprayed area and *two* outside the sprayed area, to reduce the risk that divergent changes observed between sprayed and unsprayed areas are not simply due to chance.

The abundance of the species of interest and the sampling method selected will determine the size of the study plots. Clearly plots can be smaller if species studied are very common or if the sampling method or frequency is more intensive.

Where possible the sites chosen for monitoring should be close together to ease logistical arrangements for sampling and to reduce the risk that differences in bird populations will be due to ecological and climatic differences. The ecological conditions, habitats and land use of each of the study plots should be matched as closely as possible to reduce the risk that these variables will affect the results of the study.

However, great care should be taken not to position unsprayed study plots downwind of sprayed plots as spray drift can affect areas many kilometres downwind under suitable atmospheric conditions.

Study duration

The duration of the study is determined by the need to collect pre-spray baseline data, the nature of the impact and the predicted recovery period.

- If the impact is likely to be sudden and severe, but recovery is likely to be rapid, a short study lasting from a few days before the spray treatment to a few days after the impact of the treatment occurs can be planned.
- If recovery is slow, but the process apparent within the same season as the impact, then observations over a few weeks can be planned.
- If chronic effects are anticipated due to herbicide treatments or persistent pesticide residues then studies lasting from months to years may be necessary to ensure that normal seasonal and annual fluctuations in population size are understood and the recovery process is fully monitored.

It is important to decide on the study length as soon as information is received on when pesticide operations are planned.

Accuracy of observations

Variation in sampling methodology (e.g. by using different people to count the birds) during sampling may account for more variation in the population estimate than the effects of the pesticides themselves (Berthold *et al.*, 1986). Standardization of techniques and operator uniformity is, therefore, vital to ensure that statistically valid data are collected and valid results are obtained (Fowler and Cohen, 1986; Bibby *et al.*, 1992).

Bias can be reduced, and the accuracy of work improved, by following certain *operating rules*.

- The observers must be able to identify all bird species under study reliably.
- Provide training for observers if necessary, and in time.
- Try to retain the same observer to repeat any set of observations at a particular site.
- Use additional observers to sample extra sites, ensuring they have been well briefed and trained beforehand.
- Select sampling sites which are as similar as possible and where target species can be readily detected.

- Maintain the same sampling speed and effort throughout the study (standardize procedures) (see chapter 2).
- Conduct observations at the same time each day. Restrict observations to the 3–4 h period from sunrise, when birds are most active and light conditions are good.
- If the weather changes markedly on any day discard all observations for that day (be prepared to plan for such unforeseen happenings). If different observers are involved, do not mix data sets, and make sure that all data sheets are fully labelled.
- Report full details of the methodology used and field conditions (habitat type and condition, season and weather, etc.) at the time of monitoring.

Sample replication

Replication of observations is important to reduce the risk that any changes that occur are due to chance (see chapter 2). Monitoring should be carried out in at least *two* sprayed and *two* unsprayed areas, although in some instances this may prove impossible as comparable sites, or sufficient resources, may simply not exist.

Working at more sites will increase confidence in the final results, but will require more resources.

Keep accurate records of all procedures followed.

Residues analysis

Residues analysis is time consuming and extremely expensive and fieldwork linking exposure to effect is almost non-existent. There is no point measuring residue levels unless the associated risk can be interpreted. It is recommended, therefore, that residues analysis is not attempted. If field monitoring points to an adverse impact, the 'precautionary principle' should be adopted and safer control technologies recommended and implemented if possible.

An exception may be made in the case of birds exposed to DDT or other persistent organochlorine pesticide residues. However, residues analysis should be restricted to measurements of concentrations of the pesticide and its metabolites in the brain or whole body lipid.

Planning the fieldwork

Select study areas well in advance of spraying operations.

- If possible, avoid choosing unsprayed study areas downwind of the sprayed areas as spray drift can sometimes extend over many kilometres.
- Prepare data recording sheets, and be sure that there are sufficient for the entire programme of work.
- Use good binoculars (8 × 30 to 10 × 40), bird identification books (along with sheets 1–4 used to note features of unidentified birds in the field), clip-board, stop-watch, pencils, eraser, penknife and notebook for each observer.
- Mark sampling sites by painting stones, posts or trees with white water-resistant paint or aerosol spray paint.
- Test the methodology and competence of observers well in advance of spraying operations.
- Prepare a map of the study area showing important features such as trees, streams, tracks as well as transect lines or sample points.
- Use a global positioning system (GPS) for waypoints or a compass for direction.

SAMPLING METHODS

POPULATION SIZE

Monitoring relative abundance is appropriate when there is a risk that mortality or emigration/immigration associated with spraying will take place within the duration of the study. A variety of methods are available. Their suitability depends on:

- the scale of the spraying operation
- the habitat type sprayed
- the bird species of interest: their visibility and behaviour
- resources (material and financial) available for completing the monitoring.

Timed point counts (sometimes called point counts)

This is a useful method for assessing the relative abundance of common, sedentary, non-flocking bird species in wooded or bushed habitats. Large sampling areas are usually needed (at least 20 km²). The observer monitors numbers of the species of interest, seen or heard, at a series of sample points. Sample points may be selected at random or regular intervals, or systematically, along roads, which are identified before beginning the observations. Systematic selection may be made where birds of a particular habitat are of interest, otherwise use randomly chosen sites.

Whichever method is used, sample points should never be less than 200 m apart to avoid the risk of overlapping observations. Observations at each point are made within a pre-determined radius of up to 50 m from the central point chosen. They are made over a fixed time period of 2–5 min. The actual counting time allocated for each station must be the same, although it will vary with habitat and the abundance of birds. Therefore, the time estimated to monitor 20 points (stations), assuming 10 min to complete observations and move to another station, will be about 3.5 h. Sample points are numbered clearly with coloured plastic tags, or rainproof paint.

It is recommended that *two sets* of 20 points are monitored *in the spray treatment area*, and *two similar sets* in the *untreated area*, to allow comparison of changes in treated and untreated areas. Using a vehicle, 20 points can be conveniently sampled in 2–3 h work. If no vehicle is available, allow about 1.5 h to complete 10 sample points. (This allows 8 min to move between each sample point and includes the time taken to reach the next point.)

The impact of spraying on the relative abundance of each species, or feeding guild (group of birds), is compared *within* and *between* treatments (i.e. within sprayed and within unsprayed areas, and between sprayed and unsprayed treatments). If relative abundance declines with spraying in both treated sample sets, but increases or remains constant in both untreated sample sets, an effect of spraying may be concluded (Douthwaite, 1980, 1995).

Limitations Data from a large number of samples are required, each of which must be chosen at random. The accuracy of the counts will vary with the time of day, weather, season, habitat and observer. Results are highly dependent on observer experience. Not a good method for open habitats, where birds may flee from an observer.

Fauna sampled Small to medium-sized, relatively common, non-flocking, sedentary species (e.g. flycatchers, shrikes, some ploceids). Good for songbirds, less appropriate for shy species.

Processing Direct recording of occurrence or observation on to the data sheet.

Resulting data Species lists, frequencies, species relative abundance curves or ratios, and detection rates, according to the spray treatment.

Sampling period At least 4 days of observations should be made at each set of sample points before spraying, and 4 more days shortly after spraying (i.e. 32 days fieldwork). More time will be necessary if the weather is changeable.

Equipment Binoculars and stop-watch.

Staff required 1–2 skilled observers, with vehicles.

Analyzing the data from timed point counts

- Sum the counts for each species to give totals for each census.
- Draw up a contingency table showing the highest count of each species by sample area and sample period (i.e. pre- and post-spray).
- Fewer than 20% of the cells in the table should have expected frequencies <5 , and none should be <1 . If this occurs, combine data for the less common species by diet type (frugivorous, insectivorous, etc.), method of feeding and by site. If this cannot be done, discard the species from further analysis.
- Compare frequencies of occurrence before and after spraying within treatments by using the chi-squared test. If the data are homogeneous combine counts within treatments and compare frequencies between treatments. If the data are homogeneous the risk of an effect of spraying is low.
- If the data are heterogeneous, spraying may have affected relative abundance. Examine the data by species to detect the source of heterogeneity and note especially those species that showed no decline in abundance in both unsprayed areas, but declined in both sprayed areas.
- From a knowledge of the ecology of these species, consider whether an effect of spraying seems likely.
- If an effect is probable, monitor the species through other, more intensive, methods in future spraying operations.

Fixed strip transect counts

This is a useful method for sampling the relative abundance of relatively common, medium to large, conspicuous and sedentary species in open, uniform or species-poor habitats such as bushed or wooded grassland (see Mullie and Keith, 1993a). It requires less space than timed point counts but requires more than territory mapping. More than 10 km² of pesticide-treated area are required, plus an *equivalent* untreated area which should (wherever possible) lie adjacent to the treated area and be of similar habitat type and topography.

Species of interest seen or heard within strips of known width are counted as the observer walks slowly along a fixed transect route. Transects may be of any length (an ideal length would be 1000 m), which can then be subdivided into fixed lengths of between 100 m and 1000 m, as this will make analyses easier.

Parallel transects should be 150–200 m apart in *closed* habitats or 200–500 m apart in very *open* habitats. The distance chosen **must** be adhered to throughout to avoid the risk of double counting. Transect width should be in the range of 10–100 m to either side of the observer, depending on the habitat and ease of observation; 20 m is an easily estimated width. Birds seen or heard outside the transect should **not** be counted. Assuming the observer moves at about 2 km h⁻¹, some 10–20 ha of habitat can be sampled during each morning. As a rule of thumb, 40 recordings (records) of any particular species will be necessary to provide a reasonable estimate of density. It is recommended that bird densities are monitored along at least two transects in the sprayed area, and two similar transects in the unsprayed area.

Transect counts can be made from vehicles provided the species of interest are conspicuous and there is sufficient road in the sprayed and unsprayed areas to give reasonable sample sizes. This method has been used to monitor relative abundance of diurnal raptors, sparrow-weaver colonies (Douthwaite, 1992a), and nightjars (McWilliam, 1994).

Limitations Variations in observer's abilities during the fieldwork. Procedures must be standardized as far as possible to reduce any subjective bias especially when using a number of different observers (every observer will

tend to do things differently unless clear procedures are explained beforehand). About 40 observations of any particular species are necessary to provide enough information and a reasonable estimate of density. The accuracy of the counts will vary with the time of day, weather, season, habitat and observer.

Fauna sampled Relatively common, medium to large, conspicuous and sedentary birds (e.g. tits, thrushes, woodpeckers, grassland/thicket inhabiting warblers).

Processing Direct recording of occurrence or observation to the data sheet.

Resulting data Species lists, frequencies, densities, species relative abundance, or abundance ratios by between the spray treatments.

Sampling period At least 4 days repeated observations along each transect before spraying, and 4 days afterwards. The timing of counts should be related to the expected severity and duration of spraying impact.

Equipment Binoculars and a watch (or stop-watch) are necessary.

Staff required 1–2 skilled observers.

Analysing the data from transect counts

- Plot changes in species abundance by count and transect sub-section.
- Combine sub-section counts to ensure at least 40 individuals of a species or feeding guild were sampled (on average) in the pre-spray series of samples.
- Make a table of the number of every species seen or heard along each entire transect.
- Calculate *B* Index for each species, using the following equation:

$$B = [(N/C) \times ((N_{1/2} + 1/C) \times 100)] + A$$

where *N* = number of transect sub-sections during which the species was recorded during the first hour
*N*_{1/2} = the number of transect sub-sections during which the species was recorded during the first 30 min
C = number of surveys
A = the sum of the abundance ratings (AR) > 1.

Abundance ratings are estimated as:

AR 1 = 0–5 birds; AR 2 = 6–10 birds; AR 3 = >10 birds.

- Use the Spearman Rank Correlation Coefficient test (see chapter 2) or Wilcoxon matched-pairs test to determine the significance of differences between results of transect counts in sprayed and unsprayed areas.
- Consider the evidence that changes in abundance following spray treatment were due to spraying.

Territory mapping

This is the most accurate method for monitoring population size, suitable for use in any habitat, and requiring the smallest study plots. However, it is also the most time consuming method and its applicability is limited to territorial species during the breeding season. Males sing to identify and defend their territories, which are often clearly defined. The territories of species of concern are mapped. A code will need to be generated for each species encountered, examples are given in the Appendix on page 242. Once designated, species name abbreviations must not be changed. Analysis of the data collected is quite complicated and for those interested in using this method, it is strongly recommended that reference is made to Bibby *et al.* (1992), pages 42–65, before embarking on a study using this technique.

Detailed large-scale maps of at least a scale of 1:2500 are used to plot the location of singing or displaying individuals, and their movements. All obvious features such as distinctive trees, ponds, streams or tracks should be marked on the map of the study area **before** beginning the census. Study plots should ideally be round or

square, long plots are not suitable because of the very high edge to area ratio. Relatively small study areas should be chosen, with plot size depending on ease of coverage, but varying from 10–20 ha in fairly tight canopy woodland to 50–100 ha in farmland or open wooded grassland.

A series of up to 10 visits may be necessary to establish the boundaries of all bird territories before spraying begins, and a similar number should be made afterwards. The number of visits required will vary with the duration of the visits and the degree of species richness information (with more visits required the higher the species richness) recorded during them. Where there is no real seasonality (marked differences in climate and/or photoperiod at different times of the year), timing of visits will need to be planned during the periods when many species tend to breed (e.g. during or just after the rains). It will be more difficult to observe birds when the trees are in leaf.

On each visit, the observer should walk slowly around to within approximately 50 m of the boundary at every part of the plot, noting the identity and activity of all individuals of interest and recording the observations through coded entries on the map. The observer should concentrate on the location of individuals of the same species that can be seen or heard simultaneously. Attempts to flush individuals, and the playback of tape-recorded song, will help to demarcate territorial limits. If territories extend beyond the limits of the study area, it may well be necessary to map territories that extend beyond the limits up to about 100 m in all directions, so the map will need to extend beyond the selected study area accordingly.

A separate map should be prepared and used for the records collected during each visit to the study plot (see example territory map in Figure 12.1 below). Although an early morning start will yield information more quickly (it may in fact not be possible to record information due to the large numbers of birds calling), the time of day and weather are less critical than with timed point or transect counts. It is important to mark the location of birds accurately. The duration of the visit depends upon the stamina of the observer; in any event every part of the plot must be visited at least once at each visit. Every bird encountered and its associated activities are entered on the map using the symbols prepared before the observations begin (examples of bird behaviour that will require coding with examples are given in the Appendix on page 242 and these codes must also be strictly adhered to). This method is suitable for use in any habitat type. In forested habitat only about 2 ha can be surveyed per hour while in open habitat this may increase to 15–20 ha per hour.

Fieldwork and analysis of territory mapping are very time consuming, but the work results in more accurate estimates of population size than either transect or timed point counts. This method is suitable for single species studies, provided the species are territorial (e.g. thrushes, chats, warblers).

Ideally, *two treated* and *two untreated* study plots should be monitored. *This method does assume that birds live in pairs and in territories that do not overlap.* This method is unreliable when birds are present in high densities.

Changes noted after spraying may well be represented by a marked decrease in the number of bird species present, or by changes in their behaviour when compared with an unsprayed area.

Limitations This method is very time consuming and, therefore, expensive. It is not useful for colonial species or those living in loose groups. The method assumes that birds live in pairs in discrete, non-overlapping areas, which is often not true. Even if standard guidelines are used, it is rather a subjective measure and heavily affected by the observer. It becomes less accurate at high bird densities, and is really only suitable for breeding birds. The method is thus subject to seasonal territoriality.

Fauna sampled One to a few territory holding species (e.g. warblers, chats, shrikes).

Processing Sightings are recorded directly on to maps. Concentrate on mapping unambiguous records (e.g. territorial disputes) and minimize collection of ambiguous ones (e.g. re-registering the same bird in another part of the study area after contact has been lost). Symbols will need to be devised for all species to be encountered

and separate symbols used for their behaviour. This may result in a lengthy list of different symbols (see the Appendix on page 242).

Resulting data Maps of territorial boundaries before and after spray treatment, or between treatments. Data can be complicated to analyse, depending on bird numbers in the different areas (see Bibby *et al.*, 1992, prior to any study). Territory mapping will show how the effects of pesticide treatment will affect the numbers of birds and their resultant territorial boundaries. If there is a dramatic effect on insect species, then young birds may also die through starvation, and nests may also be deserted.

Sampling period Allow for up to 10 site visits in the 3 weeks before spraying, and 10 visits afterwards (i.e. plan for visits every second day for 3 weeks).

Equipment Binoculars, a tape recorder and maps are needed.

Staff required 1–2 trained but otherwise unskilled workers, provided they are good at finding birds and can plot records accurately on maps. No vehicle is required, except for initial delivery to the site to be sampled.

Analysing the maps produced

The data collected are transferred at the end of each day to individual species maps, and each set of data maps is referred to as A, B, C, etc. This shows the chronology of the observations. Each species is represented on one map. The field map will look very complicated, but its complexity is reduced with the single species map (Marchant, 1983). All the edge territories should be included within the plot, and it is perfectly acceptable to venture a short way out of the plot if edge territories have been encountered.

Analysis of territory maps will require the input from someone who is experienced in this technique, especially when it comes to analysing the edge territories.

- Check the maps as soon as possible upon return to the office to make sure that all symbols are clear; transpose records for each species to separate transparent overlays. Make sure they are properly labelled.
- In re-plotting the information, change the species code to a visit code.
- Use the species overlays for consecutive visits to map territorial boundaries.
- Decide whether you have enough evidence to plot territorial boundaries with confidence, or whether further field visits should be made.
- At the end of the study, examine territorial changes and determine whether changes in the sprayed plots differed substantially from those in the unsprayed plots.
- Statistical tests can be used to test changes in the number of territories occupied in each area by the same species (use chi-squared tests).

OTHER METHODS FOR ESTIMATING ABUNDANCE

A modified timed point count-territory mapping method was used to monitor relative abundance of white-headed black chats (*Thamnolaea arnoti*) along roads within and beyond areas sprayed for tsetse fly control in Zimbabwe (Douthwaite, 1992b). Tape-recorded song was played back at regularly spaced points, 250–500 m apart, along roads and the response (and counts) of that species within 2.5 min noted.

Nest density

The method is suitable for areas that are treated with persistent insecticides or annually treated with insecticides or herbicides and where chronic effects on bird populations are suspected. This method is suitable for birds making obvious nests such as raptors, crows, weaver birds, colonial bee-eaters, herons or egrets. It is of *no* use where nests are camouflaged or hidden by the birds. Unless the nest is highly visible and readily identified, or

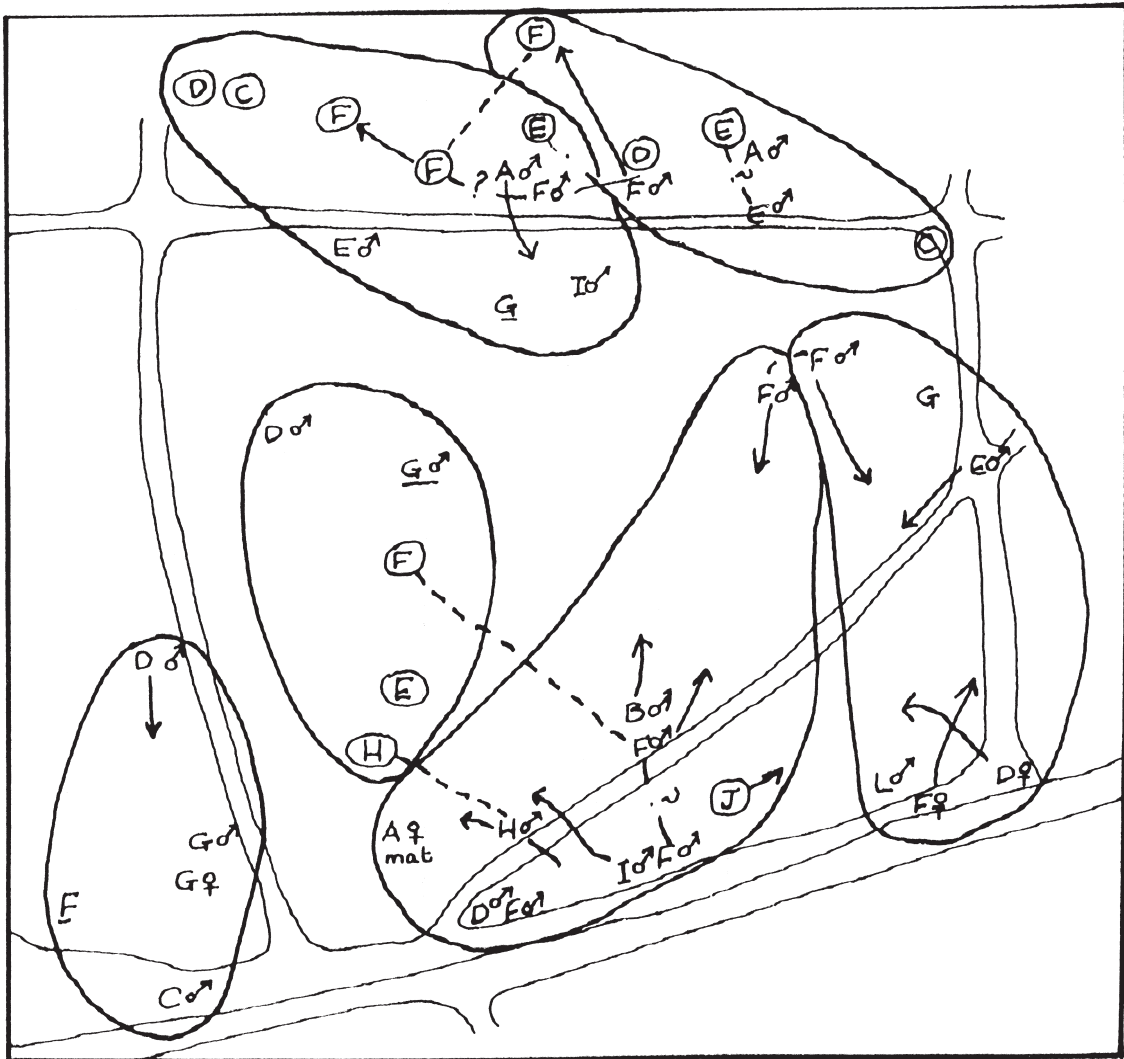

Figure 12.1: Example of a territory map compiled from numerous visit maps (see method sheet) (From *Bird Census Techniques* by Bibby, C.J., Burgess, N.D. and Hill, D.A. (1992) British Trust for Ornithology and Royal Society for the Protection of Birds, reproduced with permission of Academic Press, London.)

located easily by searching well defined habitat, the method is likely to be time consuming and unreliable. Before this technique is attempted an initial assessment of the area should be carried out to determine its suitability.

Number of nests per colony, or number of nests per square kilometre of land or kilometre of river bank or lakeshore can be checked in sprayed and unsprayed areas at any time during the breeding season. However, local assistants can often be recruited to look for nests. If local assistants are used, it is very important to impress upon them the importance of not causing damage or disturbance to the nests, as birds with eggs may readily desert. A further limitation is that the work can only be done during the breeding season so that new nests can be distinguished from old ones by the freshness of materials used or their occupancy.

Interpretation of the results must also be done with care. Habitat suitability may vary between adjacent areas and may affect nest densities (Douthwaite, 1992a; Hartley and Douthwaite, 1994), while a high density of active nests may indicate previous breeding failure rather than good conditions (Douthwaite, 1992c).

Limitations Dependent upon the ability to identify and estimate the age of nests.

Fauna sampled Species with conspicuous nests.

Processing Map nest location and record its condition and contents.

Resulting data Nest densities by spray treatment.

Sampling period Dependent upon the magnitude of pesticide effects expected and the duration of impact. For acute effects, detailed searches should be made 2–3 weeks before spraying and 2–3 weeks afterwards. For chronic effects, annual surveys are only of any real value during the breeding season.

Equipment Binoculars. Tree- or rock-climbing equipment is required to access nest sites for some species (e.g. birds of prey, some starlings or pigeons). Be aware that climbing trees or rocks should only be undertaken by experienced personnel.

Staff required Semi-skilled, but with appropriate training.

Methods for counting leks and nests in colonies are covered in Gibbons *et al.* (1996).

Analysing the observations for nest density

- Estimate the area of suitable habitat searched in the sprayed and unsprayed areas.
- Calculate the density of nests per square kilometre (or, if nests are in colonies the number of nests per colony and/or colony density per square kilometre).
- Compare the density of nests in the sprayed and unsprayed areas, or (if the nests are in colonies) average colony size, using the chi-squared test.
- If differences are apparent, consider the possibility that they were caused by habitat differences between sprayed and unsprayed areas. From observations made at nests, consider also whether they were due to greater breeding failure in one or other area.

Feeding behaviour and diet

Pesticide impacts sometimes arise indirectly, through effects on food supplies. The effects of spraying on the food supply may alter foraging success, feeding rate and diet. For monitoring purposes, the species of interest must be sedentary and easily observed and should feed on large food items in the air or on a perch so that success can be observed. The little bee-eater and pied kingfisher have both been successfully monitored using this method in the past (Douthwaite, 1982; Douthwaite and Fry, 1982). If the species feeds on the ground or in cover, or on small prey items, or ranges widely, continuity of observation will be lost and the method cannot be used.

Provided prey items are large, diet can be determined crudely by direct observation. More detailed analysis requires the examination of regurgitated pellets which contain bone, fur or arthropod exoskeleton. Shooting of birds for gizzard content analysis, may be undertaken if deemed essential and given the appropriate approval. This drastic approach should only be undertaken if it is really considered that valuable, otherwise inaccessible data will be provided. Although a skilled fieldworker can readily locate pellets on the ground, the development of a reference collection of pellets and the resultant pellet analyses, is laborious.

The aim should be to observe the feeding behaviour of a few individuals of a common insectivorous or piscivorous species in a sprayed area and make simultaneous observations in an unsprayed area nearby. Observers need not be ornithologists provided they can identify the species of interest and are good observers.

A vehicle, motorcycle or bicycle should preferably be available as it increases the observers' range and ability to find enough birds to monitor.

Limitations Ability to monitor feeding behaviour and success closely. Behaviour and success will vary with individual, time of day, weather, season and habitat.

Fauna sampled Single common, sedentary, relatively tame, insectivorous or piscivorous species (e.g. little bee-eater, pied kingfisher, drongos).

Processing The sum of records for a period (e.g. morning/afternoon/date), analysed by feeding attempt, outcome and prey type.

Resulting data Feeding rate, feeding success and diet according to spray treatment. Data will also be available for before and after treatment effects.

Sampling period A few days before and a few days after any anticipated impact.

Equipment Binoculars and a stop-watch are necessary.

Staff required Unskilled but trained, motivated observer, with transport.

Analysing the observations for feeding behaviour assessment

- Add the total duration of observations, the number of feeding attempts, the number of successful feeding attempts and items of prey by type for each observation period.
- Calculate the rate of feeding attempts, the rate of feeding, the proportion of successful attempts, and the proportions of different prey in the diet for each observation period. Express the results with, and without, the 'unknown' data, to indicate the precision of sample estimate.
- If the samples are small, combine observations on a daily basis.
- Plot the results against time and assess whether any marked changes occurred in the sprayed area shortly after spraying which exceeded variation in the pre-spray period and did not occur in the unsprayed area.
- Use contingency tables and chi-squared tests to assess the statistical differences in the various data between sprayed and unsprayed areas.

REFERENCES

BERTHOLD, P., FLIEGE, G., QUERNER, U. and WINKLER, H. (1986) Die Bestandsentwicklung von Kleinvoögeln in Mitteleuropa: Analyse von Fangzahlen. *Journal für Ornithologie*, **127**: 377–439.

BIBBY, C.J., BURGESS, N.D. and HILL, D.A. (1992) *Bird Census Techniques*. London: Academic Press/British Trust for Ornithology and Royal Society for the Protection of Birds.

DOUTHWAITE, R.J. (1980) Occurrence of birds in Acacia woodland in northern Botswana related to endosulfan sprayed for tsetse fly control. *Environmental Pollution*, **22**: 273–279.

DOUTHWAITE, R.J. (1982) Changes in Pied Kingfisher (*Ceryle rudis*) feeding related to endosulfan pollution from tsetse fly control operations in the Okavango Delta, Botswana. *Journal of Applied Ecology*, **19**: 133–141.

DOUTHWAITE, R.J. (1992a) Effects of DDT treatments applied for tsetse fly control on White-browed Sparrow-weaver (*Plocepasser mahali*) populations in north west Zimbabwe. *Journal of African Ecology*, **30**: 233–244.

DOUTHWAITE, R.J. (1992b) Effects of DDT treatments applied for tsetse fly control on White-headed Black Chat (*Thamnolaea arnoti*) populations in Zimbabwe. Part I: population changes. *Ecotoxicology*, **1**: 17–30.

DOUTHWAITE, R.J. (1992c) Effects of DDT on the Fish Eagle (*Haliaeetus vocifer*) population of Lake Kariba in Zimbabwe. *Ibis*, **134**: 250–258.

DOUTHWAITE, R.J. (1995). Occurrence and consequences of DDT residues in woodland birds following tsetse fly spraying operations in NW Zimbabwe. *Journal of Applied Ecology*, **32**: 727–738.

DOUTHWAITE, R.J. and FRY, C.H. (1982). Food and feeding behaviour of the Little Bee-eater *Merops pusillus* in relation to tsetse fly control by insecticides. *Biological Conservation*, **23**: 71–78.

FOWLER, J. and COHEN, L. (1986) *Statistics for Ornithologists*. Guide No 22. Tring: British Trust for Ornithology.

GIBBONS, D.W., HILL, D. and SUTHERLAND, W.J. (1996) Birds. pp. 227–259. In: *Ecological Census Techniques. A Handbook*. Sutherland, W.J. (ed.). Cambridge: Cambridge University Press.

HARTLEY, R.R. and DOUTHWAITE, R.J. (1994) Effects of DDT treatments applied for tsetse fly control on the African Goshawk in north-west Zimbabwe. *African Journal of Ecology*, **32**: 265–272.

MARCHANT, J.H. (1983) *BTO Common Birds Census Instructions*. Tring: British Trust for Ornithology.

MCWILLIAM, A.N. (1994) Nocturnal animals. pp. 103–133. In: *DDT in the Tropics: The Impact on Wildlife in Zimbabwe of Ground-spraying for Tsetse Fly Control*. Douthwaite, R.J. and Tingle, C.C.D. (eds). Chatham, UK: Natural Resources Institute.

MULLIE, W.C. and KEITH, J.O. (1993) Locusticide impact on birds in northern Senegal. pp. 617–620. In: *Proceedings of the VIII Pan-African Ornithological Congress*.

FURTHER READING

COLLAR, N.J., CROSBY, M.J. and STATTERSFIELD, A.J. (1994) *Birds to Watch 2. The World List of Threatened Birds*. Cambridge: Birdlife International.

EDWARDS, C.A. (1973) *Persistent Pesticides in the Environment*. Second Edition. Cleveland: CRC Press Inc.

GREAVES, M.P., SMITH, B.D. and GREIG-SMITH, P.W. (1988) *Field Methods for the Study of Environmental Effects of Pesticides. Proceedings of a Symposium Organized by the British Crop Protection Council, Churchill College Cambridge, 28–30 March 1988*. Thornton Heath: British Crop Protection Council.

HART, A.D.M. (1990) Behavioural effects in field tests of pesticides. pp. 165–180. In: *Pesticide Effects on Terrestrial Wildlife*. Somerville, L. and Walker, C.H. (eds). London: Taylor and Francis.

SOMERVILLE, L. and WALKER, C. H. (1990) *Pesticide Effects on Terrestrial Wildlife*. London: Taylor and Francis.

APPENDIX EXAMPLES OF SPECIES AND ACTIVITY CODES

SPECIES CODES

An example of some codes (in the format as used in the UK) are given below for some common East African birds. You may easily design your own, but keep a hard copy of any identification codes which you use and/or invent to ensure that you do not inadvertently duplicate the abbreviations.

WFY	=	White-eyed Slaty Flycatcher	LBR	=	Lilac-breasted Roller
HT	=	Hartlaub's Touraco	H	=	Hoopoe
PK	=	Pied Kingfisher	YbH	=	Yellowbilled Hornbill
LBe	=	Little Bee-eater	GH	=	Ground Hornbill
SM	=	Speckled Mousebird	CW	=	Cardinal Woodpecker

ACTIVITY CODES

The following are some suggested descriptions required for bird activities (modified from standard British Trust for Ornithology symbols (Bibby *et al.*, 1992) for which codes are required. For any activities not mentioned below, codes can be easily devised by the observer. These *activity codes* are used in combination with the unique *species code* used to identify each species encountered.

- Sight records with age, sex or, if appropriate, number of birds. Do not forget to record using the code the number of obvious pairs seen. (species code prefixed by its sex and number seen)
- Juvenile with either one or both parents in attendance. (species code followed by 'fam')
- Adult calling. (species code underlined)
- Adult giving alarm calls (not singing), which may have a territorial significance. (species code with double underline)
- Adult in full song. (species code encircled)
- Aggressive encounter between two birds. (species codes close together surrounded by broken circle)
- An occupied nest (do not bother to mark unoccupied nests). (species code prefixed by '*')
- Adult bird sitting on nest. (species code prefixed by '*' with 'on' after species code)
- Adult bird carrying nesting material. (species code followed by 'mat')
- Adult bird carrying food. (species code followed by 'food')
- Adult bird carrying faeces. (species code followed by 'fcs')
- A calling adult in flight. (species code with arrow through code, if calling then also underline the code)
- A singing bird seen perched but which then flies away and not observed to land. (species code encircled followed by a horizontal arrow)
- A male bird flying into the observation area and landing. (a horizontal arrow pointing to the species code followed by male sign)
- Adult bird moving between two different perches – if you are sure it is the same bird. (species code with a horizontal arrow pointing to the same code)
- Two adults in song at the same time. (codes encircled and separated by dotted lines)
- Single bird in song from different perches. (codes encircled and, if certain that they are the same birds, then the joining line is solid)
- Two different records of possibly the same bird, which may be the situation when the census route revisits an area already covered. (species codes are encircled and the adjoining lines broken by a '?').

On the daily record map, it is also important to record the wind speed (e.g. W3), using the Beaufort scale or anemometer (see chapter 5 on environmental parameters), date and time of survey locality and observer name. (From *Ecological Census Techniques. A Handbook*. (1996) Sutherland, W.J. (ed.) reproduced with permission of Cambridge University Press.)

Andrew N. McWilliam¹

Natural Resources Institute, University of Greenwich at Medway, Central Avenue,
Chatham Maritime, Kent ME4 4TB, UK

INTRODUCTION

Among mammals, species diversity and abundance world-wide are greatest for those animals collectively known as 'small mammals' (principally rats, mice, voles and shrews), amounting to over 1500 species within the orders Rodentia and Insectivora, and bats (order Chiroptera) of which there are almost 1000 species.

On account of their abundance and dependence upon plant or insect food, these two groups are themselves non-target casualties of pesticide spraying, and potential sources of secondary poisoning when eaten by predatory mammals or birds. Small mammals and bats that feed on insects are arguably more susceptible to poisoning from contaminated prey, and associated sub-lethal effects on body condition and breeding, as their higher metabolic rates require them to eat almost their own body weight of insects every day. In addition, these animals can suffer indirectly from pesticide-induced reductions in their prey populations.

Despite their obvious ecological importance, their mainly secretive or nocturnal lifestyles means that populations of small mammals and bats are not readily amenable to monitoring by observation but require trapping or specialized techniques for detection. However, most habitats will host species of both groups that can act as ecological indicators at the population level, and potentially also at a community level in diverse habitats of the tropics. Rodents and shrews normally spend their life cycles in high density populations within relatively small areas that can be effectively trapped and monitored, while insectivorous bats are efficient at integrating pesticides over more extensive areas that are subject to large-scale control operations against pests. Thus, wood mice were used as indicators of the ecological effects of different pesticide regimes used in cereal farming on the Boxworth Project (Johnson *et al.*, 1991a, b) and a community of tropical bats was used as the key indicator group to monitor the impact on small mammals of large-scale DDT spraying against tsetse fly in Zimbabwe (McWilliam, 1994).

Even assuming adequate resources, decisions made as to the size and scope of monitoring programmes depend upon factors such as pesticide toxicity, persistence, application/breakdown rate and resultant exposure of non-target fauna. Exposure and non-target response are in turn influenced by seasonal variation in climate and habitat, differences in susceptibility between species, sexes and age classes. For example, in contrast to adult males, reproductively active female bats were able to offload annually potentially lethal loads of highly persistent DDT metabolites through milk fed to their offspring. Individually marked adult wood mice, that had been fatally poisoned by methiocarb slug pellets within 2–4 days of application to fields in autumn, were rapidly replaced by juveniles immigrating from adjacent habitats.

In general, monitoring of small mammal populations should be carried out by specialists in view of the expertise required for identification and sampling. However, because these animals normally need to be individually handled, they can be marked and released to provide high quality data on the impact of pesticides over varying time periods and geographic scales. This chapter is thus intended as an introduction for managers to protocols

¹Contact address: The Macaulay Institute, Craigiebuckler, Aberdeen AB15 8QH, UK. a.mcwilliam@macaulay.ac.uk

and analyses of which they need to be aware when assessing the environmental impact of chemical treatments on such non-target groups.

PESTICIDE EFFECTS

The four major pesticide groups that small mammals are likely to be exposed to as non-target animals are: organochlorines, organophosphates, carbamates and pyrethroids. In general, any investigation of the impact of organochlorine insecticides requires a prolonged period of study as they (DDT and dieldrin) have a residual life of up to several years and being fat-soluble accumulate in the food chain. Thus, taxa at higher trophic levels, e.g. insectivorous or predatory small mammals and bats, are especially endangered. However, some organochlorines such as dieldrin and endosulfan are also acutely toxic when ingested (in food or by grooming) and sampling intervals need to be short enough to identify any post-application mortality. This would especially be the case, for example, with cover-spraying of a chemical such as endosulfan that is less persistent in the environment (half-lives recorded between 20 and 100 days) and is excreted from the body over a few days.

Although organophosphates and carbamates are not bio-accumulative, they are generally very toxic to vertebrates, both groups acting as neurotoxins by inhibiting the body's production of cholinesterase, an enzyme necessary for the transmission of nerve impulses. Pyrethroids have low persistence with half-lives of weeks and are also rapidly metabolized in mammals but are nevertheless acutely active, being neurotoxins that interfere with the sodium channel in nerve fibres. In general, studies looking at the effects of these three less persistent groups of pesticide need to concentrate more on detecting immediate post-application mortality over days and weeks rather than months and years for the persistent organochlorines. Although insectivorous animals are more likely to be affected through secondary poisoning from eating contaminated insects, it would also be appropriate to monitor herbivorous or seed-eating small mammals in situations where their food sources were sprayed (e.g. corn fields or grassland savannas).

STUDY DESIGN

It is difficult to be too prescriptive because study aims, environments and operational resources are so variable. However, investigations of the impact of pesticides on non-target fauna are normally based on comparing species abundance and population structure either between treated and control sites or before and after application at the same site.

Study plots need to be large enough to monitor mobile fauna – a minimum of 1 km² within a larger treatment area for small mammals and more in the order of 10 km² for insectivorous bats. In both cases, it is important to have replicates (randomized or stratified) to obtain a measure of the natural variation within treatments. Thus, it is statistically desirable to have at least three different sites when adopting the 'before and after' treatment approach or at least three different treated and control plots when making comparisons between different sites.

In the latter case, site selection is important as control and treated plots need to be carefully matched to reduce uncontrolled variation (i.e. compare like with like). To reduce variation caused by differences in sampling time, control and treated sites ideally should be sampled simultaneously. Therefore, they should be as close as possible to reduce travel but far enough apart to prevent any effect of treatment or exchange of populations. Naturally, if the pesticide treatment that requires monitoring is not homogeneous or evenly distributed throughout the environment, the sampling design needs to be adapted more to point surveys. For example, if termite mounds in savanna ecosystems or particular agricultural fields were targeted for control, it would be necessary to use these as the sampling replicates.

When carrying out before and after comparisons, it is also important to have an adequate pre-spray sampling period to assess natural variation in population abundance or composition. This can be problematic in assessing

the impact of emergency control operations but for most mammalian studies a minimum of 4 weeks is recommended and at least three sampling periods.

In practice, the timing and duration of study is largely determined by the nature of the chemical (degree of toxicity and persistence) and application chronology (regular and repeated treatment cycles or single control applications). However, when mammals are used as 'indicators', it is important to take into account the seasonal nature of their own population cycles as this can influence the interpretation of data. Many small mammals and bats have seasonal reproductive cycles as well as annual periods of relative inactivity (winter hibernation or dry season torpor), that critically determine relative abundance values derived from surveys. It is especially important to allow for these natural fluctuations in 'before and after' treatment comparisons, or indeed in any follow-up assessment. For example, population sizes of small mammals with large litters are greatly augmented as the young become mobile and this might mask any pesticide-induced mortality if age structure is ignored.

In general it requires weeks or months of survey to determine the severity of pesticide impact and/or recovery of mammal populations. The need for more 'precautionary' long-term monitoring is also influenced by:

- the scale of chemical application, which can be extensive in agriculture or pest outbreaks, thus reducing chances of local population recovery by gradual immigration
- the presence of protected species or habitats that need to be safeguarded.

Small mammal survey can be demanding of manpower and resources, particularly when large-scale emergency pest control operations (such as aerial control of locusts) require simultaneous monitoring of control and treated sites. As a rule of thumb, a minimum number of four people are required, even when sampling control and treated sites on alternate days. An efficient division of labour is achieved by having a team of one data recorder, one operator to empty traps, one animal handler/measurer and someone to re-bait and replace traps.

MONITORING METHODS

Although more sophisticated and intensive techniques involving radio-tagging are now available for studying small mammals, these are generally too expensive and labour-intensive for use in field assessments of non-target animals in the tropics, unless justified by a need to assess the impact of pesticides on rare or endangered species. A useful practical introduction to the subject has been presented by Kenward (1987).

The most common approach in assessing the impact of pesticides on small mammals involves their capture – mark – recapture (CMR) in a live-trapping programme using baited Longworth or Sherman traps. Grid-based layouts, although more labour-intensive, are preferable to line-trapping for long-term studies as they enable the survival, population density and home ranges of marked individuals on experimental plots to be compared before and after treatment with matched control areas.

Grids

The design of the trapping programme in respect of the length of trapping period, number and density of traps will be influenced by factors such as habitat type, density and abundance of small mammals, in addition to logistical considerations determined by the nature of the experimental or control situation. The following guidelines are derived from the literature on monitoring the response of small mammals to environmental impacts, such as pesticide applications (Douglass, 1989; Flowerdew, 1988; Greig-Smith and Westlake, 1988; Johnson *et al.*, 1991a, b; Tarrant *et al.*, 1990), will need to be modified to suit different field situations.

Sampling layout

The grid should be square for ease of marking and analysis, with a recommended 10 x 10 points trial-spaced at 5 m intervals in grassland, 10 or 15 m in woodland and 20 m in arable habitats. However, a less dense grid can be trapped over a longer period to achieve comparable catch-rates. At least two traps should be placed at each point to reduce the probability of an animal investigating an already occupied trap, although these can be of different sizes to suit particular species. In general, additional traps should be placed at each point if more than 50–60% of traps have caught animals at any one time.

Experimental design

In order to isolate treatment effects on study populations from environmental influences, it is necessary to operate simultaneously a minimum of two trapping grids before and after treatment, one in each of matched experimental and control sites. Habitat type, vegetation composition and structure need to correspond as closely as possible between the paired sites which should be separated by a distance at least great enough to prevent any spray drift into the control area. This allows each paired site to act as its own control, in addition to ensuring that any environmentally induced changes in populations on the control block can be differentiated from the effects of chemical application in the treated area. However, replication is desirable if resources are available, especially in the case of control operations that involve a variety of habitats or treatment regimes to validate and extrapolate findings between sites. With limited resources, it would be preferable to operate two replicate 7 x 7 grids instead of a single 10 x 10 array, both requiring the use of some 200 traps.

Although the length of pre- and post-treatment trial periods will be a compromise determined by balances between conflicting resource pressures and study aims, there are certain minimum requirements for a grid-trapping programme. In order to ensure that most of the grid population has been marked and enough recapture data gathered on individuals to establish their residency before treatment, a minimum of 8 days trapping data is necessary (1600 trap nights with two traps per point on a 10 x 10 array). Ideally, this should be carried out in two sessions of 4 nights, at least a week before application and over the 4 days immediately before treatment in order to distinguish resident from transient animals. Similarly, there should be at least two post-treatment monitoring sessions with trapping beginning 2 days after application to allow any immediate mortality to be detected and a follow-up survey beginning at least a week after treatment. However, time available for monitoring during pest control is often limited by operational considerations and valid differences in survivorship between control and treated grids can be obtained even when trapping is compressed into single 7-day sessions before and after treatment. If possible, it is best to plan the trapping programme to coincide with the dark phase of the moon, as catches are generally lower on clear moonlit nights. Naturally, four trapping sessions (one per week for a month) either side of application would provide better quality data.

Data analysis

The principal determinant of such trials is the proportion of resident marked individuals surviving the treatment compared with those alive after the same interval on the matched control grid. Such figures can be adequately analysed with simple non-parametric statistics like the chi-squared test.

An informative graphical method of portraying the impact of chemical applications is to plot both the cumulative number of captures and individuals against cumulative trapping effort (number of trap-nights). The position of any inflection points denoting a change in the slope of the curve can be related to treatment events. In addition, if the curve of numbers of individuals reaches a plateau, the asymptote denotes the population size at which it has been fully trapped. It is recommended that data are plotted daily to give an indication of the necessary sampling effort still required to sample most of the resident population.

However, to facilitate comparisons with other studies or between sites and sample periods some useful indices of population size and capture success are worth calculating. Although estimates of population size can be made from the proportions of marked and unmarked individuals in successive daily catches, the underlying assumptions to such models are often broken (Montgomery, 1987). Consequently, the minimum number of animals (MNA) known to be alive on the grid during the sample period is a more robust measure of its population size when most animals have been trapped (requiring high recapture rates). Another comparative index used to overcome slight differences in trapping effort between sample periods or sites is the number of captures per trap-night (divide the number of animals caught by the number of traps used and the number of nights spent trapping). Although there are various possible refinements (Gurnell and Gipps, 1989), population densities can be calculated and then compared by dividing the population size for each grid by its area.

Trap lines

Line-trapping can be used as a method to cover greater areas less intensively than a grid layout and consists of placing traps at equal intervals along line transects through a habitat.

Sampling layout and experimental design

Developed further for sampling large arable fields on the Boxworth Project, the technique consists of operating lines of 10 points at 20 m intervals with two traps per point. These are set out at a density of one trap-line for every 2 ha (i.e. each 200 m line is separated by some 100 m if equidistantly spaced) and run for 2 days only in a less labour-intensive approach. However, random sampling and replication can be ensured by running five trap-lines on a 10 ha study site (requiring 100 traps), the first line randomly assigned to say one of five 20 m intervals within the first 2 ha block and the remaining lines then spaced at equal intervals. To reduce the effects of weather, the trap-lines could be assigned randomly to different 2-day blocks over the sampling period. Again, a separate control area should be simultaneously monitored and a minimum of two pre- and two post-treatment trapping sessions, each spanning 3 days (2 full days and 2 full nights) can be carried out within 2 weeks if time is at a premium. However, it is recommended that the first post-treatment session should begin some 2 days after application, to give time for any impact from treatment, and the second trapping session to commence at least a few days after the first, say 7 days following application.

Data analysis

Treatments can also be compared by chi-squared tests using numbers caught per trap-night (or 100 trap-nights) and the proportion of animals recaptured after treatment. In addition, a density index can be calculated by summing captures of individuals over the 2-day trapping period for all trap-lines and dividing this by the sample area covered. In long-term studies where both grid and line-trapping are used concurrently, it is possible to calibrate the density index with the actual population densities found on the grids (Flowerdew, 1988).

PRACTICAL ISSUES

A good understanding of the practical live-trapping of small mammals (Gurnell and Flowerdew, 1994; Wilson *et al.*, 1996) is needed to expand on the points outlined below. The former reference has a comprehensive section on record keeping and trapping analysis and it is recommended that their formats for data sheets and summary tables be adopted.

Grid layout

Right-angles on the grid should be marked out with a prismatic compass and a 30 m tape used to measure trap intervals. Trap points can be marked out with canes, or 2 x 2 cm wooden staves cut so as to be just visible above the grass level (often over a metre high in tropical grasslands). Once an accurate baseline of canes has been

placed on one side of the grid, other points can be lined up by eye after measuring the correct interval. Both canes and associated traps should be given corresponding grid numbers with a permanent marker pen, so that animal positions can be recorded and mapped.

Traps

Longworth and Sherman traps are both suitable live-traps made from lightweight aluminium. However, where carriage space is limited, as during environmental monitoring of control operations in remote tropical areas, collapsible Sherman traps are recommended because they fold flat (see illustration on method sheet), come in a variety of sizes and strengths and can be transported in the plywood packing boxes in which they are exported by the suppliers (www.shermantraps.com).

Longworth traps are bulkier as they are made up of two sections: a tunnel with integral trip mechanism and separate nest box (see illustration on method sheet). Full details of their operation and sourcing can be found in Gurnell and Flowerdew (1994).

Traps should be placed within 1 m of the marker cane and trapping success can be improved by appropriate positioning, with the entrance flush to the ground and the trap aligned along runs in the grass or adjacent to grass tussocks. In wooded habitats or shrubby vegetation, they can be placed alongside fallen branches or logs and should always be sheltered beneath any available shade. Once the trap position has been selected on the first day, it should be kept there and care taken to keep the trip mechanism unobstructed by old bait or vegetation. The traps should be emptied of debris every morning and the bait replaced if necessary.

Baiting

Animals can be encouraged to enter traps by placing food inside them. A mixture found suitable for baiting in the tropics consists of: 1 part raisins, 2 parts peanut butter and enough rolled oats to make a mixture of a putty-like consistency. This can be rolled into balls and placed at the back of the trap, or just outside the trap if a pre-baiting period is found necessary. (Pre-baiting is the provision of bait for a limited period of 1 or 3 days with the door fixed open to familiarize animals with the traps. Although not generally recommended in time-limited field trials, it may be necessary in grassland during the first pre-spray session to discount initial avoidance of the traps, especially by voles, in any comparisons of catch rates with post-treatment periods.)

Maintenance

Traps need to be checked for animals at least twice per day – in the early morning, within 3 h of dawn, before the day warms up in order to minimize heat stress and replace bait. An additional visit in the late afternoon before dusk is required to ensure that all traps are baited and reset for the night's catch. Although the provision of bedding material in traps has not been found necessary in tropical conditions, if temperatures drop below about 10 °C, dried grass, hay, shredded paper or cotton waste should be introduced to the back of the traps.

In the tropics, experience has shown that fresh bait should be put down every second day as it tends to dry out in high temperatures and can also get depleted by insects. However, the oatmeal/raisin base of used bait can be 'refreshed' by the addition of more peanut butter and recycled. Plastic buckets with tight fitting lids are useful for preparing and carrying the bait.

ANIMAL HANDLING

Small mammals **must** be handled with care and skill. Guidance and training from an expert is essential before undertaking any of the following activities. Occupied traps should be emptied into large, heavy duty, cloth bags, at least 20 x 30 cm, with a draw-string that can be tied around the top and looped on to a stick for returning

to a vehicle or local base for identification, categorizing, measuring and marking. It is normally sufficient to open one of the doors and shake the animal gently out. It can then be restrained in the bag opening by use of gloves or another bag to facilitate examination on a flat surface. Care must be taken not to suffocate these small animals by squeezing too hard in an effort to avoid being bitten. It is recommended that animals are held by the nape of the neck, where all the loose skin is grasped between finger and thumb and held firmly against the back of the skull, thus preventing the animal from being able to turn around and bite.

Identification

Species need to be identified with the aid of relevant field guides and taxonomic keys. However, if species identification is problematic, as in many tropical habitats, animals can be described and given a temporary ID before obtaining authority to take a specimen for later identification by an expert. Go no further than this without training from a mammalogist. If necessary, animals may be killed by soaking cotton wool in chloroform or ether and placing this with the cloth collecting bag in an air-tight plastic bag for some 10 to 15 min. This also allows collection of any ectoparasites which should be stored in 70% alcohol. The specimen's abdominal cavity should be cut open longitudinally and the diaphragm punctured through to the lungs to facilitate preservation, preferably in 70% alcohol or 10% formalin solution if residue analysis is contemplated.

As the teeth are an important taxonomic feature, it often helps to prop open the mouth with a small stick before preserving and the specimen needs to be labelled with details of location, date, captor, sex and any measurements taken. These would normally be: weight, total length (tip of nose to end of the last caudal vertebra), tail length (from the base of the tail to the end of the last caudal vertebra), hindfoot length (tip of the longest claw to the heel) and ear length (from the tip to the notch). Practical details on the preparation and preservation of taxonomic specimens have been summarized by Yates *et al.* (1996).

Measuring

A set of 'Pesola' spring balances (50 g, 100 g, 300 g, 1.5 kg) should be obtained for weighing (the BTO, www.bto.org). It is easy to determine the weight of animals by subtracting the weight of the cloth bag from the combined figure taken when weighing the animal inside the cloth collection bag. If the animals are small, they can be weighed inside a small polythene bag. Severe declines in body weight may indicate a change in body condition induced by pesticides, either acting directly or through a reduction in the food supply.

A 30 cm steel rule is probably adequate for most external measurements although a pair of callipers can be useful for greater accuracy (both are obtainable from the BTO, address above, which can additionally supply cloth bags – readily made to order by local tailors in the tropics). The standard measurements listed above as an aid to identification should be recorded on first capture as these are all characters used to distinguish between species.

Reproductive condition

Animals should at least be sexed, aged and weighed before marking and release. It is also useful to distinguish between adults and juveniles on the basis of size, pelage colour (usually very grey in juveniles) and reproductive condition. Adult males normally have scrotal testes and adult females can be recognized by pregnancy or the presence of suckled nipples. Juvenile females can be further distinguished by the presence of an imperforate vagina, which is still covered with a membrane. A guide to determining breeding condition among rodents is to be found in the recommended booklet by Gurnell and Flowerdew (1994).

Marking

For short-term field trials, that last for no more than a few weeks, fur clipping is least disturbing to animals and by trimming hair from different parts of the body various combinations can provide a series of individual identifications. For example, the combination of six patches on the left and right shoulders, flanks and haunches (e.g. denoted A to F) will give 41 possible marks for each sex of each species (see Gurnell and Flowerdew, 1994, Figure 3). If the fur is found growing back on recaptured animals it can always be cut again. For long-term studies, the use of ball-chain necklaces probably causes the least disturbance. These are made from linked stainless steel balls on to which are strung individually numbered or coloured metal split rings, the construction, application and sourcing details of which are described in Rudran (1996).

BIOCHEMICAL AND RESIDUE ANALYSIS

Exposure of animals to pesticides can of course be assessed directly by taking biological samples for laboratory studies. These can be divided broadly into biochemical or residue analyses. Both require special expertise and are expensive, although they are necessary for actual confirmation of exposure to chemical treatments. Prior to residue analysis, post-mortem examinations to determine pathological or histological effects can be carried out on any moribund animals or carcasses found after spraying (Tarrant, 1988). These should be double-wrapped in aluminium foil and immediately frozen in a portable freezer in the field for subsequent analysis (see chapter 6). Although post-mortem analyses will be restricted if specimens cannot be preserved by freezing, specific organs such as liver or brain, carcasses or even alimentary tracts stored in 10% formalin in aluminium canisters are amenable to residue analysis.

Biochemical analysis

Exposure to some chemicals can be detected by biochemical changes in the blood. For example, death by organophosphate or carbamate poisoning is presumed to result from asphyxiation, through tetanus of the diaphragm, brought on by excessive stimulation of the central nervous system. This arises from an accumulation of acetylcholine as a result of the inhibition of cholinesterase enzymes by these compounds.

Sub-lethal exposure to relatively low levels of such pesticides can now be assessed for non-target bird and mammal populations (as well as people involved in application) by measuring the degree of esterase inhibition in blood serum harmlessly taken from individuals (Thompson and Walker, 1994). Although this has been successfully carried out for small mammals on the Boxworth Project in Britain, the technical resources required are considerable. In addition, the necessity to obtain good baseline control data from a large pre-spray sample of the indicator species limits the usefulness of the technique in habitats where non-target species are difficult to catch. Also, the degree of inhibition is greatly influenced by the time since exposure and varies both between species and individuals. In conclusion, the logistical constraints of fieldwork in the tropics and practical limitations of the methodology precludes this approach to detecting exposure, unless part of an intensive and long-term research project. Rather, any non-target casualties or captured animals whose behaviour indicates poisoning should be preserved for confirmatory residue analysis.

SURVEY METHODS FOR BATS

Insectivorous bats are widespread throughout most tropical areas, although their abundance is largely determined by the availability of insects, making them an excellent indicator group for monitoring the 'health' of habitats after chemical application. Their presence while flying at night can be determined by specialized live-capture techniques (mist-net, a mesh of fine nylon supported on poles; harp-trap, a rectangular frame strung vertically with fishing line), or by electronic 'bat detectors' that convert their ultrasonic echolocation calls into sounds which are audible to people.

To date there has been only one study that has used these techniques to monitor the impact of large-scale pesticide application on a community of bats, coupled with residue analysis to assess exposure (McWilliam, 1994). This involved a detailed and long-term investigation of the persistent organochlorine, DDT, with resources not generally available in most wildlife trials. As the capture and handling of bats at night is time consuming and requires comprehensive training (and in some countries formal licencing) to avoid injury to animals, the use of bat detectors is recommended for monitoring the relative abundance of bats in ecotoxicological research.

Bat detectors

Even with additional sound processing and recording equipment enabling echolocation calls to be assigned to individual species (Fenton and Bell, 1981; Vaughan *et al.*, 1997), bat detectors only provide an index of relative abundance as the bat detector cannot discriminate between individual bats. In effect, several detection events at a site, or 'bat passes', could as well be made repeatedly by the same bat passing through the detection space as by several bats flying across it in succession. In addition, the technique is biased towards those species with more intense calls that register at longer distances from the instrument. Nevertheless, the number of bat passes per unit time or transect length are measures of bat activity that can be compared between habitats or, in the context of pesticide impact, between pre-spray or control and post-spray treatments. This applies equally whether the entire ultrasonic spectrum is being covered by a 'broad-band' unit to monitor the whole fauna, or a more sensitive 'narrow-band' detector is used to sample a frequency common to the echolocation calls of a majority of species. In this respect, most surveys of general bat activity have used a frequency of 40 or 45 kHz (McWilliam, 1994; Walsh *et al.*, 1995).

A good introduction to the principles and practicalities of bat detector use is available from the Bat Conservation Trust, which can also be contacted for information on the current availability of hand-held models suitable for monitoring bat activity (www.bats.org.uk). Relatively inexpensive models used in Britain at the time of publication include the Batbox III from Stag Electronics (www.batbox.com), the Mini III from Ultra Sound Advice (www.ultrasoundadvice.co.uk), and the Skye SBR 1200 from Skye Instruments Ltd (www.skyeinstruments.com). These have been compared by Waters and Walsh (1994), who found that the Batbox III was the most sensitive of the models, although this was at the cost of less accuracy at higher frequencies. These suppliers do produce more sophisticated models which are worth considering if budgets allow. Highly regarded models of varying specification are also produced by Petersson Elektronik AB (www.batsound.com).

It is worthwhile consulting general reviews and compilations on bat detection to gain access to the literature (see 'Further Reading', page 254).

With experience and acoustic analysis it is possible for experts to distinguish between species on the basis of the character of their echolocation calls (frequency range, whether constant frequency [CF], frequency modulated [FM] in different pulse lengths and delivery combinations). However, in initial ecotoxicological surveys by novices, fewer assumptions are made if all detected sequences of at least two echolocation pulses are treated as one bat pass, without any attempted differentiation between species. In some situations it may be worthwhile separately noting bat passes that, by their increasing pulse repetition rates (a 'feeding buzz'), identify individuals that are actually foraging rather than being merely in transit. However, these categories can be combined during analysis.

If resources are available, it is possible to set up automatic monitoring stations for recording bat activity, say at equidistant points along a transect route, which are based on the recording of bat passes through the linkage of bat detectors to voice-activated tape recorders. However, although significantly reducing time spent in the field, this does require a substantial input into setting up the equipment and analysing the recordings and expert assistance is essential.

Transects

Bat detectors are conveniently used on transects, whether operated continuously while walking or driving at a standard speed through habitats or for timed periods at points selected randomly or regularly located along the route. Although some species will rarely be recorded due to the low intensity of their calls, the presence of bats generally can be detected within 10 to 50 m of most models. If chemical application is uniform over large-scale areas, such as achieved by aerial spraying, some form of stratified sampling is recommended as bats will generally forage near water, especially in the dry season, and in richer more complex habitats such as riverine forest or woodland where insect abundance is likely to be greater. Thus, after monitoring bat activity on transects through woodland in assessing the impact of ground-spraying DDT against tsetse fly in Zimbabwe, marking and recapture of bats was concentrated at matched sites in control and treated areas around seasonal pools in woodland, rivers and adjacent vegetation and around permanent water at dams (McWilliam, 1994).

In relatively safe locations, continuous sampling can be carried out on foot, perhaps in combination with timed point counts. However, in many less secure tropical habitats where wildlife or people can be encountered at night, it is advisable to carry out timed counts at predetermined points along a transect, from the roof of a 4-WD vehicle if necessary. This has the advantage of making it easier to record meteorological data at each point (cloud cover, degree of moonlight, temperature and wind speed) and make notes. Thus, even in the tropics, temperature is a determinant of the level of bat activity, mediated through its influence on insect activity.

Sampling and experimental design

Where more localized chemical application has been carried out, e.g. along linear habitats such as roadside verges, field margins, woodland edges, river or lake sides, randomly positioned or regularly spaced transects can be monitored. It is recommended that replicate transects at least 1 km in length are surveyed in both control and treated areas, with a minimum of 100 m between points if timed counts are carried out. When the area treated is less linear and more extensive, 10 km² or greater, some 15–20 points spaced 200–250 m apart can be monitored to ensure good coverage. If the treated area is extensive enough to allow parallel transects, these should be no closer than 250 m to each other. In locations where transects can be walked, a uniform speed should be adopted of between 2 and 3 km h⁻¹ and data noted or recorded on tape for later transcription, of the time taken and the number of bat passes per transect segment.

On timed point counts, the length of time required for monitoring at each spot depends upon the level of bat activity. However, from experience, a 5 min sampling period followed by an interval of 5 min to allow travel to the next spot is a reasonable compromise, allowing a 16 point transect to be covered in about 2.5 h. Monitoring should start at some fixed time between 15 and 30 min after sunset to cover the early evening peak in foraging activity. It is recommended that each replicate transect in control and treated areas is monitored over at least two sessions spaced about a week apart of 4 nights each, both before and after treatment. Two days or so should be allowed for the chemical application to be mediated by the insect population before commencing the first post-treatment session. If possible, all monitoring should be carried out during the dark phase of the moon as bat activity is often reduced on moonlit nights.

RESIDUE ANALYSIS FOR BATS

Monitoring may indicate that an acute effect is taking place and that mortality from poisoning is implicated, rather than the emigration of bats to richer food patches. In this case, specimens can be taken by a specialist (with permission from the relevant wildlife authorities), using mist nets or harp traps and preserved for residue analysis (McWilliam, 1994). If possible, specimens should be double-wrapped in aluminium foil and frozen. Alternatively, they can be stored in 10% formalin solution after opening their abdominal cavities and puncturing the diaphragm to ensure effective preservation (see chapter 6).

REFERENCES

- DOUGLASS, R.J. (1989) Assessment of the use of selected rodents in ecological monitoring. *Environmental Management*, **13** (3): 355–363.
- FENTON, M.B. and BELL, G.P. (1981) Recognition of species of insectivorous bats by their echolocation calls. *Journal of Mammalogy*, **62**: 233–243.
- FLOWERDEW, J.R. (1988) Methods for studying populations of wild mammals. pp. 67–76. In: *Field Methods for the Study of Environmental Effects of Pesticides*. Greaves, M.P., Smith, B.D. and Greig-Smith, P.W. (eds). *BCPC Monograph*, No. 40. Thornton Heath: British Crop Protection Council.
- GREIG-SMITH, P.W. and WESTLAKE, G.E. (1988) Approaches to hazard assessment for small mammals in cereal fields. pp. 67–76. In: *Field Methods for the Study of Environmental Effects of Pesticides*. Greaves, M.P., Smith, B.D. and Greig-Smith, P.W. (eds). *BCPC Monograph*, No. 40. Thornton Heath: British Crop Protection Council.
- GURNELL, J. and FLOWERDEW, J.R. (1994) *Live Trapping Small Mammals – A Practical Guide*. Third edition. *Occasional Publication*, No. 3. London: The Mammal Society.
(Address: The Mammal Society, 15 Cloisters Business Centre, 8 Battersea Park Road, London SW8 4BG, UK.)
- GURNELL, J. and GIPPS, J.H.W. (1989) Inter-trap movement and estimating rodent densities. *Journal of Zoology, London*, **200**: 289–292.
- JOHNSON, I.P., FLOWERDEW, J.R. and HARE, R. (1991a) Effects of broadcasting and of drilling methiocarb moluscicide pellets on field populations of wood mice, *Apodemus sylvaticus*. *Bulletin of Environmental Contamination and Toxicology*, **46**: 84–91.
- JOHNSON, I.P., FLOWERDEW, J.R. and HARE, R. (1991b) Populations and diet of small rodents and shrews in relation to pesticide usage. pp. 144–156. In: *The Boxworth Project: Pesticides, Cereal Farming and the Environment*. Greig-Smith, P.W., Frampton, G.K. and Hardy, A.R. (eds). London: HMSO.
- KENWARD, R.E. (1987) *Wildlife Radio Tagging: Equipment, Field Techniques and Data Analysis*. *Biological Techniques Series*. London: Academic Press.
- MCWILLIAM, A.N. (1994) Nocturnal animals. pp. 103–133. In: *DDT in the Tropics: The Impact on Wildlife in Zimbabwe of Ground-spraying for Tsetse Fly Control*. Douthwaite, R.J. and Tingle, C.C.D. (eds). Chatham, UK: Natural Resources Institute.
- MONTGOMERY, W.I. (1987) The application of capture-mark-recapture methods to the enumeration of small mammal populations. *Symposium of the Zoological Society of London*, No. 58: 25–57. Oxford: Oxford University Press.
- RUDRAN, R. (1996) Methods for marking animals. pp. 299–310. In: *Measuring and Monitoring Biological Diversity. Standard Methods for Mammals*. Wilson, D.E., Cole, F.R., Nichols, J.D., Rudran, R. and Foster, M.S. (eds). Washington DC: Smithsonian Institution Press.
- TARRANT, K.A. (1988) Histological identification of the effects of pesticides on non-target species. pp. 313–317. In: *Field Methods for the Study of Environmental Effects of Pesticides*. Greaves, M.P., Smith, B.D. and Greig-Smith, P.W. (eds). *BCPC Monograph*, No. 40. Thornton Heath: British Crop Protection Council.

TARRANT, K.A., JOHNSON, I.P., FLOWERDEW, J.R. and GREIG-SMITH, P.W. (1990) Effects of pesticide applications on small mammals in arable fields, and the recovery of their populations. pp. 173–182. In: *Proceedings of the 1990 Brighton Crop Protection Conference on Pest and Diseases*, Volume 1. Thornton Heath: British Crop Protection Council.

THOMPSON, H.M. and WALKER, C.H. (1994) Blood esterases as indicators of exposure to organophosphorus and carbamate insecticides. pp. 37–62. In: *Nondestructive Biomarkers in Vertebrates*. Fossi, M.C. and Leonzio, C. (eds). Boca Raton: Lewis.

VAUGHAN, N., JONES, G. and HARRIS, S. (1997) Habitat use by bats (Chiroptera) assessed by means of a broadband acoustic method. *Journal of Applied Ecology*, **34**: 716–730.

WALSH, A.L., HARRIS, S. and HUTSON, A.M. (1995) Abundance and habitat selection of foraging vespertilionid bats in Britain: a landscape-scale approach. *Symposia of the Zoological Society of London*, **67**: 325–344.

WILSON, D.E., COLE, F.R., NICHOLS, J.D., RUDRAN, R. and FOSTER, M.S. (eds) (1996) *Measuring and Monitoring Biological Diversity. Standard Methods for Mammals*. Washington DC: Smithsonian Institution Press.

YATES, T.L., JONES, C. and COOK, J.A. (1996) Preservation of voucher specimens. pp. 265–273. In: *Measuring and Monitoring Biological Diversity. Standard Methods for Mammals*. Wilson, D.E., Cole, F.R., Nichols, J.D., Rudran, R. and Foster, M.S. (eds). Washington DC: Smithsonian Institution Press.

FURTHER READING

AHLEN, I. (1990) *Identification of Bats in Flight*. Stockholm: Swedish Society for Conservation of Nature.

CORBET, G.B. and HILL, J.E. (1991). *A World List of Mammalian Species*. Oxford: Natural History Museum Publications/Oxford University Press.

GREIG-SMITH, P.W. (1990) Intensive study versus extensive monitoring in pesticide field trials. pp. 217–239. In: *Pesticide Effects on Terrestrial Wildlife*. Somerville, L. and Walker, C.H. (eds). London: Taylor and Francis.

KREBS, C.J. (1989) *Ecological Methodology*. New York: Harper & Row.

KUNZ, T.H., WEMMER, C. and HAYSEN, V. (1996b) Sex, age and reproductive condition. pp. 279–290. In: *Measuring and Monitoring Biological Diversity. Standard Methods for Mammals*. Wilson, D.E., Cole, F.R., Nichols, J.D., Rudran, R. and Foster, M.S. (eds). Washington DC: Smithsonian Institution Press.

TEW, T.E., TODD, I.A. and MACDONALD, D.W. (1994) The effects of trap spacing on population estimation of small mammals. *Journal of Zoology, London*, **233**: 340–344.

GLOSSARY

Abcission: The natural process by which two parts of an organism separate; leaf fall

Abiotic: Non-living

Absolute abundance: The precise number of individuals of a taxon in a given area, volume, population or community

Absorption: The process by which one substance is taken into and incorporated in another substance

Abundance: The total number of individuals of a taxon in a given area, volume, population or community

Acaricide: A chemical (usually) or biological agent for killing mite pests or disease vectors

Acetylcholinesterase: Enzyme which breaks down acetylcholine – a chemical involved in nerve transmission

Active ingredient (a. i.) concentration: The amount of the actual pesticide in grams in a given amount (usually a volume) of the commercial product. This is usually expressed as a % wt/vol; e.g. 96% fenitrothion usually means 960 grams a.i. in 1 litre (1000 cc) of product

Acute: Severe (often lethal); of short duration

Adipose tissue: Fatty tissue

Adsorption: The adhesion of molecules as an ultra-thin layer on the surface of solids or fluids

Aerial spraying: Spraying (usually of agrochemicals) from aircraft, either fixed-wing or helicopter

Agamid: Member of the lizard family Agamidae, including such Old World genera as *Agama* and *Uromastyx*

Airblast: A blast of air created by a fan or exhaust gases

Air-shear nozzle: This is an atomizer which relies on an airblast to break up the spray liquid as it is emerging at low pressure from a nozzle

Aluminium extrusion: A container made of aluminium

Ammonification: The mineralization of organic nitrogen to NH_4^+ by the action of enzymes and micro-organisms

Anemometer: Device for measuring wind speed

Anti-feedant: Property of a spray product which prevents animals (usually pest insects) from feeding on it

Anuran: An animal within the taxonomic order comprising the frogs and toads

Artificial substrate: Media such as stones, bricks and tiles used for collecting organisms that settle on them

Atomization: The process of making spray; in other words, breaking up liquid into droplets

Aridisols, Ultisols: Orders (categories) of soil taxonomy that describe soils based on a range of common characteristics

Baiting: Mixing insecticide with a material which pests will eat and placing or scattering it in a place where they will locate it

Band or hopper band: A gregarious group of locust hoppers marching together, which can vary in size and density

Barrier: In relation to locust control – a strip of vegetation sprayed with pesticide. When persistent pesticides are used against hoppers, they are usually applied in barriers so that the hopper bands march through a barrier, feeding as they go, and are killed by the pesticide ingested with the vegetation

Baseline data: Data relating to a situation before an intervention: basic or elementary data sets

Bearing: A compass bearing is the number of degrees by which a direction differs from magnetic north. North is 0, east is 90, south is 180 and west is 270. Compass bearings can be any figure between 0 and 360 degrees

Benthic: Pertaining to the river bed or lake floor

Benthic organisms: Organisms whose life habit is to live on the bottom of a river or lake

Bioaccumulation: The increase in concentration of a chemical in organs and tissues of an organism by intake from food and water

Bioconcentration: The increase in pollutant concentration from water when passing directly into aquatic species

Biodiversity: The diversity of species, genetic variability within species and differences within and between ecosystems; the variety and variability of all animals, plants and micro-organisms on earth

Bioindicator: A species (or other taxonomic grouping) selected and used to reflect biological adjustments and habitat changes

Biomagnification: Increasing concentration of chemical pollutants in animal tissue in successive members of a food chain or through a food web

Biomass: A quantitative estimate of the total weight (mass) of organisms comprising all or part of a population; all or part of any other specified unit; within a given area at a given time. May be measured as volume, live/dead/dry or ash-free weight, energy (calories); standing crop or standing stock

Biometrician: A person skilled in the statistics of biology

Biome: A biogeographical region or formation; a major regional ecological community characterized by distinctive life forms and principal plants (terrestrial biomes) or animals (marine biomes)

Biopesticide: A micro-organism which can be sprayed to infect and kill a pest

Biotic: Living

Blanket spraying: Spraying the whole of a target surface (cf. barrier spraying)

Botanical insecticide: A plant extract which can be sprayed to kill or deter pests

Brand name (also called trade name): The brand name has the first letter in upper case, e.g. Sumithion

Broad-spectrum: The property of a pesticide which kills a wide range of different organisms

Buffer zone: Region close to an ecologically sensitive area or habitation where no spraying is carried out, to avoid them being affected by drift

Calibration: This means setting up the sprayer to apply the right dose of insecticide in the right sized droplets to the right place

Cannibalism: Organisms feeding on others of the same species

Canopy: The cover provided by leaves and branches of a shrub, tree or forest

Carbonate-bicarbonate equilibrium: A relationship between pH, carbon dioxide, carbonates, H^+ , Ca and Mg in water that resists change (buffer system) in pH

Carnivore: A flesh-eating organism

Catchment area: A drainage area that contains surface and sub-surface mechanisms for storage and removal of water

Census: Population counts; systematic observations to examine absolute or relative abundance

Chemical name: The chemical name has the first letter in lower case, e.g. fenitrothion

Chitin: A hard substance forming the surface (exoskeleton) of many arthropods

Cholinesterase: An enzyme involved in nervous responses being transmitted in the motor neurone system

Cline: A gradual ecological change over a distance

Closed habitats: Habitats dominated by trees, large bushes or other vegetation which (at least partially) exclude sunlight

Cocktails: This term is sometimes applied to pesticide formulations which contain a mixture of active ingredients

Community: An assemblage of organisms that live in a particular environment and interact with one another, forming a distinctive living system, with its own composition, structure, environmental relations, development and function

Conductivity: The ability of water to conduct electricity, which is dependent on dissolved salts

Confluence: The point where two rivers or streams meet

Confound(ed): In statistics – the state occurring where the effect of a particular treatment cannot be separated from that of an uncontrolled variable also influencing the ‘experiment’

Contact action: Pesticide toxicity from passage through cuticle or skin causing mortality. The efficacy may also be assisted by secondary contact action, e.g. where an organism touches insecticide drops on vegetation or other surfaces. This compares with stomach action products which have to be eaten to be effective

Contaminant: A substance in the environment, usually (within the context of this book) as a result of human activities, at above background concentrations

Controlled droplet application (CDA): This is the technique of applying droplets in a narrow size-range believed to be most effective for the particular target and conditions

Control method: This is the equipment, pesticide and technique used for killing a pest

Control (unsprayed): Another way of referring to an untreated area often called an ‘untreated control’

Convection: The phenomenon of air being heated up by the ground and rising

Cross wind: At 90 degrees to the wind direction

Cuticle: Outer layer, often with cilia or setae, in arthropods and other invertebrates

Dambos: Areas or gullies susceptible to flooding – often used for agriculture, e.g. rice culture

Degradation: The physical, chemical or biological breakdown of a pollutant chemical

Delimit: To determine the boundaries of a target area or pest infestation

Density: Often used to mean the number of organisms in a given area, e.g. number per m²

Deposition: The term used to describe a droplet hitting any surface, vertical or horizontal, by impaction or sedimentation

Deposition profile: The shape of the graph of deposition over distance downwind from a spray pass

Detergent: A chemical which lowers surface tension – often used as cleaning agents

Diazotrophes: Organisms capable of using atmospheric nitrogen as a nutrient

Direct effect: A chemical such as a pesticide having an acute or chronic effect on behaviour and physiology of a pest or non-target organism, with no need for any intermediary process

Discriminative spray applications: Methods of applying agrochemicals which involve some reduction or limitation of target area and/or timing of application intervals to limit the amount of chemical needed

Disease vector: A pest organism that transmits a disease

Dissipation: The dispersal and/or movement of a compound such that its concentration is reduced

Diversity: The condition of having differences with respect to a given character or trait

Dose: This is the amount of active ingredient (a. i.) in grams applied to a given unit of area (usually 1 ha)

Dose-response relationship: A graphical plot showing the effects of pesticide concentrations (or any toxic chemical) on test organisms

Downwind edge: The edge of a spray block which is furthest from the direction from which the wind is coming

Drift: In terms of pesticide spraying – the movement of pesticide droplets or dust on air currents or wind

Drift (aquatic): The movement of aquatic organisms downstream carried by the current – often behavioural or in response to spate and pesticides

Droplet size: Droplet size refers to the diameter of a droplet, i.e. the size across it. It is usually measured in micrometres (also called microns) – written μm . A micrometre is 1 millionth of a metre. A 100 μm diameter dot can be seen by the naked eye; smaller droplets are difficult to see

Droplet spectrum: The range of droplet sizes produced by a given type of spray equipment

Dusting: Mixing insecticide with an inert dust such as chalk or talcum powder and sprinkling it on to the pest species, its habitat or susceptible crops

Eckman Grab: A device with jaws for sampling sediment

Ecological niche: The concept of the space occupied by a given species (or other taxonomic grouping), which includes both the physical space as well as the functional role of the species

Ecologically sensitive area (ESA): Areas of significant value in their natural state

Ecology: The study of the interrelationships between organisms and their environment

Ecosystem: A community of different species interacting with each other and the surrounding abiotic environment

Ecotoxicology: The study of the effects of pollutants on ecosystems

Ectothermy: Body temperature dependent on warmth externally

Efficacy: Usually referring to the extent of a pest kill

Efficiency: The comparison of efficacy and cost, both in terms of money and effort

Emergence traps: A device for trapping adult insects emerging from water, soil or vegetation

Emergent vegetation: Vegetation rooted in the littoral zone that protrudes from the water

Emigration: The movement of organisms out of an area

Emission height: The height at which a given spray is released into the air

Emulsifiable concentrate (EC): This is a pesticide formulation which is diluted with water and applied as an emulsion

Environment: All of an individual organism's surroundings, both inanimate (air, soil, water, etc.) and animate (other organisms, including other members of its own species)

Environmental impact: Direct or indirect effects of interventions on the environment: in the context of pesticides, the negative (or sometimes positive) effect on non-target organisms and/or their functions

Environmental services: The benefits provided by ecosystems, through ecological functions, that are used to sustain human livelihoods

Enzyme system: A range of enzymes controlling behaviour and physiology of an organism (acetyl-cholinesterase is an example)

Euphotic zone: Of lakes and rivers – the depth to which plants can photosynthesize

Eutrophic: Having high primary productivity; pertaining to waters rich in the mineral nutrients required by green plants

Faunal assemblages: Groupings of animals found in a particular site, habitat or ecosystem

Feeding guild: A group of species living in the same habitat and eating the same or similar food

Ferry time: The time an aircraft spends flying backwards and forwards between the airstrip and the target for refuelling or refilling with insecticide

Flagman: Man using a flag to mark the end of the spray passes for a sprayer operator

Fledge: To develop to winged adult stage from a final instar nymph (in insects) or from down-covered baby to feathered adult (in birds)

Food chain: A hierarchy of organisms on successive trophic levels within a community, through which energy is transferred by feeding

Foraging success: The effectiveness of the search for food

Formation spraying: Two or more sprayer operators spraying at the same time, but in a way which avoids one contaminating the other

Formulation: This is the product supplied by the manufacturer, i.e. the active ingredient mixed with solvents, stabilizers, carriers and other inert materials which make up the rest of the volume

Fossorial: Adapted for digging, burrowing and/or living underground or below the soil surface

Fungicide: A chemical or biological agent used for killing pest species of fungi

Gecko: A member of the family of lizards, Gekkonidae

Global positioning system (GPS): An instrument which uses signals from satellites orbiting the earth to estimate the users' position (latitude and longitude)

Grab sampling: A way of sampling river and lake sediment using mechanically hinged equipment

Granivorous: Grain eating; an organism that eats plant seeds

Gregarious: The habit of individuals gathering together in large numbers

Groundwater: All the water that has percolated through the surface soil into the bedrock

Guild: A group of species having similar ecological resource requirements and foraging strategies

Habitat: The locality, site and particular type of local environment occupied by an organism

Haemocytometer: A device used to count blood cells but useful also to count plankton

Half-life: The time required to reduce by 50% the concentration of a material (e.g. chemical) in a medium such as water by transport, degradation, volatilization, etc.

Hand net: A hand-held net on a pole used for aquatic and terrestrial sampling

Hazard: A source of danger. Risk from pesticides is hazard x level of exposure to the product

Heel sampling: A method of sampling rivers that involves stirring up the substrate with boot heels

Hemimetabolous: Showing incomplete metamorphosis from nymph to adult

Herbicide: A chemical (usually) or biological agent for killing plant pests

Herbivorous: Plant eating

Herpetofauna: Term used to cover both amphibian and reptile species

Heterogeneity: Having a non-uniform structure or composition

Holometabolous: Showing complete metamorphosis from larva via pupa to adult or imago

Homogeneity: Similar throughout; of uniform structure or composition

Hydraulic nozzle: This is a simple device which atomizes liquid by forcing it out of a small hole under pressure

Hypothesis: An assertion or working explanation that leads to testable predictions; an assumption providing an explanation of observed facts, proposed in order to test its consequences

Imagines: The final, fully developed adult stage of insect development (imago)

Impaction: This occurs when a droplet carried sideways by the wind lands on a vertical surface such as a plant or insect. The droplet hits the surface because of the horizontal momentum it has been given by the wind

Incremental spraying: This means spraying in a cross wind so that deposit is built up from overlapping swaths

Indicator species: See bioindicator

Indirect effect: A chemical such as a pesticide indirectly affecting an organism through its impact (acute or chronic effect) on another organism upon which the first depends, usually as food

Infauna: The total animal life within a sediment

Insect growth regulators (IGRs): Products which interfere with the growth of an organism, usually by affecting the moulting process

Insect emergence: The emergence of an adult insect from water

Insecticide: A chemical or biological agent for killing insect pests

Insectivorous: Insect-eating; an organism which eats insects

Instars: The stages through which some insect nymphs pass before becoming adults

Invertebrate: An animal with no backbone

In vivo: Pertaining to biological measurements made in the field as opposed to the laboratory

Isomer: Serially differing structures of homologous chemical formulae

LC₅₀: Lethal concentration for 50%. This is the concentration of a chemical which will kill 50% of organisms in a test population

LD₅₀: Lethal dose for 50%. This is the dose which will kill 50% of a test population

Kick sampling: Same as heel sampling

Knock-down: The property of some insecticides, notably pyrethroids, to make insects drop very quickly after spraying. They may not be dead, and if the dose was not sufficient, in some circumstances can recover

Leaching: Movement of water-soluble chemicals from the soil surface downwards to lower layers or groundwater

Lentic: Pertaining to static, calm or slow-moving aquatic habitats

Lethal: Pertaining to or causing death by direct action

Lipid: Relating to fat

Lotic: Pertaining to fast running water habitats, such as rivers and streams

Mammalian toxicity: The measure of how poisonous a product is to mammals – usually tested in the laboratory on rats, and expressed as the LD₅₀

Mandibulate herbivores: A plant-eating organism (usually an insect) with bulky, chitinous mouthparts

Marching: In relation to locusts – the behaviour of locust hopper bands which are moving together

Mark: In relation to spray application technology – to place flags or other markers such as vehicles, people or smoky fires at the corners of a spray block

Maturity: The state reached by an adult organism when its sexual organs develop and it is ready to copulate successfully. Other features may identify a mature adult, e.g. mature desert locusts are either pale yellow (solitary) or bright yellow (gregarious)

Mechanical control: Using physical methods to control pests such as beating, burning or burying

Metabolism: Use of energy and materials to provide an organism's needs for growth and reproduction; the chemical reactions that take place in cells

Metabolites: The participating molecules in and products of metabolism; in pesticide chemistry – breakdown, degradation or reaction products resulting from a given agrochemical

Metamorphosis: A marked structural transformation during the development of an organism, often representing a change from larval stage to adult

Microbial epoxidation: A microbially mediated reaction where oxygen is joined to two carbon atoms to form a cyclic, three-membered ether or oxirane, e.g. ethylene oxide

Microbial insecticides: Pesticides using viruses or bacterial preparations to kill pests

Microhabitat: A small specialized habitat or more detailed part of an overall habitat, e.g. leaf litter in woodland

Milling: Locusts (or other insects) making short flights above a population which is mostly settled. This can occur in the evening when settling at the roost, or in the morning when preparing for swarm departure

Mineralization: Breakdown of soil organic compounds to component parts

Monitoring: The systematic measurement of variables and processes over time for a specific purpose (e.g. looking for a specific type of change in a given variable; ensuring a particular criterion or standard is being met)

Morphology: The study of form and structure of organisms, with special emphasis on external features

Morphospecies: A grouping of organisms based on morphological characters alone, without consideration of other biological characteristics (often identified by means of a letter, number or other notification)

Mortality: Death. Usually used to mean the percentage kill of target and non-target organisms

Moulting: The process by which an organism sheds its skin or exoskeleton and replaces it with a new one to enable growth (see also metamorphosis)

Nematocide: A chemical (usually) or biological agent for killing nematode pests

Neurotoxic: Products which interfere with an organism's nervous system

Nitrification: A chemical and microbiological process in water and soil whereby NH_4^+ is oxidized to NO_3^-

Nitrile rubber: A synthetic rubber which is more resistant to pesticides and solvents

Non-target organism: An organism which may be affected by, but is not the object of, a human intervention (for the purpose of this handbook, usually pesticide application)

Number median diameter (NMD): This is the diameter such that half the total number of droplets are smaller and half are larger

Nuptial pad: Small hard pads that develop on the thumbs of male anurans during the breeding season (used by males to remain attached to females during amplexus or coupling)

Nymphs: These are the young of hemimetabolous invertebrates before they have developed into adults

Odometer: Device on the speedometer of a vehicle which can be used to measure distances

Oligotrophic: Having low primary productivity; pertaining to waters having low levels of the mineral nutrients required by green plants; used of substrates low in nutrients

Omnivorous: Feeding on living or dead plant and animal material

Onchocerciasis: Vector-borne human disease caused by *Onchocerca* and transmitted by adult blackflies

Open habitat: Habitats with few or no trees, bushes or other tall, dense vegetation

Operator: The person using the equipment (for this handbook, the sprayer can be staff on foot, driver in a vehicle or pilot in an aircraft)

Organochlorines: A class of pesticides characterized by atoms of carbon, hydrogen and chlorine

Organophosphates: A class of pesticides characterized by atoms of carbon, hydrogen and phosphorus

Ornithology: The study of birds

Otoliths: Small calcareous particle in the inner ear of vertebrate animals, important as sensors of gravity and acceleration

Overdose/underdose: Where more/less than the recommended dose of an insecticide has been applied

Oxygen concentration: The amount of oxygen contained in water expressed as mg l⁻¹

Parasite: An organism which has a life strategy gained at the expense of another organism

Passive drift sprayer: A sprayer which releases spray droplets passively into the cross wind. This compares with airblast sprayers which give the droplets an initial throw in the jet of air

Percentage (%) saturation: Dissolved oxygen in water expressed as a percentage of its normal holding capacity

Persistence: A property of a pesticide which enables it to remain effective for a long time in the field

Petersen Grab: A device for sampling sediment

pH: The relative measure of acidity and alkalinity – giving a measure of acidity on a scale from 0 (acid) through 7 (neutral) to 14 (alkaline)

Pheromone: Chemical released by one insect which produces an effect in another insect of the same species

Photoperiod: The light phase of a light-dark cycle

Phytoplankton: Those forms of plant life (usually microscopic) which cannot maintain their position or distribution independently of the movement of water or air

Piscivorous: Fish eating

Ploceids: Members of the family Ploceidae – the weaverbirds and sparrows

Pollutant: A substance that occurs in the environment as a result of human activity, and which has a deleterious effect on living organisms

Pooter: Apparatus for sucking up invertebrates

Population: Those individuals within one species that occur within a defined area

Portable sprayer: A sprayer which is carried by a man during spraying

Precautionary principle: For this handbook – the principle that an agrochemical is dangerous until proven safe (rather than the principle that it is safe until proven dangerous)

Predation: Animals feeding on other animals

Protective clothing: Clothing worn by a sprayer operator to protect the body from pesticide contamination

Pseudoreplication: The use of repeated observations which do not allow either for statistically valid comparisons between treatment variability and the random variation within treatments, or, which allow detection of statistical differences between observations from different areas but CANNOT conclude a 'treatment' difference

Quadrat: A small sampling area often delimited by solid material of some form (metal, wood, string, etc.), in which the number of organisms is counted

Quantitative: Numerical; based on counts, measurements, ratios or other values

Ranking: Positioning of a hierarchy of classification

Recommended dose: The amount of insecticide active ingredient which has been found to kill a given pest reliably, but without waste

Regurgitation: The re-evacuation of ingested material through the mouth

Relative abundance: The total number of individuals of one taxon compared to the total number of individuals of all other taxa combined, per unit area, volume or community; non-absolute abundance

Residual spraying: Application of a large dose of insecticide used to prolong the effects on the target organism

Residues: In chemical terms – material remaining in the environment over a period of time following application or spillage or other means of introduction

Respiration (aerobic): A process in the cells of living organisms in which oxygen and organic molecules react to produce energy, water and carbon dioxide

Rhizome: An underground stem that grows horizontally and, through branching, acts as an agent of vegetative propagation

Rhizosphere: The area immediately surrounding the roots of plants

Riffle: A shallow area of stream bed over which water flows swiftly and is broken into waves by submerged obstructions

Risk: The scientific judgement of the probability of harm; for the purposes of this book – a statistical concept relating the frequency or probability of adverse effects from exposure of organisms to toxins

River blindness: See onchocerciasis

Rodenticide: Chemical (usually) or biological agent for killing pest species of rodent

Roosting: The resting behaviour of animals (usually by clinging to vegetation or within buildings or caves)

Rotary atomizer: A piece of equipment which spins at high speed and which throws liquid pesticide off its surface to make small droplets

Route of entry: For this handbook – the route by which an insecticide enters a living organism. This can be dermal, i.e. through the skin, oral, i.e. through the mouth and stomach or inhalation, i.e. being breathed in

rpm: Revolutions per minute – the standard measure of rotational speed of an atomizer, motor engine, etc.

Run-off: Chemicals dissolved in water or adsorbed to soil particles in suspension that flow with drainage water from areas of pesticide and other agrochemical usage after rain

Schistosomiasis: Water-borne human disease caused by the fluke, *Schistosoma*, requiring aquatic snails to host a stage in its life cycle

Sedentary: Staying in one place

Sedimentation: This occurs when a droplet falls downwards and lands on a horizontal surface. The droplet hits the surface because of the force of gravity

Sequester: To set aside or separate, e.g. separate placing of pesticide residues into body fat tissue of vertebrates

Sexual dimorphism: Gender-based differences in body shape, size, form or colour

Shelf-life: The length of time a stored pesticide remains effective

Sigmoid: S-shaped

Skink: A member of the family of lizards Scincidae, including such Old World genera as *Chalcides* and *Mabuia*

Soil horizon: Horizontal layers of mature soils with specific texture and composition

Spawn: Gelatinous mass containing eggs laid by female amphibians

Species: Groups of interbreeding natural populations that are reproductively isolated from other such groups

Species inventory: List of species present at a particular site (as against a checklist, which includes all known species of a particular taxon)

Species richness: The number of species within a defined area

Specificity: For this handbook – pesticide action that is limited in effect to a narrow range of organisms

Speed of action: How fast an insecticide kills the insect after exposure

Spray block: Any area designated to receive a spray treatment

Spray drift: Pesticide carried by wind or gravity away from the target to a non-target site

Spray pass: One passage of the sprayer along its spray track

Spraying: Breaking liquid into small droplets. For this handbook – for application of pesticides to pests or their food

Stomach action: A product has stomach action if it kills a pest when eaten, rather than being touched by it (contact action)

Stratification: Organization into horizontal layers; the vertical structuring of a community or habitat into superimposed horizontal layers; the grouping of individuals in a community or habitat into particular classes; in statistics – the grouping of samples to take account of particular shared characteristics

Stratum (strata): A layer (e.g. in rock or vegetation) possessing characters that serve to distinguish it from adjacent layers

Sub-adult: Nearly adult in size, but still sexually immature

Sub-lethal: Below the concentration that directly causes death. Sub-lethal concentrations can cause behavioural, biochemical and physiological impacts that are not obvious

Substrate: A medium on which organisms feed or which they frequent – soil, leaves, sediment, etc.

Surber sampler: A device for sampling benthic invertebrates in rivers

Surface-dwelling invertebrates: Neuston or organisms that live on the surface of water

Surveillance: A continued programme of surveys that provides a series of observations over time; systematic collection of a data series over time

Swarm: A large group of insects or other animals, which can fly large distances as a single mass of individuals

Swath width: This is the width of the strip at right angles to the sprayer's track where there is 'significant' deposit

Sweep net: Hand-held net used for sampling organisms from vegetation (either terrestrial, aquatic or emergent)

Symbiotic: An association between species that may be beneficial or not

Tailwind: A wind in the same direction as the flying direction of an aircraft

Taxon: Any group of organisms considered to be sufficiently different from other such groups to be treated as a separate unit

Taxonomy: The theory and practice of describing, naming and classifying organisms; systematics

Terrestrial: Pertaining to the earth, land or ground surface

Territory: An area within the home range, occupied more or less exclusively by an animal or group of animals of the same species, and held through advertisement, display or overt defence

Thermistor/thermocouple: Probes that measure temperature

Threshold number: In pest management – the number of pests per square metre (or per hectare or per km²) when it is judged that control operations become worthwhile. This number varies from crop to crop, season to season and country to country

Topography: A detailed study or map of physical features of an area

Toxicity: The potential of a material to cause adverse effects on living organisms

Toxin: A poison

Track spacing: This is the distance between the tracks or passes of the sprayer

Transect: A route of set distance and course which is used to count numbers of a particular faunal or floral group

Treatment area: In statistics – the area deliberately subjected to a particular effect, condition or other outside influence

Trypanosomiasis: Vector-borne disease of humans and cattle caused by a trypanosome and transmitted in Africa by tsetse flies

Turbulence: The mixing of air caused by the action of wind over rough ground, around objects or through meeting of air at different temperatures, etc., or the non-uniform flow of water caused by submerged objects, etc.

Uniform deposit: For pesticides – a deposit with equal amounts at different distances downwind from a spray pass – this cannot be achieved from a single pass of a ULV sprayer

Ultra-low-volume spraying (ULV): This is the application of small volumes (e.g. usually 0.5–1 l ha⁻¹ for locusts) of concentrated pesticide in very small droplets. ULV pesticides are sprayed undiluted; they are oil-based to reduce evaporation, so they cannot be diluted with water

Upwind edge: The edge of the block nearest to the direction from where the wind is coming

Vascular: In animals – containing many blood vessels; capillaries, veins and arteries make up the vascular system that transports oxygen, nutrients and chemicals around the body in vertebrates and certain invertebrate organisms. In plants – containing conducting tissue, usually with the dominant generation differential into roots, stems and leaves

Vector: See disease vector

Vehicle-mounted sprayer: A sprayer which is mounted on a four-wheel drive pickup vehicle

Volatile: Tending to evaporate

Volume application rate (VAR): This is the volume of liquid (with ULV, the volume of product) in litres or millilitres applied to a given unit of area (l ha)

Volume median diameter (VMD): This is the diameter of the droplet such that half the spray volume is in smaller droplets and half in larger ones

VMD:NMD ratio, called 'R': This is the value of the VMD divided by the value of the NMD and gives a measure of the width of the droplet spectrum. If R is larger than 2, the spectrum is wide, if it is less than 2, it is relatively narrow and more suitable for ULV spraying. A value of 1 would mean that all of the droplets were the same size, but no sprayer can produce such a spectrum

Water-based spraying: This means using an insecticide formulation which can be mixed with water – usually emulsifiable concentrate (EC) or wettable powder (WP). The mixture is usually applied in large volumes (100s or even 1000s of l ha⁻¹)

Whirling hygrometer: Device for measuring temperature and relative humidity

Work rate: This is the area which can be treated with an agrochemical in a given time, usually expressed as hectares per hour (ha h⁻¹)

Zooplankton: Those forms of animal life (usually microscopic) which cannot easily maintain their position or distribution independently of the movement of water or air

ABBREVIATIONS

a.i.	active ingredient
ANOVA	analysis of variance
BHC	benzene hexachloride
CF	constant frequency
CMR	capture – mark – recapture
CPUE	catch per unit effort
DO	dissolved oxygen
EC	emulsifiable concentrate
EIA	environmental impact assessment
ESA	ecologically sensitive area
FAO	Food and Agriculture Organization of the United Nations
FM	frequency modulated
GLC	gas liquid chromatography
GLM	general linear model
GPS	global positioning system
HCH	hexachlorocyclohexane
HPLC	high performance liquid chromatography
IGR	insect growth regulator
IUCN	International Union for the Conservation of Nature (World Conservation Union)
LoD	lower limit of determination
MNA	minimum number of animals
NGO	non-governmental organization
NMD	number median diameter
PAR	photosynthetically active radiation
ppb	parts per billion
ppm	parts per million
OC	organochlorine pesticide
OP	organophosphate pesticide
QRA	quantitative risk assessment
QS	Sorensen's Index
rpm	revolutions per minute
SD	standard deviation
SE	standard error
SED	standard error of the difference
SPE	solid phase extraction
SS	Sum of Squares
UNCED	United Nations Conference on Environment and Development
ULV	ultra-low-volume
VAR	volume application rate
VMD	volume median diameter
WDP	water dispersible powder
WHC	water-holding capacity
WP	wettable powder

HANDBOOK and METHOD SHEETS



ECOLOGICAL MONITORING METHODS

FOR THE ASSESSMENT OF PESTICIDE
IMPACT IN THE TROPICS

Edited by

Ian F. Grant and Colin C. D. Tingle

DFID Department for
International
Development



Measuring droplets and deriving VMD and NMD

DON'T FORGET

EQUIPMENT: Microscope; stage micrometer; Porton graticule; sampling surfaces (MgO slides) with deposited spray; droplet sizing form; graph paper (VMD/NMD computer program or spreadsheet).

GRATICULE CALIBRATION AND FORM PREPARATION

Method

- Use the stage micrometer to measure the size of one of the larger circles on the Porton graticule.
- Calculate all other upper size class limits using the root 2 progression and enter them in column 2 of the droplet sizing form.
- Correct these class sizes in column 3 of the droplet sizing form for spread factor on the sampling surface. In the case of MgO, this means multiplying by 0.86. In the case of other sampling surfaces, this factor may vary with different size classes – refer to previous calibration of that sampling surface/spray formulation combination.
- Calculate the geometric mean of the size class (square root of upper limit \times lower limit) and enter into column 4. The table is now ready for data entry.

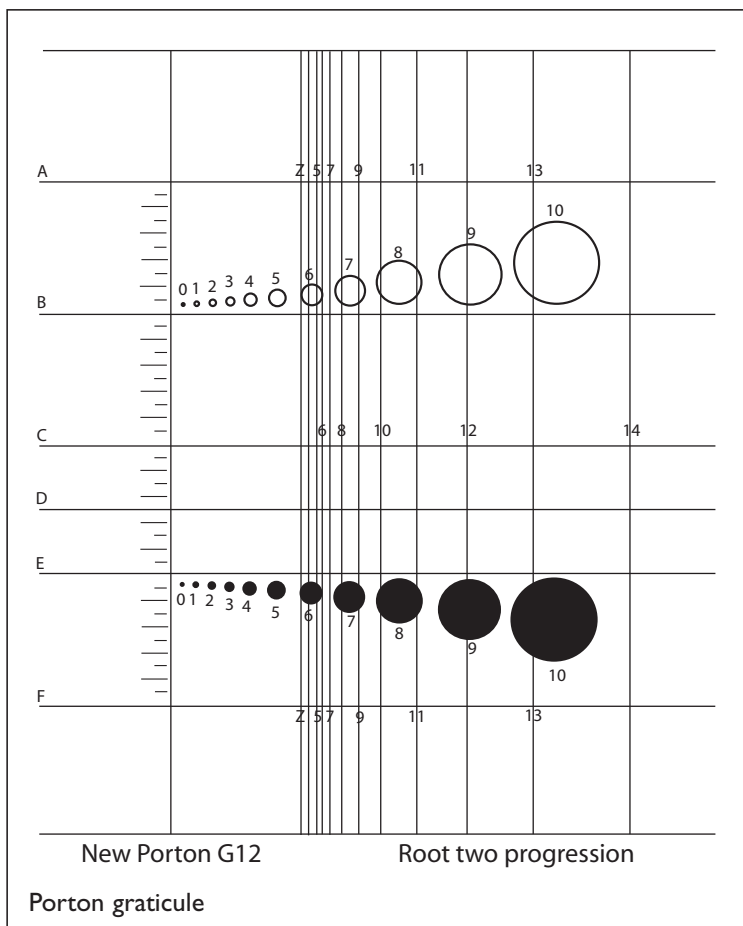

MEASURING DROPLETS

Method

- Examine an MgO slide that has been exposed to spray droplets under the microscope (transmitted light). It is best to sweep right across the full width of any sampling surface since the sizes of droplets can vary depending on where they are; more of the smaller droplets are usually found near the edges of vertical samplers. Begin to assign size classes to droplets. Each droplet can either be compared with the black circles, the empty circles or the distances between the lines on the Porton graticule. A droplet is assigned to size class 5 if it is **less than** the upper limit of the size class, i.e. if a droplet is very slightly larger than black circle number 5, it should be assigned to size class 6.
- The process is easiest if two people work together; one measures and calls out the data while the other records the data on the form.
- Measure at least 100 droplets, preferably more.
- Measure droplets on several sample slides if a more representative sample of the whole deposited spray is required. In general, examine 5–10 slides to get an accurate sample.

- Make the calculations required on the spray sizing form until data are complete in columns 6 and 9. Plot these data on graph paper using axes of droplet size and cumulative percentage. There will be one line for cumulative percentage number and one line for cumulative percentage volume. Normal graph paper is satisfactory, but using log probability graph paper gives straighter lines which are easier to interpret.
- Read off the graph paper the droplet diameter corresponding to the cumulative 50% point for number and volume to derive the NMD and VMD respectively.
- An alternative to graphing is to use a BASIC computer program or a custom Microsoft Excel spreadsheet (both available from the authors) to calculate the VMD and NMD.

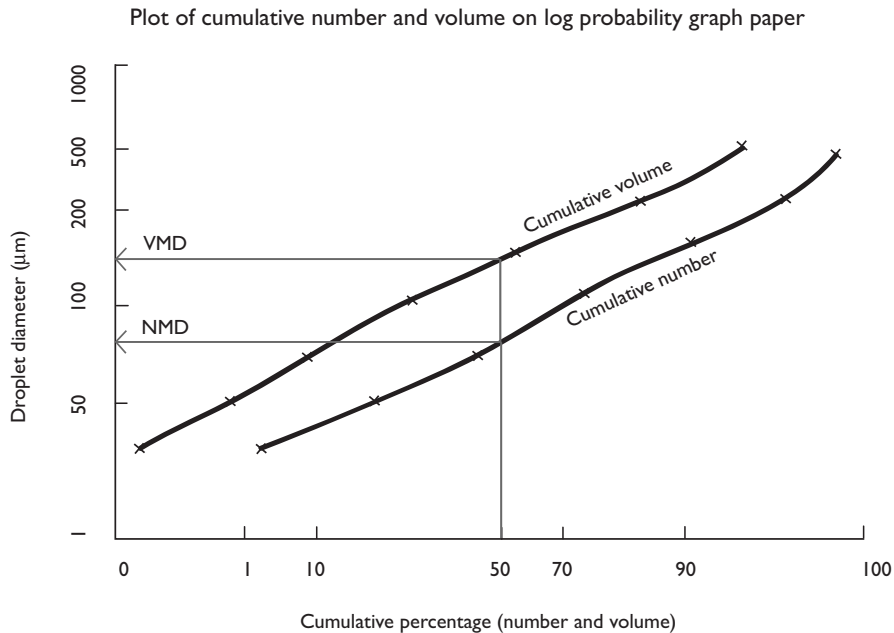

DROPLET SIZING FORM

Name	Date	Test liquid
Sprayer type	rpm/pressure:	
Sampling surface	Spread factor:	

1	2	3	4	5	6	7	8	9
Porton graticule size class number	Class upper size limit (MgO)	True upper size limit (MgO x 0.86)	Geometric mean of true size class root of upper x lower)	Number of drops in class	Accumulated percentage of total number	Drop volume (4/3 pi r ³)	Number x volume	Accumulated percentage of total volume
Units	μm	μm	μm		%	μm^3	μm^3	%
1								
2								
3								
4								
5								
6								
7								
8								
9								
10								
11								
12								
13								
14								
			Total number			Total volume		

rpm = revolutions per minute

MAKE COPIES OF THIS FORM

Measuring swath width of ULV sprayers

DON'T FORGET

EQUIPMENT: Sprayer; oil formulation; fluorescent tracer; oil-sensitive paper; glue or sticky tac; sticks to mount papers; protective clothing; nitrile gloves; tape measure; bucket; clip-board; flags; anemometer (or Beaufort scale sheet); thermometer; ultraviolet lights; counting templates; hand lens.

Method

- Find the direction of the wind and using flags, mark out a spray line at least 60 m along the proposed path of the spray operator at 90° to the wind direction. Put out a line (or several lines) of poles running downwind from the spray line at the distances indicated below. If aerial or vehicle spraying is being monitored, the distance between lines of poles needs to be greater, e.g. 500 m–1 km.

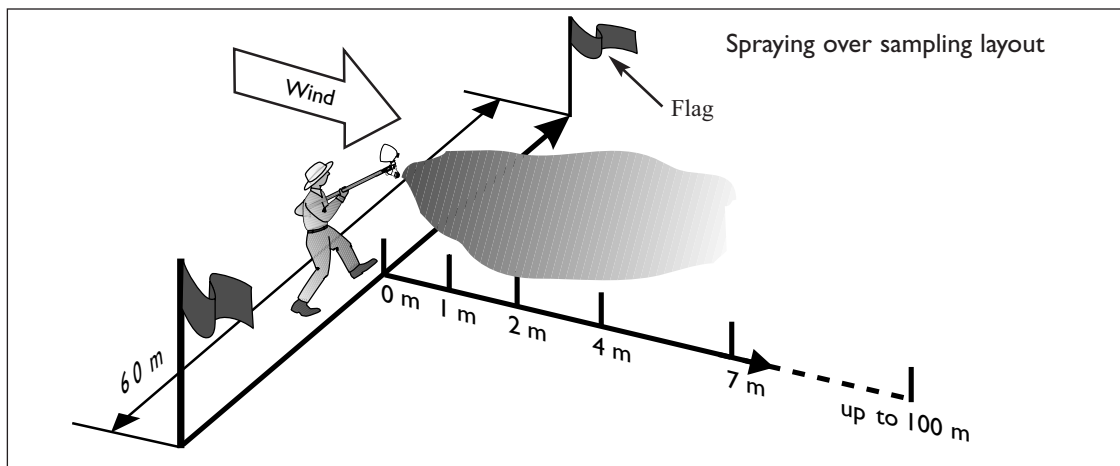

- The poles should be set at distances of 0, 1, 2, 3, 5, 7, 10, 15, 20, 30, 50, 80 and 100 m downwind (see illustration on MgO rotary sampler method sheet). These distances are appropriate for hand-held sprayers, but if vehicle-mounted sprayers or aerial sprayers are being studied, distances over which the poles are spread should be accordingly larger, perhaps covering a maximum distance of 200 m and 500 m respectively, but intervals between samplers set proportional to those given above.
- Take care with the sensitive paper because it can easily be marked if handled roughly, and any fingerprints on the 'sensitive' surface can make counting drops difficult. Only the shiny side is sensitive. **Tip:** Wear nitrile gloves. Handle the paper only by the ends of the strips and do not touch the middle. Attach the papers near the top of the poles (using pins, gum or 'bluetac') facing into the wind, with the sensitive side of the paper on the outside.
- The sprayer operator should then go ahead with the sprayer application exactly as they would for a normal spray operation.
- Record the wind speed and direction during the spraying.
- After spraying, the papers should be collected as soon as possible, labelled with the distance and the treatment they have been given, and stuck on to a piece of paper with glue (a glue stick is convenient). Do not allow anything to touch the surface of the papers as the drops may get smudged and difficult to count. **Note:** Wear protective clothing and nitrile gloves as surfaces will be contaminated with pesticide.
- In the laboratory use a counting template (shown below), ultra-violet lamp and hand lens to count the number of droplets on the papers. If there are many droplets, count the number seen in the 0.25 cm² template and multiply by 4 to give the number of droplets cm⁻². If there are very few droplets, use the 1 cm² template and no mathematical correction is necessary to give number of droplets cm⁻².
- Plot a graph of number of drops cm⁻² (on the vertical or y axis) against distance downwind (on the horizontal or x axis).

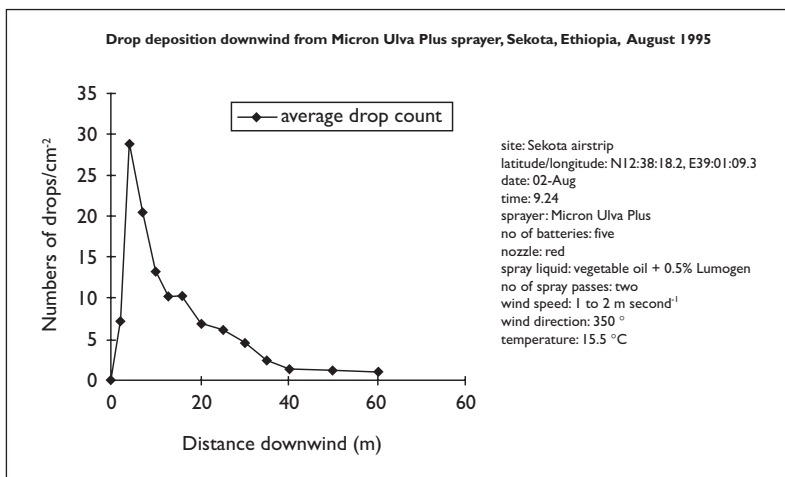
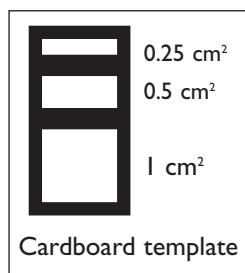

Note: The true volume distribution is likely to be somewhat different from this number distribution since the droplets counted near to the sprayer are usually larger than those collected further downwind.

OTHER CONSIDERATIONS

If calibrating a sprayer, the sprayer operator should make 3 spray passes with the sprayer along the same line. This is not normal operational spraying practice but it helps to smooth some of the natural variation in deposition encountered in the field.

If no anemometer is available, record wind speed on Beaufort scale.

Droplets should be counted as soon as possible otherwise they may fade. Counting **must** be done with 2–3 hours.

Use a form like the one shown to record the data (Droplet Counting Form).

FORM FOR DATA ENTRY DURING DROPLET COUNTING

Sampler

Date

Spray details: Spray time

Sprayer operator

Pesticide

Wind speed during spray

Formulation

Distance downwind (m)	Area used on template (0.25, 0.5 or 1 cm ²)	Number of drops (4 counts)	Average number of drops	Average number of drops per cm ²
0				
1				
2				
4				
7				
etc.				

MAKE COPIES OF THIS FORM

The loss technique for flow rate measurement

DON'T FORGET

EQUIPMENT: Notebook; pen; stop-watch or watch with a second hand; measuring cylinder (100 ml or 500 ml); protective clothing; soap and water; sprayer; insecticide with label.

For use when the spray liquid cannot be collected easily as it is emitted.

Method

- Fill the sprayer up to a known level with insecticide (either completely full or to a marked level) and spray over the target area using your normal spraying technique for a measured number of minutes (M); 10 min is usually sufficient.
- Use a measuring cylinder to measure the amount of insecticide required to refill the sprayer back to its original level. This will give the volume in litres emitted (E).
- Calculate the flow rate (F) in $l\ min^{-1}$ by using the formula below and adjust the sprayer to achieve the required value:

$$F\ (l\ min^{-1}) = \frac{E(l)}{M(min)}$$

- When the required flow rate has been achieved, repeat the flow rate check two more times to be sure there have been no errors in measurement.

OTHER CONSIDERATIONS

The manufacturer's manual should be consulted before setting flow rates for the first time. It usually gives calibration information which provides a starting point for the flow rate settings. A running check can be kept on flow rate (especially in the case of aircraft) by recording the time spent spraying and the amount of insecticide being used. If the amount of insecticide being used seems too great or too small the flow rate should be measured and reset if necessary.

Collection technique for measuring sprayer flow rate

DON'T FORGET

EQUIPMENT: Notebook; pen; stop-watch or watch with a second hand; measuring cylinder (100 ml or 500 ml); bucket; protective clothing; soap and water; sprayer; insecticide with label.

This technique is for use when spray liquid can be collected easily as it is emitted.

Method

- Put on protective clothing.
- Fill the sprayer and position it to deliver insecticide into a bucket.
- Allow the insecticide to flow from the sprayer into the container for a measured number of minutes (M). Generally 3 min is sufficient.
- Decant the contents of the bucket into the measuring cylinder to measure the number of litres emitted and collected (E).
- Calculate the flow rate (F) in l min^{-1} by using the formula below:

$$F (\text{l min}^{-1}) = \frac{E(\text{l})}{M(\text{min})}$$

- Adjust the flow rate of the spray equipment by twisting the nozzle or making other adjustments (see manufacturer's manual) to bring it closer to the required value and check it again. Keep altering and checking until the required flow rate has been achieved.
- When the required flow rate has been achieved, repeat the flow rate check two more times to be sure there have been no errors in measurement.

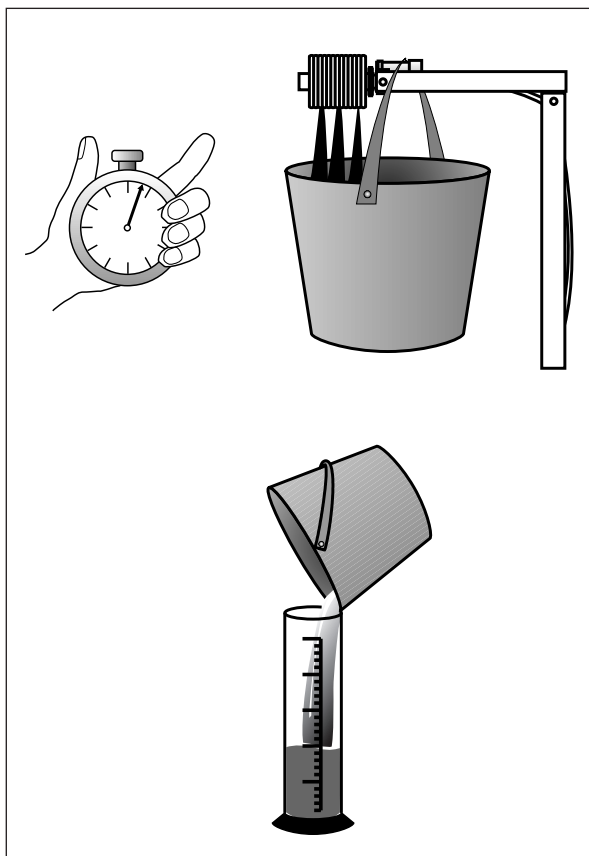

OTHER CONSIDERATIONS

The manufacturer's manual should be consulted before setting flow rates for the first time. It usually gives calibration information which provides a starting point for the flow rate settings.

A running check can be kept on flow rate (especially in the case of aircraft) by recording the time spent spraying and the amount of insecticide being used. If the amount of insecticide being used seems too great or too small the flow rate should be measured and reset if necessary.

Calibration of ULV sprayers

DON'T FORGET

EQUIPMENT: Notebook; pen; stop-watch or watch with a second hand; measuring cylinder (100 ml or 500 ml); bucket; protective clothing; soap and water; sprayer; pesticide with label; tape measure; flags or other markers; diesel fuel or kerosene.

BASIC STEPS FOR CALIBRATION

- **Identify the dose (g a.i. ha⁻¹).** Identify the pesticide active ingredient you are using and determine the recommended dose for the pesticide in g a.i. ha⁻¹.
- **Convert the dose to a volume application rate (l ha⁻¹).** Read the pesticide formulation concentration in g a.i. ha⁻¹ from the pesticide label and use the VAR formula below to calculate the volume application rate (VAR) in l ha⁻¹.
- **Calculate the required flow rate (l min⁻¹)** Use the flow rate formula below to calculate the flow rate required to achieve the VAR (using some sensible figures for track spacing and forward speed – described below).

How to calculate the volume application rate (VAR) to achieve the recommended dose

$$\text{Volume application rate (l ha}^{-1}\text{)} = \frac{\text{recommended dose (g a.i. ha}^{-1}\text{)}}{\text{formulation concentration (g a.i. ha}^{-1}\text{)}} \quad (\text{VAR formula})$$

For example, if we have a formulation of bendiocarb containing 200 g a.i. l⁻¹, we find the recommended dose for bendiocarb is 100 g a.i. ha⁻¹ and we calculate the VAR as:

$$\text{VAR (l ha}^{-1}\text{)} = \frac{100 \text{ g a.i. ha}^{-1}}{200 \text{ g a.i. l}^{-1}} = 0.5 \text{ l ha}^{-1}$$

How to calculate the sprayer settings to achieve the correct volume application rate (VAR)

To apply this correct volume application rate (which will deliver the correct dosage), adjust three spraying factors.

1. Track spacing (the distance between spray passes). If track spacing increases, VAR decreases.

How to decide what track spacing to use

- Choose a track spacing according to the manufacturer's literature, the wind conditions and users' experience of the sprayer. Typical track spacings are 10 m for hand-held spinning disc sprayers, 25 m for vehicle-mounted drift sprayers and 100 m for aircraft sprayers.
- The track spacing is determined by the type of sprayer and the wind conditions during spraying – track spacing must be large enough to allow target areas to be sprayed quickly, but not too large otherwise the pesticide will not cover the area between the spray passes evenly enough.

2. Forward speed. If forward speed increases, VAR decreases.

How to decide what sprayer speed to use

- Check the speed of the sprayer using a marked out distance and a stop-watch and use that in the calculations. For aircraft, consult the pilot to check at what speed he normally flies while spraying.
- The forward speed is mainly determined by the speed at which the sprayer can move, i.e. the speed a man can comfortably walk (typically 90 m min⁻¹), or the speed a vehicle can safely drive over rough ground (typically around 7 km h⁻¹), or the aircraft's normal flying speed (between 140 and 200 km h⁻¹).

3. Flow rate of the sprayer (also called emission rate). If flow rate increases, VAR increases.

How to decide what flow rate to use

- Apply the formula to determine what the correct flow rate should be

$$\text{Flow rate (l min}^{-1}\text{)} = \frac{\text{VAR (l ha}^{-1}\text{)} \times \text{speed (km h}^{-1}\text{)} \times \text{track spacing (m)}}{600} \quad (\text{Flow rate formula})$$

The flow rate is usually the easiest of these factors to adjust, and must be set so that when using your chosen track spacing and forward speed, the correct VAR (and dose) is applied. Use the procedure given in the method sheet on measuring sprayer flow rate to measure and set the flow rate.

An example

If you are controlling locust hopper bands with a vehicle-mounted sprayer using the pesticide bendiocarb as a 20% formulation, travelling at 4.8 km h⁻¹ and using a 25 m track spacing, the flow rate can be calculated using this formula as below. **Note:** We have already calculated that the required VAR to apply the recommended dose of this pesticide formulation is 0.5 l ha⁻¹.

$$\text{Flow rate (l min}^{-1}\text{)} = \frac{0.5 \text{ l ha}^{-1} \times 4.8 \text{ km h}^{-1} \times 25 \text{ m}}{600} = 0.1 \text{ l min}^{-1}$$

This formula can also be turned round if necessary to calculate any of the other factors:

$$\text{VAR (l ha}^{-1}\text{)} = \frac{\text{flow rate (l min}^{-1}\text{)} \times 600}{\text{speed (km h}^{-1}\text{)} \times \text{track spacing (m)}}$$

$$\text{Speed (km h}^{-1}\text{)} = \frac{\text{flow rate (l min}^{-1}\text{)} \times 600}{\text{VAR (l ha}^{-1}\text{)} \times \text{track spacing (m)}}$$

$$\text{Track spacing (m)} = \frac{\text{flow rate (l min}^{-1}\text{)} \times 600}{\text{VAR (l ha}^{-1}\text{)} \times \text{speed (km h}^{-1}\text{)}}$$

Calibration of high-volume sprayers

DON'T FORGET

EQUIPMENT: Notebook; pen; measuring cylinder or cup (20 ml); protective clothing; soap and water; sprayer; pesticide with label; tape measure; flags or other markers; diesel fuel or kerosene.

Before the user can be sure he/she is using the correct dose of pesticide on a particular crop, the VAR must be determined

MEASURING VOLUME APPLICATION RATE

Method

- From a selected starting point within the crop (select one at random, but away from the field edge), take 5 large paces and place a stick in the ground at the end of your toe. Turn through 90° and take 5 large paces. Place a stick into the ground at your toe. Repeat a third time. This will give an area of approximately 25 m² or 1/400th of a hectare, the corners marked with sticks.
- Now put the clean sprayer on a level surface and put water into the tank (no pesticide) up to a level which corresponds with one of the volume markings on the sprayer tank.
- Spray the marked out area of crop with water, as if it is pesticide.
- Put the sprayer back on to the same level surface and, using the volume markings on the sprayer, estimate the volume sprayed on to the crop. Alternatively measure the amount of water needed to fill the sprayer up to its original level.
- If the volume used is 1 litre, this corresponds to a VAR of around 400 l ha⁻¹. If the volume used is 0.5 litre, this corresponds to a VAR of around 200 l ha⁻¹, etc.

The following formula can be used to calculate the VAR if the area that has been sprayed is different:

$$\text{VAR (l ha}^{-1}\text{)} = \frac{\text{average volume used (l)} \times 10,000}{\text{area sprayed (m}^2\text{)}}$$

Adjusting volume application rate

- If the VAR is too high, the user should either fit a smaller nozzle to the sprayer or, if the nozzle is already small enough, he/she should modify the spraying technique to apply less spray to each plant, i.e. spend less time spraying it by walking faster.
- After these adjustments for equipment and/or technique, the user should measure VAR again to make sure it is appropriate.
- If spraying equipment is not capable of producing a low enough VAR, e.g. if a smaller nozzle is not available, the user must then make adjustments to the tank dose to compensate for this. For example, if the sprayer is putting a VAR of 800 l ha⁻¹ on a medium-sized crop (at least double the volume required), then the tank dose can be reduced to half of what the pesticide label says without any risk of applying too little active ingredient.

Putting in the right tank dose

- Consult the pesticide label for the volume of concentrated spray liquid (or weight of dry powder) to put in each 10 litres of water.
- Once the volume required per sprayer tank has been worked out, use a small measuring cup or measuring cylinder to add the correct amount.

OTHER CONSIDERATIONS

Sometimes, the tank dose advice is given for 15 litre sprayer or for 100 litres of water but the amount required for a particular tank volume can be worked out fairly simply.

A measuring cup should be provided by the shop which sells the pesticide. The cost of a measuring jug or cup is much less than the cost of mistakes in application, i.e. either wastage of pesticide or poor spray results.

If there is a large area of crop to treat, a large batch of spray liquid can be mixed in a drum and then knapsack sprayers filled from that. If the drum is 200 litres, it will fill a 10 litre spray tank 20 times, so add 20 times the amount of concentrate recommended for each 10 litre sprayer tank. Mix only enough for a maximum of 4 h spraying so that the mixture does not have to be left overnight.

Making magnesium oxide-coated slides

DON'T FORGET

EQUIPMENT: Bunsen burner or portable gas burner; magnesium ribbon; glass slides (either 24 mm wide or 6 mm wide); metal rack to hold slides; darkened safety goggles; tongs or pliers; gloves; slide box.

Method

- Place 5 glass slides side by side on a metal rack in a fume cupboard or well-ventilated area (put them tight up against each other). The rack should allow at least the central third of the glass slide to be exposed from below.
- Cut a length of magnesium ribbon about 20 cm long and hold one end in a pair of metal tongs or pliers.
- Put on darkened safety goggles and light the end of the ribbon with the gas burner. Immediately place the burning end underneath the glass slides but keep it at least 5 cm below the slides otherwise the heat will crack them.
- You will probably need to smoke the 5 slides with 3 or 4 lengths of magnesium ribbon.
- When you are sure there is a good layer of MgO on the slides (perhaps 0.5 mm), remove the slides carefully and place in a slide box. **Tip:** *The actual thickness of the MgO layer required will depend on the size of droplets which are to be sampled. If the layer is too thin, the droplets will punch through and shatter on the glass. If the layer is too thick, the craters formed by the droplets will be difficult to see, even with strong transmitted light.*
- The slides must always be carefully handled to avoid contact of the magnesium oxide-coated sampling area with objects and dust or other particles. The slides should be handled by the ends which are not coated with magnesium oxide.
- Slides are best when they are a few hours old. After more than 3–4 days, the MgO begins to harden and a crust forms, causing some droplets to bounce off rather than penetrate.

Use of fibre drift samplers

DON'T FORGET

EQUIPMENT: Wool samplers; foil spills; aluminium storage can; self-adhesive label; wooden crossarms 2.5 x 2.5 x 75.0 cm; wooden post; 2.5 x 2.5 x 200.0 cm; cuphooks; metal; disposable plastic gloves; plastic bag for discarded gloves; heavy hammer and iron bar for driving in the mounting posts; pliers to tighten cup hooks; scissors for cutting wool strands; permanent marker pen; 'Benchkote'; double-sided tape; small wooden block; protective clothing.

Two persons are required for the deployment and collection of the samplers. Prepare aluminium foil spills by rolling up a piece of clean aluminium foil (30 x 15 cm). These are then placed in labelled aluminium screw-top tubes for storage and transport. To lessen the risk of cross contamination, collection should begin at the wools having the least deposit, i.e. at the samplers furthest downwind from the spray source.

PREPARATION OF THE SAMPLERS

Method

- Cover a convenient bench top with a 1.5 m length of a material such as 'Benchkote'. Remove a ball of wool from its plastic storage bag and take off the manufacturer's label. Place it on the table.
- Tie a small 3 cm loop at one end of the wool strand and place this over a cup hook screwed into a small block of wood stuck to the table surface with double-sided tape at the left-hand end of the 'Benchkote'.
- Tie a knot in the wool about 10 cm from the loop and extend the wool to about 1.25 m. Cut it to this length and tie a rubber band to the end.
- Lightly stretching the wool, tie another knot in the strand to give an inter-knot distance of 1 m.
- Cut off and discard any loose ends.
- Coil the prepared sampler and place in a small envelope or sachet.
- Repeat until the required number of samplers have been prepared.

SAMPLER DEPLOYMENT

Method

- Suspend wool samplers vertically between two horizontal wooden crossarms (2.5 x 2.5 x 75.0 cm) fixed to posts driven into the ground. As many wool samplers as are required are mounted between the crossarms. For most purposes a ground to top crossarm distance of about 1.75 m has been found to be convenient.
- The distance between the crossarms is chosen so as to stretch the wools gently once in place.
- The wool strands are mounted on cuphooks screwed into the crossarms. **Tip:** To facilitate the transport of the posts and crossarms, the crossarms are fixed to the posts with heavy duty rubber bands.
- The layout of the posts in relation to the spray source can be varied according to conditions and the objective of the work. For drift over open ground in winds varying from 1.0 to 5.0 m second⁻¹, posts at 10, 25, 50, 100, 200 and 500 m downwind have been successfully used. It should be borne in mind that in terrain including obstacles such as buildings, hedges and trees, drop dispersal will be very variable because of random patterns of wind direction and strength.

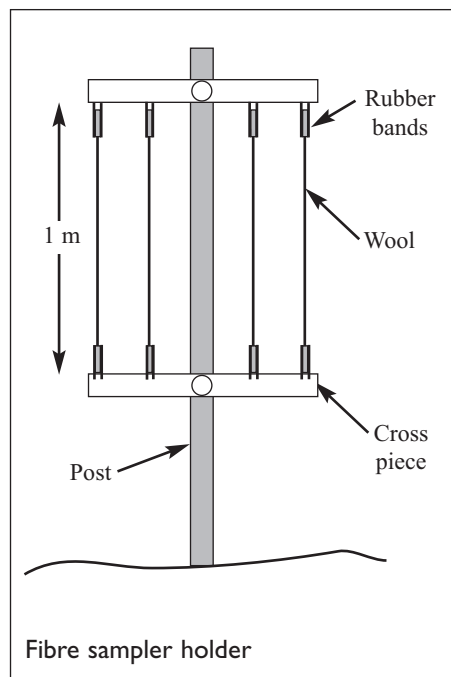

- 'Control' samples should be the first to be put in place and removed shortly before spraying to act as a check on the handling procedure.
- Because the greatest risk of accidental contamination comes from those handling the samplers, a new pair of disposable gloves should be worn at each sampling station during the mounting and removal of the wool samplers.

Deployment

- Remove a sampler from its bag.
- Hook the elastic band over a cup hook on the top crossarm. Stretching the wool strand, hook the loop at the other end over the corresponding cuphook on the lower crossarm. Do not touch the length of wool between the two knots. The strand of wool should now be sufficiently taut to be unaffected by light winds. If it is not, change the position of the crossarms until it is.
- Repeat this for all the other samplers.

Sampler collection

- Remove foil spill from its aluminium container. Twist the foil spill around the mounted sampler just below the lower knot and cut the sampler free from the cuphook with scissors. Wind the sampler on to the spill, keeping the sampler taut by pulling slightly against the elastic band.
- When the upper knot is reached, cut again and place the spill plus wool into a screw-cap aluminium can. The spill should be placed in the can in such a way that the handled ends of the spill can be cut off.
- Screw the top on firmly and label the can immediately with position of sample, pesticide used, date, etc., using a permanent marker pen.
- Repeat for all the other samplers.
- The cans should ideally be placed into some form of chilled container in order to minimize chemical losses by heat degradation or volatilization of active ingredient.

Analysis

Wool samplers can be analysed for active ingredient content in suitable residue analysis laboratories, or if a fluorescent marker dye has been added to the pesticide formulation, samplers can be analysed with a fluorimeter.

OTHER CONSIDERATIONS

In all steps of the process of preparing the wool samplers, the greatest care must be taken to avoid accidental contamination of the wool with pesticides or other chemicals. All hands and surfaces with which the wools may come into contact must be scrupulously clean. Wear nitrile (or disposable) gloves and protective clothing when collecting fibre samplers after spraying.

Two persons, one to roll up the strand and the other to do the cutting and hold the can, make the task of collection easier than one person working alone.

Use of rotary magnesium oxide sampler

DON'T FORGET

EQUIPMENT: Sampler and battery unit; magnesium oxide slides; slide box; anemometer; fine permanent marker pen; notebook; pencil; microscope; eyepiece graticule (Porton graticule) of diameter to fit microscope eyepiece tube; stage micrometer; calculator or computer.

Prepare magnesium oxide slides in advance using method sheet.

Method

- Fix the sampler to a post using a clip or using adhesive tape, making sure the rotating arms do not foul any vegetation such as long grass. Height above the ground depends on the needs of the sampling exercise, but 1.5 m is convenient.
- Note the date, the features of the location, wind direction, crop (type, height, growth stage), sprayer, liquid being sprayed, time of day, sampling layout, distance from spray source, weather, temperature, duration of sampling period, and wind speed. **Tip:** *A prepared check sheet can make sure you record everything.*
- Load the slides into the slide holder making sure the oxide faces in the direction of rotation. **Note:** Collection efficiency of stationary slides is low, but it is better to load them just before sampling starts.
- Switch on the sampler to start rotation by connecting the battery or using a fitted switch.
- Measure the wind speed throughout the period of sampling using the anemometer.
- After spraying, and after sufficient time for any airborne spray to have deposited or blown out of the sampling area, switch off the rotary sampler.
- Label slides using a permanent marker pen and replace them in the slide box.
- Transport the slide box carefully to the laboratory.
- Proceed with the measurements and calculation using the method sheet on measuring droplets and deriving VMD and NMD.

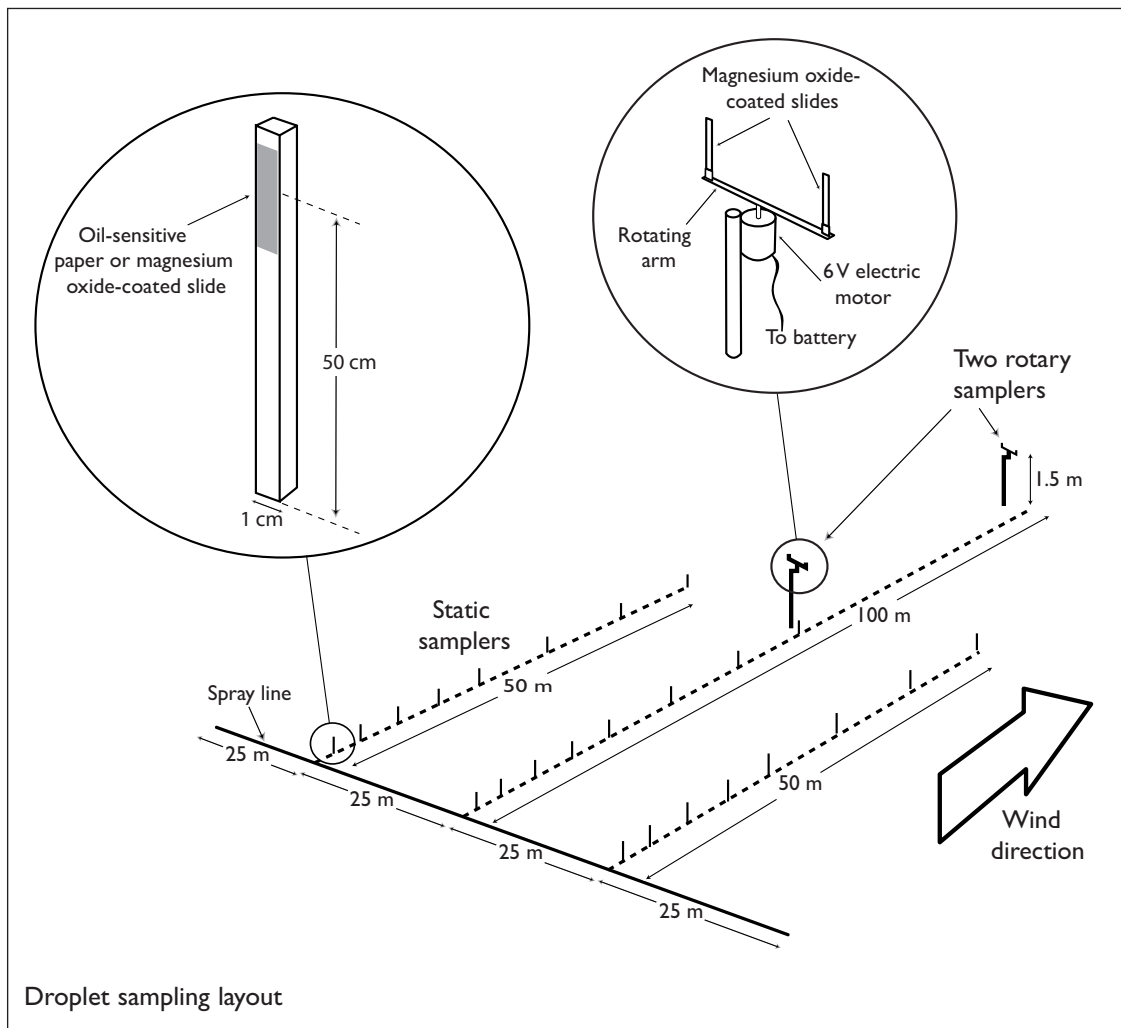

Droplet sampling layout

Meteorological methods: temperature; humidity; rainfall; wind speed

DON'T FORGET

EQUIPMENT: Maximum/minimum thermometers or thermistors and data logger; whirling hygrometer or relative humidity probe; rain gauge (coffee can, funnel and graduated cylinder); cup anemometer or propeller and vane gear; compass; meter; logger; batteries for logger.

AIR TEMPERATURE

Method

- Record maximum and minimum air temperatures regularly at all sites using a maximum/minimum thermometer. Protect bulbs from direct sunlight and wind damage. If monitoring for extended periods in any one area, take daily readings at the same time each day. Return indicator to level of mercury using a magnet after reading. Read temperature at least to the nearest 0.5 °C.
- Thermistors, thermocouples and data loggers also need protection from sunlight. A simple screen can be built from wood or grasses to house the temperature probe or max-min thermometer. Programme the data logger to provide average daily temperatures and other statistics (maximum/minimum, etc.) as required.

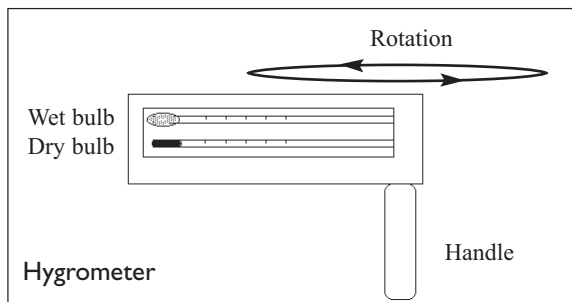

RELATIVE HUMIDITY

Method

Whirling hygrometer

- Top up the wick reservoir with water and check the wet bulb is moist before whirling the hygrometer for 1 min (like a football rattle) above your head. Make a note of the temperatures of both thermometers and use the difference in temperatures to read off the percentage relative humidity from the table provided with the hygrometer. Take readings at fixed times daily and plot average(s) against time.
- Alternatively, meter readings from relative humidity probes can be stored in the meter or a data logger.

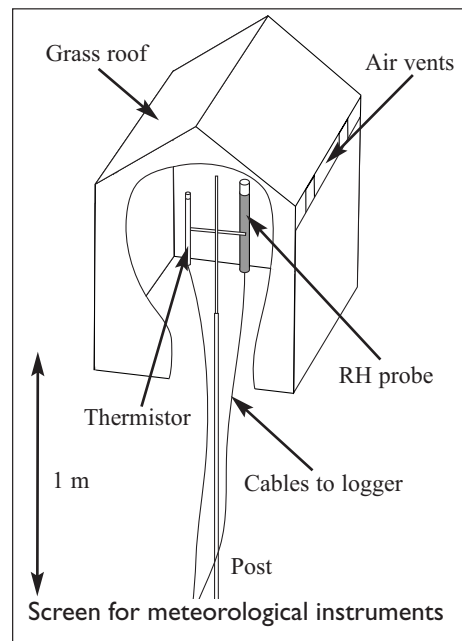

RAINFALL

Method

- Find a suitable site to place the gauge – out of direct sunlight to reduce evaporation, and away from animals, drips and splashes.
- Place a straight-sided coffee can or pan at the site and record rainfall in millimetres after a fixed period. Evaporation can produce serious errors unless rain is collected directly after the event.
- Alternatively, use a funnel set into a pot or measuring cylinder. Check and empty daily, measuring the volume of rain in the graduated cylinder and relating this to the collecting area of the funnel and report in millimetres.
- Commercial gauges are already calibrated and millimetres of rain can be read off directly and plotted against time (histogram is conventional).

WIND SPEED AND DIRECTION

Wind-sock Method

- Suspend a wind-sock on a tall pole that is unobstructed from the wind by buildings, trees, etc. Note the direction of wind using a compass. Note that direction is measured in degrees so a wind from the east (easterly) is recorded as 90°, and from the south-east as 135°. Take readings in the morning and afternoon.

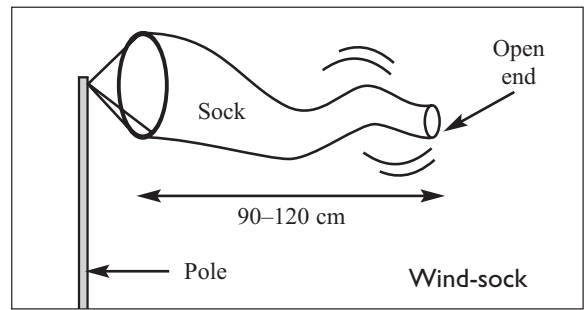

Wind vane Method

- A more accurate way is to use a wind vane, on a 6–10 ft (1.8–3.0 m) pole, connected to a meter or data logger. Recordings can be averaged daily and plotted as a radial diagram (example Figure 1.16 in chapter 1).

Anemometer Method

- Measure wind speed in an unobstructed area. Hold the anemometer or pitot gauge tube at arm's length and read off the wind speed in kilometres per hour.
- Some gauges will give a number against the pith ball path that is converted on a table to kilometres per hour.
- Daily statistics can be more easily obtained from an electronic anemometer wired to a meter/data logger.
- Repeat at the same time each day.

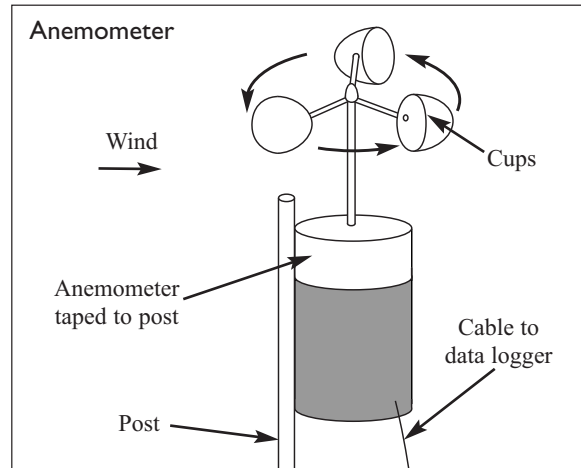

The Beaufort (Wind Force) Scale: approximate wind speed using visual cues

Beaufort Force	Wind type	Probable terrestrial features	Knots	Metres per second
0	Calm, no wind	Smoke rises vertically	0	0
1	Light air	Smoke drifts downwind; wind vane static	1–3	1–5
2	Light breeze	Wind felt on face; leaves rustle; wind vane moves	4–6	7–10
3	Gentle breeze	Leaves and twigs in constant motion; wind extends light flag	7–10	12–18
4	Moderate breeze	Dust and loose paper raised; small branches move	11–16	20–29
5	Fresh breeze	Small trees in leaf begin to sway; white crests form on inland water	17–21	31–38
6	Strong breeze	Large branches in motion; telephone lines whistle	22–27	40–49
7	Moderate gale	Whole trees in motion; walking against wind requires effort	28–33	51–60
8	Fresh gale	Twigs break off trees; progress on foot impeded	34–40	62–73
9	Severe gale	Slight structural damage to buildings (slates/tiles removed)	41–47	74–85
10	Whole gale	Trees uprooted; considerable structural damage to buildings	48–55	87–100
11	Storm	Rarely experienced; widespread destruction	57–65	104–116
12	Hurricane	Very rare and dangerous	68+	118+

Physico-chemical measurements in water

DON'T FORGET

EQUIPMENT: Oxygen, pH and conductivity meters; distilled water; pH standards and papers; thermometer; spare battery; pencil; notebook.

The electrodes, especially pH, are easily damaged or broken. Carry spare membranes and electrolyte. Calibrate meters before going into the field.

DISSOLVED OXYGEN

Method

- At the water's edge, re-check the calibration of the electrode and meter. Set the barometric pressure and water temperature (if not automatic). Switch the meter to percentage saturation and place the end of the electrode in a tube containing saturated (with water) cotton wool and leave for 30 s to equilibrate. The reading should be about 100%.
- Take a dissolved oxygen reading by waving the electrode slowly in the water for 30 s. Note the temperature, oxygen concentration in $\text{mg O}_2 \text{ l}^{-1}$ and/or percentage saturation.
- Rinse the electrode and replace the electrode tip into distilled or clean water.
- Now note the time and light conditions, e.g. sunny, overcast, etc.
- Take two readings at each site. In standing water, take surface and depth readings at intervals of 0.5 m (limited by electrode cable length). Oxygen readings are at their highest about mid afternoon.

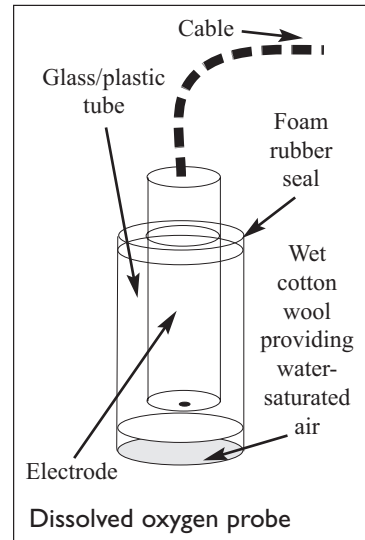

Tip: The solubility of oxygen in water varies with ambient temperature and pressure. Some oxygen meters compensate for this. The table below provides for the correction of oxygen at temperatures between 5 and 30 °C and enables the Winkler determinations to be corrected and also percentage saturation of water with oxygen to be calculated.

If the barometric pressure is known at the time of reading then a correction for pressure (negligible in terms of ecological work) can also be made:

$$\text{Solubility at pressure } x = \frac{\text{Solubility at 760 mm} \times \text{observed pressure}}{760}$$

Temperature (°C)	Oxygen solubility (mg/l)	Temperature (°C)	Oxygen solubility (mg/l)
5	12.77	18	9.46
6	12.45	19	9.27
7	12.13	20	9.08
8	11.84	21	8.91
9	11.55	22	8.74
10	11.28	23	8.57
11	11.02	24	8.42
12	10.77	25	8.26
13	10.53	26	8.12
14	10.29	27	7.97
15	10.07	28	7.84
16	9.86	29	7.70
17	9.65	30	7.57

% Saturation of water with oxygen

If the measured oxygen concentration at 17 °C was 10.6 mg O₂ l⁻¹, and using the table showing solubility of oxygen at 17 °C to be 9.65 mg l⁻¹ at 760 mm, then:

$$\% \text{ saturation} = 10.6/9.65 \times 100$$

= 110% saturation of water with oxygen.

pH

Method

- Check the calibration of the pH meter again before use – the calibration knob can get moved during transportation. Remove the electrode from its protective housing, rinse with distilled water and place in pH buffer to check calibration, rinse again.
- Follow the same procedure for oxygen measurement (second bullet point) and note the temperature if not a compensating electrode.
- For pH papers, take a sample of water in a jar and immerse the end of the paper for 30 s; remove paper and compare after a further 30-s delay with the colour comparator provided.

CONDUCTIVITY

Method

- The electrodes are more robust and calibration is usually unnecessary in the field.
- Follow the same procedure for oxygen measurement in water, and note the temperature if not a compensating electrode. Report as Siemens cm⁻¹ (or mhos cm⁻¹).
- Rinse electrode and dry before storing.

DEPTH

Method

- Measure depth with a pole in shallow water or with a rope, weighted at the end and knotted or marked at 0.5 m intervals, in deeper water. Suspend the rope from a boat and read the markers. If the water is moving, it may be difficult to suspend the rope vertically. Also, if waves are lapping the boat, take several readings and calculate the average.

WATER TEMPERATURE

Method

- Water temperatures can be measured by glass thermometer, and most oxygen, pH and conductivity meters.

OTHER CONSIDERATIONS

In slow flowing rivers and lakes, pH, oxygen and (to a lesser extent) conductivity, vary quite widely with the time of day and biological activity. Standardize the times of measurement if possible and always record time and weather conditions.

Always maintain the electrodes and meters as instructed by manufacturers – especially if they are stored for long periods.

A GPS is useful to record positions of measurements.

Turbidity

DON'T FORGET

EQUIPMENT: SUSPENDED SOLIDS: Bucket; plastic graduated cylinder; pre-weighed filter papers to fit Buchner; Buchner funnel; side-arm flask; hand vacuum pump (optional); portable balance; permanent marker pens.

UNDERWATER LIGHT/TURBIDITY: Secchi disk and line.

SUSPENDED SOLIDS

Method

- Take a sample of water in a bucket and quickly pour 500 ml–1 litre into a bottle or other clean container that can be sealed.
- Weigh a dry filter paper and put it in a Buchner or Hartley funnel attached to a side-arm flask. **Tip:** *Glass fibre papers are best because they do not absorb moisture and can be weighed before going to the field on a milligram balance; Whatman GF/C filter papers, 7 cm diameter are ideal.*
- If a hand or bench vacuum pump is available, pull a vacuum on the flask after pouring a shaken sample of known volume into the funnel. If the sample is very turbid, reduce the volume or it will take hours to filter through.
- Remove the filter paper when the surface no longer glistens and place on a drying rack in an oven (105 °C) for 1 h. Cool in a desiccator before weighing. If in the field, dry in direct sun to constant weight (repeat weighing until no significant change in weight).
- Calculate the concentration of suspended solids from the following:

concentration of suspended solids in sample = weight of dried filter paper and solids less the weight of filter paper, divided by the volume of water poured through (in ml). Multiply by 1000 (ml) for ppm.

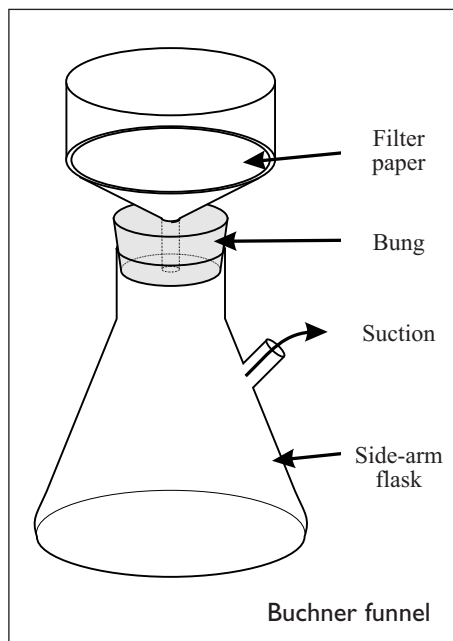

UNDERWATER LIGHT/TURBIDITY

Method

- Clean Secchi disc with a wet rag and check the security of line before lowering it into the water. Let the disc sink slowly under its own weight until it just disappears from sight. Note this depth either by pinching the line at the water surface and hauling up to measure between the pinch and disc, or from knots tied in the line (e.g. at 0.25 m intervals from disc) that are counted while hauling up.
- Repeat the measurements several times to obtain an average extinction depth for each site.
- Dry the disk and line before stowage.

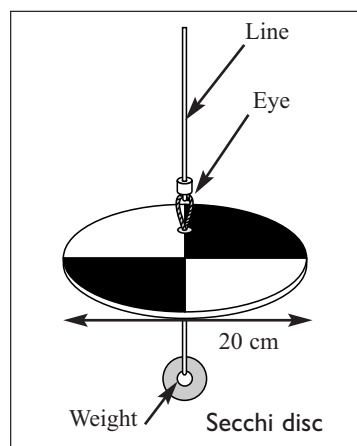

Measurement of current

DON'T FORGET

EQUIPMENT: Gessner tube; spare plastic bags and rubber bands; plastic measuring cylinder (250 ml) or flow meter; orange; two stakes (2 m length); hammer; 25 m tape measure.

Measurement of flow using a floating object is imprecise by comparison with the other methods.

CURRENT SPEED BY FLOATING OBJECT

Method

- Place two stakes in the river and measure the distance between them. Throw in an orange or other heavy, floating object and time its unimpeded travel between the two points. Repeat 2–3 times to obtain an average surface flow rate in m s^{-1}
flow rate (m s^{-1}) = distance travelled by float (m)/time to cover distance (s).
- Estimate river velocity (slower than surface velocity) by multiplying the average time by 0.8 before applying the equation above. This compensates for the drag caused by the river bed.

CURRENT SPEED BY METER

Method

- Measure the depth of the water using a pole and then set the propeller depth on the shaft at a distance of one-third of the depth – measuring from the foot of the shaft. Point the propeller of a current meter upstream and record the number of turns logged after 30 s. Repeat several times, read off the current speed from the supplied calibration graph or a factor provided with the instrument, and average the result. Repeat at various depths if the river is deep enough to warrant a velocity profile.
- For estimating flow rate through a drift net, place the propeller at the mouth of the net. Take readings at the beginning and end of the drift sampling period, e.g. at time zero and 4 h. Calculate the average current through the net. (Custom-built meters that fit into the mouth of a drift net will integrate the variable flow through the net as the latter clogs up and impedes flow. This method is the preferred but expensive option.)

CURRENT SPEED/VOLUME BY GESSNER TUBE

Method

- Close the funnel aperture with a finger and place the tube, funnel upstream, into the water. Remove finger for a few seconds to allow the water to flow into the tube before closing the aperture again. Remove the tube and measure the volume of water in the bag by pouring into a measuring cylinder. Repeat twice and at various depths if feasible. Calculate the flow rate from the formula:

flow ($\text{cm}^2 \text{ s}^{-1}$) = volume of water trapped (ml)/time (s)
x cross-sectional area of opening (πr^2)

flow volume ($\text{cm}^3 \text{ cm}^{-2} \text{ s}^{-1}$) = (volume in ml/ π) x
(r^2)/time (s).

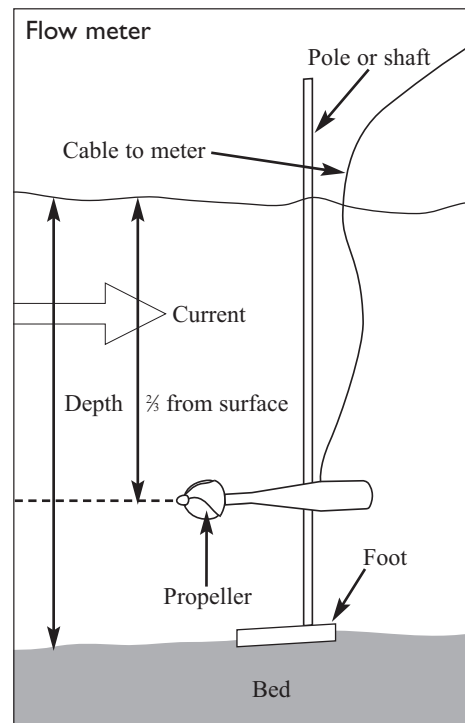

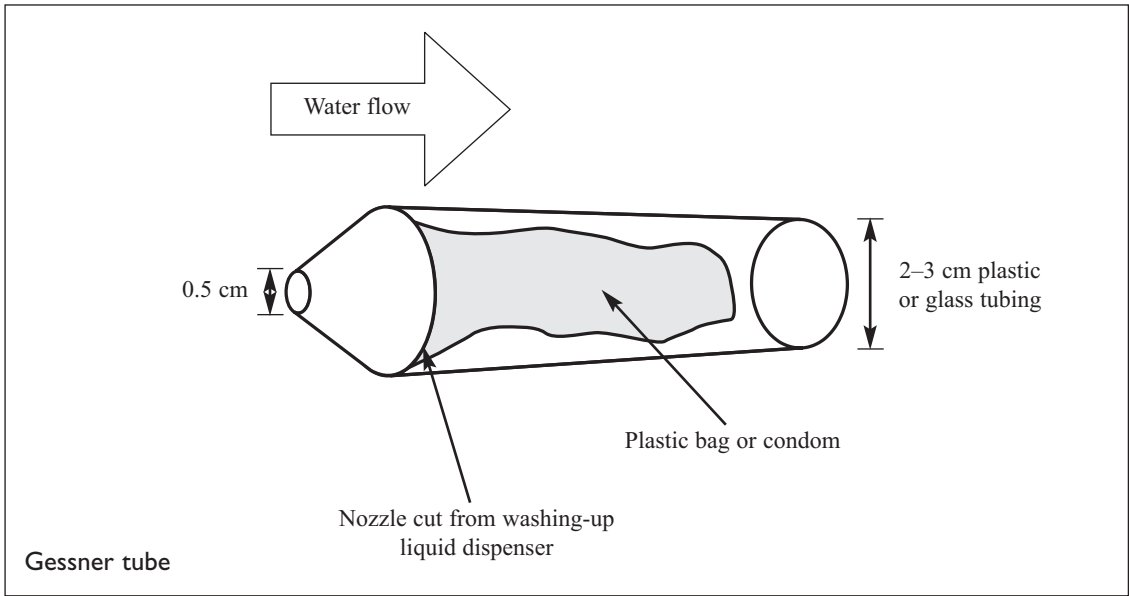

Classification of aquatic substrates

DON'T FORGET

EQUIPMENT: Cylinder sampler; scoop; set of sieves; bucket; spring balance; notebook; pencil.

The substrates of river and stream beds range from fine particles of clay to boulders. Substrate analysis can be rapid and crude or lengthy but more exacting depending on the goal. For the siting of sampling stations for monitoring work, a rapid analysis should suffice. This is normally done by eye in the first instance. The test of reasonably matched sites is to find reasonably matched biota.

RAPID ANALYSIS

Method

- If the water is clear or very shallow, just note the main characteristics of the sampling station, e.g. percentage bedrock or pebble, gravel or sand, silt and clay.
- Water flowing over solid rock just needs noting: as very few invertebrates can inhabit this substrate – algae and vegetation are more successful – the medium does not lend itself to meaningful analyses of populations.

PARTICLE SIZE ANALYSIS

Method

- Examine the substrate type in a delimited area – perhaps 1–5 m². Estimate the size range and number of rocks.
- In substrates comprising smaller categories of material, use a cylinder sampler (see method sheet from chapter 9), turning the meshed opening away from the flow, lift the pebbles out and measure their lengths.
- Using a trowel or tin can, scoop up the underlying gravel, sand and sediment and place in a sieve series, shaking them in a bucket of water or nearby pool, to separate the particulate sizes.
- Let the materials drain for 5 min and weigh each sieve separately on a spring balance to estimate the material retained – subtracting the sieve weight.
- Repeat two more times in the same delimited area to characterize and then tabulate the result as, for example, lengths of largest parameter (stones/pebbles) or weights of materials from sieves.

Substrate categories

Name	Size range	Lengths/weight
Clay	<3.9 µm	Weight
Silt	3.9–63 µm	Weight
Fine sand	0.02–0.25 mm	Weight
Medium sand	0.25–0.5 mm	Weight
Coarse sand	0.5–1.0 mm	Weight
Gravel	2–16 mm	Weight
Pebble	16–64 mm	'Lengths'
Rocks	64–256 mm	'Lengths'
Boulder	>256 mm	

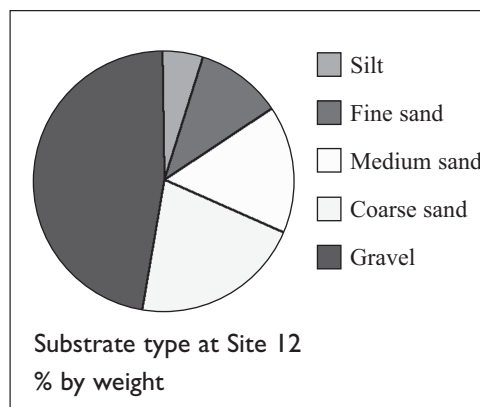

OTHER CONSIDERATIONS

A sieve series with mesh apertures of 16 mm, 2 mm, 500 µm, 250 µm, and 100 µm should suffice. Narrower aperture sieves quickly clog and so silt/clay analyses are normally determined gravimetrically in a laboratory.

Vegetative cover and shade

DON'T FORGET

EQUIPMENT: Notebook; pencil; maps; keys to vegetation; light meter; GPS.

The survey team must have a good knowledge of vegetation types. Undertake an initial field visit to decide on number and location of sites and where estimates of cover will be made.

Method

- Demarcate on a map the areas where pesticide interventions are to be made. Identify promising roads or tracks giving access to areas in sprayed and unsprayed terrain and ground-truth what appears on vegetation maps (if available) for accuracy, in terms of dominant species, e.g. *Julbernardia/Combretum* woodland, shrub savanna, grass steppe, etc.
- Members of the survey team should agree on the definitions and use of the ranks and scales for cover estimation (see suggestions in table).

Scales for estimating vegetative cover

Rank	Braun-Blanquet (% cover)
Bare ground	< 1
Rare	1–5
Occasional	6–25
Frequent	26–50
Abundant	51–75
Dominant	76–100

- Estimate the percentage cover in several areas of a potential sampling site using the Braun-Blanquet scale above. A site might be anything from 100 m² to 1 ha (100 x 100 m) depending upon cover, season and the techniques to be employed for the fauna (which may need to cover extensive ground as in bird or mammal monitoring).
- Survey to one side of the road (or vehicle) and then the other. Get a second surveyor to do the same and compare the results. Discuss any gross discrepancies and the means to ensure better objectivity in estimation.
- Make a sketch map of the area if it helps and record all the species identified and rankings made.
- Repeat the surveys at other potential sites (similar appearance) along the road or within the defined sprayed area. Mark the grid reference (or take a GPS waypoint) and number the sites in case you want to adopt them as monitoring stations.
- Repeat the whole operation in the unsprayed area until the recommended number of sites have been matched and identified.

OTHER CONSIDERATIONS

It is possible to record over 100% cover in this method because there may be several layers of vegetation. For example, there may be algae, grasses, shrubs and trees occupying different layers. Visual observation on tree canopy height and under-canopy shade may also be useful descriptors. Bear in mind that it will not be possible to discriminate between very small percentages of cover if you create more classes of scale than those shown below. Make sure that the unsprayed area is at least 10–20 km from the sprayed area, to minimize the possibility of contamination from spray drift.

Soil texture

DON'T FORGET

EQUIPMENT: Wash bottle; trowel; hand lens; paper labels; notebook; pencil; plastic bags; permanent marker pen.

Method

- Dig soil to a depth of 5–10 cm and collect a sample in a plastic bag containing a label (pencil on paper) in case a laboratory particle size analysis is later desired. Note how hard the soil was to dig: in the dry season, clay soil will be hard and of smooth appearance; sand grains will be noticeable on the surface of sandy soils. In the wet season, clay soils will be sticky, glistening, or plastic; sandy soils will be well drained, leaving grains on the surface that are visible to the naked eye (certainly with a hand lens).
- Take a handful of soil and wet it. Clay soils will absorb a lot of water compared with sandy ones. Wet almost to saturation point and then, using the thumb and forefinger, determine the amount of clay from its degree of stickiness and plasticity as follows.
 - Squeeze the soil by pressing it with a sideways/slightly forward motion of the thumb and try to form a long, thin ribbon or try to roll the soil into a thin, long ‘worm’ (± 10 cm). If either is possible, then a clay soil is indicated. If the wet clay will take your fingerprint then a clay or silty clay is indicated. If sand grains are felt at the surface of the clay then a sandy clay is indicated
 - If a short ribbon or ‘worm’ can be produced (2–4 cm) or perhaps a longer one for a short period of time, then a clay loam is indicated.
- Determine the sand and silt content by rewetting the soil and see if the soil feels like flour when rubbed between the forefinger and thumb or whether sand grains can be felt. If the soil formed short ribbons or ‘worms’ and then felt floury, a silty clay loam is indicated, or if gritty, a sandy clay loam is probable. The latter soil will not allow the ‘worm’ to be bent into a ring. Equal amounts of flouriness and grittiness indicate a clay loam.
- A soapy feel without stickiness and an inability to bend ‘worms’ into a ring indicates a silt loam.
- Sandy loams and loamy sands will not form a ribbon or ‘worm’ but will just stay together if rolled into a ball.
- A sandy soil will not form a ribbon or a ball.

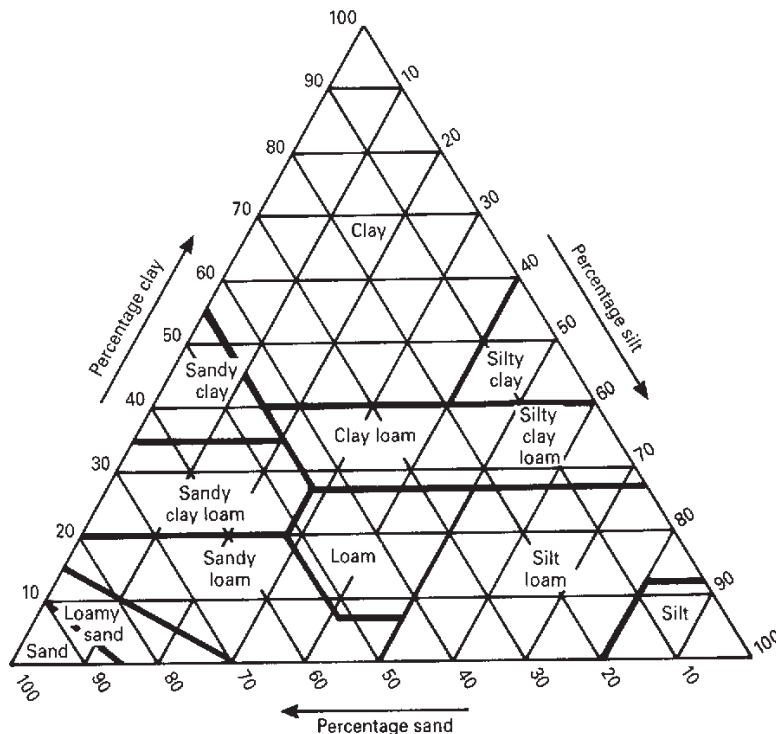

Soil moisture, water-holding capacity, soil pH

DON'T FORGET

EQUIPMENT: Plastic Petri dish; aluminium foil; portable balance; 10 cm filter papers; soil corer or tin can; distilled water; paper tissues; spatula; pH paper; pH sensitive electrode; pH meter.

Remember to calibrate the pH meter with buffers beforehand and set the slurry temperature if the meter does not automatically compensate for it.

SOIL MOISTURE

Method

- Mix a few spade-fulls of freshly dug surface soil (0–20 cm) from a sampling site and place 1–2 kg immediately into thick polythene bags and label. Double bag if the polythene or plastic bags are too thin to prevent water loss during transportation and storage.
- Pass a small sample, e.g. 500 g, through a 2 mm sieve to remove vegetation/roots before placing small amounts of soil (25–50 g) on to shallow, weighed containers (Petri dishes, tin cans, or aluminium foil). Weigh wet soils and record weight.
- Spread soils out and, if sun-drying, protect from gusts of wind.
- Air-dry the soil samples in direct sunlight to constant weight, i.e. reweigh the containers of soil periodically until there is no discernible weight change.
- Subtract the weight of the soil container from the total weight to obtain wet and dry soil weights and then calculate the moisture content from the formula:

$$\% \text{ soil moisture} = \frac{\text{weight of wet soil} - \text{weight of dry soil}}{\text{weight of dry soil}} \times 100$$

- Keep the air-dried soil in plastic bags to oven-dry later.
- On return to the laboratory, check the dry weight of the soil by placing the air-dried sample in an oven at 105 °C overnight and re-weighing.

WATER-HOLDING CAPACITY (1) Use for soils prepared for nitrification estimates.

Method

- Fold three weighed filter papers and place each in a funnel. Put 25 g of soil (collected as described in soil moisture method) in each paper and saturate the soil with water. Cover the funnel with aluminium foil and allow the soils to drain by gravity for 1 h in the shade and then reweigh.
- Sun-dry the soil to constant weight (as at fourth bullet point above).
- To estimate the water-holding capacity in grams water, use the formula:

$$\text{field capacity (g water)} = \text{weight of gravity drained soil} - \text{weight of sun-dried soil}$$

or expressed as % water at field capacity = $\frac{\text{weight of gravity drained soil} - \text{air-dried weight of soil}}{\text{air-dried weight of soil}} \times 100$

WATER-HOLDING CAPACITY (2) Use for comparison of field capacities between soils.

Method

- Take a soil core using a corer or tin can with one end removed and the other perforated with a few small nail holes. Weigh the corer or can, push into the soil and remove the core. **Note:** Use of a soil corer will minimize disturbance of the soil.
- Saturate the soil in the corer or can with water and let the water drain away under gravity for 1 h in the shade before re-weighing.
- Extract the soil from the corer/can and sun-dry to constant weight and apply the formulae from Water-Holding Capacity (1) at fifth bullet point to obtain an estimate of field capacity.

SOIL pH BY PAPER

Method

- Shake or stir equal volumes of soil (collected as described in 'Soil Moisture' method) and distilled water (e.g. 50 ml each) in a container and settle for 2–3 min until the supernatant clears.
- Momentarily dip a pH paper (range pH 4–8) into the water and compare the colour after it has developed (1 min) with the colour chart provided and read off the pH. **Tip:** *Narrow range paper (two pH units) can provide greater accuracy.*

SOIL pH BY METER

Method

- For more accuracy (preferable), suspend a pH-sensitive electrode and its reference electrode (often combined) in the soil mixture produced in the step above and swirl the soil into a slurry, reading the pH when it is stable (15 s).
- Rinse the electrode(s) with distilled water between measurement of further samples.

OTHER CONSIDERATIONS

All these methods are adapted for use in the field and will not provide the accuracy or precision of laboratory standard methods.

Sampling soil for residues

DON'T FORGET

EQUIPMENT: Clip-board (carry a plastic bag in your pocket into which you can put the board if it rains); data sheets for sample site details; spare paper; sharp pencils; pens; labels; eraser; permanent marker pens; tape measure; 25 cm ruler; penknife; clean glass jars (500 ml capacity) with aluminium foil-lined screw-caps or strong polyethylene bags 30 x 20 cm (or similar); plastic-coated wire ties for securing the bags; clean water; detergent; acetone; paper towels; cloth; spade or soil auger; digging trowel; site map; compass; GPS (optional); cool-box where available or a strong sample box to contain the sample vessels with appropriate packing (cardboard or foam rubber) to prevent glass vessels being damaged or broken during transit; protective clothing; nitrile or rubber gloves.

Thoroughly check all equipment before you go into the field.

Identify the sampling site and mark on the site map for future reference.

Decide on the sampling approach based on consideration of the sampling objectives.

Wear protective clothing when sampling in pesticide-treated areas.

SAMPLING WITH A SOIL AUGER/CORER

Method

Collect samples by:

- composite sampling method: collect five cores to a uniform depth and mix together
- depth profile sampling method: take cores to a uniform depth, remove, extrude and section with a knife, taking 10-cm depth profiles. Take three replicate cores from each site, section and combine appropriate sections. The minimum sub-sample taken in this way should be 200 g (500 ml jar approximately half-full).

SAMPLING SOIL FROM A DEPTH PROFILE

- If a soil auger/corer is not available, dig a hole to 30–50 cm depth with one side of the hole being cut vertically with a spade.
- With a ruler measure the required depth profiles and carefully remove the required layers (with spade or digging trowel), starting from the top (surface) layer (see diagrams over page).
- Again take replicates from each site and combine; the minimum sample size should be 200 g.
- Transfer the sample(s) prepared as above into a glass jar or wrap in aluminium foil and place in a polythene bag.
- Prepare a label giving the sample and site details and the date and put the label into the jar/bag. If using a bag, seal with a wire tie; if a jar, screw on cap.
- Place the sample jar or bag inside a second bag, prepare another label with all the relevant sample details. Put the label inside the outer bag and seal.
- Record the sampling details on the prepared data sheet (see page 143).
- Put the sample container into a suitable sample box for transportation. Protect with packing material.
- Clean the auger/corer and knife with water and detergent and then acetone before taking the next sample.

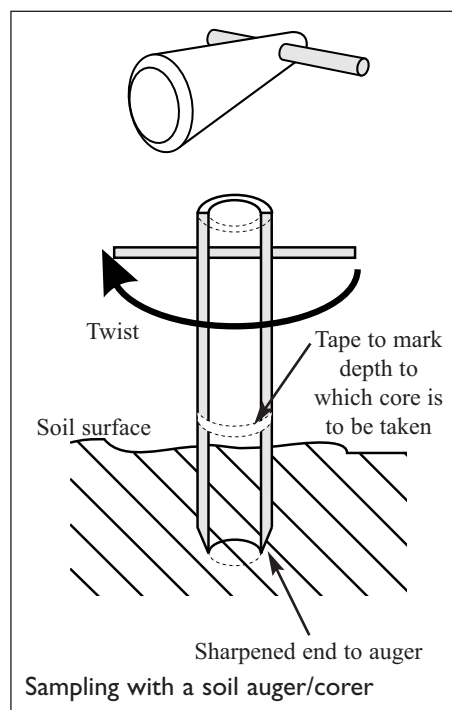

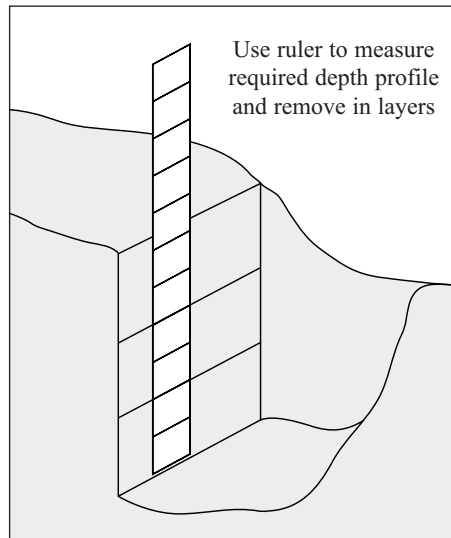
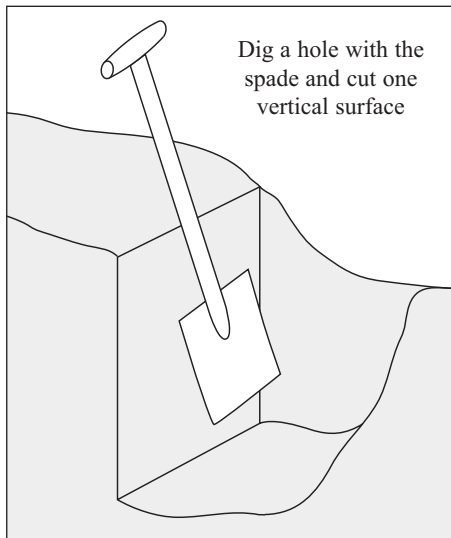

OTHER CONSIDERATIONS

Use a cool-box if available to transport the samples. On no account should the collected samples be exposed to direct sunlight or extremes of heat.

Where possible keep the samples chilled (e.g. in a refrigerator) whilst awaiting transportation to the analytical laboratory.

Always sample unsprayed areas first.

Change gloves between sample sites to avoid cross-contamination. Seal used gloves in a labelled plastic bag, until proper disposal can be organized.

Sampling water for residues

DON'T FORGET

EQUIPMENT: Clip-board (carry a plastic bag in your pocket into which you can put the board if it rains); data sheets for sample site details; spare paper; sharp pencils; pens; labels; string (various lengths including lengths up to 4 m); eraser; scissors; permanent marker pens; supply of clean glass bottles (1000 ml capacity) with teflon or aluminium foil-lined screw-caps; appropriate sampling device; dependent on depth of water at which sample is to be taken; long wooden pole; weighted cage to contain the sample vessel; wellington (rubber) boots or thigh waders (assuming sampling from the shore); rubber or nitrile gloves, preferably elbow length; cool-box where available or a strong sample box to contain the sample vessels after water collection and with appropriate packing (cardboard or foam rubber) to prevent vessels being damaged or broken during transit; protective clothing.

Thoroughly check all equipment before you go into the field.

Select the sampling site and mark the site plan or map for future reference.

When sampling from close to the shore, and particularly where it is necessary to enter the water to find a sufficient depth in which to immerse the sample vessel, it will be necessary to ensure minimum disturbance to the bed of the river/stream/lake otherwise disproportionate amounts of sediment may be included in the sample.

The depth at which the water sample is to be collected should be determined in advance.

For surface or sub-surface water, the apparatus illustrated in diagram 1 should be used; for water samples at depths between 30 cm and 2 m (approximately) the apparatus shown in diagram 2 should be used.

Wear protective clothing when sampling in pesticide-treated areas.

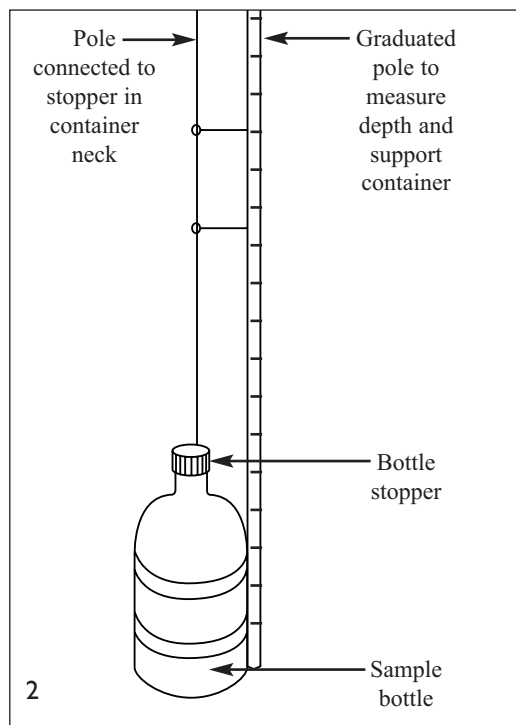
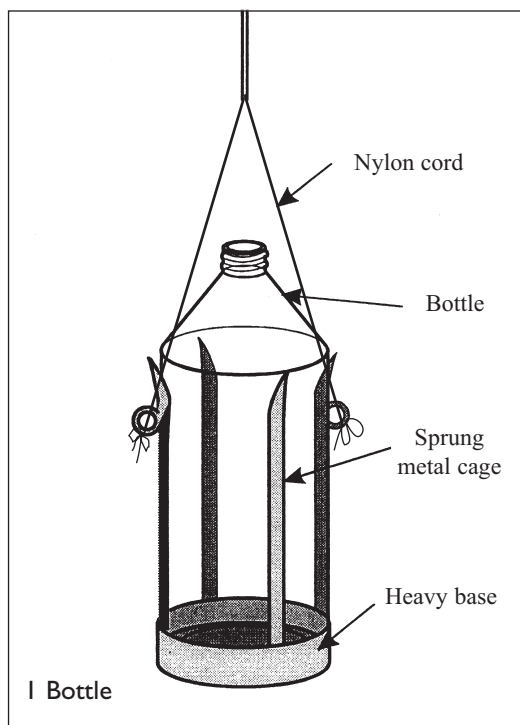

SURFACE/SUB-SURFACE WATER

Method

- The depth of the water body will determine the technique used.
- In very shallow water the container (glass bottle) should be held in a nitrile gloved hand with the opening just below the water surface to allow it to fill.

- As soon as the bottle is withdrawn from the water it should be sealed with a clean screw-cap and an appropriate label attached such that all sample details are clearly presented.
- In slightly deeper water, the bottle, contained in a weighted metal cage, can be lowered by rope into the water (diagram 1). This is a useful technique when collecting a sample from a bridge or a boat. As soon as the bottle is withdrawn from the water it should be sealed with a clean screw-cap.

SAMPLING WATER FROM A DEFINED DEPTH

Method

- The apparatus in diagram 2 should be used.
- Lower the sampling device into the water to the required depth and remove the stopper using the central pole. Allow the container to fill.
- The central pole may be used to push the stopper back into place prior to withdrawal of the bottle from the water.
- Seal the container with a screw-cap fitted securely and attach an appropriate label such that all sample details are clearly presented.

For all methods

- Record the sampling details on the prepared data sheet (see page 143) and give the sample a code number. Add that number to the sample label and, additionally, write the code number on the outer surface of the container with a permanent marker pen.
- Place the sample container into the sample box and secure it with packing material; ensure that it will not move or rattle against other containers during transportation.
- Clean the sampling device using water and detergent, rinse thoroughly and finally rinse with acetone. The outside surface of the bottles should be washed with clean water, dried and then labelled with the appropriate sample details. The metal cage or the pole mechanism should be washed with clean water or wiped with a cloth soaked in acetone, to remove any significant contamination which could be transferred when collecting the next sample. The apparatus need not be rinsed between the collection of replicates from the same site, only between sites.
- Repeat the sampling process such that a minimum of two replicate samples are collected.

OTHER CONSIDERATIONS

Sample in unsprayed areas first.

If entering the water to take a sample, use the pole to check the depth and that it is safe to proceed. Watch out for the presence of crocodiles and beware of bilharzia. Ensure that adequate protective clothing is worn when working in water.

If, when entering the water to take the sample, sediment has been disturbed, it is important to allow this to settle before taking the water sample.

When using the sub-surface sampling equipment in diagram 1, the bottle will begin filling with water as soon as it is immersed and the sample will be a composite from water at the surface/sub-surface. When using the apparatus in diagram 2, the stopper is a rubber or cork bung which fits inside the opening of the screw-cap bottle neck.

The wooden pole or weighted cage can also be used to take samples from the shore where the water is too deep to allow wading or where the bottom sediment is soft (and dangerous) or is easily disturbed. Where possible keep the samples chilled (e.g. in a refrigerator) whilst awaiting transportation to the analytical laboratory.

Where a cool-box is available, this should be used to transport the samples whilst in the field. On no account should the collected samples be exposed to direct sunlight or extremes of heat.

Where sampling from a bridge or similar may be most convenient, the sample vessel should be tied to the wooden pole and lowered into the water or the vessel put into the weighted cage which is similarly lowered into the water.

Change gloves between sample sites to avoid cross-contamination. Seal used gloves in a labelled plastic bag, until proper disposal can be organized.

Sampling sediment for residues

DON'T FORGET

EQUIPMENT: Clip-board (carry a plastic bag in your pocket into which you can put the board if it rains); data sheets for sample site details; spare paper; sharp pencils; pens; labels; string; eraser; scissors; permanent marker pens; clean glass jars (500 ml capacity) with aluminium foil-lined screw-caps or strong polyethylene bags 30 x 20 cm (or similar); plastic-coated wire ties for securing the bags; sampling tool (scoop on a pole, core-sampling device or similar); folding ruler; wellington boots or waders; rubber or nitrile gloves; 2 m wooden pole; site map; compass; tape measure; clean water; detergent; acetone; cool-box where available or a strong sample box to contain the sample vessels with appropriate packing (cardboard or foam rubber) to prevent glass vessels being damaged or broken during transit.

Thoroughly check all equipment before you go into the field.

Identify the sampling site and mark the site map.

Wear protective clothing if sampling in pesticide-treated areas.

Method

- Enter the water, checking with the long pole that it is safe to do so and that the depth is not too great.
- Insert the sampling device and lower to the substrate to take the sediment sample. Note the depth of sediment which is being sampled with the folding ruler. (If using the Eckman grab, see method sheet on grab sampling and chapter 9.)
- Transfer the sample into a glass jar or wrap in aluminium foil and place in a polythene bag after draining away any water collected with the sample; the minimum sample size should approximately half fill a 500 ml capacity jar. Secure lid on the container; if using a bag, seal with a wire tie. At each sample collection point collect a minimum of three replicates.
- Write the sample details on the outside of the bag or jar using a permanent marker pen.
- Place the sample bag or jar inside another bag, prepare a label detailing the sample and site details and put the label into the bag. Seal the outer bag.
- Repeat the sampling process such that there is a minimum of two replicates from each identified site.
- Record the sampling details on the prepared data sheets (see page 143).
- Place the sample container into the sample box and secure it with packing material; ensure that it will not move or rattle against other containers during transportation.
- Clean the sampling tool with water and detergent, followed by acetone, between samples.

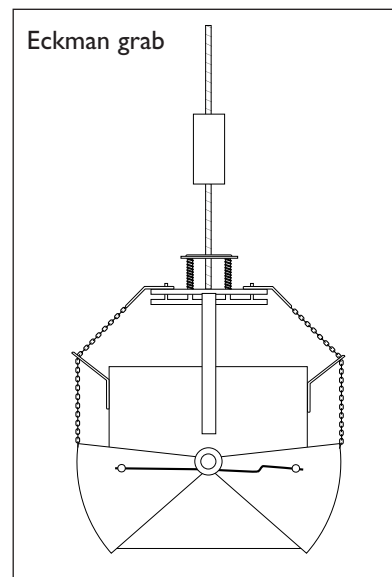
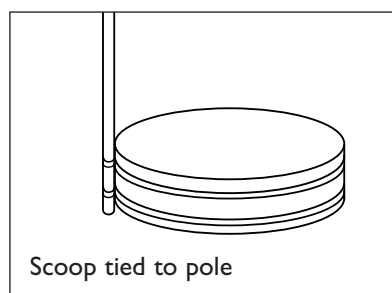

OTHER CONSIDERATIONS

Sample in unsprayed areas first.

If entering the water to take a sample, use the pole to check the depth and that it is safe to proceed. Watch out for the presence of crocodiles and beware of bilharzia. Ensure that adequate protective clothing is worn when working in water.

Change gloves between sample sites to avoid cross-contamination. Seal used gloves in a labelled plastic bag, until proper disposal can be organized.

Where a cool-box is available, it should be used to transport the samples whilst in the field. On no account should the collected samples be exposed to direct sunlight or extremes of heat.

Where possible keep the sample chilled (e.g. in a refrigerator) whilst awaiting transportation to the analytical laboratory.

Sampling terrestrial vegetation for residues

DON'T FORGET

EQUIPMENT: Clip-board (carry a plastic bag in your pocket into which you can put the board if it rains); data sheets for sample site details; spare paper; sharp pencils; pens; labels; string; eraser; scissors or penknife; permanent marker pens; supply of large, clean filter papers or clean blotting paper; manilla (paper) envelopes; cloth sachets of silica gel (kept in a sealed container before use); portable balance, 0–100 g capacity (if the samples are to be weighed in the field); disposable gloves; site map; compass; tape measure; cool-box (if available).

Thoroughly check all equipment before you go into the field.

Select the sampling site and mark the site plan for future reference.

Select the vegetation to be sampled according to the agreed sampling plan; generally only grass and leaves removed from trees and shrubs will be sampled.

Wear protective clothing when sampling in pesticide-treated areas.

Method

- Wearing disposable gloves, remove the sample (cutting required vegetation with scissors), weigh it (if necessary), note the weight and then cover the sample with filter paper or blotting paper; it is best to lay the material between sheets of paper rather than wrapping it.
- Carefully put the sample into a manilla envelope, preferably without folding.
- Write a label containing all the sample information and place the label with the sample inside the envelope.
- Copy the same information on to the outside of the envelope and on to the prepared data sheet (see page 143).
- Place a sachet of silica gel inside the envelope and close the envelope by tucking in the flap. Do not seal the envelope.
- Place the envelope into a sample box or bag, keeping the envelope horizontal where possible so that the sample is kept properly layered between the sheets of paper.
- Clean scissors with water and detergent, then wipe with acetone, before taking the next sample.

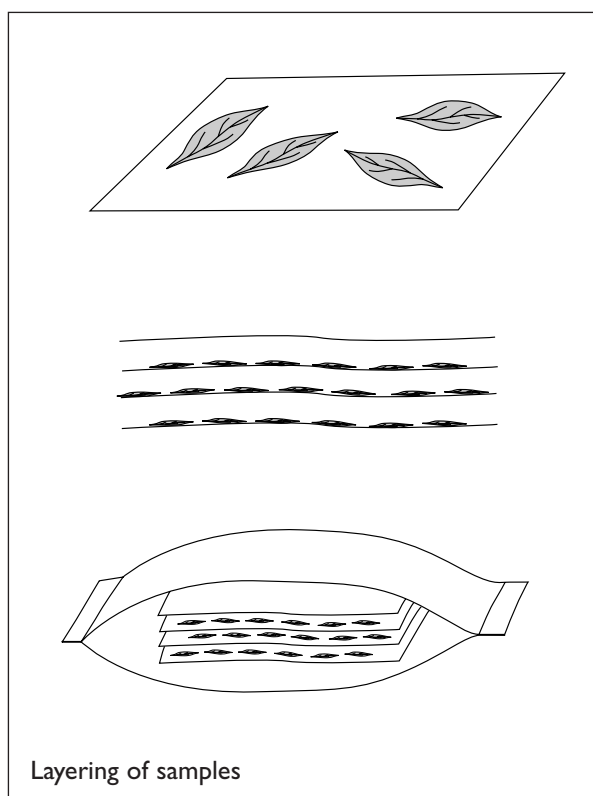

OTHER CONSIDERATIONS

Do not sample twigs or branches.

Where a cool-box is available, it should be used to transport the samples whilst in the field. On no account should the collected samples be exposed to direct sunlight or extremes of heat.

Where possible keep the envelopes chilled (e.g. in a refrigerator whilst the sample is awaiting transportation to the laboratory). **Do not freeze the samples** unless specific additional instructions have been received from the laboratory.

Remove gloves (keep in a labelled plastic bag until return to base for disposal) and put on a new pair before taking the next sample.

Sampling aquatic vegetation for residues

DON'T FORGET

EQUIPMENT: Clip-board (carry a plastic bag in your pocket into which you can put the board if it rains); data sheets for sample site details; spare paper; sharp pencils; pens; labels; string; eraser; scissors or penknife; permanent marker pens; supply of clean glass jars (250 ml capacity) with aluminium foil-lined screw-caps or strong polyethylene bags 30 x 20 cm (or similar); plastic-coated wire ties for securing the bags; wellington (rubber) boots; rubber or nitrile gloves; site map; compass; tape measure; 2 m wooden pole with hook on one end; cool-box where available or a strong sample box to contain the sample vessels with appropriate packing (cardboard or foam rubber) to prevent glass vessels being damaged or broken during transit.

Thoroughly check all equipment before you go into the field.
Select the sampling site and mark the site plan for future reference.
Wear protective clothing when sampling in pesticide-treated areas.

Method

- Where the selected vegetation can be reached from the shore take the desired sample by hand (wearing nitrile gloves) or using the pole and hook.
- Enclose the sample in clean filter paper or blotting paper to remove excess water. Where filter or blotting paper is not available, paper towels or tissue can be used. Samples of these should be provided to the analytical laboratory to check for possible co-extractives which could interfere with the analysis. Wherever possible, analytical checks on the suitability of the material should be completed before sampling commences.
- Remove the paper wrapping and place the sample into a glass jar or wrap in aluminium foil and place in a polyethylene bag; close the jar with the appropriate screw-cap or the bag with a wire tie.
- Dry the outside of the container and mark it with the sample code number.
- Place the container inside a polyethylene bag. Write a sample label containing all relevant sample details, including the sample code, and place the label inside the bag. Secure the bag with a wire tie.
- Record all sample details, including sample code, on the prepared data sheets (see page 143).
- Clean pole and hook with detergent and water, then with acetone, before taking the next sample.

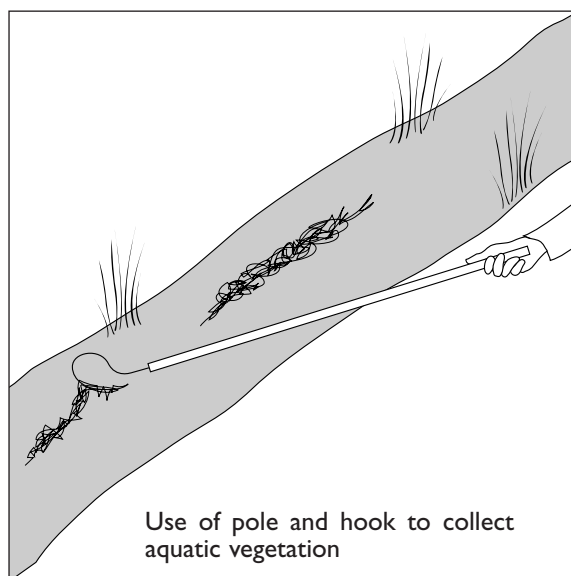

OTHER CONSIDERATIONS

If entering the water to take a sample, use the pole to check the depth and that it is safe to proceed. Watch out for the presence of crocodiles and beware of bilharzia. Ensure that adequate protective clothing is worn during sampling.

If, when entering the water to take the sample, sediment is disturbed, it is important to allow this to settle before taking the vegetation sample.

Where a cool-box is available, it should be used to transport the samples whilst in the field. On no account should the collected samples be exposed to direct sunlight or extremes of heat.

Where possible keep the sample chilled (e.g. in a refrigerator) whilst awaiting transportation to the analytical laboratory.

Replace the gloves with a new, clean pair before taking the next sample. Seal used pair in a labelled plastic bag until proper disposal can be arranged.

Sampling fish for residues

DON'T FORGET

EQUIPMENT: Clip-board (carry a plastic bag in your pocket into which you can put the board if it rains); data sheets for sample site details; spare paper; sharp pencils; pens; labels; string; eraser; scissors or penknife; permanent marker pens; supply of clean glass jars (100–200 ml capacity) with aluminium foil-lined screw-caps; supply of polyethylene bags, 25 x 50 cm, or similar; portable balance, 0–100 g or 0–1000 g capacity (where field weighing of whole samples or of organs may be necessary); supply of dilute (8–9%) formalin solution in a clean container; rubber or nitrile gloves; disposable gloves; metal tongs or forceps; sharp knife or scalpel; cotton wool; aluminium foil; acetone (analar grade); cool-box where available or a strong sample box to contain the sample vessels with appropriate packing (cardboard or foam rubber) to prevent glass jars being damaged or broken during transit.

Thoroughly check all equipment before you go into the field.
Select the sampling site and mark the site plan for future reference.
Wear protective clothing when sampling in pesticide-treated areas.

Method

- Capture the fish by appropriate means (see chapter 10). Samples can also be obtained from local fisherfolk as long as they are fresh and if the area of capture can be defined and time of capture assured.
- Where fish are small enough to constitute an individual sample, wrap each fish individually in aluminium foil and place within a polyethylene bag. Prepare a label including all relevant sample details and put the label inside the bag with the sample. Seal the bag with a wire tie. (See also bullet point 6.)
- Put the sample bag inside a second polyethylene bag and prepare and insert a second, identical label. Seal the bag with a wire tie.
- Record all sample details on the prepared data sheets (see page 143).
- Pack the samples into the sample box.
- Where individual body organs or muscle tissue are to be analysed, these are best removed on return to base camp. Where the size of the specimen makes this impracticable, the organs and tissue may have to be removed in the field and transported back to camp in glass sample bottles containing formalin solution. Weigh the tissue samples after removal and before placing in formalin; record the weights.
- Organs and tissue from the same specimen should be stored in separate bottles and the labelling and data sheet records should clearly show what has been done.
- The jars should be sealed and placed inside polyethylene bags, which are then sealed as a precaution against leakage. Each sample jar should contain a paper label, written in pencil, and the outer polyethylene bag should contain a second, identical label.
- Wash and rinse all sampling equipment, dissecting equipment and tools with water and rinse with acetone between samples.

OTHER CONSIDERATIONS

If entering the water to take a sample, use the pole to check the depth and that it is safe to proceed. Watch out for the presence of crocodiles and beware of bilharzia. Ensure that adequate protective clothing is worn.

Where dissection is required, it is important to ensure that there is no risk of sample contamination. The dissection should be carried out on a clean surface covered with a material such as aluminium foil. Fresh foil should be used for each dissection. Fresh disposable gloves should be used for each specimen and any knives or forceps used cleaned with acetone between use.

Disposable gloves should be worn for the dissection work and when handling the formalin solution. The gloves should only be used once and then removed and sealed in a labelled plastic bag, until proper disposal. Where a cool-box is available, it should be used to transport the samples whilst in the field. On no account should the collected samples be exposed to direct sunlight or extremes of heat.

Where possible keep the sample chilled (e.g. in a refrigerator) whilst awaiting transportation to the analytical laboratory.

Sampling birds and small mammals for residues

DON'T FORGET

EQUIPMENT: Clip-board (carry a plastic bag in your pocket into which you can put the board if it rains); data sheets for sample site details; spare paper; sharp pencils; pens; labels; string; eraser; scissors or penknife; permanent marker pens; supply of clean glass jars (100–500 ml capacity) with aluminium foil-lined screw-caps; supply of polyethylene bags 25 x 50 cm, or similar; supply of dilute (8–9%) formalin solution in a clean container; bird capture net; net on pole or suitable traps for small mammals; rubber or nitrile gloves; disposable gloves; metal tongs or forceps; sharp knife or scalpel; portable balance, 0–100 g capacity; cotton wool; aluminium foil; acetone (analar grade); cool-box where available or a strong sample box to contain the sample vessels with appropriate packing (cardboard or foam rubber) to prevent glass jars being damaged or broken during transit.

Thoroughly check all equipment before you go into the field.
Select the sampling site and mark the site plan for future reference.
Wear protective clothing when sampling in pesticide-treated areas.

Method

- Capture the specimen (see chapters 12 and 13) and kill by appropriate means (humanely).
- Where animals are small enough to constitute an individual sample, wrap each sample individually in aluminium foil and place within a polyethylene bag. Prepare a label including all sample details (including sex) and put the label inside the bag with the sample. Seal the bag with a wire tie.
- Put the sample bag inside a second polyethylene bag and prepare and insert a second, identical label. Seal the bag with a wire tie. (See also bullet point 7.)
- Record all sample details on the prepared data sheets (see page 143).
- Pack the samples into the sample box.
- In particularly hot climates and where chilling facilities are not immediately available, small specimens should have an incision made in the abdominal wall and the whole sample then immersed in formalin contained within a glass, screw-capped jar. The jar should be placed within a polyethylene bag which should be sealed with a wire tie. Each sample jar should contain a paper label, written in pencil, and the outer polyethylene bag should contain a second, identical label. In such cases, the sample should be weighed before immersion in formalin and the weight carefully recorded.
- Where individual body organs or muscle tissue are to be analysed, these are best removed on return to base camp. Where the size of the specimen makes this impracticable, however, and particularly in very hot climates, the organs and tissue may have to be removed in the field and transported back to camp in sample bottles containing formalin solution. The organs or body tissue sample should be weighed before immersion in formalin and the weight carefully recorded.
- Where dissection is required, it is important to ensure that there is no risk of sample contamination. The dissection should be carried out on a clean surface covered with a material such as aluminium foil. Fresh foil should be used for each dissection. Fresh disposable gloves should be used for each specimen and any knives or forceps used cleaned with acetone between use.
- Organs and tissue from the same specimen should be stored in separate bottles and the labelling and data sheet records should clearly show what has been done.
- The jars should be sealed and placed inside polyethylene bags, which are then sealed with wire ties, as a precaution against leakage.

OTHER CONSIDERATIONS

Disposable gloves should be worn for the dissection work and when handling the formalin solution. The gloves should only be used once and then removed; fresh gloves should be worn for each sample handled (used gloves being sealed in a labelled plastic bag, until proper disposal can be organized). Where a cool-box is available, it should be used to transport the samples whilst in the field. On no account should the collected samples be exposed to direct sunlight or extremes of heat. Where possible keep the sample chilled (e.g. in a refrigerator) whilst awaiting transportation to the analytical laboratory.

Sampling amphibians and reptiles for residues

DON'T FORGET

EQUIPMENT: Clip-board (carry a plastic bag in your pocket into which you can put the board if it rains); data sheets for sample site details); sharp pencils; pens; labels; string; eraser; scissors or penknife; permanent marker pens; supply of clean glass jars (100–500 ml capacity) with aluminium foil-lined screw-caps; supply of polyethylene bags large enough to contain the largest sample container; plastic-coated wire ties; supply of dilute (8–9%) formalin solution in a clean container; sample net on 1 m pole; rubber or nitrile gloves; disposable gloves; metal tongs or forceps; sharp knife or scalpel; portable balance, 0–100 g capacity; cotton wool; aluminium foil; acetone (analar grade); cool-box where available or a strong sample box to contain the sample vessels with appropriate packing (cardboard or foam rubber) to prevent glass jars being damaged or broken during transit.

Thoroughly check all equipment before you go into the field.
Select the sampling site and mark the site plan for future reference.
Wear protective clothing when sampling in pesticide-treated areas.

Method

- Using the sample net, or by hand if appropriate (wear gloves), capture the specimen and stun (e.g. for lizards, frogs, small snakes or chelonians) with a sharp tap or finger-flick to the top of the head.
- Weigh the sample and record the weight.
- Immerse the whole specimen in formalin solution in an appropriately sized glass or aluminium container. (See also bullet point 10.)
- After 30 min remove the specimen using metal tongs or forceps (formalin solution can damage human skin) and make an incision in the abdominal wall. Return the specimen to the formalin solution.
- Prepare a suitable label, written in pencil, containing all of the relevant sample information and place in the container. Seal the container with the screw-cap, ensuring that no leaks occur.
- Label the outside of the container with all relevant sample details using a permanent marker pen.
- Place the container inside a polyethylene bag and seal with a wire tie (a precaution against leakage of the formalin).
- Record the sampling details on the prepared data sheets (see page 143).
- Pack the sample container into the sample box using packing material to ensure that the container cannot move or be damaged during transportation.
- Where individual body organs are to be analysed, these are best removed on return to base camp. Where the size of the specimen makes this impracticable, the organs may have to be removed in the field and transported back to camp in sample bottles. Organs from the same specimen should be stored in separate bottles and the labelling and data sheet records should clearly show what has been done.
- Where dissection is required, it is important to ensure that there is no risk of sample contamination. The dissection should be carried out on a clean surface covered with a material such as aluminium foil. Fresh foil should be used for each dissection. Any knives or forceps used should be cleaned with acetone between use.

OTHER CONSIDERATIONS

Where the period of transportation is long or involves the use of aircraft, the specimen should be removed from the formalin (after a minimum of 48 h in the preservative) and wrapped in a formalin soaked square of cotton. The cotton bundle is then doubly wrapped in aluminium foil and sealed in a polythene bag. Ensure that all sample details are transferred to the new packaging. Wherever possible the original labels should be used; where this is not possible, ensure that all details are correctly transposed on to the new labels. **Double check** to prevent any error. Where the journey to the laboratory is made on good, level roads and there is no associated journey by air, the samples can remain in formalin solution.

Where dissection is required, it is important to ensure that there is no risk of sample contamination. The dissection should be carried out on a clean surface covered with a material such as aluminium foil. Fresh foil should be used for each dissection. Fresh disposable gloves should be used for each specimen and any knives or forceps used cleaned with acetone between use.

Disposable gloves should be worn for the dissection work and when handling the formalin solution. The gloves should only be used once and then removed; fresh gloves should be worn for each sample handled and used gloves sealed in a labelled plastic bag, until proper disposal can be arranged.

Sampling invertebrates for residues

DON'T FORGET

EQUIPMENT: Clip-board (carry a plastic bag in your pocket into which you can put the board if it rains); data sheets for sample site details; spare paper; sharp pencils; pens; labels; string; eraser; scissors or penknife; permanent marker pens; supply of clean glass jars (25–100 ml capacity) with perforated and unperforated aluminium foil-lined screw-caps; supply of polyethylene bags, 25 x 50 cm, or similar; supply of dilute (8–9%) formalin solution in a clean container; disposable gloves; metal tongs or forceps; sharp knife or scalpel; cotton wool; cool-box where available or a strong sample box to contain the sample vessels with appropriate packing (cardboard or foam rubber) to prevent glass jars being damaged or broken during transit.

Thoroughly check all equipment before you go into the field.
Select the sampling site and mark the site plan for future reference.
Wear protective clothing when collecting samples in pesticide-treated areas.

Method

- Capture the specimen by appropriate means (see chapter 8) and transfer to a suitable size aluminium container.
- Prepare a label including all sample details and put the label inside the canister with the sample. Fit the appropriate screw-cap (perforated for live insect samples, to allow ventilation or without perforation if the specimens are to be preserved in formalin or kept dry and frozen. Label the outside of the canister with the appropriate sample details or sample code.
- Where the sample is preserved in formalin, place the sample container inside a polyethylene bag and prepare and insert a second, identical label. Seal the bag with a wire tie.
- Record all sample details on the prepared data sheets (see page 143).
- Pack the samples into the sample box.
- In particularly hot climates, large specimens should have an incision made in the abdominal wall and the whole sample then immersed in formalin contained within a screw-capped jar. The jar should be placed within a polyethylene bag which should be sealed with a wire tie. Each sample jar should contain a paper label, written in pencil, and the outer polyethylene bag should contain a second, identical label.
- Disposable gloves should be worn when handling the formalin solution. The gloves should only be used once and then removed; fresh gloves should be worn for each sample handled.
- Clean any equipment used to sample or handle the invertebrates between samples, using detergent and water, rinsing thoroughly in clean water and finally in acetone.

OTHER CONSIDERATIONS

Always collect samples in unsprayed areas first; pesticide-treated areas later.
Where a cool-box is available, it should be used to transport the samples whilst in the field. On no account should the collected samples be exposed to direct sunlight or extremes of heat.
Where possible, keep the samples chilled (e.g. in a refrigerator) whilst awaiting transportation to the analytical laboratory.
Used disposable gloves should be sealed in a labelled plastic bag, until proper disposal can be organized.

Soil nitrification

DON'T FORGET

EQUIPMENT: Spade; 2 mm sieve; 500 ml plastic food containers and lids x 50; aluminium foil; plastic bags for soil sample; plastic funnels; filter papers; portable balance; distilled water; squeeze bottle; thermometer (0–50 or 100 °C); millivolt meter; nitrate and reference electrodes; standards; buffer; polythene sheet; pencil and paper; oil/water-sensitive papers; permanent marker pen.

A composite soil sample is required that is representative of soil in the treatment area. Ensure the soil type and cover vegetation is the same before digging sub-samples at bullet point 1. If there are distinctly different soils present in the treatment area, either choose the dominant type (recommended) or decide to test more than one soil.

Method

- Dig 1 kg surface soil (0–5 cm deep) from 10 sites in the area to be sprayed. Remove vegetation/roots before passing through a 2 mm soil sieve. If wet, air-dry soil a little until it can be sieved. Mix the samples together to produce a composite sample.
- Weigh 100 g soil aliquots into 40 pre-weighed plastic food containers and fasten lids. Double bag 1 kg of composite soil to assess later the texture, pH and water-holding capacity.
- Determine the soil moisture and water-holding capacity of the soil using the method sheets from chapter 5. Calculate 70% of water-holding capacity (water-holding capacity in g x 0.7).
- Wet the soils in the food containers with a solution of ammonium sulphate¹ to bring the nitrogen amendment to 100 µg NH₄-N g dry weight of soil and the soil moisture to 70% of field capacity. Now make a note of the soil weight plus container and write it on the container (not lid) in permanent marker pen.
- A short time before spraying, place 40 containers at sites within the area to be sprayed. This might be between crop rows or in the open if spraying is aerial. Arranging them in clusters of 4 is convenient for handling and logistics – perhaps 1 m apart. Also place magnesium oxide slides or water/oil-sensitive papers around each cluster of containers.
- Just before spraying remove the lids of half of them (20). Those with their lids left on (20) are designated the controls and are marked as such. In the absence of shade, place aluminium foil on the lids of the controls to reduce the heating effect.
- Replace lids as soon as possible after spraying – magnesium oxide slides and papers should show droplet deposition and confirm soils contaminated with pesticide (see chapter 4 for method to count droplets) – to reduce evaporation of soil water and bring samples to the field camp or laboratory.
- Place all the containers with their lids removed in a stout cardboard box lined with a polythene sheet. Place a few containers of water in the box to increase the relative humidity and locate the box(s) in the shade.
- Adjust soil moisture gravimetrically in all containers *daily* by placing containers on a balance and dropping water (evenly) on to the soil until the weight at fourth bullet point is reached.
- Incubate soils for up to 50 days (depending on ambient temperature) and destructively sample four treated and four controls at, e.g. days 0, 10, 20, 30 and 40. The cooler the temperature the longer the sampling period.
- Before extracting NO₃-N from soils, weigh the container and soil and then mix soil with a spatula or spoon. Take 50 g sub-samples from each of the replicates, place in a bottle and shake for 30 s with 100 ml of deionized/distilled water. Allow to settle for 30 min before repeating shaking and settling. Shake and settle a third time, then take 10 ml of supernatant and mix it with 10 ml of 2M (NH₄)₂SO₄ – an ionic strength adjustment buffer or ISAB². This is the sample that will be measured by the ion-selective electrode. Make sure your samples are labelled at all stages.

- Prepare a series of $\text{NO}_3\text{-N}$ standards³ (from 1 to 100 ppm) to calibrate the ion-selective NO_3 electrode coupled with a double junction reference electrode. Take 10 ml of each standard and add 10 ml ISAB prior to calibration. Standards and samples must be at the same temperature for measurement of millivolts (store samples and standards in a tray of water if in the field). Read off the millivolts and plot mV against concentration of the standard and then calculate the nitrate in samples as $\mu\text{g NO}_3\text{-N/g}$ dry weight of soil. Wash electrode between samples with distilled water. It does not matter if the measurement differs at the next sampling interval, which may be 10 days later, provided all samples and standards are at the same temperature when they are measured.
- Recalibrate the electrode at every sampling period, discarding the standards unless they were refrigerated.
- Average the controls and treatments for each time interval and graph the results of control and treatment as cumulative $\text{NO}_3\text{-N/ g}$ dry weight of soil against time in days (x axis).

Notes

¹ Ammonium sulphate for nitrogen amendment: dissolve 4.716 g of dry $(\text{NH}_4)_2\text{SO}_4$ in 1 litre of water. If 10 ml of water is required to bring the 100 g soil sample to 70% field capacity in step 3, then using 10 ml of the $(\text{NH}_4)_2\text{SO}_4$ solution to wet the soil will provide 47.16 mg $(\text{NH}_4)_2\text{SO}_4$, i.e. 10 mg $\text{NH}_4\text{-N}$ or 100 $\mu\text{g NH}_4\text{-N/g}$ soil.

² ISAB: 2M $(\text{NH}_4)_2\text{SO}_4$. Dissolve 264 g of $(\text{NH}_4)_2\text{SO}_4$ in 1 litre of water.

³ $\text{NO}_3\text{-N}$ standard: 100 $\mu\text{g NO}_3\text{-N ml}^{-1}$. Dry pure KNO_3 , weigh out 0.722 g and dissolve in deionized water and dilute to 1 litre in volumetric flask. Keep cold (may last 1 month) otherwise make up fresh. Make 1, 5, 10 and 50 $\mu\text{g NO}_3\text{-N}$ standards by pipetting 0.5, 2.5, 5 and 25 ml of this standard into labelled volumetric flasks (50 ml) and making up to volume. Take 10 ml of each standard, add 10 ml ISAB and measure the potential in mV. Plot on a semi-log paper to obtain a more or less straight line.

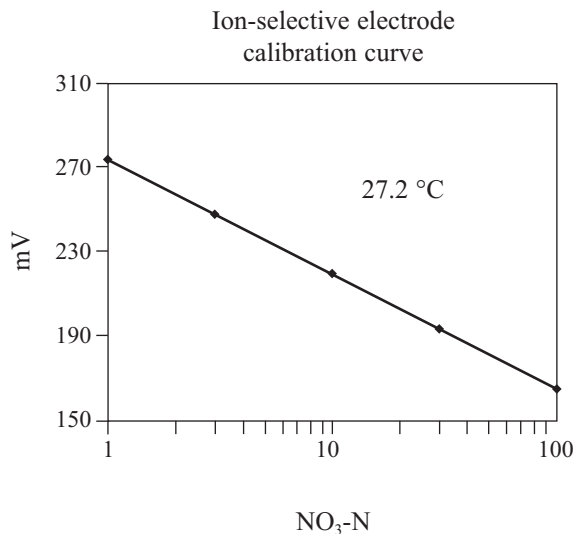

Soil respiration (long-term *in situ*)

DON'T FORGET

EQUIPMENT: Plastic bags for soil sample; distilled water; squeeze bottle; thermometer; catering size coffee cans (approximately 25 x 28 cm); screw-cap glass jars (6 x 7 cm) with air-tight lids; wire tripod; hatchet; aluminium foil; cardboard boxes; notebook; permanent marker pen; 1N NaOH.

Barium chloride is poisonous – do not pipette by mouth.

Try to match the sites as closely as possible in terms of soil type, surrounding vegetation and cover (see text in chapters 1 and 7 matching sampling sites).

Method

- Choose 5–10 matched sites for the long-term measurement of soil respiration in each of the treated and untreated areas.¹
- When at each site (not in advance) carefully pipette 20 ml (use a pipette bulb) of 1N NaOH into a glass jar placed on a wire tripod that holds the jar off the ground by about 2 cm (see inset). Place the coffee can over the jar and grind it into the soil to a depth of about 2 cm. If the site is exposed to direct sun, provide shade with a twig and grass roof or aluminium foil folded around cardboard and placed on top of the can. Note the time and allocate a site number in a notebook.
- At the same time, set two jars of NaOH inside identical but sealed coffee cans (the plastic lids are normally sufficient but a really good seal can be achieved by smearing silicone grease around the edge of the lids). Expose them under the same conditions as they will act as controls for the measurement of carbon dioxide in air trapped initially within cans.
- Return after 24 h, carefully lift the cans from the soil and collect the jar of NaOH. Cap with an air-tight lid, number the jar (not the lid) with a permanent marker pen and note the exposure time. Store the jar carefully for transport to the camp or laboratory.
- Re-set the monitoring apparatus a short distance away from the previous sites to continue monitoring over a fixed period, e.g. day 1, 2, 3, 5, 10, 20 and 30 after spraying.
- Using a Pasteur pipette, add enough 3N BaCl₂ to the NaOH solutions in the jars to precipitate BaCO₃ (a white precipitate) and then add a few drops of phenolphthalein (coloured indicator). Titrate the NaOH *slowly* with 1N HCl while swirling the jar gently taking care to avoid contact of the acid drops with the precipitate (the BaCO₃ precipitate must not dissolve). Note the titration point where the indicator changes colour.
- Calculate the carbon dioxide released from the soil using the formula:

$$\text{mg CO}_2 = \frac{(\text{ml HCl titrated for sealed cans} - \text{ml HCl titrated for cans exposed to soil})}{\text{I (normality of acid)} \times 22 \text{ (equivalent weight of CO}_2)}$$

$$\text{then convert to mg CO}_2 \text{ m}^{-2} \text{ h}^{-1} = \frac{\text{mg CO}_2 \times 10,000 \text{ cm}^2}{\text{area of soil enclosed (cm}^2) \times \text{hours of exposure}}$$

- Calculate the mean respiration rate (+/-SE) for replicate samples and graph the results of carbon dioxide released against time (x axis).

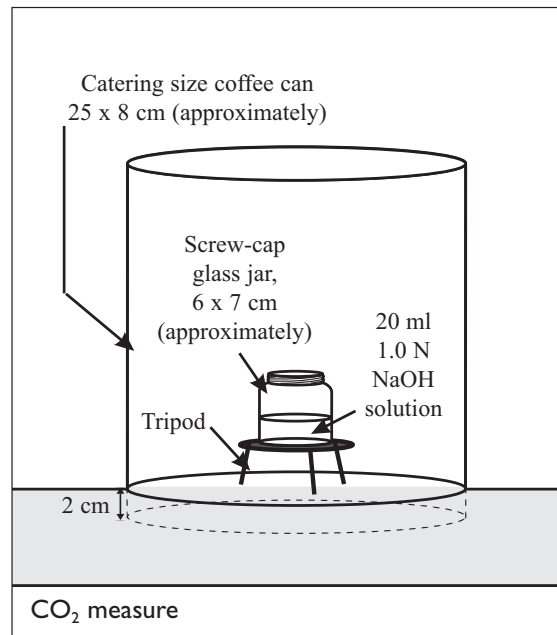

OTHER CONSIDERATIONS

¹When choosing sites, ensure that you enclose similar areas of ground avoiding roots of trees, grass and other vegetation (in crop areas place between plants), ant and termite holes. Never repeat in a short space of time at the same place.

Reagents:

N NaOH Dissolve 40 g of NaOH in 500 ml H₂O and dilute to 1 litre

N HCl Dilute 83 ml of concentrated HCl (37%) in 1 litre of H₂O

3N BaCl₂ (poisonous) Dissolve 31 g of anhydrous BaCl₂ in 100 ml of H₂O

Phenolphthalein: 1 g in 100 ml 95% ethanol.

Carry all reagents in secure containers – plastic is best for these – check lids!

Soil respiration (semi-continuous)

DON'T FORGET

EQUIPMENT: Spade; 2 mm sieve; 500 ml plastic food containers and lids x 50; aluminium foil; plastic bags for soil sample; portable balance (200 g); distilled water; squeeze bottle; thermometer; 0.5 mm sieve or pre-weighed straw material; Draeger tubes (0.02–0.3% CO₂) and bellows; modified lid for measurements; permanent marker pen; stop-watch or wrist-watch with minute hand.

A composite soil sample is required which is representative of soil in the treatment area. Match the soil type and surrounding vegetation before digging sub-samples at first bullet point. If there are distinctly different soils present in the treatment area, either choose the dominant type or decide to test more than one soil.

Method

- Dig 1 kg surface soil (0–5 cm) from 10 sites in the area at risk from pesticide, mix them together and remove vegetation/roots before passing through a 2 mm soil sieve. If too wet, air-dry until it can be sieved.
- Weigh 100 g aliquots into 40 pre-weighed food containers and apply lids.
- Double bag 1 kg of soil to assess soil texture and measure pH either in the field (see method sheets for chapter 5) or on return to the laboratory.
- Determine the soil moisture and water-holding capacity using the method sheets in chapter 5. Calculate 70% of water-holding capacity (water-holding capacity in g x 0.7).
- Add 0.5 g of dry organic matter amendment (typically dried grass) (see page 154 of chapter 7) milled to pass through a 0.5 mm sieve to each soil aliquot and mix thoroughly.
- Bring the soil moisture to 70% of field capacity by slowly adding distilled water. Now make a note of the soil weight plus container and write it on the container (not lid) using a permanent marker pen.
- A short time before spraying, place 40 containers at sites within the area to be treated. These can be placed in clusters of 4 or spaced more widely over the treated area. Also place water/oil-sensitive papers around each container to estimate pesticide deposition. Just before spraying remove the lids of half of them. Those with lids are designated as the 'controls'. In sunlight, place aluminium foil on the lids of the controls to reduce the heating effect.
- Replace lids soon after spraying to reduce evaporation noting which were exposed (write 'exposed' on the containers) and bring samples to the field camp or laboratory.
- Collect the oil/water-sensitive papers but do not touch their surfaces (see chapter 4 for method used to count droplets).
- Place all the containers with their lids loosened (to allow exchange of air) or removed in a stout cardboard box lined with a polythene sheet to reduce evaporation (incubator). Place a few containers of water in the box to increase the relative humidity and locate the box(es) in the shade.
- Adjust soil moisture gravimetrically in all containers every other day by placing containers on a balance and dropping water (evenly) on to the soil until the weight stated at fifth bullet point is reached. Incubate soils for up to 30 days and measure the carbon dioxide produced (at same time of day) at days 1, 5, 10, 20 and 30 (approximately).
- To measure carbon dioxide, remove a container from the incubator, weigh it to calculate moisture content and then fit a modified lid (see inset) which allows a thermometer access to take soil temperature and air to be sucked over the soil into a Draeger gas analysis tube. Fit the plastic tube to the bellows and pump through 1 litre of air (10 strokes) before snapping off the glass tip (take care) of a 0.02–0.3% carbon dioxide gas tube and placing the plastic tube over the cut end and the other end into the bellows. **Tip:** *Two containers can be linked together with a glass T-piece for this measurement if two special lids are made. This helps to increase the carbon dioxide concentrations when soil respiration rates are naturally low.*
- Draw air into the gas tube by squeezing the bellows *fully* and releasing *fully* 20 times (2 litre), noting the time on a stop-watch at the start and finish, and reading and noting percentage volume of carbon dioxide from the colour development against the scale on the tube. Reset the pump counter, replace the gas tube and start the next container(s).

- Every two or three samples, fit a new tube and measure the ambient carbon dioxide concentration and temperature of the air (about 1 m height). When measured at this frequency, air and drawn air temperatures are roughly equal.
- Calculate the respiration rate of soil in each container using the formula:

$$\frac{\% \text{ vol CO}_2 \text{ in sample} - \% \text{ vol CO}_2 \text{ in air} \times \text{vol air drawn through}}{100 \times \text{time taken to draw air (s)} \times \text{g dry weight soil}} \times 3600 = \text{ml CO}_2 \text{ g dry weight soil}^{-1} \text{ h}^{-1}$$

- Correct for STP (standard temperature and pressure):

$$\frac{\text{ml CO}_2 \text{ g dry weight}^{-1} \text{ h}^{-1} \times 101.3 \times 273}{101.3 \times (273 - \text{temperature of soil})}$$

- Once the volume is corrected to STP, multiply by 1.96 to obtain respiration rate in mg CO₂ g dry weight⁻¹ h⁻¹.
- Calculate the mean respiration rate and standard error of four treated and untreated samples (replicates) for each respiration sampling period and plot the results against time (x axis).

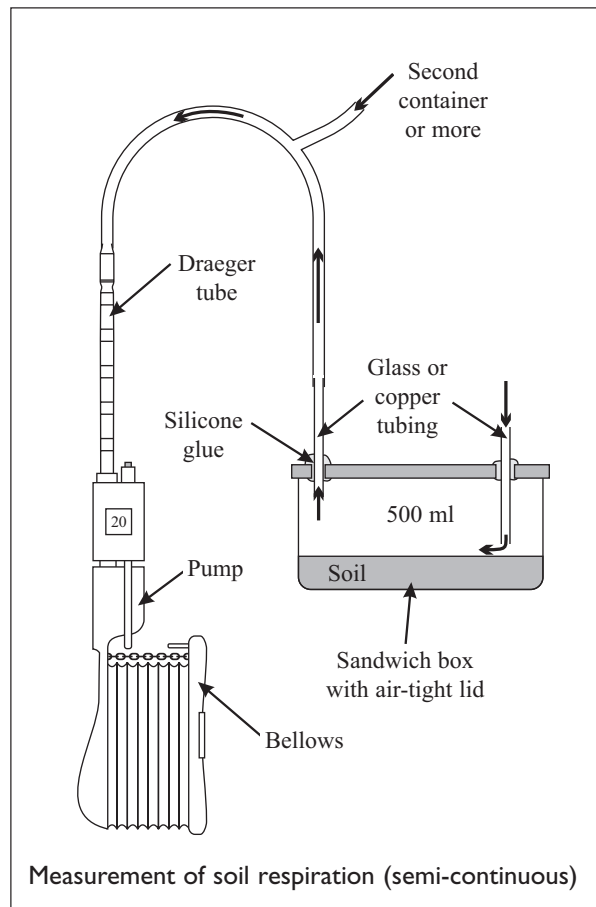

Earthworm activity estimation

DON'T FORGET

EQUIPMENT: Trowel or spade; tape measure; string (50 m); pencil and paper; plastic bags; plastic bottles; random number tables or calculator.

Standardize the time of day when counts are made.

TRANSECT METHOD

Method

- Identify possible routes for transect lines in treated and untreated areas, selecting ease of access, areas of similar vegetation, slope and general habitat for matching transect routes. Transect lengths will be determined by the size of planted areas in crop land but 10–20 m is a reasonable length in planted fields.
- Use a tape measure or string to lay a straight line, randomizing the starting location of the possible transects.
- Select five to ten m^2 areas to sample for earthworm casts at random intervals along the whole length of the transect line (use random number table or calculator function). When selected, measure and mark the sampling areas to the side of the transect (to prevent walking over them) with string or sticks.
- Count the number of earthworm casts within the sample area and where cast types of different worms are recognizable, count by cast type. Note the numbers on paper against their position along the transect. Also record the weather conditions and time of day.
- Remove or smooth out the casts with the trowel after they are counted.
- Count casts again at anything from 2-day to weekly intervals.
- Take small (200 g) soil samples from plots after observations and keep in sealed, labelled plastic bags for later pH and soil moisture determination.

QUADRAT METHOD

Method

- Where vegetation or crop spacing will allow it, throw 0.25 or 0.5 m^2 quadrats at random up to 10 times (successful landings) in treated and untreated areas. Then follow the same procedures from fourth bullet point of the transect method.

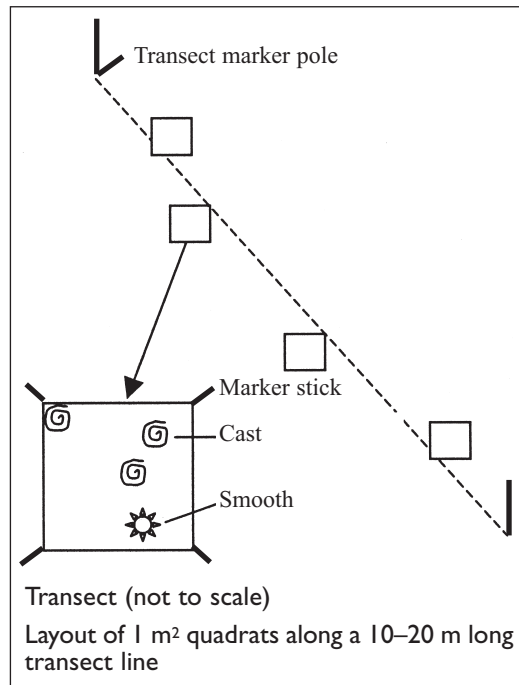

OTHER CONSIDERATIONS

Option: collect and weigh the casts (soil dry weight) to determine the turnover of soil if a long series of observations are planned (e.g. whole season).

Determine the sampling intervals from the relative severity of the pesticide impact on casting.

Express the results as mean number plus standard error of casts per $\text{m}^2 \text{ day}^{-1}$ or other comparable interval. Statistically test for differences between contaminated or treated sites and untreated/uncontaminated sites.

Plot the results of cast rate against time, and percentage soil moisture on the same graph.

Earthworm population estimation

DON'T FORGET

EQUIPMENT: Soil corer; trowel or spade; tape measure; 40% formalin; pencil and paper; rubber gloves; plastic bags; plastic bottles.

Read chapter 3 about how to safely handle formalin.

FORMALIN DRENCH

Method

- Mark out between 5 and 10 sample sites within the treated and untreated areas. Sample size should be about 0.05 m²; size is not critical but standardization of size between sites is. A cylinder of the approximate area can be used to mark the soil at selected sites. In each area to be sampled, dig some soil (200 g) with a trowel, bag in plastic and determine the soil pH and moisture level on site or later in a laboratory.
- Make up the formalin solution carefully (wear rubber gloves and do not splash on skin) by adding 20 ml 40% formalin to 4 litres of water (or 25 ml in 5 litres, 50 in 10 litres, etc.) and mix thoroughly. Measure 300 ml using a graduated cylinder or tin can and pour the diluted formalin evenly over each marked site.
- Collect the worms that emerge. Emergence time varies with soil moisture, earthworm density and proximity to the soil surface: collect at regular intervals (e.g. 15–30 min in moist, organic soils). Place in a plastic bottle labelled with the site name and sample number and add a few millilitres of drench to preserve if processing is not done on site.
- Repeat the drench after worms stop emerging to collect those burrowing deeper in the soil, particularly in drier soils. Sample earthworm populations in the area every 10–14 days, especially when the impact of persistent pesticides like DDT and soil sterilants is being investigated. Do not revisit exactly the same area that was drenched at a previous sampling event.
- Sort the worms into morphospecies and count (seek assistance with taxonomy later). Relate counts to surface area of soil.

SOIL CORES

Method

- Take 15–20 soil cores in treated and untreated areas using a steel soil corer to a depth of about 30 cm. Take the cores at random within a sample site.
- Extrude the soil from the corer into a plastic bag if not sorting on site and label (pencil on paper with site name and core number, date, etc., inside the bag).
- Sort the soil on a tray by eye, separating worms into 'morphospecies' groups before counting or weighing. Relate counts to soil volume sampled (density).
- Repeat population estimates every 10–14 days.

SOIL PITS

Method

- Digging soil pits is an alternative to taking cores. Mark out ten 25 x 25 cm plots at random in each treated and untreated area and remove soil with a trowel or spade to a depth of 30 cm (or as required), placing the dug soil in a plastic bag(s) and labelling as described at formalin drench bullet point 3 above.

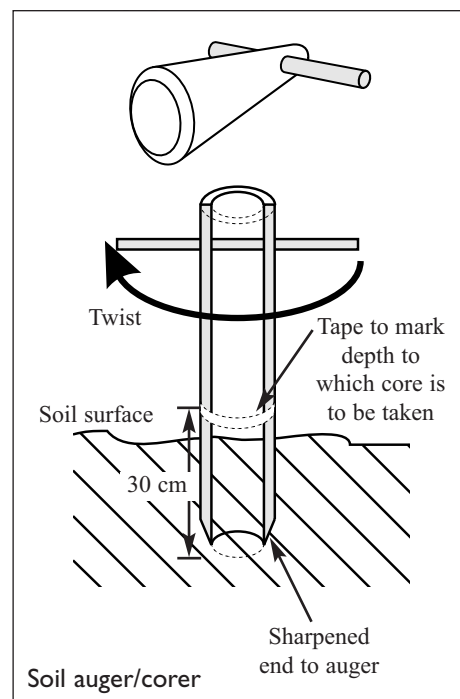

- Sort the bagged soil by eye on a white tray and separate and count the worms according to type. Express the result as a density (soil volume or surface area).
- Determine the soil pH and moisture content from some of the bagged soil.
- Repeat population estimates every 10–14 days.

OTHER CONSIDERATIONS

A soil corer can be made from 4–6 cm steel water pipe, with the cutting edge sharpened. A larger diameter corer (10 cm+) is preferable.

The formalin drench will kill vegetation so use carefully between crops.

Do not dispose of surplus drench in pools or watercourses.

In drier soils treat larger areas, such as 1 m² samples, with 10 litres drench.

Take soil pH and moisture content of bagged soil soon after sampling (within 1–2 days).

Soil algal cover

DON'T FORGET

EQUIPMENT: Quadrat; tape measure; string (50 m); pencil and paper; plastic bags.

Transect lines: number the ends of the possible transect lines – there could be many more than the three shown.

Using random number tables or picking the numbers out of a bag will decide which transect and end to begin. Stopping points along the line can also be generated using tables, assigning distance walked in metres between points.

Method

- Identify possible routes for transect lines in treated and untreated areas, selecting ease of access, areas of similar vegetation, shade and general habitat. About 20–100 m is a reasonable transect length in woodlands and grasslands. Number a few starting points and select the starting location from a table of random numbers. Use a tape measure or string to lay a straight line, using occasional sticks to mark the line (if the string is shorter than the transect line).
- Walk along the transect line stopping at 10 random intervals to place a 1 m or 0.5 m² quadrat to the right side of the transect line (thus forming a belt transect). Ideally the quadrat should be divided into 100 grid squares using tacks and nylon line (see inset).

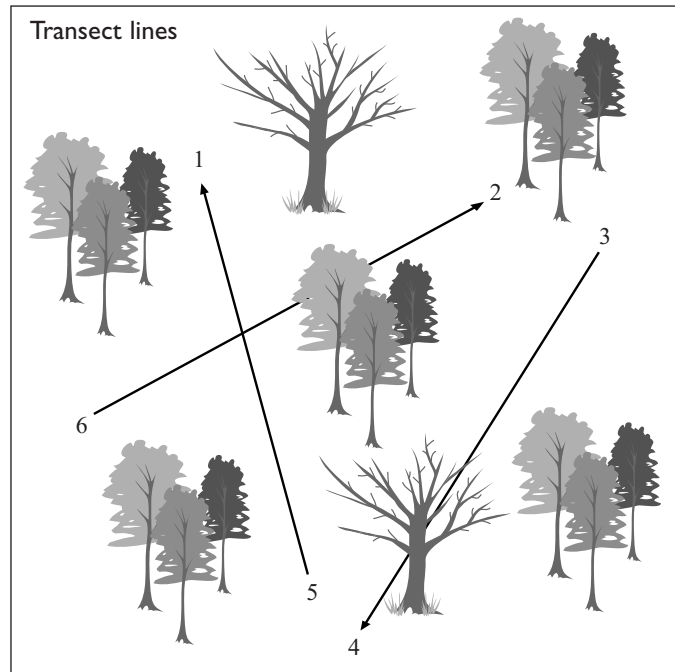

Mean algal cover approximately 50% in these four squares

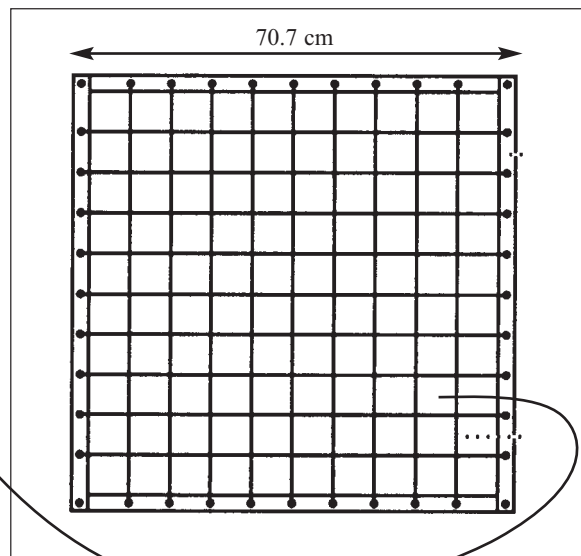
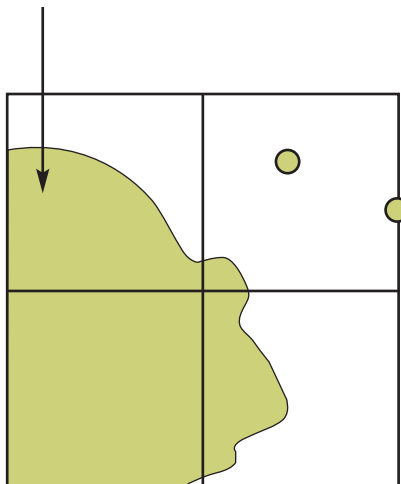

Grid square divisions on quadrat

- Assess and note the relative amount of shade from tree canopy, shrubs and open area at the transect points (see method sheets in chapter 5).
- Estimate the percentage cover of algal crusts on the soil using the grid squares: on sandy soils they show up as dark green to black patches. In open savanna grassland, algae may grow just below the surface of sandy soil, showing up as light to dark brown stains.
- Express the results as percentage cover histograms.
- Take samples back to a laboratory in a plastic bag for confirmation of algal presence by examination under a microscope. Wet the sample and leave in the light for a day or two before preparing a slide. Smear the algae very thinly over the surface of the slide, add a cover slip and examine under a high power microscope. Seek the aid of a soil microbiologist or botanist if you cannot recognize algae. It is not necessary to identify them to species.

Litter bags (microbial decomposition)

DON'T FORGET

EQUIPMENT: Litter bags; wire; pliers; spade; pick axe; notebook; pencil; labels; thick plastic bags; tape measure; permanent marker pen; paint and paint brush; marker flags or stakes.

IN ADVANCE OF MONITORING EVENT

- Cut out and sew a number of plastic mesh bags leaving one end open (50 per mesh size; see inset). Mesh should be selected to fall near the ranges described in the section 'Litter Bags' (see chapter 8), i.e. approximately 4 mm, 600 μm and 10 μm .
- Collect freshly fallen leaf litter, if available, from an untreated area after ensuring that the vegetation type is representative of the treated area. Air or oven-dry leaves (60 °C) to constant weight before removing stalks and weighing 3 g dry weight portions of dry material into the mesh bags. (If prior warning of monitoring need is too short, fresh material will suffice but measure its dry weight later.) Fill at least 20 bags of each mesh size for each treated and untreated area and sew or staple the open end.

Method

- Select five sites for the placement of bags in both treated and untreated areas, broadly matching the vegetation type between sites. Use random number tables to allocate sites and bury four bags of each mesh size horizontally in the soil at a depth of 1–3 cm at each site. Space the bags within a short distance of each other and not on top of each other (total of 120 bags). Replace the soil on top of the bags. Alternatively cut slits in the soil with a spade and insert bags vertically into the crevices, covering and tamping down the soil. Bury a few spares close by, but not in the same holes/crevices (to avoid disturbing others when dug up) to gauge the decomposition rate (see below).
- Carefully map the position of the bags in the soil as they are buried using a tape measure to measure distances from natural features (e.g. mark rocks or trees with paint). In open grasslands hammer in stakes or use piles of stones (but these may get removed); a GPS will be useful in finding these markers again.
- Leave litter bags in place from 2 to 3 months in cultivated and moist areas (or wet season) to 2 years in semi-arid environments. **Tip:** Remove a few of the spare litter bags at experimental intervals to gauge the rate of decomposition.

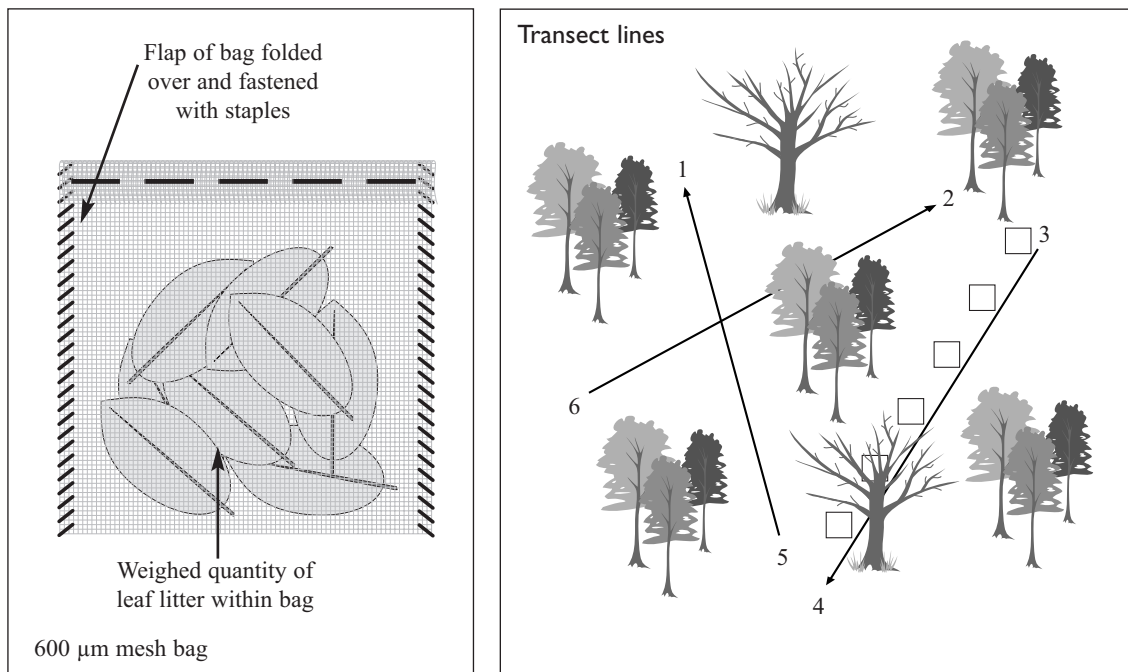

- At designated time locate the sampling site and dig a shallow trench around the area, leaving plenty of space around the buried bags to avoid damage by shovel or pick. Carefully remove the soil until the litter bags are located, remove bags from the soil (as quickly as possible if combining with a study of invertebrates) and place in a plastic bag, label and fasten using a knot or wire twist. Mark each plastic bag with site number, litter bag number, mesh size, collection date and also put a label, written in pencil, with the same information inside the bag.

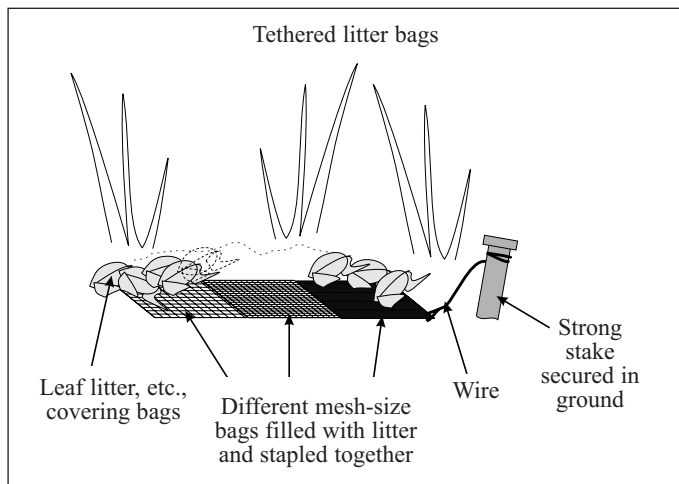

- Process the litter bags as soon as possible. Rub off soil adhering to the outside of the litter bags then sun-dry the bags to constant weight (if in camp – a day in full sun) before re-bagging – do not confuse the labels! If returning to a laboratory, oven-dry at 60 °C to constant weight, then place the contents in a sieve (0.5 mm aperture) to separate the remaining organic material. Remove grass roots that may have grown into the bag and discard, shaking the remaining soil through the sieve rather than applying pressure, as fine organic debris is easily pushed through). Oven-dry the organic material retained by the sieve at 105 °C for 12 h to remove further moisture. Cool, desiccate and weigh the litter. Treat sun-dried litter in the same way.
- Subtract the dry weight of organic matter from the dry weight of the original material and express the difference as percentage degraded.

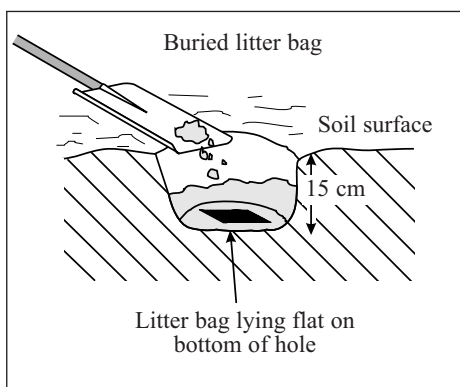

OTHER CONSIDERATIONS

If using large mesh bags (>10 μm) refer to section on litter bags in chapter 8 to accommodate the influence of invertebrate activity.

Sweep netting

DON'T FORGET

EQUIPMENT: Sweep net or butterfly net; spare bags for net; watch or stop-watch; plastic bags; permanent marker pen; bucket, box or basket; marker flags; pyrethroid insecticide spray; notebook.

Check the net for holes, tears, etc., and repair before leaving for field sampling. Carry out transects at set times of the day (e.g. 10.00–12.00 h). Sweep a minimum of 10 transects per treatment area. Select sampling sites using random number tables.

Method

- Mark the plastic bag with the site name and/or number, the date and time, and the sampler's name, using a permanent marker.
- At sample site check the net for holes, tears, etc., and that joints in the frame, etc., are tightly joined.
- Select a suitable landmark (e.g. a bush or termite mound) or push a stick or flag into the ground, and pace a set distance (e.g. 50 m) from the marker. Alternatively, sweeping can be carried out for a set time period (e.g. 3 min) or for a set number of sweeps (e.g. 50, 100).
- Take 4 or 5 paces to one side, before walking back towards the marker, sweep sampling as you go.
- Walk at a constant, steady speed, repeatedly sweeping the net from side to side through the vegetation (to cover an area of approximately 1 m on either side) until you reach the marker. Keep the height of sweep through the vegetation, the vigour of the sweep and the speed of the sweep constant throughout the transect.
- At the end of each transect, fold the net over to prevent escape of the catch and/or clasp the bag as near to the frame of the net as possible, leaving the catch free to move in the remainder of the bag.
- The catch should be transferred to a plastic bag and the top tied for storage until the catch can be sorted, identified and counted. **Tip:** If necessary, a little pyrethroid insecticide from a spray-can may be used to knock-down the catch, enabling easy transfer to the plastic bag.
- Note any important information, e.g. unusual weather (high wind speed, rain, etc.), overrun of time, vegetation type, etc., to aid future interpretation of results.

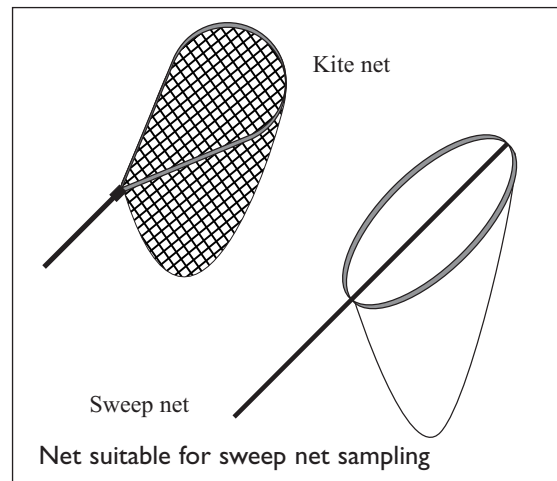

Arrangement for typical sweep net sample transect

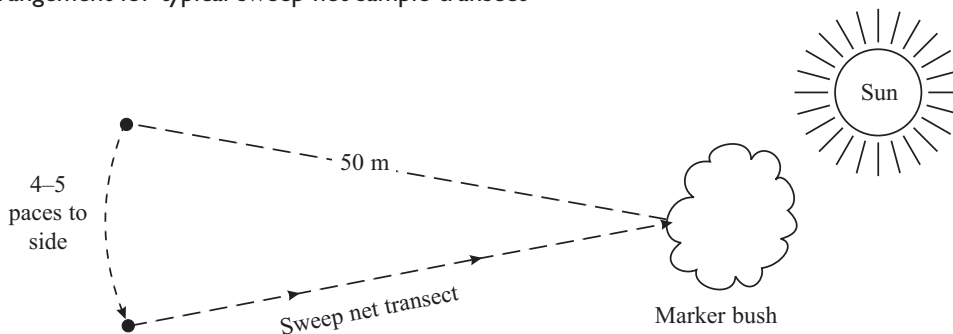



Sweep net sampling in progress

This method may also be used on trees and bushes, but a stronger mesh net *must* be used. The net should be swept repeatedly through the foliage either for a set time period (e.g. 3 min) or for a set number of sweeps (e.g. 50).

OTHER CONSIDERATIONS

Only carry out sweep net sampling in dry conditions.

The vigour of the sweep through vegetation should be kept as constant as possible, as this can affect the fauna caught.

The height at which the net is swept through the vegetation should also be kept constant. Again this can affect catch composition.

When selecting the direction in which to walk, always attempt to carry out sweeping into the sun. Shadows are then cast behind and will not cause flying invertebrates to escape as you approach.

The distance swept may be varied depending on vegetation and the invertebrate fauna of interest.

If using insecticide to knock-down catch, ensure that no insecticide is sprayed into sampling area, i.e. always contain sweep net in something (e.g. plastic bag) before spraying. Also, **do not** use spray, if samples are for residue analysis.

Do not use this method to sample spiky or thorny vegetation of any kind.

Night sweeping is beneficial for sampling some groups, e.g. grasshoppers. **Beware snakes!**

Pitfall trapping

DON'T FORGET

EQUIPMENT: Permanent marker pen; marker flags; plastic drainpipe; trap containers (plus spares); lid for trap containers; preserving fluid; trowel; trap covers; forceps; paintbrush; notebook; box for transporting traps; pencil; paper.

Trap size and type must be identical for all sample sites as must preserving fluid and dilution.

Trapping period must be the same for all sample sites.

Bury traps so that lip is absolutely level with ground surface.

Set a minimum of 20 traps per treatment area; 50 is ideal.

Select sampling sites using random number tables.

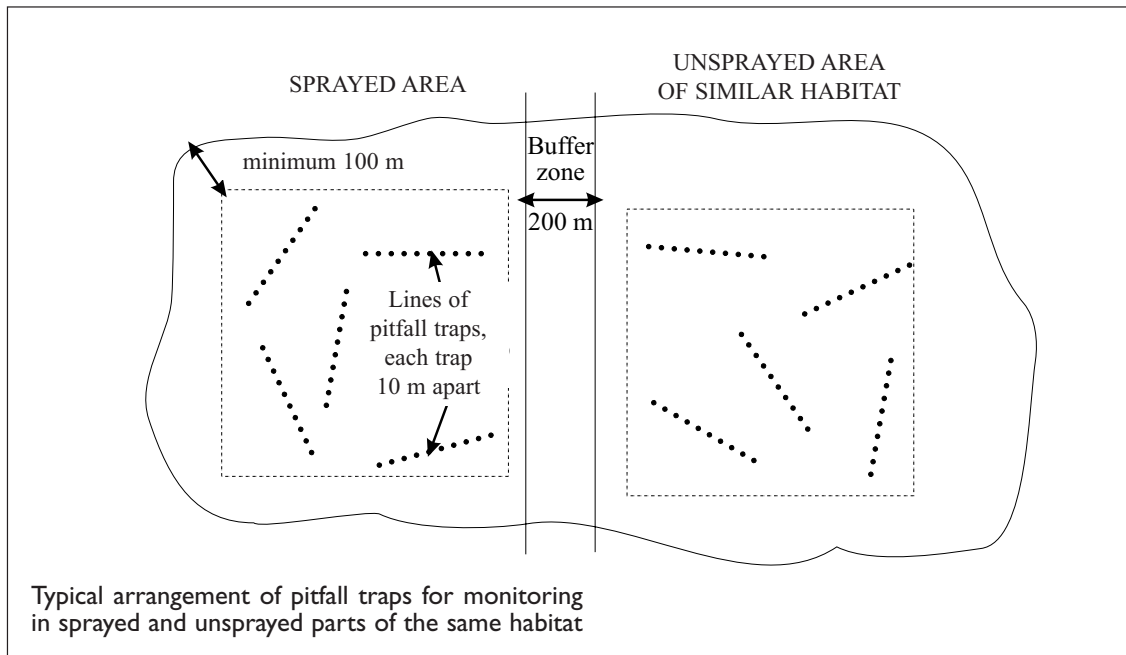

Method

- Dig a hole in the ground with a trowel or spade and sink the plastic drainpipe, standing vertically, so that the top is just below the soil surface and firm in place well.
- Mark the outside of the trap container with the site number and trap number and the date. Slip the trap container into the drainpipe and half fill with preserving fluid. Smooth the soil around the lip of the trap so that there is a slight slope down to the trap and that there are no obstructions (e.g. the lip of the trap, etc.) impeding the invertebrates from falling into the trap. Mark the position of the trap with a marker flag placed nearby or note a nearby landmark (termite mound, bush, tree, etc.). **Tip:** *If it is the rainy season, it may be necessary to put the trap on top of a slight mound (artificially constructed if necessary), though still with a slope down to the trap entrance. This will prevent water flowing into the trap and flooding it.*

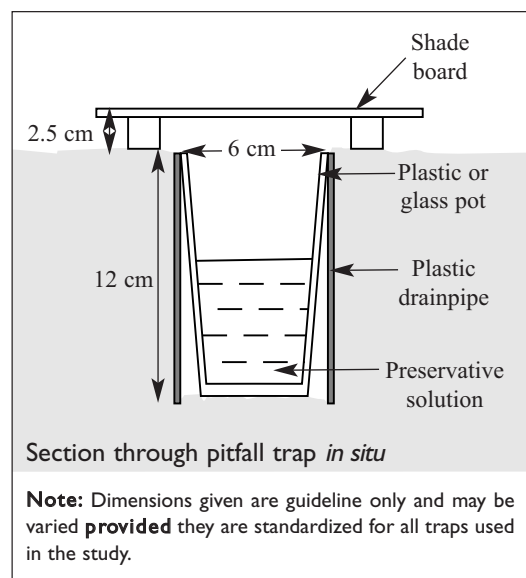

- Leave the trap in position, covered with a shade board, for set time (1 day, 5 days, 1 week, etc.). **Tip:** *Check trap frequently at first to ensure that preservative does not evaporate.*
- On subsequent visits, remove trap container with catch and place a pencil-written label with site number, trap number and date of setting and retrieval, inside the trap. Put a lid on the container. Mark a new container on the outside (as above) and half fill with preserving fluid. Replace in drainpipe sleeve and leave for set time as before.

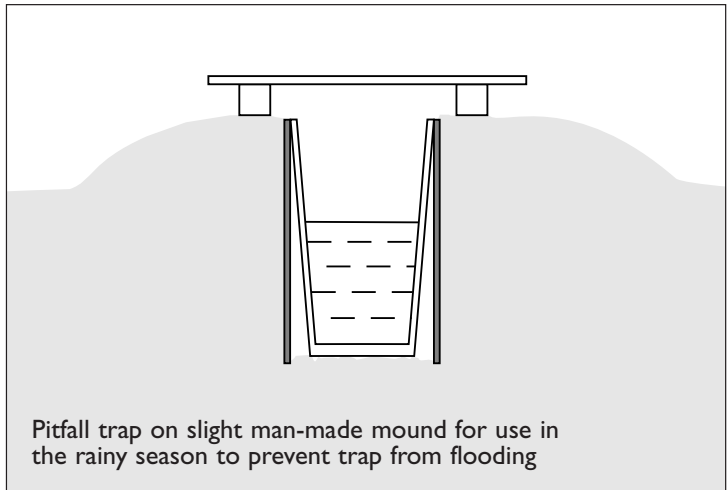

- Whilst emptying and replacing trap, note any important information, e.g. entrance to trap blocked with leaves, trap disturbed by animals, heavy rain caused traps to overflow, trap dried out, etc. This will aid future interpretation of results.
- Note vegetation surrounding trap.

OTHER CONSIDERATIONS

Avoid clearing vegetation around trap site unless absolutely necessary.

The vegetation/habitat of sample sites must be the same, as this can affect the catch, even of the same species.

If using traps without preservative, they must be emptied daily or more frequently; even then some predation of small animals is likely and should be taken into account in interpreting results.

If working in extremely wet conditions, it may be necessary to make small holes in the trap to prevent flooding of the trap. Obviously, this is only possible when trapping without preservative and when animals are large enough.

The number, arrangement and distance between traps influence sample size and should be considered in advance to ensure a good catch of the invertebrate fauna of interest. This should then be standardized between sample sites.

Beware of 'digging-in' effects. Immediately after initial placement of traps, very large catches are usual, thus the first week's worth of data are frequently spurious.

This method is good for sampling certain invertebrates and almost useless for others, thus care is needed in interpretation of results.

Food baiting for ants

DON'T FORGET

EQUIPMENT: Permanent marker pen; marker flags; Petri dishes; food baits; teaspoon; hand lens; forceps; pooter; sample vials to fit pooter; paintbrush; notebook; pencil; paper; wire mesh; transparent polythene; clothes pegs.

Bait type and quantity must be identical for all sample sites.

Sampling period must be the same for all treatment areas.

Set a minimum of 5 grids of 10 baits (i.e. 50 baits) per treatment area.

Cover baits with wire mesh to prevent removal by other animals.

During the rains, an additional cover may be necessary to prevent flooding of bait dishes, e.g. transparent polythene.

Select sampling sites carefully, to match sites as closely as possible across treatment areas.

Method

- Select a similar tract of habitat in each treatment area.
- Set several grids of dishes and put equal quantities of food bait on to each dish. A spacing of 5 m between baits, with 10 m between rows is ideal. **Tip:** *Disturb surrounding vegetation, etc., as little as possible whilst setting bait dishes. If it is the rainy season, avoid setting baits in depressions, etc., which may be flooded.*

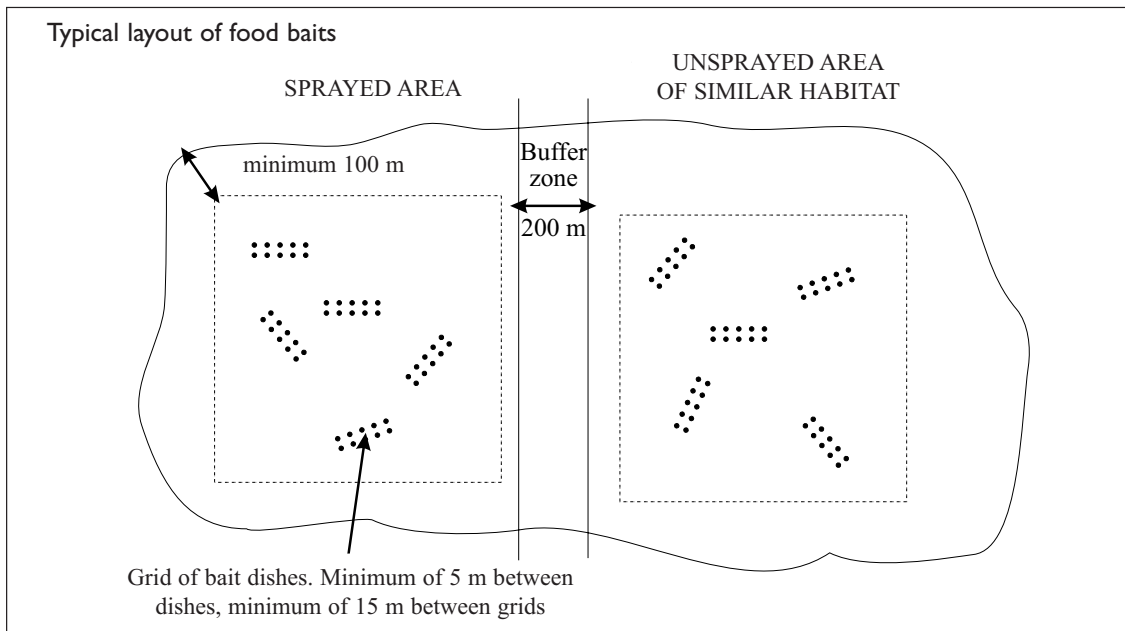

- Fish paste, peanut butter, honey and/or breakfast cereal may all be used as baits, either singly or in separate piles on the dish. Use at least one teaspoon full of bait per dish.
- Cover each bait dish with a piece of wire mesh, bent to form a dome and attached to the ground using staples or bent wire. **Tip:** *If it is the rainy season, cover the top of the mesh with a sheet of transparent polythene held in place with clothes pegs, or with a wooden board on legs, to prevent rain flooding bait dishes.*

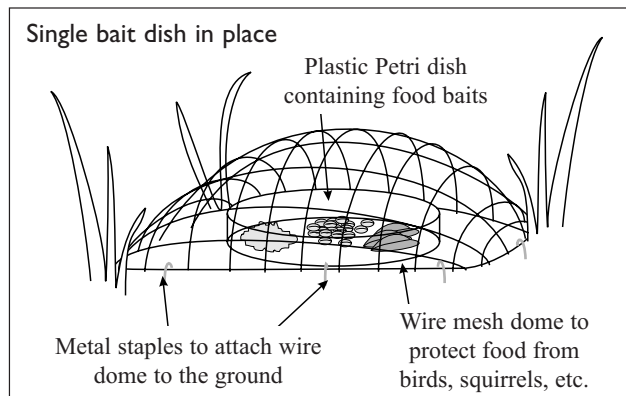

- Leave undisturbed for set periods of time, decided in advance (e.g. 30 min in first instance). Visit regularly, e.g. 30 min, 2 h, 5 h, 7 h and 24 h after setting.
- Visit the grids of baits in the same order in which they were laid out. Count the number of individuals actually found on the bait dishes (if large numbers are present, estimate total number) and identify species using a hand lens. Collect any (using a pooter or paintbrush) which cannot be identified immediately and place in a sample vial with a pencil-written label with site number, bait number and date of setting and retrieval. Fill with alcohol and put a lid on the container. Do not exceed a set time (e.g. 3 min) examining each bait.
- Record the amount of bait (%) remaining at each visit and note any important information, e.g. baits disturbed by animals, etc. This will aid future interpretation of results.
- Note vegetation surrounding each bait grid.

OTHER CONSIDERATIONS

Avoid clearing vegetation around baits unless absolutely necessary.

The vegetation/habitat of sample sites must be the same, as this can affect the ease with which the baits are found, even by the same species.

The number of ant nests and distance between them influences the speed with which baits are found and removed. Any nests seen should be noted along with their position in relation to the baits to aid interpretation of results.

Any observations relating to conflicts between species or between members from different colonies should also be noted.

Baiting should be carried out before and at intervals after spraying, e.g. 1 week, 2 weeks, 1 month and 2 months. Set baits out for standardized period (e.g. 24 h) at each of these sampling intervals.

Baiting for termites

DON'T FORGET

EQUIPMENT: Permanent marker pen; marker flags; soft wood baits; hand lens; forceps; pooter; sample vials to fit pooter; paintbrush; notebook; pencil; paper.

Bait type and quantity must be identical for all sample sites.

If using wooden baits, number and weigh them individually, keeping a record of starting weight on a spreadsheet.

Sampling period must be the same for all treatment areas.

Set a minimum of 5 grids of 10 baits (i.e. 50 baits) per treatment area.

Anchor baits carefully to avoid removal by other animals or by rain.

Select sampling sites carefully, to match sites as closely as possible across treatment areas.

Method

- Select a similar tract of habitat in each treatment area.
- Set several grids of bait boards. Attach the baits to the ground by means of large staples or bent wire, so that they are not easily moved. **Tip:** *Disturb surrounding vegetation, etc., as little as possible whilst setting boards and replace any surrounding vegetation, dead leaves, etc., which were moved aside, to provide shelter around the board. If it is the rainy season, avoid setting boards in depressions, etc., which may be flooded.*
- Leave undisturbed for set periods of time, decided in advance (e.g. 1 week, 1 month). Visit regularly. **Tip:** *If cardboard baits are used, more frequent visits are required (every 2–3 days or weekly). Similarly, baits should be visited more frequently during the wet season than during the dry season.*
- On subsequent visits, monitor the grids of baits in the same order in which they were laid out. Count the number of baits found by termites, the number attacked and the percentage of damage. Count the number and identify species of any individuals actually found on the baits using a hand lens. If large numbers are present, estimate total number. Collect any (using a pooter or paintbrush) which cannot be identified immediately and place in a sample vial with a pencil-written label with site number, board number and date of setting and retrieval. Fill with alcohol and put a lid on the container. Do not exceed a set time (e.g. 3 min) examining each bait.
- At each visit, note any important information, e.g. baits disturbed by animals, etc. This will aid future interpretation of results.

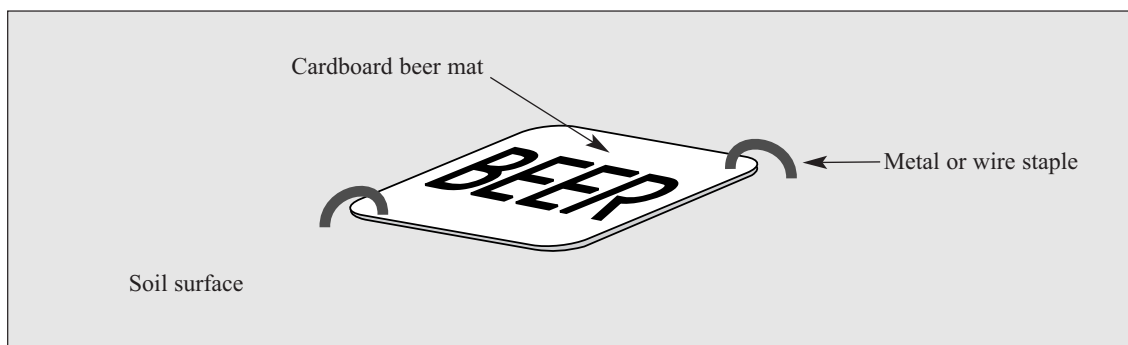
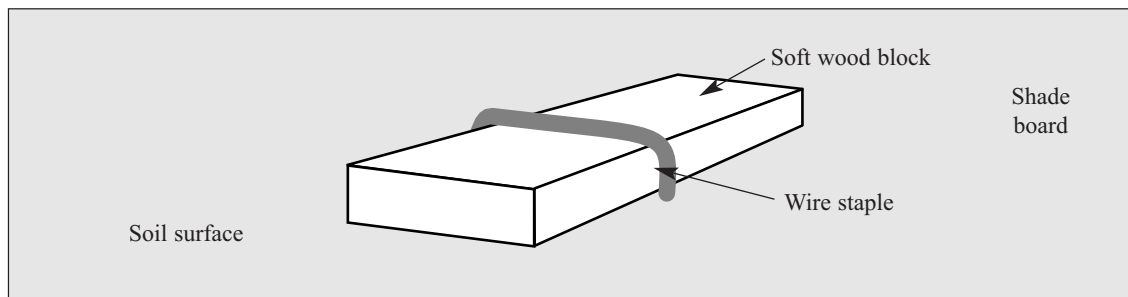

- On the final visit, remove the bait, label it with a number, the treatment area and date. Place in a labelled plastic bag. Return to the laboratory and assess final percentage damage. Weigh the bait and record the final weight on a spreadsheet.
- Note the vegetation surrounding each bait grid.

OTHER CONSIDERATIONS

Avoid clearing vegetation around baits unless absolutely necessary.

The vegetation/habitat of sample sites must be the same, as this can affect the ease with which the baits are found, even by the same species of termite.

The number of termite colonies and the distance between them influences the speed with which baits are found and attacked. Any nest (or mound) seen should be noted, along with its position in relation to the baits to aid interpretation of results.

Any observations relating to conflicts between species or between members from different colonies should also be noted.

Malaise trapping

DON'T FORGET

EQUIPMENT: Nylon mesh for Malaise trap; 6 long poles; tent pegs; guy ropes; mallet; collecting bottle and holder unit; spare collecting bottle; needle and thread; sticky tape; permanent marker pen; bucket; notebook; paper; pencil.

Check the material of trap for holes, tears, etc., and repair.

Set at least 3 traps per sample area.

Standardize (match) selection of trap sites in different treatment areas or use random number tables if sampling sites homogeneous.

Method

- Traps should be set in areas frequented by large numbers of the insects to be sampled. Thus for Hymenoptera, woodland edges, woodland rides and near hedgerows are good sites, whilst for Diptera, beside streams, watercourses or gulleys are also suitable positions.
- Erect the trap with the highest point (where the collecting unit is sited) set towards the light (i.e. facing south or pointing towards an opening in the trees or less dense vegetation). Ensure that the material of the trap is well stretched and that guy ropes are used to tension the structure.
- Mark the collection bottle with the site name and/or number, the date and time, and the sampler's name, using a permanent marker pen, fill to one third full with 70% alcohol and attach to collection unit. **Tip:** *Water traps may be placed along the bottom of the centre wall of the trap to increase the catch.*
- On each subsequent visit check the mesh of the trap for holes, tears, etc., and repair if necessary, using a needle and thread or sticky tape.

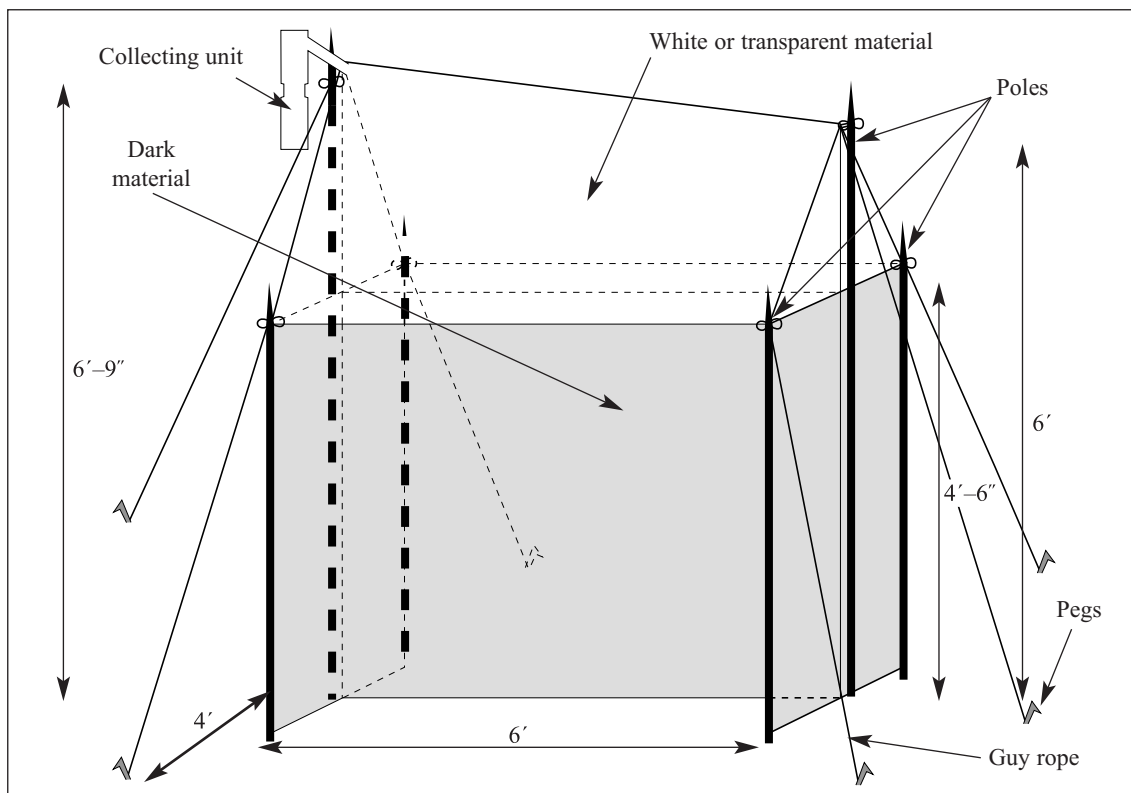

Note: Dimensions given are guideline only.

(Adapted from Figure 15 in *A Dipterist's Handbook. The Amateur Entomologist 15* (1978) published by The Amateur Entomologists' Society.)

- Traps should be serviced regularly. Any spiders webs across the entrance to the collection vessel or elsewhere should be removed. Unscrew the collection bottle, insert a pencil-written label with the site number, date, etc., and put on the screw-cap. Replace with a new collection bottle.
- Note any important information, e.g. spiders webs interfering with catch collection, unusual weather, changes in wind direction, overrun of time, surrounding vegetation type, changes in vegetation, e.g. appearance of flowers nearby, etc., to aid interpretation of results.

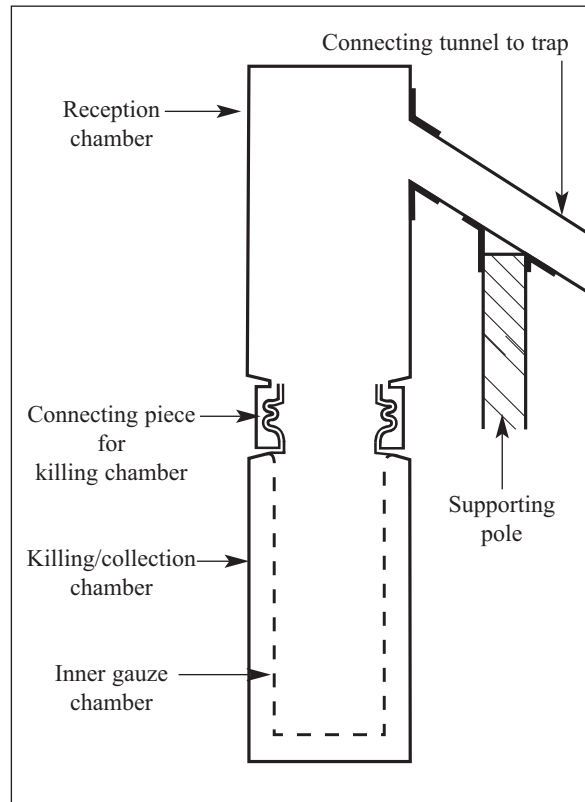

OTHER CONSIDERATIONS

Immediately before insecticide application in the sampling area, the traps should be entirely covered with large sheets of plastic and the collection bottles removed so that any insects entering the trap can escape. Traps in the untreated area should be treated in an identical manner. After spraying is complete, the plastic covers should be removed from traps and new collection bottles attached. Always collect trap catches at the same time of day for each collection period. Collection period may be 1 day, 2 days, 5 days or 7 days depending on volume of catch. Changes in surrounding vegetation can change catch composition, e.g. if a dense patch of flowers appears near a trap. Little can be done about this, but any such changes should be noted and taken into account in data interpretation.

Water traps

DON'T FORGET

EQUIPMENT: Permanent marker pen; marker flags; yellow plastic bowls or dishes; collection pots; water; glycerol; preserving fluid; muslin/nylon straining mesh; forceps; paintbrush; notebook; box for transporting traps; pencil; paper; wooden stakes; wooden boards or pie tins.

Trap size, type and colour must be identical for all sample sites.
Trapping period must be the same for all sample sites.
Set a minimum of 20 traps per treatment area; 50 is ideal.
Select sampling sites using random number tables.

Method

- Site traps in a grid or along a transect line, depending on habitat and size of area to be sampled. Traps should be at least 10 m apart. Mark the position of the trap with a marker flag placed nearby or note a nearby landmark (termite mound, bush, tree, etc.).
- At the selected sampling site, place the trap on the ground, without clearing vegetation around it, if possible. Fill with water and add a few drops of glycerol or washing-up liquid. **Tip:** *If there will be more than 3 days until the trap is emptied, add a few drops of formalin.* **Tip:** *If the vegetation is high and/or dense, set the trap on a board or pie tin raised to the height of the vegetation on a wooden stake (see overleaf).*
- Cover the trap with a wire mesh or chicken wire dome.
- Leave for set time period (1 day is recommended, but up to 1 week may be possible). **Tip:** *If it is the rainy season, it may be necessary to fill the traps less full and visit regularly to prevent the trap from overflowing.*
- When emptying traps, mark the outside of a collection pot with the site number and trap number and the date and place a pencil-written label with the same data on the inside and fill with 70% alcohol. Strain the water from the trap through a fine nylon sieve or piece of muslin into a spare dish or jug, retaining the water for reuse.
- *Carefully* pick insects out of the sieve using forceps or a paint-brush, and place in the labelled collection pot. Alternatively, wash the catch into a pot using alcohol from a wash bottle.
- Refill the trap with water and add preservative and a few drops of glycerol if necessary. Reset in original position and recover with wire.

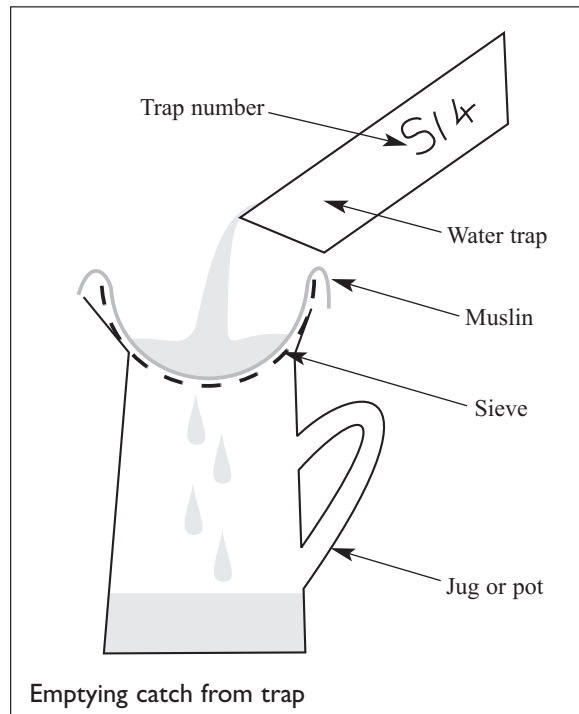
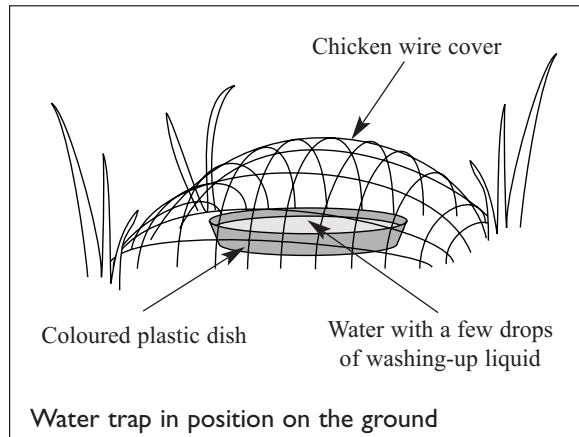

- Whilst emptying and replacing the trap, note any important information, e.g. entrance to trap blocked with leaves, trap disturbed by animals, heavy rain caused traps to overflow, trap dried out, etc. This will aid future interpretation of results.
- Note vegetation surrounding each trap.

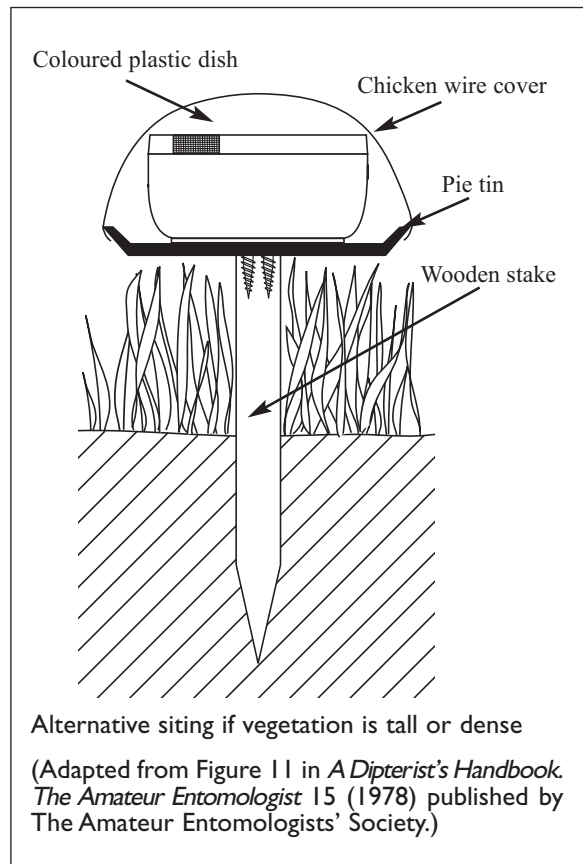

OTHER CONSIDERATIONS

Avoid clearing vegetation around trap site unless absolutely necessary.

The vegetation/habitat of sample sites must be the same, as this can affect the catch, even of the same species.

If using traps without formalin (or other) preservative, they must be emptied daily or more frequently. Alternative colours of trap dish may be used, but avoid white to ensure a good catch of the insect fauna of interest. Colour should then be standardized between sample sites.

Butterfly transects

DON'T FORGET

EQUIPMENT: Butterfly net; spare bags for net; watch or stop-watch; pen; marker flags; notebook; transect record sheets; sample vials; killing jar; thermometer.

Check the net for holes, tears, etc., and repair.

Carry out transects at set times of the day, starting between 10.00 h and 15.30 h and NOT earlier or later.

Fill in details of the transect site and environmental conditions on the transect record sheet before commencing.

Only walk transects if it is sunny or, if cloudy, if the temperature is above 18 °C. Wind speed should not exceed 6 on the Beaufort scale (see chapter 5 on environmental variables).

Method

- Choose large areas which consist of a similar mix of habitat types within each of the treatment areas. These should contain patches of similar vegetation type and general topography.
- Three transect routes should be chosen within each of these areas, again, preferably covering a similar range of microhabitats. These will act as pseudoreplicate transects and should be approximately 1–2 km in length. Each one should be walked and divided into up to 15 sections, with sections representing slight differences in vegetation type (or, if areas are extremely homogeneous, then sections should be of similar length). Marker posts or natural landmarks should be used to mark the beginning of each section.

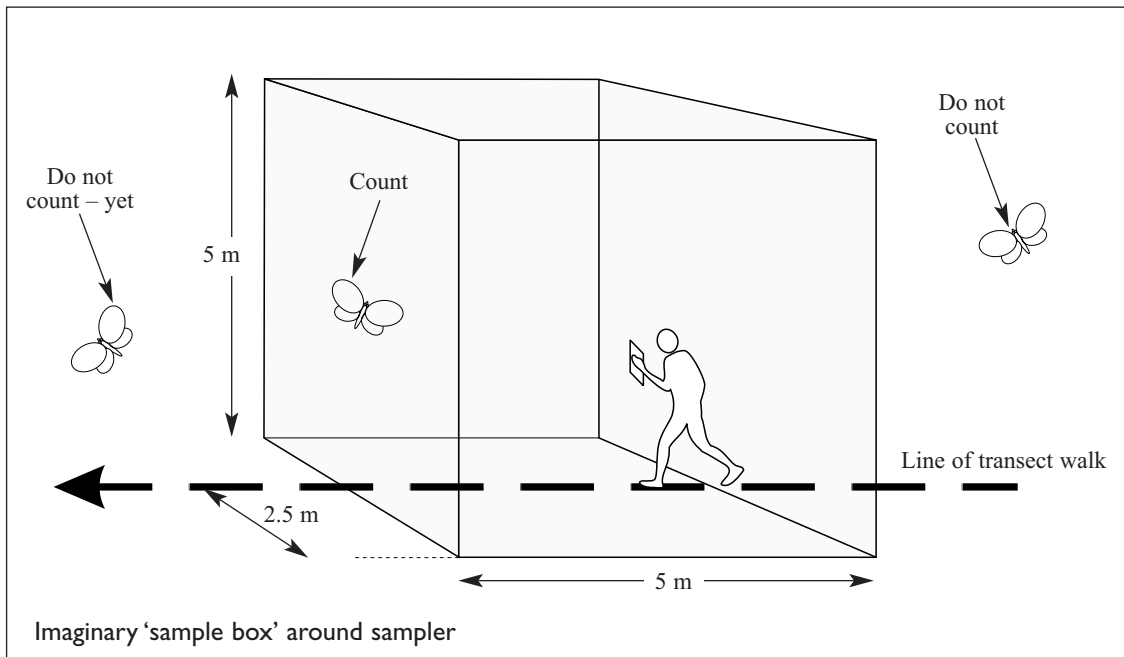
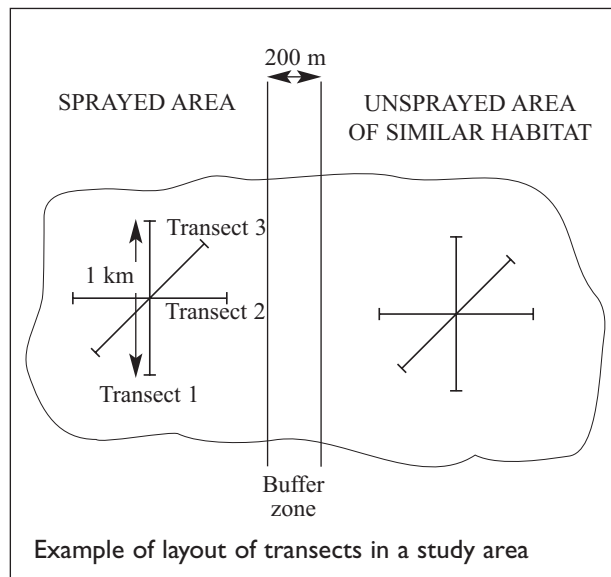

- Once the routes are set, they should be walked regularly (e.g. weekly) and the number of each species of butterfly entering an imaginary box around the recorder should be counted. This imaginary box extends 5 m in front, 2.5 m to either side and 5 m vertically. Butterflies in flight or settled should all be recorded. If species cannot be identified on the wing, they should be caught to enable identification. Only resort to killing the butterfly if it cannot be identified following examination after capture. In this case, give the butterfly a number or pseudonym on the record sheet. Any butterfly which cannot be identified and escapes capture should **NOT** be recorded. Care is needed not to record the same butterfly twice.
- If it is necessary to capture an individual, recording should begin again from the point where pursuit of the captured individual began.
- The transect should be walked at a constant, slow pace and halts should only be made to enable identification to be confirmed. Recording should cease if halts are made and begin again once walking recommences.
- At the end of each section of the transect, the total number of each species of butterfly seen should be noted on the record sheet, along with a note of whether the conditions were sunny or cloudy. **Tip:** Record sunny as 's'; cloudy as 'c' and a mixture of sun and cloud as 'c/s'. If possible, the temperature and wind speed should also be recorded at the end of each transect section.
- At the end of the transect, the end temperature and the end wind speed (on the Beaufort scale) should be recorded and the percentage sunshine over the period of the transect walk calculated.
- Note any important information, e.g. unusual weather, overrun of time, vegetation type, etc., to aid future interpretation of results.
- Attempts should be made to walk at least one transect within each treatment area during the same day.

OTHER CONSIDERATIONS

Always carry small vials and jars to allow observation and identification of any butterflies caught. Experience shows that it is best to carry out the transect in pairs, walking one behind the other. The first ('the observer') makes all observations, captures, etc., and calls out all the butterflies seen (identity and number seen). The second person records all sightings on the record sheet. The second person ('recorder') remains stationary at any point where the 'observer' has to leave the transect path to identify or capture a butterfly. Recording then recommences from the position of the 'recorder'. The recorder **never** mentions nor records any butterflies s/he sees, **only** those seen by the observer.

If only one person is available then they must observe and record butterflies seen.

Never mix the number of people. Once the sampling programme has started with 1 person, then 1 person must always do the transect. If the programme starts with 2 people *then* this must be consistent throughout the transect programme. Also, the 'observer' and 'recorder' should never swap roles.

All transect routes used should be walked specifically to record vegetation types within each transect section – identify plants to species where possible. Topography and other physical features should also be carefully recorded. This will help interpretation of results.

Any changes (e.g. flowers appearing at particular times) occurring as the sampling programme continues should also be recorded.

Trunk trapping

DON'T FORGET

EQUIPMENT: Permanent marker pen; marker flags or paint; trap containers (plus spares); lid for trap container; heavy gauge plastic sheets; scissors; sticky tape; sample pots; suction pump; preserving fluid; forceps; paintbrush; notebook; box for transporting pots; pencil; paper; rubber bands.

Trap size and type must be identical for all sample sites as must preserving fluid and dilution.

Trapping period must be the same for all sample sites.

Set a minimum of 20 traps per treatment area; 50 is ideal.

Select sampling sites using random number tables or a stratified programme.

Method

- At the selected sampling tree, hammer a 3 cm nail into the trunk about 1–1.5 m from ground level. Hang the trap container from this and fit the plastic sleeve around the trunk with the lowest point at the opposite side from the trap and the highest point pressed against the bottom of the trap container (tape this in place if necessary).
- Fold the plastic so that about 1.5 cm is flat against the trunk and the remaining 3–4 cm points down at an acute angle. Staple the plastic together at the furthest point from the trap entrance, so that it fits as tightly as possible around the tree trunk and holds in position at the correct angle. Trim off any excess plastic with scissors. If the tree has rough bark, plug any gaps between the trunk and plastic collar with wet mud (must be clayey!) alternatively use plasticine or cotton wool.
- Mark the outside of the trap container with the site number, trap number and the date in permanent marker. Also mark the tree with paint or with a marker flag so that it can be identified from a distance. Fill the trap to 2 cm with preserving fluid. Place the lid over the trap container and hold in place with a rubber band. **Tip:** Depending on temperature, a few drops of glycerol may help prevent evaporation.
- Leave the trap in position for a set time (5 days, 1 week, etc.).

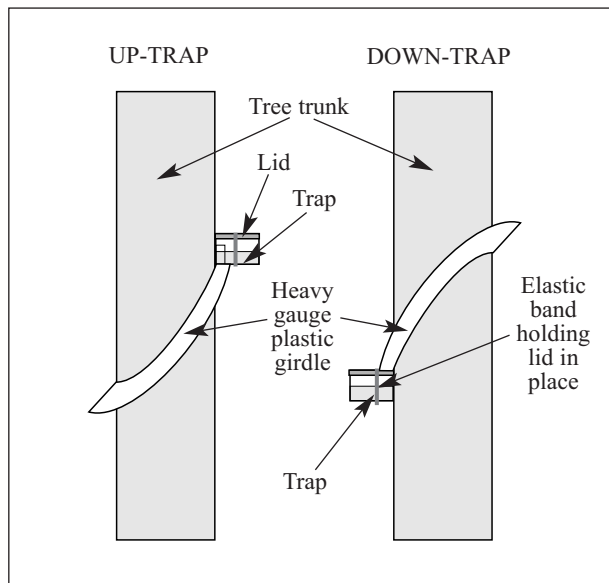
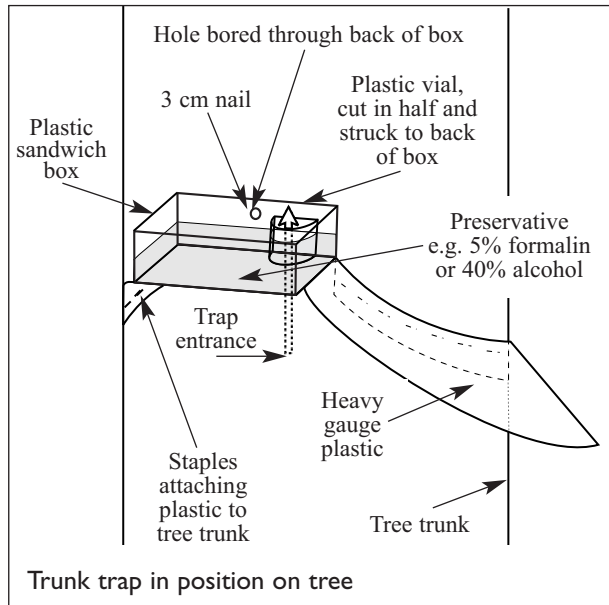

- On subsequent visits, remove the lid and pump out fluid and catch into a sample pot labelled with the site number, trap number and date of setting and retrieval, both inside (in pencil on paper) and outside the pot (in permanent marker pen). Check that all invertebrates have been successfully removed (or pick out any remainder with forceps). Refill trap with preserving fluid. Replace the lid. Leave for set time as before. Check that the clay, etc., is still in place and that invertebrates cannot escape through gaps between the trunk and the plastic.
- Whilst emptying the trap, note any important information, e.g. entrance to trap blocked with leaves, lid removed, etc. This will aid future interpretation of results.
- Note the type of tree on which the traps are hung and the vegetation surrounding trap trees.

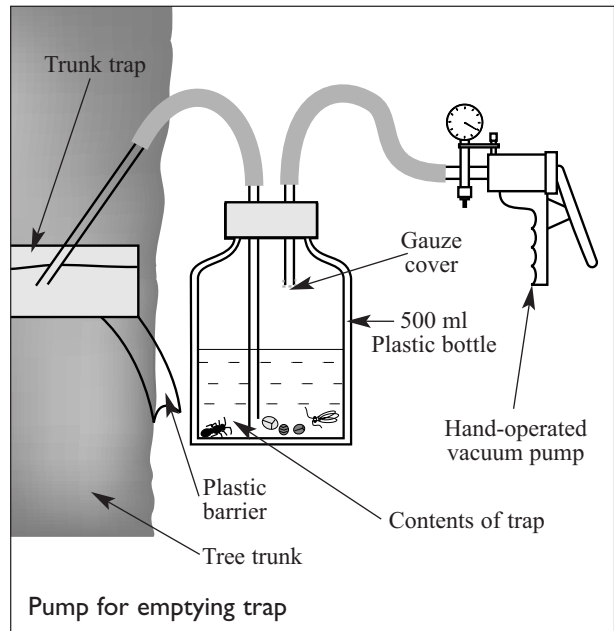

OTHER CONSIDERATIONS

Select an area on the tree with no protruding twigs, branches, etc., and avoid clearing trunk of shoots, twigs or branches unless absolutely necessary.

Once the height of the trap above ground level has been decided, this should remain constant for each tree used.

The tree type/vegetation/habitat of sample sites must be the same, as this can affect the catch, even of the same invertebrate species.

Check traps regularly at first to observe rate of evaporation of preservative. If necessary, top up.

The number, arrangement and distance between traps influences the sample size and should be considered in advance to ensure a good catch of the invertebrate fauna of interest. This should then be standardized between sample sites.

Traps can also be set to catch downward walking invertebrates, if required. See 'down trap' illustration. This method is good for sampling certain invertebrates and almost useless for others, thus care is needed in interpretation of results.

Funnel or sheet traps

DON'T FORGET

EQUIPMENT: Cotton, linen or nylon material for trap; support poles; tent pegs; guy ropes; mallet; 70% alcohol; sample vials; forceps; pooter; permanent marker pen; notebook; pencil.

Check the material for holes, tears, etc., and repair.

Set at least 3 traps per sample area; 5 is ideal if sufficient staff available.

Standardize selection of sampling sites or use random number tables or stratified sample sites.

Method

- Check the material of the trap for holes, tears, etc., and repair if necessary.
- Sheet trap: this comprises a simple sheet of white material (cotton is preferable) stretched out on the ground under trees, within the study area. The corners should be staked to the ground (or held by rocks).
- Funnel trap: this type of trap may be made using a sheet of white material (cotton is preferable) stretched out on a simple frame to form a funnel. **Tip:** Place stones in the bottom to prevent the wind overturning the trap. Alternatively, ready constructed metal traps can be purchased or made locally. The trap should be positioned on the ground under trees, within the study area. **Tip:** This type of trap can also be adapted to fit around the trunk of a tree for monitoring results from direct spraying of tree trunks.
- Set a minimum of 3 traps per treatment area (5 is preferable).
- Visit traps daily at set times of day before treatment, but in a randomized order per treatment area. Following treatment, traps should be visited several times per day, with the number and timing of visits dependent on the number of, and the area over which they are spread. **Tip:** 'Knock-down' will generally occur rapidly after aerial or mist blower treatment, thus every effort should be made to visit all traps as soon after application as possible. Several staff should be available to allow monitoring of treated and control sites contemporaneously.
- At each trap visit, mark a sample vial with the site name and/or number, the date and time, and the sampler's name, using a permanent marker pen, fill to one third full with 70% alcohol. For sheet or 'material' funnel traps, 'poot' up invertebrates lying in the trap, or collect them with forceps, and place into a labelled vial. Note estimated proportion of catch which is recovering or moving (if possible, include details of which taxa are involved). **Note:** Following pesticide application **do not** use a month-operated pooter – a vacuum pooter is needed.
- Specially made funnel traps may have a collection pot attached to the bottom of the funnel. This should be filled with 70% alcohol and, when visiting traps, any invertebrates which have not fallen into the collecting pot should be brushed in using a paintbrush, or pooted up.
- Note any important information, e.g. unusual weather, overrun of time, vegetation type, etc., to aid future interpretation of results.

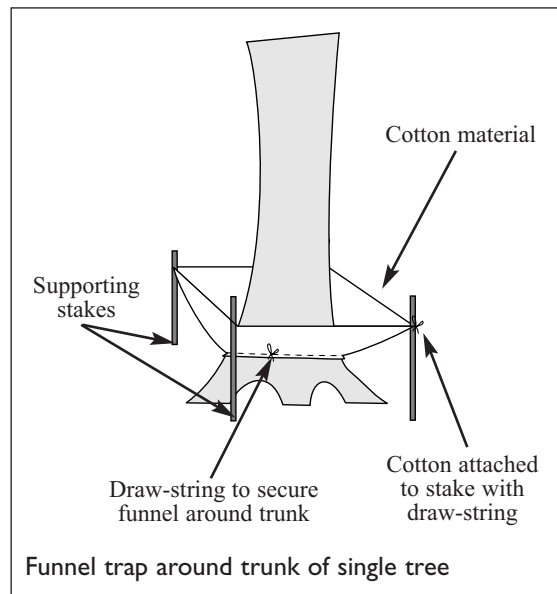
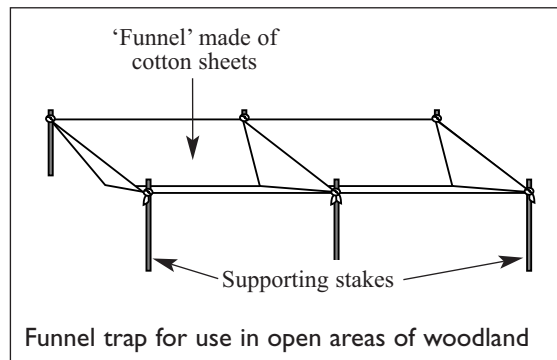

OTHER CONSIDERATIONS

Ground vegetation or other obstructions may have to be cleared to allow sheet traps to lie flat on the ground.

Matching of sample sites is very important, as tree type, spacing, canopy height, density of surrounding vegetation, etc., will all affect the catch.

Carefully consider measures to prevent removal by predators of incapacitated invertebrates from the sheet or trap by predators.

If insecticide-impregnated sheets or traps are used so that recovery from knock-down can be recorded on untreated sheets/traps, these should be impregnated with insecticide away from the study site to avoid contamination. Impregnated sheets should also be laid over clean, plastic sheeting to prevent insecticide contact with soil, leaf litter, etc.

Soil cores

DON'T FORGET

EQUIPMENT: Permanent marker pen; marker flags; trowel; soil auger; heavy gauge plastic bags; forceps; acetone or other solvent; notebook; box for transporting samples; rubber bands or wire twists; pencil; paper.

Read chapter 3 on safe handling of solvents, before going out to the field to carry out this method.

Sample cores should be taken on the same day for all sample sites.

Take a minimum of 20 cores per treatment area.

Select sampling sites using random number tables or a stratified programme.

A 3.8 cm diameter tubular auger is ideal for use with small Tulgren funnels, if this is the method to be used to extract invertebrates from the cores. Otherwise match auger size to requirements.

Method

- Mark the outside of the plastic bag with the site number and the date and also put a pencil-written label inside the bag.
- At the selected sampling site sink the auger into the ground to the required depth. Twist and remove the soil core and empty into the plastic bag. Fasten the opening tightly, using a wire twist or rubber band. **Tip:** If no auger is available, cores may be taken with a trowel, provided extreme care is taken to standardize quantity of soil removed.
- Mark the site with a flag or note a permanent feature which can be used to identify the same site in future.
- Between each core, rinse the auger (or trowel) thoroughly in solvent. **Tip:** Acetone and other chemical solvents should be handled with care. Keep solvent in a container with an air-tight cap. Solvent may be used for rinsing the auger several times within treatment areas, but should be changed before sampling in a different treatment area.
- Note vegetation surrounding sample site to aid in future interpretation of results.
- Collect all cores required as rapidly as possible and return to the laboratory, where extraction of invertebrates from the cores using Tulgren funnels should start immediately (see Tulgren Funnels Method Sheet). Extraction using flotation (see Flotation Extraction Method Sheet) requires less urgency, but should start as soon as possible.

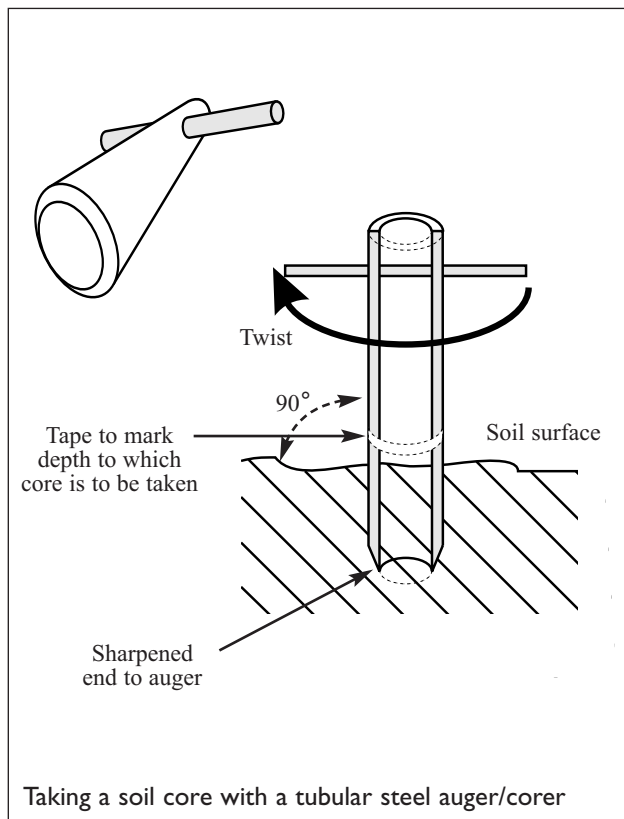

OTHER CONSIDERATIONS

Soil cores should be taken at regular intervals, before and after treatment. Timing must be assessed bearing in mind the time needed to process samples.

If required, cores may be divided so that fauna living at different depths may be extracted separately. If done, this should be standardized carefully and sub-samples appropriately labelled.

It will rarely be necessary to sample soil fauna for ecotoxicological studies at depths greater than 15 cm. This method can be used to obtain absolute estimates of population density of invertebrates, but large numbers of cores may be necessary to get reasonable numbers of many of the meso- and macro-invertebrate groups.

Litter bags for soil fauna

DON'T FORGET

EQUIPMENT: Permanent marker pen; marker flags; litter bags; trowel; spade; heavy gauge plastic bags; forceps; notebook; box for transporting samples; rubber bands or wire twists; pencil; paper.

Prepare litter bags before going to the field. Weigh out (as accurately as possible) the amount of leaf litter required (e.g. 3 g or 5 g). The leaf litter used should be exactly the same for all bags, in all treatment areas. Stuff the bags and seal using metal staples or plastic closures.

Set a minimum of 20 bags per treatment area (preferably 4 bags close together at 5 different sites).

Select sampling sites in the unsprayed area using random number tables. Carefully match these sites with similar sites in the sprayed area.

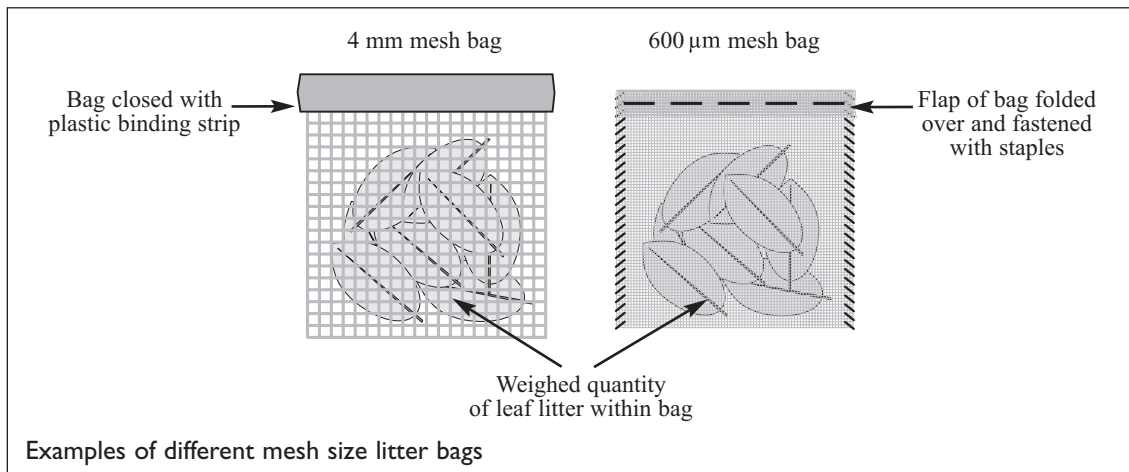

Method

- Mark the selected site with a flag or note a permanent feature which can be used to identify the same site in future. Dig a hole about 15 cm deep with a spade and check that the bottom is well broken up to allow easy movement of invertebrates. Place the (filled) litter bags flat on the bottom. Cover over with the soil which was dug out and firm it down, but do **NOT** compress. **Tip:** *If using different mesh size litter bags, these may be set in the same hole.*
- If tethered bags are used, they may be set at the same site. Drive a stake into the ground and attach a length of wire to it. Attach the wire to the mesh of the litter bags. Clear any leaf litter or other objects from the ground surface. Lay the bags flat on the ground and replace the leaf litter over the top. Avoid removing vegetation unless necessary.
- Make careful notes in a notebook to enable the site to be found again, e.g. distance from nearby trees and bushes and their position relative to the buried bags. If necessary, paint the site number on a nearby tree or rock, etc. Alternatively, use numbered marker flags.
- Leave the litter bags undisturbed for a minimum of 3 months and a maximum of 18 months before returning to collect them.
- When retrieving the litter bags, mark the outside of a heavy gauge plastic bag with the site number and litter bag number, mesh size, etc., and the date and also put a pencil-written label with the same information inside the bag.

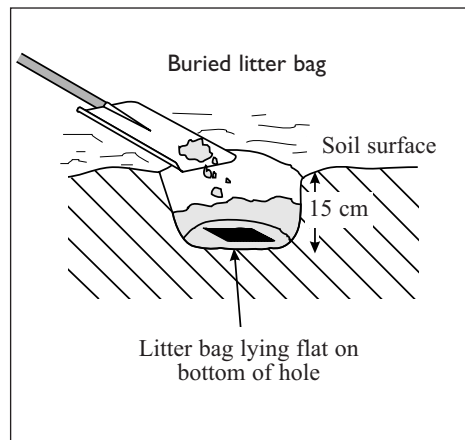

- Tethered bags should be collected first. Simply remove from the wire attached to the stake, and place in the appropriately labelled plastic bag as quickly as possible.
- For buried bags, locate the sampling site and dig a trench around the area, leaving plenty of space around the buried bags. Work quickly, carefully digging-in until the bags are located. Once found, remove from the soil as quickly as possible and place the litter bag into the appropriately marked plastic bag. Fasten the bag tightly, using a wire twist. **Tip:** Leave any soil adhering to the litter bag, so long as it is not excessive. Try to standardize this!

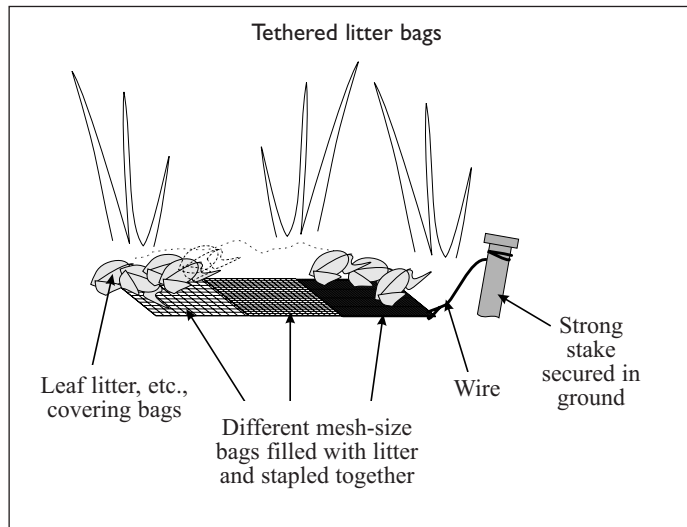

- If different mesh size bags have been used, each should be collected into a separate plastic bag and labelled appropriately.
- Bags from all sites should be collected as rapidly as possible and returned to the laboratory. Each bag should then be dealt with separately. Open the plastic bag and shake off all soil and debris from the surface of the litter bag, tapping it vigorously to dislodge any material stuck in the mesh or inside the bag. Close the plastic bag again and retain for flotation extraction of invertebrates. Open the litter bag and tip the remaining litter into a dish of water and agitate to clean off any material still adhering to the leaves. Remove the remaining, clean leaf litter, weigh each sample and record weight against litter bag number.
- Retain water and debris from washing of leaf litter and combine this with the soil and debris extracted into the plastic bag during the flotation extraction of invertebrate fauna (see Flotation Extraction Method Sheet).

OTHER CONSIDERATIONS

Before and after treatment studies are not usually possible with litter bags and so careful selection of matched sprayed and unsprayed areas is especially important. The timing of placement and retrieval of litter bags should be carefully considered in relation to the timing of the treatment and to seasonality. In the dry season fewer invertebrates are active and bags need to be left in place for longer. Different mesh sizes of litter bag can be used to assess impacts on different components of the soil fauna. If different mesh size bags are used, fauna should be extracted from bags of different mesh size separately.

Flotation for extraction of invertebrates from soil cores

DON'T FORGET

EQUIPMENT: Buckets x 3; large quantities of clean water; soil sieves of different mesh size (depending on fauna of interest), e.g. 4 mm, 1 mm, 300 μm and 100 μm ; salt; sample vials; 70% alcohol; forceps; spatula or spoon; large beakers (1 litre and 2 litre); watering can; wash bottles x 2.

Method

- Make up 2 litres of saturated salt solution in a large (plastic) beaker, by dissolving salt in water until adding more salt results in no more dissolving.
- Empty soil from the sample plastic bag into a 1 litre plastic beaker, add 750 ml saturated salt solution and stir thoroughly. Leave to stand for about 15 min.
- Pour supernatant through a bank of sieves, with the coarsest mesh sizes at the top. Collect the salt solution in another beaker; pour back on to remaining soil (topping up to 750 ml, if necessary) and stir thoroughly. Leave to stand for 5 min.
- Repeat above procedure and leave to stand for a further 5 min.
- Strain the solution again, collecting the salt solution as before.
- Wash the debris remaining in each of the sieves in the bank thoroughly with clean water. This can be done using a watering can (at least 10 litres of water), if no tap is available.
- Throw out any large pieces of organic matter from the coarse sieve, having first checked that no invertebrates are adhering to them. Carefully sift through the residue and pick out any invertebrates and place in a vial of 70% alcohol.
- Wash the residual material in the two finer mesh sieves to the side of the sieve using a jet of water from a tap or from a wash bottle. **Tip:** *Angle the sieve at about 45° and apply a jet of water to both the top and undersides of the sieve consecutively to dislodge any small invertebrates from the mesh.*
- Finally, wash the residue into a collection vial using 70% alcohol from a wash bottle. Ensure that all material from the sieve is collected. **Tip:** *Residues from fine sieves may be combined if necessary, to use fewer collecting vials.*

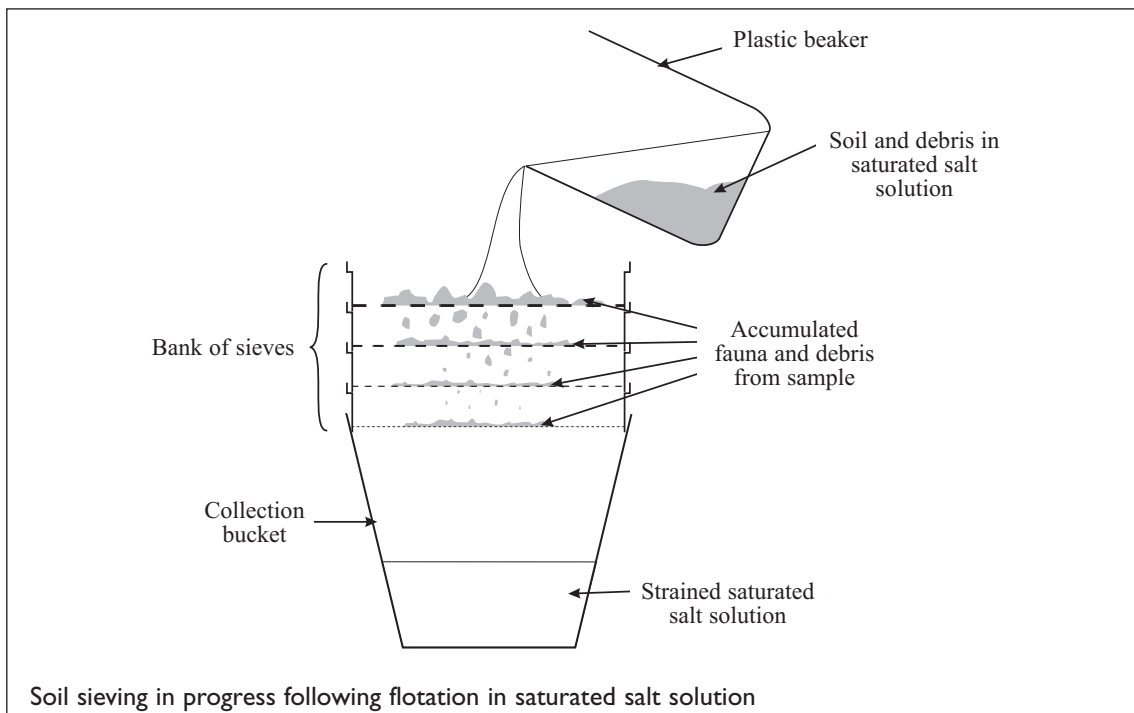

- Empty the collection into a Petri dish (or large watch glass) and examine under a binocular microscope. Ensure the sample is labelled with same data from original sample plastic bag throughout.

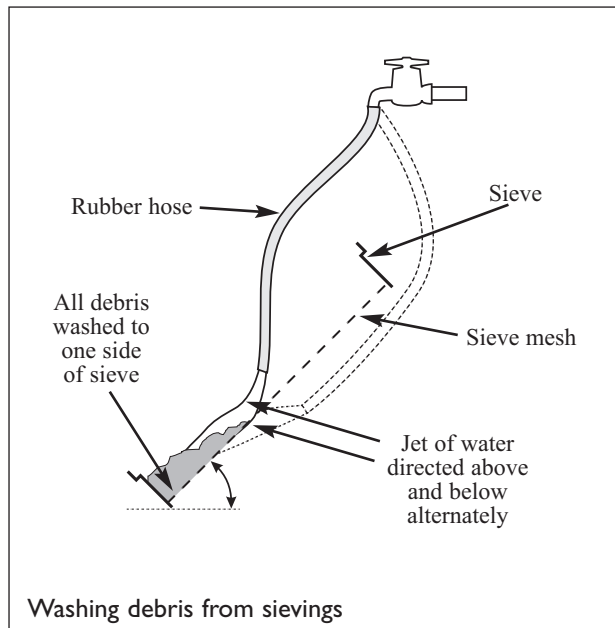

OTHER CONSIDERATIONS

This is a laboratory extraction technique, but can easily be adapted to use in the field, provided water is readily available.

It is not necessary for the fauna to be alive to be extracted from soil cores using flotation and sieving, but extraction should be carried out within 2–3 days of sample collection.

Large quantities of water are necessary to carry out this process, particularly when there are many samples.

If no laboratory space is available and extraction has to be done in the field, care should be taken that extractions from cores taken in the area treated with pesticides are **not** performed in an untreated area, or else contamination will result.

Tulgren funnels for extraction of invertebrates from soil cores

DON'T FORGET

EQUIPMENT: Tulgren funnels; Tulgren canisters; mesh grids; soil samples; sample vials; 70% alcohol; glycerol; selotape or insulating tape; permanent marker pen; pencil; paper; notebook; Tulgren hood; electric light bulbs.

Method

- Set up the Tulgren apparatus as shown, with the canister sitting in the funnel, the fine mesh grid (no finer than 600 μm) at the bottom and the coarse mesh grid above.
- Push a plastic vial, labelled on the outside with the site number and date, on to the bottom of the first Tulgren funnel in the rack. Pour the soil sample out of the appropriate sample bag into the aluminium canister on top of the funnel. **Tip:** If there is a 'cap' from the soil surface, this should be taken out and placed, upside down on top of the soil sample. This will allow any invertebrates in the 'cap' to pass downwards to the collection vial and should discourage any fauna from the rest of the sample from passing upwards.
- Tap the side of the canister firmly, 10–15 times. Any material dislodged will fall into the vial at the bottom. Remove this vial and replace with one labelled with details on the outside and details on a paper label on the inside, and half filled with 70% alcohol and a few drops of glycerol. Pour the dislodged material back into the top of the funnel.
- Fill the rest of the Tulgren canisters with the other samples in the same way. If laboratory facilities are available, switch on the electric lights above the funnels and leave for 3–5 days to extract all the invertebrates from the soil core. If no facilities are available, position the Tulgren funnels on their stand in full sun and leave for 5–10 days.
- At the end of the extraction period, remove the vials in turn and place a cap on each. Note the date of removal on the vial in permanent marker pen.
- Examine the contents of each vial in turn. Pour the contents into a petri dish and examine under a binocular microscope. Sort, count and identify the extracted fauna.

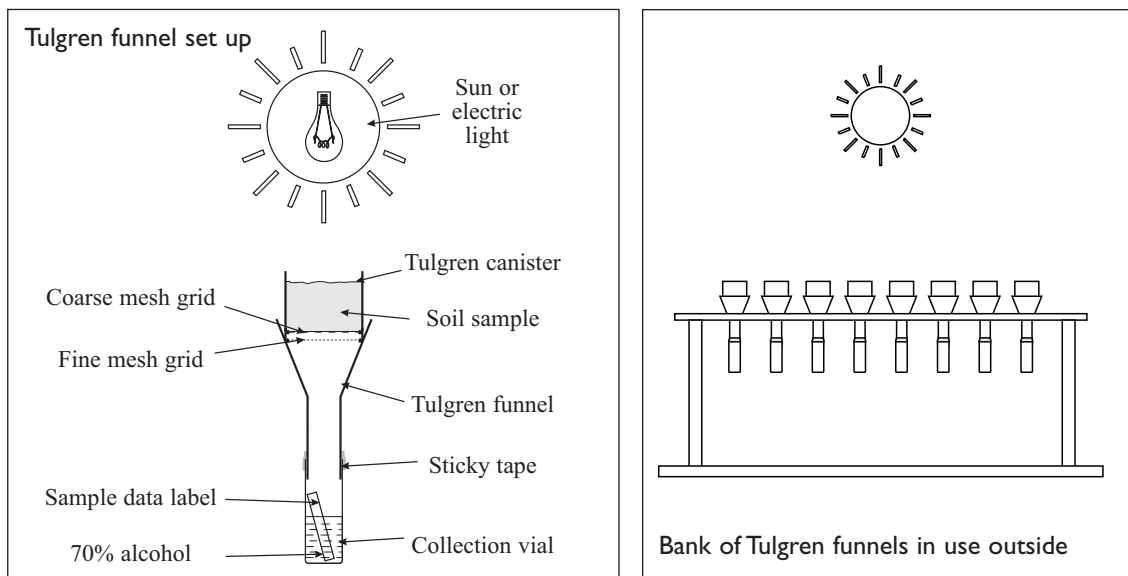

OTHER CONSIDERATIONS

This technique will only extract invertebrates of a size which can fit through the narrowest mesh grid used at the base of the aluminium canister at the top of the Tulgren apparatus. Select grid size appropriately.

Take great care that soil sample details correspond to label details on collection vial.

Termite colony health estimation

DON'T FORGET

EQUIPMENT: Permanent marker pen; marker flags; poles or stakes; hand lens; forceps; pooter; sample vials; notebook; pencil; paper.

Select a minimum of 50 mounds of each different type present per treatment area.
Select sampling sites carefully, to match sites as closely as possible across treatment areas.

Method

- Carry out an initial survey of the area to assess the density of termite mounds and types of mounds. (Are there mounds of different form or grossly different size? If so, there may be several species of termite present.)
- Select (at random) 50 mounds per treatment area of each type of mound common to all areas.¹
- 'Damage' each (selected) termite mound by plunging a wooden stake or pole bearing a numbered flag into the top of the mound. Enlarge the hole if necessary using the stake or pole, until the hole is about 5 cm diameter. **Tip:** *If the mound is too big to easily reach the top, then select a convenient position in the side, but then keep the position constant for each mound damaged.*
- Examine the damaged area and look for any sign of termite activity. Record any activity as + or no activity as - in a notebook and collect samples of the termites for identification by a taxonomist. Place in a sample vial with a pencil-written label with site number or name, mound number and date. Fill with 70% alcohol and put a lid on the container.
- Allow at least 2 min to elapse during which 'damaged' areas are observed and any termite activity recorded.
- Note vegetation surrounding each mound.
- Proceed to the next selected termite mound and repeat the above operation. Continue in this way until all selected mounds have been 'damaged'.
- Decide on the frequency of visits to observe repair of damaged mounds. **Tip:** *Visiting after 2 days and then weekly is recommended. Weekly visits are recommended for 6 weeks, followed by monthly visits.*

¹ Except where some form of discriminative spraying technique has been used, e.g. barrier spraying for locust control or ground-spraying for tsetse control. In these cases data on mounds in the areas subjected to different levels of spraying should be kept separately.

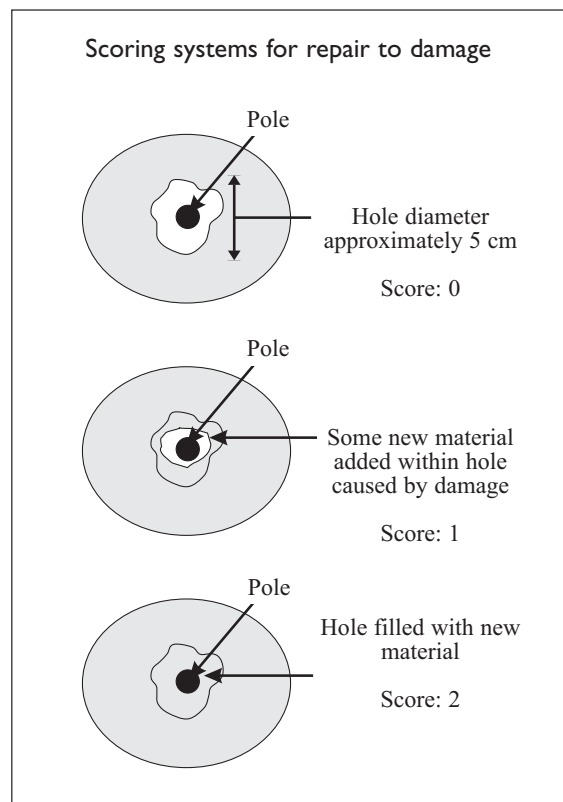
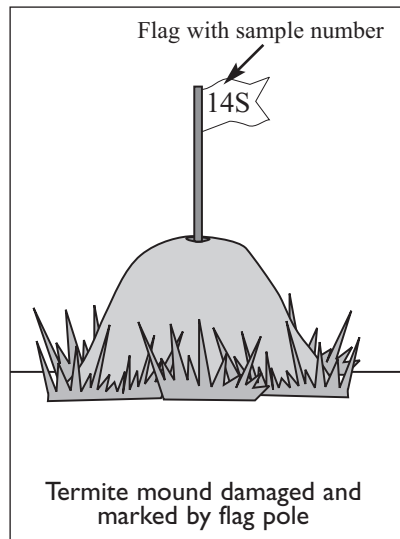

- On subsequent visits, record the extent of repair by termites to the hole in each mound, giving the repair a value from 0 to 2 (where 0 = no repair; 1 = partial repair; 2 = complete repair). If the repair to the hole is complete, note this, but then redamage the mound (following the same procedure as described above).
- Collect any termites seen (particularly soldiers or alates) for future identification of species.

OTHER CONSIDERATIONS

Where several different types of mound are identified in the initial survey, record termite activity and repair for different categories of mounds separately.

Monitoring should start a minimum of 3 weeks before pesticide treatment (preferably 6 weeks).

Whatever the state of repair to the damage, damage should be reinflicted on the day of treatment, as soon as possible after pesticide application has occurred.

Carry out damage and repair observations at the same time of day in each treatment area in case diurnal patterns affect the activity of the termites concerned.

Avoid clearing vegetation around mounds whilst inflicting damage unless absolutely necessary.

The vegetation/habitat of sample sites must be matched.

Note any other factors which may influence colony health, e.g. drought conditions, waterlogging, colony invasion by ants, damage by aardvarks or other predators, etc.

Wherever possible, carry out additional observations of colony activity, e.g. periodicity of foraging bouts from mound, timing of foraging bouts, numbers out foraging, etc.

Any observations relating to conflicts between species or between members from different colonies should also be noted.

Heel sampling

DON'T FORGET

EQUIPMENT: Hand net; plastic sample bottles; boots; permanent marker pen; 40% formalin (or 70% methanol).

Handle formalin with care (see chapter 3).

Method

- Label the collecting bottle with an identifying code, e.g. site and sample number using a thick permanent marker pen.
- Choose an area of stream to sample. Standardize substrate sampled at each site – stony riffles are preferable, but any substrate is possible provided there is a current.
- Face downstream holding a hand net in front of you so that the current enters the net.
- Grind or trample the substrate for 30 s with your heels while slowly walking backwards for a short distance (1–2 m) to dislodge organisms.
- Lift the net out of the water and splash stream water on to the outside of the net to wash invertebrates and debris stuck to the inside of net down into the collecting bottle.
- Unscrew the bottle from the net and cap, replacing the collecting bottle for the next sample. Alternatively, empty its contents into a separate, labelled container for transport.
- Add methanol or formalin unless processing is likely to be within a few hours of collection. Strain (through muslin to prevent loss of sample) off some water, about 25%, and replace with 40% formalin or 70% methanol.
- Repeat the operation at least twice more at each sample station to increase the number of species trapped but taking care not to sample from where you or others have already walked. If the sample station has two substrate types, stratify the sampling in proportion to the area: so if 60% pebble and 40% gravel with some sand, take three smaller samples (timing or area kicked) of the former and two of the latter.
- Processing: pour the contents of the bottle on to a white tray and separate the organisms from the sand, silt and debris by eye and using forceps or Pasteur pipettes for smaller organisms. Place them in bottles containing 70% alcohol: count and identify.

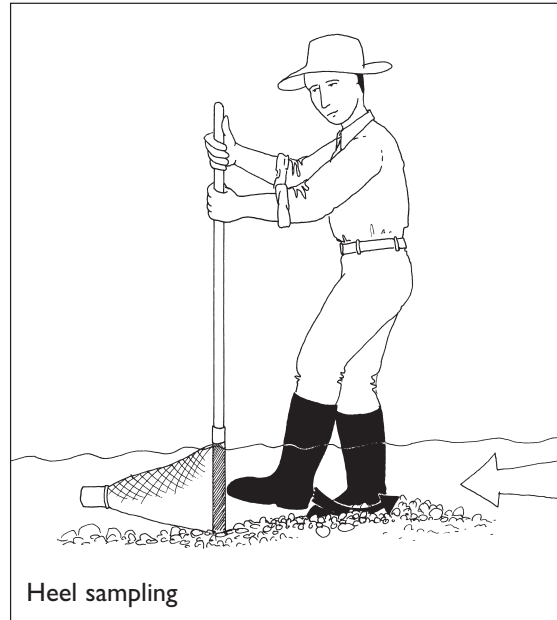

OTHER CONSIDERATIONS

Adjust the time of kicking according to the substrate to prevent clogging the net (= inefficient sampling) and sample sorting difficulties; 30 s samples are sufficient in riffles, 15 s in sediment. If you wish to increase the number of samples then you can reduce the time spent kicking or the distance sampled. This technique is useful for observing which organisms are alive/dead immediately after spraying provided no preservative is added after collection: place the contents of the bottle on a white tray before preserving.

Artificial substrates

DON'T FORGET

EQUIPMENT: Samplers; wire; stakes; netting; floats (corks); paper and pencil; sample bottles; 2 inch paintbrush; plastic bags; bucket; permanent marker pen; 40% formalin.

Handle formalin with care (see chapter 3).

Method

- Choose an area of lake or river to sample (substrate normally silt, mud or solid bedrock). Standardize the placement at each site so that the samplers are, e.g. the same distance from vegetation and shoreline; or for rivers, in similar current strengths, and exposure, e.g. positions on bedrock, sand or sediment.
- Place 4–6 samplers at each site. In static water or slow flowing rivers, rest the sampler on the substrate and mark the position carefully – draw a map and use a cork float as a marker in deeper water. In faster flowing streams secure the samplers to the bedrock using wires tied to stakes jammed into crevices.
- Leave the samplers for at least 2 weeks before retrieving. Standardize the retrieval period for each site.
- To retrieve, gently but quickly ease the sampler into a mesh bag (1 mm aperture) before lifting the sampler free of the water. This will catch most organisms that are dislodged by the activity.
- Put the bag containing the sampler into a bucket of water, wash out the bag, shake the sampler, then remove the pebbles from the wire cage (if one was used) and brush the substrate with a paintbrush to remove the more tenacious organisms.
- Strain off water in the bucket as necessary to match the volume of the sample bottle. Pour the sample into a labelled sample bottle and preserve the contents of the bottle with 40% formalin (use 4 ml for every 100 ml of sample).
- Sort and identify invertebrates. Combine the results of replicate substrates at any one sampling station and enter the data into a statistical package for analyses. Use the mean and standard error for plotting.

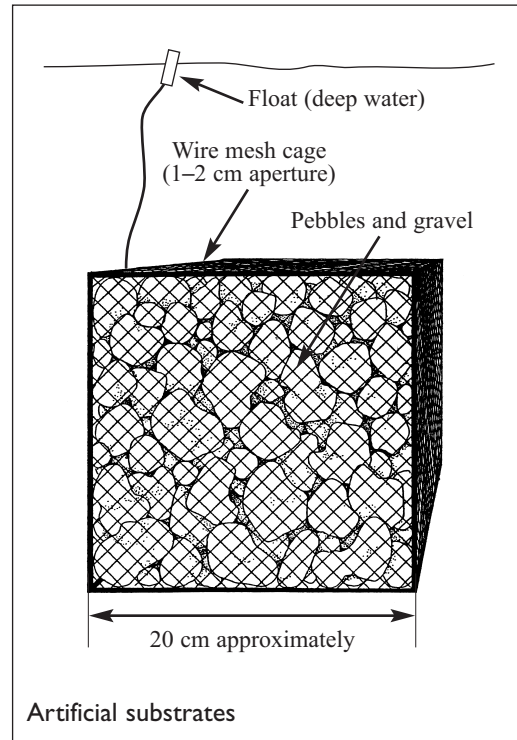

OTHER CONSIDERATIONS

Sampling of the artificial substrates is (biologically) destructive, but samplers can be replaced if continued monitoring is required. However, they must be left submerged for a least a further 2 weeks to allow re-colonization before their retrieval.

Sweep net (aquatic)

DON'T FORGET

EQUIPMENT: Sweep net; sample bottles x 20; buckets x 3; permanent marker pen; plastic bags x 20; 40% formalin; muslin.

Handle formalin with care (see chapter 3).
Standardize the time taken to sweep vegetation at all sites.

ROOTED VEGETATION

Method

- Label the collecting bottle with an identifying code, e.g. site and sample number using a permanent marker pen.
- Choose an area of vegetation to sample. Standardize the substrate sampled at each site, e.g. papyrus and *Vossia*. If 80% papyrus and 20% *Vossia*, take four papyrus and one *Vossia* sweeps.
- Hold the net with two hands and scrape the submerged stems with the metal support of the net, then sweep the area between the stems and around the roots using a constant figure of eight-like motion that prevents organisms escaping from the net.
- Continue this routine for a fixed period of time such as 1 min. Lift the net out of the water and wash the organisms and debris stuck on the sides of the net down to the bottom of the net (splash water on the outside of net to achieve this).
- Either unscrew the collecting bottle (if fitted) and tip the contents into a labelled sample bottle or invert the net into a bucket of water and wash out the organisms, straining off water (through muslin) as necessary to match the volume of the sample bottle. Pour the sample into a labelled sample bottle. Preserve the contents of the sample bottle with 40% formalin (use 4 ml for every 100 ml of sample).
- Repeat the sampling 3–4 times at each site.

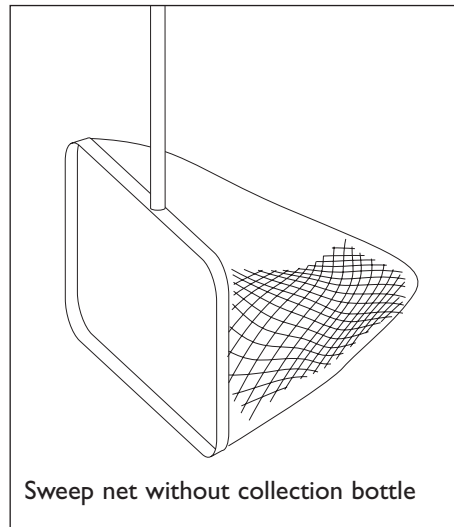

FLOATING WEEDS

Method

- Sample whole floating weeds by sweeping them quickly up into the net – do not sweep slowly as the organisms will detect movement and detach themselves from the roots.
- Invert the net into a bucket of water containing a few drops of formalin and leave the vegetation for a few minutes to help release tenacious organisms.
- After shaking thoroughly, remove the vegetation to a labelled plastic bag. Transfer the main sample (the remaining water in the bucket) to a labelled sample bottle and preserve as above.
- Take five or six samples of floating vegetation to provide an estimate of the sample variation. With floating vegetation (as opposed to rooted, floating vegetation), it is useful to relate animal density as a function of the dry weight of the vegetation, or better still, root weight or volume, as this discounts bias from above surface biomass, which is variable throughout the year.
- Sort the vegetation to remove any fauna still adhering to it on return to the camp or laboratory and consolidate the sample organisms with those of the main sample.

OTHER CONSIDERATIONS

Sweep nets can be used to capture surface-dwelling insects in open water and around vegetation.

Cylinder or box sampling

DON'T FORGET

EQUIPMENT: Cylinder, box or Surber sampler; nets x 2 (one spare); sample bottles; permanent marker pen; formalin.

Handle formalin with care (see chapter 3).

Method

- Choose an area of stream to sample. Remember the key points: standardization of substrate sampled at each site – riffles are good; stratify the sampling if there is a strong demarcation of substrate type.
- Face upstream and drive the sampler about 5 cm into the substrate (using to-and-fro rotations) so that water enters the mouth of the cylinder or box and the net is downstream. Do not sample where you have trodden.
- Lift large stones within the cylinder and remove tenacious animals, e.g. molluscs, by hand. Then stir up substrate inside the sampler for 1–2 min to dislodge organisms, allowing the current to take them into the net.
- Lift the sampler out of the water so the net hangs down. Splash stream water on to the outside of the net to wash invertebrates and debris stuck to the inside of the net down into the collecting bottle.
- Unscrew the bottle from the net and put the cap on (or empty its contents into a separate, labelled container for transport).
- Label the collecting bottle cap with an identifying code e.g. site and sample number using a permanent marker pen.
- Add methanol or formalin.

TIP: Strain a small percentage of water from the sample and replace with preservative.

- Repeat the sampling procedure 4–8 times to achieve reasonable statistics. Sort samples on a white tray containing shallow water. Combine the results of replicate samples at any one sampling station and enter the data into a statistical package for analyses.

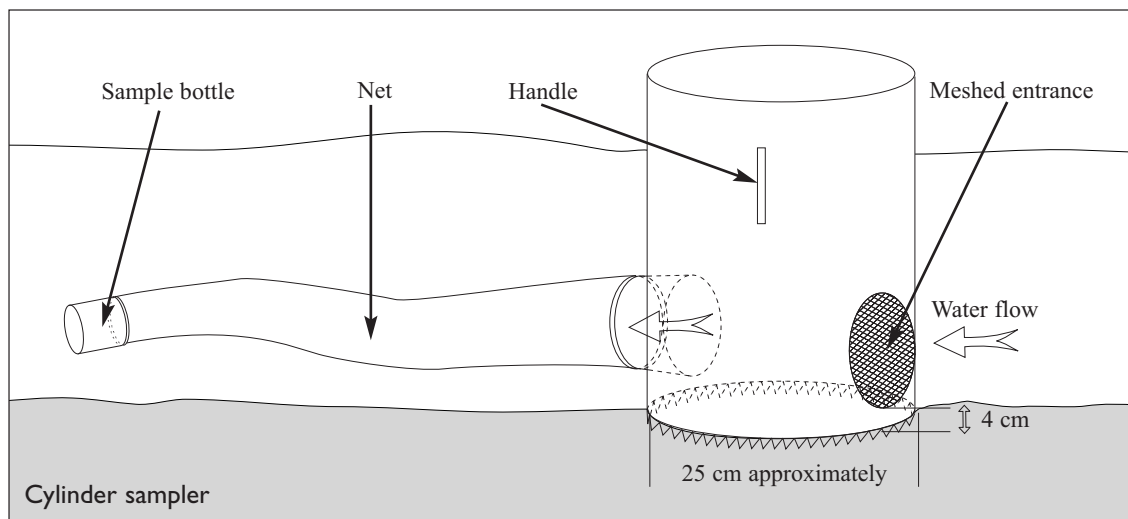

OTHER CONSIDERATIONS

Cylinder samplers can be used in sediment providing there is a water movement through the sampler that is sufficient to carry organisms into the net.

Drift sampling

DON'T FORGET

EQUIPMENT: Drift nets; hammer and stakes; tape measure; wire or string; screw-cap bottles and caps; an orange or cork; permanent marker pen; muslin; 40% formalin; flow meter.

This is a two person job.
Handle formalin with care (see chapter 3).

Method

- Set the drift net in a part of the stream channel that can be waded: in a fast flowing stream this is a two person job. Hammer the stakes into the substrate and fix the frame of the net, with the opening submerged and facing upstream, to the stakes with wire. Concrete reinforcing rods make excellent stakes. Ideally, set 2–3 nets up and downstream of spraying.
- Screw on the sampling bottle and note the time. Set the nets at the same distance from the river bed and in similar currents at all sites. The current can be gauged using a flow meter held in the mouth of the net.
- Empty the net periodically, e.g. every 24 h. During heavy rain or insecticide spraying, the time interval is shortened, perhaps to 2–4 h. Tap the net on the outside to help wash invertebrates stuck to the inside of the net down into the collecting bottle before unscrewing.
- Note whether there are signs of the net being clogged, such as eddying or backflow from the mouth of the sampler. If so, note this in a notebook for the sample number, time, etc. Empty the net more regularly if these signs are evident.
- Label the collecting bottle with an identifying code, e.g. site, sample number and time collected using a permanent marker pen.
- As the bottle will be full of water, hold some muslin over the mouth of the bottle to prevent loss of specimens and pour out some of the water (about 25%). Top up the bottle with 40% formalin unless processing is likely to be within a few hours of collection.

Calculate drift density using the area of mouth (or partial area if the net was not completely submerged), the flow rate and numbers of animals caught in a known time. If, during the sampling period, a volume of 20.1 m^3 of water passed through the net, and the sample bottle contained 102 Nematocera, then express the result as number per m^3 , i.e. $102/20.1 = 5 \text{ Nematocera/m}^3$.

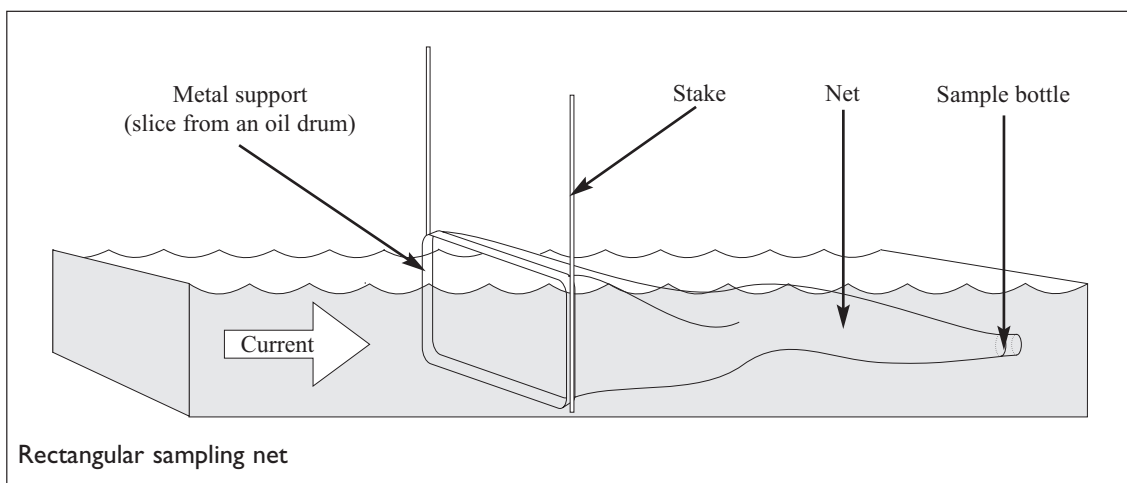

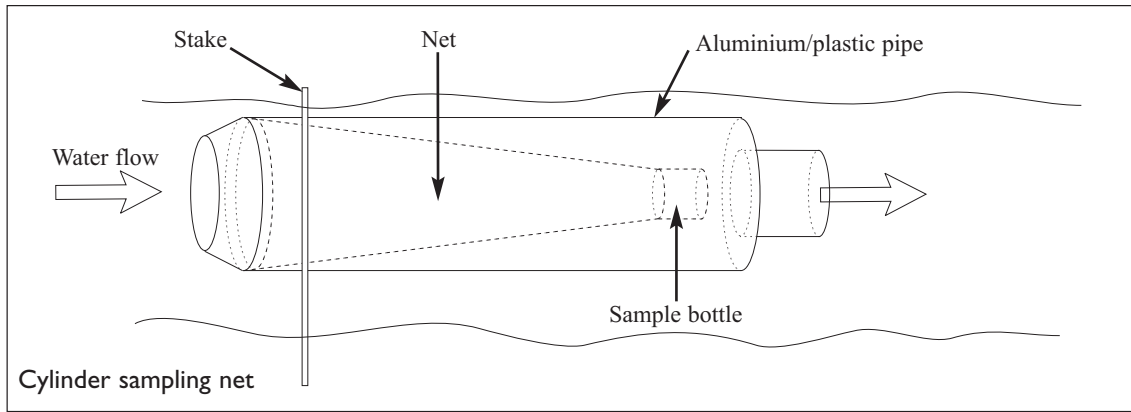

GAUGING FLOW

An approximation of the flow through the net can be made from the flow of the river – provided the net is not clogged and impeding flow. See the method sheet dealing with measurement of current using a floating object (chapter 5). If you can borrow a calibrated flow meter, that will be more accurate – especially if held in the exit pipe of a cylinder sampler. See method sheet for flow calculations.

OTHER CONSIDERATIONS

The dimensions of a drift net are not fixed. A common size for rivers is a 30 x 30 cm mouth; 30 cm x 15 cm (height) for streams.

In silt or mud the stakes must be long enough to secure the net. In rocky substrates, metal stakes can be hammered into the bed or the net tied to trees or stakes on the bank.

Note the phase of the moon, i.e. full, half and new, during sampling periods. Invertebrate drift is greatest just after sunset – moonlight will tend to change this pattern and affect catches.

Emergence traps

DON'T FORGET

EQUIPMENT: Emergence traps; collecting heads; string; rubber bands; knife; stones; sample bottles; permanent marker pen; formalin.

Handle formalin with care (see chapter 3).

Method

- Choose an area of stream or lagoon to sample that is readily accessible and not too deep: depth will be determined by the length of the trap's legs. Standardize the substrate sampled for each site, e.g. within weeds, over vegetation or sediment, etc. Emergence traps can be made with floats to sample deeper water.
- Without treading in the area over which you wish to site the trap, place the sampler in the water so that the base of the sides or cone is just beneath the water. Use rocks to level the trap or increase the height of the legs.

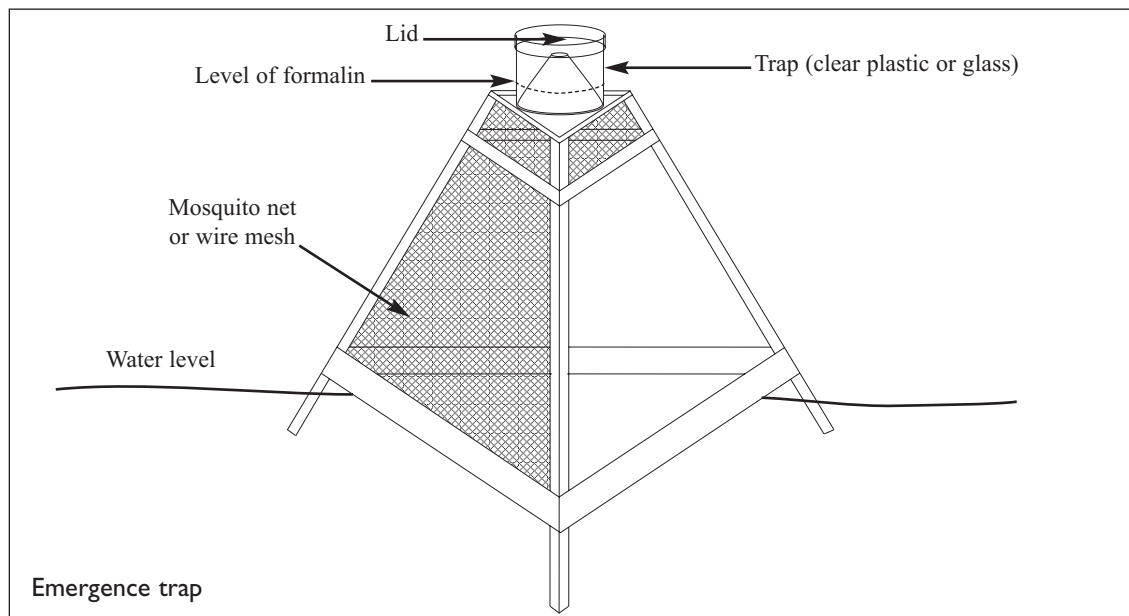

- Place the funnel trap assembly on the top and tie it down with string or rubber bands. Half fill the well with formalin and put on the lid. Locate another 3–4 traps in the vicinity remembering to standardize the substrate sampled within the site. Leave the traps in position for a period of at least 2 weeks and visit the trap every 2 days to empty the wells.
- To empty, suck out the contents of the well with a Pasteur pipette or use forceps to transfer the imagines to a sample bottle containing 4% formalin. Drop a label (pencil on paper) into the bottle and cap.
- Identify and count the imagines. Calculate the area sampled by each trap and report the density of imagines as number m^{-2} . Preserve the identified specimens in formalin, label and keep.

Tip: Keep a record of the meteorological conditions that prevail over the sampling period at all sites as rain, light and temperature can affect emergence.

OTHER CONSIDERATIONS

The example given is not the only design employed. See Mundie (1971) for other types of trap. People get curious about these traps. A notice about their purpose or a discussion with local people may reduce tampering or loss.

Plankton sampling

DON'T FORGET

EQUIPMENT: Plankton net; 10 m tow-line; weighted glass bottle and stopper; screw-cap bottles and caps; thermometer; pencil and paper; 40% formalin.

Handle formalin with care (see chapter 3).

Method

- For zooplankton, use a 250–300 μm mesh net; for phytoplankton use 75 μm mesh net. Note the time of day, which should be standardized for the site being sampled.
- Tie the tow-line to the net bridle, screw on the collecting bottle and wet the net to make it heavier before casting. Find a suitable place on the river bank or pond edge from which to cast the net, i.e. free of overhanging trees, or rocks/weeds in the water. Coil the tow-line and hold it and the net by the hoop – see diagram. Hold the end of the rope and cast out the coil and net as far as possible. Note the distance: **Tip:** if the line has knots tied at 0.5 m intervals, the distance cast can be quickly measured.
- Haul in the net at a constant speed: slowly enough to prevent it surfacing and fast enough to prevent sinking. Lift out of the water by the bridle and wash down the net by splashing water on to the outside of the mesh. Unscrew the sample bottle, strain about 10% of the water and replace with 40% formalin and insert a paper label giving site, date and length of haul written in pencil. Cap bottle and invert to mix.
- Repeat the procedure six times, numbering replicates. (The net may also be towed for a known distance from a boat.)
- Alternatively, if the plankton is dense (greenish coloured water), fill a bottle with water, or in deeper water, lower a weighted bottle from a boat/bridge and unstopper with a string tied to the stopper when at the required depth. Replicate, preserve and label as above.
- Estimate the volume of water that passed through the net from the distance hauled (m) and the area of the mouth of the net.
If the diameter of net mouth = 30 cm, then the area of mouth = πr^2 or $3.142 \times 225 = 707 \text{ cm}^2$.
If the haul was 7 m then the volume of water sampled was area of mouth \times length of haul = 4949 litre or 4.9 m^3 . (The volume of water sampled will be over-estimated because of back pressure caused by net resistance as it becomes clogged.)
- Process samples as soon as possible, as deterioration can occur (see treatment of plankton on page 191).

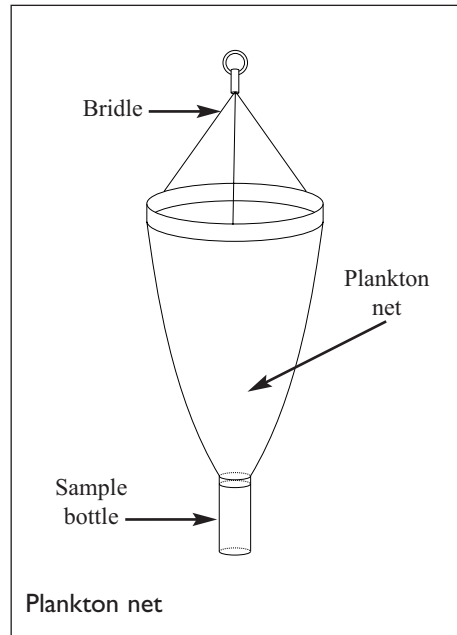

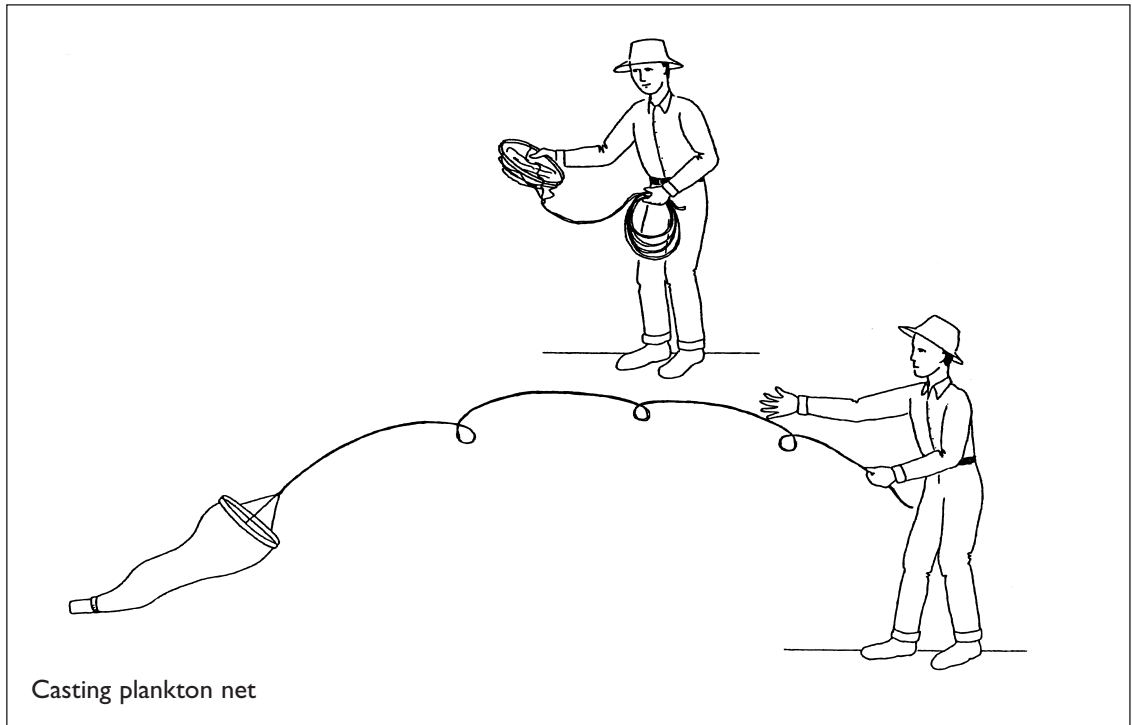

OTHER CONSIDERATIONS

In deep water and access to a boat, the plankton net can be hauled up vertically. Try and take plankton samples at the same time of day as they do change depth in response to light.

Grab sampling

DON'T FORGET

EQUIPMENT: Eckman or Petersen grab; pole; messenger or rope for grabs; strong plastic bags; wide mouth sample bottles (1 litre); buckets x 3; permanent marker pen; 40% formalin.

This is a two person job.
Handle formalin with care (see chapter 3).

ECKMAN GRAB

Method

- Select an area of shallow water that is free of rooted vegetation and stones to sample. Standardize the placement of grabs at each site so that samples are the same distance from rooted vegetation or the shoreline; or for rivers, in similar current strengths or sized pools.
- Wade out slowly (to help maintain visibility) holding the pole of the sampler at arm's length in front of you. Firmly place the sampler on flat substrate and, depending on the action of the sampler, either twist the pole and push or send the messenger down to activate the jaws.
- Lift the grab vertically and check that no sticks or stones are preventing the jaws from closing. Hold the jaws over a bucket and release the jaws to deposit the sample. Wash the grab with a *little* water to flush the sediment stuck to the walls into the bucket.
- Pour the contents of the bucket into a heavy gauge plastic bag. Pour 50 ml of 40% formalin into the bag, place a pencil written label inside, close the bag and tie a label to the neck of the bag. Squeeze the bag gently for 1 min to disperse the formalin in the mud.
- Walk a few metres away from the previous sample and repeat the procedure, taking care not to sample where you have walked; 4–8 replicate samples are required for quantitative estimations. The grab can also be used from a boat in shallow water.

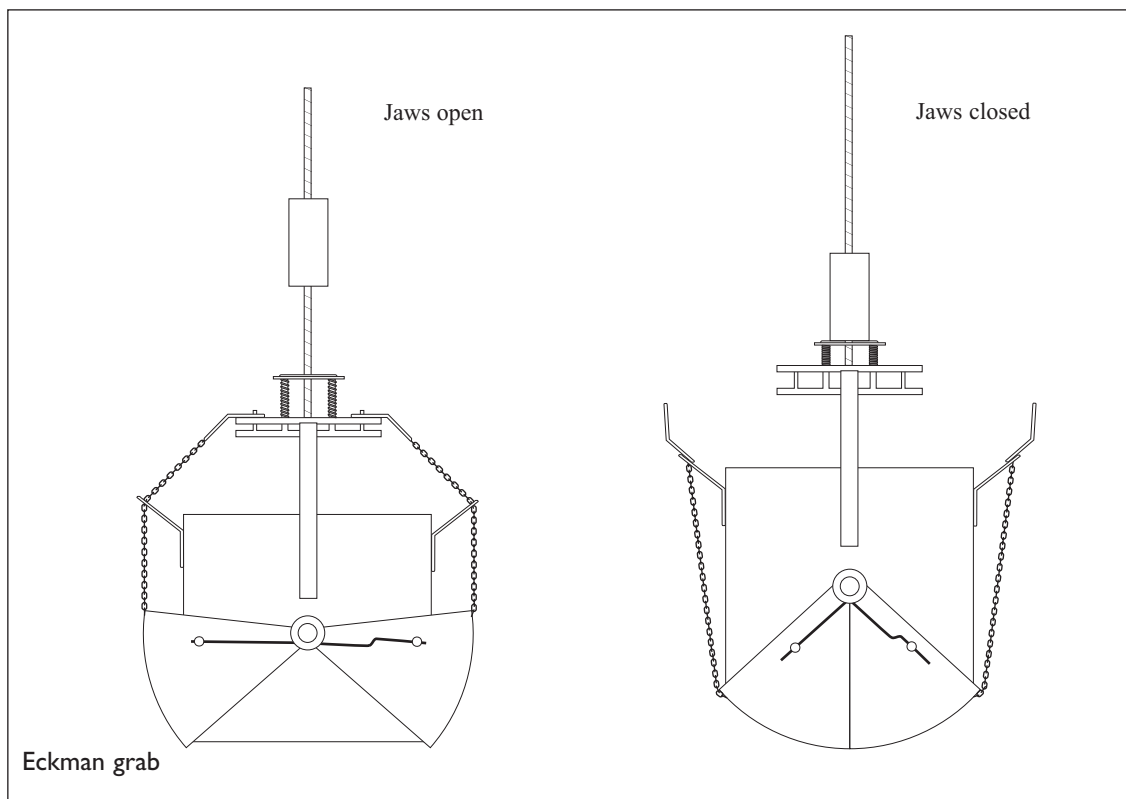

In deeper water use the Petersen grab from a boat.

PONAR AND PETERSEN GRAB

Method

- Check the depth with a stone tied to a line and then ensure you have enough rope tied to the grab. If the bottom is visible, avoid vegetation that might jam the jaws. Coil the rope, load the jaws, lift the grab over the rear of a boat/canoe and drop, allowing it to free-fall (do not burn your hands on the rope).
- Once the rope is slack, haul up the grab and check the jaws are closed properly before emptying and processing the sample as described for the Eckman grab above.

Tip: *Sieving the samples to remove mud and debris is easy to do in the lake, and the large quantities of water required to do it is frequently limiting at a camp.*

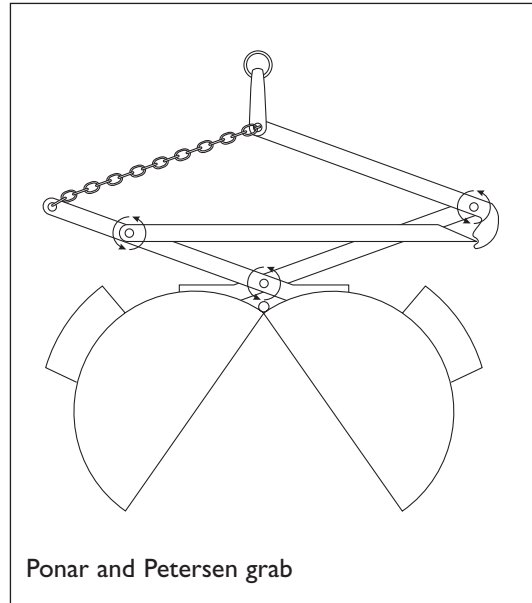

OTHER CONSIDERATIONS

Quantitation – the number of samples required will depend upon the abundance of species of interest. If the samples can be washed and sorted the same day, preservative is unnecessary – live organisms are easier to see on white trays.

Mud samples should be processed as soon as possible – within 1–2 days of return to the laboratory. Wash the mud through a series of sieves – 4 mm, 1 mm, 500 μm and 250 μm to remove stones and debris and separate organisms. Backwash the sieve contents on to a white tray and sort. Preserve the organisms in 4% formalin.

Sampling catch from local fishers

DON'T FORGET

EQUIPMENT: Measuring board; spring balances or scales; at least 10 strong plastic bags (30 x 40 cm); buckets (x 3–4); cool-box and ice (if fish are to be taken some distance before being measured); notebook; pencils; money to buy fish; permanent marker pen; at least 10 m of string for measuring nets and sampling site (**TIP:** *Mark the string in 1-m divisions with a permanent marker pen to save having to measure the string later*); Secchi disc; pH, oxygen and conductivity meters; measuring pole or string with a weight attached at one end and marked at 0.5-m intervals from the base of the weight; equipment for physico-chemical measurements is useful if capture of fish is observed at the sampling site.

Each survey team should plan an approximate timetable for each gear, fisherman or boat chosen to sample, and teams should co-ordinate their efforts between sampling sites.

Method

- Record the site where the fish are caught, even if the catch is landed at a harbour or fish market, date, fishing gear used, method of capture, start and end times of fishing, number of gears used, and measure mesh, lengths of nets, hooks or trap openings.
- Weigh the whole catch directly, or estimate the whole weight by filling buckets or baskets (often used by fishermen for transporting and selling fish) with fish and weighing them. If all the baskets cannot be weighed because the fishermen are eager to leave the site and sell fish, weigh three and count the number of baskets filled by the whole catch. The total weight of the catch is estimated by multiplying the average weight of the three baskets by the number counted.
- If possible separate catches by net, trap or haul. Separate the larger fish from the catch (fishermen will often do this for selling fish). Measure lengths and weights of the large fish individually.
- Mix the smaller fish together and randomly separate several buckets or bags full of fish. The larger the sample the more representative it will be of the whole catch. Fishermen will probably wish to sell the sample selected to the survey team, rather than wait for measurements to be made before the fish can be taken to be sold. If so, the sample can be taken back to camp or the laboratory to measure. Buying fish also allows the team to carry out observations on reproduction and feeding, and to collect parts for ageing, eggs for fecundity analysis and samples of tissue for residue analysis.
- If local people sell their fish by species, then sampling each species, as above, should be done. Weigh the total catch of each species instead of the whole catch together.
- If measurements on fish are carried out in the field, speed is essential. **Tip:** *A folding table on which to work is an advantage. Usually it is impossible to cut fish as this decreases the value, so noting species and measurements of lengths, weights and possibly collection of some scales are all that can be done.*
- For mixed species sampling, the proportion of a particular species in the sample is multiplied by the total catch weight to estimate the total weight of that species in the catch. Done for each species, this gives the species composition of the catch.
- If carrying out growth and mortality studies, sampling from local catches can provide the quantities of fish needed. If the same species appears in the catch as large and smaller fish, then the numbers of smaller fish must be estimated for the whole catch, so that the proportions of smaller to larger fish are representative of the whole catch.

OTHER CONSIDERATIONS

It is a good idea to visit the fishers at their village, market or fishing sites before sampling begins. Explain the main purpose of the study and encourage their interest in the results. This will help gain their trust and co-operation during sampling. It may be advantageous to offer incentives, such as offering to purchase catches on the sampling days. Regular visits to the fishers throughout the project will maintain their co-operation and a final visit to explain the results of the study will promote their future assistance.

Seining

DON'T FORGET

EQUIPMENT: Seine net (at least 75 m in length); stop netting of fine mesh (50 mm or less), at least 2 lengths of 50–75 m; poles for staking stop nets; strong plastic bags (at least 12); buckets (x 3–4); cool-box and ice (if fish are to be taken some distance before being measured); notebook; pencils; permanent marker pen; string (at least 10 m) for measuring the site (TIP: *Marking the string into 1-m divisions with a permanent marker pen saves having to measure the string later*); Secchi disc; temperature, pH, oxygen and conductivity meter; depth measuring pole or string with a weight attached at one end and marked out in 0.5-m intervals from the base of the weight; waders.

Method

- Set stop nets as quickly as possible. Feed stop nets out from a boat, or across shallow water by hand. Stop nets should be deep enough to reach from the surface of the water to the bottom and long enough to extend from one shore to the other. Secure stop nets beyond the water's edge to vegetation or stake on poles.
- Measure water temperature, pH, conductivity, oxygen and turbidity at this stage. Once seining commences, disturbance of the water and bottom substrate will alter measurements. Depth can be checked at this point or after seining, but before stop nets are pulled together.
- Feed seine net out close to one stop net by boat or by hand. **Tip:** *Do this as quietly as possible to avoid frightening the fish away. Attach ropes to the ends of the seine, either the top or both lines.* The top of the net should be held on the water surface and the bottom of the net on the river bed, respectively, to maintain net coverage over the whole depth. Pull the top of the seine net slowly and carefully to about 20 m from the other stop net (Figure 1). Drag one end to the stop net and along its length, closing the net round into a circle, opposite the bank where fish will be landed (Figure 2). **Tip:** *Take care not to pull the top and bottom lines together when the net is dragged.*
- Gradually close the circle, holding the net top above the water to prevent fish leaping over it and maintaining the bottom line on the river bed. Towards the end of the haul, the bottom (or 'lead') line should be pulled ahead of the top (or 'float') line to trap the fish in the bag. If the netting catches on obstacles in the water, team members should locate the problem by entering the circle from the outside (this causes less disturbance of the fish than approaching from inside), diving to the river bed may be necessary to carefully lift the net around the obstacle. Fish escaping the seine net, can be caught in subsequent seines (hauls) or when the stop nets are removed.
- As the last part of the seine net nears the shore, drag quickly as fish will be panicking at this stage.
- Carry the fish a few metres up the bank and then remove them from the netting (fish that are still alive can escape if they are at the water's edge). Store fish from each seine together in a plastic bag or bucket to keep them alive as long as possible, and prevent the fish from rotting if they are not measured for a few hours. Alternatively fish can be put into a plastic bag and into the cool-box. Each plastic bag should be labelled with site, date and seine number (the first should be 1 or A). Buckets are useful to keep plastic bags wet, which keeps the fish cool.
- Continue seining at the same site until no more fish are caught. If the survey team is efficient, then 5 or 6 will be sufficient to remove all the fish from the site. Store fish from each seine separately.
- Before removing the stop nets, measure the area between them using the string. If the site is irregular in shape, attempts to estimate the area should be made (a sketch with measurements made in the field can be plotted on graph paper later).

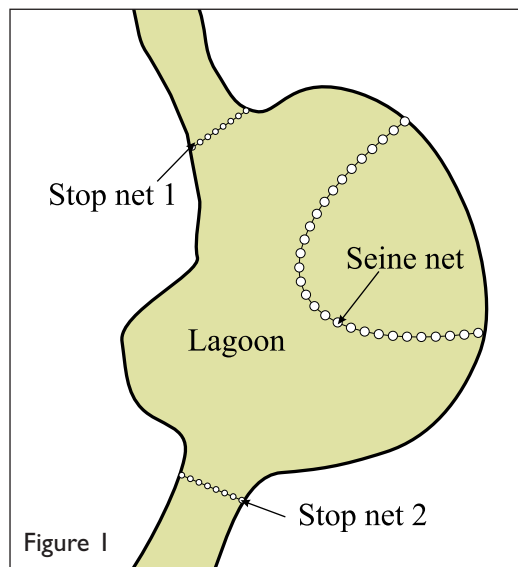

- Finally draw one of the top nets towards the other. The same care should be used to drag the stop net through the site as with the seine net. Once the nets are together, remove them from the water and take out fish entrapped between them at the shore. The stop nets may have small fishes 'gilled' in them so care must be taken to check the whole length of the stop nets. Store the fish from the stop nets separately in a plastic bag. Take all the bags of fish carefully back to the camp or laboratory for measurements.

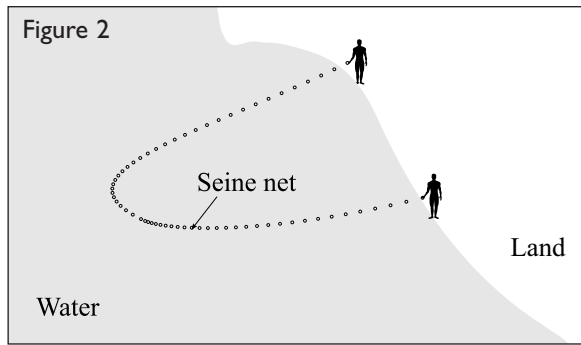

OTHER CONSIDERATIONS

On arrival at the sampling site, the team should be cautious about making noise and commotion, fish will detect vibrations on the shores and take fright.

Beware of crocodiles, hippopotamuses and bilharzia.

If the haul is carried out too slowly fish may escape from the mouth of the net. If the haul is too quick, however, the lead line of the net may lift off the bottom or the float line sink, so allowing losses.

Check nets for damage at the end of sampling. Repair any damage immediately.

Gill netting

DON'T FORGET

EQUIPMENT: Boat (dugouts or woodskins are adequate in still water, but a small motorized boat may be needed in slight flows or where turbulence can be a problem) (it is possible to set nets by wading through shallow water, but disturbance of the site is inevitable); gill nets (at intervals of 0.5 inch to 1 inch stretched mesh size, 50–100 m length per net, usually 8 nets, if larger fish are present the range should be extended); rope for securing nets; heavy weights to anchor bottom or middle set nets; floats or markers; strong plastic bags or rice sacks labelled with net number or mesh size and setting, e.g. 0.5 inch, bottom set may be net 1B, 2 inch, top set may be 4T; cool-box and ice; notebook; pencils; permanent marker pen; marked string; Secchi disc; temperature, pH, oxygen and conductivity meter; measuring pole or string with a weight attached at one end and marked out in 0.5-m intervals from the base of the weight.

Method

- Tie nets together in series from smallest to largest mesh size and pack into the boat, keeping float and lead lines separate, so that the nets do not twist.
- Plan the location and direction where the nets will be placed. Identify anchor points, such as strong vegetation close to the shoreline, or a submerged tree within the site. Alternatively, use a buoy or attach one end of the rope to a post put in place specially.
- Set gill nets for night fishing just before dusk (16.00–18.00 h in the tropics). Collect nets from night fishing at dawn (05.00–07.00 h). For daytime fishing nets set at dawn (05.00–07.00 h) and collect just before dusk (16.00–18.00 h).
Tip: For both daytime and night-time fishing, use two sets of gill nets, the second one is set when collecting the first, this saves valuable time spent removing fish from nets before resetting them.
- Secure the end of the smallest mesh net (usually with some extra rope) to the anchor point, paddle or propel the boat slowly away in the planned direction, feeding nets out carefully into position (a motor boat in reverse, means that nets can be fed out from the bow, avoiding too many snags). **Tip:** Go slowly to allow correction of any net entanglement.
- When almost all the nets have been fed out, attach the float/marker to the float line, using extra rope if the nets are for middle or bottom settings. Attach weights to the lead line to sink it to the bottom, or with extra rope to secure it in the middle or top set positions. **Tip:** Do not set the net too tightly, as this will reduce the catch due to fish bouncing off the net. Leave nets in place for the night or day.
- Measure water temperature, pH, conductivity, oxygen and turbidity. Depth measurements along the fleet of nets can be carried out to determine the depth of the water and the depth of net settings. Repeat measurements when nets are collected, so that diurnal variations can be considered.

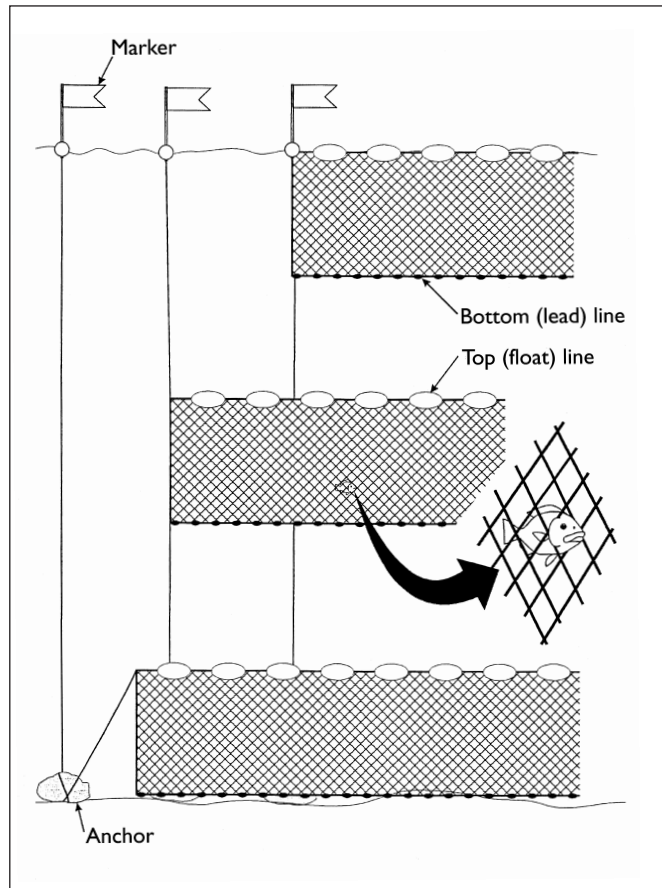

- When collecting gill nets, start with the largest mesh, i.e. the exposed end of the fleet. Gather nets into the boat as quickly as possible, so fish are kept fresh. Fish can be removed from the nets while travelling back to camp or the laboratory, or when back at camp, checking nets for damage at the same time. Store the fish in the labelled bags, keeping them moist. Storing in cool-boxes keeps fish fresh for some hours. Measurements on the fish should be carried out as soon as possible after collection.

OTHER CONSIDERATIONS

More nets should be used if manpower for measuring the catch is ample and if bottom, middle and top settings are required to cover the depth adequately.

On arrival at the site nets should be set as quickly as possible to avoid too much disturbance.

Take care when setting nets to minimize the risk of catching crocodiles, etc.

Check nets for damage at the end of sampling. Repair any damage immediately.

For both daytime and night-time fishing, the study team should either work shifts to measure fish during the evening, or fish can be frozen from the day and processed the following day with the night catch.

Daytime and night-time catches must be kept separate.

Trapping (e.g. box traps)

DON'T FORGET

EQUIPMENT: Traps; baits (TIP: *Check what kind of bait local fishers use, they will know the best attractants*), good examples are bread or cornmeal paste, tinned meat and fruit; boat; strong plastic bags (30 x 40 cm, 2 for each trap) or rice sacks labelled with trap number; cool-box and ice (if fish are to be taken some distance before being measured); notebook; pencils; permanent marker pen; string (TIP: *Marking the string into 1-m divisions with a permanent marker pen saves having to measure the string later*); Secchi disc; temperature, pH, oxygen and conductivity meter; measuring pole or string (about 10 m) with a weight attached at one end and marked out in 0.5-m intervals from the base of the weight.

Method

- Select the narrowest part of the river/stream to place the traps.
- If traps are to be baited, place bait within each trap.
- Position traps across the stream, with openings against the flow, each trap set close to the adjacent one or with space between blocked. The closer together the traps are placed, the less likely fish can swim around them.
- Make sure the traps are secure, tie together with rope or anchor them with stones or stakes.
- Traps should be checked regularly throughout the day and night, as fish are often caught just after dawn and dusk. If fish remain in the traps for long, fish can be damaged by trying to escape and predation from other fish is likely.
- Collect fish from each trap and reposition with fresh bait. Place fish in labelled bags and record the time since last checked or first set. This gives the fishing effort in trap hours.
- After setting, checking and collecting the traps, measure water temperature, pH, conductivity, oxygen and turbidity. Depth measurements along the line of traps can be carried out to determine the depth of the water and the depth of settings.
- The setting of different types of trap may differ depending on fishing traditions, seek assistance from local people.

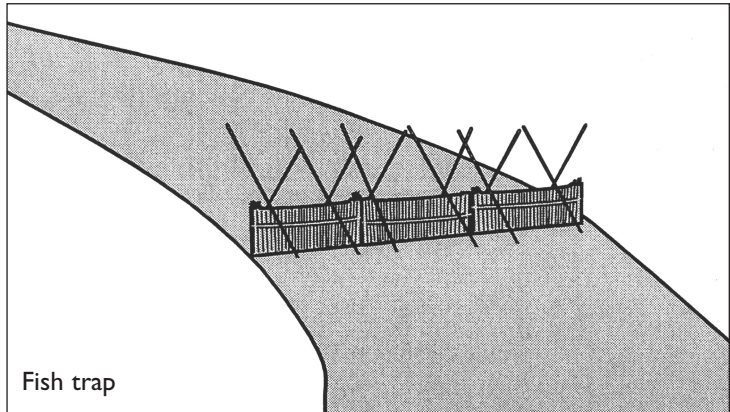

OTHER CONSIDERATIONS

There may be ownership of fishing sites for traps, in this case co-operation of fishers is essential. Trap fishermen may assist in setting and checking of traps. On arrival traps should be set as quickly as possible to avoid disturbing the site too much.

Spearing

DON'T FORGET

EQUIPMENT: Spears; boat; strong plastic bags (at least 10, 50 x 60 cm) or rice sacks; cool-box and ice (if fish are to be taken some distance before being measured); notebook; pencils; permanent marker pen; Secchi disc; temperature, pH, oxygen and conductivity meter; measuring pole or string (about 20 m long) with a weight attached at one end and marked out in 0.5-m intervals from the base of the weight.

Be aware of health and safety problems, such as crocodiles, hippopotamuses and bilharzia (waders may be useful).

Method

- Spear fishing should be carried out by local people who are well acquainted with the fishing site.
- If present when fishing occurs, place speared fish in bags, labelled with times caught, or labelled with each hour from the start to end of fishing.
- If the activities of the spear fishermen are not monitored, then ask the time fishing began and ended and store all fish caught in that day together. The precise locality of fishing must be known, if fishing occurred outside the site, then catches must be disregarded.
- At intervals throughout the day, measure water temperature, pH, conductivity, oxygen and turbidity at the fishing site. Depth measurement around the site can be carried out to determine the depth of the water and depths at which fish were caught.

OTHER CONSIDERATIONS

On arrival at the site care should be to avoid making a disturbance. Encourage fishers to help by returning fish to them after processing.

Hooking

DON'T FORGET

EQUIPMENT: Hooks; line; baits (usually meat or small fish, check with local fishers, they will know the best baits); boat; strong plastic bags or rice sacks labelled with trap number; cool-box and ice (if fish are to be taken some distance before being measured); notebook; pencils; permanent marker pen; Secchi disc; temperature, pH, oxygen and conductivity meter; measuring pole or string (about 20 m) with a weight attached at one end and marked out in 0.5-m intervals from the base of the weight.

Method

- If setting hooks on longlines, attach the hooks to the line before going to the site. **Tip:** *Placing the hooks over a strip of wood, with lines dangling between is a good way of storing hooks and preventing tangling of the lines.*
- Place the line of hooks across the river/stream and anchor securely at each end. Tying the line to trees some distance up the banks ensures that if the water level rises during the night or day, then the hooks can be retrieved.
- Put bait on each hook (in fast flowing water put bait on hooks before putting them in the water) and check that they are suspended in the water below the surface. Fix lead shot or pellets to the vertical line to sink hooks and bait to the appropriate depth. More weight is needed in faster flowing water.
- At the time of setting the hooks, measure water temperature, pH, conductivity, oxygen and turbidity at the fishing site. Take depth measurement across the river where the hooks have been set with lengths of the vertical hook lines to represent depths where fish are caught.
- For active fishing using hooks and line, record start and end time of fishing.
- Place hooked fish in labelled bags, either from the daytime or night-time fishing for set hooks and from the period of fishing for active hooking.
- When actively fishing, at intervals throughout the day, measure water temperature, pH, conductivity, oxygen and turbidity at the fishing site. Take depth measurements around the site.



Hooks stored on a line

OTHER CONSIDERATIONS

On arrival care should be to avoid making a disturbance at the site. If angling, stealth around the site during fishing is also important.

Lengths and weights

DON'T FORGET

EQUIPMENT: Measuring board; weighing scales or spring balances; notebook; pencils.

Method

- Sort the bags of fish from each sampling method.
- Take the fish out of one bag at a time and sort them into different species.
- Make a note of all the details on the bag – date, site, time of day, haul number (for seining), net number or mesh size (for gill netting).
- Start with the smallest fish, wash them to remove dirt, place on the measuring board with the snout against the end of the board. Note the species and record the total, standard and fork lengths of each fish in turn. Give each fish a code number (e.g. A1...An) so that if eggs, scales, otoliths, tissue or the whole fish are preserved, it is possible to identify each fish individually.
- Weigh each fish to the nearest gram on the scales or spring balance. If using spring balances, use the balance with the most accurate range.

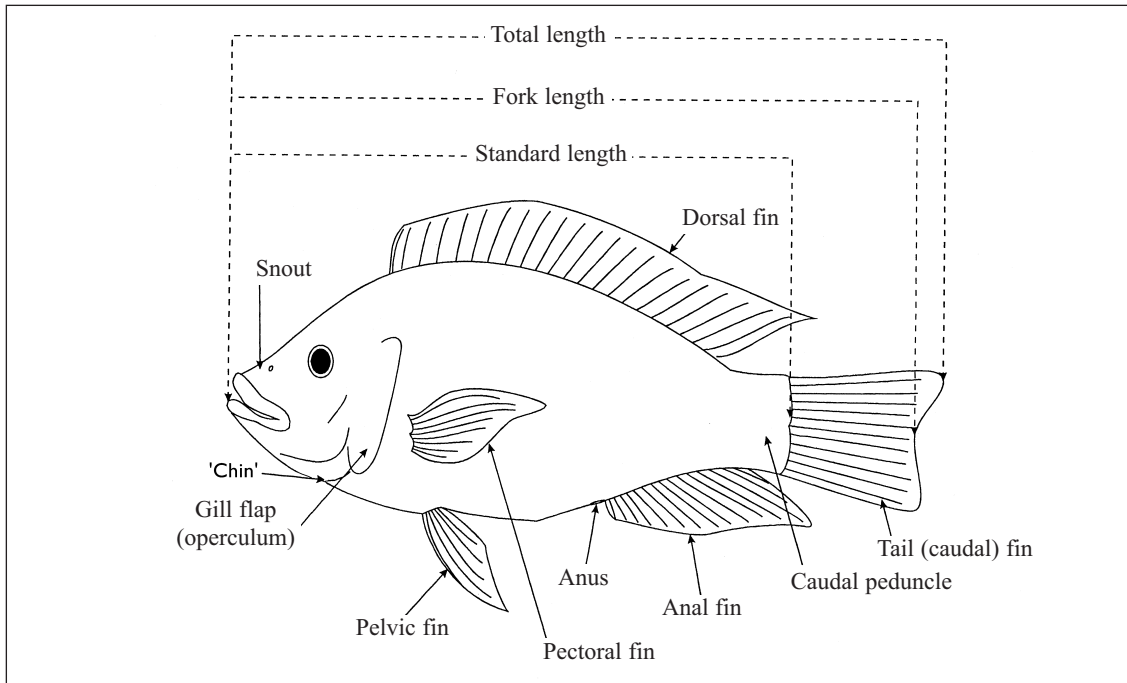

OTHER CONSIDERATIONS

Fish that have been frozen should be thawed thoroughly before measurements are made.

Gonad condition

DON'T FORGET

EQUIPMENT: Dissecting scissors; forceps; seeker; hand lens; notebook; pencils.

Method

- After taking length and weight measurements, proceed to assess the stage of reproduction.
- Cut each fish from the anus to the chin, making sure the points of the scissors are kept close to the skin. Carefully tease the gut out of the fish, observe the gonads lying below and behind the gut, near the wall of the abdomen. Check for the presence of eggs or milt by splitting the gonads and note the condition by comparing with the description in the table. Use a hand lens if the gonads are small. Record the sex and stage of reproduction, along with the other data.

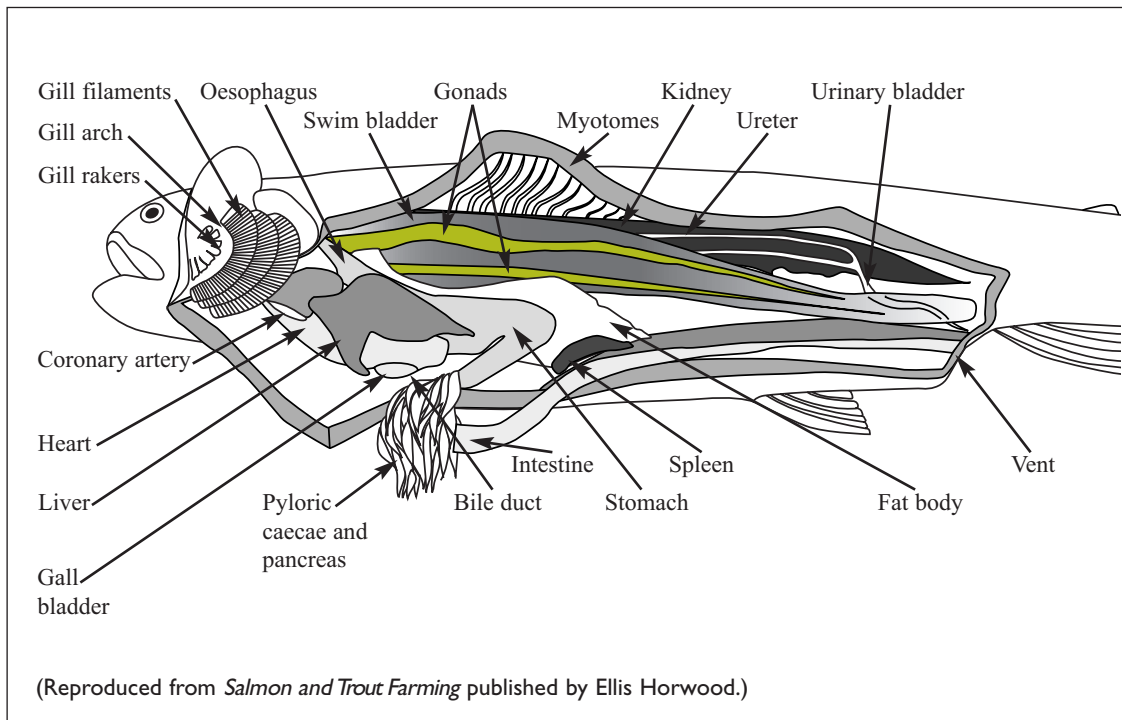

Stages of reproduction

I. IMMATURE

Young individuals that have not yet engaged in reproduction; gonads very small size.

II. RESTING STAGE

Sexual products have not yet begun to develop; gonads very small size; eggs not distinguishable to the naked eye.

III. MATURATION

Eggs distinguishable to the naked eye; a very rapid increase in weight of the gonads is in progress; testes change from transparent to pale rose in colour.

IV. MATURITY

Sexual products ripe; gonads have achieved their maximum weight, but the sexual products are still not extruded when light pressure is applied.

V. REPRODUCTION

Sexual products are extruded in response to very light pressure on the belly; weight of gonads decreases rapidly from the start of spawning to its completion.

VI. SPENT CONDITION

The sexual products have been discharged; genital aperture inflamed; gonads have the appearance of deflated sacs, the ovaries usually contain a few leftover eggs and testes some residual sperm.

VII. RESTING STAGE

Sexual products have been discharged; inflammation around the genital aperture has subsided; gonads are very small size, eggs not distinguishable to the naked eye.

(From Nikolsky, 1963.)

OTHER CONSIDERATIONS

The gonads of fish that have been frozen may not be discernable unless they are at stage IV or V.

Fecundity analysis

DON'T FORGET

EQUIPMENT: Dissecting scissors; forceps; seeker; hand lens; notebook; pencils; glass containers; preserving fluids; permanent marker pen; card for labels; analytical balance; filter paper; funnel.

Prepare preserving fluids before starting dissection of the fish.

Method

- When observing the sex and condition of the gonads, the eggs from ripe females (stages III and IV see method sheet on gonad condition) can be preserved for fecundity analysis.
- Carefully remove the whole ovaries and weigh. The ratio of fish body weight to weight of ovaries is useful for assessing the ripeness with greater certainty.
- Place the ovaries in glass bottles large enough to contain the eggs and about the same amount of preserving fluid.
- Add the preserving fluid, label (written in pencil) and mix well. Split the ovaries longitudinally and turn inside out so the fluid can penetrate around all the eggs. Shaking vigorously helps the preservation and separates the eggs from the ovarian tissue.
- Once the eggs are preserved (at least 24 h), wash off the fluid by decanting the fluid and replacing it with water and shaking. Repeat this several times.
- Sub-sampling the eggs for counting is preferable to counting all the eggs, especially if numbers exceed 1000. Gravimetric or volumetric sub-sampling methods are recommended. Gravimetric sub-sampling is described below.
- Pour the washed eggs into filter paper in a funnel. Spread on blotting paper to remove excess moisture. Air-dry the eggs on the filter paper with the edges turned up.
- When the eggs can be moved without raising the paper, all the eggs are weighed on the analytical balance. Two or more random sub-samples of at least 200 eggs should then be weighed. The fecundity estimate is obtained by multiplying by the ratio of total weight/weight of the sub-sample. Averages can be calculated from the sub-samples.

OTHER CONSIDERATIONS

Leaving ovaries too long in formalin can result in them becoming hard, making it difficult to separate the eggs from the ovarian tissue when counting is required.

Analysis of stomach contents

DON'T FORGET

EQUIPMENT: Dissecting scissors; forceps; seeker; hand lens; notebook; pencils; glass containers; preserving fluids; permanent marker pen; card for labels; petri dish; microscope; paper; funnel.

Method

- When dissecting the fish, cut up to the jaw from the anus, so the beginning of the gullet (oesophagus) can be located. Cut above the anterior opening of the stomach and below the posterior stomach opening and place the stomach in formalin. If the stomach is large, split open to allow the preserving fluid to penetrate within. Shake well and place a card label in each container, detailing site, date, method of capture and fish code number.
- Once the stomach contents are preserved (at least 5 days), identification of the items can proceed.
- Wash the stomach contents and remove stomach tissue. Place in a petri dish and use a dissecting microscope for identifying larger food items. A microscope of greater magnification will be necessary for smaller items.
- Separation of food items into broad groups is possible, but specialist assistance is needed for more detailed identification.
- Record the number of organisms in each group. The number of stomach samples in which one or more of the given food items is found expressed as a percentage of all the non-empty stomachs examined. This is the *frequency of occurrence*.
- The second method of recording stomach contents is the number of food items of a given type/group that are found in all specimens examined expressed as a percentage of all food items, estimating the relative abundance of that food item in the diet. This is called the *percentage composition* by number.

The method detailed above is based on numerical analysis. Alternatively volumetric or gravimetric analyses can be carried out.

OTHER CONSIDERATIONS

Leaving stomachs in formalin for a year or more may make the contents too hard for separation and identification. Some small items may also break down.

Collection of scales, otoliths and bones for ageing

DON'T FORGET

EQUIPMENT: Forceps; seeker; hand lens; notebook; pencils; envelopes; permanent marker pen.

If all of the fish in the sample are not needed for growth analysis, then a representative sub-sample of the catch should be taken. Approximately 200 fish of each species should be collected for ageing each month from each site.

Method

- Scales are removed from the skin with forceps, taking care not to scratch them. Take five scales, plus the key scale. Mark the key scale on the posterior part with the permanent marker pen.
- Remove any skin from the scales, dry them and store in labelled envelopes. The information on the envelope should indicate site, date, sampling method, species, fish code number, standard length and weight, in case the notebook is separated from the stored scales.
- Otoliths can be taken from scaleless fishes and have the advantage over other bony parts in that daily rings are detectable, so allowing fish less than a year old to be aged. Otoliths are in a slightly different position in different species, so dissecting the head by making different cuts is necessary (see figure overleaf).

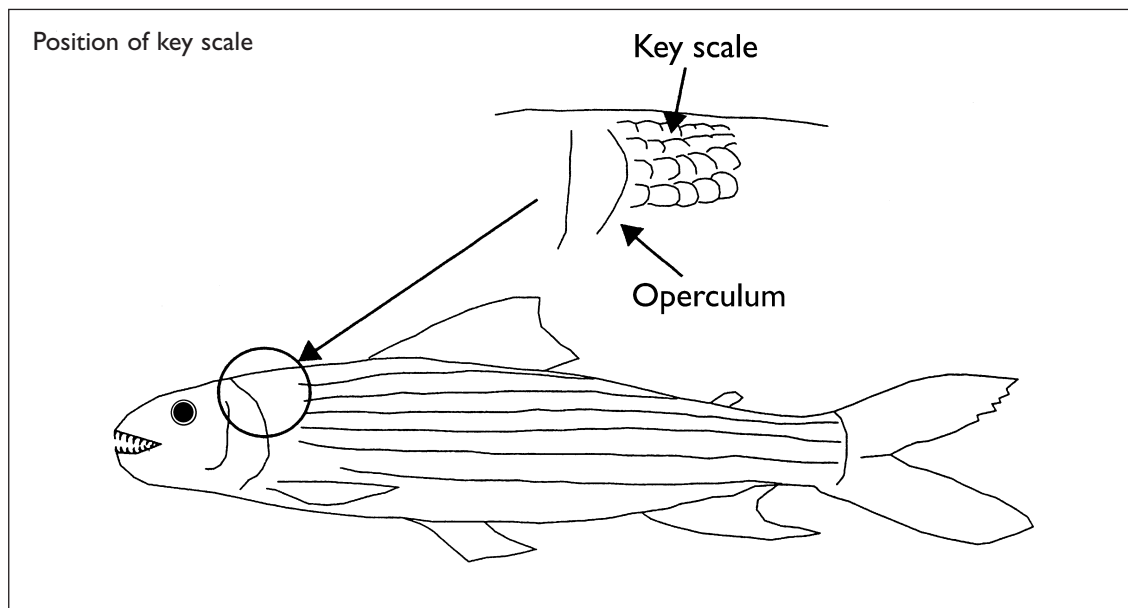

- Dry and store the otoliths in envelopes and label as with scales.
- Fish spines and vertebrae can also be collected for ageing fish. These are also suitable for fish without scales, such as catfish. The same spines and vertebrae should be taken from each fish, e.g. the first

Different positions for cuts to locate otoliths for different fish head shapes

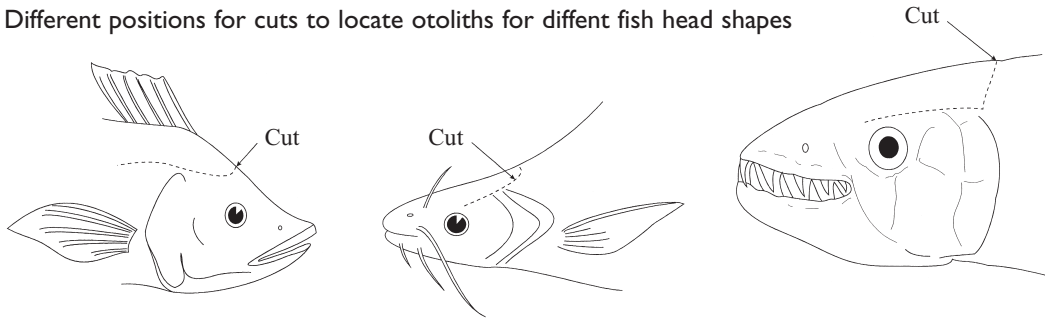

four vertebrae from the head or both pectoral spines.

- Remove tissue and skin from the bones and store in labelled envelopes as before.
- The sectioning of otoliths, spines and vertebrae and subsequent ageing from all bony parts should only be carried out by trained personnel.

OTHER CONSIDERATIONS

If assessment of growth and mortality is carried out soon after sampling, it is possible to determine whether a representative sample of the population has been obtained. If insufficient fish of a certain species have been caught or the size and age distribution is skewed, adjustments to the sampling programme may be possible.

Preservation of fish for reference and identification

DON'T FORGET

EQUIPMENT: Scissors; forceps; scalpel; seeker; hand lens; glass containers; formalin; notebook; pencils; permanent marker pen; card for labels; thin string.

Select fish for preservation that are in good condition (missing scales and damaged fins can hinder correct identification).

Method

- All specimens should be slit from the anus to the chin to allow the formalin to penetrate the body cavity.
- Make small slits in the muscle tissue of larger fish to allow preserving fluid to penetrate. These are best on the inside, from the body cavity towards the outside of the fish. Tissue greater than about 2 cm thick will not preserve quickly enough to preserve the specimen in good condition.
- Place the specimen in a glass container and cover with formalin. If several specimens are stored together, then attach small card labels with string through the gill opening. Labels should include details of site, date, sampling method, species (if known), fish code number, standard length and weight.
- Specimens for identification can be transferred into 70% ethanol after 5 days. This makes handling for the taxonomist much safer. Ethanol is easier to obtain in developing countries than formaldehyde. Long-term storage of reference collections in ethanol is more suitable.
- Regular topping up of the preservative is necessary for long-term storage.

OTHER CONSIDERATIONS

It is important to seek assistance with identification early in the sampling programme. This will enable important species to be noted for other analyses, such as growth, mortality and fecundity, streamlining the collection of body parts of these key species. Sending unknown fish in plastic bags to a specialist can speed up identification.

Visual encounter surveying (amphibians and reptiles)

DON'T FORGET

EQUIPMENT: Watch or stop-watch; digitometer (x 2); wide-beam spotlight (at night); linen bags (for live reptiles); plastic bags (for live frogs); aluminium screw-lid container with preservative solution (8–10% formalin for sampling for insecticide residue analysis); thermometer or whirling hygrometer; notebook; pencil; field guide.

Select matched sets of replicate sites in treated and untreated areas.

Starting points for the walks along a transect or within a defined area should be randomized.

Lizard tree counts should be conducted during the period of basking (usually in the morning with sunshine between approximately 08.00 and 12.00 h).

Method

- Select transect design
 - randomized walk (point-to-point transect), e.g. from tree – first randomly selected – to tree in woodland over a wide area (1), or series of randomized compass directions (2) and walk distances (within a constrained area)
 - line transect: walk single or multiple, but parallel transects, at least 250 m apart (3).
- Whether at a specific time during daylight hours or within the first 2–4 h of darkness at night, record date, exact time of start of survey, air temperature and cloud cover (in octas – an octa is the amount of cloud cover currently visible imagining the sky is divided into eight equal parts, each part is one octa).
- Zero a digitometer for recording number of individuals of a species, or trees, rocks, etc., depending on the habitat niche selected and nature of the survey.
- Ensure that sun is behind (or at less than a right angle with line of vision) so that during period of basking (usually 2–5 h after sunrise), whether in full sunshine or part shaded in, say, open woodland, a reptile is in full, or virtually uninterrupted, vision from 5–12 m away.
- Walk at a steady speed.
- A pedometer can be used to record walked distance if the quadrat or transect has not previously been plotted.

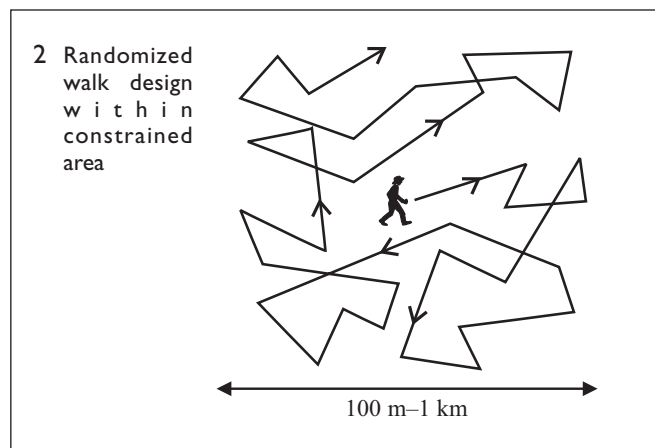
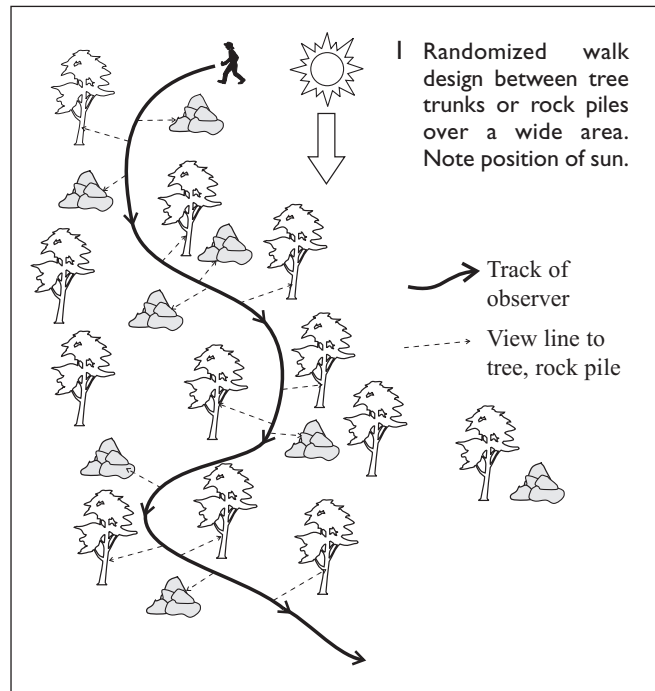

- For initial (exploratory) surveys, record the exact time that specimens of each species are observed, and also the air temperature and cloud cover at set intervals, e.g. 15 min.
- Record the number of animals seen on or by rocks, trees and bushes, or on bare ground between them, depending on species and habitat type; with more than one observer, each should be 10–20 m apart, depending on density, type and height of vegetation.
- Note any other important information that may have affected the numbers sighted, e.g sudden rain, different vegetation type or change in habitat, survey joined by a further observer.

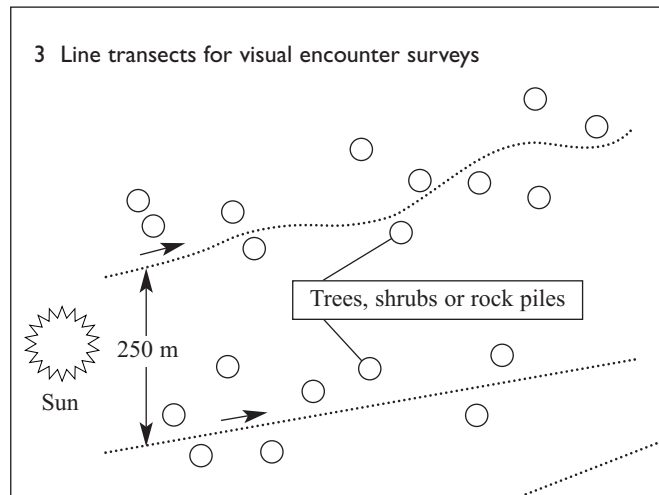

OTHER CONSIDERATIONS

Survey for reptiles during uniform behaviour, such as morning basking or first 2–3 hours of darkness after sunset.

With the sun behind you, your shadow may disturb a basking lizard whose movement usefully gives away its presence; at night, light may disturb a snake, lizard or amphibian.

Time spent surveying a site depends on the density of animals per unit area, or density of refuges, e.g. trees per unit area.

Aim to count enough refuges to be statistically meaningful (e.g. a minimum of 25 occupied trees).

Amphibian and reptile groups and species active during the day and at night differ.

For crocodiles and turtles, or frogs (all have eyes that reflect light at night) at lake or stream edges or by river banks, observations can be made from a boat, and distance may have to be measured from a scaled map later.

To record roadkills (amphibians, toads in particular during migrations, and reptiles crossing roads, especially at night, killed by passing vehicles), count the number of dead or maimed amphibians and reptiles in a length of road after a set time period, e.g. 24 h, noting previous evening's sunset air temperature, and weather over the period since the previous count. This can be useful in a long-term study over several years, or if a single road travels through an area of uniform habitat only part of which has been treated with pesticide. Roadkill numbers per kilometre can be compared in treated or untreated sections of the road over 5 or 10 km lengths.

For surveys that do not account for area density, record the number of specimens seen in relation to the number of refuge/basking sites, e.g. trees. For example, in woodland, trees are counted, and the number on which there are basking arboreal lizards (noting the species) is recorded. This gives the proportion of trunks occupied by lizards. The number of refuge/basking sites, in this case trees, that needs to be counted depends on the numbers of animals recorded during the surveys and is constrained by density and size of the woodland stand. For example, it might be necessary to count as many as 300 trees if the proportion occupied is low. On the other hand, the total number of trees available may be limited by low tree density and overall stand size. With a higher proportion of trees occupied, as few as 50 might be counted, especially if the tree density is low. At completion of the survey, recording the exact end time gives the duration, and thus also sighting frequency (number of specimens per unit of time), particularly counting individuals when more than one on a tree.

Patch sampling (amphibians and fossorial reptiles)

DON'T FORGET

EQUIPMENT: Random numbers table; watch; compass; digitometer; linen bags (for live reptiles); plastic bags (for live frogs); aluminium screw-lid container with preservative solution (8–10% formalin for sampling for insecticide residue analysis); thermometer or whirling hygrometer; notebook; pencil; field guide.

Certain amphibian species (and fossorial reptiles) are associated with particular microhabitats provided by individual or a small assemblage of logs, rocks or single bushes; these are definable as individual patches, and in effect represent separate quadrats. Randomized patch sampling is especially useful for inventorying and monitoring species restricted to a particular microhabitat, and comparing numbers and species in areas treated and untreated with pesticides.

Method

- Certain amphibian species (and fossorial reptiles) are associated with particular microhabitats provided by individual or a small assemblage of logs, rocks or single bushes; these are definable as individual patches, and in effect represent separate quadrats. Randomized patch sampling is especially useful for inventorying and monitoring species restricted to a particular microhabitat, and comparing numbers and species in areas treated and untreated with pesticides.
- Define areas for sampling in contaminated and uncontaminated zones, and record number of patches in them – this gives patch density.
- Decide at the outset the number of patches to be sampled in an area. As in the case of quadrats, 25–30 will provide adequate data for statistical comparison of matching areas with patched microhabitats.
- Number patches and use random numbers to select patches for sampling.
- Select a minimum of 30 patches per area (or per sampling period for site monitoring).
- Remove or break up the material making up the patch, e.g. turn over rocks, separate out logs or search bushes; record the numbers of each species sampled, ensuring that all of the animals associated with each patch are included. Record the total time to complete the task.
- Record in a notebook the location of the patch within the survey area, the date, time of start and end of sampling, weather conditions, air temperature and relative humidity.

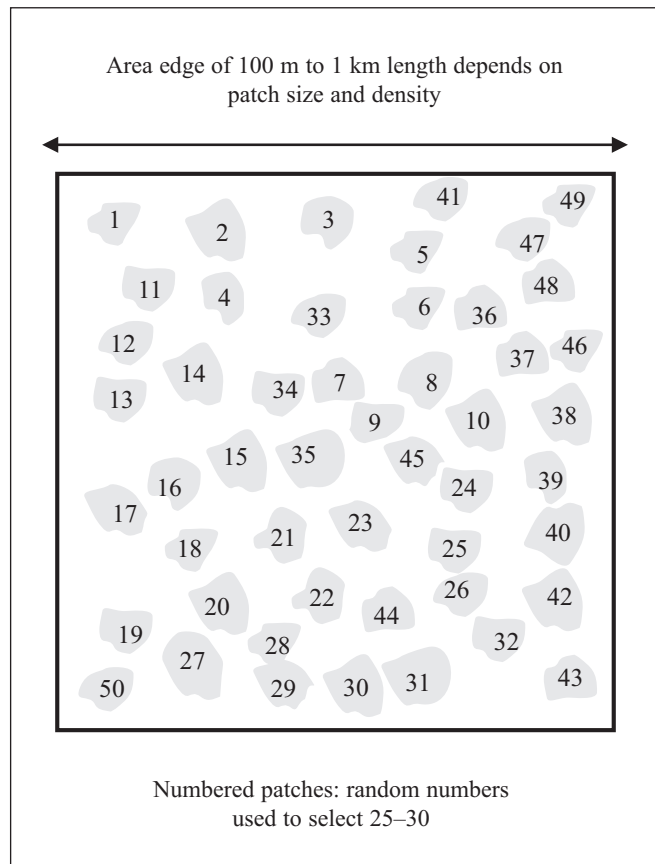

OTHER CONSIDERATIONS

Total dismantling or destruction of a patch is involved with this method, and so on grounds of habitat conservation it should only be conducted when the patch is one of many over a large area of habitat. Animals that escape from a patch before being counted bias the relative abundances of species, and so should be noted before detailed counts start and added to the total.

Although simpler statistically, the same number of patches do not have to be sampled in each area, nor do areas need to be the same size, although ideally they should be of similar overall patch density.

A single observer should, if possible, sample patches in matching areas to minimize inter-observer sampling error.

Breeding site surveying (amphibians)

DON'T FORGET

EQUIPMENT: Watch; thermometer or whirling hygrometer; waders or hip boots; wet suits; long-handled dipnets; headlamps and spare batteries (night surveys); plastic bags (for live frogs); linen bags (for live reptiles); aluminium screw-lid container with preservative solution (8–10% formalin for sampling for insecticide residue analysis); coloured flagging for marking site; waterproof data sheets; notebook; pencil; field guide.

Method

Note that this technique is effectively a visual encounter survey: line transect, but is specifically applied to amphibian breeding sites, which are distinctive rainy season phenomena.

- Select the survey area at random within matched sites in pesticide-treated and untreated areas in relation to amphibian breeding sites, and record habitat characteristics (pond, stream, lake, etc.).
- Select sites in random order, and make 6–9 surveys during the breeding season, each consisting of 2–5 1 km transects (species at densities of 1–5 ha⁻¹).
- During daylight surveys, note the position of the sun in relation to the location of animals in water and basking at the edge of the bank.
- For visual encounters:
 - walk along the pond edge at a steady preferred speed (a pedometer can be used to record the walked distances in the case of an unplotted transect), and record the species, number of individuals, location and time of each frog seen, or heard (after darkness)
 - from a boat, the distance travelled along the lake edge or river bank may have to be measured between known points from a scaled map later (see lake or stream edge or river bank transects on Visual Encounter Surveying method sheet).
- For calling amphibians, select a series of consecutive transects of 1 km length along a lake or stream edge. Transects should be spaced far enough apart for sounds from one not to interfere with another. Separation distance will have to be greater for very loud species than for quieter ones. As a separate exercise, the minimum length of distance should be measured (between approximately 100 and 500 m) at which each frog species can no longer be heard clearly – a mean and standard deviation for six distances per species. At night, note the number of calls for the first 2–3 h of darkness after sunset. As in visual encounters (see method sheet), record the species and number of individuals, habitat or microhabitat, location and sighting time of each frog seen, or calls heard as part of a chorus.
- For species that cannot be identified, collect voucher specimens by detecting the position visually during the day or locating calling individuals at night, and catching them manually or with a hand net on the shore or in water at the edge of the water body. Surveying should continue until no further species are recorded, and duration of time noted.
- At the end of surveys, record the exact time, air temperature, cloud cover (in octas, an octa is the amount of cloud cover currently visible imagining the sky is divided into eight equal parts, each part is one octa) during the day, and other weather conditions that may affect visual encounters and nocturnal calling, e.g. afternoon rainstorm.

OTHER CONSIDERATIONS

For amphibians in linear habitats, e.g. pond and lake shorelines, and along streams counted from calling individuals, detection distance does not need to be calculated – calling-male density (male:female ratio previously determined) is calculated as numbers per kilometre of linear habitat.

Time spent surveying a site depends on population levels and density of refuges.

Amphibian (and reptile) groups' activity differ during the day and at night, and during different seasons of the year due to rainfall and temperature.

To estimate population size from female anurans, record egg masses (annual recording during breeding season in a specific water body), count the number of spawn clumps (frogs) or egg strings (toads) along a lake or pond edge, and give size or length category (eggs in clumps or strings are usually too numerous to count individually, and a proportion is not fertile), after previously determining mean and standard deviation of number of eggs from a statistically meaningful number, e.g. six, of clumps or strings.

Complete species inventoring (amphibians and reptiles)

DON'T FORGET

EQUIPMENT: Linen bags (for live reptiles); plastic bags (for live amphibians); screw-lid containers with preservative solution (8–10% formalin for sampling for insecticide residue analysis); wide-beam spotlight (at night); machete; rake; snake stick; pedometer; compass; altimeter; notebook; pencil; field guide.

Inventoring is more easily done during daylight hours, but amphibians and certain lizard and snake species are visually more readily encountered when active at night. Therefore, day and night surveys are required for complete inventoring.

VISUAL ENCOUNTER – for most reptiles, and some species of amphibian

Method

- Record habitat characteristics (woodland, grassland, swamp, riverine habitat, primary rainforest, etc.).
- Whether during daylight hours or at night, record the date, exact time of start of the survey, air temperature and cloud cover (in octas, an octa is the amount of cloud cover currently visible; imagining the sky is divided into eight equal parts, each part is one octa).
- During daylight surveys, ensure that the sun is behind or at less than a right angle with line of vision so that during period of basking (usually 2–5 h after sunrise) animals sighted are in full vision from 5–12 m away.
- Walk across the habitat at a steady speed searching constantly and recording the number of animals seen on or by rocks, trees and bushes, and on bare ground between them; with more than one observer, each should be at least 10–20 m apart, depending on density, type and height of vegetation. Time spent walking and/or area covered depends on the number of animals recorded in relation to vegetation height, cover, quality and quantity.
- Record the exact time that individuals of each species are seen, and their behaviour, e.g. basking, hunting, mating, etc.
- Distances walked can be measured with a pedometer; alternatively paces can simply be counted to record distances walked, each pace being taken to measure approximately 1 m, or from previous calibration by the individual observer recording the mean number of paces taken over a measured distance of 100 or 1000 m.

MICROHABITAT SEARCHES – for many amphibian species, and additional species of reptile, especially fossorial forms (see also quadrat and transect block microhabitat sampling method sheet)

Method

- Searches in woodland with varied habitat components may involve turning stones (rocky areas), raking through leaf litter (forests with leaf litter carpet layer), probing holes and crevices with sticks (rock piles and hollow trees), splitting or dismantling old and rotten logs (fallen trunks in forests), removing epiphytes (overgrown forest trees), etc. Time spent searching and the area covered depends on the number of animals recorded, quality and quantity of vegetation cover and number of observers; searching need not continue when no further species are recorded.
- Collect voucher specimens of any species that cannot be identified.
- Note any other important information that may have affected numbers sighted, e.g. sudden rain, change of habitat or different vegetation type, unseasonably dry (or wet) or cold (or warm) weather.

OTHER CONSIDERATIONS

With the sun behind you with visual encounter surveying, your shadow may disturb a basking lizard that usefully gives away its presence.

Time spent surveying a site depends on the density of refuges, e.g. trees, or density of animals, a longer time or smaller area possibly needing to be walked in denser stands of trees, or for microhabitat block searching in thick ground vegetation.

The activity of different amphibian and reptile groups varies; some are only active during the day or at night depending on whether they are diurnal or nocturnal species; most amphibians are only active during seasonal rains; certain reptiles aestivate during warm dry periods of the year, others hibernate during winter months. Surveying and microhabitat searching for species to make up complete inventories should, therefore, be spread through the year, and conducted consecutively during different months.

Quadrat and transect block microhabitat sampling (amphibians and certain reptiles)

DON'T FORGET

EQUIPMENT: Random numbers table; quadrats: map of sampling area; metre measuring tape; 8 m square twine and four pegs; transect segments; 100-m measuring tape; string; stakes; flags to mark transects; watch; compass; digitometer; linen bags (for live reptiles); plastic bags (for live frogs); aluminium screw-lid container with preservative solution (8–10% formalin for sampling for insecticide residue analysis); thermometer or whirling hygrometer; notebook; pencil; field guide.

QUADRAT BLOCK

Method

- Represent area of interest as a rectangular grid of numbered quadrats, e.g. 100 x 100 m (1 ha) in 1 m² blocks, or 1000 x 1000 m (1 km²) in 10 m² blocks.
- Locate sampling quadrats within the grid by use of a random numbers table, with minimum departure from the ideal due to local topography.
- For a single dense population of a relatively small-sized species of around 3 individuals m⁻², select quadrats of 1 x 1 m (point sample); for a larger-sized, more widely dispersed amphibian (and fossorial reptile) multispecies populations, select 8 x 8 m quadrats (broad sample).
- Decide at the outset the number of quadrats to be sampled, 25–30 will provide adequate basic data for statistical comparison between areas.
- Choose the location of a quadrat from numbered squares on the horizontal and vertical axes using respectively the first and second digit of a three-digit random number, and drop a 1 x 1 m quadrat frame, or lay out an 8 x 8 m quadrat using stakes and twine.

TRANSECT BLOCK

Method

- Place a starting line of string of suitable length, e.g. 500 m.
- Mark out the line of string at uniform intervals, e.g. 10 m, using readily seen flags of, for example, high-coloured plastic strips.
- Use random numbers to separate apart by 1–10 m, 25 to 30 parallel (or 8 radiating) transects of 100 m long by 2 m wide extending perpendicularly from the starting line across a gradient area of interest.
- Divide each transect into 100 sub-sections of 1 x 2 m.
- Decide at the outset the number of transect blocks to be sampled; 10 sub-sections will provide in all 250–300 data blocks.
- On the basis of 250–300 data blocks, use random numbers of 1–100 to choose the location of 10 blocks from those numbered along each 100-m transect, with minimum departure from the ideal due to local topography.
- Use twine to mark out block transversely.

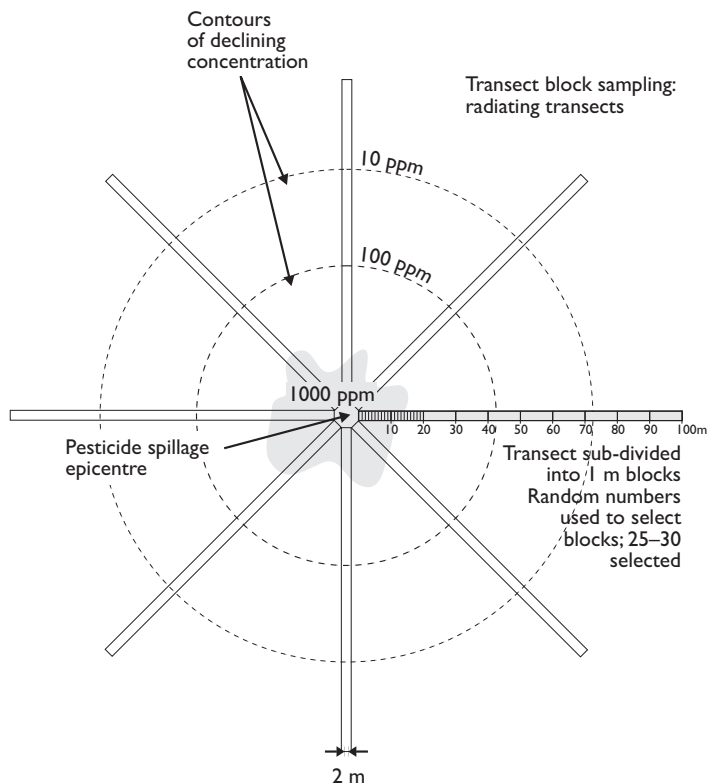

BLOCK LITTER INSPECTION

- Remove litter from 30 cm outside the quadrat or transect block edge (to see escaping animals), and progressing from the edge to the centre inside the block, remove litter and ground cover in strips parallel to the boundary twice until the entire area is covered, recording the time taken to do so.
- Record the numbers of each species seen.
- Record in a notebook the location of the quadrat within a grid or segment along the transect, and also the date, time of start and end of sampling, weather conditions, air temperature and relative humidity, vegetation type, aspect (slope), and the canopy, herb, litter, rock and log cover.

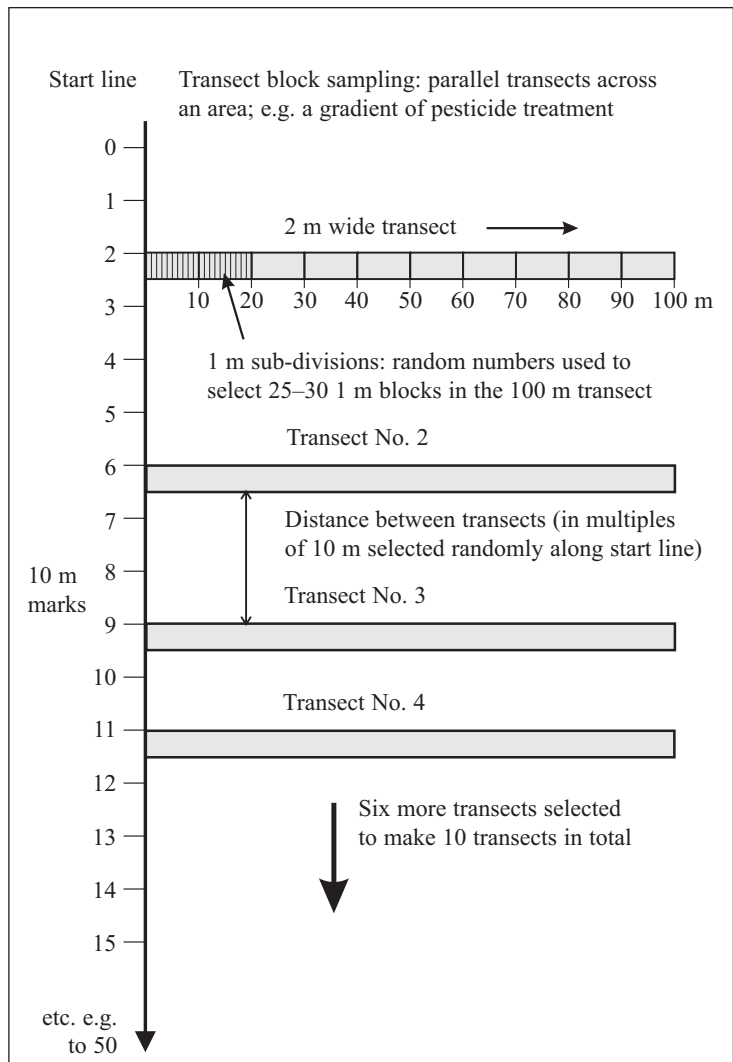

OTHER CONSIDERATIONS

Quadrats of 8 x 8 m are selected for broad sampling, rather than 10 x 10 m, since 25 x 25 feet quadrats have been used in most comparable studies previously.

The transect starting line need not be straight; it can encircle an area of pesticide spillage or follow an altitudinal contour on the side of a valley.

An alternative to long transects divided into 100 units are shorter transects; each sub-section is sampled along its entire length; 25-30 short transects will provide adequate data for statistical comparison between areas.

Another alternative is to choose fixed distances (e.g. 10 m) either along the start line or the transect lines, but not both.

To avoid obstacles such as fallen trees or rocks coming within a block, record zero animals in the case of a quadrat or, for a transect block, it is useful to have a pre-plan to move the block either 10 or 15 m on along the transect.

Quantitative sampling of amphibian larvae (and aquatic reptiles) – pond seining

DON'T FORGET

EQUIPMENT: Cast net usually 3–4 m long and 1–1.5 m wide, with mesh size of 1.5–7 mm (a much larger seine net 13–14 m long by 2 m wide, and mesh size of 7–13 mm can be used); lead weights along lower edge; floats on the upper edge; wooden pole 2.5 cm thick attached along length of upper edge; boots; watch; water temperature thermometer; headlamp (at night); linen bags (for live reptiles); plastic bags (for live amphibians); aluminium screw-lid container with preservative solution (8–10% formalin for sampling for insecticide residue analysis); notebook; pencil; field guide; method sheet for seining from chapter 10 (Fish).

Method

- Record the exact time of start of observations, air and water temperature, moon phase (clear sky) and cloud cover (in octas – an octa is the amount of cloud cover currently visible imagining the sky is divided into eight equal parts, each part is one octa).
- The seine net should be dragged slowly through the water from one pond edge to the other, allowing a few minutes between seines. (For further details on seining method, see chapter 10.)
- Record the number of individuals of a species in square metres of bottom sampled, i.e. distance travelled multiplied by seine net width.
- Capture of specimens should continue until no further species are added (this may be one sweep in a small pond or many at the edges of a lake).
- At the end of the observation period, record the exact time, air temperature, and also illumination – daylight cloud cover (sunny or overcast), darkness (dry, raining or cloudy).
- Note any other important information that may have affected numbers recorded, e.g sudden rain or decrease in temperature.

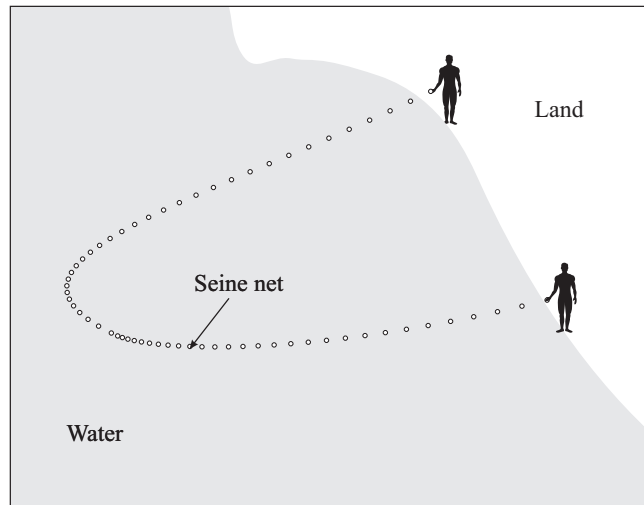

OTHER CONSIDERATIONS

Aquatic amphibians and reptiles sampled will mainly include frogs and occasionally freshwater turtles. Return the species once identified. Net seines will sometimes include fish, which should be returned to the water.

Numbers are strongly influenced by weather conditions, especially rain.

Net seining may not be required for simple monitoring of numbers, especially at night, when many species can be seen at the surface with eyes reflecting light from a wide-beam torch.

Quantitative sampling of amphibian larvae (and aquatic reptiles) – dipnetting

DON'T FORGET

EQUIPMENT: Small hand net about 10 cm wide with bendable frame (or wire mesh sieves or kitchen strainers with a handle); boots; watch; water temperature thermometer; headlamp (at night); linen bags (for live reptiles); plastic bags (for live amphibians); aluminium screw-lid container with preservative solution (8–10% formalin for sampling for insecticide residue analysis); notebook; pencil; field guide.

Method

- Gripping a small hand net by the handle, plunge it into the water, and sweep through the water from one side of the body to the other. This movement represents one standard sweep. The number of individuals of a species is recorded with each sweep.
- Record the number of individuals of a species caught in relation to the number of standardized sweeps. Alternatively, over a period of time, the number of sweeps made in an hour can be determined. This can range from 20 to 50 sweeps, and the mean number per hour requires standardization.
- Record the exact time of the start of net-sweeping, air and water temperatures, moon phase (clear sky) and cloud cover (in octas – an octa is the amount of cloud cover currently visible imagining the sky is divided into eight equal parts, each part is one octa).
- For amphibian larvae (tadpoles), estimate the water volume sampled per sweep (area of net opening multiplied by sweep length) to determine volume density.
- Capture of specimens should continue, changing the path of sweep swaths each time or position on water edge after, say, every 5–10 sweeps, until no further species are added.
- Sample all microhabitats in a pond with the net.
- At the end of the observation period, record the exact time, air temperature, and also illumination – daylight cloud cover (sunny or overcast), darkness (dry, raining or cloudy).
- Note any other important information that may have affected the numbers recorded, e.g sudden rain or decrease in temperature.

OTHER CONSIDERATIONS

Aquatic species sampled will mainly include amphibian larvae.

Any fish caught should be returned to the water.

Numbers captured depend on volume density.

Numbers are strongly influenced by weather conditions, especially rain, also whether daylight or in darkness.

Quantitative sampling of amphibian larvae (and aquatic reptiles) – trapping

DON'T FORGET

EQUIPMENT: Cylinder traps (e.g. 0.5 m long by 0.3 m diameter, or 25 x 10 cm), funnel extends inwards at either or both ends; boots; watch; water temperature thermometer; headlamp (at night); linen bags (for live reptiles); plastic bags (for live amphibians); aluminium screw-lid container with preservative solution (8–10% formalin for sampling for insecticide residue analysis); notebook; pencil; field guide.

Method

- Each trap is constructed from a used 1-litre plastic squash bottle. For a single funnel-ended cylinder trap, the bottle is cut into two halves by a circular incision at the point where it begins to taper towards the neck. The screw-top is cut off and the top (funnel) half inverted into the bottom half to form a trap. Paper-clips may be used to hold the funnel in place. A series of holes is punched into the tap to allow expulsion of air when sinking the tap into water. A length of string with a knot at the end is threaded through a hole from inside approximately halfway down the side of the lower half of the trap. When placed in a pond, the trap is tied to a stick to prevent drifting and to mark its position.
- Place the trap in a pond and record the exact time of the start of observations, air and water temperatures, moon phase (clear sky) and cloud cover (in octas – an octa is the amount of cloud cover currently visible imagining the sky is divided into eight equal parts, each part is one octa).
- Record the number of individuals and species caught in relation to time over, say, 6, 12 or 24 h periods depending on amphibian density and trap effectiveness, established beforehand.
- Trapping should continue until no further species are added.
- At the end of the observation period, record the exact time, air temperature, and also illumination – daylight cloud cover (sunny or overcast), darkness (dry, raining or cloudy).
- Note any other important information that may have affected numbers recorded, e.g sudden rain or decrease in temperature.

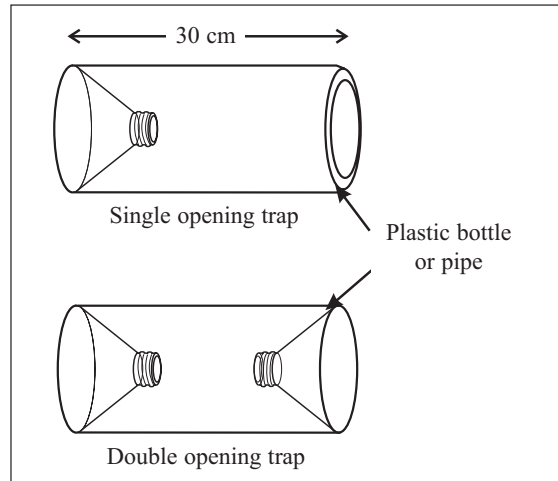

OTHER CONSIDERATIONS

Amphibians sampled will mostly be tadpoles of frogs and toads.

Any fish caught should be returned to the water.

Numbers captured are density-dependent.

Numbers are strongly influenced by weather conditions, especially rain.

Trapping may be calibrated by recording the numbers caught in an enclosure into which a known number of larvae have been placed.

General reminder

DON'T FORGET

EQUIPMENT: Clip-board with sufficient lined and plain paper; record sheets; plastic sheets (as rain cover); bird outline guide-sheets (supplied here as sheets 1–4 for photocopying); sharp pencils (HB); penknife; eraser; binoculars, 8 x 32 or 10 x 40, preferably rubber-coated for protection (with case to keep dry if raining); sheet with list of abbreviations to be used for species recorded (see Appendix in chapter 12, page 242); stop-watch or wrist watch, with elapsed-time facility; map of area to be sampled with suitable detail locations; bird identification books; plastic/cloth bags and labels for specimen samples; alcohol (methylated spirits is suitable if no alternative) or 5% formalin; syringes; paper towels; insect repellent; suitable clothing; food; water; haversack for equipment.

Method

Plan your sampling regime before you go into the field, decide the method to be used and follow it through.

- Undertake the sampling early and up until 09.30 h, or in the later afternoon, after 15.30 h.
- Mark any sample bags as soon as they are used. Never leave this task until later as you will forget the details.
- Do not be tempted to remain longer at any one site than you have allowed just because there are many birds present.
- Only record those genera and species you are certain are correctly identified or that you have identified in a form that you can use on all future counts (e.g. reference numbered, outline guides on sheets 1–4).
- For feeding parties of birds, either record their presence or absence in number classes (1–5, etc.).
- When recording raptors, it is possible during the nesting season to search for nests: note the presence or absence of green vegetation in the nest, or food debris on the ground beneath the nest to confirm occupancy.
- Be aware of migrant species that are uncommon or possibly occurring in confusing immature or female plumage.
- During sampling, keep detailed field notes (either hard copies or on a tape recorder, which will be transcribed later).
- Specimens collected for subsequent pesticide residue analysis must be labelled, preserved (if necessary) and carefully packed.
- Do not forget to note any important information on vegetation, unusual weather, or over-run of time spent during observations.

Tip: *Never rely on your memory to store field data, it always ends up in a muddle! Write information down or use a tape recorder (check batteries, bring spares!).*

OTHER CONSIDERATIONS

Mark the sampling sites/quadrats/transects for future visits, use waterproof paint (or spray paint if available).

Be sure of your chosen census technique and planned approach.

Timed point counts

DON'T FORGET

EQUIPMENT: Binoculars; clip-board (carry a plastic bag in your pocket into which you can put the board if it rains); data recording sheets; copies of Appendix A; sharp pencils; eraser; penknife; blank sheets of paper for additional notes; field guide to bird identification; a watch or stop-watch.

Thoroughly check all equipment before you go into the field.

Identify and mark the sample points in each area during preliminary surveys. Number each sample point clearly with rainproof paint on a rock, tree trunk or other permanent structure. Mark the roads and sample points on a map (see diagram 1).

Describe the habitat (topography, soil, trees, shrubs and herbs/grasses, land use, etc.) around each sample point.

Prepare and annotate the data recording sheets.

Method

- On arrival for the survey, complete the first part of the data recording form, i.e. sample area, date, time and wind speed and cloud cover (in octas, i.e. the amount of cloud cover currently visible imagining the sky divided into eight equal parts, each part is one octa). This allows time for birds to 'settle' after your arrival.
- Identify the 50 m radius area of the sample point in which birds seen or heard will be counted. Make a written note of the landmarks which identify the extent of the area.
- Record the time of starting the survey.
- Start the stop-watch on arrival at the first point. Walk slowly around the area within a 50 m radius of the first point. Ignore birds seen beyond the 50 m limit, but count any bird heard within the 50 m area (see diagram 2).
- Record numbers of *ALL* species of interest seen or heard during a set time period (3–10 min).
- If a bird party containing species of interest is present in the sampling area, extend the sampling period up to 10 min, if necessary, to enable their enumeration. Note the extra time spent.
- If a flock of birds is heard but not seen, record the presence of a flock on the record sheet with the letter F.
- Stop recording at the end of the pre-determined sample period.
- Record the time each count ends.
- After completing the sampling period, walk or drive to the next point and repeat the process.
- Check the data sheet for legibility as soon as possible upon return to the office, as the data will be fresh in your mind.

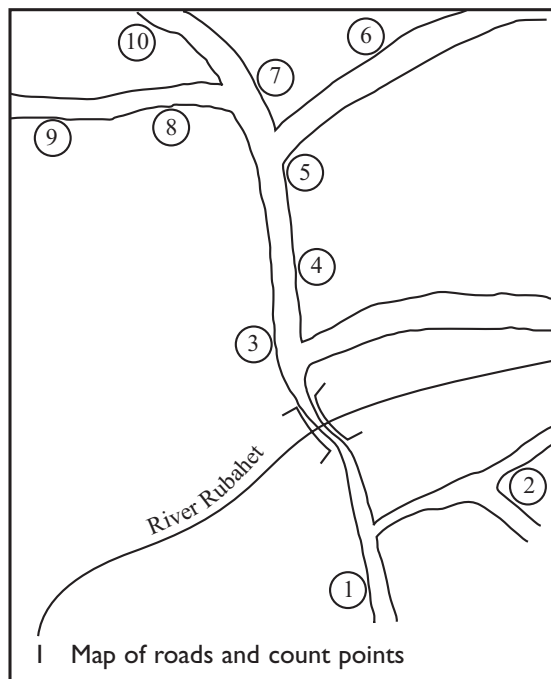

1 Map of roads and count points

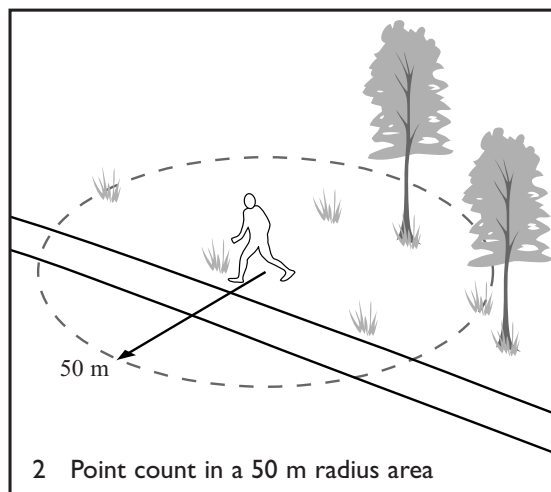

2 Point count in a 50 m radius area

OTHER CONSIDERATIONS

Visit every census point in a sample area.

If you are likely to collect dead birds, take:

- a 20 ml syringe for injecting formalin into the abdomen and brain of specimens collected
- a solution of 5% formalin in a secure container (disposable rubber gloves if available)
- a supply of strong polythene bags, and a means of fastening them (plastic-coated wire is good, or simply tie a knot in the top of the bag if you have sufficient and are not concerned about re-using them)
- some stout labels made from white card and a pencil to write labels.

Wear suitable clothing (preferably camouflaged) for the prevailing conditions, and take food, water and insect repellent. Let somebody know your route in case of breakdown.

In habitats with a high density of birds it is easy to be uncertain whether an individual has already been recorded. If in doubt, do not record.

The actual duration of the 'count' depends on the habitat and species of interest. If counts are too short then individuals are likely to be overlooked; if too long, some may be counted twice (or more).

Transect counts

DON'T FORGET

EQUIPMENT: Binoculars; clip-board (carry a plastic bag in your pocket into which you can put the board if it rains); data recording sheets; a plan of the area with the transect routes mapped; sharp pencils; eraser; penknife; notebook for additional notes; field guide to bird identification; a watch.

Thoroughly check all equipment before you go into the field.

Visit all possible transect sites in the study area (sprayed and unsprayed) and select about 8 km of transect in the area to be sprayed and about 8 km outside. Walk and sub-divide transects into approximately equal sub-sections and mark sub-section boundaries with rainproof paint or plastic streamers.

For the best visibility, choose routes where the sun will be behind you during the sampling period. Prepare maps of the study areas showing transects and sub-divisions (note landmark features which identify sub-division boundaries and keep a written record of these).

Method

- Aim to cover 4 km of transect in a morning's observation (i.e. four transects of 1000 m in 4 h).
- On arrival, complete the first part of the data recording form, i.e. sample area, date, time and wind speed and cloud cover (in octas, i.e. the amount of cloud cover currently visible imagining the sky divided into eight equal parts, each part is one octa).
- Note the time of starting.
- Walk at a slow steady pace along the transect, pausing only if necessary to identify and record numbers of **all** species of interest seen or heard within the agreed transect width (e.g. 20 m). Stop at the end of each transect sub-section and note vegetation, temperature, etc.
- Record the time the transect count ends.
- Check the legibility of your records as soon as possible on return to the laboratory.

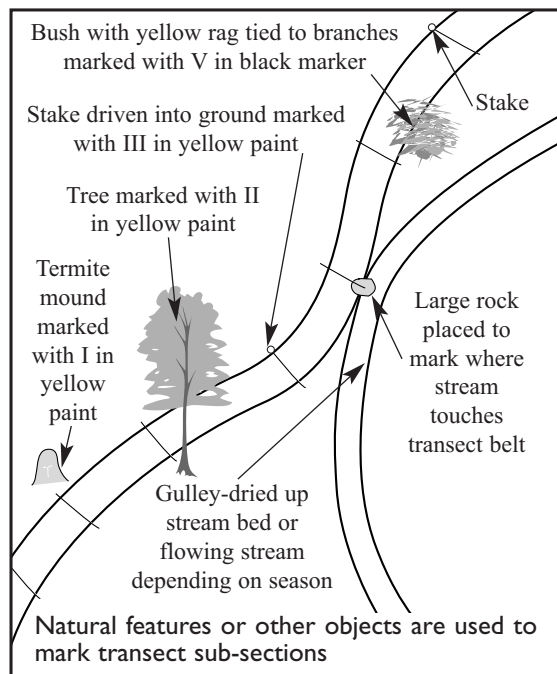
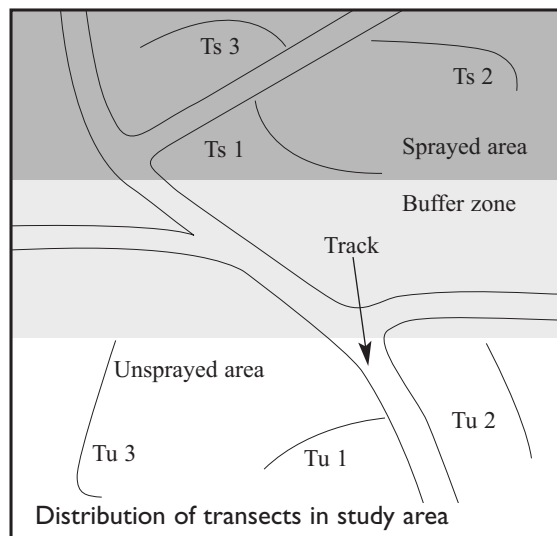

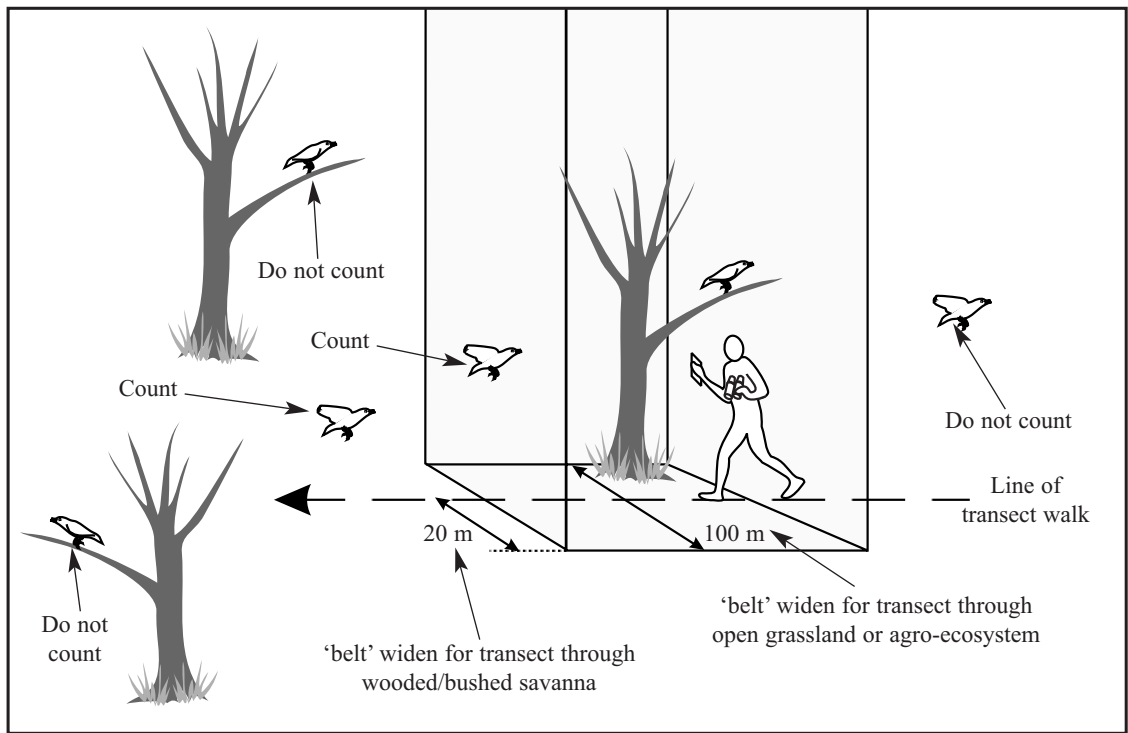

OTHER CONSIDERATIONS

On repeat visits, cover the same length of transect as on previous occasions.

If you are likely to collect dead birds, take:

- a 20 ml syringe for injecting formalin into the abdomen and brain of specimens collected
- a solution of 5% formalin in a secure container, disposable gloves if possible
- a supply of strong polythene bags, and a means of fastening them (plastic-coated wire is good, or simply tie a knot in the top of the bag if you have sufficient and are not concerned about re-using them)
- some stout labels on which to add all relevant field data made from white card and a pencil to write labels.

Wear suitable clothing (preferably camouflaged) for the prevailing conditions, and take food and water.

The length of a transect will depend on the habitat type. Suggested distances are:

150–400 m in closed habitats (rainforest, brush, reedbeds, etc.)

250–1500 m in open habitats (grassland, agricultural land, open savanna, woodland, etc.).

TRANSECT COUNTS: DATA RECORDING SHEET

Transect	Date	
Total length	Start time	GPS fix
Wind speed	End time	GPS fix
	Cloud cover	Observer

Sub-section length	1	2	3	4	5	6	7	8	Total
Species									

MAKE COPIES OF THIS SHEET FOR FIELD USE

Territory mapping

DON'T FORGET

EQUIPMENT: Binoculars; clip-board with a detailed map of the study area (carry a plastic bag in your pocket into which you can put the board if it rains); sharp pencils; eraser; penknife; tape recorder and cassette with pre-recorded song of the species of interest.

Thoroughly check all equipment *before* you go into the field.

Depending upon the availability of staff, thoroughly investigate 1–2 study plots in the area to be sprayed, and 1–2 similar ones outside. Plots should be 10–20 ha in woodland and 50–100 ha in grassland or farmland.

Prepare accurate and detailed maps of each study plot showing paths and all obvious landmarks. If there are too few landmarks, put a grid of numbered stakes in the study plot at 50 m intervals, and mark the grid on the map.

Draw up a key to symbols for species names, age, sex, nests, movements and other activities to be used on the map (see Bibby *et al.*, 1992).

Method

- At the start of a visit, fill in the basic details of the sample site (locality, date, time and weather conditions) on the record map.
- Make a note of the meteorological conditions, especially wind speed and cloud cover (in octas, i.e. the amount of cloud cover currently visible imagining the sky divided into eight equal parts, each part is one octa).
- Walk slowly through the plot recording the route taken until one of the study species is seen or heard. Plot its position and record its activity and movements during a 3 min period.
- If the bird is singing, listen for another of the same species and approach it to establish its precise position to record on the map. The territorial boundary between the two will fall somewhere in between the two song posts.
- If two birds are fighting or singing vigorously close together, the site may mark a territorial boundary. Record the event on the map.
- If the bird is feeding, flush it, follow it, and record its movements on the map. It is unlikely to move into an adjacent territory, but note the whereabouts of any others of the same species as you move.
- If time is limited, concentrate observations in areas where there remains uncertainty about territorial boundaries from previous visits.
- Repeat the process in a series of observations after spraying has been carried out.

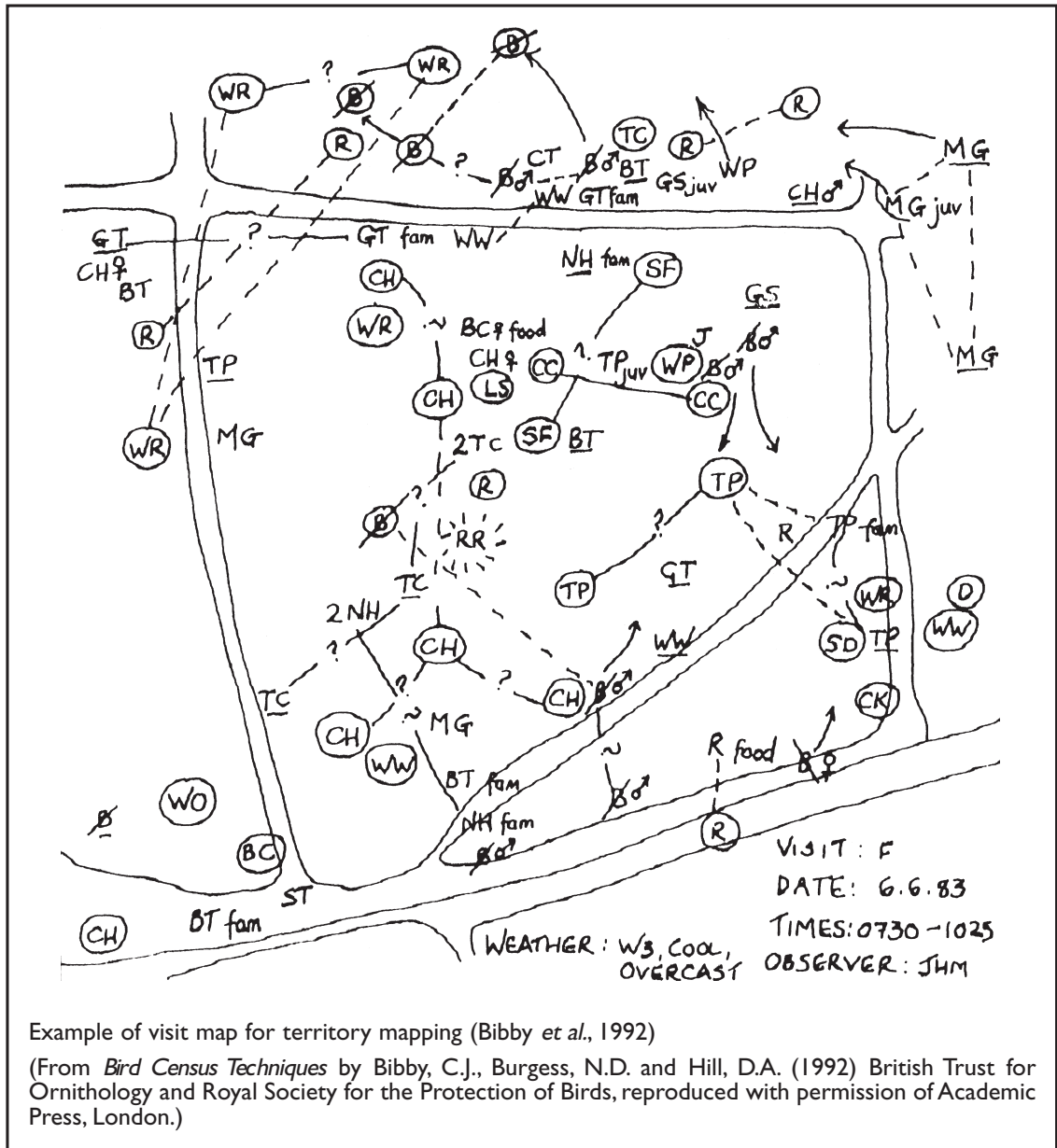

OTHER CONSIDERATIONS

An assistant is useful to keep an eye on the bird while you record details on the map.

Searching for nests is not a very productive use of time in territory mapping but if a nest is found the site should be recorded on the map.

The number of visits required to a study plot will depend on the duration of observations and activity recorded.

If it is likely that dead specimens will be collected you will need:

- a 20 ml syringe for injecting formalin into the abdomen and brain of specimens collected
- a solution of 5% formalin in a secure container, disposable gloves if possible
- a supply of strong polythene bags, and a means of fastening them (plastic-coated wire is good, or simply tie a knot in the top of the bag if you have sufficient and are not concerned about re-using them)
- some stout labels made from white card and a pencil to write labels.

Remember to wear suitable clothing (preferably camouflaged) for the prevailing conditions, and take food and water.

Nest density

DON'T FORGET

EQUIPMENT: Detailed maps (1:50,000 to 1:5000, depending on nest or colony spacing); binoculars; clip-board (carry a plastic bag in your pocket into which you can put the board if it rains); sharp pencils; eraser; penknife; notebook for additional notes; a torch and small mirror for tree hole nesting species, mounted at an angle to the handle.

Thoroughly check all equipment before you go into the field.

Investigate suitable areas in sprayed and unsprayed areas for the presence of the species of interest and similarity of ecological conditions.

Learn through careful observation of breeding birds where they nest, and what their nests look like.

Train field assistants and check their reliability.

Method

- Delineate the areas to be searched each day and prepare a map, noting features to help with nest location.
- Systematically search suitable habitat and possible nest sites. Record the location and number of nests found on the map (use GPS if possible).
- If the nests are well concealed, quietly observe adults and follow them to the nest, *but do not disturb the nest*.
- *Very carefully* examine each nest (if the bird is sitting do not disturb it) and record its status and contents in the notebook as follows:
 - old – no fresh nest material in the structure
 - new – fresh nest material present
 - used – recent droppings, or broken fragments of eggshell, suggest recent use
- record the number and condition of any eggs or chicks as follows:
 - fresh eggs – eggs warm, or if the incubating bird flushed on approach
 - eggs deserted – eggs cold, or partially covered by leaves, or cobwebs across nest entrance
 - chicks alive – down covered, or feathers still in waxy sheaths, or well-feathered
 - chicks dead – down covered, or feathers still in waxy sheaths, or well-feathered.

OTHER CONSIDERATIONS

Local hunters are often expert climbers and know where to find the nests of interest – they may make good field assistants.

Feeding behaviour and diet assessment

DON'T FORGET

EQUIPMENT: Binoculars; clip-board with data recording sheets and a detailed map of the study area (carry a plastic bag in your pocket into which you can put the board if it rains); stop-watch; sharp pencils; eraser; penknife; labelled vials to store pellets if diet is to be studied.

Thoroughly check all equipment before you go into the field.

Depending upon the availability of staff, choose one or two study areas where the species of interest is common. If only one observer is available, choose an area which will be sprayed. If two sites are available, choose a similar area outside the sprayed area.

During preliminary field visits, prepare detailed sketch maps of the study areas with grids for reference. Alternatively, name observation sites within the study areas, so that all observations made at a particular site can be analysed as a sub-set.

Method

- At the start of a visit fill in the basic details of the recording sheet, locality, date and weather conditions, especially wind speed and cloud cover (in octas, i.e. the amount of cloud cover currently visible imagining the sky divided into eight equal parts, each part is one octa).
- Locate a feeding individual of the species of interest and note the time and site reference on the data recording sheet.
- Start the stop-watch and record all feeding behaviour (number of feeding attempts, number of successful attempts, prey items caught) for as long as possible, up to 10 min.
- If the success of any feeding attempt is uncertain, or the prey cannot be identified, record the result as 'unknown'.
- If the bird moves to a new area to feed, attempt to follow it and continue observations. If this is impossible, note the time observations were ended. If the bird ceases to feed, note the time feeding ceased, and find another bird.
- After 10 min observation of a feeding bird, locate another feeding individual and repeat the process.
- Attempt to observe five or more different individuals feeding for 10 min during an observation period.
- Take a break, before repeating the work intermittently through the day.
- Repeat the work daily, at about the same times each day, for 4–5 days before the spraying operation and for a similar period afterwards. Ensure observations in sprayed and unsprayed areas are made more or less simultaneously.

OTHER CONSIDERATIONS

If it is likely that dead specimens will be collected you will need:

- a 20 ml syringe for injecting formalin into the abdomen and brain of specimens collected
- a solution of 5% formalin in a secure container
- a supply of strong polythene bags, and a means of fastening them (plastic-coated wire is good, or simply tie a knot in the top of the bag if you have sufficient and are not concerned about re-using them)
- some stout labels made from white card and a pencil to write labels.

Remember to wear suitable clothing (preferably camouflaged) for the prevailing conditions, and take food and water.

FEEDING BEHAVIOUR: DATA RECORDING SHEET

Species

Date

Area

Wind speed

Cloud cover

Observer

Map reference	Time	Feeding attempts	Successful attempts	Prey identity
Totals				

MAKE COPIES OF THIS SHEET FOR FIELD USE

BIRD SHAPES

SHEET 1

Time

Date

Time

Date

Time

Location

Location

Habitat

Habitat

Habitat

Numbers seen

Numbers seen

Numbers seen

Size in relation to:

Size in relation to:

Size in relation to:

Call

Call

Call

Behaviour notes

Behaviour notes

Behaviour notes

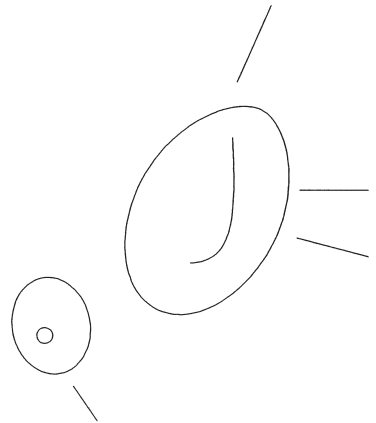
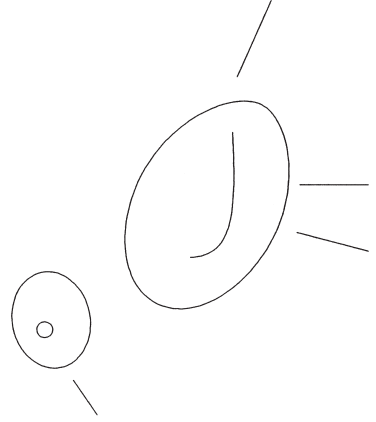
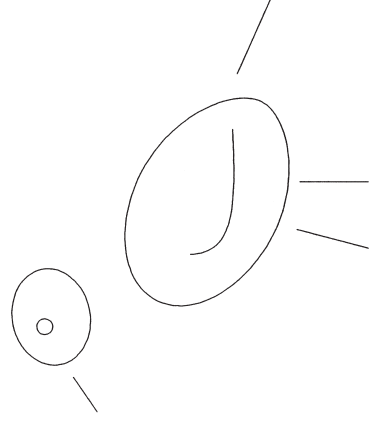

BIRD SHAPES

SHEET 2

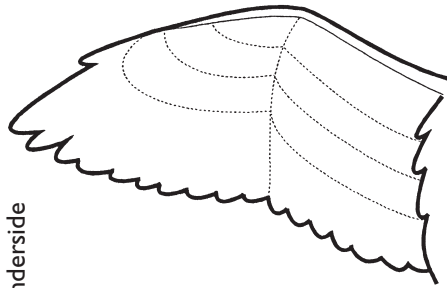

Underside

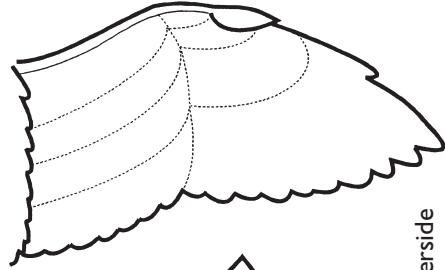

Upperside

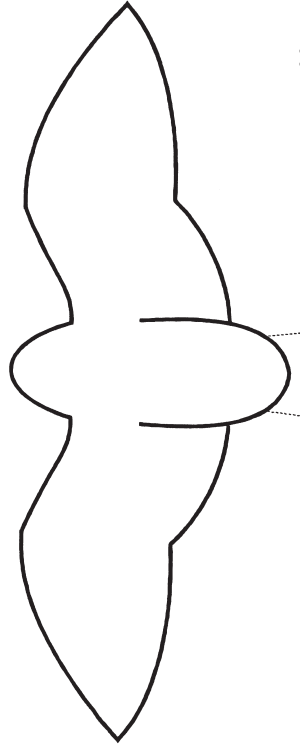

Date	Time
Location	
Habitat	
Numbers seen	
Size in relation to:	
Call	
Behaviour notes	

BIRD SHAPES

SHEET 3

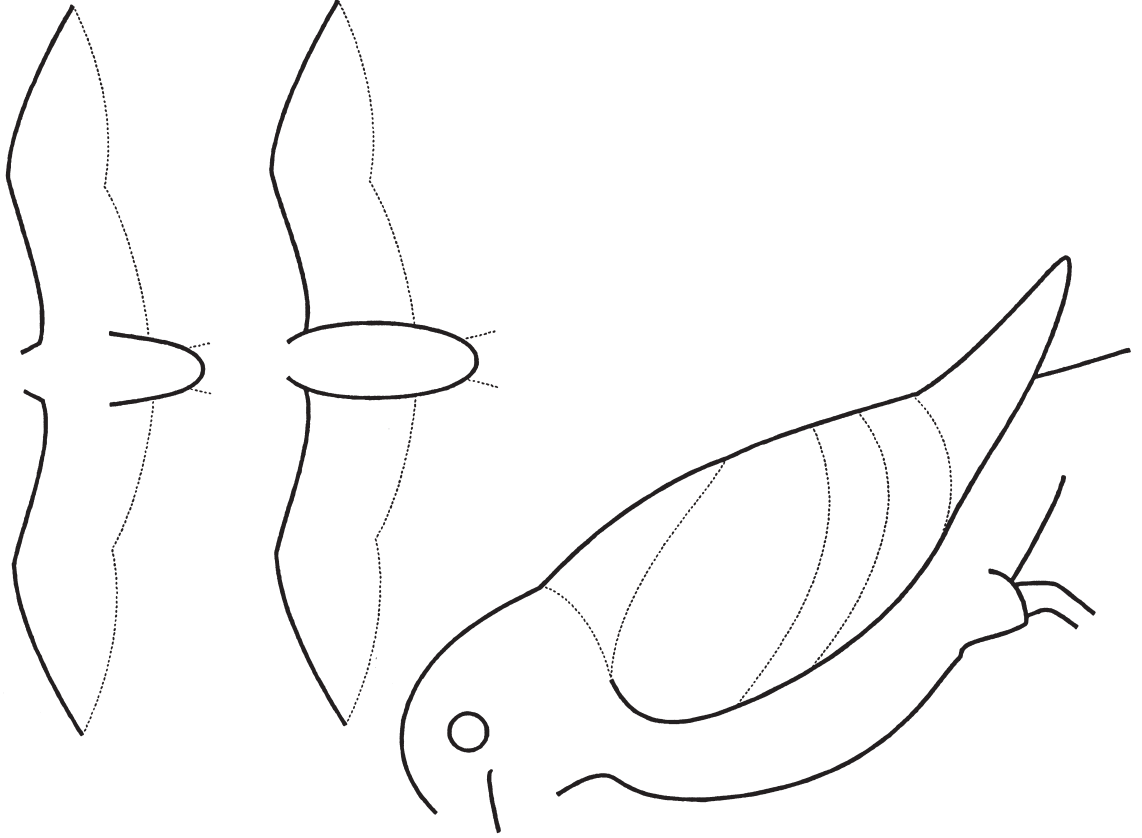

Date	Time
Location	
Habitat	
Numbers seen	
Size in relation to:	
Call	
Behaviour notes	

BIRD SHAPES

SHEET 4

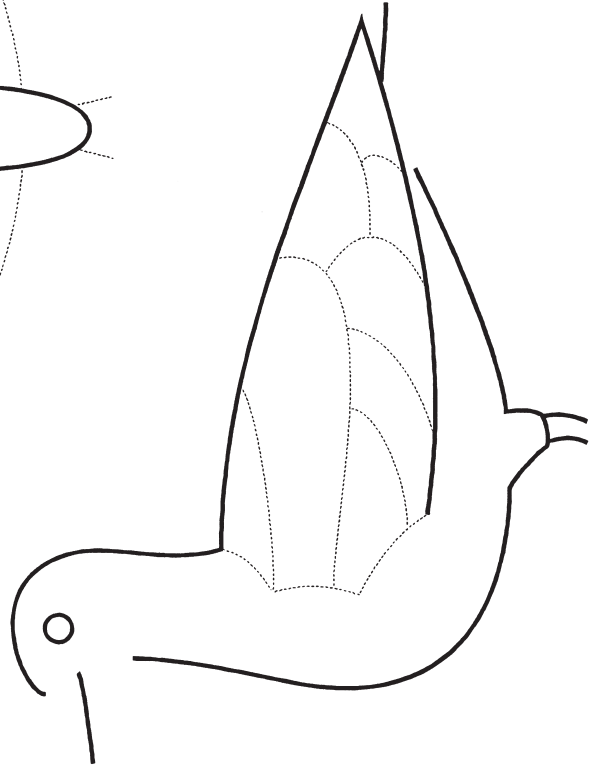
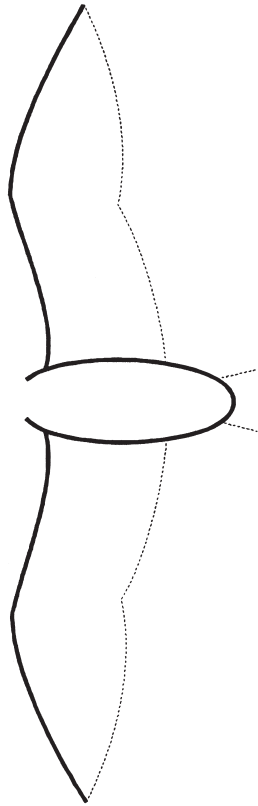
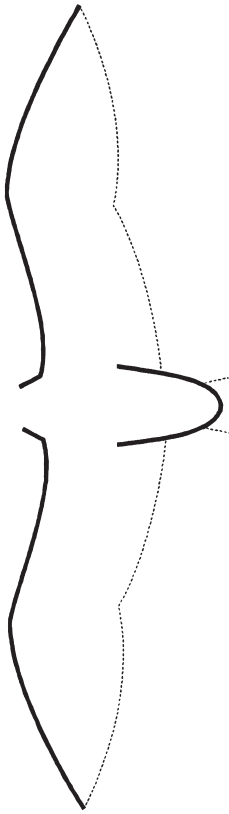

Date	Time
Location	
Habitat	
Numbers seen	
Size in relation to:	
Call	
Behaviour notes	

Line-trapping

DON'T FORGET

EQUIPMENT: Prismatic compass; 30 m tape measure; marker canes; permanent marker pen; Sherman traps in carriers; bait; bedding; cloth bags for retaining animals; Pesola balances and polythene bags for weighing; metal rule/callipers for measuring; scissors for fur clipping and list of marks available for individual identification; pencil; notebook; record sheets; portable freezer; aluminium foil or 10% formalin solution in aluminium canisters for preserving specimens for residue analysis; anaesthetic; dissecting kit; labels.

Match the habitat of trapping sites in separate treatment and control areas to ensure similarity of vegetation structure and composition. At least five trap-lines of 10 points, with two traps at each point ($n = 100$), are spaced equidistantly along transects at a density of one line per 2 ha, after the first line has been randomly sited.

Method

- Measure distances between transects and points with the 30 m tape, setting the traps 20 m apart in uniform habitats and 15 m apart in vegetation of a more complex structure. Describe the vegetation around trap points in terms of percentage cover, height and dominant species for each vertical strata (tree, shrub, herb, bare ground). Monitor at least two such 10 ha treated plots, either replicates or different application regimes.
- Position the traps with the doors flush to the ground, within 1 m of the marker canes, set along runs or next to natural objects if possible and 'camouflaged' under available vegetation. Identify each cane with an individual number and mark the associated traps correspondingly with a permanent marker pen.
- Bait and set traps for dusk, checking and re-setting as soon after dawn as possible and visiting thereafter on a 12 h schedule to collect data for 2 days and 2 nights. Replace bait every day if necessary. **Tip:** *In view of the shorter 2-day trapping sessions, environmental influences can be reduced by operating lines in two groups (or more if more lines are placed), randomly assigned different nights over a 4-day period.* Monitor populations over at least two pre- and two post-treatment trapping sessions. Note the position of any traps that have been sprung but remain empty and check the trap mechanism.
- Empty captures into cloth (or large polythene) bags for species identification, sexing and assessing reproductive condition, weighing and measuring (total length, head and body length, tail length, length of hind foot and ear length). Check each animal for the presence of individual identification and clip fur with a new mark if necessary. Transcribe all information to record sheets with appropriate data columns.
- Draw a detailed map of the monitoring areas showing positions of the trap points on the line transects. Compare the control, pre- and post-treatment capture rates (number caught per 100 trap-nights) and the proportion of recaptured individuals for each species (by sex or reproductive category if numbers are adequate). Calculate their mean body weights for each period.

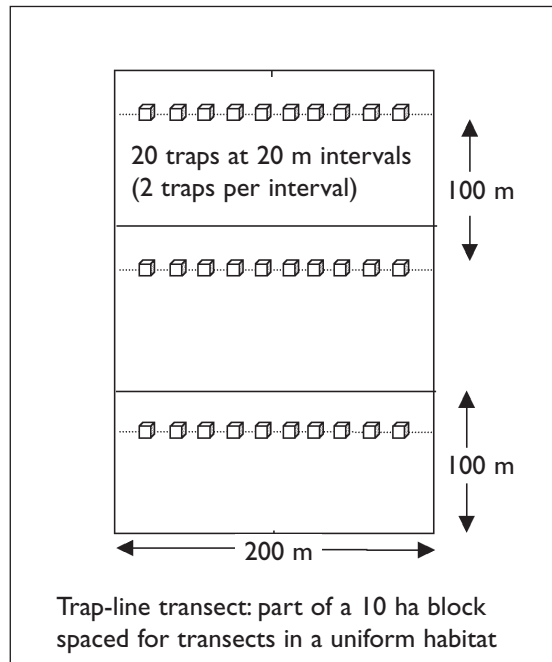

OTHER CONSIDERATIONS

Avoid disturbance to vegetation along the trap-lines.

Two people working together can speed-up trap collection.

Weather affects catches, so keep records on rainfall, temperature, humidity, cloud cover (and wind speed).

Safety: ensure immunity against tetanus, wear gloves to avoid biting and wash hands thoroughly after animal/trap handling as **small mammals can transmit infections.**

Grid trapping

DON'T FORGET

EQUIPMENT: Prismatic compass; 30 m tape measure; marker canes; permanent marker pen; Sherman traps in carriers; bait; bedding; cloth bags for retaining animals; Pesola balances and polythene bags for weighing; metal rule/callipers for measuring; scissors for fur clipping and list of marks available for individual identification; pencil; notebook; record sheets; portable freezer; aluminium foil or 10% formalin solution in aluminium canisters for preserving specimens for residue analysis; anaesthetic; dissecting kit; labels.

Match the habitat of trapping sites in separate treatment and control areas to ensure similarity of vegetation structure and composition.

Operate two treatment grids if possible, either replicates or a different application regime.

Method

- Ensure that each trapping grid consists of a minimum of 7 x 7 trap points with two traps at each, and a 10 x 10 array if resources are available. Describe vegetation by grid square in terms of percentage cover, height and dominant species for each vertical strata (tree, shrub, herb, bare ground).
- Use a prismatic compass to establish the right-angles of the grid square. Measure out trapping points with a 30 m tape by first establishing a baseline and then site along additional rows of marker canes to ensure points are in line. Space points at 20 m intervals in uniform vegetation or agricultural habitats and 10–15 m in more complex habitats.

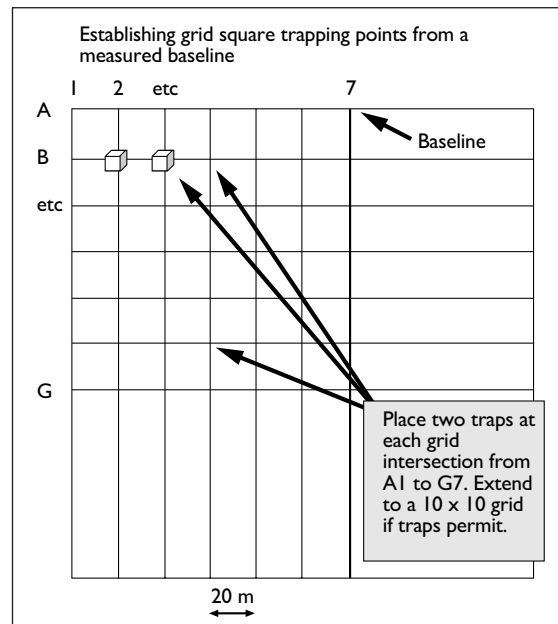

Sherman trap

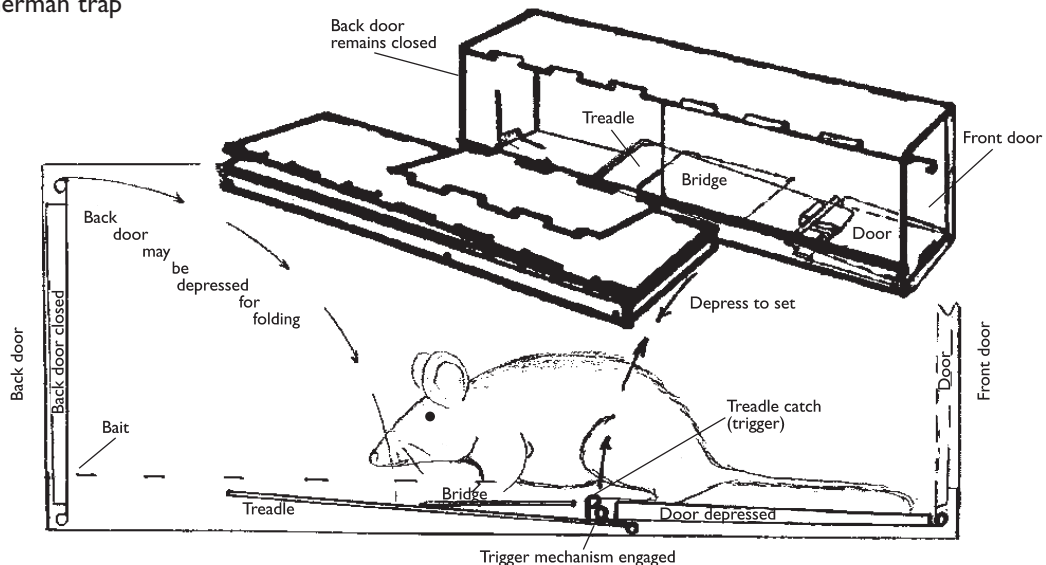

Courtesy of H. B. Sherman Traps Inc. Tallahassee, Florida, USA

- Position the traps with the doors flush to the ground, within 1 m of the marker canes, set along runs or next to natural objects if possible and 'camouflaged' under available vegetation. Identify each cane with an individual number and mark the associated traps correspondingly with a permanent marker pen.
- Bait and set traps for dusk, checking and re-setting as soon after dawn as possible and visiting thereafter on a 12 h schedule. Replace bait if necessary which should be renewed every 2 days. Note the position of any traps that have been sprung but remain empty and check the trip mechanism. Operate at least two pre- and two post-treatment trapping sessions of 4 nights each.
- Empty captures into cloth (or large polythene) bags for species identification, sexing and assessing reproductive condition, weighing and measuring (total length, head and body length, tail length, length of hind foot and ear length). Check each animal for the presence of individual identification and clip fur with a new mark if necessary. Transcribe all information to record sheets with appropriate data columns.
- Draw a detailed map of the trapping area, each grid square centred on a trap for ease of analysis. Distinguish resident from transient individuals by their multiple recapture. Delineate pre- and post-treatment territories of each resident by their capture positions on the grid and compare their mean body weights for each period.

Longworth trap

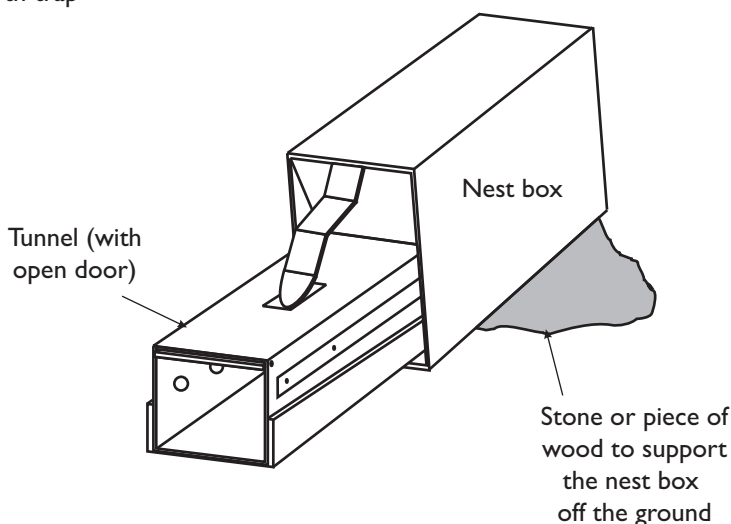

OTHER CONSIDERATIONS

Avoid disturbance to vegetation on the grid and only walk directly along trap rows; two people can each start at opposite ends of the grid to speed up trap collection.

Weather affects catches, so keep records on rainfall, temperature, humidity, cloud cover (and wind speed).

Safety: ensure immunity against tetanus, wear gloves to avoid biting and wash hands thoroughly after animal/trap handling as **small mammals can transmit infections** (leptospirosis in urine and Lyme disease via ticks).

Bat survey

DON'T FORGET

EQUIPMENT: GPS unit; prismatic compass; 100 m tape; marker canes or brush and white paint for identifying transect points; head torch; bat detector and spare batteries; stop-watch; digital thermometer and anemometer for measuring air temperature and wind speed; clip-board; pencil; data sheets plus a dictaphone for recording notes (optional).

Match the habitats in separate treatment and control areas to ensure similarity of vegetation structure and composition for at least two replicate transects in each area.

Check that the control areas are far enough away from the treatment zones to avoid downwind contamination during spraying.

Start points for transects of at least 1 km in length can be randomly selected from 1 km grid squares if appropriate maps and access are available, or from randomized segments of linear features such as habitat (woodland) edges, tracks and river banks.

Method

- Measure out, mark and map transects, with 15–20 sampling points if not continuously recording along the whole length, using tape measures, vehicle trip meters or GPS devices as appropriate. Describe the vegetation within 50 m of transect segments or around sample points in terms of percentage cover, openness, height and dominant species for each vertical strata (tree, shrub, herb, bare ground). Ensure that sample points are at least 100 m apart and any parallel transects are separated by at least 250 m.
- If using a 'narrow-band' bat detector to assess general bat activity, tune to a frequency that is common to the echolocation spectrum of as many species as possible (generally 40 or 45 kHz). When a particularly diverse species assemblage is encountered, a range of frequencies can be sampled for equal periods or a broad-band detector used to cover the entire frequency spectrum, although the latter are less sensitive. If continuously recording while walking transects, select a convenient time or distance interval to sub-sample. Alternatively, if conditions favour the use of timed point counts, try monitoring each spot initially for 5 min, reducing to no less than 2 min if there was an advantage in covering more sites and bat passes were frequent enough.
- Start monitoring at a fixed time every night, between 15 and 30 min after sunset. Assess cloud cover and moon phase, measure air temperature and wind speed at least at the beginning and end of a transect with temperatures preferably taken at each sample point or segment interval. Note the number of bat passes per transect segment if continuously recording or for each timed point count. Distinguish 'feeding buzzes' used by foraging bats from passes made by bats in transit. Sample replicate transects in control and treated areas, on randomized sequential nights if possible, ensuring that each has been monitored in at least two sessions of 4 nights both before and after treatment.
- Compare bat activity using non-parametric statistics (mean and total bat passes per unit time or distance) between pre- and post-treatment surveys and between control and treated sites if the data from replicates are homogeneous. Meteorological or habitat variables can be factored out using analyses of covariance.

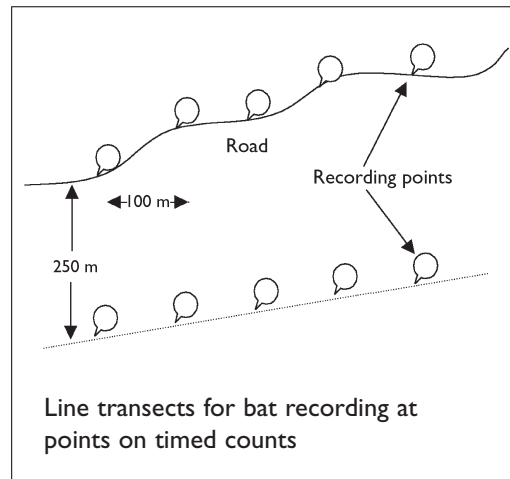

OTHER CONSIDERATIONS

Detector position: point microphone skywards at a 45° angle and be consistent in walking speed or pattern of use; on timed point counts, regularly sweep a circle around the body axis with the instrument.
Weather: avoid sampling on rainy nights as bat activity is affected.

Safety: wear suitable clothing and use insect repellent to deter mosquitoes in the tropics; ascertain the security of sampling areas and monitor transects from vehicles along ready-made vehicle tracks in wildlife reserves. Always work with a colleague for security.