



Modelling personal thermal sensations using C-Support Vector Classification (C-SVC) algorithm

Article

Published Version

Creative Commons: Attribution 4.0 (CC-BY)

Open Access

Jiang, L. and Yao, R. (2016) Modelling personal thermal sensations using C-Support Vector Classification (C-SVC) algorithm. *Building and Environment*, 99. pp. 98-106. ISSN 0360-1323 doi: <https://doi.org/10.1016/j.buildenv.2016.01.022>
Available at <http://centaur.reading.ac.uk/53605/>

It is advisable to refer to the publisher's version if you intend to cite from the work.

To link to this article DOI: <http://dx.doi.org/10.1016/j.buildenv.2016.01.022>

Publisher: Elsevier

All outputs in CentAUR are protected by Intellectual Property Rights law, including copyright law. Copyright and IPR is retained by the creators or other copyright holders. Terms and conditions for use of this material are defined in the [End User Agreement](#).

www.reading.ac.uk/centaur

CentAUR

Central Archive at the University of Reading

Reading's research outputs online

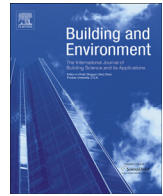

Modelling personal thermal sensations using C-Support Vector Classification (C-SVC) algorithm



Lai Jiang, Runming Yao*

School of the Built Environment, University of Reading, UK

ARTICLE INFO

Article history:

Received 13 November 2015

Received in revised form

16 January 2016

Accepted 22 January 2016

Available online 25 January 2016

Keywords:

Personalised conditioning system (PCS)

Personal thermal sensation

Modelling method

C-Support Vector Classification

ABSTRACT

The personalised conditioning system (PCS) is widely studied. Potentially, it is able to reduce energy consumption while securing occupants' thermal comfort requirements. It has been suggested that automatic optimised operation schemes for PCS should be introduced to avoid energy wastage and discomfort caused by inappropriate operation. In certain automatic operation schemes, personalised thermal sensation models are applied as key components to help in setting targets for PCS operation. In this research, a novel personal thermal sensation modelling method based on the C-Support Vector Classification (C-SVC) algorithm has been developed for PCS control. The personal thermal sensation modelling has been regarded as a classification problem. During the modelling process, the method 'learns' an occupant's thermal preferences from his/her feedback, environmental parameters and personal physiological and behavioural factors. The modelling method has been verified by comparing the actual thermal sensation vote (TSV) with the modelled one based on 20 individual cases. Furthermore, the accuracy of each individual thermal sensation model has been compared with the outcomes of the PMV model. The results indicate that the modelling method presented in this paper is an effective tool to model personal thermal sensations and could be integrated within the PCS for optimised system operation and control.

© 2016 Published by Elsevier Ltd.

1. Introduction

The type of 'personalised conditioning system' (PCS) or 'personal environment control' (PEC) is a type of energy system that controls a small area of the environment surrounding an end user [1,2]. This type of system has been regarded as a solution to achieve energy efficiency whilst satisfying an individual's thermal comfort requirements because such a system has flexibilities for occupants to moderate their surrounding microenvironment based on their individual demands [1–6]. Vesely and Zeiler [1] conducted a review to investigate the energy efficiency of the PCS. This research revealed that the control methods of PCS nowadays largely depended on the users' operations. In addition, inappropriate operation could lead to 'rebound' or 'overshoot' in system usage causing energy wastage and thermal discomfort. Therefore, energy consumption can be saved subject to the optimal operation. Frequent adjusting the system manually could distract workers'

concentration.

It has been indicated that an occupants' thermal comfort condition is important to the HVAC system operations. The occupants' sensation feedbacks to the thermal conditions can be applied to HVAC automatic control systems [7]. It is also suggested that the comfort environmental conditions could be directly derived from the occupants' sensation feedbacks then to be used to define the optimised control of the HVAC system [8]. The collected feedback information could also be used to generate a predictive models to estimate the comfort conditions to guide the HVAC control schemes [9].

Similar auto-control schemes could also be applicable to certain type of PCS, which aim to improve the thermal environment around an end user. Such type of PCS is the main focus of this research. It has been suggested that applying thermal sensation models to accurately predict individuals' thermal sensation demands is an effective solution to achieve optimal control of a personalised environmental control system [10]. Therefore, novel personal thermal sensation models based on the Support Vector Machine (SVM) algorithm are proposed in this research.

Firstly, this paper briefly reviews the existing research in

* Corresponding author. The School of the Built Environment, Whiteknights, PO Box 219, RG6, 6AW, UK.

E-mail address: r.yao@reading.ac.uk (R. Yao).

List of symbols

| | |
|-------------|---------------------------|
| T_a | Air Temperature |
| \bar{T}_r | Mean Radiant Temperature |
| V_a | Air Velocity |
| T_g | Globe Temperature |
| RH | Relative Humidity |
| MET | Metabolic Rate |
| Clo | Clothing Insulation level |

developing personal thermal sensation models and demonstrates that the thermal sensation modelling problem can be regarded as a classification problem. The SVM algorithm is a justified solution to the classification problem. The paper then introduces the procedures for training and testing of the personal thermal sensation models using experimental data. The performance of each generated individual personal thermal sensation model is also compared with the Predicted Mean Vote (PMV) index. Finally, a PCS system structure with a C-SVC-aided personal thermal sensation modelling method is presented.

2. Related work

The thermal sensation prediction is essential to indoor thermal environment design, operation and assessment. Methods of prediction have been widely adopted by design standards and guides. For example, the widely applied PMV-PPD index has been adopted by the ASHREA 55 and ISO 7730 standards [12,13]; the adaptive model using running mean temperature in the EN15251 standard [14] and the aPMV model integrated in the ‘Chinese Evaluation standard for the indoor thermal environment in civil buildings’ [15]. However, it is criticized that the thermal sensation prediction recommended by the international standards are not suitable to be directly applied as individual thermal comfort predictors in many conditions [10,16]. It is argued that these models recommended by the standards are developed for the estimation of the average thermal sensation of a large number of people under certain conditions, which may not be suitable for the situation when significant individual differences of thermal comfort preferences exist [17]. Recently, developing personal thermal sensation modelling has attracted many researchers’ interests. Table 1 lists the most current published papers on the topic and their main characteristics.

From Table 1 it can be seen that Back Propagation neural network technology has been applied to build a personal thermal

sensation model, which categorised the personal thermal sensations into three conditions: hot, neutral, and cold [17]. Comparing to the ASHRAE 7-scale sensations, this model outputs the thermal sensations in less detail. Feldmeier and Paradiso [11] developed a model that applied the Fisher Discriminant method to separate different levels of thermal sensation. It can be found that the different levels of thermal sensations are separated by linear decision boundaries in this research. Gao and Keshav [10] developed a predicted personal vote (PPV) model. However, the effectiveness of the modelling method may need further investigation, as in the presented work the evaluation process is only expressed by one case study with 12 training samples and 8 testing samples. Zhao et al. [16] introduced a Personalised Dynamic Thermal Comfort (PDTC) model, which is similar to the PPV model. It also applied a regression method to estimate the personal coefficients of the model function.

The support vector machine (SVM) algorithm has been utilised in the thermal comfort research area. Megri et al. [19] applied the support vector regression (SVR) to develop the thermal sensation model. It is claimed that their research showed the potential of using the SVM to generate the thermal index of a particular small group of people. Rana et al. [18] applied the similar ϵ -SVM regression method to generate the personal thermal sensation model and verify the feasibility of using ‘humidex’ as a predictor. The inputs of the personal model developed in this research only include temperature and humidity, or ‘humidex’ which is calculated from temperature and humidity. Megri and Rana both applied the SVM algorithm as a regression tool in their research.

Comparing all the research mentioned in this section, a research question has been raised as to whether an SVM-based personal thermal comfort model has better performance when it takes into account a complete set of environmental factors that affect thermal sensation including temperature, humidity, air velocity and mean radiant temperature. In this research, a modelling method aided by C-support Vector Classification (C-SVC) [20] is proposed for generating personal thermal sensation models. Being different to the existing thermal comfort modelling methods, this new study attempts to solve the personal thermal sensation modelling using an algorithm that particularly deals with classification problems. Comprehensive boundary decision-making methods are used here rather than directly applying linear boundaries in all cases. The input parameters of the model include the well-accepted key factors of the ambient thermal environment affecting thermal feelings, which include air temperature, mean radiant temperature, air velocity, relative humidity, clothing insulation level and activity level [21,22]. The outputs of the generated models are expected to closely match the value of the personal thermal sensation vote, which accord with the ASHRAE seven-point thermal sensation

Table 1
Properties of existing thermal sensation models.

| Paper | Name | Modelling methods | Is the model accuracy testing presented in the paper? | Are the inputs of the personal thermal sensation models involved all T_a, \bar{T}_r, V_a and RH factors ? | Are outputs of the model directly compared with the real collected TSVs with ASHRAE 7 scales? |
|-------|---|----------------------------------|---|---|---|
| [17] | Neural Network Evaluation Model (NNEM) | Back Propagation Neural Network | Yes | Yes | No |
| [11] | N/A | Fisher Discriminant | No | No | No |
| [18] | N/A | Support Vector Regression | Yes | No | Yes |
| [10] | Predicted Personal Vote Model (PPV Model) | Least Square Regression | Yes | Yes | Yes |
| [16] | Personalised Dynamic Thermal Comfort (PDTC) Model | Weighted Least Square Estimation | Yes | Yes | Yes |

scale. The format of the original thermal sensation data from the questionnaire survey has been retained. A strict evaluation rule is applied: a success prediction will only be declared if the prediction value is exactly the same as the collected true value.

3. The modelling method and algorithm

3.1. Regarding the personal thermal sensation modelling as a classification problem

In this research, the input vectors of the thermal comfort model are the environmental parameters and personal factors, while the outputs are thermal sensations. The personal thermal sensation model functions to 'map' the particular thermal conditions with an individual's thermal sensation. In this case, from machine learning prospective, the personal thermal sensation modelling issue can be regarded as a supervised learning problem [23,24]. Moreover, in previous research, the occupants' thermal feelings were collected in the form of the thermal sensation votes (TSV) based on the ASHRAE thermal comfort seven-scale scheme, i.e. cold (−3), cool (−2), slightly cool (−1), neutral (0), slightly warm (1), warm (2) and hot (3) [12]. It is logical to maintain the model predictions format to remain consistent with the format of the collected real data. In this case, the model's thermal sensation predictions will also be expressed using the ASHRAE scale detailed above. That is to say, the value used in personal thermal sensation model is discrete. These discrete data can be regarded as the label of the different thermal sensation levels. Therefore, referring to the definitions from the machine learning field in Refs. [24] and [25], the personal thermal sensation modelling problem can be regarded as a classification problem. Consequently, C-support Vector Classification (C-SVC) is chosen to support the model generation programming, which is a popular tool to solve classification problems.

3.2. The background of the C-SVC algorithm

SVM is a machine learning algorithm, which was developed into different formulations, and has been applied in various domains and regarded as an effective classification tool [26–31]. The C-SVC classifier is a separator developed by the C-SVC which is able to categorise two types of thermal sensations [20]. The basic classifier generation is illustrated in this section. For machine-learning purposes, the collected data are arranged as input and output pairs. Assume the total number of data sets is N , the input–output pairs can be expressed as (\bar{u}_i, y_i) ; $i = 1, 2, \dots, N$. The input vector \bar{u}_i contains environment parameters and personal factors. The targeted output y_i only contains one element which is the thermal sensation of a person in the circumstance, which is defined by \bar{u}_i . Let $y_i = 1$ represent the thermal sensation class number one and $y_i = -1$ represent thermal sensation class number two.

All sets of the input and output pairs are divided into training sets and test sets. Let the number of training sets be represented by M , during the training process, only training sets are used. The SVM utilises 'maximum margin hyperplane' as the decision boundary to separate two different classes when solving classification problems, and it is the optimal hyperplane that provides the maximum margin between the two classes [32]. The 'maximum margin hyperplane' is illustrated in Fig. 1. Note that this figure only depicts the situation when two classes are linearly separable. In Fig. 1, nodes expressed by the same symbol (star or triangle) belong to the same class.

The 'support vectors' are the vectors closest to the decision hyperplane derived from the training set and they define the optimal hyperplane which has the maximum margin [32]. In Fig. 1, nodes 1, 2 and 3 are selected as support vectors. The equation of the

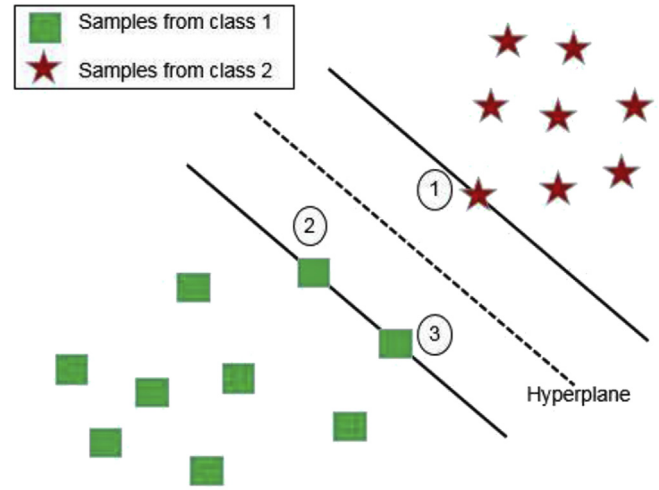

Fig. 1. Support vectors and hyperplane.

optimal hyperplane can be expressed as Equation (1) [24]:

$$\bar{\omega}^T \bar{u} + b = 0 \quad (1)$$

$\bar{\omega}$ and b are the weight vector and bias respectively, and \bar{u} is an input vector. The mathematical derivation of the C-SVC problem is briefly demonstrated in Function (2) to Function (8). Further details can be found in references [20,23,28,33].

For all the training sets and the maximum-margin hyperplane, the rule represented in Function (2) must be obeyed by:

$$y_i (\bar{\omega}^T \bar{u}_i + b) \geq 1 \quad (2)$$

It has been proved that finding the maximum margin is equivalent to finding the minimum of the output of the Function (3) [33]:

$$\theta(\bar{\omega}) = \frac{1}{2} \bar{\omega}^T \cdot \bar{\omega} \quad (3)$$

Function (3) satisfy the constrain: $y_i (\bar{\omega}^T \bar{u}_i + b) \geq 1$ $i = 1, 2, \dots, M$.

However, in real-world applications, the training data may be noisy. Furthermore, the data from the two classes may not be linearly separable. So the 'soft margin hyperplane' and the 'kernel trick' are introduced into the C-SVC algorithm to realise the classifiers in these situations. First, for the soft margin hyperplane, a parameter ξ_i is introduced, then the function going to be minimised becomes Function (4) [28,33]:

$$\min_{\bar{\omega}, b, \xi} \frac{1}{2} \bar{\omega}^T \cdot \bar{\omega} + C \sum_{i=1}^M \xi_i \quad (4)$$

The constraint condition of (4) is $y_i (\bar{\omega}^T \bar{u}_i + b) \geq 1 - \xi_i$; $\xi_i > 0$; $i = 1, 2, \dots, M$, and C is a user defined positive figure.

This research employed the 'radial-basis function' (RBF) kernel [23] for the problem of linearly inseparable cases. The kernel is used to map the input vectors from the original feature space into a higher dimensional space where the cases become linearly separable and the RBF can be expressed as Function (5):

$$K(\bar{u}_i, \bar{u}_j) = e^{-\frac{1}{2\sigma^2} \|\bar{u}_i - \bar{u}_j\|^2} \quad (5)$$

The problem of finding the maximum-margin hyperplane becomes solving the optimisation problem, which is expressed in Function (4) subject to [30]:

$$y_i (\bar{\omega}^T \bar{\varphi}(\bar{u}_i) + b) \geq 1 - \xi_i; \quad (6)$$

$$\xi_i \geq 0; \quad i = 1, 2, \dots, M \quad (7)$$

$\varphi(\bar{u}_i)$ is from the kernel function:

$$K(\bar{u}_i, \bar{u}_j) = \varphi(\bar{u}_i)^T \varphi(\bar{u}_j) \quad (8)$$

The minimisation problem of Function(4) can be converted into solving the dual problem expressed in Function (9) to Function (11) [20] [33]:

$$\min_l \frac{1}{2} \sum_{i=1}^M \sum_{j=1}^M l_i l_j y_i y_j K(\bar{u}_i, \bar{u}_j) - \sum_{i=1}^M l_i \quad (9)$$

subject to:

$$\sum_{i=1}^M l_i y_i = 0; \quad (10)$$

$$0 \leq l_i \leq C, \quad i = 1, 2, \dots, M \quad (11)$$

By finding the optimum solution of the Function (9) subject to (10) and (11), let l_{i0} and b_0 be the optimised coefficients, then the decision function $G(\bar{u})$ can be expressed as:

$$G(\bar{u}) = \text{sgn} \left(\sum_1^M y_i l_{i0} K(\bar{u}_i, \bar{u}) + b_0 \right) \quad (12)$$

If an input vector \bar{x} is submitted into Function (12), which contains environmental parameters and personal factors, and $G(\bar{x}) = 1$, this means that the generated classifier predicts the thermal sensation of the subject as being in thermal sensation class number one under the input circumstance.

In this research, there are seven levels of thermal sensations that need to be classified but the classifier described above can only identify two classes at a time. This multi-class classification problem is solved by the 'one against one' method [34], and then multiple classifiers will be generated all together to create a complete thermal sensation model for a subject. In this research, the C-SVC algorithm with the 'one against one' method has been realised by using the LIBSVM MATLAB library [20].

4. Data process and model training

In order to test the accuracy of the C-SVC-based model of the reflection and prediction of personal sensations, experimental data from a series of experiments carried out in Chongqing, China from 2008 to 2010 are used. A recent publication [35] describes the details of the experiments. The experimental indoor environment was supplied by a heating, ventilation and air conditioning (HVAC) system. Twenty-one healthy people aged between 20 and 30 years old were involved in a series of experiments. All of them stayed in Chongqing city for more than two years. One person did not complete the experiment so this individual's partial data is not used in this modelling. Every single experiment session lasted for 90 min for one person. In the first 20 min, no data was recorded as the subject was getting used to the exposed indoor environment. Then, his/her thermal comfort sensation was recorded by using a questionnaire survey in every 10 min. In the questionnaire, the thermal sensation was measured by the seven-level ASHRAE scale: cold, cool, slightly cool, neutral, slightly warm, warm and hot [12]. The ambient environmental parameters were collected in every 10 min;

whilst the questionnaire surveys were carried out. The parameters including the globe temperature, air temperature, relative humidity and air velocity were recorded by a thermal comfort monitoring station assembled in accordance with the standard ISO 7726-2001 [36]. The location of sensors were 0.6 m above the ground beside the subject. During the experiment period, all the subjects were wearing clothes with the same insulation level and were doing work having the same activity level. The settings of environmental parameters are illustrated in Table 2. All 20 subjects attended up to 10 times of 90-min' experiment sessions. A total of 1199 sets of valid data from these 20 subjects were collected, which have been used for the development and verification of models. The detailed numbers of data sets collected from each subjects are depicted in Fig. 2.

The data used as training data should not be used again as test data. Therefore, around 50% of each subject's data were used to develop the model and the remaining 50% were used to verify the accuracy of the model. Fig. 2 shows the number of samples used for training and testing the personal thermal sensation model of each individual. The real numbers of training samples and testing samples of a subject depend on the total amount of valid raw data collected from the experiment. The mean radiant temperature is calculated using Equation (14) where T_g is the globe temperature collected on-site [37].

$$\bar{T}_r = \left[(T_g + 273)^4 + \frac{1.1 \cdot 10^8 V_a^{0.6}}{\epsilon D^{0.4}} (T_g - T_a) \right]^{0.25} - 273 \quad (14)$$

Fig. 3 illustrates the input data structure and the model training process. All the data should be arranged into input and targeted output pairs to fit the C-SVC algorithm. From the figure, it can be seen that the input data required for modelling include: 1) ambient environmental parameters such as T_a , \bar{T}_r , V_a and RH and personal data such as MET and Clo ; and 2) a subject's TSV (thermal sensation vote). These data are fed into the modelling algorithm based on the C-SVC and modelled thermal sensations based on the inputted information are then produced. For a subject, only the data collected from the experiments he/she attended were used to develop his/her personal thermal sensation model.

In the development of the modelling algorithm, the LIBSVM library was applied. According to the developer of the library, two parameters: C and γ , are used to control the performance of the C-SVC algorithm. Both C and γ are user defined parameters and optimal pairing C and γ values will improve the C-SVC model quality. The regularisation parameter C controls the trade-off between the trained models' complexity and the errors [26,33] while the parameter γ determines the parameter δ in the RBF kernel Function (5), which is defined by Function (15) [20].

$$\gamma = \frac{1}{2\delta^2} \quad (15)$$

In this research, these parameters have been optimally selected by a 'grid-search' method which is recommended by the library developer [20]. It was approved as a reliable method in the existing research [26]. In the 'grid-search' procedure, a series of C and γ

Table 2
Range of environmental parameters in the controlled environment.

| Environmental parameters | Minimum value | Maximum value |
|--------------------------|---------------|---------------|
| T_g | 24.94 °C | 29.58 °C |
| T_a | 26.07 °C | 30.04 °C |
| RH | 41.5% | 80.1% |
| V_a | 0.11 m/s | 0.17 m/s |

Number of Data Sets and Times of Experiments

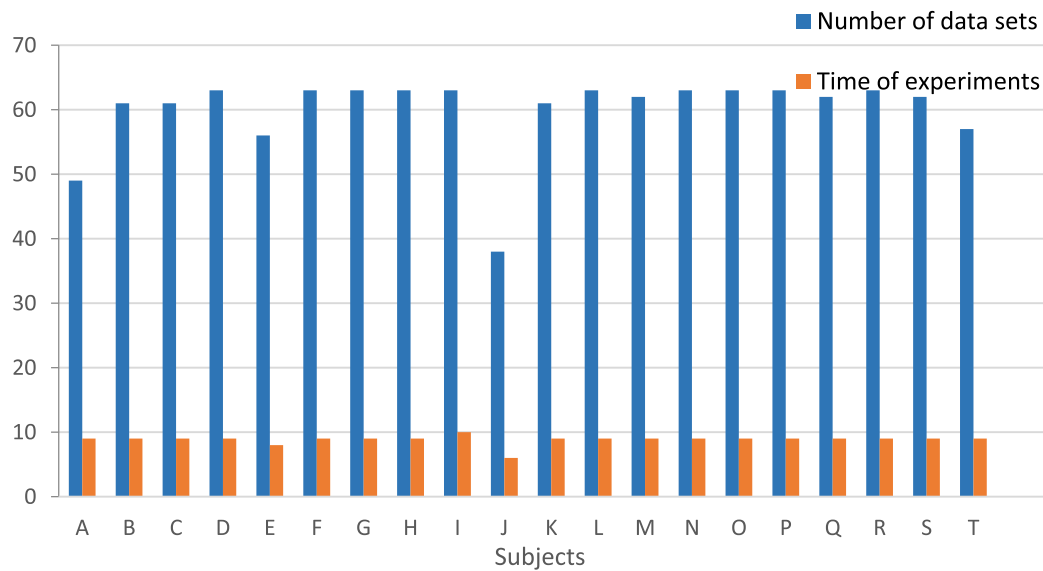

Fig. 2. Number of data sets collected from each subject.

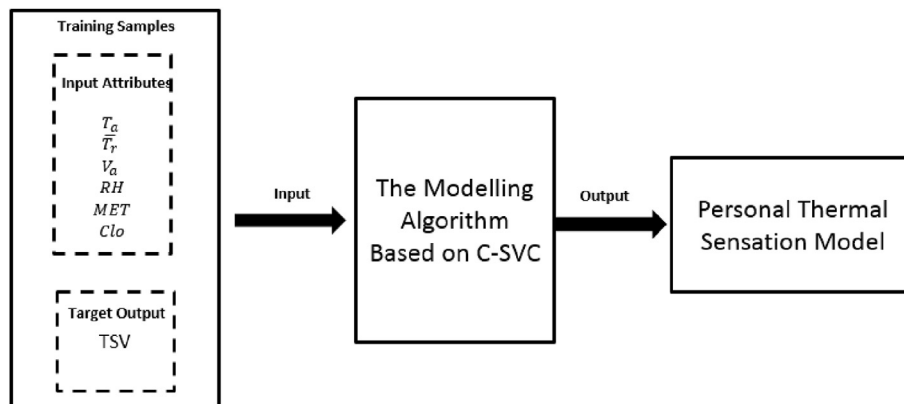

Fig. 3. Training process of the personal thermal sensation model.

values were first calculated separately. Then all the possible combinations of (C, γ) pairs were generated. Based on the performance of the modelling program, both the parameters C and γ were calculated by 2^A where A is from the data range $(-4, -3, -2, -1, 0, 1, 2, 3, 4)$. The program automatically selects one pair of (C, γ) each time then applies it to train a model. The performance of the selected (C, γ) was verified by a cross-validation method, which is integrated in the LIBSVM library. A five-fold cross-validation method was programmed. During the validation process, the program split the training sets equally into five subsets then five rounds of the modelling process were performed for each pair of (C, γ) . Once a pair was selected, the first round of modelling would started. Four subsets of data were used to train the model and the remaining part was used to validate the performance. The validation result of the model generated in this round was then saved. During the next round of modelling for the same pair of (C, γ) , the program would use another subsets as validation data sets and repeated the training and validation process then saved the validation result again. The same process would be iterated five times until all the subsets had been used once as validation data sets. All five saved test results were averaged and the average value was

used to represent the performance of the modelling program with the selected (C, γ) . In the end, the selected model was the one developed by the combination of C and γ giving the best validated performance. If more than one (C, γ) pair reached the best performance, the program would select the pair that was validated last in the whole validation process. Fig. 4 depicts the performance of different (C, γ) pairs during the model training process for subject B. It can be found that multiple (C, γ) pairs have the same performance which validation results reach 100% accurate, so after the training process, the chosen (C, γ) pair was $(16, 16)$, which is illustrated as the point Z in Fig. 4.

5. Verifications of the model

The developed individual thermal sensation model was verified by the test samples. In the test samples, the attributes T_a , \bar{T}_r , V_a , RH , MET and Clo were used as the inputs of the personal thermal sensation models. The models' predictions were compared with the actual TSV data collected from the experiment. If, under the same environmental and personal conditions, a model's prediction was equal to the actual TSV data, then the prediction would be regarded

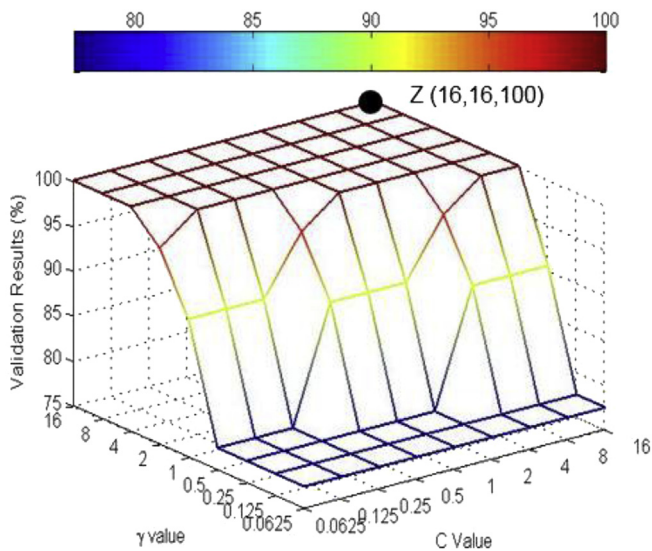

Fig. 4. Performance of different (C, γ) pairs.

as a correct prediction. The performance of a model is expressed by the model's prediction accuracy rate, which is calculated by Equation (9) [20].

Prediction Accuracy Rate = The Number of Correct Predictions / Total Number of Test Samples (9).

Fig. 5 depicts results of two series of experiments, which test the performance of two individual models for two subjects. The X axis presents the number of the experiment. The Y axis shows the TSV values. The crosses in the figure are the TSV values predicted by C-SVC-based personal thermal sensation models, and the circles represent the actual TSV data collected from the subjects. In the figure, the cross covering the circle means the model makes a correct prediction. Fig. 6 shows the accuracy rate of the predicted models for 20 subjects. From the figure, it can be seen that the average prediction accuracy is 89.82%. 17 out of 20 subjects' individual thermal sensation models have an accuracy rate higher than 80%.

6. Comparison studies

In order to further verify the performance of personal thermal sensation models based on the C-SVC algorithm, a comparative study is presented. Using the same sets of data we calculated the individual's thermal sensations by using the PMV and C-SVC methods.

According to the literature [18], if the value of the difference between PMV and the occupant's TSV is less than or equal to 0.5, then the prediction using PMV is regarded as accurate. The accuracy rate of PMV prediction was calculated according to Equation (9). Fig. 7 depicts the mean values of the accuracy rate of the PMV index and the C-SVC-generated personal thermal sensation models. It can be seen that the average accuracy rate of the personal thermal sensation models (89.82%) is significantly higher than that obtained from the PMV model (49.71%).

7. Application of the modelling method

The mismatching of demand and supply for heating and cooling of the PCS could cause energy wastage. The modelling method presented in this paper can minimise or eliminate such mismatches because the developed model can realistically reflect the occupant's

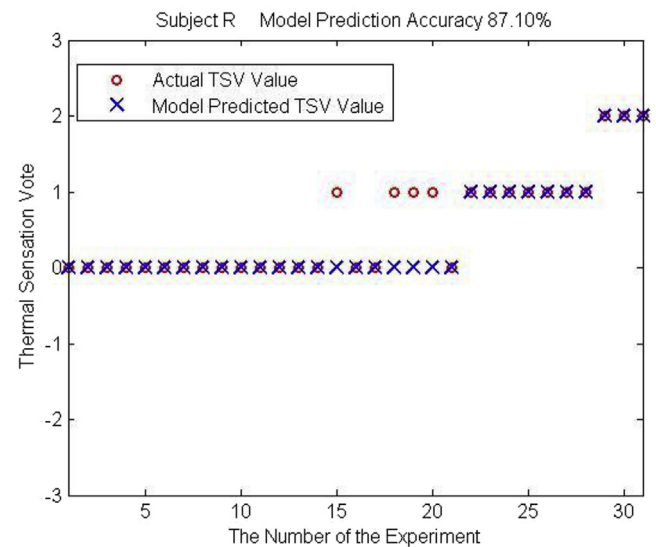
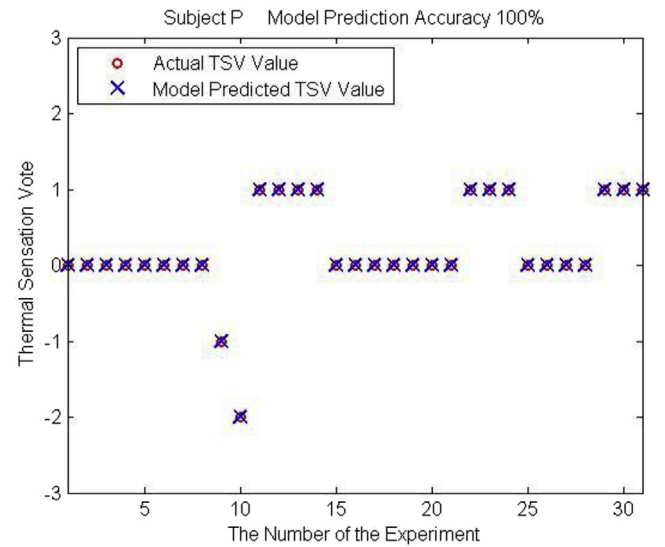

Fig. 5. Model predicted TSV VS subjects' actual TSV for subjects P and R.

thermal sensation and expectation. To realise the goal of energy efficiency of the PCS while providing thermally comfort microclimate surrounding the occupant, an intelligent system will be of useful. The feasibility and operations of the learning-algorithm-aided PCS system have been discussed in some research such as [10,11,17]. In this research, the framework of a holistic intelligent management system is proposed as illustrated in Fig. 8. The detailed description of the realisation of the intelligent control system is out of the scope of this paper. More detailed materials will be provided in following research papers due to the page limitation. We take an example of the application of this model in a personalised air supply system to demonstrate how the model can be used in personal control. The intelligent system framework is composed of five parts that are briefly described as follows:

7.1. Human-machine interface

This component plays a function of dialogue between the people and the system. It collects information from the end-user including thermal sensation vote, clothing level and activity level through clicking the pre-designed dialogue boxes. Furthermore, it will also

Models' Predictions Accuracy Rates

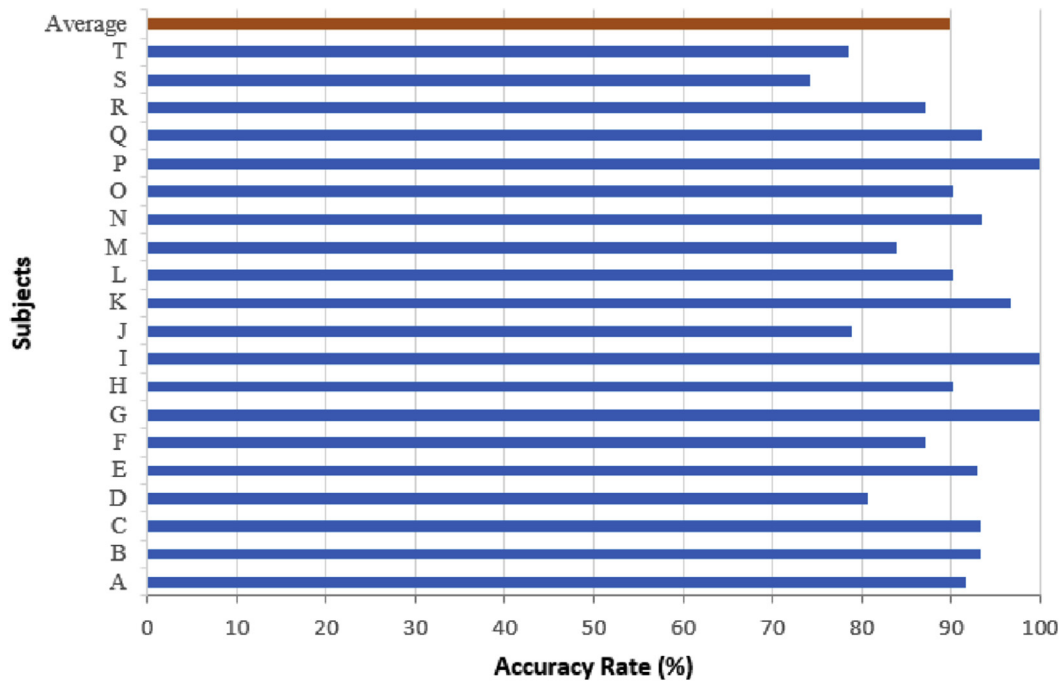

Fig. 6. Model's prediction accuracy rates.

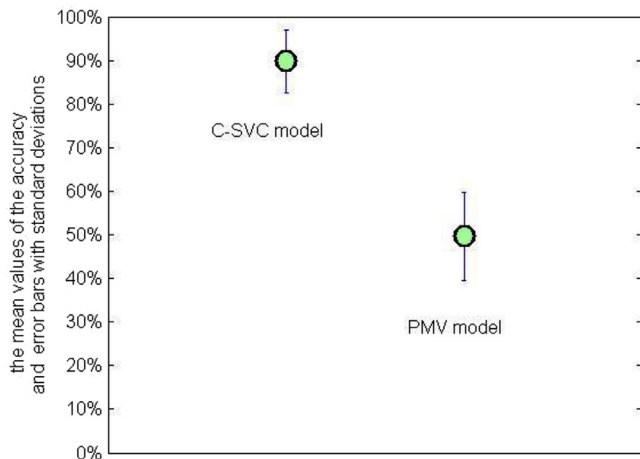

Fig. 7. Mean accuracy of PMV and C-SVC based models.

be able to visualise the physical environment condition and provide advice of alternative ways to achieve the thermal expectation based on mature thermal adaptation theory when necessary.

7.2. Sensor network

The sensor network component collects the information of ambient thermal environmental parameters including air temperature, mean radiative temperature, relative humidity and air velocity.

7.3. Information database storage

The end-user's personal thermal sensation vote initially collected will be stored and in the system therefore to form the

database for personal thermal sensation modelling. The database can be updated if the 'end-user' has any significant changes in terms of clothing level, activity level and ambient environment. It will also store the physical environment information surrounding the end-user including temperature, humidity and air velocity.

7.4. Calculator

This component embeds the C-SVC algorithm to perform personal thermal sensation modelling using the stored data sets and to predict thermal sensations. Once the model has been trained and verified, the thermal sensation information will be converted into the required supply air temperature and velocity, which is the essential information to the controller for the decision making of air supply.

7.5. Controller

An optimal decision making algorithm is embedded in the controller aimed to optimise air supply i.e. the setting of the supply air temperature velocity and humidity to match the end-user's demand. The system operation information will be fed back to the end-user through the human-machine interface.

It is worth to note that when the system starts to work, it may have higher demand on the end-user's input of the thermal sensation votes via human-machine interface so to generate the database. Once the personal thermal sensation model is established, the system has completed the 'learning' process then to be able to predict. Furthermore, the system will be able to update the database if the end-user interacts with the human-machine interface by inputting any updated information. The C-SVC algorithm will iterate the modelling and verifying process. This feature will enable the system dynamically update and reflect the end-user's demand when it is needed.

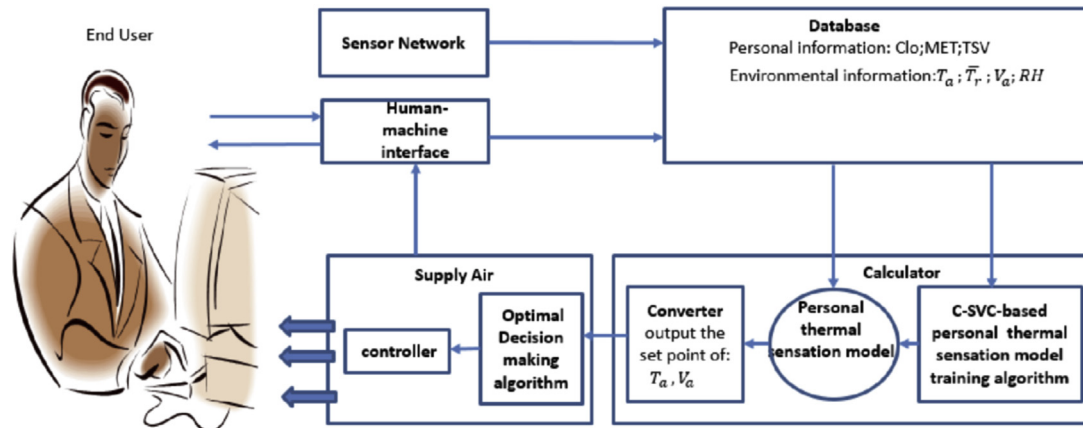

Fig. 8. The Structure and Information flow of PCS System with C-SVC Algorithm.

8. Conclusions

This paper presents a C-SVC method of modelling personal thermal sensations. The modelling method has been verified using the experimental data collected in an HVAC-supplied indoor environment with real thermal sensation votes from twenty subjects. The average rate of prediction accuracy of these models is above 89%. The results of this study indicate that the modelling problem can be regarded as a classification problem in the context of machine learning. The method will be ideally used in the intelligent control for a personalised conditioning system because the C-SVC realistically reflects an individual occupant's personal thermal preference and provides the individual's specific thermal comfort need. It is argued that people's thermal sensation could vary from season to season; the C-SVC algorithm can be re-developed on a seasonal basis in order to fully reflect the dynamic adaptation of humans. It is expected that the performance of a personalised conditioning system can be improved in terms of energy efficiency and wellbeing through intelligent control that reflects people's thermal demands. Future research to verify the method in various indoor environments such as free-running buildings will be conducted.

Acknowledgements

This research was supported by UK Engineering and Physical Sciences Research Council (EPSRC) Doctor Training Grant Number: EP/J500501/1 and EP/K503125/1/ University of Reading International Research Studentship.

References

- [1] M. Vesely, W. Zeiler, Personalized conditioning and its impact on thermal comfort and energy performance – A review, *Renew. Sustain. Energy Rev.* 34 (Jun 2014) 401–408.
- [2] H. Zhang, E. Arens, Y. Zhai, A review of the corrective power of personal comfort systems in non-neutral ambient environments, *Build. Environ.* 91 (9// 2015) 15–41.
- [3] C.S. Pan, H.C. Chiang, M.C. Yen, C.C. Wang, Thermal comfort and energy saving of a personalized PFCU air-conditioning system, *Energy Build.* 37 (May 2005) 443–449.
- [4] G.Y. Cao, H. Awbi, R.M. Yao, Y.Q. Fan, K. Siren, R. Kosonen, et al., A review of the performance of different ventilation and airflow distribution systems in buildings, *Build. Environ.* 73 (Mar 2014) 171–186.
- [5] Y.C. Zhai, H. Zhang, Y.F. Zhang, W. Pasut, E. Arens, Q.L. Meng, Comfort under personally controlled air movement in warm and humid environments, *Build. Environ.* 65 (Jul 2013) 109–117.
- [6] E.M. de Korte, M. Spiekman, L. Hoes-van Oeffelen, B. van der Zande, G. Vissenberg, G. Huiskes, et al., Personal environmental control: effects of pre-set conditions for heating and lighting on personal settings, task performance and comfort experience, *Build. Environ.* 86 (Apr 2015) 166–176.
- [7] M.V. Moreno, M.A. Zamora, A.F. Skarmeta, User-centric smart buildings for energy sustainable smart cities, *Trans. Emerg. Telecommun. Technol.* 25 (Jan 2014) 41–55.
- [8] V.L. Erickson, A.E. Cerpa, Thermovote: participatory sensing for efficient building hvac conditioning, in: *Proceedings of the Fourth ACM Workshop on Embedded Sensing Systems for Energy-efficiency in Buildings*, 2012, pp. 9–16.
- [9] F. Jazizadeh, A. Ghahramani, B. Becerik-Gerber, T. Kichkaylo, M. Orosz, Human-Building Interaction Framework for Personalized Thermal Comfort-Driven Systems in Office Buildings, *J. Comput. Civ. Eng.* 28 (Jan 1 2014) 2–16.
- [10] P.X. Gao, S. Keshav, SPOT: a smart personalized office thermal control system, in: *Proceedings of the Fourth International Conference on Future Energy Systems*, Berkeley, California, USA, 2013, pp. 237–246.
- [11] M. Feldmeier, J.A. Paradiso, Personalized HVAC control system, in: *Internet of Things (IoT)*, 2010, 2010, pp. 1–8.
- [12] ANSI/ASHRAE55-2010, ASHRAE Standard: Thermal Environmental Conditions for Human Occupancy, American Society of Heating, Refrigerating and Air-Conditioning Engineers Inc, Atlanta, USA, 2010.
- [13] ISO7730, Ergonomics of the Thermal Environment-analytical Determination and Interpretation of Thermal Comfort Using Calculation of the PMV and PPD Indices and Local Thermal Comfort Criteria, International Standard Organization, Geneva, 2005.
- [14] C. E. de Normalisation, "EN15251: 2007," Indoor Environmental Input Parameters for Design and Assessment of Energy Performance of Buildings Addressing Indoor Air Quality, Thermal Environment, Lighting and Acoustics, 2007.
- [15] GB/T50785-2012, Evaluation Standard for Indoor Thermal Environment in Civil Buildings, Ministry of Housing and Urban-Rural Development of the People's Republic of China; General Administration of Quality Supervision, Beijing, 2012. Inspection and Quarantine of the People's Republic of China.
- [16] Q.C. Zhao, Y. Zhao, F.L. Wang, J.L. Wang, Y. Jiang, F. Zhang, A data-driven method to describe the personalized dynamic thermal comfort in ordinary office environment: From model to application, *Build. Environ.* 72 (Feb 2014) 309–318.
- [17] W.W. Liu, Z.W. Lian, B. Zhao, A neural network evaluation model for individual thermal comfort, *Energy Build.* 39 (Oct 2007) 1115–1122.
- [18] R. Rana, B. Kusy, R. Jurdak, J. Wall, W. Hu, Feasibility analysis of using humidex as an indoor thermal comfort predictor, *Energy Build.* 64 (Sep 2013) 17–25.
- [19] A.C. Megri, I.E. Naqa, F. Haghghat, A learning machine approach for predicting thermal comfort indices, *Int. J. Vent.* 3 (2005) 363–376.
- [20] C.C. Chang, C.J. Lin, LIBSVM: a library for support vector machines, *Acm Trans. Intell. Syst. Technol.* 2 (2011).
- [21] P.O. Fanger, *Thermal Comfort: Analysis and Applications in Environmental Engineering*, Danish Technical Press, Copenhagen, 1970.
- [22] B.W. Olesen, Guidelines for comfort, *Ashrae J.* 42 (Aug 2000) 41–46.
- [23] C.M. Bishop, *Pattern Recognition and Machine Learning*, Springer, New York, 2006.
- [24] S.J. Russell, P. Norvig, *Artificial Intelligence: A Modern Approach*, third ed., Pearson, Boston, [Mass.], 2010.
- [25] J. Han, M. Kamber, J.P.D. Pei, *Data Mining: Concepts and Techniques*, third ed., Morgan Kaufmann, Waltham, MA, 2012 [Oxford: Elsevier Science, distributor].
- [26] X.C. Xi, A.N. Poo, S.K. Chou, Support vector regression model predictive control on a HVAC plant, *Control Eng. Pract.* 15 (Aug 2007) 897–908.
- [27] B.E. Boser, I.M. Guyon, V.N. Vapnik, A training algorithm for optimal margin classifiers, in: *Proceedings of the Fifth Annual Workshop on Computational Learning Theory*, 1992, pp. 144–152.
- [28] C. Cortes, V. Vapnik, Support-Vector Networks, *Mach. Learn.* 20 (Sep 1995) 273–297.
- [29] J.A. Banados, K.J. Espinosa, Optimizing support vector machine in classifying

- sentiments on product brands from twitter, in: 5th International Conference on Information, Intelligence, Systems and Applications, IISA 2014, 2014, p. 75.
- [30] J. Novakovic, A. Veljovic, C-support vector classification: selection of kernel and parameters in medical diagnosis, in: *Intelligent Systems and Informatics (SISY)*, 2011 IEEE 9th International Symposium on, 2011, pp. 465–470.
- [31] S.J. Zhao, X.W. Hao, X.D. Li, Segmentation of Fingerprint Images Using Support Vector Machines, in: 2008 International Symposium on Intelligent Information Technology Application, Vol II, Proceedings, 2008, pp. 423–427.
- [32] I.H. Witten, E. Frank, M.A. Hall, *Data Mining: Practical Machine Learning Tools and Techniques*, third ed., 2011.
- [33] S.S. Haykin, *Neural Networks : A Comprehensive Foundation*, second ed., Prentice-Hall International, Upper Saddle River, N.J.: Prentice Hall; London, 1999.
- [34] S. Knerr, L. Personnaz, G. Dreyfus, Single-layer learning revisited: a stepwise procedure for building and training a neural network, in: F. Soulié, J. Héroult (Eds.), *Neurocomputing*, vol. 68, Springer Berlin Heidelberg, 1990, pp. 41–50.
- [35] Y. Yang, B. Li, H. Liu, M. Tan, R. Yao, A study of adaptive thermal comfort in a well-controlled climate chamber, *Appl. Therm. Eng.* 76 (2/5/2015) 283–291.
- [36] ISO7726, in: *Ergonomics of the Thermal Environment—Instruments for Measuring Physical Quantities*, International Organization for Standardization, Geneva, 2001.
- [37] P.M. Ferreira, A.E. Ruano, S. Silva, E.Z.E. Conceicao, Neural networks based predictive control for thermal comfort and energy savings in public buildings, *Energy Build.* 55 (Dec 2012) 238–251.