

Attribution of the spatial pattern of CO₂-forced sea level change to ocean surface flux changes

Article

Published Version

Creative Commons: Attribution 3.0 (CC-BY)

Open Access

Bouttes, N. and Gregory, J. M. (2014) Attribution of the spatial pattern of CO₂-forced sea level change to ocean surface flux changes. *Environmental Research Letters*, 9. 034004. ISSN 1748-9326 doi: <https://doi.org/10.1088/1748-9326/9/3/034004>
Available at <http://centaur.reading.ac.uk/37273/>

It is advisable to refer to the publisher's version if you intend to cite from the work.

To link to this article DOI: <http://dx.doi.org/10.1088/1748-9326/9/3/034004>

Publisher: Institute of Physics

All outputs in CentAUR are protected by Intellectual Property Rights law, including copyright law. Copyright and IPR is retained by the creators or other copyright holders. Terms and conditions for use of this material are defined in the [End User Agreement](#).

www.reading.ac.uk/centaur

CentAUR

Central Archive at the University of Reading

Reading's research outputs online

Attribution of the spatial pattern of CO₂-forced sea level change to ocean surface flux changes

This content has been downloaded from IOPscience. Please scroll down to see the full text.

2014 Environ. Res. Lett. 9 034004

(<http://iopscience.iop.org/1748-9326/9/3/034004>)

View [the table of contents for this issue](#), or go to the [journal homepage](#) for more

Download details:

This content was downloaded by: nathaelle

IP Address: 134.225.100.6

This content was downloaded on 28/04/2014 at 10:13

Please note that [terms and conditions apply](#).

Attribution of the spatial pattern of CO₂-forced sea level change to ocean surface flux changes

N Bouttes¹ and J M Gregory^{1,2}

¹ NCAS-Climate, Meteorology Department, University of Reading, Reading, RG6 6BB, UK

² Met Office Hadley Centre, Exeter, EX1 3PB, UK

E-mail: n.bouttes@reading.ac.uk

Received 1 November 2013, revised 11 February 2014

Accepted for publication 14 February 2014

Published 4 March 2014

Abstract

Climate models taking part in the coupled model intercomparison project phase 5 (CMIP5) all predict a global mean sea level rise for the 21st century. Yet the sea level change is not spatially uniform and differs among models. Here we evaluate the role of air–sea fluxes of heat, water and momentum (windstress) to find the spatial pattern associated to each of them as well as the spread they can account for. Using one AOGCM to which we apply the surface flux changes from other AOGCMs, we show that the heat flux and windstress changes dominate both the pattern and the spread, but taking the freshwater flux into account as well yields a sea level change pattern in better agreement with the CMIP5 ensemble mean. Differences among the CMIP5 control ocean temperature fields have a smaller impact on the sea level change pattern.

Keywords: sea level, climate model, CMIP5

 Online supplementary data available from stacks.iop.org/ERL/9/034004/mmedia

1. Introduction

During the last hundred years, global mean sea level has been rising. The rate of rise was ~ 2 mm year⁻¹ for 1972–2008 (Church *et al* 2011), and ~ 3 mm year⁻¹ since the early 1990s (Cazenave and Nerem 2004, Llovel *et al* 2011). For the future, the climate models in the Coupled Model Intercomparison Project Phases 3 and 5 (CMIP3 and CMIP5) predict a continuing sea level rise, the rate of which depends on the scenario of anthropogenic emissions, especially of CO₂ (Pardaens *et al* 2011, Yin 2012). A large part of the historical and future sea level rise is due to the uptake of heat by the ocean and the resulting thermal expansion, which is projected to contribute about 0.2 m to global mean sea level rise during the 21st century under scenario RCP4.5, for instance (Yin 2012).

The steric sea level change due to changes in temperature and salinity is not spatially uniform, with some regions

experiencing as much as twice the global mean sea level change and others much less (Landerer *et al* 2007, Yin *et al* 2010, Pardaens *et al* 2011, Yin 2012). In particular, the future sea level change pattern is characterized by a meridional dipole in the North Atlantic with higher sea level rise north of 40°N and lower to the south, a meridional dipole in the Southern Ocean with higher sea level rise north of 50°S and lower to the south, and higher sea level rise in the Western North Pacific. These features can be seen in the model mean of CMIP5 simulations under the idealized 1% CO₂ scenario (figure 1(a)). (In all figures showing sea level change, the quantity plotted is the difference between local sea level change and the global mean, because in this analysis we are concerned only with the geographical pattern.) We choose to analyse results for this scenario, in which the atmospheric CO₂ concentration is increased by 1% each year, because it gives minimal differences in radiative forcing among models.

Although they tend to show these common features, the individual models disagree on the details and the magnitude of the regional changes (Yin *et al* 2010, Pardaens *et al* 2011, Yin

 Content from this work may be used under the terms of the [Creative Commons Attribution 3.0 licence](https://creativecommons.org/licenses/by/3.0/). Any further distribution of this work must maintain attribution to the author(s) and the title of the work, journal citation and DOI.

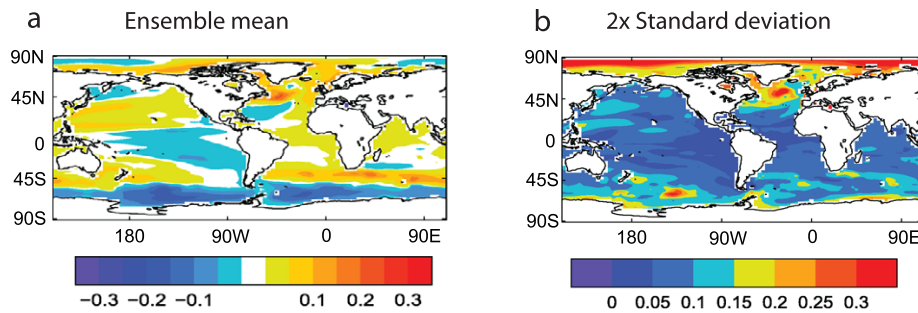

Figure 1. Multi-model (a) ensemble mean and (b) spread (twice the standard deviation) of the CMIP5 sea level change (m). All the figures show the difference between the mean of the last and first decades. Sea level change is shown relative to the global mean sea level rise i.e. negative values indicate that the local sea level rise is less than global mean sea level rise.

2012, Bouttes *et al* 2012), with the spread between the models being greatest at high latitudes (figure 1(b); see also figure S2 of Bouttes *et al* 2012, for individual models). The spatial standard deviation of sea level change gives an indication of the magnitude of the spatial variation of sea level change. After 100 years under the 1% CO₂ scenario, the CMIP5 models have a spatial standard deviation lying between 0.05 (CESM1-BGC, MRI-CGCM3 and NorESM1-ME) and 0.09 m (CanESM2, MIROC-ESM and MPI-ESM-P) (table 1).

The patterns of change in surface fluxes of momentum (windstress), heat (radiative, latent and sensible) and water (precipitation and evaporation; our diagnostics do not include river runoff or freshwater fluxes from sea ice freezing and melting) between the atmosphere and the ocean influence the pattern of sea level change, principally through their effects on ocean density; the pattern of sea level change on decadal timescales can be well-approximated by steric sea level change, with the contribution due to barotropic circulation change being comparatively unimportant (Lowe and Gregory 2006). Changes in ocean density are caused both directly, by the surface buoyancy fluxes, and indirectly, through the redistribution of interior properties caused by alterations in ocean horizontal and vertical circulation forced by changes in surface buoyancy and momentum fluxes (Bouttes *et al* 2013). For the recent past, the windstress change appears to play a role in setting the sea level change pattern in some regions, such as in the Indian and Pacific oceans (Timmermann *et al* 2010, Merrifield and Maltrud 2011, Nidheesh *et al* 2013).

For the future, models simulate various geographical patterns of the surface flux changes (figure 2). The largest changes in zonal wind stress are found in the Southern Ocean, where the spread is also the largest (figures 2(a) and (b)). The heat flux change has its greatest magnitude in the North Atlantic and is also substantial in the Southern Ocean (figure 2(c)). These regions and the Western North Pacific are where the spread is the largest (figure 2(d)). The change in fresh water flux is characterized by higher values around the equator and at high latitudes, and smaller ones around the tropics (figure 2(e)), while the greatest spread is at low latitudes (figure 2(f)). In this study we do not analyse the sea level change in the Arctic Ocean because it is likely to be linked with sea ice and runoff changes, whose effect on the

surface freshwater flux is not accounted for in the experiment setup used.

It has been shown that the windstress change has a large effect on projected 21st century sea level change in the Southern Ocean (Bouttes *et al* 2012) and Southern Indo-Pacific (Timmermann *et al* 2010), while the heat flux change dominates the sea level change in the North Atlantic (Bouttes *et al* 2013). Here we systematically evaluate the role of all three surface fluxes, both separately and in conjunction, on projected sea level change worldwide in the CMIP5 models, in terms of sea level pattern and spread between models. We also investigate the contribution to the model spread which arises from their having different control climate states of the 3D ocean temperature field.

2. Methods

To evaluate the role of the three surface fluxes on the sea level change, we use the FAMOUS model (Jones 2003, Smith *et al* 2008). FAMOUS is an AOGCM based on HadCM3 (Gordon *et al* 2000), with a lower resolution which allows it to run approximately twenty times faster. The ocean grid has a resolution of 3.75° longitude by 2.5° latitude with 20 levels, while in the atmosphere it is 7.5° longitude by 5° latitude, with 11 vertical levels.

In the simulations, FAMOUS is run under control boundary conditions (including a prescribed CO₂ value fixed at the pre-industrial level). In each simulation, the surface fluxes computed by FAMOUS are modified by the addition of anomalous surface fluxes taken from one of the CMIP5 models. The CMIP5 anomalous surface fluxes are obtained as the difference between the monthly mean flux in the CMIP5 1% CO₂ simulation and the corresponding monthly mean flux in the control simulation. By considering the difference between the 1% CO₂ and parallel pre-industrial control runs we remove any drift that would be present in the CMIP5 simulations. As well as the effect of climate change due to CO₂, the monthly anomalous fluxes also reflect internally generated variability on monthly and longer timescales in the CMIP5 model concerned. Applying the fluxes will therefore increase the variability on such timescales in the FAMOUS simulation, although this added variability and the internally generated

Table 1. CMIP5 models and experiments considered in this study. For each case, we give the spatial standard deviation of sea level change (m), excluding the Mediterranean, Baltic and Red Seas, and the Hudson Bay. In most cases, including these marginal seas changes the result by less than 0.01 m, but the numbers in brackets give the results including these marginal seas in the two cases where it makes a substantial difference. The last time shows the average over the models. The figures in this paper show the results for the restricted ensemble of nine CMIP5 models for which we have carried out FAMOUS experiments with all three flux perturbations applied together (those shown in the column marked ‘with all fluxes’). Results are shown in the supplementary material available at stacks.iop.org/ERL/9/034004/mmedia from the larger ensemble of 14 models for which we have carried out experiments with individual fluxes perturbed.

Models	CMIP5 results	FAMOUS results				With CMIP5 initial temperature
		With CMIP5 wind	With CMIP5 heat	With CMIP5 freshwater	With all fluxes	
ACCESS1-0	0.06	0.06	0.16	0.04	0.21	×
CESM1-BGC	0.05	0.06	0.08	0.05	0.09	
CNRM-CM5	0.07	0.04	0.06	0.04		×
CanESM2	0.09 (0.08)	0.09	0.09	0.05		×
FGOALS-g2	0.06	0.04	0.06	0.04		×
HadGEM2-ES	0.06	0.06	0.07	0.04	0.08	×
IPSL-CM5A-MR	0.08	0.11	0.10	0.04	0.17	×
MIROC-ESM	0.09 (0.12)	0.07	0.10	0.06	0.13	
MIROC5	0.08	0.08	0.09	0.05	0.11	
MPI-ESM-P	0.09	0.07	0.08	0.04		×
MRI-CGCM3	0.05	0.04	0.08	0.03	0.06	
NorESM1-ME	0.05	0.04	0.08	0.03	0.08	×
NorESM1-M	0.06	0.06	0.09	0.04	0.10	×
Inmcm4	0.07	0.04	0.05	0.04		
Mean	0.07 (0.07)	0.06	0.09	0.04		

variability of FAMOUS will not be correlated. Nonetheless the effect of climate change is dominant (see section 3).

When applied in FAMOUS the anomalous fluxes are updated each day by interpolation in time between monthly means. The FAMOUS simulations are run for 100 years, using the surface fluxes of the first 100 years of the CMIP5 1% CO₂ simulations. All differences shown in the figures and statistics are between the average of the last decade (years 90–99) and the first decade (years 0–9). Four sets of experiments are carried out: the first with the zonal and meridional windstress anomalies added to FAMOUS, the second with the heat flux anomalies, the third with the water flux anomalies, and the fourth with the three fluxes added simultaneously.

For the set of experiments with the heat fluxes, we use a passive tracer T_c to avoid the feedback from the change of SST (because of the additional heat flux) on the atmosphere (figure 3(a), following Bouttes *et al* 2013). T_c is initialized with T_0 , the initial value of the FAMOUS temperature field T , and is transported like T within the ocean. But unlike T , which is forced by both the heat flux F computed by FAMOUS and the anomalous flux F' from the CMIP5 models (that is, T is forced by $F + F'$), T_c is forced by F only. The surface value of T_c is used as the SST by the atmosphere model, instead of T , to compute the surface heat flux. We have verified that this method suppresses negative feedback via SST, as intended, by evaluating the volume integral of T_c during the experiment. We find that after 100 years it has hardly changed from its initial value, indicating that the area integral of F has not been significantly perturbed by the addition of heat to the ocean.

Most results in this paper are derived from the ensemble of nine CMIP5 models for which data for all three surface flux

changes as well as the sea level change were available, and for which we have run experiments with the three fluxes separately and simultaneously (see table 1). There are five other CMIP5 models for which the data were available but it was not possible to run stable simulations with all three fluxes simultaneously, because they caused too large a perturbation when imposed together; we found the stable simulations could be achieved in those cases if the applied flux changes were scaled down. This difficulty is probably related to the general oversensitivity we have found in FAMOUS to the applied flux anomalies (see section 3.5). We do not think our conclusions are qualitatively affected by the restriction to a smaller ensemble because for the simulations with fluxes perturbed individually the results are very similar (shown in the supplementary material available at stacks.iop.org/ERL/9/034004/mmedia) from the larger set of 14 CMIP5 models.

3. Sea level change and uncertainties from the surface fluxes

Imposing the CMIP5 surface flux anomalies in FAMOUS has a profound effect on regional sea level, but with different patterns for each surface flux. Note that the forced response is generally larger than the internal variability for each of the experiments (see supplementary figures D–G available at stacks.iop.org/ERL/9/034004/mmedia).

3.1. Effect of the windstress change

As previously discussed (Bouttes *et al* 2012), the windstress plays a role mainly in the Southern Ocean, where it results in

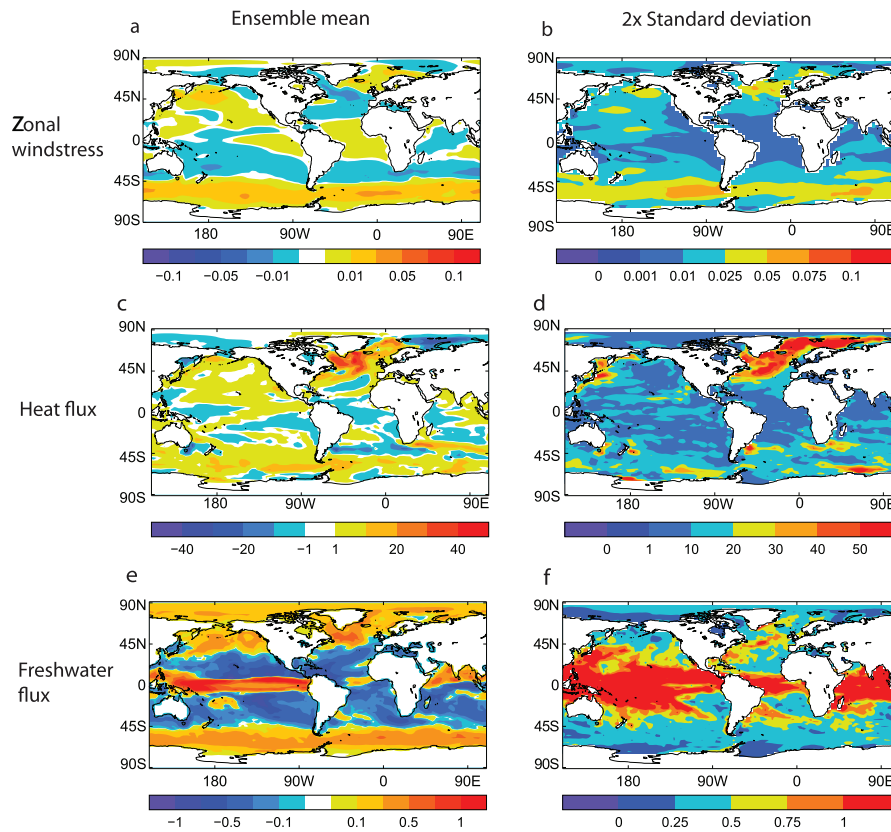

Figure 2. (a), (c) and (e) Multi-model ensemble mean and ((b), (d) and (f)) spread (twice the standard deviation) of the CMIP5 surface fluxes change: ((a) and (b)) zonal windstress change ($N m^{-2}$), ((c) and (d)) surface heat flux change into the ocean ($W m^{-2}$), ((e) and (f)) freshwater flux change into the ocean ($mm day^{-1}$).

a meridional dipole (figure 4(a)). FAMOUS does not resolve eddies in the Southern Ocean, where they can react to changes in wind stress and modify the ocean response. However, a higher resolution model which permits eddies shows results in agreement with FAMOUS with respect to the pattern of sea level change in the Southern Ocean in response to changes in winds (Frankcombe *et al* 2013). The change of winds also causes relative sea level rise in the Western North Pacific, while in the North Atlantic it generally causes lower sea level and does not explain the dipole pattern of change seen in the CMIP5 models (figure 1(a)).

The change of sea level in the Southern Ocean is mostly thermosteric (figure 5(b) resembles 5(a) in the Southern Ocean) due to the strengthened zonal windstress and increased Ekman transport which leads to a steepening of the isopycnals (Bouttes *et al* 2012). This results in higher temperature in the northern part of the Southern Ocean and lower temperature in the southern part (figure 6(a)). In the Western North Pacific, the windstress change leads to higher sea level rise. The thermosteric sea level change is most important in the west of the basin (figure 5(b)), while the halosteric sea level change shows a maximum in the central part (figure 5(c)).

3.2. Effect of the heat flux change

Unlike the windstress, the heat flux has a strong impact on the sea level change in the North Atlantic, as is analysed

in greater detail in Bouttes *et al* (2013). But it has also an effect on the sea level change in the Southern Ocean (figure 4(c)), where it results in lower sea level rise south of $45^{\circ}S$ and generally higher sea level rise north of $45^{\circ}S$. This effect reinforces the impact of the windstress change close to Antarctica, but in response to the heat flux change the area of lower sea level rise extends further north. As for the wind simulations, the change of sea level in the Southern Ocean is mostly thermosteric (figure 5(e) resembles 5(d) in the Southern Ocean). However, the processes are different: for the heat experiment, the convection is reduced due to the increased buoyancy forcing, resulting in colder temperature above 1000 m and warmer water below for the southern part, with the upper colder water dominating the sea level change (figure 6(b)). In the northern part, the sea level change is dominated by the warmer surface water resulting from the additional heat. There is also warming in a lower layer, slanting downwards to the north, due to weakened upward transport of heat by parameterized eddies and mixing along isopycnals (Gregory 2000, Banks and Gregory 2006).

In the Western North Pacific, the heat flux change leads to higher sea level rise, similar to the effect of the windstress change. As in the wind experiments, thermosteric sea level change in the heat experiments is most important in the west of the basin (figures 5(b) and (e)), and halosteric sea level change shows a maximum in the central part (figures 5(c) and

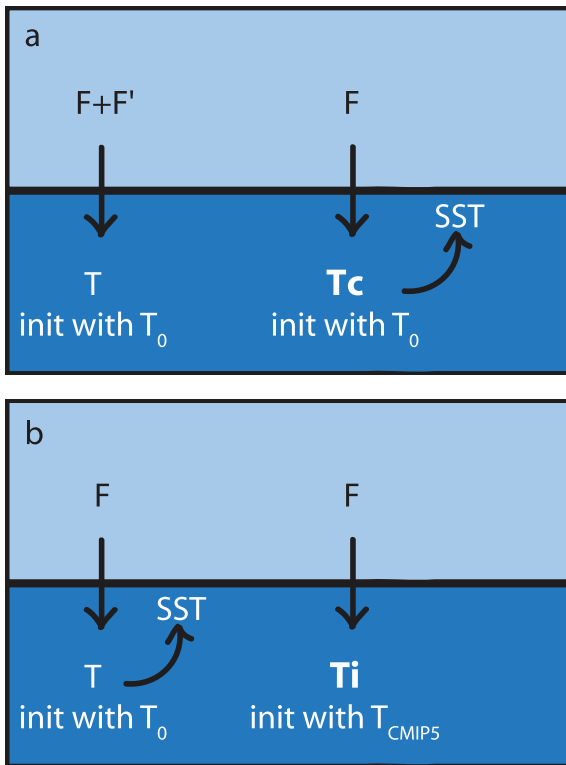

Figure 3. Schematic representation of the experimental design. (a) In the heat experiments, we use a passive tracer T_c as sea surface temperature (SST) for the atmosphere to avoid the feedback from changing the SST due to the additional heat flux. The temperature T , whose initial field is T_0 , is forced by the surface heat flux $F + F'$, with F the heat flux computed interactively by FAMOUS and F' the anomalous heat flux from the CMIP5 models. F' is computed as the difference between the surface heat flux in each CMIP5 1% CO_2 experiment and its corresponding control. The passive tracer T_c is initialized with the initial temperature field T_0 , is forced by F only and is transported like the temperature. (b) To test the impact of the initial temperature field, we use another passive tracer T_i . As T_c , T_i is forced by F , but is initialized with the CMIP5 temperature fields T_{CMIP5} . It is then transported by the circulation like T .

(f). The magnitude of the halosteric change is higher, and is due to fresher water being subducted in the subtropical gyre (figure 7(a)), which is strengthened (figure 7(b)) because of the increased zonal windstress (figure 7(c)). Note that there is no forced wind stress applied in the heat experiment. The wind stress change is caused by the atmospheric circulation responding to SST change (SST is cooled in the western North Pacific), which in turn results from the modified ocean circulation caused by the imposition of the heating anomaly. The SST change is not caused by the imposed anomalous heat flux directly, owing to the use of the passive tracer (figure 3).

3.3. Effect of the freshwater flux change

Generally, the freshwater flux has a smaller impact on the sea level change than the two others. It results in local sea level changes of typically smaller amplitude, which can for example be characterized by the model-mean spatial standard deviation of sea level change (table 1), which is 0.04 m; the corresponding statistic is 0.06 for the windstress and 0.09

for the heat flux. In the North Atlantic, the freshwater flux change contributes to the meridional dipole observed in the CMIP5 models, but with smaller amplitude than the heat flux change, especially regarding the sea level rise north of 40°N as discussed in Bouttes *et al* (2013). In the Southern Ocean, the freshwater flux change leads to higher sea level rise south of 45°S , which counteracts the changes due to the windstress and heat flux (figure 4(e)). In the Western North Pacific, it has only little effect on the regional sea level change.

Like the heat flux change, the fresh water flux modifies the buoyancy forcing. In the North Atlantic, the fresh water flux has a similar effect as the heat flux for the same reasons, with consequently thermosteric and halosteric sea level changes that resemble those in the heat flux experiments (figures 5(h) and (i)). In the Southern Ocean, the higher sea level rise is mainly halosteric (figure 5(i)), because of the freshening of surface water.

3.4. Spread due to the surface fluxes

In the FAMOUS simulations, the spread between the simulations with the fluxes from different models is mainly due to the heat and windstress changes (figures 4(b) and (d)). The freshwater flux results in very small spread and hence cannot explain the CMIP5 differences among models (figure 4(f)). In the Southern Ocean, the spread in the FAMOUS simulations is due to both the windstress and heat differences among models, while in the North Atlantic only the heat flux leads to a spread comparable to the one in the CMIP5 models.

3.5. Role of the surface fluxes added separately or simultaneously

Comparing figures 1 and 4 gives that impression that, considering all basins, the pattern of sea level change is mostly set by the windstress and heat flux change. Three quantitative measures support this conclusion. First, the area-weighted spatial standard deviation of sea level change is largest for heat flux change and smallest for freshwater flux change (table 1). Second, the area-weighted spatial correlation coefficient between the FAMOUS and CMIP5 ensemble-mean sea level change fields is 0.40 for the windstress ensemble and 0.37 for the heat ensemble, but only 0.18 for the freshwater ensemble. Third, multiple linear regression of the CMIP5 ensemble-mean sea level pattern against the three FAMOUS ensemble-mean patterns gives higher coefficients for the windstress (0.36) and heat (0.20) than the freshwater (0.02) experiments. These coefficients are scaling factors for the linear combination of the separate patterns from FAMOUS to obtain the best reconstruction to the CMIP5 field for a given model. Because they are smaller than unity, the comparison suggests that the sea level response in FAMOUS is too large (see below). The coefficients are also rather uncertain, because the separate patterns are somewhat degenerate.

When all three fluxes are applied together, the pattern of sea level change is better simulated, as shown by the higher correlation coefficient of 0.57. The main features in the North Atlantic, Southern Ocean and Western North Pacific are better represented in shape (figure 4(g)), but all have a

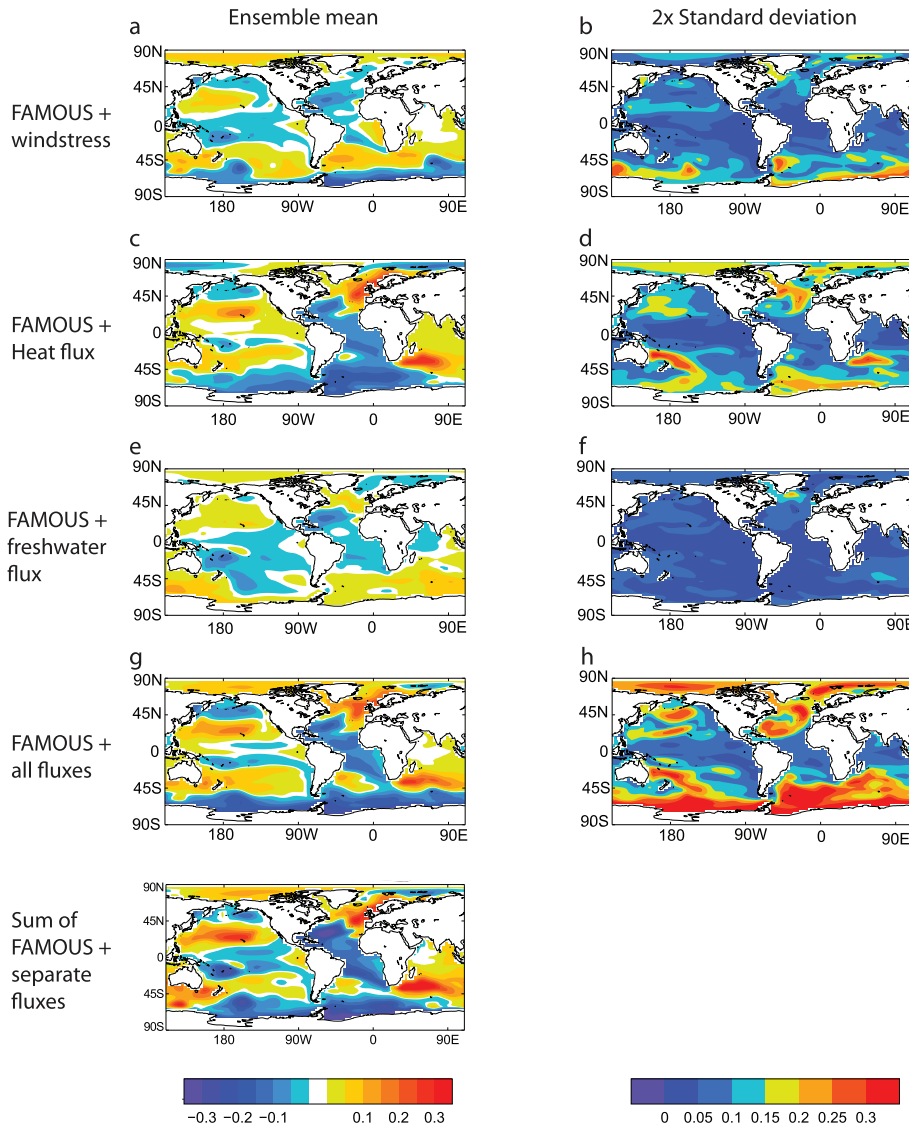

Figure 4. (a), (c), (e), (g) and (i) Ensemble mean and ((b), (d), (f) and (h)) spread (twice the standard deviation) of the FAMOUS sea level change (m) obtained with FAMOUS forced by: ((a) and (b)) the CMIP5 windstress anomalies, ((c) and (d)) the CMIP5 heat flux anomalies, ((e) and (f)) the CMIP5 freshwater flux anomalies, and ((g) and (h)) the three surface flux anomalies simultaneously. (i) Sum of the ensemble mean sea level from FAMOUS forced with the three separate surface fluxes.

larger magnitude than in CMIP5. To confirm quantitatively the visual impression of similarity given by the most prominent features, we have constructed a vector by considering the area integral of sea level change in 5 boxes: northern North Atlantic (between 40 and 70°N), southern North Atlantic (between 10 and 40°N), northern Southern Ocean (between 50 and 30°S), southern Southern Ocean (between 90 and 50°S), and western North Pacific (between 0 and 45°N and 120°E and 120°W). The correlation between this vector for the mean of the CMIP5 models and the mean of the FAMOUS simulations with all fluxes is 0.94 ($p < 0.01$). It is larger than for the simulations with the wind (0.80, $p = 0.05$), with the heat (0.72, $p = 0.09$) or with the freshwater flux (0.44, $p = 0.23$).

The coefficient from the area-weighted linear regression of the ensemble-mean CMIP5 sea level change pattern against

the ensemble-mean FAMOUS simulation with all forcings is 0.41, indicating that, in general, the FAMOUS response to the imposed fluxes is exaggerated; this is also apparent in the higher values of spatial standard deviation of sea level for the FAMOUS all-flux simulations than in CMIP5 (table 1). For the heat flux forcing, a possible explanation is that there may be a positive feedback due to anomalous advection of surface temperature anomalies (Winton *et al* 2013), which would amplify the response; this explanation does not apply to windstress or freshwater flux forcing, which are not so closely coupled to sea surface conditions. Another possible explanation is that the ocean heat uptake efficiency in FAMOUS is rather small ($0.41 \text{ W m}^{-2} \text{ K}^{-1}$) and warming is more strongly pronounced at shallow depths compared with CMIP5 models in general (cf Kuhlbrodt and Gregory

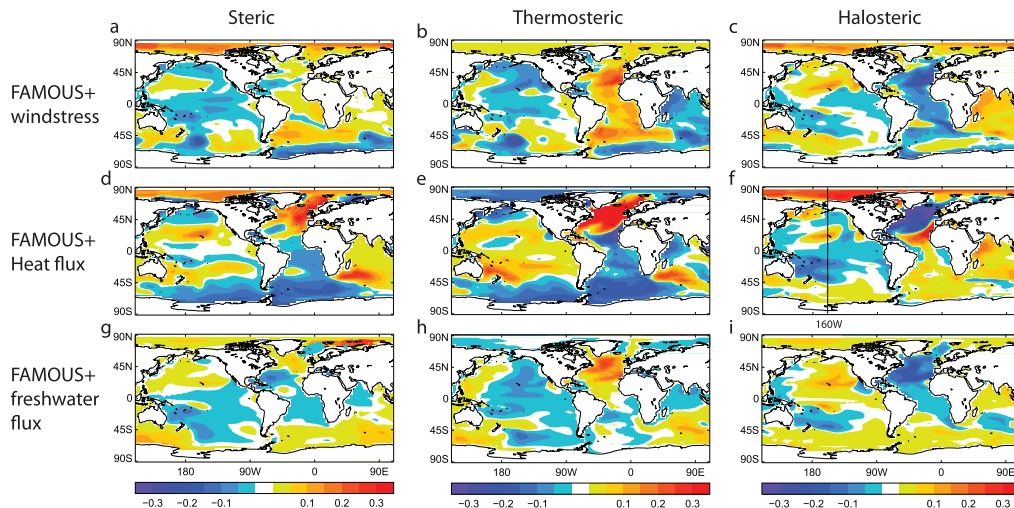

Figure 5. Ensemble means of FAMOUS ((a), (d) and (g)) steric, ((b), (e) and (h)) thermosteric and ((c), (f) and (i)) halosteric sea level change (m) for the three sets of FAMOUS experiments. The 160°W meridian used for the cross-section in figure 7 is indicated on panel f.

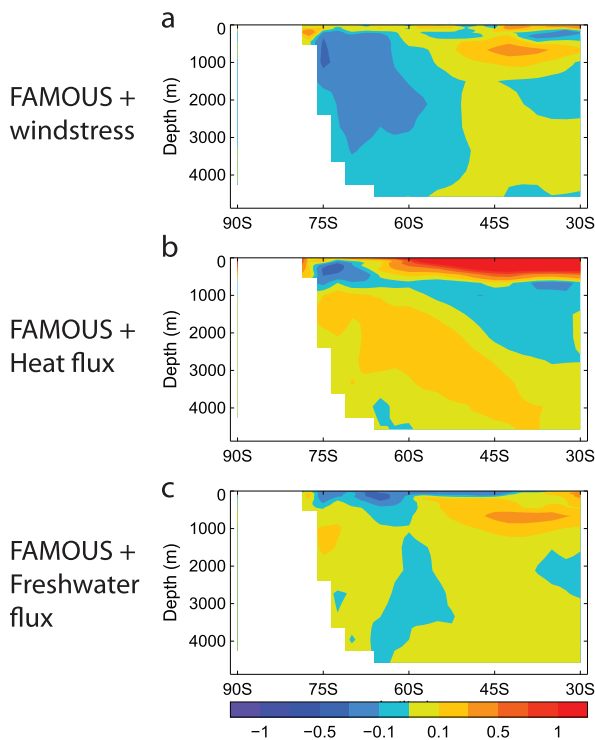

Figure 6. Temperature change (K) in the Southern Ocean for the three sets of FAMOUS experiments.

2012). This would lead to relatively larger changes in sea level gradients for a given depth-integrated heat uptake (cf Lowe and Gregory 2006, equation (9), which shows that changes in density gradients nearer the surface have a larger effect on sea surface slope). Further investigation is needed to establish the reasons for the sensitivity (see section 5).

In FAMOUS, the responses to the three surface fluxes combine linearly to be a good approximation. Adding up the patterns of sea level change simulated by FAMOUS forced by each of the surface fluxes separately gives a very similar

ensemble-mean pattern to that from the simulations with all the fluxes imposed simultaneously (figure 4(i), spatial correlation of 0.87 between the two sea level change patterns), which has likewise high values of the spatial standard deviation of sea level change (table 1).

4. Sea level change and uncertainties from the ocean control state

The simulations run with FAMOUS forced by the anomalous surface fluxes from the CMIP5 models show that model spread in predictions of surface flux changes could be the main reason for the spread in predictions of regional sea level change. Another source of spread could arise from the models having different control states i.e. their unperturbed climatological fields of temperature and salinity. Previous analyses (Lowe and Gregory 2006, Xie and Vallis 2012, Bouttes *et al* 2012, 2013) have shown that regional sea level change in response to surface momentum and buoyancy flux changes comes about largely through redistribution of temperature and salinity, because of changes in interior transports. If two models have the same change in transport processes (velocity, diffusivity or other mixing coefficients) but different initial fields, they would predict different density changes and consequent sea level change.

To investigate this possibility, we have run one simulation with FAMOUS under the 1% CO₂ scenario for each of the CMIP5 models for which the control 3D temperature fields were available (table 1). In these experiments, no anomalous fluxes are imposed. A passive tracer T_i is included (figure 3(b)), which is initialized with the CMIP5 temperature field and otherwise treated exactly like the FAMOUS ocean temperature T as regards surface flux and interior transport (T is used to compute surface heat fluxes).

The ensemble-mean thermosteric sea level change computed from the change in T_i is similar to that computed from T (figures 8(a) and (b)): the dominant features are higher sea

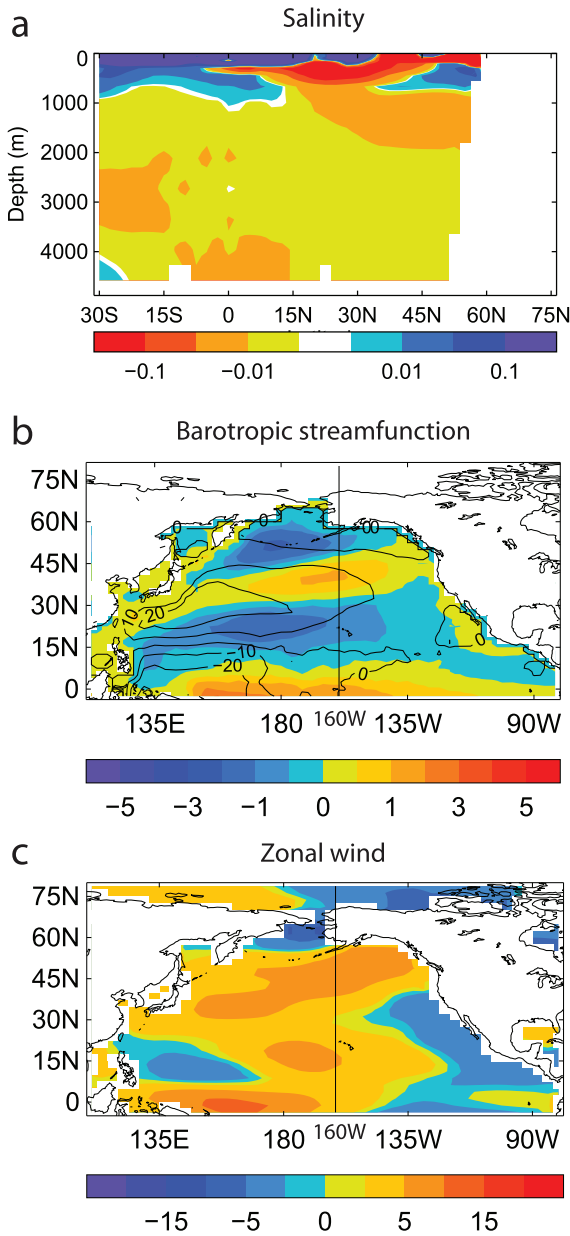

Figure 7. Ensemble mean change of (a) salinity (ppt), (b) barotropic streamfunction (Sv) and (c) zonal windstress (10^{-3} N m^{-2}) in the FAMOUS simulations forced with the surface heat flux. The salinity cross-section is in the Pacific at 160°W , which is indicated on panels b and c. The red colour for the salinity indicates less saline water which tends to increase sea level. The control barotropic streamfunction (Sv) averaged over 100 years is overplotted on panel b.

level in the North Atlantic and east of Australia, lower sea level in the Western North Pacific and Southern Ocean. The spread is relatively small except in the western part of the North Atlantic (figure 8(c)). However, even in that region it is still smaller than the sea level change. This indicates that while the spread in model control climatology may be responsible for some of the spread in sea level change, it is of minor importance compared to the model spread in the anomalous surface fluxes of heat and momentum. We note, however, that in these simulations only the passive effect of transporting

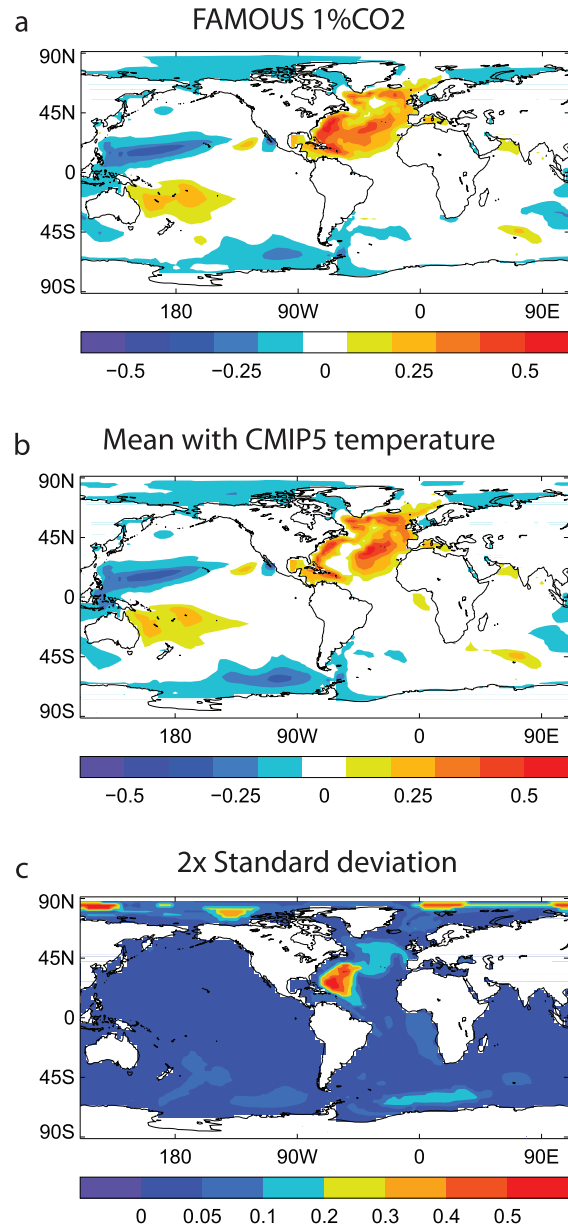

Figure 8. Effect of initial field of temperature: (a) thermosteric sea level change in FAMOUS, (b) mean thermosteric sea level change (m) in the FAMOUS experiments with the passive tracer T_i initialized with the CMIP5 temperature fields, (c) corresponding spread (twice the standard deviation) (m).

different initial fields in the same way is considered. This does not account for the differences in tracer transport due to the diversity among the models regarding resolved ocean circulation and representation of unresolved mixing by eddies, turbulence and convection.

5. Conclusions

In response to increasing CO_2 forcing, the CMIP5 and earlier AOGCMs project geographically non-uniform patterns of sea level change. There are some common features among the projections of the various models, but also many differences

in magnitude and detail. By applying surface flux changes simulated by CMIP5 AOGCMs to the FAMOUS AOGCM, we find that windstress and surface heat flux changes mostly account for the common features: together they cause an increase in the meridional sea level gradient across the Southern Ocean (greater rise to the north) and sea level rise in the Western North Pacific, while heat flux change is the cause of the dipole pattern in the North Atlantic (greater rise to the north). Changes in the surface freshwater flux have a smaller but non-negligible effect on the CMIP5 ensemble mean pattern. The main cause of the model spread in the sea level change patterns projected by the CMIP5 models is their spread in projected changes in windstress and surface heat fluxes. The effect on projected sea level change of model differences in simulating the ocean temperature field in the unperturbed climate state is relatively small.

Although FAMOUS has a relatively low resolution, qualitatively similar results for the effect of windstress change on sea level with a higher resolution eddy-permitting model gives confidence in our conclusions. It is possible that non-eddy-resolving models are systematically in error in some respects in their Southern Ocean simulation in particular. That would be a problem affecting all the CMIP5 models, none of which is eddy-resolving, whereas the emphasis of the present work is to understand the differences among these models.

Remaining differences among the CMIP5 projections of sea level change patterns that are not accounted for in the FAMOUS experiments must relate to their differences in resolved ocean circulation and representation of subgridscale tracer transports. Experiments applying a single set of typical surface flux anomalies to several models would complement our analyses of results from several sets of CMIP5 flux anomalies applied to a single model (FAMOUS). Such experiments would show whether the sea level response to imposed surface flux anomalies is typically larger than the sea level change simulated in CMIP5 experiments, and would help identify and understand the remaining part of the inter-model spread in sea level change pattern.

Acknowledgments

For their roles in producing, coordinating, and making available the CMIP5 model output, we acknowledge the climate modelling groups (listed in table 1 of this paper), the World Climate Research Programme's (WCRP) Working Group on Coupled Modelling (WGCM), and the Global Organization for Earth System Science Portals (GO-ESSP). The research leading to these results has received funding from the European Research Council under the European Community's Seventh Framework Programme (FP7/2007–2013), ERC grant agreement number 247220, project 'Seachange'. We thank the editor and two anonymous reviewers for their comments which helped improve this manuscript.

References

Banks H T and Gregory J M 2006 Mechanisms of ocean heat uptake in a coupled climate model and the implications for tracer based predictions of ocean heat uptake *Geophys. Res. Lett.* **33** L07608

- Bouttes N, Gregory J M, Kuhlbrodt T and Smith R 2013 The drivers of projected North Atlantic sea level change *Clim. Dyn.* published online
- Bouttes N, Gregory J M, Kuhlbrodt T and Suzuki T 2012 The effect of windstress change on future sea level change in the Southern Ocean *Geophys. Res. Lett.* **39** L23602
- Cazenave A and Nerem R S 2004 Present-day sea level change: observations and causes *Rev. Geophys.* **42** RG3001
- Church J A, White N J, Konikow L F, Domingues C M, Cogley J G, Rignot E, Gregory J M, van den Broeke M R, Monaghan A J and Velicogna I 2011 Revisiting the Earth's sea-level and energy budgets from 1961 to 2008 *Geophys. Res. Lett.* **38** L18601
- Frankcombe L M, Spence P, Hogg A McC, England M H and Griffies S M 2013 Sea level changes forced by Southern Ocean winds *Geophys. Res. Lett.* **40** 5710–5
- Gordon C, Cooper C, Senior C A, Banks H, Gregory J M, Johns T C, Mitchell J F B and Wood R A 2000 The simulation of SST, sea ice extents and ocean heat transports in a version of the Hadley Centre coupled model without flux adjustments *Clim. Dyn.* **16** 147–68
- Gregory J M 2000 Vertical heat transports in the ocean and their effect on time-dependent climate change *Clim. Dyn.* **16** 501–15
- Jones C 2003 A fast ocean GCM without flux adjustments *J. Atmos. Ocean. Technol.* **20** 1857–68
- Kuhlbrodt T and Gregory J M 2012 Ocean heat uptake and its consequences for the magnitude of sea level rise and climate change *Geophys. Res. Lett.* **39** L18608
- Landerer F W, Jungclauss J H and Marotzke J 2007 Regional dynamic and steric sea level change in response to the IPCC-A1B scenario *J. Phys. Oceanogr.* **37** 296–312
- Lllovel W, Meyssignac B and Cazenave A 2011 Steric sea level variations over 2004–2010 as a function of region and depth: Inference on the mass component variability in the North Atlantic Ocean *Geophys. Res. Lett.* **38** L15608
- Lowe J A and Gregory J M 2006 Understanding projections of sea level rise in a Hadley Centre coupled climate model *J. Geophys. Res.* **111** C11014
- Merrifield M A and Maltrud M E 2011 Regional sea level trends due to a Pacific trade wind intensification *Geophys. Res. Lett.* **38** L21605
- Nidheesh A G, Lengaigne M, Vialard J, Unnikrishnan A S and Dayan H 2013 Decadal and long-term sea level variability in the tropical Indo-Pacific Ocean *Clim. Dyn.* **41** 381–402
- Pardaens A K, Gregory J M and Lowe J A 2011 A model study of factors influencing projected changes in regional sea level over the twenty-first century *Clim. Dyn.* **36** 2015–33
- Smith R S, Gregory J M and Osprey A 2008 A description of the FAMOUS (version XDBUA) climate model and control run *Geosci. Model Dev.* **1** 53–68
- Timmermann A, McGregor S and Jin F-F 2010 Wind effects on past and future regional sea level trends in the Southern Indo-Pacific *J. Clim.* **23** 4429–37
- Winton M, Griffies S M, Samuels B L, Sarmiento J L and Frölicher T L 2013 Connecting changing ocean circulation with changing climate *J. Clim.* **26** 2268–78
- Xie P and Vallis G K 2012 The passive and active nature of ocean heat uptake in idealized climate change experiments *Clim. Dyn.* **38** 667–84
- Yin J 2012 Century to multi-century sea level rise projections from CMIP5 models *Geophys. Res. Lett.* **39** L17709
- Yin J, Griffies S M and Stouffer R J 2010 Spatial variability of sea level rise in twenty-first century projections *J. Clim.* **23** 4585–607