

Received March 10, 2021, accepted March 16, 2021, date of publication March 19, 2021, date of current version March 29, 2021.

Digital Object Identifier 10.1109/ACCESS.2021.3067297

Flexibility Services Provision by Frequency-Dependent Control of On-Load Tap-Changer and Distributed Energy Resources

HANNU LAAKSONEN¹, (Member, IEEE),
CHETHAN PARTHASARATHY¹, (Graduate Student Member, IEEE),
HOSNA KHAJEH¹, (Graduate Student Member, IEEE),
MIADREZA SHAFIE-KHAH¹, (Senior Member, IEEE),
AND NIKOS HATZIARGYRIOU², (Life Fellow, IEEE)

¹School of Technology and Innovations, Flexible Energy Resources, University of Vaasa, 65200 Vaasa, Finland

²School of Electrical and Computer Engineering, National Technical University of Athens, 10682 Athens, Greece

Corresponding author: Hannu Laaksonen (hannu.laaksonen@uwasa.fi)

This work was supported in part by Business Finland through the FLEXIMAR Project (Novel marketplace for energy flexibility) under Grant 6988/31/2018, and in part by Finnish companies.

ABSTRACT Distribution network connected distributed energy resources (DER) are able to provide various flexibility services for distribution system operators (DSOs) and transmission system operators (TSOs). These local and system-wide flexibility services offered by DER can support the frequency (f) and voltage (U) management of a future power system with large amounts of weather-dependent renewable generation and electric vehicles. Depending on the magnitude of frequency deviation, other active network management-based frequency control services for TSOs could also be provided by DSOs in coordination with adaptive control of DER. This paper proposes utilisation of demand response based on frequency-dependent HV/MV transformer on-load tap-changer (OLTC) operation in case of larger frequency deviations. The main principle underlying the proposed scheme lies in the voltage dependency of the distribution network connected loads. In this paper, it is also proposed to, simultaneously with frequency-dependent OLTC control, utilise reverse reactive power -voltage (QU) - and adaptive active power -voltage (PU) -droops with distribution network connected DER units during these larger frequency deviations, in order to enable better frequency support service for TSOs from DSO networks. The effectivity and potential of the proposed schemes are shown through PSCAD simulations. In addition, this paper also presents a holistic and collaborative view of potential future frequency control services which are provided by DSO network-connected resources for TSOs at different frequency deviation levels.

INDEX TERMS Distributed energy resources, flexibility services, frequency control, voltage control, active network management.

I. INTRODUCTION

In the future, flexible DER control and active network management (ANM) functionalities-based flexibility services can be increasingly provided for DSOs and TSOs. Flexible DER, i.e. flexibilities, consist of, for example, controllable distributed generation (DG), battery energy storage systems (BESSs), controllable load/demand response (DR)

The associate editor coordinating the review of this manuscript and approving it for publication was Alexander Micalef¹.

or controlled charging/discharging of electric vehicles (EVs). Typical flexibility services provided by DER can support the power system frequency (f) and local voltage (U) management at corresponding voltage levels. The flexibility services from different DERs can also enable larger scale integration of renewable energy sources (RES) and EVs, as well as minimise the system and societal costs. The effective utilisation of different flexibility services requires coordinated utilisation of different types and sizes of resources at all voltage levels (LV, MV and HV). Flexibility services provision

TABLE 1. Used Frequency Levels / Ranges for Frequency Control Services Provision.

	Frequency Levels / Ranges			
	Level 1	Level 2	Level 3	Level 4
Frequency (f) deviation from nominal f	$\leq \pm 0.1$ Hz	$\pm 0.1 - 0.2$ Hz	$\pm 0.2 - 0.5$ Hz	$\geq \pm 0.5$ Hz
Market or grid code based control	Market	Market	Market	Grid Code

must be enabled by DER management schemes, regulation, market structures and business models. Effective ANM and DER utilisation for different local and system-wide flexibility services also requires new collaborative DSO and TSO operation and planning principles based on active utilisation of flexibilities. For example, different DER units' active (P) and reactive power (Q) control modes, settings and coordination with OLTC settings and other ANM functionalities should be considered already in the planning stage. [1]–[4]

Table 1 presents the proposed and used frequency levels/ranges for market or grid code-based frequency control services in this paper. Different frequency control-related marketplaces typically cover frequency levels 1–3 and different grid code requirements will typically consider frequency level 4. Requirements for participation or provision of frequency support services are also typically dependent on the size/capacity of the flexible energy resources or DER unit. The focus in this paper is especially on frequency level 3 (± 0.2 – 0.5 Hz, Table 1).

In this paper, the utilisation of demand response based on frequency-dependent OLTC operation is proposed in case of larger deviations (level 3, Table 1) from normal frequency levels. In addition, this paper proposes to, simultaneously with frequency-dependent OLTC control, utilise reverse QU - and PU -droops of distribution network-connected DER units during level 3 (Table 1) so as to enable better frequency support service for the TSO from DSO network.

In the following, Section II provides a brief state of the art review regarding local DER control methods, coordinated OLTC control as well as conservation voltage reduction (CVR). Section III presents the study cases and used control settings for the flexibility services provision. Thereafter, the simulation results are presented in Section IV. Finally, discussion based on the simulation studies is given in Section V and final conclusions are stated in Section VI.

II. STATE-OF-THE ART

A. LOCAL DER CONTROL METHODS

Various DER units' active power (P)- and reactive power (Q)-related flexibility services can be realised by different DER unit inverter local control functions such as constant power factor ($\cos\phi$), fixed Q , $Q(P)$, $\cos\phi(P)$, $Q(U)$ / QU / Volt-Var, $P(U)$ / PU and $P(f)$ / Pf , where f is frequency and U is voltage. QU -droop control mode has typically been

the most effective and used inverter-based DG unit voltage control method in distribution networks [3]–[5].

In the previous studies [2]–[4], in order to increase DER hosting capacity and avoid curtailment of PV active power P , QU -droop has been used as a primary voltage control method, and P curtailment by PU -droop control as a secondary method. In [4], the PV hosting capacity with and without BESS at the same LV network connection point was studied with different DER unit droop settings and HV/MV substation transformer OLTC values. Based on the studies, it was concluded in [4] that flexible weekly/monthly/seasonal and coordinated QU -, PU - and Pf -droop settings (with dead-zones) are needed on LV network-connected PVs and BESSs in order to improve their flexibility services provision. These settings must be coordinated with OLTC settings (see Section II.B). It was also stated in [4] that during larger frequency deviations frequency-adaptive PU -droops could enable larger power system frequency support from PV and BESS (when connected to the same point in the LV network) as well as maximise LV network connected demand participation to frequency control. Further, in [4] new real-time adaptive management schemes for PU -droops as well as OLTC setting-dependent QU -droops were proposed in order to further improve the provision of flexibility services.

In the literature, other types of voltage and reactive power control methods have also been proposed for DER units. For example, in [6] an adaptive Volt-Var (QU)-droop control for the local control of smart inverters was presented to minimise the voltage deviations. In [7] a randomised algorithm was proposed to improve the distribution network voltage profile management also in weak MV networks with a high resistance/reactance (R/X) ratio, through coordinated P and Q control of DER units. In [8] a two-layer Volt-Var (QU) control was suggested in which the QU -droop control rate was first optimised in a distributed manner using decomposition-coordination method and the auxiliary problems principle. Next, the optimised parameters of the QU -droop control curve were set in a timescale of seconds [8]. The benefits of coordinated photovoltaic (PV) inverter control with centralised coordination of PV active power curtailment, when compared to autonomous droop control, were presented in [9], in order to increase PV hosting capacity and reduce network losses. Lastly, in [10] a modified droop control strategy was proposed to mitigate the frequency and voltage oscillation impacts on the power system's stability.

B. COORDINATED OLTC CONTROL METHODS

At HV/MV primary substations, the set values for OLTCs have traditionally been rather high because they only take into account the existence of customer loads. In addition, the same OLTC set value is typically used during the whole year. These traditional settings of OLTC, together with fixed and uncoordinated DER units droop control settings, limit the DER (like PV) and EV hosting capacity on distribution networks. Simultaneously, they also limit the capability of

DER to provide power system frequency control support, for example during very low loading, as well as increase network losses. In a similar manner as proposed for the DER unit droop control settings (Section II.A), OLTC setting value could also be adaptive in short- (time of day) and long-term (seasonal) timescales. In addition, the DER units' droop control settings would then need to be adjusted based on the OLTC setting value changes [2]–[4], [11].

In [4] real-time PQ -flow (between HV and MV networks) dependent OLTC setting value was suggested. Instead of seasonal setting, the OLTC setting value could be dependent on locally measured real-time active and reactive power flow levels (5 minute average P_{HV} and Q_{HV} values) between HV and MV networks at the HV/MV substation [4]. This PQ -flow-dependent OLTC setting -value calculation could further enable increased DER and PV hosting capacity in distribution networks and less reactive power produced by cables, and therefore decreased need for voltage control support in MV and LV networks by the flexible energy resources. In addition, the availability of demand response for provision of system-wide frequency support could simultaneously be increased.

Previously, different types of coordinated voltage control schemes with OLTC and DER have also been proposed [12], [13]. For example, in [14] a two-stage real-time Volt-Var control was proposed, in which first hourly OLTC and capacitor banks (CBs) scheduling was done, whereafter a data-driven network partition method was used to control reactive power of PVs and EVs in real-time to further mitigate the voltage violations. In [15] a multi-objective, adaptive Volt-Var control (VVC) framework was presented in which multiple devices in multiple timescales are coordinated to minimise voltage deviations and network losses simultaneously. In [16] a coordinated control strategy to control BESS along with OLTC was proposed as an optimisation problem in order to mitigate the voltage deviation and simultaneously reduce the number of OLTC operations as well as improve the battery lifetime. Then in [17] a distributed coordinated control framework was proposed in which the OLTCs are first used to mitigate possible voltage violations based on the prediction of renewable outputs and load variations. In the real-time operation stage, only if a voltage violation which cannot be managed with OLTC control alone is detected, the reactive power control of DERs will be activated [17].

C. CONSERVATION VOLTAGE REDUCTION (CVR)

CVR is a functionality which has been previously used in some countries for reducing energy and peak demand in distribution networks. Voltage reduction can be realised with OLTC at HV/MV substation transformer. The amount of peak demand reduction due to CVR is dependent on the type and voltage-dependency of customer loads connected to the corresponding distribution network. The initial idea and its large-scale utilisation has already been studied in [18]. Resistive loads, like electrical water heaters and direct electrical space heaters, typically have high voltage dependency. However,

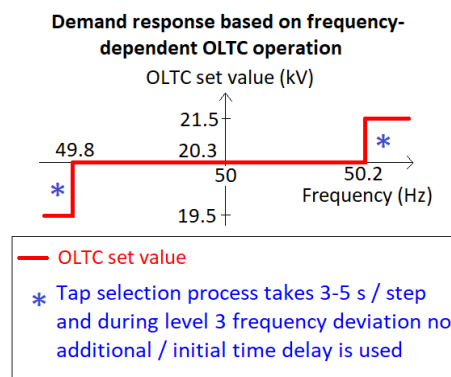

FIGURE 1. Example of the principle of the proposed frequency-dependent OLTC setting change-based demand response with an OLTC set value 20.3 kV (1.015 pu).

some other types of loads, like constant power loads, do not reduce the peak demand during voltage reduction. Therefore, the total impact of CVR on a distribution network loading is highly dependent on the mix of customer load types.

Compatibility of CVR schemes with other distribution network control schemes, such as Volt-Var control and optimisation [19], is also very important. Different types of DER units have increasingly been connected to distribution networks and they also have an effect on the operation of the CVR schemes. For example, in [20] the combined effect of CVR and DER on the LV network voltages has been studied. Then in [6] a coordinated centralised and local control approach was proposed which simultaneously tries to achieve network-level objective by CVR and mitigate the impacts of DER variability on optimal control set-points. In addition, in [21] a multi-stage multi-objective Volt-Var control strategy for smart grid-enabled CVR has been presented in the presence of high PV penetration. In [22] a centralised, three-phase AC optimal power flow (OPF)-based CVR scheme was proposed in which OLTCs and capacitors across MV and LV networks actively manage voltages to minimise energy consumption also with high PV penetration. Then, [23] studied and proposed a two-stage coordinated optimisation framework for BESS and soft open point (SOP) in high PV penetrated distribution networks incorporating DR as well as CVR schemes.

III. STUDY CASES AND CONTROL SETTINGS FOR FLEXIBILITY SERVICES PROVISION

This paper proposes the utilisation of demand response based on frequency-dependent OLTC operation during larger level 3 frequency deviations (Table 1). The idea is to utilise the voltage-dependency of the multiple distribution network connected customer loads like CVR. However, in this case the voltage-dependency of loads is utilised for frequency control purposes during larger frequency fluctuations. The idea of the proposed frequency-dependent OLTC setting change is shown in Fig. 1. The typical OLTC tap transfer time is 40–60 ms and that is much less than the slow tap changing process which takes at least 3 s/step. Idea is that during the

TABLE 2. Comparison of the proposed Frequency-Dependent Control of OLTC and DER Scheme with some State-of-The Art Solutions.

OLTC and DER Control Method	DSO or TSO Supporting Functionality / OLTC Setting Value Change	Main Target (Voltage or Current Congestion Reduction)	TSO-DSO Coordination ^{***)}	Simultaneous DER Control Adaptation ^{o)}
Traditional voltage control with OLTC	DSO / No (fixed annually)	Voltage	No	No
Coordinated voltage control with OLTC and DER	DSO / Depends on the coordination scheme	Voltage	No	No
Seasonal OLTC setting value and DER control settings	DSO / Yes (seasonally fixed)	Voltage	No	Yes (OLTC set value-dependent)
Traditional CVR-based demand reduction (peak shaving)	DSO / Yes (voltage set value reduction)	Current	No	No
Proposed frequency-dependent control of OLTC and DER	TSO / Yes (frequency deviation-dependent, also OLTC setting value increase is possible ^{o)})	Not Applicable ^{**)} (Frequency Control)	Yes	Yes (Frequency-dependent)

^{o)} When setting value is raised during large over-frequencies to increase load, DSO management and monitoring system must confirm that thermal limits are not violated
^{**)} Target is to support power system (TSO) frequency during large deviations and maintain simultaneously voltages and currents within limits
^{***)} Simultaneous consideration of DSO and TSO needs and collaborative and prioritized control of OLTC and DER
^{o)} For example, QU-droop and PU-droop settings adaptation

frequency-dependent OLTC operation, no additional initial time delay will be used (Fig. 1). In addition, this paper proposes to simultaneously utilise reverse QU- and PU-droops with distribution network connected DER units to improve the frequency support provision from the DSO network. In order to further highlight the differences, Table 2 presents a simplified comparison of the proposed frequency-dependent OLTC and DER control scheme with some state-of-the-art solutions described also in Section II.

The effectivity and potential of the proposed new schemes are studied through PSCAD simulations, with the Sundom Smart Grid (SSG) simulation model presented in Fig. 2.

The SSG model has been further developed after previous studies [2]–[4]. Table 3 shows different flexibility services for the DSOs and TSOs as well as the chosen frequency levels/ranges (Table 1) for their utilisation. The target is to improve whole power system resilience on both system-wide (TSO) and local (DSO) levels through a coordinated and holistic utilisation of flexibility services at different frequency levels with different priorities.

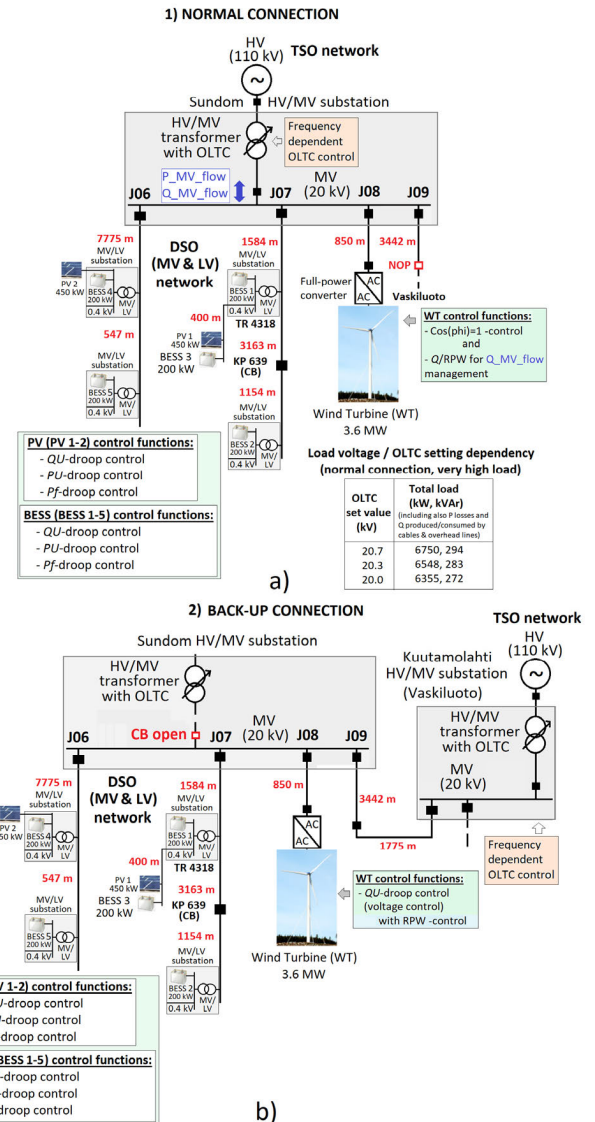

FIGURE 2. One-line diagram of the studied SSG during a) normal and b) back-up connection (see also Table 3–5 and Fig. 3–6).

The study cases used in this paper are presented in Table 4 and V with more details. Currently, during normal connection there is a 3.6 MW full-power-converter-based wind turbine (WT) connected to the SSG MV network with its own MV feeder J08 (Fig. 2a). In addition to normal connection, simulations are also done during a back-up connection (Fig. 2b). Further, potential future scenarios with five BESSs and two PV units (Fig. 2, Table 4 and 5) will be studied.

The used DER and OLTC control schemes in different study cases for flexibility services provision (Table 3) are shown in Fig. 2 and Table 4 and 5. In addition, the studies in this paper are done by utilizing Fingrid’s (Finnish TSO) Reactive Power Window (RPW) limits (see [2]). In the studied cases during normal connection, WT is responsible for fulfilling Fingrid’s RPW limits in SSG (Fig. 2). During normal operation WT is also controlled with the unity power factor/cos(φ) = 1 principle. However, during back-up

TABLE 3. Different Considered Flexibility Services for DSO & TSO and Frequency Levels / Ranges (Table 1) for Their Utilisation.

Flexibility Service	Local (DSO) or System wide (TSO) Service	Frequency Levels for Flexibility Services Utilisation ¹⁾
DER reactive power-voltage control (e.g. $\cos(\phi)$ - / QU -control)	DSO	1 & 2
DER active power-voltage control (PU -control)	DSO	1 & 2
Traditional CVR-based demand reduction (centralised congestion management by voltage reduction)	DSO	1 & 2
DER active power P -control based congestion management (current thermal limit related)	DSO	1 & 2
DER reactive power (Q) control for $P&Q$ -flow management between HV and MV networks (Reactive Power Window, RPW-control) & seasonal or real-time $P&Q$ -flow-dependent OLTC setting value	DSO/TSO	1 & 2 (Disabled at level 3 & 4)
DER active power-frequency control (Pf -control)	TSO	1 =>***, 4
DER frequency level ²⁾ -dependent adaptive PU -droop control ^{**)}	TSO	3 =>***)
OLTC frequency level ²⁾ -dependent setting value change-based demand response	TSO	3 =>***)
DER frequency level ²⁾ -dependent reverse QU -droop control ^{**)}	TSO	3 =>***)

¹⁾ See Table 1
²⁾ To support frequency control-related voltage-dependent demand response at level 3 (Table 1)
^{***)} => means 'and higher frequency levels/ranges'

TABLE 4. Simulation Study Case Details (1/2) (See Fig. 2–6 and Table 3 & 5).

Case ¹⁾ / Connection Type	Number of WT/ BESSs/ PVs	$\cos(\phi)=1$ or QU -droop (WT ^{**)}	QU -droop (BESS/ PV)	Pf -droop (BESS)	Pf -droop (PV)
1a) Normal	1/-/-	$\cos(\phi)=1$	-	-	-
1b) Back-up	1/-/-	QU	-	-	-
2a) Normal	1/-/-	$\cos(\phi)=1$	-	-	-
2b) Back-up	1/-/-	QU	-	-	-
3a) Normal	1/5/2	$\cos(\phi)=1$	1	1,2 ^{***)}	3
3b) Back-up	1/5/2	QU	1	1,2 ^{***)}	3
4a) Normal	1/5/2	$\cos(\phi)=1$	1	1,2 ^{***)}	3
4b) Back-up	1/5/2	QU	1	1,2 ^{***)}	3
5a) Normal	1/5/2	$\cos(\phi)=1$	1	1,2 ^{***)}	3
5b) Back-up	1/5/2	QU	1	1,2 ^{***)}	3

¹⁾ Load level is very high in all cases
^{**)} WT also with RPW-control in all cases
^{***)} Pf -droop 1 with BESS 4 & 5 and Pf -droop 2 with BESS 1–3

connection (e.g. during Sundom HV/MV transformer maintenance), QU -droop control (Fig. 3a) is used on WT instead of $\cos(\phi) = 1$ control (Fig. 2 and Table 4). The control functions of the other DER units (PVs and BESSs) at different frequency levels/ranges (Fig. 1) are shown in Figure 3–5.

In this paper, the focus is especially on frequency level 3 (Table 1), to study with PSCAD simulations the utilisation of

TABLE 5. Simulation Study Case Details (2/2) (See Fig. 2–6 and Table 3 and 4).

Case	Frequency Level Dependent OLTC setting value ¹⁾	PU -droop (BESS/PV)	Frequency Level Dependent PU -droop (BESS/PV)	Frequency Level Dependent Reverse QU -droop (WT/BESS/PV)
1a)	-	-	-	-
1b)	-	-	-	-
2a)	Yes	-	-	-
2b)	Yes	-	-	-
3a)	Yes	1	Yes, 2	Yes, 2
3b)	Yes	1	Yes, 2	Yes, 2
4a)	Yes	1	Yes, 2	Yes, 2
4b)	Yes	1	Yes, 2	Yes, 2
5a)	Yes	1	Yes, 2	Yes, 2 ^{**)}
5b)	Yes	1	Yes, 2	Yes, 2 ^{**)}

¹⁾ OLTC time delay $t=1.5$ s and dead-zone 1.0 %
^{**)} No reverse QU -droops with PV 1 and BESS 3

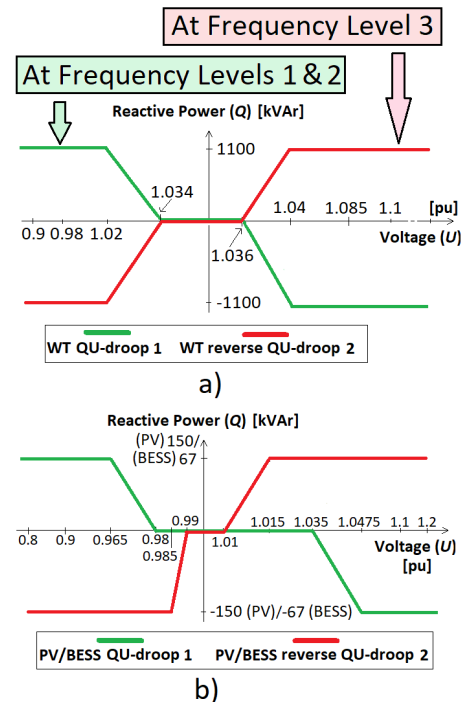

FIGURE 3. QU - and reverse QU -droop settings of a) WT and b) PVs/BESSs at different frequency levels in the PSCAD simulations (Table 1–5, Fig. 2).

frequency-dependent OLTC setting value (20.0 kV is equal to 1.0 pu) change-based demand response (Fig. 1 and 6) at level 3 simultaneously with reverse QU - (Fig. 3) and adaptive PU -droops (Fig. 4b, [4]) with the distribution network-connected DER units. The target is to achieve a better frequency support service for the TSO from the DSO network during more severe frequency deviation at level 3 (Table 1). In the PSCAD simulations, OLTC tapping delay was set during frequency level 3 to 1.5 s which is less than typical minimum 3 s tapping time (Fig. 1). This choice was made to see potential mutual effects of DER control functions and OLTC frequency-dependent operation more clearly.

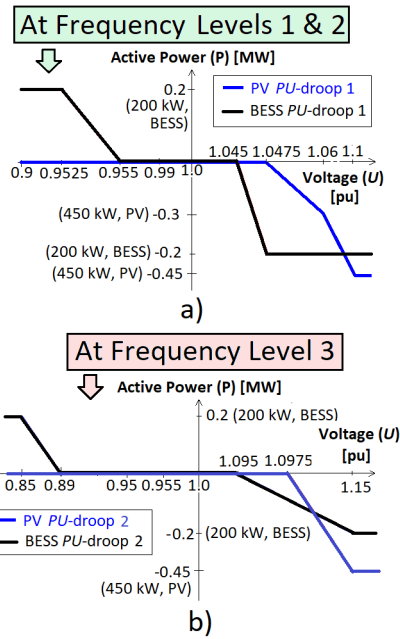

FIGURE 4. a) *PU*-droop settings of PVs/BESSs at frequency levels 1 & 2 and b) adapted *PU*-droop settings of PVs/BESSs at frequency level 3 used in the PSCAD simulations (Table 1–5, Fig. 2).

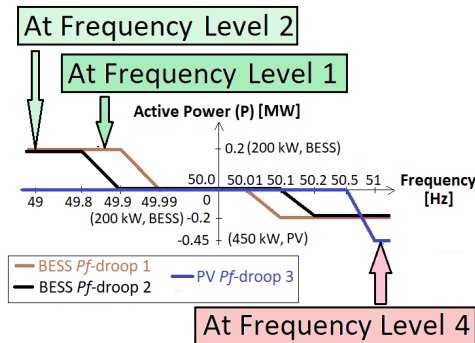

FIGURE 5. *Pf*-droop settings of PVs/BESSs at different frequency levels in the PSCAD simulations (Table 1–5, Fig. 2).

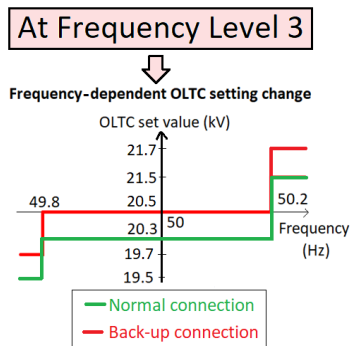

FIGURE 6. Frequency-dependent OLTC setting change at frequency level 3 during normal and back-up connection (Table 1–5, Fig. 1 & 2).

Voltage limits of 0.95 and 1.05 pu have been chosen as target limits during the steady-state operation at frequency levels 1 and 2 (Table 1). Respectively, voltage limits 0.85–0.9 pu

and 1.1–1.15 pu are used at frequency levels 3 and 4. This means that short time larger voltage deviations are allowed in the DSO network to enable improved frequency support from distribution network connected flexible energy resources during severe frequency challenges at the TSO level. In all simulated cases in this paper the load level was very high (see Fig. 2a) and only *P*-controllers on PVs and BESSs for *PU*-control were used [3] without *PU*-blocking [4]. The simulated load was mainly passive constant impedance load with some phase asymmetry included. In addition, there was one diode-based load at MV feeder J06 and J07 (Fig. 2). The total load (Fig. 2a) with OLTC set value 20.7 kV (1.035 pu) was $P_{Load_tot} = 6750$ kW and $Q_{Load_tot} = 294$ kVar (including also *P* losses and *Q* produced/consumed by distribution network lines, i.e. cables and overhead lines).

In all simulated study cases (Table 4 and V) the frequency fluctuations during $t = 10$ –250 s were similar (Fig. 7) in order to be able to compare the effect of different functionalities and settings. Due to high computational burden, the total simulation time of one simulation case in PSCAD was required to be limited to 250 s. In addition, to see the operation and potential mutual effects of different control functionalities (Fig. 3–6) during the chosen simulation time-frame, the large artificial frequency fluctuations over different frequency levels (Fig. 7) were used as input to the voltage source component in the used PSCAD model. Alternatively, the real measured frequency fluctuations could have been used as an input, but then the simulation time would have been increased significantly. Further, the main purpose in this paper simulations was to show the effectivity and possible interactions of the proposed new frequency-dependent control methods. The assumed weather-dependent variations in active power *P* output of WT (Fig. 10a) and PVs (Fig. 12a) are shown in Section IV together with the simulation results.

IV. SIMULATION RESULTS

In the following, the main simulation results from different study cases (Table 4 and V) are presented. In Section IV.A results from cases 1 and 2 (with only WT) during normal and back-up connection are shown. Then, Section IV.B presents the results from cases 3a–5a (with WT, BESSs and PVs) during normal connection. Lastly, results from cases 3b–5b (with WT, BESSs and PVs) during back-up connection are shown in Section IV.C.

A. NORMAL AND BACK-UP CONNECTION–CASE 1 & 2

The simulation results from cases 1a (normal connection), 1b (back-up connection), 2a (normal connection) and 2b (back-up connection) are presented in Figure 8–10 and Table 6.

From Figure 8 the effect of frequency-dependent OLTC setting value change in cases 2a and 2b during level 3 (Fig. 7) frequency deviations can be clearly seen. Voltages remain between the target limits in these cases after the frequency-dependent operation of the OLTC (Fig. 6). However, in case 2b (back-up connection) it can be seen (Fig. 8)

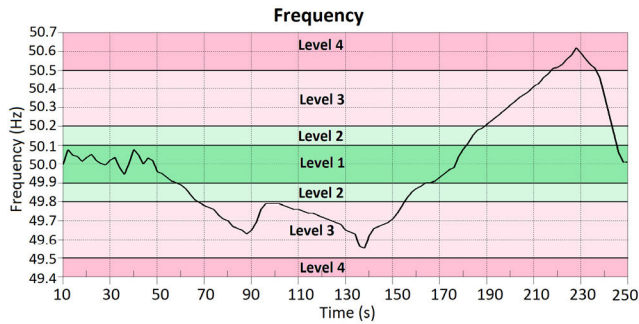

FIGURE 7. Simulated frequency fluctuations in different study cases (Table 1–5, Fig. 2–6).

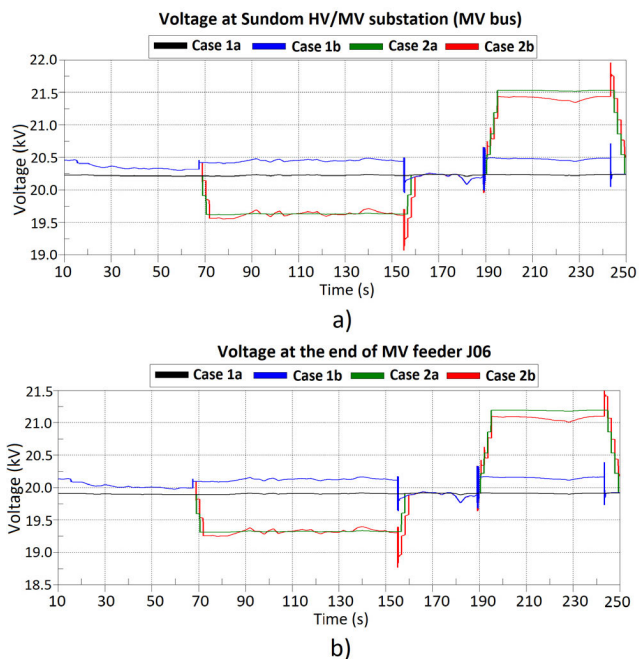

FIGURE 8. MV network voltage behaviour in study cases 1a (normal), 1b (back-up), 2a (normal) and 2b (back-up) at a) Sundom HV/MV substation MV bus and b) the end of MV feeder J06 (Table 1–5, Fig. 2–7).

that after frequency returns to level 2 (Fig. 7) OLTC first operates in the wrong direction before correct operation. Therefore, the voltage level could momentarily be too high or low. Section IV.C simulations showed in case 4b (Fig. 13a) that this kind of short OLTC incorrect operation can be avoided with simultaneous use of reverse QU -droop on WT during level 3. Other benefits from the utilisation of reverse QU -droops during level 3 frequency deviations are also presented in Section IV.C.

Figure 9a presents the effect of frequency-dependent OLTC setting value change on active power flow P_{MV_flow} at HV/MV substation, i.e. between MV (DSO) and HV (TSO) networks. The amount of frequency-dependent OLTC setting value change-based demand response (ΔP_{MV_flow}) in cases 2a (normal connection) and 2b (back-up connection) can be seen in detail in Table 6 during level 3 frequency deviations (Fig. 7) at $t = 80$ s (under-frequency)

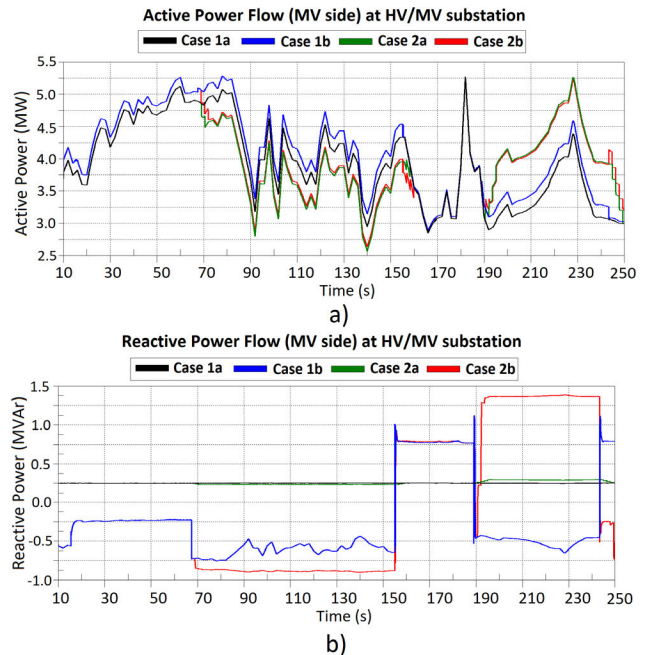

FIGURE 9. MV side a) active power flow P_{MV_flow} and b) reactive power flow Q_{MV_flow} in study cases 1a (normal), 1b (back-up), 2a (normal) and 2b (back-up) at Sundom (normal connection) or Kuutamolahti (back-up connection) HV/MV substation, (consumption = positive value) (Table 1–5, Fig. 2–7).

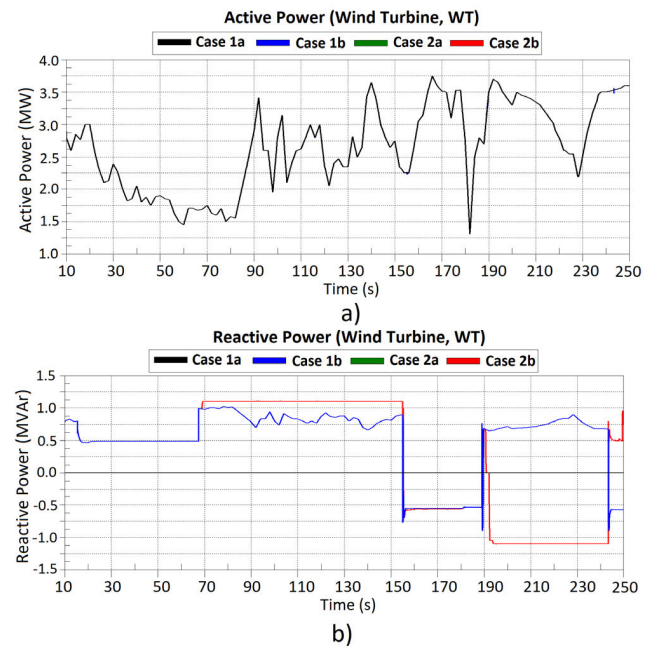

FIGURE 10. Wind turbine (WT) a) active power P_{WT} and b) reactive power Q_{WT} in study cases 1a (normal), 1b (back-up), 2a (normal) and 2b (back-up) (Table 1–5, Fig. 2–7).

and $t = 200$ s (over-frequency) when compared to cases 1a and 1b. During normal operation (cases 1a and 2a, Table 6) the frequency-dependent OLTC setting value change based demand response (ΔP_{MV_flow}) is -379 kW (at $t = 80$ s during level 3 under-frequency) and $+934$ kW

TABLE 6. Amount of OLTC frequency level-dependent setting value change-based demand response in cases 2a and 2b when compared to 1a and 1b (Level 3, See Table 1–5 and Fig. 7 & 9).

Case	P_{MV_flow} Level 3, $t=80$ s [kW]	Freq. dep. OLTC based demand response, ΔP_{MV_flow} Level 3, $t=80$ s [kW]	P_{MV_flow} Level 3, $t=200$ s [kW]	Freq. dep. OLTC based demand response, ΔP_{MV_flow} Level 3, $t=200$ s [kW]
1a) Normal	5004	-	3228	-
1b) Back-up	5212	-	3485	-
2a) Normal	4625	-379 ^{*)}	4162	+934 ^{*)}
2b) Back-up	4655	-557 ^{**)}	4140	+655 ^{**)}

^{*)} Difference between cases 1a and 2a
^{**)} Difference between cases 1b and 2b

(at $t = 200$ s during level 3 over-frequency). Respectively, during back-up connection (cases 1b and 2b, Table 6) the frequency-dependent OLTC setting value change based demand response (ΔP_{MV_flow}) is -557 kW (at $t = 80$ s during level 3 under-frequency) and $+635$ kW (at $t = 200$ s during level 3 over-frequency). From these results, it can be seen that the different control principles of the WT (Fig. 2 & 3a) and Table 4 & V) as well as different physical and electrical distance from the HV/MV substation between normal and back-up connection have an effect on the voltages during level 3 frequency deviations. Therefore, the amount of realised demand response after frequency-dependent operation of OLTC is also different between cases 2a and 2b (Table 6).

B. NORMAL CONNECTION–CASES 3a–5a

In the following, chosen simulation results from cases 3a–5a (with WT and BESSs & PVs, see Table 4 & V) during normal connection are presented in Figure 11 and 12 and Table 7.

The simulation results of this section during normal operation and in the following section (IV.C) during back-up operation show the effect of the different DER control principles and settings (Fig. 2 & 3 and Table 4 & V) as well as location of DER on the amount of realised demand response after frequency-dependent operation of OLTC during level 3 frequency deviations in different cases.

In general, the typical QU -droop curves of DER units (Fig. 3) will try to correct the local voltage decrease or increase after the frequency-dependent operation of OLTC. This reduces the amount of realised demand response because DER unit QU -droops will reduce the voltage level change during level 3 frequency deviations. Therefore, in case 4 the effect of reverse QU -droops during level 3 frequency deviations is studied and compared to case 3.

Table 7 shows the effect of reverse QU -droops (with BESSs and PVs, though not with WT during normal operation) on demand response during normal operation. The difference in ΔP_{MV_flow} between cases 4a and 3a was found to be quite small (Table 7), especially at $t = 80$ s (during level 3

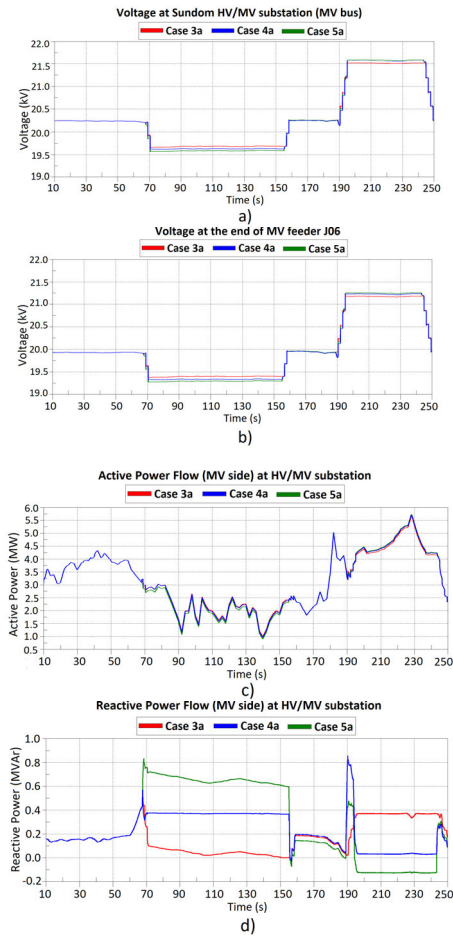

FIGURE 11. MV network voltage behaviour at a) Sundom HV/MV substation MV bus and b) at the end of MV feeder J06 as well as MV side c) active power flow P_{MV_flow} and d) reactive power flow Q_{MV_flow} at Sundom HV/MV substation (positive values in c) and d) mean consumption) in study cases 3a (normal), 4a (normal) and 5a (normal) (Table 1–5, Fig. 2–7).

under-frequency). The reason for this was found when looking at the effect of reverse QU -droop (case 4a) on PV 1 and BESS 3 (Fig. 2) connection point voltage (Fig. 12a). Figure 12a shows that due to the unwanted effect of reverse QU -droops on local LV network voltage at the PV 1 and BESS 3 connection point, the actual difference between the demand response amount of cases 4a and 3a was quite small. However, when reviewing the effect of reverse QU -droops on BESS 5 (Fig. 2) LV network connection point voltage (Fig. 13c), this kind of unwanted operation did not exist. Based on these observations, it was concluded that the LV network connection point of the DER unit should be taken into account when considering the use of reverse QU -droops on LV network-connected DER units during level 3 frequency deviation.

Therefore, in case 5, almost similar settings with case 4 were used, but here PV 1 and BESS 3 did not have the reverse QU -droops. From normal operation simulation results (Table 7) it can be seen that the wanted effect and difference between cases 3a and 5a is more clear during level 3

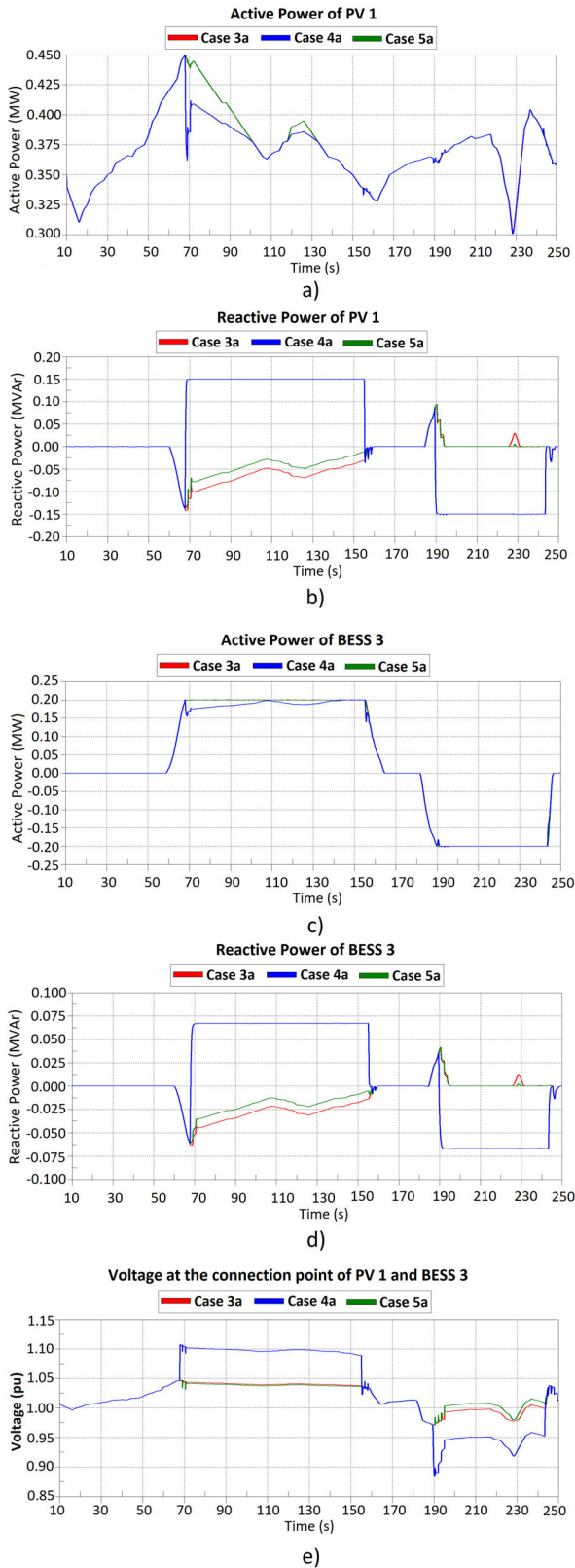

FIGURE 12. PV 1 a) active power P_{PV_1} , b) reactive power Q_{PV_1} and BESS 3 c) active power P_{BESS_3} , d) reactive power Q_{BESS_3} as well as e) LV network voltage at the connection point of PV 1 & BESS 3 in study cases 3a (normal), 4a (normal) and 5a (normal) (Table 1–5, Fig. 2–7).

TABLE 7. Effect of DER units’ reverse QU -droop on demand response in cases 4a and 5a when compared to 3a (Level 3, See Table 1–6).

Case	P_{MV_flow} Level 3, $t=80$ s [kW]	Freq. dep. Reverse QU -droop demand response, ΔP_{MV_flow} , Level 3, $t=80$ s [kW]	P_{MV_flow} Level 3, $t=200$ s [kW]	Freq. dep. Reverse QU -droop demand response, ΔP_{MV_flow} , Level 3, $t=200$ s [kW]
3a) Normal	2962	-	4390	-
4a) Normal	2960	-2 ^{*)}	4449	+59 ^{*)}
5a) Normal	2859	-103 ^{**)}	4473	+83 ^{**)}

^{*)} Difference between cases 4a and 3a
^{**)} Difference between cases 5a and 3a

frequency deviations at $t = 80$ s ($\Delta P_{MV_flow} = -103$ kW during under-frequency) and $t = 200$ s ($\Delta P_{MV_flow} = +83$ kW during over-frequency) than between cases 3a and 4a (at $t = 80$ s: $\Delta P_{MV_flow} = -2$ kW and at $t = 200$ s: $\Delta P_{MV_flow} = +59$ kW). Based on the above it can be concluded that reverse QU -droops should not be used on large LV network-connected DER units which are not directly connected to the LV side of MV/LV substations, and especially if there is also a BESS unit participating in frequency control at the same connection point with the DER unit (like PV in this case).

C. BACK-UP CONNECTION—CASES 3b–5b

In the following chosen simulation results from cases 3b–5b (with WT, BESSs and PVs, see Table 4 & 5) during back-up connection are presented in Figure 13 Table 8.

From the simulation results during back-up connection (Fig. 13 and Table 8) in cases 3b–5b, similar conclusions can be drawn to those in Section IV.B for normal operation cases 3a–5a. However, during back-up connection, due to use of reverse QU -droop also on WT (Fig. 2 & 3a) during level 3 frequency deviations, the amount of voltage change-based demand response can be increased more than during normal connection (see Table 7 & 8). This can also be seen by comparing the demand response effects (Table 8) between cases 3b, 4b and 5b during level 3 frequency deviations at $t = 80$ s (under-frequency) and $t = 200$ s (over-frequency). During back-up connection the demand response (ΔP_{MV_flow}) can be further increased with reverse QU -droops in case 4b (-136 kW) and in case 5b (-219 kW) at $t = 80$ s (during level 3 under-frequency) as well as in case 4b (+109 kW) and in case 5b (+149 kW) at $t = 200$ s (during level 3 over-frequency) when compared to case 3b (Table 8).

It can be concluded that simultaneously with frequency-dependent OLTC control, adaptive PU -droops (on all DER units) and especially reverse QU -droops on directly to MV network and directly to the LV side of MV/LV substation connected DER units enable improved voltage-dependent demand response and frequency support during level 3 frequency deviations.

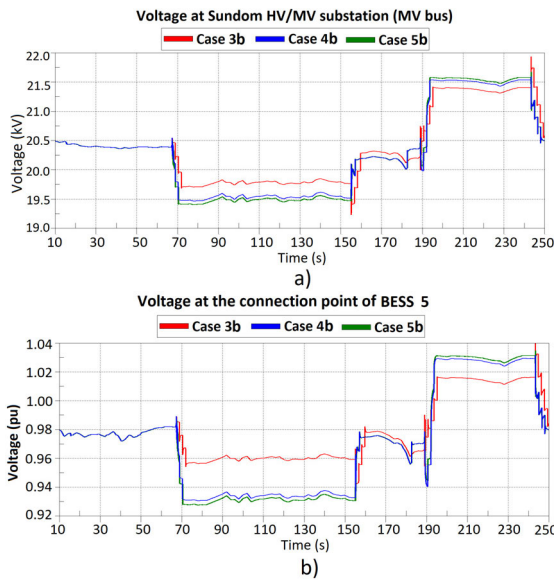

FIGURE 13. MV network voltage behaviour at a) Sundom HV/MV substation MV bus and b) LV network voltage at the connection point of BESS 5 in study cases 3b (back-up), 4b (back-up) and 5b (back-up) (Table 1–5, Fig. 2–7).

TABLE 8. Effect of DER units’ reverse *QU*-droop on demand response in cases 4b and 5b when compared to 3b (Level 3, See Table 1–7).

Case	P_{MV_flow} Level 3, $t=80$ s [kW]	Freq. dep. Reverse <i>QU</i> -droop demand response, ΔP_{MV_flow} Level 3, $t=80$ s [kW]	P_{MV_flow} Level 3, $t=200$ s [kW]	Freq. dep. Reverse <i>QU</i> -droop demand response, ΔP_{MV_flow} Level 3, $t=200$ s [kW]
3b) Back-up	3019	-	4362	-
4b) Back-up	2883	-136 ^{*)}	4471	+109 ^{*)}
5b) Back-up	2800	-219 ^{**)}	4511	+149 ^{**)}

^{*)} Difference between cases 4b and 3b
^{**)} Difference between cases 5b and 3b

V. DISCUSSION

In this section, issues related to potential conflict of interest between DSO and TSO flexibility needs as well as different flexibility services and related functionalities are discussed. In addition, the role of sector-coupling, i.e. especially integration of electricity, heat, gas and transportation sectors, will be briefly touched.

If TSO service provision (e.g. frequency control participation) by DSO network-connected DER creates voltage or thermal congestions in DSO network, conflict of interest between DSO and TSO will occur. In order to avoid conflicts, improved TSO-DSO coordination, real-time state-monitoring (based on accurate time-synchronised measurements) and short-term state-forecasting will be increasingly needed in DSO networks. Some conflicts have also been observed in real-life pilots, like in [24]. In this paper, the DER units’ *P* –control-related congestion management services during level 1 and 2 frequency deviations are taken into

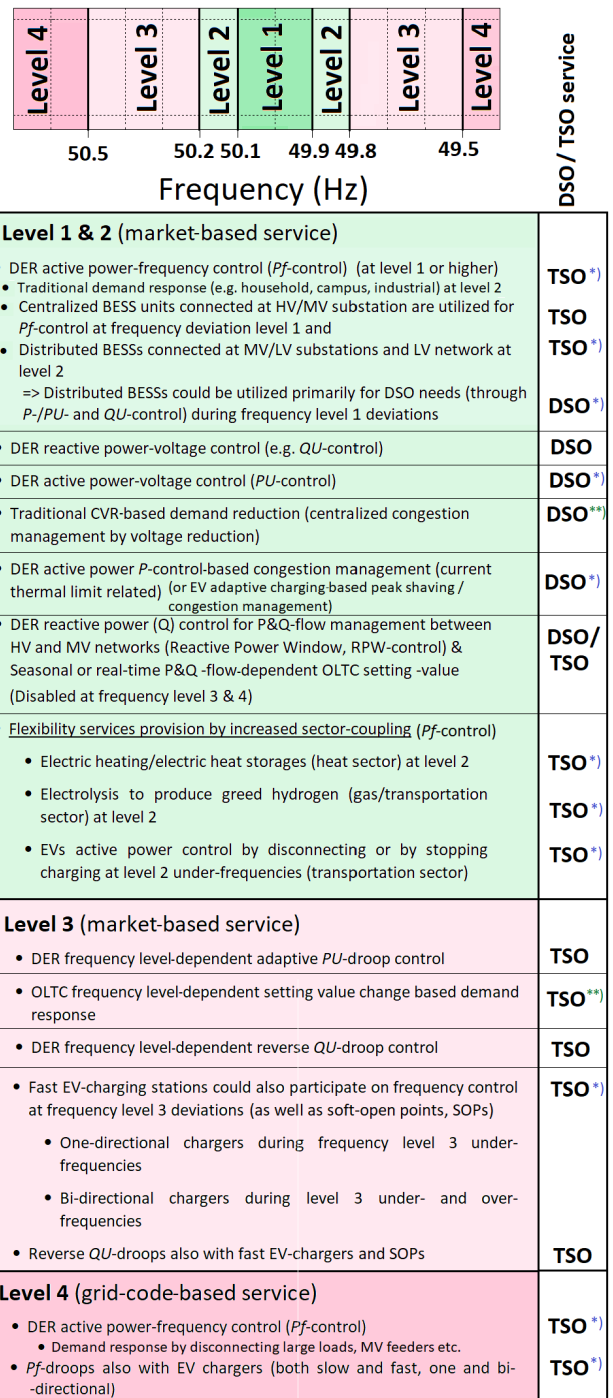

^{*)} Mutual effects and conflict of interest between these DSO and TSO services are possible depending on the network capacity, location and size of DER units etc.
^{**)} Conflict of interest between these DSO and TSO services are possible

FIGURE 14. Summary of different flexibility services for the DSOs and TSOs which could be realised in a collaborative and coordinated manner at different frequency levels/ranges (see also Table 3).

account in Table 3 (Section III) but were not studied further in the simulations from thermal limit violations viewpoint. This will be a part of future studies. Also coordination between DSO and TSO is required if the DSO is interested in utilizing the traditional CVR (Section II.C, Table 3) during level 1 and 2 frequency deviations (Table 1). This is because it affects

on the remaining demand response potential during larger level 3 under-frequency events. Related to the rapid frequency support improvement of the proposed frequency-dependent OLTC scheme, the tap changing process related time delay (Fig. 1) could be significantly reduced with full or hybrid power electronics-based OLTC technologies [25]. This would be very beneficial in future low-inertia power systems.

Partially, DSO and TSO flexibility services and related functionalities potential mutual effects and momentary conflicts of interest could be avoided by the proposed utilisation of different flexibility services and functionalities only at predefined frequency deviation levels (Table 1 & 3 and Fig. 14), for example the utilisation of DER Q -control for $P&Q$ -flow management between HV and MV networks (RPW-control) as well as seasonal or real-time $P&Q$ -flow-dependent OLTC setting value (Table 3 and Fig. 14). These functionalities should be only used during frequency level 1 and 2 deviations and they should be disabled at level 3 and 4 (Table 1 & 3 and Fig. 14) in order to avoid conflict between the level 3 frequency-dependent OLTC control-based demand response. On the other hand, some of the functionalities may also complement each other, i.e. be in the same direction. For example, the proposed frequency level 3 functionalities of this paper (frequency-dependent OLTC control and DER units' reverse QU -droops) would be compatible with the stable transition to island operation enabling Qf -droop functionality proposed in [26].

Flexibility services provision by the integration of different sectors, e.g. utilisation of EV batteries, electric heating/electric heat storages as well as electrolysis to produce green hydrogen [27], is increasingly important in future power systems [28]. Regarding EVs at home, they could also participate in frequency control by disconnecting or stopping charging at level 2 under-frequencies (Fig. 14). On the other hand, fast EV charging stations could also participate in frequency control at frequency level 3 deviations (not in smaller deviations because the priority is on fast charging). This could be done by adaptive (e.g. f /state-of-charge/ U -dependent) charging with one-directional chargers during frequency level 3 under-frequencies or adaptive charging/discharging with bi-directional chargers at level 3 under- and over-frequencies. In addition, fast EV-charging stations and soft open points (SOPs) [29] could have also similar reverse QU -droops at level 3 as other DER units. Further, grid code requirements at level 4 frequency deviations (Fig. 14) regarding e.g. Pf -droops should be similar with EV chargers than what is required from the DER units.

From DSO and TSO viewpoint, utilization of different types and sizes of BESSs' at different locations for frequency control should be done at certain frequency deviation levels. For example, centralised BESS units at HV/MV substations could be utilised for Pf -control at level 1 and distributed BESSs at MV/LV substations and LV networks at level 2 (Fig. 14). Then, distributed BESSs could be utilised primarily for DSO needs (through P -/ PU - and QU -control) during frequency level 1 deviation (Fig. 14).

VI. CONCLUSION

This paper proposed the utilisation of centralized demand response based on frequency-dependent OLTC operation during larger level 3 frequency deviations. In addition, it was suggested to utilize reverse QU - and PU -droops simultaneously with distribution network-connected DER units to achieve better combined frequency support effect with OLTC frequency-dependent control. Frequency levels 1-4 for different DSO and TSO services prioritized, coordinated and collaborative utilisation were proposed, with the aim to improve the whole power system resilience.

The focus in this paper was mainly on advanced utilisation of OLTC and DER units' adaptive or reverse droop functions for TSO flexibility services provision at level 3. During frequency levels 1 and 2, the seasonal or real-time PQ -flow (between HV and MV networks) dependent OLTC setting value should be used to enable increased DER hosting capacity in distribution networks and increased availability of demand response for provision of TSO frequency support at level 2. Based on the simulations of this paper:

- I Frequency-dependent OLTC setting value change-based demand response can be significant during level 3 frequency deviations and can be used effectively for the frequency control services provision for the TSO.
- II Simultaneously with frequency-dependent OLTC control, adaptive PU -droops (on all DER units) and especially reverse QU -droops on directly to MV network and directly to the LV side of MV/LV substation connected DER units can enable further improved voltage-dependent demand response and frequency support during level 3 frequency deviations.
- III Regarding utilisation of reverse QU -droops during level 3 frequency deviations on DER units it was noted that a) reverse QU -droop should not be used on large LV network connected DER units which are not directly connected to the LV side of MV/LV substations and especially if there is also a BESS unit participating in frequency control at the same connection point with the DER unit, e.g. PV during level 1 or 2 frequency deviations, and b) short OLTC incorrect operation was avoided during back-up connection with simultaneous use of reverse QU -droop on WT.
- IV Different control principles of the WT as well as different physical and electrical distance from HV/MV substations between normal and back-up connection have an effect on the voltages during level 3 frequency deviations. Therefore, the amount of realised demand response after frequency-dependent operation of OLTC is also different.

In order to avoid potential conflict of interests between DSOs and TSOs at certain frequency levels, proper TSO-DSO collaboration development is essential. Accurate real-time DSO network monitoring and short-term state-forecasting will also have increasingly important role in this development. Future studies could focus on the

development of overall OLTC and DER control schemes at level 3 frequency deviations. OLTC control function could, for example, act as “a master/central unit” and send commands to DER units after frequency limit violation (e.g. through low-latency, wireless 5G connection) or all DER units could use their own local frequency measurements to guarantee correct operation during level 3 frequency deviations. In addition, further research could focus on resiliency development of the flexibility service functionalities, for example by ensuring the redundancy of the used measurements, by detection of measurement errors as well as by prevention of potential false data injections. One important future development area is also forecasting the amount of available frequency-dependent OLTC control-based demand response (flexibility) in short-term. More accurate flexibility forecasts can be achieved by utilization of real-life measurements and advanced data-analytics.

REFERENCES

- [1] R. Brazier, L. Cunha, P. Hermans, G. de Jong, T. Knop, M. Lallemand, M. Merkel, A. S. Rines, M. de la Torre Rodríguez, and P. de Wit, *TSO-DSO Report, An Integrated Approach to Active System Management With The Focus on TSO-DSO Coordination in Congestion Management and Balancing*, document ENTSO-E, EDSO, EURELECTRIC, CEDEC, GEODE, 2019.
- [2] H. Laaksonen, K. Sirviö, S. Aflecht, and P. Hovila, “Multi-objective active network management scheme studied in sundom smart grid with MV and LV network connected DER units,” in *Proc. 25th Int. Conf. Electr. Distrib. CIRED*, Madrid, Spain, Jun. 2019, pp. 3–6.
- [3] H. Laaksonen, C. Parthasarathy, H. Hossein, M. Shafie-khah, and H. Khajeh, “Control and management of distribution networks with flexible energy resources,” *Int. Rev. Electr. Eng.*, vol. 15, no. 3, pp. 213–223, 2020.
- [4] H. Laaksonen, C. Parthasarathy, H. Hafezi, M. Shafie-khah, H. Khajeh, and N. Hatziaargyriou, “Solutions to increase PV hosting capacity and provision of services from flexible energy resources,” *Appl. Sci.*, vol. 10, no. 15, p. 5146, Jul. 2020.
- [5] V. Astapov, P. H. Divshali, and L. Soder, “The potential of distribution grid as an alternative source for reactive power control in transmission grid,” in *Proc. 19th Int. Sci. Conf. Electr. Power Eng. (EPE)*, May 2018, pp. 1–6.
- [6] R. R. Jha and A. Dubey, “Coordinated voltage control for conservation voltage reduction in power distribution systems,” in *Proc. IEEE Power Energy Soc. Gen. Meeting (PESGM)*, Aug. 2020, pp. 1–5.
- [7] X. Hu, Z.-W. Liu, G. Wen, X. Yu, and C. Liu, “Voltage control for distribution networks via coordinated regulation of active and reactive power of DGs,” *IEEE Trans. Smart Grid*, vol. 11, no. 5, pp. 4017–4031, Sep. 2020.
- [8] Y. Hu, W. Liu, and W. Wang, “A two-layer volt-var control method in rural distribution networks considering utilization of photovoltaic power,” *IEEE Access*, vol. 8, pp. 118417–118425, 2020.
- [9] P. Lusi, L. L. H. Andrew, A. Liebman, and G. Tack, “The added value of coordinating inverter control,” *IEEE Trans. Smart Grid*, vol. 12, no. 2, pp. 1238–1248, Mar. 2020, doi: [10.1109/TSG.2020.3030311](https://doi.org/10.1109/TSG.2020.3030311).
- [10] Y. Geng, L. Zhu, X. Song, K. Wang, and X. Li, “A modified droop control for grid-connected inverters with improved stability in the fluctuation of grid frequency and voltage magnitude,” *IEEE Access*, vol. 7, pp. 75658–75669, 2019.
- [11] Y. Wang, Y. Xu, Y. Tang, M. H. Syed, E. Guillo-Sansano, and G. M. Burt, “Decentralised-distributed hybrid voltage regulation of power distribution networks based on power inverters,” *IET Gener., Transmiss. Distrib.*, vol. 13, no. 3, pp. 444–451, Feb. 2019.
- [12] S. Repo, H. Laaksonen, and P. Järventausta, “New methods and requirements for planning of medium voltage network due to distributed generation,” in *Proc. Nordic Distrib. Asset Manage. Conf. (NORDAC)*, Espoo, Finland, 2004, pp. 1–17.
- [13] A. Kulmala, S. Repo, and P. Jarventausta, “Coordinated voltage control in distribution networks including several distributed energy resources,” *IEEE Trans. Smart Grid*, vol. 5, no. 4, pp. 2010–2020, Jul. 2014.
- [14] X. Sun, J. Qiu, and J. Zhao, “Real-time volt/var control in active distribution networks with data-driven partition method,” *IEEE Trans. Power Syst.*, early access, Nov. 16, 2020, doi: [10.1109/TPWRS.2020.3037294](https://doi.org/10.1109/TPWRS.2020.3037294).
- [15] C. Zhang, Y. Xu, Z. Y. Dong, and R. Zhang, “Multi-objective adaptive robust voltage/VAR control for high-PV penetrated distribution networks,” *IEEE Trans. Smart Grid*, vol. 11, no. 6, pp. 5288–5300, Nov. 2020.
- [16] T. Tewari, A. Mohapatra, and S. Anand, “Coordinated control of OLTC and energy storage for voltage regulation in distribution network with high PV penetration,” *IEEE Trans. Sustain. Energy*, vol. 12, no. 1, pp. 262–272, Jan. 2021.
- [17] Z. Tang, D. J. Hill, and T. Liu, “Distributed coordinated reactive power control for voltage regulation in distribution networks,” *IEEE Trans. Smart Grid*, vol. 12, no. 1, pp. 312–323, Jan. 2021.
- [18] J. G. De Steese, S. B. Merrick, and B. W. Kennedy, “Estimating methodology for a large regional application of conservation voltage reduction,” *IEEE Trans. Power Syst.*, vol. 5, no. 3, pp. 862–870, Aug. 1990.
- [19] Z. S. Hossein, A. Khodaei, W. Fan, M. S. Hossain, H. Zheng, S. A. Fard, A. Paaso, and S. Bahramirad, “Conservation voltage reduction and solt-VAR optimization: Measurement and verification benchmarking,” *IEEE Access*, vol. 8, pp. 50755–50770, 2020.
- [20] A. Bokhari, A. Raza, M. Diaz-Aguilo, F. de Leon, D. Czarkowski, R. E. Usef, and D. Wang, “Combined effect of CVR and DG penetration in the voltage profile of low-voltage secondary distribution networks,” *IEEE Trans. Power Del.*, vol. 31, no. 1, pp. 286–293, Feb. 2016.
- [21] S. Singh, V. Babu Pamshetti, A. K. Thakur, and S. P. Singh, “Multistage multiobjective Volt/VAR control for smart grid-enabled CVR with solar PV penetration,” *IEEE Syst. J.*, early access, May 25, 2020, doi: [10.1109/JSYST.2020.2992985](https://doi.org/10.1109/JSYST.2020.2992985).
- [22] L. Gutierrez-Lagos and L. F. Ochoa, “OPF-based CVR operation in PV-rich MV-LV distribution networks,” *IEEE Trans. Power Syst.*, vol. 34, no. 4, pp. 2778–2789, Jul. 2019.
- [23] V. B. Pamshetti and S. P. Singh, “Coordinated allocation of BESS and SOP in high PV penetrated distribution network incorporating DR and CVR schemes,” *IEEE Syst. J.*, early access, Dec. 18, 2020, doi: [10.1109/JSYST.2020.3041013](https://doi.org/10.1109/JSYST.2020.3041013).
- [24] (2016). *Flexibility From Residential Power Consumption: A New Market Filled With Opportunities*. Final Project Report. [Online]. Available: https://www.usef.energy/app/uploads/2016/12/EnergieKoplopersEngels_FinalReport_2016_vs4-1.pdf
- [25] N. Chen and L. E. Jonsson, “A new hybrid power electronics on-load tap changer for power transformer,” in *Proc. IEEE Appl. Power Electron. Conf. Expo. (APEC)*, Mar. 2015, pp. 1030–1037.
- [26] H. Laaksonen, “Securing passive islanding detection and enabling stable islanding with Q/f-droop control of DG unit,” *Int. Rev. Electr. Eng.*, vol. 9, no. 3, pp. 592–602, 2014.
- [27] A. E. Samani, A. D’Amicis, J. D. M. De Kooning, D. Bozalakov, P. Silva, and L. Vandevelde, “Grid balancing with a large-scale electrolyser providing primary reserve,” *IET Renew. Power Gener.*, vol. 14, no. 16, pp. 3070–3078, Oct. 2020.
- [28] Y. Jiang, F. Mei, J. Lu, and J. Lu, “Two-stage joint optimal scheduling of a distribution network with integrated energy systems,” *IEEE Access*, vol. 9, pp. 12555–12566, 2021.
- [29] K. S. Fuad, H. Hafezi, K. Kauhaniemi, and H. Laaksonen, “Soft open point in distribution networks,” *IEEE Access*, vol. 8, pp. 210550–210565, 2020.



HANNU LAAKSONEN (Member, IEEE) received the M.Sc. (Tech.) degree in electrical power engineering from the Tampere University of Technology, Tampere, Finland, in 2004, and the Ph.D. (Tech.) degree in electrical engineering from the University of Vaasa, Vaasa, Finland, in 2011. His employment experience includes working as a Research Scientist with VTT Technical Research Centre, Finland, and with the University of Vaasa. He has previously worked as a Principal Engineer at ABB Ltd., Vaasa. He is currently a Professor of Electrical Engineering with the University of Vaasa. He is also the Manager of the Smart Energy Master’s Program. His research interests include the protection of low-inertia power systems (including microgrids), active management of distributed and flexible energy resources in future smart energy systems, future-proof technology, and market concepts for smart grids.



CHETHAN PARTHASARATHY (Graduate Student Member, IEEE) received the M.Sc. degree in power engineering from Nanyang Technological University (NTU), Singapore, in 2016. He is currently pursuing the Ph.D. degree in electrical engineering with the University of Vaasa, Finland. He is currently working as a Project Researcher with the School of Technology and Innovations, University of Vaasa. Previously, from 2016 to 2018, he worked as a Research Associate at

Rolls-Royce @ NTU Corporate Laboratory. His research interests include of modelling and control of energy storage systems (ESS) integration in smart grids, characterization and modelling of lithium ion battery ESS for marine and stationary grid applications, super-capacitor and battery based hybrid energy storage systems, sizing of battery energy storage systems (BESS), and techno-economic analysis of BESS for micro-grid applications.



MIADREZA SHAFIE-KHAH (Senior Member, IEEE) received the Ph.D. degree in electrical engineering from Tarbiat Modares University, Tehran, Iran, and the second Ph.D. degree in electromechanical engineering from the University of Beira Interior (UBI), Covilha, Portugal. He held post-doctoral positions with UBI and the University of Salerno, Salerno, Italy. He is currently an Associate Professor with the University of Vaasa, Vaasa, Finland. His research interests include

power market simulation, market power monitoring, power system optimisation, demand response, electric vehicles, price and renewable forecasting, and smart grids. He received five best paper awards at IEEE Conferences. He is an Editor of the IEEE TRANSACTIONS ON SUSTAINABLE ENERGY, an Associate Editor of the IEEE SYSTEMS JOURNAL, an Editor of the IEEE OPEN ACCESS JOURNAL OF POWER AND ENERGY (OAJPE), an Associate Editor for IET-RPG, the Guest Editor-in-Chief of the IEEE OPEN ACCESS JOURNAL OF POWER AND ENERGY, and the Guest Editor of IEEE TRANSACTIONS ON CLOUD COMPUTING. He was considered one of the Outstanding Reviewers of the IEEE TRANSACTIONS ON SUSTAINABLE ENERGY, in 2014 and 2017, one of the Best Reviewers of the IEEE TRANSACTIONS ON SMART GRID, in 2016 and 2017, one of the Outstanding Reviewers of the IEEE TRANSACTIONS ON POWER SYSTEMS, in 2017 and 2018, and one of the Outstanding Reviewers of IEEE OPEN ACCESS JOURNAL OF POWER AND ENERGY, in 2020. He has coauthored more than 368 articles, and he is the Volume Editor of the book *Blockchain-based Smart Grids* (Elsevier, 2020).



HOSNA KHAJEH (Graduate Student Member, IEEE) received the M.Sc. (Tech.) degree in electrical engineering (power systems) from Semnan University, Semnan, Iran, in 2016. She is currently pursuing the Ph.D. degree with the University of Vaasa, Vaasa, Finland. She is currently working as a Project Researcher with the University of Vaasa. Her research interests include future electricity market concepts (such as flexibility markets and local peer-to-peer markets), smart grid and

microgrid scheduling, and renewable energy integration.



NIKOS HATZIARGYRIOU (Life Fellow, IEEE) is a Professor of power systems with the National Technical University of Athens. He has over ten year industrial experience as a Chairman and CEO of the Hellenic Distribution Network Operator (HEDNO) and as an Executive Vice-Chair and Deputy CEO of the Public Power Corporation (PPC), responsible for the Transmission and Distribution Divisions. He is an Honorary Member of CIGRE and the past Chair of CIGRE SC C6

“Distribution Systems and Distributed Generation.” He is the past Chair of the Power System Dynamic Performance Committee (PSDPC) and currently Editor-in-Chief of the IEEE TRANSACTIONS ON POWER SYSTEMS. He has participated in more than 60 research and development projects funded by the EU Commission, electric utilities and manufacturers for fundamental research, and practical applications. He is included in the 2016, 2017, and 2019 Thomson Reuters lists of the top 1% most cited researchers and he is a Laureate of Globe Energy Prize 2020.

...