

Durham E-Theses

*A systems study of the effect of osmotic stress on
hormone crosstalk and growth in Arabidopsis thaliana
roots*

ROWE, JAMES,HARRY

How to cite:

ROWE, JAMES,HARRY (2015) *A systems study of the effect of osmotic stress on hormone crosstalk and growth in Arabidopsis thaliana roots*, Durham theses, Durham University. Available at Durham E-Theses Online: <http://etheses.dur.ac.uk/11413/>

Use policy



This work is licensed under a [Creative Commons Attribution Non-commercial No Derivatives 3.0 United States \(CC BY-NC-ND\)](https://creativecommons.org/licenses/by-nc-nd/3.0/)

Academic Support Office, Durham University, University Office, Old Elvet, Durham DH1 3HP
e-mail: e-theses.admin@dur.ac.uk Tel: +44 0191 334 6107
<http://etheses.dur.ac.uk>

A systems study of the effect of osmotic stress on hormone crosstalk and growth in *Arabidopsis thaliana* roots

James Harry Rowe



Submitted for the qualification of Doctor of Philosophy (Ph.D.) at
The School of Biological and Biomedical Sciences, Durham University

Accepted December 2015

1 Abstract

Understanding the mechanisms regulating root development under drought conditions is an important question for plant biology and world agriculture. This thesis examines the effect of osmotic stress on the plant hormones abscisic acid (ABA), cytokinin and ethylene responses and how they mediate auxin transport, distribution and root growth via PIN proteins

Root growth is reduced under osmotic stress, and ABA responses increase. Root growth can be rescued by inhibiting ABA biosynthesis, indicating its critical role in the regulation of growth under stress. There was also a reduction in cytokinin signalling under stress.

The inhibition of root growth under osmotic stress does not require ethylene signalling, however auxin can rescue growth. Osmotic stress also modulates auxin transporter levels, particularly PIN1, which regulates auxin transport to the root tip.

As PIN1 levels are reduced under stress in an ABA-dependent manner, overriding the ethylene effect on PIN1 levels, and auxin responses decrease under stress, I present the hypothesis that ABA is limiting auxin transport to the root under stress to reduce growth.

However, the interplay between ABA, ethylene, cytokinin and auxin is tissue-specific, with the result that PIN1 and PIN2 differentially respond to osmotic stress.

Combining experimental analysis with extensive literature searches allowed the systematic construction of interaction networks, incorporating the known interactions between the hormones and stress. This network analysis reveals that ABA regulates root growth under osmotic stress conditions via interactions with cytokinin, ethylene and auxin demonstrating complicated non-linear relationships and providing a framework for further kinetic modelling. Kinetic modelling (using differential equations to simulate these interactions) of ethylene and ABA effects on PIN1 levels reveals that the hormones most likely act on the same pathway to regulate PIN1 levels.

The work presented here provides novel insights into how root growth is regulated by hormones under drought and osmotic stress conditions.

2 Preamble

2.1. Contents

1	ABSTRACT	2
2	PREAMBLE	3
2.1.	CONTENTS.....	3
2.2.	TABLE OF FIGURES.....	7
2.3.	DECLARATION AND COPYRIGHT.....	10
2.4.	ACKNOWLEDGEMENTS AND THANKS.....	11
2.5.	DEDICATION	14
3	INTRODUCTION	15
3.1.	DROUGHT STRESS AND FOOD SECURITY	16
3.2.	PROJECT AIMS.....	16
3.3.	OSMOTIC STRESS	16
3.4.	OSMOTIC STRESS RESPONSES	17
3.4.1.	<i>Osmotic stress perception</i>	17
3.4.2.	<i>Osmotic stress signalling and gene expression</i>	18
3.5.	<i>ARABIDOPSIS THALIANA</i> - THE MODEL PLANT, WITH A MODEL ROOT	19
3.6.	PLANT HORMONES.....	21
3.6.1.	<i>Auxin</i>	22
3.6.2.	<i>Cytokinin</i>	26
3.6.3.	<i>Abscisic acid (ABA)</i>	28
3.6.4.	<i>Ethylene</i>	29
3.6.5.	<i>Gibberellic Acid</i>	31
3.6.6.	<i>Brassinosteroids</i>	32
3.6.7.	<i>POLARIS (PLS)</i>	33
3.7.	MODELLING HORMONE CROSSTALK, PATTERNING AND RESPONSES	33
3.8.	THE REGULATION OF ROOT SYSTEM ARCHITECTURE UNDER OSMOTIC STRESS.....	38
3.9.	PROJECT OBJECTIVES	39
4	MATERIALS AND METHODS	40
4.1.	CHEMICAL SUPPLIERS.....	40
4.2.	PLANT MATERIALS	40
4.3.	SEED STERILISATION	40
4.4.	GROWTH CONDITIONS FOR OSMOTICALLY STRESSED SEEDLINGS.....	40
4.5.	PREPARATION OF HORMONE STOCK SOLUTIONS	41
4.6.	ANALYSIS OF ROOT LENGTH.....	41
4.7.	PREPARATION OF POLYETHYLENE GLYCOL INFUSED PLATES, ADAPTED FROM (VERSLUES <i>ET AL.</i> , 2006)	42

4.8.	RNA EXTRACTION/ DNase/ cDNA SYNTHESIS	42
4.9.	POLYMERASE CHAIN REACTION (PCR).....	43
4.10.	QUANTITATIVE REAL-TIME POLYMERASE CHAIN REACTION (qPCR)	43
4.11.	STATISTICAL ANALYSIS.....	44
4.12.	HISTOCHEMICAL STAINING OF ROOT TIPS FOR B-GLUCURONIDASE ACTIVITY.....	44
4.13.	COMPOUND LIGHT MICROSCOPY	45
4.14.	CONFOCAL LASER SCANNING MICROSCOPY	45
4.15.	ANALYSIS OF CONFOCAL IMAGES.....	45
4.16.	GEL ELECTROPHORESIS.....	46
4.17.	PRIMERS.....	46
4.18.	TRANSCRIPTOMIC ANALYSIS	47
4.19.	TRANSCRIPTOMIC EXPERIMENT SELECTION	47
4.20.	TRANSCRIPTOMIC GENE SELECTION.....	47
4.20.1.	<i>Cytokinin-responsive gene expression</i>	47
4.20.2.	<i>Auxin-responsive gene expression</i>	47
4.20.3.	<i>Abscisic acid-responsive gene expression</i>	48
4.20.4.	<i>Ethylene biosynthetic gene expression</i>	48
4.21.	MODELLING.....	48
4.21.1.	<i>Network construction</i>	48
4.21.2.	<i>Kinetic modelling</i>	49
4.21.3.	<i>Software and simulation settings</i>	50
5	THE EFFECT OF OSMOTIC STRESS AND HORMONES ON ROOT GROWTH AND MORPHOLOGY	51
5.1.	INTRODUCTION	52
5.2.	OSMOTIC STRESS TREATMENT	52
5.3.	THE EFFECT OF OSMOTIC STRESS ON THE ROOT CELL DAMAGE, DIVISION AND DIFFERENTIATION	53
5.4.	THE EFFECT OF OSMOTIC STRESS ON QUIESCENT CENTRE CELL DIVISION AND ORGANISATION	55
5.5.	THE EFFECT OF OSMOTIC STRESS ON DELLA PROTEINS	56
5.6.	THE EFFECT OF ETHYLENE ON ROOT GROWTH UNDER OSMOTIC STRESS	57
5.7.	THE EFFECT OF IAA ON PRIMARY ROOT GROWTH MERISTEM MORPHOLOGY AND UNDER OSMOTIC STRESS	58
5.8.	THE EFFECT OF ABA ON PRIMARY ROOT GROWTH UNDER OSMOTIC STRESS	61
5.9.	THE EFFECT OF OSMOTIC STRESS ON THE ACTIN AND MICROTUBULE CYTOSKELETON.....	62
5.10.	SUMMARY.....	63
6	THE EFFECT OF OSMOTIC STRESS ON ROOT HORMONE LEVELS, RESPONSES AND DISTRIBUTION.....	65
6.1.	INTRODUCTION	65
6.2.	ABSCISIC ACID-DEPENDENT AND ABSCISIC ACID-INDEPENDENT STRESS RESPONSES.....	65
6.3.	ETHYLENE RESPONSES INCREASE UNDER OSMOTIC STRESS	67
6.4.	CYTOKININ RESPONSES DECREASE UNDER OSMOTIC STRESS.....	68
6.5.	THE EFFECT OF OSMOTIC STRESS ON AUXIN TRANSPORT, LEVELS AND DISTRIBUTION	72

6.5.1.	<i>Root auxin distribution and response is altered under osmotic stress</i>	72
6.5.2.	<i>PIN1 and PIN4 levels are reduced under osmotic stress</i>	76
6.5.3.	<i>PIN2 levels increase under moderate osmotic stress, and return to normal under severe stress</i>	77
6.5.4.	<i>AUX1 levels under osmotic stress</i>	79
6.6.	POLARIS LEVELS DECREASE UNDER OSMOTIC STRESS.....	80
6.7.	THE EFFECT OF COMBINED HORMONE AND OSMOTIC STRESS TREATMENTS ON PIN1:GFP LEVELS.....	82
6.7.1.	<i>Treatment with the ethylene precursor ACC cannot rescue PIN1:GFP levels under osmotic stress</i>	82
6.7.2.	<i>ABA reduces PIN1:GFP levels and inhibiting ABA biosynthesis rescues PIN1:GFP levels under osmotic stress</i>	83
6.7.3.	<i>Ethylene cannot rescue PIN1:GFP levels under abscisic acid treatment</i>	84
6.8.	THE EFFECT OF COMBINED HORMONE AND OSMOTIC STRESS TREATMENTS ON PIN2:GFP LEVELS.....	86
6.8.1.	<i>Abscisic acid regulates PIN2:GFP levels under osmotic stress, but is not sufficient to regulate PIN2 levels independently</i>	87
6.8.2.	<i>PIN2:GFP under combined ethylene and osmotic stress treatments</i>	88
6.9.	THE EFFECT OF COMBINED ETHYLENE AND ABSCISIC ACID TREATMENT ON AUXIN DISTRIBUTION	90
6.10.	SUMMARY.....	92
7	CONSTRUCTION OF HORMONAL CROSSTALK NETWORKS UNDER OSMOTIC STRESS CONDITIONS	93
7.1.	INTRODUCTION	94
7.2.	CONSTRUCTION OF HORMONAL CROSSTALK NETWORKS FOR ROOT GROWTH UNDER OSMOTIC STRESS CONDITIONS	94
7.2.1.	<i>Formatting note</i>	94
7.2.2.	<i>Auxin signalling and crosstalk under unstressed conditions</i>	96
7.2.3.	<i>Auxin signalling and crosstalk under osmotic stress</i>	98
7.2.4.	<i>Abscisic Acid and osmotic stress</i>	99
7.2.5.	<i>Ethylene signalling and crosstalk under unstressed conditions</i>	100
7.2.6.	<i>Ethylene signalling and crosstalk under osmotic stress</i>	101
7.2.7.	<i>Cytokinin signalling and crosstalk</i>	101
7.3.	SUMMARY.....	106
8	CONSTRUCTION OF A KINETIC MODEL TO UNDERSTAND PIN1 REGULATION BY ABSCISIC ACID AND ETHYLENE	108
8.1.	INTRODUCTION	109
8.2.	A KINETIC MODEL FOR ABA TO OVERRIDE ETHYLENE TO REPRESS PIN1 TRANSCRIPTION.....	109
8.2.1.	<i>Simplifying assumptions</i>	110
8.2.2.	<i>Regulation of ethylene and abscisic acid homeostasis</i>	111
8.2.3.	<i>Regulation of PIN1 expression</i>	112

8.2.4.	<i>Model can reproduce PIN1 responses to ACC application</i>	<i>113</i>
8.2.5.	<i>The model can reproduce reduction in PIN1 levels under ABA treatment, and the overriding effect of ABA on PIN1 responses to ACC.....</i>	<i>114</i>
8.3.	MODEL PREDICTIONS.....	115
8.3.1.	<i>The model can reproduce the reduction in PIN1 levels under osmotic stress and the overriding effect of osmotic stress on ethylene regulated PIN1 levels</i>	<i>115</i>
8.3.2.	<i>The model can qualitatively reproduce the overriding effect of osmotic stress on PIN1 levels</i>	<i>116</i>
8.3.3.	<i>Examination of reaction fluxes reveals relative importance different pathways to regulation of PIN1 levels.....</i>	<i>117</i>
8.4.	INVESTIGATION INTO WHETHER ALTERNATIVE REACTION SCHEMES CAN REPRODUCE THE EXPERIMENTAL DATA	119
8.4.1.	<i>Alternative model reaction scheme</i>	<i>119</i>
8.4.2.	<i>Alternative model fitting</i>	<i>120</i>
8.4.3.	<i>Alternative model predictions</i>	<i>121</i>
9.	DISCUSSION	126
9.1.	ABSCISIC ACID LIMITS ROOT GROWTH UNDER STRESS, REDUCING MERISTEM SIZE	126
9.2.	UNDERSTANDING THE ROLE OF ETHYLENE ON ROOT GROWTH UNDER OSMOTIC STRESS	128
9.3.	REDUCED AUXIN LEVELS LIMIT ROOT GROWTH UNDER OSMOTIC STRESS.....	129
9.4.	IMPLICATIONS OF THE ALTERED AUXIN:CYTOKININ RATIO ON CELL DIVISION, CELL DIFFERENTIATION AND MERISTEM SIZE	130
9.5.	THE HORMONE CROSSTALK NETWORK HELPS US UNDERSTAND CHANGES IN HORMONE DISTRIBUTION AND ROOT GROWTH UNDER OSMOTIC STRESS	131
9.6.	UNDERSTANDING THE REGULATION OF AUXIN AND PIN1 LEVELS BY ABSCISIC ACID AND ETHYLENE	132
9.7.	PIN1 INDEPENDENT REGULATION OF AUXIN LEVELS UNDER OSMOTIC STRESS	134
9.8.	IMPROVING OUR UNDERSTANDING OF THE EFFECTS OF CYTOKININ AND AUXIN ON ROOT GROWTH.....	135
9.9.	HYDROTROPISM	135
9.10.	THE EFFECT OF MILD OSMOTIC STRESS OR LOW LEVELS OF ABA IN PROMOTING ROOT GROWTH.....	136
9.11.	BEYOND HORMONE CROSSTALK: OTHER FACTORS REGULATING ROOT GROWTH	137
9.12.	FUTURE WORK	138
9.12.1.	<i>Developing a spatiotemporal model of hormone crosstalk under osmotic stress</i>	<i>138</i>
9.12.2.	<i>Improving modelling predictions for cytokinin patterning.....</i>	<i>139</i>
9.12.3.	<i>The promotion of growth by ABA or mild osmotic stress.....</i>	<i>140</i>
9.12.4.	<i>The effect of ACC on TAA1 levels and auxin biosynthesis under osmotic stress.....</i>	<i>140</i>
9.12.5.	<i>The effect of mechanical impedance on root growth under osmotic stress</i>	<i>140</i>
9.12.6.	<i>GA/DELTA signalling.....</i>	<i>140</i>
9.13.	DROUGHT AND THE IMPACT OF THIS WORK	141
10	BIBLIOGRAPHY.....	142
11	APPENDICES.....	160

11.1.	PRIMERS USED FOR QPCR	161
11.2.	EXPERIMENTAL DATASETS USED FOR TRANSCRIPTOMIC ANALYSIS	161
11.3.	CK RESPONSIVE GENES.....	163
11.4.	AUXIN RESPONSIVE GENES	163
11.5.	ABA RESPONSIVE GENE EXPRESSION	163
11.6.	ACC BIOSYNTHETIC GENE SELECTION	164
11.7.	MODEL PARAMETERS FOR FIRST PIN1 MODEL.....	164
11.7.1.	Global parameters	164
11.8.	MODEL PARAMETERS FOR ALTERNATIVE PIN1 MODEL	165
11.8.1.	Global parameters	165

2.2. Table of figures

FIGURE 3-1	THE ZONES AND CELL TYPES OF THE ARABIDOPSIS PRIMARY ROOT	20
FIGURE 3-2	STEM CELL ORGANISATION IN THE ARABIDOPSIS PRIMARY ROOT APEX.	21
FIGURE 3-3	THE DISTRIBUTION OF THE PIN FAMILY OF AUXIN EFFLUX CARRIERS (KLEINE-VEHN & FRIML, 2008).....	23
FIGURE 3-4	ROOT GRAVITROPISM IS CAUSED BY DIFFERENTIAL DISTRIBUTION OF AUXIN	24
FIGURE 3-5	AUXIN SIGNALLING CASCADE, TAKEN FROM (MOCKAITIS & ESTELLE, 2008).....	25
FIGURE 3-6	DR5::YFP-N7 REVEALS PATTERN OF AUXIN RESPONSE IN THE ARABIDOPSIS ROOT. PURPLE: PROPIDIUM IODIDE STAINING FOR CELL WALLS. GREEN: YFP-N7.....	26
FIGURE 3-7	THE CYTOKININ SIGNALLING CASCADE, AS DESCRIBED IN THE TEXT (KIEBER & SCHALLER, 2014),	27
FIGURE 3-8	THE ABSCISIC ACID (ABA) SIGNALLING CASCADE (SHEARD & ZHENG, 2009).....	29
FIGURE 3-9	ETHYLENE SIGNALLING CASCADE A) IN THE ABSENCE OF ETHYLENE, B) IN THE PRESENCE OF ETHYLENE	30
FIGURE 3-10	THE GIBBERELLIN - GID1 - DELLA SIGNALLING PATHWAY (UEGUCHI-TANAKA <i>ET AL.</i> , 2007).....	32
FIGURE 3-11	TYPICAL EXPERIMENTAL/MODELLING WORKFLOW USED IN SYSTEMS BIOLOGY, ADAPTED FROM HTTP://WWW.MYEXPERIMENT.ORG/WORKFLOWS/2661.HTML	34
FIGURE 3-12	THE SIMPLIFIED HORMONAL CROSSTALK NETWORK, DESCRIBED IN (LIU <i>ET AL.</i> , 2010)	35
FIGURE 3-13	THE SPATIOTEMPORAL MODEL CAN REPRODUCE AUXIN RESPONSE PATTERNING. TAKEN FROM (MOORE <i>ET AL.</i> , 2015b).....	37
FIGURE 4-1	TYPICAL EXPERIMENTAL/MODELLING WORKFLOW USED IN SYSTEMS BIOLOGY, ADAPTED FROM HTTP://WWW.MYEXPERIMENT.ORG/WORKFLOWS/2661.HTML	49
FIGURE 4-2	THE WORKFLOW AND CRITERIA USED TO TURN REGULATORY RELATIONSHIPS INTO KINETIC EQUATIONS USED IN MODELLING, USED WITH PERMISSION FROM (MOORE <i>ET AL.</i> , 2015A)	50
FIGURE 5-1	VERIFICATION OF OSMOTIC STRESS TREATMENTS BY VAPOUR PRESSURE OSMOMETRY.....	53
FIGURE 5-2	MERISTEM SIZE AND CELL COUNTS ARE REDUCED UNDER OSMOTIC STRESS	54
FIGURE 5-3	PROCYCB1;2::CYCB1:2:GUS UNDER OSMOTIC STRESS	55
FIGURE 5-4	OSMOTIC STRESS DOES NOT ALTER QUIESCENT CENTRE MORPHOLOGY, OR CELL NICHE.....	56
FIGURE 5-5	PRORGA::GFP:RGA ACCUMULATES UNDER OSMOTIC STRESS	57
FIGURE 5-6	THE EFFECT OF ETHYLENE ON ROOT GROWTH UNDER OSMOTIC STRESS	58

FIGURE 5-7 AUXIN MODULATES ROOT GROWTH UNDER OSMOTIC STRESS, BUT NOT THROUGH BASIPETAL AUXIN TRANSPORT	59
FIGURE 5-8 AUXIN MODULATES MERISTEM SIZE UNDER OSMOTIC STRESS	60
FIGURE 5-9 INHIBITING ABA BIOSYNTHESIS CAN RESCUE ROOT LENGTH UNDER STRESS	61
FIGURE 5-10 THE MICROTUBULE CYTOSKELETON IS ALTERED UNDER OSMOTIC STRESS, BUT THERE IS NO OBVIOUS CHANGE IN ACTIN ORGANISATION	63
FIGURE 6-1 : ABA DEPENDENT AND INDEPENDENT STRESS RESPONSES ARE ACTIVE UNDER OSMOTIC STRESS.	66
FIGURE 6-2 ETHYLENE RESPONSES INCREASE UNDER OSMOTIC STRESS TREATMENT	68
FIGURE 6-3 CYTOKININ RESPONSES ARE REDUCED UNDER BOTH ABA TREATMENT AND OSMOTIC STRESS.....	69
FIGURE 6-4 <i>ARR5</i> EXPRESSION IS REDUCED UNDER OSMOTIC STRESS.	70
FIGURE 6-5 <i>PTCS::GFP</i> FLUORESCENCE IS UNALTERED UNDER OSMOTIC STRESS.....	71
FIGURE 6-6 AUXIN RESPONSIVE GENE EXPRESSION UNDER OSMOTIC STRESS.....	73
FIGURE 6-7 : <i>DR5</i> ACTIVITY DECREASES IN ROOTS UNDER OSMOTIC STRESS.	74
FIGURE 6-8 <i>DII-VENUS</i> FLUORESCENCE INCREASES UNDER SEVERE OSMOTIC STRESS.	75
FIGURE 6-9 : <i>PIN1</i> AND <i>PIN4</i> TRANSCRIPT AND PROTEIN LEVELS DECREASE UNDER OSMOTIC STRESS AND <i>PIN1</i> DELOCALISES FROM THE MEMBRANE.	77
FIGURE 6-10 <i>PIN2</i> LEVELS SHOW A BELL SHAPED RESPONSE TO OSMOTIC STRESS.	78
FIGURE 6-11 <i>AUX1</i> EXPRESSION IS REDUCED UNDER SEVERE OSMOTIC STRESS.....	79
FIGURE 6-12 <i>PROPLS::PLS::GFP</i> LEVELS DECREASE UNDER OSMOTIC STRESS	81
FIGURE 6-13: WHOLE SEEDLING <i>POLARIS</i> EXPRESSION INCREASES UNDER OSMOTIC STRESS.	82
FIGURE 6-14 <i>PIN1::GFP</i> RELATIVE FLUORESCENCE DECREASES UNDER OSMOTIC STRESS REGARDLESS OF ETHYLENE SIGNALLING.	83
FIGURE 6-15 INHIBITING ABA BIOSYNTHESIS RESCUES THE REDUCTION IN <i>PIN1::GFP</i> UNDER OSMOTIC STRESS	84
FIGURE 6-16 <i>ACC</i> CANNOT RESCUE ABA REPRESSION OF <i>PIN1::GFP</i> LEVELS.....	86
FIGURE 6-17 ABSCISIC ACID REGULATES <i>PIN2::GFP</i> LEVELS UNDER OSMOTIC STRESS, BUT IS NOT SUFFICIENT TO REGULATE <i>PIN2</i> LEVELS INDEPENDENTLY	88
FIGURE 6-18 ETHYLENE REGULATES THE INCREASE IN <i>PIN2::GFP</i> LEVELS UNDER OSMOTIC STRESS, BUT CANNOT MAINTAIN HIGHER <i>PIN2</i> LEVELS UNDER SEVERE STRESS	89
FIGURE 6-19 ABA AND ACC AFFECT AUXIN DISTRIBUTION IN THE ROOT TIP.	91
FIGURE 7-1 HORMONAL CROSSTALK NETWORK OF AUXIN, ETHYLENE, CYTOKININ AND THEIR ASSOCIATED GENES IN A SINGLE CELL WHEN ROOT GROWTH IS NOT SUBJECTED TO OSMOTIC STRESS, REPRESENTING THE KINETIC MODEL DEVELOPED IN (LIU <i>ET AL.</i> 2010, 2013, MOORE <i>ET AL.</i> 2015).....	95
FIGURE 7-2 SCHEMATIC DESCRIPTION OF THE 2-DIMENSIONAL ROOT STRUCTURE AND CELL-CELL COMMUNICATIONS, USED FOR CONSTRUCTION OF THE SPATIOTEMPORAL MODEL, AS DESCRIBED IN MOORE <i>ET AL.</i> (2015)	96
FIGURE 7-3 A HORMONAL CROSSTALK NETWORK FOR OSMOTIC STRESS, FOR A CELL EXPRESSING <i>PIN1</i> IN THE STELE.....	103
FIGURE 7-4 A HORMONAL CROSSTALK NETWORK FOR OSMOTIC STRESS FOR A CELL EXPRESSING <i>PIN2</i> IN THE EPIDERMIS OR CORTEX.....	104
FIGURE 7-5 A SIMPLIFIED HORMONAL CROSSTALK NETWORK FOR ROOT DEVELOPMENT UNDER OSMOTIC STRESS	105
FIGURE 8-1 A KINETIC MODEL FOR THE REGULATION OF <i>PIN1</i> EXPRESSION BY ETHYLENE AND ABA.....	110
FIGURE 8-2 MODEL PREDICTIONS OF ABA AND ET CROSS REGULATION AND HOMEOSTASIS UNDER OSMOTIC STRESS	111

FIGURE 8-3 MODEL RESULTS (BLUE LINE) OF PIN1 RESPONSES TO EXOGENOUS ACC APPLICATION ARE IN AGREEMENT WITH THE EXPERIMENTAL PIN1:GFP DATA (RED POINTS WITH SEM ERROR BARS). 113

FIGURE 8-4 MODEL RESULTS OF THE EFFECT OF EXOGENOUS APPLICATION OF ABA AND ETHYLENE ON PIN1 LEVELS 114

FIGURE 8-5 OSMOTIC STRESS CAN OVERRIDE THE EFFECTS OF ETHYLENE, TO REDUCE PIN1 LEVELS..... 115

FIGURE 8-6 THE MODEL CAN CORRECTLY PREDICT THE TREND OF EXOGENOUSLY APPLIED ABA AND INHIBITING ABA BIOSYNTHESIS UNDER OSMOTIC STRESS 116

FIGURE 8-7 MODELLED REACTION FLUXES FOR PIN1 BIOSYNTHESIS UNDER VARIOUS SCENARIOS 118

FIGURE 8-8 THE ALTERNATIVE KINETIC MODEL FOR ABA AND ET TO REGULATE PIN1 LEVELS..... 119

FIGURE 8-9 THE ALTERNATIVE MODEL RESULTS (BLUE LINE) OF PIN1 RESPONSES TO EXOGENOUS ACC APPLICATION ARE IN AGREEMENT WITH THE EXPERIMENTAL PIN1:GFP DATA (RED POINTS WITH SEM ERROR BARS). 120

FIGURE 8-10 THE ALTERNATIVE MODEL CAN REPRODUCE THE ABA-MEDIATED REDUCTION IN PIN1 LEVELS AND OVERRIDING THE EFFECT OF ABA ON ACC REGULATION OF PIN1 LEVELS..... 120

FIGURE 8-11 THE ALTERNATIVE MODEL CAN CORRECTLY PREDICT THE PIN1 RESPONSE TO OSMOTIC STRESS AND ABA PERTURBATION..... 121

FIGURE 8-12 THE ALTERNATIVE MODEL CAN CORRECTLY PREDICT THE PIN1 RESPONSE TO OSMOTIC STRESS AND ACC TREATMENT, BUT NOT INHIBITED ET BIOSYNTHESIS..... 122

FIGURE 8-13 ALTERNATIVE MODEL PIN1 BIOSYNTHESIS REACTION FLUX UNDER ETHYLENE PERTURBATION..... 123

FIGURE 8-14 VARYING THE RATE OF ET BIOSYNTHESIS PRODUCES COMPLEX NON-LINEAR EFFECTS ON PIN1 LEVELS UNDER OSMOTIC STRESS 124

FIGURE 9-1 A MODEL FOR HOW OSMOTIC STRESS AFFECTS MERISTEM SIZE AND GROWTH THROUGH ABA AND AUXIN 130

2.3. Declaration and copyright

The copyright of this thesis rests with the author. No quotation from it should be published without the author's prior written consent and information derived from it should be acknowledged. The Ivor Cutler monologue 'Looking for truth with a pin' is used with the kind permission of Dan Cutler and the Ivor Cutler Estate. The kinetic modelling chapter was performed in conjunction with Junli Liu, who has joint ownership of this material.

Material in this thesis may also be found in the following journal articles:

Rowe, J., Topping J.F., Liu, J., Lindsey, K. 2015 Abscisic acid regulates root growth under osmotic stress conditions via an interacting hormonal network with cytokinin, ethylene and auxin. *New Phytologist* (in press)

Moore S, Zhang X, Mudge A, Rowe JH, Topping JF, Liu J, Lindsey K. 2015. Spatiotemporal modelling of hormonal crosstalk explains the level and patterning of hormones and gene expression in *Arabidopsis thaliana* wild-type and mutant roots. *New Phytologist* **207**(4): 1110-1122.

Liu J, Rowe J, Lindsey K. 2014. Hormonal crosstalk for root development: a combined experimental and modeling perspective. *Frontiers in Plant Science* **5**.

2.4. Acknowledgements and thanks

First, an apology to anyone reading this for my long self-indulgent list of acknowledgements.

My thanks go to BBSRC, RCUK and Durham University for funding and support of my studies. My thanks also go to the Biophysical Sciences Institute and EPSRC, for providing me with funding for an osmometer, and various other items of equipment.

I have to thank Keith and Jen for their wonderful supervision, their patience and their friendship. I would never have got to here without your kindness and time. Thank you for the music, the friendship, the drinks and for making an oddball with social problems feel welcome. I will remember fondly evenings with Keith's guitar and sitting on your sofa, wondering at Jen's beautiful garden.

Secondly my thanks must go to Junli. The network construction and modelling chapters were carried out in conjunction with Junli, without whom I would have been completely lost! I'm sorry for my impatience and stupidity in all those meetings, I hope you've enjoyed working together as much as I have.

Anna, we started at the same time and now we're coming to the end of our PhDs I have to give you special thanks. We've walked a hard road together, but we've had so much fun too and I will miss you immensely when we go. Martin you've been a great friend, who always makes me laugh. I'm still amazed by your child-like joy at films/games etc. and I'll miss how much fun we've had. I wish you both the best in your new jobs, please keep in touch!

I have to thank everyone else who has passed through the lab for their help, and understanding, especially when I was in a bad mood. I'm looking at you Xiyan, Nathalia, Devina, Vinny, Amy, Kat, Big Sam, Little Sam and Chunli.

Flora, thanks for the drinks, the laughs and for putting up with me when I was obviously mad as balls. I'm amazed by your insight.

I have to thank Tim and Joanne for help and advice with confocal microscopy. It has been a real pleasure, and your help has been invaluable.

Dave and Jack, I'm amazed at the luck that we were forced to live together and I can't say I was expecting to still be living with you both three years later. You have both offered me friendship, advice and a sympathetic ear, but most of all, you all make me laugh and I am going to miss you.

Everyone else in the Hussey lab was a great help: Pat, Peng, Greg and Johan.

Beccy and Craig, you are two of the best people I know. You both care immensely and I owe you a lot. John Rowland, you helped me think through lots of things early on in my project and I hope you never change.

Thanks too to my friends near and far, who've helped me through or made my last few years in Durham so good: Steph, Mahony, Max, Gary, Olivia, the band, the football team, Kris, Alex,

Owen and Jesse. Thankyou A.P.B. and Chelsea for being wonderful friends who understood; I am in your debts.

Hannah, I love you and I know this whole thing hasn't been easy, but you've got me through. I am astounded by your kindness and how much you care. You make me a better person and I am so looking forward to living together again.

Mum, Lucy, Charlie, we're an odd bunch but there's no one else like you. Each of you amazes me in different ways and I love you all. I don't think I'd have got to here without you three. Mum, you're possibly the most fun, charming and strange person I've ever met. Charlie, your brain crackles with possibility, and I admire your courage. Lucy, I think you're the best of all of us. Thanks to everyone else who can claim the name McNally or Rowe, too. Families are strange and strong willed things and I would never change where I've come from.

Thanks to Marc and Nick for agreeing to examine my manuscript.

Lastly, I have to thank the alcohol and St. John's Wort, without which I'd never have finished.



Looking for Truth with a Pin

Ivor Cutler

When I got to America, I bought a sandwich at a chain store and walked into the jungle. After I'd gone a long way, I came to a great clearing but instead of agricultural ground there was a deep hole. At the bottom bent an old man. He jagged and scraped at the ruddy earth with a pin. Then he took his brush and crumb tray and used them.

'Are you looking for something?' I shouted.

'Truth' he answered. His voice rose hollowly from the hole.

'Come and eat with me' I called in a friendly tone.

He rose, slowly, out of the hole and we sat dangling our legs. I offered him my spam sandwich, but he dragged an onion out of his breast pocket and munched on it, sucking the rich juice back into his mouth as it escaped.

Lunch over, he returned to the bottom and recommenced jagging and scraping and brushing. I lay watching him, the generous nourishment of the spam running round my tubes.

After about a quarter of an hour, he called up, 'I've FOUND it!' and rose once again to the surface, transformed. He looked at peace with the world and with himself; completely self-contained.

I started to cry... great tears, great bitter tears of envy. He pointed down the hole. I handed him my watch, my money, my return ticket to London, my identity. He handed me the pin and the brush and crumb tray, then left the clearing. I dried my tears on the brush and sank down the hole, swearing softly to myself, to look for truth with a pin.

2.5. Dedication

This thesis is dedicated to the memory of my father. Jed is the reason I look at the world in the way I do. He gave me a questioning nature, a love of humanity and congenital clumsiness.

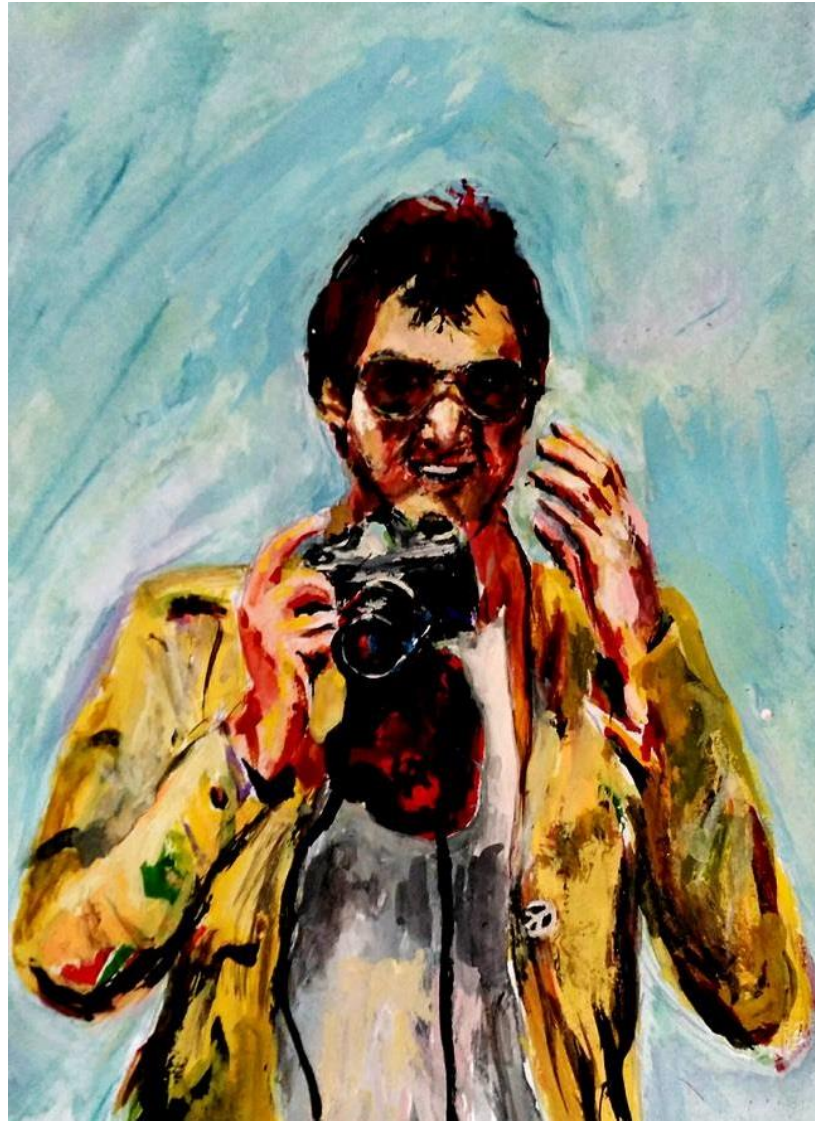

3 Introduction

3.1. Drought stress and food security

Current estimates of population growth predict nine billion people on Earth by 2050, requiring a 70-100% increase in food production, which is 38% greater than historical increases (Godfray *et al.*, 2010; Tester & Langridge, 2010; IPCC, 2014).

This comes at a time of a changing climate; global temperatures are predicted to continue increasing due to anthropogenic effects, negatively influencing crop yields (IPCC, 2014). Increased global temperatures are predicted to have widespread, complicated implications on crop yields and food security that vary with time and geography (IPCC, 2014). Increased global temperatures will cause extremes of weather, and increased drought in many regions, reducing crop yields (IPCC, 2014).

In recent decades, genetically modified crops with resistance to herbicides (Comai *et al.*, 1985), insect pests (Vaeck *et al.*, 1987), and pathogens (Fitch *et al.*, 1992) have had widespread success. Whilst biotic stresses do impact yield, by far the largest impact on yield is due to abiotic stresses, particularly low water availability (Boyer, 1982). Conferring drought resistance is therefore a major target of plant breeders, and one that so far has had limited success (Tester & Langridge, 2010).

Recent work has demonstrated that root architecture and physiology can have a big impact on drought resistance and crop yield (Uga *et al.*, 2013; Lynch *et al.*, 2014), so understanding how plants regulate growth and development under drought and osmotic stress is an important question with real world applications.

3.2. Project aims

As crosstalk between hormones is important in regulating growth, development and stress responses, I hope to understand how osmotic stress affects hormone crosstalk and whether this can explain root growth phenotypes under stress.

By using the literature and experimentation, I will then construct a hormonal crosstalk network and kinetic model under osmotic stress. This network and model will hopefully give new insights into how root growth is regulated under osmotic stress.

3.3. Osmotic stress

In this thesis, osmotic stress is considered to be the stress imposed by reduced water availability. The level of osmotic stress imposed is assessed by measuring the water potential

(Ψ) of the growth medium, using a vapour pressure osmometer. The water potential is the sum of the osmotic potential (Ψ_s) and the hydrostatic pressure (Ψ_p), and is measured in MPa.

$$\Psi = \Psi_s + \Psi_p$$

In the context of field drought stress, osmotic stress primarily occurs due to reduced rainfall decreasing water availability in soils, whereas we achieve this experimentally by increasing solute concentration in growth medium. In soils, drought can also cause increased soil hardness (Whalley *et al.*, 2005). The biological consequences of this mechanical stress are being examined separately in our group, using permeable physical barriers (Jacobsen & Lindsey, unpublished data), to allow these two effects to be uncoupled.

In this study, a high molecular weight solute (polyethylene glycol, PEG; molecular weight 8000) is used to achieve a high osmotic pressure as it is non-toxic and it is excluded by plant cells (Carpita *et al.*, 1979; Carpita, 1982; Handa *et al.*, 1982). In some studies, salt (NaCl) is used as an osmoticum, whereas others use sugar derivatives such as mannitol or sorbitol (Shabala & Lew, 2002; Takahashi *et al.*, 2002; Verslues *et al.*, 2006). As all of these solutes enter the cytoplasm and some (sodium ions and mannitol) also have documented toxicity, they are poor models the drought.

The small molecular size of salts and sugar derivatives also mean that they can quickly enter the gap between the protoplast and cell wall, and osmosis causes shrinkage of the protoplast away from the cell wall, a process known as plasmolysis (Carpita *et al.*, 1979; Carpita, 1982; Oertli, 1985). Plasmolysis is an experimental artefact and not typical of what drought stressed plants experience in the field, where the worst possible damage is shrinkage and eventual collapse of the cell wall along with the protoplast (cytorrhysis). Because PEG 8000 is has a large open structure, it cannot penetrate cell walls as quickly as sugars/salt and so very high concentrations cause cytorrhysis rather than plasmolysis (Oertli, 1985; Oertli, 1986; Verslues *et al.*, 2006).

3.4. Osmotic stress responses

3.4.1. Osmotic stress perception

There are three main theoretical mechanisms for osmoperception in plants: mechanosensing of changes in membrane tension, detection of differences in solute concentration across the cell membrane, and detection of movement or disruption of cell wall components (Haswell & Verslues, 2015). There are currently three main candidate receptors: AHK1, which may act by sensing plasma membrane solute differences; MCA1, which acts as a mechanosensitive Ca^{2+} channel; and OSCA1, which may act as a mechanosensitive Ca^{2+} channel.

3.4.1.1.AHK1

ARABIDOPSIS HISTIDINE KINASE 1 (AHK1) is a putative osmosensor that shares homology with the yeast osmosensor *sln1* (Urao *et al.*, 1999). Transforming yeast with *AHK1* restores osmotic stress responses to the *sln-ts* mutant (Urao *et al.*, 1999), and Arabidopsis *ahk1* mutants display reduced survival under drought stress (Tran *et al.*, 2007). As *ahk1* still has increased abscisic acid (ABA) levels under osmotic stress (Wohlbach *et al.*, 2008; Kumar *et al.*, 2013), it cannot be the sole osmosensor.

3.4.1.2.OSCA1

HYPEROSMOLARITY INDUCED Ca²⁺ INCREASE 1 (OSCA1) is a putative osmosensor localised to the plasma membrane (Yuan *et al.*, 2014). As calcium increases are early responses to osmotic stress and drought (Knight *et al.*, 1997), Yuan *et al.* (2014) performed a forward genetic screen for plants with an impaired cytosolic Ca²⁺ increase. Further screening for impaired developmental and physiological responses identified the *osca1* mutant. *OSCA1* encodes a calcium channel that is responsive to changes in osmolarity (Yuan *et al.*, 2014). Although OSCA appears to act upstream of ABA biosynthesis in terms of root growth and stomatal function (Yuan *et al.*, 2014), differences in ABA accumulation need to be verified experimentally, as do changes in osmotic stress responsive gene expression.

3.4.1.3.MCA1

MCA1 is a mechanosensitive ion channel that may function as an osmosensor (Nakagawa *et al.*, 2007; Furuichi *et al.*, 2012). *mca1* plants fail to penetrate hard agar (Nakagawa *et al.*, 2007), and *Xenopus* oocytes expressing MCA1 show action potentials when membrane tension increases, indicating it may be important in hypoosmotic stress responses (Furuichi *et al.*, 2012). It is however yet to be established whether MCA1 is important for responses to the hyperosmotic stress that is characteristic of drought.

3.4.2. Osmotic stress signalling and gene expression

After perception of osmotic stress, secondary messengers perform a vital role in signal transduction (Huang *et al.*, 2008). Calcium signalling can regulate the activity of multiple stress responsive promoter motifs to modulate gene expression (Whalley *et al.*, 2011). Reactive oxygen species (ROS) are produced in response to drought and salinity stress and perform a vital role in osmotic stress responsive gene expression (Miller *et al.*, 2008; Miller *et al.*, 2010).

Whilst it is important to understand how osmotic stress is perceived, this thesis will not deal with the signalling or diverse range of defensive mechanisms that exist to protect plants from stress, but will focus on developmental responses. For information on stress signalling and resilience mechanisms, there are numerous detailed and well written reviews available (e.g. (Bray, 1997; Huang *et al.*, 2012). The majority of genes regulated by osmotic stress are regulated in the same direction by ABA application (Huang *et al.*, 2008), however there are numerous genes that are not, leading to the hypothesis that there are at least separate pathways to regulate drought stress responses.

3.4.2.1.ABA-independent signalling

Dehydration and salt stress can induce expression of *DREB2A* and *DREB2B* which encode transcription factors that bind to Drought Responsive Elements (DRE) in promoters to enhance expression of dehydration responsive genes (Liu *et al.*, 1998; Nakashima *et al.*, 2000). *C-repeat binding factor 4 (CBF4)* can also be transcribed in response to osmotic stress. It encodes another transcription factor which binds to DREs to regulate stress responses (Huang *et al.*, 2012).

3.4.2.2.ABA dependent signalling

AREB/ABF transcription factors are induced by the ABA-responsive pathway (Choi *et al.*, 2000; Uno *et al.*, 2000), and their activity is regulated by ABA-dependent phosphorylation (Furihata *et al.*, 2006). AREBs bind to ABA-responsive elements in the genome to induce expression of drought responsive genes.

ABA signalling mechanisms will be discussed in more detail later in this chapter.

3.5. *Arabidopsis thaliana* - the model plant, with a model root

Arabidopsis thaliana has been used in plant research for more than 100 years. It came to prominence in the late 20th century because it is easy and fast to grow, produces a lot of seed, displays a lot of natural variability, is diploid, self-compatible and contains a small genome (Somerville & Koornneef, 2002).

In the late 1980s it became apparent that the small genome made positional cloning of any gene in *Arabidopsis* theoretically possible (Meyerowitz, 1989), and shortly after a project to sequence the entire genome was initiated. By the start of the new millennium, The Arabidopsis Genome Initiative published the first analysis of a sequenced plant genome (Arabidopsis Genome, 2000).

When the *Arabidopsis* root was characterised, it was revealed to be a highly ordered structure (Dolan *et al.*, 1993), making it an ideal system to study a diverse range of biological phenomena including patterning, polarity and hormone responses.

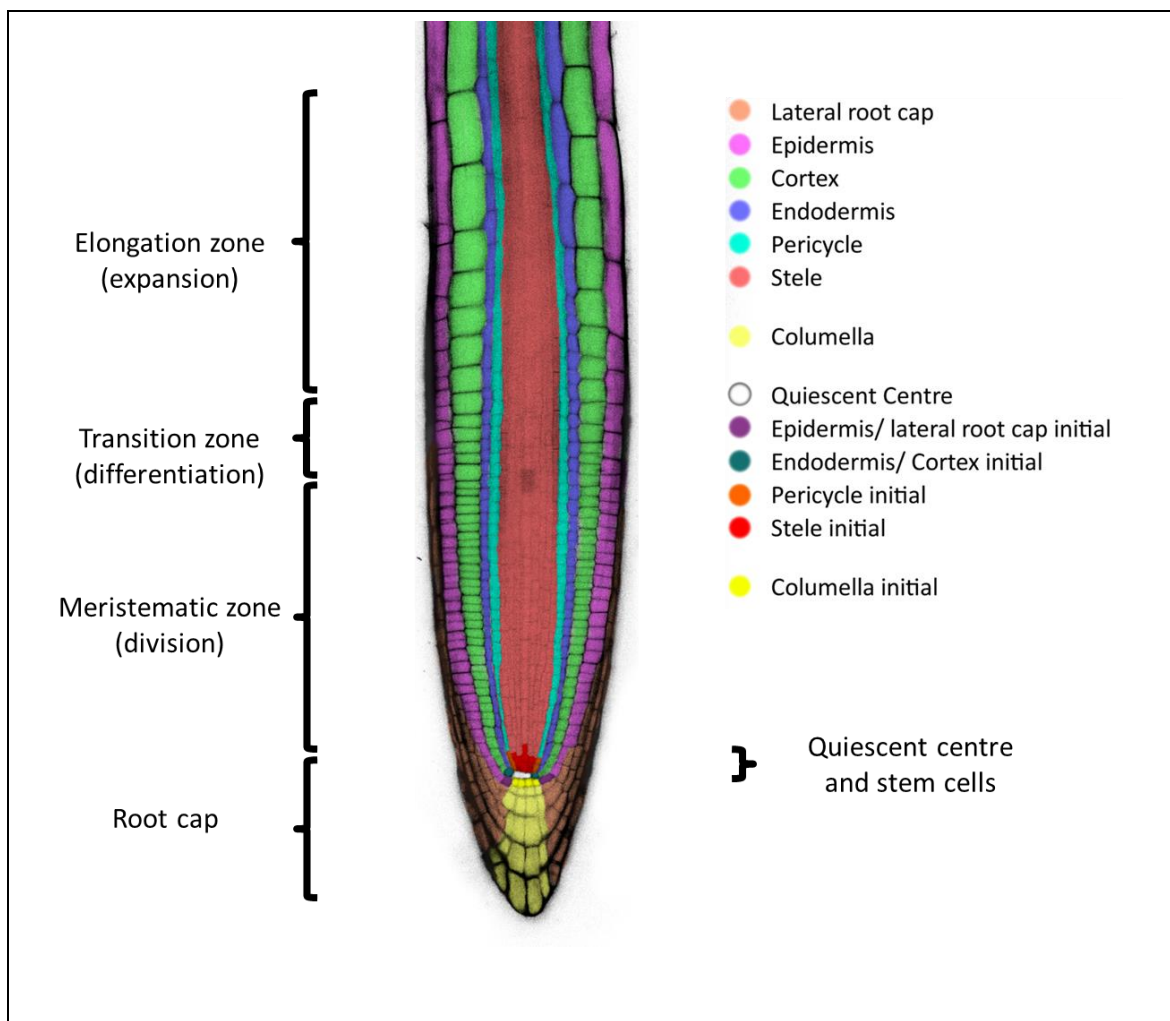

Figure 3-1 The zones and cell types of the Arabidopsis primary root

The *Arabidopsis* primary root structure. Cell files start at stem cells initials, surrounding the organising quiescent centre. Proximal to the quiescent centre, cells of the epidermis, cortex, endodermis, pericycle and vascular tissues undergo division in the meristematic zone, differentiation in the transition zone and expansion in the elongation zone. Upon leaving the elongation zone cells undergo further differentiation and gain cell identity. Lateral root cap cells divide and expand, before being sloughed off at the proximal meristem. Distal to the quiescent centre, cells divide and differentiate to form the columella.

The *Arabidopsis thaliana* primary root, as shown in Figure 3-1, is made up of concentric rings of cell files, surrounding a central stele (Dolan *et al.*, 1993). These cells, from the outside to inside at the root tip, are the lateral root cap, epidermis, cortex, endodermis, pericycle and vascular cells (xylem and phloem).

Each cell file forms a lineage that begins with the quiescent centre, which produces daughter stem cell initials during embryogenesis. The quiescent centre is made up of four cells which divide infrequently and regulate the undifferentiated state of the neighbouring initials (Figure 3-2; Dolan *et al.*, 1993; Van den Berg *et al.*, 1997). For the epidermis, cortex, endodermis and

stele, repeated divisions of the initial's daughter cells occur in the meristematic zone, before differentiation in the transition zone and expansion in the elongation zone. It is the repeated division, differentiation and elongation that forms the basis of root growth (Beemster & Baskin, 1998; Casson & Lindsey, 2003; Petricka *et al.*, 2012).

This ordered structure makes the root very amenable to study, and understanding the processes of division, differentiation and expansion can give us an in depth understanding of how root growth is regulated. These processes and structure are tightly controlled by a variety of hormones which interact to regulate growth and development (Vanstraelen & Benková, 2012; Liu *et al.*, 2014). In the next section, the major plant hormones are briefly described and their roles in regulating root growth are discussed.

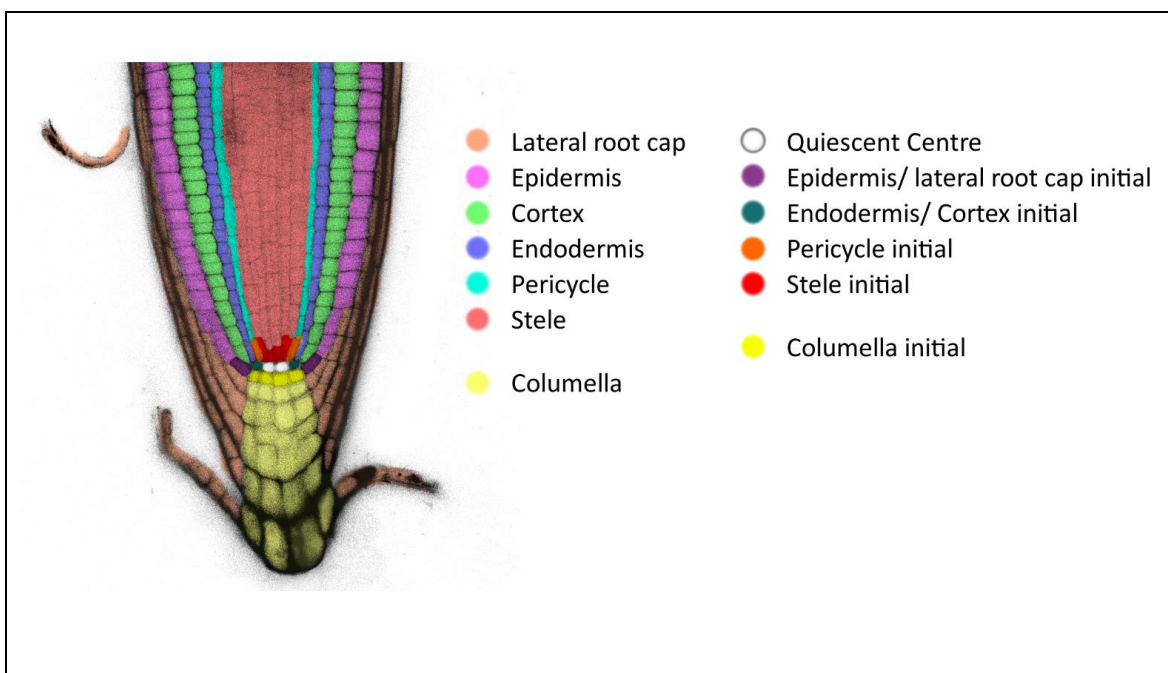

Figure 3-2 Stem cell organisation in the Arabidopsis primary root apex.

This figure illustrates the highly ordered structure of the Arabidopsis root apex, where the quiescent centre maintains the undifferentiated state of the surrounding stem cells (initials), which divide to as parent cells to the various cell files.

3.6. Plant hormones

Plant hormones such as auxin, cytokinin, ethylene and ABA control many aspects of plant growth and development and their levels can change when subjected to drought or salt stresses, so coordinating developmental changes and stress responses (Liu *et al.*, 2014). Many genes regulated by drought are also co-regulated by multiple hormones (Huang *et al.*, 2008), so it is apparent that processing multiple signals is essential to coordinating the stress response in plant development. In fact, the interaction or relative levels of different hormones have been shown to determine numerous developmental and stress responses (Skoog &

Miller, 1957; Sachs, 1982; Ghassemian *et al.*, 2000; Blilou *et al.*, 2005; Dello Iorio *et al.*, 2008; Moubayidin *et al.*, 2010; Nishiyama *et al.*, 2011).

The activities of plant hormones depend on cellular context and exhibit interactions that can be either synergistic or antagonistic. When plants are subjected to drought stress, these hormone activities also respond to osmotic stress (Liu *et al.*, 2014). An important question in understanding plant development is how hormonal crosstalk evolves under osmotic stress.

3.6.1. Auxin

In the roots, auxin can reduce the stability of DELLA proteins, which inhibit growth (Fu & Harberd, 2003), promoting cell elongation and cell division in the meristem (Blilou *et al.*, 2005).

Auxin distribution in the root is controlled by a polar transport mechanism (Blilou *et al.*, 2005; Grieneisen *et al.*, 2007). The *PIN FORMED (PIN)* family of efflux carrier proteins regulate polar transport (Friml *et al.*, 2003; Petrasek *et al.*, 2006; Wisniewska *et al.*, 2006) and can be rapidly reorganised to alter development (Heisler *et al.*, 2005) by the action of ARF-GEF mediated endosomal cycling (Kleine-Vehn *et al.*, 2008).

The distribution of the PIN proteins is depicted in Figure 3-3. Auxin is transported acropetally through the vasculature where PIN1, PIN3 and PIN7 are expressed and is then funnelled into the quiescent centre by PIN4 (Friml *et al.*, 2002a).

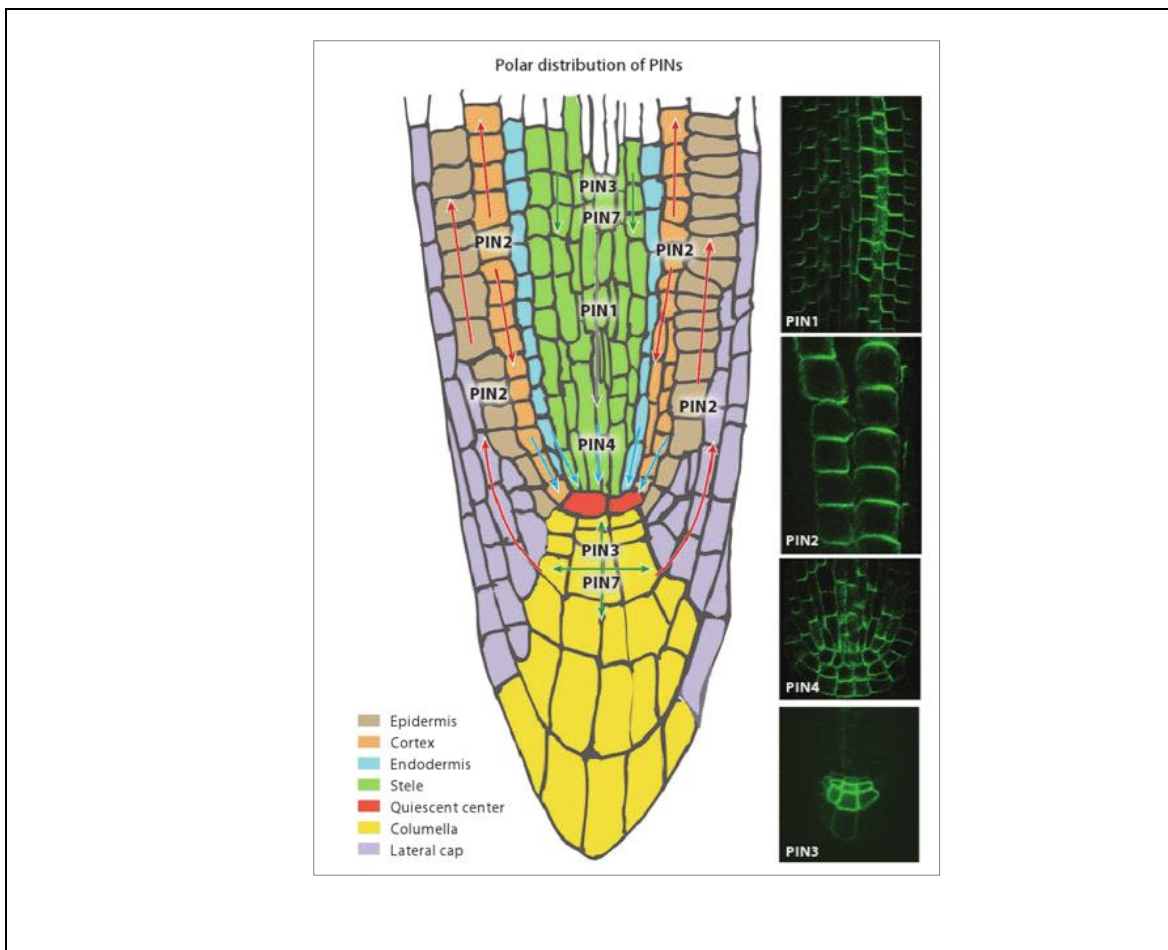

Figure 3-3 The distribution of the PIN family of auxin efflux carriers (Kleine-Vehn & Friml, 2008)

The PIN protein family determines the direction and flux of auxin in the Arabidopsis root. PIN1 transports auxin down the stele and PIN4 funnels it into the auxin maxima at the quiescent centre. PIN3 and PIN7 transport auxin out of the columella into the lateral root cap, where PIN2 transports auxin back up the root, through the epidermis and cortex, towards the elongation zone.

Cells in the columella express PIN3 and PIN7 which transport auxin to the lateral root cap. The lateral root cap, epidermis and cortex all express PIN2 which transports auxin basipetally to the elongation zone, where it limits cell expansion.

As well as the polar PIN family of efflux carriers, there is also a family of ABC transporters, which show non-polar distribution and act synergistically with PIN proteins to regulate efflux (Geisler *et al.*, 2005).

Auxin influx is facilitated by the AUX1/LAX family of carrier proteins (Bennett *et al.*, 1996; Marchant *et al.*, 1999; Yang *et al.*, 2006; Peret *et al.*, 2012).

Modulation of auxin transport can have profound consequences for growth and development, for instance redistribution of PIN3 due to gravity can cause differences in levels of auxin transport away from the root tip (Figure 3-4) (Friml *et al.*, 2002b). The different levels of auxin reaching the elongation zone consequently cause differential cell expansion on either side of the root (Swarup *et al.*, 2005). This causes the root to bend toward gravity.

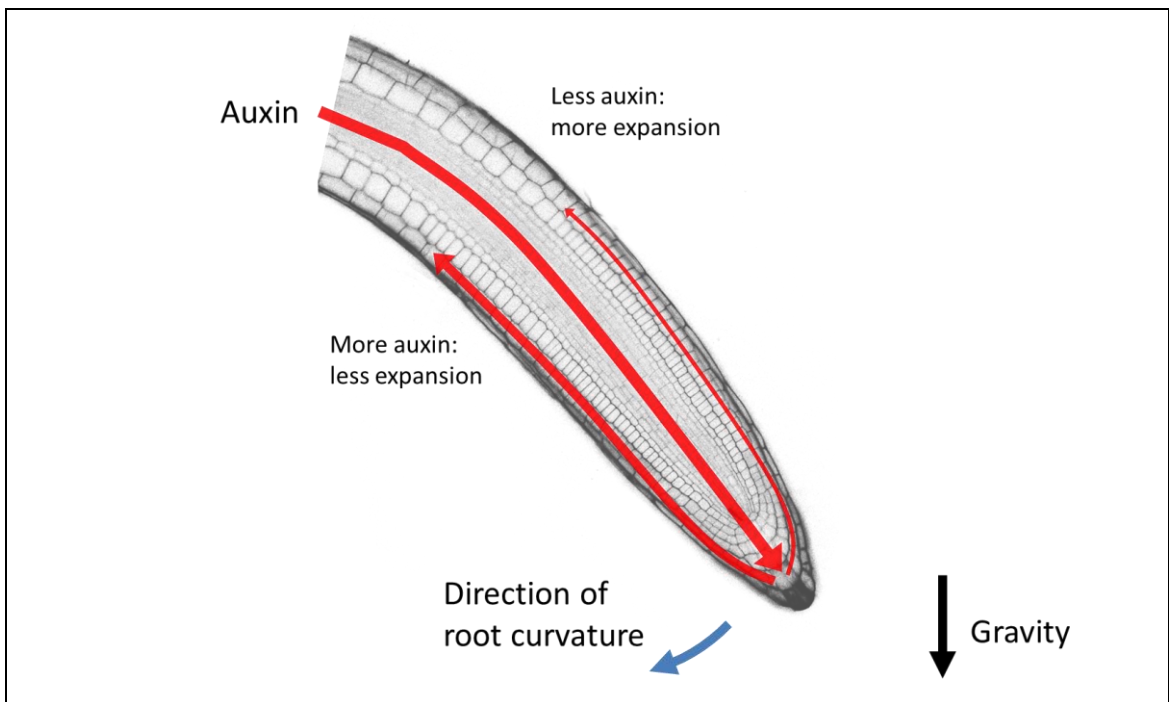

Figure 3-4 Root gravitropism is caused by differential distribution of auxin

Gravity stimulation causes basipetal auxin transport to increase on the 'bottom' side of the root, and decrease on the 'top' side of the root. As auxin inhibits cell expansion in the elongation zone, the asymmetric auxin distribution causes cells on the top of the root to expand faster, bending the root towards gravity.

Auxin signalling is mediated by proteasomal degradation. AUX/IAA proteins such as SHY2 repress the auxin response by forming heterodimers with Auxin Response Factors (ARFs), which are transcription factors (Tiwari *et al.*, 2001). The AUX/IAA repressors are targeted for degradation by the SCF^{TIR1} complex in an auxin-dependent manner (Gray *et al.*, 2001; Dharmasiri *et al.*, 2005; Kepinski & Leyser, 2005; Maraschin *et al.*, 2009), to allow active ARF-ARF dimers to assemble and auxin response genes to be transcribed.

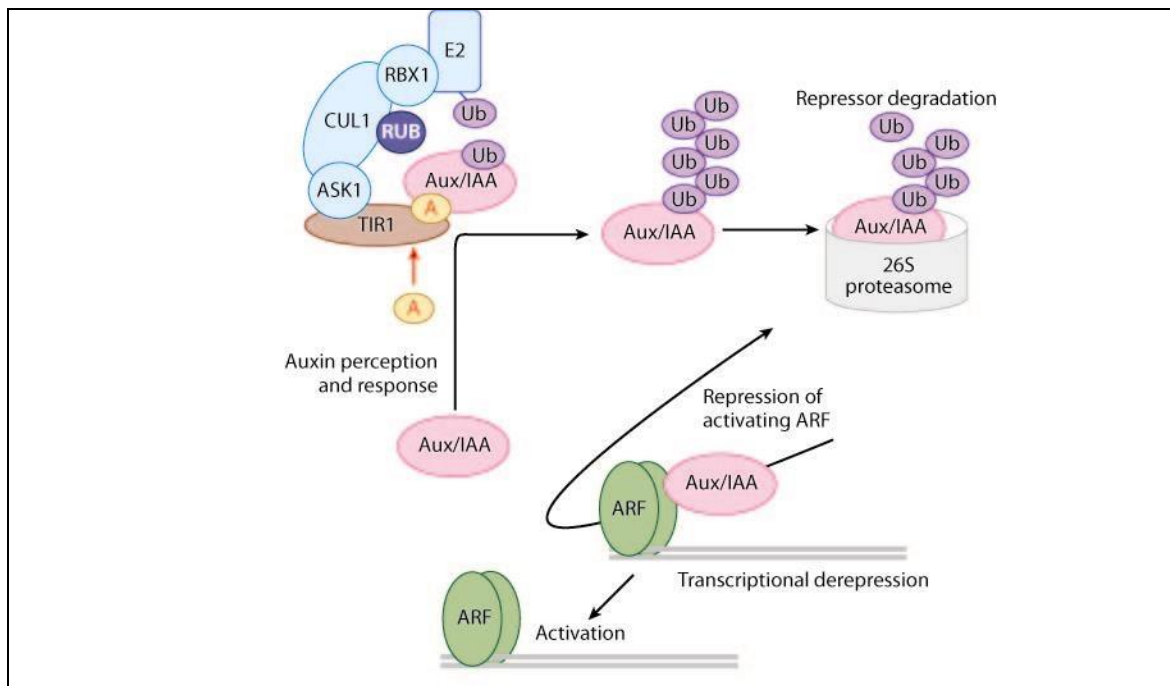

Figure 3-5 Auxin signalling cascade, taken from (Mockaitis & Estelle, 2008)

In the absence of auxin, AUX/IAA proteins repress the action of ARF transcription factors, putting a brake on the auxin signalling pathway. In the presence of auxin, the SCF^{TIR1} receptor complex targets AUX/IAA proteins for degradation, allowing ARFs to activate transcription and downstream auxin responses.

As well as inhibiting expansion in the elongation zone, auxin also promotes cell division in the meristematic zone, and inhibits differentiation (Dello Iorio *et al.*, 2007; Dello Iorio *et al.*, 2008; Moubayidin *et al.*, 2010). Accordingly, low amounts of exogenously applied auxin promote growth, whilst higher concentrations inhibit growth (Evans *et al.*, 1994).

As auxin's developmental effects are specific to cell type and developmental stages, so visualising auxin responses and patterning can tell us a lot about how root growth is being regulated. By using for example fluorescently labelled transport machinery (PIN proteins or the AUX1/LAX family of influx carriers) and auxin reporter genes (e.g. DR5, DII) we can infer the direction of auxin transport and areas of its accumulation in response to experimentation (Figure 3-6; Ulmasov *et al.*, 1997; Benkova *et al.*, 2003; Swarup *et al.*, 2004; Brunoud *et al.*, 2012).

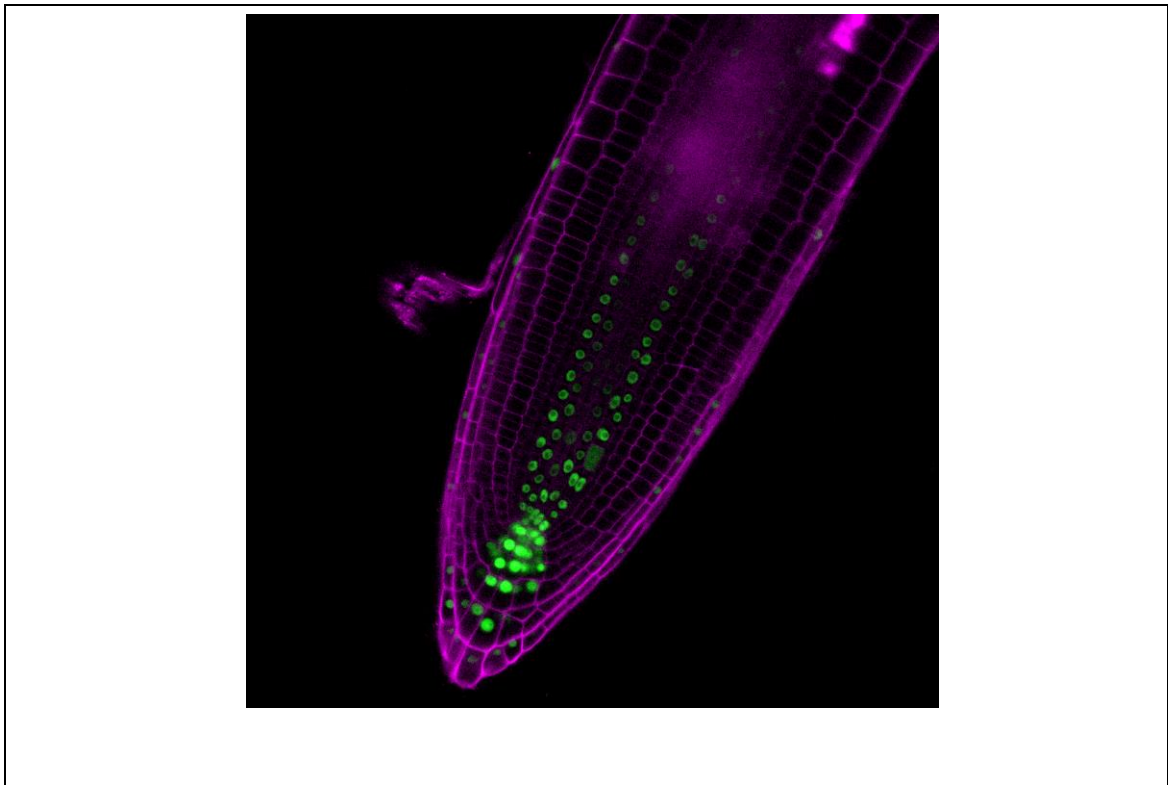

Figure 3-6 DR5::YFP-N7 reveals pattern of auxin response in the Arabidopsis root. Purple: propidium iodide staining for cell walls. Green: YFP-N7

The DR5:YFP signal (an indicator of auxin response) is strongest in the quiescent centre and the proximal columella. There is also a detectable auxin response in the stele and lateral root cap.

3.6.2. Cytokinin

In roots the cytokinin class of hormones is an important regulator of meristem function and growth. The principal site of cytokinin biosynthesis is the root and it is transported through the vasculature to the rest of the plant (Miyawaki *et al.*, 2004; Antoniadi *et al.*, 2015).

Cytokinin-deficient plants show increased root meristem size and enhanced growth, whereas increasing cytokinin has the opposite effect (Werner *et al.*, 2001; Dello loio *et al.*, 2007). Cytokinin inhibits root growth by controlling meristematic cell differentiation (Dello loio *et al.*, 2007; Dello loio *et al.*, 2008). It has been suggested that the auxin: cytokinin ratio controls meristem activity (and therefore growth) via a point of crosstalk in the auxin signalling pathway (Moubayidin *et al.*, 2010; Schaller *et al.*, 2015). In the transition zone, transcription of the auxin signalling repressor *SHY2/IAA3* has been shown to be upregulated by various type-B ARR proteins, which are the transcription factors produced downstream of cytokinin signalling (Dello loio *et al.*, 2008; Moubayidin *et al.*, 2010).

As well as regulating differentiation, cytokinin also promotes cell division (Miller *et al.*, 1955). Increased cytokinin levels can promote quiescent centre cell division (Zhang *et al.*, 2013) and in leaves cytokinin upregulates D type cyclins, promoting cell division (Dewitte *et al.*, 2007).

Cytokinin triple receptor knockout mutants show more extreme phenotypes than cytokinin-deficient plants, exhibiting extreme root and shoot growth retardation (Werner *et al.*, 2001; Nishimura *et al.*, 2004).

Cytokinin signal transduction occurs through a phosphotransfer system (Figure 3-7) that shares homology with two-component his-asp relays found in bacteria (Mizuno, 2005; To & Kieber, 2008). Cytokinin is perceived by HISTIDINE KINASE RECEPTORS (AHK2, AHK3 and AHK4), which auto-phosphorylate in the presence of cytokinin (Inoue *et al.*, 2001; Suzuki *et al.*, 2001; Ueguchi *et al.*, 2001; Yamada *et al.*, 2001). The phosphoryl group is then transferred to a member of the ARABIDOPSIS HIS POSPHOTRANSFER PROTEIN (AHP1-5) family, which activate type –A and –B ARABIDOPSIS RESPONSE REGULATORS (ARR) by phosphorylation (Tanaka *et al.*, 2004).

Active type-B ARR act as transcription factors to activate cytokinin responsive gene expression (Sakai *et al.*, 2000; Mason *et al.*, 2005). Active type-A ARR inhibit the cytokinin signalling pathway, acting as a negative feedback loop (To *et al.*, 2007). Transgenic cytokinin responsive markers (pTCS::GFP, proARR5::GFP) offer a good reflection of the patterning of cytokinin in the root, giving insights into its developmental effects (Muller & Sheen, 2008; Antoniadis *et al.*, 2015)

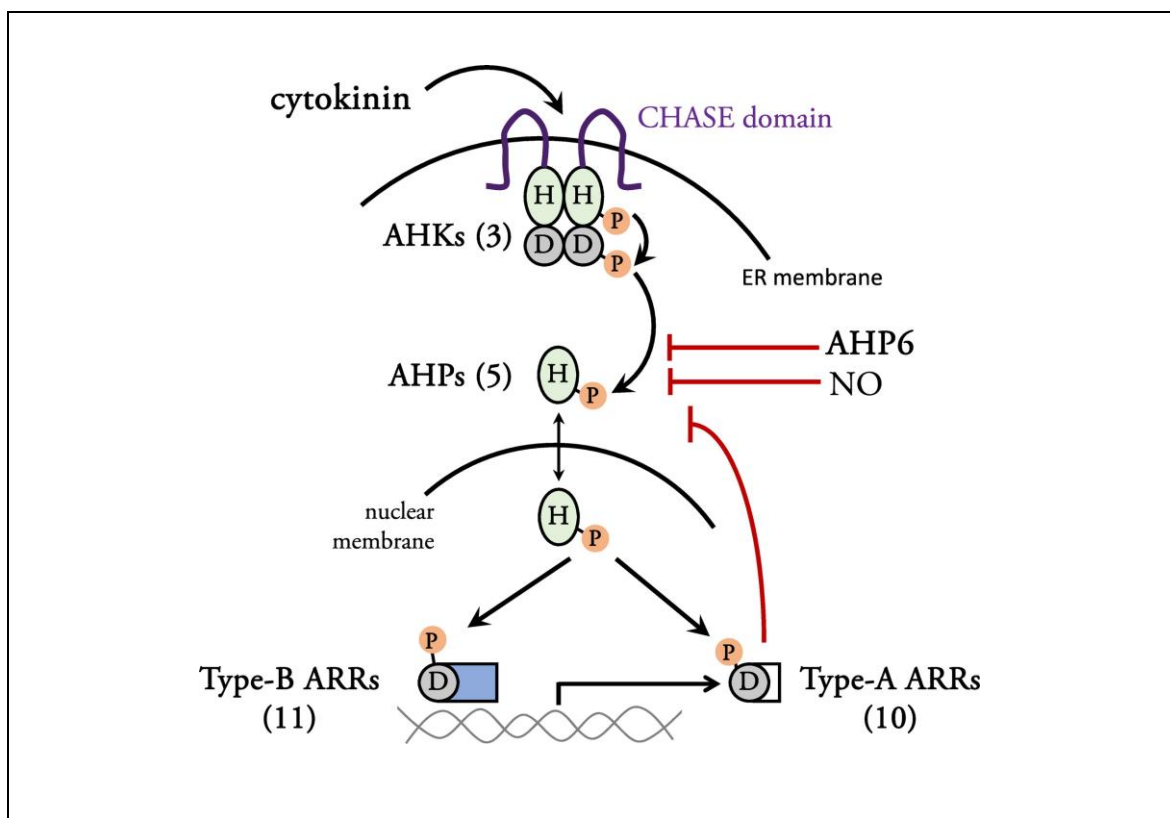

Figure 3-7 The cytokinin signalling cascade, as described in the text (Kieber & Schaller, 2014),

Cytokinins are perceived by the receptors AHK2, AHK3 and AHK4/CRE1/WOL1, which phosphorylate AHPs. AHP1, AHP2, AHP3, AHP4, and AHP5 transfer the phosphoryl group to ARR. Type-B ARR are transcription factors that are

activated by phosphorylation, whereas type-A ARR_s inhibit the signal cascade. Many type-A ARR_s contain many cytokinin-responsive promoter elements, reinforcing the negative feedback on the signalling cascade. AHP6 is a pseudo phosphotransferase protein that acts as a competitive inhibitor to the interaction between the receptors and the true AHPs. Nitrogen oxide (NO) can also inhibit the signalling cascade.

3.6.3. Abscisic acid (ABA)

ABA is a hormone that is primarily associated with dormancy and stress responses. Increased ABA biosynthesis is widely associated with abiotic stresses, particularly water stresses, where it regulates many resilience mechanisms, but it also has diverse developmental roles (Finkelstein *et al.*, 2002).

In the root, ABA can maintain quiescence in the root QC, and inhibits cell division in the meristematic zone (Zhang *et al.*, 2010). It can also regulate the rate of cell differentiation and elongation (Zhang *et al.*, 2010; Ji & Li, 2014).

Whilst there have been many candidates for ABA receptor through the years, recently the PYR/PYL/RCAR family has emerged as a group of proven receptors, responsible for a wide variety of ABA responses (Ma *et al.*, 2009; Park *et al.*, 2009; Cutler *et al.*, 2010). The PYROBACTIN RESISTANT 1 (PYR1) ABA receptor was initially identified in a screen for resistance to the herbicide pyrobactin, a seed-selective ABA agonist (Park *et al.*, 2009). The specificity of pyrobactin to PYR1 allowed the first identification of an ABA receptor, where previous screens had failed due to the high level of redundancy in the ABA receptors (Park *et al.*, 2009). The other receptors could then be identified by homology.

The PYR/PYL family bind ABA with a 'latch and gate' mechanism, that when closed allows binding to protein phosphatases (PP2Cs) such as ABSCISIC ACID INSENSITIVE 1 (ABI1) and ABI2 (Ma *et al.*, 2009; Park *et al.*, 2009). ABI1 and ABI2 act as inhibitors of ABA responses which are inhibited when bound to the active receptor (Fujii *et al.*, 2009; Park *et al.*, 2009). Targets of ABI1 and ABI2 include SUCROSE NON FERMENTING RELATED PROTEIN KINASE 2s (SnRK2s), which when released from inhibition by ABA can phosphorylate ABA RESPONSIVE ELEMENT BINDING FACTORS (ABFs; (Furiihata *et al.*, 2006; Yoshida *et al.*, 2006; Yoshida *et al.*, 2015). Phosphorylated ABFs can bind ABA Responsive Elements (ABREs) in gene promoters to activate responsive transcription (Choi *et al.*, 2000; Uno *et al.*, 2000; Furiihata *et al.*, 2006).

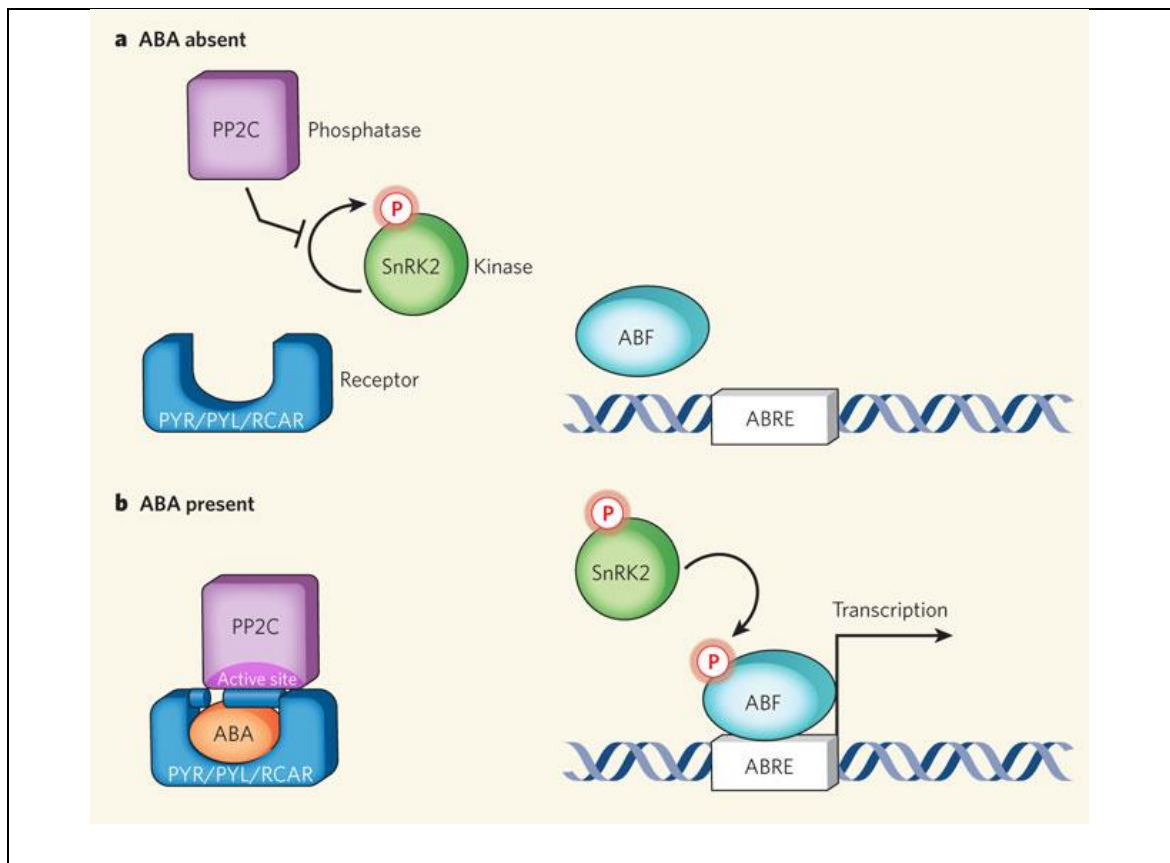

Figure 3-8 The abscisic acid (ABA) signalling cascade (Sheard & Zheng, 2009)

In the absence of ABA, PP2Cs such as ABI1 and ABI2 dephosphorylate SnRK2s, inhibiting their action. When the PYR/PYL/RCAR receptor is ABA bound, it can bind PP2Cs preventing their interaction with SnRK2s. The SnRK2s can then phosphorylate ABRE Binding Factors (ABFs, e.g. AREB1) activating them and allowing downstream transcription.

3.6.4. Ethylene

Ethylene is a plant hormone that plays important roles in growth, fruit ripening, flooding responses and many other processes (Schaller & Kieber, 2002). It is perceived by the five ethylene receptors, ETR1, ETR2, ERS1, ERS2 and EIN4, which share homology with bacterial two component signalling systems (Chang *et al.*, 1993; Hua *et al.*, 1995; Hua *et al.*, 1998; Sakai *et al.*, 1998). The ethylene signalling cascade is summarised in Figure 3-9. In the absence of ethylene the receptor interacts directly with the Raf-like kinase CONSTITUTIVE TRIPLE RESPONSE 1 (CTR1; (Kieber *et al.*, 1993; Clark *et al.*, 1998), but not through phosphorylation (Wang *et al.*, 2003) leading to its activation and inhibition of downstream responses (CTR1 is a negative regulator of the ethylene response). CTR1 phosphorylates ETHYLENE INSENSITIVE 2 (EIN2), maintaining its ER localisation (Ju *et al.*, 2012). When the receptor binds ethylene, it no longer phosphorylates CTR1, which in turn can no longer phosphorylate EIN2, and ethylene responses occur. The EIN2 carboxyl terminal end (CEND) is cleaved which localises to the nucleus, where it stabilises EIN3 (An *et al.*, 2010; Ju *et al.*, 2012; Wen *et al.*, 2012). EIN3 directly activates the transcription of ETHYLENE RESPONSE FACTOR 1 and other ERF family members promoting the ethylene response (Solano *et al.*, 1998).

Ethylene treatment causes short, fat roots with long root hairs. It appears to inhibit root growth by acting on auxin transport and biosynthesis (Strader *et al.*, 2010), and has been shown to increase the rate of auxin biosynthesis in *Arabidopsis* roots (Stepanova *et al.*, 2005; Stepanova *et al.*, 2007; Swarup *et al.*, 2007; Stepanova *et al.*, 2008).

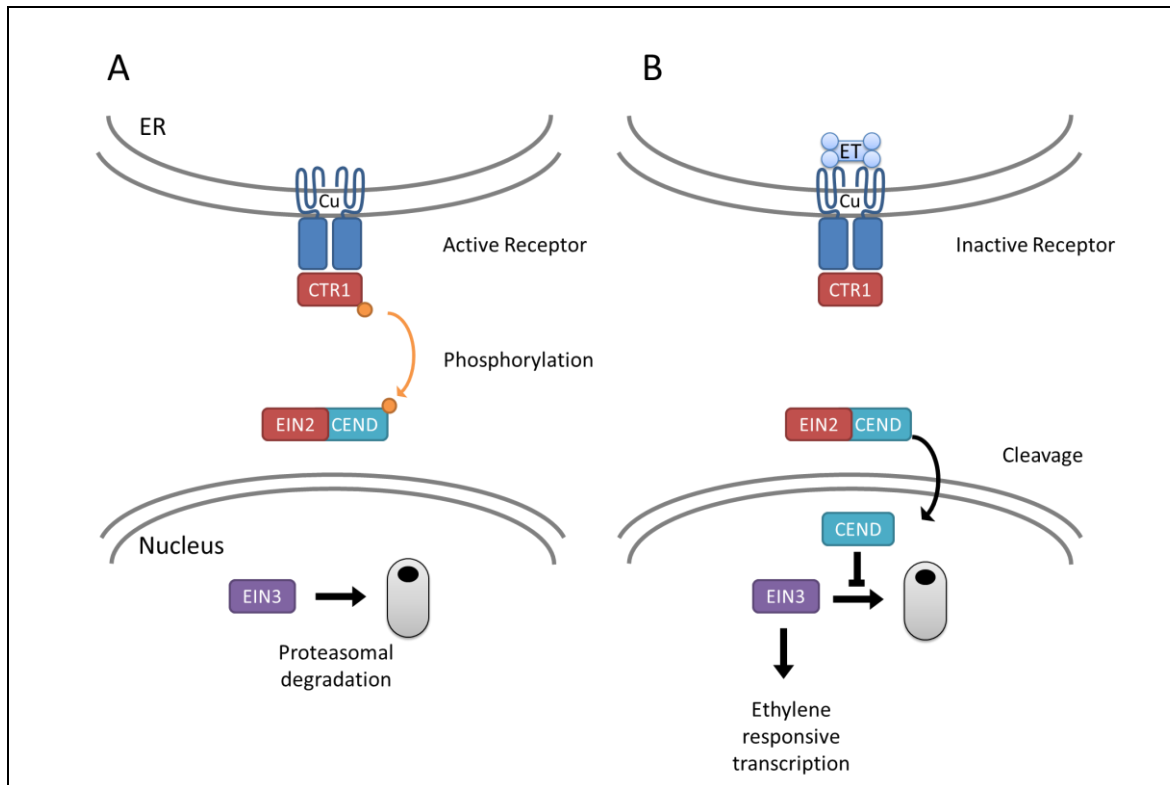

Figure 3-9 Ethylene signalling cascade A) in the absence of ethylene, B) in the presence of Ethylene

A) In the absence of ethylene, ETR1 and CTR1 are active and CTR1 phosphorylates EIN2, inhibiting its function. EIN3 is therefore targeted for degradation B) In the presence of ethylene, ETR1 and CTR1 are inactive, and so EIN2 is not phosphorylated. The C terminal end (CEND) of EIN2 is then cleaved and translocated to the nucleus, where it inhibits the degradation of EIN3, allowing EIN3 to activate ethylene responsive transcription.

Ethylene also affects the transcription and distribution of components of the auxin transport machinery, inducing *PIN2* transcription at the root tip, which polarises basipetally and is essential for much of ethylene's effect on root growth (Ruzicka *et al.*, 2007).

Recently, it has come to light that ethylene may also be playing a role to limit meristem size and growth, by inhibiting cell division in the primary root meristem, probably through increased expression of *SHY2* (Street *et al.*, 2015).

Although much of the ethylene response in the root occurs through this increased auxin biosynthesis and transport, ethylene also affects meristem activity independently of auxin. Controlling for auxin, ACC application or ethylene overproduction can increase the rate of stem cell division in the quiescent centre of the root meristem (Ortega-Martinez *et al.*, 2007).

Ethylene and auxin positively regulate each other's biosynthesis, but there is another point of crosstalk between ethylene signalling and auxin, a peptide called *POLARIS (PLS)* (Casson *et al.*, 2002; Chilley *et al.*, 2006), which will be discussed later.

3.6.5. Gibberellic Acid

Gibberellins (GA) are plant hormones that have diverse developmental roles, but are best known for promoting growth. In roots, GA can promote elongation and cell proliferation (Fu & Harberd, 2003; Achard *et al.*, 2009; Ubeda-Tomas *et al.*, 2009).

The gibberellin signalling pathway is detailed in Figure 3-10. Gibberellin binds to the receptor GID1, which facilitates the binding of DELLA proteins e.g. SLR1 in rice (Ueguchi-Tanaka *et al.*, 2005; Griffiths *et al.*, 2006; Nakajima *et al.*, 2006; Murase *et al.*, 2008). The GA-GID1-DELLA complex interacts with an SCF complex, which ubiquitinates the DELLA protein, targeting it for degradation (Dill *et al.*, 2001; Silverstone *et al.*, 2001; Fu *et al.*, 2002). There are five DELLA proteins in Arabidopsis, which act as repressors of growth and development. They contain conserved DELLA and TVHYNP amino acid sequences that are required for their GID1-regulated degradation, and a conserved GRAS domain which is required for transcriptional regulation. DELLA proteins function as the principal inhibitors of plant growth and other developmental processes, by interacting with transcription factors (de Lucas *et al.*, 2008) or by binding DNA directly. Interaction of other hormone systems with the GA – GID1 – DELLA signalling system may be the principal mechanism of growth control in plants.

Auxin is known to increase gibberellin levels (Ross *et al.*, 2000). Under gravistimulation, asymmetric auxin distribution precedes a similar gibberellin distribution, which regulates root bending (Loefke *et al.*, 2013). There is also evidence that GA can stabilise PIN localisation to the plasma membrane reinforce the basipetal auxin flow under gravistimulation (Loefke *et al.*, 2013; Li, G *et al.*, 2015).

Gibberellin also regulates meristem size (Ubeda-Tomas *et al.*, 2009). DELLA proteins are known to regulate ARR1 and cytokinin-responsive gene expression to regulate cell division in the root apical meristem (Moubayidin *et al.*, 2010; Marín-de la Rosa *et al.*, 2015).

Stress responsive hormones ethylene and abscisic acid can both stabilise DELLA protein levels to inhibit growth, as can salt stress (Achard *et al.*, 2003; Achard *et al.*, 2006). Under salt stress, RGA is SUMOylated, which prevents its degradation and allows it to bind to GID1 in the absence of GA, inhibiting the degradation of non SUMOylated RGA (Conti *et al.*, 2014). The

levels of RGA therefore increase independently of gibberellin to inhibit root growth (Achard *et al.*, 2006; Conti *et al.*, 2014).

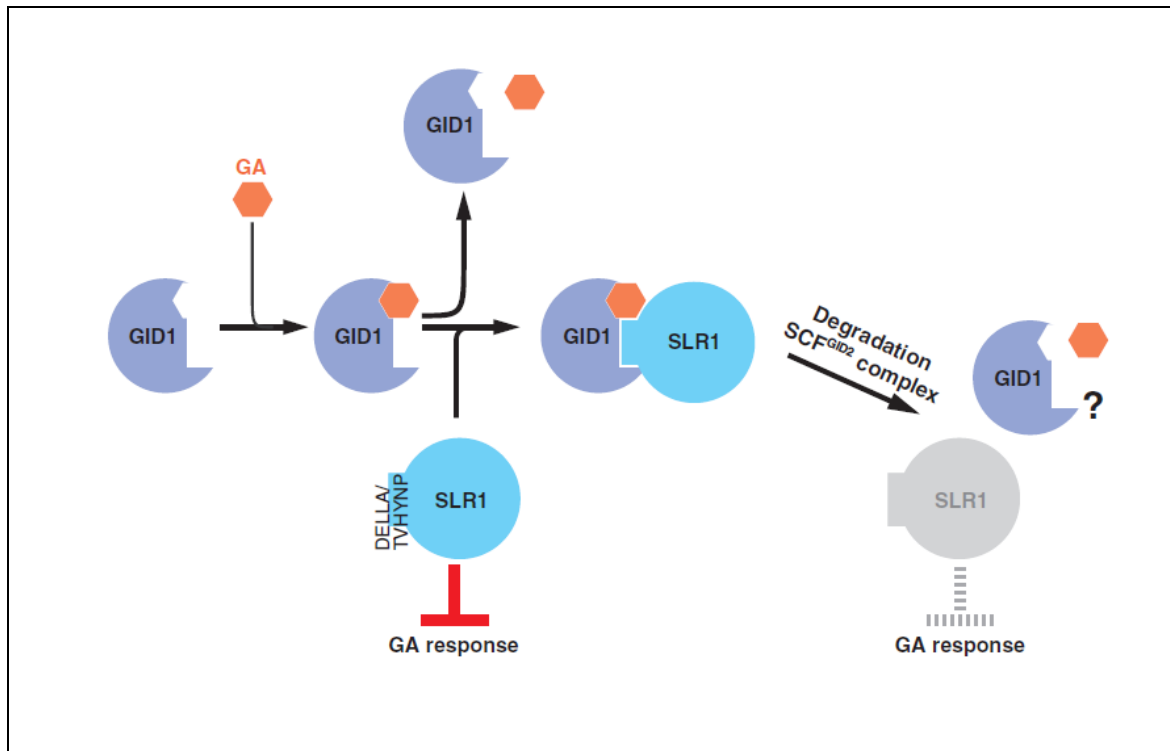

Figure 3-10 The Gibberellin - GID1 - DELLA signalling pathway (Ueguchi-Tanaka *et al.*, 2007)

When the gibberellin (GA) receptor is bound to GA, it allows DELLA proteins such as SLR1 to be targeted for proteasomal degradation. In the absence of GA, DELLA proteins are not degraded so can act as repressors of the GA response.

3.6.6. Brassinosteroids

Brassinosteroids (BR) are a class of hormones that have pleiotropic effects on growth and development through their interactions with other hormones (Clouse, 2011). This thesis will not deal with the crosstalk between brassinosteroids and other phytohormones, which could form the basis of a whole research project, so instead I will briefly outline some of their functions in root development here.

Brassinosteroids are perceived by BRASSINOSTEROID INSENSITIVE 1 (BRI1) (Wang *et al.*, 2001), a plasma membrane-localised leucine rich repeat receptor like kinase (LRR RLK). Brassinosteroids bind the extracellular domain of BRI1, causing phosphorylation of the cytoplasmic domain (Wang *et al.*, 2001). BRI1 oligomerisation and interactions with coreceptors/inhibitors regulate downstream signal transduction, eventually leading to the inactivation of the kinase BRASSINOSTEROID INSENSITIVE 2 (BIN2) in the presence of BR (Clouse, 2011). Inactivation of BIN2 means it can no longer target the BRASSINAZOLE

INSENSITIVE transcription factors (BZR1 and BZR2) allowing their nuclear translocation and activation.

Low concentrations of exogenous BR can promote root growth, whilst higher levels inhibit root growth (Chaiwanon & Wang, 2015). Brassinosteroids have been shown to regulate QC function and meristematic cell division in roots (González-García *et al.*, 2011; Hacham *et al.*, 2011; Vilarrasa-Blasi *et al.*, 2014), and show considerable crosstalk with auxin (Chung *et al.*, 2011; Chaiwanon & Wang, 2015).

There is also evidence that other plant sterols have developmental effects, as their effects on vesicle trafficking and signalling can lead to disrupted hormone transport and responses (Souter *et al.*, 2002; Lindsey *et al.*, 2003; Pullen *et al.*, 2010).

3.6.7. POLARIS (PLS)

POLARIS (PLS) is a 36 amino acid peptide that acts as a negative regulator of ethylene responses (Casson *et al.*, 2002; Chilley *et al.*, 2006). Whilst POLARIS is not a hormone as such, its interactions with auxin and ethylene responses and signalling mean it is important to understand its function in the context of this thesis. *PLS* transcription is enhanced by auxin, and repressed by ethylene (Casson *et al.*, 2002).

The *pls* null mutant displays normal levels of ethylene biosynthesis but enhanced ethylene responses, including short roots. The short root phenotype can be recovered by pharmacologically inhibiting ethylene perception or crossing with the gain-of-function ethylene resistant *etr1-1* mutant (Chilley *et al.*, 2006), implying that PLS acts at the level of the receptor. The ethylene receptor ETR1 and PLS co-localise to the endoplasmic reticulum, with *in vivo* and *in vitro* evidence of a direct interaction (Mehdi, 2009; Mudge, 2015).

The PLS peptide can bind copper *in vitro* (Mudge, 2015), and ETR1 requires a copper cofactor to bind ethylene (Rodriguez *et al.*, 1999). Flooding *pls* plants with Cu^{2+} can rescue the short root phenotype, and exogenously adding synthetic truncations of the POLARIS peptide can also rescue root length, when they include the putative copper-binding domain (Mudge, 2015). This suggests that POLARIS acts as a negative regulator of ethylene signalling by regulating the ethylene receptor through its interaction with its copper cofactor.

3.7. Modelling hormone crosstalk, patterning and responses

Systems biology is an iterative approach to science that combines experimental data and kinetic modelling to provide greater understanding. Figure 3-11 describes the typical workflow

in a modelling study. First, experimental data are used to construct one or several plausible networks of interactions. These networks are then used to create mathematical models, which are fitted to experimental data. The mathematical models are then tested against different data sets than those used for fitting. If the modelling approach fails at any stage, model construction returns to an earlier stage of the process and this failure gives insight into the nature of the biological system. If a model can predict experimental results, the model dynamics can also offer insight into the function of the biological system. Whilst all models are wrong by definition, a good model can give predictive or useful insights into the functioning of a biological system

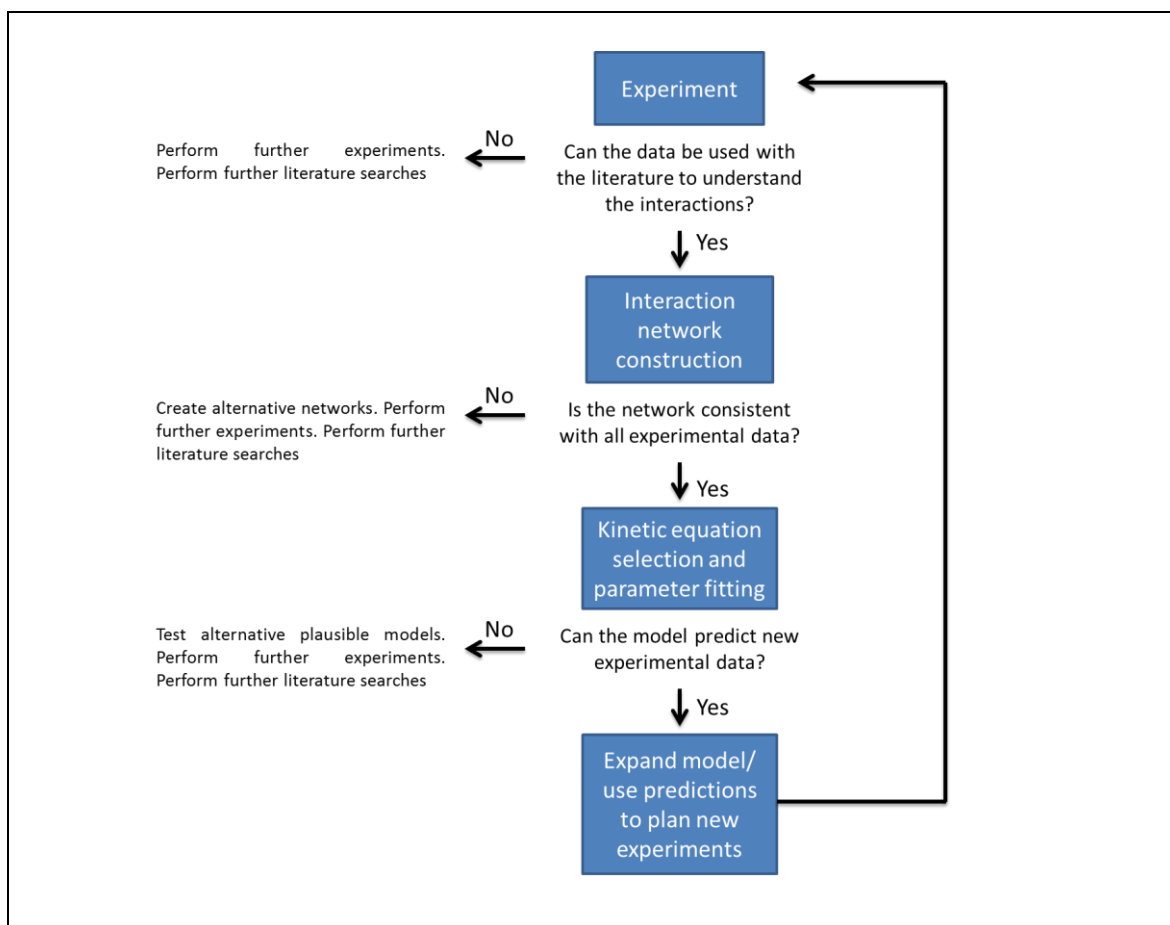

Figure 3-11 Typical experimental/modelling workflow used in systems biology, adapted from <http://www.myexperiment.org/workflows/2661.html>

There have been many kinetic models of hormone signalling published in recent years. The ethylene signalling cascade has been replicated *in silico* and can correctly predict the expression of ethylene responsive genes, in the context of plant defence (Diaz & Alvarez-Buylla, 2006). The auxin signalling cascade has been replicated, and used to predict the degradation of the DII-VENUS biosensor, in the context of understanding gravitropism (Band *et al.*, 2012b). There are also models of gibberellin signalling feedback and dilution (Band *et al.*,

2012a; Middleton *et al.*, 2012) and brassinosteroid signalling (van Esse *et al.*, 2013) however few groups have looked at the interplay between multiple hormones.

To understand better the interactions between hormones in root development, Liu *et al.* (2010) published a kinetic model of the crosstalk between ethylene, auxin and cytokinin, paying particular attention to the ethylene receptor pathway and its interactions with PLS (Figure 3-12). This model was parameterised with real data where possible, and drew upon previous experimental (Casson *et al.*, 2002; Chilley *et al.*, 2006) and modelling work (Diaz & Alvarez-Buylla, 2006) to derive its equations. Where no direct measurement was available, or the relationship was poorly defined, Liu *et al.* (2010) analysed different parameters and kinetics to fit experimental evidence qualitatively, and in some cases carried out further experimentation to better define the interactions.

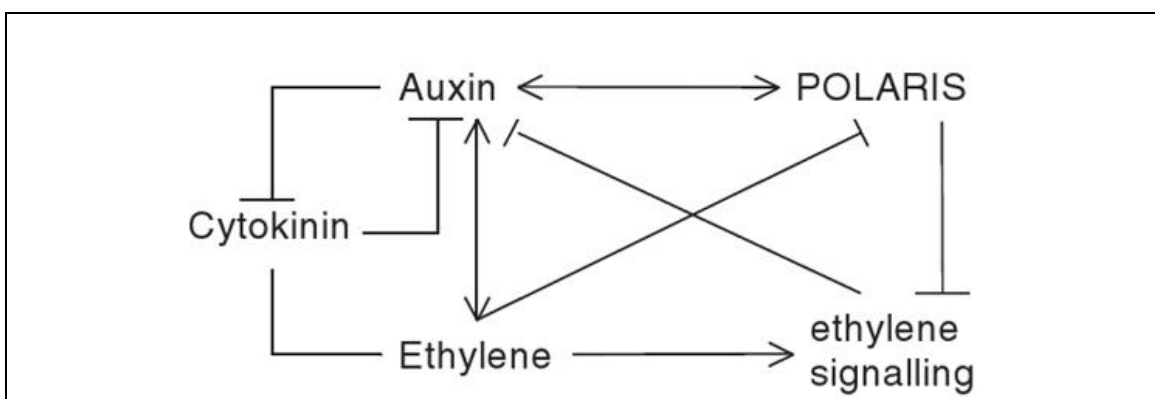

Figure 3-12 The simplified hormonal crosstalk network, described in (Liu *et al.*, 2010)

This simplified version of the network just shows the key relationships, where arrows indicate promotion and flat headed arrows indicate inhibition. Auxin and cytokinin inhibit each other's biosynthesis, but both synergistically promote ethylene biosynthesis. Ethylene promotes auxin biosynthesis and inhibits *POLARIS* expression. Auxin promotes *POLARIS* expression, inhibiting ethylene responses. *POLARIS* also promotes auxin biosynthesis.

One such analysis examined the interactions between the ethylene receptor, CTR1, ethylene and PLS. By examining different plausible points of interaction between PLS and ethylene signalling, (Liu *et al.*, 2010) showed there was no qualitative difference between using ETR1 and CTR1 as the point of interaction in simulated experiments. As the experimental evidence is stronger for ETR1 (Chilley *et al.*, 2006), their published results used this point of interaction (Liu *et al.*, 2010).

Their analysis also revealed that in order for the *pls* mutant to have signalling representative of *in vivo* experiments, PLS cannot completely activate the ethylene receptor (and so activate CTR1) and there must still be some interconversion between active and inactive states (Liu *et al.*, 2010). The interaction between PLS and ETR1 must either increase the activation of the receptor or inhibit conversion of the receptor to the inactive state, as other interactions (e.g.

an inactive PLS-ETR1 complex) gave results that didn't match experimental evidence (Liu *et al.*, 2010).

Further experimentation also helped clarify the effect of PLS on auxin concentrations (Liu *et al.*, 2010). Previously, PLS was shown experimentally to inhibit ethylene signalling (Chilley *et al.*, 2006) so the model predicted a *pls* mutant would show an increase in auxin biosynthesis, but there was no increase in auxin response or levels (Chilley *et al.*, 2006; Liu *et al.*, 2010).

This suggested that PLS might have an additional role in regulating auxin biosynthesis, for which different scenarios were also simulated (Liu *et al.*, 2010). This outcome could not be explained if PLS acts on auxin biosynthesis independently of cytokinin and ethylene's regulation, and therefore PLS must co-regulate auxin biosynthesis with ethylene and cytokinin, either separately, or in a unified pathway, as was integrated into the revised model (Liu *et al.*, 2010).

This combination of experimental and modelling analysis produced a revised crosstalk model that tallies with experimental evidence, which can be used as the basis of further modelling and experimental work and to analyse the system's dynamics. It reveals a crosstalk circuit in which auxin can be regulated by the levels of PLS and/or PLS's interaction with ethylene signalling, which adds flexibility to the relationship between ethylene and auxin concentration (Liu *et al.*, 2010).

This network was then expanded to include auxin transporter dynamics (Liu *et al.*, 2013). By integrating simple regulation of PIN protein expression by ethylene, auxin and cytokinin, the revised model could replicate the changes in the hormone levels and PIN1 or PIN2 dynamics found experimentally. The single cell models could then form the basis of a larger spatiotemporal model, which has now been constructed (Moore *et al.*, 2015b).

Previous modelling work has shown that the intercellular transport of auxin by PIN proteins can produce the auxin maximum and patterning found in Arabidopsis roots (Grieneisen *et al.*, 2007; Stoma *et al.*, 2008). With a simple root map, this work was able predict auxin patterning in transport mutants, under exogenous hormone application and under various other experimental regimes (Grieneisen *et al.*, 2007).

The auxin patterning could also be used to reproduce patterning of *PLETHORA* (*PLT*) expression (Mahonen *et al.*, 2014). PLT are transcription factors that are key in determining root zonation and development (Aida *et al.*, 2004; Galinha *et al.*, 2007; Mahonen *et al.*, 2014). Modelling of auxin distribution, and the resultant PLT levels can therefore be used to predict the zonation

and growth dynamics in a simplified Arabidopsis root (Grieneisen *et al.*, 2007; Mahonen *et al.*, 2014).

Spatiotemporal models of auxin transport and signalling which used an experimentally derived root map have demonstrated the importance of the AUX/LAX family of auxin carrier family to determining auxin maxima (Band *et al.*, 2014). This modelling work illustrates that to produce correct patterning polar auxin efflux via PIN proteins is required for correct directionality and flux, but levels of the AUX1/LAX influx carriers determines the sites of auxin accumulation (Band *et al.*, 2014).

By integrating the intracellular auxin transport (Grieneisen *et al.*, 2007) with our single cell model of hormone crosstalk a spatiotemporal model of hormone crosstalk was constructed (Moore *et al.*, 2015b). This model could reproduce patterning of auxin and ethylene responses, the expression pattern of POLARIS, and hormone levels in various mutants, as seen in Figure 3-13 (Moore *et al.*, 2015b).

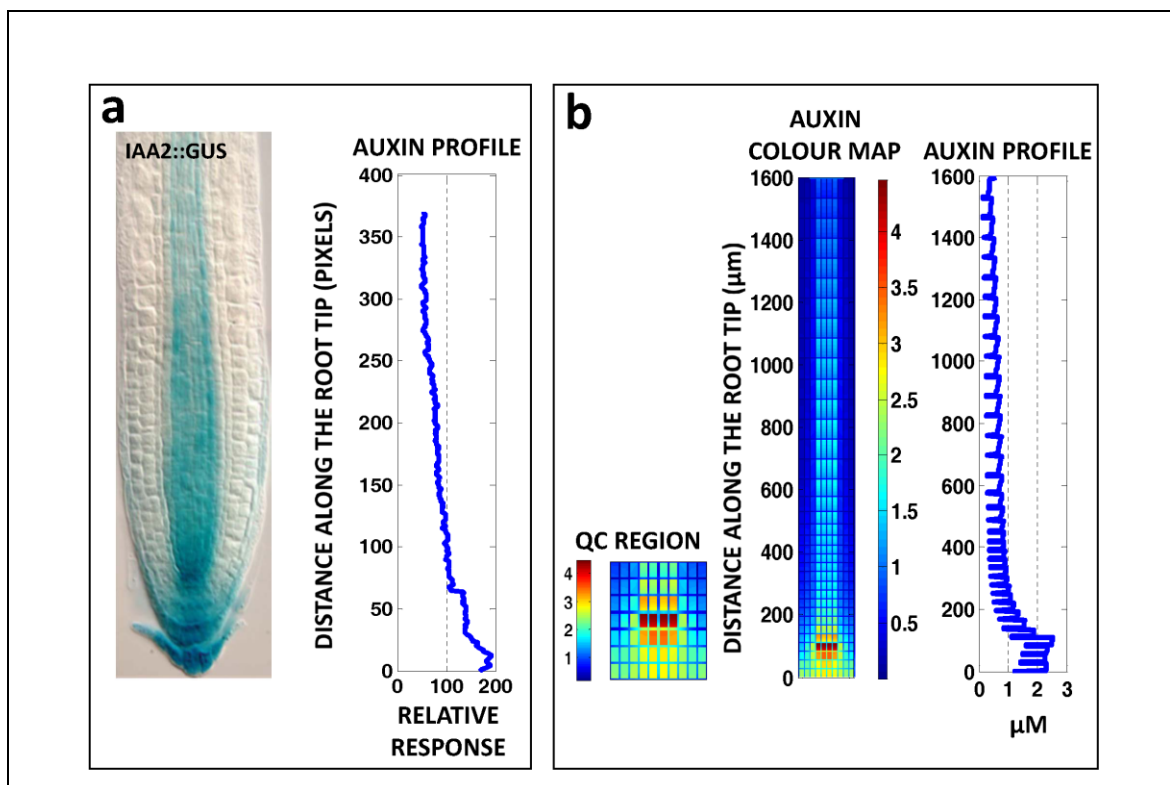

Figure 3-13 The spatiotemporal model can reproduce auxin response patterning. Taken from (Moore *et al.*, 2015b)

a) *proIAA2::GUS* an auxin responsive gene shows an auxin maxima in the quiescent centre, with a strong auxin response in the root cap and stele. b) The spatiotemporal model can reproduce this patterning of auxin response with a simplified grid based root-map.

This model then forms a fairly robust platform upon which we hope to integrate stress hormone responses and their effects on root growth. These hormonal responses to osmotic stress and their crosstalk will be discussed in the next section. The integration of my

experimental data and modelling analysis with other experimental data and modelling analysis in the literature will be detailed in the results chapters and Discussion chapter.

3.8. The regulation of root system architecture under osmotic stress

Under osmotic stress, the number of lateral roots and lateral root length in *Arabidopsis* are reduced (van der Weele *et al.*, 2000; Deak & Malamy, 2005). This regulation of lateral root initiation and elongation is probably regulated through ABA and auxin (De Smet *et al.*, 2003; Deak & Malamy, 2005). For light grown plants, primary root elongation increases under mild osmotic stress, and decreases under severe osmotic stress (van der Weele *et al.*, 2000).

The increase in elongation under mild osmotic stress appears to be ABA regulated, and associated with an increase in basipetal auxin transport (van der Weele *et al.*, 2000; Xu *et al.*, 2013). Inhibiting basipetal auxin transport, or ABA biosynthesis can prevent the increase in root length seen under osmotic stress (Xu *et al.*, 2013). ABA levels increase under osmotic stress and treating unstressed plants with low levels of exogenous ABA can promote root growth, whereas high levels inhibit root growth (Ghassemian *et al.*, 2000).

It remains to be seen whether root elongation under stress is regulated wholly through ABA or through its interactions with other hormones. Under unstressed conditions, ABA can promote ethylene biosynthesis by promoting the phosphorylation of ACC SYNTHASE 6 (ACS6) (Luo *et al.*, 2014; Thole *et al.*, 2014). Phosphorylation is known to stabilise ACS6, which is one of a family of enzymes that catalyse a critical step in ethylene biosynthesis (Vogel *et al.*, 1998; Chae *et al.*, 2003). Ethylene is known to increase basipetal auxin transport to limit root growth (Ruzicka *et al.*, 2007) and the ethylene responsive auxin transporters PIN2 and AUX1 are required to limit root growth under high levels of ABA treatment (Thole *et al.*, 2014).

It is worth noting that these *Arabidopsis* experiments, carried out on agar plates, show conflicting results with other systems. Vermiculite-based systems suggest that ABA promotes root growth in dark grown maize under water deficit, and that this is achieved by limiting ethylene biosynthesis (Sharp, 2002), but it is unclear how much of this is attributable to differences between species or differences between experimental systems. Vermiculite is mechanically harder than nutrient agar, so it may be that mechanical effects increase under water deficit (Whalley *et al.*, 2005), increasing ethylene biosynthesis (Sarquis *et al.*, 1991).

In *Arabidopsis*, there is also evidence of a second light regulated pathway, in which ABA represses ethylene biosynthesis, which may offer an alternative explanation for the discrepancy between experimental systems. ABA can repress ethylene biosynthesis by modulating the binding of the HY5 transcription factor to the *ERF11* promoter, but HY5 is

broken down in the presence of light (Osterlund *et al.*, 2000; Li *et al.*, 2011). In the presence of ABA, ERF11 represses the expression of *ACS2* and *ACS5* (Li *et al.*, 2011), which encode key enzymes in the ethylene biosynthesis pathway (Vogel *et al.*, 1998).

3.9. Project objectives

Therefore, an important question to address is what roles ethylene and ABA play to regulate growth under osmotic stress. Both hormones have been shown to also affect auxin transport (Ruzicka *et al.*, 2007; Shkolnik-Inbar & Bar-Zvi, 2010; Thole *et al.*, 2014), which is one of the primary determinants of root growth (Evans *et al.*, 1994). The first results section of my thesis will examine how these three hormones affect root growth under osmotic stress. The second results chapter will detail how osmotic stress affects hormone transport and gene expression under stress. The third results chapter will use this knowledge, as well as the literature, to create a network of all the interactions between ABA, auxin, cytokinin and ethylene under stress, providing a framework for modelling. My final results chapter will use modelling to examine a question about the regulation of PIN1 expression that arises from experimental data. My four result chapters integrate experimental data, network construction and modelling analysis, developing novel insights into how osmotic stress affects hormone crosstalk and root growth phenotypes.

4 Materials and Methods

4.1. Chemical suppliers

Chemicals and consumables were purchased from SIGMA ALDRICH, unless an alternate supplier is stated.

4.2. Plant Materials

Arabidopsis thaliana wildtype seeds were from lab stocks of the Columbia (Col-0) or C24 ecotypes, originally obtained from Lehle Seeds (Texas, USA). *polaris (pls)* mutant seeds were previously generated by GUS promoter trapping in the C24 background (Topping *et al.*, 1994; Topping & Lindsey, 1997). *proPLS::GUS*, *proPLS::PLS:GFP* and *35S::PLS* seeds (*PLSox*) in the Col-0 background were previously generated by floral dipping (Casson *et al.*, 2002).

pDR5rev::3xVENUS-N7 (Heisler *et al.*, 2005), *35S::DII-VENUS-N7* (Brunoud *et al.*, 2012), and *pTCS::GFP* (Muller & Sheen, 2008) (all Col-0 background) were obtained from the Nottingham Arabidopsis Stock Centre (NASC).

proAUX1::AUX1-YFP(116) was obtained courtesy of Ranjan Swarup (Nottingham University).

proPIN1::PIN1::GFP (Benkova *et al.*, 2003), *proPIN2::PIN2::GFP* (Xu & Scheres, 2005) and *proPIN4::PIN4::GFP* (Vieten *et al.*, 2005) were obtained courtesy of Ben Scheres (Wageningen University). *proARR5::GFP* and *proARR5::GUS* (Ws background) were obtained courtesy of Joseph Kieber (University of North Carolina).

35S::GFP:MAP4 (Marc *et al.*, 1998) and *35S::GFP:LIFEACT* (Smertenko *et al.*, 2010) were obtained courtesy of Patrick Hussey (Durham University).

proRGA::RGA::GFP (Silverstone *et al.*, 2001) (Col-0 background) were obtained courtesy of Ari Sadanandom (Durham University).

pin1-5 (SALK_097144C), *pin1-7* (SALK_047613) (Col-0 background) were obtained from uNASC and genotyped phenotypically.

4.3. Seed sterilisation

Seeds were sterilised for 30s with 70% (v/v) ethanol and ten minutes with 20% commercial bleach 0.1% Tween 20 then washed five times with sterile distilled water.

4.4. Growth conditions for osmotically stressed seedlings

Seeds were placed on 10cm round plates of half strength Murashige and Skoog (Sigma, 2.2 g/l) Agar (Sigma, 5 g/l) media and sealed with Micropore tape. To ensure simultaneous

germination, these seeds were stratified for 4-7 days at 4°C before being grown horizontally in a growth room (22°C, 18h photoperiod).

Five days after germination (DAG), the seedlings were transferred to polyethylene glycol (PEG) infused ½ MS agar plates with water potential (ψ_w) of -0.14, -0.37 or -1.2 MPa, adapted from (Verslues *et al.*, 2006). The plates were sealed with Micropore tape and placed in a growth room for 6 or 24 hours (22°C, 18h photoperiod).

For GUS staining, the seedlings were transferred three days after germination to polyethylene glycol (PEG) infused ½ MS phytigel plates adapted from (Verslues *et al.*, 2006). Because these plates were made with a high concentration of phytigel they had a different osmolarity to agar plates (ψ_w =0.15, -0.5 or -1.5 MPa), The plates were sealed with Micropore tape and placed in a growth room for three days (22°C, 18h photoperiod). The longer stress treatment was to allow for the turnover of the β -glucuronidase protein, which has a long half-life.

4.5. Preparation of hormone stock solutions

Hormones were dissolved to a 10 mM stocks as per and stored for a maximum of 1 month at -20C .

Hormone/chemical	Method
1-aminocyclopropane-1-carboxylic acid (ACC) – an ethylene precursor	0.0101 g dissolved in 10 ml sdH ₂ O and filter sterilised
Silver thiosulphate (STS, AgS ₂ O ₃) – Binds to the copper atom in ETR1 to inhibit ethylene responses	17mg of AgNO ₃ (silver nitrate) was dissolved in 5 ml of sdH ₂ O. 63.5 mg of NaS ₂ O ₃ (sodium thiosulphate) was dissolved in 5ml sdH ₂ O. Silver nitrate solution was then added dropwise to the Sodium thiosulfate to a final volume of 10 ml and filter sterilised.
Indole-3-acetic acid (IAA) – The principal free auxin in plants	Dissolved 17.5 mg IAA in 5 ml 98% ethanol. This is then topped up to 10 ml with sdH ₂ O and filter sterilised.
6-benzylamino-purine (BA) – A synthetic cytokinin	22.53 mg of BA was dissolved in 2 ml of 0.5M HCl. This was then made up to 10 ml with sdH ₂ O and filter sterilised.
<i>cis/trans</i> - Abscisic acid (ABA)	22.6 mg of ABA was dissolved in 10 ml methanol and filter sterilised
Fluridon – An inhibitor of abscisic acid biosynthesis	32.9 mg of fluridon was dissolved in 10 ml of methanol and filter sterilised

Table 4-1 Hormone stock solution preparation

4.6. Analysis of root length

The agar plates containing the seedlings were placed on an Epson 1680 pro flatbed scanner and digitised. The FIJI distribution of ImageJ 1.48 (<http://rsbweb.nih.gov/ij/>) was used to analyse the daily growth of the roots under different conditions and Microsoft Excel 2011 was used for data analysis and graphing.

4.7. Preparation of polyethylene glycol infused plates, adapted from (Verslues *et al.*, 2006)

As polyethylene glycol (PEG) breaks down in an autoclave, plates of ½ MS agar media were poured, and then an overlay solution containing the PEG was poured over the plates and time allowed for the PEG to diffuse into the medium.

Both the agar media and overlay solution contained ½ MS salts (Sigma, 2.2 g/l) and MES buffer (Sigma, 6mM, 1.2 g/l) and were adjusted to pH 5.7 by adding 0.1M KOH solution. High gel strength agar (Melford 5 g/l) was added to the base media before autoclaving.

After autoclaving, PEG-8000 (Sigma) was added to the liquid overlay solutions depending on the desired osmotic pressure of the plate (Table 4-2). 40 ml of agar media was poured onto 10 cm square plates and allowed to set, after which 60 ml of the appropriate overlay solution added. The plates were sealed with Parafilm allowed to equilibrate for 15-24 hours and the overlay solution removed before transferring seedlings and resealing with Micropore tape.

Medium water potentials were verified using a Wescor 5600 osmometer (ELITech, Berkhamsted, Herts., UK); the large sample chamber was used to allow direct measurements of solid media. Osmolarity data were verified in 10 independent measurements for each treatment.

Predicted final media water potential (ψ_w) of agar media (MPa)	PEG added to overlay solution (g/l)
-0.15 to -0.25 (Unstressed)	0
-0.3 to -0.5 (Moderate stress)	250
-1.2 to -1.5 (Severe stress)	550

Table 4-2: The mass of PEG required in 1 litre of overlay solution to achieve a desired osmotic pressure (Verslues *et al.* 2006)

4.8. RNA extraction/ DNase/ cDNA synthesis

100 mg (approximately 30 seedlings at 5 or 6 DAG) were flash frozen with liquid nitrogen. Seedlings were ground on dry ice whilst still frozen and RNA was extracted using a Sigma Spectrum Total RNA kit (Sigma Aldrich) and DNase digestion was performed with the Sigma On-column DNase kit (Sigma Aldrich). RNA concentration was determined with a Nanodrop ND1000 Spectrophotometer (ThermoFisher Scientific, Hemel Hempstead, UK).

5 ng of RNA in a 20 μ l reaction mixture was used for cDNA synthesis, using the Invitrogen Superscript III First Strand Synthesis System (Invitrogen Ltd, Paisley, UK).

cDNA was diluted 1:4 for PCR and qPCR. cDNA was tested for genomic DNA contamination by PCR amplification of *ACT2*, using primers designed over an intron (Table 11-1). Samples contaminated with genomic DNA were treated with Promega RQ1 DNase, which was then denatured before the cDNA synthesised again.

4.9. Polymerase chain reaction (PCR)

The following reaction mix made used for each PCR reaction (20µl total)

	X1
10X NH ₄ Reaction Buffer	2 µl
MgCl ₂ 50mM	0.5 µl
Bioline BioTaq	0.2 µl
dNTPs 10mM	0.2 µl
Primer F 20µM	0.5 µl
Primer R 20µM	0.5 µl
RNase/DNase free water	15.6 µl
Template	0.5 µl

An Applied G-Storm GS1 PCR machine was used with the following program:

	94°C	3 mins
30X	94°C	30s
	X°C*	30s
	72°C	45s
	72°C	7 mins

*Annealing temperature (X) was determined with a gradient PCR varying temperature from seven degrees below the T_m to two degrees above. Specific annealing temperatures are detailed in the **Primer** section.

4.10. Quantitative real-time polymerase chain reaction (qPCR)

SYBR Green Jumpstart Taq Readymix (Sigma Aldrich) was used for with a Corbett Scientific Rotorgene Q (Now Qiagen).

Reaction mix for one reaction (20 µl total):

Primer F (20µM)	0.25 µl
Primer R (20µM)	0.25 µl
cDNA	0.5 µl
SYBR Jumpstart Readymix 2X	10 µl
sdH ₂ O	9 µl

The following PCR program was used:

	95°C	7 mins
40X	95°C	20 s
	X°C*	20 s
	72°C	30 s – Data capture on FAM channel
Melt curve	50 – 95°C	3 minutes at 50 then increasing 1°C every 5 seconds

*Annealing temperatures (X) were primer specific and optimised with a gradient PCR before qPCR, as detailed above. These temperatures are detailed in the appendix (Table 11-1).

SYBR Green Jumpstart Taq Readymix (Sigma Aldrich) was used for with a Corbett Scientific Rotorgene Q (Qiagen, Manchester, UK).

Expression of each gene was calculated using the Rotorgene Q Series software v1.7, using the $\Delta\Delta CT$ method relative to expression of a paired reference gene amplification, according to the manufacturer's instructions. Amplification efficiencies of the genes of interest were checked to ensure they were all within 5% of the reference gene amplification efficiency. Melt curves were used to check for nonspecific/unwanted products and primer dimers. Stability of reference genes were verified by $\Delta\Delta CT$ comparison between all samples and the control. All sample amplifications were done in triplicate for technical repetition, with three biological replicates. AT5G15710 was selected as a reference gene, due to its stable expression patterns under osmotic stress, under hormone applications and at various developmental stages (Czechowski *et al.*, 2005).

4.11. Statistical analysis

All statistical tests were performed in Microsoft Excel 2010, using the Real Statistics add in (<http://www.real-statistics.com/>). The 0.05 level of significance was used. In general, 1 or 2 factor ANOVAs were used to test for significance, and either a Bonferroni contrast was used to means or a Tukey *post hoc* pairwise comparison was used to compare means. Uneven variances were dealt with by natural log transformation of the data before the ANOVA. Where data was non-parametric or had uneven variance, a Kruskal-Wallis test was used as an alternative to a 1 factor ANOVA.

4.12. Histochemical staining of root tips for β -glucuronidase activity

Seedlings were stained with 1 mM N-N-dimethylformamide in 100 mM sodium phosphate (pH 7.0), 10 mM EDTA, 0.5 mM Potassium ferrocyanide, 0.5 mM Potassium ferricyanide, 0.1% v/v Triton X buffer as described (Casson *et al.*, 2002). Treated seedlings were vacuum infiltrated at room temperature for 5 minutes with an Eppendorf concentrator 5301, and then incubated at 37°C until the desired staining level was achieved. The reaction was stopped with by replacing

the substrate solution with a 70% ethanol solution, in which the seedlings could be stored for a prolonged period before imaging. To image, the seedlings were rehydrated with deionised water before mounting, and transferred to a slide mounted with a chloral hydrate/glycerol/water solution (8g/2ml/1ml) or Hoyer's (Anderson, 1954) and imaged within 30 minutes.

4.13. Compound Light microscopy

Root tips were mounted in chloral hydrate/glycerol/water solution (8g/2ml/1ml) or Hoyer's solution (Anderson, 1954) and imaged on a Zeiss Axioskop microscope (Carl Zeiss, Cambridge, UK), fitted with a Retiga 2000R camera (Photometrics, Marlow, UK) and using the 20X Neoflu lens and differential interference contrast (DIC). At least three roots of each treatment were imaged, and the representative images were compiled in GIMP 2.8 software (www.gimp.org).

4.14. Confocal laser scanning Microscopy

Before transferring to osmotic stress plates, plants were screened for the same developmental stage and for fluorescence under a Leica stereo dissecting microscope with fluorescence (www.leica-microsystems.com). After 24 h osmotic treatment, roots were imaged. Whole seedlings were transferred to a propidium iodide solution (0.5 µg/mL) for 1 minute 30 seconds and washed for the same time in deionised water. Root tips were then removed with a razor blade and transferred to a slide. Roots were imaged with a Leica SP5 laser scanning confocal microscope (www.leica-microsystems.com). Gain, line averaging, detection frequencies and other microscope settings were altered between fluorescent marker lines to optimise image quality, but not between roots of the same marker line, to ensure comparability. YFP was excited with the 514 nm band of the argon laser, GFP excited with the 488 nm band of the argon laser and propidium iodide was excited at 548 nm. Sequential scans were used and detection spectra were optimised to minimise crossover between different fluorophores.

4.15. Analysis of confocal images

Images were initially processed with the LAS AF Lite software (v2.63 build 8173 <http://www.leica-microsystems.com/products/microscope-software/life-sciences/las-af-advanced-fluorescence/>).

For assessing changes in fluorescence, various tools were used, depending on the type of data required.

Image J was used to assess total mean fluorescence of DII:VENUS, PLS:GFP, proARR5:GFP, pTCS:GFP and 35S:GFP. A polygon selection was used to draw round the whole root and the 'colour histogram' tool was used to quantify the mean green channel intensity. Background

intensity was measured in an area of the image excluding the root and this value subtracted from the mean root fluorescence. Images of 5-10 individual roots were analysed for each treatment.

For PIN1:GFP fluorescence, the mean intensity in a 100 μm long selection of the stele, proximal to the quiescent centre was recorded. Images of 5-10 individual roots were analysed for each treatment.

For DII:VENUS both stele and epidermis/cortex fluorescence were measured in ImageJ. A polygon selection was used to draw around the appropriate cell files and colour histogram was used to measure mean green fluorescence. Background intensity was measured in an area of the image excluding the root and this value subtracted from the mean root fluorescence. Images of 5-10 individual roots were analysed for each treatment.

For AUX1:YFP(116) and PIN2:GFP, dynamic range and contrast were adjusted with the red propidium iodide channel to aid cell wall detection downstream, but fluorescent construct channels were not. Downstream analysis was performed with CellSet v1.5.1 (Pound *et al.*, 2012) allowing semi-automated detection of cell walls. Green channel mean fluorescence at cell walls was divided by cell wall length to give mean intensity. For PIN2:GFP, only polar membranes in the epidermis and cortex were used for analysis. For AUX1:YFP(116) only membranes in the lateral root cap were used for analysis. Images of 5-10 individual roots were analysed for each treatment.

4.16. Gel electrophoresis

Typically, gels were made with 1.2% (w/v) agarose dissolved in 1X TAE buffer by microwave. Ethidium bromide was added before pouring to give a final concentration of 0.5 $\mu\text{g/ml}$. Gels were loaded with 8 μl of PCR product with 2 μl of 5X DNA loading buffer, and run for 40 minutes at 70 V with a separate lane containing 5 μl of Biorad Hyperladder IV for size estimation. Gels were imaged with a BioRad Gel-Doc 1000.

4.17. Primers

Primers were designed with Primer-BLAST (<http://www.ncbi.nlm.nih.gov/tools/primer-blast/>) and Amplify 3.1 (<http://engels.genetics.wisc.edu/amplify/>), checked for secondary structure with the Sigma Oligonucleotide calculator (<http://www.sigmaaldrich.com/life-science/custom-oligos/custom-dna/learning-center/calculator.html>) and synthesised by MWG Eurofins (<http://www.eurofinsdna.com/>). For qPCR, primers were designed where possible on either side of an intron to ensure amplification of genomic DNA could be detected on an agarose gel or through melt curve analysis. qPCR primers were designed to amplify 80 -200 nucleotide

fragments with T_m values of approximately 60 °C. Primer sequences are listed in Table 11-1 of the Appendix.

4.18. Transcriptomic analysis

All gene expression analysis was performed using Genevestigator build 4-36-0 (Hruz *et al.*, 2008). The perturbations tool allowed comparison of the relative expression of genes under a variety of experimental treatments.

4.19. Transcriptomic experiment selection

The following criteria were used to select experiments that were comparable to our experimental condition:

- Tissue used must be Columbia (Col-0) or C24 wildtype, whole seedling or root tissue only.
- Plants must be grown in tissue culture for between 5 and 21 days old before transfer to treatment.
- Hormone treatments
- Osmotic stress treatment must be induced by transferring plants to a suitable osmoticum (i.e. PEG, mannitol or sorbitol)

Experiments are listed in Table 11-2 of the Appendix.

4.20. Transcriptomic gene selection

4.20.1. Cytokinin-responsive gene expression

Nineteen genes were selected for increased expression under cytokinin application from a previously published transcriptomic meta-analysis (Bhargava *et al.*, 2013). The genes were selected because they were significantly upregulated under cytokinin treatments in at least ten of the thirteen Genechip assays previously performed, and had their expression increase verified by another method (e.g. qPCR, northern blotting etc). This gene selection is listed in Table 11-3 of the Appendix.

4.20.2. Auxin-responsive gene expression

Seven auxin-responsive genes were selected based a previously published analysis of existing transcriptomic studies (Paponov *et al.*, 2008). These genes were selected due to significantly increased expression under exogenous auxin application in at least six of seven published data sets and showed expression specifically in root tissues. This gene selection is listed in Table 11-4 of the Appendix.

4.20.3. Abscisic acid-responsive gene expression

No meta-analysis of ABA-responsive gene expression has been performed, so 19 genes were selected based on their upregulation under ABA treatment and the prolonged stability of their response to give an indicator of ABA hormone responsiveness (Seki *et al.*, 2002). Several of these are already well characterised ABA-responsive genes (KIN2, ABI1 etc.) but the genes were also verified against other publicly available transcriptomic data sets. This gene selection is listed in Table 11-5 of the Appendix.

4.20.4. Ethylene biosynthetic gene expression

No meta-analysis of ethylene-responsive gene expression has been performed. As the level of ACC-synthase (ACS) activity limits the rate of ethylene biosynthesis, the nine true ACS genes were selected as indicators of ethylene biosynthesis. This gene selection is listed in Table 11-6 of the Appendix.

4.21. Modelling

4.21.1. Network construction

The first stage in creation of a kinetic model is construction of a network of interactions of the biological species involved. This network is a schematic representation of all the assumptions that the model will make. First experimentation and exhaustive literature searches are performed to gather all information on any potential interactions. The importance given to any potential interaction during network construction is determined by the amount of evidence supporting the interaction by systematically questioning the evidence for each interaction:

- Is there is a molecular basis for the interaction?
- Is the experimental evidence mechanistic or correlative?
- Is the evidence in the literature consistent or conflicted?
- Is the level (hormone, gene, transcript or protein etc.) that the interaction occurs at known?
- How large is the effect?

If one single network cannot explain all the phenomena, multiple networks may be constructed and tested. The systematic construction of these biological networks means they can significant insight to the biological phenomena studied, however to truly test the dynamics of the system, a quantitative kinetic model must be made.

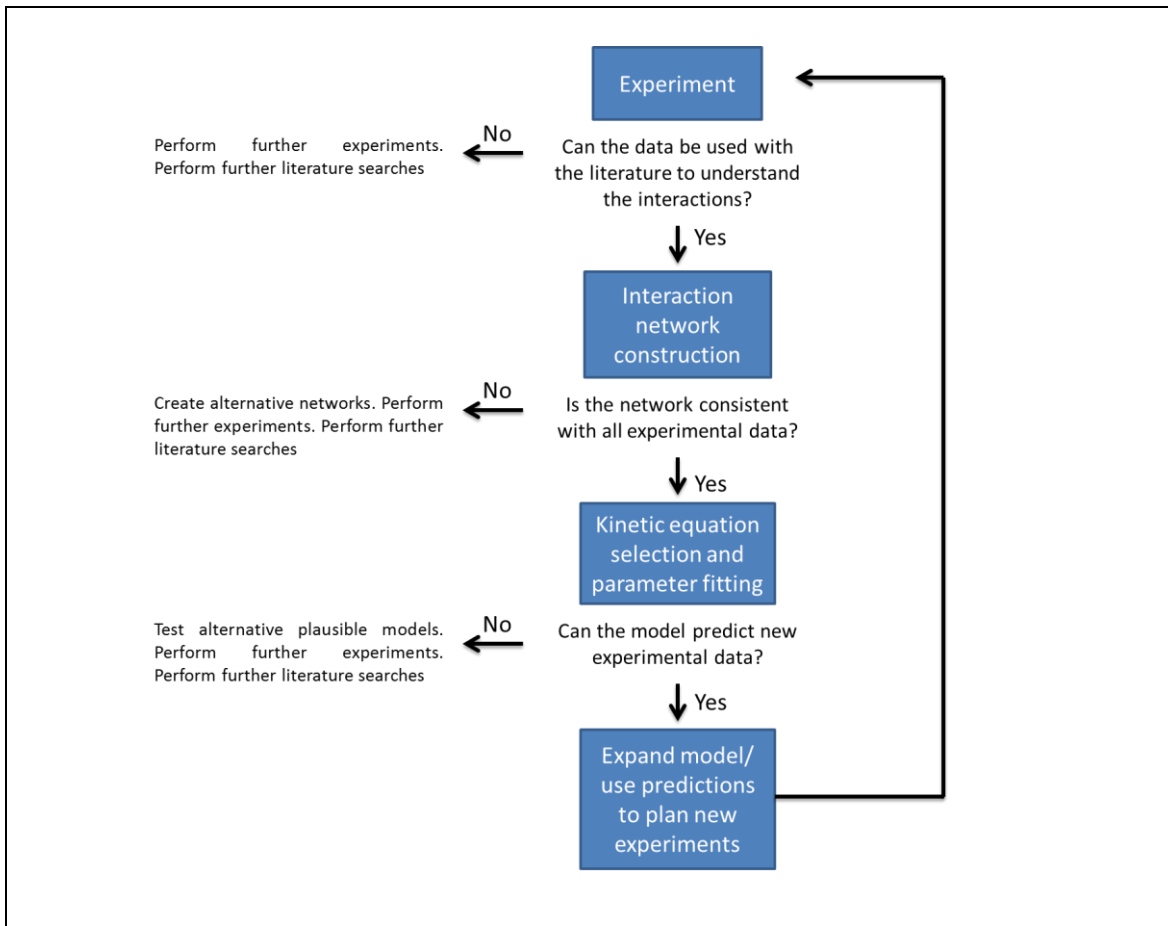

Figure 4-1 Typical experimental/modelling workflow used in systems biology, adapted from <http://www.myexperiment.org/workflows/2661.html>

4.21.2. Kinetic modelling

When producing a kinetic model, each reaction species (e.g. auxin) is given an initial concentration, and then ordinary differential equations are used to map each interaction in the network. Each species must have a kinetic equation for the rate of production, degradation or transport, determining how its concentration changes through time. Many of these reactions will be promoted or inhibited by other biological species (e.g. auxin may increase the rate of ethylene biosynthesis). As such, choosing the appropriate kinetic equation to accurately represent the kinetics and choosing the reaction parameters that are important in determining the dynamics of the model. For many interactions, there is enough biological knowledge to choose or derive an appropriate equation, for others the simplest equation can be assumed first, then its dynamics are tested to examine if it shows the correct trend. Figure 4-2 describes the typical workflow used to determine the kinetic equations when constructing the models.

Once the kinetic equations are selected, the parameters are determined by fitting the modelling predictions to experimental datasets. This is done by running timecourses until the model reaches steady state, and the concentrations of all species are compared to experimental data. If the trends in the data do not match the experimental data, parameters

are adjusted and the process is repeated until they do. Not all data is used during fitting, to allow some data to be used to test the model's predictions.

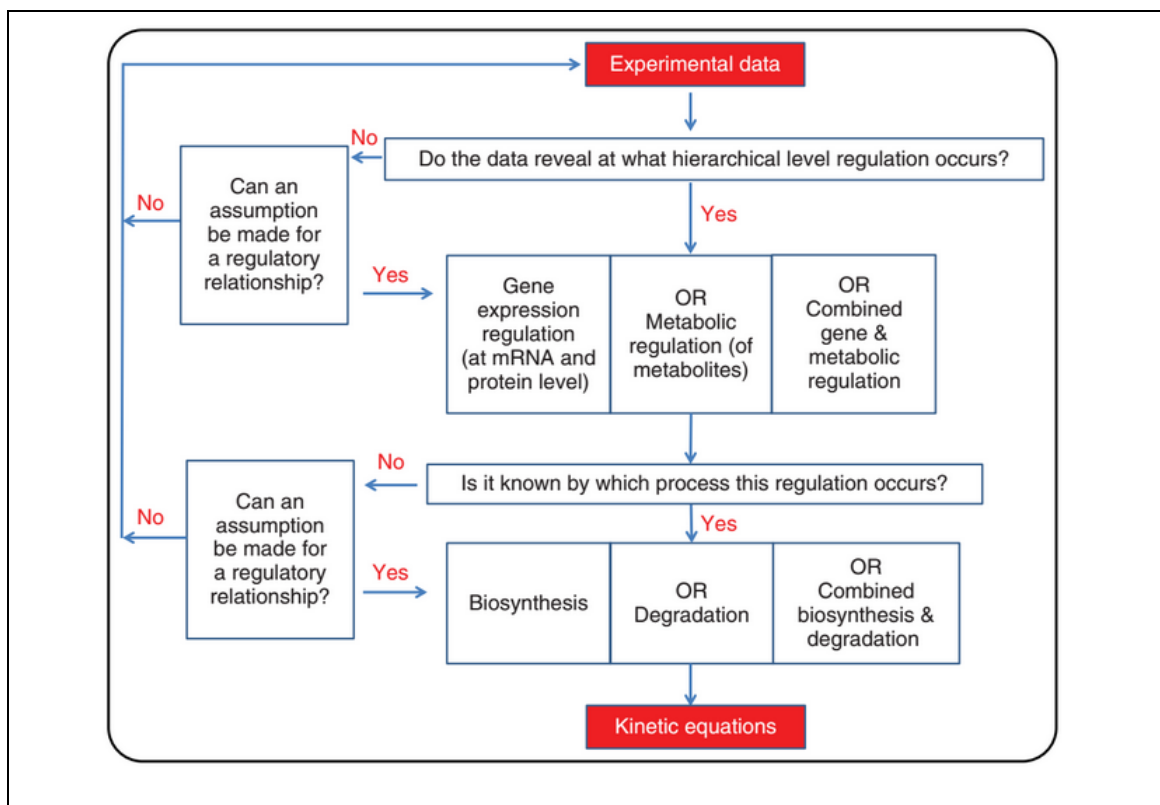

Figure 4-2 The workflow and criteria used to turn regulatory relationships into kinetic equations used in modelling, used with permission from (Moore *et al.*, 2015a)

4.21.3. Software and simulation settings

All modelling was performed in COPASI v4.11 (build 64), which allows kinetic modelling and offers a host of tools to aid in construction and testing of models (Hoops *et al.*, 2006). Much of the work was replicated independently in Berkeley Madonna by Dr. Junli Liu (Durham University) for verification (Macey *et al.*, 2000). Initially parameters were set to the default value of 0.1, and then fitted manually, to qualitatively match the data. Deterministic (LSODA) modelling was used, and in each case the model was run until it reached steady state. In the COPASI repository, the absolute tolerance (i.e. number of decimal places all simulations were performed to) for numerical computations is 1.0E-12. Much smaller absolute tolerances were also tested, and the numerical results showed that further reduction of absolute tolerances for both iterations does not improve the accuracy of numerical simulations. Data was exported from parameter scans, and plotted in Microsoft Excel. Comparisons with experimental data were performed by normalising the experimental data to the steady state unstressed, untreated value and plotting them both, to see whether it could qualitatively reproduce the data.

5 The effect of osmotic stress and hormones on root growth and morphology

5.1. Introduction

Soils form a complex environment, and roots under drought stress face multiple challenges that can alter their development. As well as osmotic stress, plants may also encounter reduced nutrient uptake and mechanical impedance (Alam, 1999; Whalley *et al.*, 2005). Less clear are the mechanisms by which these stresses mediate developmental changes.

Classic studies have shown that ABA biosynthesis and accumulated levels increase under drought stress (Zhang & Davies, 1987) and this response pathway is conserved among vascular and non-vascular land plants, including bryophytes (Takezawa *et al.*, 2015). Low levels of applied ABA or osmotic stress can increase root growth, whilst high levels can inhibit growth (Ghassemian *et al.*, 2000). Other hormones also play roles under drought - perturbing cytokinin, auxin or ethylene pathways can have effects on survival or development under osmotic stress (Tran *et al.*, 2007; Nishiyama *et al.*, 2011; Cheng *et al.*, 2013; Shi *et al.*, 2014; Cui *et al.*, 2015; Kumar & Verslues, 2015).

Extensive work has been carried out on how the crosstalk between ethylene and ABA affects root growth. Ethylene-deficient and -insensitive mutants display increased ABA biosynthesis and responses, but have reduced responsiveness to ABA inhibition of root growth (Beaudoin *et al.*, 2000; Ghassemian *et al.*, 2000; Cheng *et al.*, 2009). Phenotypic analysis of ethylene and ABA mutants has revealed little crosstalk between the signalling pathways directly (Cheng *et al.*, 2009), but ethylene regulates root growth by altering auxin transport and biosynthesis and several auxin transport mutants show reduced sensitivity to ABA in root length assays (Ruzicka *et al.*, 2007; Swarup *et al.*, 2007; Thole *et al.*, 2014).

Most of these experiments were carried out under unstressed conditions, and how hormone interactions regulate growth under osmotic stress remains poorly defined (van der Weele *et al.*, 2000; Liu *et al.*, 2014). In this chapter, the effects of osmotic stress and hormone application on root growth and morphology are examined.

5.2. Osmotic stress treatment

Osmotic stress was induced by transferring seedlings to ½ MS agar containing high molecular weight poly(ethylene glycol), PEG 8000, five days after germination (DAG) (van der Weele *et al.*, 2000; Verslues *et al.*, 2006). This allows us to allow us to examine the effects of osmotic stress independently of the solute uptake and ionic stresses that mannitol/sorbitol/salt may cause or the mechanical impedance that can result from soil drying (Verslues *et al.*, 2006). Two stress treatments were chosen - a moderate stress (-0.37 MPa) and a severe stress (-1.2 MPa), and osmotic pressures (osmolarity) of the media were verified using a vapour pressure osmometer (Figure 5-1). Plates without PEG were found to have an osmotic pressure of -0.14

MPa. Osmotic stress media was measured at the endpoint of 24 hour stress treatments on 10 separate occasions to verify consistent osmolarity.

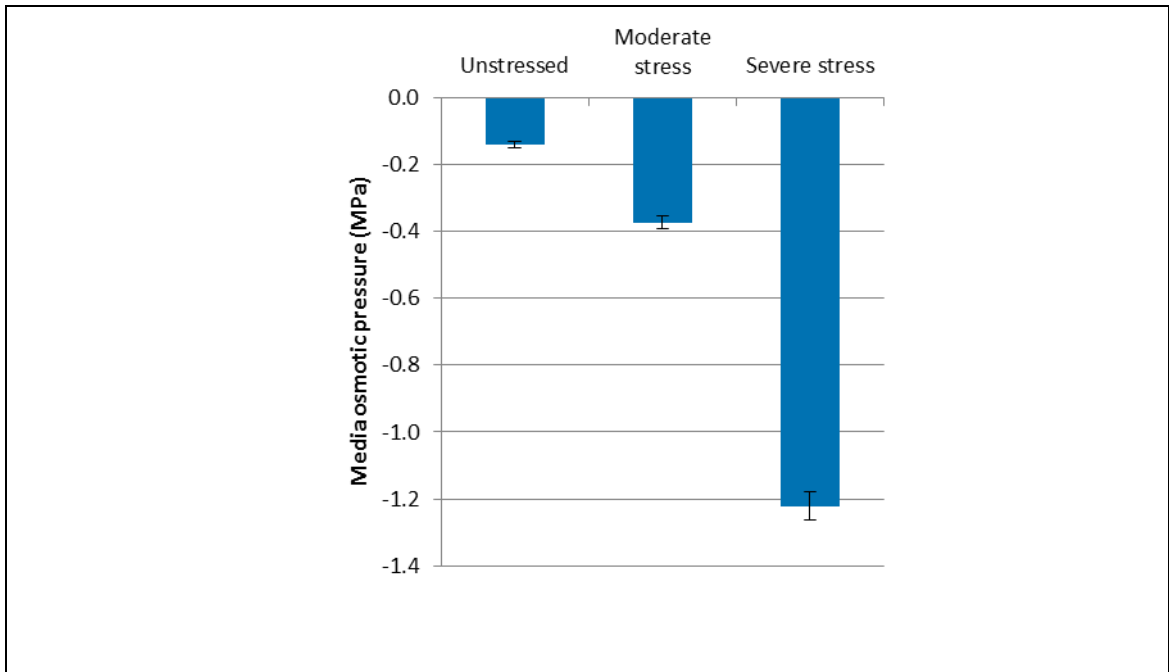

Figure 5-1 Verification of osmotic stress treatments by vapour pressure osmometry

Osmolarity of PEG infused agar medium, measured with a vapour pressure osmometer 24h after overlay solution is removed. n=10

5.3. The effect of osmotic stress on the root cell damage, division and differentiation

There are several factors that may explain the reduction in growth under osmotic stress, which can be investigated by examining changes in the morphology and cellular pattern of the root tip.

Although compatible solute and ion accumulation allows root cells to maintain their turgor under moderate osmotic stress (-0.5 MPa) (Shabala & Lew, 2002), it is possible that cells may experience a loss of turgor under severe stress. An inability to provide a more negative internal water potential than their environment, as well as ion leakage due to damaged membranes, could theoretically cause a loss of turgor and prevent cell expansion.

Severe osmotic stress can also induce programmed cell death (PCD) in Arabidopsis, which may limit growth (Duan *et al.*, 2010). Under moderate stress there very little cell death was observed (Figure 5-2). Under severe stress, cell death was more common. However, this mostly seemed to relate to how carefully the roots were stained and mounted as they were more delicate and so required more careful handling to avoid damage. Studies examining PCD have looked at severe osmotic stress for much longer treatments, with different markers (Duan *et al.*, 2010) and so a change of protocol may better show the effect of PCD on root growth.

The effect of osmotic stress and hormones on root growth and morphology

The rates of cell division, expansion and differentiation are the main developmental determinants of root growth rate, and perturbing any of these affects root morphology. Under stress, the size and number of cells in the meristematic zone decrease, indicating either premature differentiation or a reduction in the rate of cell division in the meristem (Figure 5-2).

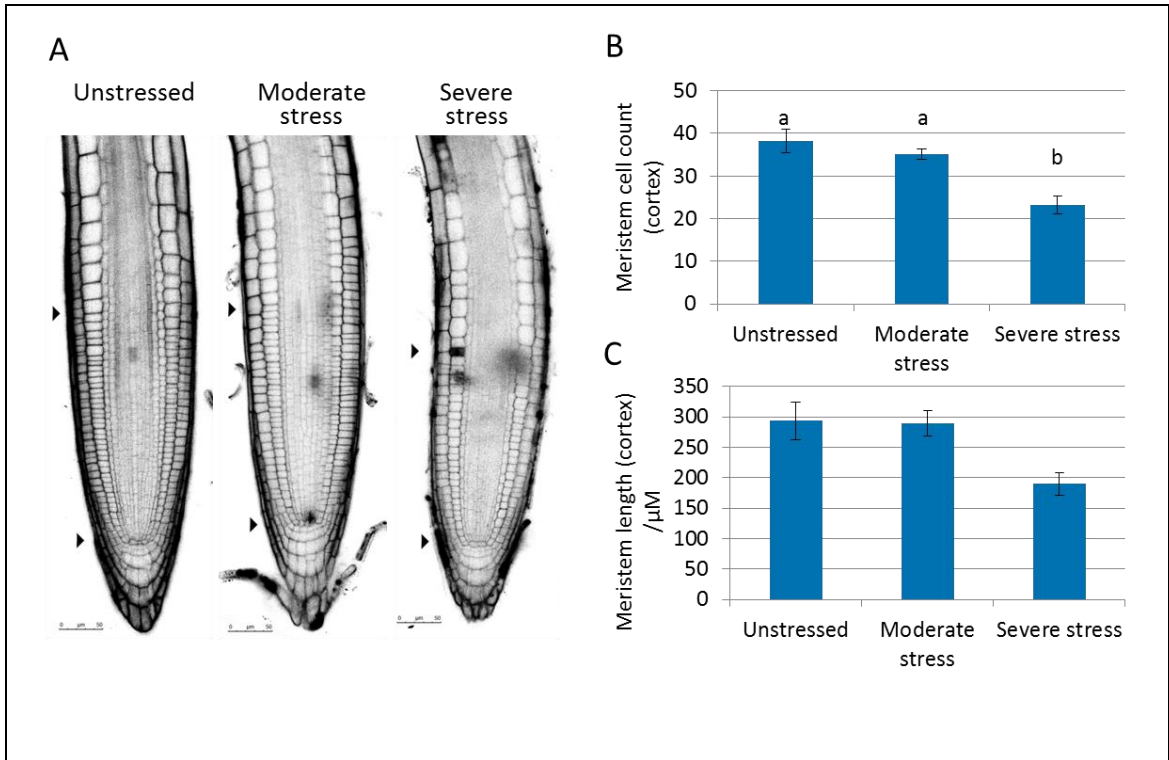

Figure 5-2 Meristem size and cell counts are reduced under osmotic stress

A) Primary root tips stained with propidium iodide after 24h osmotic stress treatment. Arrowheads indicate quiescent centre and approximate end of the meristematic zone. B) Meristematic cell count (ANOVA $P=0.002$) after 24h osmotic stress treatment. C) Meristem size (ANOVA $P=0.04$) after 24h osmotic stress treatment. Scale bars indicate $50\mu\text{m}$. Error bars indicate S.E.M. Letters indicate significance with a Tukey Pairwise comparison.

To assess whether the rate of cell division was effected by osmotic stress, the activity of the *CYCB1;2:GUS* reporter gene was examined using histochemical staining. *CYCB1;2* is expressed from the G2 to M stages of the cell cycle, so can be used as a marker for dividing cells (Bulankova *et al.*, 2013). As with the cell size assays, *CYCB1;2:GUS* enzyme activity shows the region of dividing cells is smaller under osmotic stress (Figure 5-3). Although the staining was not robust enough to allow an accurate quantification of the rate of cell division under different treatments, it does appear reduced after 48 hours severe stress (Figure 5-3). A different choice of cyclin marker might help resolve these problems and determine whether division is effected by stress.

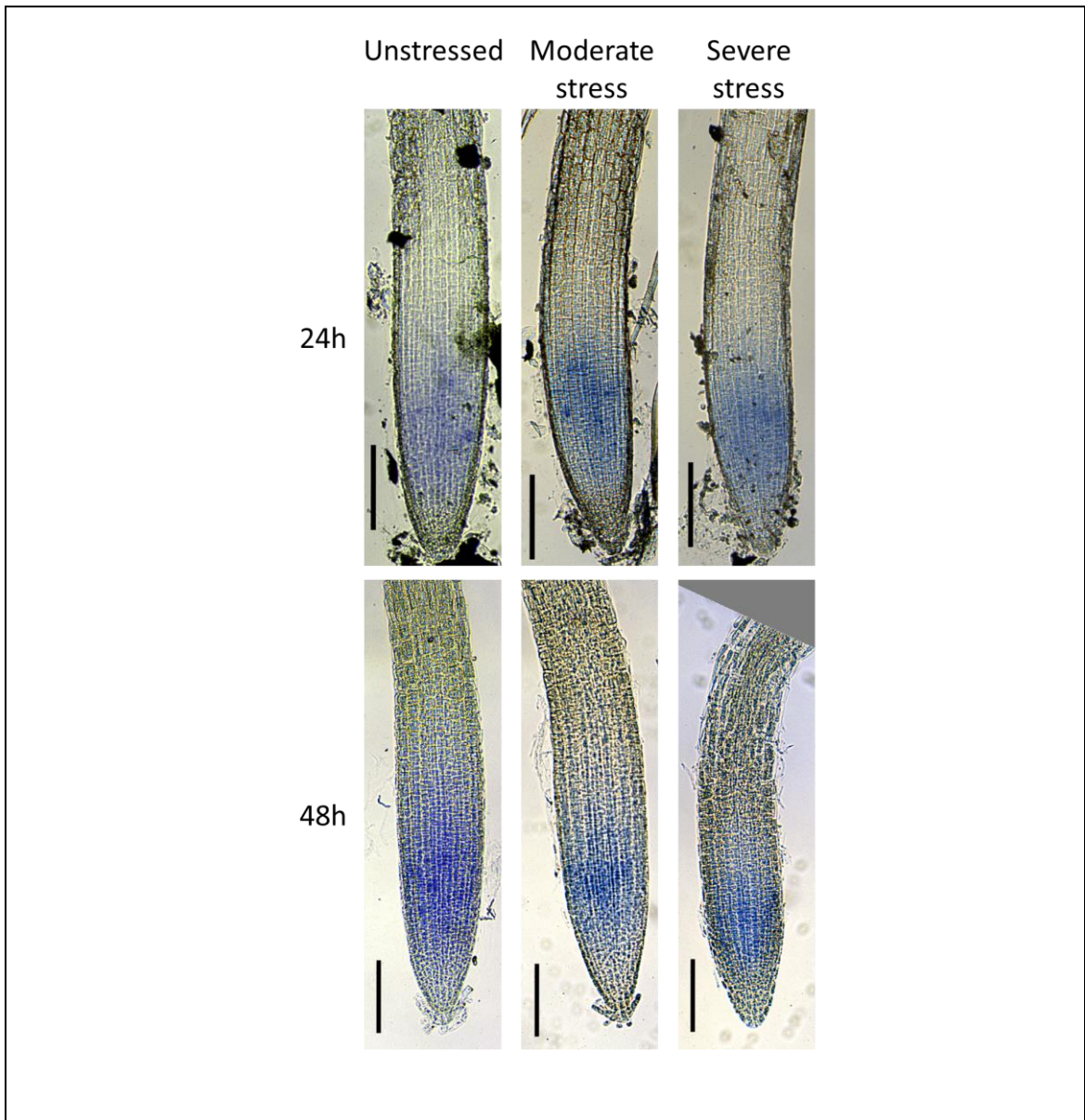

Figure 5-3 proCYCB1;2::CYCB1:2:GUS under osmotic stress

proCYCB1;2::CYCB1:2:GUS activity after 24 or 48 hours osmotic stress treatment. A stable blue precipitate indicates a cell in the G2 or M phase of cell division. Scale bars indicate 250 μ m.

5.4. The effect of osmotic stress on quiescent centre cell division and organisation

High levels of ethylene have previously been shown to induce division in the quiescent centre, (Ortega-Martinez *et al.*, 2007). ABA has been shown to repress quiescent centre cell division, even in the presence of ethylene (Zhang *et al.*, 2010). As biosynthesis of ethylene and ABA increases under osmotic stress (Zhang & Davies, 1987; Spollen *et al.*, 2000), it is possible that an interaction between these two hormones is regulating quiescence. Confocal Z-stacks were performed through the quiescent centre of at least seven roots subject to each osmotic stress regime, and stressed roots showed no obvious abnormal cell patterning (Figure 5-4)

WUS RELATED HOMEBOX5 (WOX5) is a transcription factor expressed in the quiescent centre that is required for proper meristem organisation, maintenance of the stem cell niche and

The effect of osmotic stress and hormones on root growth and morphology
 gene expression in the QC (Van den Berg *et al.*, 1997). Although replicates were limited (n=3) proWOX5::GUS activity reveals normal quiescent centre organisation.

Taken together, these results suggest that the quiescent centre maintains normal function and identity under osmotic stress and that any disruption of root growth is not occurring through QC failure. It is likely that the increased levels ABA under osmotic stress are sufficient to maintain the quiescent centre, even in the presence of increased ethylene biosynthesis.

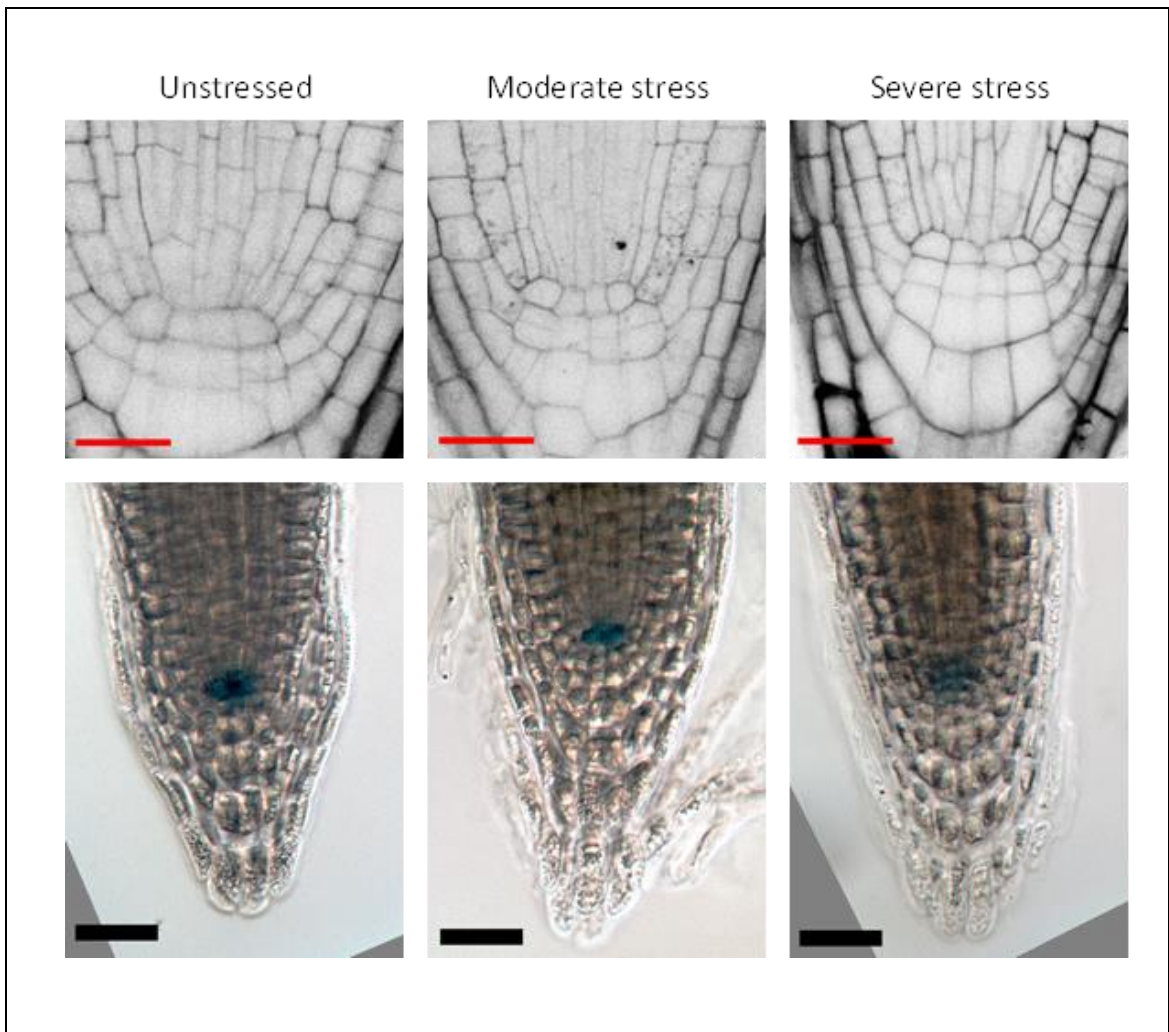

Figure 5-4 Osmotic stress does not alter quiescent centre morphology, or cell niche

A) Typical QC organisation after 24 hours osmotic stress treatment. Images are taken from a series of confocal z-stacks through the QC, none of which showed abnormal organisation (n=7) Black: propidium iodide. Scale bar indicates 20µm. B) proWOX5::GUS activity after 24 hours osmotic stress treatment. Scale bar indicates 60 µm

5.5. The effect of osmotic stress on DELLA proteins

DELLA proteins such as RGA are inhibitors of growth and elongation, and they are regulated by gibberellic acid, auxin, ethylene, abscisic acid and stress. (Achard *et al.*, 2003; Fu & Harberd, 2003; Achard *et al.*, 2006). DELLA proteins have been implicated in regulating meristem size and cell expansion in the elongation zone (Ubeda-Tomás *et al.*, 2008; Ubeda-Tomas *et al.*, 2009; Marín-de la Rosa *et al.*, 2015). Under osmotic stress, proRGA::RGA:GFP fluorescence

The effect of osmotic stress and hormones on root growth and morphology increases (Figure 5-5), which suggests a role in the regulated inhibition of root growth under osmotic stress.

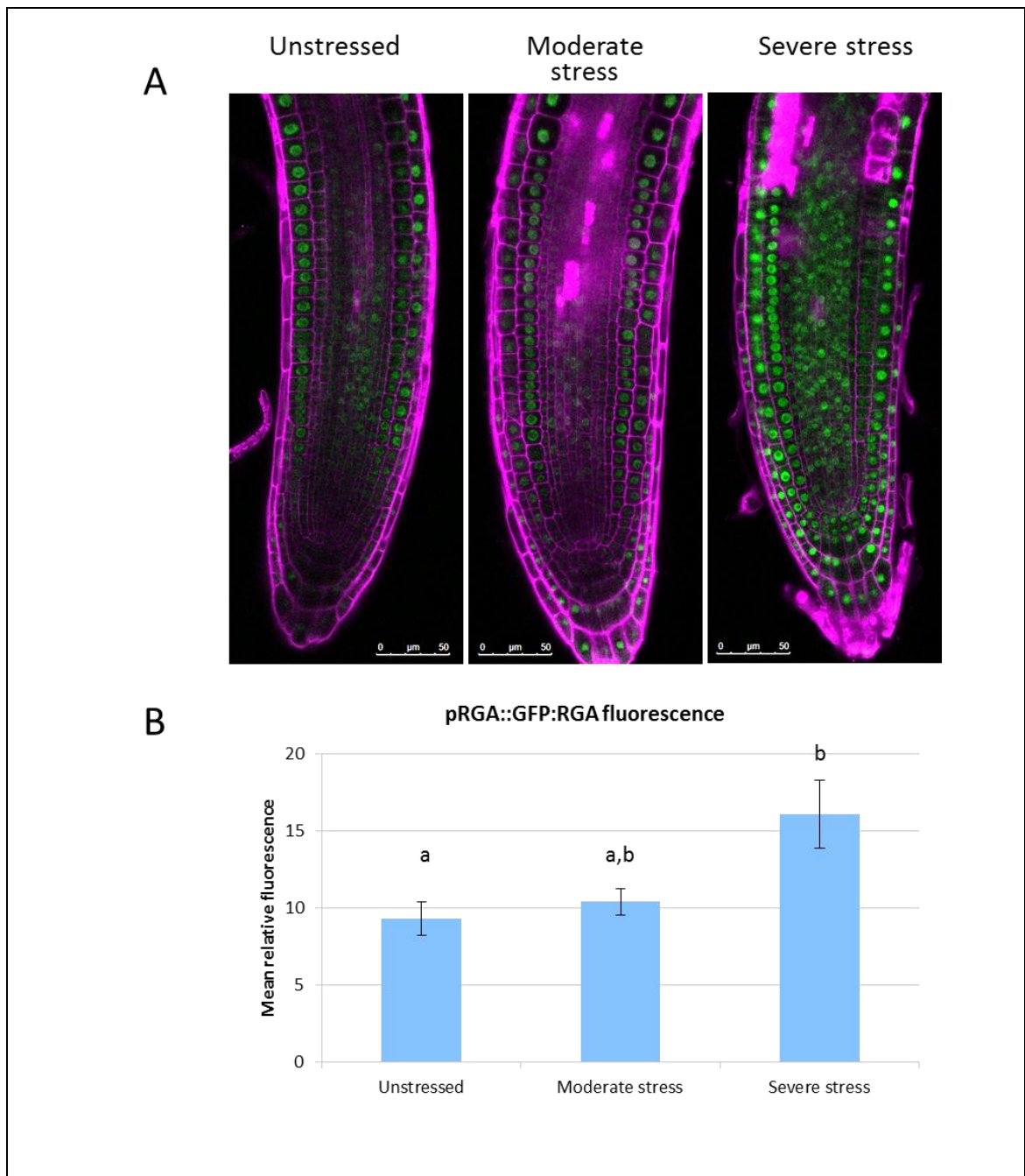

Figure 5-5 proRGA::GFP:RGA accumulates under osmotic stress

A) proRGA::GFP:RGA after 24h osmotic stress treatment. Magenta: propidium iodide. Green: GFP. Scale bars indicate 50 μ m. B) GFP:RGA fluorescence after 24h osmotic stress treatment. Measured in ImageJ, ANOVA P=0.015. Error bars indicate S.E.M. Letters indicate significance with a Tukey Pairwise comparison.

5.6. The effect of ethylene on root growth under osmotic stress

Root growth can be inhibited by pharmacologically increasing root ethylene concentration, while inhibiting ethylene biosynthesis or signalling can slightly increase root growth (Chilley *et al.*, 2006). Therefore, experiments were carried out to investigate the relationship between osmotic stress, root growth and ethylene effects.

The effect of osmotic stress and hormones on root growth and morphology

Application of the ethylene precursor ACC to plants under osmotic stress inhibits root growth further, in an additive manner. However, inhibiting ethylene signalling with silver thiosulphate was found not to be able to rescue root growth under osmotic stress (Figure 5-6A).

The EIN2 protein sits at a point of convergence in the classical ethylene signalling cascade, and the *ein2* mutant shows complete insensitivity to ethylene effects (Guzman & Ecker, 1990). *ein2* shows wildtype root growth responses to stress, further supporting the view that the reduction in root growth under stress is independent of ethylene signalling (Figure 5-6B).

Ethylene inhibits root growth in two ways - by increasing basipetal auxin transport to the elongation zone to limit cell expansion, and by limiting cell proliferation in the meristem (Ruzicka *et al.*, 2007; Swarup *et al.*, 2007; Street *et al.*, 2015). As the effects of ethylene and osmotic stress on root growth are additive and inhibiting ethylene cannot rescue root growth under stress, it is concluded that they must act separately to control root growth.

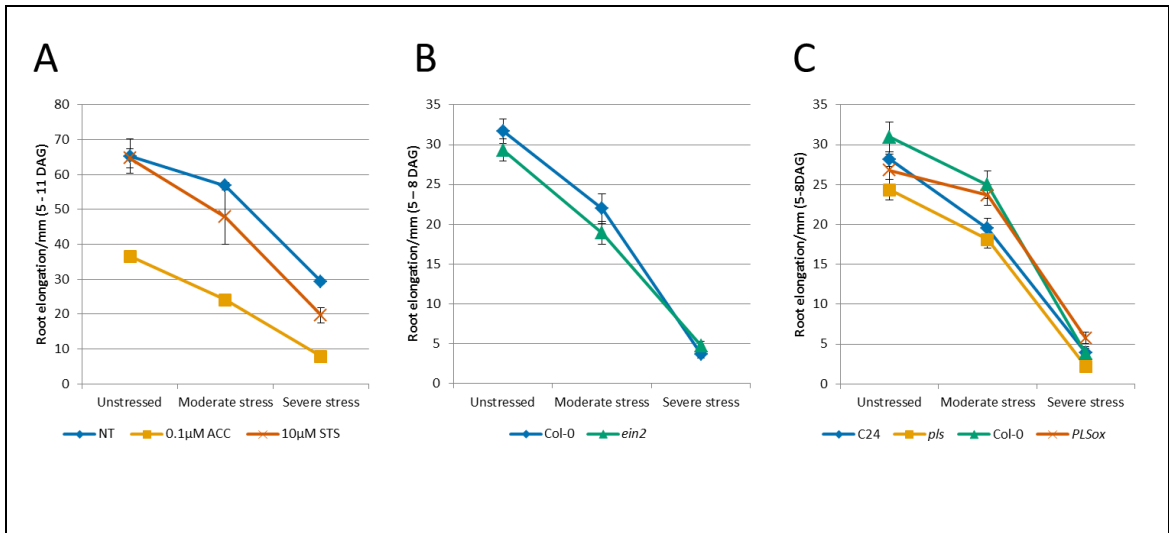

Figure 5-6 The effect of ethylene on root growth under osmotic stress

A) The effect of 1-aminocyclopropane-1-carboxylic acid (ACC) and silver thiosulphate (STS) on root growth under osmotic stress, in Col-0. B) Root growth of Col-0 and the ethylene insensitive mutant *ein2* under osmotic stress. C) Root growth of *pls* (C24 background) and the PLS overexpressor, PLSox (Col-0 background) under osmotic stress. Error bars indicate S.E.M

5.7. The effect of IAA on primary root growth meristem morphology and under osmotic stress

As *Arabidopsis* root meristem activity and cell expansion at elongation zone are regulated by auxin, the effect of auxin on root growth under osmotic stress was examined.

The majority of auxin biosynthesis occurs in aerial tissues, and auxin is transported from the shoot to the root through the vasculature (Ljung *et al.*, 2001). The auxin efflux carrier PIN1 is responsible for regulating directional transport through the stele into the meristematic zone and quiescent centre (Galweiler *et al.*, 1998). Auxin signalling in the meristem promotes cell

The effect of osmotic stress and hormones on root growth and morphology proliferation and growth, but inhibits differentiation (Dello Iorio *et al.*, 2008; Ishida *et al.*, 2010). Basipetal transport of auxin by the efflux carrier PIN2 and influx carrier AUX1 to the elongation zone is also important in regulating growth by inhibiting cell expansion (Evans *et al.*, 1994; Rashotte *et al.*, 2000; Ruzicka *et al.*, 2007; Swarup *et al.*, 2007). Supplementing growth media with low concentrations (<0.3 nM) of IAA can promote root growth, whilst higher concentrations (>1 nM) inhibit growth (Evans *et al.*, 1994).

Under unstressed conditions 0.1 nM IAA increased root growth, but under osmotic stress this auxin supplementation did not alter the root growth response or rescue meristem size (Figure 5-7A, Figure 5-8A).

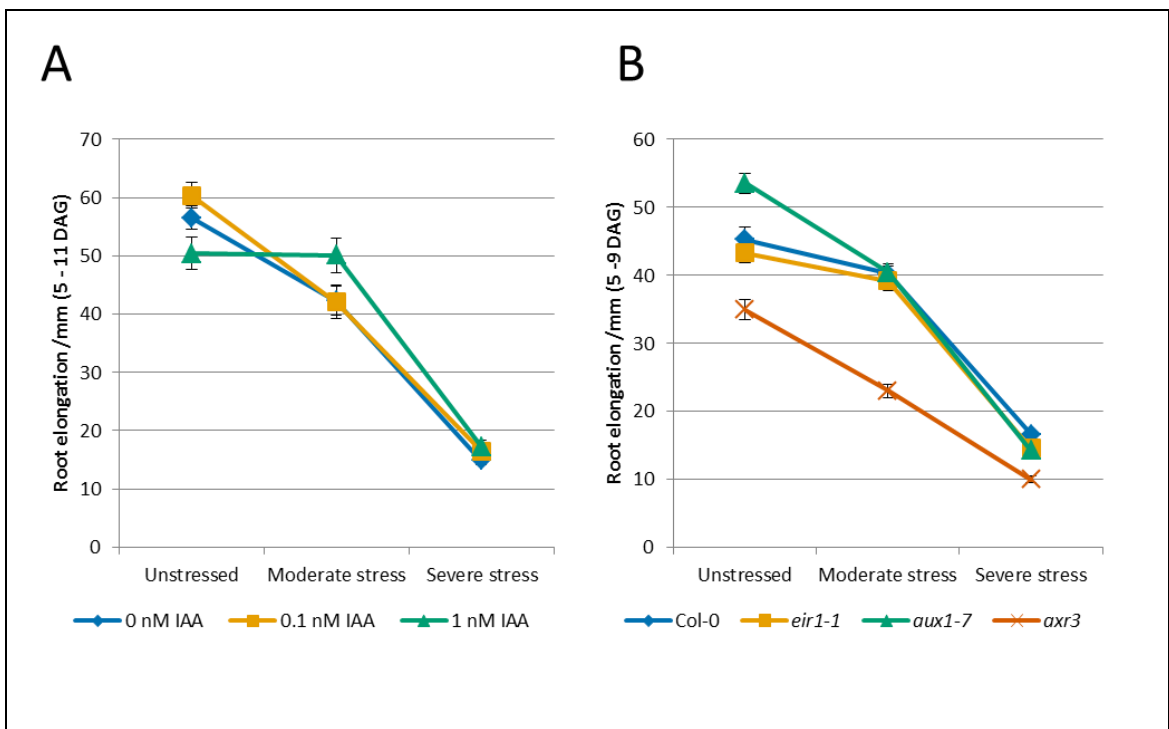

Figure 5-7 Auxin modulates root growth under osmotic stress, but not through basipetal auxin transport

A) The effect of Indole-3-acetic acid (IAA) on wildtype (Col-0) root growth under osmotic stress. B) The effect of osmotic stress on root growth on auxin transport mutants (*eir1-1/pin2* and *aux1-7*) and an auxin resistant mutant (*axr3-1*). Error bars indicate S.E.M.

Under unstressed conditions 1 nM IAA is sufficient to cause a mild inhibition of root growth, but when moderate osmotic stress medium was supplemented with 1 nM IAA, there was seen to be rescue of root growth and meristem size (Figure 5-7A, Figure 5-8A). Although there was no significant rescue of root growth under severe stress, there was a partial rescue of meristem size. This suggests that the reduction in root growth under moderate stress is due to the regulation of meristem size by auxin, but under severe stress some other factor is further inhibiting root growth.

The effect of osmotic stress and hormones on root growth and morphology

The *axr3-1* line contains a dominant stabilised mutation of the IAA17 protein that causes plants to be resistant to many auxin-regulated growth responses, including root elongation and gravitropism (Leyser *et al.*, 1996). Root growth inhibition and the reduction in meristem size were seen to be exaggerated in *axr3-1* under osmotic stress, but *eir1-1/pin2* and *aux1-7* showed near wildtype root growth responses (Figure 5-7B, Figure 5-8B). *pin1* mutant seedlings displayed a very small meristem under unstressed conditions, which showed no reduction in size under osmotic stress (Figure 5-8B).

Taken together, these results indicate that root growth under stress is modulated by auxin signalling, requiring an unperturbed auxin response pathway and transport of auxin to the meristem by PIN1. However, regulation of basipetal auxin transport by AUX1 or PIN2 is not required for the modulation of root growth by auxin signalling.

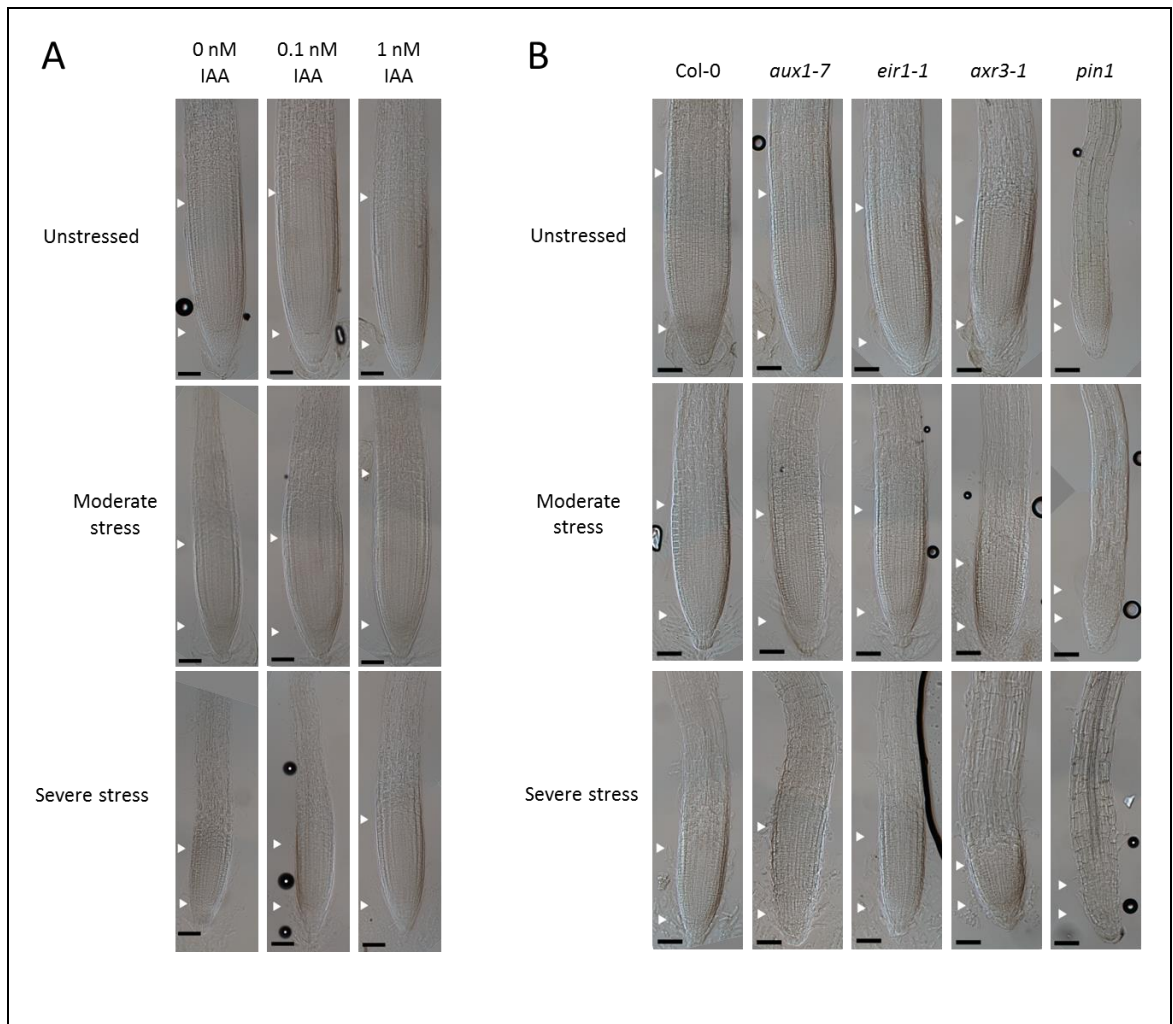

Figure 5-8 Auxin modulates meristem size under osmotic stress

A) The effect of osmotic stress and indole-3-acetic acid treatment on root morphology. Arrowheads indicate the position of the quiescent centre and the end of the meristematic zone. B) The effect of osmotic stress on root morphology in auxin transport mutants (*pin1*, *eir1-1/pin2*, *aux1-7*) and an auxin resistant mutant (*axr3-1*). Arrowheads indicate the position of the quiescent centre and the end of the meristematic zone. Meristem size was determined by looking for the last cell in the cortex before the rapid increases in cell size of the elongation zone.

5.8. The effect of ABA on primary root growth under osmotic stress

Under unstressed conditions, supplementing growth media with ABA produces a biphasic growth response: low concentrations of ABA causes an increase in root growth whilst high concentrations inhibit root growth (Mulkey *et al.*, 1983; Ghassemian *et al.*, 2000).

Supplementing growth media with a concentration of ABA that promotes growth under unstressed conditions (0.1 μM) was found to cause no significant difference in root growth under moderate and severe stress, and a treatment with concentration of ABA that inhibits root growth under unstressed conditions (1 μM) can further reduce root growth under stress (Figure 5-9).

Supplementing osmotic stress media with the ABA biosynthesis inhibitor fluridon can rescue root growth under moderate osmotic stress, but not severe stress (Figure 5-9). Taken together, these results indicate that under moderate osmotic stress, ABA levels modulate root growth responses and inhibit growth. Under severe stress, inhibiting ABA biosynthesis could not rescue root growth, implying factors other than ABA are restricting root growth.

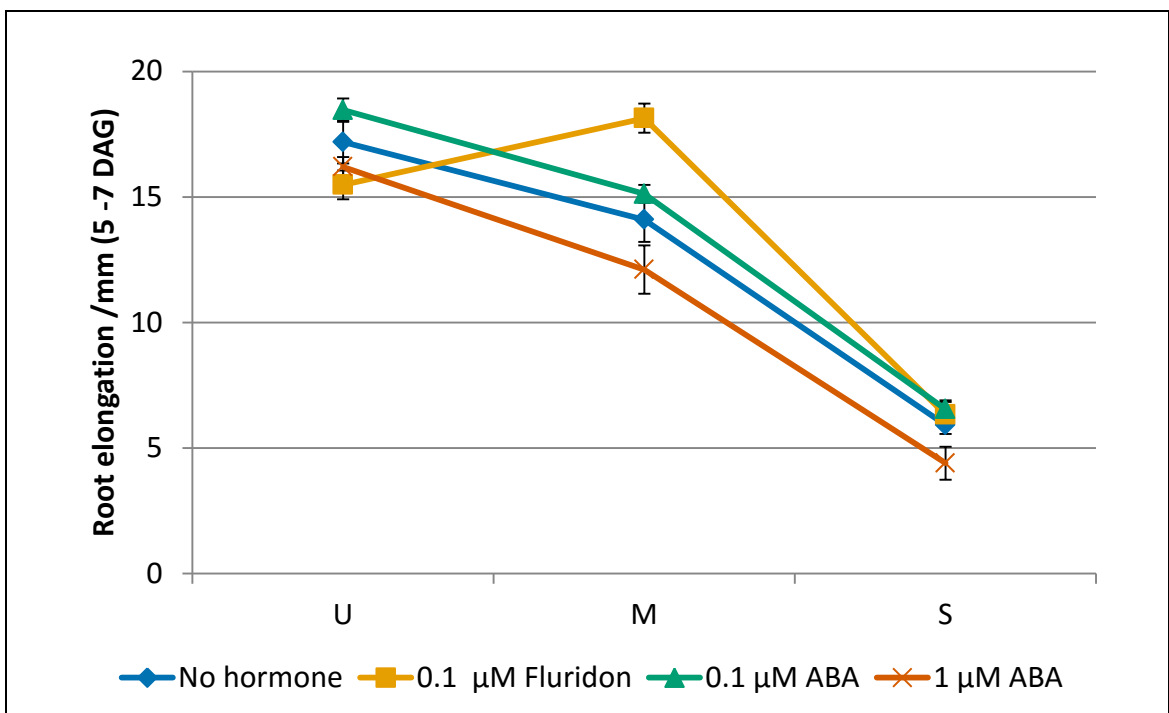

Figure 5-9 Inhibiting ABA biosynthesis can rescue root length under stress

The effect of Abscisic acid (ABA) and the ABA biosynthesis inhibitor fluridon on root growth under osmotic stress.

5.9. The effect of osmotic stress on the actin and microtubule cytoskeleton

The cytoskeleton can interact with hormone responses to have vast developmental effects (Chilley *et al.*, 2006; Hussey *et al.*, 2006). For example, the actin cytoskeleton is essential for vesicle trafficking and regulating auxin transporter localisation (Geldner *et al.*, 2003; Kleine-Vehn *et al.*, 2008). To investigate possible links between osmotic stress, hormone signalling and cytoskeleton organisation, fluorescently labelled cytoskeleton markers were examined in transgenic seedlings subjected to stress. Under osmotic stress the GFP:LA (Lifeact; Smertenko *et al.*, 2010), which reveals actin filaments, showed no obvious disruption to the organisation of the actin cytoskeleton, though actin turnover and dynamics were not measured (Figure 5-10).

In elongating root cells microtubules are arranged at the cell wall perpendicular to the direction of growth, determining the deposition of cellulose (Paredes *et al.*, 2006). This reinforcement of the cell wall is thought to constrain the cell to create anisotropic growth, and thought to be influenced by osmotic stress (Baskin, 2005; Gutierrez *et al.*, 2009). Microtubules are thought to orientate with the direction of mechanical stress in many tissues, and in the shoot apical meristem altering cell turgor with an osmoticum can cause collapse of the microtubule arrangement (Nakayama *et al.*, 2012; Sampathkumar *et al.*, 2014).

Under osmotic stress, the microtubule binding marker GFP:MAP4 showed a change in orientation (Figure 5-10). The GFP:MAP4 also showed a more punctate appearance under moderate stress and disorganisation under severe stress (Figure 5-10).

As work was carried out with GFP:MAP4, which binds microtubules (Marc *et al.*, 1998) it cannot be concluded whether the organisation of microtubule cytoskeleton is altered or if the binding of MAP4 is disrupted under osmotic stress, and this work needs to be repeated with a different marker in the future, such as *GFP:α-tubulin* for confirmation.

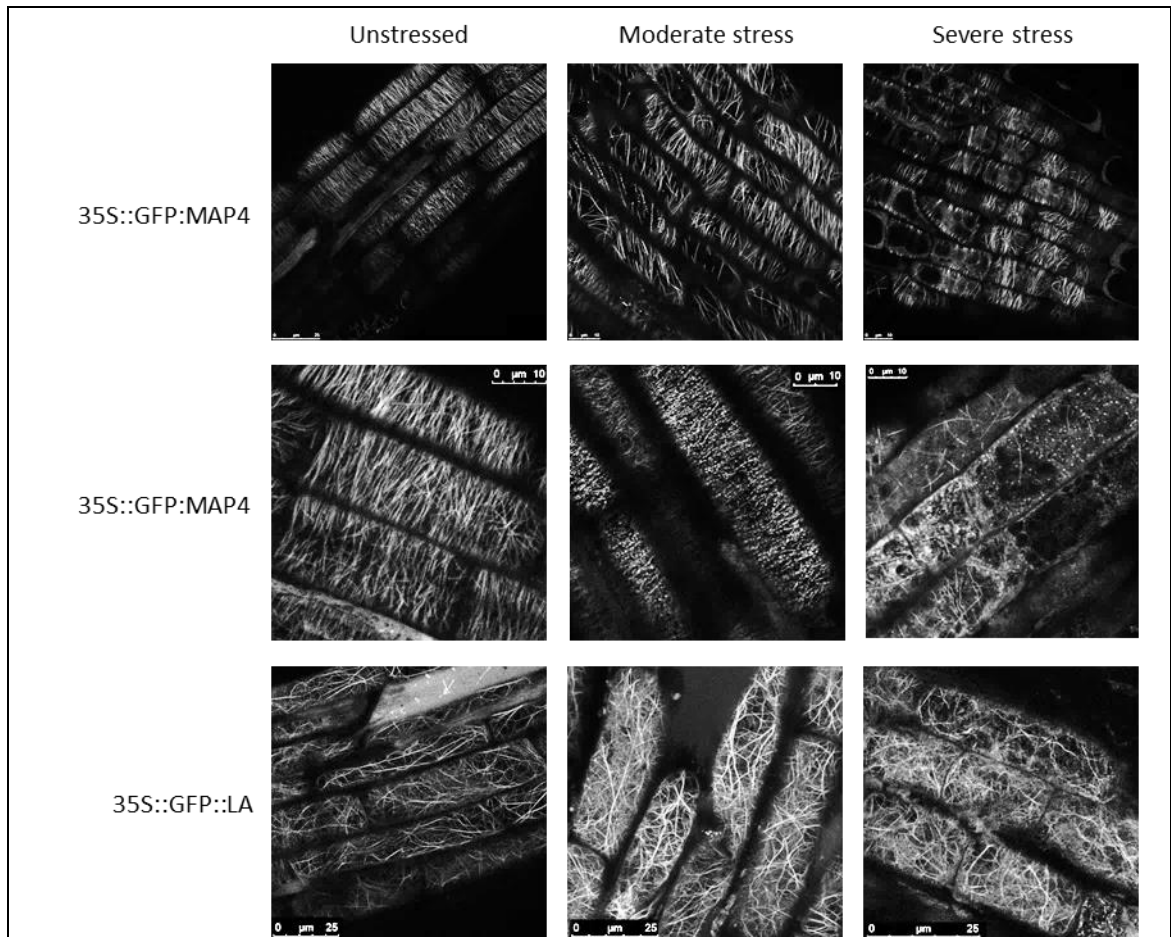

Figure 5-10 The microtubule cytoskeleton is altered under osmotic stress, but there is no obvious change in actin organisation

Localisation of the Microtubule binding fluorescent marker 35S::GFP:MAP4 and the filamentous actin binding fluorescent marker 35S::GFP:LA (Lifeact) after 24 hours osmotic stress treatment in root epidermal cells in the elongation zone.

5.10. Summary

Root growth under moderate and severe osmotic stress was found to be inhibited. This reduction in root growth was associated with increased DELLA protein levels, disrupted microtubule arrangement and a smaller root meristem.

Increased ABA biosynthesis has been implicated in many stress responses and inhibiting ABA biosynthesis can rescue root growth under moderate osmotic stress. Others have reported a reduction in the rate of cell proliferation and premature differentiation under osmotic stress, which is modulated by ABA (Ji & Li, 2014; Ji *et al.*, 2014)

Ethylene biosynthesis has been implicated in both stress responses and ABA root growth responses (Beaudoin *et al.*, 2000; Ghassemian *et al.*, 2000; Cheng *et al.*, 2013; Luo *et al.*, 2014). Whilst ethylene could further inhibit root growth under stress, stressed ethylene sensitive (*pls*) and insensitive (*ein2*) plants displayed near wildtype root growth responses. Osmotic stress must therefore act independently of ethylene responses to affect root growth.

The effect of osmotic stress and hormones on root growth and morphology

Auxin is known to regulate both cell division and differentiation in the root apical meristem (Dello Ioio *et al.*, 2008; Ishida *et al.*, 2010) and consequently auxin application could rescue both meristem size and root growth under osmotic stress, whilst auxin resistant plants displayed more severe growth responses.

Root growth under stress is modulated by auxin signalling, requiring an unperturbed auxin response pathway and transport of auxin to the meristem by PIN1. Intriguingly, auxin transporters AUX1 and PIN2 are important for both ABA and ethylene to inhibit growth in unstressed conditions (Swarup *et al.*, 2007; Thole *et al.*, 2014), but were found to have no effect on root growth under osmotic stress.

Hormone balance and signalling clearly has profound effects on root growth. The data in this chapter suggest that the modulation of hormone biosynthesis and signalling may coordinate differential root growth responses under moderate osmotic stress. In order to understand these effects, hormone responses, transport and distribution must be investigated further.

6 The effect of osmotic stress on root hormone levels, responses and distribution

6.1. Introduction

In plants, hormone responses integrate stress responses with developmental control, with many growth responses altered under osmotic stress.

Contemporary and classic studies show that abscisic acid biosynthesis increases under osmotic stress, and is responsible for many stress responses (Wright & Hiron, 1969; Zhang & Davies, 1987; Lee *et al.*, 2006; Verslues & Bray, 2006; Xu *et al.*, 2013; Kumar & Verslues, 2015; Wang *et al.*, 2015). Abscisic acid has previously been shown to affect the transport and distribution of auxin and the biosynthesis of cytokinin (Dobra *et al.*, 2010; Shkolnik-Inbar & Bar-Zvi, 2010; Nishiyama *et al.*, 2011; Xu *et al.*, 2013).

Ethylene has also been implicated as a drought responsive hormone, important for many stress responses, including compatible solute accumulation (Ichimura *et al.*, 2000; Liu & Zhang, 2004; Joo *et al.*, 2008; Skirycz *et al.*, 2011; Cheng *et al.*, 2013; Cui *et al.*, 2015). It has been shown to promote auxin biosynthesis and increase its basipetal transport in the root (Stepanova *et al.*, 2007; Swarup *et al.*, 2007)

As both ethylene and abscisic acid are important in mediating defence against osmotic stress and have profound effects on growth and development, the work described in this chapter aims to discover their effect on other phytohormone responses, which may in turn affect development.

Experimental tools employed here include fluorescence microscopy, qPCR and bioinformatics to examine the responses of auxin, cytokinin, ethylene and abscisic acid to osmotic stress.

6.2. Abscisic acid-dependent and abscisic acid-independent stress responses

Abscisic acid-dependent and -independent signalling are important responses to drought and osmotic stress (Cutler *et al.*, 2010; Mizoi *et al.*, 2012). As indicated above, abscisic acid biosynthesis increases in shoots and roots under dehydration stress (Zhang & Davies, 1987; Lee *et al.*, 2006)

ABA levels are perceived by the PYR/PYL/RCAR family of receptors, which inhibit type 2C protein phosphatase activity (Ma *et al.*, 2009; Park *et al.*, 2009; Cutler *et al.*, 2010; Klingler *et al.*, 2010). In the presence of ABA, PP2C activity is reduced, allowing downstream phosphorylation and consequent activation of ABA-responsive element Binding Factors (ABFs) (Furihata *et al.*, 2006).

The effect of osmotic stress on root hormone levels, responses and distribution

To determine whether ABA signalling is active under the osmotic stress regime used for the work described in this thesis, qPCR was performed for the *RD29B* gene which is highly ABA-responsive but not responsive to ABA-independent stress signalling (Jia *et al.*, 2012). *RD29B* expression shows a very large (up to ca. 100-fold) increase under moderate (-0.37 MPa) and severe (-1.2 MPa) osmotic stress at 6 and 24 hours (Figure 6-1A). Publicly available transcriptomic data (Hruz *et al.*, 2008) also show that other ABA-responsive genes are consistently upregulated under osmotic stress (Figure 6-1C).

The *DREB2B* gene promoter is inducible as an early response to dehydration but not to ABA treatment and contains no ABA Responsive Elements (ABRE; (Nakashima *et al.*, 2000). *DREB2B* expression increases significantly under severe stress at 6 and 24 hours, but not moderate stress (Figure 6-1B), indicating ABA-independent signalling is not as prominent under moderate stress.

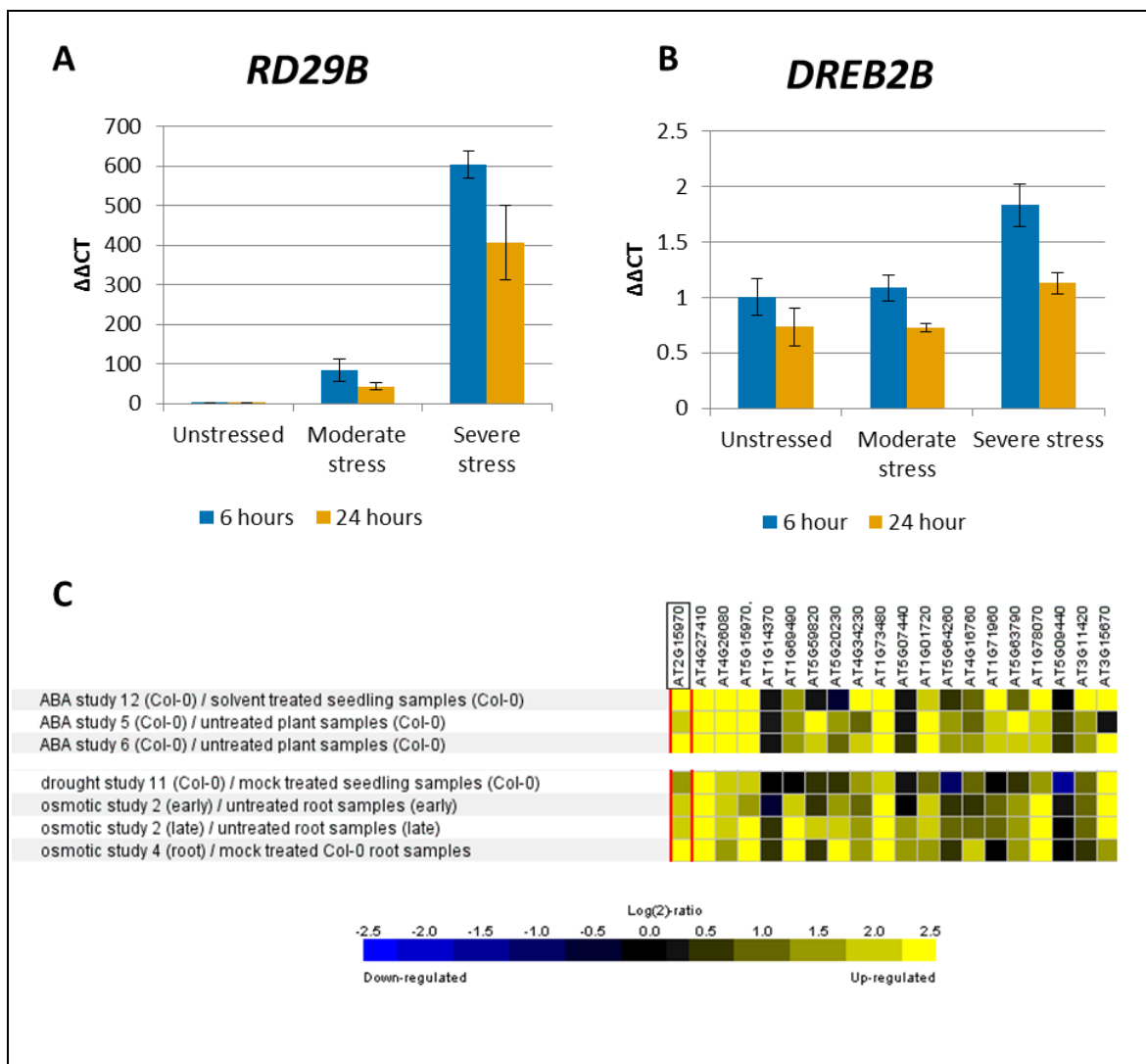

Figure 6-1 : ABA dependent and independent stress responses are active under osmotic stress.

A) *RD29B* expression relative to AT5G15710, B) *DREB2B* expression relative to AT5G15710. Col-0 seedlings were transferred from 1/2 MS plates to 1/2 MS + poly(ethylene glycol) mol. wt. 8000 at five days after germination. After

6 or 24 hours plants were frozen in liquid nitrogen and the RNA extracted for qPCR C) ABA-responsive gene expression under various osmotic stress or ABA treatments. Data obtained from publicly available Affymetrix CHIP data through Genevestigator (Hruz *et al.*, 2008).

6.3. Ethylene responses increase under osmotic stress

Ethylene is perceived by a family of five receptor kinases (ETR1, ETR2, EIN4, ERS1, ERS2) (Chang *et al.*, 1993; Hua *et al.*, 1995; Hua *et al.*, 1998; Sakai *et al.*, 1998), which dimerize to phosphorylate CONSTITUTIVE TRIPLE RESPONSE1 (CTR1), in the absence of ethylene (Kieber *et al.*, 1993; Clark *et al.*, 1998). CTR1 is a negative regulator of downstream responses, so is active in the absence of ethylene. The downstream signalling component EIN2 (Alonso *et al.*, 1999) stabilises the transcription factor EIN3 (An *et al.*, 2010), which binds the promoters of ethylene response factors, such as ERF1, activating the ethylene response (Solano *et al.*, 1998).

Previous studies have shown that ethylene biosynthesis and response increases under drought stress (Spollen *et al.*, 2000; Skirycz *et al.*, 2011; Cheng *et al.*, 2013; Cui *et al.*, 2015) and the available transcriptomic data reveal an increase in the expression of *ACC SYNTHASE (ACS)* gene family members under osmotic stress. This may be mediated by abscisic acid, which qPCR and transcriptomic data show also increases the expression of ethylene biosynthetic genes, including *ACS* (Figure 6-2B- (Hruz *et al.*, 2008; Luo *et al.*, 2014). ABA has been shown to mediate the stability of ACS6 through phosphorylation to increase ethylene biosynthesis (Luo *et al.*, 2014).

The expression of *ETHYLENE RESPONSIVE FACTOR 1 (ERF1)* is positively regulated by ethylene and negatively regulated by abscisic acid (Cheng *et al.*, 2013). After 24 hours osmotic stress treatment there is a non-significant (ANOVA $P = 0.09$) increase in ERF1 expression, indicating increased ethylene responses (Figure 6-2A).

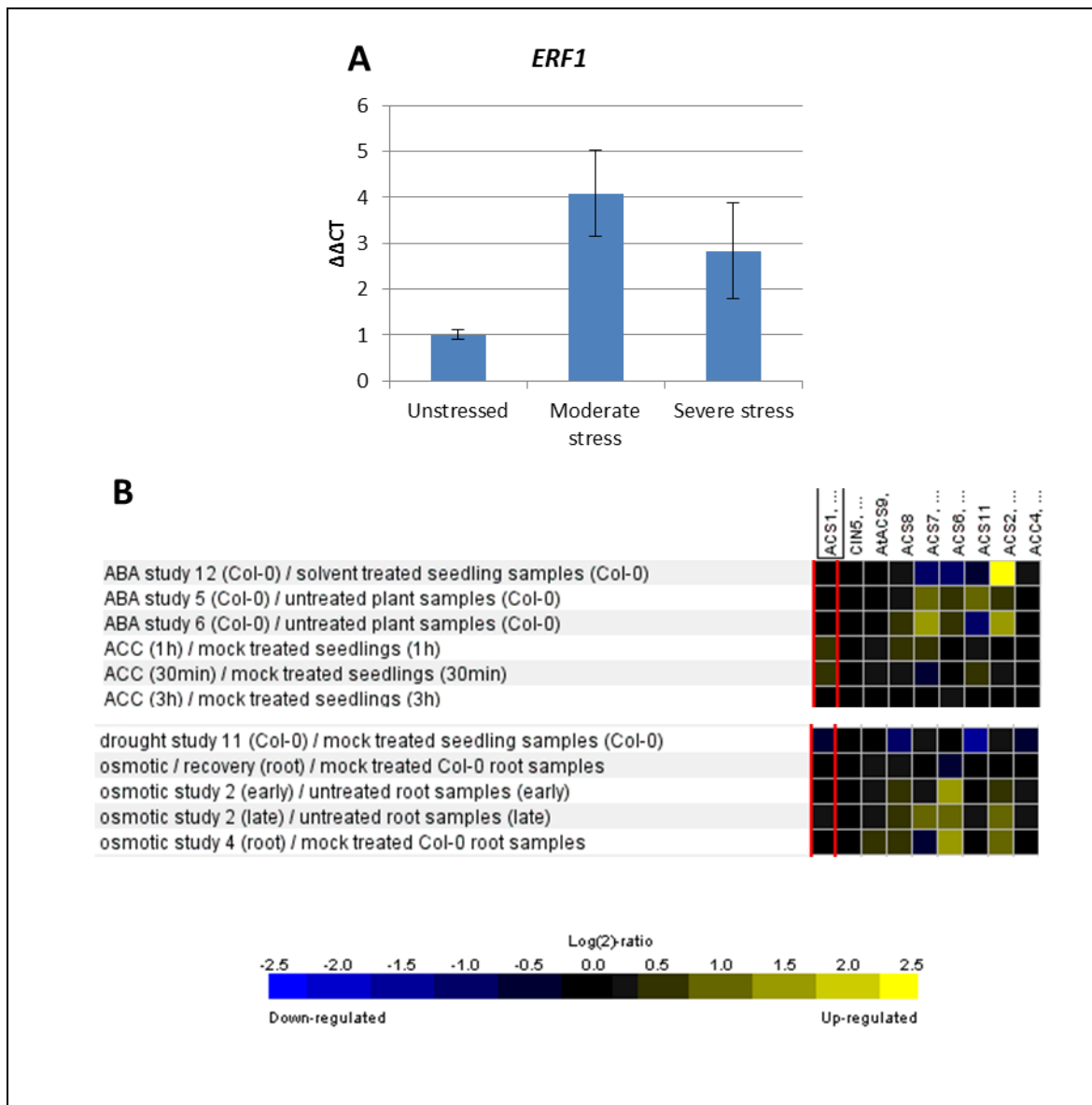

Figure 6-2 Ethylene responses increase under osmotic stress treatment

A) *ERF1* expression increases under osmotic stress Col-0 seedlings were transferred from 1/2 MS plates to 1/2 MS + poly(ethylene glycol) mol. wt. 8000 at five days after germination. After 24 hours plants were frozen in liquid nitrogen and the RNA extracted for qPCR B) Ethylene responsive gene expression under ACC, osmotic stress or ABA treatment. Data obtained from publicly available Affymetrix CHIP data through Genevestigator. (Hruz *et al.*, 2008)

6.4. Cytokinin responses decrease under osmotic stress

Cytokinins are perceived in *Arabidopsis* by a family of histidine kinases (AHK2-4), which regulate the Arabidopsis Histidine Phosphotransfer proteins (AHP1-5) (Inoue *et al.*, 2001; Suzuki *et al.*, 2001; Ueguchi *et al.*, 2001; Yamada *et al.*, 2001). AHP proteins in turn regulate a family of transcription factors called type B Arabidopsis Response Regulators (ARRs; (Tanaka *et al.*, 2004; To & Kieber, 2008).

The effect of osmotic stress on root hormone levels, responses and distribution

Publicly available transcriptomic data (Genevestigator) reveals that osmotic stress and ABA treatment can each downregulate the expression of various cytokinin-responsive genes (Figure 6-3).

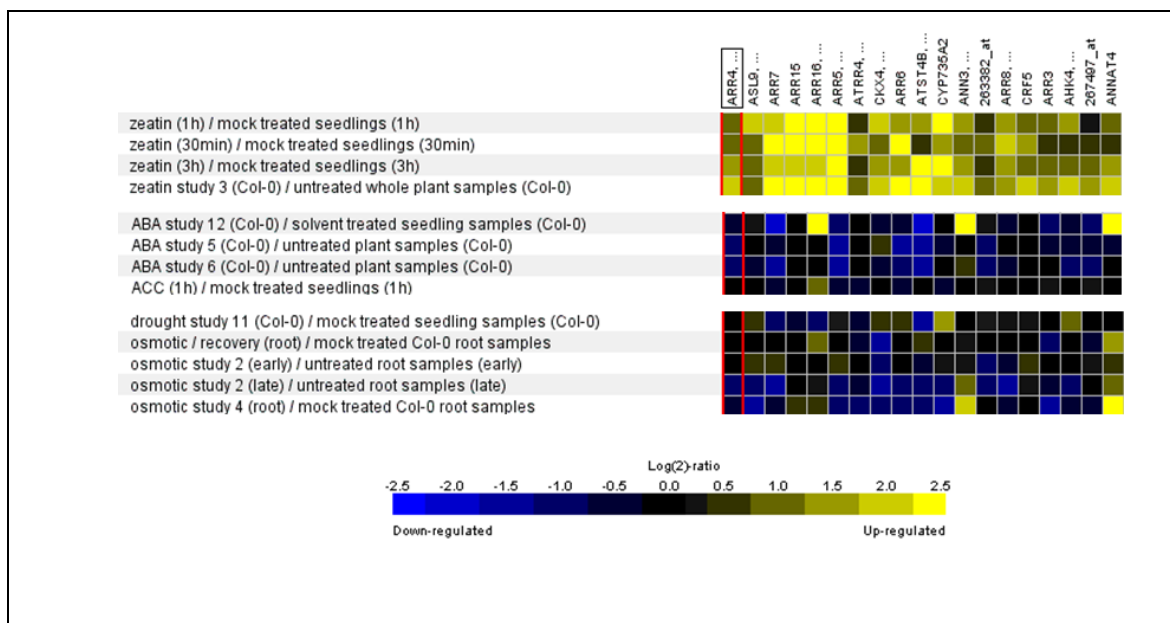

Figure 6-3 Cytokinin responses are reduced under both ABA treatment and osmotic stress

Cytokinin-responsive gene expression under CK, osmotic stress or ABA treatment. Data obtained from publicly available Affymetrix ChIP data through Genevestigator (Hruz *et al.*, 2008).

Arabidopsis Response Regulator 5 (ARR5) is a type-A negative regulator of cytokinin responses that displays increased expression under cytokinin treatment (Brandstatter & Kieber, 1998). In wildtype plants grown under standard *in vitro* conditions, proARR5::GFP fluorescence is highest in the columella and lateral root cap, with some expression in the stele (Figure 6-4). Under increasing osmotic stress pARR5::GFP activity is reduced in all tissues, disappearing from the stele (Figure 6-4B, C). ARR5 promoter::GUS fusion lines show a similar expression pattern and reduction under stress (Figure 6-4C). Under osmotic stress treatment there is a significant reduction in ARR5 relative expression, as determined by proARR5::GFP fluorescence quantification. This is supported by qPCR data, which shows a near significant reduction in ARR5 transcript abundance (ANOVA, $P=0.057$).

Transgenic *Arabidopsis* containing the *pTCS::GFP* gene construct was used to further examine further possible cytokinin responses. This synthetic reporter comprises a GFP coding region under the control of a minimal 35S promoter with six tandem repeats of a B-type Arabidopsis response regulator (ARR)-binding motif (Muller & Sheen, 2008). In the presence of cytokinin, promoter activity increases, increasing fluorescence. Unstressed pTCS::GFP seedlings show cytokinin response in the columella cells but fluorescence in the stele is much weaker than proARR5::GFP and proARR5::GUS lines. Unlike proARR5::GFP, proTCS::GFP shows no significant

The effect of osmotic stress on root hormone levels, responses and distribution change in fluorescence under moderate or severe osmotic stress although there is a downward trend of fluorescence signal under severe stress (Figure 6-5).

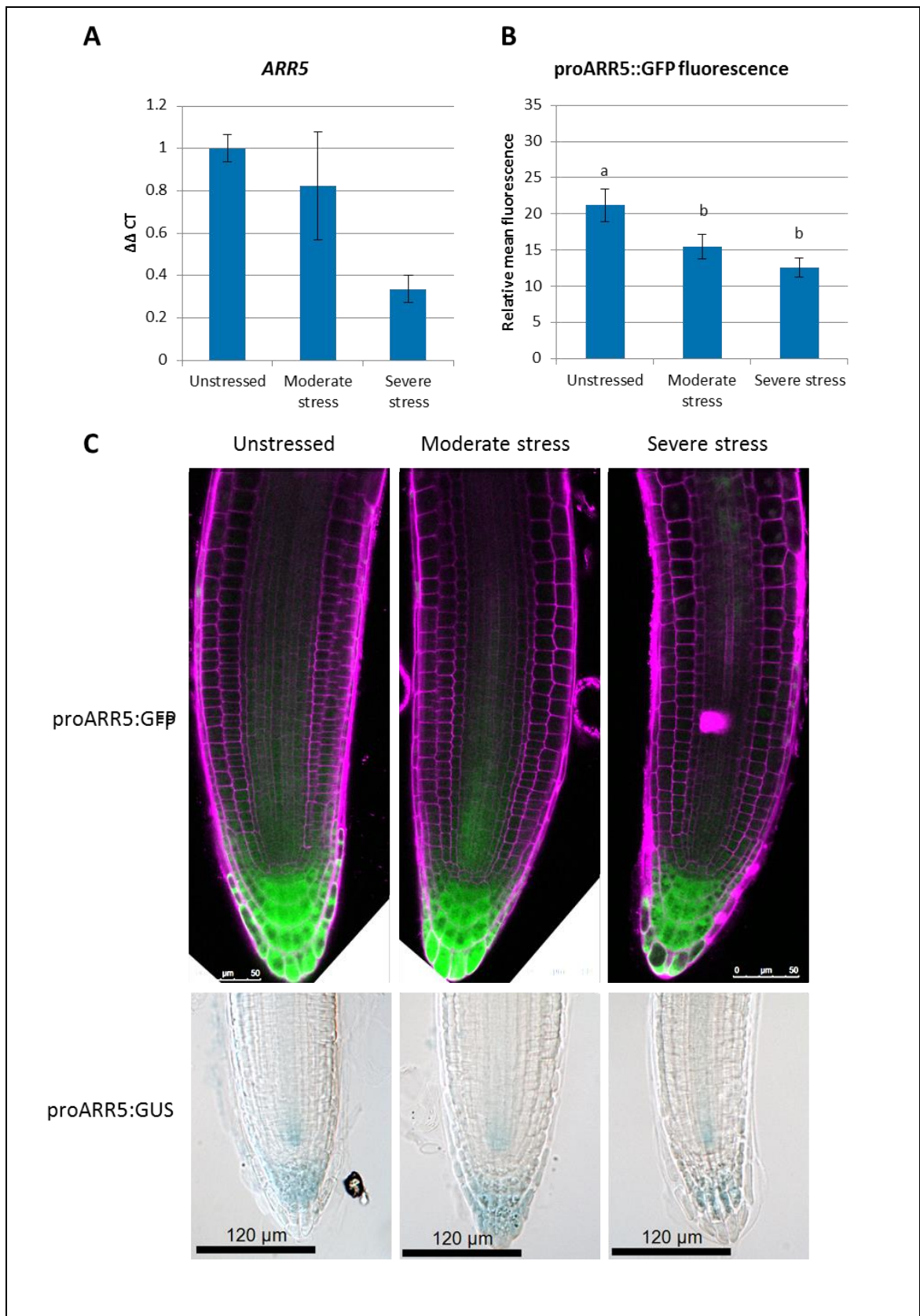

Figure 6-4 *ARR5* expression is reduced under osmotic stress.

The effect of osmotic stress on root hormone levels, responses and distribution

A) *ARR5* expression relative to *AT5G15710*. Col-0 seedlings were transferred from 1/2 MS plates to 1/2 MS + poly(ethylene glycol) mol wt. 8000 at five days after germination. After 24 hours plants were frozen in liquid nitrogen and the RNA extracted for qPCR. ANOVA P=0.057 B) *pARR5::GFP* fluorescence under osmotic stress. Measured in ImageJ, ANOVA P=0.0015, letters indicate significance with a Tukey Pairwise comparison. C) *pARR5::GFP* and *pARR5::GUS* under osmotic stress. Seedlings were transferred from 1/2 MS plates to 1/2 MS + poly(ethylene glycol) mol wt. 8000 at five days after germination. After 24h roots were stained and imaged

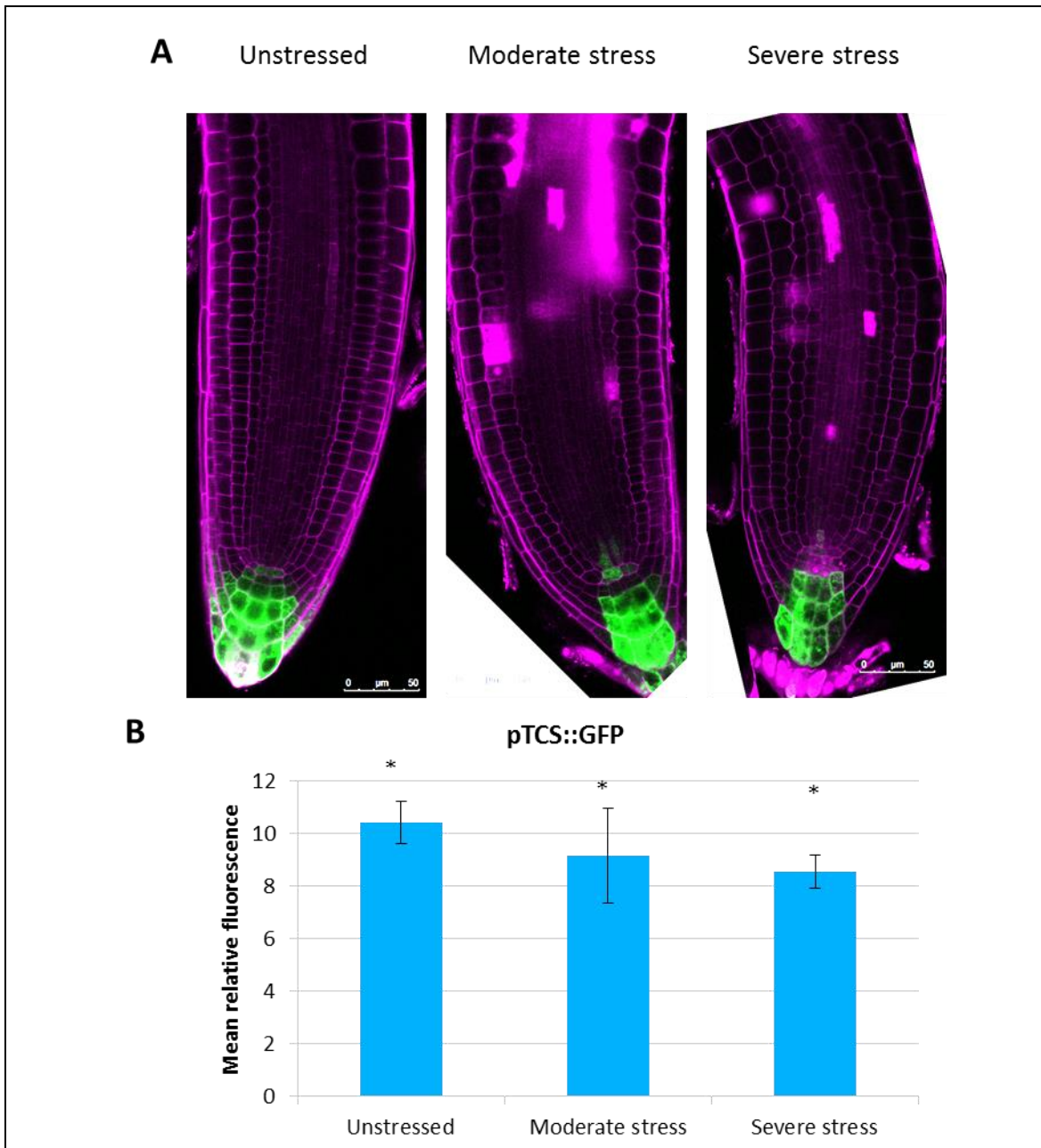

Figure 6-5 pTCS::GFP fluorescence is unaltered under osmotic stress

A) *pTCS::GFP* under osmotic stress B) *pTCS::GFP* fluorescence under osmotic stress. Measured in ImageJ, ANOVA P=0.44. *pTCS::GFP* seedlings were transferred from 1/2 MS plates to 1/2 MS + poly(ethylene glycol) mol wt. 8000 or 10 μ M 6-Benzylaminopurine (BAP) at five days after germination. After 24 hours the roots were removed, stained for cell walls for 1 minute 30s with 5 mg/ml propidium iodide (red channel), washed with deionised water for 1 minute 30 seconds and imaged with an SP5 LSCM. Scale bar indicates 50 μ m

6.5. The effect of osmotic stress on auxin transport, levels and distribution

6.5.1. Root auxin distribution and response is altered under osmotic stress

Root auxin levels and distribution are essential to normal root growth. The quiescent centre which regulates the organisation, division and differentiation of the root cells in *Arabidopsis* is maintained by an auxin maximum in the root tip (vandenBerg *et al.*, 1997; Sabatini *et al.*, 1999).

Several papers have recently implicated auxin responses in drought resistance and growth responses, however the role of auxin transport and distribution in these responses is unclear (Xu *et al.*, 2013; Shi *et al.*, 2014). So, bioinformatics, transgenic plants containing auxin biosensors and reporters were used to examine the effect of osmotic stress on auxin distribution in the root.

Publicly available transcriptomic data show that many genes that are positively regulated by auxin show reduced expression under osmotic stress treatment, suggesting that auxin levels and response may be reduced under stress (Figure 6-6).

To test this hypothesis for the effects of osmotic stress, we first examined expression of the auxin responsive *DR5::GUS* transgenic line. This reporter consists of seven tandem repeats of an auxin responsive element and a minimal cauliflower mosaic virus 35S promoter driving the transcription of a bacterial β -glucuronidase (*uidA*, *GUS*) gene (Ulmasov *et al.*, 1997). *GUS* transcription is activated in the presence of auxin, so histochemical staining for β -glucuronidase activity with X-Gluc produces a stable blue precipitate in the presence of auxin. *DR5::GUS* activity in unstressed roots shows an auxin maximum at the quiescent centre or columella initials, with a reduction in auxin responses under moderate and severe osmotic stress (Figure 6-7 and Sabatini *et al.*, 1999).

The *pDR5rev::3xVENUS-N7* line contains a rapidly folding YFP variant (VENUS) and nuclear localisation signal (N7) under the control of the auxin responsive *pDR5rev* promoter (Heisler *et al.*, 2005). Confocal microscopy of *pDR5rev::3xVENUS-N7* shows a similar pattern of auxin response in the root tip to the *DR5::GUS* line. In unstressed roots, there is an auxin maximum around the quiescent centre, and a relatively strong auxin signal in the columella cells and a weaker signal in the vasculature and lateral root cap (Figure 6-7). Under severe osmotic stress the auxin signal is reduced, as seen for the *DR5::GUS* line, and roots display only a weak auxin signal in the quiescent centre.

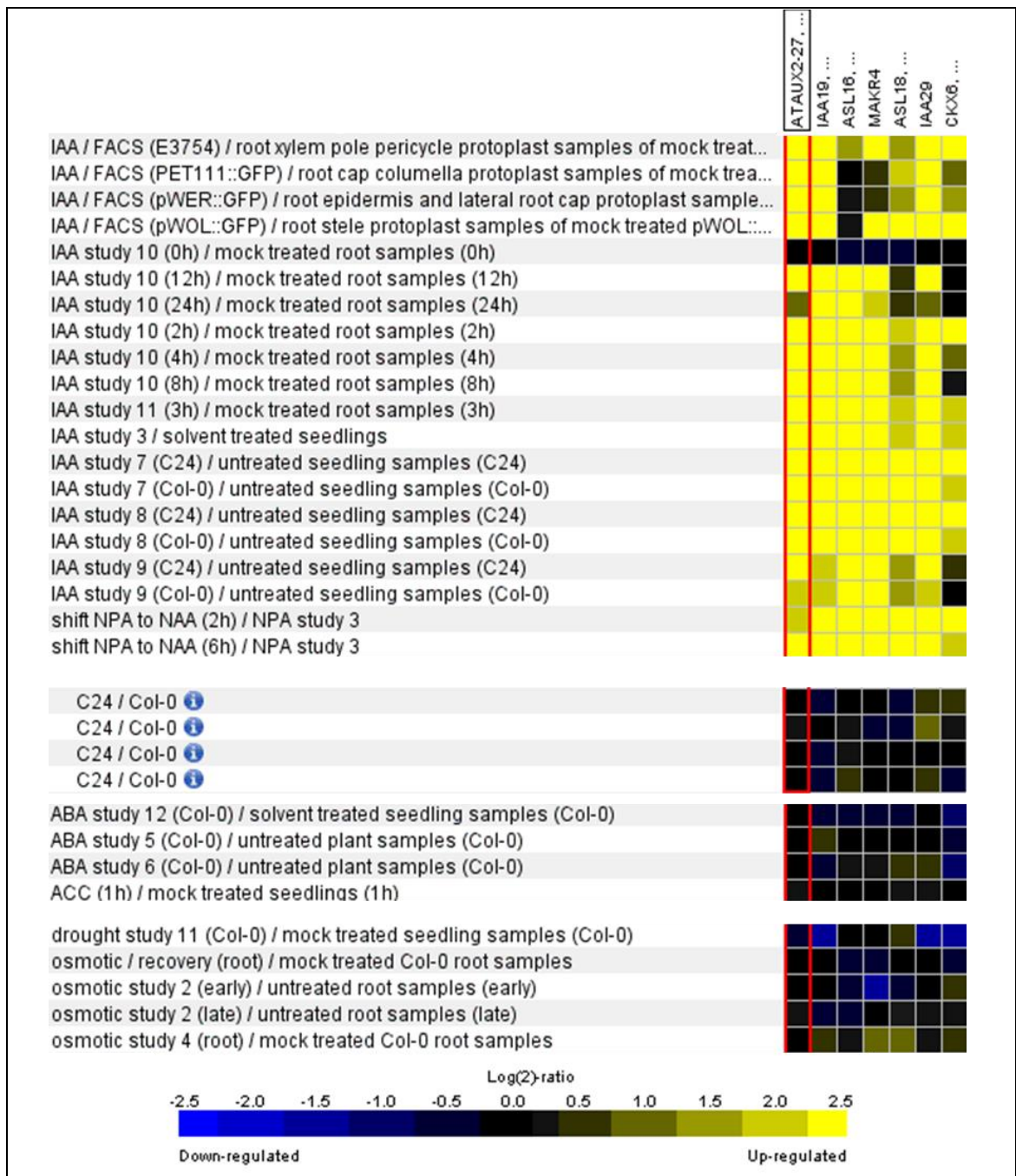

Figure 6-6 Auxin responsive gene expression under osmotic stress

Auxin responsive gene expression under auxin, osmotic stress or ABA treatment. Data obtained from publicly available Affymetrix ChIP data through Geneinvestigator.

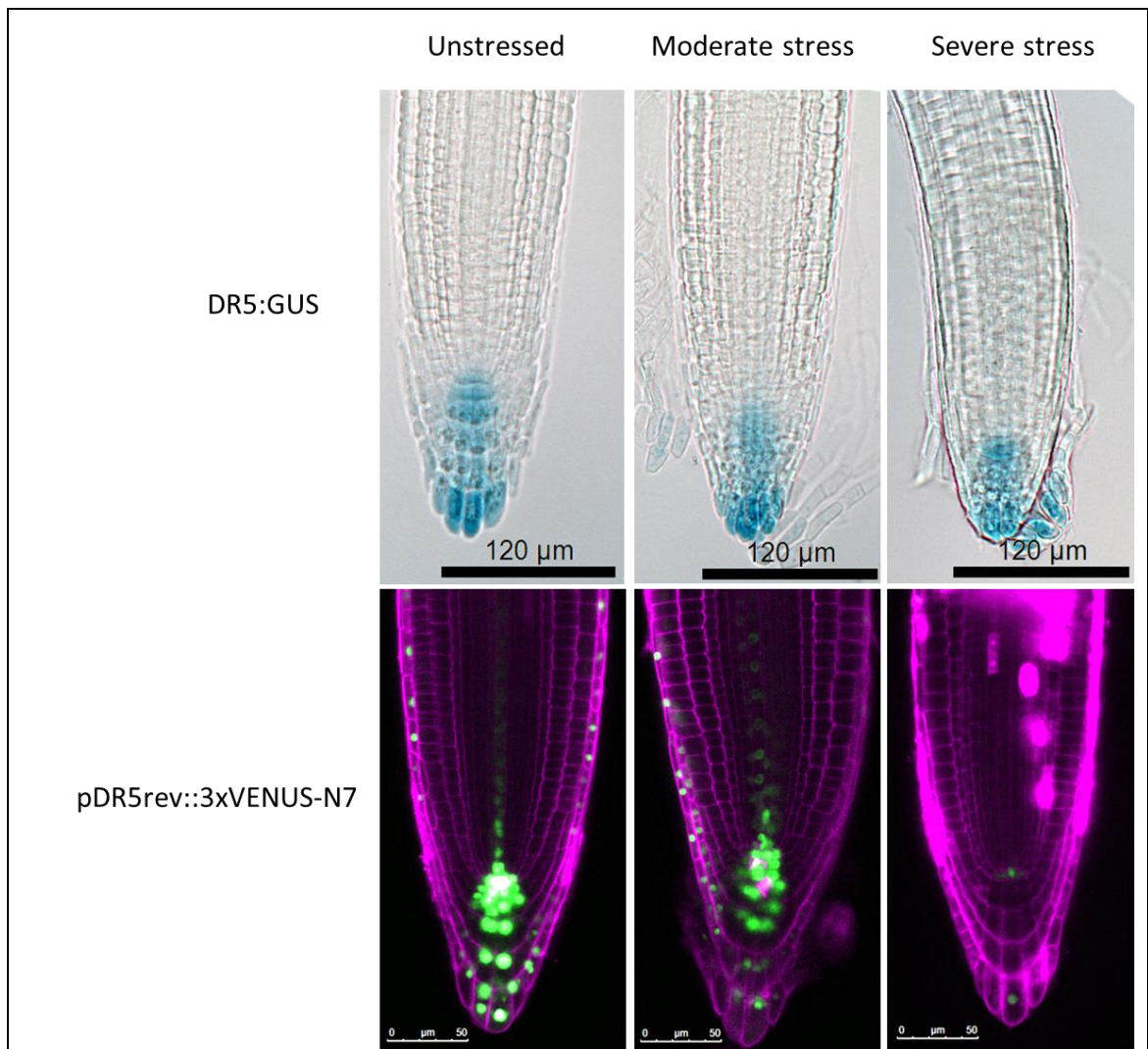

Figure 6-7 : DR5 activity decreases in roots under osmotic stress.

A) DR5::GUS seedlings were transferred from 1/2 MS plates to 1/2 MS + poly(ethylene glycol) mol wt. 8000 at three days after germination. After three days plants were stained for GUS activity and imaged with a compound microscope. B) *pDR5rev::3xVENUS-N7* seedlings were transferred from 1/2 MS plates to 1/2 MS + poly(ethylene glycol) mol wt. 8000 at five days after germination. After 24 hours the roots were removed, stained for cell walls for 2 mins with 5 mg/ml propidium iodide (magenta) and imaged with an SP5 LSCM. Scale bar indicates 50μm.

Because the DR5 promoter contains only a moderate affinity Auxin Responsive Element, it is not sensitive enough to gauge small or transient changes in auxin levels, so several other auxin biosensors have been developed to improve sensitivity (Brunoud *et al.*, 2012; Liao *et al.*, 2015). The *35S::DII::VENUS::N7* line contains the second domain (DII) of an AUX/IAA protein fused to the fluorescent VENUS protein and N7 nuclear localisation signal. In the presence of auxin, the DII region is ubiquitinated by the SCF^{TIR1} receptor complex, targeting the fusion protein to proteasomal degradation and reducing fluorescence (Maraschin *et al.*, 2009; Brunoud *et al.*, 2012).

DII::VENUS-N7 fluorescence increases in the root tip under moderate and severe osmotic stress, indicating a decrease in root auxin levels (Figure 6-8A, B).

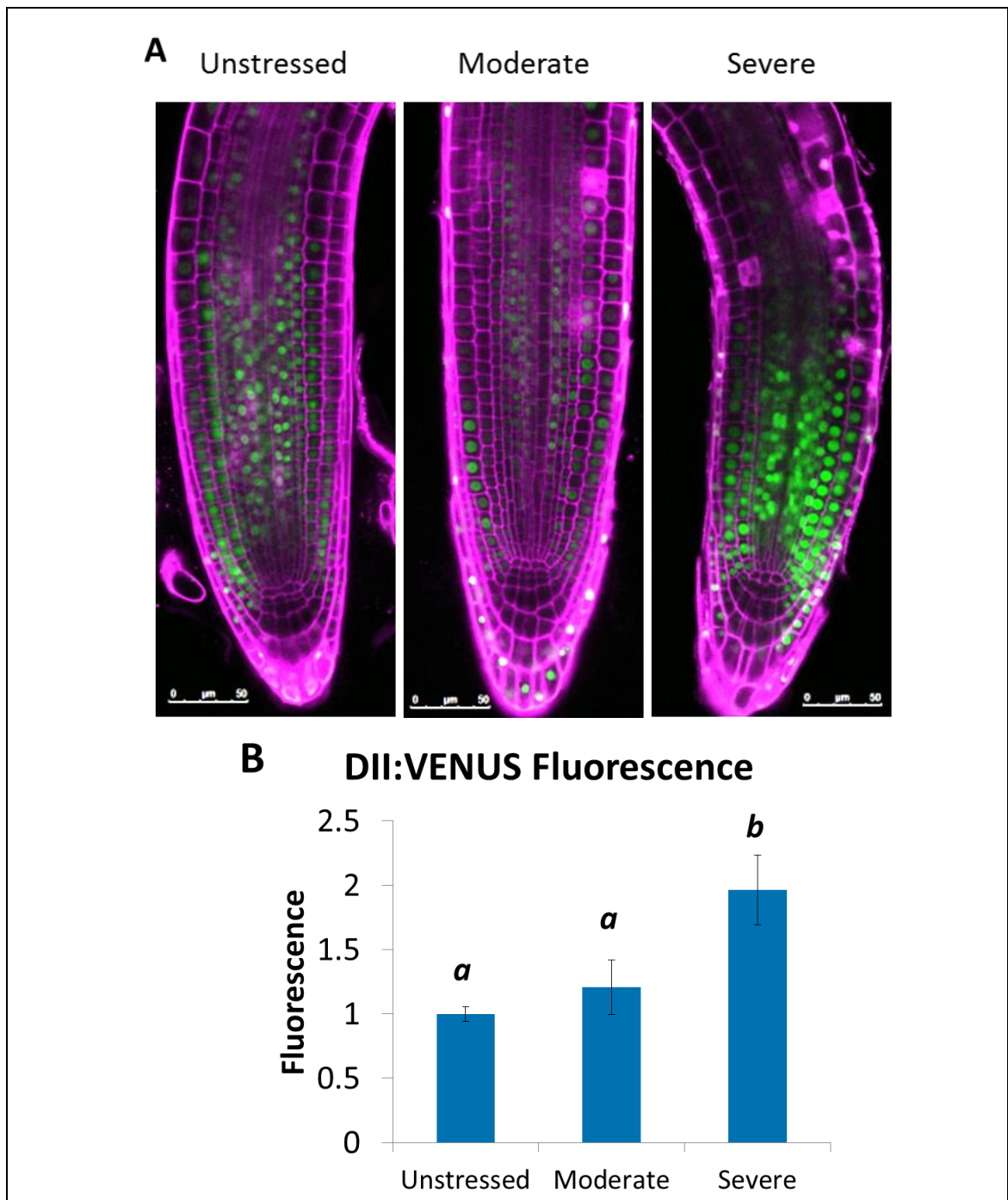

Figure 6-8 DII-VENUS fluorescence increases under severe osmotic stress.

A) P35S::DII:VENUS-N7 seedlings were transferred from 1/2 MS plates to 1/2 MS + poly(ethylene glycol) mol wt. 8000 at five days after germination. After 24 hours the roots were removed, stained for cell walls for 45 seconds with 10 mg/ml Propidium iodide, washed with deionised water for 45 seconds and imaged with an SP5 LSCM. Magenta: Propidium iodide, Green: VENUS, White: Propidium iodide/VENUS colocalisation Scale bar indicates 50µm. B): Mean relative fluorescence of six or seven imaged roots of each treatment was measured with ImageJ. ANOVA P=0.003, letters indicate significance with a Tukey pairwise comparison.

Therefore it was found that three different auxin biosensors and reporter lines suggest a decrease in the concentration of active auxin under osmotic stress. In *Arabidopsis*, auxin is transported from the shoot to the root through the vasculature. In the root, the distribution of the PIN FORMED 1 and 4 (PIN1 and PIN4) auxin efflux carrier proteins are responsible for funnelling auxin through the vasculature and into the quiescent centre (Blilou *et al.*, 2005;

The effect of osmotic stress on root hormone levels, responses and distribution Petrasek *et al.*, 2006). The reduction in auxin response under severe stress could therefore be due to changes in the expression or localisation of PIN1 or PIN4.

Auxin is transported laterally out of the columella by PIN3 and PIN7 (Friml *et al.*, 2002b). PIN2 transports auxin basipetally through the lateral root cap, epidermis and cortex to regulate cell expansion in the elongation zone (Luschnig *et al.*, 1998; Abas *et al.*, 2006). Changes in PIN2 expression may therefore also be regulating auxin levels in the root tip.

Therefore the distribution of the PIN-FORMED (PIN) auxin transport proteins was examined in seedlings subjected to osmotic stress, to determine whether they might be responsible for the observed change in auxin signal levels and distribution.

6.5.2. PIN1 and PIN4 levels are reduced under osmotic stress

PIN1 and PIN4 are localised to the plasma membrane of the vascular tissues in *Arabidopsis*. PIN1 transports auxin through the stele and PIN4 funnels auxin into its maximum at the quiescent centre (Galweiler *et al.*, 1998; Friml *et al.*, 2002a). A reduction in PIN1 or PIN4 level caused by osmotic stress could lead to a decreased root auxin concentration/response, and ultimately affect root growth.

qPCR analysis showed that when Col-0 seedlings were transferred to osmotic stress media, PIN1 and PIN4 transcript levels decreased (Figure 6-9 A). To investigate effects on the respective protein levels, *proPIN1::PIN1::GFP* and *proPIN4::PIN4::GFP* seedlings were transferred to osmotic stress media, and imaged using a LSCM. Both proteins showed a reduced fluorescence under moderate and severe osmotic stress (Figure 6-9 B and C). Under severe stress, PIN1:GFP also exhibited a loss of polarity and internalisation from the plasma membrane, and localised to an internal compartment (Figure 6-9 D). Plasmolysis has previously been shown to cause PIN1 and PIN2 internalisation and a loss of polarity (Feraru *et al.*, 2011; Nakayama *et al.*, 2012).

Previously, PIN1 protein levels have been shown to be negatively regulated by ABA (Shkolnik-Inbar & Bar-Zvi, 2010) and positively regulated by ethylene (Ruzicka *et al.*, 2007; Liu *et al.*, 2013). As both ethylene and ABA have been implicated in drought responses and have an antagonistic relationship, they may be responsible for changes in PIN1 protein level and auxin transport (Ichimura *et al.*, 2000; Sharp & LeNoble, 2002; Liu & Zhang, 2004; Lee *et al.*, 2006; Joo *et al.*, 2008).

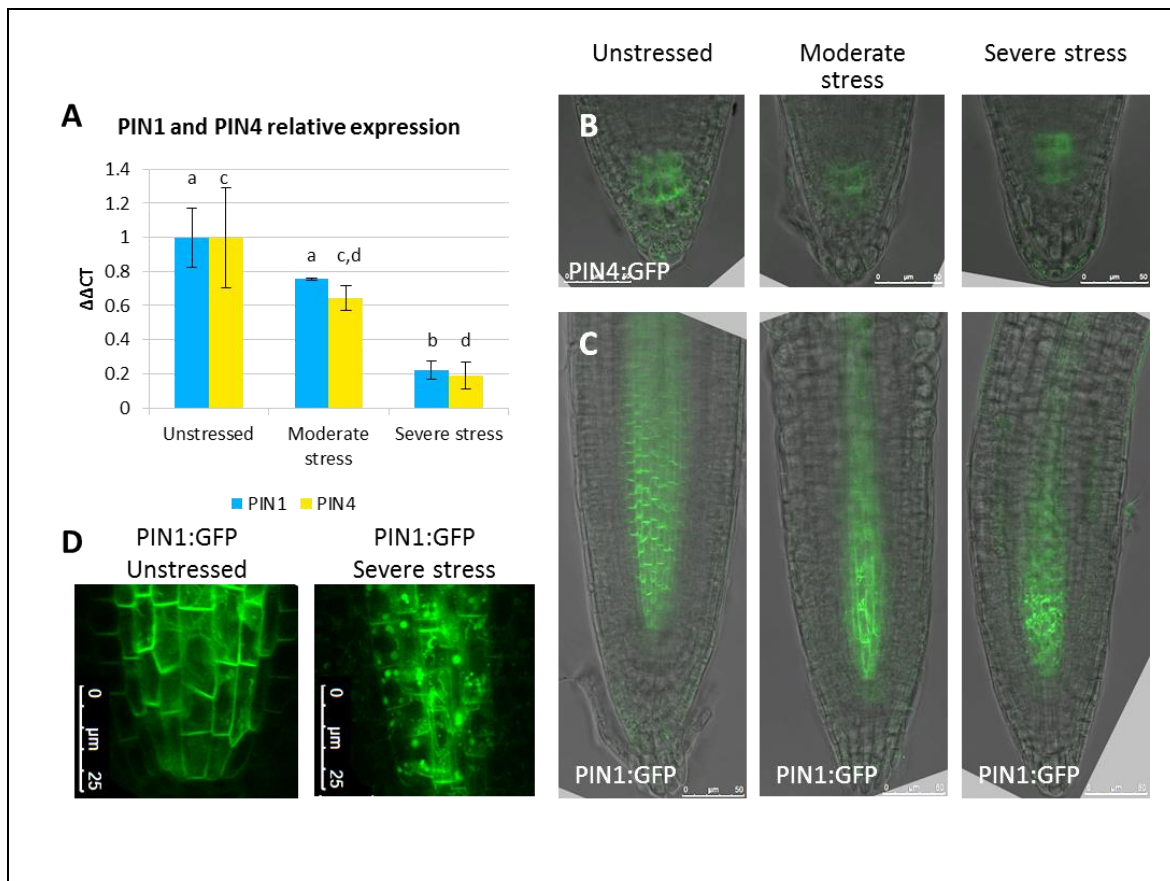

Figure 6-9 : PIN1 and PIN4 transcript and protein levels decrease under osmotic stress and PIN1 delocalises from the membrane.

A) Col-0 seedlings were transferred from 1/2 MS plates to 1/2 MS + poly(ethylene glycol) mol wt. 8000 at five days after germination. After 24 hours plants were frozen in liquid nitrogen and the RNA extracted for qPCR. Scale bars indicate the standard error of the mean. B) *proPIN4::PIN4::GFP* , C) *proPIN1::PIN1::GFP* and D) *proPIN1::PIN1::GFP* seedlings were transferred from 1/2 MS plates to 1/2 MS + poly(ethylene glycol) mol wt. 8000 at five days after germination. After 24 hours the roots were removed and imaged with a Leica SP5 LSCM. Scale bar for B) and C) indicates 50 μ m. Scale bar for D) indicates 25 μ m.

6.5.3. PIN2 levels increase under moderate osmotic stress, and return to normal under severe stress

PIN2 is an auxin transporter primarily responsible for the efflux of auxin from cells in the lateral root cap, epidermis and cortex of the root (Luschnig *et al.*, 1998; Abas *et al.*, 2006). Along with the auxin influx carrier AUX1, PIN2 transcript and protein levels therefore regulate basipetal transport in the Arabidopsis root.

Under moderate osmotic stress the same increase in PIN2 transcript and fluorescent protein levels was observed as observed in previous studies (Xu *et al.*, 2013), but under severe stress the PIN2 transcript and protein levels show some return to near unstressed levels (Figure 6-10). PIN2 protein levels have been shown to be both ABA- and ethylene-responsive (Ruzicka *et al.*, 2007; Xu *et al.*, 2013).

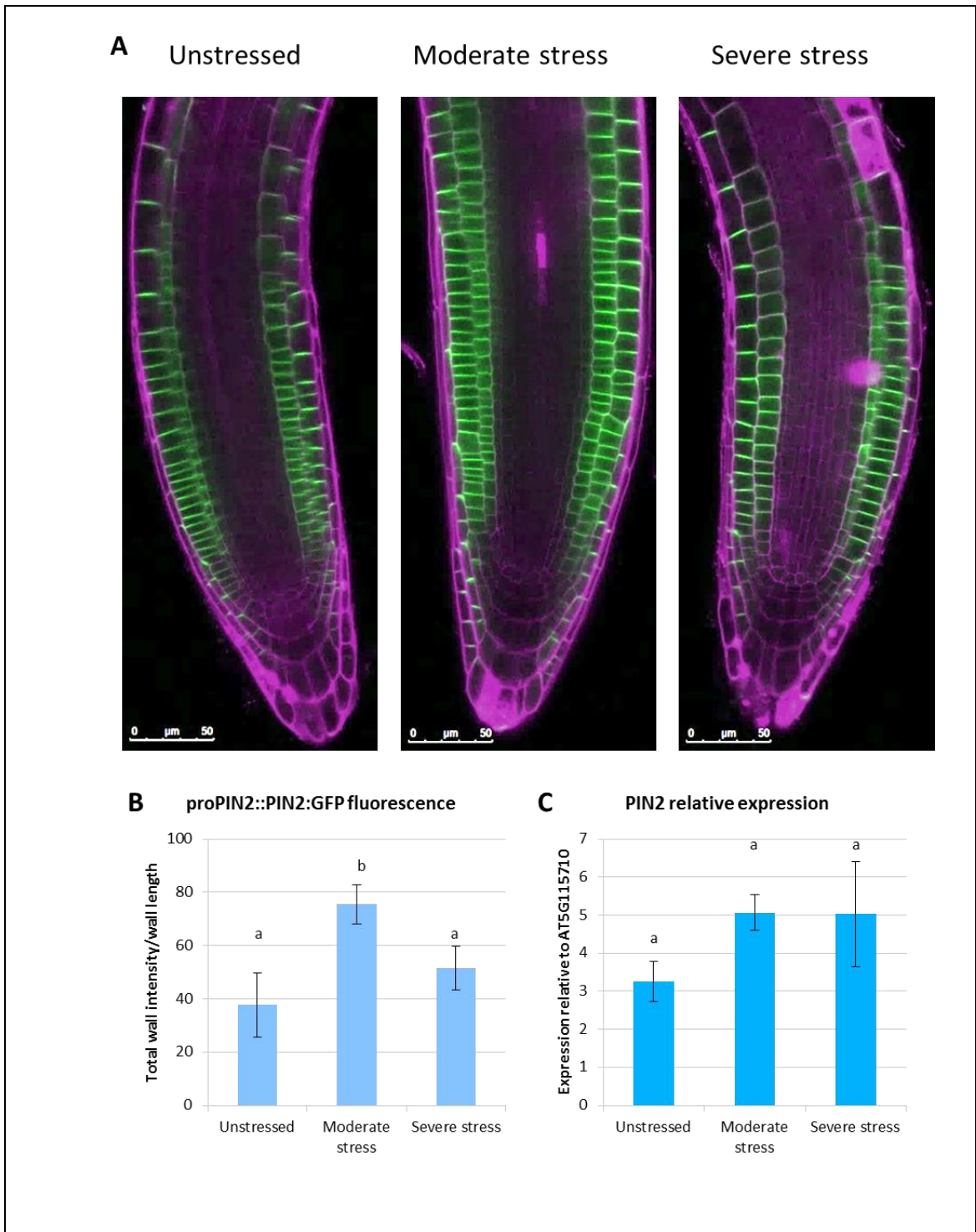

Figure 6-10 PIN2 levels show a bell shaped response to osmotic stress.

A) proPIN2::PIN2:GFP seedlings were transferred from 1/2 MS plates to 1/2 MS + poly(ethylene glycol) mol wt. 8000 at five days after germination. After 24 hours the roots were removed, stained for cell walls for 1 minute 30s with 5 mg/ml Propidium iodide (Magenta), washed with deionised water for 1 minute 30 seconds and imaged with an SP5 LSCM. Scale bar indicates 50μm B) For seven roots of each treatment, mean fluorescence of PIN2:GFP at the anterior and posterior cell walls in the cortex and epidermis was measured using CellSet. As PI staining was unreliable in stressed roots, the graph represents mean GFP fluorescence/cell wall length. C) Col-0 seedlings were transferred from 1/2 MS plates to 1/2 MS + poly(ethylene glycol) mol wt. 8000 at five days after germination. After 24 hours plants were frozen in liquid nitrogen and the RNA extracted for qPCR. Scale bars indicate the standard error of the mean.

6.5.4. AUX1 levels under osmotic stress

AUX1 is an auxin influx carrier that is expressed in the protosteles, the epidermis, the columella and the lateral root cap (Marchant *et al.*, 1999; Swarup *et al.*, 2001). It is required for root gravitropism and full ethylene responses in relation to root growth (Pickett *et al.*, 1990; Marchant *et al.*, 1999). AUX1 levels are increased by ethylene and decreased by abscisic acid (Ruzicka *et al.*, 2007; Belin *et al.*, 2009; Yang *et al.*, 2014).

To investigate the effects of osmotic stress on AUX1, qPCR of *AUX1* transcript abundance in stressed wildtype seedlings, was determined and seedlings transgenic for a proAUX1::AUX1:YFP(116) construct (Swarup *et al.*, 2004) were grown under stress and monitored by confocal imaging. Although unchanged under moderate stress, severe osmotic stress was found to reduce *AUX1* transcript abundance and lead to reduced AUX1:YFP protein fusion fluorescence (Figure 6-11).

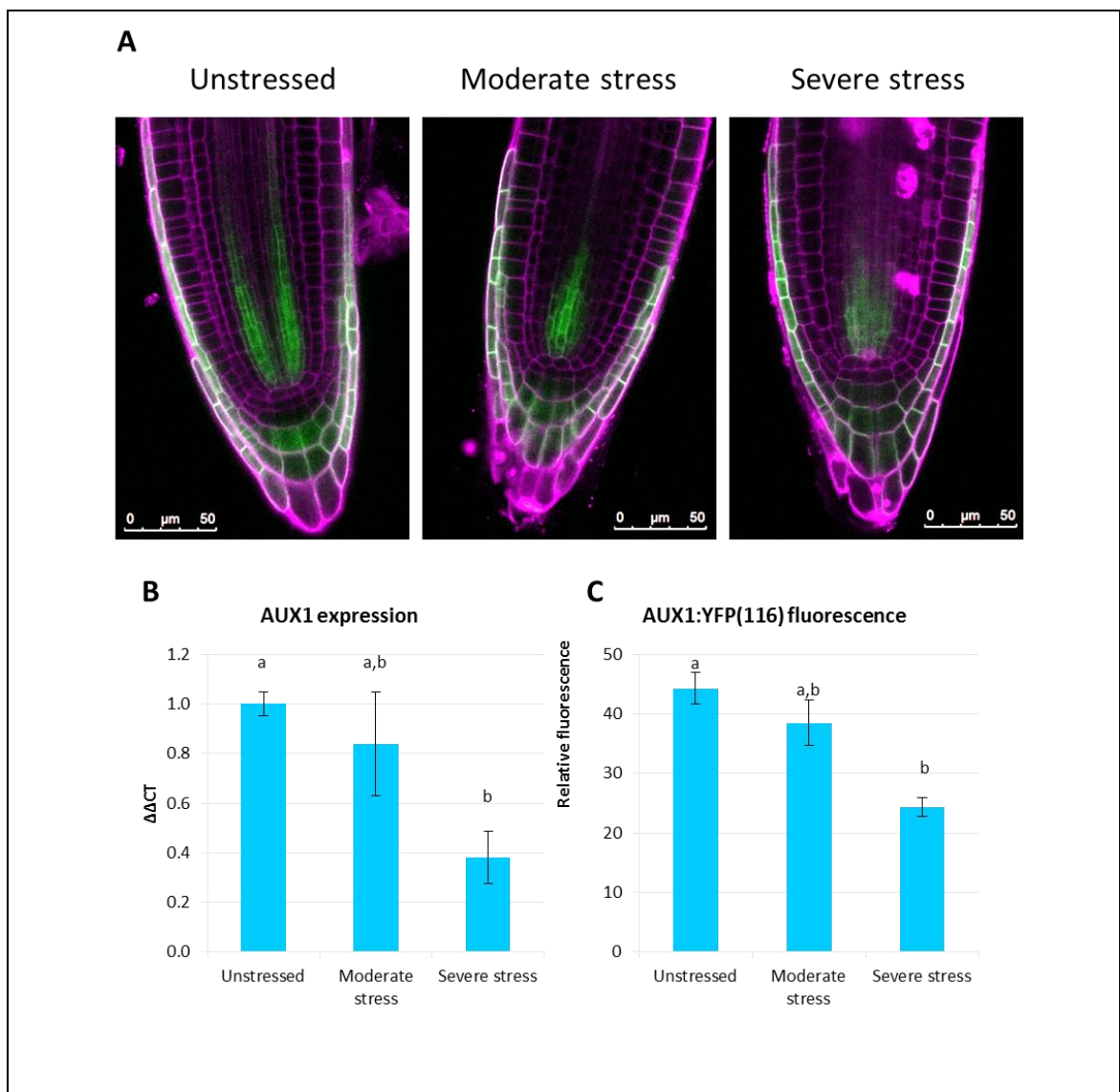

Figure 6-11 AUX1 expression is reduced under severe osmotic stress.

The effect of osmotic stress on root hormone levels, responses and distribution

A) proAUX1::AUX1:YFP(116) seedlings were transferred from 1/2 MS plates to 1/2 MS + poly(ethylene glycol) mol wt. 8000 at five days after germination. After 24 hours the roots were removed, stained for cell walls for 1 minute 30s with 5 mg/ml propidium iodide, washed with deionised water for 1 minute 30 seconds and imaged with an SP5 LSCM. Magenta: propidium iodide, Green: YFP, White: propidium iodide/YFP colocalisation. Scale bar indicates 50µm B) Col-0 seedlings were transferred from 1/2 MS plates to 1/2 MS + poly(ethylene glycol) mol wt. 8000 at five days after germination. After 24 hours plants were frozen in liquid nitrogen and the RNA extracted for qPCR. Scale bars indicate the standard error of the mean. C) Relative mean fluorescence of proAUX1::AUX1:YFP(116) seedlings after 24 hours osmotic stress treatment, measured in CellSet (Pound *et al.*, 2012). ANOVA, P<0.001

6.6. POLARIS levels decrease under osmotic stress

The POLARIS (PLS) peptide is an auxin-responsive negative regulator of ethylene responses. Genetic and modelling evidence indicate that it interacts at the level of the ethylene receptor, ETHYLENE RESPONSE 1 (ETR1) (Casson *et al.*, 2002; Chilley *et al.*, 2006; Liu *et al.*, 2010). ETR1 and PLS co-localise to the endoplasmic reticulum, with *in vivo* and *in vitro* evidence of a direct interaction (Mehdi, 2009; Mudge, 2015). The *pls* mutant displays enhanced ethylene responses, including short roots, which can be recovered by crossing with the gain-of-function *etr1-1* mutant (Chilley *et al.*, 2006). This suggests that POLARIS acts on ethylene signalling by regulating the ethylene receptor. Modelling work indicates that because PLS is auxin responsive, it adds flexibility to the relationship between auxin and ethylene signalling (Liu *et al.*, 2010)

PLS expression is highly auxin-responsive, and also transcriptionally repressed by ethylene (Casson *et al.*, 2002, Chilley *et al.*, 2006) and histochemical staining of roots shows a similar expression pattern to *DR5::GUS* or *pDR5rev::3xVENUS-N7* (Figure 6-7, Figure 6-12). In unstressed roots, *proPLS:PLS::GFP* expression is highest around the quiescent centre, though more diffuse in its expression the *DR5::GFP* for example, but like other auxin reporters its expression decreases under severe stress. Given what is known about the regulation of *PLS*, the *PLS:GFP* data suggest its reduced expression under osmotic stress may be due to reduced active auxin in the root tip, or enhanced ethylene signalling, or both.

Intriguingly, however, whole seedlings transferred to severe osmotic stress media showed no change in *PLS* transcript abundance after 6 hours but an increase, rather than decrease, after 24 hours (Figure 6-13).. Unlike other genes assessed by qPCR, the Ct values for *PLS* were very late (28-31), which indicates transcript levels were probably below the range of quantitative detectability by qPCR, throwing doubt on the validity of these transcript studies (Fig. 1-13).

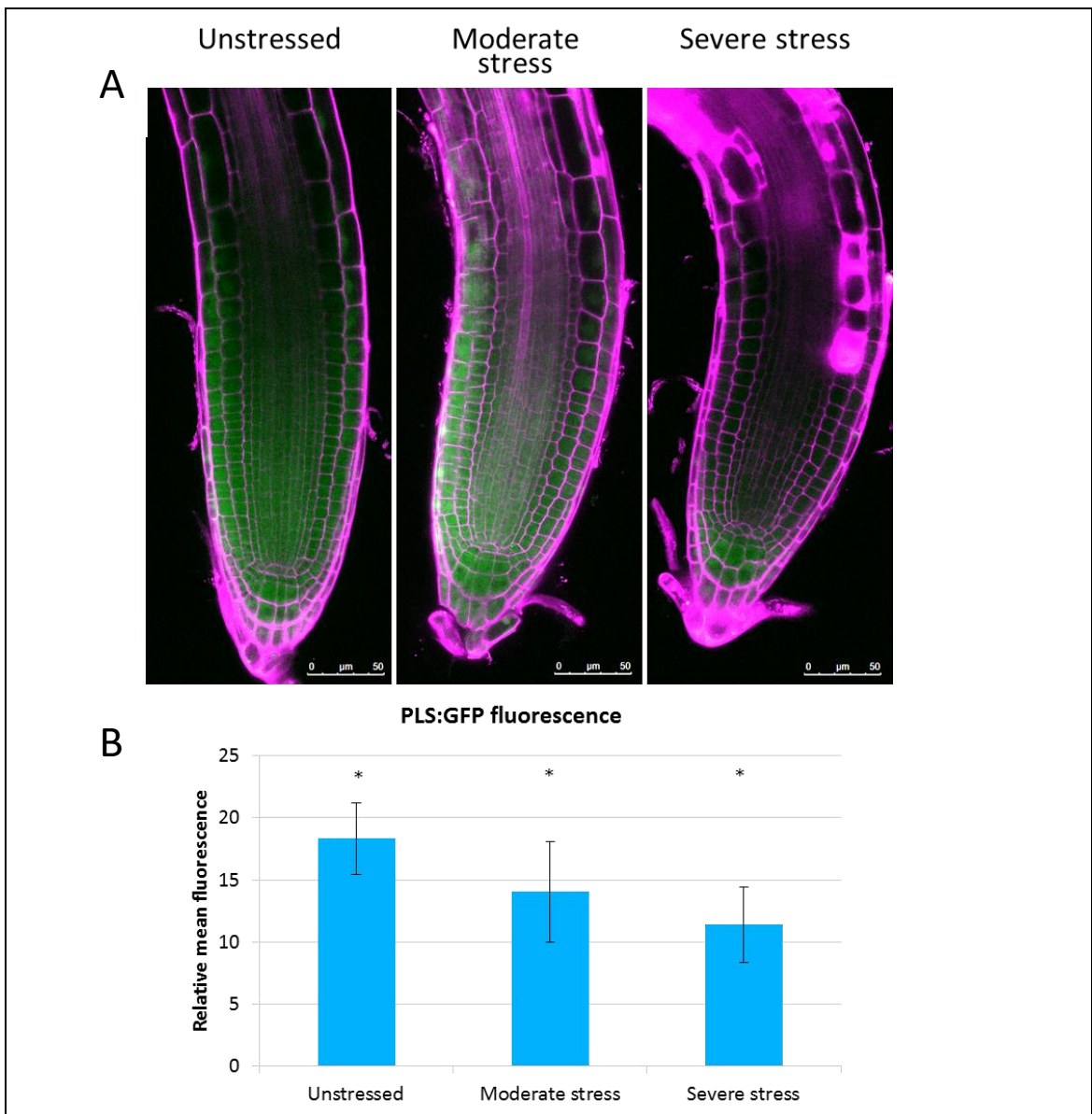

Figure 6-12 proPLS::PLS:GFP levels decrease under osmotic stress

A) proPLS::PLS:GFP seedlings were transferred from 1/2 MS plates to 1/2 MS + poly(ethylene glycol) mol wt. 8000 at five days after germination. After 24 hours the roots were removed, stained for cell walls for 1 minute 30s with 5 mg/ml propidium iodide, washed with deionised water for 1 minute 30 seconds and imaged with an SP5 LSCM. Magenta: propidium iodide, Green: GFP, White: propidium iodide/GFP colocalisation. Scale bar indicates 50 μ m. B) Mean relative fluorescence of proPLS::PLS:GFP under osmotic and hormone treatment. Seedlings were transferred from 1/2 MS plates to 1/2 MS + poly(ethylene glycol) mol wt. 8000 five days after germination. After 24 hours the roots were removed and imaged with an SP5 LSCM. B) Between 9 and 13 seedlings were imaged for each treatment and the mean fluorescence of the whole root in frame was measured using ImageJ. ANOVA, P=0.23

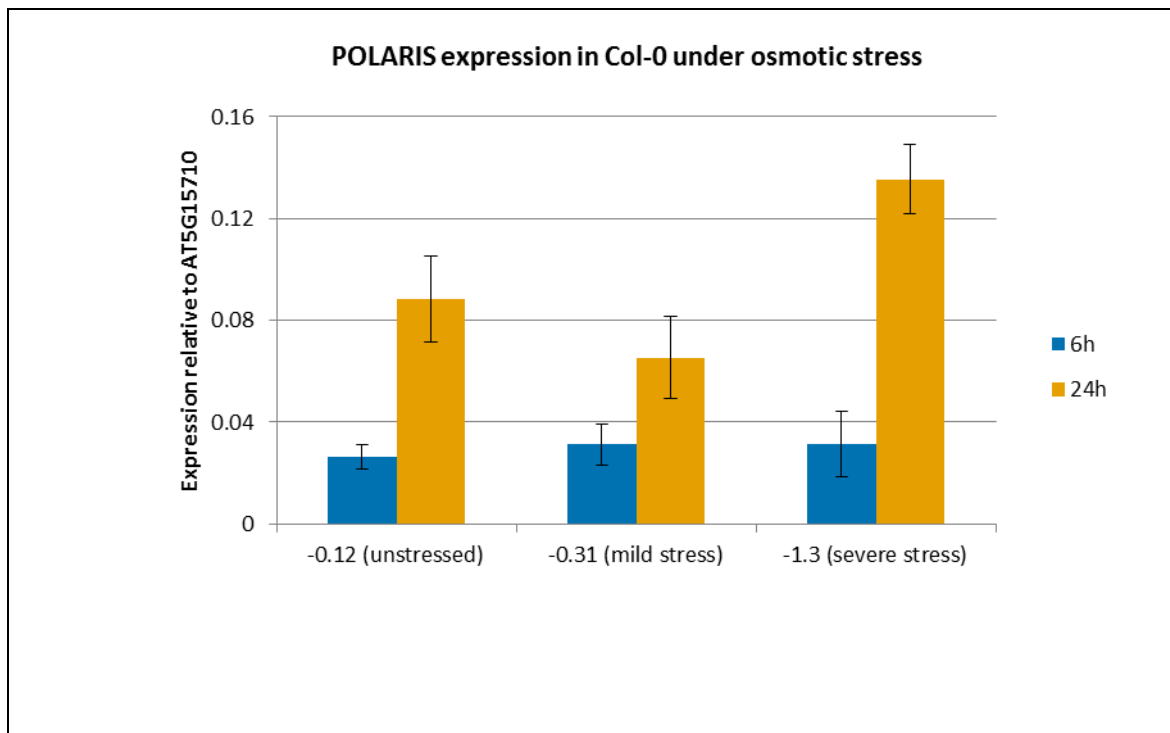

Figure 6-13: Whole seedling *POLARIS* expression increases under osmotic stress.

A) *POLARIS* expression relative to AT5G15710. Col-0 seedlings were transferred from 1/2 MS plates to 1/2 MS + poly(ethylene glycol) mol wt. 8000 at five days after germination. After 6 or 24 hours plants were frozen in liquid nitrogen and the RNA extracted for qPCR

6.7. The effect of combined hormone and osmotic stress treatments on PIN1:GFP levels

PIN1 mRNA and fusion protein levels are reduced under osmotic stress (Figure 6-9), but how this is regulated is unknown. Plants have several pathways to respond to osmotic stress, including the fast ABA-independent pathway as well as the slower ABA and ethylene pathways.

PIN1 levels are known to decrease under ABA treatment, through the transcription factor ABI4, and increase under ethylene treatment (Ruzicka *et al.*, 2007; Shkolnik-Inbar & Bar-Zvi, 2010; Liu *et al.*, 2013). Therefore, measuring PIN1 levels under combined hormone and osmotic stress treatments should indicate whether either of these hormones is responsible for the change in PIN1 levels.

6.7.1. Treatment with the ethylene precursor ACC cannot rescue PIN1:GFP levels under osmotic stress

It was found that proPIN1::PIN1:GFP transgenic seedlings subjected to osmotic stress have reduced relative PIN fusion protein fluorescence (Figure 6-14). Previous work has shown that increasing ethylene levels increases PIN1 protein levels, while inhibiting ethylene responses decreases them (Ruzicka *et al.*, 2007; Liu *et al.*, 2013). Pharmacological treatment with the ethylene precursor 1-aminocyclopropane-1-carboxylic acid (ACC) or with the ethylene

The effect of osmotic stress on root hormone levels, responses and distribution

signalling inhibitor silver thiosulphate (STS) significantly alter PIN1:GFP levels, with the trend agreeing with the literature, with ACC causing an increase and STS a decrease (Figure 6-14).

However, it was found that neither ACC nor STS treatments altered the trend in PIN1:GFP fluorescence under stress (Figure 6-14). Therefore, changes in PIN1 levels under stress appear to be regulated independently of ethylene signalling.

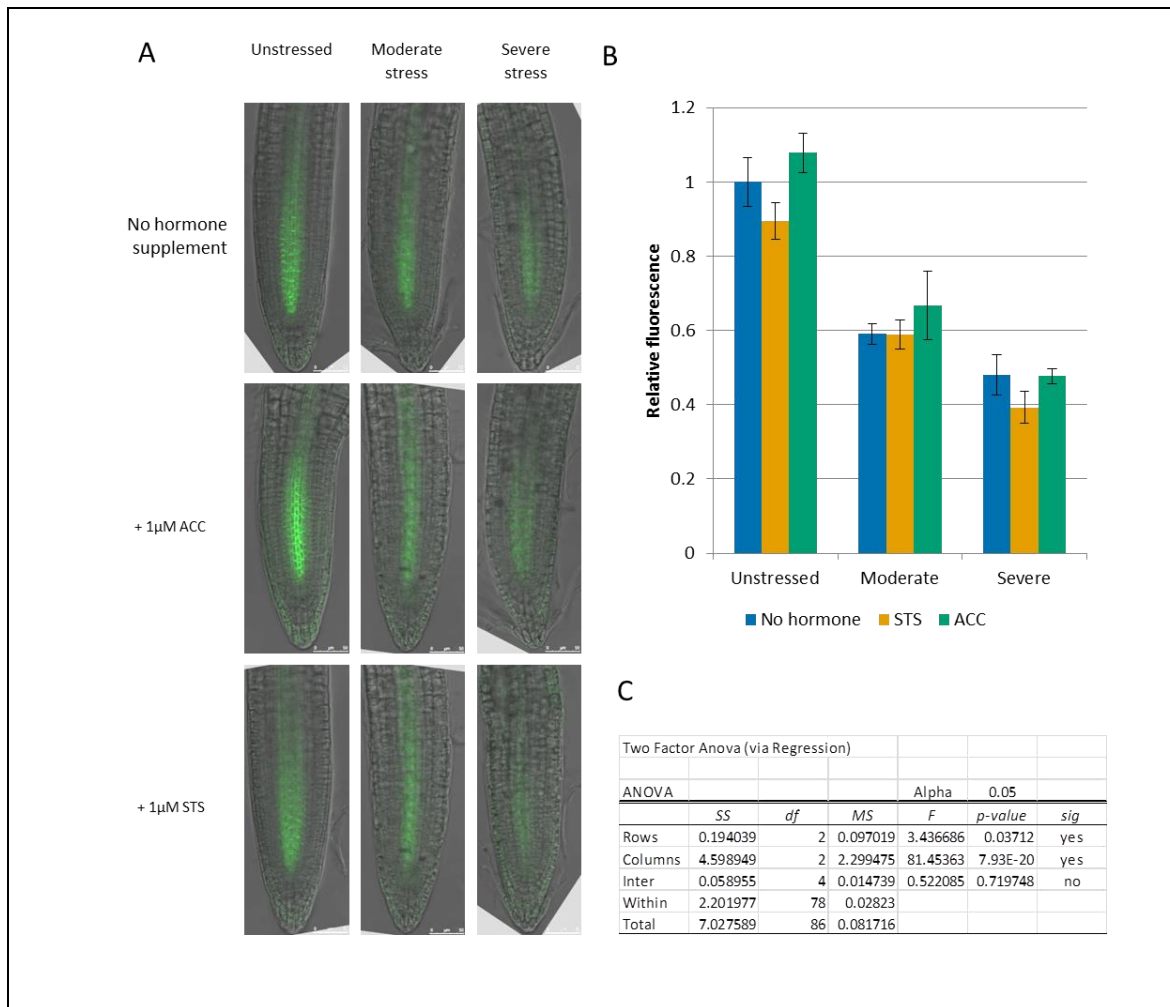

Figure 6-14 PIN1:GFP relative fluorescence decreases under osmotic stress regardless of ethylene signalling.

A) Representative images of proPIN1::PIN1:GFP under osmotic and hormone treatment. B) Mean relative fluorescence of proPIN1::PIN1:GFP under osmotic and hormone treatment. Seedlings were transferred from 1/2 MS plates to 1/2 MS + poly(ethylene glycol) mol wt. 8000 containing either 1 µM 1-aminocyclopropane-1-carboxylic acid or 1 µM silver thiosulphate at five days after germination. After 24 hours the roots were removed and imaged with an SP5 LSCM. Between 3 and 6 seedlings were imaged and the fluorescence of a 100 X 40 µm section posterior to the quiescent centre was measured in ImageJ.

6.7.2. ABA reduces PIN1:GFP levels and inhibiting ABA biosynthesis rescues PIN1:GFP levels under osmotic stress

proPIN1::PIN1:GFP seedlings treated with ABA exhibit decreased GFP fluorescence, and inhibiting ABA biosynthesis with the inhibitor fluridon increases fluorescence (P<0.001, Figure 6-15; (Shkolnik-Inbar & Bar-Zvi, 2010). proPIN1::PIN1:GFP fluorescence is also affected by

The effect of osmotic stress on root hormone levels, responses and distribution

osmotic stress ($P < 0.0001$, Figure 6-15), with increasing stress reducing PIN1 fusion protein levels. Under moderate osmotic stress, fluridon treatment can rescue PIN1 fusion protein levels, indicating an interaction between ABA signalling and osmotic stress to regulate PIN1 levels ($P = 0.05$).

Interestingly, pharmacologically increasing or decreasing ABA levels has no effect on PIN1:GFP localisation, suggesting that the changes to PIN1 trafficking occur independently of ABA signalling.

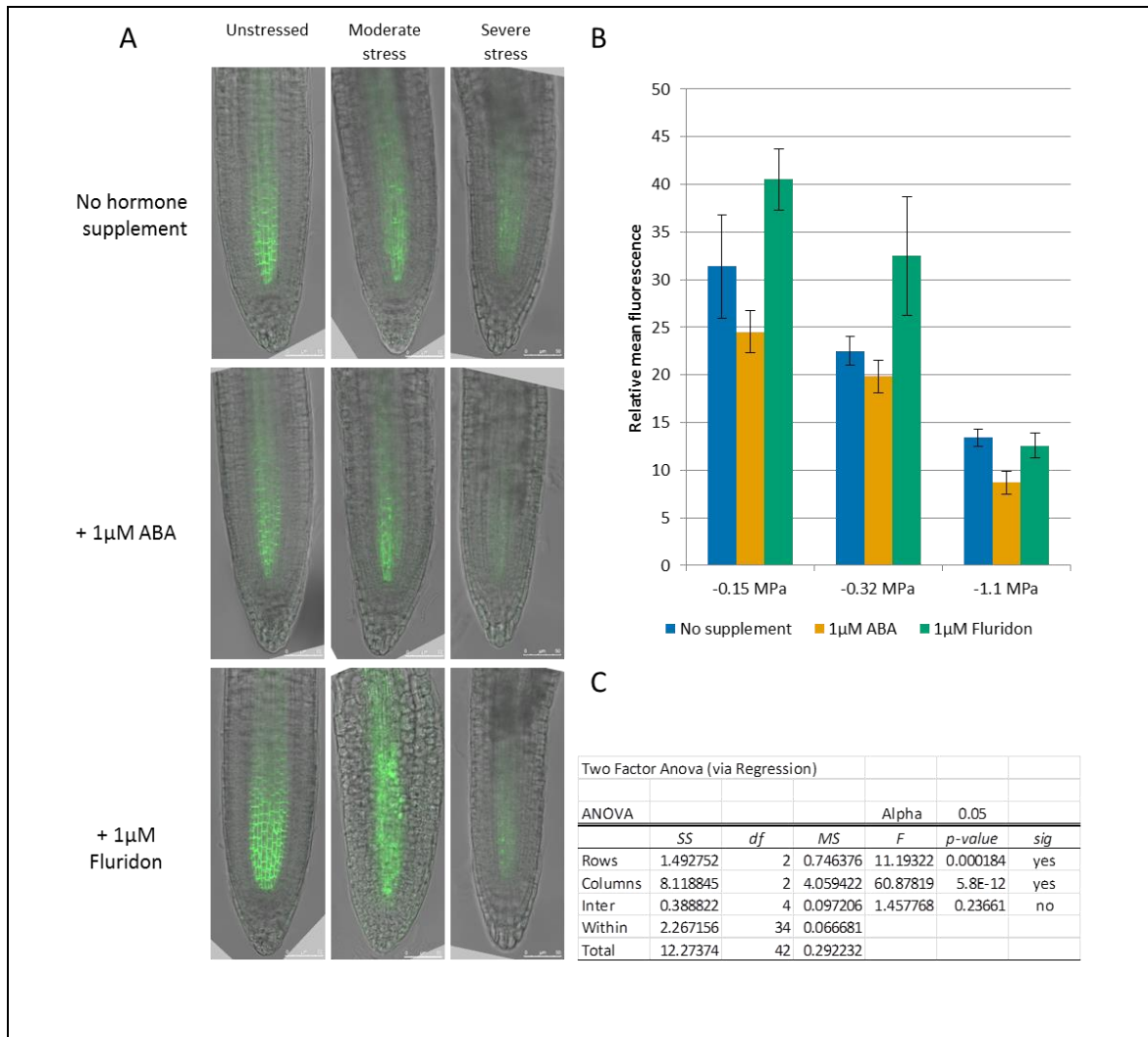

Figure 6-15 Inhibiting ABA biosynthesis rescues the reduction in PIN1:GFP under osmotic stress

A) Representative images of proPIN1::PIN1:GFP under osmotic and hormone treatment. B) Mean relative fluorescence of proPIN1::PIN1:GFP under osmotic and hormone treatment. Seedlings were transferred from 1/2 MS plates to 1/2 MS + poly(ethylene glycol) mol wt. 8000 containing 1 µM Abscisic acid or 1 µM Fluridon at five days after germination. After 24 hours the roots were removed and imaged with an SP5 LSCM. Between 4 and 7 seedlings were imaged and the fluorescence of a 100 X 40 µm section posterior to the quiescent centre was measured in ImageJ. C) ANOVA table.

6.7.3. Ethylene cannot rescue PIN1:GFP levels under abscisic acid treatment

The results presented so far suggest that ethylene can increase PIN1 levels, but this effect seems to be overridden under osmotic stress. ABA on the other hand seems to be required to

The effect of osmotic stress on root hormone levels, responses and distribution

reduce PIN1 levels under stress. To confirm these relationships it was considered important to know if treatment with ABA is sufficient to override the ethylene effect, in the absence of osmotic stress.

Treatment with ABA reduced PIN1:GFP levels, and treatment with ACC increased PIN1 levels (Figure 6-16). Combined application of ACC and ABA also showed that applying low concentrations of ABA was enough to reduce PIN1:GFP fluorescence to untreated levels, even in the presence of ACC. Intriguingly, the low concentration of ABA required to override the effect of ACC was two orders of magnitude lower than that required to reduce PIN1:GFP fluorescence below untreated levels. This indicates that ABA regulates PIN1 levels downstream of ethylene biosynthesis, either at the level of signalling or at the transcriptional level, and can override its effects.

The pathways through which ethylene increases PIN1 levels are poorly defined however ethylene can promote auxin biosynthesis in roots (Stepanova *et al.*, 2005; Stepanova *et al.*, 2008), which upregulates PIN1, through a signalling pathway involving SHY2/IAA3 (Dello Iorio *et al.*, 2008). There is currently little evidence on whether ABA also regulates SHY2 and the auxin signalling pathway in the meristem. As the abscisic acid responsive transcription factor ABI4 negatively regulates PIN1 expression (Shkolnik-Inbar & Bar-Zvi, 2010) and ethylene responses are sustained under severe stress where ABA signalling is the greatest (Figure 6-1; Figure 6-2), these results would suggest that ABA is directly regulating the PIN1 promoter under osmotic stress.

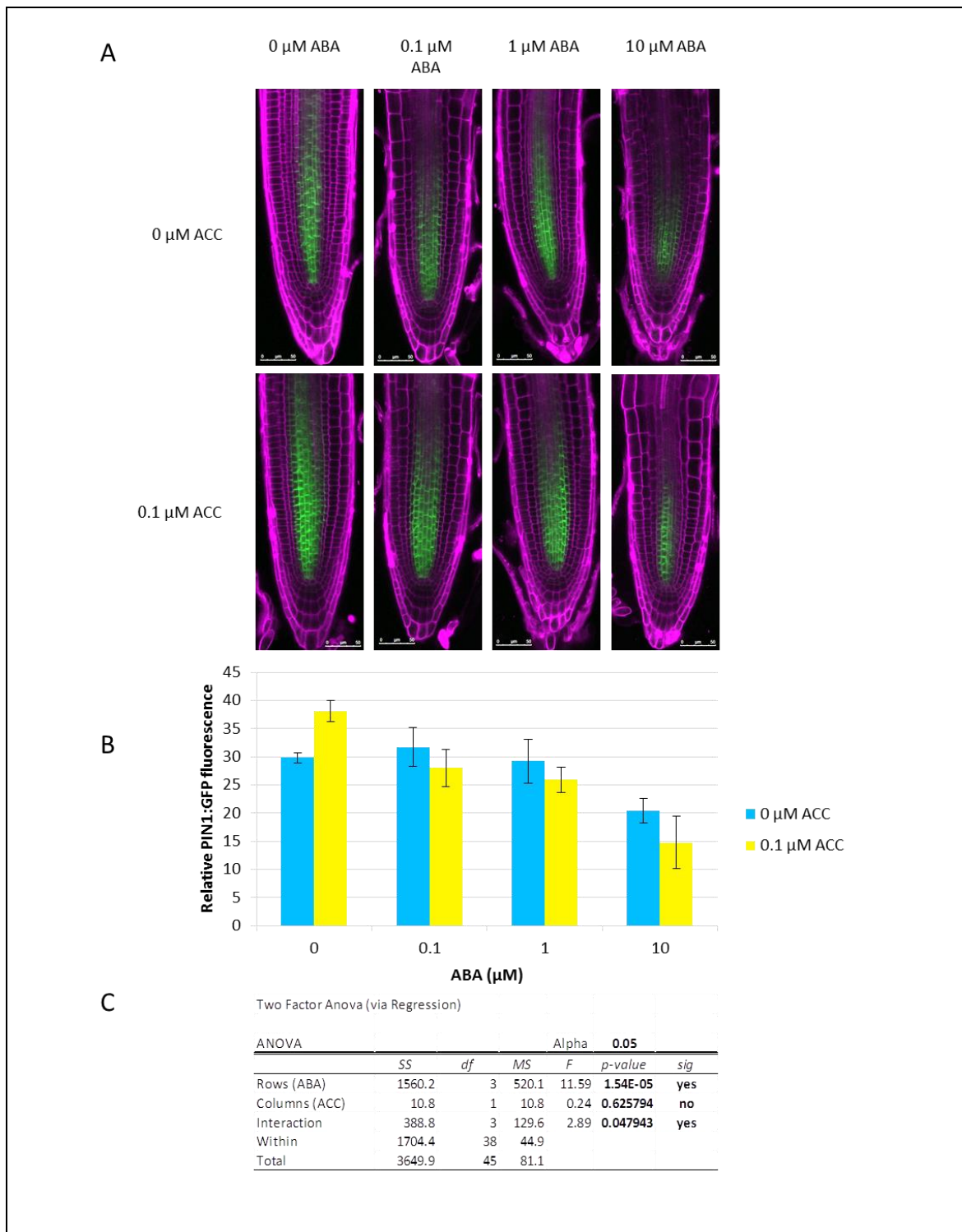

Figure 6-16 ACC cannot rescue ABA repression of PIN1:GFP levels.

A) proPIN1::PIN1:GFP seedlings were transferred from 1/2 MS plates to 1/2 MS plates containing various concentrations of ACC and/or ABA at five days after germination. After 24 hours the roots were removed, stained for cell walls for 1 minute 30s with 5 mg/ml propidium iodide washed with deionised water for 1 minute 30 seconds and imaged with an SP5 LSCM. Magenta: Propidium iodide, Green: GFP, White: Propidium iodide/GFP colocalisation. Scale bar indicates 50 μm . B) Mean relative fluorescence of proPIN1::PIN1:GFP under combined ABA and ACC treatments. C) ANOVA table

6.8. The effect of combined hormone and osmotic stress treatments on PIN2:GFP levels

Previous studies have found that mild osmotic stress or ABA treatment lead to increases in PIN2 expression and increased basipetal auxin transport (Xu *et al.*, 2013). 1004 bp upstream of

The effect of osmotic stress on root hormone levels, responses and distribution

the transcription start site the *PIN2* gene promoter is a consensus ABA responsive element (ABRE), CACGTGGC, on the positive strand, indicating that it may be ABA responsive (Choi *et al.*, 2000). Mutant screens have identified alleles of *pin2* that show differential root elongation responses to wildtype under ABA treatment.

Increases in PIN2 levels, AUX1 levels and basipetal auxin transport have also been shown to provide the characteristic ethylene root growth response, where increased auxin levels in the elongation zone, transported from the root tip, inhibit cell elongation (Ruzicka *et al.*, 2007; Swarup *et al.*, 2007).

As both ABA and ethylene responses increase under osmotic stress, it follows that they may be regulating basipetal auxin transport through PIN2 to inhibit root elongation. This possibility was therefore investigated.

6.8.1. Abscisic acid regulates PIN2:GFP levels under osmotic stress, but is not sufficient to regulate PIN2 levels independently

It was shown above that moderate osmotic stress increases *PIN2* gene expression and fluorescent protein levels, which return to unstressed levels under severe stress (Figure 6-10)

Under unstressed conditions, application of ABA or the ABA biosynthetic inhibitor fluridon has little effect on PIN2:GFP levels, with ABA possibly enhancing PIN2:GFP protein levels (Figure 6-17). However, it was found that exogenously applying ABA to moderately stressed roots prevents the increase in PIN2:GFP and inhibiting ABA biosynthesis with fluridon exacerbates the increase.

Under severe osmotic stress, where PIN2:GFP fluorescence is reduced to unstressed levels, abscisic acid application reduces it further below unstressed levels, but fluridon has little effect on PIN2:GFP.

These data show that PIN2 levels are affected by osmotic stress ($P = 2 \times 10^{-7}$), and this effect can be exaggerated/perturbed by modulating by abscisic acid levels ($P = 0.031$). The independent effect of ABA on PIN2:GFP during osmotic stress responses is not significant ($P = 0.10$).

This may indicate that ABA regulates PIN2 levels indirectly during osmotic stress, possibly by regulating ethylene levels or signalling. As the *PIN2* promoter contains an ABA responsive element and combining ABA treatment with severe stress can lower PIN2 levels below those found in unstressed roots, it is possible that ABA signalling has a direct effect on transcription.

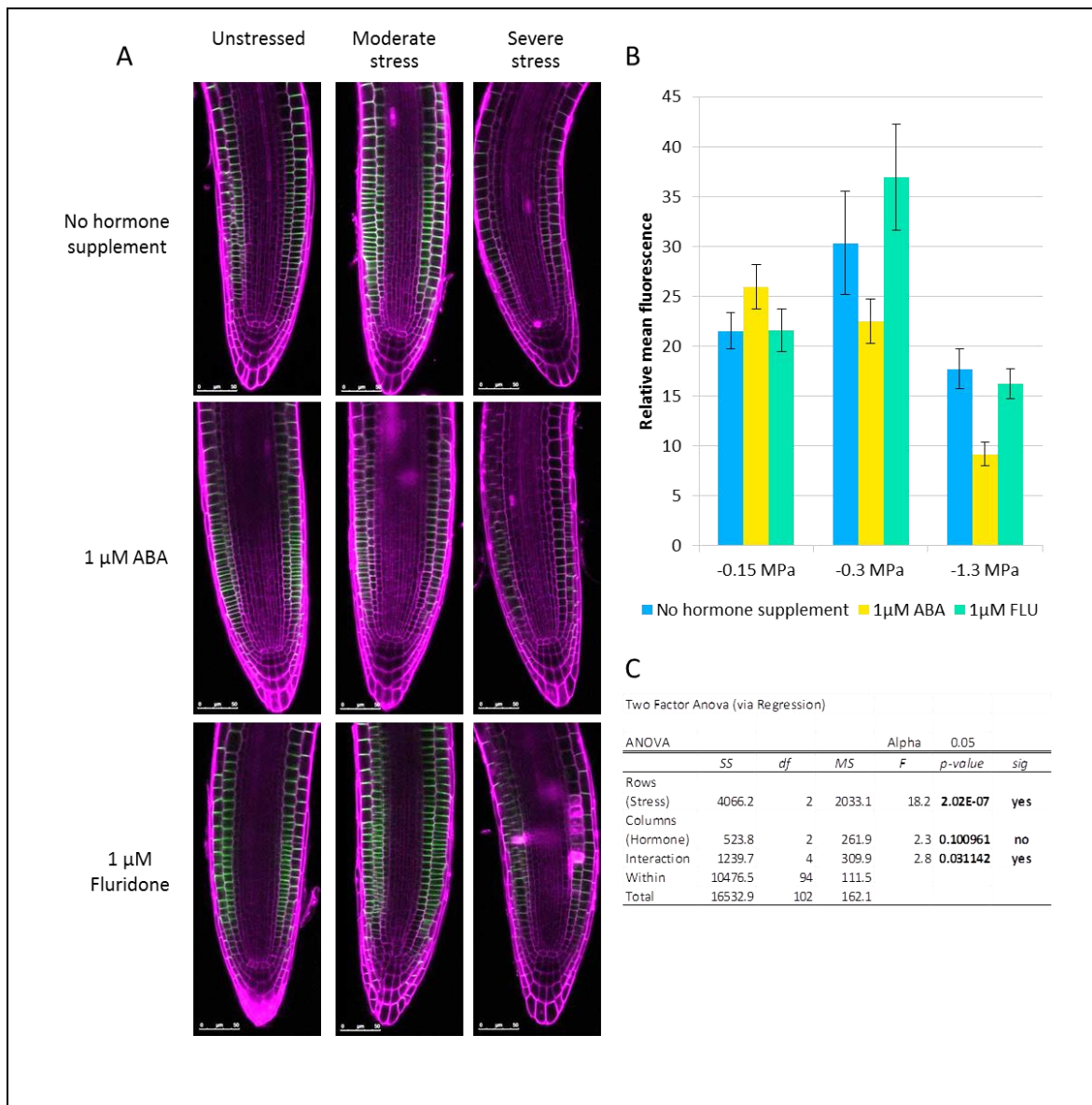

Figure 6-17 Abscisic acid regulates PIN2:GFP levels under osmotic stress, but is not sufficient to regulate PIN2 levels independently

A) Representative images of proPIN2::PIN2:GFP under osmotic and hormone treatment. B) Mean relative fluorescence of proPIN2::PIN2:GFP under osmotic and hormone treatment. Seedlings were transferred from 1/2 MS plates to 1/2 MS + poly(ethylene glycol) mol wt. 8000 containing 1 μ M Abscisic acid or 1 μ M Fluridone at five days after germination. , stained for cell walls for 1 minute 30s with 5 mg/ml propidium iodide washed with deionised water for 1 minute 30 seconds and imaged with an SP5 LSCM. Between 10 and 14 seedlings were imaged and the fluorescence of a 100 X 40 μ m section posterior to the quiescent centre was measured in ImageJ. C)ANOVA table.

6.8.2. PIN2:GFP under combined ethylene and osmotic stress treatments

Insufficient replicates were analysed to allow a robust quantitative analysis of the dynamics of PIN2:GFP fluorescence under ethylene perturbation and osmotic stress, but a qualitative assessment can be made. Treating unstressed roots with ACC increased PIN2:GFP fluorescence, while the ethylene perception inhibitor, silver thiosulphate, reduced it. Silver thiosulphate appeared to prevent the increase in PIN2:GFP under moderate osmotic stress, indicating that the increase in PIN2 levels occurs due to increased ethylene signalling. ACC treatment was insufficient to maintain the increase in PIN2:GFP fluorescence under severe

The effect of osmotic stress on root hormone levels, responses and distribution
 stress, suggesting that the high levels of ABA under severe stress may be antagonising the ethylene induced increase in PIN2.

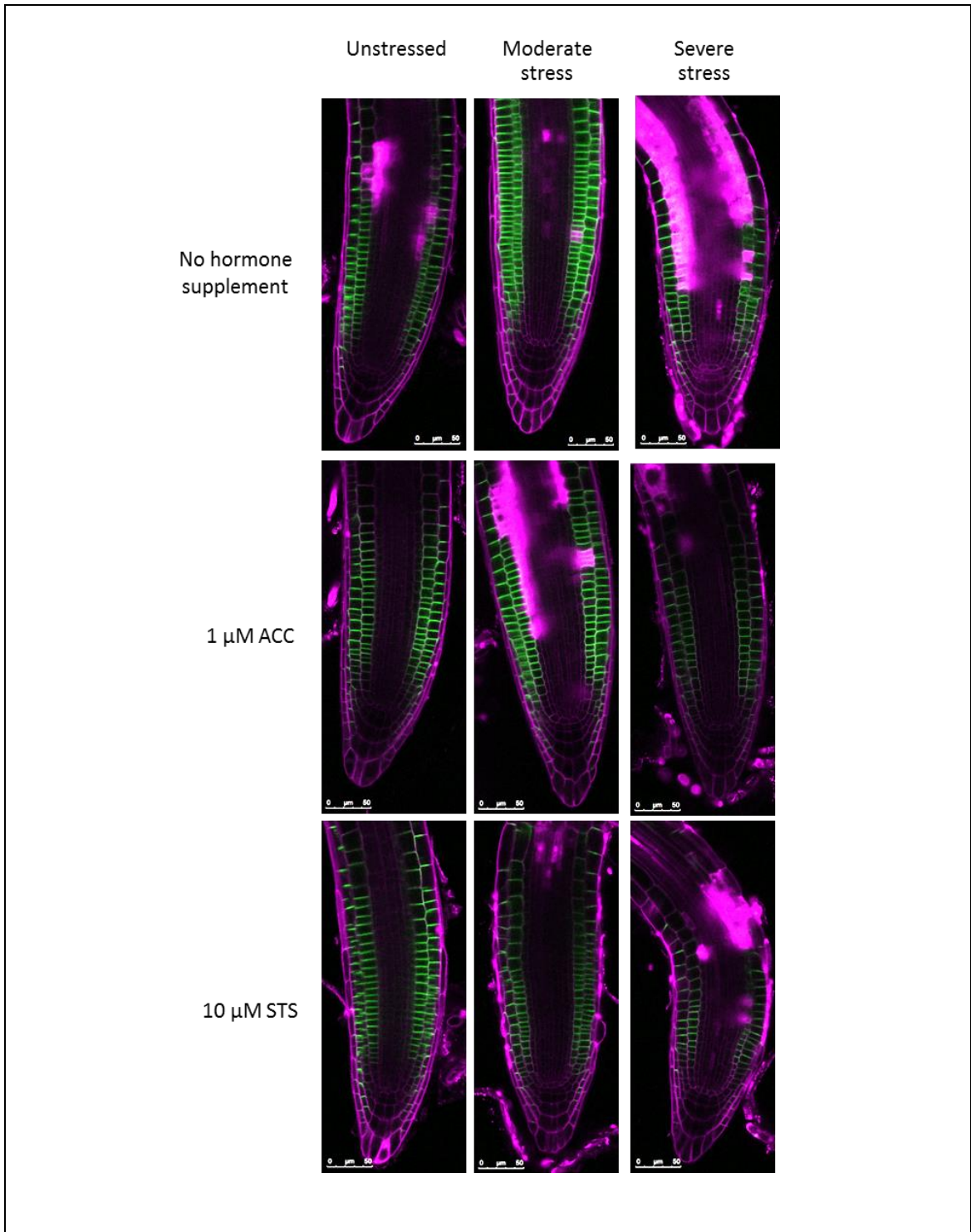

Figure 6-18 Ethylene regulates the increase in PIN2:GFP levels under osmotic stress, but cannot maintain higher PIN2 levels under severe stress

A) Representative images of proPIN2::PIN2:GFP under osmotic and hormone treatment. Seedlings were transferred from 1/2 MS plates to 1/2 MS + poly(ethylene glycol) mol wt. 8000 containing 1 μM ACC or 10 μM silver thiosulphate at five days after germination. , stained for cell walls for 1 minute 30s with 5 mg/ml propidium iodide washed with deionised water for 1 minute 30 seconds and imaged with an SP5 LSCM.

6.9. The effect of combined ethylene and abscisic acid treatment on auxin distribution

High levels of ABA application (10 μ M), and also osmotic stress were found to significantly reduce PIN1 expression, and auxin responses were reduced under stress. To examine whether the reduction in PIN1 levels under ABA application is sufficient to affect auxin levels in the meristem, DII-VENUS was used as a proxy for auxin response.

As expected, ACC treatment reduced DII:VENUS fluorescence significantly ($P=0.02$) implying that ethylene increases in auxin levels (Figure 6-19 A, B). ABA application did not produce a significant ($P=0.06$) change in DII:VENUS fluorescence, and there was no significant interaction between the effect of ABA and ACC on DII:VENUS fluorescence.

Under ABA treatment conditions that led to reduced PIN1:GFP fluorescence (10 μ M), there is no change in root DII:VENUS fluorescence (Figure 6-19), however other authors have shown a decrease in auxin response at higher exogenous ABA levels (30 μ M) (Wang *et al.*, 2011; Yang *et al.*, 2014), illustrating a possible flaw with the experimental design.

The other possibility is that auxin levels may be regulated independently of osmotic stress, either through reduced local biosynthesis, reduced transport from the shoot or increased degradation/conjugation.

Interestingly under 10 μ M ABA treatment, there is a detectable but statistically non-significant increase in DII-VENUS fluorescence in the meristematic stele (one-tailed T-test, $P=0.065$), implying that meristematic auxin levels may be reduced under this treatment, which may be due to reduced PIN1 expression.

Both ABA and ACC application were found to significantly reduce DII-VENUS fluorescence in the epidermis and cortex (Figure 6-19), with the possibility that increased auxin transport from the root tip may be occurring, perhaps due to increased PIN2 levels.

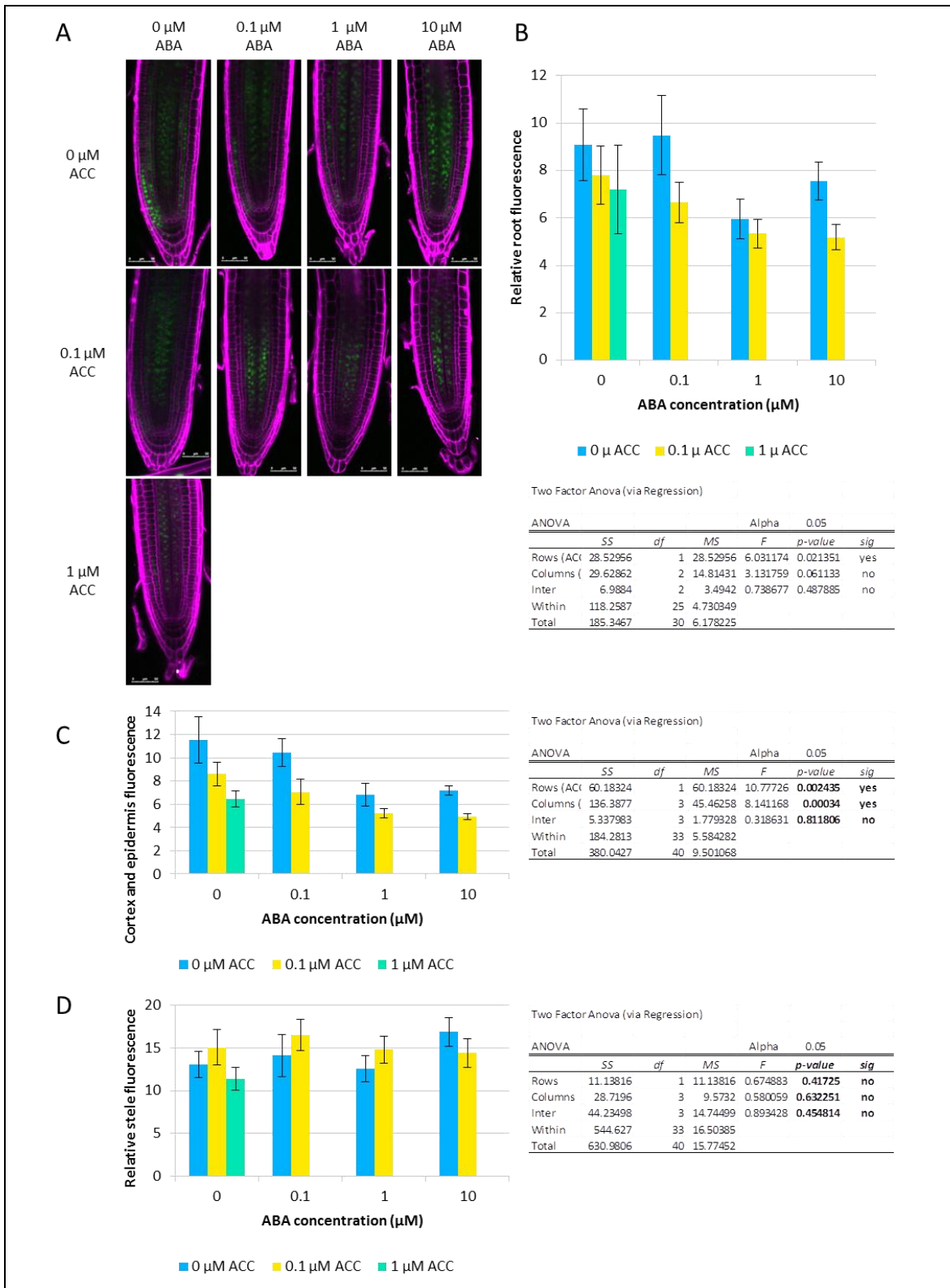

Figure 6-19 ABA and ACC affect auxin distribution in the root tip.

A) Representative images of DII-VENUS under combined ACC and ABA treatments. B) Mean relative fluorescence of DII-VENUS C) Mean relative fluorescence of DII-VENUS in the cortex and epidermis D) Mean relative fluorescence of DII-VENUS in the meristematic stele. Seedlings were transferred from 1/2 MS plates to 1/2 MS containing combinations of Abscisic acid and/or ACC at five days after germination. , stained for cell walls for 1 minute 30s with 5 mg/ml Propidium iodide washed with deionised water for 1 minute 30 seconds and imaged with an SP5 LSCM.

6.10. Summary

Previously, a large amount of evidence has shown how important the stress response hormones ABA and ethylene are for protection against osmotic stress. As well as regulating stress responses that occur on the short to medium scale, such as compatible solute accumulation (Cheng *et al.*, 2013) or regulating stomatal aperture size (Bauer *et al.*, 2013), ABA and ethylene also have numerous developmental roles (De Smet *et al.*, 2003; Ortega-Martinez *et al.*, 2007), and regulate the levels and distribution of other phytohormones (Stepanova *et al.*, 2005; Ruzicka *et al.*, 2007; Swarup *et al.*, 2007; Stepanova *et al.*, 2008; Shkolnik-Inbar & Bar-Zvi, 2010).

Data presented in this chapter show that the auxin response in the primary root meristem is reduced under osmotic stress, and this is associated with a reduction in the levels of the auxin transporters PIN1, PIN4 and AUX1. There is also an increase in PIN2 expression under stress.

Ethylene and abscisic acid responses were found to increase under osmotic stress and both can affect auxin transport. Under unstressed conditions, ethylene increases PIN1 levels, and abscisic acid reduces PIN1 levels. The reduction in PIN1 under osmotic stress is modulated by the increase in abscisic acid responses, which can override the effect of increased ethylene responses on PIN1 levels.

PIN2 expression can be increased by ethylene, abscisic acid or osmotic stress; however under stress ABA reduces PIN2 expression indicating a complex system of regulation of PIN2 expression. This complexity indicates that the combination of a) reduction of auxin response, b) increase of ethylene response and c) increase of ABA response under osmotic stress is important in regulating PIN2 expression.

There is some evidence of a reduction in cytokinin responses under osmotic stress, with *ARR5* and various other cytokinin responsive genes showing reduced expression, however the *pTCS:GFP* line shows no statistically significant reduction in fluorescence. Nevertheless cytokinin levels have previously been shown to be reduced under drought stress and ABA treatment (Dobra *et al.*, 2010; Nishiyama *et al.*, 2011).

Overall, as demonstrated by experimental data in this chapter, osmotic stress elicits complex changes in the hormone transport, response and distribution in the root tip, which may determine the growth responses under osmotic stress conditions.

7 Construction of hormonal crosstalk networks under osmotic stress conditions

7.1. Introduction

The experimental data shown in previous chapters demonstrate that root growth under osmotic stress conditions is regulated by the interplay between ABA, auxin, ethylene and cytokinin. One of the important properties of this interplay under osmotic stress is that a change in one hormone and/or its related signalling components leads to changes in other hormones and/or their related signalling components. Therefore, in order to elucidate how root growth is regulated under osmotic stress conditions, it is necessary to study the interplay between ABA, auxin, ethylene and cytokinin as an integrative system. In this chapter, I construct hormonal crosstalk networks for the regulation of root growth by osmotic stress. The systematic and comprehensive approach to their creation means they can provide insight to hormone interactions and growth as well as providing the framework for further kinetic modelling.

Our group has previously developed a hormonal interaction network for a single Arabidopsis cell by iteratively combining modelling with experimental analysis (Liu *et al.*, 2010). This paper described how such a network regulates auxin concentration in the Arabidopsis root, by controlling the relative contribution of auxin influx, biosynthesis and efflux; and by integrating auxin, ethylene and cytokinin signalling. Recently, this hormonal interaction network was developed to include PIN1 or PIN2 activities in a single Arabidopsis cell model (Liu *et al.*, 2013; Liu *et al.*, 2014), and moved on to study the spatiotemporal dynamics of hormonal crosstalk in a multi-cellular root structure (Moore *et al.*, 2015). In this chapter, ABA is integrated into the existing hormonal crosstalk network by incorporating my experimental data with the data available in the literature. By establishing the regulatory relationships between osmotic stress and relevant hormones, I construct two novel hormonal crosstalk networks for osmotic stress conditions. The aim was that these new networks would bring new understanding to hormone interactions and regulation of root growth under osmotic stress conditions.

7.2. Construction of hormonal crosstalk networks for root growth under osmotic stress conditions

7.2.1. Formatting note

In this chapter the following formatting and nomenclature are used. Unbolded text refers to a real protein, mRNA transcript or hormone, whereas **bold** text refers to its representation in the networks. An asterisk represents an active form of a component, e.g. **CTR1*** is the active form of **CTR1**. The subscript _m represents an mRNA gene transcript, whilst **p** represents the final protein i.e. **PLS_m** is translated to **PLSp**. As an example, Figure 7-1 describes the interplay of three hormones (auxin, ethylene and cytokinin) and their associated regulatory and target

genes in a single root cell when root growth is not subjected to osmotic stress. Figure 7-2 describes how cell-cell communications are established in a 2-dimensional root structure.

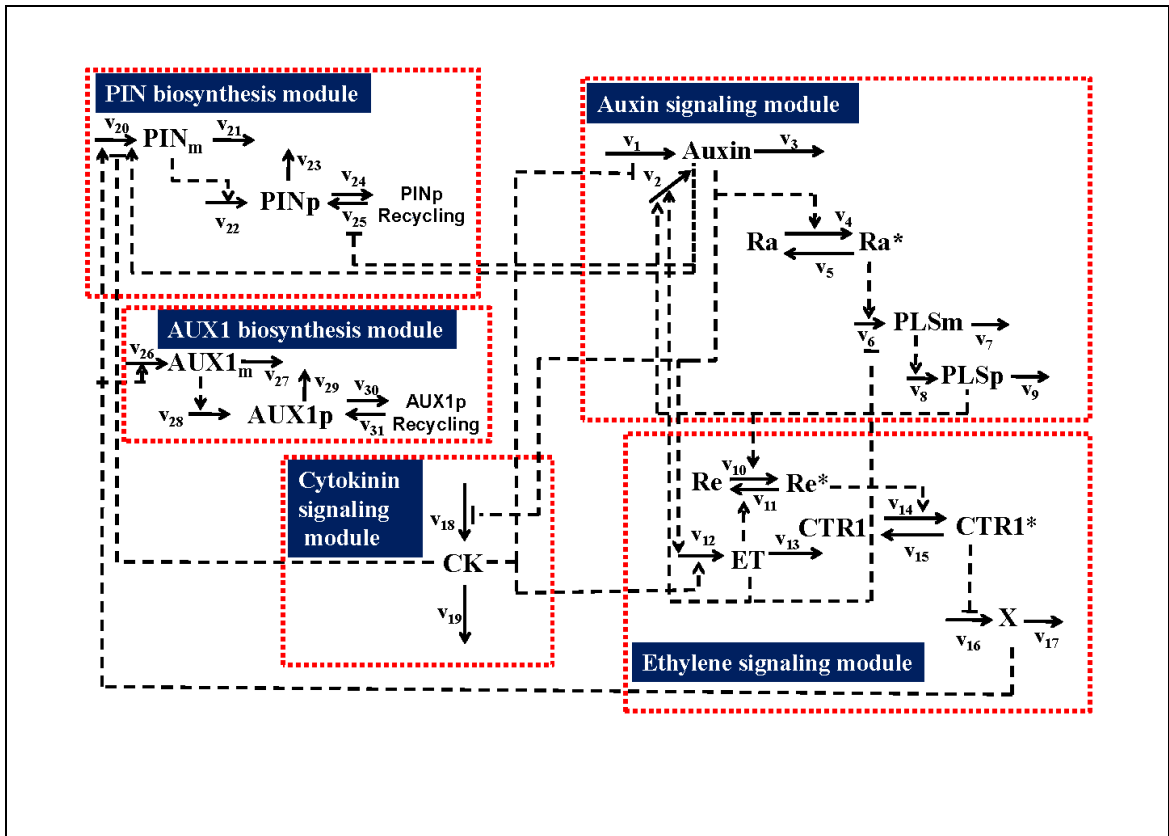

Figure 7-1 Hormonal crosstalk network of auxin, ethylene, cytokinin and their associated genes in a single cell when root growth is not subjected to osmotic stress, representing the kinetic model developed in Liu *et al.* (2010, 2013), Moore *et al.* (2015)

Species: Auxin: Auxin, ET: ethylene, CK: Cytokinin, PINm: PIN mRNA, PINp: PIN protein, PLSm: POLARIS mRNA, PLSp: POLARIS protein, X: Downstream ethylene signalling, Ra*: Active form of auxin receptor, Ra: Inactive form of auxin receptor, Re*: Active form of ethylene receptor, ETR1, Re: Inactive form of ethylene receptor, ETR1, CTR1*: Active form of CTR1, CTR1: Inactive form of CTR1, AUX1 m: AUX1 mRNA, AUX1 p: AUX1 protein.

Reactions: Arrows V_1 - V_{31} : Reactions e.g. V_1 represents auxin biosynthesis/influx. Dotted arrows: The species promotes this reaction, Dotted flat headed arrows: The species inhibits this reaction

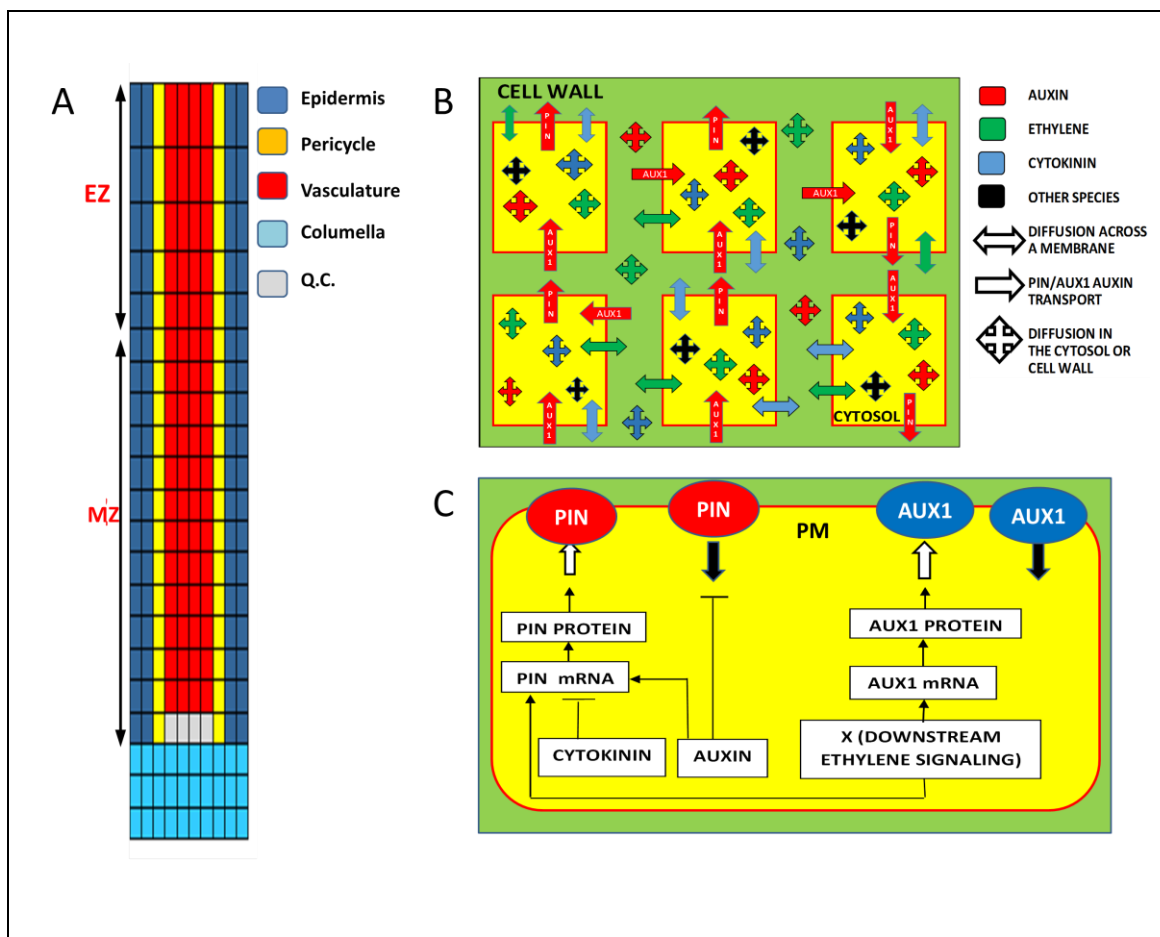

Figure 7-2 Schematic description of the 2-dimensional root structure and cell-cell communications, used for construction of the spatiotemporal model, as described in Moore *et al.* (2015)

A. Multicellular root structure (adapted from (Grieneisen *et al.*, 2007) defined by a matrix of grid points which form the root map. MZ – meristematic zone. EZ – elongation zone. B. Species flux between nearest neighbouring grid point by diffusion within the cytosol (all species) or cell wall (hormones) and hormone flux across the plasma membrane by diffusion (ET and CK) and permeability (auxin). C. Dynamic recycling of the auxin carriers PIN and AUX1 by exocytosis and endocytosis to and from the plasma membrane. Auxin inhibits endocytosis of the PIN proteins (Paciorek *et al.*, 2005).

In the following, I combine my experimental data with biological knowledge in the literature and construct hormonal crosstalk networks representing cells under osmotic stress conditions.

7.2.2. Auxin signalling and crosstalk under unstressed conditions

The phytohormone auxin is important for pattern formation, development and growth (Vanneste & Friml, 2009). Auxin concentration, distribution and flux control numerous developmental processes including root growth. Root growth and development can be considered an emergent property regulated by the auxin distribution within the root (Grieneisen *et al.*, 2007; Vanneste & Friml, 2009; Mahonen *et al.*, 2014), which is determined by regulation of biosynthesis, polar auxin transport and conjugation/degradation.

For a given cell, two sources of auxin must be considered; auxin transported into the cell and local auxin biosynthesis. Passive diffusion into the cell is relatively slow, and so the AUX1/LAX

family of auxin carriers is responsible for the majority of auxin influx (Bennett *et al.*, 1996; Kramer & Bennett, 2006; Rutschow *et al.*, 2014). In our network the AUX1/LAX family is represented by a single class of influx carrier, **AUX1**, which regulates all auxin influx (Figure 7-1, Figure 7-2c).

Under ethylene application, roots increase basipetal auxin transport by increasing AUX1 and PIN2 levels (Ruzicka *et al.*, 2007), therefore **ET** also increases **AUX1p** levels through **X**, which increases **AUX1_m** transcription.

The majority of auxin biosynthesis occurs in the aerial tissues (Ljung *et al.*, 2001) and is then transported from the shoot in a manner inhibited by ethylene (Suttle, 1988). Because the molecular mechanism behind this inhibition has not been described, our model considers an unknown molecule or molecules, designated 'X', downstream of **ET** signalling to be the source of the inhibition (Figure 7-1;(Liu *et al.*, 2010).

The network also assumes that **ET** also promotes local **Auxin** biosynthesis and **CK** represses **Auxin** biosynthesis (Eklöf *et al.*, 1997; Stepanova *et al.*, 2007) .

The *polaris (pls)* mutant displays enhanced ethylene signalling but has reduced auxin levels (Casson *et al.*, 2002; Chilly *et al.*, 2006). Modelling initially predicted that, when treated with ACC (an ethylene precursor), increased auxin would occur in both wildtype and *pls*, however experiments showed that this did not occur *in planta* (Liu *et al.*, 2010). This experimental and modelling analysis therefore reveals a secondary role for the POLARIS peptide in regulating auxin accumulation, though the mechanism is uncharacterised. The network therefore assumes that **PLS** directly regulates **Auxin** biosynthesis (Figure 7-1).

Auxin is removed from the cell by efflux, degradation and conjugation (Figure 7-2B). As auxin (IAA) is ionised in the cytosol, it becomes membrane impermeable (Kramer & Bennett, 2006). Therefore, auxin efflux is chiefly regulated by the non-polar PGP family of ABC transporters and the polar PIN-FORMED (PIN) family of auxin carriers, which work synergistically to facilitate pattern formation (Geisler *et al.*, 2005; Petrusek *et al.*, 2006; Blakeslee *et al.*, 2007).

In our existing network **Auxin** promotes **PIN1_m** or **PIN2_m** transcription, whereas **CK** (cytokinin) represses **PIN1_m** and **PIN2_m** transcription (Paciorek *et al.*, 2005; Ruzicka *et al.*, 2009). **ET** (ethylene) regulates the transcription of **PIN1_m** and **PIN2_m** expression through downstream signalling molecule **X** (Ruzicka *et al.*, 2007).

PIN1p, **PIN2p** and **AUX1p** are cycled to the plasma membrane and **Auxin** inhibits the internalisation of **PIN1p** and **PIN2p** (Figure 7-2C; Paciorek *et al.*, 2005).

Auxin is perceived by the SCF^{TIR1} complex, which ubiquitinates AUX/IAA proteins when bound to auxin (Dharmasiri *et al.*, 2005; Kepinski & Leyser, 2005; Maraschin *et al.*, 2009). The degradation of AUX/IAA proteins allows auxin response factors to dimerize and activate auxin responsive transcription. Our network simplifies this signalling cascade and assumes that the auxin receptor (**Ra**) is activated (**Ra***) by auxin to allow auxin responsive transcription, such as **PLS**.

7.2.3. Auxin signalling and crosstalk under osmotic stress

To incorporate my experimental data into the hormonal crosstalk networks under osmotic stress conditions, I include **DR5_m** and **DIIp** in the networks (Figure 7-3; Figure 7-4). The active form of auxin receptor (**Ra***) increases **DR5_m** transcription, representing *DR5::GUS* or *DR5::VENUS* transcription and increases the breakdown of **DIIp**, which represents the DII:VENUS biosensor.

Whilst it has been reported that exogenously applied ABA can increase PIN2 and basipetal auxin transport (Xu *et al.*, 2013), other work indicates that PIN1, PIN2 and AUX1 levels are reduced by high levels of ABA (Belin *et al.*, 2009; Shkolnik-Inbar & Bar-Zvi, 2010; Yang *et al.*, 2014).

Contemporary and classic studies show that ABA biosynthesis increases under osmotic stress, and is responsible for many stress responses (Wright & Hiron, 1969; Zhang & Davies, 1987; Lee *et al.*, 2006; Verslues & Bray, 2006; Xu *et al.*, 2013; Waadt *et al.*, 2014; Kumar & Verslues, 2015). As we see a decrease in *AUX1* expression under osmotic stress (Figure 6-11), we assume that *AUX1m* transcription to be repressed by **ABA** (Figure 7-3; Figure 7-4).

As the auxin efflux carriers PIN1, which is expressed in the stele, and PIN2, which is expressed in the epidermis/cortex cells, show differential responses to osmotic stress we have assumed tissue specific responses to osmotic stress.

In unstressed plants, low levels of ABA application can overcome the promotive effect of ACC on PIN1:GFP accumulation (Figure 6-16). This occurs at an ABA concentration that is two orders of magnitude lower than that required to reduce PIN1 levels in the absence of ACC. This unusual relationship may imply that ABA acts on PIN1 expression in two ways: firstly at low concentrations it acts downstream of ethylene signalling, to suppress PIN1 responses. Secondly at high concentrations it negatively regulates PIN1 levels through what is probably a separate mechanism.

Whilst the decrease in PIN1 expression could be rescued by inhibiting ABA biosynthesis under moderate stress, under severe stress it could not (Figure 6-15). This presents multiple

possibilities. The first possibility, which is most plausible, is that the level of fluridon used was insufficient to inhibit the large increase in ABA biosynthesis under osmotic stress. A second possibility is that osmotic stress may regulate PIN1 levels directly, which could be synergistic to, or independent of, ABA signalling. A third possibility is that osmotic stress may reduce xylem and phloem transport rates, therefore reducing the flow of shoot sourced auxin (Ljung *et al.*, 2001; Sevanto, 2014). Although reduced root to shoot transport under drought is well documented, the evidence for reduced shoot to root transport is indirect and we are unaware of any data measuring auxin transport rates under stress. The network (Figure 7-3) does not explicitly include vascular transport. However, we may consider that **PIN1** transport of **Auxin** is functionally similar to vascular transport.

In the first incidence, the network assumes that **ABA** can act downstream of **ET** signalling, to repress **ET** mediated **PIN1_m** transcription, and that **ABA** also acts independently of **ET** signalling to down regulate **PIN1_m** transcription (Figure 7-3).

PIN2 is expressed in the cortex/epidermis and unlike *PIN1* shows increased expression under osmotic stress (Xu *et al.*, 2013). This increase under osmotic stress appears to be regulated by ethylene responses (Figure 6-18), implying that ABA does not override the effect of ethylene on *PIN2* levels. The effect of ABA on *PIN2* in unstressed or mildly stressed plants appears to be promotive (Xu *et al.*, 2013), whereas under moderate to severe stress *PIN2* appears to be negatively regulated by ABA (Figure 6-17). In our network it is assumed that **ABA** does not directly upregulate **PIN2_m** expression and high levels of **ABA** negatively regulate **PIN2_m** transcription (Figure 7-4). Instead the increase in **PIN2_m** expression is assumed to be attributed to increased **ET** biosynthesis under osmotic stress conditions. Experimental measurements previously showed that exogenous application of IAA and ACC can each increase *PIN2* transcription and protein levels at the plasma membrane (Paciorek *et al.*, 2005; Vanneste & Friml, 2009) .

7.2.4. Abscisic acid and osmotic stress

ABA biosynthetic genes *NCED3* and *ABA2* are expressed in the root tip and vasculature, with increased expression under osmotic stress, indicating this is the site of ABA biosynthesis (Cheng *et al.*, 2002; Tan *et al.*, 2003; Boursiac *et al.*, 2013).

The PYR/PRL/RCAR family of ABA receptors are expressed differentially across root tissues; *PYR1*, *PYL1*, *PYL2* and *PYL4* show expression in the stele, *PYR1* and *PYL5* show expression in the cortex of the upper part of the root and *PYL1*, *PYL4* and *PYL8* show expression the columella (Gonzalez-Guzman *et al.*, 2012). When bound to ABA, the receptor inhibits action of PP2C, allowing SnRK2s to phosphorylate ABFs activating ABA-responsive transcription (Cutler *et al.*,

2010). In our network, for the sake of simplicity, we abstract the interaction of ABA and its receptors using a single receptor (**Raba**). The active form of this receptor (**Raba***) directly activates ABA responsive gene expression, such as **RD29B_m**.

Contemporary and classic studies show that abscisic acid biosynthesis increases under osmotic stress, and is responsible for many stress responses (Wright & Hiron, 1969; Zhang & Davies, 1987; Lee *et al.*, 2006; Verslues & Bray, 2006; Xu *et al.*, 2013; Kumar & Verslues, 2015; Wang *et al.*, 2015). This increase is larger in shoot tissues than roots (Christmann *et al.*, 2005) but is important for root growth under stress. There are at several putative osmosensors (Urao *et al.*, 1999; Reiser *et al.*, 2003; Wohlbach *et al.*, 2008; Kumar *et al.*, 2013; Yuan *et al.*, 2014) but the full signalling pathway leading to increased ABA biosynthesis is unknown. In our networks, we assume **ABA** biosynthesis increases in direct response to **Osmotic stress**.

Ethylene insensitive/deficient mutants have been shown to hyperaccumulate ABA, so our network also assumes that **ET** inhibits **ABA** biosynthesis (Beaudoin *et al.*, 2000; Ghassemian *et al.*, 2000; Wang *et al.*, 2007; Cheng *et al.*, 2009; Dong *et al.*, 2011).

7.2.5. Ethylene signalling and crosstalk under unstressed conditions

Our previous networks have assumed no active **ET** (ethylene) transport, and therefore **ET** levels are regulated through biosynthesis, degradation and passive diffusion (Figure 7-1, Figure 7-2b).

Auxin and **CK** (cytokinin) can promote **ET** (ethylene) biosynthesis, but **Auxin**- and **CK**-independent biosynthesis also occurs (Vogel *et al.*, 1998; Stepanova *et al.*, 2007; Liu *et al.*, 2010).

Ethylene is perceived by the five ethylene receptors ETR1, ETR2, ERS1, ERS2 and EIN4 (Chang *et al.*, 1993; Hua *et al.*, 1995; Hua *et al.*, 1998; Sakai *et al.*, 1998). In previous modelling analyses, these receptors are represented by a single receptor (**Re**), which when not bound to ethylene the receptor is active (**Re***), and phosphorylates **CTR1** to its active form **CTR1*** (Diaz & Alvarez-Buylla, 2006; Liu *et al.*, 2010; Liu *et al.*, 2013; Moore *et al.*, 2015b). Our group's networks (Liu *et al.*, 2010; Liu *et al.*, 2013; Moore *et al.*, 2015b) simplify the cascade, whereby **CTR1*** inhibits the expression of ethylene responsive genes such as **ERF1_m** (Figure 7-3; Figure 7-4).

The POLARIS (PLS) peptide inhibits ethylene responses by interacting with the ethylene receptor ETR1 (Mehdi, 2009; Mudge, 2015). Our network assumes that **PLS** inhibits the conversion of **Re*** to the inactive form **Re**, i.e. activates the receptor to inhibit downstream ethylene responses. In accordance with previous experimental evidence **PLS** expression is

positively regulated by **Auxin** and negatively regulated by **ET** (Casson *et al.*, 2002; Chilley *et al.*, 2006).

7.2.6. Ethylene signalling and crosstalk under osmotic stress

There are several reports of increased ethylene biosynthesis under osmotic stress and ethylene signalling has been shown to be important in many drought stress responses (Spollen *et al.*, 2000; Skirycz *et al.*, 2011; Cheng *et al.*, 2013; Cui *et al.*, 2015).

Classically ABA was thought to repress ethylene biosynthesis to help maintain root growth under stress (Spollen *et al.*, 2000; Sharp, 2002; Li *et al.*, 2011). Although ABA represses the expression of ethylene response genes such as ERF1 (Cheng *et al.*, 2013), as well as preventing ethylene induced quiescent centre cell division, there is now growing evidence that ABA promotes ethylene biosynthesis to inhibit root growth (Ortega-Martinez *et al.*, 2007; Zhang *et al.*, 2010; Cheng *et al.*, 2013; Luo *et al.*, 2014). An intact ethylene signalling cascade is required for ABA inhibition of root growth and this requires ethylene induced basipetal auxin transport components such as PIN2 and AUX1 (Beaudoin *et al.*, 2000; Ghassemian *et al.*, 2000; Luo *et al.*, 2014; Thole *et al.*, 2014).

My experimental measurements (Figure 6-19) show that ABA application also decreases DII:VENUS levels in the epidermis and cortex (implying increased auxin levels), agreeing with this hypothesis.

Therefore, experimental evidence supports the view that **ABA** can promote **ET** biosynthesis but negatively regulates aspects of its response downstream of the main signalling cascade, such as **PIN2_m**, **PIN1_m** and **ERF1_m** transcription. Our networks have included these regulatory relationships (Figure 7-3, Figure 7-4).

7.2.7. Cytokinin signalling and crosstalk

The auxin:cytokinin ratio provides tight developmental control over numerous developmental processes (Skoog & Miller, 1957; Sachs, 1982), including cell differentiation and root growth (Dello Ioio *et al.*, 2007; Dello Ioio *et al.*, 2008; Moubayidin *et al.*, 2010). Our group's previously published networks (Liu *et al.*, 2010; Liu *et al.*, 2013; Moore *et al.*, 2015b; Figure 7-1) include inhibition of **CK** biosynthesis by **Auxin**, as based on published experimental observations (Nordstrom *et al.*, 2004). The networks for hormonal crosstalk under osmotic stress include this relationship (Figure 7-3; Figure 7-4) as well as additional regulation by ABA and osmotic stress.

Drought and ABA negatively affect *trans*-zeatin type cytokinin levels by modulating expression of cytokinin biosynthesis/metabolism enzymes (Dobra *et al.*, 2010; Nishiyama *et al.*, 2011). As

it is unclear whether osmotic stress affects cytokinin levels directly or through ABA signalling, we have assumed both **ABA** and **Osmotic stress** limit **CK** biosynthesis in our networks (Figure 7-3; Figure 7-4).

Cytokinin signalling is transduced primarily through phosphorylation. Cytokinin is perceived by a series of HISTIDINE KINASE RECEPTORS (AHK2-4), which autophosphorylate in the presence of cytokinin (Inoue *et al.*, 2001; Suzuki *et al.*, 2001; Ueguchi *et al.*, 2001; Yamada *et al.*, 2001) and transfer the phosphoryl group to one of the ARABIDOPSIS HIS PHOSPHOTRANSFER PROTEIN (AHP1-5) family (To & Kieber, 2008). When phosphorylated, these AHPs phosphorylate and activate type-A and -B ARABIDOPSIS RESPONSE REGULATORS (ARRs) (Tanaka *et al.*, 2004). Active type-B ARR activate cytokinin-responsive transcription (Sakai *et al.*, 2000; Mason *et al.*, 2005), whilst active type-A ARR provide a negative feedback regulation of the cytokinin signalling cascade (To *et al.*, 2007).

In our networks, this signalling cascade is simplified to a single receptor (**Rck**), which when active (**Rck***) directly activates the expression of the cytokinin responsive gene **ARR5_m**. **ARR5_m** is translated to **ARR5_p**, which inhibits **ARR5_m** transcription (Figure 7-3; Figure 7-4).

Cytokinin deficient/insensitive mutants display reduced ABA levels but increased ABA sensitivity and drought induction of ABA biosynthesis was similar to wildtype (Nishiyama *et al.*, 2011). Lower basal levels of ABA could either be due to an increase in auxin and ethylene signalling in these mutants, suppressing ABA biosynthesis, or cytokinin could be directly regulating ABA biosynthesis. So, in the first instance, we assume no direct regulation of **ABA** biosynthesis by **CK** (Figure 7-3, Figure 7-4).

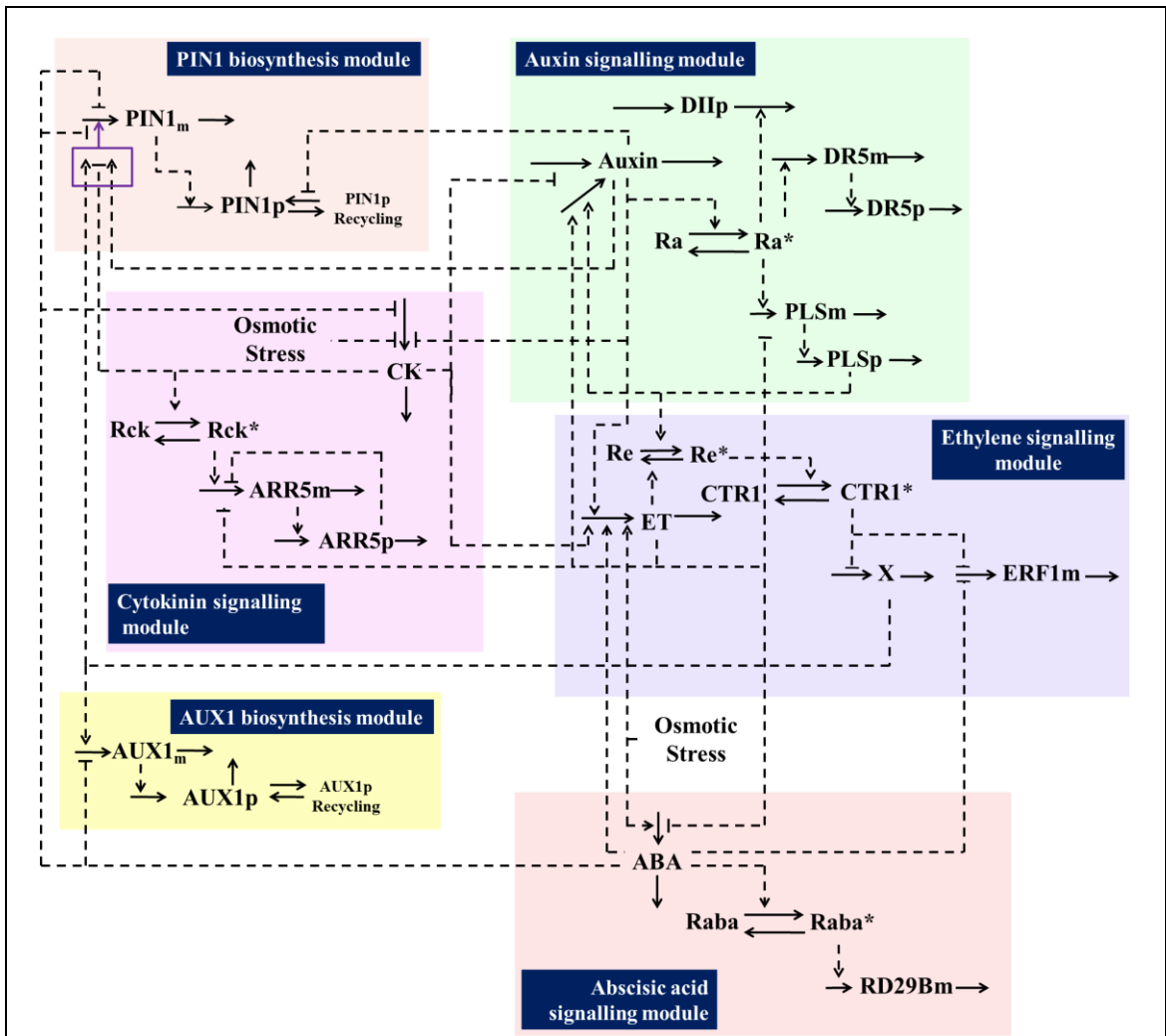

Figure 7-3 A hormonal crosstalk network for osmotic stress, for a cell expressing PIN1 in the stele

Symbols: **Auxin:** auxin, **Ra:** inactive auxin receptor, **Ra*** active auxin receptor, **DR5m:** *DR5* regulated *YFP* mRNA transcript, **DR5p:** *DR5* regulated *YFP* protein, **DIIp:** DII-VENUS protein, **PIN1m:** *PIN1* mRNA transcript, **PIN1p:** PIN1 transporter protein, **AUX1m:** *AUX1* mRNA transcript, **AUX1p:** *AUX1* transporter, **PLSm:** *POLARIS* mRNA transcript, **PLSp:** *POLARIS* peptide, **ET:** ethylene, **Re:** inactive ethylene receptor, **Re*:** active ethylene receptor, **CTR1:** inactive CTR1 kinase, **CTR1*:** active CTR1 kinase, **X:** the unknown factor that regulates auxin transport from the aerial tissues, **ERF1m:** *ERF1* mRNA transcript, **ABA:** abscisic acid, **Raba:** inactive abscisic acid receptor, **Raba*:** active abscisic acid receptor, **RD29Bm:** *RD29B* mRNA transcript **CK:** Active cytokinin, **Rck:** inactive cytokinin receptor, **Rck*:** active cytokinin receptor **ARR5m:** *ARR5* mRNA transcript, **ARR5p:** *ARR5* protein, **Osmotic stress:** The osmotic stress imposed by the growth medium

Arrows: Reactions, **Dotted arrows:** The species promotes this reaction, **Dotted flat headed arrows:** The species inhibits this reaction

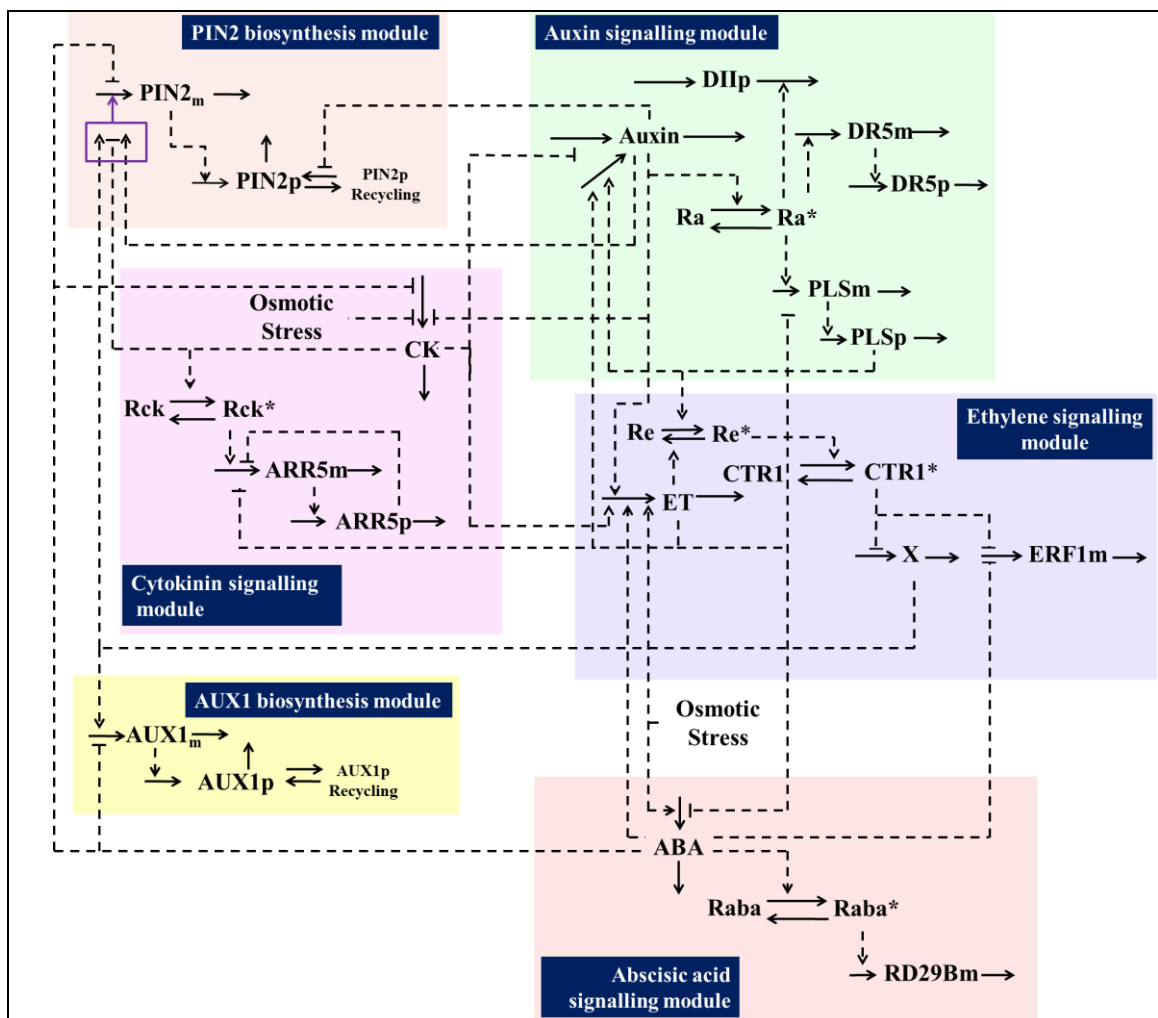

Figure 7-4 A hormonal crosstalk network for osmotic stress for a cell expressing PIN2 in the epidermis or cortex

Symbols: **Auxin:** auxin, **Ra:** inactive auxin receptor, **Ra*** active auxin receptor, **DR5m:** *DR5* regulated *YFP* mRNA transcript, **DR5p:** *DR5* regulated *YFP* protein, **DIIp:** DII-VENUS protein, **PIN2m:** *PIN2* mRNA transcript, **PIN2p:** *PIN2* transporter protein, **AUX1m:** *AUX1* mRNA transcript, **AUX1p:** *AUX1* transporter, **PLSm:** *POLARIS* mRNA transcript, **PLSp:** *POLARIS* peptide, **ET:** ethylene, **Re:** inactive ethylene receptor, **Re*:** active ethylene receptor, **CTR1:** inactive CTR1 kinase, **CTR1*:** active CTR1 kinase, **X:** the unknown factor that regulates auxin transport from the aerial tissues, **ERF1m:** *ERF1* mRNA transcript, **ABA:** abscisic acid, **Raba:** inactive abscisic acid receptor, **Raba*:** active abscisic acid receptor, **RD29Bm:** *RD29B* mRNA transcript, **CK:** Active cytokinin, **Rck:** inactive cytokinin receptor, **Rck*:** active cytokinin receptor **ARR5m:** *ARR5* mRNA transcript, **ARR5p:** *ARR5* protein, **Osmotic stress:** The osmotic stress imposed by the growth medium

Arrows: Reactions, **Dotted arrows:** The species promotes this reaction, **Dotted flat headed arrows:** The species inhibits this reaction

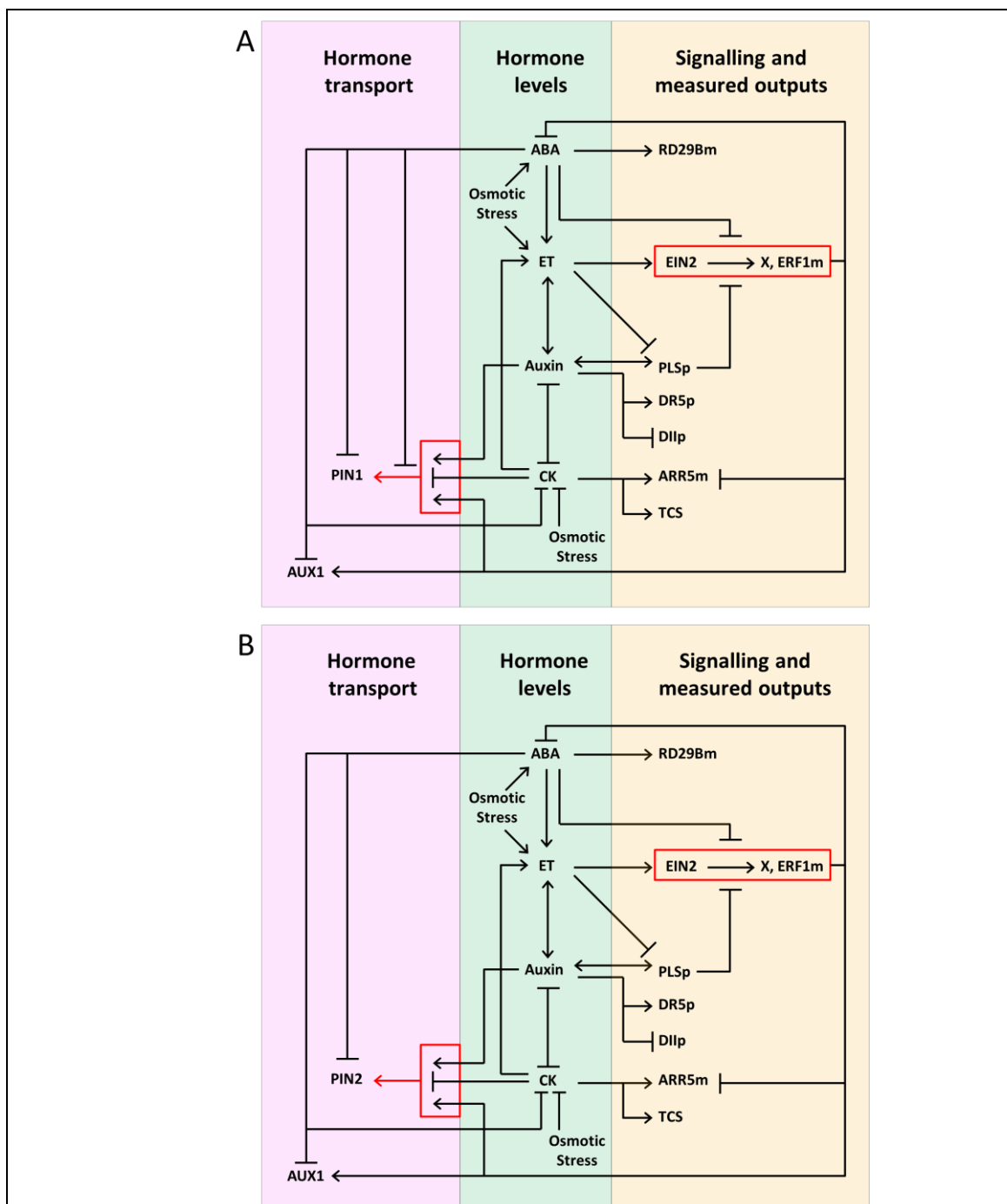

Figure 7-5 A simplified hormonal crosstalk network for root development under osmotic stress

A) A network describing hormonal crosstalk for cells in the stele, expressing PIN1. B) A network describing hormonal crosstalk for cells in epidermis/cortex, expressing PIN2.

Symbols: **Auxin:** auxin, **DR5p:** DR5 regulated YFP protein, **DIIp:** DII-VENUS protein, **PIN1:** PIN1 transporter protein, **AUX1:** AUX1 transporter, **PLS:** POLARIS peptide, **ET:** ethylene, **X :** the unknown factor that regulates auxin transport from the aerial tissues, **ERF1m** *ERF1* mRNA transcript, **ABA:** abscisic acid, **Raba:** inactive abscisic acid receptor, **Raba*:** active abscisic acid receptor, **RD29Bm :** *RD29B* mRNA transcript, **CK:** Active cytokinin, **ARR5m:** *ARR5* mRNA transcript, **TCS:** pTCS driven GFP protein, **Osmotic stress:** The osmotic stress imposed by the growth medium

Arrows: Promotion of accumulation. **Flat headed arrows:** Inhibition of accumulation

7.3. Summary

This chapter demonstrates that, by integrating my experimental data with the biological knowledge in the literature, it is possible to construct crosstalk networks to account for the interactions of auxin, ethylene, cytokinin and abscisic acid in the context of osmotic stress. These networks show that these hormones and their regulatory and target genes act as an integrative system under osmotic stress conditions. The two networks produced (Figure 7-3, Figure 7-4) can be simplified to allow easy comprehension (Figure 7-5). Figure 7-5 clearly shows the complex and nonlinear regulatory relationships of the four hormones (auxin, ethylene, cytokinin and abscisic acid) and their associated genes.

In the networks, osmotic stress promotes ABA and ethylene biosynthesis and inhibits cytokinin biosynthesis. ABA also promotes ethylene biosynthesis and inhibits cytokinin biosynthesis.

Differential regulation of *PIN1* and *PIN2* under stress means two different networks are required for different tissues. One network, for the stele, requires unusual regulation of *PIN1* expression, where small increases in ABA can override the promotive effect of ethylene and large increases in ABA inhibit *PIN1* expression.

The other network, for *PIN2* expression in epidermal and cortical cells, requires simpler regulation of auxin efflux. *PIN2* expression is promoted by ethylene and inhibited by ABA, which allows *PIN2* levels to increase under moderate osmotic stress due to increased ethylene responses, and return to unstressed levels under severe stress due to increased ABA responses.

The two networks constructed in this chapter form the foundation for exploring the spatiotemporal dynamics of hormonal crosstalk by developing kinetic models. Analysis of spatiotemporal dynamics of hormonal crosstalk will allow us to examine how multiple hormones control their levels and patterning within the root, to regulate growth and development.

The regulation of *PIN1* expression by both ethylene and ABA provides an interesting problem for the analysis of kinetic modelling, as the experimental data show complex and unintuitive regulatory relationships between *PIN1* expression and the two hormones. In particular, the regulation of *PIN1* expression by ethylene can be overridden by ABA. To the best of my knowledge, little is known about how an overriding mechanism can be formulated when two hormones interact, and there are no existing kinetic models in the literature. Thus, a modelling analysis is required to elucidate how the regulation of *PIN1* expression by ethylene can be

Construction of hormonal crosstalk networks under osmotic stress conditions overridden by ABA. The next chapter develops kinetic modelling analysis to investigate one possible mechanism to produce this overriding effect.

8 Construction of a kinetic model to understand PIN1 regulation by abscisic acid and ethylene

8.1. Introduction

The experimental work in previous chapters demonstrates that the regulation of auxin transport to the root by PIN1 is crucial to understanding root growth responses to osmotic stress. In this chapter the regulation of PIN1 levels by ABA and ethylene are investigated through kinetic modelling. A new kinetic model examining the regulation of *PIN1* transcription by ABA and ethylene was constructed, based on the experimental evidence and the network discussed previously.

This model is not designed to explain the detailed molecular basis on how PIN1 levels are regulated by ethylene and ABA, as there is not enough evidence about the signalling molecules involved. Instead, it abstracts existing biological data related to the effects of ethylene and ABA on PIN1 levels into a kinetic model, proposing several plausible mechanisms for how both ethylene and ABA could modulate PIN1 levels, and examining their merits.

The kinetic model developed in this chapter includes the flux of various pathways leading to PIN1 biosynthesis. Effects of the flux through each pathway on accumulated PIN1 levels were examined and an alternative model was constructed. By doing so, it was possible to evaluate the contribution of the various pathways to PIN1 levels. This work indicates that it is difficult to completely separate pathways regulating PIN1 biosynthesis and reproduce the trends similar to all the experimental data, offering new insight into the regulation of PIN1 levels.

8.2. A kinetic model for ABA to override ethylene to repress PIN1 transcription

The regulation of PIN1 by ethylene and ABA forms a novel and interesting problem. Experimental data (Chapter 6) demonstrate that exogenous ethylene can upregulate *PIN1* expression, but low concentrations of exogenous ABA can override this effect. As far as we are aware, there are no existing kinetic models that can produce this sort of regulation. Under high levels of ABA, the PIN1 levels are also reduced. Our experimental work shows that the regulation of PIN1 by ABA and ethylene is crucial to understanding the effects of osmotic stress (Chapter 6).

As in the previous chapter, **BOLD** text refers to the representation of a species in the model. Bold numbers preceded by the letter **R** (e.g. **R1**) refer to reactions in this model, detailed in the schematic Figure 8-1 and Table 11-1.

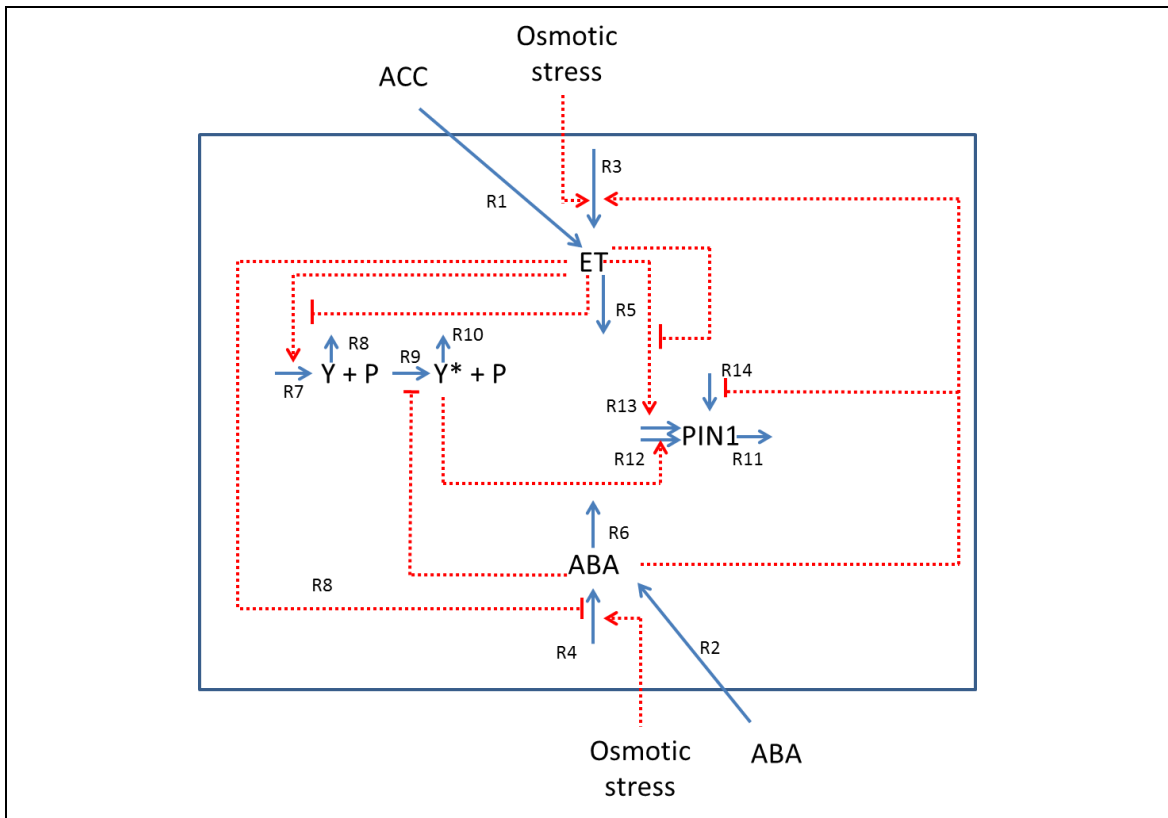

Figure 8-1 A kinetic model for the regulation of PIN1 expression by ethylene and ABA

Symbols: **ET**: Ethylene, **ACC**: Exogenously applied 1-aminocyclopropane-1-carboxylic acid (ACC), **ABA**: Abscisic acid, **PIN1**:PIN1 auxin transport protein, **Osmotic stress**: Exogenously applied osmotic stress

Reactions: **R1**: Conversion of exogenously applied **ACC** to endogenous **ET**, **R2**: Conversion of exogenously applied **ABA** to endogenous **ABA**, **R3**:**ET** biosynthesis, **R4**: **ABA** biosynthesis, **R5**:**ET** loss/degradation from the cell, **R6**:**ABA** loss/degradation from the cell, **R7**: **ET** catalysed production of hypothetical molecule **Y**, **R8**: Degradation of **Y**, **R9**: **ABA** catalysed conversion of **Y** and **P** to **Y*** and **P**, **R10**: degradation of **Y***, **R11**: Degradation of **PIN1**, **R12**: **Y*** catalysed production of **PIN1**, **R13**: Ethylene catalysed production of **PIN1**, **R14**: **ABA** inhibited production of **PIN1**

8.2.1. Simplifying assumptions

This model abstracts from the network described in the previous chapter and the literature, and for simplicity examines only those interactions that are most pertinent to the problem. Initially, the model was fitted to the effects of ABA and ET on PIN1-GFP levels and the known cross-regulatory mechanisms that determine ET and ABA levels. The model was then used to predict the responses of PIN1, ET and ABA to osmotic stress.

As such the following assumptions and simplifications were made:

- Phenotypic analysis of double ethylene and ABA mutants have revealed no evidence for interactions between their signalling cascades (Cheng *et al.*, 2009), so signalling cascades were excluded and hormone levels were assumed to be equivalent to response.
- Cytokinin, auxin, POLARIS and all related transport and signalling components were excluded for simplicity.

Construction of a kinetic model to understand PIN1 regulation by abscisic acid and ethylene

- As analysis of the ethylene and ABA effects were performed by confocal assays of PIN1-GFP fusion protein levels, we cannot be certain that PIN1-GFP levels are being regulated by transcription or at the protein level. We have assumed that PIN1 protein levels are regulated through biosynthesis, but regulating degradation may also be able to produce equivalent results.

8.2.2. Regulation of ethylene and abscisic acid homeostasis

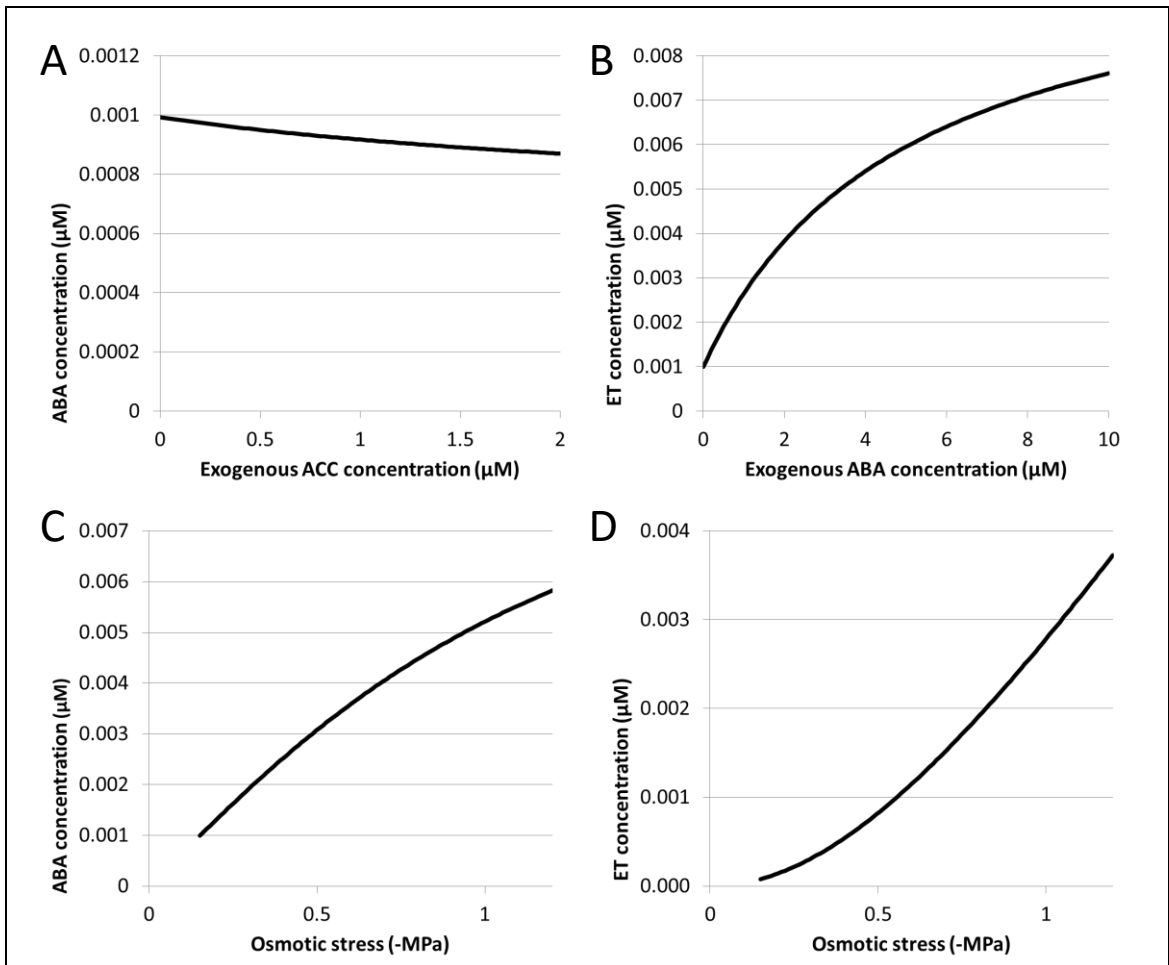

Figure 8-2 Model predictions of ABA and ET cross regulation and homeostasis under osmotic stress

A) Model predictions of ABA levels in response to ACC application. B) Model predictions of ET levels in response to exogenous ABA application. C) Model predictions of ABA levels in response to osmotic stress. D) Model predictions of ET levels in response osmotic stress.

Both **ABA** and **ET** levels are assumed to be regulated by biosynthesis (**R3** and **R4**) and their degradation (**R5** and **R6**) are assumed to follow mass action kinetics.

ABA levels are assumed to be low under unstressed conditions and biosynthesis is assumed to be promoted by **Osmotic stress** (Wright & Hiron, 1969; Zhang & Davies, 1987; Christmann *et al.*, 2005; Jones *et al.*, 2014). As ethylene insensitive mutants have increased ABA biosynthesis

Construction of a kinetic model to understand PIN1 regulation by abscisic acid and ethylene and accumulation (Cheng *et al.*, 2009), **ET** is assumed to inhibit **ABA** biosynthesis, by competitive inhibition kinetics (**R4**).

ET biosynthesis is assumed to be promoted by both **Osmotic stress** and **ABA** (**R3**), following modified Michaelis-Menten kinetics (Luo *et al.*, 2014).

After minimal parameter fitting (Table 11-1) these relationships can produce a situation where **ACC** application inhibits **ABA** accumulation, **ABA** application promotes **ET** accumulation and where **Osmotic stress** increases both **ET** and **ABA** levels (Figure 8-2).

8.2.3. Regulation of PIN1 expression

The nature of PIN1 co-regulation by ethylene and ABA is poorly defined. As such we assumed that there are three possible reaction schemes to regulate **PIN1** biosynthesis - an **ET**- (ethylene) and **ABA**-regulated reaction (**R12**), an **ET**-regulated reaction (**R13**) and an **ABA**-regulated reaction (**R14**).

Auxin has been found to positively regulate *PIN1* expression and cytokinin negatively regulates *PIN1* expression through the turnover of the AUX/IAA protein SHY2 (Dello Iorio *et al.*, 2008). As ethylene promotes auxin biosynthesis and auxin inhibits cytokinin biosynthesis (Nordstrom *et al.*, 2004; Swarup *et al.*, 2007), increasing ethylene concentrations with ACC application will therefore increase *PIN1* expression, via modulation of this pathway, which may be independent of ABA. There is therefore justification for **ET**-mediated **ABA**-independent regulation of **PIN1** levels (**R13**).

The expression of the ABA-responsive transcription factor gene *ABI4* is also upregulated by cytokinin treatment and negatively regulated by auxin (Shkolnik-Inbar & Bar-Zvi, 2010). ABA promotes *ABI4* transcription, which negatively regulates *PIN1* expression. As ACC application increases auxin biosynthesis and auxin inhibits cytokinin biosynthesis (Nordstrom *et al.*, 2004; Swarup *et al.*, 2007), *PIN1* expression will increase via modulation of *ABI4* under ethylene treatment. Therefore a pathway for ethylene and ABA to regulate PIN1 levels is plausible (**R12**).

As very low concentrations of endogenous ABA can override the promotive effect of ACC on PIN1, we have created an overriding mechanism in this pathway as follows. A signalling molecule (**Y**) is produced in response to **ET** (**R7**). The activated form of **Y** (**Y***) promotes PIN1 biosynthesis (**R12**). ABA inhibits the conversion of **Y** to **Y***, following uncompetitive inhibition (**R9**). This activation can be thought of in similar terms to a posttranslational modification, such as phosphorylation, so for clarity we have included a second molecule **P**, which can be thought of as being similar to a protein kinase. The uncompetitive inhibition in **R9** can be thought of in

Construction of a kinetic model to understand PIN1 regulation by abscisic acid and ethylene

the following manner: **Y** binds **P**, forming a **YP** complex, which becomes **Y*P**. **Y*P** dissociates to release **Y*** and **P**. **YP** can also bind with a downstream signalling molecule from **ABA** (assumed to be **ABA** here as signalling is excluded) to form a **YP-ABA** complex, therefore inhibiting the conversion of **Y** to **Y***. This reaction mechanism allows **ABA** to override the effects of **ET** on **PIN1**, consistent with experimental observations and allows this occur downstream of ethylene levels (Figure 8-3)

As the concentration of ABA required to reduce PIN1 levels significantly is two orders of magnitude larger than that required to produce the overriding mechanism, we also hypothesised that ABA is regulating PIN1 independently of ethylene. In the model, this is realised by **ABA** competitively inhibiting **PIN1** biosynthesis (**R14**).

8.2.4. Model can reproduce PIN1 responses to ACC application

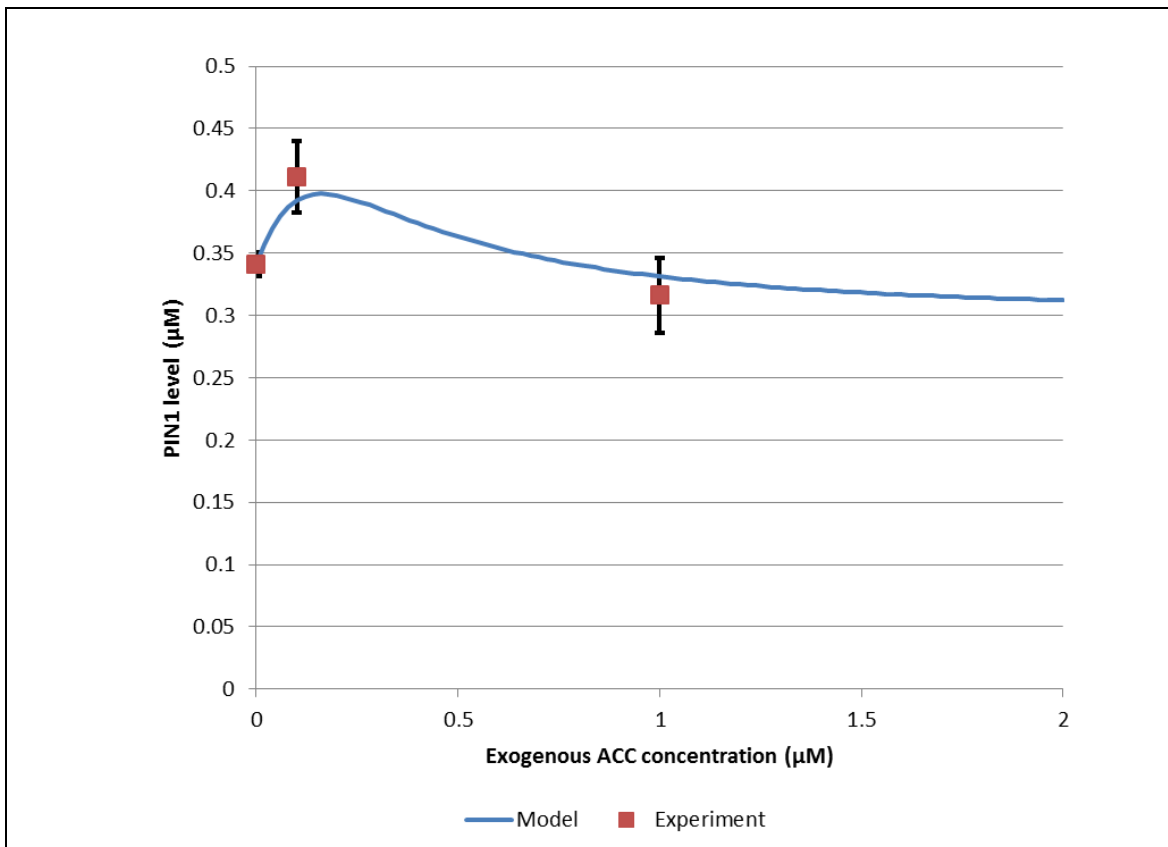

Figure 8-3 Model results (blue line) of PIN1 responses to exogenous ACC application are in agreement with the experimental PIN1:GFP data (red points with SEM error bars).

Low to medium levels of ACC application increase *PIN1* expression, whereas high levels of ACC application reduced PIN1 levels to those found in untreated plants, implying that low levels of ACC promote *PIN1* expression whereas high levels may inhibit *PIN1* expression. To accommodate this, substrate inhibition kinetics were assumed for the effects of **ET** on **PIN1** biosynthesis (**R7**, **R13**).

Construction of a kinetic model to understand PIN1 regulation by abscisic acid and ethylene

Model fitting could produce a model where **PIN1** levels increase under low concentrations of exogenously applied **ACC**, and return to baseline levels at higher concentrations, in agreement with our experimental data of PIN1:GFP fluorescence (Figure 8-3).

8.2.5. The model can reproduce reduction in PIN1 levels under ABA treatment, and the overriding effect of ABA on PIN1 responses to ACC

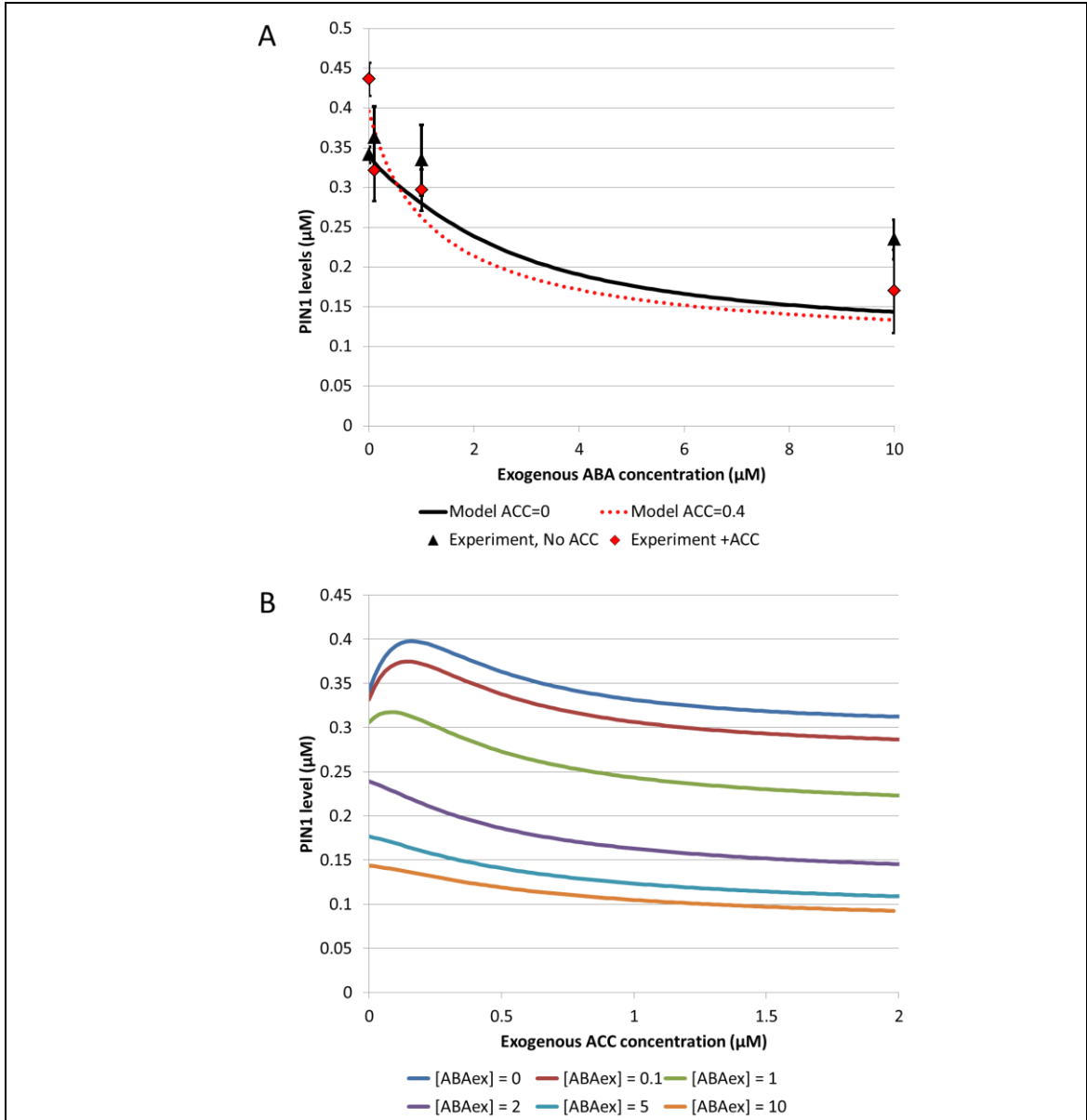

Figure 8-4 Model results of the effect of exogenous application of ABA and ethylene on PIN1 levels

A) Model predictions (lines) for **ABA** application reduce **PIN1** levels, matching experimental data (Points with SEM error bars). When **ACC** is applied (red), the model can replicate the increase in **PIN1** levels when **ABA** concentration is very low, however at higher **ABA** concentrations this increase is lost. B) Model predictions for **PIN1** levels under combined **ABA** and **ACC** levels. **ACC** application increases **PIN1** levels, however this increase is lost with **ABA** application.

After fitting, the model can replicate the reduction in PIN1 levels seen experimentally under ABA application (Figure 8-4A). When **ACC** is applied in the absence of **ABA**, **PIN1** levels

Construction of a kinetic model to understand *PIN1* regulation by abscisic acid and ethylene increase, however simultaneous **ACC** and **ABA** application causes a reduction in **PIN1** levels to match those in the absence of **ACC**, in agreement with the experimental data (Figure 8-4A). This overriding effect is best seen in Figure 8-4B, which shows that simultaneous **ABA** and **ACC** application has two effects. Firstly **ABA** dampens the increase in **PIN1** levels that occur under **ACC** application. Secondly, high levels of **ABA** reduce **PIN1** levels, regardless of **ACC** application.

8.3. Model predictions

8.3.1. The model can reproduce the reduction in *PIN1* levels under osmotic stress and the overriding effect of osmotic stress on ethylene regulated *PIN1* levels

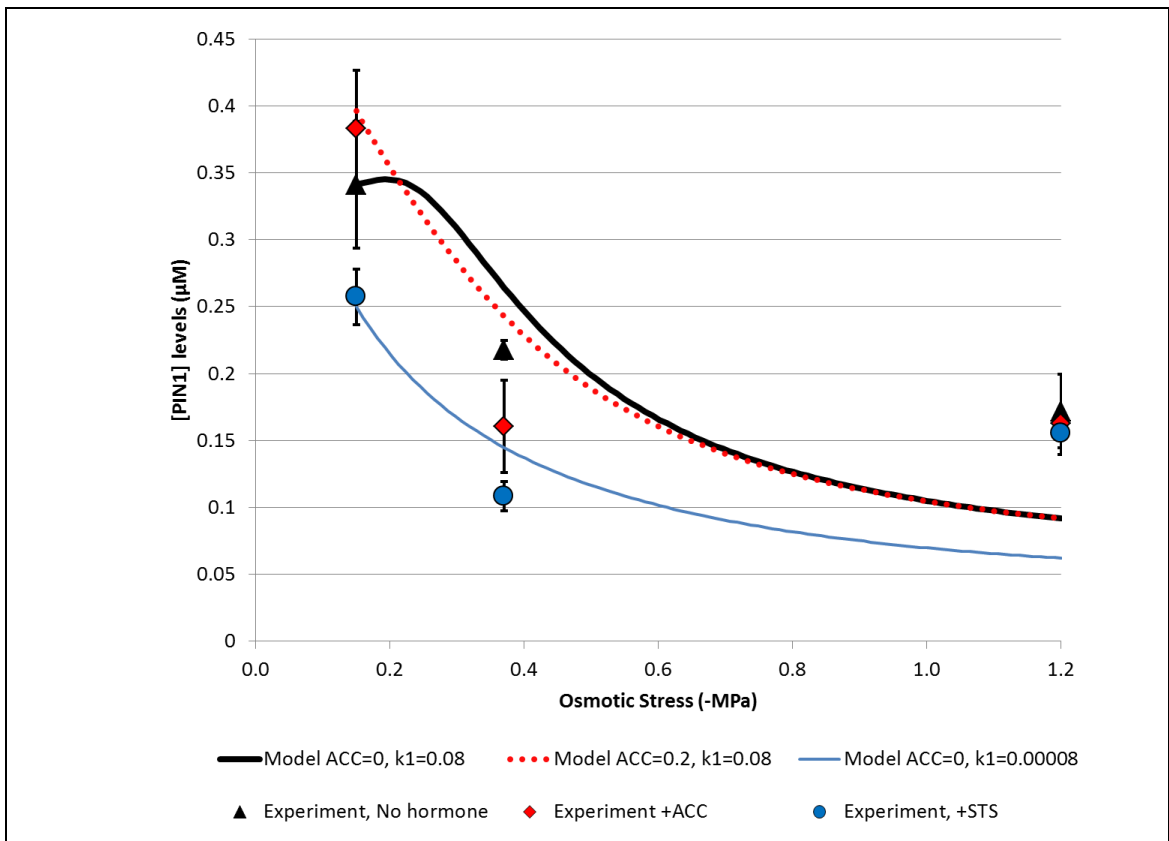

Figure 8-5 Osmotic stress can override the effects of ethylene, to reduce *PIN1* levels

Model predictions (lines) for *PIN1* levels show the same trend as experimental results (points, displaying SEM) under combined ethylene perturbation and osmotic stress. Silver thiosulphate (equivalent to reducing **R4:K1** to 0.00008, blue) reduces *PIN1* levels under stressed and unstressed conditions, whilst **ACC** application (red) increases *PIN1* levels under unstressed but not stressed conditions.

The model predicts that increasing **Osmotic stress** will decrease *PIN1* levels, in agreement with experimental data (Figure 8-5). Under unstressed conditions, **ACC** application increases *PIN1* expression, however osmotic stress overrides this effect, presumably due to increased **ABA** (Chapter 6). The model can qualitatively replicate this behaviour (Figure 8-5). As the model does not distinguish between hormone levels and signalling, the effect of ethylene perception

Construction of a kinetic model to understand PIN1 regulation by abscisic acid and ethylene inhibitors can also be examined by reducing the ET biosynthetic rate (by reducing R3:k1 to 0.00008, see model parameters Table 11-1). Experimentally inhibiting ethylene perception reduces PIN1 levels under stressed and unstressed conditions, behaviour which the model can also replicate (Figure 8-5).

8.3.2. The model can qualitatively reproduce the overriding effect of osmotic stress on PIN1 levels

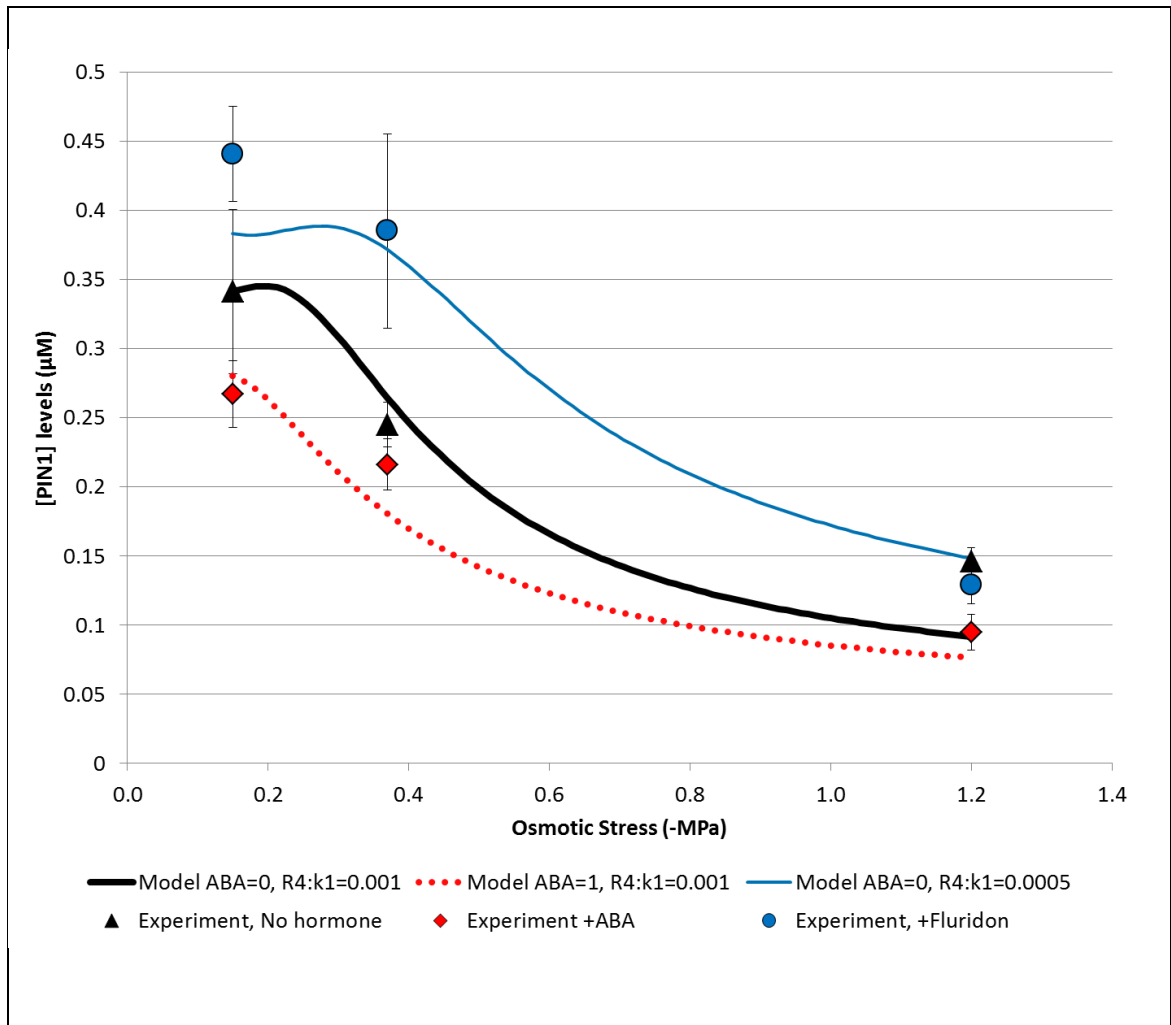

Figure 8-6 The model can correctly predict the trend of exogenously applied ABA and inhibiting ABA biosynthesis under osmotic stress

Model predictions (lines) for PIN1 levels show the same trend as experimental results (points, displaying SEM) under combined ABA perturbation and osmotic stress. Fluridon (equivalent to reducing R4:K1 to 0.0005) increases PIN1 levels under stressed and unstressed conditions, whilst ABA application reduces PIN1 levels under stressed and unstressed conditions.

Under moderate osmotic stress inhibiting ABA biosynthesis can rescue PIN1, whereas supplemental ABA enhances the reduction in PIN1 (Figure 8-6). The model can correctly predict this behaviour, by adding exogenous ABA or inhibiting ABA biosynthesis (R4:k1 = 0.0005, see model parameters Table 11-1).

8.3.3. Examination of reaction fluxes reveals relative importance different pathways to regulation of PIN1 levels.

The nature of PIN1 co-regulation by ethylene and ABA is poorly defined. As such, based on biological knowledge in the literature, it was initially assumed that there are three possible reaction schemes to regulate PIN1 biosynthesis - an ethylene- and ABA-regulated reaction (**R12**), an ethylene-regulated reaction (**R13**) and an ABA-regulated reaction (**R14**). To understand the relative contributions of these three pathways to how our model reproduces the experimental data, effects of their reaction fluxes were investigated.

For the parameter set used, under unstressed and untreated conditions, the ABA-regulated pathway (**R14**) is responsible for the majority of **PIN1** biosynthesis (Figure 8-7A). The **ET**- and **ABA**-regulated pathway (**R12**) also makes a contribution to the **PIN1** levels, but only 30% of the contribution of the **ABA**-regulated pathway. The **ET**-regulated pathway (**R13**) makes very little contribution to **PIN1** biosynthesis. As **ABA** levels increase the flux of **R12** initially increases, due to increased **ET** levels, but as **R14** flux is decreased, there is very little change in **PIN1** levels. Under higher levels of exogenous **ABA** application, **R12** flux returns to untreated levels and **R14** flux decreases, reducing total **PIN1** biosynthesis and levels.

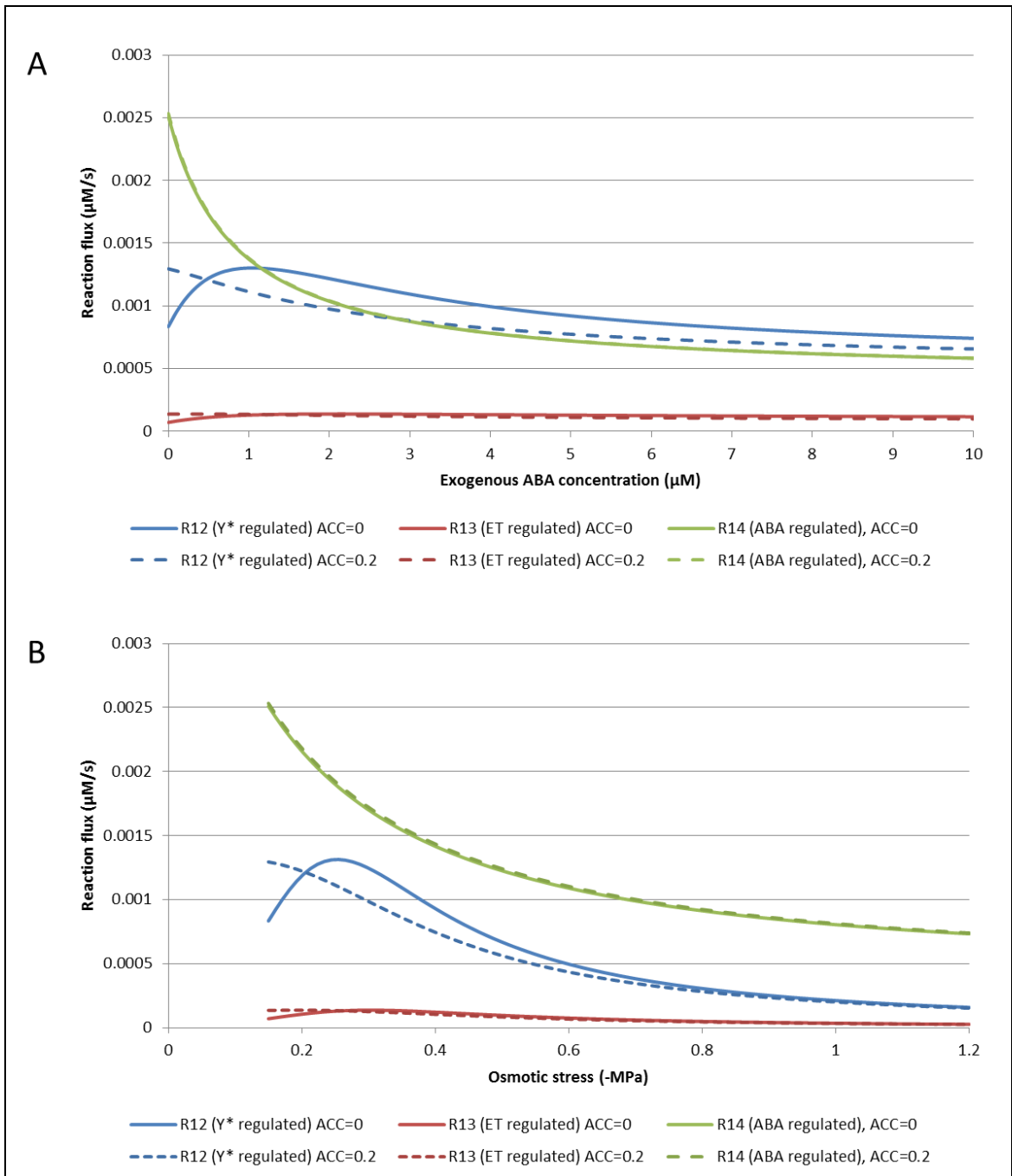

Figure 8-7 Modelled reaction fluxes for PIN1 biosynthesis under various scenarios

A) The reaction flux for **R12** (Y* regulated PIN1 biosynthesis), **R13** (ET regulated PIN1 biosynthesis) and **R14** (ABA regulated PIN1 biosynthesis) under combined ABA and ACC application (dashed lines). B) The reaction flux for **R12**, **R13** and **R14** under combined osmotic stress and ACC treatments (dashed lines).

Under ACC application, there is little change in the contribution of the ABA-regulated pathway to PIN1 levels, but the ET- and ABA-regulated pathway (**R12**) displays different behaviour. PIN1 biosynthesis increases through **R12** when exogenous ABA is low and ACC is applied to 50% of the rate of **R14** (Figure 8-7A). However, increasing exogenous ABA reduces the **R12** flux with greater sensitivity than in the absence of ABA, providing the overriding mechanism.

Construction of a kinetic model to understand PIN1 regulation by abscisic acid and ethylene

Analysis of the reaction fluxes under osmotic stress show similar patterns to ABA application, including the decrease in **R14** flux under osmotic stress and the overriding effect of osmotic stress on **R12** flux (Figure 8-7B).

8.4. Investigation into whether alternative reaction schemes can reproduce the experimental data

8.4.1. Alternative model reaction scheme

The analysis of reaction fluxes in the kinetic model (Figure 8-7) demonstrated the relatively minor role of **R13** (the **ET**-regulated pathway) for the parameters used, but the shape of the flux curve for **R13** was similar to that for **R12** (**ABA** and **ET** regulated pathway). Therefore it was examined whether it is possible to achieve the same overriding effect using just **R13** and **R14** (the **ABA**-regulated pathway).

The same **ABA** and **ET** homeostatic parameters were used for this study, but **R7**, **R8**, **R9**, **R10** and **R12** were removed (Figure 8-8).

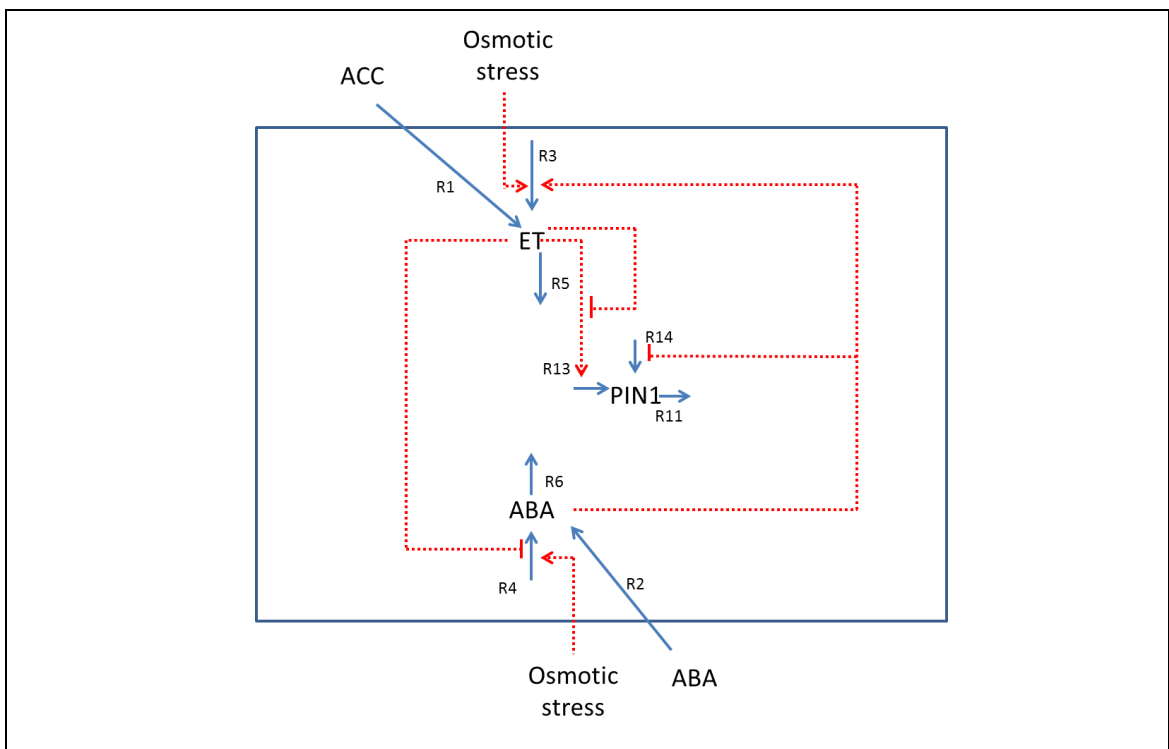

Figure 8-8 The alternative kinetic model for ABA and ET to regulate PIN1 levels

Symbols: **ET**: Ethylene, **ACC**: Exogenously applied 1-Aminocyclopropane-1-carboxylic acid (ACC), **ABA**: Abscisic acid, **PIN1**: PIN1 auxin transport protein, **Osmotic stress**: Exogenously applied osmotic stress

Reactions: **R1**: Conversion of exogenously applied **ACC** to endogenous **ET**, **R2**: Conversion of exogenously applied **ABA** to endogenous **ABA**, **R3**: **ET** biosynthesis, **R4**: **ABA** biosynthesis, **R5**: **ET** loss/degradation from the cell, **R6**: **ABA** loss/degradation from the cell, **R11**: Degradation of **PIN1**, **R13**: Ethylene catalysed production of **PIN1**, **R14**: **ABA** inhibited production of **PIN1**

8.4.2. Alternative model fitting

Other parameters were fitted in the same way as the previous kinetic model, and required a much greater biosynthetic rate for **R13** (Table 11-8). After fitting, the model could reproduce the increase **PIN1** levels under **ACC** application, the decrease in **PIN1** levels under **ABA** application (Figure 8-9). It could also reproduce the overriding effect of **ABA** on **ACC**'s regulation of **PIN1** levels (Figure 8-10).

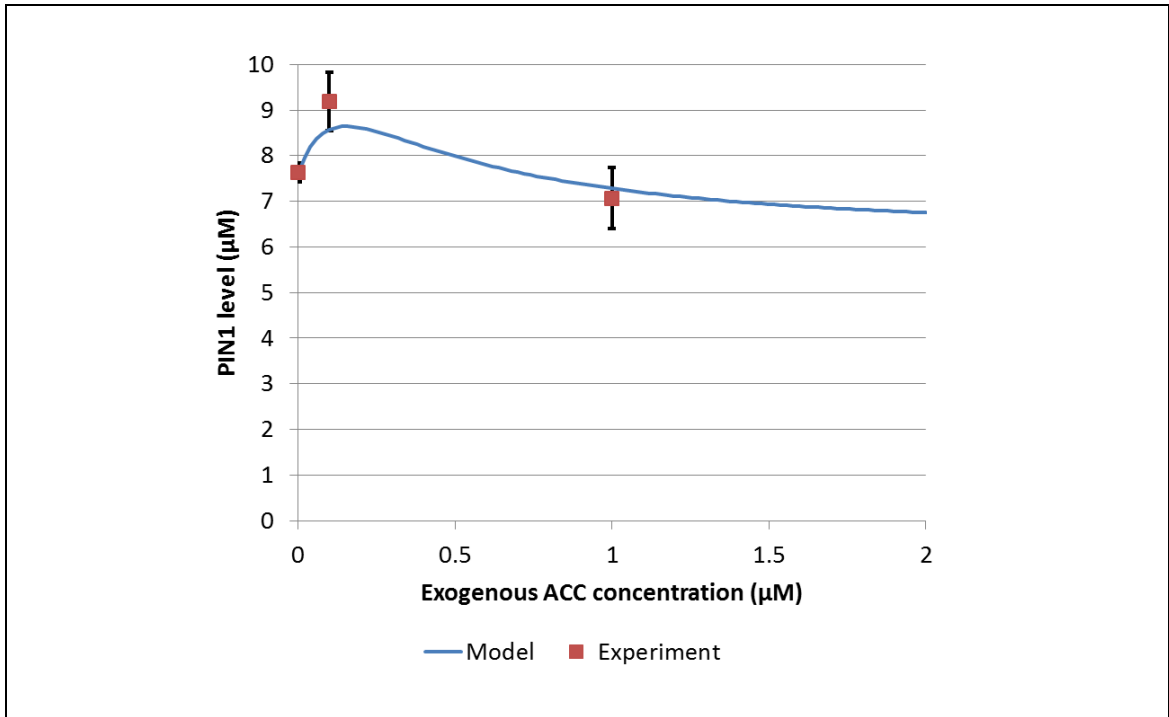

Figure 8-9 The alternative model results (blue line) of PIN1 responses to exogenous ACC application are in agreement with the experimental PIN1:GFP data (red points with SEM error bars).

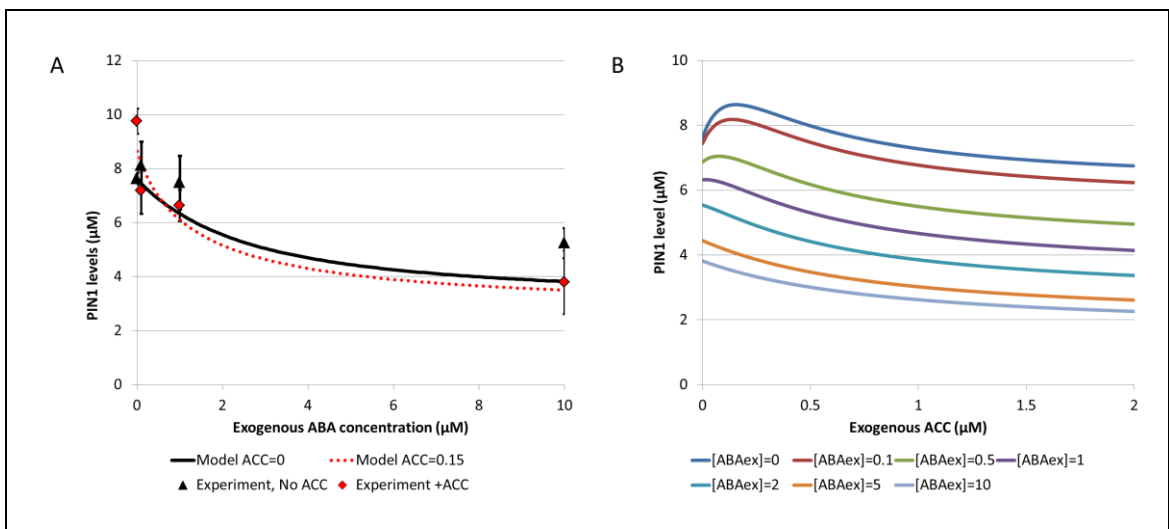

Figure 8-10 The alternative model can reproduce the ABA-mediated reduction in PIN1 levels and overriding the effect of ABA on ACC regulation of PIN1 levels

A) Alternative model predictions (lines) for **ABA** application reduce **PIN1** levels, matching experimental data (Points with SEM error bars). When **ACC** is applied (red), the model can replicate the increase in **PIN1** levels when **ABA** concentration is very low, however at higher **ABA** concentrations this increase is lost. B) Model predictions for **PIN1** levels under combined **ABA** and **ACC** levels. **ACC** application increases **PIN1** levels, however this increase is lost with **ABA** application.

8.4.3. Alternative model predictions

When the effects of osmotic stress were examined, the model could reproduce the reduction in **PIN1** levels that occurs under osmotic stress (Figure 8-11). The model could also predict the correct responses to **ABA** perturbation under osmotic stress. Increasing exogenous **ABA** reduces **PIN1** levels further under stress, whilst inhibiting **ABA** biosynthesis can rescue **PIN1** levels under moderate stress.

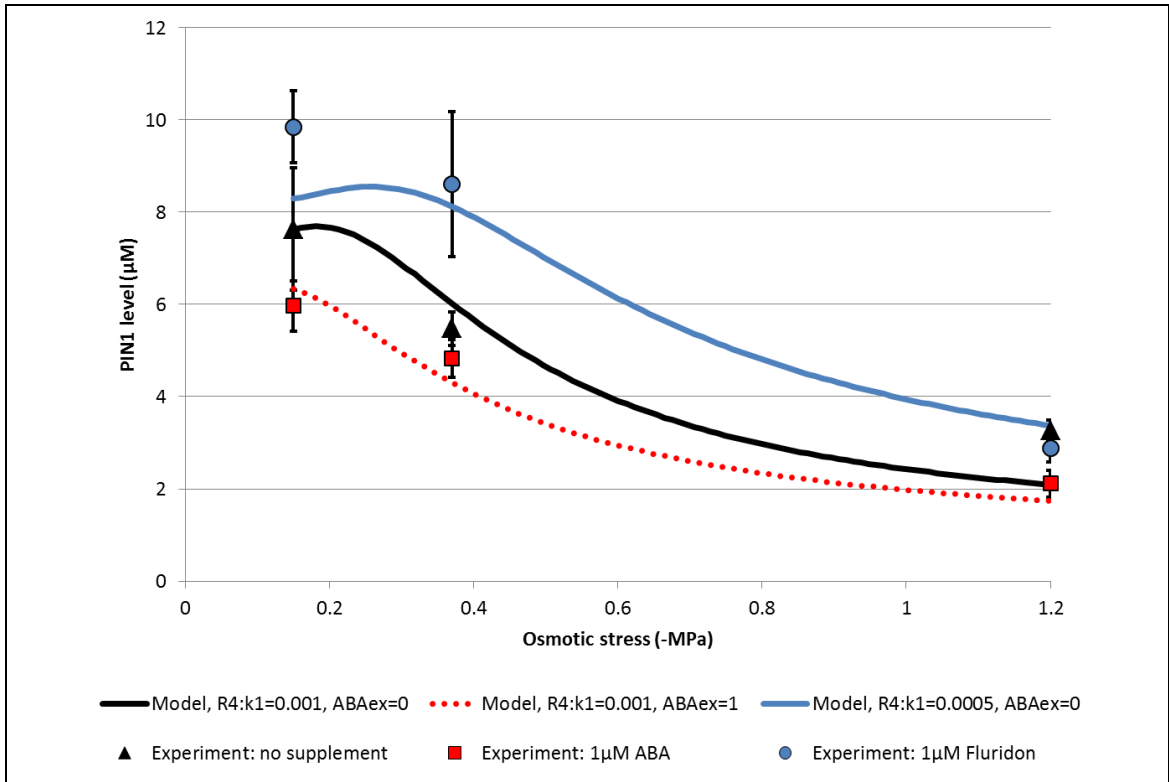

Figure 8-11 The alternative model can correctly predict the PIN1 response to osmotic stress and ABA perturbation

Alternative model predictions (lines) for **PIN1** levels show the same trend as experimental results (points, displaying SEM) under combined **ABA** perturbation and osmotic stress. Fluridon (equivalent to reducing **R4:K1** to 0.0005) increases **PIN1** levels under stressed and unstressed conditions, whilst **ABA** application reduces **PIN1** levels under stressed and unstressed conditions.

The reduced model can also correctly replicate the effect of exogenous ACC application and osmotic stress, with moderate **osmotic stress** overriding the effect of ethylene on **PIN1** levels and more severe **Osmotic stress** reducing **PIN1** levels (Figure 8-12). However, when ethylene biosynthesis is limited in the model, by reducing **R3:k1**, the model cannot replicate experimental results. Experimental data show that, under low/unstressed conditions, reducing **ET** response/biosynthesis reduces **PIN1** levels, but under increased **Osmotic stress**, the decrease in **PIN1** levels is less severe (Figure 8-12). However, the model predicts that reducing **ET** biosynthesis will maintain their **PIN1** levels under osmotic stress.

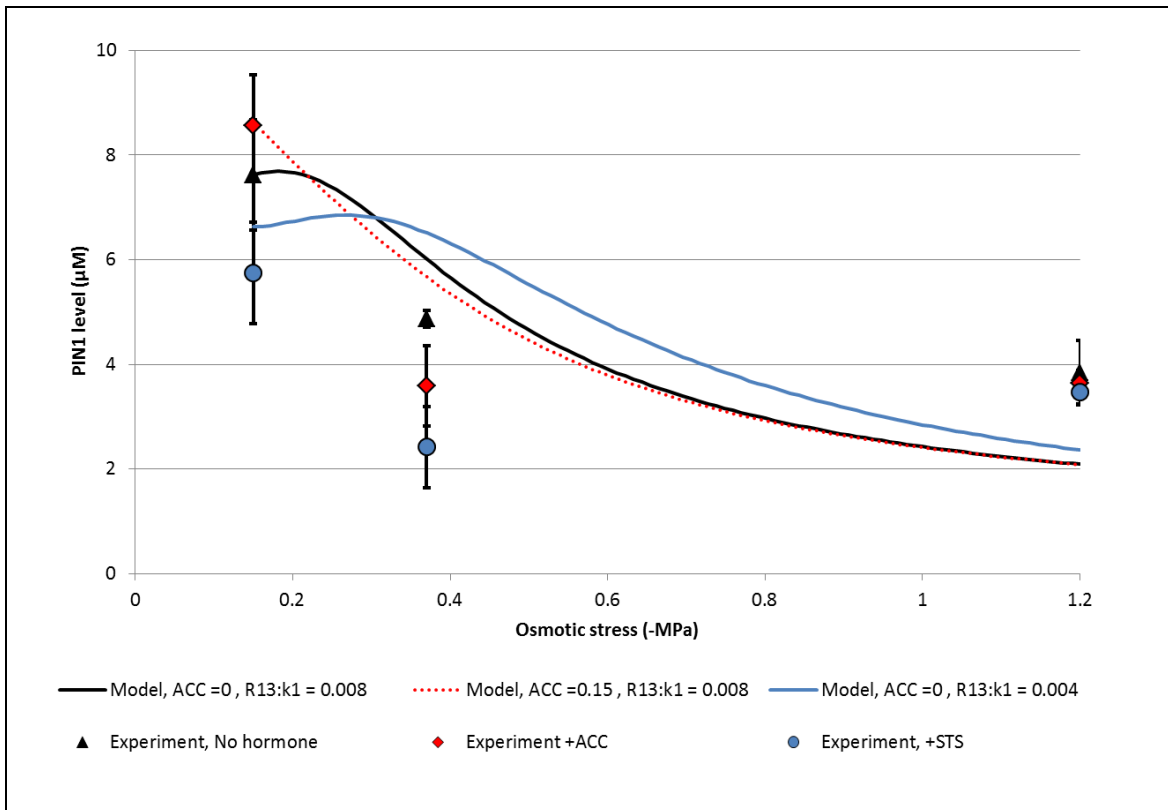

Figure 8-12 The alternative model can correctly predict the PIN1 response to osmotic stress and ACC treatment, but not inhibited ET biosynthesis

Model predictions (lines) for **PIN1** levels show the same trend as experimental results (points, displaying SEM) under combined ACC treatment and osmotic stress. However the model predictions for silver thiosulphate (equivalent to reducing **R4:K1** to 0.00008, blue) increase **PIN1** levels under osmotic stress, which disagrees with experimental data (points with SEM error bars).

To assess whether this failure to replicate the experimental results is due to changing dynamics in the **ET**-regulated pathway or the **ABA**-regulated pathway, the reaction fluxes under osmotic stress were examined (Figure 8-13). As with the previous model, the **ABA**-dependent **PIN1** biosynthetic pathway (**R14**) is responsible for the majority of **PIN1** biosynthesis when **Osmotic stress** is low. **R14** flux decreases under **Osmotic stress**, with reduced **ET** biosynthesis or increased exogenous **ACC** having very little effect.

The **ET**-regulated **PIN1** biosynthetic pathway (**R13**) is responsible for the overriding effect under osmotic stress and **ACC** treatment and also responsible for the unusual dynamics when **ET** biosynthesis is inhibited. When **ET** biosynthesis is inhibited, and plants are unstressed, the **R13** reaction flux is small; however increasing osmotic stress rapidly increases **R13** flux, to a level that is higher than **R14** flux, maintaining **PIN1** levels.

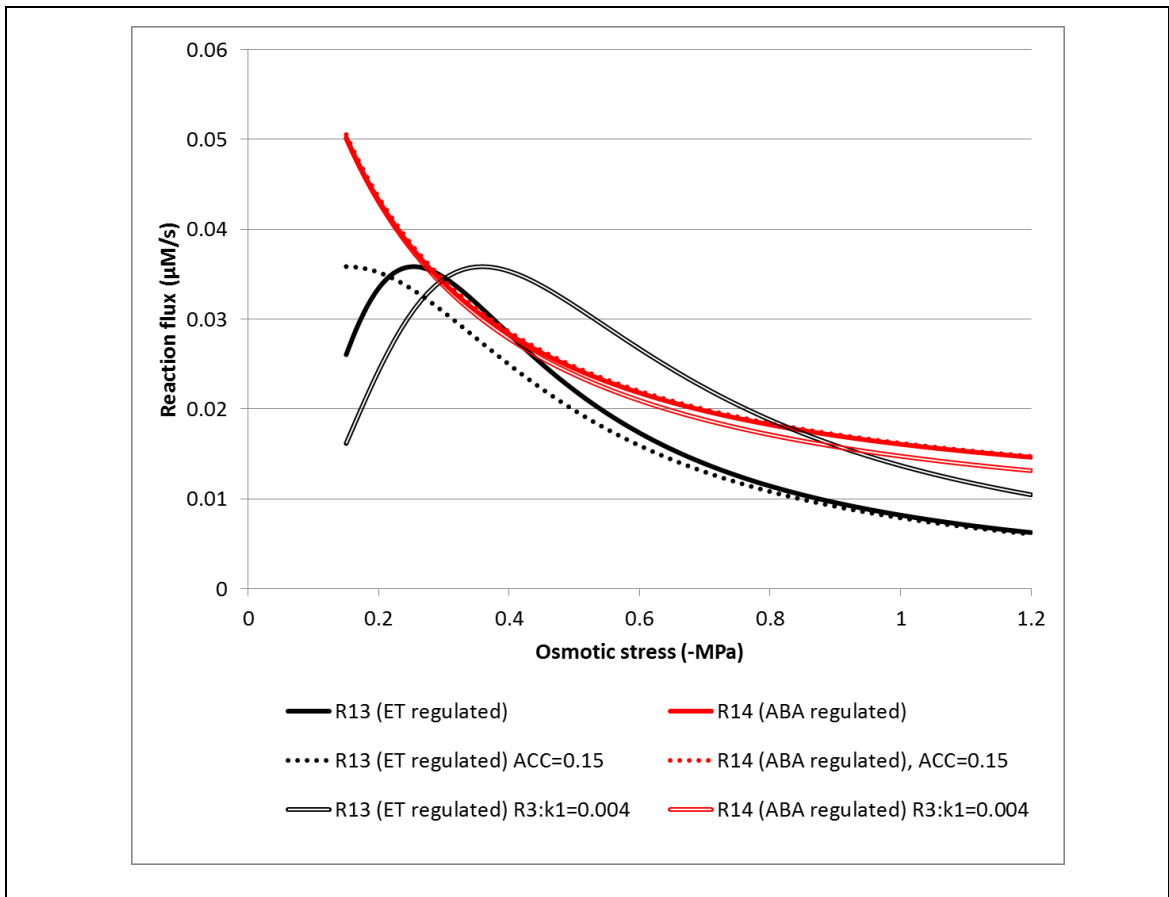

Figure 8-13 Alternative model PIN1 biosynthesis reaction flux under ethylene perturbation

To examine whether the failure to reproduce the experimental data was an artefact of a poorly chosen initial parameter for **ET** biosynthesis, the steady state **PIN1** level was examined for a variety of osmotic stress values and **R3:k1** rate constants. This revealed a complex, non-linear relationship between the rate of **ET** biosynthesis and **PIN1** levels under **Osmotic stress** (Figure 8-14). No obvious parameter range could replicate the trend seen in the data, without compromising the effect of **ET** on **PIN1** levels.

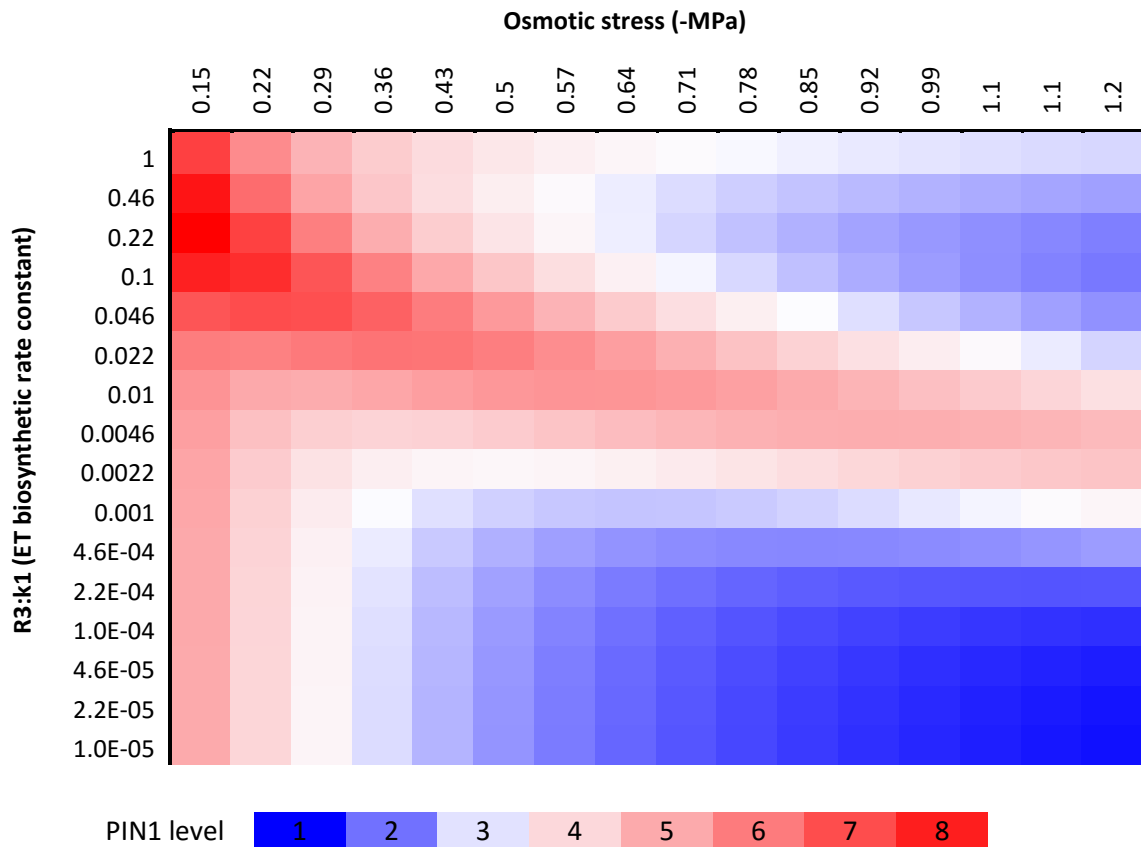

Figure 8-14 Varying the rate of ET biosynthesis produces complex non-linear effects on PIN1 levels under osmotic stress

Modelling outcomes for **PIN1** levels under various ethylene biosynthetic parameter settings (**R3:K1**), and various levels of osmotic stress. **Red**: High **PIN1** levels, **Blue**: Low **PIN1** levels.

Analysis of which pathways were responsible for the **PIN1** dynamics under either **ABA** and **ACC** treatment, or **ACC** and **Osmotic stress** treatment provided great insights into the parameter set chosen. In untreated conditions, the majority of **PIN1** biosynthesis occurred through the **ABA**-regulated pathway, which showed reduced flux under **ABA** or **Osmotic stress** treatment. The **ABA**- and **ET**-co-regulated **PIN1** biosynthetic pathway was also responsible for a significant amount of **PIN1** biosynthesis. This increased under **ACC** treatment, as expected, but the increase was overridden by small levels of **ABA** or **Osmotic stress** treatment.

As the pathway regulated by only **ET** levels was found to be responsible for very little of the **PIN1** biosynthesis, but displayed similar shape of flux curve to the **ABA**- and **ET**-regulated pathway, we decided to investigate whether excluding the **ABA**- and **ET**-regulated pathway could still reproduce the experimental data. The second network was fitted to the same data sets and could reproduce the **PIN1** responses to **ACC** and **ABA** treatments. It could correctly predict the **PIN1** response to **Osmotic stress**, with or without **ABA** perturbation.

Construction of a kinetic model to understand PIN1 regulation by abscisic acid and ethylene

Although this alternative model correctly predicts the overriding effect of **Osmotic stress** on **PIN1** levels under **ACC** treatment, it could not reproduce the reduction in **PIN1** level under **Osmotic stress** treatment when **ET** biosynthesis is inhibited. This may indicate that the simple scheme presented here is insufficient to explain the experimental data and that some sort of co-regulation as found in the first model is required to explain PIN1 levels.

Overall, this kinetic modelling analysis has provided us with a plausible reaction scheme to explain regulation of PIN1 levels by osmotic stress, ABA and ethylene. The model abstracts relevant existing biological knowledge in the literature into simple processes and describes key processes for ABA and ethylene and osmotic stress to regulate PIN1 level. Whilst this model is far from complete, it develops insights into how ABA could override the regulation of PIN1 by ethylene. It also provides a basis for a larger model, integrating the network described in the previous chapter and our previously published models (Liu *et al.*, 2010; Liu *et al.*, 2013; Moore *et al.*, 2015b). This would allow us to improve our understanding of hormone crosstalk and growth under osmotic stress.

9. Discussion

Drought stress is a major limitation on crop yields (Boyer, 1982) and root growth and development is an important determinant of crop yields and survival under drought stress (Uga *et al.*, 2013; Lynch *et al.*, 2014). Plants adapt their root growth and development significantly in response water stresses, indicating that it is an important strategy in drought resistance (van der Weele *et al.*, 2000; Sharp, 2002; Bao *et al.*, 2014; Lynch *et al.*, 2014). Low level osmotic stress can induce increased growth rates, hydrotropism and changes in patterning, to increase water uptake (van der Weele *et al.*, 2000; Takahashi *et al.*, 2002; Bao *et al.*, 2014) whilst moderate to severe osmotic stress limits growth as a protective measure (van der Weele *et al.*, 2000).

The cross-regulation of different hormones controls a host of developmental processes in plants e.g. (Skoog & Miller, 1957; Sachs, 1982; Ghassemian *et al.*, 2000; Sharp, 2002). In this thesis I have endeavoured to understand how hormones coordinate these developmental changes in the context of the exposure of roots to osmotic stress. The scope of this thesis covers i) the generation of novel experimental data, aiming to examine the regulation of root growth under osmotic stress conditions; ii) the construction of a hormonal crosstalk network, aiming to elucidate the experimental data as an integrative system; and iii) the development of a kinetic model, with the aim of the understanding how ABA overrides the effects of ethylene on PIN1 levels under osmotic stress conditions. By examining the responses to hormones traditionally associated with drought such as ABA and ethylene, and hormones associated with growth such as auxin and cytokinin, I have investigated hormonal regulation of root growth under stress. Construction of a hormonal crosstalk network and use kinetic modelling has led to new insights into the cross-regulation of these hormones, which is crucial in understanding root growth under stress. By developing a kinetic model, I have proposed mechanisms by which ABA might override the effects of ethylene on PIN1 levels under osmotic stress conditions. In the following, I further discuss some important points relevant to this work.

9.1. Abscisic acid limits root growth under stress, reducing meristem size

My experimental data have shown that ABA-dependent and ABA-independent stress responses increase under osmotic stress. ABA is a stress-responsive hormone which shows increased biosynthesis under drought and osmotic stress (Wright & Hiron, 1969; Finkelstein *et al.*, 2002). Root growth is inhibited under osmotic stress in an ABA-dependent manner, as inhibiting ABA biosynthesis with fluridion was found to rescue root growth under moderate osmotic stress (Figure 5-9).

Examination of root morphology under osmotic stress allowed us to understand how root growth was limited under stress.

Using *proWOX5::GUS*, as a marker for QC-specification, and confocal z-stacks, to examine cellular patterning, revealed no obvious abnormal QC/root tip organisation. WOX5 is a transcription factor that is expressed exclusively in the quiescent centre (QC) and is an important determinant of cell identity (Sarkar *et al.*, 2007). WOX5 expression inhibits QC cell division and represses differentiation in the surrounding stem cell initials (Sarkar *et al.*, 2007; Forzani *et al.*, 2014). It is unsurprising that the reduction in root length was not associated with failure of the quiescent centre, as ABA promotes WOX5 expression and inhibits QC cell division (Zhang *et al.*, 2010) and has numerous reported roles in promoting dormancy and quiescence (Karssen *et al.*, 1983; Lopez-Molina *et al.*, 2001; Nakashima *et al.*, 2009).

The idea that ABA inhibits cell division is consistent with both the observed osmotic stress mediated changes to the primary root meristem, which was smaller, with fewer cells (Figure 5-2) and with results in the literature. For example, other authors have reported reduced meristematic cell division as well as premature differentiation under osmotic stress (Ji & Li, 2014; Ji *et al.*, 2014). Both of these processes were shown to be ABA regulated (Ji & Li, 2014) and are therefore the likely cause of reduction in root length under osmotic stress.

One way ABA may be regulating meristem size and growth is through the GA-DELLA signalling pathway. DELLA proteins are degraded as part of the GA signalling pathway and are viewed as master regulators of plant growth (Dill *et al.*, 2001). Levels of the DELLA protein RGA increase under osmotic stress (Figure 5-5) and ABA has previously been shown to increase RGA stability (Achard *et al.*, 2006). High DELLA levels can reduce cell proliferation and the rate of differentiation to regulate meristem size (Ubeda-Tomás *et al.*, 2008; Achard *et al.*, 2009; Ubeda-Tomas *et al.*, 2009). My experimental data support this relationship between ABA and DELLA proteins (Figure 5-2; Figure 5-5)

However, auxin, cytokinin and ethylene can also interact with DELLA signalling (Achard *et al.*, 2003; Fu & Harberd, 2003; Moubayidin *et al.*, 2010) and can regulate the balance between cell division and differentiation (Dello Ioio *et al.*, 2007; Dello Ioio *et al.*, 2008; Moubayidin *et al.*, 2010; Street *et al.*, 2015). Therefore their effects on root growth under stress were also investigated.

9.2. Understanding the role of ethylene on root growth under osmotic stress

My experimental data have shown that inhibition of root growth under stress does not require ethylene signalling. In unstressed *Arabidopsis* roots, ABA can promote ethylene biosynthesis (Luo *et al.*, 2014), increasing auxin biosynthesis and basipetal transport to regulate root growth (Ruzicka *et al.*, 2007; Swarup *et al.*, 2007; Thole *et al.*, 2014). Increased auxin in the cells of the elongation zone limits cell expansion, reducing root growth.

As ABA and ethylene biosynthesis increases under osmotic stress (Skirycz *et al.*, 2011; Waadt *et al.*, 2014), it was thought this mechanism may be limiting root growth. Intriguingly, inhibiting ethylene responses genetically or pharmacologically could not rescue root growth and supplementing wildtype roots with the ethylene precursor ACC reduced root lengths in an additive manner with osmotic stress (Figure 5-6). Together these results imply that the increase in ethylene under osmotic stress is not large enough to significantly affect root growth and that ABA must be regulating root growth independently of ethylene signalling.

Studies in the maize system grown on drought stress vermiculite show that under certain conditions ethylene is key in regulating root growth under water deficit, conflicting with data from agar based systems (Sharp, 2002). In dark-grown maize, ABA-deficient roots show reduced growth under drought stress (Sharp *et al.*, 1994) and fluridon application to limit ABA biosynthesis was found to drastically increase ethylene emission under drought stress (Spollen *et al.*, 2000). Inhibiting ethylene biosynthesis or signalling could rescue the reduction in root length in ABA-deficient plants, implying that ABA maintains root growth under drought by limiting ethylene biosynthesis (Spollen *et al.*, 2000). Dark-grown maize roots show an increase in auxin levels under osmotic stress (Ribaut & Pilet, 1994), which is consistent with an increase in ethylene levels, but inconsistent with our observations of auxin responses in *Arabidopsis* roots under osmotic stress (Figure 6-6; Figure 6-7; Figure 6-8).

This difference may be resolved by consideration of the fact that de-etiolated *Arabidopsis* roots behave differently to dark-grown roots under osmotic stress (van der Weele *et al.*, 2000). In *Arabidopsis*, ABA can limit ethylene biosynthesis by increasing the binding of HY5 to the *ERF11* promoter, which inhibits the transcription of several ACS genes, which mediate ethylene biosynthesis (Li *et al.*, 2011). As HY5 is a critical component in the regulation of light-mediated development and gene expression, and is destabilised in the light (Osterlund *et al.*, 2000), it therefore follows that the inhibition of ethylene biosynthesis by ABA is stronger in dark grown seedlings. This offers one way of resolving the different results between experimental systems.

It is also worth noting that drying soils offer more mechanical resistance to growing roots, and mechanical impedance increases ethylene emission (Sarquis *et al.*, 1991; Whalley *et al.*, 2005).

Members of our lab have examined the effect of mechanical impedance on ethylene responses and their effects on auxin transport and distribution in the Arabidopsis root (Jacobsen & Lindsey, unpublished data). Under mechanical impedance root length is reduced in an ethylene dependent manner, and there are associated increases in PIN2 levels and auxin response (Jacobsen & Lindsey, unpublished data). As ABA inhibits subsets of ethylene responses (Ortega-Martinez *et al.*, 2007; Cheng *et al.*, 2013) and in some cases biosynthesis (Li *et al.*, 2011), it would be interesting to investigate the combined effects of mechanical impedance and osmotic stress on root growth.

9.3. Reduced Auxin levels limit root growth under osmotic stress

Whilst the work described in this thesis has demonstrated that ethylene does not play an essential role in limiting root growth under osmotic stress, my experimental data have shown that auxin can rescue root growth and meristem size. Therefore, basipetal auxin transport may still be important, so its effect was investigated. The basipetal auxin transport mutants *aux1* and *eir1/pin2* (Pickett *et al.*, 1990; Roman *et al.*, 1995) displayed normal root growth phenotypes under osmotic stress (Figure 5-7), but other experiments showed that root elongation under osmotic stress is still modulated by auxin levels. Root auxin response and meristem size were both found to decrease under osmotic stress (Figure 5-7 ; Figure 5-8). Whilst auxin-resistant mutants showed more severe reductions in root length under osmotic stress, supplementing stress media with exogenous auxin could rescue meristem size and root growth in wildtype (Figure 5-8). Together these data suggest that reduced auxin as a consequence of osmotic stress causes a decrease in growth rate.

Other authors have demonstrated that the auxin transporter PIN1, which is essential for auxin transport from shoot to root, shows decreased expression under ABA treatment, affecting lateral root development (Galweiler *et al.*, 1998; Shkolnik-Inbar & Bar-Zvi, 2010). The results described in Chapter 6 demonstrate that *PIN1* expression and protein levels decrease under osmotic stress and this occurs in an ABA-regulated manner, so we present the hypothesis that ABA limits auxin transport to the root under osmotic stress via effects on PIN1 (Figure 9-1). The resultant lower auxin levels would be predicted to lead to a reduction in meristem size and reduced root growth (Dello Ioio *et al.*, 2008), which is consistent with the rescue of root length under moderate stress under auxin application (Figure 5-7).

Whilst this hypothesis can seemingly explain the phenotypes we observe under osmotic stress, it also needs to be placed in the context of other phytohormones such as cytokinin, which

regulates meristem size in concert with auxin (Dello loio *et al.*, 2007; Dello loio *et al.*, 2008; Moubayidin *et al.*, 2010).

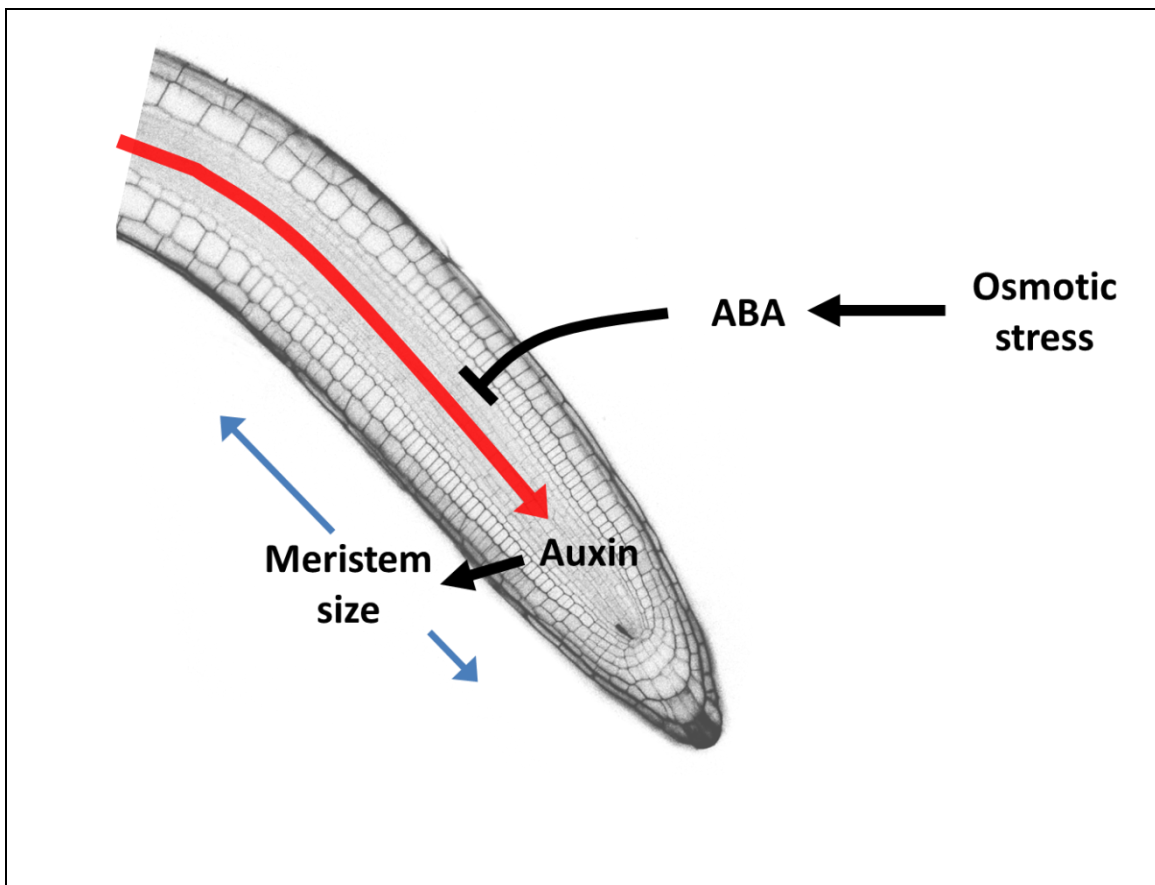

Figure 9-1 A model for how osmotic stress affects meristem size and growth through ABA and auxin

9.4. Implications of the altered auxin: cytokinin ratio on cell division, cell differentiation and meristem size

My experimental data have shown that, under osmotic stress, cytokinin responses are only slightly reduced. Cytokinin-deficient plants display increased ABA sensitivity, but cytokinin receptor mutants show increased root growth under stress (Nishiyama *et al.*, 2011; Kumar & Verslues, 2015). This indicates that cytokinin signalling acts downstream of ABA in regulating root growth under stress.

In *Arabidopsis*, the auxin: cytokinin ratio is critical in determining the rate of root growth. Cytokinin inhibits root growth by antagonising auxin, to modulate the rate of cell division and differentiation in the root apical meristem (Dello loio *et al.*, 2007; Dello loio *et al.*, 2008; Moubayidin *et al.*, 2010). As active cytokinin levels and cytokinin signalling are reduced under drought and osmotic stress (as indicated by the reduced expression of the cytokinin-sensitive proARR5::GFP reporter (Figure 6-4; (Dobra *et al.*, 2010; Nishiyama *et al.*, 2011), but the meristem is smaller, it seems likely that meristem size is primarily regulated by altered auxin responses in these conditions. In cytokinin receptor mutants, auxin sensitivity would be

predicted to increase, which may explain their increased resistance to root growth inhibition under osmotic stress. The combination of increased ABA sensitivity and enhanced root growth may account for the increase in drought stress tolerance of cytokinin-deficient plants (Tran *et al.*, 2007; Werner *et al.*, 2010; Nishiyama *et al.*, 2011).

9.5. The hormone crosstalk network helps us understand changes in hormone distribution and root growth under osmotic stress

The experimental data presented in this thesis indicate understanding the regulation of root growth under osmotic stress requires an integrated systems study of ABA, auxin, ethylene and cytokinin interactions. To better understand these interactions, I developed a network approach, combining my experimental data with evidence from the wider literature.

The hormonal crosstalk networks constructed in this thesis demonstrate the non-linear relationships between hormones regulating plant development (Figure 7-3 ; Figure 7-4). Ethylene and ABA biosynthesis is upregulated by osmotic stress (Skirycz *et al.*, 2011; Waadt *et al.*, 2014), which also down-regulates cytokinin biosynthesis (Dobra *et al.*, 2010; Nishiyama *et al.*, 2011). ABA promotes ethylene biosynthesis and inhibits cytokinin biosynthesis (Nishiyama *et al.*, 2011; Luo *et al.*, 2014).

As PIN1 and PIN2 show differential responses under osmotic stress, under ethylene treatment and under abscisic acid treatment, the networks assume different transcriptional regulatory mechanisms (Figure 7-3 ; Figure 7-4). In cortical/epidermal cells, ethylene promotes and ABA inhibits *PIN2* transcription (Figure 7-4). As ABA also promotes ethylene biosynthesis, it requires a relatively high concentration of ABA to inhibit *PIN2* accumulation. This can explain the increase in *PIN2* accumulation under moderate osmotic stress, and return to unstressed levels under severe stress (Figure 6-10). In the stele, ethylene still promotes *PIN1* transcription, however low levels of ABA can override the positive effects of ethylene on *PIN1* levels (Figure 6-16). High levels of ABA decrease *PIN1* transcription further (Figure 7-3).

These two networks can qualitatively explain the auxin distribution under osmotic stress, ethylene treatment and ABA treatment. They form a fairly robust platform for understanding hormonal crosstalk under a variety of conditions, but there are still gaps in our understanding that require quantitative modelling and further experimentation.

One such gap is our understanding of the auxin: cytokinin ratio under osmotic stress. Based on experimental data, our previous models predicted that if auxin levels decrease, auxin should stop inhibiting cytokinin biosynthesis and so cytokinin levels should increase (Nordstrom *et al.*, 2004; Liu *et al.*, 2010; Liu *et al.*, 2013; Moore *et al.*, 2015b). Under osmotic stress, however, as

auxin levels decline due to decreased PIN1-mediated transport into the root tip, cytokinin levels actually decrease (Dobra *et al.*, 2010; Nishiyama *et al.*, 2011). The network indicates that ABA (and possibly osmotic stress itself) inhibits cytokinin biosynthesis, which allows the tight regulation of the auxin: cytokinin ratio to be shifted under osmotic stress, inhibiting growth.

Conceptually this interpretation is valid, but it still needs to be shown that the model can quantitatively reproduce these results, so it is important to produce a kinetic model for hormonal crosstalk under osmotic stress. Because of the cell-specific regulation of auxin efflux by ABA and ethylene and because of the importance of hormone patterning in growth and development, a full spatiotemporal model would be the most appropriate way of proceeding.

To form the basis of further modelling work, additional investigations including modelling were performed for different scenarios for the regulation of PIN1 levels by ethylene and ABA.

9.6. Understanding the regulation of auxin and PIN1 levels by abscisic acid and ethylene

ABA is thought to reduce PIN1 levels by upregulating transcription of the transcription factor ABI4 (Shkolnik-Inbar & Bar-Zvi, 2010). *ABI4* transcription is also downregulated by auxin and promoted by cytokinin (Shkolnik-Inbar & Bar-Zvi, 2010).

SHY2 is also known to regulate *PIN1* expression (Dello Ioio *et al.*, 2008). SHY2 is an AUX/IAA protein that is broken down in the presence of auxin, to allow auxin responses (Soh *et al.*, 1999; Gray *et al.*, 2001; Tiwari *et al.*, 2001). As such, SHY2 is a key determinant of meristem size and *PIN1* expression (Dello Ioio *et al.*, 2008). *SHY2* expression is known to be upregulated by cytokinin, inhibiting auxin responses, decreasing PIN1 levels and meristem size (Dello Ioio *et al.*, 2007; Dello Ioio *et al.*, 2008).

Although ethylene has previously been shown to upregulate auxin biosynthesis and *PIN2* expression to limit cell expansion in the elongation zone (Stepanova *et al.*, 2005; Ruzicka *et al.*, 2007; Swarup *et al.*, 2007; Stepanova *et al.*, 2008), it has now been shown to upregulate *SHY2* expression in the stele, and limit root meristem size (Street *et al.*, 2015). This may explain why increases in *PIN1* expression are not as large as those for *PIN2* under ethylene application (Ruzicka *et al.*, 2007), and why high levels of ethylene application return PIN1 levels to untreated levels (Figure 8-3).

Auxin and ABA have also been shown to regulate *PLETHORA (PLT)* gene expression, to regulate growth and development (Blilou *et al.*, 2005; Mahonen *et al.*, 2014; Yang *et al.*, 2014). PLT proteins (PLT1, PLT2, PLT3, and PLT4/BBM, BABYBOOM) are transcription factors that control root patterning (Aida *et al.*, 2004; Galinha *et al.*, 2007) and regulate PIN protein accumulation (Blilou *et al.*, 2005; Mahonen *et al.*, 2014). It seems unlikely that ABA is primarily regulating

PIN1 levels through *PLT* expression, as PLT responses and changes to meristem size occur at longer temporal scales than the changes to PIN protein expression that we have observed (Figure 5-3; Figure 5-2; Figure 5-8; (Mahonen *et al.*, 2014; Yang *et al.*, 2014). Therefore ABA is most likely affecting auxin distribution which in turn modulates *PLT* expression to regulate patterning and reinforce the pattern of auxin distribution.

As we do not know at which points these various pathways converge to regulate PIN1 levels, and the experimental results for ABA and ethylene to regulate PIN1 levels produce an interesting overriding effect, kinetic modelling of this regulation assumed three different pathways.

- In the first pathway ethylene promotes **PIN1** biosynthesis, by increasing the production of a molecule (**Y**) which when active (**Y***) promotes **PIN1** protein biosynthesis (**R12**). **ABA** inhibits **PIN1** biosynthesis by inhibiting the conversion of a **Y** into its active form (**Y***). In this pathway, the production of **Y** due to **ET** includes substrate inhibition to produce the bell-shaped **ET** response.
- In the second pathway ethylene (**ET**) promotes **PIN1** biosynthesis with substrate inhibition to produce the bell shaped **ET** response (**R13**).
- In the third pathway, **ABA** inhibits the biosynthesis of **PIN1** (**R14**).

Kinetic modelling revealed that by using all three pathways and a simple model of the interactions between **ET**, **ABA** and **Osmotic Stress**, the overriding effect of **Osmotic stress** or **ABA** on **PIN1** levels could be predicted. For the parameter set used in this model, flux analysis revealed that only **R12** and **R14** are required to replicate the experimental data.

Because **R12** and **R13** had very similar shaped response curves to **ABA** and **Osmotic stress**, but the scales of their fluxes were very different, we tried to remove the **ABA** and **ET** co-regulated pathway (**R12**), and make **R13** more prominent to determine whether it could match experimental data. This produced a model that could replicate all of the experimental data, except the effect of combined **Osmotic Stress** and silver thiosulphate treatment (which inhibits ethylene signalling), indicating that it is difficult to match experimental PIN1 levels with **ABA** and **ET** acting on completely separate pathways. As well as being useful for further modelling, this also indicates that there may be crosstalk between ethylene and ABA's regulation of *PIN1* expression. Therefore examining the responsiveness of *ABI4* expression to ethylene and investigating *SHY2* levels under ABA treatment may offer further insights to the regulation of PIN1 levels.

9.7. PIN1 independent regulation of auxin levels under osmotic stress

Inhibiting ABA biosynthesis or applying exogenous auxin can rescue root elongation under osmotic stress. Our networks place auxin downstream of ABA, because ABA can regulate auxin transport through PIN1 (Shkolnik-Inbar & Bar-Zvi, 2010; Yang *et al.*, 2014), and reduced auxin levels are associated with shorter roots. If this is true, inhibiting ABA biosynthesis should be able to rescue auxin levels under osmotic stress, and this is now considered.

It is possible that the reduced auxin levels under osmotic stress are not solely due to reduced PIN1 levels. Auxin can also be redistributed in the proximal root, depending on water availability, a phenomenon known as hydropatterning (Bao *et al.*, 2014). Auxin accumulates on the 'wet' side of the root when plants are grown on agar plates or in cored soil. This may provide directionality to lateral root formation and root hair formation, which are auxin regulated processes (Casimiro *et al.*, 2001; Jones *et al.*, 2009), to allow the root to acquire water (Bao *et al.*, 2014). This phenomenon appears to occur independently of ABA biosynthesis, but requires PIN3 and the auxin biosynthetic enzyme TRYPTOPHAN AMINO TRANSFERASE OF ARABIDOPSIS 1, TAA1 (Bao *et al.*, 2014).

Both PIN3:GFP and TAA1:GFP show differential fusion protein levels across this osmotic gradient, indicating differential rates of auxin biosynthesis and transport (Bao *et al.*, 2014). As modulating TAA1 expression to effect auxin biosynthesis is key to ethylene's inhibition of root growth in unstressed conditions (Stepanova *et al.*, 2005; Stepanova *et al.*, 2008), this may help explain why osmotic stress treatment does not increase root cortex/epidermis auxin response (Figure 6-8), while combined ABA and ACC treatment does (Figure 6-19). It also offers one explanation for the relative unimportance of basipetal auxin transport and ethylene responses in regulating root growth under osmotic stress.

However, reduced TAA1 expression is unlikely to be solely responsible for the dramatic reduction in root auxin levels under osmotic stress, as the majority of auxin in the root is transported from the aerial tissues, the primary site of its biosynthesis (Ljung *et al.*, 2001; Petrášek & Friml, 2009). It is possible that auxin transport from the aerial organs may be modulated independently of PIN proteins under osmotic stress. Auxin is loaded into the phloem in the leaves, and unloaded from the phloem in the roots (Swarup *et al.*, 2001; Marchant *et al.*, 2002). Because severe drought and osmotic stress reduce xylem flow, which can theoretically lead to phloem failure (Sevanto, 2014), it is possible that auxin transport from the shoots is reduced; however this is experimentally difficult to measure and evidence in herbaceous species is currently quite poor.

9.8. Improving our understanding of the effects of cytokinin and auxin on root growth

Understanding how cytokinin and auxin interact to control growth is critical to our understanding of stress-mediated development, so better defining their relationship is essential for refining our model.

Based on experimental results (Nordstrom *et al.*, 2004), our hormonal crosstalk networks (Figure 7-3; Figure 7-4; Liu *et al.*, 2013) describe a negative regulation of auxin biosynthesis by cytokinin. However, Jones *et al.* (2010) have shown that cytokinin positively regulates auxin biosynthesis in young developing tissues (10 DAG). In previous work, our hormonal crosstalk network analysis revealed that both sets of experimental results (Nordstrom *et al.*, 2004; Jones *et al.*, 2010) can be incorporated into the hormonal crosstalk network, leading to the same conclusions about other regulatory relationships of hormonal crosstalk (Liu *et al.*, 2013).

Recent spatiotemporal model analysis shows the complexity in the patterning relationships between auxin and cytokinin (Moore *et al.*, 2015b). Even though the single cell models can correctly predict cytokinin responses under a variety of experimental conditions (Liu *et al.*, 2010; Liu *et al.*, 2013), the spatiotemporal model has difficulty in reproducing cytokinin patterning in the root (Moore *et al.*, 2015b).

Including in the model factors such as cytokinin transporters (Ko *et al.*, 2014) and tissue specific biosynthesis (Miyawaki *et al.*, 2004) may help address the cytokinin patterning and improve model predictions.

9.9. Hydrotropism

There is also the possibility that ABA transport may influence root growth, providing an interesting problem. Several proteins with the capacity to transport ABA into and out of cells have recently been identified, which are expressed in the root and may imply coordinated patterning (Kang *et al.*, 2010; Kuromori *et al.*, 2010; Kuromori & Shinozaki, 2010; Kuromori *et al.*, 2011; Kanno *et al.*, 2012). ABA responses are also important for hydrotropism, causing degradation of statoliths, and therefore suppressing gravitropism, but the mechanism that provides directionality remains poorly characterised (Takahashi *et al.*, 2003).

Auxin transport provides patterning for a host of plant developmental processes, but though auxin responses are required for hydrotropism, its transport is not, indicating that some other signal must be providing directionality (Kaneyasu *et al.*, 2007). With the advent of new FRET-based ABA biosensors, it is possible to look at changes in ABA levels and distribution at the cellular level *in vivo* (Jones *et al.*, 2014; Waadt *et al.*, 2014). By examining changes in ABA

distribution it would be possible to determine whether differential ABA distribution plays a role in hydrotropism.

Recently, it has been shown that restoring ABA signalling exclusively to the cortex cells can rescue the hydrotropic response of ABA signalling mutants (Dietrich *et al.*, 2015). Under an osmotic gradient, cortical cells were found to differentiate early, enter the endocycle and expand rapidly in an ABA dependent manner, to allow bending of the root away from drier areas (Dietrich *et al.*, 2015). Whether the differential ABA-signalling effect on hydrotropism is due to a true ABA differential remains to be determined.

It is possible that the hydrotropic effect may be contributing to root growth inhibition under osmotic stress. However, the reduction in cell division and meristem size under osmotic stress is not exclusive to the cortex (Ji & Li, 2014; Ji *et al.*, 2014) and the cortex is the only tissue responsive to ABA-mediated differentiation (Dietrich *et al.*, 2015), indicating that other mechanisms must be involved, such as regulation of auxin homeostasis. Auxin is known to regulate *PLETHORA* gene expression, which controls patterning and growth in the Arabidopsis root (Aida *et al.*, 2004; Blilou *et al.*, 2005; Galinha *et al.*, 2007). ABA has recently been shown to regulate both auxin transport and the levels of *PLETHORA* proteins to regulate root meristem size, which is consistent with our hypothesis for root growth under osmotic stress (Figure 9-1; Yang *et al.*, 2014).

9.10. The effect of mild osmotic stress or low levels of ABA in promoting root growth

Whilst this thesis has concentrated on growth inhibition under osmotic stress, mild osmotic stress or low levels of exogenously applied ABA can actually increase root growth (Ghassemian *et al.*, 2000; van der Weele *et al.*, 2000).

PIN2 transcription and *PIN2* protein levels increase under low level ABA treatment as well as mild to moderate osmotic stress (Figure 6-10; Xu *et al.*, 2013). The increase in root length under mild osmotic stress is thought to be due to the increased ABA concentration and requires basipetal auxin transport (Xu *et al.*, 2013), however the increase in root growth does not require ethylene signalling (Ghassemian *et al.*, 2000; Li, X *et al.*, 2015). This is in stark contrast to high levels of ABA, which can inhibit *PIN2* accumulation (Yang *et al.*, 2014). Because this increase in growth requires basipetal auxin transport, it is probably a different mechanism to that which causes hydrotropism (Kaneyasu *et al.*, 2007; Xu *et al.*, 2013).

Examination of meristem activity under low concentration ABA application gave interesting results. Meristem size (as measured by the epidermis) was larger, but this is not due to

increased cell proliferation, as I have evidence of reduced division (Figure 5-3), but instead it seems to be caused by a reduced rate of cell differentiation and expansion (Zhang *et al.*, 2010). Under low levels of ABA application, quiescent centre activity is also decreased, and stem cell differentiation is inhibited (Zhang *et al.*, 2010). However, root length assays were not reported in the literature (Zhang *et al.*, 2010). Therefore, it would be difficult to establish directly the link between the growth promotion by ABA and the inhibition of cell division and differentiation rate.

Low levels of auxin application can increase root growth, but higher levels are inhibitory (Evans *et al.*, 1994) and reducing auxin levels can reduce expansion of cells in the elongation zone. Therefore it follows that low levels of basipetal auxin transport may promote expansion of cells in the elongation zone whilst high levels inhibit expansion, which may explain the root growth dynamics under ABA treatment.

9.11. Beyond hormone crosstalk: other factors regulating root growth

Auxin application and ABA biosynthesis inhibition cannot completely rescue root growth under severe stress so factors other than auxin-mediated regulation of meristem size may also be limiting growth.

ROS accumulation can cause programmed cell death under prolonged severe osmotic stress, preventing growth (Duan *et al.*, 2010). To determine if this occurs in our assays, examination of cell death using TUNEL or propidium iodide staining at later time points could be performed (Duan *et al.*, 2010).

It is possible that at higher stress levels, cells exhibit reduced expansion due to reduced water availability (Shabala & Lew, 2002). Solute uptake in a plant cell causes uptake of water through osmosis, however the cell is constrained by a cell wall so the internal turgor pressure can be very high. Loosening the cell wall through acidification therefore allows the plant to use this pressure to provide growth, allowing penetration through compacted soils. If the osmotic pressure in a root's surroundings is reduced, then the plant can respond by increasing ion uptake, to maintain turgor pressure and growth. Whilst Arabidopsis roots can maintain adequate turgor pressure under moderate stress (-0.5MPa) we have no quantitative evidence for turgor maintenance under very severe stress (Shabala & Lew, 2002). Because the cotyledons and early leaves show wilting under our severe stress regime (-1.2MPa) it seems likely that the plants have some difficulty maintaining turgor and this may be contributing to reduced root growth. Quantifying this effect could be addressed with the use of pressure probes to measure cell turgor (Shabala & Lew, 2002)

Under stress, plants must also divert significant resources to protective measures such as compatible solute accumulation, antioxidant production, *LATE-EMBRYOGENESIS-ABUNDANT (LEA)* gene transcription and chaperone transcription so constitutively drought tolerant plants often display dwarf phenotypes (Bray, 1997; Kasuga *et al.*, 1999).

There is also a reduction in photosynthetic capability under osmotic stress. Stomatal apertures tend to close under water stresses, in response to locally synthesised abscisic acid, to limit transpiration and water loss (Christmann *et al.*, 2007; Bauer *et al.*, 2013). Closed stomata reduce the availability of carbon dioxide for photosynthesis, which when coupled with a reduction in Rubisco levels, and increased chloroplast oxidative stress can mean considerable reductions in photosynthetic capacity (Reddy *et al.*, 2004).

Therefore, it is possible that the competition for resources between growth and protection may be playing a role here, limiting root growth indirectly. Soil exploration is metabolically expensive and may account for more than 50% of a plant's energy allocation, so plants with less metabolically expensive root structure have improved drought tolerance (Lynch, 2007).

9.12. Future work

Above I have discussed this work in the context of the wider literature, which in itself presents many possible further avenues of research. Below, I have outlined several possible avenues for researchers to continue this project.

9.12.1. Developing a spatiotemporal model of hormone crosstalk under osmotic stress

As has been demonstrated in this thesis, hormonal crosstalk networks can be used to investigate how an integrated system of ABA, auxin, ethylene and cytokinin is formed under osmotic stress, due to the repression of ethylene effects by ABA via the enhanced transport of auxin away from the meristem and to the elongation zone.

Recently, our group has shown that spatiotemporal modelling of hormonal crosstalk can simulate and explain the level and patterning of hormones and gene expression in *Arabidopsis* wildtype and mutant roots (Moore *et al.*, 2015b). However, that hormonal crosstalk model does not include the effects of osmotic stress. Therefore, the novel hormonal crosstalk networks developed in this work provide a framework for spatiotemporal modelling of hormonal crosstalk under osmotic stress conditions, and will allow us to analyse how the patterning of multiple hormones regulate root development under osmotic stress. In particular, this will allow us to examine the mechanisms by which ABA could override ethylene induction of *PIN1* gene expression, whilst still allowing *PIN2* expression to increase. This would

also allow us to examine spatial phenomena such as hydrotropism and hydopatterning, which would be inadequately dealt with in a single- or two-cell model.

9.12.2. Improving modelling predictions for cytokinin patterning

As the current spatiotemporal model has difficulty reproducing cytokinin patterning, and experimental evidence of auxin and cytokinin cross-regulation is conflicted (Nordstrom *et al.*, 2004; Jones *et al.*, 2010), improving the modelling predictions is a priority for better understanding of root growth.

The model currently assumes that cytokinin biosynthesis occurs predominantly in the vascular and pericycle cells (modelled by limiting synthesis to the vascular and pericycle cells), and that the cytokinin biosynthesis rate is regulated by auxin concentrations (Liu *et al.*, 2010; Liu *et al.*, 2013; Moore *et al.*, 2015b). Increasing the rate for cytokinin biosynthesis in the stele and root cap would better reflect experimental evidence and may improve prediction of cytokinin patterning (Miyawaki *et al.*, 2004; Antoniadi *et al.*, 2015). This requires the setting up of an *in silico* rootmap with more realistic geometrical shape than a rectangular rootmap used in the current model (Moore *et al.*, 2015).

The potential effects of cytokinin transport may also be considered. The putative cytokinin transporter ABCG14 loads cytokinin into the xylem in the roots, allowing transport to the shoots (Ko *et al.*, 2014). *abcg14* mutant plants display a higher, but more uniform cytokinin root response, which better reflects our spatiotemporal model .

It may be that the regulation of cytokinin levels is much more tightly controlled than the simple regulatory systems that the previous iterations of the model have included. The ISOPENTENYL TRANSFERASE (IPT) family of enzymes catalyse a crucial step in cytokinin biosynthesis and show tissue specific expression sites (Miyawaki *et al.*, 2004).

As a tissue map of root cytokinin levels has recently been published (Antoniadi *et al.*, 2015), which can be compared directly to a similar maps of auxin level and response to give the auxin: cytokinin ratio in different tissues (Pettersson *et al.*, 2009; Brunoud *et al.*, 2012; Bargmann *et al.*, 2013; Pěňčík *et al.*, 2013). As expected, there is variation in the auxin: cytokinin ratio in different tissues of the root (Antoniadi *et al.*, 2015), and trying to reproduce this may help us refine our models, as well as offering developmental insights.

9.12.3. The promotion of growth by ABA or mild osmotic stress

Because the work in this thesis concentrated on the inhibition of growth under moderate osmotic stress in which basipetal auxin transport did not play a prominent role, the characterisation of PIN2 levels and auxin transport remains incomplete. Examining cortical/epidermal auxin levels and PIN2 levels under mild osmotic stress and under combined ABA and ACC treatment would give insight into the regulation of root growth under mild stress. Examining root morphology under mild stress would also help understand how root growth is regulated under these conditions. Some work has already been done on root morphology under low level ABA application, but this has focused on quiescent centre activity (Zhang *et al.*, 2010), so further work, including a kinematic analysis of growth may help elucidate how root growth is increased.

9.12.4. The effect of ACC on TAA1 levels and auxin biosynthesis under osmotic stress

Examining the expression of TAA1 under osmotic stress would help address how auxin levels in the root are modulated. Examination of the effect of ethylene on TAA1 may help us dissect out why ethylene responses and basipetal auxin transport are so unimportant in regulating root growth under stress.

9.12.5. The effect of mechanical impedance on root growth under osmotic stress

Plants in drying soil do not just encounter osmotic stress, but soils become harder, making growth more difficult (Whalley *et al.*, 2005). Ethylene biosynthesis increases under mechanical impedance, and is thought to alter auxin transport and responses (Sarquis *et al.*, 1991; Jacobsen & Lindsey, unpublished data). As ACC treatment can further reduce root length under osmotic stress, one might hypothesise that the effect of osmotic stress and mechanical impedance on root growth would be additive.

9.12.6. GA/DELTA signalling

The hormonal crosstalk network developed in this work will also allow us to further interrogate interactions with other growth-regulating hormones such as the GA/DELTA system. Several models already exist that detail how the GA signalling cascade is regulated by negative feedback loops and how hormone dilution can explain the cessation of cell expansion in the elongation zone (Band *et al.*, 2012a; Middleton *et al.*, 2012). By further integrating other hormones into the network, we should in future be able to elucidate how ABA, cytokinin, ethylene, auxin and gibberellic acid affect root growth under stress.

9.13. Drought and the impact of this work

It is becoming more and more obvious that deeper rooting crops offer one method of maintaining crop yields under drought stress (Uga *et al.*, 2013). Whilst crops have been selected for increased yield, they may not necessarily have been selected for the physiology that makes them most resilient to abiotic stresses like drought (Lynch *et al.*, 2014). Therefore understanding how root architecture contributes to drought tolerance and how development is altered in response to drought stress is an important question for world agriculture. This work has examined how osmotic stress, one component of drought stress affects growth and development in *Arabidopsis*. Root growth is reduced in a regulated manner under osmotic stress and the hormones abscisic acid and auxin are critical to this inhibition of growth. ABA inhibits auxin transport to the root tip, by regulating the auxin efflux carrier PIN1. Reduced auxin leads to reduced meristem size and root growth. The use of hormonal crosstalk networks and kinetic modelling has supported this work and offered insights into how osmotic stress affects hormone balance in the root. Therefore, this thesis goes some way to answering how crosstalk between hormones regulates root growth under osmotic stress.

10 Bibliography

- Abas L, Benjamins R, Malenica N, Paciorek T, Wiśniewska J, Moulinier-Anzola JC, Sieberer T, Friml J, Luschnig C. 2006.** Intracellular trafficking and proteolysis of the Arabidopsis auxin-efflux facilitator PIN2 are involved in root gravitropism. *Nature cell biology* **8**(3): 249-256.
- Achard P, Cheng H, De Grauwe L, Decat J, Schoutteten H, Moritz T, Van der Straeten D, Peng JR, Harberd NP. 2006.** Integration of plant responses to environmentally activated phytohormonal signals. *Science* **311**(5757): 91-94.
- Achard P, Gusti A, Cheminant S, Alioua M, Dhondt S, Coppens F, Beemster GTS, Genschik P. 2009.** Gibberellin Signaling Controls Cell Proliferation Rate in Arabidopsis. *Current Biology* **19**(14): 1188-1193.
- Achard P, Vriezen WH, Van Der Straeten D, Harberd NP. 2003.** Ethylene regulates arabidopsis development via the modulation of DELLA protein growth repressor function. *The Plant Cell* **15**(12): 2816-2825.
- Aida M, Beis D, Heidstra R, Willemsen V, Blilou I, Galinha C, Nussaume L, Noh Y-S, Amasino R, Scheres B. 2004.** The PLETHORA genes mediate patterning of the Arabidopsis root stem cell niche. *Cell* **119**(1): 109-120.
- Alam SM. 1999.** Nutrient uptake by plants under stress conditions. *Handbook of plant and crop stress 2*: 285-313.
- Alonso JM, Hirayama T, Roman G, Nourizadeh S, Ecker JR. 1999.** EIN2, a bifunctional transducer of ethylene and stress responses in Arabidopsis. *Science* **284**(5423): 2148-2152.
- An F, Zhao Q, Ji Y, Li W, Jiang Z, Yu X, Zhang C, Han Y, He W, Liu Y. 2010.** Ethylene-induced stabilization of ETHYLENE INSENSITIVE3 and EIN3-LIKE1 is mediated by proteasomal degradation of EIN3 binding F-box 1 and 2 that requires EIN2 in Arabidopsis. *The Plant Cell* **22**(7): 2384-2401.
- Anderson LE. 1954.** Hoyer's solution as a rapid permanent mounting medium for bryophytes. *Bryologist* **57**(3): 242-244.
- Antoniadi I, Plačková L, Simonovik B, Doležal K, Turnbull C, Ljung K, Novák O. 2015.** Cell-Type-Specific Cytokinin Distribution within the Arabidopsis Primary Root Apex. *The Plant Cell* **27**(7): 1955-1967.
- Arabidopsis Genome I. 2000.** Analysis of the genome sequence of the flowering plant Arabidopsis thaliana. *Nature* **408**(6814): 796.
- Band LR, Ubeda-Tomas S, Dyson RJ, Middleton AM, Hodgman TC, Owen MR, Jensen OE, Bennett MJ, King JR. 2012a.** Growth-induced hormone dilution can explain the dynamics of plant root cell elongation. *Proceedings of the National Academy of Sciences of the United States of America* **109**(19): 7577-7582.
- Band LR, Wells DM, Fozard JA, Ghetiu T, French AP, Pound MP, Wilson MH, Yu L, Li W, Hijazi HI. 2014.** Systems analysis of auxin transport in the Arabidopsis root apex. *The Plant Cell* **26**(3): 862-875.
- Band LR, Wells DM, Larrieu A, Sun JY, Middleton AM, French AP, Brunoud G, Sato EM, Wilson MH, Peret B, Oliva M, Swarup R, Sairanen I, Parry G, Ljung K, Beeckman T, Garibaldi JM, Estelle M, Owen MR, Vissenberg K, Hodgman TC, Pridmore TP, King JR, Vernoux T, Bennett MJ. 2012b.** Root gravitropism is regulated by a transient lateral auxin gradient controlled by a tipping-point mechanism. *Proceedings of the National Academy of Sciences of the United States of America* **109**(12): 4668-4673.
- Bao Y, Aggarwal P, Robbins NE, II, Sturrock CJ, Thompson MC, Tan HQ, Tham C, Duan L, Rodriguez PL, Vernoux T, Mooney SJ, Bennett MJ, Dinneny JR. 2014.** Plant roots use a patterning mechanism to position lateral root branches toward available water. *Proceedings of the National Academy of Sciences of the United States of America* **111**(25): 9319-9324.

- Bargmann BOR, Vanneste S, Krouk G, Nawy T, Efroni I, Shani E, Choe G, Friml J, Bergmann DC, Estelle M. 2013.** A map of cell type-specific auxin responses. *Molecular systems biology* **9**(1): 688.
- Baskin TI. 2005.** Anisotropic expansion of the plant cell wall. *Annu. Rev. Cell Dev. Biol.* **21**: 203-222.
- Bauer H, Ache P, Lautner S, Fromm J, Hartung W, Al-Rasheid KAS, Sonnewald S, Sonnewald U, Kneitz S, Lachmann N, Mendel RR, Bittner F, Hetherington AM, Hedrich R. 2013.** The Stomatal Response to Reduced Relative Humidity Requires Guard Cell-Autonomous ABA Synthesis. *Current Biology* **23**(1): 53-57.
- Beaudoin N, Serizet C, Gosti F, Giraudat J. 2000.** Interactions between abscisic acid and ethylene signaling cascades. *The Plant Cell* **12**(7): 1103-1115.
- Beemster GTS, Baskin TI. 1998.** Analysis of cell division and elongation underlying the developmental acceleration of root growth in *Arabidopsis thaliana*. *Plant Physiology* **116**(4): 1515-1526.
- Belin C, Megies C, Hauserova E, Lopez-Molina L. 2009.** Abscisic Acid Represses Growth of the *Arabidopsis* Embryonic Axis after Germination by Enhancing Auxin Signaling. *The Plant Cell* **21**(8): 2253-2268.
- Benkova E, Michniewicz M, Sauer M, Teichmann T, Seifertova D, Jurgens G, Friml J. 2003.** Local, efflux-dependent auxin gradients as a common module for plant organ formation. *Cell* **115**(5): 591-602.
- Bennett MJ, Marchant A, Green HG, May ST, Ward SP, Millner PA, Walker AR, Schulz B, Feldmann KA. 1996.** *Arabidopsis* AUX1 gene: a permease-like regulator of root gravitropism. *Science* **273**(5277): 948-950.
- Bhargava A, Clabaugh I, To JP, Maxwell BB, Chiang Y-H, Schaller GE, Loraine A, Kieber JJ. 2013.** Identification of Cytokinin-Responsive Genes Using Microarray Meta-Analysis and RNA-Seq in *Arabidopsis*. *Plant Physiology* **162**(1): 272-294.
- Blakeslee JJ, Bandyopadhyay A, Lee OR, Mravec J, Titapiwatanakun B, Sauer M, Makam SN, Cheng Y, Bouchard R, Adamec J, Geisler M, Nagashima A, Sakai T, Martinoia E, Friml J, Peer WA, Murphy AS. 2007.** Interactions among PIN-FORMED and P-glycoprotein auxin transporters in *Arabidopsis*. *The Plant Cell* **19**(1): 131-147.
- Blilou I, Xu J, Wildwater M, Willemsen V, Paponov I, Friml J, Heidstra R, Aida M, Palme K, Scheres B. 2005.** The PIN auxin efflux facilitator network controls growth and patterning in *Arabidopsis* roots. *Nature* **433**(7021): 39-44.
- Boursiac Y, Leran S, Corratge-Faillie C, Gojon A, Krouk G, Lacombe B. 2013.** ABA transport and transporters. *Trends in Plant Science* **18**(6): 325-333.
- Boyer JS. 1982.** PLANT PRODUCTIVITY AND ENVIRONMENT. *Science* **218**(4571): 443-448.
- Brandstatter I, Kieber JJ. 1998.** Two genes with similarity to bacterial response regulators are rapidly and specifically induced by cytokinin in *Arabidopsis*. *The Plant Cell* **10**(6): 1009-1019.
- Bray EA. 1997.** Plant responses to water deficit. *Trends in plant science* **2**(2): 48-54.
- Brunoud G, Wells DM, Oliva M, Larrieu A, Mirabet V, Burrow AH, Beeckman T, Kepinski S, Traas J, Bennett MJ, Vernoux T. 2012.** A novel sensor to map auxin response and distribution at high spatio-temporal resolution. *Nature* **482**(7383): 103-132.
- Bulankova P, Akimcheva S, Fellner N, Riha K. 2013.** Identification of *Arabidopsis* Meiotic Cyclins Reveals Functional Diversification among Plant Cyclin Genes. *Plos Genetics* **9**(5).
- Carpita N, Sabularse D, Montezinos D, Delmer DP. 1979.** Determination of the pore size of cell walls of living plant cells. *Science* **205**(4411): 1144-1147.
- Carpita NC. 1982.** Limiting diameters of pores and the surface structure of plant cell walls. *Science* **218**(4574): 813-814.
- Casimiro I, Marchant A, Bhalerao RP, Beeckman T, Dhooge S, Swarup R, Graham N, Inzé D, Sandberg G, Casero PJ. 2001.** Auxin transport promotes *Arabidopsis* lateral root initiation. *The Plant Cell* **13**(4): 843-852.

- Casson SA, Chilley PM, Topping JF, Evans IM, Souter MA, Lindsey K. 2002.** The POLARIS gene of Arabidopsis encodes a predicted peptide required for correct root growth and leaf vascular patterning. *The Plant Cell* **14**(8): 1705-1721.
- Casson SA, Lindsey K. 2003.** Genes and signalling in root development. *New Phytologist* **158**(1): 11-38.
- Chae HS, Faure F, Kieber JJ. 2003.** The eto1, eto2, and eto3 mutations and cytokinin treatment increase ethylene biosynthesis in Arabidopsis by increasing the stability of ACS protein. *The Plant Cell* **15**(2): 545-559.
- Chaiwanon J, Wang Z-Y. 2015.** Spatiotemporal Brassinosteroid Signaling and Antagonism with Auxin Pattern Stem Cell Dynamics in Arabidopsis Roots. *Current Biology* **25**(8): 1031-1042.
- Chang C, Kwok SF, Bleecker AB, Meyerowitz EM. 1993.** Arabidopsis ethylene-response gene ETR1: similarity of product to two-component regulators. *Science* **262**(5133): 539-544.
- Cheng M-C, Liao P-M, Kuo W-W, Lin T-P. 2013.** The Arabidopsis ETHYLENE RESPONSE FACTOR1 Regulates Abiotic Stress-Responsive Gene Expression by Binding to Different cis-Acting Elements in Response to Different Stress Signals. *Plant Physiology* **162**(3): 1566-1582.
- Cheng W-H, Chiang M-H, Hwang S-G, Lin P-C. 2009.** Antagonism between abscisic acid and ethylene in Arabidopsis acts in parallel with the reciprocal regulation of their metabolism and signaling pathways. *Plant Molecular Biology* **71**(1-2): 61-80.
- Cheng WH, Endo A, Zhou L, Penney J, Chen HC, Arroyo A, Leon P, Nambara E, Asami T, Seo M, Koshiba T, Sheen J. 2002.** A unique short-chain dehydrogenase/reductase in Arabidopsis glucose signaling and abscisic acid biosynthesis and functions. *The Plant Cell* **14**(11): 2723-2743.
- Chilley PM, Casson SA, Tarkowski P, Hawkins N, Wang KLC, Hussey PJ, Beale M, Ecker JR, Sandberg GK, Lindsey K. 2006.** The POLARIS peptide of Arabidopsis regulates auxin transport and root growth via effects on ethylene signaling. *The Plant Cell* **18**(11): 3058-3072.
- Choi HI, Hong JH, Ha JO, Kang JY, Kim SY. 2000.** ABFs, a family of ABA-responsive element binding factors. *Journal of Biological Chemistry* **275**(3): 1723-1730.
- Christmann A, Hoffmann T, Teplova I, Grill E, Muller A. 2005.** Generation of active pools of abscisic acid revealed by in vivo Imaging of water-stressed Arabidopsis. *Plant Physiology* **137**(1): 209-219.
- Christmann A, Weiler EW, Steudle E, Grill E. 2007.** A hydraulic signal in root-to-shoot signalling of water shortage. *The Plant Journal* **52**(1): 167-174.
- Chung Y, Maharjan PM, Lee O, Fujioka S, Jang S, Kim B, Takatsuto S, Tsujimoto M, Kim H, Cho S. 2011.** Auxin stimulates DWARF4 expression and brassinosteroid biosynthesis in Arabidopsis. *The Plant Journal* **66**(4): 564-578.
- Clark KL, Larsen PB, Wang X, Chang C. 1998.** Association of the Arabidopsis CTR1 Raf-like kinase with the ETR1 and ERS ethylene receptors. *Proceedings of the National Academy of Sciences* **95**(9): 5401-5406.
- Clouse SD. 2011.** Brassinosteroids. *The Arabidopsis Book / American Society of Plant Biologists* **9**: e0151.
- Comai L, Facciotti D, Hiatt WR, Thompson G, Rose RE, Stalker DM. 1985.** Expression in plants of a mutant aroA gene from Salmonella typhimurium confers tolerance to glyphosate.
- Conti L, Nelis S, Zhang C, Woodcock A, Swarup R, Galbiati M, Tonelli C, Napier R, Hedden P, Bennett M. 2014.** Small Ubiquitin-like Modifier protein SUMO enables plants to control growth independently of the phytohormone gibberellin. *Developmental cell* **28**(1): 102-110.
- Cui M, Lin Y, Zu Y, Efferth T, Li D, Tang Z. 2015.** Ethylene increases accumulation of compatible solutes and decreases oxidative stress to improve plant tolerance to water stress in Arabidopsis. *Journal of Plant Biology* **58**(3): 193-201.
- Cutler SR, Rodriguez PL, Finkelstein RR, Abrams SR. 2010.** Abscisic Acid: Emergence of a Core Signaling Network. *Annual Review of Plant Biology* **61**: 651-679.

- Czechowski T, Stitt M, Altmann T, Udvardi MK, Scheible WR. 2005.** Genome-wide identification and testing of superior reference genes for transcript normalization in Arabidopsis. *Plant Physiology* **139**(1): 5-17.
- de Lucas M, Davière J-M, Rodríguez-Falcón M, Pontin M, Iglesias-Pedraz JM, Lorrain S, Fankhauser C, Blázquez MA, Titarenko E, Prat S. 2008.** A molecular framework for light and gibberellin control of cell elongation. *Nature* **451**(7177): 480-484.
- De Smet I, Signora L, Beeckman T, Inze D, Foyer CH, Zhang HM. 2003.** An abscisic acid-sensitive checkpoint in lateral root development of Arabidopsis. *The Plant Journal* **33**(3): 543-555.
- Deak KI, Malamy J. 2005.** Osmotic regulation of root system architecture. *The Plant Journal* **43**(1): 17-28.
- Dello Ioio R, Linhares FS, Scacchi E, Casamitjana-Martinez E, Heidstra R, Costantino P, Sabatini S. 2007.** Cytokinins determine Arabidopsis root-meristem size by controlling cell differentiation. *Current Biology* **17**(8): 678-682.
- Dello Ioio R, Nakamura K, Moubayidin L, Perilli S, Taniguchi M, Morita MT, Aoyama T, Costantino P, Sabatini S. 2008.** A Genetic Framework for the Control of Cell Division and Differentiation in the Root Meristem. *Science* **322**(5906): 1380-1384.
- Dewitte W, Scofield S, Alcasabas AA, Maughan SC, Menges M, Braun N, Collins C, Nieuwland J, Prinsen E, Sundaresan V. 2007.** Arabidopsis CYCD3 D-type cyclins link cell proliferation and endocycles and are rate-limiting for cytokinin responses. *Proceedings of the National Academy of Sciences* **104**(36): 14537-14542.
- Dharmasiri N, Dharmasiri S, Estelle M. 2005.** The F-box protein TIR1 is an auxin receptor. *Nature* **435**(7041): 441-445.
- Diaz J, Alvarez-Buylla ER. 2006.** A model of the ethylene signaling pathway and its gene response in Arabidopsis thaliana: Pathway cross-talk and noise-filtering properties. *Chaos* **16**(2).
- Dietrich D, Fozard JA, Bennett MJ 2015.** Elucidating the mechanism of ABA action during root hydrotropism. *Society of Experimental Biology Annual Main Meeting*. Prague.
- Dill A, Jung HS, Sun TP. 2001.** The DELLA motif is essential for gibberellin-induced degradation of RGA. *Proceedings of the National Academy of Sciences of the United States of America* **98**(24): 14162-14167.
- Dobra J, Motyka V, Dobrev P, Malbeck J, Prasil IT, Haisel D, Gaudinova A, Havlova M, Gubis J, Vankova R. 2010.** Comparison of hormonal responses to heat, drought and combined stress in tobacco plants with elevated proline content. *Journal of plant physiology* **167**(16): 1360-1370.
- Dolan L, Janmaat K, Willemsen V, Linstead P, Poethig S, Roberts K, Scheres B. 1993.** Cellular organisation of the Arabidopsis thaliana root. *Development* **119**(1): 71-84.
- Dong H, Zhen Z, Peng J, Chang L, Gong Q, Wang NN. 2011.** Loss of ACS7 confers abiotic stress tolerance by modulating ABA sensitivity and accumulation in Arabidopsis. *Journal of experimental botany* **62**(14): 4875-4887.
- Duan Y, Zhang W, Li B, Wang Y, Li K, Sodmergen, Han C, Zhang Y, Li X. 2010.** An endoplasmic reticulum response pathway mediates programmed cell death of root tip induced by water stress in Arabidopsis. *New Phytologist* **186**(3): 681-695.
- Eklöf S, Åstot C, Blackwell J, Moritz T, Olsson O, Sandberg G. 1997.** Auxin-cytokinin interactions in wild-type and transgenic tobacco. *Plant and Cell Physiology* **38**(3): 225-235.
- Evans ML, Ishikawa H, Estelle MA. 1994.** Responses of Arabidopsis roots to auxin studied with high temporal resolution: comparison of wild type and auxin-response mutants. *Planta* **194**(2): 215-222.
- Feraru E, Feraru MI, Kleine-Vehn J, Martiniere A, Mouille G, Vanneste S, Vernhettes S, Runions J, Friml J. 2011.** PIN Polarity Maintenance by the Cell Wall in Arabidopsis. *Current Biology* **21**(4): 338-343.
- Finkelstein RR, Gampala SSL, Rock CD. 2002.** Abscisic acid signaling in seeds and seedlings. *The Plant Cell* **14**(suppl 1): S15-S45.

- Fitch MMM, Manshardt RM, Gonsalves D, Slightom JL, Sanford JC. 1992.** Virus resistant papaya plants derived from tissues bombarded with the coat protein gene of papaya ringspot virus. *Nature Biotechnology* **10**(11): 1466-1472.
- Forzani C, Aichinger E, Sornay E, Willemsen V, Laux T, Dewitte W, Murray JAH. 2014.** WOX5 suppresses CYCLIN D activity to establish quiescence at the center of the root stem cell niche. *Current Biology* **24**(16): 1939-1944.
- Friml J, Benkova E, Blilou I, Wisniewska J, Hamann T, Ljung K, Woody S, Sandberg G, Scheres B, Jurgens G, Palme K. 2002a.** AtPIN4 mediates sink-driven auxin gradients and root patterning in Arabidopsis. *Cell* **108**(5): 661-673.
- Friml J, Vieten A, Sauer M, Weijers D, Schwarz H, Hamann T, Offringa R, Jurgens G. 2003.** Efflux-dependent auxin gradients establish the apical-basal axis of Arabidopsis. *Nature* **426**(6963): 147-153.
- Friml J, Wisniewska J, Benkova E, Mendgen K, Palme K. 2002b.** Lateral relocation of auxin efflux regulator PIN3 mediates tropism in Arabidopsis. *Nature* **415**(6873): 806-809.
- Fu X, Richards DE, Ait-Ali T, Hynes LW, Ougham H, Peng J, Harberd NP. 2002.** Gibberellin-mediated proteasome-dependent degradation of the barley DELLA protein SLN1 repressor. *The Plant Cell* **14**(12): 3191-3200.
- Fu XD, Harberd NP. 2003.** Auxin promotes Arabidopsis root growth by modulating gibberellin response. *Nature* **421**(6924): 740-743.
- Fujii H, Chinnusamy V, Rodrigues A, Rubio S, Antoni R, Park S-Y, Cutler SR, Sheen J, Rodriguez PL, Zhu J-K. 2009.** In vitro reconstitution of an abscisic acid signalling pathway. *Nature* **462**(7273): 660-664.
- Furihata T, Maruyama K, Fujita Y, Umezawa T, Yoshida R, Shinozaki K, Yamaguchi-Shinozaki K. 2006.** Abscisic acid-dependent multisite phosphorylation regulates the activity of a transcription activator AREB1. *Proceedings of the National Academy of Sciences of the United States of America* **103**(6): 1988-1993.
- Furuichi T, Iida H, Sokabe M, Tatsumi H. 2012.** Expression of Arabidopsis MCA1 enhanced mechanosensitive channel activity in the *Xenopus laevis* oocyte plasma membrane. *Plant signaling & behavior* **7**(8): 1022-1026.
- Galinha C, Hofhuis H, Luijten M, Willemsen V, Blilou I, Heidstra R, Scheres B. 2007.** PLETHORA proteins as dose-dependent master regulators of Arabidopsis root development. *Nature* **449**(7165): 1053-1057.
- Galweiler L, Guan CH, Muller A, Wisman E, Mendgen K, Yephremov A, Palme K. 1998.** Regulation of polar auxin transport by AtPIN1 in Arabidopsis vascular tissue. *Science* **282**(5397): 2226-2230.
- Geisler M, Blakeslee JJ, Bouchard R, Lee OR, Vincenzetti V, Bandyopadhyay A, Titapiwatanakun B, Peer WA, Bailly A, Richards EL. 2005.** Cellular efflux of auxin catalyzed by the Arabidopsis MDR/PGP transporter AtPGP1. *The Plant Journal* **44**(2): 179-194.
- Geldner N, Anders N, Wolters H, Keicher J, Kornberger W, Muller P, Delbarre A, Ueda T, Nakano A, Jurgens G. 2003.** The Arabidopsis GNOM ARF-GEF mediates endosomal recycling, auxin transport, and auxin-dependent plant growth. *Cell* **112**(2): 219-230.
- Ghassemian M, Nambara E, Cutler S, Kawaide H, Kamiya Y, McCourt P. 2000.** Regulation of abscisic acid signaling by the ethylene response pathway in Arabidopsis. *The Plant Cell* **12**(7): 1117-1126.
- Godfray HCJ, Beddington JR, Crute IR, Haddad L, Lawrence D, Muir JF, Pretty J, Robinson S, Thomas SM, Toulmin C. 2010.** Food Security: The Challenge of Feeding 9 Billion People. *Science* **327**(5967): 812-818.
- Gonzalez-Guzman M, Pizzio GA, Antoni R, Vera-Sirera F, Merilo E, Bassel GW, Fernandez MA, Holdsworth MJ, Angel Perez-Amador M, Kollist H, Rodriguez PL. 2012.** Arabidopsis PYR/PYL/RCAR Receptors Play a Major Role in Quantitative Regulation of Stomatal Aperture and Transcriptional Response to Abscisic Acid. *The Plant Cell* **24**(6): 2483-2496.

- González-García M-P, Vilarrasa-Blasi J, Zhiponova M, Divol F, Mora-García S, Russinova E, Caño-Delgado AI. 2011.** Brassinosteroids control meristem size by promoting cell cycle progression in Arabidopsis roots. *Development* **138**(5): 849-859.
- Gray WM, Kepinski S, Rouse D, Leyser O, Estelle M. 2001.** Auxin regulates SCFTIR1-dependent degradation of AUX/IAA proteins. *Nature* **414**(6861): 271-276.
- Grieneisen VA, Xu J, Maree AFM, Hogeweg P, Scheres B. 2007.** Auxin transport is sufficient to generate a maximum and gradient guiding root growth. *Nature* **449**(7165): 1008-1013.
- Griffiths J, Murase K, Rieu I, Zentella R, Zhang Z-L, Powers SJ, Gong F, Phillips AL, Hedden P, Sun T-p, Thomas SG. 2006.** Genetic characterization and functional analysis of the GID1 gibberellin receptors in Arabidopsis. *The Plant Cell* **18**(12): 3399-3414.
- Gutierrez R, Lindeboom JJ, Paredes AR, Emons AMC, Ehrhardt DW. 2009.** Arabidopsis cortical microtubules position cellulose synthase delivery to the plasma membrane and interact with cellulose synthase trafficking compartments. *Nature Cell Biology* **11**(7): 797-806.
- Guzman P, Ecker JR. 1990.** Exploiting the triple response of Arabidopsis to identify ethylene-related mutants. *The Plant Cell* **2**(6): 513-523.
- Hacham Y, Holland N, Butterfield C, Ubeda-Tomas S, Bennett MJ, Chory J, Savaldi-Goldstein S. 2011.** Brassinosteroid perception in the epidermis controls root meristem size. *Development* **138**(5): 839-848.
- Handa AK, Bressan RA, Handa S, Hasegawa PM. 1982.** Characteristics of cultured tomato cells after prolonged exposure to medium containing polyethylene glycol. *Plant physiology* **69**(2): 514-521.
- Haswell ES, Verslues PE. 2015.** The ongoing search for the molecular basis of plant osmosensing. *The Journal of general physiology* **145**(5): 389-394.
- Heisler MG, Ohno C, Das P, Sieber P, Reddy GV, Long JA, Meyerowitz EM. 2005.** Patterns of auxin transport and gene expression during primordium development revealed by live imaging of the Arabidopsis inflorescence meristem. *Current Biology* **15**(21): 1899-1911.
- Hoops S, Sahle S, Gauges R, Lee C, Pahle J, Simus N, Singhal M, Xu L, Mendes P, Kummer U. 2006.** COPASI—a complex pathway simulator. *Bioinformatics* **22**(24): 3067-3074.
- Hruz T, Laule O, Szabo G, Wessendorp F, Bleuler S, Oertle L, Widmayer P, Gruissem W, Zimmermann P. 2008.** Genevestigator v3: a reference expression database for the meta-analysis of transcriptomes. *Advances in bioinformatics* **2008**.
- Hua J, Chang C, Sun Q, Meyerowitz EM. 1995.** Ethylene insensitivity conferred by Arabidopsis ERS gene. *Science* **269**(5231): 1712-1714.
- Hua J, Sakai H, Nourizadeh S, Chen QG, Bleecker AB, Ecker JR, Meyerowitz EM. 1998.** EIN4 and ERS2 are members of the putative ethylene receptor gene family in Arabidopsis. *The Plant Cell* **10**(8): 1321-1332.
- Huang D, Wu W, Abrams SR, Cutler AJ. 2008.** The relationship of drought-related gene expression in Arabidopsis thaliana to hormonal and environmental factors. *Journal of Experimental Botany* **59**(11): 2991-3007.
- Huang G-T, Ma S-L, Bai L-P, Zhang L, Ma H, Jia P, Liu J, Zhong M, Guo Z-F. 2012.** Signal transduction during cold, salt, and drought stresses in plants. *Molecular biology reports* **39**(2): 969-987.
- Hussey PJ, Ketelaar T, Deeks MJ. 2006.** Control of the actin cytoskeleton in plant cell growth. *Annu. Rev. Plant Biol.* **57**: 109-125.
- Ichimura K, Mizoguchi T, Yoshida R, Yuasa T, Shinozaki K. 2000.** Various abiotic stresses rapidly activate Arabidopsis MAP kinases ATMPK4 and ATMPK6. *The Plant Journal* **24**(5): 655-665.
- Inoue T, Higuchi M, Hashimoto Y, Seki M, Kobayashi M, Kato T, Tabata S, Shinozaki K, Kakimoto T. 2001.** Identification of CRE1 as a cytokinin receptor from Arabidopsis. *Nature* **409**(6823): 1060-1063.

- IPCC. 2014. *Climate Change 2014: Impacts, Adaptation, and Vulnerability*.
- Ishida T, Adachi S, Yoshimura M, Shimizu K, Umeda M, Sugimoto K. 2010. Auxin modulates the transition from the mitotic cycle to the endocycle in Arabidopsis. *Development* **137**(1): 63-71.
- Jacobsen A, Lindsey K unpublished data. The effect of mechanical impedance on development and root growth in Arabidopsis thaliana.
- Ji H, Li X. 2014. ABA mediates PEG-mediated premature differentiation of root apical meristem in plants. *Plant signaling & behavior* **9**(11): e977720-e977720.
- Ji H, Liu L, Li K, Xie Q, Wang Z, Zhao X, Li X. 2014. PEG-mediated osmotic stress induces premature differentiation of the root apical meristem and outgrowth of lateral roots in wheat. *Journal of Experimental Botany* **65**(17): 4863-4872.
- Jia H, Zhang S, Ruan M, Wang Y, Wang C. 2012. Analysis and application of RD29 genes in abiotic stress response. *Acta Physiologiae Plantarum* **34**(4): 1239-1250.
- Jones AM, Danielson JÅ, ManojKumar SN, Lanquar V, Grossmann G, Frommer WB. 2014. Abscisic acid dynamics in roots detected with genetically encoded FRET sensors. *Elife* **3**: e01741.
- Jones AR, Kramer EM, Knox K, Swarup R, Bennett MJ, Lazarus CM, Leyser HMO, Grierson CS. 2009. Auxin transport through non-hair cells sustains root-hair development. *Nature Cell Biology* **11**(1): 78-U156.
- Jones B, Gunneras SA, Petersson SV, Tarkowski P, Graham N, May S, Dolezal K, Sandberg G, Ljung K. 2010. Cytokinin Regulation of Auxin Synthesis in Arabidopsis Involves a Homeostatic Feedback Loop Regulated via Auxin and Cytokinin Signal Transduction. *The Plant Cell* **22**(9): 2956-2969.
- Joo S, Liu Y, Lueth A, Zhang S. 2008. MAPK phosphorylation-induced stabilization of ACS6 protein is mediated by the non-catalytic C-terminal domain, which also contains the cis-determinant for rapid degradation by the 26S proteasome pathway. *The Plant Journal* **54**(1): 129-140.
- Ju C, Yoon GM, Shemansky JM, Lin DY, Ying ZI, Chang J, Garrett WM, Kessenbrock M, Groth G, Tucker ML. 2012. CTR1 phosphorylates the central regulator EIN2 to control ethylene hormone signaling from the ER membrane to the nucleus in Arabidopsis. *Proceedings of the National Academy of Sciences* **109**(47): 19486-19491.
- Kaneyasu T, Kobayashi A, Nakayama M, Fujii N, Takahashi H, Miyazawa Y. 2007. Auxin response, but not its polar transport, plays a role in hydrotropism of Arabidopsis roots. *Journal of Experimental Botany* **58**(5): 1143-1150.
- Kang J, Hwang J-U, Lee M, Kim Y-Y, Assmann SM, Martinoia E, Lee Y. 2010. PDR-type ABC transporter mediates cellular uptake of the phytohormone abscisic acid. *Proceedings of the National Academy of Sciences of the United States of America* **107**(5): 2355-2360.
- Kanno Y, Hanada A, Chiba Y, Ichikawa T, Nakazawa M, Matsui M, Koshiba T, Kamiya Y, Seo M. 2012. Identification of an abscisic acid transporter by functional screening using the receptor complex as a sensor. *Proceedings of the National Academy of Sciences of the United States of America* **109**(24): 9653-9658.
- Karssen CM, Brinkhorst-Van der Swan DLC, Breeklund AE, Koornneef M. 1983. Induction of dormancy during seed development by endogenous abscisic acid: studies on abscisic acid deficient genotypes of Arabidopsis thaliana (L.) Heynh. *Planta* **157**(2): 158-165.
- Kasuga M, Liu Q, Miura S, Yamaguchi-Shinozaki K, Shinozaki K. 1999. Improving plant drought, salt, and freezing tolerance by gene transfer of a single stress-inducible transcription factor. *Nature biotechnology* **17**(3): 287-291.
- Kepinski S, Leyser O. 2005. The Arabidopsis F-box protein TIR1 is an auxin receptor. *Nature* **435**(7041): 446-451.
- Kieber JJ, Rothenberg M, Roman G, Feldmann KA, Ecker JR. 1993. CTR1, a negative regulator of the ethylene response pathway in Arabidopsis, encodes a member of the raf family of protein kinases. *Cell* **72**(3): 427-441.
- Kieber JJ, Schaller GE. 2014. Cytokinins. *The Arabidopsis Book*: e0168.

- Kleine-Vehn J, Dhonukshe P, Sauer M, Brewer PB, Wisniewska J, Paciorek T, Benkova E, Friml J. 2008.** ARF GEF-dependent transcytosis and polar delivery of PIN auxin carriers in Arabidopsis. *Current Biology* **18**(7): 526-531.
- Kleine-Vehn J, Friml J. 2008.** Polar Targeting and Endocytic Recycling in Auxin-Dependent Plant Development. *Annual Review of Cell and Developmental Biology* **24**: 447-473.
- Klingler JP, Batelli G, Zhu J-K. 2010.** ABA receptors: the START of a new paradigm in phytohormone signalling. *Journal of Experimental Botany* **61**(12): 3199-3210.
- Knight H, Trewavas AJ, Knight MR. 1997.** Calcium signalling in Arabidopsis thaliana responding to drought and salinity. *The Plant Journal* **12**(5): 1067-1078.
- Ko D, Kang J, Kiba T, Park J, Kojima M, Do J, Kim KY, Kwon M, Endler A, Song W-Y. 2014.** Arabidopsis ABCG14 is essential for the root-to-shoot translocation of cytokinin. *Proceedings of the National Academy of Sciences* **111**(19): 7150-7155.
- Kramer EM, Bennett MJ. 2006.** Auxin transport: a field in flux. *Trends in plant science* **11**(8): 382-386.
- Kumar MN, Jane W-N, Verslues PE. 2013.** Role of the Putative Osmosensor Arabidopsis Histidine Kinase1 in Dehydration Avoidance and Low-Water-Potential Response. *Plant Physiology* **161**(2): 942-953.
- Kumar MN, Verslues PE. 2015.** Stress physiology functions of the Arabidopsis histidine kinase cytokinin receptors. *Physiologia Plantarum* **154**(3): 369-380.
- Kuromori T, Miyaji T, Yabuuchi H, Shimizu H, Sugimoto E, Kamiya A, Moriyama Y, Shinozaki K. 2010.** ABC transporter AtABCG25 is involved in abscisic acid transport and responses. *Proceedings of the National Academy of Sciences of the United States of America* **107**(5): 2361-2366.
- Kuromori T, Shinozaki K. 2010.** ABA transport factors found in Arabidopsis ABC transporters. *Plant signaling & behavior* **5**(9): 1124-1126.
- Kuromori T, Sugimoto E, Shinozaki K. 2011.** Arabidopsis mutants of AtABCG22, an ABC transporter gene, increase water transpiration and drought susceptibility. *The Plant Journal* **67**(5): 885-894.
- Lee KH, Piao HL, Kim H-Y, Choi SM, Jiang F, Hartung W, Hwang I, Kwak JM, Lee I-J, Hwang I. 2006.** Activation of glucosidase via stress-induced polymerization rapidly increases active pools of abscisic acid. *Cell* **126**(6): 1109-1120.
- Leyser HM, Pickett FB, Dharmasiri S, Estelle M. 1996.** Mutations in the AXR3 gene of Arabidopsis result in altered auxin response including ectopic expression from the SAUR-AC1 promoter. *The Plant Journal* **10**(3): 403-413.
- Li G, Zhu C, Gan L, Ng D, Xia K. 2015.** GA3 enhances root responsiveness to exogenous IAA by modulating auxin transport and signalling in Arabidopsis. *Plant cell reports* **34**(3): 483-494.
- Li X, Chen L, Davies WJ, Forde BG 2015.** Investigating the roles of ethylene and auxin in the biphasic root growth response to abscisic acid. *Society of Experimental Biology, Annual Main Meeting*. Prague.
- Li Z, Zhang L, Yu Y, Quan R, Zhang Z, Zhang H, Huang R. 2011.** The ethylene response factor AtERF11 that is transcriptionally modulated by the bZIP transcription factor HY5 is a crucial repressor for ethylene biosynthesis in Arabidopsis. *The Plant Journal* **68**(1): 88-99.
- Liao C-Y, Smet W, Brunoud G, Yoshida S, Vernoux T, Weijers D. 2015.** Reporters for sensitive and quantitative measurement of auxin response. *Nature methods*.
- Lindsey K, Pullen ML, Topping JF. 2003.** Importance of plant sterols in pattern formation and hormone signalling. *Trends in plant science* **8**(11): 521-525.
- Liu J, Mehdi S, Topping J, Friml J, Lindsey K. 2013.** Interaction of PLS and PIN and hormonal crosstalk in Arabidopsis root development. *Frontiers in plant science* **4**: 75-75.
- Liu J, Mehdi S, Topping J, Tarkowski P, Lindsey K. 2010.** Modelling and experimental analysis of hormonal crosstalk in Arabidopsis. *Molecular Systems Biology* **6**: 373.
- Liu J, Rowe J, Lindsey K. 2014.** Hormonal crosstalk for root development: a combined experimental and modeling perspective. *Frontiers in Plant Science* **5**.

- Liu Q, Kasuga M, Sakuma Y, Abe H, Miura S, Yamaguchi-Shinozaki K, Shinozaki K. 1998.** Two transcription factors, DREB1 and DREB2, with an EREBP/AP2 DNA binding domain separate two cellular signal transduction pathways in drought- and low-temperature-responsive gene expression, respectively, in Arabidopsis. *The Plant Cell* **10**(8): 1391-1406.
- Liu YD, Zhang SQ. 2004.** Phosphorylation of 1-aminocyclopropane-1-carboxylic acid synthase by MPK6, a stress-responsive mitogen-activated protein kinase, induces ethylene biosynthesis in Arabidopsis. *The Plant Cell* **16**(12): 3386-3399.
- Ljung K, Bhalerao RP, Sandberg G. 2001.** Sites and homeostatic control of auxin biosynthesis in Arabidopsis during vegetative growth. *The Plant Journal* **28**(4): 465-474.
- Loefke C, Zwiewka M, Heilmann I, Van Montagu MCE, Teichmann T, Friml J. 2013.** Asymmetric gibberellin signaling regulates vacuolar trafficking of PIN auxin transporters during root gravitropism. *Proceedings of the National Academy of Sciences of the United States of America* **110**(9): 3627-3632.
- Lopez-Molina L, Mongrand S, Chua NH. 2001.** A postgermination developmental arrest checkpoint is mediated by abscisic acid and requires the AB15 transcription factor in Arabidopsis. *Proceedings of the National Academy of Sciences of the United States of America* **98**(8): 4782-4787.
- Luo X, Chen Z, Gao J, Gong Z. 2014.** Abscisic acid inhibits root growth in Arabidopsis through ethylene biosynthesis. *The Plant Journal* **79**(1): 44-55.
- Luschnig C, Gaxiola RA, Grisafi P, Fink GR. 1998.** EIR1, a root-specific protein involved in auxin transport, is required for gravitropism in Arabidopsis thaliana. *Genes & development* **12**(14): 2175-2187.
- Lynch JP. 2007.** Turner review no. 14. Roots of the second green revolution. *Australian Journal of Botany* **55**(5): 493-512.
- Lynch JP, Chimungu JG, Brown KM. 2014.** Root anatomical phenes associated with water acquisition from drying soil: targets for crop improvement. *Journal of Experimental Botany* **65**(21): 6155-6166.
- Ma Y, Szostkiewicz I, Korte A, Moes D, Yang Y, Christmann A, Grill E. 2009.** Regulators of PP2C phosphatase activity function as abscisic acid sensors. *Science* **324**(5930): 1064-1068.
- Macey R, Oster G, Zahnley T. 2000.** Berkeley Madonna user's guide. *University of California, Berkeley, CA.*
- Mahonen AP, Tusscher Kt, Siligato R, Smetana O, Diaz-Trivino S, Salojarvi J, Wachsman G, Prasad K, Heidstra R, Scheres B. 2014.** PLETHORA gradient formation mechanism separates auxin responses. *Nature advance online publication.*
- Maraschin FdS, Memelink J, Offringa R. 2009.** Auxin-induced, SCF(TIR1)-mediated poly-ubiquitination marks AUX/IAA proteins for degradation. *The Plant Journal* **59**(1): 100-109.
- Marc J, Granger CL, Brincat J, Fisher DD, Kao T-h, McCubbin AG, Cyr RJ. 1998.** A GFP-MAP4 reporter gene for visualizing cortical microtubule rearrangements in living epidermal cells. *The Plant Cell* **10**(11): 1927-1939.
- Marchant A, Bhalerao R, Casimiro I, Eklöf J, Casero PJ, Bennett M, Sandberg G. 2002.** AUX1 promotes lateral root formation by facilitating indole-3-acetic acid distribution between sink and source tissues in the Arabidopsis seedling. *The Plant Cell* **14**(3): 589-597.
- Marchant A, Kargul J, May ST, Muller P, Delbarre A, Perrot-Rechenmann C, Bennett MJ. 1999.** AUX1 regulates root gravitropism in Arabidopsis by facilitating auxin uptake within root apical tissues. *Embo Journal* **18**(8): 2066-2073.
- Marín-de la Rosa N, Pfeiffer A, Hill K, Locascio A, Bhalerao RP, Miskolczi P, Grønlund AL, Wanchoo-Kohli A, Thomas SG, Bennett MJ. 2015.** Genome Wide Binding Site Analysis Reveals Transcriptional Coactivation of Cytokinin-Responsive Genes by DELLA Proteins. *PLoS Genet* **11**(7): e1005337.

- Mason MG, Mathews DE, Argyros DA, Maxwell BB, Kieber JJ, Alonso JM, Ecker JR, Schaller GE. 2005.** Multiple type-B response regulators mediate cytokinin signal transduction in Arabidopsis. *The Plant Cell* **17**(11): 3007-3018.
- Mehdi S. 2009.** *Studies on the POLARIS gene of Arabidopsis*. Durham University.
- Meyerowitz EM. 1989.** Arabidopsis, a useful weed. *Cell* **56**(2): 263-269.
- Middleton AM, Ubeda-Tomas S, Griffiths J, Holman T, Hedden P, Thomas SG, Phillips AL, Holdsworth MJ, Bennett MJ, King JR, Owen MR. 2012.** Mathematical modeling elucidates the role of transcriptional feedback in gibberellin signaling. *Proceedings of the National Academy of Sciences of the United States of America* **109**(19): 7571-7576.
- Miller CO, Skoog F, Von Saltza MH, Strong FM. 1955.** Kinetin, a cell division factor from deoxyribonucleic acid. *Journal of the American Chemical Society* **77**(5): 1392-1392.
- Miller G, Shulaev V, Mittler R. 2008.** Reactive oxygen signaling and abiotic stress. *Physiologia Plantarum* **133**(3): 481-489.
- Miller GAD, Suzuki N, Ciftci-Yilmaz S, Mittler RON. 2010.** Reactive oxygen species homeostasis and signalling during drought and salinity stresses. *Plant, cell & environment* **33**(4): 453-467.
- Miyawaki K, Matsumoto-Kitano M, Kakimoto T. 2004.** Expression of cytokinin biosynthetic isopentenyltransferase genes in Arabidopsis: tissue specificity and regulation by auxin, cytokinin, and nitrate. *The Plant Journal* **37**(1): 128-138.
- Mizoi J, Shinozaki K, Yamaguchi-Shinozaki K. 2012.** AP2/ERF family transcription factors in plant abiotic stress responses. *Biochimica Et Biophysica Acta-Gen Regulatory Mechanisms* **1819**(2): 86-96.
- Mizuno T. 2005.** Two-component phosphorelay signal transduction systems in plants: from hormone responses to circadian rhythms. *Bioscience, biotechnology, and biochemistry* **69**(12): 2263-2276.
- Mockaitis K, Estelle M. 2008.** Auxin receptors and plant development: a new signaling paradigm. *Annual review of cell and developmental biology* **24**: 55-80.
- Moore S, Zhang X, Liu J, Lindsey K. 2015a.** Modelling Plant Hormone Gradients. *eLS*.
- Moore S, Zhang X, Mudge A, Rowe JH, Topping JF, Liu J, Lindsey K. 2015b.** Spatiotemporal modelling of hormonal crosstalk explains the level and patterning of hormones and gene expression in Arabidopsis thaliana wild-type and mutant roots. *New Phytologist* **207**(4): 1110-1122.
- Moubayidin L, Perilli S, Dello Ioio R, Di Mambro R, Costantino P, Sabatini S. 2010.** The Rate of Cell Differentiation Controls the Arabidopsis Root Meristem Growth Phase. *Current Biology* **20**(12): 1138-1142.
- Mudge A. 2015.** *The role of the POLARIS peptide in ethylene signalling and root development in Arabidopsis thaliana*. Durham University.
- Mulkey TJ, Evans ML, Kuzmanoff KM. 1983.** The kinetics of abscisic acid action on root growth and gravitropism. *Planta* **157**(2): 150-157.
- Muller B, Sheen J. 2008.** Cytokinin and auxin interaction in root stem-cell specification during early embryogenesis. *Nature* **453**(7198): 1094-U1097.
- Murase K, Hirano Y, Sun T-p, Hakoshima T. 2008.** Gibberellin-induced DELLA recognition by the gibberellin receptor GID1. *Nature* **456**(7221): 459-U415.
- Nakagawa Y, Katagiri T, Shinozaki K, Qi Z, Tatsumi H, Furuichi T, Kishigami A, Sokabe M, Kojima I, Sato S. 2007.** Arabidopsis plasma membrane protein crucial for Ca²⁺ influx and touch sensing in roots. *Proceedings of the National Academy of Sciences* **104**(9): 3639-3644.
- Nakajima M, Shimada A, Takashi Y, Kim YC, Park SH, Ueguchi-Tanaka M, Suzuki H, Katoh E, Iuchi S, Kobayashi M. 2006.** Identification and characterization of Arabidopsis gibberellin receptors. *The Plant Journal* **46**(5): 880-889.
- Nakashima K, Fujita Y, Kanamori N, Katagiri T, Umezawa T, Kidokoro S, Maruyama K, Yoshida T, Ishiyama K, Kobayashi M. 2009.** Three Arabidopsis SnRK2 protein kinases, SRK2D/SnRK2. 2, SRK2E/SnRK2. 6/OST1 and SRK2I/SnRK2. 3, involved in ABA signaling are essential for the control of seed development and dormancy. *Plant and Cell Physiology* **50**(7): 1345-1363.

- Nakashima K, Shinwari ZK, Sakuma Y, Seki M, Miura S, Shinozaki K, Yamaguchi-Shinozaki K. 2000.** Organization and expression of two Arabidopsis DREB2 genes encoding DRE-binding proteins involved in dehydration- and high-salinity-responsive gene expression. *Plant Molecular Biology* **42**(4): 657-665.
- Nakayama N, Smith RS, Mandel T, Robinson S, Kimura S, Boudaoud A, Kuhlemeier C. 2012.** Mechanical Regulation of Auxin-Mediated Growth. *Current Biology* **22**(16): 1468-1476.
- Nishimura C, Ohashi Y, Sato S, Kato T, Tabata S, Ueguchi C. 2004.** Genetic analysis of Arabidopsis histidine kinase genes encoding cytokinin receptors reveals their overlapping biological functions in the regulation of shoot and root growth in Arabidopsis thaliana. *Plant Cell* **16**: 1365-1377.
- Nishiyama R, Watanabe Y, Fujita Y, Dung Tien L, Kojima M, Werner T, Vankova R, Yamaguchi-Shinozaki K, Shinozaki K, Kakimoto T, Sakakibara H, Schmuelling T, Lam-Son Phan T. 2011.** Analysis of Cytokinin Mutants and Regulation of Cytokinin Metabolic Genes Reveals Important Regulatory Roles of Cytokinins in Drought, Salt and Abscisic Acid Responses, and Abscisic Acid Biosynthesis. *The Plant Cell* **23**(6): 2169-2183.
- Nordstrom A, Tarkowski P, Tarkowska D, Norbaek R, Astot C, Dolezal K, Sandberg G. 2004.** Auxin regulation of cytokinin biosynthesis in Arabidopsis thaliana: A factor of potential importance for auxin-cytokinin-regulated development. *Proceedings of the National Academy of Sciences of the United States of America* **101**(21): 8039-8044.
- Oertli JJ. 1985.** The response of plant cells to different forms of moisture stress. *Journal of plant physiology* **121**(4): 295-300.
- Oertli JJ. 1986.** The effect of cell size on cell collapse under negative turgor pressure. *Journal of plant physiology* **124**(3): 365-370.
- Ortega-Martinez O, Pernas M, Carol RJ, Dolan L. 2007.** Ethylene modulates stem cell division in the Arabidopsis thaliana root. *Science* **317**(5837): 507-510.
- Osterlund MT, Hardtke CS, Wei N, Deng XW. 2000.** Targeted destabilization of HY5 during light-regulated development of Arabidopsis. *Nature* **405**(6785): 462-466.
- Paciorek T, Zazimalova E, Ruthardt N, Petrasek J, Stierhof YD, Kleine-Vehn J, Morris DA, Emans N, Jurgens G, Geldner N, Friml J. 2005.** Auxin inhibits endocytosis and promotes its own efflux from cells. *Nature* **435**(7046): 1251-1256.
- Paponov IA, Paponov M, Teale W, Menges M, Chakrabortee S, Murray JAH, Palme K. 2008.** Comprehensive transcriptome analysis of auxin responses in Arabidopsis. *Molecular Plant* **1**(2): 321-337.
- Paredes AR, Somerville CR, Ehrhardt DW. 2006.** Visualization of cellulose synthase demonstrates functional association with microtubules. *Science* **312**(5779): 1491-1495.
- Park S-Y, Fung P, Nishimura N, Jensen DR, Fujii H, Zhao Y, Lumba S, Santiago J, Rodrigues A, Tsz-fung FC. 2009.** Abscisic acid inhibits type 2C protein phosphatases via the PYR/PYL family of START proteins. *science* **324**(5930): 1068-1071.
- Peret B, Swarup K, Ferguson A, Seth M, Yang Y, Dhondt S, James N, Casimiro I, Perry P, Syed A, Yang H, Reemmer J, Venison E, Howells C, Perez-Amador MA, Yun J, Alonso J, Beemster GTS, Laplaze L, Murphy A, Bennett MJ, Nielsen E, Swarup R. 2012.** AUX/LAX Genes Encode a Family of Auxin Influx Transporters That Perform Distinct Functions during Arabidopsis Development. *The Plant Cell* **24**(7): 2874-2885.
- Petersson SV, Johansson AI, Kowalczyk M, Makoveychuk A, Wang JY, Moritz T, Grebe M, Benfey PN, Sandberg G, Ljung K. 2009.** An Auxin Gradient and Maximum in the Arabidopsis Root Apex Shown by High-Resolution Cell-Specific Analysis of IAA Distribution and Synthesis. *The Plant Cell* **21**(6): 1659-1668.
- Petrasek J, Mravec J, Bouchard R, Blakeslee JJ, Abas M, Seifertova D, Wisniewska J, Tadele Z, Kubes M, Covanova M, Dhonukshe P, Skupa P, Benkova E, Perry L, Krecek P, Lee OR, Fink GR, Geisler M, Murphy AS, Luschnig C, Zazimalova E,**

- Friml J. 2006.** PIN proteins perform a rate-limiting function in cellular auxin efflux. *Science* **312**(5775): 914-918.
- Petricka JJ, Winter CM, Benfey PN. 2012.** Control of Arabidopsis root development. *Annual review of plant biology* **63**: 563.
- Petrášek J, Friml J. 2009.** Auxin transport routes in plant development. *Development* **136**(16): 2675-2688.
- Pickett FB, Wilson AK, Estelle M. 1990.** THE AUX1 MUTATION OF ARABIDOPSIS CONFERS BOTH AUXIN AND ETHYLENE RESISTANCE. *Plant Physiology* **94**(3): 1462-1466.
- Pound MP, French AP, Wells DM, Bennett MJ, Pridmore TP. 2012.** CellSeT: Novel Software to Extract and Analyze Structured Networks of Plant Cells from Confocal Images. *The Plant Cell* **24**(4): 1353-1361.
- Pullen M, Clark N, Zarinkamar F, Topping J, Lindsey K. 2010.** Analysis of vascular development in the hydra sterol biosynthetic mutants of Arabidopsis. *PLoS one* **5**(8): e12227-e12227.
- Pěňčík A, Simonovik B, Petersson SV, Henyková E, Simon S, Greenham K, Zhang Y, Kowalczyk M, Estelle M, Zažímalová E. 2013.** Regulation of auxin homeostasis and gradients in Arabidopsis roots through the formation of the indole-3-acetic acid catabolite 2-oxindole-3-acetic acid. *The Plant Cell* **25**(10): 3858-3870.
- Rashotte AM, Brady SR, Reed RC, Ante SJ, Muday GK. 2000.** Basipetal auxin transport is required for gravitropism in roots of Arabidopsis. *Plant Physiology* **122**(2): 481-490.
- Reddy AR, Chaitanya KV, Vivekanandan M. 2004.** Drought-induced responses of photosynthesis and antioxidant metabolism in higher plants. *Journal of plant physiology* **161**(11): 1189-1202.
- Reiser V, Raitt DC, Saito H. 2003.** Yeast osmosensor Sln1 and plant cytokinin receptor Cre1 respond to changes in turgor pressure. *Journal of Cell Biology* **161**(6): 1035-1040.
- Ribaut JM, Pilet PE. 1994.** Water stress and indol-3yl-acetic acid content of maize roots. *Planta* **193**(4): 502-507.
- Rodriguez FI, Esch JJ, Hall AE, Binder BM, Schaller GE, Bleecker AB. 1999.** A copper cofactor for the ethylene receptor ETR1 from Arabidopsis. *Science* **283**(5404): 996-998.
- Roman G, Lubarsky B, Kieber JJ, Rothenberg M, Ecker JR. 1995.** Genetic analysis of ethylene signal transduction in Arabidopsis thaliana: five novel mutant loci integrated into a stress response pathway. *Genetics* **139**(3): 1393-1409.
- Ross JJ, O'Neill DP, Smith JJ, Kerckhoffs LHJ, Elliott RC. 2000.** Evidence that auxin promotes gibberellin A(1) biosynthesis in pea. *The Plant Journal* **21**(6): 547-552.
- Rutschow HL, Baskin TI, Kramer EM. 2014.** The carrier AUXIN RESISTANT (AUX1) dominates auxin flux into Arabidopsis protoplasts. *New Phytologist* **204**(3): 536-544.
- Ruzicka K, Ljung K, Vanneste S, Podhorska R, Beeckman T, Friml J, Benkova E. 2007.** Ethylene regulates root growth through effects on auxin biosynthesis and transport-dependent auxin distribution. *The Plant Cell* **19**(7): 2197-2212.
- Ruzicka K, Simaskova M, Duclercq J, Petrusek J, Zazimalova E, Simon S, Friml J, Van Montagu MCE, Benkova E. 2009.** Cytokinin regulates root meristem activity via modulation of the polar auxin transport. *Proceedings of the National Academy of Sciences of the United States of America* **106**(11): 4284-4289.
- Sabatini S, Beis D, Wolkenfelt H, Murfett J, Guilfoyle T, Malamy J, Benfey P, Leyser O, Bechtold N, Weisbeek P, Scheres B. 1999.** An auxin-dependent distal organizer of pattern and polarity in the Arabidopsis root. *Cell* **99**(5): 463-472.
- Sachs T. 1982.** The role of auxins and cytokinins in the release of buds from dominance. *Current Contents/Agriculture Biology & Environmental Sciences*(36): 22-22.
- Sakai H, Aoyama T, Oka A. 2000.** Arabidopsis ARR1 and ARR2 response regulators operate as transcriptional activators. *The Plant Journal* **24**(6): 703-711.

- Sakai H, Hua J, Chen QG, Chang C, Medrano LJ, Bleecker AB, Meyerowitz EM. 1998.** ETR2 is an ETR1-like gene involved in ethylene signaling in Arabidopsis. *Proceedings of the National Academy of Sciences* **95**(10): 5812-5817.
- Sampathkumar A, Krupinski P, Wightman R, Milani P, Berquand A, Boudaoud A, Hamant O, Jonsson H, Meyerowitz EM. 2014.** Subcellular and supracellular mechanical stress prescribes cytoskeleton behavior in Arabidopsis cotyledon pavement cells. *Elife* **3**.
- Sarkar AK, Luijten M, Miyashima S, Lenhard M, Hashimoto T, Nakajima K, Scheres B, Heidstra R, Laux T. 2007.** Conserved factors regulate signalling in Arabidopsis thaliana shoot and root stem cell organizers. *Nature* **446**(7137): 811-814.
- Sarquis JI, Jordan WR, Morgan PW. 1991.** Ethylene evolution from maize (*Zea mays* L.) seedling roots and shoots in response to mechanical impedance. *Plant Physiology* **96**(4): 1171-1177.
- Schaller GE, Bishopp A, Kieber JJ. 2015.** The yin-yang of hormones: cytokinin and auxin interactions in plant development. *The Plant Cell* **27**(1): 44-63.
- Schaller GE, Kieber JJ. 2002.** Ethylene. *The Arabidopsis book/American Society of Plant Biologists* **1**.
- Seki M, Ishida J, Narusaka M, Fujita M, Nanjo T, Umezawa T, Kamiya A, Nakajima M, Enju A, Sakurai T. 2002.** Monitoring the expression pattern of around 7,000 Arabidopsis genes under ABA treatments using a full-length cDNA microarray. *Functional & integrative genomics* **2**(6): 282-291.
- Sevanto S. 2014.** Phloem transport and drought. *Journal of experimental botany* **65**(7): 1751-1759.
- Shabala SN, Lew RR. 2002.** Turgor regulation in osmotically stressed Arabidopsis epidermal root cells. Direct support for the role of inorganic ion uptake as revealed by concurrent flux and cell turgor measurements. *Plant Physiology* **129**(1): 290-299.
- Sharp RE. 2002.** Interaction with ethylene: changing views on the role of abscisic acid in root and shoot growth responses to water stress. *Plant Cell and Environment* **25**(2): 211-222.
- Sharp RE, LeNoble ME. 2002.** ABA, ethylene and the control of shoot and root growth under water stress. *Journal of Experimental Botany* **53**(366): 33-37.
- Sharp RE, Wu Y, Voetberg GS, Saab IN, LeNoble ME. 1994.** Confirmation that abscisic acid accumulation is required for maize primary root elongation at low water potentials. *Journal of Experimental Botany* **45**(Special Issue): 1743-1751.
- Sheard LB, Zheng N. 2009.** Plant biology: signal advance for abscisic acid. *Nature* **462**(7273): 575-576.
- Shi H, Chen L, Ye T, Liu X, Ding K, Chan Z. 2014.** Modulation of auxin content in Arabidopsis confers improved drought stress resistance. *Plant Physiology and Biochemistry* **82**: 209-217.
- Shkolnik-Inbar D, Bar-Zvi D. 2010.** ABI4 Mediates Abscisic Acid and Cytokinin Inhibition of Lateral Root Formation by Reducing Polar Auxin Transport in Arabidopsis. *The Plant Cell* **22**(11): 3560-3573.
- Silverstone AL, Jung HS, Dill A, Kawaide H, Kamiya Y, Sun TP. 2001.** Repressing a repressor: Gibberellin-induced rapid reduction of the RGA protein in Arabidopsis. *The Plant Cell* **13**(7): 1555-1565.
- Skirycz A, Claeys H, De Bodt S, Oikawa A, Shinoda S, Andriankaja M, Maleux K, Eloy NB, Coppens F, Yoo S-D, Saito K, Inzé D. 2011.** Pause-and-Stop: The Effects of Osmotic Stress on Cell Proliferation during Early Leaf Development in Arabidopsis and a Role for Ethylene Signaling in Cell Cycle Arrest. *The Plant Cell* **23**(5): 1876-1888.
- Skoog F, Miller C. 1957.** Chemical regulation of growth and organ formation in plant tissues cultured in vitro. *Symposia of the Society for Experimental Biology*(11): 118-130.
- Smertenko AP, Deeks MJ, Hussey PJ. 2010.** Strategies of actin reorganisation in plant cells. *Journal of cell science* **123**(17): 3019-3028.

- Soh MS, Hong SH, Kim BC, Vizir I, Park DH, Choi G, Hong MY, Chung Y-Y, Furuya M, Nam HG. 1999.** Regulation of both light-and auxin-mediated development by the Arabidopsis IAA3/SHY2 gene. *Journal of Plant Biology* **42**(3): 239-246.
- Solano R, Stepanova A, Chao Q, Ecker JR. 1998.** Nuclear events in ethylene signaling: a transcriptional cascade mediated by ETHYLENE-INSENSITIVE3 and ETHYLENE-RESPONSE-FACTOR1. *Genes & Development* **12**(23): 3703-3714.
- Somerville C, Koornneef M. 2002.** A fortunate choice: the history of Arabidopsis as a model plant. *Nature Reviews Genetics* **3**(11): 883-889.
- Souter M, Topping J, Pullen M, Friml J, Palme K, Hackett R, Grierson D, Lindsey K. 2002.** hydra mutants of Arabidopsis are defective in sterol profiles and auxin and ethylene signaling. *The Plant Cell* **14**(5): 1017-1031.
- Spollen WG, LeNoble ME, Samuels TD, Bernstein N, Sharp RE. 2000.** Abscisic acid accumulation maintains maize primary root elongation at low water potentials by restricting ethylene production. *Plant Physiology* **122**(3): 967-976.
- Stepanova AN, Hoyt JM, Hamilton AA, Alonso JM. 2005.** A link between ethylene and auxin uncovered by the characterization of two root-specific ethylene-insensitive mutants in Arabidopsis. *The Plant Cell* **17**(8): 2230-2242.
- Stepanova AN, Robertson-Hoyt J, Yun J, Benavente LM, Xie DY, Dolezal K, Schlereth A, Jurgens G, Alonso JM. 2008.** TAA1-mediated auxin biosynthesis is essential for hormone crosstalk and plant development. *Cell* **133**(1): 177-191.
- Stepanova AN, Yun J, Likhacheva AV, Alonso JM. 2007.** Multilevel interactions between ethylene and auxin in Arabidopsis roots. *The Plant Cell* **19**(7): 2169-2185.
- Stoma S, Lucas M, Chopard J, Schaedel M, Traas J, Godin C. 2008.** Flux-Based Transport Enhancement as a Plausible Unifying Mechanism for Auxin Transport in Meristem Development. *Plos Computational Biology* **4**(10).
- Strader LC, Chen GL, Bartel B. 2010.** Ethylene directs auxin to control root cell expansion. *The Plant Journal* **64**(5): 874-884.
- Street IH, Aman S, Zubo Y, Ramzan A, Wang X, Shakeel S, Kieber JJ, Schaller GE. 2015.** Ethylene Inhibits Cell Proliferation of the Arabidopsis Root Meristem. *Plant Physiology*.
- Suttle JC. 1988.** Effect of ethylene treatment on polar IAA transport, net IAA uptake and specific binding of N-1-naphthylphthalamic acid in tissues and microsomes isolated from etiolated pea epicotyls. *Plant Physiology* **88**(3): 795-799.
- Suzuki T, Miwa K, Ishikawa K, Yamada H, Aiba H, Mizuno T. 2001.** The Arabidopsis sensor His-kinase, AHK4, can respond to cytokinins. *Plant and Cell Physiology* **42**(2): 107-113.
- Swarup R, Friml J, Marchant A, Ljung K, Sandberg G, Palme K, Bennett M. 2001.** Localization of the auxin permease AUX1 suggests two functionally distinct hormone transport pathways operate in the Arabidopsis root apex. *Genes & Development* **15**(20): 2648-2653.
- Swarup R, Kargul J, Marchant A, Zadik D, Rahman A, Mills R, Yemm A, May S, Williams L, Millner P, Tsurumi S, Moore I, Napier R, Kerr ID, Bennett MJ. 2004.** Structure-function analysis of the presumptive Arabidopsis auxin permease AUX1. *The Plant Cell* **16**(11): 3069-3083.
- Swarup R, Kramer EM, Perry P, Knox K, Leyser HMO, Haseloff J, Beemster GTS, Bhalerao R, Bennett MJ. 2005.** Root gravitropism requires lateral root cap and epidermal cells for transport and response to a mobile auxin signal. *Nature cell biology* **7**(11): 1057-1065.
- Swarup R, Perry P, Hagenbeek D, Van Der Straeten D, Beemster GTS, Sandberg G, Bhalerao R, Ljung K, Bennett MJ. 2007.** Ethylene upregulates auxin biosynthesis in Arabidopsis seedlings to enhance inhibition of root cell elongation. *The Plant Cell* **19**(7): 2186-2196.
- Takahashi N, Goto N, Okada K, Takahashi H. 2002.** Hydrotropism in abscisic acid, wavy, and gravitropic mutants of Arabidopsis thaliana. *Planta* **216**(2): 203-211.

- Takahashi N, Yamazaki Y, Kobayashi A, Higashitani A, Takahashi H. 2003.** Hydrotropism interacts with gravitropism by degrading amyloplasts in seedling roots of *Arabidopsis* and radish. *Plant Physiology* **132**(2): 805-810.
- Takezawa D, Watanabe N, Ghosh TK, Saruhashi M, Suzuki A, Ishiyama K, Somemiya S, Kobayashi M, Sakata Y. 2015.** Epoxy-carotenoid-mediated synthesis of abscisic acid in *Physcomitrella patens* implicating conserved mechanisms for acclimation to hyperosmosis in embryophytes. *New Phytologist* **206**(1): 209-219.
- Tan BC, Joseph LM, Deng WT, Liu LJ, Li QB, Cline K, McCarty DR. 2003.** Molecular characterization of the *Arabidopsis* 9-cis epoxy-carotenoid dioxygenase gene family. *The Plant Journal* **35**(1): 44-56.
- Tanaka Y, Suzuki T, Yamashino T, Mizuno T. 2004.** Comparative studies of the AHP histidine-containing phosphotransmitters implicated in His-to-Asp phosphorelay in *Arabidopsis thaliana*. *Bioscience, biotechnology, and biochemistry* **68**(2): 462-465.
- Tester M, Langridge P. 2010.** Breeding technologies to increase crop production in a changing world. *Science* **327**(5967): 818-822.
- Thole JM, Beisner ER, Liu J, Venkova SV, Strader LC. 2014.** Abscisic Acid Regulates Root Elongation Through the Activities of Auxin and Ethylene in *Arabidopsis thaliana*. *G3-Genes Genomes Genetics* **4**(7): 1259-1274.
- Tiwari SB, Wang XJ, Hagen G, Guilfoyle TJ. 2001.** AUX/IAA proteins are active repressors, and their stability and activity are modulated by auxin. *The Plant Cell* **13**(12): 2809-2822.
- To JPC, Deruère J, Maxwell BB, Morris VF, Hutchison CE, Ferreira FJ, Schaller GE, Kieber JJ. 2007.** Cytokinin regulates type-A *Arabidopsis* response regulator activity and protein stability via two-component phosphorelay. *The Plant Cell* **19**(12): 3901-3914.
- To JPC, Kieber JJ. 2008.** Cytokinin signaling: two-components and more. *Trends in plant science* **13**(2): 85-92.
- Topping JF, Agyeman F, Henricot B, Lindsey K. 1994.** Identification of molecular markers of embryogenesis in *Arabidopsis thaliana* by promoter trapping. *The Plant Journal* **5**(6): 895-903.
- Topping JF, Lindsey K. 1997.** Promoter trap markers differentiate structural and positional components of polar development in *Arabidopsis*. *The Plant Cell* **9**(10): 1713-1725.
- Tran L-SP, Urao T, Qin F, Maruyama K, Kakimoto T, Shinozaki K, Yamaguchi-Shinozaki K. 2007.** Functional analysis of AHK1/ATHK1 and cytokinin receptor histidine kinases in response to abscisic acid, drought, and salt stress in *Arabidopsis*. *Proceedings of the National Academy of Sciences of the United States of America* **104**(51): 20623-20628.
- Ubeda-Tomas S, Federici F, Casimiro I, Beemster GTS, Bhalerao R, Swarup R, Doerner P, Haseloff J, Bennett MJ. 2009.** Gibberellin Signaling in the Endodermis Controls *Arabidopsis* Root Meristem Size. *Current Biology* **19**(14): 1194-1199.
- Ubeda-Tomás S, Swarup R, Coates J, Swarup K, Laplaze L, Beemster GTS, Hedden P, Bhalerao R, Bennett MJ. 2008.** Root growth in *Arabidopsis* requires gibberellin/DELLA signalling in the endodermis. *Nature Cell Biology* **10**(5): 625-628.
- Ueguchi C, Sato S, Kato T, Tabata S. 2001.** The AHK4 gene involved in the cytokinin-signaling pathway as a direct receptor molecule in *Arabidopsis thaliana*. *Plant and Cell Physiology* **42**(7): 751-755.
- Ueguchi-Tanaka M, Ashikari M, Nakajima M, Itoh H, Katoh E, Kobayashi M, Chow T-y, Yue-ie CH, Kitano H, Yamaguchi I. 2005.** GIBBERELLIN INSENSITIVE DWARF1 encodes a soluble receptor for gibberellin. *Nature* **437**(7059): 693-698.
- Ueguchi-Tanaka M, Nakajima M, Motoyuki A, Matsuoka M. 2007.** Gibberellin receptor and its role in gibberellin signaling in plants. *Annu. Rev. Plant Biol.* **58**: 183-198.

- Uga Y, Sugimoto K, Ogawa S, Rane J, Ishitani M, Hara N, Kitomi Y, Inukai Y, Ono K, Kanno N. 2013.** Control of root system architecture by DEEPER ROOTING 1 increases rice yield under drought conditions. *Nature Genetics* **45**(9): 1097-1102.
- Ulmasov T, Murfett J, Hagen G, Guilfoyle TJ. 1997.** Aux/IAA proteins repress expression of reporter genes containing natural and highly active synthetic auxin response elements. *The Plant Cell* **9**(11): 1963-1971.
- Uno Y, Furihata T, Abe H, Yoshida R, Shinozaki K, Yamaguchi-Shinozaki K. 2000.** Arabidopsis basic leucine zipper transcription factors involved in an abscisic acid-dependent signal transduction pathway under drought and high-salinity conditions. *Proceedings of the National Academy of Sciences* **97**(21): 11632-11637.
- Urao T, Yakubov B, Satoh R, Yamaguchi-Shinozaki K, Seki M, Hirayama T, Shinozaki K. 1999.** A transmembrane hybrid-type histidine kinase in arabidopsis functions as an osmosensor. *The Plant Cell* **11**(9): 1743-1754.
- Vaeck M, Reynaerts A, Höfte H, Jansens S, De Beuckeleer M, Dean C, Zabeau M, Montagu MV, Leemans J. 1987.** Transgenic plants protected from insect attack. *Nature* **328**: 33-37.
- Van den Berg C, Willemsen V, Hendriks G, Weisbeek P, Scheres B. 1997.** Short-range control of cell differentiation in the Arabidopsis root meristem. *Nature* **390**(6657): 287-289.
- van der Weele CM, Spollen WG, Sharp RE, Baskin TI. 2000.** Growth of Arabidopsis thaliana seedlings under water deficit studied by control of water potential in nutrient-agar media. *Journal of Experimental Botany* **51**(350): 1555-1562.
- van Esse GW, Harter K, De Vries SC. 2013.** Computational modelling of the BRI1 receptor system. *Plant Cell and Environment* **36**(9): 1728-1737.
- vandenBerg C, Willemsen V, Hendriks G, Weisbeek P, Scheres B. 1997.** Short-range control of cell differentiation in the Arabidopsis root meristem. *Nature* **390**(6657): 287-289.
- Vanneste S, Friml J. 2009.** Auxin: A Trigger for Change in Plant Development. *Cell* **136**(6): 1005-1016.
- Vanstraelen M, Benková E. 2012.** Hormonal interactions in the regulation of plant development. *Annual review of cell and developmental biology* **28**: 463-487.
- Verslues PE, Agarwal M, Katiyar-Agarwal S, Zhu J, Zhu JK. 2006.** Methods and concepts in quantifying resistance to drought, salt and freezing, abiotic stresses that affect plant water status. *The Plant Journal* **46**(6): 1092-1092.
- Verslues PE, Bray EA. 2006.** Role of abscisic acid (ABA) and Arabidopsis thaliana ABA-insensitive loci in low water potential-induced ABA and proline accumulation. *Journal of Experimental Botany* **57**(1): 201-212.
- Vieten A, Vanneste S, Wisniewska J, Benkova E, Benjamins R, Beeckman T, Luschnig C, Friml J. 2005.** Functional redundancy of PIN proteins is accompanied by auxin-independent cross-regulation of PIN expression. *Development* **132**(20): 4521-4531.
- Vilarrasa-Blasi J, González-García M-P, Frigola D, Fàbregas N, Alexiou KG, López-Bigas N, Rivas S, Jauneau A, Lohmann JU, Benfey PN. 2014.** Regulation of plant stem cell quiescence by a brassinosteroid signaling module. *Developmental cell* **30**(1): 36-47.
- Vogel JP, Woeste KE, Theologis A, Kieber JJ. 1998.** Recessive and dominant mutations in the ethylene biosynthetic gene ACS5 of Arabidopsis confer cytokinin insensitivity and ethylene overproduction, respectively. *Proceedings of the National Academy of Sciences of the United States of America* **95**(8): 4766-4771.
- Waadt R, Hitomi K, Nishimura N, Hitomi C, Adams SR, Getzoff ED, Schroeder JI. 2014.** FRET-based reporters for the direct visualization of abscisic acid concentration changes and distribution in Arabidopsis. *Elife* **3**: e01739.
- Wang L, Hua DP, He JN, Duan Y, Chen ZZ, Hong XH, Gong ZZ. 2011.** Auxin Response Factor2 (ARF2) and Its Regulated Homeodomain Gene HB33 Mediate Abscisic Acid Response in Arabidopsis. *Plos Genetics* **7**(7).

- Wang W, Hall AE, O'Malley R, Bleecker AB. 2003.** Canonical histidine kinase activity of the transmitter domain of the ETR1 ethylene receptor from Arabidopsis is not required for signal transmission. *Proceedings of the National Academy of Sciences* **100**(1): 352-357.
- Wang Y, Liu C, Li K, Sun F, Hu H, Li X, Zhao Y, Han C, Zhang W, Duan Y, Liu M. 2007.** Arabidopsis EIN2 modulates stress response through abscisic acid response pathway. *Plant Molecular Biology* **64**(6): 633-644.
- Wang Z-Y, Gehring C, Zhu J, Li F-M, Zhu J-K, Xiong L. 2015.** The Arabidopsis Vacuolar Sorting Receptor1 Is Required for Osmotic Stress-Induced Abscisic Acid Biosynthesis. *Plant Physiology* **167**(1): 137-152.
- Wang Z-Y, Seto H, Fujioka S, Yoshida S, Chory J. 2001.** BRI1 is a critical component of a plasma-membrane receptor for plant steroids. *Nature* **410**(6826): 380-383.
- Wen X, Zhang C, Ji Y, Zhao Q, He W, An F, Jiang L, Guo H. 2012.** Activation of ethylene signaling is mediated by nuclear translocation of the cleaved EIN2 carboxyl terminus. *Cell research* **22**(11): 1613.
- Werner T, Motyka V, Strnad M, Schmülling T. 2001.** Regulation of plant growth by cytokinin. *Proceedings of the National Academy of Sciences* **98**(18): 10487-10492.
- Werner T, Nehnevajova E, Kollmer I, Novak O, Strnad M, Kramer U, Schmülling T. 2010.** Root-Specific Reduction of Cytokinin Causes Enhanced Root Growth, Drought Tolerance, and Leaf Mineral Enrichment in Arabidopsis and Tobacco. *The Plant Cell* **22**(12): 3905-3920.
- Whalley HJ, Sargeant AW, Steele JFC, Lacoere T, Lamb R, Saunders NJ, Knight H, Knight MR. 2011.** Transcriptomic analysis reveals calcium regulation of specific promoter motifs in Arabidopsis. *The Plant Cell* **23**(11): 4079-4095.
- Whalley WR, Leeds-Harrison PB, Clark LJ, Gowing DJG. 2005.** Use of effective stress to predict the penetrometer resistance of unsaturated agricultural soils. *Soil & Tillage Research* **84**(1): 18-27.
- Wisniewska J, Xu J, Seifertova D, Brewer PB, Ruzicka K, Blilou I, Rouquie D, Benkova E, Scheres B, Friml J. 2006.** Polar PIN localization directs auxin flow in plants. *Science* **312**(5775): 883-883.
- Wohlbach DJ, Quirino BF, Sussman MR. 2008.** Analysis of the Arabidopsis histidine kinase ATHK1 reveals a connection between vegetative osmotic stress sensing and seed maturation. *The Plant Cell* **20**(4): 1101-1117.
- Wright STC, Hiron RWP. 1969.** (+)-Abscisic acid, growth inhibitor induced in detached wheat leaves by a period of wilting. *Nature* **224**(5220): 719.
- Xu J, Scheres B. 2005.** Dissection of Arabidopsis ADP-RIBOSYLATION FACTOR 1 function in epidermal cell polarity. *The Plant Cell* **17**(2): 525-536.
- Xu W, Jia L, Shi W, Liang J, Zhou F, Li Q, Zhang J. 2013.** Abscisic acid accumulation modulates auxin transport in the root tip to enhance proton secretion for maintaining root growth under moderate water stress. *New Phytologist* **197**(1): 139-150.
- Yamada H, Suzuki T, Terada K, Takei K, Ishikawa K, Miwa K, Yamashino T, Mizuno T. 2001.** The Arabidopsis AHK4 histidine kinase is a cytokinin-binding receptor that transduces cytokinin signals across the membrane. *Plant and Cell Physiology* **42**(9): 1017-1023.
- Yang L, Zhang J, He J, Qin Y, Hua D, Duan Y, Chen Z, Gong Z. 2014.** ABA-Mediated ROS in Mitochondria Regulate Root Meristem Activity by Controlling PLETHORA Expression in Arabidopsis. *Plos Genetics* **10**(12).
- Yang Y, Hammes UZ, Taylor CG, Schachtman DP, Nielsen E. 2006.** High-affinity auxin transport by the AUX1 influx carrier protein. *Current Biology* **16**(11): 1123-1127.
- Yoshida R, Umezawa T, Mizoguchi T, Takahashi S, Takahashi F, Shinozaki K. 2006.** The regulatory domain of SRK2E/OST1/SnRK2. 6 interacts with ABI1 and integrates abscisic acid (ABA) and osmotic stress signals controlling stomatal closure in Arabidopsis. *Journal of Biological Chemistry* **281**(8): 5310-5318.
- Yoshida T, Fujita Y, Maruyama K, Mogami J, Todaka D, Shinozaki K, Yamaguchi-Shinozaki K. 2015.** Four Arabidopsis AREB/ABF transcription factors function

- predominantly in gene expression downstream of SnRK2 kinases in abscisic acid signalling in response to osmotic stress. *Plant, cell & environment* **38**(1): 35-49.
- Yuan F, Yang H, Xue Y, Kong D, Ye R, Li C, Zhang J, Theprungsirikul L, Shrift T, Krichilsky B, Johnson DM, Swift GB, He Y, Siedow JN, Pei Z-M. 2014.** OSCA1 mediates osmotic-stress-evoked Ca²⁺ increases vital for osmosensing in Arabidopsis. *Nature* **514**(7522): 367-371.
- Zhang H, Han W, De Smet I, Talboys P, Loya R, Hassan A, Rong H, Juergens G, Knox JP, Wang M-H. 2010.** ABA promotes quiescence of the quiescent centre and suppresses stem cell differentiation in the Arabidopsis primary root meristem. *The Plant Journal* **64**(5): 764-774.
- Zhang J, Davies WJ. 1987.** Increased synthesis of ABA in partially dehydrated root-tips and ABA transport from roots to leaves. *Journal of Experimental Botany* **38**(197): 2015-2023.
- Zhang W, Swarup R, Bennett M, Schaller GE, Kieber JJ. 2013.** Cytokinin induces cell division in the quiescent center of the Arabidopsis root apical meristem. *Current Biology* **23**(20): 1979-1989.

11 Appendices

11.1. Primers used for qPCR

Gene	Primer sequences 5'-3'	Tm (°C)	Notes
<i>AT5G15710</i>	CTCTTTCGCCTCTTGGTTTG TCCTTCCCACGAGAAAACAAT	57.3 55.3	Housekeeping gene, selected due to stability in roots/under hormones/under abiotic stress (Czechowski <i>et al.</i> , 2005)
<i>RD29B</i>	GGG GAA AGG ACA TGG TGA GG GGT TTA CCA CCG AGC CAA GA	60.03 59.96	ABA -dependent drought responsive gene.
<i>DREB2B</i>	CCC ATC AGA GCC AAG ACC AA GGA CCA TTG CCT CAG AAC TC	59.67 58.26	ABA -independent, drought responsive gene, a TF which is expressed early, primer works well for qPCR with touchdown
<i>ARR5</i>	TGT CCT GAT TCT TTC GGC TT ACC CAT CTT TGT CAC TCT TGA	57.14 56.85	Consistently produces a band but with primer dimers
<i>PIN4</i>	CGGCAACAACGGAACACATA CGGTAAGCAACAAGAGCCCA	59.13 60.61	Auxin efflux carrier
<i>PIN2</i>	AATGCTGGTTGCTTTGCCTG CCTTTGGGTCGTATCGCCTT	59.97 60.11	Auxin efflux carrier
<i>PIN1</i>	TCGTTGCTTCTTATGCCGTT AGAAGAGTTATGGCAACGC	58.20 58.26	Auxin efflux carrier
<i>AUX1</i>	TCTCTCGCTCACATGCTCAC CGTCCAGCTCGGCATAAAGA	59.83 60.18	Auxin influx carrier
<i>ERF1</i>	GGTATTAGGGTTTGGCTCGG CCGAAAGCGACTCTTGAAC	58.04 58.22	Ethylene responsive gene
<i>PLS</i>	AGA CTT GTT GTG GTG ATG TT ACA TGG AGA AAT GGA CCT TC	55.10 55.02	Ethylene signalling component
<i>ACT2</i>	GGA TCG GTG GTT CCA TTC TTGC AGA GTT TGT CAC ACA CAA GTG CA	56.00 55.21	Used to verify samples were free of genomic DNA contamination. Produces a 256bp cDNA band and a 342bp genomic band

Table 11-1 Primers used for qPCR analysis of gene expression**11.2. Experimental datasets used for transcriptomic analysis**

Chemical
AgNO ₃ / mock treated seedlings
TIBA / mock treated seedlings
Hormone
ABA study 12 (Col-0) / solvent treated seedling samples (Col-0)
ABA study 5 (Col-0) / untreated plant samples (Col-0)
ABA study 6 (Col-0) / untreated plant samples (Col-0)
ACC (1h) / mock treated seedlings (1h)
ACC (30min) / mock treated seedlings (30min)
ACC (3h) / mock treated seedlings (3h)

IAA / FACS (E3754) / root xylem pole pericycle protoplast samples of mock treated E3754
IAA / FACS (PET111::GFP) / root cap columella protoplast samples of mock treated PET111::GFP
IAA / FACS (pWER::GFP) / root epidermis and lateral root cap protoplast samples of mock treated pWER::GFP
IAA / FACS (pWOL::GFP) / root stele protoplast samples of mock treated pWOL::GFP
IAA study 10 (0h) / mock treated root samples (0h)
IAA study 10 (12h) / mock treated root samples (12h)
IAA study 10 (24h) / mock treated root samples (24h)
IAA study 10 (2h) / mock treated root samples (2h)
IAA study 10 (4h) / mock treated root samples (4h)
IAA study 10 (8h) / mock treated root samples (8h)
IAA study 11 (3h) / mock treated root samples (3h)
IAA study 3 / solvent treated seedlings
IAA study 7 (C24) / untreated seedling samples (C24)
IAA study 7 (Col-0) / untreated seedling samples (Col-0)
IAA study 8 (C24) / untreated seedling samples (C24)
IAA study 8 (Col-0) / untreated seedling samples (Col-0)
IAA study 9 (C24) / untreated seedling samples (C24)
IAA study 9 (Col-0) / untreated seedling samples (Col-0)
zeatin (1h) / mock treated seedlings (1h)
zeatin (30min) / mock treated seedlings (30min)
zeatin (3h) / mock treated seedlings (3h)
zeatin study 3 (Col-0) / untreated whole plant samples (Col-0)
Stress
drought study 11 (Col-0) / mock treated seedling samples (Col-0)
osmotic study 2 (early) / untreated root samples (early)
osmotic study 2 (late) / untreated root samples (late)
osmotic study 4 (root) / mock treated Col-0 root samples
Genetic Background
C24

C24 / Col-0
C24 / Col-0
C24 / Col-0

Table 11-2 Experimental data sets used for transcriptomic analysis in Genevestigator

11.3. CK responsive genes

CK responsive gene selection	
Gene symbol	Accession No.
<i>ARR4,ATRR1,IBC7,MEE7</i>	AT1G10470
<i>ASL9,LBD3</i>	AT1G16530
<i>ARR7</i>	AT1G19050
<i>ARR15</i>	AT1G74890
<i>ARR16,RR16</i>	AT2G40670
<i>ARR5,ATRR2,IBC6,RR5</i>	AT3G48100
<i>ATRR4,ARR9</i>	AT3G57040
<i>CKX4,ATCKX4</i>	AT4G29740
<i>ARR6</i>	AT5G62920
<i>ATST4B,ST4B</i>	AT1G13420
<i>CYP735A2</i>	AT1G67110
<i>ANN3,ANNAT3</i>	AT2G38760
	AT2G40230
<i>ARR8,ATRR3,RR3</i>	AT2G41310
<i>CRF5</i>	AT2G46310
<i>ARR3</i>	AT1G59940
<i>AHK4,ATCRE1,CRE1,WOL,WOL1</i>	AT2G01830
	AT2G30540
<i>ANNAT4</i>	AT2G38750

Table 11-3 CK responsive gene selection used as a transcriptomic indicator of CK response

11.4. Auxin responsive genes

Gene symbol	Accession No.
<i>ATAUX2-27,AUX2-27,IAA5</i>	AT1G15580
<i>IAA19,MSG2</i>	AT3G15540
<i>ASL16,LBD29</i>	AT3G58190
<i>MAKR4</i>	AT2G39370
<i>ASL18,LBD16</i>	AT2G42430
<i>IAA29</i>	AT4G32280
<i>CKX6,ATCKX6,ATCKX7</i>	AT3G63440

Table 11-4 Auxin responsive gene selection used as a transcriptomic indicator of auxin response

11.5. ABA responsive gene expression

ABA responsive gene expression	
Gene symbol	Accession No.
<i>ATCOR413-PM1,ATCYP19,COR413-PM1,FL3-5A3,WCOR413,WCOR413-LIKE</i>	AT2G15970
<i>ANAC072,RD26</i>	AT4G27410

<i>ABI1,AtABI1</i>	AT4G26080
<i>KIN2,KIN1,AtCor6.6,COR6.6</i>	AT5G15970,AT5G15960
<i>APK2A,Kin1,PBL2</i>	AT1G14370
<i>ANAC029,ATNAP,NAP</i>	AT1G69490
<i>RHL41,ZAT12</i>	AT5G59820
<i>ATBCB,BCB,SAG14</i>	AT5G20230
<i>ATCAD5,CAD-5,CAD5</i>	AT4G34230
	AT1G73480
<i>GDH2</i>	AT5G07440
<i>ANAC002,ATAF1</i>	AT1G01720
<i>EXL2</i>	AT5G64260
<i>ACX1,ATACX1</i>	AT4G16760
<i>ATABCG25,ABCG25</i>	AT1G71960
<i>NAC102,ANAC102</i>	AT5G63790
	AT1G78070
<i>EXL4</i>	AT5G09440
	AT3G11420
	AT3G15670

Table 11-5 ABA responsive gene selection used as a transcriptomic indicator of ABA response

11.6. ACC Biosynthetic gene selection

ACS genes	
Gene symbol	Accession No.
<i>ACS1,ACS3,AT-ACS1</i>	AT3G61510,AT5G28360
<i>CIN5,ACS5,ATACS5,ETO2</i>	AT5G65800
<i>AtACS9,ETO3,ACS9</i>	AT3G49700
<i>ACS8</i>	AT4G37770
<i>ACS7,ATACS7</i>	AT4G26200
<i>ACS6,ATACS6</i>	AT4G11280
<i>ACS11</i>	AT4G08040
<i>ACS2,AT-ACC2</i>	AT1G01480
<i>ACC4,ACS4,ATACS4</i>	AT2G22810

Table 11-6 ACC Synthase genes used as a transcriptomic indicator of ethylene biosynthesis

11.7. Model parameters for first PIN1 model

11.7.1. Global parameters

Osmotic ref=-0.15

$$\text{Osmotic ratio} = \frac{\text{Osmotic stress} \cdot \text{osmotic ref}}{\text{osmotic ratio}}$$

OsmoticET coefficient =1

OsmoticABA coefficient=1

OsmoticET= OsmoticET coefficient · Osmotic ratio

OsmoticABA= OsmoticABA coefficient · Osmotic ratio

Reaction label	Description	Reaction scheme	Rate law	Parameters
R1	Exogenous ACC to endogenous ET	ACC -> ET	$V \cdot \frac{[ACC]}{km + [ACC]}$	km=5 μM V=0.005 μM/s
R2	Exogenous ABA to endogenous ABA	ABAex -> ABA	$V \cdot \frac{[ABAex]}{km + [ABAex]}$	km=5 μM V=0.01 μM/s
R3	ET biosynthesis	-> ET	$\frac{k1 \cdot [ABA] \cdot (1 + osmotic_{ET})}{1 + \frac{[ABA]}{k2}}$	k1=0.08 1/s k2=100 μM
R4	ABA biosynthesis	-> ABA	$\frac{k1 \cdot (1 + osmotic_{ABA})}{1 + \frac{[ET]}{k2}}$	k1=0.001 μM /s k2=0.01 μM
R5	ET degradation	ET ->	$k1 \cdot ET$	k1=1 1/s
R6	ABA degradation	ABA ->	$k1 \cdot ABA$	k1=1 1/s
R7	Y production	-> Y	$\frac{k1 \cdot \frac{[ET]}{k2}}{1 + \frac{[ET]}{k2} + \frac{[ET]^2}{k3}}$	k1=0.2 μM/s k2=0.1 μM k3=5e-8 μM ²
R8	Y degradation	Y ->	$k1 \cdot Y$	k1=0.01 1/s
R9	Y* production	Y -> Y*	$\frac{\frac{k1 \cdot \frac{[Y]}{k2}}{1 + \frac{[ABA]}{k3}}}{\frac{1}{1 + [ABA]} + \frac{[Y]}{k2}}}$	k1=1 μM /s k2=1 μM k3=1e-6 μmol/l
R10	Y* degradation	YYs* ->	$k1 \cdot Y^*$	k1=0.5 1/s
R11	PIN1 degradation	PIN1 ->	$k1 \cdot PIN1$	k1=0.01 1/s
R12	Y* regulated PIN1 production	-> PIN1	$k1 \cdot \frac{Y^*}{1 + \frac{Y^*}{k2}}$	k1=3 1/s k2=0.1 μM
R13	ET regulated PIN1 production (independent of ABA)	-> PIN1	$\frac{k1 \cdot \frac{[ET]}{k2}}{1 + \frac{[ET]}{k2} + \frac{[ET]^2}{k3}}$	k1=0.001 1/s k2=0.001 μM k3=1e-7 μM ²
R14	ABA regulated PIN1 production (independent of ET)	-> PIN1	$\frac{k1}{1 + \frac{[ABA]}{k2}}$	k1=0.005 μM/s k2=0.01 μM

Table 11-7 Parameters for the model for ABA to override the effects of ET on PIN1 levels

11.8. Model parameters for alternative PIN1 model

11.8.1. Global parameters

Osmotic ref=-0.15

$$\text{Osmotic ratio} = \frac{\text{Osmotic stress} \cdot \text{osmotic ref}}{\text{osmotic ratio}}$$

OsmoticET coefficient =1

OsmoticABA coefficient=1

OsmoticET= OsmoticET coefficient · Osmotic ratio

OsmoticABA= OsmoticABA coefficient · Osmotic ratio

Reaction label	Description	Reaction scheme	Rate law	Parameters
R1	Exogenous ACC to endogenous ET	ACC -> ET	$V \cdot \frac{[ACC]}{k_m + [ACC]}$	km=5 μM V=0.005 μM/s
R2	Exogenous ABA to endogenous ABA	ABAex -> ABA	$V \cdot \frac{[ABAex]}{k_m + [ABAex]}$	km=5 μM V=0.01 μM/s
R3	ET biosynthesis	-> ET	$\frac{k_1 \cdot [ABA] \cdot (1 + osmotic_{ET})}{1 + \frac{[ABA]}{k_2}}$	k1=0.08 1/s k2=100 μM
R4	ABA biosynthesis	-> ABA	$\frac{k_1 \cdot (1 + osmotic_{ABA})}{1 + \frac{[ET]}{k_2}}$	k1=0.001 μM /s k2=0.01 μM
R5	ET degradation	ET ->	$k_1 \cdot ET$	k1=1 1/s
R6	ABA degradation	ABA ->	$k_1 \cdot ABA$	k1=1 1/s
R11	PIN1 degradation	PIN1 ->	$k_1 \cdot PIN1$	k1=0.01 1/s
R13	ET regulated PIN1 production (independent of ABA)	-> PIN1	$\frac{k_1 \cdot \frac{[ET]}{k_2}}{1 + \frac{[ET]}{k_2} + \frac{[ET]^2}{k_3}}$	k1=0.001 1/s k2=0.0002 μM k3=5e-8 μM ²
R14	ABA regulated PIN1 production (independent of ET)	-> PIN1	$\frac{k_1}{1 + \frac{[ABA]}{k_2}}$	k1=0.1 μM/s k2=0.001 μM

Table 11-8 Parameters for the alternative model for ABA to override the effect of ET on PIN1 levels