



Title	Strategy to diagnose ultra-lean ($\phi < 0.6$) premixed flames by acetone-OH simultaneous PLIF with one-laser and one-detector combination
Author(s)	Nakamura, Yuji; Yamada, Yuichiro; Hirota, Mitsutomo; Saito, Tsutomu
Citation	Journal of Visualization, 14(1), 75-84 https://doi.org/10.1007/s12650-010-0066-6
Issue Date	2011-02
Doc URL	http://hdl.handle.net/2115/48168
Rights	The original publication is available at www.springerlink.com
Type	article (author version)
File Information	JoV14-1_75-84.pdf



[Instructions for use](#)

Strategy to Diagnose Ultra-lean ($\phi < 0.6$) Premixed Flames by Acetone-OH Simultaneous PLIF with One-laser and One- detector Combination

Nakamura, Yuji*¹, Yamada, Yuichiro*¹, Hirota, Mitsutomo*², and Saito, Tsutomu*²

**1 Division of Mechanical and Space Engineering, Hokkaido University, N 13 W 8, Kita-ku, Sapporo 060-8628, Japan*

Phone: +81-11-706-6386 (YN) // +81-11-706-6389 (YY)

Fax: +81-11-706-6386 (YN) // N/A (YY)

E-mail: yuji-mg@eng.hokudai.ac.jp (YN) // yama-rabbi@mech-hm.eng.hokudai.ac.jp (YY)

URL: <http://york-me.eng.hokudai.ac.jp/~yuji> (YN)

**2 Department of Mechanical, Aerospace, and Materials Engineering, Muroran Institute of Technology, 27-1 Mizumoto-cho, Muroran 050-8585, Japan*

Phone: +81-143-46-5367 (MH) // +81-143-46-5354 (TS)

E-mail: hirota@mmm.muroran-it.ac.jp (MH) // saito@mmm.muroran-it.ac.jp (TS)

ABSTRACT: A strategy to diagnose ultra-lean flames utilizing the “acetone-OH simultaneous PLIF” concept via a one-laser and one-detector combination system is presented. The main of the present work is to overcome difficulties encountered in our previous studies; namely, that the seeding amount of acetone used for visualization purposes must be sufficiently small in order to avoid its effect on flame structure (at least $< 5\%$ of fuel), while clear imaging also must be accomplished under such conditions. For this purpose, several important revisions have been made; 1) the 266 nm excitation line has been added to improve the fluorescence from acetone, 2) a dual-peak band-pass filter has been introduced instead of conventional blue filter and 3) controllability of fine acetone seeding has been improved. The effects of these changes on flame imaging are also investigated. Clear visualization of the flame zone of a very lean premixed flame, of which the limiting equivalence ratio is below 0.6, has been successfully achieved for the first time with one-laser and one-detector system. The time-dependent, near-extinction flame

behavior is also clearly imaged, suggesting that this method could utilize to investigate the flame extinction study.

Keywords : *Flame imaging, PLIF, Acetone, OH, Ultra-lean combustion*

1. Introduction

Ultra-lean combustion is one of the key technologies needed to achieve both low emissions and energy savings simultaneously. Because nearly 80 % of energy conversion (both chemical and thermal) is accomplished through combustion (Hayashi et al., 2000), further development of ultra-lean combustion technologies could deliver huge improvement in overall energy conversion efficiencies. However, lean combustion is inherently unstable; e.g., extinction frequently occurs, inducing acoustic instabilities and combustion noise that are capable of causing severe damage to combustors. To avoid such catastrophic scenarios, active control of combustion systems is a necessary task. For this purpose, development of visualization techniques for ultra-lean combustion, capable of assessing the local extinction process, is a crucial demand (Kohse-Hoinghaus, 2005).

To date, CH-PLIF (Planar Laser-induced Fluorescence) has been widely used for flame diagnostics since CH (or CHO) is known as the best “marker” of the thin reaction zone, corresponding to a narrow heat release zone, in hydrocarbon flames (Allen et al, 1986, Chen and Mansour, 1997, Gibaud et al., 2005, Vagelopoulos et al, 2005, Kiefer et al., 2009). However, this scheme is not the most promising in all conditions, especially near extinction conditions. For example, fluorescence signals via CH-PLIF or CHO-PLIF decrease dramatically when the mixture becomes leaner. This is due to the lack of the targeted species produced and it is true that the detection becomes extremely difficult when the equivalence ratio, ϕ , is below 0.65 (e.g., Tanahashi et al. 2002, Vagelopoulos et al, 2005). In order to overcome this difficulty, one innovative scheme was proposed by Li et al in 2007. They applied an “Alexandrite laser”, instead of a more conventionally-used YAG-Dye laser, in order to pump *multiple* state of CH simultaneously to intensify the fluorescence signal (Li et al., 2007). This is recognized as the first ever work to obtain CH image of very-lean flames ($\phi \sim 0.6$ or greater) with a high signal-to-noise ratio (S/N). Although their progress is remarkable, no other groups have followed so far. This could be because their proposed diagnostic system is quite costly thus is hardly applied to practical use.

On the other hand, authors have proposed a completely different approach to diagnose the premixed flame structure based on the “acetone-OH simultaneous PLIF concept” since 2005 (Nakamura et al., 2005, 2006, 2008, Manome et al., 2007). By this scheme, “unburnt” and “burnt” zones were simultaneously visualized via acetone seeded into fuel flow and OH generated by combustion, respectively, then, the flame zone was “indirectly” tracked by being sandwiched between them (see Fig.1; referred from Nakamura et al. 2008). The visualized zone corresponds to the preheat region so that the local flame structure could be readily known by this scheme. A highlight of this scheme is its ease of visibility even with a simplified diagnostic system; since the produced amount of OH is several orders of magnitude higher than that of CH, the observable zone (sandwiched by the acetone and OH fluorescence regimes) is easily and clearly detectable even near the extinction point. In this way, this scheme has an inherent capability to examine ultra-lean ($\phi < 0.6$) flames. Although there have been several studies that applied acetone-OH simultaneous PLIF to combustion studies (e.g., Seitzman et al., 1994, Yip et al., 1994, Tamura et al., 1998, 2000, and Sick & Wermuth, 2004; note that most past works applied to non-premixed flames), Nakamura et al., was the first to apply this concept to look for the *local flame structure* in laminar/turbulent *premixed* flames and successfully achieved clear imaging of local flamelet thickness and curvature (Nakamura et al. 2005). For demonstrative purpose, local extinction occurring under an ultra-lean mixture condition ($\phi < 0.6$) in a weakly-disturbed flow field has successfully captured by this scheme (Nakamura et al. 2006). To achieve clear imaging, it was pointed out that the selection of appropriate transmittance character of band-pass filters should be crucially important (Nakamura et al. 2008). Although this scheme brings us closer toward work on extinction studies of flames, one existing ambiguity is unresolved; namely, the possibility of modified combustion character due to the seeded-acetone. In our previous study, the amount of seeded acetone was set to be relatively large in order to obtain clear images. For example, a

fraction of almost 10 % acetone to original fuel (methane) was seeded for near-stoichiometric flames and an even greater amount (> 20 %) for lean flames. Although it has been revealed that the amount of acetone seeding had a minor effect on the burning velocity defined as methane/acetone/air mixture (Nakamura et al. 2008), the local flame structure may alter under near-extinction flame conditions, where it is believed that chemical effects may play a significant role. Although it has not been previously reported, during the experiment it was observed that the peak OH signal could be slightly varied depending on the amount of seeded acetone (> 10%, as mentioned earlier). Indeed, Degardin et al. revealed that additions of over 5 % of acetone in the mixture could alter the main flame character (Degardin et al., 2006). Because their paper deals with ultra-lean conditions ($\phi \sim 0.5$), this critical number (5 %) could be used as a reference criterion in our study as well. To this end, a reduction of seeding acetone needed to be seriously considered in order to apply the present scheme to diagnose ultra-lean flames.

In this study, the existing measurement system has been “tuned” (without any change in hardware) to overcome the above-mentioned difficulties that enable us to diagnose ultra-lean ($\phi < 0.6$) flames with high S/N, which never been done so far. Here, “no change made in hardware” means that we hold a one-laser and one-detector combination as the main system. Three major modifications are made in order to attain the objectives; introducing 1) an additional excitation line, 2) a specially-designed filter, and 3) a fine-control acetone seeder. The effectiveness of each modification on the clarity of imaging ultra-lean flames is discussed as well as usefulness of the present scheme for ultra-lean flame diagnostics, which is confirmed.

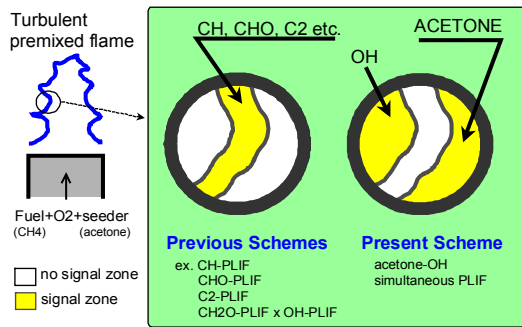

Fig.1 Schematic illustration of method to visualize the flame zone [referred from Nakamura et al. 2008]

2. Experiment

In order to satisfy the above-mentioned requirements, three major revisions were made: 1) revision in laser system, 2) revision in detector system, and 3) revision in the acetone seeding method. In this section, details of each item are shown consecutively.

2.1 Add 266 nm to Support Acetone Fluorescence

First of all, it is essential to note the contradiction that must be managed; a *high S/N* must be maintained while *reducing* the amount of acetone seeding. In this regard, increasing the fluorescence signal with a small amount of seeded acetone is an essential task. One possible candidate is intensification of the pumping power. To do so, an additional excitation line (266 nm), which has not been considered in the previous study, is introduced into the revised system. This line is added to excite acetone “selectively”, without any excitation of OH since OH does not have an absorption band around it. It is important to note that this change in pumping laser can be achieved by modification of laser optics alone, without changing any hardware. In this sense, conventional OH-PLIF hardware could be used as before. A schematic illustration of the “revised” laser system used in this study is shown in Fig.2, alongside the previous system for comparison purposes.

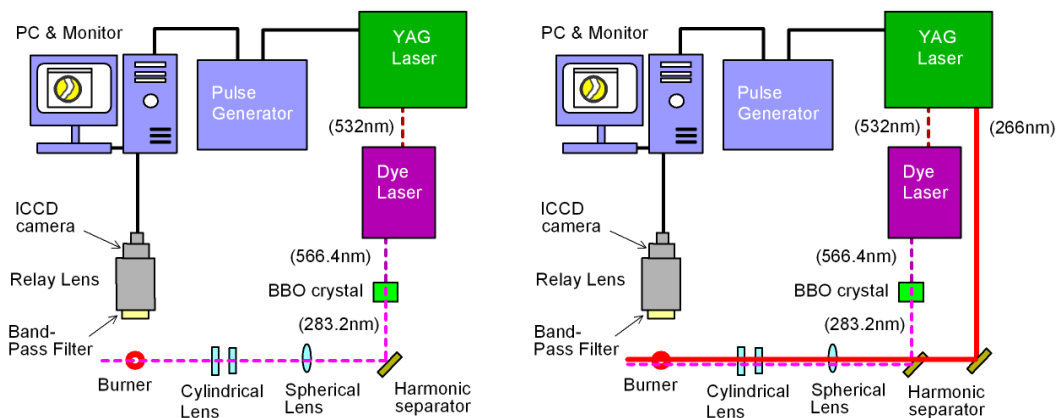

Fig.2 Schematics of applied laser systems (left: previous system, right: modified/turned system)

The laser system consists of a combination of an Nd:YAG (LS-2137, Lotis TII), producing 700 mJ pulses at 1024 nm with a repetition rate of 10 Hz, and a Dye laser (PDL-3, Spectra Physics Inc.). The pulse length is typically 5 ns in normal Q-switched operation. The infrared radiation of 1024 nm is first frequency doubled to 532 nm by second harmonics crystal, then divided into two paths by beam splitter. The one is converted to 266 nm line by fourth harmonics crystal and the other supplies into the Dye laser served as the pumping source. In the Dye laser, the 532 nm line turns into a 566.4 nm line with rhodamine 6G, then it is eventually converted into 283.22 nm line (hereafter, simply states as 283 nm line) via a BBO crystal. This corresponds to an OH absorption line of $A^2\Sigma^+ \leftarrow X^2\Pi$ transition ((1,0) band of $Q_1(7)$). Two excitation lines, 283 nm and 266 nm, are then combined and transformed into a thin sheet by lens system as shown in Fig.2. The laser power measured at the flame position is approximately 1- 3 mJ for 283 nm line and 100 mJ for 266 nm line.

It can be estimated how much this additional line enhances acetone excitation. According to Thurber et al., the absorption capability of 283 nm line by acetone is less than double that of 266 nm line within the interested temperature range (from 300 K up to decomposition temperature) (Thurber et al., 1998). Considering the fact that the power of 266 nm excitation line is roughly 30 times stronger than that of the 283 nm line in the present system, we could expect a power at least 15 times stronger to excite acetone as compared with previous studies. In other words, the amount of seeding acetone could be reduced to at least 6.7 % (1/15th) of the amount used in previous studies. This enables us to meet the first requirement of the new system, that acetone must be less than 5 % of fuel. Incidentally, if one wishes to achieve the same pumping power without any additional 266 nm line input, as proposed here, at least 15 times higher power (~ 45 mJ) is required at 283nm line. Although this is not impossible, this is obviously quite difficult to obtain via a conventional YAG-Dye laser (at least you need high-powered pumping laser).

2.2 Installation of a “Designed” Dual-peak Band-pass Filter

Although OH is produced in relatively high quantity in the combustion field, it could be reduced eventually in an ultra-lean flame at near-extinction conditions. To this end, we must collect the fluorescence signal of OH in an efficient manner. Previously, we used a commercially-available blue filter (Schott BG-12) which enabled us to provide clear flame image over a wide range of mixture conditions (Nakamura et al. 2008). However, BG-12 shows poor transmittance performance in the OH fluorescence regime (300-320nm, as an average, it is less than 5 %) and it is difficult to provide clear imaging in OH at near extinction conditions. Therefore, we introduce a *specially-designed* filter with two peaks of its transmittance spectra as shown in Fig.3; one sharp peak corresponds to the center of the OH fluorescence range (~ 308 nm), and the other is a rather broadened one that covers the entire acetone fluorescence range (350 nm ~ 500 nm). In Fig.3, for comparison purposes, the spectral transmittance curve of the previous filter (BG-12) is also shown. With this new filter, transmittance in OH fluorescence range is dramatically improved because it has more than 50 % (average) transmittance, at least a 10-fold improvement could be expected. In this sense, the much weaker OH signal can be visualized properly, which could not be accomplished by the previous system.

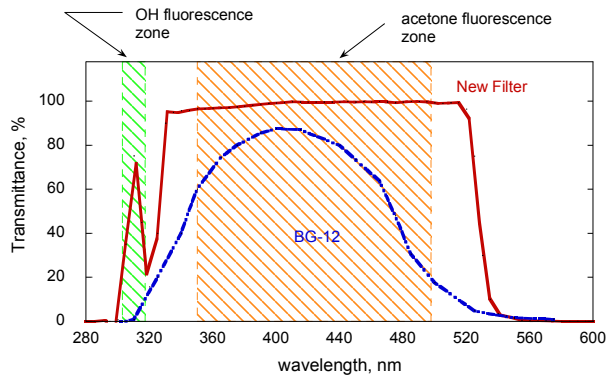

Fig.3 Transmittance spectra of the previously adopted filter (BG-12, blue) and the newly adopted filter (New Filter, red)

2.3 Acetone-Seeder: Fine Control of Acetone-seeding Amount

Since the required amount of acetone in the present system is much less than our previous studies, as pointed out in the previous section, the controllability of the amount of seeding acetone must be improved. The previously-used “bubbling” procedure resulted in too much acetone vaporization and could not be used for the present purpose. Therefore, the acetone seeder was redesigned to meet this requirement by using “JP-patent #2008-286438,” with permission granted by Hirota et al. (Hirota et al., 2008). The concept of this seeder is simple yet effective. Unlike the bubbling procedure, it is designed to generate a “sweep” flow over the surface of the acetone pool, *gently* enhancing the mass transfer, i.e., vaporization of acetone. Temperature control of the acetone pool is accomplished through a constant-thermal bath surrounding the acetone pool. The amount of acetone-seeding is controlled by modifying the volume flow rate introducing into the seeder. A fine needle valve is used for this purpose. A calibration curve of the amount of seeded acetone as a function of the revolution of the needle valve is shown in Fig.4 (the total volume flow rate introduced into acetone seeder was 1.57 ml/s). The gas flow and valve location is also indicated in the figure. Although the curve is somewhat similar to a hyperbolic-tangent function, it is important to note that linearity during the middle range of the valve rotation is established.

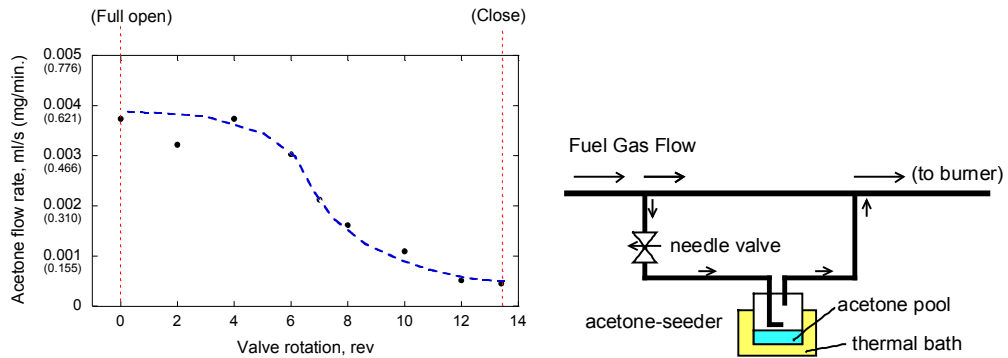

Fig.4 (left) Calibration curve of the amount of seeded acetone vs. revolution of the control valve. (right) gas line around the acetone seeder

The amount of acetone that is actually seeded into the fuel flow by using this new seeding device can also be estimated. The target object can be assumed to be a mixture of methane and air with a mixture ratio of $\phi = 0.5$, which is just below the flammability limit. In this mixture, the percentage of methane corresponds to 4.7 % of the total flow volume. In order to reduce the amount of acetone seeding so that it is less than 5 % of the total fuel volume, the corresponding percentage of acetone is approximately 0.24 % of the total volume. Under the calibration test condition, 0.25 % of acetone volume flow rate is obtained under a “full-open” condition and can be reduced to as low as one-fifth (i.e., 0.05 % of volume flow rate) by controlling the valve opening, shown in Fig.4. It is therefore reasonable that the present acetone-seeding device is more than capable of providing the target condition described above.

2.4 Test Flames and Conditions

A slot burner is used to generate a test flame for the present study, shown in Fig.5. At the burner exit, nickel-chrome wires are instrumented, equipped to sustain the ultra-lean premixed flame without blow-off. The flame holder system can be easily detached/attached and is activated only one an ultra-lean flame is employed. The total flow rate is varied up to $160.3 \text{ cm}^3/\text{s}$, corresponding to an average flow velocity of up to 50 cm/s . The equivalence ratio of the mixture is $\phi > 0.55$ for the lean flame cases, whereas it is $\phi = 2.16$ for the rich flame case. The methane-air mixture described earlier is used alongside a small amount of seeded acetone ($< 5\%$ of acetone in the mixture) for visualization purposes. Note that the equivalence ratio is calculated from the complete fuel-acetone-air mixture, not just the methane-air mixture, throughout the study. The imaging range of the PLIF and chemi-luminescence shown in this study is 14.5 mm square. Note that the amount of seeded acetone is limited to, at most 5% , of total fuel volume for all PLIF images appearing here.

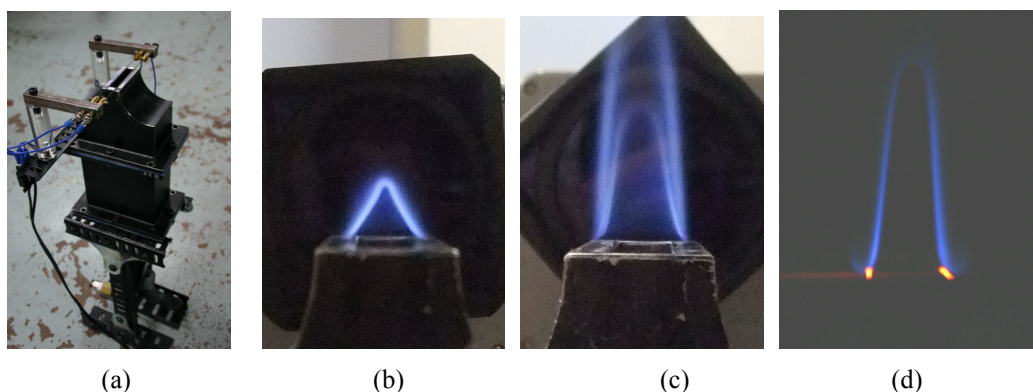

Fig.5 Burner and direct image of typical flames; (a) photo of slot burner installed in-line flame holder, (b-d) direct flame images with various equivalence ratios; (b) typical lean flame ($\phi = 0.74$), (c) rich flame ($\phi = 2.16$), and (d) ultra-lean flame ($\phi = 0.56$). Activation of flame holder is shown in red spots in (d).

3. Results and Discussion

Effect of Additional 266 nm on Flame-zone Imaging

Typical results will first be used to demonstrate the impact of the additionally applied 266 nm of excitation line on flame-zone imaging. Note that the band-pass filter used here is the same one used in our previous studies (BG-12). The effect of the dual-peak filter will be shown and discussed separately later.

Figure 6 shows how the addition of an additional excitation line (266 nm) can improve flame-zone imaging. The imaging range is centered on the flame tip to visualize the cone shape of the flame image (see Fig.5 (b)). This figure clearly shows the fact that the unburned zone is not clearly indicated because the amount of acetone seeded is insufficient, when only the 283 nm excitation line is adopted (again, the power of 283 nm excitation line is up to 3 mJ). The OH, however, is clearly shown in burned zone. Under the same mixture conditions, the 266 nm excitation line gives reasonable fluorescence intensity, but only in the unburned zone and no fluorescence is observed in the burned zone. By combining excitations of both 266 nm and 283 nm lines, a clear inverse-V shape of the signal “valley” appears as seen in Fig.6 (c), similar to the flame zone described in the previous studies (Nakamura et al., 2005, 2006, 2008). It is confirmed that the additional 266 nm excitation can dramatically improve imaging while reducing the amount of seeded acetone to less than 5% of total fuel volume, clarity which the previous approach using only excitations at 283 nm line could never access with such a limited amount of acetone.

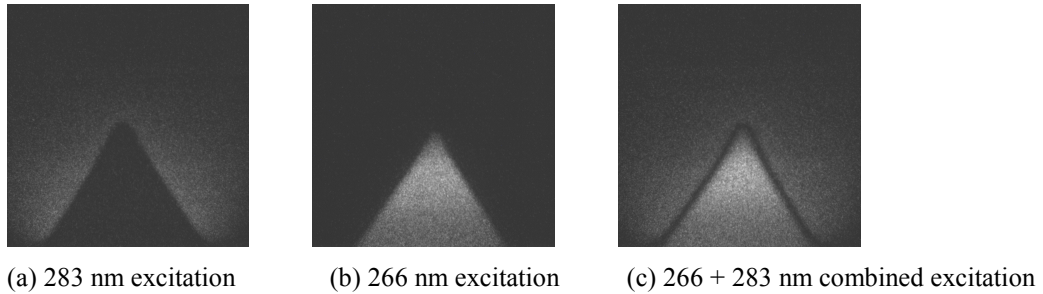

Fig.6 Effect of the excitation line on PLIF imaging in lean flames ($\phi = 0.74$, 50 cm/s average ejected velocity. Note the acetone seeding volumetric percentage is 2.9 % of the total methane volume).

As shown in our previous studies, the present visualization scheme based on acetone-OH simultaneous PLIF is capable of operation under a wide range of mixture conditions (e.g., Nakamura et al., 2008). This advantage should be sustained when the additional 266 nm excitation is adopted. Examples of visualizations of rich flames of $\phi = 2.16$ utilizing the present system are shown in Fig.7. Again, the imaging range is centered at the flame tip of the inner cone in order to visualize the double-cone structure of flame (see Fig.5 (c)).

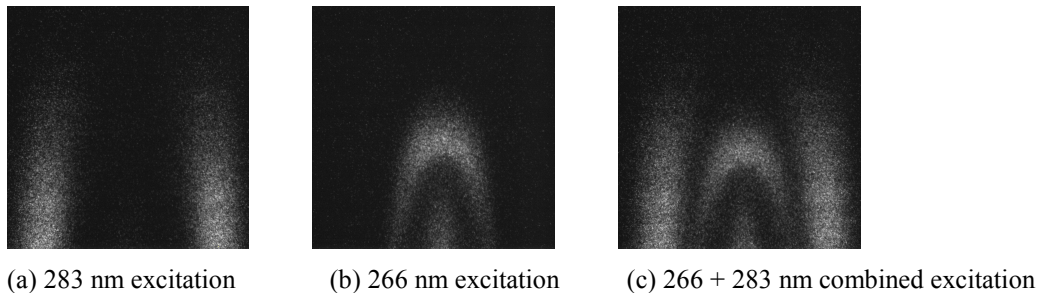

Fig.7 Typical PLIF imaging in a rich flame ($\phi = 2.19$, 16.9 cm/s average ejected velocity, where the acetone seeding volumetric percentage is 1.87 % of the total methane volume)

Figure 7 shows the typical fluorescence image of rich flames with (a) 283 nm excitation, (b) 266 nm excitation, and (c) 266+283 nm combined excitation, respectively. In (a), strong broadened fluorescence is observed along the outer flame. The fluorescence between the outer and inner cone is hardly seen, where the OH is expected to be detected. This might be because of the weakness of the power of the 283 nm excitation line. In (b), an unexpected fluorescence image is obtained; we do however observe/detect the signal “valley” along the inner flame, although the OH should not be excited by the 266 nm excitation line. Eventually, as seen in Fig.7 (c), we have three distinctive fluorescence signal zones in the image. The most inner zone should result from acetone; thus this corresponds to unburned zone, whereas the most outer zone should result from OH produced at an outer, secondary (diffusion) flame formed by excess fuel passed through the inner cone with atmospheric air. The remained middle zone is not thought to be from acetone, since it cannot pass through the hot flame due to its nature (acetone should decompose at a temperature lower than the flame temperature), nor OH. This fact suggests that the middle zone is the result of the other molecules, which could absorb the 266 nm line. One candidate is combustion-generated bi-products, likely poly-cyclic aromatic hydrocarbons (PAHs); there are known as the precursors of soot found in rich flames). It has been reported that rich methane flames ($\phi \sim 2.5$) could generate more than 300 ppm of benzene as well as 10 ppm of naphthalene (both major PAHs found in the flame) in the downstream zone (Senkan & Casaldi, 1996) and it would be enough to give a notable fluorescence signal via the 100 mJ of 266 nm excitation line intensity (Ciajolo et al., 2001). To this end, it is concluded that the present “revised” diagnostic system is inadequate for application to rich flames, which generate considerable high-carbon content molecules as combustion bi-products. In other words, the presently-revised system works *only* for very lean flames, for which PAHs’ generation is hardly expected.

3.2 Impact of Dual-peak Band-pass Filter on Flame Imaging

From now on, we focus on imaging of lean flames with “combined” excitation of 266 nm and 283 nm lines. Typical examples of chemiluminescence images and acetone-OH fluorescence images through BG-12 (wide band-pass filter) of lean flames are shown in Fig.8.

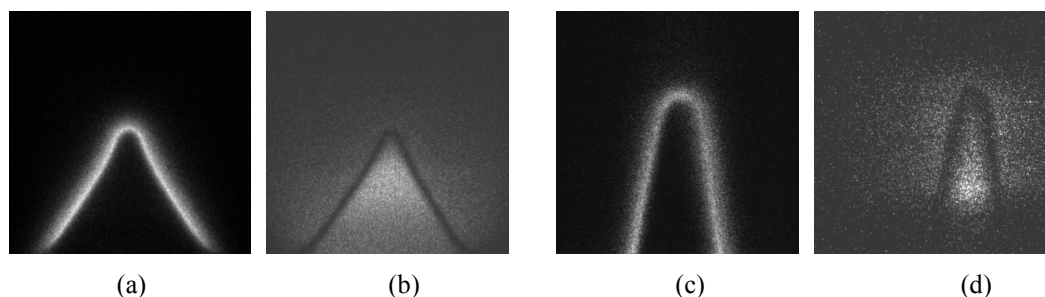

Fig.8 Effect of equivalence ratio on chemiluminescence images (a) & (c), and PLIF images (b) & (d) ((a),(b): $\phi = 0.74$, 50 cm/s average ejected velocity, where the acetone seeding volumetric percentage is 2.9 % of the total methane volume. (c),(d): $\phi = 0.61$, 50 cm/s average ejected velocity, where the acetone seeding volumetric percentage is 0.69 % of the total methane volume)

From Fig. 8, it is seen that as the mixture approaches the ultra-lean condition from (a)(b) to (c)(d), the fluorescence intensity, especially that of OH, becomes weak, resulting a signal “valley” that is difficult to obtain clearly. A new filter presented in Sec. 2.2 works well for this problem. The obtained “revised” image by using a “dual-peak” band-pass filter is shown in Fig.9.

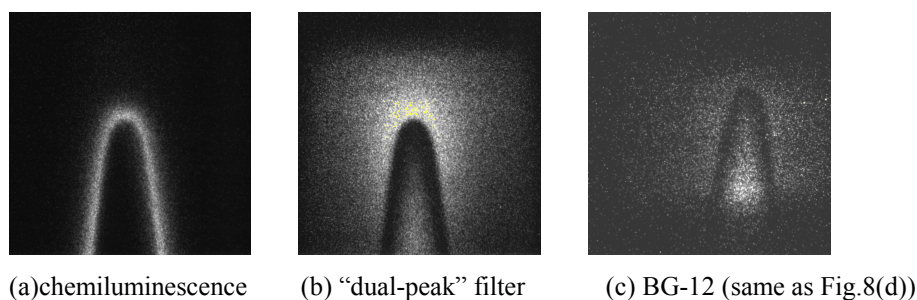

Fig.9 Effect of a “dual-peak” filter on PLIF images. (a)(b): $\phi = 0.58$, 40 cm/s average ejected velocity, where the acetone seeding volumetric percentage is 2.29 % of the total methane volume. (c) see caption of Fig.8 (d).

Figure 9 clearly shows that the fluorescence signal is dramatically intensified and the visualized image becomes clear enough to enable capturing the significant features of the highly-deformed flame tip at near-extinction conditions. According to the image, the flame tip is “sharply” concaved toward the burned (hot) zone, but not locally extinguished, giving large amounts of OH there, suggesting the local heat-release rate becomes higher. Such an inhomogeneous structure could be responsible due to a highly-stretched, curved effect at the near extinction conditions (e.g., Law & Sung, 2000). Such a qualitative trend cannot be captured with the previously-used band-pass filter, BG-12, as seen in Fig.9 (c). Another important observation is the weakness of the fluorescence from acetone at the tip. This could be due to the preheating by surrounded flames. Similar preheating trends have been found by direct temperature measurement in turbulent premixed flames by Rayleigh scattering (e.g., Kortschik et al., 2004).

Lastly, results from a demonstration of ultra-lean methane-air flames ($\phi = 0.55$) is shown in Fig.10. Under this condition, it is quite difficult to sustain a stationary flame, even though the flame holder is activated. Instead, we observe the dynamic flame behavior associated with frequent ignitions/extinctions around the flame holder (i.e., blow-off/attachment frequently occurs). In Fig.10, the typical time-dependent flame behavior captured by chemiluminescence as well as PLIF from the ultra-lean flames is shown. Note that their images are not captured simultaneously, so that only a qualitative trend is of interest here. Flames are first formed the cone shape. However, once a disturbance induces a sudden blow-off of the left-hand side of the

flame and the flame is detached, whereby eventually only one planar flame is formed. During such an unsteady “extinction procedure”, as shown in Fig.10, the time-dependent response of OH intensity with the potential flame curvature visualized by the acetone edge is clearly captured by this scheme. This demonstration reveals that this scheme could be utilize to look for dynamic flame motion at near the extinction conditions via a conventional one-laser and one-detector combination system, which no other existing visualization scheme developed thus far could achieve.

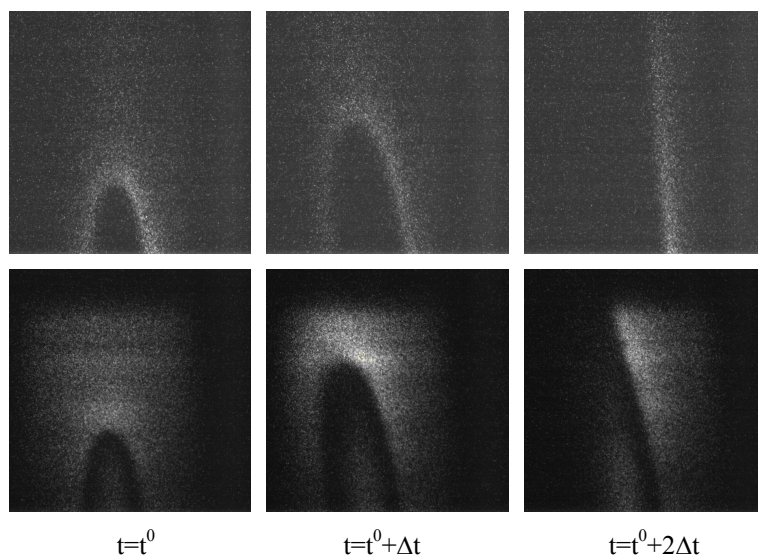

Fig.10 Imaging example to capture dynamic motion of “unsteady” ultra-lean flame. Top: chemiluminescence images, bottom: PLIF images. Time direction is from left to right with interval of $\Delta t = 0.1$ s. Condition: $\phi = 0.55$, 50 cm/s average ejected velocity, where the acetone seeding volumetric percentage is 2.58 % of the total methane volume.

Conclusion

To extend our previous flame diagnostics scheme, acetone-OH simultaneous PLIF, to diagnostics of ultra-lean flames, the diagnostic system has fully tuned, without any change in hardware in a “one-laser and one-detector combination”. Adding an excitation line, 266 nm, was shown to intensify the acetone fluorescence signal, even under reduced acetone seeding, and a specially-designed, dual-peak band-pass filter gave clear images to access the nature of the flame near extinction. Clear imaging of the flame zone in ultra-lean flames (equivalence ratios less than 0.6) has been successfully demonstrated, even the amount of seeding acetone less than 5 % of fuel, which is believed the critical condition to ensure the original flame structure. The revisions made here only work for lean flames, not for rich flames, since additional excitation line of 266 nm is thought to pump the combustion bi-products, likely polycyclic aromatic hydrocarbon (PAHs) obscuring the signal in rich flames. This is the first work to successfully visualize the instantaneous flame zone in a 2-D sliced plane under the ultra-lean conditions ($\phi < 0.6$) with a one-laser and one-detector combination, which other existing schemes have never been able to access.

Acknowledgments

This work is supported by yr 2008 General Sekiyu Research & Development Encouragement & Assistance Foundation, yr2008-2009 TEPCO Research Foundation, yr2009-2010 Steel Industry Foundation for the Advancement of Environmental Protection Technology, yr2009 The Iwatani Naoji Foundation's Research Grant, yr2009 Research Foundation for the Electrotechnology of Chubu (RFEC); all operated by YN as PI. The authors would like to thank Mr. Ito and Mr. Tsuji (Muroran Inst. Tech.) for their assistance to conduct experiment and Mr. Gollner at UCSD for fruitful discussion and polishing the manuscript.

References

- Allen, M. G., Howe, R. D., and Hanson, R. K., Digital Imaging of Reaction Zones in Hydrocarbon-Air Flames using Planar Laser-Induced Fluorescence of CH and C₂, *Optics Letter* 11-3 (1986), 126-128.
- Chen, Y. C., Mansour, M. S., Simultaneous Rayleigh Scattering and Laser-induced CH Fluorescence for Reaction Zone Imaging in High-speed Premixed Hydrocarbon Flames, *Appl. Phys. B* 64 (1997), 599-605.
- Ciajolo, A., Tregrossi, A., Barbella, R., Ragucci, R., Apicella, B., and De Joannon, M., The Relation Between Ultraviolet-Excite Fluorescence Spectroscopy and Aromatic Species Formed in Rich Laminar Ethylene Flames, *Combust. Flame* 125 (2001), 1225-1229.
- Degardin, O., Renou, B., and Boukhalfa, A. M., Simultaneous Measurement of Temperature and Fuel Mole Fraction using Acetone Planar Laser-Induced Fluorescence and Rayleigh Scattering in Stratified Flames, *Exp. Fluids* 40 (2006), 452-463.
- Gibaud, C., Snyder, J. A., Sick, V., Lindstedt, R. P., Laser-induced Fluorescence Measurements and Modeling of Absolute CH concentrations in Strained Laminar Methane/air Diffusion Flames, *Proc. Combust. Inst.*, 30-1 (2005), 455-463.
- Hayashi, S., Yamada, H., Makida, M., Short-Flame/Quick -Quench: A Unique Ultralow Emissions Combustion Concept for Gas Turbine Combustors, *Proc. Combust. Inst.*, 28-1 (2000), 1273-1280.
- Hirota, M. et al., Controllable Gasification of Liquid Matters, JP patent #2008-286438, 2008.
- Kiefer, J., Li, Z. S., Seeger, T., Leipertz, A., and Alden, M., Planar Laser-induced Fluorescence of HCO for Instantaneous Flame Front Imaging in Hydrocarbon Flames, *Proc. Combust. Inst.*, 32-1 (2009), 921-928.
- Kohse-Hoinghaus, K., Barlow, R. S., Alden, M., and Wolfrum, J., Combustion at the focus: Laser Diagnostics and Control, *Proc Combust Inst* 30-1 (2005), 89-123.
- Kortschik, C., Plessing, T., and Peters, N., Laser Optical Investigation of Turbulent Transport of Temperature Ahead of the Preheat Zone in a Premixed Flame, *Combust. Flame* 136 (2004) 43-50.
- Law, C. K., and Sung, C. J., Structure, Aerodynamics, and Geometry of Premixed Flamelets, *Prog. Ener. Combust. Sci.* 26 (2000), 459-505.
- Li, Z. S., Kiefer, J., Zetterberg, J., Linvin, M., Leipertz, A., Bai, X. S., and Alden, M., Development of Improved PLIF CH Detection using an Alexandrite Laser for Single-shot Investigation of Turbulent and Lean Flames, *Proc Combust Inst* 31-1 (2007), 727-735.
- Manome, S., Nakamura, Y., Hayashi, N., Yamamoto, K., and Yamashita, H., Study of Acetone-OH Simultaneous PLIF for Combustion Diagnostics of Turbulent Flames, *Trans. JSME Ser.B.* 73-725 (2007), 350-356.
- Nakamura, Y., Manome, S., Satomi, T., Hayashi, N., and Yamashita, H., Flame Diagnostics with Acetone-OH Simultaneous PLIF, *J. Comb. Soc. Jpn.* 47-142 (2005), 290-299 (in Japanese).
- Nakamura, Y., Manome, S., and Yamashita, H., "Diagnostics of Reactive Zone in Premixed Flames via Acetone-OH Simultaneous PLIF", *Proc. 13th International Symposium on Application of Laser Techniques to Fluid Mechanics, Lisbon Portugal (2006.6)*, S33-4 (on CD-ROM). This article is available online at http://ltces.dem.ist.utl.pt/lxaser/lxaser2006/downloads/papers/33_4.pdf
- Nakamura, Y., Manome, S., and Yamashita, H., Imaging and Diagnostics of Turbulent Methane-Air Premixed Flames by Acetone-OH Simultaneous PLIF, *J. Visualization*, 11-1 (2008), 71-78.
- Seitzman, J. M., Miller, M. F., Island, T. C., and Hanson, R. K. Double-pulse Imaging using Simultaneous OH/Acetone PLIF for Studying the Evolution of High-Speed, Reaction Mixing Layer, *Proc Combust Inst* 25-2 (1994), 1743-1750.
- Senkan, S., and Castaldi, M., Formation of Polycyclic Aromatic Hydrocarbons (PAH) in Methane Combustion: Comparative New results from Premixed Flames, *Combust. Flame* 107 (1996), 141-150.
- Sick, V., Wermuth, N., Single-shot Imaging of OH radicals and Simultaneous OH radical/acetone Imaging with a Tunable Nd: YAG Laser, *Appl. Phys. B* 79 (2004), 139-143.
- Tamura, M., Sakurai, T., Tai, H., Simultaneous Laser-Induced Fluorescence Imaging of Unburnt and Reacting Areas in Combustion Fields using a KrF Excimer Laser, *Opt. Review* 5-2, (1998), 119-123.
- Tamura, M., Sakurai, T., Tai, H., Visualization of Crevice Flow in an Engine using Laser-Induced Fluorescence, *Opt. Review* 7-2 (2000), 170-176.
- Tanahashi, M., Tsukinari, S., Saito, T., Miyauchi, T., Choi, G.-M., Ikame, M., Kishi, T., Harumi, K., and Hiraoka, K., On the Sound Generation and its Control in Turbulent Combustion Field,

Proc. 3rd Sympo. on Smart Control of Turbulence, (2002.3) (http://www.turbulence-control.gr.jp/sympo_j/FY2001/).

Thurber, M. C., Grisch, F., Kirby, B. J., Votsmeier, M., Hanson, R. K., Measurements and Modeling of Acetone Laser-Induced Fluorescence with Implications for Temperature-Imaging Diagnostics, *Appl. Opt.* 37 (1998), 4963-4978.

Vagelopoulos, C. M., and Frank, J. H., An Experimental and Numerical Study on the Adequacy of CH as a Flame Marker in Premixed Methane Flames, *Proc. Combust. Inst.* 30-1 (2005), 241-249.

Yip, B, Miller M. F., Lozano, A, Hanson, R. K. A Combined OH/Acetone Planar Laser-Induced Fluorescence Imaging Technique for Visualizing Combusting Flows, *Exp. Fluids* 17 (1994), 330-336.