



Title	Dual Channelling Mechanism of Brightness and Dimness Information in the Crayfish Visual System. (With 9 Text-figures)
Author(s)	YAMAGUCHI, Tsuneo; OHTSUKA, Teruya
Citation	北海道大學理學部紀要, 19(1), 15-30
Issue Date	1973-10
Doc URL	<a href="http://hdl.handle.net/2115/27550">http://hdl.handle.net/2115/27550</a>
Type	bulletin (article)
File Information	19(1)_P15-30.pdf



[Instructions for use](#)

# Dual Channelling Mechanism of Brightness and Dimness Information in the Crayfish Visual System.

By

Tsuneo Yamaguchi<sup>1)</sup> and Teruya Ohtsuka<sup>2)</sup>

Zoological Institute, Hokkaido University

(With 9 Text-figures)

A number of recent works have contributed to the understanding of the neural events occurring in the visual pathways of crustaceans. Most closely studied have been the Hawaiian swimming crab (Bush *et al.*, 1964; Waterman *et al.*, 1964; Wiersma *et al.*, 1964), the rock lobster (Wiersma and Yamaguchi, 1967a; Wiersma and Yanagisawa, 1971; Wiersma and York, 1972) and the crayfish (Wiersma and Yamaguchi, 1966, 1967b). Each of these workers has shown that the optic nerve contains a number of fibre classes which differ from each other in their reactivity to visual stimuli and they range from primary sensory fibres to multimodal interneurons with very complex integration. Among the visual interneurons two sets of units carry information about light intensity to the brain: the sustaining fibres whose firing rate increases in proportion to increments of light intensity, and the dimming fibres whose firing rate increases when the level of illumination decreases. It is accordingly conceivable that the visual system of all crustaceans so far studied has dual processing systems for brightness and dimness information. It is plausible that, independently of any specific functions, the occurrence of the two sets of units may somehow optimize the information transmission process. Yet, very little is known concerning the spatial and temporal integration properties that these two sets of units may have in information transmission, and the problem of functional relationship between these units.

Consequently the present experiments were carried out in the optic nerve of the crayfish (1) to give a more extensive description of the functional characteristics of the sustaining and the dimming fibres and (2) to elucidate the functional organization of their receptive fields. Furthermore, a simple model incorporating certain functional characteristics could be formulated, which explains the receptive field and discharge behaviour of these fibres.

---

Present addresses

1); Department of Biology, Faculty of Science, Okayama University.

2); Department of Physiology, School of Medicine, Keio University.

*Jour. Fac. Sci. Hokkaido Univ. Ser. VI, Zool. 19 (1), 1973.*

## Material and Methods

### I. *Material and preparation:*

In all experiments middle-sized crayfish (9–12 cm in length) *Procambarus clarki* (Girard), were used. The animals were kept in a dark pool until the experiment. A couple of days before the experiments, the rostrum was clipped off to expose the basal segments of the eyestalks. After this operation the animal was returned to the water; the wound healed completely. During the experiment the crayfish was clamped around the posterior carapace by a metal holder. All appendages and the caudal part were allowed free movement, but the claws (chelipeds) were usually fixed by a rubber band to prevent them from moving too much and dislodging the electrode.

### II. *Recording system:*

The probing electrode consisted of the bare tip of an insect pin (No. 0, Shigakonchu, Tokyo) coated with polystyrene (Q-DOPE, No. 37–2, GC Electronics Co., Division of Textron Electronics, INC, U.S.A.). In the present experiments, the methods for recording spikes from the optic nerve fibres followed those developed by Wiersma and Yamaguchi (1966, 1967b).

The electrode was manually introduced through the rather tough brownish membrane in the front of the head, going slightly lateral and down. Spikes of several millivolts were recorded when the needle point was approaching a nerve fibre.

Extensive damage of the ophthalmic artery, which sometimes led to anoxia of the optic ganglia, almost always resulted in deterioration and when it occurred, spontaneous firing of fibres increased and responsiveness to visual stimuli of the eye diminished. The electrode was advanced to a position in which spikes from one nerve fibres had a markedly greater amplitude than those from neighbouring fibres. The indifferent electrode, a coarse needle, was stuck deeply through the anterior carapace between stomach and heart, not piercing either.

The action potential spikes of the unit were always monitored with an oscilloscope (Nihon Kodan, VC-6) and a loudspeaker, and then recorded with a continuous recording camera (Nihon Kodan, PC-1B).

A simple method of on-line display of the frequency-gram of nerve fibre discharge was developed for the present experiment (Ohtsuka *et al.*, 1970).

It has been shown by Wiersma and Yamaguchi (1966, 1967b) and Aréchiga and Wiersma (1969) that the responsiveness of the sustaining fibre is greatly influenced by the general level of activity of the animal. In order to minimize all nonvisual sources of response variability, all the data in this study were obtained only in the resting state of the animal in the normal position.

### III. *Stimulating system:*

The light intensity in the laboratory during an experiment was usually kept to less than 1 lux. In most experiments, both the animal and the photoguides were set in a blackbox keeping off any diffusing light from outside.

Two kinds of stimulating light source, which could be controlled by a stimulator (Nihon Kodan, MSE-3), were employed. One was a 3 volts tungsten-filament lamp which was used mainly for relatively continuous illumination. As occasion demanded, the light levels were varied with neutral density filters (Kodak, Wratten filters) from 0 log unit to -2.70 log unit in steps of -0.54 log unit, which were inserted between the light source and the eye. The other was glow modulator tube (Sylvania, 1B59/R1130B), and the intensity of

the light emitted from this tube depends linearly on the current through the glow modulator tube. However, the spectral distribution of the light varied with different current strengths. For the purpose of the present experiments the wave length variation which occurred played no role in those cases where intensity was varied by current flow adjustment, although the neutral density filters were used in the most experiments.

These light sources were led by glass rods, brought into contact with corneas, so they could "pipe" light into the receptive field without illuminating its nearby surroundings. The intensity of illumination from the two light sources was calibrated with a solar cell against a standard intensity, which was measured with an illumination-meter (Toshiba, No. 5). The maximum intensities of the light spot measured at the position of the corneal surface were 32 lux with the glow modulator tube and 4517 lux with the tungsten lamp.

## Results

### 1. Response characteristics of sustaining fibres

In the crayfish visual system, each eye sends direct information concerning the brightness of various areas in the retina via the optic nerve fibres to the brain and to the optic ganglia of the other eye (Wiersma and Yamaguchi, 1966). One of the types of the optic fibres found by them responded to a light spot applied continuously to the retina with a sustained discharge; they named these fibres 'sustaining fibres'. They gave each of these a code number consisting of O (optic) followed by two digits.

First of all in the present experiments, we elucidated the following general characteristics of the sustaining fibres and found they agreed with those described by Wiersma and Yamaguchi (1966, 1967b). By charting the boundary of an area over which a spot light sets up spikes in its nerve fibre, the configuration of the receptive field was obtained. Each sustaining fibre was responsive over a large retinal area and apparently received an integrated input from many ommatidia. Each receptive field very clearly coincided with one of the 14 sustaining fibres described by Wiersma and Yamaguchi (1966, 1967b).

The field size did not depend on stimulus strength, the size of the exploring light spot (a diameter less than 1 mm) or the state of dark adaptation. These characteristics are very different from those of the vertebrate retina, such as the cat retina in which they depend on the intensity of the stimulus, the size of light spot and the state of dark adaptation (Barlow *et al.*, 1957).

The discharges of these fibres were characterized by continuously and indefinitely maintained levels of activity, the spike frequencies increasing as the light intensity in their receptive fields was increased: at very low light levels these fail to respond at all, while at the highest levels of activities were characterized by a tendency to be patterned in bursts (Figs. 1 and 2).

### 2. Response characteristics of dimming fibres

Wiersma and Yamaguchi (1966, 1967b) found a second class of fibres which they named the dimming fibres, differ from familiar "off" fibres in that they con-

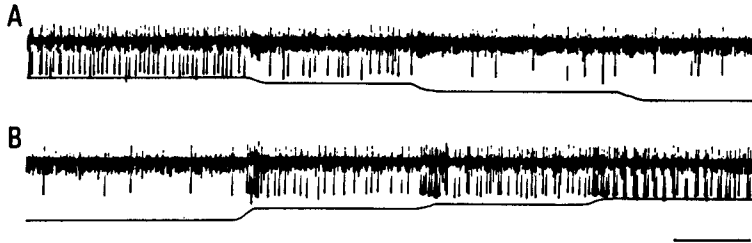

Fig. 1 Simultaneous recording of responses of both the sustaining fibre, O38 (larger spikes) and the dimming fibre, O79 (smaller spikes) to change in light intensity. In A and B their receptive fields were illuminated by a single light source. In A the light intensity was decreased in three steps from the highest intensity (0 log unit) to the lowest (-2.70 log unit), whereas in B it was increased in three steps from the lowest one to the highest one. Note antagonistic relationship between the sustaining and the dimming fibre. In the lower trace, increase in light intensity is an upward direction. Time mark; one second.

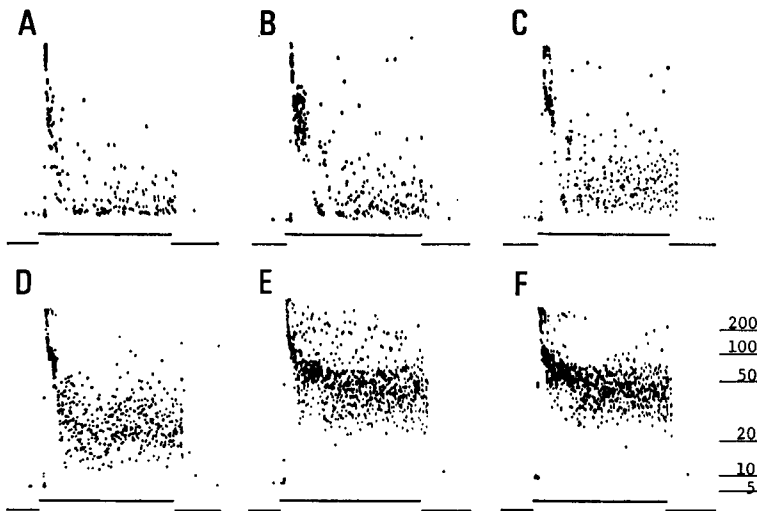

Fig. 2 Effect of increased light intensity on the discharges of a sustaining fibre (O14). Superimposed recordings of twenty successive exposures to one second light pulses (lower trace upward). A; a -2.70 log unit light spot (3 mm in diameter) with in excitatory field of O14. B; -1.16 log unit. C; -1.62 log unit. D; -1.08 log unit. E; -0.54 log unit. F; 0 log unit (4517 lux). The ordinate is spike frequency in Hz.

tinue their discharges in the dimming of the light, with a sustained response which is correlated with the degree of dimness (Figs. 1, 3 and 4). These fibres, therefore, are the counterparts of the sustaining fibres but only four receptive fields (i.e. one-third of the number for sustaining fibres), were found by Wiersma and Yamaguchi (1966, 1967b).

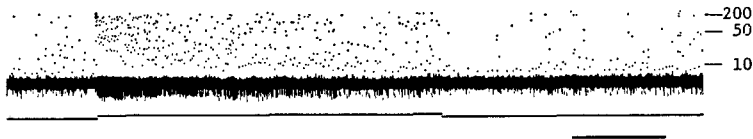

Fig. 3 Simultaneous recording of the original spike train and frequencygram of a dimming fibre, O87, which responded to about 3.5 sec. dimming light pulses on its excitatory receptive field (the back half of the eye). In the lower trace, dimming is an upward deflection. Time mark; one second.

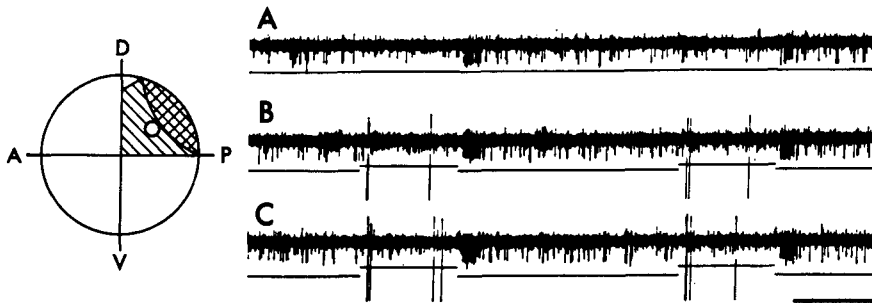

Fig. 4 Effect of increase intensity of small light spot on sustained discharge (smaller spikes) of a dimming fibre, O79 for the upper back part of the eye. The larger spikes during illumination are due to a sustaining fibre, O38 with a more peripheral and smaller field. In the inset, the approximate location of their receptive fields (diagonally hatched parts) and the light spot (open circle) are indicated. Light intensities are  $-2.70$  log unit in A,  $-1.62$  in B and 0 in C. In the lower trace, light on is an upward direction. Time mark; one second.

The spike frequencies of the dimming fibres depended not only on the degree of dimness, but also on the preceding light level. Figure 4 shows the effect of increased intensity of preceding light on sustained discharge of a dimming fibre, O79. In this case, light spots of 1 sec. duration with various intensities ( $-2.70$  log unit in A,  $-1.62$  in B and 0 in C) were given to its receptive field. The average frequencies of spikes elicited were about 51/sec. in A, 59/sec. in B and 89/sec. in C, respectively. Therefore, it is apparent that increasing the intensity of the preceding light on an receptive field results in an increased excitatory effect.

It was found that background illumination is one of the most potent factors in altering the discharges. In Figure 5, two superimposed light spots were employed, one was steady background, the other was turned on and off successively by trigger pulses from the stimulator. The background light level was varied in four steps with neutral density filters but the dimming pulse was kept at six lux during the experiments. Therefore, each time the dimming pulse was turned off, the total light intensity over the eye surface fell by six lux. Figure 5 shows that the firing rate of the dimming fibre depends upon the light level of background:

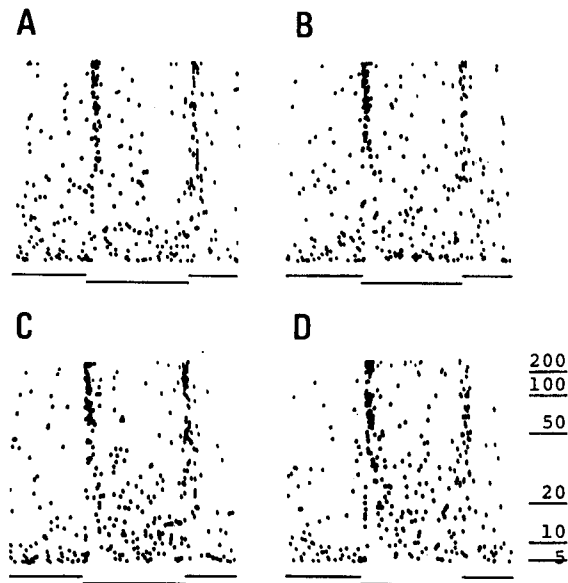

Fig. 5 Effect of decreasing background light intensity on the discharges of a dimming fibre (O79). Superimposed recordings of responses to turning off the test light for one second (lower trace downward). Intensities of background light were  $-1.08$  log unit in A,  $-1.62$  in B,  $-2.16$  in C and  $-2.70$  in D. One of the test light was kept at  $-2.70$  log unit.

the weaker the background illumination, the more the firing rate increases.

In the present experiment, we established a dimming fibres with a new receptive field covered the posterior half of the eye (coded O87), in addition to four fibres which have already established by Wiersma and Yamaguchi (1966).

### 3. Interaction between the excitatory receptive field and inhibitory complementary receptive field.

It may be assumed that one of the basic contributions of the interneurons between the ommatidia and the ganglionic layers which give rise to the optic fibres consists in modifying the pattern of discharges which are set up by excitation of reticular cells in ommatidia. The spikes emerging through the optic nerve show the result of a complex series of events which have taken place in ommatidia and optic ganglia, such as spatial interaction and temporal processes of summation, facilitation and inhibition. However, we have as yet very little information as what mechanism is involved in the visual events occurring in crustacean ommatidia and optic ganglia. In the present experiments, therefore, we aimed to elucidate the interaction between the receptive field and its surroundings which is a fundamental characteristic in the complex series of visual events.

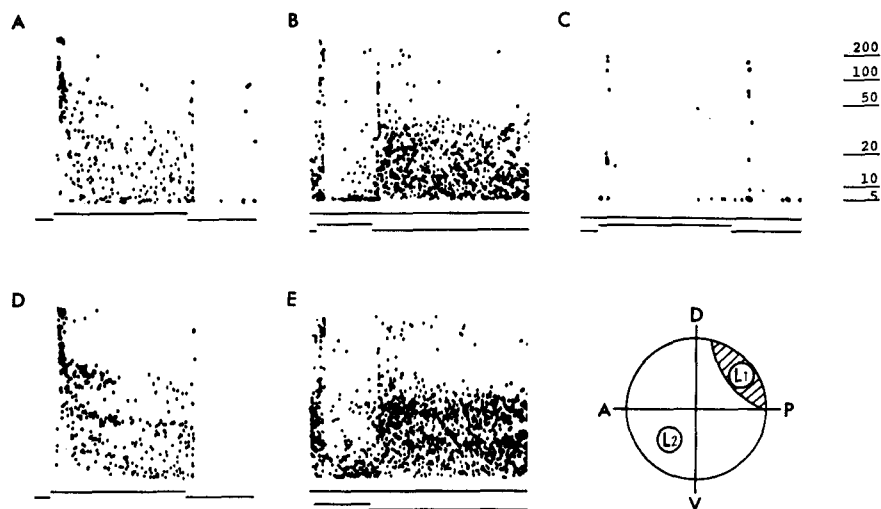

Fig. 6 Frequencygrams of the response of a sustaining fibre O38, its excitatory receptive field is shown in hatched region of the inset, to light pulses on various parts of the retina. In each record, the transient responses to twenty successive light pulses of one second or the steady state responses to continuous light were superimposed. Direction of turning on light is upward. A and D; responses to light pulse on the excitatory receptive field ( $L_1$ ). Light intensities are  $-1.62$  log unit in A and  $-1.08$  in D. B and E; inhibitory effect of light pulse kept at a constant intensity, on the inhibitory complementary receptive field ( $L_2$ ) on the discharge. Duration of light pulse one second. C; on-off responses to light pulse of one second on the complementary field ( $L_2$ ). Calibration bars on the right hand side represent the instantaneous frequency in Hz. A, C and D are same time base.

(1) *Interaction between the excitatory and inhibitory fields of the sustaining fibre.*

In one series of experiments, one of the exploring light spots, 1 mm in diameter, was brought close and perpendicular to the receptive field of the eye surface by a micromanipulator. In Figure 6 A and D, transient responses to twenty successive light spot stimuli are superimposed. These consisted of an initial burst followed by a very gradually established sustained firing rate, and immediate cessation of "off". These responses to turning the light on were substantially the same over most of the receptive field. Two spots of light were projected onto the retina; each came from a separate light source, and the location, size, brightness and duration illumination were controlled electronically. One light spot illuminated continuously the excitatory receptive field ( $L_1$ ), while the other spot was located at the opposite pole of the eye ( $L_2$ ), out of the excitatory field. Turning it on during the discharge caused by the first excitatory light showed a very pronounced inhibitory effect, but on turning it off the original frequency was quickly restored (B and E). In C, light spot on the surround without excitatory



light caused transient "on" and "off" responses. These responses may be due to diffused light on the excitatory field from light spot or to the rebound of inhibitory effect. From these facts it may be said that each sustaining unit integrates the light intensities in its own excitatory field and is under the inhibitory influence of the whole of the remainder of the eye surface. Moreover, these facts agree with the results obtained by Wiersma and Yamaguchi (1967b).

(2) *Interaction between receptive field and its complement for the dimming fibre.*

The dimming fibres respond to decreasing light intensities in their own receptive fields with an increased frequency both in the initial burst and during the generally established sustained firing rate, as shown in Figure 7 A. Their firing rates correlate with the degree of dimness in their receptive fields.

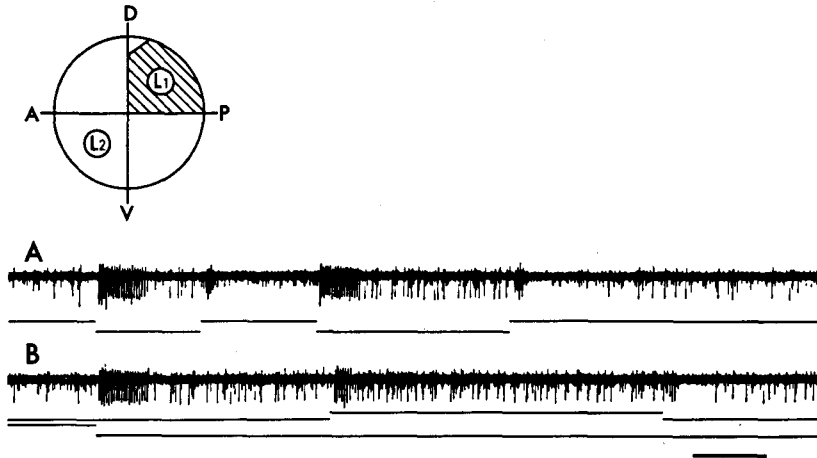

Fig. 7 Effect of small light spots on the inhibitory complementary receptive field on the discharge of the dimming fibre, O79. A; effect of turning on light repeatedly in the excitatory receptive field ( $L_1$ ), lower trace upward, light on. B; effect of two light spots, one of them located within the receptive field ( $L_1$ ), lower trace upward, light on, and the other outside of it ( $L_2$ ), middle trace upward, light on. Note that the rate of discharge following light dimming on the excitatory field was increased by light on its complement. Time mark; one second.

The interaction between responses to separate light stimuli to the receptive field and its complement is shown in Figure 7 B. The illumination ( $L_1$ ) on the receptive field of a dimming unit, O79 was started before the recording and its discharge frequency was very low, depending on the degree of dimness in its receptive field. After cessation of this illumination, there appeared a dimming response with the initial burst and the maintained firing. The rate of discharge following light dimming on the receptive field was increased with initial burst by

illumination of another light spot on the outside of the receptive field ( $L_2$ ), i.e. its complement, but on turning it off the original frequency was quickly restored. When a stimulus of the type to which the fibre was sensitive, i.e. a dimming pulse, was given anywhere in the complementary field then the response was inhibited. These findings indicate each dimming fibre integrates the dimness of its own field and is under the excitatory influence of the whole remainder of the retina and its discharge may express the balance between these opposing and interacting contributions.

4. *A contrasting relationship between the sustaining fibres and dimming fibres.*

It was found that there is an antagonistic relationship between the sustaining and the dimming fibres. This is illustrated by the following experiments.

On the occasions when the responses from both a sustaining fibre and a dimming fibre were recorded simultaneously from the same lead, various areas in their receptive fields and complements were stimulated with small light spot.

One of the results is summarized in Figure 8. In this figure, the responses from both a sustaining fibre for the upper back ridge of the eye O38 (large spikes) and

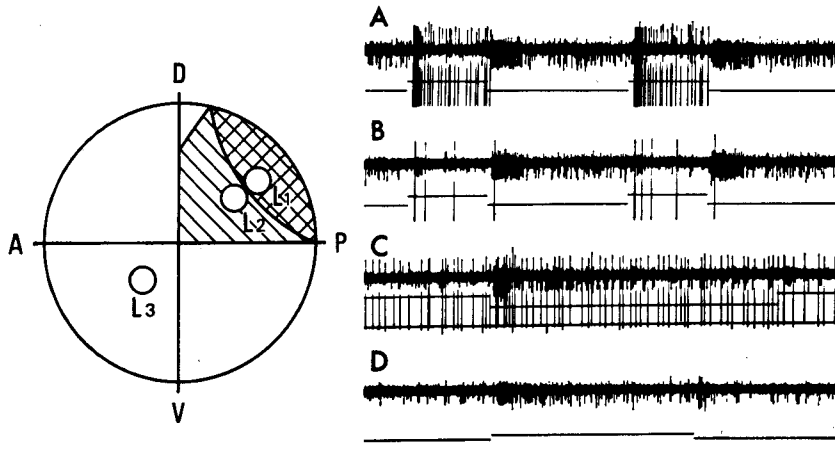

Fig. 8 Effect of small light spots on different parts of the retina on the discharges of the sustaining fibre for the upper back eye rim, O38 (larger spikes) and the dimming fibre for the upper back part of the eye, O79 (smaller spikes). In the inset the approximate location of their excitatory fields (diagonally hatched parts) and the light spots (open circles,  $L_1$ - $L_3$ ) are indicated. A; light spot on  $L_1$  which was located within both the excitatory fields (lower trace upward). B; light spot on  $L_2$  which was located within excitatory field of the dimming fibre, but mainly outside that of the sustaining fibre (lower trace upward). C; dimming of one light spot on  $L_2$  (middle trace down ward) during constant illumination on  $L_1$ . D; light spot on  $L_3$  which was located outside both the excitatory fields (lower trace upward). Time mark; one second.

and a dimming fibre for the upper back part of the eye, O79 (small spikes) were recorded simultaneously. The inset of the figure shows the approximate locations of their receptive fields (diagonally hatched parts) and also three areas ( $L_1$ ,  $L_2$  and  $L_3$ ) were stimulated independently with light spot. Both the units responded reciprocally to the turning on or off of the light spot when it was located within both their receptive fields, as shown in the record A. When the light spot was brought to  $L_2$ , the responses were as shown in record B. It was still within the receptive field of the dimming unit and this responded as in record A, but the discharge of the sustaining unit was shortened to only 4 or 5 spikes indicating that the stimulus was mainly outside its excitatory field. In record C, dimming of the light spot on  $L_2$  during continuous illumination of  $L_1$  increased the firing rate of the sustaining unit and caused a discharge of the dimming unit. When the light spot was completely outside of their excitatory fields ( $L_3$ ) as in record D, only the dimming unit responded. These results indicate that in both the units functionally the receptive field and its surroundings are opposed, the one tending to inhibit or excite the other. From a functional point of view, the important finding is not that the sustaining and dimming unit excite reciprocally or antagonistically under any circumstances, but that both the units are subjected to multiple influence from their receptive fields and surroundings and then, their discharges will represent the balance between these opposing and interacting contributions, respectively. This means that brightness and dimness informations are processed independently in the optic ganglion in the crayfish eye.

### Discussion

From the facts described in the results, we would like to indicate in the first place the contrasting behaviour between the sustaining fibre and the dimming fibre in their excitability at various light level. Each unit in the sustaining fibres integrates the light intensities in its excitatory field and is under the inhibitory influence of the whole remainder of the eye surface, meanwhile each of the dimming fibres integrates the degree of dimness in its excitatory receptive field and is under the inhibitory influence of the complementary field. Moreover these two fibres do not interact with each other. All these favour a dualistic theory of two contrasting neuronal systems — the sustaining fibre or brightness system showing on activation in light and the dimming fibre or dimness system showing on inhibition in light and off activation after illumination. Two sets of higher order visual neurones which carry information about light intensity, such as the sustaining and the dimming fibre have been also founded in the other crustaceans (in the Hawaiian swimming crab, Waterman *et al.*, 1964; Wiersma *et al.*, 1964; in the rock lobster, Wiersma and Yamaguchi, 1967a; in the green crab, Wiersma, 1970) in the insects (in the locust, Burt and Catton, 1960; Horridge *et al.*, 1965; in the butterfly, Swihart, 1968; in the lubber grasshopper, Northrop and Guignon, 1970) and in *Limulus* (Snodderly, 1971). It is quite possible, therefore that in the arthropod's

visual system these contrasting neurones play a important role in the spatial and temporal integration of light intensity, though no experimental results have yet been made which allow one to evaluate the present theory, except the case of the crayfish.

To design a neural model which includes dual processing systems of brightness and dimness information, it is necessary to define the general nature of neurones and synapses. Two assumptions are made, (1) each neurone releases only one type of transmitter (Dale's hypothesis); this is either always excitatory or inhibitory, (2) spontaneously firing neurones exist normally in the optic ganglia and fire at a certain frequency level without any apparent stimulus clues. It is plausible to suppose that rate of released transmitter chemicals is proportional rise in the frequency of spikes generated in the primary neurone and a certain number of excitatory afferent fibres of primary neurones converge upon one outgoing fibre. If then each incoming fibre secreted the same kind of transmitter substance, the frequency of outgoing spikes would be linearly related to the weighted mean of the incoming frequencies. In this way, the receptive field would be formed. Then the afferent fibres of the secondary neurone form two independent channels; one triggers an excitatory-outgoing neurone, and the other triggers an inhibitory-outgoing neurone. The former is merely a relay neurone, which transmits only information from the secondary neurone, controls the frequency of outgoing spikes of a fourth neurone, and is laterally modulated by inhibitory synapses from the remainder of the converging receptors. The output spike pattern from this fourth neurone is observed as a sustaining fibre response. The latter controls by inhibition the spontaneous firing neurone, which is laterally modulated by excitatory synapses from the remainder of the converging receptors, and the output spikes from this neurone are observed as a dimming fibre response. It has been already reported that in invertebrate visual systems the generation of "off" response is achieved by synaptic inhibition, the "off" discharge occurring in a higher order neurone, such as the dimming fibre (e.g., Ruck, 1961; Gwilliam, 1963; Chappell and Dowling, 1972; Dowling and Chappell, 1972; Millecchia and Gwilliam, 1972).

From the considerations mentioned above a neural model as shown in Figure 9 is proposed. In this model only two separate receptive fields ( $F_1$  and  $F_2$ ) which do not overlap, are illustrated for convenience. The function of the subsequent network is as follows.

$F_1$  is a secondary neurone, and sums inputs from primary neurones from one portion of the eye, and  $F_2$  is also one from the other portion of the eye. Then these secondary neurones are divided into two independent channels, one triggers an excitatory-outgoing neurone, the other an inhibitory-outgoing neurone. The former controls the fourth neurone, whose outgoing spikes are observed as a sustaining fibre response, which are denoted as S.F. ( $F_1$ ) and S.F. ( $F_2$ ) in Figure 9. However, these neurones are also modulated by inhibitory influences from their complements:  $F_1$  is influenced by  $F_2$  (complement of  $F_1$ , so we may call

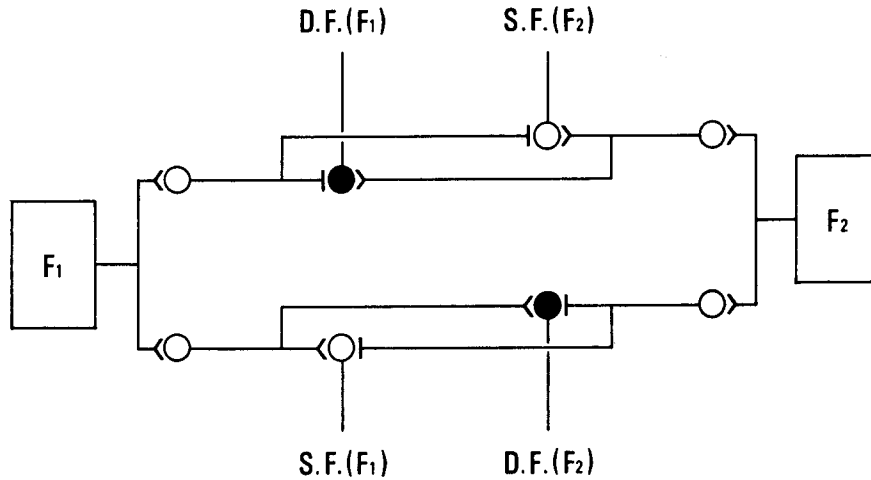

Fig. 9 Functional model of a dual processing system of brightness and dimness information.  $F_1$  and  $F_2$  are assumed receptive fields, which do not overlap. S.F. ( $F_1$ ); sustaining fibre responding to illumination within  $F_1$  receptive field. S.F. ( $F_2$ ); sustaining fibre responding to illumination within  $F_2$  receptive field. D.F. ( $F_1$ ); dimming fibre responding to dimming within  $F_2$  receptive field. D.F. ( $F_2$ ); dimming fibre responding to dimming within  $F_2$  receptive field. An open circle represents "ordinary neuron" and a filled circle "spontaneously discharging neuron". Excitatory connections are shown by Ys and inhibitory connections by bars. The connection in the model thus do not represent neural pathways, in any literal sense.

$F_2$  as a inhibitory field), and  $F_2$  is also influenced reciprocally by  $F_1$ . The inhibitory synapses are commonly connected to the dimming fibre (D.F. ( $F_1$ ) and D.F. ( $F_2$ )) modulating neurones. The latter controls also the discharge from the fourth neurone which is the dimming fibre or spontaneously firing neurone. This spontaneously firing neurone is also modulated excitatory by inputs from the complement. The excitatory synapses are all connected to the sustaining fibres (S.F. ( $F_2$ ) and S.F. ( $F_1$ )). On the matter of reducing redundancy in the nervous system, it seems to be all right to consider that certain neurones act dually at a predominant synapse and modulating synapse, the difference being caused by synaptic weights or some unknown conditions.

The response from the sustaining fibre in the model can be expressed by the following equation:

$$R(\text{S.F.}) = E + i \quad (1)$$

In this equation the term  $R(\text{S.F.})$  stands for the response of the sustaining fibre which can be measured by the steady frequency of its discharge of spikes while it is subjected to inhibition from its steadily illuminated complementary field. The term  $E$  represents the magnitude of the external excitation supplied by the

stimulating light of given intensity to the excitatory field. It can be measured by the frequency of discharge of the excitatory field response would have in the absence of any inhibitory effect from the inhibitory field, that is, when the receptive field of the sustaining fibre alone is illuminated at the given intensity. This excitatory receptive field is considered to be the summation of the individual excitatory responses of the receptors and a discussion about interommatidial connections in the receptive field or complementary field is not necessary in the present paper. The term  $i$  represents the inhibitory influence exerted on the excitatory field response by the complementary field; it is some function, as yet to be specified, of the summation of receptor outputs in the complementary field.

The response of dimming fibre can be expressed by the following equation:

$$R(D.F.) = Es + I + e \quad (2)$$

In this equation the term  $R$  (D.F.) stands for the response of the dimming fibre under observation, measured by the steady frequency of its discharge while it is subjected to excitation by steady illumination on the complementary field (note that the excitatory influence from the complementary field is opposite to that for a sustaining fibre). The term  $Es$  is spontaneous activity of the neurone. The term  $I$  is proportional to the external excitation supplied by the stimulating light of a given intensity. It is to be measured by the frequency of discharge that the excitatory receptive field response would have in the absence of any excitatory effect from the complementary field, that is, when the receptive field of the dimming fibre alone is illuminated at the given intensity. The term  $e$  represents the excitatory influence exerted on the excitatory field response by inhibitory complementary field, it is also some function of the summative activity of receptors in the complementary field. Implicit in our use of this notation is the understanding of several restrictions:  $R$  (S.F.),  $R$  (D.F.),  $E$ ,  $Es$  and  $e$ , being frequencies cannot be negative, while the quantities  $I$  and  $i$  are restricted to negative values, since we are dealing with a purely inhibitory interaction. For the present paper, we will restrict our consideration to the steady state response, after all of the transients associated with turning on of the stimulating light and establishing the inhibitory interaction have subsided.

In the equations (1) and (2) the term  $i$  and  $e$  would represent the total inhibitory or excitatory influence exerted by the combination of all the neighbouring elements that are activated by a given pattern of retinal illumination. However, they could be expressed as a set of "partial" terms, each representing the action of some neighbour on the element under consideration. Each partial inhibitory or excitatory term is to be written as a function of the responses  $R$  (S.F.) or  $R$  (D.F.) of the particular neighbour whose action it represents; this expresses the experimentally established principle of mutual independence of fibre responses. The law of combination of inhibitory influences turns out to be a simple one: the partial inhibitory terms are merely added to express the total inhibition exerted on a given receptor. Thus for a certain sustaining fibre, the total inhibition

exerted by the complement field is expressed as a function taking the form of weighted sum of the  $i_j$ .

$$i = \sum w_j i_j \quad (3)$$

This law of "spatial summation" of inhibitory influences is not an prior assumption; it has been derived from experimental findings by Wiersma and Yamaguchi (1967b). In the same manner, the excitatory influence in (2) is expressed as follows:

$$e = \sum w_j' e_j \quad (4)$$

We can now write explicitly  $n$  simultaneous linear equations describing the interaction of a set of  $n$  interacting elemental units; (1) is expressed as follows:

$$R(\text{S.F.}) = E + \sum w_j i_j \quad (5)$$

Restrictions: all  $R(\text{S.F.})$ ,  $E$ ,  $w_j \geq 0$

$$i_j \leq 0$$

(2) is also described as follows

$$R(\text{D.F.}) = E_s + I + \sum w_j' e_j \quad (6)$$

Restrictions: all  $R(\text{D.F.})$ ,  $E_s$ ,  $w_j' e_j \geq 0$

$$I \leq 0$$

The restrictions require the following comment:  $w_j$  or  $w_j'$  will be the "actual" weight or coefficient, representing the inhibitory action of  $j$ -th element unit.

Hartline (1957) studied ommatidial interconnections in the compound eye of *Limulus*, found reciprocal inhibition between them, and established the concept of "lateral inhibition". The similar types of lateral inhibition at the level of higher order visual neurones of the other arthropods were described by Horridge *et al.* (1965), Wiersma and Yamaguchi (1967a), Arnett (1971), Zettler and Järvillehto (1972) and Mimura (1972). However, we consider from the present results that the Hartline's concept was standing on one-side out of the information processing mechanism in the visual system, and overlooked another side of visual system. Almost no attention has been paid to the lateral excitation, although higher nervous system has generally lateral excitation mechanism. This theoretical model of a dual information processing system may furnish a prototype for the construction of theories of more complex interacting systems, such as those detecting movement or producing the optokinetic reaction, and furthermore for highly organized nervous centres, basic principles may be difficult to establish by direct experiment, and the patterns of interaction may be extremely complex.

We have based the theory of the dual information processing system in the eye of the crayfish on postulates that have been derived inductively from certain experimental observations. It would be much more desirable, of course, to have a complete knowledge of the underlying mechanism of the receptor unit and of

the excitatory and inhibitory processes, and a complete description of the histological and functional interconnections of the interacting units. Undoubtedly, such knowledge would permit the derivation of fundamental postulates on which could be based an exact and rigorous theory of the interaction. It is conceivable that future investigations will show that the present results can be generalized in the visual system of the arthropods at least of the crustacea.

A paper (Aréchiga and Yanagisawa 1973. *Vision Res.* **13**: 731-744) "Inhibition of visual units in the crayfish" has appeared while the present paper was in preparation. Their results are qualitatively quite similar to the present studies.

### Summary

1. Unit responses were obtained from the optic nerve of the crayfish, *Procambarus clarki* (Girard) with steel needle electrode.

2. Discharges of the sustaining fibre increased proportionally with light increase; each sustaining fiber integrated the degree of brightness in its excitatory receptive field and is under the inhibitory influence of the whole remainder of the eye surface or the inhibitory receptive field.

3. Discharges of the dimming fibre increased proportionally with light decrease; each dimming fibre integrated the degree of dimness in its excitatory receptive field and is under the inhibitory influence of the whole remainder of the eye or the inhibitory receptive field.

4. The discharges of the sustaining fibre and the dimming fibre did not interact with each other.

5. A dual processing system of brightness and dimness information of the sustaining fibre and the dimming fibre was discussed.

6. A neural model of such a dual information processing system was constructed.

*Acknowledgement:* The authors express their deep gratitude to Prof. Mituo Tamasige for his helpful suggestions and criticisms. We also thank Dr. J.A. Coles for his assistance in preparing the manuscript.

### References

- Aréchiga, H. and C. A. G. Wiersma 1969. Circadian rhythm of responsiveness in crayfish visual units. *J. Neurobiol.* **1**: 71-85.
- Arnett, D. W. 1971. Spatial and temporal integration properties of units in the optic ganglion of dipterans. *Ibid.* **35**: 429-444.
- Barlow, H. B., Fitz Hugh, R. and S. W. Kuffler 1957. Change of organization in the receptive fields of the cat's retina during dark adaptation. *J. Physiol.* **137**: 338-354.
- Burt, E. T. and W. T. Catton 1960. The properties of single-unit discharges in the optic lobe of the locust. *Ibid.* **154**: 479-490.
- Bush, B. M. H., Wiersma, C. A. G. and T. H. Waterman 1964. Efferent mechanoreceptive responses in the optic nerve of the crab *Podophthalmus*. *J. cell. comp. Physiol.*



64: 327-345.

- Chappell, R. L. and J. E. Dowling 1972. Neural organization of the median ocellus of the dragonfly. I. Intracellular electrical activity. *J. gen. Physiol.* **60**: 121-147.
- Dowling, J. E. and R. L. Chappell 1972. Neural organization of the median ocellus of the dragonfly. II. Synaptic structure. *Ibid.* **60**: 148-165.
- Gwilliam, G. F. 1963. The mechanism of the shadow reflex in cirripedia. I. Electrical activity in the supraoesopharyngeal ganglion and ocellar nerve. *Biol. Bull.* **125**: 470-485.
- Hartline, H. K. and F. Ratliff 1957. Inhibitory interaction of receptor units in the eye of *Limulus*. *J. gen. Physiol.* **40**: 357-376.
- Horridge, G. A., Scholes, J. H., Shaw, S. and J. Tunstall 1965. Extracellular recordings from single neurones in the optic lobe and brain of the locust. In "The Physiology of the Insect Central Nervous System" (Ed. by Treherne, J.E. and J.W.L. Beament), pp. 165-202. Academic Press, New York.
- Millecchia, R. and G. F. Gwilliam 1972. Photoreception in a barnacle: Electrophysiology of the shadow reflex path-way in *Balanus cariosus*. *Science* **177**: 438-441.
- Mimura, K. 1972. Neural mechanisms, subserving directional selectivity of movement in the optic lobe of the fly. *J. comp. Physiol.* **80**: 409-437.
- Northrop, R. B. and E. F. Guignon 1970. Information processing in the optic lobes of the lubber grasshopper. *J. Insect Physiol.* **16**: 691-713.
- Ohtsuka, T., Shimozawa, T. and T. Yamaguchi 1970. A simple method of the instantaneous frequencygram of nerve impulses. *Zoological Magazine* **79**: 211-213.
- Ruck, P. 1961. Electrophysiology of the insect dorsal ocellus. I. Origin of the components of the electroretinogram. *J. gen. Physiol.* **44**: 605-627.
- Snodderly, D. M., Jr. 1971. Processing of visual inputs by brain of *Limulus*. *J. Neurophysiol.* **34**: 588-611.
- Swihart, S. L. 1968. Single unit activity in the visual pathway of the butterfly *Heliconius erato*. *J. Insect Physiol.* **14**: 1589-1601.
- Waterman, T. H., Wiersma, C. A. G. and B. M. H. Bush 1964. Afferent visual responses in the optic nerve of the crab, *Podophthalmus*. *J. cell. comp. Physiol.* **63**: 135-155.
- Wiersma, C. A. G. 1970. Neural components of the optic nerve of the crab, *Carcinus maenas*. *Proc. Kon. Ned. Akad. Wet.* **C73**: 25-34.
- , Bush, B. M. H. and T. H. Waterman 1964. Efferent visual responses of contralateral origin in the optic nerve of the crab *Podophthalmus*. *J. cell comp. Physiol.* **64**: 309-326.
- and T. Yamaguchi 1966. The neuronal components of the optic nerve of the crayfish as studied by single unit analysis. *J. comp. Neurol.* **128**: 333-358.
- and ——— 1967a. Integration of visual stimuli in the rock lobster. *Vision Res.* **7**: 197-204.
- and ——— 1967b. Integration of visual stimuli by the crayfish central nervous system. *J. exp. Biol.* **47**: 409-431.
- and K. Yanagisawa 1971. On types of interneurons responding to visual stimulation present in the optic nerve of the rock lobster, *Panulirus interruptus*. *J. Neurobiol.* **2**: 291-309.
- and B. York 1972. Properties of the seeing fibres in the rock lobster: Field structure, habituation, attention and distraction. *Vision Res.* **12**: 627-640.
- Zettler, F. and M. Järvilehto 1972. Lateral inhibition in an insect eye. *Z. vergl. Physiol.* **76**: 233-244.