

*Prior information use and response
caution in perceptual decision-making: no
evidence for a relationship with autistic-
like traits*

Article

Published Version

Creative Commons: Attribution 4.0 (CC-BY)

Open Access

Retzler, C., Boehm, U., Cai, J., Cochrane, A. and Manning, C.
ORCID: <https://orcid.org/0000-0001-6862-2525> (2021) Prior
information use and response caution in perceptual decision-
making: no evidence for a relationship with autistic-like traits.
Quarterly Journal of Experimental Psychology. ISSN 1747-
0218 doi: <https://doi.org/10.1177/17470218211019939>
Available at <https://centaur.reading.ac.uk/97438/>

It is advisable to refer to the publisher's version if you intend to cite from the
work. See [Guidance on citing](#).

To link to this article DOI: <http://dx.doi.org/10.1177/17470218211019939>

Publisher: Sage

All outputs in CentAUR are protected by Intellectual Property Rights law,
including copyright law. Copyright and IPR is retained by the creators or other
copyright holders. Terms and conditions for use of this material are defined in
the [End User Agreement](#).

www.reading.ac.uk/centaur

CentAUR

Central Archive at the University of Reading

Reading's research outputs online

Prior information use and response caution in perceptual decision-making: No evidence for a relationship with autistic-like traits



Chris Retzler¹, Udo Boehm², Jing Cai³,
Aimee Cochrane³ and Catherine Manning^{3,4}

Quarterly Journal of Experimental
Psychology
1–13

© Experimental Psychology Society 2021



Article reuse guidelines:

sagepub.com/journals-permissions

DOI: 10.1177/17470218211019939

qjep.sagepub.com



Abstract

Interpreting the world around us requires integrating incoming sensory signals with prior information. Autistic individuals have been proposed to rely less on prior information and make more cautious responses than non-autistic individuals. Here, we investigated whether these purported features of autistic perception vary as a function of autistic-like traits in the general population. We used a diffusion model framework, whereby decisions are modelled as noisy evidence accumulation processes towards one of two bounds. Within this framework, prior information can bias the starting point of the evidence accumulation process. Our pre-registered hypotheses were that higher autistic-like traits would relate to reduced starting point bias caused by prior information and increased response caution (wider boundary separation). 222 participants discriminated the direction of coherent motion stimuli as quickly and accurately as possible. Stimuli were preceded with a neutral cue (square) or a directional cue (arrow). 80% of the directional cues validly predicted the upcoming motion direction. We modelled accuracy and response time data using a hierarchical Bayesian model in which starting point varied with cue condition. We found no evidence for our hypotheses, with starting point bias and response caution seemingly unrelated to Adult Autism Spectrum Quotient (AQ) scores. Alongside future research applying this paradigm to autistic individuals, our findings will help refine theories regarding the role of prior information and altered decision-making strategies in autistic perception. Our study also has implications for models of bias in perceptual decision-making, as the most plausible model was one that incorporated bias in both decision-making and sensory processing.

Keywords

Autism spectrum; perceptual decisions; motion processing; diffusion model

Received: 4 November 2020; revised: 26 February 2021; accepted: 13 April 2021

Introduction

Processing visual information and integrating it with prior experience to guide decisions is key to successfully interacting with the dynamic world around us. These processes may function differently in autism, a neurodevelopmental condition characterised by social communication difficulties and repetitive and restricted patterns of behaviour and interests (see Pellicano & Burr, 2012; Robertson & Baron-Cohen, 2017, for reviews). One aspect of visual processing that has received much focus in autism research is motion perception, with some studies reporting reduced motion sensitivity in autism (Manning et al., 2013; Milne et al.,

¹Department of Psychology, University of Huddersfield, Huddersfield, UK

²Department of Psychology, University of Amsterdam, Amsterdam, The Netherlands

³Department of Experimental Psychology, University of Oxford, Oxford, UK

⁴School of Psychology and Clinical Language Sciences, University of Reading, Reading, UK

Corresponding author:

Catherine Manning, School of Psychology and Clinical Language Sciences, University of Reading, Reading RG6 6ES, UK.

Email: c.a.manning@reading.ac.uk

2002; Pellicano et al., 2005), while other studies show improved sensitivity (Chen et al., 2012; Foss-Feig et al., 2013; Manning et al., 2015) or similar performance in autistic individuals relative to neurotypical individuals (Del Viva et al., 2006; Jones et al., 2011). This disparate literature may be due to differences in participant samples and the type of experimental task or stimuli used (see Kaiser & Shiffrar, 2009; Simmons et al., 2009, for reviews). Yet, despite these differences across studies, evidence has emerged for a small reduction in sensitivity in autistic individuals in motion coherence and biological motion tasks which require perceiving the overall motion of a cloud of dots or a point-light figure, respectively (Van der Hallen et al., 2019). These tasks have in common that they require integrating motion signals over space (“global” motion sensitivity).

It is possible that differences between autistic and non-autistic individuals in perceptual tasks will become more pronounced when introducing prior information which can bias responses. Using a Bayesian framework, Pellicano and Burr (2012) suggested that autistic individuals rely less on prior information than neurotypical individuals, and instead rely more on incoming sensory signals. Although this might lead to autistic individuals perceiving the world more veridically in some situations, performance may be adversely affected in others. Developments of this theory have been rooted in the predictive coding framework (see Clark, 2013, for review), where priors and sensory signals are reframed as predictions and prediction errors; again these theories suggest that the balance between prior information and sensory signals is atypical in autism (Friston et al., 2013; Lawson et al., 2014; Van de Cruys et al., 2018).

The current investigation aimed to better understand individual differences in motion processing and decision-making. Specifically, we investigated whether the use of prior information in a motion processing task varies as a function of autistic-like traits in the neurotypical population. This research can inform and guide studies of individuals with a clinical diagnosis of autism because autistic-like traits have been proposed to vary continuously across the population, with autistic individuals lying at one end of this continuum (Baron-Cohen et al., 2001; Constantino & Todd, 2003). Indeed, Grinter et al. (2009) reported that individuals with high levels of autistic-like traits have increased motion coherence thresholds, like diagnosed autistic individuals, suggesting that the results obtained in this study may be relevant for understanding perceptual performance in autism (but see Burghoorn et al., 2020). In addition, some studies have shown relationships between autistic-like traits and prior information use (Aru et al., 2018; Karvelis et al., 2018; Powell et al., 2016; Skewes et al., 2015), suggesting that weaker priors may extend to individuals with high levels of autistic-like traits (but see also Andermane et al., 2020; Tulver et al., 2019).

This study assesses the influence of prior knowledge on motion coherence discrimination using the diffusion model framework (Ratcliff & Rouder, 1998), in which decisions are modelled as noisy evidence accumulation processes towards one of the two decision bounds. The diffusion model provides greater insight regarding the cognitive processes underlying task performance than traditional accuracy and response time (RT) measures, and can provide alternative explanations of the behavioural results. For example, in our own work, the diffusion model has allowed us to conclude that inattentive children’s reduced task accuracy was due to less efficient information processing rather than a speed-accuracy trade-off (Retzler et al., 2020), and that age-related differences in children’s motion sensitivity are driven by changes in both speed-accuracy trade-offs and efficiency of information processing (Manning et al., 2021).

The main parameters of the diffusion model are drift rate, boundary separation, starting point, and non-decision time. The drift rate parameter reflects the efficiency of information processing, which corresponds to the rate of information accumulation over time towards one of two decision boundaries (see Figure 1). Drift rates will be lower during hard decisions, such as when two stimuli are difficult to discriminate, and higher during easier discriminations. The separation of decision boundaries reflects speed-accuracy trade-off, or response caution. Wider boundaries reflect a tendency to require more evidence before reaching a decision, whereas a less cautious approach would be reflected in reduced boundary separation. The position of the starting point in relation to the boundaries determines whether there is a bias towards one response over another. If the starting point is closer to one boundary then there is a greater likelihood of reaching that boundary on a given trial and thus a bias towards that response. If the starting point is equidistant from each boundary then there is no bias towards one response over the other. Finally, non-decision time reflects processes outside of the decision-making process including encoding and response preparation. More complex models with parameters for trial by trial variability in drift rate, non-decision time, and starting point can be constructed but fitting these models requires more data than is typically acquired from behavioural tasks and the parameters of the simplified model used here are the most cognitively interesting (Lerche & Voss, 2016).

The two main ways in which prior information can influence decision-making within the diffusion model framework, are through a change in drift rate (Diederich & Busemeyer, 2006; Ratcliff, 1985), or in a biased starting point (Bogacz et al., 2006; Diederich & Busemeyer, 2006; Link & Heath, 1975; Voss et al., 2004). In cases where the decision-maker is aware of the biasing information prior to the onset of evidence accumulation then we would expect the bias to be reflected in the starting point parameter of the diffusion model (van Ravenzwaaij et al., 2012). For

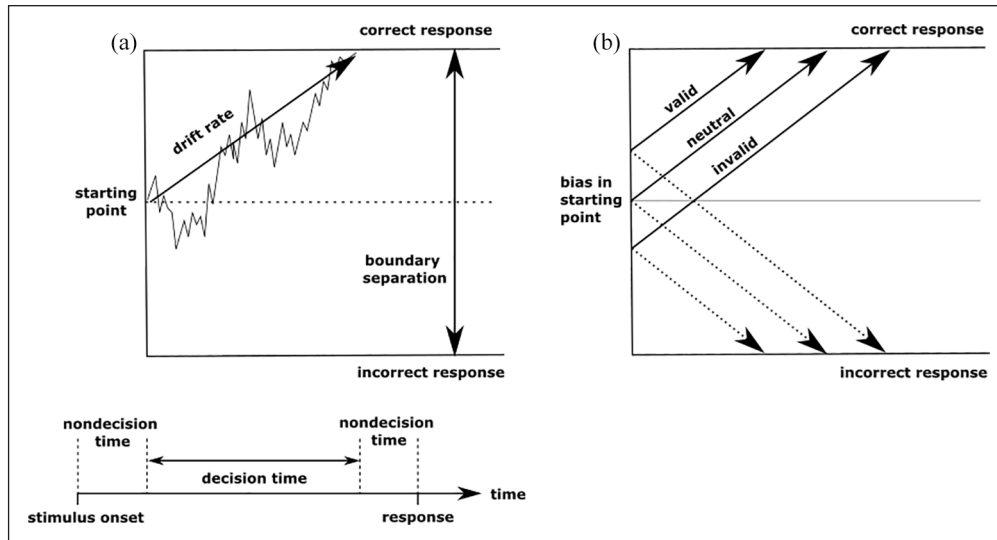

Figure 1. Representation of the diffusion model showing the noisy accumulation of information from the starting point towards a decision boundary (a) and the hypothesised effects of providing valid, neutral, and invalid cues on the starting point (b).

example, Mulder et al. (2012) found that presenting probabilistic directional cues immediately before random dot motion stimuli biased the starting point of the decision-making process in typical adults towards the cued direction (see also Forstmann et al., 2010). Similarly, Rao et al. (2012) trained macaques on a task in which arrow cues indicated the prior probability of stimulus motion. They used activity in the lateral intraparietal area (LIP) to investigate the effects of bias on decision-making, and found that the bias cue changed the initial activity of the LIP neurons (analogous to the starting point) but did not change the scale of sensory evidence (drift rate).

Here, we used a task similar to that of Mulder et al. (2012) to investigate whether the extent of starting point bias following probabilistic cues varied as a function of autistic-like traits in a neurotypical population. We also tested a second hypothesis based on previous research using the diffusion model which has shown increased response caution (i.e., wider boundary separation) in autistic individuals compared with neurotypical individuals (Pirrone et al., 2017; Pirrone et al., 2020). We investigated whether this tendency extends to members of the general population with high levels of autistic traits in our motion task. Interestingly, one previous study that investigated the relationship between autistic traits and diffusion model parameters in a neurotypical population reported no correlation between autistic-like traits and response caution in three tasks, including a motion coherence task (Pirrone et al., 2018). However, this study had a small sample size ($n=39$) which may have been underpowered to detect an effect.

In this study, we investigated the relationship between autistic-like traits and performance on a random-dot motion paradigm in which prior probability information

indicated the likely direction of motion. The accuracy and RT data from this task were then modelled using the diffusion model and the resulting parameters related to autistic-like trait scores using a plausible values approach (Ly et al., 2017, 2018). Our pre-registered hypotheses (<https://osf.io/jqpxy/>) were that individuals with higher levels of autistic-like traits would show (1) a lesser extent of starting point bias when presented with prior probability information, and (2) wider response boundaries, than individuals with lower levels of autistic-like traits (i.e., a negative and positive correlation, respectively). The difficulty level (stimulus strength) was tailored to each individual's sensitivity so that we did not expect estimates of drift rate to vary systematically with levels of autistic-like traits.

Methods

Participants

A total of 241 participants were recruited primarily from the student populations at the Universities of Huddersfield and Oxford, of which 17 were excluded as they self-reported a diagnosis of a neurological, developmental, or psychiatric disorder, and two were excluded due to equipment malfunction. The remaining 222 participants were aged between 17 and 56 years ($M=20.86$ years, $SD=5.02$ years), had self-reported normal or corrected-to-normal vision and were fluent English speakers. Sex data were only recorded for 196 participants of whom 148 were female. The data were collected in undergraduate lab sessions at the University of Huddersfield ($n=152$) and as part of undergraduate student projects at the University of Oxford ($n=70$). Total scores on the Adult Autism Spectrum Quotient (AQ; Baron-Cohen et al., 2001) were

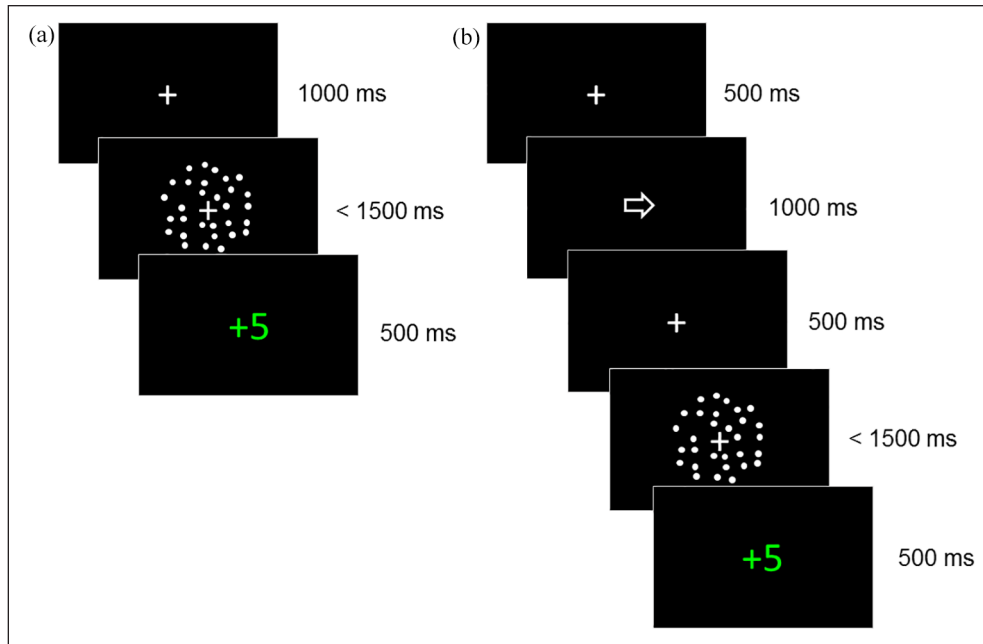

Figure 2. Representation of trial structure in initial staircase phase (a) and main experimental phase (b). (a) Representation of a trial in the initial staircase phase with feedback for a correct response made between 100 and 1,500 ms following the motion stimulus. (b) Representation of a trial in the experimental phase where a directional cue (arrow) was presented before the motion stimulus with feedback for a correct response made between 100 and 1,500 ms.

between 4 and 40 ($M=17$, $SD=6.77$). Item-level AQ scores were not recorded for data collected at the University of Huddersfield. Of those who self-reported handedness, 210 were right-handed and 8 were left-handed. Six participants did not complete all five blocks of the task due to time restrictions but were retained in the data set. The study was approved by the ethical review boards at the respective institutions (University of Oxford Medical Sciences Inter-Divisional Research Ethics Committee [R64394/RE002; R64395/RE001]; University of Huddersfield, School of Human and Health Sciences Research Ethics Panel SREP/2017/104) and written informed consent was obtained from each subject.

Stimuli

The task was presented on calibrated monitors with a frame rate of 60 Hz using PsychoPy software (Peirce, 2009; Peirce et al., 2019). Stimuli were white dots (diameter $\sim 12^\circ$) moving on a black background within a circular aperture (diameter 10°), with a speed of $5^\circ/s$. An average of 100 dots were presented per frame and each dot “lived” for six frames, after which it was terminated. With each new frame, the dot either moved positions randomly or in line with the motion direction. Dots moving in line with the motion direction were signal dots and those moving randomly were noise dots. The noise dots followed a random but constant direction. A fixation cross (width 0.8°)

was present before and during stimulus presentation (see Figure 2).

Procedure

The task was based on that used by Mulder et al. (2012), and involved participants deciding the coherent motion direction of a random dot pattern. Participants sat 50 cm from the monitor and were instructed to judge whether most of the dots were going to the left or the right, and to indicate their response using the left and right arrow keys on the keyboard. The experiment began with a staircase phase to estimate the coherence level at which the participant responded with an accuracy of 80% correct. This staircase procedure was designed to titrate the difficulty level to each participant’s sensitivity, ensuring that each participant made errors to obtain stable model fits (see also Mulder et al., 2012). In each trial, a fixation dot was presented for 1,000 ms before the motion stimulus, which was presented until the participant responded or until 1,500 ms elapsed (see Figure 2a). Trial-by-trial feedback was given following the participant’s response. If participants responded within 100 and 1,500 ms, they were given 5 points (shown in green text) for a correct response or 0 points (shown in red text) for an incorrect response. Otherwise, participants were warned that they had responded too quickly (“too fast” in red text for responses under 100 ms) or too slowly (“miss” in red text for

responses over 1,500 ms). In this phase, there were two randomly interleaved QUEST staircases (Watson & Pelli, 1983) with 40 trials each: one staircase for each motion direction. Each QUEST had a starting value of 70% coherence and was restricted to values between 1% and 100% coherence. A threshold estimate was obtained for each QUEST using the mode of the posterior distribution, and these estimates were averaged to provide a single threshold estimate.

This threshold estimate was then used as the stimulus level for the main experimental phase, which consisted of five blocks of 40 trials. In this phase, a central cue (width 0.8°) was presented for 1,000 ms before the motion stimulus, with a fixation cross presented for 500 ms before and after the cue (Figure 2b). Half of the trials had neutral, non-directional cues (a square), while the other half of the trials had directional arrow cues. 80% of the arrow cues validly predicted the upcoming motion direction, while the remaining 20% of the arrow cues were invalid. The stimuli moved leftward on half of the trials. Trial order was randomised within each block. Participants were advised that the arrows would indicate the most likely direction of the upcoming stimulus, but that the squares would not give any information about the upcoming stimulus. As before, participants were asked to respond as accurately and quickly as possible and trial-by-trial feedback was given. In addition, participants saw their total number of points at the end of each block. The experimental code can be found at <https://osf.io/jqpxy/>. Participants also completed an online or paper version of the AQ (Baron-Cohen et al., 2001) yielding a total score ranging from 0 to 50.

Data filtering

Trials with very fast (under 200 ms), or very slow (over 1,500 ms), response times were removed from each participant's data set. An average of 98.22% of trials were retained (range: 54.5%–100%).

Pre-registered analyses (Model 1)

A Bayesian, hierarchical Wiener diffusion model (Vandekerckhove et al., 2011) was fit to the response time and accuracy data using Stan and the RStan package (Stan Development Team, 2020). Following Mulder et al. (2012), we used accuracy coding (collapsing across leftward and rightward stimuli), categorising trials as correct and incorrect trials in valid, invalid, and neutral conditions. As Mulder et al. (2012) reported that prior probability information biases the starting point (but not the drift rate), our pre-registered analyses modelled only a condition effect on starting point. The drift rate δ , boundary separation α , and non-decision time τ were estimated for each participant with population means $\mu_\delta, \mu_\alpha, \mu_\tau$ and variances $\sigma_\delta^2, \sigma_\alpha^2, \sigma_\tau^2$. The priors for the group-level distributions were based on

previous work (Manning et al., 2021; Matzke & Wagenmakers, 2009) and participant-level prior distributions were truncated to ensure plausibility. Following Mulder et al. (2012), the starting point for the neutral cue trials (condition $c=1$; $\beta_{(p1)}$) was fixed at 0.5 (i.e., exactly halfway between the correct and incorrect boundary). The starting point for valid and invalid trials was modelled with a symmetric condition effect, such that valid cues bias the participant towards the correct response and invalid cues bias the participant towards the incorrect response with the same magnitude. The condition effect was modelled using Rouder et al.'s (2012) Bayesian analysis of variance (ANOVA) framework. For valid trials (condition $c=2$), the starting point $\beta_{(p2)}$ for participant p was drawn from a truncated normal distribution with a mean $0.5 + \theta\sigma_\epsilon$, where θ is the standardised effect size and σ_ϵ is the residual standard deviation. For invalid trials (condition $c=3$), the starting point was $1 - \beta_{(p2)}$. A graphical representation of Model 1 is presented in Figure 3.

We sampled from the posterior distribution using three parallel chains with 15,000 iterations, each with a burn in period of 6,000 samples, resulting in 27,000 retained samples. Starting values for all parameters were drawn from uniform distributions within the range of admissible parameter values. We posted the model on the Open Science Framework before investigating relationships with AQ, to ensure that our analyses were not biased according to our hypotheses. Finally, we used a plausible values approach (Ly et al., 2017) to investigate relationships between AQ scores and our parameters of interest (change in starting point across conditions $\beta_{(p2)} - 0.5$, and boundary separation α). Rather than performing frequentist correlational analyses on point estimates derived from the posterior distribution, the plausible values approach takes account of both uncertainty in the posterior distribution and uncertainty in generalising from a sample to the population. Briefly, correlations between each of 3,000 posterior draws for a given parameter and AQ were computed, resulting in a distribution of plausible correlations. For each plausible correlation, the implied analytic posterior population distribution was computed and subsequently averaged across plausible draws (Ly et al., 2018; <https://github.com/AlexanderLyNL/bstats>). We then computed the 95% equal tail credible interval for the posterior distribution of the population correlation and the Bayesian p -value, defined as the area of the posterior distribution above or below zero (Klauer, 2010; Skippen et al., 2019). A 95% credible interval encompassing zero suggests no reliable correlation. Models, data, and analysis scripts are available at <https://osf.io/jqpxy/>

Exploratory analyses

Some areas of misfitting were identified in the posterior predictive plots for our pre-registered model (Model 1,

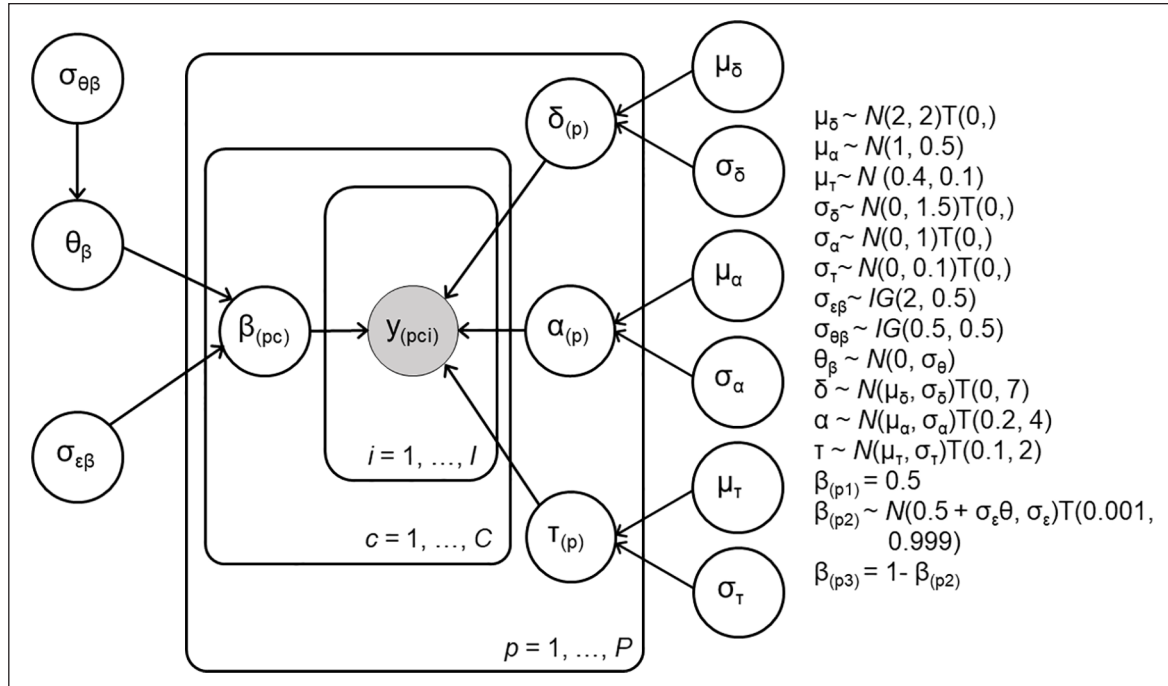

Figure 3. Graphical representation of Model 1 with condition effect on starting point. The data $y_{(pci)}$ for each participant p , condition c , and trial i were assumed to be distributed according to the diffusion model's first passage time distribution with drift rate δ , boundary separation α , non-decision time τ and starting point β parameters. In the neutral condition ($c = 1$), the starting point β is fixed at 0.5. Starting point β is estimated with a symmetric effect in valid ($c = 2$) and invalid ($c = 3$) conditions.

Supplementary Figure S1), particularly at the shortest and longest RT quantiles, with the model predicting wider response time distributions than those present in the data. We therefore built two further models to see if these would provide a better fit to the data. Model 2 had a symmetric condition effect on drift rate δ while starting point β was fixed at 0.5 for all conditions (see Supplementary Figure S2). For each participant p in condition c , drift rate ($\delta_{(pc)}$) was drawn from a truncated normal distribution with a mean determined by μ_{δ} and a standardised effect size with standard deviation σ_{δ} . Model 3 had condition effects on both starting point β and drift rate δ (see Supplementary Figure S3). We computed log marginal likelihoods for each model with warp-III bridge sampling (Gronau, Heathcote, & Matzke, 2020; Meng & Schilling, 2002; Meng & Wong, 1996), using the bridgesampling R package (Gronau, Singmann, & Wagenmakers, 2020), with six repetitions and a maximum of 20,000 iterations. Based on the marginal likelihoods, we then calculated Bayes factors to determine the most plausible model.

Results

AQ, accuracy, and response time

The coherence level presented to participants in the experimental phase based on their staircase trials ranged between 0.06 and 1 ($M = 0.71$, $SD = 0.31$). The coherence level presented did not correlate with AQ, $r(220) = -0.02$,

Table 1. Task performance metrics.

Measure	Cue type		
	Neutral	Valid	Invalid
Median RT (SD)	0.60 (0.11)	0.56 (0.12)	0.61 (0.13)
Accuracy (SD)	79.21 (15.02)	85.01 (11.78)	68.72 (23.57)

RT: response time; SD: standard deviation.

Mean and standard deviation of median response time (RT) for correct trials in seconds and percentage accuracy for each cue type.

95% CI = $[-0.15, 0.11]$, showing that the adaptive procedure did not lead to important between-participants differences as a function of AQ.

Table 1 shows the mean of participants' median RTs for correct trials and accuracy across cue conditions. As expected, accuracy was highest for valid trials and lowest for invalid trials, and response times were slightly faster in valid trials than in neutral and invalid trials. Figure 4 plots accuracy and median RT as a function of AQ score, and Table 2 presents correlation coefficients between these performance measures and AQ score. As shown, accuracy and RT did not appear to vary systematically with AQ score.

Pre-registered diffusion model analysis

Our pre-registered analysis used a model (Model 1) with a condition effect on starting point (Figure 3). The model

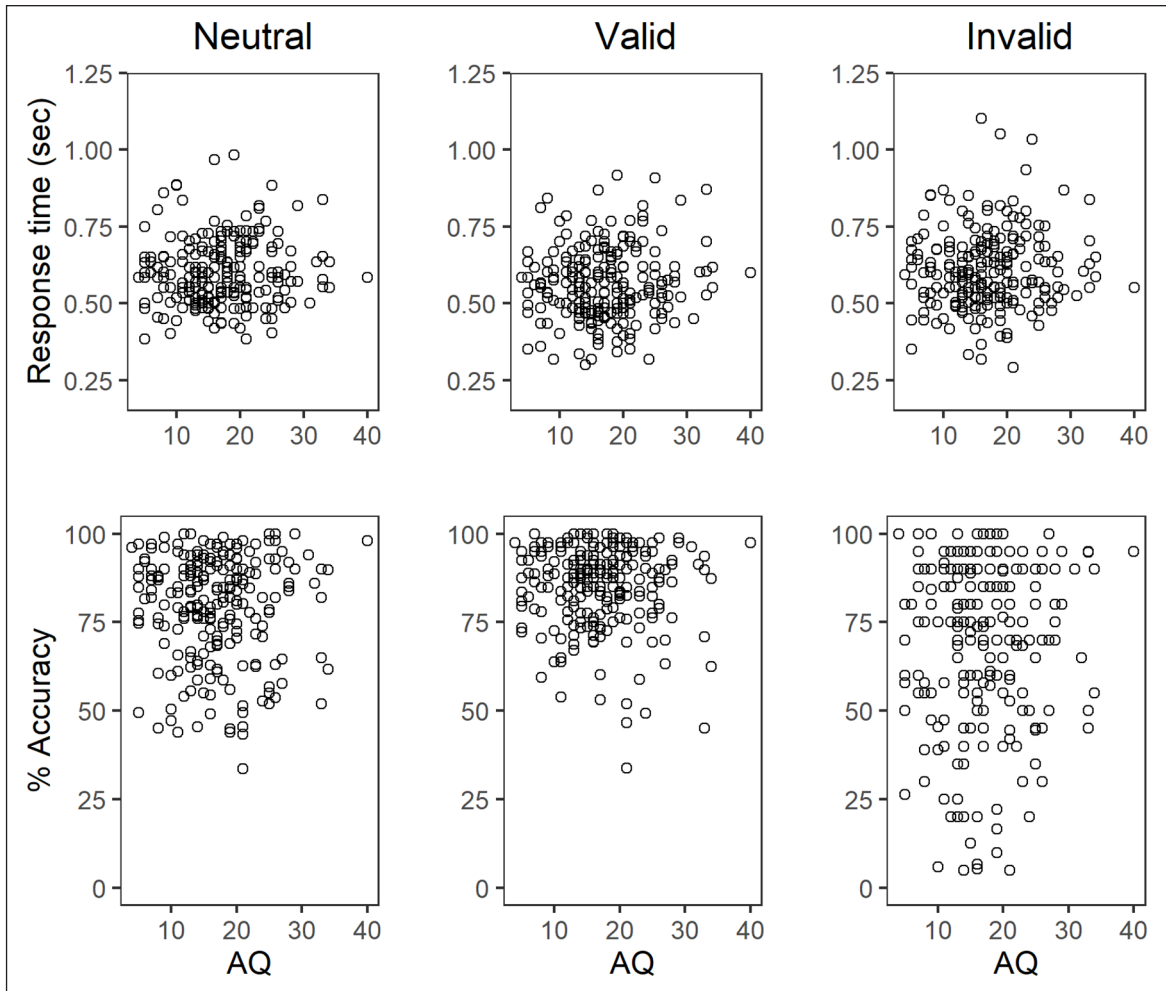

Figure 4. Scatterplots showing the relationship between autism spectrum quotient (AQ) scores and accuracy and median response times for correct trials.

Table 2. Correlations between autism spectrum quotient (AQ) scores and accuracy and median response times for correct trials following neutral, valid, and invalid cues.

Measure	Correlation with AQ	
	R	CI
Median RT		
Neutral	0.05	[-0.08, 0.18]
Valid	0.08	[-0.05, 0.21]
Invalid	0.06	[-0.07, 0.19]
% Accuracy		
Neutral	-0.02	[-0.15, 0.11]
Valid	-0.05	[-0.18, 0.09]
Invalid	0.05	[-0.09, 0.18]

AQ: Adult Autism Spectrum Quotient; CI: 95% confidence intervals; RT: response time.

converged well, with Gelman–Rubin diagnostic values (Gelman & Rubin, 1992) close to 1 (range=0.999–1.000). Posterior predictives for this model can be found in

Supplementary Figure S1. Overall, starting point varied with condition in the expected direction, with valid cues biasing responses towards the correct response and invalid cues biasing responses towards the incorrect response (see Figure 5). However, as shown in Figure 6 (left panel), some participants showed a change in starting point in the opposite direction, which may reflect measurement error due to the relatively small number of trials for each participant.

Our first hypothesis was that the change in starting point between neutral and cued conditions (i.e., $\beta_{(p2)} - 0.5$) would vary as a function of autistic traits. Figure 6 shows the plausible correlations and population correlation distribution for this relationship. The 95% equal tail credible interval for the population correlation posterior distribution spanned zero [-0.17, 0.11] (Bayesian p -value = .34), suggesting no reliable relationship between AQ and effect of prior information on starting point.

Our second hypothesis was that boundary separation α would correlate with AQ scores. Again, we found no evidence for this relationship (Figure 7), with the

population correlation posterior distribution having a 95% equal-tailed credible interval of $[-.16, .11]$ (Bayesian p -value = .37).

Exploratory analyses

As the posterior predictives for Model 1 showed some areas of mis-fitting, we compared this model with Model 2, which allowed drift rate to vary across cue conditions while starting point was fixed at 0.5 (Supplementary Figure S2), and Model 3, which allowed both drift rate and starting point to vary according to cue conditions (Supplementary Figure S3). Posterior predictives for these additional

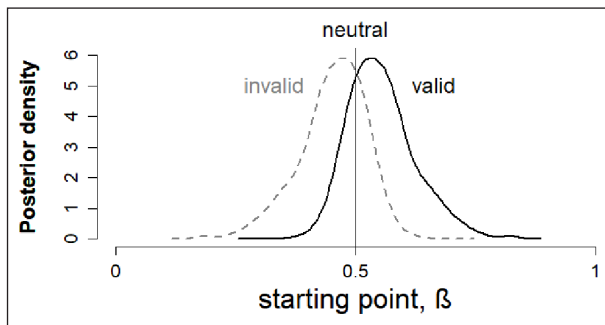

Figure 5. Posterior density of starting point values for valid and invalid cue conditions in Model 1. In the pre-registered analyses (Model 1), starting point β for the neutral condition was fixed at 0.5 and a symmetric effect in valid and invalid cue conditions was modelled, with the posterior distribution shifting towards 1 (the correct boundary) in the valid condition, and towards 0 (the incorrect boundary) in the invalid condition.

models can be found in Supplementary Figures S4 and S5. It is worth noting that the same pattern of misfitting found with Model 1 in the most extreme RT quantiles is also evident for these models. Bridge sampling estimated the log marginal likelihood of Models 1 to 3 to be $-5,076.57$, $-4,956.39$, and $-4,863.51$, respectively. Both Model 2 (with a condition effect on drift rate) and Model 3 (with a condition effect on both drift rate and starting point) were preferred over Model 1 (which had a condition effect only on starting point), with log Bayes factors of 120.19 for the comparison between Models 2 and 1, and 213.07 for the comparison between Models 3 and 1. Out of the two additional models, Model 3 was preferred (log Bayes factor = 92.89), suggesting that a model with condition effects on both drift rate and starting point provided the best fit to the data. The posterior mean for drift rate was slightly higher in the valid cue condition ($M = 1.59$, $SD = 0.79$) than in the neutral condition ($M = 1.33$, $SD = 0.83$), showing that sensory evidence accumulation was accelerated following valid cues. Importantly, when applying the plausible values approach to the posterior samples from this model, we still did not find evidence to support our hypotheses (see Supplementary Figures S6 and S7). We also investigated whether change in drift rate related to AQ. There was no clear evidence of a relationship (see Supplementary Figure S8) with a 95% equal-tailed credible interval of $[-.20, .08]$ (Bayesian p -value = .19).

Discussion

In this study, we investigated how perceptual decision-making varies as a function of autistic-like traits in a large

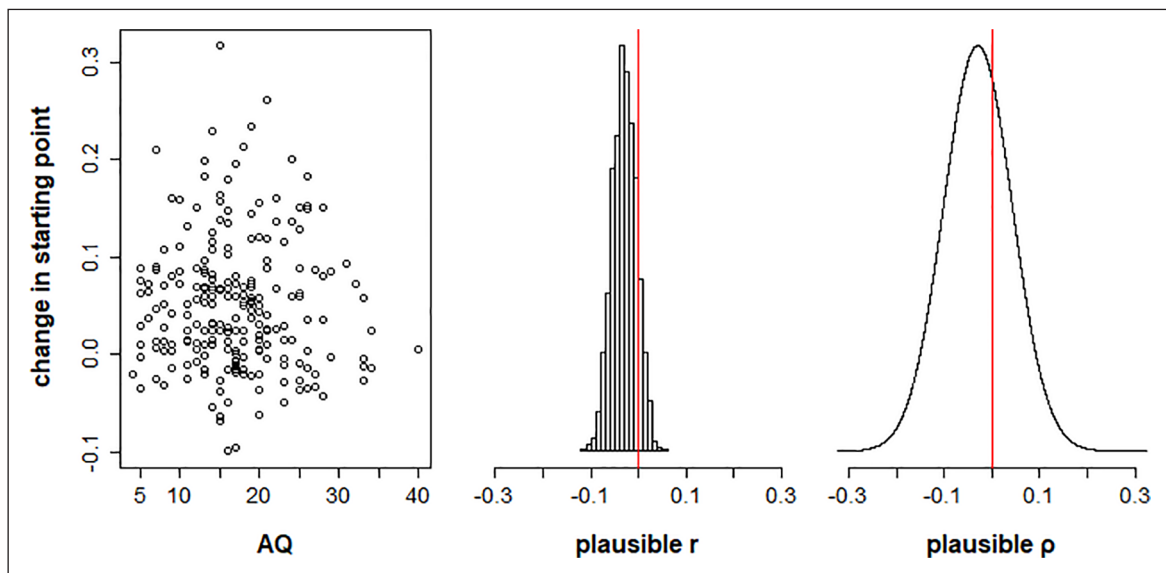

Figure 6. Plots showing the relationship between autism spectrum quotient (AQ) scores and change in starting point between validly cued and neutral trials, for Model 1. The left panel plots posterior mean estimates of change in starting point ($\beta_{(p2)} - 0.5$) for each participant as a function of AQ score. The middle panel shows the distribution of plausible correlations r between change in starting point and AQ in the sample. The right panel shows the posterior distribution of the plausible population correlation, ρ .

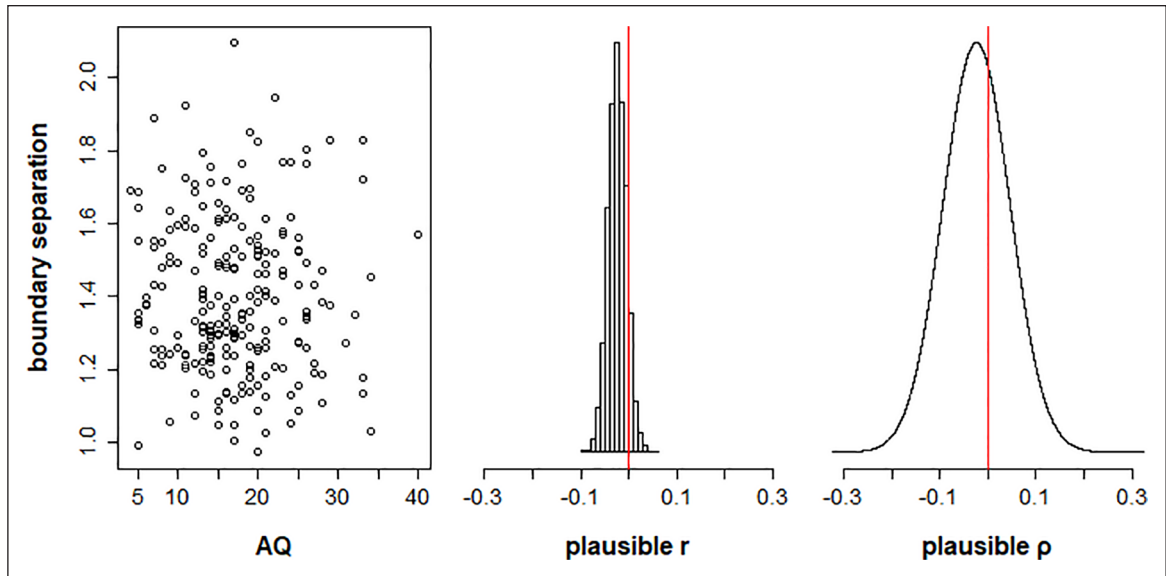

Figure 7. Plots showing the relationship between autism spectrum quotient (AQ) scores and boundary separation between validly cued and neutral trials, for Model 1. The left panel plots posterior mean estimates of boundary separation α for each participant as a function of AQ score. The middle panel shows the distribution of plausible correlations r between boundary separation and AQ in the sample. The right panel shows the posterior distribution of the plausible population correlation, ρ .

sample of the general population using a diffusion model framework. We used a motion direction discrimination task with probabilistic cues that have been reported to bias the starting point of the decision-making process, meaning that less sensory evidence is required to trigger a response towards the cued direction (Mulder et al., 2012). Following accounts of reduced reliance on prior information in autism (Pellicano & Burr, 2012), we hypothesised that starting point biases would be reduced in people with high levels of autistic-like traits compared with those with low levels of autistic-like traits. Yet, we found no evidence for a relationship between starting point bias and autistic-like traits. Similarly, we found no evidence for our hypothesis that individuals with high levels of autistic-like traits would make more cautious responses (with wider decision boundaries) than individuals with low levels of autistic-like traits. We consider three possible interpretations of these results.

First, our results may suggest that the proposed differences in prior information use and response caution in autism (Pellicano & Burr, 2012; Pirrone et al., 2017; Pirrone et al., 2020) do not extend to individual differences in autistic-like traits in the general population. Although some previous studies have found support for the weakened priors account in non-clinical populations with high levels of autistic-like traits (Powell et al., 2016; Skewes et al., 2015), others have not (Andermane et al., 2020; Ewbank et al., 2016; Tulver et al., 2019). Pirrone et al. (2018) reported previously that increased response caution did not vary as a function of autistic-like traits in the general population, which we also report here in a larger

sample with a different paradigm. It is possible that our staircase procedure designed to titrate difficulty levels across participants may have inadvertently influenced boundary separation settings across the sample, so extensions of this paradigm could be optimised for assessing boundary separation differences as a function of AQ. Previous failures to extend findings from autistic populations to non-autistic populations have challenged the idea that the perceptual differences found in autism vary along a continuum across the whole population (Gregory & Plaisted-Grant, 2016). Perhaps, more generally, autism should be conceptualised as a qualitatively distinct category relative to the typical population (e.g., Frazier et al., 2010). It is therefore crucial to present our task and modelling approach to diagnosed autistic individuals to contextualise the clinical relevance of our result.

Second, there are methodological limitations with the AQ that may obscure relationships with perceptual decision-making parameters. First, AQ scores do not correspond perfectly to diagnoses, with many autistic people scoring below the cut-off (Ashwood et al., 2016; Bishop & Seltzer, 2012), and no clear relationship between AQ scores and standard clinical measures (Bishop & Seltzer, 2012). It has also been suggested that the construct measured by the AQ is not continuous, as assumed, but instead categorical (James et al., 2016), making it difficult to interpret relationships (or lack thereof) with the total AQ score (see also English et al., 2020). Similarly, Agelink van Rentergem et al. (2019) reported that some of the items on the AQ function differently between autistic and non-autistic samples. Although alternative scoring algorithms

have been proposed to mitigate some of these challenges (Agelink van Rentergem et al., 2019; English et al., 2020), we were unable to use these as we did not have access to item-level data from all participants. Yet, despite the conceptual and methodological issues associated with the AQ, some studies have nonetheless reported relationships between AQ scores and prior information use in different tasks (Powell et al., 2016; Skewes et al., 2015).

This discrepancy leads us to our final interpretation of our results, which is that only some types of prior information use are altered in autism. Accordingly, mixed findings are emerging from studies comparing diagnosed autistic and non-autistic individuals (e.g., Croydon et al., 2017; Karaminis et al., 2016; Pell et al., 2016; Skewes & Gebauer, 2016; Van de Cruys et al., 2018). This mixed pattern of results could reflect the fact that there are many different types of prior information which influence perception through different timescales (see Series & Seitz, 2013, for review), which may be selectively affected in autism. For example, in our study, the prior information is explicit and immediately precedes the stimulus, changing from trial-to-trial, whereas in other studies the prior distribution is implicitly learned over a block of trials (e.g., Karvelis et al., 2018) or built up during experience of the world outside the experimental session (e.g., Powell et al., 2016). Interestingly, Tulver et al. (2019) found no single factor explaining individual differences in the effects of prior information in different perceptual tasks, arguing that priors can only be understood in reference to specific tasks and stimuli. Ultimately, large studies presenting multiple tasks with different types of prior information to both autistic and non-autistic individuals would inform us about which aspects of prior information use are atypical in autism, and which of these extend to individual differences in autistic-like traits. Such an investigation would in turn inform theoretical accounts regarding prior information use in autism. Moreover, future research will be required to investigate the level of processing at which autism-related differences arise: the extent to which prior information is processed, the extent to which it is incorporated into a mental representation, and/or the extent to which subsequent decision-making uses that prior information.

The results of our exploratory analyses also have implications for models of bias in perceptual decision-making tasks. Previous studies have reported that prior information about the likely upcoming motion direction (Forstmann et al., 2010; Mulder et al., 2012) or pain intensity (Wiech et al., 2014) biases the starting point of the decision-making process, rather than biasing the drift rate. According to these studies, prior information alters the decision-making process while leaving sensory processing unaffected—a suggestion which has been supported by single cell recordings in monkeys (Rao et al., 2012). Yet in our exploratory analyses, we found that a model allowing drift rate to vary following probabilistic cues was more plausible than a

model with a change in starting point, with the most plausible model being one with effects on both drift rate and starting point. Although we are not the first to report bias in drift rate as a result of prior information (Hanks et al., 2011; van Ravenzwaaij et al., 2012), previous reports have used tasks where the prior probability of stimulus motion was manipulated within a block. The differences between our results and those obtained using a similar paradigm by Mulder et al. (2012) could be because Mulder et al. used a more complex model that can account for random trial-by-trial variability in bias. The importance of trial-by-trial fluctuations in bias could be modelled in future work using reinforcement learning models incorporating diffusion processes (Pedersen et al., 2017) or modified diffusion models where the starting point depends on the previous decision (Olianezhad et al., 2019). Importantly, attending to a certain direction can modulate the response of direction-selective cells (see Carrasco, 2011; Maunsell & Treue, 2006, for reviews) and change the gain and tuning of population responses (Ling et al., 2009), providing a potential mechanism for the effect of directional cues on drift rate that we report. However, as this result was not hypothesised, future confirmatory studies are required. Crucially, the model of bias chosen did not affect our conclusions: neither bias in starting point nor bias in drift rate related to autistic-like traits.

Conclusion

In this study, we used a diffusion model framework to investigate whether perceptual decision-making characteristics vary as a function of autistic-like traits in the general population. We found no evidence for our hypotheses that individuals with high levels of autistic-like traits would incorporate prior information into their decisions to a lesser extent, and respond more cautiously, than those with low levels of autistic-like traits. With future application to diagnosed autistic individuals, this paradigm will be useful for probing the limits to theories proposing reduced prior information use in autism.

Acknowledgements

The authors are grateful to Martijn Mulder for assisting with study design by answering questions about the original paradigm.

Declaration of conflicting interests

The author(s) declared no potential conflicts of interest with respect to the research, authorship, and/or publication of this article.

Funding

The author(s) disclosed receipt of the following financial support for the research, authorship, and/or publication of this article: This work was supported by the Wellcome Trust (grant number: 204685/Z/16/Z) and the Department of Experimental Psychology at the University of Oxford.

ORCID iD

Catherine Manning  <https://orcid.org/0000-0001-6862-2525>

Data accessibility statement

The data and materials from the present experiment are publicly available at the Open Science Framework website: <https://osf.io/jqpxy/>

Supplementary material

The supplementary material is available at: qjep.sagepub.com

References

- Agelink van Rentergem, J. A., Lever, A. G., & Geurts, H. M. (2019). Negatively phrased items of the autism spectrum quotient function differently for groups with and without autism. *Autism, 23*(7), 1752–1764. <https://doi.org/10.1177/1362361319828361>
- Andermane, N., Bosten, J. M., Seth, A. K., & Ward, J. (2020). Individual differences in the tendency to see the expected. *Consciousness and Cognition, 85*, 102989. <https://doi.org/10.1016/j.concog.2020.102989>
- Aru, J., Tulver, K., & Bachmann, T. (2018). It's all in your head: Expectations create illusory perception in a dual-task setup. *Consciousness and Cognition, 65*, 197–208. <https://doi.org/10.1016/j.concog.2018.09.001>
- Ashwood, K. L., Gillan, N., Horder, J., Hayward, H., Woodhouse, E., McEwen, F. S., Findon, J., Eklund, H., Spain, D., Wilson, C. E., Cadman, T., Young, S., Stoencheva, V., Murphy, C. M., Robertson, D., Charman, T., Bolton, P., Glaser, K., Asherson, P., . . . Murphy, D. G. (2016). Predicting the diagnosis of autism in adults using the autism-spectrum quotient (AQ) questionnaire. *Psychological Medicine, 46*(12), 2595–2604. <https://doi.org/10.1017/S0033291716001082>
- Baron-Cohen, S., Wheelwright, S., Skinner, R., Martin, J., & Clubley, E. (2001). The autism-spectrum quotient (AQ): Evidence from Asperger syndrome/high-functioning autism, males and females, scientists and mathematicians. *Journal of Autism and Developmental Disorders, 31*(1), 5–17. <https://doi.org/10.1023/a:1005653411471>
- Bishop, S. L., & Seltzer, M. M. (2012). Self-reported autism symptoms in adults with autism spectrum disorders. *Journal of Autism and Developmental Disorders, 42*(11), 2354–2363. <https://doi.org/10.1007/s10803-012-1483-2>
- Bogacz, R., Brown, E., Moehlis, J., Holmes, P., & Cohen, J. D. (2006). The physics of optimal decision making: A formal analysis of models of performance in two-alternative forced-choice tasks. *Psychological Review, 113*(4), 700–765. <https://doi.org/10.1037/0033-295X.113.4.700>
- Burghoorn, F., Dingemans, M., van Lier, R., & van Leeuwen, T. M. (2020). The relation between autistic traits, the degree of synaesthesia, and local/global visual perception. *Journal of Autism and Developmental Disorders, 50*(1), 12–29. <https://doi.org/10.1007/s10803-019-04222-7>
- Carrasco, M. (2011). Visual attention: The past 25 years. *Vision Research, 51*(13), 1484–1525. <https://doi.org/10.1016/j.visres.2011.04.012>
- Chen, Y., Norton, D. J., McBain, R., Gold, J., Frazier, J. A., & Coyle, J. T. (2012). Enhanced local processing of dynamic visual information in autism: Evidence from speed discrimination. *Neuropsychologia, 50*(5), 733–739. <https://doi.org/10.1016/j.neuropsychologia.2012.01.007>
- Clark, A. (2013). Whatever next? Predictive brains, situated agents, and the future of cognitive science. *Behavioral and Brain Sciences, 36*(3), 181–204. <https://doi.org/10.1017/S0140525X12000477>
- Constantino, J. N., & Todd, R. D. (2003). Autistic traits in the general population: A Twin Study. *Archives of General Psychiatry, 60*(5), 524–530. <https://doi.org/10.1001/archpsyc.60.5.524>
- Croydon, A., Karaminis, T., Neil, L., Burr, D., & Pellicano, E. (2017). The light-from-above prior is intact in autistic children. *Journal of Experimental Child Psychology, 161*, 113–125. <https://doi.org/10.1016/j.jecp.2017.04.005>
- Del Viva, M. M., Igliazzi, R., Tancredi, R., & Brizzolara, D. (2006). Spatial and motion integration in children with autism. *Vision Research, 46*(8), 1242–1252. <https://doi.org/10.1016/j.visres.2005.10.018>
- Diederich, A., & Busemeyer, J. R. (2006). Modeling the effects of payoff on response bias in a perceptual discrimination task: Bound-change, drift-rate-change, or two-stage-processing hypothesis. *Perception & Psychophysics, 68*(2), 194–207. <https://doi.org/10.3758/BF03193669>
- English, M. C. W., Gignac, G. E., Visser, T. A. W., Whitehouse, A. J. O., & Maybery, M. T. (2020). A comprehensive psychometric analysis of autism-spectrum quotient factor models using two large samples: Model recommendations and the influence of divergent traits on total-scale scores. *Autism Research, 13*(1), 45–60. <https://doi.org/10.1002/aur.2198>
- Ewbank, M. P., von dem Hagen, E. A. H., Powell, T. E., Henson, R. N., & Calder, A. J. (2016). The effect of perceptual expectation on repetition suppression to faces is not modulated by variation in autistic traits. *Cortex, 80*, 51–60. <https://doi.org/10.1016/j.cortex.2015.10.011>
- Forstmann, B. U., Brown, S., Dutilh, G., Neumann, J., & Wagenmakers, E.-J. (2010). The neural substrate of prior information in perceptual decision making: A model-based analysis. *Frontiers in Human Neuroscience, 4*, Article 40. <https://doi.org/10.3389/fnhum.2010.00040>
- Foss-Feig, J. H., Tadin, D., Schauder, K. B., & Cascio, C. J. (2013). A substantial and unexpected enhancement of motion perception in autism. *Journal of Neuroscience, 33*(19), 8243–8249. <https://doi.org/10.1523/JNEUROSCI.1608-12.2013>
- Frazier, T. W., Youngstrom, E. A., Sinclair, L., Kubu, C. S., Law, P., Rezai, A., Constantino, J. N., & Eng, C. (2010). Autism spectrum disorders as a qualitatively distinct category from typical behavior in a large, clinically ascertained sample. *Assessment, 17*(3), 308–320. <https://doi.org/10.1177/1073191109356534>
- Friston, K. J., Lawson, R., & Frith, C. D. (2013). On hyperpriors and hypopriors: Comment on Pellicano and Burr. *Trends in Cognitive Sciences, 17*(1), 1. <https://doi.org/10.1016/j.tics.2012.11.003>
- Gelman, A., & Rubin, D. B. (1992). Inference from iterative simulation using multiple sequences. *Statistical Science, 7*(4), 457–472. <https://doi.org/10.1214/ss/1177011136>
- Gregory, B. L., & Plaisted-Grant, K. C. (2016). The autism-spectrum quotient and visual search: Shallow and deep autis-

- tic endophenotypes. *Journal of Autism and Developmental Disorders*, 46(5), 1503–1512. <https://doi.org/10.1007/s10803-013-1951-3>
- Grinter, E. J., Maybery, M. T., Van Beek, P. L., Pellicano, E., Badcock, J. C., & Badcock, D. R. (2009). Global visual processing and self-rated autistic-like traits. *Journal of Autism and Developmental Disorders*, 39(9), 1278–1290. <https://doi.org/10.1007/s10803-009-0740-5>
- Gronau, Q. F., Heathcote, A., & Matzke, D. (2020). Computing Bayes factors for evidence-accumulation models using Warp-III bridge sampling. *Behavior Research Methods*, 52(2), 918–937. <https://doi.org/10.3758/s13428-019-01290-6>
- Gronau, Q. F., Singmann, H., & Wagenmakers, E.-J. (2020). Bridgesampling: An R package for estimating normalizing constants. *Journal of Statistical Software*, 92(1), 1–29. <https://doi.org/10.18637/jss.v092.i10>
- Hanks, T. D., Mazurek, M. E., Kiani, R., Hopp, E., & Shadlen, M. N. (2011). Elapsed decision time affects the weighting of prior probability in a perceptual decision task. *The Journal of Neuroscience*, 31(17), 6339–6352. <https://doi.org/10.1523/JNEUROSCI.5613-10.2011>
- James, R. J. E., Dubey, I., Smith, D., Ropar, D., & Tunney, R. J. (2016). The latent structure of autistic traits: A taxometric, latent class and latent profile analysis of the adult autism spectrum quotient. *Journal of Autism and Developmental Disorders*, 46(12), 3712–3728. <https://doi.org/10.1007/s10803-016-2897-z>
- Jones, C. R. G., Swettenham, J., Charman, T., Marsden, A. J. S., Tregay, J., Baird, G., Simonoff, E., & Happé, F. (2011). No evidence for a fundamental visual motion processing deficit in adolescents with autism spectrum disorders. *Autism Research*, 4(5), 347–357. <https://doi.org/10.1002/aur.209>
- Kaiser, M. D., & Shiffrar, M. (2009). The visual perception of motion by observers with autism spectrum disorders: A review and synthesis. *Psychonomic Bulletin & Review*, 16(5), 761–777. <https://doi.org/10.3758/PBR.16.5.761>
- Karaminis, T., Cicchini, G. M., Neil, L., Cappagli, G., Aagten-Murphy, D., Burr, D., & Pellicano, E. (2016). Central tendency effects in time interval reproduction in autism. *Scientific Reports*, 6(1), 28570. <https://doi.org/10.1038/srep28570>
- Karvelis, P., Seitz, A. R., Lawrie, S. M., & Seriès, P. (2018). Autistic traits, but not schizotypy, predict increased weighting of sensory information in Bayesian visual integration. *eLife*, 7, Article e34115. <https://doi.org/10.7554/eLife.34115>
- Klauer, K. C. (2010). Hierarchical multinomial processing tree models: A latent-trait approach. *Psychometrika*, 75(1), 70–98. <https://doi.org/10.1007/s11336-009-9141-0>
- Lawson, R. P., Rees, G., & Friston, K. J. (2014). An aberrant precision account of autism. *Frontiers in Human Neuroscience*, 8, Article 302. <https://doi.org/10.3389/fnhum.2014.00302>
- Lerche, V., & Voss, A. (2016). Model complexity in diffusion modeling: Benefits of making the model more parsimonious. *Frontiers in Psychology*, 7, Article 1324. <https://doi.org/10.3389/fpsyg.2016.01324>
- Ling, S., Liu, T., & Carrasco, M. (2009). How spatial and feature-based attention affect the gain and tuning of population responses. *Vision Research*, 49(10), 1194–1204. <https://doi.org/10.1016/j.visres.2008.05.025>
- Link, S. W., & Heath, R. A. (1975). A sequential theory of psychological discrimination. *Psychometrika*, 40(1), 77–105. <https://doi.org/10.1007/BF02291481>
- Ly, A., Boehm, U., Heathcote, A., Turner, B. M., Forstmann, B., Marsman, M., & Matzke, D. (2017). A flexible and efficient hierarchical Bayesian approach to the exploration of individual differences in cognitive-model-based neuroscience. In A. A. Moustafa (Ed.), *Computational models of brain and behavior* (pp. 467–480). John Wiley.
- Ly, A., Marsman, M., & Wagenmakers, E.-J. (2018). Analytic posteriors for Pearson's correlation coefficient. *Statistica Neerlandica*, 72(1), 4–13. <https://doi.org/10.1111/stan.12111>
- Manning, C., Charman, T., & Pellicano, E. (2013). Processing slow and fast motion in children with autism spectrum conditions. *Autism Research*, 6(6), 531–541. <https://doi.org/10.1002/aur.1309>
- Manning, C., Tibber, M. S., Charman, T., Dakin, S. C., & Pellicano, E. (2015). Enhanced integration of motion information in children with autism. *Journal of Neuroscience*, 35(18), 6979–6986. <https://doi.org/10.1523/JNEUROSCI.4645-14.2015>
- Manning, C., Wagenmakers, E.-J., Norcia, A. M., Scerif, G., & Boehm, U. (2021). Perceptual decision-making in children: Age-related differences and EEG correlates. *Computational Brain & Behavior*, 4, 53–69. <https://doi.org/10.1007/s42113-020-00087-7>
- Matzke, D., & Wagenmakers, E. J. (2009). Psychological interpretation of the ex-Gaussian and shifted Wald parameters: A diffusion model analysis. *Psychonomic Bulletin & Review*, 16(5), 798–817.
- Maunsell, J. H. R., & Treue, S. (2006). Feature-based attention in visual cortex. *Trends in Neurosciences*, 29(6), 317–322. <https://doi.org/10.1016/j.tins.2006.04.001>
- Meng, X.-L., & Schilling, S. (2002). Warp bridge sampling. *Journal of Computational and Graphical Statistics*, 11(3), 552–586. <https://doi.org/10.1198/106186002457>
- Meng, X.-L., & Wong, W. H. (1996). Simulating ratios of normalizing constants via a simple identity: A theoretical exploration. *Statistica Sinica*, 6, 831–860. <https://www.jstor.org/stable/24306045>
- Milne, E., Swettenham, J., Hansen, P., Campbell, R., Jeffries, H., & Plaisted, K. (2002). High motion coherence thresholds in children with autism. *Journal of Child Psychology and Psychiatry, and Allied Disciplines*, 43(2), 255–263. <https://doi.org/10.1111/1469-7610.00018>
- Mulder, M. J., Wagenmakers, E.-J., Ratcliff, R., Boekel, W., & Forstmann, B. U. (2012). Bias in the brain: A diffusion model analysis of prior probability and potential payoff. *Journal of Neuroscience*, 32(7), 2335–2343. <https://doi.org/10.1523/JNEUROSCI.4156-11.2012>
- Olianezhad, F., Zabbah, S., Tohidi-Moghaddam, M., & Ebrahimpour, R. (2019). Residual information of previous decision affects evidence accumulation in current decision. *Frontiers in Behavioral Neuroscience*, 13, Article 9. <https://doi.org/10.3389/fnbeh.2019.00009>
- Pedersen, M. L., Frank, M. J., & Biele, G. (2017). The drift diffusion model as the choice rule in reinforcement learning. *Psychonomic Bulletin & Review*, 24(4), 1234–1251. <https://doi.org/10.3758/s13423-016-1199-y>
- Pearce, J. W. (2009). Generating stimuli for neuroscience using PsychoPy. *Frontiers in Neuroinformatics*, 2, Article 10. <https://doi.org/10.3389/neuro.11.010.2008>
- Pearce, J. W., Gray, J. R., Simpson, S., MacAskill, M., Höchenberger, R., Sogo, H., Kastman, E., & Lindeløv, J. K. (2019). PsychoPy2: Experiments in behavior made easy.

- Behavior Research Methods*, 51(1), 195–203. <https://doi.org/10.3758/s13428-018-01193-y>
- Pell, P. J., Mareschal, I., Calder, A. J., von dem Hagen, E. A. H., Clifford, C. W. G., Baron-Cohen, S., & Ewbank, M. P. (2016). Intact priors for gaze direction in adults with high-functioning autism spectrum conditions. *Molecular Autism*, 7(1), 25. <https://doi.org/10.1186/s13229-016-0085-9>
- Pellicano, E., & Burr, D. (2012). When the world becomes “too real”: A Bayesian explanation of autistic perception. *Trends in Cognitive Sciences*, 16(10), 504–510. <https://doi.org/10.1016/j.tics.2012.08.009>
- Pellicano, E., Gibson, L., Maybery, M., Durkin, K., & Badcock, D. R. (2005). Abnormal global processing along the dorsal visual pathway in autism: A possible mechanism for weak visuospatial coherence? *Neuropsychologia*, 43(7), 1044–1053. <https://doi.org/10.1016/j.neuropsychologia.2004.10.003>
- Pirrone, A., Dickinson, A., Gomez, R., Stafford, T., & Milne, E. (2017). Understanding perceptual judgment in autism spectrum disorder using the drift diffusion model. *Neuropsychology*, 31(2), 173–180. <https://doi.org/10.1037/neu0000320>
- Pirrone, A., Johnson, I., Stafford, T., & Milne, E. (2020). A diffusion model decomposition of orientation discrimination in children with autism spectrum disorder. *European Journal of Developmental Psychology*, 17(2), 213–230. <https://doi.org/10.1080/17405629.2018.1561364>
- Pirrone, A., Wen, W., Li, S., Baker, D. H., & Milne, E. (2018). Autistic traits in the neurotypical population do not predict increased response conservativeness in perceptual decision making. *Perception*, 47(10–11), 1081–1096. <https://doi.org/10.1177/0301006618802689>
- Powell, G., Meredith, Z., McMillin, R., & Freeman, T. C. A. (2016). Bayesian models of individual differences: Combining autistic traits and sensory thresholds to predict motion perception. *Psychological Science*, 27(12), 1562–1572. <https://doi.org/10.1177/0956797616665351>
- Rao, V., DeAngelis, G. C., & Snyder, L. H. (2012). Neural correlates of prior expectations of motion in the lateral intraparietal and middle temporal areas. *The Journal of Neuroscience*, 32(29), 10063–10074. <https://doi.org/10.1523/JNEUROSCI.5948-11.2012>
- Ratcliff, R. (1985). Theoretical interpretations of the speed and accuracy of positive and negative responses. *Psychological Review*, 92(2), 212–225. <https://doi.org/10.1037/0033-295X.92.2.212>
- Ratcliff, R., & Rouder, J. N. (1998). Modeling response times for two-choice decisions. *Psychological Science*, 9(5), 347–356. <https://doi.org/10.1111/1467-9280.00067>
- Retzler, J., Retzler, C., Groom, M., Johnson, S., & Cragg, L. (2020). Using drift diffusion modeling to understand inattentive behavior in preterm and term-born children. *Neuropsychology*, 34(1), 77–87. <https://doi.org/10.1037/neu0000590>
- Robertson, C. E., & Baron-Cohen, S. (2017). Sensory perception in autism. *Nature Reviews Neuroscience*, 18(11), 671–684. <https://doi.org/10.1038/nrn.2017.112>
- Rouder, J. N., Morey, R. D., Speckman, P. L., & Province, J. M. (2012). Default Bayes factors for ANOVA designs. *Journal of Mathematical Psychology*, 56(5), 356–374. <https://doi.org/10.1016/j.jmp.2012.08.001>
- Series, P., & Seitz, A. (2013). Learning what to expect (in visual perception). *Frontiers in Human Neuroscience*, 7, Article 668. <https://doi.org/10.3389/fnhum.2013.00668>
- Simmons, D. R., Robertson, A. E., McKay, L. S., Toal, E., McAleer, P., & Pollick, F. E. (2009). Vision in autism spectrum disorders. *Vision Research*, 49(22), 2705–2739. <https://doi.org/10.1016/j.visres.2009.08.005>
- Skewes, J. C., & Gebauer, L. (2016). Brief report: Suboptimal auditory localization in autism spectrum disorder: Support for the Bayesian account of sensory symptoms. *Journal of Autism and Developmental Disorders*, 46(7), 2539–2547. <https://doi.org/10.1007/s10803-016-2774-9>
- Skewes, J. C., Jegindø, E.-M., & Gebauer, L. (2015). Perceptual inference and autistic traits. *Autism*, 19(3), 301–307. <https://doi.org/10.1177/1362361313519872>
- Skippen, P., Matzke, D., Heathcote, A., Fulham, W. R., Michie, P., & Karayanidis, F. (2019). Reliability of triggering inhibitory process is a better predictor of impulsivity than SSRT. *Acta Psychologica*, 192, 104–117. <https://doi.org/10.1016/j.actpsy.2018.10.016>
- Stan Development Team (2020). *RStan: the R interface to Stan*. R package version 2.21.2. <http://mc-stan.org/>
- Tulver, K., Aru, J., Rutiku, R., & Bachmann, T. (2019). Individual differences in the effects of priors on perception: A multi-paradigm approach. *Cognition*, 187, 167–177. <https://doi.org/10.1016/j.cognition.2019.03.008>
- Van de Cruys, S., Vanmarcke, S., Steyaert, J., & Wagemans, J. (2018). Intact perceptual bias in autism contradicts the decreased normalization model. *Scientific Reports*, 8(1), 12559. <https://doi.org/10.1038/s41598-018-31042-z>
- Vandekerckhove, J., Tuerlinckx, F., & Lee, M. D. (2011). Hierarchical diffusion models for two-choice response times. *Psychological Methods*, 16(1), 44–62. <https://doi.org/10.1037/a0021765>
- Van der Hallen, R., Manning, C., Evers, K., & Wagemans, J. (2019). Global motion perception in autism spectrum disorder: A meta-analysis. *Journal of Autism and Developmental Disorders*, 49(12), 4901–4918. <https://doi.org/10.1007/s10803-019-04194-8>
- van Ravenzwaaij, D., Mulder, M. J., Tuerlinckx, F., & Wagenmakers, E.-J. (2012). Do the dynamics of prior information depend on task context? An analysis of optimal performance and an empirical test. *Frontiers in Psychology*, 3, Article 132. <https://doi.org/10.3389/fpsyg.2012.00132>
- Voss, A., Rothermund, K., & Voss, J. (2004). Interpreting the parameters of the diffusion model: An empirical validation. *Memory & Cognition*, 32(7), 1206–1220. <https://doi.org/10.3758/BF03196893>
- Watson, A. B., & Pelli, D. G. (1983). Quest: A Bayesian adaptive psychometric method. *Perception & Psychophysics*, 33(2), 113–120. <https://doi.org/10.3758/BF03202828>
- Wiech, K., Vandekerckhove, J., Zaman, J., Tuerlinckx, F., Vlaeyen, J. W. S., & Tracey, I. (2014). Influence of prior information on pain involves biased perceptual decision-making. *Current Biology*, 24(15), R679–R681. <https://doi.org/10.1016/j.cub.2014.06.022>