

Electronic Supplementary Information (ESI)

An Efficient Nickel-Catalyzed Alkenylation of Functionalized Benzylic Halides with Alkenylaluminum Reagents

Deepak B. Biradar and Han-Mou Gau*

Department of Chemistry, National Chung Hsing University, Taichung 402, Taiwan

e-mail: hmgau@dragon.nchu.edu.tw

Table of Contents

¹H and ¹³C NMR Spectra of Coupling Products	S-3
1. (<i>E</i>)-hept-2-enylbenzene (2a)	S-3
2. (<i>E</i>)-1-(hept-2-enyl)-2-methylbenzene (2b)	S-5
3. (<i>E</i>)-1-(hept-2-enyl)-3-methylbenzene (2c)	S-7
4. (<i>E</i>)-1-(hept-2-enyl)-4-methylbenzene (2d)	S-9
5. (<i>E</i>)-1-(hept-2-enyl)-3-methoxybenzene (2e)	S-11
6. (<i>E</i>)-1-(hept-2-enyl)-4-methoxybenzene (2f)	S-13
7. (<i>E</i>)-(4-(hept-2-enyl)phenyl)(methyl)sulfane (2g)	S-15
8. (<i>E</i>)-1- <i>tert</i> -butyl-4-(hept-2-enyl)benzene (2h)	S-17
9. (<i>E</i>)-2-(hept-2-enyl)biphenyl (2i)	S-19
10. (<i>E</i>)-3-(hept-2-enyl)biphenyl (2j)	S-21
11. (<i>E</i>)-1-(hept-2-enyl)-3,5-dimethoxybenzene (2k)	S-23
12. (<i>E</i>)-1-chloro-4-(hept-2-enyl)benzene (2l)	S-25
13. (<i>E</i>)-1-(hept-2-enyl)-3,5-bis(trifluoromethyl)benzene (2m)	S-27
14. (<i>E</i>)-methyl 4-(hept-2-enyl)benzoate (2n)	S-29
15. (<i>E</i>)-1,4-diphenylbut-2-ene (2o)	S-31
16. (<i>E</i>)-(3-cyclohexylallyl)benzene (2p)	S-33
17. (<i>E</i>)-3-(3-phenylprop-1-enyl)thiophene (2q)	S-35
18. (<i>E</i>)-1-fluoro-4-(hept-2-enyl)benzene (2r)	S-37
19. (<i>E</i>)-1-(hept-2-enyl)-4-vinylbenzene (2s)	S-39

^1H and ^{13}C NMR Spectra of Coupling Products

1. (*E*)-hept-2-enylbenzene (2a)

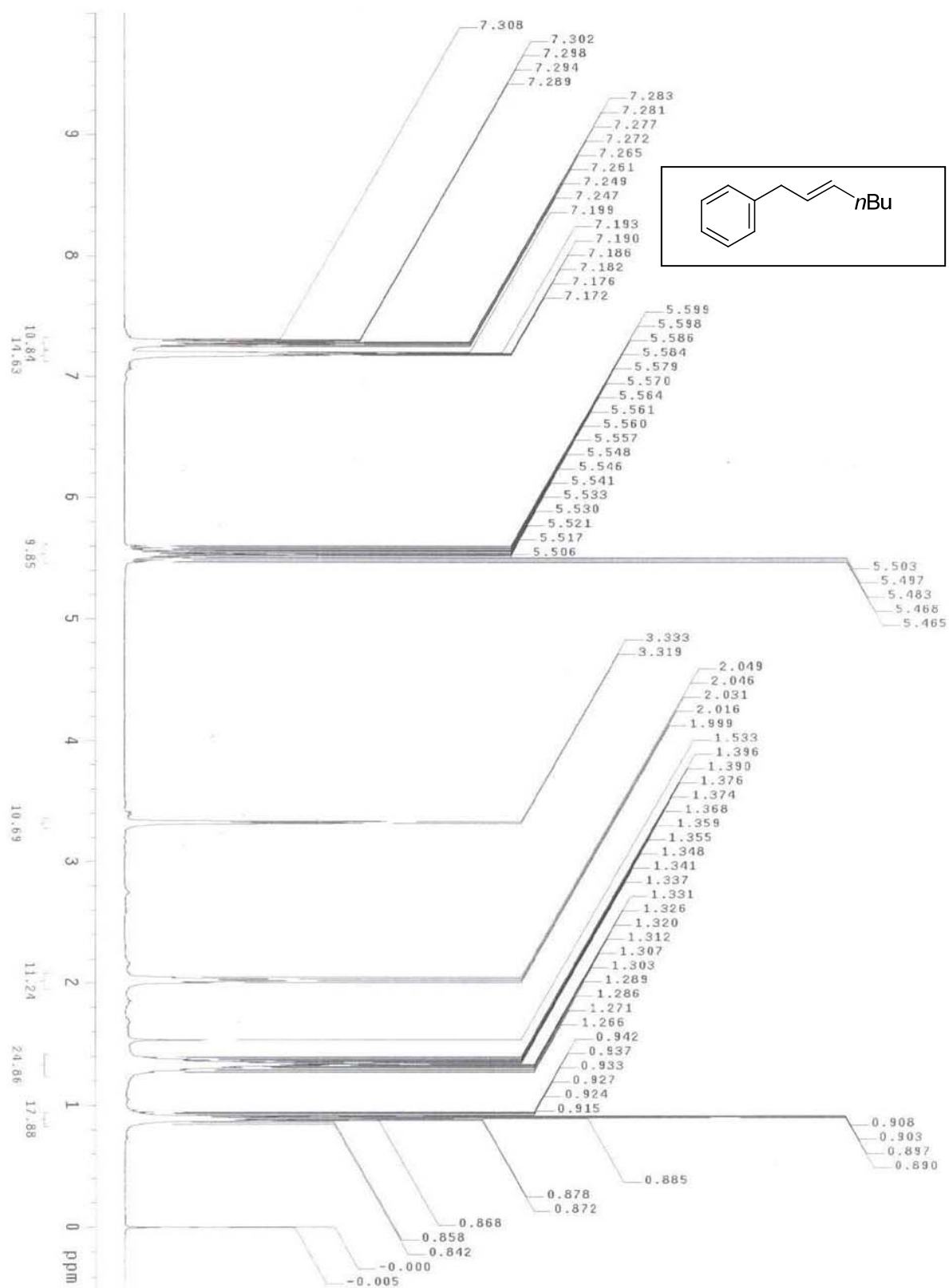

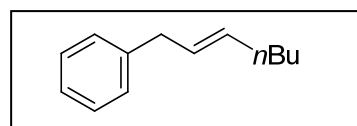
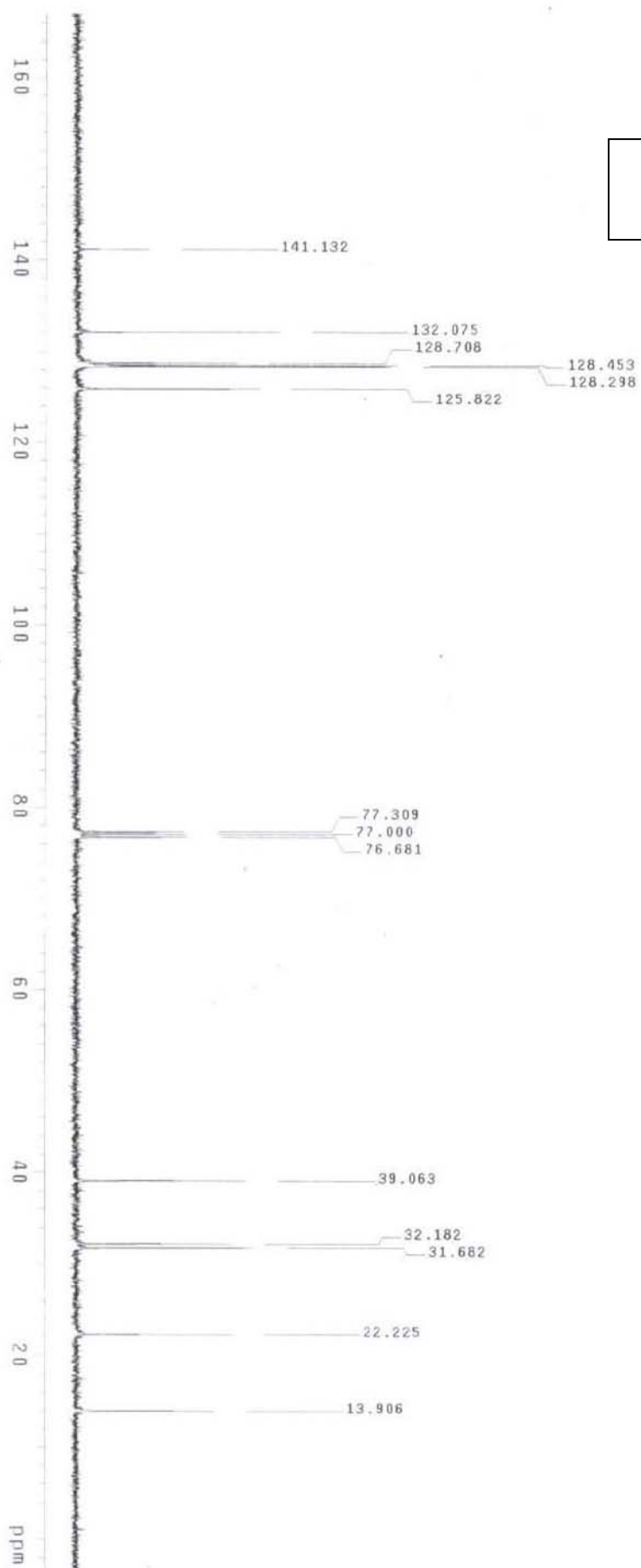

2. (E)-1-(hept-2-enyl)-2-methylbenzene (2b)

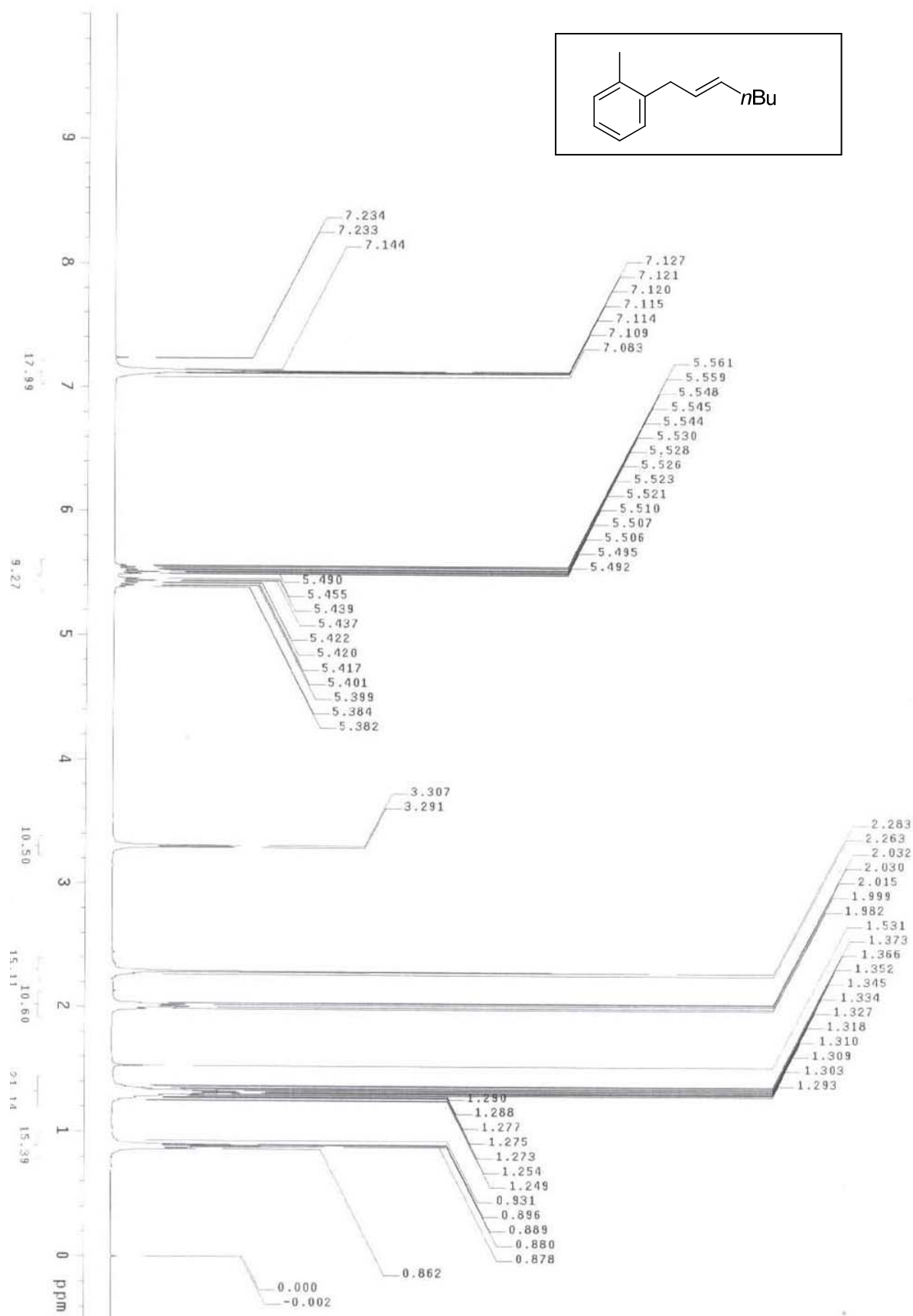

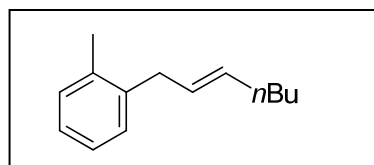
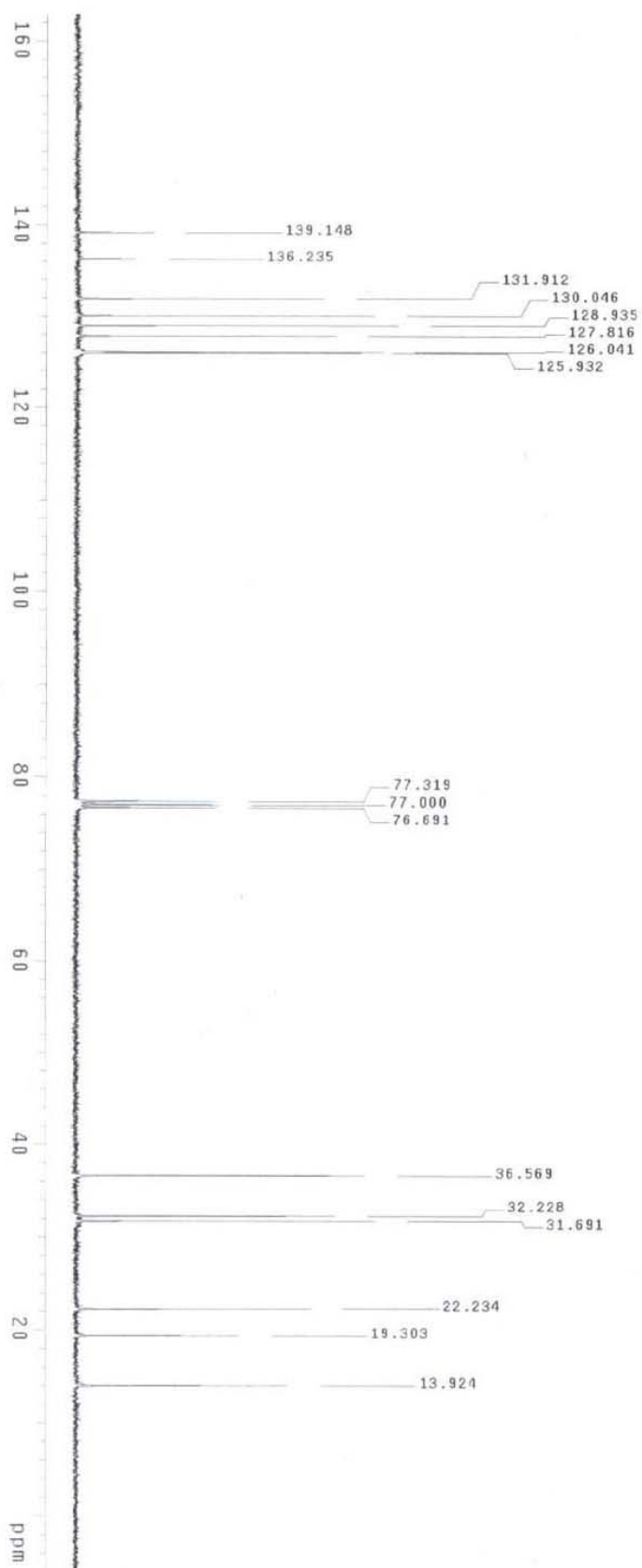

3. (E)-1-(hept-2-enyl)-3-methylbenzene (2c)

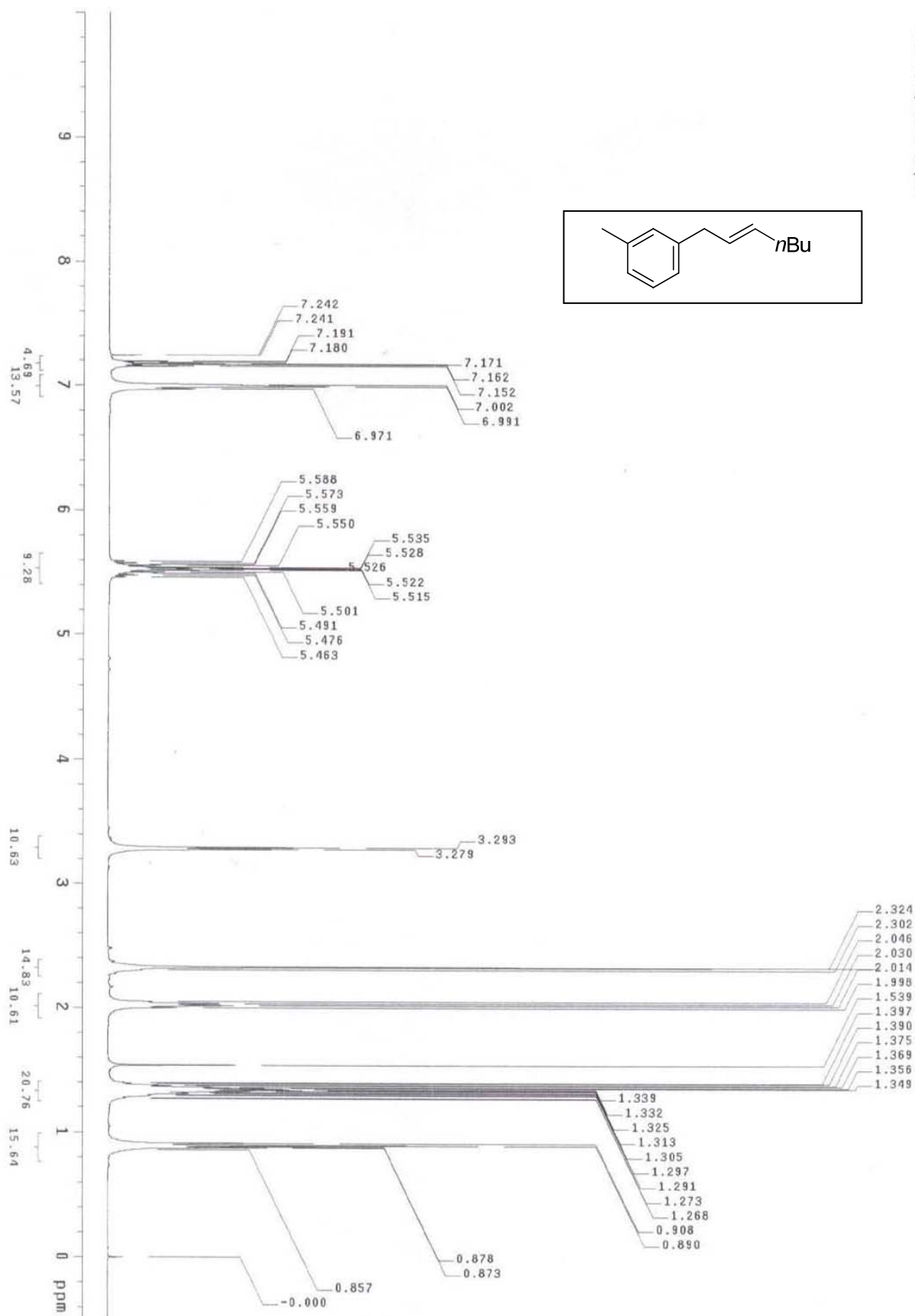

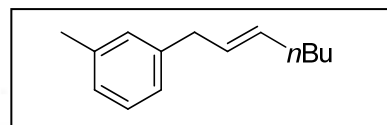
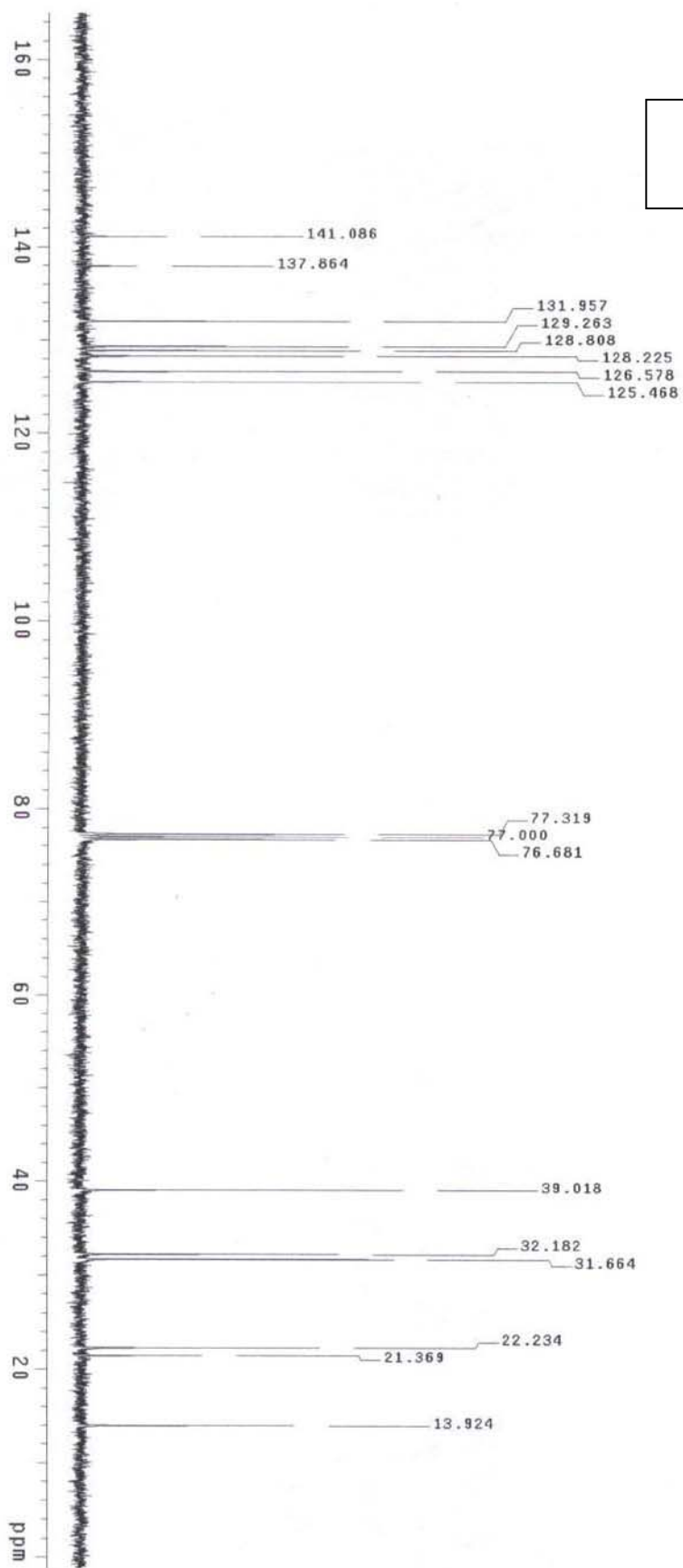

4. (E)-1-(hept-2-enyl)-4-methylbenzene (2d)

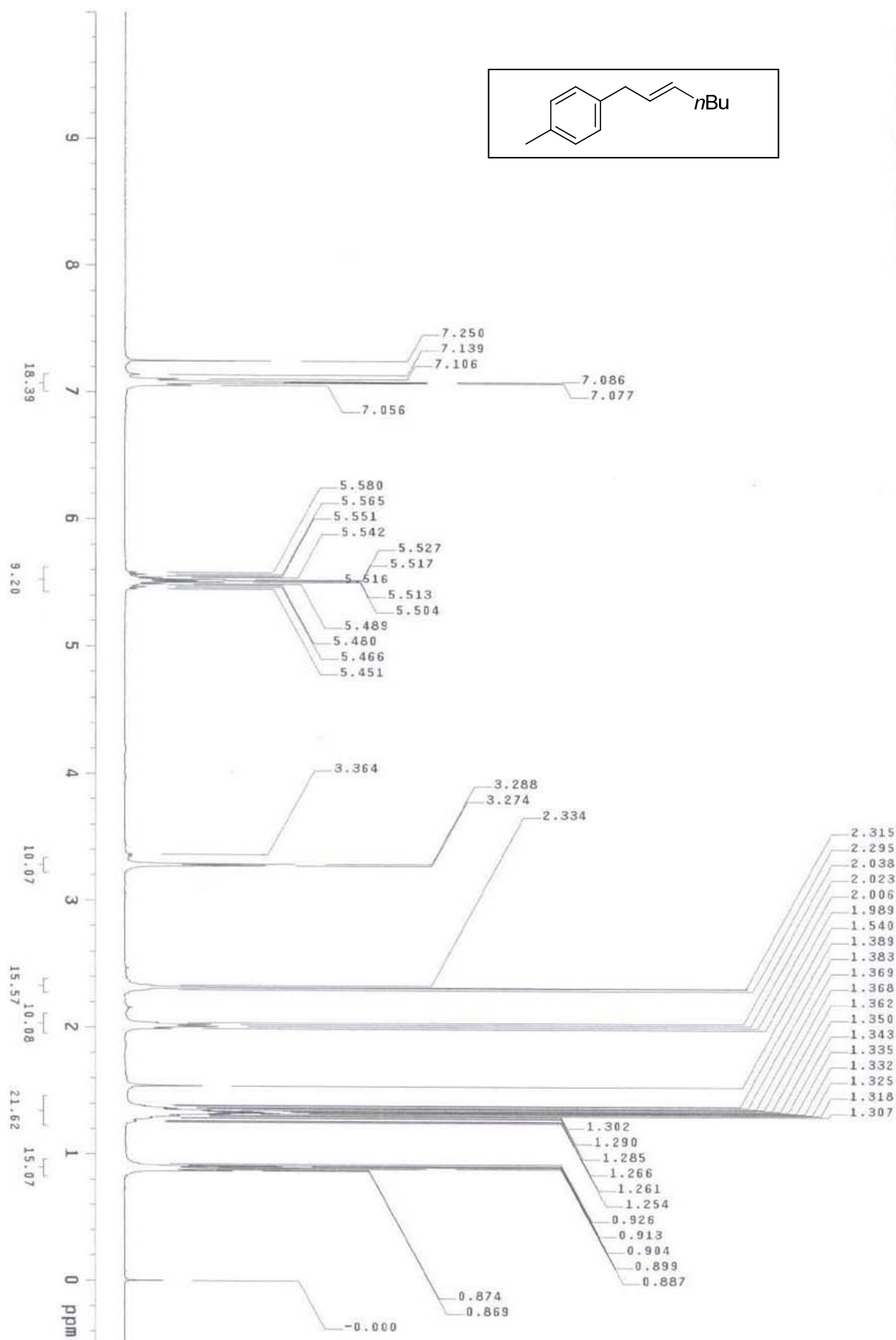

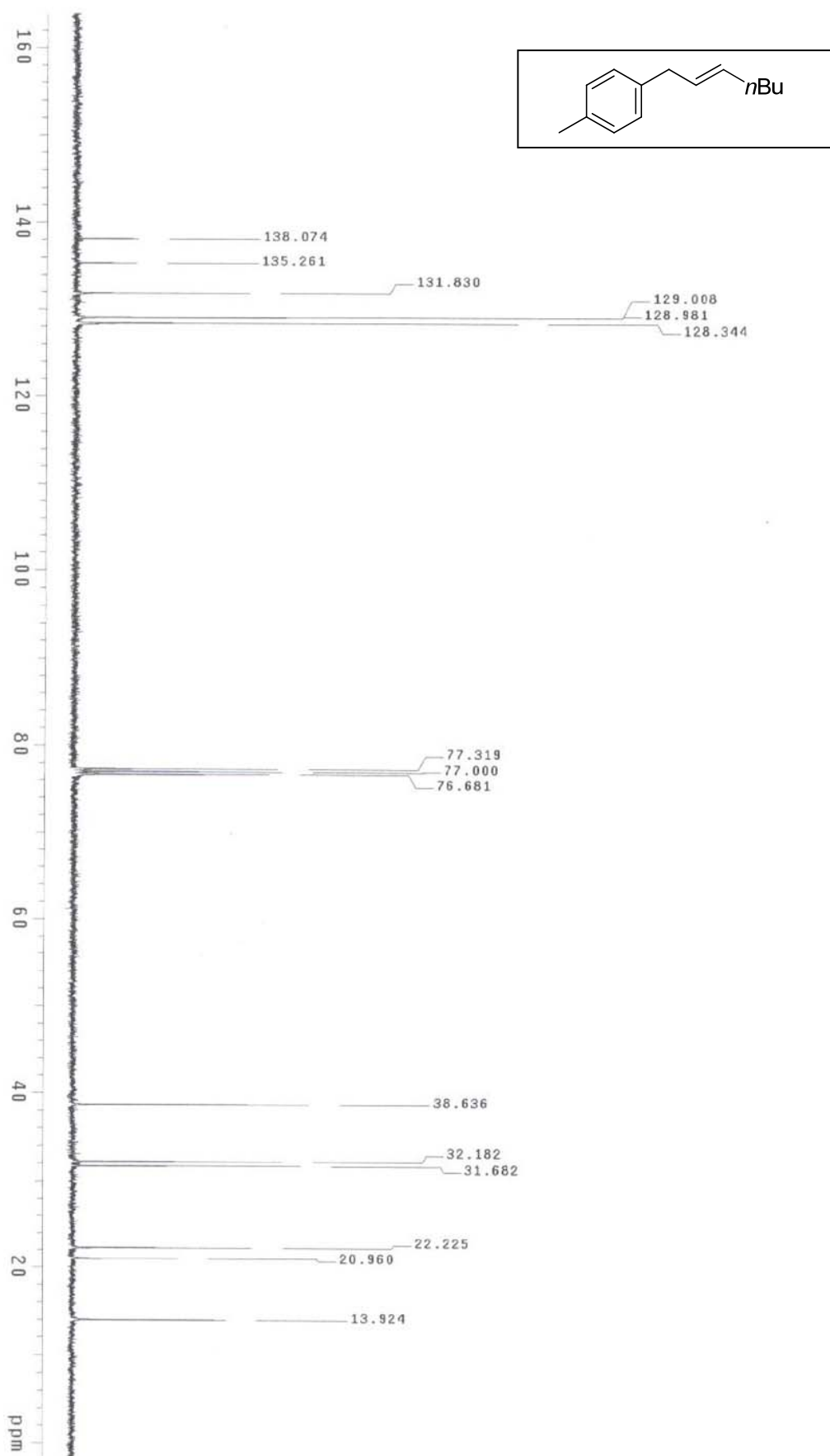

5. (*E*)-1-(hept-2-enyl)-3-methoxybenzene (2e)

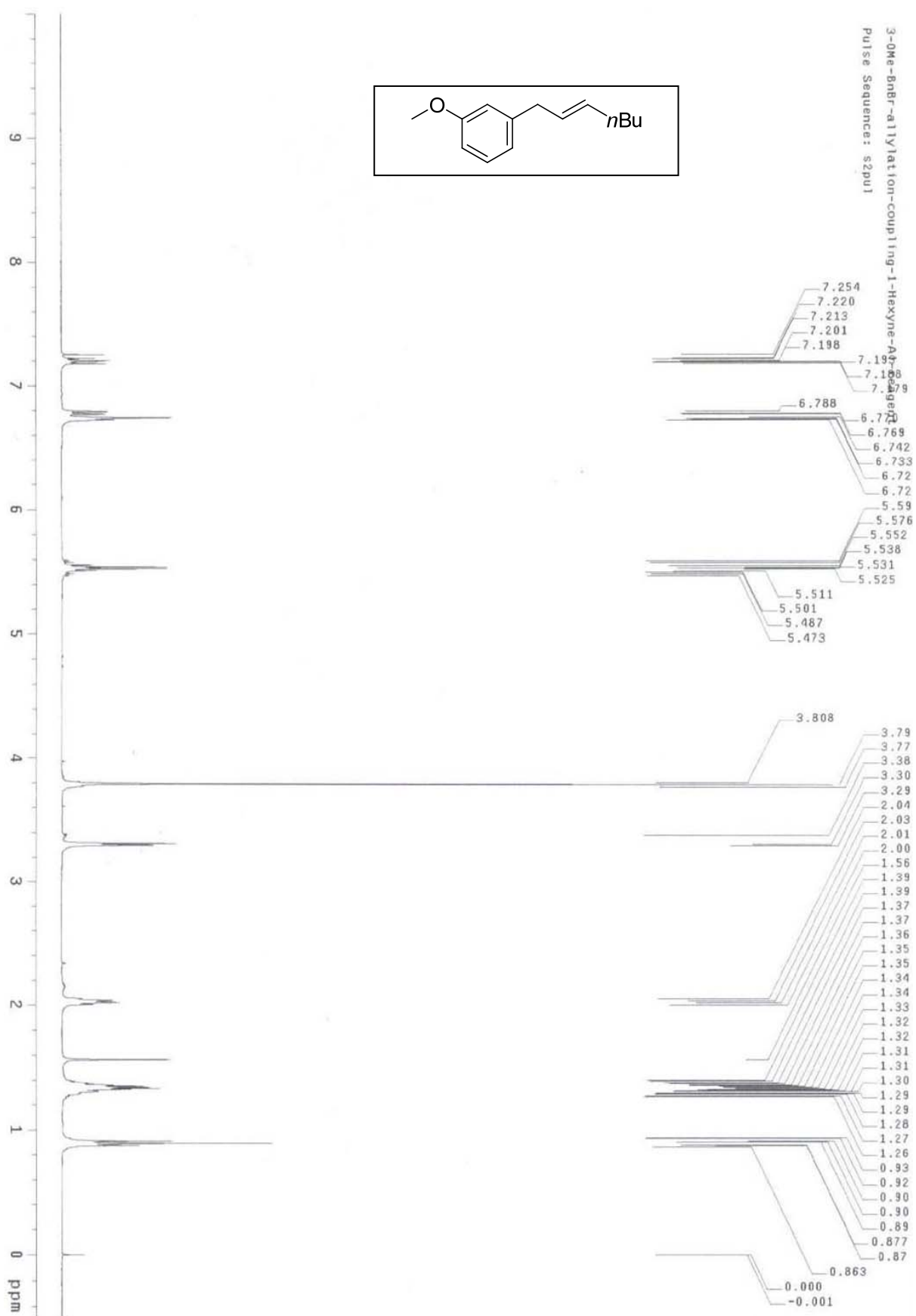

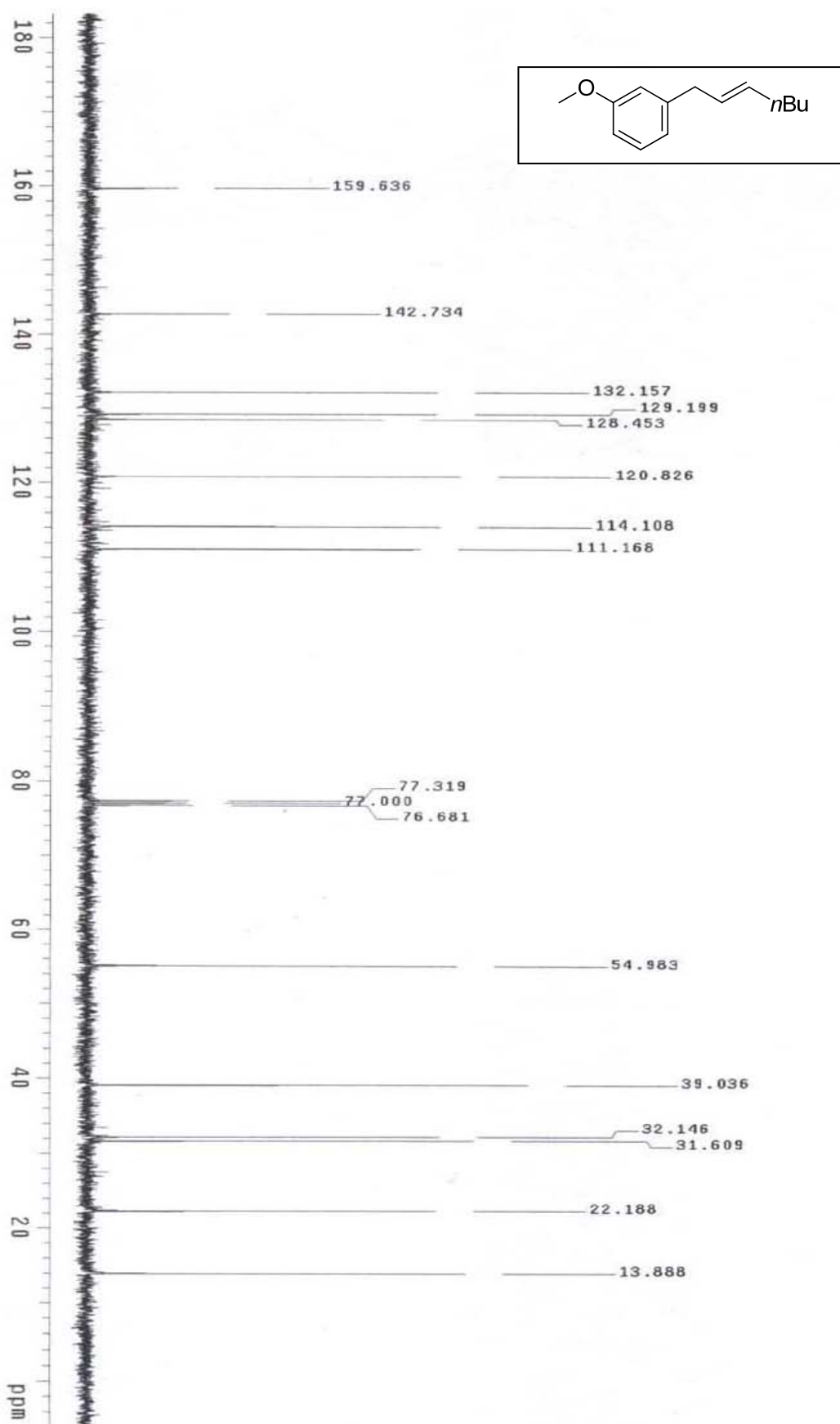

6. (E)-1-(hept-2-enyl)-4-methoxybenzene (2f)

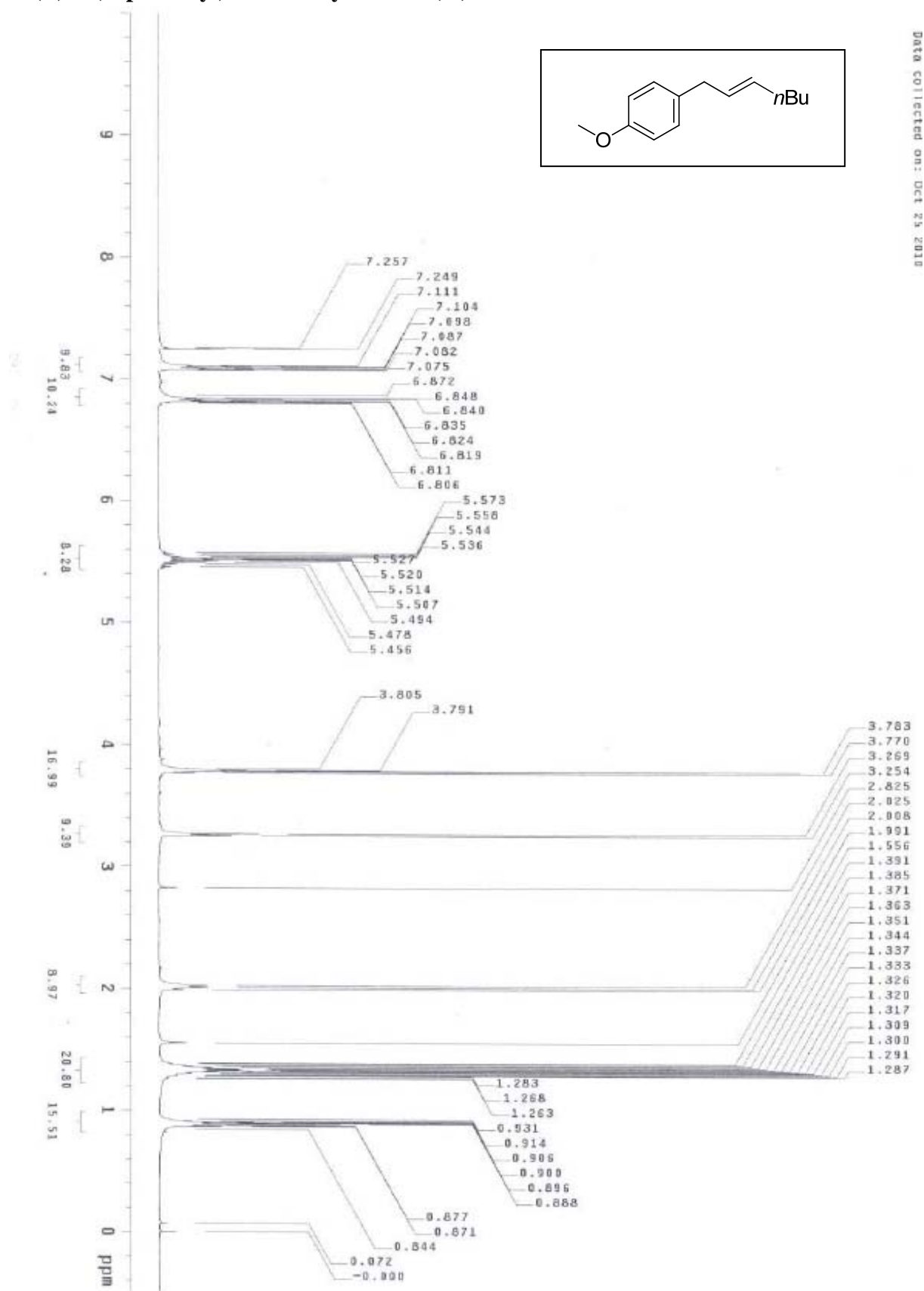

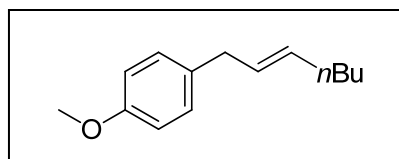
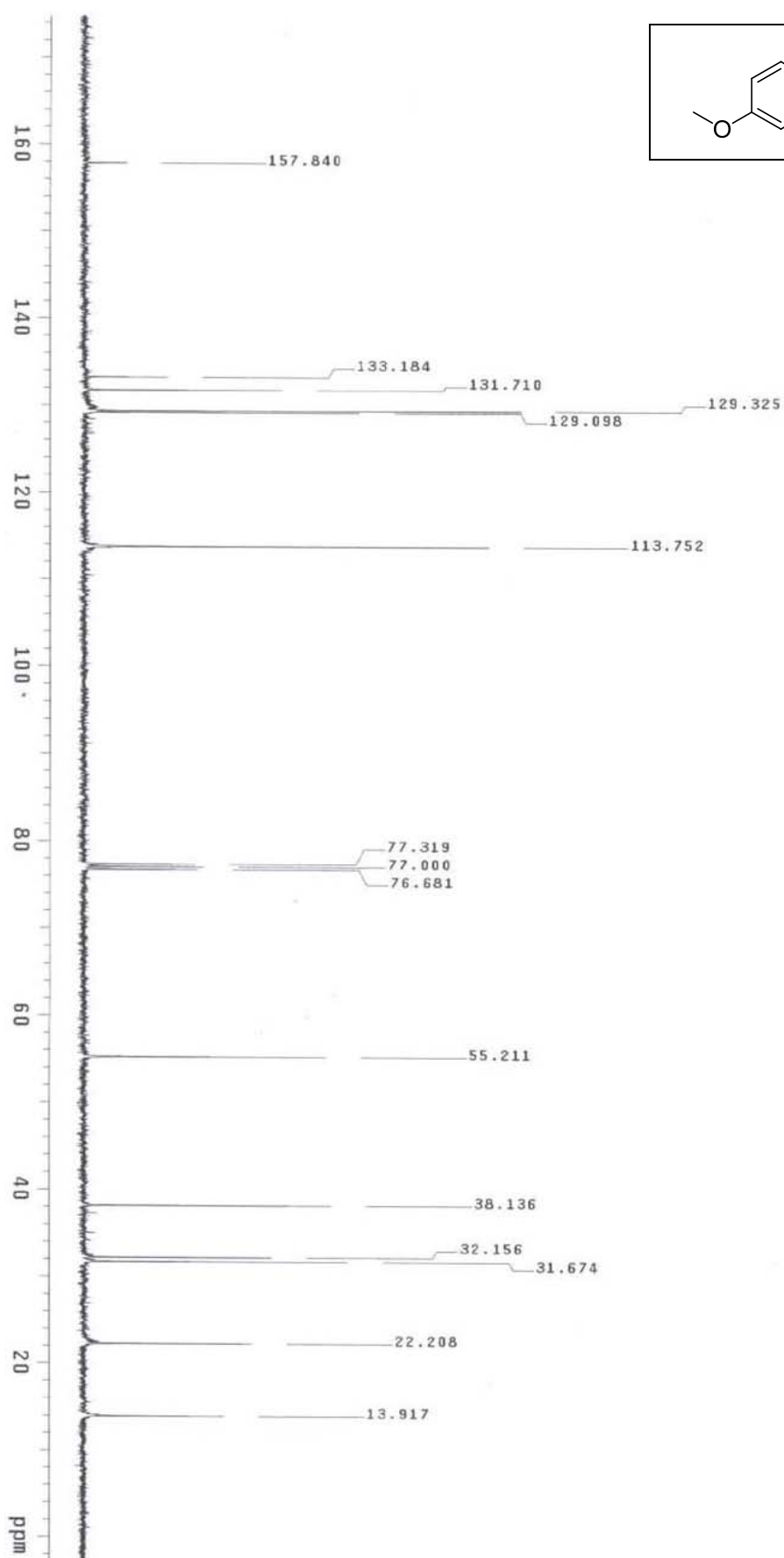

7. (E)-4-(hept-2-enyl)phenyl(methyl)sulfane (2g)

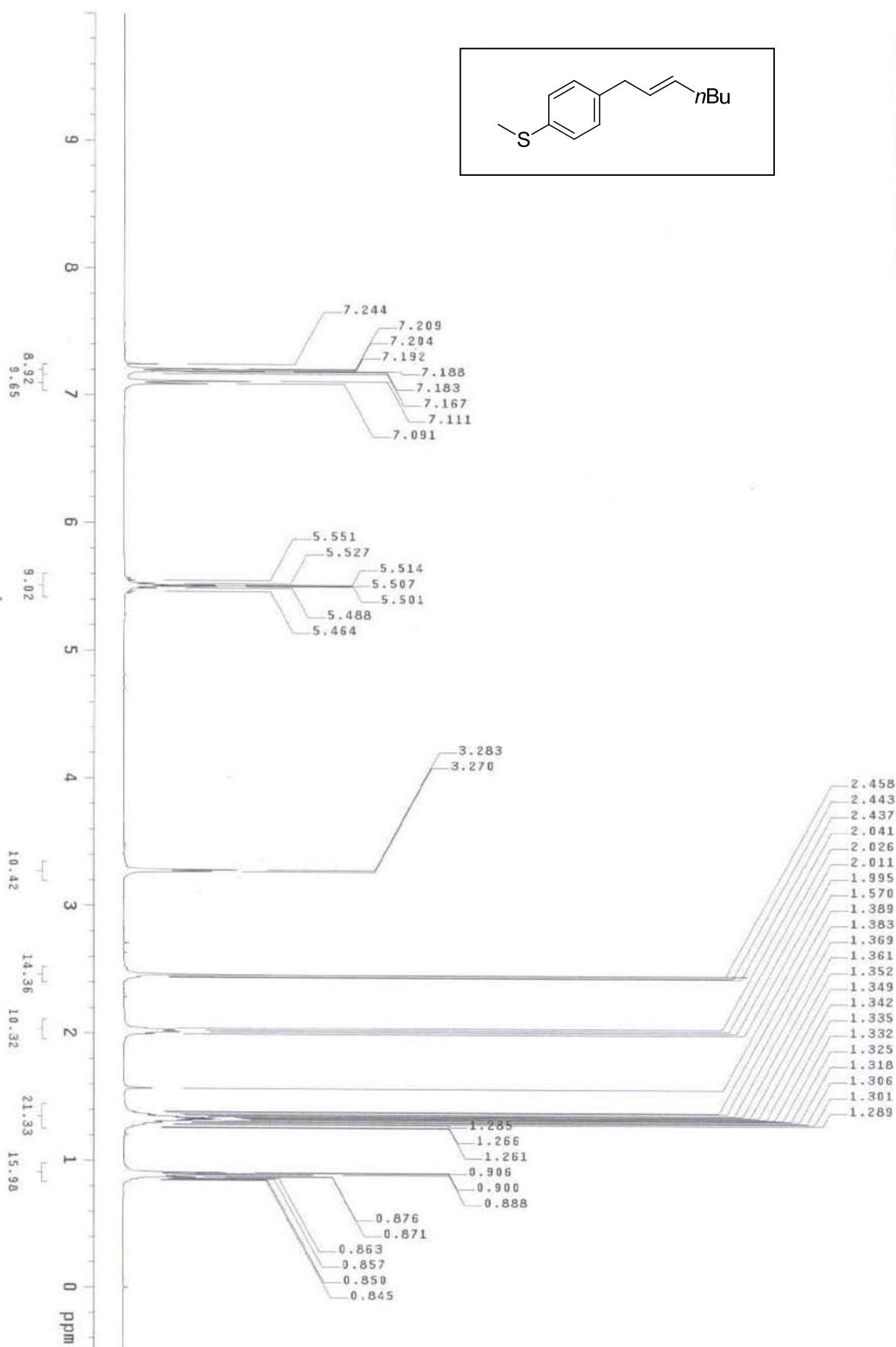

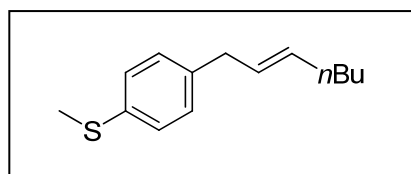
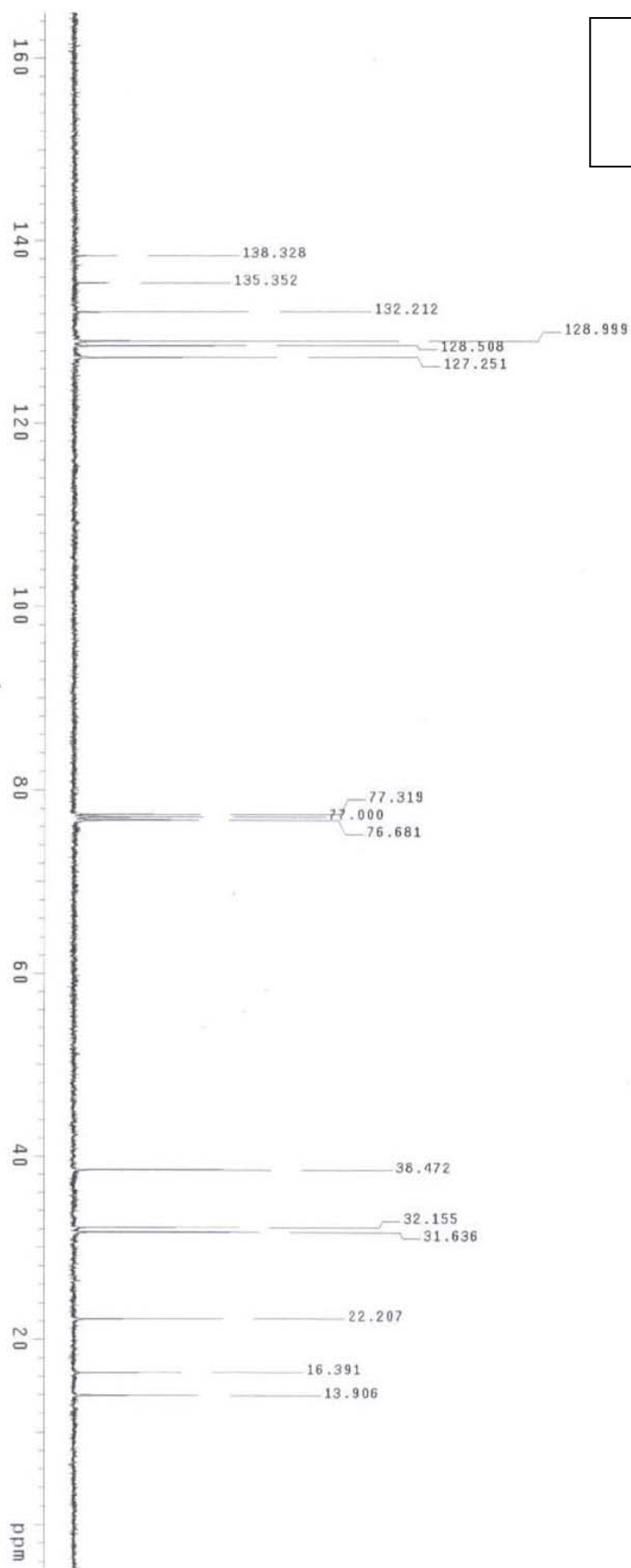

8. (E)-1-tert-butyl-4-(hept-2-enyl)benzene (2h)

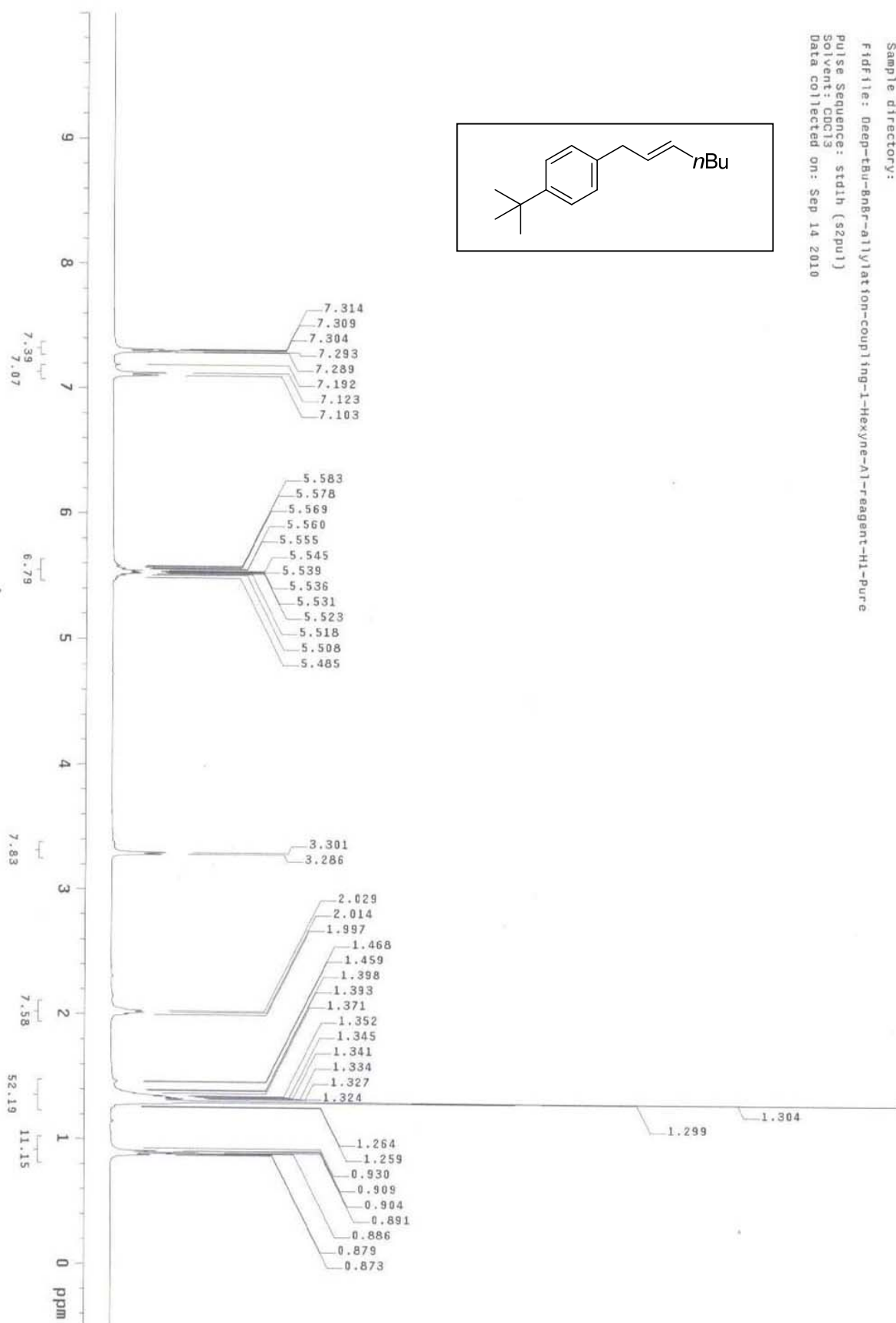

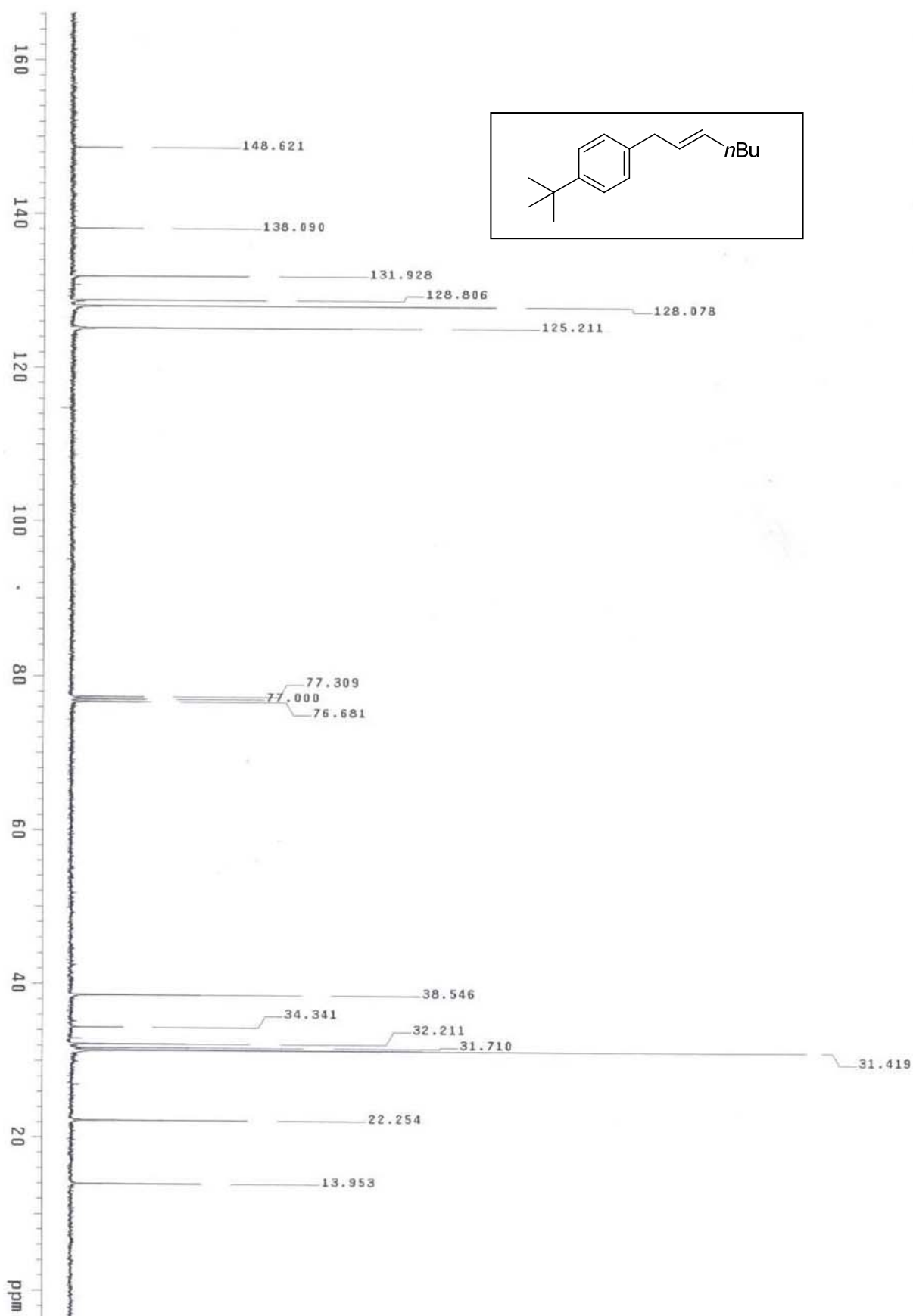

9. (*E*)-2-(hept-2-enyl)biphenyl (2i)

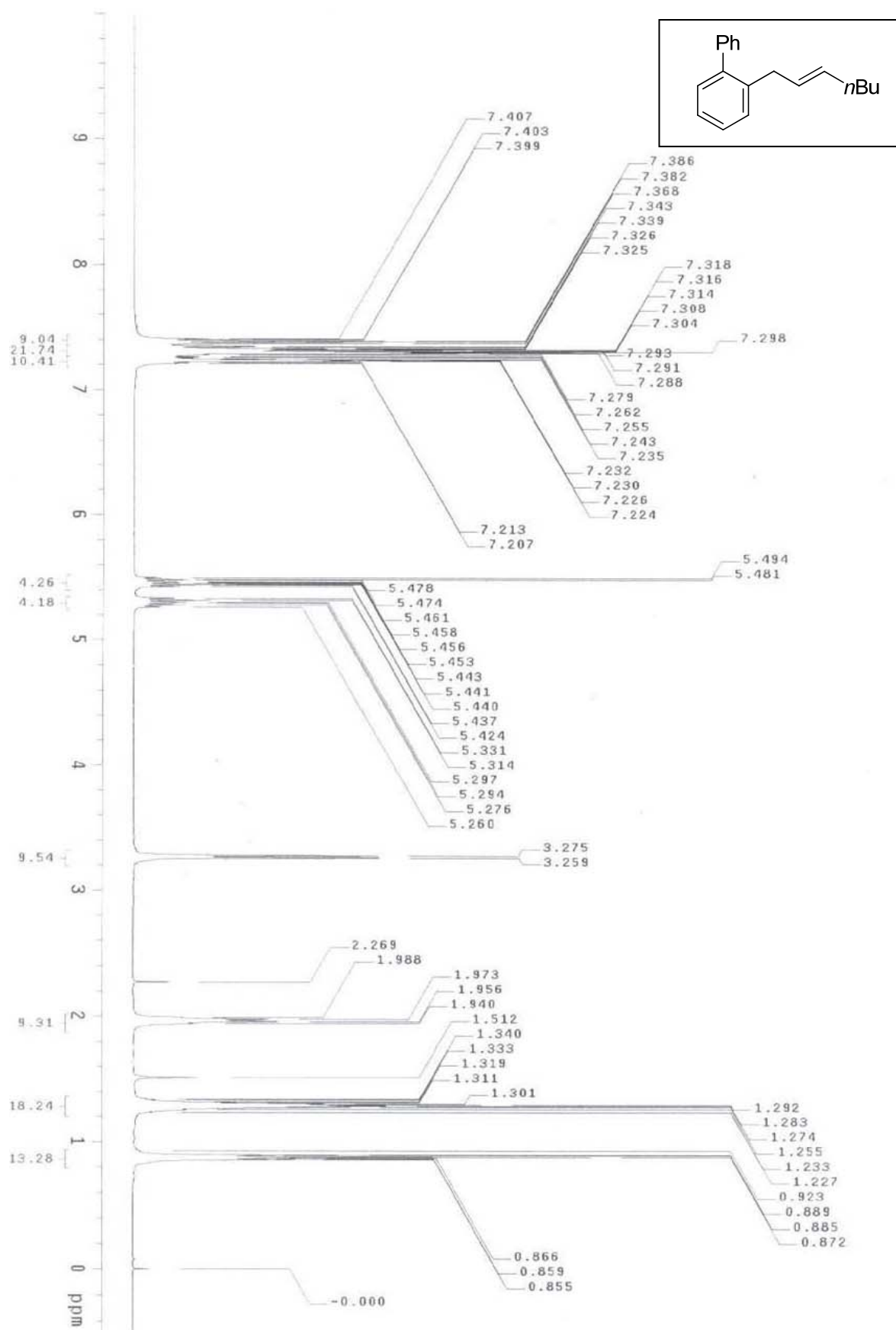

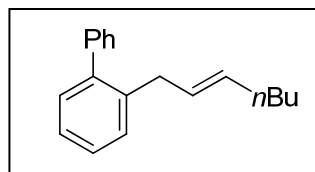
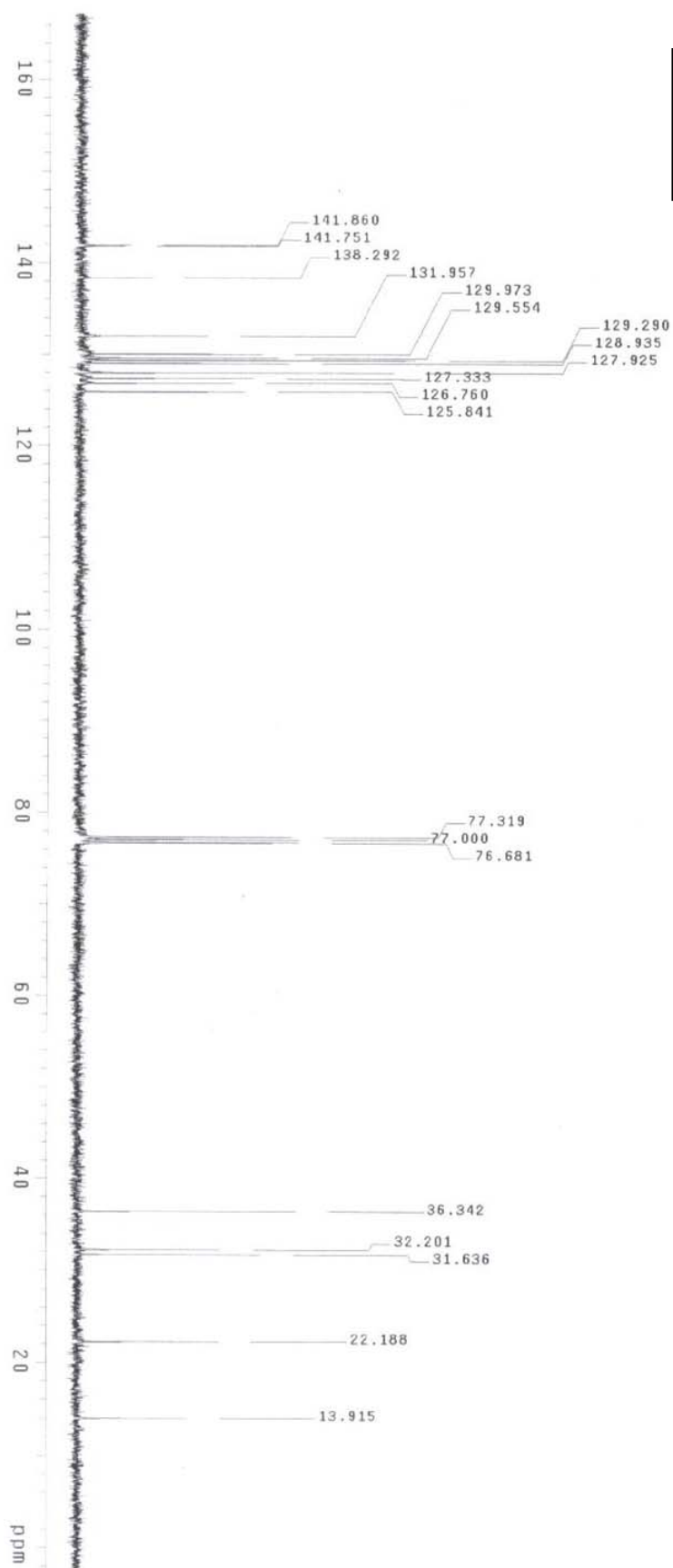

10. (*E*)-3-(hept-2-enyl)biphenyl (2j)

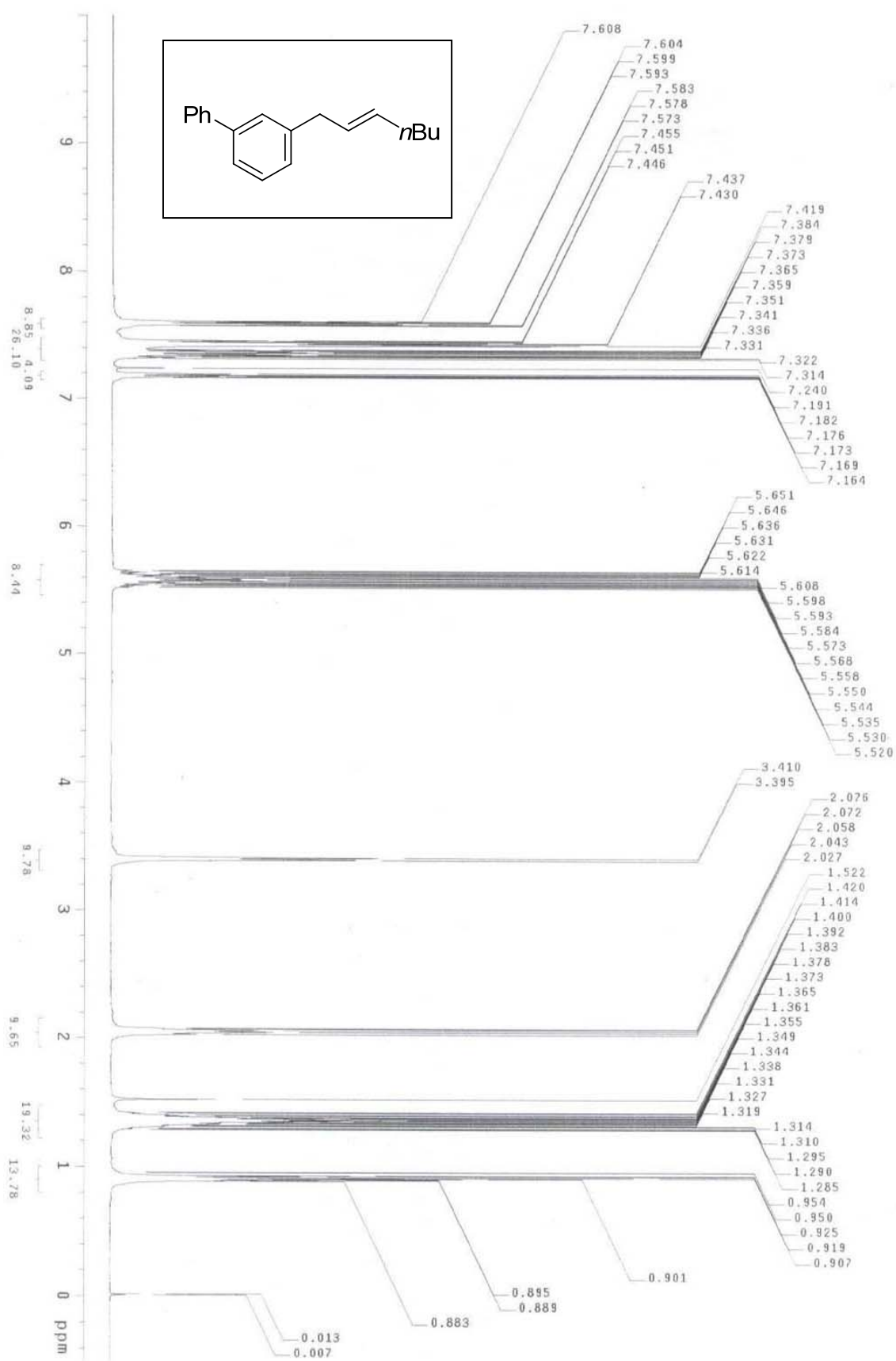

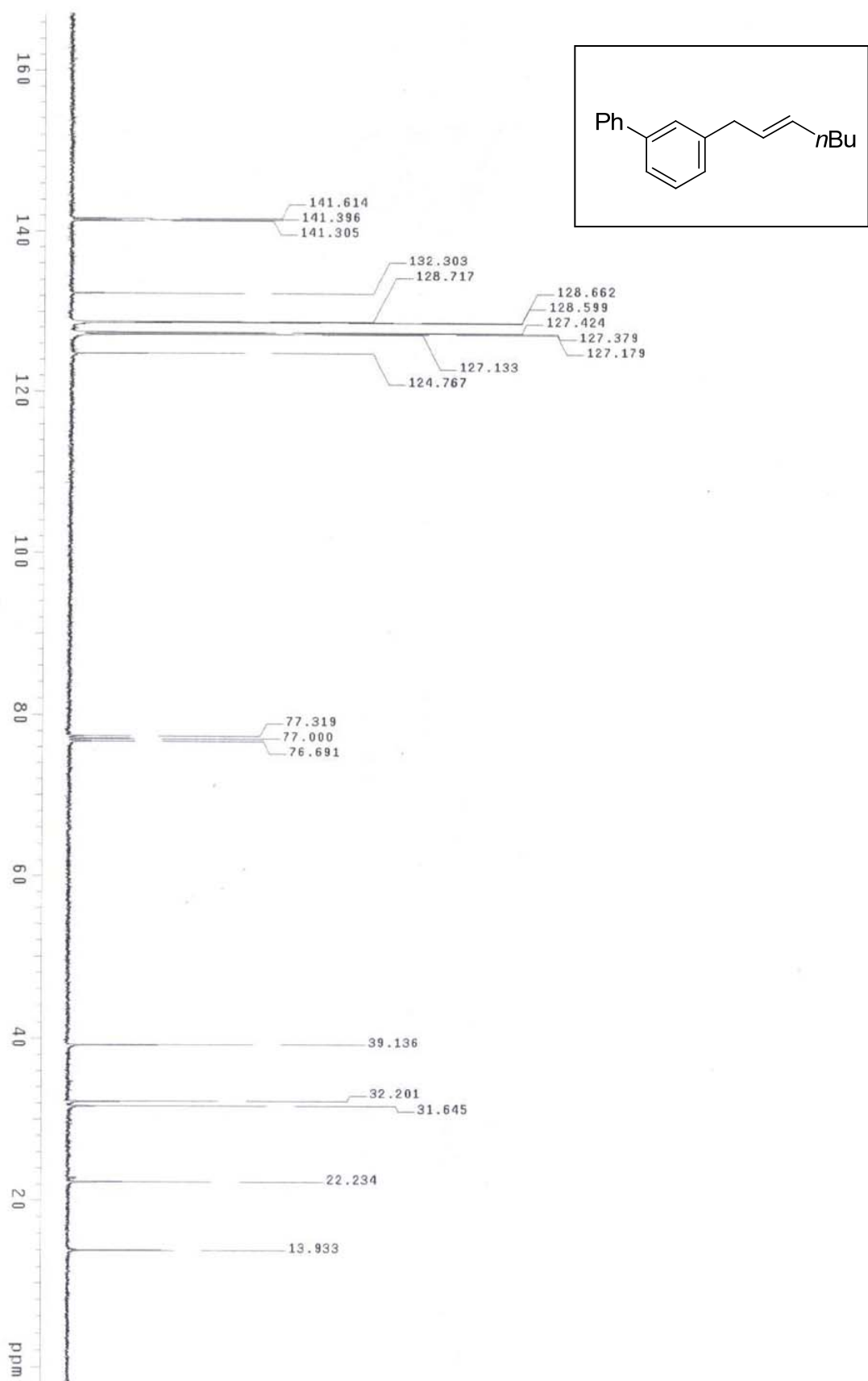

11. (*E*)-1-(hept-2-enyl)-3,5-dimethoxybenzene (2k)

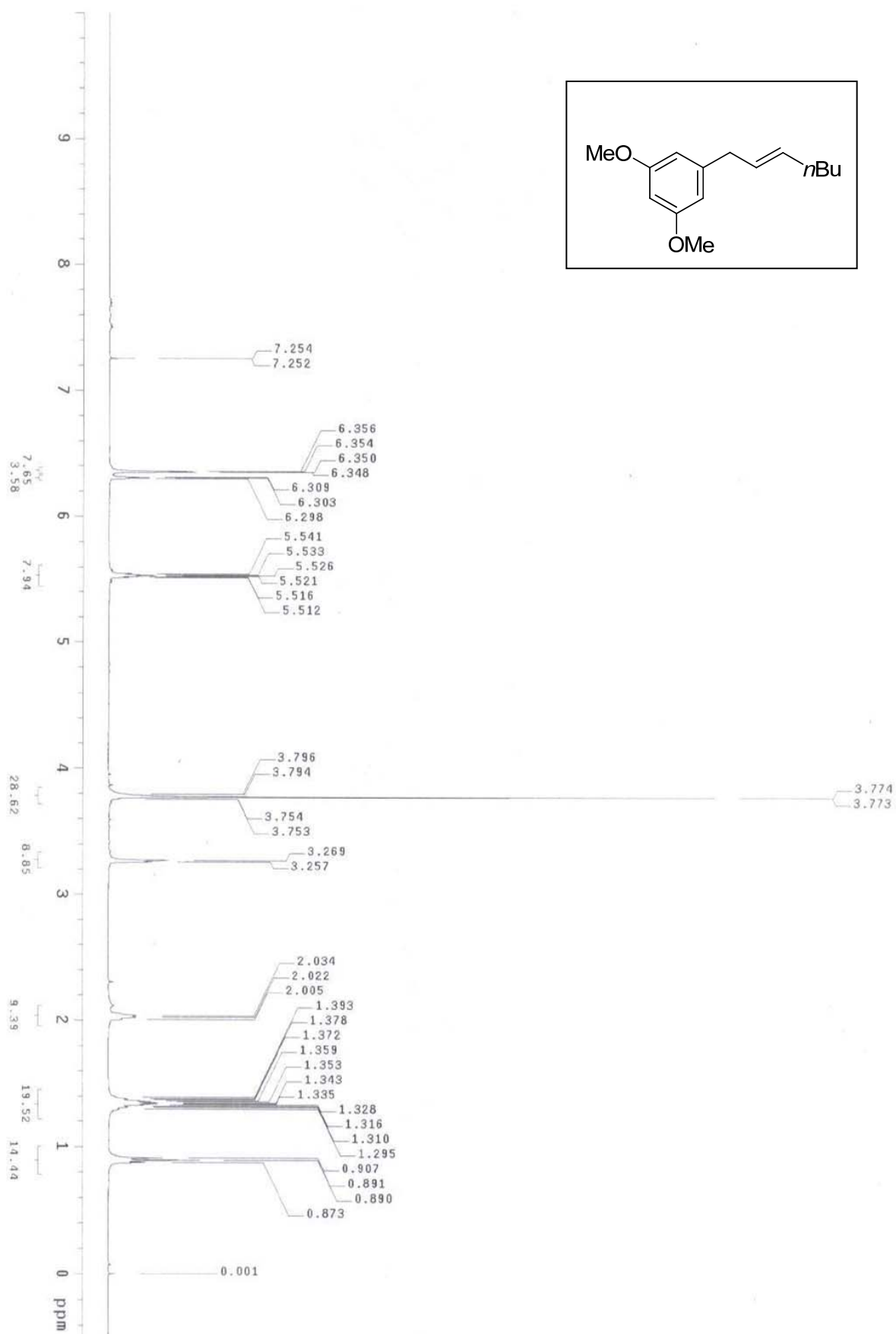

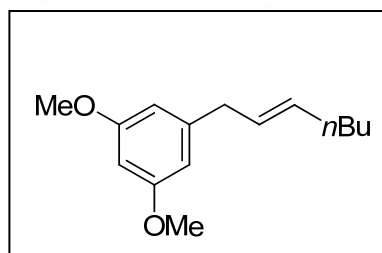
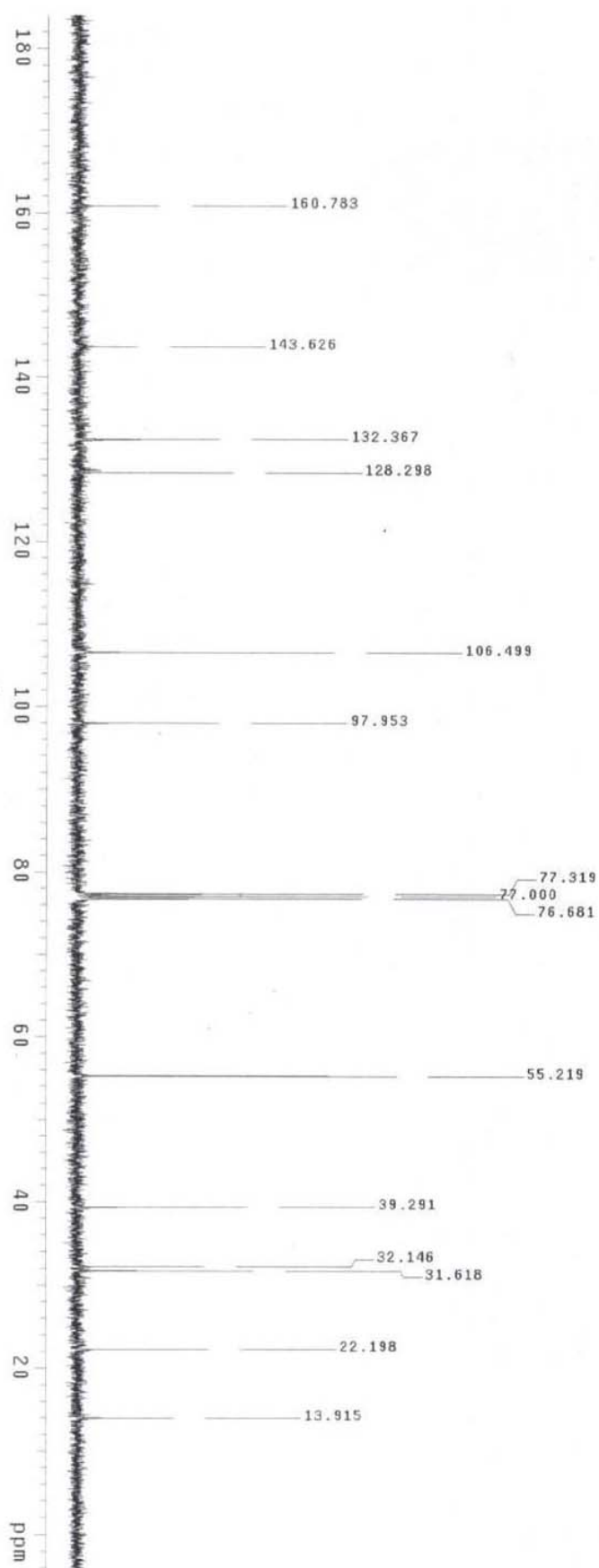

12. (E)-1-chloro-4-(hept-2-enyl)benzene (2l)

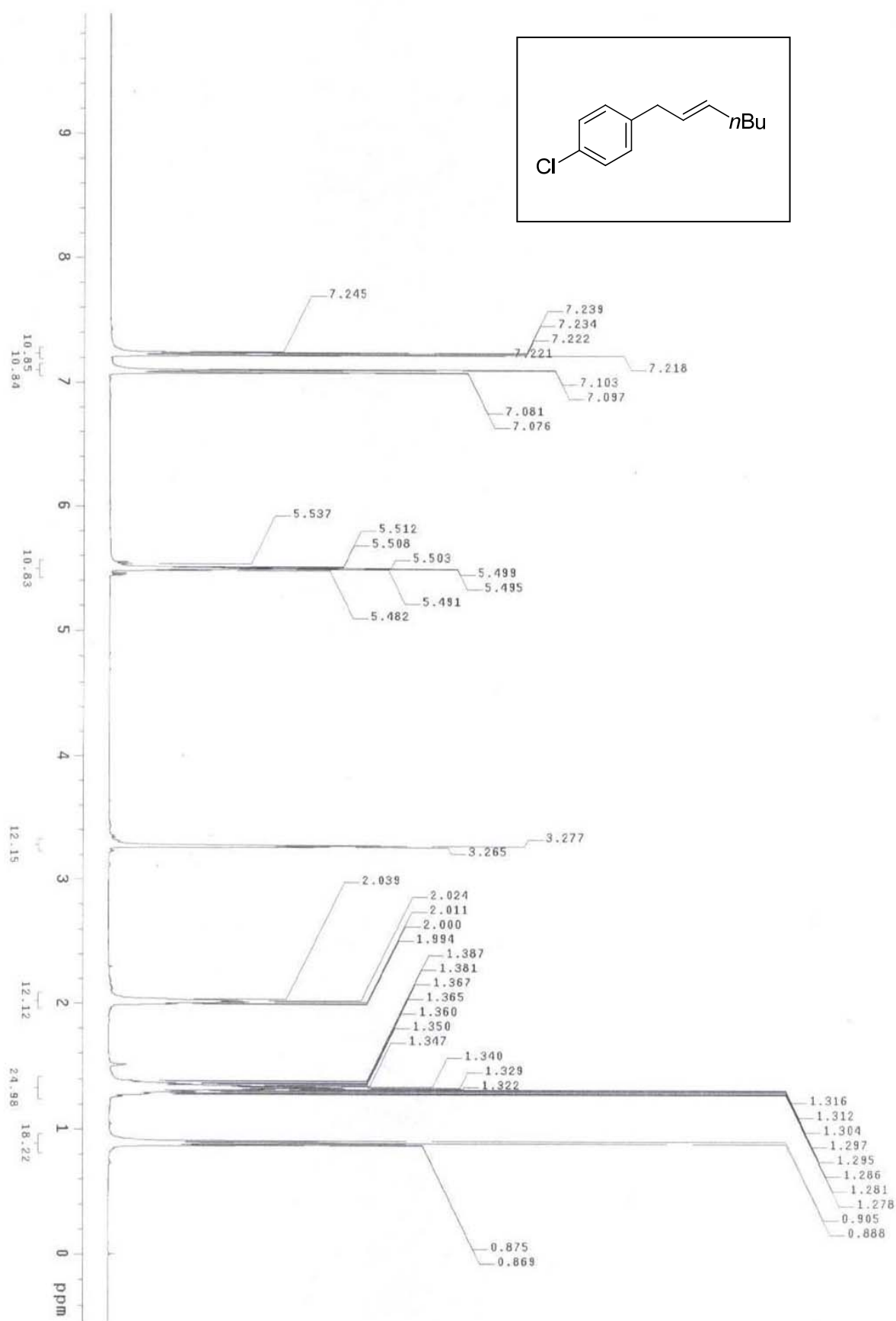

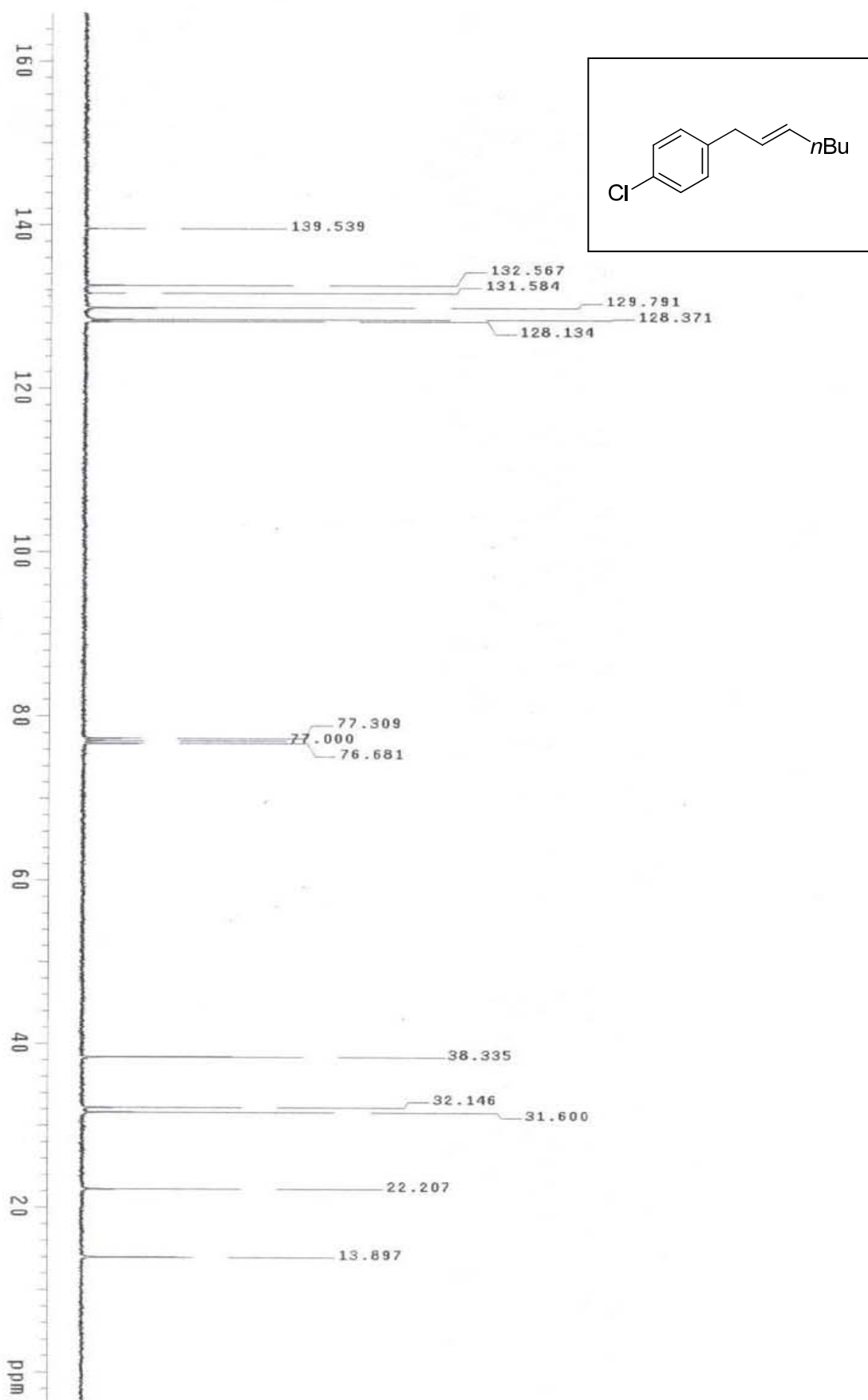

13. (*E*)-1-(hept-2-enyl)-3,5-bis(trifluoromethyl)benzene (2m)

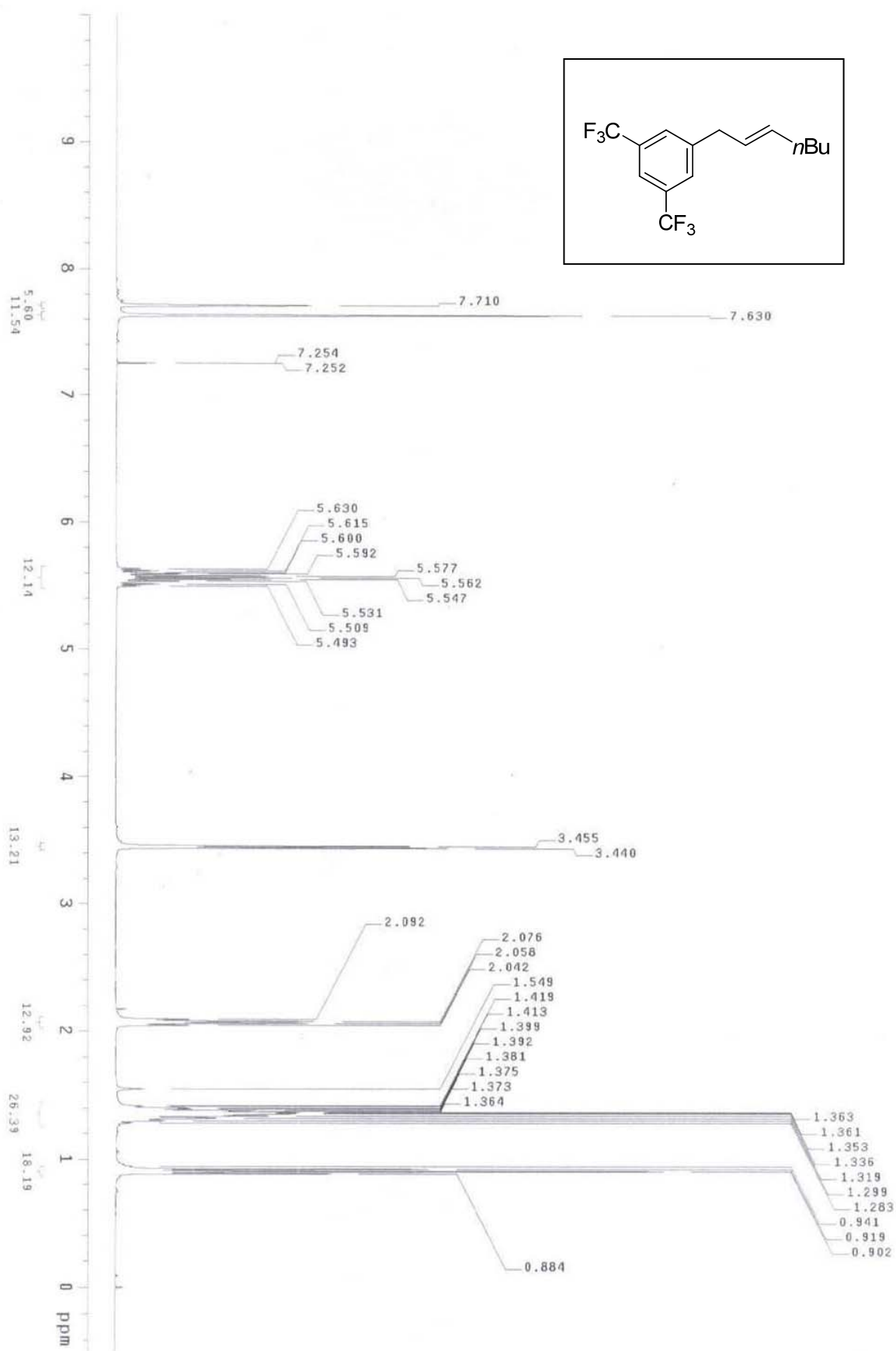

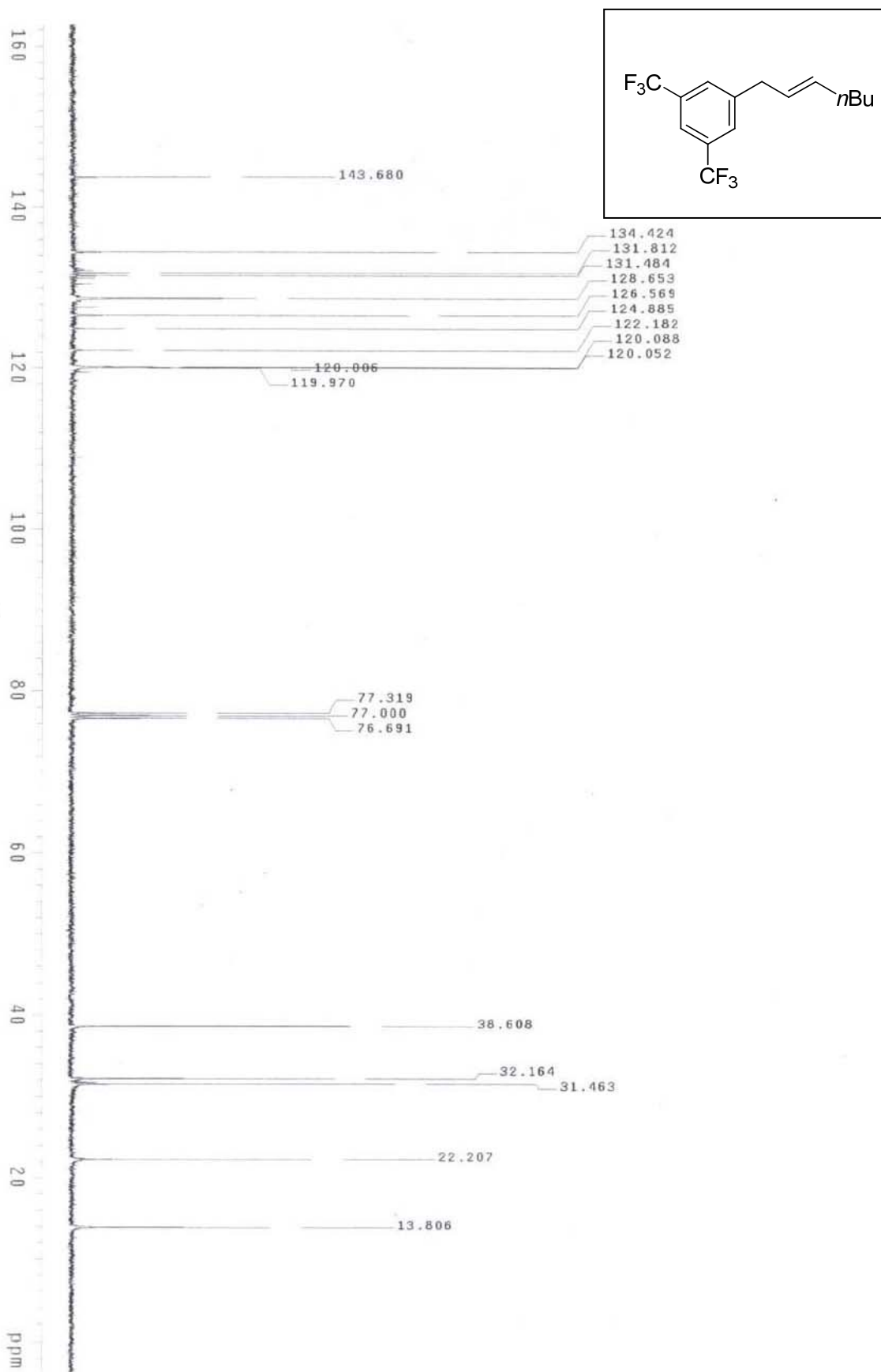

14. (*E*)-methyl 4-(hept-2-enyl)benzoate (2n)

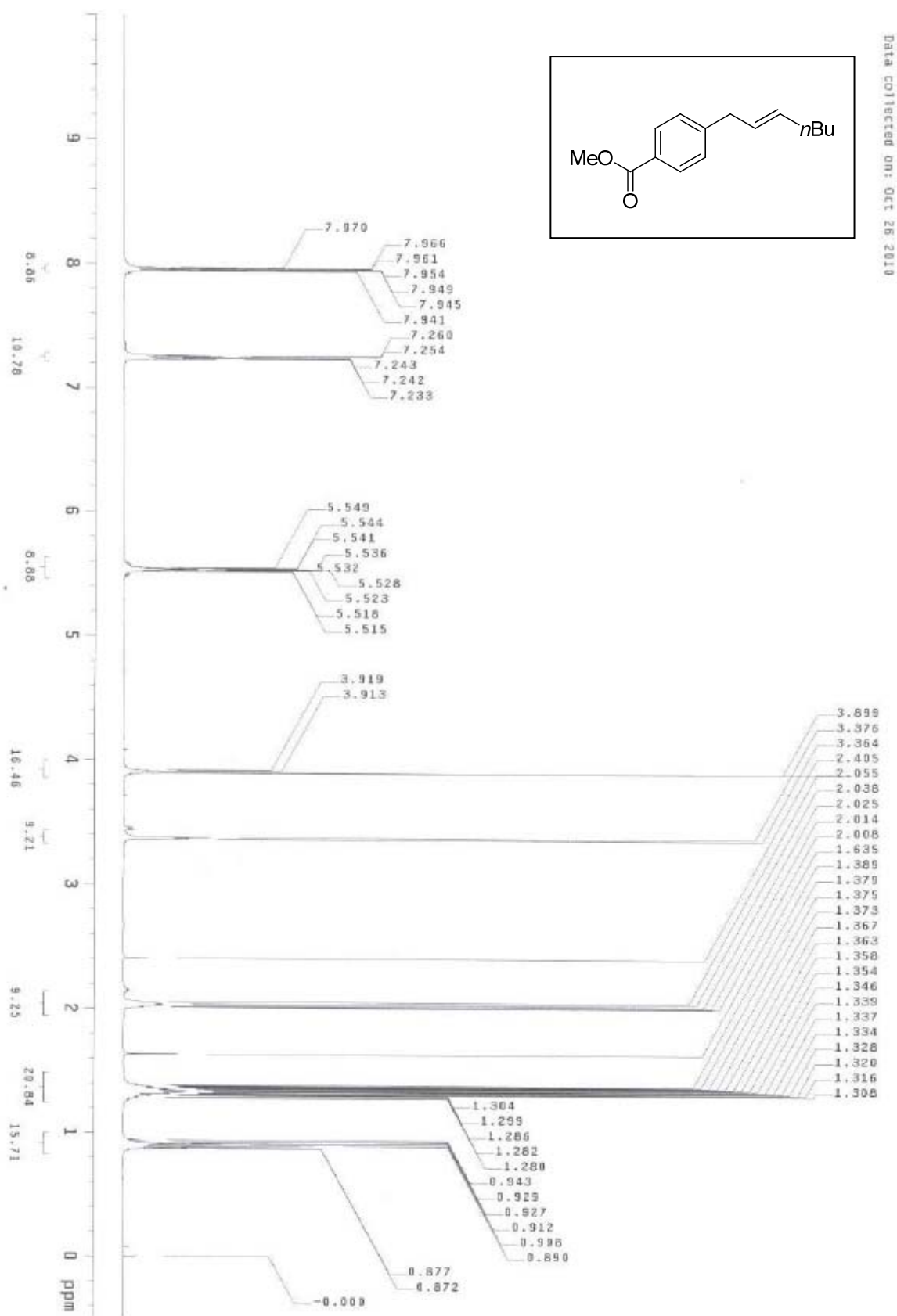

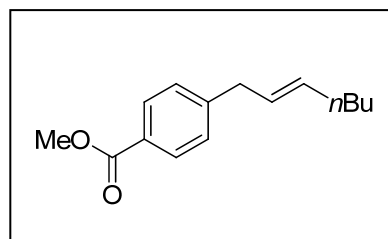

15. (*E*)-1,4-diphenylbut-2-ene (2o)

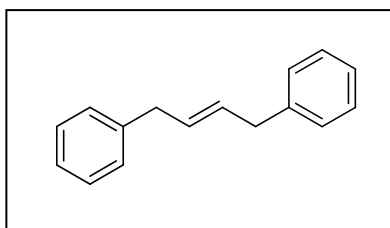
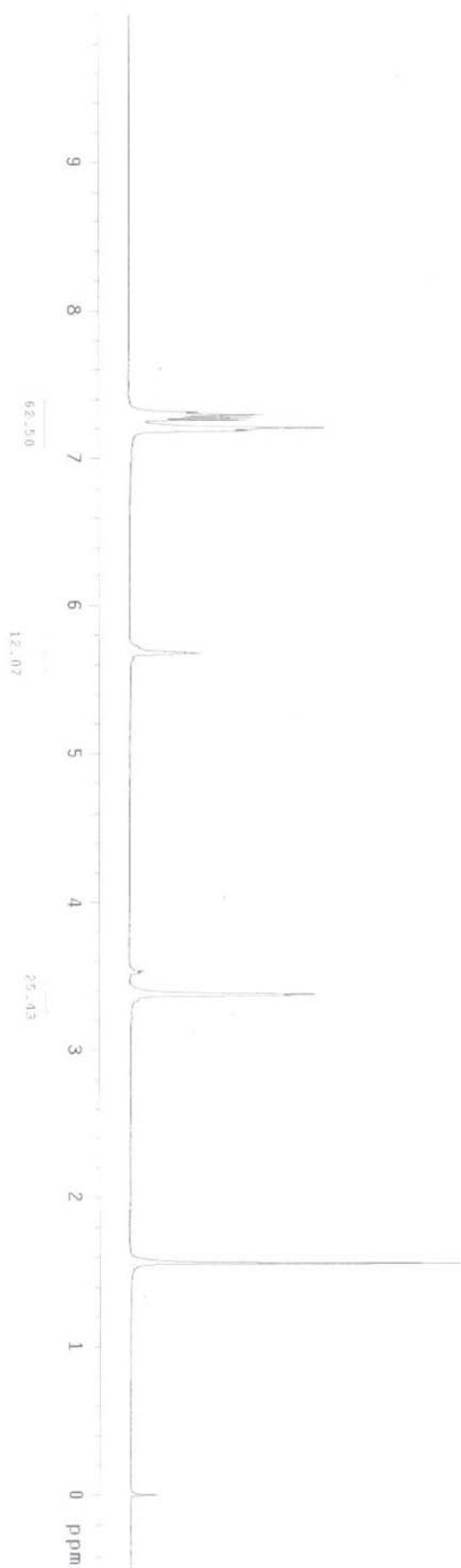

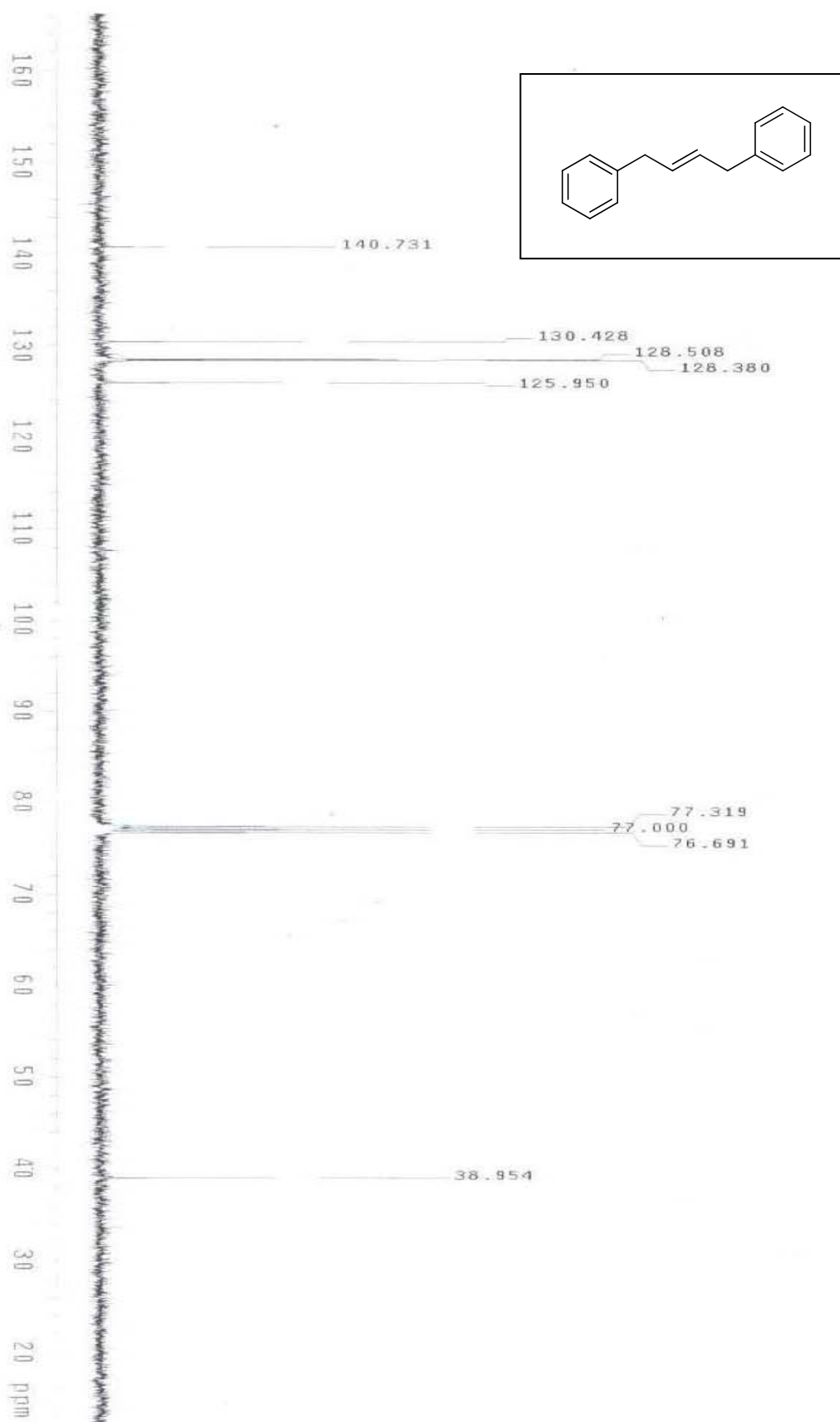

16. (E)-(3-cyclohexylallyl)benzene (2p)

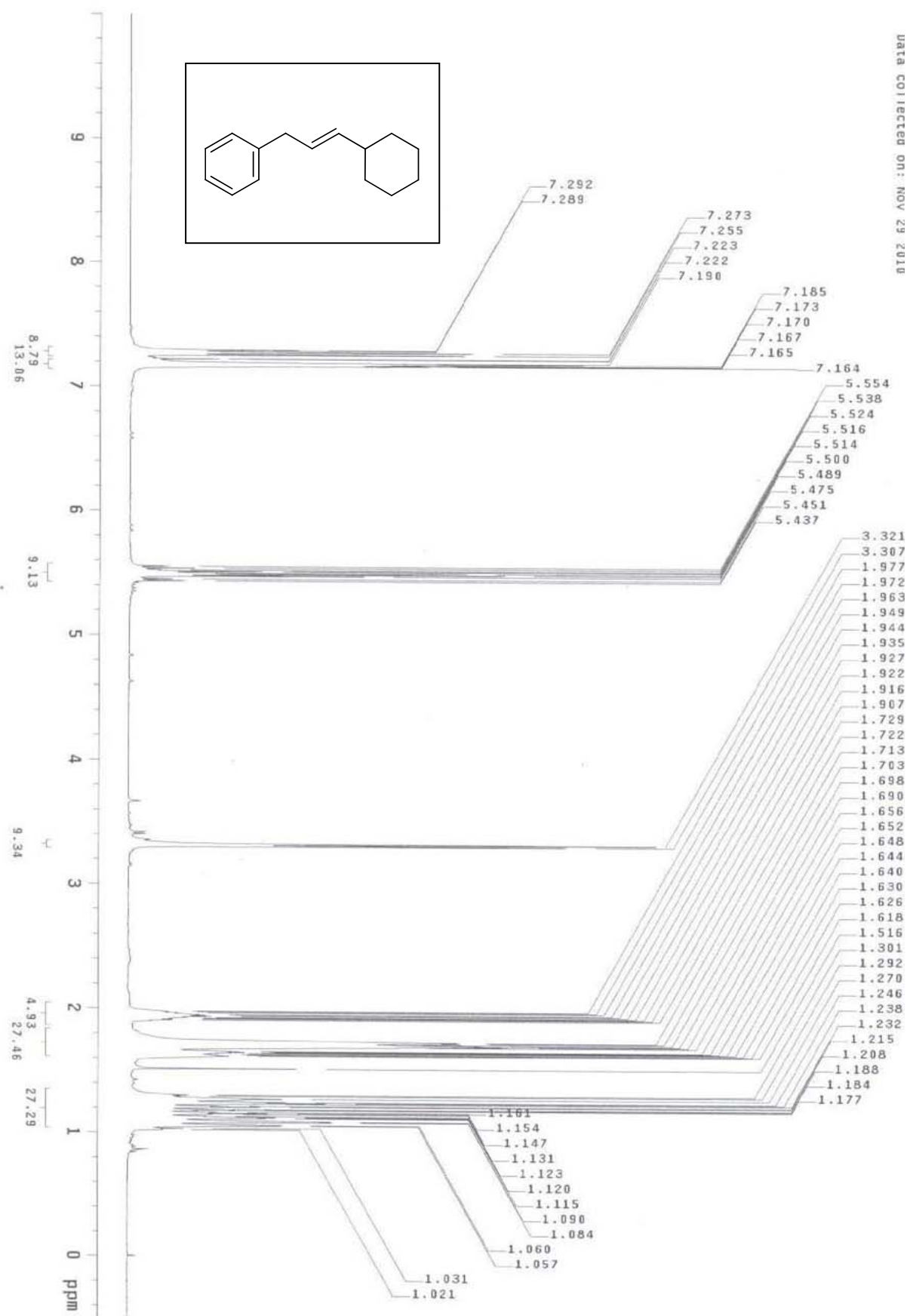

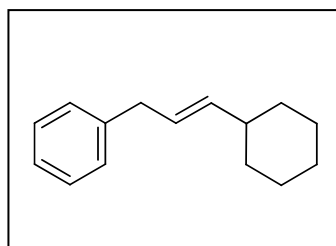
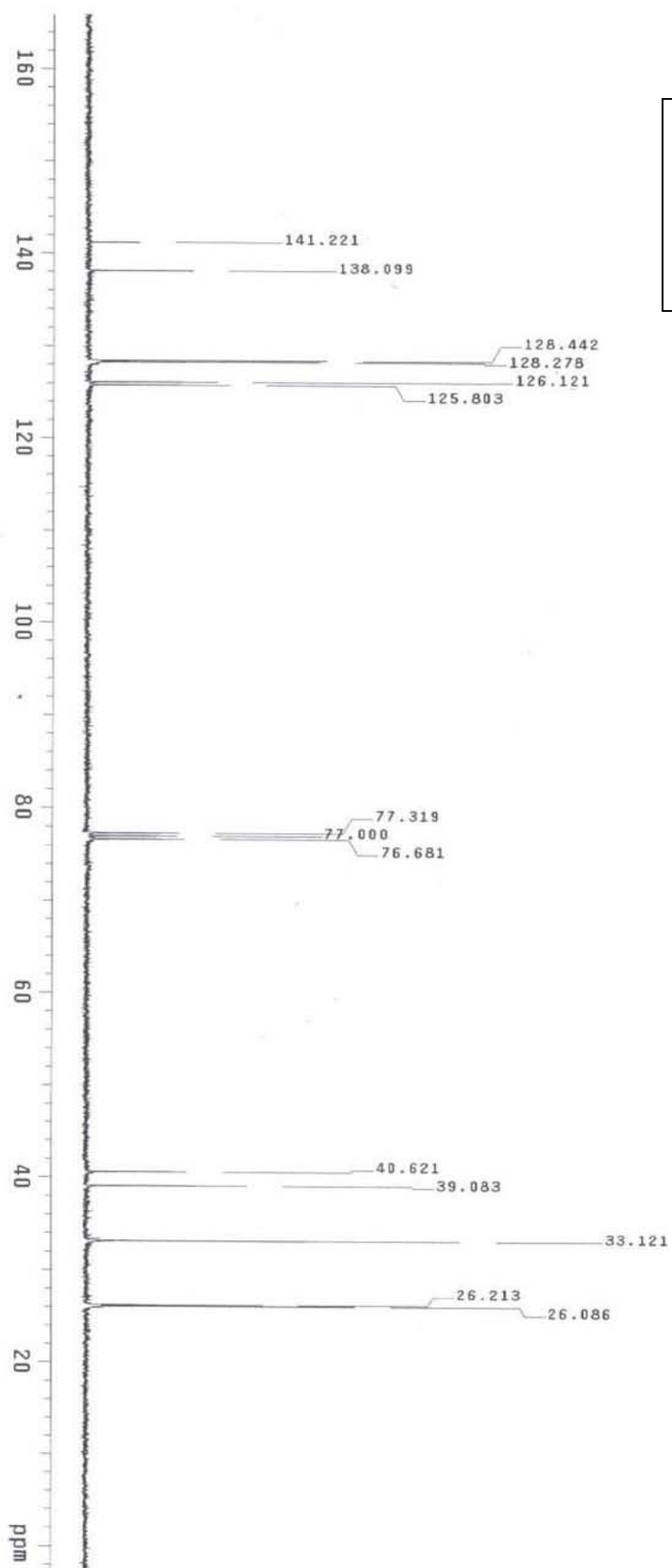

17. (E)-3-(3-phenylprop-1-enyl)thiophene (2q)

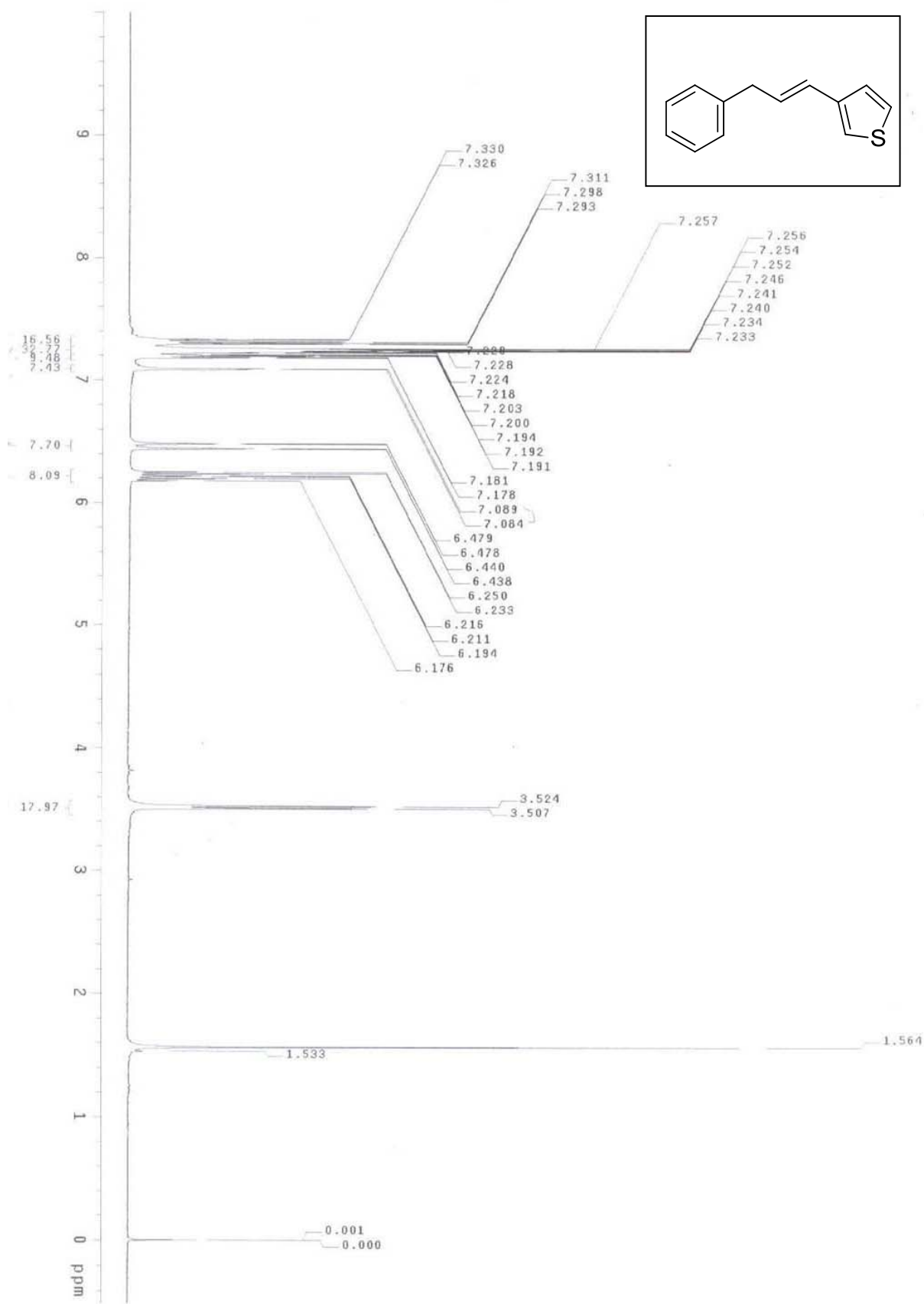

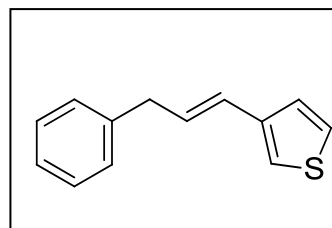
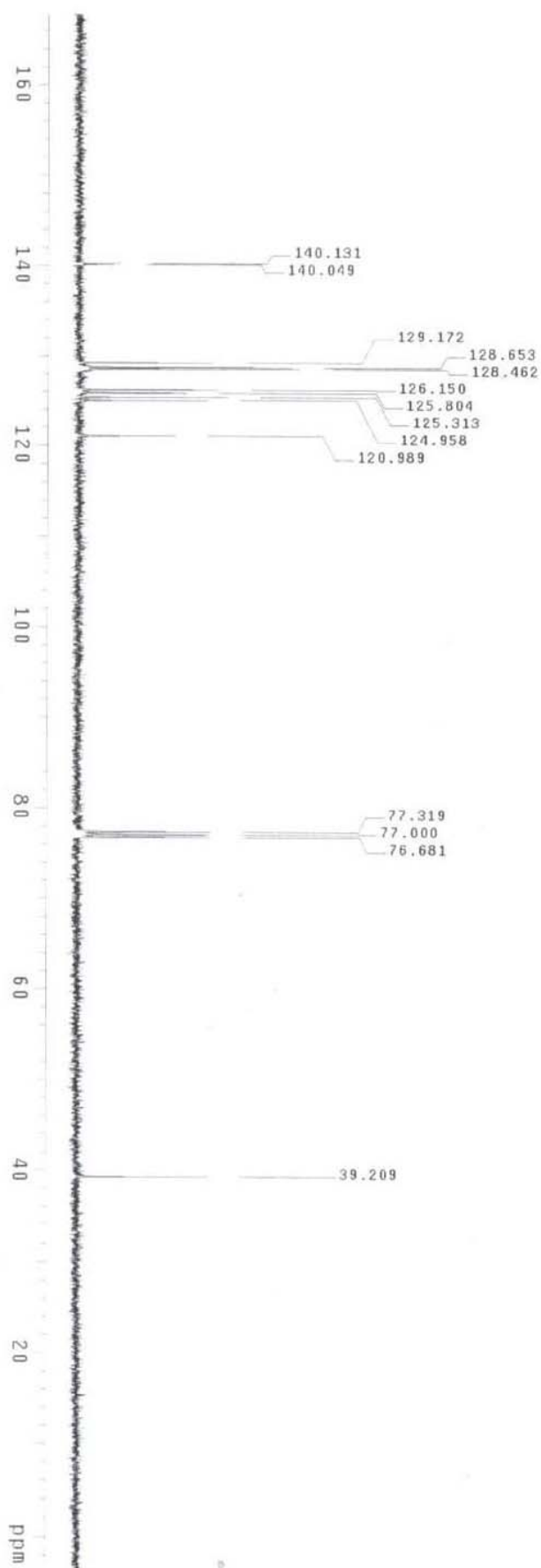

18. (E)-1-fluoro-4-(hept-2-enyl)benzene (2r)

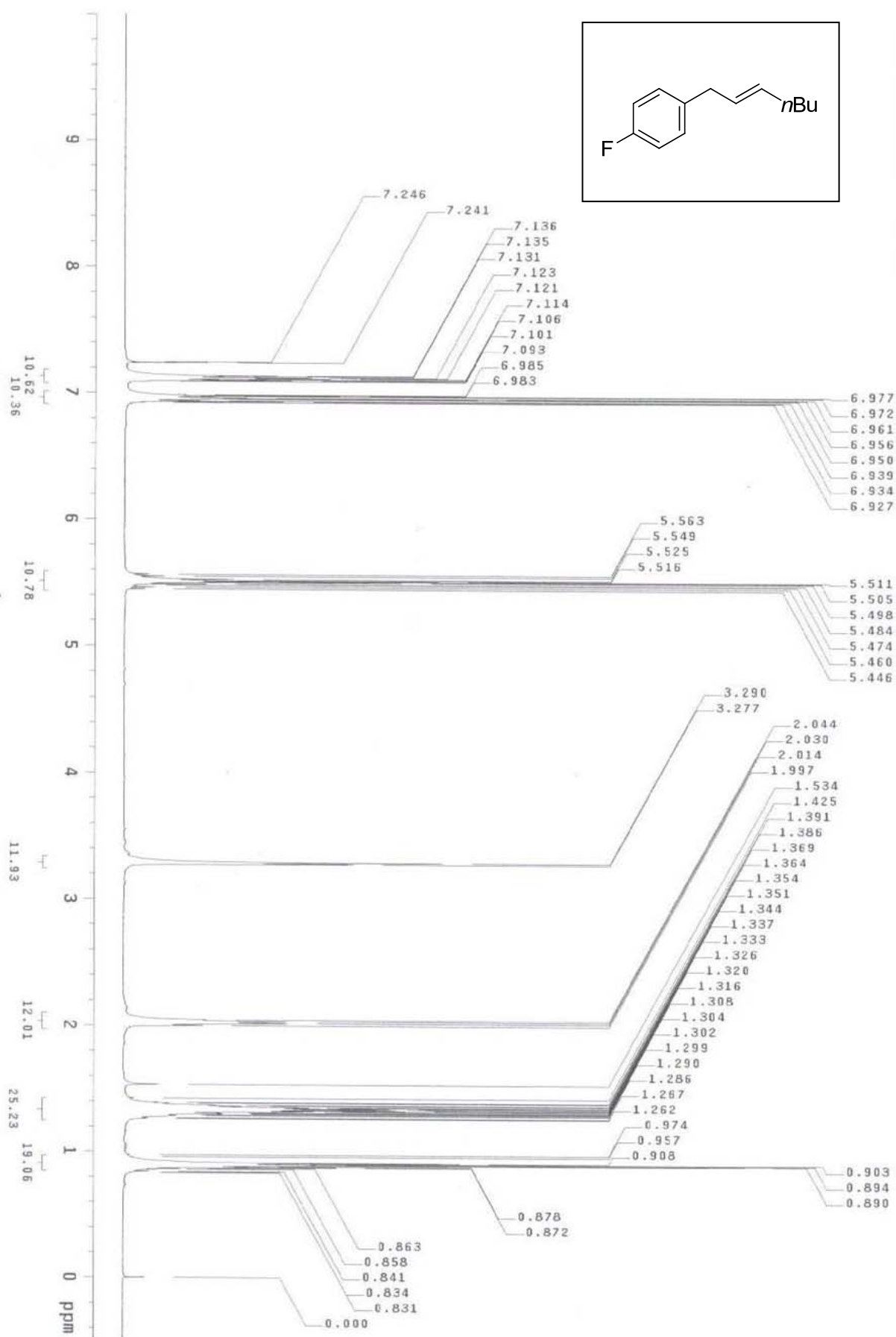

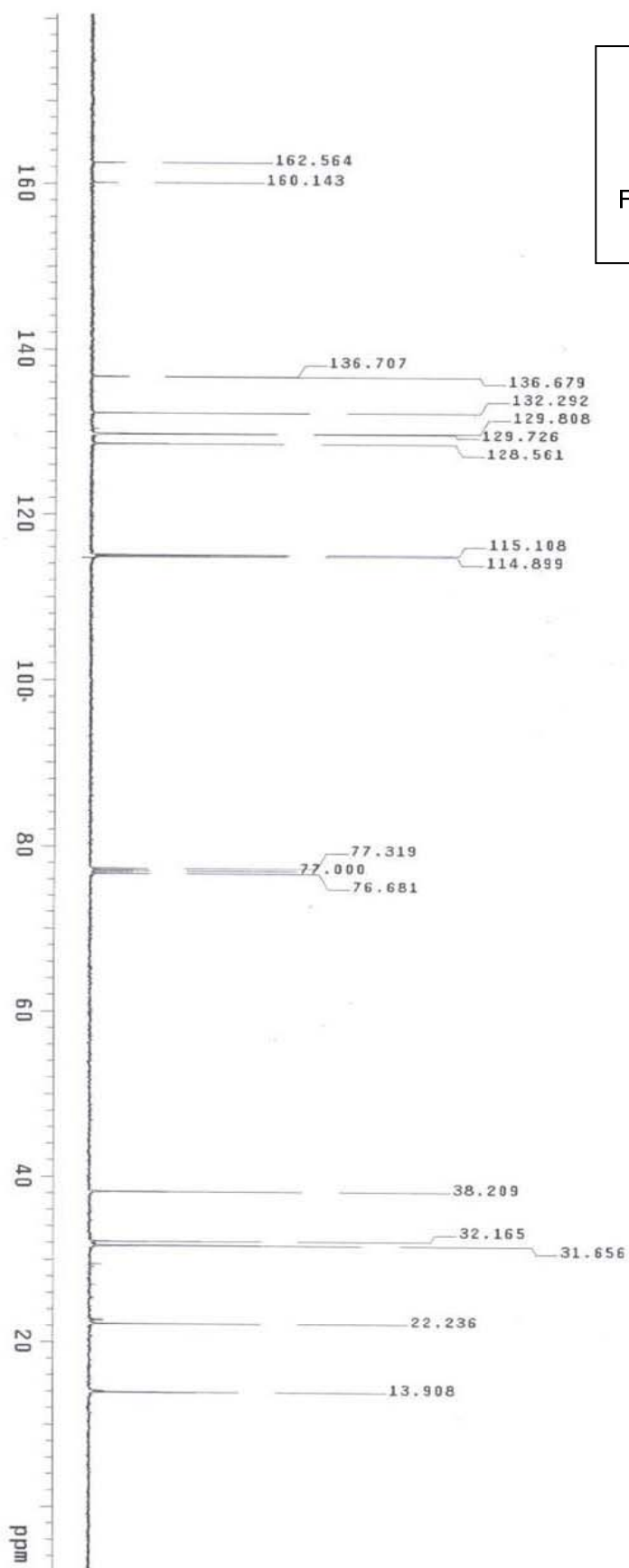

19. (E)-1-(hept-2-enyl)-4-vinylbenzene (2s)

