

WHOI-KAUST-CTR-2009-02

**Woods Hole Oceanographic Institution  
King Abdullah University of Science and Technology**



---

---

**King Abdullah University of Science and Technology (KAUST)  
Mooring Deployment Cruise and Fieldwork Report**

**Fall 2008**

**R/V *Oceanus* Voyage 449-5**

**October 9, 2008–October 14, 2008**

by

J. Thomas Farrar

Steven Lentz

James Churchill

Paul Bouchard

Jason Smith

John Kemp

Jeff Lord

Geoff Allsup

David Hosom

**Collaborative Technical Report**

Funding for this report was provided by the King Abdullah University of Science and Technology (KAUST) under a cooperative research agreement with Woods Hole Oceanographic Institution.

Approved for public release; Distribution limited to non-military agencies.



Upper Ocean Processes Group  
Woods Hole Oceanographic Institution  
Woods Hole, MA 02543  
UOP Technical Report 2009-04

**WHOI-KAUST-CTR-2009-02**

**King Abdullah University of Science and Technology (KAUST) Mooring  
Deployment Cruise and Fieldwork Report**

**Fall 2008 R/V *Oceanus* Voyage 449-5  
October 9, 2008–October 14, 2008**

by

J. Thomas Farrar, Steven Lentz, James Churchill, Paul Bouchard, Jason Smith,  
John Kemp, Jeff Lord, Geoff Allsup, David Hosom

July 2009

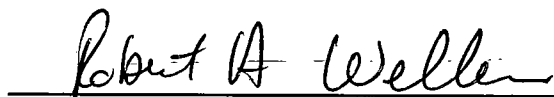
**Collaborative Technical Report**

Funding for this report was provided by the King Abdullah University of Science  
and Technology (KAUST) under a cooperative research agreement with  
Woods Hole Oceanographic Institution (WHOI).

This report should be cited as: Woods Hole Oceanog. Inst.  
Tech. Rept., WHOI-KAUST-CTR-2009-02.

Approved for public release; Distribution limited to non-military agencies.

**Approved for Distribution:**



Robert A. Weller, Chair, Department of Physical Oceanography  
Woods Hole Oceanographic Institution



Representative for King Abdullah University of Science and Technology



## ABSTRACT

King Abdullah University of Science and Technology (KAUST) is being built near Thuwal, Saudi Arabia with the goal of becoming a world-class, graduate-level research university. As a step toward this goal, KAUST has partnered with the Woods Hole Oceanographic Institution (WHOI) to undertake various studies of the oceanography of the Red Sea in order to establish a research program in ocean sciences by the time the university opens its doors in the fall of 2009.

Two of the KAUST-WHOI research projects involve deployment of surface moorings and associated instrumentation to measure physical properties of the Red Sea, such as temperature, salinity, and currents, at four locations off the coast of Saudi Arabia. The goal of these measurements is to better understand the evolution and dynamics of the circulation and air-sea interaction in the Red Sea. Two surface moorings and two bottom tripods (PI, Steven Lentz) were deployed at 50-55-m depth near 21°57'N, 38°46'E over the continental shelf close to the Saudi coast. An additional surface mooring/bottom tripod pair was deployed near 21°58'N, 38°50'E at the outer fringe of a reef system directly onshore of the shelf mooring/tripod pairs (PI, Lentz). The coastal moorings carry instruments to estimate temperature, salinity, and fluorescence; and the nearby bottom tripods support instruments to measure bottom pressure and the vertical profile of the currents. Additional instruments, principally bottom temperature sensors, were deployed over the reef system onshore of the shelf moorings. One air-sea interaction mooring (PI, J. Thomas Farrar) was deployed at 693-m depth near 22°10'N, 38°30'E. The air-sea interaction mooring carries instruments for measuring temperature, salinity, (water) velocity, winds, air temperature, humidity, barometric pressure, incident sunlight, infrared radiation, precipitation, and surface waves. A coastal meteorological tower was also installed on the KAUST campus in Thuwal (PI, Farrar).

These measurements are of value because there are few time series of oceanographic and meteorological properties of the Red Sea that can be used to characterize the circulation, test numerical models of the Red Sea circulation, or formulate theoretical models of the physics of the Red Sea circulation. These measurements will permit a characterization of the Red Sea circulation with high temporal resolution at the mooring locations, and accurate *in-situ* estimates of the air-sea exchange of heat, freshwater, and momentum.

In October 2008, a cruise was made aboard the *R/V Oceanus* to deploy the shelf and air-sea interaction moorings, and other fieldwork (e.g., tower instrumentation and deployment of reef instrumentation) was conducted after the cruise. Some additional data were collected during the cruise with shipboard instrumentation. This report documents the cruise and the data collected during the fall 2008 fieldwork.



# TABLE OF CONTENTS

<b>ABSTRACT .....</b>	<b>3</b>
<b>TABLE OF CONTENTS .....</b>	<b>5</b>
<b>LIST OF FIGURES.....</b>	<b>6</b>
<b>LIST OF TABLES.....</b>	<b>6</b>
<b>I. PROJECT BACKGROUND AND PURPOSE.....</b>	<b>7</b>
<b>II. KAUST FALL 2008 MOORING DEPLOYMENT CRUISE.....</b>	<b>10</b>
A. OVERVIEW .....	10
B. PRE-CRUISE AND CRUISE DETAILS .....	12
<b>III. AIR-SEA INTERACTION MOORING .....</b>	<b>14</b>
A. OVERVIEW .....	14
B. SURFACE INSTRUMENTS .....	14
C. SUBSURFACE INSTRUMENTS .....	18
1. <i>Subsurface Argos Transmitter</i> .....	18
2. <i>MicroCat Conductivity and Temperature Recorder</i> .....	18
3. <i>SBE-39 Temperature Recorder</i> .....	18
4. <i>RBR TR1060</i> .....	18
5. <i>RBR XR-420CT/CTD</i> .....	18
6. <i>RDI ADCPs</i> .....	19
7. <i>VMCMs</i> .....	19
8. <i>Acoustic Release</i> .....	19
D. TELEMETRY SYSTEMS.....	21
E. BOTTOM SURVEY AND SOUND SPEED CORRECTION .....	22
F. AIR-SEA INTERACTION MOORING DEPLOYMENT .....	24
1. <i>Antifoulant Application</i> .....	24
2. <i>Deck Work During Deployment</i> .....	25
5. <i>Other notes</i> .....	25
G. KNOWN ISSUES .....	27
<b>IV. COASTAL MOORINGS AND BOTTOM TRIPODS.....</b>	<b>29</b>
A. SHELF MOORINGS AND BOTTOM TRIPODS DEPLOYED FROM OCEANUS .....	29
B. REEF-EDGE MOORING AND BOTTOM TRIPOD DEPLOYED FROM THE KAUST WHALER .....	30
C. REEF ARRAY DEPLOYED FROM THE KAUST WHALER .....	31
<b>V. SHIPBOARD MEASUREMENTS.....</b>	<b>43</b>
<b>VI. COASTAL METEOROLOGICAL TOWER .....</b>	<b>45</b>
<b>REFERENCES .....</b>	<b>52</b>
<b>ACKNOWLEDGEMENTS .....</b>	<b>53</b>
<b>APPENDIX A – MOORING LOG (AIR-SEA INTERACTION MOORING).....</b>	<b>54</b>
<b>APPENDIX B – SHIPBOARD UNDERWAY DATA FORMAT.....</b>	<b>64</b>

## LIST OF FIGURES

Figure II-1: The KAUST Fall 2008 Leg-1 area of operations.....	11
Figure II-2: The KAUST Fall 2008 Leg-1 cruise track and mooring sites.....	12
Figure III-1: Schematic of complete buoy meteorological system.....	15
Figure III-2: Meteorological buoy after deployment.....	16
Figure III-3: Mooring diagram for KAUST air-sea interaction mooring.....	20
Figure III-4: Schematic of subsurface telemetry system.....	21
Figure III-5: Bathymetric survey track and data.....	23
Figure III-6: Bathymetric survey track and data (close up).....	24
Figure III-7: Meteorological buoy during deployment.....	26
Figure IV-1: Coastal mooring sites and survey lines.....	35
Figure IV-2: Reef instrumentation locations superimposed on LandSat image.....	36
Figure IV-3: Two views of the surface buoy supporting mooring K1.....	37
Figure IV-4: Deployment of mooring K2.....	38
Figure IV-5: Mooring diagram for K1 and K2 shelf moorings.....	39
Figure IV-6: Deployment of the K1 (shelf-edge) bottom tripod.....	40
Figure IV-7: Mooring diagram for reef-edge mooring.....	41
Figure IV-8: Surface buoy of the reef-edge mooring.....	42
Figure V-1: Locations of all CTD stations and cruise track.....	44
Figure VI-1: Glen Martin Engineering, Inc., brochure for AN Self-supporting tower.....	45
Figure VI-2: Installation of meteorological tower.....	46
Figure VI-3: Schematic of tower meteorological system.....	48
Figure VI-4: Installation of tower instruments.....	49
Figure VI-5: Meteorological tower after installation of instruments.....	50
Figure VI-6: Close-up of tower meteorological system after installation.....	51

## LIST OF TABLES

Table I-1: Measurements taken by the KAUST air-sea interaction surface mooring.....	8
Table II-1: KAUST 2008 Leg-1 Science Party.....	10
Table III-1: Measurement heights and sensor types for meteorological buoy.....	18
Table III-2: Instrument IDs for Loggers K-01 and K-02.....	19
Table III-3: Sampling schemes for subsurface instruments.....	20
Table III-4: Mooring deployment details.....	25
Table III-5: Air-sea interaction mooring anti-foul applications.....	26
Table IV-1: Coastal array instrument locations.....	34
Table IV-2: Instrument arrangement on shelf-edge mooring K1.....	35
Table IV-3: Instrument arrangement on shelf-edge tripod K1.....	35
Table IV-4: Instrument arrangement on mid-shelf mooring K2.....	36
Table IV-5: Instrument arrangement on mid-shelf tripod K2.....	36
Table IV-6: Instrument arrangement on reef-edge mooring K4.....	37
Table IV-7: Instrument arrangement on reef-edge tripod K4.....	37
Table IV-8: Instrument arrangement on reef frame KR.....	37
Table IV-9: Sample rates for shelf and reef instruments.....	37
Table V-1: Times and locations of CTD casts.....	44
Table VI-1: Sensor heights on the meteorological tower.....	49

## I. PROJECT BACKGROUND AND PURPOSE

King Abdullah University of Science and Technology (KAUST) is being built near Thuwal, Saudi Arabia with the goal of becoming a world-class, graduate-level research university. As a step toward this goal, KAUST has partnered with the Woods Hole Oceanographic Institution (WHOI) to undertake various studies of the oceanography of the Red Sea in order to establish a research program in ocean sciences by the time the university opens its doors in the fall of 2009. A formal agreement between the two institutions was signed in October 2007. The multi-year agreement includes three major lines of collaborative research, including:

- A three-year fisheries and aquaculture project that will produce an integrated bioeconomic model of the Red Sea coast of Saudi Arabia, describing the dynamic relationships among fish stocks and the fisheries that harvest them;
- A coastal hydrography and circulation project that will provide the first comprehensive description of the physical oceanography in the Red Sea;
- Studies of coral reef ecology that offer a baseline for long-term monitoring of the coastal environment.

The research described here is part of the second line of research, the effort to study the “coastal hydrography and circulation of the Red Sea.” Many members of the WHOI Physical Oceanography Department are performing work on this project. There are seven different observational and modeling research projects under this effort, and they collectively address the following goals stated in the research proposal submitted to KAUST:

- (1) Collect two years of time series measurements of oceanographic and meteorological parameters at a number of sites near KAUST, including a meteorological tower on the coast, using state-of-the-art instruments suitable for climate studies. These stations would represent the foundation of a coastal observing network along the entire Saudi Arabian coast.
- (2) Conduct regional physical/biological surveys near KAUST. These surveys will document meso-scale processes that are important to the exchange of water properties and organisms between the reef and offshore waters.
- (3) Develop new, high-resolution numerical models for predicting currents and meteorological conditions in the Red Sea. The new high-quality observations will be used to verify model results.
- (4) Conduct large-scale hydrographic and current surveys to document seasonal and interannual variability in water mass properties and currents throughout most of the Red Sea coastal waters off Saudi Arabia. These exploratory surveys would represent the first systematic mapping of the physical characteristics of the Saudi coastal waters and will be used to determine seasonal variability and the most appropriate sites for a coastal observing network.

The work described in this report addresses the first goal.

Two of the KAUST-WHOI research projects involve deployment of surface moorings and associated instrumentation to measure physical properties of the Red Sea, such as temperature,



salinity, and currents, at a number of locations off the coast of Saudi Arabia. The goal of these measurements is to better understand the evolution and dynamics of the circulation and air-sea interaction in the Red Sea.

This report deals with the instrumentation set out in October 2008 as part of a research cruise aboard the *R/V Oceanus* and as part of subsequent field work done immediately following the cruise. During the *Oceanus* cruise, two surface moorings and two bottom tripods were deployed at 50-55-m depth near 21°57'N, 38°46'E, over the continental shelf close to the Saudi coast (PI, Steven Lentz). These coastal moorings carry instruments to estimate temperature, salinity, and fluorescence, and the nearby bottom tripods support instruments to measure bottom pressure and the vertical profile of the currents. In addition, an air-sea interaction mooring (PI, J. Thomas Farrar) was deployed at 697-m depth near 22°10'N, 38°30'E. The air-sea interaction mooring carries instruments for measuring physical properties above and below the sea surface, described in Table I-1.

Following the cruise, a coastal meteorological tower was installed on the KAUST campus in Thuwal (PI, Farrar), a shallow coastal mooring/bottom tripod pair was deployed near the other coastal moorings (PI, Lentz), and an array of temperature sensors was deployed over a reef system onshore of the coastal moorings (PI, Lentz).

**Table I-1: Type of measurements taken by the KAUST air-sea interaction surface mooring.**

Surface Measurements	Subsurface Measurements
Wind speed	Temperature
Wind direction	Conductivity
Air temperature	Current speed
Sea surface temperature	Current direction
Barometric pressure	
Relative humidity	
Incoming shortwave radiation	
Incoming longwave radiation	
Precipitation	
Surface wave height and direction	

This collection of measurements will be of value because there are few time series of oceanographic and meteorological properties of the Red Sea that can be used to characterize the Red Sea circulation and atmospheric forcing, test numerical models of the Red Sea circulation, or formulate theoretical models of the physics of the Red Sea circulation. These measurements will permit a characterization of the Red Sea circulation with high temporal resolution at the mooring locations and accurate *in-situ* estimates of the air-sea exchange of heat, freshwater, and momentum.

This report documents the work done on the 9-14 October 2008 cruise (Voyage 449-5 of the *R/V Oceanus*) and the associated fieldwork done during October 2008. The cruise operations included:

- 1) Deployment of a surface mooring with meteorological buoy at 675-m depth near 22°10'N, 38°29'E (J.T. Farrar).

- 2) Deployment of two surface moorings and two bottom tripods at 50-55-m depth near 21°57'N, 38°46'E (S. Lentz).
- 3) Bathymetric surveys to determine suitable deployment locations prior to mooring deployments (Farrar/Lentz).
- 4) CTD casts to estimate sound speed for bathymetric surveys and to characterize the spatial variability of temperature and salinity in the vicinity of the mooring sites.
- 5) SCUBA diving for biological sampling (L. Madin).

The field operations conducted after *Oceanus* cruise accomplished the following:

- 1) Installation of a coastal meteorological tower on the KAUST campus in Thuwal (J.T. Farrar).
- 2) Deployment of a coastal mooring/bottom tripod pair on the inner shelf (S. Lentz).
- 3) Deployment of an array of sensors over a reef system onshore of the coastal moorings (S. Lentz).

## II. KAUST FALL 2008 MOORING DEPLOYMENT CRUISE

### A. Overview

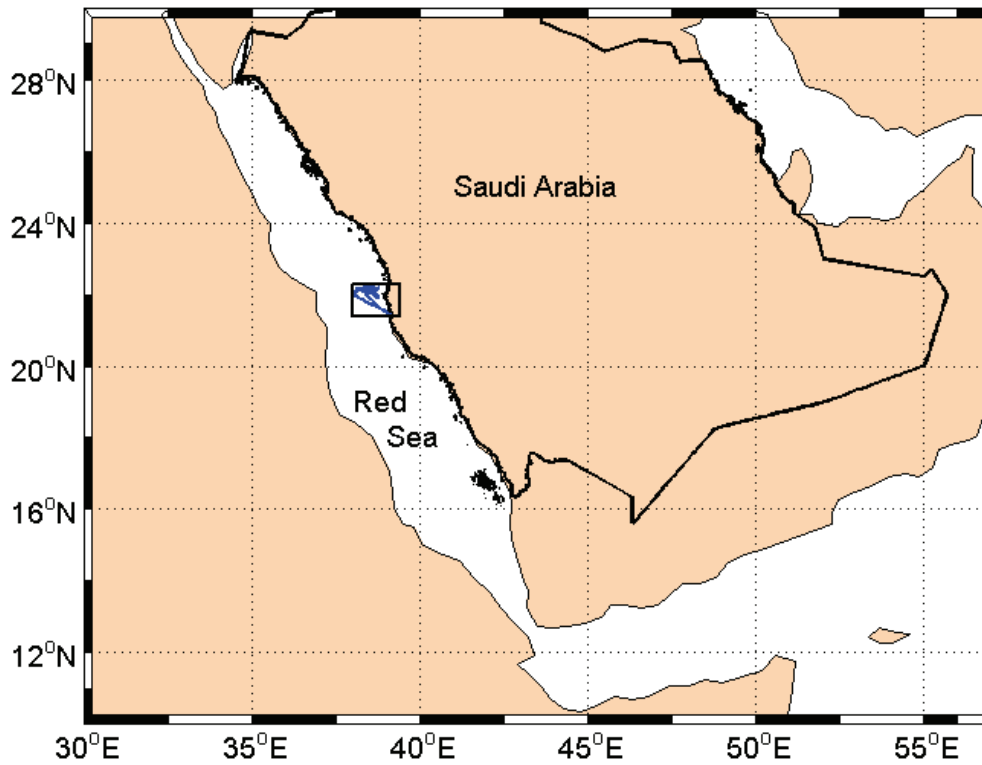
Many tasks were completed during the KAUST Fall 2008 Cruise aboard the R/V *Oceanus* (Voyage 449-5), including:

1. Deployment of one surface mooring with meteorological sensors on the buoy tower and oceanographic instruments attached to the mooring line.
2. Deployment of two coastal surface moorings equipped with instruments to measure temperature, conductivity, and fluorescence.
3. Deployment of two bottom tripods next to the coastal moorings to measure bottom pressure and vertical profiles of currents.
4. Bathymetric surveys in the vicinity of the mooring sites.
5. CTD casts were conducted to characterize the spatial variability in the vicinity of the mooring sites.
6. Underway data was collected with the ship's standard equipment, including an IMET suite and ADCP.

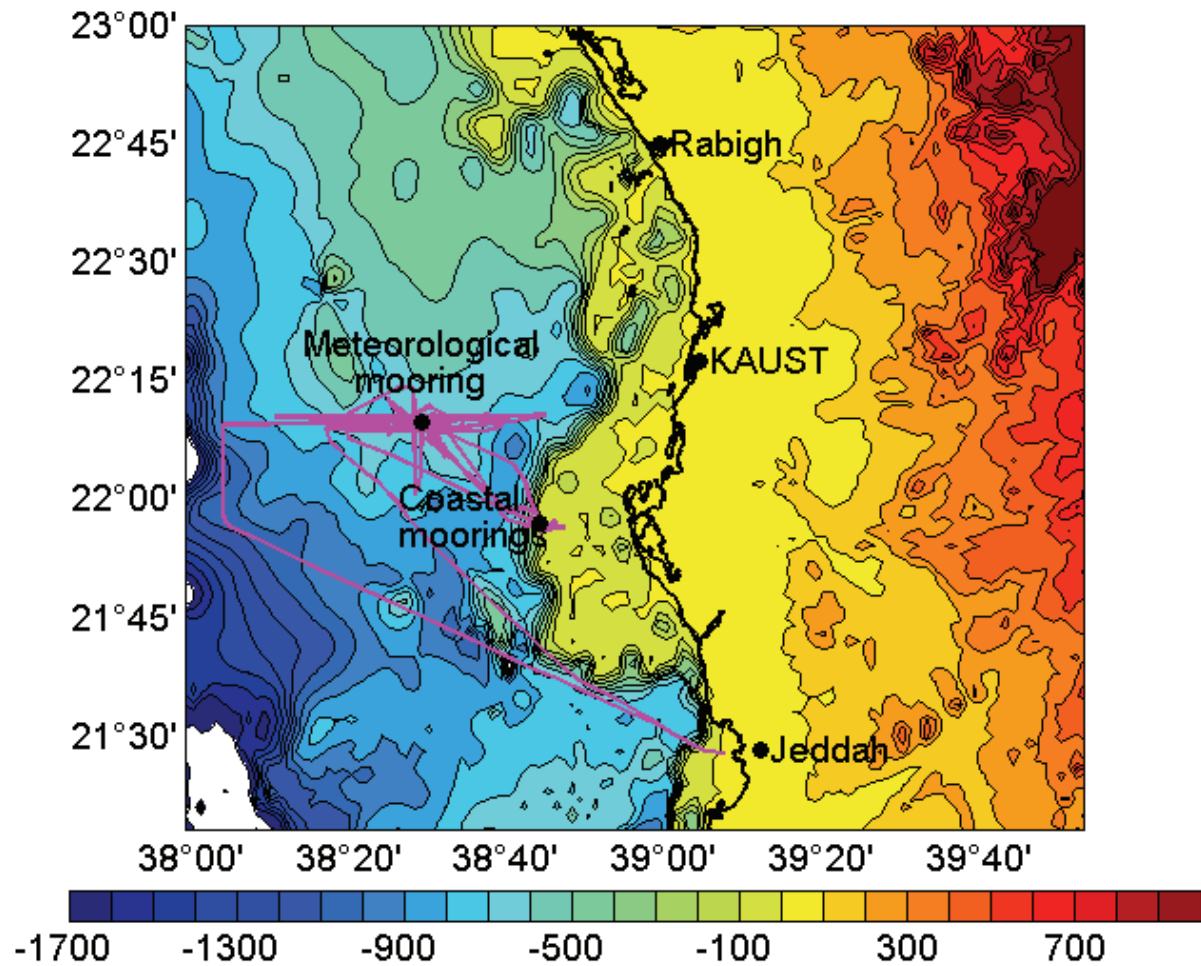
On 9 October 2008, the ship departed the Jeddah Islamic Port in Jeddah, Saudi Arabia, and the ship returned to Jeddah on 14 October 2008. Voyage 449-5 of the *Oceanus* is also known as “KAUST Leg 1” because it was the first of three KAUST-WHOI cruises planned for fall 2008. Table II-1 lists the scientific participants aboard during the cruise. Figure II-1 shows the area of operations for the cruise, and Figure II-2 shows the ship's track.

**Table II-1: KAUST Fall 2008 Leg-1 science party**

Name	Affiliation
J. Thomas Farrar	WHOI, Chief Scientist
Yasser Abualnaja	King Abdulaziz University
Alaa Al-Barakati	King Abdulaziz University
Susan Avery	WHOI
Paul Bouchard	WHOI
James Churchill	WHOI
Brian Hogue	WHOI
Erich Horgan	WHOI
John Kemp	WHOI
Steven Lentz	WHOI
Laurence Madin	WHOI
Katherine Madin	WHOI



**Figure II-1: The KAUST Fall 2008 Leg-1 area of operations in its large-scale context. The actual cruise track is indicated by a blue line. The cruise track is shown in more detail in Figure II-2.**



**Figure II-2: The KAUST Fall 2008 Leg-1 cruise track (pink line). Background coloring and color scale indicate the ocean depth and land elevation in meters (from GEBCO 1-min bathymetry product).**

### **B. Pre-Cruise and Cruise Details**

Preparation for the 2008 KAUST cruise began months before sailing with the initial calibration and testing of the instruments and the construction of the moorings and buoys. After calibration, meteorological instruments were gathered and placed on the buoy for testing. (This outdoor testing is referred to as the burn-in phase.) Burn-in details are not presented in this report, but the burn-in data have been documented carefully for the purpose of tracking instrument performance.

All equipment was shipped to Jeddah during August and September of 2008. Surface and subsurface instrument preparation started on 4 October when the science personnel obtained the certificates required for entry into the Jeddah Islamic Seaport. Equipment was loaded on the *Oceanus* in port on 8 October.

9 October 2008 – *R/V Oceanus* departed Jeddah 10:27 UTC. The science party held a science meeting and participated in safety training. The ship proceeded along the planned track to begin the bathymetry survey near the air-sea interaction mooring site. One CTD cast was performed near the planned mooring site for use in estimating the sound speed for the bathymetric survey.

10 October 2008 – Around 3:00 UTC, we began steaming from the air-sea interaction mooring site to the coastal site. We arrived at the coastal site at 6:00 UTC, performed a bottom survey, collected five CTD casts to form a cross-shelf section, and departed for the air-sea interaction mooring site at 18:00 UTC. All five CTD casts were within about half a nautical mile of 21°56.8'N, 38°45.0'E.

11 October 2008 – The air-sea interaction mooring was deployed at a site selected based on the 9 October bottom survey. During the early morning hours, the ship performed a set-and-drift and practice approach. To confirm functionality of the mooring's acoustic release, the release was lowered to depth on the CTD package (02:55 UTC). Deck operations started at 6:30 UTC. The buoy was in the water at 6:58 UTC, and the anchor was dropped at 12:09:30 UTC at 22°09.690'N, 38°29.996'E. After deployment, it became clear that the telemetry system for the ADCP velocity measurements was not functioning. A SCUBA dive was conducted and three CTD casts were conducted within 10 nmi of the mooring site after the mooring deployment.

12 October 2008 – The coastal moorings and bottom tripods were deployed at a site selected based on the 10 October bottom survey. A CTD cast was performed by each mooring for sensor intercalibration. In the evening, we returned to the air-sea interaction mooring to attempt to fix the ADCP telemetry system by communicating with the underwater acoustic modems using the Benthos shipboard system.

13 October 2008 – Work on the ADCP telemetry system continued until around 10:00 UTC. SCUBA dives, comparison of shipboard and buoy meteorological data, and four CTD casts were performed during the remaining time.

14 October 2008 – Around 00:30 UTC, scientific operations were halted and the ship began steaming to port. We reached the dock around 0900 UTC.

### III. AIR-SEA INTERACTION MOORING

#### A. Overview

The surface buoy used in this project is equipped with meteorological instrumentation, including two Improved Meteorological (IMET) systems. The mooring line also carries current meters, and conductivity and temperature recorders.

This mooring is of a "stretch-hose" design utilizing wire rope, chain, and five short shots of WHOI-designed rubber stretch hose and has a scope of 0.95 (scope is defined as slack length/water depth). The buoy is a 2.8-meter diameter foam buoy with an aluminum tower.

#### B. Surface Instruments

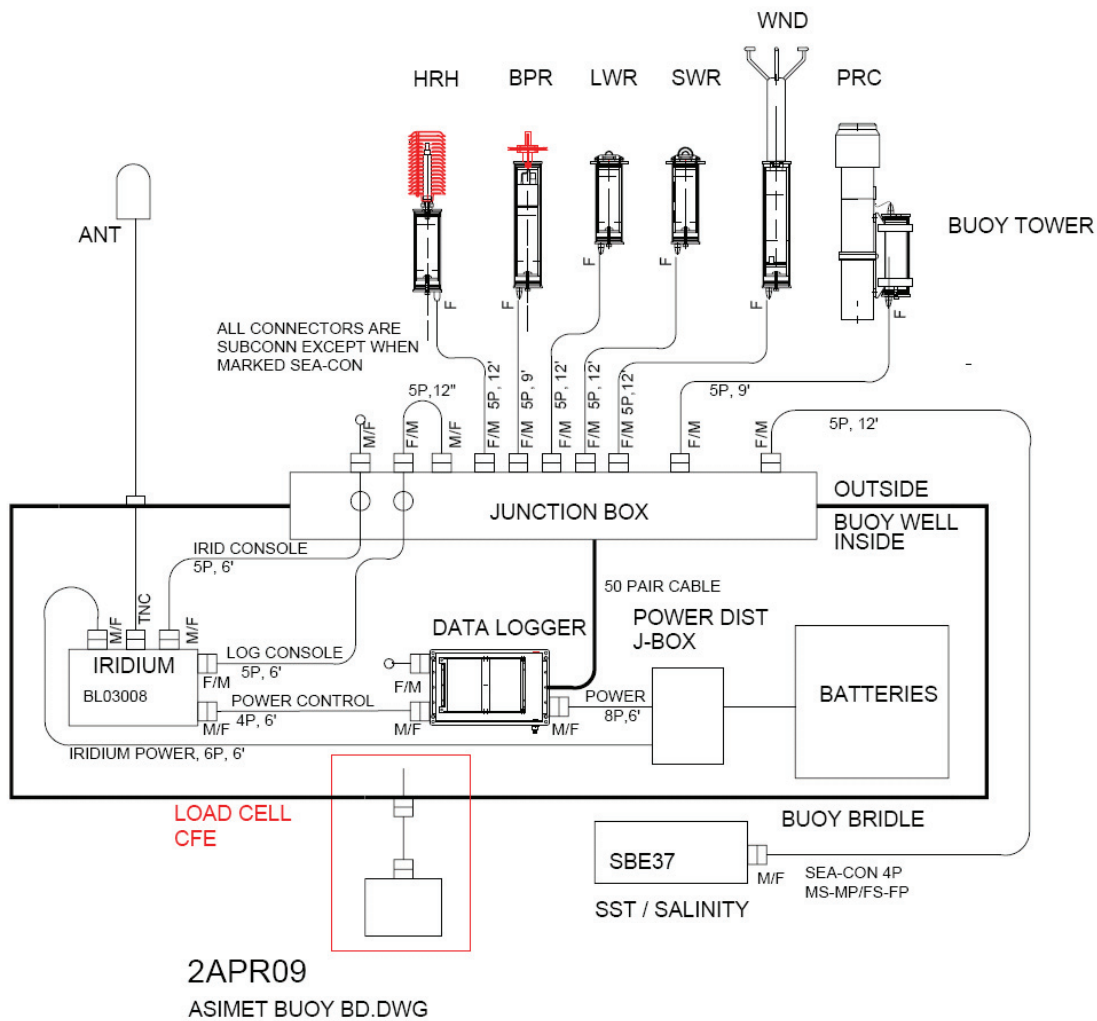
There are two independent IMET systems (Hosom et al., 1995; Payne and Anderson, 1999) on the buoy (Figures III-1 and III-2). These systems measure the following parameters once per minute, and transmit hourly averages via satellite:

- relative humidity with air temperature
- barometric pressure
- precipitation
- wind speed and direction
- shortwave radiation
- longwave radiation
- near-surface ocean temperature and conductivity

All IMET modules are modified for lower power consumption so that a non-rechargeable alkaline battery pack can be used. Near-surface temperature and conductivity are measured with two SeaBird MicroCat instruments with RS-485 interfaces attached to the bottom of the buoy.

A LOGR53 Main Electronics logger was used. This consists of a two-board set of CPU and interface which handles the power and communications to the individual IMET modules as well as optional PTT or internal barometer or internal A/D board. All modules are sampled at the start of each logging interval. All the "live" interval data is available via the D and E commands on the primary RS232 "console" interface used for all LOGR53 communications.

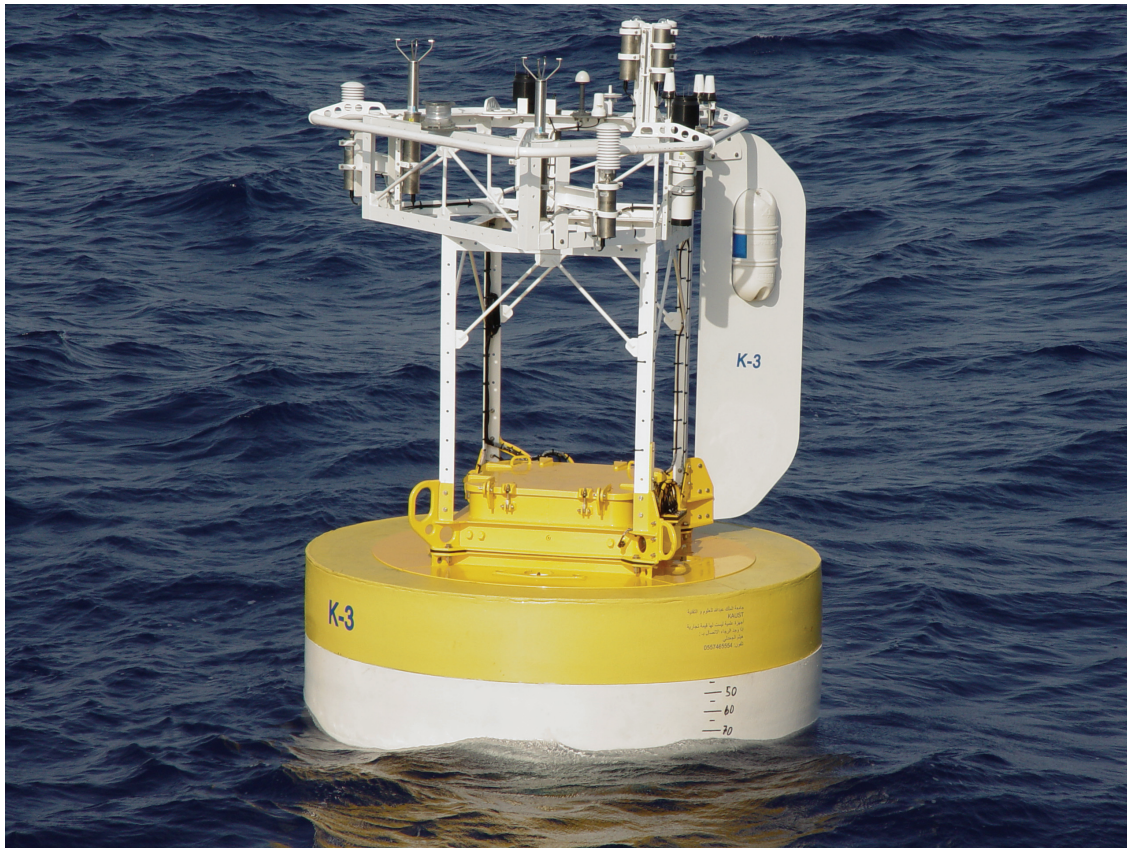
The LOGR53 CPU board is based on a Dallas Semiconductor DS87C530 microcontroller. DS87C530 internal peripherals include a real time clock and 2 universal asynchronous receiver-transmitter (uart); 2 additional uarts are included on the CPU board as well. Also present on the CPU board is a PCMCIA adapter for the CompactFlash card included with the system; at a 1-minute logging interval, there is enough storage for over 400 days of data. A standard CR2032 lithium coin cell provides battery-backup for the real time clock. Operating parameters are stored in EEPROM and are *not* dependent on the backup battery. A normally unused RS485 console interface at P1 is also present on this board.



**Figure III-1: Schematic representation of complete buoy meteorological system. The buoy carries two of these packages. Note that there is no load cell on the KAUST buoy.**

The LOGR53IF Interface board handles power and communications distribution to the IMET modules as well as interface to various options such as PTT or A/D modules. Connector P12 is the main RS232 "console" interface to the LOGR53 and can also be used to apply external power (up to about 100 MA) to the system during test. The main +12-15V battery stack (for the base logger with CompactFlash card) is connected to P13; the "sensor" +12-15V battery stack (which typically powers the IMET modules) is connected to P14; the "aux" battery stack (which typically powers the optional PTT) is connected to P19. Regulated +5V power for the system is produced on this board.





**Figure III-2: Meteorological buoy after deployment. (Photo by Yasser Abualnaja.)**

Parameters recorded on a CompactFlash card:

**TIME**

**WND** - wind east and north velocity; wind speed average, max, and min; last wind vane direction, and last compass direction

**BPR** - barometric pressure

**HRH** - relative humidity and air temperature

**SWR** - short wave radiation

**LWR** - dome temperature, body temperature, thermopile voltage, and long wave radiation

**PRC** - precipitation level

**SST** - sea surface temperature and conductivity

**ADI** - multiplexed optional parameter value from A/D module (only 1 of 8 in each record)

IMET Iridium modules transmit via satellite the most recent four hours of one-hour averages from the IMET modules. Data are also logged redundantly on flash cards within each meteorological module. The sonic wind modules were modified to record the measured speed of sound and “sonic temperature” on their flash cards.

In addition to the IMET measurements, the buoy also carried an instrument to measure the height and direction of surface waves (Bouchard and Farrar, 2008). This instrument was loaned to the UOP Group by the U.S. National Data Buoy Center.

For the meteorological packages, instrument types and measurement heights are given in Table III-1. The instrument IDs and their associated loggers are indicated in Table III-2.

Parameter(s) measured	Sensor	Height above buoy deck (deck is ~75 cm above sea level)
HRH/ATMP	Rotronic MP-101A	230 cm
BPR	Heise DXD (Dresser Instruments)	240 cm
Sonic WND	Gill Instruments WindObserver II Ultrasonic Anemometer	270 cm
PRC	RM Young 50202 Self-siphoning rain gauge	250 cm
LWR	Eppley Precision Infrared Radiometer (PIR)	280 cm
SWR	Eppley Precision Spectral Pyranometer (PSP)	280 cm
SST	SeaBird Electronics SBE37-SI	-150 cm

**Table III-1: Measurement heights and sensor types for IMET measurements. The buoy deck is estimated to be 75 cm above the mean water line, so add 75 cm to height above deck to obtain height above sea level.**

Parameter(s) measured	IDs on Logger K-01	IDs on Logger K-02
HRH/ATMP	358	359
BPR	306	307
Sonic WND	208	204
PRC	313	314
LWR	309	310
SWR	345	347
SST	5997	5996

**Table III-2: Instrument IDs for Loggers K-01 and K-02.**

### **C. Subsurface Instruments**

The following sections describe individual instruments on the buoy bridle and mooring line. Figure III-3 shows how the instruments are configured on the mooring. Table III-3 gives an overview of sampling schemes for the subsurface instruments.

#### **1. Subsurface Argos Transmitter**

An NACLS, Inc. Subsurface Mooring Monitor (SMM) was mounted upside down in one of the vertical through-holes in the buoy foam. This is a backup recovery aid in the event that the buoy parted from the mooring and the buoy flipped upside down. If the buoy turns upside down, the transmitter will turn on to report the position of the buoy.

#### **2. MicroCat Conductivity and Temperature Recorder**

The MicroCat, model SBE37, is a high-accuracy conductivity and temperature recorder with internal battery and memory. It is designed for long-term mooring deployments and includes a standard serial interface to communicate with a PC. Its recorded data are stored in non-volatile FLASH memory. The temperature range is  $-5^{\circ}$  to  $+35^{\circ}\text{C}$ , and the conductivity range is 0 to 6 Siemens/meter. (Seabird claims linearity in the conductivity response well beyond 6 S/m.) The pressure housing is made of titanium and is rated for 7,000 meters. The shallowest MicroCats were mounted on the bridle of the buoy and wired to the IMET systems. These were equipped with RS-485 interfaces. Two SBE37's were equipped with inductive modems for telemetry of data.

#### **3. SBE-39 Temperature Recorder**

The Sea-bird model SBE-39 is a small, light weight, durable and reliable temperature logger. Two SBE39's were equipped with inductive modems for telemetry of data. Some sensors had internal thermistors, and some sensors had external thermistors.

#### **4. RBR TR1060**

The TR1060 is a small, accurate temperature logger in a Delrin™ housing rated to 1200 m. The TR-1060 is calibrated to an accuracy of  $\pm 0.002^{\circ}\text{C}$  (ITS-90 and NIST traceable standards). The standard thermistor has a time constant of less than 3 seconds. The TR-1060 has a measurement range of  $-5^{\circ}\text{C}$  to  $+35^{\circ}\text{C}$  in the standard calibration used for KAUST.

#### **5. RBR XR-420CT/CTD**

The XR-420CT is an autonomous logger for temperature and conductivity. The XR-420CTD measures temperature, conductivity, and pressure. Conductivity is measured with an inductive

cell with a range 0 to 70mS/cm and noise level of  $\sim 3\mu\text{S}/\text{cm}$  rms. The XR-420 is calibrated to an accuracy of  $\pm 0.002^\circ\text{C}$  (ITS-90 and NIST traceable standards). Pressure measurements are accurate to 0.05% of the rated depth of the pressure sensor.

#### 6. RDI ADCP (one 600 KHz and two 300 KHz)

Acoustic Doppler Current Profilers (ADCPs) manufactured by RDI were used to measure currents in the upper part of the water column.

#### 7. VMCM

Three Vector Measuring Current Meters were used to measure currents at and below 351 m depth. Orthogonal propellers with a cosine response allow direct measurement of the current vector at 1-minute intervals.

#### 8. Acoustic Release

The acoustic release used on the mooring is an EG&G Model 8242. This release can be triggered by an acoustic signal and will release the mooring from the anchor. The releases were tested at depth prior to deployment to ensure that they were in proper working order.

Instrument	Start time	Sample interval	Notes
RBR XR420	0100, 7 Oct 2008	1 minute	
RBR XR420CTD	0100, 7 Oct 2008	2 minute	
RBR TR1060	0100, 7 Oct 2008	30 second	
SBE39		5 minute	
SBE37		5 minute	
Inductive SBE 37&39 (see note for exception)	0100, 5 Oct. 2008	15 minute	SBE39#4312 start 0405, 11 Oct 2008
NGVM-061	08:44:00, 04OCT08	1 minute	1st sample @ 08:45:00 04OCT08
NGVM-038	08:44:15, 04OCT08	1 minute	1st sample @ 08:45:00 04OCT08
NGVM-013	10:29:30, 09OCT08	1 minute	1st sample @ 10:30:00 09OCT08
RDI 300 kHz	1200, 7 Oct 2008	60, 1-sec pings every 12 minutes	Salinity set to 36 PSU; 50, 2-m bins; 4-m blank
RDI 600 kHz (telem.)	$\sim$ 0759 13 Oct 2008 (started via modem during shipboard troubleshooting)	60, 1-sec pings every 15 minutes	Salinity set to 38 PSU; 22, 2-m bins; 3-m blank

**Table III-3: Overview of sampling schemes for subsurface instrumentation.**

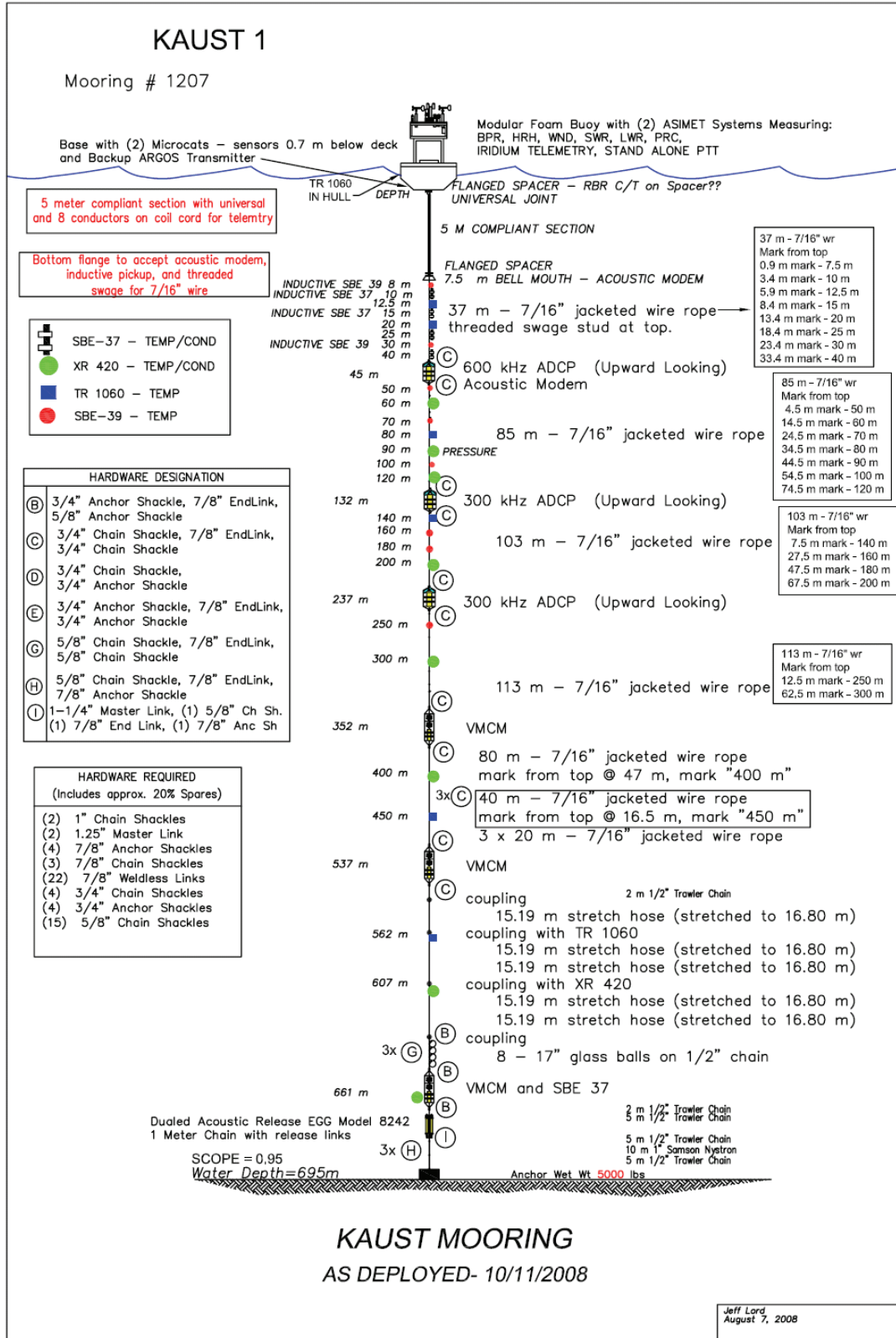


Figure III-3: Mooring Diagram for KAUST air-sea interaction mooring.

## D. Telemetry Systems

The buoy carries telemetry systems for both meteorological packages and for the telemetry of subsurface temperature, salinity, and velocity. The data are sent to WHOI via the Iridium satellite network, a network used for satellite phone and data communications. A UOP Technote was recently published on the inductive part of the subsurface telemetry system (WHOI Upper Ocean Processes Group, 2007), but the KAUST mooring also carries an acoustic telemetry system for telemetry of velocity data from an ADCP, a part of the system that is not documented elsewhere.

The components of the subsurface telemetry system are represented schematically in Figure III-4. The acoustic telemetry system suffered a failure during the hour immediately prior to deployment. This failure and attempts to troubleshoot the failure are described in Section II.G, “Known Issues”. At this time, we believe that the failure was caused by a toggle switch in the RDI ADCP that controls serial output protocol being in between positions. The switch is located near the head and near a wiring harness that may have been pressed against the switch when the pressure case was closed.

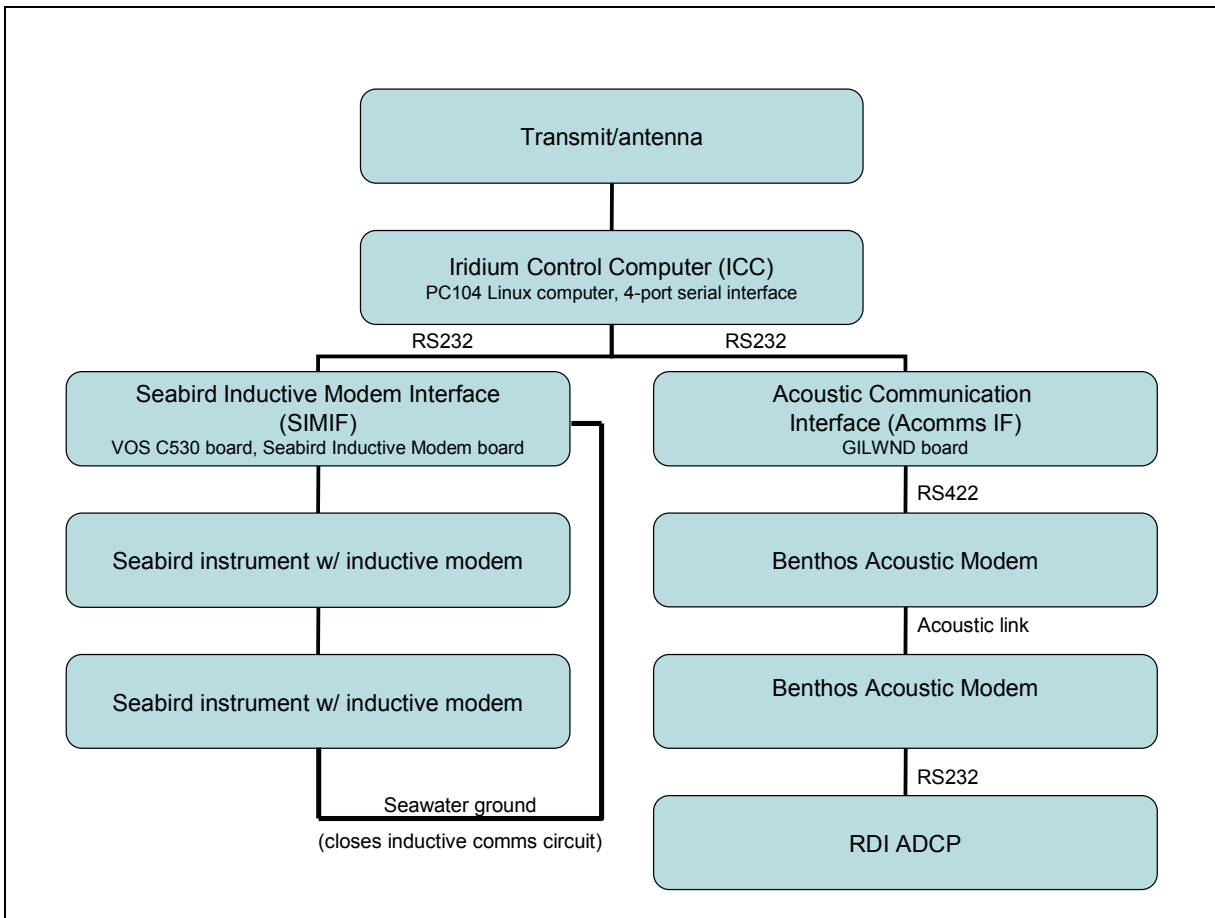


Figure III-4: Schematic of subsurface telemetry system.

## **E. Bottom Survey and Sound Speed Correction**

A bathymetric survey was conducted in the vicinity of the planned mooring location. This mooring, being of the ‘stretch-hose’ design rather than an inverse catenary design, had relatively stringent requirements for water depth. For this mooring, the design specification for scope (mooring length over water depth) was 0.95 with a tolerance of -0.01. (The minus sign on the tolerance indicates that the water depth could be slightly deeper than the target depth, but not shallower.) In other words, the deployment depth needed to be known within about 1% of the water depth, or about 7 m! Thus, a bottom survey was conducted to identify a region with a fairly flat bottom, and, once the depth of this flat spot was determined, we added shots of wire to the mooring to get the appropriate scope.

*NOTE: The ship’s technician told us that we needed to add 4-m to the depth to correct for the depth of the transducer. In the shipboard data documentation, it says the correction is already applied. The WHOI Shipboard Science Support Group reports that the correction is normally applied automatically, and examination of the ship’s bathymetry processing system indicates it was applied in this case also. Thus, the deployment depth is 693 m, rather than 697 m as was thought at the time of deployment.*

### **1. Sound speed estimate**

The high salinity in the Red Sea makes Red Sea water dense, giving a relatively high speed of sound. The Matthews Table for sound speed in seawater gives a value of 1536-1537 m/s for 600-m to 800-m depths in the Red Sea. (The original 1939 Matthews Table is reprinted in Bialek, 1966.) However, the accuracy of the value in the Matthews Table was suspect because of the relatively sparse information on the hydrographic properties of the Red Sea.

To address this uncertainty, independent checks of the sound speed were made by two methods at the nominal mooring site. The first was to use the CTD and its altimeter to obtain an independent estimate of bottom depth. The CTD altimeter (Benthos/Datasonics PSA-916 altimeter) uses a relatively high frequency sonar signal to track the distance from the bottom, and this altimeter has a range of about 45 m. The altimeter range can be added to the CTD depth measurement to obtain the total depth. Errors in this estimate are associated mainly with the altimeter: (1) there is no sound speed correction in the altimeter measurement, and (2) the altimeter may not be looking directly down. Both of these errors should be small owing to the relatively small distance (<45 m) measured by the altimeter.

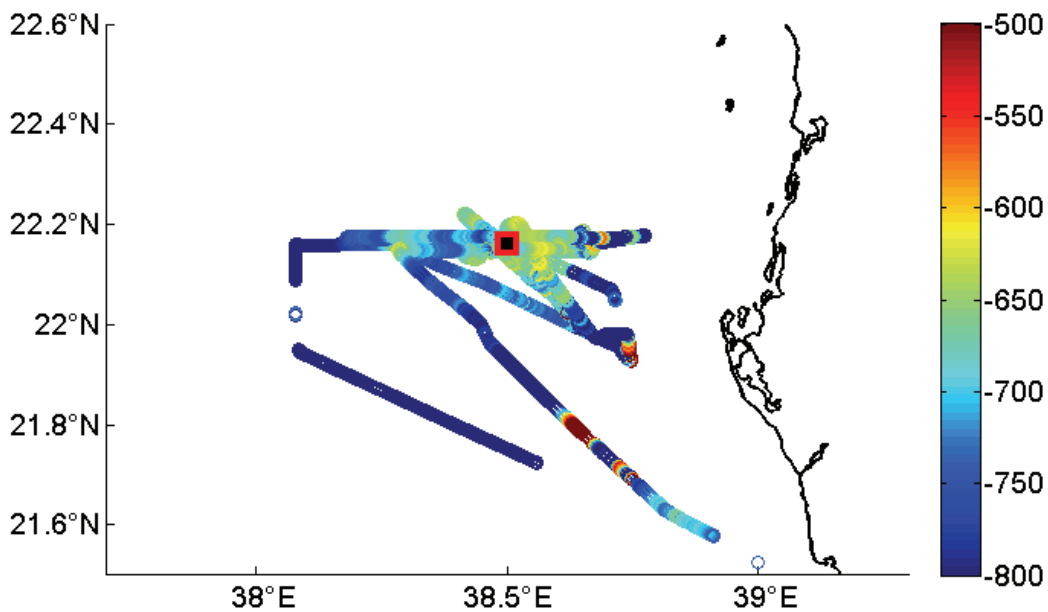
At the nominal mooring location where the 12-kHz depth sounder indicated a depth of 660 m (based on a sound speed of 1500 m/s), the altimeter read 25 m +/- 0.2 m when the CTD was at a depth of 655.5 m. Thus, by this estimate, the sound speed was 1546 m/s.

The second method was to use the measured temperature and salinity to compute the sound speed. Using the data from the same CTD cast, the vertical average of the sound speed profile was 1541.1 m/s. (Strictly speaking, the average of the sound-speed profile is not equal to the average speed of a sound wave as it travels through the water column, but this difference is expected to be slight.)

Based on these two tests, the sound speed is estimated to be 1543.5 +/- 2.5 m/s. In other words, depth readings from the sounder that are estimated assuming a 1500 m/s sound speed need to be corrected to larger depths by 2.9% (i.e., 1543.5/1500). If the Matthews Table value (1536.5 m/s) were used for the correction, the depth would be in error by 0.46%, or about 3.2 m at the mooring site.

## 2. Bottom survey

The bottom survey of the air-sea interaction mooring site was carried out on 9 October 2008. A large scale view of the survey track and data is shown in Figure III-5, and a more restricted area is shown in Figure III-6. This survey data will also be used to select a site for the 2009 deployment.



**Figure III-5: Bathymetric survey track and *uncorrected* depth in meters. The mooring deployment site is indicated by a red/black square. A sound speed of 1500 m/s was assumed in estimating the uncorrected depth.**



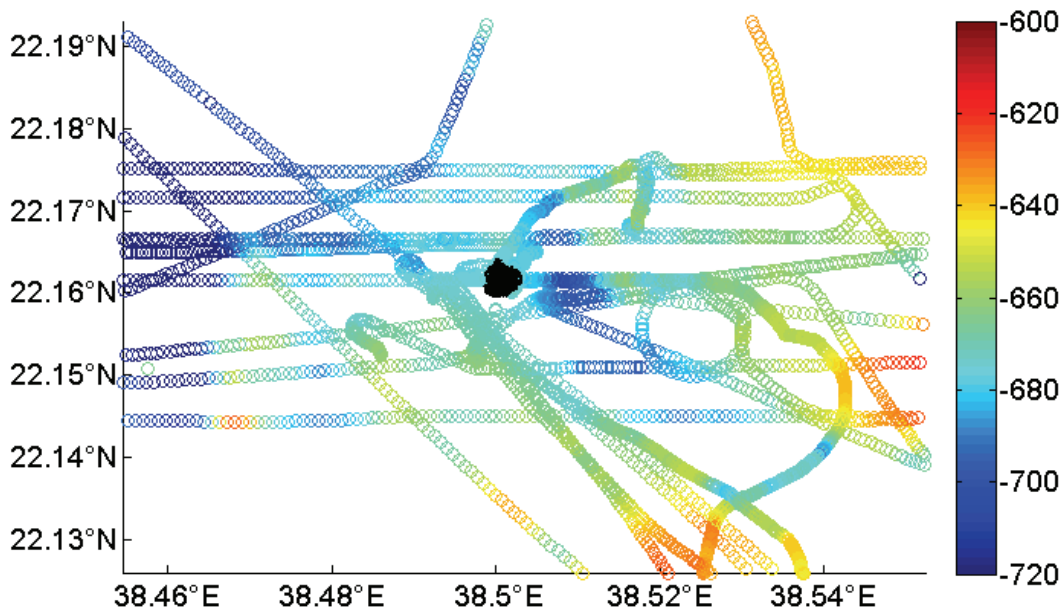


Figure III-6: View of the bathymetry measurements (m, *uncorrected*) in the vicinity of the mooring site. The mooring’s watch circle (from deployment until 26 February 2009) is indicated by a black ‘dot’.

## F. Air-Sea Interaction Mooring Deployment

The mooring was deployed on 11 October 2008, and is intended to be recovered approximately one year later. Table III-4 gives an overview of deployment operations.

Table III-4: Mooring deployment details

<b>Deployment</b>	Date	November 13, 2005
	Time	12:09 UTC
	Position at Anchor Drop	22° 09.690’ N, 38°29.996’ E
	Deployed by	Kemp
	Recorder	Farrar
	Ship	R/V <i>Oceanus</i>
	Cruise No.	Voyage #449-5
	Depth	697 m
	Anchor Position	22° 09.638’ N, 38°30.069’ E

### 1. Antifoulant Application

Previous moorings have been used as test beds for a number of different antifouling coatings. These tests have previously led the Upper Ocean Process group to rely on E Paint Company’s, SUNWAVE as the anti fouling coating used on the buoy hull.

Instead of the age-old method of leaching toxic heavy metals, the patented E Paint approach takes visible light and oxygen in water to create peroxides that inhibit the settling larvae of fouling organisms. Photo generation of peroxides and the addition of an organic co-biocide,

which rapidly degrades in water to benign by-products, make E Paint an effective alternative to organotin antifouling paints. These paints have been repetitively tested in the field, and show good bonding and anti-fouling characteristics.

SUNWAVE is a two-part, water-based, antifouling coating that offers an eco-friendly approach to controlling biofouling. The product claims superior adhesion and durability. SUNWAVE appears to be a viable alternative to organotin, copper, and other more toxic coatings used on earlier buoys.

**Table III-5: Air-sea interaction mooring anti-foul applications**

<b>Description</b>	<b>Coating</b>	<b>Color</b>	<b>Coats</b>	<b>Method</b>
Buoy Hull	E-Paint Primer	Gray	1	Roller
	SUNWAVE	White	4	Roller
SBE 37s on hull bottom	ZO	White	1	SPRAY

It is not clear how productive the region where the buoy is deployed will be. The first turnaround, in 2009, will give more insight to productivity, and coatings may be adjusted based on what is observed after recovery.

E-Paint Bio-Grease was applied to transducer head on the 600 KHz ADCP.

## **2. Deck Work During Deployment**

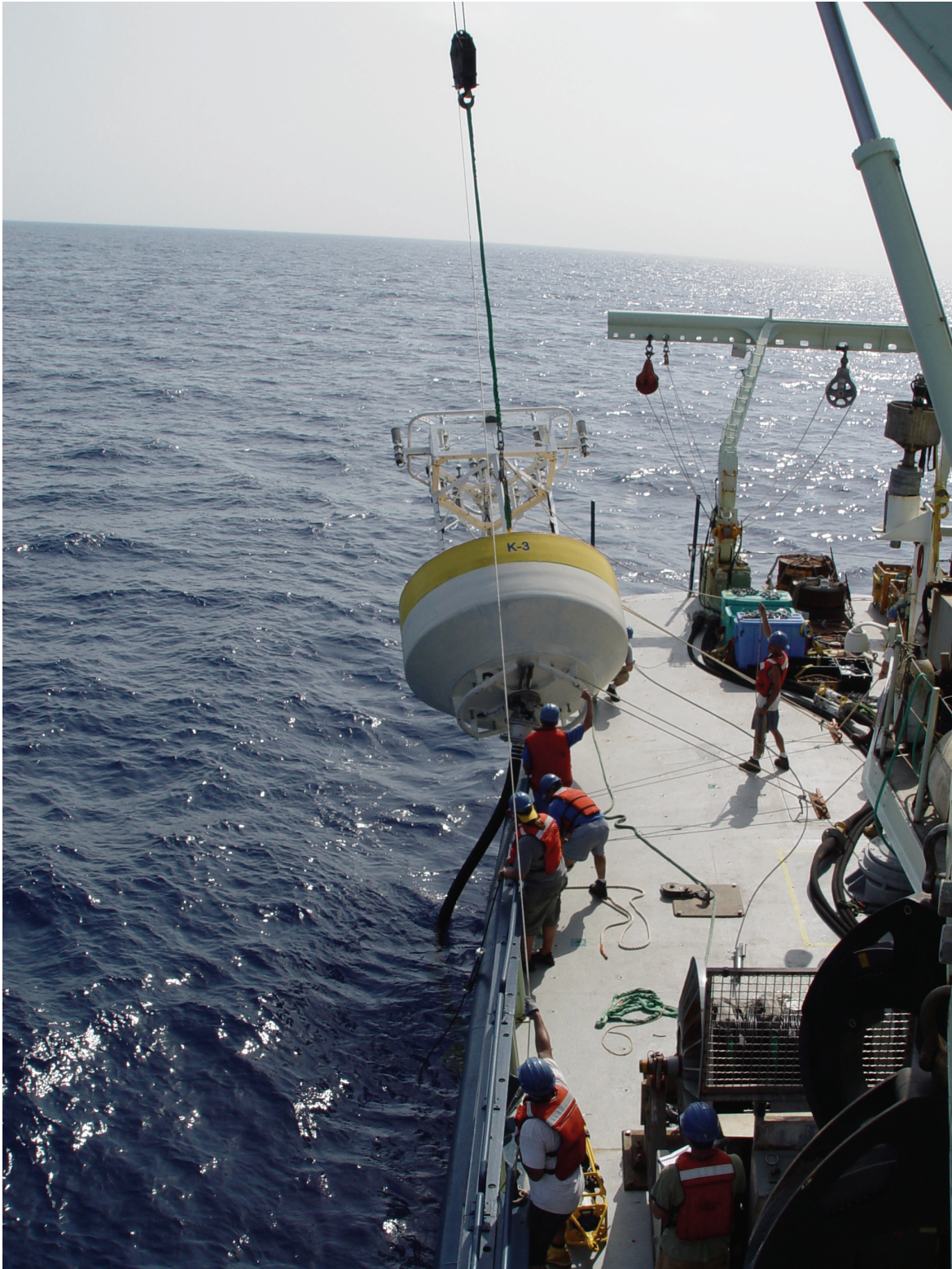
The surface mooring was deployed in a similar fashion to other UOP surface moorings. This two-phase technique involved the placing the buoy and about 20-m of the upper part of the mooring over the starboard side of the ship. Phase 2 was the deployment of the remaining mooring components using the A-frame on the stern.

Eight glass balls on 1/2" mooring chain were attached to the mooring above the bottom VMCM. These were deployed using stopper lines to ease them across the deck and over the stern. Under the VMCM was chain and the dual acoustic releases and the anchor. Once the tension of the mooring was passed to the anchor, the crane was used to lift a tip plate and deploy the anchor.

## **3. Other Notes**

On the day of deployment, we failed to attach the instruments that were intended to be attached to the potted electrical compliant-chain assembly (or EM Chain). See Figure III-7, which shows the buoy and EM Chain assembly during deployment.

Note that 15 m of extra wire shots were added to the original mooring design to adjust the design to the actual deployment depth (Figure III-3).



**Figure III-7: Meteorological buoy during deployment. Note that there are no instruments clamped to the black EM Chain assembly below the buoy. (Photo by Yasser Abualnaja.)**

## **G. Known Issues**

As is not unusual with projects of this complexity, several subsystems are not working as intended, either because of equipment failures or human error. These problems are described below.

### **1. SIMIF (Seabird Inductive Modem Interface) timing error**

Immediately after deployment, while verifying functionality of the telemetry systems, a problem was detected with telemetry of the ADCP velocities. In the process of troubleshooting, we noticed that, although the inductive telemetry system (SBE instruments) was relaying data, the time stamp from the SIMIF was roughly 50 days fast. During setup and testing on deck, Bouchard had created capture files while querying the instruments. By comparing the time reported by the instruments to the SIMIF (the SIMIF polls the instruments every 5 minutes) to the time reported by the SIMIF, we can estimate the error to be +51.875 days (51 days, 21 hours) with an uncertainty of about 5 minutes. This offset is being used to correct the timestamp of the telemetered data. The instruments record their own timestamp internally, and these times will be available upon recovery.

### **2. Acoustic telemetry of 300 kHz RDI ADCP data**

About 12 minutes before the RDI was recorded as having gone in the water, an Iridium message came through with three good transmissions (in air), and the fourth transmission was a response to the 'break' command. (The break response indicates that a break command was received and the instrument is standing by for commands. This means it is not sampling.) The break response also contains an indication of whether serial communication is in RS232, RS422, or 'communication does not compute' (e.g., 232/422 switch is in between positions). We were getting status B, indicating RS422 rather than RS232 as expected.

We went to the buoy and used the Benthos deck-box modem to listen in on acoustic transmissions. The RDI was giving the break response every few minutes at irregular intervals. The modem link was robust, and there were no acoustic transmissions preceding the break response, indicating that the top side modem was not sending the break command. We understand the modems to be entirely passive, so we think that the RDI was giving the break response on its own.

When we sent a break from the deck box, the RDI gave a break response, but instead of saying it was in 422 mode, it gave the AB response indicating neither 422 nor 232. We eventually realized that issuing a break command just after it gave an unsolicited break response would cause it to respond and say it was in 232 mode (status A). At that point, we could take control of the RDI and issue commands as if we were hooked up to it with a comm cable and a terminal emulator (e.g., procomm). However, it would continue to give unsolicited break responses, sometimes as often as every 55 seconds. This disrupted our ability to troubleshoot. We could send the 'go' command (i.e., CS), but the RDI would stop after 1-3 minutes and give a break response.

We decided to try disabling the serial out and all of the PD12 commands, so we set the RDI up as for a normal deployment with no telemetry. The break responses stopped. After a few sampling periods, we sent our own break command and read the directory of the RDI. It was recording. We re-established communications and restarted it again. After a total of about 1.5 hours with no break responses for the two deployments, we attempted to reprogram to do telemetry and troubleshoot by incrementally changing toward full telemetry setup. However, we could not get control of the RDI for about 30 minutes, and we were nervous enough that we simply gave it the 'go' command when we did establish communications.

The RDI seemed to be logging data and we did not hear any more break responses, so we hope to have surface currents next year when we recover the instrument. We verified about 4 hours of logging with no break responses. Possible causes of this problem may be: (1) RS232/422 switch is between positions, (2) RDI thinks command set is inconsistent and is trying to restart, or (3) PD12 command set ('subset serial out data') has bugs, as we have already seen with the PB command on NTAS. We are pretty confident that the acoustic modems and top-side parts in the buoy did not cause this problem. One lesson here is that the Benthos deck-box modem is worth having onboard.

### **3. Failure to deploy instruments on the Electro-Mechanical Chain (a.k.a., compliance member)**

We failed to attach several instruments that were supposed to be clamped to the EM Chain (see Figure III-7). This was an oversight on the part of the recorder/observer (Farrar). While this is not likely to happen during the 2009 deployment, ways of preventing this in the future include having someone besides the Chief Scientist serve as recorder, performing a more thorough pre-deployment check of the setup on deck, and reviewing the mooring design with all of the science party so that there are more people who might catch mistakes of this sort.

### **4. WAMDAS (wave unit) magnetic variation setting**

The WAMDAS unit accepts a preprogrammed value of local magnetic variation. While the WAMDAS was being tested and configured at WHOI, the magnetic variation was set to the local value  $-15.25^\circ$ . This value was never replaced with the value estimated for the mooring site, which should have been  $+2.98333^\circ$ . This will need to be accounted for in processing and in the telemetered data.

### **5. Logger K01 telemetry failure**

The telemetry system associated with Logger K01, one of the two buoy met loggers, ceased to function on 5 Nov 2008, with the last message being at 0518 UTC. (As of 27 February 2009, telemetry is being received from Logger K02.) The cause of this problem is not known, but the failure was coincident with a rain event, and we suspect that the antenna or cabling may not have been water tight. The other logger reported a small amount of rain occurring between 0620 and 0719, which is during the first 4-hour time interval for which no data appeared from Logger K01. This system should be scrutinized almost immediately after recovery, and an at-sea repair operation is currently under consideration.

## IV. COASTAL MOORINGS AND BOTTOM TRIPODS

During the *Oceanus* cruise, two bottom tripods and two moorings with surface buoys were deployed (under the direction of PI, Steven Lentz) over the shelf region near 22 °N. These were set out as part of a study component aimed at better understanding: hydrodynamics over the western Red Sea shelf, water exchange between the shelf and the deep regions of the Red Sea, and the impact of hydrodynamic and water exchange process on plankton biomass over the shelf. Following leg 1 of the *Oceanus* cruise, an additional bottom tripod and mooring were deployed in shallow water, roughly onshore of the moorings and tripods deployed from the *Oceanus*. This was done using the 32-foot Boston Whaler owned by KAUST (KAUST-1). The Whaler was also used to set out instrumentation on the coral reef system onshore of the coastal moorings and tripods. The data from this reef array will be combined with the data from the shelf moorings and tripods to examine the exchange between the shelf and the adjacent reef.

### A. Shelf Moorings and Bottom Tripods Deployed from the *Oceanus*.

The shelf moorings and tripods were deployed on October 12 at locations (Table IV-1) selected using the bathymetry data acquired on October 10 (Figure IV-1). The pre-cruise plan was to deploy one mooring/tripod pair near the shelf-edge and a second at the mid-shelf. This was modified, however, due to difficulty finding bathymetry sufficiently smooth for the bottom tripods (which needed to be at an orientation close to horizontal). The bottom survey data indicated rough small-scale bathymetry over much of the shelf, presumably due to reef structures. In addition, there was concern in bringing the *Oceanus* close to the Qita Dukais reef system at the edge of the shelf (Figures IV-1 and IV-2). As a result, the tripod/mooring pairs were deployed closer to each other than originally planned (Figure IV-1).

The moorings were each supported by a surface buoy (fabricated at WHOI) outfitted with a radar reflector and a light set to flash at 4 s intervals (Figures IV-3 and IV-4). Each mooring line was affixed with temperature sensors, combination chlorophyll-a/turbidity sensors and CTDs (Tables IV-2 through IV-5 and Figure IV-5).

Manufactured by Onset Computer Corporation, the moorings' temperature sensors (Onset's Temp Pro sensors) are rated at an accuracy of 0.2 °C. These are relatively "slow response" temperature sensors. Their 90% response time to temperature changes is rated at 5 min. The combination chlorophyll-a/turbidity sensors attached to the mooring lines (the *ECO* FLNTU models manufactured by Wet Labs) have an accuracy rating of 0.01 µg/l for chlorophyll-a and 0.01 NTU for turbidity. Each of these units is equipped with an anti-fouling biowiper, which covers the optical sensor window when the instrument is inactive and moves away to expose the window during a measurement cycle. The MicroCAT CTDs are similar to those described in Section III.C.2.

The "shelf-edge" mooring (mooring K1) was set out in 54 m of water roughly 2.5 km from the actual shelf-edge. The "mid-shelf" mooring (mooring K2) was deployed in 52 m of water approximately 1.3 km to the east of mooring K1 (Table IV-1, Figure IV-1)

An instrumented tripod was set out near each mooring. To obtain profiles of currents over most of the water column, each tripod was outfitted with a Teledyne RDI ADCP (see Section III.C.6) set with the sensors in an upward looking orientation (Figure IV-6). A 300-kHz ADCP was affixed to the “shelf-edge” tripod (tripod K1), and a 600-kHz unit was attached to the “mid-shelf” tripod (K2). Both ADCPs were set to acquire velocity averages within 1-m vertical bins every 30 min. The measurement interval was set to 250 s for the 300-kHz ADCP and to 300 s for the 600-kHz unit. Each ADCP was also programmed to acquire a block of data every 4 h, which will be used to determine directional surface wave spectra.

A SBE 26*plus* Seagauge Wave and Tide Recorder (manufactured by Sea Bird Electronics) was also affixed to each tripod. Both Seagauges were programmed to record averaged pressure (related to sea surface elevation) every min.

After each tripod was assembled and fully instrumented, we acquired data to correct the ADCP compass for the effects of magnetic material on the tripod. This was done following the RDI compass calibration procedure and involved rotating the tripod through a full circle. The calibration data revealed a serious flaw with the compass of the 600-kHz ADCP. Subsequent to the calibration, we ran a number of tests on the compass and conferred frequently with technicians from RDI, but were unable to repair the compass. As a result, the 600-kHz ADCP was deployed without a satisfactorily working compass. This will, of course, compromise the analysis and interpretation of data from the ADCP. However, there are numerous options for dealing with the lack of compass data, which we will explore in the data processing and analysis phase.

## **B. Reef-edge Mooring and Bottom Tripod Deployed from the KAUST Whaler.**

Following Leg 1 of the *Oceanus* cruise, we (Churchill and Lentz) acquired bathymetric data from the Qita Dukais reef system using Northstar 6000i navigation system aboard the KAUST’s 32’ Boston Whaler. The data were logged to a laptop computer, which was connected to the Northstar with the help of Paul Bouchard. Using the bathymetric data, coupled with diver observations, we identified a reef at the seaward edge of the Qita Dukais reef system (Figures IV-1 and IV-2) as a suitable location for the reef-edge mooring and tripod. The reef top was determined to be at a depth of 5 m.

The mooring and tripod were deployed, under the direction of John Kemp, on 18 October, 2008. To facilitate deployment operations, a davit and plywood deck had been mounted onto the Whaler forward of the center console. The tripod was deployed in 11 m of water on a narrow patch of sand situated along the seaward fringe of the reef. The mooring was set out in 20 m of water, roughly 160 m seaward of the tripod. It was supported at the surface by a “coastal” buoy, onto which a light and radar reflector were attached (Figures IV-7 and IV-8). The mooring and tripod were outfitted with an array of instruments similar to those affixed to the shelf moorings and tripods (Tables IV-6 and IV-7). The 1200 kHz ADCP mounted on the tripod was programmed to record velocity averages in 0.25 m vertical bands every 15 min, and to record waves every 4 h.

### C. Reef Array Deployed from the KAUST Whaler.

On 18-19 October, an array of temperature sensors were distributed over 5 reefs of the Qita Dukais reef system (Table IV-1; Figures IV-1 and IV-2). Each sensor was attached to a small lead weight and placed on the reef bottom by a snorkeler. One sensor was placed on the crest of the reef adjacent to the reef-edge mooring and tripod. Most heavily instrumented, with 7 temperature sensors, was a reef situated on the northwest fringe of the reef system (Figure IV-2). Also emplaced on this reef was an aluminum frame set on the bottom and outfitted with a Nortek model AquaDopp high-resolution profiling acoustic current meter and a Sea Bird Electronics Microcat (Tables IV-1 and IV-8). The AquaDopp was programmed to record velocities and waves every hour (see Table IV-9 for sampling intervals of all instruments affixed to the moorings and tripods deployed over the shelf and reef), with velocities measured in 10 cm bands extending from roughly 10 cm above the sensor head (located 1 m below the sea surface at the time of deployment) to within 10-20 cm of the sea surface.

<u>latitude</u> °N	<u>longitude</u> °E	<u>depth</u> m	<u>Description</u>
21 56.711	38 46.161	55	shelf-edge tripod K1
21 56.790	38 46.085	54	shelf-edge mooring K1
21 56.749	38 46.877	52	mid-shelf tripod K2
21 56.729	38 46.872	52	mid-shelf mooring K2
21 57.619	38 50.243	11	reef-edge tripod K4
21 57.575	38 50.200	20	reef-edge mooring K4
21 58.045	38 50.180	1.35	reef-frame KR
21 57.923	38 50.225	1.6	RBR-1
21 57.955	38 50.206	0.6	RBR-2
21 58.158	38 50.084	2.5	RBR-3
21 57.627	38 50.249	4.4	H-1
21 57.955	38 50.206	0.6	H-2
21 58.034	38 50.154	0.6	H-3
21 58.024	38 50.113	1.75	H-4
21 58.047	38 50.211	1.2	H-5
21 58.900	38 50.780	2.0	H-6
21 58.823	38 50.826	0.85	H-7
21 58.799	38 50.857	0.65	H-8
21 58.800	38 51.156	0.85	H-9
21 57.763	38 51.445	1.80	H-10
21 57.768	38 51.414	0.65	H-11

**Table IV-1: Locations of moorings, tripods and instruments set out during Oct. 2008 as part of the KAUST *Oceanus* cruise 449-5 (top 4 entries) and during subsequent work from the KAUST 32-ft Boston Whaler (all other entries). Details of the instrumentation deployed on the tripods, moorings and reef frame are given in Tables IV-2 through IV-8. Sample interval of all instruments are given in Table IV-9. RBR refers to Richard Brancker Research Ltd. model TR-1060 temperature recorders. Deployed on the bottom at the indicated depths, these “fast response” temperature sensors were set to record data at 30-s intervals. H refers to Onset Computer Corporation Temp Pro (HOBO) temperature sensors, also deployed on the bottom at the indicated depths. These recorded temperatures at 15-m intervals.**



Instrument	Serial number	Depth
MicroCat	6040	0.6 m (on buoy)
TempPro	1284100	1.2 m (on buoy)
MicroCat	6041	3.4 m
Fluorometer	1015	4.3 m
TempPro	1282477	6.0 m
TempPro	1282478	7.9 m
MicroCat	6042	9.9 m
Fluorometer	1016	10.90 m
TempPro	1282479	14.9 m
TempPro	1282480	18.2 m
TempPro	1282481	21.7 m
MicroCat	6050	24.7 m
TempPro	1282482	29.2 m
TempPro	1282483	33.2 m
TempPro	1282484	36.2 m
MicroCat	6048	40.3 m
TempPro	1282485	43.3 m
Fluorometer	1017	45.3 m
TempPro	1282476	45.5 m
MicroCat	6036	47.5 m

**Table IV-2: Instrument arrangement on shelf-edge mooring K1.**

Instrument	Serial number	Height
ADCP 300kHz	10484	72 cm above floor
Seagauge	1152	38 cm above floor
Pinger	#51 (36Khz 5-6-5-8)	
Release	32825 553013 (90 m line)	

**Table IV-3: Instrument arrangement on shelf-edge tripod K1.**

Instrument	Serial number	Depth
MicroCat	6039	0.6 m on buoy
TempPro	1284101	1.2 m on buoy
MicroCat	6049	3.3 m
Fluorometer	1018	4.1 m
TempPro	1282487	6.0 m
TempPro	1282488	7.9 m
MicroCat	6046	9.9 m
Fluorometer	1019	11.1 m
TempPro	1282489	14.9 m
TempPro	1282490	18.3 m
Fluorometer	1020	19.8 m
TempPro	1282491	21.8 m
MicroCat	6047	24.9 m
TempPro	1282492	28.9 m
TempPro	1282493	32.9 m
TempPro	1282494	35.9 m
MicroCat	6045	39.9 m
TempPro	1282486	43.0 m
TempPro	1282495	45.2 m
MicroCat	6037	47.3 m

**Table IV-4: Instrument arrangement on mid-shelf mooring K2.**

Instrument	Serial number	Depth/height
ADCP 600kHz (Bad compass)	10843	72 cm above floor
Seagauge	1147	39.5 cm above floor
pinger	#52 (37kHz; 5-7-8-7)	
Release	#32830 553124 (90 m line)	

**Table IV-5: Instrument arrangement on mid-shelf tripod K2**

Instrument	Serial number	Depth
MicroCat	6038	0.6 m on buoy
TempPro	1282496	1.3 m
MicroCat	6044	2.3 m
Fluorometer	1021	3.3 m
TempPro	1282497	3.5 m
TempPro	1282498	4.1 m
TempPro	1282499	5.1 m
TempPro	1282500	6.1 m
TempPro	1282501	7.1 m
TempPro	1282502	8.1 m
MicroCat	6051	9.8 m

**Table IV-6: Instrument arrangement on reef-edge mooring K4.**

Instrument	Serial number	Height
ADCP 1200kHz	10833 (20 m)	72 cm above floor
Seagauge	1154 (20 m)	20 cm above floor
pinger	#53 (38kHz; 5-7-8-8)	
Release	#32829 553107 (20 m line)	

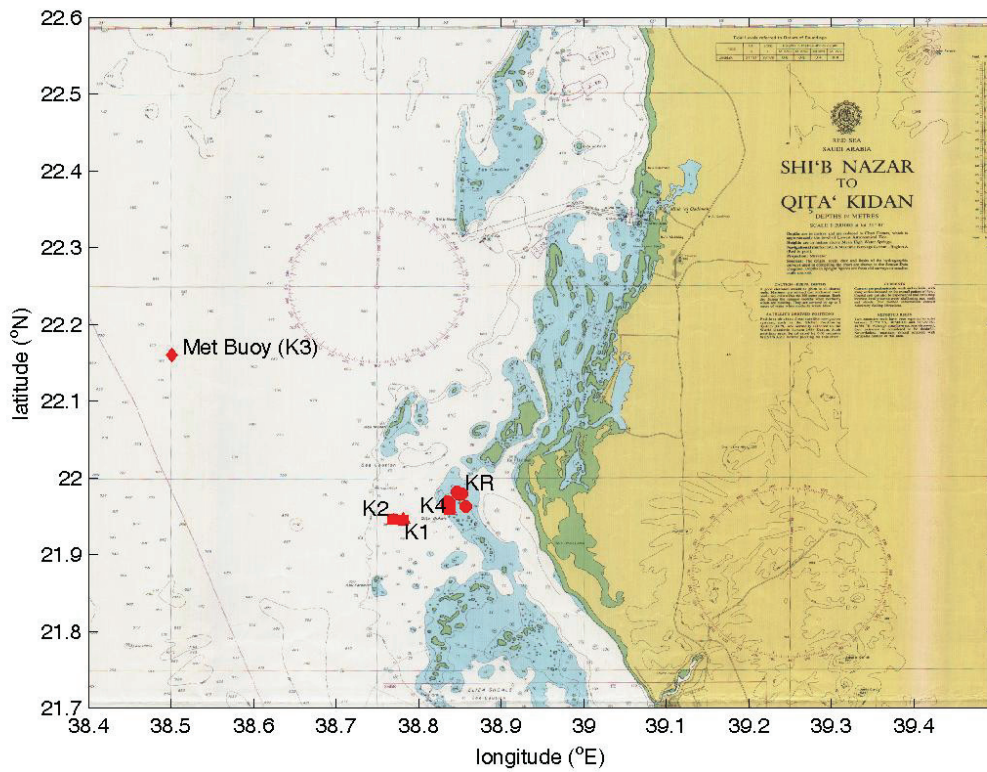
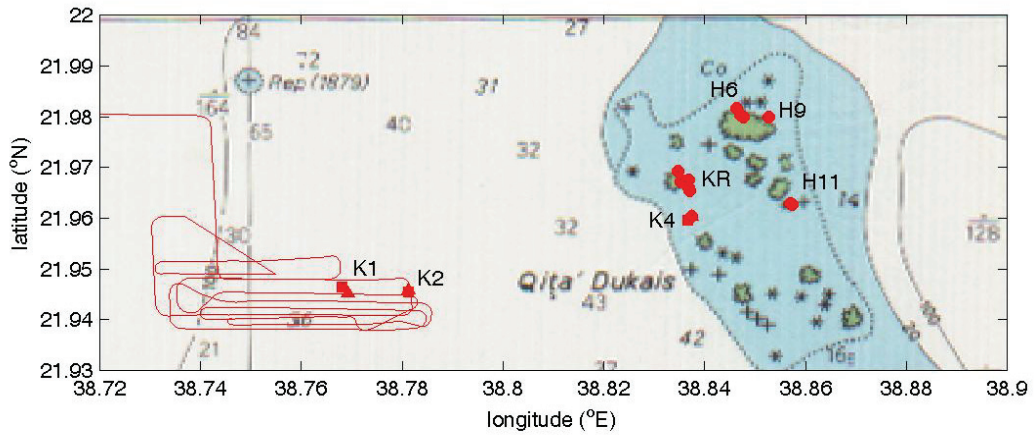
**Table IV-7: Instrument arrangement on reef-edge tripod K4.**

Instrument	Serial number	Depth
Nortek 2000kHz		1 m below surface
MicroCat	6050	1 m below surface
pinger	#50 (35kHz; 5-6-5-7)	

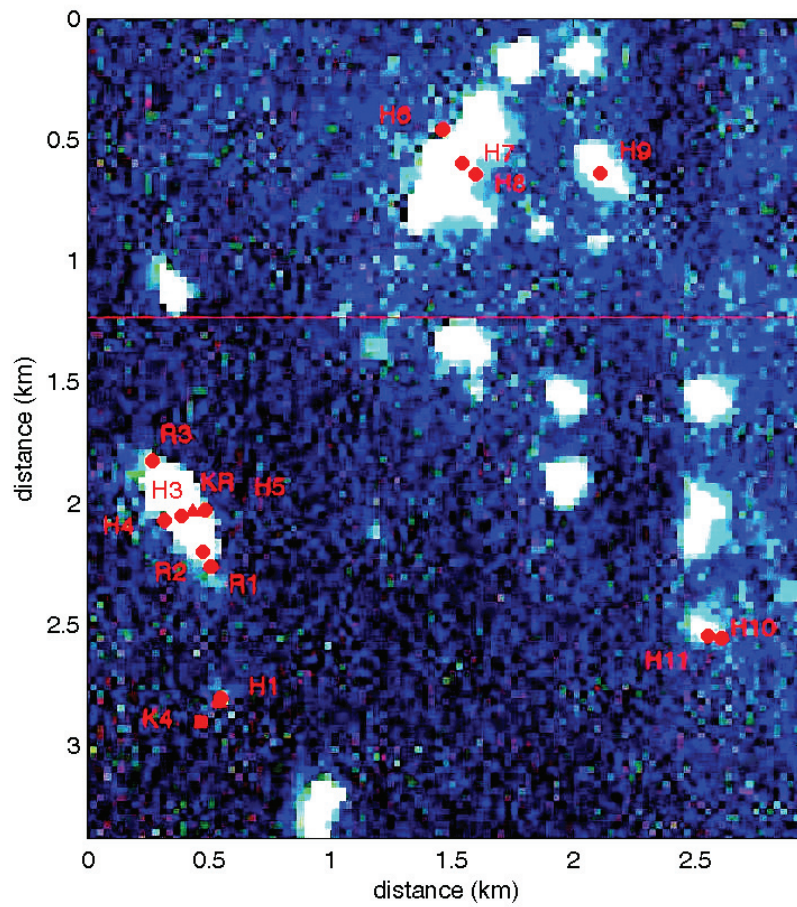
**Table IV-8: Instrument arrangement on reef frame KR.**

Microcats (shelf and reef)	2.5 min
HOBO T-pods (shelf and reef)	15 min
RBR T-pods (reef)	30 sec
Fluorometers	10 samples every h
Sea-gauges	1 min
ADCPs (shelf)	Currents every 30 min; waves every 4 h
ADCPs (reef-edge)	Currents every 15 min; waves every 4 h
Nortek	Currents and waves every h

**Table IV-9: Sample rates for shelf and reef instruments.**



**Figure IV-1: A fine-scale (upper) and a larger-scale (lower) view of the locations of the moorings and bathymetric survey lines, superimposed on an Admiralty chart of the eastern Red Sea.**



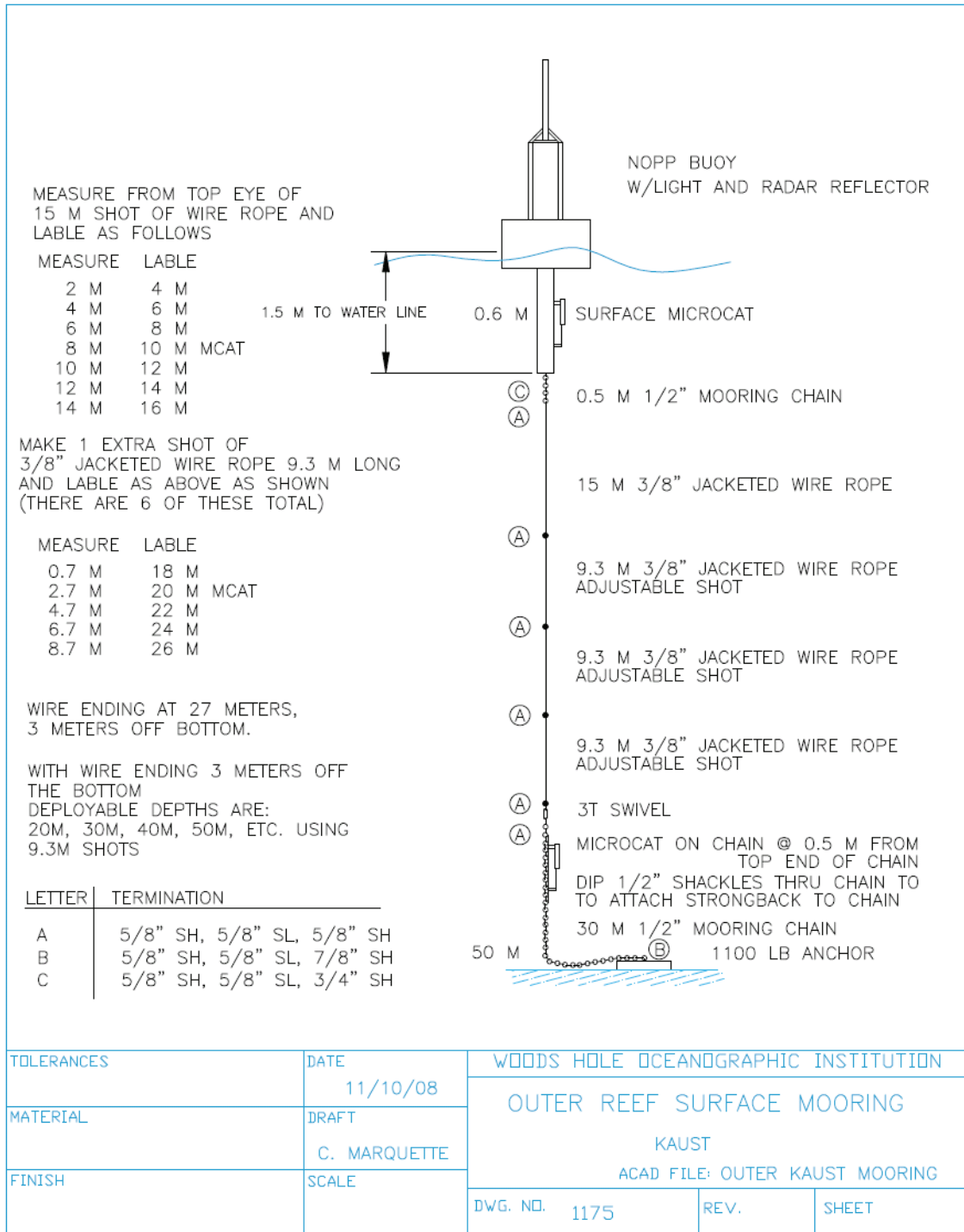
**Figure IV-2: Reef instrumentation locations superimposed on a LandSat image (provided by Simon Thorrold). Light areas are shallow coral reefs.**



**Figure IV-3. Two views of the surface buoy supporting mooring K1. The upper photograph shows the K1 buoy on deck (with the K2 buoy in the background). The white cylinder attached to the underside of the buoy is a Microcat CTD. The lower photograph shows the K1 buoy shortly after deployment (photos courtesy of Susan Avery).**

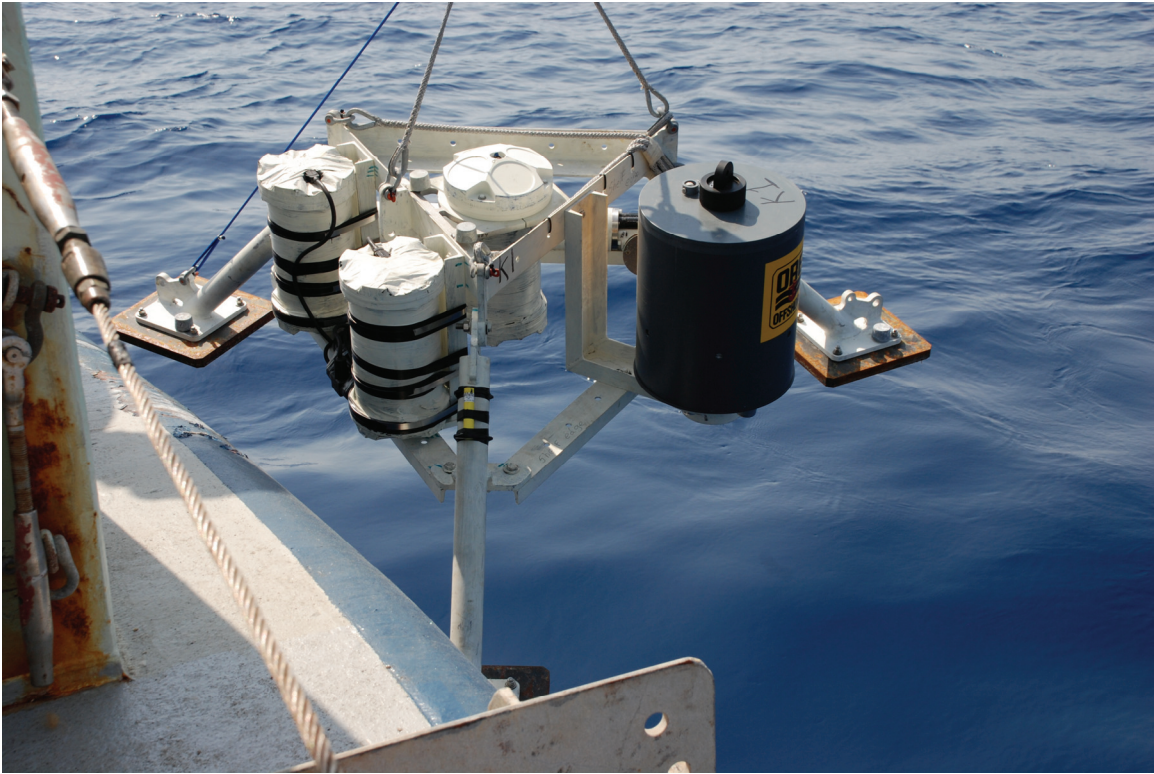


**Figure IV-4: Deployment of mooring K2. A upper portion of the mooring line is visible (photograph courtesy of Susan Avery).**

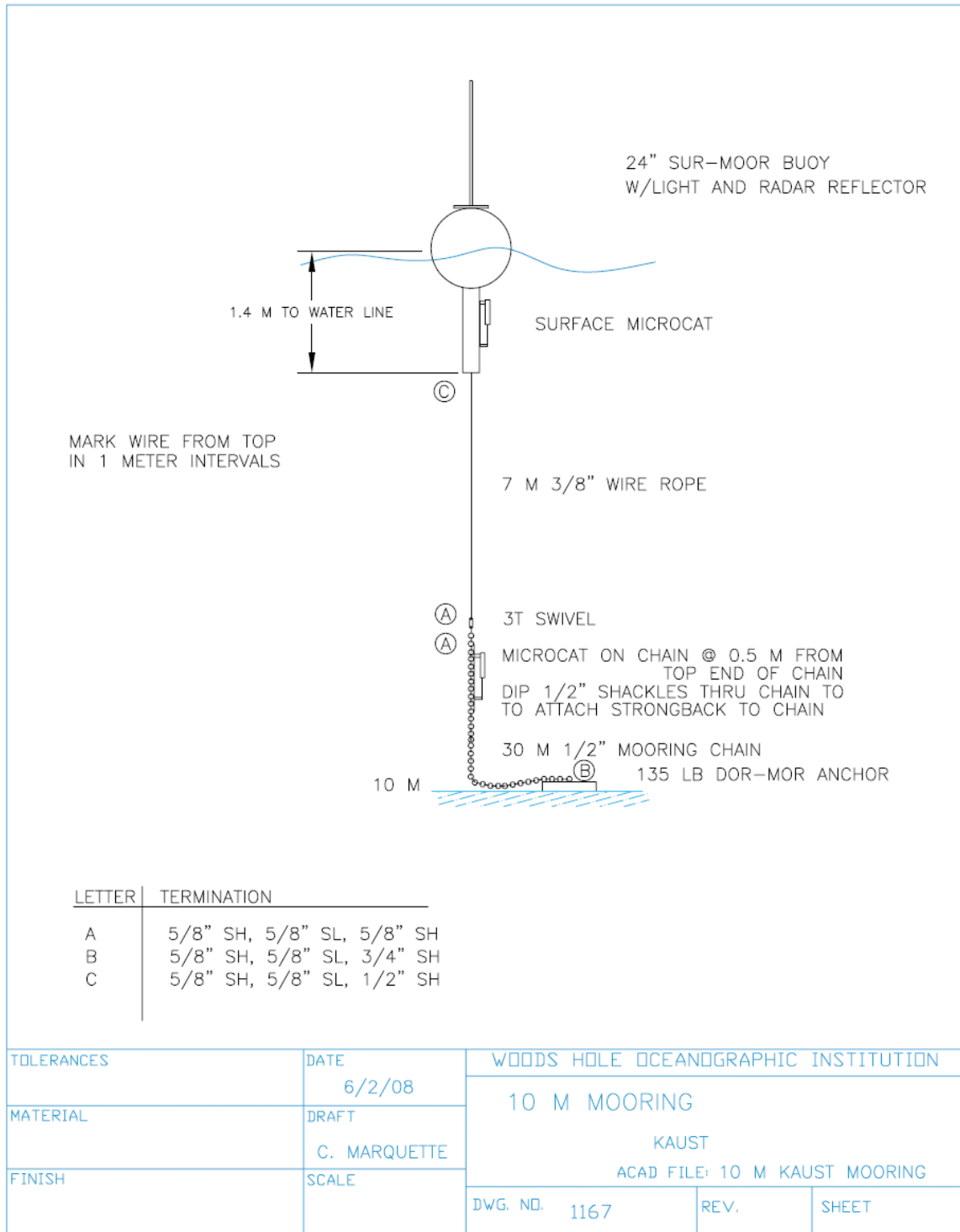


**Figure IV-5: Mooring diagram for the K1 and K2 shelf moorings.**





**Figure IV-6: Deployment of the K1 (shelf-edge) bottom tripod. The instrument in the center of the frame is a 300-kHz ADCP. The white canisters attached to one side of the tripod house extra ADCP batteries. The gray canister is an ORE acoustic release unit housing 90 m of line for tripod recovery. The small yellow cylinder taped to the tripod leg closest to the viewer is an acoustic transponder. Attached to the leg furthest from the viewer, and not clearly visible here, is a Seaguage pressure recorder (photo courtesy of Susan Avery).**



**Figure IV-7: Mooring diagram for the reef-edge mooring.**



**Figure IV-8: The surface buoy of the reef-edge mooring, showing the light and radar reflector at the top of the buoy mast.**

## V. SHIPBOARD MEASUREMENTS

The R/V *Oceanus* is equipped with a SeaBird 911+ CTD (Conductivity, Temperature, and Depth) Acquisition System. The instrument provides in-situ measurements of hydrographic parameters (temperature, conductivity, pressure, dissolved oxygen, turbidity, and fluorescence) as it is lowered through the water column. The package consists of 24 10-liter bottles triggered by a SeaBird Carousel, and data is acquired on a dedicated CTD computer in the Main lab.

During the cruise, 16 CTD casts were made with the *Oceanus*' CTD rosette. See Table V-1 for details of cast times and locations. The CTD locations are plotted in Figure V-1.

Cast number	Time (UTC)	Lat	Lon	Notes
1	Oct 09 2008 17:55:02	22 09.15 N	038 29.15 E	
2	Oct 10 2008 13:44:49	21 56.90 N	038 44.49 E	
3	Oct 10 2008 15:55:36	21 56.89 N	038 44.81 E	
4	Oct 10 2008 16:27:20	21 56.84 N	038 45.04 E	
5	Oct 10 2008 17:02:08	21 56.77 N	038 45.17 E	
6	Oct 10 2008 17:30:32	21 56.94 N	038 45.48 E	
7	Oct 11 2008 02:55:45	22 09.66 N	038 29.57 E	
8	Oct 11 2008 17:47:11	22 09.74 N	038 39.94 E	
9	Oct 11 2008 19:25:52	22 09.16 N	038 29.83 E	
10	Oct 11 2008 20:57:51	22 09.69 N	038 20.45 E	
11	Oct 12 2008 11:52:10	21 56.90 N	038 46.93 E	
12	Oct 12 2008 15:40:09	21 56.77 N	038 45.93 E	
13	Oct 13 2008 12:43:42	22 09.76 N	038 30.15 E	
14	Oct 13 2008 15:48:54	22 09.61 N	038 09.89 E	File 14
15	Oct 13 2008 17:02:10	22 09.58 N	038 04.96 E	File 16
16	Oct 13 2008 19:01:18	21 56.98 N	038 05.09 E	File 18

**Table V-1: Times and locations of CTD casts. Note that the filenames do not correspond to the cast number for casts 15-16. (File number 15 contains no data and file number 17 does not exist.) CTD locations are also shown in Figure IV-1.**

Shipboard systems on the R/V *Oceanus* automatically collected other data during the cruise. Two shipboard ADCPs collected measurements of upper-ocean currents along the ship's track. A Knudsen depth sounder operating at 12 and 3.5 KHz frequencies provides an estimate of the water depth. These data can be found on the Cruise Data Disc in the folders "adcp" and "knudsen". The Knudsen files with suffix "kea" are ascii (i.e., text) versions of the raw binary data (\*.keb files) recorded by the instrument. The data from the 75 and 150 KHz ADCPs are in the subfolders "raw/os75" and "raw/nb150". Other folders contain derivative products and processing files and inputs.

Parameters such as wind speed, wind direction, barometric pressure, air temperature, sea surface temperature, and sea surface salinity are also measured by automated systems. These data are in the “underway” subdirectory of the data disc. The data format is described in Appendix B.

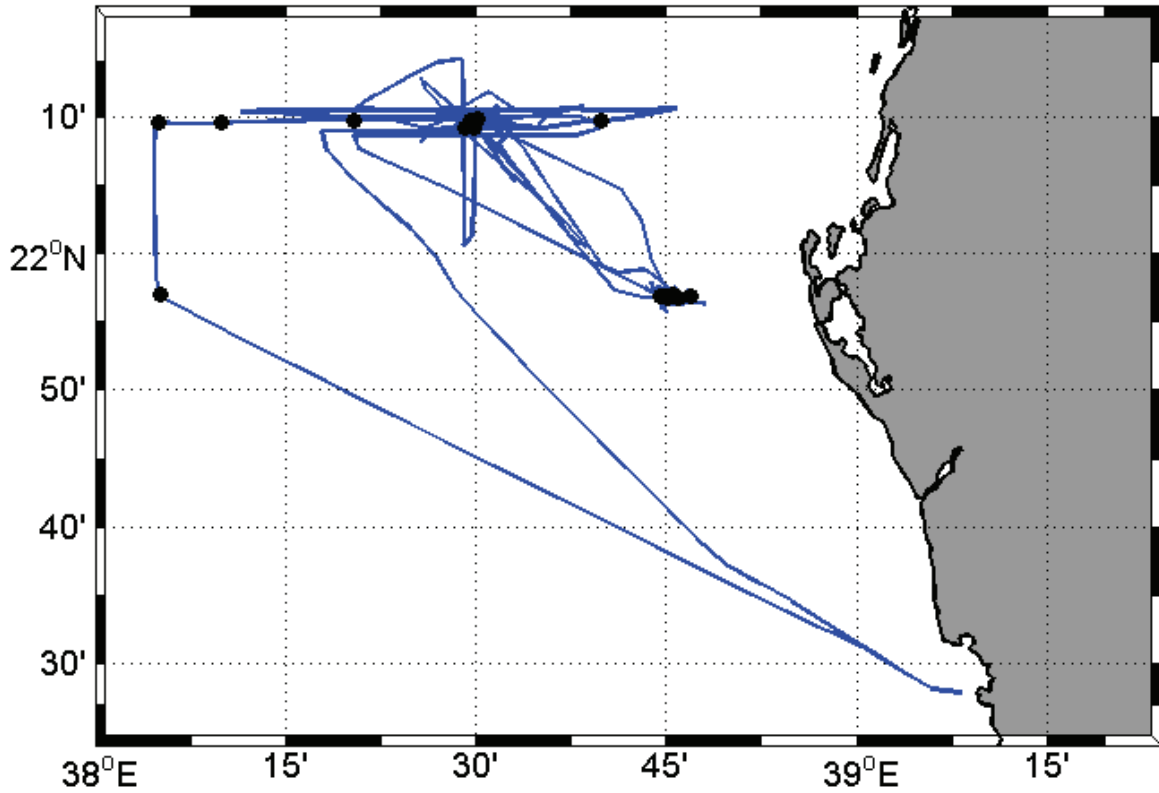


Figure V-1: Locations of all CTD stations (black circles) and cruise track (blue line).

## VI. COASTAL METEOROLOGICAL TOWER

A 30-foot meteorological tower was installed on the KAUST campus at Thuwal, and the mounting brackets for the meteorological instruments were used to raise the instruments to a height of about 10 m above ground level.

The galvanized steel tower was manufactured by Glen Martin Engineering, Inc (Booneville, MO, USA), and the model number is HD-30. The HD-30 is the bottom three sections of Glen Martin's 100-foot tower (Figure VI-1). The tower design and the specific instrument load were reviewed and certified by Michael L. Gardner, P.E. of Tower Engineering Professionals, Inc. (Rayleigh, NC, USA). Because design standards and building codes for Thuwal were not available, this design review was conducted to ensure conformity with United States tower code ANSI/TIA EIA-222-F-1996 (TIA) and Massachusetts State Building Code, 7<sup>th</sup> Edition. Mr. Gardner certified that the tower can withstand 120 mph wind gusts for normal (Cape Cod) soil parameters.

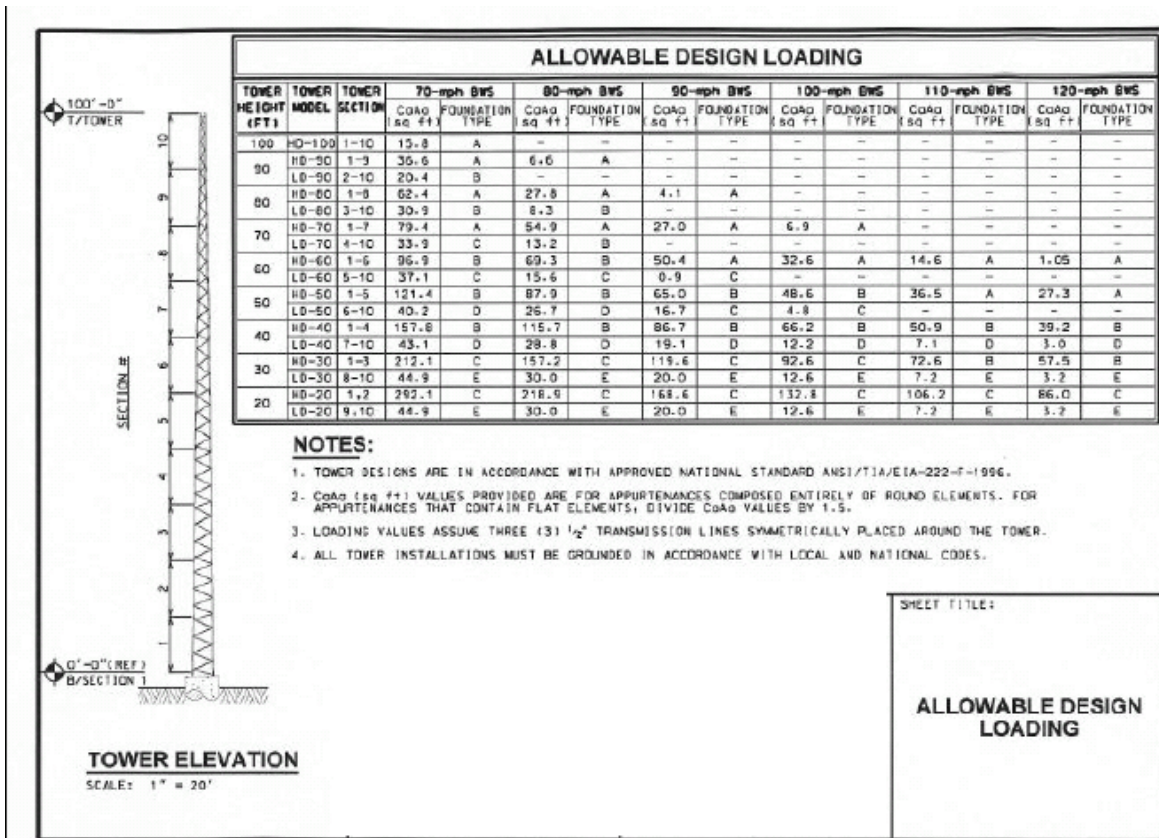


Figure VI-1: A table reproduced from the Glen Martin Engineering, Inc brochure for the “AN Self-supporting tower”. The HD-30 model used for KAUST is the bottom three sections of the 100-foot tower shown.

The tower location, from a handheld GPS (Garmin GPSmap 478), is 22°17.823'N, 39°05.567'E. KAUST was responsible for laying the tower foundation, building the tower, and erecting the tower. KAUST hired outside contractors for this work. The tower was supposed to be constructed before WHOI personnel arrived in Saudi Arabia in late September, but the tower was actually erected on 17 October 2008. Figure VI-2 shows a photo of the tower as it was hoisted into place over the foundation.



**Figure VI-2: Installation of the meteorological tower on 17 October 2008 at 22°17.823'N, 39°05.567'E. Construction cranes on the KAUST campus can be seen in the distance.**

The height of the tower top was not measured, but it should be about 30 feet above the top of the foundation, which was about 6 inches above ground level. At present, our best estimate of the tower-top height is 30.5 feet, or 9.29 m, above ground level. Ground level is 5-10 feet above sea level (which varies seasonally and is higher in winter). Except for a nearby light post (visible in Figure VI-2), there are no flow obstructions within a radius of at least 120 feet (or several tower heights).

After installation, the tower had a perceptible tilt—a level was not available when the instruments were mounted, but the tilt was estimated to be 2-3° away from the coast (and in the direction of the afternoon wind). When the tower is serviced in 2009, the tower tilt should be measured to allow correction of shortwave radiation and wind measurements. (The instruments should be leveled for the 2009 deployment.)

There is also some concern about how well the sonic anemometer direction was aligned with true north. Since the tower wind sensor is in a fixed orientation (unlike on a buoy), the wind unit was purchased without a compass. We used a handheld GPS to determine the direction of true north, and a person in the tower held a ~4-foot piece of board along the two prongs that should align with north while a person on the ground sighted the alignment. This worked reasonably well, but it was challenging for the person in the tower to hold the board and rotate the anemometer. The alignment error is believed to be 1-2°, or less, but this alignment should be checked by a more robust means prior to removal of the existing wind unit.

The tower carries a modified VOS (Volunteer Observing Ship) IMET package, measuring short- and long-wave radiation, vector winds, precipitation, humidity, and air temperature. The sensors are identical to those on the buoy, but the electronics are housed in fiberglass cases. The tower also carries an Iridium telemetry system that is identical to the buoy’s system. The system is powered by a rechargeable solar system, and there are three VOS battery cans installed for backup power. The backup batteries should supply three months of power if the solar system fails. A schematic of the tower system is shown in Figure VI-3.

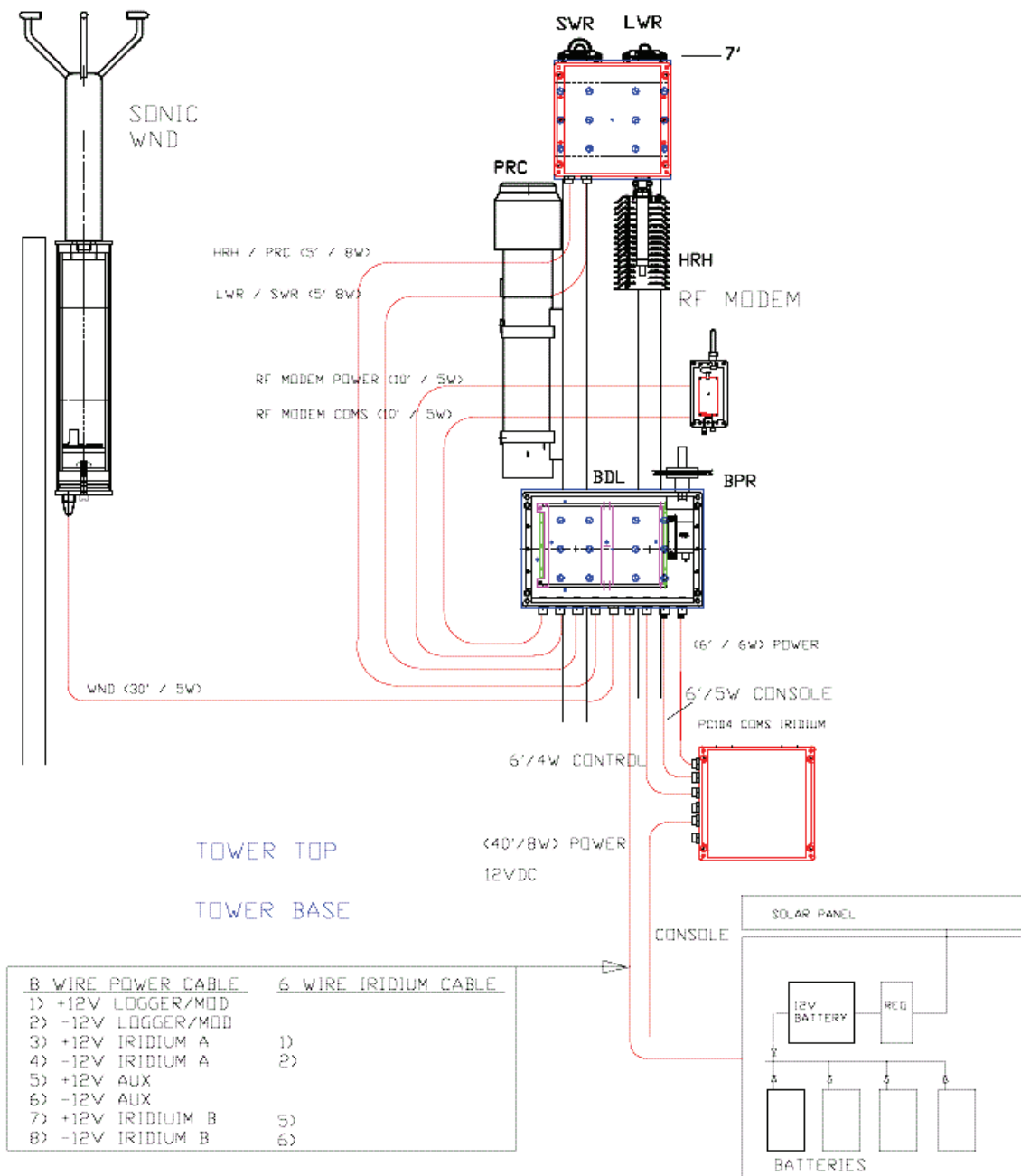
The meteorological instruments were installed by Paul Bouchard, Jason Smith, and Tom Farrar on 18 October 2008. Bouchard and Farrar climbed the tower, and Smith provided support from the ground (Figure VI-4). Instruments and tools were hoisted to the tower top using rope and a small block.

On 18 October 2008, the IMET package was started at 10:10:00 UTC. The Iridium system was started at 11:26:30 UTC, and a precipitation gauge fill-and-drain was performed at 11:32:50 UTC. No shortwave/longwave spikes were performed. Estimated measurement heights are given in Table VI-1. The tower is shown after installation in Figure VI-5, and a close up of the instrument configuration is shown in Figure VI-6.

Parameter	Measurement from top of tower to...	Height above tower top (measured)	Height above ground (based on estimated height of tower top, nominally 9.3 m)
wind	transducers	109 cm	10.39 m
Precip	Top of cup	74 cm	10.04 m
swr/lwr	Top of LHPS box	108 cm	10.38 m
RH/atmp	Not measured, but fixed relative to swr/lwr (42 cm below top of LHPS box)	66 cm (estimated from swr/lwr and box measurement)	9.99 m
bpr	Midpoint of plates	Not measured; box top estimated to be 15 cm below RH/atmp and BPR sensor is 35 cm below box top	~9.5 m

**Table VI-1: Sensor heights on the meteorological tower.**





**Figure VI-3: Schematic of tower meteorological system, including telemetry and power systems.**



**Figure VI-4: Installation of tower instruments. Farrar and Bouchard are in the tower, and Smith and the tower contractor are on the ground.**



**Figure VI-5: The meteorological tower after installation of instruments, telemetry system, and power system.**



**Figure VI-6: Close-up photo of meteorological system after installation.**

## References

Bialek, E.L., Editor. 1966. Handbook of Oceanographic Tables. Special Publication, SP-68, U.S. Naval Oceanographic Office, Washington, D.C.

Bouchard, P.R. and J.T. Farrar, 2008. Preliminary techniques for measuring waves on UOP buoys. Technical note of the WHOI Upper Ocean Processes Group. Available on request- contact Tom Farrar (jfarrar@whoi.edu) or visit <http://uop.whoi.edu/>.

Hosom, D.S., R.A. Weller, R.E. Payne, and K.E. Prada, 1995. The IMET (Improved Meteorology) Ship and Buoy Systems. *J. Atmos. Oc. Tech.*, **12**, 527-540.

Payne, R.E. and S.P. Anderson, 1999. A new look at the calibration and use of Eppley Precision Infrared Radiometers. Part II: Calibration and use of the Woods Hole Oceanographic Institution Improved Meteorology Precision Infrared Radiometer. *J. Atmos. Oc. Tech.*, **16**, 739-751.

WHOI Upper Ocean Processes Group, 2007. Inductive telemetry for UOP Ocean Reference Station moorings. Technical note of the WHOI Upper Ocean Processes Group. Available on request- contact Tom Farrar (jfarrar@whoi.edu) or visit <http://uop.whoi.edu/>.

## ACKNOWLEDGEMENTS

This project was funded through grants from the King Abdullah University of Science and Technology (Grant #USA 00002). We are grateful for help from the crew of the R/V *Oceanus* and numerous KAUST personnel, including Yasser Kattan, Abdulaziz Alsuwailem, and Haitham Al Jahdali. We also enjoyed the help and comradeship of Professor Alaa Al-Barakati and Professor Yasser Abualnaja during the cruise, and Professor Abualnaja assisted with work on the tower. Thanks also go to Mohsen Al Jahdali and Mohamed Juwamel for their work on the reef operations from the 32' Whaler.

# APPENDIX A – MOORING LOGS

## Moored Station Log

(fill out log with black ball point pen only)

ARRAY NAME AND NO. K40ST1 MOORED STATION NO. 1207

### Launch (anchor over)

Date (day-mon-yr) 11 October 2008 Time 12:09:30 UTC  
Latitude (N/S, deg-min) 22° 09.690'N Longitude (E/W, deg-min) 38° 29.996'E  
Deployed by WHOI/Kemp Recorder/Observer Farrar  
Ship and Cruise No. R/V Oceanus Intended Duration 12 months  
Depth Recorder Reading 674 m Correction Source CTD depth + altimeter  
Depth Correction \_\_\_\_\_ m + computed from CTD S, T, P  
Corrected Water Depth 697 ± 1 m Magnetic Variation (E/W) \_\_\_\_\_  
Argos Platform ID No. 3 Iridium IDs Additional Argos Info on pages 2 and 3

Lat (N/S) 22° 09.638'N Long. (E/W) 38° 30.069'E  
Surveyed Anchor Position → Survey not conducted; pos'n based on close approach to buoy (scope 0.95)

### Acoustic Release Model ORE offshore 8242X (dual release)

Release No. 32735 / 32736 Tested to \_\_\_\_\_ m  
Receiver No. \_\_\_\_\_ Release Command 652363 / 652404  
Enable 672376 / 672432 Disable 672411 / 672457  
Interrogate Freq. 11 kHz Reply Freq. 12 kHz

### Recovery (release fired)

Date (day-mon-yr) \_\_\_\_\_ Time \_\_\_\_\_ UTC  
Latitude (N/S, deg-min) \_\_\_\_\_ Longitude (E/W, deg-min) \_\_\_\_\_  
Recovered by \_\_\_\_\_ Recorder/Observer \_\_\_\_\_  
Ship and Cruise No. \_\_\_\_\_ Actual duration \_\_\_\_\_ days  
Distance from actual waterline to buoy deck 70-75 cm (deployment cruise) m





Moored Station Number

UTC

Item No.	Length (m)	Item	Inst No.	Time Over	Notes	Data No.	Depth (m)	Time Back	Notes
1	7.5	Acoustic modem 9462	43939		Bottom of Compliant				Receiver
2	8.0	SBE-39	<del>4312</del>		Inductive				ID 08
3	10.0	SBE-37	6000		Inductive up				ID 03
4	12.5	TR-1060	14977						
5	15.0	SBE-37	6001		Inductive				ID 04
6	20.0	TR-1060	14974						
7	25.0	SBE-37	<del>4308</del>		S/Ns fixed 10 Feb 2009, JF				
8	30.0	SBE-39	<del>4309</del>			Inductive			
9	40.0	SBE-37	6063	7:11:40					
10	44.0	RE/ADCP	10816	7:11:00	600 kHz				
11	44.0	Acoustic modem 11330	43943	7:12:00	w/RDI				Transmitter
12	50	SBE 39	4149	7:14:24					internal
13	60	XR420	5224	7:16:06					
14	70	SBE 39	4148	7:18:06					internal
15	80	TR1060	14972	7:19:41					
16	90	XR420CP	13249	7:23:49					pressure
17	100	SBE 39	4146	7:25:27					internal
18	120	XR420	15225	7:28:46					
19	131	300 kHz NDI	10777	7:34:24					up
20	140	TR1060	14860	7:35:32					
21	160	SBE 39	3800	7:37:13					external
22	180	SBE 39	4195	7:38:51					internal

Item No.	Length (m)	Item	Inst No.	Time Over	Notes	Data No.	Depth (m)	Time Back	Notes
23	200	XR420	15246	7:47:40					
24	236	<del>300R12</del> RDI	10765	7:48:54					
25	250	SBE 39	3794	<del>7:50:45</del>					up
26	300	XR420	15223	7:54:24					external
27	351	VMCM	038	8:01:58	bands off				
28	400	XR420	15247	8:05:19					
29	450	TR1060	14978	8:10:33					
30	550	VMCM	061	8:55:50	bands off				
31	570	TR1060	<del>14977</del>	8:44:30	bands off stretch hose coupling				
32	604	<del>SBE 39</del>	<del>15377</del>	8:55:58	stretch hose coupling				
33	648	VMCM	013	9:18:00	stretch hose linkage				SN 14975
34	648	SBE 39	6061	9:18:00	bands off				
35					ON VMCM cage				
36									
37									
38									
39									
40									
41									
42									
43									
44									
45									

↑ 10m

↑ 5m

↑ vs. orig drawing

KAUST Red Sea shelf moored array deployment

Shelf-edge mooring October 2008 deployment Date: 10/12/2008

tentative deployment location 21.9465 (21 56.79')N 38.7666(38 45.60')E

depth range 45-50 m

Deployment location: 21° 56.79' 38° 46.085' Time: 10:17:09

Water depth: 49.5 + 4 m from surface + sound speed corr.

Identification (buoy): K-1 light working 10/12

1  
24.67  
478  
27.45  
372  
33.17  
6.25  
7.37  
36.82  
3.48  
4.15 4.5

Instrument	Serial number	Depth/height (m)	Comments
MicroCat	6040 ✓	1 m on buoy 60 m 0.6 m	Poison plug removed
TempPro	1284100 ✓	2 m on buoy 1.2 m	
MicroCat	6041 ✓	3 m 3.37 m	Poison plug removed
Fluorometer	1015 ✓ 12:50:49	4 m 4.32 m	Replace dummy plug Cap removed Shutter opens ✓
TempPro	1282477 ✓	6 m 5.97	
TempPro	1282478 ✓	8 m 7.94	
MicroCat	6042 ✓	10 m 9.88	Poison plug removed
Fluorometer	1016 ✓ 1:00:35	11 m 10.90	Replace dummy plug Cap removed Shutter opens
TempPro	1282479 ✓	15 m 14.92	
TempPro	1282480 ✓	18 m 18.23	
TempPro	1282481 ✓	22 m 21.73	
MicroCat	6050 ✓	25 m 24.67	Poison plug removed
TempPro	1282482 ✓	29 m 28.21	
TempPro	1282483 ✓	33 m 33.17	
TempPro	1282484 ✓	36 m 36.20	
MicroCat	6048 ✓	40 m 40.30	Poison plug removed
TempPro	1282485 ✓	43 m 43.27	
Fluorometer	1017 ✓	45 m 45.25 12:57:00	Replace dummy plug Cap removed Shutter opens ✓
TempPro	1282476 ✓	46 m 45.5	
MicroCat	6036 ✓	48 m strongback 47.5	Poison plug removed

42.97  
2.28 263  
1.50  
0.91  
2.41  
0.96  
1.91  
2.02  
2.41  
4.43  
1.54  
3.504  
8.43  
1.45  
2.47  
4.00  
12.43  
2.48  
14.43  
3.80  
7.27  
2.77  
22.20  
2.47  
4.54  
24.67  
2.

KAUST Red Sea shelf moored array deployment

**Shelf-edge tripod** October 2008 deployment Date: 10/12/2008

tentative deployment location 21.9465 (21 56.79')N 38.7666(38 45.60')E

depth range 45-50 m, ADCP set for ? m

Deployment location: 21° 56.711' 38° 46.161' Time: 11:00:10 UTC <sup>2:00:10</sup>

Water depth: 249.9 + 4 m transducer + sound speed correction

Identification (buoy): shelf edge (KI)

Instrument	Serial number	Depth/height (m)	Comments
ADCP 300kHz Waves	10484 (128 m) ✓	72 cm above floor (69.5 cm above 2.5 cm thick foot pads.	Correct depth range? <del>Cap off, pressure port clear</del>
Seagauge	1152 (128 m) ✓	38 cm above floor 35.5 cm above pads	
Pinger	#51 ✓ (36Khz 5-6-5-8)		On Oct 6
Release	32825 ✓ 553013 (90m)		

Spare pinger #60 (34 kHz 3-3-4-4) – on Oct 6

From underway and time of deployment  
21° 56.722' 38° 46.117' This might be more accurate.

KAUST Red Sea shelf moored array deployment

Mid-Shelf mooring October 2008 deployment Date: 10/12/2008

tentative deployment location 21.9459(21 56.75')N 38.7803 (38 46.82') E

depth 45-50 m

Deployment location: 21° 56.729' 38° 46.872' Time: 10:44:34  
7:44:34 UTC

Water depth: 48.3 m + 4 m + sound speed

Identification (buoy): buoy K2 (Light working 10/12)

Instrument	Serial number	Depth/height (m)	Comments
MicroCat	6039 ✓	1 m on buoy 0.6 m 60 cm	Poison plug removed
TempPro	1284101 ✓	2 m buoy 1.2 m	
MicroCat	6049 ✓	3 m 3.25	
Fluorometer	1018 ✓	4 m 2.63 4.12 m	Replace dummy plug Cap removed 10:21 Shutter opens (LT)
TempPro	1282487 ✓	6 m 1.55 5.98	
TempPro	1282488 ✓	8 m 7.93	
MicroCat	6046 ✓	10 m 9.93	Poison plug removed
Fluorometer	1019 ✓	11 m 3.2 11.13	Replace dummy plug Cap removed Shutter opens 10:24 LT
TempPro	1282489 ✓	15 m 14.93	
TempPro	1282490 ✓	18 m 18.31	
Fluorometer	1020 ✓	20 m 19.76	Replace dummy plug Cap removed Shutter opens 10:25 LT
TempPro	1282491 ✓	22 m 21.8	
MicroCat	6047 ✓	25 m 24.85	Poison plug removed
TempPro	1282492 ✓	29 m 28.87	
TempPro	1282493 ✓	33 m 32.89	<del>no comment</del>
TempPro	1282494 ✓	36 m 35.88	
MicroCat	6045 ✓	40 m 39.88	Poison plug removed
TempPro	1282495 486	43 m 42.97	
TempPro	1282488 495	46 m 45.18	
MicroCat	6037 ✓	48 m strongback 47.25	Poison plug removed

0.50  
 2.93 4m  
 4.43  
 3.5  
 7.73  
 6.47  
 14.4  
 16.4  
 18.91  
 3.8  
 3.36  
 20.3  
 4.55  
 8.57  
 8.86  
 38.66  
 1.73  
 11.72  
 1.48  
 38.64  
 1.24  
 42.64  
 42.64  
 2.84  
 4.61

KAUST Red Sea shelf moored array deployment

**Mid-Shelf tripod** October 2008 deployment Date: 10/12/2008

tentative deployment location 21.9459(21 56.75')N 38.7803 (38 46.82') E

depth 45-50 m

Deployment location: 21°56.749' 38°46.877 Time: 08:09:00 UTC

Water depth: ~ 48.3 m + 4 m + sound speed

Identification (buoy): buoy MID SHELF (K2)

Instrument	Serial number	Depth/height (m)	Comments
ADCP 600kHz	10843 (50 m) ✓	72 cm above floor 69.5 cm above 2.5 cm foot pads	Correct depth range? Cap-off pressure port clear ✓
Seagauge	1147 (50 m) ✓	39.5 cm above floor (37 cm above pads)	
pinger	#52 ✓ (37kHz; 5-7-8-7)		On Oct 6
Release	#32830 ✓ 553124 90m		

Ship heading 131°  
tripod consists toward bow

KAUST Red Sea shelf moored array deployment

**Onshore tripod** October 2008 deployment Date: 18 Oct 2008

tentative deployment location 21.964 (21 57.84') N 38.869 (38 52.14')E

water depth 11-13 m

Deployment location: 21° 57.619' N 38° 50.243' E Time: 10:00 a

Water depth: 11 m

Identification (buoy): K4 tripod

check  
10/14 10:00am  
JTC

Instrument	Serial number	Depth/height (m)	Comments
ADCP 1200kHz	10833 (20 m)	72 cm above floor	Correct depth range? ✓ Cap off (had to pressure port clear ✓
Seagauge	1154 (20 m)	# 18 cm above pads (0.5cm)	
pinger	#53 (38kHz; 5-7-8-8)		On Oct 6
Release	#32829 553107 (20m)		

dive on  
it to  
remove  
cap hat  
way through  
deployment

see churchill's notes on positions, etc.

KAUST Red Sea shelf moored array deployment

Onshore mooring October 2008 deployment Date: 18 Oct 2008

tentative deployment location 21.964 (21.57.84") N 38.869 (38.52.14") E

water depth 11-13 m max ADCP depth 12 m (13 m)

Deployment location:  $21^{\circ} 57.64' N$   $38^{\circ} 50.23' E$  Time: ~ 11:00 am LT

Water depth: 19.6 m  
 Identification (buoy): K4 buoy Reef Edge

Instrument	Serial number	Depth/height (m)	Comments
MicroCat	6038	<del>1 m</del> on buoy 0.6 m	Poison plug removed ✓
TempPro	1282496	<del>1.5 m</del> bottom buoy or top wire 1.24 m	
MicroCat	6044	<del>2 m</del> 2.27 m	Poison plug removed ✓
Fluorometer	1021	<del>3 m</del> 3.27 m	Replace dummy plug ✓ Cap removed ✓ Shutter opens ✓
TempPro	1282497	3.2 m 3.5 m	
TempPro	1282498	4 m 4.05	
TempPro	1282499	5 m 5.05	
TempPro	1282500	6 m 6.07	
TempPro	1282501	7 m 7.07	
TempPro	1282502	8 m 8.06	
MicroCat	6051	9.8 m strongback 105 cm below eye 9.75 m	Poison plug removed ✓

2.64  
8.2  
1.41  
4.64  
1.43  
time from Churchill  
Turned on 11:07 am local time  
end of schedule  
6.64  
2.25  
8.89  
8.7  
1.05

get depth from Churchill



KAUST Red Sea shelf moored array deployment  
**reef tripod** October 2008 deployment Date: 18 Oct 2008  
 tentative deployment location 21.964 (21 57.84') N 38.845 (38 50.70')E  
 water depth 1-2 m

Deployment location: 21° 58.045' N 38° 50.180' E Time: Afternoon  
 Water depth: 1.35 m  
 Identification (buoy): \_\_\_\_\_

Instrument	Serial number	Depth/height (m)	Comments
Nortek 2000kHz		0.97m below surface	
MicroCat	6050	same as nortek head	Poison plug removed ✓
pinger	#50 (35kHz; 5-6-5-7)		Stowed in Nortek Box On Oct 6.

see churchill's notes for position/depth

KAUST Red Sea shelf moored array deployment  
**reef temperature array** October 2008 deployment  
 Date: 18 - 19 Oct 2008  
 tentative deployment location water depth 1-2 m

Deployment location: \_\_\_\_\_ Time: \_\_\_\_\_

site	Instrument	Serial number	Water depth (m)	locations
H1	TempPro Pinger	1282503 #38 (34kHz; 3-4-7-4)	4.4	21 57.627 38 50.249
R1	Branker	19502	1.6	21 57.923 38 50.225
H2	TempPro Pinger	1282504 #39 (35kHz; 3-4-7-5)	0.6	21 57.955 38 50.206
R2	Branker	19503	0.6	21 57.955 38 50.206
H3	TempPro Pinger	1282505 #40 (36kHz; 3-5-5-7)	0.6	21 58.034 38 50.154
R3	Branker	19504	2.5	21 58.158 38 50.084
H4	TempPro Pinger	1284093 #41 (37kHz; 3-5-5-8)	1.75	21 58.024 38 50.113
H5	TempPro Pinger	1284094 #42 (38kHz; 3-6-3-6)	1.2	21 58.047 38 50.211
H6	TempPro Pinger	1284095 #43 (39kHz; 3-6-3-7)	2.0	21 58.900 38 50.780
H7	TempPro Pinger	1284096 #54 (39kHz; 6-8-6-8)	0.85	21 58.823 38 50.826
H8	TempPro Pinger	1284097 #49 (34kHz; 4-8-6-8)	0.65	21 58.799 38 50.857
H9	TempPro Pinger	1284098 #55 (6-8-8-7)	0.85	21 58.800 38 51.156
H10	TempPro Pinger	1284102 #60 (3-3-4-4)	1.80	21 57.763 38 51.445
H11	TempPro	1284099	0.65	21 57.768 38 51.414

All pingers turned on Oct 6; positions from Churchill's notes

## Appendix B: Shipboard Underway Data Format

*The data and data format for the shipboard underway data is described in the file "underway/MetaData.txt" on the Cruise Data Disc. The content of this file is shown below.*

R/V Oceanus Calliope metadata file  
Wed 08/Oct/2008 05:05:32  
Current time zone: GMT Standard Time

---

### 12kHz depth (Depth12)

Format: xxxx.x (meters)

Depth in meters obtained from the Knudsen 12 kHz channel. 4 meter transducer depth correction has been applied (see Knudsen bathymetry data string).

---

### 3.5kHz depth (Depth35)

Format: xxxx.x (meters)

Depth in meters obtained from the Knudsen 3.5 kHz channel. 4 meter transducer depth correction has been applied (see Knudsen bathymetry data string).

---

### Air Temperature; IMET HRH (AirTmp1)

Format: xx.xxx (degrees C)

Data is obtained from IMET\_HRH primary sensor.

Sensor is mounted on the forward mast, 15m above the waterline.

---

### Air temperature, PTU (AirTmp\_2)

Degrees C

Data obtained from Vaisala PTU200 sensor mounted on the forward mast 15m above the waterline.

---

### Air temperature; WXT (C) (WXT5\_Ta)

Ta = Air temperature, degrees C

Data obtained from Vaisala WXT510 mounted on the forward mast 15m above the waterline.

---

### Ashtech Heading, Pitch & Roll (PASHR)

\$PASHR,ATT NMEA string

Format: \$PASHR,ATT,tttt.t,hhh.hh,+ppp.pp,+rrr.rr,mrms,brms,x

tttt.t = GPS time in seconds of week

hhh.hh = Heading (degrees)

ppp.pp = Pitch (degrees)

rrr.rr = Roll (degrees)

mrms = Measurement rms error in meters  
brms = Baseline rms error in meters  
x = Attitude reset flag

Example: \$PASHR,ATT,153663.5,092.09,-000.48,+000.04,0.0027,0.0103.0

Pitch - Bow up is positive; Roll - Port side up is positive

MRMS is the average double difference carrier phase residual. Typical values are 2-3 millimeters  
BRMS is the RMS error for the differences between calibrated baseline magnitudes and computed baseline magnitudes for the three vectors formed by Antenna 1 to the other three antennas. Typical values are 1-3 cm but will increase under high PDOP conditions.

Attitude reset flag: 0 = attitude computed correctly, pitch and roll are valid; 1 = attitude ambiguities have not been solved; pitch & roll set to 0.0

---

Barometric pressure (BPR)

Barometric pressure, MilliBars

Data obtained from Vaisala PTU200 sensor

Data is not corrected for altitude; sensor is mounted on the forward mast, 15m above the waterline

---

Barometric pressure; WXT (hPa) (WXT5\_Pa)

Pa = Barometric pressure, hPa

Data obtained from Vaisala WXT510

Data is not corrected for altitude; sensor is mounted on the forward mast, 15m above the waterline.

---

Decimal Latitude (dec\_lat)

Latitude in decimal degrees obtained from the Furuno 1850 GPS receiver.

Format: +/-dd.dddd (North is positive)

---

Decimal Longitude (dec\_lon)

Longitude in decimal degrees obtained from the Furuno 1850 GPS receiver.

Format: +/-ddd.dddd (East is positive)

---

Distance to waypoint (BWR) (DTWP)

Distance in nautical miles to the next waypoint. Value is obtained from the NMEA \$GPBWR data output from the Furuno GP1850-WD GPS receiver.

---

Distance to waypoint (RMB) (WP\_Dist)

Distance in nautical miles to the next waypoint. Value is obtained from the NMEA \$GPRMB data output from the Furuno GP1850-WD GPS receiver.

---

EDO speedlog (SPDLG)

NMEA VLW, VBW & VHW data output

VLW = Distance since reset (water & ground)

VHW = Heading and speed (water relative)  
\$VDVHW,a.a,T,b.b,M,c.c,N,d.d,K\*hh  
a.a Heading (true)  
b.b Heading (magnetic)  
c.c Water speed (knots)  
d.d Water speed (km/hr)

VBW = Water & ground referenced speed  
\$VDVBW,a.a,b.b,A,c.c,d.d,Ae.e,A,f.f,A\*hh  
A = Valid, V = Invalid  
a.a Longitudinal water speed (knots)  
b.b Transverse water speed (knots)  
c.c Longitudinal ground speed (knots)  
d.d Transverse ground speed (knots)  
e.e Stern transverse water speed (knots)  
f.f Stern transverse ground speed (knots)  
Transverse: "-" = port, Logitudinal: "-" = astern

---

#### Sea Surface Conductivity (SSCND)

Falmouth Scientific TSG (OCM-S-212) sea surface conductivity

Format: xx.xxxx (mmho/cm or milli-Siemens/centimeter)

OCM sensor is mounted in the bow thruster room on the suction side of the clean sea water distribution pump. Sea water intake is from a bow inlet located 4m below the waterline.

---

#### Sea Surface Temperature (SSTMP)

Falmouth Scientific TSG (OTM-S-212) sea surface temperature

Format: xx.xxxx (degrees C)

OTM sensor is mounted in the bow thruster room on the suction side of the clean sea water distribution pump. Sea water intake is from a bow inlet 4m below the waterline.

---

#### GP1850 GPS BWR (GPBWR\_GP1850)

Furuno GP1850-WD NMEA GPBWR data output.

\$GPBWR,UTC,Lat,N/S,Lon,E/W,Bearing,T, Bearing,M, distance,N,ccc,mode\*hh

This string provides UTC time plus distance and bearing to next waypoint.

T= true

M=magnetic

N=Nautical Miles

ccc=waypoint ID

Mode: Autonomous, Diff, Est, Manual input, Simulator, Not valid

---

#### GP1850 GPS GGA (GPGGA\_GP1850)

Furuno GP1850-WD NMEA GPGGA data string.

Format:

\$GPGGA,Time,Lat,N/S,Lon,E/W,FixQuality,NumSats,HDOP,Alt,M,GeoidAlt,DgpsUpdate,DgpsStation,Checksum

Time: UTC time [17:08:34 UTC]  
Lat, N/S: Latitude in degrees and decimal minutes [4124.8963, N]  
Lon, E/W: Longitude in degrees and decimal minutes [08151.6838, W]  
FixQuality:  
0 = Invalid  
1 = GPS fix  
2 = DGPS fix  
[1]  
NumSats: Number of satellites in view [05]  
HDOP: Horizontal dilution of precision [1.5]  
Alt,M: Altitude in meters above mean sea level [280.2, M]  
GeodAlt,M: Height of geoid above WGS84 ellipsoid [-34.0, M]  
DgpsUpdate: time since last DGPS update [blank]  
DgpsStation: DGPS station reference ID [blank]  
Checksum [\*75]

---

GP1850 GPS RMB (GPRMB\_GP1850)  
Furuno GP1850-WD NMEA GPRMB data string.

Format: \$--RMB,DA,x.x,L/R,OID,DID,Lat,N/S,Lon,E/W,r.r,b.b,v.v,AS\*hh<cr><lf>  
DA = Data Status ("A" = valid, "V" = receiver warning)  
x.x = Cross track error (nautical miles)  
L/R = Direct to steer (left/right)  
OID = Origin waypoint ID  
DID = Destination waypoint ID  
Lat,N/S = Destination Latitude  
Lon,E/W = Destination Longitude  
r.r = Range to destination (nautical miles)  
b.b = Bearing to destination (degrees true)  
v.v = Destination closing velocity (knots)  
AS = Arrival status (A=Arrival circle entered, V=not entered)  
hh = checksum

This string allows calculation of time and distance to next waypoint.

---

GP1850 GPS RMC (GPRMC\_GP1850)  
Furuno GP1850-WD NMEA GPRMC data output.

Format: \$--RMC,hmmss.ss,S,Lat,N/S,Lon,E/W,x.x,y.y,ddmmyy,m.m,E/W\*hh<cr><lf>  
Time = UTC of position fix  
S = Status ("A" = valid, "V" = receiver warning)  
Lat & Lon  
x.x = speed over ground (knots)  
y.y = Course over ground (degrees true)  
ddmmyy = date  
m.m,E/W = magnetic variation, degrees  
("E" subtracts from true, "W" adds to true)  
hh = checksum

---

GP1850 GPS ZTG (GPZTG\_GP1850)  
Furuno GP1850-WD NMEA GPZTG data output.  
This string contains UTC time and time to waypoint #ccc.  
\$GPZTG,hhmmss.ss,hhmmss.ss,ccc\*hh

---

GPS course over ground (GPS\_COG)  
Course over ground (true) obtained from NMEA GPS\_VTG data sentence.  
Format: xxx.x (degrees)

---

Latitude (GPS\_Lat)  
GPS Latitude formatted for display.  
Format: dd° mm.mmmm, N/S

---

Longitude (GPS\_Lon)  
GPS Longitude formatted for display.  
Format: ddd° mm.mmmm, E/W

---

GPS Navigational data (GPS)  
Complete NMEA data output from the primary GPS receiver (WGS84 datum).

The single digit following the position information in the GPS\_GGA data string indicates the type of GPS fix as follows:

0=No valid fix; 1=Standard; 2=Differential; 3=P-Code

NMEA GPS\_GGA data sentence: Header , UTC of position, Latitude, N/S, Longitude, E/W, Quality indicator, Number of satellites in use, Horizontal dilution, Altitude, M (meters), Geoidal separation, M (meters), Age of differential data (secs), Differential reference station I.D. \* checksum.  
(Lat & Lon values are "degrees minutes.decimal\_minutes")

NMEA GPS-VTG data sentence: Header, Course, T (degrees true), Course, M (magnetic), Speed, N (knots), Speed, K (km/hr) \* checksum.

The Primary GPS source is currently the Furuno GP1850-WD GPS.

---

GPS speed over ground (GPS\_SOG)  
Speed over ground (knots) obtained from NMEA GPS\_VTG data sentence.  
Format: xx.xx (knots)

---

GPS type (GPS\_TYPE)  
GPS position type (Std, Diff, P-Code)  
GPS position type indicator obtained from the "quality indicator" included as part of the GPS NMEA GGA data sentence.

---

Gyro heading (Gyro)

Ship's heading (degrees true) obtained from the Gyro NMEA HEHDT data sentence.

Format: xxx.x (degrees true)

---

IMET Temperature (IMET\_Temp)

Temperature data from IMET temperature sensor. This sensor is not normally installed; temperature data is usually obtained from the IMET humidity sensor.

Sensor is mounted on the forward mast, 15m above the waterline.

---

IMET Wind (IMET\_WND)

Format: X, Y, Total, Max, Min, LastVane, LastCompass, C1, C2

Wind X (m/sec), Positive for a stbd to port wind  
Wind Y (m/sec), Positive for a bow to stern wind  
Wind Total (m/sec), Averaged over previous minute  
Wind Max (m/sec, 15 sec interval),  
Wind Min (m/sec, 15 sec interval),  
Last Vane Reading (deg),  
Last Compass Reading (deg),  
Counter1 ("0"), Counter2 ("4")

Note - Wind direction is not provided as a single quantity. Direction values are ship relative. The wind sensor does not have a compass installed (value should always be 0.0).

Sensor is mounted on the forward mast, 15m above the waterline.

---

IMET Barometric Pressure (IMET\_BPR)

Format: xxxx.xx (milli-bars)

Data is not corrected for sensor altitude; sensor is mounted on the forward mast, 15m above the waterline.

---

IMET Precipitation (IMET\_PRC)

Format: Last minute (mm/min) Last hour (mm/hr) Present level (mm)

---

IMET Shortwave Radiation (IMET\_SWR)

Format: xxxx.x (watts/square meter)

The Eppley Laboratory, Inc. precision pyranometer has a wavelength range of 0.3 to 3 um. Sensor is mounted on the forward mast, 15m above the waterline.

---

IMET Humidity & Temperature (IMET\_HRH)

Format: xx.xxx (%RH), xx.xxx (C)

Note - Humidity and Air temperature data are both obtained from this instrument.

Sensor is mounted on the forward mast, 15m above the waterline.



---

True wind speed & direction (TWind)

Format: Speed, Direction (meters/sec, degrees)

Wind direction is given in meteorological terms; a 0 degree wind comes from the north. Ship speed and direction of travel are obtained from GPS data (GGA SOG & COG). Sensor mounting orientation is corrected using the direction the ship is pointing obtained from the gyro (the ship is not necessarily moving in the direction its pointing).

Sensor is mounted on the forward mast, 15m above the waterline.

---

Knudsen bathymetry (PKEL99)

Depth data obtained from the Knudsen bathymetry system. Values have been corrected for transducer depth (4 meters).

Format: Header (\$PKEL99), 12 kHz depth (meters), Transducer draft, 3.5 kHz depth (meters), Transducer draft, Speed of sound (m/s),

Lat (dd mm.mmm N/S), Lon (ddd mm.mmm E/W)

"Speed of sound" is the manually entered value used by the Knudsen to calculate depth.

---

Latitude (Lat)

Latitude obtained from primary GPS receiver expressed in degrees & minutes.

(i.e. 4131.436,N is 41 degrees, 31.436 minutes North Latitude)

---

Longitude (Lon)

Longitude obtained from primary GPS receiver expressed in degrees & minutes.

(i.e. 07040.336, W is 70 degrees, 40.336 minutes West Longitude)

---

NMEA Gyro (HEHDT)

Ship's heading obtained from the Sperry Gyro.

NMEA format: Header (\$HEHDT), Heading (degrees), T (true),

Heading (degrees), M (magnetic) \* checksum.

Version 2.20 (1/1/97) of the NMEA 0183 standard does not show magnetic heading in this data sentence and the validity of this item is questionable.

---

NMEA depth (PKDMS)

Format: \$PKDMS, xxxx.xx, f, xxx.xx, M, xxxx.xx, F \*CS

(f = Feet, M = Meters, F = Fathoms)

12 kHz Depth value from Knudsen bathymetry system in NMEA format.

---

Position from GPS receiver (Lat Lon)

Latitude & Longitude in decimal degrees.

Format: +/- dd.dxxxxx +/- ddd.dxxxxx (N & E are positive values)

---

Precipitation (PRC)

Format: x.xx (mm/hr)

Data is obtained from the IMET precipitation sensor on the forward mast, 15m above the waterline.

---

Pressure, Temperature, Humidity (PTU200)

Vaisala PTU200

Format: pppp.p, tt.t, hh

p = barometric pressure (mbar)

t = temperature (degrees C)

h = humidity (%)

Oceanus: Address = 10, Format cmd = 4.1 P ", " 3.1 T ", " 3.0 RH #r#n

Averaging time = 5 seconds (press = 2.5, RH = 2.5)

---

Rain accumulation; WXT (mm) (WXT5\_Rc)

Rc = Rain accumulation, mm (accumulation is updated in 10 sec intervals)

The accumulation value is reset only when the sensor power is reset.

Data obtained from Vaisala WXT510. Sensor is mounted on the forward mast, 15m above the waterline.

---

Rain intensity; (mm/hr) (WXT5\_Ri)

Ri = Rain intensity, mm/hour

Data obtained from Vaisala WXT510. Sensor is mounted on the forward mast, 15m above the waterline.

---

Relative humidity (HRH\_2)

Format: xx.xxx (%RH)

Data obtained from Vaisala PTU200 sensor.

---

Relative humidity; IMET HRH (HRH)

Format: xx.xxx (%RH)

Data is obtained from IMET\_HRH primary sensor. Sensor is mounted on the forward mast, 15m above the waterline.

---

Relative humidity; WXT (%) (WXT5\_Ua)

Ua = Relative humidity, %

Data obtained from Vaisala WXT510. Sensor is mounted on the forward mast, 15m above the waterline.

---

SBE21 Temp & Cond (SBE21\_TC)

Temperature - degree C (-5 to +35, +/- 0.01)

Conductivity - mmho/cm (0 to 70, +/- 0.01)

1 Siemens/meter = 10 mmho/cm

---

SBE21 conductivity (sbe21cnd)  
Format: dd.ddd mmho/cm (0-70, +/- 0.01)  
Based on ITS90 temperature calculations

1 Siemens/meter = 10 mmho/cm

---

SBE21 temperature (sbe21Tmp)  
Format: dd.ddd degrees C (-5 to +35, +/- 0.01)  
Based on ITS90 calibration coefficients  
( $T_{68} = 1.00024 * T_{90}$ )

---

SBE21 thermosalinograph (sbe21)  
Format: ttttcccc T & C raw frequency values (hex)  
Sensor is connected to the clean seawater system in the Wet Lab.

---

SBE45 conductivity (SBE45C)  
Surface conductivity from SBE45  
Format: cc.ccccc (mS/cm)  
( $S/m * 10 = mS/cm$ )

---

SBE45 salinity (SBE45S)  
Surface Salinity from SBE45  
Format: sss.ssss (psu)

---

SBE45 sea temperature (SBE45T)  
Sea surface temperature from SBE45  
Format: ttt.tttt (degrees C, ITS-90)

---

SBE45 sound velocity (SBE45V)  
Surface sound velocity from SBE45  
Format: xxxxx.xxx (m/sec)

---

SBE45 thermosalinograph (SBE45)  
Serial #4530841-0063  
Data Output Format:  
ttt.tttt, cc.ccccc, sss.ssss, vvvvv.vvv  
where  
t = temperature (degrees Celsius, ITS-90)  
c = conductivity (S/m) mS/cm =  $10 * S/m$   
s = salinity (psu)  
v = sound velocity (meters/second)  
All data is separated with a comma and a space.

Sensor is connected to the clean seawater system in the Wet Lab. See SSTMP or SBE48 for best sea surface temperature data.

---

SBE48 Sea surface temperature (SBE48T)

Serial #480019

Format xx.xxxx

Sea surface temperature (C) measured through the hull with a magnetically coupled SBE48. Sensor is located in the bow at about the same location as the FSI thermosalinograph. Sensor housing is contained in an insulation jacket to limit effect of ambient bow chamber air.

---

Salinity (Salinity)

Format: Salinity (PSU)

Salinity calculated from FSI sea surface temperature and conductivity data values in accordance with UNESCO 44.

---

Sea surface fluorometer (Fluorometer)

WetLabs Wet-Star fluorometer located in the Wet Lab clean seawater piping. A MetraByte A/D converter is used to convert the 0-5 vdc fluorometer output to serial data. This device sets the output decimal point as necessary for best resolution, which results in a 1 vdc fluorometer value being represented as +01000.00 in the raw MetraByte serial stream.

\*\*WetLabs Wet-Star fluorometer Specifications:

Response time: 0.17 sec (analog); 0.125 sec (digital, optional)

Input: 7-15 VDC

Output: 0-5 VDC (analog); 0-4095 counts (digital, optional)

Current draw: < 40 mA (analog); < 80 mA (digital, optional)

Linearity: = 99% R2

Chlorophyll:

Dynamic ranges: 0.03 -75 µg/l (standard); 0.06-150 µg/l (optional)

Sensitivity: 0.03 µg/l

Excitation: 460 nm

Emission: 695 nm

CDOM

Dynamic ranges: 1000 ppb (estuarine waters)

250 ppb (near-coastal waters)

100 ppb (open ocean waters)

Sensitivity: 0.100 ppb quinine sulfate dihydrate

Excitation: 370 nm (10 nm FWHM)

Emission: 460 nm (120 nm FWHM)

Uranine

Dynamic range: 0-4000 µg/l uranine

Sensitivity: 1 µg/l uranine

Excitation: 485 nm

Emission: 532 nm

Rhodamine

Excitation: 470 nm

Emission: 590 nm

Phycoerythrin  
Excitation: 525 nm  
Emission: 575 nm

---

Ship speed (SPD)  
Ship speed in knots extracted from EDO Speedlog VHW data string.  
Format: xx.x (knots) Water relative

---

Short wave radiation (SWR)  
Format: xxx.x watts/square meter  
Calibration @ 25 degrees C, Aug. 31, 2006  
8.38 x 10<sup>-6</sup> volts per watt/square meter  
Raw data is in micro-volts; Raw/8.38 = w/m<sup>2</sup>  
Sensor is mounted on bow mast at a height of 15 m above the waterline.

---

Shortwave radiation - Raw data (SWR\_Raw)  
The precision pyranometer manufactured by Eppley Laboratory, Inc. has a wavelength range of 0.3 to 3 um. Sensor output voltage range is 0-10 milli-volts for typical SWR values of 0-1000 watts/square meter. Metrabyte A/D converter output is in micro-volts (noon reading in Woods Hole is likely to be between 2000 and 5000).

Sensor serial # 34730F3  
Installed Sept. 14, 2006  
Calibration @ 25 degrees C, Aug. 31, 2006  
8.38 x 10<sup>-6</sup> volts per watt/square meter

---

Sound velocity (SSV)  
Format: vvvv.vvvv (meters/sec)  
Surface sound velocity calculated from FSI sea surface temperature and conductivity data values. Intermediate salinity values are calculated in accordance with UNESCO 44.

---

Sperry MK37 Gyro (HEHDT\_MK37)  
Format: \$HEHDT,xxx.x,T  
Ship's Sperry MK37 gyro heading (degrees true)

---

True wind direction (Wnd\_Dir)  
Format: xxx.x (degrees)  
Wind direction obtained from the IMET wind sensor and corrected for ship heading (gyro) plus ship course and speed (GPS SOG & COG). Sensor is mounted on the forward mast, 15m above the waterline.

---

True wind speed (Wnd\_Spd)  
Format: xx.xx (meters/sec)

Wind speed obtained from the IMET wind sensor and corrected for ship heading (gyro) plus ship course and speed (GPS SOG & COG). Sensor is mounted on the forward mast, 15m above the waterline.

---

Turner fluorometer data (TF10\_data)

Fluorometer data from Turner Designs Model 10. Full scale = 1 volt (1000.00 from MetraByte A/D module). Exact value is not in agreement with instrument's front panel meter due to the characteristics of the calibration resistor. Science party is responsible for recording comparative readings during the cruise if needed.

---

Turner fluorometer range (TF10\_Range)

Fluorometer range setting from Turner Designs Model 10 (full scale = 1 volt). Actual values reported by the MetraByte A/D module (1000.00=1 volt) are not in agreement with the value indicated in the Turner manual due to the accuracy of the calibration resistor. Actual readings are per the following table (science party should check these values at some point during the cruise):

Range	Expected	Actual
X0	0.0v	000.10
X3.16	0.4v	488.60
X10	0.7v	831.00
X31.6	1.0v	9999.99

---

Acoustic wind sensor (WS425)

Format: \$P<id>MWV,direction,ref,speed,units,status\*CS

<id>; sensor's polling address

Direction; 0-359 degrees

Reference; R = relative, T = True

Speed; wind speed value

Units; K = km/hr, M = m/sec, N = kt

Status; A = data valid, V = data invalid

\*CS; checksum

Data is ship relative. "45" degree wind comes over the stbd quarter. Sensor is mounted on the forward mast, 15 meters above the waterline.

Data request polling address = \$WIPAQ,\*72\013\010

Checksum (8 bit XOR) must include \$ and \* characters

---

WS425 Rel Wind direction (WS425\_Dm)

Vaisala acoustic wind sensor

Wind direction is relative to the ship. "45" degree wind comes in over the stbd quarter.

Sensor is mounted on the forward mast, 15m above the waterline.

---

WS425 Rel Wind speed (WS425\_Sm)

Vaisala acoustic wind sensor

Wind speed relative to the ship (m/s)  
Sensor is mounted on the forward mast, 15m above the waterline.

---

WS425 True wind direction (WS425\_TD)

True wind direction in degrees

Values are calculated from the Vaisala WS425 acoustic wind sensor raw data corrected for sensor alignment error and combined with ship's gyro heading and GPS SOG and COG values. A "0" degree wind comes from the north.

---

WS425 True wind spd & dir (WS425\_TSD)

True wind speed (m/s) and direction (degrees)

Values are calculated from the Vaisala WS425 Acoustic wind sensor raw data corrected for sensor alignment error and combined with ship's gyro heading and GPS SOG and COG values.

Wind direction is given in meteorological terms; a "0" degree wind comes from the north.

---

WS425 True wind speed (WS425\_TS)

True wind speed (m/s)

Values are calculated from the Vaisala WS425 acoustic wind sensor raw data corrected for sensor alignment error and combined with ship's gyro heading and GPS SOG and COG values.

---

Rel Wind direction (Deg) (WXT5\_Dm)

Dm = Wind direction, deg (2 Hz samples, 10 sec average).

A "0" deg wind comes over the bow, "90" deg comes over the stbd side.

Data obtained from Vaisala WXT510 and has not been corrected for sensor mounting alignment error. Sensor is mounted on the forward mast, 15m above the waterline.

---

Rel Wind speed (m/s) (WXT5\_Sm)

Sm = Wind speed average, m/sec (2 Hz, 10 sec sample period)

Data obtained from Vaisala WXT510

Sensor is mounted on the forward mast, 15m above the waterline.

---

WXT510 True wind speed (WXT\_TS)

True wind speed (m/s)

Values are calculated from the Vaisala WXT510 Weather Transmitter raw data corrected for sensor alignment error and combined with ship's gyro heading and GPS SOG and COG values.

---

WXT510 True wind direction (WXT\_TD)

True wind direction in degrees

Values are calculated from the Vaisala WXT510 Weather Transmitter raw data corrected for sensor alignment error and combined with ship's gyro heading and GPS SOG and COG values. A "0" degree wind comes from the north.

---

## WXT510 #5 MET sensor (WXT5)

Vaisala WXT510 Weather Transmitter

Data Format:

WXT5 39240.67178 16:07:22 5R0,Dm=048D,Sn=0.0M,Sm=0.1M,  
Sx=0.2M,Ta=24.5C,Ua=35.7P,Pa=1018.2H,Rc=0.00M,Ri=0.0M

WXT5 39240.67178 16:07:22 = Calliope designator and time values  
(time stamps are GMT)

5R0 = Instrument's polled data request ("5" is inst address)

Dm = Wind direction, deg (2 Hz samples, 10 sec average)

Sn = Wind speed min, m/sec (2 Hz, 10 sec sample period)

Sm = Wind speed average, m/sec (2 Hz, 10 sec sample period)

Sx = Wind speed max, m/sec (2 Hz, 10 sec sample period)

Ta = Air temperature, degrees C

Ua = Relative humidity, %

Pa = Barometric pressure, hPa

Rc = Rain accumulation, mm (updated in 10 sec intervals)

Ri = Rain intensity, mm/hour

The rain accumulation value is reset only when the sensor power is reset. Wind speed and direction are given in meteorological terms: a "0" degree wind comes from the bow; a "90" degree wind comes from the Stbd side. Wind speed and direction values are ship relative and direction has not been corrected for mounting alignment error. Wind sampling is done at 2 Hz and averaged over 10 seconds - new data is available at 10 sec intervals.

### WXT5\_Dm

Ship relative wind direction (degrees), not corrected for sensor mounting alignment error.

Data Format: xxx

Wind direction is given in meteorological terms: a "0" degree wind comes from the bow; a "90" degree wind comes from the Stbd side. Wind sampling is done at 2 Hz and averaged over 10 seconds - new data is available at 10 sec intervals.

### WXT5\_Sm

Ship relative wind speed (m/s)

Data Format: xx.x

Wind sampling is done at 2 Hz and averaged over 10 seconds - new data is available at 10 sec intervals.

### WXT5\_Rc

Rain accumulation (mm)

Data Format: xx.xx

This value continues to increase until the sensor is reset as the result of power cycling (data polling does not reset the count).

### WXT5\_Ri

Rain intensity (mm/hr)

Data Format: x.x



This value is calculated over 10 second intervals.

Vaisala Meteorological Instruments  
June 12, 2007  
Instrument WXT510AAC1BC00B0  
Serial # C1240003  
Test Date: 24th May 2007  
Installed date 24 June 2007

---

WXT510 True wind spd & dir (WXT5\_TSD)  
True wind speed (m/s) and direction (degrees)  
Values are calculated from the Vaisala WXT510 Weather Transmitter raw data corrected for sensor alignment error and combined with ship's gyro heading and GPS SOG and COG values.  
Wind direction is given in meteorological terms; a "0" degree wind comes from the north.  
Sensor is mounted on the forward mast, 15m above the waterline.

---

---

Defined constants:

IMETSensorOffset = 0.0  
WXT510SensorOffset = 0.0  
WS425SensorOffset = 0.0

---

---

Auxiliary information:

Calliope Data Files  
June 16, 2008

General considerations - The Calliope system does not normally log all the data available or all the data it obtains and uses internally; it logs a subset on a timed basis individually specified for each data item. Data is frequently obtained and used for calculations without being logged due to a difference between the data collection interval and the log cycle. If the log file recording rate was not the same as the data collection rate, post-processing calculations may not give the same answers as the originals even though all calculations are done correctly. This is because the original calculations would have new data available at the collection rate whereas post-processing would only have the logged data subset.

The true wind calculation provides a good example; determining true wind speed and direction requires the wind sensor data plus heading from a compass or gyro and COG and SOG from a GPS. Normally heading data is obtained at a rapid rate compared to wind data but they are both recorded at about the same interval. This means that when the Calliope code makes the true wind calculation it is likely to use newly obtained heading data, which may not be logged. Clearly, attempting to check the Calliope

calculations using the logged data will be difficult but, if the logging rates have been chosen reasonably, post-processing will provide valid, useful results.

Log Files - The Calliope system generates data files of two types: 1) asynchronous, single-item-per-line, time stamped ASCII and 2) synchronous, multi-item-per-line, comma delimited (CSV). A single file of the first type is always created containing data items logged at the time interval specified by the Calliope configuration. Each line starts with a data identifier followed by the date and time given in the form used by Visual Basic (number of days since Dec. 31, 1899; the 31st is day #1) and then the time in normal human readable form. These values are followed by the data terminated with a `<cr><lf>`. Log files are normally created at midnight GMT and the name of the file provides ship and creation date information with a “.dat” extension. The date value within the file name is always based on GMT. The first line of the file provides ship, date and initialization local time information. The second line indicates the local time zone and the third provides a reminder that Calliope data timestamps are always GMT. This is followed by a line containing “\*\*\*\*\*” indicating the start of recorded data.

The Calliope data collection application always uses GMT timestamp values regardless of the time zone setting of the application computer. However, the start time for new data files is controlled by an entry in the configuration file. Regardless of when a file is started, the date information used to construct the file name is based on GMT. Note however that any date and time information included in the data file headers is local time. If date or time values are included in data files as logged values, these will also be local values (with GMT timestamps). Time values are handled in this manner to allow more convenient use of local time for controlling Calliope’s activities if desired. As an example, starting new files at a particular local time can be preferable to midnight GMT when instrumentation deployment activities are scheduled on a daily basis. Note that GMT will be used exclusively if the computer’s time is set to GMT.

All lines after the header’s “\*\*\*\*\*” contain data as shown in the following example taken from an Oceanus file named “OC020915.dat”. For this example, most items are being logged at 1-minute intervals; HEHDT, PKEL99, Salinity, and SSV are exceptions. The header indicates that the Calliope computer was set to Azores Standard Time, which is one hour behind GMT. The file was started at approximately midnight local time and the timestamps reflect the 1 hour difference between local and GMT.

R/V Oceanus Calliope data file, Sun 15/Sep/2002 00:00:11

Current time zone: Azores Standard Time (GMT-1)

Data timestamps are GMT

\*\*\*\*\*

```
IMET_WND      37514.00031 01:00:26 1.14 -2.55 2.8 3.3 2.4 161.2 0 4
IMET_HRH 37514.00031      01:00:26 99.253 19.819
IMET_SWR      37514.00031      01:00:26 0.1
IMET_BPR      37514.00031      01:00:26 1021.66
IMET_PRC      37514.00032      01:00:27 -0.00 0.00 7.69
SSTMP 37514.00032      01:00:27 +24.6322
SSCND 37514.00032      01:00:27 +50.0594
HEHDT 37514.00032      01:00:27 $HEHDT,025.7,T
PKEL99 37514.00034      01:00:29 $PKEL99,15.01,00.00,1500
Salinity 37514.04216      01:00:42 33.0489
```

```

SSV      37514.04216      01:00:42 1531.3961
TWind   37514.04216      01:00:43 2.7932 181.6
GPS      37514.04217      01:00:44 $GPGGA,010043.043,4131.4319,N,
07040.3348,W,3,08,1.0,026.0,M,034.4,M,,*75,$GPGXP,010043,4131.4319,N,07
040.3348,W*5D,$GPGLL,4131.4319,N,07040.3348,W,010043.043,A*21,$GPVTG,34
1.5,T,357.1,M,000.0,N,000.0,K*4D
HEHDT   37514.04228      01:00:58 $HEHDT,025.7,T
IMET_WND 37514.04249      01:01:11 1.14 -2.55 2.8 3.3 2.4 161.2 0.0 0 4
IMET_HRH 37514.04266      01:01:26 99.253 19.818
IMET_SWR 37514.04266      01:01:26 0.1
IMET_BPR 37514.04267      01:01:26 1021.71
IMET_PRC 37514.04267      01:01:27 0.00 0.00 7.69
SSTMP   37514.04268      01:01:27 +24.6304
SSCND   37514.04268      01:01:28 +50.0560
HEHDT   37514.04268      01:01:28 $HEHDT,025.6,T
TWind   37514.04286      01:01:43 2.8356 183.7
GPS      37514.04286      01:01:43 $GPGGA,010142.043,4131.4306,N,
07040.3343,W,3,08,1.0,028.3,M,034.4,M,,*7D,$GPGXP,010142,4131.4306,N,07
040.3343,W*58,$GPGLL,4131.4306,N,07040.3343,W,010142.043,A*24,$GPVTG,34
1.5,T,357.1,M,000.0,N,000.0,K*4D
HEHDT   37514.04306      01:01:58 $HEHDT,025.7,T
IMET_WND 37514.04318      01:02:11 1.06 -2.63 2.8 3.5 2.4 165.3 0.0 0 4
IMET_HRH 37514.04336      01:02:26 99.253 19.804
IMET_SWR 37514.04336      01:02:26 0.0
IMET_BPR 37514.04336      01:02:26 1021.70
IMET_PRC 37514.04336      01:02:26 0.00 0.00 7.70
SSTMP   37514.04337      01:02:27 +24.6314
SSCND   37514.04337      01:02:27 +50.0593
HEHDT   37514.04337      01:02:27 $HEHDT,025.7,T
PKEL99  37514.04339      01:02:29 $PKEL99,15.02,00.00,1500
Salinity 37514.04354      01:02:42 33.0511
SSV      37514.04354      01:02:42 1531.3987
TWind   37514.04354      01:02:42 2.5863 181.0

```

Note that the GPS data in the above example contains line-formatting characters that are not normally present in the real data files. The GPS data item above was defined as four NMEA sentences and the Calliope program concatenates multi-line data, replacing line termination characters with commas. <cr><lf> characters are only present at the end of each data item.

The “CSV” format file uses the same naming convention except that an underscore and two-digit number follow the date/time. The extension is always “csv”. CSV files are normally started at midnight GMT but the start time can be delayed by an amount specified in the configuration file. CSV files begin with a header line that identifies the ship and a line that identifies the data items in each of the following comma delimited columns. The last item in this second line is always the header line’s checksum. The content of these files can be changed by a number of methods and if this is done, a new file is created having a new file name; the two-digit number following the underscore is incremented. The header line identifying the file’s data items is also corrected.

The rate at which data is added to a CSV file is normally once per minute but this can be changed by an entry in the Calliope configuration file. Each line begins with a date and GMT time stamp and contains the most recent data available at the time of the entry. Data is not repeated; if new data is not available when a line is to be added, the corresponding column is left blank. The final item in each line is the checksum of the data identifier header line - not the data line's checksum. This is included so that when data lines of this type are broadcast to other applications, it is possible for these applications to determine if the correct header is being used. The following is an example taken from the file "OC020915\_00.csv".

R/V Oceanus Calliope CSV data file (timestamps are GMT)

```
Date, Time, SSTMP, SSCND, Gyro, Salinity, Wnd_Spd, Wnd_Dir, Depth, HdChkSum=OF
2002/09/15, 00:00:25, +24.630, +50.058, 025.7, 33.049, 2.67, 185.4, 115.01, 0F
2002/09/15, 00:01:25, +24.631, +50.060, 025.6, 33.050, 2.79, 181.5, 115.02, 0F
2002/09/15, 00:02:25, +24.631, +50.059, 025.7, 33.050, 2.83, 183.7, 115.01, 0F
2002/09/15, 00:03:25, +24.633, +50.057, 025.7, 33.047, 2.58, 181.0, 115.03, 0F
2002/09/15, 00:04:25, +24.633, +50.060, 025.7, 33.049, 2.43, 181.8, 115.06, 0F
2002/09/15, 00:05:25, +24.633, +50.057, 025.6, 33.046, 2.66, 178.1, 115.01, 0F
2002/09/15, 00:06:25, +24.633, +50.057, 025.7, 33.047, 2.49, 179.5, 115.01, 0F
2002/09/15, 00:07:25, +24.632, +50.060, 025.6, 33.050, 2.71, 181.5, 115.01, 0F
2002/09/15, 00:08:25, +24.632, +50.061, 025.7, 33.051, 3.02, 179.2, 115.03, 0F
2002/09/15, 00:09:25, +24.632, +50.058, 025.7, 33.048, 2.76, 180.6, 115.04, 0F
2002/09/15, 00:10:25, +24.630, +50.058, 025.7, 33.049, 3.03, 178.9, 115.03, 0F
2002/09/15, 00:11:25, +24.632, +50.058, 025.7, 33.048, 3.47, 178.2, 115.02, 0F
```

Special Files - A Calliope file entry transaction definition can define special files having a specified name and data content. The data format will be as described above for the asynchronous .dat file. Files of this type are generally used to record a limited amount of data, possibly triggered by an "event" of some nature.

Raw Data Files - The Calliope data input code can be configured to time stamp (GMT) and log all data received on a particular port. The same file name can be specified for more than one port allowing a single raw data file to hold a number of different data items. Raw data file names are specified when the files are activated; Calliope appends the yymmdd date and will always use a ".dat" extension (i.e. Pitch\_080415.dat).

## Metadata

The Calliope system generates a metadata file (Metadata.txt - possibly this file). This is a simple text file containing information on the various data sources listed by sensor name and the designator used in the header information of the primary data file types. The file also lists the constants defined by files in the Constants directory (i.e. calibration constants) and includes a copy of the file Metadata2.txt (located in the Calliope/Metadata directory), which can contain addition information entered by the application user. Hopefully, the resulting Metadata file contains enough information to make effective use of the data contained in the other files (i.e. format, units, sensor type, calibration dates, etc.).

In addition, there may be a second metadata file in the primary data directory named MetaDataAux.txt. This file is intended to provide a location for initialization and other functions to store useful but non-data information obtained from sensor interrogations

(such as the calibration date of an IMET sensor).

#### Timestamp formats

The Calliope data collection application always uses GMT timestamp values regardless of the time zone setting of the application computer. Also, the date used to generate the name of a data file is based on GMT. However, new files are not necessarily started at midnight GMT (file start times are controlled by an entry in the Calliope configuration file) and any date and time information included in data file headers is local time. If date or time values are included as logged values in data files, these will also be local values. The Calliope ".dat" data file headers indicate the local time zone setting when the file was started.

Individual items in Calliope ".dat" data files are time stamped with two different formats. The first timestamp value is in the format used by Microsoft Visual Basic: the number of days since December 31, 1899 (Dec. 31 is day 1, not day 0). Its primary purpose is to provide a continuously increasing date and time indicator for use in data graphing applications. The VB format facilitates this for some applications but converting the number to the normal human readable form can be painful. The second timestamp value (hh:mm:ss format) in combination with the date in the file header may eliminate the need for this conversion. If not, the following may be helpful:

00.00 is 00:00:00 on Dec. 30, 1899.  
00.50 is 12:00:00 (noon) on the same day.  
35390.58333 is 14:00:00 May 15, 1998.

□