

Woods Hole Oceanographic Institution

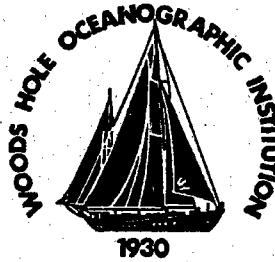

The JASON Remotely Operated Vehicle System

by

Robert D. Ballard

DOCUMENT
LIBRARY
Woods Hole Oceanographic
Institution

February 1993

Technical Report

Funding was provided by the Office of Naval Research
under Contract No. N00014-90-J-1912.

Approved for public release; distribution unlimited.

WHOI-93-34

The JASON Remotely Operated Vehicle System

by

Robert D. Ballard

Woods Hole Oceanographic Institution
Woods Hole, Massachusetts 02543

February 1993

Technical Report

Funding was provided by the Office of Naval Research
under Contract No. N00014-90-J-1912.

Reproduction in whole or in part is permitted for any purpose of the United States
overnment. This report should be cited as Woods Hole Oceanog. Inst. Tech. Rept.,
WHOI-93-34.

Approved for public release; distribution unlimited.

Approved for Distribution:



George V. Frisk, Chair
Department of Applied Ocean Physics
and Engineering



THE JASON REMOTELY OPERATED VEHICLE SYSTEM

by Dr. Robert D. Ballard

Director, Center for Marine Exploration
Woods Hole Oceanographic Institution

Abstract - The JASON remotely operated vehicle (ROV) system has been under development for the last decade. After a number of engineering test cruises, including the discovery of the R.M.S. *Titanic* and the German Battleship *Bismarck*, this ROV system is now being implemented in oceanographic investigations. This paper explains its development history and its unique ability to carry out a broad range of scientific research.

INTRODUCTION

Prior to 1972, large-scale geophysical and geological investigations resulted in the emergence of a new global theory called Plate Tectonics which explained the structure and dynamics of the earth (ref. 1). Central to this theory is the Mid-Ocean Ridge (MOR); a 72,000-km (40,000-mile) long mountain range which is the largest feature on the earth (ref. 2). The MOR is of particular interest to earth scientists because it is along its axis that newly formed crustal material is being emplaced volcanically and subsequently rifted and transported laterally by tectonic forces associated with diverging crustal plates (ref. 3). The geophysical measurement techniques used to define this global theory (i.e., gravity, heat flow, magnetics, seismology, and regional bathymetry) lacked the resolution necessary to delineate the detailed geological processes taking place along the rifted axis of the MOR. Based on these large-scale investigations, however, it became clear in the mid-1970's that a better understanding of ridge axis processes required the application of traditional land-based field mapping techniques using manned submersibles (ref. 4).

The first major scientific program to investigate the MOR using manned submersibles was Project FAMOUS (French-American Mid-Ocean Undersea Study) and took place between 1972 and 1974 (ref. 5). The goal of this project was to use diving vehicles to address a number of important geological questions within the rift valley on a segment of the MOR called the Mid-Atlantic Ridge (MAR). The three manned vehicles used during Project FAMOUS were the French bathyscaph ARCHIMEDE and the submersible CYANA as well as the American submersible ALVIN (ref. 6). In all, forty-two dives were made, which collected 1,360 kg (3,000 lbs.) of carefully selected rock samples and over 100,000 photographs along a network of precisely navigated geologic traverses across the rift valley and in the adjacent transform faults (ref. 6, 7). Project FAMOUS was a highly successful program that resulted in a number of important scientific articles and proved the value of manned submersible operations in the deep sea (ref. 7).

FAMOUS was followed in rapid succession by a series of equally important scientific expeditions using manned submersibles in the Cayman Trough (ref. 8), Galapagos Rift (ref. 9), and East Pacific Rise (EPR) (ref. 10) and on return trips to the MAR (ref. 11). These subsequent efforts resulted in major new discoveries in marine science including hydrothermal vent fields and their unique benthic communities in the Galapagos Rift (ref. 9) and polymetallic-sulfide deposits and "black smokers" on the EPR at 21° North (ref. 10).

This ten-year period from 1972 to 1981 was clearly the "decade of manned submersibles." But despite their many successes which continue to this day (ref. 12), manned submersibles have certain inherent technological characteristics that will always limit their ultimate efficiency. An average dive on ALVIN, for example, results in three to four hours of actual bottom time (ref. 13). Manned presence also requires the submersible to be large and expensive for reasons of life support and safety and only one or two scientists can participate on each dive. A typical vehicle weighing twenty tons requires a large, expensive ship and sophisticated handling system. Space is also limited inside the pressure sphere which greatly reduces the supporting documentation a scientist can carry as well as instrumentation for data acquisition and analysis.

An average manned submersible expedition lasts 21 to 28 days, during which any one scientist in the science party may make 3 to 5 dives (ref. 13). In other words, three weeks to a month at sea will result, on average, in nine to fifteen hours on the bottom for each participating member.

Finally, it is important to point out that "manned" operations are not truly manned. Unlike the astronauts on the moon, a scientist cannot get out of the submersible and walk around on the bottom of the ocean using their hands freely to pick up samples or place instruments. An aquanaut is trapped inside the pressurized capsule, must look through a small window to see the outside world, and must use a mechanical arm to pick up samples or do desired manipulation. In other words, "manned" submersible operations are by definition partially "unmanned" at best.

Despite all these inherent limitations, the scientific community made the decision in the late 1970's and throughout the 1980's that taking a scientist to the bottom of the ocean was worth the expense given the unique contribution they could make in-situ. This decision proved wise and resulted in some of the most important discoveries ever made by marine scientists seeking to better understand the geology, geophysics, biology, and chemistry of the deep sea (ref. 7, 9, 10, 14).

By the early 1980's, however, new technological innovations made it possible to develop a new exploration vehicle system that would be neither manned nor unmanned but a hybrid of the two (i.e., a "teleoperated" system). A teleoperated system permits an operator to control a vehicle from a distance by means of either a tether or acoustic link. A distributed control system permits the operator to change easily from full robotic control to manual control as well as a continuous series of combinations between these two extremes (ref. 15).

Teleoperated systems are particularly useful in the deep sea since, as previously stated, the operator cannot leave the pressure sphere and work under ambient conditions. The basic question is, "Where is the person located when they are looking out the viewport or operating the manipulators?". Since manipulator commands can move back and forth between the operator and the end effectors at the speed of light, being situated in the pressure sphere or on the surface makes little difference. The correct question to ask is "Is the view the operator has of the environment they are working in superior from inside a manned submersible or can that view be replicated by a teleoperated vehicle system controlled from the surface?". Compared to the early unmanned vehicles like Deep-Tow and ANGUS used during Project FAMOUS (ref. 16,17), manned presence was clearly superior. Neither of these vehicles could be dynamically controlled to the precision necessary to carry out manipulation and the bandwidth of the data link of Deep-Tow would permit only a slow-scan black-and-white image to be transmitted to the surface.

By the early 1980's, however, the development of fiber-optic cables, digital low-light level imaging systems, and advances in robotics and control (ref. 18) made the development of an advanced teleoperated unmanned vehicle system possible.

JASON DEVELOPMENT PROGRAM

(Basic Design Constraints)

In 1982, the Deep Submergence Laboratory (DSL) was formed at the Woods Hole Oceanographic Institution (WHOI) to develop the first deep water teleoperated exploration vehicle system for the scientific community.

Funding for this integrated exploration vehicle came from three primary sources: the Office of Naval Research (ONR), the Office of Naval Technology (ONT), and the Deep Submergence Systems Division of the Deputy Chief of Naval Operations for Submarine Warfare (Op-23). Additional support came from the National Science Foundation (NSF) to partially fund the development of the fiber-optic cable technology and a shipboard dynamic positioning system.

Figure 1 illustrates the basic elements of the JASON system which includes a dynamically controlled surface ship, shipboard control center, fiber-optic wire and winch system, the MEDEA relay vehicle, the remotely operated vehicle JASON, a satellite link, and shore-based control and data processing center(s).

The short-term goal of this development program was to place the human operators in an advanced control center aboard ship connected by a high-bandwidth fiber-optic tether to the vehicles below. The long-term objective of the program, however, is to permit a larger network of scientists to have full participation in the at-sea operations from shore-based satellite downlink sites, including full control of the vehicles from shore.

Figure 1: Schematic of MEDEA/JASON remotely operated vehicle system deployed from dynamically positioned surface support ship. Real-time signals transmitted up the fiber-optic cable are relayed to shore-based station by way of a satellite link.

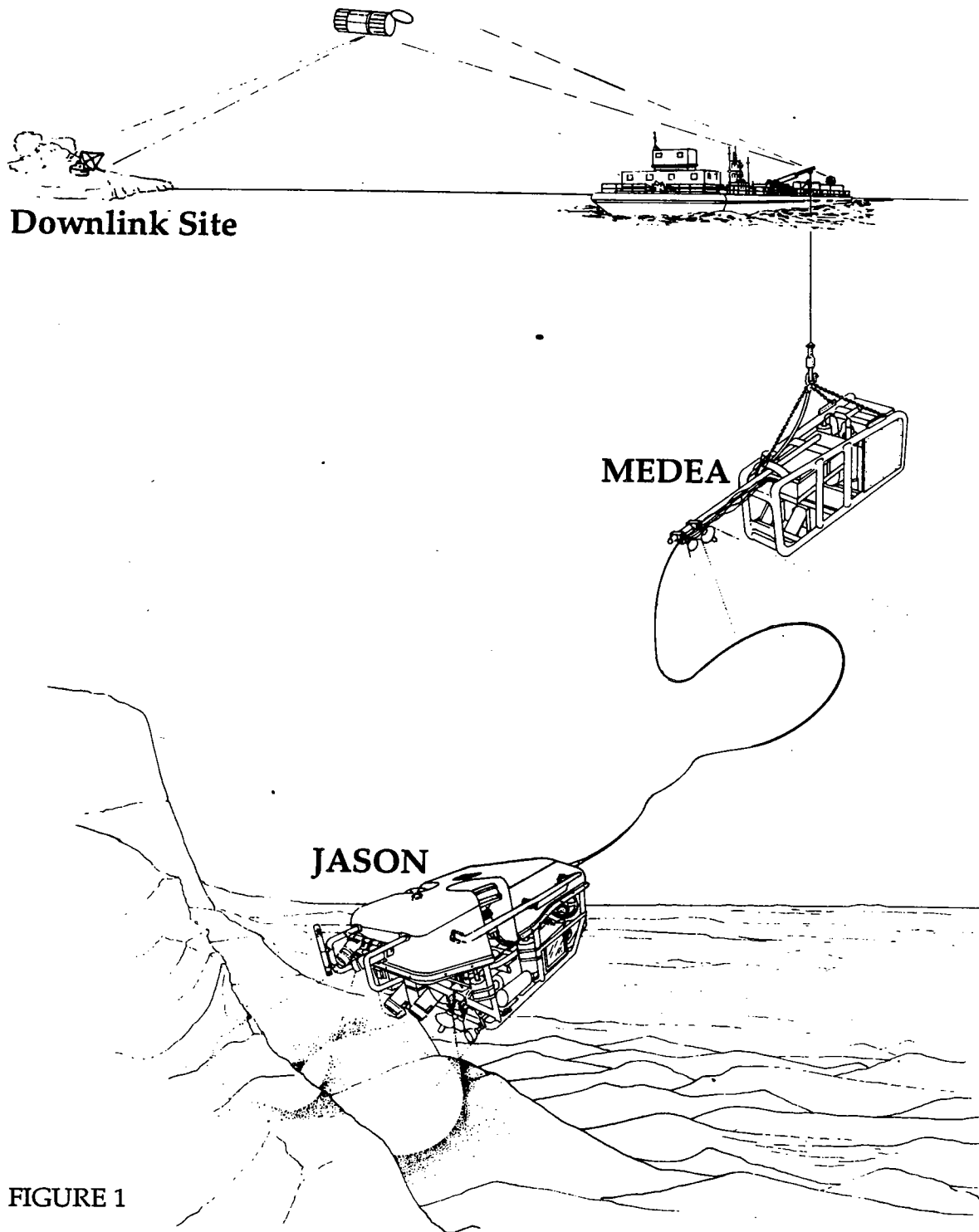

FIGURE 1

Although a teleoperated system like the JASON vehicle can perform a wide range of missions in the deep sea, the primary purpose for its development was an outgrowth of the earlier ALVIN geological mapping programs carried out on the Mid-Ocean Ridge.

Exploration and mapping in the MOR requires an overlapping family of vehicles and associated sensors that allow an investigator to look at a broad range of features varying in size from entire segments of the mountain range to individual lava flow forms. Figure 2 illustrates the spectrum of sensors used to span such a range of scales. It clearly demonstrates the classic trade-off in range versus resolution. Acoustic sensors like multi-narrow beam sonar systems and side-scan sonars are used to obtain a large-area view of the underwater terrain while visual systems like ANGUS and human observers inside a submersible can document small-scale features.

Historically, a gap existed between acoustic and visual imaging systems. Scientists found it difficult at times to cross-correlate acoustic and visual data sets. During Project FAMOUS, for example, scientists diving in ALVIN found the detailed multi-narrow beam sonar maps they carried with them to be a more generalized representation of the seafloor morphology than they initially expected. Depressions were found to be much deeper and adjacent volcanic peaks separated by narrow ravines were, at times, contoured as a single volcanic edifice, greatly complicating the mapping effort.

Given this traditional "gap" (shaded area in figure 2) in the mapping systems available to geologists at that time, the design objective of the JASON development effort as well as of the towed vehicles ARGO and the AMS-120 (ref. 19) was to bridge this gap with the combined use of high-frequency acoustic sensors and low-light level large-area visual sensors as well as by high-resolution visual-imaging devices and remote manipulation.

In short, the goal of the program was to make it easy for an investigator to move from one scale of geologic features to the next independent of whether one data set was collected with an acoustical sensor and the other with a visual imaging sensor. This approach to multisensor terrain modelling heavily influenced the development program (ref. 20, 21, 22).

In such a model, underwater features are viewed as a composite of three-dimensional spatial decompositions of cubical volume elements called voxels. A voxel is represented by a stochastic multisensor feature vector that characterizes the physical properties within each volume. Such modelling is an evolving process. As a new sensor is used in a previously mapped area, its data are merged with the previous data set using what has been termed a stochastic backprojection. Using this approach, information about the physical properties of the terrain occupying a particular voxel can be combined with earlier data regardless of whether these different sets of information

**DEEP SUBMERGENCE LABORATORY
COMPARISON OF UNDERWATER REMOTE-SENSING SYSTEMS**

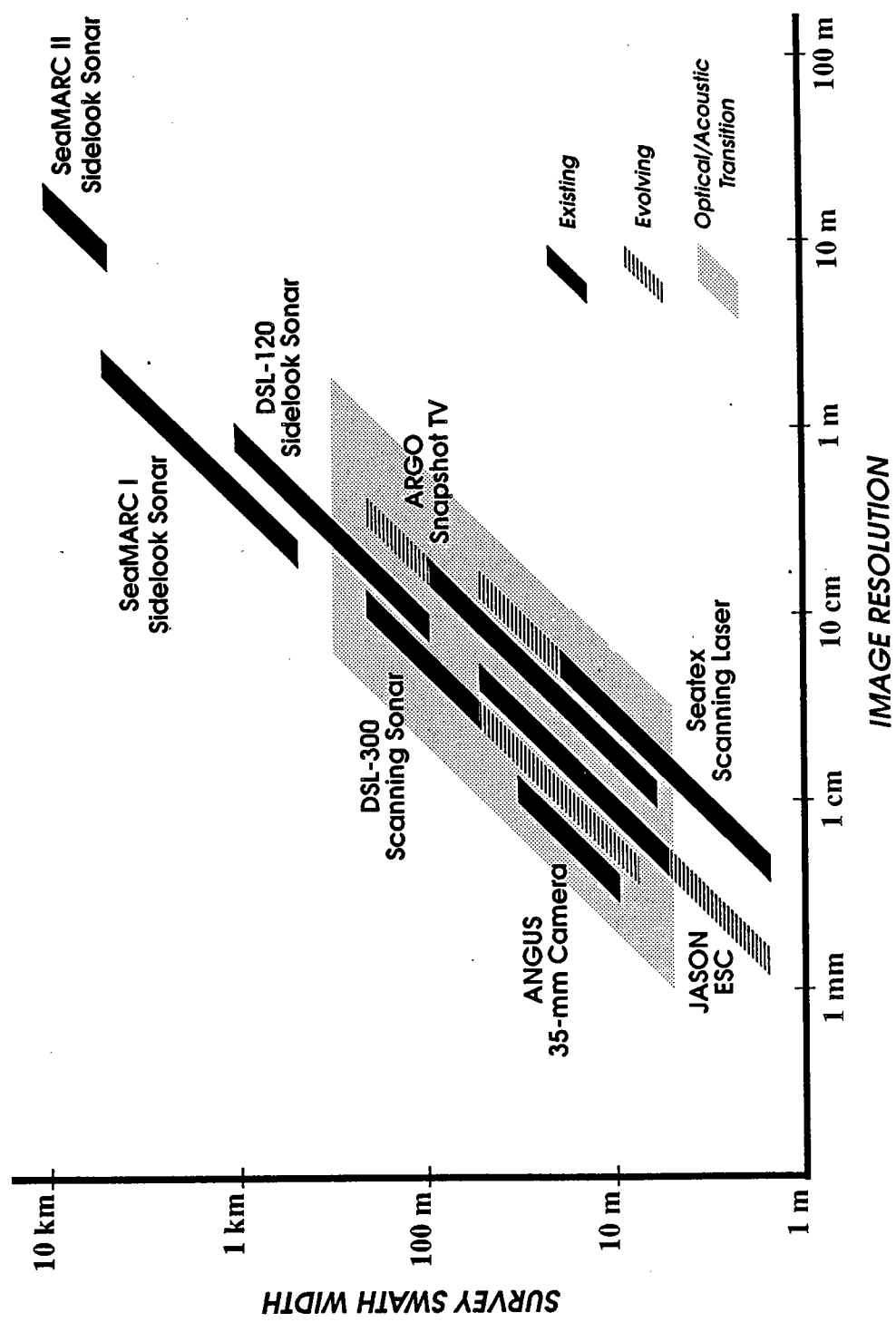

Figure 2: Comparison of various underwater mapping systems based upon their survey swath width versus their image resolution. The ARGO/JASON development program concentrated on shaded area where transition occurs between optical and acoustic sensors.

FIGURE 2

were obtained using a digital acoustical or visual sensor. One data set is no longer compared to a previous data set; it is combined to provide a better representation of the terrain under investigation.

But having the theoretical potential to develop multisensor modelling of various deep underwater terrains like the MOR is not the same as having the operational capability to produce high-quality data. To do that requires the development of vehicle system(s) equipped with high-resolution digital sensors operated at a level of precision and control not possible at the time the JASON development began in 1982. It was recognized early in the JASON development effort that hydrodynamic nonlinearities would dominate efforts to control the vehicle precisely enough to permit multisensor modelling and sophisticated manipulation (ref. 15).

At a number of levels, navigation is central to the precise vehicle control needed to accomplish the design goals of the JASON system. The first level of control needed was the development of a dynamic positioning system.

A number of dynamic positioning systems existed in the early 1980's, primarily within the offshore oil and gas industry, but their principal goal was to dynamically position a ship, not vehicles suspended at great depth beneath them.

To accomplish this task required a higher level of control dominated by the nonlinear behavior of the ship in varying wind and sea conditions, the behavior of the suspended fiber-optic cable connecting the teleoperated control center on the surface to the relay vehicle 7,000 meters (20,000 feet) below, and the hydrodynamics of the vehicle itself (ref. 23, 24, 25, 26).

To develop the software necessary to provide the desired level of dynamic control, an experiment was carried out in the Navy's AUTECH range, where the three-dimensional behavior of the cable under a variety of towed and stationary maneuvers could be carefully documented. A 0.68-inch tow cable similar to the JASON fiber-optic cable then under design was instrumented for high frequency motions, primarily those caused by vortex-induced vibrations, using self recording accelerometers. The highly accurate tracking system in the AUTECH range itself was used to measure low-frequency motions (ref. 27, 28, 29, 30). This experiment proved highly successful, confirmed the previous cable and vehicle dynamic modelling (ref. 23), and led to new insight into vortex-induced vibration for a deep-water ROV system.

Based upon these test results, an initial dynamic positioning test was carried out on the R/V KNORR in September of 1987. The tests were conducted in 2,700 meters of water under moderate sea conditions (sea state 2.5; winds of 8-15 knots) without a vehicle or cable. The station-keeping performance of the ship was excellent with a 25 meter root-mean-square (RMS) using an acoustic long-baseline system and 12 meters using a global satellite tracking system.

A final combined test of the ship-cable-vehicle system was conducted in August of 1988 with the R/V KNORR. Tests were carried out in water depths ranging from 700 to 3,000 meters using what would eventually become the MEDEA relay vehicle. The tests were successful and provided excellent results and further refinement to the modelling dynamics.

The next level of navigation and control dealt with the JASON vehicle itself. The dynamic positioning of the relay vehicle (MEDEA) within its 15-meter watch circle and the use of a neutrally buoyant tether connecting it to JASON, decoupled the surface motion propagated down the cable to the relay vehicle and did not transmit those motions to JASON. Therefore, JASON was free of surface action and capable of precise control.

Existing bottom-mounted acoustic-transponder tracking systems, however, lacked the precision necessary to control JASON for the highest level of multi-sensor modelling. To meet this requirement, two high-frequency navigation systems were developed. The first was called SHARPS and was developed with two initial applications in mind. Since the development of JASON would take over 5 years and involve a great deal of testing in a small test tank, a precision navigation system was needed which could operate in a small tank having numerous acoustic multipaths.

SHARPS filled this need. It is a 300-kHz broadband hardwired transponder navigation system that can operate inside a metal test tank. Angular resolution is about 1 degree, range resolution is better than 2 cm, and the maximum update rate is 10 samples/second. A three-transponder array can cover an area approximately 100 meters on a side. Since MEDEA is hardwired to JASON, the SHARPS system can also be used to precisely determine relative relationships between both vehicles while working in the deep sea.

The second system developed is called EXACT and has characteristics similar to the SHARPS system, only it is wireless and has a maximum update rate of 5 samples/second. This system is ideal for deep-water ROV operations where a hardwired system is impractical. The bottom transponder network is self-calibrating and can be used to navigate both MEDEA and JASON relative to the bottom or relative to a long-baseline transponder network fixed within geographical coordinates. Navigation relative to the bottom terrain using this system is better than 2 cm. With the EXACT system the desired navigational precision needed to control JASON for multisensor modelling can be achieved.

Good navigation, however, must be complemented by a good control design. In addition to a precise knowledge of the vehicle's x, y, and z positions, multi-sensor modelling requires a great deal of information about the vehicle's behavior, and special care must be given to its basic design. As a result, JASON's control sensors include instruments that measure acceleration and attitude. The vehicle's heading is determined by a flux-gate compass and a directional gyro. Acceleration is measured in

three axes using servo accelerometers, and pitch and roll is measured using a two-axis inclinometer. Absolute depth and the vehicle's altitude off the bottom are also recorded.

(Early Operational Experience - JASON Design Phase-1982 to 1989)

Prior to the construction of the JASON vehicle, a variety of existing ROVs were tested in the Lab's tank and off the dock under dynamic closed-loop control using the SHARPS tracking system.

The dynamics of a vehicle in the deep sea are nonlinear, and care given during the design phase of a vehicle can greatly enhance its performance in the field. During these early tests, particular attention was given to eliminate open-loop coupling between translations and rotations by placement of the vehicle's thrusters relative to the vehicle's centers of mass and drag. An analysis was carried out of JASON's ducted thrusters, which are difficult actuators to control. This static and dynamic analysis of the thrusters, however, reduced the uncertainties associated with their thrust characteristics and improved their low-level control over the thrusters broad dynamic range (ref. 31).

During the JASON vehicle design a series of tests was conducted in the tank facility to determine how well an ROV could be controlled. These tests included automated track following and an interactive mode called "joystick auto." In the first case, the vehicle was commanded to follow prearranged tracklines. This could be a typical request from a scientist who wanted to make a detailed acoustic or visual survey of a small area like a hydrothermal vent field. Previous users of manned submersibles and other ROV systems have found that both classes of vehicles are very poor side-scan sonar platforms because they lack the ability to control their heading. The ROV used in the test, however, could control its heading to less than one degree and run automated tracks with RMS off-track errors of 0.36 meters (ref. 32).

Figure 3 illustrates the second trials conducted using an interactive automatic mode. During "joystick auto" the vehicle is in closed-loop control in all axes but the pilot can provide it with a continuous series of horizontal velocity commands that permit continuous involvement by the pilot during the survey runs but at a greatly reduced supervisory level of control. This greatly decreases the pilot's workload which is mandatory for JASON dive profiles that will last many days instead of a typical submersible dive lasting three hours on the bottom.

The first major vehicle development by DSL engineers was the ARGO search system (ref. 19). Since a new fiber-optic cable was still under design, the first vehicle effort was built around the then standard 0.68-inch coaxial cable used by the academic community.

Figure 3: Test tank results of ROV under closed-loop control using SHARPS tracking system. Dashed lines are desired tracklines while the solid line is the actual track the vehicle followed.

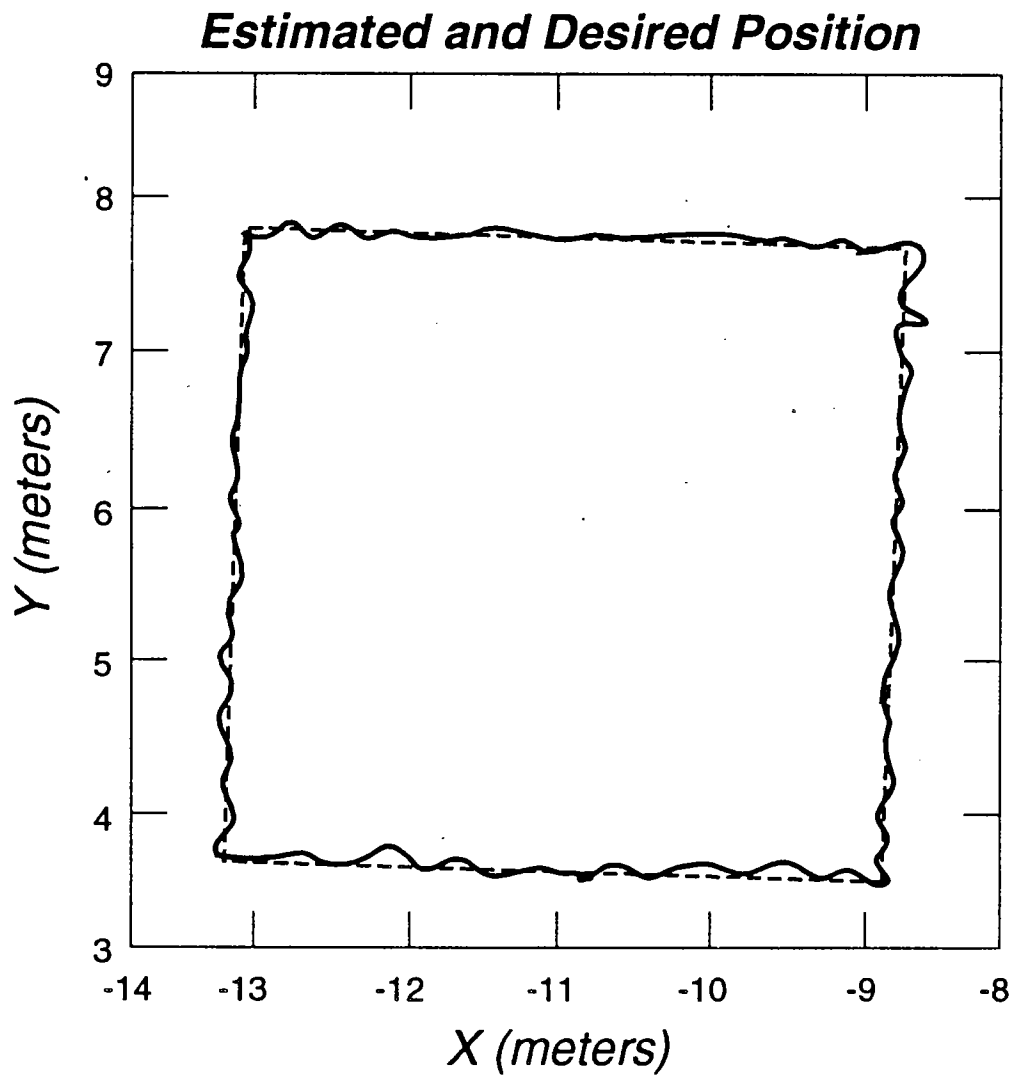

FIGURE 3

ARGO was designed to operate to 7-km (20,000-feet), and included a suite of both acoustic and optical imaging sensors. The acoustic sensors are a standard 100-kHz side-scan sonar and a down-looking altimeter. ARGO, however, is designed to maintain constant visual contact with the bottom. As a result, major emphasis was placed on its visual imaging capability. During its initial design phase, a number of test cruises were conducted with the submersible ALVIN on which was mounted a low-light-level Silicon Intensified Target (SIT) black-and-white video camera. These experiments helped in the design of ARGO's lighting system, which permits useful imagery to an altitude of 15 meters.

Three SIT cameras are mounted on ARGO: a forward-looking wide-angle camera, a down-looking, wide-angle camera, and a down-looking zoom camera. Incandescent running lights mounted approximately 4 meters aft of the cameras provide illumination for real-time video imaging while strobe lights are used in conjunction with color cameras. Color photography, however, can only be accomplished when the vehicle is flown at a lower altitude of approximately 5-7 meters. Later, a cryogenically cooled high-resolution digital electronic still camera (ESC) was developed, that made it possible to obtain high quality images while flying the vehicle at its normal 15-meter operational altitude (ref. 33).

ARGO's first test cruise was conducted in the summer of 1984 for the Navy. Its second cruise in the summer of 1985 resulted in the successful location of the British luxury liner R.M.S. TITANIC (ref. 34, 35).

Since 1985, ARGO has been involved in a number of scientific and military programs including the location of the sunken German Battleship BISMARCK in the summer of 1989 (ref. 36) and two major investigations of the volcanic and tectonic processes occurring along the axis of the East Pacific Rise (ref. 37, 38).

In 1986, following the discovery of the TITANIC by the ARGO search vehicle, the first fiber-optic cable was under design but not yet built, and testing of the dynamic positioning system was still underway.

For these reasons, a decision was made to move forward with the development of a JASON prototype vehicle called JASON, Jr., or JJ, which could be deployed from the submersible ALVIN. This provided additional experience in ROV systems including the development of tether management and vehicle-control systems. JJ's first field deployment proved successful resulting in a detailed inspection of the TITANIC (ref. 39).

In the summer of 1988, a cruise was conducted in the Mediterranean to test the new dynamic positioning system on the R/V KNORR as well as the system's first fiber-optic cable. Both tests proved successful and lead to the final JASON design followed by its construction.

Critical to JASON's ability to collect high bandwidth data is the fiber-optic telemetry system connecting JASON to the team of scientists and engineers working in shipboard control center.

As figure 1 illustrates, two cables are needed to perform this function. The first is a 7-km long 17.3-mm (0.68-inch) diameter steel armored fiber-optic cable, which connects the relay vehicle MEDEA to the surface. The cable contains three copper conductors and three single-mode optical fibers. It also has two contrahelical torque-balanced outer layers of high strength steel that provide a breaking strength corresponding to an 18,000-kg load (40,000 lbs.).

The second cable connects MEDEA to JASON. It is neutrally buoyant, 15 mm (0.60 inch) in diameter, and approximately 100 meters long. Like the tow cable, it also has three copper conductors and three single-mode optical fibers, but uses Spectra fibers instead of steel armor to provide strength at a reduced size and weight. This cable has a working strength of 1,300 kg (3,000 lbs) and a breaking strength of 5,400 kg (12,000 lbs).

MEDEA and JASON (figure 1) were both designed to take full advantage of the large bandwidth available on the three optical fibers. Four continuous video channels are available with up to three being used by JASON or up to two by MEDEA. Each vehicle can support eight different video sources which can be switched from the surface to the available channels. These channels are capable of transmitting near-broadcast quality video signals. Each vehicle also has two audio channels with a bandwidth of 15 kHz.

Both vehicles have a total of ten full-duplex high-speed serial lines, and each is capable of operating at a maximum synchronous rate of 10 Mbit/sec. On both vehicles, one of these full-duplex channels is split into ten low-speed serial channels running at a maximum rate of 9.6 Kbaud. One of the full-duplex high speed channels is used to implement a real-time oriented local area network that provides high level access between all computers in the vehicles and on the surface. The network is based upon an industry standard physical layer (pronet 10) and standard software protocols (TCP/IP). The network provides for improved performance that benefits advanced control of the vehicles and the manipulator. Through a link to an Ethernet on the ship, the network provides science users with high level, low latency access to many vehicle sensors for both data logging and real-time display. In addition to the network, several of the high speed serial lines are also available to the scientist.

PRESENT JASON VEHICLE AND RECENT OPERATIONAL EXPERIENCE

(Sub-Sea Systems)

The initial JASON vehicle design envisioned a relay vehicle that could carry JASON and its tether-management system during the descent and ascent phase of each dive. Once the combined system had reached its operational depth, JASON would drive out of the relay vehicle and carry out its assigned mission until returning to the vehicle for the trip back to the surface (ref. 19).

Since the original ARGO vehicle was not built for this function and it was designed to operate on a coaxial cable, a second and larger ARGO was built in 1989. It was called HUGO which stood for a Huge ARGO system.

Unfortunately, when this combined system was launched on its first deployment in May of 1989, it proved too light, and severe snap loading during a storm led to the failure of the fiber-optic cable termination and the loss of HUGO and JASON in 3,000 feet of water (ref. 40).

Fortunately, the combined system was recovered using a test sled and the ship's dynamic positioning. Given this experience, however, it was felt a two-body system should be deployed in the future to eliminate such snap loading and greatly reduce the size of the launch and recovery system.

This decision led to the development of the MEDEA relay vehicle as illustrated in figures 1 and 4. MEDEA weighs approximately 500 kg and its main steel tubular frame is about 1.8 meters in length. Its various subsystems are shown in figure 4, most important of which are its black-and-white or color video cameras, navigational beacons, lights, and the junction box where the power lines and optical fibers in the armored cable coming down from the surface are connected to similar copper wires and fibers in the neutrally buoyant cable leading to JASON. It is the MEDEA vehicle which is dynamically positioned by the surface ship and maintains a watch circle of 15-20 meters above JASON. MEDEA serves two primary roles: the first is to decouple surface motions from JASON and the second is to provide the scientists and engineers in the control van with a high-altitude view of JASON. Manned and unmanned operations carried out close to the bottom are easily blinded by small topographic features. It is easy not to see the big picture. MEDEA, which is generally 15 to 30 meters above the bottom can oversee JASON in its work setting and observe a much larger area.

Figure 5 is the most recent illustration of the JASON vehicle. Although its basic subsystems change little from cruise to cruise, its array of sensors continues to evolve and change according to the mission. These major sensor systems are described in greater detail in the following pages.

Towed Camera Sled MEDEA

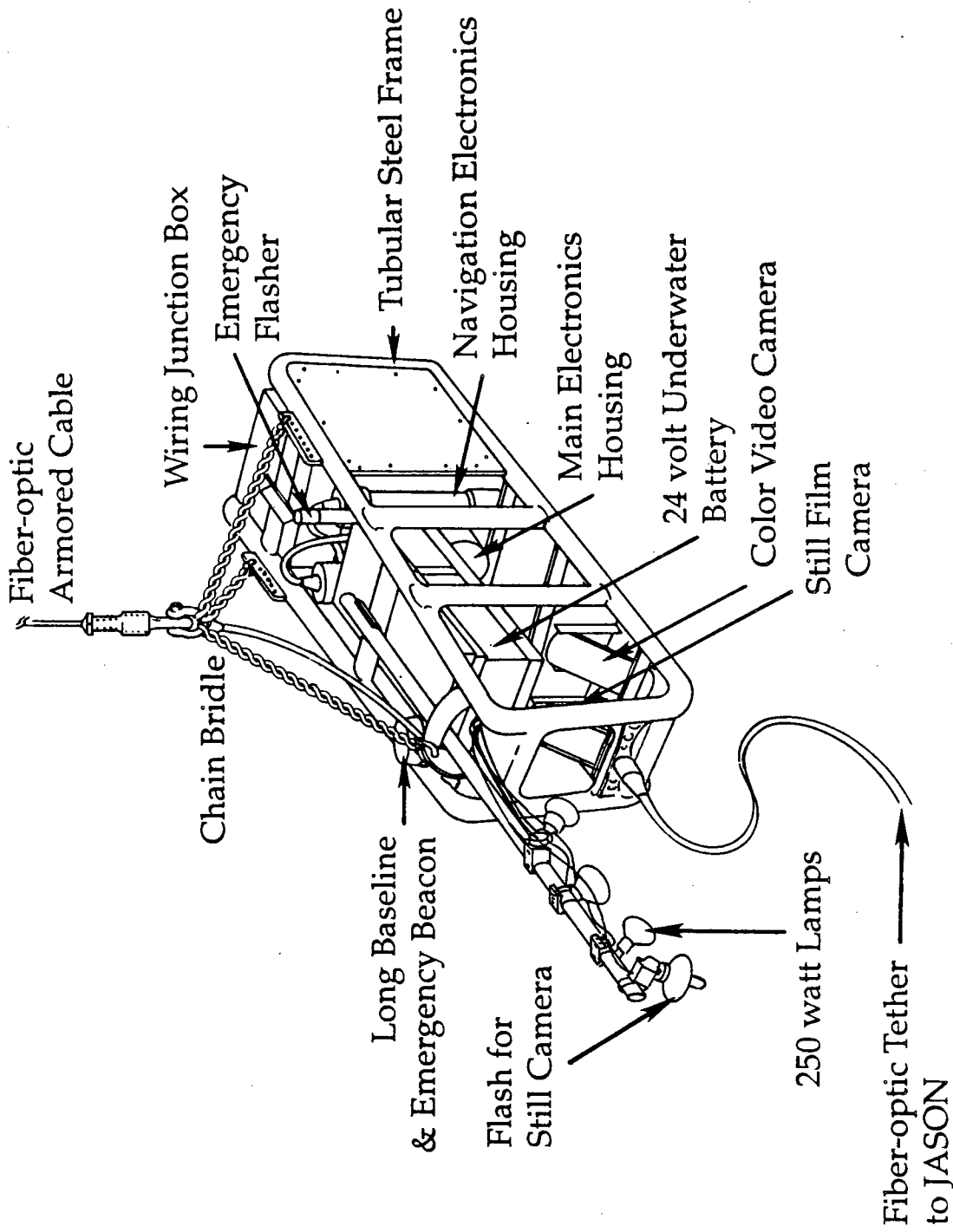

Figure 4: MEDEA vehicle used in conjunction with the JASON ROV. MEDEA acts as a relay vehicle between JASON and surface ship. It dampens out surface motions and acts as an "eye in the sky" observing JASON's movements in the terrain below.

FIGURE 4

Remotely Operated Vehicle (ROV) JASON

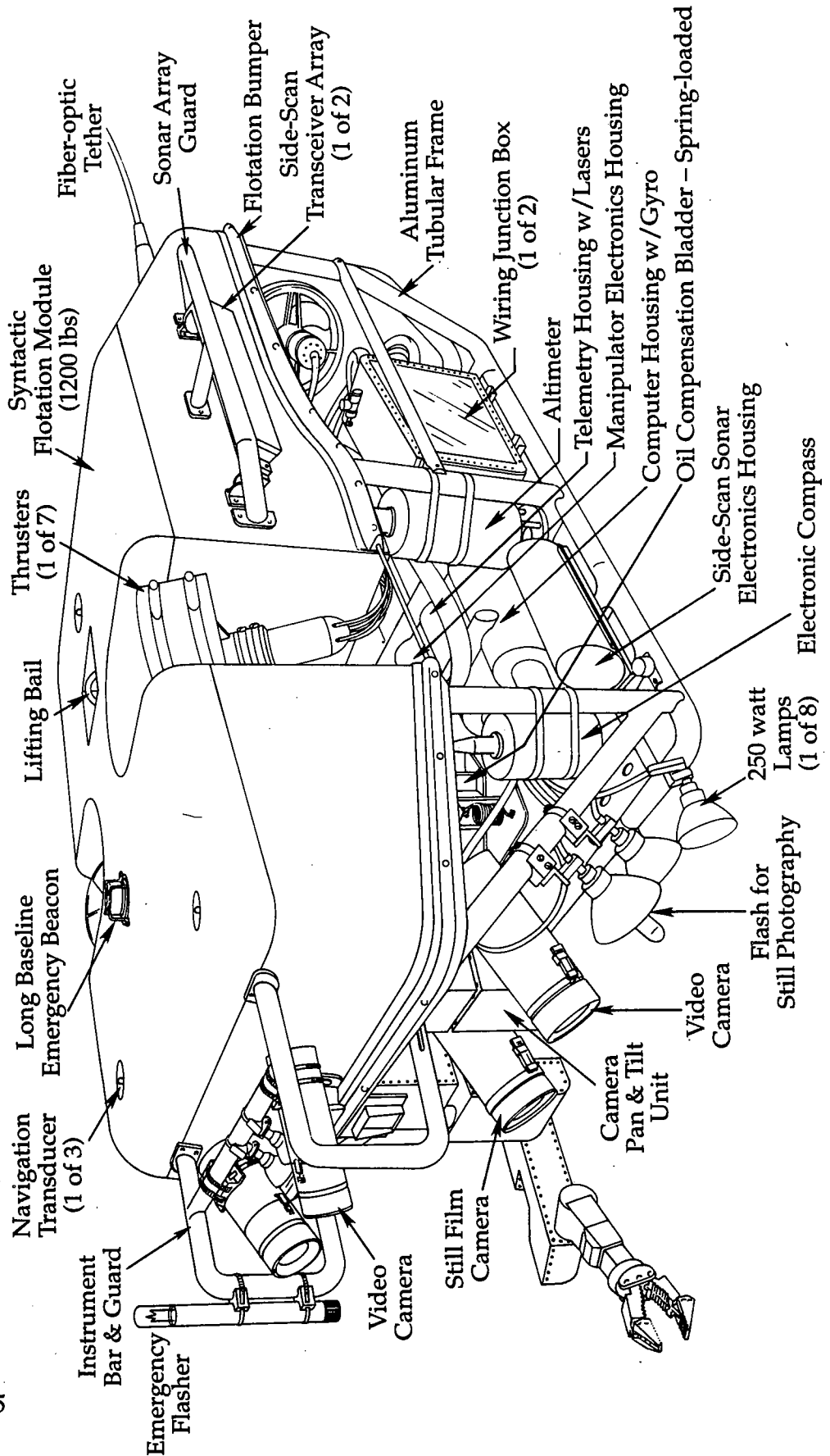

FIGURE 5

Figure 5: JASON ROV system and its various components. The actual configuration of these components varies as a function of the ROV's particular mission requirements.

(Top-Side System)

Figure 6 illustrates a standard seaboard layout for the JASON vehicle system. It consists of: (1) workshop and supply vans, (2) in-water vehicles (JASON/MEDEA or AMS-120/depressor weight), (3) overboard handling system (crane, A-frame, and line tuggers), (4) fiber-optic winch system (traction unit, level winder, take-up drum, slip-ring assembly, and power supply), (5) control van, (6) data processing center, and (7) remote displays.

Once the vehicles are in the water, total control of all systems (winch, ship, and MEDEA/JASON or AMS-120) transfers to the control van complex (figure 6). This complex normally holds eleven to twelve people; five to six operational personnel and six from the science party.

The science party consists of a watch leader, data logger, and room for other observers if desired. The Chief Scientist has three watch leaders which implement the operational/science plan. The data logger works with the JASON engineer to keep track of all the images being recorded on three beta recorders. Normally that includes the electronic still images (which are also stored on disc), the 1-chip and 3-chip color video cameras on JASON but can include a variety of other images. The data logger provides a quick description of each electronic still image collected every 20 seconds and the JASON engineer can perform a limited amount of real-time image processing and enhancement on those images if requested. The data logger also maintains an electronic log book for the watch leader (i.e., loss of navigation, problems with JASON, what the JASON engineers has turned on and off aboard JASON, etc.). Other observers take their direction from the watch leader and commonly record their own observations.

The operational team consists of a navigator, JASON pilot, and manipulator operator positioned in front of the main display unit (figure 7); sonar operator and MEDEA flyer (figure 8); and JASON engineer (figure 9).

The navigator works with the ship's watch, the JASON pilot, and watch leader to coordinate the overall operation. When the dynamic positioning (DP) system is engaged, control of the ship is transferred from the bridge to the navigator and a constant line of communications is maintained should the bridge need to suddenly assume control of the ship due to loss of DP or for ship safety. The navigator takes his orders from the watch leader and informs the pilot of his actions.

Figure 10 displays the basic navigational information about all three primary systems (ship, MEDEA or fish, and JASON or ROV). The last five positions for each, recorded at 20 second intervals, are shown. These lists include Greenwich Mean Time (GMT), raw travel times in seconds from three transponders (A, B, and C) for the ship, MEDEA, and JASON (Ship, Fish, ROV); their x, y, and z positions in meters for all three (E, N, and Z); speed over the ground (SOG) for ship and MEDEA; ship's gyro; what transponder baseline is being used (i.e., AB); what side of the baseline the vehicle is on

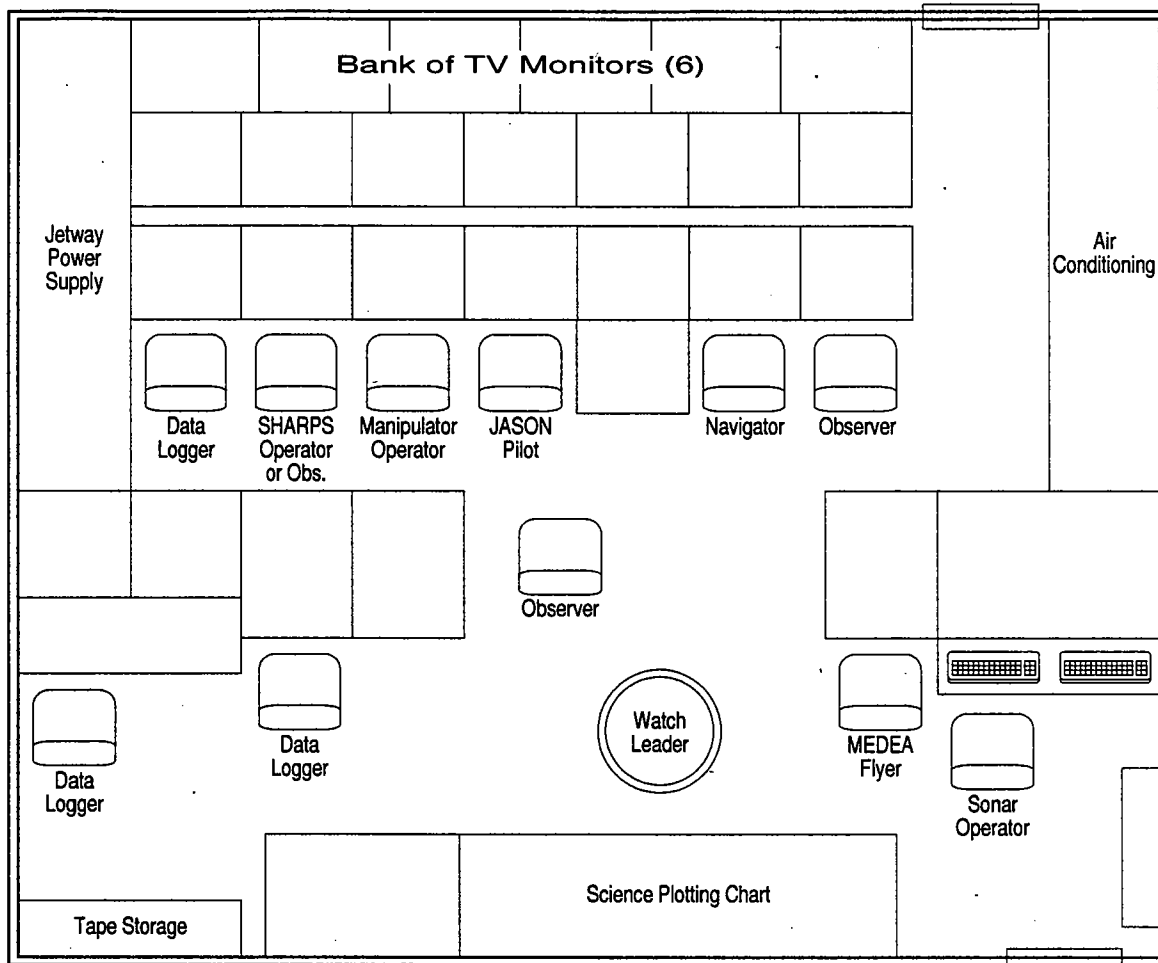

Control Van Layout

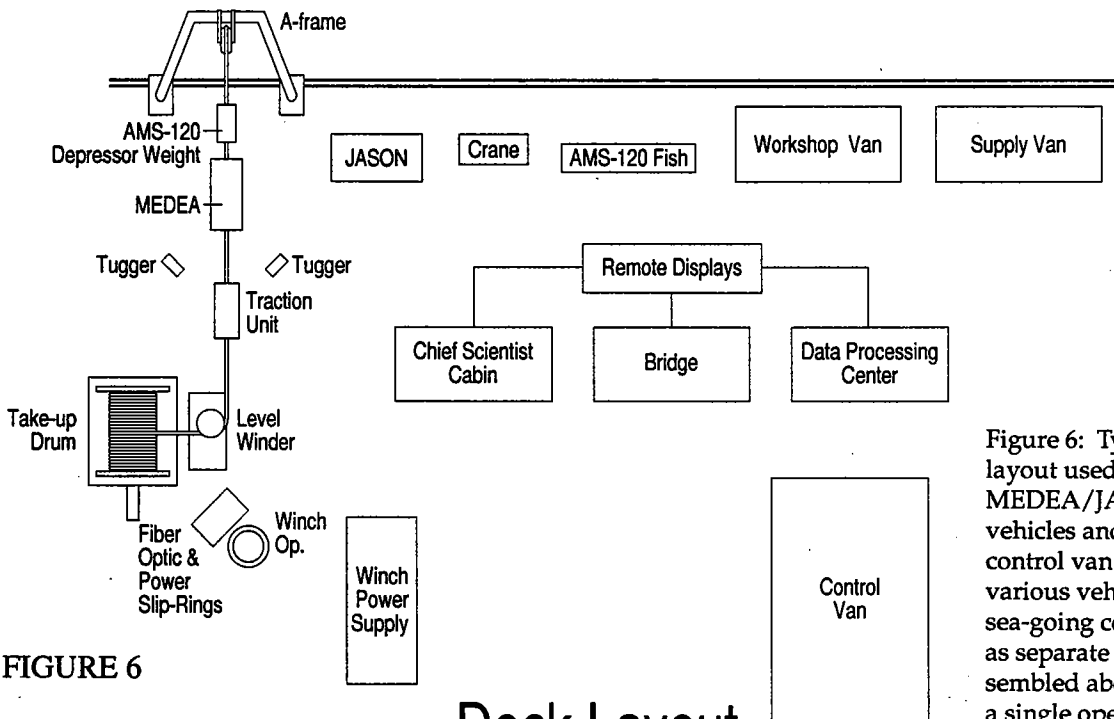

FIGURE 6

Deck Layout

Figure 6: Typical shipboard layout used to support MEDEA/JASON/AMS-120 vehicles and layout of surface control van used to operate various vehicle systems. Two sea-going containers shipped as separate units are assembled aboard ship to create a single operations center.

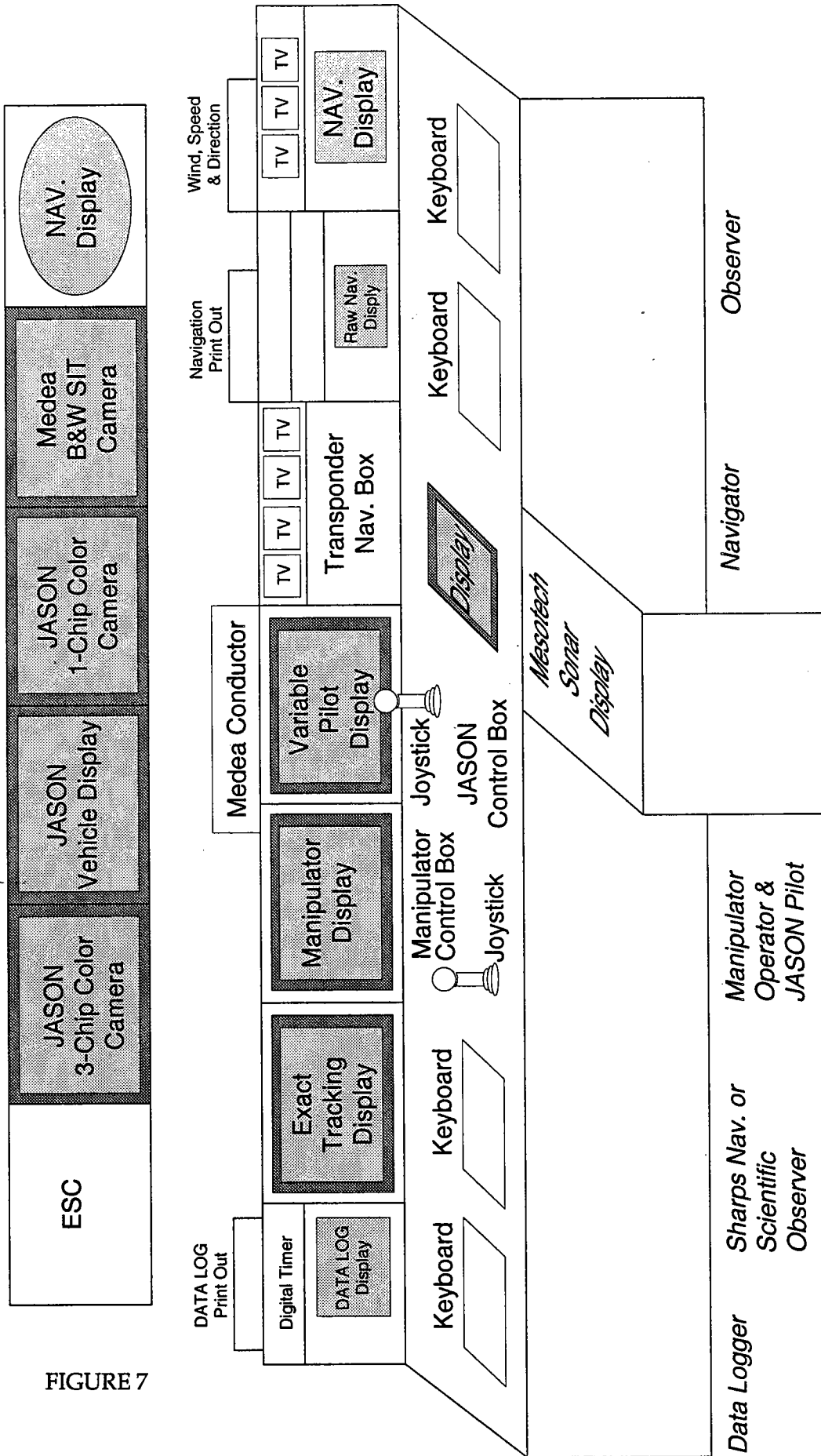

FIGURE 7

Figure 7: Main control console at which sits the navigator, data logger, JASON pilot, and other engineers and scientists which varies during the course of any given mission.

FIGURE 8

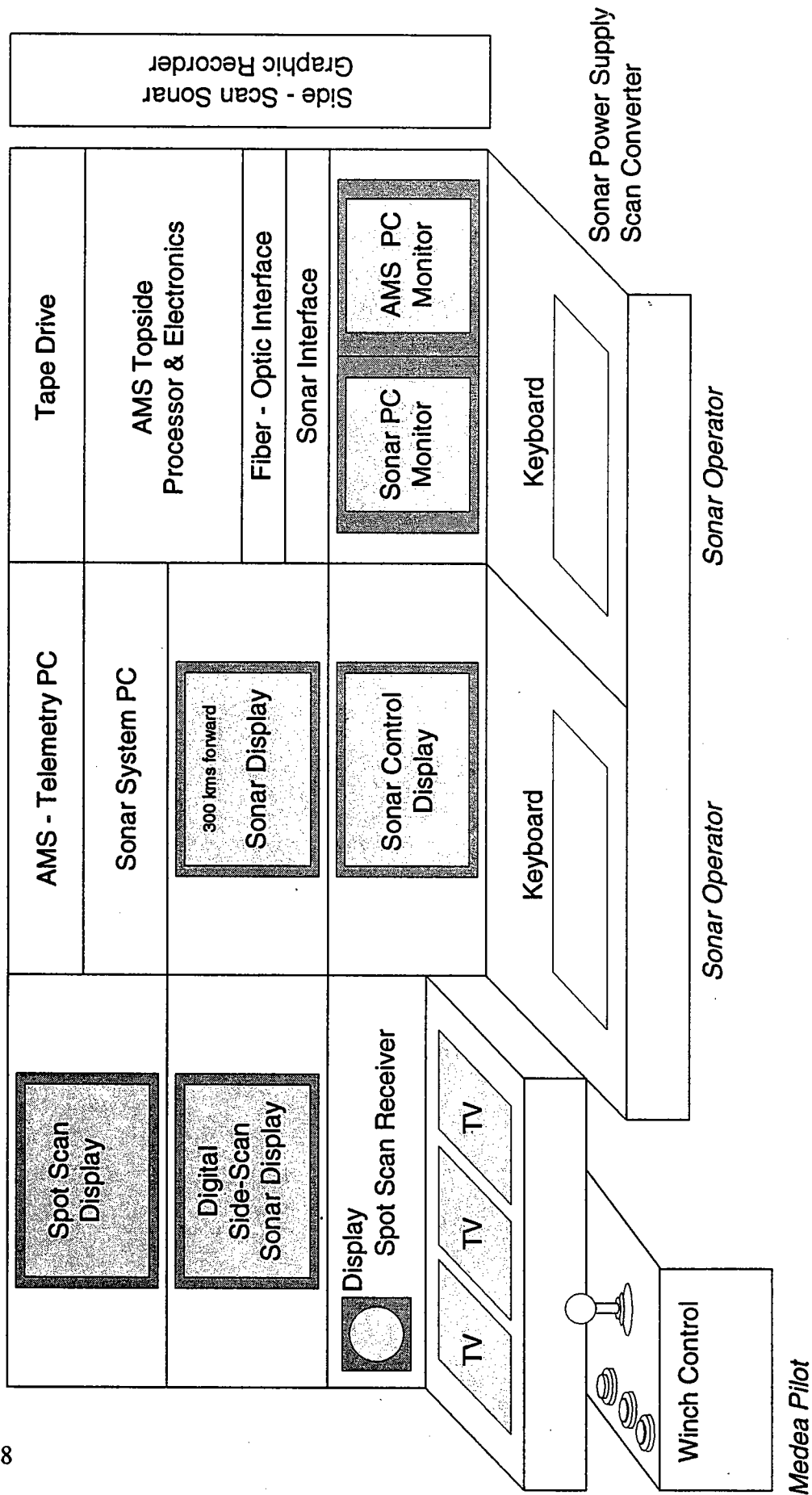
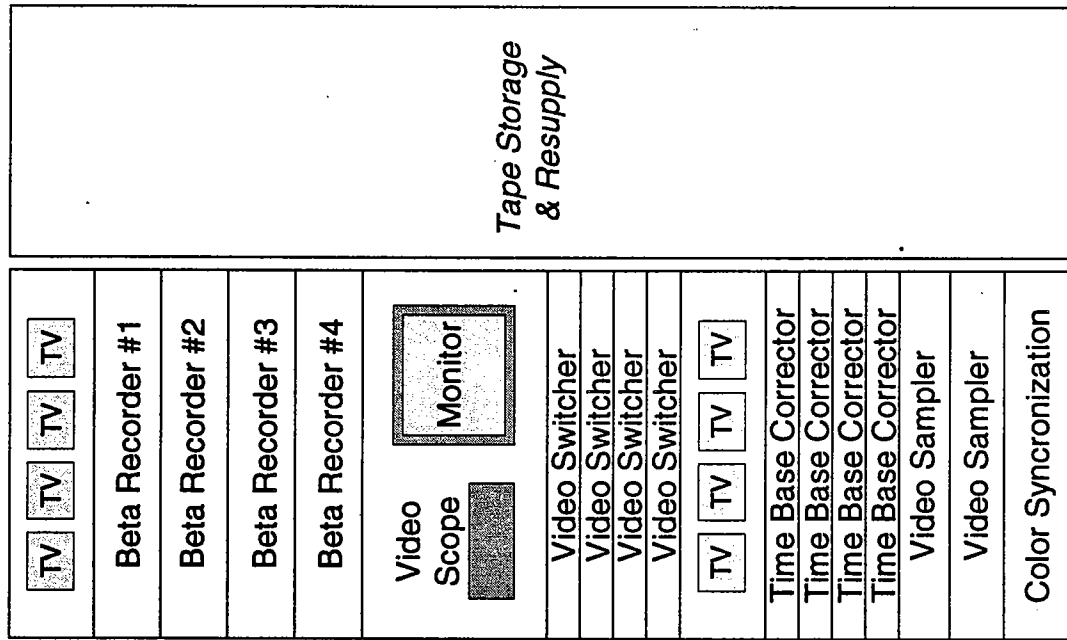

Figure 8: Console used to support the MEDEA pilot and sonar operators.

FIGURE 9



JASON Engineer

Figure 9: Console used by JASON engineer.

(i.e., CC or CW); the scant range in seconds from ship to MEDEA (S-Fish) and from ship to JASON (Ship-ROV); and heading of JASON (HDG). Also shown are the minimum ranges in seconds that have been applied to each travel time from each of the three transponders for the ship, MEDEA, and JASON as well as their slant ranges. This helps to eliminate earlier acoustic multipaths. Velocity filters can also be applied to filter out bad position fixes. Deep or shallow tells the navigator whether JASON or MEDEA are operating shallower or deeper than the height of the transponder net. At the very bottom of the display, data logging information is given that includes what ancillary units (i.e., plotter, disc recorder, printer, loran, or global positioning system) are on or off.

Figure 11 is the primary navigational monitor displayed throughout the control van and other locations on board ship. Its basic component is an x-y graphics display in long-baseline coordinates (east and north in meters from an arbitrary origin which places all work in positive coordinates). On this display is shown a wide variety of information that includes: (1) the desired tracklines for the survey being conducted, (2) obstacles on the bottom (1, 2, etc.) which may be transponders, bottom instruments, etc., (3) location of an elevator carrying instruments to the bottom or samples to the surface (closed diamond), (4) the locations of JASON and MEDEA (open diamond and cross), and (5) information about the ship. Ship information has three separate indicators. The inverted "t" represents the next desired goal for the ship's DP position, the open ellipse the present desired position of the ship, and "X" the present position of the ship based upon either GPS or long-baseline (LBL) navigation. In the upper right-hand corner is a compass display of the ship's gyro heading and the direction the ship is traveling based upon the previous two fixes. Beneath (but not shown in figure 11) is: (1) the x and y position for the present (Goal) desired ship location, (2) the present x and y of the ship either based upon LBL or GPS navigation, (3) ship's speed, and (4) the x, y and z positions of JASON, MEDEA, and the elevator. In the lower left-hand corner is range and bearing information for the ship to its present desired location and JASON or MEDEA's range and bearing to a target on the bottom. Additional information is also displayed regarding the time that has elapsed since the last fix was given to the DP system and information about the DP system's ability to hold position as well as DISC logging information.

With all of this information at the navigator's disposition, he can maneuver the ship so that MEDEA is placed in a location that permits JASON to either follow a desired survey trackline or work at a stationary point.

Seated next to the navigator is the JASON pilot. He can observe the six main monitors controlled by the JASON engineer as well as select various displays on the monitors in front of him. Normally that includes: (1) a MESOTECH sonar display (in five separate incremental scales ranging from 10 to 200 meters) of the bottom beneath JASON and (2) the most important video view from JASON at any given moment (i.e., rear, high-resolution down, or pan and tilt camera). Situated at his console is the JASON control box (figure 12). On the left is a grip control for thrusting JASON up or down. Next to it is a push button for taking a color still image. To its right is the pan

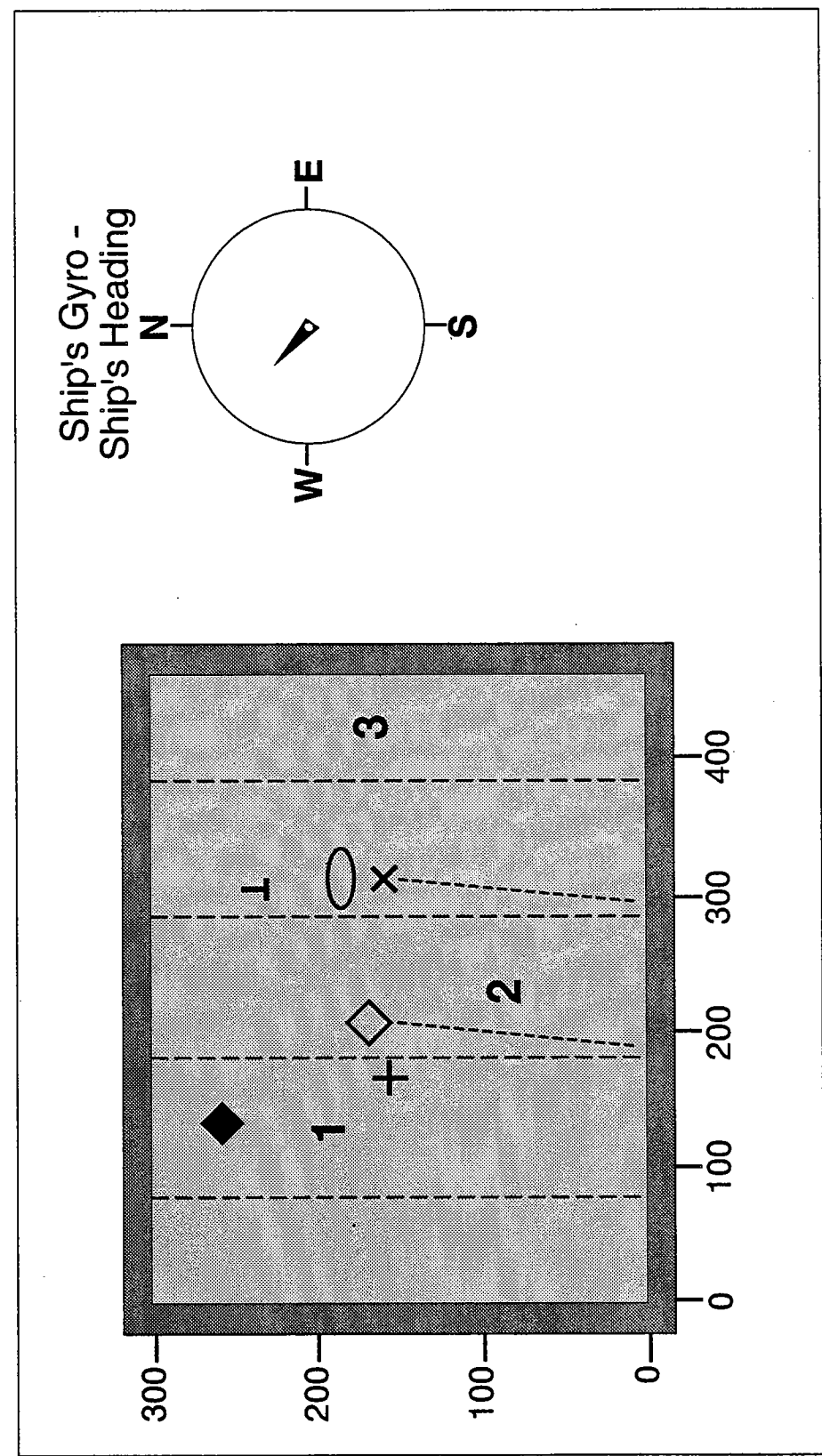

FIGURE 11

- ◆ Elevator
- ◇ JASON
- Desired Ship Position
- × Present Ship Position
- ⊥ Goal Point Ship Position
- ⊕ Medea
- 1, 2, 3 Transponders
- Desired Tracklines

Figure 11: Primary navigational display used at different locations aboard ship to monitor the locations of the various systems being used at any one time.

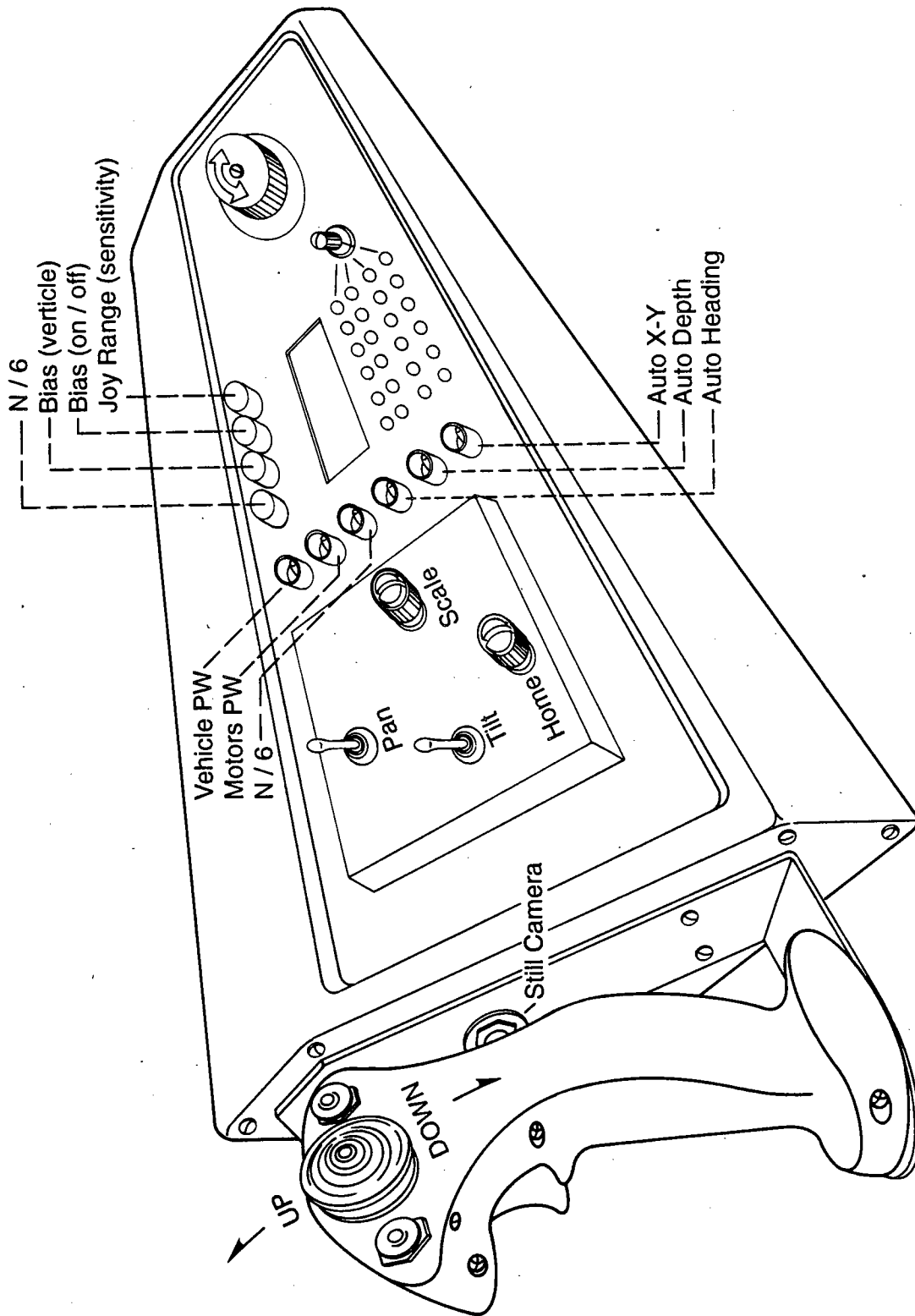

Figure 12: JASON control box used by JASON pilot.

FIGURE 12

and tilt control with switches and dials to operate pan, tilt, speed of pan, and homing to pre-set position. In the center is a vertical series of switches which control vehicle power, motor power, auto heading, auto depth, and auto x, y. The horizontal series of switches control vertical bias on/off, amount of vertical bias, and the sensitivity of the joystick. On the right is the joystick which when twisted in a clockwise or counter-clockwise position rotates the vehicle in either direction. Pushing the joystick in any of 360 directions, commands JASON's seven thrusters to move the vehicle in that direction at a rate set by the joystick sensitivity dial.

If JASON is being tracked by the LBL navigation system, the slow up-date rate of navigational fixes commonly makes the auto controls difficult to use but if the EXACT system is in use, closed-loop control can commonly be attained permitting the EXACT navigator to assume control of the vehicle.

The sonar operator is in charge of all the sonar systems on JASON as well as the data management associated with their proper recording and display. The MEDEA flyer takes his instructions from the JASON pilot and raises and lowers MEDEA as required. The manipulator operator sits next to the pilot when needed and has his own separate computer display and joystick control.

The best way to illustrate the versatility of the JASON vehicle system is to briefly outline some of the missions on which it has been used. To date, they have involved both marine archeological efforts as well as more traditional geologic mapping programs.

(1989 JASON Project in the Mediterranean Sea)

In 1989, a program was carried out in the Mediterranean that used the JASON vehicle on its first major field operation. The program was called the JASON Project and was specifically designed for young pre-college students to interest them in science and technology by letting them participate in a live scientific expedition using a sophisticated satellite network (ref. 40).

As stated before, the long-term goal of the JASON development program is to permit scientists ashore to participate in real-time exploration by connecting the at-sea control van to a similar display room ashore by means of a satellite link.

The JASON Project, therefore, provided DSL with the opportunity to develop this additional technology by making Woods Hole one of twelve initial downlink sites in the 1989 Mediterranean program. A downlink site consists of a bank of computer consoles similar to those in the at-sea control van along with three large projector TV screens placed in an auditorium with a seating capacity of 300-400. There were two-way audio links between all the sites so students could ask questions during the 84 live programs broadcast over a two-week period in May of 1989.

The Mediterranean program had two scientific objectives. The first was the investigation of a large volcano named Marsili Seamount located in the central portion of the Tyrrhenian Sea between Italy, Sicily, and Sardinia (ref. 40, 41). The second was the archeological investigation of a 4th century A.D. merchant ship lost along the trade route leading from ancient Carthage to Rome (ref. 40, 42).

Both efforts were carried out in approximately 1,000 to 1,500 meters of water and involved the combined use of JASON and MEDEA. The primary instrument suite on JASON included a manipulator, sample basket, side-scan sonar, a high-resolution 3-chip color television camera, a color still camera, a variety of color and black-and-white television cameras, and the standard instruments mentioned previously.

The JASON vehicle was driven manually in conjunction with a long-baseline navigation system. The pilot could control the vehicle's heading and altitude automatically as well as use an auto-bias control to compensate for being either too heavy or too light. The transponder network was used to dynamically position the surface ship and the MEDEA relay vehicle.

The most challenging aspects of this program were the recovery of over 54 ancient artifacts from the shipwreck site using a manipulator system developed at DSL (ref. 43). Most commercially available manipulators are designed for highly structured tasks characterized by military and oil and gas requirements. Scientific missions, however, are highly unpredictable and commonly demand much finer control.

The design criteria for the JASON manipulator involved the ability to (1) control low forces and torques, (2) work within the lift capability of the vehicle and (3) operate within the vehicle's field of view. The manipulator uses a series of joints having low-friction cables and pulleys that have a moderate ratio with zero-backlash. They are driven by high-performance brushless DC servomotors and each joint is oil filled to compensate for the pressure that exists at the vehicle's full operating depth of 7,000 meters (20,000 feet). The recovery scheme involved both the manipulator and an elevator dropped from the surface (figure 13) and proved highly successful. The elevator free-fell to the bottom and was tracked on its way down by the long-baseline navigation system.

JASON's manipulator was modified to hold a large set of tongs that conformed to an object such as an ancient amphora, before applying any pressure. Once grasped by the tongs, JASON thrust up off the bottom and carried the amphora to the elevator. This was repeated four to six times before the elevator was acoustically commanded to release an ascent weight and rise back to the surface where it was emptied and sent back to the bottom. In all, 13 separate elevator round-trips were made without damage to any of the artifacts.

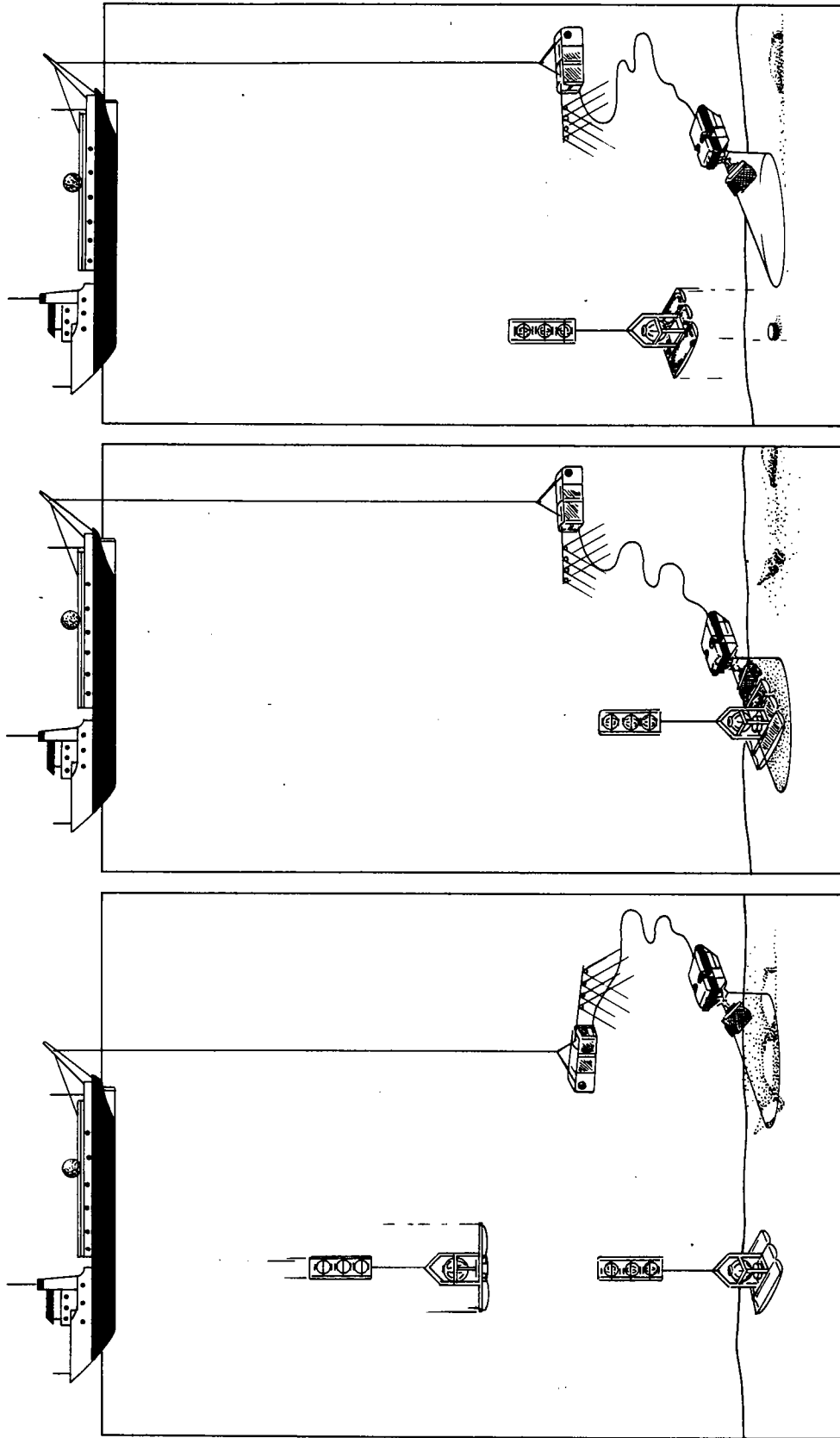

Figure 13: Elevator system used to transport equipment or instruments to the bottom or to recover samples collected by JASON. Elevator free-falls to the bottom and its location is monitored by the tracking system during descent. JASON/MEDEA are then vectored to its location using the ship's dynamic positioning system where they either pick up or place various items. The elevator is then acoustically commanded to drop a weight and rise back to the surface where it is then recovered and prepared for a subsequent lowering.

FIGURE 13

(1990 JASON Project in Lake Ontario)

The focus of the 1990 JASON Project in Lake Ontario was the archeological investigation of two warships, the HAMILTON and SCOURGE, lost in a storm in 300 feet of water during the War of 1812 (ref. 44). Both ships sit upright on the bottom in a high state of preservation.

A large barge carrying the control van was placed in a four-point mooring above the HAMILTON for one week and the SCOURGE for a second week. Three 300-kHz SHARPS transducers were attached to the barge and two lowered to the bottom. A 675-kHz pencil-beam MESOTECH 971 sonar was mounted on the front of JASON with the beam scanning in the vertical plane. JASON and MEDEA were lowered to the wreck site and JASON was placed in autoheading normal to the long axis of the ship and at a constant altitude just above bottom (figure 14a). The horizontal servo loops were activated, which held the vehicle in a dynamically controlled hovering position. The "joystick auto" mode was then engaged permitting the pilot to move the vehicle laterally along the sway axis of JASON. In this mode a deflection of the joystick to the right or left moved the vehicle precisely in that direction and the amount the joystick deflection was proportional to its lateral speed. This method of control greatly simplified the survey effort and reduced pilot fatigue. The resulting display, constructed using stochastic backprojection techniques (ref. 22), is a three-dimensional characterization of the ship, which in the case of figure 14 represents the warship SCOURGE.

A second sonar survey was carried out on both ships using a laser guided 1-Mhz Spotrange sonar having a narrow beam width of 1.5 degrees pointing down at 30 degrees from horizontal (ref. 45). In this particular application, the auto-control was used to hold the vehicle at a constant altitude along a line normal to the hull (figure 14b). The pilot then moved JASON back and forth along the trackline normal to the hull before moving to another line. Figure 14b illustrates one of the cross sections constructed during this survey. This same system was used through a ship's window to map a portion of its interior.

A third survey was conducted of each ship using a thermoelectrically cooled charged-coupled device (CCD) digital electronic black-and-white still camera (ref. 33). By cooling the CCD chip to -40° C, its dynamic range and sensitivity is greatly increased. Mounted either in the vertical or horizontal mode, JASON made a series of closed-loop controlled photo runs along and over the ships using the "joystick auto" mode. After collecting the data set, each image underwent standard enhancement to remove particle backscatter characteristic of images collected in turbid water as well as adaptive histogram equalization to compensate for uneven lighting. Working at a PIXAR workstation, the processor was able to construct a mosaic of the HAMILTON while in the field. This at-sea processing effort included interactive dragging, rotating, blending, scaling, and tie-point warping.

Figure 14(a): JASON in closed-loop control using SHARPS tracking system with the vehicle operating in "joystick auto" mode. This mode automatically places the long-axis of JASON perpendicular to the long-axis of the warship SCOURGE at a given stand-off distance and vehicle altitude. Using the MESOTECH sonar in a vertical scanning mode, a vertical line of digital information is collected representing the distance between the scanner and the bottom/ship. The pilot then moves JASON laterally to a new position and the scan is repeated. The result is a three-dimensional characterization of that portion of the ship "visible" to the scanner.

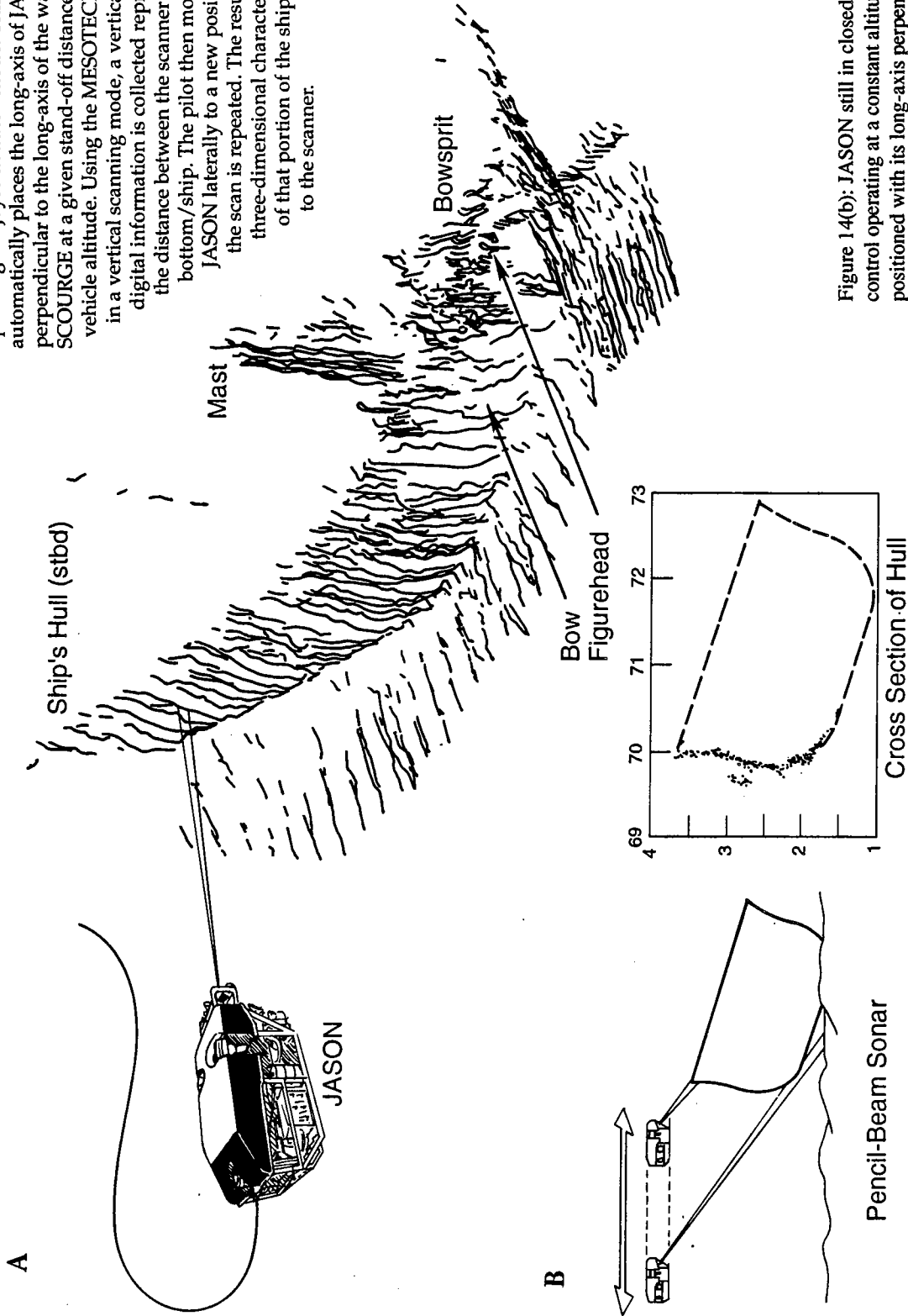

Figure 14(b): JASON still in closed-loop control operating at a constant altitude, positioned with its long-axis perpendicular to the long-axis of the ship. But instead of moving laterally along the strike of the ship, the pilot moves JASON back and forth from the ship. During these traverses a laser guided narrow beam Spotrange sonar scans the ship. The result is a series of cross sections of that side of the ship "visible" to this sensor.

FIGURE 14

An initial picture was selected upon which the mosaic was built. An adjacent processed image was then placed on the display and moved into position using a mouse. Using several tie-points, the new image was panned, zoomed, and blended to fit the initial image. Flicking back and forth, the operator used a least squares algorithm to warp and fit the image into position. When satisfied with the fit, he combined the images building the mosaic until it was completed (figure 15).

At the end of each of the 60 live broadcasts, a student was selected from the audience and brought to the control console situated at the downlink sites. There, a joystick control box and a computer-graphics display were connected to the JASON controls aboard ship by a digital satellite datalink. This link made it possible for the students to assume control of the JASON vehicle. The JASON pilot in the at-sea control van could transfer as much control of the vehicle to the student as he felt they could handle. This experiment clearly demonstrated that remote piloting by scientists in on-shore downlink sites is possible.

(1991 Juan de Fuca-CREST Project)

In July and August of 1991, the first major comprehensive science program using the JASON vehicle system in the MOR (ref. 46) was carried out in the rift valley of the Juan de Fuca Ridge (Endeavour segment at 48° north, figure 16). This program was the first to utilize JASON's full deep-ocean capabilities.

JASON, as previously stated, was designed to fill the traditional "gap" between acoustical and optical mapping systems. Prior to this cruise, the Juan de Fuca study area had undergone extensive investigation using a wide variety of mapping systems.

At the long-range low-resolution end of the spectrum, previous studies included the use of a SEABEAM swath-mapping sonar system (ref. 47, 48), SEAMARC I (ref. 49, 50), and SEAMARC II (ref. 51). The frequencies of these sonars range from 12 kHz (SEABEAM and SEAMARC I) to 27 and 30 kHz (SEAMARC II). In selected areas a limited amount of 100-kHz deep-towed side-scan sonar data was also collected (ref. 47).

At the short-range high-resolution opposite end of the spectrum, studies were carried out using deep-towed still camera and video television systems (ref. 48, 52), and the manned submersible ALVIN (ref. 12, 53).

Although these studies have helped significantly to better understand the volcanic, hydrothermal, and tectonic processes occurring along the axis of the MOR, comparison—or more importantly the merging of these data sets to provide a single coherent picture—has not yet been attained. It was within this context that the July/August 1991 JASON expedition was planned and executed.

FIGURE 15

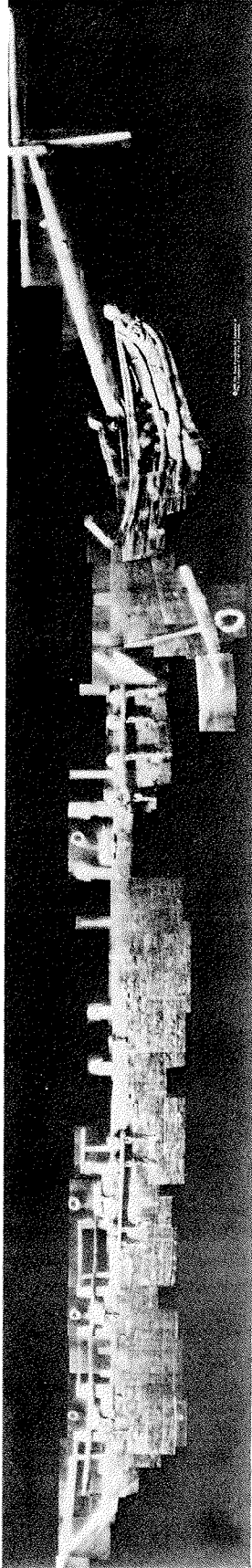

Figure 15: A partial mosaic of the warship HAMILTON constructed using approximately 109 individual electronic still camera images.

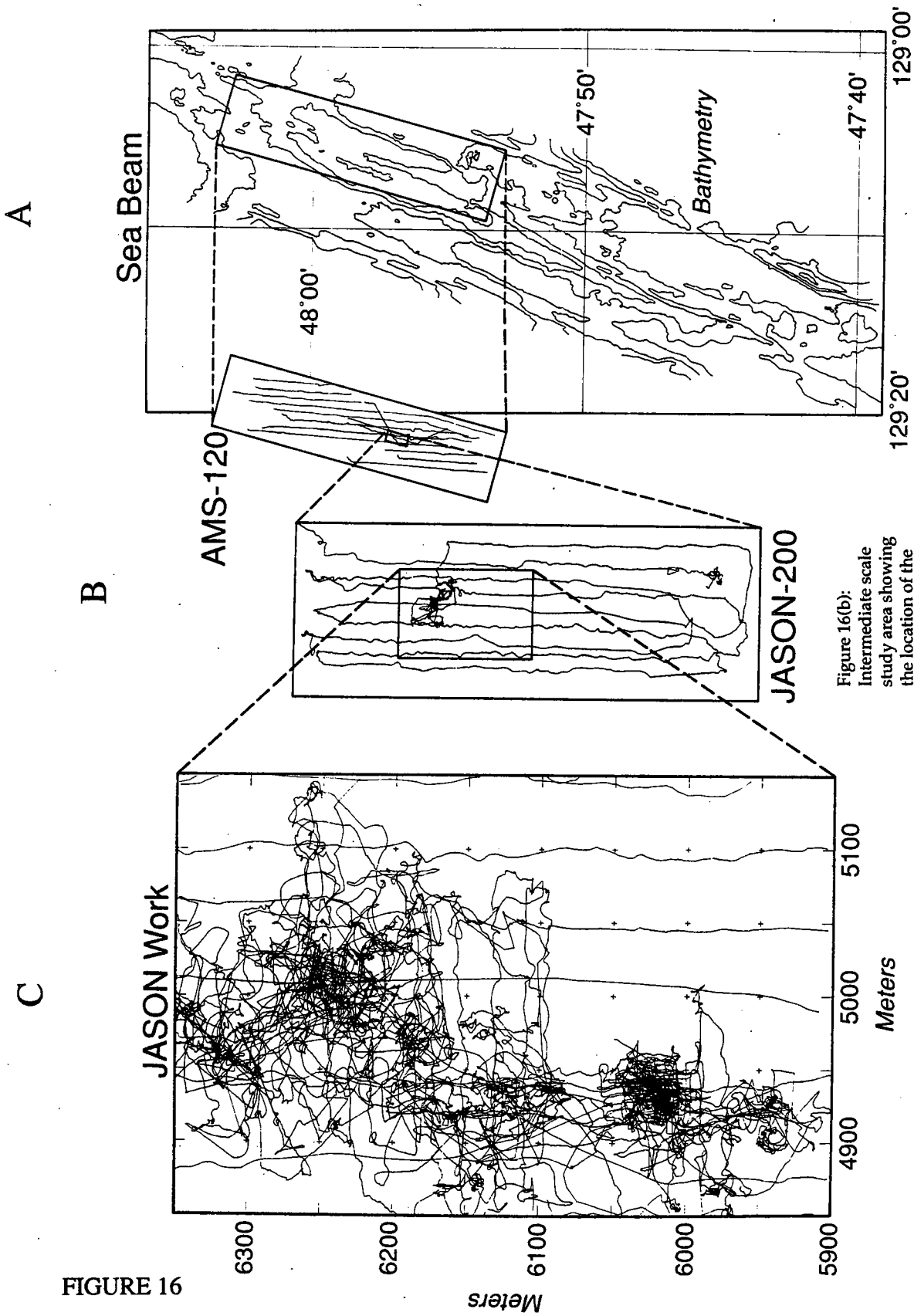

FIGURE 16

Figure 16(a): Simplified large-scale bathymetric map of Endeavour Segment of the Juan de Fuca Ridge where the Crest Project was carried out in the summer of 1991. Rectangle delineates area where the AMS-120 (figure 17) was used to make a series of parallel tracklines. This split-beam bathymetric side-scan sonar measures both the intensity and the phase of the returning signals to generate both shadow-graph and bathymetric maps.

Figure 16(b): Intermediate scale study area showing the location of the primary work area as well as a series of tracklines carried out by JASON.

Figure 16(c): Tracklines of the JASON vehicle in primary work area. X and Y coordinates relative to an arbitrary point of origin.

The first data set collected was a detailed systematic survey of the rift axis within a rectangle 18 km along axis by 4 km normal to axis (figure 16a) using DSL's AMS-120 side-scan sonar system (figure 17). This 120-kHz split-beam sonar was designed and developed by DSL in cooperation with the Applied Physics Laboratory (APL) at the University of Washington and Acoustic Marine Systems, Inc. (ref. 20). The system's calibrated transducers permit accurate backscatter measurements and its dual receivers provide phase information which can be used to construct high-resolution swath bathymetry. This data set resulted in a bathymetric map and side-scan sonar records that have a higher resolution than the previously mentioned SEABEAM, SEAMARC I & II, and 100-kHz side-scan surveys.

Within the AMS-120 survey area, a second mapping effort was conducted using JASON/MEDEA covering an area 7 km along strike by 2.5 km across strike (figures 17b and 19). A series of along axis lines at a spacing of 50 m were run with overlapping side-scan sonar coverage using the vehicle's 200-kHz split-beam bathymetric sonar that was similarly developed by DSL and APL. This system can also measure the phase of the returning signals to construct bathymetric maps. During these runs the vehicle's MESOTECH 675-kHz pencil-beam sonar was mounted in the down-looking mode, scanning perpendicular to the trackline. The lines were run at an altitude of 10-15 meters which permitted use of JASON's electronic still camera which took an image every 20 seconds.

Following this intermediate scale mapping effort delineated in figure 17b, JASON began a series of individual investigations in an area 450 by 300 meters on its sides (figure 17c). This included a finer scale survey using a network of 300-kHz EXACT transponders. These units were placed on an elevator and dropped from the surface in the area to be surveyed. JASON took the transponders from the elevator and deployed them in the desired tracking configuration.

With its tracking precision of a few centimeters and a high update rate of 5 fixes per second, JASON was placed periodically in closed-loop control. Using a cursor on the computer graphic display, the navigator not the pilot commanded the vehicle to run a series of closely spaced survey lines (figure 20).

Conductivity, temperature, and Mn sensors were mounted on the front of JASON. A series of navigated lines using both the long-baseline and EXACT tracking systems were made at varying altitudes of 10, 50, and 80 meters above one of the major vent systems (figure 21).

This series of survey lines was followed by a series of runs around the sulfide structure with the MESOTECH sonar scanning in the vertical plane. With this information, a three-dimensional model of the hydrothermal plume could be constructed relative to the vent structure.

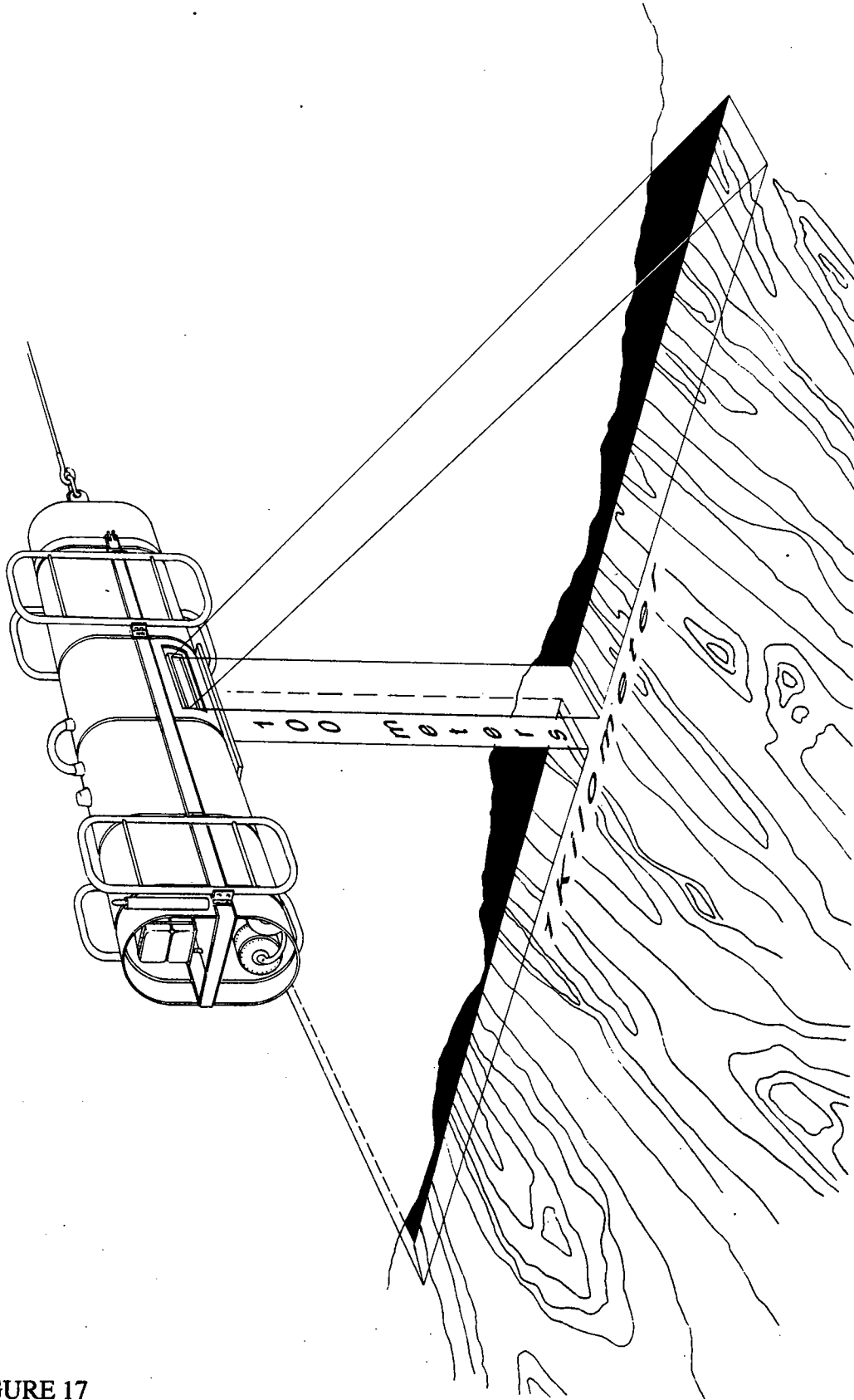

FIGURE 17

Figure 17: Generalized schematic of AMS-120 sonar vehicle being flown at an altitude of 100 meters during its survey of overall study area (figure 16a).

Figure 18: Schematic showing the approximate "footprint" of each acoustic and visual sensor on JASON used during the intermediate scale survey (figure 16b) of the study area.

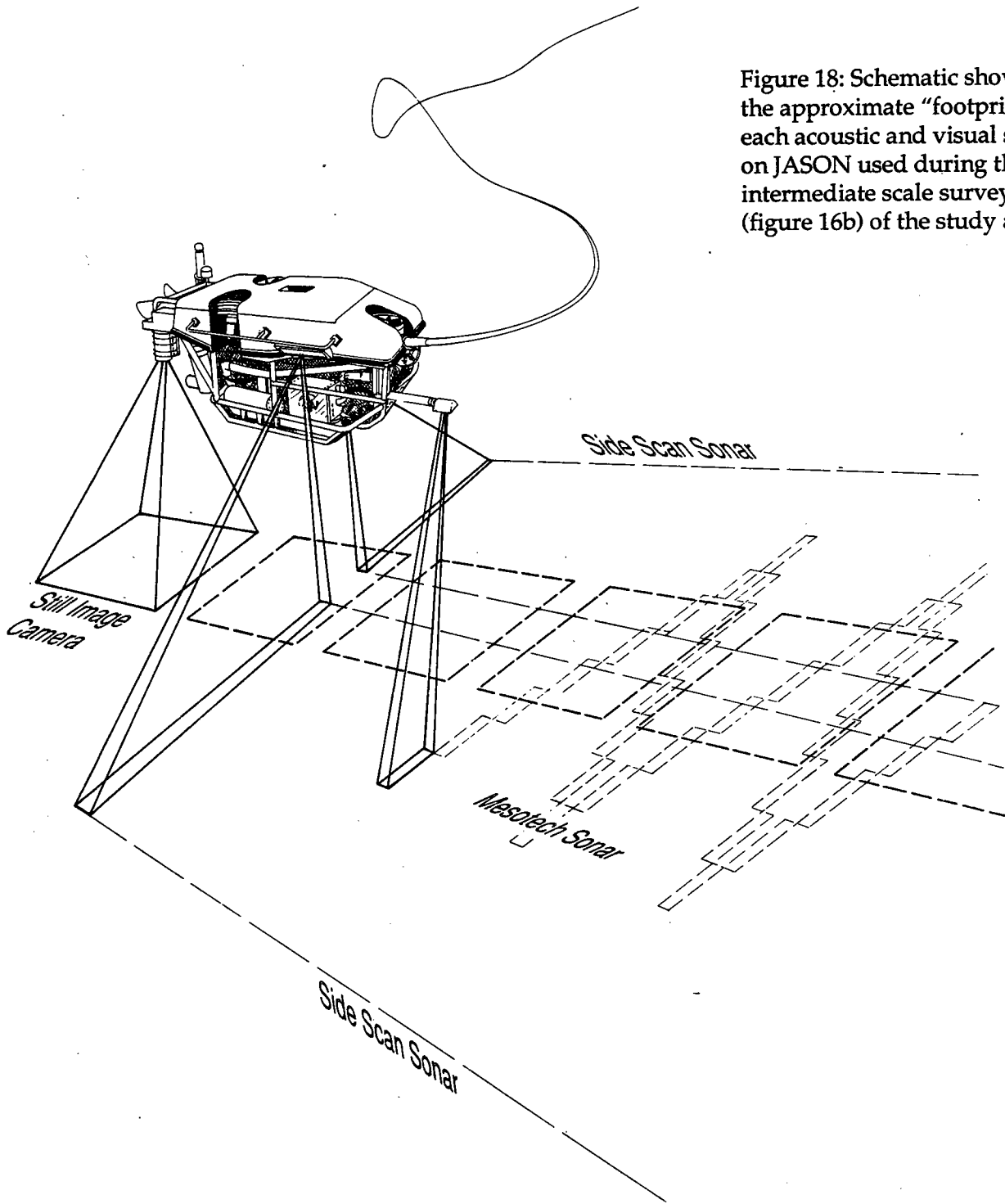

FIGURE 18

JASON Tracklines, day 227 (0700-0900)

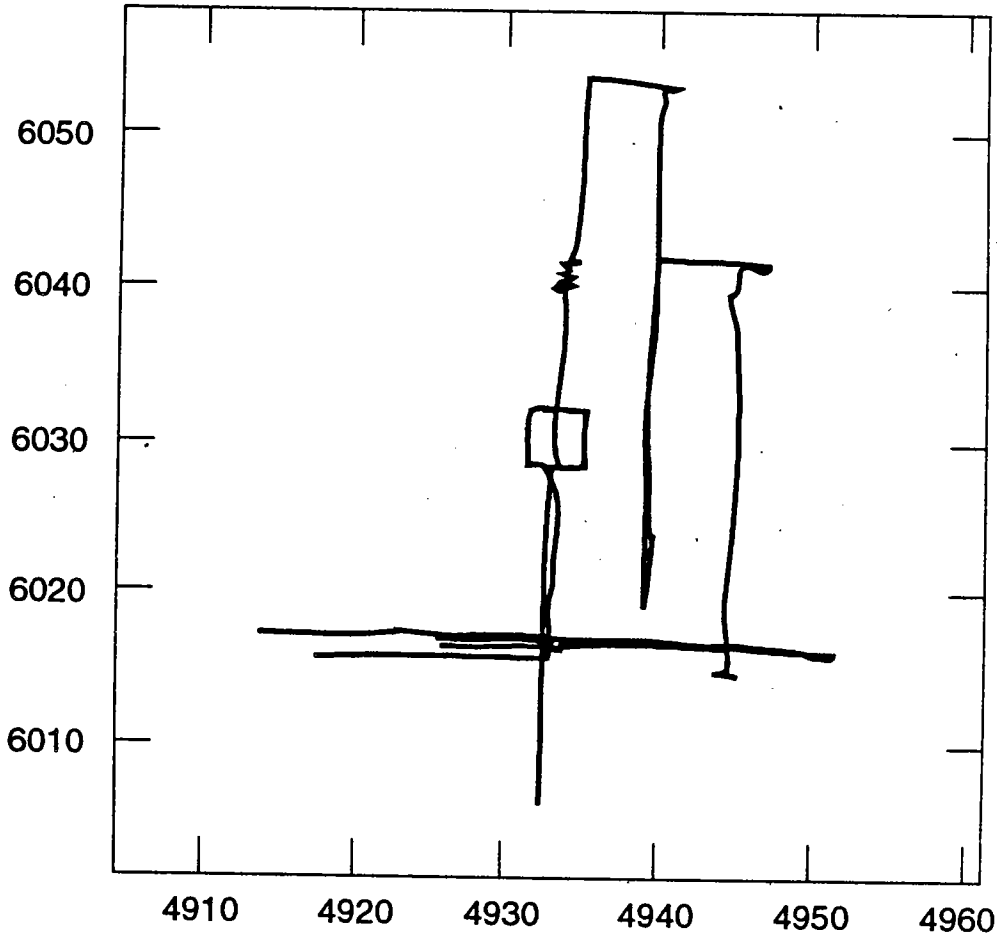

Figure 19: A portion of the trackline coverage carried out by JASON above a high-temperature "Black smoker" in the JASON work area (figure 16C). JASON is under closed-looped control using the EXACT tracking system having a tracking precision of better than 2 cm.

FIGURE 19

Figure 20: Diagram of JASON working above high-temperature "Black smoker." Tracklines at various altitudes are shown as well as the "foot-print" of the electronic still camera and Mesotech scanning sonar. Also shown are the graphic displays of the conductivity and temperature sensors on JASON.

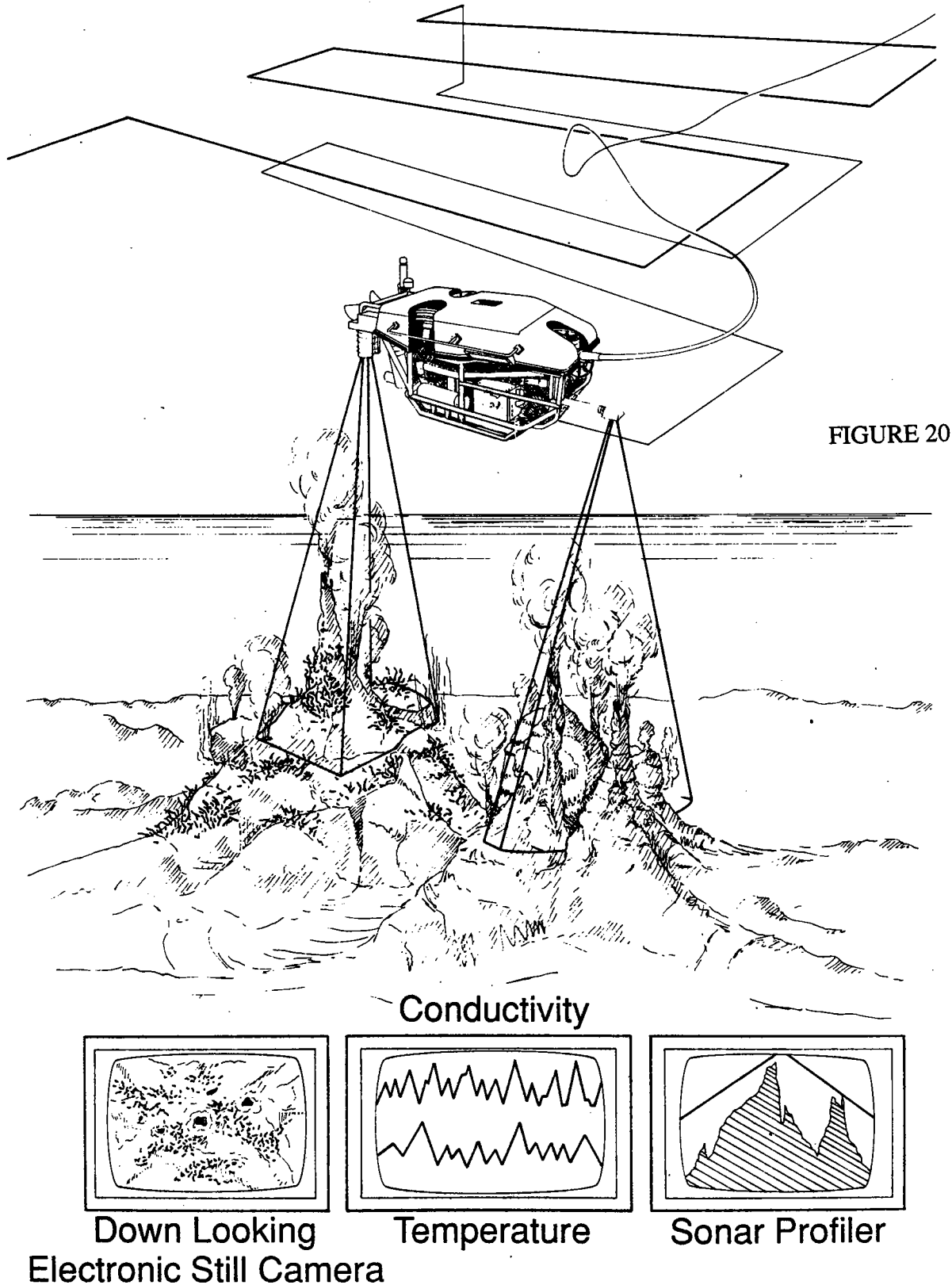

FIGURE 20

This unique data set then made it possible for the scientist to "zoom in" on specific targets of interest. In this case, a network of gjar, small horst and graben structures, and numerous hydrothermal sites including tall sulfide accumulations and "black smoking" chimneys.

While investigating these specific sites, the pilot could either operate the vehicle in manual mode or use the EXACT tracking system to obtain closed-loop control. During this final phase of investigation, JASON's two high-quality color cameras obtained spectacular video coverage and electronic still images (figure 21). In all, JASON spent more than 190 hours on the bottom, collected nearly 700 hours of video from its various cameras systems, obtained more than 18,000 electronic still images, made approximately 40 EXACT navigated runs in the hydrothermal plumes, and digitized the bottom terrain with its various sonar systems.

FUTURE DEVELOPMENT OBJECTIVES

Although the JASON vehicle system has proven its ability to carry out sophisticated missions in the complex terrain of the Mid-Ocean Ridge, much remains to be done before it becomes a highly routine operation. The most important issue to address is real-time processing of the massive amount of data this fiber-optic system can collect. Scientists accustomed to using a manned system have learned to quickly process their observations after three hours on the bottom each day. But a system working 24 hours a day with a tremendous number of acoustic and visual sensors can rapidly overwhelm even a team of experienced scientists.

More can be done to process this information in real-time at sea but, clearly, expeditions of the future will require a completely different approach to mapping. A large number of scientists need to be involved to fully utilize the potential of the JASON system. It is felt that this can best be done through a satellite link to shore. At the present time several marine institutions have joined the JASON Project network. They include the Woods Hole Oceanographic Institution, Bermuda Biological Station, the Graduate School of Oceanography at the University of Rhode Island, Mote Marine Laboratory, the Harbor Branch Foundation, the Great Lake Studies Group at the University of Wisconsin, and the Orange County Marine Institute. Although these organizations joined the network for its pre-college educational program, the same system can be used to network scientists on future research expeditions.

In early 1993, a major expedition is planned in the Gulf of California in the northern and southern troughs of Guaymas Basin (figure 22). This area of intense hydrothermal activity will be investigated using a combination of manned, unmanned, and shore-based downlink sites (figure 23).

Figure 21: JASON working along the side of a sulfide chimney ("Black smoker") in the area of a flange (pool of high-temperature fluid). Inserts show sensors being used at that moment (electronic still camera in down-looking mode, scanning sonar in downlooking mode, I-chip (wide angle) color television image, and 3-chip high-resolution (zoom) color television image. Both TV cameras are looking forward.

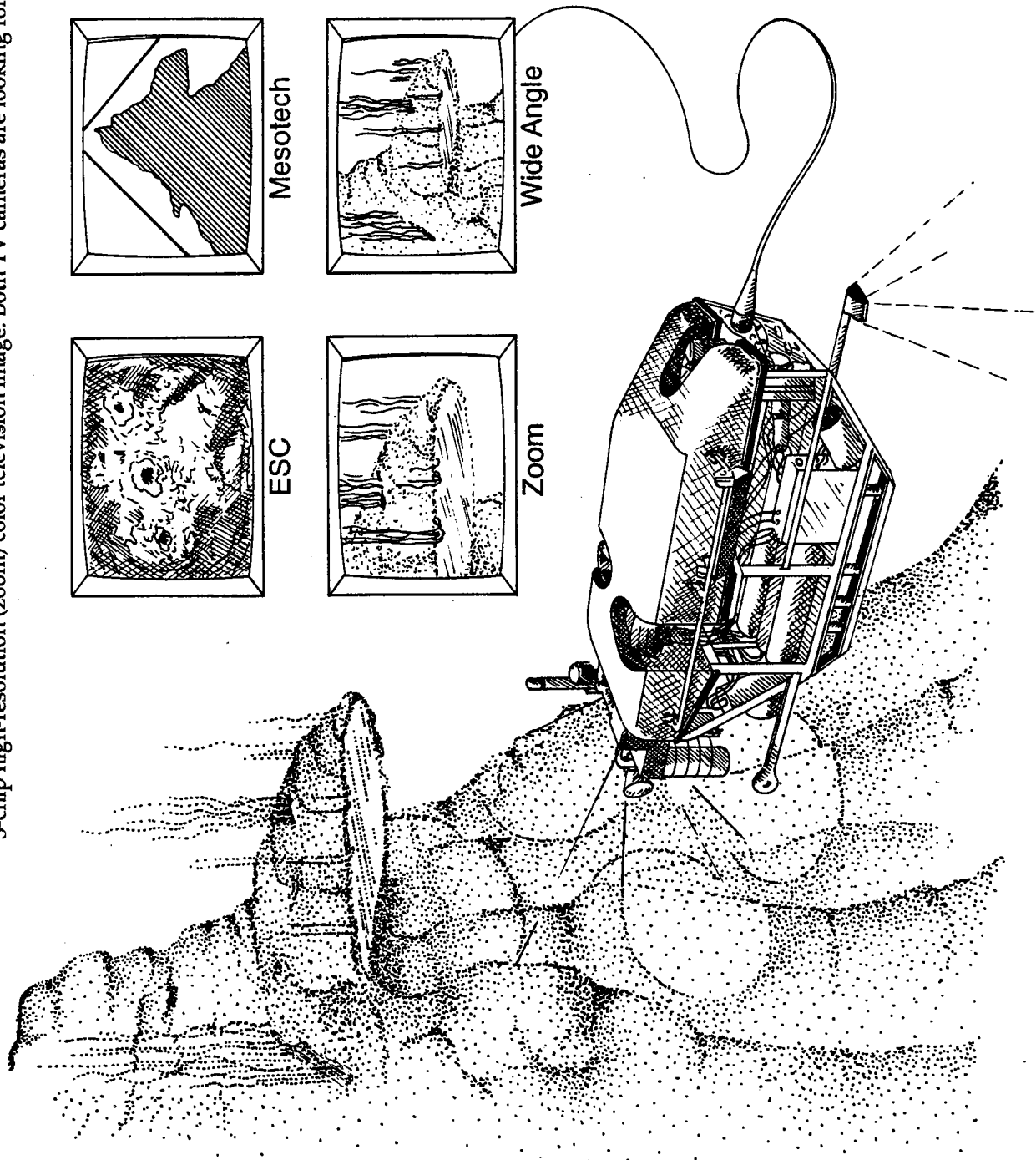

FIGURE 21

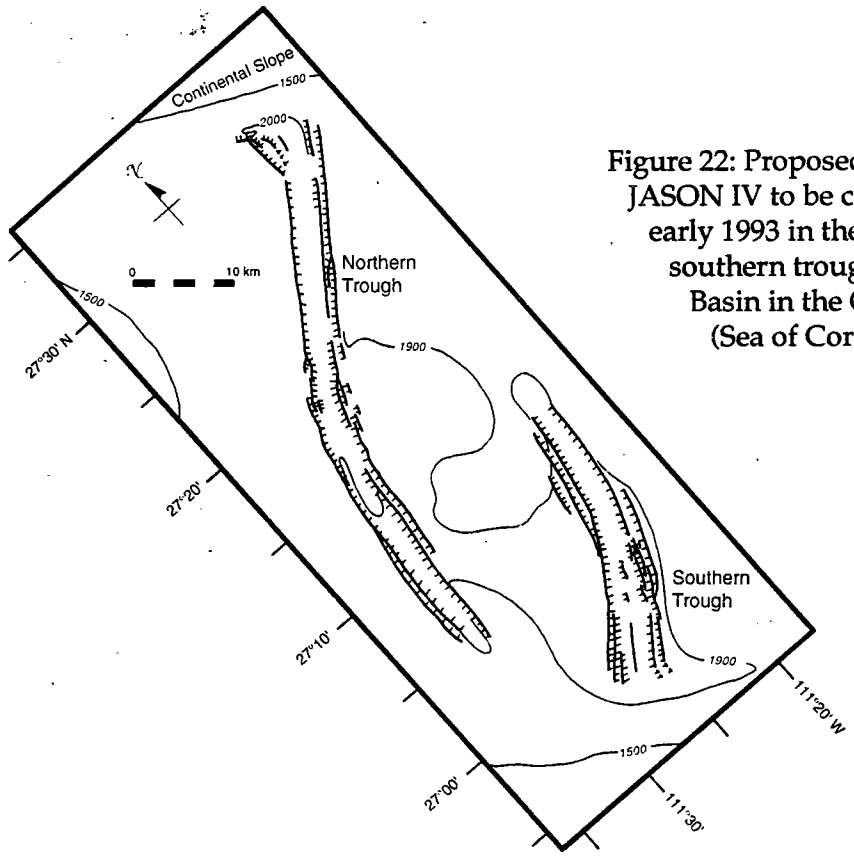
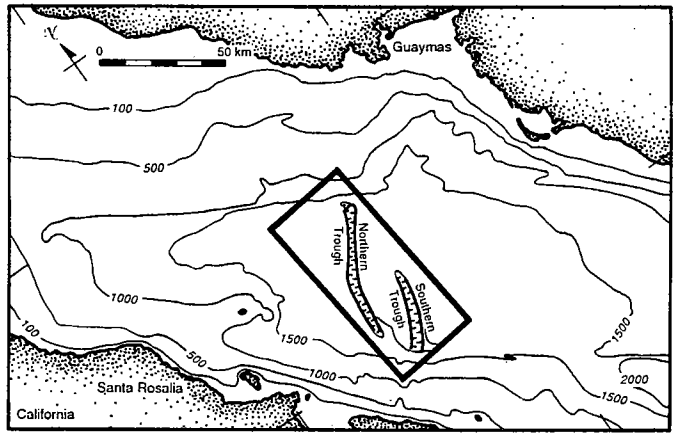
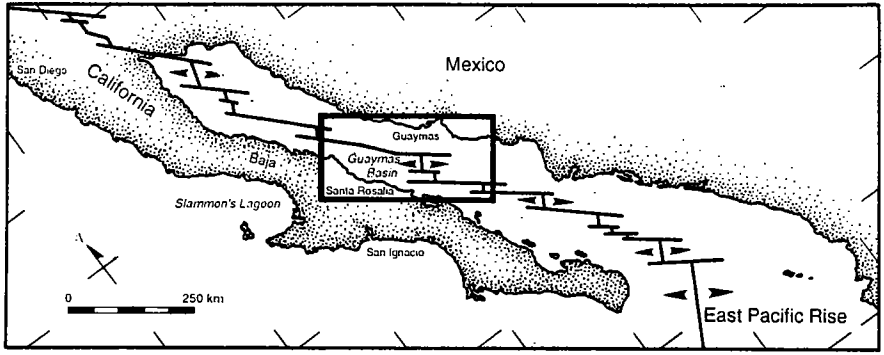

Figure 22: Proposed study area for JASON IV to be carried out in early 1993 in the northern and southern troughs of Guaymas Basin in the Gulf of California (Sea of Cortez).

FIGURE 22

FIGURE 23

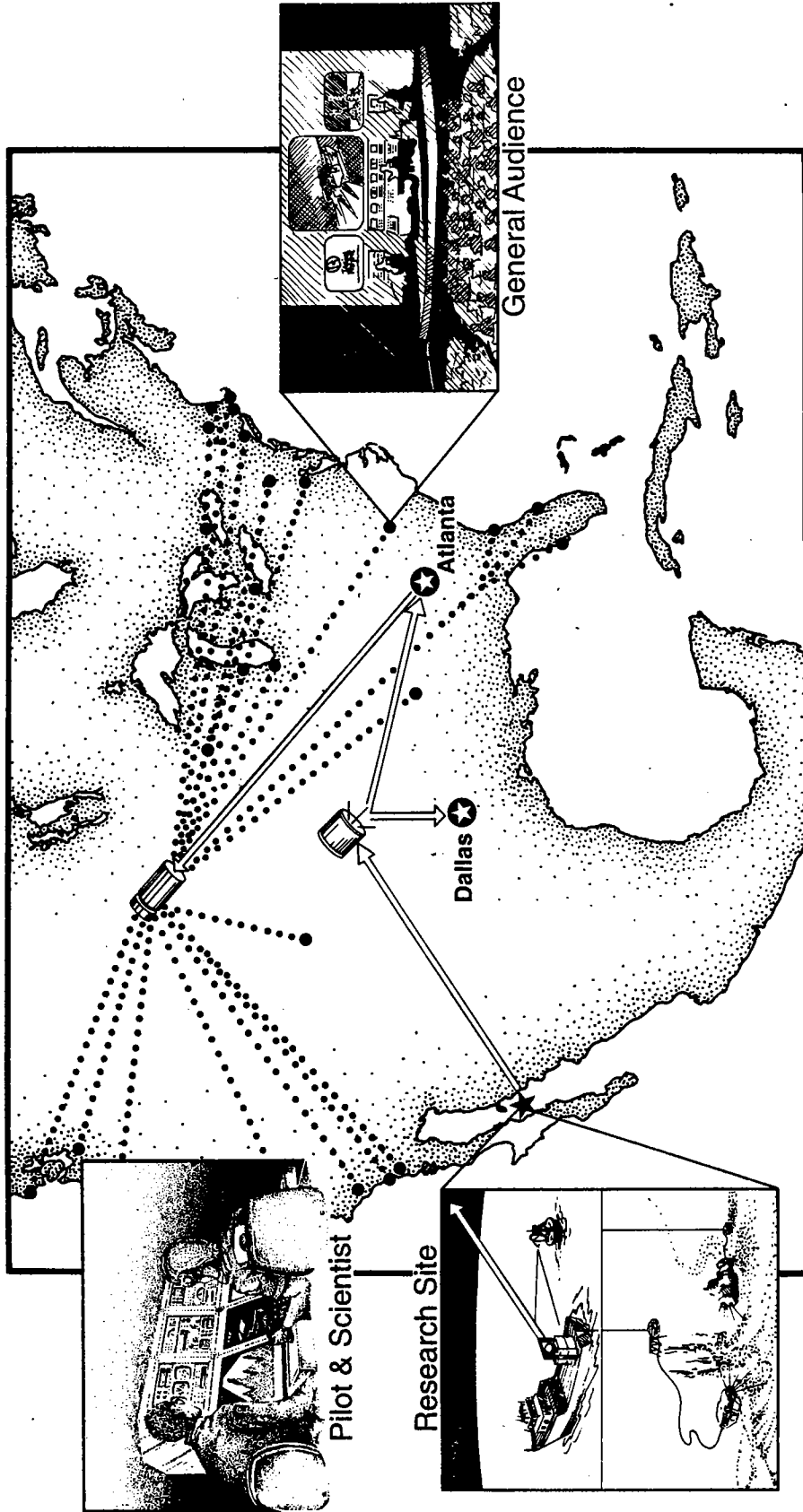

Figure 23: Telecommunications network to be used during JASON IV. It consists of the at-sea operating assets (R/V LANEY CHOUEST, submersible TURTLE, and ROV JASON/MEDEA); production site in Atlanta, Georgia; mission control in Dallas Texas; various general audience downlink sites (JASON PINS sites) in Canada and the United States (downlink site in Britain, not shown); international and domestic satellites to transmit live audio and visual signals, and two science downlinks in California and Woods Hole. Also not shown is JASON worksite in San Ignacio lagoon on the west side of Baja California.

This expedition is both a scientific expedition and the fourth year of the JASON Project. The at-sea elements include the R/V LANEY CHOUEST, the deep submersible TURTLE, the MEDEA/JASON system, 28 interactive downlink sites and 2 remote science sites.

TURTLE and MEDEA/JASON will both be in the water at the same time. The science party will be split into three groups; those inside TURTLE, those in JASON's control van, and those at the various interactive downlink sites. Two basic downlink sites will be involved. Approximately 25-30 sites will be located in auditoriums in the United States, Canada, and Great Britain. These sites will be filled with students and teachers as well as scientists monitoring the program. Two sites, one at Woods Hole and the other in California will be in research laboratories where a JASON pilot and JASON engineer will work with various scientists conducting a variety of experiments using JASON in both low-temperature and high-temperature vent fields in Guaymas Basin.

References:

1. Hess, H.H., 1962, History of the ocean basins: in A.E.J. Engel, H.L. James, and B.P. Leonard, eds., Petrologic Studies; Geological Society of America, p. 599-620.
2. Heezen, B.C., and Ewing, M., 1961, The Mid-Ocean Ridge and its extension through the Arctic Basin; in Geology of the Arctic; Canada, University Toronto Press, p. 622-642.
3. LePichon, X., 1968, Sea-floor spreading and continental drift; Journal of Geophysical Research, v. 73, p. 3661-3697.
4. Ocean Science Committee, 1972, Understanding the Mid-Atlantic Ridge, Special Report of NAS-NRC Ocean Affairs Board, Jan. 24-28.
5. Heirtzler, J.R. and vanAndel, Tj.H., 1977, Project FAMOUS: Its origin, programs and setting; Geological Society of America Bulletin, v. 88, p. 481-487.
6. Ballard, R.D., and vanAndel, Tj.H., 1977, Project FAMOUS: Operational techniques and American submersible operations; Geological Society of America Bulletin, v. 88, p. 495-506.
7. Ballard, R.D., Bryan, W.B., Heirtzler, J.R., Keller, G., Moore, J.G., and van Andel, Tj.H., 1975, Manned submersible observations in the FAMOUS area: Mid-Atlantic Ridge, Science, v. 190, p. 103-108.
8. CAYTROUGH (Ballard, R., Bryan, W., Dick, H., Emery, K.O., Thompson, G. Uchupi, E., et al.), 1979, Geological and geophysical investigation of the Mid-Cayman Rise spreading center; Initial Results and Observations; in Deep Drilling Results in the Atlantic Ocean, Ocean Crust, Maurice Ewing Series 2; American Geophysical Union, p. 66-93.
9. Corliss, J.B., et al., 1979, Submarine thermal springs on the Galápagos Rift, Science, v. 203, p. 1073-1083.
10. Rise Project Group, 1980, East Pacific Rise; Hot springs and geophysical experiments, Science, v. 207, no. 4438, p. 1421-1433.
11. Crane, K. and Ballard, R.D., 1981, Volcanics and structure of the FAMOUS Narrogate Rift: Evidence for cyclic evolution, AMAR 1, Journal of Geophysical Research, v. 86, no. B6, p. 5112-5124.
12. Delaney, J.R., Robigou, V. McDuff, R.E., and Tivey, M.K., in press, Detailed geologic relationships of a vigorous hydrothermal system: The

Endeavour vent field, northern Juan de Fuca Ridge, Journal of Geophysical Research.

13. Woods Hole Oceanographic Institution, Deep Submergence Vehicle Alvin, 25th Anniversary 1964-1989.
14. Tunncliffe, Verena, 1991, The biology of hydrothermal vents: Ecology and Evolution, Oceanogr. Mar. Bio. Annu. Rev., v. 29, p. 319-407.
15. Yoerger, D.R., Newman, J.B. and Slotine, J.-J.E., 1986, Supervisory control system for the JASON ROV, IEEE Journal Oceanic Engineering, OE-11, p. 392-400.
16. MacDonald, K.C., and Luyendyk, B.P., 1977, Deep-tow studies of the structure of the Mid-Atlantic Ridge crest near lat. 37°N; Geological Society of America Bulletin, v. 88, p. 621-636.
17. Ballard, R.D., and Moore, J.G., 1977, Photographic atlas of the rift valley; New York, Springer-Verlag.
18. Ballard, R.D., 1982, Argo and Jason, Oceanus, v. 25, p. 30-35
19. Ballard, R.D. Yoerger, D.R., Stewart, W.K., and Bowen, A., 1991, Argo/Jason: A remotely operated survey and sampling system for full-ocean depth, IEEE Oceans 91 Proceedings, v. 1, p. 71-75.
20. Stewart, W.K., 1987a, A non-deterministic approach to 3-D modeling underwater, in Proceedings, Symposium on Unmanned Untethered Submersible Technology, University of New Hampshire, Marine Systems Lab., p. 283-309.
21. Stewart, W. K., 1987b, Computer modeling and imaging underwater, Computers in Science, v. 1, p. 22-32.
22. Stewart, W.K., 1989, Multisensor Modelling Underwater with Uncertain Information, Ph.D. Thesis, MIT/Woods Hole Oceanographic Institution Joint Program, July 1988; MIT Artificial Intelligence Laboratory, Technical Report 1143.
23. Burgess, J.J. and Triantafyllou, M.S., 1987, Time domain simulation of the dynamics of ocean towing lines, Proceedings, Third International Symposium on Practical Design of Ships and Mobile Units, Trondheim, Norway.

24. Hover, F.S. 1989a, Parametric identification of deeply towed vehicle systems using an analytical model and experimental data, Proceedings, Oceans '89, Seattle, Washington, v. 5, p. 1715.
25. Hover, F.S. 1989b, Deeply towed underwater vehicle system: A verified analytical procedure for creating parameterized dynamic models, M.S. Thesis MIT/Woods Hole Oceanographic Institution Joint Program in Oceanography and Ocean Engineering.
26. Hover, F.S., Triantafyllou, M.S. and Grosenbaugh, M.A., 1990, Modelling the dynamics of a deeply towed underwater vehicle system, Proceedings, European Offshore Mechanics Symposium, Trondheim, Norway.
27. Grosenbaugh, M.A., 1990, The effect of unsteady motion on drag forces and flow-induced vibrations of a long vertical tow cable, Proceedings, European Offshore Mechanics Symposium, Trondheim, Norway.
28. Yoerger, D.R., Grosenbaugh, M.A., Triantafyllou, M.S., and Burgess, J., 1991, Drag Forces and Flow-Induced Vibrations of a Long Vertical Tow Cable - Part I: Steady-State Towing Conditions, ASME Journal of Offshore Mechanics and Arctic Engineering, v. 113, no. 1, p. 117-127.
29. Grosenbaugh, M.A., Yoerger, D.R., Hover, F.S. and Triantafyllou, M.S., 1991, Drag forces and flow-induced vibrations of a long vertical tow cable - Part II; Unsteady towing conditons, ASME Journal of Offshore Mechanics and Arctic Engineering, v. 113, no. 3, p. 199-204.
30. Grosenbaugh, M.A., Yoerger, D.R., and Triantafyllou, M.S., 1989, A full-scale experimental study of the effect of shear current on the vortex-induced vibration and quasi-static configuration of a long tow cable, ASME Proceedings, 8th Conference Offshore Mechanics and Arctic Eng., The Hague, Netherlands.
31. Yoerger, D.R. Cooke, J.G., and Slotine, J.-J.E., 1990, The influence of thruster dynamics on underwater vehicle behavior and their incorporation into control system design, IEEE Journal of Oceanic Engineering, v. OE-15, p. 167-178.
32. Yoerger, D.R., and Newman, J.B., 1989, Control of remotely operated vehicles for precise survey, Proceedings, ROV '89, San Diego, California, p. 123-127.
33. Harris, S.E., Squires, R.J., and Bergeron, E.M., 1987, Underwater imagery using an electronic still camera, Proceedings, MTS/IEEE Oceans '87, p. 1242-1245.

34. Uchupi, E., Muck, M. and Ballard, R.D., 1988, Geology of the TITANIC Site and Vicinity, Deep-Sea Research, v. 35, no. 7, p. 1093-1110.
35. Ballard, R.D., 1987, The Discovery of the TITANIC, Warner Communications, Madison Press Books.
36. Ballard, R.D., 1990, The Discovery of the BISMARCK, Warner Communications, Madison Press Books.
37. ARGORISE Group, 1988, An ANGUS/ARGO study of the neovolcanic zone along the East Pacific Rise from the Clipperton Fracture Zone to 12° N., Geo-Marine Letters, v. 8, p. 131-138.
38. Haymon, R., Fornari, D., Edwards, M., Carbotte, S., Wright, D. and Macdonald, K.C., in press, Hydrothermal vent distribution along the East Pacific Rise (9 degrees 09 - 54 minutes N) and its relationship to magmatic and tectonic processes on fast-spreading Mid-Ocean Ridges, Earth and Planetary Science Letters.
39. Ballard, R.D., 1986, A Long Last Look at TITANIC, National Geographic Magazine, v. 170, no. 6.
40. Ballard, R.D., 1990, The Lost Wreck of the ISIS, Random House, Madison Press Books.
41. Uchupi, E. and Ballard, R.D., 1989, Evidence of Hydrothermal Activity on Marsili Seamount, Tyrrhenian Basin, Deep-Sea Research v. 36 no. 9, 1443-1448.
42. McCann, Anna, 1992, The ISIS Shipwreck: Jason Project 1989, Journal of Roman Archeology (in press)
43. Yoerger, D.R., Schempf, H. and DiPietro, D.M., 1991, Design and performance evaluation of an actively compliant underwater manipulator for full-ocean depth, Journal Robotic Systems, v. 8, p. 371-392.
44. National Science Teachers Association, 1990, Great Lakes JASON Curriculum, ISBN 0-87355-091-9.
45. Yoerger, D.R., 1990, Precise Control of Underwater Robots: Why and How, in International Advanced Robotics Programme Workshop on Mobile Robots for Subsea Environments, Monterey, California.
46. Delaney, J.R., et al., in preparation, JASON Juan de Fuca cruise.

47. Hammond, S.R., Malahoff, A., Embley, R.W., Currie, R.G., Davis, E.E., Riddihough, R.P., and Sawyer, B.S., 1984, Preliminary Seabeam bathymetry of the Juan de Fuca Ridge map series: Earth Physics Branch, EMR, Open File 84-6.
48. Karsten, J.L., Hammond, S.R., Davis, E.E., and Currie, R.G., 1986, Detailed geomorphology and tectonics of the Endeavour segment, Juan de Fuca Ridge: New results from Seabeam swath mapping, Geological Society of America Bulletin, v. 97, p. 213-221.
49. Crane, K., Aikman, F., Ryan, W.B.F., Embley, R.W., Hammond, S.R., Malahoff, A., and Lupton, J.E., 1985, The distribution of geothermal fields on the Juan de Fuca Ridge: Journal Geophysical Research, v. 90, p. 727-744.
50. Kappel, E.S. and Ryan, W.B.F., 1986, Volcanic episodicity and a non-steady rift valley along Northeast Pacific spreading centers: Evidence from Sea MARC I, Journal of Geophysical Research, v. 91, p. 13,925-13,940.
51. Davis, E.E., Currie, R.G., Sawyer, B.S., and Hussong, D.M., 1984, Juan de Fuca Ridge atlas of Sea MARC II acoustic imagery: Earth Physics Branch Open File Report 84-17.
52. Tivey, M.K. and Delaney, J.R., 1985, Sulfide deposits from the Endeavour Segment of the Juan de Fuca Ridge, Mar. Min., v. 5, p. 165-179.
53. Johnson, H. P. and Holmes, M.L., 1989, Evolution in plate tectonics: The Juan de Fuca Ridge, in Winterer, E.L., Hussong, D.M., and Decker, R.W., eds., The Eastern Pacific and Hawaii: Boulder, Colorado, Geological Society of America, The Geology of North America, v. N., p. 73-91.

DOCUMENT LIBRARY

Distribution List for Technical Report Exchange - July 1, 1993

University of California, San Diego
SIO Library 0175C (TRC)
9500 Gilman Drive
La Jolla, CA 92093-0175

Hancock Library of Biology & Oceanography
Alan Hancock Laboratory
University of Southern California
University Park
Los Angeles, CA 90089-0371

Gifts & Exchanges
Library
Bedford Institute of Oceanography
P.O. Box 1006
Dartmouth, NS, B2Y 4A2, CANADA

Office of the International Ice Patrol
c/o Coast Guard R & D Center
Avery Point
Groton, CT 06340

NOAA/EDIS Miami Library Center
4301 Rickenbacker Causeway
Miami, FL 33149

Library
Skidaway Institute of Oceanography
P.O. Box 13687
Savannah, GA 31416

Institute of Geophysics
University of Hawaii
Library Room 252
2525 Correa Road
Honolulu, HI 96822

Marine Resources Information Center
Building E38-320
MIT
Cambridge, MA 02139

Library
Lamont-Doherty Geological Observatory
Columbia University
Palisades, NY 10964

Library
Serials Department
Oregon State University
Corvallis, OR 97331

Pell Marine Science Library
University of Rhode Island
Narragansett Bay Campus
Narragansett, RI 02882

Working Collection
Texas A&M University
Dept. of Oceanography
College Station, TX 77843

Fisheries-Oceanography Library
151 Oceanography Teaching Bldg.
University of Washington
Seattle, WA 98195

Library
R.S.M.A.S.
University of Miami
4600 Rickenbacker Causeway
Miami, FL 33149

Maury Oceanographic Library
Naval Oceanographic Office
Stennis Space Center
NSTL, MS 39522-5001

Library
Institute of Ocean Sciences
P.O. Box 6000
Sidney, B.C. V8L 4B2
CANADA

Library
Institute of Oceanographic Sciences
Deacon Laboratory
Wormley, Godalming
Surrey GU8 5UB
UNITED KINGDOM

The Librarian
CSIRO Marine Laboratories
G.P.O. Box 1538
Hobart, Tasmania
AUSTRALIA 7001

Library
Proudman Oceanographic Laboratory
Bidston Observatory
Birkenhead
Merseyside L43 7 RA
UNITED KINGDOM

IFREMER
Centre de Brest
Service Documentation - Publications
BP 70 29280 PLOUZANE
FRANCE

REPORT DOCUMENTATION PAGE	1. REPORT NO. WHOI-93-34	2.	3. Recipient's Accession No.
4. Title and Subtitle The JASON Remotely Operated Vehicle System		5. Report Date February 1993	
7. Author(s) Robert D. Ballard		8. Performing Organization Rept. No. WHOI-93-34	
9. Performing Organization Name and Address Woods Hole Oceanographic Institution Woods Hole, Massachusetts 02543		10. Project/Task/Work Unit No.	
12. Sponsoring Organization Name and Address Office of Naval Research		11. Contract(C) or Grant(G) No. (C) N00014-90-J-1912 (G)	
15. Supplementary Notes This report should be cited as: Woods Hole Oceanog. Inst. Tech. Rept., WHOI-93-34.		13. Type of Report & Period Covered Technical Report	
16. Abstract (Limit: 200 words) The JASON remotely operated vehicle (ROV) system has been under development for the last decade. After a number of engineering test cruises, including the discovery of the R.M.S. Titanic and the German Battleship Bismarck, this ROV system is now being implemented in oceanographic investigations. This paper explains its development history and its unique ability to carry out a broad range of scientific research.		14.	
17. Document Analysis a. Descriptors deep submergence engineering robotics and control telepresence and telecommunications b. Identifiers/Open-Ended Terms c. COSATI Field/Group			
18. Availability Statement Approved for public release; distribution unlimited.		19. Security Class (This Report) UNCLASSIFIED	21. No. of Pages 53
		20. Security Class (This Page)	22. Price