

Woods Hole Oceanographic Institution

WHOI-95-14

COPY 1

Technical Report

July 1995

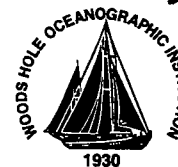

---

## Arabian Sea Mixed Layer Dynamics Experiment

Mooring Deployment Cruise Report

R/V *Thomas Thompson* Cruise Number 46

14 April- 29 April 1995

by

Richard A. Trask

Robert A. Weller

William M. Ostrom

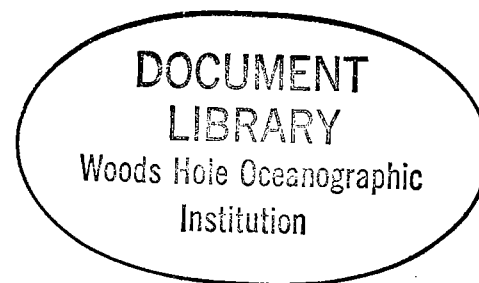

July 1995

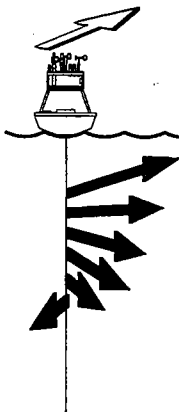

Upper Ocean Processes Group  
Woods Hole Oceanographic Institution  
Woods Hole, Massachusetts 02543 U.S.A.

UOP Technical Report 95-4

WHOI-95-14  
UOP 95-04

Arabian Sea Mixed Layer Dynamics Experiment Mooring Deployment  
Cruise Report

R/V *Thomas Thompson* Cruise Number 46  
14 April- 29 April 1995

by

Richard P. Trask  
Robert A. Weller  
William M. Ostrom

Woods Hole Oceanographic Institution  
Woods Hole, Massachusetts 02543

July 1995

Technical Report

Funding was provided by the Office of Naval Research through  
Grant No. N00014-94-1-0161.

Reproduction in whole or in part is permitted for any purpose of the United States  
Government. This report should be cited as Woods Hole Oceanog. Inst. Tech. Rept.,  
WHOI-95-14.

Approved for public release; distribution unlimited.

Approved for Distribution:



Philip L. Richardson, Chair  
Department of Physical Oceanography

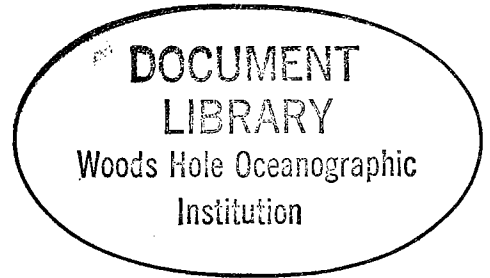

## Abstract

An array of surface and subsurface moorings were recovered and redeployed in the Arabian Sea to provide high quality time series of local forcing and upper ocean currents, temperature, and conductivity in order to investigate the dynamics of the ocean's response to the monsoonal forcing characteristic of the area. The moored array was first deployed during R/V *Thomas Thompson* cruise number 40 and then recovered and redeployed during cruise number 46.

One Woods Hole Oceanographic Institution (WHOI) surface mooring, two Scripps Institution of Oceanography (SIO) surface moorings and one of two University of Washington (UW) Profiling Current Meter moorings were recovered and redeployed during R/V *Thomas Thompson* cruise number 46. The array was deployed in October 1994 as part of the Office of Naval Research funded Arabian Sea experiment. Two six-month deployments were planned. The moorings were deployed at 15.5°N 61.5°E (WHOI), 15.7°N 61.3°E (SIO), 15.7°N 61.7°E (UW), and 15.3°N 61.7°E (UW).

The WHOI surface mooring was outfitted with two meteorological data collection systems. A Vector Averaging Wind Recorder and an IMET system made measurements of wind speed and direction, sea surface temperature, air temperature, short wave radiation, long wave radiation, barometric pressure, relative humidity and precipitation. Subsurface instrumentation included Vector Measuring Current Meters, Multi-Variable Moored Systems, conductivity and temperature recorders and single point temperature recorders.

Expendable bathythermograph (XBT) data and conductivity-temperature-depth (CTD) data were collected while in transit to the site and at mooring locations. A surface drifter with near-surface (.25 to 2.5 meters depth) temperature array was deployed for three 12 hour periods during the cruise in close proximity to the WHOI surface buoy. Acoustic Doppler Current Profiler and shipboard meteorological data were collected throughout the cruise.

This report describes in a general manner the work that took place during the R/V *Thomas Thompson* cruise number 46 which was the mooring turnaround cruise for the moored array program. A detailed description of the WHOI surface mooring and its instrumentation is provided. Information about the XBT and CTD data and near-surface temperature data collected during the cruise is also included.

## Table of Contents

	Page
List of Figures .....	4
List of Tables .....	5
 Section 1: Introduction.....	 6
Section 2: The Moored Array .....	10
A. WHOI Surface Mooring.....	10
B. WHOI Instrumentation .....	14
1. Meteorological Instrumentation.....	14
a. Vector Averaging Wind Recorder .....	14
b. IMET Meteorological System.....	18
c. Stand Alone Relative Humidity/Temperature Inst. ....	20
2. Sub-Surface Instrumentation .....	21
a. Buoy Tension Recorder\.....	21
b. Sub-surface Argos Transmitter .....	21
c. SEACAT Conductivity and Temperature Recorders .....	21
d. Dissolved Oxygen Sensor.....	24
e. Brancker Temperature Recorders.....	24
f. Miniature Temperature Recorder (MTR).....	26
g. WHOI Vector Measuring Current Meters .....	26
h. USC Multi-Variable Moored System .....	27
I. LDEO Multi-Variable Moored System .....	27
j. Tracor Applied Sciences Bio-Acoustic Instrument.....	27
 Section 3: Ancillary Instrumentation .....	 28
A. WHOI Shipboard Meteorological System.....	28
B. WHOI Drifter with Near-surface Temperature Array .....	29
 Section 4: Cruise Chronology .....	 31
 Acknowledgments.....	 43
References.....	43
 Appendix 1: Cruise Participants .....	 44
Appendix 2: XBT Information.....	45
Appendix 3: CTD Positions .....	60
Appendix 4: Instrument Summary.....	64
Appendix 5: Wind Direction Comparison Tests .....	67
Appendix 6: WHOI Instrument Time Marks .....	70
Appendix 7: WHOI VMCM Record Format. ....	72
Appendix 8: TN 046 Deck Layout Drawings .....	73
Appendix 9: Deployment and Recovery Information About WHOI Instrumentation of the UW PCM South Mooring .....	83
Appendix 10: Antifouling Coating Tests .....	85

## List of Figures

	Page
Figure 1: Arabian Sea mooring cruise schedule.....	7
Figure 2: Cruise track and mooring locations.....	8
Figure 3: Arabian Sea moored array instrument locations.....	11
Figure 4: WHOI surface mooring schematic.....	12
Figure 5: Near-surface temperature array on the WHOI Arabian Sea 1 discus buoy. ....	25
Figure 6: Drifting temperature array used during TN 046.....	30
Figure 7: Schematic of the SIO northern surface mooring.....	33
Figure 8: Schematic of the UW southern Profiling Current Meter mooring. ....	35
Figure 9: WHOI surface mooring acoustic release survey.....	41
Figure A2-1: A plot of XBT locations during TN 046. ....	46
Figure A2-2: Overplot of outbound XBT profiles 1-10.....	48
Figure A2-3: Overplot of outbound XBT profiles 11-20.....	49
Figure A2-4: Overplot of outbound XBT profiles 21-30.....	50
Figure A2-5: Overplot of outbound XBT profiles 31-41.....	51
Figure A2-6: Overplot of inbound XBT profiles 1-10.....	54
Figure A2-7: Overplot of inbound XBT profiles 11,12, and 14-21. ....	55
Figure A2-8: Overplot of inbound XBT profiles 22-31.....	56
Figure A2-9: Overplot of inbound XBT profiles 32-37 and 39-42. ....	57
Figure A2-10: Overplot of inbound XBT profiles 43-52.....	58
Figure A2-11: Overplot of inbound XBT profiles 53, and 55-60. ....	59
Figure A5-1: VAWR and IMET wind direction comparison tests conducted at WHOI. ....	68
Figure A5-2: VAWR and IMET wind direction comparison tests conducted in Muscat, Oman.....	69
Figures A8-1 to 9: Deck layout drawings showing the rotation of mooring equipment for each phase of the cruise.....	74-82
Figure A10-1: Antifouling paint test locations on the Arabian Sea 1 discus buoy hull.....	87
Figure A10-2: Antifouling paint test locations on the Arabian Sea 2 discus buoy hull.....	88

## List of Tables

	Page
Table 1: Mooring deployment information from Arabian Sea 1.....	9
Table 2: Mooring deployment information from Arabian Sea 2.....	9
Table 3: Arabian Sea 2 Moored Array Instrumentation.....	15
Table 4: VAWR Sensor Specifications.....	16
Table 5: IMET Sensor Specifications.....	19
Table 6: IMET Modules deployed during Arabian Sea 2.....	19
Table 7: IMET Modules deployed during Arabian Sea 1.....	20
Table 8: Sensors mounted on the Arabian Sea 1, WHOI surface buoy and their respective elevations.....	22
Table 9: Sensors mounted on the Arabian Sea 2, WHOI surface buoy and their respective elevations.....	23
Table 10: Temperature recorders used with the drifting temperature array and their respective depths.....	31
Table 11: Nominal depths of the five WHOI VMCMs on the first deployment of the southern profiling current meter mooring.....	36
Table A2-1: Outbound XBT deployment times, positions and corresponding bucket temperatures from TN 046. ....	47
Table A2-2: Inbound XBT deployment times, positions and corresponding bucket temperatures from TN 046. ....	52
Table A3-1: CTD stations taken during TN046.....	61

## Section 1: Introduction

The R/V *Thomas Thompson* cruise number 46 (TN046) departed Muscat, Oman, on 14 April 1995 at 0345 UTC. The purpose of the cruise was to recover and redeploy one Woods Hole Oceanographic Institution (WHOI) surface mooring, two Scripps Institution of Oceanography (SIO) surface moorings and one University of Washington (UW) subsurface profiling current meter (PCM) mooring. All of the moorings were part of the Office of Naval Research funded Arabian Sea experiment. This was the second of three cruises planned for the experiment. The final recovery of all moorings is planned for October 1995. The mooring deployment schedule is shown in Figure 1.

The cruise involved personnel from the Woods Hole Oceanographic Institution, Scripps Institution of Oceanography, University of Southern California (USC), Lamont Doherty Earth Observatory (LDEO), Japan Marine Science and Technology Center (JAMSTEC), and University of Washington. Appendix 1 lists the cruise participants. Figure 2 shows the cruise track and the mooring locations. Table 1 lists the deployment and recovery dates for the first setting of the moored array as well as the surveyed anchor positions. Table 2 lists the deployment dates and positions of the moorings that were redeployed during TN046.

While enroute to and from the moored array at the beginning and end of the cruise hourly expendable bathythermograph (XBT) data were collected. The XBT positions and several composite plots of the XBT profiles appear in Appendix 2. A total of 35 conductivity-temperature-depth (CTD) casts were made throughout the cruise. Casts 6 through 17 and 24 to 35 were done in a to yo fashion between the surface and 50 meters depth as the ship maintained position near a drifting temperature array. Most of the other profiles were done in conjunction with a particular mooring site. Appendix 3 contains a listing of the CTD positions, start times and maximum depth of the stations.

This report has, in addition to this introduction, three sections. The second section primarily describes the WHOI mooring and the instrumentation that was deployed on the WHOI mooring. The third section describes several pieces of ancillary equipment used during the cruise. The fourth section is a chronology of the entire cruise.

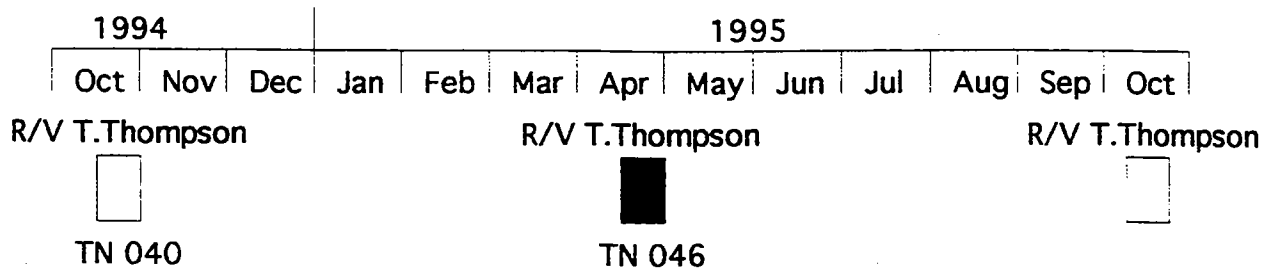

First 6 Month Setting of WHOI and SIO Surface Moorings

Second 6 Month Setting of WHOI and SIO Surface Moorings

First 6 month deployment of UW Southern PCM Mooring

Second 6 month deployment of UW Southern PCM Mooring

One Year Deployment of UW Northern PCM Mooring

Figure 1. Arabian Sea mooring cruise schedule.



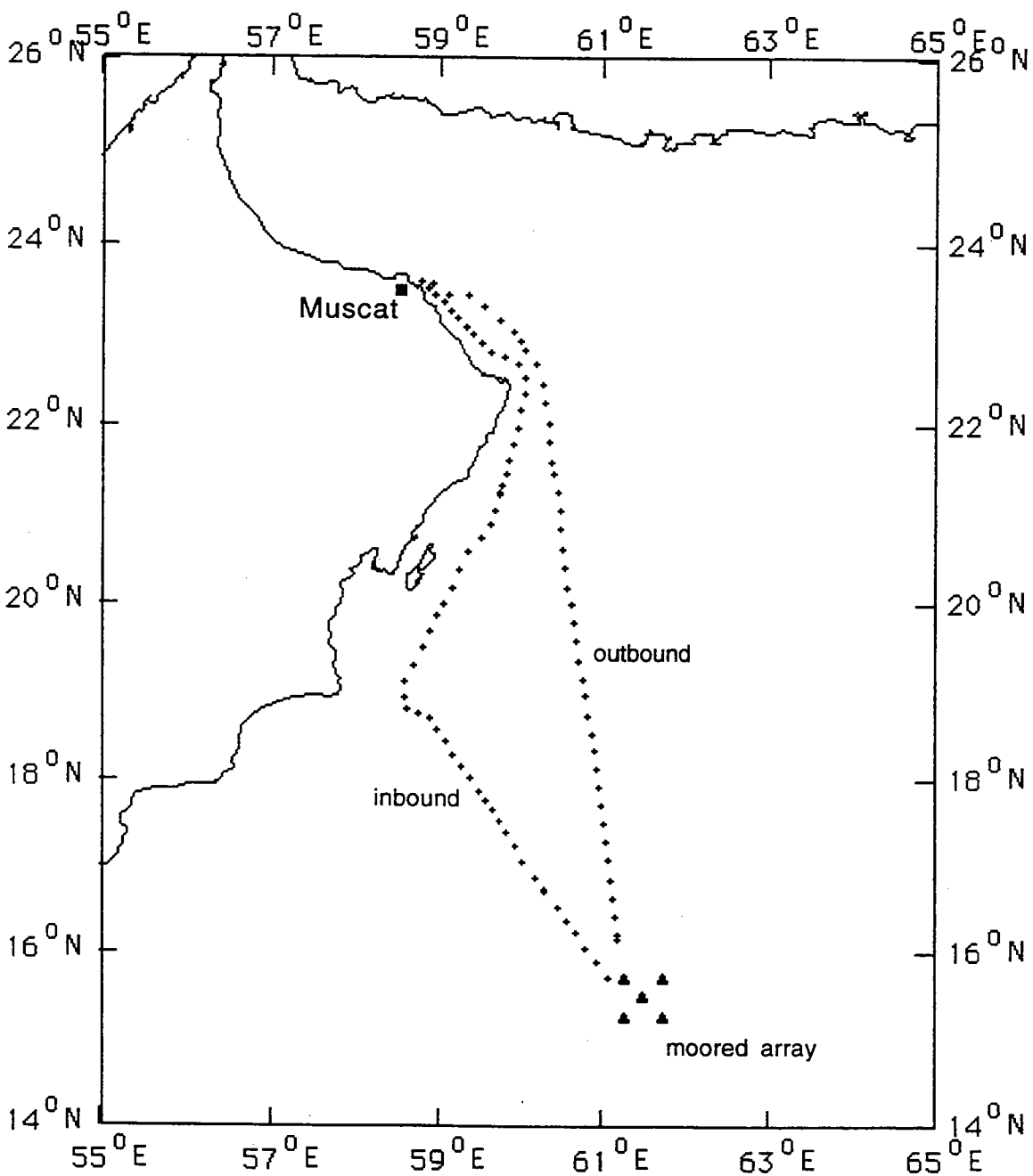

Figure 2: Cruise track and mooring locations.

**Table 1. Arabian Sea 1 Mooring Deployment Information**

Mooring (WHOI Moor. Reference No.)	Deployment Date and Time	Recovery Date and Time	Anchor Position
WHOI Discus Buoy (969)	15 October 1994 @1048 UTC	20 April 1995 @ 0105 UTC	15° 30.04'N 61° 29.99'E
SIO Northern Buoy	17 October 1994 @0723 UTC	16 April 1995 @ 0359 UTC	15° 43.53'N 61° 15.94'E
SIO Southern Buoy	18 October 1994 @0649 UTC	23 April 1995 @ 0221 UTC	15° 16.53'N 61° 16.11'E
UW Northern PCM (972)	23 October 1994	Not Recovered During TN 046	15° 43.90'N 61° 44.53'E
UW Southern PCM (970)	19 October 1994	18 April 1995	15° 16.37'N 61° 44.07'E

**Table 2. Arabian Sea 2 Mooring Deployment Information**

Mooring (WHOI Moor. Reference No.)	Deployment Date and Time	Anchor Position
WHOI Discus Buoy (975)	22 April 1995 @ 0939 UTC	15° 30.07'N 61° 30.05'E
SIO Northern Buoy	17 April 1995 @ 0715 UTC	15° 43.39'N 61° 15.86'E
SIO Southern Buoy	24 April 1995 @ 0715 UTC	15° 16.52'N 61° 16.12'E
UW Northern PCM (972)	23 October 1994	15° 43.90'N 61° 44.53'E
UW Southern PCM (976)	25 April 1995 @ 0650 UTC	15° 16.11'N 61° 43.82'E

## Section 2: The Moored Array

Four moorings were recovered and redeployed during cruise number 46 of the R/V *Thomas Thompson*. The central mooring in the array was a WHOI / Upper Ocean Processes (UOP) group surface mooring with meteorological and oceanographic instrumentation. The WHOI mooring will be described in greater detail in the following sections. To the west of the WHOI mooring were two SIO surface moorings utilizing 7'-6" diameter toroid shaped buoys for their primary flotation. The SIO moorings were given a north and south designation. The SIO buoys were outfitted with a tower that contained two redundant meteorological systems measuring wind speed and direction, air temperature, sea surface temperature, short wave radiation, and barometric pressure. The subsurface instrumentation on each SIO mooring included a downward looking Acoustic Doppler Current Profiler (ADCP) mounted in the buoy bridle and 10 temperature recorders mounted on the wire in the upper 150 meters. Two additional temperature recorders were added to the second setting of the southern SIO surface mooring at 170 and 190 meters. To the east of the WHOI surface mooring there were two University of Washington subsurface PCM moorings. These were also given a north and south designation. The PCM was designed to cycle between 26 and 202.5 meters. Both PCM moorings had a WHOI temperature logger mounted on the top sphere of the mooring at approximately 20 meters depth and another at approximately 250 meters depth. The southern PCM mooring also had five WHOI Vector Measuring Current Meters (VMCMs) at approximately 300, 500, 750, 1500 and 3000 meters depth. During TN046 only the southern PCM mooring was recovered and redeployed due to concerns about water depth and the depth of the upper sphere. Figure 3 schematically shows all five moorings and the location of the subsurface instrumentation.

### A. WHOI Surface Mooring

The WHOI mooring deployed in the Arabian Sea is shown schematically in Figure 4. The surface buoy is a three meter diameter discus buoy with a two part aluminum tower and rigid bridle. Eighteen meteorological sensors are mounted on the top half of the buoy tower and are described in the following section. Ten near-surface oceanographic sensors are attached to the bridle and buoy hull.

The mooring is an inverse catenary design utilizing wire rope, chain, nylon and polypropylene line and has a scope (Scope = slack length/water depth) of 1.22. In addition to the buoy-mounted instruments the mooring supports an additional 27 recording packages, some of which have multiple sensors.

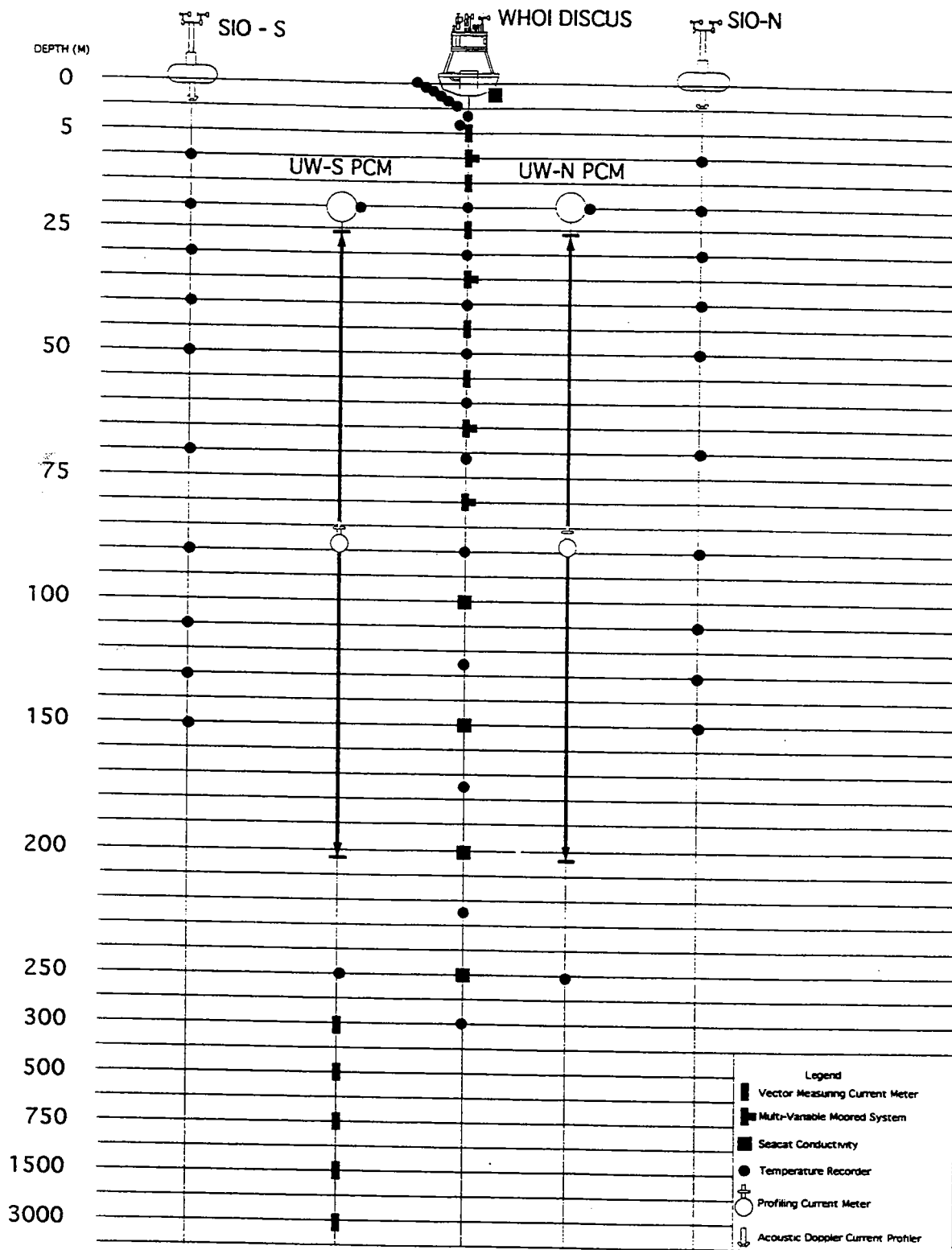
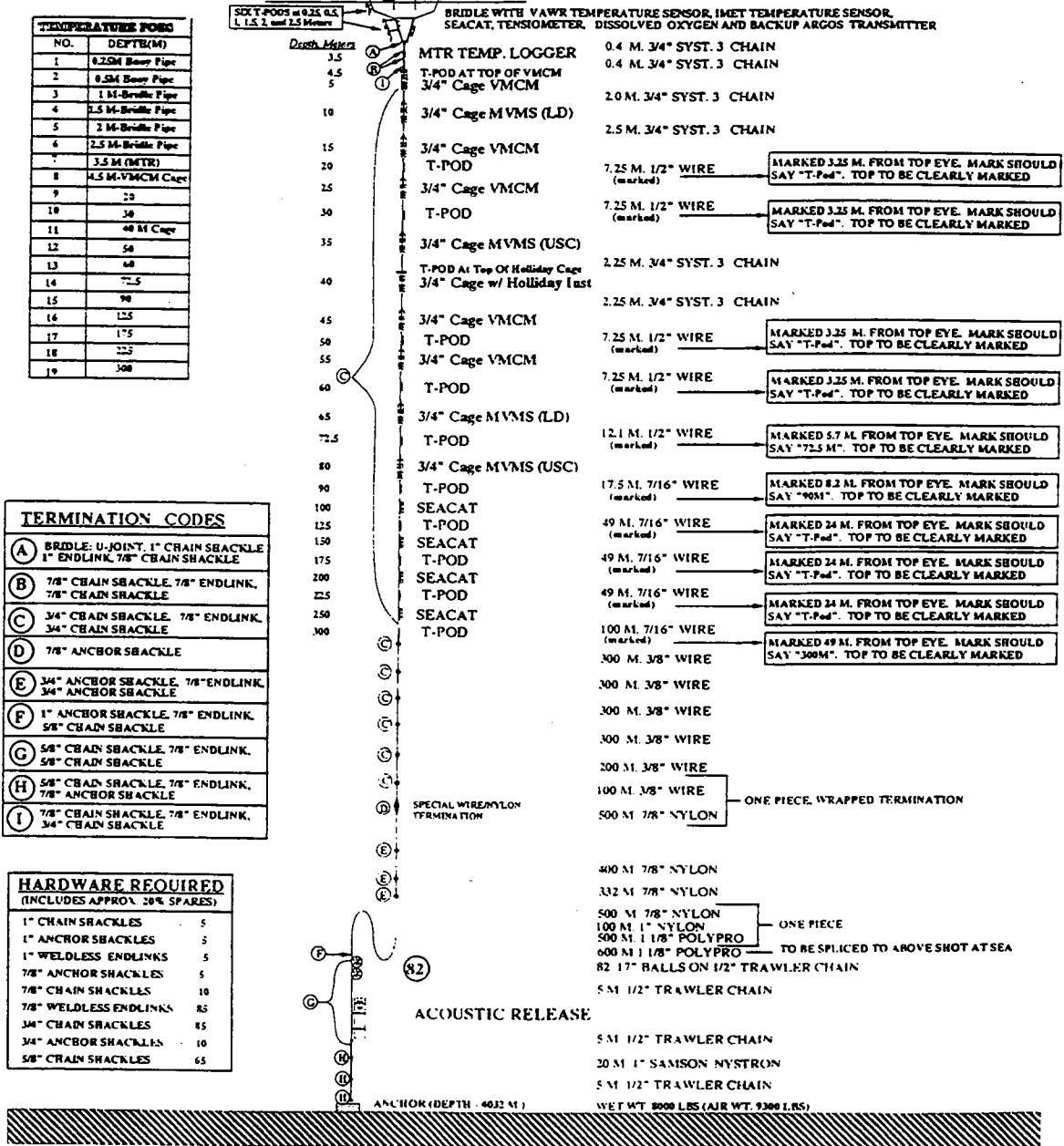

Figure 3: Arabian Sea moored array instrument locations.

MAXIMUM DIAMETER OF BUOY  
WATCH CIRCLE = 3.5 N. MILES

3 meter Discus Buoy with VAWR (With  
Argos Telemetry), IMET, and Tension  
Argos Transmitter



# ARABIAN SEA MOORING

NOMINAL POSITION - 15.5° N 61.5° E

C. TUPPER & TRASK  
APRIL 4, 1994  
REV 18 MAY 94  
REV 15 JUN 94  
REV 20 OCT 94

Figure 4: WHOI surface mooring schematic.

The design of the Arabian Sea mooring took into consideration the high wind and sea state conditions expected during the monsoons. It is believed that the static and dynamic loads that the Arabian Sea surface mooring will experience during the second setting are of such magnitude and duration that conventional designs used successfully in the past in more benign environments may not last in the Arabian Sea. This is because the dynamic loading may be so severe that ultimate strength considerations are superseded by the fatigue properties of the standard hardware components.

During the mooring design process cyclic fatigue tests were conducted on pear rings, shackles, wire rope, load cages, and chain to study the fatigue life of these various components. The fatigue tests showed that weldless sling links also known as pear rings have a relatively short fatigue life when cycled with tensions that a mooring in the Arabian Sea might experience. These components were replaced by 7/8" weldless end links which faired very well during the fatigue tests. In the same manner 3/4" shackles were found to have marginal fatigue characteristics when subjected to the expected tensions. By shot peening the 3/4" shackles their fatigue characteristics improved greatly.

Shot peening is a process whereby a component is blasted with small spherical media called shot in a manner similar to the process of sand blasting. It differs from sand blasting in that the media used in shot peening is more rounded rather than angular and sharp as in sand blasting. Each piece of shot acts like a small ball peen hammer and tends to dimple the surface that it strikes. At each dimple site the surface fiber of the material is placed in tension. Immediately below the surface of each dimple the material is highly stressed in compression so as to counteract the tensile stress at the surface. A shot peened part with its many overlapping dimples therefore has a surface layer with residual compressive stress. Cracks do not tend to initiate or propagate in a compressive stress zone. Since cracks usually start at the surface, a shot peened component will take longer to develop a crack thereby increasing the fatigue life of the part. Many materials will also increase in surface hardness due to the cold working effect of shot peening.

The compressive stresses introduced by shot peening increase the resistance to fatigue failures, corrosion fatigue, stress corrosion cracking, hydrogen assisted cracking, fretting, galling, and erosion caused by cavitation. The benefits of cold working include work hardening, and intergranular corrosion resistance.

Another in-line component that was reviewed during the design process was the load cages of the VMCM. Cage fabrication specifications were found to be so loosely defined that there was considerable variability from cage to cage. With the help of Stonebridge Corp the appropriate

welding specifications were identified. In addition it was felt that dye penetrant inspection of all welds by a certified inspector would provide a level of quality control not present in our existing cages. For new fabrication certification of the origin of the material was added.

Stonebridge also provided assistance in designing a gusset to be welded between the longitudinal members and the end bales to stiffen the cage and improve its fatigue life. Gussets were retrofitted to the existing WHOI VMCM cages by Stonebridge Corp. While the cages were being outfitted with gussets they also had their welds brought up to specification and dye penetrant inspected. New cages were fabricated for the Multi-Variable Moored Systems (MVMS) and bio-acoustic instruments according to the new specifications.

## **B. WHOI Instrumentation**

A total of 36 recording instruments with 94 sensors were deployed on the WHOI Arabian Sea 2 surface mooring. There were two meteorological systems, nine current meters (four with bio-optical sensors), 18 temperature data loggers, five conductivity recording instruments, one tension recorder and one bio-acoustic instrument. The subsurface instrumentation deployed during this cruise is shown in Table 3. Appendix 4 has a complete listing of all WHOI instrumentation that was deployed during TN 40 and TN 46. The listing shows for each instrument type the instrument serial number, the mooring on which it was deployed and the corresponding depth.

### **1. Meteorological Instrumentation**

The WHOI discus buoy was outfitted with two separate meteorological packages. One system was a Vector Averaging Wind Recorder (VAWR) which logged and telemetered data from eight meteorological sensors. The second meteorological data recording system called IMET (for Improved METeorological measurements) logged data from nine meteorological sensors. A third instrument made an independent measurement of relative humidity and temperature and recorded the data internally. All three systems are described in detail below.

#### *a. Vector Averaging Wind Recorder*

One of the two meteorological units mounted on the 3 meter discus buoy is a Vector Averaging Wind Recorder. The VAWR is configured to measure wind speed, wind direction, short wave radiation, long wave radiation, relative humidity, barometric pressure, air temperature, and sea surface temperature.

Recording on a digital cassette the VAWR is writing data to tape every 7.50 minutes. Table 4 shows the type of sensors used for the meteorological measurements and the sampling scheme.

**Table 3: Arabian Sea 2 Moored Array Instrumentation**

April to October 95

Depth (m)	SIO-S	UW-S PCM	WHOI	UW-N PCM	SIO-N
0.25			T-3291		
0.5			T-3299		
1			T-3280		
1			SST V720WR		
1			IMET SST		
1.5	ADCP 195		T-3263		ADCP 196
1.5			SEACAT 928		
1.5			DO S/N 60		
2			T-3274		
2.5			T-3271		
3.5			MTR-3250		
4.5			T-3341		
5			VM-050		
10	SIO T-5467		LD MVMS 203805		SIO T-3267
15			VM-030		
20	SIO T-5459	T-3835	T-4488	T-3279	SIO T-3311
25			VM-034		
30	SIO T-5464		T-3283		SIO T-5461
35			USC MVMS 200203		
40	SIO T-5466		BIO-ACOUSTIC		SIO T-5456
40			T-3309		
45			VM-003		
50	SIO T-5455		T-4492		SIO T-5465
55			VM-014		
60			T-3296		
65			LD MVMS 500301		
70	SIO T-5457	PCM 08-1		PCM 07-2	SIO T-3710
72.5			T-3699		
80			USC MVMS 200201		
90	SIO T-3714		T-2535		SIO T-5458
100			SEACAT 927		
110	SIO T-3282				SIO T-3302
125			T-2536		
130	SIO T-3304				SIO T-5462
150	SIO T-3316		SEACAT 144		SIO T-5463
170	SIO T-3285				
175			T-3308		
190	SIO T-5460				
200			SEACAT 929		
225			T-3702		
250		T-2533	SEACAT 142	T-2541	
300		VM-016	T-4495		
500		VM-018			
750		VM-021			
1500		VM-025			
3000		VM-038			

**Legend**

T-####	WHOI Temperature Recorder
SIO T-####	SIO Temperature Recorder
Seacat ###	Seacat Conductivity and Temperature Recorder
ADCP ###	SIO Acoustic Doppler Current Profiler
Bio Acoustic	Tracor Science Applications Bio Acoustic Instrument
USC MVMS #####	University of Southern California Multi-Variable Moored System
LD MVMS #####	Lamont Doherty Earth Observatory Multi-Variable Moored System
MTR-####	WHOI Temperature Recorder



**Table 4. VAWR Sensor Specifications**

Parameter	Sensor Type	Nominal Accuracy	Comments
Wind Speed	R.M. Young 3-cup 3-cup Anemometer	+5% +/-2%	Vector-averaged Note 6
Wind Direction	Integral vane w/vane follower WHOI/EG&G	+/- 1 bit 5.6 degrees	Vector-averaged
Insolation	Pyranometer Eppley 8-48	+/-3% of reading	Averaged
Longwave Radiation	Pyrgeometer Eppley PIR	+/- 10%	Averaged
Thermopile	PIR		Note 4
Body Temp.	10K @ 25 deg. C		Note 5
Dome Temp.	10K @ 25 deg. C		
Relative Humidity	Variable Dielectric Conductor Vaisala Humicap 0062HM	+/- 2% RH	3.515 sec. Sample Note 1
Barometric Pressure	Quartz crystal Digiquartz Paroscientific Model 215, 216	+/- 0.2 mbars wind < 20 m/s	2.636 sec. Sample Note 1
Sea Temperature	Thermistor Thermometrics 4K @ 25 degrees C	+/- .005 deg C	Note 2
Air Temperature	Thermistor Yellow Springs #44034 5K @ 25 degrees C	+/- 0.2 deg C wind > 5 m/s	Note 3

**Notes:**

1. Relative Humidity and Barometric Pressure are burst samples taken in the middle of the recording interval.
2. Sea temperature is measured during the first quarter of the recording interval, for one quarter of the record time.
3. Air temperature is measured during the second quarter of the recording interval, for one quarter of the record time. Error associated with solar heating is not included in accuracy.
4. LWR body temperature is measured during the third quarter of the recording interval, for one quarter of the record time. Error associated with solar heating is not included in accuracy.
5. LWR dome temperature is measured during the fourth quarter of the recording interval, for one quarter of the record time.
6. Over estimation of wind speed is characteristic of cup anemometers.

Data from the VAWR was telemetered via satellite back to WHOI through Service Argos. The VAWR Argos transmitter has three PTT ID numbers for data transmission, one of which is used for obtaining position information.

The standard temperature range typically used in the VAWR is 0 to 30°C. This range was modified to be 0 to 35°C for the Arabian Sea experiment due to the expected high temperatures.

The VAWR sea surface temperature (SST) sensor was mounted on the bridle at a depth of approximately 1 meter. A continuous length of cable was run from the VAWR to the buoy deck and then down to the bridle-mounted SST sensor via an external aluminum pipe mounted on the side of the buoy to protect the cable. This method eliminates the need for multiple bulkhead connectors which can affect the temperature reading.

The VAWR deployed in the Arabian Sea experiment was modified to measure and record several long wave radiation parameters. The outputs from the thermopile, dome temperature and body temperature were recorded by the VAWR.

Wind tunnel tests have shown that the cage bars of the VAWR wind sensor have in the past caused the vane to be offset, depending upon where the vane was in relation to the cage bars. If the vane was oriented such that it was in close proximity to one of the cage bars the turbulence around the bar tended to offset the vane from its true direction.

The findings of these tests and recent experience with one instrument from another experiment that was missing a vane upon recovery brought about some changes to the VAWR vane for the Arabian Sea experiment. The length of the vane was shortened to 6.5". The general shape of the vane however, was not changed. The pivot rod was slotted so that the edge of the vane could be inserted. Nylon screws through the pivot rod secured the vane to the pivot rod. Two part epoxy was used as a filler to smooth the transition between the pivot bar and the vane as well as to provide extra strength to the joint.

The vane cage bars for the Arabian Sea experiment VAWR were inclined such that when viewed from above it appears as if the top had been rotated clockwise relative to the bottom plate. The VAWR was mounted on the buoy such that the VAWR lubber line is not perpendicular to the front face of the buoy. It was rotated approximately 15° in a clockwise direction so as to offset the location of the rear cage bar.

Prior to shipment to Oman the air and sea temperature sensors as well as the relative humidity sensors were calibrated at WHOI. The calibrations of the barometric pressure sensors

were checked at WHOI and if found out of specification were returned to the manufacturer for recalibration. The short wave and long wave radiation sensors were calibrated by the manufacturer. The wind direction sensor readings were compared with a known bearing to a fixed target both at WHOI and in Muscat. Details of the direction comparison tests can be found in Appendix 5. In addition the meteorological instruments were left running on the buoy for two months prior to shipment to burn-in all systems and work out the bugs. The data was compared with standards at WHOI.

#### *b. IMET Meteorological System*

The IMET meteorological sensor system for the Arabian Sea WHOI Central buoy consists of nine IMET sensor modules. The modules measure the following parameters:

1. Relative humidity with temperature;
2. Barometric pressure;
3. Air temperature (RM Young passive shield);
4. Air temperature (aspirated shield);
5. Sea surface temperature;
6. Precipitation;
7. Wind speed and direction;
8. Short wave radiation;
9. Long wave radiation.

All IMET modules for the Arabian Sea were modified for lower power consumption so that a non-rechargeable alkaline battery pack could be used.

The data logger for the system is based on an Onset Computer Corp. Model 7 Tattletale computer with hard drive, also configured and programmed with power conservation in mind. An associated interface board ties the Model 7 via individual power and RS-485 communications lines to each of the 9 IMET modules.

The IMET sensors used on the Arabian Sea 1 and 2 deployments are listed in Table 5. Tables 6 and 7 list the IMET modules and their associated software deployed in April 95 and October 94 respectively.

#### *Arabian Sea IMET Sampling*

The logger polls all modules at one minute intervals (takes several seconds) and then goes to low power sleep mode for the rest of the minute. Data is written to disk once per hour.

The air temperature, sea surface temperature, barometric pressure, relative humidity, long wave radiation and precipitation modules take a sample once per minute and then go to low power sleep mode for the rest of the minute.

**Table 5. IMET Sensor Specifications.**

Parameter	Sensor	Nominal Accuracy
Air Temperature	Platinum Resistance Thermometer	+/- .25° C
Sea Temperature	Platinum Resistance Thermometer	+/- .005° C
Relative Humidity	Rotronic MP-100F	+/- 3%
Barometric Pressure	Quartz crystal AIR DB-1A	+/- .5 mbar
Wind Speed and Wind Direction	R.M. Young model 5103 Wind Monitor	-3% (speed) +/- 1.5° (dir)
Shortwave Radiation	Temperature Compensated Thermopile Eppley PSP	+/- 3%
Longwave Radiation	Pyrgometer Eppley PIR	+/- 10%
Precipitation	R.M. Young Model 50201 Self siphoning rain gauge	+/- 10%

**Table 6. IMET Modules deployed during Arabian Sea 2.**

Module	Software Version Used
HRH #108	IMETHRH v2.2
WND #111	IMETWND v2.2
LWR #103	IMETLWR v2.0
SST #006	IMETTMP v2.0
TMP #105	IMETTMP v2.0
SWR #104	IMETSWR v2.1
BPR #106	IMETBPR v2.0
PRC #108	METPRC v2.1
TMP #106 (ASPIRATED)	IMETTMP v2.0
LOGGER #228	LOGGER10 v1.5

**Table 7. IMET Modules deployed during Arabian Sea 1.**

Module	Software Version Used
HRH #111	IMETHRH v2.2
WND #104	IMETWND v2.0
LWR #101	IMETLWR v2.0
SST #106	IMETTMP v2.0
TMP #101	IMETTMP v2.0
SWR #109	IMETSWR v2.1
BPR #107	IMETBPR v2.0
PRC #101	IMETPRC v2.1
TMP #108 (ASPIRATED)	IMETTMP v2.0
LOGGER #226	LOGGER10 v1.5

The short wave radiation module takes a sample every 10 seconds and produces a running one minute average of the six most recent samples. It goes to low power sleep mode between 10 second samples.

The vane on the wind module is sampled at one second intervals and averaged over 15 seconds. The compass is sampled every 15 seconds and the wind speed is averaged every 15 seconds. East and north current components are computed every 15 seconds.

Once a minute the logger stores an average east and north component that is an average of the most recent four 15 second averages. In addition average speed from four 15 second averages is stored, along with the maximum and minimum speed during the previous minute, average vane computed from four 15 second averages, and the most recent compass reading.

*c. Stand Alone Relative Humidity / Temperature Instrument*

A self contained relative humidity and temperature instrument was mounted on the tower of the WHOI discus buoy. This instrument, developed and built by members of the Upper Ocean Processes Group, takes a single point measurement of both relative humidity and temperature at a desired record interval. The sensor used is a Rotronics MP-100. The relative humidity and temperature measurements are made inside a protective Grotex shield. The logger is an Onset Computer Corp. model 4A Tattletale with expanded memory to 512K. The unit is powered by its own internal battery pack.

The mechanical housing is PVC pipe which has been machined to accept end caps with an O-ring seal. A multi-plate radiation shield protects the sensors from direct sunlight and is similar to

that used on the VAWR relative humidity sensor. The recording interval was set to 3.75 minutes for the Arabian Sea experiment.

The height (and depth) of the buoy and bridle mounted instrumentation can be found in Tables 8 and 9 for the first and second mooring deployments respectively. Actual water line measurements were made on the recovered buoy from the first deployment. The predicted water line on the Arabian Sea 2 buoy is .38 meters (as measured on the recovered buoy) below the buoy deck but will be checked when the buoy is recovered.

## 2. Sub-Surface Instrumentation

### *a. Buoy Tension Recorder*

Buoy tension was measured at the base of the buoy bridle using a D.J. Instruments Co. tension cell and recorded using an Onset Computer Corp. Model 6 Tattletale. The tension cell was rated from 0 to 10,000 pounds. The sampling rate for tension in a 12 hour period beginning at 0000 UTC and 1200 UTC is as follows:

45 minutes of 4 Hz tension

15 minutes of 20 second max/min/average of 4 Hz tension

11 hours of 20 second max/min/average of 4 Hz tension

This is repeated every 12 hours for a 24 hour cycle.

The data is then stored to a hard disk on the Tattletale.

An Argos transmitter is connected to the tension logger so that a single point tension measurement is included with every transmission. Position information is provided by Service Argos in conjunction with the tension transmissions.

### *b. Sub-Surface Argos Transmitter*

An NACLS Inc. Subsurface Mooring Monitor (SMM) is mounted upside down on the bridle of the discus buoy as a backup recovery aid in the event that the mooring parts and the buoy flips upside down. The SMM has an internal mercury switch which turns an Argos transmitter on when the unit is upright. If the mooring parted and the buoy became unstable and flipped upside down the Argos transmitter would switch on and the buoy position could be tracked.

### *c. SEACAT Conductivity and Temperature Recorders*

There were five Seabird Inc. Seacat conductivity and temperature recorders deployed on the WHOI surface mooring. The shallowest Seacat was mounted directly to the bridle of the discus buoy. The other four were mounted on in-line tension bars and deployed at 100, 150, 200 and 250 meters depth. The stainless tension rods recovered from the first discus mooring showed signs of corrosion, particularly those deployed at 100 and 150 meters depth. These depths

**Table 8: Sensors mounted on the WHOI Arabian Sea 1 surface buoy deployed from October 1994 to April 1995.**

Parameter	Sensor ID	Elevation relative to buoy deck (meters)	Elevation relative to water line (meters)	Measurement Location
VAWR	V721WR			
Air Temp	Therm. 5804	2.3	2.68	Mid Shield
Relative Hum	V-034-001	2.31	2.69	Mid Shield
Barom. Press	S/N 46398	2.38	2.76	Center of port
Wind Speed	V721WR	2.98	3.36	Center of cups
Wind Direction	V721WR	2.69	3.07	Mid Vane
Short Wave	S/N 25418	3.04	3.42	Base of dome
Long Wave	S/N 28463	3.04	3.42	Base of dome
Sea Temp	Therm. 5005	-1.3	-0.92	End of probe
IMET	Logger No. 226			
Air Temp	TMP 101	2.36	2.74	Mid Shield
Relative Hum	HRH 111	2.36	2.74	Mid Shield
Barom. Press	BPR 107	2.39	2.77	Center of port
Wind Speed	WND 104	2.78	3.16	Prop Axis
Wind Direction	WND 104	2.78	3.16	Prop Axis
Short Wave	SWR 109	3.04	3.42	Base of dome
Long Wave	LWR 101	3.04	3.42	Base of dome
Precipitation	PRC 101	2.76	3.14	Top of Funnel
Sea Temp	SST 106	-1.27	-0.89	End of probe
Aspirated Air Temp	TMP 108	1.82	2.2	Opening of port
Stand alone RH w/ temp	002	2.6	2.98	Mid Shield
Seacat	S/N 1179	-1.8	-1.42	At temp probe
Dissolved Oxygen	60	-1.8	-1.42	Sensor end
Temperature Recorder	5432	-1.75	-1.37	Thermistor end
Temperature Recorder	3836	-0.55	-0.17	Thermistor end
Temperature Recorder	3662	-0.81	-0.43	Thermistor end
Temperature Recorder	4483	-1.30	-0.92	Thermistor end
Temperature Recorder	3667	-1.79	-1.41	Thermistor end
Temperature Recorder	3839	-2.29	-1.91	Thermistor end
Temperature Recorder	3762	-2.78	-2.4	Thermistor end

(-) indicates distance below reference indicated  
Distance between buoy deck and water line was .38 meters

**Table 9: Sensors mounted on the WHOI Arabian Sea 2 surface buoy deployed from April 1995 to October 1995.**

Parameter	Sensor ID	Elevation relative to buoy deck (meters)	Measurement Location
VAWR	V720WR		
Air Temp	Therm. 5854	2.32	Edge of 3rd plate from top
Relative Hum	V-029	2.34	Edge of 3rd plate from top
Barom. Press	S/N 44147	2.38	Center of port
Wind Speed	V720WR	2.96	Center of cups
Wind Direction	V720WR	2.69	Mid Vane
Short Wave	S/N 21972	3.03	Base of dome
Long Wave	S/N 28459	3.03	Base of dome
Sea Temp	Therm. 5568	-1.3	End of probe
IMET	Logger No. 228		
Air Temp	TMP 105	2.38	Edge of 3rd plate from top
Relative Hum	HRH 108	2.41	Edge of 3rd plate from top
Barom. Press	BPR 106	2.48	Center of port
Wind Speed	WND 111	2.87	Prop Axis
Wind Direction	WND 111	2.87	Prop Axis
Short Wave	SWR 104	3.03	Base of dome
Long Wave	LWR 103	3.04	Base of dome
Precipitation	PRC 108	2.74	Top of Funnel
Sea Temp	SST 006	-1.27	End of probe
Aspirated Air Temp	TMP 106	1.81	Opening of port
Stand alone RH w/ temp	005/27439	2.6	Edge of 3rd plate from top
Seacat	928	-1.8	At Temp Probe
Dissolved Oxygen	60	-1.8	Sensor end
Temperature Recorder	3291	-0.56	Thermistor end
Temperature Recorder	3299	-0.80	Thermistor end
Temperature Recorder	3280	-1.31	Thermistor end
Temperature Recorder	3263	-1.80	Thermistor end
Temperature Recorder	3274	-2.30	Thermistor end
Temperature Recorder	3271	-2.80	Thermistor end
Tension Cell	43845		Base of bridle

(-) indicates distance below buoy deck

Nominal distance between buoy deck and water line is .38 meters



coincide with an oxygen minimum zone and the corrosion observed may be the result of low oxygen corrosion. Tension rods deployed on the second setting were outfitted with anodes on the bolts that secure the band clamps.

The Seacat takes a single point measurement of salinity and temperature at the desired sample rate. On the UOP mooring the Seacats sampled every 7.5 minutes. A time mark was recorded on Seacats recovered from the first deployment and those deployed during TN 046 by submerging the instrument in a cold water bath. Appendix 6 lists the times each of the instruments were placed in the cold.

*d. Dissolved Oxygen Sensor*

A LDEO self powered internally recording dissolved oxygen instrument was mounted to the buoy bridle at 1.5 meters depth. This same instrument had been deployed on the first WHOI mooring and was redeployed on the second setting.

*e. Brancker Temperature Recorders*

A total of 17 Richard Brancker Research Ltd. temperature data loggers (also known as "Branckers" or "T-Pods") were deployed at various depths from .25 meters to 300 meters on the WHOI surface mooring. Figure 4 (mooring schematic) lists the depths where T-Pods were located. The Brancker temperature loggers take a single point temperature measurement every record sample. The UOP Branckers were set for a record rate of 15 minutes.

Six Branckers were mounted on the buoy hull and bridle at depths ranging from approximately .25 meters down to 2.5 meters. Figure 5 shows the discus buoy hull and the location of the six near-surface T-Pods. The near-surface temperature loggers are mounted in multi-plate solar radiation shields which are intended to minimize the direct solar heating of the instrument. The instruments were originally positioned relative to a predicted waterline which was based on a prediction of the mooring tensions. The waterline of the buoy from the first deployment at the time of recovery was measured to be .38 meters below the buoy deck. This placed the individual sensors at .17, .43, .92, 1.41, 1.91, and 2.4 meters below the surface. Figure 5 shows the bridle configuration from the Arabian Sea 1 deployment. The instruments for the second deployment were located at the same depths as the first deployment. The mean location of the waterline for the second deployment will be measured when that buoy is recovered. The actual depths of the sensors will then be computed. The waterline obviously depends on the tension of the mooring such that during periods of high tension the sensors will tend to be deeper than during low tension periods.

# UOP Arabian Sea 1 Discus Bridle Configuration

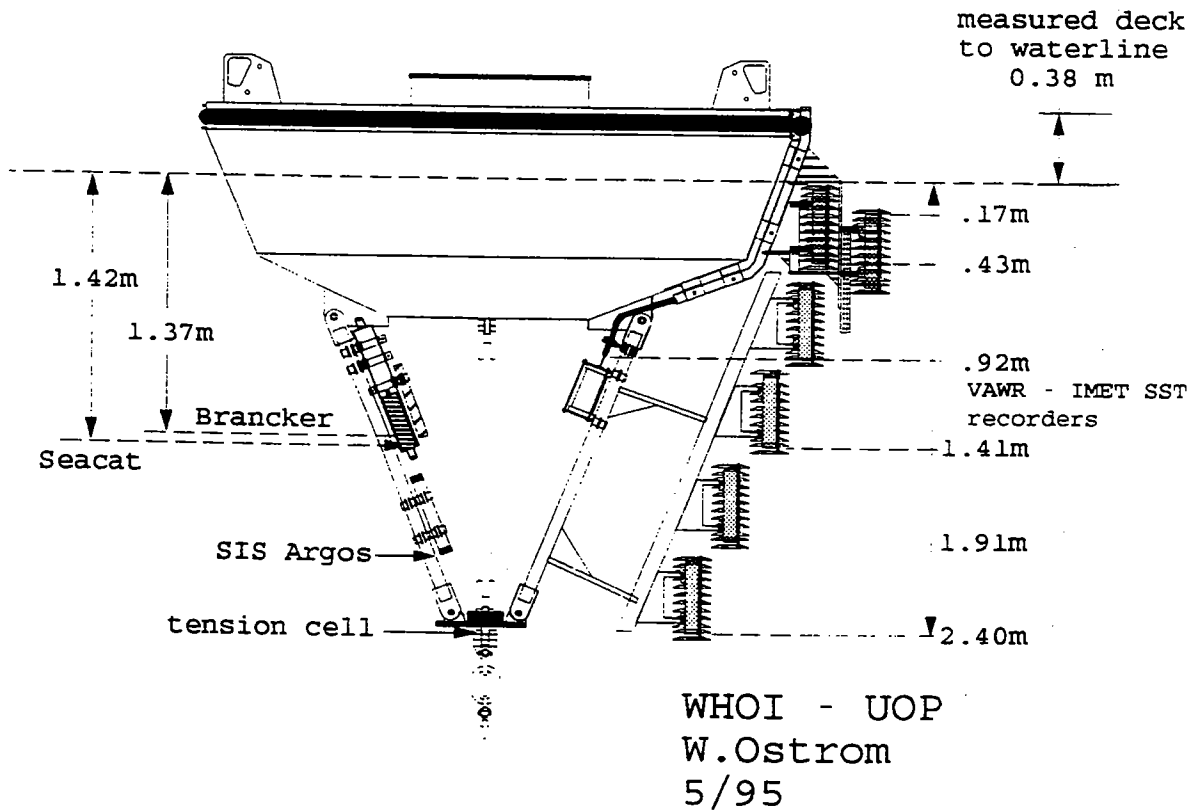

Figure 5: Near-surface temperature array on the WHOI discus buoy.

Two UOP Brankers were deployed on each of the University of Washington PCM moorings. Both moorings had one mounted on the top sphere at approximately 20 meters depth and the other was at 250 meters depth. The two instruments on the southern PCM mooring which was turned around during TN046 were replaced with two different recently calibrated instruments for the second six-month deployment. A time mark was recorded on the temperature loggers that were recovered as well as deployed during TN046. Appendix 6 lists the times each of the instruments were placed in the cold.

*f. Miniature Temperature Recorder*

A single Pacific Marine Environmental Lab (PMEL), Miniature Temperature Recorder (MTR) was mounted at 3.5 meters depth in-line on the mooring. The MTR was mounted inside a 5-sided heavy duty steel box which was attached to an in-line tension bar. Such a mounting arrangement was necessary to protect the MTR since its close proximity to the buoy bridle places it in a very vulnerable location during deployment and recovery. The MTR takes a single point temperature measurement every record sample which for the Arabian Sea deployment was set at 7.5 minutes.

*g. WHOI Vector Measuring Current Meters*

Five WHOI Vector Measuring Current Meters (VMCMs) were deployed on the WHOI surface mooring at 5, 15, 25, 45, and 55 meters depth. The five surface mooring VMCMs record data on digital cassette every 3.75 minutes. A description of how each parameter is sampled is provided in Appendix 7.

The WHOI VMCMs incorporated several changes to the standard EG&G Sea Link product. These included different propeller bearings, a different plastic for the propeller blades and a redesign of the instrument cage including recent gusseting specifically for the Arabian Sea deployment. All VMCMs deployed on the WHOI surface mooring had cages with 3/4" cage rods and a single cross brace to support the sting between the two sets of propellers. See Section 2-A of this report for more details about the cage gusseting.

The VMCMs were outfitted with Silicone Nitride bearings, which have performed well in previous at-sea deployments. During the Subduction experiment VMCM propeller assemblies outfitted with similar bearings were deployed for a total of 24 months without any bearing failures. The propeller blades used in the Arabian Sea were made from injection molded Delrin® 100 ST. Details about the VMCM bearings and propeller blade material can be found in Trask and Brink (1993).

Five WHOI VMCMs were also deployed on the University of Washington southern PCM mooring. Their nominal depths were 300, 500, 750, 1500, and 3000 meters. The record rate of the PCM mooring VMCMs was 7.5 minutes since a one year deployment was planned. Due to concerns about water depth at the southern PCM site and the depth of the top sphere the southern PCM mooring was recovered and redeployed during TN046. The recovered VMCMs were redeployed with new tapes at their previous depths. Propeller shaft bearings and propeller materials were the same as those used on the WHOI surface mooring VMCMs. The VMCM cages used on the PCM mooring had 1/2" cage rods and a single cross brace to support the sting.

*h. USC Multi-Variable Moored System*

USC deployed two Multi-Variable Moored Systems (MVMS) units at 35 meters and 80 meters. Each MVMS records current vectors, rotor counts, compass, temperature, PAR, dissolved oxygen, dissolved oxygen temperature, ~5 cm transmissometer, fluorometer, conductivity, and natural fluorescence (683 nm) at 3.75 minute time intervals set to Global Positioning System (GPS) time and synchronized to the hour mark.

*i. LDEO Multi-Variable Moored System*

LDEO deployed two Multi-Variable Moored Systems at 10 meters and 65 meters. On the LDEO MVMS instruments conductivity, temperature, dissolved oxygen, transmissometer, 683, fluorometer and PAR sensors record data every 4 minutes. Current measurements made by a VMCM were recorded every 7.5 minutes.

The manufacturers of the various MVMS sensors are listed below:

Sensor	Manufacturer
VMCM current sensor	EG&G
Conductivity	Sea bird
Temperature	Sea bird
Dissolved Oxygen	Endeco
Transmissometer	Sea Tech
683	Bio Spherical Instruments
Fluorometer	Sea Tech
PAR	Bio Spherical Instruments

*j. Tracor Applied Sciences Bio-Acoustic Instrument*

A Tracor Applied Sciences bio-acoustic transceiver array measuring backscattering at multiple frequencies to give zooplankton estimates by size distributions was deployed on the WHOI surface mooring at 40 meters. Backscattering at frequencies of 104, 165, 420, 700, 1100, 1850 and 3000 kHz are recorded each hour. Selected frequencies are also recorded on the half hour.

## Section 3: Ancillary Instrumentation

### A. WHOI Shipboard Meteorological System

Following the deployment of a surface buoy and prior to its recovery it is common practice to position the ship approximately .25 miles downwind of the buoy so that shipboard meteorological observations can be made and compared with the data collected by the buoy. While close to the buoy, its Argos transmissions can be received, decoded and compared with the shipboard observations. The comparison of data provides a means to check that the buoy-mounted sensors have not been damaged during deployment. Similarly if a sensor is damaged during recovery it may not be able to be recalibrated. If accurate shipboard observations are made prior to recovery it provides a means to evaluate the sensor's performance at the end of the deployment.

An independent meteorological data recording system was mounted to the jackstaff of the *R/V Thomas Thompson* for use during cruise number 46. The package contains wind speed and direction, air temperature, relative humidity, and barometric pressure sensors. The relative humidity/air temperature sensor is a Rotronic MP-100 sensor that is aspirated to provide values uncontaminated by solar heating. The sensor is the same as is used in the IMET relative humidity module and the standalone relative humidity with temperature instrument. The wind sensor is an R.M. Young propeller anemometer, also used in the IMET wind module. Barometric pressure is measured with a Rosemount type 1201 system which consumes too much power for buoy use but is excellent when it can be powered by 110 VAC. It senses the pressure through a Gill port to minimize the dynamic effects of the wind.

For logging the data a Campbell Scientific Inc. (CSI) model CR10 meteorological data logger was used. This is the smallest of their line and is hermetically sealed in a stainless steel housing. Its 0.2% accuracy in voltage measurements is adequate for the barometric pressure, air temperature, and relative humidity sensor outputs, and its pulse counting ability is designed for the Young anemometer. The barometer and CR10 data logger are housed in a cylinder beneath the Gill port. The CR10 totals the anemometer counts over 10 second intervals and samples the other parameters every 10 seconds. The 10 second values are averaged over one minute and stored internally. Storage capacity is about 2.5 days. A cable for both power and communications runs back to a laboratory space on the ship. CSI software provides a means to upload the stored values to the PC's disk and permits the display of the 10 second samples on a PC screen.

## B. WHOI Drifter with Near-Surface Temperature Array

The WHOI discus buoy deployed in the Arabian Sea is outfitted with a near surface temperature array consisting of six Brancker temperature recorders. Each instrument has a multi-plate radiation shield similar to that found on an air temperature sensor to prevent direct heating by incoming solar radiation. The instruments are mounted to the side of the discus hull and parallel to the buoy bridle at nominal depths of .25, .5, 1.0, 1.5, 2, and 2.5 meters.

The affect of the discus buoy hull on the near surface temperature structure is not well understood. The sensor array is aligned with the wind vane on the buoy and is therefore oriented downwind of the buoy hull. Flow past a moored buoy can create turbulence around the hull. There is concern that surface flow turbulence created by the hull may disturb the temperature structure. If this is the case, measurements made alongside the hull may not be representative of the temperature structure in the adjacent undisturbed water.

To address this concern an identical set of measurements were made from a freely drifting structure that was intended to minimize any disturbance of the temperature structure. The drifting measurements were made in close proximity to the buoy so that the two data sets could be compared.

The structure used for supporting the drifting temperature array was a modified three-ball radio float. The radio float has an aluminum pipe frame with three 17" glass balls attached to it which provide approximately 150 pounds of buoyancy. The radio float is normally used as a recovery aid at the top of subsurface moorings. In its normal configuration it has a submersible radio and light that are pressure switch activated and turn on when they come to the surface, signaling that the top of the mooring is on the surface. For the drifting temperature array a 3" PVC pipe was added to the side of the float to which was attached the temperature recorders. The pipe was located to the side so as to minimize any shadowing from the three glass balls. The drifter array was outfitted with the same type of temperature recorders with multi-plate radiation shields as was on the discus buoy. Figure 6 shows the temperature array attached to the 3-ball radio float. The temperature recorders were placed at the same depths as the discus buoy mounted recorders.

Three 12 hour long experiments were conducted with the drifting temperature array (a.k.a. DrifTAr) during *R/V Thomas Thompson* cruise number 46. The drifter was deployed approximately .25 miles away from the discus buoy just as the sun was coming up (approximately 0200 UTC) and remained in the water until sunset (approximately 1400 UTC). Table 10 lists the temperature recorders used on DrifTAr and indicates their respective depths. The temperature recorders used on the drifter started recording data early in the cruise at a one minute record interval

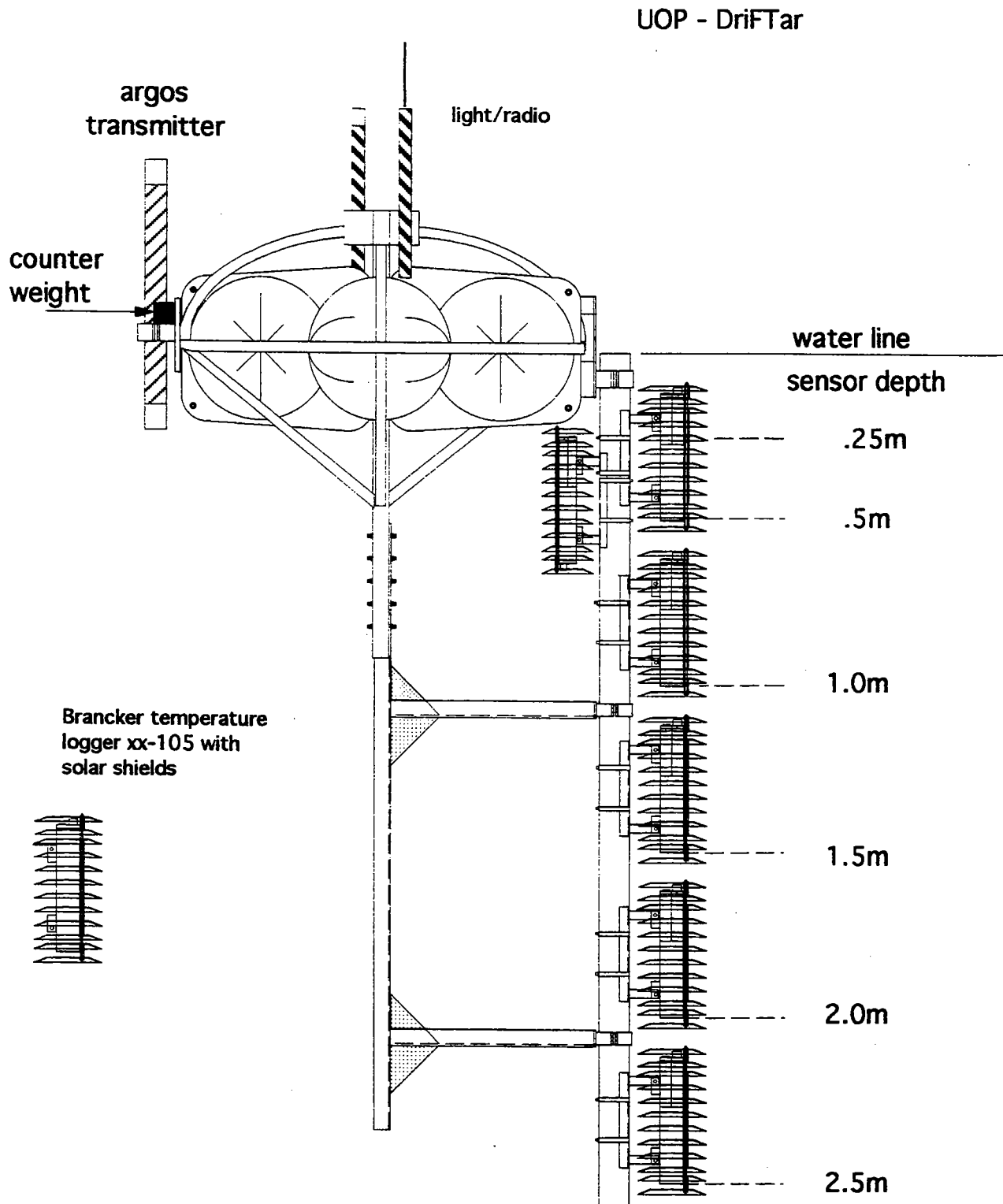

Figure 6. Drifting temperature array used during TN 046.

and were left running while on deck between drifter experiments. During the DriftAr experiments, range and bearing measurements were made to the drifter and the WHOI discus buoy from the ship.

**Table 10. Temperature recorders used on the drifting temperature array and their respective depths.**

Recorder	Depth
4228	.25 m
4402	.50 m
3838	1.0 m
3704	1.5 m
3764	2.0 m
3837	2.5 m

#### **Section 4: Cruise Chronology**

*R/V Thomas Thompson* cruise number 46 departed Muscat, Oman, on 14 April 95 at 0345 UTC. The purpose of the cruise was to recover and redeploy four moorings as part of the Arabian Sea experiment.

While enroute to the mooring sites 42 T-7 Sippican XBTs were deployed hourly on the half hour beginning at 0430 UTC on 14 April 95. At 1110 UTC the ship was stopped and the CTD system was tested. The test was terminated and the CTD recovered after determining that the system was not functioning properly. Once the CTD was recovered the WHOI near-surface temperature drifter was deployed at 1145 UTC 14 April 95 and tethered to the ship to determine if it was properly ballasted. Satisfied with the drifter displacement it was recovered and disassembled. Following the drifter test the mooring releases were wire tested.

The hourly XBTs continued until 0030 UTC on 16 April 95. The SIO ALACE float number 393 was deployed at 0035 UTC 16 April 95. Following the ALACE deployment a second test of the CTD system was conducted, however it continued to malfunction.



### *SIO Northern Surface Mooring Recovery*

The first mooring to be recovered was the northern SIO surface mooring which took place on 16 April 95. The SIO surface mooring had two suites of meteorological sensors measuring wind speed and direction, barometric pressure, air temperature, short wave radiation, and sea surface temperature. Housed in the bridle of the toroid buoy was a downward-looking acoustic doppler current profiler. Additional subsurface instrumentation included ten temperature recorders attached to the upper shot of wire.

The SIO mooring was recovered bottom first. The ship's small boat was deployed and took the surface buoy in tow while the mooring's acoustic release was fired. Towing the buoy while the balls came to the surface was thought to help string out the balls and keep the mooring spread out and less likely to foul on itself. Once the glass ball flotation from the bottom of the mooring was sighted on the surface the small boat left the buoy and connected a tag line into the glass balls. The glass balls came to the surface in a single wuzzle. The glass balls then were towed to the ship with the small boat. Once close to the ship a tag line from the Lebus winch was connected to the glass balls and recovery of the glass balls commenced. The mooring was recovered up to the 50 meter temperature recorder. At this point the upper shot of wire was intentionally cut and terminated with an eye using Crosby clips so that it could be easily passed around to the port side where the buoy was to be recovered. The small boat was once again redeployed to assist in pulling the buoy around to the port side where it was connected to the crane and recovered.

Disassembly of the SIO northern mooring began immediately after recovery. The meteorological system and ADCP were removed so that they could be turned around for redeployment on the southern SIO mooring. During the remainder of the evening the CTD was troubleshoot. The problem turned out to be related to a malfunctioning water pump on the conductivity cell.

### *SIO Northern Surface Mooring Deployment*

The following day (17 April 95) the new northern SIO surface mooring deployment began at 0249 UTC. Figure 7 is a schematic of the SIO northern surface mooring. The surface buoy for this deployment had been prepared in Muscat with new instrumentation. The deployment proceeded without any problems and the anchor was deployed at 0715 UTC. The GPS anchor position for the northern SIO surface mooring was determined to be 15°43.39'N, 61°15.86'E.

# Arab Sea Leg II North

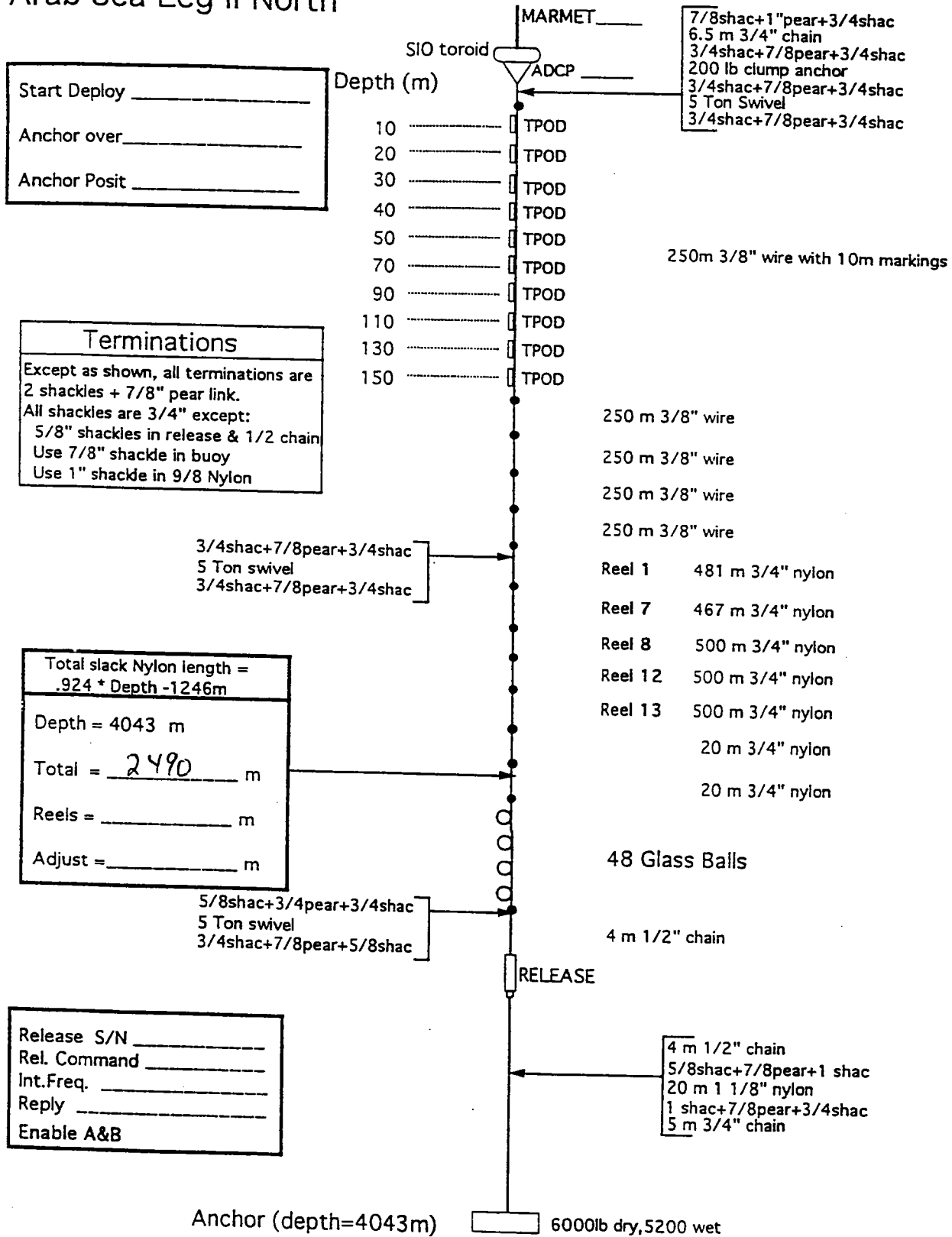

Figure 7: Schematic of the SIO northern surface mooring.

Following the acoustic release/anchor survey a shallow CTD station near the SIO northern mooring was conducted. The CTD station was terminated at a depth of 679 meters since it was felt that the ship was getting too close to the SIO mooring.

The ship then transited from the northern SIO mooring south past the southern SIO mooring collecting underway observations (meteorological and doppler measurements). The ship then steamed to the southern PCM mooring site. A CTD was made at the site prior to the PCM mooring recovery.

#### *UW Southern PCM Mooring Recovery*

The PCM mooring (Figure 8) is a two part mooring. The upper section contains a stainless steel sphere, the profiling current meter, and guide line. The lower section is a standard subsurface mooring with a 2000 pound buoyancy syntactic foam sphere as the primary buoyancy and distributed glass ball buoyancy along the mooring and at the bottom. The two sections are separated by an acoustic release. The upper part of the mooring is recovered first by firing the upper release so as to minimize the chances of damaging the profiling current meter.

Recovery of the southern PCM mooring after six months was not originally planned. Both the northern and southern PCM moorings were to be deployed for one year. However, there was concern when it was determined that the desired depth of the top sphere was considerably less than the design depth of 20 meters. The northern PCM mooring was so shallow that the top occasionally came to the surface after it was deployed in October 1994. The problem was traced to incorrect depth recorder readings which affected both PCM moorings deployed during the October cruise. The northern mooring was recovered and redeployed during the deployment cruise in October 1994 using the spare anchor that was onboard at the time. Since there was not enough mooring equipment to reset the southern mooring it was left in place until returning to the site in April 1995. For details about the October deployment cruise see Trask *et al.*, 1995.

The southern PCM mooring was recovered on April 18, 1995. The top of the mooring was released and towed to the ship with the small boat. Recovery of the lower part followed without any problems. It, too, was towed by the small boat after the release was fired. The small boat continued to tow the 60" sphere until the bottom cluster of glass balls were on the surface. The large sphere was then towed to the ship and recovery commenced through the stern A-frame.

In addition to the profiling current meter the southern PCM mooring also had five WHOI VMCMs and two WHOI Brancker temperature recorders. Two of the WHOI VMCMs (VM016 and VM018) had external temperature pods that leaked. The screws that secure the top of the

# ARSEA / PCM Mooring # 1

04/25/75

J.T.S.  
2nd Deployment  
Rev # 1

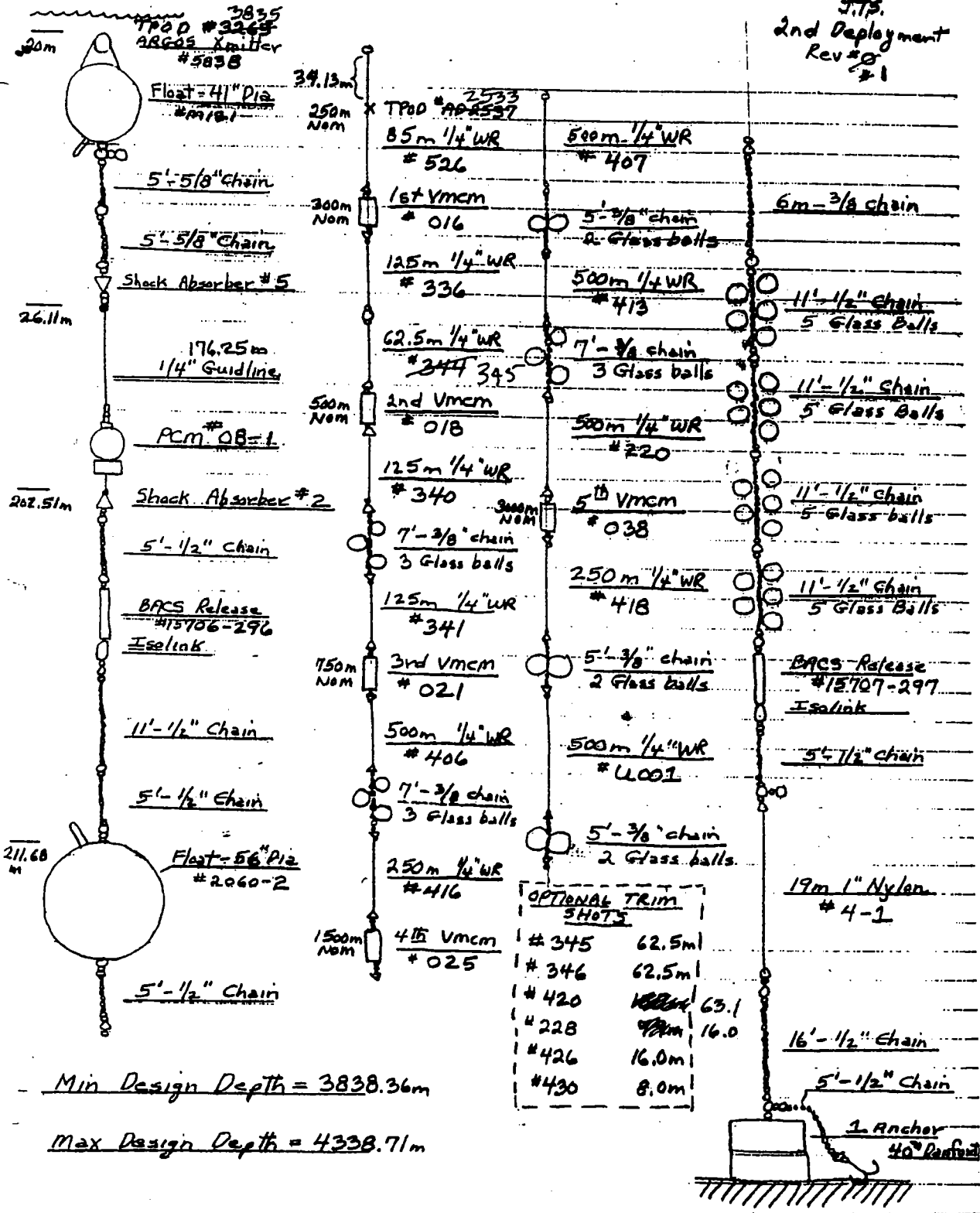

Figure 8: Schematic of the UW southern Profiling Current Meter mooring.

external temperature pod had backed out and water was found inside the pod itself. The sting from instrument VM-018 had also flooded. In addition a compass problem was detected with VM-021 after interrogating it through the Serial ASCII Instrumentation Loop (SAIL) connector. The temperature pods on VM-016 and VM-018 were replaced and a new sting and rotor card were installed on VM-018. A new compass card was installed in VM-021 to correct the compass problem in that instrument. The data tapes from all the VMCMs on the southern PCM mooring were removed and new tapes installed. The Brancker temperature recorder attached to the top sphere (S/N 3265) appeared to work for only four months. At the time of recovery the battery voltage was down. The other Brancker temperature recorder (S/N 2537 at 250 meters depth) appeared to collect data for the entire deployment.

Since the first southern PCM mooring was deployed approximately 15 meters too shallow all predicted VMCM depths need to be corrected. Table 11 indicates the nominal depth of the five VMCMs given the new depth information.

**Table 11. Nominal depths of the 5 WHOI VMCMs on the first deployment of the southern profiling current meter mooring.**

VMCM	Nominal depth as deployed
VM-016	286.69 m
VM-018	478.23 meters
VM-021	734.96 meters
VM-025	1494.90 meters
VM-038	3011.31 meters

The same VMCMs that were deployed on the first setting of the southern PCM mooring were redeployed. Two calibrated (at WHOI) Brancker temperature recorders replaced the instruments from the first deployment.

Following the mooring recovery a 4000 meter deep CTD station was taken at the southern PCM mooring site. The ship then transited to the WHOI discus buoy where a 1000 meter deep CTD station was taken.

At 0144 UTC on 19 April 1995 the near surface temperature array drifter was deployed approximately .25 miles to the south of the discus buoy. The ship was kept between .25 and .5 miles from the drifter and a series of CTD casts were taken. Four times per hour, beginning at the half hour, the CTD was lowered to 50 meters depth at a rate of 13 meters per minute. Each down up sequence took about 10 minutes with only minimal time on the surface between each down up sequence. After four lowerings the CTD was recovered and the ship was repositioned to within

.25 miles of the drifter. The cycle was repeated every hour for 12 hours. At 1427 UTC the drifter was recovered. Following the drifter recovery a shallow 200 meter deep CTD station was taken near the discus buoy.

While the drifter study was underway the small boat (with Ostrom, Trask and two crew members) visited the WHOI discus buoy and photographed the condition of the buoy and surface sensors. The area around the discus buoy was teeming with fish and sharks. While nearby the discus the waterline was noted relative to several reference marks on the buoy hull.

### *WHOI Surface Buoy Recovery*

Recovery of the WHOI surface mooring began on 20 April 1995 at 0105 UTC. The ship was positioned approximately .25 miles from the buoy and the acoustic release was fired. Once the glass ball flotation came to the surface (approximately 45 minutes after firing the release) the small boat towed the glass balls to the ship where the tag line to the glass balls was transferred to the ship. Recovery of the glass balls commenced at 0211 UTC. The recovery proceeded without incident. The last instrument to be recovered before recovering the buoy was the bio-acoustic instrument at 40 meters. After recovering the 40 meter instrument the mooring was cast adrift. The small boat attached the pickup line to the buoy and towed the buoy to the port side of the ship where it was recovered without any problems. The remainder of the instrumentation was recovered using the crane at the port side of the ship.

The uppermost VMCM at 5 meters (VM-011) depth had an unusually heavy growth of goose neck barnacles. The barnacles fully encapsulated the instrument and interfered with the ability of the upper and lower rotors to spin freely. It should be noted, however, that the rotors could still be spun by hand. The MVMS at 10 meters also had a heavy growth of goose neck barnacles. The next WHOI VMCM at 15 meters (VM-037) only had a few barnacles on the rotors but they did not obstruct their free spinning. WHOI VMCM at 25 meters depth (VM-039) had only one barnacle on the upper rotor and both rotors spun freely. The remaining two WHOI VMCMs at 45 and 55 meters (VM-033 and VM-015 respectively) were clean and all rotors spun freely.

After recovery of the buoy the waterline noted earlier during a small boat excursion to the buoy was measured relative to the buoy deck. The waterline was 38 cm below the buoy deck. Correct sensor elevations are shown in Table 9 based on this information.

The post deployment check of the WHOI VMCMs indicated that all were still working electronically on recovery and had pulled the appropriate amount of tape. The data tapes were

removed from the instruments for processing at a later date. The Seacat data were read from the instruments and all recorded data for the duration of the deployment. All but one Brancker temperature recorder worked for the duration of the experiment. The one instrument with the short record was located at 72.5 meters depth (instrument number 4481). The VAWR collected data for the duration of the deployment. The IMET instrument was working on recovery and the data from that instrument were read and stored on optical disk.

The sub-surface bridle mounted sensors were moderately covered with gooseneck barnacles as was the buoy bridle. The hull, however, was relatively clean. There was heavy growth of barnacles between the multi-plate radiation shields on the hull mounted near surface Brancker temperature recorders. Most of the growth occurred on the nylon spacers between the plates. The IMET SST probe was clean of any barnacles and the VAWR SST pod only had a few barnacles growing on it. In addition to barnacles on the bridle-mounted Seacat there was also a crab observed in the tube of the conductivity cell.

The shot peened shackles that were recovered from the mooring appeared in good condition. These shackles were Xylan coated rather than galvanized because the galvanizing temperature tends to negate the affects of the shot peening. The Xylan coating process was selected because it does not require as high a temperature for the application process. The Xylan coating stood up well during the six month deployment. After recovery the coating had a tendency to chip off and subsequent rusting occurred. Several of the shackles used in the upper 150 meters had enlarged shackle pin holes. The 1/2" wire rope swage sockets had a considerable amount of surface corrosion and is most likely attributed to their not being galvanized.

Two of the Seacat tension rods had a considerable amount of corrosion under the neoprene used on the inner surface of the clamping bands. The regions which showed the most corrosion were in the vicinity of the welded areas. The tension rods were fabricated by the same manufacturer of the VMCM cages which did not display any corrosion problems. One difference between the two was that the Seacat tension rods were not electropolished nor did they have any sacrificial anodes attached. The tension rods with the most corrosion were deployed at 100 and 150 meters depth. The deeper of these is in the vicinity of the oxygen minimum zone of the water column and there is speculation that the tension rods in that area experienced low oxygen corrosion. The shackle on the top of the Seacat tension rod at 150 meters had an enlarged cotter pin hole.

Following the recovery of the WHOI surface mooring a considerable amount of time was spent cleaning instrumentation. Several Brancker clamps as well as Seacat tension rods had to be

transferred to the new instruments for use during the second deployment. The Lamont dissolved oxygen sensor from the first deployment also had to be turned around for redeployment on the buoy bridle and several buoy cable runs and IMET cable keepers had to be installed on the new buoy. Based on the amount of fouling on the upper instrumentation additional coats of antifouling paint were applied to the VMCMs and the sub-surface buoy-mounted instruments. The buoy- and bridle-mounted near-surface temperature recorders were also given an extra coat of antifouling paint. Based on the amount of cleaning that had not been anticipated and the amount of work required to finalize the last details for the second deployment it was decided to postpone the deployment of the WHOI surface mooring one day so that everyone could respond to the findings from the first deployment.

The following day (21 April 95) the drifting near-surface temperature array (DrifTAr) was deployed at 0151 UTC. The ship stayed within radar contact of the drifter at all times while making a series of north-south transits past the buoy. Ranges and bearings to the drifter as well as shipboard ADCP and meteorological data were collected throughout the day. At 1030 UTC the ship was directed to steam two triangular patterns around the drifter. At 1145 UTC the ship was positioned .5 mile downwind of the drifter where it remained until the drifter was recovered at 1401 UTC.

#### *WHOI Surface Buoy Deployment*

Deployment of the WHOI surface mooring began at 0200 UTC on 22 April 1995. The ship was positioned five miles down-current (east southeast) of the desired anchor site. The upper 35 meters of the mooring was deployed on the port side beginning with the 35 meter USC MVMS and the 2.25 meter shot of 3/4" chain below it. The instrumentation and wire rope above 35 meters were lowered into the water and suspended from the ship on the port side. The buoy was then attached to the upper instrumentation and deployed without any problems at 0235 UTC. The lower end of the instrument string was hauled back up to the 2.25 meter shot of chain below the 35 meter MVMS and the Tracor Applied Sciences bio-acoustic instrument was placed in line and the remaining instruments were deployed without incident.

The mooring was towed for about 70 minutes after all the synthetics had been deployed. The glass balls were then deployed along with the acoustic release and the mooring was again rigged for towing as the ship moved into position. The anchor was deployed at 0939 UTC.

An acoustic release/anchor survey was conducted once the buoy appeared to have settled out. The water depth at the site was 4021 meters corrected (4001 m depth recorder reading plus 15 meter sound speed correction plus a 5 meter correction for transducer depth). The difference in depth between this deployment and the October 94 deployment is not a spatial difference but rather



due to the depth recorder reading. See Trask *et al.* (1995) for a description of the depth determination problems experienced during the October 94 deployment cruise. A sound speed of 1506 meters per second was used during the acoustic release survey (Figure 9). The GPS anchor position was determined to be 15°30.07'N latitude and 61°30.05'E longitude.

There were some minor differences between the first deployment and the second. The Seacat tension rods were outfitted with two large size Brancker zinc anodes. The anodes were drilled and taped for a 3/8" x 16 thread so that they could be screwed onto the ends of the clamping bolts. One of the VMCM cages that was deployed was not electropolished. It was, however, anode protected. It will be interesting to see if the lack of electropolishing has any affect on the corrosion resistance characteristics of the cage. The size cotter pins used with the 3/4" and 5/8" shackles was increased from 3/16" to 7/32" diameter pins. The reason for the larger size is that it fits more snugly in the shackle and is therefore less likely to wear as much as a loosely fitted pin. As mentioned earlier additional coats of antifouling paint were applied to reduce the bio-fouling observed on the upper instrumentation of the first mooring.

Following the acoustic release survey the ship was positioned down-current from the buoy approximately one mile and a 1000 meter deep CTD station was taken. Following the CTD station at the WHOI buoy the ship steamed to the northern PCM mooring where another 1000 meter deep CTD station was taken. The ship then transited to the SIO southern surface mooring where a CTD station was taken prior to starting the recovery of that mooring.

#### *SIO Southern Surface Mooring Recovery*

The southern SIO surface mooring was recovered on 23 April 1995. The small boat was used to tow the toroid buoy while the acoustic release was fired and the glass balls came to the surface. Once the balls were spotted on the surface the small boat proceeded to the glass balls and brought the balls to the ship. The tow line was transferred to the ship and recovery of the glass balls commenced. The mooring recovery continued to the last shot of wire below the buoy which had ten Brancker temperature recorders clamped to the wire. The temperature recorders were recovered up to and including the 50 meter instrument. At this point in the recovery a pennant with swage socket on one end was Crosby clipped to the wire shot and the mooring wire was cut. A 2 meter length of 3/4" chain was attached to the bottom of the wire shot to act as a depressor weight and the upper part of the mooring and buoy were cast adrift. The small boat towed the buoy around to the port side of the ship where it was connected to the crane and recovered without incident. The wire and temperature recorders that remained below the buoy were recovered by pulling the wire in by hand.

Arabian Sea 2  
WHOI Surface Mooring  
Acoustic Release Survey  
22 April 1995

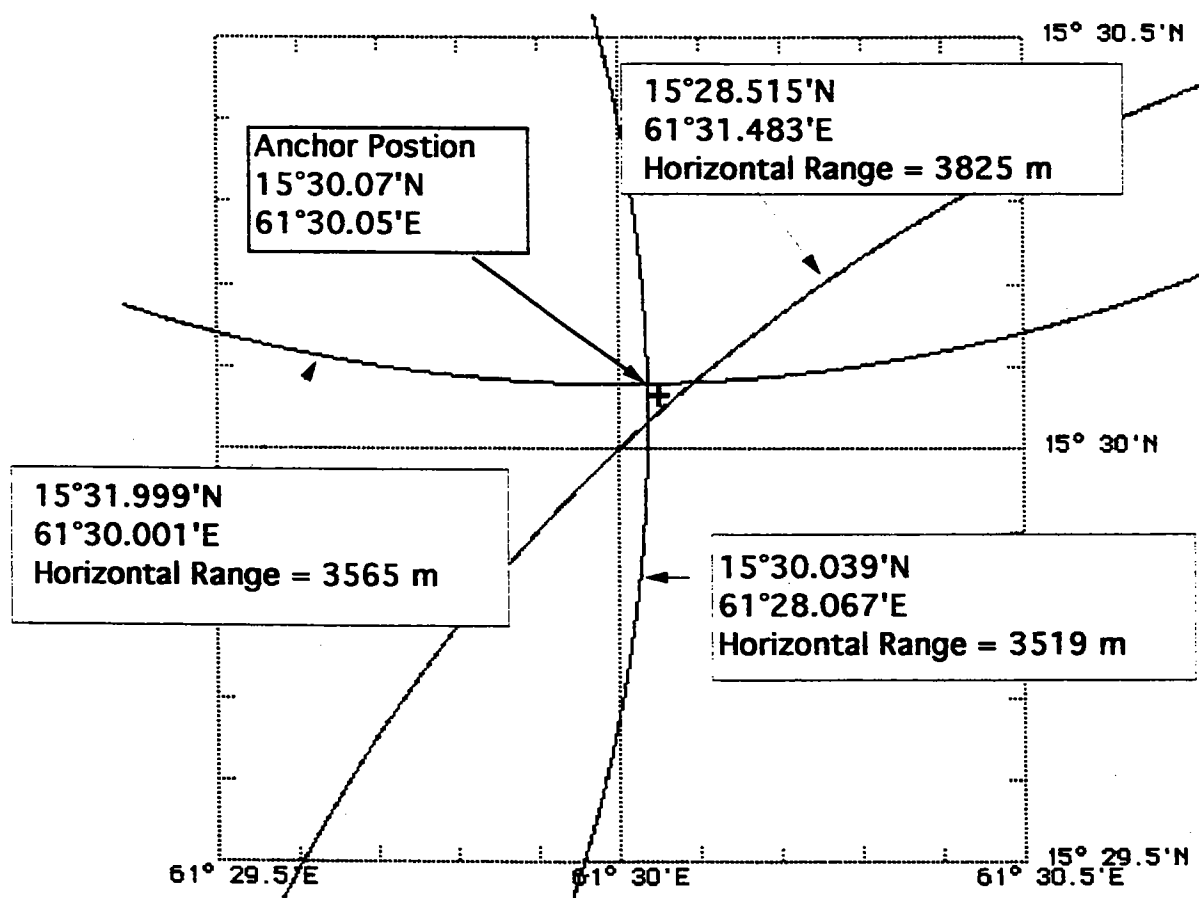

Figure 9: Acoustic release survey of the Arabian Sea 2 WHOI surface mooring.

The ship then transited around the perimeter of the array making ADCP and shipboard meteorological observations.

#### *SIO Southern Surface Mooring Deployment*

The deployment of the southern SIO surface mooring began at 0206 UTC on 24 April 1995. The ship was positioned 3.5 miles from the anchor site. The Brancker temperature recorders in the upper 50 meters were pre-attached to the mooring line prior to deployment of the surface buoy. The surface buoy was deployed without incident. Once the buoy had settled out behind the ship the mooring line was hauled back to the 50 meter temperature recorder and then pay out of the mooring line began. A total of 12 temperature recorders were attached to the mooring. The two additional spare instruments were deployed at 170 and 190 meters. The anchor was deployed at 0715 UTC. A survey of the acoustic release followed. The GPS anchor position of the southern SIO surface mooring was determined to be 15°16.52'N, 61°16.12'E.

Following the acoustic release survey a shallow 200 meter deep CTD station was taken close to the SIO southern surface mooring. The ship then steamed to the southern PCM mooring site.

#### *UW Southern PCM Mooring Deployment*

The southern PCM mooring deployment began on 25 April 1995 at 0155 UTC. The deployment started relatively smoothly although near the end of the operation things were a bit rushed since the target drop site was overshoot slightly. In addition to PCM number 08 the southern PCM mooring carried five WHOI VMCMs and two temperature recorders. The VMCMs were deployed at nominal depths of 300, 500, 750, 1500 and 3000 meters. The same VMCMs that were deployed on the first southern PCM mooring were redeployed at the same depths. Newly calibrated temperature recorders were deployed on the top sphere which has a nominal depth of 20 meters and at 250 meters depth. A survey of the acoustic release followed the deployment. The GPS anchor position for the southern PCM mooring was 15°16.11'N, 61°43.82'E.

A 1000 meter deep CTD station was taken after completing the anchor survey. The ship then steamed to the WHOI discus mooring and was positioned .25 miles downwind of the buoy. Shipboard meteorological observations and ADCP data were collected.

On 26 April 1995 the drifting near-surface temperature array was deployed at 0131 UTC approximately .25 miles downwind of the WHOI buoy. Hourly, on the half hour, the CTD was lowered to 50 meters depth at a rate of 13 meters per minute. After four lowerings the CTD was

recovered and the ship was repositioned to within .25 miles of the drifter. The cycle was repeated every hour for 12 hours. At 1425 UTC the drifter was recovered.

Following the drifter recovery the ship headed for Muscat. Hourly XBTs were started at 2000 UTC (26 April 1995) and continued during the transit to Muscat. The ship arrived in Muscat at 0430 UTC on 29 April 1995.

## Acknowledgments

The captain and crew of the *R/V Thomas Thompson* were key contributors to the success of this Arabian Sea mooring turnaround cruise. Their professional and friendly nature throughout the trip is certainly worthy of special mention here. For all those who hauled glass balls, dragged wire rope coils, and assisted wherever a helping hand was needed we thank you. Your efforts did not go unnoticed. Special thanks to Jack Shillingford who came out of retirement to participate in this cruise and keep all entertained with a variety of stories.

The WHOI mooring was designed by George Tupper and as always carefully prepared by the WHOI rigging shop under the direction of Dave (Super Shackle) Simoneau. We sincerely thank Nancy Brink and Mary Ann Lucas for their help in preparing this report.

This work was supported by the Office of Naval Research Grant No. N00014-94-0161.

## References

- Trask, Richard P. and Nancy J. Brink, 1993: The Subduction Experiment. Cruise Report: *R/V Oceanus* Cruise Number 240 Leg 3, Subduction 1 Mooring Deployment Cruise, 17 June–5 July 1991, Upper Ocean Processes Group, UOP Technical Report 93-1, Woods Hole Oceanographic Institution Technical Report, WHOI-93-12, 77 pages.
- Trask, Richard P., Bryan S. Way, William M. Ostrom, Geoffrey P. Allsup, and Robert A. Weller, 1995: Arabian Sea Mixed Layer Dynamics Experiment, Mooring Deployment Cruise Report, *R/V Thomas Thompson* Cruise Number 40, 11 October–25 October 1994. Upper Ocean Processes Group, UOP Technical Report 95-1, Woods Hole Oceanographic Institution Technical Report WHOI-95-01, 64 pages.

## Appendix 1

### Cruise Participants

Robert Weller,	Woods Hole Oceanographic Institution, Chief Scientist
Charles Eriksen	University of Washington
Daniel Rudnick	Scripps Institution of Oceanography
Neil Bogue	University of Washington
Jack Shillingford	Charles Stark Draper Labs
Jim Dufour	Scripps Institution of Oceanography
Lloyd Regier	Scripps Institution of Oceanography
Eric Tirrell	Scripps Institution of Oceanography
William Ostrom	Woods Hole Oceanographic Institution
Bryan Way	Woods Hole Oceanographic Institution
Paul Bouchard	Woods Hole Oceanographic Institution
Rick Trask	Woods Hole Oceanographic Institution
Derek Manov	University of Southern California
David Sigurdson	University of Southern California
Marcella Stern	Lamont Doherty Earth Observatory
Miguel Maccio	Lamont Doherty Earth Observatory
Chris Kinkade	Lamont Doherty Earth Observatory
Yoshi Kuroda	Japan Marine Science and Technology Center
Will Peterson	University of Washington
Bill Martin	University of Washington

## Appendix 2

### XBT Information

One hundred and one XBTs were deployed during TN 046. The T-7 probes were purchased from Sippican Ocean Systems Inc. in Marion, Massachusetts. The XBT data was logged using the shipboard data acquisition system. Figure A2-1 is a map showing the location of XBTs taken while enroute to the mooring site (outbound) and when returning to Muscat (inbound) at the end of the cruise. Table A2-1 lists the dates and positions of the outbound XBTs along with the corresponding bucket temperatures. Figures A2-2 through A2-5 show the outbound XBT temperature profiles in groups of ten. Each successive profile is offset by 2°C from the previous one. Table A2-2 lists the dates and positions of the inbound XBTs and Figures A2-6 through A2-11 show the temperature profiles from the inbound XBTs.

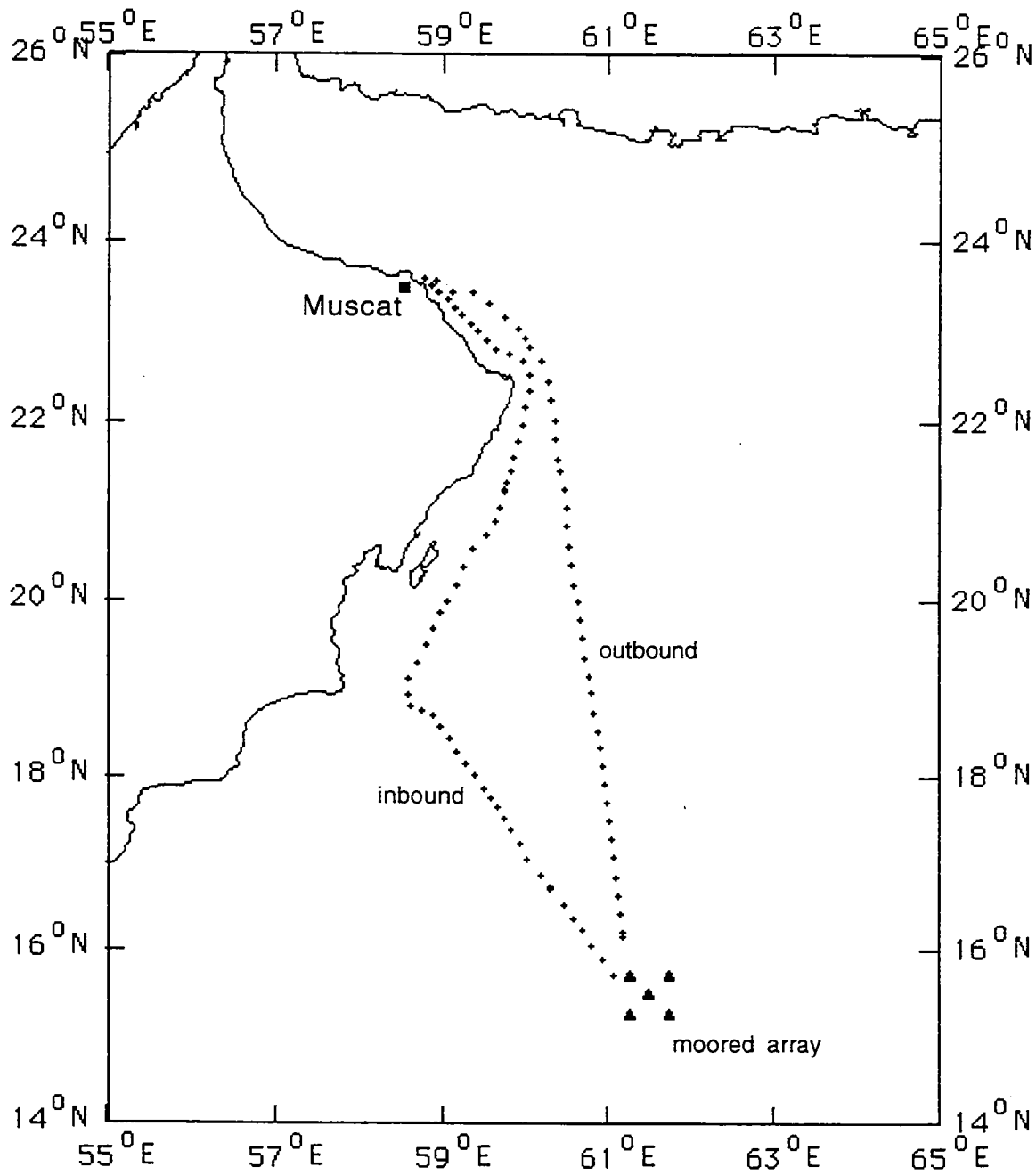

Figure A2-1: A plot of XBT locations during TN 046

**Table A2-1: Outbound XBT deployment times, positions and corresponding bucket temperatures from TN046.**

XBT #	Date	Time (UTC)	Latitude	Longitude	Bucket Temp
1	04-14-1995	05:35:13	23 33.8 N	58 55.5 E	25.8
2	04-14-1995	06:32:22	23 26.7 N	59 07.5 E	25.9
3	04-14-1995	07:30:01	23 25.9 N	59 20.9 E	25.9
4	04-14-1995	08:28:02	23 19.3 N	59 32.3 E	26.0
5	04-14-1995	10:28:25	23 02.1 N	59 54.3 E	-----
6	04-14-1995	11:35:25	22 56.9 N	60 00.6 E	26.2
7	04-14-1995	15:33:49	22 50.7 N	60 03.7 E	25.8
8	04-14-1995	16:28:56	22 40.9 N	60 12.0 E	26.2
9	04-14-1995	17:34:49	22 27.7 N	60 16.6 E	26.4
10	04-14-1995	18:29:14	22 14.7 N	60 18.9 E	26.3
11	04-14-1995	19:29:23	22 01.7 N	60 21.9 E	26.4
12	04-14-1995	20:35:38	21 48.9 N	60 22.5 E	-----
13	04-14-1995	21:34:23	21 36.1 N	60 35.3 E	26.0
14	04-14-1995	22:30:34	21 28.2 N	60 26.6 E	26.5
15	04-14-1995	23:30:30	21 16.1 N	60 28.5 E	26.8
16	04-15-1995	00:35:30	21 03.9 N	60 30.5 E	26.9
17	04-15-1995	01:29:30	20 51.3 N	60 29.6 E	26.8
18	04-15-1995	02:28:44	20 38.4 N	60 31.6 E	26.8
19	04-15-1995	03:28:51	20 25.2 N	60 33.6 E	26.6
20	04-15-1995	04:31:22	20 12.1 N	60 35.6 E	26.7
21	04-15-1995	05:31:01	20 00.2 N	60 38.0 E	26.9
22	04-15-1995	06:28:48	19 47.4 N	60 40.3 E	26.9
23	04-15-1995	07:32:04	19 34.3 N	60 42.2 E	26.9
24	04-15-1995	08:34:16	19 20.5 N	60 44.1 E	27.1
25	04-15-1995	09:28:07	19 09.0 N	60 46.1 E	27.5
26	04-15-1995	10:27:37	18 56.8 N	60 48.1 E	27.9
27	04-15-1995	11:30:15	18 43.7 N	60 50.4 E	27.8
28	04-15-1995	11:30:15	18 43.7 N	60 50.4 E	27.8
29	04-15-1995	12:33:19	18 30.7 N	60 53.1 E	-----
30	04-15-1995	13:29:38	18 19.9 N	60 54.8 E	-----
31	04-15-1995	14:28:50	18 07.7 N	60 56.5 E	-----
32	04-15-1995	15:28:29	17 55.4 N	60 58.2 E	27.8
33	04-15-1995	16:39:11	17 42.5 N	60 59.7 E	27.8
34	04-15-1995	17:34:01	17 30.3 N	61 01.3 E	27.7
35	04-15-1995	18:39:29	17 17.2 N	61 03.0 E	27.6
36	04-15-1995	19:34:26	17 04.5 N	61 04.8 E	27.7
37	04-15-1995	20:33:25	16 51.5 N	61 06.4 E	27.8
38	04-15-1995	21:34:17	16 38.2 N	61 07.9 E	27.7
39	04-15-1995	22:35:36	16 25.8 N	61 09.8 E	27.8
40	04-15-1995	23:45:02	16 10.5 N	61 12.2 E	27.8
41	04-16-1995	00:29:28	16 01.1 N	61 13.5 E	28.0



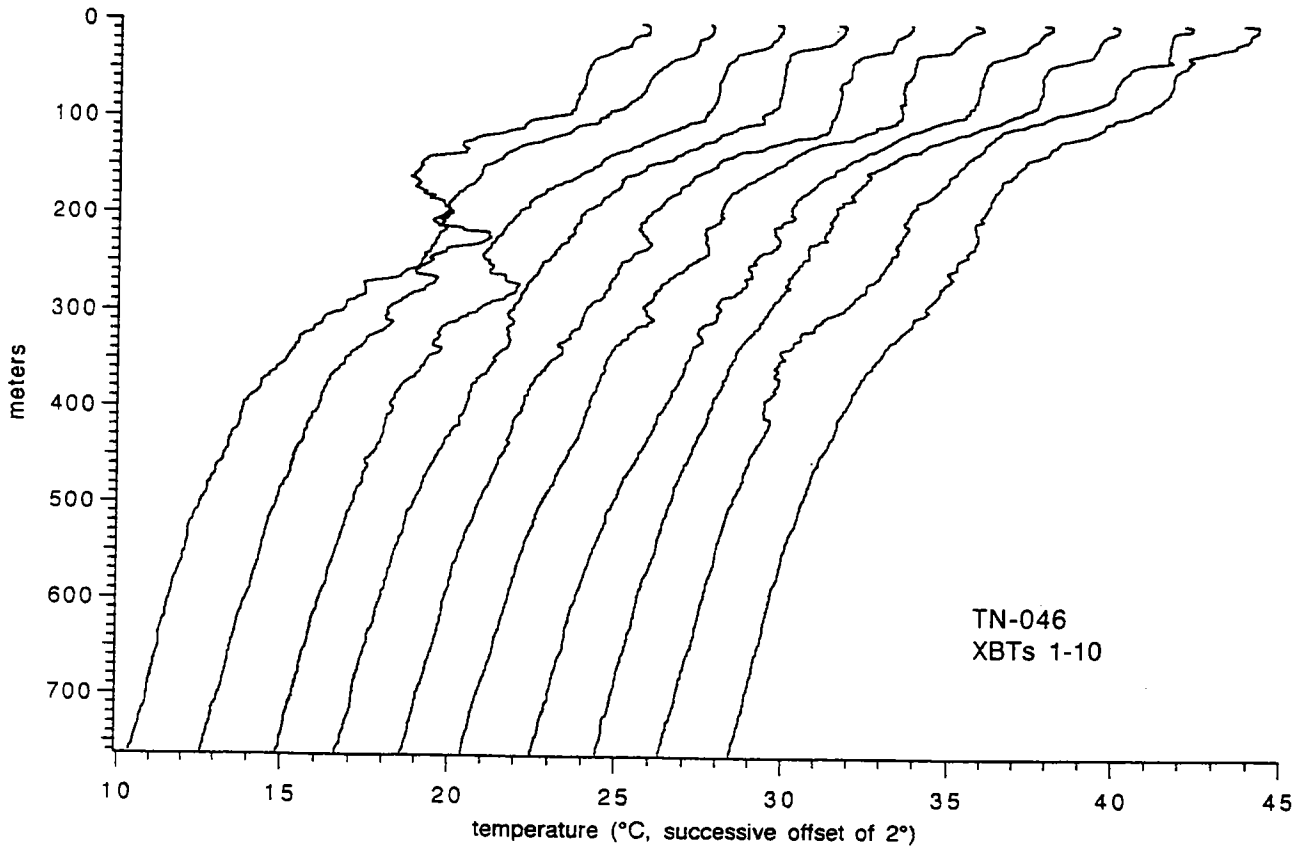

Figure A2-2: Overplot of outbound XBT profiles 1-10.

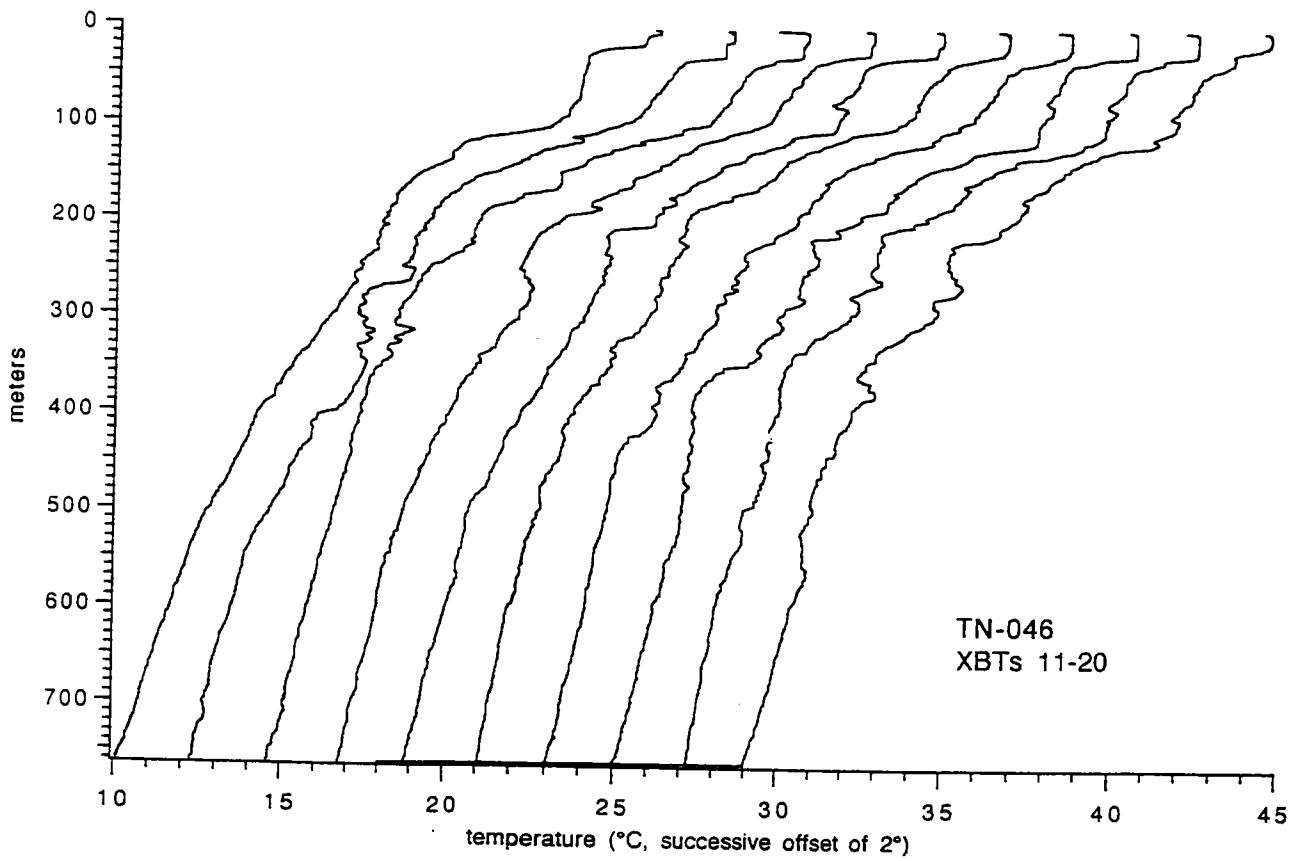

Figure A2-3: Overplot of outbound XBT profiles 11-20.

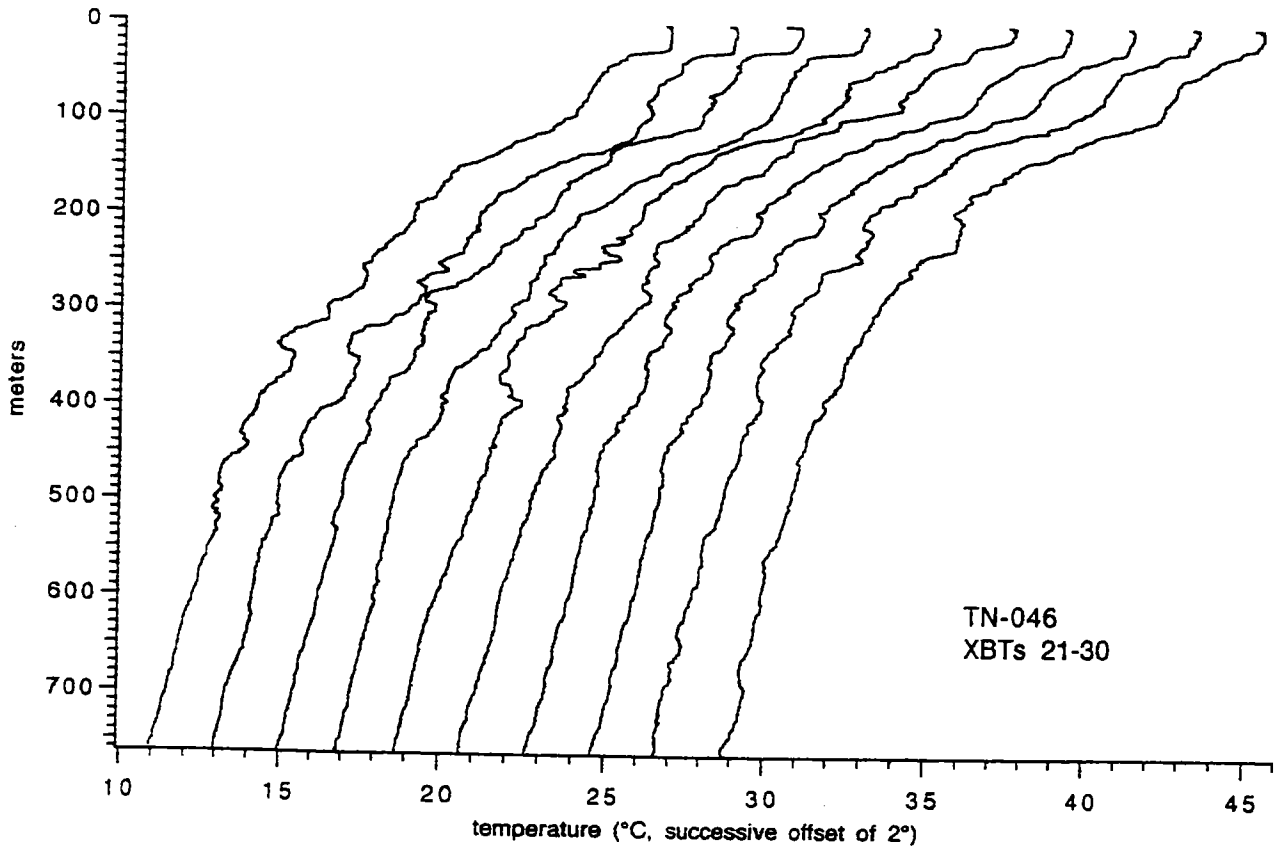

Figure A2-4: Overplot of outbound XBT profiles 21-30.

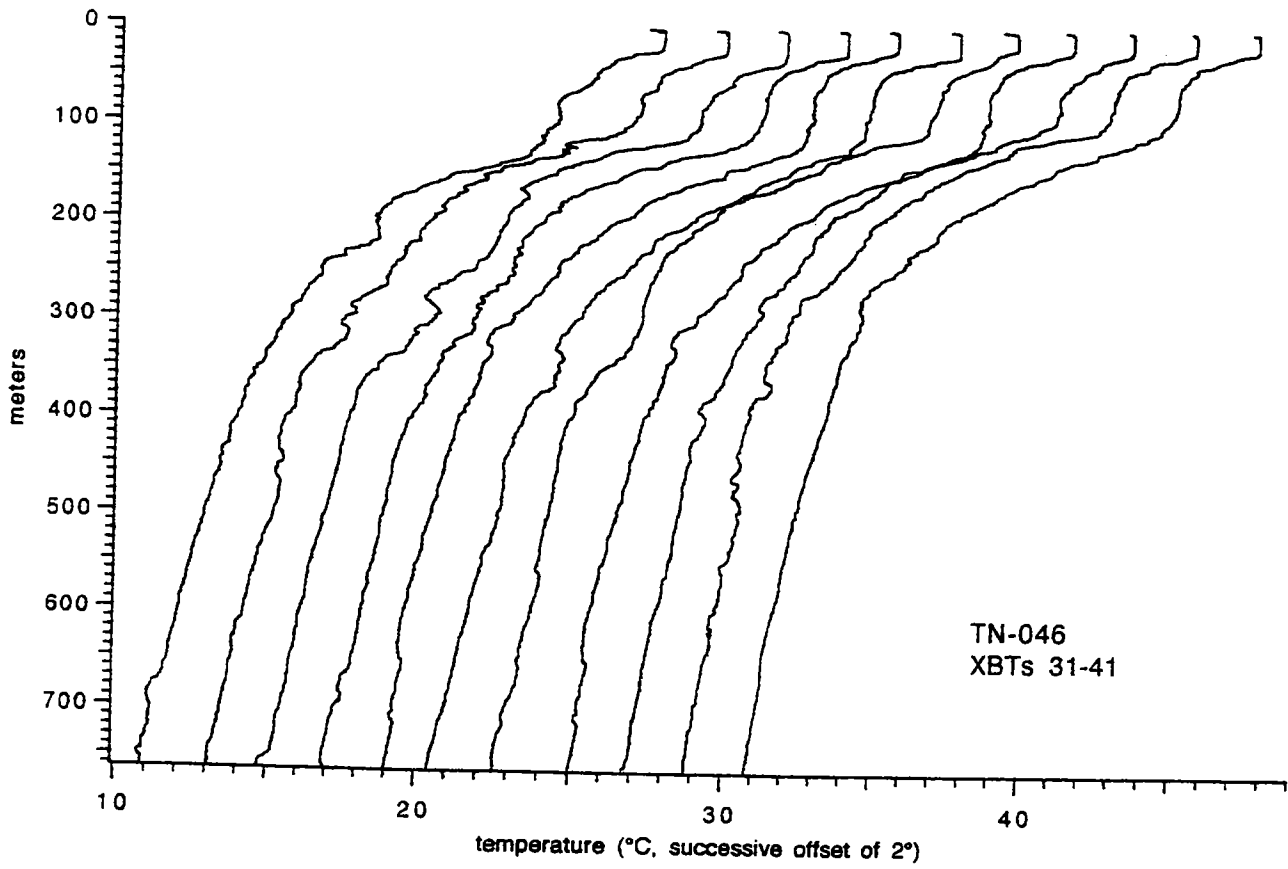

Figure A2-5: Overplot of outbound XBT profiles 31-41.

**Table A2-2: Inbound XBT deployment times, positions and corresponding bucket temperatures from TN046.**

XBT#	Date	Time (UTC)	Latitude	Longitude	Bucket Temp
1	04-26-1995	16:05:29	15 43.03 N	61 04.83 E	29.5
2	04-26-1995	17:00:12	15 53.91 N	60 56.38 E	29.0
3	04-26-1995	18:00:29	16 04.41 N	60 48.24 E	29.4
4	04-26-1995	18:58:18	16 14.67 N	60 41.23 E	29.5
5	04-26-1995	20:07:17	16 22.93 N	60 35.39 E	29.3
6	04-26-1995	21:00:50	16 31.82 N	60 27.95 E	29.1
7	04-26-1995	22:11:36	16 44.74 N	60 18.28 E	29.0
8	04-26-1995	23:00:23	16 53.06 N	60 11.62 E	29.0
9	04-27-1995	00:03:54	17 04.23 N	60 03.23 E	29.0
10	04-27-1995	01:01:13	17 143.95 N	59 55.76 E	29.0
11	04-27-1995	01:59:26	17 24.38 N	59 49.46 E	27.9
12	04-27-1995	02:58:08	17 31.31 N	59 44.30 E	28.7
13	Bad XBT -- wire break				
14	04-27-1995	04:07:57	17 39.81 N	59 39.20 E	28.9
15	04-27-1995	04:59:09	17 45.27 N	59 34.63 E	28.9
16	04-27-1995	05:59:42	17 52.52 N	59 29.52 E	28.6
17	04-27-1995	06:59:36	18 00.93 N	59 22.98 E	28.7
18	04-27-1995	07:59:13	18 08.94 N	59 16.56 E	29.1
19	04-27-1995	09:00:06	18 17.23 N	59 10.52 E	29.1
20	04-27-1995	09:59:59	18 25.66 N	59 04.83 E	29.2
21	04-27-1995	10:59:42	18 34.07 N	58 58.88 E	29.0
22	04-27-1995	12:01:54	18 41.13 N	58 52.92 E	29.0
23	04-27-1995	12:58:14	18 44.46 N	58 45.21 E	29.0
24	04-27-1995	14:00:18	18 48.80 N	58 37.046 E	28.4
25	04-27-1995	15:01:19	18 56.43 N	58 34.87 E	28.0
26	04-27-1995	15:56:20	19 06.88 N	58 35.90 E	29.2
27	04-27-1995	16:59:27	19 18.17 N	58 41.59 E	29.0
28	04-27-1995	17:59:57	19 29.24 N	58 47.88 E	29.0
29	04-27-1995	19:00:02	19 40.11 N	58 53.57 E	28.4
30	04-27-1995	20:00:24	19 50.87 N	58 57.99 E	27.1
31	04-27-1995	20:58:36	20 01.35 N	59 04.06 E	27.4
32	04-27-1995	21:56:45	20 12.24 N	59 09.61 E	27.3
33	04-27-1995	22:57:28	20 23.83 N	59 15.71 E	27.4
34	04-28-1995	00:02:41	20 35.89 N	59 21.89 E	27.5
35	04-28-1995	00:59:53	20 44.80 N	59 31.17 E	27.4
36	04-28-1995	01:59:55	20 54.32 N	59 37.24 E	26.7
37	04-28-1995	02:59:12	21 04.11 N	59 41.64 E	26.8
38	Bad XBT -- wire break				
39	04-28-1995	04:15:10	21 15.33 N	59 44.95 E	26.7
40	04-28-1995	04:59:37	21 20.89 N	59 46.61 E	26.9
41	04-28-1995	05:59:51	21 28.30 N	59 49.83 E	26.0
42	04-28-1995	06:57:36	21 37.48 N	59 51.38 E	26.0
43	04-28-1995	08:00:16	21 48.61 N	59 54.70 E	26.8
44	04-28-1995	09:00:10	21 59.32 N	59 57.66 E	27.1
45	04-28-1995	10:01:45	22 10.30 N	60 00.94 E	27.3

**Table A2-2 (continued)**

Thompson 46 - Inbound XBTs (Continued)

XBT#	Date	Time (UTC)	Latitude	Longitude	Bucket Temp
46	04-28-1995	10:57:55	22 20.70 N	60 04.23 E	27.5
47	04-28-1995	12:01:33	22 32.36 N	60 04.88 E	27.41
48	04-28-1995	12:59:38	22 41.38 N	59 57.43 E	27.46
49	04-28-1995	13:59:49	22 45.46 N	59 48.08 E	26.96
50	04-28-1995	15:00:25	22 48.52 N	59 38.32 E	27.05
51	04-28-1995	16:01:17	22 54.06 N	59 31.28 E	Memo
52	04-28-1995	17:00:23	23 00.26 N	59 24.48 E	Memo
53	04-28-1995	17:55:53	23 05.28 N	59 19.48 E	Memo
54	Bad XBT -- wire break				
55	04-28-1995	19:01:49	23 11.09 N	59 13.20 E	Memo
56	04-28-1995	20:00:09	23 16.03 N	59 08.22 E	27.14
57	04-28-1995	20:59:07	23 21.64 N	59 02.95 E	Memo
58	04-28-1995	22:01:35	23 26.55 N	58 57.54 E	26.96
59	04-28-1995	22:57:36	23 30.74 N	58 52.49 E	27.12
60	04-28-1995	23:59:12	23 34.68 N	58 47.50 E	27.43

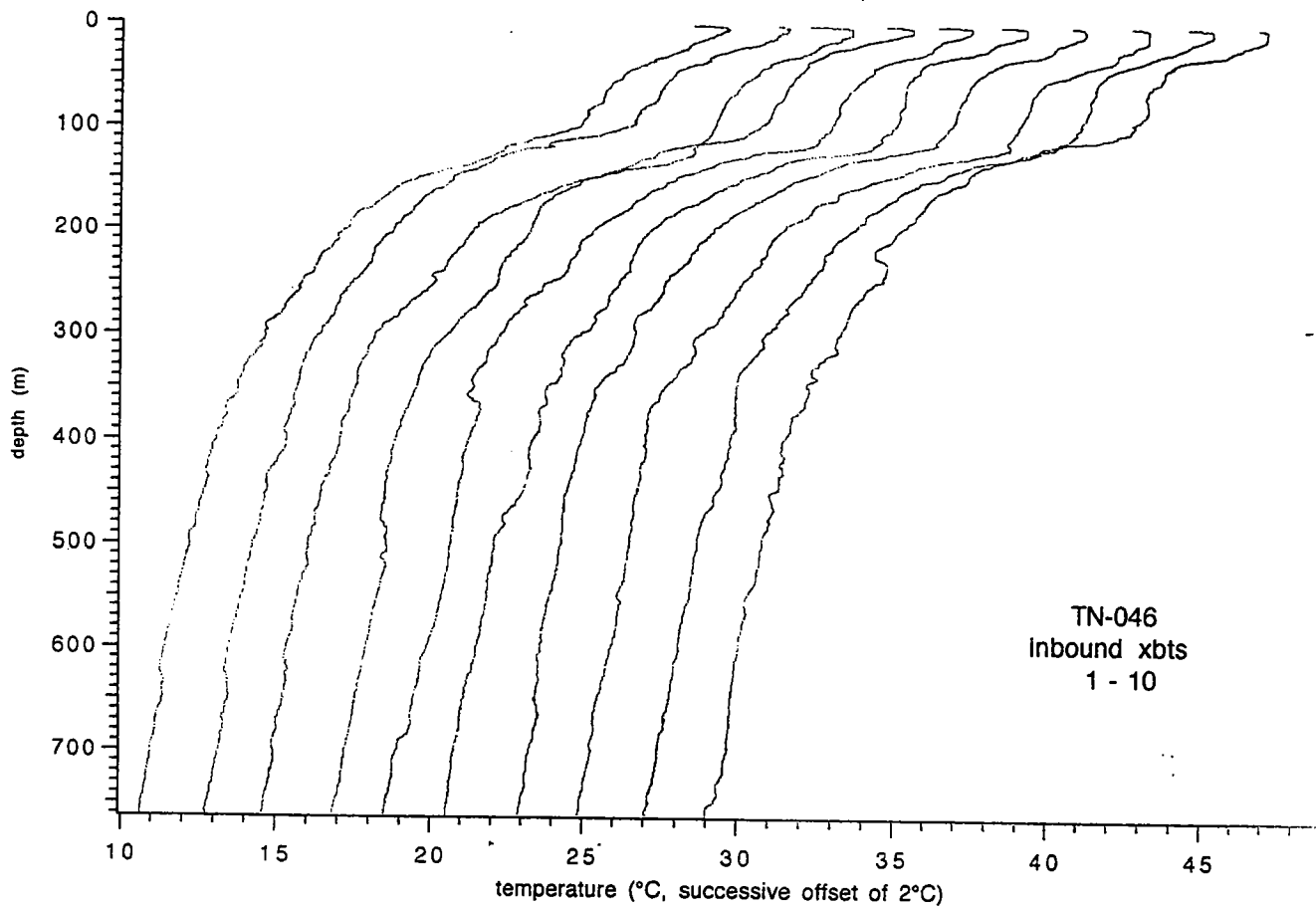

Figure A2-6: Overplot of inbound XBT profiles 1-10.

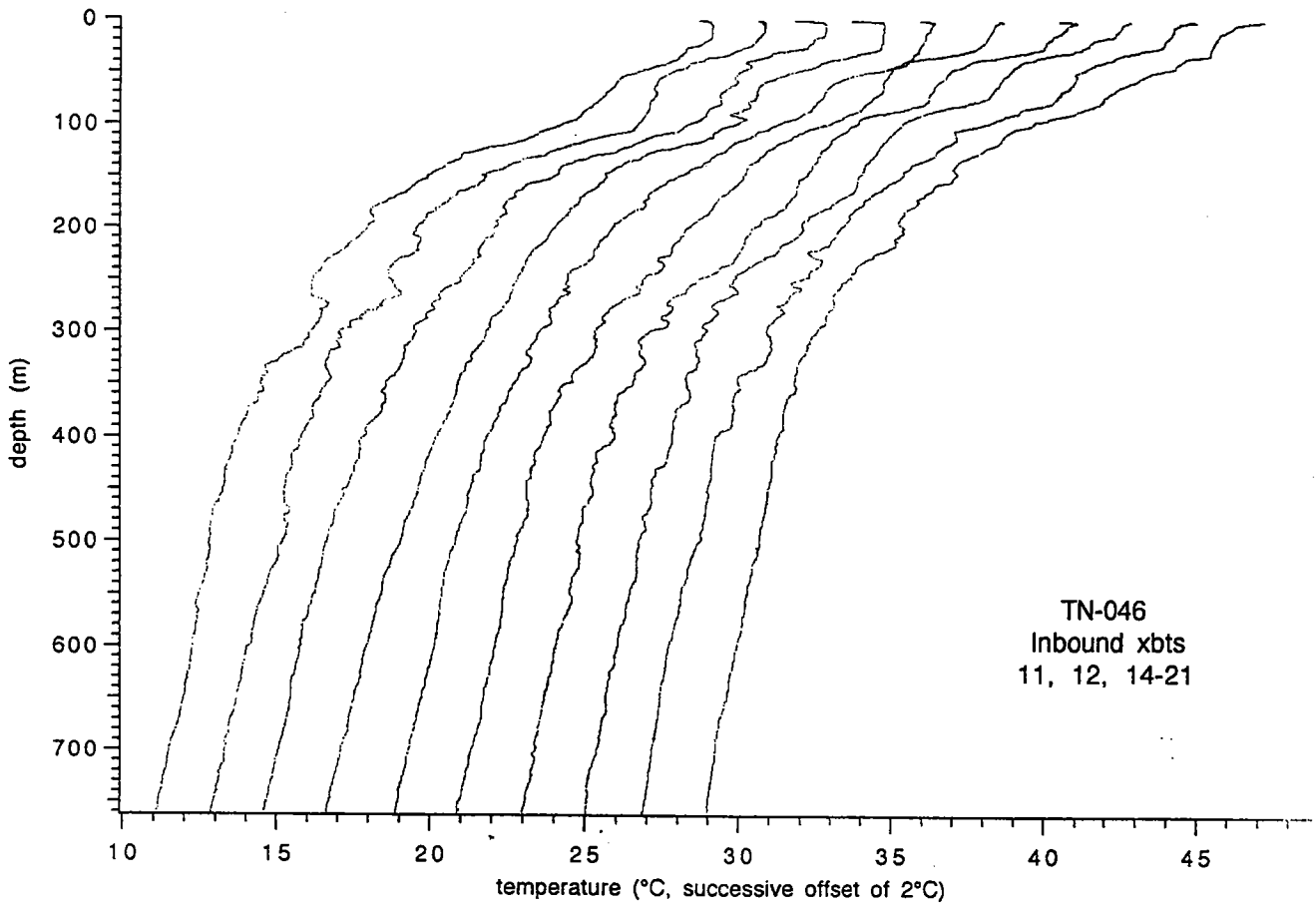

Figure A2-7: Overplot of inbound XBT profiles 11, 12, and 14-21.



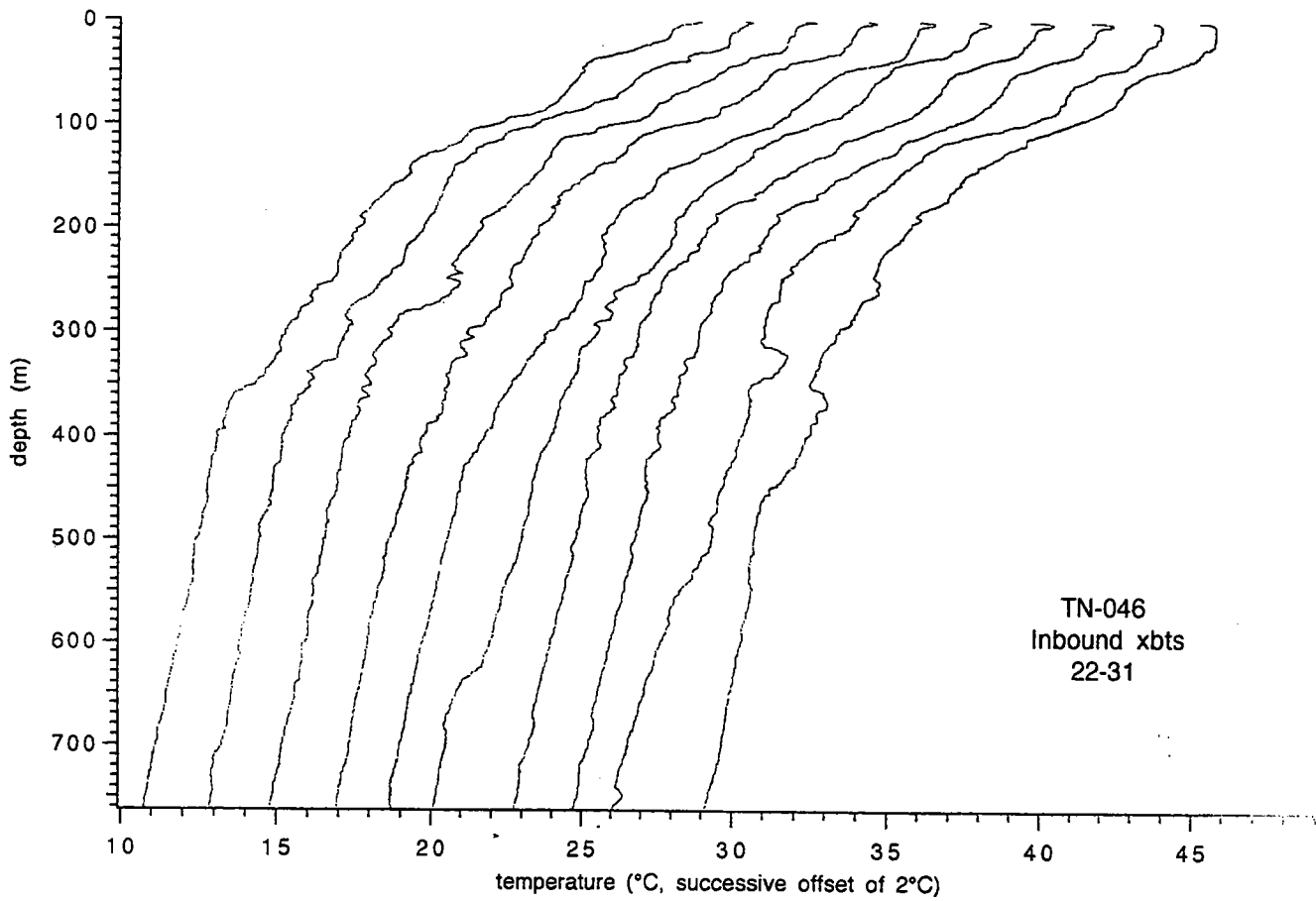

Figure A2-8: Overplot of inbound XBT profiles 22-31.

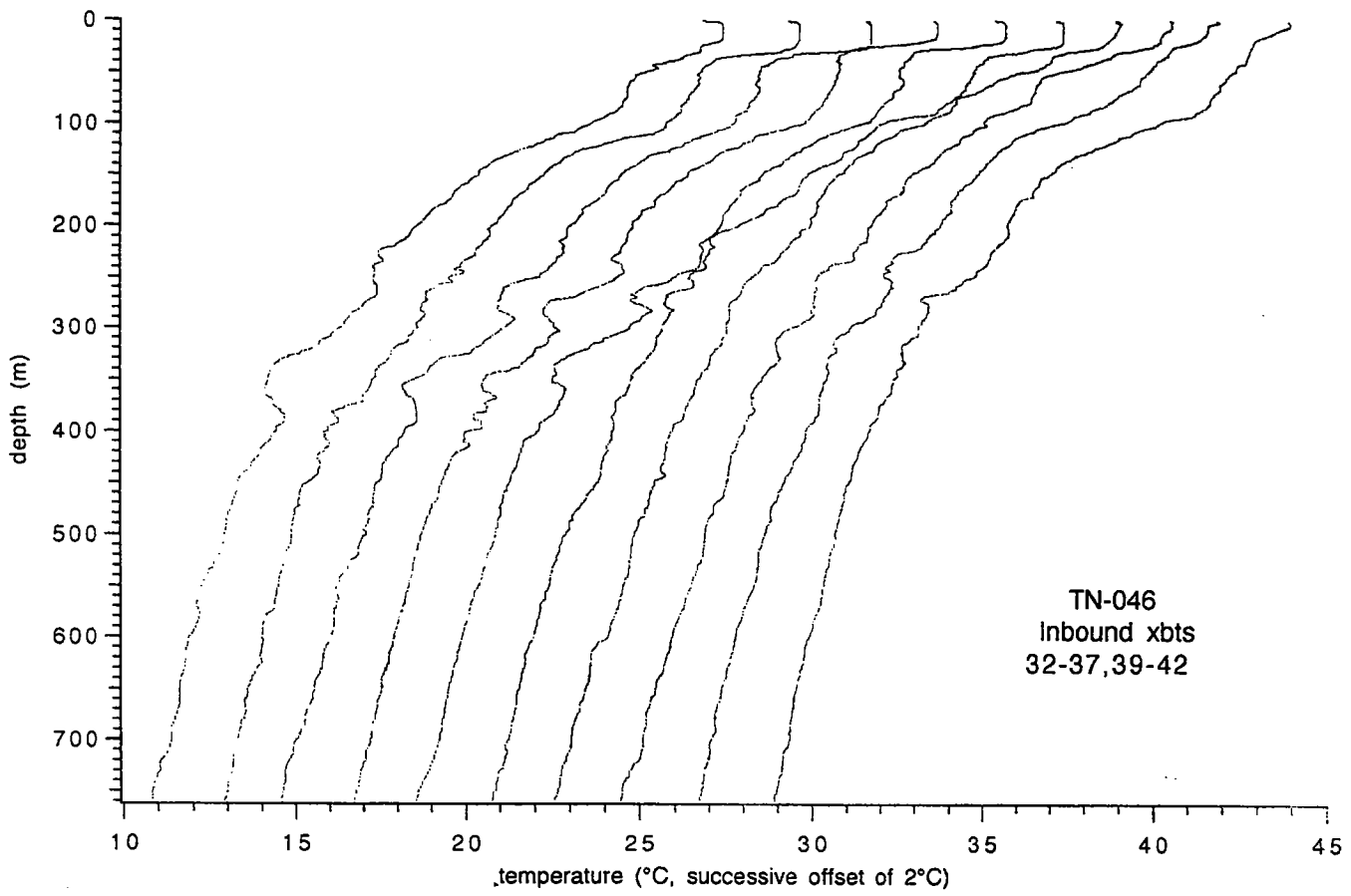

Figure A2-9: Overplot of inbound XBT profiles 32-37 and 39-42.

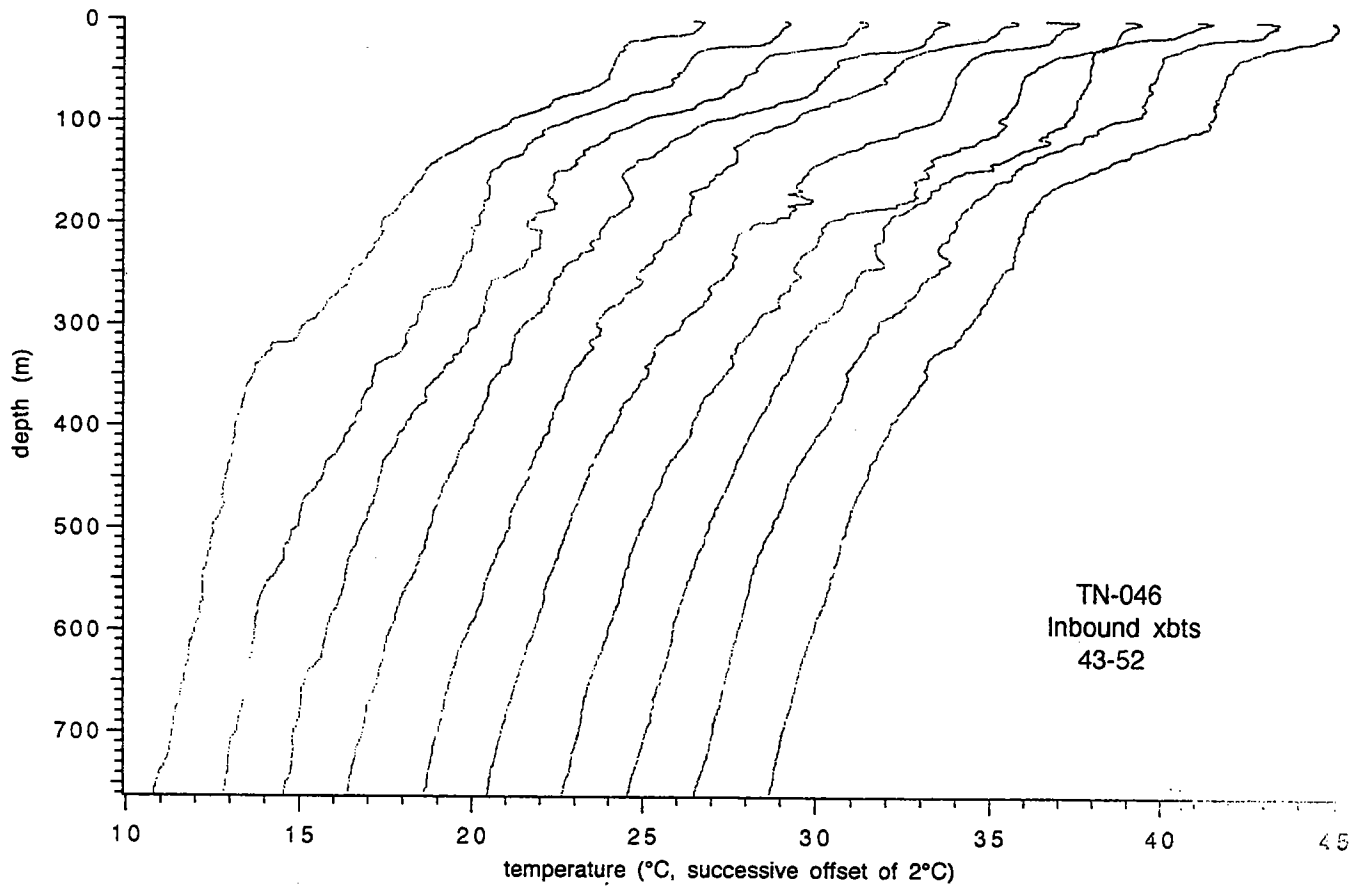

Figure A2-10: Overplot of inbound XBT profiles 43–52.

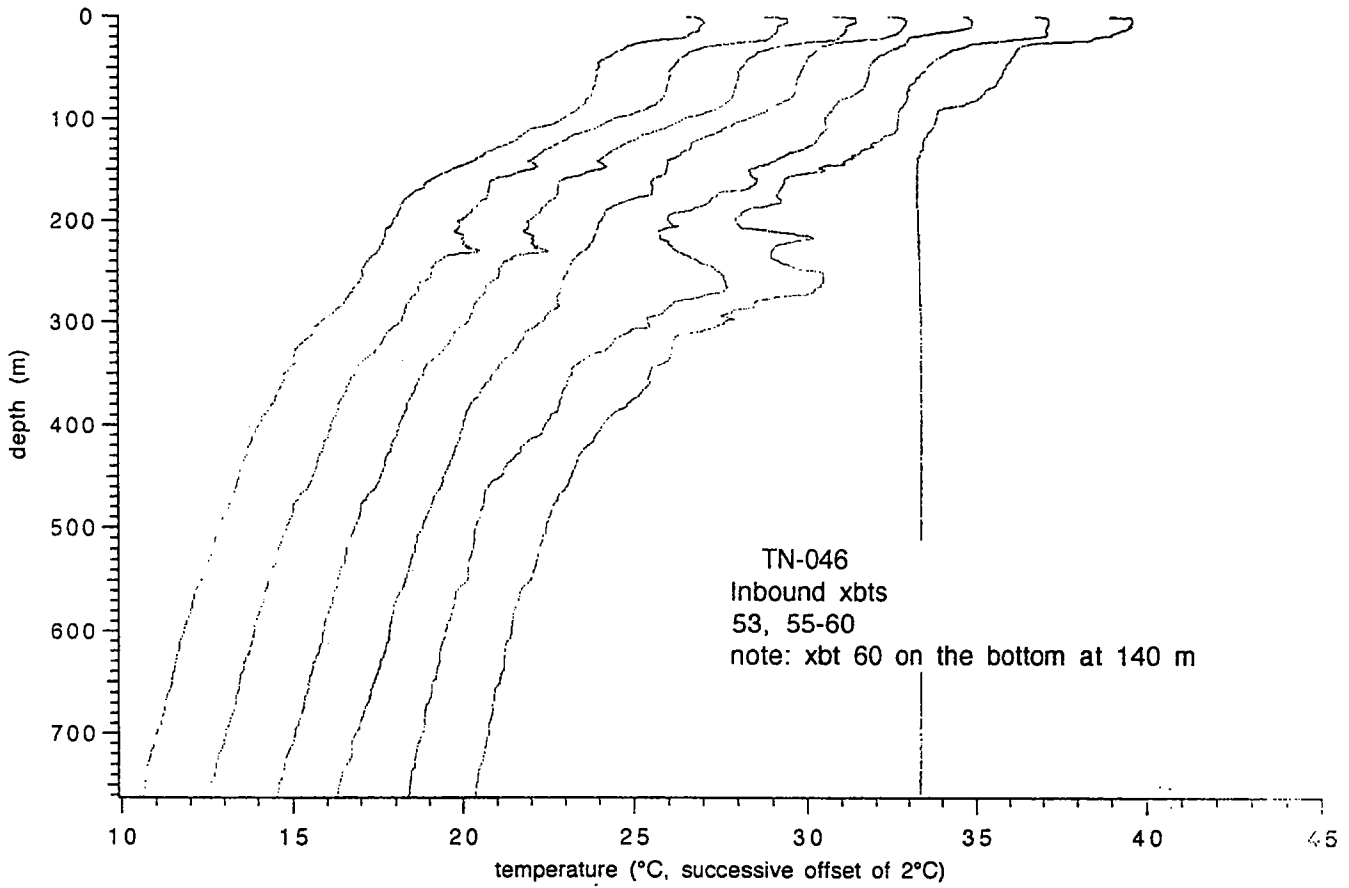

Figure A2-11: Overplot of inbound XBT profiles 53 and 55-60.

## **Appendix 3**

### **CTD Positions**

CTD stations were taken in close proximity to each of the mooring sites before recovery and after redeployment. Individual casts are denoted by single CTD station numbers. A series of to yo CTD stations were taken in conjunction with the deployment of a drifting near-surface temperature array. While the drifter was in the water the CTD was lowered to approximately 50 meters depth at a rate of 13 meters per minute and brought back to the surface at about the same rate. Each down up sequence took about 10 minutes with only minimal time on the surface between lowering. After four lowerings the CTD was recovered and brought back on board the ship. The cycle was repeated every hour on the half hour while the drifter was in the water which was typically for 12 hours. The hyphenated station numbers represent the to yo stations. The first number was incremented by one each time the CTD was deployed from the ship. The second number represents the particular down-up sequence.

**Table A3-1: CTD stations taken during R/V Thomas Thompson Cruise number 46.**

Station No.	Date	Start Time	Start Latitude	Start Longitude	Max. Depth (meters)
1	Test of system				
2	17-Apr-95	1047 UTC	15°43.8038' N	61° 16.1642'E	670
3	17-Apr-95	2356 UTC	15°15.9191'N	61° 43.7995'E	252
4	18-Apr-95	1111 UTC	15°16.3728'N	61° 44.0674'E	4017
5	18-Apr-95	1717 UTC	15° 28.8364'N	61° 29.5218'E	1010
6-1	19-Apr-95	0230 UTC	15°28.8021'N	61° 29.1125'E	54.67
6-2	19-Apr-95	0241 UTC	15°28.8021'N	61° 29.1125'E	54.67
6-3	19-Apr-95	0251 UTC	15°28.8021'N	61° 29.1125'E	53.68
6-4	19-Apr-95	0302 UTC	15°28.7511'N	61°28.7838'E	54.67
7-1	19-Apr-95	0333 UTC	15°29.0056'N	61°28.7844'E	54.67
7-2	19-Apr-95	0341 UTC	15 29.0549'N	61°28.7427	54.67
7-3	19-Apr-95	0350 UTC	15 29.0820'N	61 28.6806'E	52.68
7-4	19-Apr-95	0400 UTC	15 29.1201'N	61 28.6229'E	53.68
8-1	19-Apr-95	0430 UTC	15 29.1701'N	61 28.4539'E	52.68
8-2	19-Apr-95	0440 UTC	15 29.2048'N	61 28.3962'E	52.68
8-3	19-Apr-95	0449 UTC	15 29.2222'N	61 28.3513'E	52.68
8-4	19-Apr-95	0458 UTC	15 29.2327'N	61 28.2996'E	52.68
9-1	19-Apr-95	0537 UTC	15 29.1929'N	61 28.3316'E	53.68
9-2	19-Apr-95	0547 UTC	15 29.2160'N	61 28.3530'E	52.68
9-3	19-Apr-95	0557 UTC	15 29.2043'N	61 28.3613'E	52.68
9-4	19-Apr-95	0605 UTC	15 29.1813'N	61 28.3719'E	53.68
10-1	19-Apr-95	0632 UTC	15 29.1919'N	61 28.2934'E	53.68
10-2	19-Apr-95	0641 UTC	15 29.1996'N	61 28.2373'E	54.67
10-3	19-Apr-95	0650 UTC	15 29.1789'N	61 28.2334'E	53.68
10-4	19-Apr-95	0659 UTC	15 29.2019'N	61 28.1599'E	54.67
11-1	19-Apr-95	0732 UTC	15 29.0908'N	61 28.0237'E	54.67
11-2	19-Apr-95	0741 UTC	15 29.0408'N	61 27.9849'E	54.67
11-3	19-Apr-95	0750 UTC	15 29.0340'N	61 27.9613'E	54.67
11-4	19-Apr-95	0759 UTC	15 29.0157'N	61 27.9350'E	54.67
12-1	19-Apr-95	0830 UTC	15 28.8881'N	61 27.8881'E	54.67
12-2	19-Apr-95	0839 UTC	15 28.8808'N	61 27.8554'E	53.68
12-3	19-Apr-95	0848 UTC	15 28.8811'N	61 27.8584'E	54.67
12-4	19-Apr-95	0857 UTC	15 28.8580'N	61 27.8400'E	52.68
13-1	19-Apr-95				
13-2	19-Apr-95	0939 UTC	15 28.5851'N	61 27.6485'E	53.68
13-3	19-Apr-95	0947 UTC	15 28.5694'N	61 27.6094'E	54.67
13-4	19-Apr-95	0956 UTC	15 28.5544'N	61 27.5737'E	54.67
14-1	19-Apr-95	1031 UTC	15 28.4418'N	61 27.3926'E	54.67
14-2	19-Apr-95	1040 UTC	15 28.4174'N	61 27.3425'E	54.67
14-3	19-Apr-95	1049 UTC	15 28.3871'N	61 27.2936'E	54.67

Table A3-1 continued

14-4	19-Apr-95	1058 UTC	15	28.3414'N	61	27.2233'E	53.68
15-1	19-Apr-95	1130 UTC	15	28.2212'N	61	26.8442'E	54.67
15-2	19-Apr-95	1139 UTC	15	28.1869'N	61	26.7400'E	54.67
15-3	19-Apr-95	1148 UTC	15	28.1547'N	61	26.6374'E	54.67
15-4	19-Apr-95	1157 UTC	15	28.1098'N	61	26.5575'E	53.68
16-1	19-Apr-95	1231 UTC	15	27.9216'N	61	26.2749'E	54.67
16-2	19-Apr-95	1240 UTC	15	27.8677'N	61	26.1960'E	53.68
16-3	19-Apr-95	1249 UTC	15	27.8076'N	61	26.1099'E	54.67
16-4	19-Apr-95	1258 UTC	15	27.7278'N	61	26.0351'E	53.68
17-1	19-Apr-95	1332 UTC	15	27.4607'N	61	25.8498'E	53.68
17-2	19-Apr-95	1341 UTC	15	27.3843'N	61	25.7494'E	53.68
17-3	19-Apr-95	1350 UTC	15	27.3023'N	61	25.6543'E	53.68
17-4	19-Apr-95	1359 UTC	15	27.2243'N	61	25.5490'E	54.67
18	19-Apr-95	1507 UTC	15	28.7801'N	61	28.7809'E	204.69
19	22-Apr-95	1245 UTC	15	30.0320'N	61	28.2470'E	1001.64
20	22-Apr-95	1554 UTC	15	43.9020'N	61	43.9840'E	1001.63
21	23-Apr-95	0049 UTC	15	17.1590'N	61	16.0630'E	203.7
22	24-Apr-95	1038 UTC	15	16.2320'N	61	15.3930'E	206
23	25-Apr-95	1150 UTC	15	15.6300'N	61	43.4940'E	1001.65
24-1	26-Apr-95	0236 UTC	15	29.9790'N	61	28.0860'E	53.68
24-2	26-Apr-95	0245 UTC	15	30.0250'N	61	27.9590'E	53.68
24-3	26-Apr-95	0255 UTC	15	30.0340'N	61	27.8800'E	54.67
24-4	26-Apr-95	0304 UTC	15	30.0750'N	61	27.7880'E	53.68
25-1	26-Apr-95	0331 UTC	15	29.6260'N	61	27.3110'E	53.68
25-2	26-Apr-95	0340 UTC	15	29.6300'N	61	27.1670'E	53.68
25-3	26-Apr-95	0349 UTC	15	29.6330'N	61	27.0520'E	53
25-4	26-Apr-95	0358 UTC	15	29.6200'N	61	26.9190'E	52.68
26-1	26-Apr-95	0433 UTC	15	29.5520'N	61	26.4240'E	52.68
26-2	26-Apr-95	0442 UTC	15	29.5270'N	61	26.2220'E	52.68
26-3	26-Apr-95	0451 UTC	15	29.5330'N	61	26.1380'E	52.68
26-4	26-Apr-95	0500 UTC	15	29.6260'N	61	26.0170'E	52.68
27-1	26-Apr-95	0532 UTC	15	29.6480'N	61	25.4690'E	52.68
27-2	26-Apr-95	0541 UTC	15	29.6370'N	61	25.3200'E	52.68
27-3	26-Apr-95	0550 UTC	15	29.6090'N	61	25.2400'E	52.68
27-4	26-Apr-95	0558 UTC	15	29.6080'N	61	25.1000'E	52.68
28-1	26-Apr-95	0631 UTC	15	29.6370'N	61	24.8600'E	52.68
28-2	26-Apr-95	0640 UTC	15	29.6580'N	61	24.7910'E	52.68
28-3	26-Apr-95	0648 UTC	15	29.6900'N	61	24.6900'N	52.68
28-4	26-Apr-95	0657 UTC	15	29.6750'N	61	24.6150'E	52.68
29-1	26-Apr-95	0730 UTC	15	29.4850'N	61	24.1350'E	52.68
29-2	26-Apr-95	0739 UTC	15	29.4970'N	61	24.0290'E	52.68
29-3	26-Apr-95	0748 UTC	15	29.5530'N	61	23.9110'E	52.68
29-4	26-Apr-95	0757 UTC	15	29.6390'N	61	23.8000'E	52.68
30-1	26-Apr-95	0830 UTC	15	29.7410'N	61	23.3869'E	53.68

Table A3-1 continued

30-2	26-Apr-95	0839 UTC	15	29.7160'N	61	23.2260'E	52.6
30-3	26-Apr-95	0848 UTC	15	29.7610'N	61	23.1300'E	52.68
30-4	26-Apr-95	0856 UTC	15	29.7830'N	61	23.0460'E	52.68
31-1	26-Apr-95	0931 UTC	15	30.0090'N	61	22.5950'E	52.68
31-2	26-Apr-95	0939 UTC	15	30.0990'N	61	22.5050'E	52.68
31-3	26-Apr-95	0948 UTC	15	30.1560'N	61	22.4090'E	52.68
31-4	26-Apr-95	0956 UTC	15	30.2310'N	61	22.3390'E	53.68
32-1	26-Apr-95	1031 UTC	15	30.5500'N	61	22.0900'E	53.68
32-2	26-Apr-95	1039 UTC	15	30.6040'N	61	22.0000'E	52.68
32-3	26-Apr-95	1048 UTC	15	30.6250'N	61	21.9680'E	52.68
32-4	26-Apr-95	1057 UTC	15	30.6710'N	61	21.9220'E	52.68
33-1	26-Apr-95	1130 UTC	15	30.8380'N	61	21.7240'E	52.68
33-2	26-Apr-95	1138 UTC	15	30.9780'N	61	21.6310'E	52.68
33-3	26-Apr-95	1147 UTC	15	31.0400'N	61	21.5870'E	52.68
33-4	26-Apr-95	1156 UTC	15	31.0940'N	61	21.5060'E	53
34-1	26-Apr-95	1230 UTC	15	31.6490'N	61	21.3710'E	53.68
34-2	26-Apr-95	1239 UTC	15	31.6420'N	61	21.2740'E	53.68
34-3	26-Apr-95	1248 UTC	15	31.7060'N	61	21.1690'E	53.68
34-4	26-Apr-95	1257 UTC	15	31.7100'N	61	21.1940'E	53.68
35-1	26-Apr-95	1330 UTC	15	31.6880'N	61	20.8960'E	53.68
35-2	26-Apr-95	1339 UTC	15	31.7090'N	61	20.8100'E	53.68
35-3	26-Apr-95	1348 UTC	15	31.7590'N	61	20.7640'E	53.68
35-4	26-Apr-95	1356 UTC	15	31.8010'N	61	20.7030'E	53.68



**Appendix 4**  
**Arabian Sea Instrument Summary**

Instrument No.            Mooring            Depth (meters)

Brancker Temperature Recorders

2533	PCM South 2	250.00
2534	WHOI Central 1	300.00
2535	WHOI Central 2	90.00
2536	WHOI Central 2	125.00
2537	PCM South 1	250.00
2541	PCM North	250.00
3259	WHOI Central 1	20.00
3263	WHOI Central 2	1.50
3265	PCM South 1	20.00
3271	WHOI Central 2	2.50
3274	WHOI Central 2	2.00
3279	PCM North	20.00
3280	WHOI Central 2	1.00
3283	WHOI Central 2	30.00
3291	WHOI Central 2	0.25
3296	WHOI Central 2	60.00
3299	WHOI Central 2	0.50
3301	WHOI Central 1	90.00
3305	WHOI Central 1	30.00
3308	WHOI Central 2	175.00
3309	WHOI Central 2	40.00
3341	WHOI Central 2	4.50
3662	WHOI Central 1	0.43
3667	WHOI Central 1	1.41
3699	WHOI Central 2	72.50
3702	WHOI Central 2	225.00
3703	WHOI Central 1	40.00
3704	DrifTAr	1.50
3761	WHOI Central 1	175.00
3762	WHOI Central 1	2.40
3763	WHOI Central 1	4.50
3764	DrifTAr	2.00
3835	PCM South 2	20.00
3836	WHOI Central 1	0.17
3837	DrifTAr	2.50

Instrument No.	Mooring	Depth (meters)
----------------	---------	----------------

Brancker Temperature Recorders Continued

3838	DrifTAr	1.00
3839	WHOI Central 1	1.91
4228	DrifTAr	0.25
4402	DrifTAr	0.50
4481	WHOI Central 1	72.50
4483	WHOI Central 1	0.92
4487	WHOI Central 1	60.00
4488	WHOI Central 2	20.00
4489	WHOI Central 1	50.00
4491	WHOI Central 1	125.00
4492	WHOI Central 2	50.00
4493	WHOI Central 1	225.00
4495	WHOI Central 2	300.00
5432	WHOI Central 1	1.37

VMCMs

VM-003	WHOI Central 2	45.00
VM-011	WHOI Central 1	5.00
VM-014	WHOI Central 2	55.00
VM-015	WHOI Central 1	55.00
VM-016	PCM South 1 and 2	300.00
VM-018	PCM South 1 and 2	500.00
VM-021	PCM South 1 and 2	750.00
VM-025	PCM South 1 and 2	1500.00
VM-030	WHOI Central 2	15.00
VM-033	WHOI Central 1	45.00
VM-034	WHOI Central 2	25.00
VM-037	WHOI Central 1	15.00
VM-038	PCM South 1 and 2	3000.00
VM-039	WHOI Central 1	25.00
VM-050	WHOI Central 2	5.00

Instrument No.	Mooring	Depth (meters)
----------------	---------	----------------

Arabian Sea Instrument Summary Continued

MVMS

200201-USC	WHOI Central 2	80.00
200203-USC	WHOI Central 2	35.00
203805-LD	WHOI Central 2	10.00
302703-LD	WHOI Central 1	10.00
401405-LD	WHOI Central 1	65.00
500301-LD	WHOI Central 2	65.00
500501-USC	WHOI Central 1	35.00
500601-USC	WHOI Central 1	80.00

Seacats

142	WHOI Central 2	250.00
144	WHOI Central 2	150.00
357	WHOI Central 1	100.00
927	WHOI Central 2	100.00
928	WHOI Central 2	1.50
929	WHOI Central 2	200.00
992	WHOI Central 1	200.00
993	WHOI Central 1	250.00
994	WHOI Central 1	150.00
1179	WHOI Central 1	1.50

MTR

3240	WHOI Central 1	3.50
3250	WHOI Central 2	3.50

## Appendix 5

### Wind Direction Sensor Comparison Tests

Part of the preparation of the meteorological packages includes checking the wind direction sensors. This consists of placing each buoy on a test station that can be rotated through 360° and directing the wind vane to a fixed target at 60° intervals. The direction is then computed from the instrument compass and vane direction data. This procedure was followed both in Woods Hole prior to shipping and again in Muscat on the dock prior to loading the buoys on the ship.

The test site in Woods Hole was located at the southern corner of the Clark South Laboratory parking area. This site showed little horizontal or vertical spatial variation in the magnetic field. The buoys were mounted each in turn on a wooden and masonite turntable, and the direction of a tree near the Clark building was measured from six buoy orientations. At each of the six positions the wind vane was aligned to the tree by eye and locked in position. The data was then read directly from the instrument. In the case of the VAWR the compass and vane positions are added to obtain the wind vane direction in oceanographic convention (i.e., the wind direction of flow from the north is 180°). The magnetic bearing to the tree from the test site is 309°.

Selection of a test site in Muscat was limited to the dock area. All the magnetic problems associated with a dock were assumed to be present. Large 40' containers were located near the site and trucks would be passing through the area periodically. A crude survey of the Muscat test site was made using a diver's compass. The direction checks in Muscat were conducted to identify any gross problems that might have occurred in the instrumentation during shipping and should not be considered a calibration since careful selection of the site was not possible. The magnetic bearing to the distant object sited in Muscat was 245°.

Direction comparison tests with VAWR V720 WR were conducted in Woods Hole between January 20–24, 1995. The IMET wind module that was deployed on the Arabian Sea 2 surface buoy (WND 111) had a direction comparison test conducted on 23 January 1995. Both units were tested in Muscat, Oman, on 7 April 1995. Figures A5-1 and A5-2 show the Woods Hole and Muscat results respectively.

# Arabian Sea 2 Primary Buoy Spin Data

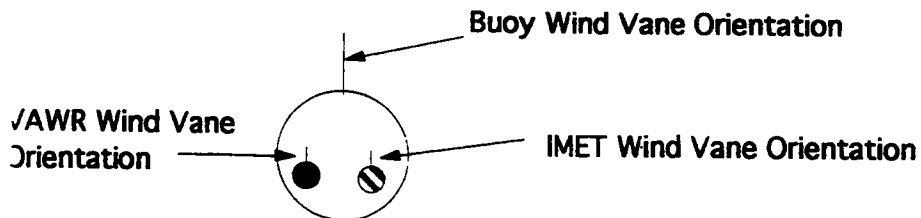
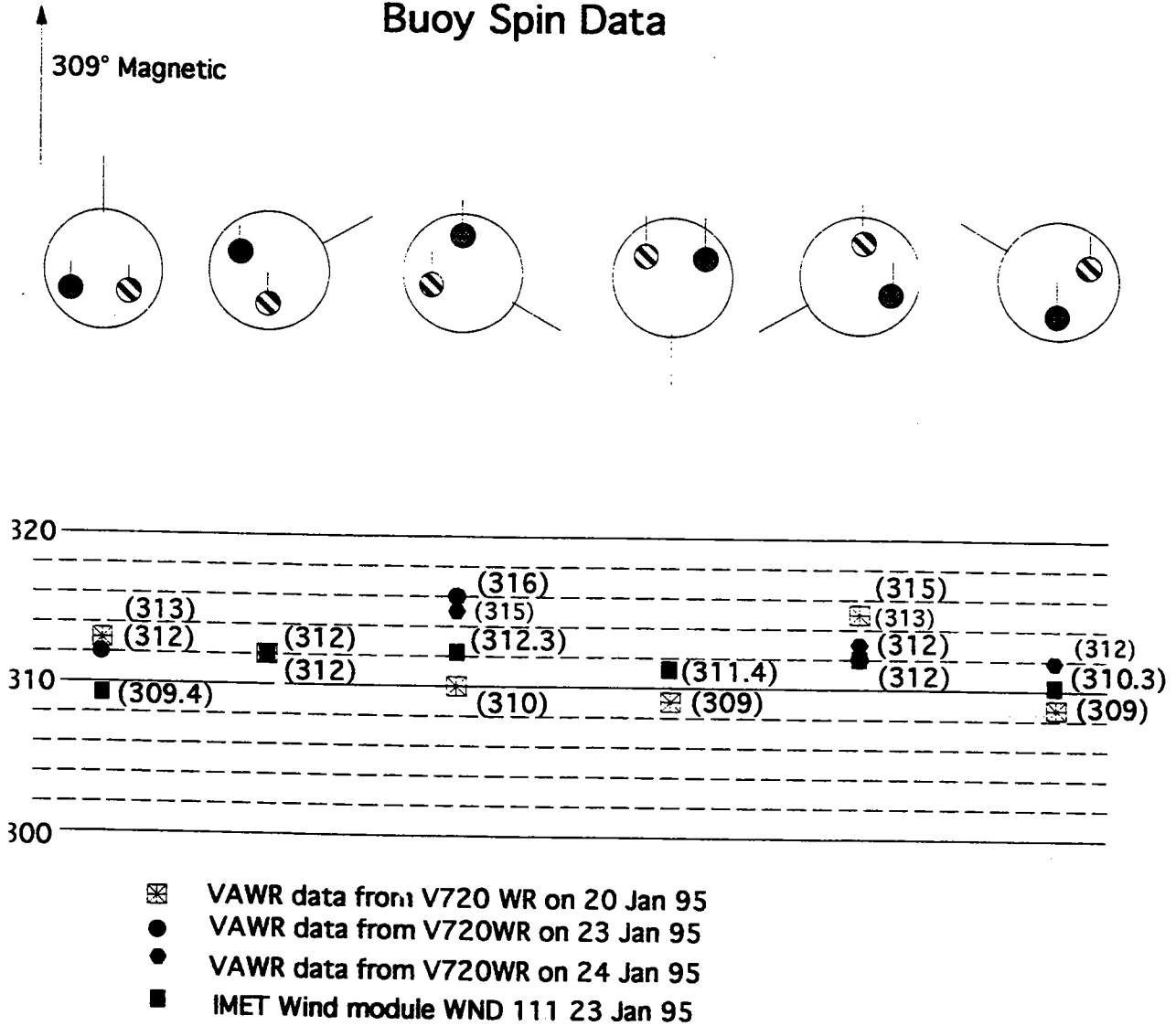

R. Trask  
24 Jan 95

Figure A5-1. Wind direction comparison tests conducted at WHOI.

# Arabian Sea 2 Buoy Spin Data 7 April 1995

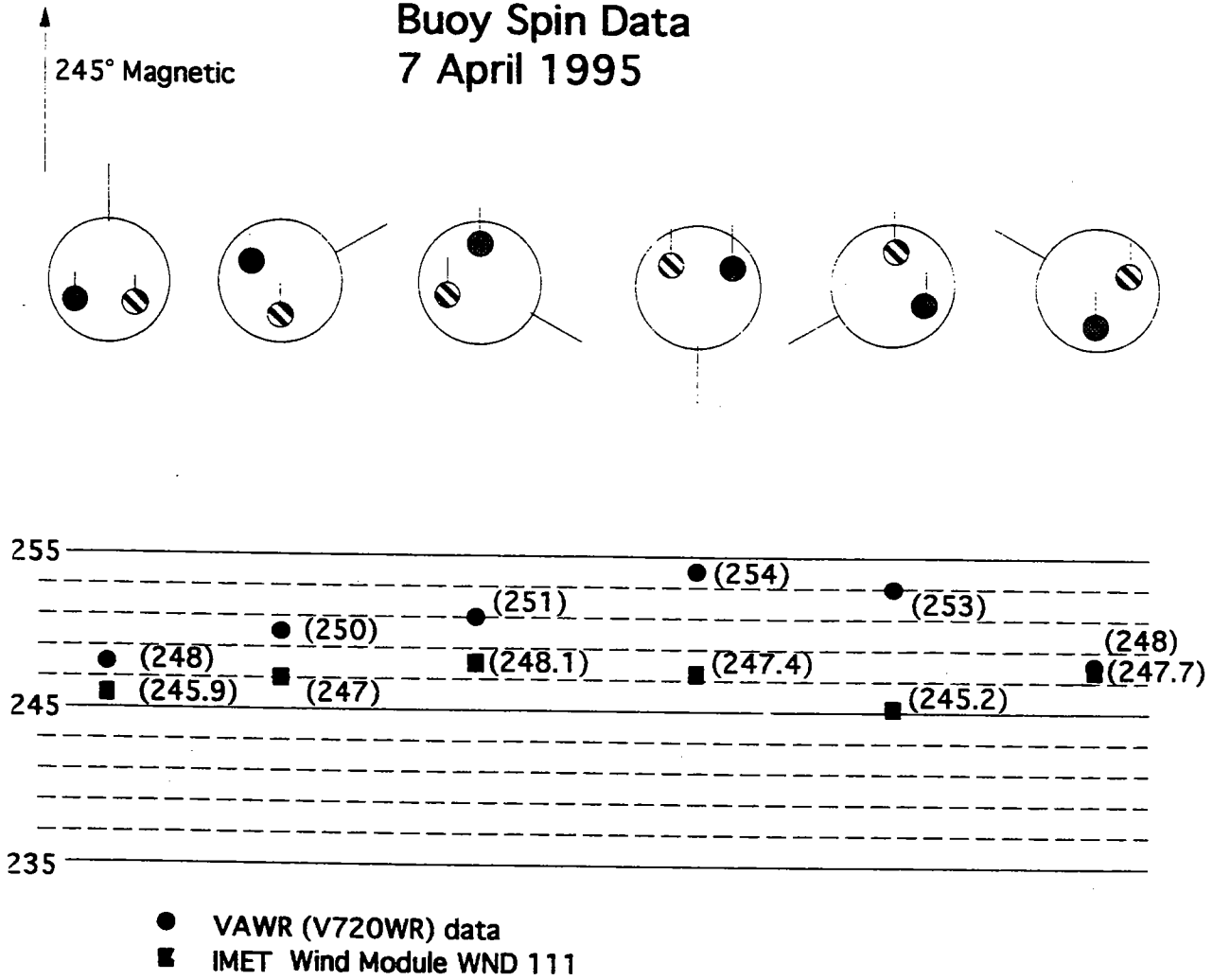

Data shown is with Aspirator Off

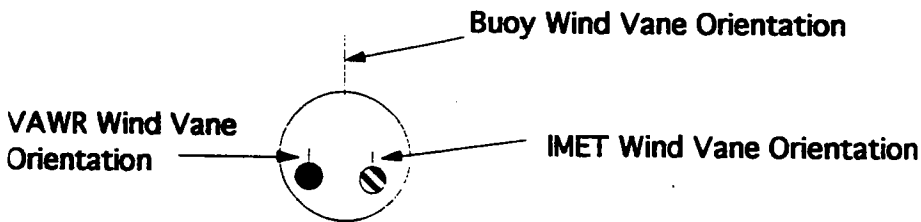

R. Trask  
B. Way  
7 April 95

Figure A5-2. Wind direction comparison tests conducted in Muscat, Oman.

**Appendix 6**  
**Arabian Sea 1 Timing Information**

	Pre-deployment time mark			Post-deployment time mark		
	Date	Time In UTC	Time Out UTC	Date	Time In UTC	Time Out UTC
<b>Branckers</b>						
2534	4-Oct-94	0911	1002	21-Apr-95	4:01:15	4:50:55
2537	4-Oct-94	0910	1021	No Post-deployment time mark		
2541	4-Oct-94	0910	1021	1 Year deployment on UW PCM North		
3259	4-Oct-94	0913	1000	21-Apr-95	3:59:30	4:53:00
3265	4-Oct-94	0915	1022	No Post-deployment time mark		
3279	4-Oct-94	0916	1021	1 Year deployment on UW PCM North		
3301	4-Oct-94	0913	0958	21-Apr-95	4:01:30	4:49:10
3305	4-Oct-94	0914	0957	21-Apr-95	3:59:00	4:51:20
3703	4-Oct-94	0915	0958	21-Apr-95	4:02:50	4:47:25
3761	4-Oct-94	0912	0959	21-Apr-95	3:59:30	4:51:50
	5-Oct-94	0849	0942			
3763	4-Oct-94	0916	0959	21-Apr-95	4:00:22	4:53:20
4481	4-Oct-94	0911	1000	21-Apr-95	4:01:15	4:50:00
	5-Oct-94	0849	0942			
4487	4-Oct-94	0912	1000	21-Apr-95	4:02:05	4:46:30
4489	4-Oct-94	0912	1000	21-Apr-95	4:01:50	4:46:25
4491	4-Oct-94	0913	0958	21-Apr-95	4:02:15	4:47:00
4493	4-Oct-94	0914	0957	21-Apr-95	4:00:45	4:52:30
5432	5-Oct-94	1051	1129	21-Apr-95	4:03:02	4:47:44
<b>Branckers w/ sunshields</b>						
3662	4-Oct-94	0924	0955	21-Apr-95	4:01:30	4:49:35
3667	4-Oct-94	0924	0955	21-Apr-95	4:02:39	4:48:05
3762	4-Oct-94	0923	0955	21-Apr-95	4:00:22	4:50:00
3836	4-Oct-94	0923	0955	21-Apr-95	4:02:25	4:48:20
3839	4-Oct-94	0924	0955	21-Apr-95	4:00:45	4:50:30
4483	4-Oct-94	0922	0955	21-Apr-95	3:59:00	4:52:10
<b>MTRs</b>						
3240	5-Oct-94	1051	1128	21-Apr-95	4:03:15	4:48:50
3247	5-Oct-94	1051	1128	Not deployed (spare instrument)		
<b>Seacats</b>						
357	5-Oct-94	0852	0909	21-Apr-95	5:34:15	6:09:00
391	5-Oct-94	0852	0909	Not deployed (spare instrument)		
992	4-Oct-94	0918	0934	21-Apr-95	5:35:05	6:09:32
993	4-Oct-94	0918	0934	21-Apr-95	5:33:30	6:07:50
994	4-Oct-94	0918	0934	21-Apr-95	5:35:48	6:08:47
1179	5-Oct-94	0853	0909	21-Apr-95	5:36:40	6:08:20

## Appendix 6 continued

**Arabian Sea 2 Timing Information**

	Pre-deployment time mark		
	Date	Time In UTC	Time Out UTC
<b>Branckers</b>			
2533	7-Apr-95	7:16:20	7:48:37
2535	7-Apr-95	7:17:35	7:47:45
2536	7-Apr-95	7:19:25	7:50:47
3263	7-Apr-95	7:35:14	8:11:18
3271	7-Apr-95	7:36:34	8:11:30
3274	7-Apr-95	7:35:27	8:11:00
3280	7-Apr-95	7:36:50	8:11:44
3283	7-Apr-95	7:17:58	7:49:53
3291	7-Apr-95	7:33:24	8:10:18
3296	7-Apr-95	7:17:58	7:50:02
3299	7-Apr-95	7:33:33	8:10:42
3308	7-Apr-95	7:18:25	7:49:42
3309	7-Apr-95	7:18:20	7:48:47
3341	7-Apr-95	7:16:50	7:48:10
3507	7-Apr-95	7:17:10	7:48:00
3508	7-Apr-95	7:17:10	7:47:53
3699	7-Apr-95	7:18:25	7:50:13
3702	7-Apr-95	7:18:55	7:49:19
3835	7-Apr-95	7:17:35	7:48:54
4488	7-Apr-95	7:18:55	7:49:28
4492	7-Apr-95	7:16:50	7:48:25
4495	7-Apr-95	7:19:25	7:50:36
<b>Drifter Branckers</b>			
3704	17-Apr-95	9:21:34	9:26:51
3764	17-Apr-95	9:27:20	9:32:08
3837	17-Apr-95	9:27:26	9:32:08
3838	17-Apr-95	9:32:29	9:37:32
4228	17-Apr-95	9:21:40	9:27:05
4402	17-Apr-95	9:32:33	9:37:32
<b>MTPs</b>			
3247	7-Apr-95	7:19:46	7:37:30
3250	7-Apr-95	7:19:38	7:37:41
<b>Seacats</b>			
142	7-Apr-95	7:20:19	7:33:01
143 A	7-Apr-95	7:20:43	7:32:35
144	7-Apr-95	7:21:39	7:35:45
927	7-Apr-95	7:21:22	7:33:49
928	7-Apr-95	7:21:22	7:33:58
929	7-Apr-95	7:20:30	7:32:50



## Appendix 7

### VMCM Record Format

#### 1. RECORD COUNTER (TIME)

The first 16 bits (4 characters) of data comprise the record number. The counter is incremented once each data record. The first record number is one and is used to initialize the instrument. The data and length of the first record may be invalid and should be ignored. Record two contains data for the first record interval. After 65535 records, the record counter will reset to zero and begin its normal counting.

#### 2. NORTH VECTOR

Each vector is scaled from a 24 bit accumulator and stored in a 16 bit floating-point representation. This vector is the algebraic sum of the NORTH component of current flow from each sample.

#### 3. EAST VECTOR

Each vector is scaled from a 24 bit accumulator and stored in a 16 bit floating-point representation. This vector is the algebraic sum of the EAST component of current flow from each sample.

#### 4. ROTOR 2 (X CURRENT FLOW) (UPPER)

The rotor counts are an algebraic sum of the counts for a record interval. Rotor counts are scaled from a 24 bit accumulator and stored as a 16 bit floating number.

#### 5. ROTOR 1 (Y CURRENT FLOW) (LOWER)

The rotor counts are an algebraic sum of the counts for a record interval. Rotor counts are scaled from a 24 bit accumulator and stored as a 16 bit floating number.

#### 6. COMPASS

The compass field is an 8 bit 2's complement number (-128 to +128 decimal). The stored value is measured at the beginning of the last sample of the record interval.

#### 7. TEMPERATURE

One temperature sample is taken just before the end of the last record interval.

Record interval = 2 seconds to 2 hours

Sample interval = .25 seconds to 2 seconds in quarter second steps

PREAMBLE/ TIME/ NORTH/ EAST/ R2/ R1/ COMPASS/ TEMP/ PARITY

(2)            (4)    (4)    (4)   (4) (4)    (2)    (4)    (1)

(X) = Number of characters

## Appendix 8

### TN 046 Deck Layout Drawings

Figures A8-1 through A8-9 depict the deck layout of the R/V *Thomas Thompson* as moorings were recovered and deployed during TN 046. As the cruise progressed buoys had to be moved in a clockwise rotation. Figure A8-1 shows the deck layout at the time the ship left Muscat. The deck layout in Figure A8-2 is as it appeared following the northern SIO surface mooring recovery. The toroid buoy was disassembled and the toroid hull was stowed forward of the Lebus power pack. Following the redeployment of the northern SIO surface mooring the deck appeared as shown in Figure A8-3. Figure A8-4 shows the deck following the recovery of the southern UW PCM mooring. The next mooring operation was the recovery of the WHOI discus buoy. Figure A8-5 shows the location of the surface buoys following that recovery. The WHOI Arabian Sea 1 buoy was transferred to the starboard side prior to launching the Arabian Sea 2 discus buoy from the port side as shown in Figure A8-6. Figure A8-7 shows the deck layout following the recovery of the SIO southern surface mooring. The tower and bridle from the southern SIO buoy were disassembled and the toroid was laid flat on the deck. Figure A8-8 depicts the deck following the redeployment of the southern SIO mooring. The last mooring operation was the deployment of UW southern PCM mooring. The deck following that deployment is shown in Figure A8-9.

- Science Gear Weights (ea)
- deck box @ 1000 lbs.
  - SIO anchor @ 3000 lbs.
  - UOP anchor @ 9300 lbs.
  - UW anchor @ 5000 lbs.
  - SIO toriod @ 2500 lbs.
  - UOP discus @ 3500 lbs.
  - Lebus power pack @ 4500 lbs.
  - Lebus capstan @ 4900 lbs.
  - Lebus spoiler @ 2000 lbs.
  - wire/nylon reels 70 @ 150 lbs.
  - air tuggers @ 300 lbs.
  - glass ball van @ 13000 lbs.
  - dragging gear @ 2000 lbs.

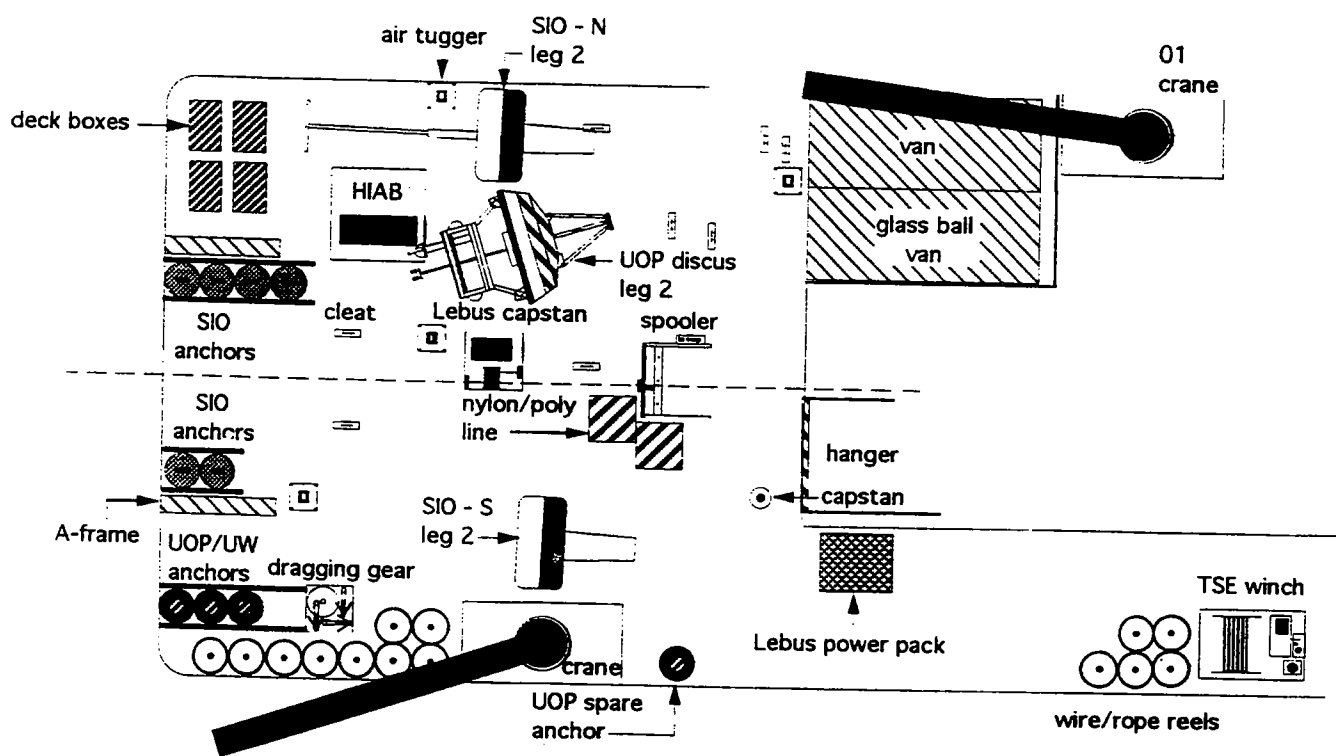

Arabian Sea  
 TN - 046  
 4/7/95  
 W.Ostrom  
 phase #1  
 departure layout  
 96900 lbs.  
 scale 1" = 15'

Figure A8-1: Deck layout at the time the ship left Muscat.

Science Gear Weights (ea)

- deck box @ 1000 lbs.
- SIO anchor @ 3000 lbs.
- UOP anchor @ 9300 lbs.
- UW anchor @ 5000 lbs.
- SIO toriod @ 2500 lbs.
- UOP discus @ 3500 lbs.
- Lebus power pack @4500 lbs.
- Lebus capstan @ 4900 lbs.
- Lebus spoiler @ 2000 lbs.
- wire/nylon reels 70 @ 150 lbs.
- air tuggers @ 300 lbs.
- glass ball van @ 13000 lbs.
- dragging gear @ 2000 lbs.

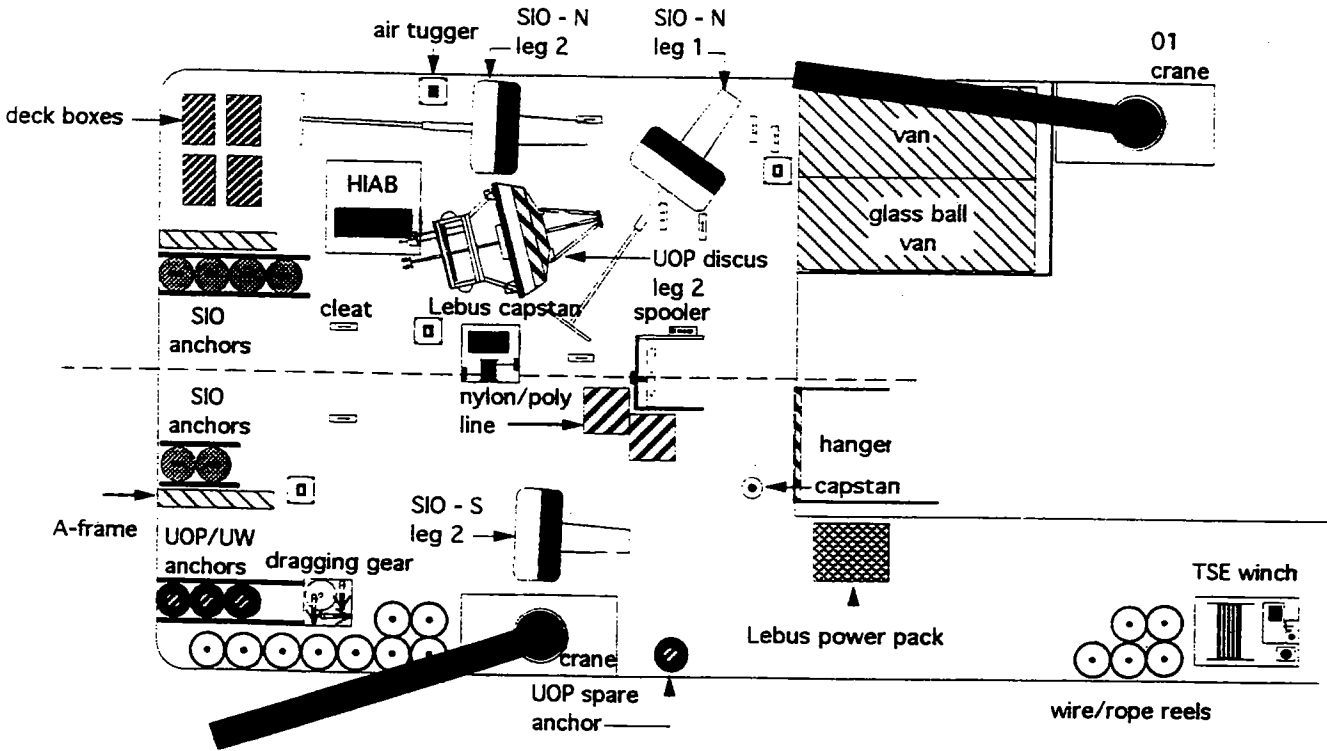

Arabian Sea  
 TN - 046  
 4/7/95  
 W.Ostrom  
 phase #2  
 SIO - N recovery  
 102400 lbs.  
 scale 1"= 15'

Figure A8-2: Deck layout following the northern SIO surface mooring recovery.

Science Gear Weights (ea)

- deck box @ 1000 lbs.
- SIO anchor @ 3000 lbs.
- UOP anchor @ 9300 lbs.
- UW anchor @ 5000 lbs.
- SIO toriod @ 2500 lbs.
- UOP discus @ 3500 lbs.
- Lebus power pack @ 4500 lbs.
- Lebus capstan @ 4900 lbs.
- Lebus spoiler @ 2000 lbs.
- wire/nylon reels 70 @ 150 lbs.
- air tuggers @ 300 lbs.
- glass ball van @ 13000 lbs.
- dragging gear @ 2000 lbs.

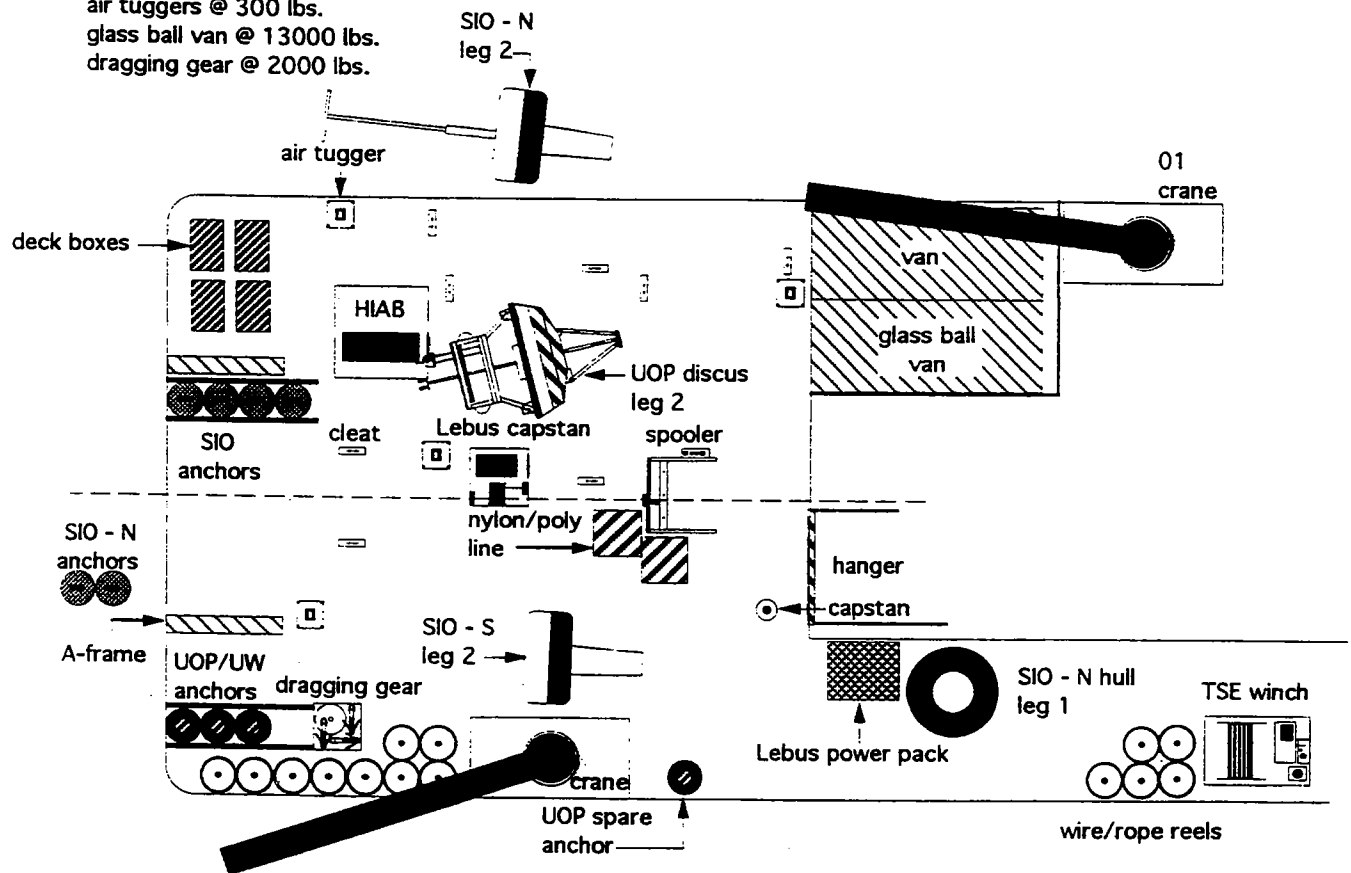

Arabian Sea  
 TN - 046  
 4/7/95  
 W.Ostrom  
 phase #3  
 SIO - N deployment  
 90900 lbs.  
 scale 1" = 15'

Figure A8-3: Deck layout following the redeployment of the northern SIO surface mooring.

Science Gear Weights (ea)

- deck box @ 1000 lbs.
- SIO anchor @ 3000 lbs.
- UOP anchor @ 9300 lbs.
- UW anchor @ 5000 lbs.
- SIO toriod @ 2500 lbs.
- UOP discus @ 3500 lbs.
- Lebus power pack @ 4500 lbs.
- Lebus capstan @ 4900 lbs.
- Lebus spoiler @ 2000 lbs.
- wire/nylon reels 70 @ 150 lbs.
- air tuggers @ 300 lbs.
- glass ball van @ 13000 lbs.
- dragging gear @ 2000 lbs.

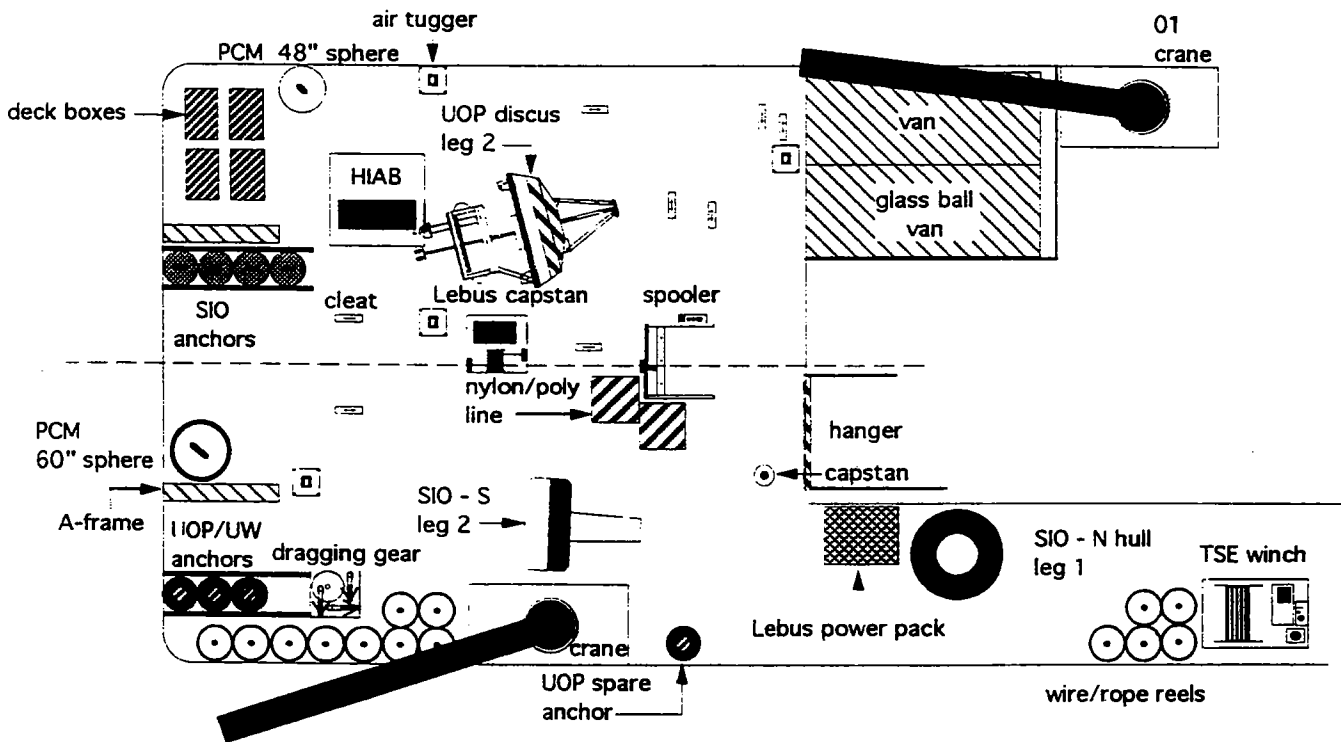

Arabian Sea  
 TN - 046  
 4/7/95  
 W.Ostrom  
 phase #4  
 PCM - S recovery  
 91650 lbs.  
 scale 1" = 15'

Figure A8-4: Deck layout following the recovery of the southern UW PCM mooring.

Science Gear Weights (ea)

- deck box @ 1000 lbs.
- SIO anchor @ 3000 lbs.
- UOP anchor @ 9300 lbs.
- UW anchor @ 5000 lbs.
- SIO toriod @ 2500 lbs.
- UOP discus @ 3500 lbs.
- Lebus power pack @ 4500 lbs.
- Lebus capstan @ 4900 lbs.
- Lebus spoiler @ 2000 lbs.
- wire/nylon reels 70 @ 150 lbs.
- air tuggers @ 300 lbs.
- glass ball van @ 13000 lbs.
- dragging gear @ 2000 lbs.

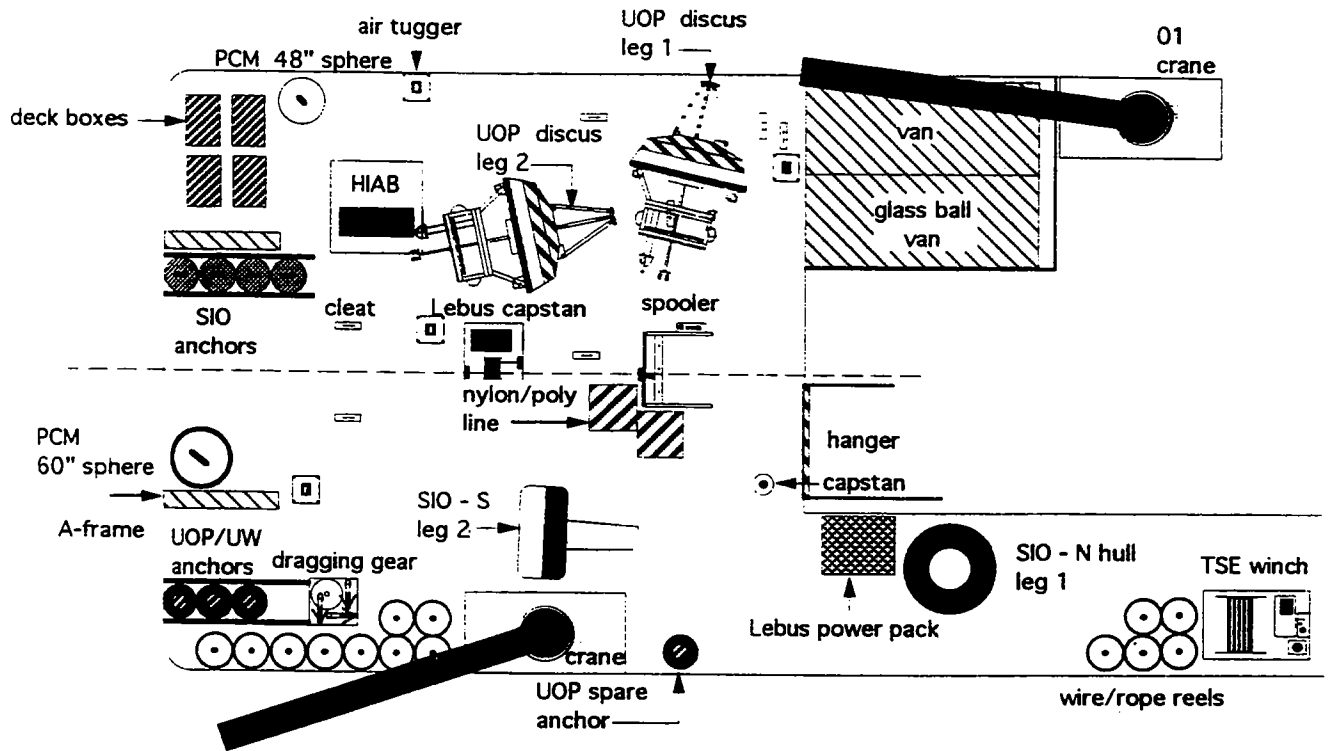

Arabian Sea  
 TN - 046  
 4/7/95  
 W.Ostrom  
 phase #5  
 UOP discus recovery  
 99150 lbs.  
 scale 1"= 15'

Figure A8-5: Location of the surface buoys following the recovery of the WHOI discus buoy.

Science Gear Weights (ea)

- deck box @ 1000 lbs.
- SIO anchor @ 3000 lbs.
- UOP anchor @ 9300 lbs.
- UW anchor @ 5000 lbs.
- SIO toriod @ 2500 lbs.
- UOP discus @ 3500 lbs.
- Lebus power pack @ 4500 lbs.
- Lebus capstan @ 4900 lbs.
- Lebus spoiler @ 2000 lbs.
- wire/nylon reels 70 @ 150 lbs.
- air tuggers @ 300 lbs.
- glass ball van @ 13000 lbs.
- dragging gear @ 2000 lbs.

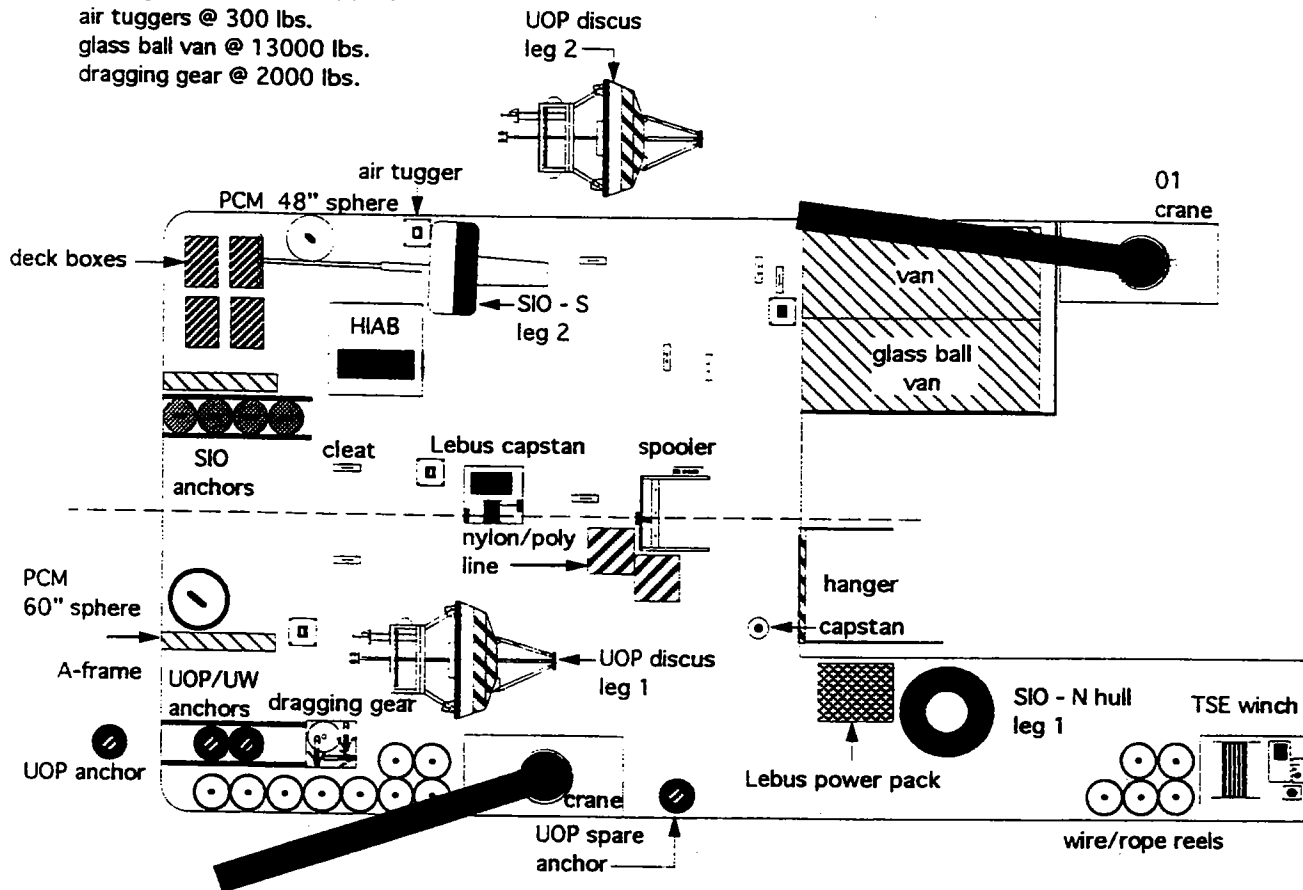

Arabian Sea  
 TN - 046  
 4/7/95  
 W.Ostrom  
 phase #6  
 UOP discus deployment  
 82350 lbs.  
 scale 1" = 15'

Figure A8-6: Deck layout prior to launching the Arabian Sea 2 discus buoy.



Science Gear Weights (ea)  
 deck box @ 1000 lbs.  
 SIO anchor @ 3000 lbs.  
 UOP anchor @ 9300 lbs.  
 UW anchor @ 5000 lbs.  
 SIO toriod @ 2500 lbs.  
 UOP discus @ 3500 lbs.  
 Lebus power pack @ 4500 lbs.  
 Lebus capstan @ 4900 lbs.  
 Lebus spoiler @ 2000 lbs.  
 wire/nylon reels 70 @ 150 lbs.  
 air tuggers @ 300 lbs.  
 glass ball van @ 13000 lbs.  
 dragging gear @ 2000 lbs.

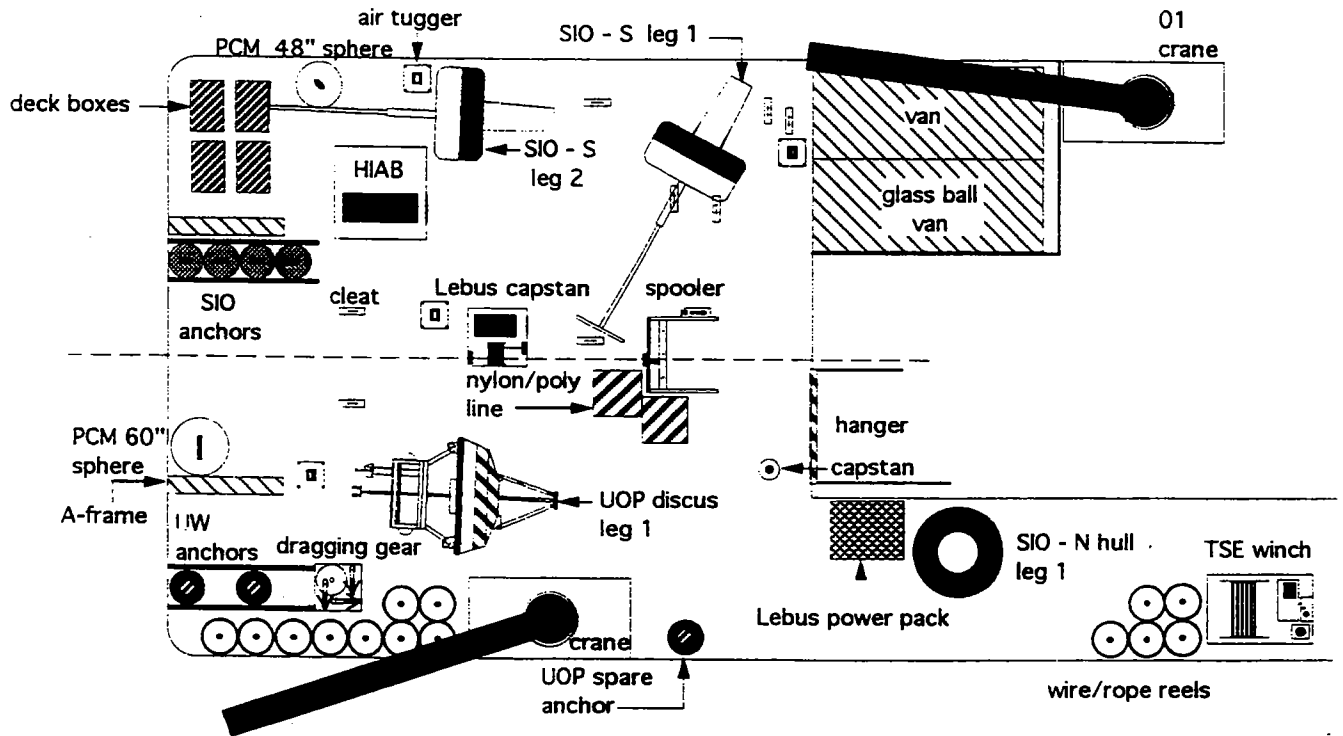

Arabian Sea  
 TN - 046  
 4/7/95  
 W.Ostrom  
 phase #7  
 SIO - S recovery  
 87850 lbs.  
 scale 1" = 15'

Figure A8-7: Deck layout following the recovery of the SIO southern surface mooring.

Science Gear Weights (ea)

- deck box @ 1000 lbs.
- SIO anchor @ 3000 lbs.
- UOP anchor @ 9300 lbs.
- UW anchor @ 5000 lbs.
- SIO toriod @ 2500 lbs.
- UOP discus @ 3500 lbs.
- Lebus power pack @4500 lbs.
- Lebus capstan @ 4900 lbs.
- Lebus spoiler @ 2000 lbs.
- wire/nylon reels 70 @ 150 lbs.
- air tuggers @ 300 lbs.
- glass ball van @ 13000 lbs.
- dragging gear @ 2000 lbs.

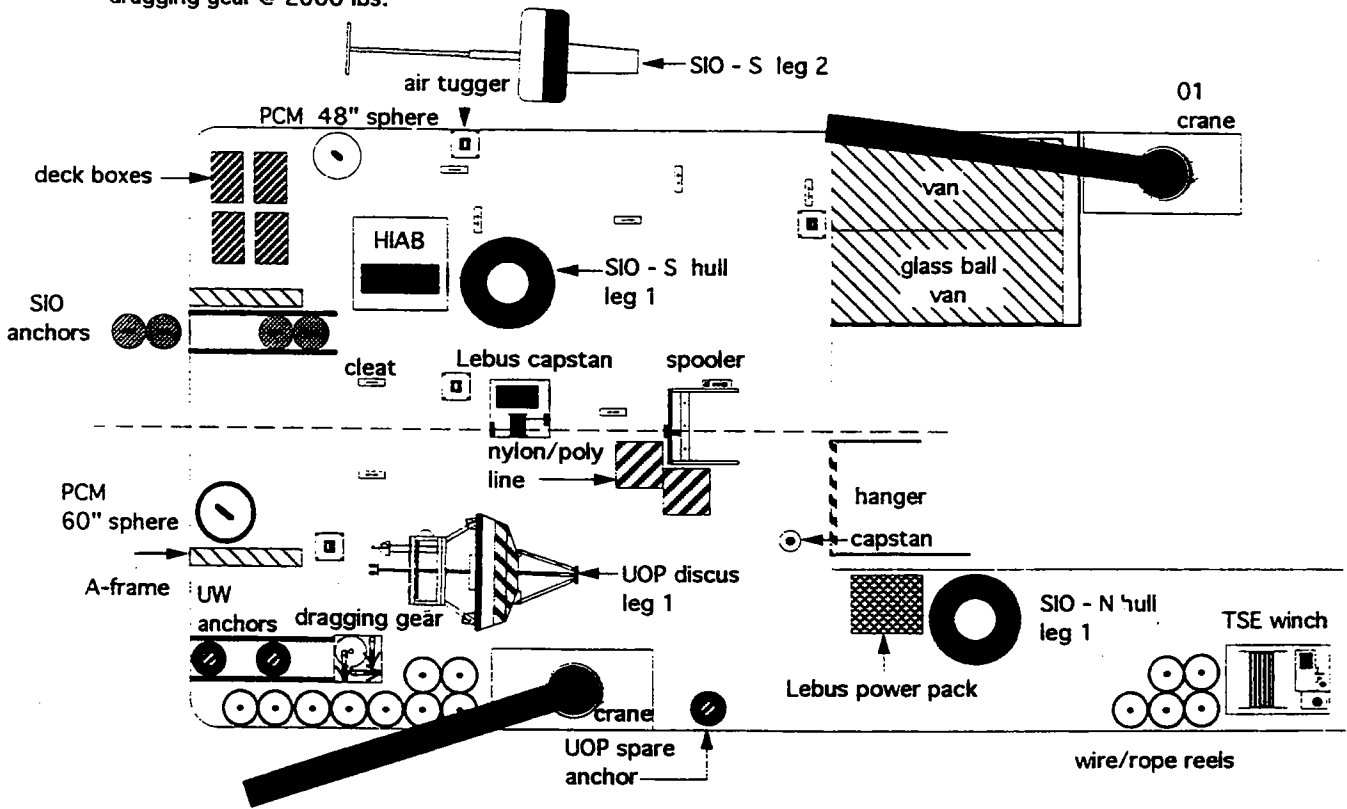

Arabian Sea  
 TN - 046  
 4/7/95  
 W.Ostrom  
 phase #8  
 SIO south leg 2 depolyment  
 92850 lbs.  
 scale 1" = 15'

Figure A8-8: Deck layout following the redeployment of the southern SIO mooring.

Science Gear Weights (ea)  
 deck box @ 1000 lbs.  
 SIO anchor @ 3000 lbs.  
 UOP anchor @ 9300 lbs.  
 UW anchor @ 5000 lbs.  
 SIO toriod @ 2500 lbs.  
 UOP discus @ 3500 lbs.  
 Lebus power pack @4500 lbs.  
 Lebus capstan @ 4900 lbs.  
 Lebus spoiler @ 2000 lbs.  
 wire/nylon reels 70 @ 150 lbs.  
 air tuggers @ 300 lbs.  
 glass ball van @ 13000 lbs.  
 dragging gear @ 2000 lbs.

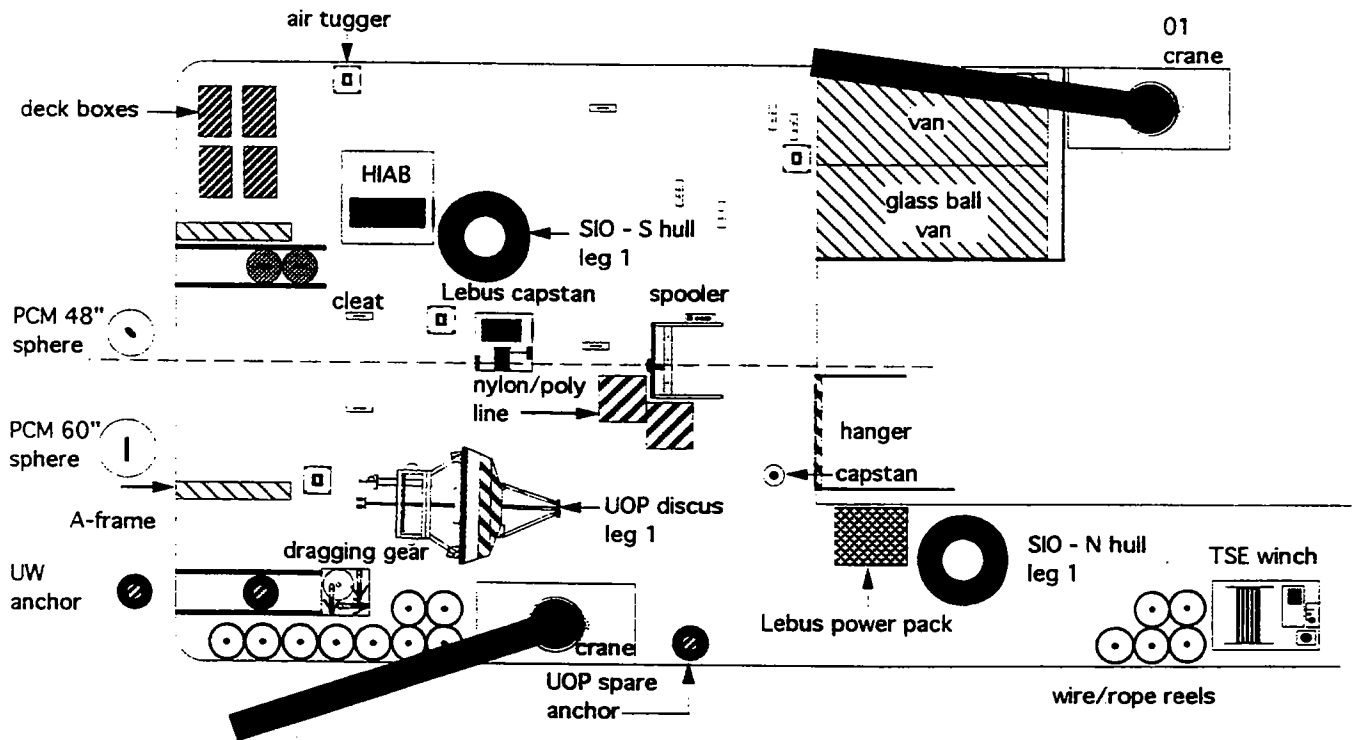

Arabian Sea  
 TN - 046  
 4/7/95  
 W.Ostrom  
 phase #9  
 PCM - S deployment  
 75600 lbs.  
 scale 1" = 15'

Figure A8-9: Deck layout following the deployment of the UW southern PCM mooring.

## Appendix 9.

### Deployment and Recovery Information about WHOI Instrumentation on the UW PCM Moorings

Southern PCM Mooring (WHOI Mooring Reference No. 970)  
Deployed 19 October 94  
Position: 15°16.37'N, 61°44.07'E  
Recovered 18 April 95

INST NO.	TIME OVER	TIME BACK	NOTES
T-POD 3265	0202 UTC	0222 UTC	
T-POD 2537	0329 UTC	0551 UTC	
VM-016	0341 UTC (Bands off at 0338 UTC)	0553 UTC	Temp Pod Leak
VM-018	0407 UTC (Bands off at 0405 UTC)	0614 UTC	Temp Pod Leak Zero rotor counts
VM-021	0427 UTC (Bands off at 0425 UTC)	0632 UTC	Compass Problem
VM-025	0457 UTC (Bands off at 0455 UTC)	0704 UTC	
VM-038	0549 UTC (Bands off at 0547 UTC)	0757 UTC	

## Appendix 9 Continued

### Northern PCM Mooring (WHOI Mooring Reference No. 972)

T-POD number 3279 was mounted on the top sphere (intended to be at 20 meters depth) and deployed on 20 October 94 at 0153 UTC. It was recovered at 0240 UTC so that the ship could be repositioned to a new deployment start position. T-POD 3279 was then redeployed at 0542 UTC.

T-POD 2541 was deployed at 0635 UTC. It was intended to be at 250 meters depth. (Actual depths are approximately 15–20 meters less.)

For reference purposes all moorings that have WHOI instrumentation are given a WHOI mooring reference number even though they may not be a WHOI mooring. The first short deployment of the UW northern PCM mooring was given WHOI mooring reference number 971.

After receiving information that the top sphere was occasionally on the surface the northern PCM mooring was recovered on 22 October 94.

T-POD 3279 was out of the water at 1054 UTC and T-POD 2541 was out of the water at 1114 UTC.

The northern PCM mooring was re-deployed (WHOI Mooring Reference No. 972) on 23 October 94. T-POD 3279 was again deployed on the top sphere at 0221 UTC and T-POD 2541 was in the water at 0310 UTC.

## Appendix 10

### Antifouling Coating Tests

The Upper Oceans Processes group has over the years used Amercoat No. 635 (tributyltin ablative) to antifoul the aluminum hulls of the discus buoys. Generally this coating has performed satisfactorily. It is however a regulated substance due to its high toxicity to non-targeted marine animals. For several years alternate coatings that are compatible with aluminum have been tested for their effectiveness as antifoulants in current flow regimes of 0 to 4 knots for periods up to eight months.

One test coating was called Chemotex which is a non-toxic calcium carbonate alkaloid. The discus hull from the Arabian Sea 1 deployment had five test areas (12"x12") that were coated with Chemotex around the chine of the hull (Figure A10-1). Half of each test area was coated with Chemotex and the other half was left uncoated to act as a control. The remainder of the hull was coated with Amercoat No. 635.

Upon recovery of the buoy in April 1995 it was found that the Chemotex and non-antifouled control areas had similar amounts of fouling. The marine growth was typically a fine hairy weed with a few gooseneck barnacles attached. The Chemotex coating appeared to have ablated completely away but still managed to remain clear of barnacles. The location of the test areas around the chine may have helped prevent barnacles from attaching due to the greater current flow as compared to the area around the bridle legs and near-surface temperature array where there was considerable fouling.

The remaining areas coated with Amercoat No. 635 had considerable colonies of gooseneck barnacles wherever the coating had either ablated away or where there was a holiday in the coating. The failure of the Amercoat and Chemotex coatings appeared to be linked to an insufficient mil thickness during application.

The discus hull for the Arabian Sea 2 deployment and two VMCM cages at 5 and 15 meters depth were coated with three varieties of antifouling paint. The coatings used were Amercoat No. 635 (white), Chemotex (gray), and No Foul (black). No Foul is a non-toxic hydrogen peroxide release ablative. The Arabian Sea 2 discus buoy had five test areas (Figure A10-2) located around the chine.

Each test area was divided into three sections 4" x 16". One of the three sections was left uncoated. The other two sections had coatings of No Foul and Chemotex. Amercoat no.635 was

used to coat the remainder of the hull. The No Foul and Chemotex sections had three coats each with approximately 4 mil thickness. The Amercoat No. 635 also had three coats totaling 12 mils. The Amercoat was also applied to the bridle and hull-mounted instrumentation. The VMCM instrument case, sting and three 3/4" cage rods were painted with Amercoat No. 635. No Foul and Chemotex paints were applied to the fourth 3/4" cage rod.

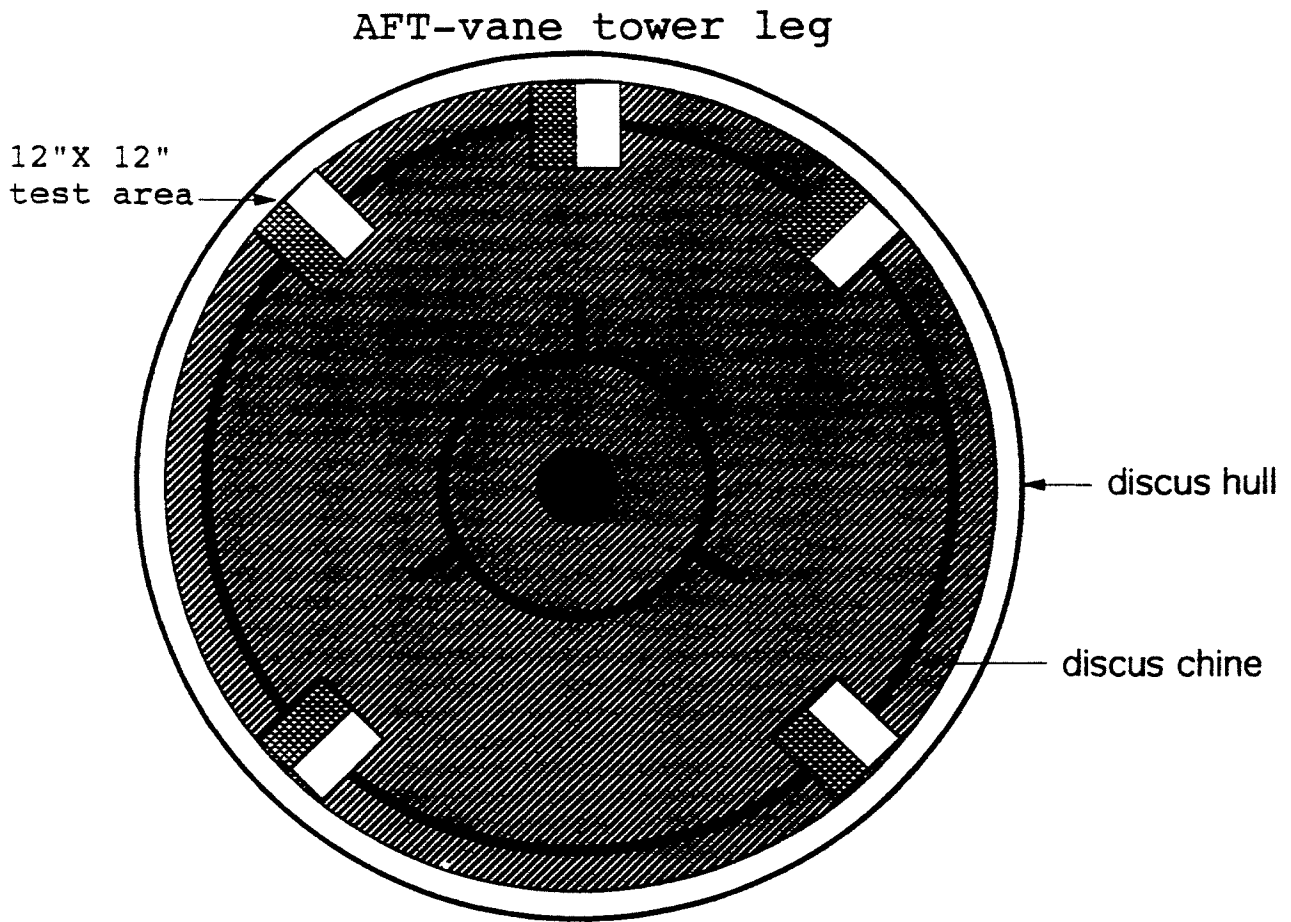

Forward

Legend



	Chemotex gray
	Ameron #635 white
	Uncoated

Figure A10-1. Antifouling paint test locations on the Arabian Sea 1 discus buoy hull.



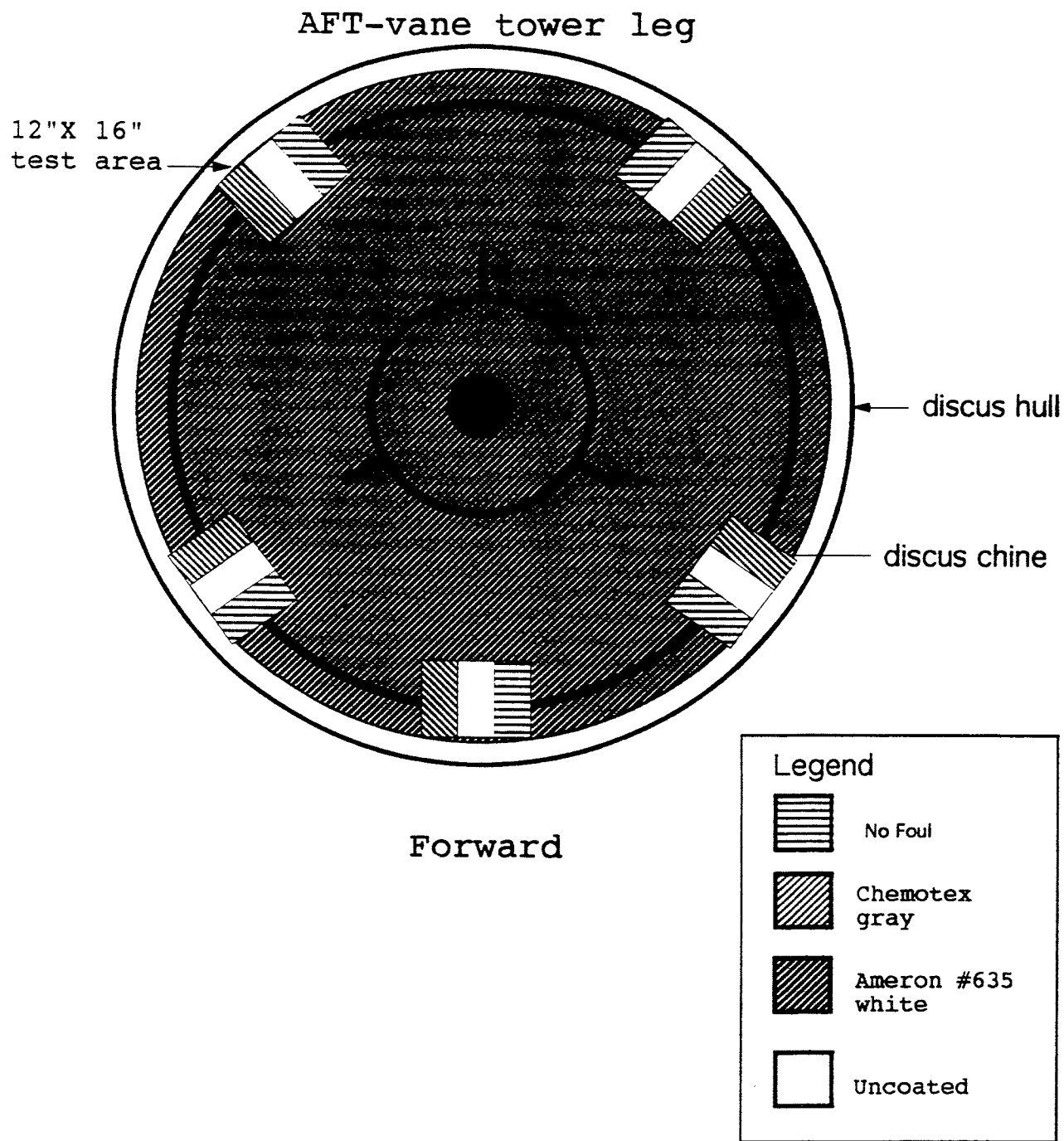

Figure A10-2. Antifouling paint test locations on the Arabian Sea 2 discus buoy hull.

## DOCUMENT LIBRARY

*Distribution List for Technical Report Exchange – May 1995*

University of California, San Diego  
SIO Library 0175C  
9500 Gilman Drive  
La Jolla, CA 92093-0175

Hancock Library of Biology & Oceanography  
Alan Hancock Laboratory  
University of Southern California  
University Park  
Los Angeles, CA 90089-0371

Gifts & Exchanges  
Library  
Bedford Institute of Oceanography  
P.O. Box 1006  
Dartmouth, NS, B2Y 4A2, CANADA

Commander  
International Ice Patrol  
1082 Shennecossett Road  
Groton, CT 06340-6095

NOAA/EDIS Miami Library Center  
4301 Rickenbacker Causeway  
Miami, FL 33149

Research Library  
U.S. Army Corps of Engineers  
Waterways Experiment Station  
3909 Halls Ferry Road  
Vicksburg, MS 39180-6199

Institute of Geophysics  
University of Hawaii  
Library Room 252  
2525 Correa Road  
Honolulu, HI 96822

Marine Resources Information Center  
Building E38-320  
MIT  
Cambridge, MA 02139

Library  
Lamont-Doherty Geological Observatory  
Columbia University  
Palisades, NY 10964

Library  
Serials Department  
Oregon State University  
Corvallis, OR 97331

Pell Marine Science Library  
University of Rhode Island  
Narragansett Bay Campus  
Narragansett, RI 02882

Working Collection  
Texas A&M University  
Dept. of Oceanography  
College Station, TX 77843

Fisheries-Oceanography Library  
151 Oceanography Teaching Bldg.  
University of Washington  
Seattle, WA 98195

Library  
R.S.M.A.S.  
University of Miami  
4600 Rickenbacker Causeway  
Miami, FL 33149

Maury Oceanographic Library  
Naval Oceanographic Office  
Building 1003 South  
1002 Balch Blvd.  
Stennis Space Center, MS, 39522-5001

Library  
Institute of Ocean Sciences  
P.O. Box 6000  
Sidney, B.C. V8L 4B2  
CANADA

Library  
Institute of Oceanographic Sciences  
Deacon Laboratory  
Wormley, Godalming  
Surrey GU8 5UB  
UNITED KINGDOM

The Librarian  
CSIRO Marine Laboratories  
G.P.O. Box 1538  
Hobart, Tasmania  
AUSTRALIA 7001

Library  
Proudman Oceanographic Laboratory  
Bidston Observatory  
Birkenhead  
Merseyside L43 7 RA  
UNITED KINGDOM

IFREMER  
Centre de Brest  
Service Documentation - Publications  
BP 70 29280 PLOUZANE  
FRANCE

REPORT DOCUMENTATION PAGE	1. REPORT NO. WHOI-95-14	2 UOP 95-04	3. Recipient's Accession No.
4. Title and Subtitle Arabian Sea Mixed Layer Dynamics Experiment Mooring Deployment Cruise Report R/V <i>Thomas Thompson</i> Cruise Number 46 14 April- 29 April 1995			5. Report Date July 1995
7. Author(s) Richard P. Trask, Robert A. Weller, William M. Ostrom			6
9. Performing Organization Name and Address  Woods Hole Oceanographic Institution Woods Hole, Massachusetts 02543			8. Performing Organization Rept. No. WHOI-95-14
12. Sponsoring Organization Name and Address Office of Naval Research			10. Project/Task/Work Unit No.
15. Supplementary Notes This report should be cited as: Woods Hole Oceanog. Inst. Tech. Rept., WHOI-95-14.			11. Contract(C) or Grant(G) No. (C) N00014-94-1-0161 (G)
16. Abstract (Limit: 200 words)  This report describes in a general manner the work that took place during the R/V <i>Thomas Thompson</i> cruise number 46 which was the mooring turnaround cruise for the moored array program. A detailed description of the WHOI surface mooring and its instrumentation is provided. Information about the XBT and CTD data and near-surface temperature data collected during the cruise is also included.			13. Type of Report & Period Covered Technical Report
17. Document Analysis a. Descriptors air-sea interaction moored instruments Arabian Sea  b. Identifiers/Open-Ended Terms   c. COSATI Field/Group			14.
18. Availability Statement Approved for public release; distribution unlimited.		19. Security Class (This Report) UNCLASSIFIED	21. No. of Pages 92
		20. Security Class (This Page)	22. Price