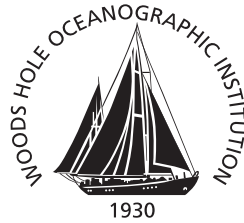


# Woods Hole Oceanographic Institution



---

---

## Stratus Ocean Reference Station (20°S, 85°W), Mooring Recovery and Deployment Cruise, *R/V Ron Brown* Cruise 04-11, December 5 - December 24, 2004

by

Keir Colbo<sup>1</sup>

Robert Weller<sup>1</sup>

Jeff Lord<sup>1</sup>

Jason Smith<sup>1</sup>

Paul Bouchard<sup>1</sup>

Chris Fairall<sup>2</sup>

Frank Bradley<sup>3</sup>

Dan Wolfe<sup>2</sup>

Efthymios Serpetzoglou<sup>4</sup>

Jason Tomlinson<sup>5</sup>

Alvaro Gustavo Vera Tisandie<sup>6</sup>

Juan Francisco Santibanez Bustos<sup>7</sup>

<sup>1</sup>Woods Hole Oceanographic Institution, <sup>2</sup>NOAA Environmental Technology Laboratory, <sup>3</sup>CSIRO, Australia <sup>4</sup>University of Miami,  
<sup>5</sup>Texas A&M University, <sup>6</sup>Servicio Hidrografico y Oceanografico de l'Armada (Chile), <sup>7</sup>University of Concepcion

May 2005

## Technical Report

Funding was provided by the National Oceanic and Atmospheric Administration under Contract Number NA17RJ1225.

Approved for public release; distribution unlimited.



**Upper Ocean Processes Group**  
**Woods Hole Oceanographic Institution**  
**Woods Hole, MA 02543**  
**UOP Technical Report 2005-02**

---

---

WHOI-2006-06

UOP-2005-02

**Stratus Ocean Reference Station (20S, 85W),  
Mooring Recovery and Deployment Cruise,  
R/V *Ron Brown* Cruise 04-11,  
December 5 - December 24, 2004**

by

Keir Colbo<sup>1</sup>

Robert Weller<sup>1</sup>

Jeff Lord<sup>1</sup>

Jason Smith<sup>1</sup>

Paul Bouchard<sup>1</sup>

Chris Fairall<sup>2</sup>

Frank Bradley<sup>3</sup>

Dan Wolfe<sup>2</sup>

Efthymios Serpetzoglou<sup>4</sup>

Jason Tomlinson<sup>5</sup>

Alvaro Gustavo Vera Tisandie<sup>6</sup>

Juan Francisco Santibanez Bustos<sup>7</sup>

<sup>1</sup>Woods Hole Oceanographic Institution | <sup>2</sup>NOAA Environmental Technology Laboratory

<sup>3</sup>CSIRO, Australia | <sup>4</sup>University of Miami

<sup>5</sup>Texas A&M University | <sup>6</sup>Servicio Hidrografico y Oceanografico de l'Armada (Chile)

<sup>7</sup>University of Concepcion

May 2005

**Technical Report**

Funding was provided by the National Oceanic and Atmospheric Administration  
under Contract Number NA17RJ1225.

Reproduction in whole or in part is permitted for any purpose of the United States  
Government. This report should be cited as Woods Hole Oceanog. Inst. Tech. Rept.,  
WHOI-2005-06.

Approved for public release; distribution unlimited.

**Approved for Distribution:**

  
Nelson G. Hogg, Chair

Department of Physical Oceanography



## ABSTRACT

The Ocean Reference Station at 20° S, 85° W under the stratus clouds west of northern Chile and Peru is being maintained to provide ongoing, climate-quality records of surface meteorology, of air-sea fluxes of heat, freshwater, and momentum, and of upper ocean temperature, salinity, and velocity variability. The Stratus Ocean Reference Station (ORS Stratus) is supported by the National Oceanic and Atmospheric Administration's (NOAA) Climate Observation Program. It is recovered and redeployed annually, with cruises that have come between October and December.

During the December 2004 cruise of NOAA's R/V *Ronald H. Brown* to the ORS Stratus site, the primary activities were the recovery of the WHOI surface mooring that had been deployed in November 2003, the deployment of a new WHOI surface mooring at that site, the in-situ calibration of the buoy meteorological sensors by comparison with instrumentation put on board by staff of the NOAA Environmental Technology Laboratory (ETL), and observations of the stratus clouds and lower atmosphere by NOAA ETL and Jason Tomlinson from Texas A&M.

The ORS Stratus buoys are equipped with two Improved Meteorological systems, which provide surface wind speed and direction, air temperature, relative humidity, barometric pressure, incoming shortwave radiation, incoming longwave radiation, precipitation rate, and sea surface temperature. The IMET data are made available in near real time using satellite telemetry. The mooring line carries instruments to measure ocean salinity, temperature, and currents. The ETL instrumentation used during the 2004 cruise included cloud radar, radiosonde balloons, and sensors for mean and turbulent surface meteorology. The atmospheric observations also benefited from the C-Band radar mounted on the R/V *Ronald H. Brown*.

In addition to this work, buoy work was done in support of the Chilean Navy Hydrographic and Oceanographic Service (SHOA). A tsunami warning mooring was reinstalled at 75°W, 20°S for SHOA, after the previous buoy installed last year failed. SHOA personnel were onboard to direct the deployment and to gain experience. Four students from the University of Concepcion collected hydrographic data and water samples. One other Chilean student from the University of Chile was involved in the atmospheric sampling program, with a particular focus on the near coast jet. Finally, the cruise hosted a teacher participating in NOAA's Teacher at Sea Program, Mary Esther Cook, who used her experience to develop lessons for her class back in Arkansas.



This Page Left Intentionally Blank.

# TABLE OF CONTENTS

|  |           |
|--|-----------|
| ABSTRACT.....  | III       |
| TABLE OF CONTENTS.....   | V         |
| LIST OF FIGURES.....   | VI        |
| LIST OF TABLES.....  | VIII      |
| ABBREVIATIONS.....   | IX        |
| <b>I. PROJECT BACKGROUND AND PURPOSE.....</b>  | <b>1</b>  |
| <b>II. STRATUS 2003 CRUISE.....</b>  | <b>4</b>  |
| A. OVERVIEW.....   | 4         |
| B. PRE-CRUISE AND CRUISE DETAILS.....  | 6         |
| <b>III. ORS STRATUS MOORINGS.....</b>  | <b>9</b>  |
| A. OVERVIEW.....   | 9         |
| B. SURFACE INSTRUMENTS.....  | 10        |
| 1. <i>Improved Meteorological (IMET) Systems</i> .....                                 | 10        |
| 2. <i>Stand-alone Relative Humidity/Temperature Instrument (Stratus 4 only)</i> .....  | 11        |
| C. SUBSURFACE INSTRUMENTS.....   | 11        |
| 1. <i>Floating SST Sensor</i> .....  | 11        |
| 2. <i>Subsurface Argos Transmitter</i> .....   | 12        |
| 3. <i>SeaCat Conductivity and Temperature Recorders</i> .....                          | 12        |
| 4. <i>MicroCat Conductivity and Temperature Recorder</i> .....                         | 12        |
| 5. <i>Brancker Temperature Recorders (TPOD)</i> .....                                  | 12        |
| 6. <i>Brancker XR-420 Temperature and Conductivity Recorder (Stratus 5 only)</i> ..... | 12        |
| 7. <i>SBE-39 Temperature Recorder</i> .....  | 13        |
| 8. <i>Vector Measuring Current Meters</i> .....  | 13        |
| 9. <i>Aanderaa Current Meter (Stratus 5 only)</i> .....                                | 13        |
| 10. <i>RDI Acoustic Doppler Current Profiler</i> .....                                 | 13        |
| 11. <i>SonTek Argonaut MD Current Meter</i> .....                                      | 13        |
| 12. <i>Acoustic Release</i> .....  | 13        |
| D. STRATUS 4 RECOVERY.....   | 14        |
| 1. <i>Mooring Description</i> .....  | 14        |
| 2. <i>Recovery Process</i> .....   | 17        |
| 3. <i>Time Spikes</i> .....  | 19        |
| 4. <i>Antifoulant performance</i> .....  | 22        |
| E. STRATUS 5 DEPLOYMENT.....   | 25        |
| 1. <i>Mooring Description</i> .....  | 25        |
| 2. <i>Time Spikes</i> .....  | 29        |
| 3. <i>Antifoulant Application</i> .....  | 29        |
| 4. <i>Deployment Process</i> .....   | 30        |
| 5. <i>Anchor Position Triangulation</i> .....  | 35        |
| <b>IV. SHIPBOARD MEASUREMENTS.....</b>   | <b>37</b> |
| <b>V. ETL MEASUREMENTS.....</b>  | <b>42</b> |
| <b>VI. ADDITIONAL CRUISE ACTIVITIES.....</b>   | <b>68</b> |
| A. DEPLOYMENT OF DRIFTERS AND UNDERWAY WATCH.....                                      | 68        |
| B. SHOA DART TSUNAMI BUOY.....   | 69        |

|  |            |
|--|------------|
| C. TAMU MEASUREMENTS.....                                  | 72         |
| 1. Introduction and Instrument Overview.....               | 72         |
| 2. Method.....   | 73         |
| 3. Overview of Data Collected and Preliminary Results..... | 73         |
| 4. Conclusions.....  | 74         |
| D. TEACHER-AT-SEA PROGRAM.....                             | 77         |
| 1. Bucket/Thermosalinograph Comparisons.....               | 78         |
| <b>ACKNOWLEDGEMENTS.....</b>                               | <b>81</b>  |
| <b>APPENDIX A – CRUISE LOGISTICS.....</b>                  | <b>82</b>  |
| <b>APPENDIX B – MOORING LOGS.....</b>                      | <b>83</b>  |
| <b>APPENDIX C – BUOY SPINS.....</b>                        | <b>101</b> |
| <b>APPENDIX D – INSTRUMENT NOTES.....</b>                  | <b>109</b> |
| A. SUBSURFACE SETUP NOTES.....                             | 109        |
| B. IMET SETUP NOTES.....                                   | 113        |

## LIST OF FIGURES

|   |    |
|---|----|
| Figure 1: The R/V Ron Brown in port in Arica, Chile.....  | 2  |
| Figure 2: The Stratus 2004 cruise track.....  | 6  |
| Figure 3: An SBE-16 (SeaCat) painted with white anti-foulant.....   | 7  |
| Figure 4: The Stratus 4 buoy after deployment with the R/V Roger Revelle in the background.....   | 9  |
| Figure 5: The Stratus 5 mooring diagram.....  | 28 |
| Figure 6: The Stratus 5 anchor survey.....  | 36 |
| Figure 7: Bathymetry map for the Stratus location.....  | 37 |
| Figure 8: CTD cast number 00 (from December 7th 2004).....  | 40 |
| Figure 9: CTD cast number 17 (from December 11th 2004).....   | 40 |
| Figure 10: CTD cast number 18 (from December 16th 2004).....  | 41 |
| Figure 11: Temperature, salinity and density along the CTD transect (between December 7th and December 17th, 2004).....                         | 41 |
| Figure 12. Cruise track for RBH on December 10 (DOY 345).....   | 49 |
| Figure 13. Time series of near-surface ocean temperature (green) and 15-m air temperature (blue) for December 10th. ....                        | 49 |
| Figure 14: True wind direction from the ETL sonic anemometer (18 m) and the IMET prop/vane (15 m). ....   | 50 |
| Figure 15: True wind speed from the ETL sonic anemometer (18 m) and the ship's prop/vane (15 m). ....   | 50 |
| Figure 16: Time series of downward solar flux from ETL and ship Eppley sensors. The green line is a model of the expected clear sky value. .... | 51 |
| Figure 17: Time series of downward IR flux from ETL and ship Eppley sensors. The green line is a model of the expected clear sky value. ....    | 51 |
| Figure 18: Time series of non-solar surface heat flux components: sensible (blue), latent (green), and net IR (red). ....                       | 52 |

|  |    |
|--|----|
| Figure 19: Time series of net heat flux to the ocean surface. The values at the top of the graph are the average for the day. ....   | 52 |
| Figure 20: Cloud-base height information extracted from the ceilometer backscatter information.....  | 53 |
| Figure 21: Time-height cross-section data from the 94 GHz cloud radar for day 345 (December 10, 2004): upper panel, backscatter intensity; middle panel, mean Doppler vertical velocity; lower panel, Doppler width. The deep vertical streaks are drizzle. 54 | 54 |
| Figure 22: Time series of data from the 3-channel microwave radiometer: upper panel, column water vapor; middle panel, column water liquid; lower panel, brightness temperatures at 21 GHz and 31 GHz.....   | 55 |
| Figure 23: Time-height cross-section of wind speed and direction for December 10th, 2004. Barb orientation gives wind direction; color gives wind speed. ....  | 56 |
| Figure 24: Cruise track for the entire Stratus 2004 cruise.....  | 56 |
| Figure 25: Time series of near-surface ocean temperature (blue) and 15m air temperature (green) for the Stratus 2004 cruise .....  | 57 |
| Figure 26: Time series of wind speed (upper panel), northerly component (middle panel), and easterly component (lower panel) for the Stratus 2004 cruise .....   | 57 |
| Figure 27: Diurnal average of northerly and easterly wind components for periods of the cruise near 20° S .....  | 58 |
| Figure 28: Time series of 24 hour average heat flux components: solar flux (circles), latent heat flux (triangles), sensible heat flux (diamonds), and net infrared flux (crosses) ..  | 58 |
| Figure 29: Time series of daily averaged radiative cloud forcing: infrared cloud forcing (green), solar cloud forcing (blue).....  | 59 |
| Figure 30: Selected variables from the East-West transect along 20° S: upper panel, wind speed; middle panel, sea surface temperature (blue) and air temperature (green); lower panel, sensible (blue) and latent (green) heat fluxes .....                    | 59 |
| Figure 31: Same as in figure 30, but for the West-East transect from 20° S, 90° W to 28° S, 72° W .....  | 60 |
| Figure 32: Time-height color contour plots from rawinsondes launched during the Stratus 2004 cruise. The upper panel is potential temperature; the lower panel is relative humidity .....  | 61 |
| Figure 33: As in figure 32, but upper panel is wind speed; lower panel is wind direction .   | 62 |
| Figure 34: Time series of low cloud base heights for the Stratus 2004 cruise .....   | 63 |
| Figure 35: Time series of microwave radiometer derived values for column integrated water vapor (upper panel) and column integrated liquid water (lower panel).....  | 64 |
| Figure 36: Comparisons of simultaneous Assman psychrometer (cross) and ship (circle) readings for air temperature. Psychrometer values corrected to 15m (ETL and ship instrument height).....  | 65 |
| Figure 37: As in figure 36, but for specific humidity .....  | 65 |
| Figure 38: Time series of specific humidity for the Stratus 2004 cruise: ETL (blue), ship (green), corrected psychrometer (red) .....  | 66 |
| Figure 39: Latent heat flux averaged in wind speed bins for the Stratus 2004 cruise: bulk values (cross), direct values (circle). Symbols with lines are medians; symbols without lines are means.....   | 66 |

|   |    |
|---|----|
| Figure 40: Average bulk latent heat flux vs. direct values for wind speeds between 0 and 10 m/s during the Stratus 2004 cruise: mean values (cross), median values (circle).. | 67 |
| Figure 41: Schematic of the DART mooring system.....  | 69 |
| Figure 42: The surface buoy portion of the DART mooring.....  | 71 |
| Figure 43: The aerosol size distribution during the Stratus 2004 cruise.....  | 75 |
| Figure 44: The number concentration as measured by the TDMA during the Stratus 2004 cruise.....   | 75 |
| Figure 45: The APS number distribution at ambient temperature during the Stratus 2004 cruise.....   | 76 |
| Figure 46: As in figure 45 but at 1000 °C.....  | 76 |
| Figure 47: The number concentration at ambient temperature (blue) and at 1000 °C (red)  | 77 |
| Figure 48: Comparison of bucket and TSG temperature values.....   | 80 |

## LIST OF TABLES

|   |    |
|---|----|
| Table 1: Type of measurements taken by the Stratus moorings.....                | 2  |
| Table 2: Stratus 2004 science party .....                                       | 4  |
| Table 3: Stratus 2004 ship's crew.....  | 5  |
| Table 4: Stratus 4 deployment and recovery overview .....                       | 14 |
| Table 5: Stratus 4 surface buoy instrumentation.....                            | 15 |
| Table 6: Stratus 4 subsurface instrumentation.....                              | 16 |
| Table 7: Stratus 4 pre-deployment timing spikes (sub-surface instruments) ..... | 20 |
| Table 8: Stratus 4 pre-deployment timing spikes (surface instruments).....      | 21 |
| Table 9: Stratus 4 post-deployment timing spikes .....                          | 22 |
| Table 10: Stratus 4 anti-foulant details.....                                   | 24 |
| Table 11: Stratus 5 deployment details .....                                    | 25 |
| Table 12: Stratus 5 surface buoy instrumentation.....                           | 26 |
| Table 13: Stratus 5 subsurface instrumentation.....                             | 27 |
| Table 14: Stratus 5 pre-deployment timing spikes.....                           | 29 |
| Table 15: Stratus 5 antifoulant details.....                                    | 30 |
| Table 16: Stratus 2004 cruise CTD depths, times and locations .....             | 39 |
| Table 17: Deployment times and locations for the ARGO floats.....               | 68 |
| Table 18: Deployment times and locations for the surface drifters .....         | 68 |

## ABBREVIATIONS

|        |   |
|--------|---|
| ADCP   | Acoustic Doppler Current Meter                      |
| CLIVAR | Climate Variability                                 |
| CTD    | Conductivity Temperature Depth                      |
| EPIC   | Eastern Pacific Investigation of Climate            |
| ETL    | NOAA Environmental Technology Laboratory            |
| IMET   | Improved Meteorological Systems                     |
| NDBC   | National Data Buoy Center                           |
| NOAA   | National Oceanic and Atmospheric Administration     |
| ORS    | Ocean Reference Station                             |
| PMEL   | NOAA Pacific Marine Environmental Laboratory        |
| SBE    | Sea Bird Electronics                                |
| SCG    | Shipboard Computer Group                            |
| SHOA   | Chilean Navy Hydrographic and Oceanographic Service |
| SIO    | Scripps Institution of Oceanography                 |
| SST    | Sea-Surface Temperature                             |
| TAMU   | Texas A&M University                                |
| UOP    | Upper Ocean Processes Group                         |
| VMCM   | Vector Measuring Current Meter                      |
| WHOI   | Woods Hole Oceanographic Institution                |

This Page Left Intentionally Blank.

## **I. PROJECT BACKGROUND AND PURPOSE**

The primary purposes of this cruise were to recover and then deploy a new well-instrumented surface mooring under the stratocumulus clouds found off Chile and Peru, to make shipboard meteorological and air-sea flux observations, to document and establish the accuracy of the moored meteorological observations, and to observe the oceanic and atmospheric variability in the stratus deck region.

The mooring at 20°S, 85°W was first deployed in October 2000 as a component of the Enhanced Monitoring element of the Eastern Pacific Investigation of Climate (EPIC) program and was called Stratus 1. Since then cruises in October 2001, October 2002, and November 2003 have recovered the old buoy and subsurface instrumentation, and deployed new moorings.

Stratus 4 (November 2003) marked the first deployment supported by NOAA's Climate Observation Program. The Stratus site has been designated an Ocean Reference Station and a Surface Flux Reference Site. The objectives of maintaining a long term surface mooring at the Stratus site are to obtain high quality in-situ time series of surface meteorology, air-sea fluxes, upper ocean temperature, salinity, and velocity variability. This region is of critical importance to climate predictability and science and has previously been poorly sampled and not well replicated in climate models. The instrumentation deployed at the site is designed to observe the air-sea exchanges of heat, freshwater, and momentum, to observe the temporal evolution of sea surface temperature and of the vertical structure of the upper 450 m of the ocean, and to document and quantify the local coupling of the atmosphere and ocean in this region. Air-sea coupling under the stratus clouds is not well understood, and numerical models show broad scale sensitivity over the Pacific to cloud and air-sea interaction parameterization in this region.

Telemetered meteorological data is not inserted on the Global Telecommunication System (GTS) for routine ingestion in numerical weather models; rather, it is made available by FTP from WHOI to provide an independent data set to evaluate operational model performance in the stratus deck region. After recovery, high sampling rate (up to 1 minute), internally recorded data are processed, and the calibrated meteorological, air-sea flux, and oceanographic data are made available for validation and improvement of models and remote sensing methods, to support development of improved air-sea flux fields, and to support various climate research activities.

The Stratus moorings carry two redundant sets of meteorological sensors and the mooring line carries a set of oceanographic instruments (Table 1).



**Table 1: Type of measurements taken by the Stratus moorings.**

| Surface Measurements         | Subsurface Measurements |
|------------------------------|-------------------------|
| Wind speed                   | Temperature             |
| Wind direction               | Conductivity            |
| Air temperature              | Current speed           |
| Sea surface temperature      | Current direction       |
| Barometric pressure          |                         |
| Relative humidity            |                         |
| Incoming shortwave radiation |                         |
| Incoming longwave radiation  |                         |
| Precipitation                |                         |

The Stratus 2004 work constituted leg 04-11 of the *R/V Ron Brown* and began in Arica, Chile, on December 5, 2004, and ended on December 24, 2004, in Valparaiso, Chile. To further support surface validation of satellite data and increased understanding of the ocean in the eastern South Pacific, 15 drogued surface drifters and 8 profiling ARGO floats were deployed in the South Pacific from the *Ron Brown* along the cruise track. Figure 1 shows the *Ron Brown* in port in Arica, Chile.



**Figure 1: The R/V Ron Brown in port in Arica, Chile**

Because of the importance of establishing and documenting the accuracy of the meteorological and air-sea flux records collected by the Stratus moorings, extensive shipboard meteorological and air-sea flux instrumentation was installed on the *Ron Brown* and operated by members of the NOAA Environmental Technology Laboratory. Twenty-four hours during the cruise was dedicated to carrying out comparisons between the shipboard sensors and those on the Stratus 4 buoy, which had been at sea for 13 months.

An additional day was spent comparing shipboard instruments with those on the newly deployed Stratus 5 buoy. The ETL group also operated a cloud radar and launched radiosonde balloons every 4-6 hours to further document the stratus cloud region. Jason Tomlinson from Texas A&M University made observations of aerosols. The R/V *Ron Brown* also carried out routine underway oceanographic and meteorological observations. This included the logging of the ship's IMET system, thermosalinograph and C-Band radar.

The Stratus 5 cruise supported several Chilean oceanographic projects. On the passage east toward the Stratus Ocean Reference Site, a day of ship time was dedicated to deploying a tsunami-warning buoy for the Chilean Navy Hydrographic and Oceanographic Service (SHOA). Originally deployed on the Stratus 4 cruise, the DART buoy had suffered a battery malfunction and failed. Four members of SHOA were on board to direct the deployment of the new buoy and bottom pressure sensor system. Extensive CTD casts with water samples were performed along 20° S in support of researchers from the University of Concepcion. Additionally, the final leg of the Stratus cruise, parallel to the coast, was carried out at the request of researchers from the University of Chile who are interested in the intensification of the coastal atmospheric jet.

This NOAA-funded cruise included participation by the NOAA Teacher-at-Sea program, with Mary Cook, a teacher from Batesville, Arkansas, and Diane Stanitski, a NOAA program manager, on board. Mary Cook was in contact with her classroom, and developed educational material shared via the Teacher-at-Sea website.

All participants were invited to contribute to this cruise report, which is written to provide documentation of the work done during the cruise and to serve as the supporting documentation of the underway data that has been provided to the national observer from Chile (Alvaro Vera) who was on board the *Ron Brown* for this cruise.

## II. STRATUS 2003 CRUISE

### A. Overview

Many tasks were completed during the Stratus 2004 Cruise aboard the R/V *Ron Brown*, including:

1. Retrieval of the Stratus 4 mooring (Section III)
2. Deployment of the Stratus 5 mooring (Section III)
3. Argos Solo Float and SVAP Drifter Deployments (Section V)
4. SHOA Tsunami Mooring Deployment (Section V)
5. CTD and Bottle Work (Section V)
6. ETL Measurements (Section V)
7. TAMU Measurements (Section V)
8. Teacher-at-Sea Program (Section V).

The cruise (RB-04-11) began in Arica, Chile, on December 5, 2004, and proceeded along 19° 40'S to the DART buoy and then the IMET buoy. The R/V *Ron Brown* then continued westward to 90° W, at which point the track headed southeast past St. Felix Island. After passing near the island the cruise turned eastward to 150km from the coast. Maintaining this distance from shore, the ship traveled to Valparaiso, Chile, where it docked on December 23, 2004. Tables 2 and 3 list the scientific participants and crewmembers during the cruise respectively. Figure 2 shows the ship track of the Stratus 2004 cruise.

**Table 2: Stratus 2004 science party**

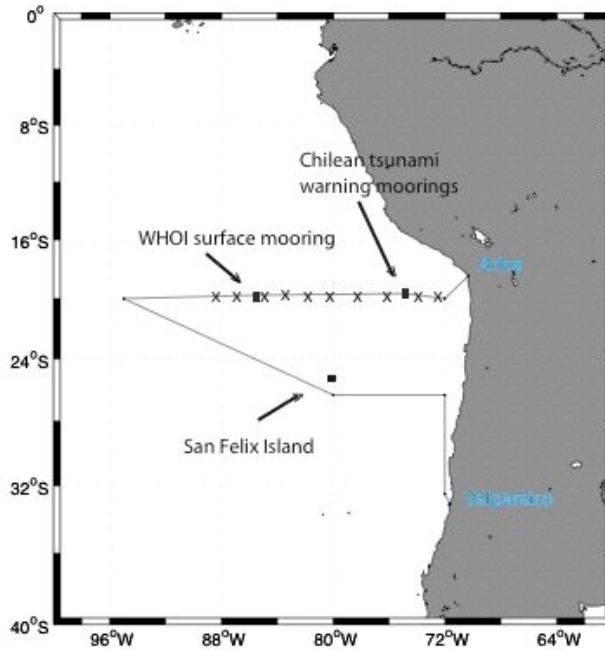
| <b>Name</b>                       | <b>Affiliation</b>  |
|-----------------------------------|---------------------|
| Frank Bradley                     | CSIRO               |
| Chris Fairall                     | NOAA ETL            |
| Daniel Wolfe                      | NOAA ETL            |
| Diane Stanitski                   | NOAA OGP            |
| Mary Cook                         | NOAA Teacher at Sea |
| Alvaro Gustavo Vera Tisandie      | SHOA, Chile         |
| Nelson Orellana Cruces            | SHOA, Chile         |
| Juan Pablo Belmar Palacios        | SHOA, Chile         |
| Jorge Araya Leal                  | SHOA, Chile         |
| Jason Tomlinson                   | Texas A&M           |
| David Painemal                    | U. Chile            |
| Juan Francisco Santibanez Bustos  | U. Concepcion       |
| Alexander Galan Mejia             | U. Concepcion       |
| Eduardo Emiliano Navaroo Vallejos | U. Concepcion       |
| Silvana Andrea Collodo Fabbri     | U. Concepcion       |
| Efthymios Serpetzoglou            | U. Miami            |
| Jason Smith                       | WHOI UOP Group      |
| Jeff Lord                         | WHOI UOP Group      |
| Keir Colbo                        | WHOI UOP Group      |
| Paul Bouchard                     | WHOI UOP Group      |
| Robert Weller                     | WHOI UOP Group      |

**Table 3: Stratus 2004 ship's crew**

| <b>Name</b>          | <b>Title</b>   |
|----------------------|--|
| Cmdr. Timothy Wright | Commanding Officer                                       |
| Lt. Elizabeth Jones  | Acting Executive Officer and<br>Field Operations Officer |
| Lt. Les Cruise       | Medical Officer  |
| Lt. JG Jeffrey Shoup | Ensign   |
| Silas Ayers          | Ensign   |
| Jackie Almeida       | Ensign   |
| Bruce Cowden         | Bosun  |
| Dave Owen            | BGL  |
| Reggie Williams      | DU   |
| Victoria Carpenter   | AB   |
| Jim Melton           | AB   |
| Phil Pokorski        | OS   |
| Teresa Moss          | AB   |
| Jonathan Shannahoff  | Scientific Technician                                    |
| Mike Gowan           | Chief Engineer   |
| Eric Powell          | 3AE  |
| Wayne Smith          | AE   |
| Pam St. Amand        | 3AE  |
| Herbert Watson       | Wiper  |
| Richard Whitehead    | Chief Steward  |
| Karen Bailey         | Chief Cook   |
| Sean Smith           | Second Cook  |

**Important Locations:**

Arica, Chile: 18° 28' S, 70° 20' W  
DART Buoy: 19° 42' S, 74° 49' W  
WHOI Buoy: 20° S, 85° W  
Valparaiso, Chile: 33° 10' S, 71° 38' W



Planned cruise track for cruise RB-04-12 of the NOAA Ship Ronald H. Brown, from Arica, Chile to Valparaiso, Chile. CTD station locations designated by "x". These locations may change depending on the time available during the cruise to make CTD stations. Weather balloons will be launched every four hours.

**Figure 2: The Stratus 2004 cruise track**

## B. Pre-Cruise and Cruise Details

Preparation for the Stratus 2004 cruise began months before sailing with the initial calibration and testing of the instruments. During the spring of 2004 instruments were gathered and placed on the mooring for testing (this is referred to as the burn-in phase). Burn-in details are not presented in this cruise report, but have been documented carefully for instrument performance tracking purposes.

In September 2004, members of the UOP group met the R/V *Ron Brown* in Charleston, South Carolina, to load and prepare equipment. Although some additional equipment was later loaded in Miami, Florida, and Arica, Chile. Loading the majority of the mooring in Charleston saves significant costs and avoids potential international customs delays.

The UOP group transited from Boston to Arica on the 28<sup>th</sup> and 29<sup>th</sup> of November. The R/V *Ron Brown* arrived on November 30<sup>th</sup>. After initial port authorization was granted for members of the science party and the ship had cleared customs, work began on preparing

for the cruise. On December 2, a shore side crane moved two containers, the buoy and the winch from the forward O2 deck to the aft deck so that unloading could begin. Over the next two days the buoy was assembled and tested. Buoy spins were performed on the dock and the underside was painted with antifoulant. On December 2nd the buoy was powered up and it began transmitting data via the Argos satellite connection.

The calm conditions were also used to prepare other aspects of the cruise. The WHOI UOP sonic anemometer was mounted to the bow mast, at approximately 12.4 m above the water line. Subsurface instruments (MicroCats, SeaCats, Brankers, SBE49s, SonTeks, VMCMs Aanderaas, and an RDI) were prepared, programmed and time spiked over the next 3 days. After spiking, the instruments were attached to the load bars and trawl guards were attached. The instruments in the upper 70m were then painted with antifoulant to control barnacle growth (Figure 3).



**Figure 3: An SBE-16 (SeaCat) painted with white anti-foulant**

The contingent from SHOA arrived on December 4th, along with the DART buoy and mooring hardware. The students from the University of Concepcion arrived on the morning of December 5. The CTD rosette and the rest of the water sampling gear, which the Chileans were providing, were loaded on board that morning.

The R/V *Ron Brown* left Arica at 15:00 local time (L) on December 5. An all science team meeting was held that afternoon where the chief scientist (Weller) outlined the cruise plan, and the ship's field operations officer (Lt. Jones) addressed the governing rules and regulations aboard the *Ron Brown*. Later that day, a second meeting was arranged between the science party, the CO, bosun and chief engineer to discuss detailed logistics of the cruise, and address any perceived problems.

At 7:30L on December 6, Daniel Wolfe gave an overview of radiosonde deployment procedures for interested members of the science party. At 9:30L Jeff Lord went over the deployment procedure for the SOLO floats and surface drifters. Before lunch, a fire and boat drill was conducted to familiarize the science party with emergency procedures. A bucket thermometer schedule was organized for the next 24 hours to test the reliability of the ship's thermosalinograph measurements.

Later that day the ship arrived at the location of the DART mooring. Deployment of the surface buoy began, with the anchor being dropped by 18:00L. Working through the night the bottom pressure sensor was lowered to the bottom, and communications were checked to ensure the system was functioning properly. On the morning of December 7, the ship's small boat was launched for a visual inspection of the DART buoy. Details of the DART buoy operation are presented in section V.

Once underway toward the WHOI buoy a test CTD station was performed to ensure that the gear was working properly. A CTD meeting was held with the science crew, the CO and the ship's ET officer to outline safe working procedures. A watch schedule was developed for the WHOI and NOAA staff to assist the Chileans in CTD sampling.

On December 7th through 10th, the ship was underway to the Stratus mooring site and underway watch standing continued. During the early morning of December 11, 2004, the R/V *Ron Brown* sighted the Stratus 4 mooring and took up station several hundred meters downwind with the bow oriented toward the buoy. After breakfast on December 11, the small boat was launched for a visual inspection of the mooring. Some fouling was visible on the hull, but the floating SST instrument was still moving well in its track. The water line was estimated to be 0.3 m below the deck. For the rest of December 11, the *Ron Brown* maintained station downwind of the buoy for sensor comparison purposes.

December 12 was the recovery day for the Stratus 4 mooring. The release was fired at 10:46 UTC, and the glass balls were sighted at the surface about 40 minutes later. Mooring recovery continued smoothly, and was completed by 18:10 UTC. On December 13, Stratus 4 instruments were post-spiked, download of the data began, and preparations were made for the Stratus 5 deployment. The Stratus 5 deployment commenced at 11:06 UTC on December 14, 2004, with the anchor drop at 18:25 UTC. Details of the recovery and deployment are given in Section III.

December 15 was dedicated to data comparison between sensors onboard the ship and the Stratus 5 surface instruments. A trip was made in the small boat to the Stratus 5 mooring for a visual inspection; all instruments looked to be in good condition. A break on the protective frame guard was noted, where the block had impacted the buoy during deployment. This was deemed to be acceptable. Early on the morning of December 16 a deep CTD cast was performed near the mooring. The *Ron Brown* then proceeded west toward 90° W, with the underway watch resuming.

CTDs continued along the 20° S line through the morning of December 17, when the *Ron Brown* turned toward St. Felix Island. During the two day transit to St. Felix the only underway operations were SOLO float and drifter launches approximately every four hours. St. Felix Island was sighted at 18:00L, at which time the ship turned east toward the coast. The *Ron Brown* entered the port in Valparaiso on the morning of December 23, and unloading began shortly thereafter. The UOP group returned on December 29.

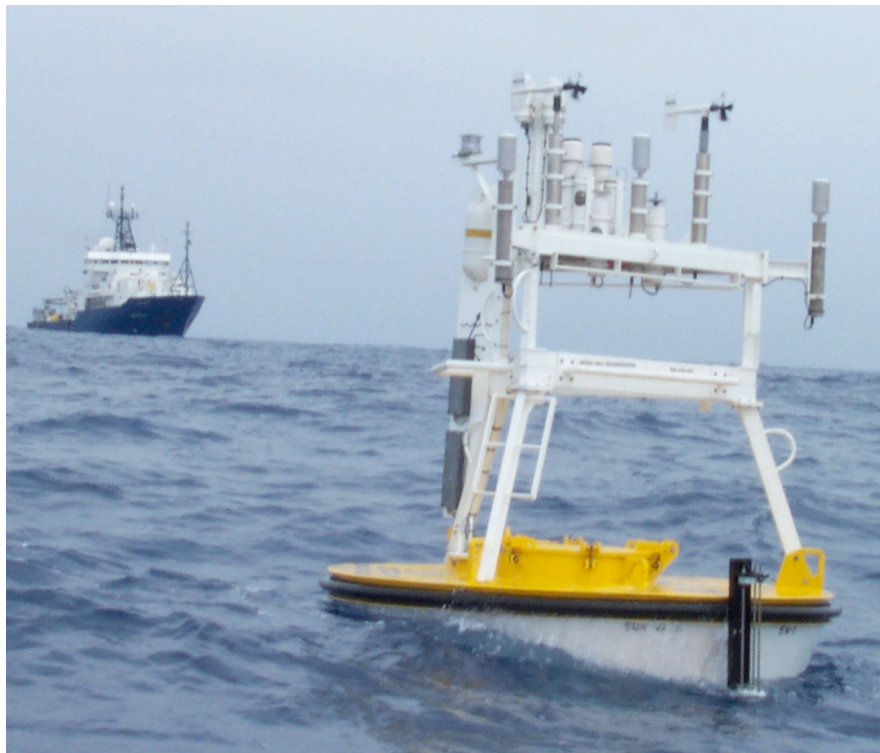
### III. ORS STRATUS MOORINGS

#### A. Overview

The three-meter buoys used in the Stratus project are equipped with meteorological instrumentation, including two Improved Meteorological (IMET) systems (Figure 4). The mooring line also carries vector measuring current meters, conductivity and temperature recorders, and a selection of acoustic current meters.

The WHOI mooring is an inverse catenary design utilizing wire rope, chain, nylon and polypropylene line and has a scope of 1.25 (Scope = slack length/water depth). The Stratus 5 surface buoy is a newly designed three-meter diameter foam buoy with an aluminum tower and rigid bridle. The previous moorings had been similar but consisted of a single-piece aluminum hull. The design of these surface moorings took into consideration the predicted currents, winds, and sea-state conditions expected during the deployment duration.

The instrument systems recovered on the Stratus 4 mooring and deployed on the Stratus 5 mooring are described in detail below.



**Figure 4: The Stratus 4 buoy after deployment with the R/V Roger Revelle in the background**



## B. Surface Instruments

### 1. Improved Meteorological (IMET) Systems

There are two independent IMET systems on the Stratus buoys. These systems measure the following parameters once per minute, and transmit hourly averages via satellite:

- relative humidity with air temperature
- barometric pressure
- precipitation
- wind speed and direction
- shortwave radiation
- longwave radiation
- near-surface ocean temperature and conductivity

All IMET modules for the Stratus experiment were modified for lower power consumption so that a non-rechargeable alkaline battery pack could be used. Near-surface temperature and conductivity were measured with a SeaBird MicroCat with an RS-485 interface.

A LOGR53 Main Electronics logger was used. This consists of a two-board set of CPU and interface which handles the power and communications to the individual ASIMET modules as well as optional PTT or internal barometer or internal A/D board. All modules are sampled at the start of each logging interval. All the "live" interval data is available via the D and E commands on the primary RS232 "console" interface used for all LOGR53 communications.

The LOGR53 CPU board is based on a Dallas Semiconductor DS87C530 microcontroller. DS87C530 internal peripherals include a real time clock and 2 universal asynchronous receiver-transmitter (uart); 2 additional uarts are included on the CPU board as well. Also present on the CPU board is a PCMCIA interface for the 20MB FLASH memory card included with the system; at a 1-minute logging interval, there is enough storage for over 400 days of data. A standard CR2032 lithium coin cell provides battery-backup for the real time clock. Operating parameters are stored in EEPROM and are *not* dependent on the backup battery. A normally unused RS485 console interface at P1 is also present on this board.

The LOGR53IF Interface board handles power and communications distribution to the ASIMET modules as well as interface to various options such as PTT or A/D modules. Connector P12 is the main RS232 "console" interface to the LOGR53 and can also be used to apply external power (up to about 100 MA) to the system during test. The main +12-15V battery stack (for the base logger with FLASH card) is connected to P13; the "sensor" +12-15V battery stack (which typically powers the ASIMET modules) is connected to P14; the "aux" battery stack (which typically powers the optional PTT) is connected to P19. Regulated +5V power for the system is produced on this board.

Parameters recorded on a FLASH card:

**TIME**

**WND** - wind east and north velocity; wind speed average, max, and min; last wind vane direction, and last compass direction

**BPR** - barometric pressure

**HRH** - relative humidity and air temperature

**SWR** - short wave radiation

**LWR** - dome temperature, body temperature, thermopile voltage, and long wave radiation

**PRC** - precipitation level

**SST** - sea surface temperature and conductivity

**ADI** - multiplexed optional parameter value from A/D module (only 1 of 8 in each record)

An IMET Argos PTT module is set for three IDs and transmits via satellite the most recent six hours of one-hour averages from the IMET modules. At the start of each hour, the previous hour's data are averaged and sent to the PTT, bumping the oldest hour's data out of the data buffer.

## **2. Stand-alone Relative Humidity/Temperature Instrument (Stratus 4 only)**

A self-contained relative humidity and air temperature instrument was mounted on the tower of the Stratus buoy. This instrument, developed and built by members of the UOP Group, takes a single point measurement of both relative humidity and temperature at a desired record interval. The sensor used was a Rotronics MP-101A. The relative humidity and temperature measurements are made inside a protective Teflon shield. Measurements are taken every two minutes, and are stored on an eight mega-byte FLASH card.

## **C. Subsurface Instruments**

The following sections describe individual instruments on the buoy bridle and mooring line. Sections D and E will give more instrumentation information specific to each mooring. Where possible, instruments were protected from being fouled by fishing lines by "trawl-guards" designed and fabricated at WHOI. These guards are meant to keep lines from hanging up on the in-line instruments.

### **1. Floating SST Sensor**

A Sea-Bird SBE-39 was placed in a floating holder (a buoyant block of synthetic foam sliding up and down along 3 stainless steel guide rods) in order to sample the sea temperature as close as possible to the sea surface. The Sea-Bird model SBE-39 is a small, lightweight, durable and reliable temperature logger that was set to record the sea surface temperature every 5 minutes.

## **2. Subsurface Argos Transmitter**

An NACLS, Inc. Subsurface Mooring Monitor (SMM) was mounted upside down on the bridle of the discus buoy. This was a backup recovery aid in the event that the mooring parted and the buoy flipped upside down.

## **3. SeaCat Conductivity and Temperature Recorders**

The model SBE 16 SeaCat was designed to measure and record temperature and conductivity at high levels of accuracy. Powered by internal batteries, a SeaCat is capable of recording data for periods of a year or more. Data are acquired at intervals set by the user. An internal back-up battery supports memory and the real-time clock in the event of failure or exhaustion of the main battery supply. The SeaCat is capable of storing a total of 260,821 samples. A sample rate of 5 minutes was used on the Stratus SeaCats. The shallowest SeaCat was mounted directly to the bridle of the discus buoy. The others were mounted on in-line tension bars and deployed at various depths throughout the moorings. The conductivity cell is protected from bio-fouling by the placement of antifoulant cylinders at each end of the conductivity cell tube.

## **4. MicroCat Conductivity and Temperature Recorder**

The MicroCat, model SBE37, is a high-accuracy conductivity and temperature recorder with internal battery and memory. It is designed for long-term mooring deployments and includes a standard serial interface to communicate with a PC. Its recorded data are stored in non-volatile FLASH memory. The temperature range is -5° to +35°C, and the conductivity range is 0 to 6 Siemens/meter. The pressure housing is made of titanium and is rated for 7,000 meters. The MicroCat is capable of storing 419,430 samples of temperature, conductivity and time. The sampling interval of the Stratus 1 MicroCats was five minutes. The shallowest MicroCats were mounted on the bridle of the discus buoy and wired to the IMET systems. These were equipped with RS-485 interfaces. The deeper instruments were mounted on in-line tension bars and deployed at various depths throughout the moorings. The conductivity cell is protected from bio-fouling by the placement of antifoulant cylinders at each end of the conductivity cell tube.

## **5. Brancker Temperature Recorders (TPOD)**

The Brancker temperature recorders are self-recording, single-point temperature loggers. The operating temperature range for this instrument is 2° to 34°C. It has internal battery and logging, with the capability of storing 24,000 samples in one deployment. A PC is used to communicate with the Brancker via serial cable for instrument set-up and data download. The Branckers were set to record data every 30 minutes.

## **6. Brancker XR-420 Temperature and Conductivity Recorder (Stratus 5 only)**

As a test, a single Brancker XR-420 CT self-recording temperature and conductivity logger was placed on the mooring line. The operating temperature range for this instrument is -5° to 35°C. It has internal battery and logging, with the capability of storing 1,200,000 samples in one deployment. A PC is used to communicate with the Brancker via serial

cable for instrument set-up and data download. The Brancker XR-420 was set to record data every 30 minutes.

#### **7. SBE-39 Temperature Recorder**

The Sea-bird model SBE-39 is a small, light weight, durable and reliable temperature logger that was set to record temperature every 5 minutes.

#### **8. Vector Measuring Current Meters**

The VMCM has two orthogonal cosine response propeller sensors that measured the components of horizontal current velocity parallel to the axles of the two-propeller sensors. The orientation of the instrument relative to magnetic north was determined by a flux gate compass. East and north components of velocity were computed continuously, averaged and then stored. All the VMCMs deployed from Stratus 4 onward have been next generation models that have newer circuit boards and record on flash memory cards instead of cassette tape. Temperature was also recorded using a thermistor mounted in a fast response pod, which was mounted on the top end cap of the VMCM. The VMCMs were set to record once a minute.

#### **9. Aanderaa Current Meter (Stratus 5 only)**

An Aanderaa Recording Current Meter, Model RCM 11, was used on the Stratus 3 mooring. This current meter features the Mk II Doppler Current Sensor DCS 3820. The RCM comes equipped with an eight ton mooring frame and was used in-line with the mooring line. It was set to sample every 10 minutes

#### **10. RDI Acoustic Doppler Current Profiler**

An RD Instruments (RDI) Workhorse Acoustic Doppler Current Profiler (ADCP, Model WHS300-1) was mounted at 135 m looking upwards on the mooring line. The RDI ADCP measures a profile of current velocities. The Stratus RDI is typically set up as follows: 10 m bin size, 12 bins, 60 pings per ensemble, 1 ping per second, 1 hour sample interval, beam coordinates.

#### **11. SonTek Argonaut MD Current Meter**

Several SonTek Argonaut MD current meters have been used in the upper portion of the mooring line. The three-beam 1.5Mhz single point current meter is designed for long term mooring deployments, and can store over 90,000 samples.

#### **12. Acoustic Release**

The acoustic release used on the Stratus moorings is an EG&G Model 322. This release can be triggered by an acoustic signal and will release the mooring from the anchor. Releases are tested at depth prior to deployment to ensure that they are in proper working order.

## D. Stratus 4 Recovery

The Stratus 4 mooring was deployed in November 2003 and recovered in December 2004. Table 4 below gives an overview of recovery and deployment operations.

**Table 4: Stratus 4 deployment and recovery overview**

|                   |                                      |                               |
|-------------------|--------------------------------------|-------------------------------|
| <b>Deployment</b> | Date                                 | November 19, 2003             |
|                   | Time                                 | 20:31:30 UTC                  |
|                   | Position at Anchor Drop              | 19° 45.951' S, 85° 30.239' W  |
|                   | Deployed by                          | Lord, Ryder                   |
|                   | Recorder                             | Lara Hutto                    |
|                   | Ship                                 | R/V <i>Roger Revelle</i>      |
|                   | Cruise No.                           | Dana 03                       |
|                   | Depth                                | 4441                          |
|                   | Anchor Position                      | 19° 45.911' S, 85° 30.405' W  |
| <b>Recovery</b>   | Date                                 | December 12, 2004             |
|                   | Time                                 | 10:46 UTC                     |
|                   | Position of Recovery (Release fired) | 19° 46.278' S, 85° 30.854' W  |
|                   | Recovered by                         | Lord, Smith, Weller, Bouchard |
|                   | Recorder                             | Keir Colbo                    |
|                   | Ship                                 | R/V <i>Ronald H. Brown</i>    |
|                   | Cruise No.                           | RB-11-04                      |

### 1. Mooring Description

The Stratus 4 mooring was instrumented with meteorological instrumentation on the buoy and subsurface oceanographic equipment on the mooring line. Tables 5 and 6 below detail the instrumentation.

**Table 5: Stratus 4 surface buoy instrumentation**

| <b>Instrument</b>   | <b>ID Number</b>                 | <b>Height<sup>8</sup> (cm)</b> |
|---------------------|----------------------------------|--------------------------------|
| <b>System #1</b>    |                                  |                                |
| Data Logger         | L01                              |                                |
| Relative Humidity   | HRH 223                          | 257                            |
| Wind Module         | WND 212                          | 297                            |
| Barometric Pressure | BPR 006                          | 237                            |
| Shortwave Radiation | SWR 102                          | 316                            |
| Longwave Radiation  | LWR 204                          | 316                            |
| Precipitation       | PRC 004                          | 273                            |
| Argos Transmitter   | ID 9805<br>ID 9807<br>ID 9811    |                                |
| <b>System #2</b>    |                                  |                                |
| Data Logger         | L02                              |                                |
| Relative Humidity   | HRH 221                          | 257                            |
| Wind Module         | WND 206                          | 297                            |
| Barometric Pressure | BPR 110                          | 236                            |
| Shortwave Radiation | SWR 104                          | 316                            |
| Longwave Radiation  | LWR 104                          | 316                            |
| Precipitation       | PRC 109                          | 275                            |
| Argos Transmitter   | ID 24337<br>ID 27970<br>ID 27971 |                                |
| <b>Stand Alone</b>  |                                  |                                |
| Relative Humidity   | HRH 227                          | 273                            |
| Argos Transmitter   | ID 11427                         |                                |

---

<sup>8</sup> Heights given are measured from the buoy deck, which was 0.25 meters above the mean waterline.

**Table 6: Stratus 4 subsurface instrumentation**

| Depth (m)         | Instrument        | Serial Number | Measurement              |
|-------------------|-------------------|---------------|--------------------------|
| Floater           | SBE39             | 0717          | Temperature              |
| 1.16 <sup>9</sup> | SBE16             | 1877          | Temperature and Salinity |
| 1.16 <sup>6</sup> | SBE37             | 1834          | Temperature and Salinity |
| 1.20 <sup>6</sup> | SBE37             | 1837          | Temperature and Salinity |
| 3.9               | SBE16             | 1882          | Temperature and Salinity |
| 7                 | SBE16             | 0146          | Temperature and Salinity |
| 10                | VMCM              | 033           | Currents and Temperature |
| 13                | SonTek            | D171          | Currents and Temperature |
| 16                | SBE16             | 1879          | Temperature and Salinity |
| 20                | VMCM              | 066           | Currents and Temperature |
| 25                | TPOD              | 3667          | Temperature              |
| 30                | SBE16             | 2324          | Temperature and Salinity |
| 32.5              | SonTek            | D197          | Currents and Temperature |
| 35                | TPOD              | 3839          | Temperature              |
| 40                | SBE16             | 0927          | Temperature and Salinity |
| 45                | VMCM              | 053           | Currents and Temperature |
| 50                | SBE16             | 0994          | Temperature and Salinity |
| 55                | SonTek            | D193          | Currents and Temperature |
| 62.5              | SBE16             | 1878          | Temperature and Salinity |
| 70                | TPOD              | 4483          | Temperature              |
| 77.5              | TPOD              | 3703          | Temperature              |
| 85                | SBE16             | 0993          | Temperature and Salinity |
| 88.5              | VMCM BEARING TEST | TEST          | Currents and Temperature |
| 92.5              | TPOD              | 3701          | Temperature              |
| 100               | TPOD              | 4481          | Temperature              |
| 115               | TPOD              | 4493          | Temperature              |
| 130               | SBE16             | 0928          | Temperature and Salinity |
| 135               | RDI               | 1220          | Currents and Temperature |
| 145               | TPOD              | 3309          | Temperature              |
| 160               | SBE37             | 2011          | Temperature and Salinity |
| 175               | TPOD w/ clamp     | 4488          | Temperature              |
| 190               | VMCM              | 030           | Currents and Temperature |
| 192               | SBE16             | 2322          | Temperature and Salinity |
| 222               | SBE37             | 1899          | Temperature and Salinity |
| 238               | VMCM              | 073           | Currents and Temperature |
| 254               | TPOD              | 4489          | Temperature              |
| 280               | TPOD w/ clamp     | 3305          | Temperature              |
| 293.75            | VMCM              | 068           | Currents and Temperature |
| 354.35            | VMCM              | 057           | Currents and Temperature |
| 400               | SBE39             | 0282          | Temperature              |
| 450               | SBE39             | 0203          | Temperature              |
| ~4400             | Acoustic Release  | 339           | N/A                      |

<sup>9</sup> Assumes deck is 0.25m above waterline

## 2. Recovery Process

The Stratus 4 mooring was recovered on December 12, 2004. To prepare for recovery the *R/V Ron Brown* was positioned roughly 1/2 mile upwind from the anchor position. The acoustic release was fired to separate the anchor from the mooring line at 10:46:50 UTC. After about 40 minutes the glass balls surfaced. Once the glass balls were on the surface, the ship approached the cluster of glass balls along the starboard side. The ship's small boat was used to tow the glass balls aft where they could be secured to the winch line via a lift sling.

The TSE mooring winch leader was reeved through the gifford block and around to the starboard quarter. A 5-ton pick-up hook was shackled to a 12 foot and 6 foot lift all sling. The pick-up hook was snapped into a section of chain. The lift all sling was walked aft and shackled into the winch leader. The *Ron Brown* went slow ahead so the glass balls would be astern of the ship. The winch hauled the winch leader and the lift all sling to bring a section of glass balls over the stern. Two stopper lines were snapped into a sling link and then made fast to the deck cleats. The winch leader was payed out and the lift all sling was disconnected.

A 12-foot blue amstel pick-up pendant was then shackled to the winch leader and was hooked to a sling link. The winch was hauled in to take the tension from the stopper lines. The two stopper lines were eased out and cleared from the cleats. The winch hauled in the glass balls over the stern. Stopper lines were then reattached to take tension from the winch. Two air tuggers were also used to haul in and control the cluster of glass balls.

Once all the glass balls were on board, stopper lines were hooked into the 1-1/8" polypropylene and made fast. The amstel pendant was then hooked into the sling link above the release. The winch hauled the release on board. Stopper lines were attached to the chain aft of the release and the winch was payed out. Glass balls were disconnected and hauled to the port side near the rag top container to be loaded by the crane.

Once the balls were clear, the 1-1/8" polypropylene was attached to the hydraulic capstan. The 1400m of 1-1/8" polypropylene, 100m of 1" nylon and three 500m lengths of 7/8" nylon were hauled in and placed in 3 wire baskets.

Hauling stopped at the end of the third 500 meter shot of nylon. Two stopper lines were hooked into the sling link between the 500 and 150 meter shot of nylon and made fast to the deck cleats.

The winch leader was shackled to the 150m shot of nylon. The winch took up the slack and the two stopper lines were eased off and cleared. Hauling began with the 150m shot of nylon and continued with the 200/100m nylon and 3/8" wire rope special termination, and the three shots of 500 meters of 3/8" wire rope. Two SBE-39s were clamped on the 3/8" wire rope and recovered before being dragged over the fantail. Hauling continued with the



100 meter shot of 3/8 wire rope. At the end of the 100 meter shot, a traveling block was rigged and recovering the instruments took place.

The procedure for recovering the instruments went as follows: with A-frame boomed out over the stern, the winch hauled in the wire. The first instrument was stopped about 2 feet above the deck and the A-frame was boomed in. Two stopper lines were hooked into the sling link and made fast to the deck cleats. The winch payed out slowly to lower the instrument to the deck. The instrument was disconnected from the hardware and moved to a staging area for pictures. The wire rope from the winch was then shackled to the load. The winch took up the slack and the stopper lines were eased off and then cleared. The A-frame was boomed out and hauling continued until the next instrument.

The above procedure was continued throughout the recovery operation until the SonTek at 55 meters was recovered. Once the SonTek was recovered, a shackle and 5/8" pear link was shackled to a link on the 3/4" chain. A 20 meter Samson slip line was made fast to one deck cleat and then passed through the pear link and made fast to the other deck cleat. The stopper lines were eased off and cleared so that the Samson slip line had the load. The slip line was eased out so the discus buoy and the remaining 45 meters of instruments went adrift. The ship went slow ahead to move away from the buoy.

Prior to departure, a section of bulwark was removed along the port side for recovering the discus buoy. The rescue boat was deployed, approached the buoy and hooked into the bail with a pendant and lift sling. A tag line was bent into the 8 foot green sling. The *Ron Brown* slowly approached the small boat and buoy, keeping the buoy along the port side of the ship. A heaving line was thrown to the small boat and was tied to the tag line. The line was hauled back to the ship with the port side crane standing by. The green sling was hooked into the block of the crane. The crane lifted the buoy from the water and swung inboard so the buoy would rest on the side of the ship. The tugger lines were attached to bails on the buoy. The buoy was hoisted up and then swung inboard while the tuggers kept tension on buoy to keep from swinging.

Once the buoy was on deck, wooden wedges were placed under the hull and aircraft straps were used to secure the buoy. A stopper line was used to stop off on the 0.52m shot of 3/4" chain between the buoy universal and the first instrument. The forward tugger with a chain hook shackled to the thimble was also used to stop off on the chain. The shackle was disconnected from the universal plate located at the bottom of the bridle legs.

An 8 foot lift all sling was placed through the sling link at the top of the first instrument and hooked in the crane's block. The crane took the load, and the stopper line was eased off and cleared. The crane hoisted the first two instruments and stopper line was hooked into a bite of chain. Once the stopper line had the load the crane lowered the instruments to the deck. The instruments were disconnected and the crane was repositioned over the load. The lift all sling was placed through the sling link and hooked into the crane. The crane took the load and the stopper line was eased off and cleared. The crane lifted the next

section of instruments and the above procedure was used to recover the remaining instruments.

### **3. Time Spikes**

Timing spikes were applied to some of the instruments recovered from Stratus 4. These spikes were performed so that responses in the data file could be checked against a known time. Water was added to the precipitation modules. Black bags were placed on the long and shortwave radiation sensors to block as much light as possible. The relative humidity modules were also bagged. Instruments measuring temperature were placed in ice baths or in a large refrigerator. The VMCM rotors were spun and then blocked. Tables 7 and 8 give the details of the timing spikes for pre-deployment of Stratus 4 and Table 9 gives the post-recovery timing spikes. Additional information on clock checks is given in Appendix F.

**Table 7: Stratus 4 pre-deployment timing spikes (sub-surface instruments)**

| <b>Instrument</b> | <b>Serial #</b> | <b>Time 1</b> |           | <b>Time 2</b> |           |
|-------------------|-----------------|---------------|-----------|---------------|-----------|
| SBE39             | 0717            | 11/8/2003     | 17:35:00  | 11/8/2003     | 19:13:45  |
| SBE16             | 1877            | 11/8/2003     | 16:51:00  | 11/8/2003     | 19:13:30  |
| SBE37             | 1834            | 11/9/2003     | 17:04:30  | 11/9/2003     | 18:10:00  |
| SBE37             | 1837            | 11/9/2003     | 17:04:30  | 11/9/2003     | 18:10:00  |
| SBE16             | 1882            | 11/13/2003    | 13:39:30  | 11/13/2003    | 15:15:45  |
| SBE16             | 0146            | 11/13/2003    | 13:42:30  | 11/13/2003    | 15:18:15  |
| VMCM              | 033             | N/A           | N/A       | N/A           | N/A       |
| SonTek            | D171            | 11/12/2003    | 13:55:30  | 11/12/2003    | 15:11:00  |
| SBE16             | 1879            | 11/13/2003    | 15:40:00  | 11/13/2003    | 17:43:00  |
| VMCM              | 066             | N/A           | N/A       | N/A           | N/A       |
| TPOD              | 3667            | 11/13/2003    | 19:58:45  | 11/13/2003    | 21:33:30  |
| SBE16             | 2324            | 11/13/2003    | 19:55:45  | 11/13/2003    | 21:35:00  |
| SonTek            | D197            | 11/12/2003    | 13:51:30  | 11/12/2003    | 15:08:00  |
| TPOD              | 3839            | 11/14/2003    | 13:29:00  | 11/14/2003    | 15:40:30  |
| SBE16             | 0927            | 11/13/2003    | 17:55:00  | 11/13/2003    | 19:22:45  |
| VMCM              | 053             | N/A           | N/A       | N/A           | N/A       |
| SBE16             | 0994            | 11/14/2003    | 13:25:45  | 11/14/2003    | 15:41:45  |
| SonTek            | D193            | 11/12/2003    | ~14:01:00 | 11/12/2003    | ~15:13:00 |
| SBE16             | 1878            | 11/13/2003    | 19:52:45  | 11/13/2003    | 21:37:00  |
| TPOD              | 4483            | 11/14/2003    | 13:28:10  | 11/14/2003    | 15:39:15  |
| TPOD              | 3703            | 11/14/2003    | 13:30:00  | 11/14/2003    | 15:37:50  |
| SBE16             | 0993            | 11/13/2003    | 17:58:00  | 11/13/2003    | 19:24:15  |
| TPOD              | 3701            | 11/13/2003    | 15:41:45  | 11/13/2003    | 17:45:45  |
| TPOD              | 4481            | 11/13/2003    | 20:06:15  | 11/13/2003    | 21:31:30  |
| TPOD              | 4493            | 11/13/2003    | 18:00:15  | 11/13/2003    | 19:20:15  |
| SBE16             | 0928            | 11/13/2003    | 15:36:10  | 11/13/2003    | 17:40:20  |
| RDI               | 1220            | 11/11/2003    | 22:57:00  | 11/12/2003    | 00:35:00  |
| TPOD              | 3309            | 11/15/2003    | 13:41:30  | 11/15/2003    | 15:20:30  |
| SBE37             | 2011            | 11/15/2003    | 13:41:00  | 11/15/2003    | 15:20:45  |
| TPOD w/ clamp     | 4488            | 11/13/2003    | 18:03:00  | 11/13/2003    | 19:25:45  |
| VMCM              | 030             | N/A           | N/A       | N/A           | N/A       |
| SBE16             | 2322            | 11/15/2003    | 13:39:15  | 11/15/2003    | 15:21:15  |
| SBE37             | 1899            | 11/15/2003    | 13:40:00  | 11/15/2003    | 15:21:00  |
| VMCM              | 073             | N/A           | N/A       | N/A           | N/A       |
| TPOD              | 4489            | 11/13/2003    | 13:46:00  | 11/13/2003    | 15:12:45  |
| TPOD w/ clamp     | 3305            | 11/13/2003    | 18:03:00  | 11/13/2003    | 19:27:00  |
| VMCM              | 068             | N/A           | N/A       | N/A           | N/A       |
| VMCM              | 057             | N/A           | N/A       | N/A           | N/A       |
| SBE39             | 0282            | 11/13/2003    | 18:07:00  | 11/13/2003    | 19:29:45  |
| SBE39             | 0203            | 11/13/2003    | 18:07:00  | 11/13/2003    | 19:28:30  |

**Table 8: Stratus 4 pre-deployment timing spikes (surface instruments)**

| <b>Instrument</b>   | <b>Serial #</b> | <b>Time 1</b> |          | <b>Time 2</b> |          |
|---------------------|-----------------|---------------|----------|---------------|----------|
| Relative Humidity   | HRH 223         | 11/9/2003     | 18:19:00 | 11/9/2003     | 20:17:30 |
| Wind                | WND 212         | 11/14/2003    | 14:23:00 | 11/15/2003    | 12:30:00 |
| Precipitation       | PRC 004         | 11/7/2003     | 20:14:00 | N/A           | N/A      |
| Longwave Radiation  | LWR 204         | 11/9/2003     | 18:05:00 | 11/9/2003     | 20:10:30 |
| Shortwave Radiation | SWR 102         | 11/9/2003     | 18:16:30 | 11/9/2003     | 20:12:00 |
| Barometric Pressure | BPR 006         | N/A           | N/A      | N/A           | N/A      |
| Relative Humidity   | HRH 221         | 11/9/2003     | 18:22:45 | 11/9/2003     | 20:14:30 |
| Wind                | WND 206         | 11/14/2003    | 14:23:00 | 11/15/2003    | 12:30:00 |
| Precipitation       | PRC 109         | 11/7/2003     | 20:15:00 | N/A           | N/A      |
| Longwave Radiation  | LWR 104         | 11/9/2003     | 18:07:00 | 11/9/2003     | 20:11:00 |
| Shortwave Radiation | SWR 104         | 11/9/2003     | 18:14:00 | 11/9/2003     | 20:13:00 |
| Barometric Pressure | BPR 110         | N/A           | N/A      | N/A           | N/A      |
| Relative Humidity   | HRH 227         | 11/9/2003     | 18:21:00 | 11/9/2003     | 20:16:00 |

**Table 9: Stratus 4 post-deployment timing spikes**

| Instrument          | Serial #   | Time 1    |          | Time 2    |          |
|---------------------|--|-----------|----------|-----------|----------|
| Wind <sup>10</sup>  | WND 212  | 13 Dec 04 | 12:42:45 |           |          |
| Longwave Radiation  | LWR 204  | 13 Dec 04 | 11:06:00 | 13 Dec 04 | 11:58:30 |
| Shortwave Radiation | SWR 102  | 13 Dec 04 | 11:07:00 | 13 Dec 04 | 11:58:30 |
| Wind                | WND 206  | 13 Dec 04 | 12:43:30 |           |          |
| Longwave Radiation  | LWR 104  | 13 Dec 04 | 11:06:00 | 13 Dec 04 | 11:58:30 |
| Shortwave Radiation | SWR 104  | 13 Dec 04 | 11:07:00 | 13 Dec 04 | 11:58:30 |
| SBE39               | 0717   | 13 Dec 04 | 12:45:30 | 13 Dec 04 | 13:39:30 |
| SBE 39              | 0282, 0203   | 13 Dec 04 | 12:07:30 | 13 Dec 04 | 13:39:30 |
| SBE16               | 1877, 1882, 0146, 1879, 2324, 0927, 0994, 1878, 0993, 0928, 2322 | 13 Dec 04 | 12:16:30 | 13 Dec 04 | 13:35:30 |
| SBE37               | 1834, 1837   | 13 Dec 04 | 10:52:00 | 13 Dec 04 | 12:01:00 |
| SBE37               | 1899, 2011   | 13 Dec 04 | 12:07:30 | 13 Dec 04 | 13:39:30 |
| TPOD                | 3667, 3839, 4483, 3701, 4481, 4493, 3309, 4488, 4489, 3305, 3703 | 15 Dec 04 | 18:42:00 | 15 Dec 04 | 20:17:00 |
| SonTek              | D171, D197, D193   | 13 Dec 04 | 16:45:30 | 13 Dec 04 | 19:08:30 |
| RDI                 | 1220   | 13 Dec 04 | 10:44:00 | 13 Dec 04 | 12:10:00 |

|      | S/N | Blocked               | 1 <sup>st</sup> Spin   | 2 <sup>nd</sup> Spin  |
|------|-----|-----------------------|--|-----------------------|
| VMCM | 033 | 12 Dec 2004, 17:51:00 | 14 Dec 2004, 10:05:30 (upper)<br>14 Dec 2004, 10:04:30 (lower) | 15 Dec 2004, 08,44:30 |
| VMCM | 066 | 12 Dec 2004, 17:55:00 | 14 Dec 2004, 09:58:30 (upper)<br>14 Dec 2004, 09:59:30 (lower) | 15 Dec 2004, 08:45:30 |
| VMCM | 053 | 12 Dec 2004, 18:04:00 | 14 Dec 2004, 09:56:30  | 15 Dec 2004, 08:41:30 |
| VMCM | 030 | 12 Dec 2004, 16:00:00 | 14 Dec 2004, 10:03:30  | 15 Dec 2004, 08:43:30 |
| VMCM | 073 | 12 Dec 2004, 15:49:00 | 14 Dec 2004, 09:57:30  | 15 Dec 2004, 08:42:30 |
| VMCM | 068 | 12 Dec 2004, 15:33:00 | 14 Dec 2004, 09:55:30  | 15 Dec 2004, 08:40:30 |
| VMCM | 057 | 12 Dec 2004, 15:26:00 | 14 Dec 2004, 09:54:30  | 15 Dec 2004, 08:39:30 |

#### 4. Antifoulant performance

Previous discus moorings have been used as test beds for a number of different antifouling coatings. The desire has been to move from organotin-based antifouling paints to a product that is less toxic to the user, and more environmentally friendly. These tests have previously led the Upper Ocean Process group to rely on E Paint Company's, SN-1 as the antifouling coating used on the buoy hull and the majority of instruments deployed.

<sup>10</sup> Wind module time refers to vanes off.

Instead of the age-old method of leaching toxic heavy metals, the patented E Paint approach takes visible light and oxygen in water to create peroxides that inhibit the settling larvae of fouling organisms. Photogeneration of peroxides and the addition of an organic co-biocide, which rapidly degrades in water to benign by-products, make E Paint's SN-1 an effective alternative to organotin antifouling paints. This paint has been repetitively tested in the field and has shown good bonding and antifouling characteristics, as well as a good service life up to 8 months.

However, certain instruments are adversely affected by even the slightest fouling. To date, adjuncts must be used to insure the most protection on those instruments.

For Stratus 4, E Paint was interested in determining the erosion rates and fouling resistance of two new antifoul coatings; commercial grade SN-1 and SUNWAVE. Commercial grade SN-1 is a harder, less soluble, version of the original product. The product is well suited for use in the photic zone where UV degradation is problematic. SUNWAVE is a two part water-based antifouling coating that offers a truly eco-friendly approach to controlling biofouling. The product should offer superior adhesion and durability. Results from this study will validate the new version of SN-1 and SUNWAVE as viable alternatives to organotin, copper, and other more toxic coatings.

In addition to the hull tests, a proprietary product from E Paint was tested as an alternative to TBT on mechanical current meters. This product has been applied to two load bars deployed near the surface where fouling is greatest.

The table below shows methods used for coating the buoy hull and instrumentation for the Stratus 4 deployment. Below the table are observations of the recovered buoy and instruments.

**Table 10: Stratus 4 anti-foulant details**

| Description   | Coating            | Color  | Coats               | Method                 |
|---|--------------------|--------|---------------------|------------------------|
| Discuss Hull<br>Right half – facing anemometer                                    | CG SN-1            | White  | 2                   | Roller                 |
|   |                    | Grey   | 1                   | Roller                 |
|   |                    | Black  | 1                   | Roller                 |
| Discuss Hull<br>Left Half – facing anemometer                                     | SUNWAVE            | Black  | 1                   | Roller                 |
|   |                    | Yellow | 1                   | Roller                 |
|   |                    | White  | 2                   | Roller                 |
| Floating SST  | SN-1               | White  | 2                   | Brush                  |
| SST Frame   | E Paint P          | Brown  | 1                   | Spray                  |
| Bridle Legs   | SN-1               | White  | 3                   | Spray                  |
| Instruments On Bridle Legs  | SN-1               | White  | 2                   | Brush<br>Taped 2 legs\ |
|   | Mylar Wrap         | Clear  |                     |                        |
| Load Bars and Trawl Guards  | SN-1 E             | White  | 2<br>2 @ 3.7, 1 @ 7 | Spray/Brush<br>Spray   |
|   | Paint P            | Brown  |                     |                        |
| **All instruments to 70 Meters<br>40 M SeaCat _ radially<br>62.5 M SeaCat axially | SN-1               | White  | 1                   | Brush                  |
| Seacat/Microcat shields   | SN-1               | White  | 1                   | Spray                  |
| VMCM props  | SN-1               | Blue   | 1                   | Spray/Brush<br>Spray   |
|   | TBT                | Clear  | 2                   |                        |
| VMCM cage<br>& case clamps  | SN-1               | White  | 2                   | Spray                  |
|   |                    |        | 2                   | Brush                  |
| RDI ADCP heads (135m)   | Trilux<br>w/biolux | Red    | 1                   | Brush                  |

\*\* SonTek moved to 32.5 meters was not coated.

Overall fouling appeared to be less on the Stratus 4 buoy and mooring components than on earlier moorings. This appears to be a product of the environment more than the effectiveness of antifouling coatings.

Fouling below 20m was similar to fouling on Stratus 1-3. Fouling from sea surface to 20m appeared to be much less than in Stratus 1-3.

- Gooseneck barnacles were found on instruments as deep as 190 meters.
- The only heavy fouling was on instruments mounted to the bridle legs, and the 10 meter VMCM pressure case. Moderate fouling ended at 55 meters, and fouling below 70 meters was negligible.
- Most of the SN-1 used on instruments had ablated almost completely. It is uncertain if the product slowed the growth of barnacles prior to complete ablation.
- There is no significant fouling on titanium trawl guards or Stainless Steel cage parts. It doesn't appear worthwhile to paint these parts.
- Load bars get some fouling whether coated or not.

- Barnacle density is heaviest near neoprene strips, and at crevices such as where delrin clamps wrap around an instrument, or where a T/C shield mounts to pressure cases.
- Fouling on VMCM propellers was very light. Probably a combination of the light overall fouling, and the use of TBT prior to deployment.
- Fouling on the hull and bridle was somewhat reduced from the Stratus 3 mooring, and cleanup was relatively easy. Light algae coated the submerged area of the hull. Ablation of the SN-1 and SUNWAVE was about equal. The SN-1 side cleaned up more easily than the SUNWAVE side.

## E. Stratus 5 Deployment

The Stratus 5 mooring was deployed on December 14, 2004, and is scheduled to be recovered approximately one year later. Table 11 below gives an overview of deployment operations.

**Table 11: Stratus 5 deployment details**

| Stratus 5         |                         |                                |
|-------------------|-------------------------|--------------------------------|
| <b>Deployment</b> | Date                    | December 14, 2004              |
|                   | Time                    | 18:25 UTC                      |
|                   | Position at Anchor Drop | 19° 44.728' S<br>85° 31.159' W |
|                   | Deployed by             | Lord, Weller                   |
|                   | Recorder                | Keir Colbo                     |
|                   | Ship                    | R/V <i>Ronald H. Brown</i>     |
|                   | Cruise No.              | RB-11-04                       |
|                   | Depth                   | 4425 m                         |
|                   | Anchor Position         | 19° 44.741' S<br>85° 31.360' W |

Before deployment, a bottom survey was carried out with the *Ron Brown's* Simrad multibeam sonar in order to identify a relatively flat region. Since the recovered mooring had shown no signs of fishing activity, it was decided that the new mooring should be redeployed in the same location as the previous year's mooring

### 1. Mooring Description

The Stratus 5 mooring was equipped with meteorological instrumentation on the buoy, and subsurface oceanographic equipment on the mooring line. Tables 12 and 13 below detail the instrumentation. Figure 5 is a schematic representation of the Stratus 4 mooring.



**Table 12: Stratus 5 surface buoy instrumentation**

| <b>Instrument</b>                      | <b>ID Number</b>                 | <b>Height<sup>11</sup> (cm)</b> | <b>Version</b> |
|--|----------------------------------|---------------------------------|----------------|
| <b>System #1</b>                       |                                  |                                 |                |
| Data Logger                            | L-04                             |                                 |                |
| Relative Humidity                      | HRH 216                          | 244                             | v3.2           |
| Wind Module                            | WND 221                          | 221                             | v3.5/v1.5      |
| Precipitation                          | PRC 206                          | 206                             | v3.4/v1.7      |
| Longwave Radiation                     | LWR 218                          | 282.5                           | v3.5/v1.6      |
| Shortwave Radiation                    | SWR 219                          | 282.5                           | v3.3/v1.6      |
| Barometric Pressure                    | BPR 216                          | 247                             | v3.3 (Heise)   |
| Argos Transmitter (Wildcat PTT #12789) | ID 27916<br>ID 27917<br>ID 27918 |                                 |                |
| <b>System #2</b>                       |                                  |                                 |                |
| Data Logger                            | L-05                             |                                 |                |
| Relative Humidity                      | HRH 232                          | 246                             | V3.2           |
| Wind Module                            | WND 225                          | 271                             | V3.5/v1.5      |
| Precipitation                          | PRC 205                          | 239                             | V3.4/v1.7      |
| Longwave Radiation                     | LWR 502                          | 283                             | V3.5/v1.6      |
| Shortwave Radiation                    | SWR 209                          | 282.5                           | V3.3/v1.6      |
| Barometric Pressure                    | BPR 217                          | 247                             | V3.3 (Heise)   |
| Argos Transmitter (Wildcat PTT #18171) | ID 27919<br>ID 27920<br>ID 27921 |                                 |                |

---

<sup>11</sup> Heights given are measured from the buoy deck, which was estimated to be 0.7m above the mean water line. The Stratus 5 mooring consisted of a new synthetic foam buoy which rides higher in the water than the previous aluminum 3m discus buoys.

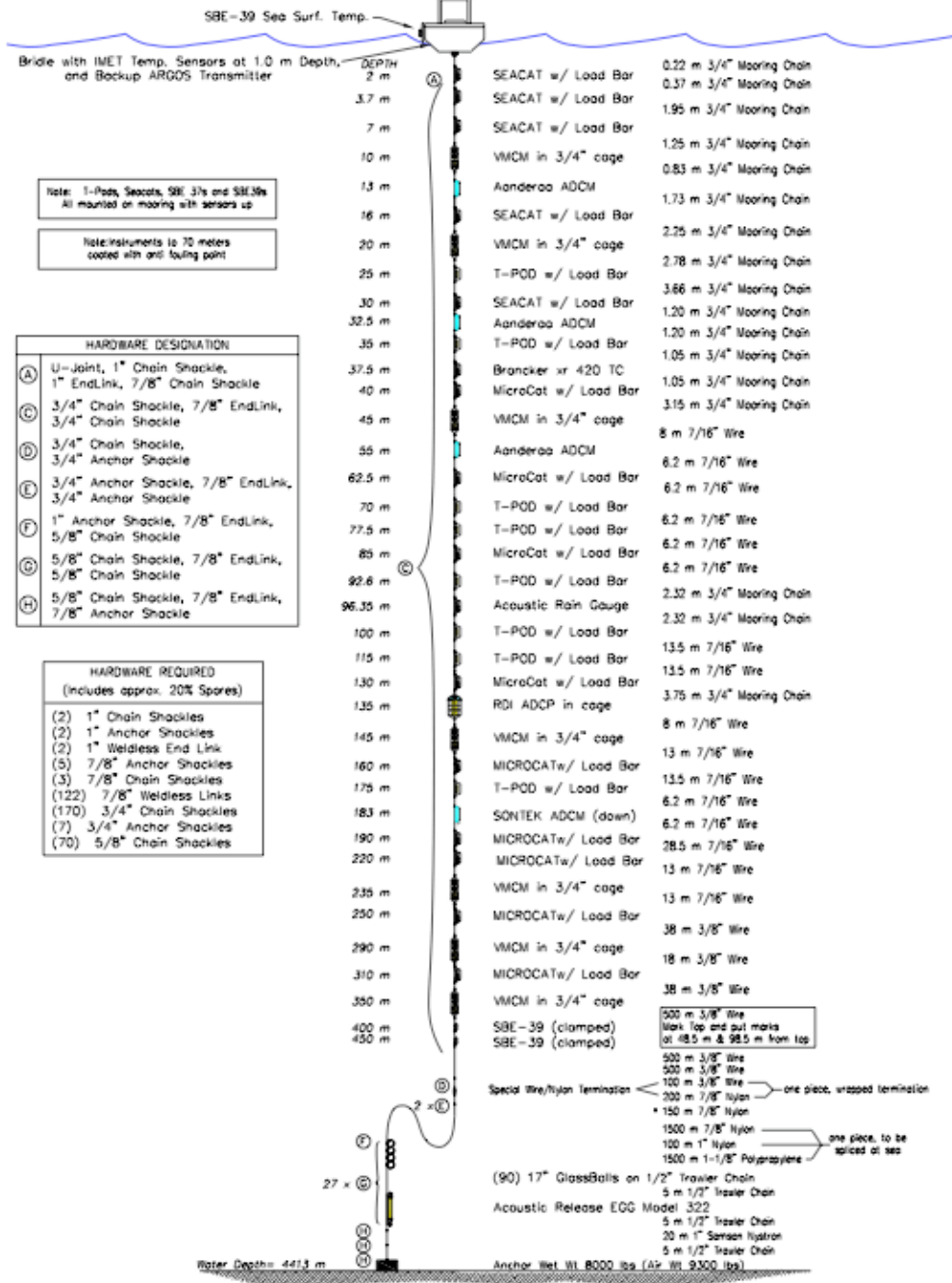
**Table 13: Stratus 5 subsurface instrumentation**

| Depth (m)          | Instrument       | Serial Number | Measurement              |
|--------------------|------------------|---------------|--------------------------|
| Floater            | SBE39            | 0718          | Temperature              |
| 0.81 <sup>12</sup> | SBE37            | 1305          | Temperature and Salinity |
| 0.81 <sup>12</sup> | SBE37            | 1841          | Temperature and Salinity |
| 2                  | SBE16            | 1873          | Temperature and Salinity |
| 3.7                | SBE16            | 1875          | Temperature and Salinity |
| 7                  | SBE16            | 1880          | Temperature and Salinity |
| 10                 | VMCM             | 037           | Velocity and Temperature |
| 13                 | Aanderaa         | 013           | Velocity and Temperature |
| 16                 | SBE16            | 1881          | Temperature and Salinity |
| 20                 | VMCM             | 032           | Velocity and Temperature |
| 25                 | TPOD             | 3258          | Temperature              |
| 30                 | SBE16            | 2323          | Temperature and Salinity |
| 32.5               | Aanderaa         | 078           | Velocity and Temperature |
| 35                 | TPOD             | 3283          | Temperature              |
| 37.5               | XR-420           | 10514         | Temperature and Salinity |
| 40                 | SBE37            | 1325          | Temperature and Salinity |
| 45                 | VMCM             | 038           | Velocity and Temperature |
| 55                 | Aanderaa         | 079           | Velocity and Temperature |
| 62.5               | SBE37            | 1326          | Temperature and Salinity |
| 70                 | TPOD             | 3704          | Temperature              |
| 77.5               | TPOD             | 3762          | Temperature              |
| 85                 | SBE37            | 1328          | Temperature and Salinity |
| 92.6               | TPOD             | 3830          | Temperature              |
| 96.3               | SBE37            | 1909          | Temperature and Salinity |
| 100                | TPOD             | 3831          | Temperature              |
| 115                | TPOD             | 3836          | Temperature              |
| 130                | SBE37            | 1329          | Temperature and Salinity |
| 135                | RDI              | 1218          | Velocity and Temperature |
| 145                | VMCM             | 042           | Velocity and Temperature |
| 160                | SBE37            | 1330          | Temperature and Salinity |
| 175                | TPOD             | 3837          | Temperature              |
| 183                | SonTek           | D208          | Velocity and Temperature |
| 190                | SBE37            | 1906          | Temperature and Salinity |
| 220                | SBE37            | 1908          | Temperature and Salinity |
| 235                | VMCM             | 058           | Velocity and Temperature |
| 250                | SBE37            | 2012          | Temperature              |
| 290                | VMCM             | 0075          | Velocity and Temperature |
| 310                | SBE37            | 2015          | Temperature and Salinity |
| 350                | VMCM             | 010           | Velocity and Temperature |
| 400                | SBE39            | 0048          | Temperature              |
| 450                | SBE39            | 0049          | Temperature              |
| ~4400              | Acoustic Release | 339           | N/A                      |

<sup>12</sup> Assumes buoy deck is 0.70m above mean waterline

MAX. DIA. BUOY WATCH CIRCLE = 3.7 N.Miles

3 m Discus Buoy with the following equipment:  
 (2) IMET/ARGOS Telemetry,  
 (1) Floating Sea Surface Temperature Sensor



**STRATUS-5 MOORING**  
 Version 2 - 08/20/04

Figure 5: The Stratus 5 mooring diagram

## 2. Time Spikes

Timing spikes were applied to some of the Stratus 5 mooring instrumentation prior to deployment. These spikes will help with data processing by allowing timing to be checked on the instruments. Table 14 below details the timing spike information.

**Table 14: Stratus 5 pre-deployment timing spikes**

| Instrument        | Serial #   | Time 1    |                      | Time 2    |          |
|-------------------|--|-----------|----------------------|-----------|----------|
| Relative Humidity | HRH 216  | 11/9/2003 | 18:19:00             | 11/9/2003 | 20:17:30 |
| Precipitation     | PRC 206  | 5 Dec 04  | 10:33:30             |           |          |
| Precipitation     | PRC 205  | 5 Dec 04  | 10:33:30             |           |          |
| SBE39             | 0718, 0048, 0049   | 4 Dec 04  | 11:42:00             | 4 Dec 04  | 12:42:00 |
| SBE37             | 1325, 1326, 1328,<br>1329, 1330, 1906,<br>1908, 2012, 2015 | 4 Dec 04  | 12:43:00             | 4 Dec 04  | 14:02:00 |
| SBE37             | 1909   | 5 Dec 04  | 10:28:00             | 5 Dec 04  | 14:02:00 |
| SBE16             | 1873, 1875, 1880,<br>1881, 2323                            | 5 Dec 04  | 12:47:00             | 5 Dec 04  | 13:47:00 |
| Brancker          | 3258, 3282, 3704,<br>3762, 3830, 3831,<br>3836, 3837       | 5 Dec 04  | 10:25:00             | 5 Dec 04  | 12:42:00 |
| Aanderaa          | 013, 078, 079  | 4 Dec 04  | 14:03:00             | 4 Dec 04  | 15:48:00 |
| RDI               | 1218   | 7 Dec 04  | 11:02:00             | 7 Dec 04  | 14:10:00 |
| XR 420            | 10514  | 7 Dec 04  | 11:03:30             | 7 Dec 04  | 13:53:00 |
| VMCM              | 042  | 9 Dec 04  | 15:08:30             | 9 Dec 04  | 19:26:30 |
|                   | 032  | 9 Dec 04  | 15:09:30             | 9 Dec 04  | 19:27:30 |
|                   | 038  | 9 Dec 04  | 15:10:30             | 9 Dec 04  | 19:29:30 |
|                   | 075  | 9 Dec 04  | 15:11:30             | 9 Dec 04  | 19:28:30 |
|                   | 058  | 9 Dec 04  | 15:13:30<br>15:14:30 | 9 Dec 04  | 19:30:30 |
|                   | 010  | 9 Dec 04  | 15:16:30             | 9 Dec 04  | 19:32:30 |
|                   | 037  | 9 Dec 04  | 15:17:30             | 9 Dec 04  | 19:31:30 |

## 3. Antifoulant Application

The Stratus 5 mooring was used for continued testing of E-paint products. An E-paint product, ZO, which has similar properties to the Trilux coating was used extensively on subsurface instruments for Stratus 5. Antifoulant coatings used on Stratus 5 are listed in Table 15.

**Table 15: Stratus 5 antifoulant details**

| <b>Description</b>                                   | <b>Coating</b>      | <b>Color</b> | <b>Coats</b>  | <b>Method</b>                           |
|--|---------------------|--------------|---|---|
| Buoy Hull  | SUNWAVE             | White        | 3   | Roller                                  |
| Floating SST   | ZO                  | White        | 2   | Brush                                   |
| SST Frame  | Trilux w/biolux     | Red          | 2   | Brush                                   |
| SBE 37s on hull bottom                               | Sunwave             | White        | 1   | Brush                                   |
| Load Bars and Trawl Guards                           | ZO                  | WHITE        | Brushed in area of sensors. Some bars had residual coatings |   |
| **All instruments to 70 Meters                       | ZO                  | White        | 1   | Brush – applied only in area of sensors |
| Seacat/Microcat shields                              | SN-1                | White        | 1   | Spray                                   |
| RDI ADCP heads (135m)<br>RDI Frame<br>Aanderaa heads | Trilux w/biolux     | Red          | 1   | Brush                                   |
| VMCM #037 10 m                                       |                     |              |   |   |
| Props  | Epaint “p” -TBT     | White/Clr    | 2/2   | Spray/Spray                             |
| Sting  | ZO – TBT            | White/Clr    | 2/2   | Brush/Spray                             |
| Cage   | Trilux - TBT        | Red/Clr      | 2/2   | Brush/Spray                             |
| VMCM #032 20 m                                       |                     |              |   |   |
| Props  | Epaint “p” -TBT     | White/Clr    | 2/2   | Spray/Spray                             |
| Sting  | ZO – TBT            | White/Clr    | 2/2   | Brush/Spray                             |
| Cage   | Trilux              | Red/Clr      | 2/2   | Brush/Spray                             |
| VMCM #038 45 m                                       |                     |              |   |   |
| Props  | Clean Seas -TBT     | Red/Clr      | 2/2   | Spray/Spray                             |
| Sting  | ZO – TBT            | White/Clr    | 2/2   | Brush/Spray                             |
| Cage   | Trilux              | Red/Clr      | 2/2   | Brush/Spray                             |
| VMCM #042 145 m                                      |                     |              |   |   |
| Props  | Clean Seas -TBT     | Red/Clr      | 2/2   | Spray/Spray                             |
| Sting  | ZO – TBT            | White/Clr    | 2/2   | Brush/Spray                             |
| Cage   | Trilux              | Red/Clr      | 2/2   | Brush/Spray                             |
| VMCM case  | Mylar               | Clear        | 1   | Wrapped                                 |
| VMCM clamps  | ZO                  | White        | 1   | Brush                                   |
| ADCM/ADCP transducers                                | Epaint – Bio Grease |              | 1   | Grease applied with gloves              |

\*\* Brancker T-pod: coated at end cap near thermistor and down case 3”

SeaCats and MicroCats: shields removed and coated, tubes coated, and end of pressure case coated

Aanderaas: Coated with ZO around heads (not transducers), down stem to case

VMCMs below 145 meters had some coatings on props and cages by coincidence. These instruments will show no fouling whether treated or not.

#### 4. Deployment Process

The Stratus 5 surface mooring was set using the UOP two phase mooring technique. Phase 1 involves the lowering of approximately 50 meters of instrumentation followed by the buoy over the port side of the ship. Phase 2 is the deployment of the remaining mooring components through the A-frame. The benefits from lowering the first 50 meters of instrumentation are: (1) it allows controlled lowering of the upper instrumentation; (2)

the suspended instrumentation attached to the buoy's bridle acts as a sea anchor to stabilize the buoy during deployment; and (3) the length of payed out mooring wire and instrumentation provides adequate scope for the buoy to clear the stern without capsizing or hitting the ship. The remainder of the mooring is deployed over the stern. The following narrative is the actual step-by-step procedure used for the Stratus 5 mooring deployed from the R/V *Ron Brown*.

The TSE winch drum was pre-wound with the following mooring components listed from deep to shallow:

- 150 m 7/8" nylon
- 200 m 7/8" nylon – nylon to wire shot
- 100 m 3/8" wire - nylon to wire shot
- 500 m 3/8" wire
- 500 m 3/8" wire
- 500 m 3/8" wire
- 8.0 m 3/8" wire

A tension cart was used to pretension the nylon and wire during the winding process.

The ship was positioned nine nautical miles downwind and down current from the desired anchor site. An earlier bottom survey indicated this track would take the ship over an area with consistent ocean depth. This allowed an acceptable margin of error for delays or drift off the desired track.

Prior to the deployment of the mooring, 100 meters of 3/8" diameter wire rope was payed out to allow its bitter end to be passed out through the center of the A-frame and around the aft port quarter and forward along the port rail to the instrument lowering area.

The four hauling wire handlers were stationed around the aft port rail. Their positions were in front of the TSE winch, center of the A-frame, aft port quarter, and approximately 5 meters forward along the port rail. The wire handlers' job was to keep the hauling wire from fouling in the ship's propellers and to pass the wire around the stern to the line handlers on the port rail.

To begin the mooring deployment, the ship hove to with the bow positioned with the wind slightly on the port bow. The crane was extended out so that there was a minimum of 10 meters of free whip hanging over the instrument lowering area. All subsurface instruments for this phase had been staged in order of deployment on the port side main deck. All instrumentation had their chain or wire shot pre-secured to the bottom of the instrument. A shackle and ring was attached to the bottom of each shot of chain or wire.

The first instrument segment to be lowered was the VMCM at 45m. The instrument lowering began by shackling the bitter end of the hauling wire to the free end of the VMCM. The crane whip hook suspended over the instrument lowering area was lowered

to approximately 1 meter off the deck. A 6-foot long “Lift All” sling was hooked onto the crane and shackled through a ring to the top of the VMCM.

The crane was raised up so that the chain and instrument were lifted off the deck. The crane swung outboard to clear the ship’s side, and slowly lowered the whip and attached mooring components down into the water. The TSE winch payed out the hauling wire simultaneously. The wire handlers positioned around the stern eased wire over the port side, paying out enough wire to keep the mooring segment vertical in the water. The crane was then directed to swing slightly inboard and lower to the deck. The stopper line was hauled in enough to take the load from the crane and made fast to the deck. The hook on the crane was removed. Lowering continued with 5-8m of instruments and chain being picked up and placed successively over the side.

The operation of lowering the upper mooring components was repeated up to the final SeaCat. The load from this instrument cluster was stopped off in the end link at the top of the instrument load bar. This allowed enough slack to connect the buoy bridle to the instrument cluster. The free end of 0.52 meter 3/4” chain was then shackled to the 1” end link attached to the discus bridle universal joint.

The second phase of the operation was the launching of the buoy. There were three slip lines rigged on the discus to maintain control during the lift. Lines were rigged on the bridle, tower bail and a buoy deck bail. The 30 ft. bridle slip line was used to stabilize the bridle and allow the hull to pivot on the apex at the start of the lift. The 50 ft. tower slip line was rigged to check the tower as the hull swung outboard. A 75 ft. buoy deck bail slip line was rigged to prevent the buoy from spinning as the buoy settled in the water. This is used so the quick release hook, hanging from the crane’s whip, could be released without fouling against the tower. The buoy deck bail slip line was removed just following the release of the buoy. An additional line was tied to the crane hook to help pull the crane block away from the tower’s meteorological sensors once the quick release hook had been triggered and the buoy cast adrift.

With three slip lines in place, the crane was directed to swing over the discus buoy. A four-foot sling hitched through the quick release hook, was attached to the crane block. The quick release hook was attached directly to the main lifting bail. Slight tension was taken up on the whip to hold the buoy. The chain lashings, binding the discus to the deck, were removed. The stopper line holding the suspended 40 meters instrumentation was eased off to allow the discus to take the hanging load. The discus was raised up and swung outboard as the slip lines kept the hull in check. The tower slip line was removed first, followed by the bridle slip line. Once the discus had settled into the water (approximately 20 ft. from the side of the ship), and the release hook had gone slack, the quick release was tripped. The crane swung forward to keep the block away from the buoy, but a wave caused the block to swing into the protective guard around the instruments. The slip line to the buoy deck bail was cleared at about the same time. The ship then maneuvered slowly ahead to allow the buoy to come around to the stern.

The TSE winch operator slowly hauled in the slack wire once the discus had drifted behind the ship. The ship's speed was increased to 1/2 knot through the water to maintain a safe distance between the buoy and the ship. The bottom end of the shot of chain shackled to the hauling wire was pulled in and stopped off at the transom. The next instrument, 45 meter depth VMCM and pre attached chain shot shackled to the end of the stopped off chain. The free end of chain, shackled to the bottom of the VMCM cage, was shackled to the free end of hauling wire. The hauling wire was pulled onto the TSE winch to take up the slack on the chain. The winch slowly took the mooring tension from the stopper line hooked onto the chain shot ahead of the VMCM.

A traveling snatch block was suspended from the A-frame using the heavy duty air tugger to adjust the height of the block. Two frapping lines were attached to the block to keep it from swinging out of control. The block was opened and installed over the chain on the bottom side of the VMCM. This block was hauled up to about 8 feet off the deck, lifting the VMCM off the deck as it was raised. By controlling the A-frame, block height, and winch speed, the VMCM was lifted clear of the deck and over the transom. The winch payed out to the next termination. The termination was stopped off using lines on cleats, and the hauling wire removed while the next instrument was attached to the mooring.

The next several instruments were deployed in a similar manner. Soon, short shots of chain were replaced by longer shots of 7/16" jacketed wire rope. When pulling the slack on these longer shots, the terminations were covered with a canvas wrap before being wound onto the winch drum. The purpose of the canvas was to cover the shackles and wire rope termination and prevent damage from point loading the lower layers of wire rope and nylon already on the drum. The process of instrument insertion was repeated for the remaining instruments down to 354 meters.

All the wire and nylon on the TSE winch drum was payed out, and the end of the nylon was stopped off to a deck cleat. The mooring was set up for temporary towing. A 5-meter length of 1/2" trawler chain was secured to the stopped off nylon end. A second stopper line was hooked onto the chain. Both stoppers were eased out so that 1 to 2 meters of the chain shot was past the stern and secured to deck cleats.

A tension cart was secured on the fantail, aft of the winch. A 500-meter reel of 7/8" nylon line was mounted to the cart. The nylon was wound onto the winch. The free end of the nylon was shackled to the stopped off 1/2" chain and hauled in, pulling the deployed nylon termination back onto the deck. This termination was stopped off and the towing chain was removed. The nylon terminations were shackled together and pay out continued.

The long lengths of wire and nylon were payed out approximately 10% slower than the ship's speed through the water. Payout speed was monitored using a digital tachometer, Ametek model #1726. The selected readout from the tachometer was in miles per hour. A table was created to compare ships speed and wire payout.



While the wire and nylon line was being payed out, the crane was used to lift the 96 glass balls out of the rag top container. These balls were staged fore and aft, in four ball segments, just aft of the container.

Once the nylon line was payed out, it was stopped off two meters from the transom, and the winch line removed. An H-bit cleat was positioned in front of the TSE winch and secured to the deck. The free end of the 2000 meter shot of nylon/polypropylene line, stowed in two wire baskets was bent around the H-bit and passed on to the stopped off mooring line. The shackle connection between the two nylon shots was made. The line handler at the H-bit pulled in all the residual slack and held the line tight against the H-bit. The stopper lines were then eased off and removed. The person handling the line on the H-Bit kept the mooring line parallel to the H-bit with moderate back tension. The H-bit line handler and one assistant eased the mooring line out of the wire basket and around the H-bit at the appropriate pay out speed relative to the ships speed.

When the end of the polypropylene line was reached, pay out was stopped and a Yale grip was used to take tension off the polypropylene line. The winch tag line was shackled to the end of the polypropylene line. The polypropylene line was removed from the H-Bit. The winch line and mooring line were wound up taking the mooring tension away from the stopper line on the Yale grip. The stopper line was removed. The TSE winch payed out the mooring line until the thimble was approximately 1 meter from the ship's transom.

The deployment of 96 - 17" glass balls was accomplished using two 20 meter long stopper lines reeved through the two 10" snatch blocks secured to the front of the winch. This configuration of the deck stopper fair lead allowed for the maximum available distance between the TSE winch and the transom, while keeping the mooring components centered in the front of winch.

The 92 glass balls were bolted on 1/2" trawler chain in 4 ball (4 meter) increments. The 24 sections of chain and glass balls were laid out on the deck, and shackled together in pairs. The first string of glass balls was dragged aft and connected to the stopped off polypropylene line. The glass balls were stretched out up to the front of the winch. Two stopper lines with hooks were attached to the end of the section of glass balls closest to the front of the winch. The line was pulled tight and secured to deck cleats. The winch line was eased off, and the load transferred. The stoppers were payed out slowly as the balls went off the transom.

The stopper lines were payed out until one glass ball outboard of the stopper's hook remained on deck with a segment of 1/2" trawler chain bent over the transom. The stopper lines were secured to the deck. Another two segments of glass balls on chain was dragged into position and attached to the mooring. One of the stopper lines was removed and hooked into the end link closest to the TSE winch, then the second stopper was moved up

as well. Tension was pulled up, and lines made fast to a cleat. This process of attaching balls and slipping over the transom continued until all 96 balls were on the mooring line.

The acoustic release and attached 1/2" trawler chain segments were deployed using an air tugger hauling line reeved through a block hung in the A-frame, and the TSE winch. Shackled to the end of tugger line was a 1/2" chain grab. The 20 meter 1" Samson anchor pennant was shackled to the TSE winch tag line and wound onto the winch. The acoustic release was positioned on the fantail 1 meter from the transom. The stopped off 5 meter length of 1/2" trawler chain was shackled to the top of the release. A 5-meter length of 1/2" chain was shackled to the bottom of the release and the loose end of the chain secured to the anchor pennant. The A-frame was positioned so the hanging air tugger line and chain grab was over the top end of the release. The tugger line was lowered and hooked onto the 1/2" chain approximately 1 meter from the bottom end of the release. The anchor pennant was drawn up so that all available slack in the line was taken up on the winch drum. The tugger line was hauled in lifting the release off the deck. The A-frame was shifted outboard with the winch slowly paying out its line. The tugger line hauled in and payed out during this shift out board in order to keep the release off the deck as the instrument passed over the transom. Once the release had cleared the deck, the TSE winch payout was stopped and the tugger line was removed. The winch payed out the rest of the chain and the 20 Meter anchor pennant. The pennant was stopped off 2 meters from the transom.

The last 5 meter shot of 1/2" trawler chain was attached to the anchor and the anchor pennant. A 5/8" chain shackle and 5/8" pear link was attached to the chain approximately two meters from the anchor. A 20-meter length of 1" Samson line was passed through this link and secured to two cleats in the deck, just forward of the A-frame stop pedestal. The mooring load was transferred from the stopper line on the pennant to the slip line on the chain.

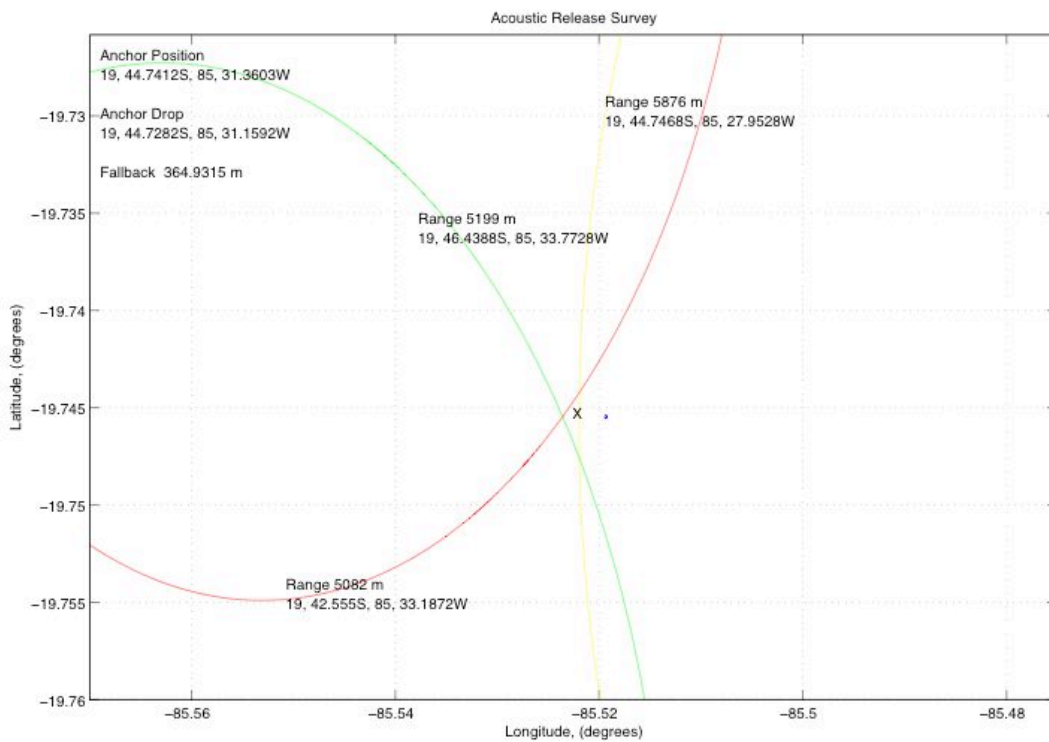
Deck bolts were removed from the anchor tip plate. The Starboard crane was shifted so the crane whip would hang over, and slightly aft of the anchor. The whip was lowered and the whip hook secured to the tip plate chain bridle. A slight strain was applied to the bridle. The chain lashings were removed from the anchor. The Samson line was slipped off, transferring the mooring tension to the 1/2" chain and anchor. The line was pulled clear and the crane whip raised 0.5 meters lifting the forward side of the tip plate causing the anchor to slide overboard.

### **5. Anchor Position Triangulation**

After deployment, the exact position of the anchor was determined. At three points surrounding the anchor, the release was pinged and a distance determined. Through simple geometry, the anchor position was determined. Figure 6 shows the ranging pattern used to determine anchor position. The anchor was dropped at 19° 44.728' S, 85° 31.159' W, where the water depth (corrected) was 4425 m.

Latitude of Position 1: 19° 44.7468' S  
 Longitude of Position 1: 85° 27.9528' W  
 Range of Position 1: 5876 m  
 Latitude of Position 2: 19° 46.4388' S  
 Longitude of Position 2: 85° 33.7728' W  
 Range of Position 2: 5199 m  
 Latitude of Position 3: 19° 42.555' S  
 Longitude of Position 3: 85° 33.1872' W  
 Range of Position 3: 5082 m

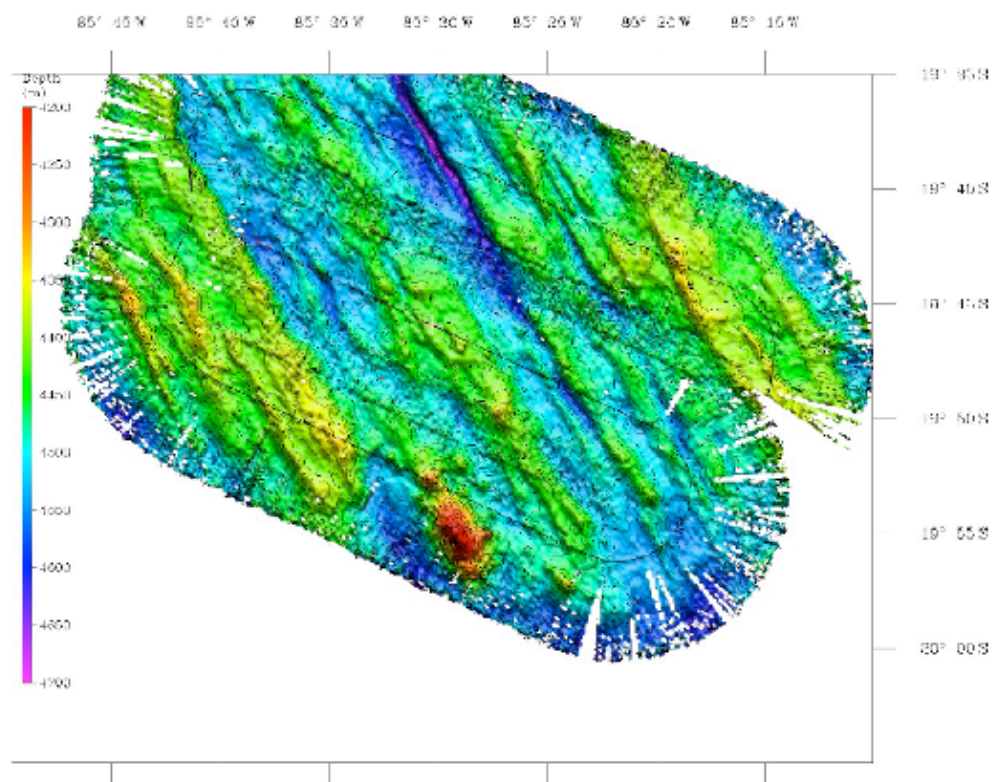
Position of Anchor drop: 19° 44.728' S, 85° 31.159' W  
 Position of Anchor on Bottom: 19° 44.741' S, 85° 31.360' W  
 Fallback: 365 m (8.2% of water depth)



**Figure 6: The Stratus 5 anchor survey**

## IV. SHIPBOARD MEASUREMENTS

The R/V *Ron Brown* was equipped with a variety of scientific and navigational equipment during the Stratus 2003 cruise. This section gives some basic data plots from the underway data. Figure 7 shows bathymetry produced by the shipboard computer technician.



**Figure 7: Bathymetry map for the Stratus location.**

A total of 24 CTD stations were taken from R/V *R. H. Brown* during the cruise RB-11-04. A 21 Niskin bottle rosette/ CTD (Sea-Bird 19 plus) system was used for all stations. The CTD and rosette were provided by SHOA (Chilean Navy Hydrographic and Oceanographic Service) and UDEC (University of Concepcion, Chile), respectively. The CTD was additionally equipped with an oxygen sensor (model SBE-43).

The 24 CTD stations were approximately 0.6° of longitude apart and were taken to 1000 m depth along a track between 74° 55.67' and 90° 00.015' W (see table 16). Water samples were collected from different depths in conjunction with some of the CTD casts.

The water samples collected through the water column were used for salinity analysis, microbial activity experiment (anaerobic ammonium-oxidation rates), oxygen measurement (Winkler method), nutrients concentration analysis, environmental genomic DNA collection, and cell abundances. The results will be obtained after processing of samples at Department of Oceanography of the University of Concepcion.

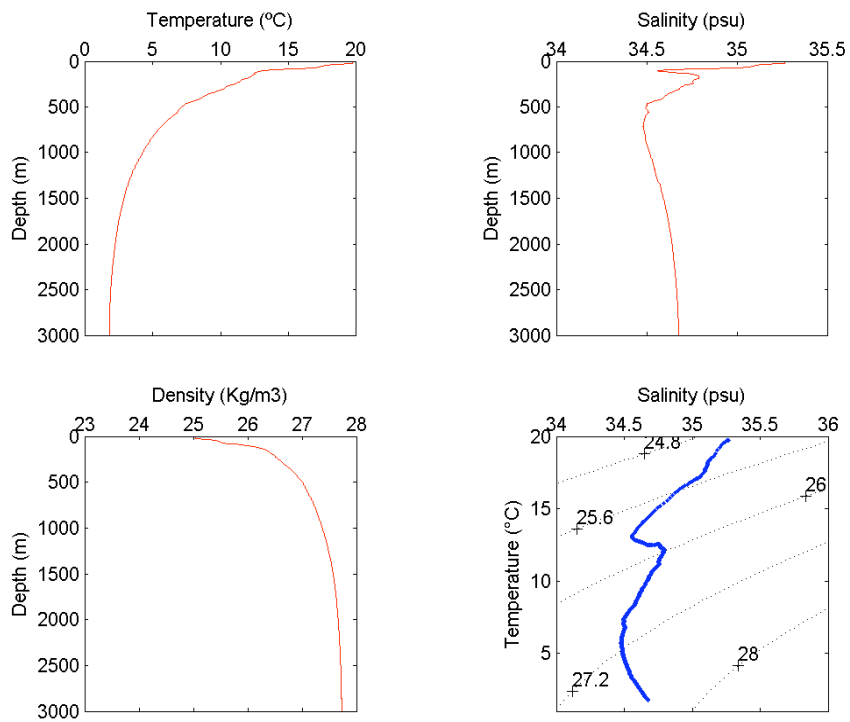
At the location of the WHOI mooring, a 3000 m CTD station was effected one day before the recovering of Stratus buoy and another 3000 m CTD station one day after the deployment of the new Stratus buoy (see figures 9 and 10).

Once the mooring work was finished, the CTDs were continued at the stations along the transit toward station 24.

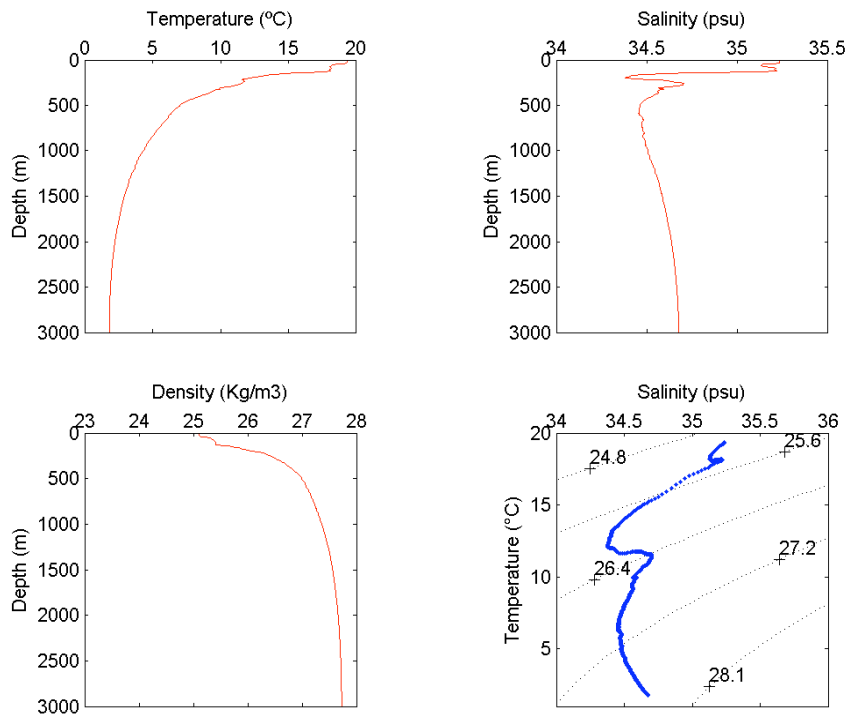
Figures 8 to 10 display the profiles of temperature, salinity, and density, as well as T-S diagrams, for 3000 m depth cast obtained from CTD station 00, 17 and 18, respectively. Figure 11 shows temperature, salinity and density along the CTD transect from 5 to 1000 m depth.

**Table 16: Stratus 2004 cruise CTD depths, times and locations**

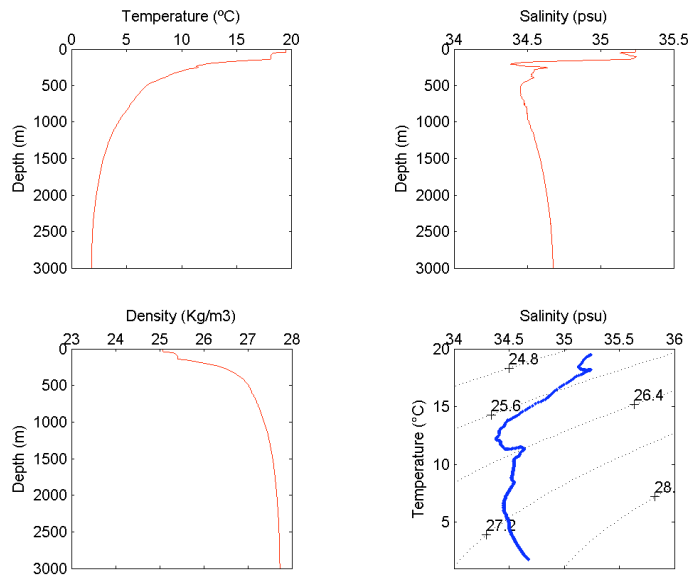
| CTD Stations | CTD file | Date      | Start time (UTC) | Start latitude | Start longitude | Water Depth (m) | CTD Depth (m) |
|--------------|----------|-----------|------------------|----------------|-----------------|-----------------|---------------|
| 0            | est_00   | 07 Dec 04 | 15:15            | 19°41.54'      | 74°55.67        |                 |               |
| 1            | est_01   | 07 Dec 04 | 18:28            | 19°39.99'      | 74°59.99        | 5006            | 1000          |
| 2            | est_02   | 07 Dec 04 | 23:29            | 19°39.99       | 75°39.99        | 4595            | 1000          |
| 3            | est_03   | 08 Dec 04 | 04:44            | 19°39.97       | 76°20.006       | 4724            | 1000          |
| 4            | est_04   | 08 Dec 04 | 09:35            | 19°40.035      | 77°00.018       | 4798            | 1000          |
| 5            | est_05   | 08 Dec 04 | 14:28            | 19°39.99       | 77°39.99        | 4354            | 1000          |
| 6            | est_06   | 08 Dec 04 | 21:26            | 19°40.04       | 78°19.9         | 4520            | 1000          |
| 7            | est_07   | 09 Dec 04 | 02:19            | 19°39.948      | 79°00           | 4182            | 1000          |
| 8            | est_08   | 09 Dec 04 | 07:07            | 19°39.968      | 79°39.901       | 3789            | 1000          |
| 9            | est_09   | 09 Dec 04 | 11:48            | 19°40.028      | 80°20.075       | 1005            | 900           |
| 10           | est_10   | 09 Dec 04 | 16:30            | 19°39.969      | 81°00.049       | 3980            | 1000          |
| 11           | est_11   | 09 Dec 04 | 21:10            | 19°40.008      | 81°39.867       | 3833            | 1000          |
| 12           | est_12   | 10 Dec 04 | 01:59            | 19°40.005      | 82°19.967       | 4239            | 1000          |
| 13           | est_13   | 10 Dec 04 | 06:41            | 19°40.057      | 83°00.091       | 4455            | 1000          |
| 14           | est_14   | 10 Dec 04 | 11:22            | 19°40.013      | 83°40.03        | 4499            | 1000          |
| 15           | est_15   | 10 Dec 04 | 16:15            | 19°39.99       | 84°20.039       | 4518            | 1000          |
| 16           | est_16   | 10 Dec 04 | 20:53            | 19°40.006      | 85°00.036       | 4559            | 1000          |
| 17           | est_17   | 11 Dec 04 | 00:35            | 19°49.338      | 85°26.627       | 4399            | 3000          |
| 18           | est_18   | 16 Dec 04 | 03:58            | 19°39.998      | 85°39.996       | 4519            | 3000          |
| 19           | est_19   | 16 Dec 04 | 10:06            | 19°44.805      | 86°19.903       | 4325            | 1000          |
| 20           | est_20   | 16 Dec 04 | 17:04            | 19°43.502      | 87°20.056       | 4303            | 1000          |
| 21           | est_21   | 16 Dec 04 | 21:52            | 19°42.568      | 87°59.981       | 4188            | 1000          |
| 22           | est_22   | 17 Dec 04 | 02:40            | 19°41.798      | 88°40.016       | 4397            | 1000          |
| 23           | est_23   | 17 Dec 04 | 07:24            | 19°40.841      | 89°20.073       | 4071            | 1000          |
| 24           | est_24   | 17 Dec 04 | 12:20            | 19°40.001      | 90°00.015       | 4335            | 1000          |



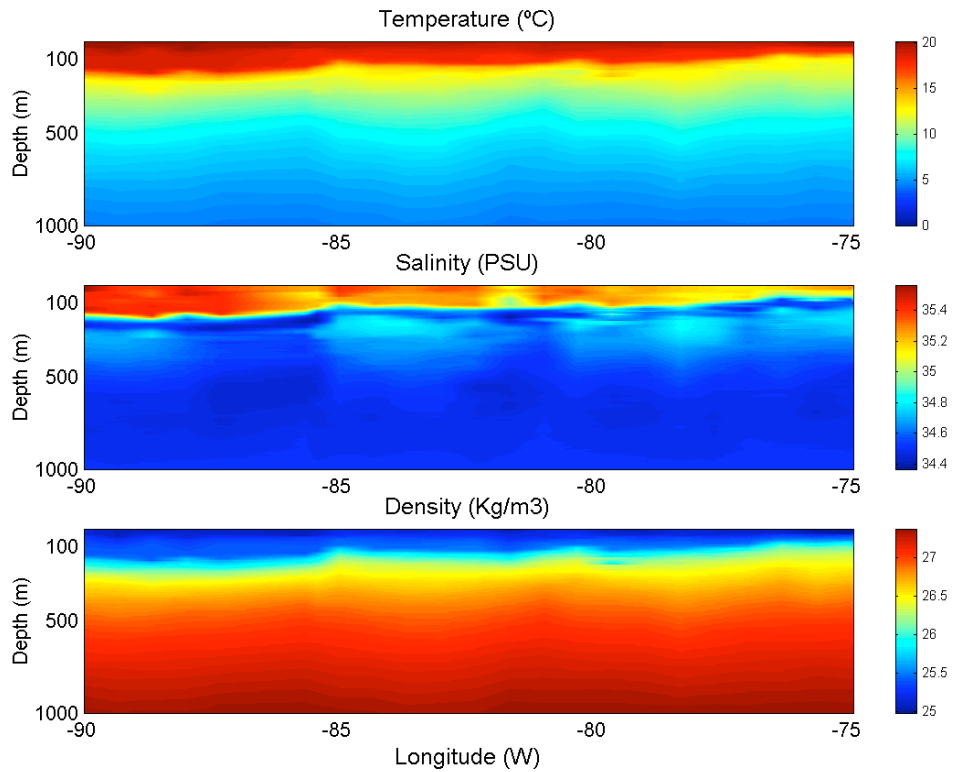
**Figure 8: CTD cast number 00 (from December 7th 2004)**



**Figure 9: CTD cast number 17 (from December 11th 2004)**



**Figure 10: CTD cast number 18 (from December 16th 2004)**



**Figure 11: Temperature, salinity and density along the CTD transect (between December 7th and December 17th, 2004)**



## V. ETL MEASUREMENTS

Results from the ETL Cloud and Flux Group, Texas A&M University, and University of Miami Measurements

### 1. Background on Measurement Systems

The ETL air-sea flux and cloud group conducted measurements of fluxes and near-surface bulk meteorology during the fall field program to recover the WHOI Ocean Reference Station buoy at 20 S Latitude 85 W Longitude. The ETL flux system was installed initially in New England in June 2004, used on the ICARTT field study in July and August, and brought back into full operation in Puerto Rico in late September 2004. The system was operated on the Tropical Atmosphere Ocean (TAO) tender cruise prior to the Stratus cruise. The air-sea flux system consists of five components: (1) A fast turbulence system with ship motion corrections mounted on the jackstaff. The jackstaff sensors are: INUSA Sonic anemometer, OPHIR IR-2000 IR-hygrometer, LiCor LI-7500 fast CO<sub>2</sub>/hygrometer, and a Systron-Donner motion-pak; (2) A mean T/RH sensor in an aspirator on the jackstaff; (3) Solar and IR radiometers (Eppley pyranometers and pyrgeometer) mounted on top of a seatainer on the 02 deck; (4) A near surface sea surface temperature sensor consisting of a floating thermistor deployed off port side with outrigger; (5) An optical rain gauge mounted on the bow tower. Slow mean data (T/RH, PIR/PSP, etc) are digitized on Campbell 21x datalogger and transmitted via RS-232 as 1-minute averages. A central data acquisition computer logs all sources of data via RS-232 digital transmission:

1. Sonic Anemometer
2. LiCor CO<sub>2</sub>/H<sub>2</sub>O
3. Slow means (Campbell 21x)
4. Not used
5. OPHIR hygrometer
6. Systron-Donner Motion-Pak
7. Ship's SCS
8. ETL GPS

The 8 data sources are archived at full time resolution. At sea we run a set of programs each day for preliminary data analysis and quality control. As part of this process, we produce a quick-look ASCII file that is a summary of fluxes and means. The data in this file come from three sources: The ETL sonic anemometer (acquired at 21.3 Hz), the Shipboard Computer System (SCS) (acquired at 2 sec intervals), and the ETL mean measurement systems (sampled at 1 sec and averaged to 1 min). The sonic has 5 channels of data; the SCS file has 15 channels, and the ETL mean system has 42 channels. A series of programs are run that read these data files, decode them, and write daily text files at 1 min time resolution. A second set of programs reads the daily 1-min text files, time matches the three data sources, averages them to 5 or 30 minutes, computes fluxes, and writes new daily flux files. The 5-min daily flux files have been combined and rewritten as a single file to form the file *flux\_5hf\_stratus\_04.txt*. The 1-min daily ASCII files are

stored as *proc\_nam\_dayDDD.txt* (nam='pc', 'scs', or 'son'; DDD=yearday where 000 GMT January 1, 2004 =1.00). File structure is described in the original MATLAB files that write the data, *pvt\_nam\_03.m*.

ETL/Flux and University of Miami (UM) also operated six remote systems: a Vaisala CT-25K cloud base ceilometer, a 94 GHz vertically pointed FM-CW Doppler cloud radar, a 20.6-31.65-90.0 GHz microwave radiometer, a 35GHz Doppler cloud radar, a 915 MHz Doppler wind profiler, and the *Ronald H. Brown's* scanning Doppler C-band radar. The ceilometer is a vertically pointing lidar that determines the height of cloud bottoms from time-of-flight of the backscatter return from the cloud. The time resolution is 30 seconds and the vertical resolution is 15 m. The raw backscatter profile and cloud base height information deduced from the instrument's internal algorithm are stored in daily files with the naming convention *CRVYYDDD.raw* where YY=04 and DDD=Julian day. File structure is described in *ceilo\_readme\_stratus04.txt*.

ETL/Flux and UM used an integrated system in a seatainer that includes a Doppler K-band cloud radar (MMCR) and the 3-channel microwave radiometer. The UM FM-CW 94-GHz radar was mounted on a tripod on the deck and the data system was in the seatainer. The cloud radar systems can be used to deduce profiles of cloud droplet size, number concentration, liquid water concentration etc. in stratus clouds. If drizzle (i.e., droplets of radius greater than about 50  $\mu\text{m}$ ) is present in significant amounts, then the microphysical properties of the drizzle can be obtained from the first three moments of the Doppler spectrum. The MMCR radar is extremely sensitive and can detect most cirrus and fair weather cumulus clouds. The Doppler capability can also be used to measure in-cloud vertical velocity statistics. The UM radar is less sensitive but is ideal to detect drizzle and heavier cloud amounts. The C-band radar was operated continuously with a scan sequence program consisting of alternating a 0.5 deg elevation survey scan, RHI's, and a multiple elevation angle volume scan.

A second seatainer on the 02 deck housed an aerosol measurement system from the Texas A&M University. The Aerosol Research Group of Texas A&M University continuously monitored the aerosol distribution and concentration using a Tandem Differential Mobility Analyzer (TDMA) throughout the Stratus 2004 cruise.

Particularly in the latter half of the cruise, cloud cover was quite variable and sometimes cloud patterns change remarkably rapidly. For the record, five or six times a day photographs were taken of the sky in four directions relative to the ship (over starboard, astern, port, and bow), especially at times of rapid cloud development. The timing of each set of four photographs was carefully noted so that the directions could be converted to earth coordinates, knowing the ship's heading at that time.

## 2. Selected Samples

### *a. Flux Data*

Preliminary flux data is shown for yearday=345 (December 10, 2004) as the RHB approached the buoy site at 20 S 85 W (Figure 12). The time series of ocean and air temperature is given in Figure 13. The water temperature is about 19.5C and the air temperature is about 19.3C. The true wind direction (Figure 14) and true wind speed (Figure 15) show modulation by boundary-layer scale organization. The effect of clouds on the downward solar flux is shown in Figure 16 and on the IR flux in Figure 17. For the solar flux, broken clouds are apparent in the jagged form of the curve during the afternoon. For IR flux, clear skies have values of about  $330 \text{ Wm}^{-2}$  and cloudy skies values around  $400 \text{ Wm}^{-2}$ . The IR flux suggests some small breaks in the clouds in late afternoon. Figure 18 shows the time series of four of the five primary components of the surface heat balance of the ocean (solar flux is left out). The largest term is the latent heat (evaporation) flux, followed by the net IR flux (downward minus upward); the sensible heat flux and the flux carried by precipitation are very small. We are using the meteorological sign convention for the turbulent fluxes so all three fluxes actually cool the interface in this case. The time series of net heat flux to the ocean is shown in Figure 19. The sum of the components in Figure 18 is about  $-100 \text{ Wm}^{-2}$ , which can be seen in the night time values; the large positive peak during the day is due to the solar flux. The integral over the entire day gives an average flux of  $72 \text{ Wm}^{-2}$ , indicating strong warming of the ocean mixed layer even on an overcast day.

### *b. Remote Sensing Data*

A sample ceilometer 24-hr time series for cloud base height for December 10 is shown in Figure 20. This day had 98% cloud cover and two sets of cloud base heights: the dominant stratocumulus layer with cloud bases 900 to 1100 m and occasional lower level 'scud' clouds with bases about 500 m. Small amounts of drizzle can be seen as the few low-altitude dots early in the day. A sample time-height cross-section (Figure 21) from the UM cloud radar is shown for a 24-hr period on December 10. The panels indicated the intensity of the return (upper), the mean fall velocity of the scattering droplets (middle panel), and the Doppler width of the return. This happens to be a day with low cloud cover; clouds are fairly thin with tops at 1.0 - 1.2 km. Light drizzle events are apparent at 0830 and 1430 UTC; the radar is much more sensitive to drizzle than the ceilometer. The ETL microwave cloud radar (MMCR) suffered a component failure on the fourth day of the cruise.

A time series from the microwave radiometer is shown in Figure 22. The middle panel shows the integrated liquid water path (LWP) of the stratus clouds. The peak early in the evening (0300 UTC) corresponds to light drizzle observed on the ceilometer (lower dots in Figure 20). Note that LWP declines steadily after sunrise (345.45 GMT) except for the blip associated with the scud cloud at 2000 GMT.

The scanning C-band (5 cm wavelength) Doppler radar ran continuously recording large volumes of data (no examples shown here). The wind profiler operates at 33 cm wavelength where it is sensitive enough to detect returns from turbulent variations in radar refractive index, principally associated with gradients in atmospheric moisture; it is also sensitive to precipitation. Sensitivity to moisture gradients causes the marine inversion to show up clearly as the band at 1.3 km. Both of these factors cause improved height performance in stormy conditions. The winds are shown in Figure 23 as a standard meteorological wind bard plot (time going right to left). Winds in the boundary layer are predominately from the SE.

### 3. Cruise Summary Results

#### *a. Basic Time Series*

The ship track for the entire cruise is shown in Figure 24. The 5-min resolution time series for sea and air temperature are shown in Figure 25 and for wind speed and N/E components in Figure 26. The change in conditions for the first day of the record is associated with the run southwest from Arica, Chile, to the DART buoy at 20 S. The near-surface sea-air temperature is near zero in the vicinity of the WHOI buoy; this is consistent with the buoy climatology for December. The mean diurnal cycle for the wind components (Figure 27) shows a weak diurnal variation with a minimum near 1300L - 1500L. There is also a weak semidiurnal cycle (atmospheric tide?) in the wind and air temperature variables. Primarily because of the healthy wind speeds (about 8 m/s), there is only a small diurnal signal (0.15 C) in the sea surface temperature. Time series for flux quantities are shown as daily averages. Figure 28 gives the flux components and Figure 29 the cloud forcing for net surface radiative fluxes. Cloud forcing is the difference between the measured radiative flux and that expected if there were no clouds. It is essentially a measure of the effect of clouds on the energy budget of the ocean. A negative cloud forcing implies the cloud cools the ocean (e.g., by reflecting solar flux).

The diurnal cycle of cloudiness (i.e., thinning or clearing after local noon) at 20 S leads to fairly large values of net heat flux and solar flux at 20 S; afternoon clearing leads to a much greater 24-hr average solar flux. Just for amusement, bulk meteorological variables and turbulent heat fluxes are shown for the transect from 70 W to 90 W along 20 S in Figure 30. This shows the winds increasing gradually away from the coast and a minimum in latent heat flux at 80 W. The return transect was taken at an angle towards Valparaiso, Chile (see Figure 31). The W to E transect looks similar initially, but in the second half colder water is encountered nearing the coast versus warmer water near the coast in Figure 30. The coastal jet is apparent as the 12.5 m/s peak in the wind speed at about 74 W.

#### *b. Boundary Layer and Cloud Properties*

Beginning on December 6 and ending on December 22 we completed 75 successful rawinsonde launches. While at the WHOI buoy sondes were done 6 times daily; otherwise, they were done 4 times daily. A time-height color contour plot of potential temperature is shown in the upper panel of Figure 32; the lower panel shows the relative

humidity. A pronounced temperature inversion is evident at approximately 1.7-2.5 km. This inversion defines the boundary layer (BL) depth, which is initially about 1.7 km but on day 347 (Dec. 12) begins to increase and reaches 2.5 km by day 353 (Dec. 18). The large scale moisture feature evident in the RH plot at 23 km in the beginning of the record descends steadily to 5 km by December 18. This descent rate is consistent with a divergence of about  $1.0\text{E-}6 \text{ s}^{-1}$ . The time series of wind speed and direction are shown in Figure 33. The winds are consistent with climatology, with southeasterlies prevailing within the boundary layer and westerlies aloft. The nominal height for the transition from westerlies to easterlies descended steadily during the experiment in coincidence with the moisture transition described above.

The time series of cloud base height from the ceilometer is shown in Figure 34. Throughout the cruise the ceilometer was giving a fault code indicating optical feedback in the detection loop. This indicates a deterioration of the optical fiber that carries the signal to the detector. Thus, the ceilometer was operating at reduced sensitivity, especially during daytime when sunlight contaminates the detection of clouds. As a result, the ceilometer did not detect many clouds particularly the higher cloud bases later in the cruise; when clouds are detected, the cloud base height is accurate. The increase in cloud base height after 344 is consistent with the increase with inversion height. The time series of data from the microwave radiometer is shown in Figure 35. The microwave radiometers are calibrated using a tipcal process that requires clear skies. This was done repeatedly in port, but after day 340 sky conditions did not permit new tipcals. Judging from the near-zero liquid water contents during limited periods with skies clear directly overhead, it appears that the calibration may have drifted to a positive bias later in the cruise. This will be evaluated in the future.

#### **4. Intercomparisons**

Intercomparisons are a key strategy in data quality assurance for the climate reference buoys and the use of research vessel measurements for climate-quality data archives. The ETL flux system is intended to produce measurements of turbulent flux bulk variables and radiative fluxes that have the required accuracy for climate research. For this cruise, a set of intercomparisons was done for bulk meteorology and radiative fluxes.

\*The ETL flux system acquired all relevant ship IMET-based measurements.

\*ETL and ship radiative fluxes were compared with the WHOI buoy (sitting on the deck) and an array of IMET radiative sensors (mounted in an array on the 03 deck).

\*A carefully executed set of psychrometer measurements was taken regularly during the cruise as a reference for air temperature and humidity.

\*Direct measurements of turbulent fluxes from the ETL system were compared with bulk fluxes for the cruise.

##### *a. ETL-Ship Comparisons*

We compared ETL and ship measurements for wind speed and direction, water and air temperature, relative humidity, and solar and IR downward radiative flux. All measurements agreed within the accuracy required for flux evaluations. The ship wind

system does experience flow blockage by the jackstaff for relative winds from the starboard side. One ship solar flux sensor read 4% higher than ETL. A second sensor was deployed for one day and it agreed with the ETL values within 1%. A detailed analysis will be done later.

*b. Psychrometer Comparisons*

As in some previous cruises, the accuracy of our Vaisala temperature and humidity measurements was checked against a hand-held Assman psychrometer. About 5 times throughout the day, when the wind was within  $\pm 90^\circ$  of dead ahead, the Assman wet and dry bulb temperatures were sampled through either port or starboard chocks on the foredeck. These locations were adopted on earlier cruises, rather than over the bow itself, because they offer shading of the thermometers from the sun. The chocks are at a height of approximately 9 meters above the sea surface, compared with 15m for the Vaisala. These are spot values to be compared with our standard 5-minute averages, so some scatter is expected, but averaged over the cruise the comparison should be valid.

The CSIRO Assman is normally used for these measurements because its thermometers have been calibrated, but its ventilation motor broke its spring early in the cruise. An ETL Assman on board has therefore been used for the remainder of the cruise, after comparing the thermometers from the two instruments in a water bath. This indicated that a slight ( $-0.1^\circ\text{C}$ ) correction was needed to both ETL thermometers. The comparison will be repeated more carefully at the end of the cruise, and the cruise-long data set re-calculated with all necessary corrections.

ETL, ship, and psychrometer values were compared for air temperature and specific humidity. The 9-meter psychrometer values were corrected to 15 m using similarity theory (based on the measured fluxes). The average correction was  $-0.01\text{ C}$  for temperature and  $-0.10\text{ g/kg}$  for humidity. The results for 79 samples are shown as scatter plots in Figures 36 and 37; means are summarized in the table of mean values and standard deviations of differences given below:

|                                | Mean ETL | Mean Ship | Mean Psy | Ensemble     | $\sigma(\text{ETL-ship})$ | $\sigma(\text{ETL-Psy})$ |
|--------------------------------|----------|-----------|----------|--------------|---------------------------|--------------------------|
| $T_{\text{air}}\text{ (C)}$    | 19.22    | 19.13     | 19.28    | <b>19.21</b> | 0.094                     | 0.23                     |
| $Q_{\text{air}}\text{ (g/kg)}$ | 10.07    | 10.00     | 9.97     | <b>10.01</b> | 0.090                     | 0.23                     |

The differences ( $0.09\text{ C}$  and  $0.07\text{ g/kg}$ ) in ETL and ship values are too small to be resolved by the psychrometer (accurate on average to  $0.1\text{ C}$  and  $0.1\text{ g/kg}$ ). All three sensors are within required accuracy ( $0.1\text{ C}$  or  $\text{g/kg}$ ) of the ensemble mean. To give a sense of the quality of the comparisons, the time series for specific humidity is shown with the ETL, ship, and Psychrometric values (Figure 38).

### *c. Direct Versus Bulk Flux Algorithm Comparisons*

ETL direct fluxes were computed using our standard software for motion corrections. This is a preliminary analysis; more detailed evaluation will be done in the future. Some 210 hourly values that passed screening criteria for the period 340-352 were used (Figure 39). The bulk algorithm (COARE model version 3.0) agreed well on average for sensible, latent, and momentum fluxes. Agreement was better than for many past cruises. Direct and bulk fluxes were compared by averaging in wind speed bins. Figure 39 shows the results for the stratus04 cruise where means and medians are compared. Direct latent heat flux in this case is the average of OPHIR hygrometer covariance, OPHIR hygrometer inertial-dissipation, and Licor-7500 hygrometer covariance values. These same values are shown as an x-y scatter plot in Figure 40. Overall agreement for total mean/median latent heat flux is within 5%.

## **5. ETL Data Cruise Archive**

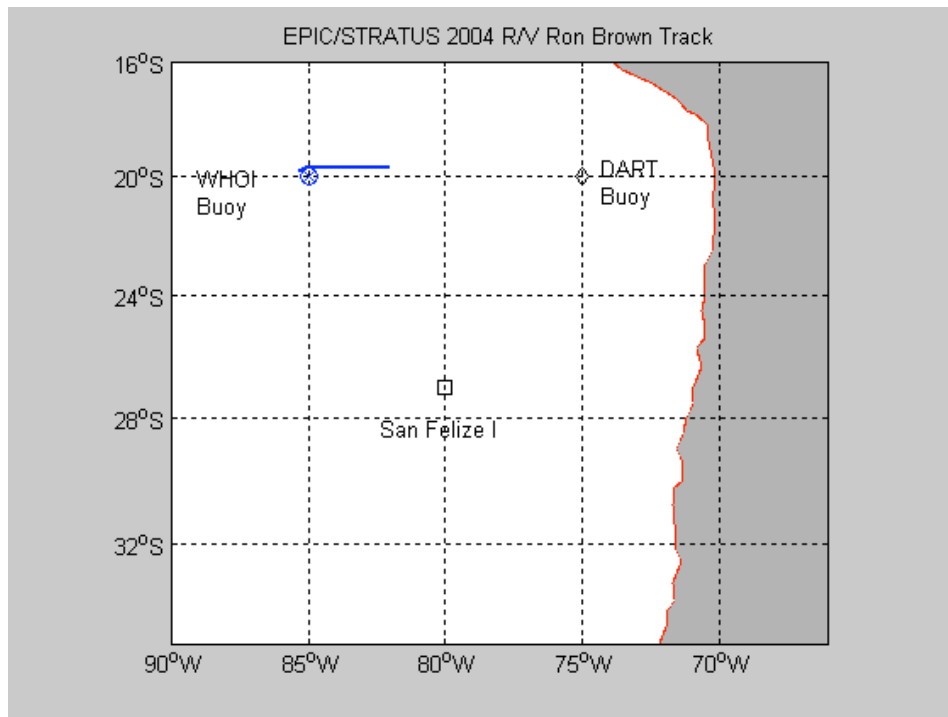
Selected data products and some raw data were made available at the end of the cruise for the joint cruise archive. Some systems (radar, turbulence, microwave radiometer) generate too extravagantly to be practical to share. Compared to processed information, the raw data is of little use for most people. For the cloud radar and the C-band radar we have made available image files only; full digital data will be available later from the ETL website. For the microwave radiometer, the time series after some processing and averaging is given. No direct turbulent flux information is provided; that will be available after re-processing is done back in Boulder. However, bulk fluxes are available in the flux summary file

### Data Archive Directories

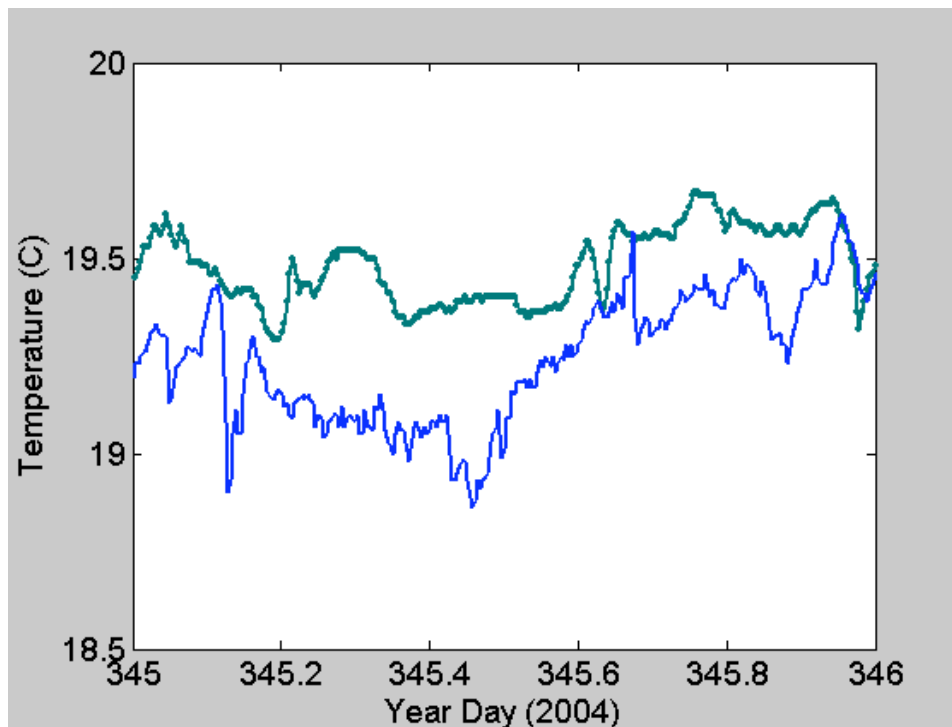
|           |   |
|-----------|---|
| Ceilo     | Ceilorimeter files (processed file, images)                                       |
| Flux      | Air-sea flux files (processed flux files: daily files, cruise file, some m-files) |
| Sondes    | Rawinsonde files (.EDT)   |
| Microw    | Microwave radiometer files (processed files; graphic display)                     |
| Radar     | Image files from cloud radar  |
| Reports   | Documentation (cruise report, summary image files)                                |
| UProf     | Image and data files from the wind profiler                                       |
| Pics      | Powerpoint files of sky pictures  |
| UMFMCW    | Image files from U. Miami 94-GHz FMCW cloud radar.                                |
| Satellite | Image files from the Terrascan satellite receiver                                 |

### Contact for ETL Questions:

C. Fairall  
NOAA Environmental Technology Laboratory  
325 Broadway  
Boulder, CO USA 80305  
303-497-3253  
chris.fairall@noaa.gov

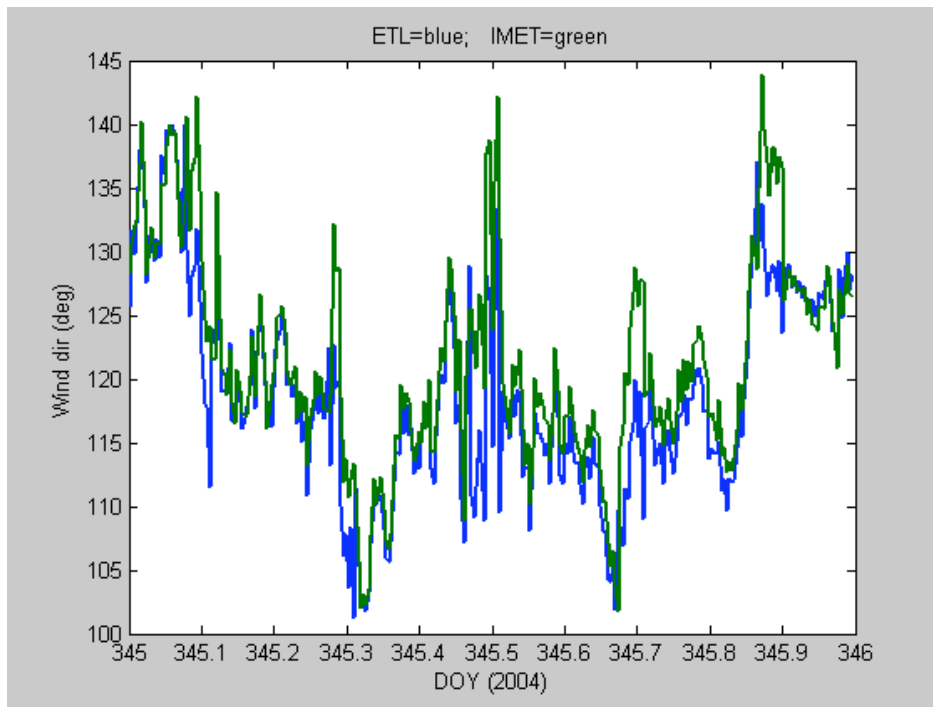


**Figure 12. Cruise track for RBH on December 10 (DOY 345).**

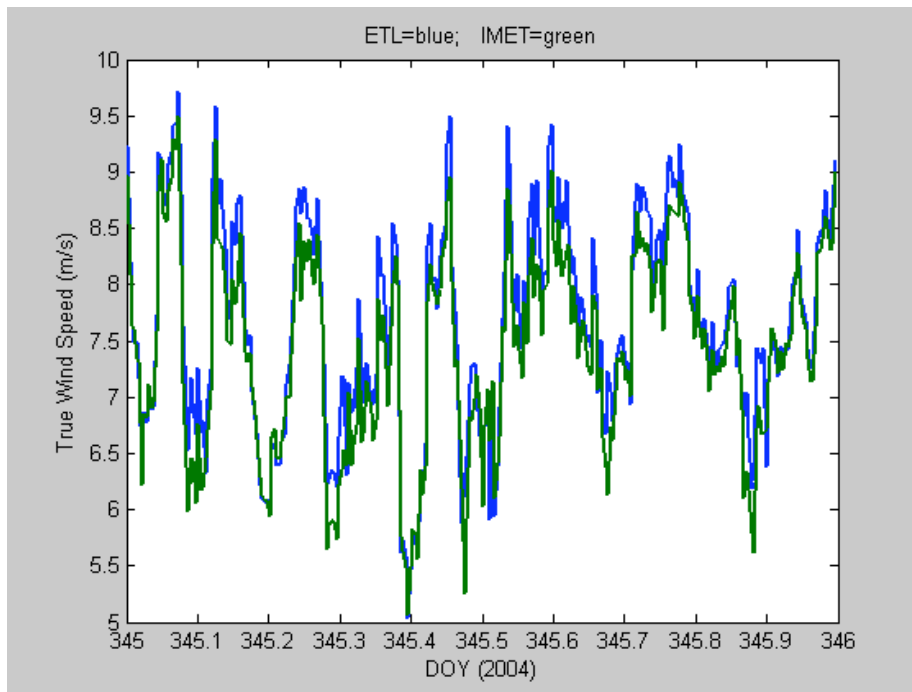


**Figure 13. Time series of near-surface ocean temperature (green) and 15-m air temperature (blue) for December 10th.**

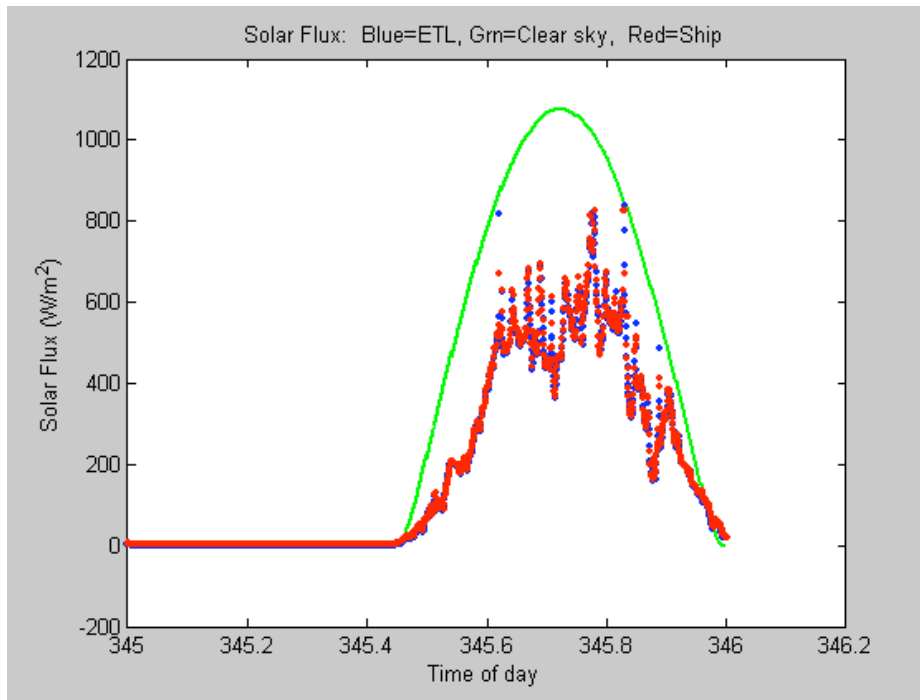




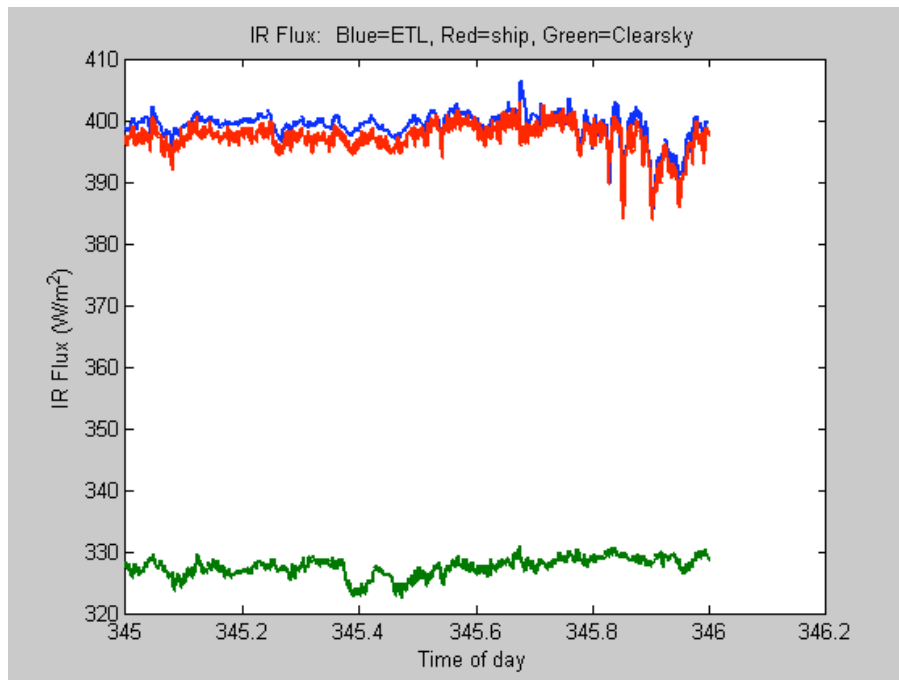
**Figure 14: True wind direction from the ETL sonic anemometer (18 m) and the IMET prop/vane (15 m).**



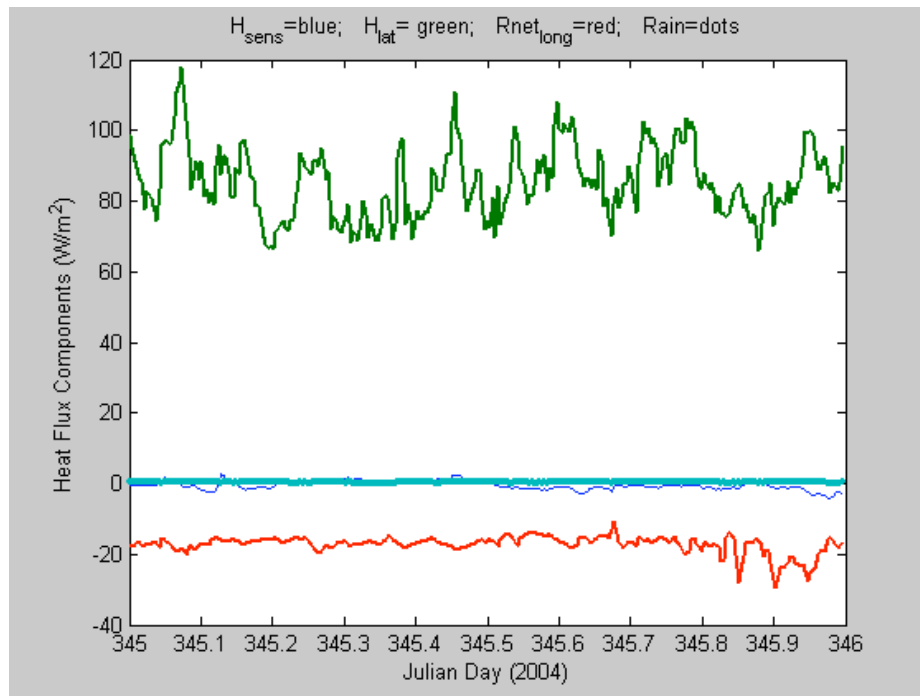
**Figure 15: True wind speed from the ETL sonic anemometer (18 m) and the ship's prop/vane (15 m).**



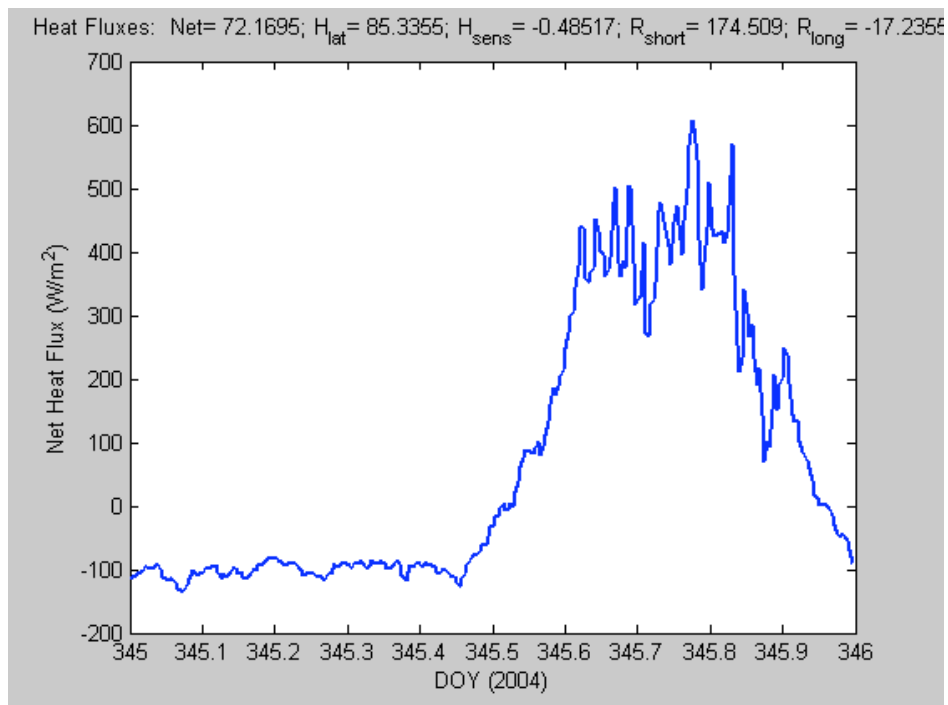
**Figure 16: Time series of downward solar flux from ETL and ship Eppley sensors. The green line is a model of the expected clear sky value.**



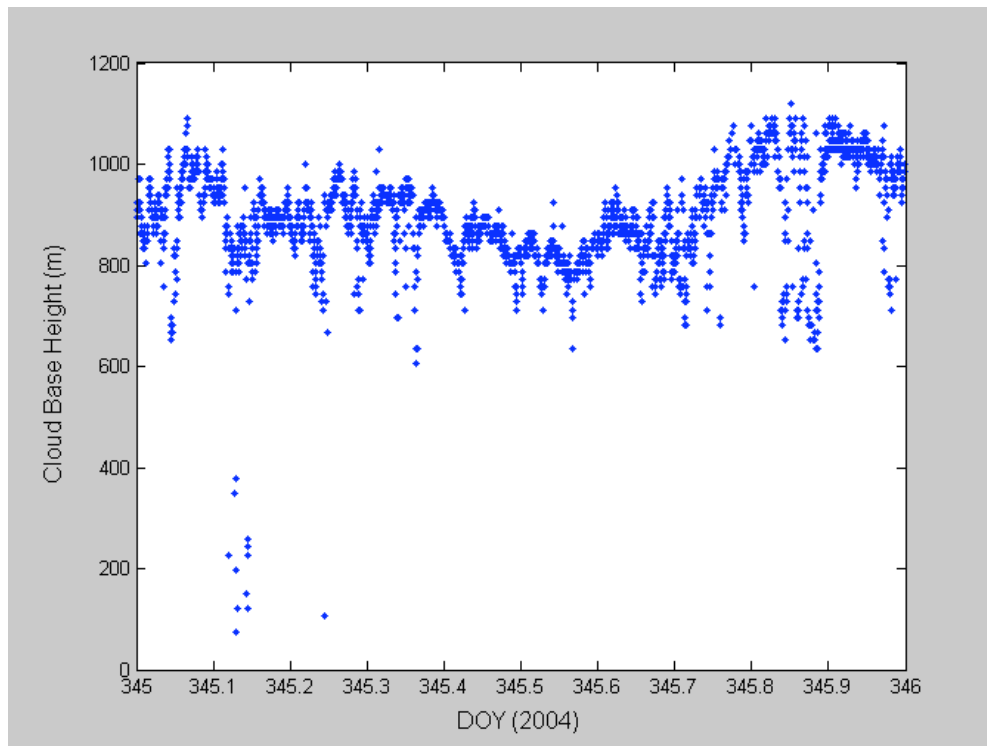
**Figure 17: Time series of downward IR flux from ETL and ship Eppley sensors. The green line is a model of the expected clear sky value.**



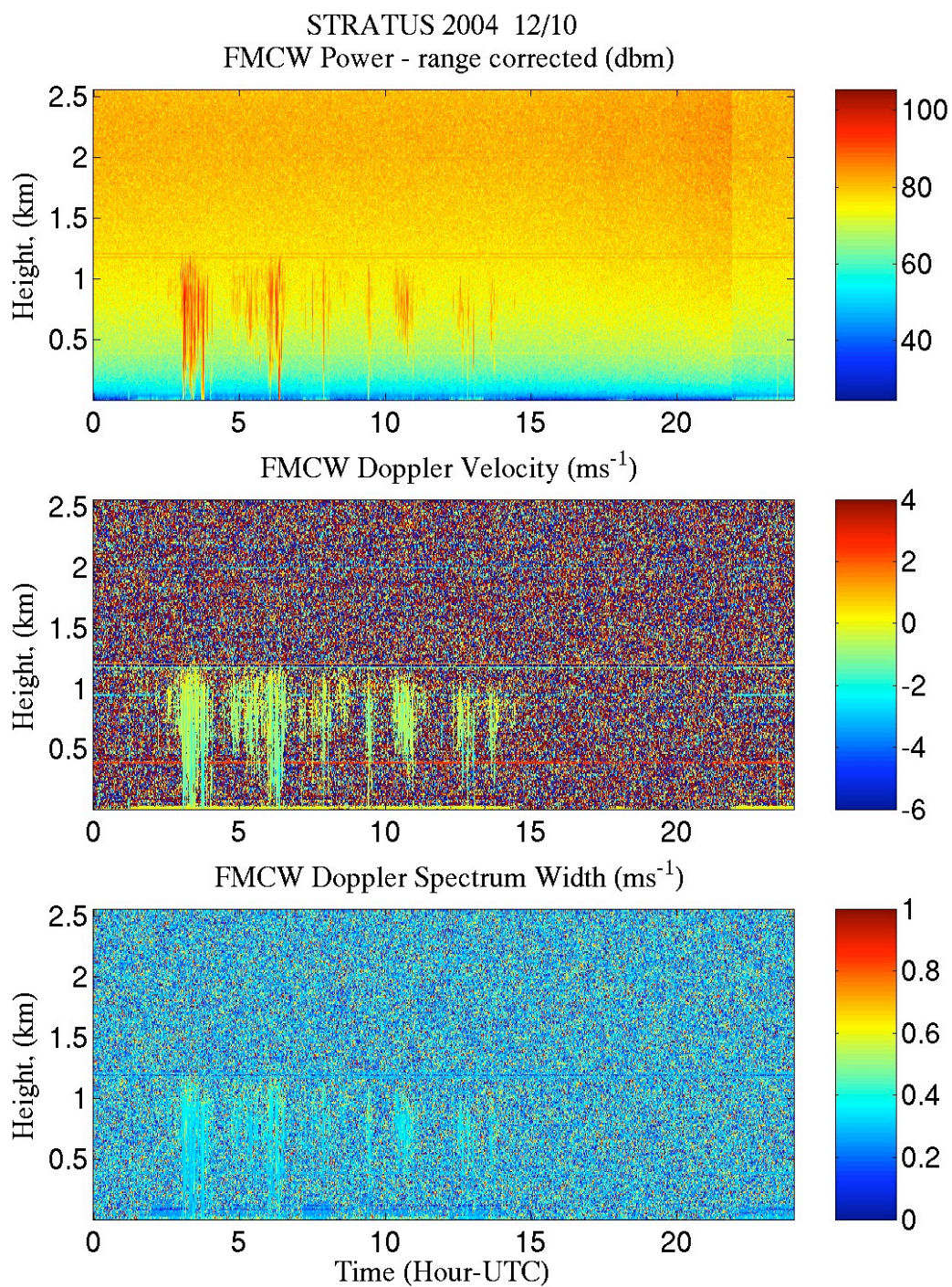
**Figure 18: Time series of non-solar surface heat flux components: sensible (blue), latent (green), and net IR (red).**



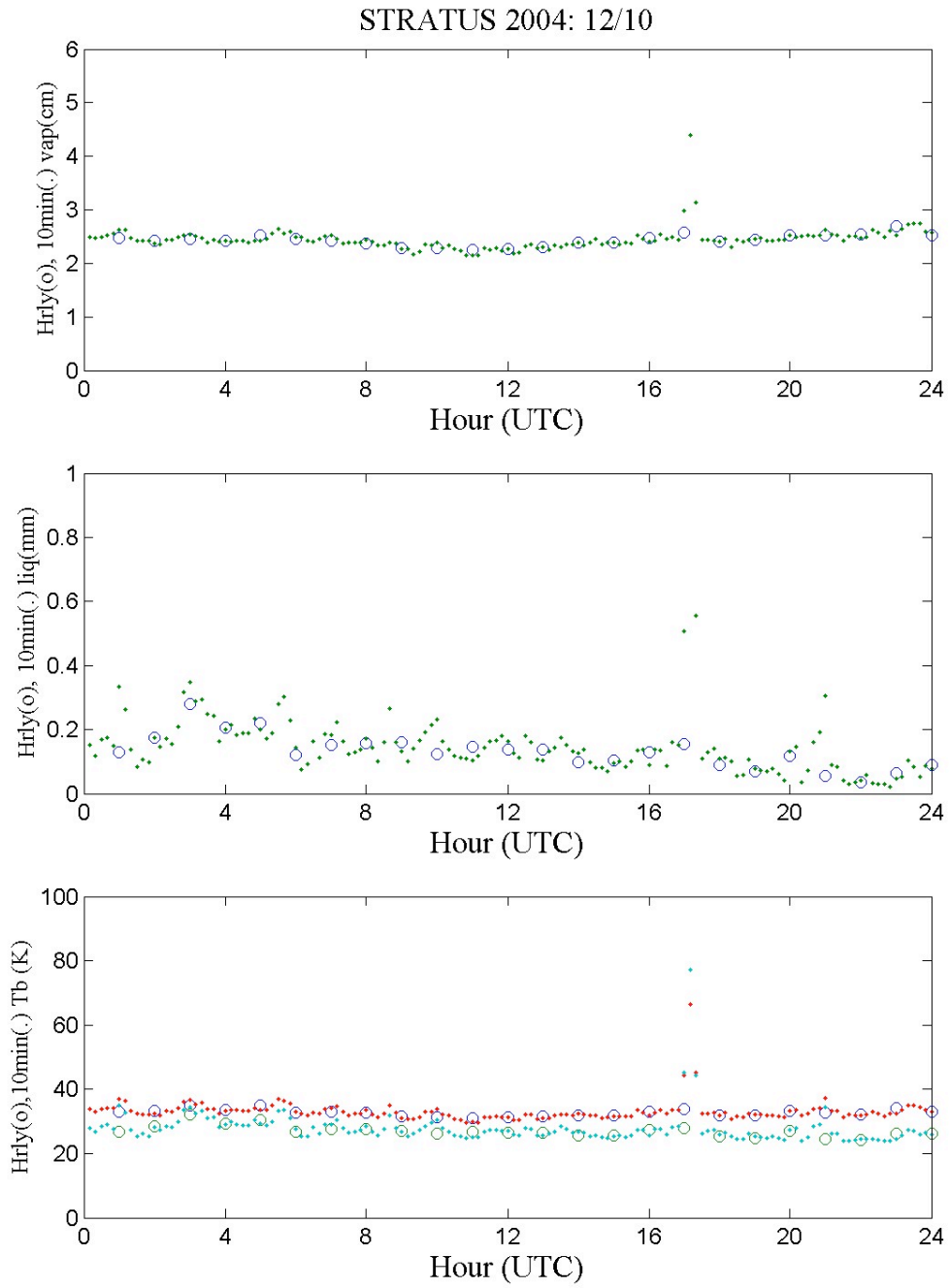
**Figure 19: Time series of net heat flux to the ocean surface. The values at the top of the graph are the average for the day.**



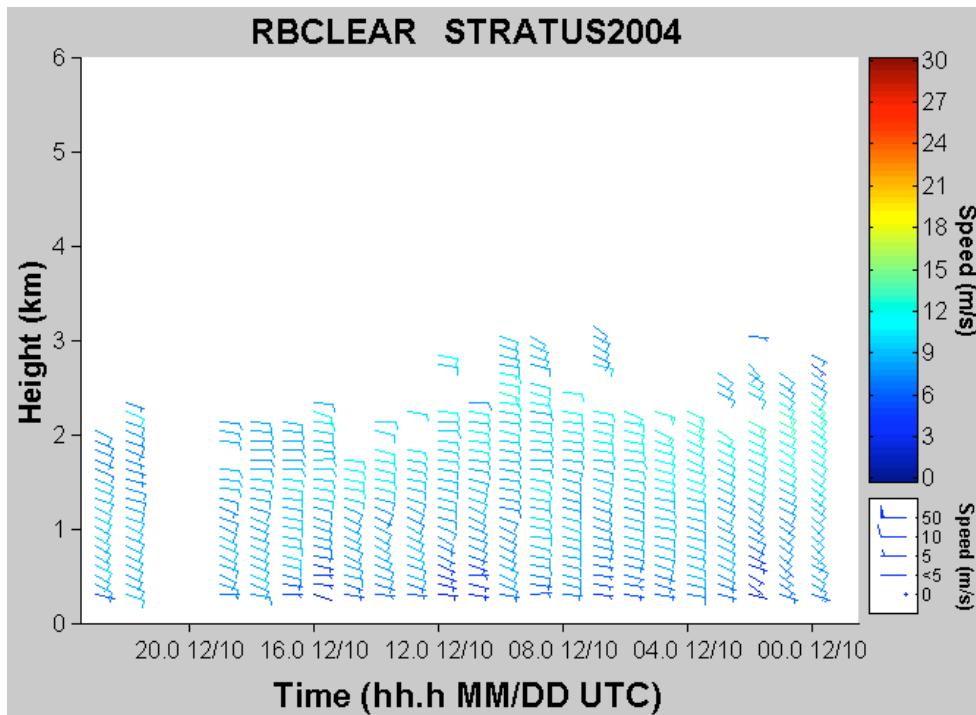
**Figure 20: Cloud-base height information extracted from the ceilometer backscatter information**



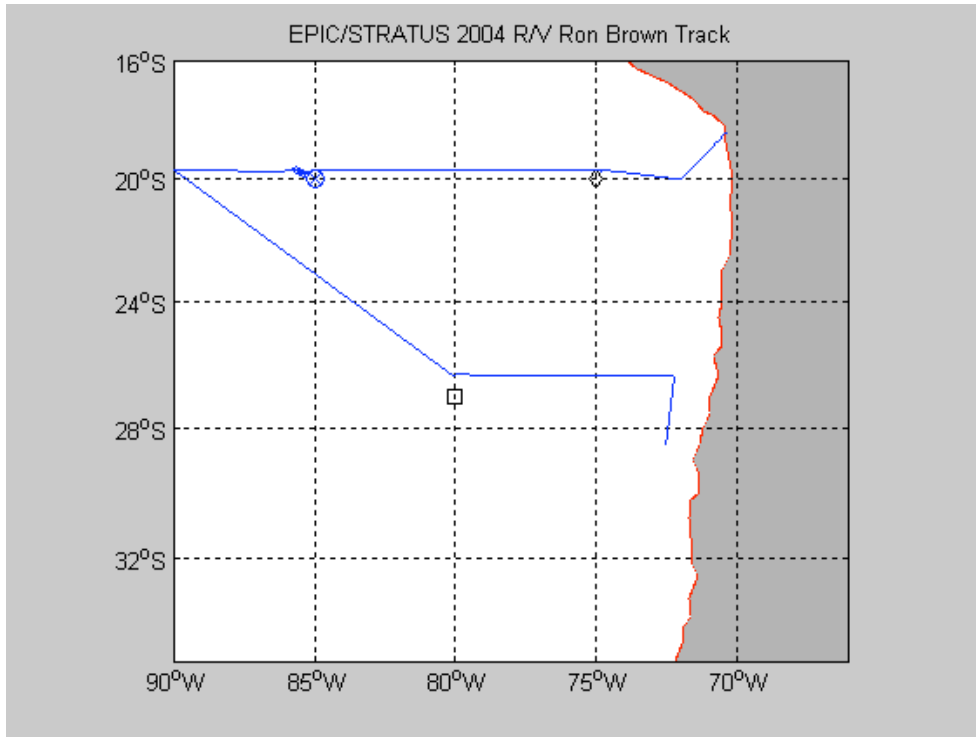
**Figure 21: Time-height cross-section data from the 94 GHz cloud radar for day 345 (December 10, 2004): upper panel, backscatter intensity; middle panel, mean Doppler vertical velocity; lower panel, Doppler width. The deep vertical streaks are drizzle.**



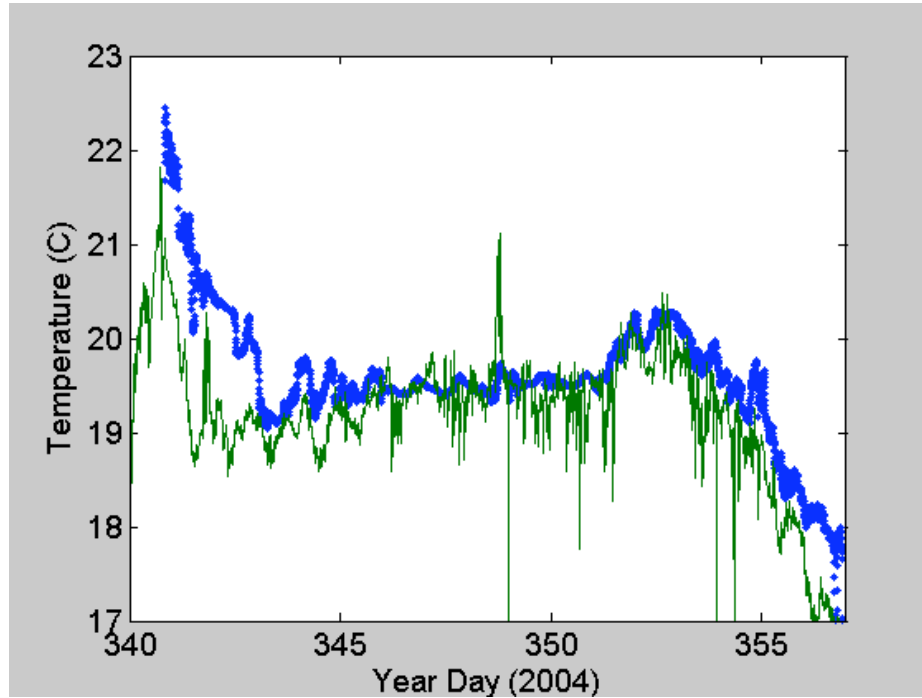
**Figure 22: Time series of data from the 3-channel microwave radiometer: upper panel, column water vapor; middle panel, column water liquid; lower panel, brightness temperatures at 21 GHz and 31 GHz.**



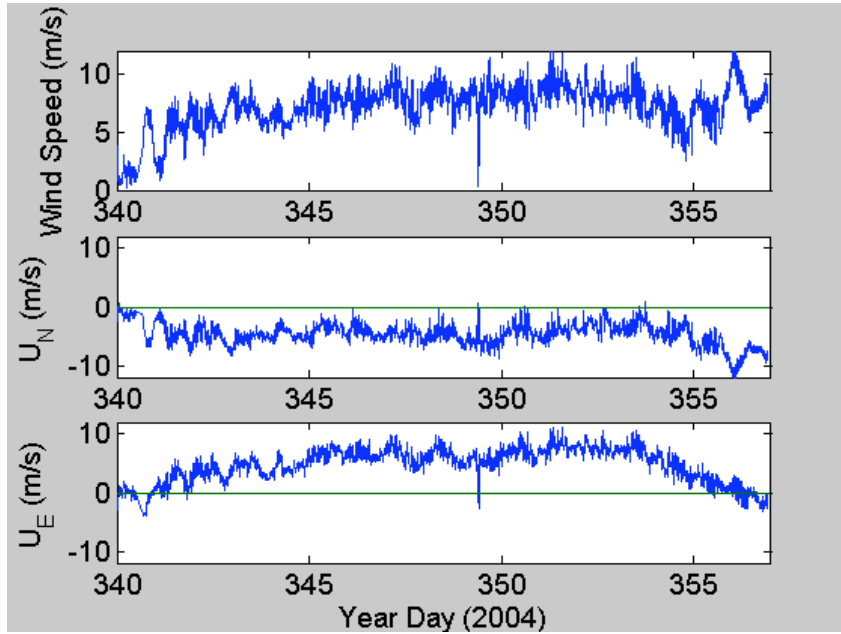
**Figure 23: Time-height cross-section of wind speed and direction for December 10th, 2004. Barb orientation gives wind direction; color gives wind speed.**



**Figure 24: Cruise track for the entire Stratus 2004 cruise**



**Figure 25: Time series of near-surface ocean temperature (blue) and 15m air temperature (green) for the Stratus 2004 cruise**



**Figure 26: Time series of wind speed (upper panel), northerly component (middle panel), and easterly component (lower panel) for the Stratus 2004 cruise**



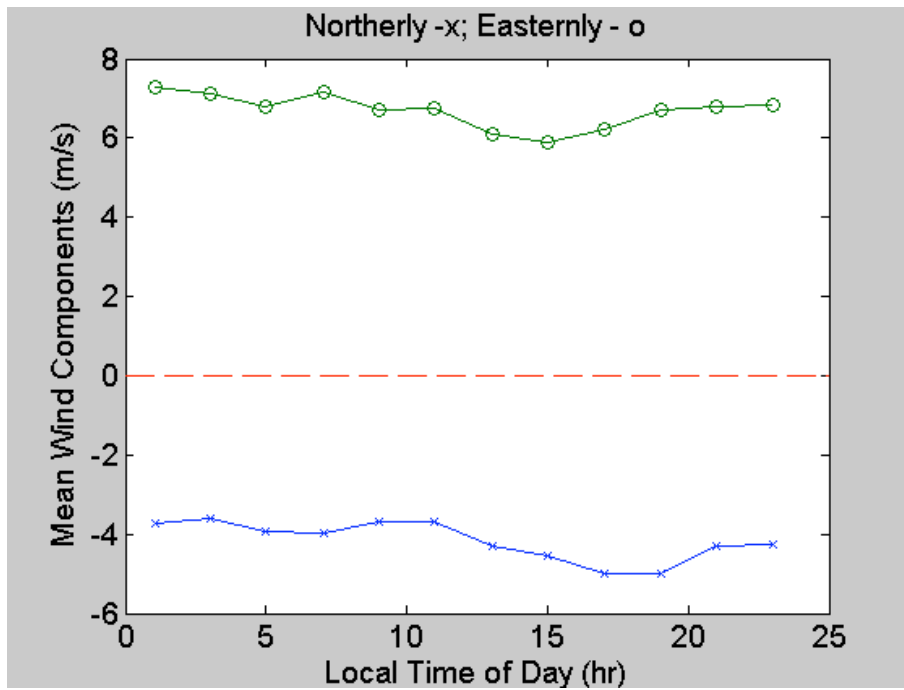


Figure 27: Diurnal average of northerly and easterly wind components for periods of the cruise near 20° S

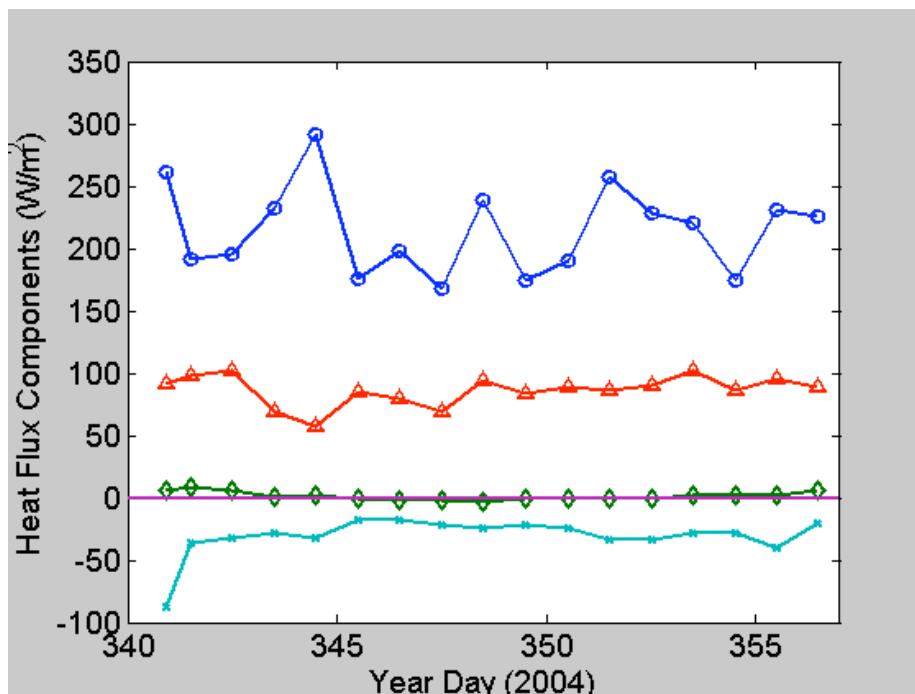
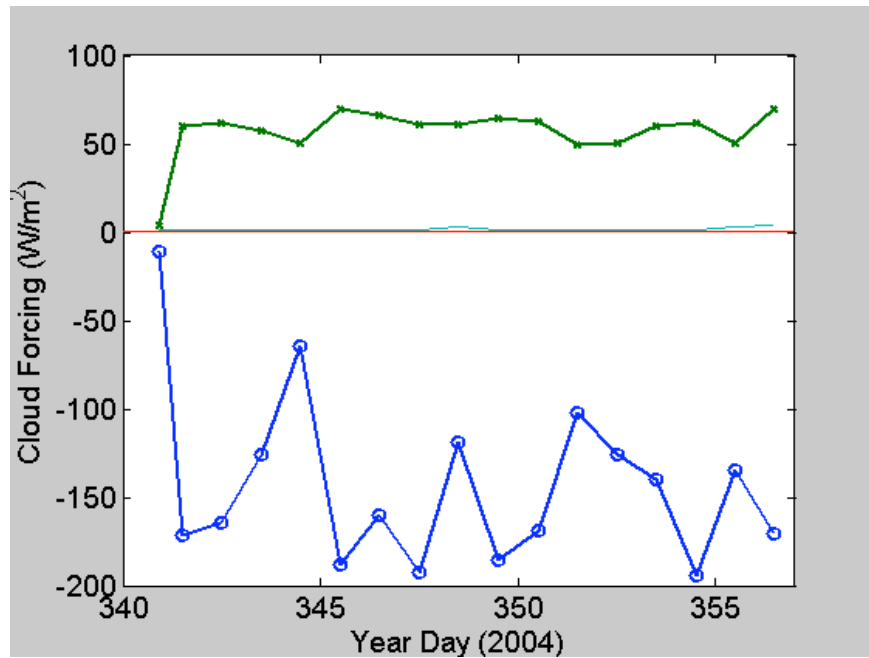
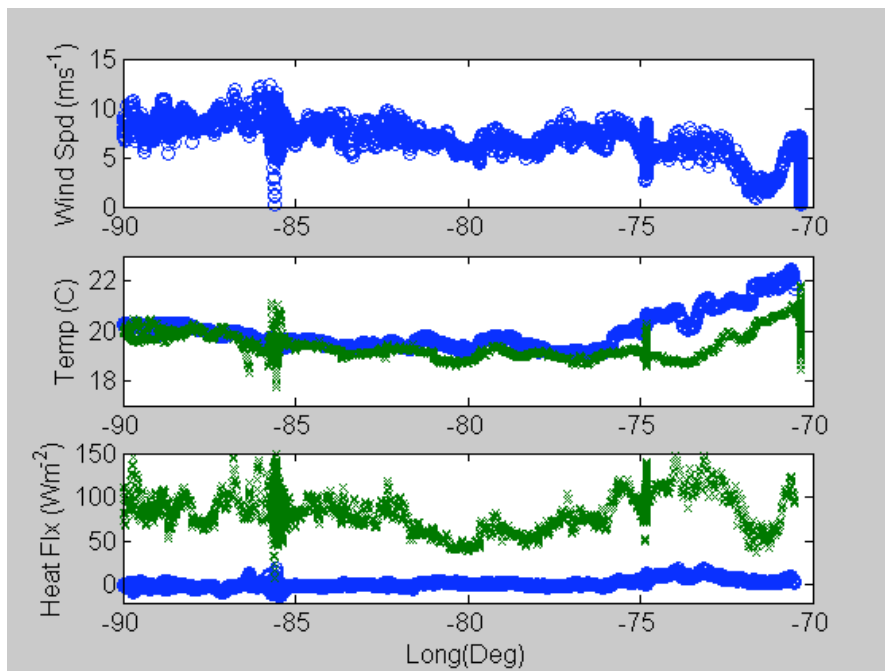


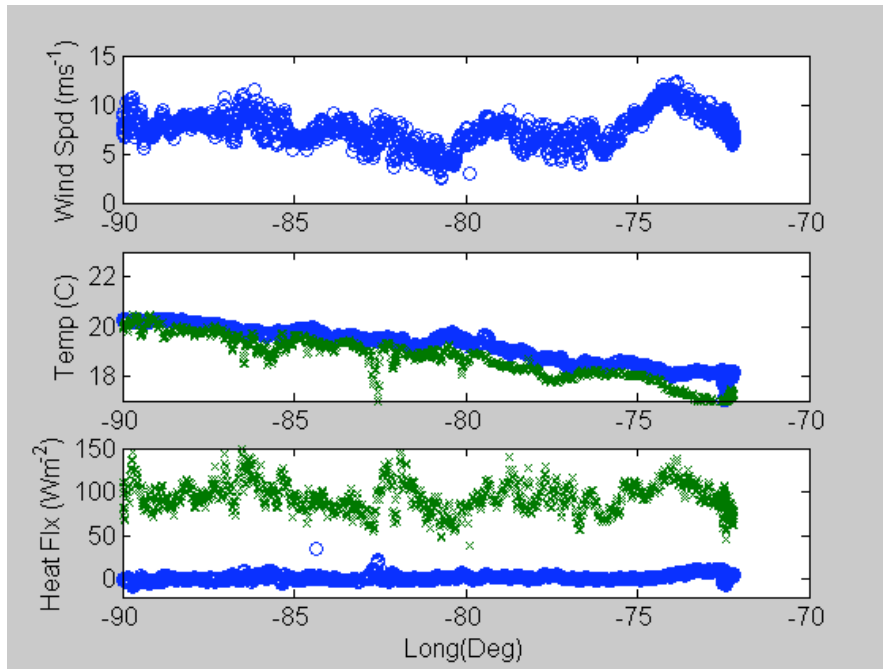
Figure 28: Time series of 24 hour average heat flux components: solar flux (circles), latent heat flux (triangles), sensible heat flux (diamonds), and net infrared flux (crosses)



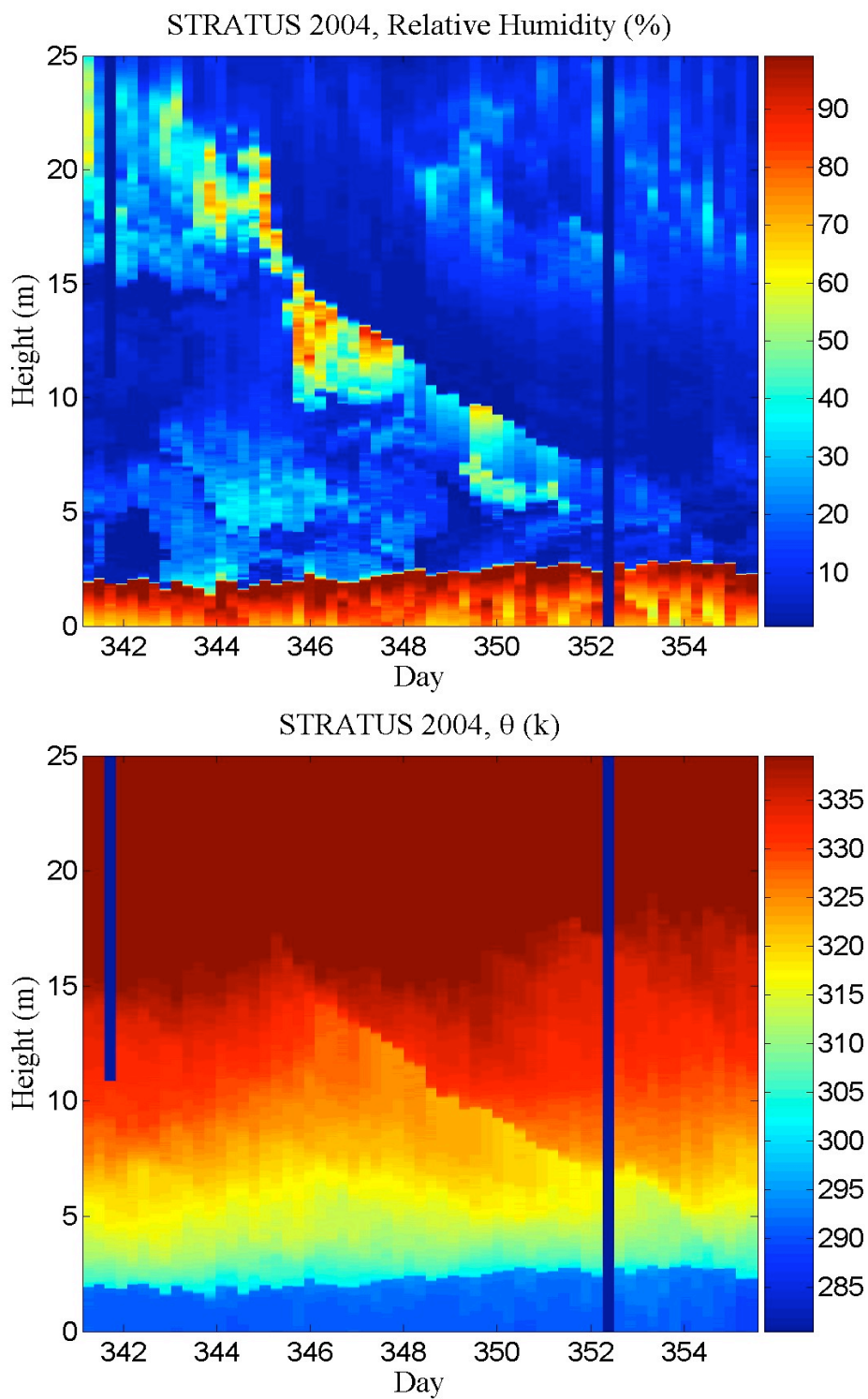
**Figure 29: Time series of daily averaged radiative cloud forcing: infrared cloud forcing (green), solar cloud forcing (blue)**



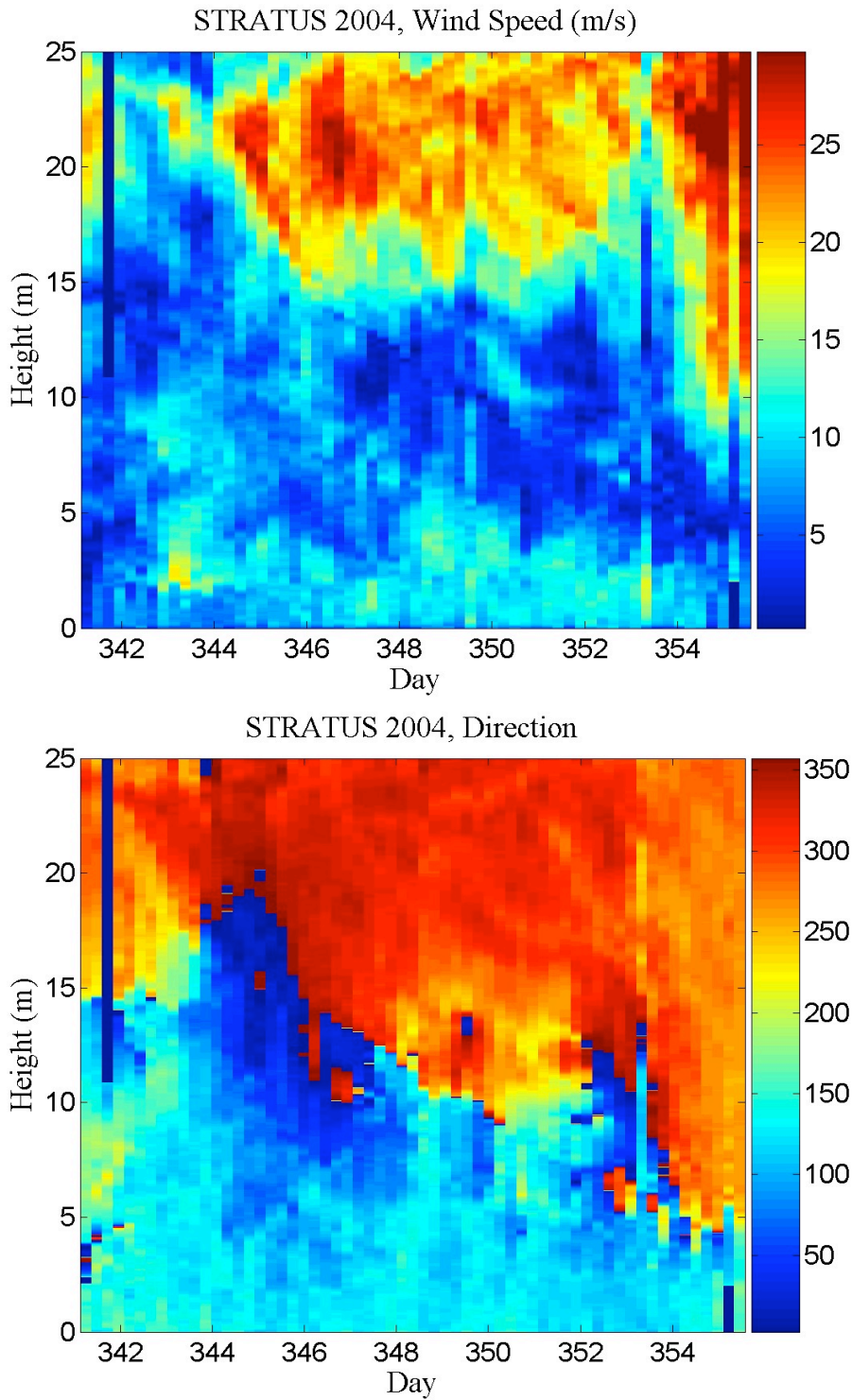
**Figure 30: Selected variables from the East-West transect along 20° S: upper panel, wind speed; middle panel, sea surface temperature (blue) and air temperature (green); lower panel, sensible (blue) and latent (green) heat fluxes**



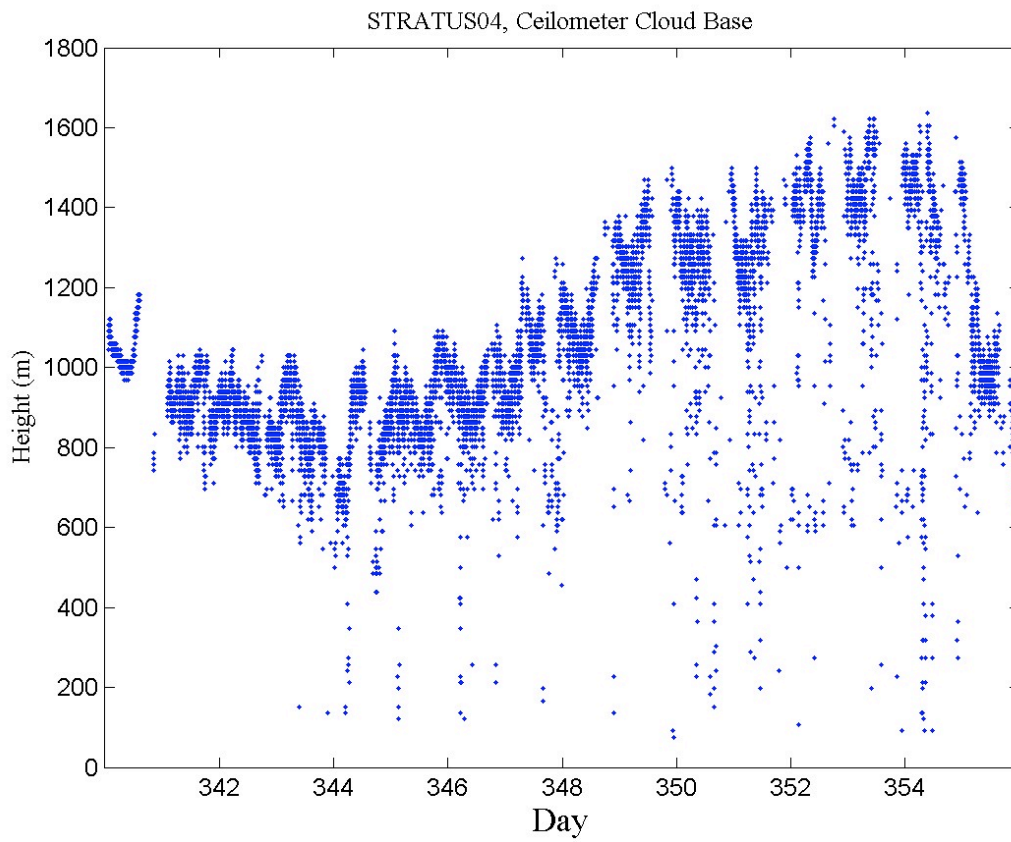
**Figure 31: Same as in figure 30, but for the West-East transect from 20° S, 90° W to 28° S, 72° W**



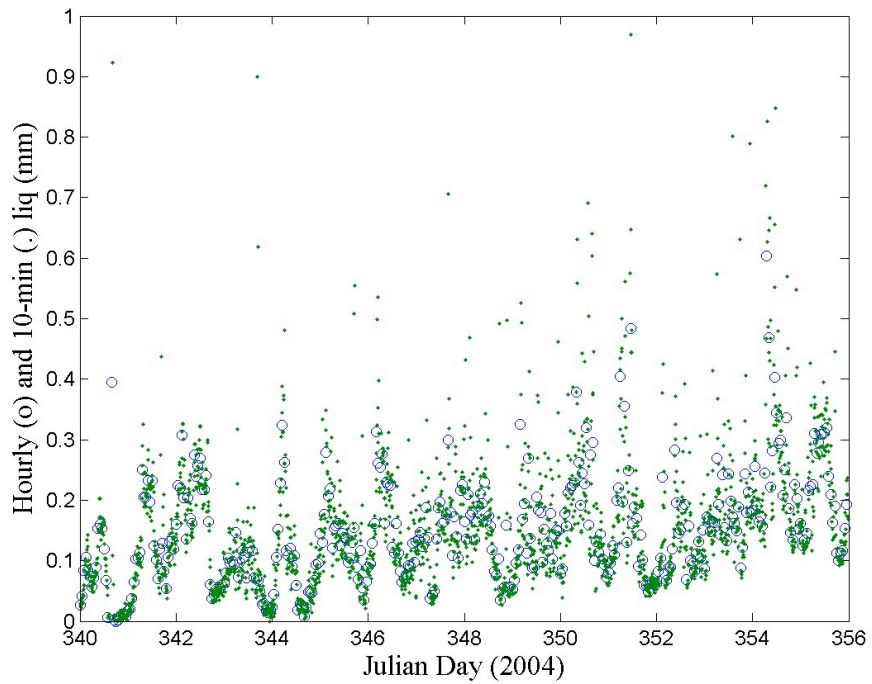
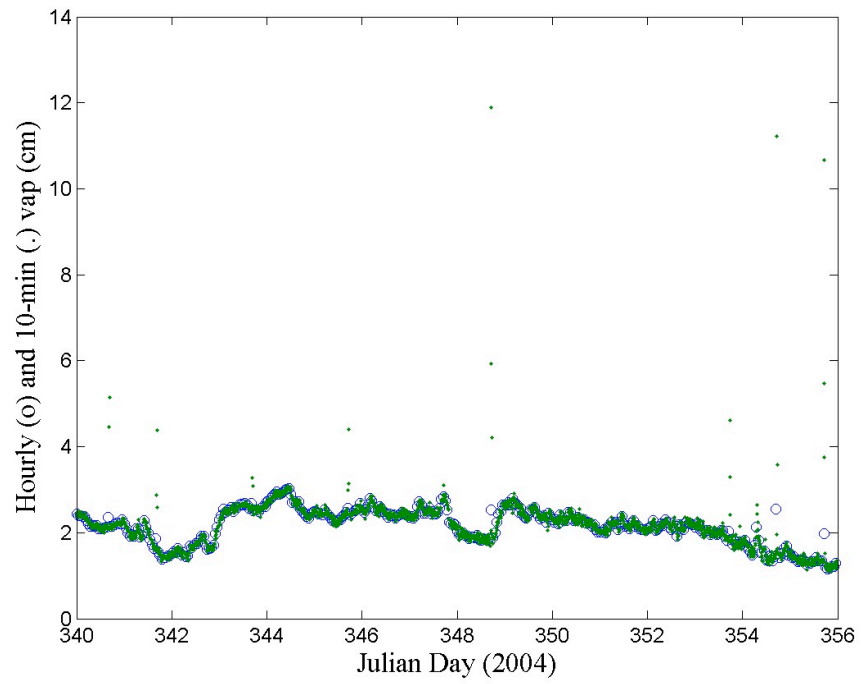
**Figure 32: Time-height color contour plots from rawinsondes launched during the Stratus 2004 cruise. The upper panel is potential temperature; the lower panel is relative humidity**



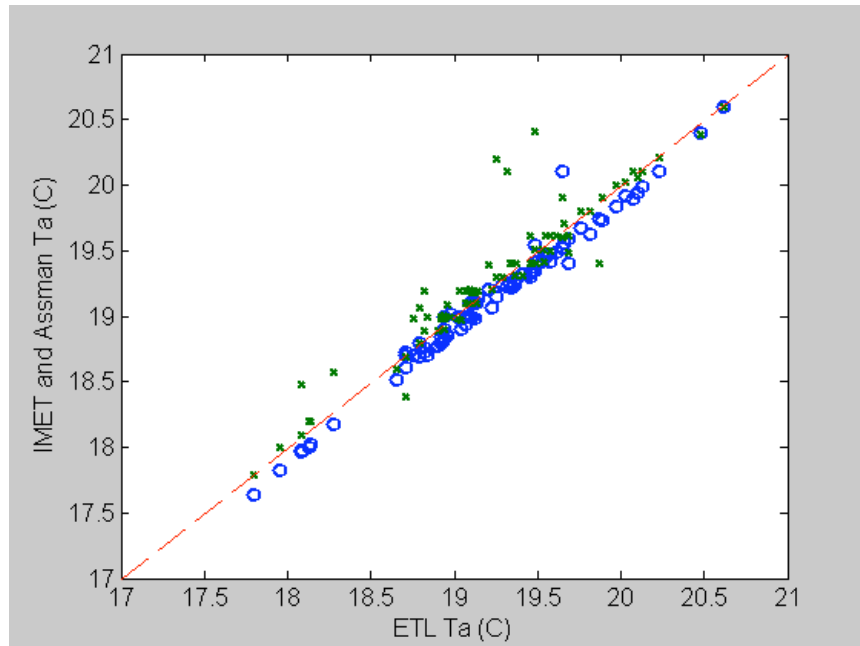
**Figure 33: As in figure 32, but upper panel is wind speed; lower panel is wind direction**



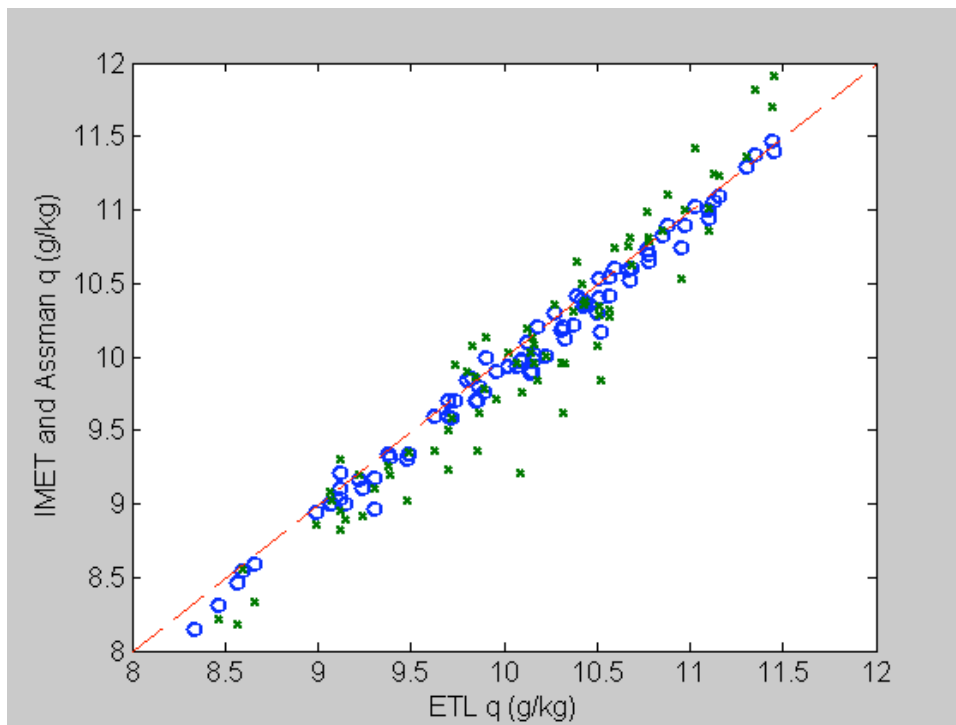
**Figure 34: Time series of low cloud base heights for the Stratus 2004 cruise**



**Figure 35: Time series of microwave radiometer derived values for column integrated water vapor (upper panel) and column integrated liquid water (lower panel)**

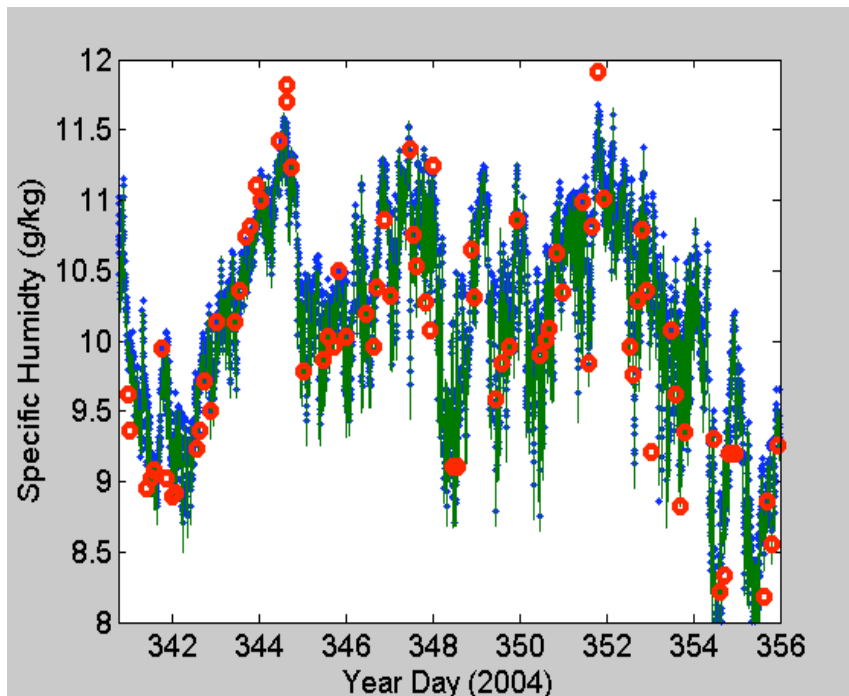


**Figure 36: Comparisons of simultaneous Assman psychrometer (cross) and ship (circle) readings for air temperature. Psychrometer values corrected to 15m (ETL and ship instrument height)**

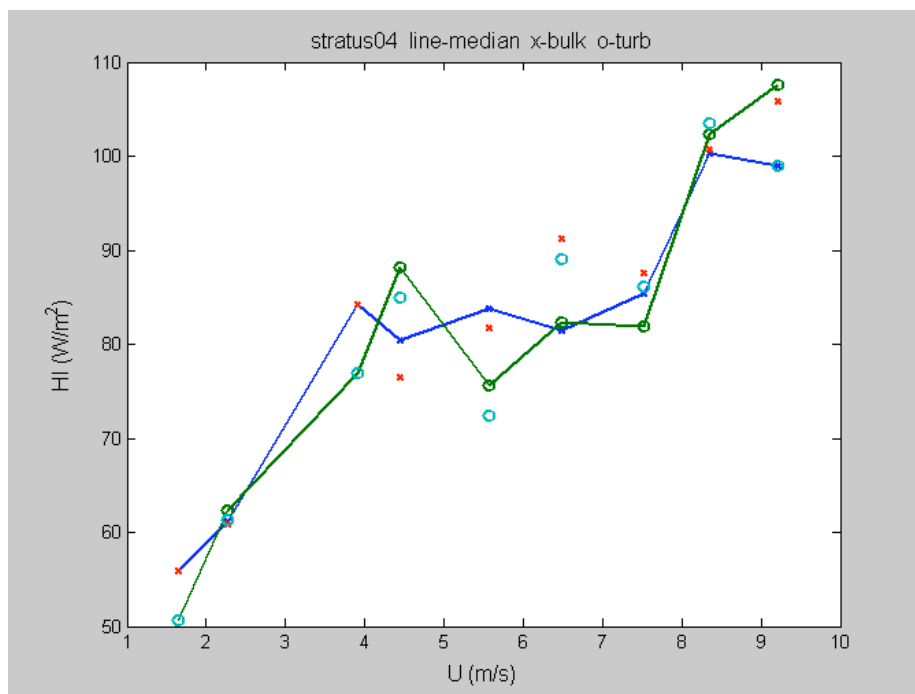


**Figure 37: As in figure 36, but for specific humidity**

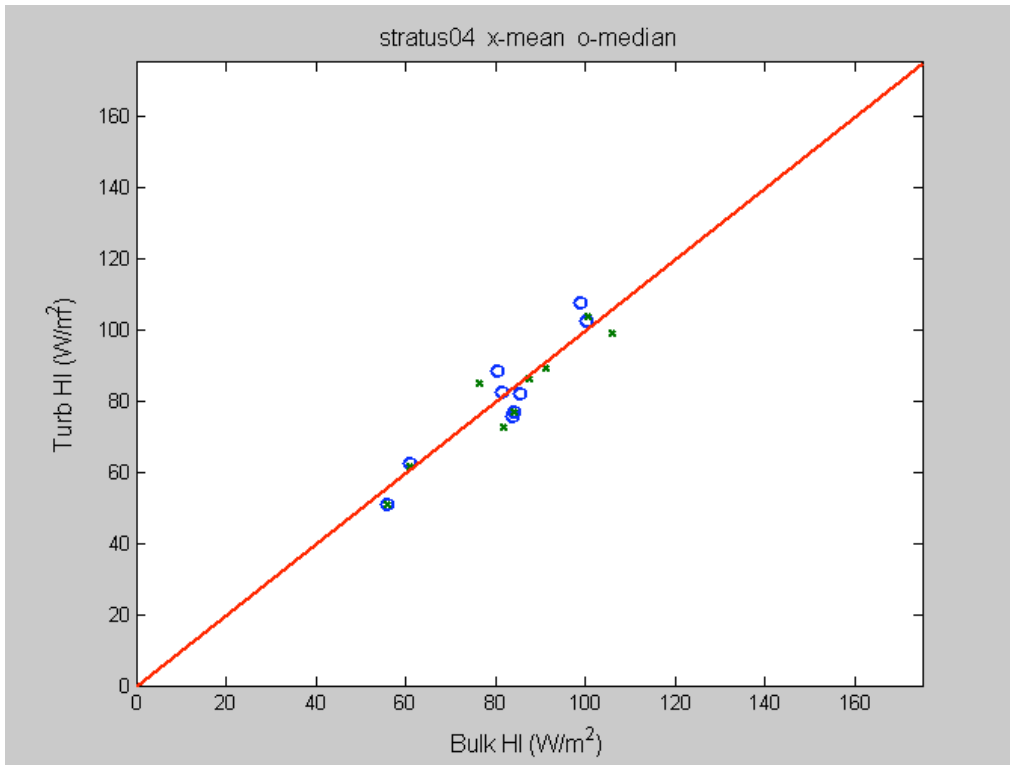




**Figure 38: Time series of specific humidity for the Stratus 2004 cruise: ETL (blue), ship (green), corrected psychrometer (red)**



**Figure 39: Latent heat flux averaged in wind speed bins for the Stratus 2004 cruise: bulk values (cross), direct values (circle). Symbols with lines are medians; symbols without lines are means**



**Figure 40: Average bulk latent heat flux vs. direct values for wind speeds between 0 and 10 m/s during the Stratus 2004 cruise: mean values (cross), median values (circle)**

## VI. ADDITIONAL CRUISE ACTIVITIES

### A. Deployment of Drifters and Underway Watch

During the Stratus 2003 cruise, a 24-hour watch schedule was set up. Watch standers were responsible for updating the cruise log, deploying ARGO floats and surface drifters, assisting the ETL group with radiosonde deployments, and taking water temperature readings with a bucket thermometer.

The floats and drifters were deployed at specified locations. The ship was not stopped for deployments of the ARGO floats or surface drifters. Deployment details are given below in Tables 16 and 17.

**Table 17: Deployment times and locations for the ARGO floats**

| Float # | Self Test Date and Time (UTC) | Deployment Date and Time (UTC) | Latitude    | Longitude    |
|---------|-------------------------------|--------------------------------|-------------|--------------|
| 353     | 06 Dec 04, 09:00              | 17 Dec 04, 16:16               | 20 00.00' S | 89 30.85' W  |
| 345     | 17 Dec 04, 18:52              | 17 Dec 04, 00:43               | 21 00.20' S | 88 02.30' W  |
| 347     | 17 Dec 04, 18:52:30           | 18 Dec 04, 09:02               | 21 59.8' S  | 86 35.2' W   |
| 344     | 18 Dec 04, 14:41              | 18 Dec 04, 17:58               | 23 00.6' S  | 85 05.2' W   |
| 355     | 19 Dec 04, 10:40              | 19 Dec 04, 10:56               | 25 00.35' S | 82 05.96' W  |
| 356     | 19 Dec 04, 10:40              | 19 Dec 04, 19:22               | 25 59.91' S | 80 35.75' W  |
| 346     | 19 Dec 04, 14:49              | 20 Dec 04, 07:01               | 26 19.98' S | 78 05.157' W |
| 354     | 20 Dec 04, 11:37              | 20 Dec 04, 16:26               | 26 19.99' S | 75 59.30' W  |

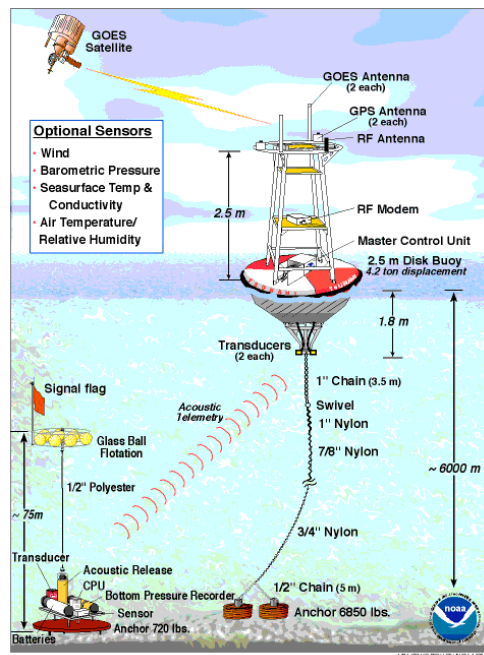
**Table 18: Deployment times and locations for the surface drifters**

| Drifter # | Date and Time (UTC) | Latitude     | Longitude    |
|-----------|---------------------|--------------|--------------|
| 44017     | 08 Dec 04, 19:14    | 19 40.010' S | 77 58.587' W |
| 44030     | 09 Dec 04, 20:56    | 19 39.990' S | 82 00.498' W |
| 44016     | 10 Dec 04, 07:26    | 19 40.061' S | 83 00.84' W  |
| 44020     | 10 Dec 04, 12:43    | 19 39.998' S | 83 43.440' W |
| 44015     | 10 Dec 04, 14:17    | 19 39.997' S | 83 59.645' W |
| 44025     | 10 Dec 04, 18:57    | 19 39.998' S | 84 40.24' W  |
| 44018     | 10 Dec 04, 21:41    | 19 40.068' S | 85 00.20' W  |
| 44019     | 17 Dec 04, 16:16    | 20 00.00' S  | 89 30.85' W  |
| 44021     | 17 Dec 04, 20:29    | 20 30.00' S  | 88 47.20' W  |
| 44023     | 18 Dec 04, 04:50    | 21 29.98' S  | 87 19.50' W  |
| 44029     | 18 Dec 04, 13:32    | 22 30.10' S  | 85 50.60' W  |
| 44026     | 18 Dec 04, 22:05    | 23 30.71' S  | 84 20.24' W  |
| 44034     | 19 Dec 04, 02:25    | 24 00.30' S  | 83 25.70' W  |
| 44022     | 19 Dec 04, 06:41    | 24 29.80' S  | 82 52.00' W  |
| 44024     | 19 Dec 04, 10:56    | 25 00.39' S  | 82 05.96' W  |

## B. SHOA DART Tsunami Buoy

The Hydrographic and Oceanographic Service (SHOA) made an effort to acquire and deploy a DART system (Deep-Ocean Assessment and Reporting of Tsunami) for its early tsunami detection and real-time reporting capability. Although seismic networks and coastal tide gauges are indispensable for assessing the hazard during an actual event, an improvement in the speed and accuracy of real-time forecasts of tsunami inundation for specific sites requires direct tsunami measurement between the source and a threatened community. Currently, only a network of real-time reporting, deep-ocean bottom pressure (BPR) stations can provide this capability.

Tsunamis can be highly directional. DART stations must be properly spaced to provide reliable estimates of the primary direction and magnitude of the energy propagation. A method for detector siting will consider various tradeoffs between early tsunami detection, adequate source zone coverage, and DART system survivability. A proposed network will be designed to provide adequate coverage of tsunamis originating in source regions that threaten Chile coastal communities: The Nazca Subduction Zone.



**Figure 41: Schematic of the DART mooring system**

The DART mooring system is illustrated in Figure 41. Each system consists of a seafloor BPR and a moored surface buoy with related electronics for real-time communications. The BPR uses a pressure transducer manufactured by Paroscientific, Inc., to make 15-second averaged measurements of the pressure exerted on it by the overlying water column. These transducers use a very thin quartz crystal beam, electrically induced to vibrate at their lowest resonant mode. In DART applications, the transducer is sensitive to

changes in wave height of less than a millimeter. An acoustic link is used to transmit data from the BPR on the seafloor to the surface buoy (Figure 42). The data are then relayed via a NOAA Geostationary Operational Environmental Satellite (GOES) satellite link to ground stations, which demodulate the signals for immediate dissemination to Sistema Nacional de Alarma de Maremotos (SNAM) in SHOA.

The buoy, installed on the ocean's surface establishes real-time communication with the GOES satellite. The system has two ways of reporting the information, one standard system and one warning system. The standard is the normal way of working by which four assessments of the ocean level, averaged every 15 minutes, are received every hour. When the internal software detects the generation of an event, a variation of more than 4 cm, the system stops the standard mode of operation and switches to the warning mode. While in warning mode, it submits average assessments every 15 seconds; these are forwarded for a few minutes during the first messages, then following are one-minute average messages for at least three hours if no other event is detected.

The DART (Deep-Ocean Assessment and Reporting of Tsunami) Project was created in order to efficiently and quickly confirm the generation of a potentially destructive tsunami, as well as to support the ongoing effort to develop and implement an early detection capability and real-time report of tsunamis in the deep ocean. This project was created as part of the National Tsunami Hazard Mitigation Program (NTHMP) of the United States.

The Hydrographic and Oceanographic Service of the Navy of Chile, in charge of the National Seaquake Warning System of Chile (SNAM), is making an effort to improve its capabilities to comply with responsibilities assigned by law; therefore in November 2003, a DART system was installed off the north coast of Chile, near Iquique. Unfortunately, the system had a problem with batteries, and in June 2004 the DART buoy and BPR was removed. The DART system has been designed to function for at least two years without maintenance.



**Figure 42: The surface buoy portion of the DART mooring**

On December 6, 2004, SHOA staff initiated the preparation work for the installation of the buoy. The work started by anchoring the surface buoy, which was tied on the starboard, on the ship's deck. Once the buoy was in the ocean its gear was deployed. First, a 7/16" steel covered cable was dropped, then nylon cable followed, to achieve an approximate depth of 4284 m; these were tied to 6850 kg of dead weight.

Once the anchoring of the buoy was finished, by dropping the dead weight at approximately 19:00L, the preparation work for the anchoring of the bottom-pressure sensor (BPR) started.

The work followed a certain order, starting with the high depth glass spheres that will allow the recovery of the instrument; these were connected to nylon and finally to a 50 m nylon rope that is then tied to the BPR, which contains dead weight in its base. Once the mooring was checked, the BPR anchoring maneuver started, and was completed at 21:10L.

The DART system's technology will allow the National Sequake Warning System to improve its capability to evaluate and disseminate warnings in an efficient and timely manner and will avoid false alarms and possible losses as a consequence. The anchoring of this first DART buoy in Chile (19°42'S, 074°49'W) and in South America, is a big step towards mitigation efforts against tsunamigenic events in close and long range sites. This is not only a great contribution to the Chilean coastal communities, but also to the coastal communities in the Pacific Basin and to the International Tsunami Warning System.

## C. TAMU Measurements

The aerosol research group of Texas A&M University measured the distribution and concentration of aerosols from a 0.01- $\mu\text{m}$  to 15- $\mu\text{m}$  diameter over the Southeast Pacific Ocean during Stratus 2004 using a Tandem Differential Mobility Analyzer and Heated Aerodynamic Particle Sizer (TSI Model 3321). The instruments, also, investigated the composition of the aerosols.

The distribution exhibited a strong bimodal pattern typical of the marine boundary layer. Through the 18<sup>th</sup> of December, the total number concentration varied from 137.60  $\text{cm}^{-3}$  to 676.37  $\text{cm}^{-3}$ , with an average of  $350 \pm 150$  ( $\text{cm}^{-3}$ ). The average CCN concentration (particles greater than roughly 0.1- $\mu\text{m}$ ) was on the order of  $182 \pm 44$  ( $\text{cm}^{-3}$ ), and the average non-CCN concentration was  $168 \pm 82$  ( $\text{cm}^{-3}$ ).

### 1. Introduction and Instrument Overview

Aerosols over the southeast Pacific Ocean have rarely been studied in detail even though they have a profound effect on the lifetime and scattering efficiency of the persistent Stratus deck over this region of the world. During Stratus 2004, The Aerosol Research Group of Texas A&M University used a Tandem Differential Mobility Analyzer (TDMA) and a Heated Aerodynamic Particle Sizer (HAPS) (TSI Model 3321) aboard the R/V *Ronald H. Brown* to gain insight into aerosol distribution, concentration, and composition for diameters ranging from 0.01- $\mu\text{m}$  up to 15- $\mu\text{m}$ . These instruments in conjunction with measurements from the Environmental Technology Laboratory, also, investigated the effect of entrainment, advection, scavenging, and production on the aerosol population.

The Tandem Differential Mobility Analyzer, as its name implies, has two DMA's in tandem. This allows for the unique ability to not only be able to measure the distribution and concentration of aerosols from 0.01  $\mu\text{m}$  to 0.8  $\mu\text{m}$ , but also to measure hygroscopic growth and volatility properties over a range of temperatures from ambient up to 300<sup>o</sup>C. These latter measurements give insight into the chemical makeup of the aerosols and will be discussed later in the report.

The DMA itself works on the basis of electric mobility. For a given positively charged particle diameter, a known negative voltage will move it a certain distance,  $\Delta x$ . As filtered sheath flow moves the particle through the chamber, the negatively charged inner column pulls the particle towards it. For a unique negative voltage, a unique particle diameter will clear a thin opening located at the bottom of the chamber and be passed into a condensation nucleus counter. If the voltage is too strong the particle will shatter against the inner cylinder or if it is too weak the particle will pass right by the opening. For the above two scenarios, the particles are collected into the sheath air and removed by a HEPA filter. The DMA measures a number distribution by ramping the voltage up and then back down to cover the range of aerosol diameters being measured. The aerosol sample drawn into the DMA is dried using a nafion tube and ionized using Po-210.

The HAPS system is used to measure the concentration of aerosols from 0.6- $\mu\text{m}$  to 15- $\mu\text{m}$  using a TSI Aerodynamic Particle Sizer. To allow for the diffusion drier to lower the RH past 30%, the sample and sheath flow for the APS were split into two flows. This allows for a sample flow of 1 L/min and a filtered sheath flow of 4 L/min that is dried using a nafion tube. After the diffusion dryer, the sample flow will pass the aerosols to the APS through either an ambient temperature path or through a furnace heated at 1000 $^{\circ}\text{C}$  depending on what valve is currently open. The later path allows for the concentration of dust to be determined due to a volatility temperature of 600-800 $^{\circ}\text{C}$  for sea salt. The APS uniquely determines the diameter by accelerating a particle through two laser beams. The time it takes the particle to break both beams determines its diameter. This instrument is run concurrently with the TDMA measurements.

## 2. Method

The TDMA measurement sequence is broken down into loops. At the start of a loop a number distribution is first measured by the upstream DMA. For the Stratus 2004 cruise a 10-min scan time was used throughout due to the low concentration of aerosols in the marine boundary layer. At the completion of the distribution, the TDMA begins to measure the growth factor for a given aerosol size. This involves scans over 8 monodisperse sizes ranging from 0.013- $\mu\text{m}$  up to 0.6- $\mu\text{m}$  produced by the upstream DMA. The monodisperse aerosol is then exposed to a relative humidity of 85%. Afterwards, the downstream DMA scans over a specific range of diameters to determine by what ratio the aerosol has grown. This ratio of growth is dependent on the composition of the aerosol, *i.e.* sodium chloride has a growth factor of about 2.2 and ammonium bisulfate of about 1.53 at 85% relative humidity.

At 12 UTC every day, a dry temperature scan was conducted (35% RH). This occurred during the growth factor measurements for a 0.05- $\mu\text{m}$  and 0.2- $\mu\text{m}$  monodisperse aerosol. The volatility of an aerosol is another method for inferring composition, *i.e.* sulfuric acid volatilizes within a range from 40 $^{\circ}\text{C}$  to 150 $^{\circ}\text{C}$  (measurements made during Stratus 2003 found it to be around 90 $^{\circ}\text{C}$ ) and ammonium bisulfate within a range from 150 $^{\circ}\text{C}$  to 300 $^{\circ}\text{C}$ .

Upon completion of all growth factor scans and any temperature scans, the data is saved and a new loop is begun. The HAPS is running continuously throughout all DMA and TDMA measurements and once a loop is finished the valves are turned.

## 3. Overview of Data Collected and Preliminary Results

The TDMA continuously monitored the aerosol distribution and concentration throughout the Stratus 2004 cruise. The number distribution and concentration of aerosols from 0.010- $\mu\text{m}$  to 0.800- $\mu\text{m}$  from December 8<sup>th</sup> till the 18<sup>th</sup> are shown in Figures 43 and 44 respectively. The distribution was strongly bimodal throughout the cruise as result of cloud processing, which is typical of the marine boundary layer. The concentration varied over a time scale of several days as seen in figure 44. The average total number concentration from December 8<sup>th</sup> to the 18<sup>th</sup> was  $350 \pm 150 \text{ cm}^{-3}$ , with an average CCN concentration of  $182 \pm 44 \text{ cm}^{-3}$  and an average non-CCN concentration of  $168 \pm 82 \text{ cm}^{-3}$ .

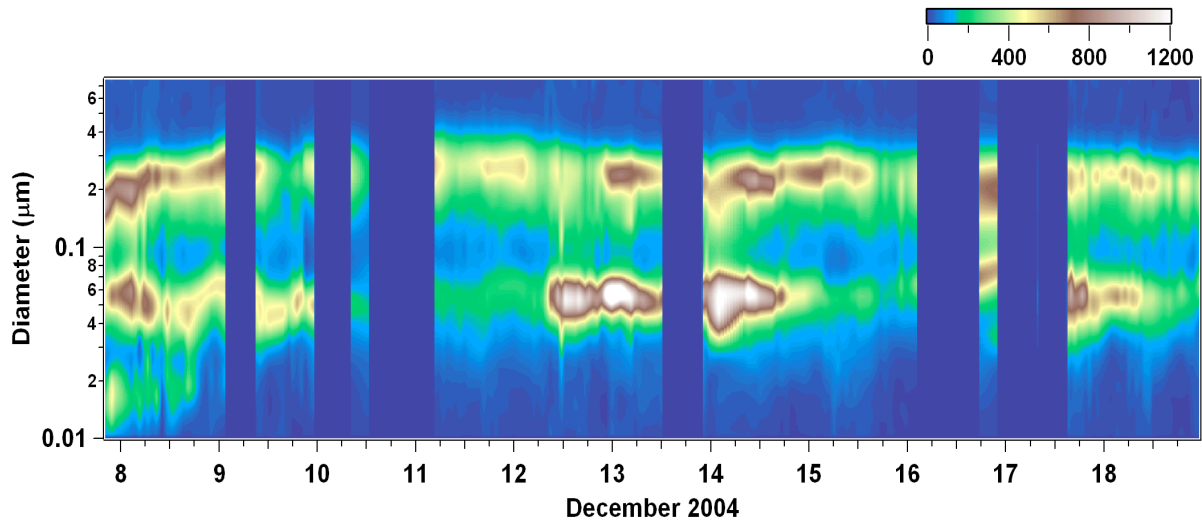


An interesting preliminary result was the variability of the non-CCN particles. These will be looked at in detail in future analyses with data collected by ETL for any correlations with meteorological conditions and for any possible influences from entrainment, advection, production, or scavenging. The CCN particles, though, were relatively constant compared to the non-CCN.

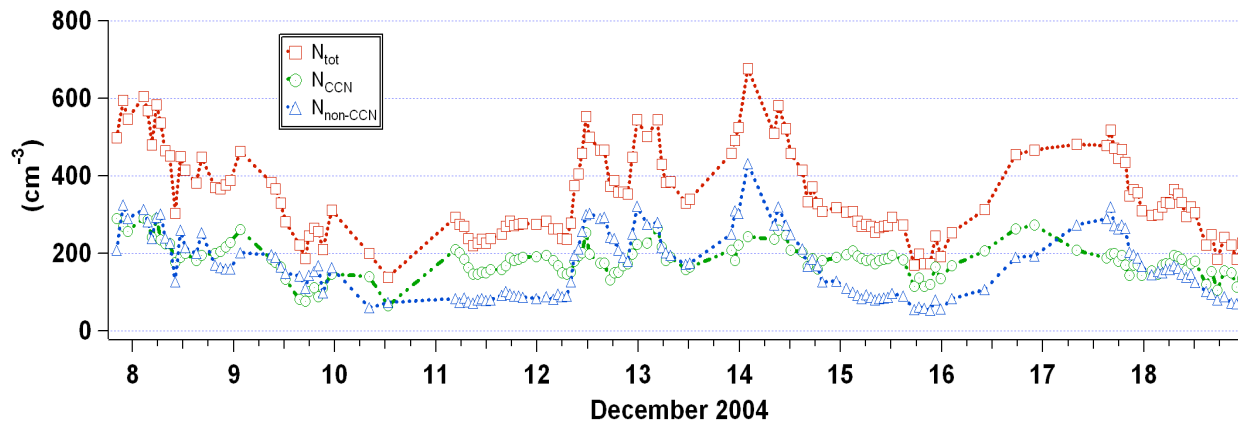
The heated APS ran continuously throughout the cruise and the number distribution and concentration at ambient temperature and at 1000°C through the 18<sup>th</sup> of December are displayed in Figures 45 to 47. The data from the 5<sup>th</sup> till the 15<sup>th</sup>, unfortunately, was biased low. This occurred due to a leak in the sample flow that allowed sheath air to be introduced. The distribution and concentration of aerosol diameters from 0.6- $\mu\text{m}$  to 15- $\mu\text{m}$  from the 16<sup>th</sup> to the 18<sup>th</sup> exhibited the presence of a residual aerosol. The number concentration at ambient temperature was  $1.4 \pm 0.6 \text{ cm}^{-3}$  and at 1000°C it was  $0.5 \pm 0.3 \text{ cm}^{-3}$ . On average, about 37% of the original number concentration made it through the furnace. It is doubtful that that residual amount was composed entirely of dust and it may have been, instead, due to incomplete volatilization. Further work will be done back at Texas A&M University to test the instrument and the validity of the above results.

#### **4. Conclusions**

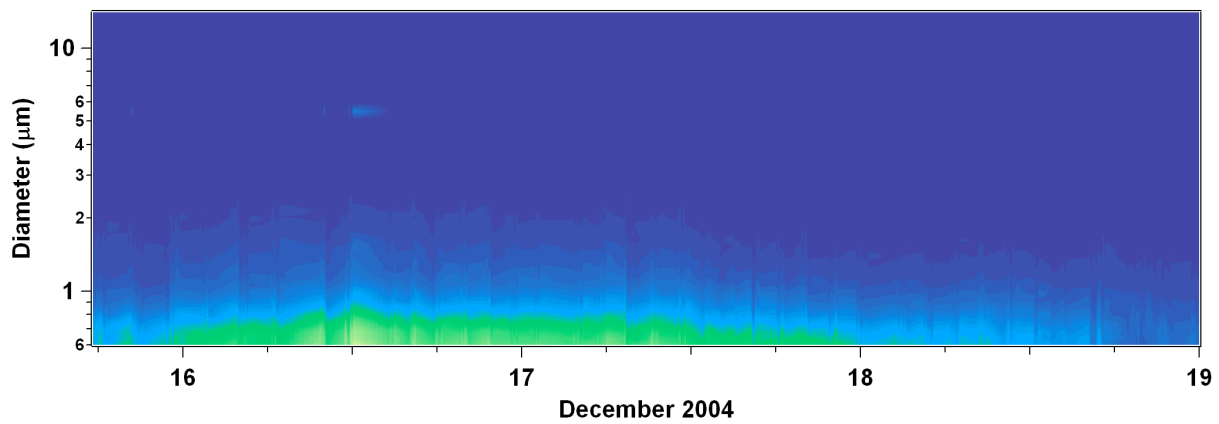
The measurements conducted during Stratus 2004 will lead to a better understanding of the distribution, concentration, and composition of aerosols over the Southeast Pacific Ocean. The distribution of aerosols was similar to other stratus regions around the world displaying a strong bimodal pattern. The total number concentration of aerosols varied from  $137.60 \text{ cm}^{-3}$  to  $676.37 \text{ cm}^{-3}$  with an average value of  $350 \pm 150 \text{ cm}^{-3}$ . Average CCN concentration are  $182 \pm 44 \text{ cm}^{-3}$ , and the average non-CCN concentration is  $168 \pm 82 \text{ cm}^{-3}$ . The exact composition of the aerosol before and after cloud processing was different as shown by the temperature scans. Though both were composed of various types of sulfates, the non-CCN particles appeared to be composed of a higher concentration of organics. Once completely analyzed, this data set will achieve a better understanding of the composition of the aerosols, the role they play in cloud processes, and how advection, entrainment, production, and scavenging effect the aerosol populations over the Southeast Pacific Ocean.



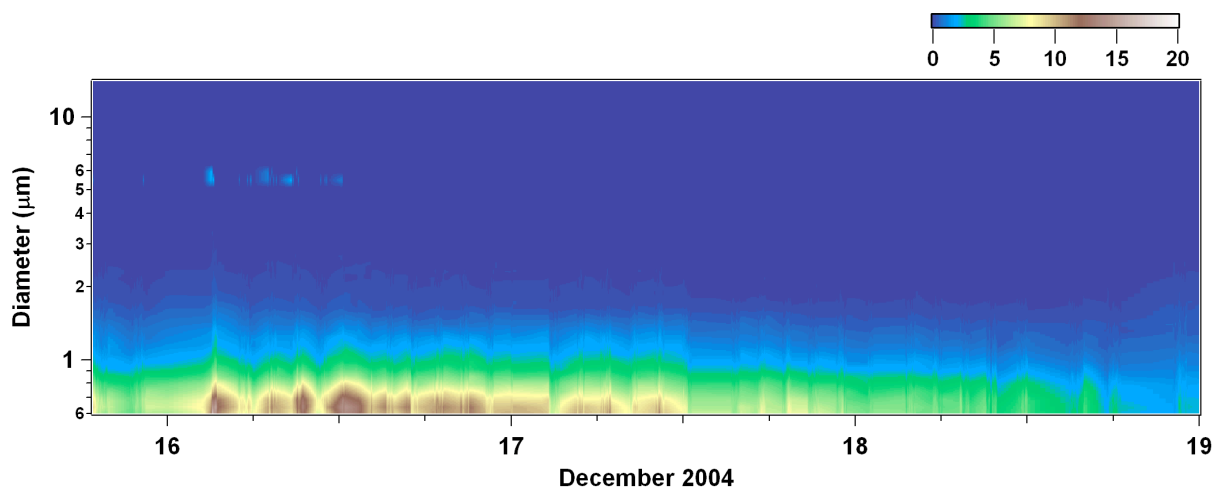
**Figure 43: The aerosol size distribution during the Stratus 2004 cruise**



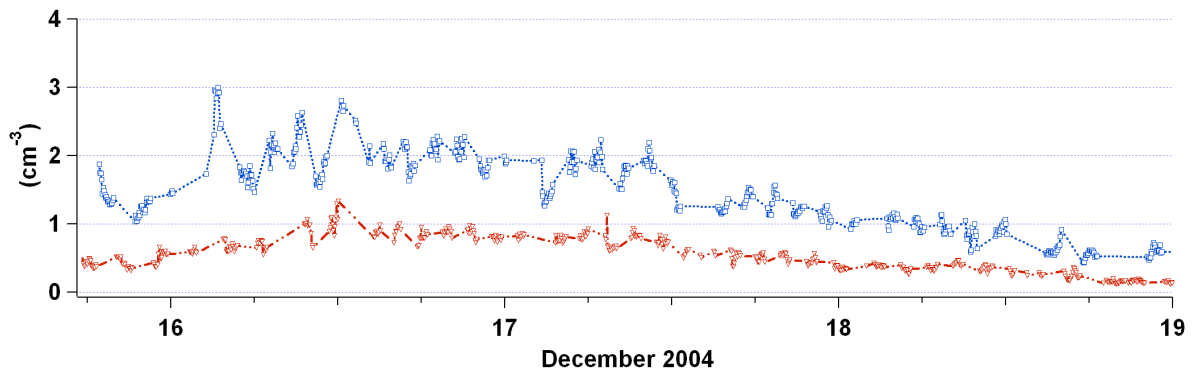
**Figure 44: The number concentration as measured by the TDMA during the Stratus 2004 cruise**



**Figure 45: The APS number distribution at ambient temperature during the Stratus 2004 cruise**



**Figure 46: As in figure 45 but at 1000 °C**



**Figure 47: The number concentration at ambient temperature (blue) and at 1000 °C (red)**

#### **D. Teacher-at-Sea Program**

During the Stratus 2004 cruise, an 8<sup>th</sup> grade science teacher participated in scientific operations on board. Mary Cook, teacher at Southside Middle School in Batesville, Arkansas (link to school: <http://southside.k12.ar.us/middle/middle.htm>) was sponsored by the National Oceanic and Atmospheric Administration's (NOAA) Teacher at Sea Program and NOAA's Office of Global Programs (OGP).

Mary participated in radiosonde balloon releases, drifting buoy and Argo float releases and produced the text for a children's book in conjunction with Bruce Cowden (illustrator) and Diane Stanitski (editor). The book is focused on the scientific instrumentation and endeavors on board the R/V *Ronald H. Brown* during the Stratus 2004 cruise and is geared toward 5<sup>th</sup> – 9<sup>th</sup> grade students.

Mary Cook was the first teacher to participate in the Adopt a Drifter Program (ADP) sponsored by NOAA's Office of Climate Observation. She and her students adopted a drifting buoy, decorated it with her school's stickers and the names of her 120 students, and deployed the buoy at 19°40.010'S, 77°58.587'W on December 8, 2004. Her students and fellow teachers at Southside Middle School were able to track their buoy as it made its way across the Pacific Ocean. Mary is developing lesson plans focused specifically on the drifting buoy network and the processes linked with the drifter's movement (e.g., wind circulation and ocean currents).

Viviana Zamorano, a middle school science teacher at Escuela America in Arica, Chile, partnered with Mary as part of the ADP. Viviana, a former Teacher at Sea who participated on the Stratus 2003 cruise, and her students toured the R/V *Ronald H. Brown*

when it was in port in Arica and then communicated with Mary throughout the cruise. A drifter was deployed in Viviana's school's honor. Debra Brice and her students at San Marcos Middle School in San Diego adopted a third buoy. Debra was a former Teacher at Sea on the Stratus 2003 cruise and is a middle school science teacher.

During the Stratus 2004 cruise, Mary assisted with science operations including mooring deployments and recoveries. She wrote daily logs, took photos, interviewed science and crew members and hosted the show, "Six O'clock Science on the Fantail," where she discussed the day's research activities with scientists on board. Mary communicated with her class and other land-based teachers and their students regarding all of her activities on the R/V *Ronald H. Brown*. Diane Stanitski, of NOAA's Office of Climate Observation, provided assistance with videography, photography, and web communications. All of Mary's videos, photos, and logs are available at <http://www.ogp.noaa.gov/stratus/index.html>.

### **1. Bucket/Thermosalinograph Comparisons**

Bucket temperature readings were taken by Mary Cook (NOAA Teacher at Sea) and Diane Stanitski (NOAA Office of Global Programs) from December 6-8, 2004, to make comparisons with thermosalinograph (TSG) readings taken from the hull of the *Ronald H. Brown* at the ship's seawater intake. The SEACAT thermosalinograph, Model SBE 21, determines sea surface temperature and conductivity as the *Ronald H. Brown* is underway. TSG data are simultaneously datalogged and transmitted to allow for real-time data acquisition. Comparisons of the bucket thermometer and TSG were made during the day and night to determine the accuracy of the TSG readings. The data and graphed results are found below (Figure 48). The maximum temperature difference was 0.25°C. It was quickly determined that the TSG readings were adequate to obtain sea surface temperatures without the addition of the bucket thermometer readings during the remainder of the cruise.

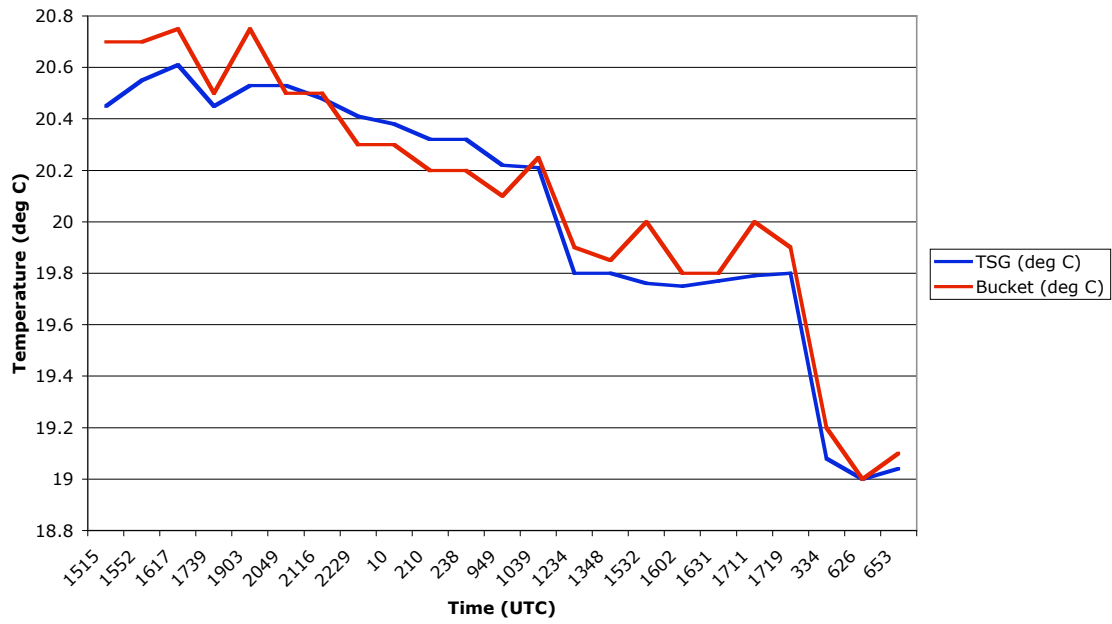
Table 19. Bucket and TSG measurements.

| <b>Date</b>    | <b>Time<br/>(UTC)</b> | <b>TSG<br/>(deg C)</b> | <b>Bucket<br/>(deg C)</b> | <b>Difference<br/>(deg C)</b> |      |
|----------------|-----------------------|------------------------|---------------------------|-------------------------------|------|
| <b>12/6/04</b> | <b>1515</b>           | 20.45                  | 20.7                      | -0.25                         |      |
|                | <b>1552</b>           | 20.55                  | 20.7                      | -0.15                         |      |
|                | <b>1617</b>           | 20.61                  | 20.75                     | -0.14                         |      |
|                | <b>1739</b>           | 20.45                  | 20.5                      | -0.05                         |      |
|                | <b>1903</b>           | 20.53                  | 20.75                     | -0.22                         |      |
|                | <b>2049</b>           | 20.53                  | 20.5                      | 0.03                          |      |
|                | <b>2116</b>           | 20.48                  | 20.5                      | -0.02                         |      |
|                | <b>2229</b>           | 20.41                  | 20.3                      | 0.11                          |      |
|                | <b>12/7/04</b>        | <b>10</b>              | 20.38                     | 20.3                          | 0.08 |
|                |                       | <b>210</b>             | 20.32                     | 20.2                          | 0.12 |
| <b>238</b>     |                       | 20.32                  | 20.2                      | 0.12                          |      |
| <b>949</b>     |                       | 20.22                  | 20.1                      | 0.12                          |      |
| <b>1039</b>    |                       | 20.21                  | 20.25                     | -0.04                         |      |
| <b>1234</b>    |                       | 19.8                   | 19.9                      | -0.1                          |      |
| <b>1348</b>    |                       | 19.8                   | 19.85                     | -0.05                         |      |
| <b>1532</b>    |                       | 19.76                  | 20                        | -0.24                         |      |
| <b>1602</b>    |                       | 19.75                  | 19.8                      | -0.05                         |      |
| <b>1631</b>    |                       | 19.77                  | 19.8                      | -0.03                         |      |
| <b>1711</b>    |                       | 19.79                  | 20                        | -0.21                         |      |
| <b>1719</b>    |                       | 19.8                   | 19.9                      | -0.1                          |      |
| <b>12/8/04</b> | <b>334</b>            | 19.08                  | 19.2                      | -0.12                         |      |
|                | <b>626</b>            | 19                     | 19                        | 0                             |      |
|                | <b>653</b>            | 19.04                  | 19.1                      | -0.06                         |      |

**Maximum Temp Difference = 0.25 deg C**

**Minimum Temp Difference = 0.0 deg C**

**Bucket vs. Thermosalinograph Temperature Comparison  
Stratus Cruise, Ronald H. Brown  
December 6-8, 2004**



**Figure 48: Comparison of bucket and TSG temperature values**

## **ACKNOWLEDGEMENTS**

This project was funded through grants from the Office of Global Programs of the National Oceanic and Atmospheric Administration (NOAA Grant NA17RJ1225). The UOP Group would like to thank the crew of the R/V *Ronald H. Brown*, NOAA ETL, SHOA and all of the scientific staff for their help during the Stratus 2004 cruise.



## APPENDIX A – CRUISE LOGISTICS

### Hotel in Arica

Arica Hotel  
Av. Commandante San Martin 599  
Arica, Chile  
56-58 254 540 fax 56-58 231 133  
e-mail: [resarica@panamericanahoteles.cl](mailto:resarica@panamericanahoteles.cl)  
more info at <http://www.panamericanahoteles.cl>  
note country code for Chile is 56, so from U.S., dial 011 56 58 254 540

### Hotel in Valparaiso

O'Higgins Hotel  
Plaza Vergara SN  
Vina del Mar  
Chile  
56-32-682-000  
e-mail: [resarica@panamericanahoteles.cl](mailto:resarica@panamericanahoteles.cl)  
more info at <http://www.panamericanahoteles.cl>  
note country code for Chile is 56, so from U.S., dial 011 56 32 682 000

R/V Ron Brown: More information about ship: <http://www.moc.noaa.gov/rb/>

### Agent in Chile

Mr. Renzo Caprile  
Phone: 011 56 58 250238 fax: 011 56 58 269229  
(56 in country code for Chile)  
Email [arica@ajbroom.cl](mailto:arica@ajbroom.cl)  
Copy email to Jean Aguila  
[operations@ajbroom.cl](mailto:operations@ajbroom.cl)  
011 56-32-268200 fax 011 56-32-213308

Ag Maritimas Broom Arica, Ltda  
Artruro Prat 391  
Floor 10 Off 106  
ARICA – CHILE

Mail could be sent to:

MASTER  
RV Ron Brown  
%Ag Maritimas Broom Arica, Ltda.  
Artruro Prat 391 Floor 10  
Off 76  
Arica, Chile

# APPENDIX B – MOORING LOGS

## Moored Station Log

PAGE 1

(fill out log with black ball point pen only)

ARRAY NAME AND NO. Stratus 4 MOORED STATION NO. 1119

### Launch (anchor over)

Date 11/19/2003 Time 20:31:30 UTC  
day-mon-year

Latitude 19° 45.951' N or  S Longitude 85° 30.239' E or  W  
deg-min deg-min

Position Source: GPS, LORAN, SAT. NAV., OTHER GPS

Deployed by: Lord, Ryder Recorder/Observer: Hutto

Ship and Cruise No Revelle, Dana 03 Intended duration: 365 days

Depth Recorder Reading 4441 m Correction Source: Already

Depth Correction N/A m applied

Corrected Water Depth N/A m Magnetic Variation: \_\_\_\_\_ E or W

Anchor Position: Lat. 19° 45.951' N or  S Long. 85° 30.405' E or  W

Argos Platform ID No. see p. 2 Additional Argos Info may be found on pages 2 and 3.

### Acoustic Release Information

Release No. 339 Tested to 1500 meters

Receiver No. 6 Release Command 63

Interrogate Freq. 11 kHz Reply Freq. 10 kHz

### Recovery (release fired)

Date 12 December 2004 Time 10:46:50 UTC  
day-mon-year

Latitude 19° 46.278' N or  S Longitude 85° 30.854' E or  W  
deg-min deg-min

Position Source: GPS, LORAN, SAT. NAV., OTHER GPS

Recovered by: Lord, Weller, Smith, Bouchard Recorder/Observer: Keir Colbo

Ship and Cruise No. Ron Brown 11-04 Actual duration: 388 days

Distance from actual waterline to buoy deck 0.25 meters

4413 read at anchor site





MOORED STATION NUMBER

1119

Depth from drawing (m)

| Item No. | Lgth [m] | Item             | Inst No.   | Time Over                     | Notes | Data No.           | Calc Dpth | Time Back | Notes                         |
|----------|----------|------------------|------------|-------------------------------|-------|--------------------|-----------|-----------|-------------------------------|
|          | 1        | 0.52             | 3/4" chain |                               |       |                    |           | 17:48     |                               |
| 3.9      | 2        |                  | SBE16      | 1882                          | 13:13 |                    |           | 17:48     | can't read S/N                |
|          | 3        | 1.8              | 3/4" chain |                               |       |                    |           |           |                               |
| 7        | 4        |                  | SBE16      | 0146                          | 12:58 |                    |           | 17:48     |                               |
|          | 5        | 1.2              | 3/4" chain |                               |       |                    |           |           |                               |
| 10       | 6        |                  | VMCM       | 033                           | 12:55 | 12:52:33 bands off |           | 17:50     | bands on 17:51 can't read S/N |
|          | 7        | 0.97             | 3/4" chain |                               |       |                    |           |           |                               |
| 13       | 8        |                  | Sontek     | D171                          | 12:53 |                    |           | 17:53     | can't read S/N                |
|          | 9        | 1.50             | 3/4" chain |                               |       |                    |           |           |                               |
| 16       | 10       |                  | SBE16      | 1879                          | 12:50 |                    |           | 17:53     | barracle in salinity cell     |
|          | 11       | 2.25             | 3/4" chain |                               |       |                    |           |           |                               |
| 20       | 12       |                  | VMCM       | 006                           | 12:46 | 12:44:50 bands off |           | 17:55     | 17:55 bands on can't read S/N |
|          | 13       | 2.85             | 3/4" chain |                               |       |                    |           |           |                               |
| 25       | 14       |                  | TPOD       | 3667                          | 12:46 |                    |           | 17:56     |                               |
|          | 15       | 3.66             | 3/4" chain |                               |       |                    |           |           |                               |
| 30       | 16       |                  | SBE16      | 2324                          | 12:39 |                    |           | 17:58     |                               |
|          | 17       | 0.75             | 3/4" chain |                               |       |                    |           |           |                               |
| 32.5     | 18       |                  | Sontek     | D197                          | 12:39 |                    |           | 18:01     | Not sure of S/N A few on hen  |
|          | 19       | 1.5              | 3/4" chain |                               |       |                    |           |           |                               |
| 35       | 20       |                  | TPOD       | 3839                          | 12:36 |                    |           | 18:01     |                               |
|          |          | <b>Date/Time</b> |            | <b>Comments</b>               |       |                    |           |           |                               |
|          |          | 11/19/2003       |            | Buoy in water 13:13           |       |                    |           |           |                               |
|          |          | 12 December 04   |            | Buoy on deck and secure 17:45 |       |                    |           |           |                               |
|          |          |                  |            |                               |       |                    |           |           |                               |
|          |          |                  |            |                               |       |                    |           |           |                               |

MOORED STATION NUMBER

1119

Depth from Drawing (m)

| Item No.  | Lgth [m] | Item              | Inst No. | Time Over | Notes | Data No. | Calc Dpth | Time Back | Notes                               |
|-----------|----------|-------------------|----------|-----------|-------|----------|-----------|-----------|-------------------------------------|
| 21        | 3.98     | 3/4" chain        |          |           |       |          |           |           |                                     |
| 40 22     |          | SBE16             | 0927     | 12:33     |       |          |           | 18:02     |                                     |
| 23        | 3.22     | 3/4" chain        |          |           |       |          |           |           |                                     |
| 45 24     |          | VMCM              | 053      | 13:30     |       |          |           | 18:04     | 18.04 bands on                      |
| 25        | 2.75     | 3/4" chain        |          |           |       |          |           |           |                                     |
| 50 26     |          | SBE16             | 0994     | 13:34     |       |          |           | 18:05     |                                     |
| 27        | 3.15     | 3/4" chain        |          |           |       |          |           |           |                                     |
| 55 28     |          | Sontek            | D193     | 13:36     |       |          |           | 16:48     | Drop remaining instruments in water |
| 29        | 5.3      | 7/16" wire        |          |           |       |          |           |           |                                     |
| 62.5 30   |          | SBE16             | 1878     | 13:39     |       |          |           | 16:45     |                                     |
| 31        | 6.2      | 7/16" wire        |          |           |       |          |           |           |                                     |
| 70 32     |          | TPOD              | 4483     | 13:44     |       |          |           | 16:42     |                                     |
| 33        | 6.2      | 7/16" wire        |          |           |       |          |           |           |                                     |
| 77.5 34   |          | TPOD              | 3703     | 13:47     |       |          |           | 16:39     |                                     |
| 35        | 6.2      | 7/16" wire        |          |           |       |          |           |           |                                     |
| 85 36     |          | SBE16             | 0993     | 13:49     |       |          |           | 16:36     | didn't get S/N under haul gear      |
| 37        | 1.85     | 3/4" chain        |          |           |       |          |           |           |                                     |
| 88.5 38   |          | VMCM bearing test | Test     | 13:53     |       |          |           | 16:33     |                                     |
| 39        | 1.85     | 3/4" chain        |          |           |       |          |           |           |                                     |
| 92.5 40   |          | TPOD              | 3701     | 13:55     |       |          |           | 16:29     |                                     |
| Date/Time |          | Comments          |          |           |       |          |           |           |                                     |
|           |          |                   |          |           |       |          |           |           |                                     |
|           |          |                   |          |           |       |          |           |           |                                     |
|           |          |                   |          |           |       |          |           |           |                                     |
|           |          |                   |          |           |       |          |           |           |                                     |
|           |          |                   |          |           |       |          |           |           |                                     |

MOORED STATION NUMBER 1119

Depth from drawing (m)

| Item No.  | Lgth [m] | Item       | Inst No. | Time Over | Notes      | Data No. | Calc Dpth | Time Back | Notes                        |
|-----------|----------|------------|----------|-----------|------------|----------|-----------|-----------|------------------------------|
|           | 6.2      | 7/16" wire |          |           |            |          |           |           |                              |
| 100       |          | TPOD       | 4481     | 13:58     |            |          |           | 16:26     |                              |
|           | 14       | 7/16" wire |          |           |            |          |           |           |                              |
| 115       |          | TPOD       | 4493     | 14:03     |            |          |           | 16:19     |                              |
|           | 14       | 7/16" wire |          |           |            |          |           |           |                              |
| 130       |          | SBE16      | 0928     | 14:05     |            |          |           | 16:16     |                              |
|           | 3.43     | 3/4" chain |          |           |            |          |           |           |                              |
| 135       |          | RDI        | 1220     | 14:10     | looking up |          |           | 16:13     | few barnacles<br>heads clean |
|           | 8        | 7/16" wire |          |           |            |          |           |           |                              |
| 145       |          | TPOD       | 3309     | 14:12     |            |          |           | 16:10     | 1 barnacle                   |
|           | 14       | 7/16" wire |          |           |            |          |           |           |                              |
| 160       |          | SBE37      | 2011     | 14:21     |            |          |           | 16:08     |                              |
|           | 28.5     | 7/16" wire |          |           |            |          |           |           |                              |
| 175       |          | TPOD       | 4488     | 14:23     | on wire    |          |           | 16:04     |                              |
|           |          |            |          |           |            |          |           |           |                              |
| 190       |          | VMCM       | 030      | 14:29     |            |          |           | 15:59     | heads @ 16:00 1 barn         |
|           |          |            |          |           |            |          |           |           |                              |
| 192       |          | SBE16      | 2322     | 14:29     |            |          |           | 15:59     |                              |
|           | 28.5     | 7/16" wire |          |           |            |          |           |           |                              |
| 222       |          | SBE37      | 1899     | 14:34     |            |          |           | 15:53     |                              |
| Date/Time |          | Comments   |          |           |            |          |           |           |                              |
|           |          |            |          |           |            |          |           |           |                              |
|           |          |            |          |           |            |          |           |           |                              |
|           |          |            |          |           |            |          |           |           |                              |
|           |          |            |          |           |            |          |           |           |                              |
|           |          |            |          |           |            |          |           |           |                              |

MOORED STATION NUMBER 1119

| Item No.       | Lgth [m] | Item                               | Inst No.   | Time Over | Notes                                   | Data No. | Calc Dpth | Time Back              | Notes                                       |
|----------------|----------|------------------------------------|------------|-----------|---|----------|-----------|------------------------|---|
|                | 61       | 14                                 | 7/16" wire |           |   |          |           |                        |   |
| 238            | 62       |                                    | VMCM 073   | 14:39     | 14:55:30 bands of 6                     |          |           | 15:47                  | 15:49 bands on                              |
|                | 63       | 14                                 | 7/16" wire |           |   |          |           |                        |   |
| 254            | 64       |                                    | TPOD 4489  | 14:43     |   |          |           | 15:42                  |   |
|                | 65       | 38                                 | 3/8" wire  |           |   |          |           |                        |   |
| 280            | 66       |                                    | TPOD 3305  | 14:50     |   |          |           | 15:37                  |   |
|                | 67       |                                    |            |           |   |          |           |                        |   |
| 294            | 68       |                                    | VMCM 068   | 14:54     | 14:52:10 bands of 6 red trim came loose |          |           | 15:32                  | bands @ 15:33                               |
|                | 69       | 58                                 | 3/8" wire  |           |   |          |           |                        |   |
| 354            | 70       |                                    | VMCM 057   | 15:08     | 15:03:15 bands of 6                     |          |           | 15:26                  | refers banded @ 15:26                       |
|                | 71       | 100                                | 3/8" wire  |           |   |          |           |                        |   |
| 400            | 72       |                                    | SBE39 0282 | 15:11     |   |          |           | 15:26                  |   |
|                | 73       |                                    |            |           |   |          |           |                        |   |
| 450            | 74       |                                    | SBE39 0203 | 15:13     |   |          |           | 15:19                  |   |
|                | 75       | 500                                | 3/8" wire  | 15:33     |   |          |           | 15:17                  |   |
|                | 76       | 500                                | 3/8" wire  | 15:51     |   |          |           | 15:07                  |   |
|                | 77       | 500                                | 3/8" wire  | 16:04     |   |          |           | 14:55 14:41            |   |
|                | 78       | 100                                | 3/8" wire  | 16:08     |   |          |           | 14:41 <del>14:37</del> | Mary took over and changed system slightly. |
|                | 79       | 200                                | 7/8" nylon | 16:16     |   |          |           | 14:37 <del>14:29</del> |   |
|                | 80       | 150                                | 7/8" nylon | 16:23     |   |          |           | 14:21                  | switch to winch                             |
| Date/Time      |          | Comments                           |            |           |   |          |           |                        |   |
| 11/19/03       |          | 14:56 Stop to work on block.       |            |           |   |          |           |                        |   |
| 12 December 04 |          | 13:59 Switch From capstan to winch |            |           |   |          |           |                        |   |
|                |          |                                    |            |           |   |          |           |                        |   |
|                |          |                                    |            |           |   |          |           |                        |   |



MOORED STATION NUMBER 1119

| Item No.    | Lgth [m] | Item                              | Inst No. | Time Over               | Notes   | Data No. | Calc Dpth | Time Back | Notes   |
|-------------|----------|-----------------------------------|----------|-------------------------|---------|----------|-----------|-----------|---------|
| 81          | 500      | 7/8" nylon                        |          | 16:38                   |         |          |           | 13:58     |         |
| 82          | 500      | 7/8" nylon                        |          | 17:24                   |         |          |           | 13:40     |         |
| 83          | 500      | 7/8" nylon                        |          | 17:53                   |         |          |           | 13:20     |         |
| 84          | 100      | 1" nylon                          |          | 18:14                   |         |          |           | 13:08     |         |
| 85          | 1400     | 1 1/8" poly                       |          | 19:09                   |         |          |           | 13:06     |         |
| 86          |          | 96 glass<br>balls (17")           |          | 1 - 19:15<br>96 - 19:49 |         |          |           | 12:14     | 3 burst |
| 87          | 5        | Chain                             |          | 19:53                   |         |          |           | 12:15     |         |
| 88          |          | release                           | 339      | 20:04                   | pin out |          |           | 12:15     |         |
| 89          | 5        | Chain                             |          | 20:16                   |         |          |           |           |         |
| 90          | 20       | nylon                             |          | 20:22                   |         |          |           |           |         |
| 91          | 5        | Chain                             |          | 20:31:30                |         |          |           |           |         |
| 92          |          | anchor                            |          | 20:31:30                |         |          |           |           |         |
| 93          |          |                                   |          |                         |         |          |           |           |         |
| 94          |          |                                   |          |                         |         |          |           |           |         |
| 95          |          |                                   |          |                         |         |          |           |           |         |
| 96          |          |                                   |          |                         |         |          |           |           |         |
| 97          |          |                                   |          |                         |         |          |           |           |         |
| 98          |          |                                   |          |                         |         |          |           |           |         |
| 99          |          |                                   |          |                         |         |          |           |           |         |
| 100         |          |                                   |          |                         |         |          |           |           |         |
| Date/Time   |          | Comments                          |          |                         |         |          |           |           |         |
| 11/19/03    |          | 16:58 tied off for spooling       |          |                         |         |          |           |           |         |
| 11/19/03    |          | 17:49 tied off for h-bit          |          |                         |         |          |           |           |         |
| 12 Dec 2004 |          | 12:38 First splice in 1 1/8" poly |          |                         |         |          |           |           |         |
|             |          | 13:05 2nd splice                  |          |                         |         |          |           |           |         |



MOORED STATION NUMBER 1119

| Date/Time | Comments                      |
|-----------|-------------------------------|
| 12 Dec 04 | Range 4449 sknt               |
|           | Fired 10:47 UTC First try     |
|           | 11:29 UTC Balls on surface    |
|           |                               |
|           | All on board and secure 18:09 |
|           |                               |
|           |                               |
|           |                               |
|           |                               |
|           |                               |
|           |                               |
|           |                               |
|           |                               |
|           |                               |
|           |                               |
|           |                               |
|           |                               |
|           |                               |
|           |                               |
|           |                               |
|           |                               |
|           |                               |
|           |                               |
|           |                               |
|           |                               |
|           |                               |
|           |                               |
|           |                               |
|           |                               |
|           |                               |
|           |                               |
|           |                               |
|           |                               |
|           |                               |
|           |                               |
|           |                               |

# Moored Station Log

PAGE 1

(fill out log with black ball point pen only)

ARRAY NAME AND NO. Stratus 5 MOORED STATION NO. 1145

## Launch (anchor over)

Date 14 December 2004 Time 18:25 UTC  
day-mon-year  
Latitude 19° 44.728' N or  S Longitude 85° 31.159' E or  W  
deg-min deg-min  
Position Source: GPS, LORAN, SAT. NAV., OTHER GPS  
Deployed by: Lord, Weller Recorder/Observer: Keir Colbo  
Ship and Cruise No Ron Brown 11-04 Intended duration: 365 days  
Depth Recorder Reading 44.25 m Correction Source: Already  
Depth Correction N/A m Applied  
Corrected Water Depth N/A m Magnetic Variation: \_\_\_\_\_ E or W  
Anchor Position: Lat. 19° 44.741' N or  S Long. 85° 31.360' E or  W  
Argos Platform ID No. see page 2 Additional Argos Info may be found  
on pages 2 and 3.

## Acoustic Release Information

Release No. 503121 Tested to 1500 meters  
Receiver No. 3 Release Command 33  
Interrogate Freq. 11 kHz Reply Freq. 10 kHz

## Recovery (release fired)

Date \_\_\_\_\_ Time \_\_\_\_\_ UTC  
day-mon-year  
Latitude \_\_\_\_\_ N or S Longitude \_\_\_\_\_ E or W  
deg-min deg-min  
Position Source: GPS, LORAN, SAT. NAV., OTHER \_\_\_\_\_  
Recovered by: \_\_\_\_\_ Recorder/Observer: \_\_\_\_\_  
Ship and Cruise No. \_\_\_\_\_ Actual duration: \_\_\_\_\_ days  
Distance from actual waterline to buoy deck \_\_\_\_\_ meters

Surface Components

Buoy Type \_\_\_\_\_ Color(s) Hull yellow white Tower white  
 Buoy Markings if Found adrift contact Woods Hole Oceanographic Woods Hole, MA  
02543 USA 508-548-1401

| Surface Instrumentation |          |          |   |
|-------------------------|----------|----------|---|
| Item                    | ID       | Height * | Comments                                      |
| Data Logger             | L-04     |          | System #1                                     |
| Rel. Humidity           | 216      | 244      | v3.2  |
| wind                    | 221      | 270.5    | <del>v3.3 (Heise)</del> v3.5/v1.5             |
| Precip.                 | 206      | 239      | <del>v3.5/v1.5</del> v3.4/v1.7                |
| Longwave                | 218      | 282.5    | v3.5/v1.6                                     |
| Shortwave               | 219      | 282.5    | v3.3/v1.6                                     |
| Baro. Pressure          | 216      | 247      | v3.3 (Heise)                                  |
| ARGOS PTT               | ID 27916 |          | Wildcat # 12789                               |
|                         | ID 27917 |          |   |
|                         | ID 27918 |          |   |
| Data Logger             | L-05     |          | System #2                                     |
| Rel. Humidity           | 232      | 246      | v3.2  |
| wind                    | 225      | 271      | v3.5/v1.5                                     |
| Precip.                 | 205      | 239      | v3.4/v1.7                                     |
| Longwave                | 502      | 283      | v3.5/v1.6                                     |
| Shortwave               | 209      | 282.5    | v3.3/v1.6                                     |
| Baro. Pressure          | 217      | 247      | v3.3 (Heise)                                  |
| ARGOS PTT               | ID 27919 |          | Wildcat # 18171                               |
|                         | ID 27920 |          |   |
|                         | ID 27921 |          |   |
| <del>BPR</del>          |          |          | <del>ASIMET/stand alone</del><br>not deployed |
| ARGOS SIS               | ID 24576 |          | S/N # 104                                     |

\* Height above buoy deck in centimeters

| Sub-Surface Instrumentation on Buoy and Bridle |      |        |   |
|--|------|--------|---|
| Item   | ID   | Depth† | Comments  |
| SBE-37   | 1841 | 151    | attached to system #1                               |
| SBE-37   | 1305 | 151    | attached to system #2                               |
| SBE39  | 0718 | 0      | Floating SST  |
|  |      |        |   |
|  |      |        |   |
|  |      |        |   |
|  |      |        |   |
|  |      |        |   |
|  |      |        | Estimated height of deck<br>above waterline = 0.70m |
|  |      |        |   |
|  |      |        |   |
|  |      |        |   |
|  |      |        |   |
|  |      |        |   |
|  |      |        |   |
| † Depth below buoy deck in centimeters         |      |        |   |

**Sub-Surface Components**

|                           | Type                       | Size(s)  | Manufacturer |       |  |
|---------------------------|----------------------------|----------|--------------|-------|--|
| Chain                     |                            |          |              |       |  |
| Wire Rope                 |                            |          |              |       |  |
|                           |                            |          |              |       |  |
| Synthetics                |                            |          |              |       |  |
|                           |                            |          |              |       |  |
| Hardware                  |                            |          |              |       |  |
|                           |                            |          |              |       |  |
|                           |                            |          |              |       |  |
| Flotation                 | Type (G.B.s, Spheres, etc) | Size     | Quantity     | Color |  |
|                           |                            |          |              |       |  |
|                           |                            |          |              |       |  |
|                           |                            |          |              |       |  |
| No. of Flotation Clusters |                            | 90 balls |              |       |  |
| Anchor Dry Weight         |                            | 9300 lbs |              |       |  |

MOORED STATION NUMBER 1145

Depth From Diagram (m)

| Item No. | Lgth [m] | Item                   | Inst No.   | Time Over                                | Notes | Data No.              | Calc Dpth | Time Back | Notes |
|----------|----------|------------------------|------------|--|-------|-----------------------|-----------|-----------|-------|
|          | 1        | 0.22                   | 3/4" chain |  |       |                       |           |           |       |
| 2        | 2        |                        | SBE-16     | 1873                                     |       |                       |           |           |       |
|          | 3        | 0.37m                  | 3/4" chain |  |       |                       |           |           |       |
| 3.7      | 4        |                        | SBE-16     | 1875                                     | 11:36 |                       |           |           |       |
|          | 5        | 1.95m                  | 3/4" chain |  |       |                       |           |           |       |
| 7        | 6        |                        | SBE-16     | 1880                                     | 11:33 |                       |           |           |       |
|          | 7        | 1.25                   | 3/4" chain |  |       |                       |           |           |       |
| 10       | 8        |                        | VMCM       | 037                                      | 11:33 | bands off<br>11:27    |           |           |       |
|          | 9        | 0.83                   | 3/4" chain |  |       |                       |           |           |       |
| 13       | 10       |                        | Aanderaa   | 013                                      | 11:30 |                       |           |           |       |
|          | 11       | 1.73                   | 3/4" chain |  |       |                       |           |           |       |
| 16       | 12       |                        | SBE-16     | 1881                                     | 11:30 |                       |           |           |       |
|          | 13       | 2.25                   | 3/4" chain |  |       |                       |           |           |       |
| 20       | 14       |                        | VMCM       | 032                                      | 11:28 | bands off<br>11:24:30 |           |           |       |
|          | 15       | 2.78                   | 3/4" chain |  |       |                       |           |           |       |
| 25       | 16       |                        | T-POD      | 3258                                     | 11:25 |                       |           |           |       |
|          | 17       | 3.66                   | 3/4" chain |  |       |                       |           |           |       |
| 30       | 18       |                        | SBE-16     | 2323                                     | 11:24 |                       |           |           |       |
|          | 19       | 1.20                   | 3/4" chain |  |       |                       |           |           |       |
| 32.5     | 20       |                        | Aanderaa   | 78                                       | 11:22 |                       |           |           |       |
|          |          | <b>Date/Time (UTC)</b> |            | <b>Comments</b>                          |       |                       |           |           |       |
|          |          | 14 December 04/11:06   |            | Start operations 19°42.65' S 85°37.57' W |       |                       |           |           |       |
|          |          | 14 December 04/11:50   |            | Buoy in water                            |       |                       |           |           |       |
|          |          |                        |            |  |       |                       |           |           |       |
|          |          |                        |            |  |       |                       |           |           |       |
|          |          |                        |            |  |       |                       |           |           |       |

Depth From Diagram (m)

MOORED STATION NUMBER 1145

|      | Item No. | Lgth [m]          | Item       | Inst No.                             | Time Over | Notes                      | Data No. | Calc Dpth | Time Back | Notes |
|------|----------|-------------------|------------|--------------------------------------|-----------|----------------------------|----------|-----------|-----------|-------|
|      | 21       | 1.20              | 3/4" chain |                                      |           |                            |          |           |           |       |
| 35   | 22       |                   | T-POD      | 3283                                 | 11:22     |                            |          |           |           |       |
|      | 23       | 1.05              | 3/4" chain |                                      |           |                            |          |           |           |       |
| 37.5 | 24       |                   | xr 420     | 10514                                | 11:20     |                            |          |           |           |       |
|      | 25       | 1.05              | 3/4" chain |                                      |           |                            |          |           |           |       |
| 40   | 26       |                   | SBE37      | 1325                                 | 11:20     |                            |          |           |           |       |
|      | 27       | 3.15              | 3/4" chain |                                      |           |                            |          |           |           |       |
| 45   | 28       |                   | VMCM       | 038                                  | 11:11     | bands off and spin (11:14) |          |           |           |       |
|      | 29       | 8.0               | 7/16" wire |                                      |           |                            |          |           |           |       |
| 55   | 30       |                   | Aanderaag  | 079                                  | 12:04     |                            |          |           |           |       |
|      | 31       | 6.2               | 7/16" wire |                                      |           |                            |          |           |           |       |
| 62.5 | 32       |                   | SBE37      | 1326                                 | 12:08     |                            |          |           |           |       |
|      | 33       | 6.2               | 7/16" wire |                                      |           |                            |          |           |           |       |
| 70   | 34       |                   | T-POD      | 3704                                 | 12:12     |                            |          |           |           |       |
|      | 35       | 6.2               | 7/16" wire |                                      |           |                            |          |           |           |       |
| 77.5 | 36       |                   | T-POD      | 3762                                 | 12:24     |                            |          |           |           |       |
|      | 37       | 6.2               | 7/16" wire |                                      |           |                            |          |           |           |       |
| 85   | 38       |                   | SBE37      | 1328                                 | 12:27     |                            |          |           |           |       |
|      | 39       | 6.2               | 7/16" wire |                                      |           |                            |          |           |           |       |
| 92.6 | 40       |                   | T-POD      | 3830                                 | 12:31     |                            |          |           |           |       |
|      |          | <b>Date/Time</b>  |            | <b>Comments</b>                      |           |                            |          |           |           |       |
|      |          | 14 Dec 04 / 12:19 |            | Switched to hanging block on A-Frame |           |                            |          |           |           |       |
|      |          |                   |            |                                      |           |                            |          |           |           |       |
|      |          |                   |            |                                      |           |                            |          |           |           |       |
|      |          |                   |            |                                      |           |                            |          |           |           |       |
|      |          |                   |            |                                      |           |                            |          |           |           |       |



MOORED STATION NUMBER 1145

Depth  
From  
Diagram (m)

|           | Item No. | Lgth [m] | Item       | Inst No. | Time Over | Notes              | Data No. | Calc Dpth | Time Back | Notes |
|-----------|----------|----------|------------|----------|-----------|--------------------|----------|-----------|-----------|-------|
|           | 41       | 2.32     | 3/4" chain |          |           |                    |          |           |           |       |
| 96.3      | 42       |          | SBE 37     | 1909     | 12:34     |                    |          |           |           |       |
|           | 43       | 2.32     | 3/4" chain |          |           |                    |          |           |           |       |
| 100       | 44       |          | TPOD       | 3831     | 12:37     |                    |          |           |           |       |
|           | 45       | 13.5     | 1/16" wire |          |           |                    |          |           |           |       |
| 115       | 46       |          | TPOD       | 3836     | 12:42     |                    |          |           |           |       |
|           | 47       | 13.5     | 1/16" wire |          |           |                    |          |           |           |       |
| 130       | 48       |          | SBE 37     | 1329     | 12:45     |                    |          |           |           |       |
|           | 49       | 3.75     | 3/4" chain |          |           |                    |          |           |           |       |
| 135       | 50       |          | RDI        | 1218     | 12:50     |                    |          |           |           |       |
|           | 51       | 8.0      | 1/16" wire |          |           |                    |          |           |           |       |
| 145       | 52       |          | VMCM       | 042      | 12:56     | bands off<br>12:51 |          |           |           |       |
|           | 53       | 13.0     | 1/16" wire |          |           |                    |          |           |           |       |
| 160       | 54       |          | SBE 37     | 1330     | 12:59     |                    |          |           |           |       |
|           | 55       | 13.5     | 1/16" wire |          |           |                    |          |           |           |       |
| 175       | 56       |          | T-POD      | 3837     | 13:02     |                    |          |           |           |       |
|           | 57       | 6.2      | 1/16" wire |          |           |                    |          |           |           |       |
| 183       | 58       |          | Sontek     | 208      | 13:05     |                    |          |           |           |       |
|           | 59       | 6.2      | 1/16" wire |          |           |                    |          |           |           |       |
| 190       | 60       |          | SBE 37     | 1906     | 13:10     |                    |          |           |           |       |
| Date/Time |          | Comments |            |          |           |                    |          |           |           |       |
|           |          |          |            |          |           |                    |          |           |           |       |
|           |          |          |            |          |           |                    |          |           |           |       |
|           |          |          |            |          |           |                    |          |           |           |       |
|           |          |          |            |          |           |                    |          |           |           |       |
|           |          |          |            |          |           |                    |          |           |           |       |

MOORED STATION NUMBER

1145

Depth  
From  
Diagram (m)

|     | Item No. | Lgth [m]  | Item       | Inst No. | Time Over | Notes                             | Data No. | Calc Dpth | Time Back | Notes |
|-----|----------|-----------|------------|----------|-----------|-----------------------------------|----------|-----------|-----------|-------|
|     | 61       | 23.5      | 7/16" wire |          |           |                                   |          |           |           |       |
| 220 | 62       |           | SBE37      | 1908     | 13:15     |                                   |          |           |           |       |
|     | 63       | 13.0      | 7/16" wire |          |           |                                   |          |           |           |       |
| 235 | 64       |           | VMCM       | 058      | 13:21     | bands off<br>13:16:30<br>13:16:30 |          |           |           |       |
|     | 65       | 13.0      | 7/16" wire |          |           |                                   |          |           |           |       |
| 250 | 66       |           | SBE37      | 2012     | 13:27     |                                   |          |           |           |       |
|     | 67       | 38.0      | 3/8" wire  |          |           |                                   |          |           |           |       |
| 290 | 68       |           | VMCM       | 075      | 13:33     | bands off<br>13:28:30             |          |           |           |       |
|     | 69       | 18.0      | 3/8" wire  |          |           |                                   |          |           |           |       |
| 310 | 70       |           | SBE37      | 2015     | 13:38     |                                   |          |           |           |       |
|     | 71       | 38.0      | 3/8" wire  |          |           |                                   |          |           |           |       |
| 350 | 72       |           | VMCM       | 010      | 13:44     | bands off<br>13:29:30             |          |           |           |       |
|     | 73       | 500       | 3/8" wire  |          |           |                                   |          |           |           |       |
| 400 | 74       |           | SBE39      | 0048     | 13:46     | clamped on                        |          |           |           |       |
| 450 | 75       |           | SBE39      | 0049     | 13:48     | clamped on                        |          |           |           |       |
|     | 76       | 500       | 3/8" wire  |          | 13:58     |                                   |          |           |           |       |
|     | 77       | 500       | 3/8" wire  |          | 14:17     |                                   |          |           |           |       |
|     | 78       | 100       | 3/8" wire  |          | 14:34     | one piece                         |          |           |           |       |
|     | 79       | 200       | 7/8" nylon |          | 14:40     | wrapped                           |          |           |           |       |
|     | 80       | 150       | 7/8" nylon |          | 14:56     |                                   |          |           |           |       |
|     |          | Date/Time |            | Comments |           |                                   |          |           |           |       |
|     |          |           |            |          |           |                                   |          |           |           |       |
|     |          |           |            |          |           |                                   |          |           |           |       |
|     |          |           |            |          |           |                                   |          |           |           |       |
|     |          |           |            |          |           |                                   |          |           |           |       |
|     |          |           |            |          |           |                                   |          |           |           |       |

MOORED STATION NUMBER 1145

| Item No. | Lgth [m]        | Item        | Inst No.                                   | Time Over | Notes                     | Data No. | Calc Dpth | Time Back | Notes |
|----------|-----------------|-------------|--|-----------|---------------------------|----------|-----------|-----------|-------|
| 81       | 1500            | 7/8" nylon  |  | 15:08     |                           |          |           |           |       |
| 82       | 100             | 1" nylon    |  |           |                           |          |           |           |       |
| 83       | 1500            | 1 1/2" poly |  | 15:55     | yale grip 50m from bottom |          |           |           |       |
| 84       | 90 <sup>2</sup> | glass balls |  | 16:50     | added 2 from diagram      |          |           |           |       |
| 85       | 5               | 1/2" chain  |  | 17:28     |                           |          |           |           |       |
| 86       |                 | release     | 503121                                     | 18:05     | pulled pin                |          |           |           |       |
| 87       | 5               | 1/2" chain  |  | 18:13     |                           |          |           |           |       |
| 88       | 20              | nystrum     |  | 18:15     |                           |          |           |           |       |
| 89       | 5               | 1/2" chain  |  | 18:22     |                           |          |           |           |       |
| 90       |                 | anchor      |  | 18:25     |                           |          |           |           |       |
| 91       |                 |             |  |           |                           |          |           |           |       |
| 92       |                 |             |  |           |                           |          |           |           |       |
| 93       | 5               | chain       | (added 5m of chain between poly and balls) |           |                           |          |           |           |       |
| 94       |                 |             |  |           |                           |          |           |           |       |
| 95       |                 |             |  |           |                           |          |           |           |       |
| 96       |                 |             |  |           |                           |          |           |           |       |
| 97       |                 |             |  |           |                           |          |           |           |       |
| 98       |                 |             |  |           |                           |          |           |           |       |
| 99       |                 |             |  |           |                           |          |           |           |       |
| 100      |                 |             |  |           |                           |          |           |           |       |

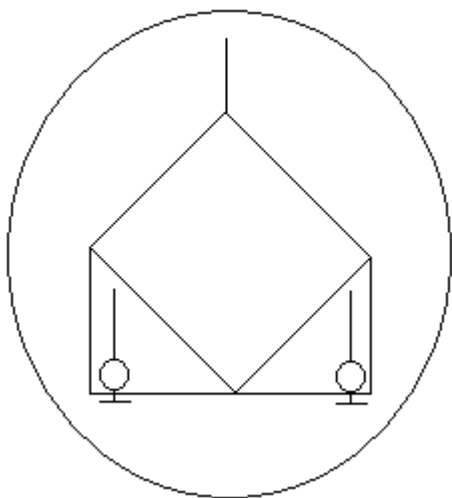
| Date/Time        | Comments                               |
|------------------|--|
| 14 Dec 04/ 15:07 | Stop to transition from winch to H-bit |
| 14 Dec 04/ 16:05 | splice in poly                         |
| 14 Dec 04/ 16:07 | another splice in poly                 |
| 14 Dec 04/ 16:20 | " " "                                  |
| 14 Dec 04/ 16:35 | poly on winch, off H-bit               |
| 14 Dec 04/ 17:30 | towing for position                    |

## 1111

## APPENDIX C – BUOY SPINS

### STRATUS 5 Primary Buoy Spin Woods Hole

309 deg. Heading

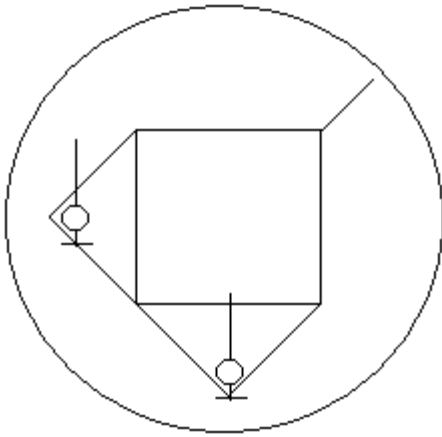


Vanes Secured Time/Date UTC: 17:23:30, 11 JUN 04

| System 1                   | Compass | Vane  | Direction | Time UTC |
|----------------------------|---------|-------|-----------|----------|
| Logger #: L04              |         |       |           |          |
| Stop Sampling: 17:36:15    |         |       |           |          |
| Wind #: WND221             | 131.5   | 179.0 | 310.5     | 17:37:00 |
| Restart Sampling: 17:37:15 |         |       |           |          |

| System 2                   | Compass | Vane  | Direction | Time UTC |
|----------------------------|---------|-------|-----------|----------|
| Logger #: L05              |         |       |           |          |
| Stop Sampling: 17:38:30    |         |       |           |          |
| Wind #: WND225             | 136.3   | 178.8 | 315.1     | 17:39:00 |
| Restart Sampling: 17:39:15 |         |       |           |          |

309 deg. Heading



Vanes Secured Time/Date UTC: 17:43:30, 11 JUN 04

| System 1 | Compass | Vane | Direction | Time UTC |
|----------|---------|------|-----------|----------|
|----------|---------|------|-----------|----------|

Logger #: L04

Stop Sampling: 17:54:30

|                |       |       |       |          |
|----------------|-------|-------|-------|----------|
| Wind #: WND221 | 171.9 | 137.1 | 308.0 | 17:55:00 |
|----------------|-------|-------|-------|----------|

Restart Sampling: 17:55:30

| System 2 | Compass | Vane | Direction | Time UTC |
|----------|---------|------|-----------|----------|
|----------|---------|------|-----------|----------|

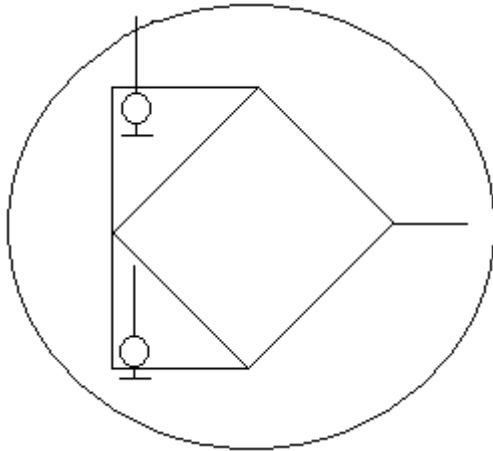
Logger #: L05

Stop Sampling: 17:56:30

|                |       |       |       |          |
|----------------|-------|-------|-------|----------|
| Wind #: WND225 | 173.8 | 137.0 | 310.8 | 17:57:00 |
|----------------|-------|-------|-------|----------|

Restart Sampling: 17:57:30

309 deg. Heading

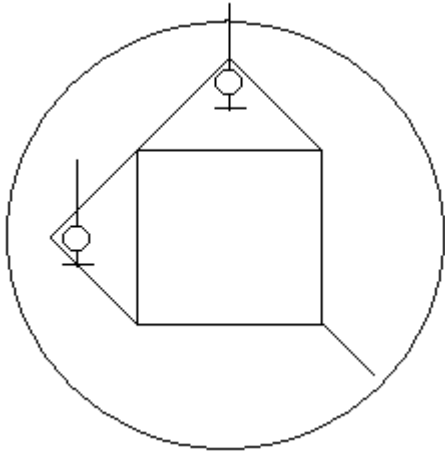


Vanes Secured Time/Date UTC: 18:01:00, 11 JUN 04

| System 1                   | Compass | Vane | Direction | Time UTC |
|----------------------------|---------|------|-----------|----------|
| Logger #: L04              |         |      |           |          |
| Stop Sampling: 18:18:15    |         |      |           |          |
| Wind #: WND221             | 219.8   | 89.8 | 309.6     | 18:18:45 |
| Restart Sampling: 18:19:00 |         |      |           |          |

| System 2                   | Compass | Vane | Direction | Time UTC |
|----------------------------|---------|------|-----------|----------|
| Logger #: L05              |         |      |           |          |
| Stop Sampling: 18:19:30    |         |      |           |          |
| Wind #: WND225             | 217.5   | 89.8 | 307.3     | 18:20:00 |
| Restart Sampling: 18:20:30 |         |      |           |          |

309 deg. Heading

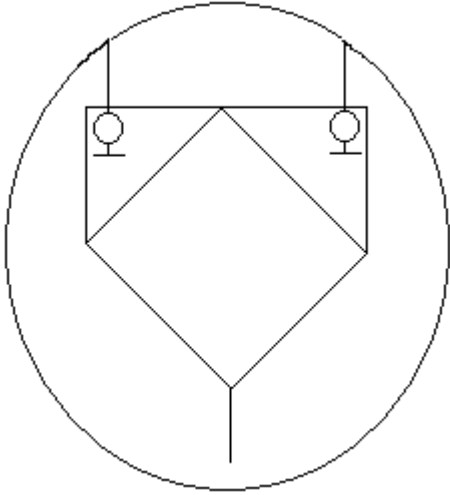


Vanes Secured Time/Date UTC: 18:24:00, 11 JUN 04

| System 1                   | Compass | Vane | Direction | Time UTC |
|----------------------------|---------|------|-----------|----------|
| Logger #: L04              |         |      |           |          |
| Stop Sampling: 18:35:30    |         |      |           |          |
| Wind #: WND221             | 264.6   | 45.2 | 309.8     | 18:36:00 |
| Restart Sampling: 18:36:30 |         |      |           |          |

| System 2                   | Compass | Vane | Direction | Time UTC |
|----------------------------|---------|------|-----------|----------|
| Logger #: L05              |         |      |           |          |
| Stop Sampling: 18:36:45    |         |      |           |          |
| Wind #: WND225             | 261.5   | 46.8 | 308.3     | 18:37:15 |
| Restart Sampling: 18:37:45 |         |      |           |          |

309 deg. Heading



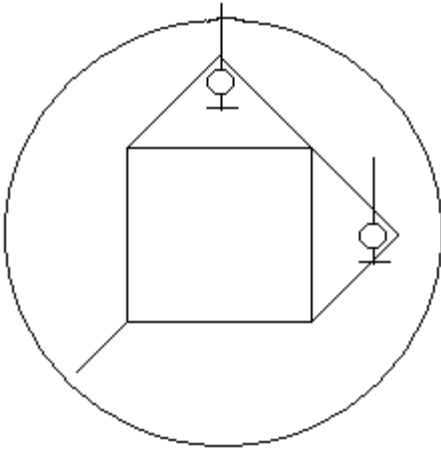
Vanes Secured Time/Date UTC: 18:41:00, 11 JUN 04

| System 1                   | Compass | Vane  | Direction | Time UTC |
|----------------------------|---------|-------|-----------|----------|
| Logger #: L04              |         |       |           |          |
| Stop Sampling: 18:52:30    |         |       |           |          |
| Wind #: WND221             | 313.0   | 356.3 | 309.3     | 18:53:00 |
| Restart Sampling: 18:53:30 |         |       |           |          |

| System 2                   | Compass | Vane  | Direction | Time UTC |
|----------------------------|---------|-------|-----------|----------|
| Logger #: L05              |         |       |           |          |
| Stop Sampling: 18:53:45    |         |       |           |          |
| Wind #: WND225             | 312.9   | 359.1 | 312.0     | 18:54:30 |
| Restart Sampling: 18:54:45 |         |       |           |          |



309 deg. Heading

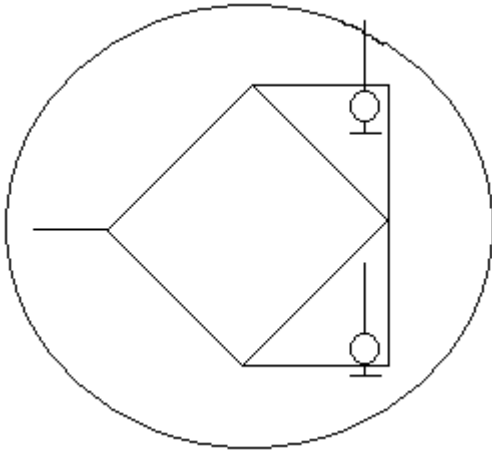


Vanes Secured Time/Date UTC: 18:58:00, 11 JUN 04

| System 1                   | Compass | Vane  | Direction | Time UTC |
|----------------------------|---------|-------|-----------|----------|
| Logger #: L04              |         |       |           |          |
| Stop Sampling: 19:09:30    |         |       |           |          |
| Wind #: WND221             | 354.4   | 315.0 | 309.4     | 19:10:00 |
| Restart Sampling: 19:10:30 |         |       |           |          |

| System 2                   | Compass | Vane  | Direction | Time UTC |
|----------------------------|---------|-------|-----------|----------|
| Logger #: L05              |         |       |           |          |
| Stop Sampling: 19:11:00    |         |       |           |          |
| Wind #: WND225             | 354.0   | 317.8 | 311.8     | 19:11:30 |
| Restart Sampling: 19:12:00 |         |       |           |          |

309 deg. Heading

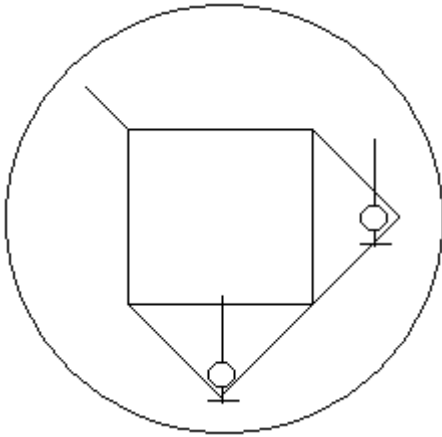


Vanes Secured Time/Date UTC: 19:15:00, 11 JUN 04

| System 1                   | Compass | Vane  | Direction | Time UTC |
|----------------------------|---------|-------|-----------|----------|
| Logger #: L04              |         |       |           |          |
| Stop Sampling: 19:32:15    |         |       |           |          |
| Wind #: WND221             | 43.4    | 266.3 | 309.7     | 19:32:45 |
| Restart Sampling: 19:33:30 |         |       |           |          |

| System 2                   | Compass | Vane  | Direction | Time UTC |
|----------------------------|---------|-------|-----------|----------|
| Logger #: L05              |         |       |           |          |
| Stop Sampling: 19:33:45    |         |       |           |          |
| Wind #: WND225             | 43.6    | 267.3 | 310.9     | 19:34:15 |
| Restart Sampling: 19:34:30 |         |       |           |          |

309 deg. Heading



Vanes Secured Time/Date UTC: 19:38:00, 11 JUN 04

| System 1                   | Compass | Vane  | Direction | Time UTC |
|----------------------------|---------|-------|-----------|----------|
| Logger #: L04              |         |       |           |          |
| Stop Sampling: 19:49:30    |         |       |           |          |
| Wind #: WND221             | 88.0    | 221.3 | 309.3     | 19:50:00 |
| Restart Sampling: 19:50:30 |         |       |           |          |

| System 2                   | Compass | Vane  | Direction | Time UTC |
|----------------------------|---------|-------|-----------|----------|
| Logger #: L05              |         |       |           |          |
| Stop Sampling: 19:50:45    |         |       |           |          |
| Wind #: WND225             | 92.3    | 222.2 | 314.5     | 19:51:15 |
| Restart Sampling: 19:51:45 |         |       |           |          |

## **APPENDIX D – INSTRUMENT NOTES**

### **A. Subsurface Setup Notes**

#### **Stratus 5**

##### **Aanderaa**

- Do not use burst mode.
- Recording Interval – 30 minutes
- Temperature Range – High
- Ping Setting – 600 per interval
- Measure tilt, but turn off automatic tilt correction of current measurements.
- Assuming RCM11, lithium battery (30 Ah), 20 minute interval, 600 pings per interval, 4 channels and extended data storage unit, the instrument will be able to run for 388 days.

##### **RDI**

- Transducer depth = 135 m
- Cell size = 10 m
- Number of cells = 12
- Pings per ensemble = 60
- Time per ensemble = 1 hr.
- Time per ping = 1 min.
- Defined water salinity should be set at 35 (an average of salinity from 135 m to 15 m during Stratus 3).

##### **SonTek**

- Check that compass is in downward looking configuration
- Use ENU coordinate system
- No pressure sensor is installed
- Record in metric units
- Defined water salinity should be set at 34.51 ppt (this is an average of the salinity recorded on Stratus 3 at a depth of 190 m)
- Using standard Argonaut MD battery pack
- Averaging Rate = 110 s, Sampling Interval equals 900 s
- This setup gives a predicted velocity precision (standard deviation) of 0.73 cm/s
- This setup yields a battery life of 400.91 days and recorder life of 560.14 days.

##### **SBE39**

- Sampling rate = 5 minutes.

##### **SBE37**

- Sampling rate = 5 minutes.

### SBE16

- Sampling rate = 5 minutes.

### NGVM

- Sampling rate = 1 minute.

### TPOD

Sampling rate = 30 minutes.

### STRATUS 4 Instrument Clock Checks

| Instrument  | Serial Number | Clock    | Date      | Actual Time UTC     | Stop        |
|-------------|---------------|----------|-----------|---------------------|-------------|
| SBE-39      | 0717          | 08:21:29 | 15 DEC 04 | 08:22:00, 15 DEC 04 | 08:23:00    |
|             | 0282          | 08:23:10 | 15 DEC 04 | 08:23:30, 15 DEC 04 | 08:24:00    |
|             | 0203          | 08:22:46 | 15 DEC 04 | 08:24:30, 15 DEC 04 | 08:25:00    |
| SBE-1621    | 1877          | 13:51:30 | 16 DEC 04 | 13:50:30, 15 DEC 04 | 13:55:00    |
|             | 1882          | 21:45:01 | 16 DEC 04 | 21:44:00, 15 DEC 04 | 21:43:00    |
|             | 0146          | 12:00:58 | 17 DEC 04 | 12:00:45, 16 DEC 04 | 12:01:10    |
|             | 1879          | 12:45:36 | 17 DEC 04 | 12:44:42, 16 DEC 04 | 12:45:10    |
|             | 2324          | 21:30:20 | 16 DEC 04 | 21:29:30, 15 DEC 04 | 21:30:00    |
|             | 0927          | 20:45:02 | 16 DEC 04 | 20:44:30, 15 DEC 04 | 20:45:15    |
| Low battery | 0994          | 08:27:51 | 17 DEC 04 | 08:24:00, 16 DEC 04 | Logging- no |
|             | 1878          | 08:12:41 | 16 DEC 04 | 08:12:30, 16 DEC 04 | 08:13:00    |
|             | 0993          | 11:14:45 | 17 DEC 04 | 11:14:10, 16 DEC 04 | 11:14:40    |
|             | 0928          | 08:15:56 | 17 DEC 04 | 08:15:30, 16 DEC 04 | 08:16:30    |
|             | 2322          | 20:44:14 | 16 DEC 04 | 20:46:12, 15 DEC 04 | 20:47:00    |
| SBE-37      | 1834          | 14:02:36 | 15 DEC 04 | 14:02:03, 15 DEC 04 | 13:58:00    |
|             | 1837          | 11:06:34 | 15 DEC 04 | 11:05:44, 15 DEC 04 | 11:05:04    |
|             | 1899          | 20:41:44 | 15 DEC 04 | 20:39:00, 15 DEC 04 | 20:40:00    |
|             | 2011          | 13:48:00 | 15 DEC 04 | 13:45:00, 15 DEC 04 | 13:45:30    |

| VMCM | Serial Number | Clock               | Time UTC            | Stop sampling       | Records |
|------|---------------|---------------------|---------------------|---------------------|---------|
|      | 033           | 10:10:02, 15 DEC 04 | 10:09:00, 15 DEC 04 | 16:54:45, 16 DEC 04 | 568427  |
|      | 066           | 10:01:42, 15 DEC 04 | 10:03:00, 15 DEC 04 | 17:08:30, 16 DEC 04 | 569991  |
|      | 053           | 10:00:52, 15 DEC 04 | 10:01:00, 15 DEC 04 | 17:25:30, 16 DEC 04 | 569916  |
|      | 030           | 10:03:37, 15 DEC 04 | 10:07:30, 15 DEC 04 | 13:18:45, 16 DEC 04 | 568176  |
|      | 073           | 10:02:09, 15 DEC 04 | 10:05:00, 15 DEC 04 | 13:33:45, 16 DEC 04 | 569539  |
|      | 068           | 09:56:45, 15 DEC 04 | 09:59:00, 15 DEC 04 | 13:53:00, 16 DEC 04 | 569650  |
|      | 057           | 09:38:18, 15 DEC 04 | 09:44:00, 15 DEC 04 | 14:11:00, 15 DEC04  | 569626  |

|        |      |                     |                     |     |         |
|--------|------|---------------------|---------------------|-----|---------|
| RDI    | 1220 | 15:18:38, 15 DEC 04 | 15:20:15, 15 DEC 04 | N/A | 3831235 |
| SonTek | D171 | 16:57:57, 15 DEC 04 | 16:58:00, 15 DEC 04 | N/A | 1498530 |
|        | D197 | 17:33:11, 15 DEC 04 | 17:34:30, 15 DEC 04 | N/A | 1498644 |
|        | D193 | 15:29:45, 15 DEC 04 | 15:31:00, 15 DEC 04 | N/A | 1498302 |

| XX-105 | Serial Number | Clock    | Date      | Actual Time UTC | Stop      | Samples |
|--------|---------------|----------|-----------|-----------------|-----------|---------|
|        | 3667          | 08:07:46 | 18 DEC 04 | 07:58:17        | 17 DEC 04 | 19791   |
|        | 3839          | 08:02:08 | 18 DEC 04 | 07:51:49        | 17 DEC 04 | 19791   |
|        | 4483          | 09:29:19 | 17 DEC 04 | 09:27:43        | 17 DEC 04 | 19793   |
|        | 3703          | 09:42:22 | 18 DEC 04 | 09:33:03        | 17 DEC 04 | 19794   |
|        | 3701          | 09:45:30 | 17 DEC 04 | 09:37:48        | 17 DEC 04 | 19794   |
|        | 4481          | 09:42:17 | 18 DEC 04 | 09:45:05        | 17 DEC 04 | 19794   |
|        | 4493          | 09:49:17 | 17 DEC 04 | 09:50:19        | 17 DEC 04 | 19716   |
|        | 3309          | 09:58:45 | 18 DEC 04 | 09:54:50        | 17 DEC 04 | 19794   |
|        | 4488          | 11:07:08 | 17 DEC 04 | 11:13:09        | 17 DEC 04 | 19797   |
|        | 3305          | 11:09:03 | 18 DEC 04 | 11:17:45        | 17 DEC 04 | 19797   |
|        | 4489          | 11:22:31 | 17 DEC 04 | 11:23:23        | 17 DEC 04 | 19797   |

Bag the Solars (ON) Note Time/Date UTC: LWR's @ 11:06:00 & SWR's @ 11:07:00, 13 DEC 04  
 Unbag Solars (OFF) Note Time/Date UTC: 11:58:30, 13 DEC 04

Temperature Spike SST's (IN) Note Time/Date UTC: 10:52:00, 13 DEC 04  
 Temperature Spike SST's (OUT) Note Time/Date UTC: 12:01:00, 3 DEC 04

WND206 Vane/Prop Assy removed @ 12:43:30, 13 DEC 04  
 WND212 Vane/Prop Assy removed @ 12:42:45, 13 DEC 04

Primary 1 Logger clock check (#STAT) Note Time/Date UTC: 11:35:00, 13 DEC 04  
 Primary 1 Logger clock check Note Time/Date from Logger (L-01): 11:43:44, 13 DEC 04

Primary 2 Logger clock check (#STAT) Note Time/Date UTC: 11:37:30, 13 DEC 04  
 Primary 2 Logger clock check Note Time/Date from Logger (L-02): 11:46:43, 13 DEC 04

Primary 1 Logger Stop Sampling Note Time/Date UTC: 13:01:30, 13 DEC 04  
 Logger 1 Records Used: 575918  
 Primary 2 Logger Stop Sampling Note Time/Date UTC: 13:03:00, 13 DEC 04  
 Logger 2 Records Used: 575925

Dump Data/Remove FLASH Card Primary 1 Logger: Done  
 Dump Data/Remove FLASH Card Primary 2 Logger: Done

Clock check Modules (attach form) \_\_\_\_\_

Dump Data/Remove FLASH Card Primary 1 Modules \_\_\_\_\_  
 Dump Data/Remove FLASH Card Primary 2 Modules \_\_\_\_\_  
 Dump Data SBE-37's (SST's) \_\_\_\_\_

Record Battery Power System 1: Logger = 14.22, Module = 13.34, PTT = 15.94  
Record Battery Power System 2: Logger = 13.34, Module = 13.66, PTT = 15.94  
Power Down Systems: Done

Temperature Spike Under water Inst.'s Note Time/Date UTC ( approx. 1 hr. )

|  |   |
|--|---|
| Seacat's: 12:16:30, 13 DEC 04 (IN)       | Ser. Num.'s: 1877, 1882, 0146, 1879, 2324, 0927 |
| 13:35:30, 13 DEC 04 (OUT)                | 0994, 1878, 0993, 0928, 2322                    |
| SBE-37'S: 12:07:30, 13 DEC 04 (IN)       | Ser. Num.'s: 2011, 1899                         |
| 13:39:30, 13 DEC 04 (OUT)                |   |
| SBE-39'S: 12:07:30, 13 DEC 04 (IN)       | Ser. Num.'s: 0282, 0203                         |
| 13:39:30, 13 DEC 04 (OUT)                |   |
| SBE-39 Floater: 16:45:30, 13 DEC 04 (IN) | Ser. Num: 0717                                  |
| 13:39:30, 13 DEC 04 (OUT)                |   |
| Brancker's: 18:42:00, 15 DEC 04 (IN)     | Ser. Num.'s:3667, 3839, 4483, 3703, 3701,4481,  |
| 20:17:00, 15 DEC 04 (OUT)                | 4493, 3309, 4488, 3305, 4489                    |
| SonTek's: 16:45:30, 13 DEC 04 (IN)       | Ser. Num.'s: D171, D193, D197                   |
| 19:08:30, 13 DEC 04 (OUT)                |   |
| RDI : 10:44:00, 13 DEC 04 (IN)           | Ser. Num.: 1220                                 |
| 12:10:00, 13 DEC 04 (OUT)                |   |

VMCM Rotor Spins:

VM-033 blocked @ 17:51:00, 12 DEC 04  
1<sup>st</sup> spins @ 10:05:30 (Upper), 10:04:30 (Lower), 14 DEC 04  
2<sup>nd</sup> spins @ 08:44:30, 15 DEC 04

VM-066 blocked @ 17:55:00, 12 DEC 04  
1<sup>st</sup> spins @ 09:58:30 (Upper), 09:59:30 (Lower), 14 DEC 04  
2<sup>nd</sup> spins @ 08:45:30, 15 DEC 04

VM-053 blocked @ 18:04:00, 12 DEC 04  
1<sup>st</sup> spins @ 09:56:30, 14 DEC 04  
2<sup>nd</sup> spins @ 08:41:30, 15 DEC 04

VM-030 blocked @ 16:00:00, 12 DEC 04  
1<sup>st</sup> spins @ 10:03:30, 14 DEC 04  
2<sup>nd</sup> spins @ 08:43:30, 15 DEC 04

VM-073 blocked @ 15:49:00, 12 DEC 04  
1<sup>st</sup> spins @ 09:57:30, 14 DEC 04  
2<sup>nd</sup> spins @ 08:42:30, 15 DEC 04

VM-068 blocked @ 15:33:00, 12 DEC 04  
1<sup>st</sup> spins @ 09:55:30, 14 DEC 04  
2<sup>nd</sup> spins @ 08:40:30, 15 DEC 04

VM-057 blocked @ 15:26:00, 12 DEC 04  
1<sup>st</sup> spins @ 09:54:30, 14 DEC 04  
2<sup>nd</sup> spins @ 08:39:30, 15 DEC 04

## B. IMET Setup Notes

### Asimet setups

#### Lwr218

Address = LWR01  
C530 FW = Voslwr53 v3.5  
LWRF FW = Voslwr53 v1.6  
Time set @ 30Nov04 15:57:00 utc  
8Mb erased  
Test mode: passed  
Note: Shielding completed

#### Lwr502

Address = LWR01  
C530 FW = Voslwr53 v3.5  
LWRF FW = Voslwr53 v1.6  
Time set @ 30Nov04 16:14:00 utc  
8Mb erased  
Test mode: passed  
Note: Shielding completed

#### SWR209

Address = SWR01  
C530 FW = Vosswr53 v3.3  
HPS FW = HPS-SWR v1.6  
Time set @ 30Nov04 16:28:15 utc  
8Mb erased  
Test mode: passed  
Note: Shielding completed

#### SWR219

Address = SWR01  
C530 FW = Vosswr53 v3.3  
HPS FW = HPS-SWR v1.6  
Time set @ 30Nov04 16:44:00 utc  
8Mb erased  
Test mode: passed  
Note: Shielding completed

#### HRH216

Address = HRH01  
C530 FW = Voshrh53 v3.2  
HPS FW = HPS-HRH v1.6  
Time set @ 30Nov04 16:50:40 utc  
8Mb erased  
Test mode: passed

#### HRH222

Address = HRH01  
C530 FW = Voshrh53 v3.2  
HPS FW = HPS-HRH v1.6  
Time set @ 30Nov04 16:56:20 utc  
8Mb erased  
Test mode: FAILED  
Note: This unit had previously performed very well during the entire burn-in. Upon disassembly the Rotronic sensor had droplet of water in it. Will go to the spare which is suspected of having a small temperature bias.

#### HRH232

Address = HRH01  
C530 FW = Voshrh53 v3.2  
HPS FW = HPS-HRH v1.6  
Time set @ 30Nov04 17:18:00 utc  
8Mb erased  
Test mode: passed

#### BPR216

Address = BPR01  
C530 FW = Vosbpr53 v3.3(Heise)  
Time set @ 30Nov04 17:31:33 utc  
8Mb erased  
Test mode: passed

#### BPR217

Address = BPR01  
C530 FW = Vosbpr53 v3.3(Heise)  
Time set @ 30Nov04 17:36:10 utc



8Mb erased  
Test mode: passed

PRC205  
Address = PRC01  
C530 FW = VosPRC53 v3.4  
HPS FW = HPS-PRC v1.7  
Time set @ 30Nov04 17:45:20 utc  
8Mb erased  
Test mode: passed

PRC214  
Address = PRC01  
C530 FW = VosPRC53 v3.4  
HPS FW = HPS-PRC v1.7  
Time set @ 30Nov04 17:50:47 utc  
8Mb erased  
Test mode: passed

WND221  
Address = WND01  
C530 FW = Voswnd53 v3.5  
Pic FW = Picwnd v1.5  
Time set @ 30Nov04 17:56:08 utc  
8Mb erased  
Test mode: passed

WND225  
Address = WND01  
C530 FW = Voswnd53 v3.5  
Pic FW = Picwnd v1.5  
Time set @ 30Nov04 18:02:40 utc  
8Mb erased  
Test mode: passed

LWR505  
Address = LWR01  
C530 FW = Voslwr53 v3.5  
LWRF FW = Voslwr v 1.6  
Time set @ 02Dec04 11:28:40 utc  
8mb erased  
Test mode: passed

LWR208  
Address = LWR01  
C530 FW = Voslwr53 v3.5  
LWRF FW = Voslwr v 1.6  
Time set @ 02Dec04 11:45:48 utc  
8mb erased  
Test mode: passed

KZ001  
Address = LWR01  
C530 FW = VoslwrKZ v4.0  
Time set @ 01Dec04 11:01:29 utc  
8mb erased  
Test mode: passed

SWR801  
Address = SWR01  
C530 FW = Vosswr53 v3.3  
Time set @ 01Dec04 11:06:08 utc  
8mb erased  
Test mode: passed

SWR201  
Address = SWR01  
C530 FW = Vosswr53 v3.3  
Time set @ 01Dec04 11:12:50 utc  
8mb erased  
Test mode: passed

LWR216  
Address = LWR01  
C530 FW = Voslwr53 v3.5  
LWRF FW = Voslwr v 1.6  
Added black body constants  
Time set @ 01Dec04 17:50:32 utc  
4mb erased  
Test mode: passed

SST SBE37-SM s/n 1841  
RS-485  
FW version = 2.2  
Total samples free = 233016  
Clock set and checked  
Format = 1

Storetime = Y  
Outputsal = N  
OutputSV = N  
RefPress = 0  
Interval = 300  
Samplenum = 0  
StartMMDDYY = 120104  
StartHHMMSS = 193000  
Startlater OK

SST SBE37-SM s/n 1305  
RS-485  
FW version = 2.2A  
Total samples free = 233016  
Clock set and checked  
Format = 1  
Storetime = Y  
Outputsal = N  
OutputSV = N  
RefPress = 0  
Interval = 300  
Samplenum = 0  
StartMMDDYY = 120104  
StartHHMMSS = 193000  
Startlater OK

Hobo Pro RH-AT logger  
s/n = 276452  
Set time @ 13:36:00 02Dec04  
Samples on the half hour.

02Dec04  
SWR Buoy Dump  
SWR209 and SWR219  
No real signs of Argos contamination

03Dec04  
Yellow test logger  
Looking back from bow of ship (left to right)  
New Amp LWR into logger L3  
KZ LWR into logger L4  
LWR505 into logger L2  
LWR216 into logger L1

Logger  
SWR201 into logger S2  
SWR801 into logger S1  
  
SBE16 s/n 1873  
V4.1b  
DS ok  
TM Pass  
IR ok  
ST 120304 193315 ok  
SI 300 ok  
TI 120504 010000 300 ok  
IL ok  
GL ok  
DS ok  
Vlith = 5.3v  
Vmain = 10.8v  
260821 samples free  
Instrument dessicated  
Poison plugs installed

SBE16 s/n 1875  
V4.1b  
DS ok  
TM Pass  
IR ok  
ST 120304 193950 ok  
SI 300 ok  
TI 120504 010000 300 ok  
IL ok  
GL ok  
DS ok  
Vlith = 5.0v  
Vmain = 10.8v  
260821 samples free  
Instrument dessicated  
Poison plugs installed

SBE16 s/n 1880  
V4.1b  
DS ok  
TM Pass  
IR ok  
ST 120404 133403 ok

SI 300 ok  
TI 120504 010000 300 ok  
IL ok  
GL ok  
DS ok  
Vlith = 5.4v  
Vmain = 10.9v  
260821 samples free  
Instrument dessicated  
Poison plugs installed

SBE16 s/n 2323

V4.1a  
DS ok  
TM Pass  
IR ok  
ST 120404 184420 ok  
SI 300 ok  
TI 120504 010000 300 ok  
IL ok  
GL ok  
DS ok  
Vlith = 5.1v  
Vmain = 10.9v  
260821 samples free  
Instrument dessicated  
Poison plugs installed

SBE16 s/n 1881

V4.1  
DS ok  
TM Pass  
IR ok  
ST 120404 194612 ok  
SI 300 ok  
TI 120504 010000 300 ok  
IL ok  
GL ok  
DS ok  
Vlith = 4.6v  
Vmain = 10.9v  
260821 samples free  
Instrument dessicated  
Poison plugs installed

SBE37-SM s/n 1909  
RS-232  
Total samples free = 190650  
Clock set and checked  
Format = 1  
Storetime = Y  
Outputsal = N  
OutputSV = N  
RefPress = 0  
Interval = 300  
Samplenum = 0  
StartMMDDYY = 120504  
StartHHMMSS = 010000  
Startlater OK

Note: While siphoning the PRC's noticed that PRC214 would not completely siphon down. PRC214 gauge removed at 21:01:00. Back on at 21:26:00. No improvement. Prep PRC206

PRC206  
Address = PRC01  
C530 FW = VosPRC53 v3.4  
HPS FW = HPS-PRC v1.7  
Time set @ 05Dec04 22:03:00 utc  
8Mb erased  
Test mode: passed  
Replaced PRC214 w/ PRC206  
On Buoy at 22:55:00  
Cycled plus added a little water at 23:01:30

8Dec04 16:35:00 utc  
added little bit of water to both precip

Instruments recovered from Stratus 4

SBE37 s/n 1837 RS-485  
Stopped logging @ 11:00:30  
UTC 11:05:04 15Dec04  
SBE 11:06:34 15Dec04  
Records used: 115748

SBE37 s/n 1834 RS-485  
Stopped logging @13:58:00  
UTC 14:02:03 15Dec04  
SBE 14:02:36 15Dec04  
Records used: 115783

LWR204  
9598 records used  
UTC 17:02:00 15Dec04  
LWR 17:46:34 15Dec04  
Flash card to Paul

HRH221  
9599 records used  
UTC 17:17:12 15Dec04  
HRH 17:26:37 15Dec04  
Values ok  
Flash card to Paul

HRH227  
9676 records used  
UTC 17:37:20 15Dec04  
HRH 17:37:48 15Dec04  
Flash card to Paul

WND206  
9581 records used  
UTC 17:55:10 15Dec04  
WND 18:07:40 15Dec04  
Flash card to Paul

WND212  
9595 records used  
UTC 18:21:38 15Dec04  
WND 18:35:33 15Dec04  
Flash card to Paul

HRH223  
9599 records used  
UTC 18:37:14 15Dec04  
HRH 18:49:45 15Dec04  
Values ok  
Flash card to Paul

SBE16 s/n 2322  
V4.1a  
UTC 20:46:12 15Dec04  
SBE 20:44:14 16Dec04  
Note: Date set improperly?  
Stopped sampling 20:47:00 15Dec04  
Samples used = 118318

SBE16 s/n 1882  
V4.1  
UTC 21:44:00 15Dec04  
SBE 21:45:01 16Dec04  
Note: Date set improperly?  
Stopped sampling 21:43:00 15Dec04  
Samples used = 118329

SBE16 s/n 993  
V4.1b  
UTC 11:14:10 16Dec04  
SBE 11:14:45 17Dec04  
Note: Date set improperly?  
Stopped sampling 11:14:40 16Dec04  
Samples used = 118492

SBE16 s/n 146  
V4.1b  
UTC 12:00:45 16Dec04  
SBE 12:00:58 17Dec04  
Note: Date set improperly?  
Stopped sampling 12:01:10 16Dec04  
Samples used = 118501

SBE16 s/n 1879  
V4.1b  
UTC 12:44:42 16Dec04  
SBE 12:45:36 17Dec04  
Note: Date set improperly?  
Stopped sampling 12:45:10 16Dec04  
Samples used = 118510

|  |                                      |  |                                     |
|--|--------------------------------------|--|-------------------------------------|
| <b>REPORT DOCUMENTATION PAGE</b>   | <b>1. REPORT NO.</b><br>WHOI-2006-06 | <b>2.</b><br>UOP-2005-02   | <b>3. Recipient's Accession No.</b> |
| <b>4. Title and Subtitle</b><br>Stratus Ocean Reference Station (20S, 85W), Mooring Recovery and Deployment Cruise, R/V Ron Brown Cruise 04-11, December 5 - December 24, 2004   |                                      | <b>5. Report Date</b><br>May 2005                                    |                                     |
| <b>7. Author(s)</b> Keir Colbo, Robert Weller, Jeff Lord, Jason Smith, Paul Bouchard, Chris Fairall, Frank Bradley, Dan Wolfe, Efthymios Serpetzoglou, Jason Tomlinson,  |                                      | <b>8. Performing Organization Rept. No.</b><br>WHOI-2006-06          |                                     |
| <b>9. Performing Organization Name and Address</b><br><br>Woods Hole Oceanographic Institution<br>Woods Hole, Massachusetts 02543  |                                      | <b>10. Project/Task/Work Unit No.</b>                                |                                     |
| <b>12. Sponsoring Organization Name and Address</b><br><br>NOAA  |                                      | <b>11. Contract(C) or Grant(G) No.</b><br>(C) NOAA NA17RJ1225<br>(G) |                                     |
| <b>15. Supplementary Notes</b><br>This report should be cited as: Woods Hole Oceanog. Inst. Tech. Rept., WHOI-2005-06.   |                                      | <b>13. Type of Report &amp; Period Covered</b><br>Technical Report   |                                     |
| <b>16. Abstract (Limit: 200 words)</b><br>The Ocean Reference Station at 20° S, 85° W under the stratus clouds west of northern Chile and Peru is being maintained to provide ongoing, climate-quality records of surface meteorology, of air-sea fluxes of heat, freshwater, and momentum, and of upper ocean temperature, salinity, and velocity variability. The Stratus Ocean Reference Station (ORS Stratus) is supported by the National Oceanic and Atmospheric Administration's (NOAA) Climate Observation Program. It is recovered and redeployed annually, with cruises that have come between October and December. During the December 2004 cruise of NOAA's R/V <i>Ronald H. Brown</i> to the ORS Stratus site, the primary activities were the recovery of the WHOI surface mooring that had been deployed in November 2003, the deployment of a new WHOI surface mooring at that site, the in-situ calibration of the buoy meteorological sensors by comparison with instrumentation put on board by staff of the NOAA Environmental Technology Laboratory (ETL), and observations of the stratus clouds and lower atmosphere by NOAA ETL and Jason Tomlinson from Texas A&M. |                                      | <b>14.</b>   |                                     |
| <b>17. Document Analysis a. Descriptors</b><br>air-sea fluxes<br>upper ocean variability<br>stratus clouds<br><br><b>b. Identifiers/Open-Ended Terms</b><br><br><br><br><b>c. COSATI Field/Group</b>   |                                      |  |                                     |
| <b>18. Availability Statement</b><br><br>Approved for public release; distribution unlimited.  |                                      | <b>19. Security Class (This Report)</b><br><b>UNCLASSIFIED</b>       | <b>21. No. of Pages</b><br>131      |
|  |                                      | <b>20. Security Class (This Page)</b>                                | <b>22. Price</b>                    |

## DOCUMENT LIBRARY

*Distribution List for Technical Report Exchange – July 1998*

University of California, San Diego  
SIO Library 0175C  
9500 Gilman Drive  
La Jolla, CA 92093-0175

Hancock Library of Biology & Oceanography  
Alan Hancock Laboratory  
University of Southern California  
University Park  
Los Angeles, CA 90089-0371

Gifts & Exchanges  
Library  
Bedford Institute of Oceanography  
P.O. Box 1006  
Dartmouth, NS, B2Y 4A2, CANADA

NOAA/EDIS Miami Library Center  
4301 Rickenbacker Causeway  
Miami, FL 33149

Research Library  
U.S. Army Corps of Engineers  
Waterways Experiment Station  
3909 Halls Ferry Road  
Vicksburg, MS 39180-6199

Marine Resources Information Center  
Building E38-320  
MIT  
Cambridge, MA 02139

Library  
Lamont-Doherty Geological Observatory  
Columbia University  
Palisades, NY 10964

Library  
Serials Department  
Oregon State University  
Corvallis, OR 97331

Pell Marine Science Library  
University of Rhode Island  
Narragansett Bay Campus  
Narragansett, RI 02882

Working Collection  
Texas A&M University  
Dept. of Oceanography  
College Station, TX 77843

Fisheries-Oceanography Library  
151 Oceanography Teaching Bldg.  
University of Washington  
Seattle, WA 98195

Library  
R.S.M.A.S.  
University of Miami  
4600 Rickenbacker Causeway  
Miami, FL 33149

Maury Oceanographic Library  
Naval Oceanographic Office  
Building 1003 South  
1002 Balch Blvd.  
Stennis Space Center, MS, 39522-5001

Library  
Institute of Ocean Sciences  
P.O. Box 6000  
Sidney, B.C. V8L 4B2  
CANADA

National Oceanographic Library  
Southampton Oceanography Centre  
European Way  
Southampton SO14 3ZH  
UK

The Librarian  
CSIRO Marine Laboratories  
G.P.O. Box 1538  
Hobart, Tasmania  
AUSTRALIA 7001

Library  
Proudman Oceanographic Laboratory  
Bidston Observatory  
Birkenhead  
Merseyside L43 7 RA  
UNITED KINGDOM

IFREMER  
Bibliothèque La Pérouse  
Centre de Documentation sur la Mer  
15 rue Dumont d'Urville  
Technopôle Brest-Iroise  
BP 70 — 29280 Plouzané — FRANCE