

Woods Hole Oceanographic Institution

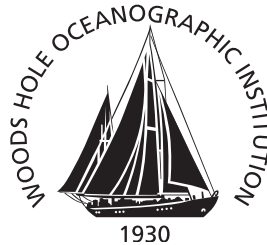

Deployment of the Northern Fish Cage and Mooring, University of New Hampshire — Open Ocean Aquaculture Program Summer 2000

by

James D. Irish, Walter Paul, William M. Ostrom
Woods Hole Oceanographic Institution

Michael Chambers, Dave Fredriksson
University of New Hampshire

Matt Stommel
Fishing Vessel *Nobska*

Woods Hole Oceanographic Institution
Woods Hole, Massachusetts 02543

September 2000

Technical Report

Funding was provided by the National Oceanic and Atmospheric Administration for the Open Ocean Aquaculture Project under Contract No. NA86RG0016 to the University of New Hampshire and under Subcontracts 00-394 and 01-442 to the Woods Hole Oceanographic Institution.

Approved for public release; distribution unlimited.

WHOI-2001-01

Deployment of the Northern Fish Cage and Mooring,
University of New Hampshire – Open Ocean Aquaculture Program
Summer 2000

by

James D. Irish, Walter Paul, William M. Ostrom
Woods Hole Oceanographic Institution

Michael Chambers, Dave Fredriksson
University of New Hampshire

Matt Stommel
Fishing Vessel *Nobska*

September 2000

Technical Report

Funding was provided by National Oceanic and Atmospheric Administration for the Open Ocean Aquaculture Project under Contract No. NA86RG0016 to the University of New Hampshire and under Subcontracts 00-394 and 01-442 to the Woods Hole Oceanographic Institution

Reproduction in whole or in part is permitted for any purpose of the United States Government. This report should be cited as Woods Hole Oceanog. Inst. Tech. Rept., WHOI-2001-01.

Approved for public release; distribution unlimited.

Approved for Distribution:

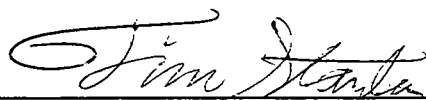

Timothy K. Stanton, Chair

Department of Applied Ocean Physics and Engineering

MBL/WHOI



0 0301 0040743 3

ABSTRACT

The University of New Hampshire - Open Ocean Aquaculture (UNH-OOA) program has worked for the past few years on developing the technology and methodology to deploy and maintain fish cages in open, exposed northern waters. In June 1999, two Sea Station octagonal net cages by Ocean Spar Technologies were deployed with their UNH designed and constructed moorings. In June 2000 the Northern Cage and its mooring were retrieved, examined and repaired, and readied for redeployment. This was a complex operation, initiated by a team of UNH ocean engineers led by Dr. Barbaros Celikkol. This year's effort was expanded with the addition of a Program Manager (Michael Chambers), the Fishing Vessel *Nobska*, and researchers from the Woods Hole Oceanographic Institution (WHOI). During the week of 21 to 25 August 2000, the cage and mooring were assembled and deployed at the UNH-OOA site seven miles offshore of the New Hampshire coast, south of the Isle of Shoals. This collaborative effort involved members of the UNH Mechanical Engineering Dept., UNH divers, members of the WHOI Applied Ocean Physics & Engineering Dept. and the Captain and crew of the FV *Nobska*. Ship support for the deployment was provided by the R/V *Gulf Challenger and Galen J.* (UNH) and the FV *Nobska* (a 100 foot fishing vessel based at Woods Hole, MA). The work was favored by light wind and sea conditions. The endeavor resulted in the successful placement of the North Cage and its complex mooring system with load cells and environmental sensors. Unexpected and unexplained tangling of the mooring system, in particular near its grid corner points, was encountered and corrected.

Table of Contents

| | |
|--|----|
| Abstract | 2 |
| Table of Contents | 3 |
| List of Tables | 4 |
| List of Figures | 4 |
| List of Pictures | 5 |
| 1.0 Vessels, Personnel and Tasks | 6 |
| 2.0 The UNH Fish Cage Mooring System | 7 |
| 2.1 Anchor Leg Assembly: | 7 |
| 2.2 Crown Line Assembly: | 7 |
| 2.3 Bridle Line Assembly: | 9 |
| 3.0 Preparation for Fish Cage and Mooring Deployment | 10 |
| 3.1 Fish Cage | 10 |
| 3.2 Antifouling protection on cage net and mooring lines | 12 |
| 3.3 Preparation of a Telemetry Conductor Cable Link | 12 |
| 3.4 Modification of Anchor line mooring and Anchor pickup crown line mooring | 13 |
| 3.41. Anchor Leg Mooring Changes | 13 |
| 3.42 Crown Line Mooring Changes | 14 |
| 3.43 Anchor Recovery and Handling | 14 |
| 3.5 Load Cell additions to the Northeast Grid Corner rope ring. | 15 |
| 4.0 Deployment Work on Monday and Tuesday August 21 and 22, 2000 | 16 |
| 4.1 Fish Cage Assembly at Portsmouth Naval Dry Dock No. 3 | 16 |
| 4.2 <i>Nobska</i> Loading and Departing WHOI. | 18 |
| 5.0 Deployment Work on Tuesday, August 22, 2000 | 18 |
| 5.1 <i>Nobska</i> arrival and Deployment of Temporary Mooring | 18 |
| 5.2 Loading and Deploying Mooring from <i>Nobska</i> | 20 |
| 5.21 Loading of Mooring Gear | 20 |
| 5.22 Deployment of the Southern to Fish Cage Mooring Legs | 21 |
| 6.0 Deployment Work on Wednesday, August 23, 2000 | 27 |
| 6.1 <i>Gulf Challenger</i> Fish Cage Tow | 27 |
| 6.2 Northern Cage Anchor Deployment | 29 |
| 7.0 Deployment Work on Thursday, August 24, 2000 | 30 |
| 7.1 Connecting the North Cage to its Mooring | 31 |
| 7.2 Unexpected Entanglement and Fix | 31 |
| 7.3 Completion of the Cage Mooring | 33 |
| 7.4 Tensioning of the Northern Cage Mooring | 33 |
| 8.0 Deployment Work on Friday August 25, 2000 | 35 |
| 9.0 Assessment of Effort | 35 |
| 10.0 Lessons Learned and Unresolved Issues: | 35 |
| Acknowledgements | 36 |

| | |
|---|----|
| References | 36 |
| Appendix I: Marking of Mooring Components | 36 |
| Appendix II: Service of the University of New Hampshire, Open Ocean Aquaculture Program's Moorings and Fish Cage with the FV <i>Nobska</i> | 38 |
| Goal and Tasks | 38 |
| Monday 19 June 2000 | 40 |
| Tuesday 20 June 2000 | 40 |
| Figure 1. Counter weight recovery bridle design | 41 |
| Photo P001161 - Counter weight recovery | 42 |
| Photo P001166 - Northern fish cage at surface | 43 |
| Photo P001172 - <i>Nobska</i> towing fish cage | 44 |
| Figure 2. Temporary fish cage mooring | 45 |
| Photo P001272 - Cut end of anchor line | 46 |
| Wednesday 21 June 2000 | 47 |
| Photo P001189 - Cutting anchor chain | 47 |
| Photo P001254 - Unloading <i>Nobska</i> | 48 |
| Photo P001178 - Wrapping anchor line on aft net reel | 49 |
| Photo P001223 - Wrapping anchor chain on aft net reel | 50 |
| Photo P001240 - Wrapping fish cage net on aft net reel | 51 |
| Thursday 21 June 2000 | 52 |
| P001244 - Towing fish cage rim to Portsmouth | 52 |
| Friday 22 June 2000 | 53 |
| Summary of Findings | 54 |
| P622006 - Anchor from leg A | 54 |
| P001196 - Anchor from leg C | 55 |
| P001259 - Anchor from leg B | 56 |
| P001258 - Anchor from leg D | 56 |
| P001287 - Shackle from Leg B at steamer chain | 57 |
| List of Tables | |
| Table 1: Components of the Anchor Leg Assembly | 8 |
| Table 2: Components of the Crown Line Leg Mooring Assembly | 9 |
| Table 3: Components of the Bridle Line Assembly | 9 |
| Table 4: Color Coding of Mooring Components | 13 |
| List of Figures: | |
| Figure 1. Whole Fish Cage Mooring | 7 |
| Figure 2. Whole mooring leg assembly | 8 |
| Figure 3. Anchor Leg Assembly | 9 |
| Figure 4. Crown Line Assembly | 10 |
| Figure 5. Steamer Chain compliance on Crown Line | 11 |
| Figure 6. Bridle Assembly | 15 |
| Figure 7. A scale drawing of the grid corner and bridle lines. | 16 |

| | |
|--|----|
| Figure 8. A top view of the Northeast Corner ring with four load cells attached | 17 |
| Figure 9. A drawing of the possible movement of load cells to estimate wire lengths. | 17 |
| Figure 10. Temporary Cage Mooring | 19 |
| Figure 11. Geometry and Slack in Bridle lines as Cage is lowered | 37 |

List of Pictures:

| | |
|--|----|
| Picture 1. Telemetry cable on lower riser line | 14 |
| Picture 2. Logistics planning, Will Ostrom and Michael Chambers | 19 |
| Picture 3. Anchor chain on aft net reel | 20 |
| Picture 4. Anchor chain and rope on net reel | 20 |
| Picture 5. Rope securing anchor chain to net reel with end links free | 20 |
| Picture 6. Shoreside crane loading anchor | 21 |
| Picture 7. Anchor being positioned on port rail | 21 |
| Picture 8. Anchor secured to rail with backchain and long link chain to winch | 21 |
| Picture 9. Loading lines | 22 |
| Picture 10. Preparing grid corner buoy | 22 |
| Picture 11. Grid corner ring | 22 |
| Picture 12. Load cell in line to anchor from grid ring | 22 |
| Picture 13. Grid corner buoy attaching grid line and lower riser line | 22 |
| Picture 14. Nobska paying out anchor line as steams to stream mooring | 23 |
| Picture 15. Welding shackles on lower part of mooring | 23 |
| Picture 16. Connecting 7/8" chain to 2 1/4" anchor chain | 23 |
| Picture 17. Mooring weight now on anchor and trawl winch | 23 |
| Picture 18. Four link pieces of 2 1/4" anchor chain with 3/4" chain for compliance | 24 |
| Picture 19. Attaching 3/4" chain with four links of anchor chain | 24 |
| Picture 20. Lifting compliance chain with trawl winch | 24 |
| Picture 21. Compliance chain lifted over rail | 24 |
| Picture 22. Crown line being wound on net reel | 25 |
| Picture 23. Crown line attached to chain on rail | 25 |
| Picture 24. Crown line with mooring weight on net reel | 25 |
| Picture 25. Load transferred back to trawl winch | 25 |
| Picture 26. Making up chain to temporary crown marker buoys | 26 |
| Picture 27. Temporary marker buoys in water ready to deploy moorint | 26 |
| Picture 28. Will Ostrom slipping line to deploy mooring | 26 |
| Picture 29. Will Ostrom in WHOI's Zodiac | 26 |
| Picture 30. Anchor hooked over rail on first deployment | 27 |
| Picture 31. Loading anchor line and arranging deck | 27 |
| Picture 32. R/V <i>Galen J.</i> | 27 |
| Picture 33. Fish Cage under tow in Piscataqua River | 28 |
| Picture 34. R/V <i>Gulf Challenger</i> with fish cage in tow | 29 |
| Picture 35. FV <i>Nobska</i> on way to UNH-OOA site | 30 |
| Picture 36. Northeast grid corner ring with four load cells and strongback | 31 |
| Picture 37. Northern fish cage with bridle lines attached to top of spar | 31 |
| Picture 38. Attaching cage to northwest corner | 31 |
| Picture 39. Attaching cage to southwest corner | 32 |
| Picture 40. Untangling Northwest corner of Northern cage | 32 |
| Picture 41. Northeast corner of southern cage tangled | 34 |

Preparation and Deployment of UNH-OOA North Cage, August 2000, Cruise Report

1.0 The Vessels, Personnel and Tasks:

The vessels:

R/V *Gulf Challenger*, UNH – Paul Pellitier (Capt.), Ken Houtler (Mate).

R/V *Galen J*, UNH – Noel Carlson or Michael Chambers (Capt.)

F/V *Nobska*, Woods Hole – Matt Stommel (Capt.)

The Personnel:

From UNH:

- Michael Chambers, Project Manager
- Paul Lavoie, Research Engineer
- Dave Fredriksson, System Design Engineer and Diving Support,
- Noel Carlson, Captain and Diving Support
- Liz Kintzing, Dive Safety Officer
- Glenn Rice, Technical and Diving Support
- John Ahern, Engineering Support.

From Net Systems:

- Tim Gregg, Technical Representative

From the *Nobska*:

- Matt Stommel, owner and captain,
- Joe, Sean, Leicester, and Chad, crew

From WHOI:

- Jim Irish, Instrumentation and WHOI Logistics,
- Will Ostrom, Rigging and Installation of Mooring System,
- Walter Paul, Mooring System Design, Rope and Cable Details

The Tasks:

- To transfer and assemble the North Cage at the Portsmouth Naval Shipyard.
- To instrument the North Cage with environmental sensors and load cells during its assembly.
- To conduct “normal mode” tests by releasing the cage from a crane that had displaced the cage from its equilibrium position and observing the response and damping as the cage oscillates about its mean depth.
- To tow the North Cage from the Portsmouth Naval Shipyard to the OOA site 1.3 miles south of the Isles of Shoals, a distance of approximately 12 nautical miles, and to moor the cage to a temporary mooring deployed by the *Nobska* on her way into Portsmouth, NH.
- To assemble, transport to the site, and deploy the four anchor/leg mooring for the fish cage,
- To tow the fish cage into its mooring and connect it to the mooring,

- To tension the Northern Cage mooring system to bring the cage into its desired moored position,
- To relax the South Cage mooring and grid and repair the fouled NE corner rope ring,
- To replace the spar crown buoys and chain adjustments on the South Cage,
- To retension the South Cage mooring system.

2.0 The UNH Fish Cage Mooring System.

The fish cage moorings are complicated, four-anchor grid systems shown in Figure 1 (Tsukrov et al., 2000). These moorings can support a variety of fish cages, and accommodate a maximum up and down movement of the Ocean Spar net cage deployed this year and last. This cage has two operating positions - up and down. The cage can be at the surface (shown) or down (below the grid lines) with the counter weight on the bottom. To show and discuss the moorings in detail, each leg of the mooring system (Figure 2) is broken up into sections (1) the anchor leg assembly, (2) the crown line assembly, and (3) the bridle line assembly.

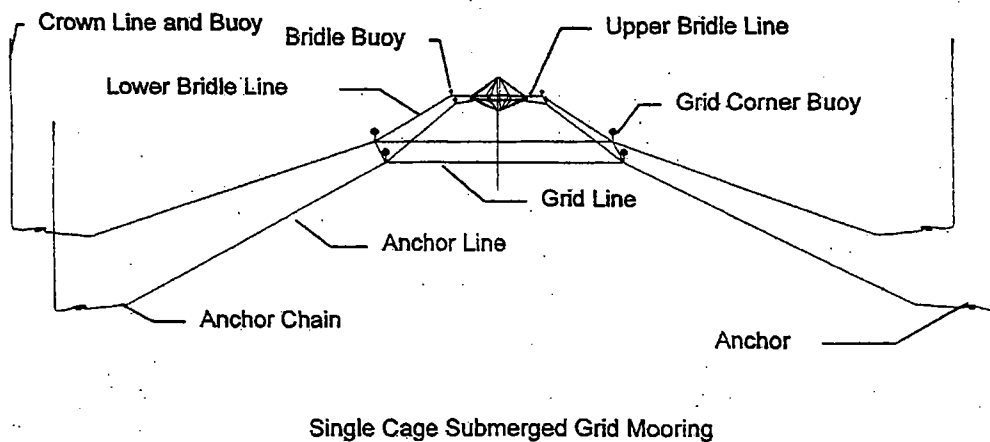

Figure 1. The whole mooring system as deployed in 1999. In 2000, load cells were added in the anchor line at each grid corner and the bridle buoys were not deployed.

2.1 Anchor Leg Assembly:

The anchor leg assembly links the grid corner ring and square rope grid to the 1000 kg Sampson anchor. The components of each of the four anchor mooring legs are listed in Table 1, and shown (in a not to scale assembly drawing of the original anchor mooring leg without the load cell and 7/8 inch chain) in Figure 3.

2.2 Crown Line Assembly:

The mooring is positioned (anchor picked up to relax the mooring and pulled to retention the mooring) and the anchor lowered to the bottom during deployment by a crown line attached to the back end of the Samson anchor. The crown line components are listed in Table 3 and shown (in a not to scale assembly drawing of the original crown line assembly) in Figure 4. The

modifications for the addition of the short the sections of steamer chain to add compliance to the spar buoy while handling from the *Nobska's* trawl winch is shown in Figure 5.

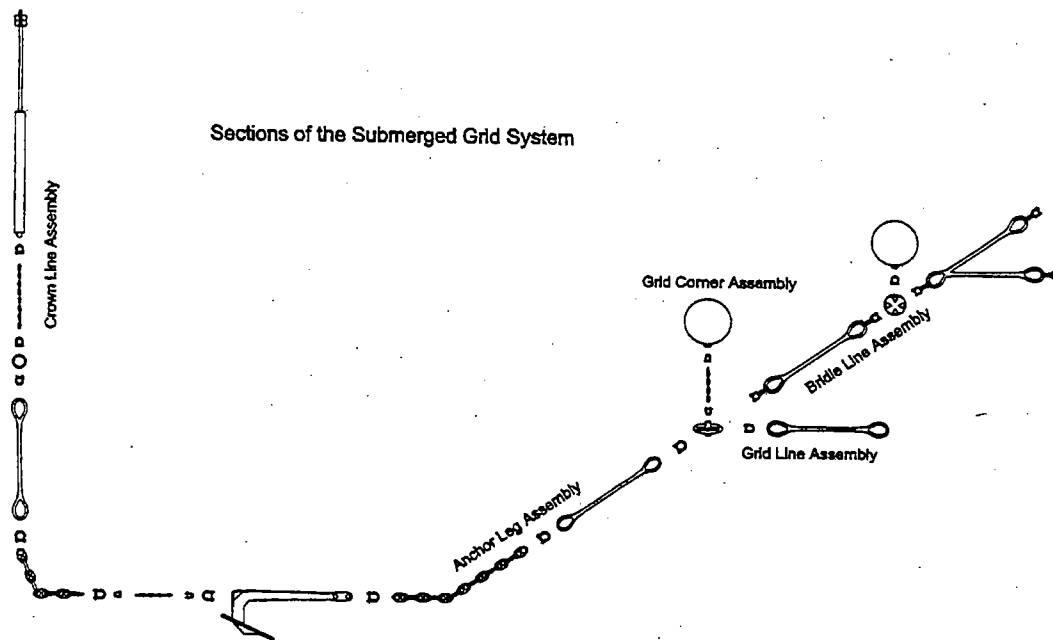

Figure 2. A whole mooring leg assembly, showing the three components shown in more detail in Figures 3, 4 and 5 and components listed in Tables 1, 2 and 3.

TABLE 1: Components of the Anchor Leg Assembly

| |
|---|
| A 1,000 kg (2,200 lb) Samson SM12 fluke anchor |
| A 9 meter (30 foot) length of 7/8 inch Grade 80 chain between the anchor and the steamer chain (new added component) |
| A 27 meter (90 foot) length of 57 mm (2¼ inch) stud link steamer chain |
| A 100 meter (328 foot) length 40 mm (1 5/8 inch) diameter Phyllistran PSP 130 polyester mooring rope with braided cover and factory delivered eye splices with thimbles |
| A 20,000 lb load cell assembly mounted on a long “strongback” steel bar (new component) |
| A Gaelforce MK IV steel grid corner rope ring |
| A 2 meter section of 25 mm (1 inch) long-link chain, the grid corner buoy mooring chain |
| A 94 cm (37 inch) Buoy Tech spherical steel buoy as grid corner float |
| Connecting 1½-inch (38 mm) standard shackles and 1 1/8 inch (29 mm) SPA 15 ton working load shackles into the 7/8-inch Grade 80 chain. |
| A 65-meter (213-foot) length of 40 mm (1 5/8 inch) 3-strand polyolefin East Coast Polysteel, grid line. |

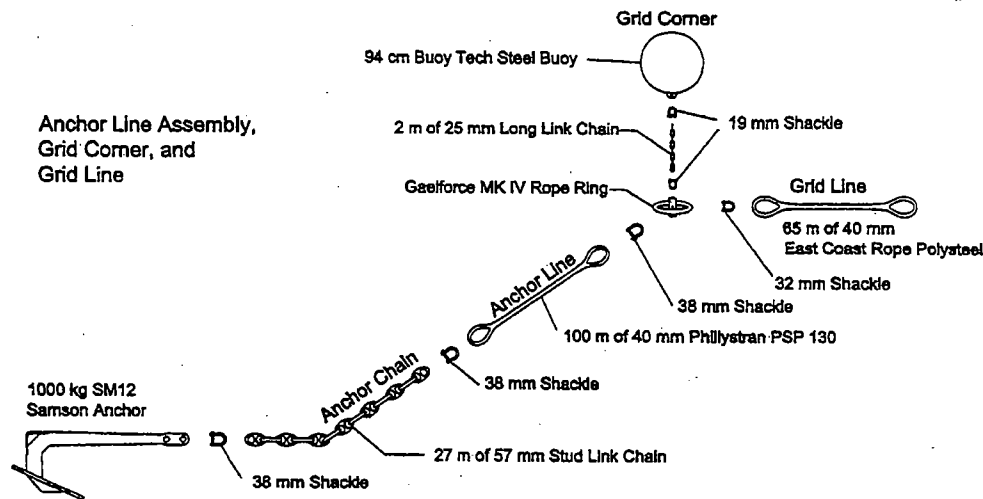

Figure 3. The anchor mooring assembly as deployed in summer 1999. The summer 2000 deployment added the load cell and its recorder-mounting strongback between the 100 meters of Phillystran anchor line and the Gaelforce Rope Ring, and a 30-foot length of 7/8-inch Grade 80 chain between the Samson anchor and the 2¼-inch stud-link anchor chain. The load cells are self contained, diver serviceable packages that were shackled into the mooring.

Table 2: Components of the Crown Line Assembly

| |
|--|
| 9 meters (30 feet) of 25 mm (1 inch) long-link chain to which is attached short sections (6 pieces of 4 links each) of 2¼ inch steamer chain (new component) |
| 41 meters (135 feet) of 48 mm (2 inch) Gaelforce SeaSteel rope Polypropylene co-polymer 8-strand plaited rope, plaited, with an eyesplice with thimble at each end |
| 3 meters (10 feet) of 25 mm (1 inch) long-link chain) |
| Temporary polypropylene crown buoy and orange Norway marker ball |
| Connecting 1½-inch (38-mm) and 25-mm (1-inch) shackles and 16 cm (6 inch) steel rope rings |

2.3 Bridle Line Assembly:

The cage is attached to the four anchors and grid lines with four bridle line assemblies. The components of each bridle line assembly are listed in Table 4, and shown in (a not to scale assembly drawing of the bridle lines) in Figure 6.

Table 3: Components of the Bridle Line Assembly.

| |
|---|
| A 33 meter (100 foot) length of 48 mm (2 inch) American Group Bluesteel rope with eyes and thimbles at each end, called the lower bridle line or sometimes the riser line |
| A four hole flounder plate, |
| Two 11 meter (36 foot) lengths of Polyester 12 Plait with the eyes at each end wrapped with Spectra line used to secure the shackles |
| Connecting 1½ inch and 1 inch shackles. |

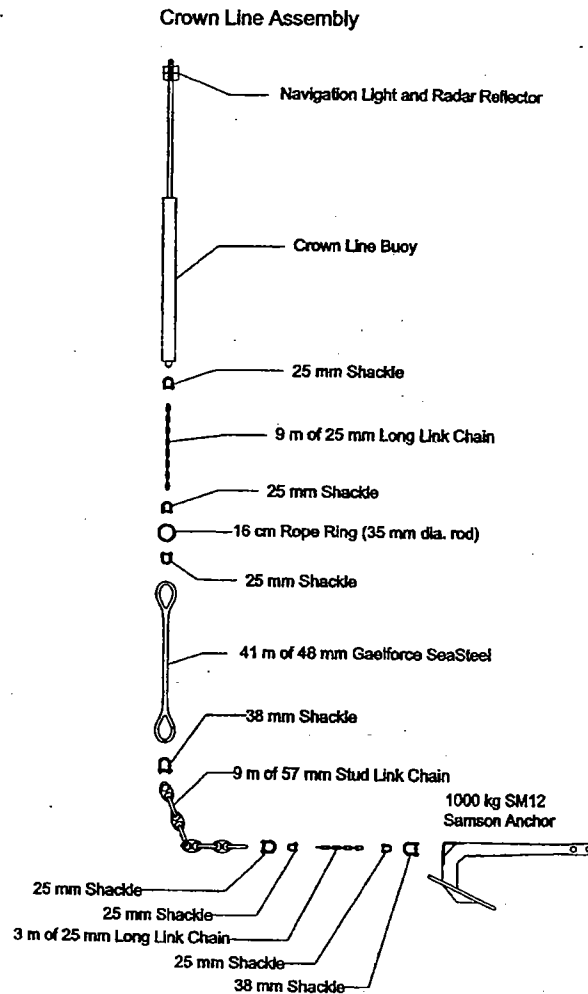

Figure 4. The crown line assembly for positioning the anchor and tensioning the mooring. The buoys deployed were 37-inch polyethylene spheres that will be replaced by new spar-type buoys with light and radar reflector.

3.0 Preparation for Fish Cage and Mooring Deployment

3.1 Fish Cage

Since the recovery of the North cage and mooring in June 2000 (see Appendix II), the UNH team has focused on the cleaning, inspection, and repair of the various components. Where necessary, new lines, chains, parts, and shackles were ordered and assembled. Alterations and improvements to the mooring and crown lines were made to ease deployment as described in section 3.4.

The fish cage rim was disassembled and tested for leaks. Because the fish cage was floating lower than normal, and at an angle it was suspected that there may have been some loss of buoyancy due to flooding in the rim. Each section was pressurized and tested for leaks with

soapy water. Two of the sections were found to have small pinholes in the flat plates connecting the sections where holes had been sealed after the sections were hot dip galvanized. The holes were repaired. Although pinhole leaks were found, no water was found in the rim sections. It is believed that these rim sections maintained a certain amount of integrity while deployed because they were pressurized. Once the pinholes were repaired, the rim sections were re-pressurized to approximately 30 psi.

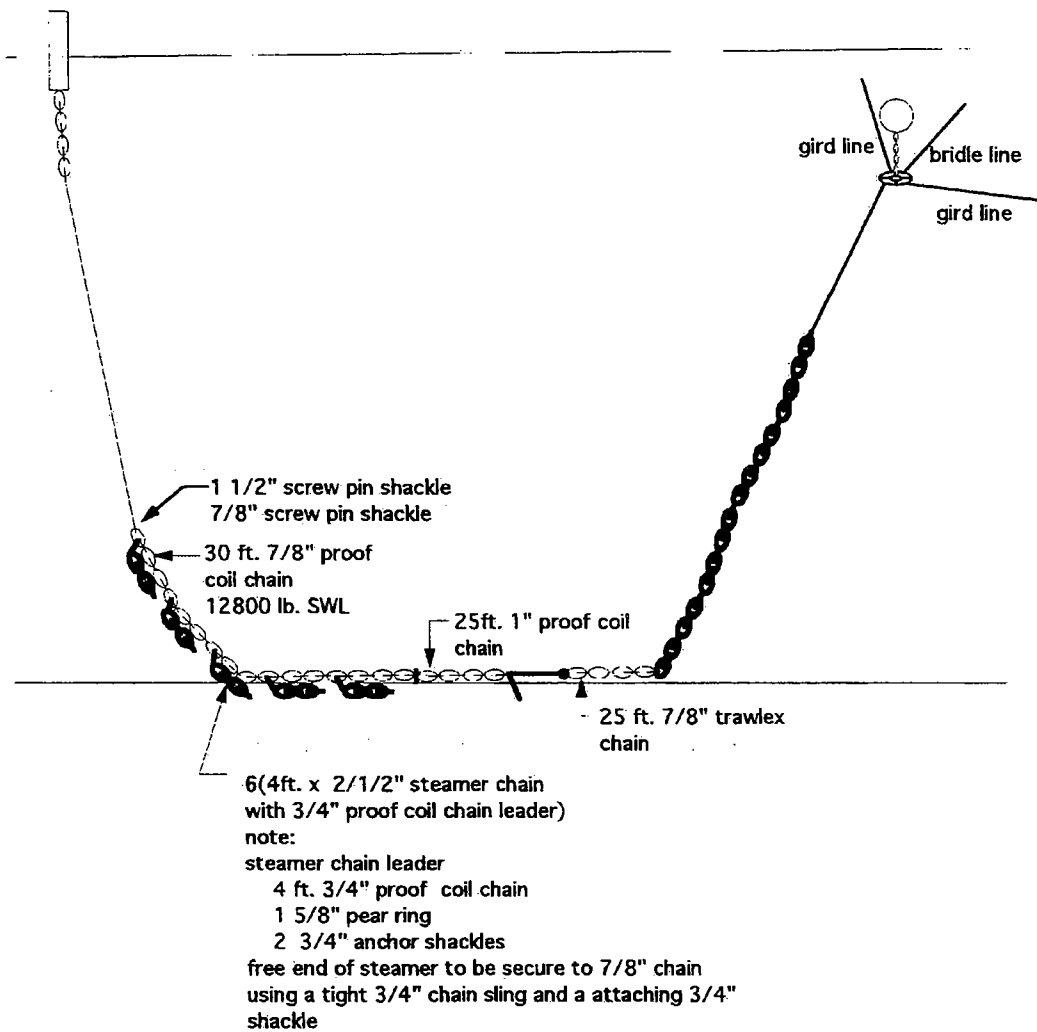

Figure 5. A sketch of the mooring configuration modifications to Figure 3 and 4 with the revised addition of 7/8 inch trawlex chain and the sections of steamer chain.

UNH also drilled holes in the top plate of the fish cage central spar for mounting tubes for the electronics to be placed on the fish cage at a later date. Environmental sensors were to be deployed in the fish cage. These included pressure (burst sampled for waves and averaged to half hourly values to determine average cage depth), temperature for water properties in the cage for comparison with the nearby monitoring mooring, and an optical backscattering sensor. Also,

an acoustic Doppler current meter would determine the water velocity in the cage, again to compare with the ADCP velocity measured on the monitoring mooring. These sensors were mounted on a bracket that bolted to the cage in the through-spar rod holding the old feeding tube in place. UNH also welded two tabs on the cage, so that the sensor clamp could be bolted to the spar. The electrical cables ran up a pipe that bolted to the deck of the spar, and the cables passes through a hole drilled in the deck to reach the electronics to be mounted on top of the deck at a later date.

In addition, two load cells on short mounting bars with electrical cables to the spar were readied and antichafing gear applied for mounting on the fish cage in the Portsmouth Naval Shipyard Dry Dock. Other preparatory activities that occurred just prior to deployment include:

Thursday August 17, 2000 - On board the *Galen J.*, Michael Chambers, Noel Carlson, and Glen Rice dove and inspected the Navy Dry Dock number 3. Submarine bulkheads were marked with buoys prior to cage transfer and construction to prevent any underwater collisions of the spar and bulkheads.

Friday August 18, 2000 - The Sea Station spar with counter weight and rim (see Baldwin, et al., 2000) was deployed into the river at the Port Authority pier and towed by the R/V *Gulf Challenger* (Captain Paul Pelletier and first mate Ken Houtler) to the Portsmouth Navy Ship Yard Dry Dock No. 3. The cage was moored in the middle of the dry dock over the weekend for early construction for Monday morning August 21.

Saturday August 19, 2000 - Alex Walsh from E-Paint delivered the remaining antifouling coated mooring lines and fish cage net to the Port Authority Pier. A final check was made of the fish cage and mooring components.

3.2 Antifouling protection on cage net and mooring lines

Due to extensive bio-fouling of the net and mooring lines during the 1999-2000 deployment, an anti-fouling paint was located and applied to all lines and the fish cage net for this deployment. This will test the benefits in reduced cage cleaning effort, and test for any adverse effects to the fish. E-Paint, East Falmouth, MA, was recommended. This company produces and applies a variety of anti-fouling paints. Alex Welsh, technical representative for E-Paint, suggested their No Foul SN-1 anti-fouling paint. This EPA approved paint is copper and tin-free, and utilizes hydrogen peroxide as an active ingredient. The hydrogen peroxide maintains a surface that is inhospitable to fouling organisms for up to 12 months. No Foul SN-1 has been tested and used on US Coast Guard, Navy and Army Corp of Engineers vessels.

The painting process of the net and mooring components took approximately three weeks to finish. The different components were coated with different colors to aid in their recognition onshore as well as in the ocean. The color schemes adopted for the mooring components are listed in Table 4.

3.3 Preparation of a Telemetry Conductor Cable Link

To enable data telemetry from the NE grid corner load cells, the Northeast corner lower bridle and cage bridle lines had a ½ inch diameter electrical cable with a heavily insulated neoprene jacket added. WHOI received these two lines from E-Paint after the antifouling material had been applied, so that WHOI could add conductors for the telemetry link. Walter Paul and Jim Irish measured the elongation and contraction of these lines under tension to 5,000 lbs. to determine the Poisson Ratio for the rope. This is the ratio of the diameter contraction to

axial elongation. From this the proper wrap angle for a conductor cable, spiraled around the rope was determined. At this wrap angle, the electrical cable will allow the rope to stretch under load with close to zero stretch the conductor itself, only stretching of the helical coil geometry (which does not stretch the copper wires). The cable was wrapped around the lower bridle and cage bridle lines with a constant wrap angle of about 45 to 50°. The cable was tied tightly to the riser line with help of heavy nylon braided net twine (see Picture 1). This maintains the coiled geometry in the riser cable that is paramount to its ability to stretch as a coil without stretching the conductor wires to failure, while the riser line is elongated under applied mooring tension.

TABLE 4: Color Coding of Mooring Components

| Mooring Component | Code Color |
|-------------------------------------|---|
| Lower Bridle Lines | Red |
| Grid Lines | Red |
| Upper Bridle (or Cage Bridle) Lines | White |
| Fish Cage Net | White |
| Crown Line | Blue |
| Crown leg Chain | Blue |
| Anchor Line | White |
| 2¼ inch Stud Link Anchor Chain | Red tags on "up" end Yellow tags on anchor end |

3.4 Modification of Anchor line mooring and Anchor pickup crown line mooring

To deploy the moorings utilizing the capabilities and within the limitations of the *Nobska*, a methodology was developed by Mat Stommel and Will Ostrom with input from Jim Irish, Dave Fredriksson and Walter Paul that would:

- Simplify and speed up the mooring deployment and recovery operations
- Remove and minimize dangerous mooring operations
- Ease handling of the heavy components (anchors, steamer chain, etc.)
- Fully utilize the potential of the winch and net reel capability of the FV *Nobska* for expediency and safety of handling.

These modifications to the original mooring configuration were:

3.41 Anchor Leg Mooring Changes - Figures 3 and 5.

To allow the connection of the anchor chain (wound on the aft net reel) with the anchor (hung over the gallows block on the trawl winch off the side of the *Nobska*), a 9-meter (30 foot) length of 7/8 inch Grade 80 trawlex galvanized chain (29,000 pound working strength) was added between the anchor and the 2¼-inch stud link (steamer) anchor chain. The working strength of the chain and shackles exceeds the 20,000 lbs. specified by the UNH design team.

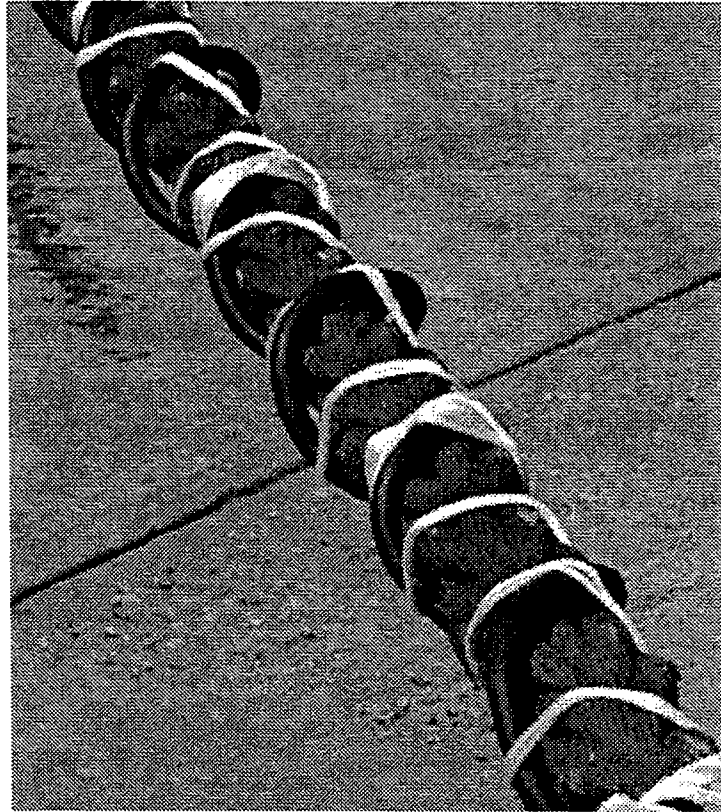

Picture 1. The dark electrical cable helixed around the lower riser line (red antifouling painted) and secured with virgin Nylon fish twine. In addition, a ¼ inch diameter green polybraid rope was subsequently wrapped around the riser line and cable, and secured by hitching. The polybraid provided chafing and abrasion protection for the electrical cable. The virgin Nylon fishing twine will shrink once immersed in seawater, and thereby keep a tight grip on the conductor cable.

3.42 Crown Line Mooring Changes - Figures 4 and 5

Since the steamer chain shackles, and the crown line thimbles will not pass through the gallows blocks of the *Nobska* for easy handling by its trawl winch, the following changes to the crown line mooring were made. The 9 meters of steamer chain on the crown line were cut into 6 four link sections, and these 6 sections were attached to a 30 foot section of new 7/8 inch proof coil chain by ¾ inch chain and ¾ inch shackles supplied by WHOI. This allows the chain portion of the crown line mooring to pass through the gallows block under control of the *Nobska's* trawl winch during deployment. The steamer chain sections were then attached on the waterside of the gallows block. Therefore, the same catenary characteristics and compliance of the crown line mooring were maintained, as it is important for the response of the spar marker buoys to wave and tidal forcing. The advantage of these modifications is a significant increase in deployment safety and control. The modifications 3.41 and 3.42 are shown on the mooring sketch in Figure 5.

3.43 Anchor Recovery and Handling

To allow each anchor to be connected or disconnected quickly to and from the two mooring lines (one at each end), a 3.5-meter (12-foot) section of 7/8-inch proof coil chain was added as a loop around the anchor. Two shackles were used to attach the anchor to the

becoming entangled, or overstretched while allowing the lines connected to the grid corner rope ring to move with the weather and grid configuration. This means that the cables can move in three dimensions, and a hint of the motion what must be accounted for is shown in the section from anchor line to lower bridle line in Figure 9.

4.0 Deployment Work on Monday and Tuesday, August 21 and 22, 2000

4.1 Fish Cage Assembly at the Portsmouth Naval Ship Yard Dry Dock No. 3

A team of UNH and Net Systems personnel worked at Dry Dock No. 3 on Monday from Gary Normandeau's barge (Pickering Marine) and the RV *Galen J.* to assemble the cage system. The net was lowered by crane and attached to the top of the cage with eight quick connectors, the perimeter lines were stretched (by a rope come-along) and attached to the rim, and lines were attached to the tensioning/harvest ring at the bottom of the cage with 1 inch shackles. The harvest ring was then lowered to the bottom of the spar spreading and tightening the net. The harvest ring was maintained in place by four bolts and wing nuts that are periodically adjusted. The newly painted nylon net with a 4 cm stretch gave off a Caribbean blue glow in the water.

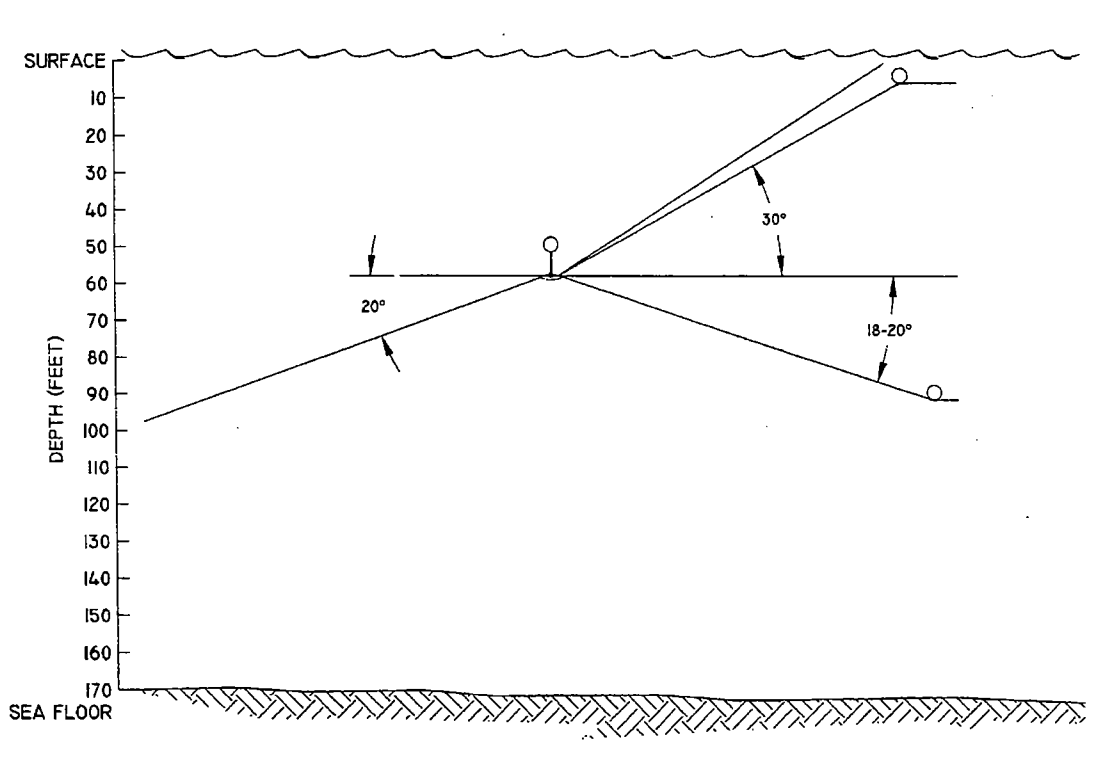

Figure 7. A to scale drawing of the top of the anchor line, the grid corner rig and float and the lower bridle line. The lower bridle line is shown in its two positions (1) cage on the surface with line up, and (2) counter weight on bottom and cage in lower position. Significant slack will be generated in the lower bridle lines when the cage is lowered from the position at the sea surface to the level of the grid lines.

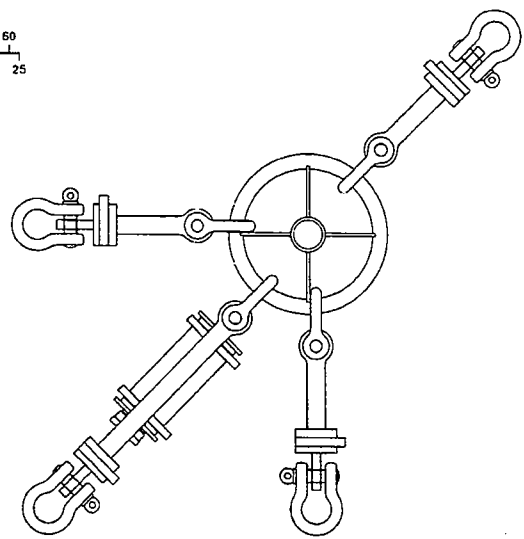
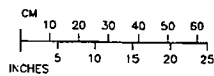
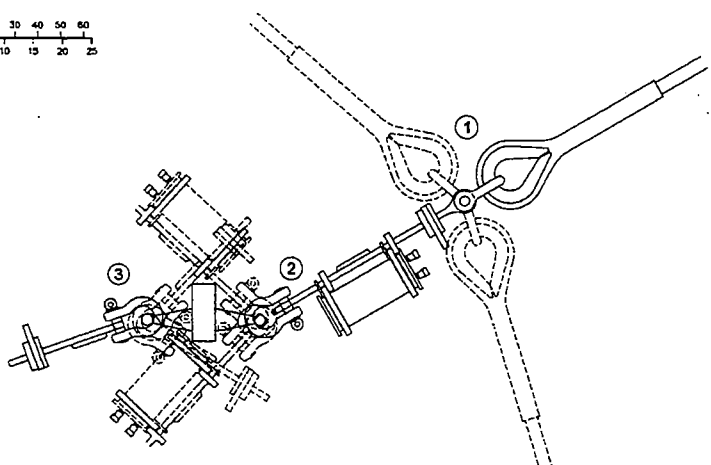
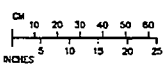

Figure 8. A top view of the Northeast grid corner rope ring with four load cells attached. The strongback to the lower left (in the lower riser line side of ring) carries the electronics pressure case with batteries and recorder for the four load cells. The telemetry wire runs from the electronics to the transmitter on the fish cage. The load cell cables to the electronics pressure case and the telemetry cable from the pressure case to the fish cage are not shown. There is concern for entanglement and damage of the electrical conductors in served and a hardware modification is planned.



- POSSIBLE POSITIONS:
- ① TELEMETRY MODULE AGAINST RISER LINE
 - ② TELEMETRY MODULE STRONGBACK AGAINST GRID CORNER RING
 - ③ GRID CORNER RING AGAINST ANCHOR LINE STRONGBACK

Figure 9. In running the electrical cables from the electronics to the four load cells, enough slack had to be in the cables, and they had to be protected from abrasion by all possible movement of the load cells, anchor line, lower bridle line, and cage bridle line.

On Tuesday, while the *Nobska* was working on the first two anchors, another crew was working at the Portsmouth Naval Shipyard completing the Northern net cage for deployment. Two load cells were attached to the cage rim, and electrical cables run from the load cells up to the cage platform. The electrical cables were attached to the net rope with tie wraps. Slack was left in the cables to allow for movement of the load cells. The electrical cables were tied to the net after the tensioning ring had been fully extended to pull the net tight. In addition, the cage bridle lines were attached to the load cells, one of which contained the electrical telemetry cable from the northeast corner. This wire was also run up the net and tie wrapped into position. The environmental sensors (pressure, temperature, optical backscattering and acoustic currents) were mounted on a frame that bolted to the fish cage spar. This was lowered into position with the barge crane and held by a rope while bolted. The cables from the environmental sensors were run through a hole in the spar deck, and the telemetry and load cell cables were protected from chafing by garden hose and also run through the hole in the spar deck. This hole leads into the electronics mounting tubes that will be installed by divers later.

When the cage was assembled, Dave Fredriksson tied an InterOcean S4 current meter inside the net to measure the water velocity in the net during the cage tow out to the site on the next day. Jim Irish also prepared a Sea Bird pressure instrument that Dave attached to the bottom of the fish cage. Then the barge crane was used to lift the cage as high as safe (about 1 meter), and a pelican quick-release was used to drop the cage. The response as the cage moved back to equilibrium position will give parameters important to understanding the cage's behavior as a damped harmonic oscillator. Four separate observations were made. The Sea Bird pressure sensor was set to sample at 4 Hz for 14.5 minutes every 15 minutes. Good data was collected and is being analyzed to assist the cage and mooring modeling effort. The cage overshot about 10% of the displacement, and reached a maximum negative displacement about 25 seconds after release.

4.2 *Nobska* Loading and Departing WHOI.

The ropes with electrical cables, a 1,100 lb anchor for possible offshore fish cage "normal mode" tests, chain, hardware, temporary fish cage mooring and shipboard support equipment was loaded on the FV *Nobska* on Friday and Monday. It departed the WHOI dock at 1400 EDT on Monday 21 August for the Port Authority Pier in Portsmouth, New Hampshire. On board the *Nobska* were its crew and Will Ostrom from WHOI. Jim Irish drove up on Monday with the load cells and environmental sensors, and Walter Paul followed on Tuesday with the four-load cell corner ring assembly.

5.0 Deployment work on Tuesday August 22, 2000

5.1 *Nobska* Arrival and Deployment of Temporary Mooring

The *Nobska* arrived at the UNH-OOA site at first light, and deployed a mooring with a 2,000 lbs DorMor anchor, surface float and marker buoy about ½ mile west of the Southern fish cage. This mooring (Figure 10) was the same as deployed off White Island during the recovery in June 2000. It was used to anchor the cage overnight prior to its attachment to the grid mooring system on Thursday 24 August 2000.

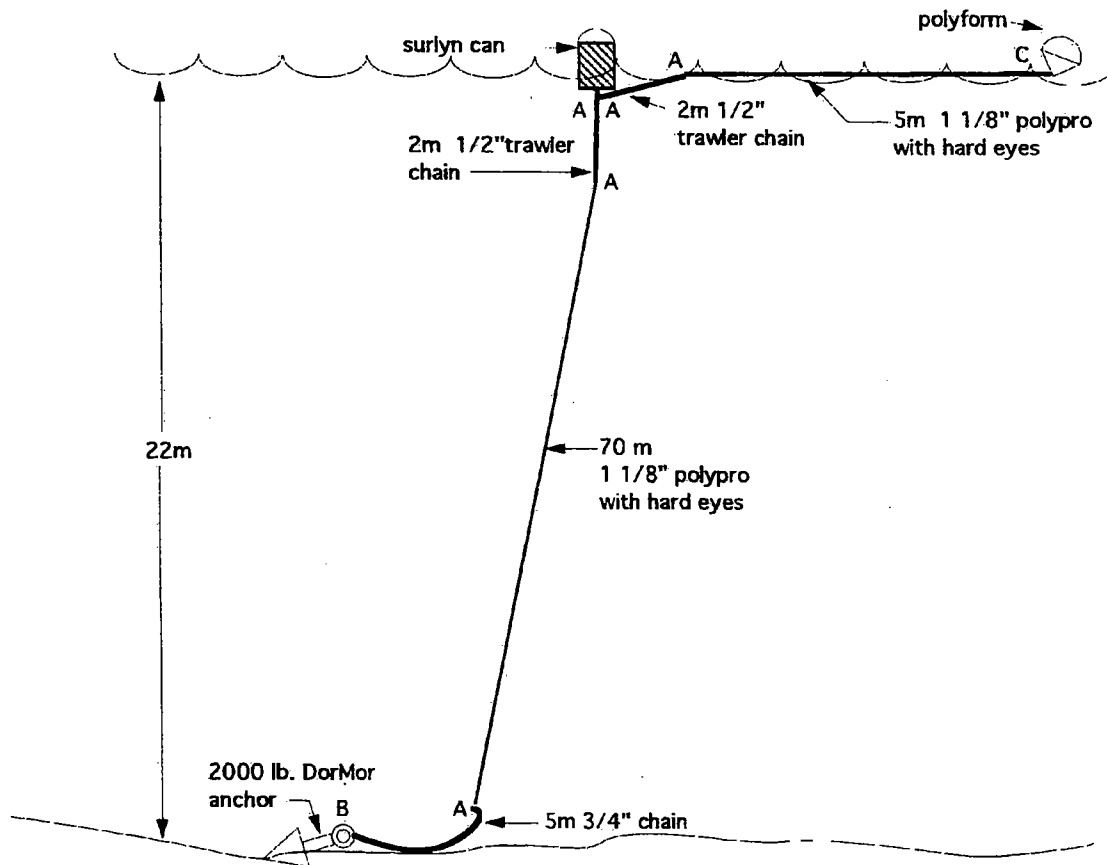

Figure 10. The temporary fish cage mooring deployed off White Island in June 2000 is shown. The same mooring was deployed on 21 August near the southern fish cage in 51 meters of water.

The *Nobska* then proceeded to the New Hampshire Port Authority Pier in Portsmouth to meet with the UNH team to finalize last minute logistics (Picture 2) and to load the mooring system for the two southern anchors. The mooring legs were carefully placed on the deck of the *Nobska* with the assistance of the Badger Rand crane so that the different components could be shackled together as they were deployed from the stern. The loading operation, under the direction of Mat Stommel, Will Ostrom and Michael Chambers started about 0730.

After loading the heavy gear, the *Nobska* sailed out to the UNH-OOA site and deployed the Southwest and Southeast anchor moorings,



Picture 2. Planning loading - Will Ostrom left front and Michael Chambers left rear.

using the attached crown-line assembly to safely position the anchors. To prevent the two moorings from fouling, the grid line

connected the two steel flotation spheres that were visible on the surface. At this point, each anchor leg had three surface buoys attached (the temporary polypropylene crown buoy with Norway ball, and the steel grid corner buoy). The weather was calm, easing the deployment work.

5.2 Loading and Deploying Moorings from the *Nobska*

5.2.1 Loading of Mooring Gear

The FV *Nobska* was loaded in a specific order and in a specific way to ease in the subsequent mooring deployment. First, the shore-based crane swung aboard a 90-foot length of 2¼-inch steamer chain. This chain was then wound on the aft net drum so that it paid out forward of the drum (Picture 3). To allow this chain to be disconnected from the drum, a 100-foot length of 1 1/8 inch Samson 2-in-1 Nylon line was used. One end was attached to one side of the net drum, and the second end passed through the steamer chain, on the fourth link from the end (Picture 5). Then the second end of the rope was attached to the other side of the net drum. The drum was then wound up, first reeling in 50 feet of line on each side of the drum, then the 90 feet of steamer chain. The free end of the steamer chain was then attached back on itself and secured with rope so that it wouldn't shift as the drum was rotated further. The anchor line was then shackled into the end of the anchor chain, and was wound up on the aft net reel on top of the steamer chain (Picture 4). The anchor chain was marked with red and yellow tags near each end. The convention used was that the yellow end would be the upward end of each mooring.

The anchor was handled next. The 30 feet of 1 inch long-link chain was attached to the *Nobska's* trawl wire through the trawl block on one side of the ship. The trawl wire was attached to the second link of the long-link chain (Picture 8), leaving the end link free for attachment of the mooring during deployment. The chain was then wound up on the drum until the end was hanging



Picture 3. Anchor chain wound on aft net reel ready for deployment.



Picture 4. Anchor chain and line wound on aft net reel ready for deployment.



Picture 5. Line holding chain to net reel with four free links left loose at end for easy handling to attach chain to anchor.

just below the level of the *Nobska's* rail. The anchor was then swung over by the shore side crane with two sling lines so that it was horizontal (Picture 6). The anchor was positioned with the fluke forward and the 1-inch chain attached to the back of the anchor (Figure 7). The other end was tied off with a slip line to the stern of the *Nobska*. At this point a chain across the anchor back between the anchor leg and crown leg of the mooring was attached. The anchor was attached to the chain with a 1½-inch shackle into the anchor, then a smaller 1¼-inch shackle into the smaller chain. The anchor's back chain was shackled into these smaller chains (Picture 8), so that on recovery, the 1½-inch shackles could be cut to free the anchor from

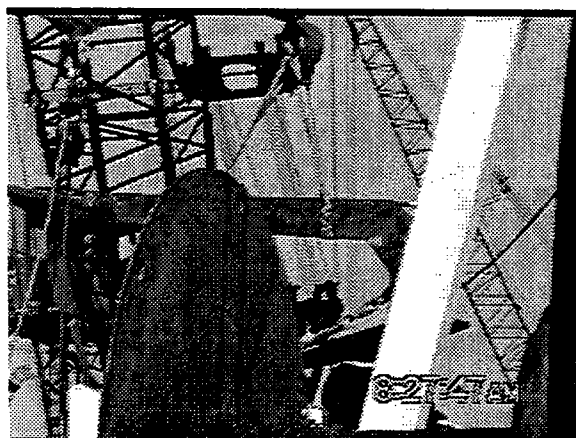

Picture 6. Shoreside crane swinging anchor over in horizontal orientation on slings.

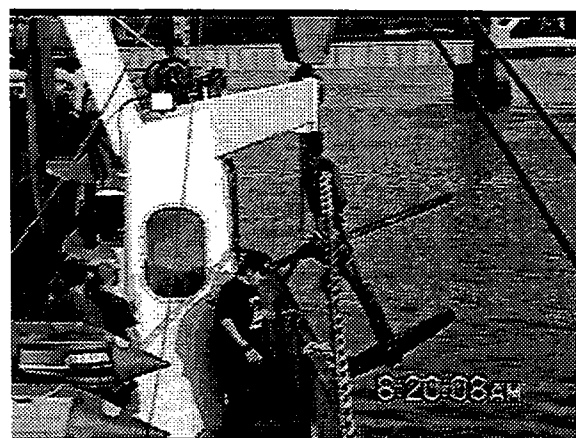

Picture 7. Anchor being positioned on port rail and being held by 1" chain from fluke end or anchor, running to trawl winch.

the mooring. The back chain would hold the mooring together, so that it could be wound on the aft net reel in one length (both crown line and anchor legs) without having to be taken apart - speeding up the mooring recovery and making it safer.



Figure 8. Anchor secured to rail. Back chain is visible hanging over rail. Chain runs to trawl winch on right with free link.

The second anchor chain was loaded onto the *Nobska* and faked out on deck under the mid-deck net reel. The second anchor and chain were assembled on the trawl winch on the other side of the ship so that two anchors were rigged ready to go. The second anchor line, shackles, grid lines, corner ring and 37 inch steel buoys were loaded on the deck to complete the required components for two moorings (Picture 9). Then the ship was able to sail to the site for mooring deployment.

5.22 Deployment of the Southern to Fish Cage Mooring Legs

Once at the site, the mooring deployment commenced. On Tuesday, the southwest anchor was deployed first, then the southeast. The first operation was rigging the steel corner float and grid corner ring (see Figure 3). The float was attached to the ring with 2 meters of chain (Picture 10). The anchor line was attached to the

load cell that was shackled to the rope ring (Pictures 11 and 12). All shackles above the grid lines were seized with stainless wire. On some of the buoys, the grid line was attached, coiled and tied to the side-eye on the buoy for later deployment (Picture 13). The steel grid corner float was then picked by the ship's outhaul winch and the ring lowered down the stern ramp (Picture 10). When released, the buoy and rope ring floated away from the ship that was steaming at about ½ knot (Picture 14). This forward motion pulled the mooring components away from the ship and streamed them out behind in line so that they would not tangle. All shackles below the anchor rope and

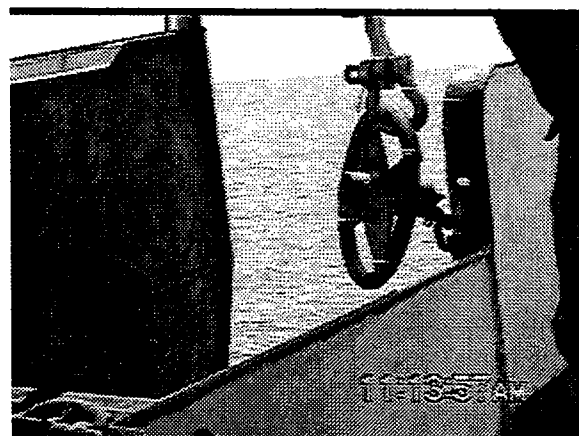

Picture 11. Grid ring after steel ball deployment with shackle to load cell visible at top.



Picture 9. Loading grid line. Steel and polypropylene floats, grid corner rings and hardware will be loaded next.

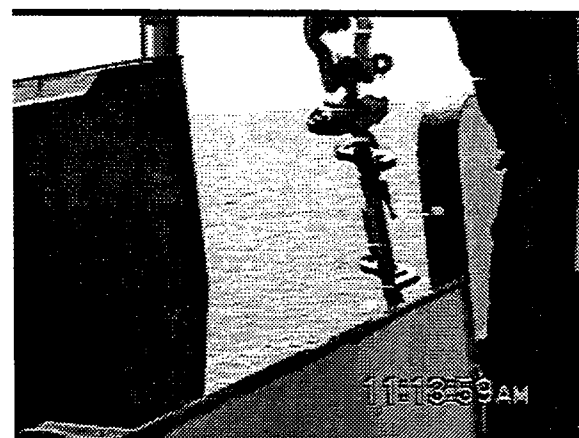

Picture 12. Load cell and strongback being lowered on anchor rope.



Picture 10. The grid ring (upper right) is attached to the steel ball and deployed.



Picture 13. Grid line and lower riser lines attached to steel grid corner buoy.

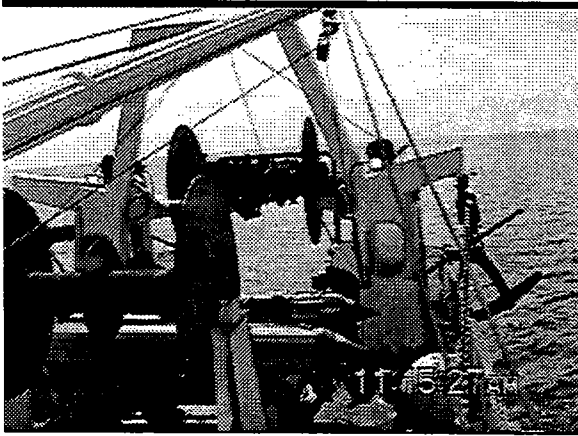

Picture 14. Nobska steaming at ½ knot while paying out anchor line. Buoy is just visible above block holding anchor.

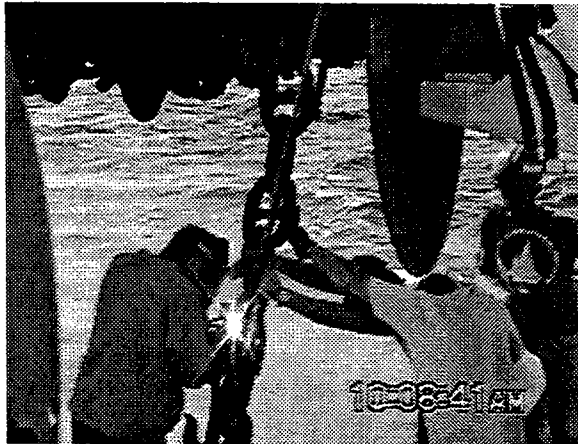

Picture 15. All shackles below the grid lines were welded as they were deployed.



Picture 16. Attaching 7/8" chain from 2 1/4" anchor chain to anchor at rail.

crown line ropes were welded as they were deployed (Picture 15). This meant that all mooring components were checked one last time as they were deployed to assure that no shackle was missed.

When the anchor line on the aft net drum was spooled out, the net reel continued to pay out the 2¼-inch stud link anchor chain until the end with the last three free links was reached (see Figure 3 and Picture 5). With the steamer chain paying out from the forward end of the net drum, these links were reachable from deck for attachment to the anchor. The 30 feet of 7/8 inch Grade 80 chain was then run from the 2¼- inch stud link steamer chain, around the rail and shackled into the anchor and welded (Picture 15 and 16). The net drum then slacked out the chain until the weight was taken on the anchor, and the 100 feet of rope was loose. It was detached from one end of the drum and pulled free. The slip line on the anchor's shank was eased out and the anchor and chain were then entirely on the trawl winch, which was capable of working with the entire mooring load (Picture 17).

Now the short sections of four links of steamer chain were attached to the 1-inch long-link chain on the trawl winch. About 6 feet of chain was first paid out. Then the

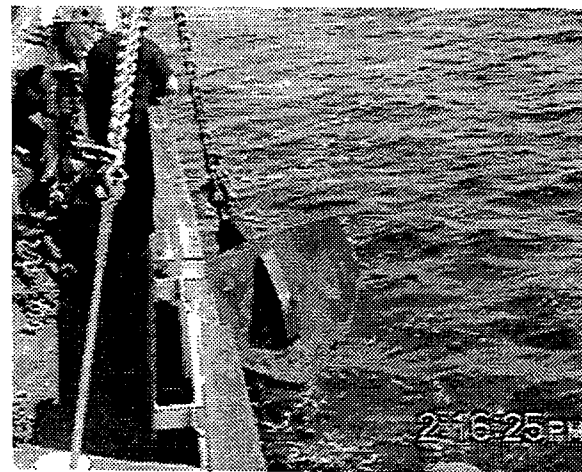

Picture 17. Anchor with full weight of mooring chain hands on port trawl winch.

first section of chain was attached (Picture 19). A 4 foot section of $\frac{3}{4}$ inch chain run through the steamer chain allowed it to be shackled into the 1 inch long-link chain without having to lift the heavy steamer chain from the deck (Picture 18). The trawl winch then raised this above the rail (Picture 20), and the lower end was attached by a 12-inch section of $\frac{3}{4}$ inch chain and $\frac{3}{4}$ inch shackle (Picture 21). The trawl winch then went up and down lowering about 8 feet each time to attach and deploy six sections of steamer chain of four links each. This nicely filled out the 30 feet of 1 inch long-link chain to give the spar



Picture 20. Lifting $2\frac{1}{4}$ " chain links above rail with trawl winch.



Picture 18. Four link sections of steamer chain with $\frac{3}{4}$ " chain on deck ready to use.



Picture 21. Attaching bottom of shot of four links of $2\frac{1}{4}$ " chain to 1" crown line chain.



Picture 19. Will Ostrom attaching $\frac{3}{4}$ " chain to 1" long link chain on crown line.

buoy the required mooring weight increase per foot in compliance with the buoy's increase in buoyancy when pulled down do to wave action.

While this steamer chain was being attached to the 1-inch long-link chain, the crown line was spooled on the aft net drum (Picture 22). A tag line of about 100 feet of $1\frac{1}{4}$ inch Samson 2-in-1 line was spooled on the drum, then the 41-meter crown line (see Figure 4) attached (with the rope ring first) and wound up. The trawl winch was then paid out until the wire was through the block, and the chain hanging at the rail with the last link free. A 1-inch shackle was put

into the chain and attached to a 1½-inch shackle that fit into the thimble in the crown line on the aft net reel (Picture 23). The trawl winch was then paid out until the crown line took the strain. The aft net drum was reeled in so that the trawl wire could be disconnected from the mooring (Picture 24). Now the entire mooring was hanging off the aft net reel. The crown line was lowered until the end was reached, and the ring was shackled into the trawl winch. The load was transferred back to the trawl winch (Picture 25) as the ship prepared to tow the mooring into position.



Picture 22. Crown line being wound on aft net drum.



Picture 23. The crown line is shackled into the 1" chain on the trawl winch.

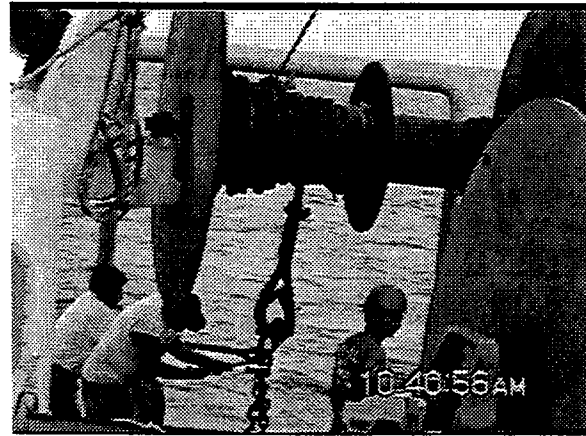

Picture 24. Mooring weight on net drum and trawl winch wire being removed.

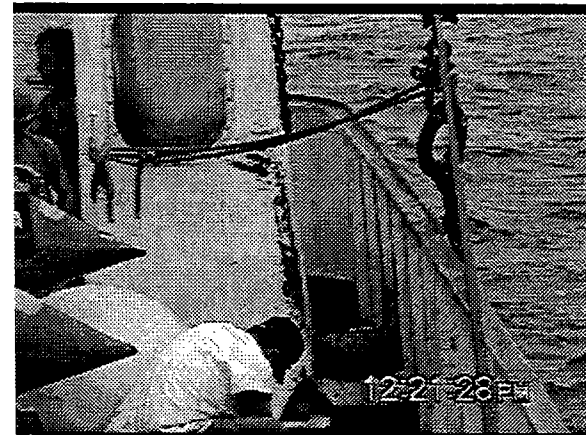

Picture 25. The load was transferred back to the trawl winch and a slip line attached.

The 37-inch polypropylene temporary crown buoy and a Norway marker ball were then assembled to the 9 meter length of long-link adjustment chain (Picture 26), and attached to the ring in the top of the crown line. The ship then steamed toward the deployment position. A slip line was rigged through the steel ring for the final deployment (Picture 25). As the site was approached the poly ball and Norway ball were lifted over the rail and allowed to float behind the boat (Picture 27). The trawl winch wire was removed, and the mooring held on the slip line. As the site was reached the slip line was released and the mooring deployed (Picture 28).



Picture 26. The small Norway ball and larger polypropylene temporary marker crown marker buoy are attached with chain.

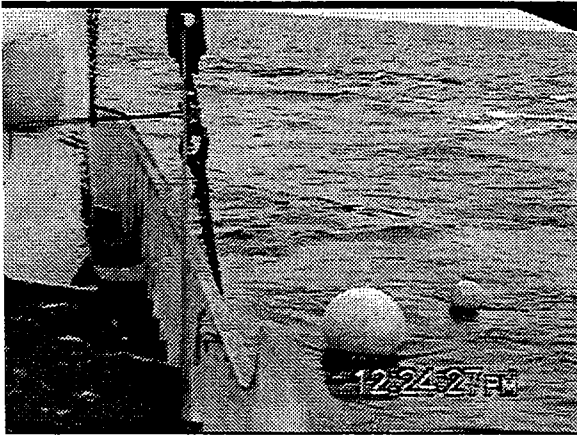

Picture 27. The temporary marker buoys over the rail, the mooring on the trawl winch, the slip line attached as the Nobska steams to the deployment site.



Picture 28. Will Ostrom releasing the slip line to deploy the mooring.

The ship then rigged the chain, lines, etc. from the stock on deck to deploy the second anchor that was hanging off the gallows block on the other rail. The same procedure was used to deploy the anchor in the desired position. The drop site was selected to be about 100 feet toward the center of the mooring from the designed anchor site. This would give the mooring the slack needed for assembly and placement of the fish cage. To prevent the two grid corner buoys from being swept around and tangled with the crown line buoys by the tidal currents, a grid line was attached between the two southern grid corner rings. This line was retrieved from the first (Southwest) buoy and brought to the Southeast buoy by WHOI's small boat (a 18 foot hard bottom Zodiac) by Sean and Will (Picture 29). The *Nobska* picked up the Southeast buoy and brought the rope ring out of the water. The small boat shackled in the grid line and backed off as the *Nobska* redeployed the buoy. That ended the first day, and the *Nobska* headed back to the dock to load the second set of two anchors on the following morning to deploy the two northern anchors.



Picture 29. Will Ostrom in WHOI's Zodiac.

One difficulty was encountered with the anchor on the first deployment. It was positioned too high against the *Nobska*'s rail. When the anchor chain weight was put on

the anchor as the aft net reel paid out, the anchor fluke swung up and neatly hooked itself over the rail (Picture 30). This was quite difficult to remove, as the entire weight of the anchor and anchor chain was holding it in position. Therefore, the anchor should be positioned well below the rail so that this does not happen.

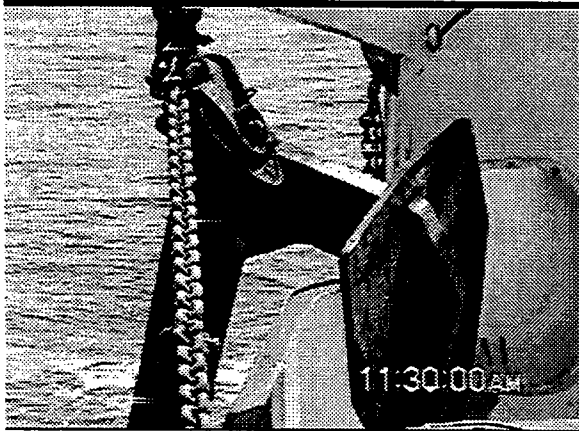

Picture 30. Anchor with weight of anchor chain hooked over the *Nobska's* rail.

A key to smooth operation at sea was the shoreside rigging and setting the hardware on the ship in optimum location and order so that a minimum amount of time had to be spent at sea rigging and moving hardware around (Pictures 9, 18 and 31).

A bail (a standard galvanized pear link with bolt pad welded on) was added to the top of the steel grid corner buoys and was critical to enabling the *Nobska* to grab hold and lift the steel balls to get at the rope ring for attaching grid and lower bridle lines. Also, it might have been better if all the grid lines and lower bridle lines were attached to the grid corner balls upon deployment.

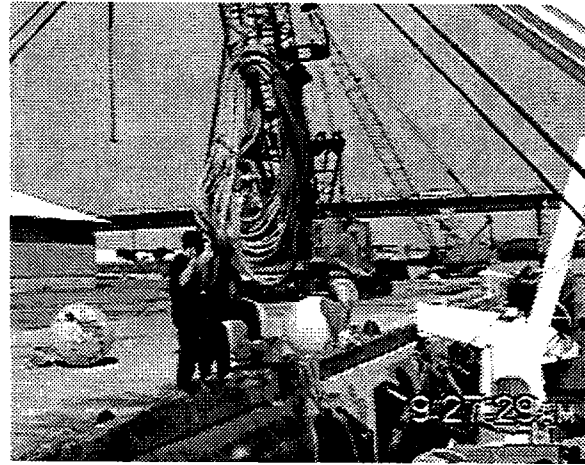

Picture 31. Loading anchor lines on deck for later deployment.

However, with only one eye on one side of the ball, it would have been difficult to keep the lines separate, but having them attached to the balls and using small boats such as the *Zodiac* (Picture 29) and *Galen J.* (Picture 32) would simplify operations. Throughout the deployment, the use of small boats to supplement the *Nobska* was paramount to a successful deployment.



Picture 32. UNH Research Vessel *Galen J.*

6.0 Deployment work on Wednesday August 23, 2000

6.1 R/V *Gulf Challenger* Tow of Fish Cage

At 5:45 AM the *Gulf Challenger* left her mooring at the New Hampshire State Fish Pier to pick up the refurbished and cleaned North Cage from Portsmouth Naval Shipyard Dry Dock No. 3 and tow it to the OOA site. The time of the tow was selected to best utilize the tidal currents flowing out of the Piscataqua River and into the Gulf of Maine toward the mooring site.

The tow was started near the slack water of the high tide, and progressed seaward as the tide ebbed. During this tow, a load cell was connected in the towline aft of the a-frame as show in Picture 33. This load cell allowed the drag versus current velocity to be measured, as well as keep track of the tension in the line so that the line was in no danger of breaking and the peak tension was low enough that it did not damage the A-frame of the *Gulf Challenger*.



Picture 33. The fish cage can be seen being towed behind the Gulf Challenger in the Piscataqua River. The towing cable seen was attached to the bridle lines on the fish cage on one end and a load cell on the other. The load cell is in the dark open frame seen at the left end of the tow rope above the deck. The other end of the load cell was restrained by a line running over a block in the A-frame and down to the winch and cleat on deck.

Jim Irish attached the load cell to a Synergetics data system and logged the results on a notebook computer. The line tension was measured at 5 second (for the first part of the tow) and 2 second (for the last part of the tow) intervals during the tow to an accuracy of ± 5 lbs. Also, a GPS receiver was recorded at 1-second intervals on a second notebook computer to determine the ship's position and to measure its speed over the bottom. A typical tow speed of 1.5 knots generated an average of 3,300 lbs. of tension. The tension varied with the waves about this mean with peak loads of greater than 5,000 lbs. (variations of 1,000 to 5,000 lbs. were typical). The tension was kept below 5,000 lbs. to avoid damaging the *Gulf Challenger's* A-frame. The cage was towed at varying velocities to investigate the load - speed relationship.

David Fredriksson measured the water velocities relative to the ship during the tow by three means and collected data at approximately one half hour intervals with the help of whoever was handy. A Marsh-McBirney electromagnetic current meter was used to collect water velocities over the side of the towing vessel at a depth of about 0.3 meters. A second measurement was made with the *Gulf Challenger's* onboard ADCP at a depth of 5.12 meters. A third measurement was made with an internally recording S4 electromagnetic current meter placed inside the fish cage at a depth of 3 meters. The intent of the internal cage velocity measurement was to investigate the net blockage.

6.2 Northern Cage Anchor Deployment

Back at the Port Authority Pier, the *Nobska* started loading the remaining mooring components for the Northwest and Northeast anchor deployments at 7 AM with the aid of the Badger Rand crane. The mooring gear again consisted of two anchor line moorings and their crown or pickup moorings as shown in Figures 2, 3, and 4 and the remaining grid lines and all the bridle lines. Loading was done as described for Tuesday, 22 August. While heading out to sea, the fully loaded *Nobska* (see Picture 35) passed the *Gulf Challenger* with the fish cage in tow (Picture 34) on her slow journey to the OOA site.

Once on station the *Nobska* deployed the Northwest and Northeast anchor line moorings at their designated positions (100 feet toward the center from their final desired position) with help of the crown line assemblies. The grid line was attached between the two northern grid corner rings so that the east-west channel between the moorings was free to tow the fish cage into position on the following day. Michael Chambers was on board the *Nobska* to aid with the anchor-line mooring deployment. Walter Paul had brought the four-load cells and grid corner ring that was to go into the Northeast corner.

During the afternoon, the prevailing southeast wind increased to 15 knots and started to build a short choppy sea. After completion of the mooring deployment around 2:30 PM, the *Nobska* checked the southern cage anchors/crown buoys, but did not have any material on board to undertake any of the planned servicing there. Therefore, the *Nobska* took over the cage tow from the *Gulf Challenger* who was slowed to about $\frac{3}{4}$ knot speed over the ground by the turn of the tide that was then flowing north. The tension in the tow was

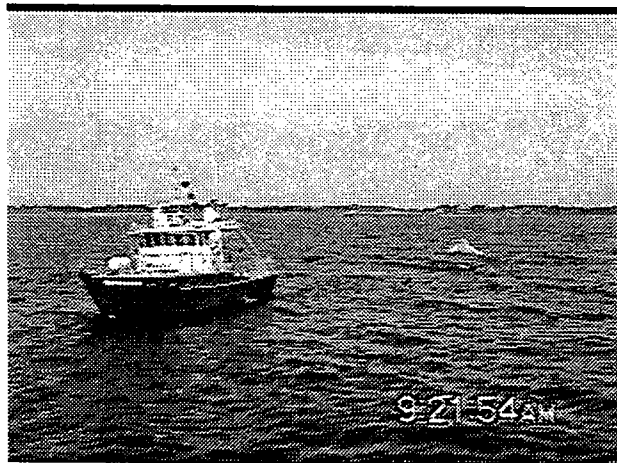

Picture 34. R/V *Gulf Challenger* towing the Northern fish cage from Portsmouth to the UNH-OOA site.

still exceeding 5,000 lb., and increased if the ship's speed was increased. With the increase in sea with the increasing wind, the fluctuations in tension were increasing with time also. With still over one mile away from the overnight mooring the *Nobska* was able to easily tow the cage up to 2 knots speed and connected it to the temporary mooring west of the OOA site. After this operation the *Nobska* steamed back to the Port Authority Pier.

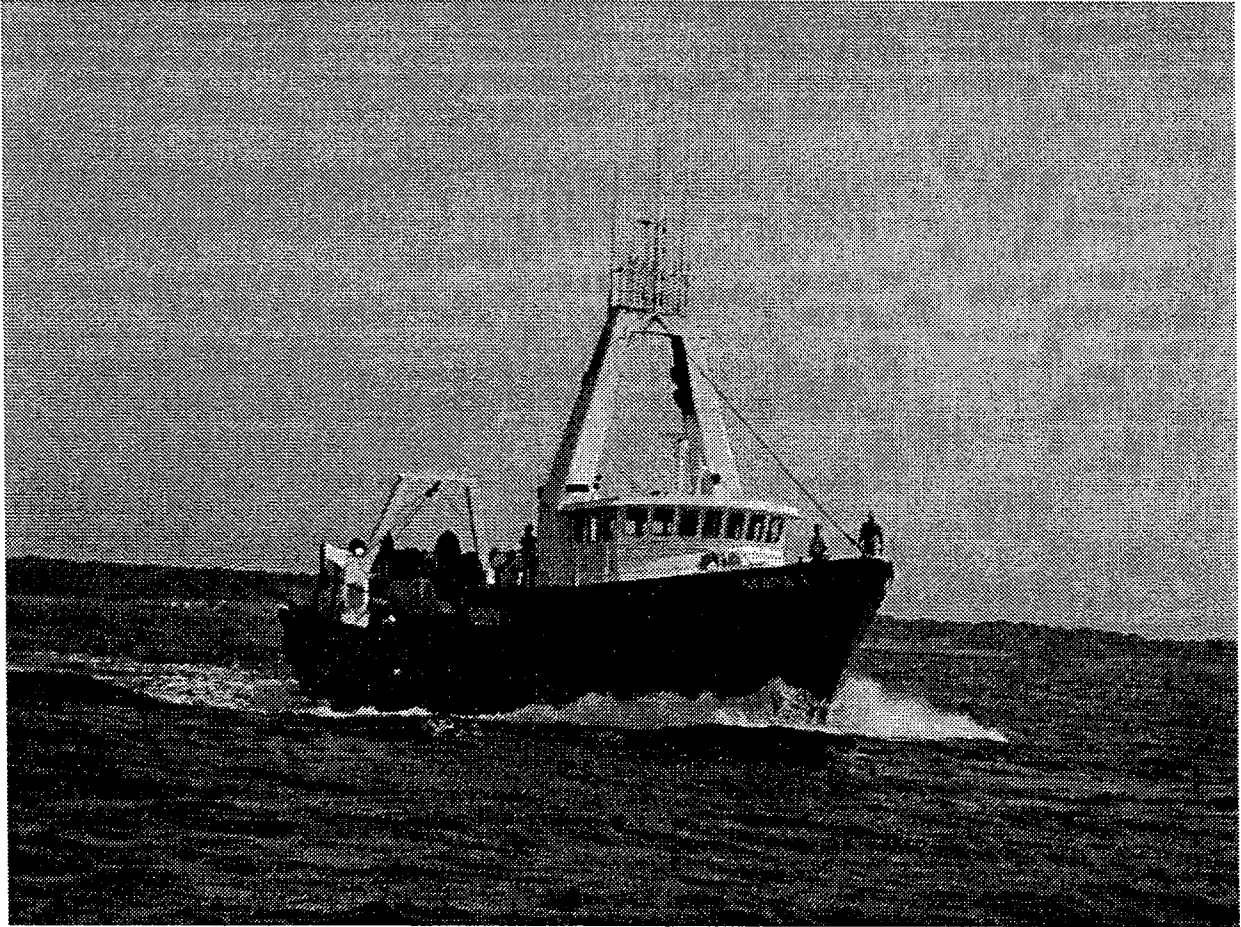

Picture 35. The fishing vessel *Nobska* steaming past the *Gulf Challenger* to deploy the northern two anchors and moorings at the fish cage site.

7.0 Deployment Work on Thursday, August 24, 2000

The *Nobska* departed the Port Authority Pier at 6:15 am and was on site at 7:30 am with Will Ostrom, Jim Irish and Walter Paul. The weather was calm and the seas from the prior day had decreased to a gentle 3-foot dead swell. The current was headed easterly with about $\frac{1}{2}$ knot speed. Also, heading to the site was the RV *Galen J*, a small lobster-boat type vessel from UNH with Michael Chambers as skipper, David Fredriksson, Glenn Rice, and Tim Gregg as divers and technical support.

As first job the *Nobska* prepared the mooring for the fish cage by picked up the Southwest, Southeast and Northwest grid buoys and suspended a lower bridle line as a coil from each grid buoy (Picture 13). At the same time a grid line was attached to the Southwest and Northeast buoys to close the grid once the fish cage was in position. The Northeast riser line had the electrical telemetry cable and was deployed and attached to the cage later with the assistance of the *Galen J*. This is the telemetry cable connecting the more heavily instrumented Northeast grid corner (Figure 8 and Picture 36). to one of the Northeast bridle lines to the telemetry transmitter on the fish cage.



Picture 36. Northeast corner grid ring with four load cells and recorder strongback.

7.1 Connecting the North Cage to its Mooring

The *Galen J.* arrived at the site around 8:40 am, and both vessels started to move the cage from its temporary mooring into its designated position between the anchors at the OOA site. The *Galen J.* sent divers to the fish cage to detach the Northwest cage bridle lines (Picture 37) and attach a Norway marker buoy for the *Nobska*. The *Nobska* grabbed the marker buoy and attached it to the trawl winch cable. The *Galen J.* then detached the fish cage from the temporary mooring and held onto the line, being towed by the *Nobska*. The *Galen J.* helped steer the cage so it did not tangle with the mooring, especially the Southwest crown line and buoy. The *Nobska* towed the fish cage over, and picked up the Northwest grid buoy. The lower bridle line was broken off the buoy and attached to the cage bridle lines, and the grid ring and buoy reset (Picture 38). This was rather hurriedly done as the *Nobska* was being set by the tidal current back down on the fish cage. At 9:30 AM the cage was hooked up via its bridle and riser line to the Northwest grid ring.

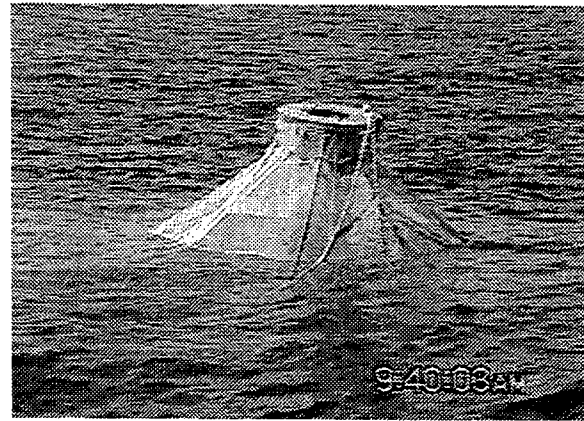

Picture 37. Northern fish cage with cage bridle lines seen attached to the top plate.



Picture 38. The Northwestern corner grid buoy with riser line attached. The line is being attached to the fish cage in the back left while the *Galen J.* stands by.

7.2 Unexpected Entanglement and Fix

The slow easterly current was to have drifted the cage down into its final position. However, it soon became clear that there was some problem, as the cage appeared to remain too close to the Northwest steel grid corner buoy. The *Nobska* moved to the Southwest corner buoy, and picked it up to moor the ship there. UNH divers then attempted to assess the problem, there seems to be a major entanglement of the lower riser line over the grid line and grid corner. To see if this could be pulled out, a 600-foot length of 1

inch three strand Poly-plus rope was spooled from the *Nobska*, with the *Galen J.* towing the rope across the net grid and attaching it to the net cage. The *Nobska* pulled itself and the Southwest corner buoy to the fish net and attached the lower riser line to the cage bridle line (Picture 39). There appeared to be much slack in the mooring system, so this was easily accomplished, but the excessive slack seems to allow lines to become more easily tangled. This operation was repeated with the Southeast corner buoy to attach the cage to the southern mooring points before the tidal currents turned and started running northward.

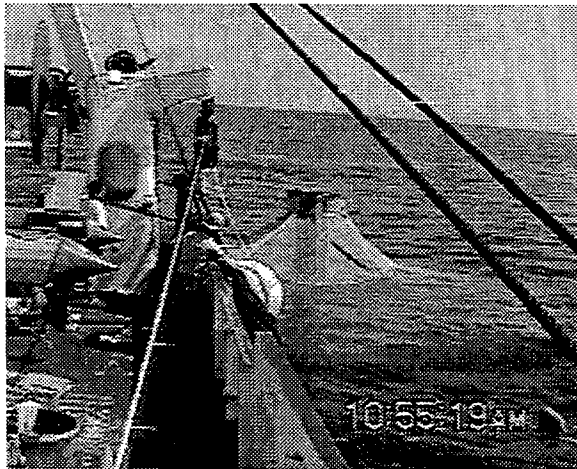

Picture 39. The Southwest grid corner is attached to the fish cage.

As the northwest riser line to the cage was still tangled, and the grid buoy was much too close to the net. At 12:30 PM the *Nobska* then recovered the Northwest corner buoy to repair the problem (Picture 40). The bridle lines from the fish cage were tangled on the load cell shackle. When this was cleared, it was clear that both the bridle lines and the riser line seemed to have wrapped around the Northwest anchor line.

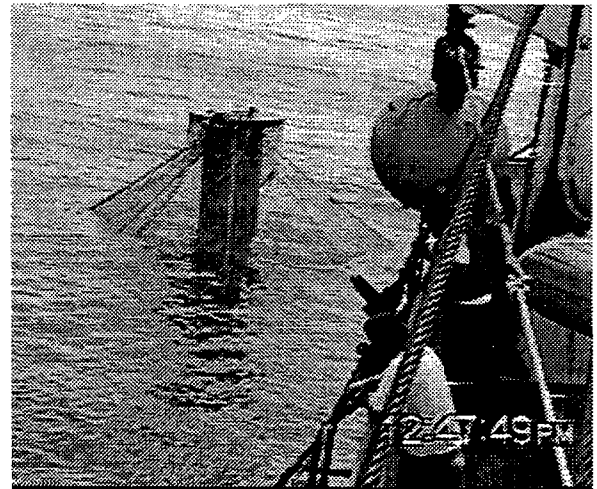

Picture 40. The Northwest corner grid buoy is recovered and the cage bridle line and riser line untangled.

This must have happened during the deployment of these lines near the Northwest grid corner ring when we were trying to be careful not to tangle things up. The northwest grid corner ring with its tangled ropes was lifted out of the water into the stern ramp of the FV *Nobska*. The R/V *Galen J.* assisted by pulling on the *Nobska* to keep her from drifting into the fish cage. The entanglement operation was messy. Will Ostrom and Matt Stommel lowered themselves from the Northwest grid ring, dangling from the steep slope of the stern ramp of the *Nobska*. The heavy lower bridle line was disconnected from the grid corner ring and unwrapped it from the anchor line and reshackled. The lines were slowly paid out as the grid tension took up the slack to assure that nothing was tangled. Then the grid ring and buoy was redeployed. This operation, lasting over 20 minutes, was only possible due to the fairly light swell flushing gently up and down the stern chute, leading only to soaked shoes and pants. The bridle and grid line tangle was finally freed and operations complete at 1:15 PM.

7.3 Completion of the Cage Mooring

Subsequently the Northeast lower bridle conductor rope and the Northeast cage bridle cable were connected together by the *Galen J.* The conductor and rope was then brought over to the *Nobska* which had recovered the Northeast grid ring and buoy, and attached to the load cell on the grid ring. While the *Nobska* held the Northeast grid corner ring and buoy, the *Galen J.* towed the Northeast to Southeast grid line from the Northeast corner to the Southeast corner. The *Galen J.* overshot the buoy, and had to come back. Then she put divers into the water to attach the grid line to the Southeast buoy. The *Nobska* released the Northeast grid corner, and stood by. She assisted in the operation by putting her small boat in the water and taking over shackles and hammer required to attach the grid line to the Southeast grid ring.

The cage was now completely connected and three of the four grid lines connected. Matt Stommel visited Michael Chambers on the *Galen J.* with the *Nobska*'s Zodiac together with Will Ostrom, to discuss the completion of the mooring work. The next step was the deployment of the Southwest to Northwest grid line. The Zodiac pulled this line over to the *Galen J.* and divers at the Northwest grid corner, who attached it to the rope ring. This closed the grid and the mooring was complete. A northerly tidal current of about one knot had developed, pushing the cage off center much closer to the northeast and northwest grid corner buoys. The southeast and southwest grid corner floats begin to submerge under the increased current drag of the cage.

While *Galen J.* divers swam on the cage, Jim Irish and Will Ostrom in the Zodiac pulled up the electrical connection at the flounder (with a diver attached line) and joined the two electrical wires together and secured them with abrasion protection around the flounder plate between northeast bridle cable and northeast riser cable. The telemetry cable was then complete from the load cell with data logger at the riser line to the top of the spar where the telemetry transmitter would be located. While this operation was underway, the *Galen J.* had been placing small fish floats on the grid buoys with 20 meters (65 feet) of line. These markers helped in determining when the mooring grid was tensioned properly and the grid buoys had been pulled under water to the proper depth.

7.4 Tensioning of the Northern Cage Mooring

Finally, at 3:30 PM the *Nobska* started to pull on the Northwest anchor through its crown-line mooring to tension the mooring grid (the Southeast and Northwest anchors). She pulled out several hundred feet watching the marker floats on the grid buoys. They were observed to go under, and the cage also was observed to go down a few minutes later and surfaced again after two minutes. When the cage finally surfaced, the deck plate was not as high out of the water as when the grid was untensioned. Then the Northeast crown line was retrieved, and the Northeast to Southwest anchor pair tensioned. With the marker floats just going under, the cage went down and was not observed to surface. The *Galen J.* went over to survey, and sighted the cage some 5 feet under water. They prepared a marker buoy for the cage.

The *Nobska* moved to the southern crown lines. The intention was to pull them east and west to separate them the correct distance. The Southeast crown line was grabbed and after a short high-tension peak the anchor is freed and the cage resurfaced. As the ship had trouble pulling to the east with the strong Northerly tide, the anchor was lowered again. The cage remained with its top a few feet above sea level. It was decided that the Southern legs would be

properly positioned and tensioned on Friday morning when the Southerly tide would help keep the *Nobska* from becoming tangled in the mooring, and help pull the crown line in the desired direction. The *Nobska* returned to the State Pier, arriving around 6 PM. In tensioning the fish cage mooring properly, the tidal currents played an important role in moving the ship and cage, and must be planned for in order to complete the operation.

Jim Irish and W. Paul left for Cape Cod that night, and Will Ostrom remained with the *Nobska* to work with UNH personnel on Friday and return with the *Nobska* on Friday night.

8.0 Deployment Work on Friday, August 25, 2000

The *Nobska* returned to the site with UNH personnel on board to finalize the tension on the North Cage mooring and to replace some crown line components on the Southern fish cage. On the Northern site, divers found the southwest mooring was tangled around the grid and was recovered and untangled. Then the mooring system was tensioned to operating configuration as shown in Figure 1. The bottom counter weight of the net cage was not lowered at this time as this operation was previously conducted safely on the *Gulf Challenger* using divers to cut the anchor free. Everything seems to be in position.

The South Cage mooring was inspected by divers earlier in the month and they found that the northeast lower bridge line was fouled around the corner buoy (Picture 41). This was untangled, but was redeployed with a badly chafed rope splice. Afterwards, the old remaining spar crown buoys (northeast and southeast) were brought on board and cut into several pieces for storage. The old buoys were replaced with 37-inch polypropylene floats and shorter chain adjustment links added. The northwest and southwest crown buoys (polypropylene floats) were also pulled and shorter adjustment chain replaced the old crown line chain. Upon replacement of each crown line chain, the *Nobska* would pull and tighten the anchor leg.



Picture 41. The Northeast grid corner ring with tangled lines and biofouling is recovered and untangled. Wear on the lower grid line is seen in upper left.

Tensioning of the cage and grid to the appropriate depth was facilitated by the use of marker buoys attached onto the four steel balls. The marker buoys were tied with a 21.5 m (70 foot) line. Each crown line and anchor was then pulled until the marker buoy disappeared from the surface indicating the steel ball was now at the appropriate operating/tensioning depth of about 21 m.

After the Southern cage work was completed, the *Nobska* returned to the Port Authority Pier to unload the UNH personnel and load a 1,100 lb. anchor. At 3:30 PM the *Nobska* left Portsmouth for Woods Hole. On her way south she retrieved the temporary anchor mooring for the North Cage.

9.0 Assessment of Effort:

Despite a number of somewhat mysterious line entanglements near the grid corners, which were untangled (often with the assistance of two vessels at the site), this was a very successful operation. A more complex mooring – due to the sensitive nature of the electro-mechanical grid and riser mooring cables, and the incorporation of nine load cells with their supporting strongbacks into the mooring system, was deployed and positioned at the OOA site. This was a team effort between the UNH research vessels *Gulf Challenger* and *Galen J.* and the fishing vessel *Nobska*. The *Nobska* proved to be a powerful and most versatile vessel. Her 4 independently operating winches, 3 powered net reels, and a 33 ft loading boom powered by 4 independent winches, with lifting capacities up to 35,000 lbs, allow the complex retrieval and deployment operations to be conducted rapidly and effectively. The needed transfer of lines, often under high loads, from one winch to another was achieved smoothly. The UNH diver assistance was vital, as was the ability of the UNH vessels to help with the mooring of net cage and the unexpected entanglement of the mooring members near and at the grid corner rings. The skillful handling of the *Nobska* by its skipper Matt Stommel and the rapid handling of the mooring and temporary retrieval operations by WHOI mooring technician Will Ostrom and the professional *Nobska* crew greatly accelerated the flow of work. The overall guidance of Michael Chambers, heading up the UNH team, was mandatory for the overall success of the mission. The UNH North Cage is now back in operation ready for fish, and ready for final instrumentation and recorders.

10.0 Lessons Learned and Unresolved Issues:

The importance of fully preparing and clearly marking all mooring components is obvious. All lines or special hardware should be furnished with the proper shackles or other connecting hardware before assembling the mooring gear for loading onto the deploying ship. See Appendix 1 for Details.

On several lines (particularly the grid lines) the shackles were not attached at the dock. The shackles on hand were found to be undersized, and had to be forced on with a sledgehammer over the rope's thimbles during the deployment operations, leading to avoidable delays (like requiring an extra roundtrip of the rubber boat from a corner float to the *Nobska* to get the hammer.) By attachment of the shackles onshore there is no need to worry about the sufficient number and size of shackles beyond spares.

Of some mystery was the entangled conditions of the different ropes meeting at the grid corner. Even the most careful orientation of the ropes prior to deployment seems not to exclude the occurrence of tangling. As example, if the two grid ropes meeting at a grid corner are shackled in the wrong positions of the corner ring, an entanglement is understandable. But it seems to be that the grid corner float can somehow dive under the grid line and start an entanglement, which is not understandable.

Careful diver observation of submerged grid corners may help to understand what is going on. Semi-slack conditions on the lee side of the prevailing current may cause a problem, since it allows the grid rings to come closer together, and the riser and anchor lines engage at steeper angles with the grid corner ring. The steeper grid line angle may allow a strutting grid corner float to wrap around the grid line. The inclined pull of anchor and cage bridle lines will result in the tilting over of the grid corner ring towards the anchor, since it is pulled in a more

inclined direction by the ropes. The grid ring's orientation will result from the parallelogram of forces of the vertical flotation pull, and the inclined direction of anchor-line and bridle-line tensions, and to a certain extent the grid line forces and directions.

Finally, the operation was performed in a period of mostly low wind and sea state conditions, and good visibility. This seems to be mandatory to perform the work. With winds over 10 to 15 knots and sea state over 3 feet the work becomes a lot more complex and dangerous.

Acknowledgements:

This work was supported by the Open Ocean Aquaculture Demonstration Project, funded by NOAA/Sea Grant contract number NA86RG0016 to the University of New Hampshire with Subcontracts to the Woods Hole Oceanographic Institution. The authors would like to thank the WHOI rigging shop, Mike O'Connell (a WHOI summer student who tested and calibrated the load cells), Mathiew Ostrom for the videos from which many of the mooring operation pictures were taken, and the University of New Hampshire Divers.

References:

- Baldwin, K., B. Celikkol, R. Steen, D. Michelin, E. Muller and P. Lavoie, "Open Ocean Aquaculture Engineering: Mooring & Net Pen Deployment," *Marine Tech. Soc. Jour.*, 34, 53-58, 2000.
- Fredriksson, D. W., M. R. Swift, E. Muller, K. Baldwin and B. Celikkol, "Open Ocean Aquaculture Engineering, System Design and Physical Modeling," *Marine Tech. Soc. Jour.*, 34, 41-52, 2000.
- Tsukrov, I.I., M. Ozbay, D.W. Fredriksson, M.R. Swift, K. Baldwin, B. Celikkol, "Open Ocean Aquaculture Engineering: Numerical Modeling," *Marine Tech. Soc. Jour.*, 34, 29-40, 2000.

Appendix 1: Marking of Mooring Components

All lines should be clearly marked with weather resistant labels by indelible ink pens as well, marking example: “SW Anchor Line, Grid Corner End”.

Of particular importance was the distinct marking of each grid corner ring. Each grid corner ring has four ropes attached, and the position of each rope should be clearly indicated on the ring. The guessing game when the ring is hanging from an overhead boom raised above you and rope ends are coming from four different directions is amazing, and the result is not necessarily correct.

Marking example for SW grid corner ring: “SW Anchor Rope, SW Bridle Rope, SW-NW Gridline, SW-SE Grid Line”; mark the appropriate position of each terminating area clearly on the grid corner ring.

Also marking the grid corner buoys with their location (NE, SE, SW, NW) proved to be helpful. It is easy to lose orientation and or sight of floats in particular in waves or entanglements, and the letters help.

Marking of the load cell “strongbacks” also has to be done on shore, indicating which side goes where. Example: “NE Anchor Line Load Cell”, mark “Grid Ring End” and “Anchor line End”. (On the NE grid ring four load cells were connected, it is easy to mix them up during assembly on board ship).

The NE Riser and one of the two NE Bridle Lines are furnished with the telemetry cable. The Riser line has to be marked with “Grid Corner End” and “Cage End”. The conductor terminations have to be checked to have matching interfaces.

All this seems trivial, but greatly benefits the smooth flow of operations at sea.

Appendix 2: Service of the University of New Hampshire, Open Ocean Aquaculture Program's Moorings and Fish Cage with the FV *Nobska* 19-23 June 2000

James D. Irish and William M. Ostrom, Woods Hole Oceanographic Institution,
Dave Fredriksson, University of New Hampshire

Goal: The goal of this operation was to combine WHOI and UNH mooring expertise with the FV *Nobska* to service the UNH Open Ocean Aquaculture moorings and fish cages, concentrating on the northern cage.

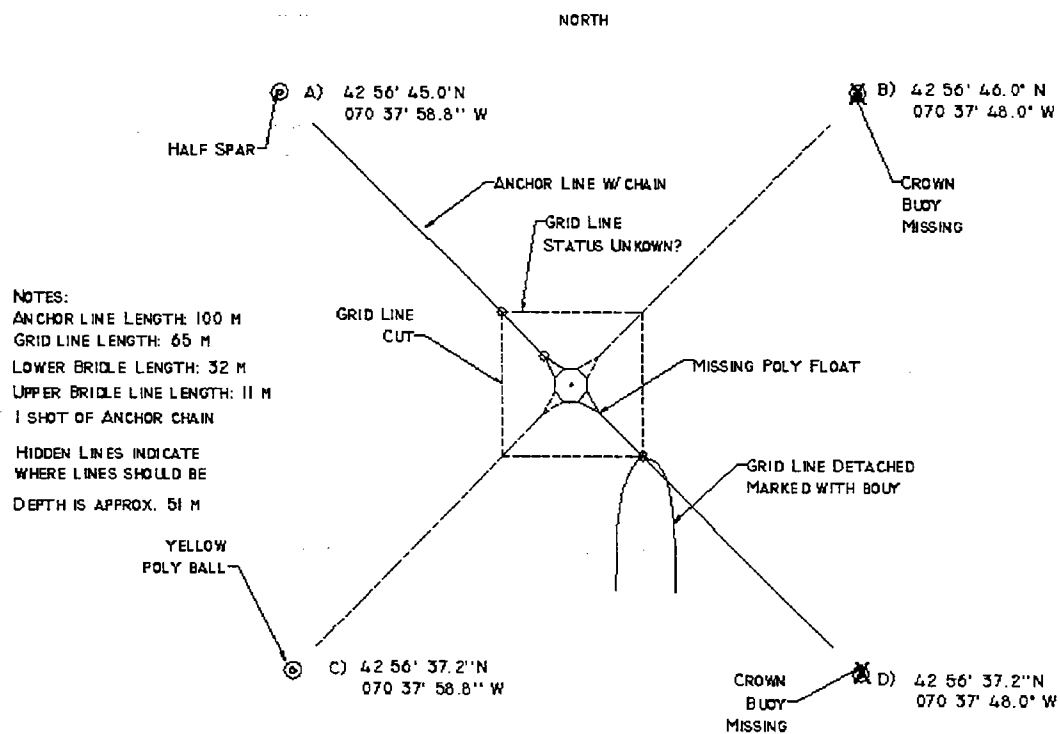

The present condition of the northern fish cage and mooring as illustrated above was assembled as a best estimate of its status from surveys by UNH divers.

Tasks for WHOI and the FV *Nobska*:

1. Relax the Northern grid from crown buoy "A."
2. Detach the Northern fish cage from the mooring at the two attachment points from anchors attached to crown buoys "A" and "D."
3. Tow the fish cage to White Island (or another sheltered site selected by UNH) and anchor it with mooring provided by WHOI. UNH would then remove the net and disassemble the cage for towing to Portsmouth, NH by the *Gulf Challenger* or the *Nobska*.

4. Recover the four anchors, anchor lines, crown lines, grid lines, etc. to completely remove the Northern cage mooring.
5. Take the components to the Port Authority Pier in Portsmouth, NH and unload them for further study of mooring wear and for reassembly for deployment later in the summer.
6. Tow the spar, and/or cage rim to the Port Authority Pier for servicing by UNH and Ocean Spar personnel.
7. Replace the damaged spar buoy on southern cage crown line with a polypropylene float supplied by UNH
8. Recover and replace the crown line and missing buoy on the NW corner of the Southern cage with another polypropylene ball.

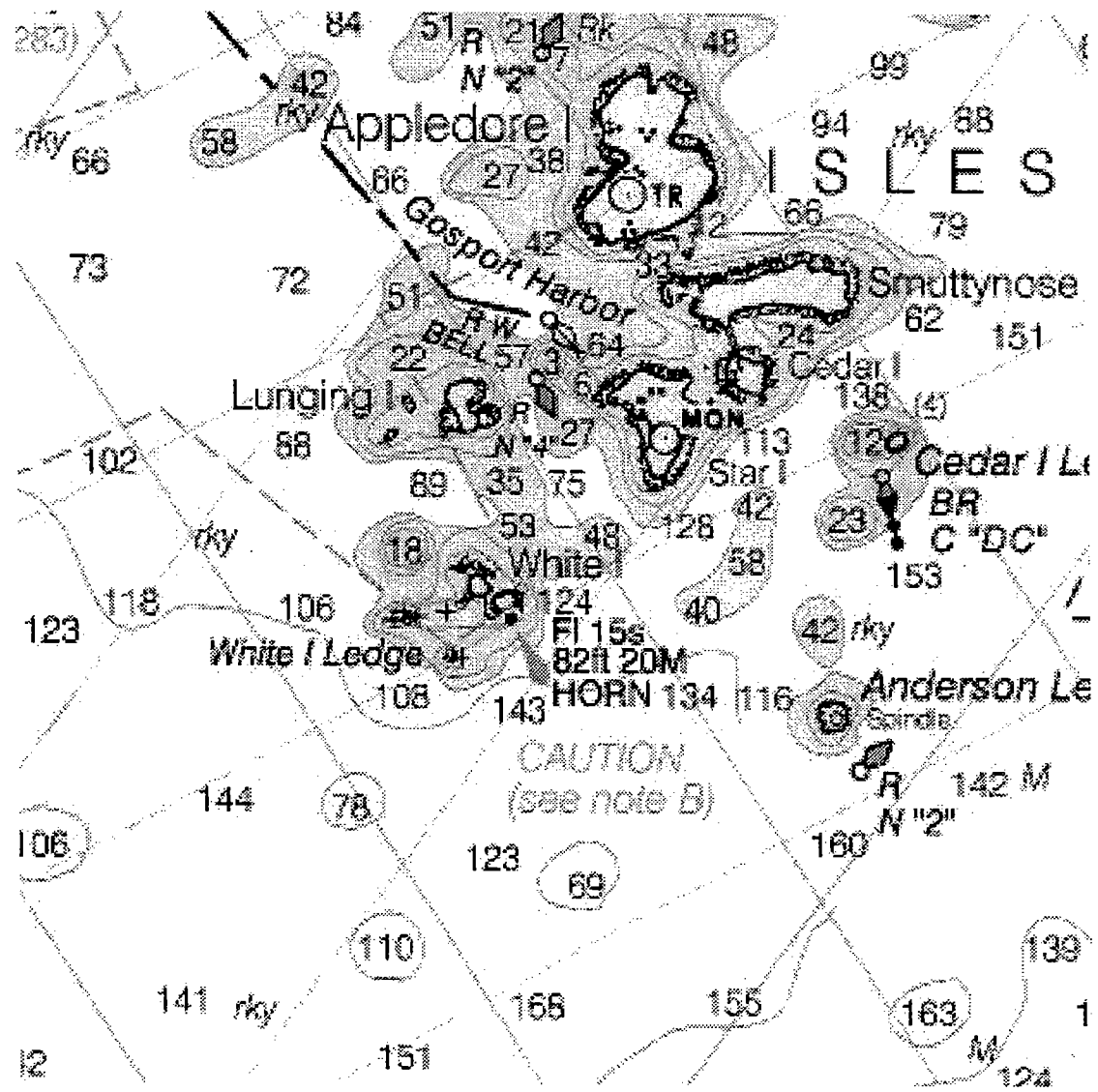

Chart of the Isle of Shoals Region. The fish cage was moored about the "i" in White of White Island, and the UNH Aquaculture site is the bottom of the chart in the center.

Monday - 19 June

1230 - FV *Nobska* at WHOI pier. Deck boxes, fish cage mooring, load cell support, etc. loaded and secured for transit to NH. Will Ostrom will ride ship up.

1330 - FV *Nobska* departs WHOI dock to NH via Vineyard Sound.

Tuesday - 20 June

~0300 *Nobska* arrives Isle of Shoals site and waits for the *Gulf Challenger*.

0530 - Irish meets the *Gulf Challenger* at the NH State fish pier with the UNH crew.

0545 - *Nobska* departs fish pier for OOA site.

0615 - Personnel transferred to *Nobska* and a review of operations plan. *Nobska* has Will Ostrom and Jim Irish from WHOI and Barbaros Celikkol, Paul Lavoie and Dave Fredriksson from UNH. Michael Chambers and divers are aboard the *Gulf Challenger* with the UNH film crew.

0720 - Start work. *Nobska* retrieved lifting line with bridle attached to the northern fish cage counter weight installed by UNH divers on Friday (See Figure 1). The *Nobska* pulled the weight to the surface by winding the recovery rope up on the aft fish drum until the anchor was at the stern. Then the port winch cable was run through the port gallows and shackled to the anchor. The anchor was then picked up out of the water and held on the rail (see photo P001161 below). The tether to the fish cage was released and UNH personnel in an AVON inflatable boat took the tether back to the fish cage and secured it so it would not interfere with future operations. The counter weight was then transferred to the *Nobska*'s boom and secured on deck amidships for transit. Matt Stommel estimates that the weight was greater than 6,000 lbs. by the pull on the winch and crane, but the counter weight was not weighed. While this operation was being done, Irish with help from Fredriksson set up a GARMAN GPS receiver and notebook computer to log data on ship's position and speed over the ground, a Synergetics data system to digitize and a notebook computer to log data from the load cells. The load cells were attached to the data system and set on the 01 level deck for zeroing so the electrical cables were out of the way on the main deck for operations. Dave Fredriksson set up a Marsh McBirney electromagnetic current meter to obtain velocity measurements of the ship relative to the water.

0800 - *Nobska* picked up the crown line marker buoy "A" and relaxed the grid until the steel grid floatation balls were observed on the surface. The fish cage floated with a marked tilt (see photo P001166 below).

0820 - Releasing the fish cage. The grid line from anchor "D" was grappled off the stern. A second grid line was hooked along with this line, and was seen to be running under the fish cage. This line was cut as we weren't sure where it ran or how to untangle it. When the line was cut, a heavily fouled steel grid corner buoy was seen to surface that might be the missing buoy and line to anchor "B"! Then the cage was detached where the bridle lines attach to the riser line. The *Nobska* moved over to the other side of the fish cage and detached the bridle lines from anchor "A" to the riser line. These were attached to the *Nobska*'s two steel winch lines going through the gallows blocks.

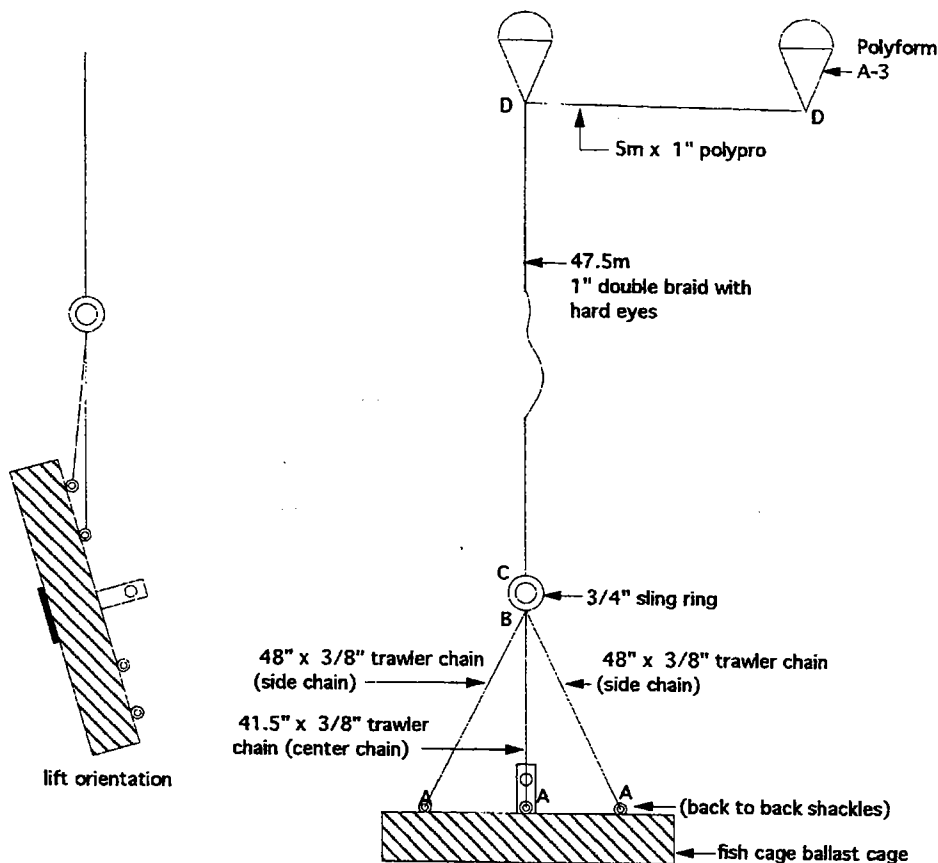

UNH ballast weight lifting line
 W.Ostrom (WHOI)
 6/14/00

A = 1/2" chain shackle 1/2" screw pin shackle

B = 1/2" chain shackle (1 per each bridle leg)

C = 3/4" anchor shackle

D = 7/8" anchor shackle 3/4" pear ring 1" screw pin shackle

Note : center bridle leg will be painted yellow

Figure 1. WHOI design of the recovery bridle for the fish cage counter weight.

0900 - The fish cage was then towed out of the grid. However, it didn't clear the buoys before we were hung up. Divers from the *Gulf Challenger* determined that the lines from anchor "B" were still attached to the fish cage, and they unshackled these lines and the *Nobska* was able to pull the cage free of the moorings.

1000 - The poly tow lines supplied by WHOI were attached to the 1-inch bridle lines on the fish cage, and the cage dropped back of the *Nobska*. The ship stopped and the load cells

were placed between the poly lines and the ship's steel winch cables. The electrical cables from the load cells were run to the data system on the bridge that supplied switched battery power to the load cells, and digitized the resulting signal.

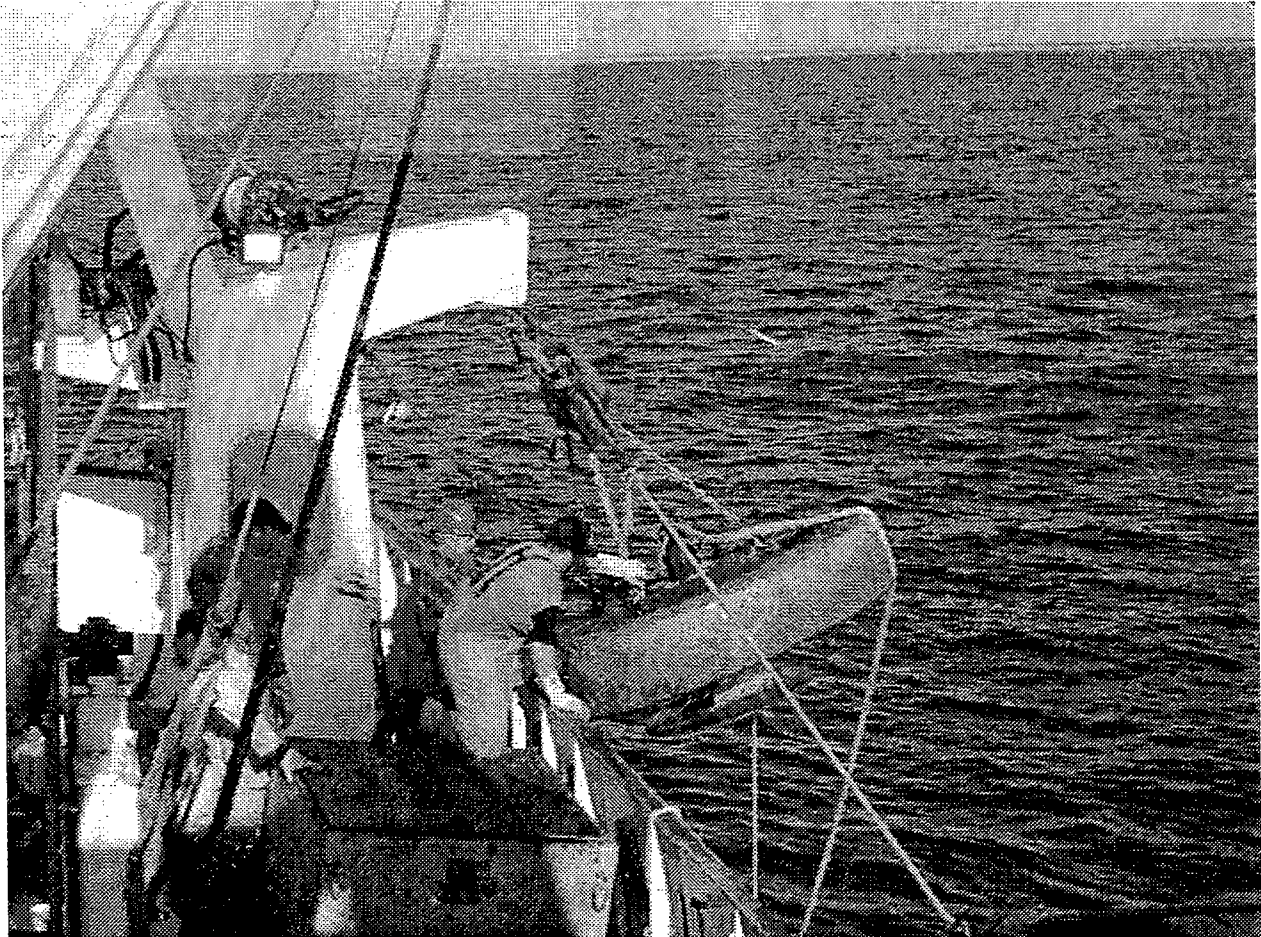

Photo P001161 - the northern fish cage counter weight being recovered by the FV Nobska.

1010 - The slowest the ship could go was about 1.5 knots, and a first point was taken here. Dave Fredriksson on the main deck used a Marsh McBirney electromagnetic current meter to get the speed of the ship relative to the water. The GPS log gave the speed over ground and the data system gave the output of the load cells. Log files were made of all data for later analysis. A drift test while the *Nobska* was waiting to connect with the cage indicated currents less than 0.1 m/s in the region.

1013 - The ship started a turn toward the mooring site, the load cells show a shift in tension between the two cells. When steaming straight, the tension was nearly equal. The fish cage towed with the rim at the water line, and the back of the rim underwater (see photo P001172 below).

1015 - speeded up to 1.7 kts

1017 - speeded up to 1.9 kts. A quick back-of-the-envelope calculation showed that at 2.0 kts speed (relative to the water via EM current meter, or 1.9 kts via GPS over the

ground), the tension (sum of both load cells averaged over six 5-second readings) was 6,150 lbs. A very reasonable number considering the cage was half out of the water and the fish net in the water was heavily fouled with mussels.

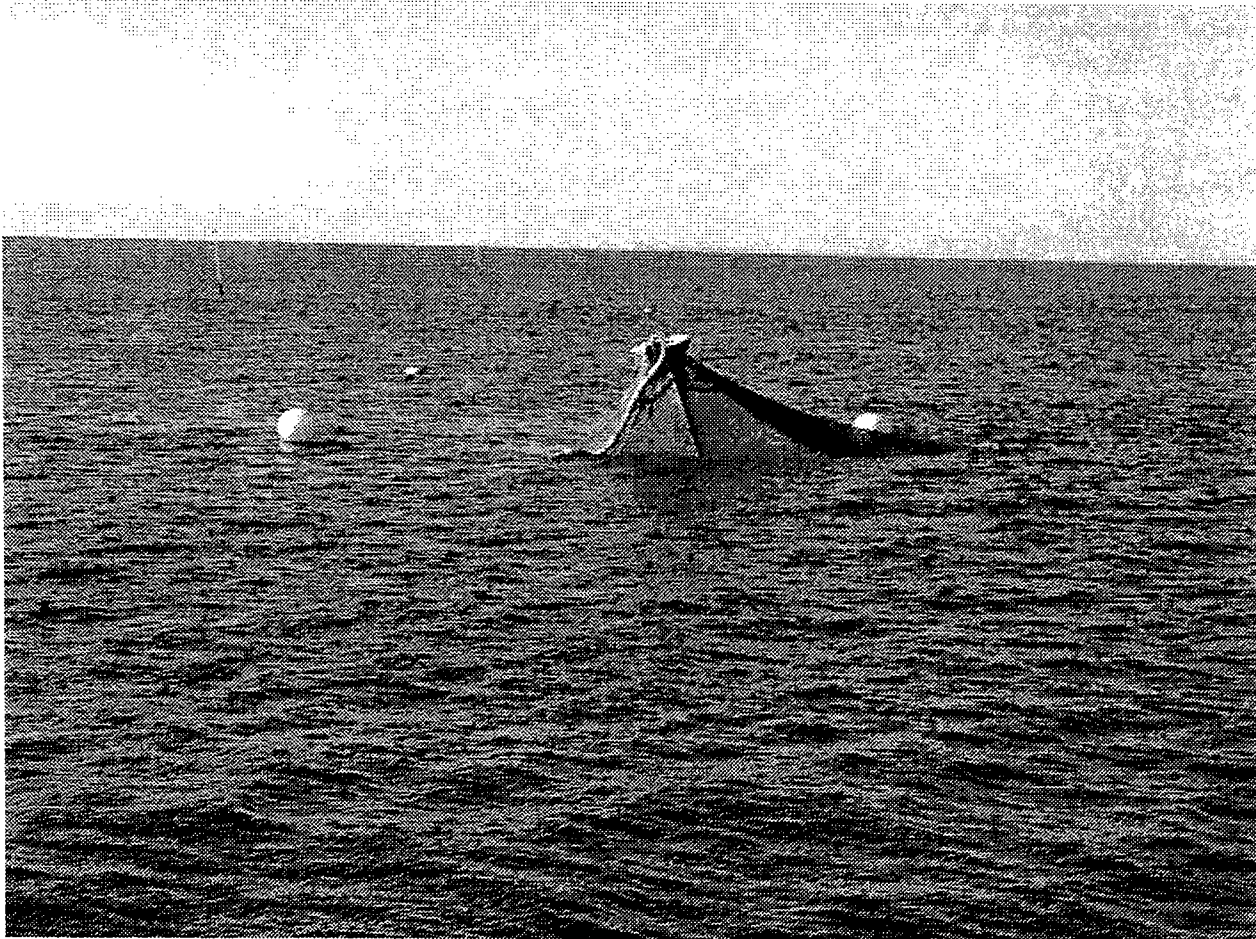

Photo P001166 - the fish cage after the counter weight was removed and the grid relaxed. The cage floated with a marked list to one side.

1023 - End of test and load cells were taken out of towing line. The fish cage was then towed toward the hi-flyer marker deployed by the *Gulf Challenger* between Lunging and White Islands. As the *Nobska* drew abreast of White Island the tow velocity dropped as a strong current against us was encountered. It was decided that the cage was in a good position (11 fathoms depth) so we would anchor the cage there. A plan of the cage mooring is given in Figure 2 below.

1112 - The anchor with line and float (See Figure 2) attached to the fish cage were deployed. The anchor was released with the fathometer reading 12 fathoms while the fish cage was in 11 fathoms. The *Nobska* then returned to recover the northern fish cage anchors while the *Gulf Challenger* worked on the fish cage.

1230 - Starting recovery of the cut anchor and crown line "C."

1310 - steamer chain wrapped around anchor

1400 - anchor on deck and cleaning up. The *Gulf Challenger* not having much luck, so *Nobska* will not plan on towing/carrying the spar to Portsmouth today and will fill deck with anchors, buoys, etc. By the barnacle growth and rust patterns on the anchor it was determined that this anchor was upside down, that is with the fluke in the water rather than in the bottom. Going for the northwest anchor with spar marker buoy - "A."

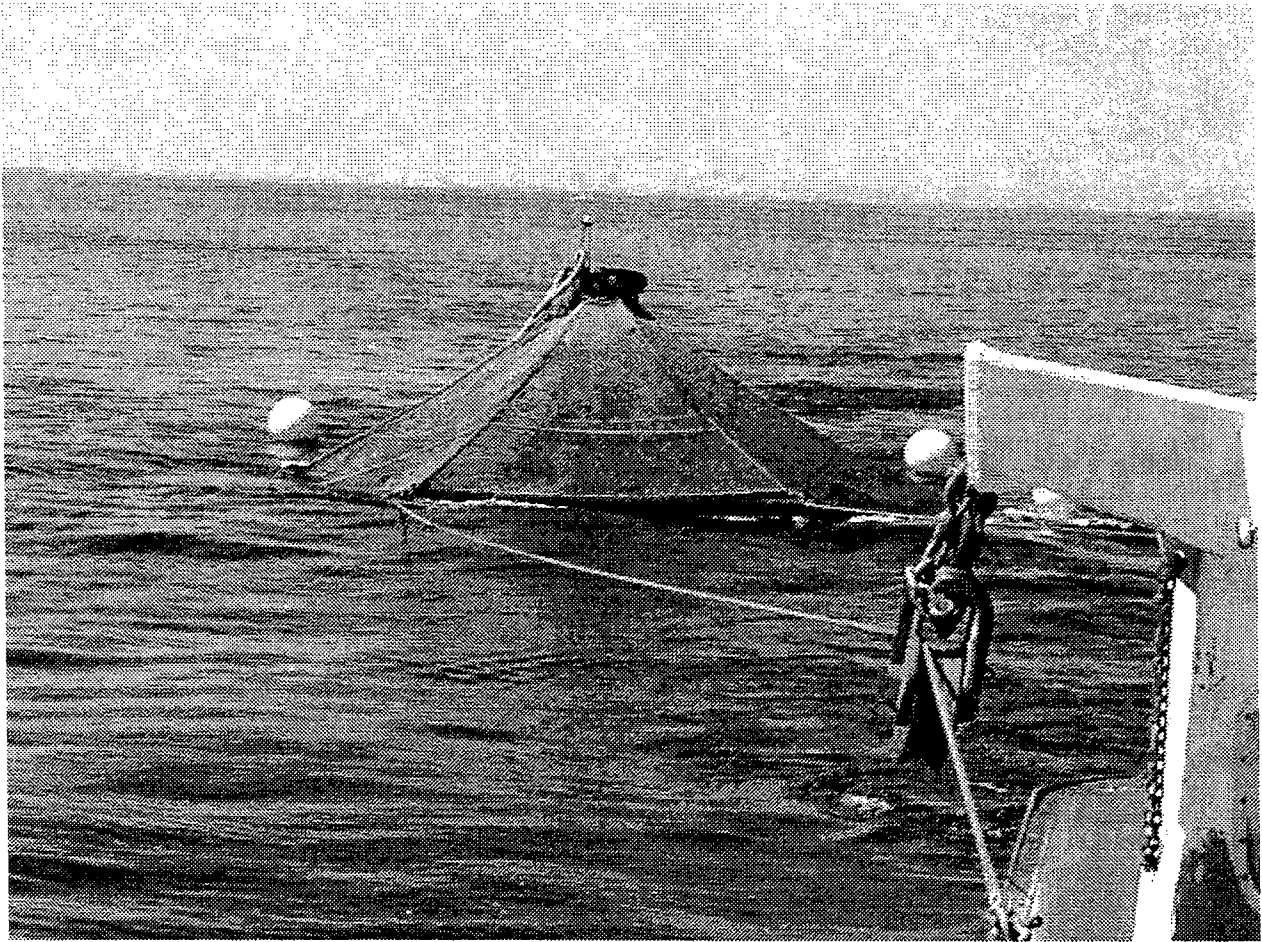
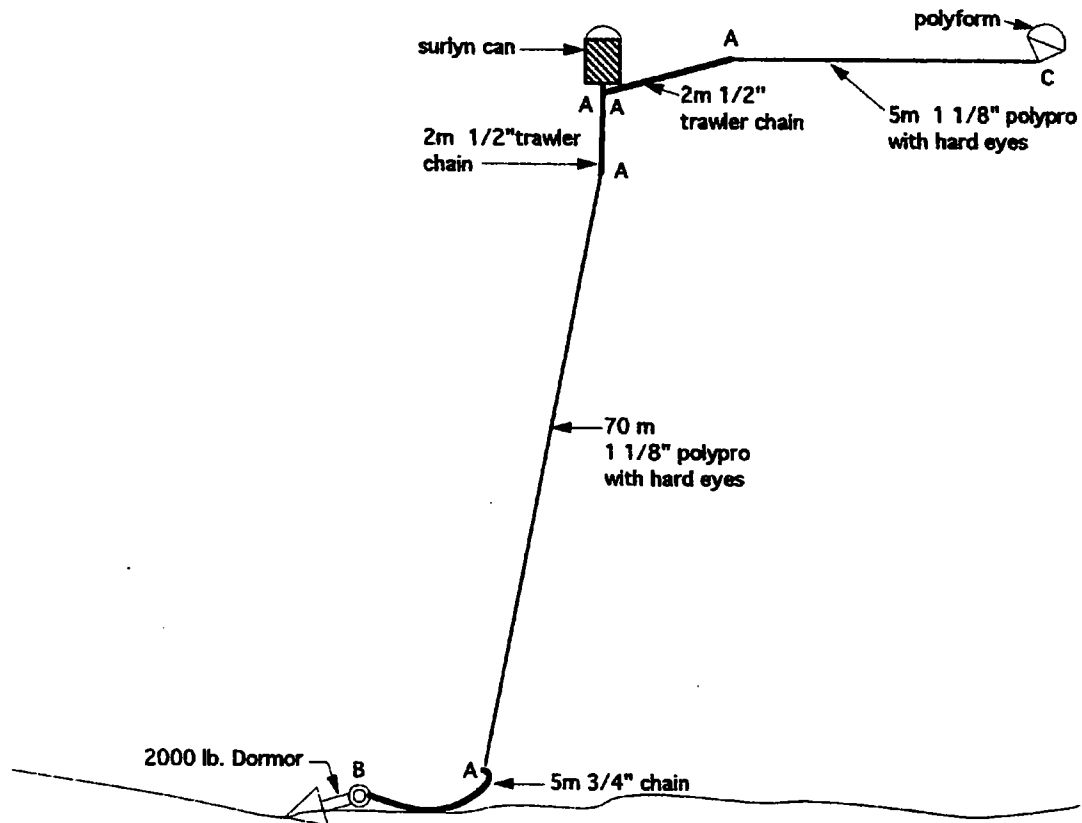

Photo P001172 - Nobska towing the fish cage. The red poly lines are visible, as well as the bridle lines at the fish cage. The load cells were coupled in at the lower edge of the picture where the shackle is visible. The fish cage towed easily with the front edge of the rim just out of the water.

The end of the cut anchor line was retrieved with the mooring "C" and was inspected. It looked as if about 3/4 of the line was cut cleanly with one cut, and that there were at least two more lesser cuts in the remaining fibers (See photo P001272 below). There is the possibility of cutting the rope with the anchor during deployment or more probably during relaxing of the grid if the anchor was lifted off the bottom and carried too far toward the cage. The cut was clean and probably not caused by a fisherman dragging it aboard. This is an interesting mystery that we may be able to further study by examining the cut end. The end was bagged in plastic to protect it from picking up other dirt and materials from the ship and pier.

1420 - Spar "A" aboard and being disconnected. Chain length adjuster not really used and hanging as a weight. Suggest that this be removed to reduce wear of chain on crown line.



- Hardware key**
 A = 5/8" anchor shackie
 3/4" pear ring
 5/8" anchor shackie
 B = 3/4" anchor shackie
 C = 1" screw pin shackie
 5/8" pear ring
 5/8" anchor shackie

- shackle / hardware count**
 5/8" anchor shackie = 14
 3/4" pear ring = 8
 1" screw pin shackie = 2
 2 x 5m 3/4" chain
 3 x 2m 1/2" trawler
 2 x 70m 1 1/8" polypro with hard eyes
 2 x 5m 1 1/8" polypro with hard eyes
 2 x polyform buoys
 1 x surlyn can buoy

UNH fish cage mooring
 W.Ostrom
 6/14/00

Figure 2. WHOI design and component lists for temporary cage mooring.

1440 - winding crown line on aft fish reel.

1510 - at small chain at anchor. Anchor is also fouled with steamer chain wrapped around it. Chain cut with torch to be able to recover (See photo P001189 below).

1630 - anchor all aboard and steaming for Portsmouth while pressure washing and hosing off buoys, lines, etc. By barnacle growth and rust line, it appears as if this anchor was also upside down, fluke in the water rather than in the bottom. This anchor was not dragged around and may be an indicator of a problem with the anchor deployment method used previously or the tensioning and relaxing of the mooring during the past year. The weight of the large amount of steamer chain acted as a good anchor to help hold the fish cage in place.



Photo P001272 - The cut end of the anchor line. There is one main cut most of the way through the line seen at the left. Another cut is visible just to the left of Walter Paul's finger, and at least two more cuts at the far right. The cuts were clean indicating that it was not torn apart or cut by rubbing against a rusted wire rope. The location of the break, close to the anchor end, and its appearance suggests possible cutting by the fairly sharp edges of the Sampson anchor.

1730 - at Port Authority pier and tying up for the night by the large cranes for ease in offloading in the morning.



Photo P001189 - Mat Stommel (left) cutting chain wrapped around anchor while Will Ostrom (right) keeps water on line so that sparks from the cutting torch will not burn line holding the anchor chain for recovery on the aft fish reel.

Wednesday - 21 June 2000

0630 – *Nobska* at Port Authority Pier. Crane operators on hand. Michael Chambers there and discussing plan of action for day. *Nobska* will unload and then proceed to pull remaining anchors. *Gulf Challenger* will work on removal of fish net. Matt Stommel suggested that the net might be tied and dropped to the bottom with marker buoy for the *Nobska* to recover and wind on their aft net reel.

0730 – Started offloading operations using (See photo P001254 below) and large Port Authority cranes. Poly and Steel balls first, then the anchor, counter weight, lines and finally chain were unloaded. The chain was stretched out on pier by Port Authority forklift. Most of Dave Fredriksson's tags marking which piece came from which mooring remained in place.

0845 – Done offloading moorings "A" and "C" (western two moorings) and departing Port Authority Dock for site to recover moorings "B" and "D" on eastern side of Northern site and to tow in the fish cage.

1000 – At the northern fish cage site, weather calm with light winds. Three sets of surface floats visible implying that we may have the marker buoy for the northeast anchor "B" which we thought might not have a marker and we would have to try and drag for it. Decision was made to recover the Norway ball on down-wind end of the series of buoys and see what we have. Picked up the marker and the steel grid corner buoy. Grid corner with lines present brought aboard. One lower bridle line and two grid lines attached to corner. Also anchor line. One bridle line retrieved that was freshly cut (This was the line recovered and cut by the *Nobska* when servicing mooring yesterday as it ran under cage.) It is probable that this got tangled under the cage and mooring so was not seen and identified earlier by the divers. The lines going down seen by the divers were probably the lines from this mooring leading down under the cage where they were tangled. This line was heavily fouled with about 18-inch diameter of mussels. A second grid line lead to another anchor and so was buoyed off with Norway ball float marked "UNH." A full lower bridle line was recovered with shackle at far end with pin missing (assumed removed by UNH divers). All lines were fouled with heavy mussel growth. Grid corner was broken out of lines and anchor line attached to aft drum.

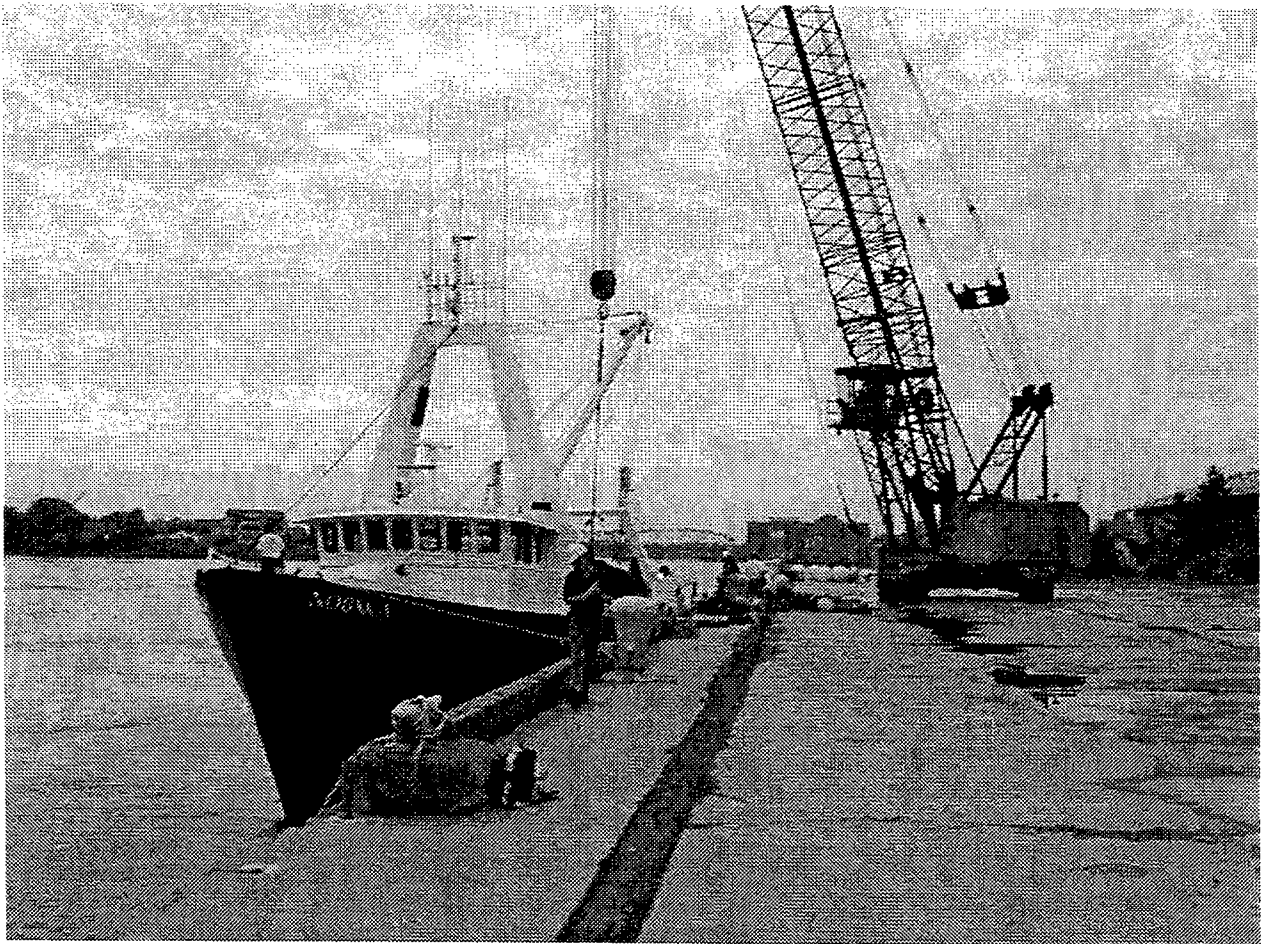

Photo P001254 - Port Authority crane offloading gear from the Nobska on the 2nd morning.

1020 – pulling on anchor line on aft drum, winding up line (See photo P001178). Less mussel fouling on this line.

1030 - pulled anchor line up to steamer chain. It is obvious that the anchor is off the bottom as the *Nobska* is now drifting downwind toward White Island. Again the torch was used to cut the shackle between the chain and anchor line.

1050 - cut 2¼ inch anchor chain so can wind on aft drum (see winding operation in photo P001223 below). Got anchor up so can see that chain is fouled on anchor again. The wind is up significantly - a few white caps - wind speed is estimated 15 knots.

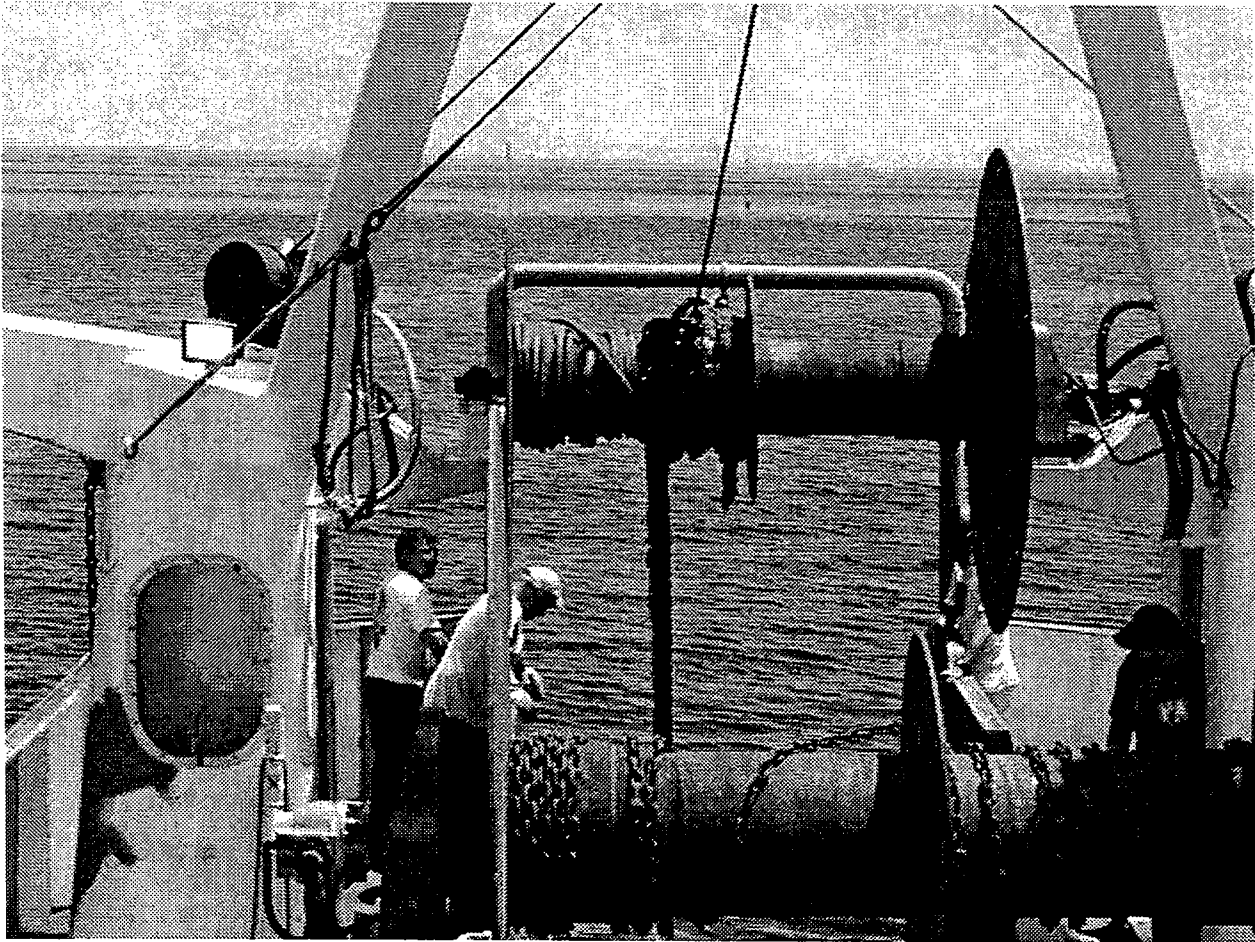

Photo P001178 - winding the mildly mussel-fouled anchor line on the aft net reel.

1120 - anchor at rail, working with anchor to untangle chain. Cut chain off anchor to get on board. Cut chain on both ends of anchor.

1135 - winding in crown line chain. Got entire crown line to the buoy and another two-color (black and yellow) poly line was wrapped where spar buoy should be. It appears that the 3/8-inch bail on the buoy broke, as the mooring shackle was present.

1140 - anchor at rail recovering.

1150 - anchor on deck. Drifted almost up to White Island. *Gulf Challenger* says that they will be ready for *Nobska* in just over an hour, the *Nobska* will proceed to recover last anchor and mooring.

- 1210 – getting the downwind part of anchor – pick up poly float up stern ramp.
- 1215 – grid corner and buoy aboard. Breaking buoy off. Wind up to ~20 kts.
- 1220 – winding bridle line from polyethylene ball to polyform float on aft reel. Grid line on central reel from polyethylene ball and a second grid line on second polyform float and then lower bridle line to polyethylene buoy retrieved ok.
- 1235 – wrapping anchor line up on center reel.

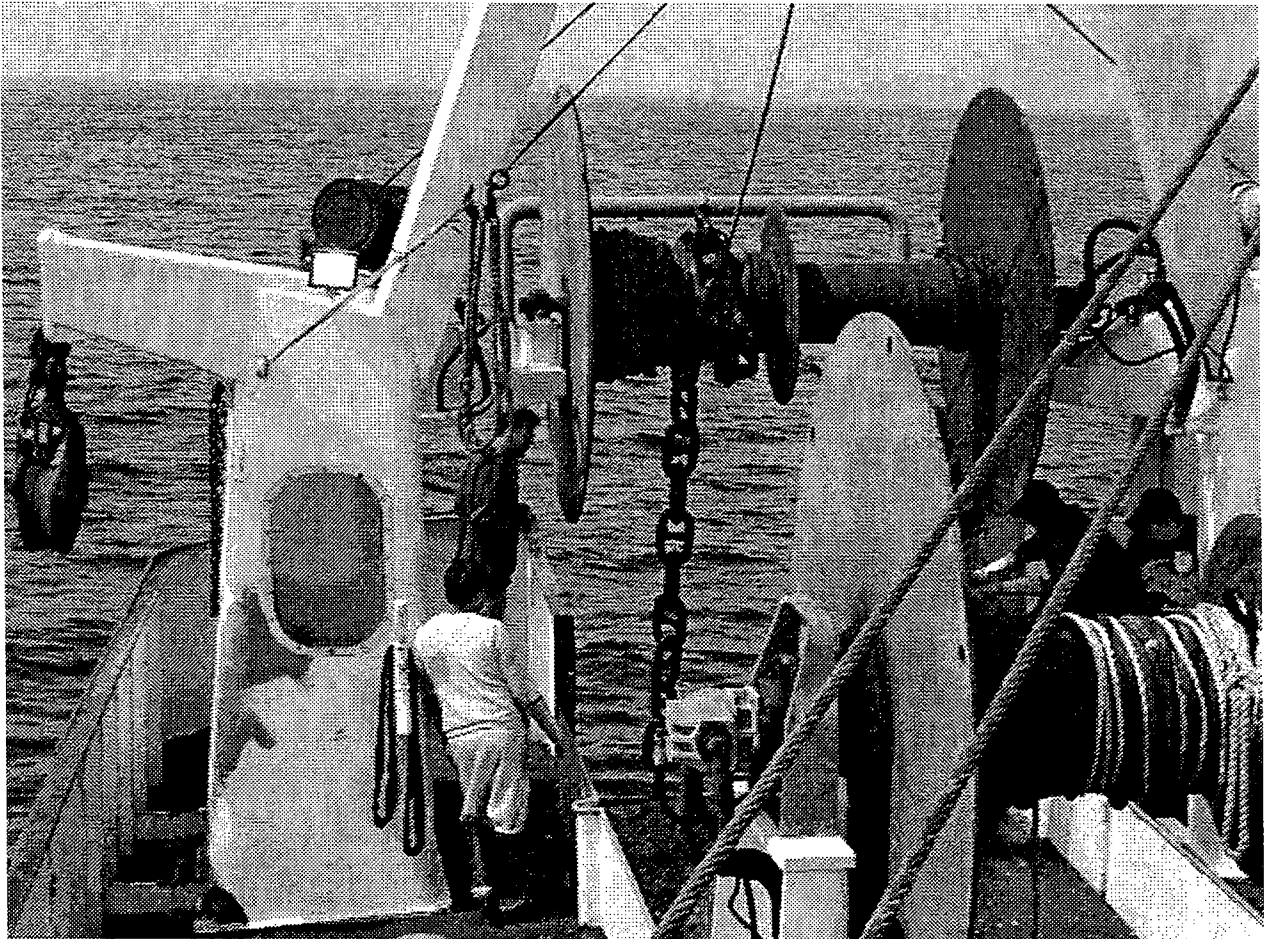

Photo P001223 - winding the 2¼ inch stud link anchor chain on the aft net reel.

- 1250 – Recovered mooring to anchor chain. The *Nobska* had a problem pulling the anchor out of the bottom. However, we just waited and let the waves gently work it out.
- 1300 – Cutting off shot of chain on last anchor. Anchor here was also fouled in chain. It should be noted that all four of the four anchors recovered at the northern cage were fouled in their 90-foot length of 2¼-inch stud link anchor chain.
- 1310 – *Gulf Challenger* done and starting to tow spar to Portsmouth. *Nobska* will pick up net and follow with rim when done.
- 1330 – recovered crown line. Broken at buoy attachment point again.

1400 – moved away from land so we wouldn't hit the lighthouse. Starting to recover anchor with chain wrapped around it. *Gulf Challenger* doing well with tow to Portsmouth. Plan on offloading tomorrow morning 0800.

1425 – chain all aboard – cut off anchor

1430 – anchor aboard and securing. Heading for net and rim. Only one Norway ball on net.

1500 – net aboard OK - wrapped up on aft reel in less than two minutes (see photo P001240 below)



Photo P001240 - winding the northern fish cage net onto the Nobska aft net reel. The whole operation from pickup of the buoy to net wound upon the net reel took about two minutes.

1515 – planning recovery and starting for yellow can to pick up rim tow.

1535 – towing rim on the 1 inch polyester bridle lines to the *Nobska's* two winches with steel cables through the gallows blocks. The rim was towed fairly close to the boat to lift the front edge of the rim so it could not dive down into the water. Rim towing fairly nicely at 3 to 5 knots. (See photo P001244 below).

1550 – 6.7 knots – noticed normal mode oscillations in ring so slowed down to 5 kts.

1600 – about 5.2 knots speed over ground for rest of tow.

1730 - arrived at Port Authority pier and tied up *Nobska* downriver from the spar. The rim was tied with two lines - one to the *Nobska* and the other to the dock to prevent the rim from hitting the *Nobska* or going under the dock. The rim was floating level with water like there was no major leakage in any one rim section. This was encouraging as it was thought that at least one of the rims had leaked and not providing sufficient buoyancy.

Thursday - 22 June 2000

0800 - Offloading the *Nobska* with second deck load of anchors, floats, lines, etc.

0900 - The *Nobska* will return to the OOA demonstration site to repair the crown line floats "E" and "G" of the south cage system. Two polyethylene floats, an extra crown line, an anchor line, and a spar 1-inch adjustment chain was loaded aboard for spare material in case any component needed replacing.

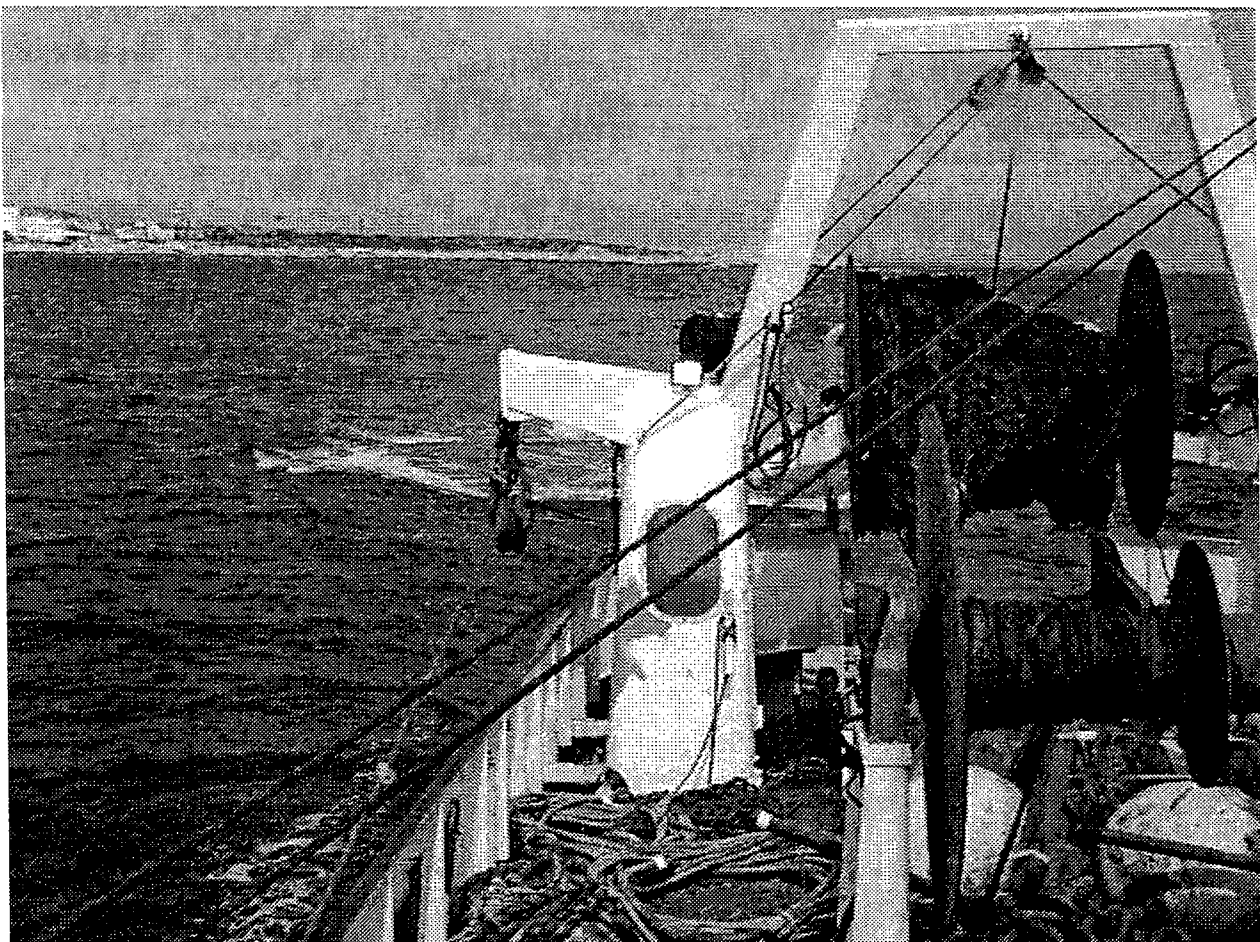

Photo P001244 - Towing the rim at about 5 kts with Star Island in the background.

1000 - (approx): Arrived at the demonstration site and recorded GPS position of the crown buoys "F" and "H."

F - 42° 56' 36.6" N x 70° 37' 48.0" W

H - 42° 56' 28.8" N x 70° 37' 48.0" W

- 1100 - Start at crown line "G." Pull the existing spar buoy without light or radar reflector aboard the *Nobska* and detached it from the mooring. Attached a polyball with 5 feet of ½ inch chain. Also attached to the polyethylene float was a tag line connected to a small Norway ball for ease of recovery when the *Gulf Challenger* replaces the polyethylene float with a permanent marker buoy.
- 1230 - "G" marker buoy replacement completed. New buoy positioned at 42° 56.478' N x 70° 37.922' W. When the *Nobska* was ready to drop the new crown buoy overboard with the crown line coming pretty straight up from the anchor and steamer chain, the anchor line was visible on the 's fish finder about 9 feet above the bottom. This implies that the *Nobska* had dragged the crown line back over the anchor (which she was trying not to do) or that the 90 feet of steamer chain was wrapped on the anchor and shortened the distance to the anchor line. The fish finder transducer was located about 50 feet forward of the aft deck where the marker buoy was being held ready to release.
- 1245 - Begin dragging for missing crown line at "E."
- 1330 - Grapnel caught on stud link of anchor leg between anchor and anchor line.
- 1400: Begin the process of pulling up sections of anchor and crown line components cutting as needed.
- 1440 - Reconnected pieces of chain with shackles with pins welded and redeployed. Crown line polyethylene float deployed with 15 m of ½ inch chain and Norway ball. New position at 42° 56.6' N x 70° 37.926' W. When the anchor was pulled out (taking care not to tangle the steamer chain) the crown line buoy was extended farther than the other buoys from the cage. This may be further indication that the other anchors may be fouled. The *Nobska* had difficulty in deploying the anchor system without fouling. It is clear that the anchor must be lowered by the crown like to orient the anchor properly. We also suggest that UNH check the depth of the buoys and tensioning of the south cage before stocking with fish.

Also, the fact that this mooring was deployed with care to keep the mooring from tangling, and that the other mooring serviced gave indication of being fouled in its chain, it is suggested that a side scan survey be done to see if the other anchors are fouled, and we might consider retrieving and resetting the rest of the anchors on the south cage to assure they are working as designed. However, as the moorings haven't moved much due to the weight of the chain and anchor, it would be for reasons of wear and component damage that this should be considered.

When operations were completed, Dave Fredriksson (the UNH crew) and the spare parts (lines, shackles, etc.) brought along in case the *Nobska* needed to service the anchor or crown line, were returned to the Port Authority pier. And the *Nobska* headed for Woods Hole with a stop in Cape Cod Bay for another anchor retrieval for another project.

Friday - 23 June 2000

- 1330 - *Nobska* arrived at WHOI dock and dragging gear, deck boxes, temporary cage mooring hardware, etc. were unloaded.
- 1530 - *Nobska* heading for berth and UNH OOA operations complete.

Summary of findings:

1. The *Nobska* is a very unique and versatile boat that is capable of servicing the UNH-OOA moorings.
2. All four anchors on the North cage (and the one recovered on the south cage) were fouled in the steamer chain. The cut leg "C" might be expected to be fouled as it was dragged around. The *Nobska* could have possibly fouled anchor "D" as we were set back over it by the wind during recovery. However, there is no way we could have fouled "B" as we recover it from the grid buoy back pulling against the wind and waves, and it was wrapped up as much as the others. There is the very real potential that when relaxing the grid, that the anchor could be dragged further than the buoyancy of the corner buoy can take up, and the anchor could be set down on the chain, or worse on the anchor line.
3. Two of the anchors ("A" and "C") were upside down (See photos P6220006 and P001196). The barnacle growth and mud line on both of these anchors indicated that they were not dug into the ground and holding. The mooring was being held by the amount of steamer chain and the weight of the anchor on the bottom, rather than the holding power of the fluke in the sand or mud. The northeast corner anchor "B" had only dug about a 1/3 of the fluke into the bottom (See photo P001258). This would be the anchor taking most of the load during winter storms.

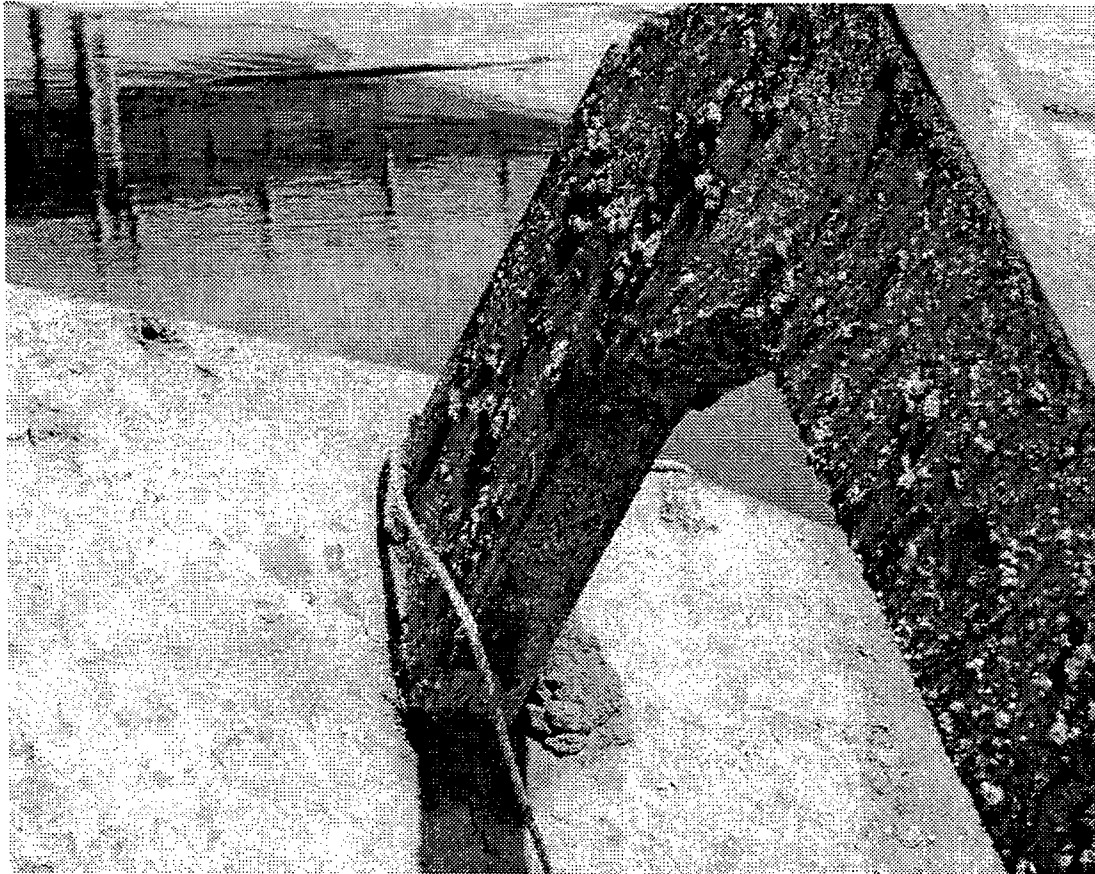

Photo P6220006 - Anchor from leg "A." The mud line is seen just down from the top of the shank on the anchor on the top right.

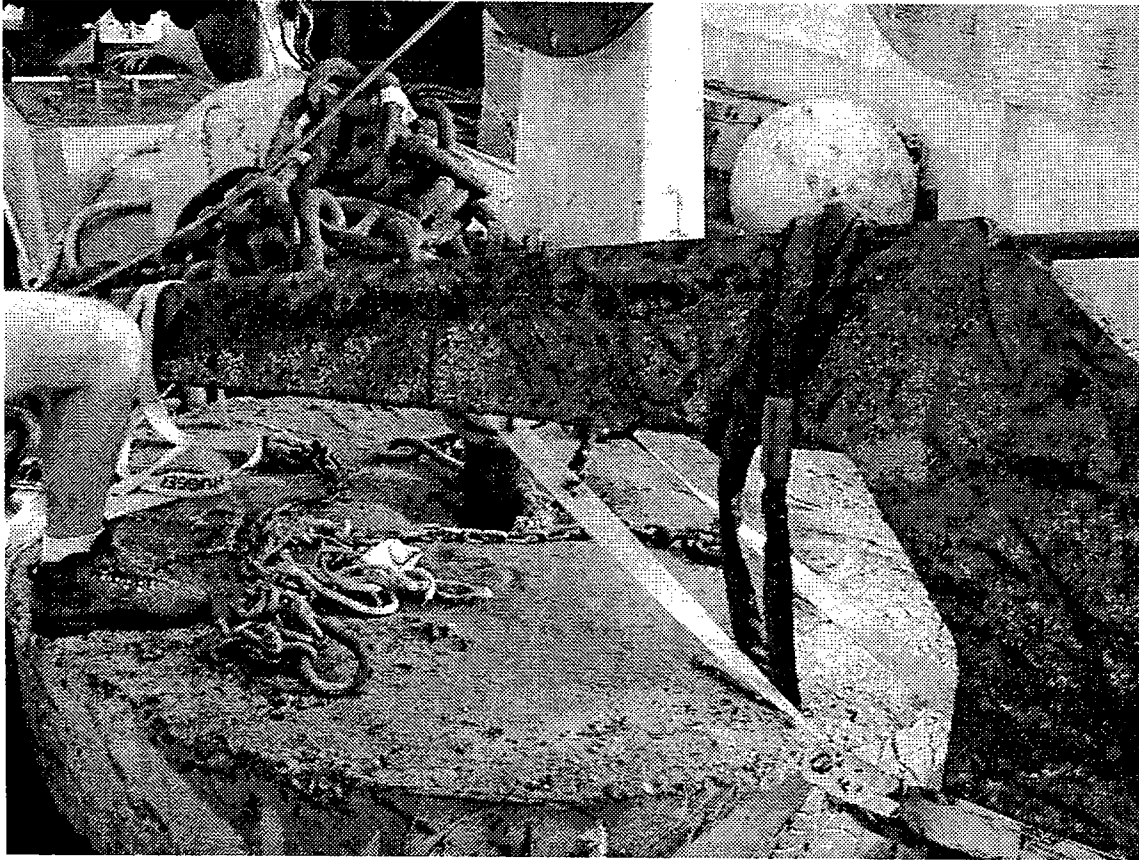

Photo P001196 - Anchor from leg "C." The mud line is clear on this as the dark line running up the anchor shank, indicating that this anchor was also upside down.

4. The only anchor fully embedded on the north cage was "D" (see photo P001258 below.) The barnacle and mud line showed that it was fully "set." However, the anchor shank was sticking out of the mud at an upward angle, possibly held up by the fouled steamer chain.
5. The most wear on any shackle was the 1 1/2 inch shackle connecting the anchor to the mooring line on the NE corner "B" (see photo P001287 below.) This showed significant wear, but was not about to break. Another shackle at a flounder plate showed some wear, but nothing to worry about. The rest of the shackles showed minimal wear and should be good for another year.
6. All lines (except those cut) appeared to be in good shape. There was some wear on one riser line near a poly buoy which may have been caused by this buoy's motion in the wave field rubbing on the line. We might suggest using smaller floatation here to reduce the area on the buoy for wave drag. Eliminating the buoy would simplify the mooring, but not clear how this would effect the dynamics of the mooring (Tsukrov et al., 2000).
7. The fish cage moorings were oversized. Significant savings may be had by reducing the size of hardware and amount of steamer chain. It is recommended that we rethink the mooring design and try a second-generation mooring for the redeployment of the North cage during the instrumented test this fall and winter.

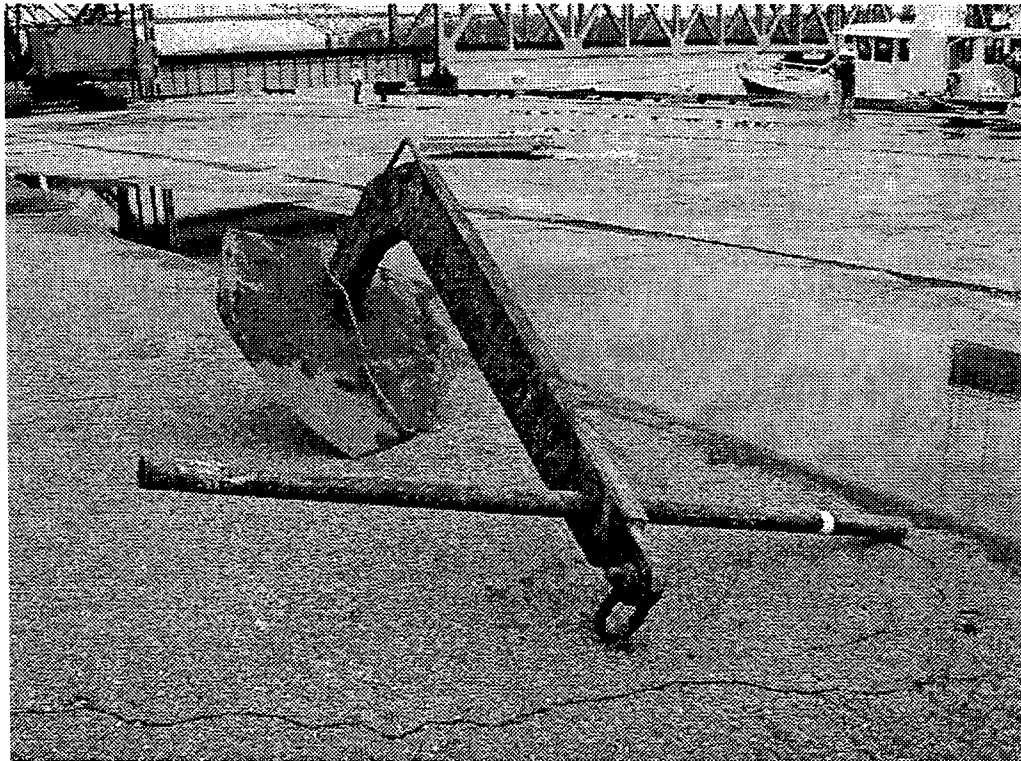

Photo P001259 - Anchor from leg "B." The mudline can be seen about 1/3 of the way up the anchor fluke indicating that the NE corner anchor was not fully embedded in the mud.

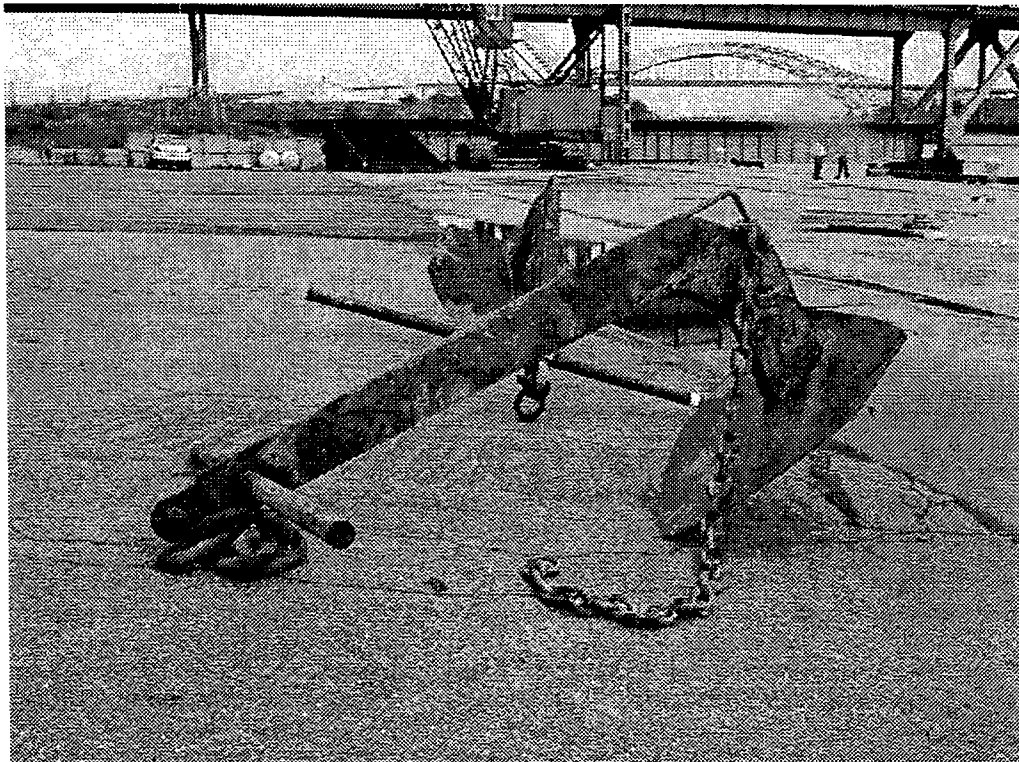

Photo P001258 - Anchor from leg "D." This anchor was fully embedded and the mud line can be seen running forward from where the crown chain attaches to the anchor.

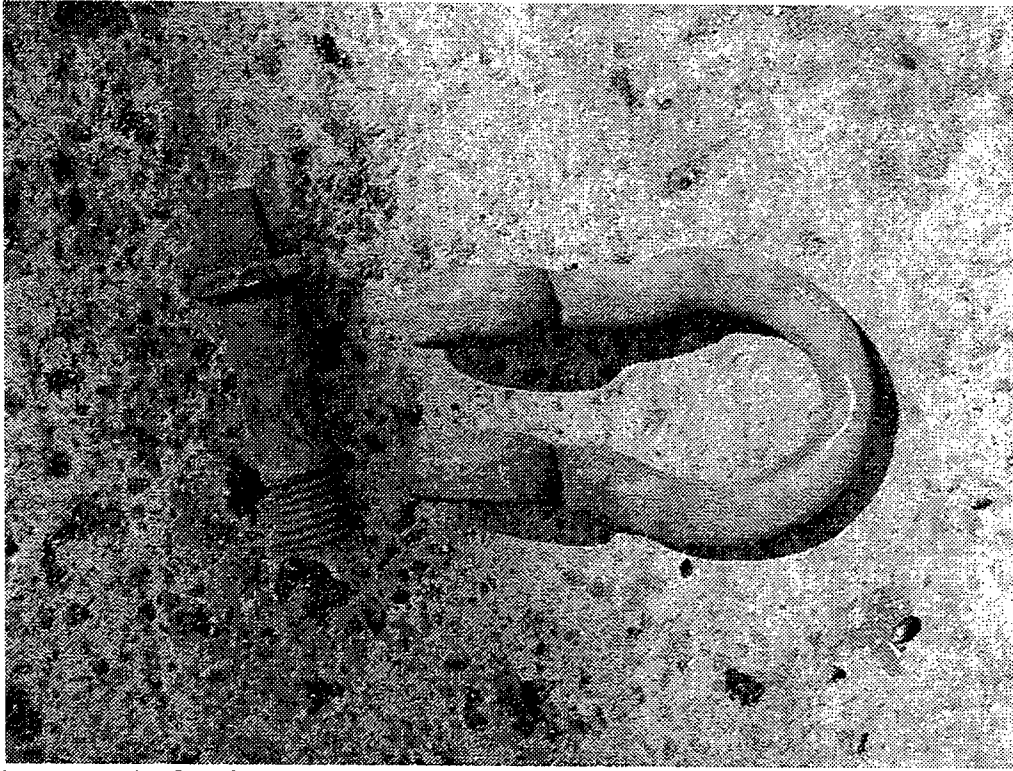

Photo P001287 - Anchor line shackle from leg "B." This is the most worn component in the northern cage mooring system. As expected, it was in the NE corner where the steamer chain attached to the anchor line. The pin (in the shadow on the left) is also worn. The bending of the two jaws of the shackle was done during the recovery operation.

DOCUMENT LIBRARY

Distribution List for Technical Report Exchange – July 1998

University of California, San Diego
SIO Library 0175C
9500 Gilman Drive
La Jolla, CA 92093-0175

Hancock Library of Biology & Oceanography
Alan Hancock Laboratory
University of Southern California
University Park
Los Angeles, CA 90089-0371

Gifts & Exchanges
Library
Bedford Institute of Oceanography
P.O. Box 1006
Dartmouth, NS, B2Y 4A2, CANADA

NOAA/EDIS Miami Library Center
4301 Rickenbacker Causeway
Miami, FL 33149

Research Library
U.S. Army Corps of Engineers
Waterways Experiment Station
3909 Halls Ferry Road
Vicksburg, MS 39180-6199

Marine Resources Information Center
Building E38-320
MIT
Cambridge, MA 02139

Library
Lamont-Doherty Geological Observatory
Columbia University
Palisades, NY 10964

Library
Serials Department
Oregon State University
Corvallis, OR 97331

Pell Marine Science Library
University of Rhode Island
Narragansett Bay Campus
Narragansett, RI 02882

Working Collection
Texas A&M University
Dept. of Oceanography
College Station, TX 77843

Fisheries-Oceanography Library
151 Oceanography Teaching Bldg.
University of Washington
Seattle, WA 98195

Library
R.S.M.A.S.
University of Miami
4600 Rickenbacker Causeway
Miami, FL 33149

Maury Oceanographic Library
Naval Oceanographic Office
Building 1003 South
1002 Balch Blvd.
Stennis Space Center, MS, 39522-5001

Library
Institute of Ocean Sciences
P.O. Box 6000
Sidney, B.C. V8L 4B2
CANADA

National Oceanographic Library
Southampton Oceanography Centre
European Way
Southampton SO14 3ZH
UK

The Librarian
CSIRO Marine Laboratories
G.P.O. Box 1538
Hobart, Tasmania
AUSTRALIA 7001

Library
Proudman Oceanographic Laboratory
Bidston Observatory
Birkenhead
Merseyside L43 7 RA
UNITED KINGDOM

IFREMER
Centre de Brest
Service Documentation - Publications
BP 70 29280 PLOUZANE
FRANCE

| | | | |
|--|-------------------------------|---|---|
| REPORT DOCUMENTATION PAGE | 1. REPORT NO. WHOI-2001-01 | 2. | 3. Recipient's Accession No. |
| 4. Title and Subtitle Deployment of the Northern Fish Cage and Mooring, University of New Hampshire – Open Ocean Aquaculture Program, Summer 2000 | | 5. Report Date September 2000 | 6. |
| 7. Author(s) James D. Irish, Walter Paul, William M. Ostrom, Michael Chambers, Dave Fredriksson, Matt Stommel | | 8. Performing Organization Rept. No. WHOI-2001-01 | |
| 9. Performing Organization Name and Address Woods Hole Oceanographic Institution Woods Hole, Massachusetts 02543 | | 10. Project/Task/Work Unit No. | 11. Contract(C) or Grant(G) No. (C) NA86RG0016 (G) WHOI 00-394 WHOI 01-442 |
| 12. Sponsoring Organization Name and Address NOAA Woods Hole Oceanographic Institution | | 13. Type of Report & Period Covered Technical Report | |
| 15. Supplementary Notes This report should be cited as: Woods Hole Oceanog. Inst. Tech. Rept., WHOI-2001-01. | | 14. | |
| 16. Abstract (Limit: 200 words) The University of New Hampshire - Open Ocean Aquaculture (UNH-OOA) program is developing the technology and methodology to deploy and maintain fish cages in open, exposed northern waters as part of an aquaculture demonstration project. In 1999 two Sea Station net cages were deployed with their UNH designed and constructed moorings. In June 2000 the Northern cage and its mooring were retrieved, examined, and readied for redeployment. The second year's effort involved a new UNH Program Manager, the Fishing Vessel <i>Nobska</i> , and researchers from the Woods Hole Oceanographic Institution (WHOI). During 21 to 25 August 2000, the cage and mooring were assembled and deployed at the UNH-OOA site seven miles offshore of the New Hampshire coast. This effort involved members of the UNH Mechanical Engineering Dept., UNH divers, members of the WHOI Applied Ocean Physics & Engineering Dept. and the Captain and crew of the FV <i>Nobska</i> . Ship support for the deployment was provided by the <i>Gulf Challenger and Galen J.</i> (UNH) and the <i>Nobska</i> . The work was favored by light wind and sea conditions. The endeavor resulted in the successful placement of the North Cage and its mooring system with load cells and environmental sensors. | | | |
| 17. Document Analysis a. Descriptors aquaculture mooring fish cage b. Identifiers/Open-Ended Terms c. COSATI Field/Group | | | |
| 18. Availability Statement Approved for public release; distribution unlimited. | | 19. Security Class (This Report) UNCLASSIFIED | 21. No. of Pages 61 |
| | | 20. Security Class (This Page) | 22. Price |

