

1995

## Is there a difference in cortical representation between dominant and non-dominant arm muscles of elite badminton players?

Dylan J. Edwards  
*Edith Cowan University*

Follow this and additional works at: [https://ro.ecu.edu.au/theses\\_hons](https://ro.ecu.edu.au/theses_hons)



Part of the [Biomechanics Commons](#), [Exercise Physiology Commons](#), and the [Sports Sciences Commons](#)

---

### Recommended Citation

Edwards, D. J. (1995). *Is there a difference in cortical representation between dominant and non-dominant arm muscles of elite badminton players?*. [https://ro.ecu.edu.au/theses\\_hons/273](https://ro.ecu.edu.au/theses_hons/273)

This Thesis is posted at Research Online.  
[https://ro.ecu.edu.au/theses\\_hons/273](https://ro.ecu.edu.au/theses_hons/273)

# Edith Cowan University

## Copyright Warning

You may print or download ONE copy of this document for the purpose of your own research or study.

The University does not authorize you to copy, communicate or otherwise make available electronically to any other person any copyright material contained on this site.

You are reminded of the following:

- Copyright owners are entitled to take legal action against persons who infringe their copyright.
- A reproduction of material that is protected by copyright may be a copyright infringement. Where the reproduction of such material is done without attribution of authorship, with false attribution of authorship or the authorship is treated in a derogatory manner, this may be a breach of the author's moral rights contained in Part IX of the Copyright Act 1968 (Cth).
- Courts have the power to impose a wide range of civil and criminal sanctions for infringement of copyright, infringement of moral rights and other offences under the Copyright Act 1968 (Cth). Higher penalties may apply, and higher damages may be awarded, for offences and infringements involving the conversion of material into digital or electronic form.

**IS THERE A DIFFERENCE IN CORTICAL REPRESENTATION  
BETWEEN DOMINANT AND NON-DOMINANT ARM MUSCLES  
OF ELITE BADMINTON PLAYERS ?**

**BY**

**Dylan J. Edwards**

**Bachelor of Applied Science (Sports Science)**

**A thesis submitted in partial fulfilment of the requirements for the award of**

**Bachelor of Applied Science (Sport Science) with Honours**

**Date of Submission : 27 / 1 / 95**

## USE OF THESIS

The Use of Thesis statement is not included in this version of the thesis.

## ACKNOWLEDGMENTS

I would like to thank Dr. Frank Mastaglia and Dr. Gary Thickbroom for allowing me to conduct my Honours project at the Australian Neuromuscular Research Institute. Thankyou also to my supervisors Dr. Paul Sacco for your time, effort, enthusiasm and advice, and Dr. Colin James for helping throughout the year, and giving me a push when I needed it.

To Gary and Michelle for always helping out and making sure I could use the testing and computer equipment whenever I needed, and also for advice and constructive criticism on my work.

To Dr. Shirley Wilson for travelling all the way from Queensland to examine my thesis, and for being so efficient in marking it.

To Alan Pearce for organising all of the athlete subjects, and to all of the subjects for their time and patience.

To Bernadette for bringing me food and keeping the motivation up on those long nights while completing my thesis.

To Olivia for understanding my absence during January and being just as caring.

Thankyou to my parents for still looking after me, and for bringing me into this world to contribute my piece to science.

## DECLARATION

"I certify that this thesis does not incorporate without acknowledgment any material previously submitted for a degree or diploma in any institution of higher education; and that to the best of my knowledge and belief it does not contain any material previously published or written by another person except where due reference is made in the text".

## ABSTRACT

Training for sport involves the development of skill and coordination. The physiological changes associated with skill acquisition are complex and at present poorly understood. One of the areas in the central nervous system thought to be involved with skill acquisition is the cerebral motor cortex where localised areas are responsible for controlling specific muscle groups. Learning or improving a motor skill may require reorganisation of the cortical areas controlling relevant muscles to accommodate the new skill. To test this idea we studied a group of elite badminton players that were highly skilled in their dominant playing arm. Transcranial magnetic stimulation was used to stimulate the motor cortex, and surface electrodes recorded the evoked muscle response. A forearm wrist flexor muscle was examined in this study and a comparison was made between the representation of this muscle on the motor cortex, with that of the contralateral untrained muscle. The experiments were repeated in a control group of normal subjects to assess if any interhemispheric differences occur under normal conditions. In order to quantify the results, topographic maps were produced illustrating the area of representation of each muscle on the cortex, and the centre of the map. The maps showed the representation taken from the amplitude of the evoked response, and the silent period following this response. Comparison of the maps revealed no significant differences between the trained and untrained muscles, in the size of the representation, or the excitability of the area. The location of the maps was slightly posterior for the athlete group, particularly in the dominant hemisphere, which also showed a non-significant more lateral placement compared to the control group. Skill differences between the dominant and non-dominant arm in badminton players is not reflected in the representation of the muscles on the motor cortex.

## TABLE OF CONTENTS

	Page Number
Declaration	iii
Abstract	iv
Table of Contents	v
List of Figures	vii
<b>CHAPTER</b>	
1. Introduction	1
2. Literature Review	
<i>Lateral preference</i>	4
<i>Hemispheric asymmetry, cerebral dominance and handedness</i>	6
<i>Motor cortex and voluntary movement</i>	8
<i>Stimulation of the motor cortex</i>	9
<i>Muscular facilitation</i>	10
<i>Evoked potential mapping of the motor cortex</i>	11
<i>MEP maps</i>	11
<i>Silent period maps</i>	12
<i>Plasticity of the motor cortex</i>	13
3. Methods	
<i>Subjects</i>	18
<i>Stimulation</i>	18
<i>Stimulus sites</i>	19
<i>Recording of muscular response</i>	19
<i>Facilitation</i>	20
<i>Thresholds</i>	21
<i>Mapping of the motor cortex</i>	22
<i>Map compilation and interpretation</i>	23
<i>Statistical analysis</i>	24
4. Results	
<i>Maximum voluntary EMG</i>	29
<i>Threshold curves</i>	29
<i>Maximum MEP amplitude</i>	30
<i>SP duration</i>	31
<i>Typical MEP and SP maps</i>	31
<i>Area of MEP maps</i>	33
<i>Area of SP maps</i>	33
<i>Optimal latitude of MEP and SP maps</i>	34
<i>Optimal longitude of MEP and SP maps</i>	35
<i>Optimal sites for MEP and SP maps</i>	37
5. Discussion	47



References	54
Appendices	58
A. Subject consent form	
B. Tabulated results for the control and athlete groups	
C. Control group - MEP maps	
SP maps	
Threshold curves	
D. Athlete group - MEP maps	
SP maps	
Threshold curves	

## List of figures

Figure	Page number
1. Cap with stimulus sites, and figure eight stimulus coil	25
2. Muscular facilitation of FCU	25
3. Threshold waveforms	26
4. Example MEP maps of FCU	27
5. Diagram of MEP and silent period	28
6. Mean EMG levels for MVC of FCU	38
7. Typical FCU threshold curve	39
8. Mean threshold level for each group	39
9. Mean maximum MEP amplitude	40
10. Mean maximum duration of EMG silent period	40
11. Typical MEP mapped representations of FCU in the control group	41
12. Typical SP mapped representations of FCU in the control group	41
13. Typical MEP mapped representations of FCU in the athlete group	42
14. Typical SP mapped representations of FCU in the athlete group	42
15. Area of the representation from MEP maps for both groups	43
16. Area of the representation from SP maps for both groups	43
17. Optimal latitude of the centre of the MEP maps for both groups	44
18. Optimal latitude of the centre of the SP maps for both groups	44
19. Optimal longitude of the centre of the MEP maps for both groups	45
20. Optimal longitude of the centre of the SP maps for both groups	45
21. Optimal sites from the MEP maps for each subject in both groups	46
22. Optimal sites from the SP maps for each subject in both groups	46

## CHAPTER ONE

### Introduction

Sport-related scientific research, endeavours to improve athletic performance through an enhanced understanding of the functioning of the human body. One of the areas of interest to sports scientists is the acquisition of motor skills. Skill can be defined as the precision and efficiency with which one executes a motor task. Knowledge of skill acquisition can assist in the planning of training programs to optimise the development of important sport skills. This could lead to faster development of new skills and maximise coordination and skill in elite athletes. The wider community may also benefit as more effective teaching strategies are implemented to improve motor learning in people with coordination problems.

The physiological changes associated with skill acquisition are poorly understood and probably involve numerous anatomical structures within the central nervous system (CNS). One area of the CNS thought to be involved with skill acquisition is the primary motor cortex, where localised areas are responsible for controlling specific muscle groups. The role of the motor cortex in the sequence of events controlling human voluntary movement, and also its anatomical position, make the motor cortex both convenient and appropriate to examine in this study.

The purpose of this study was to compare the corticomotor excitability and cortical representation of muscles which are highly trained for skilled movements, with untrained contralateral muscles. Comparison of the two will indicate if prolonged changes occur in the motor cortex with skill development. It was hypothesised in this study that the skill development in training for a sport would cause a change in the size

of the representation of the target muscle in the motor cortex, or a change in the excitability of that area.

The localised areas on the motor cortex controlling muscles of the upper extremity are the most accessible and popular for central stimulation and mapping experiments. These muscles also have the lowest thresholds for activation (Brouwer & Ashby, 1990), and hence more comfortable stimulus intensities can be used. Common muscles to be studied are in the hand, arm and shoulder and few experiments have examined the forearm muscles. For this reason and the fact that these muscles are used in many sporting skills this study has examined a wrist flexor muscle. In elite badminton players, the dominant arm is highly skilled, particularly in specific wrist movements. The wrist flexor muscles are used in a number of badminton shots (Lo & Stark, 1991; Broer & Houtz, 1967) however, the frequency of activation of these muscles during a game or training is not specified. By examining the muscles of sportspersons that are skilled unilaterally, it is possible to use the non-dominant side to assess changes that may occur as a result of activity and/or skill development.

Original investigation of the function of the motor cortex used direct electrical stimulation of the exposed cortex (Penfield & Boldrey, 1937, cited in Wassermann, McShane, Hallet, Cohen, 1992). Currently, stimulation of the cortex can be achieved using electrical stimulation with electrode placement either sub-dural or on the skull, or by transcranial magnetic stimulation (TMS). TMS uses a large pulsed magnetic field to induce currents within the nervous tissue. TMS can be used to examine the cortical motor outputs in humans, by stimulating over the scalp of the subject and recording muscular activity from the contralateral or ipsilateral target muscle. More specifically,

this method can be used to examine cortical excitability, and to map the representational area of specific muscles on the motor cortex.

Contrary to earlier ideas, recent research has indicated that neural remodelling can occur in the mature nervous system (Aglioti, Bonazzi, Cortese, 1994). There is clear evidence that the cortical representation of muscle groups can change in certain pathological conditions, but few studies have examined the potential for change to occur under normal conditions. Pascual-Leone, Grafman and Hallet (1994) studied the representation of muscles before and after learning a simple motor task in normal subjects. The findings showed evidence for significant differences in the representation of the target muscles with training. However, information on motor cortex plasticity as a result of athletic training for highly skilled movements is absent from the literature. This is the first study to investigate the nature of the training response of athletes by looking at the control level of voluntary motor activity, and assessing interhemispheric differences in cortical motor outputs as they project to trained and non-trained muscles.

## CHAPTER TWO

### Literature Review

#### *Lateral preference*

In performing both simple and sophisticated unilateral motor tasks, most individuals express a clear lateral preference to the side of the body performing the task. This occurs in every day activities and in sporting situations where the most proficient hand or foot is used to execute the task. There has been a tendency to view skill, strength, and preference as relatively interchangeable indicators of the dominant hand; however, evidence suggests that they are separable aspects of behaviour perhaps mediated by different mechanisms (Porac & Coren, 1981). The concept of lateral preference suggests an element of choice. For example, the preferred hand is the hand chosen when only one hand can be used for a given activity. One would assume then that the chosen member of paired limbs would be the better or more proficient of the two but this is not always true. Strength and skill, for example can be affected by environmental factors and may be independent of preference.

Much of the research in lateral preference and sensorimotor performance has been in the interest of isolating variables that might help athletes obtain maximum levels of proficiency. Porac and Coren (1981) studied athletes from a wide variety of sports (including badminton) and varying levels of proficiency to determine how sidedness and preference affected sports performance. They suggest that in the same way that we are right or left handed, we are also right or left footed, eyed, and eared. They also suggested that proficiency in badminton is very much related to hand eye coordination. If

the preferred eye is on the same side of the body as the preferred hand, the individual has a larger useful visual field in the sector of the environment where most of the activity is occurring. If visual input is monitoring both the projectile to be hit and the racquet that will strike it, ipsilateral hand-eye positioning means that both the target and the racquet will enter the visual field of the preferred eye earlier than would be the case if monitoring was done by a contralateral preferred eye. In this case the useable visible field would be obstructed by the bridge of the nose. With the earlier appearance of the hand to the ipsilateral preferred eye, there is more time to make minor adjustments to the ongoing swing and hence improve overall accuracy. It appears then that the use of both the preferred hand and preferred eye contribute independent advantages that act to increase speed of performance. They concluded that right or left sidedness alone does not seem to affect sports proficiency. The combination of lateral preferences, and ambisidedness versus consistent preference is more predictive of ability.

The apparent physical symmetry of the human body has created a great deal of interest for research about the mechanisms that give rise to the functional asymmetries seen in the common displays of handedness and other lateral preferences. Many theories have been developed attempting to explain why one hand is dominant and also how it became dominant. Some early attempts were made to correlate handedness with anatomical and physiological asymmetries, others link it to genetic factors explaining that handedness is determined before birth (Porac & Coren, 1981). Other theories suggest that the reason most people are right handed may be due to left handed individuals having learned to use their right hand skilfully out of necessity, because many tasks in today's society require the skilful use of the right hand. No definite conclusions have

been drawn from these approaches and contemporary researchers have shifted their attention to neural control systems.

### *Hemispheric asymmetry, cerebral dominance and handedness*

Hemispheric asymmetries in the brain have been the focus of more recent research explaining lateral preferences. Structural differences include a heavier, larger or denser left hemisphere (Bastian, 1869; Boyd, 1861, cited in Porac & Coren, 1981), a greater complexity of and a greater number of convolutions in the left hemisphere (Bateman, 1869; Cunningham, 1902, cited in Porac & Coren, 1981), and substantial differences in the fissure lengths (Porac & Coren, 1981), specifically the Sylvian fissure (LeMay & Culebras, 1972; Rubens et al., 1976, cited in Koff, Naeser, Pieniadz, Foundas, Levine, 1986). The observation of such asymmetries has previously been linked to lateral preference behaviour, however, sufficient evidence has not been produced to support these claims. Porac and Coren (1981) state that hand preference is not predictable directly from, nor strongly correlated with, anatomically definable asymmetries in the brain.

Cerebral dominance refers to one side of the brain being more important for certain functions than the other side (Galaburda, LeMay, Kemper, Geschwind, 1978). Each hemisphere is dominant for particular functions: for example the left for language and certain spatial functions; the right for other spatial functions, attention, and at least some aspects of emotion (Geschwind, 1983). One of the behaviours in which dominance effects are prominent is handedness. With regard to motor function, the cerebral hemisphere controlling the preferred hand is referred to as the dominant hemisphere for handedness. With the majority of the population being right handed (Porac and Coren,



1981) the dominant hemisphere for handedness is generally the left. Haaland and Harrington (1989, cited in Kim, Ashe, Mendrich, Ellermann, Merkle, Ugurbil, Georgopoulos, 1993) reported that motor function deficits resulting from a left hemispheric lesion are more pronounced than those resulting from a right hemispheric lesion. These results indicate that dominance may occur for handedness, however the research does not explain whether the dominance is due to hemispheric asymmetries or some other factor. Galaburda et al. (1978) suggests that structural differences between the hemispheres may underlie cerebral dominance. Koff et al. (1986) concluded that if structural differences are substrates for handedness, it appears more likely that they are related to at least some aspects of language dominance than to cerebral dominance for handedness.

The fact that one hemisphere may be dominant for handedness is particularly relevant for this study as interhemispheric comparisons may reveal interhemispheric differences in the representation of the wrist flexors for both groups of subjects. If this is the case it may be due to hemispheric asymmetries. Wilson, Thickbroom, Mastaglia (1993a) investigated the representations of two intrinsic hand muscles of normal subjects using TMS mapping for both the dominant and non-dominant hands. The result of this study showed no significant difference between the two sides indicating that handedness alone, is not sufficient to show a difference in cortical representation for muscles. It is also unknown if other hand muscles or more proximal muscles, show the same results. Excitability differences in the motor cortex and handedness has also been investigated (Macdonell, Shapiro, Chiappa, Helmers, Cros, Day, Shahani, Phil, 1991). The results showed lower cortical thresholds for the activation of spinal motor neurons for the dominant hand muscle (abductor digiti minimi).

### *Motor cortex and voluntary movement*

Current concepts regarding the motor areas of the cerebral cortex, derived from studies of cortical lesions and metabolic activity of the cerebral cortex during motor tasks, delineate three major motor areas in humans (Fox, Bowers, Foss, 1988). These are the primary motor area (area 4 of Brodmann's chart, precentral gyrus), the premotor area (Brodmann's area 6, gyrus anterior to the pre-central gyrus), and the supplementary motor area (medial frontal cortex anterior to the premotor area). The primary motor cortex is essential to voluntary action, and destructive focal lesions in this area cause paralysis of voluntary movement.

Measurements of regional cerebral blood flow (CBF) and metabolism have demonstrated that the primary motor cortex is activated only when voluntary movements are executed (Mazziotta & Phelps, 1984). The pyramidal tract, made up of long axons of the pyramidal cells, is the route used to send impulses from the motor cortex to the lower motor neurons of the spinal cord which terminate in skeletal muscle. Most of the pyramidal tract fibres cross over before entering the spinal cord so that the right motor cortex controls the muscles of the left side of the body and vice versa. The pre-motor cortex is especially concerned with the acquisition of specialised motor skills. Lesions involving the premotor region generally cause a transient deficit in acquired motor skills (Freund & Hummelsheim, 1985; Fox, Bowers, Foss, 1988). The pre-motor area may respond to direct electrical stimulation with isolated movements of individual contralateral muscles, but significantly higher stimulation is required than for the primary motor cortex (Ransom & Clark 1959). The supplementary motor area is also activated

during voluntary motor activity, and lesions in this area may result in a reduction in spontaneous motor activity that may be accompanied by a reduction in speech production. Roland (1984) found that an increase in metabolic activity in this area during the planning and execution of voluntary movement occurs during routine voluntary movements (such as walking) and non-routine voluntary movements (such as performing a new skill or activity). Stimulation of the supplementary motor area produces synergic and bilateral movements, such as raising of the contralateral arm with turning of the head and eyes toward the arm.

#### *Stimulation of the motor cortex*

Direct stimulation of the motor cortex will evoke a muscular contraction and the muscle activated will depend on the point of stimulation. Early studies have used electrical stimulation applied directly onto the cerebral cortex (of patients undergoing craniotomy) to investigate which area of the cortex controls the different muscle groups (Penfield and Boldrey, 1937, cited in Wassermann, McShane, Hallet, Cohen, 1992). Several attempts to stimulate the brain through the intact skull were made in the 1950's using trains of electrical stimuli delivered through electrodes over the motor strip and most were unsuccessful (Rothwell, Day, Thompson, Marsden, 1990). In 1980 Merton and Morton devised a method of electrical stimulation through the intact scalp that achieved an evoked muscular response. They claimed that previous experiments attempting to stimulate through the intact scalp had problems with the electrical resistance given by the skull and scalp, and experiments have been stopped by pain or otherwise failed. By using brief but very high voltage shocks they found that this reduced the effective resistance and it was possible to stimulate the cortex without undue

discomfort. Monopolar and bipolar electrical stimulation has been used in transcranial stimulation studies, with the bipolar stimulation either anodal or cathodal. Stimulation through electrodes on the scalp reduce the localisation of the stimulus on the cortex, and more localised stimuli are given with electrodes on the brain surface however the application of this technique is limited.

Magnetic stimulation was introduced initially for peripheral nerve stimulation in 1985 and was soon adopted for brain stimulation. Unlike the electrical method of stimulation, magnetic stimulation is relatively painless, since the currents induced on the scalp are small. With TMS the the rapid discharge of current through a coil held over the scalp generates a time varying magnetic field which in turn induces current flow in the underlying brain (Barker, Jalinous, Freeston, 1985). Current flow induced in the cortex is sufficient to activate pyramidal tract neurones (PTNs) trans-synaptically (Day, Dressler, Martens de Noordhout, Marsden, Nakashima, Rothwell, Thompson, 1989) and, under some circumstances directly (Berardelli, Inghilleri, Cruccu, Manfredi, 1990), and can lead to multiple descending volleys in PTNs projecting to the motor neuron. When the membrane excitability of the motor neuron reaches threshold, a measurable response in the surface EMG may be recorded, the motor evoked potential (MEP).

#### *Muscular facilitation*

Many stimulation experiments examining the human motor cortex have stimulated the cortex of relaxed individuals, and the threshold levels to evoke MEPs were thought to be related directly to the stimulus intensity. Current ideas are that the degree of muscular response and threshold depend on both the stimulus intensity (Valls-Sole, Tolosa, Pujol, 1992), and the state of relaxation/contraction of the target muscle (Rothwell, Thompson,

Day, Dick, Kachi, Cowan, Marsden, 1987). A tonic voluntary contraction of the target muscle during stimulation, decreases the threshold (Mazzocchio, Rothwell, Day, Thompson, 1994), and decreases the onset latency of the MEP (Hess, Mills, Murray, 1987; Day, Thompson, Dick, Nakashima, Marsden, 1987).

### *Evoked potential mapping of the motor cortex*

By means of the early stimulation experiments, it has been possible to outline most of the motor projection from the motor cortex. Various body parts have been represented or mapped onto the motor cortex, and the representation of each body part, is proportionate in size to the skill with which the part is used in fine voluntary movement. The accuracy of the early stimulation experiments can be questioned due to the observation of gross body movements following stimulation of the cortex, and the body part representations are only an estimation. Following the development of increasingly focal stimulation techniques, TMS has been applied in exploratory studies of the organisation of the human corticomotor representation. Current techniques used for mapping require recording of the muscular response following the stimulation of the motor cortex, and allow the representation of individual muscles to be mapped.

### *MEP maps*

By stimulating specific scalp sites and measuring the MEP responses it is possible to map the representation of individual muscles on the cortex. Wilson et al. (1993a) mapped the representation of two intrinsic hand muscles on the motor cortex in normal subjects. The study used TMS to stimulate the cortex, and surface electrodes placed over abductor pollicis brevis (APB) and abductor digiti minimi (ADM) recorded the muscular response.

The results showed the mapped representations of APB and ADM were large and overlapping but that there was a statistically significant separation of the two areas, the APB being more laterally placed than the ADM area. The two representations showed no significant interhemispheric differences which suggests that handedness may not affect the representation of hand muscles on the motor cortex. The results also indicated that this method could produce reliable and reproducible maps of the muscular representations on the motor cortex. Wassermann, McShane, Hallet and Cohen (1991) examined four upper extremity muscles bilaterally in normal subjects. TMS was used to map the representations, and the maps were described in terms of number of excitable scalp positions, amplitude of MEPs, scalp positions for evoking the largest MEP amplitudes, and threshold for producing MEPs. Distal muscles were found to have larger representations with higher amplitude MEPs and lower thresholds. Both the biceps and deltoid on the left side had larger representations and higher MEP amplitudes than on the right contrary to the interhemispheric comparisons for more distal muscles as found by Wilson et al. (1993a).

### *Silent period maps*

Transcranial magnetic stimulation of the motor cortex has both excitatory and inhibitory effects on muscles (Rothwell, Thompson, Day, Boyd, Marsden, 1991). Stimulation during voluntary contraction produces an MEP followed by a silent period (SP) in the EMG (Cantello, Gianelli, Civardi, Mutani, 1991) before a return of the voluntary EMG signal. Other studies have characterised the TMS SP in hand muscles (Wassermann, Pascual-Leone, Valls-Sole, Toro, Cohen, Hallet, 1993; Wilson, Thickbroom, Mastaglia, 1993b), and more proximal muscles of the arm, and also following stimulation of the

ipsilateral hemisphere (Wassermann, Pascual-Leone, Hallet, 1994). Wilson et al. (1993b) mapped the SP on the motor cortex by measuring its duration following stimulation at multiple scalp sites, and compared the SP representation with that of the MEP maps for the same muscle (APB). The results from this study showed the silent period representation to surround and encompass the MEP area.

### *Plasticity of the motor cortex*

The representation of muscles in the motor cortex have been found to be capable of change in people who have had amputations (Cohen, Bandinelli, Findley, Hallet, 1991). The study examined the representation of muscles proximal to the stump (biceps and deltoid) and contralateral muscles by MEPs in response to TMS. Stimulation evoked larger MEPs, recruited a larger percentage of the motor neuron pool, and elicited MEPs at lower intensities of stimulation in muscles ipsilateral to the stump than in contralateral muscles. Also, muscles ipsilateral to the stump were found to be activated from a larger area than those contralateral to the stump. The findings were supported in experiments analysing the motor cortex of subjects following lower limb amputation in man (Fuhr, Cohen, Dang, Findley, Haghighi, Oro, Hallet, 1992). Similar studies examining subjects with spinal cord injuries have also been reported (Levy, Amassian, Traad, Cadwell, 1990; Topka, Cohen, Cole, Hallet, 1991). These studies identified a pattern of motor system reorganisation that results in enlarged muscle representation areas and larger motor evoked potentials for muscles immediately proximal to the lesion. Furthermore, findings are supported in animal models where motor outputs are reorganised after peripheral nerve lesions (Merzenich, Kaas, Wall, Sur, Nelson, Felleman, 1983; Huerta, Wall, Kaas,

1986; Kalaska & Pomeranz, 1979), removal of body parts (Kelahan, Ray, Carson, Massey, Doetsch, 1981; Merzenich, Nelson, Stryker, Cynder, Shoppmann, Zook, 1984; Pons, Garraghty, Ommaya, Kaas, Taub, Mishkin, 1991; Calford, Tweedale, 1990) and reversible limb deafferentation by local anaesthesia (Metzler & Marks, 1979). Such capability of the motor cortex to modulate outflow to specific muscle groups introduces the possibility that these mechanisms may play a role in adaptation to environmental needs, such as the learning of precision tasks, enhanced performance, special training conditions and exercise.

The nervous system may undergo changes according to the patterns of use, thereby providing a substrate for the acquisition of new skills. Proficiency in a motor task may require a change in the cortical motor outputs to accommodate new skills (Brasil-Neto, Cohen, Pascual-Leone, Jabir, Wall, Hallet, 1992). Brasil-Neto et al. (1992) suggest that human motor outputs can experience both short and long term changes. The short term changes are referred to as "modulation" and the long term changes as "reorganisation". Modulation of muscular representation on the motor cortex has been demonstrated immediately after learning a motor task (Pascual-Leone, Grafman, Hallet, 1994). Normal subjects were required to learn sequential finger movements, and TMS was used to map the cortical motor outputs to the right first dorsal interosseus, abductor digiti minimi, forearm finger flexors, and abductor pollicis brevis muscles. Results from this study showed that modulation of the cortex occurs rapidly during the learning phase of the task by the increase of skill development, and soon after this phase there is a rapid return of the cortical motor outputs to their baseline topography. This is also evident in studies examining regional cerebral blood flow and acquisition of motor skills (Seitz, Roland, Bohm, 1990; Grafton, Mazziotta, Presty, 1992).



Weiller et al. (1992, cited in Pascual-Leone, Grafman, Hallet, 1994) suggest that as a motor sequence is learned, the contribution of the motor cortex is attenuated and other brain structures assume more active roles in the execution of the task. Although the relationship between changes of motor thresholds in relation to motor learning have not been described in the literature, an increased excitability of the area of representation following ischaemic nerve block (Brasil-Neto, Valls-Sole, Pascual-Leone, Cammarota, Amassian, Cracco, Maccabee, Cracco, Hallet, Cohen, 1993), and amputation (Cohen et al., 1991) has been reported to be associated with motor reorganisation.

Brasil-Neto et al. (1992) examined rapid reversible modulation of human motor outputs after transient deafferentation of the forearm in normal subjects using TMS. To study the timing of these changes they recorded MEPs in the arm muscles before, during, and after anaesthetic block of the forearm and hand. The amplitudes of MEPs from biceps, which was the muscle immediately proximal to the block, gradually increased with anaesthesia and then returned to preanesthesia levels shortly after the anaesthesia was ended. MEPs from the contralateral arm were unaffected. They suggest that similar fast changes in motor output organisation may be associated with learning skilled motor tasks in humans. The rapid time course of this modulation is most compatible with unmasking of previously existing connections, perhaps as a result of decreased inhibition or increased synaptic efficacy in existing neural circuits (Asanuma & Keller, 1991). The acquisition of new skills appears to cause short-term changes to the motor cortex and could lead to structural changes in the intracortical and subcortical networks as the skill becomes more learned and automated (Pons et al., 1991; Ramachandran, Rogers-Ramachandran, Stewart, 1992).

Similar findings have come from studies of plasticity of the sensorimotor cortex representation of the reading finger in Braille readers. Pascual-Leone and Torres (1993a) recorded somatosensory evoked potentials (SEPs) in one group of subjects and controls, and TMS was used in another group of subjects. TMS was used to interfere with the functioning of the sensory cortex, and from this they determined the size of the sensorimotor cortical representation of the tip of the index finger. The results of the reading finger were then compared to those of the contralateral non-reading finger. The findings from this experiment suggest that reading Braille is associated with the expansion of the sensorimotor cortical representation of the reading finger. The motor cortical outputs of the FDI and ADM muscles of Braille readers has also been examined bilaterally (Pascual-Leone, Cammarota, Wassermann, Brasil-Neto, Cohen, Hallet, 1993b). In the control group, the interhemispheric representations were not significantly different for both muscles. In the Braille group, the reading hand had a significantly larger representation for the FDI compared to the contralateral muscle. The representation of ADM however, was significantly smaller for the dominant hand. They suggest that the cortical representation of the reading finger in the Braille readers is enlarged at the expense of the representation of other fingers. They also explain that these differences were not due to differences in motor thresholds. The subjects in the Braille studies were proficient adult Braille readers that had learned Braille in childhood. The fact the these changes are present in Braille readers suggest that long term changes to the motor cortex representation may occur as a result of practising a skill on a regular basis over a long period of time. Elite athletes may show the similar long term changes from years of regular training for skilled movements.

## *Summary*

Throughout life specific molecular, biochemical, electrophysiological and structural changes take place in central nervous system neurons and neuronal networks in response to activity and behaviour (Cotman and Nieto-Sanpedro, 1982; Farley and Alkon, 1985). These plastic changes are part of the structural and physiological processes for recovery of function after injury, learning and memory (Marshall, 1984; Lederhendler and Alkon, 1986; Kaas, 1991). Plasticity in the human motor system has been studied using transcranial magnetic stimulation of individuals following amputation (Cohen et al., 1991; Furlong et al., 1992) and spinal cord injuries (Topka et al., 1991), and a pattern of motor system reorganisation that results in enlarged muscle representation areas of the motor cortex and larger motor evoked potentials for muscles immediately proximal to the lesion has been demonstrated. Such capability of the motor cortex to modulate outflow to specific muscle groups introduces the possibility that these mechanisms may play a role in adaptation to learning of precision tasks, enhanced performance, special training conditions and exercise.

## CHAPTER THREE

### Methods

#### *Subjects*

Studies were performed on eight elite badminton players and nine control subjects with no known neurological disorders. The badminton group (current and former state representatives) included six males and two females, aged 21-30 years (mean, 25.4 yrs) of which all subjects were right handed as assessed by a standard handedness questionnaire (Bryden, 1976). The control group included eight males and one female, aged 19-31 years (mean, 24.4 yrs) of which eight were right handed and one was left handed. In each subject the corticomotor representation of the flexor carpi ulnaris (FCU) muscles of both arms was investigated. All subjects attended one testing session only, during which, both FCU muscles were examined (dominant arm first). The subjects were tested at the Australian Neuromuscular Research Institute laboratories and each session lasted approximately two hours. Each subject was informed of the procedures involved in participation, and signed a consent form prior to participation in the study (Appendix A). The project had approval from the Human Rights Committee of the University of Western Australia.

#### *Stimulation*

A Magstim 200 magnetic stimulator with a 50mm diameter figure eight coil was used. The stimulator coil was held in position against the scalp, with the centre of the figure eight coil (as previously located by X-ray) over the site to be stimulated. The

orientation of the coil can affect the recorded results due a change in the direction of current flow within the cortex. To maintain consistency, the coil was held in the same orientation for all sites stimulated (tangential to the skull with the handle posterior).

### *Stimulus sites*

To locate the stimulus sites, a flexible, translucent, rubber cap was fitted over the scalp of the subject with pre-marked sites at spacings of one centimetre (Fig. 1). The cap was held in place by two velcro straps and positioned using anatomical landmarks to locate the centre of the cap on the vertex of the scalp. Measurements between the nasion and inion, and the left and right preauricular crease were used to locate the vertex at the mid-point and intersection of the nasion-inion line, and the inter-aural line. Stimulus sites were located using a latitude/longitude based coordinate system. Latitude was defined as the distance over the scalp from the nasion-inion line, and longitude as the distance from the inter-aural line.

### *Recording of muscular response*

Surface electromyograph (EMG) electrodes were placed over the flexor carpi ulnaris muscle of each arm. The active electrode was placed over the motor point of the muscle, with the inactive electrode 10mm distal. The earth electrode was placed over the lateral epicondyle of the humerus. The amplified signal was high pass filtered at 10 Hz and low pass at 2 kHz, and the digitised data was collected at a rate of 200 Hz for 500 ms after TMS.

### *Facilitation*

A muscle in a slightly contracted state will be activated by TMS at a lower stimulus intensity than a relaxed muscle (Mazzocchio et al., 1994). By using a lower stimulus intensity and slightly contracting the target muscle, neighbouring muscles are less likely to be activated during the experiment. It was important that surrounding muscles were activated as little as possible, as this may cause interference in the EMG recording. A method of facilitation of the FCU was adopted in this study in an attempt to isolate this muscle (as illustrated in Figure 2). Subjects were carefully instructed on the manoeuvre involved in facilitation of the FCU, and were given ample time to familiarise themselves with the technique. The arm being examined was rested on a pillow in a supinated position with the wrist adducted to 50% of its range of motion, and flexed to 50% of its range of motion. During facilitation, the muscle was contracted isometrically in this position using the opposite hand as a resistance. To keep consistency for dominant/non-dominant muscles and between subjects, it was necessary to quantify the contraction level for facilitation of FCU. Each subject performed an isometric maximal voluntary contraction (in the above facilitation position) against a manual restraint for five seconds. The root mean square (rms) of the EMG interference patterns during the five second contraction was used as a measure of the maximal voluntary EMG activity. During stimulation, subjects were required to maintain facilitation of the FCU muscle at 10% of the maximal voluntary contraction (MVC) for that muscle. A computer (286-PC) displayed the level of contraction as feedback to the subject to maintain that level. The display showed a bar graph illustrating the current level of contraction, which was updated approximately every 500 ms. The computer allowed stimulation to occur only if

the subject maintained the contraction within the range of 10% +/- 3% of the maximal contraction for 1.5 sec

### *Thresholds*

To familiarise each subject with the sensation of magnetic stimulation, four stimuli were given. The site of stimulation was in the region expected to control FCU (as determined by previous experiments) at a longitude of 0cm and a latitude of 4cm from the vertex. The stimulation intensity was 30% of the stimulator output (output range of the Magstim 200 being 0-100%) which in most cases was below the subject's threshold and caused no muscular response. This was repeated at increasing intensities until each stimuli produced distinct motor evoked potentials (MEPs) with an amplitude clearly above that of the background level of EMG. This usually occurred at approximately 70-75% of the stimulator output. Four stimuli were recorded, at three separate sites moving laterally along the interaural line, to determine which site produced the largest response at the same intensity. The site with the largest response was closest to the centre of the area controlling FCU. This procedure was done to locate the optimum site for determination of the thresholds responses.

To determine the threshold level of stimulation required to produce MEPs in each subject, the optimal site (as described above) was stimulated at 30% intensity and repeated at increments of 5% until an intensity was reached where individual waveforms had ceased to become larger, or 100% intensity stimulation had been achieved. This stage was often accompanied by MEPs decreasing in amplitude and becoming more polyphasic, possibly due to contribution from neighbouring muscles to the EMG. At each intensity, four stimuli were given 5sec apart, and the EMG level was recorded. Threshold

for the mapping procedure was defined as the intensity at which at least two out of four stimuli evoked a MEP discernible above background EMG. Figure 3 illustrates recorded MEP responses during the thresholding procedure. The left hand axis numbers each 500msec EMG trace and the base axis gives an indication of the time scale for which each event occurs. Each set of four stimuli represents a 5% increment in intensity starting with epochs 1-4 at 30%. With each increase in intensity the MEP becomes larger and always begins at approximately 20msec following a stimulus. Associated with the increase in MEP amplitude is the length of the silent period in the following EMG. The peak-to-peak amplitude of the MEPs was averaged and recorded for each intensity. Threshold data for MEP amplitude at each stimulus intensity was plotted to produce threshold curves. A line of best fit was then calculated to the data, and a precise value for the threshold level was determined from the intensity at which the line of best fit intersected a line representing two standard deviations above the mean background EMG level. The calculated threshold was used for interhemispheric and intergroup threshold comparisons.

### *Mapping of the Motor Cortex*

The methodology for mapping of the motor cortex has been previously described (Wilson et al., 1993a) and this study has followed the same procedure for stimulating the cortex, compiling the map and interpreting the data.

During the mapping process, the stimulator intensity was set at the lowest threshold obtained over each hemisphere separately, plus 20% of stimulator output to ensure that the intensity was high enough to evoke a response, and to maintain a consistent level above threshold for each hemisphere. The difference in mapping



intensities between hemispheres was within 10% in all but one subject. The first site stimulated for mapping was the same site used to examine thresholds, being close to the estimated centre of the motor area for FCU. Mapping this muscle on the motor cortex required the stimulation of all sites around the estimated centre of the map. At each stimulus site (1cm equidistant in latitude, 2cm in longitude) moving away from the estimated centre, the MEP response became smaller, until a site was reached where stimulation caused no measurable MEP response discernible above background EMG. All sites around the estimated centre were stimulated until no measurable response was recorded after stimulation and this signified the border of the representation for the target muscle. This generally required the stimulation of 25-30 sites. Four muscle responses to stimulation of each scalp position were recorded and the average of the four responses was assigned to represent the scalp position stimulated.

#### *Map compilation and interpretation*

For each hemisphere, MEP waveforms from each site were reviewed off line by the experimenter and those not containing artefact were averaged. The peak-to-peak amplitude of the averaged MEP waveforms at each scalp site were assigned to that site as an index of the contribution of the underlying cortex to the control of FCU. The latitude and longitude of stimulus sites over the scalp (in centimetres) was converted to positions on an idealised sphere of half circumference given by the subjects inter-aural distance. The sites were then defined in degrees by their latitude and longitude compensating for differences in head size between subjects. From the MEP amplitude measured at discrete sites over the hemisphere, the expected MEP amplitude for intermediate sites on the hemisphere was estimated. The results are presented in map

form, where a square matrix is used to represent the scalp viewed from above the vertex. The map shows a two dimensional representation of FCU on the motor cortex in contralateral cerebral hemispheres (Fig. 4). The map indicates the optimal stimulus site (in centimetres latitude and longitude) and contours according to the muscle EMG response, decreasing towards the edge of the map until no response is measured. The shaded contours are scaled in the key at the base of the figure, and represent from zero (clear) to one hundred percent (black) of the maximum amplitude that is measured or estimated for that representation. The optimal site of each representation which occurs at the calculated point of maximum amplitude is marked on the map with a white cross. The area of the map is calculated (in centimetres squared) from and above the 50% and 75% contours, and this study has used the 50% area in all subjects. To map the silent period, the individual waveforms were again reviewed and the SP duration in milliseconds (ms) was cursored. The duration was recorded beginning from the onset of the MEP, and ending at the return of the pre-MEP EMG activity (Fig. 5). The mean SP duration from the four waveforms at each site was used for SP map calculation. Data was presented in the same format as the MEP maps.

### *Statistical analysis*

Data was statically analysed using non-parametric tests. Interhemispheric differences in MEP and SP map area, threshold, maximum amplitude for MEP's, optimal stimulus location (latitude and longitude), SP duration, and MVC EMG amplitude, were tested using the Wilcoxin signed rank test. The Mann-Whitney U-test was used for comparisons between control and athlete groups. The level of significance for all tests was set at  $P < 0.02$ .

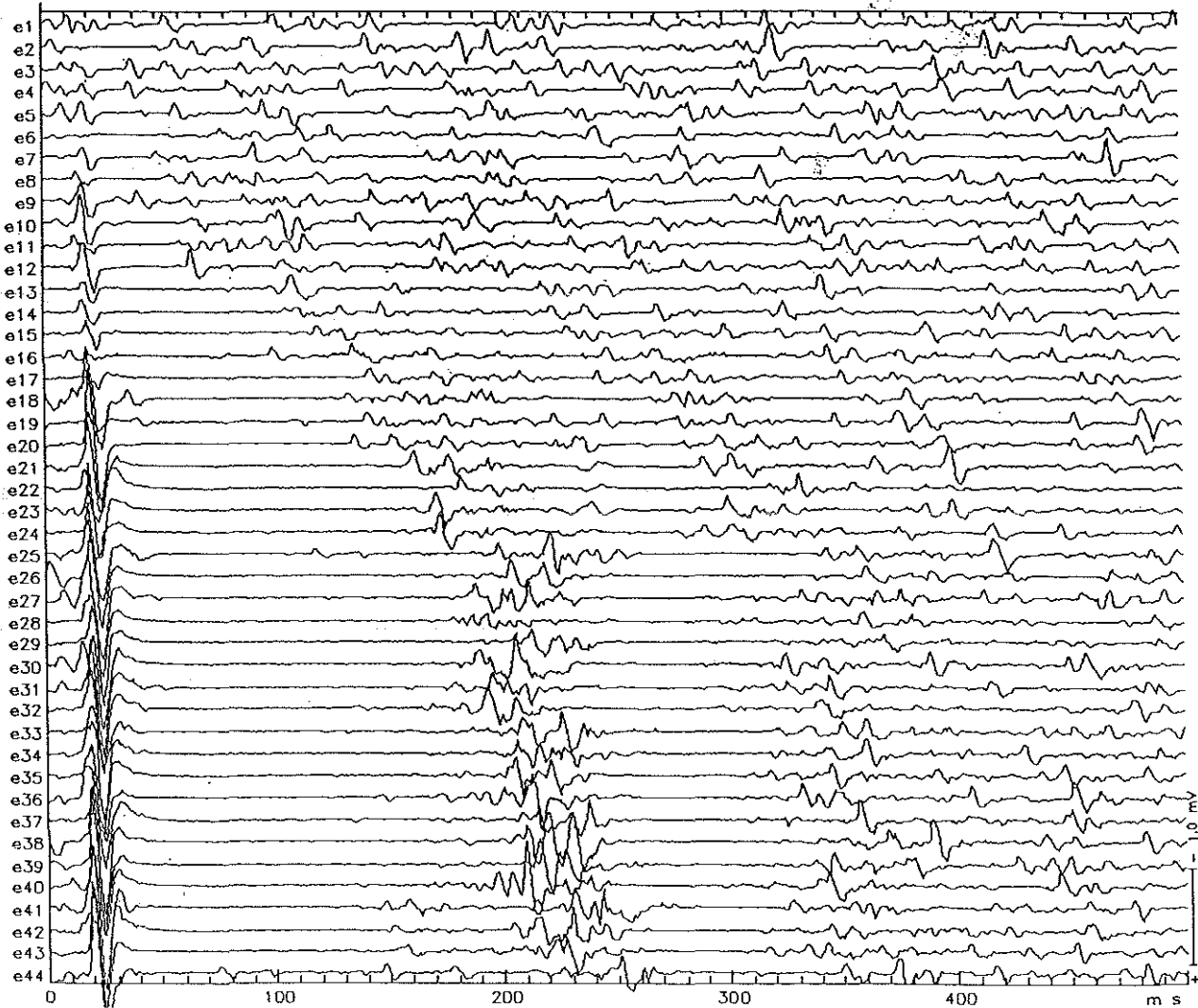
**Figure 1.** The photograph illustrates the cap used to locate stimulus sites over the scalp and the figure eight coil used for stimulation.



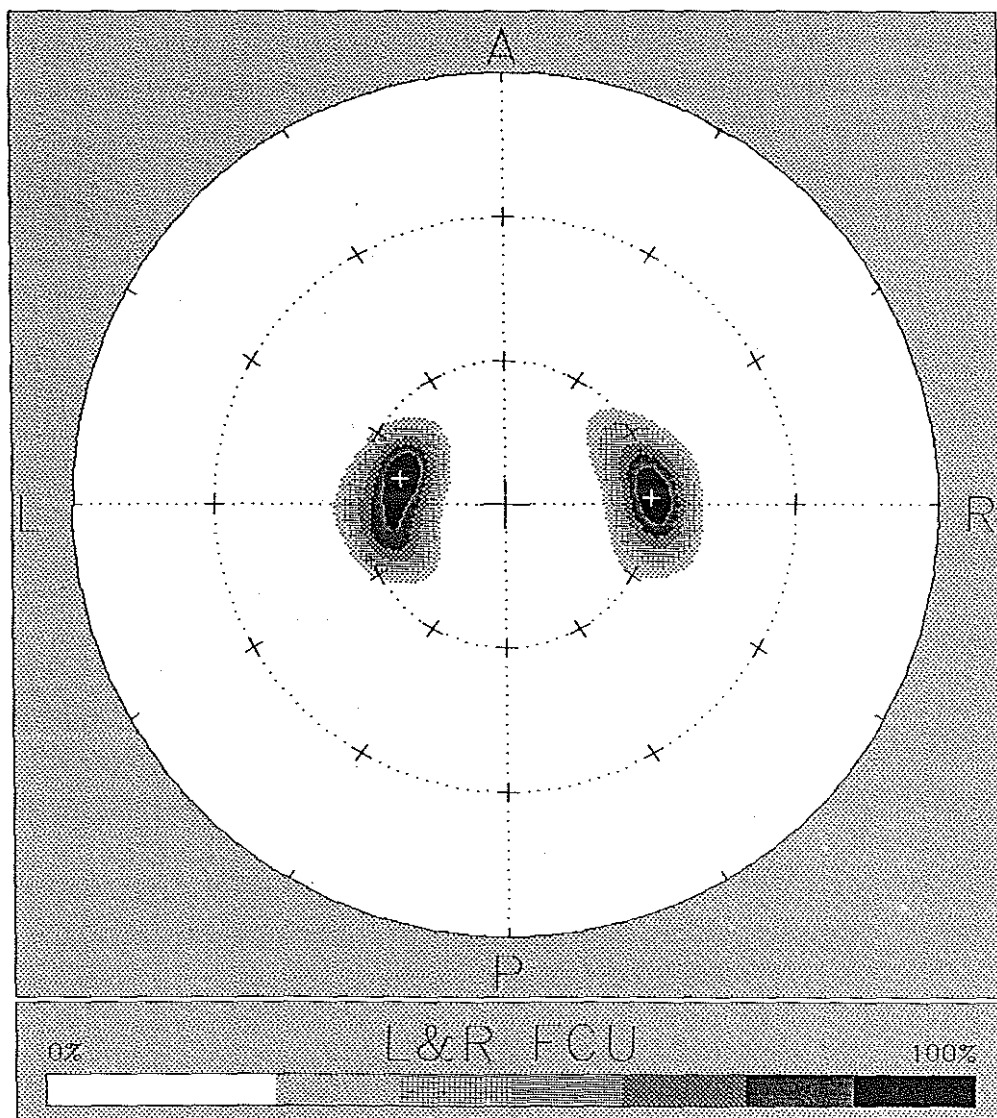
**Figure 2.** The method of facilitation adopted in this study to isolate FCU with wrist flexion and adduction. An isometric contraction using the opposing hand as resistance.



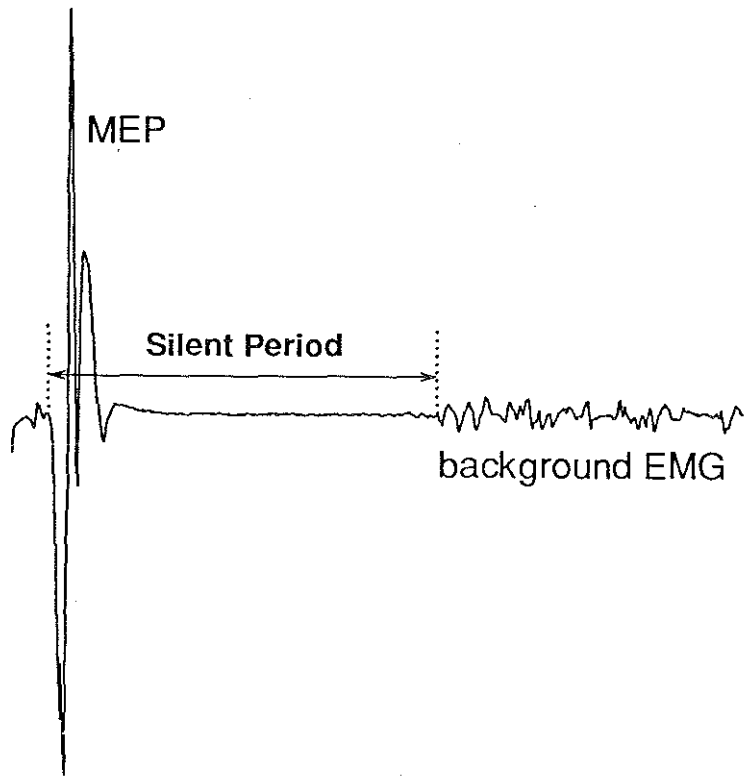
**Figure 3.** The recorded responses during the threshold procedure with four individual waveforms at each stimulus intensity. The diagram illustrates the increasing MEP amplitude with increased stimulus intensity and an associated increase in SP duration.



**Figure 4.** This represents the head viewed from above the vertex. The area of representation for FCU is mapped on the contralateral cerebral hemisphere. The optimal stimulus site is indicated by the white cross in each map. The contours represent percentages of the maximum amplitude for the map, decreasing towards the edge of the map as the MEP response decreases.



**Figure 5.** This illustrates an MEP followed by a silent period in the EMG. The SP duration was recorded beginning from the onset of the MEP, and ending at the return of the pre-EMG activity.



## CHAPTER FOUR

### Results

All results are tabulated in Appendix B. For the control group, the MEP and SP maps, and threshold curves, are presented in Appendix C for each individual. The same information for the athlete group is presented in Appendix D. All group means are given in the text  $\pm$  the standard error of the mean (sem).

#### *Maximum voluntary EMG*

The mean rms EMG level obtained from FCU muscles during maximal voluntary wrist flexion is displayed in Figure 6. The control group had a greater mean rms EMG in the dominant arm ( $0.371\text{mV} \pm 0.047$ ) compared to the non-dominant arm ( $0.302\text{mV} \pm 0.049$ ). The difference of  $0.069\text{mV}$  is was not significant. A difference of similar magnitude is present between the dominant and non-dominant arm in the athlete group, however the non-dominant arm shows the larger EMG ( $0.363 \pm 0.059\text{mV}$ ) compared to the contralateral arm ( $0.276 \pm 0.035\text{mV}$ ). As with the control group, the difference in EMG ( $0.087\text{mV}$ ) between arms in the athlete group is small. Interhemispheric and intergroup comparisons show a small and statistically non-significant difference in maximum voluntary EMG between the two sides.

#### *Threshold curves*

Figure 7 shows a typical FCU threshold curve illustrating the line of best fit to the averaged data at each stimulus intensity at 5% increments. The S-shaped curve is

characteristic of most of the threshold graphs in this study. The initial part of the curve represents sub-threshold stimulus intensities. As the stimulus intensity increased to threshold level a measurable response (MEP) was measured with an amplitude approximately equal to the amplitude two standard deviations above the mean EMG. After this point, increases in stimulus intensity cause more dramatic increases in MEP amplitude and hence the steeper gradient of the curve. The rapid rise in amplitude with increased stimulus intensity ceases approximately 20% above the threshold level. At and beyond this point, increases in stimulus intensity produce more polyphasic responses with no further increases peak-to-peak MEP amplitude, resulting in a plateau of the threshold curve. There were no noticeable differences in the slope of the threshold curves between hemispheres or groups of subjects.

The mean threshold level (Fig. 8) was within five percent for each hemisphere in both subject groups, and was not significantly different both between hemispheres of each group, and between groups. For the control group, the mean threshold of the dominant hemisphere was  $49.00 \pm 3.88\%$ , and that of the non-dominant hemisphere was  $50.11 \pm 3.96\%$ , a difference of 1.1% which was not significant. The threshold range for the control group was 35-78%, and in the athlete group was 36-77%.

#### *Maximum MEP amplitude*

The mean maximum peak-to-peak MEP amplitude as calculated from the fit of the MEP maps is represented in Figure 9. The mean amplitude for the control group dominant hemisphere was  $2.20 \pm 0.56\text{mV}$ , and for the non-dominant hemisphere was  $0.92 \pm 0.16\text{mV}$ . In the athlete group the dominant side was  $1.40 \pm 0.14\text{mV}$  compared to the non-dominant side mean  $1.23 \pm 0.29\text{mV}$ . For both groups, the interhemispheric



difference was small and statistically not significant. The control group on average had a greater MEP amplitude in the dominant hemisphere than the athlete group (by 0.79mV), and in the non-dominant hemisphere the athlete group had larger amplitudes but the difference was smaller (0.31mV) and the intergroup differences were also not statistically significant.

### *SP duration*

The mean maximum duration of the EMG silent period is displayed in Figure 10 and was fairly consistent between hemispheres for both subject groups, being within 12ms of all the muscles studied. The mean maximum SP duration for the control group dominant side was  $164.8 \pm 8.83$ ms, with the non-dominant side 8.4msec less at  $154.9 \pm 7.29$ ms. The athlete group showed an interhemispheric difference of 10.2msec with the non-dominant hemisphere mean ( $166.6 \pm 15.83$ ms) greater than the dominant ( $156.4 \pm 9.49$ ms). There was no statistically significant difference in the inter-group comparisons, or in the interhemispheric comparisons for each group.

### *Typical MEP and SP maps*

The MEP map (Fig. 11) illustrates the representation of both FCU muscles on the contralateral cerebral hemispheres of one subject from the control group. The map represents areas where the largest MEP amplitudes were recorded (as indicated by the darker contours) and the optimal stimulation site (as indicated by the cross in the centre). The perimeter of the lightest contour of each FCU representation shows that as a whole, they were similar in size, shape, and location. Small differences in these parameters were common in interhemispheric comparisons between all subjects in this study, however

they were not significantly different. The location of the optimal stimulus sites are typical of the control group MEP maps with the dominant hemisphere site positioned slightly anterior.

The silent period was mapped from the same waveforms used to map MEP amplitude, and Figure 12 illustrates the SP map of the same control subject which also has data values close to the mean of the control group. The contours represent the SP duration with the darker contours corresponding to an increase in length of SP. Comparisons between the two representations show a size difference which was commonly observed in the other control subjects, although there is no trend to suggest a consistently larger representations in one hemisphere. The optimal location was quite even between hemispheres in both latitude and longitude in Figure 12, however other control subjects showed larger variations. Comparison of the MEP and SP map representation (compare Fig. 11&12) shows that silent period maps are clearly larger than the MEP maps. This was true for both hemispheres and consistent in all control subjects. The location of the representation in each hemisphere was similar between the SP and MEP maps although the shape was slightly different in all contours.

Figure 13 illustrates the MEP maps of one subject selected from the athlete group which demonstrates the typical shape, size and optimal stimulus sites from the group. The area of representation was quite similar for both maps in Figure 13. The difference in shape was small and the variation was consistent with the other athlete MEP maps. The silent period map of the same athlete is presented in Figure 14 and was typical of the athlete group. This map shows a more posterior optimal site on in the dominant hemisphere compared to its contralateral side. The difference in shape of the two representations was not uncommon to the variation shown in other interhemispheric

comparisons in the athlete group. The map shows the dominant hemisphere to have a larger area than the non-dominant side as was the case for most of the athlete group. The area of the SP maps for each hemisphere between the athlete and control was not significantly different. The comparison between the MEP map area and SP map area in each hemisphere of the athlete shows a substantially larger SP map than MEP map on both sides, and this occurred in all subjects in the athlete and control groups.

#### *Area of MEP maps*

The mean area of the maps calculated by the MEP amplitude is shown in Figure 15. Interhemispherically there is little difference in both groups. The control group showed a dominant hemisphere mean area of  $12.71 \pm 0.94\text{cm}^2$  and non-dominant area of  $12.29 \pm 1.17\text{cm}^2$ . In the athlete group the mean for the dominant side was  $11.59 \pm 1.96\text{cm}^2$ , and  $10.68 \pm 0.74\text{cm}^2$  in the non-dominant side. The interhemispheric difference for both groups was not statistically significant. The mean area of the athlete group maps were smaller than the controls for both hemispheres although the difference was also not significant.

#### *Area of SP maps*

Both the control and athlete groups showed larger SP maps areas on the dominant hemisphere compared to the non-dominant hemisphere (Fig. 16), the interhemispheric differences of the mean being  $1.71\text{cm}^2$  and  $3.3\text{cm}^2$  ( $P=0.05$ ), for the control and athlete groups respectively. Intra-hemispheric comparison between the MEP

map area and the SP map area was significantly different in the control and the athlete group.

#### *Optimal latitude of MEP and SP maps*

The mean latitude of the optimal sites from the MEP maps is illustrated in Figure 17 for both groups. The Y-axis represents the nasion-inion line and the X-axis represents the distance from the vertex. The negative numbers on the X-axis represent centimetres of latitude, on the hemisphere for the centres of areas controlling the dominant FCU muscle. The control group showed an interhemispheric difference in mean latitude of 0.06cm with the non-dominant hemisphere mean ( $5.16 \pm 0.25\text{cm}$ ) being more lateral to the dominant ( $5.1 \pm 0.15\text{cm}$ ). The interhemispheric difference in the athlete group is 0.23cm with the dominant hemisphere being more lateral ( $5.24 \pm 0.2\text{cm}$ ) to the non-dominant ( $5.01 \pm 0.25\text{cm}$ ). The graph shows the very little and non-significant difference in optimal latitude, both between hemispheres in each group, and between groups.

Figure 18 shows the mean optimal latitudes of the silent period maps for both groups. The interhemispheric difference in the control group is small (0.04cm) with the dominant side marginally lateral ( $4.98 \pm 0.23\text{cm}$ ) to the non-dominant ( $4.94 \pm 0.23\text{cm}$ ). In the athlete group the optimal latitude in the non-dominant hemisphere was  $4.84 \pm 0.19\text{cm}$  from the vertex, and in the dominant hemisphere was  $5.58 \pm 0.31\text{cm}$ , the latter being more lateral by 0.74cm. The control and athlete group show similar mean latitudes (difference= 0.1cm) in the non-dominant hemisphere. In the dominant hemisphere the group difference was larger (0.6cm) with the athlete group at 5.58cm, and the control group at 4.98cm from the vertex. Comparison between the optimal latitude from the MEP maps and the optimal latitude from the SP maps shows a difference in each

hemisphere for both groups. In the control group the mean latitude from the MEP maps were further from the vertex than the SP maps (dominant side difference= 0.12cm, non-dominant side difference= 0.22cm). The athlete group shows the SP mean to be further from the vertex than the MEP mean on the dominant side (by 0.22cm), and closer to the vertex on the non-dominant side (by 0.17cm). Intergroup comparisons show little difference in optimal latitude in both MEP and SP maps, with the exception of the dominant hemisphere in the SP maps, where the mean for the athlete group is comparatively quite lateral to the control group.

#### *Optimal longitude of MEP and SP maps*

Figure 19 shows the mean optimal longitude of the optimal sites taken from the MEP maps in both groups. The X-axis represents the interaural line and the Y-axis shows the distance from the interaural line. The negative direction on the Y-axis indicates that the mean longitude is posterior to the interaural line. In the control group the longitude mean in the dominant side was  $0.59 \pm 0.27\text{cm}$  which was anterior (difference= 0.49cm) to the non-dominant side at  $0.17 \pm 0.21\text{cm}$ , and both were anterior to the interaural line. In the athlete group the non-dominant side mean longitude ( $0.11 \pm 0.3\text{cm}$ ) was anterior to the dominant side ( $-0.4 \pm 0.21\text{cm}$ ). The non-dominant side was anterior to the interaural line, and the dominant side was posterior (difference= 0.51cm). The graph shows that the mean for both hemispheres in each group is anterior of the interaural line except for the dominant side in the athlete group which is distinctively posterior. In both the dominant and non-dominant hemisphere the mean longitude for the control group was anterior to the athlete group. Although the mean values vary between groups particularly in the dominant side, the range is quite large as indicated by the

standard error bars. Intergroup and interhemispheric differences in longitude were not statistically significant.

Figure 20 shows the mean optimal longitude taken from the silent period maps and the representation is in the same format as figure 19. The interhemispheric difference in the control group is 0.42cm with the dominant side mean ( $0.21 \pm 0.37\text{cm}$ ) anterior to the non-dominant side ( $-0.21 \pm 0.4\text{cm}$ ). In the athlete group the difference between the two sides was 0.83cm, with the dominant side ( $0.8 \pm 0.21\text{cm}$ ) posterior to the non-dominant side ( $0.03 \pm 0.29\text{cm}$ ). Comparisons between each group show the dominant hemisphere to have a relatively large difference in mean longitude (1.1cm) with the control group being more anterior. In the non-dominant side, the difference between groups was smaller (0.51cm) and the control mean is posterior to the athlete mean.

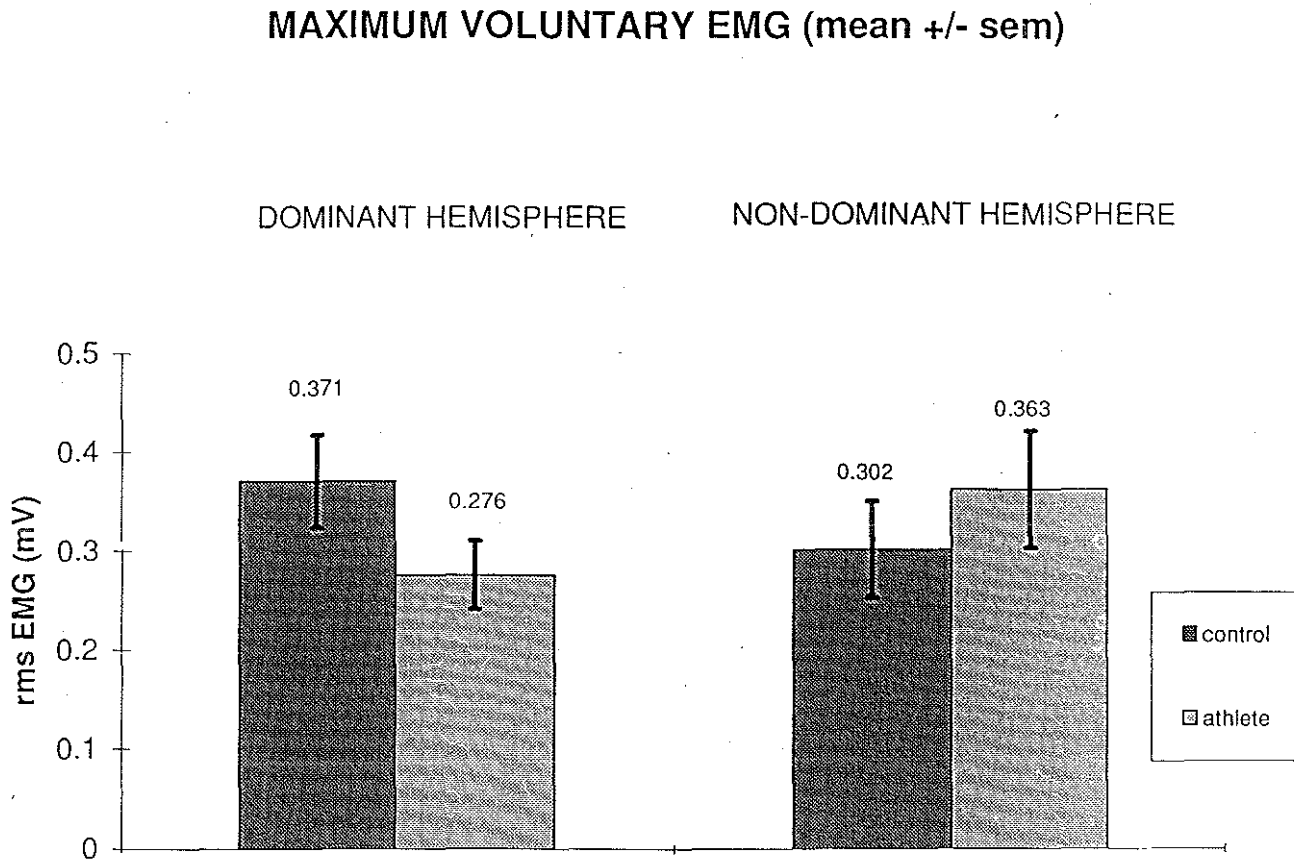
Comparisons between the optimal longitude of the MEP maps, and that of the SP maps for each hemisphere show a general shift posterior in both groups in the SP maps. The mean longitude for the control group dominant hemisphere was  $0.59 \pm 0.27\text{cm}$  for the MEP maps, and  $0.21 \pm 0.4\text{cm}$  for the SP maps (difference= $0.38\text{cm}$ ), and in the non-dominant hemisphere was  $0.17 \pm 0.21\text{cm}$  and  $-0.21 \pm 0.37\text{cm}$  respectively (difference= $0.38$ ). In the athlete group the longitude in the dominant side was  $-0.4 \pm 0.21\text{cm}$  for the MEP maps, and  $-0.8 \pm 0.21\text{cm}$  for the SP maps (difference= $0.4$ ). In the non-dominant hemisphere for this group the mean MEP longitude was  $0.11 \pm 0.3\text{cm}$  and the SP longitude was  $0.03 \pm 0.29\text{cm}$  (difference= $0.08\text{cm}$ ). The two graphs highlight the posterior placement of the optimal longitude in the dominant hemisphere of the athlete group, and the posterior shift in map centres in the SP maps, however the differences are not statistically significant.

### *Optimal sites for MEP and SP maps*

Figure 21 shows the individual optimal latitude and longitude sites taken from the MEP maps plotted in relation to one another on a two dimensional graph. The origin of the graph axes represent the vertex with the X-axis (optimal latitude) being the interaural line and the Y-axis (optimal longitude) being the nasion-inion line. From the graph it is evident that both groups exhibit similar optimal latitudes particularly in the dominant hemisphere. The range of latitudes do not show any trends that may suggest hemispheric differences between each group. A larger variation in optimum longitude of the MEP maps is clearly evident in each hemisphere for both groups. In the dominant hemisphere, the athlete group longitudes show a posterior distribution (six out of eight subjects with map centres behind the interaural line). In contrast, the dominant hemisphere of the control group had a more anterior distribution of map position, with seven out of nine subjects having MEP maps centred in front of the interaural line.

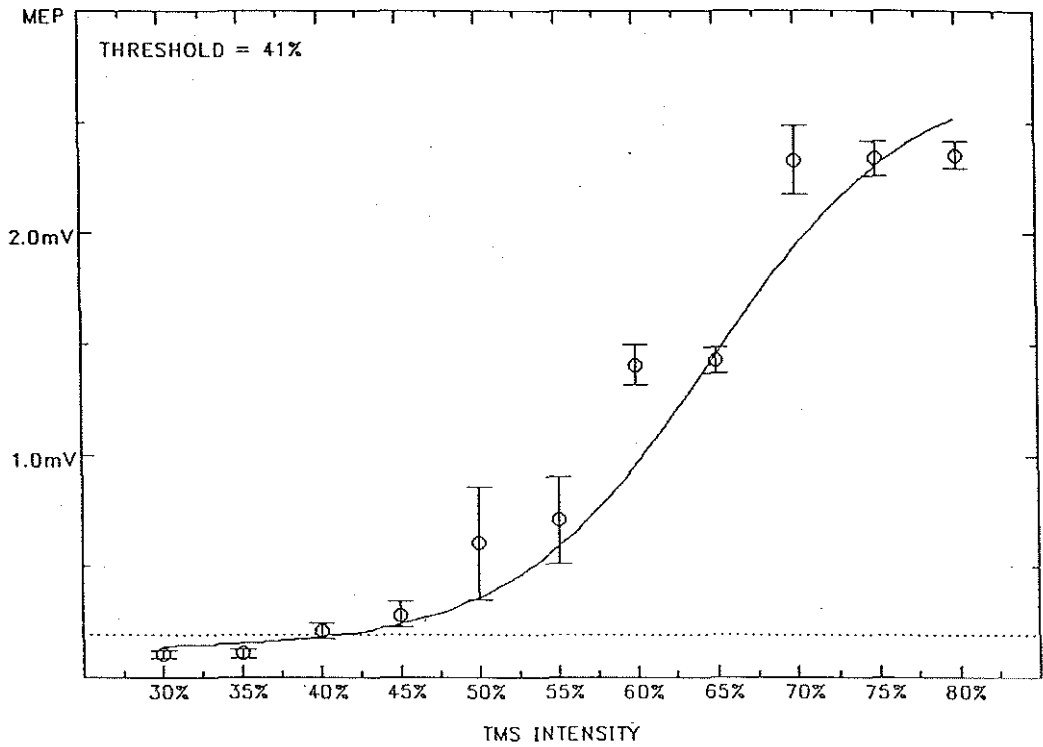
Figure 22 displays the optimal sites from the SP maps on each hemisphere of both groups. The control group showed a similar range in latitudes (approximately 2cm) to that seen in the MEP maps in both hemispheres. In comparison, the athletes tended to have a larger range of latitude (approximately 3cm). Like the MEP latitudes, the longitudes of the SP map centres tended to show a greater dispersion in the dominant hemisphere of both groups studied, with the control group having 4cm dispersion of mean results. The latter finding was largely due to a single subject having a SP map centred 2cm behind the interaural line.

Figure 6. The mean voluntary EMG level obtained from FCU muscles during maximal voluntary wrist flexion.



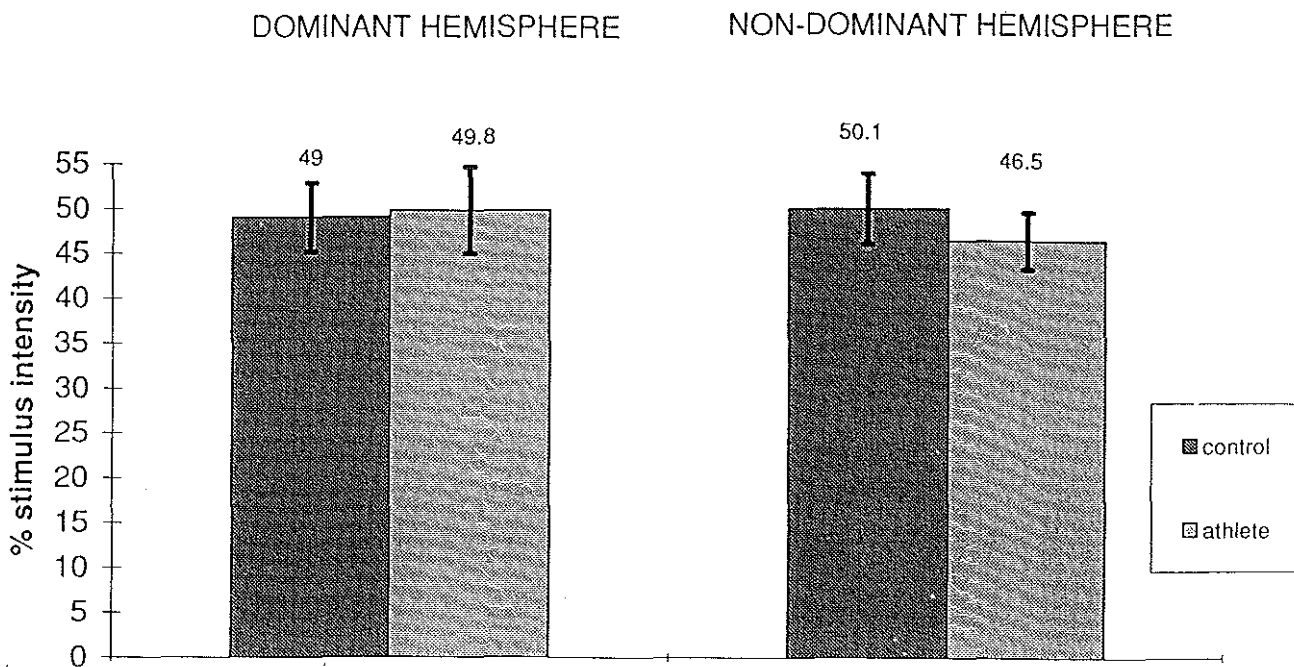


**Figure 7.** A typical FCU threshold curve illustrating the line of best fit to the averaged data at each stimulus intensity.



**Figure 8.** The mean threshold level recorded for each group.

**CALCULATED THRESHOLD (mean +/- sem)**



### MAXIMUM MEP AMPLITUDE (mean +/- sem)

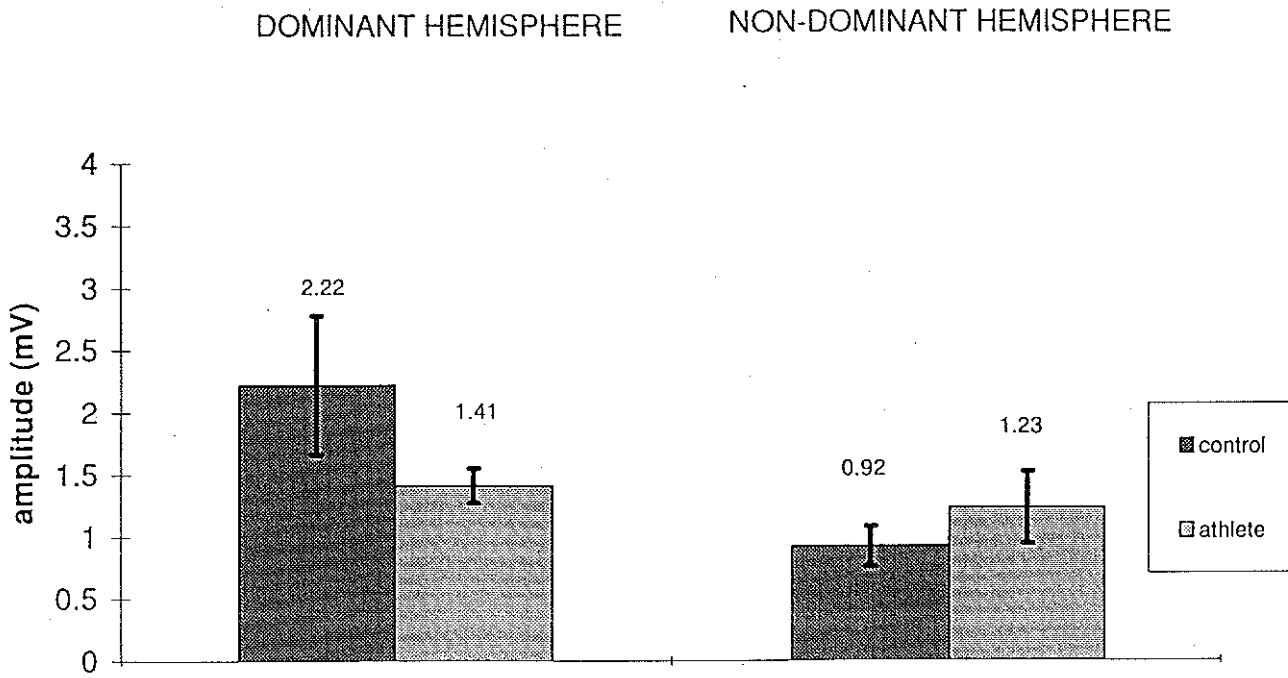


Figure 10. The mean maximum duration of the EMG silent period.

### SILENT PERIOD DURATION (mean +/- sem)

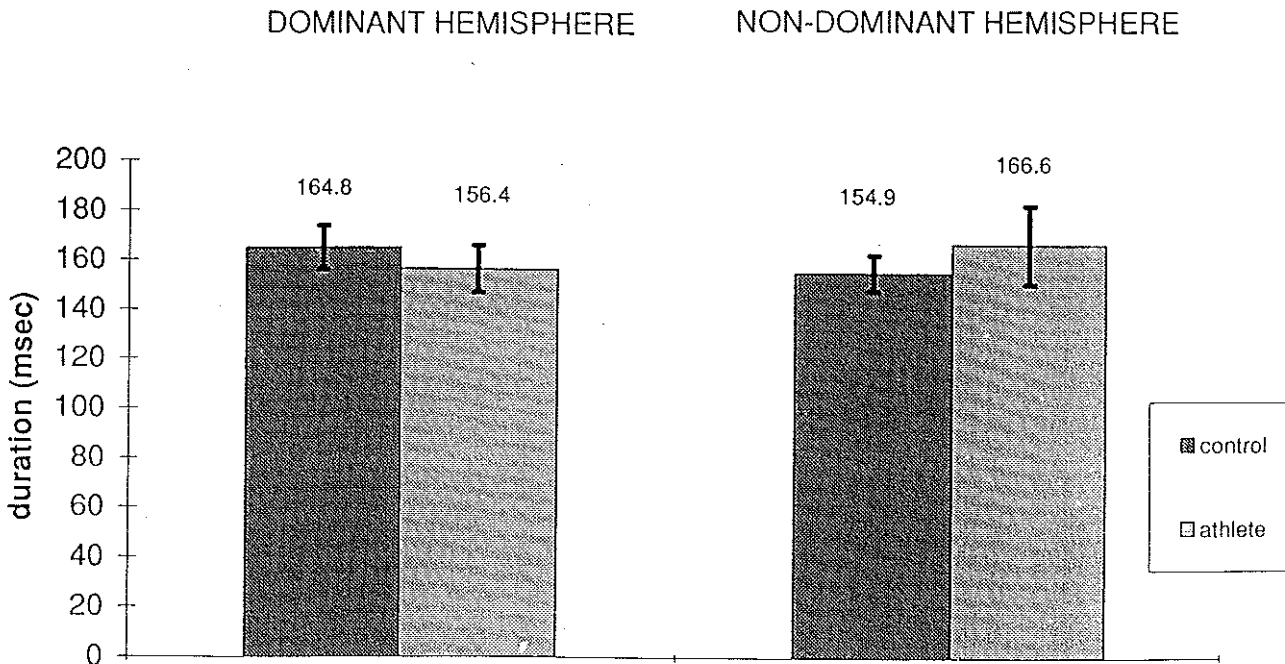


Figure 11. Typical MEP mapped representations of FCU of the control group.

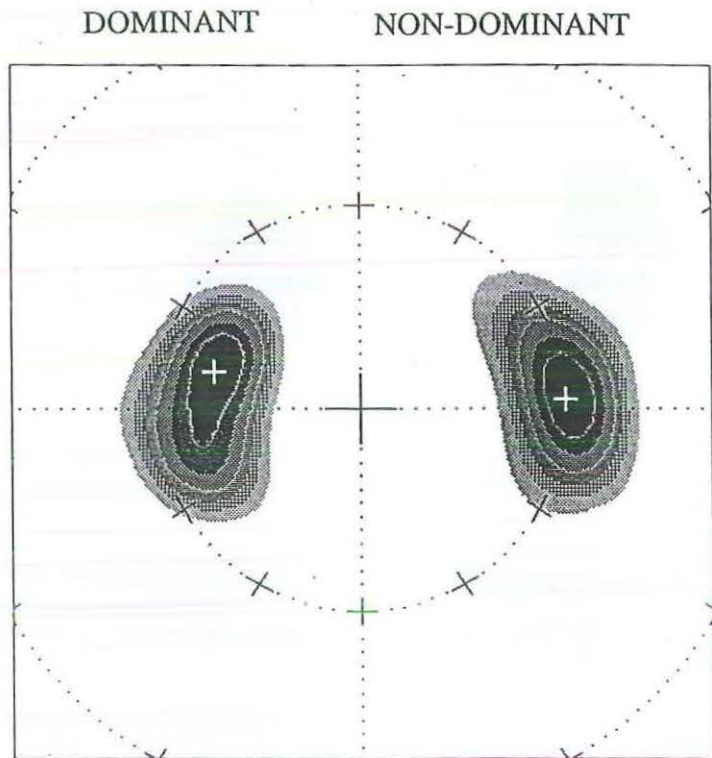
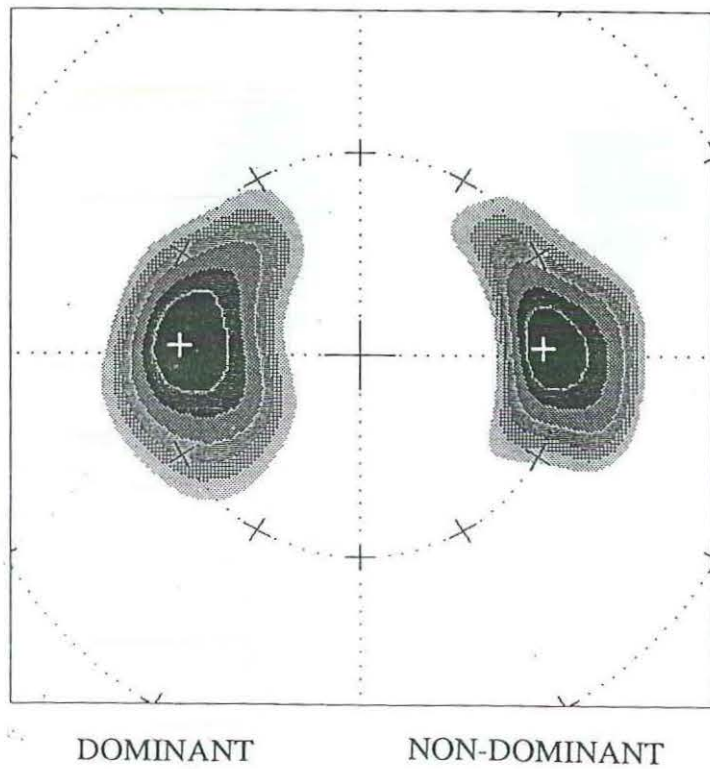
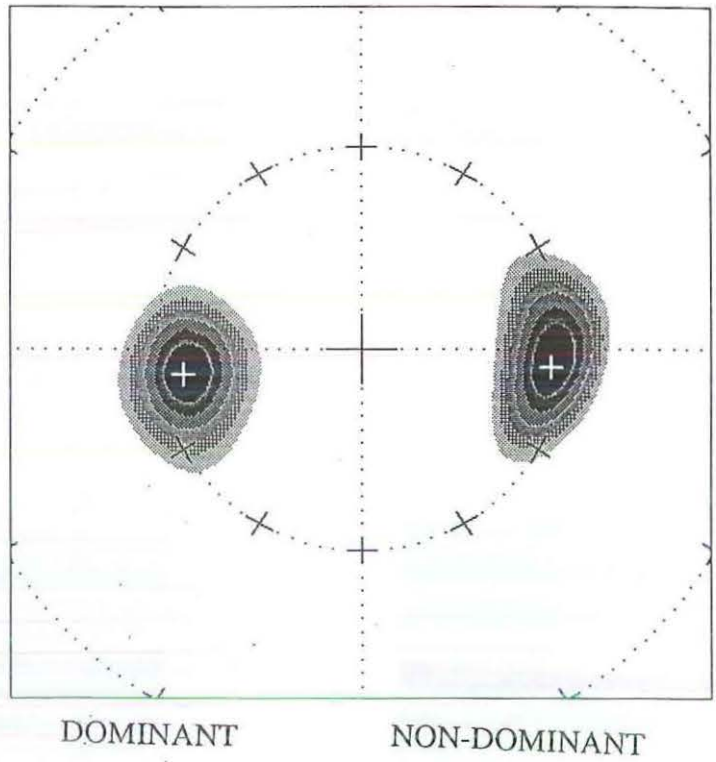


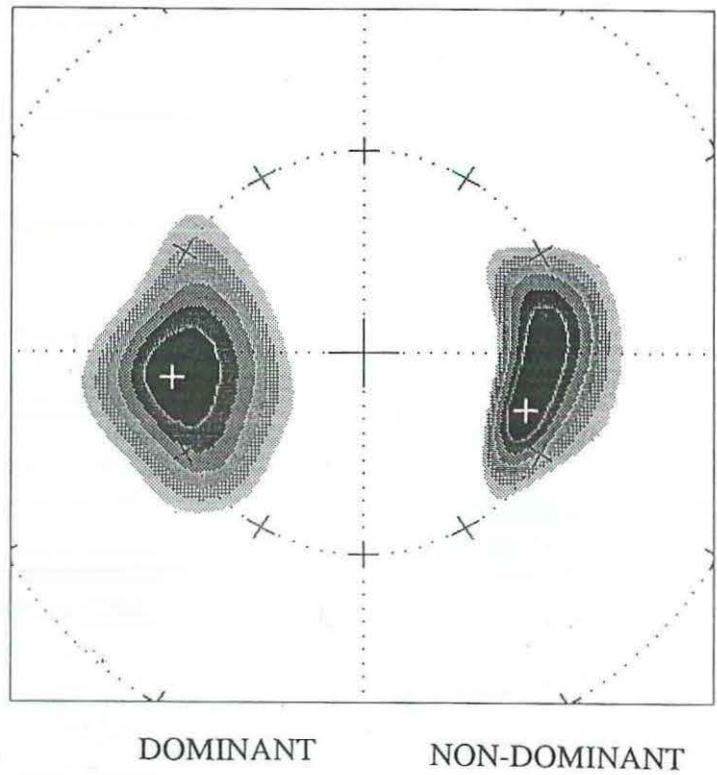
Figure 12. Typical SP mapped representations of FCU in the control group.



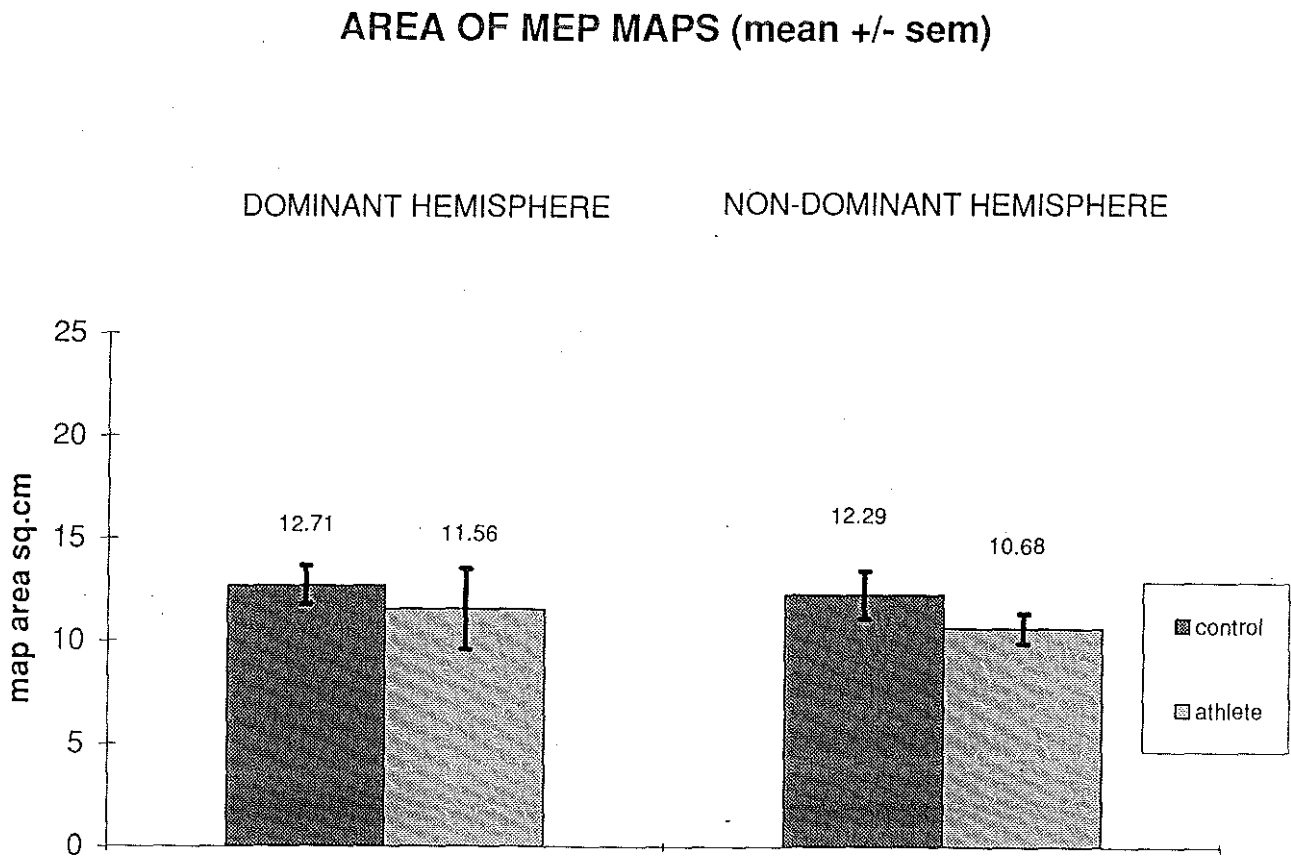
**Figure 13.** Typical MEP mapped representations of FCU in the athlete group.



**Figure 14.** Typical SP mapped representations of FCU in the athlete group.



**Figure 15.** The area of the representation from the MEP maps for athlete and control groups.



**Figure 16.** The area of the representation from the SP maps for athlete and control groups.

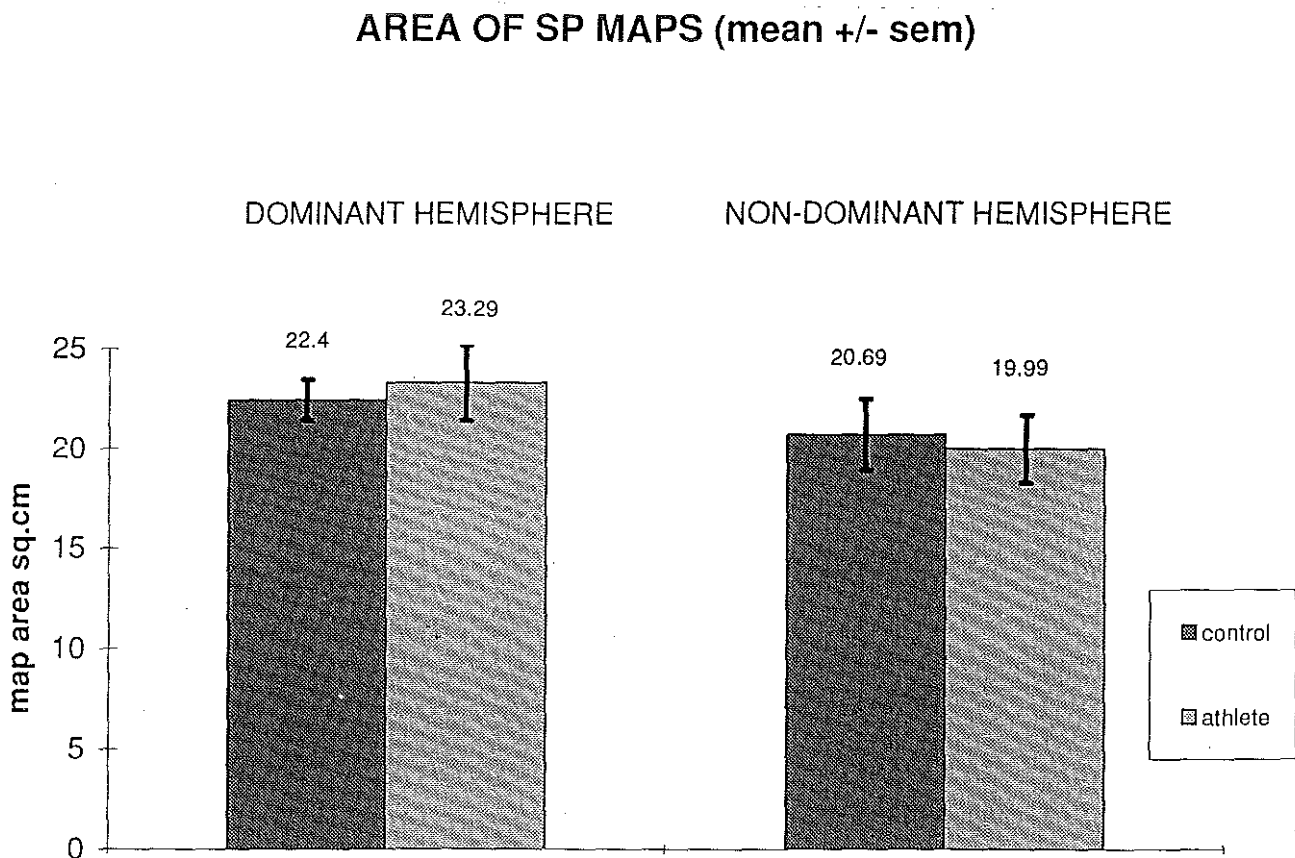


Figure 17. The optimal latitude of the centre of the MEP maps in the athlete and control groups.

### OPTIMAL LATITUDE OF MEP MAPS (mean +/- sem)

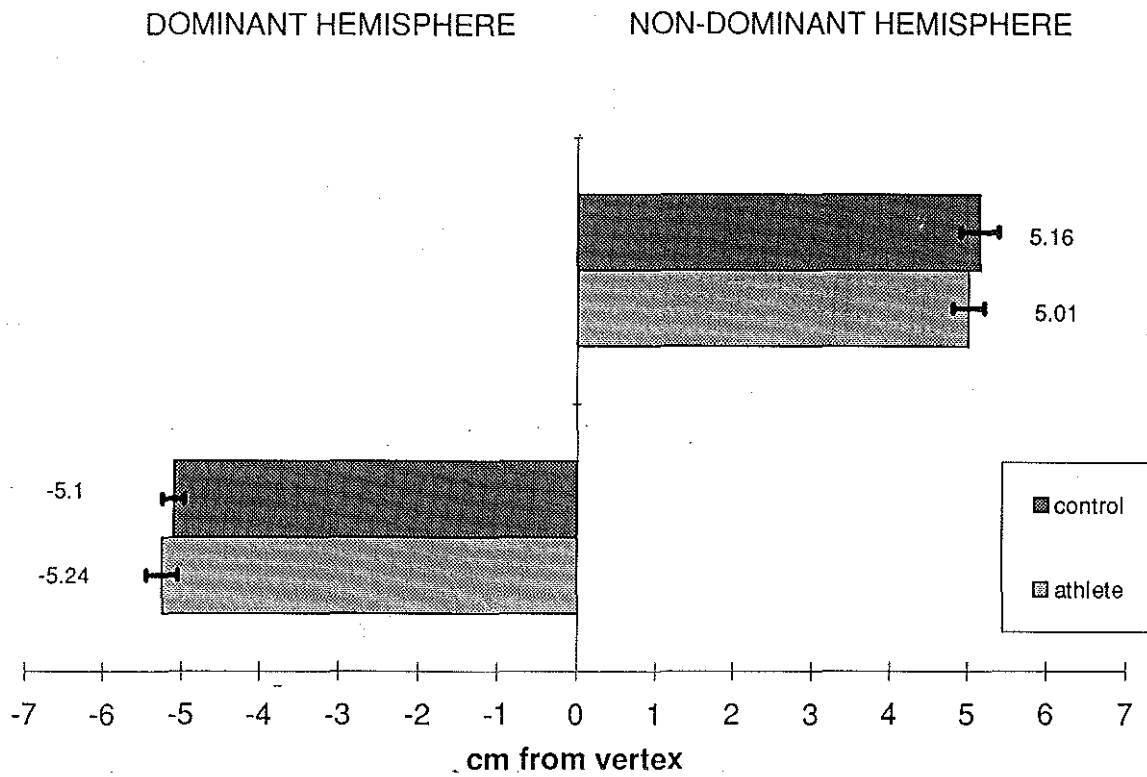
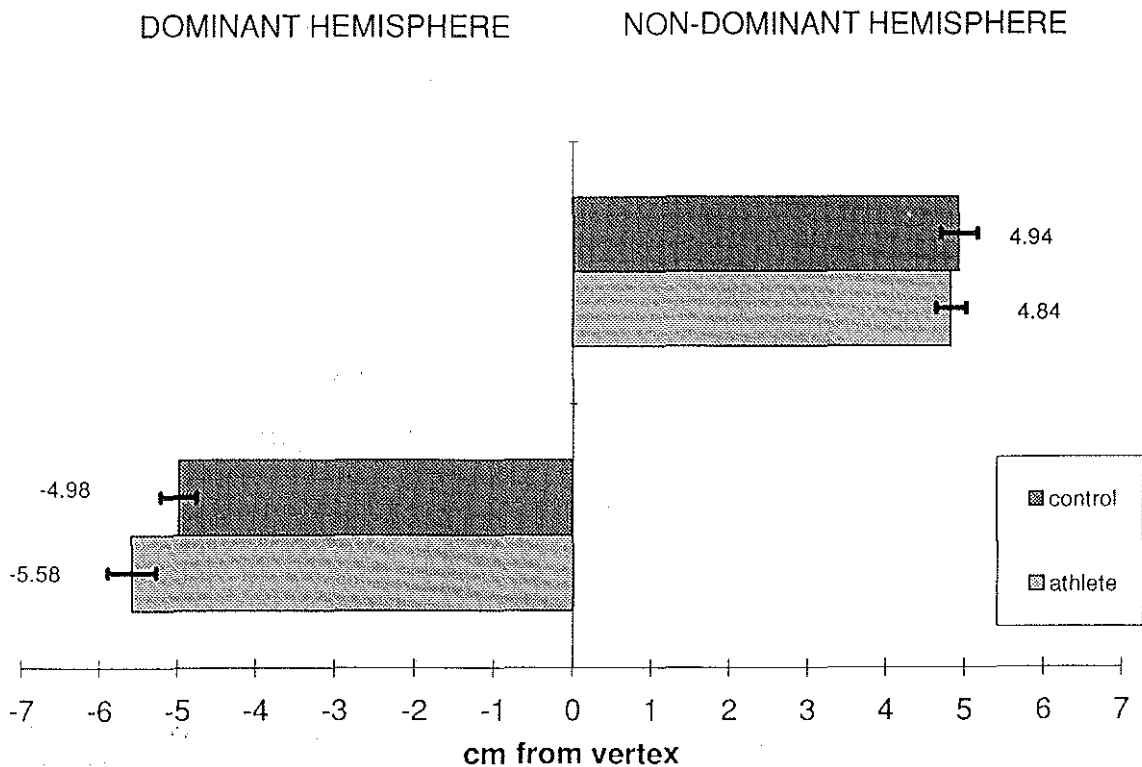


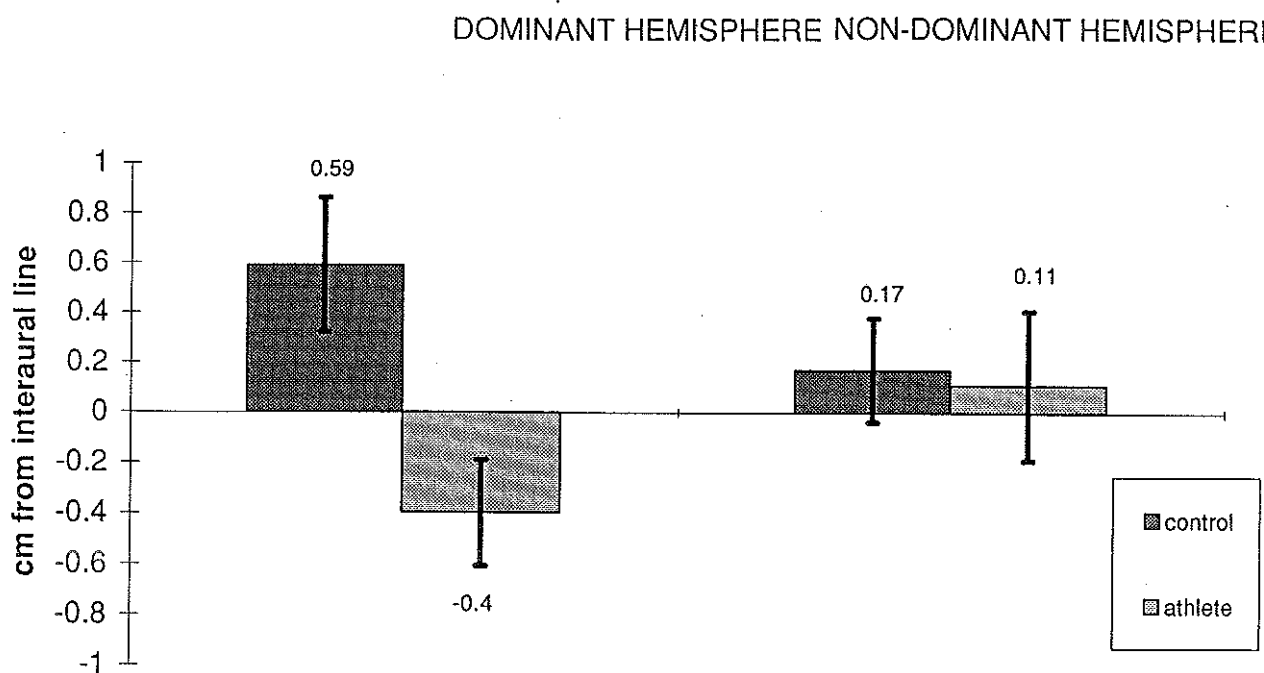
Figure 18. The optimal latitude of the centre of the SP maps in the athlete and control groups.

### OPTIMAL LATITUDE OF SP MAPS (mean +/- sem)



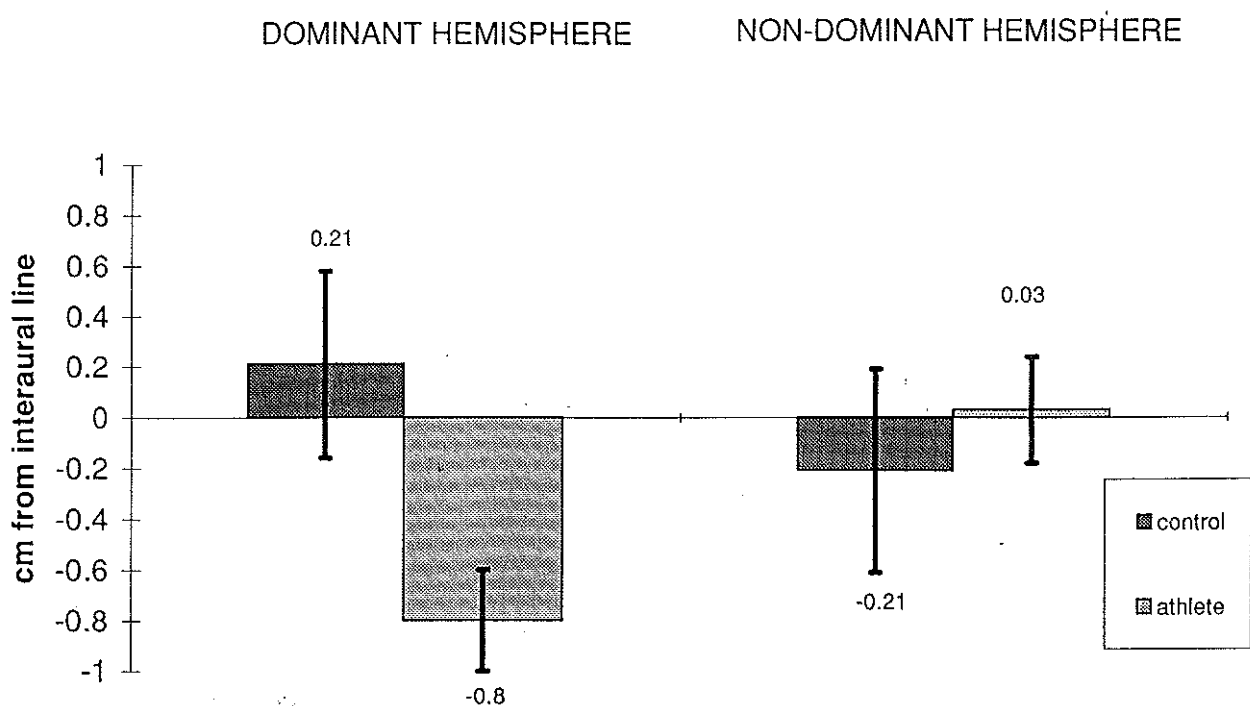
**Figure 19.** The optimal longitude of the centre of the MEP maps in the athlete and control groups.

**OPTIMAL LONGITUDE OF MEP MAPS (mean +/- sem)**

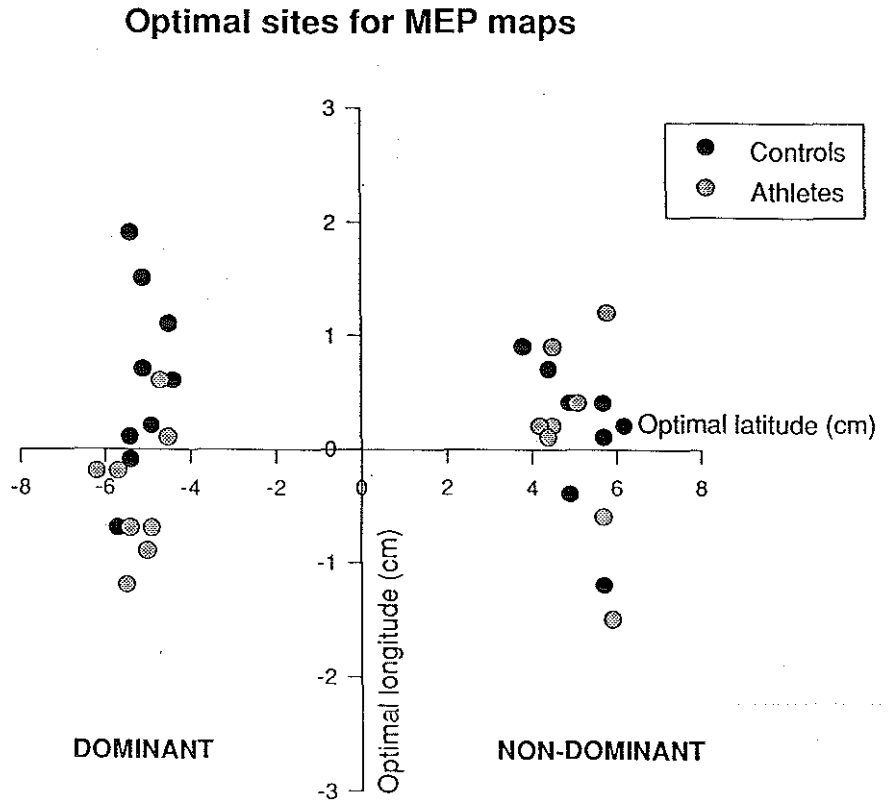


**Figure 20.** The optimal longitude of the centre of the SP maps in the athlete and control groups.

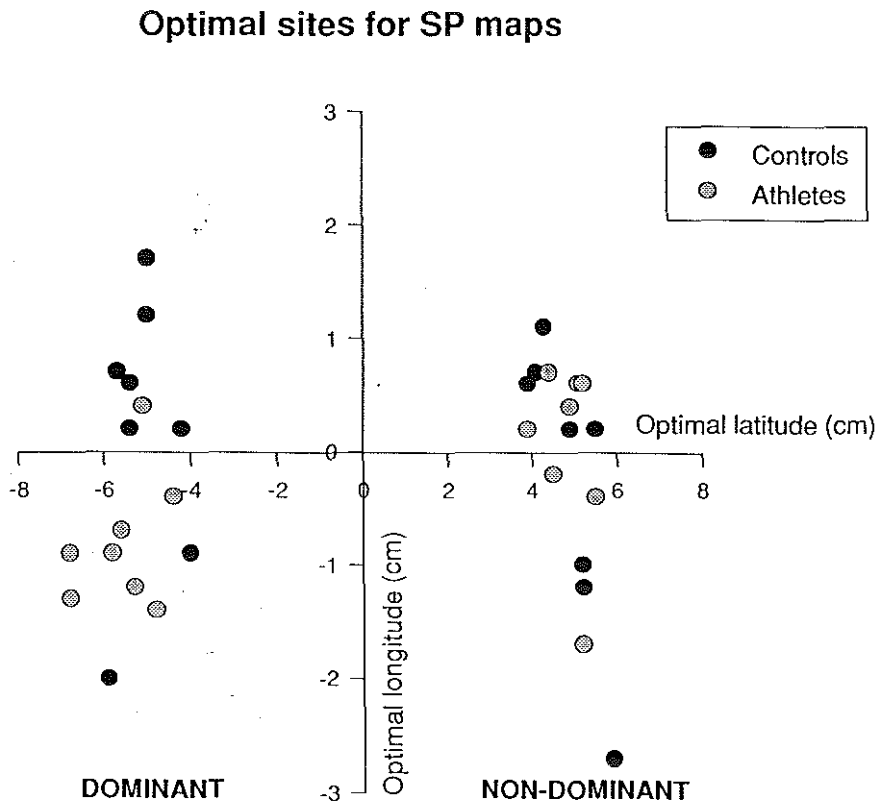
**OPTIMAL LONGITUDE OF SP MAPS (mean +/- sem)**



**Figure 21.** The diagram represents a view of the scalp looking down, with the X-axis as the nasion-inion line, and the Y-axis as the interaural line. The graph displays the individual centres for both groups of subjects as taken from the MEP maps.



**Figure 22.** This graph displays the individual centres for both groups of subjects as taken from the SP maps.





## CHAPTER FIVE

### Discussion

This study has compared the cortical motor representations of a wrist flexor muscle FCU in trained elite badminton players, to those of untrained muscle, in order to identify any differences that may occur in the representation on the motor cortex in relation to muscle use. We hypothesised that there would be differences in the size of the representation and excitability of the motor cortex responsible for controlling the FCU. Interhemispheric comparisons in the athletes showed no significant differences in the size of the representation for MEPs or SPs, and no difference in the excitability between the dominant and non-dominant sides.

By selecting subjects for the study that were skilled unilaterally it was possible to examine the FCU contralateral to the dominant, as the untrained sample. A group of non-trained subjects was used to control for any differences in the representations that may be due to factors other than training, such as handedness. There were two main reasons for examining the FCU in this study. Firstly, the muscle is used regularly in badminton and is activated in coordination with other forearm flexors and extensors to produce fine control of the racquet, and is therefore highly skilled in these movements (Lo & Stark, 1991). Secondly, it can be activated in relative isolation and evoked responses to TMS can be recorded using surface electrodes. Since no previous mapping studies of the FCU have been reported, it has been necessary to characterise the cortical representation of the muscle relative to that of more proximal and distal arm muscles.

In this study we found that using TMS to stimulate the cortex and recording the size of the evoked response, it was possible to map the representation of FCU on the cerebral cortex. By repeating the mapping procedure in three of the subjects, we found the maps to be reproducible. The area of the representations for FCU in the control group (dominant= $12.71 \pm 0.94\text{cm}^2$ , non-dominant= $12.29 \pm 1.17\text{cm}^2$ ) were similar to those found in the hand muscle abductor pollicis brevis (APB) (dominant= $14.1 \pm 4.2\text{cm}^2$ , non-dominant= $13.0 \pm 4.8\text{cm}^2$ ), but smaller than abductor digiti minimi (ADM) (dominant= $16.2 \pm 5.6\text{cm}^2$ , non-dominant= $13.0 \pm 3.9\text{cm}^2$ ) when compared to a different subject group (Wilson et al., 1993a). The mean latitudes for the control group centre of MEP maps in this study (dominant= $5.1 \pm 0.15\text{cm}$ , non-dominant= $5.16 \pm 0.25\text{cm}$ ), were slightly medial to those for APB (dominant= $5.98 \pm 0.04\text{cm}$ , non-dominant= $5.81 \pm 0.08\text{cm}$ ) and ADM (dominant= $5.79 \pm 0.04\text{cm}$ , non-dominant= $5.28 \pm 0.06\text{cm}$ ). Wassermann et al. (1992) mapped the representations of four upper extremity muscles (APB, flexor carpi radialis, biceps brachii and deltoid) in normal subjects. The results from this study showed distal muscles to have larger representations as would be expected from the motor homunculus where the fingers and hand are shown to have a larger representation on the motor cortex than more proximal muscles.

Interhemispheric comparisons in representational area in the control group of this study were not significantly different between the right and left hand, and this is in agreement with the findings by Wilson et al. (1993a) where no differences in area of the representations were reported between the dominant and non-dominant hemisphere. Wasserman et al. (1992) found that in the biceps and deltoid only, area was significantly greater on the non-dominant hemisphere, whereas with APB the dominant hemisphere showed the larger representations. In this study, comparison of the dominant and non-

dominant hemispheres in the athlete group showed no significant difference in the MEP map area. This indicates that skilful use of the FCU in badminton on a regular basis, is not sufficient to cause prolonged changes to the size of the MEP maps when compared to normal use for the non-dominant hand. Interhemispheric differences in the athletes are consistent with those of the control group and it can be concluded that this type of training does not cause significant long term changes in the size of the representation for FCU.

It appears that although there may be biological asymmetries in the structure and function of the brain relating to cerebral dominance and handedness (Galaburda et al., 1978), this is not reflected at the level of the primary motor cortex, specifically in the representation of single muscles. This study found no trends in dominance or handedness with respect to map representations.

This study also mapped the representation of the silent period following the MEP measured in FCU. In the control group, the size and topography of the SP map varied between hemispheres and between subjects however no trends were evident and there were no statistically significant differences. There was no difference in size of the SP representation between the dominant and non-dominant FCU. The silent period representation was larger than the MEP representation within each hemisphere for all subjects. This is consistent with findings by Wilson et al. (1993b) where the SP representation was found to be significantly larger, and encompass the MEP representation for APB.

The silent period representations in the athlete group were similar to the control group in that they were all larger than the MEP maps, however, the athlete group showed larger silent period maps on the dominant hemisphere and this was not shown in

the control group. Differences in the interhemispheric SP areas have not been described in the literature possibly due to the fact that there have been no noticeable differences in the normal subjects that have been investigated. This suggests that there is probably minimal difference in the area of the silent period representation in normal subjects due to handedness. The larger area of silent period maps on the dominant hemisphere in the athletes was only a trend and possibly more athletes would need to be tested to validate this claim as statistically significant. The silent period after cortical stimulation is generated by several mechanisms (Inghilleri, Berardelli, Cruccu, Manfredi, 1993). In the first 50ms, spinal factors operate, with a possible contribution by descending inhibitory fibres. The later part of the silent period probably results from inhibitory effects at the cortical level. Wilson et al. (1993a) suggest that inhibitory processes may act to limit or contain the excitatory output, and that this may contribute to fine discriminatory motor control. Wilson et al. (1993b) found that the centre of the MEP maps and the SP maps were very close. In this study the range of centres between MEP and SP maps were fairly consistent in latitude for the control group and the non-dominant hemisphere of the athlete group, however the dominant hemisphere of the athlete group showed a more lateral SP centre. The longitude of all SP maps were posterior to the MEP map centres. The posterior placement of the athlete dominant hemisphere MEP map centre relative to the other centres, was also reflected in the SP map. A possible explanation is that this may represent the convergence of a greater degree of sensorimotor integration in the dominant hemisphere of the athletes. However other studies examining the changes in cortical representation between skilled and normal muscles have claimed representational area differences, but have not reported changes in location (Pascual-Leone et al., 1993a; Pascual-Leone et al., 1993b).

For both groups in this study threshold differences between hemispheres and between subjects, were negligible and not statistically significant. These findings are in agreement with Macdonell et al. (1991) who found no significant difference in thresholds between the two sides, and contrary to Cohen et al. 1991 who indicate excitability differences with higher amplitude MEPs and lower thresholds in the dominant hemisphere of normal subjects.

The maximal voluntary EMG signals were not significantly different between dominant and non-dominant sides, or between subjects. This gives some indication that the skilled and unskilled muscles have similar characteristics. Strength differences are not always consistent with skill differences and handedness (Porac and Coren, 1981), and although we did not measure wrist flexor strength, no obvious differences were observed in the forearm sizes of the dominant and non-dominant arms in the athletes.

From the results of this study it can be concluded that there are no long term changes to the size of the cortical representation projecting to the dominant FCU in badminton players. These findings are contrary to those found in the case of the Braille subjects that have been exposed to regular skilled training of the hand muscles (Pascual-Leone et al., 1993). These studies found differences in the size of the representations in somatosensory cortex to the reading hand of Braille readers. The cause of these changes is unknown. It may be due to fine control of skilled movement, or it may be due purely to the regular activation of the muscle (Pascual-Leone et al., 1993). The learning of simple motor tasks with regular practise over a short period of time has shown that modulation of the area of the representation can occur while learning the skill but the changes are only short term (Pascual-Leone et al., 1994). This may be the case when learning a new sports skill. Cortical modulation may have occurred in the badminton

players during the learning phase of the skill and then once the skill was learned and automated, the representation may have resumed its normal size. It may be necessary to examine the athletes before, during, and after learning a new skill to determine if modulation occurs.

This study has found that the cortical representations of muscles in unilaterally skilled sportspersons are generally symmetrical, with subtle interhemispheric differences in the centre of the representations and silent period area. The results suggest that performance differences related to general handedness, and between highly skilled and contralateral non-skilled hands during motor tasks, is not reflected in the size of the muscular representation in the motor cortex or the excitability.

Pons et al. (1991) suggests that as a skill becomes automatic (as is the case with the badminton players), there may be structural changes in the intracortical networks and this could be the reason why a larger representation in the dominant hemisphere is not present. It may be possible that the dominant side representational area has experienced a change in the 'wiring' pattern of the corticomotor cells as a result of training. Divergence of neuronal connections to synergist muscles to that of FCU, may assist with fine motor control and explain why an increase in skill is present without an increase in representational area.

In summary, it is evident that badminton players show superior skill in the racquet arm during performance, when compared to the non-dominant arm. This difference is not reflected in the representation of forearm muscles on the motor cortex between cerebral hemispheres. It may be that this method of examining the motor cortex does not detect the changes that occur in the cortex with skill development, or the changes may occur at higher levels of motor control. Programmed movements may be

stored in subcortical areas such as the cerebellum and basal ganglia which were not investigated in this study. It may be necessary to investigate other motor areas, or higher levels of motor control, to detect significant differences between trained and untrained muscles in the central nervous system.

## References

- Aglioti, S., Bonazzi, A., Cortese, F. (1994) Phantom lower limb as a perceptual marker of neural plasticity in the mature human brain. Proc.R.Soc.Lond. B (225) 273-278
- Asanuma, H., Keller, A. (1991) Neuronal mechanisms of motor learning in mammals. Neuroreport (2) 217-224
- Barker, A.T., Jalinous, R., Freeston, I.L. (1985) Non-invasive magnetic stimulation of human motor cortex. Lancet, i :1106-1107
- Berardelli, A., Inghilleri, M., Cruccu, G., Manfredi, M. (1990) Descending volley after electrical and magnetic transcranial stimulation in man. Neurosci Lett., (112) 54-58
- Brasil-Neto, J.P., Valls-Sole, J, Pascual-Leone, A., Cammarota, A., Amassian, V.E., Cracco, R., Maccabee, P., Cracco, J., Hallet, M., Cohen, L.G. (1993) Rapid modulation of human cortical motor outputs following ischaemic nerve block. Brain (116) 511-525
- Brasil-Neto, J.P., Cohen, L.G., Pascual-Leone, A., Jabir, F.K., Wall, R.T., Hallet, M. (1992) Rapid reversible modulation of human motor outputs after transient deafferentation of the forearm: A study with transcranial magnetic stimulation. Neurology (42) 1302-1306
- Broer, M.R., Houtz, S.J. (1967) Patterns of muscular activity in selected sports skills: and electromyographic study. pp.23-27,42-47, Charles C. Thomas, Publisher
- Brouwer, B., Ashby, P. (1990) Corticospinal projections to upper and lower spinal motoneurons in man. Electroencephalography and Clinical Neurophysiology (76), 509-519
- Bryden, M.P. (1976) Measuring handedness with questionnaires. Neuropsychologica (15) 617-624
- Calford, M.B., Tweedale, R. (1990) Interhemispheric transfer of plasticity in the cerebral cortex. Science (249) 805-807
- Cantello, R., Gianelli, M., Civardi, C., Mutani, R. (1992) Magnetic brain stimulation: the silent period after the motor evoked potential. Neurology (42) 1951-1959
- Cohen, L.G., Bandinelli, S., Findley, T.W., Hallet, M. (1991) Motor reorganisation after upper limb amputation in man. A study with focal magnetic stimulation. Brain (114) 615-627
- Cotman, C.W., Nieto-Sanpedro, M. (1982) Brain function, synapse renewal, and plasticity. Annual Review of Psychology (33) 371-401



- Day, B.L., Thompson, P.D., Dick, J.P., Nakashima, K., Marsden, D.C. (1987) Different sites of action of electrical and magnetic stimulation of the human brain. Neuroscience Letters (75) 101-106
- Day, B.L., Dressler, D., Maertens de Noordhout, A., Marsden, C.D., Nakashima, K., Rothwell, J.C., Thompson, P.D. (1989) Electric and magnetic stimulation of human motor cortex: Surface EMG and single motor unit responses. J.Physiol. (412) 449-473
- Farley, J., Alkon, D.L. (1985) Cellular mechanisms of learning , memory, and information storage. Annual Review of Psychology (36) 419-494
- Fox, E.L., Bowers, R.W., Foss, M.L. (1988) The physiological basis of physical education and athletics 4th Ed. Wm.C.Brown Publishers Dubuque, Iowa
- Freund, H-J., Hummelsheim, H. (1985) Lesions of the pre-motor cortex in man. Brain (108) 697-733
- Fuhr, P., Cohen, L.G., Dang, N., Findley, T., Haghghi, S., Oro, J. et al. (1992) Physiological analysis of motor reorganisation following lower limb amputation. Electroencephalography and Clinical Neurophysiology (85) 53-60
- Galaburda, A.M., LeMay, M., Kemper, T.L., Geschwind, N. (1978) Right-left asymmetry's in the brain. Science (199) 852-856
- Geschwind, N. (1983) Biological foundations of cerebral dominance. Trends in Neuroscience (14) 361-377
- Grafton, S.T., Mazziotta, J.C., Presty S, et al. (1992) Functional anatomy of human procedural learning determined with regional cerebral blood flow and PET. J. Neurosci. (12) 2542-2548
- Hess, C., W., Mills, K.R., Murray, N.M.F. (1987) Responses in small hand muscles from magnetic stimulation of the human brain. J.Physiol. (388) 397-419
- Huerta, M.F., Wall, J.T. Kaas J.H. (1986) Changes in topography of somatosensory cortex after nerve loss in adult and neonatal marmoset monkeys (abstract). Soc. Neurosci. Abstr. (12) 954
- Kaas,J.H. (1991) Plasticity of sensory and motor maps in adult mammals. Annual Review of Neuroscience (14) 137-167
- Kalaska, J., Pomeranz, B. (1979) Chronic paw denervation causes an age-dependent appearance of novel responses from forearm in "paw cortex" of kittens and adult cats. J. Neurophysiol. (42) 618-633
- Kelahan, A.M., Ray, R.H., Carson, L.V., Massey, C.E., Doetsch, G.S. (1981) Functional reorganisation of adult raccoon somatosensory cerebral cortex following neonatal digit amputation. Brain Res. (223) 151-159

- Kim, S.G., Ashe, J., Hendrich, K., Ellermann, J.M., Merkle, H., Ugurbil, K., Georgopoulos, A.P. (1993) Functional magnetic resonance imaging of motor cortex: Hemispheric asymmetry and handedness. Science (261) 615-617
- Koff, K., Naeser, M.A., Pieniadz, J.M., Foundas, A.L., Levine, H.L. (1986) Computed tomographic scan hemispheric asymmetry's in right- and left-handed male and female subjects. Arch. Neurol. (43) 487-491
- Lederhendler, I., Alkon, D.L. (1986) Implicating casual relations between cellular function and learning behaviour. Behavioural Neuroscience (100) 833-838
- Levy, W.J., Amassian, V.E., Traad, M., Cadwell, J. (1990) Focal magnetic coil stimulation reveals motor cortical system reorganized in humans after traumatic quadriplegia. Brain Research (510) 130-134
- Lo, D., Stark, K. (1991) The badminton overhead shot. National Strength and Conditioning Association Journal 13(4) pp.6-13,87-88
- Macdonell, R.A.L., Shapiro, B.E., Chiappa, K.H., Helmers, S.L., Cros, D., Day, B.J., Shahani, B.T., Phil, D. (1991) Hemispheric threshold differences for motor evoked potentials produced by magnetic coil stimulation. Neurology (41) 1441-1444
- Marshall, J.F. (1984) Brain function: neural adaptations and recovery from injury. Annual Review of Psychology (35) 277-308
- Mazziotta, J., Phelps, M. (1984) Positron computed tomographic studies of cerebral metabolic responses to complex motor tasks. Neurology (34) 116-120
- Mazzocchio, R., Rothwell, J.C., Day, B.L., Thompson, P.D. (1994) Effect of tonic voluntary activity on the excitability of human motor cortex. J. Physiol (474.2) 261-267
- Merzenich, M.M., Nelson, R.J., Stryker M.P., Cynder, M.S., Shoppmann, A., Zook, J.M. (1984) Somatosensory cortical map changes following digit amputation in adult monkeys. J. Comp. Neurol. (224) 591-605
- Merzenich, M.M., Kaas, J.H., Wall J.T., Sur M., Nelson, R.J., Felleman, D.J. (1983) Progression of change following median nerve section in the cortical representation of the hand in areas 3b and 1 in adult owl and squirrel monkeys. Neuroscience (10) 639-665
- Metzler, J., Mark, P.S. (1979) Functional changes in cat somatic sensory-motor cortex during short term reversible epidermal blocks. Brain Res. (177) 379-383
- Pascual-Leone, A., Grafman, J., Hallet, M. (1994) Modulation of cortical motor output maps during development of implicit and explicit knowledge. Science (263) 1287-1289
- Pascual-Leone, L., Torres, F. (1993a) Plasticity of the sensorimotor cortex representation of the reading finger in Braille readers. Brain (116) 39-52

- Pascual-Leone, A., Cammarota, A., Wassermann, E.M., Brasil-Neto, J.P., Cohen, G., Hallet, M. (1993b) Modulation of motor cortical outputs to the reading hand of braille readers. Ann. Neurol. (34) 33-37
- Pons, T.P., Garraghty, P.E., Ommaya, A.K., Kaas, J.H., Taub, E., Mishkin, M. (1991) Massive cortical reorganisation after sensory deafferentation in adult macaques. Science (252) 1857-1860
- Porac, C., Coren, S. (1981) Lateral preferences and human behaviour Springer-Verlag pp.13-191
- Ramachandran, V.S., Rogers-Ramachandran, D., Stewart, M. (1992) Perceptual correlates of massive cortical reorganisation. Science (258) 1159-1160
- Ransom, S., Clark, S. (1959) The anatomy of the nervous system. Its development and function pp.357-382 W.B.Sanders, Philadelphia
- Roland, P. (1984) Metabolic measurements of the working frontal cortex in man. Trends Neurosci. (7) 430-435
- Rothwell, J.C., Thompson, P.D., Day B.L., Boyd, S., Marsden.C.D. (1991) Stimulation of the human motor cortex through scalp. Exp. Physiol. (76) 159-20
- Rothwell, J.C., Day, B.L., Thompson, P.D., Marsden, C.D. (1990) The physiology of electrical and magnetic stimulation of the human brain through the intact scalp. In Motor Disturbances II Academic Press Limited
- Rothwell, J.C., Thompson, B.L., Day, B.L., Dick, J.P.R., Kachi, T., Cowan, J.M.A., Marsden, C.D. (1987) Motor cortex stimulation in intact man. Brain (110) 1173-1190
- Seitz, R.J., Roland, E., Bohm, C., et al. (1990) Motor learning in a man: a positron emission tomographic study. Neuroreport (1) 57-60
- Thompson, P.D., Rothwell, J.C. Day B.L., Dressler, D., Maertens de Noordhout, A., Topka, H., Cohen, L.G., Cole, R.A., Hallet, M. (1991) Reorganization of corticospinal pathways following spinal cord injury. Neurology (41) 1276-1283
- Valls-Sole, J., Tolosa, E.S., Pujol, M. (1992) Myokimic discharges and enhanced facial nerve reflex responses after recovery from idiopathic facial palsy. Muscle and Nerve (15) 37-42
- Wassermann, E.M., Pascual-Leone, A., Hallet, M. (1994) Cortical motor representation of the ipsilateral hand and arm. Experimental Brain Research (100) 121-132
- Wassermann, E.M., Pascual-Leone, A., Valls-Sole, J., Toro, C., Cohen, L.G., Hallet, M. (1993) Topography of the inhibitory and excitatory responses to transcranial magnetic stimulation in a hand muscle. Electroencephalography and Clinical Neurophysiology (89) 424-433

Wassermann, E.M., McShane, L.M., Hallet, M., Cohen, L.G. (1992) Non-invasive mapping of muscle representations in human motor cortex. Electroencephalography and Clinical Neurophysiology (85) 1-8

Wilson, S.A., Thickbroom, G.W., Mastaglia, F.L. (1993a) Transcranial magnetic stimulation mapping of the motor cortex in normal subjects. The representation of two intrinsic hand muscles. J. Neurological Sciences (118) 134-144

Wilson, S.A., Thickbroom, G.W., Mastaglia, F.L. (1993b) Topography of excitatory and inhibitory muscle responses evoked by transcranial magnetic stimulation in the human motor cortex Neuroscience Letters (154) 52-56

**Appendix A**

**Australian Neuromuscular Research Institute: Consent Form**

*Mapping of wrist flexor muscles*

**Procedure:** The procedure is non-invasive. Electrode discs will be taped onto the biceps and wrist flexor muscles. The activity in the muscles will be recorded via these electrodes and the information will be fed into the computer. Magnetic stimulation will be used. A snugly fitting cap with pre-marked spacings will be placed on the head. The magnetic coil will be positioned on various sites of the cap and that part of the brain will be stimulated. Each stimulation will be very short, much less than 1 second. This is not painful, but some small movements may be noticed in the target muscle. Occasionally, tingling or a tap on the scalp may be felt. During the session you will be asked to contract muscles in the arm maximally for 5 seconds and submaximally also during the stimulation. You will be shown how to perform these contractions and will be given a chance to practice. We will start the session with a few practice runs, and there will be a rest period after each set of trials. There are very few possible discomforts associated with these procedures. On rare occasions magnetic stimulation may cause a headache. If this occurs, or for any other reason you wish to stop the session, we will stop the session. I understand that I am free to withdraw from the study at any time.

I acknowledge that I have read the above statement which explains the nature and object and the possible risks of the investigation and the statement has been explained to me to my satisfaction. Before signing this document I have been given the opportunity to ask any questions relating to any possible physical or mental harm I might suffer as a result of my participation and I have received satisfactory answers. I agree that research data gathered from the result of the study may be published provided my name is not used.

In the light of the forgoing, I hereby release the Australian Neuromuscular Research Institute or any employee, member or representative thereof, from all or any claim that I may have arising out of my participation on this experiment. I understand that this document in no way limits my rights at law from any damage that might arise from negligence on the part of the investigators.

To the best of my knowledge I am not pregnant. I do not have a cardiac pacemaker and I do not have metal implants in my head.

....., age.....years, agree to participate as a subject in a study of the type described above.

Signed.....  
Date.....

Witness.....

control group	DOMINANT HEMISPHERE						DOMINANT HEMISPHERE (CONTROLS)						
	MEP MAPS						SILENT PERIOD MAPS						
	LAT	LONG	AREA	THRESH	CAL THR	AMP(mV)	MAX(uV)	LAT	LONG	AREA	DUR(ms)		
1.00	5.10	0.70	11.30	45.00	45.00	3.20	566.90	5.40	0.60	19.50	198.00		
2.00	4.40	0.60	9.50	35.00		4.60	132.00	5.00	1.20	26.00	189.00		
3.00	5.40	1.90	15.20	45.00	43.00	1.70	568.00	5.00	1.70	25.80	158.00		
4.00	4.50	1.10	16.20	45.00	35.00	3.60	392.80	5.40	0.20	24.70	167.00		
5.00	4.90	0.20	11.00	50.00	55.00	0.85	408.70	4.20	0.20	21.10	202.00		
6.00	5.40	0.10	12.90	75.00	67.00	0.63	255.90	4.00	-0.90	18.20	132.00		
7.00	5.10	1.50	16.50	65.00	64.00	0.54	397.50	4.20	0.20	20.40	140.00		
8.00	5.70	-0.70	8.80	50.00	41.00	4.20	292.60	5.90	-2.00	25.50	137.00		
9.00	5.40	-0.10	13.00	45.00	42.00	0.69	325.30	5.70	0.70	20.40	160.00		
	<b>MEAN</b>	5.10	0.59	12.71	50.56	49.00	2.22	371.08	4.98	0.21	22.40	164.78	
	<b>STDEV</b>	0.44	0.82	2.81	12.10	11.63	1.67	140.71	0.70	1.10	3.07	26.48	
	<b>SEM</b>	0.15	0.27	0.94	4.03	3.88	0.56	46.90	<b>SEM</b>	0.23	0.37	1.02	8.83
athlete group	DOMINANT HEMISPHERE						DOMINANT HEMISPHERE (ATHLETES)						
	MEP MAPS						SILENT PERIOD MAPS						
	LAT	LONG	AREA	THRESH	CAL THR	AMP(mV)	MAX(uV)	LAT	LONG	AREA	DUR(ms)		
1.00	4.70	0.60	9.30	45.00	45.00	2.00	208.90	5.10	0.40	23.10	164.00		
2.00	4.90	-0.70	9.50	45.00	36.00	1.60	127.20	4.80	-1.40	23.80	149.00		
3.00	4.50	0.10	7.80	65.00	61.00	1.30	284.00	4.40	-0.40	16.00	105.00		
4.00	5.50	-1.20	8.40	40.00	42.00	1.40	244.60	5.30	-1.20	19.00	147.00		
5.00	5.00	-0.90	12.10	55.00	53.00	0.68	361.00	6.80	-1.30	25.80	160.00		
6.00	5.40	-0.70	9.00	65.00	77.00	1.60	250.20	5.80	-0.90	22.40	166.00		
7.00	5.70	-0.20	24.60	45.00	38.00	1.50	273.90	5.60	-0.70	34.10	201.00		
8.00	6.20	-0.20	12.00	45.00	46.00	1.20	458.30	6.80	-0.90	22.10	159.00		
	<b>MEAN</b>	5.24	-0.40	11.59	53.13	49.75	1.41	276.01	5.58	-0.80	23.29	156.38	
	<b>STDEV</b>	0.57	0.59	5.48	15.10	13.65	0.38	99.16	0.87	0.59	5.31	26.58	
	<b>sem</b>	0.20	0.21	1.96	5.39	4.87	0.14	35.41	<b>SEM</b>	0.31	0.21	1.90	9.49

NON-DOMINANT HEMISPHERE				NON-DOMINANT HEMISPHERE (CONTROLS)							
MEP MAPS				SILENT PERIOD MAPS							
LAT	LONG	AREA	THRESH	CAL THR	AMP(mV)	MAX(uV)		LAT	LONG	AREA	DUR(ms)
3.80	0.90	15.20	45.00	42.00	0.79	435.00		3.90	0.60	21.70	156.00
4.90	0.40	14.40	40.00	38.00	0.80	129.10		5.20	-1.20	32.30	162.00
5.70	0.40	7.60	45.00	43.00	1.70	441.20		5.50	0.20	22.80	165.00
6.20	0.20	13.20	50.00	48.00	1.10	485.60		5.50	0.20	18.40	130.00
4.90	-0.40	12.50	50.00	50.00	0.98	447.50		5.20	-1.00	20.40	188.00
5.70	-1.20	18.20	75.00	78.00	0.16	157.60		5.90	-2.70	21.30	149.00
4.40	0.70	11.40	55.00	57.00	0.65	220.00		4.10	0.70	20.50	143.00
5.70	0.10	7.30	55.00	51.00	1.50	274.80		4.90	0.20	15.40	121.00
5.10	0.40	10.80	45.00	44.00	0.59	135.10		4.30	1.10	13.40	160.00
5.16	0.17	12.29	51.11	50.11	0.92	302.88		4.94	-0.21	20.69	154.89
0.75	0.63	3.51	10.24	11.89	0.47	149.17		0.70	1.20	5.33	21.87
0.25	0.21	1.17	3.41	3.96	0.16	49.72		0.23	0.40	1.78	7.20
NON-DOMINANT HEMISPHERE				NON-DOMINANT HEMISPHERE(ATHLETES)							
				SILENT PERIOD MAPS							
LAT	LONG	AREA	THRESH	CAL THR	AMP(mV)	MAX(uV)		LAT	LONG	AREA	DUR(ms)
4.50	0.20	10.90	45.00	50.00	0.30	171.10		4.40	0.70	21.30	163.00
4.20	0.20	11.50	45.00	37.00	1.40	185.80		3.90	0.20	23.60	187.00
4.50	0.90	10.00	55.00	56.00	3.00	663.50		5.10	0.60	15.20	168.00
4.40	0.10	7.30	45.00	44.00	0.67	272.00		4.50	-0.20	24.70	120.00
5.90	-1.50	13.20	40.00	41.00	1.10	471.00		5.50	-0.40	19.30	250.00
5.70	-0.60	9.80	65.00	62.00	0.80	451.00		5.20	-1.70	15.40	120.00
5.80	1.20	13.50	45.00	37.00	1.60	295.20		4.90	0.40	26.50	194.00
5.10	0.40	9.20	45.00	45.00	1.00	400.50		5.20	0.60	13.90	131.00
5.01	0.11	10.68	48.13	46.50	1.23	363.76		4.84	0.03	19.99	166.63
0.70	0.85	2.07	7.99	8.96	0.82	165.71		0.53	0.80	4.79	44.32
0.25	0.30	0.74	2.85	3.20	0.29	59.18		0.19	0.29	1.71	15.83

## APPENDIX C

### CONTROL GROUP MEP MAPS

\* Indicates dominant hemisphere



URN: unspecified AGE: unspecified SEX: unspecified

DATE: Wed Aug 31 15:40:36 1994 - printed Wed Aug 31 19:23:13 1994.

FILE: /home/gary/pc/data/mapping/dylan/dert.flx1

SERIES: CONTROL 1

COMMENTS: map of right wrist flexor

URN: unspecified AGE: unspecified SEX: unspecified

DATE: Wed Aug 31 14:41:00 1994 - printed Wed Aug 31 19:47:30 1994.

FILE: /home/gary/pc/data/mapping/dylan/del.flx1

SERIES: CONTROL 1

COMMENTS: map of left flexors

should be  
maxim

**CALCULATION OPTIONS**      **DISPLAY OPTIONS**

Add zeroed sites.:  around edges      Position map...: at 1 x 1 in a 1 x 1 grid [CLEAR MAP] [KEY] [PRO]

Limit calculation.:  1 deg outer limit      Map screen size.:  512x512 MAX RES      Viewing direction...:  Vertex

Set resolution...:  256x256 matrix      Upper threshold.:  sites *should be image*      UT value (u,m,z)...:

Interpolation...:  spline fit      Lower threshold.:  sites      LT value (u,m,z)...:

Data source...:  AMP      Colour table...:  8&W 8 levels      Invert colour table:  yes

Map background.:  white      Show gray scale key:  yes

Show sites...:  no      Show reference grid:  black

**SAYE & RESTORE IMAGE**      **MASKING & MAGNIFY OPTIONS**

Image label...: r fcu      Draw with mask.:  yes, in min colour Blow up image...:  no

Restore...:  full map      Add to mask...:  add pixels (min)      Brush width...:  4

Restore % scaled.:  no

[Calculate] [Draw] [Quantitate] [Save pixels] [Save matrix] [Retrieve] [Hide] [Quit]

Clear data    Load data    Done

Units:  mV    Loc:  Optimal    Lta:  no    Heaf:  all

SITE:	Real	Fit	SITE:	Real	Fit	SITE:	Real	Fit
-5,8:	2.51	2.46	-9,8:	0.18	0.26	-4,8:	1.59	1.83
-6,2:	3.21	2.83	-8,2:	0.82	0.68	-4,2:	2.04	1.87
-6,4:	1.21	1.36	-8,4:	0.15	0.14	-4,4:	0.24	0.46
-6,6:	0.12	0.35	-9,6:	0.97	0.96	-1,-2:	0.12	0.26
-6,-2:	0.56	0.69	-9,2:	0.13	0.22	-3,4:	0.24	0.32
-6,-4:	0.18	0.97	-5,8:	2.86	2.89	-3,2:	0.18	0.69
-7,8:	0.87	1.13	-5,2:	2.39	3.04			
-7,4:	0.74	0.73	-5,4:	2.84	1.56			
-7,2:	1.57	1.62	-5,6:	0.14	0.18			
-7,6:	0.12	0.83	-5,-2:	0.85	0.89			
-7,-2:	0.16	0.15	-5,-4:	0.14	0.84			

Sum of squares error of fit is 2.24

\*Optimal\* latitude is at 24.8 degrees ( 5.1 ca)

\*Optimal\* longitude is at 8.4 degrees ( 0.7 ca)

-----: IMAGE > 501    : IMAGE > 754

COG latitude : 23.8deg ( 4.9ca) : 23.8deg ( 4.9ca)

COG longitude: 15.0deg ( 1.2ca) : 14.2deg ( 1.2ca)

ANT longitude: 47.0deg ( 3.9ca) : 34.2deg ( 2.8ca)

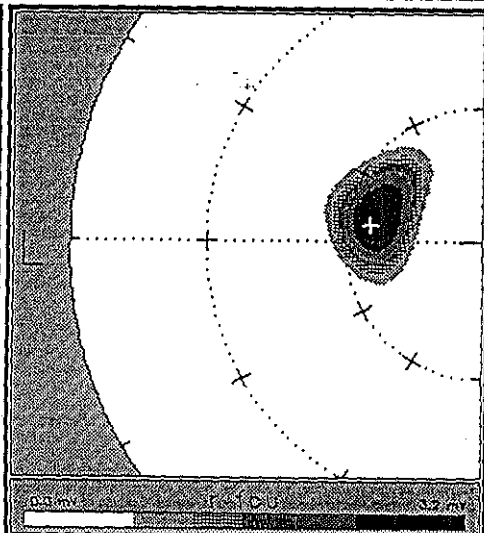
POST longitude: -13.8deg (-1.1ca) : -3.8deg (-0.3ca)

NEDL latitude : 15.6deg ( 3.2ca) : 17.8deg ( 2.7ca)

LATL latitude : 32.6deg ( 6.7ca) : 28.8deg ( 6.1ca)

Elongation : 4.5/3.5ca = 1.4 : 3.2/2.5ca = 1.3

Surface area : 11.3 ca2 : 5.3 ca2



**CALCULATION OPTIONS**      **DISPLAY OPTIONS**

Add zeroed sites.:  around edges      Position map...: at 1 x 1 in a 1 x 1 grid [CLEAR MAP] [KEY] [PRO]

Limit calculation.:  1 deg outer limit      Map screen size.:  512x512 MAX RES      Viewing direction...:  Vertex

Set resolution...:  256x256 matrix      Upper threshold.:  sites      UT value (u,m,z)...:

Interpolation...:  spline fit      Lower threshold.:  sites      LT value (u,m,z)...:

Data source...:  AMP      Colour table...:  8&W 8 levels      Invert colour table:  yes

Map background.:  white      Show gray scale key:  yes

Show sites...:  no      Show reference grid:  black

**SAYE & RESTORE IMAGE**      **MASKING & MAGNIFY OPTIONS**

Image label...: ? fcu      Draw with mask.:  yes, in min colour Blow up image...:  no

Restore...:  full map      Add to mask...:  add pixels (min)      Brush width...:  4

Restore % scaled.:  no

[Calculate] [Draw] [Quantitate] [Save pixels] [Save matrix] [Retrieve] [Hide] [Quit]

Clear data    Load data    Done

Units:  mV    Loc:  Optimal    Lta:  no    Heaf:  all

SITE:	Real	Fit	SITE:	Real	Fit	SITE:	Real	Fit
4,8:	0.52	0.67	6,8:	0.76	0.58	3,4:	0.17	0.11
4,2:	0.65	0.74	6,2:	0.79	0.58	3,-2:	0.18	0.12
4,4:	0.88	0.21	6,4:	0.16	0.18	2,8:	0.28	0.33
4,-2:	0.25	0.38	6,-2:	0.18	0.28	2,2:	0.24	0.29
4,-4:	0.09	0.97	6,-4:	0.18	0.28	2,-2:	0.04	0.31
5,8:	0.65	0.71	7,8:	0.13	0.24	1,8:	0.65	0.18
5,2:	0.66	0.73	7,2:	0.25	0.28			
5,4:	0.17	0.15	7,-2:	0.12	0.09			
5,6:	0.19	0.04	8,8:	0.06	-0.01			
5,-2:	0.57	0.36	3,8:	0.04	0.50			
5,-4:	0.06	0.11	3,2:	0.69	0.53			

Sum of squares error of fit is 6.98

\*Optimal\* latitude is at 18.6 degrees ( 3.8 ca)

\*Optimal\* longitude is at 13.7 degrees ( 0.3 ca)

-----: IMAGE > 501    : IMAGE > 754

COG latitude : 13.7deg ( 4.9ca) : 20.3deg ( 4.2ca)

COG longitude: 11.8deg ( 0.8ca) : 12.5deg ( 0.9ca)

ANT longitude: 44.3deg ( 3.1ca) : 35.3deg ( 2.6ca)

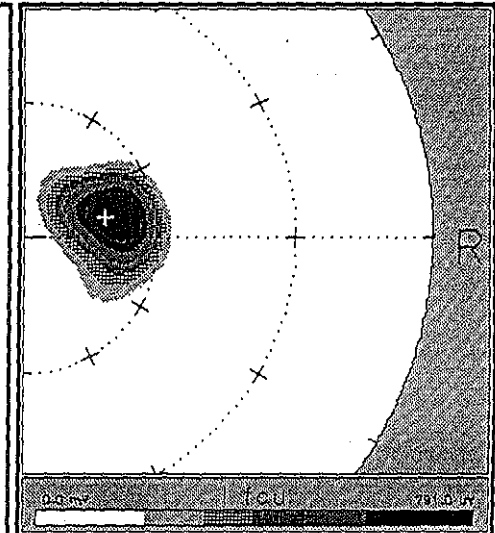
POST longitude: -21.1deg (-1.5ca) : -6.1deg (-0.4ca)

NEDL latitude : 5.7deg ( 2.8ca) : 13.3deg ( 2.7ca)

LATL latitude : 31.7deg ( 6.3ca) : 28.3deg ( 5.8ca)

Elongation : 4.6/4.5ca = 1.0 : 3.0/3.1ca = 1.0

Surface area : 15.2 ca2 : 7.3 ca2



URN: unspecified AGE: unspecified SEX: unspecified

DATE: Mon Sep 12 19:06:49 1994 - printed Tue Sep 27 13:33:45 1994.

FILE: /home/gary/pc/data/mapping/dylan/aart.flx

SERIES: mapping r fcu **CONTROL 2**

COMMENTS:

URN: unspecified AGE: unspecified SEX: unspecified

DATE: Mon Sep 12 17:34:49 1994 - printed Wed Sep 28 19:09:51 1994.

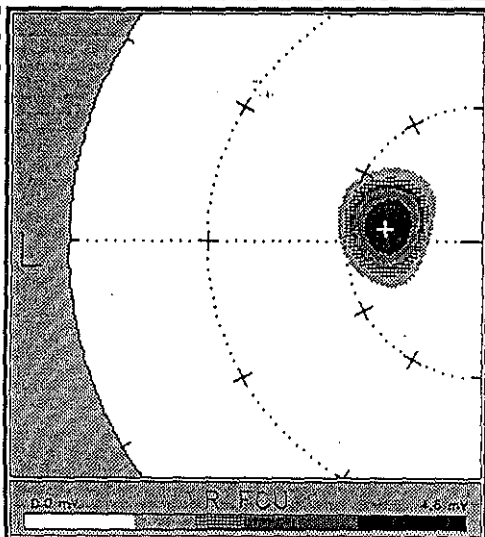
FILE: /home/gary/pc/data/mapping/dylan/aart.flx

SERIES: **CONTROL 2**

COMMENTS:

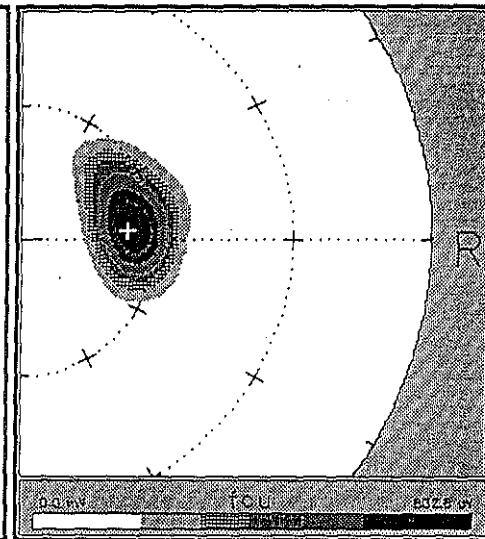
CALCULATION OPTIONS		DISPLAY OPTIONS	
Add zeroed sites: <input type="radio"/> around edges	Position map...: at 1 x 1 in a 1 x 1 grid [CLEAR MAP] [KEY] [PRO]	Map screen size: <input type="radio"/> 512x512 MAX RES	Viewing direction...: <input type="radio"/> Vertex
Limit calculation: <input type="radio"/> 1 deg outer limit	Upper threshold: <input type="radio"/> image	UT value (u,m,z)...:	LT value (u,m,z)...:
Set resolution...: <input type="radio"/> 256x256 matrix	Lower threshold: <input type="radio"/> sites	Colour table...: <input type="radio"/> 8&H 8 levels	Invert colour table: <input type="radio"/> yes
Interpolation...: <input type="radio"/> spline fit	Map background...: <input type="radio"/> white	Show grey scale key: <input type="radio"/> yes	Show reference grid: <input type="radio"/> black
Data source...: <input type="radio"/> MAXMIN	Show sites...: <input type="radio"/> no	MASKING & MAGNIFY OPTIONS	
SITE & RESTORE IMAGE		Draw with mask...: <input type="radio"/> yes, in min colour	Blow up image...: <input type="radio"/> no
Image label...: R FCU	Restore...: <input type="radio"/> full map	Add to mask...: <input type="radio"/> add pixels (min)	Brush width...: <input type="radio"/> 4
Restore & scaled: <input type="radio"/> no	<input type="button" value="Calculate"/> <input type="button" value="Draw"/> <input type="button" value="Quantitate"/> <input type="button" value="Save pixels"/> <input type="button" value="Save matrix"/> <input type="button" value="Retrieve"/> <input type="button" value="Hide"/> <input type="button" value="Quit"/>		

Clear data		Load data		Done	
Units: <input type="radio"/> mV	Loc: <input type="radio"/> Optimal	Ltr: <input type="radio"/> no	Neat: <input type="radio"/> all		
SITE: Real Fit	SITE: Real Fit	SITE: Real Fit			
-3,8: 3.75 4.91	-6,6: 0.08 0.07	-4,8: 4.32 3.75			
-5,2: 2.77 3.62	-7,8: 0.49 0.63	-4,2: 3.03 2.90			
-3,4: 0.67 0.89	-7,2: 0.88 0.96	-4,4: 1.52 1.49			
-5,6: 0.16 0.14	-7,4: 0.24 0.32	-4,-2: 0.59 0.36			
-5,-2: 1.33 1.28	-7,-2: 0.15 0.06	-3,8: 1.95 2.20			
-5,-4: 0.16 0.17	-6,8: 0.13 0.02	-3,2: 0.79 1.32			
-6,8: 2.74 2.45	-8,2: 0.18 0.12				
-6,2: 3.24 2.62	-8,4: 0.09 0.12				
-6,4: 0.68 0.65	-8,-2: 0.05 0.03				
-6,-2: 0.31 0.66	-9,8: 0.10 0.19				
-6,-4: 0.13 0.18	-9,2: 0.11 0.07				
Sum of squares error of fit is 3.48					
*Optimal* latitude is at 21.3deg ( 4.4ca)					
*Optimal* longitude is at 7.5 degrees ( 0.6 ca)					
-----: IMAGE > 50% : IMAGE > 75%					
COG latitude :	21.3deg ( 4.4ca) :	21.3deg ( 4.4ca)			
COG longitude :	10.2deg ( 0.8ca) :	10.0deg ( 0.7ca)			
ANT longitude :	39.2deg ( 2.9ca) :	29.0deg ( 2.2ca)			
POST longitude :	-16.8deg (-1.3ca) :	-6.0deg (-0.4ca)			
NEOL latitude :	13.3deg ( 2.7ca) :	15.3deg ( 3.1ca)			
LATL latitude :	29.3deg ( 6.0ca) :	27.3deg ( 5.6ca)			
Elongation :	4.2/3.0ca = 1.3 :	2.6/2.3ca = 1.1			
Surface area :	9.5 ca2 :	6.2 ca2			



CALCULATION OPTIONS		DISPLAY OPTIONS	
Add zeroed sites: <input type="radio"/> around edges	Position map...: at 1 x 1 in a 1 x 1 grid [CLEAR MAP] [KEY] [PRO]	Map screen size: <input type="radio"/> 512x512 MAX RES	Viewing direction...: <input type="radio"/> Vertex
Limit calculation: <input type="radio"/> 1 deg outer limit	Upper threshold: <input type="radio"/> image	UT value (u,m,z)...:	LT value (u,m,z)...:
Set resolution...: <input type="radio"/> 256x256 matrix	Lower threshold: <input type="radio"/> sites	Colour table...: <input type="radio"/> 8&H 8 levels	Invert colour table: <input type="radio"/> yes
Interpolation...: <input type="radio"/> spline fit	Map background...: <input type="radio"/> white	Show grey scale key: <input type="radio"/> yes	Show reference grid: <input type="radio"/> black
Data source...: <input type="radio"/> MAXMIN	Show sites...: <input type="radio"/> no	MASKING & MAGNIFY OPTIONS	
SAVE & RESTORE IMAGE		Draw with mask...: <input type="radio"/> yes, in min colour	Blow up image...: <input type="radio"/> no
Image label...: fcu	Restore...: <input type="radio"/> full map	Add to mask...: <input type="radio"/> add pixels (min)	Brush width...: <input type="radio"/> 4
Restore & scaled: <input type="radio"/> no	<input type="button" value="Calculate"/> <input type="button" value="Draw"/> <input type="button" value="Quantitate"/> <input type="button" value="Save pixels"/> <input type="button" value="Save matrix"/> <input type="button" value="Retrieve"/> <input type="button" value="Hide"/> <input type="button" value="Quit"/>		

Clear data		Load data		Done	
Units: <input type="radio"/> mV	Loc: <input type="radio"/> Optimal	Ltr: <input type="radio"/> no	Neat: <input type="radio"/> all		
SITE: Real Fit	SITE: Real Fit	SITE: Real Fit			
5,8: 0.05 0.76	6,-4: 0.08 0.07	4,8: 0.44 0.48			
5,2: 0.62 0.66	7,8: 0.30 0.43	4,2: 0.43 0.45			
5,4: 0.37 0.35	7,2: 0.33 0.40	4,4: 0.86 1.16			
5,6: 0.10 0.09	7,4: 0.20 0.24	4,-2: 0.07 0.11			
5,-2: 0.25 0.32	7,-2: 0.41 0.27	3,8: 0.19 0.29			
5,-4: 0.11 0.08	8,8: 0.16 0.19	3,2: 0.15 0.13			
6,8: 0.73 0.72	6,2: 0.37 0.23				
6,2: 0.62 0.62	8,4: 0.07 0.11				
6,4: 0.39 0.38	8,-2: 0.06 0.13				
6,8: 0.16 0.11	9,8: 0.06 0.02				
6,-2: 0.26 0.38	9,2: 0.06 0.11				
Sum of squares error of fit is 2.58					
*Optimal* latitude is at 23.0 degrees ( 4.8 ca)					
*Optimal* longitude is at 4.8 degrees ( 0.4 ca)					
-----: IMAGE > 50% : IMAGE > 75%					
COG latitude :	24.5deg ( 5.8ca) :	24.7deg ( 5.1ca)			
COG longitude :	9.3deg ( 0.8ca) :	7.4deg ( 0.6ca)			
ANT longitude :	43.3deg ( 3.5ca) :	28.4deg ( 2.4ca)			
POST longitude :	-29.7deg (-1.8ca) :	-19.6deg (-0.9ca)			
NEOL latitude :	16.3deg ( 3.4ca) :	19.7deg ( 4.6ca)			
LATL latitude :	34.5deg ( 7.1ca) :	31.7deg ( 6.5ca)			
Elongation :	5.6/3.7ca = 1.5 :	3.3/2.5ca = 1.4			
Surface area :	14.4 ca2 :	6.2 ca2			



URN: unspecified AGE: unspecified SEX: unspecified

DATE: Thu Sep 22 11:14:28 1994 - printed Thu Sep 22 13:00:25 1994.

FILE: /home/gary/pc/data/mapping/dylan/jart.fx

SERIES: mapping R FCU

COMMENTS: CONTROL 3

URN: unspecified AGE: unspecified SEX: unspecified

DATE: Thu Sep 22 10:14:25 1994 - printed Thu Sep 22 12:43:45 1994.

FILE: /home/gary/pc/data/mapping/dylan/jal.fx

SERIES: mapping L FCU

COMMENTS: CONTROL 3

**CALCULATION OPTIONS**

Add zeroed sites:  around edges  
 Limit calculation:  1 deg outer limit  
 Set resolution:  256x256 matrix  
 Interpolation:  spline fit  
 Data source:  AMP

**DISPLAY OPTIONS**

Position map...: at 1 x 1 in a 1 x 1 grid [CLEAR MAP] [KEY] [PRO]  
 Map screen size:  512x512 MAX RES Viewing direction:  Vertex  
 Upper threshold:  image UT value (u,m,t)....  
 Lower threshold:  sites LT value (u,m,t)....  
 Colour table:  8&H 8 levels Invert colour table:  yes  
 Map background:  white Show grey scale key:  yes  
 Show sites:  no Show reference grid:  black

**MASKING & MAGNIFY OPTIONS**

Draw with mask:  yes, in min colour Blow up image:  no  
 Add to mask:  add pixels (min) Brush width:  4

**SAVE & RESTORE IMAGE**

Image label: R FCU  
 Restore:  full map  
 Restore & scaled:  no

Calculate Draw Quantitate Save pixels Save matrix Retrieve Hide Quit

Clear data Load data Done

Units: mV Loc: Optimal Lta: no Head: all

SITE:	Real Fit	SITE:	Real Fit	SITE:	Real Fit
-6,8:	1.64 1.64	-5,2:	0.73 0.73		
-4,2:	1.06 1.10	-5,4:	0.89 0.92		
-6,4:	0.67 0.60	-3,-2:	0.17 0.11		
-6,-2:	0.21 0.29	-4,8:	0.43 0.47		
-7,8:	1.00 1.01	-4,2:	0.80 1.10		
-7,2:	1.08 0.85	-3,8:	0.00 0.05		
-7,4:	0.87 0.67				
-7,-2:	1.26 1.29				
-8,8:	0.96 0.11				
-8,2:	0.85 0.13				
-5,8:	1.31 1.27				

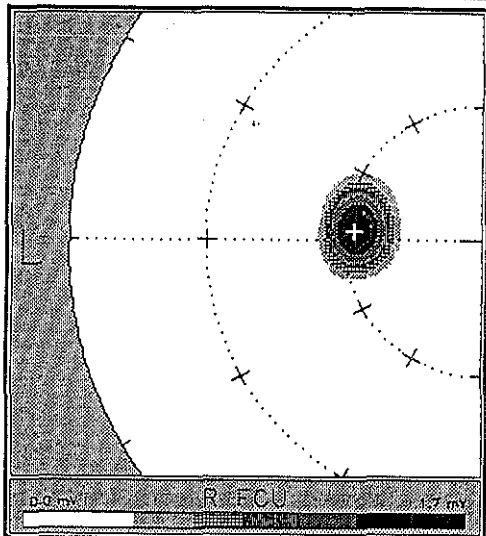
Sum of squares error of fit is 0.78

'Optimal' latitude is at 27.8 degrees ( 5.7 ca)  
 'Optimal' longitude is at 4.1 degrees ( 8.4 ca)

----- IMAGE > 50% : IMAGE > 75%

COG latitude:	27.2deg ( 5.6ca)	27.4deg ( 5.6ca)
COG longitude:	3.5deg ( 8.6ca)	3.0deg ( 9.5ca)
ANT longitude:	23.5deg ( 2.4ca)	19.0deg ( 1.3ca)
POST longitude:	-11.1deg (-1.6ca)	-5.2deg (-0.6ca)
HEAD latitude:	19.2deg ( 4.0ca)	21.4deg ( 4.4ca)
LATL latitude:	34.2deg ( 7.8ca)	32.4deg ( 6.7ca)
Elongation:	3.5/3.1ca = 1.1	2.5/2.3ca = 1.1
Surface area:	7.6 ca2	3.5 ca2

R FCU



**CALCULATION OPTIONS**

Add zeroed sites:  around edges  
 Limit calculation:  1 deg outer limit  
 Set resolution:  256x256 matrix  
 Interpolation:  spline fit  
 Data source:  MAXMIN

**DISPLAY OPTIONS**

Position map...: at 1 x 1 in a 1 x 1 grid [CLEAR MAP] [KEY] [PRO]  
 Map screen size:  512x512 MAX RES Viewing direction:  Vertex  
 Upper threshold:  image UT value (u,m,t)....  
 Lower threshold:  sites LT value (u,m,t)....  
 Colour table:  8&H 8 levels Invert colour table:  yes  
 Map background:  white Show grey scale key:  yes  
 Show sites:  no Show reference grid:  black

**MASKING & MAGNIFY OPTIONS**

Draw with mask:  yes, in min colour Blow up image:  no  
 Add to mask:  add pixels (min) Brush width:  4

**SAVE & RESTORE IMAGE**

Image label: L FCU  
 Restore:  full map  
 Restore & scaled:  no

Calculate Draw Quantitate Save pixels Save matrix Retrieve Hide Quit

Clear data Load data Done

Units: mV Loc: Optimal Lta: no Head: all

SITE:	Real Fit	SITE:	Real Fit	SITE:	Real Fit
5,8:	1.24 1.10	6,-4:	0.67 0.66	9,2:	0.16 0.22
5,2:	1.64 1.55	7,0:	0.64 0.75	9,4:	0.10 0.21
5,4:	1.16 0.96	7,2:	1.27 1.30	4,8:	0.70 0.68
5,6:	0.17 0.15	7,4:	1.12 1.15	4,2:	0.67 0.64
5,-2:	0.35 0.37	7,6:	0.27 0.18	4,4:	0.31 0.32
5,-4:	0.12 0.05	7,-2:	0.34 0.25	4,-2:	0.05 0.14
6,8:	0.92 1.09	8,4:	0.34 0.41	3,8:	0.22 0.22
6,2:	1.76 1.70	8,2:	0.99 0.66	3,2:	0.17 0.17
6,4:	1.07 1.22	6,4:	0.93 0.89		
6,6:	0.11 0.23	8,6:	0.69 0.14		
6,-2:	0.40 0.40	8,8:	0.10 0.06		

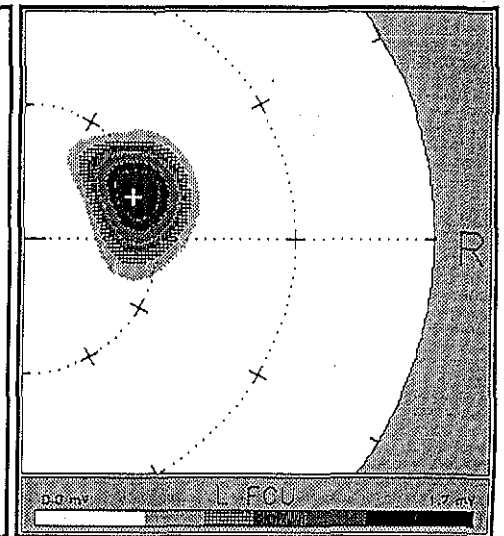
Sum of squares error of fit is 1.58

'Optimal' latitude is at 26.2 degrees ( 5.4 ca)  
 'Optimal' longitude is at 20.7 degrees ( 1.9 ca)

----- IMAGE > 50% : IMAGE > 75%

COG latitude:	26.9deg ( 5.5ca)	27.1deg ( 5.6ca)
COG longitude:	21.4deg ( 2.0ca)	21.0deg ( 2.0ca)
ANT longitude:	46.4deg ( 4.5ca)	39.0deg ( 3.7ca)
POST longitude:	-6.6deg (-0.6ca)	5.0deg ( 0.5ca)
HEAD latitude:	17.9deg ( 3.7ca)	21.1deg ( 4.3ca)
LATL latitude:	38.9deg ( 8.6ca)	35.1deg ( 7.2ca)
Elongation:	5.1/4.3ca = 1.2	3.2/2.9ca = 1.1
Surface area:	15.2 ca2	6.8 ca2

L FCU



DATE: Fri Sep 23 11:40:07 1994 - printed Tue Sep 27 12:19:20 1994.

FILE: /home/gary/pc/data/mapping/dylan/sclr.flx

SERIES: mapping R FCU CONTROL 4

COMMENTS:

URN: unspecified AGE: unspecified SEX: unspecified

DATE: Fri Sep 23 10:55:48 1994 - printed Mon Sep 26 17:36:32 1994.

FILE: /home/gary/pc/data/mapping/dylan/scl.flx

SERIES: CONTROL 4

COMMENTS: map of left fcu

**CALCULATION OPTIONS**

Add zeroed sites.:  around edges  
 Limit calculation.:  1 deg outer limit  
 Set resolution...:  256x256 matrix  
 Interpolation...:  spline fit  
 Data source...:  MAXMIN

**DISPLAY OPTIONS**

Position map...: at 1 x 1 in a 1 x 1 grid [CLEAR MAP] [KEY] [PRO]  
 Map screen size:  512x512 MAX RES Viewing direction...:  Vertex  
 Upper threshold:  image UT value (u,m,x)...:  
 Lower threshold:  sites LT value (u,m,x)...:  
 Colour table...:  8&W 8 levels Invert colour table:  yes  
 Map background.:  white Show grey scale key:  yes  
 Show sites...:  no Show reference grid:  black

**MASKING & MAGNIFY OPTIONS**

Draw with mask.:  yes, in min colour Blow up image...:  no  
 Add to mask...:  add pixels (min) Brush width...:  4

**SAVE & RESTORE IMAGE**

Image label...: R FCU  
 Restore...:  full map  
 Restore & scaled.:  no

Calculate Draw Quantitate Save pixels Save matrix Retrieve Hide Quit

Clear data Load data Done

Units:  MV Loc:  Optimal Lis:  no Keels:  all

SITE:	Real	Fit	SITE:	Real	Fit	SITE:	Real	Fit
-6,-2:	2.84	2.34	-8,-2:	8.18	8.97	-4,-2:	1.52	1.55
-6,-4:	1.83	8.98	-8,-2:	8.15	8.11	-4,-4:	8.45	-8.06
-6,-6:	8.86	-6.84	-5,-1:	2.85	3.32	-3,-8:	1.67	1.37
-6,-2:	2.41	2.49	-5,-2:	3.67	3.38	-3,-2:	8.17	8.79
-6,-4:	8.16	8.43	-5,-4:	8.63	1.18	-3,-2:	8.16	8.22
-7,-1:	2.16	1.46	-5,-6:	8.18	-8.46	-2,-1:	8.18	-8.28
-7,-2:	8.93	8.84	-5,-2:	3.12	2.67	-6,-1:	2.47	2.66
-7,-4:	8.47	8.12	-5,-4:	8.39	8.47			
-7,-2:	1.13	1.23	-4,-1:	2.97	2.72			
-7,-4:	8.14	8.44	-4,-2:	3.22	2.61			
-8,-1:	8.16	8.51	-4,-4:	8.11	-8.05			

Sum of squares error of fit is 3.08

'Optimal' latitude is at 21.9 degrees ( 4.5 ca)  
 'Optimal' longitude is at 13.8 degrees ( 1.1 ca)

----- IMAGE > 508 ----- IMAGE > 758

COG latitude: 22.3deg ( 4.6ca) : 22.2deg ( 4.6ca)  
 COG longitude: 3.1deg ( 8.2ca) : 5.1deg ( 8.4ca)  
 ANT longitude: 45.1deg ( 3.3ca) : 36.1deg ( 2.8ca)  
 POST longitude: -34.9deg (-2.7ca) : -22.5deg (-1.8ca)  
 MEDL latitude: 14.3deg ( 2.8ca) : 17.2deg ( 3.5ca)  
 LATL latitude: 31.3deg ( 8.4ca) : 27.2deg ( 5.6ca)  
 Elongation: 5.2/3.3ca = 1.8 : 4.6/2.1ca = 2.2  
 Surface area: 16.2 ca2 : 8.1 ca2

D.M.V. R FCU 4.6 MV

**CALCULATION OPTIONS**

Add zeroed sites.:  around edges  
 Limit calculation.:  1 deg outer limit  
 Set resolution...:  256x256 matrix  
 Interpolation...:  spline fit  
 Data source...:  none selected!

**DISPLAY OPTIONS**

Position map...: at 1 x 1 in a 1 x 1 grid [CLEAR MAP] [KEY] [PRO]  
 Map screen size:  512x512 MAX RES Viewing direction...:  Vertex  
 Upper threshold:  image UT value (u,m,x)...:  
 Lower threshold:  sites LT value (u,m,x)...:  
 Colour table...:  8&W 8 levels Invert colour table:  yes  
 Map background.:  white Show grey scale key:  yes  
 Show sites...:  no Show reference grid:  black

**MASKING & MAGNIFY OPTIONS**

Draw with mask.:  no Blow up image...:  no  
 Add to mask...:  clear mask Brush width...:  4

**SAVE & RESTORE IMAGE**

Image label...: left fcu  
 Restore...:  full map  
 Restore & scaled.:  no

Calculate Draw Quantitate Save pixels Save matrix Retrieve Hide Quit

Clear data Load data Done

Units:  UV Loc:  Optimal Lis:  no Keels:  all

SITE:	Real	Fit	SITE:	Real	Fit	SITE:	Real	Fit
4,-2:	198	61	6,-4:	289	388	8,-4:	8	8
4,-4:	151	131	7,-4:	61	188	8,-2:	58	106
4,-2:	68	154	7,-2:	528	678	8,-1:	51	151
5,-2:	222	246	7,-1:	1245	1948	8,-2:	129	139
5,-1:	352	572	7,-2:	874	828	8,-1:	8	-16
5,-2:	578	543	7,-4:	498	322	18,-2:	8	-31
5,-4:	338	233	8,-4:	66	61	18,-1:	8	-76
6,-4:	171	98	8,-2:	735	541	18,-2:	8	18
6,-2:	598	548	8,-1:	688	687			
6,-1:	828	1824	8,-2:	648	537			
6,-2:	945	867	8,-4:	73	137			

Sum of squares error of fit is 3.58

'Optimal' latitude is at 36.2 degrees ( 6.2 ca)  
 'Optimal' longitude is at 2.3 degrees ( 8.2 ca)

----- IMAGE > 508 ----- IMAGE > 758

COG latitude: 29.9deg ( 6.1ca) : 30.2deg ( 6.2ca)  
 COG longitude: 4.1deg ( 8.1ca) : 3.7deg ( 8.1ca)  
 ANT longitude: 32.1deg ( 3.3ca) : 21.7deg ( 2.2ca)  
 POST longitude: -19.9deg (-2.8ca) : -12.3deg (-1.3ca)  
 MEDL latitude: 22.9deg ( 4.7ca) : 25.2deg ( 5.2ca)  
 LATL latitude: 38.9deg ( 8.9ca) : 36.2deg ( 7.4ca)  
 Elongation: 5.3/3.3ca = 1.6 : 3.5/2.3ca = 1.6  
 Surface area: 13.2 ca2 : 5.8 ca2

D.M.V. left fcu 4.6 MV

URN: unspecified AGE: 19 years SEX: unspecified

DATE: Wed Oct 05 15:09:50 1994 - printed Thu Oct 6 15:21:56 1994.

FILE: /home/gary/pc/data/mapping/dylan/jert.flx

SERIES: mapping FCU CONTROL 5

COMMENTS: CONTROL DATA

URN: unspecified AGE: 19 years SEX: unspecified

DATE: Wed Oct 05 16:16:30 1994 - printed Fri Oct 7 18:53:37 1994.

FILE: /home/gary/pc/data/mapping/dylan/jel.flx

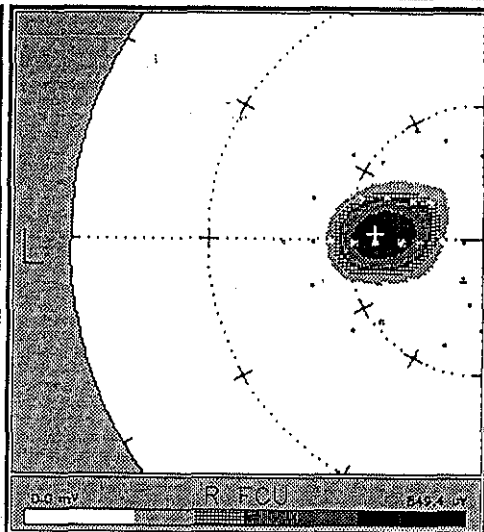
SERIES: mapping Left FCU CONTROL 5

COMMENTS: CONTROL DATA

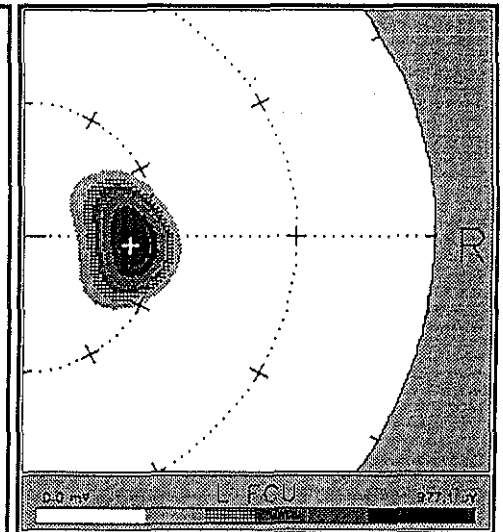
CALCULATION OPTIONS		DISPLAY OPTIONS	
Add zeroed sites.: <input type="radio"/> around edges	Position map...: at 1 x 1 in a 1 x 1 grid [CLEAR MAP] [KEY] [PRO]	Map screen size: <input type="radio"/> 512x512 MAX RES	Viewing direction...: <input type="radio"/> Vortex
Limit calculation: <input type="radio"/> 1 deg outer limit	Upper threshold: <input type="radio"/> image	UT value (u,m,z)...:	
Set resolution...: <input type="radio"/> 256x256 matrix	Lower threshold: <input type="radio"/> sites	LT value (u,m,z)...:	
Interpolation...: <input type="radio"/> spline fit	Colour table...: <input type="radio"/> B&W & levels	Invert colour table: <input type="radio"/> yes	
Data source...: <input type="radio"/> AMP	Map background.: <input type="radio"/> white	Show gray scale key: <input type="radio"/> yes	
	Show sites...: <input checked="" type="radio"/> black	Show reference grid: <input type="radio"/> black	
SAVE & RESTORE IMAGE			
Image label...: R FCU	Restore...: <input type="radio"/> full map	Draw with mask.: <input type="radio"/> yes, in min colour	Blow up image...: <input type="radio"/> no
	Restore & scaled.: <input type="radio"/> no	Add to mask...: <input type="radio"/> creates default mask/brush width...	<input type="radio"/> 4
<input type="button" value="Calculate"/>	<input type="button" value="Draw"/>	<input type="button" value="Quantitate"/>	<input type="button" value="Save pixels"/>
<input type="button" value="Save matrix"/>	<input type="button" value="Retrieve"/>	<input type="button" value="Quit"/>	

CALCULATION OPTIONS		DISPLAY OPTIONS	
Add zeroed sites.: <input type="radio"/> around edges	Position map...: at 1 x 1 in a 1 x 1 grid [CLEAR MAP] [KEY] [PRO]	Map screen size: <input type="radio"/> 512x512 MAX RES	Viewing direction...: <input type="radio"/> Vortex
Limit calculation: <input type="radio"/> 1 deg outer limit	Upper threshold: <input type="radio"/> image	UT value (u,m,z)...:	
Set resolution...: <input type="radio"/> 256x256 matrix	Lower threshold: <input type="radio"/> sites	LT value (u,m,z)...:	
Interpolation...: <input type="radio"/> spline fit	Colour table...: <input type="radio"/> B&W & levels	Invert colour table: <input type="radio"/> yes	
Data source...: <input type="radio"/> MAXMIN	Map background.: <input type="radio"/> white	Show gray scale key: <input type="radio"/> yes	
	Show sites...: <input type="radio"/> no	Show reference grid: <input type="radio"/> black	
SAVE & RESTORE IMAGE			
Image label...: L FCU	Restore...: <input type="radio"/> full map	Draw with mask.: <input type="radio"/> yes, in min colour	Blow up image...: <input type="radio"/> no
	Restore & scaled.: <input type="radio"/> no	Add to mask...: <input type="radio"/> creates default mask/brush width...	<input type="radio"/> 4
<input type="button" value="Calculate"/>	<input type="button" value="Draw"/>	<input type="button" value="Quantitate"/>	<input type="button" value="Save pixels"/>
<input type="button" value="Save matrix"/>	<input type="button" value="Retrieve"/>	<input type="button" value="Quit"/>	

Clear data		Load data		Done	
Units: <input type="radio"/> mV	Locs: <input type="radio"/> Optimal	Line: <input type="radio"/> no	Heal: <input type="radio"/> all		
SITE: Real Fit	SITE: Real Fit	SITE: Real Fit	SITE: Real Fit		
-5,0: 0.54 0.04	-7,2: 0.10 0.12	-3,-2: 0.35 0.12			
-5,2: 0.32 0.45	-7,-2: 0.16 0.13	-4,0: 0.54 0.75			
-5,4: 0.82 0.45	-6,0: 0.08 0.02	-2,0: 0.09 0.25			
-5,-2: 0.29 0.24	-4,0: 0.63 0.75	-2,2: 0.96 0.07			
-5,-4: 0.66 0.47	-4,2: 0.50 0.40				
-6,0: 0.65 0.71	-4,4: 0.07 0.09				
-6,2: 0.37 0.34	-4,-2: 0.20 0.21				
-4,4: 0.11 0.06	-4,-4: 0.03 0.05				
-6,-2: 0.14 0.22	-3,0: 0.04 0.37				
-4,-4: 0.96 0.02	-3,2: 0.31 0.32				
-7,0: 0.20 0.35	-3,4: 0.09 0.06				
Sum of squares error of fit is 6.28					
*Optimal* latitude is at 23.7 degrees ( 4.9 ca)					
*Optimal* longitude is at 2.9 degrees ( 8.2 ca)					
IMAGE > 500	IMAGE > 750				
COG latitude: 21.7deg ( 4.3ca)	22.1deg ( 4.5ca)				
COG longitude: 3.8deg ( 0.3ca)	3.4deg ( 0.3ca)				
ANT longitude: 27.8deg ( 2.1ca)	18.4deg ( 1.4ca)				
POST longitude: -16.2deg (-1.2ca)	-9.6deg (-0.7ca)				
NEGL latitude: 18.7deg ( 2.2ca)	14.1deg ( 2.3ca)				
LATL latitude: 32.7deg ( 6.7ca)	25.1deg ( 5.8ca)				
Elongation: 7.3/4.3ca = 0.7	2.2/3.1ca = 0.7				
Surface area: 11.6 ca2	4.5 ca2				



Clear data		Load data		Done	
Units: <input type="radio"/> mV	Locs: <input type="radio"/> Optimal	Line: <input type="radio"/> no	Heal: <input type="radio"/> all		
SITE: Real Fit	SITE: Real Fit	SITE: Real Fit	SITE: Real Fit		
5,0: 1.01 0.02	7,2: 0.22 0.22	3,-2: 0.20 0.24			
5,2: 0.02 0.04	7,-2: 0.46 0.04	3,-2: 0.14 0.16			
5,4: 0.07 0.11	7,-4: 0.10 0.06	2,0: 0.09 0.14			
5,-2: 0.70 0.65	0,0: 0.11 0.12				
5,-4: 0.11 0.15	0,-2: 0.13 0.12				
6,0: 0.90 0.09	4,0: 0.41 0.67				
6,2: 0.47 0.55	4,2: 0.30 0.46				
6,4: 0.11 0.11	4,4: 0.09 0.05				
6,-2: 0.70 0.72	4,-2: 0.30 0.41				
6,-4: 0.15 0.10	4,-4: 0.13 0.10				
7,0: 0.62 0.50	3,0: 0.50 0.32				
Sum of squares error of fit is 3.58					
*Optimal* latitude is at 23.0 degrees ( 4.9 ca)					
*Optimal* longitude is at -4.0 degrees (-8.4 ca)					
IMAGE > 500	IMAGE > 750				
COG latitude: 23.3deg ( 4.8ca)	23.9deg ( 4.9ca)				
COG longitude: -1.6deg (-1.1ca)	-2.2deg (-0.2ca)				
ANT longitude: 30.4deg ( 2.5ca)	10.0deg ( 1.6ca)				
POST longitude: -30.6deg (-2.5ca)	-21.2deg (-1.8ca)				
NEGL latitude: 16.3deg ( 3.3ca)	10.9deg ( 3.8ca)				
LATL latitude: 33.3deg ( 6.8ca)	30.9deg ( 6.4ca)				
Elongation: 5.6/2.3ca = 1.4	3.0/2.5ca = 1.4				
Surface area: 12.5 ca2	5.7 ca2				





URN: unspecified AGE: 28 years SEX: female

DATE: Mon Oct 10 15:23:44 1994 - printed Mon Oct 10 18:39:29 1994.

FILE: /home/gary/pc/data/mapping/dylan/mtrt.flx2

SERIES: Control **CONTRX 6**

COMMENTS: Right FCU - Dominant

URN: unspecified AGE: 28 years SEX: female

DATE: Mon Oct 10 16:38:55 1994 - printed Mon Oct 10 17:57:10 1994.

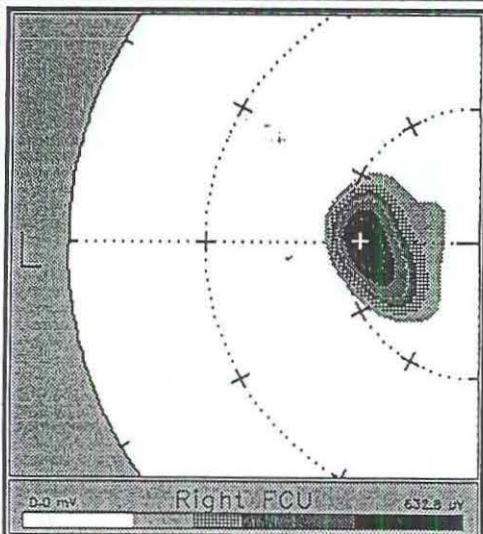
FILE: /home/gary/pc/data/mapping/dylan/mlt.flx2

SERIES: Control **CONTROL 6**

COMMENTS: Left FCU - NonDominant

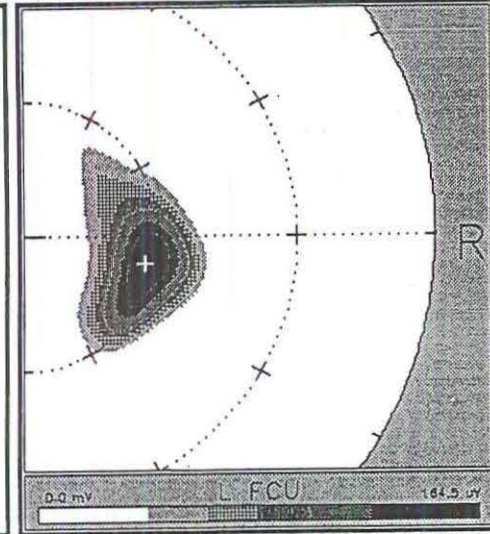
CALCULATION OPTIONS		DISPLAY OPTIONS	
Add zeroed sites.: <input type="radio"/> around edges	Position map...: at 1 x 1 in a 1 x 1 grid [CLEAR MAP] [KEY] [PRO]	Map screen size: <input type="radio"/> 512x512 MAX RES	Viewing direction...: <input type="radio"/> Vertex
Limit calculation: <input type="radio"/> 1 deg outer limit	Upper threshold: <input type="radio"/> image	UT value (u,m,z)...:	Lower threshold: <input type="radio"/> sites
Set resolution...: <input type="radio"/> 256x256 matrix	Interpolation...: <input type="radio"/> spline fit	Colour table...: <input type="radio"/> 8&M 8 levels	LT value (u,m,z)...:
Data source...: <input type="radio"/> AMP		Map background...: <input type="radio"/> white	Invert colour table: <input type="radio"/> yes
		Show sites...: <input type="radio"/> no	Show grey scale key: <input type="radio"/> yes
			Show reference grid: <input type="radio"/> black
SAVE & RESTORE IMAGE		MASKING & MAGNIFY OPTIONS	
Image label...: Right FCU	Draw with mask...: <input type="radio"/> yes, in min colour	Blow up image...: <input type="radio"/> no	Restore & scaled...: <input type="radio"/> no
Restore...: <input type="radio"/> full map	Add to mask...: <input type="radio"/> create default mask	maskrush width...: <input type="radio"/> 4	
Restore & scaled...: <input type="radio"/> no			
Calculate	Draw	Quantitate	Save pixels
Save matrix	Retrieve	Quit	

Clear data		Load data		Done	
Units: <input type="radio"/> mV	Loc: <input type="radio"/> Optimal	Lin: <input type="radio"/> no	Heel: <input type="radio"/> all		
SITE: Real Fit	SITE: Real Fit	SITE: Real Fit	SITE: Real Fit		
-4,2: 0.14 0.19	-6,2: 0.52 0.39				
-4,8: 0.44 0.39	-6,4: 0.14 0.19				
-4,4: 0.87 0.87	-7,8: 0.19 0.24				
-4,-2: 0.21 0.30	-7,2: 0.89 0.18				
-4,-4: 0.17 0.14	-7,-2: 0.17 0.83				
-5,8: 0.43 0.64	-3,8: 0.31 0.26				
-5,2: 0.31 0.34	-3,2: 0.17 0.16				
-5,4: 0.85 0.85	-3,-2: 0.24 0.23				
-5,-2: 0.73 0.40	-2,8: 0.22 0.19				
-5,-4: 0.16 0.17					
-6,8: 0.71 0.50					
Sum of squares error of fit is 0.78					
'Optimal' latitude is at 26.1 degree ( 5.4 ca)					
'Optimal' longitude is at 8.9 degree ( 8.1 ca)					
IMAGE > 50%		IMAGE > 75%			
COG latitude: 23.2deg ( 4.8ca)	24.3deg ( 5.8ca)				
COG longitude: -3.3deg (-8.3ca)	-1.7deg (-8.1ca)				
ANT latitude: 28.7deg ( 2.3ca)	19.3deg ( 1.6ca)				
POST longitude: -35.3deg (-2.3ca)	-18.7deg (-1.6ca)				
MEDL latitude: 14.2deg ( 2.9ca)	18.3deg ( 3.8ca)				
LATL latitude: 31.2deg ( 6.4ca)	38.3deg ( 6.2ca)				
Elongation: 5.2/3.5ca = 1.5	3.2/2.5ca = 1.3				
Surface area: 12.9 ca2	5.6 ca2				



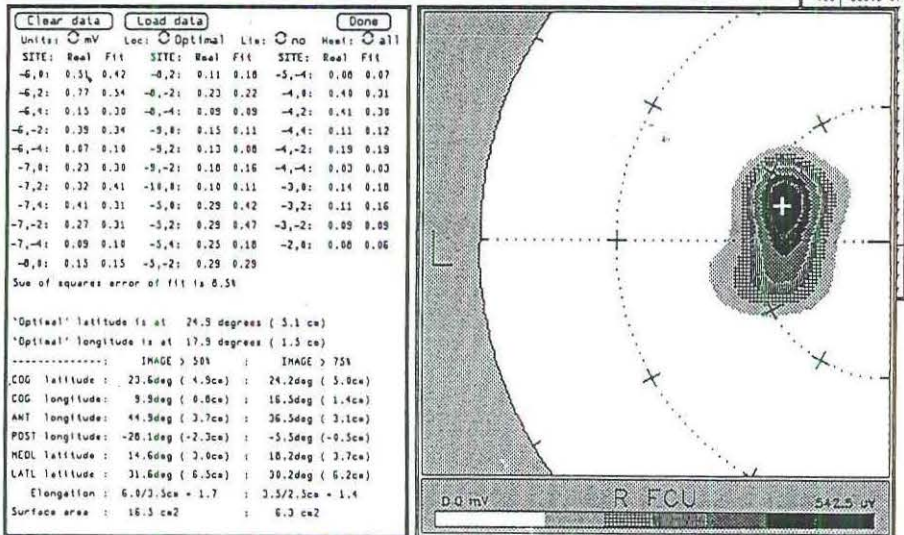
CALCULATION OPTIONS		DISPLAY OPTIONS	
Add zeroed sites.: <input type="radio"/> around edges	Position map...: at 1 x 1 in a 1 x 1 grid [CLEAR MAP] [KEY] [PRO]	Map screen size: <input type="radio"/> 512x512 MAX RES	Viewing direction...: <input type="radio"/> Vertex
Limit calculation: <input type="radio"/> 1 deg outer limit	Upper threshold: <input type="radio"/> image	UT value (u,m,z)...:	Lower threshold: <input type="radio"/> sites
Set resolution...: <input type="radio"/> 256x256 matrix	Interpolation...: <input type="radio"/> spline fit	Colour table...: <input type="radio"/> 8&M 8 levels	LT value (u,m,z)...:
Data source...: <input type="radio"/> MAXMIN		Map background...: <input type="radio"/> white	Invert colour table: <input type="radio"/> yes
		Show sites...: <input type="radio"/> no	Show grey scale key: <input type="radio"/> yes
			Show reference grid: <input type="radio"/> black
SAVE & RESTORE IMAGE		MASKING & MAGNIFY OPTIONS	
Image label...: FCU	Draw with mask...: <input type="radio"/> yes, in min colour	Blow up image...: <input type="radio"/> no	Restore & scaled...: <input type="radio"/> no
Restore...: <input type="radio"/> full map	Add to mask...: <input type="radio"/> create default mask	maskrush width...: <input type="radio"/> 4	
Restore & scaled...: <input type="radio"/> no			
Calculate	Draw	Quantitate	Save pixels
Save matrix	Retrieve	Quit	

Clear data		Load data		Done	
Units: <input type="radio"/> mV	Loc: <input type="radio"/> Optimal	Lin: <input type="radio"/> no	Heel: <input type="radio"/> all		
SITE: Real Fit	SITE: Real Fit	SITE: Real Fit	SITE: Real Fit		
4,8: 0.87 0.87	6,-2: 0.16 0.16				
4,2: 0.87 0.86	6,-4: 0.15 0.12				
4,-2: 0.87 0.86	6,-6: 0.84 0.84				
4,-4: 0.84 0.82	7,8: 0.18 0.12				
5,8: 0.18 0.13	7,-2: 0.11 0.13				
5,2: 0.88 0.88	7,-4: 0.88 0.89				
5,4: 0.85 0.85	7,2: 0.87 0.85				
5,-2: 0.14 0.13	8,8: 0.87 0.87				
5,-4: 0.85 0.88	8,-2: 0.18 0.89				
6,8: 0.18 0.15	6,4: 0.83 0.83				
6,2: 0.86 0.88	3,8: 0.84 0.84				
Sum of squares error of fit is 2.78					
'Optimal' latitude is at 27.6 degree ( 5.7 ca)					
'Optimal' longitude is at -12.6 degree (-1.2 ca)					
IMAGE > 50%		IMAGE > 75%			
COG latitude: 26.3deg ( 5.3ca)	27.5deg ( 5.6ca)				
COG longitude: -14.4deg (-1.3ca)	-14.2deg (-1.3ca)				
ANT latitude: 28.6deg ( 1.5ca)	5.8deg ( 8.9ca)				
POST longitude: -58.4deg (-4.7ca)	-29.2deg (-3.7ca)				
MEDL latitude: 17.3deg ( 3.7ca)	22.5deg ( 4.6ca)				
LATL latitude: 37.3deg ( 7.8ca)	34.5deg ( 7.1ca)				
Elongation: 6.6/4.1ca = 1.6	4.6/2.5ca = 1.9				
Surface area: 18.2 ca2	8.3 ca2				



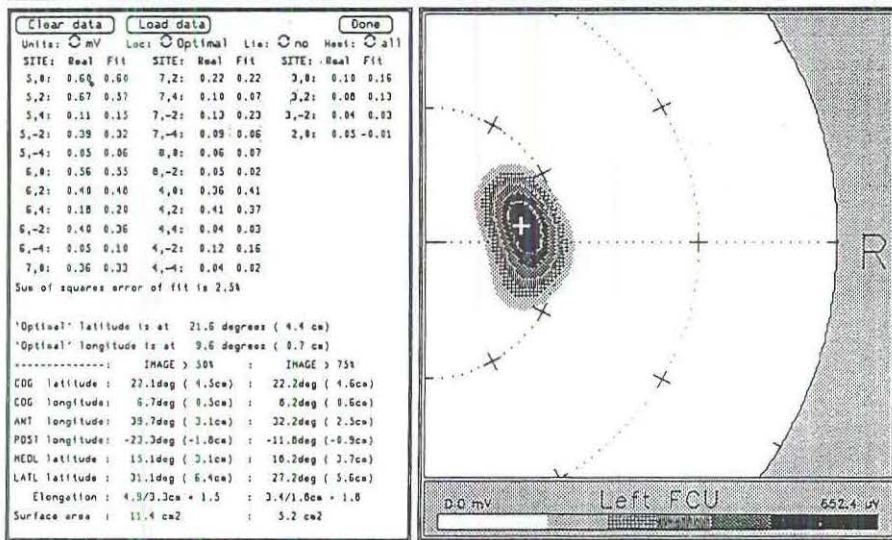
URN: unspecified AGE: 22 years SEX: male  
 DATE: Tue Oct 25 09:59:50 1994 - printed Mon Nov 7 17:50:32 1994.  
 FILE: /home/gary/pc/data/mapping/dylan/rsrt.flx  
 SERIES: Control - Weighdlifung **CONTROL 7**  
 COMMENTS: R FCU - Dominant

CALCULATION OPTIONS		DISPLAT OPTIONS	
Add zeroed sites: <input type="radio"/> around edges	Position map...: at 1 x 1 in a 1 x 1 grid [CLEAR MAP] [KEY] [PRO]	Map screen size: <input type="radio"/> 512x512 MAX RES	Viewing direction...: <input type="radio"/> Vertex
Limit calculation: <input type="radio"/> 1 deg outer limit	Upper threshold: <input type="radio"/> image	UT value (u,m,z)...:	Lower threshold: <input type="radio"/> sites
Set resolution...: <input type="radio"/> 256x256 matrix	Interpolation...: <input type="radio"/> spline fit	Colour table...: <input type="radio"/> 8&W & levels	Invert colour table: <input type="radio"/> yes
Data source...: <input type="radio"/> AMP	Map background...: <input type="radio"/> white	Show grey scale key: <input type="radio"/> yes	Map background...: <input type="radio"/> white
Image label...: R FCU	Show sites...: <input type="radio"/> no	Show reference grid: <input type="radio"/> black	
Restore...: <input type="radio"/> full map	Draw with mask: <input type="radio"/> yes, in min colour	Blow up image...: <input type="radio"/> no	
Restore % scaled: <input type="radio"/> no	Add to mask...: <input type="radio"/> create default maskrush width...: 4		
Calculate	Draw	Quantitate	Save pixels
Save matrix	Retrieve	TherWorks	Quit



URN: unspecified AGE: 22 years SEX: male  
 DATE: Tue Oct 25 11:14:51 1994 - printed Mon Nov 7 17:00:12 1994.  
 FILE: /home/gary/pc/data/mapping/dylan/rsl.flx  
 SERIES: Control **CONTROL 7**  
 COMMENTS: L FCU - Non-Dominant

CALCULATION OPTIONS		DISPLAY OPTIONS	
Add zeroed sites: <input type="radio"/> around edges	Position map...: at 1 x 1 in a 1 x 1 grid [CLEAR MAP] [KEY] [PRO]	Map screen size: <input type="radio"/> 512x512 MAX RES	Viewing direction...: <input type="radio"/> Vertex
Limit calculation: <input type="radio"/> 1 deg outer limit	Upper threshold: <input type="radio"/> image	UT value (u,m,z)...:	Lower threshold: <input type="radio"/> sites
Set resolution...: <input type="radio"/> 256x256 matrix	Interpolation...: <input type="radio"/> spline fit	Colour table...: <input type="radio"/> 8&W & levels	Invert colour table: <input type="radio"/> yes
Data source...: <input type="radio"/> AMP	Map background...: <input type="radio"/> white	Show grey scale key: <input type="radio"/> yes	Map background...: <input type="radio"/> white
Image label...: Left FCU	Show sites...: <input type="radio"/> no	Show reference grid: <input type="radio"/> black	
Restore...: <input type="radio"/> full map	Draw with mask: <input type="radio"/> yes, in min colour	Blow up image...: <input type="radio"/> no	
Restore % scaled: <input type="radio"/> no	Add to mask...: <input type="radio"/> create default maskrush width...: 4		
Calculate	Draw	Quantitate	Save pixels
Save matrix	Retrieve	TherWorks	Quit



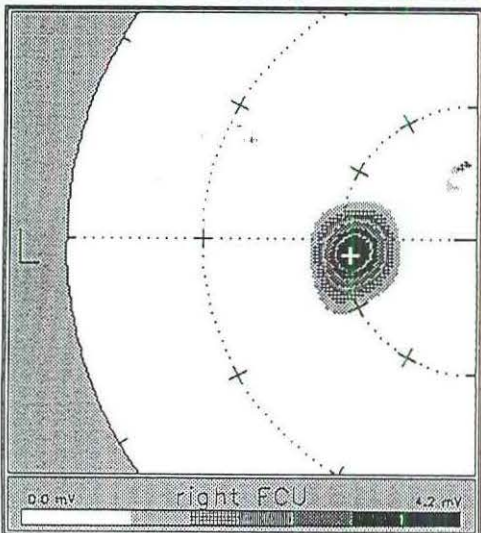


URN: unspecified AGE: 29 years SEX: male  
 DATE: Mon Dec 12 11:38:37 1994 - printed Sat Dec 17 16:08:17 1994.  
 FILE: /home/gary/pc/data/mapping/dylan/bprt.flx  
 SERIES: CONTROL *CONTROL 8*  
 COMMENTS: RIGHT HAND NON-DOMINANT

URN: unspecified AGE: unspecified SEX: unspecified  
 DATE: Mon Dec 12 12:45:57 1994 - printed Sat Dec 17 15:45:11 1994.  
 FILE: /home/gary/pc/data/mapping/dylan/bpl.flx  
 SERIES: control *CONTROL 8*  
 COMMENTS: left, non-dominant arm

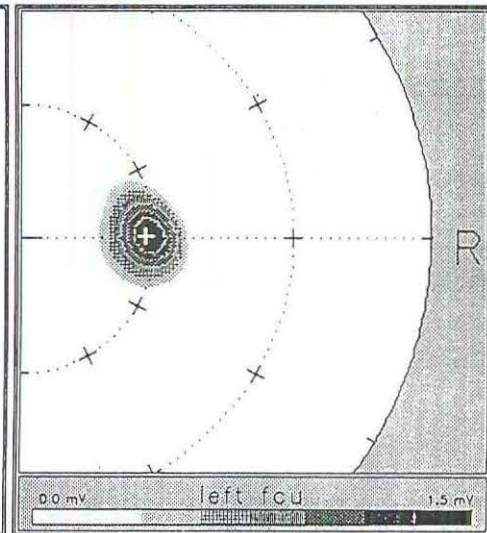
CALCULATION OPTIONS		DISPLAY OPTIONS	
Add zeroed sites.: <input type="radio"/> around edges	Limit calculation: <input type="radio"/> 1 deg outer limit	Position map...: at 1 x 1 in a 1 x 1 grid [CLEAR MAP] [KEY] [PRO]	Map screen size: <input type="radio"/> 512x512 MAX RES
Set resolution...: <input type="radio"/> 256x256 matrix	Interpolation...: <input type="radio"/> spline fit	Viewing direction...: <input type="radio"/> Vertex	Upper threshold: <input type="radio"/> image
Data source...: <input type="radio"/> AMP		UT value (u,m,%)...:	Lower threshold: <input type="radio"/> sites
		LT value (u,m,%)...:	Colour table...: <input type="radio"/> B&W 8 levels
			Invert colour table: <input type="radio"/> yes
			Map background...: <input type="radio"/> white
			Show grey scale key: <input type="radio"/> yes
			Show sites...: <input type="radio"/> no
			Show reference grid: <input type="radio"/> black
WASKING & MAGNIFY OPTIONS			
Draw with mask...: <input type="radio"/> yes, in min colour	Blow up image...: <input type="radio"/> no		
Add to mask...: <input type="radio"/> create default mask	maskrush width...: <input type="radio"/> 4		
SAVE & RESTORE IMAGE			
Image label...: right FCU			
Restore...: <input type="radio"/> full map			
Restore & scaled...: <input type="radio"/> no			
Buttons: Calculate Draw Quantitate Save pixels Save matrix Retrieve The Works Quit			

Clear data	Load data	Done
Units: <input type="radio"/> mV	Loc: <input type="radio"/> Optimal	Li: <input type="radio"/> no
Heal: <input type="radio"/> all		
SITE: Real Fit	SITE: Real Fit	SITE: Real Fit
-6,2: 0.50 1.04	-8,2: 0.61 0.56	-5,-2: 2.41 1.55
-6,-4: 0.10 0.18	-8,-4: 0.08 0.05	-5,-4: 0.07 0.03
-8,-2: 1.41 2.60	-8,-2: 3.60 2.42	-4,0: 0.23 1.07
-6,-4: 0.13 0.13	-8,-4: 1.06 0.96	-4,-2: 0.19 0.09
-7,-4: 2.47 2.62	-8,-6: 0.05 0.06	-4,-2: 0.10 0.30
-7,2: 0.09 0.00	-9,8: 0.47 0.37	-6,-8: 5.10 3.04
-7,4: 0.12 0.00	-8,2: 0.13 0.10	
-7,-2: 2.07 3.10	-9,-2: 0.05 0.32	
-7,-4: 0.62 0.60	-5,2: 0.09 0.77	
-7,-6: 0.06 0.87	-5,-4: 0.08 0.05	
-8,8: 2.60 2.27	-5,8: 3.25 2.79	
Sum of squares error of fit is 9.94		
*Optimal* latitude is at 28.0 degrees ( 5.7 ca)		
*Optimal* longitude is at -7.4 degrees (-0.7 ca)		
-----: IMAGE > 50% : IMAGE > 75%		
COG latitude : 26.9deg ( 5.5ca)	: 27.3deg ( 5.6ca)	
COG longitude: -5.9deg (-0.5ca)	: -6.1deg (-0.6ca)	
ANT longitude: 13.1deg ( 1.2ca)	: 6.9deg ( 0.6ca)	
POST longitude: -23.9deg (-2.2ca)	: -17.1deg (-1.6ca)	
HEDL latitude : 10.9deg ( 3.9ca)	: 21.3deg ( 4.4ca)	
LATL latitude : 34.9deg ( 7.2ca)	: 32.3deg ( 6.6ca)	
Elongation : 3.4/3.3ca = 1.0	: 2.3/2.3ca = 1.0	
Surface area : 0.0 ca2	: 3.9 ca2	



CALCULATION OPTIONS		DISPLAY OPTIONS	
Add zeroed sites.: <input type="radio"/> around edges	Limit calculation: <input type="radio"/> 1 deg outer limit	Position map...: at 1 x 1 in a 1 x 1 grid [CLEAR MAP] [KEY] [PRO]	Map screen size: <input type="radio"/> 512x512 MAX RES
Set resolution...: <input type="radio"/> 256x256 matrix	Interpolation...: <input type="radio"/> spline fit	Viewing direction...: <input type="radio"/> Vertex	Upper threshold: <input type="radio"/> image
Data source...: <input type="radio"/> AMP		UT value (u,m,%)...:	Lower threshold: <input type="radio"/> sites
		LT value (u,m,%)...:	Colour table...: <input type="radio"/> B&W 8 levels
			Invert colour table: <input type="radio"/> yes
			Map background...: <input type="radio"/> white
			Show grey scale key: <input type="radio"/> yes
			Show sites...: <input type="radio"/> no
			Show reference grid: <input type="radio"/> black
WASKING & MAGNIFY OPTIONS			
Draw with mask...: <input type="radio"/> yes, in min colour	Blow up image...: <input type="radio"/> no		
Add to mask...: <input type="radio"/> create default mask	maskrush width...: <input type="radio"/> 4		
SAVE & RESTORE IMAGE			
Image label...: left fcU			
Restore...: <input type="radio"/> full map			
Restore & scaled...: <input type="radio"/> no			
Buttons: Calculate Draw Quantitate Save pixels Save matrix Retrieve The Works Quit			

Clear data	Load data	Done
Units: <input type="radio"/> mV	Loc: <input type="radio"/> Optimal	Li: <input type="radio"/> no
Heal: <input type="radio"/> all		
SITE: Real Fit	SITE: Real Fit	SITE: Real Fit
7,0: 2.31 1.40	6,0: 0.94 1.32	4,2: 0.11 0.13
7,2: 0.60 0.74	6,2: 0.72 0.75	4,-2: 0.09 0.13
7,4: 0.19 0.00	6,4: 0.10 0.17	3,0: 0.10 0.07
7,-2: 0.55 0.61	6,-2: 0.33 0.47	
7,-4: 0.23 0.14	6,-4: 0.05 0.10	
8,8: 0.50 0.97	5,8: 0.79 0.00	
8,2: 0.25 0.26	5,2: 0.55 0.43	
8,-2: 0.31 0.46	5,4: 0.06 0.07	
8,-4: 0.17 0.12	5,-2: 0.54 0.20	
9,8: 0.26 0.12	5,-4: 0.03 0.06	
9,-2: 0.12 0.00	4,8: 0.29 0.35	
Sum of squares error of fit is 13.36		
*Optimal* latitude is at 27.7 degrees ( 5.7 ca)		
*Optimal* longitude is at 0.0 degrees ( 0.1 ca)		
-----: IMAGE > 50% : IMAGE > 75%		
COG latitude : 27.0deg ( 5.7ca)	: 20.1deg ( 5.8ca)	
COG longitude: 1.3deg ( 0.1ca)	: 1.2deg ( 0.1ca)	
ANT longitude: 20.3deg ( 1.9ca)	: 14.2deg ( 1.4ca)	
POST longitude: -14.7deg (-1.4ca)	: -9.6deg (-0.9ca)	
HEDL latitude : 28.0deg ( 4.3ca)	: 23.1deg ( 4.7ca)	
LATL latitude : 35.0deg ( 7.4ca)	: 34.1deg ( 7.0ca)	
Elongation : 3.4/3.1ca = 1.1	: 2.3/2.3ca = 1.0	
Surface area : 7.3 ca2	: 3.3 ca2	





## CONTROL GROUP SP MAPS

\* Indicates dominant hemisphere

URN: unspecified AGE: unspecified SEX: unspecified

DATE: Wed Aug 31 14:41:00 1994 - printed Thu Jan 12 13:25:12 1995.

FILE: /home/gary/pc/data/mapping/dylan/dcl.flx1

SERIES: CONTROL 1

COMMENTS: map of left flexors

DATE: Wed Aug 31 15:40:36 1994 - printed Thu Sep 8 10:58:23 1994.

FILE: /home/gary/pc/data/mapping/dylan/dcl.flx1

SERIES: CONTROL 1

COMMENTS: map of right wrist flexor

**CALCULATION OPTIONS**      **DISPLAT OPTIONS**

Add zeroed sites.:  around edges      Position map...: at 1 x 1 in a 1 x 1 grid [CLEAR MAP] [KEY] [PRO]

Limit calculation.:  1 deg outer limit      Map screen size.:  512x512 MAX RES      Viewing direction...:  Vertex

Set resolution...:  256x256 matrix      Upper threshold.:  image      UT value (u,m,x)...:       Image

Interpolation...:  spline fit      Lower threshold.:  sites      LT value (u,m,x)...:       spline fit

Data source...:  none selected!      Colour table...:  8&H 8 levels      Invert colour table.:  yes

Map background.:  white      Show grey scale key.:  yes

Show sites...:  no      Show reference grid.:  black

**SAVE & RESTORE IMAGE**

Image label...: 4,-2

Restore...:  full map      Draw with mask.:  yes, in min colour      Blow up image...:  no

Restore & scaled.:  no      Add to mask...:  create default mask/brush width...:  4

**MASKING & MAGNIFY OPTIONS**

Calculate   Draw   Quantitate   Save pixels   Save matrix   Retrieve   The Horke   Quit

Clear data   Load data   Done

Units:  mSec   Loc:  Optimal   Lis:  no   Hest:  all

SITE:	Real	Fit	SITE:	Real	Fit	SITE:	Real	Fit
1,0:	44	48	4,2:	123	147	6,2:	145	125
2,-2:	43	26	4,4:	63	87	6,4:	33	57
2,0:	82	65	5,-4:	65	71	7,-2:	45	39
2,2:	54	73	5,-2:	131	114	7,0:	61	72
3,-2:	44	63	5,0:	136	162	7,2:	64	74
3,0:	144	125	5,2:	142	146	8,0:	34	31
3,2:	142	118	5,4:	99	76			
3,4:	75	46	5,6:	67	59			
4,-4:	74	57	6,-4:	47	47			
4,-2:	88	106	6,-2:	82	86			
4,0:	155	162	6,0:	149	131			

Sum of squares error of fit is 2.04, interaural = cc

'Optimal' latitude is at 19.1 degree ( 3.9 cm)

'Optimal' longitude is at 0.5 degree ( 0.6 cm)

----- IMAGE > 50%      IMAGE > 75%

COG latitude: 19.0deg ( 3.5cm)      19.8deg ( 4.1cm)

COG longitude: 8.3deg ( 0.6cm)      8.4deg ( 0.6cm)

ANT longitude: 58.3deg ( 3.5cm)      35.4deg ( 2.5cm)

POST longitude: -41.7deg (-2.8cm)      -18.6deg (-1.3cm)

MEDL latitude: 8.0deg ( 1.6cm)      12.8deg ( 2.6cm)

LATL latitude: 32.0deg ( 6.6cm)      28.8deg ( 5.9cm)

Elongation: 6.7/4.9cm = 1.4      3.6/3.3cm = 1.2

Surface area: 21.7 cm2      9.3 cm2

0.0 ms      4,-2      0.7 ms

**CALCULATION OPTIONS**      **DISPLAT OPTIONS**

Add zeroed sites.:  around edges      Position map...: at 1 x 1 in a 1 x 1 grid [CLEAR MAP] [KEY] [PRO]

Limit calculation.:  1 deg outer limit      Map screen size.:  512x512 MAX RES      Viewing direction...:  Vertex

Set resolution...:  256x256 matrix      Upper threshold.:  image      UT value (u,m,x)...:       Image

Interpolation...:  spline fit      Lower threshold.:  sites      LT value (u,m,x)...:       spline fit

Data source...:  none selected!      Colour table...:  8&H 8 levels      Invert colour table.:  yes

Map background.:  white      Show grey scale key.:  yes

Show sites...:  no      Show reference grid.:  black

**SAVE & RESTORE IMAGE**

Image label...: SP,r fcu

Restore...:  full map      Draw with mask.:  yes, in min colour      Blow up image...:  no

Restore & scaled.:  no      Add to mask...:  add pixels (min)      Brush width...:  4

**MASKING & MAGNIFY OPTIONS**

Calculate   Draw   Quantitate   Save pixels   Save matrix   Retrieve   Hide   Quit

Clear data   Load data   Done

Units:  mSec   Loc:  Optimal   Lis:  no   Hest:  all

SITE:	Real	Fit	SITE:	Real	Fit	SITE:	Real	Fit
-6,0:	182	182	-6,0:	60	69	-4,0:	142	197
-6,2:	169	170	-6,2:	192	98	-4,2:	127	125
-6,4:	136	135	-6,4:	57	64	-4,4:	45	55
-6,6:	36	46	-6,6:	0	0	-4,6:	24	24
-6,-2:	96	108	-6,-2:	44	41	-3,2:	46	33
-6,-4:	35	40	-6,-4:	168	178			
-7,0:	142	131	-5,2:	171	179			
-7,4:	112	103	-5,4:	138	122			
-7,2:	144	141	-5,6:	34	26			
-7,6:	41	41	-5,-2:	113	96			
-7,-2:	66	67	-5,-4:	34	21			

Sum of squares error of fit is 1.24

'Optimal' latitude is at 26.3 degree ( 5.6 cm)

'Optimal' longitude is at 6.1 degree ( 0.6 cm)

----- IMAGE > 50%      IMAGE > 75%

COG latitude: 24.9deg ( 5.1cm)      24.3deg ( 5.1cm)

COG longitude: 14.1deg ( 1.2cm)      12.9deg ( 1.1cm)

ANT longitude: 54.1deg ( 4.7cm)      41.5deg ( 3.6cm)

POST longitude: -23.9deg (-2.1cm)      -13.1deg (-1.1cm)

MEDL latitude: 13.9deg ( 3.3cm)      16.9deg ( 3.8cm)

LATL latitude: 36.9deg ( 7.6cm)      31.9deg ( 6.6cm)

Elongation: 6.7/4.3cm = 1.6      4.8/2.7cm = 1.8

Surface area: 18.5 cm2      9.3 cm2

0.0 ms      SP,r fcu      0.6 ms

URN: unspecified AGE: unspecified SEX: unspecified

DATE: Mon Sep 12 19:06:49 1994 - printed Sun Jan 15 15:24:30 1995.

FILE: /home/gary/pc/data/mapping/dylan/aart.flx

SERIES: mapping r fcu CONTROL 2

COMMENTS:

URN: unspecified AGE: unspecified SEX: unspecified

DATE: Mon Sep 12 17:34:49 1994 - printed Sun Jan 15 15:46:44 1995.

FILE: /home/gary/pc/data/mapping/dylan/aal.flx

SERIES: CONTROL 2.

COMMENTS:

CALCULATION OPTIONS      DISPLAY OPTIONS

Add zeroed sites:  around edges      Position map...: at 1 x 1 in a 1 x 1 grid [CLEAR MAP] [KEY] [PRO]

Limit calculation:  1 deg outer limit      Map screen size:  512x512 MAX RES      Viewing direction...:  Vertex

Set resolution...:  256x256 matrix      Upper threshold:  image      UT value (u,m,z)...:

Interpolation...:  spline fit      Lower threshold:  sites      LT value (u,m,z)...:

Data source...:  none selected!      Colour table...:  8&H & levels      Invert colour table:  yes

Map background...:  white      Show grey scale key:  yes

Show sites...:  no      Show reference grid:  black

SAVE & RESTORE IMAGE

Image label...: -3,2

Restore...:  full map

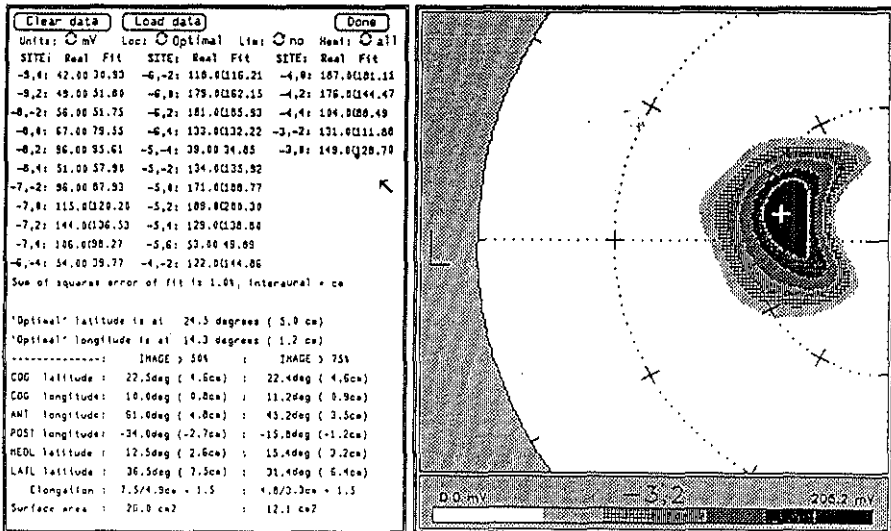
Restore & scaled:  no

MASKING & MAGNIFY OPTIONS

Draw with mask...:  yes, in min colour Blow up image...:  no

Add to mask...:  create default mask/rush width...:  4

Calculate   Draw   Quantitate   Save pixels   Save matrix   Retrieve   The Works   Quit



CALCULATION OPTIONS      DISPLAY OPTIONS

Add zeroed sites:  around edges      Position map...: at 1 x 1 in a 1 x 1 grid [CLEAR MAP] [KEY] [PRO]

Limit calculation:  1 deg outer limit      Map screen size:  512x512 MAX RES      Viewing direction...:  Vertex

Set resolution...:  256x256 matrix      Upper threshold:  image      UT value (u,m,z)...:

Interpolation...:  spline fit      Lower threshold:  sites      LT value (u,m,z)...:

Data source...:  none selected!      Colour table...:  8&H & levels      Invert colour table:  yes

Map background...:  white      Show grey scale key:  yes

Show sites...:  no      Show reference grid:  black

SAVE & RESTORE IMAGE

Image label...: 3,2

Restore...:  full map

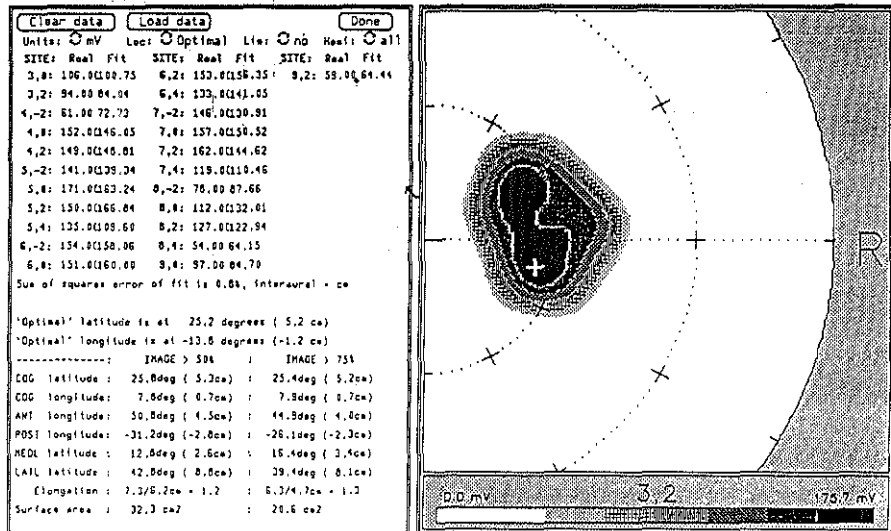
Restore & scaled:  no

MASKING & MAGNIFY OPTIONS

Draw with mask...:  yes, in min colour Blow up image...:  no

Add to mask...:  create default mask/rush width...:  4

Calculate   Draw   Quantitate   Save pixels   Save matrix   Retrieve   The Works   Quit



URN: unspecified AGE: unspecified SEX: unspecified

DATE: Thu Sep 22 11:14:28 1994 - printed Wed Jan 25 23:25:14 1995.

FILE: /home/gary/pc/data/mapping/dylan/jart.flx

SERIES: mapping R FCU CONTROL 3

COMMENTS:

URN: unspecified AGE: unspecified SEX: unspecified

DATE: Thu Sep 22 10:14:25 1994 - printed Mon Jan 16 20:09:14 1995.

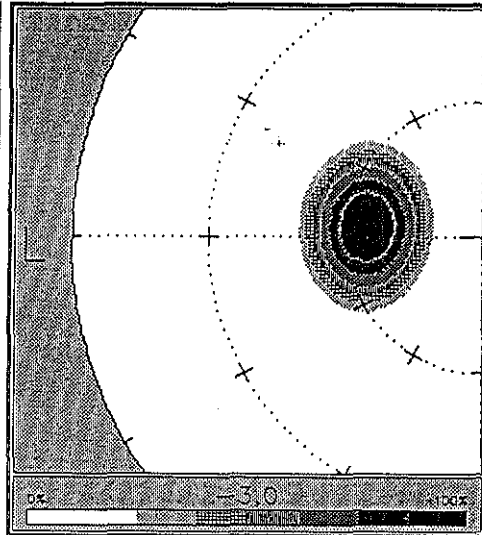
FILE: /home/gary/pc/data/mapping/dylan/jal.flx

SERIES: mapping L FCU CONTROL 3

COMMENTS:

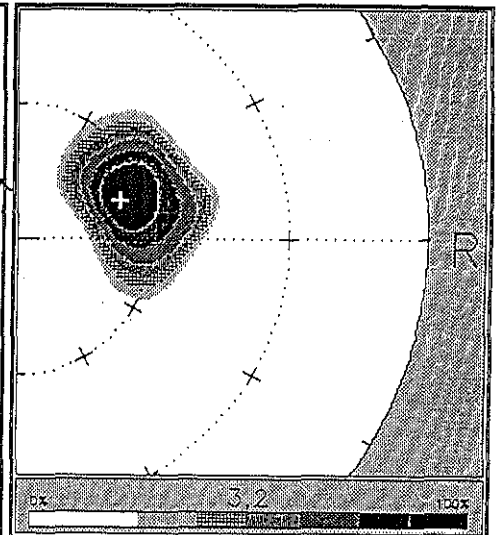
CALCULATION OPTIONS		DISPLAY OPTIONS	
Add zeroed sites.: <input type="radio"/> around edges	Position map...: at 1 x 1 in a 1 x 1 grid [CLEAR MAP] [KEY] [PRO]	Map screen size: <input type="radio"/> 512x512 MAX RES	Viewing direction...: <input type="radio"/> Vertex
Limit calculation: <input type="radio"/> 1 deg outer limit	Upper threshold: <input type="radio"/> image	UT value (u,m,t)...: 100%	
Set resolution...: <input type="radio"/> 256x256 matrix	Lower threshold: <input type="radio"/> sites	LT value (u,m,t)...: 0%	
Interpolation...: <input type="radio"/> spline fit	Colour table...: <input type="radio"/> B&W 8 levels	Invert colour table: <input type="radio"/> yes	
Data source...: <input type="radio"/> none selected!	Map background...: <input type="radio"/> white	Show grey scale key: <input type="radio"/> yes	
SAVE & RESTORE IMAGE		Show sites...: <input type="radio"/> no	Show reference grid: <input type="radio"/> black
Image label...: -3,0	MASKING & MAGNIFY OPTIONS		
Restore...: <input type="radio"/> full map	Draw with mask...: <input type="radio"/> no	Blow up image...: <input type="radio"/> no	
Restore % scaled: <input type="radio"/> no	Add to mask...: <input type="radio"/> clear mask	Brush width...: <input type="radio"/> 4	
Calculate	Draw	Quantitate	Save pixels
Save matrix	Retrieve	The Works	Quit

Clear data		Load data		Done	
Units: <input type="radio"/> mV	Lecl: <input type="radio"/> no	Li: <input type="radio"/> no	Rest: <input type="radio"/> all		
SITE: Real Fit	SITE: Real Fit	SITE: Real Fit	SITE: Real Fit		
-6,1: -----	-3,2: -----				
-6,2: -----	-4,1: -----				
-7,-2: -----	-4,2: -----				
-7,1: -----	-3,1: -----				
-7,2: -----					
-7,1: -----					
-6,-2: -----					
-6,1: -----					
-6,2: -----					
-5,-2: -----					
-5,1: -----					



CALCULATION OPTIONS		DISPLAY OPTIONS	
Add zeroed sites.: <input type="radio"/> around edges	Position map...: at 1 x 1 in a 1 x 1 grid [CLEAR MAP] [KEY] [PRO]	Map screen size: <input type="radio"/> 512x512 MAX RES	Viewing direction...: <input type="radio"/> Vertex
Limit calculation: <input type="radio"/> 1 deg outer limit	Upper threshold: <input type="radio"/> image	UT value (u,m,t)...: 100%	
Set resolution...: <input type="radio"/> 256x256 matrix	Lower threshold: <input type="radio"/> sites	LT value (u,m,t)...: 0%	
Interpolation...: <input type="radio"/> spline fit	Colour table...: <input type="radio"/> B&W 8 levels	Invert colour table: <input type="radio"/> yes	
Data source...: <input type="radio"/> none selected!	Map background...: <input type="radio"/> white	Show grey scale key: <input type="radio"/> yes	
SAVE & RESTORE IMAGE		Show sites...: <input type="radio"/> no	Show reference grid: <input type="radio"/> black
Image label...: 3,2	MASKING & MAGNIFY OPTIONS		
Restore...: <input type="radio"/> full map	Draw with mask...: <input type="radio"/> yes, in min colour	Blow up image...: <input type="radio"/> no	
Restore % scaled: <input type="radio"/> no	Add to mask...: <input type="radio"/> create default mask	Brush width...: <input type="radio"/> 4	
Calculate	Draw	Quantitate	Save pixels
Save matrix	Retrieve	The Works	Quit

Clear data		Load data		Done	
Units: <input type="radio"/> mV	Lecl: <input type="radio"/> no	Li: <input type="radio"/> no	Rest: <input type="radio"/> all		
SITE: Real Fit	SITE: Real Fit	SITE: Real Fit	SITE: Real Fit		
3,2: 38.69 40.46	5,4: 187.90 113.84	9,2: 75.09 73.74			
4,8: 76.69 70.62	5,6: 51.26 38.28				
4,2: 126.04 90.97	7,-2: 59.00 55.72				
4,4: 45.60 38.18	7,0: 89.00 106.29				
5,-2: 50.09 40.95	7,2: 116.00 126.55				
5,8: 108.90 115.19	7,4: 129.00 119.83				
5,2: 131.62 42.67	7,6: 46.00 49.60				
5,4: 87.60 91.61	8,0: 95.00 85.35				
6,-2: 52.00 62.00	8,2: 109.00 110.13				
6,8: 126.00 119.05	8,4: 102.00 85.37				
6,2: 150.90 44.83	8,6: 45.00 49.10				
Sum of squares error of fit is 0.5%, interaural = ca					
*Optimal* latitude is at 24.4 degrees ( 5.0 cm)					
*Optimal* longitude is at 29.2 degrees ( 1.7 cm)					
-----: IMAGE > 50% : IMAGE > 75%					
COG latitude :	27.7deg ( 5.7cm)	:	27.5deg ( 5.6cm)		
COG longitude:	18.3deg ( 1.8cm)	:	18.6deg ( 1.8cm)		
ANT longitude:	52.3deg ( 5.8cm)	:	42.6deg ( 4.0cm)		
POST longitude:	-16.7deg (-1.6cm)	:	-3.4deg (-4.3cm)		
MEDL latitude :	15.7deg ( 3.2cm)	:	18.5deg ( 3.8cm)		
LATL latitude :	42.7deg ( 8.8cm)	:	37.5deg ( 7.7cm)		
Elongation :	6.6/5.6cm = 1.2	:	4.4/3.9cm = 1.1		
Surface area :	25.8 cm2	:	13.0 cm2		



URN: unspecified AGE: unspecified SEX: unspecified

DATE: Fri Sep 23 11:40:07 1994 - printed Mon Jan 16 20:32:56 1995.

FILE: /home/gary/pc/data/mapping/dylan/sctrl.flx

SERIES: mapping R FCU CONTROL 4

COMMENTS:

URN: unspecified AGE: unspecified SEX: unspecified

DATE: Fri Sep 23 10:55:48 1994 - printed Mon Jan 16 20:49:58 1995.

FILE: /home/gary/pc/data/mapping/dylan/scl.flx

SERIES: CONTROL 6

COMMENTS: map of left fcu

**CALCULATION OPTIONS**

Add zeroed sites.:  around edges  
 Limit calculation.:  1 deg outer limit  
 Set resolution....:  256x256 matrix  
 Interpolation....:  spline fit  
 Data source.....:  none selected

**DISPLAY OPTIONS**

Position map....: at 1 x 1 in a 1 x 1 grid [CLEAR MAP] [KEY] [PRO]  
 Map screen size.:  512x512 MAX RES  
 Viewing direction.:  Vertex  
 Upper threshold.:  image  
 Lower threshold.:  sites  
 Colour table....:  B&W & levels  
 Map background.:  white  
 Show sites.....:  no

**SAVE & RESTORE IMAGE**

Image label.....: -2,0  
 Restore.....:  full map  
 Restore & scaled.:  no

**MASKING & MAGNIFY OPTIONS**

Draw with mask.:  yes, in min colour  
 Add to mask....:  create default mask  
 Blow up image....:  no  
 Brush width.....:  4

[Calculate] [Draw] [Quantitate] [Save pixels] [Save matrix] [Retrieve] [The Works] [Quit]

Clear data Load data Done

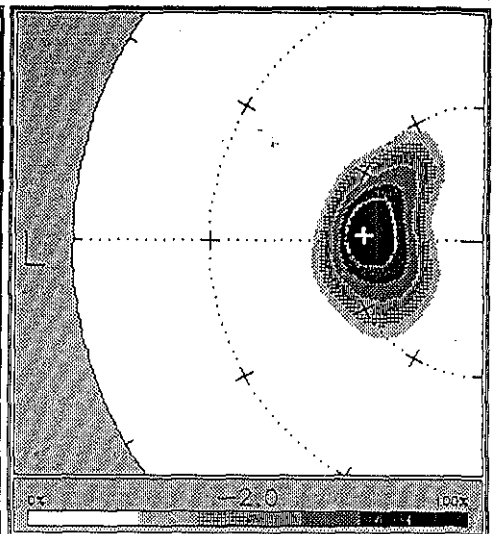
Units:  mV Loc:  Optimal Lin:  no Heat:  all

SITE:	Real Fit	SITE:	Real Fit	SITE:	Real Fit
-6,-2:	51.00 53.59	-6,4:	95.00 91.26	-3,-2:	75.00 61.55
-8,0:	45.00 51.39	-8,6:	55.00 47.99	-3,8:	117.00 97.72
-7,-4:	54.00 56.78	-5,-4:	80.00 56.00	-3,2:	41.00 52.07
-7,-2:	115.00 91.02	-5,-2:	132.00 124.77		
-7,0:	128.00 120.56	-5,8:	167.00 173.62		
-7,2:	97.00 97.44	-5,2:	134.00 152.00		
-7,4:	42.00 48.92	-5,4:	104.00 107.27		
-6,-4:	78.00 73.22	-4,-2:	100.00 113.94		
-6,-2:	126.00 120.48	-4,8:	155.00 145.00		
-6,8:	167.00 170.95	-4,2:	126.00 115.89		
-6,2:	163.00 149.67	-4,4:	81.00 48.96		

Sum of squares error of fit is 0.81, interaural = ca

\*Optimal\* latitude is at 26.1 degrees ( 5.4 ca)  
 \*Optimal\* longitude is at 2.6 degrees ( 0.2 ca)

IMAGE > 50%	IMAGE > 75%
COG latitude: 23.0deg ( 4.7ca)	24.0deg ( 4.3ca)
COG longitude: 3.1deg ( 0.2ca)	3.2deg ( 0.3ca)
ANT longitude: 56.1deg ( 4.3ca)	34.2deg ( 2.3ca)
POST longitude: -49.9deg (-3.3ca)	-22.0deg (-1.3ca)
HEAD latitude: 13.0deg ( 2.7ca)	16.0deg ( 3.3ca)
LATL latitude: 35.0deg ( 7.2ca)	32.0deg ( 6.6ca)
Elongation: 7.8/4.5ca = 1.7	4.8/2.3ca = 1.4
Surface area: 24.7 ca2	11.4 ca2



**CALCULATION OPTIONS**

Add zeroed sites.:  around edges  
 Limit calculation.:  1 deg outer limit  
 Set resolution....:  256x256 matrix  
 Interpolation....:  spline fit  
 Data source.....:  none selected

**DISPLAY OPTIONS**

Position map....: at 1 x 1 in a 1 x 1 grid [CLEAR MAP] [KEY] [PRO]  
 Map screen size.:  512x512 MAX RES  
 Viewing direction.:  Vertex  
 Upper threshold.:  image  
 Lower threshold.:  sites  
 Colour table....:  B&W & levels  
 Map background.:  white  
 Show sites.....:  no

**SAVE & RESTORE IMAGE**

Image label.....: 4,2  
 Restore.....:  full map  
 Restore & scaled.:  no

**MASKING & MAGNIFY OPTIONS**

Draw with mask.:  yes, in min colour  
 Add to mask....:  create default mask  
 Blow up image....:  no  
 Brush width.....:  4

[Calculate] [Draw] [Quantitate] [Save pixels] [Save matrix] [Retrieve] [The Works] [Quit]

Clear data Load data Done

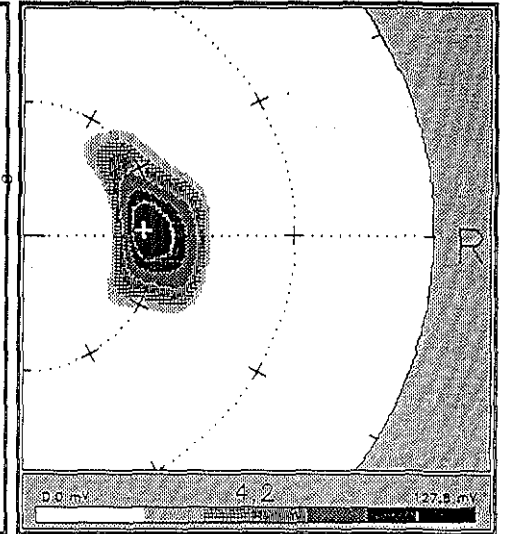
Units:  mV Loc:  Optimal Lin:  no Heat:  all

SITE:	Real Fit	SITE:	Real Fit	SITE:	Real Fit
5,-2:	52.00 54.54	7,4:	45.00 43.26		
5,8:	162.00 194.99	8,-2:	95.00 93.00		
5,2:	94.00 76.18	8,8:	89.00 89.95		
5,4:	39.00 44.12	8,2:	71.00 69.66		
6,-2:	79.00 86.99				
6,8:	130.00 127.00				
6,2:	84.00 101.40				
6,4:	66.00 64.92				
7,-2:	76.00 87.14				
7,8:	117.00 12.49				
7,2:	85.00 85.20				

Sum of squares error of fit is 1.04, interaural = ca

\*Optimal\* latitude is at 26.9 degrees ( 5.5 ca)  
 \*Optimal\* longitude is at 2.6 degrees ( 0.2 ca)

IMAGE > 50%	IMAGE > 75%
COG latitude: 29.7deg ( 6.0ca)	29.1deg ( 5.0ca)
COG longitude: 2.9deg ( 0.2ca)	1.7deg ( 0.2ca)
ANT longitude: 30.5deg ( 3.3ca)	22.7deg ( 2.3ca)
POST longitude: -23.6deg (-2.4ca)	-14.3deg (-1.4ca)
HEAD latitude: 21.3deg ( 4.4ca)	23.1deg ( 4.7ca)
LATL latitude: 48.3deg ( 8.3ca)	37.1deg ( 7.6ca)
Elongation: 6.2/3.5ca = 1.6	3.7/2.3ca = 1.3
Surface area: 18.4 ca2	8.0 ca2



URN: unspecified AGE: 19 years SEX: unspecified

DATE: Wed Oct 05 15:09:50 1994 - printed Mon Jan 16 21:11:17 1995.

FILE: /home/gary/pc/data/mapping/dylan/jert.flx

SERIES: mapping FCU CONTROL 5

COMMENTS: CONTROL DATA

URN: unspecified AGE: 19 years SEX: unspecified

DATE: Wed Oct 05 16:16:30 1994 - printed Mon Jan 16 21:32:18 1995.

FILE: /home/gary/pc/data/mapping/dylan/jel.flx

SERIES: mapping Left FCU CONTROL 5

COMMENTS: CONTROL DATA

**CALCULATION OPTIONS**

Add zeroed sites:  around edges  
 Limit calculation:  1 deg outer limit  
 Set resolution:  256x256 matrix  
 Interpolation:  spline fit  
 Data source:  none selected!

**DISPLAY OPTIONS**

Position map...: at 1 x 1 in a 1 x 1 grid [CLEAR MAP] [KEY] [PRO]  
 Map screen size:  512x512 MAX RES Viewing direction...:  Vortex  
 Upper threshold:  image UT value (u,m,t)...:  
 Lower threshold:  sites LT value (u,m,t)...:  
 Colour table...:  8&W & levels Invert colour table:  yes  
 Map background:  white Show grey scale key:  yes  
 Show sites:  no Show reference grid:  black

**MASKING & MAGNIFY OPTIONS**

Draw with mask:  yes, in min colour Blow up image:  no  
 Add to mask:  create default mask/brush width:  4

**SAVE & RESTORE IMAGE**

Image label:  -2,2  
 Restore:  full map  
 Restore & scaled:  no

Calculate Draw Quantitate Save pixels Save matrix Retrieve The Works Quit

Clear data Load data Done

Units:  mV Loc:  Optimal Lta:  no Heal:  all

SITE: Real Fit	SITE: Real Fit	SITE: Real Fit
-7,-2: 172.00152.98	-4,-2: 139.00139.05	
-7,4: 141.00140.82	-3,-2: 101.0095.52	
-6,-4: 57.00 48.66	-3,4: 150.00149.13	
-6,-2: 117.00146.70	-2,4: 39.00 59.49	
-6,4: 172.00160.58		
-6,2: 158.00149.49		
-5,-2: 152.00144.39		
-5,4: 202.00192.69		
-5,2: 149.00159.49		
-4,-2: 152.00147.02		
-4,4: 192.00189.60		

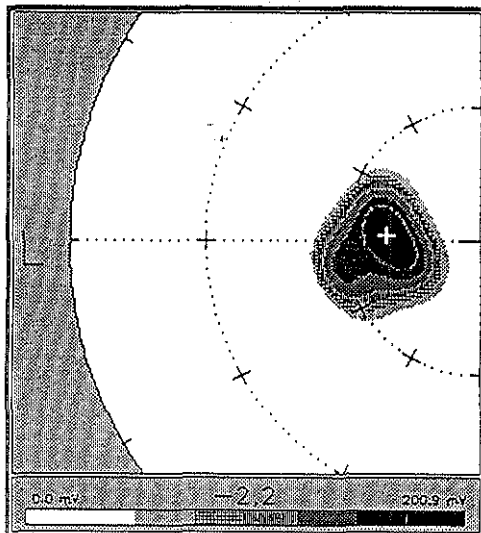
Sus of squares error of fit is 1.04, interaural = ca

'Optimal' latitude is at 20.5 degrees (4.2 ca)  
 'Optimal' longitude is at 3.4 degrees (0.2 ca)

----- IMAGE > 50% : IMAGE > 75%

COG	latitude	longitude	latitude	longitude
COG	latitude: 22.5deg (4.6ca)	longitude: -0.4deg (-0.3ca)	22.1deg (4.3ca)	-1.6deg (-0.1ca)
ANT	latitude: 36.6deg (2.3ca)	longitude: -34.4deg (-2.7ca)	27.4deg (2.1ca)	-20.6deg (-1.6ca)
POST	latitude: 0.5deg (1.7ca)	longitude: 35.6deg (7.3ca)	12.1deg (2.5ca)	31.1deg (6.4ca)
MDL	latitude: 35.6deg (7.3ca)	longitude: 5.6/5.3ca = 1.0	31.1deg (6.4ca)	3.7/3.3ca = 0.8
LATL	latitude: 21.1 ca2	longitude: 11.3 ca2		

0.0 mV -2.2 200.0 mV



**CALCULATION OPTIONS**

Add zeroed sites:  around edges  
 Limit calculation:  1 deg outer limit  
 Set resolution:  256x256 matrix  
 Interpolation:  spline fit  
 Data source:  none selected!

**DISPLAY OPTIONS**

Position map...: at 1 x 1 in a 1 x 1 grid [CLEAR MAP] [KEY] [PRO]  
 Map screen size:  512x512 MAX RES Viewing direction...:  Vortex  
 Upper threshold:  image UT value (u,m,t)...:  
 Lower threshold:  sites LT value (u,m,t)...:  
 Colour table...:  8&W & levels Invert colour table:  yes  
 Map background:  white Show grey scale key:  yes  
 Show sites:  no Show reference grid:  black

**MASKING & MAGNIFY OPTIONS**

Draw with mask:  yes, in min colour Blow up image:  no  
 Add to mask:  create default mask/brush width:  4

**SAVE & RESTORE IMAGE**

Image label:  2,0  
 Restore:  full map  
 Restore & scaled:  no

Calculate Draw Quantitate Save pixels Save matrix Retrieve The Works Quit

Clear data Load data Done

Units:  mV Loc:  Optimal Lta:  no Heal:  all

SITE: Real Fit	SITE: Real Fit	SITE: Real Fit
3,-2: 41.00 35.83	6,-2: 100.00104.99	
3,4: 81.00 74.92	6,4: 179.00192.27	
3,2: 34.00 39.25	6,2: 170.00170.85	
4,-2: 84.00 102.87	7,-4: 58.00 59.93	
4,4: 167.00149.45	7,-2: 152.00154.52	
4,2: 118.00113.45	7,4: 169.00165.96	
5,-2: 160.00156.60	7,2: 164.00160.10	
5,4: 176.00165.60		
5,2: 154.00150.22		
5,4: 37.00 31.19		
6,-4: 37.00 46.35		

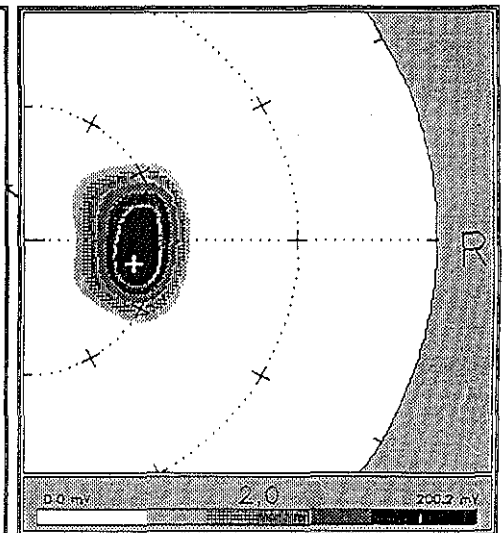
Sus of squares error of fit is 0.44, interaural = ca

'Optimal' latitude is at 25.1 degrees (5.2 ca)  
 'Optimal' longitude is at -12.0 degrees (-1.0 ca)

----- IMAGE > 50% : IMAGE > 75%

COG	latitude	longitude	latitude	longitude
COG	latitude: 24.6deg (5.1ca)	longitude: 9.4deg (0.0ca)	23.1deg (5.2ca)	-0.6deg (-0.1ca)
ANT	latitude: 35.4deg (3.0ca)	longitude: -33.8deg (-2.3ca)	26.4deg (2.3ca)	-25.6deg (-2.2ca)
POST	latitude: 14.6deg (3.0ca)	longitude: 35.6deg (7.3ca)	18.1deg (3.7ca)	33.1deg (6.8ca)
LATL	latitude: 20.4 ca2	longitude: 11.2 ca2		

0.0 mV 2.0 200.0 mV

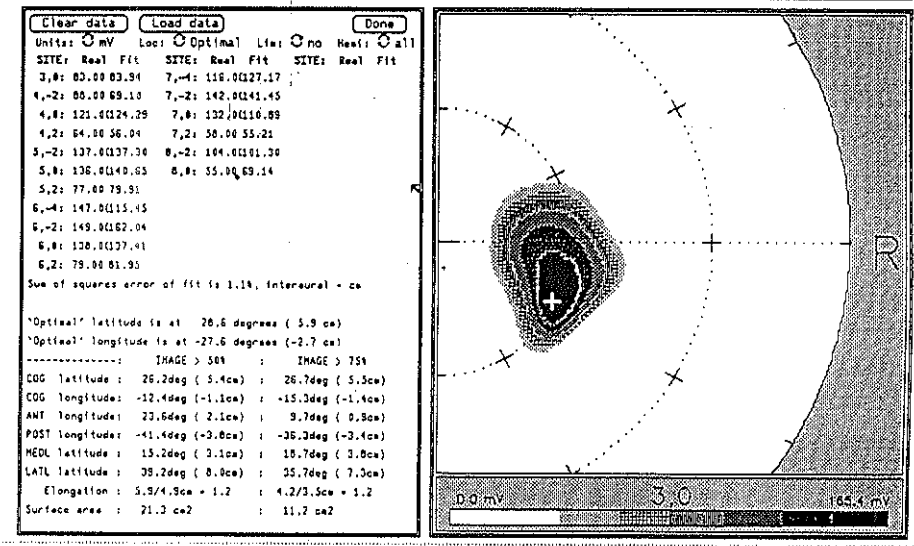
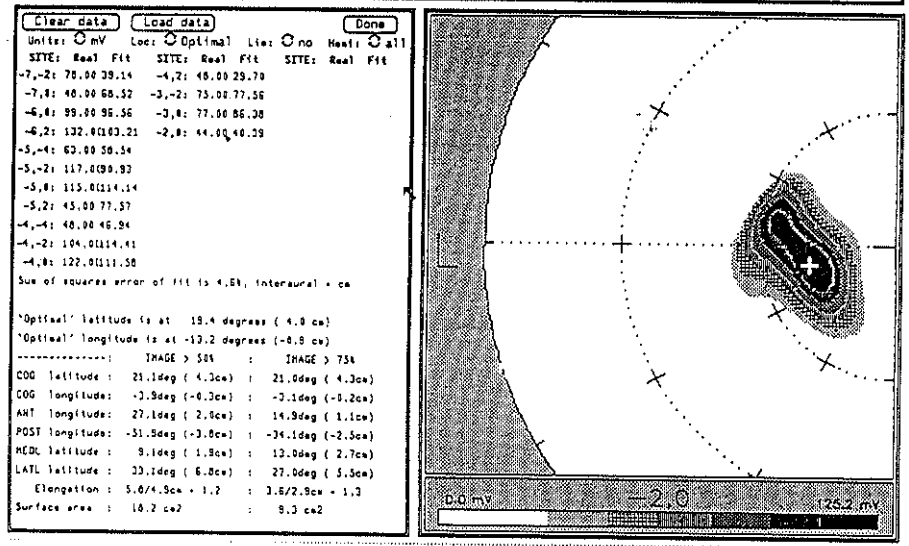


URN: unspecified AGE: 28 years SEX: female  
 DATE: Mon Oct 10 15:23:44 1994 - printed Mon Jan 16 21:49:10 1995.  
 FILE: /home/gary/pc/data/mapping/dylan/mrt.flx2  
 SERIES: Control **CONTROL 6**  
 COMMENTS: Right FCU - Dominant

URN: unspecified AGE: 28 years SEX: female  
 DATE: Mon Oct 10 16:38:55 1994 - printed Mon Jan 16 22:12:47 1995.  
 FILE: /home/gary/pc/data/mapping/dylan/mlt.flx2  
 SERIES: Control **CONTROL 6**  
 COMMENTS: Left FCU - NonDominant

CALCULATION OPTIONS		DISPLAY OPTIONS	
Add zeroed sites: <input type="radio"/> around edges	Limit calculation: <input type="radio"/> 1 deg outer limit	Position map...: at 1 x 1 in a 1 x 1 grid [CLEAR MAP] [KEY] [PRO]	Map screen size: <input type="radio"/> 512x512 MAX RES
Set resolution...: <input type="radio"/> 256x256 matrix	Interpolation...: <input type="radio"/> spline fit	Viewing direction...: <input type="radio"/> Vertex	Upper threshold: <input type="radio"/> image
Data source...: <input type="radio"/> none selected!		UT value (u,m,z)...:	Lower threshold: <input type="radio"/> sites
		LT value (u,m,z)...:	Colour table...: <input type="radio"/> B&W & levels
			Map background...: <input type="radio"/> white
			Show sites...: <input type="radio"/> no
			Show grey scale key: <input type="radio"/> yes
			Show reference grid: <input type="radio"/> black
SAVE & RESTORE IMAGE		MASKING & MAGNIFY OPTIONS	
Image label...: -2,0	Restore...: <input type="radio"/> full map	Draw with mask...: <input type="radio"/> yes, in min colour	Blow up image...: <input type="radio"/> no
Restore % scaled: <input type="radio"/> no	Add to mask...: <input type="radio"/> create default mask	Blow up image...: <input type="radio"/> no	Blow up image...: <input type="radio"/> 4
Calculate	Draw	Quantitate	Save pixels
Save matrix	Retrieve	The Works	Quit

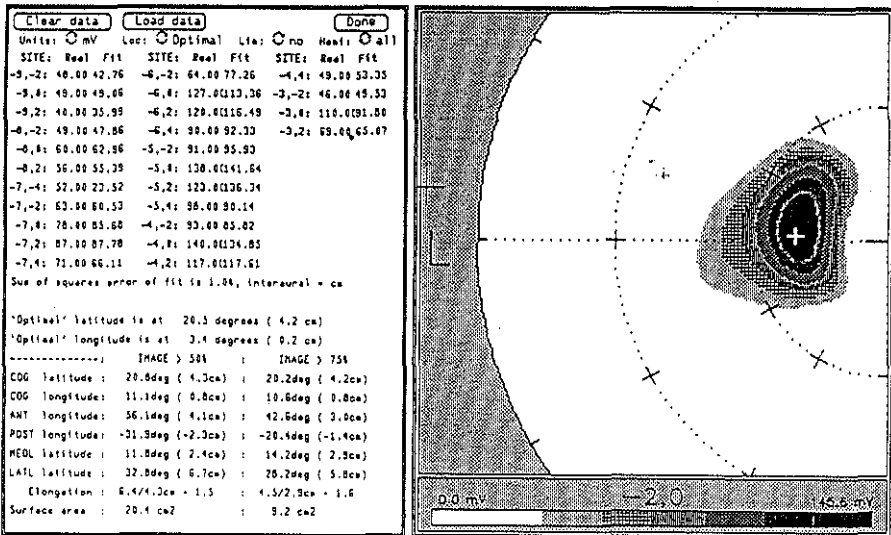
CALCULATION OPTIONS		DISPLAY OPTIONS	
Add zeroed sites: <input type="radio"/> around edges	Limit calculation: <input type="radio"/> 1 deg outer limit	Position map...: at 1 x 1 in a 1 x 1 grid [CLEAR MAP] [KEY] [PRO]	Map screen size: <input type="radio"/> 512x512 MAX RES
Set resolution...: <input type="radio"/> 256x256 matrix	Interpolation...: <input type="radio"/> spline fit	Viewing direction...: <input type="radio"/> Vertex	Upper threshold: <input type="radio"/> image
Data source...: <input type="radio"/> none selected!		UT value (u,m,z)...:	Lower threshold: <input type="radio"/> sites
		LT value (u,m,z)...:	Colour table...: <input type="radio"/> B&W & levels
			Map background...: <input type="radio"/> white
			Show sites...: <input type="radio"/> no
			Show grey scale key: <input type="radio"/> yes
			Show reference grid: <input type="radio"/> black
SAVE & RESTORE IMAGE		MASKING & MAGNIFY OPTIONS	
Image label...: 3,0	Restore...: <input type="radio"/> full map	Draw with mask...: <input type="radio"/> yes, in min colour	Blow up image...: <input type="radio"/> no
Restore % scaled: <input type="radio"/> no	Add to mask...: <input type="radio"/> create default mask	Blow up image...: <input type="radio"/> no	Blow up image...: <input type="radio"/> 4
Calculate	Draw	Quantitate	Save pixels
Save matrix	Retrieve	The Works	Quit



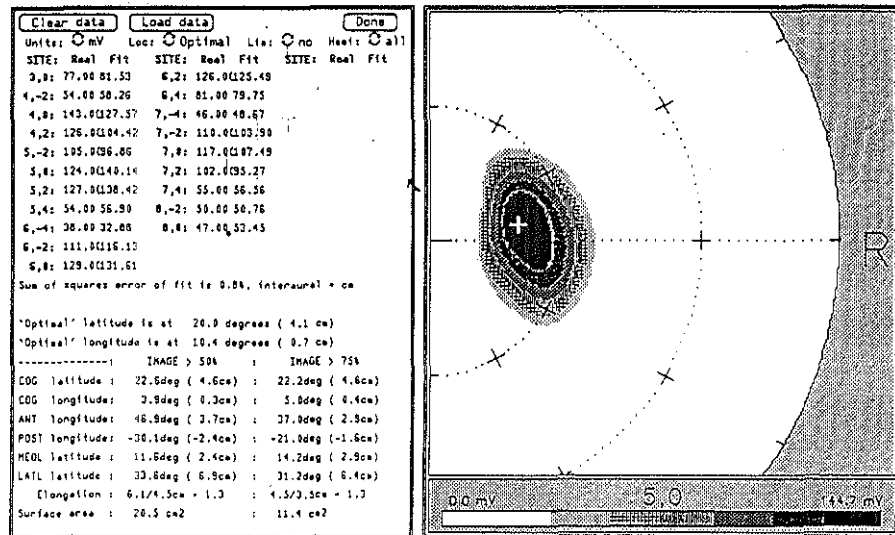
URN: unspecified AGE: 22 years SEX: male  
 DATE: Tue Oct 25 09:59:50 1994 - printed Mon Jan 16 22:33:07 1995.  
 FILE: /home/gary/pc/data/mapping/dylan/rsrl.flx  
 SERIES: Control - Weighlifting **CONTROL 7**  
 COMMENTS: R FCU - Dominant

URN: unspecified AGE: 22 years SEX: male  
 DATE: Tue Oct 25 11:14:51 1994 - printed Mon Jan 16 22:49:04 1995.  
 FILE: /home/gary/pc/data/mapping/dylan/rsrl.flx  
 SERIES: Control **CONTROL 7**  
 COMMENTS: L FCU - Non-Dominant

CALCULATION OPTIONS		DISPLAY OPTIONS	
Add zeroed sites: <input type="radio"/> around edges	Position map...: at 1 x 1 in a 1 x 1 grid [CLEAR MAP] [KEY] [PRO]	Map screen size: <input type="radio"/> 512x512 MAX RES	Viewing direction...: <input type="radio"/> Vertex
Limit calculation: <input type="radio"/> 1 deg outer limit	Upper threshold: <input type="radio"/> image	UT value (u,m,%):...	LT value (u,m,%):...
Set resolution...: <input type="radio"/> 256x256 matrix	Lower threshold: <input type="radio"/> sites	Colour table...: <input type="radio"/> 8&H & levels	Invert colour table: <input type="radio"/> yes
Interpolation...: <input type="radio"/> spline fit	Map background...: <input type="radio"/> white	Map background...: <input type="radio"/> white	Show grey scale key: <input type="radio"/> yes
Data source...: <input type="radio"/> none selected!	Show sites...: <input type="radio"/> no	Show sites...: <input type="radio"/> no	Show reference grid: <input type="radio"/> black
<b>SAVE &amp; RESTORE IMAGE</b>		<b>MASKING &amp; MAGNIFY OPTIONS</b>	
Image label...: -2.0	Restore...: <input type="radio"/> full map	Draw with mask...: <input type="radio"/> yes, in min colour	Blow up image...: <input type="radio"/> no
Restore & scaled...: <input type="radio"/> no	Add to mask...: <input type="radio"/> create default mask/brush width...: 4	Add to mask...: <input type="radio"/> create default mask/brush width...: 4	
[Calculate] [Draw] [Quantitate] [Save pixels] [Save matrix] [Retrieve] [The Works] [Quit]			



CALCULATION OPTIONS		DISPLAY OPTIONS	
Add zeroed sites: <input type="radio"/> around edges	Position map...: at 1 x 1 in a 1 x 1 grid [CLEAR MAP] [KEY] [PRO]	Map screen size: <input type="radio"/> 512x512 MAX RES	Viewing direction...: <input type="radio"/> Vertex
Limit calculation: <input type="radio"/> 1 deg outer limit	Upper threshold: <input type="radio"/> image	UT value (u,m,%):...	LT value (u,m,%):...
Set resolution...: <input type="radio"/> 256x256 matrix	Lower threshold: <input type="radio"/> sites	Colour table...: <input type="radio"/> 8&H & levels	Invert colour table: <input type="radio"/> yes
Interpolation...: <input type="radio"/> spline fit	Map background...: <input type="radio"/> white	Map background...: <input type="radio"/> white	Show grey scale key: <input type="radio"/> yes
Data source...: <input type="radio"/> none selected!	Show sites...: <input type="radio"/> no	Show sites...: <input type="radio"/> no	Show reference grid: <input type="radio"/> black
<b>SAVE &amp; RESTORE IMAGE</b>		<b>MASKING &amp; MAGNIFY OPTIONS</b>	
Image label...: 5.0	Restore...: <input type="radio"/> full map	Draw with mask...: <input type="radio"/> yes, in min colour	Blow up image...: <input type="radio"/> no
Restore & scaled...: <input type="radio"/> no	Add to mask...: <input type="radio"/> create default mask/brush width...: 4	Add to mask...: <input type="radio"/> create default mask/brush width...: 4	
[Calculate] [Draw] [Quantitate] [Save pixels] [Save matrix] [Retrieve] [The Works] [Quit]			





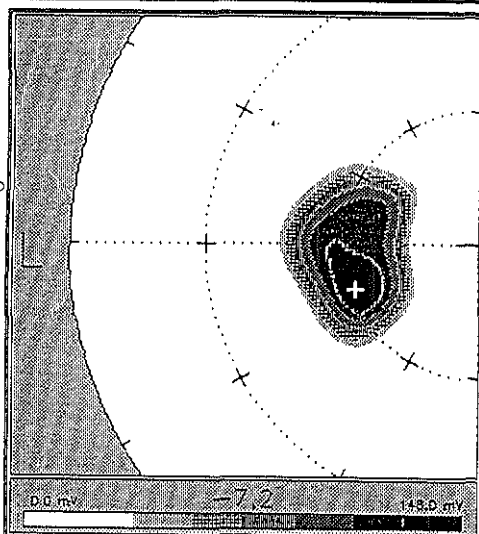
URN: unspecified AGE: 29 years SEX: male  
 DATE: Mon Dec 12 11:38:37 1994 - printed Tue Jan 17 10:02:56 1995.  
 FILE: /home/gary/pc/data/mapping/dylan/bprt.flx  
 SERIES: CONTROL CONTROL 8  
 COMMENTS: RIGHT HAND ~~NON~~-DOMINANT

URN: unspecified AGE: unspecified SEX: unspecified  
 DATE: Mon Dec 12 12:45:57 1994 - printed Tue Jan 17 10:26:09 1995.  
 FILE: /home/gary/pc/data/mapping/dylan/bpl.flx  
 SERIES: control CONTROL 8  
 COMMENTS: left, non-dominant arm

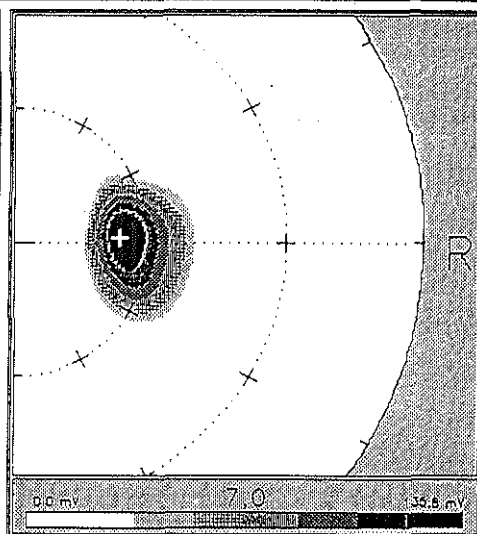
CALCULATION OPTIONS		DISPLAY OPTIONS	
Add zeroed sites: <input type="radio"/> around edges	Limit calculation: <input type="radio"/> 1 deg outer limit	Position map...: at 1 x 1 in a 1 x 1 grid [CLEAR MAP] [KEY] [PRD]	Map screen size: <input type="radio"/> 512x512 MAX RES
Set resolution...: <input type="radio"/> 256x256 matrix	Interpolation...: <input type="radio"/> spline fit	Viewing direction...: <input type="radio"/> Vertex	Upper threshold: <input type="radio"/> image
Data source...: <input type="radio"/> none selected!		UT value (u,m,λ)...:	Lower threshold: <input type="radio"/> sites
		LT value (u,m,λ)...:	Colour table...: <input type="radio"/> 8&W & levels
			Invert colour table: <input type="radio"/> yes
			Map background: <input type="radio"/> white
			Show grey scale key: <input type="radio"/> yes
			Show sites...: <input type="radio"/> no
			Show reference grid: <input type="radio"/> black
SAVE & RESTORE IMAGE		MASKING & MAGNIFY OPTIONS	
Image label...: -7,2	Restore...: <input type="radio"/> full map	Draw with mask...: <input type="radio"/> yes, in min colour	Blow up image...: <input type="radio"/> no
	Restore % scaled: <input type="radio"/> no	Add to mask...: <input type="radio"/> create default mask/rush width	.....: <input type="radio"/> 4
Calculate	Draw	Quantitate	Save pixels
Save matrix	Retrieve	The Works	Quit

CALCULATION OPTIONS		DISPLAY OPTIONS	
Add zeroed sites: <input type="radio"/> around edges	Limit calculation: <input type="radio"/> 1 deg outer limit	Position map...: at 1 x 1 in a 1 x 1 grid [CLEAR MAP] [KEY] [PRD]	Map screen size: <input type="radio"/> 512x512 MAX RES
Set resolution...: <input type="radio"/> 256x256 matrix	Interpolation...: <input type="radio"/> spline fit	Viewing direction...: <input type="radio"/> Vertex	Upper threshold: <input type="radio"/> image
Data source...: <input type="radio"/> none selected!		UT value (u,m,λ)...:	Lower threshold: <input type="radio"/> sites
		LT value (u,m,λ)...:	Colour table...: <input type="radio"/> 8&W & levels
			Invert colour table: <input type="radio"/> yes
			Map background: <input type="radio"/> white
			Show grey scale key: <input type="radio"/> yes
			Show sites...: <input type="radio"/> no
			Show reference grid: <input type="radio"/> black
SAVE & RESTORE IMAGE		MASKING & MAGNIFY OPTIONS	
Image label...: 7,0	Restore...: <input type="radio"/> full map	Draw with mask...: <input type="radio"/> yes, in min colour	Blow up image...: <input type="radio"/> no
	Restore % scaled: <input type="radio"/> no	Add to mask...: <input type="radio"/> create default mask/rush width	.....: <input type="radio"/> 4
Calculate	Draw	Quantitate	Save pixels
Save matrix	Retrieve	The Works	Quit

Clear data	Load data	Done
Units: <input type="radio"/> mV	Loc: <input type="radio"/> Optimal	Lit: <input type="radio"/> no
Meat: <input type="radio"/> all		
SITE: Real Fit	SITE: Real Fit	SITE: Real Fit
-8,1: 196,0026,79	-6,-1: 69,00 64,59	
-9,2: 91,90 75,64	-6,-2: 133,0042,20	
-8,-1: 97,00 96,84	-4,1: 117,00125,20	
-8,-2: 127,00126,46	-4,2: 182,00126,59	
-6,1: 127,00126,21	-3,-2: 112,00114,11	
-6,2: 182,00192,13	-5,1: 135,00112,34	
-7,-1: 116,00167,45	-3,2: 110,00165,60	
-7,-2: 137,00142,95	-4,-2: 57,00 51,12	
-7,1: 137,00129,09	-4,1: 71,00 69,21	
-7,2: 116,00136,20	-4,2: 56,00 54,45	
-7,1: 77,00 40,72		
Sum of squares error of fit is 0.93, interaural = cc		
*Optimal* latitude is at 20,7 degrees ( 5.9 ca)		
*Optimal* longitude is at -20,5 degrees (-2.0 ca)		
IMAGE > 50%	IMAGE > 75%	
COG latitude: 27.5deg ( 5.6ca)	27.5deg ( 5.7ca)	
COG longitude: -4.1deg (-0.4ca)	-5.7deg (-0.5ca)	
ANT longitude: 32.5deg ( 3.1ca)	29.3deg ( 2.2ca)	
POST longitude: -29.3deg (-3.7ca)	-34.7deg (-3.3ca)	
MEDL latitude: 16.5deg ( 3.4ca)	19.5deg ( 4.0ca)	
LATL latitude: 40.5deg ( 0.3ca)	36.5deg ( 7.5ca)	
Elongation: 6.8/4.5ca = 1.4	5.5/3.5ca = 1.6	
Surface area: 25.5 ca2	14.0 ca2	



Clear data	Load data	Done
Units: <input type="radio"/> mV	Loc: <input type="radio"/> Optimal	Lit: <input type="radio"/> no
Meat: <input type="radio"/> all		
SITE: Real Fit	SITE: Real Fit	SITE: Real Fit
4,1: 64,00 61,73	5,-2: 75,00 00,20	
5,-2: 72,00 62,35	8,1: 99,00 06,65	
5,1: 115,00119,42	8,2: 56,00 67,42	
5,2: 96,00 77,30		
6,-2: 114,00100,52		
6,1: 121,00134,07		
6,2: 198,00109,42		
7,-2: 101,00104,12		
7,1: 167,00114,34		
7,2: 105,0009,06		
8,-1: 54,00 37,62		
Sum of squares error of fit is 1.24, interaural = cc		
*Optimal* latitude is at 23,7 degrees ( 4.9 ca)		
*Optimal* longitude is at 2,9 degrees ( 6.2 ca)		
IMAGE > 50%	IMAGE > 75%	
COG latitude: 26.5deg ( 5.4ca)	25.6deg ( 5.3ca)	
COG longitude: -1.0deg (-0.1ca)	0.4deg ( 1.0ca)	
ANT longitude: 29.0deg ( 2.7ca)	22.4deg ( 2.6ca)	
POST longitude: -27.0deg (-2.5ca)	-17.6deg (-1.6ca)	
MEDL latitude: 17.5deg ( 0.8ca)	19.8deg ( 4.0ca)	
LATL latitude: 37.5deg ( 7.7ca)	32.6deg ( 6.7ca)	
Elongation: 5.1/4.1ca = 1.2	3.5/2.7ca = 1.3	
Surface area: 15.4 ca2	7.6 ca2	



URN: unspecified AGE: 31 years SEX: male

DATE: Fri Dec 16 16:19:27 1994 - printed Tue Jan 17 11:01:11 1995.

FILE: /home/gary/pc/data/mapping/dylan/psrt.flx3

SERIES: Control CONTROL 9

COMMENTS: Right - Dominant

URN: unspecified AGE: unspecified SEX: unspecified

DATE: Fri Dec 16 17:13:51 1994 - printed Tue Jan 17 10:41:00 1995.

FILE: /home/gary/pc/data/mapping/dylan/psl.flx3

SERIES: CONTROL 9

COMMENTS:

**CALCULATION OPTIONS**

Add zeroed sites.:  around edges  
 Limit calculation.:  1 deg outer limit  
 Set resolution.:  256x256 matrix  
 Interpolation.:  spline fit  
 Data source.:  none selected!

**SAVE & RESTORE IMAGE**

Image label.: -4,0  
 Restore.:  full map  
 Restore % scaled.:  no

**DISPLAY OPTIONS**

Position map.: at 1 x 1 in a 1 x 1 grid [CLEAR MAP] [KEY] [PRO]  
 Map screen size.:  512x512 MAX RES  
 Viewing direction.:  Vertex  
 Upper threshold.:  image  
 Lower threshold.:  sites  
 Colour table.:  B&W & levels  
 Invert colour table.:  yes  
 Show grey scale key.:  yes  
 Show reference grid.:  black

**MASKING & MAGNIFY OPTIONS**

Draw with mask.:  yes, in min colour Blow up image.:  no  
 Add to mask.:  create default mask/rush width.:  4

[Calculate] [Draw] [Quantitate] [Save pixels] [Save matrix] [Retrieve] [The Works] [Quit]

[Clear data] [Load data] [Done]

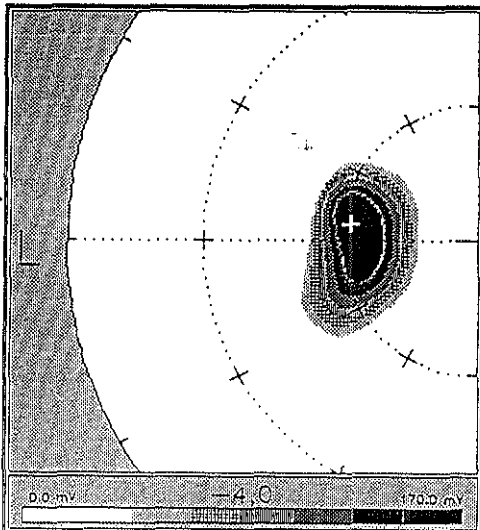
Units:  mV Loc:  Optimal Lit:  no Heat:  all

SITE:	Real Fit	SITE:	Real Fit	SITE:	Real Fit
-6,-4:	54.00 52.53	-3,-2:	144.00135.56		
-8,-2:	64.00 66.42	-4,-2:	57.00 64.28		
-7,-4:	81.00 62.00	-4,-1:	145.00132.61		
-7,-2:	106.00115.29	-4,-2:	83.00 78.16		
-7,-1:	129.00105.28	-3,-1:	50.00 58.04		
-7,-2:	126.00118.63				
-6,-2:	146.00144.66				
-6,-1:	130.00158.55				
-6,-2:	145.00155.69				
-5,-2:	141.00129.47				
-5,-1:	100.00166.09				

Sum of squares error of fit is 1.21, interaural = ca

\*Optimal\* latitude is at 28.0 degree ( 5.7 cm)  
 \*Optimal\* longitude is at 7.4 degree ( 0.7 cm)

	IMAGE > 50%	IMAGE > 75%
COG latitude:	26.0deg ( 5.3cm)	26.0deg ( 5.3cm)
COG longitude:	-0.6deg (-0.1cm)	1.4deg ( 0.3cm)
AMT longitude:	35.4deg ( 3.2cm)	27.4deg ( 2.3cm)
POST longitude:	-32.6deg (-2.5cm)	-25.6deg (-2.3cm)
NEOL latitude:	14.0deg ( 2.9cm)	18.0deg ( 3.7cm)
LATL latitude:	33.0deg ( 7.2cm)	32.0deg ( 6.0cm)
Elongation:	6.1/4.3cm = 1.4	4.0/2.9cm = 1.7
Surface area:	70.4 cm <sup>2</sup>	13.7 cm <sup>2</sup>



**CALCULATION OPTIONS**

Add zeroed sites.:  around edges  
 Limit calculation.:  1 deg outer limit  
 Set resolution.:  256x256 matrix  
 Interpolation.:  spline fit  
 Data source.:  none selected!

**SAVE & RESTORE IMAGE**

Image label.: 5,0  
 Restore.:  full map  
 Restore % scaled.:  no

**DISPLAY OPTIONS**

Position map.: at 1 x 1 in a 1 x 1 grid [CLEAR MAP] [KEY] [PRO]  
 Map screen size.:  512x512 MAX RES  
 Viewing direction.:  Vertex  
 Upper threshold.:  image  
 Lower threshold.:  sites  
 Colour table.:  B&W & levels  
 Invert colour table.:  yes  
 Show grey scale key.:  yes  
 Show reference grid.:  black

**MASKING & MAGNIFY OPTIONS**

Draw with mask.:  yes, in min colour Blow up image.:  no  
 Add to mask.:  create default mask/rush width.:  4

[Calculate] [Draw] [Quantitate] [Save pixels] [Save matrix] [Retrieve] [The Works] [Quit]

[Clear data] [Load data] [Done]

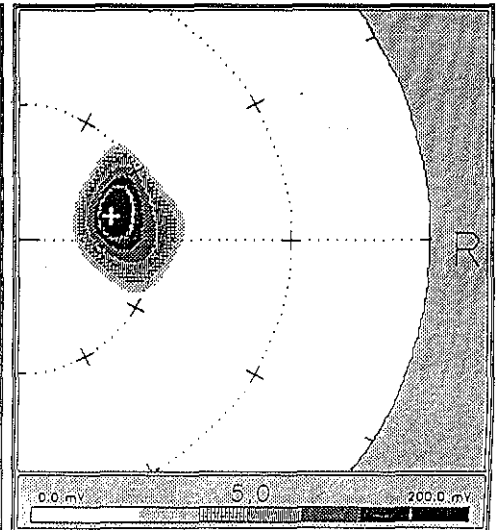
Units:  mV Loc:  Optimal Lit:  no Heat:  all

SITE:	Real Fit	SITE:	Real Fit	SITE:	Real Fit
3,-1:	71.00 77.76	7,-2:	54.00 60.22		
4,-1:	152.00157.15				
4,-2:	166.00139.14				
5,-2:	89.00 62.83				
5,-1:	103.00165.95				
5,-2:	179.00191.35				
6,-2:	64.00 69.30				
6,-1:	137.00133.15				
6,-2:	136.00140.34				
6,-1:	116.0094.18				
7,-1:	93.00 64.42				

Sum of squares error of fit is 1.08, interaural = ca

\*Optimal\* latitude is at 21.1 degree ( 4.3 cm)  
 \*Optimal\* longitude is at 14.3 degree ( 1.1 cm)

	IMAGE > 50%	IMAGE > 75%
COG latitude:	20.6deg ( 4.9cm)	22.8deg ( 4.7cm)
COG longitude:	12.0deg ( 1.9cm)	14.8deg ( 1.2cm)
AMT longitude:	29.9deg ( 3.2cm)	33.8deg ( 2.7cm)
POST longitude:	-15.0deg (-1.2cm)	-5.2deg (-0.4cm)
NEOL latitude:	14.6deg ( 3.0cm)	16.8deg ( 3.4cm)
LATL latitude:	30.6deg ( 6.9cm)	28.0deg ( 5.9cm)
Elongation:	4.4/2.9cm = 1.5	3.1/2.3cm = 1.3
Surface area:	13.4 cm <sup>2</sup>	3.9 cm <sup>2</sup>



## CONTROL GROUP THRESHOLD CURVES

\* Indicates dominant hemisphere

URN: unspecified AGE: unspecified SEX: unspecified

DATE: Wed Aug 31 15:40:36 1994 - printed Mon Dec 19 09:54:27 1994.

FILE: /home/gary/pc/data/mapping/dylan/dert.flx1

SERIES: CONTROL 1

COMMENTS: map of right wrist flexor

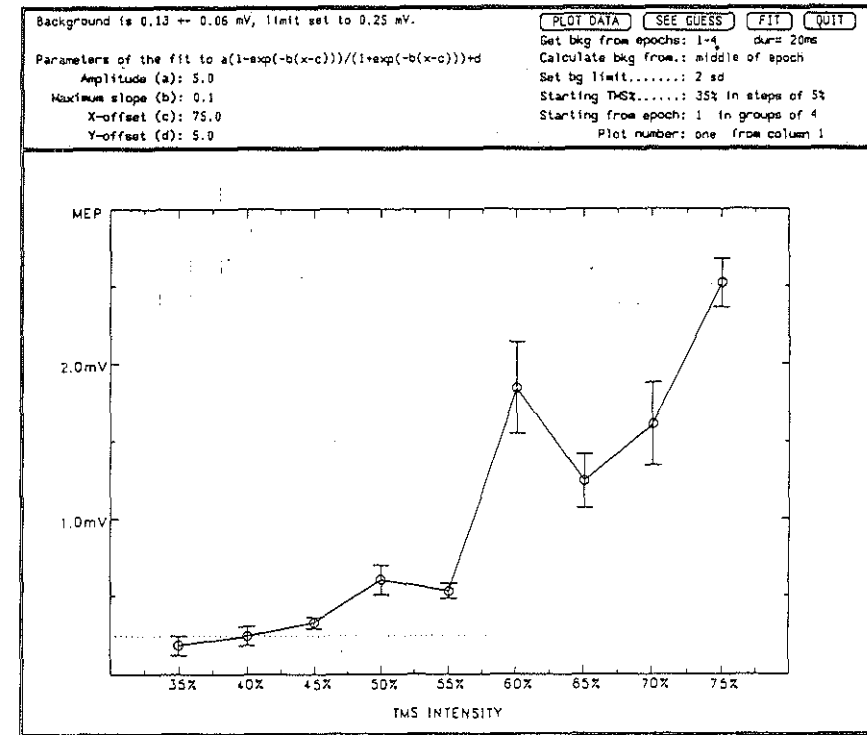
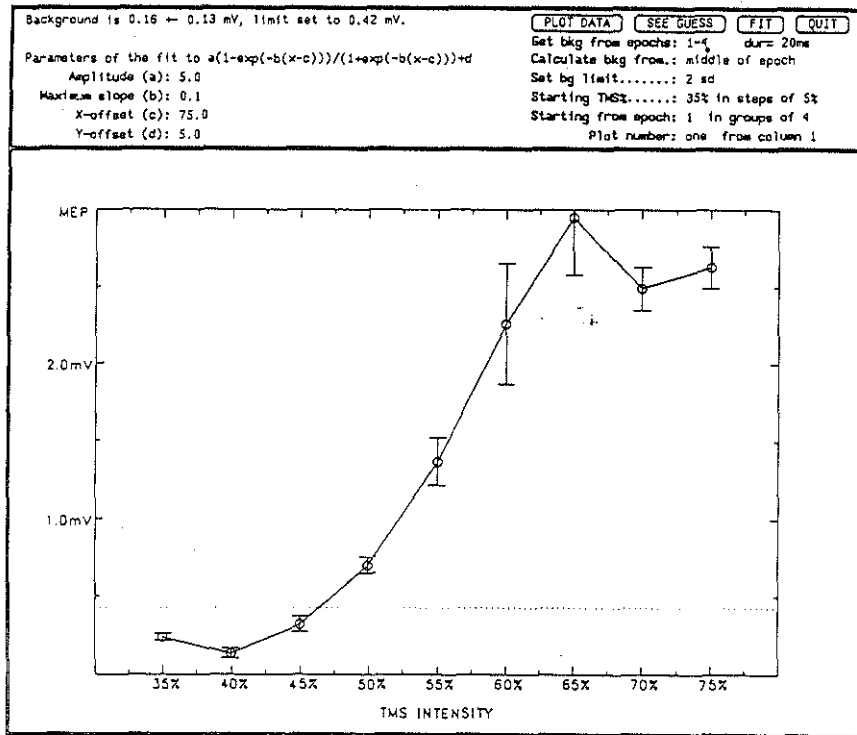
URN: unspecified AGE: unspecified SEX: unspecified

DATE: Wed Aug 31 14:41:00 1994 - printed Mon Dec 19 09:51:05 1994.

FILE: /home/gary/pc/data/mapping/dylan/dcl.flx1

SERIES: CONTROL 1

COMMENTS: map of left flexors



\*

URN: unspecified AGE: unspecified SEX: unspecified

DATE: Mon Sep 12 19:06:49 1994 - printed Mon Dec 19 10:03:06 1994.

FILE: /home/gary/pc/data/mapping/dylan/aart.flx

SERIES: mapping r fcu CONTROL 2

COMMENTS:

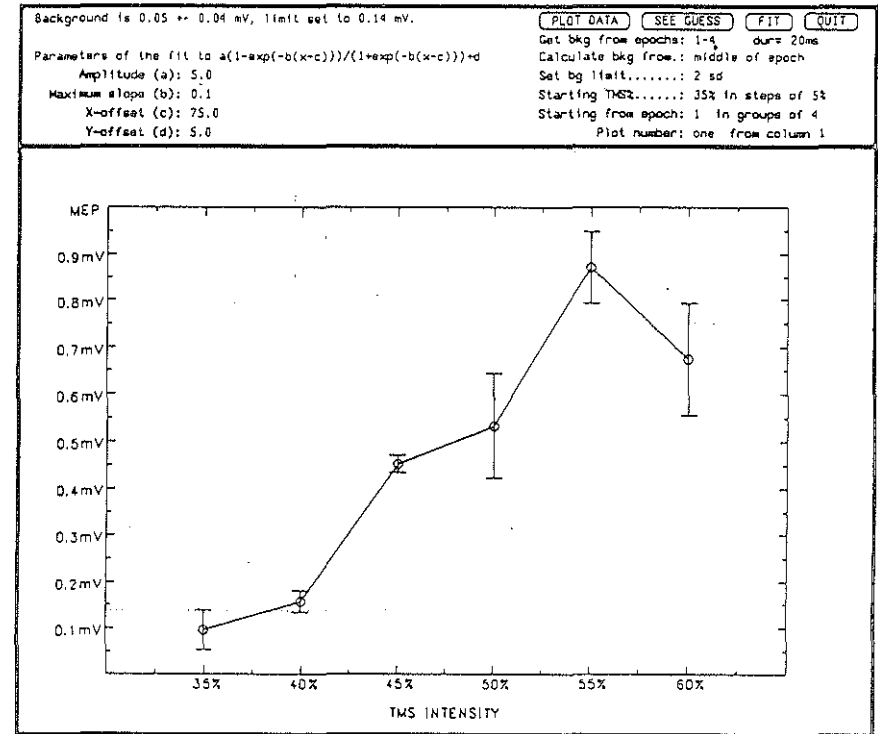
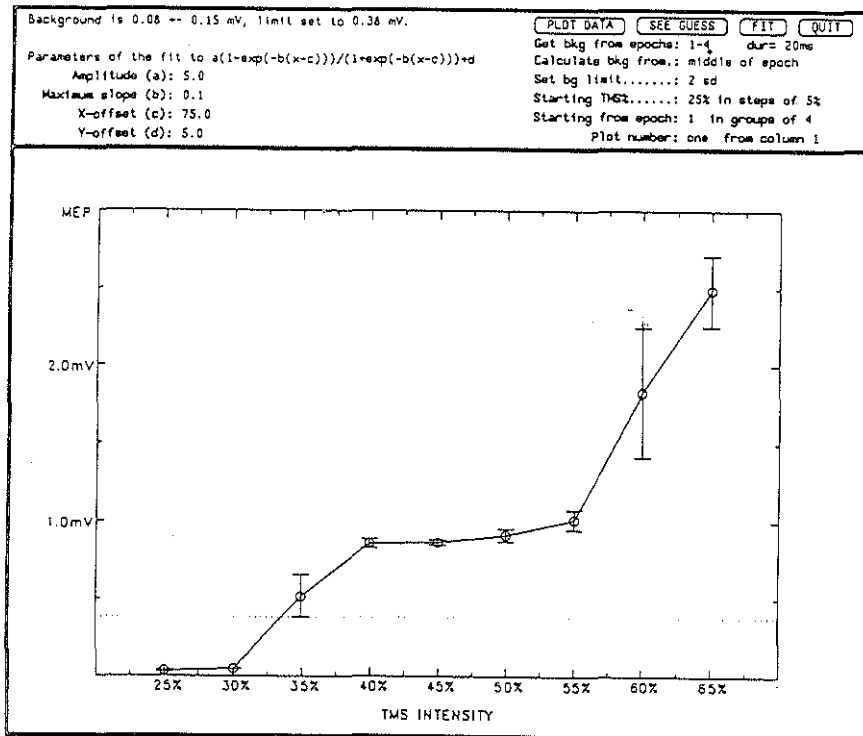
URN: unspecified AGE: unspecified SEX: unspecified

DATE: Mon Sep 12 17:34:49 1994 - printed Mon Dec 19 10:12:35 1994.

FILE: /home/gary/pc/data/mapping/dylan/aalflx

SERIES: CONTROL 2

COMMENTS:



\*

URN: unspecified AGE: unspecified SEX: unspecified

DATE: Thu Sep 22 10:14:25 1994 - printed Mon Dec 19 11:09:05 1994.

FILE: /home/gary/pc/data/mapping/dylan/jal.flx

SERIES: mapping L FCU CONTROL 3

COMMENTS:

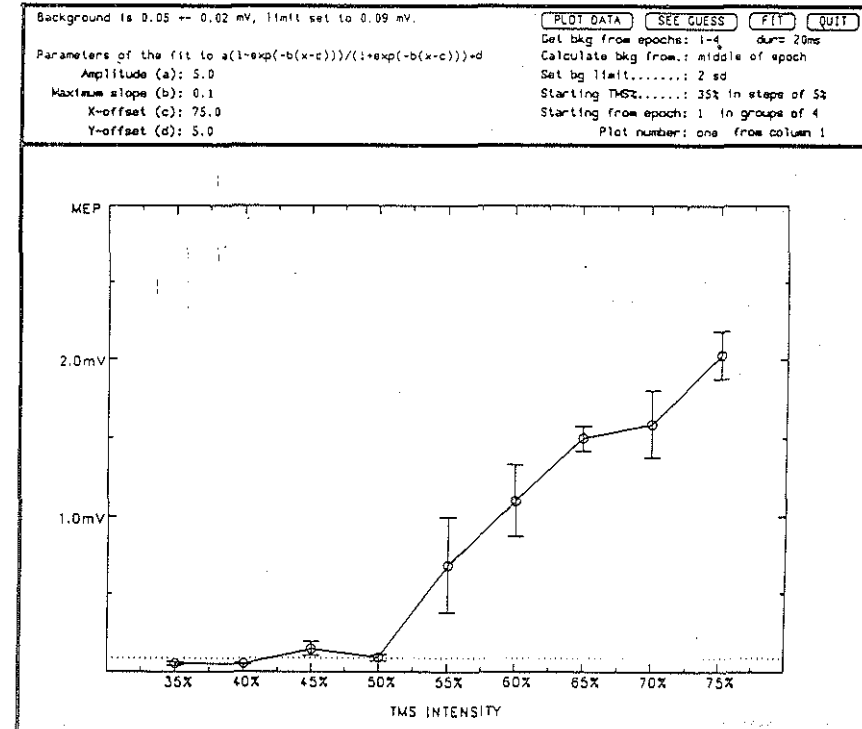
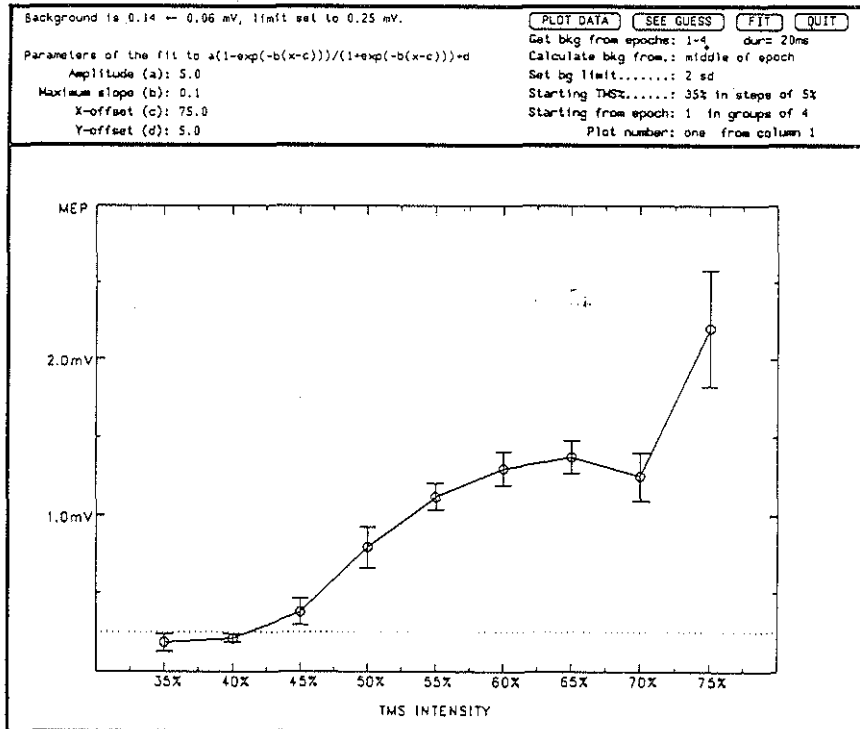
URN: unspecified AGE: unspecified SEX: unspecified

DATE: Thu Sep 22 11:14:28 1994 - printed Mon Dec 19 11:06:14 1994.

FILE: /home/gary/pc/data/mapping/dylan/jar.flx

SERIES: mapping R FCU CONTROL 3

COMMENTS:



\*

URN: unspecified      AGE: unspecified      SEX: unspecified

DATE: Fri Sep 23 11:40:07 1994 - printed Mon Dec 19 11:11:56 1994.

FILE: /home/gary/pc/data/mapping/dylan/scl.flx

SERIES: mapping R FCU      CONTROL 4

COMMENTS:

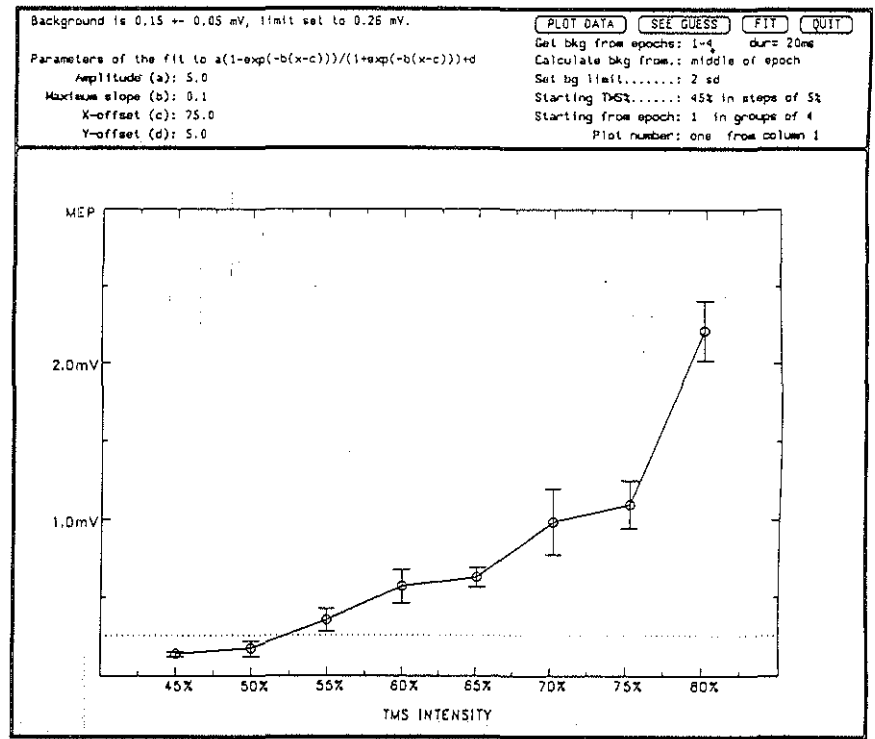
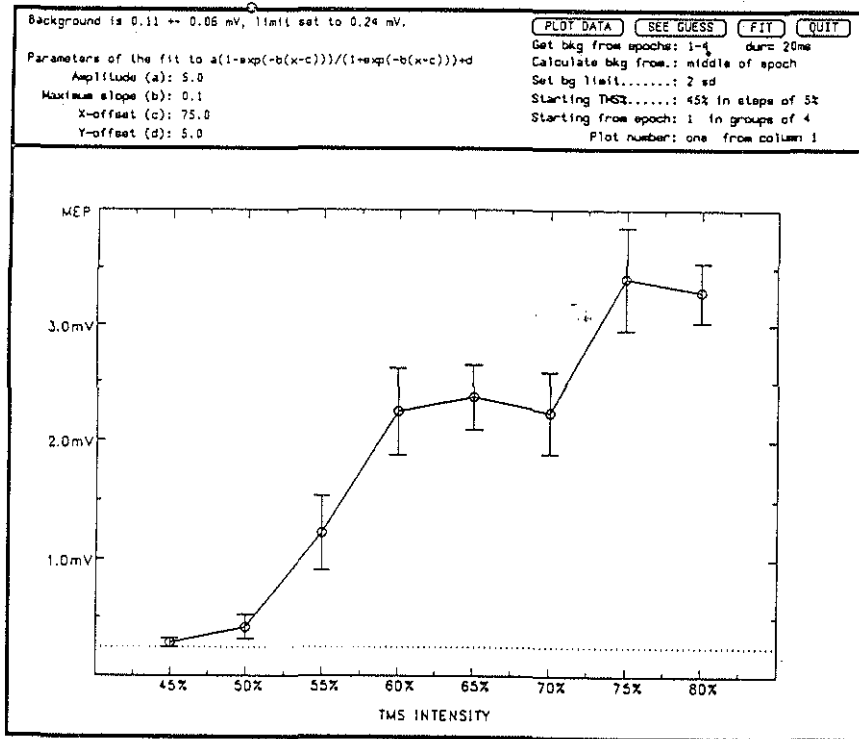
URN: unspecified      AGE: unspecified      SEX: unspecified

DATE: Fri Sep 23 10:55:48 1994 - printed Mon Dec 19 11:14:14 1994.

FILE: /home/gary/pc/data/mapping/dylan/scl.flx

SERIES: CONTROL 4

COMMENTS: map of left fcu



\*

URN: unspecified AGE: 19 years SEX: unspecified

DATE: Wed Oct 05 15:09:50 1994 - printed Mon Dec 19 11:21:31 1994.

FILE: /home/gary/pc/data/mapping/dylan/jert.flx

SERIES: mapping FCU CONTROL 5

COMMENTS: CONTROL DATA

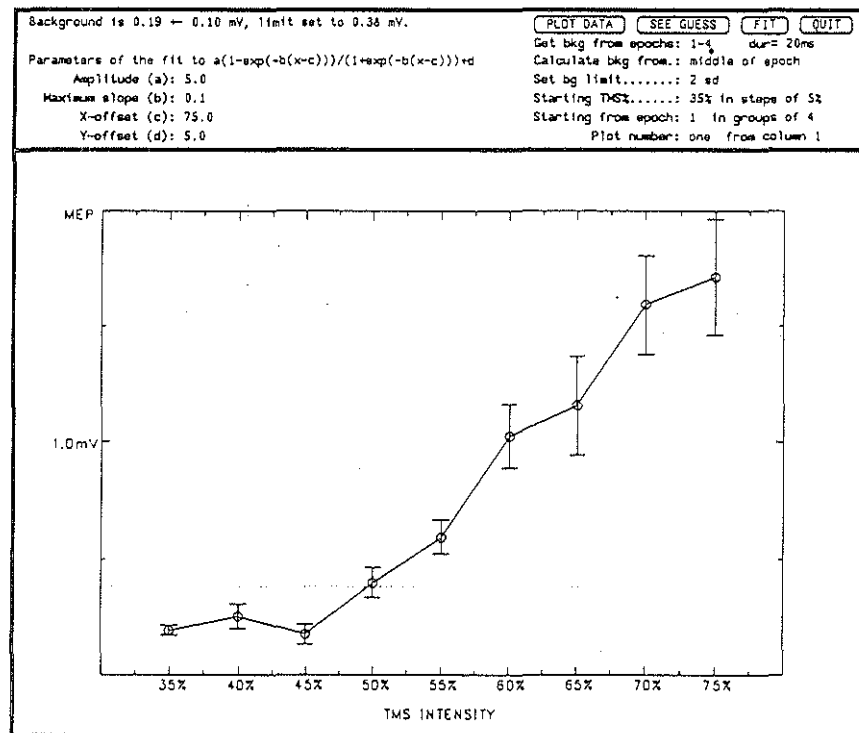
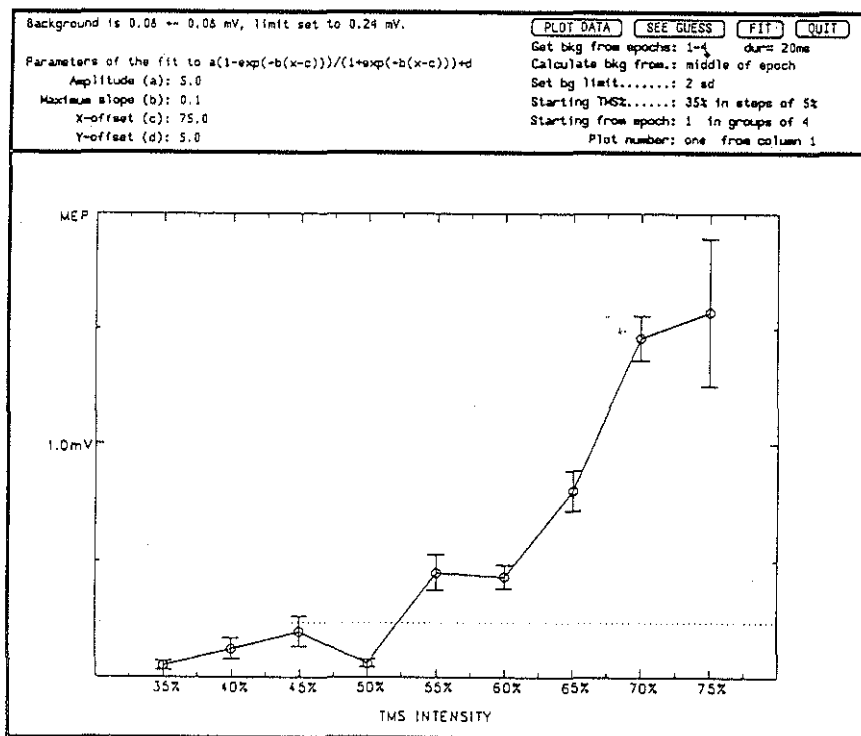
URN: unspecified AGE: 19 years SEX: unspecified

DATE: Wed Oct 05 16:16:30 1994 - printed Mon Dec 19 11:19:23 1994.

FILE: /home/gary/pc/data/mapping/dylan/jel.flx

SERIES: mapping Left FCU CONTROL 5

COMMENTS: CONTROL DATA



\*



URN: unspecified AGE: 28 years SEX: female

DATE: Mon Oct 10 15:23:44 1994 - printed Mon Dec 19 11:25:03 1994.

FILE: /home/gary/pc/data/mapping/dylan/mtrl.flx2

SERIES: Control CONTROL 6

COMMENTS: Right FCU - Dominant

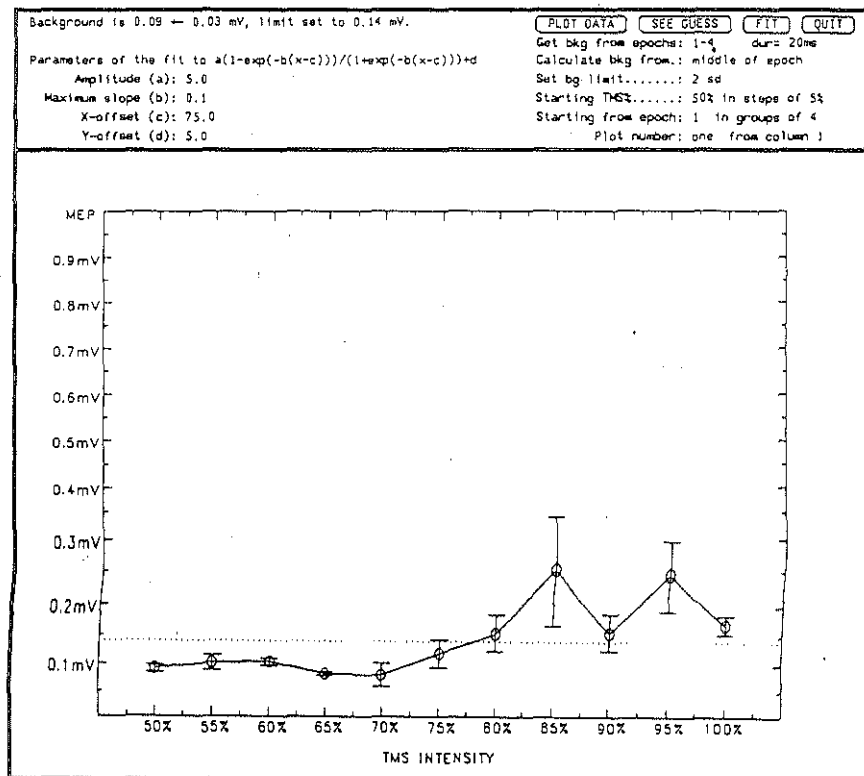
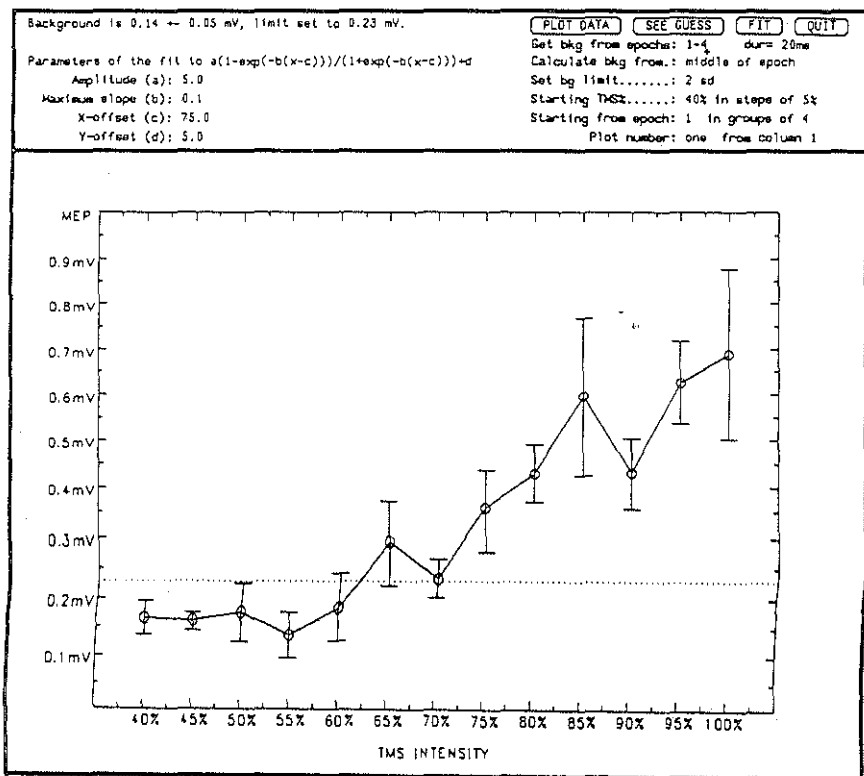
URN: unspecified AGE: 28 years SEX: female

DATE: Mon Oct 10 16:38:55 1994 - printed Mon Dec 19 11:27:29 1994.

FILE: /home/gary/pc/data/mapping/dylan/mlL.flx2

SERIES: Control CONTROL 6

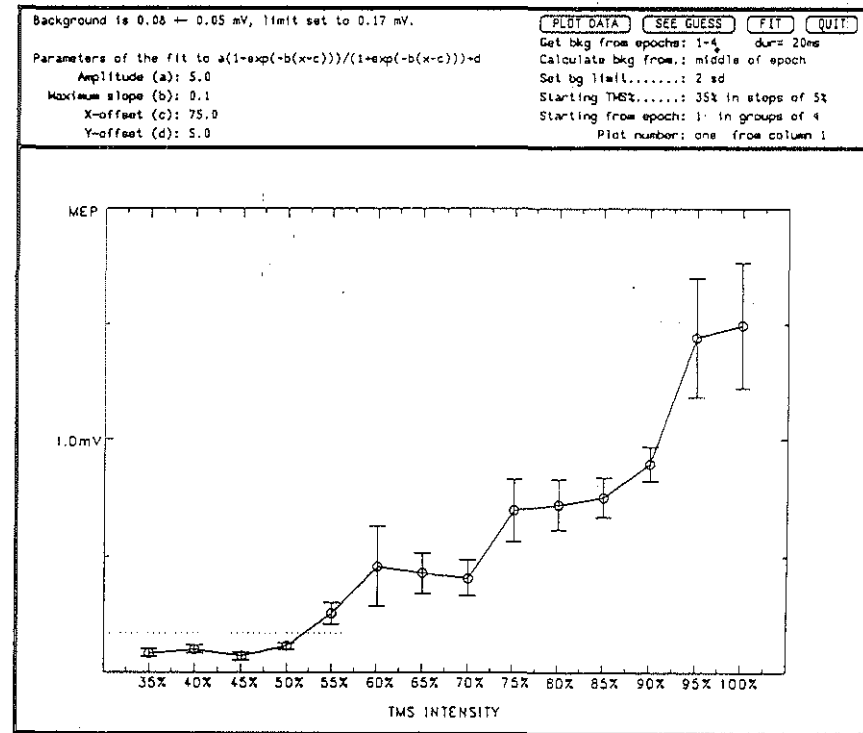
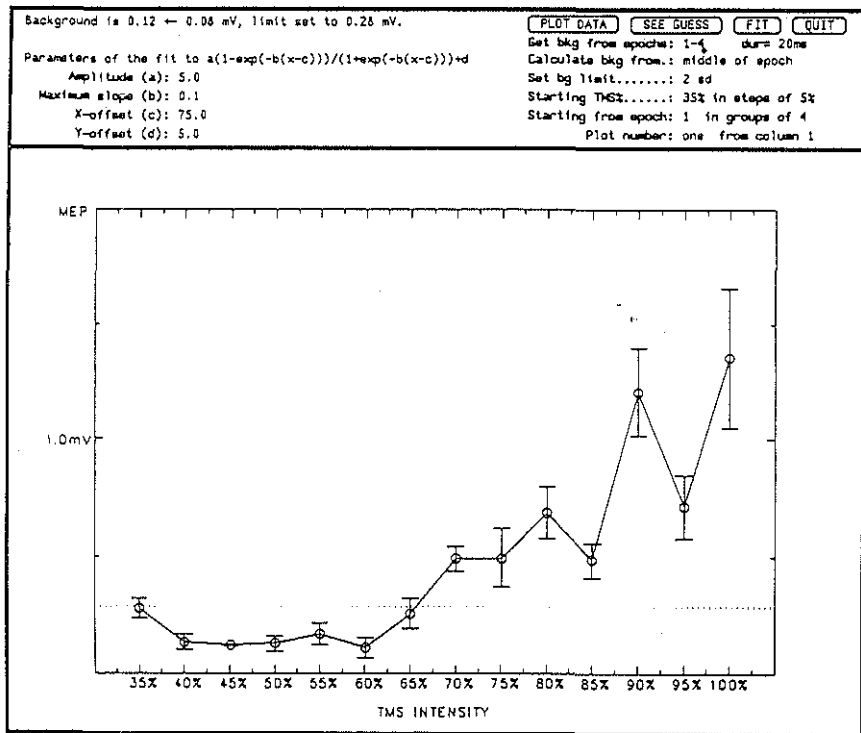
COMMENTS: Left FCU - NonDominant



\*

URN: unspecified AGE: 22 years SEX: male  
 DATE: Tue Oct 25 09:59:50 1994 - printed Mon Nov 7 17:35:11 1994.  
 FILE: /home/gary/pc/data/mapping/dylan/rsrt.flx  
 SERIES: Control - Weighlifting CONTROL 7  
 COMMENTS: R FCU - Dominant

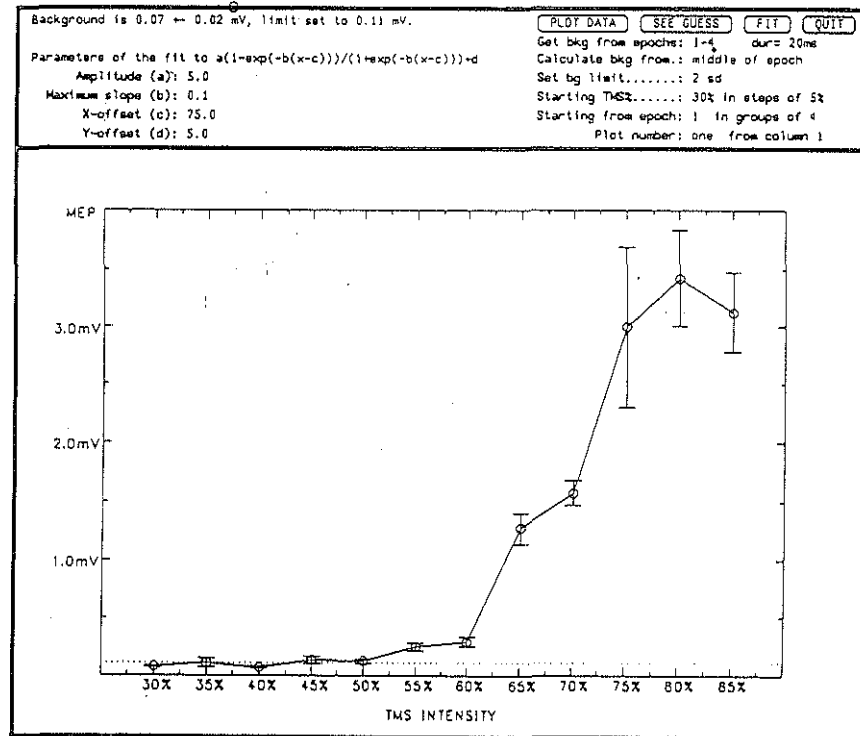
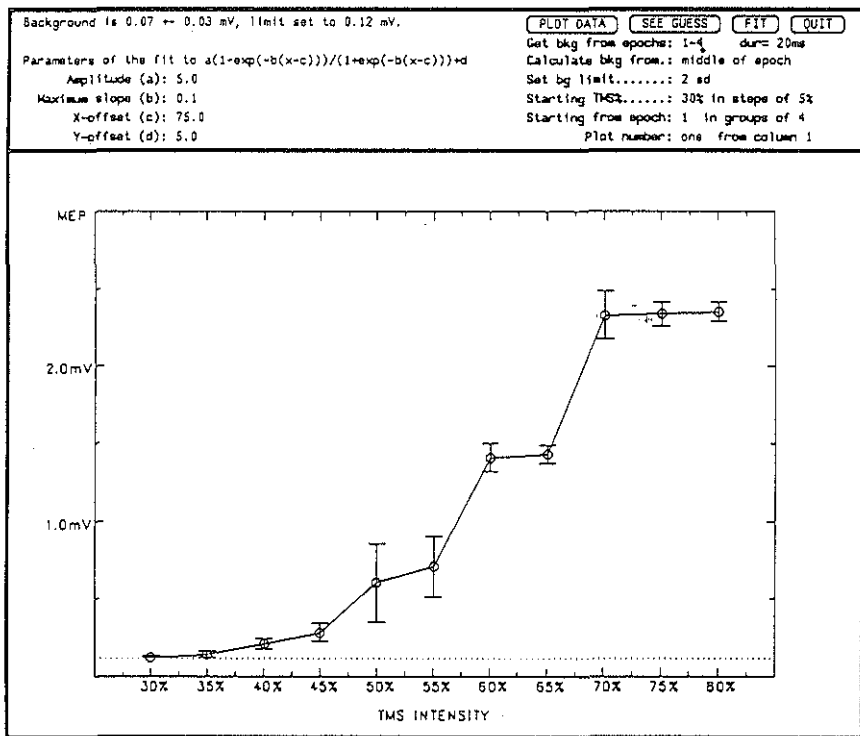
URN: unspecified AGE: 22 years SEX: male  
 DATE: Tue Oct 25 11:14:51 1994 - printed Mon Dec 19 11:32:48 1994.  
 FILE: /home/gary/pc/data/mapping/dylan/rsr.flx  
 SERIES: Control CONTROL 7  
 COMMENTS: L FCU - Non-Dominant



\*

URN: unspecified AGE: 29 years SEX: male  
 DATE: Mon Dec 12 11:38:37 1994 - printed Mon Dec 19 12:00:21 1994.  
 FILE: /home/gary/pc/data/mapping/dylan/bprt.flx  
 SERIES: CONTROL CONTROL 8  
 COMMENTS: RIGHT HAND NON-DOMINANT

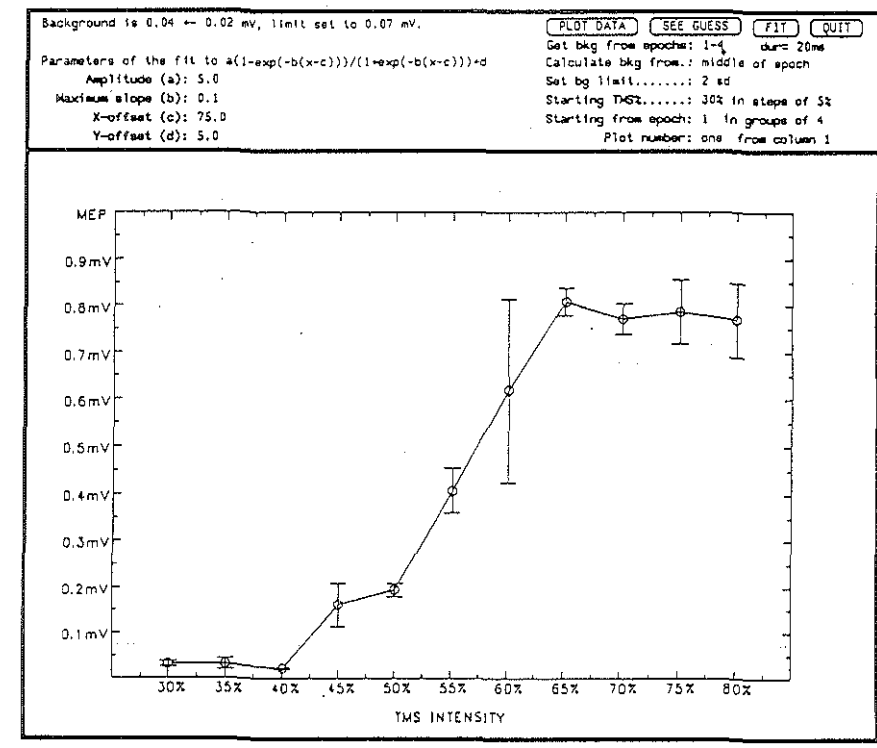
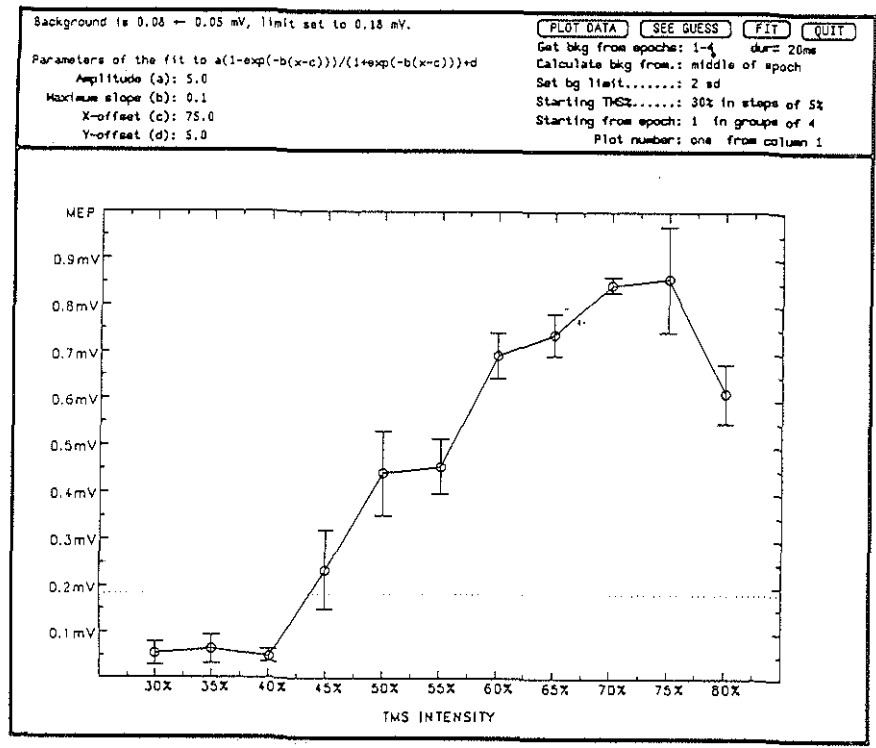
URN: unspecified AGE: unspecified SEX: unspecified  
 DATE: Mon Dec 12 12:45:57 1994 - printed Mon Dec 19 12:03:39 1994.  
 FILE: /home/gary/pc/data/mapping/dylan/bpl.flx  
 SERIES: control CONTROL 8  
 COMMENTS: left, non-dominant arm



\*

URN: unspecified    AGE: 31 years    SEX: male  
 DATE: Fri Dec 16 16:19:27 1994 - printed Fri Dec 16 17:14:18 1994.  
 FILE: /home/gary/pc/data/mapping/dylan/psri.flx3  
 SERIES: Control    CONTROL 9  
 COMMENTS: Right - Dominant

URN: unspecified    AGE: unspecified    SEX: unspecified  
 DATE: Fri Dec 16 17:13:51 1994 - printed Fri Dec 16 17:42:54 1994.  
 FILE: /home/gary/pc/data/mapping/dylan/psl.flx3  
 SERIES: CONTROL 9  
 COMMENTS:



## APPENDIX D

### ATHLETE GROUP MEP MAPS

\* Indicates dominant hemisphere

URN: unspecified AGE: 23 years SEX: unspecified

DATE: Mon Sep 19 16:20:39 1994 - printed Wed Sep 28 19:40:10 1994.

FILE: /home/gary/pc/data/mapping/dylan/lmr.flx

SERIES: ATHLETE 1

COMMENTS: right fcu

URN: unspecified AGE: unspecified SEX: unspecified

DATE: Mon Sep 19 17:41:17 1994 - printed Thu Sep 29 12:12:23 1994.

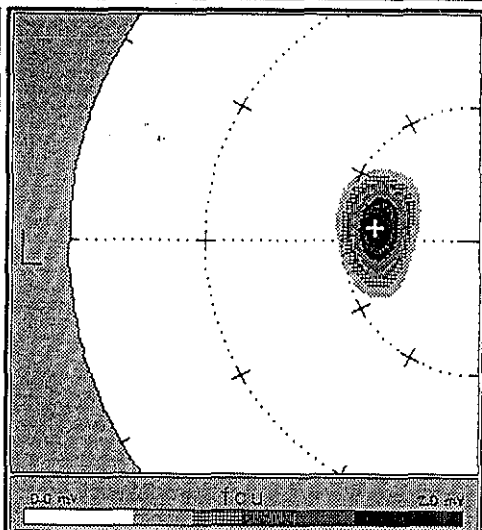
FILE: /home/gary/pc/data/mapping/dylan/lml.flx

SERIES: ATHLETE 1

COMMENTS: left fcu

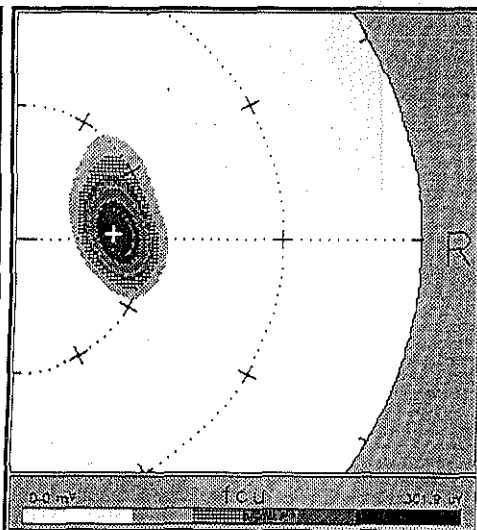
CALCULATION OPTIONS		DISPLAY OPTIONS	
Add zeroed sites.: <input type="radio"/> around edges	Position map...: at 1 x 1 in a 1 x 1 grid [CLEAR MAP] [KEY] [PRD]	Map screen size: <input type="radio"/> S12xS12 MAX RES	Viewing direction...: <input type="radio"/> Vertex
Limit calculation: <input type="radio"/> 1 deg outer limit	Upper threshold: <input type="radio"/> image	UT value (u,m,x)....:	LT value (u,m,x)....:
Set resolution...: <input type="radio"/> 256x256 matrix	Lower threshold: <input type="radio"/> sites	Invert colour table: <input type="radio"/> yes	Show grey scale key: <input type="radio"/> yes
Interpolation...: <input type="radio"/> spline fit	Colour table...: <input type="radio"/> B&W 8 levels	Map background...: <input type="radio"/> white	Show reference grid: <input type="radio"/> black
Data source...: <input type="radio"/> MAXMIN	Map background...: <input type="radio"/> white	Show sites...: <input type="radio"/> no	
SAVE & RESTORE IMAGE		MASKING & MAGNIFY OPTIONS	
Image label...: fcu	Draw with mask...: <input type="radio"/> no	Blow up image...: <input type="radio"/> no	Brush width...: <input type="radio"/> 4
Restore...: <input type="radio"/> full map	Restore & scaled...: <input type="radio"/> no	Add to mask...: <input type="radio"/> clear mask	
Calculate	Draw	Quantitate	Save pixels
Save matrix	Retrieve	Hide	Quit

Clear data			Load data			Done
Units: <input type="radio"/> mV	Loc: <input type="radio"/> Optimal	Lin: <input type="radio"/> no	Heal: <input type="radio"/> all			
SITE: Real Fit	SITE: Real Fit	SITE: Real Fit				
-5,8: 1.95 1.51	-3,-2: 0.00 -0.06	-6,8: 0.03 -0.04				
-5,2: 1.71 1.59	-2,8: 0.04 -0.16	-8,2: 0.04 0.09				
-5,4: 0.14 0.17	-6,4: 1.16 1.18					
-5,-2: 1.17 0.07	-4,2: 1.13 1.21					
-5,-4: 0.07 0.04	-4,4: 0.17 0.23					
-4,8: 1.40 1.42	-6,-2: 0.47 0.83					
-4,2: 0.36 0.53	-6,-4: 0.03 0.17					
-4,4: 0.00 0.01	-7,4: 0.13 0.21					
-4,-2: 0.11 0.36	-7,2: 0.40 0.39					
-3,8: 0.16 0.52	-7,4: 0.11 0.09					
-3,2: 0.12 0.21	-7,-2: 0.10 0.07					
Sum of squares error of fit is 2.05						
*Optimal* latitude is at 23.1 degrees ( 4.7 ca)						
*Optimal* longitude is at 7.0 degrees ( 0.6 ca)						
----- IMAGE > 50% ----- IMAGE > 75%						
COG latitude :	22.4deg ( 4.6ca)	:	22.4deg ( 4.6ca)			
COG longitude:	7.2deg ( 0.6ca)	:	7.7deg ( 0.6ca)			
ANT longitude:	36.2deg ( 2.0ca)	:	26.7deg ( 2.1ca)			
POST longitude:	-20.8deg (-1.6ca)	:	-5.3deg (-0.7ca)			
HEDL latitude :	15.4deg ( 3.2ca)	:	16.4deg ( 3.4ca)			
LATL latitude :	29.4deg ( 6.0ca)	:	26.4deg ( 5.4ca)			
Elongation :	4.5/2.9ca = 1.6	:	2.8/2.1ca = 1.4			
Surface area :	9.3 ca2	:	4.8 ca2			



CALCULATION OPTIONS		DISPLAY OPTIONS	
Add zeroed sites.: <input type="radio"/> around edges	Position map...: at 1 x 1 in a 1 x 1 grid [CLEAR MAP] [KEY] [PRD]	Map screen size: <input type="radio"/> S12xS12 MAX RES	Viewing direction...: <input type="radio"/> Vertex
Limit calculation: <input type="radio"/> 1 deg outer limit	Upper threshold: <input type="radio"/> image	UT value (u,m,x)....:	LT value (u,m,x)....:
Set resolution...: <input type="radio"/> 256x256 matrix	Lower threshold: <input type="radio"/> sites	Invert colour table: <input type="radio"/> yes	Show grey scale key: <input type="radio"/> yes
Interpolation...: <input type="radio"/> spline fit	Colour table...: <input type="radio"/> B&W 8 levels	Map background...: <input type="radio"/> white	Show reference grid: <input type="radio"/> black
Data source...: <input type="radio"/> MAXMIN	Map background...: <input type="radio"/> white	Show sites...: <input type="radio"/> no	
SAVE & RESTORE IMAGE		MASKING & MAGNIFY OPTIONS	
Image label...: fcu	Draw with mask...: <input type="radio"/> no	Blow up image...: <input type="radio"/> no	Brush width...: <input type="radio"/> 4
Restore...: <input type="radio"/> full map	Restore & scaled...: <input type="radio"/> no	Add to mask...: <input type="radio"/> clear mask	
Calculate	Draw	Quantitate	Save pixels
Save matrix	Retrieve	Hide	Quit

Clear data			Load data			Done
Units: <input type="radio"/> mV	Loc: <input type="radio"/> Optimal	Lin: <input type="radio"/> no	Heal: <input type="radio"/> all			
SITE: Real Fit	SITE: Real Fit	SITE: Real Fit				
5,8: 0.30 0.39	7,-2: 0.05 0.00					
5,2: 0.21 0.22	7,2: 0.00 0.07					
5,4: 0.06 0.08	7,4: 0.07 0.00					
5,-2: 0.02 0.10	8,8: 0.05 0.05					
6,8: 0.17 0.23	8,2: 0.04 0.04					
6,2: 0.16 0.17	4,8: 0.20 0.22					
6,4: 0.16 0.12	4,2: 0.17 0.16					
6,6: 0.05 0.04	4,4: 0.05 0.03					
6,-2: 0.21 0.14	4,-2: 0.05 0.02					
6,-4: 0.03 0.02	3,8: 0.09 0.10					
7,0: 0.11 0.10	3,2: 0.05 0.06					
Sum of squares error of fit is 6.48						
*Optimal* latitude is at 22.1 degrees ( 4.5 ca)						
*Optimal* longitude is at 3.1 degrees ( 0.2 ca)						
----- IMAGE > 50% ----- IMAGE > 75%						
COG latitude :	23.0deg ( 4.7ca)	:	22.9deg ( 4.7ca)			
COG longitude:	5.0deg ( 0.5ca)	:	4.3deg ( 0.3ca)			
ANT longitude:	35.0deg ( 2.3ca)	:	24.3deg ( 1.9ca)			
POST longitude:	-18.2deg (-1.5ca)	:	-11.7deg (-0.9ca)			
HEDL latitude :	15.0deg ( 3.1ca)	:	17.3deg ( 3.7ca)			
LATL latitude :	32.0deg ( 6.5ca)	:	27.9deg ( 5.7ca)			
Elongation :	4.3/3.5ca = 1.2	:	2.9/2.1ca = 1.4			
Surface area :	10.3 ca2	:	4.6 ca2			

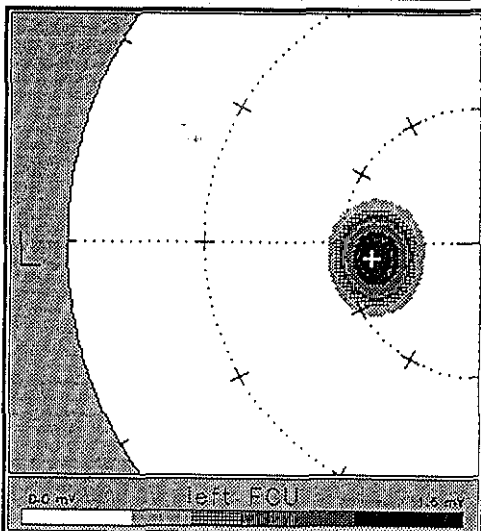


URN: unspecified AGE: 33 years SEX: female  
 DATE: Wed Sep 28 16:04:38 1994 - printed Wed Sep 28 18:52:29 1994.  
 FILE: /home/gary/pc/data/mapping/dylan/cwrt.flx2  
 SERIES: ATHLETE 2  
 COMMENTS: Right FCU -Badminton

URN: unspecified AGE: unspecified SEX: unspecified  
 DATE: Wed Sep 28 17:01:26 1994 - printed Wed Sep 28 18:26:21 1994.  
 FILE: /home/gary/pc/data/mapping/dylan/cwl.flx  
 SERIES: ATHLETE 2  
 COMMENTS: left wrist flexor map

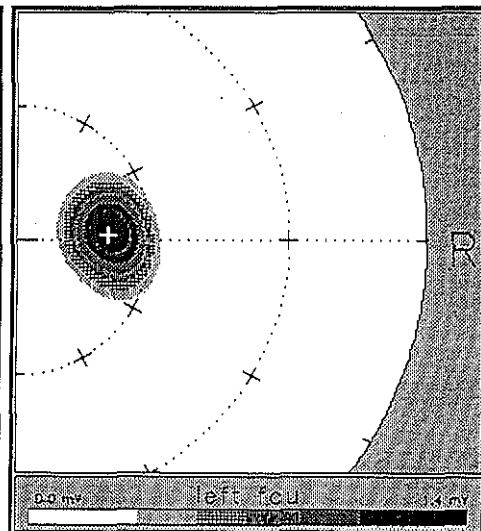
CALCULATION OPTIONS		DISPLAY OPTIONS	
Add zeroed sites.: <input type="radio"/> around edges	Position map...: at 1 x 1 in a 1 x 1 grid [CLEAR MAP] [KEY] [PRO]	Map screen size: <input type="radio"/> 512x512 MAX RES	Viewing direction...: <input type="radio"/> Vertex
Limit calculation...: <input type="radio"/> 1 deg outer limit	Upper threshold: <input type="radio"/> image	UT value (u,m,2)...:	Lower threshold: <input type="radio"/> sites
Set resolution...: <input type="radio"/> 256x256 matrix	Colour table...: <input type="radio"/> 8&H & levels	LT value (u,m,2)...:	Invert colour table: <input type="radio"/> yes
Interpolation...: <input type="radio"/> spline fit	Map background...: <input type="radio"/> white	Show gray scale key: <input type="radio"/> yes	Show reference grid: <input type="radio"/> black
Data source...: <input type="radio"/> MAXMIN	Show sites...: <input type="radio"/> no	MASKING & MAGNIFY OPTIONS	
SAVE & RESTORE IMAGE		Draw with mask...: <input type="radio"/> yes, in min colour	Blow up image...: <input type="radio"/> no
Image label...: left FCU	Restore...: <input type="radio"/> full map	Add to mask...: <input type="radio"/> add pixels (min)	Brush width...: <input type="radio"/> 4
Restore & scaled...: <input type="radio"/> no	<input type="button" value="Calculate"/> <input type="button" value="Draw"/> <input type="button" value="Quantitate"/> <input type="button" value="Save pixels"/> <input type="button" value="Save matrix"/> <input type="button" value="Retrieve"/> <input type="button" value="Hide"/> <input type="button" value="Quit"/>		

Clear data	Load data	Done
Units: <input type="radio"/> mV	Loc: <input type="radio"/> Optimal	Liv: <input type="radio"/> no
Heat: <input type="radio"/> all		
SITE: Real Fit	SITE: Real Fit	SITE: Real Fit
-1,1: 1.29 1.29	-6,-2: 0.92 0.97	-3,-2: 0.11 0.16
-1,2: 0.23 0.30	-5,-4: 0.17 0.20	-2,1: 0.09 0.12
-1,-2: 0.75 0.82	-7,1: 0.11 0.30	
-1,-1: 0.45 0.83	-7,2: 0.16 0.65	
-3,1: 1.30 1.52	-7,-2: 0.25 0.34	
-5,2: 0.50 0.46	-7,-1: 0.13 0.09	
-5,1: 0.06 0.04	-8,1: 0.07 -0.03	
-5,-2: 1.07 1.26	-8,-2: 0.07 -0.01	
-5,-1: 0.12 0.15	-3,1: 0.03 0.62	
-6,1: 1.30 1.06	-3,2: 0.07 0.06	
-6,2: 0.23 0.29	-3,-1: 0.07 0.06	
Sum of squares error of fit is 1.31		
*Optimal* latitude is at 24.0 degrees ( 4.3 ca)		
*Optimal* longitude is at -0.7 degrees (-0.7 ca)		
----- IMAGE > 50%   IMAGE > 75%		
COG latitude : 23.1deg ( 4.6ca)   23.2deg ( 4.8ca)		
COG longitude : -8.1deg (-4.7ca)   -8.1deg (-6.7ca)		
ANT longitude : 17.9deg ( 1.4ca)   9.9deg ( 4.8ca)		
POST longitude : -32.1deg (-2.6ca)   -24.1deg (-2.0ca)		
REDL latitude : 14.1deg ( 2.5ca)   17.2deg ( 3.5ca)		
LATL latitude : 31.1deg ( 6.4ca)   28.2deg ( 5.8ca)		
Elongation : 4.8/3.5ca = 1.2   2.8/2.3ca = 1.2		
Surface area : 9.5 ca2   4.3 ca2		



CALCULATION OPTIONS		DISPLAY OPTIONS	
Add zeroed sites.: <input type="radio"/> around edges	Position map...: at 1 x 1 in a 1 x 1 grid [CLEAR MAP] [KEY] [PRO]	Map screen size: <input type="radio"/> 512x512 MAX RES	Viewing direction...: <input type="radio"/> Vertex
Limit calculation...: <input type="radio"/> 1 deg outer limit	Upper threshold: <input type="radio"/> image	UT value (u,m,2)...:	Lower threshold: <input type="radio"/> sites
Set resolution...: <input type="radio"/> 256x256 matrix	Colour table...: <input type="radio"/> 8&H & levels	LT value (u,m,2)...:	Invert colour table: <input type="radio"/> yes
Interpolation...: <input type="radio"/> spline fit	Map background...: <input type="radio"/> white	Show gray scale key: <input type="radio"/> yes	Show reference grid: <input type="radio"/> black
Data source...: <input type="radio"/> MAXMIN	Show sites...: <input type="radio"/> no	MASKING & MAGNIFY OPTIONS	
SAVE & RESTORE IMAGE		Draw with mask...: <input type="radio"/> yes, in min colour	Blow up image...: <input type="radio"/> no
Image label...: left FCU	Restore...: <input type="radio"/> full map	Add to mask...: <input type="radio"/> add pixels (min)	Brush width...: <input type="radio"/> 4
Restore & scaled...: <input type="radio"/> no	<input type="button" value="Calculate"/> <input type="button" value="Draw"/> <input type="button" value="Quantitate"/> <input type="button" value="Save pixels"/> <input type="button" value="Save matrix"/> <input type="button" value="Retrieve"/> <input type="button" value="Hide"/> <input type="button" value="Quit"/>		

Clear data	Load data	Done
Units: <input type="radio"/> mV	Loc: <input type="radio"/> Optimal	Liv: <input type="radio"/> no
Heat: <input type="radio"/> all		
SITE: Real Fit	SITE: Real Fit	SITE: Real Fit
5,1: 1.29 1.25	7,-2: 0.10 0.12	
5,2: 1.09 0.93	7,2: 0.03 -0.03	
5,4: 0.09 0.12	4,1: 0.09 1.28	
5,-2: 0.73 0.65	4,2: 0.73 0.06	
5,-1: 0.02 0.06	4,4: 0.04 0.00	
6,1: 0.75 0.75	4,-2: 0.36 0.45	
6,2: 0.42 0.50	4,-1: 0.02 -0.04	
6,4: 0.05 0.04	3,1: 1.49 0.91	
6,-2: 0.40 0.50	3,2: 0.30 0.37	
6,-1: 0.05 0.03	3,-2: 0.05 0.09	
7,1: 0.09 0.07	2,1: 0.11 0.34	
Sum of squares error of fit is 7.61		
*Optimal* latitude is at 20.5 degrees ( 4.2 ca)		
*Optimal* longitude is at 3.4 degrees ( 0.2 ca)		
----- IMAGE > 50%   IMAGE > 75%		
COG latitude : 20.9deg ( 4.3ca)   20.8deg ( 4.3ca)		
COG longitude : 4.5deg ( 0.3ca)   5.3deg ( 0.4ca)		
ANT longitude : 34.5deg ( 2.5ca)   25.3deg ( 1.0ca)		
POST longitude : -21.5deg (-1.6ca)   -10.7deg (-6.8ca)		
REDL latitude : 11.9deg ( 2.4ca)   14.8deg ( 3.1ca)		
LATL latitude : 30.9deg ( 6.3ca)   27.8deg ( 5.7ca)		
Elongation : 4.1/3.5ca = 1.1   2.6/2.7ca = 1.0		
Surface area : 11.5 ca2   5.4 ca2		



URN: unspecified AGE: 21 years SEX: male  
 DATE: Fri Oct 14 13:29:04 1994 - printed Tue Oct 18 14:20:55 1994.  
 FILE: /home/gary/pc/data/mapping/dylan/ecrL.flx  
 SERIES: Badminton **ATHLETE 3**  
 COMMENTS: R FCU-DOMINANT

URN: unspecified AGE: 21 years SEX: male  
 DATE: Fri Oct 14 14:28:42 1994 - printed Mon Oct 17 15:01:31 1994.  
 FILE: /home/gary/pc/data/mapping/dylan/ecl.flx  
 SERIES: Badminton **ATHLETE 3**  
 COMMENTS: L FCU-NonDominant

**CALCULATION OPTIONS**  
 Add zeroed sites.:  around edges  
 Limit calculation.:  1 deg outer limit  
 Set resolution.:  256x256 matrix  
 Interpolation.:  spline fit  
 Data source.:  MAXMIN

**DISPLAY OPTIONS**  
 Position map.: at 1 x 1 in a 1 x 1 grid [CLEAR MAP] [KEY] [PRO]  
 Map screen size.:  512x512 MAX RES Viewing direction.:  Vertex  
 Upper threshold.:  image UT value (u,m,z)....  
 Lower threshold.:  sites LT value (u,m,z)....  
 Colour table.:  B&W & levels Invert colour table.:  yes  
 Map background.:  white Show grey scale key.:  yes  
 Show sites.:  no Show reference grid.:  black

**SAVE & RESTORE IMAGE**  
 Image label.: R FCU

**MASKING & MAGNIFY OPTIONS**  
 Restore.:  full map Draw with mask.:  yes, in min colour Blow up image.:  no  
 Restore & scaled.:  no Add to mask.:  create default mask/brush width.:  4

Buttons: Calculate Draw Quantitate Save pixels Save matrix Retrieve **Quit**

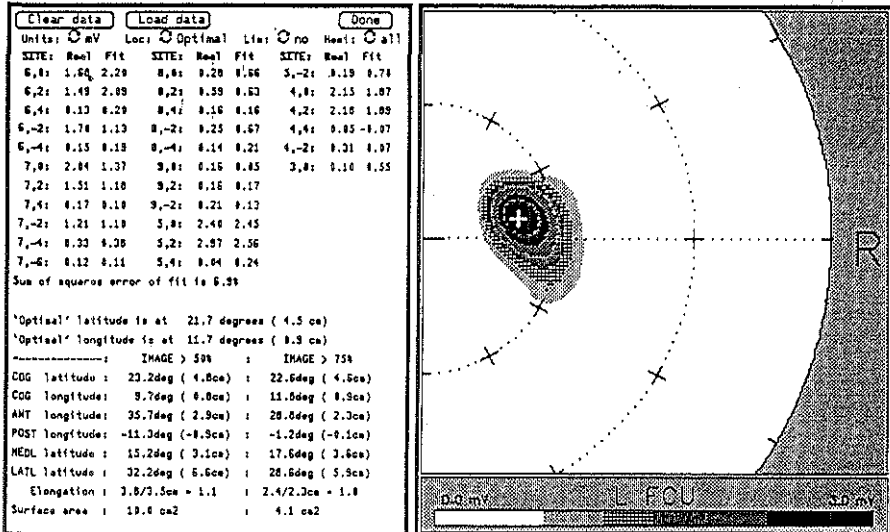
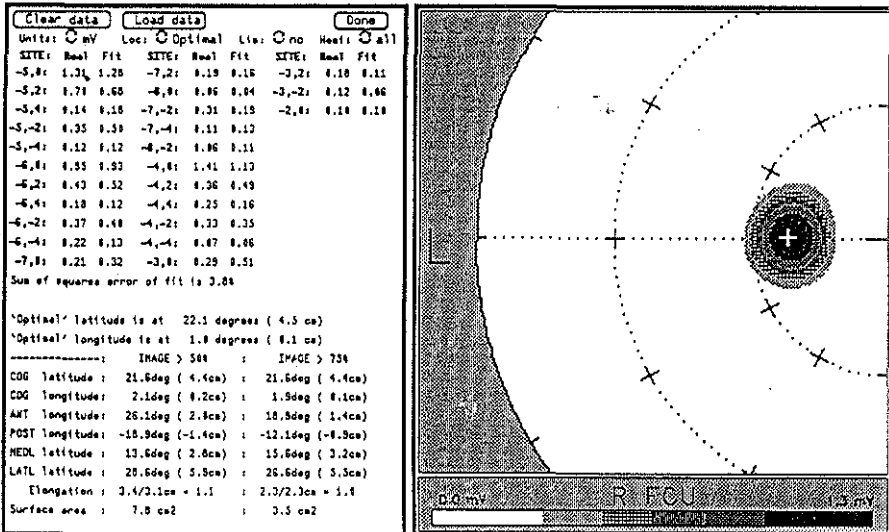
**CALCULATION OPTIONS**  
 Add zeroed sites.:  around edges  
 Limit calculation.:  1 deg outer limit  
 Set resolution.:  256x256 matrix  
 Interpolation.:  spline fit  
 Data source.:  MAXMIN

**DISPLAY OPTIONS**  
 Position map.: at 1 x 1 in a 1 x 1 grid [CLEAR MAP] [KEY] [PRO]  
 Map screen size.:  512x512 MAX RES Viewing direction.:  Vertex  
 Upper threshold.:  image UT value (u,m,z)....  
 Lower threshold.:  sites LT value (u,m,z)....  
 Colour table.:  B&W & levels Invert colour table.:  yes  
 Map background.:  white Show grey scale key.:  yes  
 Show sites.:  no Show reference grid.:  black

**SAVE & RESTORE IMAGE**  
 Image label.: L FCU

**MASKING & MAGNIFY OPTIONS**  
 Restore.:  full map Draw with mask.:  yes, in min colour Blow up image.:  no  
 Restore & scaled.:  no Add to mask.:  add pixels (min) brush width.:  4

Buttons: Calculate Draw Quantitate Save pixels Save matrix Retrieve **The Works** Quit





URN: unspecified AGE: unspecified SEX: female

DATE: Fri Oct 21 15:55:08 1994 - printed Mon Oct 24 17:11:43 1994.

FILE: /home/gary/pc/data/mapping/dylan/fdr.ftx

SERIES: Badminton ATHLETE 4

COMMENTS: R FCU-Dominant

URN: unspecified AGE: unspecified SEX: female

DATE: Fri Oct 21 16:33:44 1994 - printed Mon Oct 24 16:35:58 1994.

FILE: /home/gary/pc/data/mapping/dylan/fdl.ftx

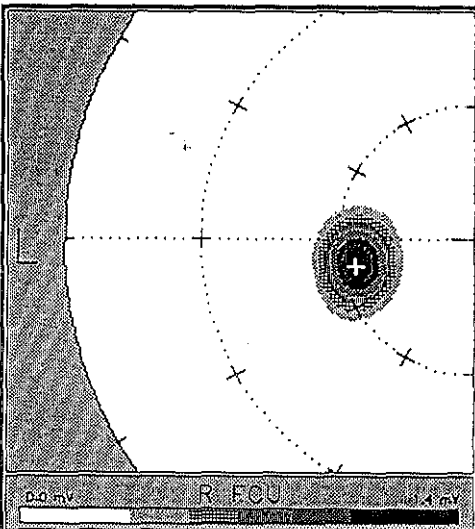
SERIES: Badminton ATHLETE 4

COMMENTS: L FCU-NonDominant

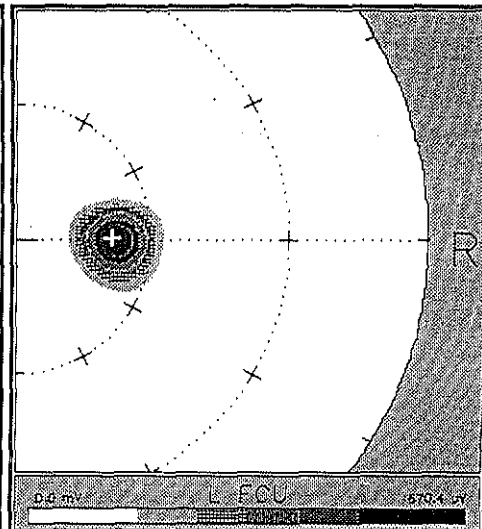
CALCULATION OPTIONS		DISPLAY OPTIONS	
Add zeroed sites.: <input type="radio"/> around edges	Position map...: at 1 x 1 in a 1 x 1 grid [CLEAR MAP] [KEY] [PRO]	Map screen size: <input type="radio"/> 512x512 MAX RES	Viewing direction...: <input type="radio"/> Vertex
Limit calculation: <input type="radio"/> 1 deg outer limit	Upper threshold: <input type="radio"/> image	UT value (u,m,z)...:	
Set resolution...: <input type="radio"/> 256x256 matrix	Lower threshold: <input type="radio"/> sites	LT value (u,m,z)...:	
Interpolation...: <input type="radio"/> spline fit	Colour table...: <input type="radio"/> B&W & levels	Invert colour table: <input type="radio"/> yes	
Data source...: <input type="radio"/> SPL	Map background...: <input type="radio"/> white	Show grey scale key: <input type="radio"/> yes	
SAVE & RESTORE IMAGE		MASKING & MAGNIFY OPTIONS	
Image label...: R FCU	Draw with mask...: <input type="radio"/> yes, in min colour	Blow up image...: <input type="radio"/> no	
Restore...: <input type="radio"/> full map	Add to mask...: <input type="radio"/> create default mask	Brush width...: <input type="radio"/> 4	
Restore & scaled: <input type="radio"/> no			
Calculate	Draw	Quantitate	Save pixels
Save matrix	Retrieve	Undo Works	Quit

CALCULATION OPTIONS		DISPLAY OPTIONS	
Add zeroed sites.: <input type="radio"/> around edges	Position map...: at 1 x 1 in a 1 x 1 grid [CLEAR MAP] [KEY] [PRO]	Map screen size: <input type="radio"/> 512x512 MAX RES	Viewing direction...: <input type="radio"/> Vertex
Limit calculation: <input type="radio"/> 1 deg outer limit	Upper threshold: <input type="radio"/> image	UT value (u,m,z)...:	
Set resolution...: <input type="radio"/> 256x256 matrix	Lower threshold: <input type="radio"/> sites	LT value (u,m,z)...:	
Interpolation...: <input type="radio"/> spline fit	Colour table...: <input type="radio"/> B&W & levels	Invert colour table: <input type="radio"/> yes	
Data source...: <input type="radio"/> MAXMIN	Map background...: <input type="radio"/> white	Show grey scale key: <input type="radio"/> yes	
SAVE & RESTORE IMAGE		MASKING & MAGNIFY OPTIONS	
Image label...: L FCU	Draw with mask...: <input type="radio"/> yes, in min colour	Blow up image...: <input type="radio"/> no	
Restore...: <input type="radio"/> full map	Add to mask...: <input type="radio"/> create default mask	Brush width...: <input type="radio"/> 4	
Restore & scaled: <input type="radio"/> no			
Calculate	Draw	Quantitate	Save pixels
Save matrix	Retrieve	Undo Works	Quit

Units: <input type="radio"/> mV	Loc: <input type="radio"/> Optimal	Lie: <input type="radio"/> no	Heal: <input type="radio"/> all
SITE: Real Fit	SITE: Real Fit	SITE: Real Fit	
-6,-1: 1.25 0.81	-7,-6: 0.95 0.82	-5,-2: 0.24 0.20	
-6,-2: 0.28 0.22	-8,-1: 0.15 0.24	-5,-4: 0.87 0.87	
-6,-4: 0.86 0.87	-8,-2: 0.86 0.82	-5,-2: 1.65 0.82	
-6,-2: 1.17 1.18	-8,-4: 0.28 0.24	-5,-4: 0.89 0.85	
-6,-4: 0.14 0.22	-8,-6: 0.87 0.88	-5,-6: 0.84 0.87	
-6,-6: 0.83 0.83	-8,-2: 0.27 0.37	-4,-1: 0.51 0.50	
-7,-1: 0.64 0.68	-9,-1: 0.84 0.81	-4,-2: 0.10 0.09	
-7,-2: 0.80 0.11	-9,-2: 0.85 0.82	-4,-2: 0.18 0.28	
-7,-4: 0.85 0.84	-9,-4: 0.87 0.88	-4,-4: 0.86 0.81	
-7,-2: 0.92 0.85	-11,-2: 0.83 0.84	-3,-1: 0.11 0.05	
-7,-4: 0.31 0.24	-5,-6: 0.82 1.00		0.83
Sum of squares error of fit is 2.31			
*Optimal* latitude is at 26.8 degrees ( 5.5 cm)			
*Optimal* longitude is at -13.0 degrees (-1.2 cm)			
----- IMAGE > 50x			
COG latitude: 26.3deg ( 5.4cm)	COG longitude: -11.1deg (-1.0cm)	ANT longitude: 8.5deg ( 4.3cm)	POST longitude: -31.1deg (-2.8cm)
NEOL latitude: 18.3deg ( 2.8cm)	LATL latitude: 33.3deg ( 6.8cm)	Elongation: 3.7/3.1cm = 1.2	Surface area: 8.4 cm <sup>2</sup>



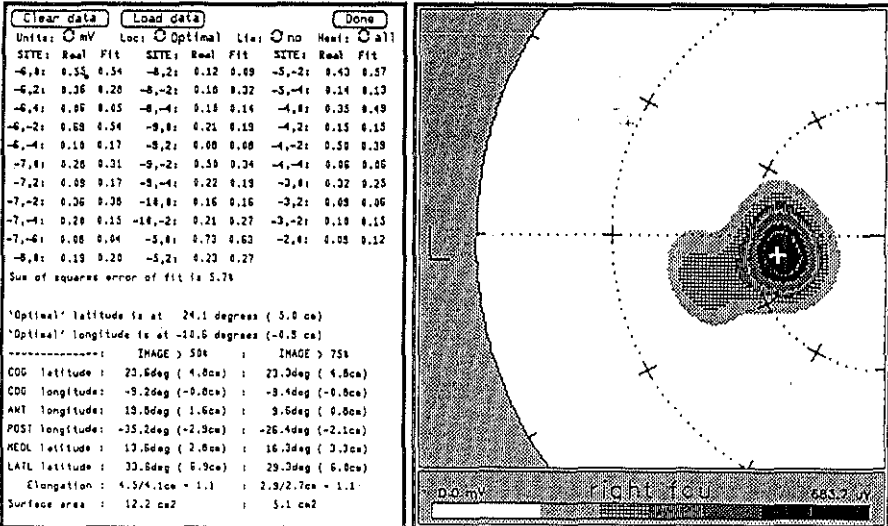
Units: <input type="radio"/> mV	Loc: <input type="radio"/> Optimal	Lie: <input type="radio"/> no	Heal: <input type="radio"/> all
SITE: Real Fit	SITE: Real Fit	SITE: Real Fit	
5,-1: 1.03 0.67	7,-4: 0.18 0.08	4,-4: 0.87 0.86	
5,-2: 0.87 0.17	8,-1: 0.87 0.83	5,-6: 0.84 0.86	
5,-4: 0.17 0.27	8,-2: 0.87 0.85	6,-6: 0.84 0.86	
5,-4: 0.87 0.85	8,-4: 0.18 0.08	7,-6: 0.85 0.87	
6,-1: 1.06 0.51	4,-1: 0.46 0.56	8,-6: 0.85 0.85	
6,-2: 0.88 0.13	4,-2: 0.13 0.11	9,-2: 0.85 0.86	
6,-2: 0.25 0.25	4,-2: 0.14 0.14	9,-4: 0.85 0.87	
6,-4: 0.18 0.67	3,-1: 0.20 0.25		
7,-1: 0.13 0.20	3,-2: 0.87 0.83		
7,-2: 0.88 0.85	3,-2: 0.86 0.81		
7,-2: 0.14 0.13	2,-1: 0.86 0.86		
Sum of squares error of fit is 12.14			
*Optimal* latitude is at 21.3 degrees ( 4.4 cm)			
*Optimal* longitude is at 1.1 degrees ( 4.1 cm)			
----- IMAGE > 50x			
COG latitude: 22.1deg ( 4.6cm)	COG longitude: -9.7deg (-0.1cm)	ANT longitude: 26.3deg ( 1.6cm)	POST longitude: -18.7deg (-1.4cm)
NEOL latitude: 14.1deg ( 2.9cm)	LATL latitude: 38.1deg ( 6.2cm)	Elongation: 3.6/3.3cm = 0.9	Surface area: 7.3 cm <sup>2</sup>



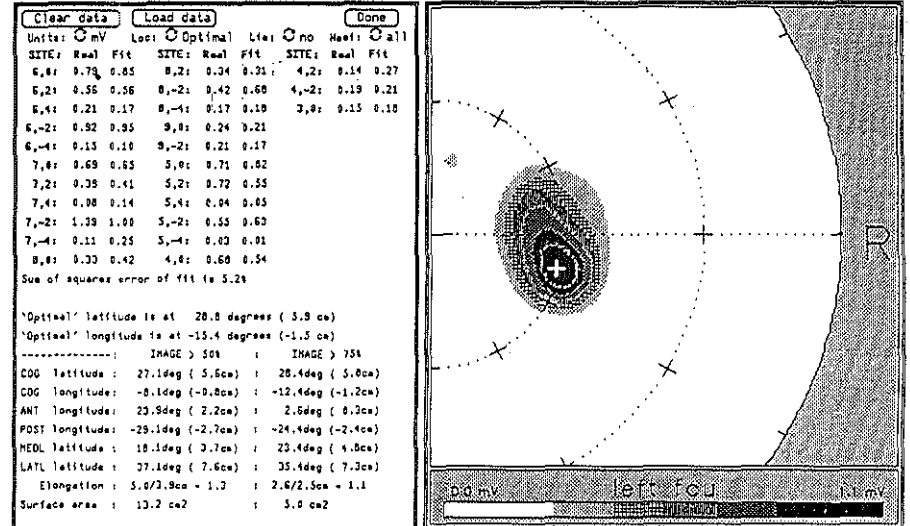
URN: unspecified AGE: 25 years SEX: male  
 DATE: Wed Oct 26 14:25:02 1994 - printed Fri Nov 4 16:38:22 1994.  
 FILE: /home/gary/pc/data/mapping/dylan/aprt.flxb  
 SERIES: badders **ATHLETE 5**  
 COMMENTS: right h dominant

URN: unspecified AGE: unspecified SEX: unspecified  
 DATE: Wed Oct 26 15:31:40 1994 - printed Mon Nov 7 16:14:56 1994.  
 FILE: /home/gary/pc/data/mapping/dylan/apl.flxb  
 SERIES: badders **ATHLETE 5**  
 COMMENTS: non-dominant wrist flexor

CALCULATION OPTIONS		DISPLAY OPTIONS	
Add zeroed sites: <input type="radio"/> around edges	Position map...: at 1 x 1 in a 1 x 1 grid [CLEAR MAP] [KEY] [PRO]	Map screen size: <input type="radio"/> 512x512 MAX RES	Viewing direction...: <input type="radio"/> Vertex
Limit calculation: <input type="radio"/> 1 deg outer limit	Upper threshold: <input type="radio"/> image	UT value (u,m,z)...:	LT value (u,m,z)...:
Set resolution...: <input type="radio"/> 256x256 matrix	Lower threshold: <input type="radio"/> sites	Invert colour table: <input type="radio"/> yes	Show grey scale key: <input type="radio"/> yes
Interpolation...: <input type="radio"/> spline fit	Colour table...: <input type="radio"/> 8&W 8 levels	Show reference grid: <input type="radio"/> black	
Data source...: <input type="radio"/> AMP	Map background...: <input type="radio"/> white		
SAVE & RESTORE IMAGE			
Image label...: right fou	DRAW WITH MASK: <input type="radio"/> yes, in min colour Blow up image...: <input type="radio"/> no		
Restore...: <input type="radio"/> full map	Add to mask...: <input type="radio"/> create default mask/rush width...: <input type="radio"/> 4		
Restore & scaled: <input type="radio"/> no			
<input type="button" value="Calculate"/> <input type="button" value="Draw"/> <input type="button" value="Quantitate"/> <input type="button" value="Save pixels"/> <input type="button" value="Save matrix"/> <input type="button" value="Retrieve"/> <input type="button" value="The Works"/> <input type="button" value="Quit"/>			



CALCULATION OPTIONS		DISPLAY OPTIONS	
Add zeroed sites: <input type="radio"/> around edges	Position map...: at 1 x 1 in a 1 x 1 grid [CLEAR MAP] [KEY] [PRO]	Map screen size: <input type="radio"/> 512x512 MAX RES	Viewing direction...: <input type="radio"/> Vertex
Limit calculation: <input type="radio"/> 1 deg outer limit	Upper threshold: <input type="radio"/> image	UT value (u,m,z)...:	LT value (u,m,z)...:
Set resolution...: <input type="radio"/> 256x256 matrix	Lower threshold: <input type="radio"/> sites	Invert colour table: <input type="radio"/> yes	Show grey scale key: <input type="radio"/> yes
Interpolation...: <input type="radio"/> spline fit	Colour table...: <input type="radio"/> 8&W 8 levels	Show reference grid: <input type="radio"/> black	
Data source...: <input type="radio"/> AMP	Map background...: <input type="radio"/> white		
SAVE & RESTORE IMAGE			
Image label...: left fou	DRAW WITH MASK: <input type="radio"/> yes, in min colour Blow up image...: <input type="radio"/> no		
Restore...: <input type="radio"/> full map	Add to mask...: <input type="radio"/> create default mask/rush width...: <input type="radio"/> 4		
Restore & scaled: <input type="radio"/> no			
<input type="button" value="Calculate"/> <input type="button" value="Draw"/> <input type="button" value="Quantitate"/> <input type="button" value="Save pixels"/> <input type="button" value="Save matrix"/> <input type="button" value="Retrieve"/> <input type="button" value="The Works"/> <input type="button" value="Quit"/>			



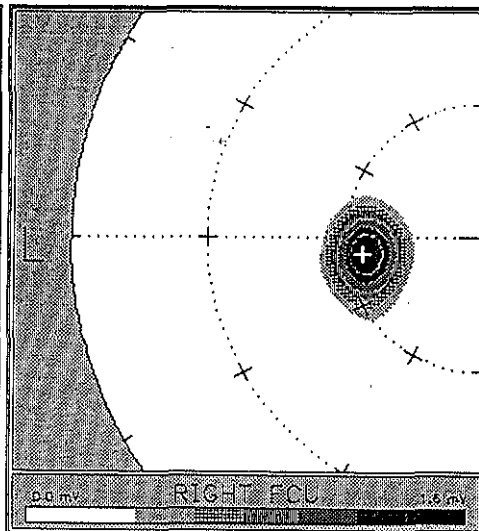
URN: unspecified AGE: 24 years SEX: male  
 DATE: Fri Nov 11 14:29:41 1994 - printed Wed Nov 16 16:57:38 1994.  
 FILE: /home/gary/pc/data/mapping/dylan/dfrl.flx  
 SERIES: BADMINTON ATHLETE 6  
 COMMENTS: RIGHT HAND DOMINANT

URN: unspecified AGE: 24 years SEX: male  
 DATE: Fri Nov 11 16:00:39 1994 - printed Fri Nov 11 17:11:22 1994.  
 FILE: /home/gary/pc/data/mapping/dylan/dfl.flx  
 SERIES: BADMINTON ATHLETE 6  
 COMMENTS: LEFT HAND NON DOMINANT

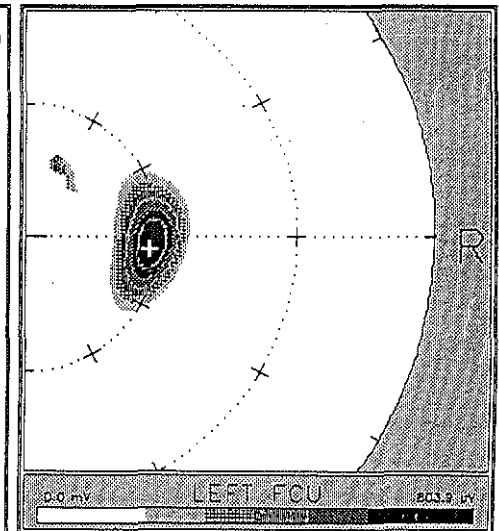
CALCULATION OPTIONS		DISPLAY OPTIONS	
Add zeroed sites.: <input type="radio"/> around edges	Position map...: at 1 x 1 in a 1 x 1 grid [CLEAR MAP] [KEY] [PRO]	Map screen size: <input type="radio"/> 512x512 MAX RES	Viewing direction...: <input type="radio"/> Vertex
Limit calculation: <input type="radio"/> 1 deg outer limit	Upper threshold: <input type="radio"/> image	UT value (u,m,t)...:	LT value (u,m,t)...:
Set resolution...: <input type="radio"/> 256x256 matrix	Lower threshold: <input type="radio"/> sites	Colour table...: <input type="radio"/> B&W 8 levels	Invert colour table: <input type="radio"/> yes
Interpolation...: <input type="radio"/> spline fit	Map background...: <input type="radio"/> white	Show grey scale key: <input type="radio"/> yes	Show reference grid: <input type="radio"/> black
Data source...: <input type="radio"/> AMP	Show sites...: <input type="radio"/> no	Draw with mask...: <input type="radio"/> yes, in min colour	Blow up image...: <input type="radio"/> no
<b>SAVE &amp; RESTORE IMAGE</b>		<b>MASKING &amp; MAGNIFY OPTIONS</b>	
Image label...: RIGHT FCU	Restore...: <input type="radio"/> full map	Add to mask...: <input type="radio"/> create default mask	Brush width...: <input type="radio"/> 4
Restore & scaled.: <input type="radio"/> no	Calculate	Draw	Quantitate
Calculate	Draw	Quantitate	Save pixels
Save matrix	Retrieve	The Works	Quit

CALCULATION OPTIONS		DISPLAY OPTIONS	
Add zeroed sites.: <input type="radio"/> around edges	Position map...: at 1 x 1 in a 1 x 1 grid [CLEAR MAP] [KEY] [PRO]	Map screen size: <input type="radio"/> 512x512 MAX RES	Viewing direction...: <input type="radio"/> Vertex
Limit calculation: <input type="radio"/> 1 deg outer limit	Upper threshold: <input type="radio"/> image	UT value (u,m,t)...:	LT value (u,m,t)...:
Set resolution...: <input type="radio"/> 256x256 matrix	Lower threshold: <input type="radio"/> sites	Colour table...: <input type="radio"/> B&W 8 levels	Invert colour table: <input type="radio"/> yes
Interpolation...: <input type="radio"/> spline fit	Map background...: <input type="radio"/> white	Show grey scale key: <input type="radio"/> yes	Show reference grid: <input type="radio"/> black
Data source...: <input type="radio"/> AMP	Show sites...: <input type="radio"/> no	Draw with mask...: <input type="radio"/> yes, in min colour	Blow up image...: <input type="radio"/> no
<b>SAVE &amp; RESTORE IMAGE</b>		<b>MASKING &amp; MAGNIFY OPTIONS</b>	
Image label...: LEFT FCU	Restore...: <input type="radio"/> full map	Add to mask...: <input type="radio"/> create default mask	Brush width...: <input type="radio"/> 4
Restore & scaled.: <input type="radio"/> no	Calculate	Draw	Quantitate
Calculate	Draw	Quantitate	Save pixels
Save matrix	Retrieve	The Works	Quit

Clear data		Load data		Done	
Units: <input type="radio"/> mV	Loc: <input type="radio"/> Optimal	Lit: <input type="radio"/> no	Heat: <input type="radio"/> all		
SITE: Real Fit	SITE: Real Fit	SITE: Real Fit			
-3,2: 0.96 0.24	-7,4: 0.00 0.05	-4,2: 0.08 0.92			
-5,-2: 0.78 0.81	-7,-2: 1.13 1.18	-4,-2: 0.22 0.27			
-5,-4: 0.67 0.83	-7,-4: 0.79 0.47	-4,-4: 0.10 0.05			
-6,4: 1.67 1.49	-7,-6: 0.45 0.47	-3,-8: 0.07 0.20			
-6,2: 0.55 0.46	-8,8: 0.18 0.39	-3,-2: 0.07 0.04			
-4,4: 0.97 0.82	-8,-2: 0.05 0.03	-5,8: 0.98 1.19			
-6,-2: 1.30 1.30	-8,-2: 0.57 0.51				
-4,-4: 0.14 0.34	-8,-4: 0.00 0.23				
-6,-6: 0.67 0.90	-8,8: 0.07 -0.01				
-7,8: 1.21 1.16	-9,-2: 0.07 0.08				
-7,2: 0.35 0.41	-4,8: 0.08 0.64				
Sum of squares error of fit is 3.35					
*Optimal* latitude is at 26.4 degrees ( 5.4 ca)					
*Optimal* longitude is at -7.8 degrees (-0.7 ca)					
----- IMAGE > 50% : IMAGE > 75%					
CGD latitude :	25.7deg ( 5.3ca)	25.8deg ( 5.3ca)			
CGD longitude :	-8.2deg (-0.7ca)	-7.6deg (-0.7ca)			
ANT longitude :	15.0deg ( 1.4ca)	8.4deg ( 0.7ca)			
POST longitude :	-29.2deg (-2.6ca)	-21.6deg (-1.9ca)			
HEDL latitude :	16.7deg ( 3.4ca)	19.0deg ( 4.1ca)			
LATL latitude :	33.7deg ( 6.3ca)	30.8deg ( 6.3ca)			
Elongation :	4.6/3.5ca = 1.1	2.7/2.3ca = 1.2			
Surface area :	9.8 ca2	4.1 ca2			



Clear data		Load data		Done	
Units: <input type="radio"/> mV	Loc: <input type="radio"/> Optimal	Lit: <input type="radio"/> no	Heat: <input type="radio"/> all		
SITE: Real Fit	SITE: Real Fit	SITE: Real Fit			
7,8: 1.14 0.77	6,4: 0.00 0.05	6,2: 0.77 0.58			
7,2: 0.50 0.48	6,-2: 0.77 0.58	7,4: 0.89 0.10			
7,-4: 0.89 0.10	6,-4: 0.12 0.13	7,-2: 0.49 0.57			
7,-8: 0.15 0.16	5,2: 0.22 0.14	6,-8: 0.12 0.21			
8,2: 0.22 0.27	4,8: 0.09 0.03	8,-2: 0.14 0.14			
5,8: 0.83 -0.09	6,8: 0.59 0.74	6,2: 0.34 0.49			
Sum of squares error of fit is 10.34					
*Optimal* latitude is at 27.9 degrees ( 5.7 ca)					
*Optimal* longitude is at -5.8 degrees (-0.6 ca)					
----- IMAGE > 50% : IMAGE > 75%					
CGD latitude :	26.0deg ( 5.5ca)	27.2deg ( 5.6ca)			
CGD longitude :	-1.8deg (-0.1ca)	-2.0deg (-0.2ca)			
ANT longitude :	21.6deg ( 1.9ca)	12.0deg ( 1.1ca)			
POST longitude :	-28.8deg (-2.6ca)	-19.0deg (-1.8ca)			
HEDL latitude :	21.8deg ( 4.5ca)	24.2deg ( 5.0ca)			
LATL latitude :	35.8deg ( 7.4ca)	33.2deg ( 6.6ca)			
Elongation :	4.5/2.9ca = 1.6	2.9/1.8ca = 1.6			
Surface area :	9.8 ca2	4.4 ca2			



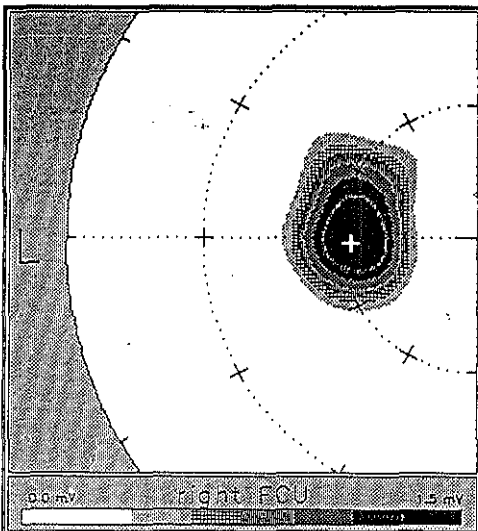
URN: unspecified AGE: 21 years SEX: male  
 DATE: Fri Nov 25 13:47:53 1994 - printed Fri Dec 2 14:53:40 1994.  
 FILE: /home/gary/pc/data/mapping/dylan/mbrt.flx  
 SERIES: BADMINTON ATHLETE 7  
 COMMENTS: RIGHT FCU

URN: unspecified AGE: 21 years SEX: male  
 DATE: Fri Nov 25 15:01:13 1994 - printed Fri Dec 2 14:15:04 1994.  
 FILE: /home/gary/pc/data/mapping/dylan/mbl.flx  
 SERIES: BADMINTON ATHLETE 7  
 COMMENTS: LEFT FCU NON-DOMINANT

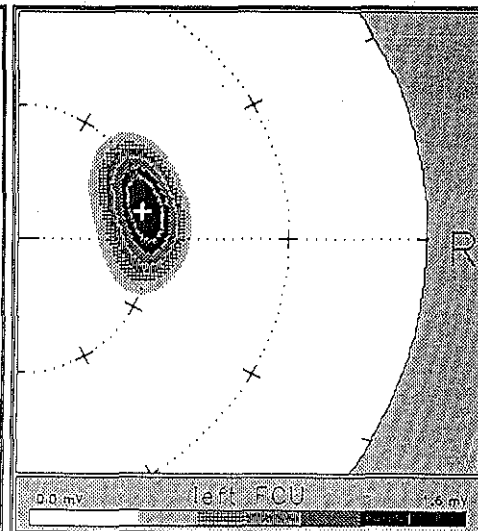
CALCULATION OPTIONS		DISPLAY OPTIONS	
Add zeroed sites.: <input type="radio"/> around edges	Position map...: at 1 x 1 in a 1 x 1 grid [CLEAR MAP] [KEY] [PRO]	Map screen size: <input checked="" type="radio"/> 512x512 MAX RES	Viewing direction...: <input type="radio"/> Vertex
Limit calculation: <input type="radio"/> 1 deg outer limit	Upper threshold: <input type="radio"/> image	Lower threshold: <input type="radio"/> sites	UT value (u,m,x)...:
Set resolution...: <input checked="" type="radio"/> 256x256 matrix	Interpolation...: <input type="radio"/> spline fit	Colour table...: <input type="radio"/> B&W & levels	LY value (u,m,x)...:
Data source...: <input type="radio"/> AMP	Map background...: <input type="radio"/> white	Show sites...: <input type="radio"/> no	Show grey scale key: <input type="radio"/> yes
<b>SAYE &amp; RESTORE IMAGE</b>		<b>MASKING &amp; MAGNIFY OPTIONS</b>	
Image label...: right FCU	Restore...: <input type="radio"/> full map	Draw with mask...: <input type="radio"/> yes, in min colour	Show up image...: <input type="radio"/> no
Restore & scaled...: <input type="radio"/> no	Add to mask...: <input type="radio"/> create default mask	Blur width...: <input type="radio"/> 4	
Calculate	Draw	Quantitate	Save pixels
Save matrix	Retrieve	The Works	Quit

CALCULATION OPTIONS		DISPLAY OPTIONS	
Add zeroed sites.: <input type="radio"/> around edges	Position map...: at 1 x 1 in a 1 x 1 grid [CLEAR MAP] [KEY] [PRO]	Map screen size: <input checked="" type="radio"/> 512x512 MAX RES	Viewing direction...: <input type="radio"/> Vertex
Limit calculation: <input type="radio"/> 1 deg outer limit	Upper threshold: <input type="radio"/> image	Lower threshold: <input type="radio"/> sites	UT value (u,m,x)...:
Set resolution...: <input checked="" type="radio"/> 256x256 matrix	Interpolation...: <input type="radio"/> spline fit	Colour table...: <input type="radio"/> B&W & levels	LY value (u,m,x)...:
Data source...: <input type="radio"/> AMP	Map background...: <input type="radio"/> white	Show sites...: <input type="radio"/> no	Show grey scale key: <input type="radio"/> yes
<b>SAYE &amp; RESTORE IMAGE</b>		<b>MASKING &amp; MAGNIFY OPTIONS</b>	
Image label...: left FCU	Restore...: <input type="radio"/> full map	Draw with mask...: <input type="radio"/> yes, in min colour	Show up image...: <input type="radio"/> no
Restore & scaled...: <input type="radio"/> no	Add to mask...: <input type="radio"/> create default mask	Blur width...: <input type="radio"/> 4	
Calculate	Draw	Quantitate	Save pixels
Save matrix	Retrieve	The Works	Quit

Clear data		Load data		Done	
Units: <input checked="" type="radio"/> mV	Loc: <input checked="" type="radio"/> Optimal	List: <input type="radio"/> no	Reel: <input checked="" type="radio"/> all		
SITE: Reel Fit	SITE: Reel Fit	SITE: Reel Fit	SITE: Reel Fit		
-7,8: 1.89 1.27	-8,8: 8.29 8.40	-5,2: 1.46 1.16			
-7,2: 1.44 1.22	-8,2: 9.26 8.32	-5,4: 8.55 8.50			
-7,4: 8.79 8.82	-8,4: 4.28 8.38	-5,-2: 1.41 8.89			
-7,6: 8.12 8.84	-8,-2: 8.13 8.14	-5,-4: 8.12 8.87			
-7,-2: 1.21 8.98	-8,8: 8.12 8.11	-4,8: 1.38 1.07			
-7,-4: 8.15 8.15	-6,8: 1.19 1.49	-4,2: 8.43 8.62			
-8,8: 1.32 1.86	-6,2: 1.14 1.32	-4,4: 8.15 8.05			
-8,2: 8.84 8.81	-6,4: 8.81 8.71	-4,-2: 8.25 8.49			
-8,4: 8.79 1.73	-6,-2: 8.73 1.10	-3,8: 8.15 8.47			
-8,-2: 8.71 8.78	-6,-4: 8.89 8.17				
-8,-4: 8.11 8.88	-5,8: 1.30 1.46				
Sum of squares error of fit is 6.0%					
*Optimal* latitude is at 27.7 degrees (5.7 cm)					
*Optimal* longitude is at -2.5 degrees (-0.2 cm)					
IMAGE > 50%		IMAGE > 75%			
CGG latitude: 26.9deg (5.5cm)	CGG longitude: 5.5deg (0.5cm)	CGG latitude: 27.0deg (5.9cm)	CGG longitude: 3.8deg (0.6cm)		
ANT latitude: 41.5deg (3.6cm)	ANT longitude: 29.8deg (2.8cm)	ANT latitude: 42.0deg (4.1cm)	ANT longitude: 32.2deg (3.2cm)		
POST latitude: -28.3deg (-2.6cm)	POST longitude: -20.2deg (-1.9cm)	POST latitude: -14.6deg (-1.4cm)	POST longitude: -5.8deg (-0.8cm)		
NEGL latitude: 14.3deg (1.1cm)	NEGL longitude: 18.0deg (1.7cm)	NEGL latitude: 21.5deg (1.4cm)	NEGL longitude: 23.8deg (1.9cm)		
LATL latitude: 39.9deg (3.2cm)	LATL longitude: 36.8deg (2.4cm)	LATL latitude: 37.5deg (2.7cm)	LATL longitude: 34.8deg (2.7cm)		
Elongation: 6.4/3.1cm = 1.2	Elongation: 4.7/3.7cm = 1.3	Elongation: 5.5/3.3cm = 1.7	Elongation: 3.8/2.3cm = 1.7		
Surface area: 24.6 cm <sup>2</sup>	Surface area: 13.3 cm <sup>2</sup>	Surface area: 13.5 cm <sup>2</sup>	Surface area: 6.2 cm <sup>2</sup>		



Clear data		Load data		Done	
Units: <input checked="" type="radio"/> mV	Loc: <input checked="" type="radio"/> Optimal	List: <input type="radio"/> no	Reel: <input checked="" type="radio"/> all		
SITE: Reel Fit	SITE: Reel Fit	SITE: Reel Fit	SITE: Reel Fit		
6,8: 1.15 1.34	7,-4: 8.89 8.95	5,4: 8.29 8.29			
6,2: 1.77 1.49	8,8: 8.39 8.69	5,-2: 8.34 8.34			
6,4: 8.76 8.81	8,2: 8.34 8.65	5,-4: 8.65 8.84			
6,6: 8.84 8.85	8,4: 8.21 8.30	4,8: 8.69 8.48			
6,-2: 8.54 8.59	8,6: 8.66 8.89	4,2: 8.65 8.37			
6,-4: 8.65 8.96	8,-2: 8.96 8.22	4,4: 8.97 8.84			
7,8: 1.47 1.15	9,8: 8.88 8.83	4,-2: 8.12 8.13			
7,2: 1.39 1.27	9,2: 8.89 8.92	3,8: 8.11 8.19			
7,4: 1.11 8.91	9,4: 8.12 -8.00	3,2: 8.03 8.17			
7,6: 8.16 8.15	5,8: 8.74 8.90				
7,-2: 8.68 8.51	5,2: 8.54 8.96				
Sum of squares error of fit is 7.0%					
*Optimal* latitude is at 28.4 degrees (5.8 cm)					
*Optimal* longitude is at 12.3 degrees (1.2 cm)					
IMAGE > 50%		IMAGE > 75%			
CGG latitude: 28.5deg (5.9cm)	CGG longitude: 13.0deg (1.3cm)	CGG latitude: 28.8deg (5.9cm)	CGG longitude: 13.2deg (1.3cm)		
ANT latitude: 42.0deg (4.1cm)	ANT longitude: 32.2deg (3.2cm)	ANT latitude: 42.0deg (4.1cm)	ANT longitude: 32.2deg (3.2cm)		
POST latitude: -14.6deg (-1.4cm)	POST longitude: -5.8deg (-0.8cm)	POST latitude: -14.6deg (-1.4cm)	POST longitude: -5.8deg (-0.8cm)		
NEGL latitude: 21.5deg (1.4cm)	NEGL longitude: 23.8deg (1.9cm)	NEGL latitude: 21.5deg (1.4cm)	NEGL longitude: 23.8deg (1.9cm)		
LATL latitude: 37.5deg (2.7cm)	LATL longitude: 34.8deg (2.7cm)	LATL latitude: 37.5deg (2.7cm)	LATL longitude: 34.8deg (2.7cm)		
Elongation: 5.5/3.3cm = 1.7	Elongation: 3.8/2.3cm = 1.7	Elongation: 5.5/3.3cm = 1.7	Elongation: 3.8/2.3cm = 1.7		
Surface area: 13.5 cm <sup>2</sup>	Surface area: 6.2 cm <sup>2</sup>	Surface area: 13.5 cm <sup>2</sup>	Surface area: 6.2 cm <sup>2</sup>		



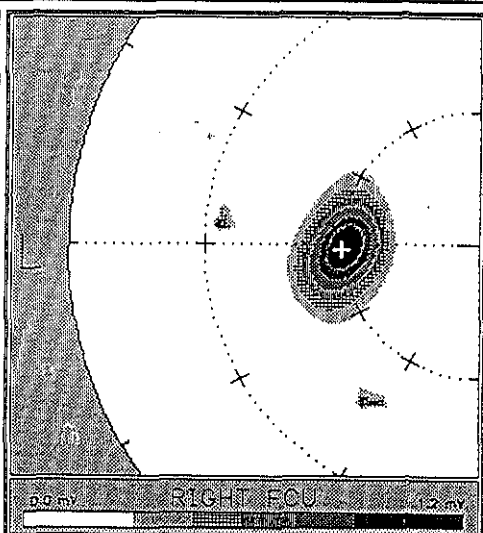
URN: unspecified      AGE: 30 years      SEX: male  
 DATE: Tue Dec 20 11:15:43 1994 - printed Thu Dec 22 21:03:24 1994.  
 FILE: /home/gary/pc/data/mapping/dylan/gpr.flx  
 SERIES: BADMINTON      **ATHLETE 8**  
 COMMENTS: RIGHT HAND DOMINANT

URN: unspecified      AGE: 30 years      SEX: male  
 DATE: Tue Dec 20 12:07:42 1994 - printed Thu Dec 22 20:44:50 1994.  
 FILE: /home/gary/pc/data/mapping/dylan/gpl.flx  
 SERIES: BADMINTON      **ATHLETE 8**  
 COMMENTS: LEFT HAND NON-DOMINANT

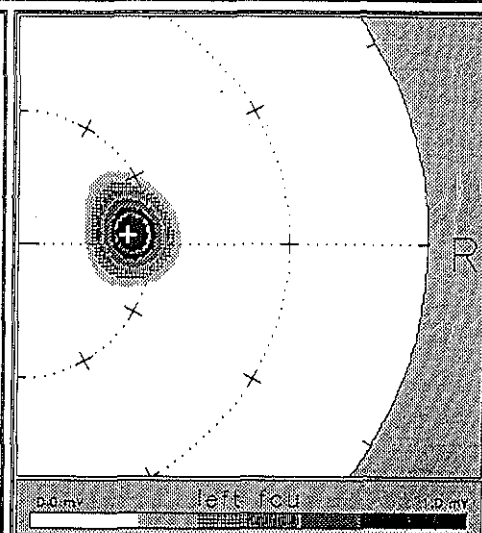
CALCULATION OPTIONS		DISPLAY OPTIONS	
Add zeroed sites: <input type="radio"/> around edges	Position map...: at 1 x 1 in a 1 x 1 grid [CLEAR MAP] [KEY] [PRO]	Map screen size: <input type="radio"/> 512x512 MAX RES	Viewing direction...: <input type="radio"/> Vortex
Limit calculation: <input type="radio"/> 1 deg outer limit	Upper threshold: <input type="radio"/> image	UT value (u,m,%):	
Set resolution...: <input type="radio"/> 256x256 matrix	Lower threshold: <input type="radio"/> sites	LT value (u,m,%):	
Interpolation...: <input type="radio"/> spline fit	Colour table...: <input type="radio"/> B&W & levels	Invert colour table: <input type="radio"/> yes	
Data source...: <input type="radio"/> AMP	Map background...: <input type="radio"/> white	Show grey scale key: <input type="radio"/> yes	
	Show sites...: <input type="radio"/> no	Show reference grid: <input type="radio"/> black	
<b>SAYE &amp; RESTORE IMAGE</b>		<b>MASKING &amp; MAGNIFY OPTIONS</b>	
Image label...: RIGHT FCU	Draw with mask: <input type="radio"/> yes, in min colour	Slow up image...: <input type="radio"/> no	
Restore...: <input type="radio"/> full map	Add to mask...: <input type="radio"/> create default mask	Brush width...: <input type="radio"/> 4	
Restore & scaled...: <input type="radio"/> no			
Calculate	Draw	Quantitate	Save pixels
		Save matrix	Retrieve
		Thru Works	Quit

CALCULATION OPTIONS		DISPLAY OPTIONS	
Add zeroed sites: <input type="radio"/> around edges	Position map...: at 1 x 1 in a 1 x 1 grid [CLEAR MAP] [KEY] [PRO]	Map screen size: <input type="radio"/> 512x512 MAX RES	Viewing direction...: <input type="radio"/> Vortex
Limit calculation: <input type="radio"/> 1 deg outer limit	Upper threshold: <input type="radio"/> image	UT value (u,m,%):	
Set resolution...: <input type="radio"/> 256x256 matrix	Lower threshold: <input type="radio"/> sites	LT value (u,m,%):	
Interpolation...: <input type="radio"/> spline fit	Colour table...: <input type="radio"/> B&W & levels	Invert colour table: <input type="radio"/> yes	
Data source...: <input type="radio"/> AMP	Map background...: <input type="radio"/> white	Show grey scale key: <input type="radio"/> yes	
	Show sites...: <input type="radio"/> no	Show reference grid: <input type="radio"/> black	
<b>SAYE &amp; RESTORE IMAGE</b>		<b>MASKING &amp; MAGNIFY OPTIONS</b>	
Image label...: left fcu	Draw with mask: <input type="radio"/> yes, in min colour	Slow up image...: <input type="radio"/> no	
Restore...: <input type="radio"/> full map	Add to mask...: <input type="radio"/> create default mask	Brush width...: <input type="radio"/> 4	
Restore & scaled...: <input type="radio"/> no			
Calculate	Draw	Quantitate	Save pixels
		Save matrix	Retrieve
		Thru Works	Quit

Clear data		Load data		Done	
Unit: <input type="radio"/> mV	Loc: <input type="radio"/> Optimal	Lin: <input type="radio"/> no	Heal: <input type="radio"/> all		
SITE: Real Fit	SITE: Real Fit	SITE: Real Fit			
-3,0: 1.51 1.20	-6,6: 0.10 0.07	-5,-2: 0.99 0.12			
-3,2: 0.52 0.35	-7,8: 0.48 0.31	-4,8: 0.39 0.70			
-3,4: 0.11 0.13	-7,2: 0.29 0.18	-4,2: 0.17 0.18			
-5,-2: 0.42 0.48	-7,4: 0.86 0.81	-4,4: 0.05 0.07			
-5,-4: 0.11 0.12	-7,-2: 0.76 0.54	-4,-2: 0.23 0.16			
-6,8: 0.09 1.00	-7,-4: 0.21 0.15	-4,-4: 0.07 0.09			
-6,2: 0.42 0.49	-8,8: 0.07 0.06	-3,8: 0.10 0.13			
-4,4: 0.27 0.18	-8,2: 0.08 0.04	-3,2: 0.06 0.03			
-6,-2: 0.32 0.68	-8,-2: 0.96 0.10	-3,-2: 0.06 0.07			
-6,-4: 0.16 0.11	-8,-4: 0.09 0.12	-2,8: 0.06 0.05			
-6,-6: 0.04 0.06	-8,8: 0.06 0.07				
Sum of squares error of fit is 5.25					
*Optimal* latitude is at 38.2 degrees ( 6.2 ca)					
*Optimal* longitude is at -2.3 degrees (-0.2 ca)					
----- IMAGE > 50% : IMAGE > 75%					
COG latitude: 39.2deg ( 6.2ca)	: 29.9deg ( 6.1ca)				
COG longitude: -3.4deg (-0.4ca)	: -1.8deg (-0.2ca)				
ANT longitude: 21.6deg ( 2.2ca)	: 14.1deg ( 1.4ca)				
POST longitude: -21.6deg (-2.2ca)	: -13.8deg (-1.4ca)				
NEOL latitude: 21.2deg ( 4.4ca)	: 22.9deg ( 4.7ca)				
LATL latitude: 38.2deg ( 7.8ca)	: 35.9deg ( 7.4ca)				
Elongation: 4.5/3.5ca = 1.3	: 2.9/2.7ca = 1.1				
Surface area: 12.4 ca2	: 5.1 ca2				



Clear data		Load data		Done	
Unit: <input type="radio"/> mV	Loc: <input type="radio"/> Optimal	Lin: <input type="radio"/> no	Heal: <input type="radio"/> all		
SITE: Real Fit	SITE: Real Fit	SITE: Real Fit			
5,2: 0.51 0.58	7,-2: 0.99 0.03	3,-2: 0.00 0.06			
5,4: 0.12 0.12	7,-4: 0.00 0.07	2,8: 0.04 -0.01			
5,-2: 0.13 0.17	8,8: 0.05 0.03	5,8: 0.05 0.01			
5,-4: 0.06 0.07	8,-2: 0.10 0.06				
6,4: 0.51 0.53	4,8: 0.37 0.06				
6,2: 0.30 0.31	4,2: 0.49 0.46				
6,4: 0.05 0.02	4,4: 0.06 0.07				
6,-2: 0.09 0.09	4,-2: 0.14 0.14				
6,-4: 0.11 0.06	4,-4: 0.10 0.10				
7,8: 0.10 0.08	3,4: 0.21 0.33				
7,2: 0.04 -0.00	3,2: 0.10 0.10				
Sum of squares error of fit is 1.93					
*Optimal* latitude is at 24.6 degrees ( 5.1 ca)					
*Optimal* longitude is at 4.7 degrees ( 0.4 ca)					
----- IMAGE > 50% : IMAGE > 75%					
COG latitude: 25.3deg ( 5.2ca)	: 25.4deg ( 5.2ca)				
COG longitude: 6.1deg ( 4.5ca)	: 5.9deg ( 4.5ca)				
ANT longitude: 36.1deg ( 2.6ca)	: 21.9deg ( 1.9ca)				
POST longitude: -13.8deg (-1.2ca)	: -7.1deg (-0.8ca)				
NEOL latitude: 17.3deg ( 3.6ca)	: 20.4deg ( 4.2ca)				
LATL latitude: 34.3deg ( 7.0ca)	: 31.4deg ( 6.4ca)				
Elongation: 3.9/3.5ca = 1.1	: 2.6/2.3ca = 1.1				
Surface area: 9.2 ca2	: 4.1 ca2				



# ATHLETE GROUP SP MAPS

\* Indicates dominant hemisphere

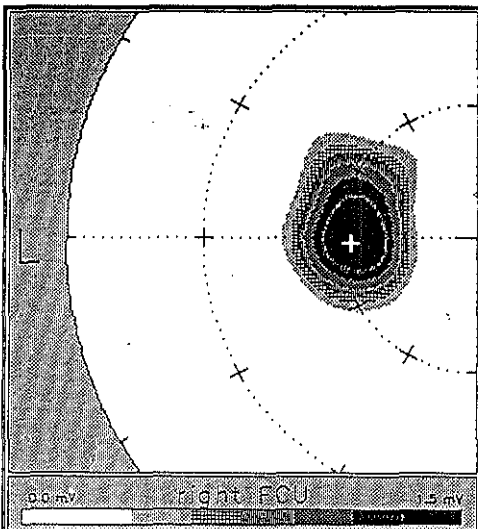
URN: unspecified AGE: 21 years SEX: male  
 DATE: Fri Nov 25 13:47:53 1994 - printed Fri Dec 2 14:53:40 1994.  
 FILE: /home/gary/pc/data/mapping/dylan/mbrt.flx  
 SERIES: BADMINTON ATHLETE 7  
 COMMENTS: RIGHT FCU

URN: unspecified AGE: 21 years SEX: male  
 DATE: Fri Nov 25 15:01:13 1994 - printed Fri Dec 2 14:15:04 1994.  
 FILE: /home/gary/pc/data/mapping/dylan/mbl.flx  
 SERIES: BADMINTON ATHLETE 7  
 COMMENTS: LEFT FCU NON-DOMINANT

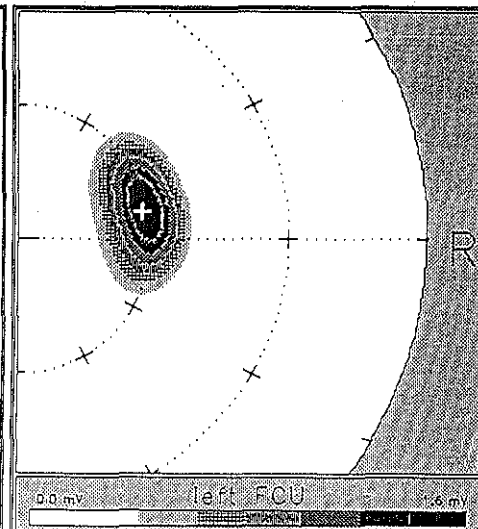
CALCULATION OPTIONS		DISPLAY OPTIONS	
Add zeroed sites.: <input type="radio"/> around edges	Position map...: at 1 x 1 in a 1 x 1 grid [CLEAR MAP] [KEY] [PRO]	Map screen size: <input checked="" type="radio"/> 512x512 MAX RES	Viewing direction...: <input type="radio"/> Vertex
Limit calculation: <input type="radio"/> 1 deg outer limit	Upper threshold: <input type="radio"/> image	Lower threshold: <input type="radio"/> sites	UT value (u,m,x)...:
Set resolution...: <input checked="" type="radio"/> 256x256 matrix	Interpolation...: <input type="radio"/> spline fit	Colour table...: <input type="radio"/> B&W & levels	LY value (u,m,x)...:
Data source...: <input type="radio"/> AMP	Map background...: <input type="radio"/> white	Show sites...: <input type="radio"/> no	Show grey scale key: <input type="radio"/> yes
SAVE & RESTORE IMAGE		MASKING & MAGNIFY OPTIONS	
Image label...: right FCU	Restore...: <input type="radio"/> full map	Draw with mask...: <input type="radio"/> yes, in min colour	Show up image...: <input type="radio"/> no
Restore & scaled...: <input type="radio"/> no	Add to mask...: <input type="radio"/> create default mask	Brush width...: <input checked="" type="radio"/> 4	
Calculate	Draw	Quantitate	Save pixels
Save matrix	Retrieve	The Works	Quit

CALCULATION OPTIONS		DISPLAY OPTIONS	
Add zeroed sites.: <input type="radio"/> around edges	Position map...: at 1 x 1 in a 1 x 1 grid [CLEAR MAP] [KEY] [PRO]	Map screen size: <input checked="" type="radio"/> 512x512 MAX RES	Viewing direction...: <input type="radio"/> Vertex
Limit calculation: <input type="radio"/> 1 deg outer limit	Upper threshold: <input type="radio"/> image	Lower threshold: <input type="radio"/> sites	UT value (u,m,x)...:
Set resolution...: <input checked="" type="radio"/> 256x256 matrix	Interpolation...: <input type="radio"/> spline fit	Colour table...: <input type="radio"/> B&W & levels	LY value (u,m,x)...:
Data source...: <input type="radio"/> AMP	Map background...: <input type="radio"/> white	Show sites...: <input type="radio"/> no	Show grey scale key: <input type="radio"/> yes
SAVE & RESTORE IMAGE		MASKING & MAGNIFY OPTIONS	
Image label...: left FCU	Restore...: <input type="radio"/> full map	Draw with mask...: <input type="radio"/> yes, in min colour	Show up image...: <input type="radio"/> no
Restore & scaled...: <input type="radio"/> no	Add to mask...: <input type="radio"/> create default mask	Brush width...: <input checked="" type="radio"/> 4	
Calculate	Draw	Quantitate	Save pixels
Save matrix	Retrieve	The Works	Quit

Clear data		Load data		Done	
Units: <input checked="" type="radio"/> mV	Loc: <input checked="" type="radio"/> Optimal	List: <input type="radio"/> no	Heat: <input checked="" type="radio"/> all		
SITE: Real Fit	SITE: Real Fit	SITE: Real Fit	SITE: Real Fit		
-7,8: 1.89 1.27	-8,8: 8.29 8.40	-5,2: 1.46 1.16			
-7,2: 1.44 1.22	-8,2: 9.26 8.32	-5,4: 8.55 8.50			
-7,4: 8.79 8.82	-8,4: 4.28 8.38	-5,-2: 1.41 8.89			
-7,6: 8.12 8.84	-8,-2: 8.13 8.14	-5,-4: 8.12 8.87			
-7,-2: 1.21 8.98	-8,8: 8.12 8.11	-4,8: 1.38 1.07			
-7,-4: 8.15 8.15	-6,8: 1.19 1.49	-4,2: 8.43 8.62			
-8,8: 1.32 1.86	-6,2: 1.14 1.32	-4,4: 8.15 8.05			
-8,2: 8.84 8.81	-6,4: 8.81 8.71	-4,-2: 8.25 8.49			
-8,4: 8.79 1.73	-6,-2: 8.73 1.10	-3,8: 8.15 8.47			
-8,-2: 8.71 8.78	-6,-4: 8.88 8.17				
-8,-4: 8.11 8.88	-5,8: 1.38 1.46				
Sum of squares error of fit is 6.0%					
*Optimal* latitude is at 27.7 degrees (5.7 cm)					
*Optimal* longitude is at -2.5 degrees (-0.2 cm)					
IMAGE > 50%		IMAGE > 75%			
CGG latitude: 26.9deg (5.5cm)	CGG longitude: 5.5deg (0.5cm)	CGG latitude: 27.0deg (5.9cm)	CGG longitude: 3.8deg (0.6cm)		
ANT latitude: 41.5deg (3.6cm)	ANT longitude: 29.8deg (2.8cm)	ANT latitude: 42.0deg (4.1cm)	ANT longitude: 32.2deg (3.2cm)		
POST latitude: -28.3deg (-2.6cm)	POST longitude: -20.2deg (-1.9cm)	POST latitude: -14.6deg (-1.4cm)	POST longitude: -5.8deg (-0.8cm)		
NEGL latitude: 14.3deg (1.1cm)	NEGL longitude: 18.0deg (1.7cm)	NEGL latitude: 21.5deg (1.4cm)	NEGL longitude: 23.8deg (1.9cm)		
LATL latitude: 39.9deg (3.2cm)	LATL longitude: 36.8deg (2.4cm)	LATL latitude: 37.5deg (2.7cm)	LATL longitude: 34.8deg (2.2cm)		
Elongation: 6.4/3.1cm = 1.2	Surface area: 24.6 cm <sup>2</sup>	Elongation: 4.7/2.7cm = 1.3	Surface area: 13.3 cm <sup>2</sup>		



Clear data		Load data		Done	
Units: <input checked="" type="radio"/> mV	Loc: <input checked="" type="radio"/> Optimal	List: <input type="radio"/> no	Heat: <input checked="" type="radio"/> all		
SITE: Real Fit	SITE: Real Fit	SITE: Real Fit	SITE: Real Fit		
6,8: 1.15 1.34	7,-4: 8.88 8.95	5,4: 8.28 8.29			
6,2: 1.77 1.49	8,8: 8.38 8.60	5,-2: 8.34 8.34			
6,4: 8.76 8.81	8,2: 8.34 8.65	5,-4: 8.65 8.84			
6,6: 8.84 8.85	8,4: 8.21 8.38	4,8: 8.69 8.48			
6,-2: 8.54 8.58	8,6: 8.68 8.88	4,2: 8.65 8.37			
6,-4: 8.65 8.86	8,-2: 8.86 8.22	4,4: 8.87 8.84			
7,8: 1.47 1.15	9,8: 8.88 8.83	4,-2: 8.12 8.13			
7,2: 1.39 1.27	9,2: 8.88 8.82	3,8: 8.11 8.18			
7,4: 1.11 8.91	9,4: 8.12 8.88	3,2: 8.03 8.17			
7,6: 8.16 8.15	5,8: 8.74 8.88				
7,-2: 8.68 8.51	5,2: 8.54 8.96				
Sum of squares error of fit is 7.0%					
*Optimal* latitude is at 28.4 degrees (5.8 cm)					
*Optimal* longitude is at 12.3 degrees (1.2 cm)					
IMAGE > 50%		IMAGE > 75%			
CGG latitude: 28.5deg (5.9cm)	CGG longitude: 13.0deg (1.3cm)	CGG latitude: 28.8deg (5.9cm)	CGG longitude: 13.2deg (1.3cm)		
ANT latitude: 42.0deg (4.1cm)	ANT longitude: 32.2deg (3.2cm)	ANT latitude: 42.0deg (4.1cm)	ANT longitude: 32.2deg (3.2cm)		
POST latitude: -14.6deg (-1.4cm)	POST longitude: -5.8deg (-0.8cm)	POST latitude: -14.6deg (-1.4cm)	POST longitude: -5.8deg (-0.8cm)		
NEGL latitude: 21.5deg (1.4cm)	NEGL longitude: 23.8deg (1.9cm)	NEGL latitude: 21.5deg (1.4cm)	NEGL longitude: 23.8deg (1.9cm)		
LATL latitude: 37.5deg (2.7cm)	LATL longitude: 34.8deg (2.2cm)	LATL latitude: 37.5deg (2.7cm)	LATL longitude: 34.8deg (2.2cm)		
Elongation: 5.5/3.3cm = 1.7	Surface area: 13.5 cm <sup>2</sup>	Elongation: 3.8/2.3cm = 1.7	Surface area: 6.2 cm <sup>2</sup>		



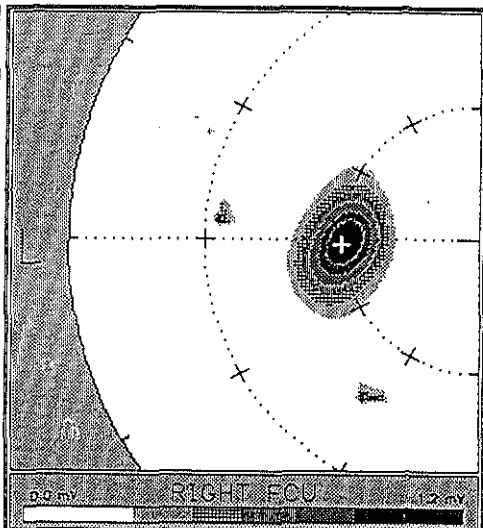
URN: unspecified AGE: 30 years SEX: male  
 DATE: Tue Dec 20 11:15:43 1994 - printed Thu Dec 22 21:03:24 1994.  
 FILE: /home/gary/pc/data/mapping/dylan/gpr.flx  
 SERIES: BADMINTON **ATHLETE 8**  
 COMMENTS: RIGHT HAND DOMINANT

URN: unspecified AGE: 30 years SEX: male  
 DATE: Tue Dec 20 12:07:42 1994 - printed Thu Dec 22 20:44:50 1994.  
 FILE: /home/gary/pc/data/mapping/dylan/gpl.flx  
 SERIES: BADMINTON **ATHLETE 8**  
 COMMENTS: LEFT HAND NON-DOMINANT

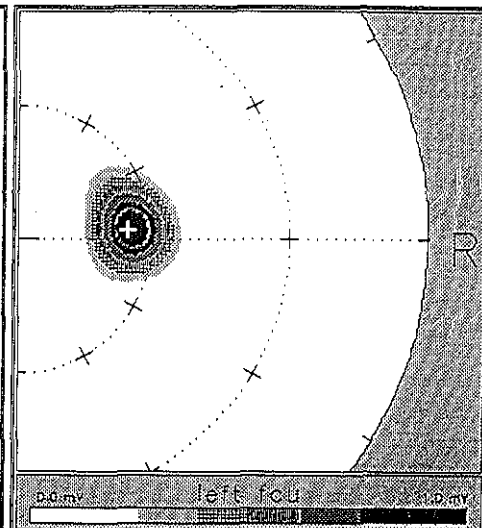
CALCULATION OPTIONS		DISPLAY OPTIONS	
Add zeroed sites: <input type="radio"/> around edges	Position map...: at 1 x 1 in a 1 x 1 grid [CLEAR MAP] [KEY] [PRO]	Map screen size: <input type="radio"/> 512x512 MAX RES	Viewing direction...: <input type="radio"/> Vortex
Limit calculation: <input type="radio"/> 1 deg outer limit	Upper threshold: <input type="radio"/> image	UT value (u,m,%):	
Set resolution...: <input type="radio"/> 256x256 matrix	Lower threshold: <input type="radio"/> sites	LT value (u,m,%):	
Interpolation...: <input type="radio"/> spline fit	Colour table...: <input type="radio"/> B&W & levels	Invert colour table: <input type="radio"/> yes	
Data source...: <input type="radio"/> AMP	Map background...: <input type="radio"/> white	Show grey scale key: <input type="radio"/> yes	
	Show sites...: <input type="radio"/> no	Show reference grid: <input type="radio"/> black	
<b>SAYE &amp; RESTORE IMAGE</b>		<b>MASKING &amp; MAGNIFY OPTIONS</b>	
Image label...: RIGHT FCU	Draw with mask: <input type="radio"/> yes, in min colour	Slow up image...: <input type="radio"/> no	
Restore...: <input type="radio"/> full map	Add to mask...: <input type="radio"/> create default mask	Brush width...: <input type="radio"/> 4	
Restore & scaled...: <input type="radio"/> no			
Calculate	Draw	Quantitate	Save pixels
		Save matrix	Retrieve
		Thru Works	Quit

CALCULATION OPTIONS		DISPLAY OPTIONS	
Add zeroed sites: <input type="radio"/> around edges	Position map...: at 1 x 1 in a 1 x 1 grid [CLEAR MAP] [KEY] [PRO]	Map screen size: <input type="radio"/> 512x512 MAX RES	Viewing direction...: <input type="radio"/> Vortex
Limit calculation: <input type="radio"/> 1 deg outer limit	Upper threshold: <input type="radio"/> image	UT value (u,m,%):	
Set resolution...: <input type="radio"/> 256x256 matrix	Lower threshold: <input type="radio"/> sites	LT value (u,m,%):	
Interpolation...: <input type="radio"/> spline fit	Colour table...: <input type="radio"/> B&W & levels	Invert colour table: <input type="radio"/> yes	
Data source...: <input type="radio"/> AMP	Map background...: <input type="radio"/> white	Show grey scale key: <input type="radio"/> yes	
	Show sites...: <input type="radio"/> no	Show reference grid: <input type="radio"/> black	
<b>SAYE &amp; RESTORE IMAGE</b>		<b>MASKING &amp; MAGNIFY OPTIONS</b>	
Image label...: left fcu	Draw with mask: <input type="radio"/> yes, in min colour	Slow up image...: <input type="radio"/> no	
Restore...: <input type="radio"/> full map	Add to mask...: <input type="radio"/> create default mask	Brush width...: <input type="radio"/> 4	
Restore & scaled...: <input type="radio"/> no			
Calculate	Draw	Quantitate	Save pixels
		Save matrix	Retrieve
		Thru Works	Quit

Clear data		Load data		Done	
Unit: <input type="radio"/> mV	Loc: <input type="radio"/> Optimal	Lin: <input type="radio"/> no	Heal: <input type="radio"/> all		
SITE: Real Fit	SITE: Real Fit	SITE: Real Fit			
-3,0: 1.51 1.20	-6,6: 0.10 0.07	-5,-2: 0.99 0.12			
-3,2: 0.52 0.35	-7,8: 0.48 0.31	-4,8: 0.39 0.70			
-3,4: 0.11 0.13	-7,2: 0.29 0.18	-4,2: 0.17 0.18			
-5,-2: 0.42 0.48	-7,4: 0.86 0.81	-4,4: 0.05 0.07			
-5,-4: 0.11 0.12	-7,-2: 0.78 0.54	-4,-2: 0.23 0.16			
-6,8: 0.09 1.00	-7,-4: 0.21 0.15	-4,-4: 0.07 0.09			
-6,2: 0.42 0.49	-8,8: 0.07 0.06	-3,8: 0.10 0.13			
-4,4: 0.27 0.18	-8,2: 0.08 0.04	-3,2: 0.06 0.03			
-6,-2: 0.32 0.68	-8,-2: 0.96 0.10	-3,-2: 0.06 0.07			
-6,-4: 0.16 0.11	-8,-4: 0.09 0.12	-2,8: 0.06 0.05			
-6,-6: 0.04 0.06	-8,8: 0.06 0.07				
Sum of squares error of fit is 5.25					
*Optimal* latitude is at 38.2 degrees ( 6.2 ca)					
*Optimal* longitude is at -2.3 degrees (-0.2 ca)					
----- IMAGE > 50% : IMAGE > 75%					
COG latitude: 39.2deg ( 6.2ca)	: 29.9deg ( 6.1ca)				
COG longitude: -3.4deg (-0.4ca)	: -1.8deg (-0.2ca)				
ANT longitude: 21.6deg ( 2.2ca)	: 14.1deg ( 1.4ca)				
POST longitude: -21.6deg (-2.2ca)	: -13.8deg (-1.4ca)				
NEOL latitude: 21.2deg ( 4.4ca)	: 22.9deg ( 4.7ca)				
LATL latitude: 38.2deg ( 7.8ca)	: 35.9deg ( 7.4ca)				
Elongation: 4.5/3.5ca = 1.3	: 2.9/2.7ca = 1.1				
Surface area: 12.4 ca2	: 5.1 ca2				



Clear data		Load data		Done	
Unit: <input type="radio"/> mV	Loc: <input type="radio"/> Optimal	Lin: <input type="radio"/> no	Heal: <input type="radio"/> all		
SITE: Real Fit	SITE: Real Fit	SITE: Real Fit			
3,2: 0.51 0.38	7,-2: 0.99 0.03	3,-2: 0.00 0.06			
5,4: 0.12 0.12	7,-4: 0.00 0.07	2,8: 0.04 0.01			
5,-2: 0.13 0.17	8,8: 0.05 0.03	5,8: 0.05 0.01			
5,-4: 0.06 0.07	8,-2: 0.10 0.06				
6,4: 0.51 0.53	4,8: 0.37 0.06				
6,2: 0.30 0.31	4,2: 0.49 0.48				
6,4: 0.05 0.02	4,4: 0.06 0.07				
6,-2: 0.09 0.09	4,-2: 0.14 0.14				
6,-4: 0.11 0.06	4,-4: 0.10 0.10				
7,8: 0.10 0.08	3,4: 0.21 0.33				
7,2: 0.04 0.00	3,2: 0.10 0.10				
Sum of squares error of fit is 1.93					
*Optimal* latitude is at 24.6 degrees ( 5.1 ca)					
*Optimal* longitude is at 4.7 degrees ( 0.4 ca)					
----- IMAGE > 50% : IMAGE > 75%					
COG latitude: 25.3deg ( 5.2ca)	: 25.4deg ( 5.2ca)				
COG longitude: 6.1deg ( 4.5ca)	: 5.9deg ( 4.5ca)				
ANT longitude: 36.1deg ( 2.6ca)	: 21.9deg ( 1.9ca)				
POST longitude: -13.8deg (-1.2ca)	: -7.1deg (-0.8ca)				
NEOL latitude: 17.3deg ( 3.6ca)	: 20.4deg ( 4.2ca)				
LATL latitude: 34.3deg ( 7.0ca)	: 31.4deg ( 6.4ca)				
Elongation: 3.9/3.5ca = 1.1	: 2.6/2.3ca = 1.1				
Surface area: 9.2 ca2	: 4.1 ca2				





URN: unspecified AGE: 23 years SEX: unspecified

DATE: Mon Sep 19 16:20:39 1994 - printed Sun Jan 15 13:09:32 1995.

FILE: /home/gary/pc/data/mapping/dylan/Amr.flx

SERIES: ATHLETE 1

COMMENTS: right feu

URN: unspecified AGE: unspecified SEX: unspecified

DATE: Mon Sep 19 17:41:17 1994 - printed Sun Jan 15 13:32:40 1995.

FILE: /home/gary/pc/data/mapping/dylan/Amr.flx

SERIES: ATHLETE 1

COMMENTS: left feu

**CALCULATION OPTIONS**

Add zeroed sites:  around edges  
 Limit calculation:  1 deg outer limit  
 Set resolution:  256x256 matrix  
 Interpolation:  spline fit  
 Data source:  none selected!

**SAVE & RESTORE IMAGE**

Image label:   
 Restore:  full map  
 Restore & scaled:  no

**DISPLAY OPTIONS**

Position map:  at 1 x 1 in a 1 x 1 grid [CLEAR MAP] [KEY] [PRO]  
 Map screen size:  512x512 MAX RES  
 Viewing direction:  Vertex  
 Upper threshold:  image  
 UT value (u,m,z):  
 Lower threshold:  sites  
 LT value (u,m,z):  
 Colour table:  8&W 8 levels  
 Invert colour table:  yes  
 Map background:  white  
 Show grey scale key:  yes  
 Show sites:  no  
 Show reference grid:  black

**MASKING & MAGNIFY OPTIONS**

Draw with mask:  yes, in min colour Blow up image:  no  
 Add to mask:  create default mask/rush width:  4

Calculate Draw Quantitate Save pixels Save matrix Retrieve The Works Quit

Clear data Load data Done

Units:  mV Loc:  Optimal Lta:  no Heat:  all

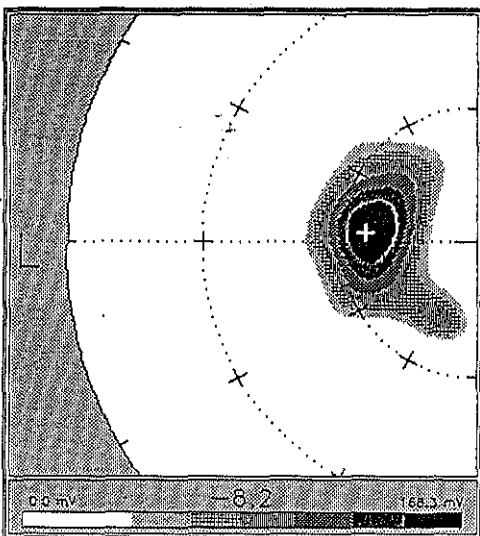
SITE: Real Fit	SITE: Real Fit	SITE: Real Fit
-8,1: 56.00 50.36	-5,1: 164.01165.01	
-7,-2: 74.00 69.99	-5,2: 130.01146.03	
-7,1: 106.01100.24	-5,4: 79.00 81.24	
-7,2: 112.0185.49	-4,-4: 122.0196.81	
-7,4: 37.00 50.36	-4,-2: 60.00 85.29	
-6,-2: 114.0119.55	-4,1: 140.01138.44	
-6,1: 137.01149.32	-4,2: 134.01124.00	
-6,2: 130.01135.76	-4,4: 60.00 55.09	
-6,4: 195.0101.71	-3,-2: 40.00 55.29	
-5,-4: 52.00 55.46	-3,1: 122.0190.59	
-5,-2: 125.01112.74	-3,2: 50.00 70.55	

Sun of squares error of fit is 1.91; Interaural = ca

\*Optimal\* latitude is at 24.6 degrees ( 5.1 cm)  
 \*Optimal\* longitude is at 4.7 degrees ( 0.4 cm)

IMAGE > 50%	IMAGE > 75%
COG latitude: 22.4deg ( 4.6cm)	23.3deg ( 4.8cm)
COG longitude: 5.3deg ( 0.4cm)	6.5deg ( 0.5cm)
ANT longitude: 54.3deg ( 4.3cm)	34.5deg ( 2.6cm)
POST longitude: -34.3deg (-2.7cm)	-19.3deg (-1.6cm)
MEDL latitude: 12.4deg ( 2.6cm)	16.3deg ( 3.4cm)
LATL latitude: 34.4deg ( 7.1cm)	31.3deg ( 6.5cm)
Elongation: 7.0/4.5cm = 1.5	4.4/3.1cm = 1.4
Surface area: 23.1 cm <sup>2</sup>	9.8 cm <sup>2</sup>

0.0 mV -8,2 164.0 mV



**CALCULATION OPTIONS**

Add zeroed sites:  around edges  
 Limit calculation:  1 deg outer limit  
 Set resolution:  256x256 matrix  
 Interpolation:  spline fit  
 Data source:  none selected!

**SAVE & RESTORE IMAGE**

Image label:   
 Restore:  full map  
 Restore & scaled:  no

**DISPLAY OPTIONS**

Position map:  at 1 x 1 in a 1 x 1 grid [CLEAR MAP] [KEY] [PRO]  
 Map screen size:  512x512 MAX RES  
 Viewing direction:  Vertex  
 Upper threshold:  image  
 UT value (u,m,z):  
 Lower threshold:  sites  
 LT value (u,m,z):  
 Colour table:  8&W 8 levels  
 Invert colour table:  yes  
 Map background:  white  
 Show grey scale key:  yes  
 Show sites:  no  
 Show reference grid:  black

**MASKING & MAGNIFY OPTIONS**

Draw with mask:  yes, in min colour Blow up image:  no  
 Add to mask:  create default mask/rush width:  4

Calculate Draw Quantitate Save pixels Save matrix Retrieve The Works Quit

Clear data Load data Done

Units:  mV Loc:  Optimal Lta:  no Heat:  all

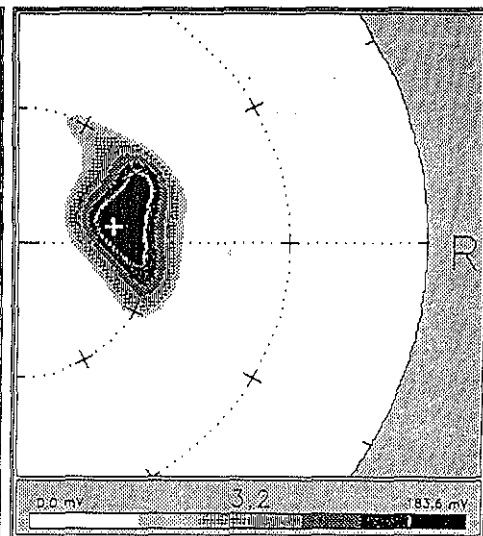
SITE: Real Fit	SITE: Real Fit	SITE: Real Fit
3,1: 71.00 76.00	6,4: 105.01110.50	
3,2: 50.00 49.46	6,6: 72.00 59.90	
4,1: 155.01130.19	7,-2: 107.0107.04	
4,2: 147.01124.25	7,1: 106.0100.80	
5,-2: 60.00 67.34	7,2: 163.01136.36	
5,1: 160.01174.15	7,4: 140.01127.21	
5,2: 159.01165.66	8,1: 40.00 24.33	
5,4: 56.00 61.11	0,2: 51.20 60.60	
6,-2: 133.01129.03		
6,1: 162.01161.35		
6,2: 156.01173.53		

Sun of squares error of fit is 1.11; Interaural = ca

\*Optimal\* latitude is at 21.6 degrees ( 4.4 cm)  
 \*Optimal\* longitude is at 9.6 degrees ( 0.7 cm)

IMAGE > 50%	IMAGE > 75%
COG latitude: 25.1deg ( 5.2cm)	25.1deg ( 5.2cm)
COG longitude: 11.2deg ( 1.0cm)	11.3deg ( 1.0cm)
ANT longitude: 44.2deg ( 3.5cm)	32.5deg ( 2.8cm)
POST longitude: -21.0deg (-1.9cm)	-14.3deg (-1.3cm)
MEDL latitude: 14.1deg ( 2.9cm)	16.1deg ( 3.3cm)
LATL latitude: 35.1deg ( 7.2cm)	32.1deg ( 6.6cm)
Elongation: 5.0/4.3cm = 1.3	4.1/3.3cm = 1.2
Surface area: 21.3 cm <sup>2</sup>	11.0 cm <sup>2</sup>

0.0 mV 3,2 183.6 mV



URN: unspecified AGE: 33 years SEX: female

DATE: Wed Sep 28 16:04:38 1994 - printed Sun Jan 15 14:30:15 1995.

FILE: /home/gary/pc/data/mapping/dylan/cwrt.flx2

SERIES: ATHLETE 2

COMMENTS: Right FCU - Badminton

URN: unspecified AGE: unspecified SEX: unspecified

DATE: Wed Sep 28 17:01:26 1994 - printed Sun Jan 15 14:53:27 1995.

FILE: /home/gary/pc/data/mapping/dylan/cwl.flx

SERIES: ATHLETE 2

COMMENTS: left wrist/flexor-map

**CALCULATION OPTIONS**

Add zeroed sites:  around edges  
 Limit calculation:  1 deg outer limit  
 Set resolution:  256x256 matrix  
 Interpolation:  spline fit  
 Data source:  none selected!

**SAVE & RESTORE IMAGE**

Image label:  -2,0  
 Restore:  full map  
 Restore & scaled:  no

**DISPLAY OPTIONS**

Position map...: at 1 x 1 in a 1 x 1 grid [CLEAR MAP] [KEY] [PRD]  
 Map screen size:  512x512 MAX RES Viewing direction:  Vertex  
 Upper threshold:  image UT value (u,m,%):  
 Lower threshold:  sites LT value (u,m,%):  
 Colour table:  B&W & levels Invert colour table:  yes  
 Map background:  white Show grey scale key:  yes  
 Show sites:  no Show reference grid:  black

**MASKING & MAGNIFY OPTIONS**

Draw with mask:  yes, in min colour Blow up image:  no  
 Add to mask:  create default mask/brush width:  4

[Calculate] [Draw] [Quantitate] [Save pixels] [Save matrix] [Retrieve] [The Works] [Quit]

Clear data Load data Done

Units:  mV Loc:  Optimal Ltr:  no Heat:  all

SITE: Real Fit	SITE: Real Fit	SITE: Real Fit
-6,-2: 46.00 47.36	-5,-2: 146.00150.06	-3,2: 53.00 49.04
-6,8: 56.00 38.77	-5,8: 149.00145.52	-2,8: 59.00 35.02
-7,-4: 60.00 62.07	-5,2: 104.0084.90	
-7,-2: 64.00 87.23	-5,4: 32.00 26.27	
-7,8: 74.00 84.29	-4,-2: 122.0035.00	
-7,2: 44.00 46.75	-4,8: 121.00140.40	
-6,-4: 83.00 97.16	-4,2: 74.00 60.01	
-6,-2: 126.00120.42	-4,4: 38.00 37.06	
-6,8: 132.00127.96	-3,-4: 23.00 19.44	
-6,2: 63.00 65.69	-3,-2: 103.0078.72	
-5,-4: 104.0077.58	-3,8: 120.00110.68	

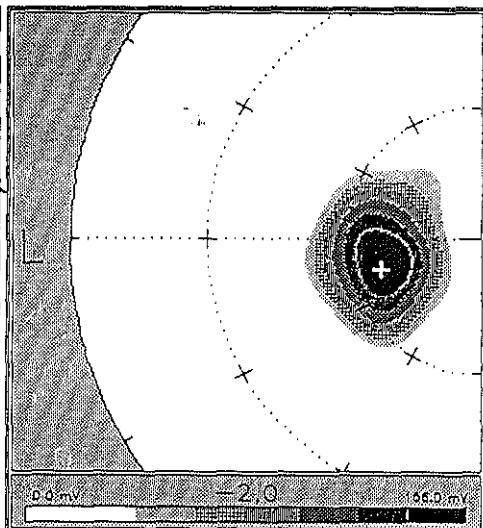
Sum of squares error of fit is 1.34, internal = ca

\*Optimal\* latitude is at 23.1 degrees ( 4.0 ca)  
 \*Optimal\* longitude is at -17.2 degrees (-1.4 ca)

-----: IMAGE > 50% : IMAGE > 75%

COG latitude	COG longitude	ANT longitude	POST longitude	NEDL latitude	LATL latitude
22.8deg ( 4.7ca)	22.7deg ( 4.7ca)	31.4deg ( 2.3ca)	-17.6deg (-3.8ca)	3.8deg ( 2.0ca)	34.0deg ( 7.2ca)
-10.6deg (-0.8ca)	-11.6deg (-0.9ca)	15.4deg ( 1.2ca)	-37.6deg (-3.0ca)	12.7deg ( 2.6ca)	20.7deg ( 6.3ca)

Elongation: 6.3/5.1ca = 1.2 : 4.2/3.7ca = 1.1  
 Surface area: 23.6 ca2 : 11.6 ca2



**CALCULATION OPTIONS**

Add zeroed sites:  around edges  
 Limit calculation:  1 deg outer limit  
 Set resolution:  256x256 matrix  
 Interpolation:  spline fit  
 Data source:  none selected!

**SAVE & RESTORE IMAGE**

Image label:  2,0  
 Restore:  full map  
 Restore & scaled:  no

**DISPLAY OPTIONS**

Position map...: at 1 x 1 in a 1 x 1 grid [CLEAR MAP] [KEY] [PRD]  
 Map screen size:  512x512 MAX RES Viewing direction:  Vertex  
 Upper threshold:  image UT value (u,m,%):  
 Lower threshold:  sites LT value (u,m,%):  
 Colour table:  B&W & levels Invert colour table:  yes  
 Map background:  white Show grey scale key:  yes  
 Show sites:  no Show reference grid:  black

**MASKING & MAGNIFY OPTIONS**

Draw with mask:  yes, in min colour Blow up image:  no  
 Add to mask:  create default mask/brush width:  4

[Calculate] [Draw] [Quantitate] [Save pixels] [Save matrix] [Retrieve] [The Works] [Quit]

Clear data Load data Done

Units:  mV Loc:  Optimal Ltr:  no Heat:  all

SITE: Real Fit	SITE: Real Fit	SITE: Real Fit
2,8: 67.00 73.30	5,4: 167.00177.35	
3,-2: 54.00 64.02	5,2: 149.00152.30	
3,8: 169.00151.63	5,4: 58.00 62.11	
3,2: 100.00101.19	6,-4: 33.00 55.10	
4,-4: 48.00 44.95	6,-2: 133.00127.51	
4,-2: 141.00130.82	6,8: 142.00145.66	
4,8: 167.00165.36	6,2: 127.00115.66	
4,2: 151.00152.94	6,4: 57.00 53.12	
4,4: 48.00 40.40	7,-2: 104.0090.71	
5,-4: 86.00 84.00	7,8: 87.00 84.60	
5,-2: 146.00149.71	7,2: 54.00 57.41	

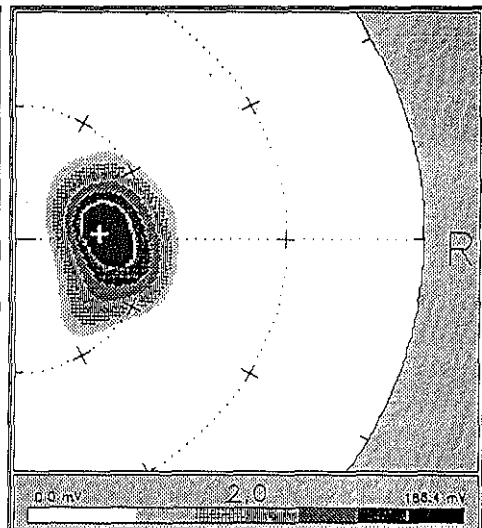
Sum of squares error of fit is 0.45, internal = ca

\*Optimal\* latitude is at 18.9 degrees ( 3.9 ca)  
 \*Optimal\* longitude is at 3.7 degrees ( 0.2 ca)

-----: IMAGE > 50% : IMAGE > 75%

COG latitude	COG longitude	ANT longitude	POST longitude	NEDL latitude	LATL latitude
21.4deg ( 4.4ca)	21.2deg ( 4.4ca)	44.4deg ( 2.3ca)	-43.6deg (-3.3ca)	19.4deg ( 2.1ca)	34.4deg ( 7.1ca)
-0.6deg (-0.0ca)	0.9deg ( 0.1ca)	21.3deg ( 2.4ca)	-26.1deg (-1.9ca)	13.2deg ( 2.7ca)	30.2deg ( 6.2ca)

Elongation: 6.6/4.9ca = 1.3 : 4.3/3.5ca = 1.2  
 Surface area: 23.6 ca2 : 11.6 ca2



\*

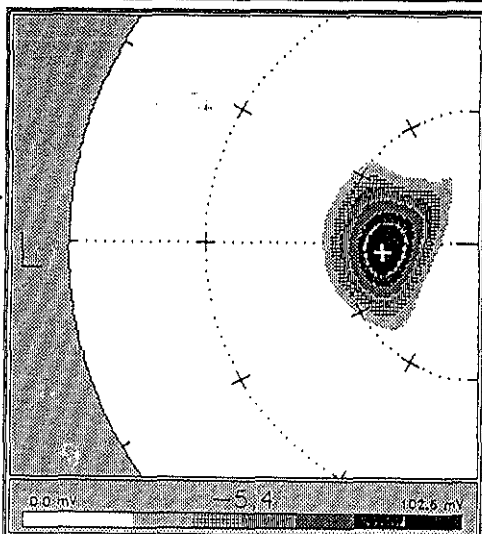
URN: unspecified AGE: 21 years SEX: male  
 DATE: Fri Oct 14 13:29:04 1994 - printed Sun Jan 15 16:33:20 1995.  
 FILE: /home/gary/pc/data/mapping/dylan/ecr.flx  
 SERIES: Badminton **ATHLETE 3**  
 COMMENTS: R FCU-DOMINANT

URN: unspecified AGE: 21 years SEX: male  
 DATE: Fri Oct 14 14:28:42 1994 - printed Sun Jan 15 16:12:58 1995.  
 FILE: /home/gary/pc/data/mapping/dylan/eci.flx  
 SERIES: Badminton **ATHLETE 3**  
 COMMENTS: L FCU-NonDominant

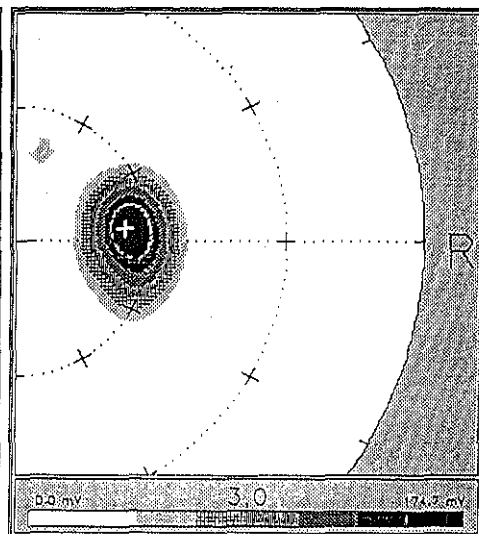
CALCULATION OPTIONS		DISPLAY OPTIONS	
Add zeroed sites: <input type="radio"/> around edges	Position map...: at 1 x 1 in a 1 x 1 grid [CLEAR MAP] [KEY] [PRO]	Map screen size: <input type="radio"/> 512x512 MAX RES	Viewing direction...: <input type="radio"/> Vertex
Limit calculation: <input type="radio"/> 1 deg outer limit	Upper threshold: <input type="radio"/> image	UT value (u,m,%)...	LT value (u,m,%)...
Set resolution...: <input type="radio"/> 256x256 matrix	Lower threshold: <input type="radio"/> sites	Colour table...: <input type="radio"/> B&W & levels	Invert colour table: <input type="radio"/> yes
Interpolation...: <input type="radio"/> spline fit	Map background: <input type="radio"/> white	Show grey scale key: <input type="radio"/> yes	Show reference grid: <input type="radio"/> black
Data source...: <input type="radio"/> none selected!	Show sites...: <input type="radio"/> no		
SAVE & RESTORE IMAGE		MASKING & MAGNIFY OPTIONS	
Image label...: -5,4	Restore...: <input type="radio"/> full map	Draw with mask: <input type="radio"/> yes, in min colour	Blow up image...: <input type="radio"/> no
Restore & scaled: <input type="radio"/> no	Add to mask...: <input type="radio"/> create default mask	Blow up width...: <input type="radio"/> 4	
[Calculate] [Draw] [Quantitate] [Save pixels] [Save matrix] [Retrieve] [The Works] [Quit]			

CALCULATION OPTIONS		DISPLAY OPTIONS	
Add zeroed sites: <input type="radio"/> around edges	Position map...: at 1 x 1 in a 1 x 1 grid [CLEAR MAP] [KEY] [PRO]	Map screen size: <input type="radio"/> 512x512 MAX RES	Viewing direction...: <input type="radio"/> Vertex
Limit calculation: <input type="radio"/> 1 deg outer limit	Upper threshold: <input type="radio"/> image	UT value (u,m,%)...	LT value (u,m,%)...
Set resolution...: <input type="radio"/> 256x256 matrix	Lower threshold: <input type="radio"/> sites	Colour table...: <input type="radio"/> B&W & levels	Invert colour table: <input type="radio"/> yes
Interpolation...: <input type="radio"/> spline fit	Map background: <input type="radio"/> white	Show grey scale key: <input type="radio"/> yes	Show reference grid: <input type="radio"/> black
Data source...: <input type="radio"/> none selected!	Show sites...: <input type="radio"/> no		
SAVE & RESTORE IMAGE		MASKING & MAGNIFY OPTIONS	
Image label...: 3,0	Restore...: <input type="radio"/> full map	Draw with mask: <input type="radio"/> yes, in min colour	Blow up image...: <input type="radio"/> no
Restore & scaled: <input type="radio"/> no	Add to mask...: <input type="radio"/> create default mask	Blow up width...: <input type="radio"/> 4	
[Calculate] [Draw] [Quantitate] [Save pixels] [Save matrix] [Retrieve] [The Works] [Quit]			

Clear data		Load data		Done	
Units: Real Fit	Loc: <input type="radio"/> Optimal	Lis: <input type="radio"/> no	Reef: <input type="radio"/> all	SITE: Real Fit	SITE: Real Fit
-7,-2: 36.00 36.24	-5,-2: 60.00 69.60				
-7,8: 45.00 42.39	-4,-2: 71.00 36.30				
-7,2: 35.00 07.30	-4,8: 101.00 06.07				
-6,-4: 36.00 31.96	-4,-2: 63.00 64.00				
-6,-2: 63.00 67.27	-4,4: 31.00 25.99				
-6,8: 75.00 77.47	-3,8: 52.00 63.04				
-6,2: 57.00 61.02	-3,2: 54.00 46.81				
-6,4: 33.00 24.70	-2,8: 34.00 29.97				
-5,-4: 22.00 25.35					
-5,-2: 71.00 79.46					
-5,8: 105.00 09.24					
Sum of squares error of fit is 1.18, Interaural = cc					
*Optimal* latitude is at 21.6 degrees ( 4.4 cm)					
*Optimal* longitude is at -5.4 degrees (-6.4 cm)					
-----: IMAGE > 50% : IMAGE > 75%					
COG latitude:	20.9deg ( 4.3cm)	29.9deg ( 4.3cm)			
COG longitude:	-9.1deg (-9.0cm)	-2.9deg (-6.1cm)			
ANT longitude:	34.9deg ( 2.6cm)	22.0deg ( 1.8cm)			
POST longitude:	-35.1deg (-2.6cm)	-24.0deg (-1.8cm)			
MDL latitude:	19.9deg ( 2.2cm)	13.9deg ( 2.9cm)			
LATL latitude:	36.9deg ( 6.4cm)	27.9deg ( 5.7cm)			
Elongation:	5.1/4.3cm = 1.2	3.4/2.9cm = 1.2			
Surface area:	16.0 cm <sup>2</sup>	6.8 cm <sup>2</sup>			



Clear data		Load data		Done	
Units: Real Fit	Loc: <input type="radio"/> Optimal	Lis: <input type="radio"/> no	Reef: <input type="radio"/> all	SITE: Real Fit	SITE: Real Fit
3,8: 56.00 44.00	6,2: 149.00 145.14				
4,-2: 68.00 47.70	6,4: 38.00 21.50				
4,8: 93.00 119.16	7,-4: 30.00 42.15				
4,2: 72.00 68.93	7,-2: 96.00 100.69				
4,4: 35.00 26.28	7,8: 130.00 120.34				
5,-2: 66.00 90.71	7,2: 104.00 111.85				
5,8: 160.00 60.50	7,4: 35.00 36.54				
5,2: 137.00 126.08	8,-2: 57.00 57.29				
6,-4: 30.00 30.00	8,8: 77.00 72.37				
6,-2: 123.00 113.42	8,2: 59.00 61.01				
6,8: 163.00 60.40					
Sum of squares error of fit is 1.24, Interaural = cc					
*Optimal* latitude is at 24.7 degrees ( 5.1 cm)					
*Optimal* longitude is at 6.5 degrees ( 0.6 cm)					
-----: IMAGE > 50% : IMAGE > 75%					
COG latitude:	25.6deg ( 5.3cm)	25.7deg ( 5.3cm)			
COG longitude:	2.0deg ( 0.3cm)	4.3deg ( 0.4cm)			
ANT longitude:	31.0deg ( 2.8cm)	23.5deg ( 2.1cm)			
POST longitude:	-25.2deg (-2.2cm)	-14.5deg (-1.3cm)			
MDL latitude:	15.6deg ( 3.2cm)	19.7deg ( 4.1cm)			
LATL latitude:	36.6deg ( 7.5cm)	37.7deg ( 6.7cm)			
Elongation:	5.1/4.3cm = 1.2	3.4/2.7cm = 1.3			
Surface area:	15.2 cm <sup>2</sup>	6.9 cm <sup>2</sup>			



URN: unspecified AGE: unspecified SEX: female

DATE: Fri Oct 21 15:55:08 1994 - printed Sun Jan 15 17:05:53 1995.

FILE: /home/gary/pc/data/mapping/dylan/fdrl.flx

SERIES: Badminton ATHLETE 4

COMMENTS: R FCU-Dominant

URN: unspecified AGE: unspecified SEX: female

DATE: Fri Oct 21 16:33:44 1994 - printed Mon Jan 16 17:00:21 1995.

FILE: /home/gary/pc/data/mapping/dylan/dli.flx

SERIES: Badminton ATHLETE 4

COMMENTS: L FCU-NonDominant

**CALCULATION OPTIONS**

Add zeroed sites.:  around edges  
 Limit calculation.:  1 deg outer limit  
 Set resolution.:  256x256 matrix  
 Interpolation.:  spline fit  
 Data source.:  none selected!

**DISPLAY OPTIONS**

Position map.: at 1 x 1 in a 1 x 1 grid [CLEAR MAP] [KEY] [PRO]  
 Map screen size.:  512x512 MAX RES Viewing direction.:  Vertex  
 Upper threshold.:  image UT value (u,m,%):  
 Lower threshold.:  sites LT value (u,m,%):  
 Colour table.:  B&W & levels Invert colour table:  yes  
 Map background.:  white Show grey scale key:  yes  
 Show sites.:  no Show reference grid:  black

**MASKING & MAGNIFY OPTIONS**

Draw with mask.:  yes, in min colour Blow up image.:  no  
 Add to mask.:  create default mask/brush width.:  4

**SAVE & RESTORE IMAGE**

Image label.: -3,-2  
 Restore.:  full map  
 Restore % scaled.:  no

Calculate Draw Quantitate Save pixels Save matrix Retrieve The Works Quit

**CALCULATION OPTIONS**

Add zeroed sites.:  around edges  
 Limit calculation.:  1 deg outer limit  
 Set resolution.:  256x256 matrix  
 Interpolation.:  spline fit  
 Data source.:  none selected!

**DISPLAY OPTIONS**

Position map.: at 1 x 1 in a 1 x 1 grid [CLEAR MAP] [KEY] [PRO]  
 Map screen size.:  512x512 MAX RES Viewing direction.:  Vertex  
 Upper threshold.:  image UT value (u,m,%): 100%  
 Lower threshold.:  value LT value (u,m,%): 0%  
 Colour table.:  B&W & levels Invert colour table:  yes  
 Map background.:  white Show grey scale key:  yes  
 Show sites.:  no Show reference grid:  black

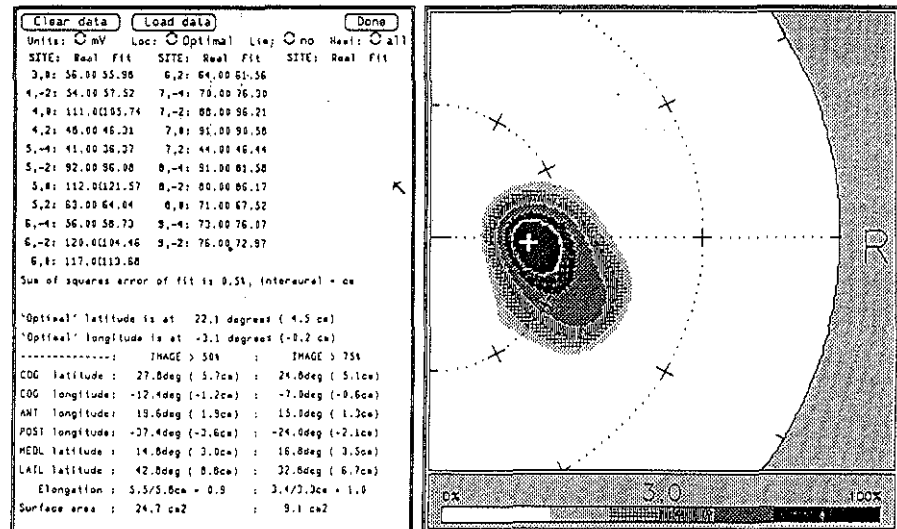
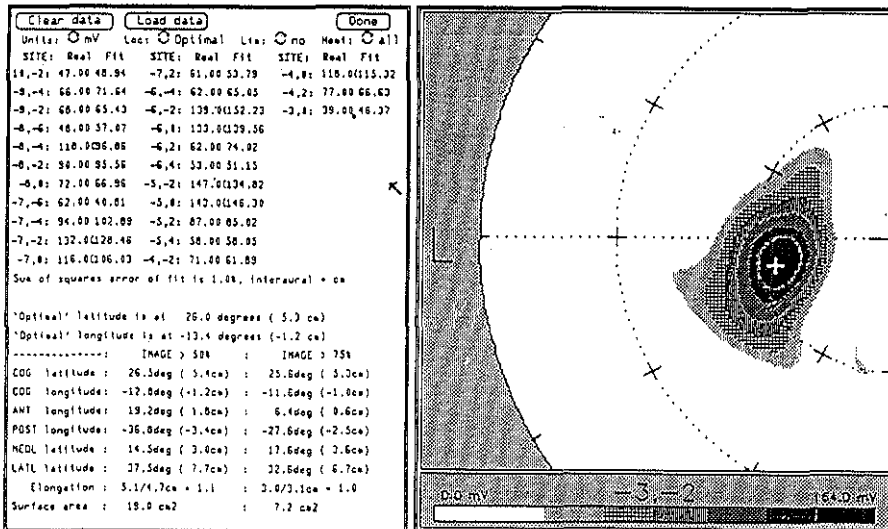
**MASKING & MAGNIFY OPTIONS**

Draw with mask.:  yes, in min colour Blow up image.:  no  
 Add to mask.:  create default mask/brush width.:  4

**SAVE & RESTORE IMAGE**

Image label.: 3,0  
 Restore.:  full map  
 Restore % scaled.:  yes

Calculate Draw Quantitate Save pixels Save matrix Retrieve The Works Quit



\*

URN: unspecified AGE: 25 years SEX: male  
 DATE: Wed Oct 26 14:25:02 1994 - printed Sun Jan 15 18:52:45 1995.  
 FILE: /home/gary/pc/data/mapping/dylan/aprt.flxb  
 SERIES: badders **ATHLETE 5**  
 COMMENTS: right h dominant

URN: unspecified AGE: unspecified SEX: unspecified  
 DATE: Wed Oct 26 15:31:40 1994 - printed Sun Jan 15 19:20:03 1995.  
 FILE: /home/gary/pc/data/mapping/dylan/apl.flxb  
 SERIES: badders **ATHLETE 5**  
 COMMENTS: non-dominant wrist flexor

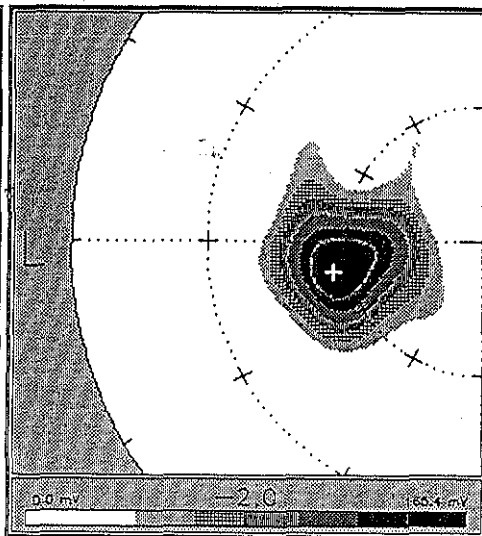
CALCULATION OPTIONS		DISPLAY OPTIONS	
Add zeroed sites: <input type="radio"/> around edges	Limit calculation: <input type="radio"/> 1 deg outer limit	Position map...: at 1 x 1 in a .1 x 1 grid [CLEAR MAP] [KEY] [PRO]	Map screen size: <input type="radio"/> 512x512 MAX RES
Set resolution...: <input type="radio"/> 256x256 matrix	Interpolation...: <input type="radio"/> spline fit	Viewing direction...: <input type="radio"/> Vertex	Upper threshold: <input type="radio"/> image
Data source...: <input type="radio"/> none selected!		UT value (u,m,s)...:	Lower threshold: <input type="radio"/> sites
		LT value (u,m,s)...:	Colour table...: <input type="radio"/> B&W & levels
			Invert colour table: <input type="radio"/> yes
			Map background: <input type="radio"/> white
			Show grey scale key: <input type="radio"/> yes
			Show sites...: <input type="radio"/> no
			Show reference grid: <input type="radio"/> black
MASKING & MAGNIFY OPTIONS			
Image label...: -2,0	Restore...: <input type="radio"/> full map	Draw with mask...: <input type="radio"/> yes, in min colour	Blow up image...: <input type="radio"/> no
Restore % scaled...: <input type="radio"/> no	Add to mask...: <input type="radio"/> create default mask	Blow up image...: <input type="radio"/> no	Blow up image...: <input type="radio"/> no
		Add to mask...: <input type="radio"/> create default mask	Blow up image...: <input type="radio"/> no

Buttons: Calculate Draw Quantitate Save pixels Save matrix Retrieve The Works Quit

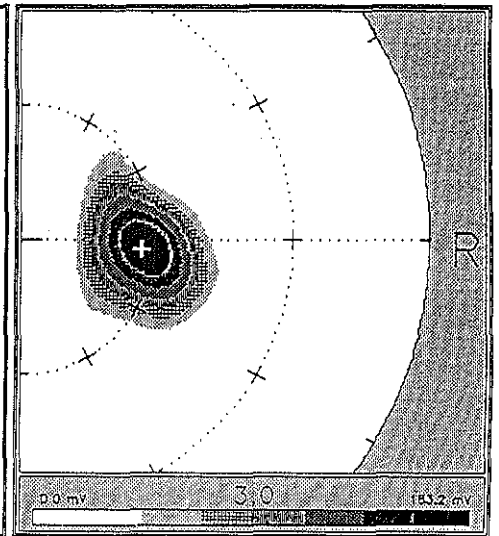
CALCULATION OPTIONS		DISPLAY OPTIONS	
Add zeroed sites: <input type="radio"/> around edges	Limit calculation: <input type="radio"/> 1 deg outer limit	Position map...: at 1 x 1 in a .1 x 1 grid [CLEAR MAP] [KEY] [PRO]	Map screen size: <input type="radio"/> 512x512 MAX RES
Set resolution...: <input type="radio"/> 256x256 matrix	Interpolation...: <input type="radio"/> spline fit	Viewing direction...: <input type="radio"/> Vertex	Upper threshold: <input type="radio"/> image
Data source...: <input type="radio"/> none selected!		UT value (u,m,s)...:	Lower threshold: <input type="radio"/> sites
		LT value (u,m,s)...:	Colour table...: <input type="radio"/> B&W & levels
			Invert colour table: <input type="radio"/> yes
			Map background: <input type="radio"/> white
			Show grey scale key: <input type="radio"/> yes
			Show sites...: <input type="radio"/> no
			Show reference grid: <input type="radio"/> black
MASKING & MAGNIFY OPTIONS			
Image label...: 3,0	Restore...: <input type="radio"/> full map	Draw with mask...: <input type="radio"/> yes, in min colour	Blow up image...: <input type="radio"/> no
Restore % scaled...: <input type="radio"/> no	Add to mask...: <input type="radio"/> create default mask	Blow up image...: <input type="radio"/> no	Blow up image...: <input type="radio"/> no
		Add to mask...: <input type="radio"/> create default mask	Blow up image...: <input type="radio"/> no

Buttons: Calculate Draw Quantitate Save pixels Save matrix Retrieve The Works Quit

Clear data	Load data	Done
Units: <input type="radio"/> mV	Loc: <input type="radio"/> Optimal	Fit: <input type="radio"/> no
Site: Real Fit	Site: Real Fit	Site: Real Fit
10,-2: 57.00 63.06	-7,-4: 85.00 91.07	-5,-2: 66.00 73.72
-10,-4: 69.00 63.59	-7,-2: 160.00 158.04	-5,-4: 53.00 40.94
-9,-4: 61.00 71.76	-7,-8: 152.00 148.44	-4,-4: 45.00 41.08
-9,-2: 129.00 110.34	-7,-2: 54.00 68.24	-4,-2: 61.00 81.08
-9,-8: 114.00 112.81	-6,-4: 52.00 59.97	-4,-8: 132.00 112.68
-9,-2: 59.00 74.64	-6,-2: 150.00 137.04	-4,-2: 56.00 56.78
-9,-4: 66.00 46.31	-6,-8: 136.00 145.18	-3,-2: 60.00 49.88
-8,-4: 117.00 89.11	-6,-2: 77.00 65.04	-3,-8: 60.00 60.81
-8,-2: 133.00 152.35	-5,-4: 53.00 46.25	-2,-8: 29.00 31.24
-8,-8: 143.00 141.62	-5,-2: 110.00 110.11	
-8,-2: 104.00 101.91	-5,-8: 124.00 137.93	
Sum of squares error of fit is 1.49, intersural = ca		
*Optimal* latitude is at 33.3 degree ( 0.0 ca)		
*Optimal* longitude is at -11.8 degree (-1.3 ca)		
-----: IMAGE > 50% : IMAGE > 75%		
COG latitude: 30.2deg ( 5.2ca)	30.8deg ( 6.3ca)	
COG longitude: -8.7deg (-0.3ca)	-9.2deg (-1.0ca)	
ANT longitude: 15.3deg ( 1.6ca)	6.8deg ( 0.7ca)	
POST longitude: -35.7deg (-3.7ca)	-27.2deg (-2.3ca)	
NECL latitude: 13.2deg ( 2.7ca)	19.8deg ( 4.3ca)	
LALT latitude: 45.2deg ( 9.3ca)	49.8deg ( 8.4ca)	
Elongation: 5.3/5.0ca = 0.8	3.6/4.3ca = 0.8	
Surface area: 25.0 ca2	11.0 ca2	



Clear data	Load data	Done
Units: <input type="radio"/> mV	Loc: <input type="radio"/> Optimal	Fit: <input type="radio"/> no
Site: Real Fit	Site: Real Fit	Site: Real Fit
3,-8: 59.00 57.94	6,-8: 146.00 101.19	9,-2: 70.00 89.93
4,-2: 82.00 76.07	6,-2: 90.00 115.21	9,-8: 65.00 50.09
4,-8: 124.00 125.77	6,-4: 69.00 57.97	
4,-2: 59.00 74.64	7,-4: 51.00 55.94	
5,-4: 43.00 37.32	7,-2: 137.00 147.52	
5,-2: 101.00 115.16	7,-8: 250.00 161.89	
5,-8: 153.00 167.03	7,-2: 83.00 77.34	
5,-2: 163.00 124.91	6,-4: 60.00 58.96	
5,-4: 33.00 38.34	8,-2: 124.00 129.48	
6,-4: 39.00 43.16	8,-8: 53.00 110.42	
6,-2: 163.00 137.06	8,-2: 53.00 46.02	
Sum of squares error of fit is 6.24, intersural = ca		
*Optimal* latitude is at 27.0 degree ( 5.5 ca)		
*Optimal* longitude is at -4.3 degree (-0.4 ca)		
-----: IMAGE > 50% : IMAGE > 75%		
COG latitude: 26.9deg ( 5.5ca)	27.2deg ( 5.6ca)	
COG longitude: -4.1deg (-0.4ca)	-3.6deg (-0.3ca)	
ANT longitude: 27.9deg ( 2.6ca)	15.4deg ( 1.4ca)	
POST longitude: -28.1deg (-2.8ca)	-18.6deg (-1.8ca)	
NECL latitude: 14.9deg ( 3.1ca)	19.2deg ( 4.0ca)	
LALT latitude: 39.9deg ( 6.2ca)	36.2deg ( 7.4ca)	
Elongation: 5.2/5.1ca = 1.0	3.2/3.3ca = 0.9	
Surface area: 19.3 ca2	8.7 ca2	

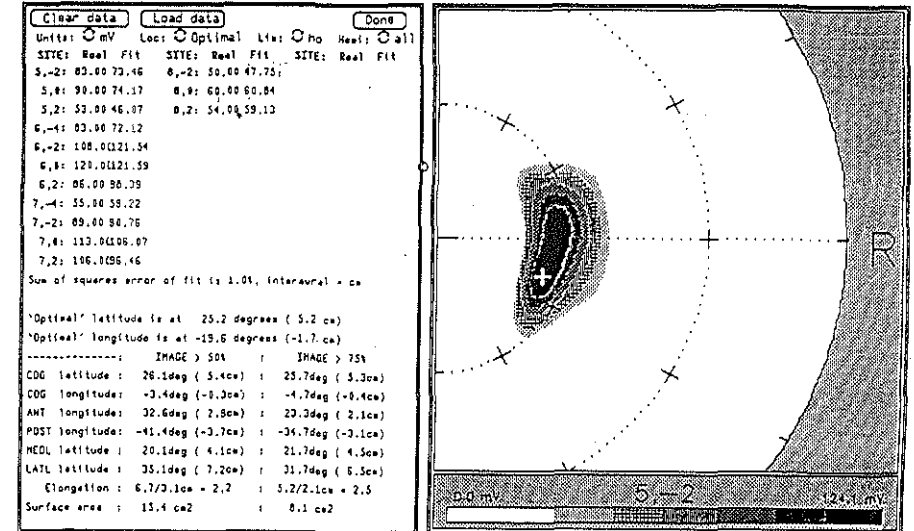
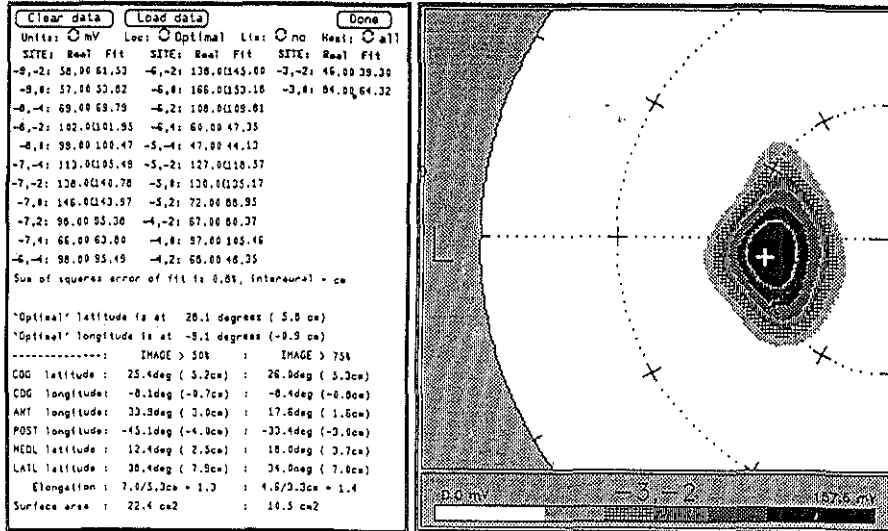


URN: unspecified AGE: 24 years SEX: male  
 DATE: Fri Nov 11 14:29:41 1994 - printed Sun Jan 15 20:34:39 1995.  
 FILE: /home/gary/pc/data/mapping/dylan/dfr.flx  
 SERIES: BADMINTON ATHLETE 6  
 COMMENTS: RIGHT HAND DOMINANT

URN: unspecified AGE: 24 years SEX: male  
 DATE: Fri Nov 11 16:00:39 1994 - printed Sun Jan 15 21:17:12 1995.  
 FILE: /home/gary/pc/data/mapping/dylan/dfr.flx  
 SERIES: BADMINTON ATHLETE 6  
 COMMENTS: LEFT HAND NON DOMINANT

CALCULATION OPTIONS		DISPLAY OPTIONS	
Add zeroed sites: <input type="radio"/> around edges	Position map...: at 1 x 1 in a 1 x 1 grid [CLEAR MAP] [KEY] [PRO]	Map screen size: <input type="radio"/> 512x512 MAX RES	Viewing direction...: <input type="radio"/> Vertax
Limit calculation: <input type="radio"/> 1 deg outer limit	Map upper threshold: <input type="radio"/> image	UT value (u,m,2)...:	LT value (u,m,2)...:
Set resolution...: <input type="radio"/> 256x256 matrix	Lower threshold: <input type="radio"/> sites	Colour table...: <input type="radio"/> 8&H & levels	Invert colour table: <input type="radio"/> yes
Interpolation...: <input type="radio"/> spline fit	Map background...: <input type="radio"/> white	Show gray scale key: <input type="radio"/> yes	Show reference grid: <input type="radio"/> black
Data source...: <input type="radio"/> none selected!	Show sites...: <input type="radio"/> no	MASKING & MAGNIFY OPTIONS	
SAVE & RESTORE IMAGE		Draw with mask...: <input type="radio"/> yes, in min colour	Blow up image...: <input type="radio"/> no
Image label...: -3,-2	Restore...: <input type="radio"/> full map	Add to mask...: <input type="radio"/> create default mask	Mask width...: <input type="radio"/> 4
Restore & scaled: <input type="radio"/> no	<input type="button" value="Calculate"/> <input type="button" value="Draw"/> <input type="button" value="Quantitate"/> <input type="button" value="Save pixels"/> <input type="button" value="Save matrix"/> <input type="button" value="Retrieve"/> <input type="button" value="The Works"/> <input type="button" value="Quit"/>		

CALCULATION OPTIONS		DISPLAY OPTIONS	
Add zeroed sites: <input type="radio"/> around edges	Position map...: at 1 x 1 in a 1 x 1 grid [CLEAR MAP] [KEY] [PRO]	Map screen size: <input type="radio"/> 512x512 MAX RES	Viewing direction...: <input type="radio"/> Vertax
Limit calculation: <input type="radio"/> 1 deg outer limit	Map upper threshold: <input type="radio"/> image	UT value (u,m,2)...:	LT value (u,m,2)...:
Set resolution...: <input type="radio"/> 256x256 matrix	Lower threshold: <input type="radio"/> sites	Colour table...: <input type="radio"/> 8&H & levels	Invert colour table: <input type="radio"/> yes
Interpolation...: <input type="radio"/> spline fit	Map background...: <input type="radio"/> white	Show gray scale key: <input type="radio"/> yes	Show reference grid: <input type="radio"/> black
Data source...: <input type="radio"/> none selected!	Show sites...: <input type="radio"/> no	MASKING & MAGNIFY OPTIONS	
SAVE & RESTORE IMAGE		Draw with mask...: <input type="radio"/> yes, in min colour	Blow up image...: <input type="radio"/> no
Image label...: -3,-2	Restore...: <input type="radio"/> full map	Add to mask...: <input type="radio"/> create default mask	Mask width...: <input type="radio"/> 4
Restore & scaled: <input type="radio"/> no	<input type="button" value="Calculate"/> <input type="button" value="Draw"/> <input type="button" value="Quantitate"/> <input type="button" value="Save pixels"/> <input type="button" value="Save matrix"/> <input type="button" value="Retrieve"/> <input type="button" value="The Works"/> <input type="button" value="Quit"/>		



URN: unspecified AGE: 21 years SEX: male  
 DATE: Fri Nov 25 13:47:53 1994 - printed Mon Jan 16 18:39:30 1995.  
 FILE: /home/gary/pc/data/mapping/dylan/mbrt.flx  
 SERIES: BADMINTON ATHLETE 7  
 COMMENTS: RIGHT FCU

URN: unspecified AGE: 21 years SEX: male  
 DATE: Fri Nov 25 15:01:13 1994 - printed Wed Jan 25 23:19:34 1995.  
 FILE: /home/gary/pc/data/mapping/dylan/mbl.flx  
 SERIES: BADMINTON ATHLETE 7  
 COMMENTS: LEFT FCU NON-DOMINANT

**CALCULATION OPTIONS**      **DISPLAY OPTIONS**

Add zeroed sites:  around edges      Position map...: at 1 x 1 in a 1 x 1 grid [CLEAR MAP] [KEY] [PRO]

Limit calculation:  1 deg outer limit      Map screen size:  512x512 MAX RES      Viewing direction...:  Vortex

Set resolution...:  256x256 matrix      Upper threshold:  image      UT value (u,m,t)...: 100%

Interpolation...:  spline fit      Lower threshold:  sites      LT value (u,m,t)...: 0%

Data source...:  none selected!      Colour table...:  8&W 8 levels      Invert colour table:  yes

Map background:  white      Show grey scale key:  yes

Show sites...:  no      Show reference grid:  black

**SAVE & RESTORE IMAGE**      **MASKING & MAGNIFY OPTIONS**

Image label...: -7,0      Draw with mask:  yes, in min colour      Blow up image...:  no

Restore...:  full map      Add to mask...:  create default mask/brush width...: 4

Restore & scaled:  yes

Buttons: Calculate Draw Quantitate Save pixels Save matrix Retrieve The Works Quit

**CALCULATION OPTIONS**      **DISPLAY OPTIONS**

Add zeroed sites:  around edges      Position map...: at 1 x 1 in a 1 x 1 grid [CLEAR MAP] [KEY] [PRO]

Limit calculation:  1 deg outer limit      Map screen size:  512x512 MAX RES      Viewing direction...:  Vortex

Set resolution...:  256x256 matrix      Upper threshold:  image      UT value (u,m,t)...: 100%

Interpolation...:  spline fit      Lower threshold:  sites      LT value (u,m,t)...: 0%

Data source...:  none selected!      Colour table...:  8&W 8 levels      Invert colour table:  yes

Map background:  white      Show grey scale key:  yes

Show sites...:  no      Show reference grid:  black

**SAVE & RESTORE IMAGE**      **MASKING & MAGNIFY OPTIONS**

Image label...: 6,0      Draw with mask:  no      Blow up image...:  no

Restore...:  full map      Add to mask...:  clear mask      Brush width...: 4

Restore & scaled:  no

Buttons: Calculate Draw Quantitate Save pixels Save matrix Retrieve The Works Quit

Clear data Load data Done

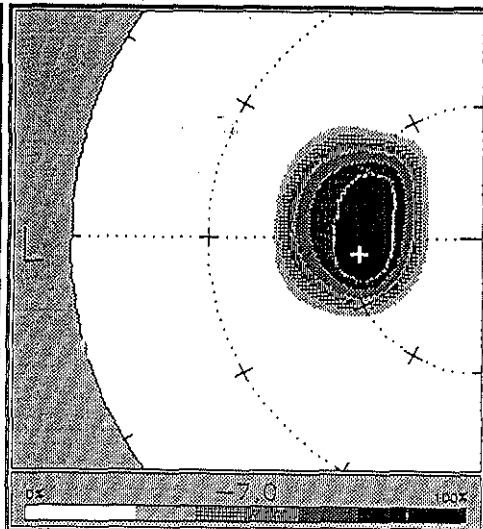
Units:  mV      Loc:  Optimal      Lim:  no      Neef:  all

SITE:	Real	Fit	SITE:	Real	Fit	SITE:	Real	Fit
-9,-2:	04.08	01.02	-7,2:	189.0	0103.67	-4,8:	170.0	0169.30
-9,8:	121.0	0119.90	-7,4:	141.0	0149.76	-4,2:	155.0	0130.12
-9,2:	129.0	0124.29	-6,-2:	172.0	0104.75	-3,8:	79.0	0105.10
-8,4:	83.16	0109.07	-6,8:	206.0	0102.70			
-8,-2:	132.0	0139.97	-6,2:	214.0	0107.26			
-8,8:	181.0	0165.72	-6,4:	151.0	0149.21			
-8,2:	167.0	0160.74	-5,-2:	130.0	0132.45			
-8,8:	142.0	0121.07	-5,8:	201.0	0104.37			
-7,-4:	59.0	0137.57	-5,2:	167.0	0103.14			
-7,-2:	165.0	0101.03	-5,4:	187.0	0104.56			
-7,8:	103.0	0104.79	-4,-2:	77.0	0135.50			

Sua of squares error of fit is 0.39, interaural = ca

\*Optimal\* latitude is at 27.2 degrees ( 5.6 ca)  
 \*Optimal\* longitude is at -7.7 degrees (-0.7 ca)

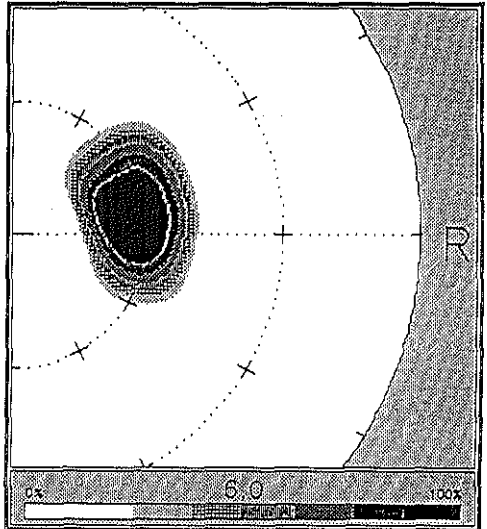
	IMAGE > 50%	IMAGE > 75%
COG latitude :	28.9deg ( 5.6ca)	27.4deg ( 5.6ca)
COG longitude :	7.7deg ( 0.7ca)	7.2deg ( 0.7ca)
AHL longitude :	47.7deg ( 4.6ca)	39.2deg ( 3.7ca)
POST longitude :	-30.2deg (-2.9ca)	-22.0deg (-2.3ca)
MDL latitude :	14.0deg ( 2.5ca)	16.4deg ( 3.4ca)
LAL latitude :	44.0deg ( 9.0ca)	39.4deg ( 8.1ca)
Elongation :	7.5/6.2ca = 1.2	6.6/4.7ca = 1.2
Surface area :	34.1 ca2	20.1 ca2



Clear data Load data Done

Units:  mV      Loc:  no      Lim:  no      Neef:  all

SITE:	Real	Fit	SITE:	Real	Fit	SITE:	Real	Fit
4,8:	-----	7,8:	-----	-----	-----	-----	-----	-----
4,2:	-----	7,2:	-----	-----	-----	-----	-----	-----
5,-2:	-----	7,4:	-----	-----	-----	-----	-----	-----
5,8:	-----	8,-2:	-----	-----	-----	-----	-----	-----
5,2:	-----	8,8:	-----	-----	-----	-----	-----	-----
5,4:	-----	8,2:	-----	-----	-----	-----	-----	-----
6,-2:	-----	8,4:	-----	-----	-----	-----	-----	-----
6,8:	-----	-----	-----	-----	-----	-----	-----	-----
6,2:	-----	-----	-----	-----	-----	-----	-----	-----
6,4:	-----	-----	-----	-----	-----	-----	-----	-----
7,-2:	-----	-----	-----	-----	-----	-----	-----	-----



\*

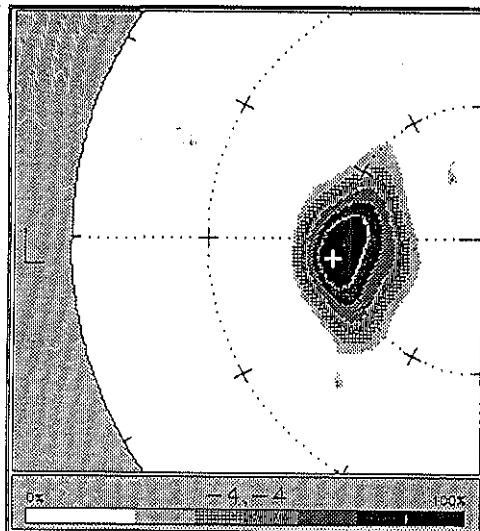
URN: unspecified AGE: 30 years SEX: male  
 DATE: Tue Dec 20 11:15:43 1994 - printed Mon Jan 16 18:12:28 1995.  
 FILE: /home/gary/pc/data/mapping/dylan/gprt.flx  
 SERIES: BADMINTON **ATHLETE 8**  
 COMMENTS: RIGHT HAND DOMINANT

URN: unspecified AGE: 30 years SEX: male  
 DATE: Tue Dec 20 12:07:42 1994 - printed Mon Jan 16 17:42:58 1995.  
 FILE: /home/gary/pc/data/mapping/dylan/gpl.flx  
 SERIES: BADMINTON **ATHLETE 8**  
 COMMENTS: LEFT HAND NON-DOMINANT

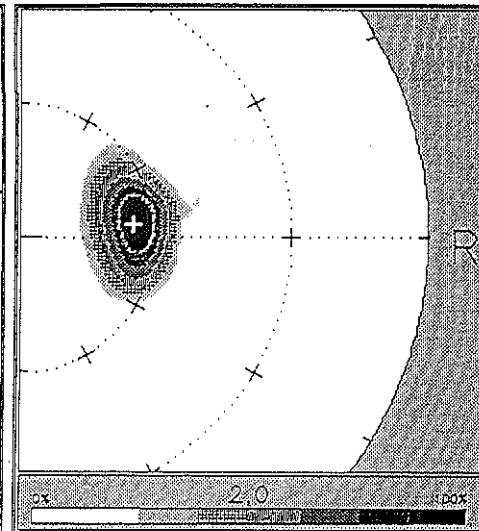
CALCULATION OPTIONS		DISPLAY OPTIONS	
Add zeroed sites: <input type="radio"/> around edges	Position map...: at 1 x 1 in a 1 x 1 grid [CLEAR MAP] [KEY] [PRO]	Map screen size: <input type="radio"/> 512x512 MAX RES	Viewing direction...: <input type="radio"/> Vertex
Limit calculation: <input type="radio"/> 1 deg outer limit	Upper threshold: <input type="radio"/> image	UT value (u,m,t)...: 100%	
Set resolution...: <input type="radio"/> 256x256 matrix	Lower threshold: <input type="radio"/> value.....	LT value (u,m,t)...: 0%	
Interpolation...: <input type="radio"/> spline fit	Colour table...: <input type="radio"/> 8&W & levels	Invert colour table: <input type="radio"/> yes	
Data source...: <input type="radio"/> none selected!	Map background...: <input type="radio"/> white	Show grey scale key: <input type="radio"/> yes	
	Show sites...: <input type="radio"/> no	Show reference grid: <input type="radio"/> black	
<b>SAVE &amp; RESTORE IMAGE</b>		<b>MASKING &amp; MAGNIFY OPTIONS</b>	
Image label...: -4,-4	Draw with mask...: <input type="radio"/> yes, in min colour Blow up image...: <input type="radio"/> no	Restore...: <input type="radio"/> full map	Add to mask...: <input type="radio"/> create default mask/brush width...: <input type="radio"/> 4
Restore & scaled...: <input type="radio"/> yes			
<input type="button" value="Calculate"/>	<input type="button" value="Draw"/>	<input type="button" value="Quantitate"/>	<input type="button" value="Save pixels"/>
<input type="button" value="Save matrix"/>	<input type="button" value="Retrieve"/>	<input type="button" value="The Works"/>	<input type="button" value="Quit"/>

CALCULATION OPTIONS		DISPLAY OPTIONS	
Add zeroed sites: <input type="radio"/> around edges	Position map...: at 1 x 1 in a 1 x 1 grid [CLEAR MAP] [KEY] [PRO]	Map screen size: <input type="radio"/> 512x512 MAX RES	Viewing direction...: <input type="radio"/> Vertex
Limit calculation: <input type="radio"/> 1 deg outer limit	Upper threshold: <input type="radio"/> image	UT value (u,m,t)...: 100%	
Set resolution...: <input type="radio"/> 256x256 matrix	Lower threshold: <input type="radio"/> value.....	LT value (u,m,t)...: 0%	
Interpolation...: <input type="radio"/> spline fit	Colour table...: <input type="radio"/> 8&W & levels	Invert colour table: <input type="radio"/> yes	
Data source...: <input type="radio"/> none selected!	Map background...: <input type="radio"/> white	Show grey scale key: <input type="radio"/> yes	
	Show sites...: <input type="radio"/> no	Show reference grid: <input type="radio"/> black	
<b>SAVE &amp; RESTORE IMAGE</b>		<b>MASKING &amp; MAGNIFY OPTIONS</b>	
Image label...: 2,0	Draw with mask...: <input type="radio"/> yes, in min colour Blow up image...: <input type="radio"/> no	Restore...: <input type="radio"/> full map	Add to mask...: <input type="radio"/> create default mask/brush width...: <input type="radio"/> 4
Restore & scaled...: <input type="radio"/> yes			
<input type="button" value="Calculate"/>	<input type="button" value="Draw"/>	<input type="button" value="Quantitate"/>	<input type="button" value="Save pixels"/>
<input type="button" value="Save matrix"/>	<input type="button" value="Retrieve"/>	<input type="button" value="The Works"/>	<input type="button" value="Quit"/>

Clear data	Load data	Done
Units: <input type="radio"/> mV	Loc: <input type="radio"/> Optimal	Lin: <input type="radio"/> no
Heat: <input type="radio"/> all		
SITE: Real Fit	SITE: Real Fit	SITE: Real Fit
-0,-4: 57.00 70.39	-4,-4: 63.00 54.00	6,-4: 41.00 31.41
-0,-2: 57.00 47.40	-5,-2: 116.00 131.22	4,-2: 59.00 48.60
-0,0: 48.00 48.00	-5,0: 157.00 179.65	4,0: 125.00 125.27
-7,-4: 63.00 53.53	-3,-2: 109.00 115.23	7,-2: 64.00 51.27
-7,-2: 129.00 87.87	-5,4: 38.00 34.62	5,-2: 72.00 79.52
-7,0: 133.00 95.95	-4,-2: 96.00 75.11	5,0: 131.00 139.07
-7,2: 89.00 37.70	-4,0: 152.00 134.80	5,2: 145.00 128.15
-6,-4: 78.00 71.29	-4,-2: 66.00 67.60	5,4: 44.00 41.40
-6,-2: 144.00 53.19	-3,0: 53.00 62.44	6,-2: 67.00 45.61
-6,0: 135.00 71.01		6,0: 99.00 84.05
-6,2: 111.00 65.41		6,2: 197.00 76.82
Sum of squares error of fit is 3.38, interaural = ca		
*Optimal* latitude is at 32.8 degrees ( 6.0 ca)		
*Optimal* longitude is at -7.7 degrees (-0.9 ca)		
----- IMAGE > 50%   IMAGE > 75%		
COG latitude: 28.6deg ( 5.5ca)	: 29.3deg ( 6.1ca)	
COG longitude: -5.7deg (-0.5ca)	: -4.6deg (-0.5ca)	
ANT longitude: 32.3deg ( 3.2ca)	: 17.4deg ( 1.6ca)	
POST longitude: -36.7deg (-3.6ca)	: -25.6deg (-2.6ca)	
MEOL latitude: 15.6deg ( 3.2ca)	: 20.5deg ( 4.2ca)	
LATL latitude: 49.6deg ( 8.3ca)	: 37.5deg ( 7.7ca)	
Elongation: 6.0/5.1ca = 1.3	: 4.4/3.5ca = 1.2	
Surface area: 22.1 ca2	: 10.4 ca2	



Clear data	Load data	Done
Units: <input type="radio"/> mV	Loc: <input type="radio"/> Optimal	Lin: <input type="radio"/> no
Heat: <input type="radio"/> all		
SITE: Real Fit	SITE: Real Fit	SITE: Real Fit
3,-4: 63.00 54.00	6,-4: 41.00 31.41	
4,-2: 59.00 48.60	7,-4: 43.00 42.55	
4,0: 125.00 125.27	7,-2: 56.00 32.56	
4,2: 102.00 84.61	7,0: 64.00 51.27	
5,-2: 72.00 79.52	7,2: 48.00 17.64	
5,0: 131.00 139.07		
5,2: 145.00 128.15		
5,4: 44.00 41.40		
6,-2: 67.00 45.61		
6,0: 99.00 84.05		
6,2: 197.00 76.82		
Sum of squares error of fit is 3.41, interaural = ca		
*Optimal* latitude is at 25.5 degrees ( 5.2 ca)		
*Optimal* longitude is at 6.3 degrees ( 0.6 ca)		
----- IMAGE > 50%   IMAGE > 75%		
COG latitude: 25.3deg ( 5.2ca)	: 25.7deg ( 5.3ca)	
COG longitude: 6.3deg ( 0.5ca)	: 6.7deg ( 0.6ca)	
ANT longitude: 36.3deg ( 3.2ca)	: 27.7deg ( 2.3ca)	
POST longitude: -23.7deg (-2.1ca)	: -14.3deg (-1.3ca)	
MEOL latitude: 17.3deg ( 3.5ca)	: 19.7deg ( 4.0ca)	
LATL latitude: 35.3deg ( 7.2ca)	: 32.7deg ( 6.7ca)	
Elongation: 5.3/3.7ca = 1.4	: 3.7/2.7ca = 1.4	
Surface area: 13.9 ca2	: 6.4 ca2	





# ATHLETE GROUP THRESHOLD CURVES

\* Indicates dominant hemisphere

URN: unspecified      AGE: 23 years      SEX: unspecified

DATE: Mon Sep 19 16:20:39 1994 - printed Sun Dec 18 15:41:06 1994.

FILE: /home/gary/pc/data/mapping/dylan/1mr.fix

SERIES: ATHLETE 1

COMMENTS: right fcu

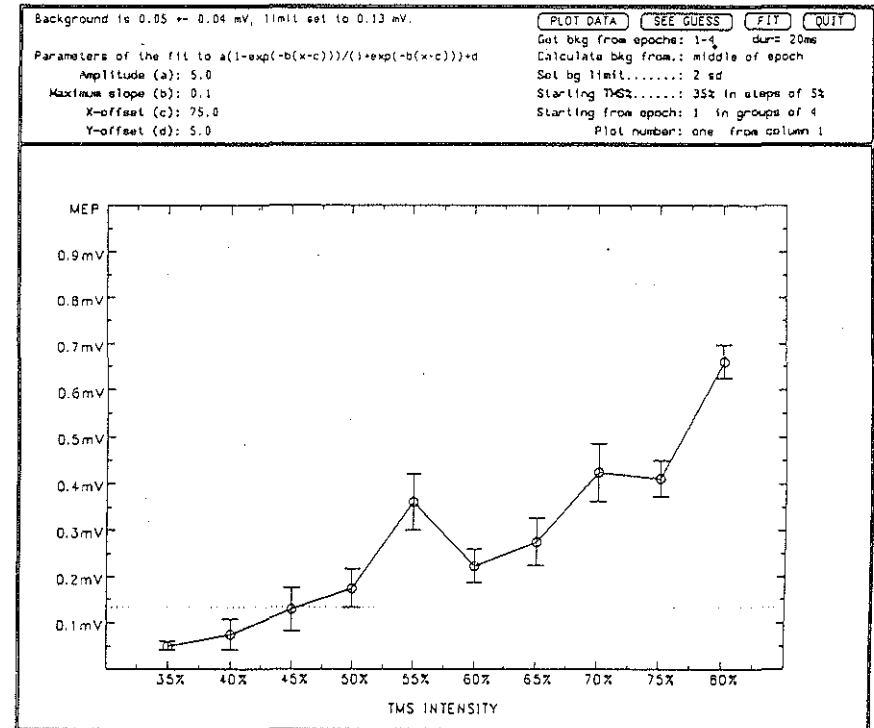
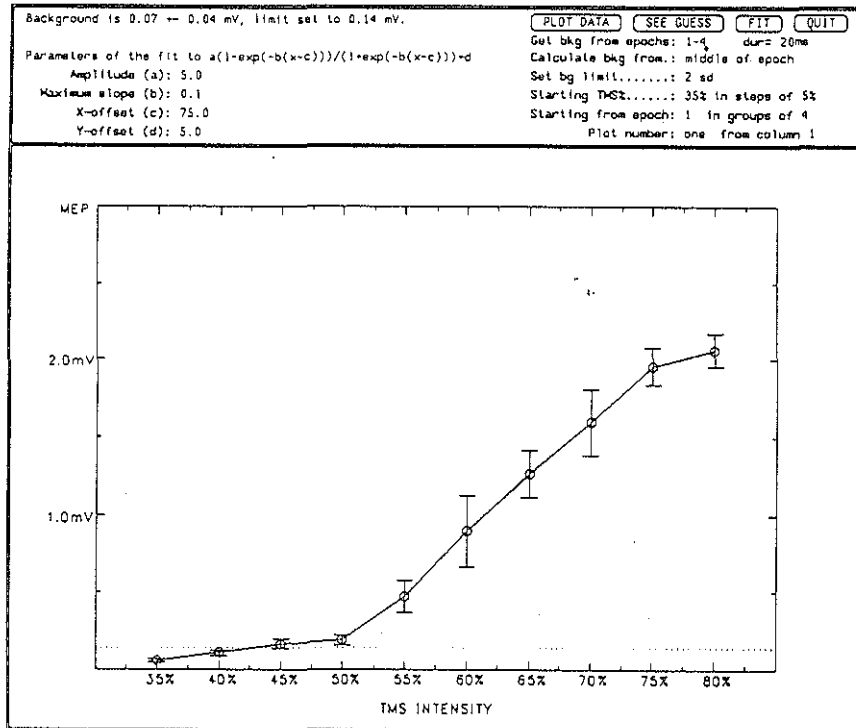
URN: unspecified      AGE: unspecified      SEX: unspecified

DATE: Mon Sep 19 17:41:17 1994 - printed Sun Dec 18 15:37:22 1994.

FILE: /home/gary/pc/data/mapping/dylan/1ml.fix

SERIES: ATHLETE 1

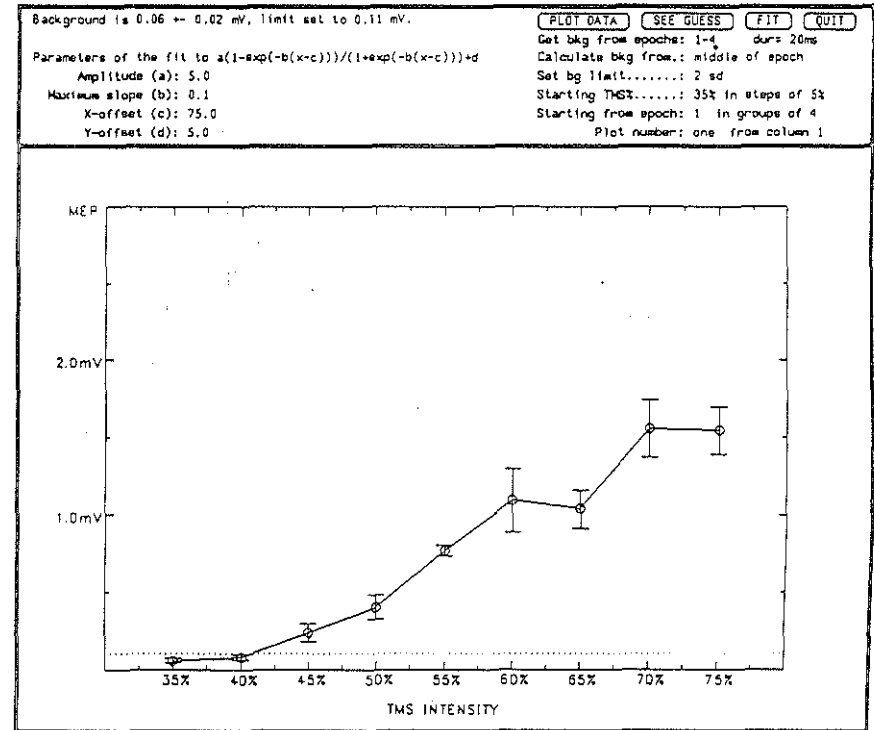
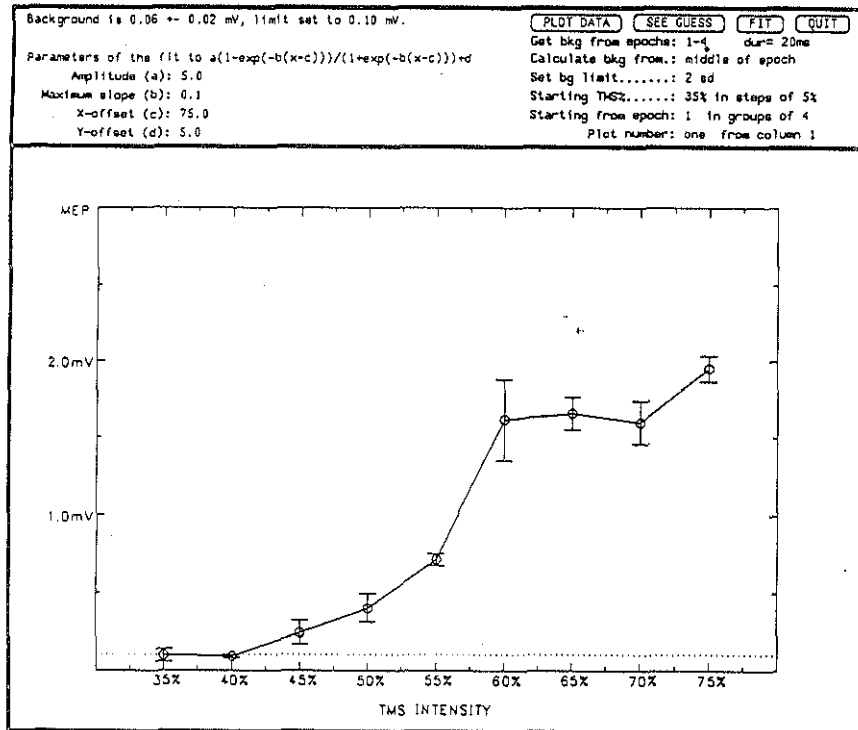
COMMENTS: left fcu



\*

URN: unspecified      AGE: 33 years      SEX: female  
 DATE: Wed Sep 28 16:04:38 1994 - printed Sun Dec 18 15:44:59 1994.  
 FILE: /home/gary/pc/data/mapping/dylan/cwrt.flx2  
 SERIES: **ATHLETE 2**  
 COMMENTS: Right FCU -Badminton

URN: unspecified      AGE: unspecified      SEX: unspecified  
 DATE: Wed Sep 28 17:01:26 1994 - printed Sun Dec 18 15:48:21 1994.  
 FILE: /home/gary/pc/data/mapping/dylan/cwl.flx  
 SERIES: **ATHLETE 2**  
 COMMENTS: left wrist flexor map



\*

URN: unspecified AGE: 21 years SEX: male  
 DATE: Fri Oct 14 13:29:04 1994 - printed Fri Oct 14 14:04:38 1994.

FILE: /home/gary/pc/data/mapping/dylan/ecrt.flx

SERIES: Badminton ATHLETE 3

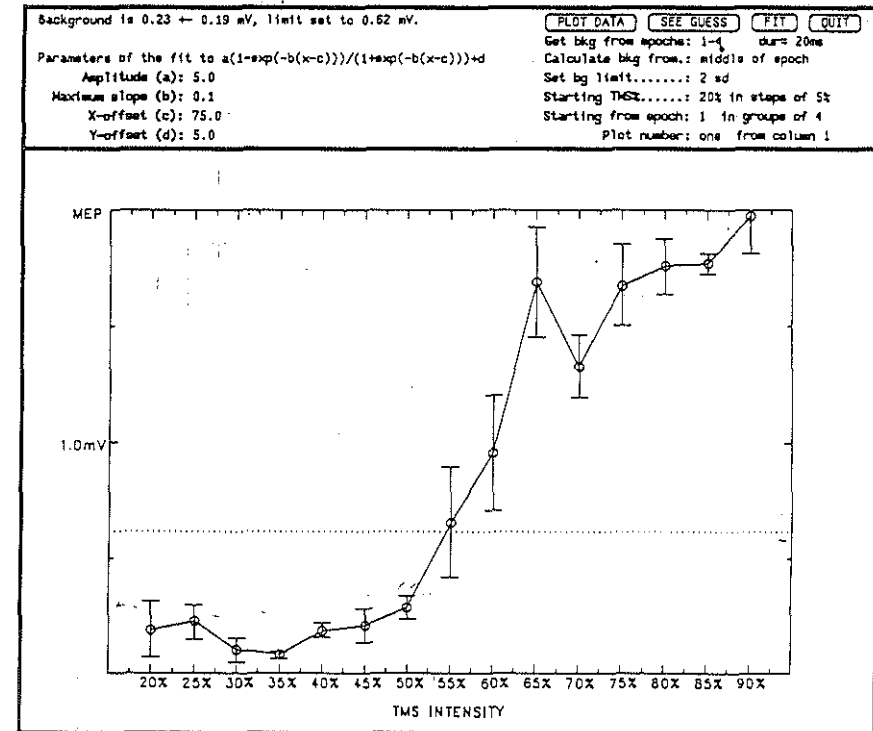
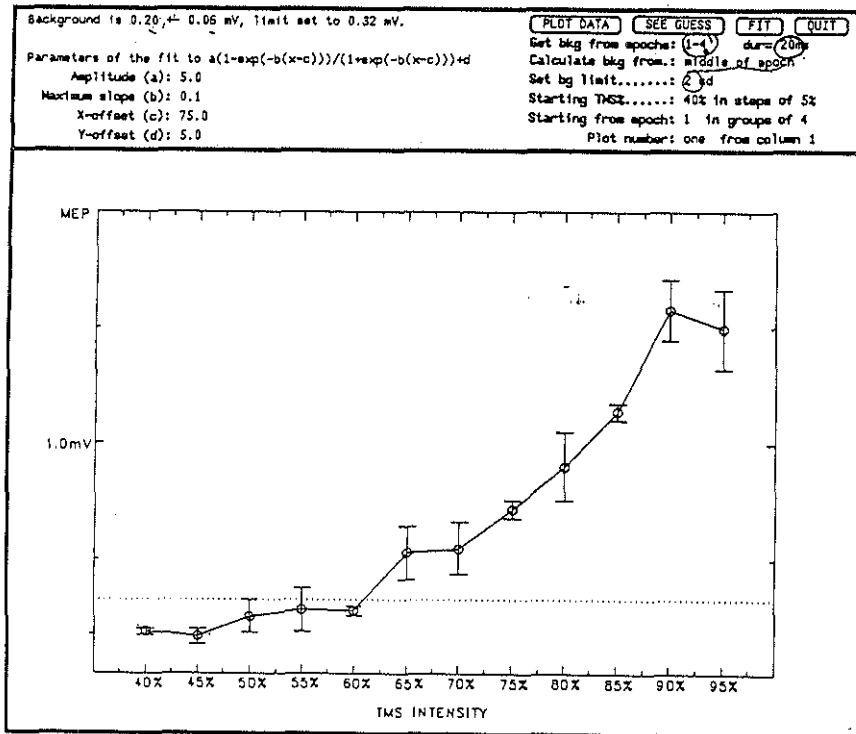
COMMENTS: R FCU-DOMINANT

URN: unspecified AGE: 21 years SEX: male  
 DATE: Fri Oct 14 14:28:42 1994 - printed Fri Oct 14 14:58:14 1994.

FILE: /home/gary/pc/data/mapping/dylan/ecl.flx

SERIES: Badminton ATHLETE 3

COMMENTS: L FCU-NonDominant



URN: unspecified      AGE: unspecified      SEX: female

DATE: Fri Oct 21 15:55:08 1994 - printed Fri Oct 21 16:29:19 1994.

FILE: /home/gary/pc/data/mapping/dylan/fdrt.flx

SERIES: Badminton **ATHLETE 4**

COMMENTS: R FCU-Dominant

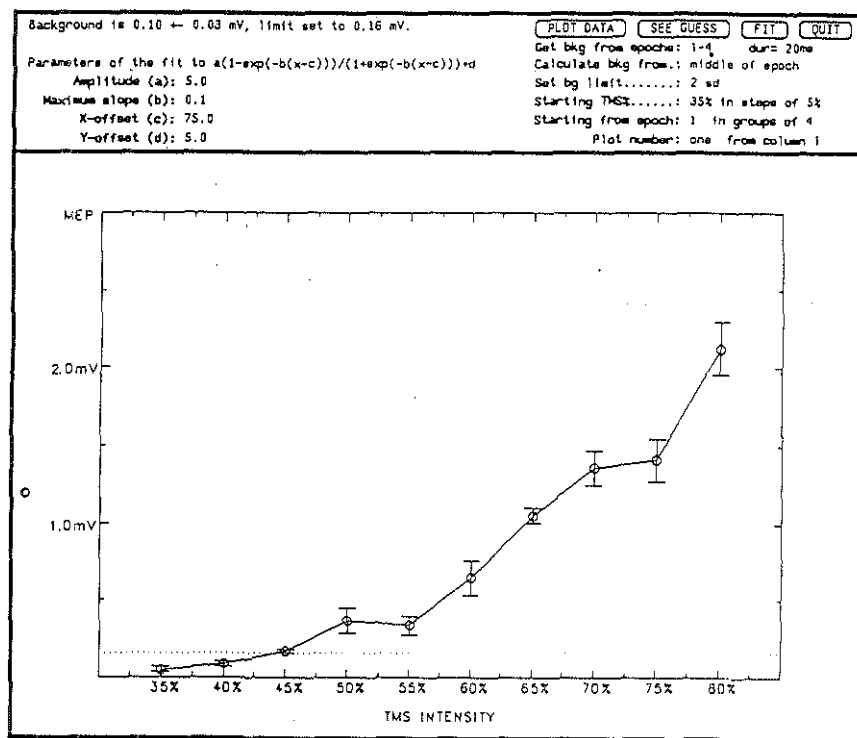
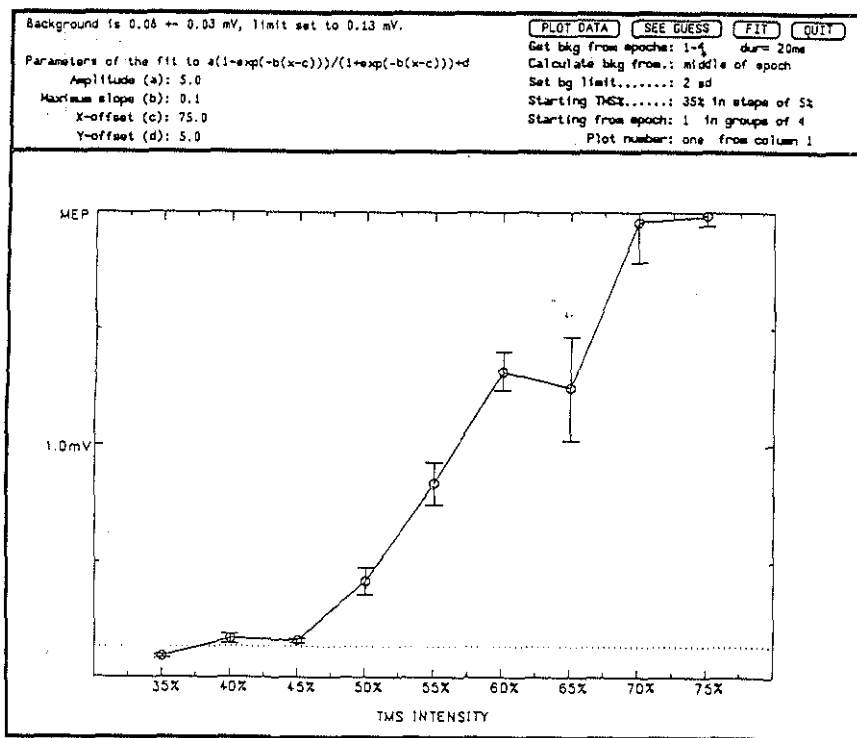
URN: unspecified      AGE: unspecified      SEX: female

DATE: Fri Oct 21 16:33:44 1994 - printed Fri Oct 21 17:06:12 1994.

FILE: /home/gary/pc/data/mapping/dylan/fdlr.flx

SERIES: Badminton **ATHLETE 4**

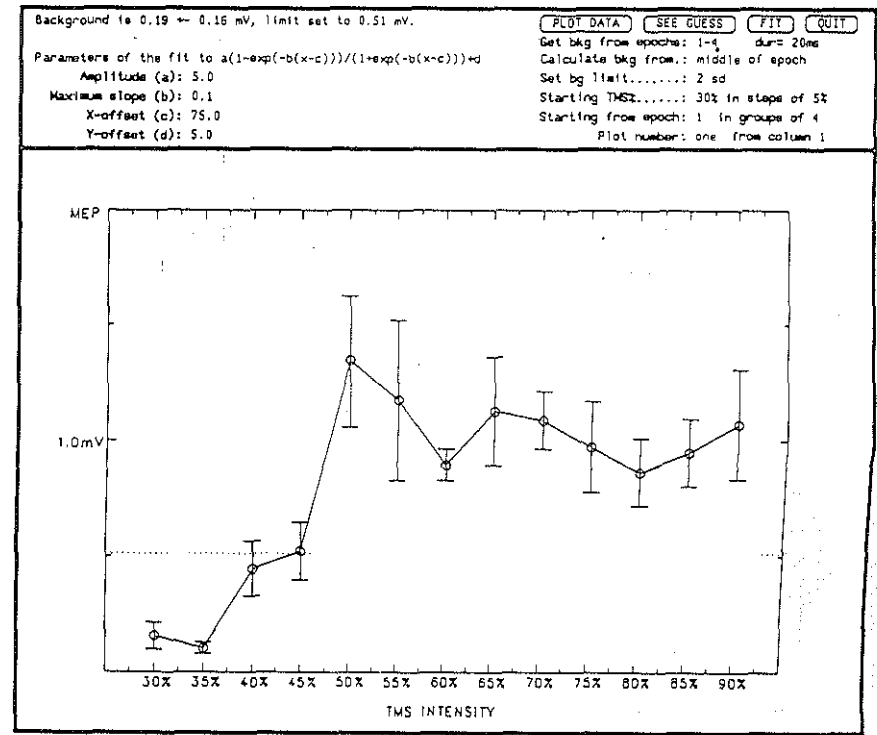
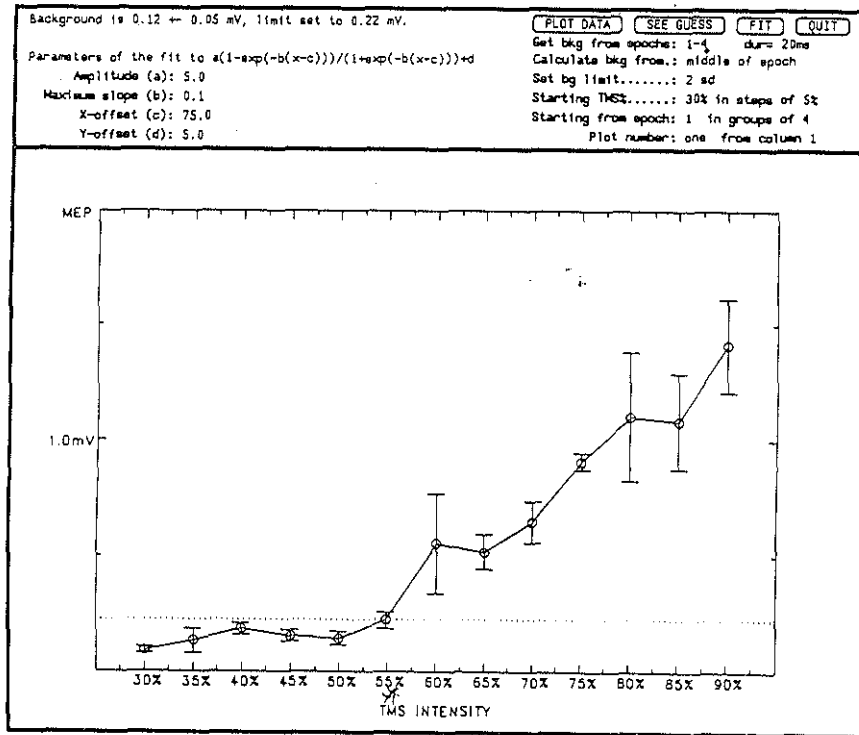
COMMENTS: L FCU-NonDominant



\*

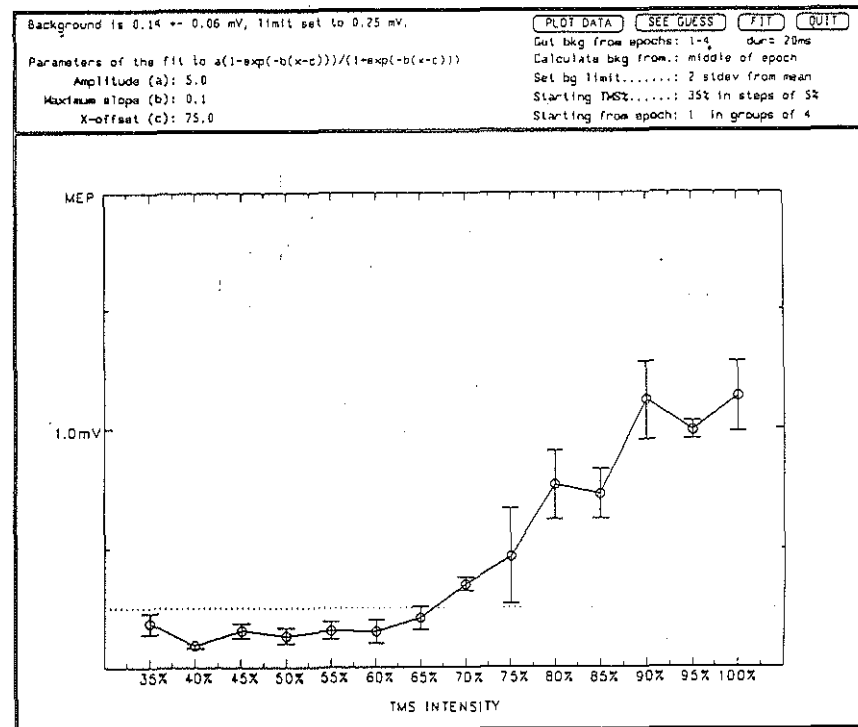
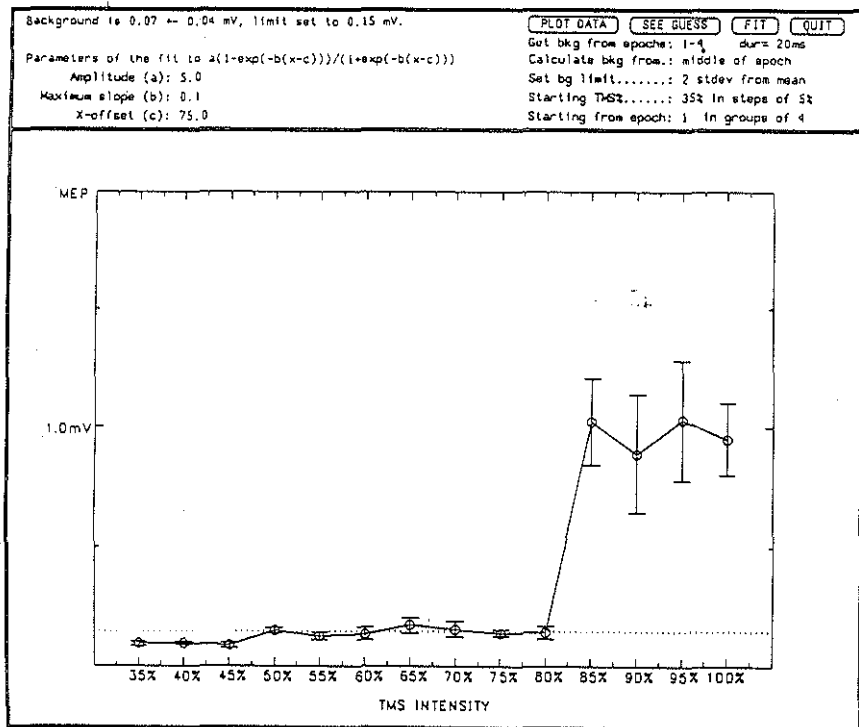
URN: unspecified      AGE: 25 years      SEX: male  
 DATE: Wed Oct 26 14:25:02 1994 - printed Wed Oct 26 15:07:39 1994.  
 FILE: /home/gary/pc/data/mapping/dylan/apr1.flxb  
 SERIES: badders **ATHLETE 5**  
 COMMENTS: right h dominant

URN: unspecified      AGE: unspecified      SEX: unspecified  
 DATE: Wed Oct 26 15:31:40 1994 - printed Wed Oct 26 15:56:59 1994.  
 FILE: /home/gary/pc/data/mapping/dylan/ap1.flxb  
 SERIES: badders **ATHLETE 5**  
 COMMENTS: non-dominant wrist flexor

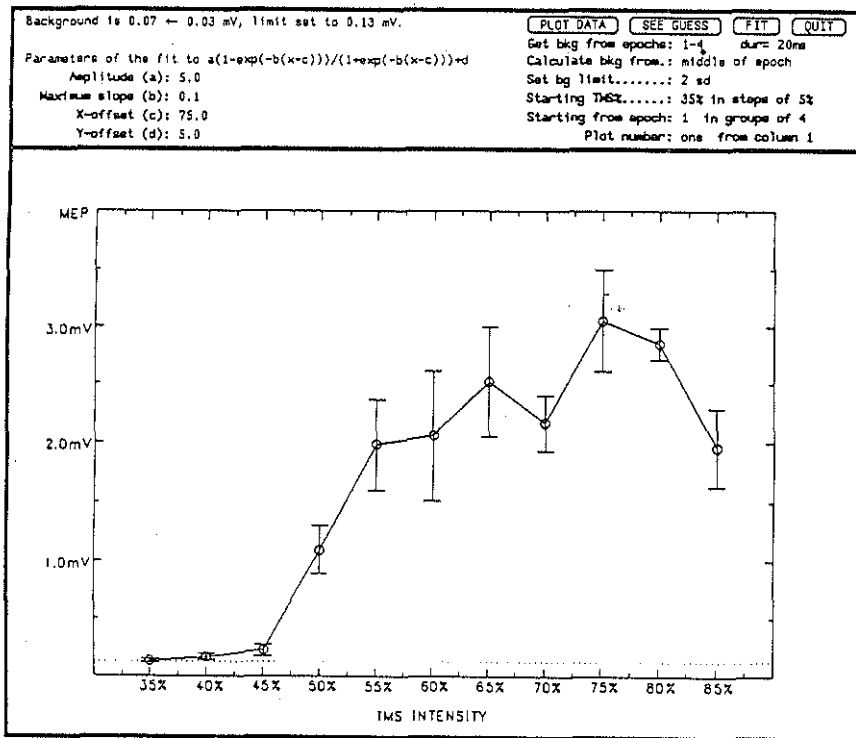


URN: unspecified AGE: 24 years SEX: male  
 DATE: Fri Nov 11 14:29:41 1994 - printed Fri Nov 11 15:10:10 1994.  
 FILE: /home/gary/pc/data/mapping/dylan/dfrl.flx  
 SERIES: BADMINTON ATHLETE 6  
 COMMENTS: RIGHT HAND DOMINANT

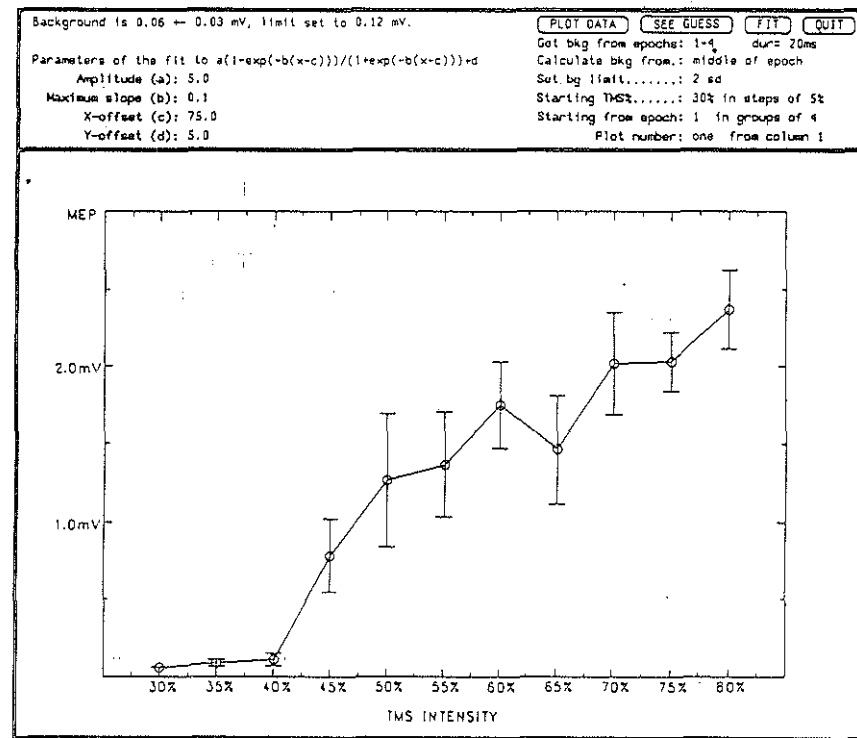
URN: unspecified AGE: 24 years SEX: male  
 DATE: Fri Nov 11 16:00:39 1994 - printed Fri Nov 11 16:22:21 1994.  
 FILE: /home/gary/pc/data/mapping/dylan/dfl.flx  
 SERIES: BADMINTON ATHLETE 6  
 COMMENTS: LEFT HAND NON DOMINANT



URN: unspecified AGE: 21 years SEX: male  
 DATE: Fri Nov 25 13:47:53 1994 - printed Fri Nov 25 14:27:45 1994.  
 FILE: /home/gary/pc/data/mapping/dylan/mbrl.flx  
 SERIES: BADMINTON ATHLETE 7  
 COMMENTS: RIGHT FCU



URN: unspecified AGE: 21 years SEX: male  
 DATE: Fri Nov 25 15:01:13 1994 - printed Sun Dec 18 16:23:08 1994.  
 FILE: /home/gary/pc/data/mapping/dylan/mbl.flx  
 SERIES: BADMINTON ATHLETE 7  
 COMMENTS: LEFT FCU NON-DOMINANT





URN: unspecified AGE: 21 years SEX: male

DATE: Fri Nov 25 13:47:53 1994 - printed Fri Nov 25 14:27:45 1994.

FILE: /home/gary/pc/data/mapping/dylan/mbrt.flx

SERIES: BADMINTON ATHLETE 7

COMMENTS: RIGHT FCU

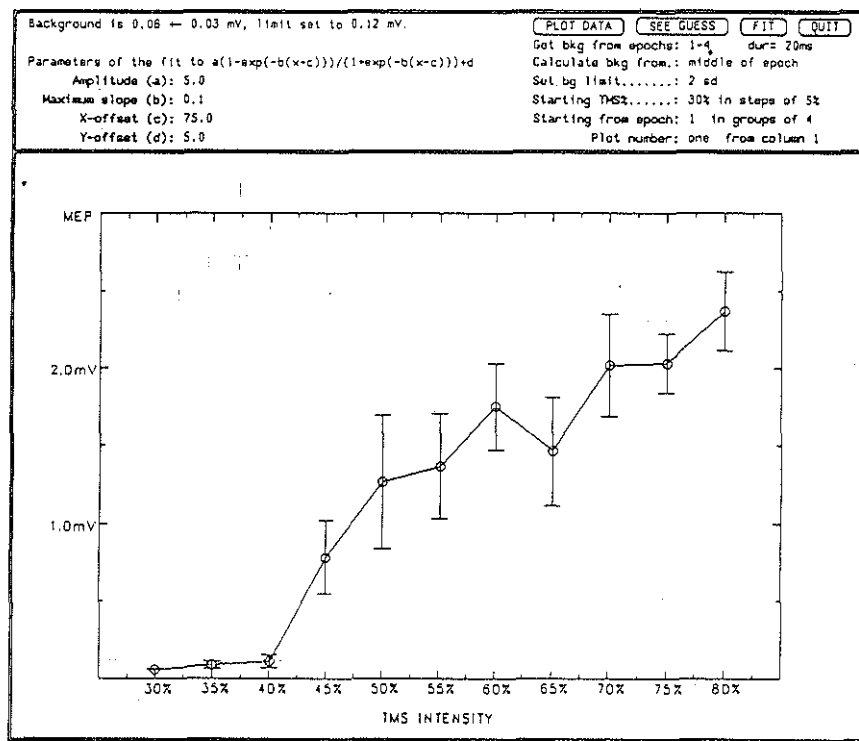
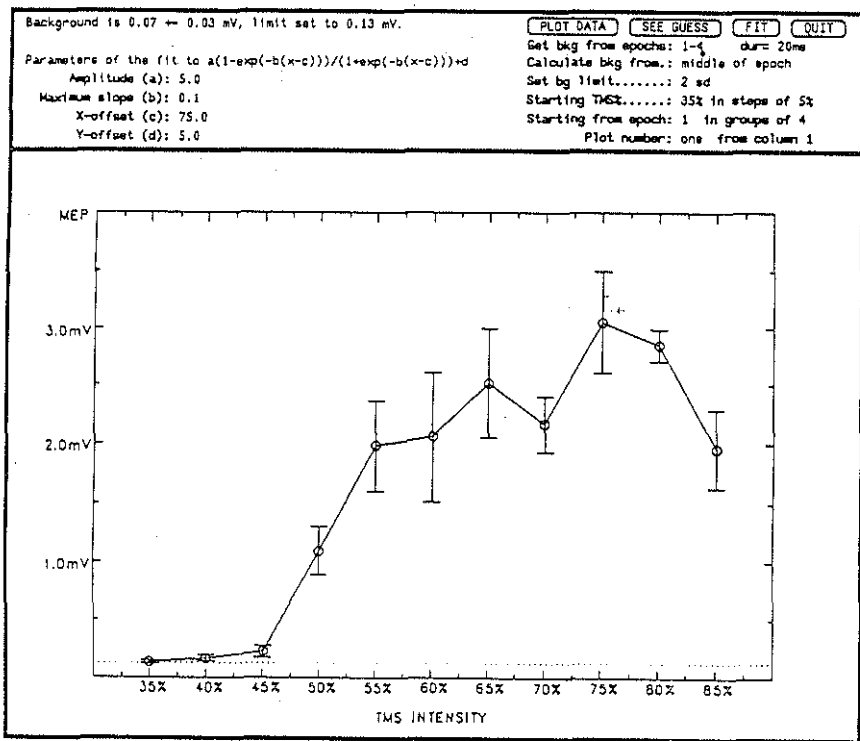
URN: unspecified AGE: 21 years SEX: male

DATE: Fri Nov 25 15:01:13 1994 - printed Sun Dec 18 16:23:08 1994.

FILE: /home/gary/pc/data/mapping/dylan/mbl.flx

SERIES: BADMINTON ATHLETE 7

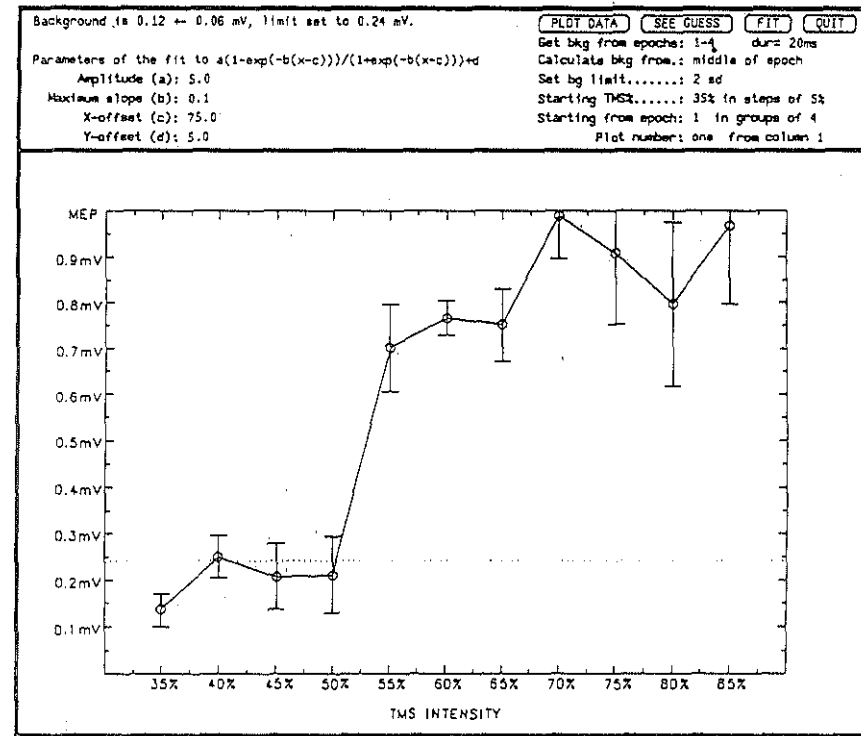
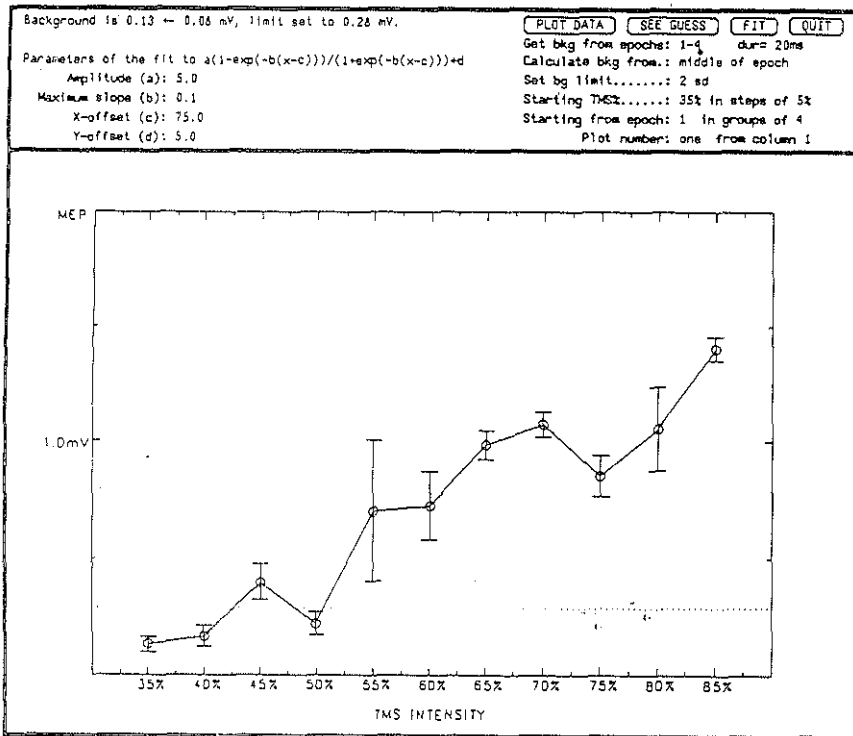
COMMENTS: LEFT FCU NON-DOMINANT



\*

URN: unspecified      AGE: 30 years      SEX: male  
 DATE: Tue Dec 20 11:15:43 1994 - printed Tue Dec 20 11:42:34 1994.  
 FILE: /home/gary/pc/data/mapping/dylan/gprt.flx  
 SERIES: BADMINTON *ATHLETE 8*  
 COMMENTS: RIGHT HAND DOMINANT

URN: unspecified      AGE: 30 years      SEX: male  
 DATE: Tue Dec 20 12:07:42 1994 - printed Tue Dec 20 12:31:50 1994.  
 FILE: /home/gary/pc/data/mapping/dylan/gpl.flx  
 SERIES: BADMINTON *ATHLETE 8*  
 COMMENTS: LEFT HAND NON-DOMINANT



\*