

**Uptake of heavy metals by vegetable  
plants grown on contaminated soils,  
their bioavailability and speciation**

**Marisa Intawongse**

A thesis submitted in partial fulfilment of the  
requirements of Northumbria University for the degree  
of Doctor of Philosophy

August 2007

## **Declaration**

This thesis records the results of experiments conducted by myself in the School of Applied Sciences, Northumbria University under the supervision of Prof. John R. Dean between November 2003 and February 2007. It is of my own composition and has not previously been submitted in part, or in whole, for a higher degree.

## Abstract

This research aimed to investigate the bioavailability of 9 metals (Cr, Mn, Fe, Ni, Cu, Zn, Mo, Cd, and Pb) to vegetable crops (spinach, lettuce, carrot and radish) cultivated in compost soils at different levels of metal contamination. The uptake and accumulation of these metals by the plants were examined. The elemental speciation using SEC-UV-ICP-MS and Nanospray Mass Spectrometry had been performed to characterize the metal containing species induced in the plants exposed to metal stress. In order to evaluate potential health risks arising from ingestion of the metal contaminated plants, the oral bioaccessibility i.e. the use of an *in vitro* physiologically based extraction test (PBET) simulating the transition of the metal pollutants in the plants into the human gastrointestinal system was undertaken.

It was found that, with the exception of Cr, metal concentrations (Mn, Fe, Ni, Cu, Zn, Mo and Cd) in lettuce, spinach, carrot and radish depended on the concentrations of the total metal in the soils in which the plants were grown. For Pb, the amounts accumulated in the leafy vegetables also depended on their levels of contamination in the soils while the root vegetables had rather low uptake and the uptake levels did not increase when higher levels of contamination were applied. Mn, Fe and Zn were relatively easily mobilised from soils to plants; they tended to accumulate in all plants studied at high concentrations. The elements which were more enriched in leaves included Mn and Zn (in all plant types), and Fe and Cd (only in the root vegetables). In contrast, Fe, Ni, Cu, Mo and Pb were accumulated more in roots of the leafy vegetables. Among all plants studied, it was observed that carrot had low uptake for all elements (Cr, Ni, Cu, Mo, Cd and Pb), except for Mn, Fe, Zn which were found in all plants. The metal mobilised from soil to plant as indicated by the metal contents accumulated in the plants decreased in the order  $Mn \gg Zn > Fe > Cu > Mo > Ni > Cd > Pb \approx Cr$ .

The metal bioavailability to plants was assessed by measuring transfer factor (TF) values of the metals based on total metal contents in the soils. It was found that the order of TF values was  $Mn > Zn \gg Cd > Ni > Cu > Mo \approx Pb > Cr \approx Fe$ . The mean TF values of each element irrespective of plant types were 1.93, 1.77, 0.485, 0.194,

0.111, 0.052, 0.045, 0.037 and 0.036 for Mn, Zn, Cd, Ni, Cu, Mo, Pb, Cr, and Fe, respectively. Hence, Mn and Zn were most bioavailable to plants i.e. they can be transferred from soils to plants more easily than Ni, Cu, Mo, Pb, Cr and Fe. Whereas, the bioavailability of Cd was relatively moderate. In addition, the results enabled the development of statistical regression models that are suited to predict metal uptake by plants. It indicated that the relationship between the TF values and the extractable soil metals followed the power regression curve. However, there were some cases in which it did not follow the power regression curve but a linear model, these are; Mn (for carrot leaves and radish roots), Mo (for spinach roots and carrot roots), and Cd (for lettuce leaves, spinach roots and leaves and carrot roots).

In the multi-elemental speciation study, it was found that a common association of the metals (Cd, Cu, Mo, Pb, and Zn) to the high molecular weight (MW) fractions (8160 Da) was observed in all plant extracts. The lower MW fractions of approximately 1000 – 3000 Da of Cd, Cu, Mo, Ni, Pb, and Zn containing compounds were found to be present in all plant extracts. Iron was not detected in the roots of carrot and radish, but present as both high MW (8200 Da) and low MW (2500 Da) compounds in the leaves of spinach and lettuce. To characterize the individual metal containing species present in the plant samples, the Nanospray Mass Spectrometry was employed. Unfortunately, no evidence from this analysis can confirm that these compounds are related to the phytochelatin family.

The PBET (Physiologically-Based Extraction Test) results indicated that the Cr and Pb bioaccessibility of the plant samples were similar in the gastric phase i.e. relatively low amounts of the metals were extracted in all plants. Whereas, there was greater bioaccessibility for both Cr and Pb in the intestinal extraction. For Fe, the high content was dissolved in the gastric and intestinal phases for carrot and radish, while there were slightly smaller amounts found in lettuce and spinach. Mn, Zn, Cu, Ni, Mo and Cd had similar bioaccessibility i.e. most of the metal contents were dissolved in the gastric and intestinal phase for every vegetable plant studied and this indicates the potential for absorption.



The pollutant linkages can be identified in this study i.e. the 9 metals (pollutants), soils and plants (pathways), and humans (receptors). Hence, the framework for risk assessment to humans from the food chain exposures for metals via soil-plant-human route can be established based on a comparison between the predicted exposure levels (total intake via all pathways) and the established toxicological levels set by regulatory agencies or environmental authorities.

## **Acknowledgements**

A very special thanks goes to Prof. John R. Dean, my principal supervisor, for his invaluable guidance and support during the course of my research. Dr. Elizabeth Smith and Dr. Rinke Vinkenoog are acknowledged for their advice in growing plants. I would like to thank Dr. Renli Ma for helping me in the speciation study and Ms. Meng Zhang for analysis using Nanospray Mass Spectrometry. The technical support of Mr. Dave Osborne, Mr. Ed Ludkin, Mr. Gary Askwith, Mr. Jim Creighton, and Mr. Steve Reed, and all members of the School of Applied Sciences, Northumbria University, are also acknowledged.

I would like to express my gratitude to the Royal Thai Government for the scholarship awarded for my PhD study. Suratthani Rajabhat University is acknowledged for giving the permission for study leave during the 4 year period.

Finally but most importantly, I would like to thank my family and friends for being there at all times for me with continuous support, patience, and love.

# Contents

	page
Declaration	i
Abstract	ii
Acknowledgements	v
Contents	vi
Glossary of Terms	xi
List of Tables	xiii
List of Figures	xvi
<b>Chapter 1: Metals in the environment</b>	<b>1</b>
1.1 Introduction	1
1.2 Metals of interest, their occurrences in soils and toxicity	1
1.2.1 Chromium (Cr)	3
1.2.2 Manganese (Mn)	4
1.2.3 Iron (Fe)	4
1.2.4 Nickel (Ni)	5
1.2.5 Copper (Cu)	6
1.2.6 Zinc (Zn)	6
1.2.7 Molybdenum (Mo)	7
1.2.8 Cadmium (Cd)	8
1.2.9 Lead (Pb)	8
1.3 Metal species, mobility and bioavailability in soils	9
1.4 Effects of soil properties on the bioavailability of metals	11
1.4.1 pH	11
1.4.2 Organic matter	13
1.4.3 Cation exchange capacity (CEC)	14
1.4.4 Redox conditions	15
1.4.5 Oxides of iron, manganese and aluminium	15
1.4.6 Other ions	16
1.5 Uptake and accumulation of metals in plants	16

1.6 Metal speciation in plants	18
1.7 Oral bioaccessibility of metals	21
1.7.1 <i>In vitro</i> bioaccessibility strategies	22
1.7.2 Assessing bioaccessibility	23
1.8 Legislation regarding metal pollution	30
1.9 Aims of the study	34
1.10 References	35
<b>Chapter 2: Instrumental techniques applied for metal analysis</b>	<b>49</b>
2.1 Inductively coupled plasma (ICP-MS)	49
2.1.1 Sample introduction for ICP-MS	49
2.1.2 Plasma source	51
2.1.3 Interfaces	52
2.1.4 Ion focusing systems	54
2.1.5 Mass spectrometers	54
2.1.6 Reaction/collision cells	57
2.1.7 Detectors	58
2.1.8 Methods of quantitation	59
2.1.9 Interferences	62
2.2 Size exclusion chromatography (SEC) coupled with ICP-MS	63
2.2.1 SEC columns and separation mechanism	64
2.2.2 SEC mobile phase and flow rate	65
2.2.3 Detectors	66
2.3 Summary	67
2.4 References	68
<b>Section A: Uptake of heavy metals by plants and their bioavailability</b>	<b>71</b>
<b>Chapter 3: Metal bioavailability in soils</b>	<b>72</b>
3.1 Introduction	72
3.2 Experimental	74
3.2.1 Chemicals and apparatus	74
3.2.2 Methodology	75
3.2.2.1 Preparation of heavy metal contaminated soils	75

3.2.2.2	Reproducibility of the preparation of the spiked compost soils	76
3.2.2.3	Soil characterization	76
3.2.2.4	Soil extraction procedure for pseudo-total metal analysis	78
3.2.2.5	Chemical selective extraction	79
3.3	Results and discussion	82
3.3.1	Analytical features of heavy metal determination using ICP-MS	82
3.3.2	Reproducibility of the preparation of the spiked compost soils	86
3.3.3	Soil characterization	86
3.3.4	Total metal determination in soil samples	87
3.3.5	Determination of the extractable soil metals	88
3.3.5.1	Comparison with indicative values of the CRM	88
3.3.5.2	Extractable soil metals	91
3.4	Summary	95
3.5	References	96
 <b>Chapter 4: Uptake and accumulation of metals in vegetable plants</b>		99
4.1	Introduction	99
4.2	Experimental	99
4.2.1	Chemicals and apparatus	99
4.2.2	Methodology	100
4.2.2.1	Growing vegetable plants and sample collection	100
4.2.2.2	Vegetable digestion procedure for total metal analysis	100
4.2.2.3	Total metal determination by ICP-MS	101
4.3	Results and discussion	101
4.3.1	Total metal determination in plant samples	101
4.3.2	Uptake of heavy metals by vegetable plants	102
4.4	Summary	114
4.5	References	115
 <b>Chapter 5: Relationship of metals in soils and metals taken up by plants</b>		116
5.1	Introduction	116
5.2	Soil-to-plant transfer factors (TF) of heavy metals	116

5.3 Correlation analysis of total metals accumulated in plants and total, EDTA-, CH <sub>3</sub> COOH-, CaCl <sub>2</sub> -, and H <sub>2</sub> O extractable metals in soils	124
5.4 The regression models for predicting TF values of metals in plants	129
5.5 Summary	139
5.6 References	141
<b>Section B: Metal speciation</b>	143
<b>Chapter 6: Multi-element speciation in vegetable plants</b>	144
6.1 Introduction	144
6.2 Experimental	146
6.2.1 Chemicals and apparatus	146
6.2.2 Methodology	147
6.2.2.1 Growing of vegetable plants	147
6.2.2.2 Sample preparation for SEC	148
6.2.2.3 Sample analysis by SEC-UV-ICP-MS	148
6.2.2.4 Total metal determination of plant CRMs	148
6.2.2.5 Static Nanospray MS analysis	148
6.3 Results and discussion	149
6.3.1 Total metal content of plant samples	149
6.3.2 Analysis of extractable metal content in plant samples	151
6.3.3 Size exclusion chromatogram of plant extracts	151
6.3.4 Static Nanospray MS spectrum of plant extracts	159
6.4 Summary	168
6.5 References	169
<b>Section C: Human bioaccessibility</b>	171
<b>Chapter 7: Bioaccessibility of metals in vegetable plants</b>	172
7.1 Introduction	172
7.2 Experimental	173
7.2.1 Chemicals and apparatus	173
7.2.2 Methodology	173
7.2.2.1 Growing of vegetable plants	173
7.2.2.2 Total metal determination of plant samples and plant	173

CRMs	
7.2.2.3 The PBET experiment	174
7.2.2.4 Sample analysis by ICP-MS	174
7.2.2.5 Calculation of bioaccessibility	175
7.3 Results and discussion	175
7.3.1 ICP-MS analysis of the plant CRMs	175
7.3.2 Evaluation of the PBET approach by digestion of the CRMs	176
7.3.3 The equilibrium of the intestinal digestion phase	177
7.3.4 Bioaccessibility of the plants	179
7.3.5 Comparison of total metal analysis and PBET experiment	185
7.4 Summary	205
7.5 References	206
<b>Chapter 8: Conclusions and future work</b>	208
8.1 Conclusions	208
8.2 Future work	214
8.3 References	214
List of Publications	215

## Glossary of Terms

AAS	atomic absorption spectroscopy
ACN	acetonitrile
BCR	The Community Bureau of Reference
BGS	British Geological Survey
CCT	collision cell technology
CEC	cation exchange capacity
cps	counts per second
CRM	certified reference material
Da	Dalton
DCP	direct current plasma
DEFRA	Department for Environment, Food and Rural Affairs
DOC	dissolved organic carbon
DTPA	diethylenetriamine pentaacetic acid
DW	dry weight
EA	The Environmental Agency
ED-XRF	energy dispersive x-ray fluorescence
EDTA	ethylenediamine tetraacetic acid
FA	fulvic acid
FAAS	flame atomic absorption spectroscopy
FP	flame photometer
HA	humic acid
ICP-AES	inductively coupled plasma – atomic emission spectroscopy
ICP-MS	inductively coupled plasma – mass spectrometry
i.d.	internal diameter
kV	kilovolt
LC-MS	liquid chromatography – mass spectrometry
LOD	limit of detection
m/z	mass-to-charge ratio
MAFF	Ministry of Agriculture, Fisheries and Food
MIP	microwave-induced plasma
MW	molecular weight



NIST	National Institute of Standards and Technology
o.d.	outer diameter
PBET	physiologically based extraction test
PC	phytochelatin
PEEK	polyaryletheretherketone
ppb	parts per billion
ppm	parts per million
ppt	parts per trillion
RF	radio frequency
rpm	revolutions per minute
RSD	relative standard deviation
SD	standard deviation
SEC	size exclusion chromatography
SGV	soil guideline values
SM&T	The Standards, Measurements and Testing Programme
SOM	soil organic matter
TF	transfer factor
TFA	trifluoroacetic acid
Tris	tris(hydroxymethyl)aminomethane
USEPA	United States Environmental Protection Agency
UV	ultraviolet
www	world wide web

***Codes for the plant samples studied***

LT-R	lettuce roots
LT-L	lettuce leaves
SP-R	spinach roots
SP-L	spinach leaves
CR-R	carrot roots
CR-L	carrot leaves
RD-R	radish roots
RD-L	radish leaves

## List of Tables

	page
<b>Table 1.1</b> Metals/metalloids in soils derived from normal and geochemically anomalous parent materials in Britain	2
<b>Table 1.2</b> Relative mobility / bioavailability of metal species	10
<b>Table 1.3</b> Comparison of different gastrointestinal approaches	25
<b>Table 1.4</b> Fourth Daughter Directive target values for arsenic, cadmium and nickel concentrations	31
<b>Table 1.5</b> Soil guideline values (SGVs, in mg/kg DW soil) according to land use for selected metals	33
<b>Table 3.1</b> Single extraction methods which are diagnostic of plant uptake	73
<b>Table 3.2</b> The approximate levels of metal contamination in soils	76
<b>Table 3.3</b> Summary of the experimental procedures for the chemical selective extractions applied to the soil samples	81
<b>Table 3.4</b> Instrumental operating conditions for ICP-MS	82
<b>Table 3.5</b> Detection limits for the ICP-MS in both standard and CCT operating mode	82
<b>Table 3.6</b> Metal concentrations in the spiked compost soils analysed by ED-XRF	86
<b>Table 3.7</b> Characteristics (mean $\pm$ SD) of the soil samples used in the study (n = 3)	87
<b>Table 3.8</b> Total metal concentrations (mg/kg, DW) in soil certified reference materials (BCR 146R)	88
<b>Table 3.9 (A-D)</b> Mean metal concentrations (mg/kg, DW) of compost for growing spinach, lettuce, carrot and radish in different treatments	89
<b>Table 3.10</b> EDTA and CH <sub>3</sub> COOH extractable contents in the CRM (BCR 700) obtained using a reciprocating and an end-over-end shaker	91
<b>Table 4.1</b> Instrumental operating conditions for ICP-MS	101
<b>Table 4.2</b> Total metal concentrations (mg/kg, DW) in plant certified reference materials (spinach leaves and bush twigs and leaves CRMs)	102
<b>Table 4.3 (A-D)</b> Metal concentrations found in plants (mg/kg, DW)	104

<b>Table 4.4</b> Levels of metal accumulated in lettuce, spinach, radish and carrot	114
<b>Table 5.1 (A-D)</b> Ratio of concentrations of metal in plants to metal in soils, Transfer Factor (TF) values	117
<b>Table 5.2</b> Ranges of the transfer factors (TF) from soil to plant	125
<b>Table 5.3</b> Correlation coefficients at 95% significance level	125
<b>Table 5.4 (A-I)</b> Correlation coefficients between total metal in the vegetables and the total or EDTA-, CH <sub>3</sub> COOH-, CaCl <sub>2</sub> -, H <sub>2</sub> O-extractable metal in soils (mg/kg, DW)	126
<b>Table 5.5</b> Relationship between the TF values of Cr (y) and the EDTA extractable Cr in soils (x)	130
<b>Table 5.6</b> Relationship between the TF values of Mn (y) and the EDTA extractable Mn in soils (x)	132
<b>Table 5.7</b> Relationship between the TF values of Fe (y) and the total Fe in soils (x)	133
<b>Table 5.8</b> Relationship between the TF values of Ni (y) and the total Ni in soils (x)	134
<b>Table 5.9</b> Relationship between the TF values of Cu (y) and the total Cu in soils (x)	135
<b>Table 5.10</b> Relationship between the TF values of Zn (y) and the EDTA extractable Zn in soils (x)	136
<b>Table 5.11</b> Relationship between the TF values of Mo (y) and the H <sub>2</sub> O extractable Mo in soils (x)	137
<b>Table 5.12</b> Relationship between the TF values of Cd (y) and the total Cd in soils (x)	138
<b>Table 5.13</b> Relationship between the TF values of Pb (y) and the EDTA extractable Pb in soils (x)	139
<b>Table 5.14</b> Extractants used for regression analysis in predicting metal uptake by plants	140
<b>Table 6.1</b> Instrumental operating conditions for (A) SEC-UV and (B) ICP-MS	147
<b>Table 6.2</b> Total metal concentrations (mg/kg, DW) in plant CRMs	150
<b>Table 6.3</b> Extractable metal determination in plants using ultrasonic extraction with Tris-HCl (Extractant A) compared with the total metal content in plants using acid digestion (Extractant B)	152

<b>Table 6.4</b> Characterisation of SEC Column	153
<b>Table 6.5</b> Multi-element fractionation of plant extracts using SEC-UV-ICP-MS	160
<b>Table 7.1</b> Instrumental operating conditions for ICP-MS	175
<b>Table 7.2</b> Total concentrations (mg/kg, DW) in plant CRMs	178
<b>Table 7.3 (A-B)</b> Bioaccessibility of the metals in plant CRMs	186
<b>Table 7.4</b> The extraction equilibrium of the intestinal digestion phase	188
<b>Table 7.5 (A – D)</b> Bioaccessible and total metal concentrations found in lettuce	189
<b>Table 7.6 (A – D)</b> Bioaccessible and total metal concentrations found in spinach	193
<b>Table 7.7 (A – D)</b> Bioaccessible and total metal concentrations found in carrot	197
<b>Table 7.8 (A – D)</b> Bioaccessible and total metal concentrations found in radish	201

## List of Figures

	page
<b>Figure 1.1</b> A typical dose-response curve for essential and non-essential trace elements	3
<b>Figure 1.2</b> Key processes governing the partition of metals between the solid and solution phases of soils	11
<b>Figure 1.3</b> The desorption characteristics of lead as a function of pH	12
<b>Figure 1.4</b> The path of aqueous solution into roots	17
<b>Figure 1.5</b> Basic structure of Glutathione (tripeptide) and Phytochelatins (polypeptide)	20
<b>Figure 1.6</b> A structural model of PC-Cd complexes	21
<b>Figure 1.7</b> Overview of the study	34
<b>Figure 2.1</b> Components of a typical quadrupole ICP-MS	49
<b>Figure 2.2</b> Schematic diagram of a pneumatic concentric nebulizer	50
<b>Figure 2.3</b> Schematic diagram of a double-pass spray chamber (Scott-type)	51
<b>Figure 2.4</b> Schematic diagram of an ICP torch and load coil	53
<b>Figure 2.5</b> Schematic diagram of the ICP – mass spectrometer interface	53
<b>Figure 2.6</b> Typical ion lenses configuration in ICP-MS	54
<b>Figure 2.7</b> The quadrupole analyzer arrangement	55
<b>Figure 2.8</b> The layout of a high-resolution, double-focusing mass spectrometer	56
<b>Figure 2.9</b> The layout of time-of-flight mass spectrometer	57
<b>Figure 2.10</b> The layout of a typical collision cell technology instrument	58
<b>Figure 2.11</b> Schematic diagram of a continuous dynode electron multiplier	59
<b>Figure 2.12</b> Schematic diagram of the coupling of the SEC-ICP-MS	65
<b>Figure 2.13</b> Typical chromatogram of SEC with UV detection	66
<b>Figure 3.1</b> Calibration curves of ICP-MS analysis created by plotting ion intensity (ICPS) against ion concentration (ppb) of the standards	83
<b>Figure 3.2 (A-D)</b> Percentage of the total metal in the soils (control, low, medium and high treatment) extracted with EDTA, CH <sub>3</sub> COOH, CaCl <sub>2</sub> and H <sub>2</sub> O, respectively	92
<b>Figure 4.1A</b> Cr concentrations in roots and leaves of lettuce, spinach, carrot	103

and radish grown on the control (C), low (L), medium (M) and high (H) soil treatments	
<b>Figure 4.1B</b> Mn concentrations in roots and leaves of lettuce, spinach, carrot and radish grown on the control (C), low (L), medium (M) and high (H) soil treatments	108
<b>Figure 4.1C</b> Fe concentrations in roots and leaves of lettuce, spinach, carrot and radish grown on the control (C), low (L), medium (M) and high (H) soil treatments	109
<b>Figure 4.1D</b> Ni concentrations in roots and leaves of lettuce, spinach, carrot and radish grown on the control (C), low (L), medium (M) and high (H) soil treatments	110
<b>Figure 4.1E</b> Cu concentrations in roots and leaves of lettuce, spinach, carrot and radish grown on the control (C), low (L), medium (M) and high (H) soil treatments	110
<b>Figure 4.1F</b> Zn concentrations in roots and leaves of lettuce, spinach, carrot and radish grown on the control (C), low (L), medium (M) and high (H) soil treatments	111
<b>Figure 4.1G</b> Mo concentrations in roots and leaves of lettuce, spinach, carrot and radish grown on the control (C), low (L), medium (M) and high (H) soil treatments	112
<b>Figure 4.1H</b> Cd concentrations in roots and leaves of lettuce, spinach, carrot and radish grown on the control (C), low (L), medium (M) and high (H) soil treatments	112
<b>Figure 4.1I</b> Pb concentrations in roots and leaves of lettuce, spinach, carrot and radish grown on the control (C), low (L), medium (M) and high (H) soil treatments	113
<b>Figure 5.1</b> Soil-to-plant transfer factors values of Cr ( $TF_{Cr}$ ) as a function of the total soil concentrations	119
<b>Figure 5.2</b> Soil-to-plant transfer factors values of Mn ( $TF_{Mn}$ ) as a function of the total soil concentrations	120
<b>Figure 5.3</b> Soil-to-plant transfer factors values of Fe ( $TF_{Fe}$ ) as a function of the total soil concentrations	120
<b>Figure 5.4</b> Soil-to-plant transfer factors values of Ni ( $TF_{Ni}$ ) as a function of the	121

total soil concentrations	
<b>Figure 5.5</b> Soil-to-plant transfer factors values of Cu ( $TF_{Cu}$ ) as a function of the total soil concentrations	122
<b>Figure 5.6</b> Soil-to-plant transfer factors values of Zn ( $TF_{Zn}$ ) as a function of the total soil concentrations	122
<b>Figure 5.7</b> Soil-to-plant transfer factors values of Mo ( $TF_{Mo}$ ) as a function of the total soil concentrations	123
<b>Figure 5.8</b> Soil-to-plant transfer factors values of Cd ( $TF_{Cd}$ ) as a function of the total soil concentrations	123
<b>Figure 5.9</b> Soil-to-plant transfer factors values of Pb ( $TF_{Pb}$ ) as a function of the total soil concentrations	124
<b>Figure 5.10</b> Relationship between the TF values of Cr (y) and EDTA extractable Cr in soils (x)	130
<b>Figure 5.11</b> Relationship between the TF values of Mn (y) and EDTA extractable Mn in soils (x)	132
<b>Figure 5.12</b> Relationship between the TF values of Fe (y) and total Fe in soils (x)	133
<b>Figure 5.13</b> Relationship between the TF values of Ni (y) and the total Ni in soils (x)	134
<b>Figure 5.14</b> Relationship between the TF values of Cu (y) and the total Cu in soils (x)	135
<b>Figure 5.15</b> Relationship between the TF values of Zn (y) and EDTA extractable Zn in soils (x)	136
<b>Figure 5.16</b> Relationship between the TF values of Mo (y) and H <sub>2</sub> O extractable Mo in soils (x)	137
<b>Figure 5.17</b> Relationship between the TF values of Cd (y) and total Cd in soils (x)	138
<b>Figure 5.18</b> Relationship between the TF values of Pb (y) and EDTA extractable Pb in soils (x)	139
<b>Figure 6.1</b> Calibration curve of the SEC column	153
<b>Figure 6.2 (A-D)</b> Chromatographic profiles of multi-element in (A) Spinach, (B) Lettuce, (C) Carrot, and (D) Radish	155
<b>Figure 6.3 (A-D)</b> Static Nanospray Mass spectrum of multi-element in (A)	164

Spinach, (B) Lettuce, (C) Carrot, and (D) Radish

**Figure 7.1 (A – I)** Percentage bioaccessibility of the metals in lettuce, spinach, carrot and radish grown on the control (C), low (L), medium (M) and high (H) soil treatments 181

**Figure 8.1** Flow chart for risk assessment to human health from contaminated soil 213



# Chapter 1

## Metals in the environment

### 1.1 Introduction

Metals are derived from natural components or geological sources as well as from human activities or anthropogenic sources. It is believed that man's use of metals seriously began to affect the environment during the Industrial Revolution 200 years ago. Metals can be dispersed, both naturally and by human activities into air, land and sea. However, the soil environment will be the main focus of this research. There are numerous sources of metals in soils including (Reichman, 2002): Natural e.g. soil parent material, volcanic eruptions, and forest fires; Agricultural e.g. fertilisers, sewage sludges, and pesticides; Energy and fuel production e.g. emissions from power stations; Mining and smelting e.g. tailings, smelting, refining and transportation; Automobiles e.g. combustion of petroleum fuels; Urban / industrial complexes e.g. incineration of wastes and waste disposal; and, Recycling operations e.g. melting of scrap. Most metals are stable and cannot be degraded or destroyed, and therefore they tend to accumulate in soils and sediments (Anderson, 2003). Metal contamination issues are becoming increasingly common, the occurrence of metals in soils, both natural and polluted, has been the subject of a number of studies (Muller and Anke, 1994; Sanchez-Camazano *et al.*, 1994; Dudka *et al.*, 1996; Caussy *et al.*, 2003; Cui *et al.*, 2004). High concentrations of metals in soil can pose a risk to agricultural production and to human health. Typical normal ranges of metals/metalloids in soils and examples of high concentrations due to natural geological sources in Britain and their possible effects are shown in Table 1.1.

### 1.2 Metals of interest, their occurrences in soils and toxicity

There are about 45 different metals utilized in industrial processes to an extent which may lead to their exposure to humans (Nriagu, 1984). Information on metabolism and toxicity in plants, animals and humans are fairly well documented for most metals e.g. Fe, Zn, Cu, Se, Pb, Cd, Hg and As. However, for some of these the information is scarcely available. Metals can be classified by their known essentiality to living organisms as essential and non-essential elements. The essential elements including

Cr, Co, Cu, Fe, Mn, Mo, Ni, Se and Zn are required by organisms at some level and become toxic at some higher levels of exposure. Non-essential elements including As, Sb, Cd, Pb, Hg, Tl, Sn and Ag are toxic and not required by organisms at any level (McGrath, 2001). A typical dose-response curve for essential and non-essential trace elements is shown in Figure 1.1.

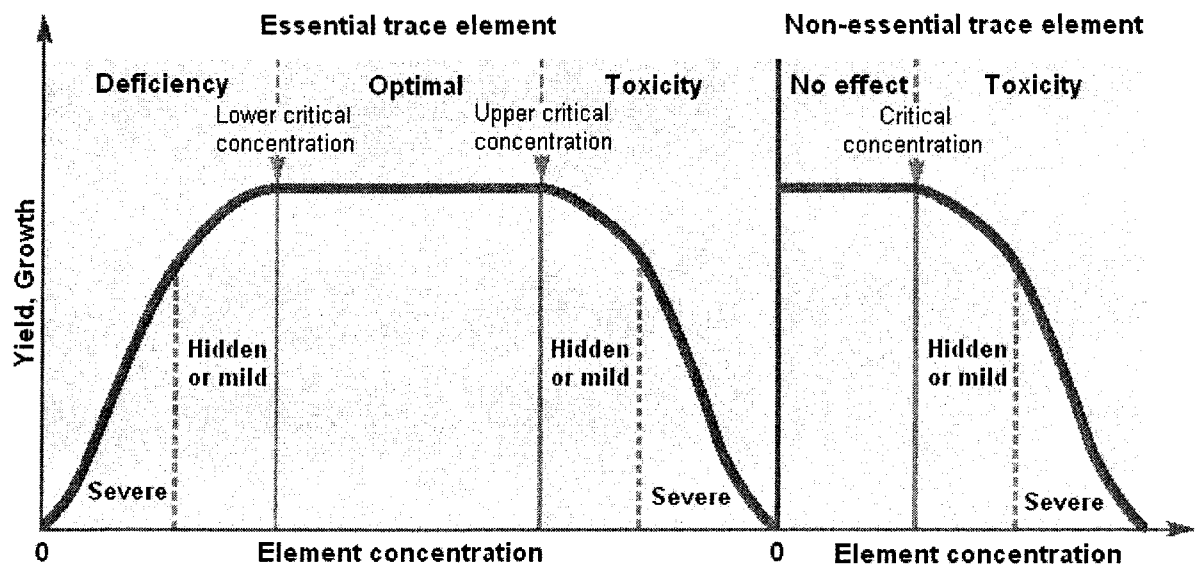
**Table 1.1** Metals/metalloids in soils derived from normal and geochemically anomalous parent materials in Britain (Nriagu, 1984)

Metal/ Metalloid	Typical normal range (mg/kg)	Metal-rich soils (mg/kg)	Sources	Possible effects
As	<5-40	up to 2500 up to 250	Mineralization Metamorphosed rocks around Dartmoor	Toxicity in plants and livestock; excess in food crops
Cd	<1-2	up to 30 up to 20	Mineralization Carboniferous black shale	Excess in food crops
Cu	2-60	up to 2000	Mineralization	Toxicity in cereal crops
Mo	<1-5	10-100	Marine black shales of varying age	Molybdenosis- or molybdenum-induced hypocuprosis in cattle
Ni	2-100	up to 8000	Ultra-basic rocks in Scotland	Toxicity in cereal and other crops
Pb	10-150	1% or more	Mineralization	Toxicity in livestock, excess in foodstuffs
Se	<1-2	up to 7 up to 500	Marine black shales in England and Wales Namurian shales in Ireland	No effect  Chronic selenosis in horses and cattle
Zn	25-200	1% or more	Mineralization	Toxicity in cereal crops

This research concentrates on 9 metals i.e. Cr, Mn, Fe, Ni, Cu, Zn, Mo, Cd and Pb which represent both essential and nonessential elements. Critical total metal concentrations (in mg/kg) in soils i.e. the range of values above which toxicity is considered to be possible are: 70 – 400 (Zn), 3 – 8 (Cd), 60 – 125 (Cu), 100 – 400 (Pb), 15000 – 30000 (Mn), 100 (Ni) (Alloway, 1995), and 75 – 100 (Cr) (Ross, 1994). A brief review regarding their occurrence in soil, uses, deficiency and toxicity of each metal is now presented.

### 1.2.1 Chromium (Cr)

Chromium is fairly abundant. The only important Cr ore is chromite, a mineral of the spinel group, with the formula  $(\text{Fe,Mg})\text{O}(\text{Cr,Al,Fe})_2\text{O}_3$  (Committee on Biologic Effects of Atmospheric Pollutants, 1974). The ore contains chromic oxide ( $\text{Cr}_2\text{O}_3$ ) and ferrous oxide ( $\text{FeO}$ ). Chromium can exist in a variety of oxidation states, but commonly occurs as trivalent and hexavalent. The important Cr ions are chromates and dichromates, which are easily reduced to trivalent Cr in acid solution and in the presence of organic matter (Committee on Biologic Effects of Atmospheric Pollutants, 1974). Concentration of Cr in soils is usually between 80 – 200 mg/kg. High Cr content has been associated with infertility of some soils.



**Figure 1.1** A typical dose-response curve for essential and non-essential trace elements (Alloway, 2004)

Chromium is used in the leather tanning industry, the manufacture of catalysts, pigments and paints, fungicides, the ceramic and glass industry, photography, chrome alloy and Cr metal production, chrome plating, and corrosion control (World Health Organization (WHO), 2003). Chromium is an essential nutrient that helps the body use sugar, protein, and fat. Deficiency results in impaired growth and longevity, and disturbances in glucose, lipid, and protein metabolism (Calabrese *et al.*, 1985). Chronic exposure to hexavalent Cr is reported to induce renal failure, anaemia, haemolysis and liver failure (UK Food Standards Agency, 2003).

### 1.2.2 Manganese (Mn)

Manganese is next to Fe in the periodic table, and is similar to it in chemical behaviour and is often closely associated with it in its natural occurrence (Committee on Biologic Effects of Atmospheric Pollutants, 1973). It is widely distributed in igneous and sedimentary rocks and constitutes about 0.10% of the earth's crust. Manganese can have valences of 1, 2, 3, 4, 6 and 7 in its compounds. However, it is divalent in the most stable salts, and the pyrolusite dioxide ( $\text{MnO}_2$ ) is the most stable and important mineral ore of Mn. Manganese also occurs as sulphide, carbonate and silicate.

Manganese is used primarily in the production of iron, steel, alloy and has a number of other uses e.g. dry cell batteries, paint driers, pigments, and catalysts. High concentrations of Mn in soil have occurred as a result of mining and industrial pollution. Manganese is necessary for the formation of connective tissue and bone, amino acid, carbohydrate and lipid metabolism, embryonic development of the inner ear, and reproductive function (Levy *et al.*, 2004). Manganese is present in foods, particularly green vegetables (2 mg/kg), nuts (14.9 mg/kg), bread (8 mg/kg), tea (2.71 mg/kg) and other cereals (6.81 mg/kg) (UK Food Standards Agency, 2003). Exposure of Mn may occur via food and inhalation. Airborne particles of Mn can be exposed through inhalation by miners, smelters and workers in the manufacture of dry batteries. Miners who have inhaled Mn contaminated air develop a severe psychiatric disorder resembling schizophrenia, along with progressive central nervous system deterioration resulting in permanent crippling (Calabrese *et al.*, 1985). This condition is called *laura mangania*.

### 1.2.3 Iron (Fe)

Iron is element number 26 in the periodic table and has an atomic weight of 55.85. Iron is common and abundant in the earth's crust (ca 4.7 %), occurring primarily in oxidic ores: haematite and magnetite. The most common Fe containing minerals in soils are the ferric oxyhydroxides. Iron is combined in crystal structures either as divalent ferrous or trivalent ferric ions. In metallic form, it is chemically unstable and slowly oxidized and converted to ferrous and ferric compounds. In water solution, it occurs as Fe (II) or Fe (III), or as inorganic or organic ferrous or ferric complexes.

Iron is primarily ferric in most soils, although the ferrous state may be predominant in some soils that are flooded and rich in organic matter (Committee on Medical and Biologic Effects of Environmental Pollutants, 1979).

Plants require a continuous supply of Fe for growth because it is an essential component of many enzymatic functions and light energy transferring compounds in photosynthesis. In the human body, Fe is mainly in the form of haemoglobin within circulating erythrocytes, which serve to transport oxygen. As a key element in many structural functions, Fe deficiency can cause many abnormalities e.g. effects on physical performance, growth, and reproduction.

The critical toxicity concentrations for total Fe in plants are quite high, measuring 400 to 1000 mg/kg (Mortvedt *et al.*, 1991). In human, acute toxicity of ingested Fe is unlikely to be encountered from any source other than medical Fe (Committee on Medical and Biologic Effects of Environmental Pollutants, 1979). However, soluble ferric salts may produce irritation of the gastrointestinal tract, characterized by abdominal pain and diarrhea, when given in large doses especially on an empty stomach (Boyd, 1973).

#### **1.2.4 Nickel (Ni)**

Nickel is ubiquitous in the earth's crust and mainly occurs in sulphide and oxide ores. It is particularly concentrated in basic rocks (~ 150 mg/kg) with much lower concentrations in granite (~ 0.5 mg/kg) (Bennett, 1981). Hence, the Ni content in soil may range widely depending on mineral composition. Nickel is known primarily for its divalent compounds since the most important oxidation state of the element is +2. Nickel also exists as certain compounds in which the oxidation state of the metal is between -1 to +4. It is used in stainless steel production, Ni-Cd batteries, alloys, and electroplating. Nickel contamination may occur from emissions of metal mining, smelting, and refining operations; nickel plating and alloy manufacturing; land disposal of sludges, and disposal as effluents (Eisler, 1998b).

Nickel is present in a number of enzymes in plants and microorganisms. In humans, Ni influences Fe absorption and metabolism, and may be an essential component of

the haemopoietic process (UK Food Standards Agency, 2003). Its deficiency has not been observed in humans. Nickel is relatively non-toxic through the oral route due to limited intestinal absorption (Bennett, 1981). Contact with Ni and with solution of Ni salts may result in dermatitis (Committee on Medical and Biologic Effects of Environmental Pollutants, 1975). Acute Ni exposure is associated with a variety of clinical symptoms and signs including nausea, vomiting, diarrhoea, visual disturbance, and headache. Chronic inhalation of Ni and its compounds is associated with an increased risk of lung cancer (UK Food Standards Agency, 2003).

### **1.2.5 Copper (Cu)**

Copper occurs naturally in the environment in a wide range of mineral deposits e.g. mineral sulphide, carbonate and silicate deposits. The three most important sources of Cu are chalcocite ( $\text{Cu}_2\text{S}$ ), chalcopyrite ( $\text{CuFeS}_2$ ), and malachite ( $\text{CuCO}_3 \cdot \text{Cu(OH)}_2$ ) (Eisler, 1998a). Copper is present in relatively low concentrations in soils at about 50 mg/kg. Most Cu is used for electrical equipment. Copper is also used for construction such as roofing and plumbing pipes.

In plants, Cu is essential in seed production, disease resistance and regulation of water. Copper in excess can cause phytotoxicity in plants and it has been used as an algicide to control algal blooms. It can cause plant damage if, for example, it is present at too high concentration in sewage sludge which is applied to agricultural land (Wase and Forster, 1997). Copper is required by humans in trace levels in order to help haemoglobin formation and carbohydrate metabolism. It is also incorporated into many specific Cu proteins such as cytochrome oxidase, tyrosinase, and erythrocyte superoxide dismutase (Irwin, 1997). Copper deficiency and toxicity are observed rarely in humans. It can be exposed to humans via food and drinking water. Single exposure to 30 mg/L of Cu or greater in drinking water resulted in gastrointestinal effects (vomiting, diarrhea, and abdominal pain) in healthy humans (Geogopoulos *et al.*, 2001).

### **1.2.6 Zinc (Zn)**

Zinc is one of the ubiquitous heavy metals and constitutes approx. 0.004% of the earth's substance (Browning, 1969). It occurs naturally in ore minerals, especially as

sphalerite (ZnS) which is often associated with the sulphides of other metallic elements e.g. Cd, Cu, and Fe. Zinc is also found as ZnCO<sub>3</sub>. Other forms of Zn are usually products of the oxidation of ZnS. In soil solution, it is present as Zn<sup>2+</sup>, Zn(OH)<sub>2</sub>, ZnSO<sub>4</sub> and ZnHPO<sub>4</sub>. The hydroxide Zn(OH)<sup>+</sup> is adsorbed on Fe and Mn oxides and clay minerals containing Al and Si lattices (Lindsay, 1979).

The main use of Zn is for galvanization of iron and steel to prevent rust and corrosion. Metallic Zn is mixed with other metals to form alloys such as brass and bronze and also used to make dry cell batteries. Zinc oxide is used in the manufacture of paints, rubber, ceramic and many other products. Total Zn in non-polluted agricultural soils is generally below 500 mg/kg, whereas the concentrations in polluted soils could be higher than 3000 mg/kg (Long *et al.*, 2003). The increased level of Zn in soil is mainly caused by disposal of Zn wastes from the manufacturing industries. Sludge and fertilizer also contribute to high levels of Zn in the soil.

There has been reported that a deficiency of Zn can cause a reduction in photosynthesis by 50% - 70% depending on the plant species and the severity of the deficiency (Alloway, 2004). Excess Zn is toxic to plants and humans. It is generally assumed that leaf Zn levels in excess of 300-600 mg/kg dry weight is considered to be toxic to plants (Marschner, 1995). The information on Zn toxicity in humans is scarce.

### **1.2.7 Molybdenum (Mo)**

Molybdenum is relatively low abundant in soils, there is usually less than 5 mg/kg. It naturally occurs in association with other elements e.g. Cu. Molybdenite (MoS<sub>2</sub>) is the major ore mineral for Mo. The predominant form of Mo occurring in soil is the molybdate anion, MoO<sub>4</sub><sup>2-</sup>. Molybdate is quite strongly attached to clay particles or organic matter in soils.

The two largest uses of Mo are as an alloy in stainless steels and in alloy steels. Molybdenum also is an important material for the chemicals and lubricant industries. As a pure metal, Mo is used because of its high melting temperatures (2610 °C) as filament supports in light bulbs, metal-working dies and furnace parts.

In plants, Mo is required in a small amount (micronutrient) for bacterial nitrogen fixation. In humans, it serves as a component of several enzymes including aldehyde oxidase, sulphite oxidase, and xanthine oxidase, which are important in protein catabolism (Calabrese *et al.*, 1985). The diet is a major source of Mo for humans. Molybdenum deficiency is rare in humans but it can be seen in animals. High concentrations of Mo in water and food have been associated with gout in humans.

### **1.2.8 Cadmium (Cd)**

Cadmium natural concentration in soil is very low and it occurs as the sulphide mineral (CdS). Most Cd is produced as a by-product of Zn smelting, as it is usually found with Zn in the environment. Cadmium is bound in clay and basic soil but is more mobile in sandy and acidic soils. It has a number of uses including Ni-Cd batteries, pigments for plastics, Cd coatings, PVC stabilisers and alloys. Cadmium is present in sewage sludges which are utilized as fertilizer and can contribute 90 % of the total Cd input to soil (Bennett, 1981). It is also released into the environment upon incineration of plastics.

Cadmium is a highly toxic element which, in humans, can cause serious damage to the kidneys and bones, and is probably best known for its association with itai-itai disease (Wase and Foster, 1997). Cadmium can be exposed to humans by inhalation and ingestion. Various types of food are the major source of exposure, even though gastrointestinal absorption is limited to around 5 % (Nriagu, 1984). It can accumulate in the liver and kidney and at toxic levels it impairs the function of these organs. However, humans are protected against chronic exposure to low levels of Cd by the sulphur-rich protein called metallothionein (Baird, 1999). This protein can complex almost all ingested Cd<sup>2+</sup>, and the complex is subsequently eliminated in the urine.

### **1.2.9 Lead (Pb)**

The primary form of Pb in the natural state is the insoluble sulphide ore, galena, PbS (Bennett, 1981). Lead can be found as other compounds including PbO<sub>2</sub>, PbCO<sub>3</sub> and PbSO<sub>4</sub>. The Pb contents in soils are typically in the range 10 to 150 mg/kg (Nriagu, 1984). It is generally higher in urban and industrial areas compared to rural areas. Lead has many different uses. It is used to make batteries, ammunition (lead shot),



metal products (solder and pipes), and devices to shield X-rays. The uses of Pb can result in sources of transfer to humans, such as from improperly disposed of industrial waste into agricultural soils, air, and water.

The immobilization of Pb in soil is greatest in soils of high cation exchange capacity (Bennett, 1981). Lead enters plants by root uptake from soil or by direct deposition from air. The natural Pb levels in plants, animals and humans are very low.

Lead enters the body mainly by inhalation and ingestion. The most important route of exposure is ingestion of Pb-contaminated food (Nriagu, 1984). The effects of Pb toxicity in humans include hypertension and brain damage (Wase and Foster, 1997). It may cause both acute and chronic effects, mainly in the haematopoietic, nervous, gastrointestinal and renal systems (Bennett, 1981).

### **1.3 Metal species, mobility and bioavailability in soils**

It is generally accepted that total metal content in soils is not a good indicator of exposure or risk to plants or humans. Only a portion of the total quantity of pollutant present in soil is potentially available for uptake by organisms. This concept is referred to as the biological availability (or bioavailability) of a chemical (Kendall *et al.*, 2001). Peijnenburg and Jager (2003) have defined 'bioavailable fraction' as the fraction of the total amount of a chemical present in a specific environment compartment that, within a given time span, is either available or can be made available for uptake by (micro)organisms or plants, or by ingestion of food. Another generally accepted definition of bioavailability is the extent to which a chemical can be absorbed by a living organism and reach the systemic circulation (Kelley *et al.*, 2002).

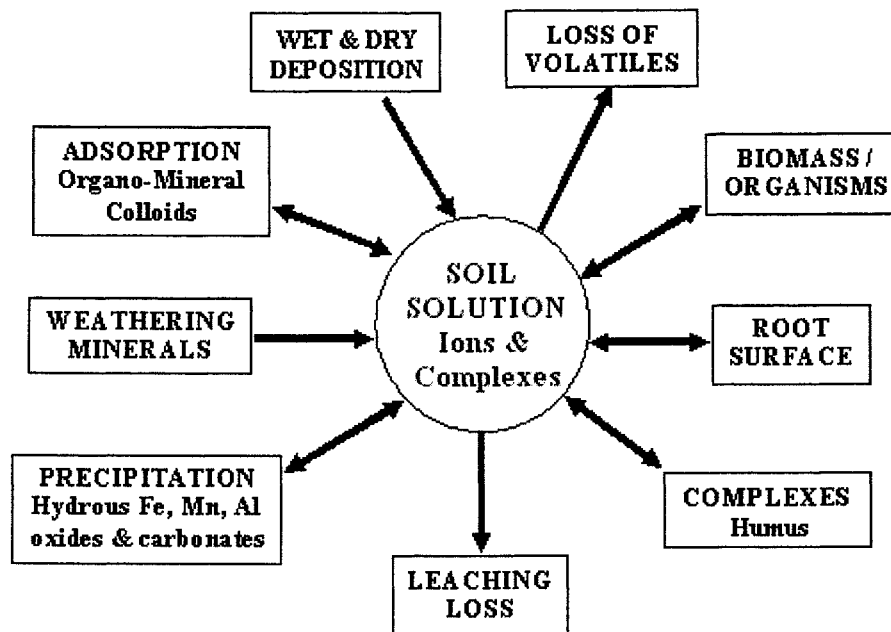
In the soil environment, the mobility and the fate of metals is regulated via their partitioning between the soil and soil solution (Lee *et al.*, 1998). In other words, metal bioavailability in soil is largely dependent on the partition of the metals between the solid and solution phases. Various species of the metals can exist in solution either as free ions or as complexes associated with organic (i.e. functional groups such as carboxyl and phenolic) or inorganic (e.g. anions such as  $\text{OH}^-$ ,  $\text{CO}_3^{2-}$ ,

SO<sub>4</sub><sup>2-</sup>, NO<sub>3</sub><sup>-</sup>, or Cl<sup>-</sup>) ligands. Examples of such complexes include cadmium chloride (CdCl<sup>-</sup>), methylmercury (CH<sub>3</sub>Hg<sup>+</sup>), and lead bicarbonate (PbHCO<sub>3</sub><sup>+</sup>). The existence of metals in the solid phase can be subject to a number of sorption mechanisms e.g. ion exchange or surface complexation. In addition, they can be coprecipitated with other minerals e.g. oxides of Fe, Al and Mn, present as carbonates in the soil. Hence, metals in solid phase may be partitioned into various fractions. The relative mobility and bioavailability of metals associated with different fractions is given in Table 1.2.

**Table 1.2** Relative mobility / bioavailability of metal species (Salomons, 1995)

<b>Metal species and association</b>	<b>Mobility / Bioavailability</b>
Exchangeable cations	High. Changes in the major cationic composition (e.g. estuarine environment) may cause a release due to ion exchange
Metal compounds associated Fe-Mn oxides	Medium. Changes in redox conditions (reducing conditions) may cause a release but if sulphide is present insoluble metal sulphides are formed
Metals bound or fixed inside organic substances	Medium. After decomposition of the organic matter
Metals associated with the sulphide minerals	Strongly dependent on environmental conditions. Under oxygen-rich conditions, oxidation of sulphides occurs
Metals bound or fixed inside mineral particles	Low. After weathering and/or decomposition

Ions in soil solution generally are more available for a variety of processes, including plant uptake and transport; however, metal ions in the solid phase may become available if environmental conditions and time change (Rieuwerts *et al.*, 1998; Kelley *et al.*, 2002). The key processes governing the partition of metals between the solid and solution phases of soils are shown in Figure 1.2. These processes influence the partition of metal ions in the liquid and solid phase, and are responsible for their mobility and bioavailability.



**Figure 1.2** Key processes governing the partition of metals between the solid and solution phases of soils (Rieuwerts *et al.*, 1998)

#### 1.4 Effects of soil properties on the bioavailability of metals

The bioavailability of metals in soils will depend on their form and concentration in the parent material and their input through fertilisers, sewage sludge and aerial deposition (Antoniadis, 1998). It will also be affected by leaching processes, adsorption and desorption from the solid phase and mineralization of the organic matter. Their bioavailability will be subsequently controlled by a number of soil properties which regulate these processes. Generally, conditions resulting in less fixation of metal in soil (e.g. low pH, low organic matter content) lead to greater bioavailability to living organisms. Influential soil properties include pH, organic matter content, cation exchange capacity, redox conditions, the presence of hydrous hydroxides, and other ions. The main factors are discussed below:

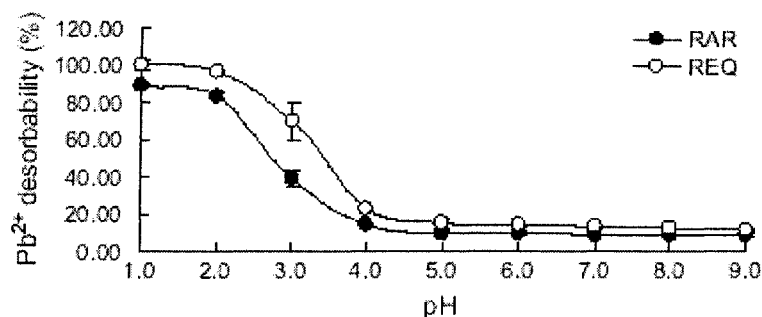
##### 1.4.1 pH

Soil pH is a determination of the soil solution's acidity and alkalinity. By definition, pH is the negative logarithm (base 10) of the hydrogen ion concentration in a solution, that is,

$$\text{pH} = -\log [\text{H}^+] \quad (1.1)$$

Hydrogen ions are strongly attached to the surface negative charges, and they have the power to replace most other cations (Alloway, 1995). Soil pH is probably the most important factor governing metal speciation, solubility from mineral surfaces, transport, and eventual bioavailability of metals in aqueous solutions (Harter, 1983). Evans (1989) explained that pH has a significant effect on metal dynamics because it controls adsorption and precipitation, which are the main mechanisms of metal retention in soils. Metal solubility tends to increase at lower pH. With the exception of Mo, Se and As, the mobility of trace elements is reduced with increasing soil pH because of the precipitation as insoluble hydroxides, carbonates and organic complexes (Silveira *et al.*, 2003). In a typical temperate environment, such as the UK, soils normally have a pH in the range 4-8 (Alloway, 1995). The optimum pH for most arable crops is 6.5 on mineral soils and 5.5 on peaty soils.

Many researchers have shown that soil pH has a large effect on metal bioavailability. Evans *et al.* (1995) investigated the role of changes in pH to the content of soluble Cd, Co, Cr, Cu, Pb, Ni, V and Zn in soils to which sewage sludge had been applied. It was indicated that for all the metals, their contents in soils increased markedly as the pH decreased below about pH 5. Another example is a recent report of Yang *et al.* (2006) which studied the effect of pH on Pb<sup>2+</sup> bioavailability in two variable charge soils (one developed from arenaceous rock, RAR; and the other derived from quaternary red earths, REQ). They showed that an acidic environment (pH < 5) was favourable for Pb<sup>2+</sup> desorption and the desorptability (% of Pb desorbed of the total adsorbed) of Pb<sup>2+</sup> decreased with increasing solution pH (Figure 1.3).



**Figure 1.3** The desorption characteristics of lead as a function of pH (Yang *et al.*, 2006)

### 1.4.2 Organic matter

Soil organic matter (SOM) refers to the non-living organic material in the soil, which makes up by far the major portion of the total organic components (Bigham, 1996). Hence, it can be of plant, animal or microbial origin and may be relatively fresh or highly decomposed and transformed. In physical terms, organic matter improves the stability of soil aggregates resulting in better aeration of the soil and better water retention. It also contributes, in chemical terms, to the increase of the adsorption sites as it increases the solid phase of the soil. In general, the composition of SOM is dominated by large molecular weight humin and humic acid (HA) compounds and lower molecular weight fulvic acids (FA) (Ross, 1994). It tends to be highly reactive toward ionic and polar contaminants because ionisable functional groups within natural organic matter (e.g. carboxylate, phenolate, sulphydral, amino and phosphate groups) have a propensity to bind metal ions and form stable complexes (National Research Council of the National Academies, 2003). The amount of organic matter found in soil significantly influences metal bioavailability. It is considered as the most important soil constituent that retains heavy metals. Generally, fulvic-metal complexes are soluble, while humic-metal complexes are insoluble (McBride, 1995). Depending on the complex solubility, metal-organic complexes can be found either in the liquid or in the solid phase (Silveira *et al.*, 2003).

Several studies have investigated the influence of soil organic matter content on metal mobility and bioavailability. Schaecke *et al.* (2002) evaluated biosolid application rates (equivalent 82-330 tons of dry matter per hectare) incorporated in 0-25 cm depth of a Haplic Chernozem site in the dry belt of Central Germany. Different doses of sewage sludge had been applied in 1982, 1983, and 1985. The aim of the investigation was to study the fate of heavy metals (Zn, Cd, Cu, Ni, Pb and Cr), and to determine their concentration in the different soil fractions. Eleven years after the last application, metals supplied with the sludge had moved as far as 50 cm in depth. Concentrations of Zn, Cd, Cu, Ni and Cr in the saturation extract of the sampled soil layers were closely correlated to concentrations of dissolved organic carbon (DOC), i.e. the heavy metal displacement was partly linked to the DOC movement in soil. Halim *et al.* (2003) evaluated the influence of soil amendment with an exogenous humic material on the environmental mobility and potential availability of Cd, Cu,

Pb, Ni and Zn. The results showed that addition of HA generally reduced the extractability of the soluble and exchangeable forms of metals. This effect was directly related to the amount of added HA and increased with ageing.

### **1.4.3 Cation exchange capacity (CEC)**

There are always sufficient cations held by electrostatic forces on soil particle surfaces to balance the surface negative charge known as the cation exchange capacity or CEC (Rowell, 1994). The determination of exchangeable ions in soil requires that ions on soil exchange sites be forced into solution in which they can be effectively measured. However, the measurement of CEC is complicated by the fact that it is affected by both pH and ionic strength of the soil solution, especially in highly weathered soils and other soils rich in Al and Fe oxides, hydroxides, and amorphous clays (Robertson *et al.*, 1999). The distribution of major exchangeable cations in productive agricultural soils is generally  $\text{Ca}^{2+} > \text{Mg}^{2+} > \text{K}^+ > \text{Na}^+ \approx \text{NH}_4^+$ , roughly 80% is Ca, 15% is Mg, 4% is K, and 1% is Na (Bohn *et al.*, 2001).

Most heavy metals (with certain exceptions, including the metalloids As, Sb and Se and the metals Mo and V) exist mainly as cations in the soil solution, and their adsorption therefore depends on the density of negative charges on the surfaces of the soil colloids (Alloway, 1995). In order to maintain electroneutrality, the surface negative charge is balanced by an equal quantity of cations from the soil solution, and this cation exchange, between the balance and solution cations, is reversible (Brown, 1954 cited in Alloway, 1995). The cations form weak, electrostatic bonds with the soil surface and are easily exchanged with other, similarly adsorbed cations (Evans, 1989). Soils with significant negative charge have a high cation exchange capacity and low cation mobility (Kelley *et al.*, 2002). Soils with high clay or organic matter content tend to have a high CEC whereas sandy soils have a relatively low CEC. The CEC varied from 10 mmol/kg for coarse-textured soils to 500 to 600 mmol/kg for fine-textured soils containing large amounts of 2:1 layer silicate minerals and organic matter (Bohn *et al.*, 2001).

#### **1.4.4 Redox conditions**

Redox is a short term for the reduction-oxidation reaction, the processes involved in the flow of electrons from a reducing agent (reducer) to an oxidizing agent (oxidant) (Rieuwerts *et al.*, 1998). Redox equilibria are controlled by the aqueous free-electron activity, which can be expressed as either the pE value (the negative log of the electron activity) or the redox potential,  $E_h$  (the millivolt difference in potential between a Pt electrode and a standard hydrogen electrode) (Lindsay, 1979). High redox potentials are typically recorded in dry, well aerated soils (which favour the existence of oxidised species) whilst soils prone to waterlogging and rich in organic matter tend to have low  $E_h$  values (associated with reduced species) (Evans, 1989). Oxidic soil conditions usually give  $E_h$  values in the range +300 to +800 mV (pE 5.1-13.5) whereas anaerobic soils have values from +118 to -414 mV (pE +2 to -7) (Bailey, 1980 and Rowell, 1981 cited in Alloway, 1995). The conversion factor for the unit is  $E_h$  (mV) = 59.2 pE (Lindsay, 1979).

Sims and Patrick (1978) studied the influence of redox potential on the distribution of Fe, Mn, Zn and Cu in Mhoon silty clay loam soil. It indicated that greater amounts of the metals were found in the exchangeable and organic extractions at low pH and  $E_h$  than at high pH or  $E_h$ . In contrast, the amounts (except Mn) in the water-soluble fraction were greater at high pH or  $E_h$ . Another report investigated the effect of redox potential on solubilities of Pb, Cd, and Zn from a contaminated soil (Chuan *et al.*, 1996). Results showed that metal solubilities increased as redox potential decreased, when compared under the same pH values.

#### **1.4.5 Oxides of iron, manganese and aluminium**

The oxides of Fe, Mn and Al, which are commonly referred to as hydrous oxides play an important role in the chemical behaviour of metals in soils (Alloway, 1995). They affect metal availability in soils mainly by specific adsorption to surface hydroxyl groups and non-specific adsorption (exchange) and precipitation as the discrete metal oxide or hydroxide (Reichman, 2002). Increasing hydrous oxide contents in soils provides more sites for adsorption of metals, thus reducing the directly bioavailable metal (Qiao and Ho, 1996).

#### **1.4.6 Other ions**

The competition between heavy metals with other ions present in the soil system has a very significant effect on metal mobility. A well recognised competition occurs between macronutrients (e.g. Ca, P, K and S). It was reported that increasing the solution Ca concentration by a factor of 10 ( $10^{-3}$  to  $10^{-2}$  M) reduced the adsorption capacity of Cd by 67% (Christensen, 1984).

#### **1.5 Uptake and accumulation of metals in plants**

Whereas metal contamination is widespread, the occurrence of heavy metals in agricultural soils is a major concern. Taken up by plants, heavy metals may enter the food chain in significant amounts. Hence, people could be at risk of adverse health effects from consuming vegetables grown in soils containing elevated metal concentrations. For instance, it is estimated that approximately half of human Pb intake is through food, with around half originating from plants (Nasreddine and Parent-Massin, 2002). According to the Environmental Protection Agency (EPA), Pb is the most common heavy metal contaminant in the environment (Watanabe, 1997) and may be toxic to organisms even when absorbed in small amounts. Cadmium and Pb are the elements of most concern because of their potential for toxicity or accumulation in plants and animals (Wolnik *et al.*, 1983). Although metals such as Zn, Cu and Mn are essential trace elements for plants and animals, they can also be dangerous at high exposure levels. For example, poisoning incidents with symptoms of gastrointestinal distress, nausea and diarrhoea have been reported after a single or short-term exposure to concentrations of Zn in water or beverages of 1000 - 2500 mg/L (World Health Organization (WHO), 2001). At high doses of certain metal compounds, of the order of several grams, chronic toxicity or carcinogenicity as well as fatality may occur.

Certain crops such as spinach, lettuce, carrot, radish, and zucchini can accumulate heavy metals e.g. Cd, Cu, Mn, Pb and Zn in their tissues (Sauerbeck, 1991; Muller *et al.*, 1994; Hooda, 1997; Bahemuka and Mubofu, 1999; Cobb *et al.*, 2000; Mattina *et al.*, 2003; Hough *et al.*, 2004; Zhou *et al.*, 2005). Generally, uptake is increased in plants that are grown in areas with increased soil contamination. Among the metals, Cd and Zn are fairly mobile and readily absorbed by plants (Mench *et al.*, 1994). In

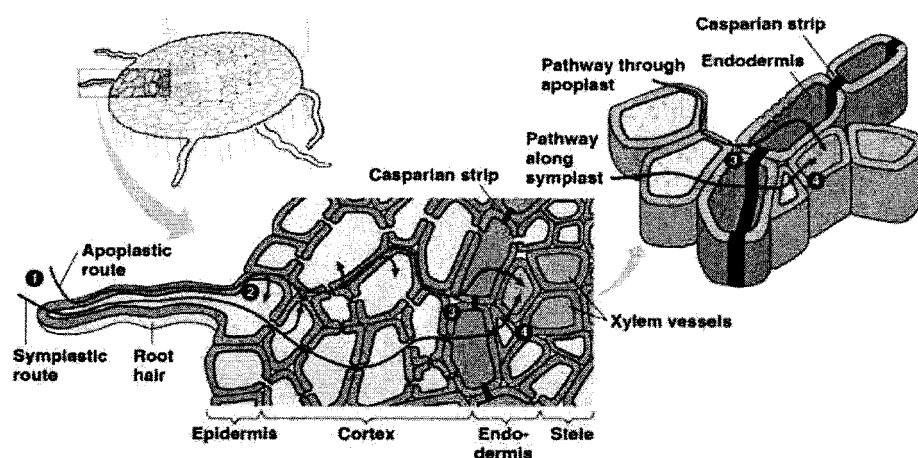


contrast, Cu and Pb are strongly adsorbed onto soil particles reducing their availability to plants (World Health Organization (WHO), 1989;1998). In addition, they are bound to organic matter, as well as being adsorbed by carbonate minerals and hydrous iron and manganese oxides. In recent years, extensive research has been conducted on estimation of the bioavailability and toxicity of metals in soils. However, no methods are currently available to allow accurate prediction of plant uptake or phytotoxicity, adverse effects on human health, or ecotoxicity resulting from metal pollution of soils (Nolan *et al.*, 2003).

### Plant uptake mechanisms

Plants obtain the inorganic nutrients they need from soil. However, plants are not perfectly selective so that, in addition to essential nutrients, they may take up minerals that are redundant or even toxic (Marschner, 1995). Uptake of metals into plant roots is a complex process involving transfer of metals from the soil solution to the root surface and inside the root cells (Reichman, 2002). Ions are absorbed along with water from the solution that surrounds soil particles. The solution enters the root at the root hairs which are the extensions of epidermal cells. Grace (2004) reported that the uptake is via two mechanisms as shown in Figure 1.4, these are;

- The cytoplasm of root cells (symplast) i.e. it crosses the plasma membrane and then passes from cell to cell through plasmodesmata.
- In the nonliving parts of the root (apoplast) i.e. in the spaces between the cells and in the cells walls themselves. This solution has not crossed a plasma membrane.



**Figure 1.4** The path of aqueous solution into roots (Grace, 2004)

However, the inner boundary of the cortex, the endodermis, is impervious to water because of a band of matrix called the casparian strip (Kimball, 2004). Therefore, to enter the stele, apoplastic solution must enter the symplasm of the endodermal cells. From here it can pass by plasmodesmata into the cells of the stele. Once inside the stele, solution is again free to move between cells and enters into the xylem.

Metal ions, once taken up by roots can either be stored by roots or transported to the shoot (Cai and Ma, 2003). Transport of metal ions to shoots is essentially driven by mass upward flow of water created by the transpiration stream (Kochian, 1991).

Organic acids and amino acids have frequently been reported to be the potential metal chelators, which most likely facilitate metal translocation through xylem (Srivastava *et al.*, 1999; Nigam *et al.*, 2001; Clemens *et al.*, 2002; Lesage *et al.*, 2005). Without being chelated by ligands, movement of metal cations from roots to shoot is expected to be severely retarded as xylem cell walls have a high cation exchange capability (Cai *et al.*, 2003).

### **1.6 Metal speciation in plants**

Over the past decades, the term “speciation” is frequently used in publications related to trace element determinations. The International Union for Pure and Applied Chemistry (IUPAC) has defined the term “chemical species” as a form of an element specified as to isotopic composition, electronic or oxidation state, and/or complex or molecular structure (Templeton *et al.*, 2000). According to this definition, speciation analysis denotes the analytical activities of identifying and/or measuring the quantities of one or more individual chemical species in a sample. From a chemical point of view elemental species can be divided into redox states, organometallic species (containing a covalent carbon-metal bond) and coordination complexes. The latter include simple (e.g. halide) or complex (e.g. citrate, tartrate, oxalate, phytate, amino acids, oligopeptides) ligands, macrocyclic chelating ligands (e.g. porphyrins), or macromolecules (e.g. polypeptides, proteins, DNA restriction fragments, polysaccharides) (Szpunar and Lobinski, 2003).

It has long been known that heavy metals play important roles in genomic functions and metabolic pathways within living organisms, therefore they are considered as

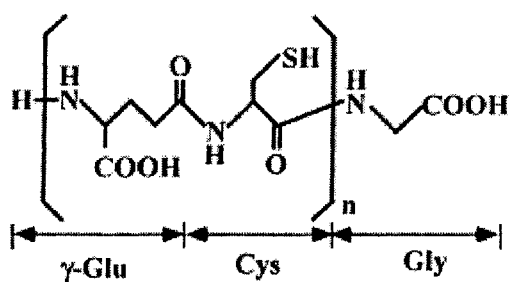
essential constituents e.g. Mo, Mn, Fe, Co, Cu and Zn. In addition, a number of other elements (e.g. V, Cr, Ni) are recognised to be beneficial to life (Szpunar, 2000). Whereas, some metals (e.g. Hg, Pb, Cd) and metalloids (As) can be harmful at extremely low concentration levels resulting in growth inhibition and death of the organism. The toxicity of metals, their environmental mobility and tendency to be accumulated in living systems are strictly correlated with their chemical forms; usually, knowledge of the total concentration gives only poor information about the potential risk (Morabito, 1995). Hence, the particular chemical species, e.g. inorganic, organic, organometallic is important in determining the toxicity of an element. Some examples showing various impacts that different species of one element can have on organisms are listed as the following (Michalke, 2003);

Chromium	Cr(III) is essential, participating in glucose metabolism. Cr(VI) is highly toxic and carcinogenic.
Copper	Ionic Cu(II) shows toxicity in aquatic systems, whereas humic Cu complexes are generally non-toxic.
Iron	The absorption capability for Fe(II) is lower compared with that for Fe(III). However, only Fe(II) is effective against Fe deficiency.
Zinc	It occurs as Zn-casein-Ca-P micelles in cow's milk and its availability for newborns is low. In human milk the Zn species is a Zn-citrate complex that is easily broken down in the infant's intestinal tract, making Zn highly available.

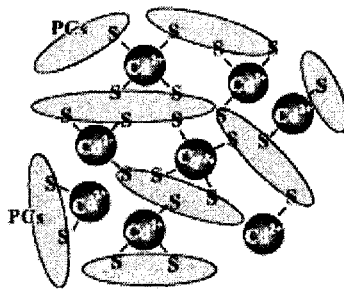
Plants protect themselves against metal poisoning by generating a number of tolerance systems. They have developed, on one side, efficient and specific mechanisms by which heavy metals are taken up and transformed into a physiologically tolerance form, providing the essential elements for the plants' metabolic function (Zenk, 1996). On the other side, excess of these essential elements or those harmful metal ions that do not function in metabolism, have to be metabolically inactivated and exposed by plants. The most frequent case involves the biosynthesis of a ligand, such as a phenolic compound, organic acid or oligo- or polypeptide that would be able to complex the excess of the toxic element into a compound innocuous to the organism (Zenk, 1996; Vacchina *et al.*, 1999a). In

particular, a class of oligopeptides called phytochelatins (PCs) was found to play a crucial role in the detoxification and homeostasis of heavy metals in plants (Zenk, 1996; Vacchina *et al.*, 1999b).

Phytochelatins (PCs) are a family of metal-complexing peptides that have a general formula  $(\gamma\text{-Glutamyl-Cysteinyl})_n\text{-Glycine}$ , where  $n = 2\text{-}11$  (Hall, 2002) and have molecular weights in the range 200-3000 Da (Sanz-Medel *et al.*, 2003). The basic structure of PCs is presented in Figure 1.5. They are synthesized non-translationally using glutathione (GSH) as a substrate by  $\gamma$ -glutamylcysteine dipeptyl transpeptidase (PC synthase), an enzyme that is activated in the presence of metal ions (Cobbett, 2000). PC synthase catalyses the transfer of  $\gamma$ Glu-Cys from GSH to another GSH molecule to form PC2, or to  $(\gamma\text{Glu-Cys})_n\text{-Gly}$  to form PC chain lengths of  $n+1$  (Kawakami *et al.*, 2006). PCs can detoxify metals by forming a metal-PC complex in which the metal is bound to the thiol group of the cysteine unit (Zenk, 1996; Vacchina *et al.*, 1999b). PCs form complexes with heavy metals such as Cd, Cu, Zn, Hg, Ag and As. In the structural model of a PC-Cd complex, for example, the Cd co-ordinately binds one, two, three or, at the maximum capacity, four sulphur atoms from either single or multiple PC molecules, resulting in amorphous complexes as shown in Figure 1.6 (Hirata *et al.*, 2005). Different plant species synthesise analogous families of PCs, which analogically bind metals creating chelate complexes (Polec-Pawlak *et al.*, 2005).



**Figure 1.5** Basic structure of Glutathione (tripeptide) and Phytochelatins (polypeptide). The general formula is  $(\gamma\text{-Glu-Cys})_n\text{-Gly}$ , where: Glu, Glutamate; Cys, Cysteine; and, Gly, Glycine (Hirata *et al.*, 2005)



**Figure 1.6** A structural model of PC-Cd complexes (Cruz *et al.*, 2002; Hirata *et al.*, 2005)

### 1.7 Oral bioaccessibility of metals

The environmental risk to humans from metals by consuming soil and contaminated vegetables can be assessed by measuring their bioaccessibility. Bioaccessibility has been defined as the fraction of a compound that is released from its matrix in the gastrointestinal tract, and thus becomes available for intestinal absorption i.e. enters the blood stream (Oomen *et al.*, 2002). Several *in vitro* approaches have been developed in attempts to mimic the effects of the human digestion process. They are commonly described in the scientific literature under the specific name of the physiologically-based extraction test (PBET) or more generally, a simulated *in vitro* gastrointestinal extraction procedure.

There are a number of *in vivo* approaches available to evaluate the bioavailability of metals for humans, e.g. from soil, dust or food. However, each method has its limitations. Information obtained from *in vivo* studies can be difficult to interpret due to physiological discrepancies between humans and the experimental animals adopted. Such problems led to the development of *in vitro* systems, based on gastrointestinal extraction including the so called physiologically-based extraction test (PBET). The technique measures the fraction of a metal which is solubilised from a sample under simulated gastrointestinal conditions and which therefore is available for absorption (Kelley *et al.*, 2002). The simulated parameters representative of the human digestive tract include stomach and small intestinal pH and chemistry, soil-to-solution ratio, stomach mixing, and stomach emptying rates. Several *in vitro* methods have been developed (Miller *et al.*, 1981; Crews *et al.*, 1983; Ruby *et al.*, 1993; Hack and Selenka, 1996). All of the PBET models involve simulated gastric extraction with

pepsin and with a mixture of pancreatin, amylase and bile salt in the intestinal stage. Researchers have shown that the *in vitro* study results can be correlated to bioavailability determined by *in vivo* studies (Ruby *et al.*, 1996). The approaches can be simple, rapid and low in cost and may provide insights not achievable in whole animal studies (Miller *et al.*, 1981).

### **1.7.1 *In vitro* bioaccessibility strategies**

*In vitro* extraction procedures to assess bioaccessibility seek to mimic processes that occur in typically two (or three) distinct, but linked, areas of the human digestive system i.e. (mouth) stomach and small intestine.

#### ***Mouth***

The mouth is the point where the process of mechanical grinding of samples, in the presence of saliva, takes place at a pH of 6.5. Soil and food samples are masticated allowing larger sample components to be broken down into smaller fragments, thereby increasing the surface area. This process also acts to lubricate the samples by adding of saliva. The entire process in the mouth will last from a few seconds to minutes. The samples are then transported via the oesophagus or gullet into the stomach in a few seconds.

#### ***Stomach***

The hydrochloric acidic environment of the stomach (pH 1-5) will allow dissolution of labile mineral oxides, sulfides and carbonates that release metals. The presence of pepsin, a protease enzyme which is more effective in acid conditions, breaks down proteins and hence aids dissolution of the samples. Samples can be retained in the stomach from a few minutes (8 min) to several hours (3 h).

#### ***Small intestines***

The small intestine is made up of three components, duodenum, jejunum and ileum. Samples are subjected to further treatment in the small intestines by intestinal juices, comprising of a series of enzymes (trypsin, pancreatin and amylase), bile salts and bicarbonate. The effect of this process is to breakdown polysaccharides, proteins and fats to make them more amenable to absorption. Samples can be retained in the

duodenum for 30-45 min (at pH 4-5.5), in the jejunum for 1.5-2 h (at pH 5.5-7.0), and the ileum for 5-7 h (at pH 7.0-7.5). The absorption process mostly takes place in the small intestine where final stage of digestion occurs.

As a result of these processes it is important to use *in vitro* procedures that mimic them as closely as possible. In general, therefore, samples should be treated as follows:

- A temperature of 37 °C throughout all extractions;
- pH 6.5 in the presence of saliva for about 2 min (may not be as important because time is so short);
- pH 1-4 using hydrochloric acid and pepsin for about 3 h; and,
- pH 4-7.5 in the presence of intestinal juices for about 7 h.

### 1.7.2 Assessing bioaccessibility

*In vitro* extraction procedures make use of simulated gastric and intestinal juices which are applied to samples to try to predict the availability of metals for human absorption. During the past two decades, several approaches have been investigated to assess bioaccessibility of metals in soil and food samples. The system was developed originally to assess the bioavailability of iron from food for nutrition studies (Miller *et al.*, 1981). The methods are both rapid and inexpensive, requiring only a day and only a small fraction of the cost of an *in vivo* study (Kelley *et al.*, 2002). Most methods are static gastrointestinal models which simulate transit through the human digestive tract by sequential exposure of the samples to simulate mouth, gastric, and small intestinal conditions (Oomen *et al.*, 2002). Only a few groups of researchers have carried out dynamic gastrointestinal models which mimic the gradual transit of extracted mixtures through the simulated physiological conditions in the digestive tract (Method H in Table 1.3). Static models are more convenient than dynamic models in terms of ease of use.

Table 1.3 provides a summary of *in vitro* approaches with various experimental designs that have been employed for evaluating the oral bioaccessibility of selected metals from soil and food samples. In comparing these different gastrointestinal approaches, the following aspects are considered;

### ***Operational characteristics***

#### **(1) Temperature**

In all methods, a temperature of 37 °C is maintained throughout all extraction procedures. This temperature was chosen to coincide with normal body temperature thereby allowing all digestion enzymes to operate effectively.

#### **(2) Solid-to-solution ratio**

The solid-to-solution ratios are different among the approaches and vary from 1:2 to 1:150 (g/mL). An investigation into the bioaccessibility of As, Cd, Cr, Ni and Pb, as a function of the solid-to-solution ratio has been performed (Hamel *et al.*, 1998). The authors indicated that bioaccessibility of these metals in synthetic gastric juice was affected only slightly by changes in the solid-to-solution ratios in the range 1:100 to 1:5000 (g/mL).

#### **(3) Mixing and incubation time**

In order to simulate gastrointestinal mixing, the procedures employ a variety of shaking techniques e.g. shaking water bath, mechanical stirring, argon gas dispersion, end-over-end rotation or peristaltic movement. Each approach involves mixing the sample for a set period of time in each step of the extraction phase. The incubation time for gastric juice extraction is in the range 1-4 h, whereas an incubation time of 1-5 h is used for intestinal juice extraction.

#### **(4) Addition of alimentary components**

The presence of food in *in vivo* studies will alter the composition of the digestive juices and affect transit times, so it is important in *in vitro* studies to simulate the conditions of the food. Alimentary components e.g. whole milk powder, dough (starch) and cream should therefore be added to the synthetic gastric juices to mobilize the contaminants and be more representative of human digestion (Rodriguez *et al.*, 1999; Oomen *et al.*, 2002).



**Table 1.3** Comparison of different gastrointestinal approaches

Description	Method A	Method B	Method C	Method D	Method E	Method F	Method G	Method H
Element studied	Fe	Cd, Cu, Fe, Pb, Zn	As, Cd, Pb	As, Pb	As	As, Cd, Pb	As, Cd, Pb	As, Cd, Pb
Test sample	Test meals	50 g foods e.g. beef, soya, crab, bread	2.0 g dry soil	0.4 g dry soil / mine wastes	4 g dry soil	10 g dry soil	0.6 g dry soil	10 g dry soil
Solid : solution ratio	NA	50:100 (1:2)	2 : 100 (1:50)	0.4 : 40 (1:100)	4:600 (1:150)	10:25 (1:2.5)	0.6:22.5 (1:38)	10:300 (1:30)
Mixing	Water bath with shaker	Water bath with shaker	Agitator, 200 rpm	Passing Ar gas, 1.0 L/min through the reaction vessel	Ar gas dispersion	Mechanical stirring, 150 rpm	End-over-end rotation, 55 rpm	Peristaltic movements
Temperature	37 °C	37 °C	37 °C	37 °C	37 °C	37 °C	37 °C	37 °C
Mouth	na	na	na	na	na	na	na	na
Volume of saliva							9.0 mL	50 mL
saliva pH							pH 6.5	pH 5
Incubation time							5 min	5 min
Stomach								
Gastric pH	pH 2	pH 1.8	pH 2.0	pH 1.3 – 4.0	pH 1.8	pH 4.0	pH 1.07	Initial pH 5.0 decreasing to pH 3.5, 2.5, 2.0 after 30, 60, 90 min, respectively

**Table 1.3** (continued)

<b>Description</b>	<b>Method A</b>	<b>Method B</b>	<b>Method C</b>	<b>Method D</b>	<b>Method E</b>	<b>Method F</b>	<b>Method G</b>	<b>Method H</b>
Enzymes and other substances	16 g pepsin in 0.1 N HCl (made up to 100 mL with 0.1 N HCl)	10 mg/mL pepsin in saline hydrochloric acid (0.15 M NaCl; 0.02 M HCl)	Pepsin, mucine, 50 g/L whole milk powder (and no milk powder)	1.25 g pepsin, 0.5 g citrate, 0.5 g malate, 420 µL lactic acid, 500µL acetic acid in 1 L distilled water	1% pepsin in 0.15 M NaCl, + 200 g dough	15 g Nutrilon plus, 16 g pectin, 8 g mucin, 5 g starch, 1 g cellobiose, 1 g glucose, 2 g protease peptone, and 18 mL cream in 1 L distilled water	Gastric juice (pepsin, mucin, BSA)	Lipase, pepsin
Volume of gastric juice	Volume provided 0.5 g pepsin per 100 g of meal	100 mL	100 mL	40 mL	600 mL	25 mL	13.5 mL	250 mL
Incubation time	2 h	4 h	2 h	1 h	1 h	3 h	2 h	Gradual secretion gastric content at 0.5 mL/min

Table 1.3 (continued)

Description	Method A	Method B	Method C	Method D	Method E	Method F	Method G	Method H
Small intestine Intestinal pH	pH 5	pH 7.4	pH 7.5	pH 7.0	pH 5.5	pH 6.5	pH 7.8 – 8.0	pH 6.5 (duodenum), pH 6.8 (jejunum), pH 7.2 (ileum) Pancreatin, porcine
Enzymes and other substances	4 g pancreatin and 25 g bile extract in 0.1 M NaHCO <sub>3</sub> (made up to 1 L with 0.1 M NaHCO <sub>3</sub> )	Equal volumes of (a) 30 mg/mL pancreatin plus 10 mg/mL amylase and (b) bile salts (1.5 g/L) in 0.15 M NaCl 100 mL	Trypsin, pancreatin, 4.5 g/L bile in chyme	70 mg bile salt and 20 mg pancreatin	2.10 g bile extract and 0.21 g pancreatin	12 g NaHCO <sub>3</sub> , 4 g bovine bile, and 0.9 g pancreatin in 1 L distilled water	27 mL duodenal juice (pancreatin and lipase) and 9 mL bile juice	
Volume of intestinal juice	5 mL	100 mL	100 mL	40 mL	600 mL	15 mL	36 mL	3 x 70 mL (3 sections: duodenum, jejunum and ileum) Duodenal secretion
Incubation time	2 h	4 h	6 h	1 - 3 h	1 h	5 h	2 h	gastric content at 1 mL/min (total digestion time 360 min)

**Table 1.3** (continued)

<b>Description</b>	<b>Method A</b>	<b>Method B</b>	<b>Method C</b>	<b>Method D</b>	<b>Method E</b>	<b>Method F</b>	<b>Method G</b>	<b>Method H</b>
Digestate treatment	na	Centrifuged in glass centrifuge bottle	7000 g, 10 min	2100 g, 25 min	10000 rpm, 15 min	7000 g, 10 min	3000 g, 5 min	Dialysis
Filtration	na	na	na	na	0.45 µm filter	na	na	na
Analytical technique	AAS	ETAAS (Cd, Pb), DCP-AES (Cu, Fe, Zn)	AAS	ICP-AES	HG-ICP-AES	ICP-AES	ICP-MS	ICP-AES (Cd, Pb), HAAS (As)
Reference	(Miller <i>et al.</i> , 1981)	(Crews <i>et al.</i> , 1985)	(Rotard <i>et al.</i> , 1995; Oomen <i>et al.</i> , 2002)	(Ruby <i>et al.</i> , 1996)	(Rodriguez <i>et al.</i> , 1999)	(Oomen <i>et al.</i> , 2002)	(Rotard <i>et al.</i> , 1995; Oomen <i>et al.</i> , 2002)	(Minekus <i>et al.</i> , 1995; Oomen <i>et al.</i> , 2002)

AAS, atomic absorption spectroscopy; DCP-AES, direct current plasma-atomic emission spectroscopy; ETAAS, electrothermal atomisation atomic absorption spectroscopy ; HG-ICP-AES, hydride generation-inductively coupled plasma-atomic emission spectroscopy; ICP-AES, inductively coupled plasma-atomic emission spectroscopy; ICP-MS, inductively coupled plasma-mass spectrometry.

#### (5) Mouth compartment

As the pH of saliva is close to neutral, it is not expected to facilitate significant metal dissolution from soil or food samples. For most approaches, it is assumed that saliva has only a negligible effect on the level of mobilization of contaminants (Oomen *et al.*, 2002) therefore in most cases only simulated gastric and intestinal juice extractions have been performed.

#### (6) Enzymes

The major enzyme involved in gastric juice extraction comprises a solution containing pepsin with concentrations in the range 1.25–10 mg/mL. The enzyme is prepared in a dilute hydrochloric acid solution with the pH of the solution being adjusted in the range 1.1 to 4.0 across the different approaches. Intestinal enzymes mainly include pancreatin and bile salt. Pancreatin is a mixture of the fat dissolving enzyme (lipase), the protein enzyme (protease), and an enzyme to breakdown carbohydrates (amylase). Bile salts act to help dissolve fat and aid in absorption in the small intestine. The pH of intestinal juice is maintained in the range 5.0 to 8.0.

#### (7) Separation prior to analysis

Prior to analysis the metals released into solution need to be separated from each simulated gastrointestinal stage. The approaches used may include centrifugation, filtration and/or dialysis. The choice and the use of these approaches may also influence the recovery of metals and will need to be considered in developing of robust approaches.

#### (8) Analytical techniques

The soluble fractions obtained from each simulated extraction step are subsequently determined by appropriate analytical techniques such as flame, hydride or graphite furnace atomic absorption spectroscopy (AAS), inductively coupled plasma-atomic emission spectroscopy (ICP-AES), or inductively coupled plasma-mass spectrometry (ICP-MS).

### ***Validity of methods for measuring bioaccessibility***

A number of different *in vitro* test methods are available to measure the bioaccessibility of metals from soil and food samples, but the results are not generally comparable between methods, particularly when the tests are applied by different laboratories. Some models aim to simulate very different conditions, e.g. pica behaviour with low or high solid-to-solution ratios, fast conditions and fed conditions. As the *in vitro* model is based on human physiology, data from animal studies (*in vivo*) should be used to check the predictive value of the models. Quantitative validation of the *in vitro* test is needed prior to application of the approach either on specific samples or in a general study. At present, the validation of the approaches is incomplete due to the lack of sufficient *in vivo* data, and the lack of suitable certified reference materials (CRMs) for human bioaccessibility studies.

Some validated data is available for As and Pb. A validation of the *in vitro* (method E, Table 1.3) approach for predicting As in contaminated soils and solid media against a young swine model has been published (Rodriguez *et al.*, 1999). The correlation between results from this test and the *in vivo* data showed good agreement for both the stomach and intestinal extraction phase, so this approach could be used to establish bioaccessibility of As. Another *in vitro* approach (method D, Table 1.3) was also investigated in comparison with *in vivo* studies (Ruby *et al.*, 1996). The study indicated good predictive ability for Pb i.e. the results were linearly correlated with *in vivo* results. In addition, method D (Table 1.3) was demonstrated to be highly reproducible for As in several different laboratories (Kelley *et al.*, 2002).

### **1.8 Legislation regarding metal pollution**

There are a number of national and international legislations regarding metal pollution. Most of the legislations do not directly address metal contamination of the soil but a result of protecting other environment compartments, e.g. air and water. The 1998 Protocol to the 1979 Convention on Long-Range Transboundary Air Pollution (CLRTAP), an important United Nations agreement that has successfully reduced damage to human health and the environment caused by transboundary pollution (Anderson, 2003). The CLRTAP agreement has 49 Parties, and 36 of these have signed the 1998 Protocol on heavy metals. The protocol targets three

transboundary pollutants airborne across national borders; Cd, Pb and Hg. The UK signed the Protocol on 24<sup>th</sup> June 1998, making a commitment to reduce annual airborne emissions of the three metals to below 1990 levels and applying controls to several stationary sources and products containing the pollutants (DEFRA, 2002a).

The European Union has developed legislation which regulates heavy metals in the form of EU Directives. The Framework Directive 96/62/EC set out a common strategy to define and set objectives for ambient air quality (Anderson, 2003). There are three so-called Daughter Directives that specified limit values for various substances identified in the Framework Directive as below;

- Directive 1999/30/EC relating to limit values for sulphur dioxide, nitrogen dioxide and oxides of nitrogen, particulate matter and lead. A limit value for lead is 500 ng/m<sup>3</sup> which was specified based on WHO guidelines;
- Directive 2000/69/EC relating to limit values for benzene and carbon monoxide and,
- Directive 2002/3/EC relating to ozone in ambient air

Recently, the European Commission has prepared a proposal for a 4<sup>th</sup> Daughter Directive on heavy metals covering the remaining substances identified in the Framework Directive i.e. As, Cd, Hg, Ni and polycyclic aromatic hydrocarbons (PAH). The target values for As, Cd and Ni concentrations are shown in Table 1.4. Member States are required to provide reports on the measurement of ambient air quality according to the specifications laid out in the directive.

**Table 1.4** Fourth Daughter Directive target values for arsenic, cadmium and nickel concentrations

<b>Pollutant</b>	<b>Target value (ng/m<sup>3</sup>)</b>
Arsenic	6
Cadmium	5
Nickel	20

In the UK, the Environmental Protection Act 1990 regulates the pollution control of all environmental media. It exists in eight parts but only part IIA has significant implications for land pollution. The contaminated land regime set out in Part IIA was introduced in England on 1 April 2000, in Scotland on 14 July 2000, and on 1 July 2001 in Wales. Part IIA creates a new framework to identify and clean up (known as remediation) of contaminated land, where contamination poses unacceptable risks to human health or the environment. The regime is jointly regulated by local authorities (LA's) and the Environment Agency (or the Scottish Environmental Protection Agency (SEPA) in Scotland). Local authorities are the primary regulators and take the lead role. Land is defined as 'Contaminated Land' if there is a "significant pollutant linkage" present. There must be evidence of a 'contaminant-pathway-receptor' relationship which means there should be a contaminant present, a receptor that could be harmed by the contaminant, for example humans, and a pathway linking the two.

The only legal requirement in the UK relating to the metal content of agricultural soils are those contained in the *Sludge (Use in Agriculture) Regulations 1989 as amended 1990* (DEFRA, 2004). These regulations prohibit the use of sewage sludge when certain concentrations are exceeded. Subsequently they have been adopted as guidance figures for agricultural land in general in the *MAFF Soil Code of Good Agricultural Practice*. In this publication farmers and land managers are advised to seek advice if soil metal concentrations are approached or exceed the limits.

### **Soil guideline values**

In the UK, soil guideline values (SGVs) have been developed for a range of metals/metalloids in order to assess the risk to humans. In selecting the potential contaminants to be explored two criteria have been used (DEFRA/EA, 2002b):

- 1) contaminants should be commonly found on many sites and at concentrations likely to cause harm, and
- 2) contaminants that show a potential risk to humans and / or have the potential to cause issues associated with natural waters, ecosystem or the integrity of buildings.



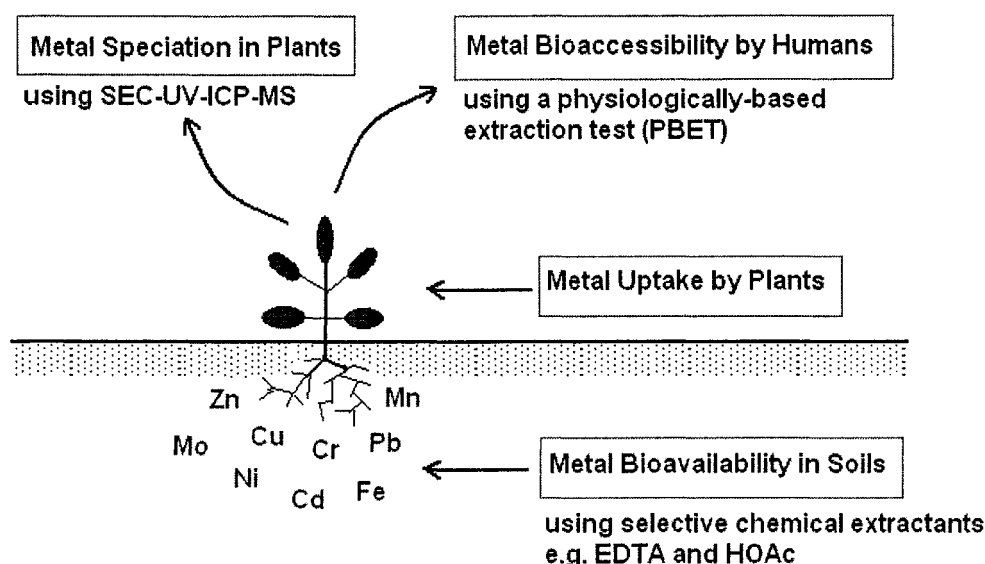
**Table 1.5** Soil guideline values (SGVs, in mg/kg DW soil) according to land use for selected metals. NB: \* values alter with respect to pH; 1, 2 and 8 mg/kg DW soil for pH 6, 7 and 8, respectively.

<b>Metals / Metalloid</b>	<b>Standard land use</b>				<b>Reference</b>
	Residential with plant uptake	Residential without plant uptake	Allotments	Commercial / industrial	
As	20	20	20	500	(DEFRA/EA, 2002c)
Cd	1-8*	30	1-8*	1400	(DEFRA/EA, 2002d)
Cr	130	200	130	5000	(DEFRA/EA, 2002e)
Pb	450	450	450	750	(DEFRA/EA, 2002f)
Hg	8	15	8	480	(DEFRA/EA, 2002g)
Ni	50	75	50	5000	(DEFRA/EA, 2002h)
Se	35	260	35	5000	(DEFRA/EA, 2002i)

Soil guideline values represent ‘intervention values’ i.e. an indicator that a soil concentration above the stated level might provide an unacceptable risk to humans and that further investigation and/or remediation is required (Dean, 2007). As well as the numerical values associated with the concentration of the contaminant, limits are indicated for a range of land uses. The standard land uses defined are residential, allotments and commercial / industrial. Soil guideline values, according to the different land uses, for selected metals are shown in Table 1.5.

## 1.9 Aims of the study

There are four sub-experiments in this study as presented in Figure 1.7 consisting of metal bioavailability in soils, uptake and accumulation of metals in plants grown on the contaminated soils, metal speciation in plants, and human bioaccessibility of metals in plants.



**Figure 1.7** Overview of the study

These experiments are designed to achieve the following aims;

- 1) To determine metal bioavailability in soils using a range of chemical extractions
- 2) To assess the uptake and accumulation of metals in plants grown on metal contaminated soils
- 3) To relate metal bioavailability in the contaminated soils with the amount accumulated in the plants grown on the soils
- 4) To study metal species distribution in the plants using Size Exclusion Chromatography (SEC) with online detection by Inductively Coupled Plasma - Mass Spectrometry (ICP-MS), and characterize the metal species using Nanospray Mass Spectrometry
- 5) To evaluate the *in vitro* gastrointestinal extraction as a technique for assessing human bioaccessibility of metals in the plants

### 1.10 References

- Alloway, B. J. (1995). Soil Processes and the Behaviour of Heavy Metals. in Alloway, B. J. (Ed.) *Heavy Metals in Soils*. Glasgow: Blackie Academic & Professional.
- Alloway, B. J. (2004). 'Zinc in Soils and Crop Nutrition', International Zinc Association', Available at: [http://www.zinc-crops.org/Crops/Alloway-PDF/ALLOWAY\\_PRINT.pdf](http://www.zinc-crops.org/Crops/Alloway-PDF/ALLOWAY_PRINT.pdf) (Accessed: 8 March 2007).
- Anderson, D. (2003). 'Introduction to Heavy Metal Monitoring', Centre for Ecology & Hydrology', Available at: [http://www.heavymetals.ceh.ac.uk/resources/CEH\\_hm\\_intro.PDF](http://www.heavymetals.ceh.ac.uk/resources/CEH_hm_intro.PDF) (Accessed: 2 March 2007).
- Antoniadis, V. (1998), '*Heavy Metal Availability and Mobility in Sewage Sludge-Treated Soils*', PhD Thesis, The University of Reading, Department of Soil Science.
- Bahemuka, T. E., and Mubofu, E. B. (1999). 'Heavy Metals in Edible Green Vegetables Grown Along the Sites of the Sinza and Msimbazi Rivers in Dar Es Salaam, Tanzania', *Food Chemistry*, 66, 63-66.
- Baird, C. (1999). *Environmental Chemistry*. 2nd Ed. New York: W.H. Freeman and Company.
- Bennett, B. G. (1981). '*Exposure Commitment Assessments of Environmental Pollutants Vol. 1, No.1*'. London: University of London. (MARC Report Number 23).
- Bigham, J. M. (1996). *Methods of Soil Analysis Part 3 Chemical Methods*. Sparks, D. L., Page, A. L., Helmke, P. A., Leppert, R. H., Soltanpour, P. N., Tabatabai, M. A., Johnston, C. T. and Summer, M. E. (Ed.) Wisconsin: Soil Science Society of America, Inc.
- Bohn, H. L., McNeal, B. L., and O'Connor, G. A. (2001). *Soil Chemistry*. 3rd Ed. New York: John Wiley & Sons.

Boyd, E. M. (1973). *Toxicity of Pure Foods*. Ohio: The CRC Press Inc.

Browning, E. (1969). *Toxicity of Industrial Metals*. 2nd Ed. London: Butterworths.

Cai, Y., and Ma, L. Q. (2003). 'Metal Tolerance, Accumulation, and Detoxification in Plants with Emphasis on Arsenic in Terrestrial Plants', American Chemical Society. Available at: <http://lqma.ifas.ufl.edu/Publication/Cai-02.pdf> (Accessed: 12 March 2007).

Calabrese, E. J., Canada, A. T., and Sacco, C. (1985). 'Trace Elements and Public Health', *Annual Review of Public Health*, 6, 131-146.

Caussy, D., Gochfeld, M., Gurzau, E., Neagu, C., and Ruedel, H. (2003). 'Lessons from Case Studies of Metals: Investigating Exposure, Bioavailability, and Risk', *Ecotoxicology and Environmental Safety*, 56, 45-51.

Christensen, T. H. (1984). 'Cadmium Soil Sorption at Low Concentrations: I. Effect of Time, Cadmium Load, pH, and Calcium', *Water, Air, and Soil Pollution*, 21, 105-114.

Chuan, M. C., Shu, G. Y., and Liu, J. C. (1996). 'Solubility of Heavy Metals in a Contaminated Soil: Effects of Redox Potential and pH', *Water, Air and Soil Pollution*, 90, 543-556.

Clemens, S., Palmgren, M. G., and Kramer, U. (2002). 'A Long Way Ahead: Understanding and Engineering Plant Metal Accumulation', *Trends in Plant Science*, 7, 309-315.

Cobb, G. P., Sands, K., Waters, M., Wixson, B. G., and Dorward-King, E. (2000). 'Accumulation of Heavy Metals by Vegetables Grown in Mine Wastes', *Environmental Toxicology and Chemistry*, 19, 600-607.

- Cobbett, C. S. (2000). 'Phytochelatin and Their Roles in Heavy Metal Detoxification', *Plant Physiology*, 123, 825-832.
- Committee on Biologic Effects of Atmospheric Pollutants (1973). *Manganese*. Washington D.C.: National Academy of Sciences.
- Committee on Biologic Effects of Atmospheric Pollutants (1974). *Chromium*. Washington D.C.: National Academy of Sciences.
- Committee on Medical and Biologic Effects of Environmental Pollutants (1975). *Nickel*. Washington D.C.: National Academy of Sciences.
- Committee on Medical and Biologic Effects of Environmental Pollutants (1979). *Iron*. Baltimore: University Park Press.
- Crews, H. M., Burrell, J. A., and McWeeny, D. J. (1985). 'Comparison of Trace Elements Solubility from Food Items Treated Separately and in Combination', *Z Lebensm Unters Forsch*, 180, 405-410.
- Crews, H. M., Burrell, J. A., and McWeeny, D. J. (1983). 'Preliminary Enzymolysis Studies on Trace Element Extractability from Food', *Journal of the Science of Food and Agriculture*, 34, 997-1004.
- Cruz, B. H., Diaz-Cruz, J. M., Sestakova, I., Velek, J., Arino, C., and Esteban, M. (2002). 'Differential Pulse Voltammetric Study of the Complexation of Cd(II) by the Phytochelatin (Gamma-Glu-Cys)(2)Gly Assisted by Multivariate Curve Resolution', *Journal of Electroanalytical Chemistry*, 520, 111-118.
- Cui, Y.-J., Zhu, Y.-G., Zhai, R.-H., Chen, D.-Y., Huang, Y.-Z., Qiu, Y., and Liang, J.-Z. (2004). 'Transfer of Metals from Soil to Vegetables in an Area near a Smelter in Nanning, China', *Environment International*, 30, 785-791.

Dean, J. R. (2007). *Bioavailability, Bioaccessibility and Mobility of Environmental Contaminants*. Chichester: John Wiley & Sons.

DEFRA (Department for Environment, Food and Rural Affairs) (2002a). '*UK Prepares to Ratify Protocol on Air Pollutants*', Available at: <http://www.defra.gov.uk/news/2002/020320a.htm> (Accessed: 20 January 2007).

DEFRA (Department for Environment, Food and Rural Affairs) (2004). '*Contamination of Agricultural Land & Part IIA of the Environmental Protection Act 1990*', Contaminated land branch. Available at: <http://www.defra.gov.uk/environment/land/contaminated/pdf/clan4-04.pdf> (Accessed: 1 January 2007).

DEFRA/EA (Department for Environment, Food and Rural Affairs and the Environment Agency) (2002b). '*Potential Contaminants for the Assessment of Land*', R&D Publication CLR 8, Environment Agency.

DEFRA/EA (Department for Environment, Food and Rural Affairs and the Environment Agency) (2002c). '*Soil Guidelines Values for Arsenic Contamination*', R&D Publication SGV 1, Environment Agency.

DEFRA/EA (Department for Environment, Food and Rural Affairs and the Environment Agency) (2002d). '*Soil Guidelines Values for Cadmium Contamination*', R&D Publication SGV 3, Environment Agency.

DEFRA/EA (Department for Environment, Food and Rural Affairs and the Environment Agency) (2002e). '*Soil Guidelines Values for Chromium Contamination*', R&D Publication SGV 4, Environment Agency.

DEFRA/EA (Department for Environment, Food and Rural Affairs and the Environment Agency) (2002f). '*Soil Guidelines Values for Lead Contamination*', R&D Publication SGV 10, Environment Agency.

DEFRA/EA (Department for Environment, Food and Rural Affairs and the Environment Agency) (2002g). '*Soil Guidelines Values for Inorganic Mercury Contamination*', R&D Publication SGV 5, Environment Agency.

DEFRA/EA (Department for Environment, Food and Rural Affairs and the Environment Agency) (2002h). '*Soil Guidelines Values for Nickel Contamination*', R&D Publication SGV 7, Environment Agency.

DEFRA/EA (Department for Environment, Food and Rural Affairs and the Environment Agency) (2002i). '*Soil Guidelines Values for Selenium Contamination*', R&D Publication SGV 9, Environment Agency.

Dudka, S., Piotrowska, M., and Terelak, H. (1996). 'Transfer of Cadmium, Lead, and Zinc from Industrially Contaminated Soil to Crop Plants: A Field Study', *Environmental Pollution*, 94, 181-188.

Eisler, R. (1998a). '*Copper Hazards to Fish, Wildlife, and Invertebrates: A Synoptic Review*'. MD: U.S. Geological Survey, Biological Resources Division. (Biological Science Report USGS/BRD/BSR--1998--0002).

Eisler, R. (1998b). '*Nickel Hazards to Fish, Wildlife, and Invertebrates: A Synoptic Review*'. MD: U.S. Geological Survey. (Contaminant Hazard Reviews Report No.34).

Evans, L. J. (1989). 'Chemistry of Metal Retention by Soils', *Environmental Science and Technology*, 23, 1046-1056.

Evans, L. J., Spiers, G. A., and Zhao, G. (1995). 'Chemical Aspects of Heavy Metal Solubility with Reference to Sewage Sludge Amended Soils', *International Journal of Environmental Analytical Chemistry*, 59, 291-302.

Geogopoulos, P. G., Roy, A., Yonone-Lioy, M. J., Opiekun, R. E., and Lioy, P. J. (2001). 'Copper: Environmental Dynamics and Human Exposure Issues', The International Copper Association, Environmental and Occupational Health Sciences

Institute (EOHHSI). Available at:

[http://ccl.rutgers.edu/reports/ICA/ICA2002\\_copper1.pdf](http://ccl.rutgers.edu/reports/ICA/ICA2002_copper1.pdf) (Accessed: 10 January 2007).

Grace, S. (2004). 'Introduction to Botany', University of Arkansas at Little Rock, Available at: <http://www.ualr.edu/~botany/images.html#Roots> (Accessed: 23 February 2007).

Hack, A., and Selenka, F. (1996). 'Mobilization of PAH and PCB from Contaminated Soil Using a Digestive Tract Model', *Toxicology Letters*, 88, 199-210.

Halim, M., Conte, P., and Piccolo, A. (2003). 'Potential Availability of Heavy Metals to Phytoextraction from Contaminated Soils Induced by Exogenous Humic Substances', *Chemosphere*, 52, 265-275.

Hall, J. L. (2002). 'Cellular Mechanisms for Heavy Metal Detoxification and Tolerance', *Journal of Experimental Botany*, 53, 1-11.

Hamel, S. C., Buckley, B., and Liroy, P. J. (1998). 'Bioaccessibility of Metals in Soils for Different Liquid to Solid Ratios in Synthetic Gastric Fluid', *Environmental Science and Technology*, 32, 358-362.

Harter, R. D. (1983). 'Effect of Soil pH on Adsorption of Lead, Copper, Zinc and Nickel', *Soil Science Society of America Journal*, 47, 47-51.

Hirata, K., Tsuji, N., and Miyamoto, K. (2005). 'Biosynthetic Regulation of Phytochelatins, Heavy Metal-Binding Peptides', *Journal of Bioscience and Bioengineering*, 100, 593-599.

Hooda, P. S. (1997). 'Plant Availability of Heavy Metals in Soils Previously Amended with Heavy Applications of Sewage Sludge', *Journal of the Science of Food and Agriculture*, 73, 446-454.



Hough, R. L., Breward, N., Young, S. D., Crout, N. M. J., Tye, A. M., Moir, A. M., and Thornton, I. (2004). 'Assessing Potential Risk of Heavy Metal Exposure from Consumption of Home-Produced Vegetables by Urban Populations', *Environmental Health Perspectives*, 112, 215-221.

Irwin, R. J. (1997). 'Environmental Contaminant Encyclopedia Copper Entry', Water Resources Divisions, Water Operations Branch. Available at: <http://www.nature.nps.gov/hazardssafety/toxic/copper.pdf> (Accessed: 15 March 2007).

Kawakami, S. K., Gledhill, M., and Achterberg, E. P. (2006). 'Determination of Phytochelatins and Glutathione in Phytoplankton from Natural Waters Using HPLC with Fluorescence Detection', *Trends in Analytical Chemistry*, 25, 133-142.

Kelley, M. E., Brauning, S. E., Schoof, R. A., and Ruby, M. V. (2002). *Assessing Oral Bioavailability of Metals in Soil*. Ohio: Battelle Press.

Kendall, R. J., Anderson, T. A., Baker, R. J., Bens, C. M., Carr, J. A., Chiodo, L. A., Dickerson, R. L., Dixon, K. R., Frame, L. T., Hooper, M. J., Martin, C. F., McMurry, S. T., Patino, R., Smith, E. E., and Theodorakis, C. W. (2001). 'Ecotoxicology', in Klaassen, C. D. (Ed.) *Toxicology. The Basic Science of Poisons*. New York: McGraw-Hill.

Kimball, J. W. (2004). 'The Pathway of Water', Available at: [http://users.rcn.com/jkimball.ma.ultranet/BiologyPages/X/Xylem.html#The\\_Pathway\\_of\\_Water](http://users.rcn.com/jkimball.ma.ultranet/BiologyPages/X/Xylem.html#The_Pathway_of_Water) (Accessed: 20 March 2007).

Kochian, L. V. (1991). 'Mechanisms of Micronutrient Uptake, Translocation, and Interactions in Plants', in Mortvedt, J. J., Cox, F. R., Shuman, L. M. and Welch, R. M. (Ed.) *Micronutrients in Agriculture*. 2nd Ed. Madison, WI: Soil Science Society of America.

Lee, S.-Z., Chang, L., Yang, H.-H., Chen, C.-M., and Liu, M.-C. (1998). 'Adsorption

Characteristics of Lead onto Soils', *Journal of Hazardous Materials A*, 63, 37-49.

Lesage, E., Meers, E., Vervaeke, P., Lamsal, S., Hopgood, M., Tack, F. M. G., and Verloo, M. G. (2005). 'Enhanced Phytoextraction: II. Effect of EDTA and Citric Acid on Heavy Metal Uptake by *Helianthus Annuus* from a Calcareous Soil', *International Journal of Phytoremediation*, 7, 143-152.

Levy, L. S., Aitken, R. J., Holmes, P., Hughes, J., Hurley, F., Rumsby, P. C., Searl, A., Shuker, L. K., Spurgeon, A., and Warren, F. (2004). '*Occupational Exposure Limits: Criteria Document for Manganese and Inorganic Manganese Compounds*'. Leicester: the Institute for Environment and Health and the Institute of Occupational Medicine. (IEH Web Report W17).

Lindsay, W. L. (1979). *Chemical Equilibria in Soils*. New York: John Wiley & Sons.

Long, X. X., Yang, X. E., Ni, W. Z., Ye, Z. Q., He, Z. L., Calvert, D. V., and Stoffella, J. P. (2003). 'Assessing Zinc Thresholds for Phytotoxicity and Potential Dietary Toxicity in Selected Vegetable Crops', *Communications in Soil Science and Plant Analysis*, 34, 1421-1434.

Marschner, H. (1995). *Mineral Nutrition of Higher Plants*. 2nd Ed. London: Academic Press.

Mattina, M. I., Iannucci-Berger, W., Musante, C., and White, J. C. (2003). 'Concurrent Plant Uptake of Heavy Metals and Persistent Organic Pollutants from Soil', *Environmental Pollution*, 124, 375-378.

McBride, M. B. (1995). 'Toxic Metal Accumulation from Agricultural Use of Sludge: Are USEPA Regulations Protective?' *Journal of Environmental Quality*, 24, 5-18.

McGrath, S. P. (2001). 'How Organisms Live with Heavy Metals in the Environment', The International Council on Metals and the Environment. Available at: [www.icme.com](http://www.icme.com) (Accessed: 1 March 2007).

Mench, M., Vangronsveld, J., Didier, V., and Clijsters, H. (1994). 'Evaluating of Metal Mobility, Plant Availability and Immobilization by Chemical Agents in a Limed-Silty Soil', *Environmental Pollution*, 86, 279-286.

Michalke, B. (2003). 'Element Speciation Definitions, Analytical Methodology, and Some Examples', *Ecotoxicology and Environmental Safety*, 56, 122-139.

Miller, D. D., Schriker, B. R., Rasmussen, R. R., and Campen, D. V. (1981). 'An *in Vitro* Method for Estimation of Iron Availability from Meals', *The American Journal of Clinical Nutrition*, 34, 2248-2256.

Minekus, M., Marteau, P., Havenaar, R., and Veld, J. H. J. H. (1995). 'A Multicompartmental Dynamic Computer-Controlled Model Simulating the Stomach and Small Intestine', *ALTA*, 23, 197-209.

Morabito, R. (1995). 'Extraction Techniques in Speciation Analysis of Environmental Samples', *Fresenius Journal of Analytical Chemistry*, 351, 378-385.

Mortvedt, J. J., Cox, F. R., Shuman, L. M., and Welch, R. M. (1991). *Micronutrients in Agriculture*. 2nd Ed. Soil Science Society of America, Inc.

Muller, M., and Anke, M. (1994). 'Distribution of Cadmium in the Food Chain (Soil-Plant-Human) of a Cadmium Exposed Area and the Health Risks of the General Population', *The Science of the Total Environment*, 156, 151-158.

Nasreddine, L., and Parent-Massin, D. (2002). 'Food Contamination by Metals and Pesticides in the European Union. Should We Worry?' *Toxicology Letters*, 127, 29-41.

National Research Council of the National Academies (2003). *Bioavailability of Contaminants in Soils and Sediments: Process, Tools, and Applications*. Washington D.C.: The National Academic Press.

Nigam, R., Srivastava, S., Prakash, S., and Srivastava, M. M. (2001). 'Cadmium Mobilisation and Plant Availability - the Impact of Organic Acids Commonly Exuded from Roots', *Plant and Soil*, 230, 107-113.

Nolan, A. L., Lombi, E., and McLaughlin, M. J. (2003). 'Metal Bioaccumulation and Toxicity in Soils - Why Bother with Speciation?' *Australian Journal of Chemistry*, 56, 77-91.

Nriagu, J. O. (1984). *Changing Metal Cycles and Human Health*. Berlin: Springer-Verlag.

Oomen, A. G., Hack, A., Minekus, M., Zeijdner, E., Schoeters, G., Verstraete, W., Wiele, T. V. D., Wragg, J., Rompelberg, C. J. M., Sips, A. J. A. M., and Wijnen, J. H. V. (2002). 'Comparison of Five *in Vitro* Digestion Models to Study the Bioaccessibility of Soil Contaminants', *Environmental Science and Technology*, 36, 3326-3334.

Peijnenburg, W. J. G. M., and Jager, T. (2003). 'Monitoring Approaches to Assess Bioaccessibility and Bioavailability of Metals: Matrix Issues', *Ecotoxicology and Environmental Safety*, 56, 63-77.

Polec-Pawlak, K., Ruzik, R., Abramski, K., Ciurzynska, M., and Gawronska, H. (2005). 'Cadmium Speciation in *Arabidopsis Thaliana* as a Strategy to Study Metal Accumulation System in Plants', *Analytica Chimica Acta*, 540, 61-70.

Qiao, L., and Ho, G. (1996). 'The Effect of Clay Amendment on Speciation of Heavy Metals in Sewage Sludge', *Water Science and Technology*, 34, 413-420.

Reichman, S. M. (2002). *The Responses of Plants to Metal Toxicity: A Review Focusing on Copper, Manganese and Zinc*, Melbourne: Australian Minerals & Energy Environment Foundation.

Rieuwerts, J. S., Thornton, I., Farago, M. E., and Ashmore, M. R. (1998). 'Factors Influencing Metal Bioavailability in Soils: Preliminary Investigations for the Development of Critical Loads Approach for Metals', *Chemical Speciation and Bioavailability*, 10, 61-75.

Robertson, G. P., Sollins, P., Ellis, B. G., and Lajtha, K. (1999). *Exchangeable Ions, pH, and Cation Exchange Capacity*. in Robertson, G. P., Coleman, D. C., Bledsoe, C. S. and Sollins, P. (Ed.) New York: Oxford University Press.

Rodriguez, R. R., Basta, N. T., Casteel, S. W., and Pace, L. W. (1999). 'An *in Vitro* Gastrointestinal Method to Estimate Bioavailable Arsenic in Contaminated Soils and Solid Media', *Environmental Science and Technology*, 33, 642-649.

Ross, S. M. (1994). 'Retention, Transformation and Mobility of Toxic Metals in Soils', in Ross, S. M. (Ed.) *Toxic Metals in Soil-Plant Systems*. Chichester: John Wiley & Sons.

Rotard, W., Christmann, W., Knoth, W., and Mailahn, W. (1995). 'Determination of Absorption Availability of PCDD/PCDF from 'Kieselrot' (Red Slag) in the Digestive Tract - Simulation of the Digestion of Technogenic Soil', *UWSF-Z. Umweltchem. Okotox.*, 7, 3-9.

Rowell, D. L. (1994). *Soil Science: Methods and Applications*. Essex: Pearson Education Limited.

Ruby, M. V., Davis, A., Link, T. E., Schoof, R., Chaney, R. L., Freeman, G. B., and Bergstrom, P. (1993). 'Development of an *in Vitro* Screening Test to Evaluate the *in Vivo* Bioaccessibility of Ingested Mine-Waste Lead', *Environmental Science and Technology*, 27, 2870-2877.

Ruby, M. V., Davis, A., Schoof, R., Eberle, S., and Sellstone, C. M. (1996). 'Estimation of Lead and Arsenic Bioavailability Using a Physiologically Based Extraction Test', *Environmental Science and Technology*, 30, 422-430.

- Salomons, W. (1995). 'Environmental Impact of Metals Derived from Mining Activities: Processes, Predictions, Prevention', *Journal of Geochemical Exploration*, 52, 5-23.
- Sanchez-Camazano, M., Sanchez-Martin, M. J., and Lorenzo, L. F. (1994). 'Lead and Cadmium in Soils and Vegetables from Urban Gardens of Salamanca (Spain)', *The Science of the Total Environment*, 146/147, 163-168.
- Sanz-Medel, A., Montes-Bayón, M., and Sánchez, M. L. F. (2003). 'Trace Element Speciation by ICP-MS in Large Biomolecules and Its Potential for Proteomics', *Analytical Bioanalytical Chemistry*, 377, 236-247.
- Sauerbeck, D. R. (1991). 'Plant, Element and Soil Properties Governing Uptake and Availability of Heavy Metals Derived from Sewage Sludge', *Water, Air and Soil Pollution*, 57-58, 227-237.
- Schaecke, W., Tanneberg, H., and Schilling, G. (2002). 'Behaviour of Heavy Metals from Sewage Sludge in a Chernozem of the Dry Belt in Saxony-Anhalt/Germany', *Journal of Plant Nutrition and Soil Science*, 165, 609-617.
- Silveira, M. L. A., Alleoni, L. R. F., and Guilherme, L. R. G. (2003). 'Biosolids and Heavy Metals in Soils', *Scientia Agricola*, 60, 793-806.
- Sims, J. L., and Patrick, W. H. (1978). 'The Distribution of Micronutrient Cations in Soil under Conditions of Varying Redox Potential and pH', *Soil Science Society of America Journal*, 42, 258-262.
- Srivastava, S., Prakash, S., and Srivastava, M. (1999). 'Chromium Mobilisation and Plant Availability - the Impact of Organic Complexation Ligands', *Plant and Soil*, 212, 203-208.
- Szpunar, J. (2000). 'Bio-Inorganic Speciation Analysis by Hyphenated Techniques', *The Analyst*, 125, 963-988.

Szpunar, J., and Lobinski, R. (2003). *Hyphenated Techniques in Speciation Analysis*, Smith, R. M. (Ed.) Cambridge: The Royal Society of Chemistry.

Templeton, D. M., Ariese, F., Cornelis, R., Danielsson, L., Muntau, H., Leeuwen, H. P. V., and Lobinski, R. (2000). 'Guidelines for Terms Related to Chemical Speciation and Fractionation of Elements. Definitions, Structural Aspects, and Methodological Approaches', *Pure and Applied Chemistry*, 72, 1453-1470.

UK Food Standards Agency. (2003). 'Safe Upper Levels for Vitamins and Minerals', Expert Group on Vitamins and Minerals. Available at: <http://www.food.gov.uk/multimedia/pdfs/vitmin2003.pdf> (Accessed: 15 January 2007).

Vacchina, V., Chassaing, H., Oven, M., Zenk, M. H., and Lobinski, R. (1999a). 'Characterisation and Determination of Phytochelatins in Plant Extracts by Electrospray Tandem Mass Spectrometry', *The Analyst*, 124, 1425-1430.

Vacchina, V., Polec, K., and Szpunar, J. (1999b). 'Speciation of Cadmium in Plant Tissues by Size-Exclusion Chromatography with ICP-MS Detection', *Journal of Analytical Atomic Spectrometry*, 14, 1557-1566.

Wase, J., and Forster, C. (1997). *Biosorbents for Metal Ions*. London: Taylor & Francis Ltd.

Watanabe, M. A. (1997). 'Phytoremediation on the Brink of Commercialization', *Environmental Science and Technology*, 31, 182A-186A.

Wolnik, K. A., Fricke, F. L., Capar, S. G., Braude, G. L., Meyer, M. W., Satzger, R. D., and Bonnin, E. (1983). 'Elements in Major Raw Agricultural Crops in the United States. 1. Cadmium and Lead in Lettuce, Peanuts, Potatoes, Soybeans, Sweet Corn, and Wheat', *Journal of Agriculture and Food Chemistry*, 31, 1240-1244.

World Health Organization (WHO). (1989). 'Environmental Health Criteria for Lead', Available at: <http://www.inchem.org/documents/ehc/ehc/ehc85.htm> (Accessed: 1 February 2007).

World Health Organization (WHO). (1998). 'Environmental Health Criteria for Copper', Available at: <http://www.inchem.org/documents/ehc/ehc/ehc221.htm> (Accessed: 1 February 2007).

World Health Organization (WHO). (2001). 'Environmental Health Criteria for Zinc', Available at: <http://www.inchem.org/documents/ehc/ehc/ehc221.htm> (Accessed: 1 February 2007).

World Health Organization (WHO). (2003). 'Chromium in Drinking-Water: Background Document for Development of WHO Guidelines for Drinking-Water Quality'. Available at: [http://www.who.int/water\\_sanitation\\_health/dwq/chemicals/chromium.pdf](http://www.who.int/water_sanitation_health/dwq/chemicals/chromium.pdf) (Accessed: 12 January 2007).

Yang, J. Y., Yang, X. E., He, Z. L., Shentu, J. L., and Stoffella, P. J. (2006). 'Effects of pH, Organic Acids, and Inorganic Ions on Lead Desorption from Soils', *Environmental Pollution*, 143, 9-15.

Zenk, M. H. (1996). 'Heavy Metal Detoxification in Higher Plants - A Review', *Gene*, 179, 21-30.

Zhou, D.-M., Hao, X.-Z., Wang, Y.-J., Dong, Y.-H., and Cang, L. (2005). 'Copper and Zinc Uptake by Radish and Pakchoi as Affected by Application of Livestock and Poultry Manures', *Chemosphere*, 59, 167-175.

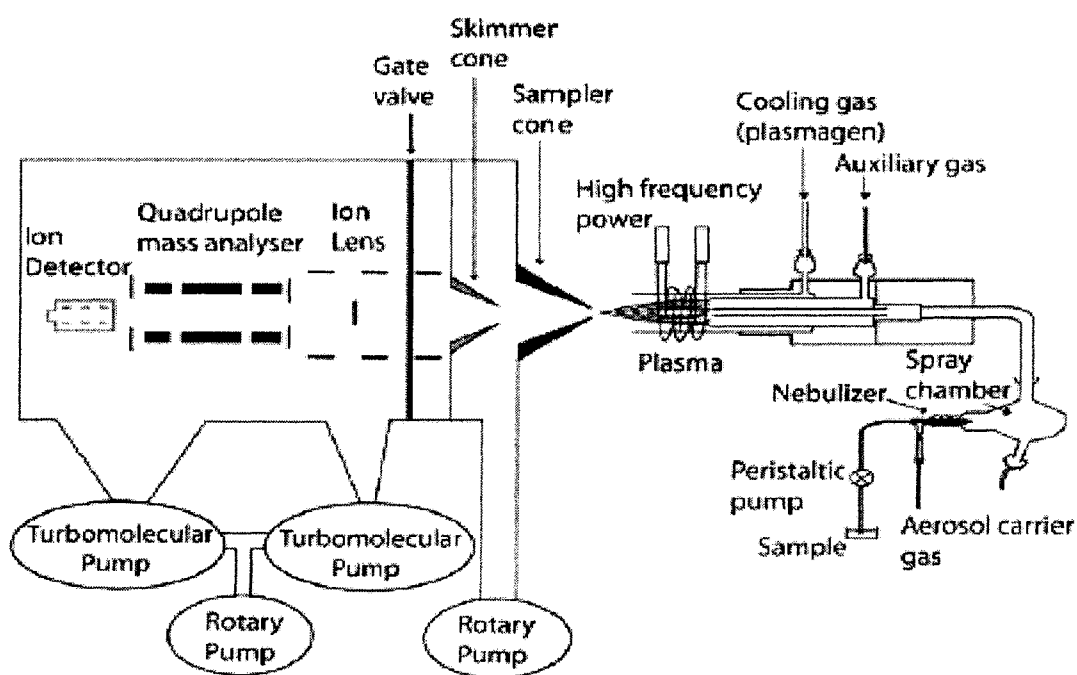


## Chapter 2

### Instrumental techniques applied for metal analysis

#### 2.1 Inductively coupled plasma (ICP-MS)

ICP-MS was developed in the mid 1980s (McCurdy and Potter, 2001) and became a powerful analytical technique for measurement of trace metals. It offers extremely low detection limits in sub-ppt levels with good accuracy and precision, a wide linear dynamic range, and simple spectra. In addition, its unique features include the capability to perform the measurement in multielement analysis mode and to measure individual isotopes of the analyte elements. ICP-MS has been involved in a diverse range of applications e.g. environmental, geological, semiconductor, biomedical, and nuclear application fields (Thomas, 2004). The components of a typical quadrupole ICP-MS are shown in Figure 2.1.



**Figure 2.1** Components of a typical quadrupole ICP-MS (Tylor, 2007)

##### 2.1.1 Sample introduction for ICP-MS

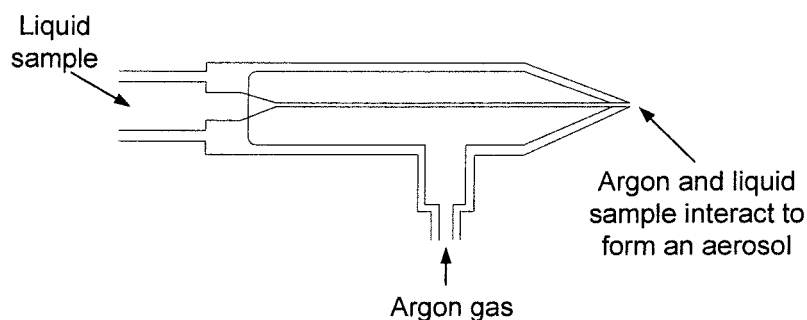
Even though ICP-MS was developed primarily to analyse liquid samples, the technique has been adapted over years to handle gas, solids and slurries (Thomas, 2004). However, some preliminary form of sample preparation is required to modify

the sample prior to introduction by means of dissolution, digestion, filtration, grinding, fusion, polishing (Taylor, 2001). These sample preparation steps will assist in the reproducible presentation of the sample to the plasma for ionization prior to analysis. Gaseous samples can be introduced within the injector gas flow which is considered the most straight forward introduction approach (Taylor, 2001). In addition, this can be done by other different approaches including hydride generation, cold-vapor generation and chromatographic techniques. Solids and slurries are introduced via laser ablation, spark atomization, slurry nebulization and field flow fractionation. The details of these sample introduction systems for gas, solids and slurries are not described in this chapter, as they are outside the scope of the thesis.

For liquid samples, the most common approach to introduce a liquid into an ICP-MS is the combination of a nebulizer and spray chamber. The main function of the sample introduction process is to convert the liquid sample into a fine aerosol, which results in only a small portion (often < 2%) of the sample reaching the ICP. The mechanisms of sample introduction process involve two separate events i.e. aerosol generation using a nebulizer and droplet selection by way of a spray chamber.

### **Nebulizers**

At present, the most common nebulizer design is the pneumatic concentric glass nebulizer (Figure 2.2). It operates according to the Venturi effect principle (Dean, 2005) i.e. argon gas introduced in the side arm is able to exit at the nozzle, hence allowing the development of a region of lower pressure. This results in liquid sample being drawn up through the capillary tube and exiting through the nozzle. The low pressure and high speed of argon gas flow allow a coarse aerosol to be generated.

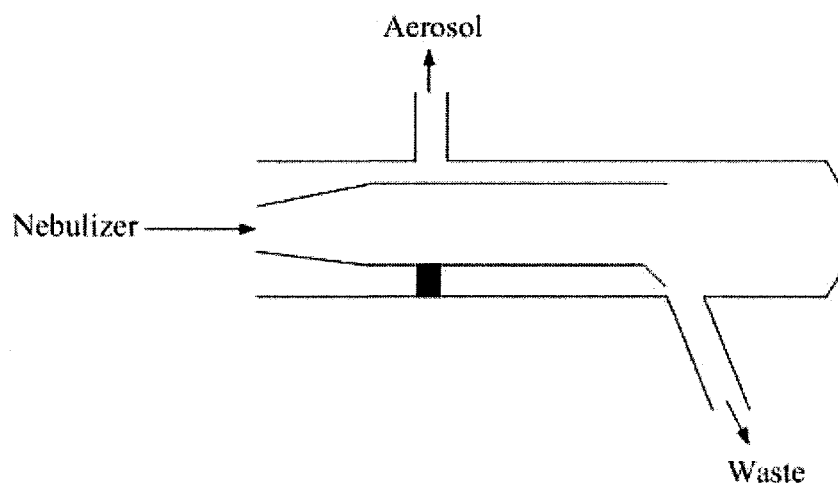


**Figure 2.2** Schematic diagram of a pneumatic concentric nebulizer

## Spray chambers

The coarse aerosol produced by the nebulization process directly enters into the plasma source inducing cooling of the plasma leading to severe matrix interferences (Dean, 2005). The spray chamber performs the function of rejecting the larger aerosol droplets and also smoothing out nebulization pulses produced by the peristaltic pump (Thomas, 2004). There are several designs of spray chamber including double-pass or the Scott design, cyclonic and single-pass or cylindrical type. By far, the double-pass spray chamber is the most common design (Figure 2.3). An ideal spray chamber should have all of the following features (Dean, 2005):

- a large surface area to induce collisions and fragmentation of the coarse aerosol
- minimal dead volume to prevent dilution of the sample
- easy removal of condensed sample to waste without inducing pressure pulsing



**Figure 2.3** Schematic diagram of a double-pass spray chamber (Scott-type)

### 2.1.2 Plasma source

A plasma is defined as an electrically neutral gas made up of positive ions and free electrons of an inert gas, typically argon. It has sufficient high energy to atomize, ionize, and excite virtually all elements in the periodic table (Taylor, 2001). There are many types of plasmas used in atomic spectroscopy e.g. the radiofrequency inductively coupled plasma (ICP), direct-current plasma (DCP), microwave-induced plasma (MIP) and glow discharge. However, the ICP has proved the most useful as an ion source for analytical mass spectrometry because of some limitations of the

other approaches. Thomas (2004) stated that the DCP and MIP instrumentation were prone to interference effects and had some usability and reliability problems; hence the techniques were not widely accepted.

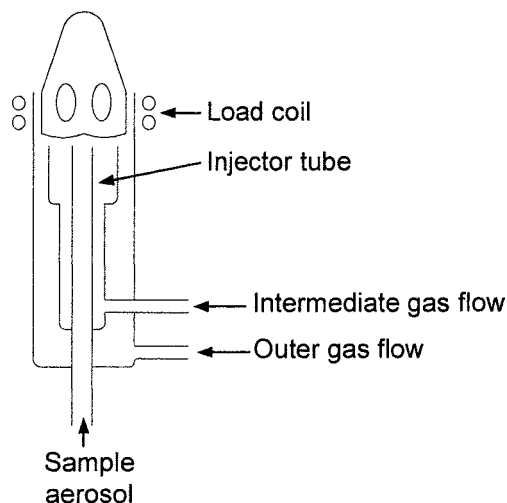
### **Inductively Coupled Plasma (ICP)**

The ICP is formed in a plasma torch consisting of three concentric quartz tubes which are the outer tube, the intermediate and the inner tube (or the sample injector) (Figure 2.4). The sample aerosol from the nebulization / spray chamber is introduced to the plasma through the inner tube consisting of a capillary tube. A coolant gas (argon) is introduced through the external tube having tangentially arranged entry points. The intermediate between the sample injector and the outer tube is used for the introduction of an auxiliary flow of argon gas to assist in the formation of the plasma and force the plasma away from the tip of the injector (Taylor, 2001). The plasma torch is mounted horizontally and positioned centrally in the copper load coil which is connected to a radio frequency (RF) generator. Power input to the ICP is applied to the load coil, typically in the range 0.5 – 1.5 kW at a frequency of 27 or 40 MHz (Dean, 2005) producing an intense electromagnetic field. In order to initiate the plasma, a high-voltage spark is applied to the argon carrier gas flowing through the torch causing collisions and ionization of the argon gas and the plasma is ignited at the open end of the torch. Temperature in the plasma can be as high as 10,000 K at the outer regions of the plasma. In contrast, the central region of the plasma where the sample is introduced has much lower temperature, usually in the range from 6500 to 7050 K (Thomas, 2004).

#### **2.1.3 Interfaces**

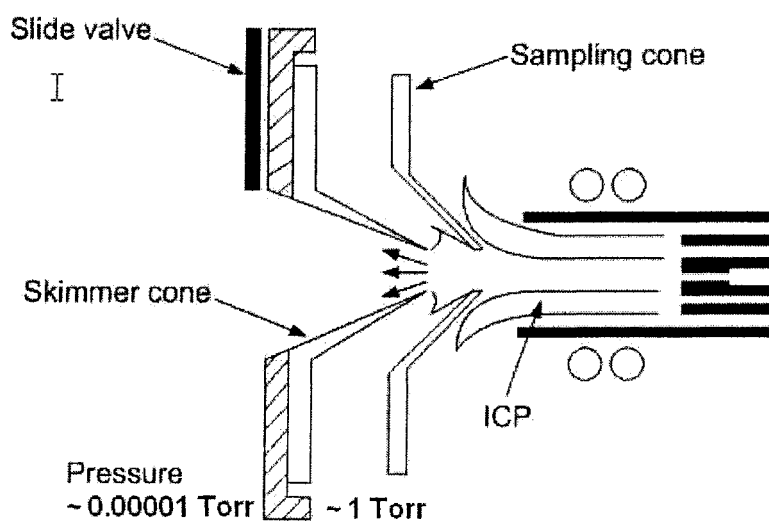
The role of the interface region is to efficiently transfer the ions produced in the plasma which is at atmospheric pressure (760 Torr) to a high vacuum mass analyzer (at approximately  $10^{-5}$  Torr) where they are isolated and their concentrations in the ion beam are measured. A typical ICP-MS interface is shown in Figure 2.5. The interface consists of two metallic cones i.e. a water-cooled outer sampling cone which is positioned in the plasma, and an additional cone called a skimmer cone positioned behind the sampling cone a few millimetres. The sampling cone which has an orifice of 0.8 – 1.2 mm i.d. is typically made of nickel because of its high thermal

conductivity and relative resistance to corrosion and its robust nature (Dean, 2005). The ions generated in the plasma pass into the first cone through the small orifice of the cone and they are transported to the skimmer cone which has a smaller orifice (typically made of nickel with a 0.4 – 0.8 mm i.d.).



**Figure 2.4** Schematic diagram of an ICP torch and load coil

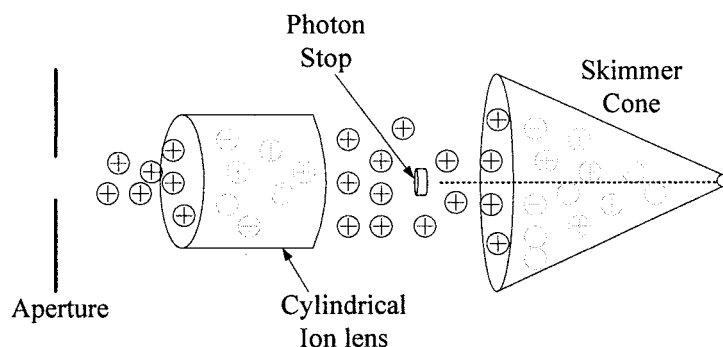
The region between the sampling and skimmer cones is maintained at about 1 Torr using a mechanical pump, while the region behind the skimmer cone is reduced to approximately  $10^{-5}$  Torr with a turbomolecular pump.



**Figure 2.5** Schematic diagram of the ICP – mass spectrometer interface

### 2.1.4 Ion focusing systems

The function of the ion focusing system is to transport the maximum number of analyte ions extracted from the interface region to the mass separation device, while rejecting as many of the matrix components and nonanalyte-based species as possible (Thomas, 2004). This is achieved by using a series of electrostatic lenses called ion optics which are mounted between the skimmer cone and mass separation device. A turbomolecular pump is used to maintain the operating vacuum in this region. A schematic diagram of a typical ion lenses configuration is shown in Figure 2.6. The photon stop is the first component of an ion lens placed behind the skimmer cone. This stop prevents photons, particulates and neutral species entering the mass analyzer, but allows the positive analyte ions to move around it. It is highly undesirable for photons to reach the electron multiplier detector because they can significantly increase the background signal (Taylor, 2001). The electrostatic lens which has a positive charge serves to collimate the ion beam and focus it into the entrance aperture of the mass analyser.



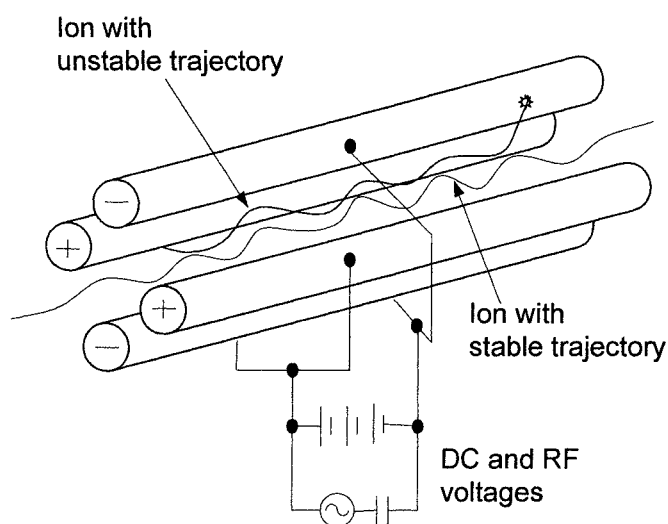
**Figure 2.6** Typical ion lenses configuration in ICP-MS

### 2.1.5 Mass spectrometers

Once the analyte ions exit the ion optics, they are then guided into the mass spectrometer which is positioned between the ion optics and the detector. The ions are separated according to their mass-to-charge ratio by the mass analyzer maintained at a vacuum of approximately  $10^{-6}$  Torr with an additional turbomolecular pump to the one that is used for the lens chamber (Thomas, 2004). Basically, three different types of mass analyzer are commercially available i.e. quadrupole mass spectrometer, sector-field mass spectrometer, and time of flight.

### Quadrupole mass spectrometer

Quadrupole mass spectrometer was the first to be commercialized in the early 1980s and is still the most common mass filter used in ICP-MS. It consists of four straight metal rods (typically 15 – 20 cm in length and about 1 cm in diameter) positioned parallel to and equidistant from the central axis (Figure 2.7) (Dean, 2005). Both a direct current (DC) field and a radio frequency (RF) voltage is applied to opposite pairs of the rods, affecting the trajectory of ions travelling down the flight path centred between the four rods. By selecting the appropriate DC and RF voltages on each pair of rods, ions of a given mass/charge ratio will be allowed to pass through the quadrupole analyser to the detector. Other ions of different mass/charge ratio will not be detected; they are unstable, collide with the rods and are rejected from the quadrupole.

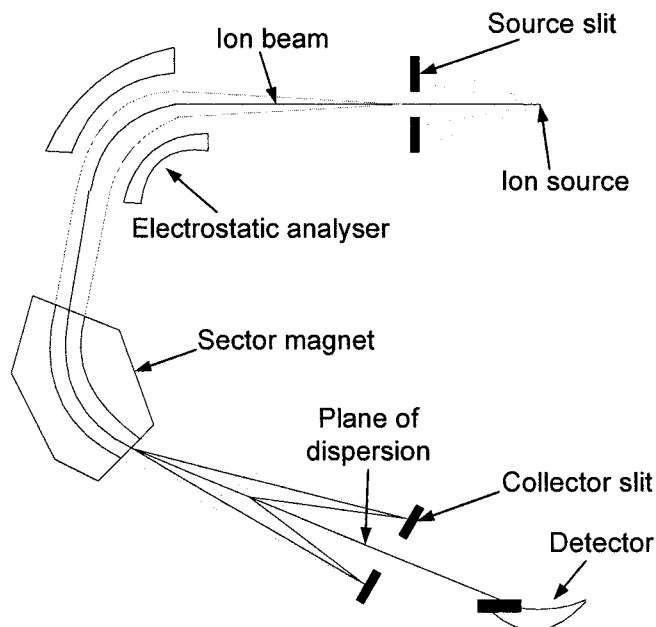


**Figure 2.7** The quadrupole analyzer arrangement

### Sector-field mass spectrometer

The lack of resolution for a quadrupole instrument (i.e. limited to unit-mass resolution) led to the development of a high resolution mass spectrometer based on a double-focusing geometry, which requires a magnetic and an electric-sector field. This system, as shown in Figure 2.8, consists of an electrostatic analyser (ESA) and a magnetic analyser. The ESA is used to filter the ions according to their kinetic energy, irrespective of their  $m/z$ , and the magnetic analyser is used to separate ions according to their  $m/z$ . Hence, this high-resolution mass analyser is able to focus both the energy and  $m/z$  ratio. In addition to both analysers, the crucial aspect of the high-

resolution instrument is the introduction of narrow entry and exit slits which control the number of ions entering to the detector at any one time (Dean, 2005). Consequently, mass resolution can be increased up to 10,000 amu allowing elimination of many polyatomic interferences.



**Figure 2.8** The layout of a high-resolution, double-focusing mass spectrometer

### Time-of-flight mass spectrometer

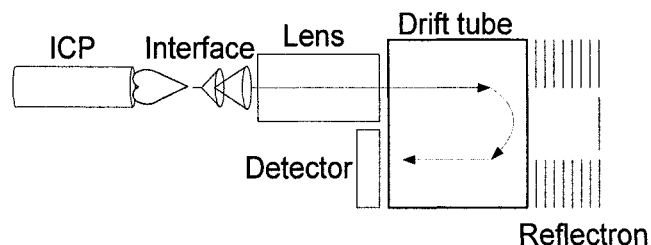
A time-of-flight (TOF) does not rely on magnetic, electrostatic or an RF field to filter ions of different  $m/z$  ratios, but based on the principle that the kinetic energy (KE) of an ion is directly proportional to its mass ( $m$ ) and velocity ( $V$ ) as shown in the following equation (Thomas, 2004):

$$KE = \frac{1}{2} mV^2 \quad (2.1)$$

The lighter ions, which are travelling faster, reach the detector before the heavier ions. As a population of ions with different  $m/z$  ratios has the same kinetic energy given by an accelerating voltage, each ion will travel through the time-of-flight spectrometer at a different velocity based on its mass, as a result be separated from other different ions.



In order to improve resolution of the TOF mass analyser, the drift path length is increased by the introduction of an ion reflector or 'reflectron'. This reverses the flow direction of the ions, as well as doubling the flight path.



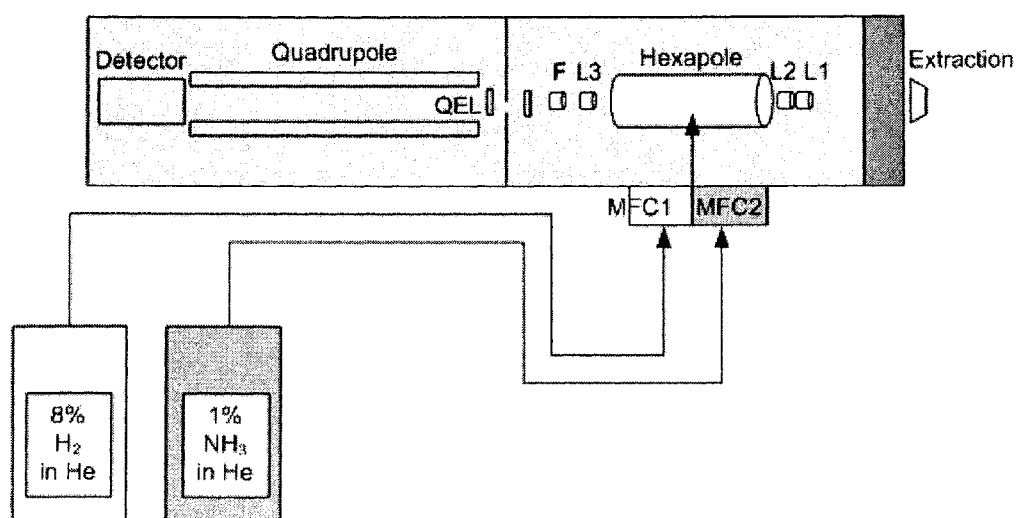
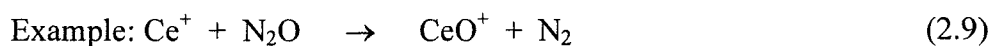
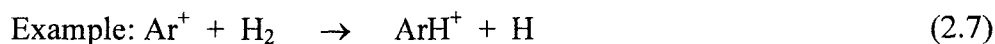
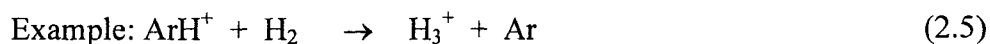
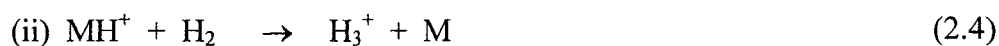
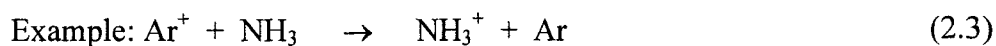
**Figure 2.9** The layout of time-of-flight mass spectrometer

### 2.1.6 Reaction/collision cells

The reaction/collision cell technology (CCT) has been developed for ICP-MS to remove or minimize polyatomic spectral interferences generated by ions derived from the plasma gas, matrix components, or the solvent/acid used in sample preparation. Examples of these interferences include  $^{40}\text{Ar}^{16}\text{O}^+$  on the determination of  $^{56}\text{Fe}^+$ ;  $^{38}\text{ArH}^+$  on the determination of  $^{39}\text{K}^+$ ;  $^{40}\text{Ar}^+$  on the determination of  $^{40}\text{Ca}^+$ ;  $^{40}\text{Ar}^{40}\text{Ar}^+$  on the determination of  $^{80}\text{Se}^+$ ;  $^{40}\text{Ar}^{35}\text{Cl}^+$  on the determination of  $^{75}\text{As}^+$ ;  $^{40}\text{Ar}^{12}\text{C}^+$  on the determination of  $^{52}\text{Cr}^+$ ; and  $^{35}\text{Cl}^{16}\text{O}^+$  on the determination of  $^{51}\text{V}^+$  (Thomas, 2004).

The reaction/collision cell is mounted in the mass spectrometer, normally located between the ion lenses and the mass analyser. The layout of a typical reaction/collision cell is shown in Figure 2.10. A gas filled multipole (hexapole) is responsible for the removal of the interferences by converting to harmless non-interfering species. Ions of interest will be free from interference and emerge from the reaction/collision cell, where they are then guided to the quadrupole for mass separation as the normal manner. A number of reaction mechanisms have been proved to take place: (i) charge transfer reactions; (ii) proton transfer; (iii) hydrogen atom transfer; and (iv) atom transfer as the following (M, interferent; X, reagent gas; H, hydrogen; O, Oxygen) (Iglesias *et al.*, 2002).



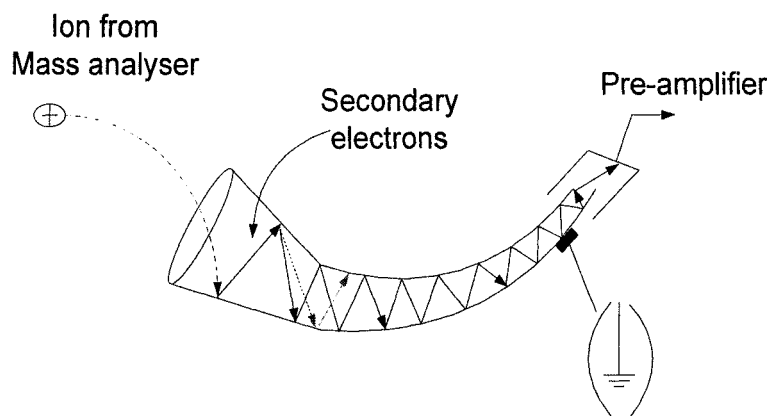


**Figure 2.10** The layout of a typical collision cell technology instrument (L1, L2, and L3 is lenses 1, 2, and 3, respectively; F is focusing lenses; QEL is quadrupole extraction lenses; and MFC1 and MFC2 is mass flow controller 1 and 2, respectively)

### 2.1.7 Detectors

For ultra-trace analysis, a continuous dynode electron multiplier (Figure 2.11) is the most widely used detector of ICP-MS systems. It performs the function of converting ion currents emerging from the mass analyser into a measurable electrical current. The detector consists of an open tube with a wide entrance cone, with the inside of the tube being coated with a lead oxide semi-conducting material. A high negative potential (e.g. -3 kV) to attract positive ions is applied at the entrance and the cone is kept 'at ground' near the collector (Dean, 2005). An ion emerging from the mass analyser is attracted to the high negative potential of the cone. When the ion collides at the surface inside the tube, one or more secondary electrons are formed. These

secondary electrons are attracted towards the grounded collector within the tube. As these electrons collide with the surface coating, more secondary electrons are ejected. This multiplication of electrons is repeated until all of the electrons (up to  $10^8$  electrons) are collected. This pulse of electrons is further detected by a very fast pre-amplifier and recorded as a number of ion 'counts per second'.



**Figure 2.11** Schematic diagram of a continuous dynode electron multiplier

When ion currents exceed  $10^6$  cps, a Faraday cup detector, which is an analogue detector consisting of a metallic cup to collect the ion beam, is used to measure high ion currents directly (Taylor, 2001). There is no control over the applied voltage with this detector, so they can only be used for high ion currents i.e. their lower working range is in the order of  $10^4$  cps (Thomas, 2004).

### 2.1.8 Methods of quantitation

Quantitation is the process to determine analyte concentrations in unknown samples. In ICP-MS, a range of quantitation techniques are applicable including external standardization, standard addition, isotope dilution and internal standardization.

#### External standardization

External standardization is the most straightforward quantitation technique involving measuring a blank solution followed by a series of standard solutions that approximate the concentration of the analyte. Typically, a blank and up to five standards containing different analyte concentrations are measured followed by the unknown samples. A calibration curve over the anticipated calibration range is created by plotting ion intensity (counts per second) of the elements of interest

against concentrations of the analyte in the standards. The intensities of the unknown samples are read against the calibration curve. However, this type of calibration is usually applied when there is little difference between the standard and the sample.

### **Standard addition**

This mode of calibration is used to minimize sample-specific matrix effects by spiking samples with known concentrations of analytes (Thomas, 2004). Hence, a calibration curve is established with the same matrix of the unknown sample. The procedure involves preparing a minimum of three known quantity spiked additions of the analyte to equal aliquots of the sample (Taylor, 2001). Under identical analysis conditions, the intensity responses for the spiked samples with an unspiked aliquot of the sample are measured. The calibration curve is plotted between the ion intensity for the analyte in each sample and the concentration of the analyte added in the spiked sample.

### **Isotope dilution**

The ratio of two stable isotopes of an element can be determined by independently measuring their ion current. The isotope ratio is then calculated by dividing one m/z isotope ion current by the other m/z isotope ion current. The isotope dilution quantitation is based on the precise spiking of an accurately known quantity of an enriched stable isotope of the analyte of interest to the unknown sample. By measuring the modified analyte isotope ratio, the concentration of the analyte in the original sample can be determined by the isotope dilution equation as follows (Thomas, 2004):

$$C_{\text{analyte}} = \frac{[A_{\text{spike}} - (R \times B_{\text{spike}})] \times W_{\text{spike}}}{[R \times (B_{\text{sample}} - A_{\text{sample}})] \times W_{\text{sample}}} \quad (2.10)$$

Where

- $C_{\text{analyte}}$  = concentration of the analyte in the original sample
- $A_{\text{spike}}$  = % of higher abundance isotope in spiked enriched isotope
- $B_{\text{spike}}$  = % of lower abundance isotope in spiked enriched isotope
- $W_{\text{spike}}$  = weight of spiked enriched isotope

$R$  = ratio of the % of higher abundance isotope to lower abundance isotope in the spiked sample

$B_{\text{sample}}$  = % of higher natural abundance isotope in sample

$A_{\text{sample}}$  = % of lower natural abundance isotope in sample

$W_{\text{sample}}$  = weight of sample

The isotope dilution technique is extremely accurate as the results are based on measuring the two isotope solutions at the same time. This compensates for imprecision of the signal from sample introduction-related noise such as plasma instability, peristaltic pump pulsations, and nebulization fluctuations. However, the technique has some limitations including the following:

- The analyte of interest must have more than one isotope. Unfortunately, there are several elements that are monoisotopic e.g.  $^9\text{Be}$ ,  $^{23}\text{Na}$ ,  $^{27}\text{Al}$ ,  $^{55}\text{Mn}$ , and  $^{75}\text{As}$
- Certified enriched isotopic standards are required.
- It does not compensate for spectral interferences, and then an external blank solution must always be measured.

### **Internal standardization**

The use of an internal standard is helpful for drift correction in analyte sensitivity caused by variations in the concentration and type of matrix components found in the sample. An internal standard is a non-analyte isotope that is added to blank solutions, and all samples and standards at a fixed known concentration before analysis (Thomas, 2004). After acquiring ion current data, changes in the ratios of the internal standard intensities are then used to correct the analyte concentrations in the samples. The most appropriate internal standard element is one that is closely located to the analyte in the mass spectrum as it is selected based on the similarity of ionization characteristic to the analyte. For optimal results, three or four internal standard elements are added to the blank, samples and standards when the multi-element analysis covering a wide mass range is performed. The element isotopes that have been used as internal standards include  $^{72}\text{Ge}$ ,  $^{74}\text{Ge}$ ,  $^{113}\text{In}$ ,  $^{115}\text{In}$ ,  $^{103}\text{Rh}$ ,  $^{45}\text{Sc}$ ,  $^{159}\text{Tb}$ ,  $^{169}\text{Th}$ , and  $^{89}\text{Yt}$ .

### 2.1.9 Interferences

Potential interferences in the ICP-MS can be broadly classified, according to their origin, into spectral (isobaric and molecular) and non-spectral. However, the most common problem encountered using quadrupole mass analyser is related to the relatively large number of spectral interferences (Majidi, 2004). Spectral interferences are produced by the high excitation temperatures attained in the ICP. Despite the high temperature in the ICP, molecular ions originating from the plasma gas (Ar), entrained air, the solvent/acids used to prepare the sample generate in the ICP and their signal may complicate the mass spectrum and analyte quantitation to a large extent (Vanhaecke and Kollensperger, 2003).

#### Isobaric interferences

These types of interferences occur as a result of different isotopes of other elements in the sample creating spectral interferences at the same mass as the analyte. To obtain the most sensitive analysis, the most abundant isotope for a given element should be selected. However, an alternative isotope will be used when the isobaric interference exists. For example, the most abundant isotope of zinc is  $^{64}\text{Zn}$  (48.9%). But nickel occurs at the same mass, even though it is only 0.9% abundant, and will interfere with the trace analysis of zinc. Thus, an alternative mass,  $^{66}\text{Zn}$ , which is 27.8% abundant, is selected to prevent isobaric interferences. Selecting a minor isotope for analysis may not be significant if the element is present at a high enough concentration in the sample because of the inherent sensitivity of the ICP-MS (Dean, 2005).

#### Polyatomic (molecular) interferences

Polyatomic interferences are due to the recombination of the element of interest and matrix ions associated with plasma gas, aqueous solution, and acids used in the preparation of sample. The most abundant species in the plasma is the  $^{40}\text{Ar}_2^+$  dimer molecule at  $m/z$  80, second only to the  $^{40}\text{Ar}^+$  ion at  $m/z$  40 (Taylor, 2001). Hence, the analysis of  $^{80}\text{Se}^+$  and  $^{40}\text{Ca}^+$  are interfered. Other molecules can be formed from hydride (H) and hydroxide (OH) originating either from aqueous solution or air, e.g.  $^{40}\text{Ar}^{16}\text{O}^1\text{H}^+$ ,  $^{40}\text{Ar}^1\text{H}^+$ , and  $^{40}\text{Ar}^{16}\text{O}^+$ . While the most common type of acids used including  $\text{HNO}_3$ ,  $\text{HCl}$ ,  $\text{H}_2\text{SO}_4$ ,  $\text{HClO}_4$  and  $\text{HF}$  will generate polyatomic molecules

containing N, O, Cl, S and F. One of the most severe interferences is the overlap of the molecule  $^{40}\text{Ar}^{35}\text{Cl}^+$  with the monoisotopic element  $^{75}\text{As}^+$ .

### **Double charged polyatomic (molecular) interferences**

Another type of molecular interference is derived from the formation of doubly charged species e.g. Ce, La, Sr, Th and Ba. These interferences occur when an ion is generated with a double positive charge as opposed to a normal single charge and produces an isotopic peak at half its mass. For example,  $^{138}\text{Ba}^{2+}$  ion occurs at atomic mass of 69 interfering with the measurement of ion current of  $^{69}\text{Ga}^+$ . Another example is  $^{140}\text{Ce}^{2+}$  ion, which has m/z of 70 and interfere  $^{70}\text{Ge}^+$  and  $^{70}\text{Zn}^+$  measurement. This type of interferences can usually be minimized by careful optimization of the nebulizer gas flow, RF power, and sampling position within the plasma (Thomas, 2004).

### **Non-spectral interferences**

Non-spectral interferences or matrix-induced signal suppression or enhancement can occur either from sample matrix component or physical effects. For example, when high concentrations of acids are aspirated into the plasma, this causes a suppression of the analyte's signal. The reason for matrix induced interferences is not well understood, but it is thought that they are caused by a combination of ionization properties and space charge effects from the ion lenses (Taylor, 2001). In addition, high concentration levels of salts/solids in samples (e.g. sea water) will result in blockage problems in the nebulizer or the build-up of salts/solids on the sampling cone. Aqueous dilution of the sample matrix can be employed to reduce the amount of matrix interferent in the sample. Other possible remedies for these interferences include use of internal standard, choice of nebulizer, matrix-matched standards, and the method of standard additions.

## **2.2 Size exclusion chromatography (SEC) coupled with ICP-MS**

ICP-MS can not be applied for elemental speciation since all molecules of interest introduced into the ICP ion source are broken down into atoms, which are subsequently ionized. However, if the different chemical species can be separated from one another before their introduction into the plasma, then it can be used as a

highly sensitive and element-specific on-line multielement detector (Vanhaecke *et al.*, 2003). Elemental species in biological samples can be separated with diverse principles depending on their various chemical and physiochemical properties (Suzuki, 1998). Separation techniques that have been employed in speciation analyses include gas chromatography (GC), different modes of HPLC, capillary electrophoresis (CE), and supercritical fluid chromatography (SFC). However, separation by SEC, based on the molecular size of the species, is considered as a first approximation to the molecular weight (MW) distribution of the associated species present in the biological samples (Sanz-Medel *et al.*, 2003). In addition, this chromatographic separation technique is able to minimize changes in the existing species as it allows the use of biological buffers and physiological pH in the mobile phase. SEC has the advantage over other HPLC techniques of the high tolerance to biological matrices (Szpunar, 2000). It is a gentle method of chromatographic separation and normally does not result in a loss of element species or on-column alterations (Michalke, 2003). A limitation is the number of theoretical plates in SEC is small. The column shows limited peak capacity arising from the small elution volumes of the peak; thus for a complex multicomponent sample, complete resolution of the peaks is normally not achieved (Szpunar, 2000).

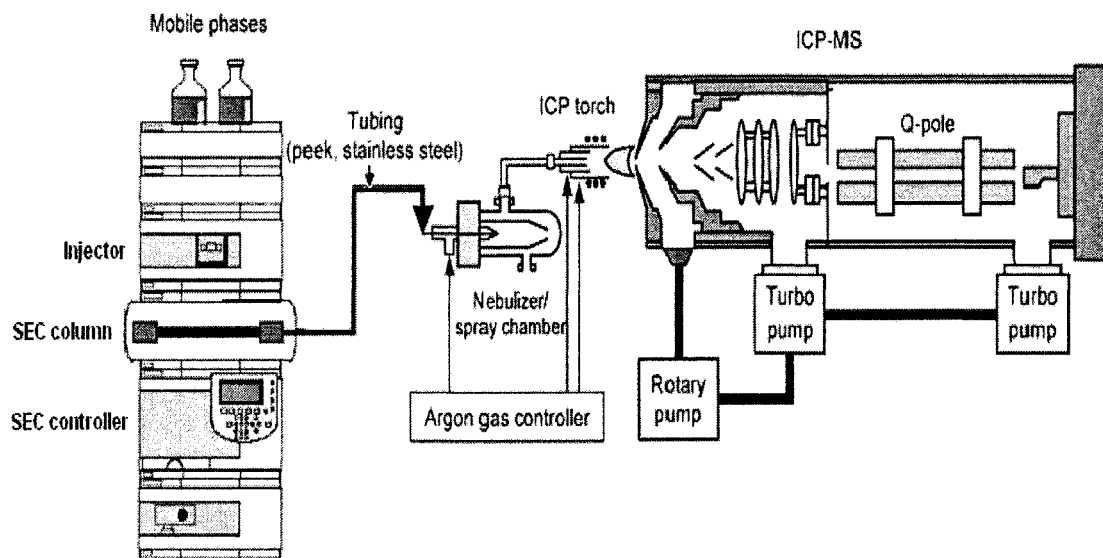
The coupling of SEC to ICP-MS is shown in Figure 2.12. This is achieved through tubing connected between the outlet of SEC column and the inlet of the ICP nebulizer. The main precaution to be taken is that the flow rate of the SEC mobile phase is compatible with the sample uptake rate of the ICP-MS.

### **2.2.1 SEC columns and separation mechanism**

SEC is used to separate molecules according to differences in size as they pass through a medium packed in the column. The application in an aqueous system is referred to as gel filtration, and the application in a non-aqueous system is termed gel permeation chromatography. The media (stationary phases) have been used for separation of peptides / proteins and include dextran or agarose, silica particles and cross-linked polymer resin beads (Harvey, 2000). They are a porous matrix in the form of spherical particles. The average pore size of the media used varies from 100 to 1000 Å (Makarov and Szpunar, 1998). The pore size distribution (uniformity) of



the media is an important criterion for the choice of the stationary phase. The media with high uniformity (low particle size distribution) facilitate the elution of molecules in narrow peaks resulting in high resolution fractionation (Amersham Biosciences, 2002). In addition, they should be chemically stable over a broad pH range during elution with thousands of column volumes of mobile phase.



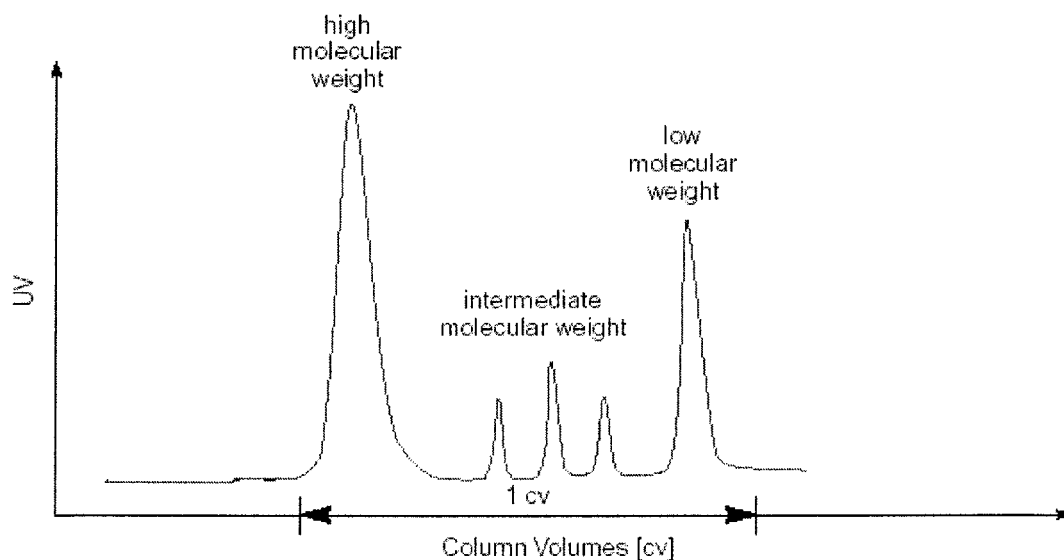
**Figure 2.12** Schematic diagram of the coupling of the SEC-ICP-MS (Sanz-Medel *et al.*, 2003)

The separation mechanism is not based on chemical interactions as in other types of LC but rather on the ability of an analyte (solute) to enter into the pores of the stationary phase (Ackley and Caruso, 2003). Smaller molecules spend proportionally more time within the pores and, consequently, take longer to pass through the gel filtration medium and elute from the column. A typical chromatogram of SEC with UV detection is shown in Figure 2.13.

### 2.2.2 SEC mobile phase and flow rate

An ideal mobile phase in separation by SEC is that it can prevent structural changes, denaturation of proteins and destruction of protein-metal complexes (Michalke and Schramel, 1990) and does not interact with the packing material. In practice, various aqueous mobile phases of fairly high ionic strength have been employed e.g. Tris-

HCl, formate, phosphate and acetate buffer (Makarov *et al.*, 1998). Tris-HCl up to 50 mM was found to be well tolerated by ICP-MS, whereas 50 mM phosphate buffers have been reported to cause the rapid erosion and clogging of the nickel sampling cone (Szpunar and Lobinski, 2003).



**Figure 2.13** Typical chromatogram of SEC with UV detection, adapted from Amersham Biosciences (2001)

In order to achieve a separation, the flow rate of the mobile phase must be optimised to allow time for molecules of interest to diffuse in and out of the column. The entire separation takes place as one column volume of the mobile phase passes through the column. Normally, samples can be eluted isocratically from the SEC column using a single buffer system (Amersham Biosciences, 2002). Typical SEC flow rates of 0.5 – 1.5 mL/min were found to be compatible with the sample uptake rate of the ICP-MS (Szpunar *et al.*, 2003).

### 2.2.3 Detectors

A UV detector is the most common means for visualising a SEC chromatogram (Harvey, 2000). The light source is typically a deuterium lamp providing light intensity from 190 to 400 nm. Many compounds absorb light in this range, including substances having one or more double bonds and those that have unshared electrons, e.g. aromatic and compounds containing C=O, C=S and N=N groups (Scott, 2000).

The wavelength selected for UV detection must provide acceptable absorbance by the compound of interest, combined with acceptable light transmittance by the mobile phase (Snyder *et al.*, 1997). In operating the UV detector, light from the light source is focused into a flow cell, and the transmitted light intensity (I) is measured at the photodetector (a diode). Usually, light from the lamp is also directed to a reference diode for measurement of the original light intensity (I<sub>0</sub>). The signal from the two diodes is converted into absorbance (A) as the equation below:

$$A = \log \frac{I}{I_0} \quad (2.11)$$

According to the Beer-Lambert law as stated in equation (2.12), absorbance (A) of the radiation is proportional to the analyte concentration (C) in the flow cell and the length of the cell (L), where  $\epsilon$  is the analyte molar absorptivity.

$$A = C\epsilon L \quad (2.12)$$

### 2.3 Summary

This chapter has highlighted instrumental techniques mainly applied for metal analysis in this research i.e. the ICP-MS and the SEC coupled with ICP-MS. The main approach to sample introduction system for ICP-MS is via a nebulizer/spray chamber arrangement. The fundamentals of plasma formation and the other important aspects of ICP-MS including interfaces, ion focusing systems, mass spectrometer designs, reaction/collision cells and detectors have been described. In addition, a range of methods of quantitation applicable for ICP-MS and the potential interferences have been discussed. The principle of operation and practical aspects of SEC are also introduced which include SEC columns, separation mechanisms, mobile phase and flow rate, and detectors.

## 2.4 References

Ackley, K. L., and Caruso, J. A. (2003). 'Separation Techniques: Liquid Chromatography', in Cornelis, R., Caruso, J., Crews, H., and Heumann, K. (Ed.) *Handbook of Elemental Speciation: Techniques and Methodology*. Chichester: John Wiley & Sons.

Amersham Biosciences. (2001). 'Protein Purification Handbook', Available at: [www.amershambiosciences.com](http://www.amershambiosciences.com) (Accessed: 5 March 2007).

Amersham Biosciences. (2002). 'Gel Filtration: Principles and Methods', Available at: [www.chromatography.amershambiosciences.com](http://www.chromatography.amershambiosciences.com) (Accessed: 5 March 2007).

Dean, J. R. (2005). *Practical Inductively Coupled Plasma Spectroscopy*. Chichester: John Wiley & Sons.

Harvey, D. (2000). *Modern Analytical Chemistry*. Boston: McGraw-Hill.

Iglesias, M., Gilon, N., Poussel, E., and Mermet, J. (2002). 'Evaluation of an ICP-Collision/Reaction Cell-MS System for the Sensitive Determination of Spectrally Interfered and Non-Interfered Elements Using the Same Gas Conditions', *Journal of Analytical Atomic Spectrometry*, 17, 1240-1247.

Majidi, V. (2004). 'Atomic Spectrometry', in Meyers, R. A. (Ed.) *Encyclopedia of Physical Science and Technology*. 3rd. Ed. Connecticut: Academic Press.

Makarov, A., and Szpunar, J. (1998). 'The Coupling of Size-Exclusion HPLC with ICP-MS in Bioinorganic Analysis', *Analisis Magazine*, 26, M44-M48.

McCurdy, E., and Potter, D. (2001). 'Optimising ICP-MS for the Determination of Trace Metals in High Matrix Samples', *Spectroscopy Europe*, 13, 14-20.

Michalke, B. (2003). 'Element Speciation Definitions, Analytical Methodology, and Some Examples', *Ecotoxicology and Environmental Safety*, 56, 122-139.

Michalke, B., and Schramel, P. (1990). 'Protein Fractionation and Cd-Speciation in Human Breast-Milk by HPLC and Voltammetry', *Journal of Trace Element and Electrolytes in Health and Disease*, 4, 163-167.

Sanz-Medel, A., Montes-Bayón, M., and Sánchez, M. L. F. (2003). 'Trace Element Speciation by ICP-MS in Large Biomolecules and Its Potential for Proteomics', *Analytical Bioanalytical Chemistry*, 377, 236-247.

Scott, R. P. W. (2000). *Encyclopedia of Separation Science. II: Chromatography: Liquid/Detectors: UV/Visible Detection*. Connecticut: Academic Press.

Snyder, L. R., Kirkland, J. J., and Glajch, J. L. (1997). *Practical HPLC Method Development*. 2nd Ed. New York: Wiley Interscience.

Suzuki, K. T. (1998). 'Hyphenated Techniques as Tools for Speciating Biological Metals: Metallothionein and Metal-Binding Proteins', *Analisis Magazine*, 26, M57-M61.

Szpunar, J. (2000). 'Bio-Inorganic Speciation Analysis by Hyphenated Techniques', *The Analyst*, 125, 963-988.

Szpunar, J., and Lobinski, R. (2003). *Hyphenated Techniques in Speciation Analysis*, Smith, R. M. (Ed.) Cambridge: The Royal Society of Chemistry.

Taylor, H. E. (2001). *Inductively Coupled Plasma-Mass Spectrometry*. California: Academic Press.

Thomas, R. (2004). *Practical Guide to ICP-MS*. New York: Marcel Dekker, Inc.

Tylor, G. (2007). 'Technical Note: ICP-OES, ICP-MS and AAS. Techniques Compared', Jobin Yvon S.A.S, Horiba Group. Available at: <http://www.jobinyvon.com/usadivisions/Emission/applications/TN05.pdf> (Accessed: 21 March 2007).

Vanhaecke, F., and Kollensperger, G. (2003). 'Detection by ICP-Mass Spectrometry',  
in Heumann, K. (Ed.) *Handbook of Elemental Speciation: Techniques and  
Methodology*. Chichester: John Wiley & Sons.

## **Section A**

### **Uptake of heavy metals by plants and their bioavailability**

## Chapter 3

### Metal bioavailability in soils

#### 3.1 Introduction

The fraction of heavy metals which can be readily mobilised in the soil environment and taken up by plant roots is considered as the bioavailable fraction. The “bioavailability” concept has been discussed in section 1.3 (Chapter 1). Total metal concentrations in soil do not necessarily correspond with metal bioavailability. The bioavailability to plants of heavy metals depends on a number of physical and chemical factors in the soil (see section 1.4, Chapter 1). These include soil properties e.g. pH, organic matter content, redox potential, cation exchange capacity (CEC), sulphate, carbonate, hydroxide, soil texture and clay content. Apart from these factors, metal absorption by plants is influenced by the characteristics of the plants themselves (Hund-Rinke and Kordel, 2003).

#### Chemical selective extraction

To assess the bioavailability of heavy metals from a contaminated soil to a crop plant, the selection of an extractant which simulates the plant-available fraction of the element is of importance (Helgesen and Larsen, 1998). These extraction procedures are designed to extract element contents correlated with the availability of the element to the plants (Lopez-Sanchez *et al.*, 2002). During recent decades, a large number of extractants have been applied for both single extractions (McGrath, 1996; Hooda, 1997; Quevauviller, 1998; Lu *et al.*, 2003; Chojnacka *et al.*, 2005) and sequential extractions (Tessier *et al.*, 1979; McGrath, 1996; Rauret *et al.*, 1999; Mossop and Davidson, 2003). Single extractions are mainly used to evaluate the exchangeable fraction of elements in soil. The method has been widely employed to predict toxicity and deficiencies in crops and in animals eating such crops (Dean, 2003). Table 3.1 summarises the most frequently used single extractants which correlate to plant uptake. It can be seen from the table that chemical selective extraction covers a large spectrum of extractants. These include chelating agents, such as EDTA and DTPA, neutral unbuffered salt solution, mainly CaCl<sub>2</sub>, NaNO<sub>3</sub> or NH<sub>4</sub>NO<sub>3</sub>, and weak acids such as 2.5% v/v acetic acid. Novozamsky *et al.* (1993) stated that the chelating



agents as their sodium or ammonium salts are widely used as extractants, mainly because of their ability to form very stable, water-soluble and well-defined complexes with a wide range of polyvalent cations. Among the unbuffered salt solutions,  $\text{CaCl}_2$  is preferred as it is a solution which has more or less the same salt concentration (0.01 M) as the average soil solution and  $\text{Ca}^{2+}$  is the dominant cation on the adsorption complex of soils (Novozamsky *et al.*, 1993).

**Table 3.1** Single extraction methods which are diagnostic of plant uptake (Ure, 1996)

Extractant	Element	Correlated plant content
Water	Cd, Cu, Zn	Wheat, lettuce
0.05 mol/L EDTA <sup>a</sup>	Cd, Cu, Ni, Pb, Zn	Arable crops
0.05 mol/L EDTA <sup>a</sup>	Se, Mo	Greenhouse crops
DTPA <sup>b</sup>	Cd, Cu, Fe, Mn, Ni, Zn	Beans, lettuce, maize, sorghum, wheat
2.5% v/v acetic acid	Cd, Co, Cr, Ni, Pb, Zn	Arable crops, herbage
1 mol/L Amm. acetate, pH 7	Mo, Ni, Pb, Zn	Herbage, oats, rice, sorghum, Swiss chard
Amm. acetate/EDTA (0.5 mol/L : 0.02 mol/l)	Cu, Fe, Mn, Zn	Wheat
0.05 mol/L $\text{CaCl}_2$	Cd, Pb	Vegetable
0.1 mol/L $\text{NaNO}_3$	Cd, Pb	Vegetable
1 mol/L Amm. nitrate	Cd, Pb	Vegetable

<sup>a</sup>EDTA, ethylenediaminetetraacetic acid (diammonium salt);

<sup>b</sup>DTPA, 0.005 mol/L diethylenetriaminepentaacetic acid + 0.1 mol/L triethanolamine + 0.01 mol/L  $\text{CaCl}_2$

The use of EDTA has proved to be a more reliable and consistent test in predicting the accumulation of metals in plants compared to DTPA,  $\text{NH}_4\text{NO}_3$  and  $\text{CaCl}_2$  (Hooda, 1997). In general, higher percentages are extracted with EDTA in comparison with DTPA. About 63% of the total Cd in soil was extracted by this medium (Mench *et al.*, 1994). The ability of the extractants to assess the metal bioavailability to plants depends on the extractant used, the metal of interest, the plant species and soil-type variation used in the studies. Thus, not all methods are useful to study all heavy metals under different soil conditions. However, the Standards, Materials and Testing Programme (SM&T) of the European Union have developed the standardised

extraction procedures applied for single extractant including 0.05 mol/L EDTA, 0.43 mol/L acetic acid and 1 mol/L ammonium acetate.

### **Sequential extraction**

Sequential chemical extractions, which are more complicated, have been developed using a series of different reagents to extract metals from soil. The extractions are usually applied to assess metal association with the different solid-phase components in sediments. The procedure under the designed SM&T program of the European Union consists of three main stages, plus a final (residual fraction) stage (Quevauviller, 1998). Stage 1 involves the use of 0.11 mol/L acetic acid which can extract acid-soluble metals; stage 2, 0.5 mol/L hydroxyammoniumchloride, which extracts (reducible phase) metals bound to iron/manganese oxides; and stage 3, 8.8 mol/L hydrogen peroxide and 1 mol/L ammonium acetate (oxidizable phase), for organic matter bound to metals. The final stage (residual fraction), an aqua regia extraction, has been employed to assess the residual fraction. Being operationally-defined procedures, sequential extraction inevitably gives results that are highly dependent on the given parameters of the procedure used, such as the extractant (pH, concentration, type), extraction time and temperature, methods of shaking and phase separation (Shiowatana *et al.*, 2001).

In this study, metal contaminated soils used for growing plants were spiked with the metal salt solutions. The aim of this experiment was to examine the bioavailability of metals to plants from soils contaminated with heavy metals.

## **3.2 Experimental**

### **3.2.1 Chemicals and apparatus**

All chemicals used were of analytical grade. Cadmium (II) nitrate, copper (II) nitrate, iron (III) nitrate, manganese (II) nitrate, zinc (II) nitrate, EDTA, glacial acetic acid, ammonium acetate and concentrated nitric acid were provided by Fisher Scientific (Leicester, UK). Chromium (III) nitrate was obtained from Merck, Darmstadt, Germany. Calcium chloride and nickel (II) nitrate were obtained from Acros Organics (New Jersey, USA). Ammonium molybdate, lead (II) nitrate, concentrated ammonia solution (25%), concentrated hydrochloric acid and 30% hydrogen peroxide were

provided by BDH Chemicals Ltd. (Poole, England). A multi-element standard for K, Ca, Mg, Na, Cr, Mn, Fe, Ni, Cu, Zn, Mo, Cd and Pb and internal standard solutions for Sc, In and Tb were purchased from SPEXCertiPrep (Middlesex, UK). 18.2 M $\Omega$  x cm ultra pure water used was produced by a Direct-Q<sup>TM</sup> Millipore System (Molsheim, France).

Compost soil (Levington multipurpose compost) obtained from a local garden centre was used for preparing metal contaminated soil used in this study. The certified reference material (CRM) used in soil total metal analysis was a sewage sludge (BCR 146R) purchased from the Laboratory of the Government Chemist (LGC), London, UK. The soil certified reference material (CRM) used in selective chemical extraction was an organic-rich soil (BCR 700) for extractable trace elements obtained from the European Commission Community Bureau of Reference (Brussels, Belgium).

All glasswares were cleaned with 10% HNO<sub>3</sub> overnight and rinsed with deionised water 2-3 times before use. An end-over-end shaker (Stuart Rotator SB3) was purchased from Barloworld Scientific Limited, Staffordshire, UK. A reciprocating shaker (HS501 IKA Laboratechnik) was obtained from Scientific Laboratory Supplies, Nottingham, UK. A heating block (2006 Digestor, Foss Tecator, Hoganas, Sweden) was used to digest soil samples for total metal analysis. A pH meter (3010 JENWAY) from VWR international, Leicester, UK. ICP mass spectrometer XSeries II (Thermo Electron Corporation, Cheshire, UK) was used to determine metal concentrations in soil samples. ED-XRF analysis was performed using a Spectro X-Lab 2000 instrument fitted with a Gresham Si(Li) detector from SPECTRO A.I. GmbH & Co. KG, Kleve, Germany.

### **3.2.2 Methodology**

#### **3.2.2.1 Preparation of heavy metal contaminated soils**

Contaminated soils spiked at three concentration levels (low, medium and high) and control soil (unadulterated) were used for this study. A control soil is one to which no spiking of heavy metal had been made. Before spiking, compost soil was passed through a 2 mm sieve and air dried for 48 h. For the low concentration level (approximately 5 times unadulterated concentration), a metal solution at the

approximate levels (50, 400, 3000, 40, 150, 100, 100, 5 and 25 mg/kg for Cr, Mn, Fe, Ni, Cu, Zn, Mo, Cd and Pb, respectively) was prepared to spike into the soil. The soil was weighed, approximately 300 g for each mixing, and placed in a stainless steel tray. Then, the soil was thoroughly mixed with the metal solution to ensure homogeneity and air dried to allow excessive water to evaporate. The spiked soil was left for two weeks before planting to ensure chemical-soil contact. The medium and high concentration level (approximately 10 and 15 times unadulterated concentration, respectively) were prepared in the same manner as described above. The approximate levels of metal contamination in soils prepared are shown in Table 3.2.

**Table 3.2** The approximate levels of metal contamination in soils

Element	Approximate concentration (mg/kg)			
	Control	Low	Medium	High
Cr	10	50	100	150
Mn	80	400	800	1200
Fe	1000	3000	4500	6000
Ni	8	40	80	120
Cu	30	150	300	450
Zn	15	100	200	400
Mo	40	100	200	300
Cd	1	5	10	15
Pb	5	25	50	75

### 3.2.2.2 Reproducibility of the preparation of the spiked compost soils

Sub-samples of the spiked soils (low, medium and high concentration) were collected to assess their mixing reproducibility prior to use for growing plants. The samples were determined for total metal concentrations using Energy Dispersive X-Ray Fluorescence Spectroscopy (ED-XRF).

### 3.2.2.3 Soil characterization

#### Soil pH

The pH was determined in a soil: deionised water suspension 1: 2.5 w/v (Strowbel *et al.*, 2005) as follows; 5 g of soil sample (air dried) was accurately weighed into a 50

mL Sarstedt extraction tube. 12.5 mL of deionised water was added to the soil. The sample was placed on a shaker and agitated at 30 rpm for 10 min. Then, the sample was left to stand for 10 min. A pH meter was calibrated using buffer solutions of pH 4 and 7 and used to measure the pH of the sample.

### **Soil organic matter content**

Soil organic matter content was determined using the method of loss on ignition as described by Baize (1993). 5 g of soil sample (oven dried) was accurately weighed into a pre-weighed crucible. The weight of the soil (W) and the weight of soil plus crucible (W1) were recorded. The sample was placed in a pre-heated muffle furnace (400 °C) for 4 hours. The sample was then removed from the furnace and placed in a desiccator to cool. The sample was re-weighed and the weight was recorded (W2). The soil organic matter (OM) content, expressed as a percentage, was calculated as follows;

$$\text{OM (\%)} = \frac{W1 - W2}{W} \times 100 \quad (3.1)$$

### **Cation exchange capacity (CEC)**

CEC was determined according to the procedure described by Robertson *et al.* (1999). Generally, this involves displacement of ion exchange sites on clay and organic matter surfaces of a soil with ions from an extractant, usually a strong salt solution. The extractant, now containing exchangeable soil ions in addition to ions from the added salt, is separated from soil by filtering or centrifugation and is then analysed for the ions of interest. NH<sub>4</sub>OAc is recommended as a choice of salt solution as it will not interfere with subsequent chemical analysis of the extracted solution and it is also useful because NH<sub>4</sub><sup>+</sup> and acetate ion will volatilize and thus not accumulate on the burners of FAAS/FP (Robertson *et al.*, 1999). Hence, the following procedures were carried out for CEC determination; 4 g sample of fresh sieved soil was weighed into a 50 mL Sarstedt extraction tube. 40 mL of 1 M NH<sub>4</sub>OAc, pH 7.0 (77.1 g NH<sub>4</sub>OAc was added to 950 mL deionised water, adjusted pH to 7.0 with acetic acid or aqueous ammonia, and made up the volume to 1.0 L with deionised water) was added to the sample. The sample was agitated on a shaker at 30 rpm for 1 h, after

which it was centrifuged at 1000 rpm for 10 min. The supernatant was removed and filtered through a Whatman No.41 filter paper for analysis. The cations exchanged ( $K^+$ ,  $Ca^{2+}$ ,  $Mg^{2+}$ , and  $Na^+$ ) were measured by a Flame Atomic Absorption Spectrometer (a Perkin-Elmer Analyst 100, Cambridge, UK) for  $Ca^{2+}/Mg^{2+}$  and a Flame Photometer (Evans Electro Selenium LTD, Essex, UK) for  $Na^+/K^+$ . The CEC was calculated as follows;

***Gravimetric basis – Element mass***

$$\mu\text{g element / g soil} = (C \times V) / W \quad (3.2)$$

where

- C = concentration of ion in extract in mg/L
- V = volume of extractant
- W = dry mass of soil

***Gravimetric basis – Element moles of charge***

$$\text{cmol}_c \text{ element / kg} = (C_g \times n) / (10 \times A) \quad (3.3)$$

where

- $C_g$  = element mass on gravimetric basis, as  $\mu\text{g element / g soil}$
- n = valence of ion
- A = atomic mass of ion

Hence,

$$\text{CEC (cmol}_c \text{ / kg)} = \text{exch } K^+ + \text{exch } Ca^{2+} + \text{exch } Mg^{2+} + \text{exch } Na^+ \quad (3.4)$$

where

exch  $K^+$  etc. = concentrations of individual ions expressed as  $\text{cmol}_c \text{ / kg dry soil}$

**3.2.2.4 Soil extraction procedure for pseudo-total metal analysis**

The standard extraction procedure (Method 3050B – Acid Digestion of Sediments, Sludges and Soils) developed by the USEPA (1996) was employed for pseudo-total metal analysis. Soil samples beneath plant roots were collected when harvesting the plant. 1 g of soil sample (oven dried at 70°C for 48 hours) was accurately weighed into a digestion tube and 10 mL 1:1 v/v concentrated nitric acid: deionised water added. The sample was then heated at 95 °C on a heating block for 15 min without boiling. After cooling at room temperature for 5 min, 5 mL concentrated  $HNO_3$  was added and the sample was heated at 95 °C for 30 min. Additional 5 mL concentrated

HNO<sub>3</sub> was added until no brown fumes were given off. The solution was allowed to evaporate to < 5 mL. After cooling, 2 mL of deionised water and 3 mL of 30% H<sub>2</sub>O<sub>2</sub> were added and heated (< 120 °C) until effervescence subsided and the solution cooled. Additional H<sub>2</sub>O<sub>2</sub> was added until effervescence ceased (but no more than 10 mL H<sub>2</sub>O<sub>2</sub> was added). This stage was continued for 2 h. Then, the solution was allowed to evaporate to < 5 mL. After cooling, 10 mL concentrated HCl was added and the solution was heated (< 120 °C) for 15 min. After cooling, the sample was filtered through Whatman No.41 filter paper into a 100 mL volumetric flask, and then made up to the mark with deionised water.

### **3.2.2.5 Chemical selective extraction**

Chemical selective extractions of the soil were carried out in order to predict the proportion of the total metal content that is available for plant uptake. The following chemicals have been chosen to perform soil extraction: EDTA, CH<sub>3</sub>COOH, CaCl<sub>2</sub> and H<sub>2</sub>O. The extraction protocols using EDTA, CH<sub>3</sub>COOH and CaCl<sub>2</sub> applied in this experiment are based on that developed by the Standard Measurement and Testing Program (formerly BCR) of the European Community (Lopez-Sanchez *et al.*, 2002). However, the CRM (BCR 700) used for method validation and quality control is only available for the EDTA and CH<sub>3</sub>COOH extraction. In order to determine water soluble fraction of the metals, the H<sub>2</sub>O extraction procedure was carried out according to that of the Deutsches Institut fuer Normung (Schramel *et al.*, 2000). A blank extraction (without soil) with each set of analyses was always carried out and corrected for the soil sample measurement. All soil extractable metals were analysed by ICP-MS.

#### **EDTA extraction**

0.05 M EDTA was prepared as ammonium salt solution by adding in a beaker 14.612 g EDTA to 80 mL deionised water. The dissolution was achieved by gradually adding 13 mL of ammonia solution (25%). The solution was then transferred to a 1.0 L polyethylene container and approximately 900 mL of deionised water was added. The pH of the solution was adjusted to 7.00 ± 0.05 by adding a few drops of ammonia or HCl as appropriate and the solution was made up to 1.0 L with deionised water.

2 g of soil sample (oven dried) was weighed into a 50 mL Sarstedt extraction tube and 20 mL of 0.05 M EDTA (pH 7.0) was added. The obtained mixture was shaken in an end-over-end shaker at 30 rpm for 1 h at a room temperature. Immediately, the mixture was centrifuged for 10 min at 3000 rpm and the supernatant was decanted, filtered through a Whatman No.41 filter paper and stored in a polyethylene bottle at 4 °C until analysis.

#### **CH<sub>3</sub>COOH extraction**

0.43 M CH<sub>3</sub>COOH was prepared by adding 25 mL of glacial acetic acid to about 500 mL of deionised water in a 1.0 L polyethylene container. The solution was then made up to 1.0 L with deionised water.

1 g of soil sample (oven dried) was weighed into a 50 mL Sarstedt extraction tube and 40 mL of 0.43 M CH<sub>3</sub>COOH was added. The obtained mixture was shaken in an end-over-end shaker at 30 rpm for 16 h at a room temperature. Immediately, the mixture was centrifuged for 10 min at 3000 rpm and the supernatant was decanted, filtered through a Whatman No.41 filter paper and stored in a polyethylene bottle at 4 °C until analysis.

It is noted that, for EDTA and CH<sub>3</sub>COOH extraction, two types of the shakers i.e. an end-over-end shaker and the reciprocating shaker were applied with the CRM (BCR 700) to compare the extraction results when the different types of shaker applied at the same speed of shaking and the same extraction period.

#### **CaCl<sub>2</sub> extraction**

0.01 M CaCl<sub>2</sub> was prepared by adding 1.47 g CaCl<sub>2</sub>.2H<sub>2</sub>O to a 1.0 L polyethylene container. The solution was then made up to 1.0 L with deionised water.

2 g of soil sample (oven dried) was weighed into a 50 mL Sarstedt extraction tube and 20 mL of 0.01 M CaCl<sub>2</sub> was added. The obtained mixture was shaken in an end-over-end shaker at 30 rpm for 3 h at a room temperature. Immediately, the mixture was centrifuged for 10 min at 3000 rpm and the supernatant was decanted, filtered through



a Whatman No.41 filter paper and stored in a polyethylene bottle. The extracts were analysed by ICP-MS immediately.

### **H<sub>2</sub>O extraction**

2 g of soil sample (oven dried) was weighed into a 50 mL Sarstedt extraction tube and 20 mL of deionised H<sub>2</sub>O was added. The obtained mixture was shaken in an end-over-end shaker at 30 rpm for 24 h at a room temperature. Immediately, the mixture was centrifuged for 10 min at 3000 rpm and the supernatant was decanted, filtered through a Whatman No.41 filter paper and stored in a polyethylene bottle. The extracts were analysed by ICP-MS immediately.

The extraction procedures using EDTA, CH<sub>3</sub>COOH, CaCl<sub>2</sub> and H<sub>2</sub>O are summarized in Table 3.3.

**Table 3.3** Summary of the experimental procedures for the chemical selective extractions applied to the soil samples

<b>Extractant</b>	<b>Phase extracted</b>	<b>Soil: solution ratio (w/v)</b>	<b>Extraction period (h)</b>
0.05 M EDTA, pH 7.0	Organically and carbonate bound fractions	1: 10	1
0.43 M CH <sub>3</sub> COOH, pH 2.7	Exchangeable and carbonate bound fraction	1: 40	16
0.01 M CaCl <sub>2</sub> , pH 5.5	Exchangeable fraction	1: 10	3
Deionised H <sub>2</sub> O, pH 5.5	Water soluble fraction	1: 10	24

### **Sample analysis by ICP-MS**

ICP-MS measurement conditions were optimised daily using the built-in PlasmaLab software procedure. The operating conditions are shown in Table 3.4. Samples of the soil extracts were analysed by ICP-MS using an external calibration technique. Sc, In and Tb internal standard (10 µg/L) were added to all samples, blanks and standard

solutions. The quality control of the measurements was done by measuring CRMs (soil CRMs) every ten samples. A blank was analysed with each analytical batch.

**Table 3.4** Instrumental operating conditions for ICP-MS

ICP-MS conditions	Standard Mode	CCT mode
Forward power	1400 W	1400 W
Cool gas flow	13.0 L/min	13.0 L/min
Auxiliary gas flow	0.90 L/min	0.90 L/min
Nebuliser gas flow	0.80 L/min	0.80 L/min
Collision cell gas	NA	4.50 L/min 7% $H_2$ /93%He
Quadrupole bias	-1.0 V	-14.0 V
Hexapole bias	0.0 V	-15.0 V
Dwell time per isotope	10 ms	10 ms
Isotopes monitored	$^{52}Cr$ , $^{55}Mn$ , $^{56}Fe$ , $^{60}Ni$ , $^{63}Cu$ , $^{66}Zn$ , $^{95}Mo$ , $^{111}Cd$ and $^{208}Pb$	$^{52}Cr$ , $^{55}Mn$ , $^{56}Fe$ , $^{60}Ni$ , $^{63}Cu$ , $^{66}Zn$ , $^{95}Mo$ , $^{111}Cd$ and $^{208}Pb$
Internal standards	$^{45}Sc$ , $^{115}In$ and $^{159}Tb$	$^{45}Sc$ , $^{115}In$ and $^{159}Tb$

### 3.3 Results and discussion

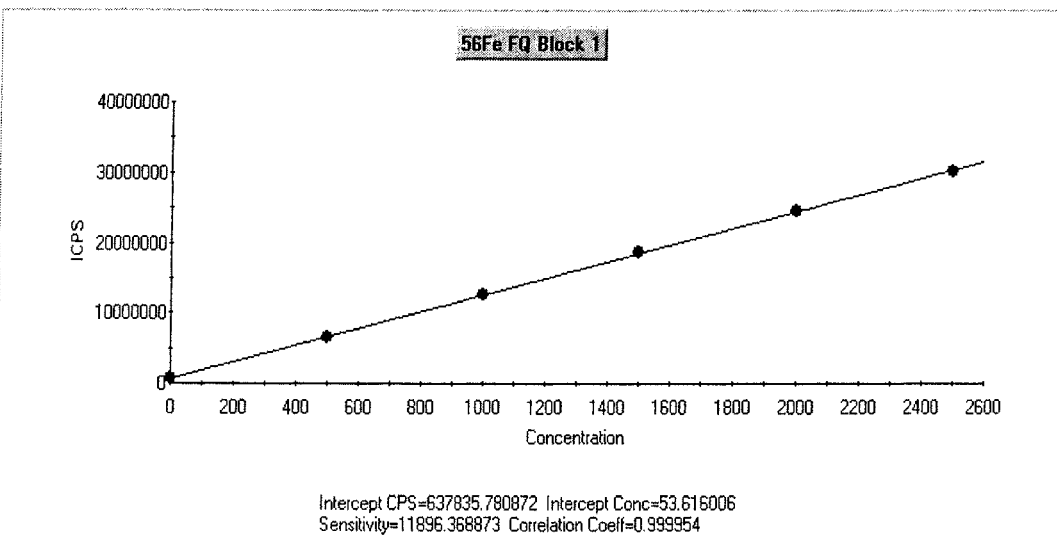
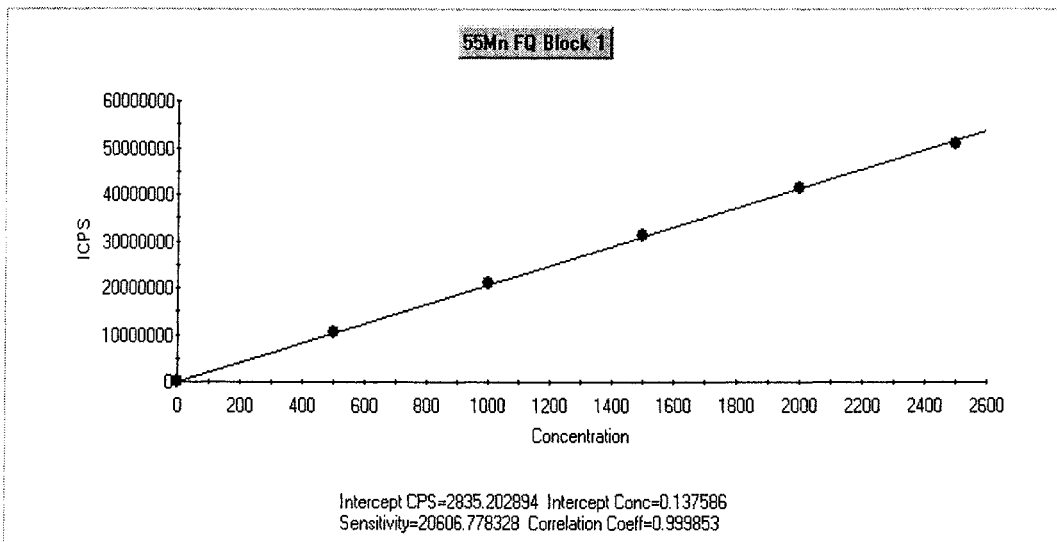
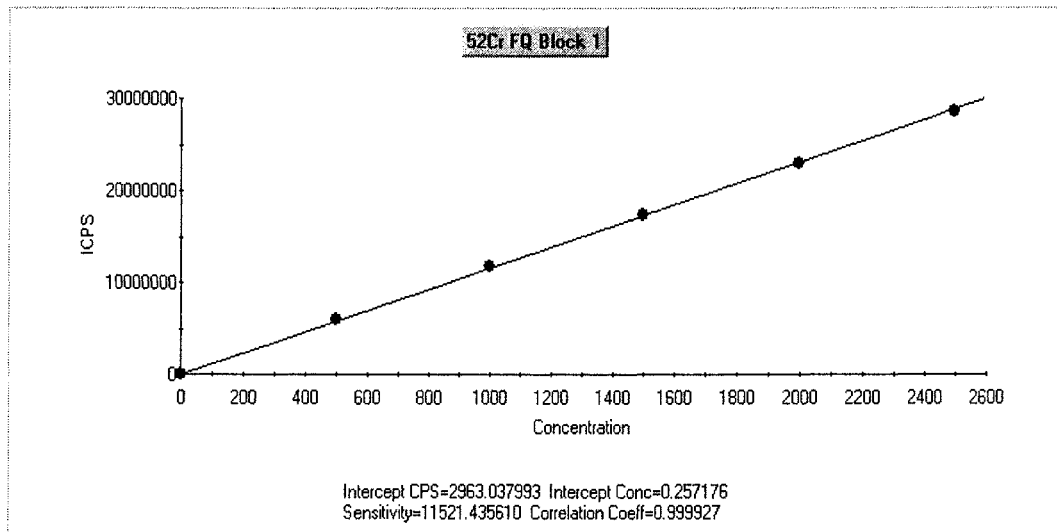
#### 3.3.1 Analytical features of heavy metal determination using ICP-MS

Standard calibration curves were established with six standards, with concentrations ranging from 0.0 to 2.5  $\mu g/mL$ , as shown in Figure 3.1. Detection limits were calculated using the expression  $3.S_{blank} / b$ , where  $S_{blank}$  is the standard deviation of at least seven replicate measurements of blanks and  $b$  is the slope of calibration curve. The detection limit values measured are given in Table 3.5.

**Table 3.5** Detection limits for the ICP-MS in both standard and CCT operating mode

Operating Mode	Detection limits (ng/mL)								
	$^{52}Cr$	$^{55}Mn$	$^{56}Fe$	$^{60}Ni$	$^{63}Cu$	$^{66}Zn$	$^{95}Mo$	$^{111}Cd$	$^{208}Pb$
Standard	1.6	0.5	3.6	8.8	1.8	69	3.5	0.03	0.05
CCT	0.7	0.1	2.5	0.6	0.2	14	1.0	0.04	0.03

**Figure 3.1** Calibration curves of ICP-MS analysis created by plotting ion intensity (ICPS) against ion concentration (ppb) of the standards



**Figure 3.1 (continued)**

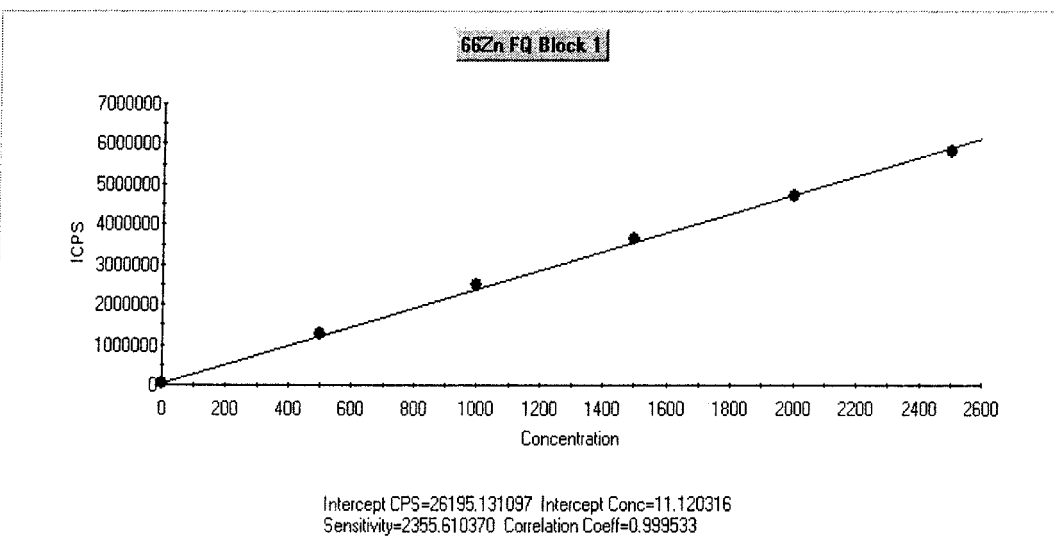
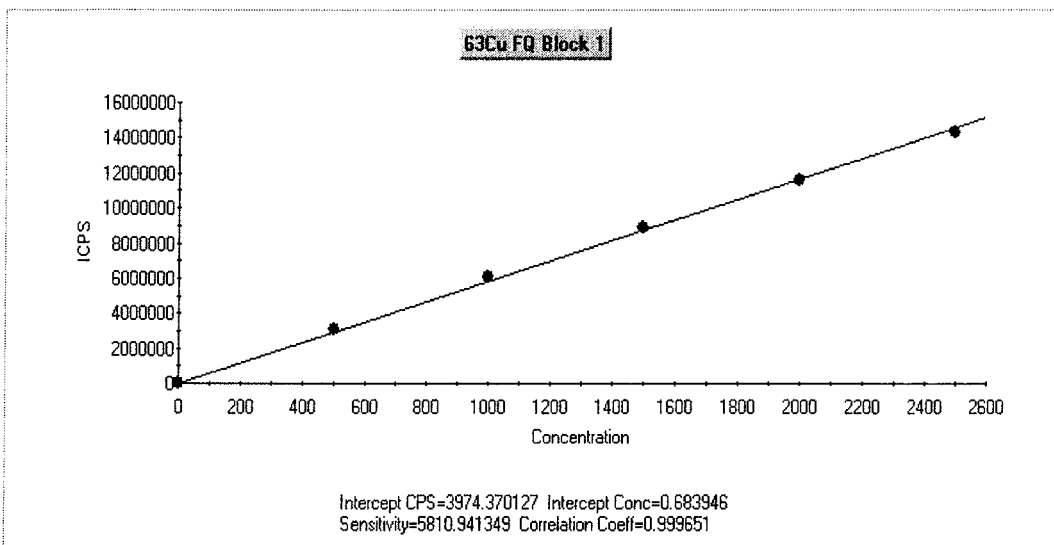
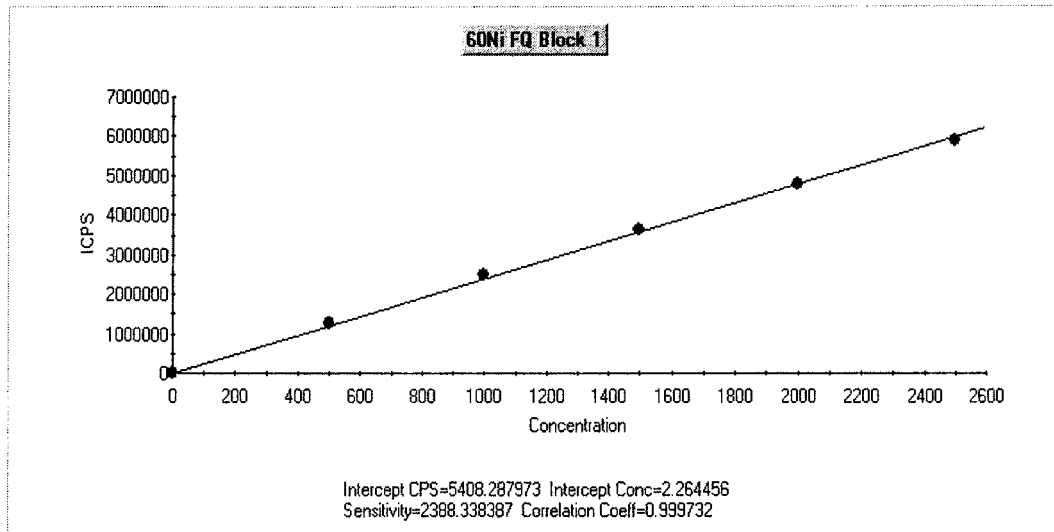
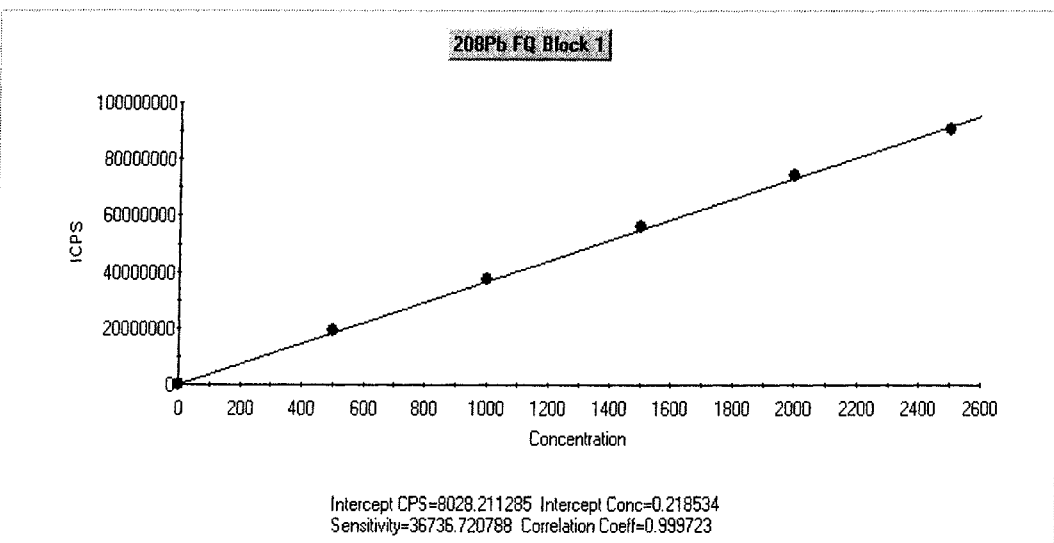
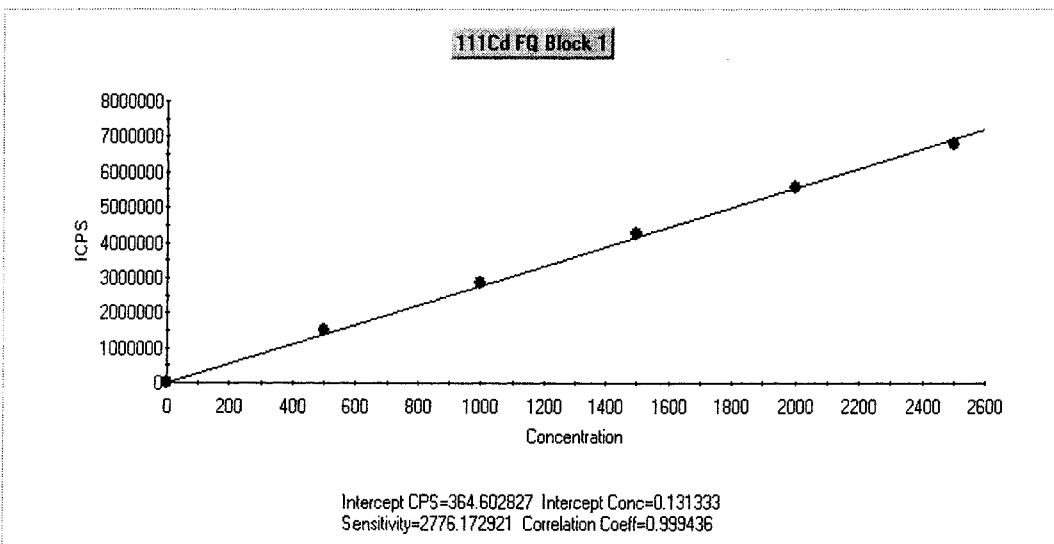
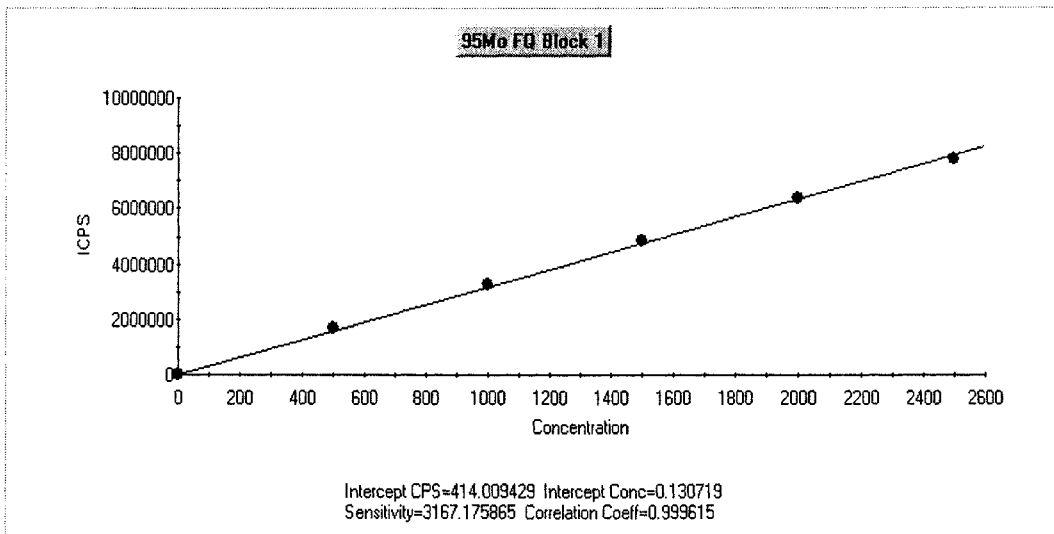


Figure 3.1 (continued)



### 3.3.2 Reproducibility of the preparation of the spiked compost soils

In order to check reproducibility of the preparation of the spiked compost soils, representative sub-samples of the spiked compost were collected at the time of spiking, oven dried at 70 °C for 48 hours and analysed by ED-XRF. Table 3.6 shows the percentage standard deviation (%RSD) of Cr, Mn, Fe, Ni, Cu, Zn, Mo, Cd and Pb of the spiked compost ranged from 8 - 10, 4 - 7, 5 - 10, 4 - 9, 3 - 10, 3 - 8, 8 - 11, 5 - 9 and 5 - 9%, respectively (n = 8). The %RSD was calculated using equation (3.5) where SD is the standard deviation. This implies that the metals added in the compost were evenly distributed, reproducible and appropriate to be used as the metal contaminated soils in this experiment.

$$\%RSD = \frac{SD}{\text{mean}} \times 100 \quad (3.5)$$

**Table 3.6** Metal concentrations in the spiked compost soils analysed by ED-XRF

Element	Metal concentrations in the spiked compost (mg/kg), n = 8					
	Low		Medium		High	
	mean ± SD	%RSD	mean ± SD	%RSD	mean ± SD	%RSD
Cr	53 ± 5	10	119 ± 10	8	171 ± 13	8
Mn	582 ± 33	6	993 ± 67	7	1411 ± 61	4
Fe	4051 ± 270	7	5406 ± 289	5	7334 ± 714	10
Ni	48 ± 4	9	96 ± 4	4	134 ± 6	5
Cu	163 ± 17	10	315 ± 11	3	517 ± 33	6
Zn	162 ± 13	8	332 ± 10	3	472 ± 15	3
Mo	138 ± 11	8	250 ± 20	8	336 ± 36	11
Cd	5.0 ± 0.5	9	11.8 ± 0.8	7	17.6 ± 0.8	5
Pb	31 ± 3	9	54 ± 3	5	91 ± 4	5

### 3.3.3 Soil characterization

The metal contaminated soils used in this study were analysed for organic matter content (%OM), pH and cation exchange capacity (CEC). These data are given in Table 3.7.

### 3.3.4 Total metal determination in soil samples

In order to assess the accuracy of the method, the soil CRM (Sewage sludge, BCR 146R) was acid digested and analysed by ICP-MS in both standard (STD) and collision cell technology (CCT) modes. The values obtained for the CRM are presented in Table 3.8. On the basis of the mean percentage recoveries found in the CRM, the following operating modes were identified as the most appropriate for each element;

*CCT mode:* Cr, Mn, Fe, Ni, Cu, and Zn

*STD mode:* Mo, Cd and Pb

**Table 3.7** Characteristics (mean  $\pm$  SD) of the soil samples used in the study (n = 3)

Soils	pH	% OM	CEC, cmol <sub>c</sub> /kg
Control	5.25 $\pm$ 0.06	94.0 $\pm$ 0.4	109 $\pm$ 3
Low	4.51 $\pm$ 0.03	94.5 $\pm$ 0.6	98 $\pm$ 1
Medium	4.28 $\pm$ 0.03	93.8 $\pm$ 0.4	99 $\pm$ 2
High	4.01 $\pm$ 0.06	93.0 $\pm$ 0.6	102 $\pm$ 2

To determine total metals in spiked soils, all soil samples digested with concentrated HNO<sub>3</sub>, 30% H<sub>2</sub>O<sub>2</sub> and HCl were analysed for total metal concentration using the experimentally determined ICP-MS operating mode conditions as stressed for the CRM. Table 3.9 (A-D) shows mean total metal concentrations (mg/kg, DW) of metal spiked compost used for growing spinach, lettuce, carrot and radish in different treatments including the unadulterated soil (control). The total metal concentrations of the composts under the experiment varied widely from unadulterated-low-medium-high level. Concentrations in the unadulterated treatment ranged from 7.8 – 8.6, 53.3 – 61.1, 688 – 947, 2.1 – 3.8, 34.1 – 39.8, 14.9 – 18.7, 36.3 – 41.4, 0.1 – 0.2 and 4.5 – 5.0 mg/kg (DW) for Cr, Mn, Fe, Ni, Cu, Zn, Mo, Cd and Pb, respectively; the low treatment ranged from 49.6 – 53.2, 348 – 379, 3065 – 3693, 37.7 – 43.7, 135 – 151, 104 – 110, 128 – 138, 5.6 – 6.7 and 27.3 – 29.7 mg/kg (DW) for Cr, Mn, Fe, Ni, Cu, Zn, Mo, Cd and Pb, respectively; the medium treatment ranged from 105 – 118, 704 – 907, 4584 – 5121, 87.6 – 97.2, 239 – 262, 250 – 257, 173 – 183, 12.8 – 15.8 and 51.1

– 60.4 mg/kg (DW) for Cr, Mn, Fe, Ni, Cu, Zn, Mo, Cd and Pb, respectively; and the high treatment ranged from 157 – 194, 1228 – 1308, 5945 – 7219, 99 – 170, 371 – 479, 344 – 413, 301 – 324, 19.7 – 21.9 and 78.3 – 88.2 mg/kg (DW) for Cr, Mn, Fe, Ni, Cu, Zn, Mo, Cd and Pb, respectively.

**Table 3.8** Total metal concentrations (mg/kg, DW) in soil certified reference materials (BCR 146R). NB: Measured values in brackets represent mean percentage recovery

Element	BCR 146R, Sewage sludge		
	Certified value Mean ± SD	Measured value Mean ± SD (n = 14)	
		STD mode	CCT mode
<sup>52</sup> Cr	196 ± 7	171 ± 17 (87)	205 ± 3 (105)
<sup>55</sup> Mn	324 ± 7	297 ± 36 (92)	338 ± 24 (104)
<sup>56</sup> Fe	(17700)	18494 ± 2665 (104)	17941 ± 1455 (101)
<sup>60</sup> Ni	69.7 ± 4.0	78.1 ± 4.0 (112)	71.6 ± 6.5 (103)
<sup>63</sup> Cu	838 ± 16	691 ± 38 (82)	859 ± 54 (103)
<sup>66</sup> Zn	3061 ± 59	2938 ± 252 (96)	3128 ± 200 (102)
<sup>95</sup> Mo	NA	12.1 ± 0.9	11.3 ± 1.0
<sup>111</sup> Cd	18.8 ± 0.5	19.5 ± 1.1 (104)	19.6 ± 0.6 (104)
<sup>208</sup> Pb	609 ± 14	577 ± 22 (95)	641 ± 19 (105)

### 3.3.5 Determination of the extractable soil metals

#### 3.3.5.1 Comparison with indicative values of the CRM

The CRM (organic rich soil, BCR 700) was extracted with EDTA and CH<sub>3</sub>COOH using two different types of the shakers i.e. the reciprocating and end-over-end shakers. The extracts were analysed for their available contents by ICP-MS. Table 3.10 (A-B) shows the CRM values for the EDTA and CH<sub>3</sub>COOH extractable contents of the soil and the obtained results in this study. It is clearly indicated that the end-over-end shaker gave results which are in good agreement with the certified values, whereas the reciprocating shaker gave much lower percentage recoveries compared to the certified values. The results were in accordance with those obtained by the participants in the collaborative studies of the ST&M programme (Lopez-Sanchez *et al.*, 2002). In their technical meeting (Lopez-Sanchez *et al.*, 2002), it was stated that



the results of laboratories using a reciprocating shaker were rejected as the repetition of the analyses clearly showed that it gave systematically low results of the CRM. Hence, it can be concluded that the shaker type was considered to be an important parameter and these extraction procedures can be applied to soil analysis according to the operationally defined procedure e.g. the shaker type and speed, the shaking period and centrifugation or filtration.

**Table 3.9 (A-D)** Mean metal concentrations (mg/kg, DW) of compost for growing spinach, lettuce, carrot and radish in different treatments

(A) Spinach soil

Element	Concentrations (mg/kg, DW), Mean $\pm$ SD, n = 3			
	Control	Low	Medium	High
Cr	8.3 $\pm$ 1.6	52.6 $\pm$ 8.6	117.9 $\pm$ 23.1	193.8 $\pm$ 31.3
Mn	53.3 $\pm$ 7.7	379.2 $\pm$ 54.0	704.3 $\pm$ 48.5	1241.3 $\pm$ 8.4
Fe	858.3 $\pm$ 124.8	3693.3 $\pm$ 599.3	4584 $\pm$ 533.0	6689.7 $\pm$ 641.8
Ni	3.1 $\pm$ 0.6	43.1 $\pm$ 5.6	93.1 $\pm$ 16.6	169.5 $\pm$ 13.1
Cu	39.8 $\pm$ 3.3	139.9 $\pm$ 6.7	260.1 $\pm$ 14.7	479.2 $\pm$ 84.8
Zn	18.3 $\pm$ 4.1	108.9 $\pm$ 12.2	256.5 $\pm$ 39.1	413.1 $\pm$ 89.5
Mo	39.6 $\pm$ 3.9	128.8 $\pm$ 6.9	172.5 $\pm$ 29.3	324.1 $\pm$ 52.1
Cd	0.1 $\pm$ 0.05	6.7 $\pm$ 0.7	12.9 $\pm$ 1.4	20.0 $\pm$ 2.7
Pb	5.0 $\pm$ 1.2	27.5 $\pm$ 0.4	53.7 $\pm$ 2.1	88.2 $\pm$ 5.8

(B) Lettuce soil

Element	Concentrations (mg/kg, DW), Mean $\pm$ SD, n = 3			
	Control	Low	Medium	High
Cr	7.8 $\pm$ 1.3	53.2 $\pm$ 5.8	105.0 $\pm$ 15.6	157.1 $\pm$ 19.4
Mn	54.8 $\pm$ 8.0	347.6 $\pm$ 27.7	906.8 $\pm$ 63.6	1308 $\pm$ 15.6
Fe	687.6 $\pm$ 45.4	3089.7 $\pm$ 221.7	5121.7 $\pm$ 187.5	6233.3 $\pm$ 296.2
Ni	3.8 $\pm$ 0.7	43.7 $\pm$ 2.2	87.6 $\pm$ 6.6	141.8 $\pm$ 18.3
Cu	34.1 $\pm$ 1.9	149.5 $\pm$ 8.8	239.3 $\pm$ 35.7	371.3 $\pm$ 23.3
Zn	16.8 $\pm$ 1.9	109.5 $\pm$ 6.8	256.3 $\pm$ 46.6	376.6 $\pm$ 96.7
Mo	36.3 $\pm$ 3.3	138.0 $\pm$ 15.9	182.9 $\pm$ 30.4	301.1 $\pm$ 43.5
Cd	0.2 $\pm$ 0.02	5.8 $\pm$ 0.5	13.2 $\pm$ 1.8	21.9 $\pm$ 2.6
Pb	4.7 $\pm$ 1.1	29.7 $\pm$ 0.8	51.2 $\pm$ 0.9	80.5 $\pm$ 6.3

**Table 3.9 (continued)****(C) Carrot soil**

<b>Element</b>	<b>Concentrations (mg/kg, DW), Mean <math>\pm</math> SD, n = 3</b>			
	<b>Control</b>	<b>Low</b>	<b>Medium</b>	<b>High</b>
Cr	8.3 $\pm$ 2.7	49.6 $\pm$ 7.4	114.8 $\pm$ 14.6	169.9 $\pm$ 33.7
Mn	61.1 $\pm$ 7.7	375.9 $\pm$ 44.4	749.8 $\pm$ 74.0	1228.3 $\pm$ 23.7
Fe	869.1 $\pm$ 130.8	3337.3 $\pm$ 233.6	4736.0 $\pm$ 426.0	7219.0 $\pm$ 138.0
Ni	2.1 $\pm$ 1.1	37.7 $\pm$ 5.0	89.0 $\pm$ 10.2	99.4 $\pm$ 12.7
Cu	35.1 $\pm$ 4.1	150.5 $\pm$ 6.2	262.0 $\pm$ 12.4	387.9 $\pm$ 34.5
Zn	18.7 $\pm$ 4.5	106.6 $\pm$ 11.6	250.2 $\pm$ 27.9	344.2 $\pm$ 42.8
Mo	39.0 $\pm$ 5.2	128.1 $\pm$ 4.7	179.9 $\pm$ 36.8	314.5 $\pm$ 59.0
Cd	0.2 $\pm$ 0.04	6.5 $\pm$ 0.9	15.8 $\pm$ 0.3	19.8 $\pm$ 1.9
Pb	4.8 $\pm$ 1.0	27.6 $\pm$ 1.0	51.1 $\pm$ 3.2	78.9 $\pm$ 0.5

**(D) Radish soil**

<b>Element</b>	<b>Concentrations (mg/kg, DW), Mean <math>\pm</math> SD, n = 3</b>			
	<b>Control</b>	<b>Low</b>	<b>Medium</b>	<b>High</b>
Cr	8.6 $\pm$ 1.6	52.9 $\pm$ 8.9	117.6 $\pm$ 11.6	166.2 $\pm$ 15.1
Mn	59.3 $\pm$ 11.4	357.0 $\pm$ 31.3	883.3 $\pm$ 60.0	1296.7 $\pm$ 103.4
Fe	947.4 $\pm$ 309.4	3064.7 $\pm$ 146.2	4794.3 $\pm$ 81.1	5945.0 $\pm$ 321.0
Ni	3.2 $\pm$ 1.3	42.7 $\pm$ 6.4	97.2 $\pm$ 3.6	147.8 $\pm$ 5.1
Cu	38.6 $\pm$ 2.3	134.6 $\pm$ 12.1	260.3 $\pm$ 1.4	465.0 $\pm$ 138.3
Zn	14.9 $\pm$ 3.1	104.3 $\pm$ 15.1	257.3 $\pm$ 28.0	350.9 $\pm$ 55.0
Mo	41.4 $\pm$ 3.9	129.3 $\pm$ 9.1	177.7 $\pm$ 37.1	308.9 $\pm$ 70.9
Cd	0.2 $\pm$ 0.03	5.6 $\pm$ 0.9	12.8 $\pm$ 2.3	19.7 $\pm$ 3.4
Pb	4.5 $\pm$ 1.1	27.3 $\pm$ 0.7	60.4 $\pm$ 5.3	78.3 $\pm$ 3.8

**Table 3.10** EDTA and CH<sub>3</sub>COOH extractable contents in the CRM (BCR 700) obtained using a reciprocating and an end-over-end shaker. NB: Measured values in brackets represent mean percentage recovery

(A) EDTA extraction

Element	CRM values (mg/kg)	Concentrations (mg/kg, DW), Mean $\pm$ SD, n= 6	
		Reciprocating shaker	End-over-end shaker
Cr	10.1 $\pm$ 0.9	8.1 $\pm$ 0.5 (80)	9.2 $\pm$ 0.2 (91)
Mn	na	88 $\pm$ 3	146 $\pm$ 6
Fe	na	723 $\pm$ 25	1224 $\pm$ 95
Ni	53.2 $\pm$ 2.8	29.4 $\pm$ 0.7 (55)	51.5 $\pm$ 1.0 (97)
Cu	89.4 $\pm$ 2.8	55.5 $\pm$ 1.6 (62)	91.9 $\pm$ 1.3 (103)
Zn	510 $\pm$ 17	330 $\pm$ 8 (65)	455 $\pm$ 5 (89)
Mo	na	1.69 $\pm$ 0.03	1.10 $\pm$ 0.08
Cd	65.2 $\pm$ 3.5	44.9 $\pm$ 0.9 (69)	65.7 $\pm$ 5.1 (101)
Pb	103 $\pm$ 5	60.7 $\pm$ 0.5 (59)	101.9 $\pm$ 0.9 (99)

(B) CH<sub>3</sub>COOH extraction

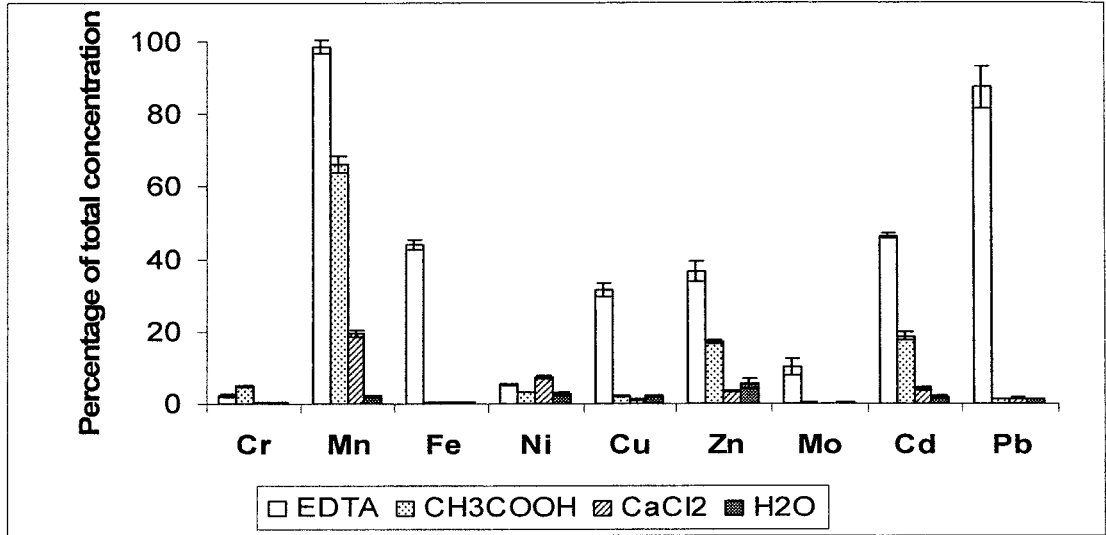
Element	CRM values (mg/kg)	Concentrations (mg/kg, DW), Mean $\pm$ SD, n= 6	
		Reciprocating shaker	End-over-end shaker
Cr	19.0 $\pm$ 1.1	4.8 $\pm$ 0.7 (25)	20.5 $\pm$ 0.7 (108)
Mn	na	92.7 $\pm$ 13.8	266 $\pm$ 19
Fe	na	95.7 $\pm$ 7.1	33.0 $\pm$ 1.8
Ni	99.0 $\pm$ 5.1	25.9 $\pm$ 5.1 (26)	102.8 $\pm$ 2.6 (104)
Cu	36.3 $\pm$ 1.6	9.4 $\pm$ 1.6 (26)	37.3 $\pm$ 2.6 (103)
Zn	719 $\pm$ 24	324.9 $\pm$ 21.9 (45)	715.7 $\pm$ 55.5 (100)
Mo	na	0.52 $\pm$ 0.09	0.06 $\pm$ 0.01
Cd	67.5 $\pm$ 2.8	21.9 $\pm$ 3.3 (32)	67.1 $\pm$ 2.5 (99)
Pb	4.85 $\pm$ 0.38	2.65 $\pm$ 0.42 (55)	4.82 $\pm$ 0.44 (99)

### 3.3.5.2 Extractable soil metals

The soil samples used in this study were extracted with EDTA, CH<sub>3</sub>COOH, CaCl<sub>2</sub> and H<sub>2</sub>O using an end-over-end shaker. The soil extracts were then analysed for their extractable metal contents using ICP-MS. Figure 3.2 (A-D) shows the percentage of the total metal in the soils (control, low, medium and high treatment) extracted with EDTA, CH<sub>3</sub>COOH, CaCl<sub>2</sub> and H<sub>2</sub>O, respectively.

**Figure 3.2 (A-D)** Percentage of the total metal in the soils (control, low, medium and high treatment) extracted with EDTA, CH<sub>3</sub>COOH, CaCl<sub>2</sub> and H<sub>2</sub>O, respectively

(A) Control treatment



(B) Low treatment

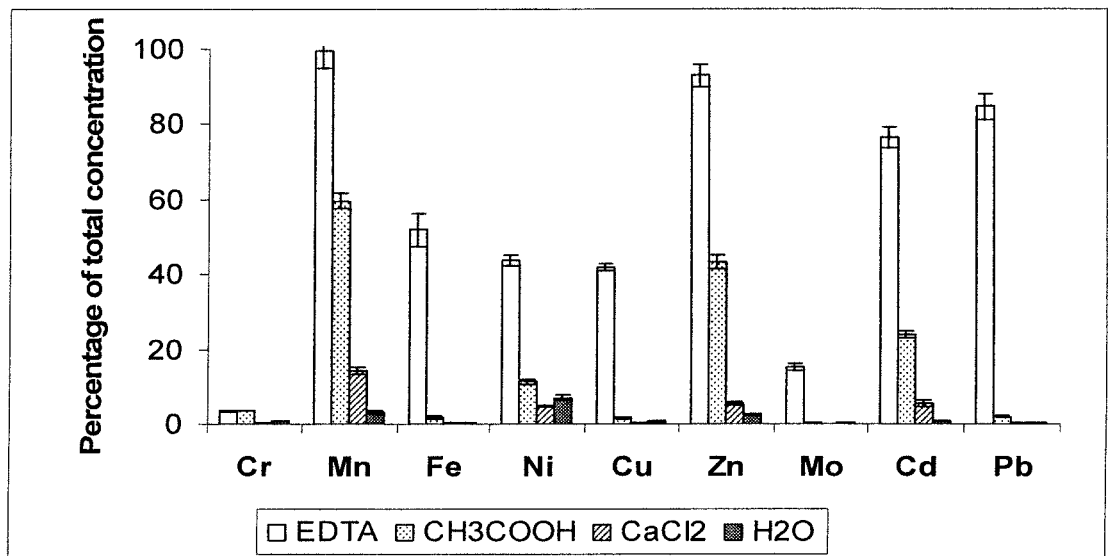
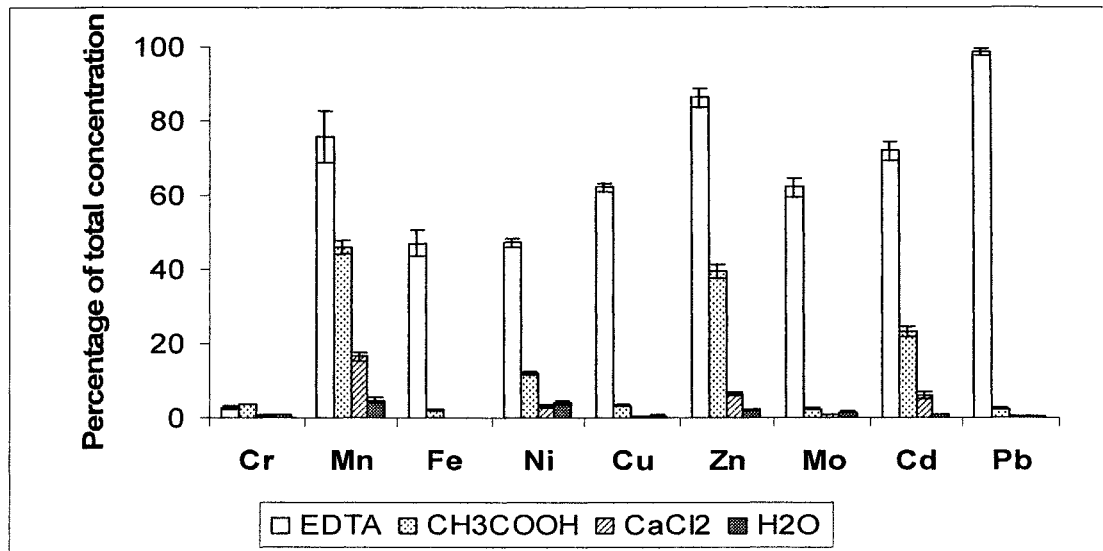
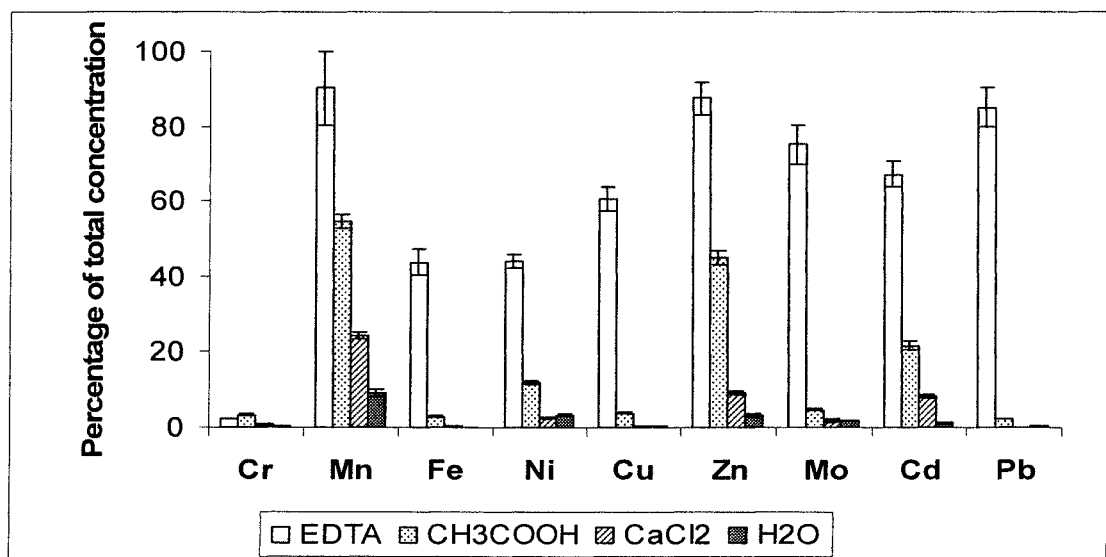


Figure 3.2 (continued)

(C) Medium treatment



(D) High treatment



Generally, the extractable metals followed the descending order EDTA > CH<sub>3</sub>COOH > CaCl<sub>2</sub> > H<sub>2</sub>O. EDTA which is a strong chelating agent extracted relatively more metals from soils than other extractants. It has been reported to remove water soluble metals, exchangeable metals, organically bound metals, and metals occluded in oxides.

### **Extractable chromium**

It was found that less than 5% of Cr can be extracted with each extractant. In every soil treatment, most Cr content remained in the soil matrix.

### **Extractable manganese**

In the control, low, medium and high soil treatment, the Mn percentage extracted with EDTA ranged from 76 - 90%; extracted with CH<sub>3</sub>COOH ranged from 46 – 66%; extracted with CaCl<sub>2</sub> ranged from 14 - 24%; and extracted with H<sub>2</sub>O ranged from 2 - 9%.

### **Extractable iron**

Fe was extracted the most with EDTA i.e. the Fe extractable percentage ranged from 44 - 52% in the control, low, medium and high soil treatment whereas the Fe amounts extracted with CH<sub>3</sub>COOH (< 3%), CaCl<sub>2</sub> (< 0.4%) and H<sub>2</sub>O (< 0.4%) were very minimal in all soil treatments.

### **Extractable nickel**

In the control, low, medium and high soil treatment, respectively the Ni percentage extracted with EDTA was 5, 44, 47 and 44%; extracted with CH<sub>3</sub>COOH was 3, 11, 12 and 12%; extracted with CaCl<sub>2</sub> was 8, 5, 3 and 3%; and extracted with H<sub>2</sub>O was 3, 7, 4 and 3%.

### **Extractable copper**

The amount of Cu was extracted the most with EDTA i.e. the extractable percentage ranged from 32 - 62% in the control, low, medium and high soil treatment whereas the Cu amounts extracted with CH<sub>3</sub>COOH (< 4%), CaCl<sub>2</sub> (< 1%) and H<sub>2</sub>O (< 2%) were minimal in all soil treatments.

### **Extractable zinc**

In the control, low, medium and high soil treatment, respectively the Zn percentage extracted with EDTA was 37, 93, 86 and 87%; extracted with CH<sub>3</sub>COOH was 17, 43, 40 and 45%; extracted with CaCl<sub>2</sub> was 4, 5, 6 and 9%; and extracted with H<sub>2</sub>O was 6, 3, 2 and 3%.

### **Extractable molybdenum**

Mo was extracted the most with EDTA i.e. the Mo extractable percentage was 10, 15, 62 and 75% in the control, low, medium and high soil treatment, respectively whereas the Mo amounts extracted with CH<sub>3</sub>COOH (< 5%), CaCl<sub>2</sub> (< 2%) and H<sub>2</sub>O (< 2%) were minimal in all soil treatments.

### **Extractable cadmium**

EDTA gave much higher extractable contents of Cd than CH<sub>3</sub>COOH (ranged from 18 – 24%), CaCl<sub>2</sub> (ranged from 4 – 8%) and H<sub>2</sub>O (< 2%) i.e. 47, 76, 72 and 67% of the total Cd were extracted in the control, low, medium and high soil treatment, respectively.

### **Extractable lead**

Pb was extracted to the greatest extent using EDTA i.e. the Pb extractable percentage was 87, 85, 99 and 85% in the control, low, medium and high soil treatment, respectively whereas the Pb amounts extracted with CH<sub>3</sub>COOH (< 3%), CaCl<sub>2</sub> (< 2%) and H<sub>2</sub>O (< 1%) were minimal in all soil treatments.

## **3.4 Summary**

Metal contaminated soils were prepared to use for growing plants in this research by spiking with metal solutions at different levels of contamination specified as control (no spiking), low, medium and high soil treatment. Soil samples were characterised for pH, organic matter (OM) content, and CEC. The control soil was considered as weakly acid (pH 5.25), the low (pH 4.51) and medium (pH 4.28) soil treatments were acid, and the high soil treatment (pH 4.01) was very acid. The acidity was identified according to Baize (1993). The OM percentages were similar in all soils ranging from 93.0 – 94.5%. The CEC of the control, low, medium and high soil treatment was 109, 98, 99 and 102 cmol<sub>c</sub>/kg, respectively.

Total metal concentrations in the soils were determined and found that these contents varied widely from control-low-medium-high soil treatments. Extractions of heavy metals in the soil samples using a range of chemical selective extractants (EDTA, CH<sub>3</sub>COOH, CaCl<sub>2</sub>, H<sub>2</sub>O) were carried out in order to study their bioavailability to

plants when they were grown on these contaminated soils. It was found that the extractability percentages in all soil treatments (control, low, medium and high treatment) applied with the extractants are ranked in descending orders as follows;

For Mn, Zn and Cd;                    EDTA >> CH<sub>3</sub>COOH > CaCl<sub>2</sub> > H<sub>2</sub>O.

For Fe, Cu, Ni, Mo and Pb;    EDTA >> CH<sub>3</sub>COOH > CaCl<sub>2</sub> ≈ H<sub>2</sub>O.

For Cr;                                    low extractability for all extractants

In Chapter 4, the plants grown on these contaminated soils will be investigated for their metal uptake and accumulation. In addition, the relationship of metal in soils (both total and extractable metal) and metal taken up by plants will be presented in Chapter 5.

### 3.5 References

Baize, D. (1993). *Soil Science Analyses: A Guide to Current Use*. Chichester: John Wiley & Sons.

Chojnacka, K., Chojnacki, A., Gorecka, H., and Gorecki, H. (2005). 'Bioavailability of Heavy Metals from Polluted Soils to Plants', *The Science of the Total Environment*, 337, 175-182.

Dean, J. R. (2003). *Methods for Environmental Trace Analysis*. Chichester: John Wiley & Sons.

Helgesen, H., and Larsen, E. H. (1998). 'Bioavailability and Speciation of Arsenic in Carrots Grown in Contaminated Soil', *The Analyst*, 123, 791-796.

Hooda, P. S. (1997). 'Plant Availability of Heavy Metals in Soils Previously Amended with Heavy Applications of Sewage Sludge', *Journal of the Science of Food and Agriculture*, 73, 446-454.

Hund-Rinke, K., and Kordel, W. (2003). 'Underlying Issues in Bioaccessibility and Bioavailability: Experimental Methods', *Ecotoxicology and Environmental Safety*, 56,



52-62.

Lopez-Sanchez, J. F., Sahuquillo, A., Rauret, G., Lachica, M., Barahona, E., Gomez, A., Ure, A. M., Muntau, H., and Quevauviller, P. (2002). 'Extraction Procedures for Soil Analysis', in Quevauviller, P. (Ed.) *Methodologies in Soil and Sediment Fractionation Studies: Single and Sequential Extraction Procedures*. Cambridge: The Royal Society of Chemistry.

Lu, A., Zhang, S., Shan, X.-Q., Wang, S., and Wang, Z. (2003). 'Application of Microwave Extraction for the Evaluation of Bioavailability of Rare Earth Elements in Soils', *Chemosphere*, 53, 1067-1075.

McGrath, D. (1996). 'Application of Single and Sequential Extraction Procedures to Polluted and Unpolluted Soils', *The Science of the Total Environment*, 178, 37-44.

Mench, M., Vangronsveld, J., Didier, V., and Clijsters, H. (1994). 'Evaluating of Metal Mobility, Plant Availability and Immobilization by Chemical Agents in a Limed-Silty Soil', *Environmental Pollution*, 86, 279-286.

Mossop, K. F., and Davidson, C. M. (2003). 'Comparison of Original and Modified BCR Sequential Extraction Procedures for the Fractionation of Copper, Iron, Lead, Manganese and Zinc in Soils and Sediments', *Analytica Chimica Acta*, 478, 111-118.

Novozamsky, I., Lexmond, T. M., and Houba, V. J. G. (1993). 'A Single Extraction Procedure of Soil for Evaluation of Uptake of Some Heavy Metals by Plants', *International Journal of Environmental Analytical Chemistry*, 51, 47-58.

Quevauviller, P. (1998). 'Operationally Defined Extraction Procedures for Soil and Sediment Analysis I. Standardization', *Trends in Analytical Chemistry*, 17, 289-298.

Rauret, G., Lopez-Sanchez, J. F., Sahuquillo, A., Rubio, R., Davidson, C., Ure, A., and Quevauviller, P. (1999). 'Improvement of the BCR Three Step Sequential

Extraction Procedure Prior to the Certification of New Sediment and Soil Reference Materials', *Journal of Environmental Monitoring*, 1, 57-61.

Robertson, G. P., Sollins, P., Ellis, B. G., and Lajtha, K. (1999). *Exchangeable Ions, pH, and Cation Exchange Capacity*. in Robertson, G. P., Coleman, D. C., Bledsoe, C. S. and Sollins, P. (Ed.) New York: Oxford University Press.

Schramel, O., Michalke, B., and Kettrup, A. (2000). 'Study of the Copper Distribution in Contaminated Soils of Hop Fields by Single and Sequential Extraction Procedures', *The Science of the Total Environment*, 263, 11-22.

Shiowatana, J., Tantidanai, N., Nookabkaew, S., and Nacapricha, D. (2001). 'A Flow System for the Determination of Metal Speciation in Soil by Sequential Extraction', *Environment International*, 26, 381-387.

Strowbel, B. W., Borggaard, O. K., Hansen, H. C. B., Andersen, M. K., and Raulund-Rasmussen, K. (2005). 'Dissolved Organic Carbon and Decreasing pH Mobilize Cadmium and Copper in Soil', *European Journal of Soil Science*, 56, 189-196.

Tessier, A., Campbell, P. G. C., and Bisson, M. (1979). 'Sequential Extraction Procedure for the Speciation of Particulate Trace Metals', *Analytical Chemistry*, 51, 844-851.

Ure, A. M. (1996). 'Single Extraction Schemes for Soil Analysis and Related Applications', *The Science of the Total Environment*, 178, 3-10.

USEPA. (1996). '*EPA Method 3050B: Acid Digestion of Sediments, Sludges and Soils*'. Springfield, VA: National Technical Information Service.

## Chapter 4

### Uptake and accumulation of metals in vegetable plants

#### 4.1 Introduction

Plants have the ability to absorb heavy metals from the environment e.g. soil, water and air. Hence, the mobilization of different trace elements at toxic levels in the environment can result in accumulation of the pollutants in the food chain. In soil metal contamination, soil-to-plant transfer of heavy metals is considered the major pathway of human exposure (Cui *et al.*, 2004). Mechanisms of heavy metals uptake by plants are introduced in Section 1.5 (Chapter 1). In general, there are two stages in metal ion uptake into the xylem: (i) passive uptake via the apoplast, and (ii) active uptake via the symplast (Ross and Kaye, 1994). This chapter aims to assess the uptake and accumulation of metals (Cr, Mn, Fe, Ni, Cu, Zn, Mo, Cd and Pb) for lettuce, spinach, radish and carrot cultivated on soils spiked with inorganic salt solutions in the greenhouse.

#### 4.2 Experimental

##### 4.2.1 Chemicals and apparatus

All chemicals used were of analytical grade. Concentrated nitric acid was provided by Fisher Scientific (Leicester, UK). Concentrated hydrochloric acid, concentrated sulphuric acid and 30% hydrogen peroxide were provided by BDH Chemicals Ltd. (Poole, England). A multi-element standard for Cr, Mn, Fe, Ni, Cu, Zn, Mo, Cd and Pb and internal standard solutions for Sc, In and Tb were purchased from SPEXCertiPrep (Middlesex, UK). 18.2 M $\Omega$  x cm ultra pure water used was produced by a Direct-Q<sup>TM</sup> Millipore System (Molsheim, France).

Certified reference materials (CRM) used in plant analysis were spinach leaves (SRM 1570a) purchased from the National Institute of Standards and Technology, Gaithersburg, MD, USA and bush twigs and leaves (GBW07063) obtained from the Institute of Geophysical and Geochemical Exploration, Langfang, China.

A heating block (2006 Digestor, Foss Tecator) was used to digest plant samples for

total metal analysis. ICP mass spectrometer XSeries II (Thermo Electron Corporation, Cheshire, UK) was used to determine metal concentrations in plant and soil samples.

## **4.2.2 Methodology**

### **4.2.2.1 Growing vegetable plants and sample collection**

Seeds of spinach (*Spinacia oleracea* var. Perpetual, 697), lettuce (*Lactuca sativa* var. Rollo Rossa, 574), carrot (*Daucus carota* var. Parmex, 473) and radish (*Raphanus sativus* var. French Breakfast 3, 542) obtained directly from local markets (Thompson & Morgan (UK) Ltd.) were germinated in plastic trays and seedlings transplanted, after two weeks, into individual plastic pots containing 100 g of metal contaminated soil. The plants were grown in soil contaminated at low, medium and high concentration with 9 plants per treatment (The metal contaminated soils were prepared as described in Chapter 3, Section 3.2.2.1 – 3.2.2.2). Nine plants of spinach, lettuce, radish and carrot were also planted in unadulterated soil as control samples. NB: The plants will be used in 3 experiments (plant uptake, oral bioaccessibility and metal speciation study), i.e. 3 plants per each experiment. The plants were watered daily with distilled water and grown under artificial light, using a sodium lighting system at  $150 \text{ Wm}^{-2}$  for periods of 16 hours daylight and 8 hours dark. The temperature was maintained within the range 12.1 to 25.3 °C with humidity between 38 and 89 %. Mature plants i.e. 6-8 week growth, were harvested. Roots and leaves were separated and thoroughly washed including a final rinse with distilled water and stored at -18 °C until required for analysis. Total metal determinations were carried out for plant samples (both roots and leaves).

### **4.2.2.2 Vegetable digestion procedure for total metal analysis**

Into a digestion tube, 1 g (accurately weighed) of plant sample (oven dried at 70 °C for 48 h) was placed and 10 mL concentrated HNO<sub>3</sub> added. The sample was then heated to 95 °C on the heating block for approx. 1 h. After cooling, 5 mL of concentrated H<sub>2</sub>SO<sub>4</sub> was added and the sample was heated to 140 °C until charring first appears. After cooling, 5 mL of concentrated HNO<sub>3</sub> was added and heated to 180 °C. Further aliquots of HNO<sub>3</sub> were added until the sample digest appeared clear or a pale straw colour. After cooling, 1 mL of 500 g/L H<sub>2</sub>O<sub>2</sub> was added and heated to 200

°C. This procedure was repeated until brown fumes ceased to appear. After cooling, 10 mL of distilled water and 0.5 mL of concentrated HNO<sub>3</sub> were added and heated to 200 °C until white fumes were evolved. After cooling, 10 mL of distilled water and 1 mL of 500 g/L H<sub>2</sub>O<sub>2</sub> were added and heated to 240 °C until white fumes were evolved. Finally, the digest was cooled and filtered through Whatman No.41 filter paper into a 50 mL volumetric flask, then made up to the mark with deionised water.

#### 4.2.2.3 Total metal determination by ICP-MS

ICP-MS measurement conditions were optimised daily using the built-in PlasmaLab software procedure. The operating conditions are shown in Table 4.1. Samples of the plant extracts were analysed by ICP-MS using an external calibration technique. Sc, In and Tb internal standard (10 µg/L) were added to all samples, blanks and standard solutions. The quality control of the measurements was done by measuring CRMs (spinach leaves and bush twigs and leaves CRMs) every ten samples. A blank was analysed with each analytical batch.

**Table 4.1** Instrumental operating conditions for ICP-MS

ICP-MS conditions	Standard Mode	CCT mode
Forward power	1400 W	1400 W
Cool gas flow	13.0 L/min	13.0 L/min
Auxiliary gas flow	0.90 L/min	0.90 L/min
Nebulizer gas flow	0.80 L/min	0.80 L/min
Collision cell gas	NA	4.75 L/min 7%H <sub>2</sub> /93%He
Quadrupole bias	-1.0 V	-14.0 V
Hexapole bias	0.0 V	-16.0 V
Dwell time per isotope	10 ms	10 ms
Isotopes monitored	<sup>52</sup> Cr, <sup>55</sup> Mn, <sup>56</sup> Fe, <sup>60</sup> Ni, <sup>63</sup> Cu, <sup>66</sup> Zn, <sup>95</sup> Mo, <sup>111</sup> Cd and <sup>208</sup> Pb	<sup>52</sup> Cr, <sup>55</sup> Mn, <sup>56</sup> Fe, <sup>60</sup> Ni, <sup>63</sup> Cu, <sup>66</sup> Zn, <sup>95</sup> Mo, <sup>111</sup> Cd and <sup>208</sup> Pb
Internal standards	<sup>45</sup> Sc, <sup>115</sup> In and <sup>159</sup> Tb	<sup>45</sup> Sc, <sup>115</sup> In and <sup>159</sup> Tb

### 4.3 Results and discussion

#### 4.3.1 Total metal determination in plant samples

The accuracy of the analytical method was evaluated. This was done by carrying out

acid digestions on the CRMs (spinach leaves and bush twigs and leaves CRMs) followed by ICP-MS analysis in both standard (STD) and collision cell technology (CCT) modes. The results are shown in Table 4.2. On the basis of the mean percentage recoveries found in the CRMs, the following operating modes were identified as the most appropriate for element determination in future plant analysis; CCT mode: Mn, Ni, Cu, and Zn, and STD mode: Cr, Fe, Mo, Cd and Pb.

**Table 4.2** Total metal concentrations (mg/kg, DW) in plant certified reference materials (spinach leaves and bush twigs and leaves CRMs). NB: Measured values in brackets represent mean percentage recovery

Element	SRM 1570a, Spinach leaves			GBW 07603, Bush twigs and leaves		
	Certified value Mean $\pm$ SD	Measured value Mean $\pm$ SD (n = 20)		Certified value Mean $\pm$ SD	Measured value Mean $\pm$ SD (n = 20)	
		Standard mode	CCT mode		Standard mode	CCT mode
<sup>52</sup> Cr	na	2.31 $\pm$ 0.46	1.64 $\pm$ 0.32	2.6 $\pm$ 0.1	2.9 $\pm$ 0.7 (111)	1.8 $\pm$ 0.2 (70)
<sup>55</sup> Mn	75.9 $\pm$ 1.9	69.4 $\pm$ 5.6 (91)	71.4 $\pm$ 5.5 (94)	61 $\pm$ 3	58 $\pm$ 4 (94)	60 $\pm$ 3 (99)
<sup>56</sup> Fe	na	na	na	1070 $\pm$ 40	1001 $\pm$ 103 (94)	1200 $\pm$ 302 (112)
<sup>60</sup> Ni	2.14 $\pm$ 0.10	2.47 $\pm$ 0.41 (115)	2.33 $\pm$ 0.44 (109)	1.7 $\pm$ 0.2	2.4 $\pm$ 0.4 (142)	2.0 $\pm$ 0.5 (120)
<sup>63</sup> Cu	12.2 $\pm$ 0.6	11.7 $\pm$ 1.0 (96)	12.2 $\pm$ 0.4 (100)	6.6 $\pm$ 0.4	6.2 $\pm$ 0.5 (94)	6.5 $\pm$ 0.3 (98)
<sup>66</sup> Zn	82 $\pm$ 3	78.9 $\pm$ 2.7 (96)	79.5 $\pm$ 6.5 (97)	55 $\pm$ 2	67.2 $\pm$ 5.6 (122)	51.9 $\pm$ 4.1 (94)
<sup>95</sup> Mo	na	0.41 $\pm$ 0.08	0.43 $\pm$ 0.13	0.28 $\pm$ 0.03	0.29 $\pm$ 0.06 (104)	0.30 $\pm$ 0.03 (108)
<sup>111</sup> Cd	2.89 $\pm$ 0.07	2.35 $\pm$ 0.20 (81)	2.33 $\pm$ 0.44 (81)	(0.38)	0.37 $\pm$ 0.07 (97)	0.46 $\pm$ 0.09 (120)
<sup>208</sup> Pb	na	0.31 $\pm$ 0.06	0.62 $\pm$ 0.26	47 $\pm$ 2	54 $\pm$ 6 (115)	36 $\pm$ 1 (77)

#### 4.3.2 Uptake of heavy metals by vegetable plants

After the plant materials had been acid digested, the ICP-MS instrument was employed to determine total metal concentrations found in their roots and leaves.

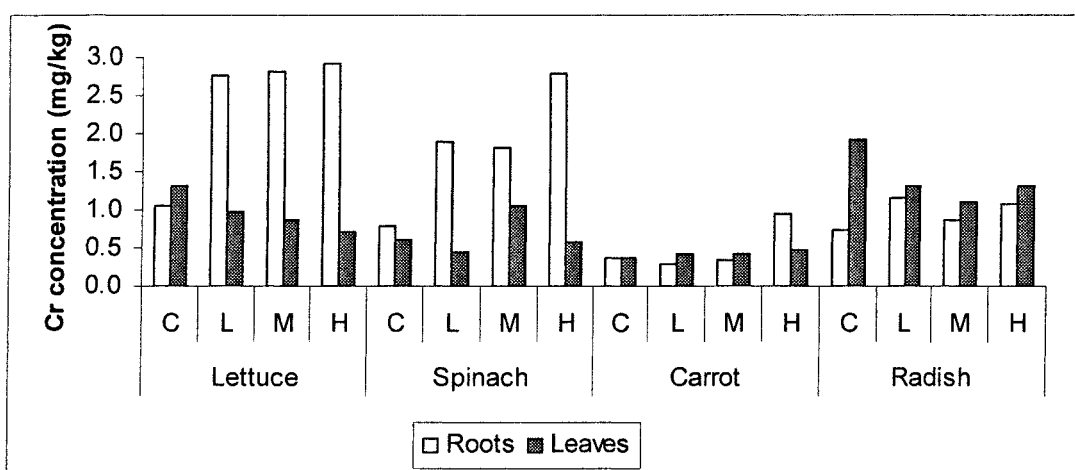
Table 4.3 (A-D) present the mean total concentrations of metals in roots and leaves of the 4 vegetables grown on different treatments of contaminated soils. Lettuce and

spinach represented the edible vegetable leaves (above ground) and carrot and radish represented edible vegetable roots (underground). Figure 4.1 (A – I) show the concentrations of the individual metal taken up into plant leaves and roots. It was noted that the plants subjected to the high metal soil concentrations were visibly not as healthy as plants subjected to lower metal soil concentrations.

### *Chromium*

Chromium concentrations in all plants were relatively low (Figure 4.1A). The greatest amounts of Cr found in the roots of lettuce (2.91 mg/kg) were grown in the highest level of soil metal contamination. The concentrations of Cr ranged from 0.70 – 2.91, 0.45 – 2.79, 0.30 – 0.96 and 0.74 – 1.92 mg/kg for lettuce, spinach, carrot and radish, respectively. It was observed that the uptake levels in lettuce and spinach roots were relatively higher than in their leaves, while the uptake levels in radish leaves were slightly higher than in their roots. Whereas, there was no notable difference in uptake between the roots and the leaves of carrot in all treatments, except in the high soil treatment that uptake levels in their roots were slightly higher than in the leaves.

**Figure 4.1A** Cr concentrations in roots and leaves of lettuce, spinach, carrot and radish grown on the control (C), low (L), medium (M) and high (H) soil treatments



**Table 4.3 (A-D)** Metal concentrations found in plants (mg/kg, DW)

(A) Lettuce

Element	Metal concentrations (mg/kg, DW), Mean $\pm$ SD (n = 3)											
	Control		Low		Medium		High					
	Leaves	Roots	Leaves	Roots	Leaves	Roots	Leaves	Roots				
Cr	1.31 $\pm$ 0.50	1.05 $\pm$ 0.54	0.96 $\pm$ 0.20	2.75 $\pm$ 1.10	0.86 $\pm$ 0.31	2.82 $\pm$ 1.15	0.70 $\pm$ 0.17	2.91 $\pm$ 1.04				
Mn	215 $\pm$ 18	195 $\pm$ 33	653 $\pm$ 50	595 $\pm$ 68	1515 $\pm$ 58	464 $\pm$ 90	2613 $\pm$ 341	802 $\pm$ 85				
Fe	82.5 $\pm$ 7.0	71.7 $\pm$ 4.3	69.1 $\pm$ 4.7	211.0 $\pm$ 15.8	68.1 $\pm$ 6.5	199.5 $\pm$ 38.5	206.3 $\pm$ 113.7	244.2 $\pm$ 26.6				
Ni	2.0 $\pm$ 0.9	3.4 $\pm$ 1.1	2.6 $\pm$ 0.4	9.6 $\pm$ 1.5	5.0 $\pm$ 0.6	12.7 $\pm$ 1.8	11.0 $\pm$ 2.5	21.7 $\pm$ 3.1				
Cu	7.9 $\pm$ 0.2	23.5 $\pm$ 1.1	9.1 $\pm$ 1.4	41.9 $\pm$ 5.7	10.3 $\pm$ 0.2	40.0 $\pm$ 8.2	11.4 $\pm$ 0.5	76.1 $\pm$ 16.2				
Zn	95.3 $\pm$ 14.3	116.6 $\pm$ 9.3	94.0 $\pm$ 17.9	229.7 $\pm$ 50.5	307.4 $\pm$ 36.3	210.8 $\pm$ 17.4	525.1 $\pm$ 100.5	519.8 $\pm$ 92.1				
Mo	0.46 $\pm$ 0.02	3.68 $\pm$ 0.53	0.98 $\pm$ 0.63	8.64 $\pm$ 1.09	2.27 $\pm$ 0.89	27.99 $\pm$ 4.51	2.08 $\pm$ 0.88	40.99 $\pm$ 6.60				
Cd	0.13 $\pm$ 0.08	0.02 $\pm$ 0.01	3.03 $\pm$ 0.74	2.85 $\pm$ 0.87	6.92 $\pm$ 2.02	5.63 $\pm$ 2.10	15.32 $\pm$ 5.32	19.54 $\pm$ 5.45				
Pb	0.49 $\pm$ 0.18	2.03 $\pm$ 0.48	0.90 $\pm$ 1.10	2.82 $\pm$ 1.46	0.44 $\pm$ 0.59	5.42 $\pm$ 1.42	0.13 $\pm$ 0.11	10.71 $\pm$ 0.10				



**Table 4.3 (continued)**

(B) Spinach

Element	Metal concentrations (mg/kg, DW), Mean $\pm$ SD (n = 3)											
	Control		Low		Medium		High					
	Leaves	Roots	Leaves	Roots	Leaves	Roots	Leaves	Roots				
Cr	0.60 $\pm$ 0.46	0.79 $\pm$ 0.67	0.45 $\pm$ 0.34	1.88 $\pm$ 0.65	1.05 $\pm$ 0.99	1.83 $\pm$ 0.96	0.59 $\pm$ 0.37	2.79 $\pm$ 1.42				
Mn	288 $\pm$ 24	154 $\pm$ 9	1280 $\pm$ 220	387 $\pm$ 28	2495 $\pm$ 191	353 $\pm$ 34	4336 $\pm$ 1071	1094 $\pm$ 164				
Fe	49.0 $\pm$ 21.0	36.2 $\pm$ 14.4	55.3 $\pm$ 22.3	127.6 $\pm$ 1.3	107.3 $\pm$ 41.1	183.0 $\pm$ 38.0	87.7 $\pm$ 35.5	238.7 $\pm$ 40.9				
Ni	1.3 $\pm$ 0.6	1.4 $\pm$ 0.8	2.5 $\pm$ 1.1	7.0 $\pm$ 3.1	8.9 $\pm$ 1.7	10.3 $\pm$ 0.9	19.3 $\pm$ 3.5	26.6 $\pm$ 2.4				
Cu	4.9 $\pm$ 0.7	20.4 $\pm$ 1.3	10.2 $\pm$ 1.9	27.9 $\pm$ 1.1	15.4 $\pm$ 1.6	24.6 $\pm$ 1.8	15.5 $\pm$ 1.8	37.7 $\pm$ 2.6				
Zn	65.1 $\pm$ 28.1	53.5 $\pm$ 34.1	103.9 $\pm$ 19.3	84.8 $\pm$ 35.0	341.6 $\pm$ 43.6	172.9 $\pm$ 26.9	592.1 $\pm$ 277.7	295.0 $\pm$ 52.9				
Mo	1.43 $\pm$ 0.46	0.99 $\pm$ 0.37	4.19 $\pm$ 4.53	6.04 $\pm$ 1.35	3.58 $\pm$ 0.47	15.56 $\pm$ 2.43	4.00 $\pm$ 1.04	19.69 $\pm$ 3.66				
Cd	0.14 $\pm$ 0.10	0.08 $\pm$ 0.06	2.46 $\pm$ 0.65	4.08 $\pm$ 1.47	7.86 $\pm$ 1.89	4.34 $\pm$ 0.99	18.44 $\pm$ 8.90	10.28 $\pm$ 2.64				
Pb	0.74 $\pm$ 0.89	0.11 $\pm$ 0.03	0.40 $\pm$ 0.20	1.49 $\pm$ 0.34	0.44 $\pm$ 0.18	2.93 $\pm$ 1.07	0.68 $\pm$ 0.21	5.18 $\pm$ 1.92				

**Table 4.3 (continued)**

(C) Carrot

Element	Metal concentrations (mg/kg, DW), Mean $\pm$ SD (n = 3)											
	Control		Low		Medium		High					
	Leaves	Roots	Leaves	Roots	Leaves	Roots	Leaves	Roots				
Cr	0.37 $\pm$ 0.20	0.36 $\pm$ 0.21	0.42 $\pm$ 0.22	0.30 $\pm$ 0.26	0.42 $\pm$ 0.18	0.35 $\pm$ 0.27	0.48 $\pm$ 0.18	0.96 $\pm$ 0.61				
Mn	218 $\pm$ 43	19 $\pm$ 0.3	1184 $\pm$ 86	46 $\pm$ 12	3218 $\pm$ 330	144 $\pm$ 37	4065 $\pm$ 436	215 $\pm$ 18				
Fe	65.8 $\pm$ 20.5	18.5 $\pm$ 1.4	87.6 $\pm$ 22.3	13.1 $\pm$ 0.9	124.5 $\pm$ 35.8	19.7 $\pm$ 3.9	134.3 $\pm$ 55.4	24.5 $\pm$ 9.9				
Ni	0.9 $\pm$ 0.2	0.6 $\pm$ 0.1	1.4 $\pm$ 0.4	1.2 $\pm$ 0.1	4.4 $\pm$ 0.4	2.4 $\pm$ 0.3	7.2 $\pm$ 2.1	4.9 $\pm$ 1.1				
Cu	3.3 $\pm$ 0.6	2.1 $\pm$ 0.2	4.5 $\pm$ 0.8	2.7 $\pm$ 0.4	6.7 $\pm$ 2.4	6.8 $\pm$ 0.8	9.2 $\pm$ 2.7	9.6 $\pm$ 2.5				
Zn	34.3 $\pm$ 9.5	20.8 $\pm$ 2.9	141.2 $\pm$ 41.1	40.6 $\pm$ 14.3	231.1 $\pm$ 74.3	83.6 $\pm$ 7.7	369.3 $\pm$ 134.3	68.5 $\pm$ 16.3				
Mo	0.89 $\pm$ 0.24	0.21 $\pm$ 0.08	2.23 $\pm$ 2.24	1.07 $\pm$ 0.31	5.45 $\pm$ 1.88	3.90 $\pm$ 2.71	8.72 $\pm$ 6.42	3.17 $\pm$ 3.82				
Cd	0.11 $\pm$ 0.05	0.06 $\pm$ 0.02	2.67 $\pm$ 0.96	1.61 $\pm$ 0.49	4.34 $\pm$ 0.98	3.52 $\pm$ 0.53	8.00 $\pm$ 1.87	3.83 $\pm$ 0.94				
Pb	0.07 $\pm$ 0.03	0.06 $\pm$ 0.02	0.11 $\pm$ 0.07	0.08 $\pm$ 0.01	0.12 $\pm$ 0.07	0.06 $\pm$ 0.03	0.18 $\pm$ 0.06	0.20 $\pm$ 0.08				

**Table 4.3 (continued)**

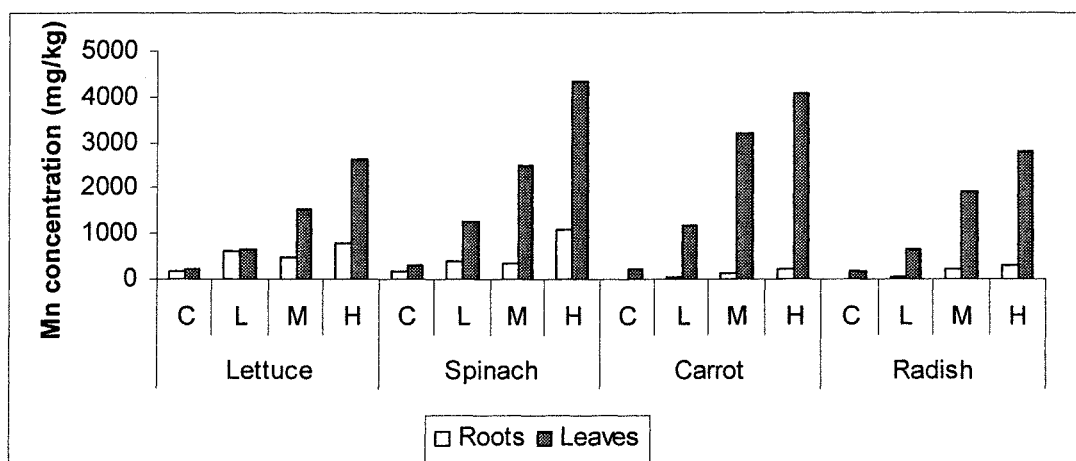
(D) Radish

Element	Metal concentrations (mg/kg, DW), Mean $\pm$ SD (n = 3)											
	Control		Low		Medium		High					
	Leaves	Roots	Leaves	Roots	Leaves	Roots	Leaves	Roots				
Cr	1.92 $\pm$ 1.37	0.74 $\pm$ 0.38	1.31 $\pm$ 0.71	1.16 $\pm$ 0.60	1.10 $\pm$ 0.27	0.86 $\pm$ 0.31	1.31 $\pm$ 0.82	1.08 $\pm$ 0.44				
Mn	162 $\pm$ 21	16 $\pm$ 1	658 $\pm$ 58	49 $\pm$ 1	1913 $\pm$ 255	228 $\pm$ 45	2796 $\pm$ 115	315 $\pm$ 56				
Fe	100.4 $\pm$ 16.8	27.1 $\pm$ 8.3	122.9 $\pm$ 34.1	25.3 $\pm$ 1.1	183.1 $\pm$ 29.0	23.9 $\pm$ 7.6	193.2 $\pm$ 48.0	28.8 $\pm$ 12.5				
Ni	1.5 $\pm$ 0.3	2.1 $\pm$ 0.3	2.6 $\pm$ 0.6	4.2 $\pm$ 0.7	5.3 $\pm$ 1.7	5.5 $\pm$ 0.4	10.7 $\pm$ 3.6	9.2 $\pm$ 0.6				
Cu	4.7 $\pm$ 0.6	2.7 $\pm$ 0.1	4.7 $\pm$ 0.7	3.2 $\pm$ 0.3	10.9 $\pm$ 3.9	5.8 $\pm$ 1.6	23.8 $\pm$ 3.1	8.6 $\pm$ 0.3				
Zn	58.1 $\pm$ 15.2	66.0 $\pm$ 13.5	180.8 $\pm$ 27.6	108.2 $\pm$ 8.1	381.6 $\pm$ 57.7	328.8 $\pm$ 96.3	518.0 $\pm$ 35.1	470.8 $\pm$ 150.8				
Mo	2.20 $\pm$ 0.35	1.01 $\pm$ 0.19	2.11 $\pm$ 0.78	1.59 $\pm$ 0.63	24.30 $\pm$ 6.26	36.85 $\pm$ 6.21	34.54 $\pm$ 2.58	41.91 $\pm$ 16.04				
Cd	0.19 $\pm$ 0.06	0.06 $\pm$ 0.04	1.88 $\pm$ 0.45	0.46 $\pm$ 0.18	6.36 $\pm$ 2.81	1.81 $\pm$ 0.48	10.94 $\pm$ 1.89	3.66 $\pm$ 0.75				
Pb	0.24 $\pm$ 0.01	0.12 $\pm$ 0.07	0.22 $\pm$ 0.19	0.40 $\pm$ 0.25	0.42 $\pm$ 0.21	0.47 $\pm$ 0.24	0.19 $\pm$ 0.10	0.37 $\pm$ 0.08				

### *Manganese*

Manganese was abundant in the plants, especially in their leaves (Figure 4.1B). The concentrations of Mn ranged from 195 – 2613, 154 – 4336, 19 – 4065 and 16 – 2796 mg/kg in lettuce, spinach, carrot and radish, respectively. The leaves of all plants contain more manganese than their roots and their uptake levels were increased by the increasing levels of metal contamination. The greatest amounts of Mn accumulated in the plants were 4336, 4065 and 3218 mg/kg in the leaves of spinach (high treatment), carrot (high treatment) and carrot (medium treatment), respectively. The Mn content was lowest in radish roots (16 mg/kg) in the control treatment.

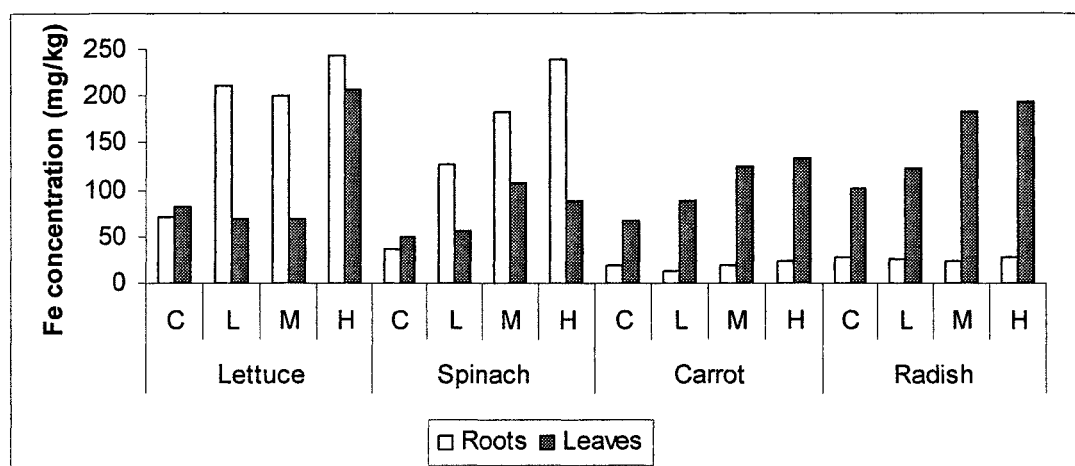
**Figure 4.1B** Mn concentrations in roots and leaves of lettuce, spinach, carrot and radish grown on the control (C), low (L), medium (M) and high (H) treatments



### *Iron*

Iron concentrations in all plants ranged from 68 – 244, 36 – 239, 13 – 134 and 24 – 193 mg/kg in lettuce, spinach, carrot and radish, respectively. The greatest amounts of Fe were 244, 239 and 211 mg/kg in lettuce and spinach roots (high treatments) and lettuce roots (low treatment), respectively. The roots of lettuce and spinach accumulated significantly higher amounts of Fe than in their leaves, except in the control treatment the uptake levels in their leaves were slightly higher than in the roots. Conversely, the Fe amounts taken up in carrot and radish leaves were relatively greater than in their roots for every soil treatment as shown in Figure 4.1C. The Fe content was lowest in carrot roots (13 mg/kg) from the low treatment.

**Figure 4.1C** Fe concentrations in roots and leaves of lettuce, spinach, carrot and radish grown on the control (C), low (L), medium (M) and high (H) soil treatments



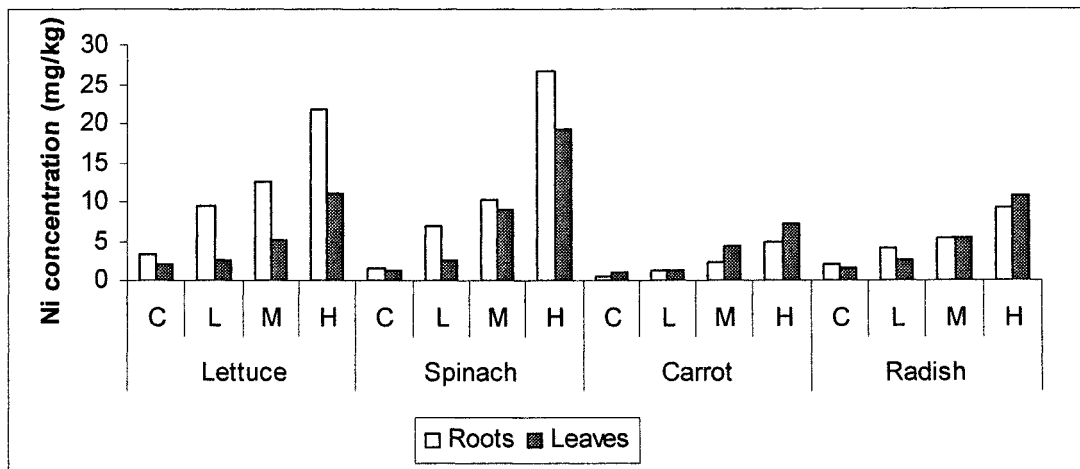
#### *Nickel*

The leafy vegetables accumulated more amounts of Ni than the root vegetables (Figure 4.1D). Their concentration levels were always increased when they were grown in the higher levels of metal contamination. Ni concentrations in all plants ranged from 2.0 – 21.7, 1.3 – 26.6, 0.6 – 7.2 and 1.5 – 10.7 mg/kg in lettuce, spinach, carrot and radish, respectively. The greatest amounts of Ni accumulated in the plants were 26.6, 21.7 and 19.3 mg/kg in spinach and lettuce roots (high treatments), and spinach leaves (high treatment), respectively. The Ni content was lowest in carrot roots (0.6 mg/kg) from the control treatment.

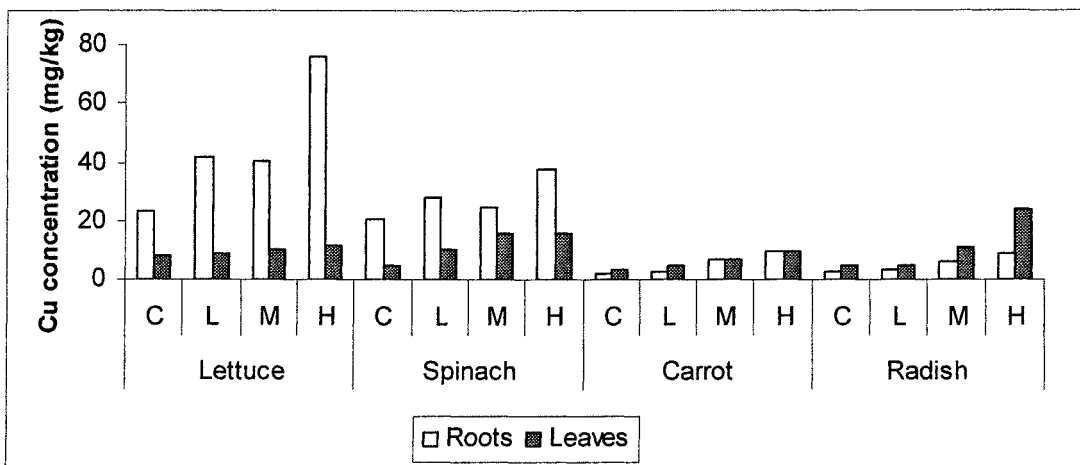
#### *Copper*

Copper uptake was relatively higher in roots than in leaves for lettuce and spinach for every treatment. In contrast, copper concentrations in radish and carrot leaves from every treatment (except the leaves of carrot in medium and high treatments) were higher than in roots as shown in Figure 4.1E. Cu concentrations in all plants ranged from 7.9 – 76.1, 4.9 – 37.7, 2.1 – 9.6 and 2.7 – 23.8 mg/kg in lettuce, spinach, carrot and radish, respectively. The greatest amounts of Cu accumulated in the plants were 76.1, 41.9 and 40.0 mg/kg in the high, low and medium treatment of lettuce roots, respectively. The Cu content was lowest in carrot roots (2.1 mg/kg) from the control treatment.

**Figure 4.1D** Ni concentrations in roots and leaves of lettuce, spinach, carrot and radish grown on the control (C), low (L), medium (M) and high (H) soil treatments



**Figure 4.1E** Cu concentrations in roots and leaves of lettuce, spinach, carrot and radish grown on the control (C), low (L), medium (M) and high (H) soil treatments

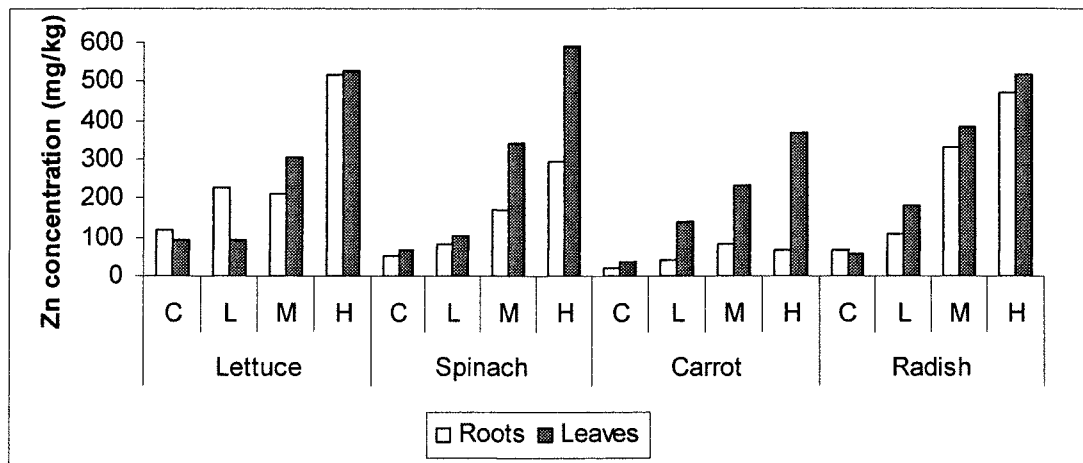


### Zinc

Zinc concentrations in leaves of lettuce, spinach, carrot and radish were relatively higher than their roots for every treatment, except the lettuce leaves (control and low treatments) and the radish leaves (control treatment) which were relatively lower (Figure 4.1F). The highest zinc contents were found in high treatments of spinach leaves, lettuce leaves, and lettuce roots with concentrations of 592, 525 and 520 mg/kg, respectively. This is in agreement with a previous study showing that lettuce

and spinach accumulated zinc to a greater extent (Sauerbeck, 1991). It is generally assumed that leaf Zn levels in excess of 300 – 600 mg/kg (DW) is considered to be toxic to plants (Marschnar, 1995). The Zn content was lowest in carrot roots (21 mg/kg) from the control treatment.

**Figure 4.1F** Zn concentrations in roots and leaves of lettuce, spinach, carrot and radish grown on the control (C), low (L), medium (M) and high (H) soil treatments



### *Molybdenum*

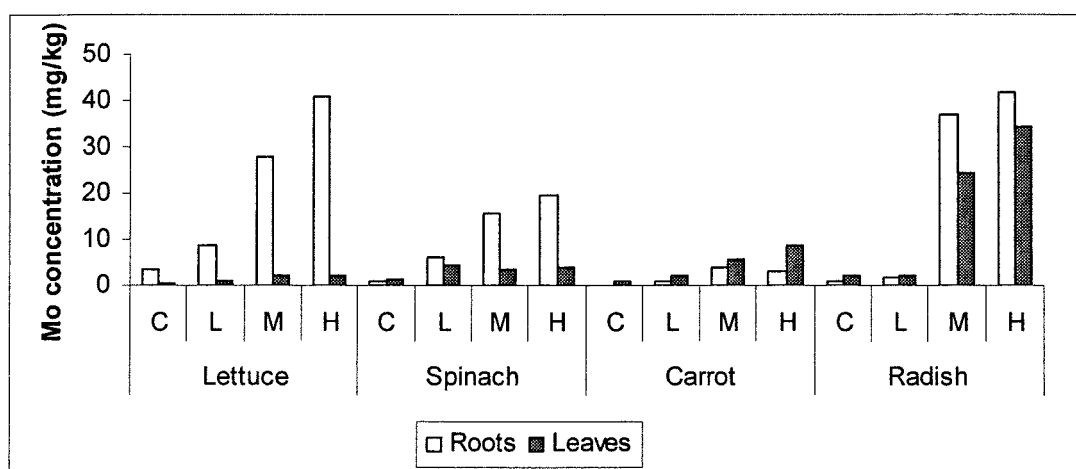
Molybdenum concentrations in all plants ranged from 0.5 – 41.0, 1.0 – 19.7, 0.2 – 8.7 and 1.0 – 41.9 mg/kg in lettuce, spinach, carrot and radish, respectively. The highest amounts of Mo were 41.9, 41.0 and 36.9 mg/kg in radish and lettuce roots (high treatments) and radish roots (medium treatment), respectively. The roots of lettuce and spinach accumulated relatively higher amounts of Mo than in their leaves, except in the control treatment of spinach where uptake levels in their roots were slightly lower. Conversely, the Mo concentrations taken up in carrot and radish leaves were relatively greater than in their roots for every treatment except in the case of medium and high treatment of radish as shown in Figure 4.1G. The Mo content was lowest in carrot roots (0.2 mg/kg) from the control treatment.

### *Cadmium*

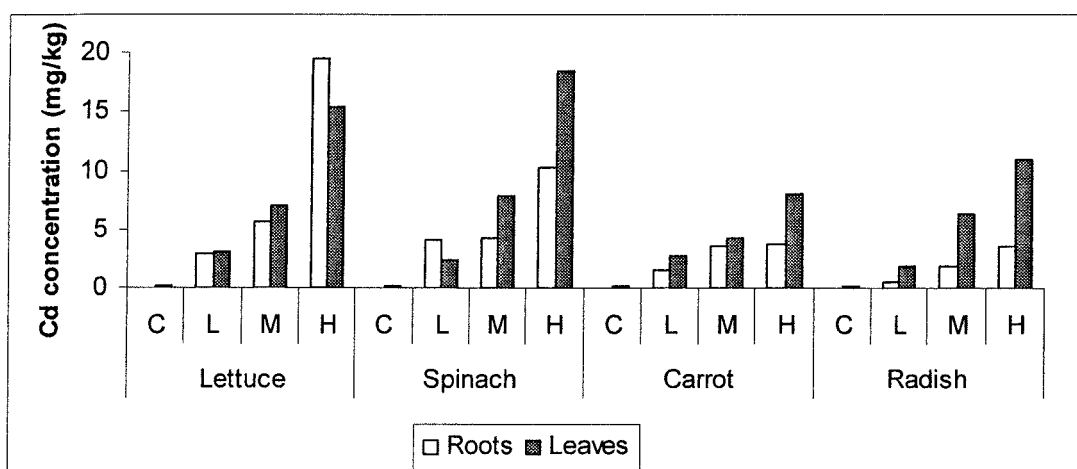
Cadmium contents in the leaves of lettuce, spinach, carrot and radish were higher than in their roots, except for lettuce (high treatment) and spinach (low treatment)

where uptake levels in their leaves were slightly lower (Figure 4.1H). Cd concentrations in all plants ranged from 0.02 – 19.5, 0.08 – 18.4, 0.06 – 8.0 and 0.06 – 10.9 mg/kg in lettuce, spinach, carrot and radish, respectively. The highest Cd contents were found in the high treatments of lettuce roots, spinach leaves and lettuce leaves with the concentrations of 19.5, 18.4 and 15.3 mg/kg, respectively. The lowest Cd concentration was in lettuce roots (0.02 mg/kg) in the unadulterated soil.

**Figure 4.1G** Mo concentrations in roots and leaves of lettuce, spinach, carrot and radish grown on the control (C), low (L), medium (M) and high (H) soil treatments



**Figure 4.1H** Cd concentrations in roots and leaves of lettuce, spinach, carrot and radish grown on the control (C), low (L), medium (M) and high (H) soil treatments

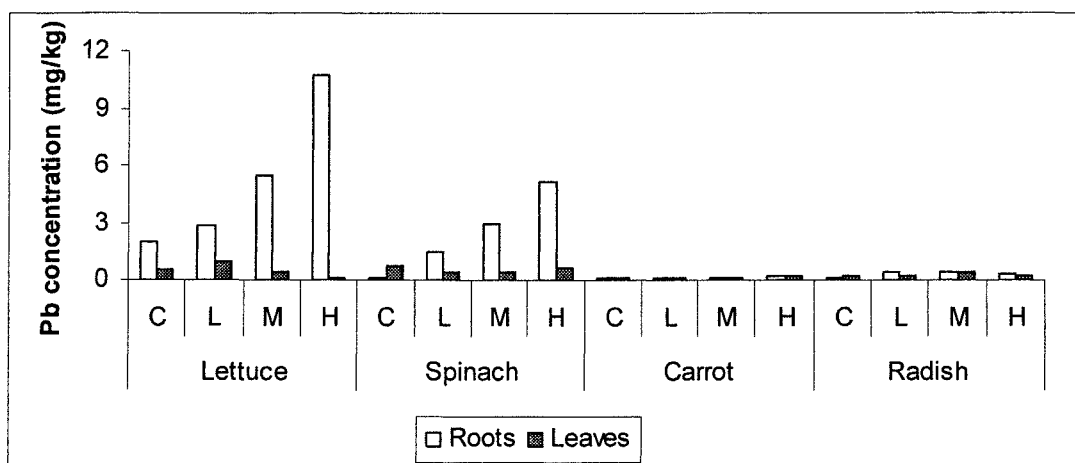




### Lead

Lead concentrations in all plants ranged from 0.44 – 10.72, 0.11 – 5.18, 0.06 – 0.20 and 0.12 – 0.47 mg/kg in lettuce, spinach, carrot and radish, respectively. The highest amounts of Pb were 10.72, 5.42 and 5.18 mg/kg in lettuce roots (high and medium treatments) and spinach roots (high treatment), respectively whereas Pb contents were lower than 3 mg/kg for all other treatments. The roots of lettuce, spinach and radish accumulated relatively higher amounts of Pb than in their leaves, except in the control treatment of spinach and radish where uptake levels in their roots were slightly lower (Figure 4.11). There was no notable difference in Pb uptake by carrot between their roots and leaves. The Pb content was lowest in carrot roots (0.06 mg/kg) from the control treatment.

**Figure 4.11** Pb concentrations in roots and leaves of lettuce, spinach, carrot and radish grown on the control (C), low (L), medium (M) and high (H) soil treatments



### *Influence of plant species on metal uptake*

It was observed that individual plant types greatly differ in metal uptake. Mn, Fe and Zn were always abundant in the plants studied, whereas Cr and Pb tended to be taken up by all plants to the least extent. Ni and Cd concentrations were considered moderate in uptake by lettuce and spinach, but lower in carrot and radish. The uptake of Cu and Mo were moderate in lettuce, spinach and radish, while there was lower accumulation by carrots. The levels of metal accumulated in lettuce, spinach, carrot and radish is summarized in Table 4.4.

**Table 4.4** Levels of metal accumulated in lettuce, spinach, radish and carrot  
 NB: L, Low level of accumulation (less than 10 mg/kg); M, Moderate level of accumulation (less than 100 mg/kg); and H, High level of metal accumulation (more than 100 mg/kg)

Element	Metal uptake levels			
	Lettuce	Spinach	Carrot	Radish
Cr	L	L	L	L
Mn	H	H	H	H
Fe	H	H	H	H
Ni	M	M	L	L
Cu	M	M	L	M
Zn	H	H	H	H
Mo	M	M	L	M
Cd	M	M	L	L
Pb	L	L	L	L

#### 4.4 Summary

After the vegetable crops were grown on the metal contaminated soils, the mature plants were harvested and analysed for their total metal concentrations in the roots and leaves. With the exception of chromium, metal concentrations (Mn, Fe, Ni, Cu, Zn, Mo and Cd) in lettuce, spinach, carrot and radish depended on the concentrations of the (total) metal in the soils in which the plants were grown i.e. the accumulated metal contents in the plants were increased when the higher levels of metal contamination in the soils were applied. For Pb, the amounts accumulated in the leafy vegetables also depended on their levels of contamination in the soils while the root vegetables had a rather low Pb uptake, and the uptake levels did not increase when higher levels of contamination were applied. The metal contents in the unadulterated plants were relatively lower than those in the plants grown on contaminated soil treatments.

Mn, Fe and Zn were relatively easily mobilized from soils to plants; they tended to accumulate in all plants studied at high concentrations e.g. 1515, 2495, 3218, 1913 mg/kg of Mn were found in LT-L, SP-L, CT-L, and RD-L, respectively. The

elements which were more enriched in leaves include Mn and Zn (in all plant types), Fe and Cd (only in the root vegetables). In contrast, Fe, Ni, Cu, Mo and Pb were accumulated more in roots of the leafy vegetables. Among all plants studied, it was observed that carrot had low uptake for all elements (Cr, Ni, Cu, Mo, Cd and Pb), except for Mn, Fe, Zn which were found in all plants.

Under these experimental conditions, the metal mobilised from soil to plant as indicated by the metal contents accumulated in the plants decreased in the order Mn >> Zn > Fe > Cu > Mo > Ni > Cd > Pb ≈ Cr.

#### **4.5 References**

Cui, Y.-J., Zhu, Y.-G., Zhai, R.-H., Chen, D.-Y., Huang, Y.-Z., Qiu, Y., and Liang, J.-Z. (2004). 'Transfer of Metals from Soil to Vegetables in an Area near a Smelter in Nanning, China', *Environment International*, 30, 785-791.

Marschner, H. (1995). *Mineral Nutrition of Higher Plants*. 2nd Ed. London: Academic Press.

Ross, S. M., and Kaye, K. J. (1994). 'The Meaning of Metal Toxicity in Soil-Plant Systems', in Ross, S. M. (Ed.) *Toxic Metals in Soil-Plant Systems*. Chichester: John Wiley & Sons.

Sauerbeck, D. R. (1991). 'Plant, Element and Soil Properties Governing Uptake and Availability of Heavy Metals Derived from Sewage Sludge', *Water, Air and Soil Pollution*, 57-58, 227-237.

## Chapter 5

### Relationship of metals in soils and metals taken up by plants

#### 5.1 Introduction

The extractable metal contents in the soils used for growing plants in this study were obtained as described in Chapter 3, and four vegetable crops (spinach, lettuce, carrot and radish) were grown on the metal contaminated soils and analysed for their total metal contents in the plant materials i.e. roots and leaves as shown in Chapter 4.

According to these data produced, it was now important to establish the relationship of metal in soils (both total metal and extractable metal) and metals taken up by plants in order to try to predict metal bioavailability to plants.

#### 5.2 Soil-to-plant transfer factors (TF) of heavy metals

One approach to assess the bioavailability of metal to plants is to calculate the transfer factor (TF) value, as defined in the following equation (Sauerbeck, 1991; Gray *et al.*, 1999; Huang *et al.*, 2003; Cui *et al.*, 2004; Wang *et al.*, 2004; Chojnacka *et al.*, 2005):

$$TF = \frac{C_{plant}}{C_{total-soil}} \quad (5.1)$$

where  $C_{plant}$  is the concentration of an element in the plant material (dry weight basis) and  $C_{total-soil}$  is the total concentration of the same element in the soil (dry weight basis) where the plant was grown. The higher the value of TF, the more mobile/available the metal is. Hence, the high TF values may exert potential risk to human health. TF values were always used to describe the accumulation of chemicals in organisms, especially, those live in contaminated environments (Wang *et al.*, 2004). According to USEPA (1992), TF values are a major parameter determining the risk of human exposure to metals in soils.

The TF values of the metals for the plants studied are presented in Table 5.1 (A-D). The results indicate that the TF values of metals for various vegetables varied greatly

between plant types and soil treatments. It was observed that the TF values of some metals (Cr, Ni, Cu, Zn and Fe) decreased when the plants were grown in higher soil contamination. This was in agreement with previous findings, Hooda (1997) reported that the TF values of Ni, Cu and Zn for spinach leaves and carrot roots grown on the uncontaminated soils were higher than those grown on sludge contaminated soils, e.g. the TF values of Ni, Cu and Zn was 0.5, 1.8, and 2.3, respectively for the spinach leaves grown on the uncontaminated soils whereas the TF values decreased to 0.2, 0.2, and 1.2, respectively for those grown on the sludge contaminated soils.

**Table 5.1 (A-D)** Ratio of concentrations of metal in plants to metal in soils, Transfer Factor (TF) values

(A) Lettuce

Element	TF values of metals in lettuce uptake							
	Control		Low		Medium		High	
	Leaves	Roots	Leaves	Roots	Leaves	Roots	Leaves	Roots
Cr	0.17	0.13	0.02	0.05	0.01	0.03	0.004	0.02
Mn	3.92	3.56	1.88	1.71	1.67	0.51	2.00	0.61
Fe	0.12	0.10	0.02	0.07	0.01	0.04	0.03	0.04
Ni	0.53	0.89	0.06	0.22	0.06	0.14	0.08	0.15
Cu	0.23	0.69	0.06	0.28	0.04	0.17	0.03	0.20
Zn	5.67	6.94	0.86	2.10	1.20	0.82	1.39	1.38
Mo	0.013	0.10	0.007	0.06	0.012	0.15	0.007	0.14
Cd	0.65	0.10	0.52	0.49	0.52	0.43	0.70	0.89
Pb	0.104	0.432	0.030	0.095	0.009	0.106	0.002	0.133

(B) Spinach

Element	TF values of metals in spinach uptake							
	Control		Low		Medium		High	
	Leaves	Roots	Leaves	Roots	Leaves	Roots	Leaves	Roots
Cr	0.07	0.10	0.01	0.04	0.01	0.02	0.003	0.01
Mn	5.40	2.89	3.38	1.02	3.54	0.50	3.49	0.88
Fe	0.06	0.04	0.01	0.03	0.02	0.04	0.01	0.04
Ni	0.42	0.45	0.06	0.16	0.10	0.11	0.11	0.16
Cu	0.12	0.51	0.07	0.20	0.06	0.09	0.03	0.08
Zn	3.56	2.92	0.95	0.78	1.33	0.67	1.43	0.71
Mo	0.04	0.03	0.03	0.05	0.02	0.09	0.012	0.06
Cd	1.40	0.80	0.37	0.61	0.61	0.34	0.92	0.51
Pb	0.148	0.022	0.015	0.054	0.008	0.055	0.008	0.059

**Table 5.1 (continued)****(C) Carrot**

Element	TF values of metals in carrot uptake							
	Control		Low		Medium		High	
	Leaves	Roots	Leaves	Roots	Leaves	Roots	Leaves	Roots
Cr	0.045	0.043	0.008	0.006	0.004	0.003	0.003	0.006
Mn	3.57	0.31	3.15	0.12	4.29	0.19	3.31	0.18
Fe	0.08	0.02	0.03	0.0039	0.03	0.0042	0.02	0.0034
Ni	0.43	0.29	0.04	0.03	0.05	0.03	0.07	0.05
Cu	0.09	0.06	0.03	0.018	0.03	0.03	0.026	0.025
Zn	1.83	1.11	1.32	0.38	0.92	0.33	1.07	0.20
Mo	0.023	0.005	0.017	0.008	0.030	0.022	0.028	0.010
Cd	0.55	0.30	0.41	0.25	0.27	0.22	0.40	0.19
Pb	0.015	0.013	0.004	0.003	0.002	0.001	0.002	0.003

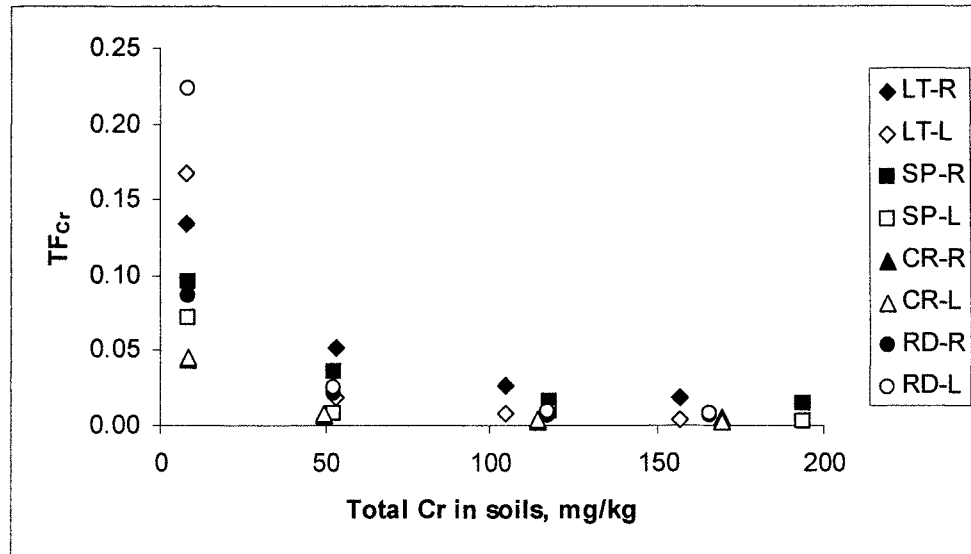
**(D) Radish**

Element	TF values of metals in radish uptake							
	Control		Low		Medium		High	
	Leaves	Roots	Leaves	Roots	Leaves	Roots	Leaves	Roots
Cr	0.22	0.09	0.02	0.02	0.01	0.01	0.01	0.01
Mn	2.73	0.27	1.84	0.14	2.17	0.26	2.16	0.24
Fe	0.11	0.03	0.04	0.01	0.04	0.0050	0.03	0.0048
Ni	0.47	0.66	0.06	0.10	0.05	0.06	0.07	0.06
Cu	0.12	0.07	0.03	0.02	0.04	0.02	0.05	0.02
Zn	3.90	4.43	1.73	1.04	1.48	1.28	1.48	1.34
Mo	0.053	0.024	0.016	0.012	0.137	0.207	0.112	0.136
Cd	0.95	0.30	0.34	0.08	0.50	0.14	0.56	0.19
Pb	0.053	0.027	0.008	0.015	0.007	0.008	0.002	0.005

*Chromium*

The  $TF_{Cr}$  values varied from 0.003 in CR-R, CR-L and SP-L to 0.22 in RD-L as shown in Figure 5.1. The mean  $TF_{Cr}$  values irrespective of plant type was  $0.037 \pm 0.052$  ( $n = 32$ ). For most vegetables studied, the  $TF_{Cr}$  values were extremely low (less than 0.10). The TF values higher than 0.10 were only observed in RD-L (0.22), LT-L (0.17) and LT-R (0.13). This implies that it is very difficult for Cr to transfer from the soils to the plants i.e. Cr bioavailability in soil is very low. However, the  $TF_{Cr}$  values were higher when the plants were grown on the unadulterated soil while they were slightly decreased with increasing total soil Cr.

**Figure 5.1** Soil-to-plant transfer factors values of Cr ( $TF_{Cr}$ ) as a function of the total soil concentrations



### *Manganese*

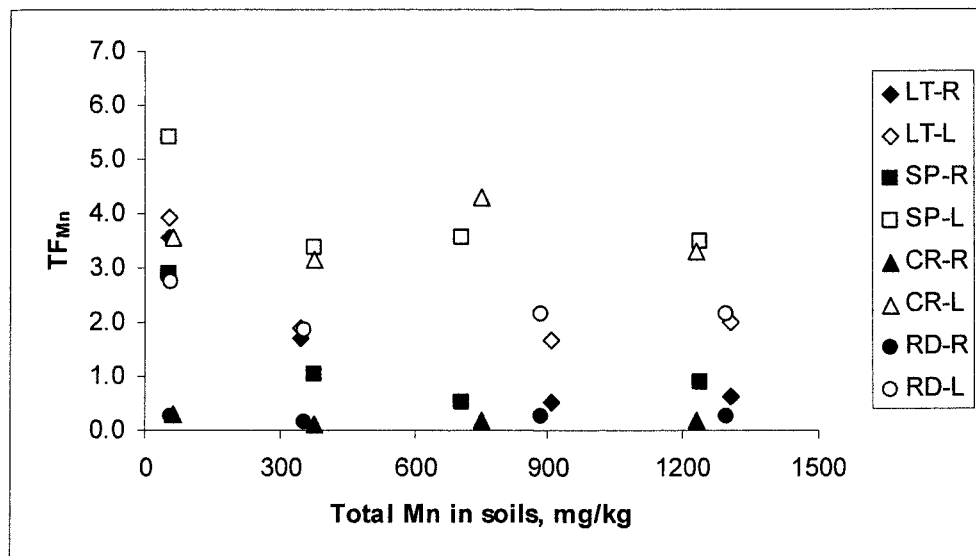
The  $TF_{Mn}$  values ranged from 0.12 in CR-R to 5.40 in SP-L as shown in Figure 5.2. The mean  $TF_{Mn}$  value irrespective of plant type was  $1.93 \pm 1.51$  ( $n = 32$ ). The much higher  $TF_{Mn}$  values compared to  $TF_{Cr}$  are attributed to greater mobility and bioavailability of Mn in the soils. This is due to the soils used in this experiment being acidic, hence Mn becomes more available to plants. The data of Figure 5.2 clearly indicate that  $TF_{Mn}$  values in plant leaves were higher than that in the roots. Mn is known to be stored in the chloroplasts of plant cells and quantities much in excess in plants are sequestered in vacuoles (McCain *et al.*, 1990). However, the physiological mechanisms of Mn tolerance are still largely unknown, but it has been reported that high Mn tolerance is associated with restricted absorption and translocation of excess Mn to the shoot (Wang *et al.*, 2002).

### *Iron*

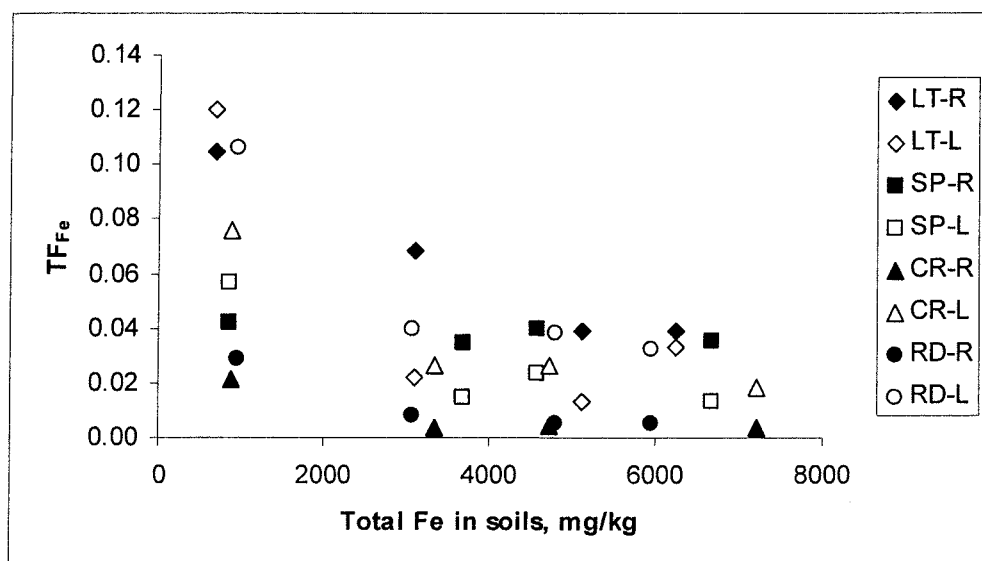
The  $TF_{Fe}$  values varied from 0.003 in CR-R to 0.12 in LT-L as shown in Figure 5.3. The mean  $TF_{Fe}$  value irrespective of plant type was  $0.036 \pm 0.030$  ( $n = 32$ ). The  $TF_{Fe}$  values were considerably as low as  $TF_{Cr}$  values. In the previous chapter, we know that Cr concentrations in all plants were relatively low ( $< 2.91$  mg/kg), while Fe concentrations in the plants were much higher ranging from 68 – 244, 36 – 239, 13 –

134 and 24 – 193 mg/kg in lettuce, spinach, carrot and radish, respectively. As the TF value of the metal based on the total metal concentrations in soils, then it enables to provide information of bioavailability of the metal in the soil to plant. Hence, Fe bioavailability is as low as Cr i.e. it is difficult for both Fe and Cr to transfer from the soil to the plants eventhough the accumulated amounts of the Fe in the plants were higher than Cr.

**Figure 5.2** Soil-to-plant transfer factors values of Mn ( $TF_{Mn}$ ) as a function of the total soil concentrations



**Figure 5.3** Soil-to-plant transfer factors values of Fe ( $TF_{Fe}$ ) as a function of the total soil concentrations

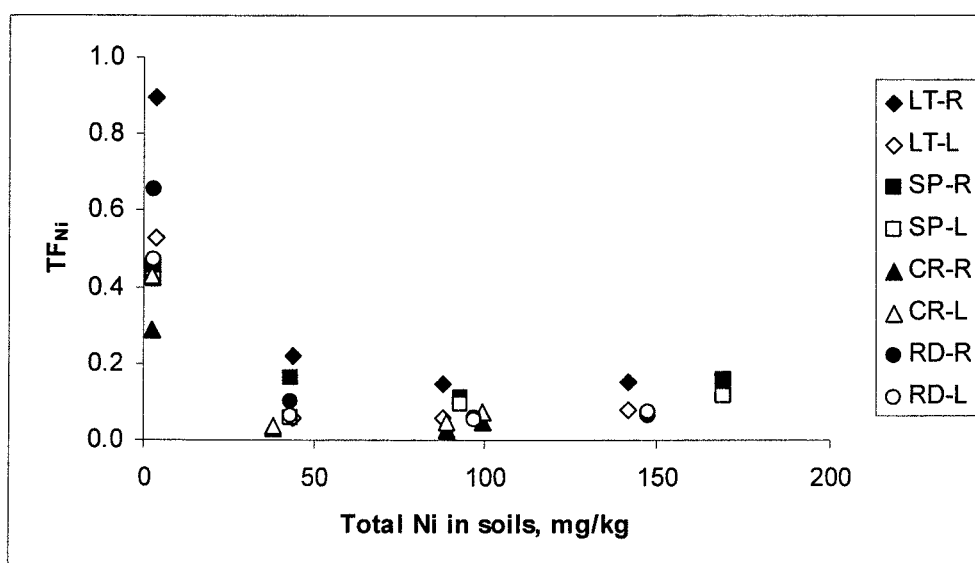




### Nickel

The  $TF_{Ni}$  values varied from 0.03 in CR-R to 0.89 in LT-R as shown in Figure 5.4. The mean  $TF_{Ni}$  value irrespective of plant type was  $0.194 \pm 0.213$  ( $n = 32$ ). The  $TF_{Ni}$  values were high when the plants were grown on the unadulterated soil. There were no significant differences of the  $TF_{Ni}$  values when the total soil Ni was increased.

**Figure 5.4** Soil-to-plant transfer factors values of Ni ( $TF_{Ni}$ ) as a function of the total soil concentrations



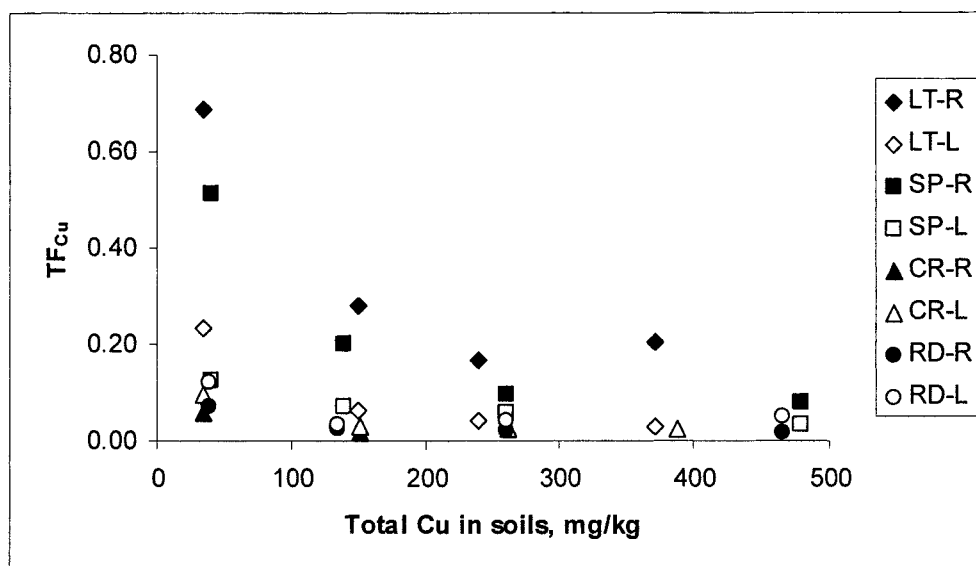
### Copper

The  $TF_{Cu}$  values varied from 0.018 in CR-R to 0.69 in LT-R as shown in Figure 5.5. The mean  $TF_{Cu}$  value irrespective of plant type was  $0.111 \pm 0.147$  ( $n = 32$ ). The  $TF_{Cu}$  values were relatively decreased with increasing total soil Cu, for spinach and lettuce. For carrot and radish, there were no significant differences when increasing total soil Cu was applied.

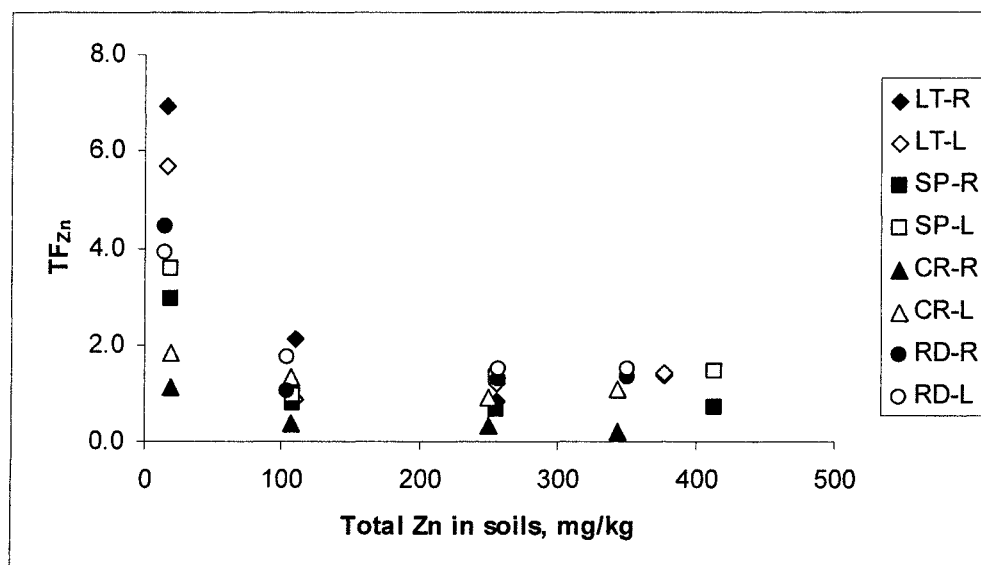
### Zinc

The  $TF_{Zn}$  values varied from 0.20 in CR-R to 6.94 in LT-R as shown in Figure 5.6. The mean  $TF_{Zn}$  value irrespective of plant type was  $1.77 \pm 1.55$  ( $n = 32$ ). The  $TF_{Zn}$  values were high when the plants were grown on the unadulterated soil. There were no significant differences of the  $TF_{Zn}$  values when the total soil Zn was increased.

**Figure 5.5** Soil-to-plant transfer factors values of Cu ( $TF_{Cu}$ ) as a function of the total soil concentrations



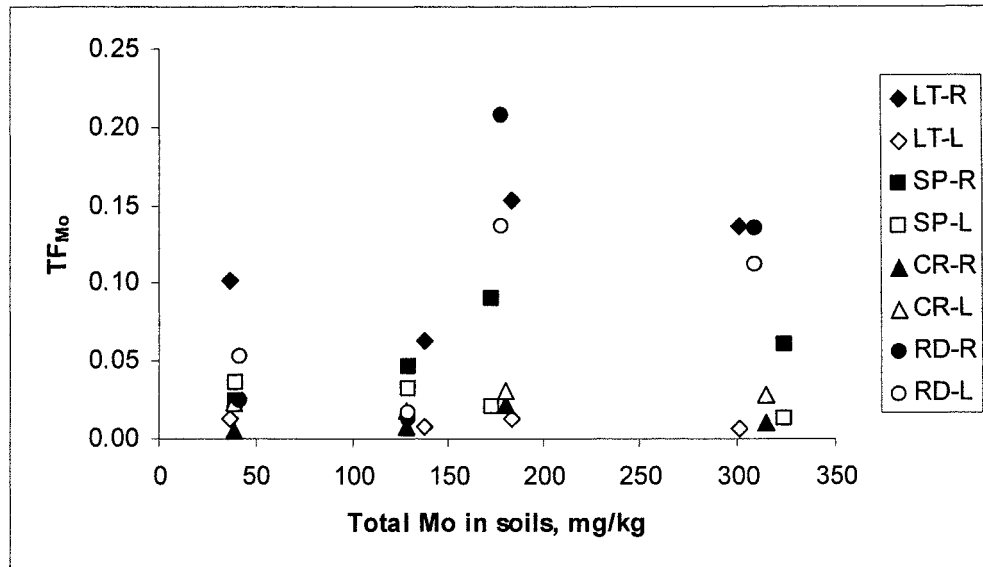
**Figure 5.6** Soil-to-plant transfer factors values of Zn ( $TF_{Zn}$ ) as a function of the total soil concentrations



### *Molybdenum*

The  $TF_{Mo}$  values varied from 0.005 in CR-R to 0.207 in RD-R as shown in Figure 5.7. The mean  $TF_{Mo}$  value irrespective of plant type was  $0.052 \pm 0.053$  ( $n = 32$ ). The  $TF_{Mo}$  values were extremely low in all plants and not increased with increasing total soil Mo. Hence, the Mo bioavailability is very low similar to Cr and Fe.

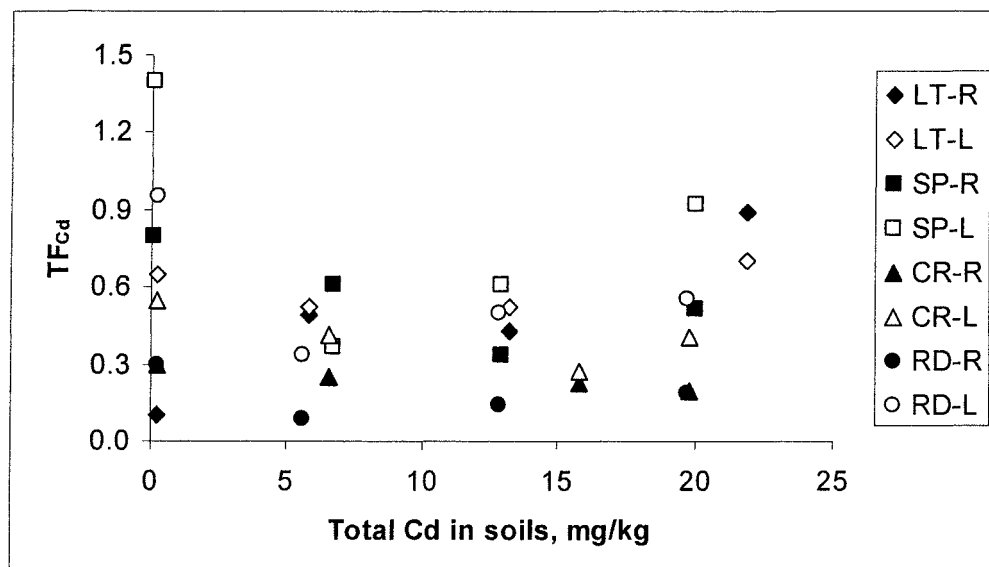
**Figure 5.7** Soil-to-plant transfer factors values of Mo ( $TF_{Mo}$ ) as a function of the total soil concentrations



*Cadmium*

The  $TF_{Cd}$  values varied from 0.08 in RD-R to 1.40 in SP-L as shown in Figure 5.8. The mean  $TF_{Cd}$  value irrespective of plant type was  $0.485 \pm 0.286$  ( $n = 32$ ). The  $TF_{Cd}$  values were moderate in all plants and not increased with increasing total soil Cd.

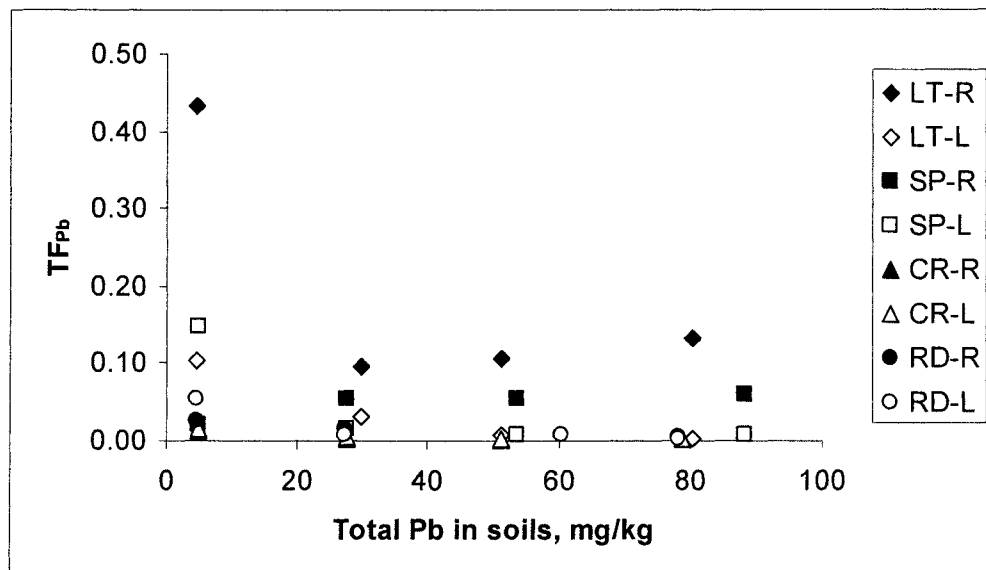
**Figure 5.8** Soil-to-plant transfer factors values of Cd ( $TF_{Cd}$ ) as a function of the total soil concentrations



### Lead

The  $TF_{Pb}$  values varied from 0.001 in CR-R to 0.432 in LT-R as shown in Figure 5.9. The mean  $TF_{Pb}$  value irrespective of plant type was  $0.045 \pm 0.082$  ( $n = 32$ ). The  $TF_{Pb}$  values were lower than 0.15 for all plants studied except in the LT-R and they were not increased with increasing total soil Pb. Hence, the Pb bioavailability is very low similar to Cr, Fe and Mo.

**Figure 5.9** Soil-to-plant transfer factors values of Pb ( $TF_{Pb}$ ) as a function of the total soil concentrations



On the whole, the order of the transfer factor was  $Mn > Zn \gg Cd > Ni > Cu > Mo \approx Pb > Cr \approx Fe$ . Typical ranges of TF values of the metals in the plants and their means irrespective of plant type are summarized in Table 5.2.

### 5.3 Correlation analysis of total metals accumulated in plants and total, EDTA-, $CH_3COOH$ -, $CaCl_2$ -, and $H_2O$ extractable metals in soils

Correlation is the statistical term for the degree of fit to regression lines i.e. how well the experimental points fit a straight line. It is referred to as the ‘**correlation coefficient,  $r$** ’ and the value of  $r$  is given by the following formula (Miller and Miller, 1993):

$$r = \frac{\Sigma[(x_i - \bar{x})(y_i - \bar{y})]}{[\Sigma(x_i - \bar{x})^2 \Sigma(y_i - \bar{y})^2]^{1/2}} \quad (5.1)$$

**Table 5.2** Ranges of the transfer factors (TF) from soil to plant

Element	Range of TF values	Mean $\pm$ SD, n = 32
Cr	0.003 – 0.22	0.037 $\pm$ 0.052
Mn	0.12 – 5.40	1.93 $\pm$ 1.51
Fe	0.003 – 0.12	0.036 $\pm$ 0.030
Ni	0.03 – 0.89	0.194 $\pm$ 0.213
Cu	0.018 – 0.69	0.111 $\pm$ 0.147
Zn	0.20 – 6.94	1.77 $\pm$ 1.55
Mo	0.005 – 0.207	0.052 $\pm$ 0.053
Cd	0.08 – 1.40	0.485 $\pm$ 0.286
Pb	0.001 – 0.432	0.045 $\pm$ 0.082

The  $r$  values are in the range  $-1 \leq r \leq +1$ . There is a perfect positive correlation when  $r = +1$ , no correlation between  $x$  and  $y$  when  $r = 0$ , and a perfect negative correlation where  $r = -1$ . Hence, the closer the  $r$  value is to 1 or -1, the stronger the relationship between the two variables. As the number of data points increases a significant correlation is attained at lower values of  $r$ . Table 5.3 gives the  $r$  values above which it can be 95 % certain that the correlation is significant (Rowell, 1994).

**Table 5.3** Correlation coefficients at 95% significance level (df, degree of freedom =  $n - 1$ )

df	r	df	r	df	r
1	1.00	11	0.55	25	0.38
2	0.95	12	0.53	30	0.35
3	0.88	13	0.51	35	0.33
4	0.81	14	0.50	40	0.30
5	0.76	15	0.48	45	0.29
6	0.71	16	0.47	50	0.27
7	0.67	17	0.46	60	0.25
8	0.63	18	0.44	70	0.23
9	0.60	19	0.43	80	0.22
10	0.58	20	0.42	90	0.21
				100	0.20

For the results of total and extractable metals, 4 data points give 3 degrees of freedom and  $r$  must be  $> 0.88$  to be significantly correlated.

**Table 5.4 (A-I)** Correlation coefficients between total metal in the vegetables and the total or EDTA-, CH<sub>3</sub>COOH-, CaCl<sub>2</sub>-, H<sub>2</sub>O-extractable metal in soils (mg/kg, DW).

\* indicates significant correlations at the probability level of P < 0.05.

(A) Chromium

Correlation coefficients	Total Cr	EDTA-Cr	CH <sub>3</sub> COOH-Cr	CaCl <sub>2</sub> -Cr	H <sub>2</sub> O-Cr
LT-R	0.799	0.910*	0.820	0.671	0.869
LT-L	-0.956*	-0.992*	-0.962*	-0.886*	-0.973*
SP-R	0.932*	0.939*	0.923*	0.894*	0.907*
SP-L	0.275	0.311	0.322	0.210	0.388
CR-R	0.785	0.641	0.745	0.883*	0.651
CR-L	0.947*	0.917*	0.931*	0.940*	0.896*
RD-R	0.458	0.552	0.450	0.375	0.459
RD-L	-0.723	-0.858	-0.759	-0.571	-0.836

(B) Manganese

Correlation coefficients	Total Mn	EDTA-Mn	CH <sub>3</sub> COOH-Mn	CaCl <sub>2</sub> -Mn	H <sub>2</sub> O-Mn
LT-R	0.800	0.857	0.854	0.810	0.806
LT-L	0.989*	0.997*	0.997*	0.995*	0.980*
SP-R	0.857	0.920*	0.919*	0.940*	0.962*
SP-L	0.988*	1.000*	1.000*	0.991*	0.975*
CR-R	0.995*	0.986*	0.987*	0.981*	0.956*
CR-L	0.995*	0.972*	0.973*	0.944*	0.904*
RD-R	0.992*	0.971*	0.972*	0.963*	0.932*
RD-L	0.999*	0.989*	0.989*	0.976*	0.948*

(C) Iron

Correlation coefficients	Total Fe	EDTA-Fe	CH <sub>3</sub> COOH-Fe	CaCl <sub>2</sub> -Fe	H <sub>2</sub> O-Fe
LT-R	0.898*	0.927*	0.856	0.812	0.950*
LT-L	0.600	0.516	0.744	0.868	0.710
SP-R	0.996*	0.987*	0.987*	0.939*	0.972*
SP-L	0.837	0.834	0.768	0.616	0.618
CR-R	0.586	0.489	0.694	0.728	0.501
CR-L	0.989*	0.973*	0.971*	0.894*	0.896*
RD-R	0.077	-0.021	0.269	0.469	0.256
RD-L	0.973*	0.952*	0.956*	0.874	0.858

**Table 5.4 (continued)****(D) Nickel**

<b>Correlation coefficients</b>	<b>Total Ni</b>	<b>EDTA-Ni</b>	<b>CH<sub>3</sub>COOH-Ni</b>	<b>CaCl<sub>2</sub>-Ni</b>	<b>H<sub>2</sub>O-Ni</b>
LT-R	0.989*	0.980*	0.987*	0.927*	0.919*
LT-L	0.948*	0.929*	0.944*	0.793	0.765
SP-R	0.961*	0.942*	0.956*	0.841	0.832
SP-L	0.967*	0.954*	0.964*	0.828	0.793
CR-R	0.975*	0.961*	0.971*	0.848	0.820
CR-L	0.978*	0.973*	0.978*	0.866	0.819
RD-R	0.988*	0.977*	0.985*	0.908*	0.896*
RD-L	0.970*	0.956*	0.967*	0.836	0.807

**(E) Copper**

<b>Correlation coefficients</b>	<b>Total Cu</b>	<b>EDTA-Cu</b>	<b>CH<sub>3</sub>COOH-Cu</b>	<b>CaCl<sub>2</sub>-Cu</b>	<b>H<sub>2</sub>O-Cu</b>
LT-R	0.938*	0.904*	0.916*	0.901*	0.869
LT-L	0.994*	0.995*	0.971*	0.983*	0.998*
SP-R	0.885*	0.834	0.845	0.827	0.797
SP-L	0.926*	0.929*	0.867	0.900*	0.964*
CR-R	0.962*	0.988*	0.993*	0.996*	0.974*
CR-L	0.989*	0.997*	0.997*	0.998*	0.982*
RD-R	0.965*	0.984*	0.999*	0.995*	0.960*
RD-L	0.924*	0.937*	0.976*	0.958*	0.893*

**(F) Zinc**

<b>Correlation coefficients</b>	<b>Total Zn</b>	<b>EDTA-Zn</b>	<b>CH<sub>3</sub>COOH-Zn</b>	<b>CaCl<sub>2</sub>-Zn</b>	<b>H<sub>2</sub>O-Zn</b>
LT-R	0.873	0.879*	0.911*	0.943*	0.963*
LT-L	0.963*	0.954*	0.967*	0.986*	0.976*
SP-R	0.980*	0.976*	0.988*	0.999*	0.993*
SP-L	0.979*	0.972*	0.982*	0.992*	0.983*
CR-R	0.859	0.857	0.815	0.730	0.686
CR-L	0.992*	0.995*	0.998*	0.982*	0.975*
RD-R	0.989*	0.982*	0.982*	0.976*	0.958*
RD-L	0.999*	0.998*	0.993*	0.967*	0.950*

**Table 5.4 (continued)****(G) Molybdenum**

<b>Correlation coefficients</b>	<b>Total Mo</b>	<b>EDTA-Mo</b>	<b>CH<sub>3</sub>COOH-Mo</b>	<b>CaCl<sub>2</sub>-Mo</b>	<b>H<sub>2</sub>O-Mo</b>
LT-R	0.948*	0.987*	0.946*	0.935*	0.991*
LT-L	0.841	0.837	0.732	0.712	0.853
SP-R	0.952*	0.952*	0.889*	0.875	0.957*
SP-L	0.757	0.519	0.461	0.453	0.505
CR-R	0.787	0.797	0.682	0.659	0.816
CR-L	0.969*	0.994*	0.964*	0.956*	0.994*
RD-R	0.856	0.930*	0.858	0.842	0.944*
RD-L	0.900*	0.976*	0.931*	0.919*	0.985*

**(H) Cadmium**

<b>Correlation coefficients</b>	<b>Total Cd</b>	<b>EDTA-Cd</b>	<b>CH<sub>3</sub>COOH-Cd</b>	<b>CaCl<sub>2</sub>-Cd</b>	<b>H<sub>2</sub>O-Cd</b>
LT-R	0.944*	0.926*	0.927*	0.986*	0.995*
LT-L	0.986*	0.976*	0.977*	1.000*	0.997*
SP-R	0.954*	0.949*	0.947*	0.967*	0.974*
SP-L	0.979*	0.966*	0.967*	0.999*	0.996*
CR-R	0.946*	0.961*	0.961*	0.875	0.844
CR-L	0.993*	0.991*	0.990*	0.986*	0.981*
RD-R	0.986*	0.975*	0.977*	0.995*	0.987*
RD-L	0.995*	0.989*	0.991*	0.988*	0.974*

**(I) Lead**

<b>Correlation coefficients</b>	<b>Total Pb</b>	<b>EDTA-Pb</b>	<b>CH<sub>3</sub>COOH-Pb</b>	<b>CaCl<sub>2</sub>-Pb</b>	<b>H<sub>2</sub>O-Pb</b>
LT-R	0.956*	0.930*	0.941*	0.809	0.881*
LT-L	-0.641	-0.636	-0.653	-0.654	-0.764
SP-R	0.997*	0.985*	0.990*	0.875	0.913*
SP-L	-0.074	-0.128	-0.099	-0.168	-0.011
CR-R	0.812	0.738	0.758	0.489	0.592
CR-L	0.976*	0.944*	0.951*	0.771	0.812
RD-R	0.656	0.703	0.681	0.705	0.598
RD-L	0.013	0.133	0.106	0.447	0.328



#### **5.4 The regression models for predicting TF values of metals in plants**

Wang *et al.* (2006) proposed that the soil-to-plant TF values is an index for comparing the ability of plants to take up soil metals and the TF values for a given crop and metal are the mean of a group of data. This approach is reasonable when the crop samples are collected from soils of which the metal concentrations are evenly distributed over a wide range. Hence, the researchers suggested that the soil-to-plant transfer factors for a given crop-metal system should be estimated from the regression model between the TF values and the corresponding soil metal concentrations.

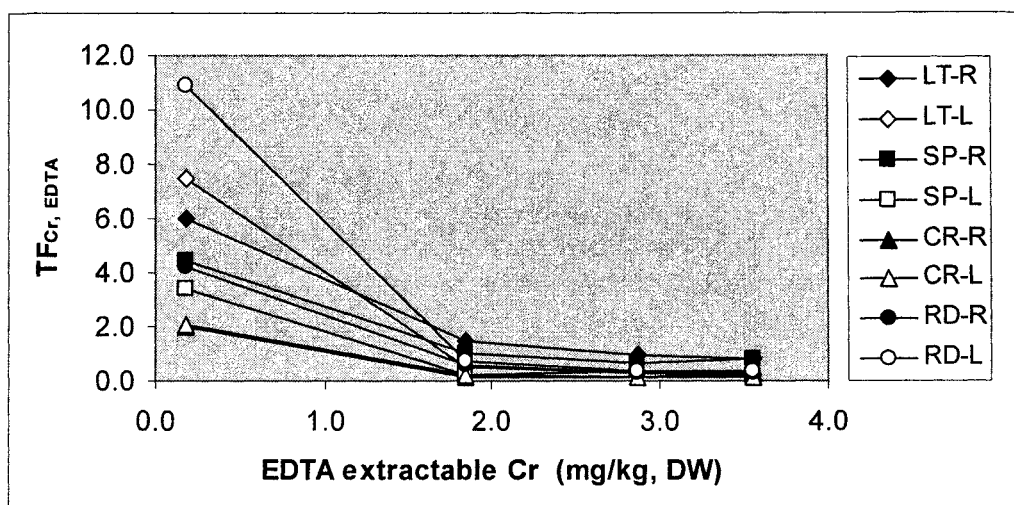
In this study, the corresponding soil metal concentrations can be determined using the correlation analysis. The TF value does not necessarily have to be measured based on total metal in soil. It can be measured based on metal content extracted by a single chemical extraction if the extraction provides a better measure of metal accumulation by plants (Huang *et al.*, 2003). Hence, soil total metals or extractable metals for TF measurement is justified by considering the most highly correlated results between the soil metals and the amounts accumulated in the plants studied.

The use of statistical methods to determine the line of best fit through a set of data is known as regression, the line is then called a regression line and the equation of the line is called a regression equation (Rowell, 1994). The coefficient of determination ( $R^2$ ) indicates the proportion of variation in a data set accounted for by a statistical regression model.  $R^2$  can vary from 0 to 1.0. The closer  $R^2$  is to 1, the greater is the predictive ability of the regression model over all the sample observations. If the  $R^2 = 1$ , then all the sample data fall exactly on the regression line and the regression model fits the data perfectly.

#### ***Chromium***

As we know that, from Table 5.4 (A), the amounts of Cr accumulated in the plants are most correlated to the EDTA extractable Cr in soils, therefore the data of EDTA extractable Cr were taken for simulating regression models in order to predict the TF values of Cr in plants as shown in Figure 5.10.

**Figure 5.10** Relationship between the TF values of Cr (y) and EDTA extractable Cr in soils (x)



**Table 5.5** Relationship between the TF values of Cr (y) and the EDTA extractable Cr in soils (x)

Plants	Equation for $TF_{EDTA}$	$R^2$
LT-R	$y = 1.9852x^{-0.6473}$	0.9928
LT-L	$y = 0.9848x^{-1.1775}$	0.9972
SP-R	$y = 1.4804x^{-0.6285}$	0.9746
SP-L	$y = 0.6312x^{-0.9472}$	0.9353
CR-R	$y = 0.4163x^{-0.8441}$	0.8534
CR-L	$y = 0.4107x^{-0.9363}$	0.9983
RD-R	$y = 0.9162x^{-0.891}$	0.9868
RD-L	$y = 1.4457x^{-1.159}$	0.9971

From the regression equation obtained in Table 5.5, it shows that the relationship between the  $TF_{Cr}$  for every plant sample and the EDTA extractable Cr in soil followed the power regression curves with the coefficient of determination ( $R^2$ ) ranging from 0.8534 to 0.9983.

To demonstrate this regression model, it is assumed that the EDTA extractable Cr from a given soil sample is 3 mg/kg dry weight. The estimated  $TF_{Cr}$  in the roots of lettuce if they were grown on this soil can be obtained from the following calculation;

$$y = 1.9852x^{-0.6473}$$

And  $x = 3 \text{ mg/kg}$

Hence,  $y = 1.9852 (3)^{-0.6473}$

$$y = 0.9749$$

And the amount of Cr accumulated in the plant can be calculated from equation (5.1) as follows:

$$C_{\text{Plant}} = \text{TF}_{\text{Cr}} \times C_{\text{EDTA}}$$

where  $C_{\text{plant}}$  and  $C_{\text{EDTA}}$  is the concentration of metal in the plant and the EDTA-extractable soil Cr, respectively.

$$\text{Hence, } C_{\text{plant}} = 0.9749 \times 3 = 2.9247 \text{ mg/kg}$$

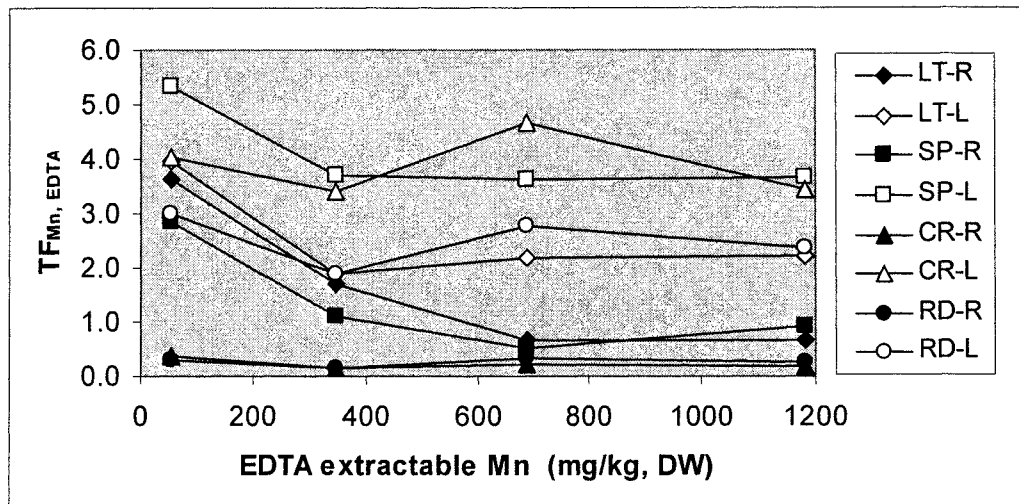
Then, we can estimate that the  $\text{TF}_{\text{Cr}}$  of the lettuce roots is 0.9749 if the plants were grown on this soil implying that 2.9247 mg/kg of Cr could be accumulated in the plant. However, a large number of samples should be collected to obtain the more robust regression model for estimating soil-to-plant transfer factor values.

For the other heavy metals studied, their TF values of each plant sample can be predicted from their corresponding regression models in a similar manner as chromium.

### ***Manganese***

From Table 5.4 (B), the amounts of Mn accumulated in the plants are most correlated to the EDTA extractable Mn in the soils; therefore the data of EDTA extractable Mn were taken for simulating regression models in order to predict the TF values of Mn in plants as shown in Figure 5.11. The regression equations obtained for all plant samples are given in Table 5.6.

**Figure 5.11** Relationship between the TF values of Mn (y) and EDTA extractable Mn in soils (x)



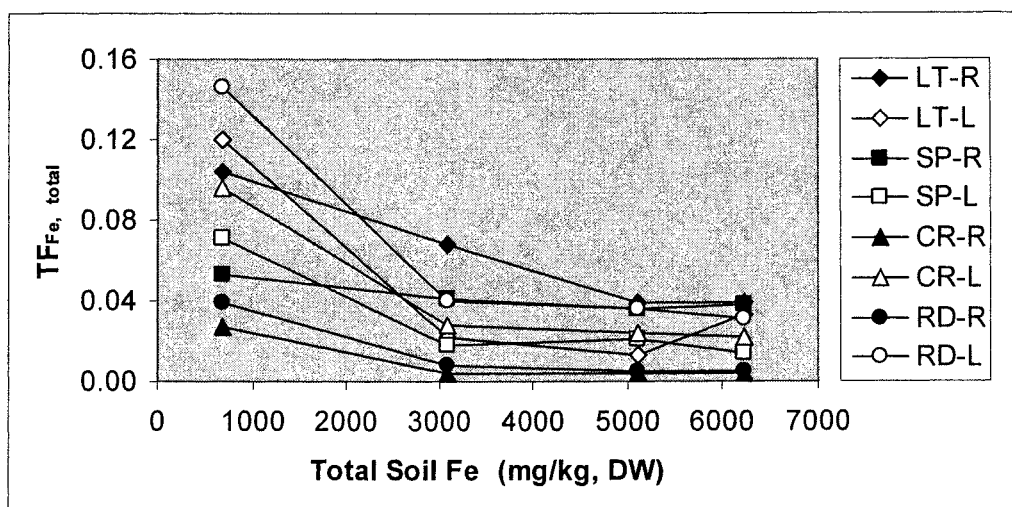
**Table 5.6** Relationship between the TF values of Mn (y) and the EDTA extractable Mn in soils (x)

Plants	Equation for TF <sub>EDTA</sub>	R <sup>2</sup>
LT-R	$y = 38.893x^{-0.58}$	0.9234
LT-L	$y = 8.0309x^{-0.2019}$	0.6848
SP-R	$y = 16.625x^{-0.4618}$	0.7612
SP-L	$y = 8.627x^{-0.13}$	0.8721
CR-R	$y = 0.7115x^{-0.2118}$	0.4823
CR-L	$y = -0.0002x + 4.0112$	0.0287
RD-R	$y = 3E-05x + 0.2448$	0.0247
RD-L	$y = 3.5402x^{-0.0609}$	0.1661

### Iron

From Table 5.4 (C), the amounts of Fe accumulated in the plants are most correlated to the total Fe in soils, therefore the data of total Fe in soils were taken for simulating regression models in order to predict the TF values of Fe in plants as shown in Figure 5.12. The regression equations obtained for all plant samples are given in Table 5.7.

**Figure 5.12** Relationship between the TF values of Fe (y) and total Fe in soils (x)



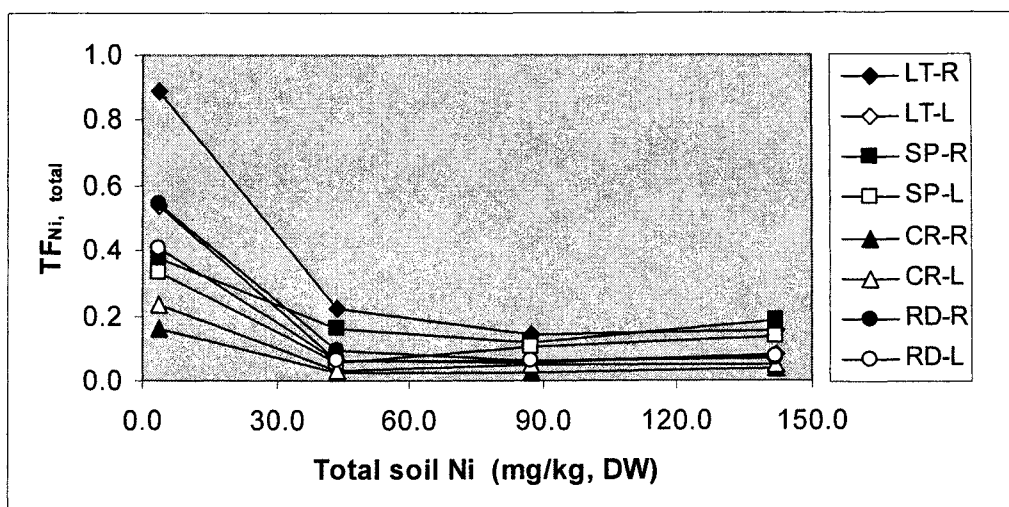
**Table 5.7** Relationship between the TF values of Fe (y) and the total Fe in soils (x)

Plants	Equation for $TF_{total}$	$R^2$
LT-R	$y = 2.1625x^{-0.4558}$	0.9089
LT-L	$y = 19.724x^{-0.8031}$	0.7284
SP-R	$y = 0.1532x^{-0.164}$	0.9387
SP-L	$y = 6.2085x^{-0.6938}$	0.9145
CR-R	$y = 10.001x^{-0.9228}$	0.9319
CR-L	$y = 7.9983x^{-0.6839}$	0.9797
RD-R	$y = 28.356x^{-1.0099}$	0.9938
RD-L	$y = 14.177x^{-0.7084}$	0.9708

### *Nickel*

From Table 5.4 (D), the amounts of Ni accumulated in the plants are most correlated to the total Ni in soils, therefore the data of total Ni were taken for simulating regression models in order to predict the TF values of Ni in plants as shown in Figure 5.13. The regression equations obtained for all plant samples are given in Table 5.8.

**Figure 5.13** Relationship between the TF values of Ni (y) and the total Ni in soils (x)



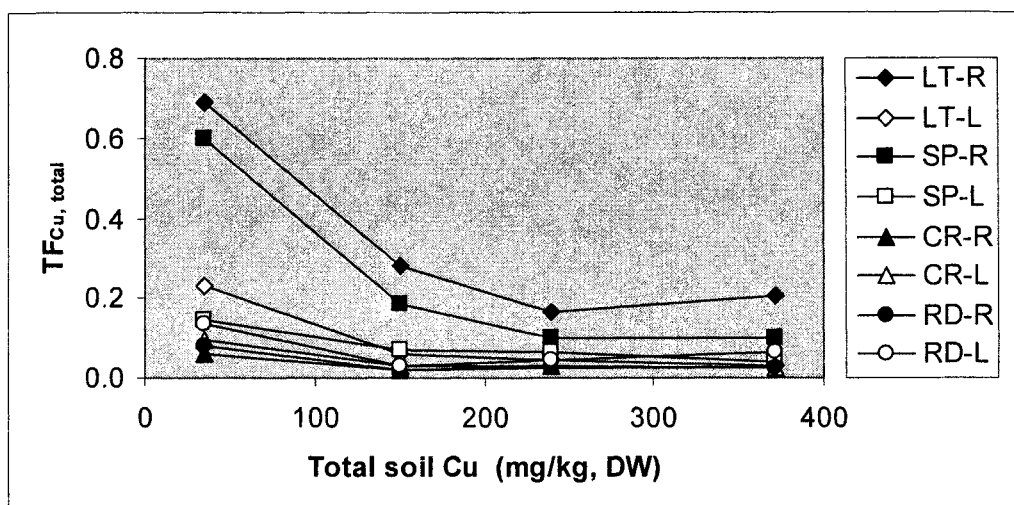
**Table 5.8** Relationship between the TF values of Ni (y) and the total Ni in soils (x)

Plants	Equation for $TF_{total}$	$R^2$
LT-R	$y = 1.7007x^{-0.5208}$	0.9740
LT-L	$y = 1.0125x^{-0.6123}$	0.8470
SP-R	$y = 0.4925x^{-0.2604}$	0.7234
SP-L	$y = 0.4034x^{-0.3148}$	0.4780
CR-R	$y = 0.2678x^{-0.4892}$	0.8366
CR-L	$y = 0.3602x^{-0.467}$	0.7293
RD-R	$y = 1.1806x^{-0.6282}$	0.9725
RD-L	$y = 0.6933x^{-0.5267}$	0.8361

### **Copper**

From Table 5.4 (E), the amount of Cu accumulated in the plants are most correlated to the total Cu in soils, therefore the data of total Cu were taken for simulating regression models in order to predict the TF values of Cu in plants as shown in Figure 5.14. The regression equations obtained for all plant samples are given in Table 5.9.

**Figure 5.14** Relationship between the TF values of Cu (y) and the total Cu in soils (x)



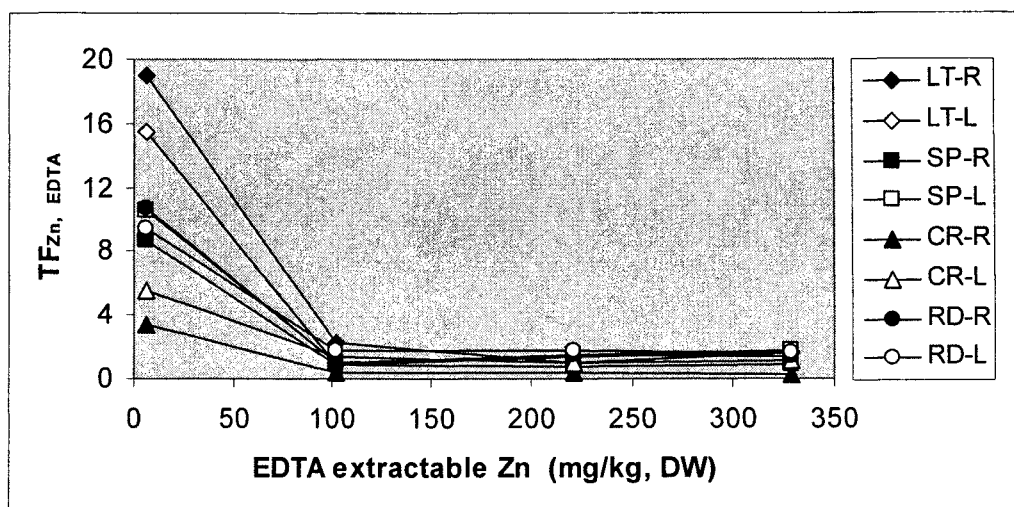
**Table 5.9** Relationship between the TF values of Cu (y) and the total Cu in soils (x)

Plants	Equation for $TF_{total}$	$R^2$
LT-R	$y = 5.0062x^{-0.575}$	0.9086
LT-L	$y = 4.6071x^{-0.8531}$	0.9978
SP-R	$y = 9.5453x^{-0.7916}$	0.9714
SP-L	$y = 0.812x^{-0.487}$	0.9660
CR-R	$y = 0.1951x^{-0.3756}$	0.5802
CR-L	$y = 0.7162x^{-0.5905}$	0.9420
RD-R	$y = 0.4961x^{-0.5534}$	0.8332
RD-L	$y = 0.4346x^{-0.3985}$	0.4377

### *Zinc*

From Table 5.4 (F), the amounts of Zn accumulated in the plants are most correlated to the EDTA extractable Zn in soils, therefore the data of EDTA extractable Zn were taken for simulating regression models in order to predict the TF values of Zn in plants as shown in Figure 5.15. The regression equations obtained for all plant samples are given in Table 5.10.

**Figure 5.15** Relationship between the TF values of Zn (y) and EDTA extractable Zn in soils (x)



**Table 5.10** Relationship between the TF values of Zn (y) and the EDTA extractable Zn in soils (x)

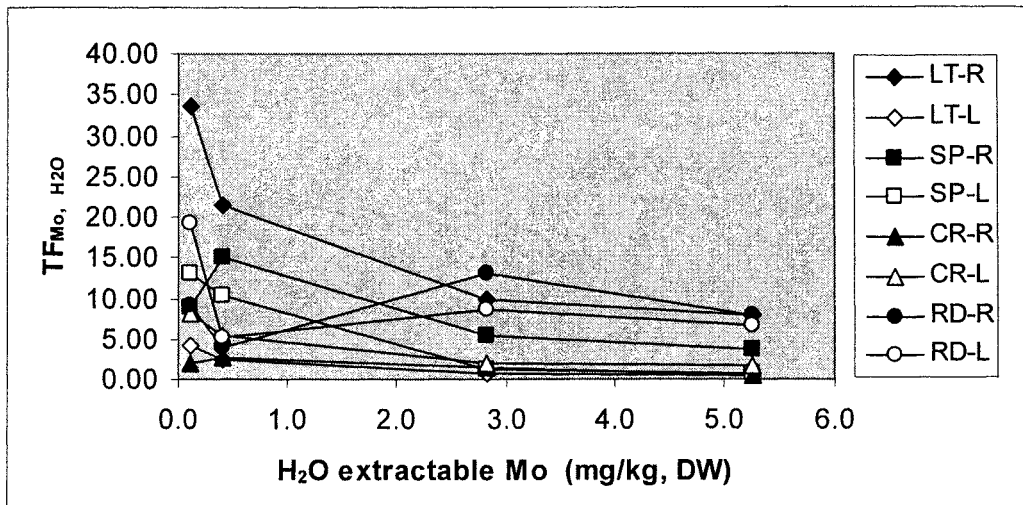
Plants	Equation for $TF_{EDTA}$	$R^2$
LT-R	$y = 64.784x^{-0.7099}$	0.9385
LT-L	$y = 39.056x^{-0.6353}$	0.8046
SP-R	$y = 23.583x^{-0.6247}$	0.9151
SP-L	$y = 21.483x^{-0.5029}$	0.7632
CR-R	$y = 11.044x^{-0.672}$	0.9738
CR-L	$y = 11.689x^{-0.4326}$	0.9719
RD-R	$y = 24.244x^{-0.5424}$	0.8433
RD-L	$y = 20.434x^{-0.4679}$	0.9511

### ***Molybdenum***

From Table 5.4 (G), the amounts of Mo accumulated in the plants are most correlated to the H<sub>2</sub>O extractable Mo in soils, therefore the data of H<sub>2</sub>O extractable Mo were taken for simulating regression models in order to predict the TF values of Mo in plants as shown in Figure 5.16. The regression equations obtained for all plant samples are given in Table 5.11.



**Figure 5.16** Relationship between the TF values of Mo (y) and H<sub>2</sub>O extractable Mo in soils (x)



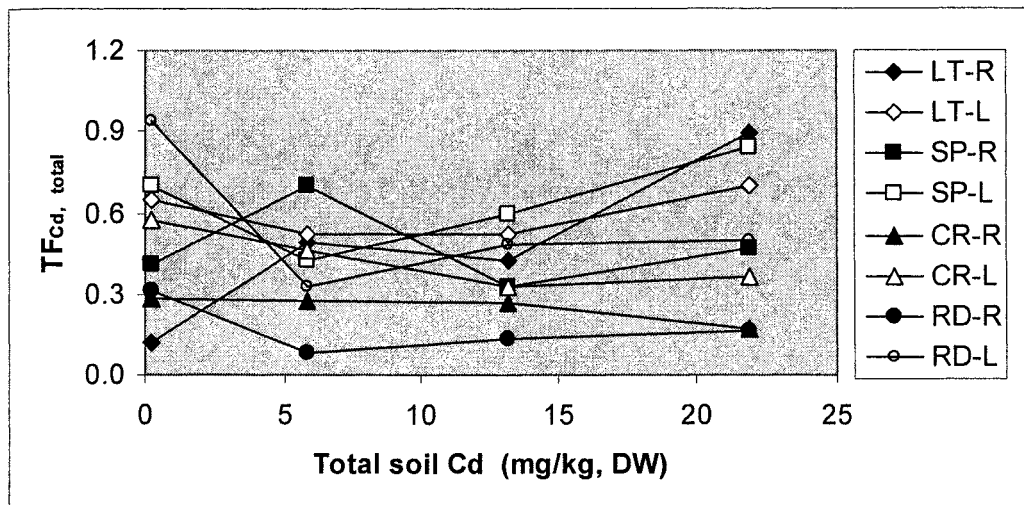
**Table 5.11** Relationship between the TF values of Mo (y) and the H<sub>2</sub>O extractable Mo in soils (x)

Plants	Equation for TF <sub>H<sub>2</sub>O</sub>	R <sup>2</sup>
LT-R	$y = 14.752x^{-0.3802}$	0.9991
LT-L	$y = 1.259x^{-0.5898}$	0.9745
SP-R	$y = -1.6817x + 11.929$	0.6648
SP-L	$y = 3.1107x^{-0.7899}$	0.9441
CR-R	$y = -0.3332x + 2.3603$	0.8551
CR-L	$y = 3.3097x^{-0.4361}$	0.9856
RD-R	$y = 7.9066x^{0.0875}$	0.0963
RD-L	$y = 8.5231x^{-0.1874}$	0.3415

### **Cadmium**

From Table 5.4 (H), the amounts of Cd accumulated in the plants are most correlated to the total Cd in soils, therefore the data of total Cd in soils were taken for simulating regression models in order to predict the TF values of Cd in plants as shown in Figure 5.17. The regression equations obtained for all plant samples are given in Table 5.12.

**Figure 5.17** Relationship between the TF values of Cd (y) and total Cd in soils (x)



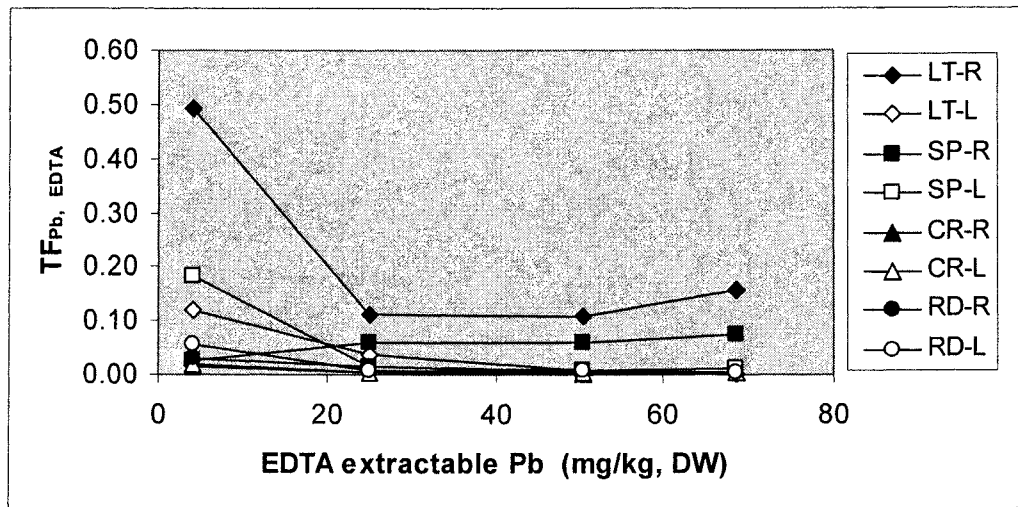
**Table 5.12** Relationship between the TF values of Cd (y) and the total Cd in soils (x)

Plants	Equation for $TF_{total}$	$R^2$
LT-R	$y = 0.2218x^{0.3827}$	0.9200
LT-L	$y = 0.0029x + 0.5692$	0.0950
SP-R	$y = -0.0032x + 0.5115$	0.0358
SP-L	$y = 0.0098x + 0.5391$	0.2735
CR-R	$y = -0.0049x + 0.3014$	0.8050
CR-L	$y = 0.4919x^{-0.1059}$	0.8203
RD-R	$y = 0.1985x^{-0.1747}$	0.4304
RD-L	$y = 0.6544x^{-0.1572}$	0.5722

### **Lead**

From Table 5.4 (I), the amounts of Pb accumulated in the plants are most correlated to the EDTA extractable Pb in soils, therefore the data of EDTA extractable Pb were taken for simulating regression models in order to predict the TF values of Pb in plants as shown in Figure 5.18. The regression equations obtained for all plant samples are given in Table 5.13.

**Figure 5.18** Relationship between the TF values of Pb (y) and EDTA extractable Pb in soils (x)



**Table 5.13** Relationship between the TF values of Pb (y) and the EDTA extractable Pb in soils (x)

Plants	Equation for $TF_{EDTA}$	$R^2$
LT-R	$y = 0.8326x^{-0.4885}$	0.7485
LT-L	$y = 1.0649x^{-1.3106}$	0.8363
SP-R	$y = 0.0159x^{0.3633}$	0.9400
SP-L	$y = 0.7545x^{-1.1018}$	0.9598
CR-R	$y = 0.0338x^{-0.7091}$	0.7888
CR-L	$y = 0.0448x^{-0.7066}$	0.9791
RD-R	$y = 0.0731x^{-0.5536}$	0.8966
RD-L	$y = 0.2226x^{-0.9587}$	0.9251

### 5.5 Summary

In this study, the bioavailability of metals to plants was investigated. This was done by measuring transfer factor (TF) values of metals based on total metal contents in soils. It was found that the order of TF values was  $Mn > Zn \gg Cd > Ni > Cu > Mo \approx Pb > Cr \approx Fe$ . The mean TF values of each element irrespective of plant types were 1.93, 1.77, 0.485, 0.194, 0.111, 0.052, 0.045, 0.037 and 0.036 for Mn, Zn, Cd, Ni, Cu, Mo, Pb, Cr, and Fe, respectively. Hence, Mn and Zn were most bioavailable to plants i.e. they can be transferred from soils to plants more easily than Ni, Cu, Mo, Pb, Cr

and Fe which are less bioavailable. Whereas, the bioavailability of Cd was relatively moderate.

The relationships of metals in soils and metals taken up by plants were established by using statistical correlation and regression analysis. Soil metals were extracted with both an acid mixture (for total metal analysis) and a range of chemical extractants including EDTA, CH<sub>3</sub>COOH, CaCl<sub>2</sub> and H<sub>2</sub>O. Then, the extractable metals were analysed for their correlation with the amounts of metal accumulated in plants. The extractant which gave best correlation was used for establishing a regression model for predicting TF values of metal in plants. It was found that each element was best predicted by a different extractant as summarized in the table below.

**Table 5.14** Extractants used for regression analysis in predicting metal uptake by plants

Element	Extractant
Fe, Ni, Cu, Cd	Acid mixture (HNO <sub>3</sub> + H <sub>2</sub> O <sub>2</sub> + HCl)
Cr, Mn, Zn, Pb	0.05 M EDTA
-	0.43 M CH <sub>3</sub> COOH
-	0.01 M CaCl <sub>2</sub>
Mo	Deionised H <sub>2</sub> O

From the regression equations obtained for almost every case, it indicated that the relationship between the TF values and the extractable soil metals followed the power regression curve which has the general equation of  $y = ax^b$ ; where a, b are constants, x is the independent variable (extractable soil metal concentration), and y is the dependent variable (TF values). There were some cases that did not follow the power regression curve but a linear model ( $y = ax + b$ ), these are; Mn (for CR-L and RD-R), Mo (for SP-R and CR-R), and Cd (for LT-L, SP-R, SP-L and CR-R). However, it was observed that not all regression models are appropriate for prediction of the bioavailability of metals to plants as their powers of prediction were too low. These include the models for prediction of Mn (for CR-L, RD-R and RD-L), Cu (for RD-L), Mo (for RD-R and RD-L) and Cd (for LT-L, SP-R, SP-L and RD-R).

## 5.6 References

- Chojnacka, K., Chojnacki, A., Gorecka, H., and Gorecki, H. (2005). 'Bioavailability of Heavy Metals from Polluted Soils to Plants', *The Science of the Total Environment*, 337, 175-182.
- Cui, Y.-J., Zhu, Y.-G., Zhai, R.-H., Chen, D.-Y., Huang, Y.-Z., Qiu, Y., and Liang, J.-Z. (2004). 'Transfer of Metals from Soil to Vegetables in an Area near a Smelter in Nanning, China', *Environment International*, 30, 785-791.
- Gray, C. W., McLaren, R. G., Roberts, A. H. C., and Condron, L. M. (1999). 'Cadmium Phytoavailability in Some New Zealand Soils', *Australian Journal of Soil Research*, 37, 461-477.
- Hooda, P. S. (1997). 'Plant Availability of Heavy Metals in Soils Previously Amended with Heavy Applications of Sewage Sludge', *Journal of the Science of Food and Agriculture*, 73, 446-454.
- Huang, B., Kuo, S., and Bembenek, R. (2003). 'Cadmium Uptake by Lettuce from Soil Amended with Phosphorus and Trace Element Fertilizers', *Water, Air and Soil Pollution*, 147, 109-127.
- McCain, D. C., Marsh, K. B., and Peterson, L. A. (1990). 'Excess Manganese Accumulates in Vacuoles of Potato Leaves', *Potato Research*, 33, 389-397.
- Miller, J. C., and Miller, J. N. (1993). *Statistics for Analytical Chemistry*. 3rd Ed. Chichester: Ellis Horwood Limited.
- Rowell, D. L. (1994). *Soil Science: Methods and Applications*. Essex: Pearson Education Limited.
- Sauerbeck, D. R. (1991). 'Plant, Element and Soil Properties Governing Uptake and Availability of Heavy Metals Derived from Sewage Sludge', *Water, Air and Soil Pollution*, 57-58, 227-237.

USEPA. (1992). *'The Technical Support Document for Land Application of Sewage Sludge'*. Washington, D.C.: Office of Water. (822/R-93-001a and 001b).

Wang, G., Su, M., Chen, Y., Lin, F., Luo, D., and Gao, S. (2006). 'Transfer Characteristics of Cadmium and Lead from Soil to the Edible Parts of Six Vegetable Species in Southeastern China', *Environmental Pollution*, 144, 127-135.

Wang, X.-P., Shan, X.-Q., Zhang, S.-Z., and Wen, B. (2004). 'A Model for Evaluation of the Phytoavailability of Trace Elements to Vegetables under the Field Conditions', *Chemosphere*, 55, 811-822.

Wang, Y. X., Wu, P., Wu, Y. R., and Yan, X. L. (2002). 'Molecular Marker Analysis of Manganese Toxicity Tolerance in Rice under Greenhouse Conditions', *Plant and Soil*, 238, 227-233.

## **Section B**

### **Metal speciation**

## Chapter 6

### Multi-element speciation in vegetable plants

#### 6.1 Introduction

Plants are known to biosynthesize, in response to metal stress, metal-binding species called Phytochelatins (PC). Metal speciation in plants has been discussed in Section 1.6 (Chapter 1). Various analytical approaches have been proposed to study metal speciation in plants (Vacchina *et al.*, 1999). The coupling between a separation technique and an element specific detector for elemental speciation analysis include different modes of HPLC and capillary zone electrophoresis (CZE), in terms of separation, and flame AAS, ICP-AES, ICP-MS or electrospray MS, in terms of detection (Szpunar and Lobinski, 1999). Reverse phase liquid chromatography (RPLC) with non-polar stationary phase (usually a covalently bound C<sub>8</sub> or C<sub>18</sub> linear hydrocarbon) and a relatively polar mobile phase, is one of the most widely used techniques for separation of peptides and proteins (Szpunar *et al.*, 1999; Ackley and Caruso, 2003; Polec-Pawlak *et al.*, 2005). RPLC offers high resolution and reproducibility of the results but requires post-column derivatization of the sulphhydryl groups prior specific detection of PCs (Polec-Pawlak *et al.*, 2005).

Size exclusion chromatography (SEC), despite limited resolution, with on-line detection of metal ions by ICP-MS has been preferred for the initial screening of an unknown sample to characterize the metal-containing species (Makarov and Szpunar, 1998; Szpunar, 2000). Various extractants have been tested for metal-binding phytochemical compounds and Tris-HCl buffer (pH 7.5) has been frequently used along with ammonium acetate. SEC columns with different optimum separation ranges have been employed and the majority of reported work focused on relatively low molecular weight (MW) species, e.g. <10 kDa. Commercially available columns have been evaluated in terms of metal-complex stability and reproducibility (Vacchina *et al.*, 1999; Persson *et al.*, 2006). Additional UV detection usually at 254 nm based on the metal-thiolate bond is featured in many studies.



Vacchina *et al.* (1999) optimized the SEC-ICP-MS approach for speciation of Cd in plant tissues (maize) and cells. In addition to complexes with PC<sub>2</sub> (540 Da), PC<sub>3</sub> (772 Da) and PC<sub>4</sub> (1004 Da), a fraction with a MW of 6800 Da was characterized in all tested samples as a mixed complex with different PC ligands. Scarano and Morelli (2002) studied the Cd and Pb complexes with PCs in laboratory cultures of the marine diatom *Phaeodactylum tricornutum*. The formation of Cd- and Pb-PC<sub>n</sub> complexes with n-value from 3 to 6 was demonstrated (PC<sub>2</sub> complexes not found probably due to dissociation during cellular extract preparation). The complexes with Cd appeared to be different from those with Pb for the number of peptide molecules involved (one molecule of peptide binds Pb while two or more molecules bind Cd) and for the number of metal ion bound (the metal/peptide molar ratio in Cd-PC<sub>n</sub> complexes was higher than in Pb-PC<sub>n</sub> complexes). Further study identified five stable Cd-PC<sub>n</sub> complexes (n = 2-6) (Morelli *et al.*, 2002). These complexes exhibited luminescence and UV transition at 280 nm and the apparent MW was 8-12 kDa. The 66% of the total PC  $\gamma$ -Glu-Cys units in these complexes were polymerized as PC<sub>4</sub>. Wei *et al.* (2003) observed that PCs induced in roots of *Agropyron elongatum* under Cd stress were not only bound to Cd, but also to Cu. Montes-Bayon *et al.* (2004) studied *Brassica juncea* (Indian mustard) as a model for As accumulation using ammonium acetate buffer for the extraction and SEC separation prior to ICP-MS detection. Two main As-containing species were found, one at about 2 kDa and the other below 1.2 kDa. The first As species was associated to thiol groups and the presence of PCs was confirmed. A potential As-PC<sub>4</sub> complex was extracted from *Brassica* leaves. Very recently, Persson *et al.* (2006) examined the most prominent Cd species in barley by SEC-ICP-MS. One fraction, ranging from 700-1800 Da, was detected in the shoots; while two additional fractions ranging from 2900-4600 and 6700-15,000 Da were found in the roots. Further identification revealed three different families of PCs. The PCs induced by Cd toxicity also bound several essential trace elements including Ni, Cu and Zn; and the species distributed between the 700-1800 Da and 6700-15,000 Da fractions.

Knowledge about chemical species of the elements can lead to an understanding of chemical and biochemical reactions involving these species, thus providing information about toxicity or essentiality (Michalke, 2003). Therefore, it is important

to perform element speciation analysis in biological samples. This chapter aims to study multi-elemental distribution in the plant samples using SEC with online detection by ICP-MS and characterize the metal-containing species by Nanospray MS analysis.

## **6.2 Experimental**

### **6.2.1 Chemicals and apparatus**

Cysteine, Vitamin B12 and Insulin from Sigma (Missouri, USA) were used to calibrate the column. They were dissolved in 20 mM Tris-HCl (Sigma, Missouri, USA) pH 7.5. Multi-element standards for Cr, Fe, Ni, Cu, Zn, Mo, Cd and Pb and internal standard solution for Sc, In and Tb were purchased from SPEXCertiPrep (Middlesex, UK). Acetonitrile (ACN) and Trifluoroacetic acid (TFA) were purchased from Fluka (Gillingham, UK). 18.2 M $\Omega$  x cm ultra pure water used was produced by a Direct-Q<sup>TM</sup> Millipore System (Molsheim, France). Certified reference materials (CRM) used were tea leaves (INCT-TL-1) obtained from the Institute of Nuclear Chemistry and Technology, Warsaw, Poland and spinach leaves (SRM 1570a) purchased from the National Institute of Standards and Technology, Maryland, USA.

The chromatographic system consisted of a Pharmacia LKB Pump (P500) with an Omnifit six-port sample injection valve fitted with a 100  $\mu$ L loop. Peptide separations were carried out using the Superdex Peptide 10/300 GL column with the optimum separation range (peptides) of 100 – 7000 Da. A UV detector (Kontron 430A) was used for monitoring the metal-complexing peptides eluted from the SEC column. The size exclusion chromatographic system was coupled to the ICP-MS instrument by 45 cm of FEP tubing (0.5 mm i.d.) running from the column outlet to the inlet of the pneumatic nebulizer. The IC Acrodisc 13 mm Syringe Filters with 0.45  $\mu$ m Supor (PES) Membrane (Sigma) were used to filter the samples before injection into the SEC column. Reversed-phase pipette tips ZipTip<sup>®</sup> for sample preparation and Econotip<sup>TM</sup> for nanospray MS were obtained from Presearch, Hampshire, UK.

All ICP-MS measurements were carried out with a ICP mass spectrometer XSeries II (Thermo Electron Corporation, Cheshire, UK). The operating conditions are shown in

Table 6.1. The Finnigan LCQ Advantage MS detector (Thermo Electron Corporation, Cheshire, UK) was used for Nanospray MS analysis.

## 6.2.2 Methodology

### 6.2.2.1 Growing of vegetable plants

The samples used for this experiment were taken from the plants grown in the medium level of metal spiking soil as described in Chapter 4 - Section 4.2.2.1.

**Table 6.1** Instrumental operating conditions for (A) SEC-UV and (B) ICP-MS

#### (A) SEC-UV

<b>Chromatographic separation conditions</b>	
Column	Superdex Peptide 10/300 GL (10 x 300 mm, 13 µm)
Mobile phase	20 mM Tris-HCl, pH 7.5
Flow rate	0.5 mL/min
Injection volume	100 µL
λ monitored	254 nm

#### (B) ICP-MS

<b>ICP-MS conditions</b>	<b>Standard Mode</b>	<b>CCT mode</b>
Forward power	1400 W	1400 W
Cool gas flow	13.0 L/min	13.0 L/min
Auxiliary gas flow	0.90 L/min	0.90 L/min
Nebulizer gas flow	0.80 L/min	0.80 L/min
Collision cell gas	NA	4.75 L/min 7% $H_2$ /93% $He$
Quadrupole bias	-1.0 V	-14.0 V
Hexapole bias	0.0 V	-16.0 V
Dwell time per isotope	30 ms	30 ms
Isotopes monitored	$^{52}Cr$ , $^{56}Fe$ , $^{60}Ni$ , $^{63}Cu$ , $^{66}Zn$ , $^{95}Mo$ , $^{111}Cd$ and $^{208}Pb$	$^{52}Cr$ , $^{56}Fe$ , $^{60}Ni$ , $^{63}Cu$ , $^{66}Zn$ , $^{95}Mo$ , $^{111}Cd$ and $^{208}Pb$
Internal standards	$^{45}Sc$ , $^{115}In$ and $^{159}Tb$	$^{45}Sc$ , $^{115}In$ and $^{159}Tb$

#### **6.2.2.2 Sample preparation for SEC**

Plant extracts were prepared for SEC analysis as the following conditions. The plants were frozen in liquid nitrogen and ground with a mortar and pestle. The homogenate (1 g) was mixed with 20 mL of 20 mM Tris-HCl (pH 7.5) buffer solution in a 50 mL centrifuge tube. The mixture was extracted in an ultrasonic bath for 45 min and centrifuged for 30 min at 8500 rpm. To prevent over-heating of the mixture by ultrasonication, the water in the ultrasonic bath was renewed after the first 20 minute extraction. The supernatant was filtered through a Whatman No.41 filter paper.

#### **6.2.2.3 Sample analysis by SEC-UV-ICP-MS**

The detection of different fractions was performed using an on-line SEC-UV-ICP-MS. Molecular masses of the eluted compounds were estimated by column calibration using a mixture of 0.75 mg/mL Cysteine (121.1 Da), 0.05 mg/mL Vitamin B12 (1355 Da) and 20 mg/mL Insulin (5734 Da). The samples (100  $\mu$ L) were injected into the column. The samples were eluted with a mobile phase (20 mM Tris-HCl, pH 7.5) at a flow rate of 0.5 mL/min. The eluted fractions were monitored sequentially with a UV detector (254 nm) and ICP-MS detection. The time delay between the two detectors was about 20 seconds.

#### **6.2.2.4 Total metal determination of plant CRMs**

The plant CRMs were acid digested as the procedures given in Chapter 4 (Section 4.2.2.2).

#### **6.2.2.5 Static Nanospray MS analysis**

##### **Sample preparation for Static Nanospray MS analysis**

Plant extracts prepared in section 6.2.2.2 were treated using C<sub>18</sub> ZipTip as the sample preparation for MS analysis. The C<sub>18</sub> ZipTip is a 10  $\mu$ L pipette tip with a bed of chromatography media fixed at its end and intended for purifying and concentrating femtomoles to picomoles of peptide samples prior to analysis. The procedures are as follows: Using a 10  $\mu$ L Gilson micropipette, the ZipTips were rehydrated by aspirating and dispensing 10  $\mu$ L of wetting solution (50 % ACN) twice, and then were equilibrated by aspirating and dispensing 10  $\mu$ L of equilibration solution (0.1 % TFA) 3 times. The peptides were bonded onto the C<sub>18</sub> ZipTip media by aspirating and

dispensing the samples up to 10 cycles for maximum binding. The salt was removed by aspirating the wash solution (0.1 % TFA) in and dispensing to waste, which was repeated 3 times. The peptides were eluted by aspirating and dispensing elution solution (0.1 % TFA / 50 % ACN) through the ZipTip into a clean vial, this was repeated 5 times. The sample kept in the vial was ready for Nanospray MS analysis.

### **Loading sample into a Static Nanospray emitter**

The standard coating EconoTip<sup>TM</sup> 1.2 mm / 1  $\mu$ m (tube o.d. / i.d.) was used as a sample emitter. The sample emitter was cut at the flat end to a length of 2.5 to 2.7 cm prior to loading the sample. Using a 20  $\mu$ L Gilson micropipette equipped with a 20  $\mu$ L GELoader tip (Eppendorf), 10  $\mu$ L of each sample was transferred slowly into the sample emitter to avoid the formation of air bubbles. Then, the sample emitter was inserted into the nose cone tip mounting assembly, and it was gently pushed further into the assembly until 1 to 1.5 mm of the emitter was left outside of the probe tip.

### **Acquiring data using the Static Nanospray**

The 'static NSI tune method' was selected through Tune Plus window. A setting for spray voltage was at 1.0 kV and sheath gas was not used for a static Nanospray ion source. Full scan type and scan mass range m/z 150 – 2000 were selected through Define Scan dialog. Through Acquire Data dialog, 100 scans for each sample were collected. The spectra of each sample were previewed in Tune Plus window. When the signals were stable, the Tune Plus window was closed. The data were acquired through 'Run a Sample' function in Xcalibur V 1.3. The LCQ Advantage MS was selected as 'In Use and Start Instrument'. Each run was collected for about 10 min, and the process was monitored through 'Real Time Plot' function.

## **6.3 Results and discussion**

### **6.3.1 Total metal content of plant samples**

The total metal content of plant certified reference materials (Spinach leaves, SRM 1570a; and Tea leaves, INCT-TL-1) were analysed in both standard and collision cell technology (CCT) modes using ICP-MS. The latter was used to circumnavigate potential molecular interferences from either the plant material, extraction solvent or plasma-related. The CCT mode was operated using a 7% $H_2$ /93% $He$  mixture to

eliminate interferences. By an ion-molecule collision mechanism, polyatomic interfering ions like  $^{40}\text{Ar}^{16}\text{O}^+$  and  $^{40}\text{Ar}^{12}\text{C}^+$  will either be converted to a non-interfering species or the metal ion will be converted to another ion which is not interfered with (Thomas, 2004). The results are shown in Table 6.2.

**Table 6.2** Total metal concentrations (mg/kg, DW) in plant CRMs

NB: Measured values in bracket represent mean percentage recovery.

Element	SRM 1570a, Spinach leaves			CRM INCT-TL-1, Tea leaves		
	Certified value Mean $\pm$ SD	Measured value Mean $\pm$ SD (n=5)		Certified value Mean $\pm$ SD	Measured value Mean $\pm$ SD (n=5)	
		Standard mode	CCT mode		Standard mode	CCT mode
$^{52}\text{Cr}$	na	2.23 $\pm$ 0.13	1.54 $\pm$ 0.05	1.91 $\pm$ 0.22	2.05 $\pm$ 0.13 (107)	1.90 $\pm$ 0.11 (99)
$^{56}\text{Fe}$	na	na	na	(432)	503 $\pm$ 40 (116)	420 $\pm$ 18 (97)
$^{60}\text{Ni}$	2.14 $\pm$ 0.10	1.45 $\pm$ 0.38 (68)	1.65 $\pm$ 0.34 (77)	6.12 $\pm$ 0.52	4.95 $\pm$ 0.22 (81)	5.98 $\pm$ 0.32 (98)
$^{63}\text{Cu}$	12.2 $\pm$ 0.6	8.8 $\pm$ 2.1 (72)	15.7 $\pm$ 2.4 (129)	20.4 $\pm$ 1.5	16.7 $\pm$ 0.8 (82)	22.3 $\pm$ 1.3 (109)
$^{66}\text{Zn}$	82 $\pm$ 3	80 $\pm$ 7 (98)	86 $\pm$ 12 (105)	34.7 $\pm$ 2.7	56.8 $\pm$ 6.1 (164)	39.0 $\pm$ 2.0 (112)
$^{95}\text{Mo}$	na	0.61 $\pm$ 0.03	0.60 $\pm$ 0.05	na	0.14 $\pm$ 0.03	0.11 $\pm$ 0.02
$^{111}\text{Cd}$	2.89 $\pm$ 0.07	3.08 $\pm$ 0.27 (107)	2.68 $\pm$ 0.38 (93)	0.0302 $\pm$ 0.004	0.0314 $\pm$ 0.0081 (104)	0.0306 $\pm$ 0.0059 (101)
$^{208}\text{Pb}$	na	0.57 $\pm$ 0.03	0.59 $\pm$ 0.02	1.78 $\pm$ 0.24	1.59 $\pm$ 0.33 (89)	1.57 $\pm$ 0.43 (88)

It can be seen that the choice of ICP-MS operating mode is important when analyzing plant extracts. On the basis of the elements determined in both CRMs the following operating modes were identified as the most appropriate. It was concluded that the following elements would be determined in CCT mode: Cr (99% recovery in Tea CRM, no data available for Spinach CRM, Fe (97% recovery in Tea CRM; no data available for Spinach CRM), Ni (highest recovery i.e. 77% in Spinach CRM and 98% recovery in Tea CRM), Cu (in Spinach CRM both operating modes gave recoveries that were equidistant from the mean while in Tea CRM the closest concentration to the certified value i.e. 109% recovery, was obtained in this mode), Zn (in Spinach

CRM both operating modes gave recoveries that were equidistant from the mean while in Tea CRM the closest concentration to the certified value i.e. 112% recovery, was obtained in this mode), whereas in standard mode it was possible to determine the following elements: Mo (no data to substantiate but expected to be relatively free from molecular interferences at 95 amu), Cd (107% recovery in Spinach CRM, 104% recovery in Tea CRM, and Pb (89% recovery in Tea CRM, no data available for Spinach CRM). All future plants samples were analysed using these experimentally determined ICP-MS operating mode conditions.

### **6.3.2 Analysis of extractable metal content in plant samples**

Sub-samples of plants that had been previously grown under artificial light in contaminated soil were both acid digested and extracted using ultrasonic extraction with 20 mM Tris HCl, pH 7.5 and analysed for their total metal content. For the purpose of this work only the edible part of the plant was analysed i.e. for carrot and radish the roots, while for spinach and lettuce the leaves.

The results, shown in Table 6.3, indicate the lower concentration of metals extracted by ultrasonic extraction with 20 mM Tris HCl, pH 7.5 compared to the total acid digestion approach. Typical ultrasonic extraction to acid digestion percentage ratios range from 1.8 to 5.0 for Cr; 1.7 to 8.0 for Fe; 6.4 to 42.1 for Ni; 14.7 to 53.8 for Cu; 1.4 to 8.0 for Zn; 2.1 to 12.8 for Mo; 2.9 to 8.6 for Cd; and, 12.0 to 50.0 for Pb. It is noted that Cu, Ni and Pb have the highest extraction efficiencies with ultrasonic extraction with 20 mM Tris HCl, pH 7.5.

### **6.3.3 Size exclusion chromatogram of plant extracts**

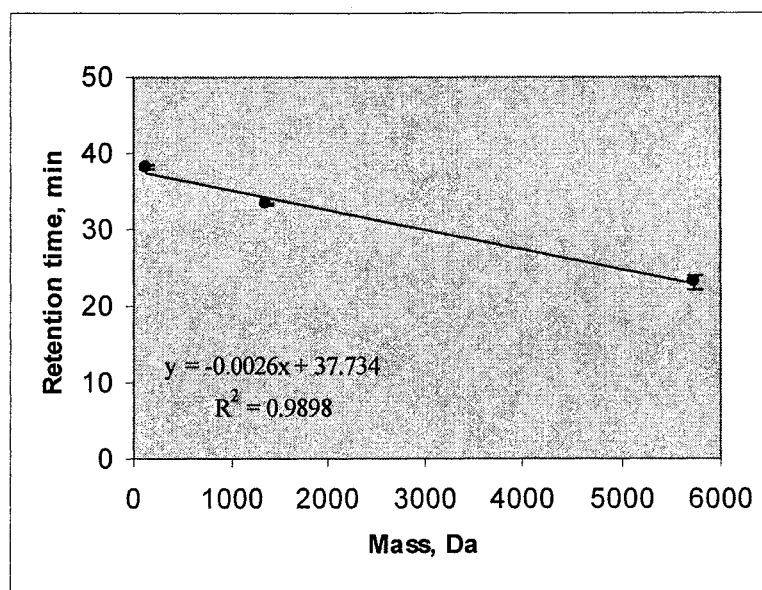
SEC was used to determine the multi-elemental distribution of the different molecular weight fractions in the plant extracts. The column was directly coupled via a UV-visible detector (254 nm) directly to the sample introduction system of the ICP-MS. This allowed extracts to be assessed in terms of their molecular absorption and elemental composition.

**Table 6.3** Extractable metal determination in plants using ultrasonic extraction with Tris-HCl (Extractant A) compared with the total metal content in plants using acid digestion (Extractant B). NB: \* means percent recovery

Element	Extractant	Total metal concentration (mg/kg), Mean $\pm$ SD (n=3)			
		Spinach	Lettuce	Carrot	Radish
<sup>52</sup> Cr	A	0.02 $\pm$ 0.01	0.03 $\pm$ 0.01	0.02 $\pm$ 0.01	0.03 $\pm$ 0.01
	B	1.1 $\pm$ 1.0	0.9 $\pm$ 0.3	0.4 $\pm$ 0.3	0.9 $\pm$ 0.3
	%*	<b>1.8</b>	<b>3.3</b>	<b>5.0</b>	<b>3.3</b>
<sup>56</sup> Fe	A	3.0 $\pm$ 0.1	2.5 $\pm$ 0.2	1.6 $\pm$ 0.1	0.4 $\pm$ 0.1
	B	107.3 $\pm$ 41.1	68.1 $\pm$ 6.5	19.7 $\pm$ 3.9	23.9 $\pm$ 7.6
	%*	<b>2.8</b>	<b>3.7</b>	<b>8.0</b>	<b>1.7</b>
<sup>60</sup> Ni	A	1.9 $\pm$ 0.1	0.9 $\pm$ 0.1	1.0 $\pm$ 0.1	0.4 $\pm$ 0.1
	B	8.9 $\pm$ 1.7	5.0 $\pm$ 0.6	2.4 $\pm$ 0.3	5.5 $\pm$ 0.4
	%*	<b>20.9</b>	<b>18.2</b>	<b>42.1</b>	<b>6.4</b>
<sup>63</sup> Cu	A	3.9 $\pm$ 0.1	2.6 $\pm$ 0.1	3.7 $\pm$ 0.1	0.9 $\pm$ 0.1
	B	15.4 $\pm$ 1.6	10.3 $\pm$ 0.2	6.8 $\pm$ 0.8	5.8 $\pm$ 1.6
	%*	<b>25.2</b>	<b>25.1</b>	<b>53.8</b>	<b>14.7</b>
<sup>66</sup> Zn	A	12.5 $\pm$ 0.1	7.3 $\pm$ 0.2	6.7 $\pm$ 0.1	4.5 $\pm$ 0.1
	B	341.6 $\pm$ 43.6	307.4 $\pm$ 36.3	83.6 $\pm$ 7.7	328.8 $\pm$ 96.3
	%*	<b>3.7</b>	<b>2.4</b>	<b>8.0</b>	<b>1.4</b>
<sup>95</sup> Mo	A	0.5 $\pm$ 0.1	0.2 $\pm$ 0.1	0.3 $\pm$ 0.1	0.2 $\pm$ 0.1
	B	3.6 $\pm$ 0.5	2.3 $\pm$ 0.9	3.9 $\pm$ 2.7	36.5 $\pm$ 8.7
	%*	<b>12.8</b>	<b>10.0</b>	<b>7.7</b>	<b>2.1</b>
<sup>111</sup> Cd	A	0.6 $\pm$ 0.1	0.15 $\pm$ 0.1	0.3 $\pm$ 0.1	0.06 $\pm$ 0.1
	B	7.9 $\pm$ 1.9	6.9 $\pm$ 2.0	3.5 $\pm$ 0.5	1.8 $\pm$ 0.5
	%*	<b>7.6</b>	<b>2.9</b>	<b>8.6</b>	<b>3.3</b>
<sup>208</sup> Pb	A	0.05 $\pm$ 0.02	0.11 $\pm$ 0.05	0.03 $\pm$ 0.01	0.06 $\pm$ 0.01
	B	0.4 $\pm$ 0.2	0.4 $\pm$ 0.6	0.06 $\pm$ 0.03	0.5 $\pm$ 0.2
	%*	<b>12.5</b>	<b>27.5</b>	<b>50.0</b>	<b>12.0</b>

In order to calibrate the size exclusion column, three standards (Cysteine, Vitamin B12 and Insulin) were introduced and detected using UV-visible spectroscopy at 254 nm. The retention times of the standards with respect to their molecular weight are shown in Table 6.4. By fitting the line of best fit to the data produced the following equation:  $y = -0.0026x + 37.734$ , with a correlation of determination of  $R^2 = 0.9898$  as shown in Figure 6.1. This equation was used to calculate the molecular weight (MW) of each different fraction in the plant samples.





**Figure 6.1** Calibration curve of the SEC column

**Table 6.4** Characterisation of SEC Column

Compound	Cysteine	Vitamin B12	Insulin
Molecular weight (Da)	121.2	1355	5734
Mean retention time SD (min) (n = 5)	38.1 ± 0.2	33.4 ± 0.1	23.1 ± 0.9

Extracts were then analysed using the directly coupled SEC-UV-ICP-MS system to fractionate the molecular weight components of the different plant types. Individual element isotope chromatograms together with UV data at 254 nm for each plant type were produced. Figure 6.2 (A-D) shows the SEC-UV-ICP-MS chromatograms for (a) spinach, (b) lettuce, (c) carrot, and (d) radish. The SEC-UV (254 nm) chromatogram shows some peak profiles correspond to the peaks obtained from ICP-MS; a peak at the retention time of 33.25 min of the SEC-UV (Figure 6.2A) corresponds to Fe, Ni, Cu, Zn, Cd and Pb of ICP-MS chromatogram, a peak at the retention time of 32.01 (Figure 6.2B) corresponds to Fe, Ni, Cu, Zn, Cd and Pb of the ICP-MS chromatogram. Whereas some peaks detected by ICP-MS have no UV absorption e.g. Cu at a retention time of 25 min (Figure 6.2A) and Zn at a retention time of 25 min (Figure 6.2C). Since ICP-MS detection is much more sensitive than the UV detection, therefore, peaks in the ICP-MS chromatogram may have no corresponding peak in the UV chromatogram. In contrast, a peak at the retention time of 40.49 (Figure 6.2A)

has no corresponding peak in the ICP-MS chromatogram. This peak could be some organic acids found in the plants that absorbed the UV radiation and give a strong intensity in the UV chromatogram.

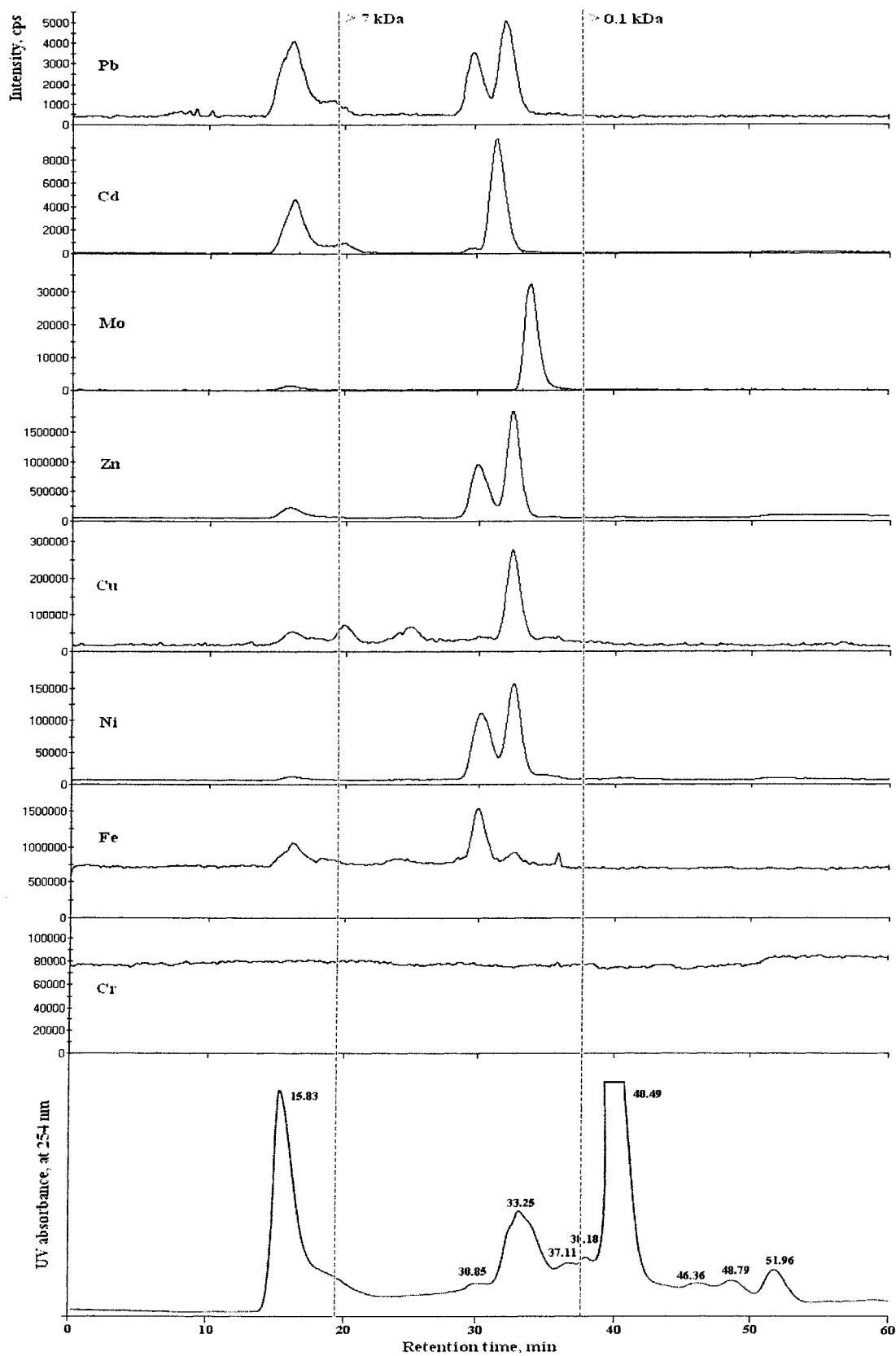
In general terms the metal chromatograms have similar profiles for Cd, Cu, Mo, Pb and Zn in all four extracts (spinach leaves, lettuce leaves, carrot roots and radish roots). For Cr, as expected, it was not recovered in any plant extracts as its total concentration (pre-column fraction) was too low (0.02 – 0.03 mg/kg). However, significant differences are noted for the Fe and Ni chromatograms. Similar metal-containing chromatogram profiles for Fe and Ni were obtained for the leaf extracts of spinach and lettuce, while similar, but different metal-containing chromatogram profiles existed between Fe and Ni in the root extracts of carrot and radish.

Quantification of each detected element is shown in Table 6.5 (A-D). Mean recoveries based on element extractable using 20 mM Tris-HCl at pH 7.5, irrespective of the element and plant type is  $74 \pm 44\%$  ( $n = 26$ ); for individual elements the mean values are:  $71 \pm 37\%$  Fe ( $n = 2$ ),  $132 \pm 21\%$  Ni ( $n = 4$ ),  $67 \pm 41\%$  Cu ( $n = 4$ ),  $88 \pm 40\%$  Zn ( $n = 4$ ),  $101 \pm 24\%$  Mo ( $n = 4$ ),  $28 \pm 9\%$  Cd ( $n = 4$ ) and  $28 \pm 14\%$  Pb while for the different plant types the values are:  $94 \pm 40\%$  spinach leaves ( $n = 7$ ),  $77 \pm 53\%$  lettuce leaves ( $n = 7$ ),  $67 \pm 44\%$  carrot root ( $n = 6$ ) and  $52 \pm 37\%$  radish root ( $n = 6$ ). It was noted that, for Cd and Pb, their Tris-HCl extractable amounts were minimal in all plant extracts; the maximum of 0.6 mg/kg Cd found in spinach and 0.1 mg/kg Pb in lettuce. Consequently, the amounts detected from SEC-ICP-MS were significantly low. However, their fractions eluted were mainly associated to high and low MW; Cd containing compounds (approx. 8000 Da, at 16-17 min and 2340 Da, at 31-32 min) and Pb containing compounds (approx. 8186 Da, at 16-17 min and 2542 Da, at 30-33 min).

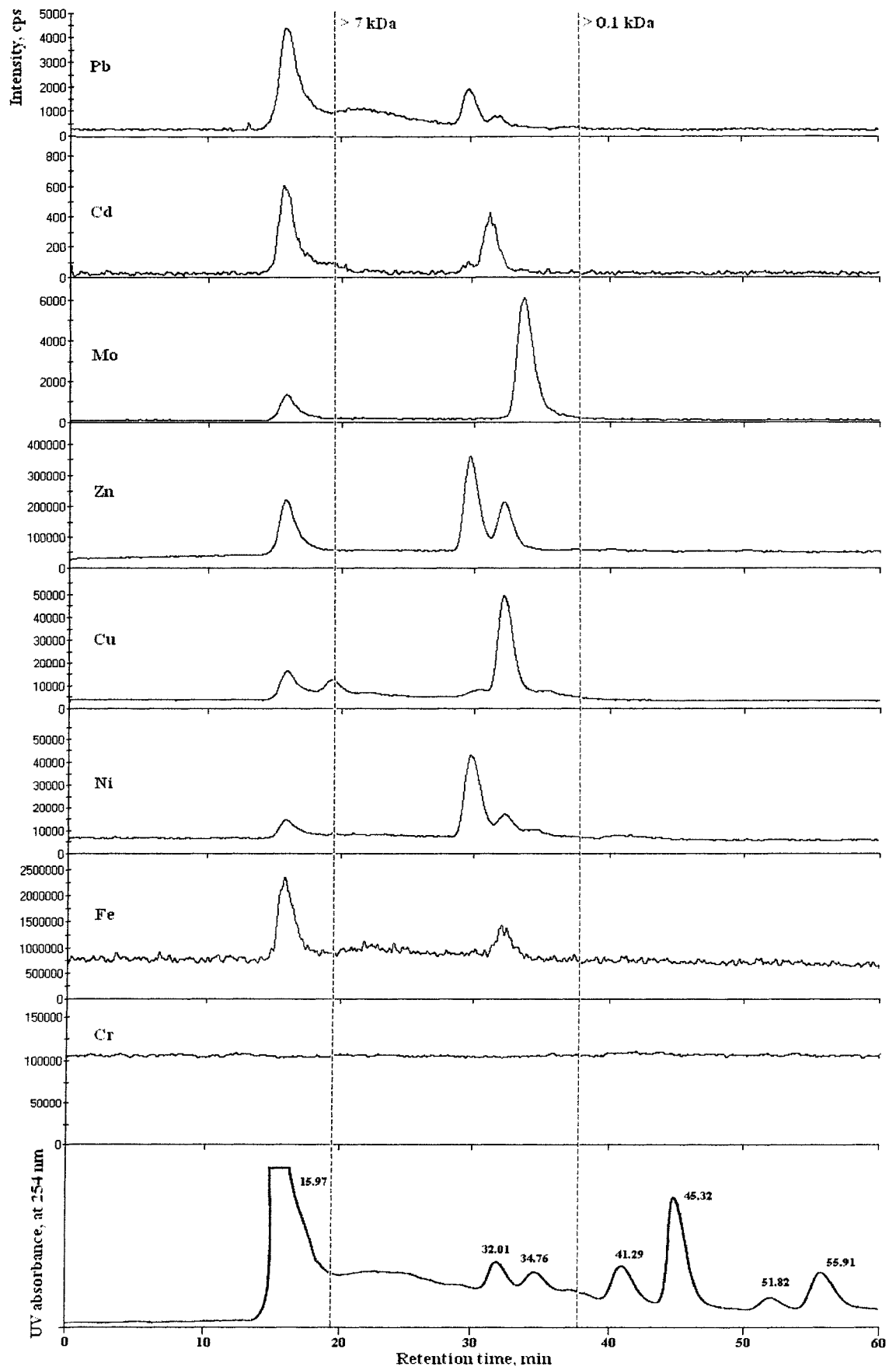
In the case of spinach and lettuce leaves, all metals (Cu, Fe, Mo, Ni, Zn, Cd and Pb) are detected in the highest MW component (approximately 8160 Da) at approximately 16 min. Cu, Cd and Pb are associated with mid-MW extracted material (approximately 6744 Da) at a retention time of 20 min (Cu and Fe are detected in spinach leaves only at a retention time of 24.6 min (approximately 5052 Da), whereas

**Figure 6.2** Chromatographic profiles of multi-elements in (A) Spinach, (B) Lettuce, (C) Carrot, and (D) Radish

(A) Spinach



**Figure 6.2 (continued) (B) Lettuce**



**Figure 6.2 (continued) (C) Carrot**

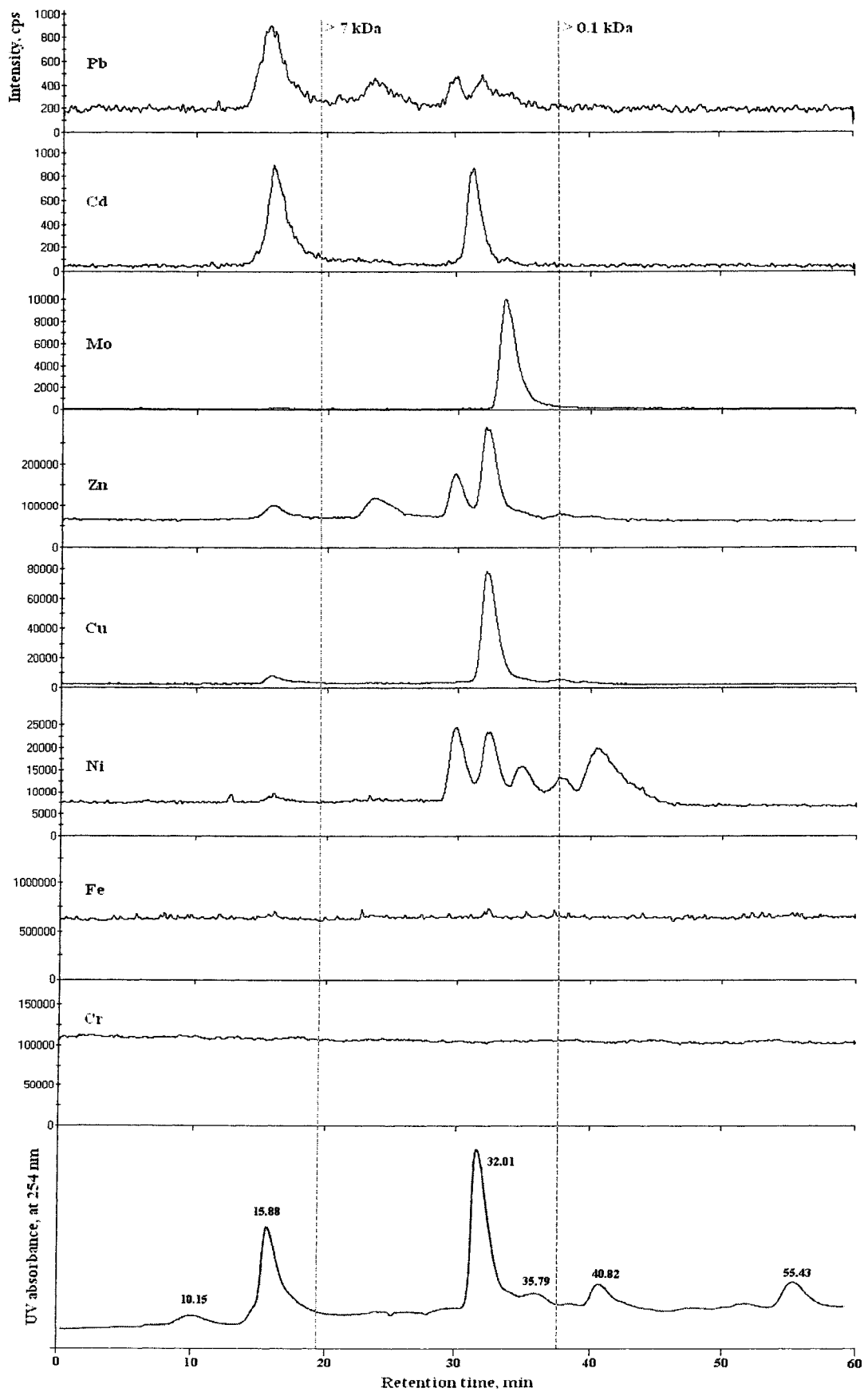
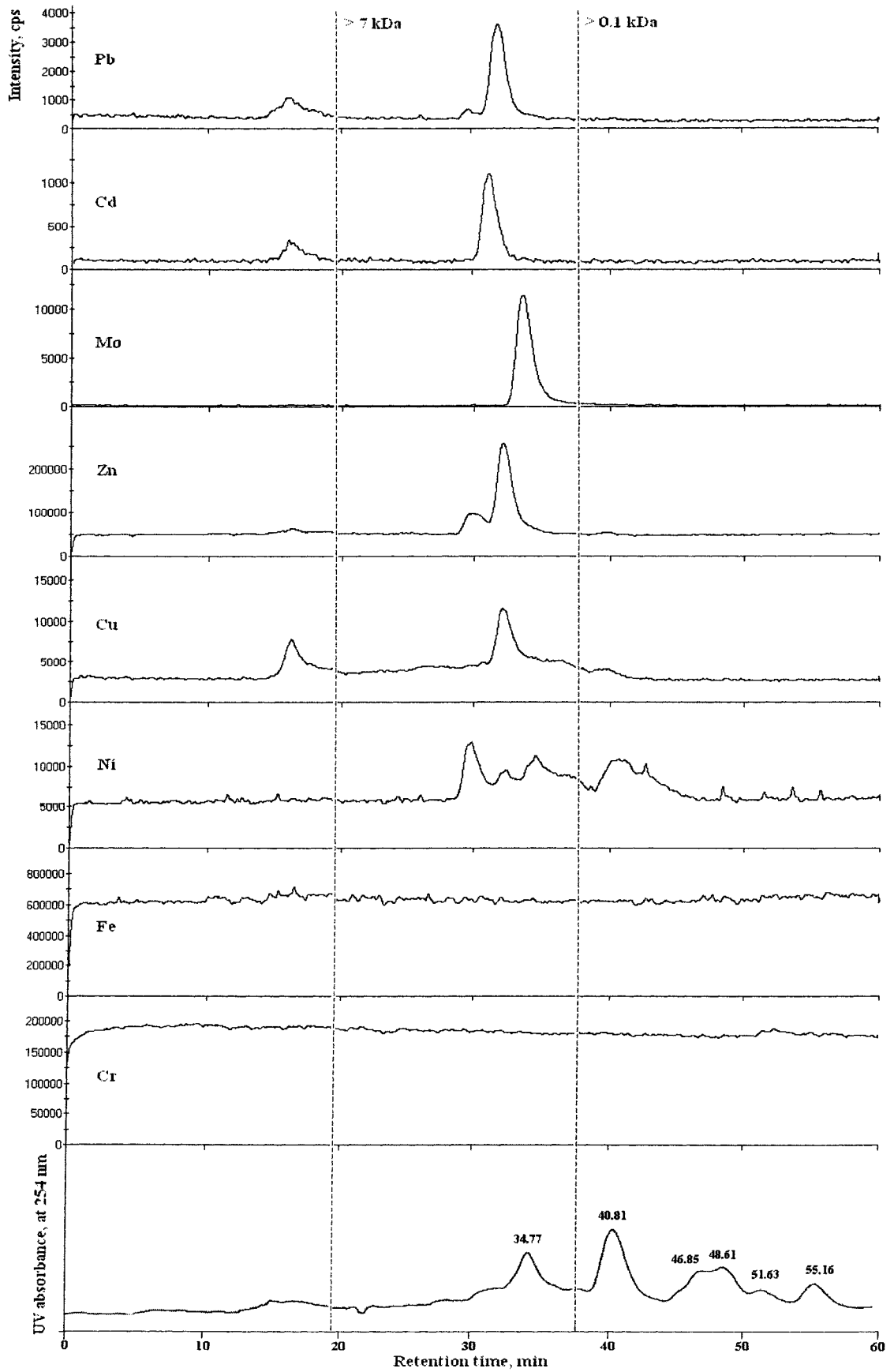


Figure 6.2 (continued) (D) Radish



for the lower MW material (approximately 2990 Da) Fe, Ni, Zn and Pb have compounds at 30 min, Fe, Ni, Cu, Zn and Pb at retention times of approximately 33 min (approximately 1854 Da), while the lowest metal-containing MW compounds (approximately 1190 Da) are determined for Mo only at approximately 35 min. In the case of carrot and radish roots, Cu, Mo, Zn, Cd and Pb are detected in the highest MW component (approximately 8140 Da) at approximately 16 min (Ni was detected in carrot only). Zn and Pb are detected in carrot root at a retention time of 24.5 min (approximately 5090 Da). In the case of lower MW material (approximately 3052 Da) Ni, Zn and Pb have compounds at 30 min, Ni, Cu, Zn, Cd and Pb at retention times of approximately 33 min (approximately 1898 Da), whereas Ni and Mo at retention times of approximately 35 min (approximately 860 Da). Low metal containing MW compounds (< 100 Da) are determined for Ni (and Cu in radish root) at approximately 38-42 min.

#### **6.3.4 Static Nanospray MS spectrum of plant extracts**

From SEC-UV-ICP-MS analysis, some metal-containing species were found to be present in the plant extracts but it cannot provide the accurate speciation information for the compounds. Our assumption here is that these compounds are PC-metal complexes generating in plants exposed with a high level of heavy metals. To prove this assumption, the SEC-UV fractions corresponding to these metal containing species were collected for MS analysis. Also, the original plant extracts were purified and concentrated using ZipTip and further analysed by a Static Nanospray MS detector for the characterization of these metal-containing species. The protonated molecular ions of PC<sub>2</sub>, PC<sub>3</sub>, PC<sub>4</sub>,..., and PC<sub>11</sub> are expected to appear at m/z 540, 772, 1004, 1236, 1468, 1705, 1938, 2171, 2404, and 2637, respectively (Yen *et al.*, 1999). MS analysis results for the SEC-UV fractions revealed that there was no peak corresponded to the PC compounds. While, the spectrums obtained for spinach, lettuce, carrot and radish extracts which were purified with ZipTip are shown in Figure 6.3 (A-D). The MS spectrum of the plant extracts purified with ZipTip show no peak indicating evidence related to the PC compounds. Hence, the presence of metal-containing compounds by SEC-ICP-MS analysis suggests that the initial compounds were metal complexes, but the accurate species could not be identified by Nanospray MS with respect to the sample purification procedures used in this experiment.

**Table 6.5** Multi-element fractionation of plant extracts using SEC-UV-ICP-MS  
 (\* recovery is based on metal extractable using 20 mM Tris HCl at pH 7.5)

**(A) Spinach leaves**

Isotope and Element	Retention time range (min)	Retention time (min)	Mean concentration $\pm$ SD ( $\mu\text{g}/\text{kg}$ ) (n = 3)	Calculated Molecular weight (Da)	
<sup>52</sup> Cr	-	-	nd	-	
<sup>56</sup> Fe	14.1-18.0	16.1	870 $\pm$ 31	8321	
	18.0-20.3	19.2	129 $\pm$ 17	7128	
	22.6-26.0	24.3	179 $\pm$ 12	5167	
	28.3-31.6	30.0	1484 $\pm$ 347	2975	
	35.5-37.5	36.5	271 $\pm$ 31	475	
	<b><math>\Sigma</math> components</b>			<b>2933 <math>\pm</math> 353</b>	
	<b>Recovery*</b>			<b>97%</b>	
<sup>60</sup> Ni	14.0-18.4	16.2	86 $\pm$ 14	8282	
	28.5-31.5	30.0	1112 $\pm$ 326	2975	
	31.5-34.7	33.1	1378 $\pm$ 356	1782	
	<b><math>\Sigma</math> components</b>			<b>2576 <math>\pm</math> 691</b>	
	<b>Recovery*</b>			<b>138%</b>	
<sup>63</sup> Cu	14.3-18.5	16.4	457 $\pm$ 127	8205	
	18.7-21.8	20.3	557 $\pm$ 35	6705	
	22.7-27.0	24.9	659 $\pm$ 50	4936	
	30.9-34.4	32.7	3145 $\pm$ 275	1936	
	<b><math>\Sigma</math> components</b>			<b>4818 <math>\pm</math> 316</b>	
	<b>Recovery*</b>			<b>124%</b>	
<sup>66</sup> Zn	14.2-18.7	16.5	1545 $\pm$ 79	8167	
	28.3-31.4	30.0	5484 $\pm$ 1114	2975	
	31.4-34.4	32.9	9582 $\pm$ 909	1859	
	<b><math>\Sigma</math> components</b>			<b>16611 <math>\pm</math> 2097</b>	
	<b>Recovery*</b>			<b>133%</b>	
<sup>95</sup> Mo	14.2-18.5	16.4	18 $\pm$ 2	8205	
	32.1-37.3	34.7	360 $\pm$ 34	1167	
	<b><math>\Sigma</math> components</b>			<b>378 <math>\pm</math> 35</b>	
	<b>Recovery*</b>			<b>82%</b>	
<sup>111</sup> Cd	14.3-18.7	16.5	84 $\pm$ 5	8167	
	18.5-22.0	20.3	6 $\pm$ 0.1	6705	
	29.7-33.9	31.8	146 $\pm$ 9	2282	
	<b><math>\Sigma</math> components</b>			<b>236 <math>\pm</math> 12</b>	
	<b>Recovery*</b>			<b>39%</b>	
<sup>208</sup> Pb	14.1-18.4	16.3	10 $\pm$ 1	8244	
	18.2-20.7	19.5	0.6 $\pm$ 0.1	7013	
	28.1-31.0	30.0	4 $\pm$ 1	2975	
	30.9-34.3	32.6	9 $\pm$ 0.3	1975	
	<b><math>\Sigma</math> components</b>			<b>24 <math>\pm</math> 2</b>	
	<b>Recovery*</b>			<b>48%</b>	



**Table 6.5 (continued)**

**(B) Lettuce leaves**

<b>Isotope and Element</b>	<b>Retention time range (min)</b>	<b>Retention time (min)</b>	<b>Mean concentration <math>\pm</math> SD (<math>\mu\text{g}/\text{kg}</math>) (n = 3)</b>	<b>Calculated Molecular weight (Da)</b>
<sup>52</sup> Cr	-	-	nd	-
<sup>56</sup> Fe	14.1-18.9	16.5	4472 $\pm$ 2435	8167
	31.0-33.9	32.5	1224 $\pm$ 1688	2013
	<b><math>\Sigma</math> components</b>		<b>5696 <math>\pm</math> 4111</b>	
	<b>Recovery*</b>		<b>44%</b>	
<sup>60</sup> Ni	14.7-18.9	16.8	268 $\pm$ 45	8052
	28.3-31.6	30.0	985 $\pm$ 123	2975
	31.6-34.0	32.8	94 $\pm$ 27	1898
	34.0-36.3	35.2	24 $\pm$ 8	975
	<b><math>\Sigma</math> components</b>		<b>1371 <math>\pm</math> 132</b>	
	<b>Recovery*</b>		<b>151%</b>	
<sup>63</sup> Cu	14.6-18.5	16.6	312 $\pm$ 33	8128
	18.5-21.5	20.0	121 $\pm$ 11	6782
	28.7-31.3	30.0	17 $\pm$ 10	2975
	31.3-35.0	33.2	994 $\pm$ 45	1744
	35.0-38.6	36.8	17 $\pm$ 8	359
	<b><math>\Sigma</math> components</b>		<b>1461 <math>\pm</math> 69</b>	
	<b>Recovery*</b>		<b>57%</b>	
<sup>66</sup> Zn	13.8-20.0	16.9	3099 $\pm$ 454	8013
	28.1-31.5	29.8	3334 $\pm$ 148	3052
	31.5-34.8	33.2	1265 $\pm$ 201	1744
	<b><math>\Sigma</math> components</b>		<b>7698 <math>\pm</math> 343</b>	
	<b>Recovery*</b>		<b>105%</b>	
<sup>95</sup> Mo	13.6-20.0	16.8	32 $\pm$ 2	8052
	31.1-38.1	34.6	138 $\pm$ 9	1205
	<b><math>\Sigma</math> components</b>		<b>170 <math>\pm</math> 9</b>	
	<b>Recovery*</b>		<b>135%</b>	
<sup>111</sup> Cd	13.8-21.6	17.7	21 $\pm$ 0.3	7705
	28.6-34.9	31.2	12 $\pm$ 1	2513
	<b><math>\Sigma</math> components</b>		<b>33 <math>\pm</math> 1</b>	
	<b>Recovery*</b>		<b>22%</b>	
<sup>208</sup> Pb	13.6-19.9	16.8	21 $\pm$ 2	8052
	28.4-31.3	29.9	3 $\pm$ 1	3013
	31.1-33.7	32.4	0.8 $\pm$ 0.02	2052
	<b><math>\Sigma</math> components</b>		<b>25 <math>\pm</math> 1</b>	
	<b>Recovery*</b>		<b>23%</b>	

Table 6.5 (continued)

## (C) Carrot roots

Isotope and Element	Retention time range (min)	Retention time (min)	Mean concentration $\pm$ SD ( $\mu\text{g}/\text{kg}$ ) (n = 3)	Calculated Molecular weight (Da)	
$^{52}\text{Cr}$	-	-	nd	-	
$^{56}\text{Fe}$	-	-	nd	-	
$^{60}\text{Ni}$	14.7-18.1	16.4	31 $\pm$ 12	8205	
	28.5-31.3	30.0	329 $\pm$ 47	2975	
	31.3-34.0	32.7	289 $\pm$ 11	1936	
	34.0-36.7	35.4	97 $\pm$ 27	898	
	36.7-39.0	37.9	62 $\pm$ 10	< 100	
	39.0-46.3	42.7	579 $\pm$ 44	< 100	
	<b><math>\Sigma</math> components</b>		<b>1387 <math>\pm</math> 133</b>		
<b>Recovery*</b>		<b>137%</b>			
$^{63}\text{Cu}$	14.6-18.3	16.5	126 $\pm$ 7	8167	
	30.3-36.4	33.4	2061 $\pm$ 17	1667	
	<b><math>\Sigma</math> components</b>		<b>2187 <math>\pm</math> 18</b>		
	<b>Recovery*</b>		<b>60%</b>		
$^{66}\text{Zn}$	14.1-18.9	16.5	435 $\pm$ 35	8167	
	21.9-27.1	24.5	917 $\pm$ 156	5090	
	28.5-31.2	30.0	976 $\pm$ 143	2975	
	31.2-34.9	33.1	2697 $\pm$ 102	1782	
	<b><math>\Sigma</math> components</b>		<b>5025 <math>\pm</math> 223</b>		
<b>Recovery*</b>		<b>75%</b>			
$^{95}\text{Mo}$	14.8-18.6	16.7	1.3 $\pm$ 0.4	8090	
	31.8-39.3	35.6	262 $\pm$ 4	821	
	<b><math>\Sigma</math> components</b>		<b>263 <math>\pm</math> 4</b>		
	<b>Recovery*</b>		<b>88%</b>		
$^{111}\text{Cd}$	13.3-20.5	16.9	33.4 $\pm$ 1.6	8013	
	29.4-34.7	32.1	22.3 $\pm$ 0.6	2167	
	<b><math>\Sigma</math> components</b>		<b>55.8 <math>\pm</math> 1.5</b>		
	<b>Recovery*</b>		<b>19%</b>		
$^{208}\text{Pb}$	13.3-19.4	16.4	4.5 $\pm$ 0.4	8205	
	21.2-27.1	24.2	1.3 $\pm$ 0.1	5205	
	28.7-31.0	29.9	0.6 $\pm$ 0.1	3013	
	30.8-35.2	33.0	0.8 $\pm$ 0.1	1821	
	<b><math>\Sigma</math> components</b>		<b>7.1 <math>\pm</math> 0.3</b>		
<b>Recovery*</b>		<b>24%</b>			

Table 6.5 (continued)

## (D) Radish roots

Isotope and Element	Retention time range (min)	Retention time (min)	Mean concentration $\pm$ SD ( $\mu\text{g}/\text{kg}$ ) (n = 3)	Calculated Molecular weight (Da)
$^{52}\text{Cr}$	-	-	nd	-
$^{56}\text{Fe}$	-	-	nd	-
$^{60}\text{Ni}$	28.1-31.0	29.6	100 $\pm$ 5	3128
	31.0-33.0	32.0	17 $\pm$ 3	2205
	33.0-38.5	35.8	45 $\pm$ 4	744
	38.5-45.7	42.1	191 $\pm$ 23	< 100
	<b><math>\Sigma</math> components</b>		<b>353 <math>\pm</math> 26</b>	
	<b>Recovery*</b>		<b>101%</b>	
$^{63}\text{Cu}$	13.9-20.1	17.0	79 $\pm$ 13	7975
	30.2-34.7	32.5	123 $\pm$ 19	2013
	35.0-38.4	36.7	10 $\pm$ 3	398
	38.4-41.3	39.9	10 $\pm$ 2	< 100
	<b><math>\Sigma</math> components</b>		<b>222 <math>\pm</math> 9</b>	
	<b>Recovery*</b>		<b>26%</b>	
$^{66}\text{Zn}$	14.3-18.8	16.6	59 $\pm$ 16	8128
	28.1-31.0	29.6	275 $\pm$ 19	3128
	31.0-35.2	33.1	1431 $\pm$ 58	1782
	<b><math>\Sigma</math> components</b>		<b>1765 <math>\pm</math> 27</b>	
	<b>Recovery*</b>		<b>39%</b>	
$^{95}\text{Mo}$	14.3-18.3	16.3	1.0 $\pm$ 0.2	8244
	31.4-38.9	35.2	174 $\pm$ 6	975
	<b><math>\Sigma</math> components</b>		<b>175 <math>\pm</math> 6</b>	
	<b>Recovery*</b>		<b>97%</b>	
$^{111}\text{Cd}$	14.3-18.8	16.6	4.0 $\pm$ 0.7	8128
	29.4-33.6	31.5	16.2 $\pm$ 0.9	2398
	<b><math>\Sigma</math> components</b>		<b>20.2 <math>\pm</math> 0.9</b>	
	<b>Recovery*</b>		<b>33%</b>	
$^{208}\text{Pb}$	13.5-19.0	16.3	2.7 $\pm$ 0.3	8244
	27.9-30.5	29.2	0.2 $\pm$ 0.1	3282
	30.0-33.9	32.0	7.3 $\pm$ 0.4	2205
	<b><math>\Sigma</math> components</b>		<b>10.2 <math>\pm</math> 0.6</b>	
	<b>Recovery*</b>		<b>17%</b>	

**Figure 6.3** Static Nanospray Mass spectrum of multi-elements in (A) Spinach, (B) Lettuce, (C) Carrot, and (D) Radish  
**(A) Spinach**

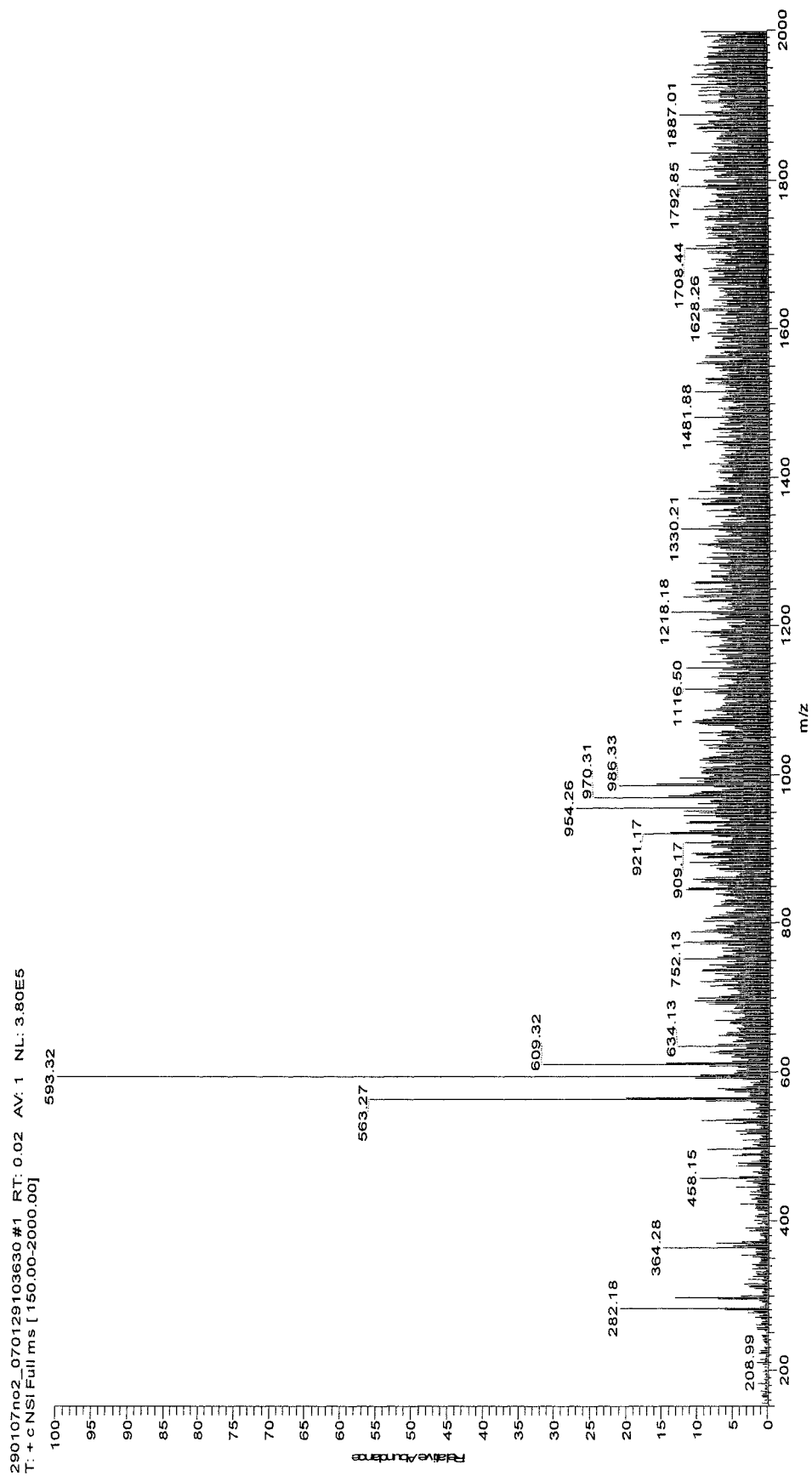


Figure 6.3 (Continued)

(B) Lettuce

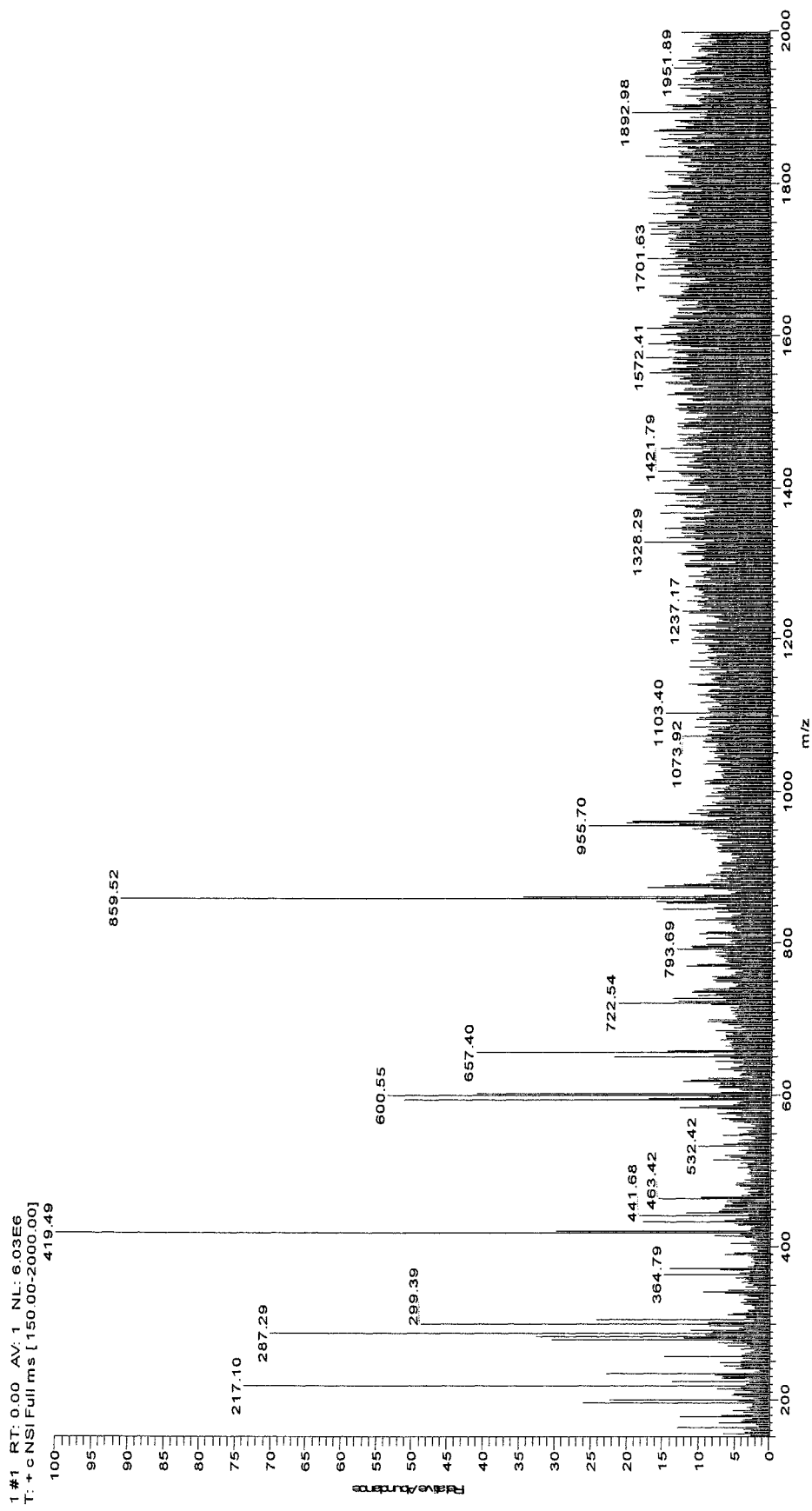


Figure 6.3 (Continued)

(C) Carrot

290107no3 #1 RT: 0.01 AV: 1 NL: 9.18E5  
T: + c NSI Full ms [150.00-2000.00]  
282.50

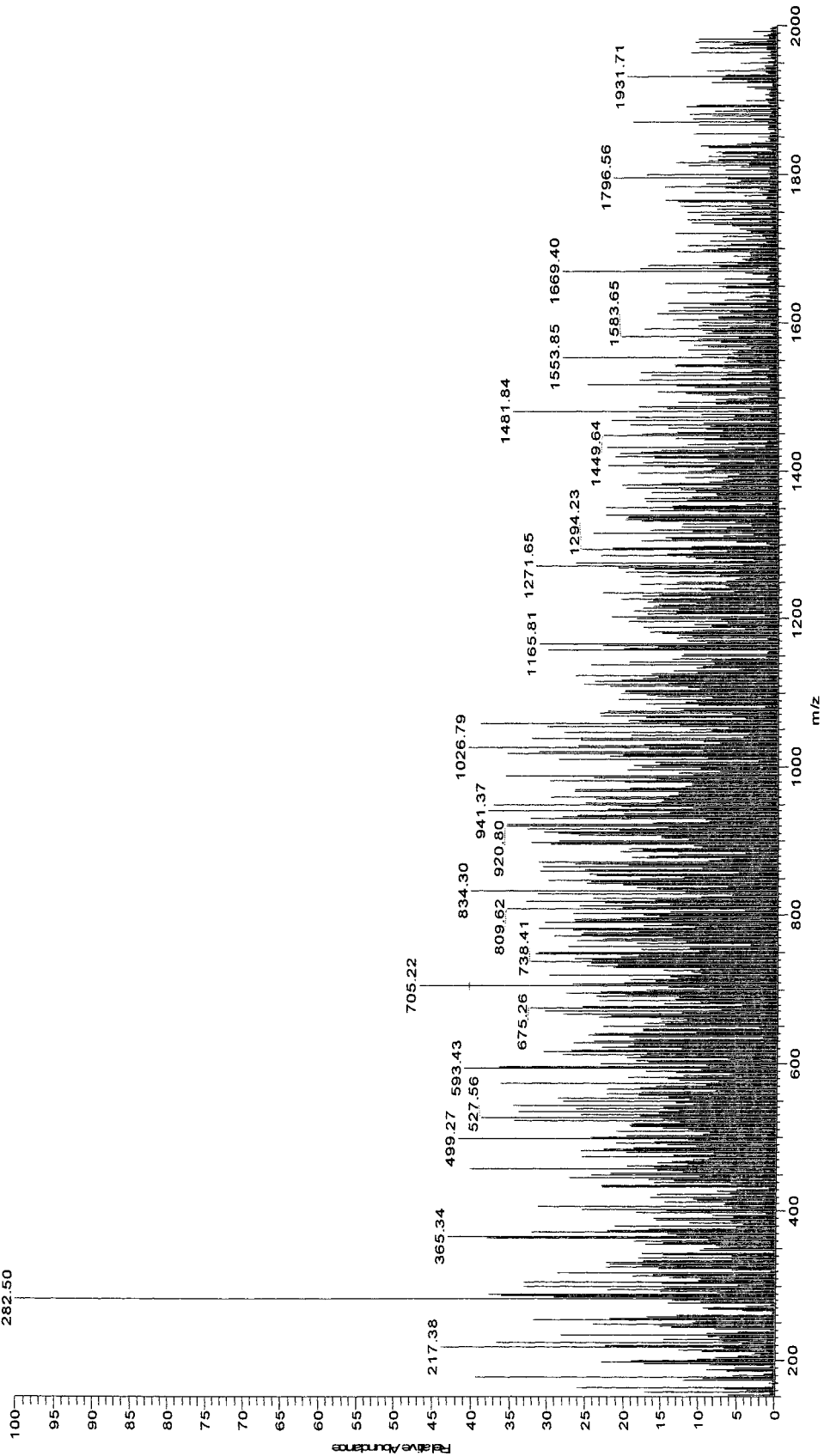
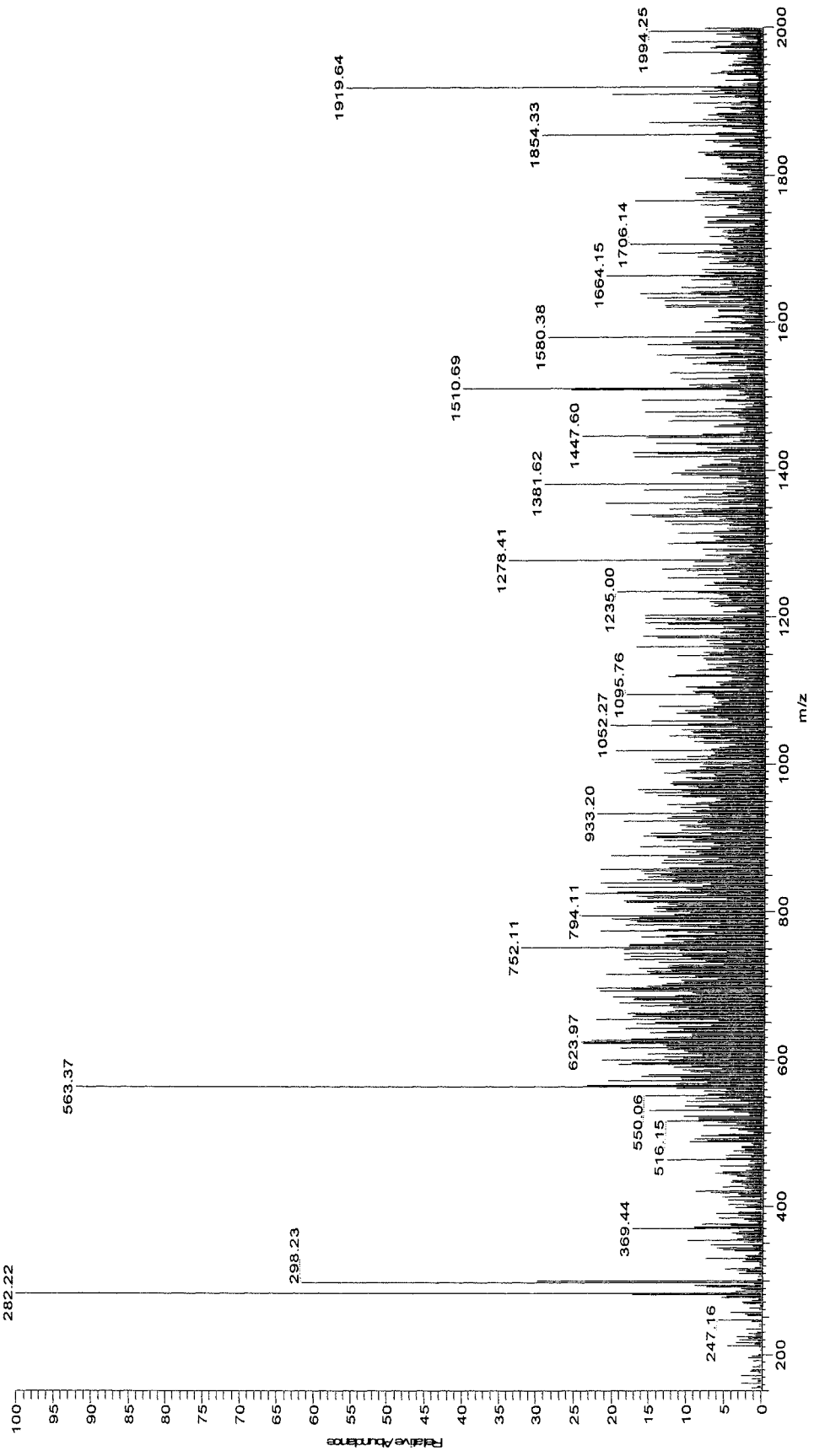


Figure 6.3 (Continued)

(D) Radish

290107no4 #1 RT: 0.02 AV: 1 NL: 1.19E5  
T: + c.NSI Full.ms [150.00-2000.00]  
282.22



#### 6.4 Summary

A multi-elemental speciation study in spinach, lettuce, carrot and radish has been performed using SEC-UV-ICP-MS. The fractionation profiles of the plant samples provide information on the association of metals with the compounds present in the plants. A common association of the metals (Cd, Cu, Mo, Pb and Zn) to the high MW fractions (8160 Da, at approx. 16 min) was observed in all plant extracts. The lower MW fractions of approximately 1000 – 3000 Da of Cd, Cu, Mo, Ni, Pb and Zn containing compounds (at the retention time of 30-35 min) were found to be present in all plant extracts. For Fe, it was not detected in the roots of carrot and radish, but present as both high MW (8200 Da) and low MW (2500 Da) compounds in the leaves of spinach and lettuce.

However, these results obtained from SEC-UV-ICP-MS can be considered as initial steps in the elemental speciation study. The multidimensional separation techniques and the use of the identification tools such as electrospray ionization (ESI) MS are required to identify the individual metal containing species present in the plant samples. In this study, the Nanospray MS detector was employed in order to try to elucidate these metal containing compounds detected in the SEC-UV-ICP-MS. Unfortunately, no evidence from this MS analysis can confirm that these compounds are related to the PC family which are known to occur in plants with high levels of metal exposure. More study of characterization of these metals binding to the compounds detected by SEC-UV-ICP-MS should be investigated. Especially, the preconcentration steps of the compounds before identification by Nanospray MS should be optimized as these steps are very important for the successful application of Nanospray MS due to its poorer sensitivity in comparison with ICP-MS (Polec *et al.*, 2002).



## 6.5 References

- Ackley, K. L., and Caruso, J. A. (2003). 'Separation Techniques: Liquid Chromatography', in Cornelis, R., Caruso, J., Crews, H. and Heumann, K. (Ed.) *Handbook of Elemental Speciation: Techniques and Methodology*. Chichester: John Wiley & Sons.
- Makarov, A., and Szpunar, J. (1998). 'The Coupling of Size-Exclusion HPLC with ICP-MS in Bioinorganic Analysis', *Analisis Magazine*, 26, M44-M48.
- Michalke, B. (2003). 'Element Speciation Definitions, Analytical Methodology, and Some Examples', *Ecotoxicology and Environmental Safety*, 56, 122-139.
- Montes-Bayon, M., Meija J., LeDuc, D. L., Terry, N., Caruso, J. A., and Sanz-Medel, A. (2004). 'HPLC-ICP-MS and ESI-Q-TOF Analysis of Biomolecules Induced in *Brassica juncea* during Arsenic Accumulation', *Journal of Analytical Atomic Spectrometry*, 19, 153-158.
- Morelli, E., Cruz, B. H., Somovigo, S., and Scarano, G. (2002). 'Speciation of Cadmium-gamma-glutamyl Peptides Complexes in Cells of the Marine Microalga *Phaeodactylum tricornutum*', *Plant Science*, 163, 807-813.
- Persson, D. P., Hansen, T. H., Holm, P. E., Schjoerring, J. K., Hansen, H. C. B., Nielsen, J., Cakmak, I., and Husted, S. (2006). 'Multi-elemental Speciation Analysis of Barley Genotypes Differing in Tolerance to Cadmium Toxicity Using SEC-ICP-MS and ESI-TOF-MS', *Journal of Analytical Atomic Spectrometry*, 21, 996-1005.
- Polec, K., Perez-Calvo, M., Garcia-Arribas, O., Szpunar, J., Ribas-Ozonas, B., and Lobinski, R. (2002). 'Investigation of Metal Complexes with Metallothionein in Rat Tissues by Hyphenated Techniques', *Journal of Inorganic Biochemistry*, 88, 197-206.
- Polec-Pawlak, K., Ruzik, R., Abramski, K., Ciurzynska, M., and Gawronska, H.

(2005). 'Cadmium Speciation in *Arabidopsis Thaliana* as a Strategy to Study Metal Accumulation System in Plants', *Analytica Chimica Acta*, 540, 61-70.

Scarano, G., and Morelli, E. (2002). 'Characterization of Cadmium- and Lead-Phytochelatin Complexes Formed in a Marine Microalga in Response to Metal Exposure', *Biometals*, 15: 145-151.

Szpunar, J., and Lobinski, R. (1999). 'Species-Selective Analysis for Metal-Biomacromolecular Complexes Using Hyphenated Techniques', *Pure and Applied Chemistry*, 71, 899-918.

Szpunar, J. (2000). 'Bio-inorganic Speciation Analysis by Hyphenated Techniques', *The Analyst*, 125, 963-988.

Thomas, R. (2004). *Practical Guide to ICP-MS*. New York: Marcel Dekker, Inc.

Vacchina, V., Polec, K., and Szpunar, J. (1999). 'Speciation of Cadmium in Plant Tissues by Size-Exclusion Chromatography with ICP-MS Detection', *Journal of Analytical Atomic Spectrometry*, 14, 1557-1566.

Wei, Z. G., Wong, J. W. C, and Chen, D. Y. (2003). 'Speciation of Heavy Metal Binding Non-protein Thiols in *Agropyron elongatum* by Size-exclusion HPLC-ICP-MS', *Microchemical Journal*, 74, 207-213.

Yen, T., Villa, J. A., and DeWitt, J. G. (1999). 'Analysis of Phytochelatin–Cadmium Complexes from Plant Tissue Culture Using Nano-Electrospray Ionization Tandem Mass Spectrometry and Capillary Liquid Chromatography/Electrospray Ionization Tandem Mass Spectrometry', *Journal of Mass Spectrometry*, 34, 930-941.

## **Section C**

### **Human bioaccessibility**

## Chapter 7

### Bioaccessibility of metals in vegetable plants

#### 7.1 Introduction

Knowledge of oral bioaccessibility of a contaminant (see Section 1.7 in Chapter 1) is useful and valid for estimating potential human health risks. As bioaccessibility data is essentially related to the amount of contaminant in the animal/human bloodstream, then data must be produced from the dosing of animals with contaminated samples and the subsequent measurement of the contaminant in the blood or organs of the animals i.e. the use of *in vivo* animal models (Cave *et al.*, 2002). However, since *in vivo* studies are both expensive and laborious, and the possibility of measuring certain parameters during the experiments is often limited (Cabanero *et al.*, 2004), the data are normally determined in an *in vitro* environment and represents the amount of contaminant dissolved in the gastrointestinal tract.

This chapter concentrates on the use of a physiologically-based extraction test (PBET) to determine oral bioaccessibility of metals in the contaminated plant samples, in case they were consumed by animal/humans. The procedure applied (Method D, Table 1.3 in Chapter 1) as first described by Ruby *et al.* (1996) and modified later in 2002 by the British Geological Survey (BGS) to be less cumbersome and difficult to carry out for the following reasons (Cave *et al.*, 2002):

- Difficulties in obtaining reproducible mixing of the sample with argon gas whilst manipulating the samples in the temperature controlled water bath.
- The dialysis bag containing the sodium carbonate solution can be easily ruptured and takes a long time for the pH to rise to 7 for the small intestine phase extraction.

In this study, a controlled temperature shaking water bath was used to obtain reproducible mixing of the sample. Medlin 1997 (quoted in Wragg and Cave, 2002) showed that it was not necessary to maintain anaerobic conditions in the extraction solution and the digestion could be carried out in screw-top polyethylene vessels.

Rodriguez *et al.* (1999) showed that the use of the NaHCO<sub>3</sub> – packed dialysis tubing can be replaced by addition of a NaHCO<sub>3</sub> solution to raise the pH of the intestinal solution to 7.

## **7.2 Experimental**

### **7.2.1 Chemicals and apparatus**

All chemicals used were of analytical grade. Concentrated hydrochloric acid, acetic acid, sodium bicarbonate, pepsin-A powder 1 Anson unit per g (lactose as diluent) and pancreatin were provided by BDH Chemicals Ltd. (Poole, UK), bile salts, sodium malate, sodium citrate and lactic acid by Sigma (Missouri, USA). A multi-element standard for Cr, Mn, Fe, Ni, Cu, Zn, Mo, Cd and Pb and internal standard solutions for Sc, In and Tb were purchased from SPEXCertiPrep (Middlesex, UK). 18.2 MΩ x cm ultra pure water used was produced by a Direct-Q™ Millipore System (Molsheim, France). Certified reference materials (CRM) used were tea leaves (INCT-TL-1) obtained from the Institute of Nuclear Chemistry and Technology (Warszawa, Poland) and spinach leaves (SRM 1570a) purchased from the National Institute of Standards and Technology (Gaithersburg, MD, USA).

All ICP-MS measurements were carried out with an ICP mass spectrometer XSeries II (Thermo Electron Corporation, Cheshire, UK). A controlled temperature shaking water bath (Grant Instruments Ltd., OLS 200, Cambridge, UK) was employed for the PBET experiment. A heating block (2006 Digestor, Foss Tecator, Hoganas, Sweden) was used for acid digestion of plant samples.

### **7.2.2 Methodology**

#### **7.2.2.1 Growing of vegetable plants**

The samples used for this experiment were taken from the plants grown on the metal contaminated soils as described in Chapter 4 (Section 4.2.2.1).

#### **7.2.2.2 Total metal determination of plant samples and plant CRMs**

Plant samples and CRMs were acid digested as the procedures given in Chapter 4 (Section 4.2.2.2).

### 7.2.2.3 The PBET experiment

The PBET experiment consists of two sequential processes, a gastric and an intestinal digestion, each one carried out employing simulated human conditions (enzymes, pH and temperature). In the first stage, 0.3 g (accurately weighed) of ground plant samples (oven dried at 70 °C for 48 h) was placed into a 50 mL screw-cap Sarstedt tube and treated with 30 mL of gastric solution (1.25 g pepsin, 0.50 g sodium malate, 0.50 g sodium citrate, 420 µL lactic acid and 500 µL acetic acid made up to 1 L with de-ionised water, adjusted to pH 2.5 with conc. HCl). The mixture was then shaken at 100 rpm in a thermostatic bath maintained at 37 °C. After 1 h, the solution was centrifuged at 3000 rpm for 10 min and a 5 mL aliquot was removed and filtered through a 0.45 µm filter disk for analysis. 5.0 mL of the original gastric solution was then backflushed through the filter into the sample tube to retain the original solid: solution ratio i.e. 0.3: 30 g/mL.

The second stage, 52.5 mg bile salts and 15 mg pancreatin were added into the sample tube and the mixture was adjusted to pH 7.0 with saturated NaHCO<sub>3</sub>. The sample was then shaken at 100 rpm in a thermostatic bath maintained at 37 °C for a further 2 h when a second 5.0 mL aliquot was removed and filtered. After an additional 2 h the last 5.0 mL extract was removed and filtered. The final sample was used to check that small intestinal equilibrium has been reached (Cave *et al.*, 2002). The bioaccessible metal contents of plant extracts (gastric and intestinal fractions) were determined by ICP-MS. The resultant sample residue was further digested by aqua regia as described by Rauret *et al.* (2000) and analysed by ICP-MS (residual fraction).

### 7.2.2.4 Sample analysis by ICP-MS

ICP-MS measurement conditions were optimised daily using the built-in PlasmaLab software procedure. The operating conditions are shown in Table 7.1. Samples of the plant extracts were analysed by ICP-MS using an external calibration technique. Sc, In and Tb internal standard (10 µg/L) were added to all samples, blanks and standard solutions. The quality control of the measurements was done by measuring

CRMs (tea leaves and spinach leaves) every ten samples. A blank was analysed with each analytical batch.

**Table 7.1** Instrumental operating conditions for ICP-MS

ICP-MS conditions	Standard Mode	CCT mode
Forward power	1400 W	1400 W
Cool gas flow	13.0 L/min	13.0 L/min
Auxiliary gas flow	0.90 L/min	0.90 L/min
Nebulizer gas flow	0.80 L/min	0.80 L/min
Collision cell gas	NA	5.00 L/min 7% $H_2$ /93% $He$
Quadrupole bias	-0.5 V	-14.0 V
Hexapole bias	0.0 V	-15.0 V
Dwell time per isotope	10 ms	10 ms
Isotopes monitored	$^{52}Cr$ , $^{55}Mn$ , $^{56}Fe$ , $^{60}Ni$ , $^{63}Cu$ , $^{66}Zn$ , $^{95}Mo$ , $^{111}Cd$ and $^{208}Pb$	$^{52}Cr$ , $^{55}Mn$ , $^{56}Fe$ , $^{60}Ni$ , $^{63}Cu$ , $^{66}Zn$ , $^{95}Mo$ , $^{111}Cd$ and $^{208}Pb$
Internal standards	$^{45}Sc$ , $^{115}In$ and $^{159}Tb$	$^{45}Sc$ , $^{115}In$ and $^{159}Tb$

### 7.2.2.5 Calculation of bioaccessibility

The bioaccessibility measurements are normally reported as relative bioaccessibility expressed as a percentage and calculated per digestion according to the following equation (Oomen *et al.*, 2002);

Bioaccessibility (%) =

$$\frac{\text{Metal mobilized from plant sample during digestion } (\mu\text{g}) \times 100}{\text{Metal present in plant sample before digestion } (\mu\text{g})}$$

## 7.3 Results and discussion

### 7.3.1 ICP-MS analysis of the plant CRMs

The quality of the ICP-MS measurement data was evaluated by analysing the plant certified reference materials (Spinach leaves; SRM 1570a, and Tea leaves; INCT-TL-1) in both standard and collision cell technology (CCT) modes. The latter is used to circumnavigate potential molecular interferences from either the plant

material, extraction solvent or plasma-related. The CRMs were run in between every 10 sample measurements to check the sensitivity of the instruments. The obtained results and the percent recovery for the total metal analysis are shown in Table 7.2. On the basis of the elements determined in both CRMs the following operating modes were identified as the most appropriate. For Cr, both operating modes gave only slight differences in percent recovery (102% in standard mode compared to 103% in CCT mode) for tea CRM, and 2.06 mg/kg in standard mode compared to 2.01 mg/kg in CCT mode for spinach CRM (no certified value available for Cr in the CRM). Similarly for Mn in spinach CRM, 98% recovery obtained in standard mode and 97% recovery in CCT mode, no data available for tea CRM. However, both Cr, Mn were chosen to be measured in CCT mode as it gave smaller deviations over the period of analysis. In the case of Fe, Ni, Cu and Zn, it was obvious that the results in CCT mode gave better percent recoveries than when they were analysed in standard mode for both tea CRM and spinach CRM. It is known that the first row transition metals often have major polyatomic interferences in ICP-MS analysis (Townsend, 2000). For Mo, Cd and Pb, it was expected to be relatively free from molecular interferences at 95, 111 and 208 amu, and the measured values obtained from both standard and CCT mode were not significantly different. For Cd, both operating modes showed no differences in percent recoveries (101%). Therefore, it was concluded that Cr, Mn, Fe, Ni, Cu and Zn would be determined in CCT mode, whereas in standard mode it was considered to determine the following elements: Mo, Cd and Pb. All future plants samples were analysed using these experimentally determined ICP-MS operating mode conditions.

### **7.3.2 Evaluation of the PBET approach by digestion of the CRMs**

The CRMs (tea leaves and spinach leaves) were enzymatically digested and analysed in the same manner as the plant samples, in order to evaluate the PBET approach. The *in vitro* results (gastric, intestinal and residual) were compared to the certified values for total metal and are given in Tables 7.3 A-B. The results obtained for Cr, Fe, Cu, and Pb in the tea CRM after application of the enzymatic extraction procedure, were in good agreement with the certified values for total metals i.e. the



sum of the amounts dissolved in gastric, intestinal and residual (phase I+II+III) were close to those from the total amounts indicated in the certified values for total metal. The mean concentrations of phase I+II+III were 2.04, 437, 21.7 and 1.73 mg/kg whereas the total metal certified values were 1.91, 432, 20.4 and 1.78 mg/kg for Cr, Fe, Cu and Pb, respectively. However, the mean concentrations of Mn, Ni, Zn, and Cd were slightly different from the means of the certified values, but they still fell within the standard deviation ranges. No data was available for Mo in the tea CRM, and its content extracted from the PBET plus the amount left in the residual fraction was minimal (0.087 mg/kg). In the case of the spinach CRM, Ni and Cd results were satisfactory. The results obtained from the PBET were 2.06 and 2.73 mg/kg compared to 2.14 and 2.89 mg/kg of the certified value for Ni and Cd, respectively. In contrast, the PBET results for Mn, Cu and Zn gave relatively higher concentrations than the amounts found in the spinach CRM i.e. the PBET results were 83.0, 14.2 and 92 mg/kg compared to 75.9, 12.2 and 82 mg/kg of the total metal certified values for Mn, Cu and Zn, respectively. This may be attributed to the rather high concentrations of the spinach CRM analysed by ICP-MS for these particular elements (as shown in Table 7.2) i.e. the measured values would be up to 83 (73.6+9.4), 15.8 (13.5+2.3) and 92.2 (84.6+7.6) mg/kg for Mn, Cu and Zn, respectively. No certified values were available for Cr, Fe, Mo and Pb in the spinach CRM.

### **7.3.3 The equilibrium of the intestinal digestion phase**

During digestion, it has been shown that the absorption process mostly takes place in the small intestine, where final stage of digestion occurs (Widmaier *et al.*, 2006). It is therefore necessary to mimic the transit times through the gut, irrespective of whether an equilibrium has been reached in the *in vitro* gastrointestinal extraction procedure i.e. the sample is retained in the intestinal solution as closely as it normally lasts in animals/human digestion. This will allow us to produce reliable data from the PBET. In this experiment, samples were treated with intestinal juices at pH 7 for 2 h, and then a sample aliquot was removed for analysis. This sample is referred to as *intestinal phase IIA*. An additional 2 h was continued in this process and the final sample aliquot (referred to as *intestinal phase IIB*) was used to check

whether the intestinal digestion equilibrium had been reached. The two values for intestinal extraction (intestinal phase IIA and IIB) represent 2 h and 4 h residence time under the intestinal compartment conditions.

**Table 7.2** Total concentrations (mg/kg, DW) in plant CRMs

Element	SRM 1570a, Spinach leaves			CRM INCT-TL-1, Tea leaves		
	Certified value Mean $\pm$ SD	Measured value (Mean $\pm$ SD, n = 40)		Certified value Mean $\pm$ SD	Measured value (Mean $\pm$ SD, n = 40)	
		Standard Mode	CCT Mode		Standard Mode	CCT Mode
Cr	na	2.06 $\pm$ 0.44	2.01 $\pm$ 0.40	1.91 $\pm$ 0.22	1.95 $\pm$ 0.50 (102)	1.96 $\pm$ 0.27 (103)
Mn	75.9 $\pm$ 1.9	74.1 $\pm$ 11.1 (98)	73.6 $\pm$ 9.4 (97)	1570 $\pm$ 110	na	na
Fe	na	na	na	(432)	386 $\pm$ 131 (89)	423 $\pm$ 35 (98)
Ni	2.14 $\pm$ 0.10	2.99 $\pm$ 1.44 (140)	2.24 $\pm$ 0.39 (105)	6.12 $\pm$ 0.52	6.55 $\pm$ 1.68 (107)	6.10 $\pm$ 0.61 (100)
Cu	12.2 $\pm$ 0.6	16.2 $\pm$ 7.1 (133)	13.5 $\pm$ 2.3 (111)	20.4 $\pm$ 1.5	23.1 $\pm$ 5.2 (113)	20.5 $\pm$ 1.8 (101)
Zn	82 $\pm$ 3	80.7 $\pm$ 9.0 (98)	84.6 $\pm$ 7.6 (103)	34.7 $\pm$ 2.7	41.0 $\pm$ 7.5 (118)	34.2 $\pm$ 2.2 (99)
Mo	na	0.62 $\pm$ 0.13	0.61 $\pm$ 0.12	na	0.13 $\pm$ 0.04	0.18 $\pm$ 0.08
Cd	2.89 $\pm$ 0.07	2.91 $\pm$ 0.25 (101)	2.92 $\pm$ 0.38 (101)	0.0302 $\pm$ 0.004	na	na
Pb	na	0.70 $\pm$ 0.16	0.70 $\pm$ 0.13	1.78 $\pm$ 0.24	1.03 $\pm$ 0.26 (58)	1.00 $\pm$ 0.22 (56)

NB: na, Not Applicable. Numbers in brackets represent percentage recovery for the measured values

The statistical hypothesis test (t-test: paired two sample for means) was applied to prove whether the two values have any significant differences. The t-stat and p values together with intestinal IIA and IIB concentrations are shown in Table 7.4. For the tea CRM, every metal except Fe gave the absolute t-stat values less than the t-critical (which is 4.303 at 5% significance level) and the p-values higher than 0.05. This means the hypothesis is accepted i.e. there is no significant evidence, at the 5% significance level, that the mean of phase IIA is different from the mean of

phase IIB. Whereas the t-stat for Fe is 5.899 and lies outside the interval (-4.303, 4.303), the hypothesis is rejected i.e. the mean of phase IIA is different from the mean of phase IIB at the 5% significance level. However, the mean of phase IIA is not different from the mean of phase IIB, at 1% significance level. Similarly, the hypothesis test was also applied for spinach CRM; it clearly indicated that every metal (Cr, Mn, Fe, Ni, Cu, Zn, Mo, Cd, and Pb) gave the t-stat values less than the t-critical (which is 4.303 at 5% significance level) and the p-values higher than 0.05 i.e. there is no significant evidence that the mean of phase IIA is different from the mean of phase IIB. It is therefore concluded that the intestinal digestion equilibrium had been reached at the first 2 h of the PBET extraction and the data in this phase (phase IIA) represent the amounts of metal dissolved from the plants in the intestinal compartment conditions.

#### **7.3.4 Bioaccessibility of the plants**

The oral bioaccessibility of metals from the vegetable plants were assessed using an *in vitro* physiologically based extraction test. For the purpose of this work only the edible part of the plant was analysed i.e. for carrot and radish the roots, while for spinach and lettuce the leaves. After the plant samples were treated with gastric and intestinal juices in the PBET experiment, the gastric and intestinal fractions were collected and analysed by ICP-MS. The residuals were also acid digested and analysed by ICP-MS. The bioaccessible concentrations together with the total metal concentrations in the plants are reported in Table 7.5 – 7.8 (A-D) for lettuce, spinach, carrot and radish, respectively. The A, B, C and D represent the data for the control, low, medium and high level, respectively which are the different metal spiking levels. The data are also presented as the percentage bioaccessibility of Cr, Pb, Fe, Mn, Ni, Cu, Zn, Mo and Cd in Figure 7.1 A – I, respectively.

#### **Chromium**

The Cr bioaccessibility was rather low i.e. only a small content was mobilised from the plants in the gastric phase; 4-9%, 7-24%, 12-20% and 7-13% of the total concentrations in lettuce, spinach, carrot and radish, respectively. The bioaccessible Cr in the intestinal phase was relatively higher than those in the gastric phase; 12-

25%, 12-44%, 11-37% and 15-28% of the total amounts in lettuce, spinach, carrot and radish, respectively. Most of the Cr was left in the residual phase; 67-79%, 32-81%, 47-77% and 60-78% of the total amounts in lettuce, spinach, carrot and radish, respectively.

### **Lead**

The bioaccessible amount of Pb in the plants was similar to Cr i.e. rather a small amount of Pb dissolved in the gastric phase; 11-26%, 14-27%, 11-21% and 7-23% of the total amounts in lettuce, spinach, carrot and radish, respectively. The solubility of Pb in the intestinal phase was relatively higher than Cr; 29-50%, 20-30%, 28-46% and 33-61% of the total amounts in lettuce, spinach, carrot and radish, respectively. The Pb percentage left in the residual was higher than every other metal, except Cr; 34-58%, 53-70%, 41-52% and 27-59% of the total amounts in lettuce, spinach, carrot and radish, respectively.

### **Manganese**

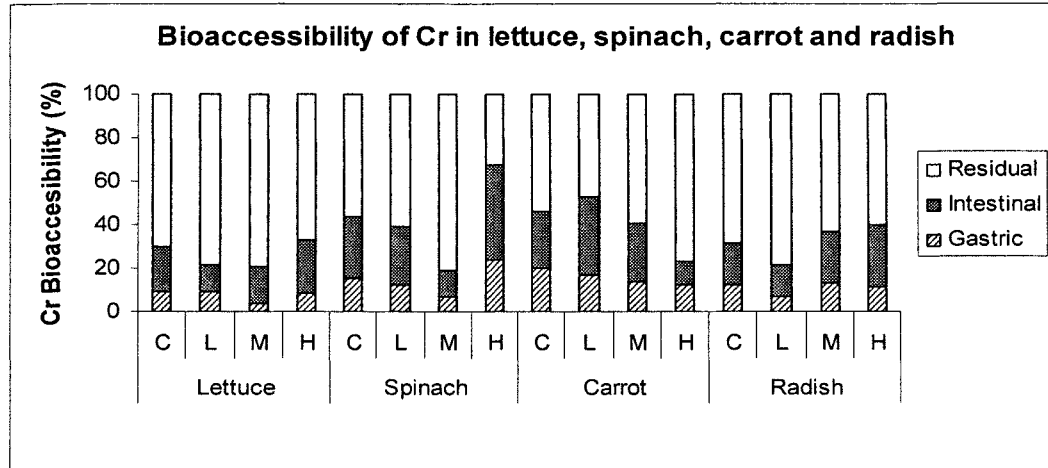
The bioaccessibility of Mn was similar to Zn, Cu, Ni, Mo and Cd i.e. most of the metal contents were dissolved in the gastric and intestinal phase for every vegetable plant studied. In the gastric phase, 47-50%, 38-46%, 32-48% and 38-49% of the total Mn was found in lettuce, spinach, carrot and radish, respectively. In the intestinal phase, 32-38%, 36-50%, 43-51% and 43-54% of the total Mn was measured in lettuce, spinach, carrot and radish, respectively. The small content of Mn that remained in the residual fraction was; 12-18%, 11-17%, 6-17% and 8-10% of the total metal in lettuce, spinach, carrot and radish, respectively.

### **Nickel**

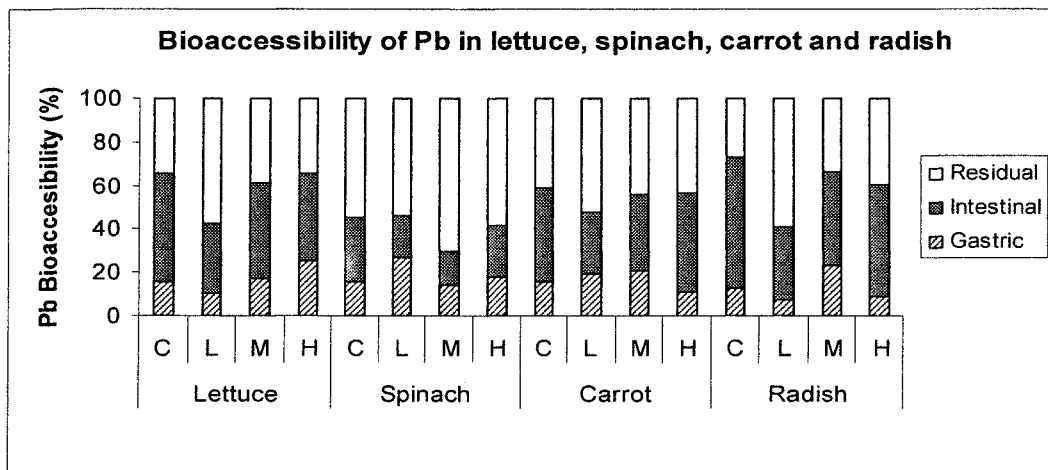
The percentage of soluble Ni in the gastric phase in lettuce, spinach, carrot and radish was 24-42%, 28-29%, 16-51% and 21-45%, respectively. The major content of Ni in lettuce (35-55%) and spinach (37-60%) was extracted in the intestinal phase, while it was slightly lower in carrot (28-56%) and radish (28-50%). The content measured in the residual phase was 14-37%, 12-35%, 13-57% and 9-52% of the total Ni in lettuce, spinach, carrot and radish, respectively.

**Figure 7.1 (A – I)** Percentage bioaccessibility of the metals in lettuce, spinach, carrot and radish grown on the control (C), low (L), medium (M) and high (H) soil treatments

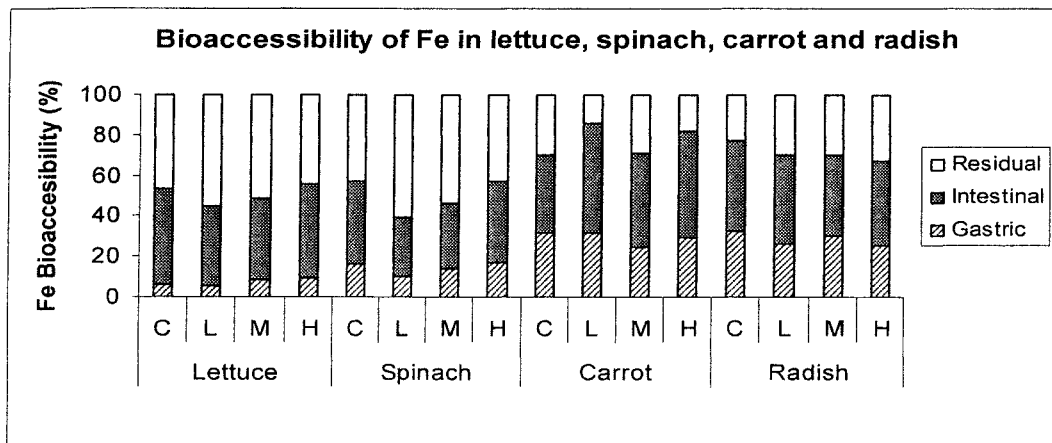
**(A) Chromium**



**(B) Lead**

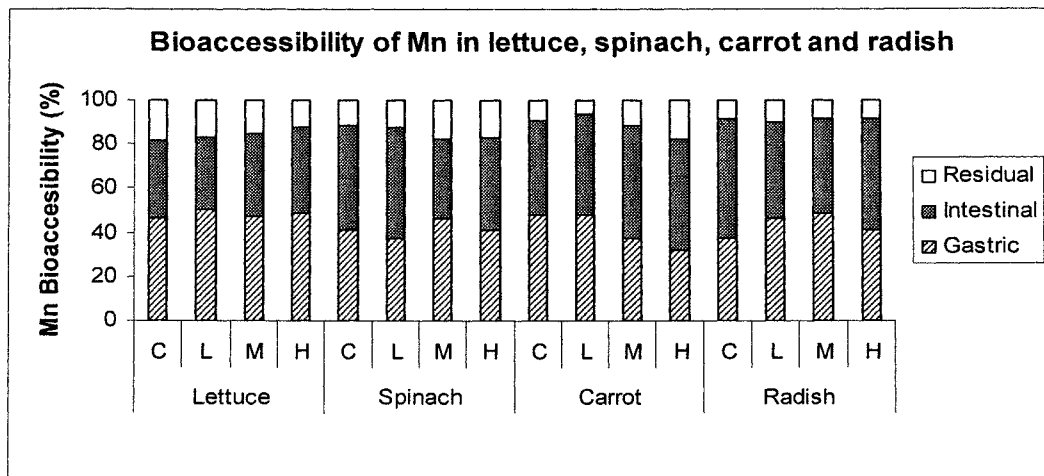


**(C) Iron**

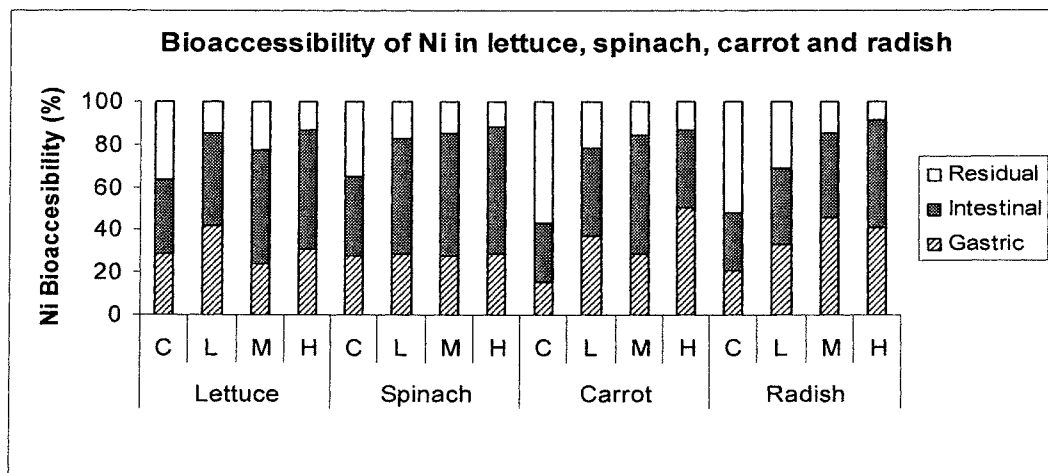


**Figure 7.1 (continued)**

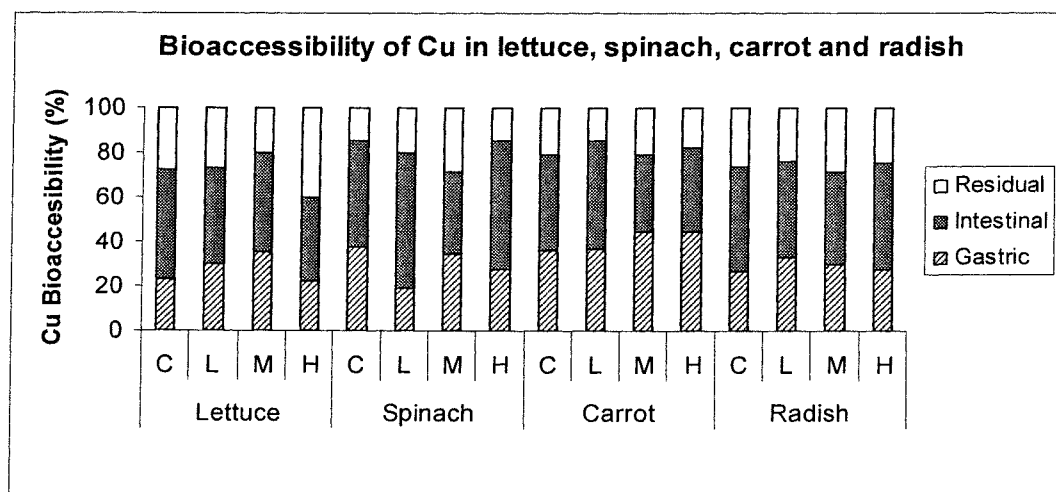
**(D) Manganese**



**(E) Nickel**

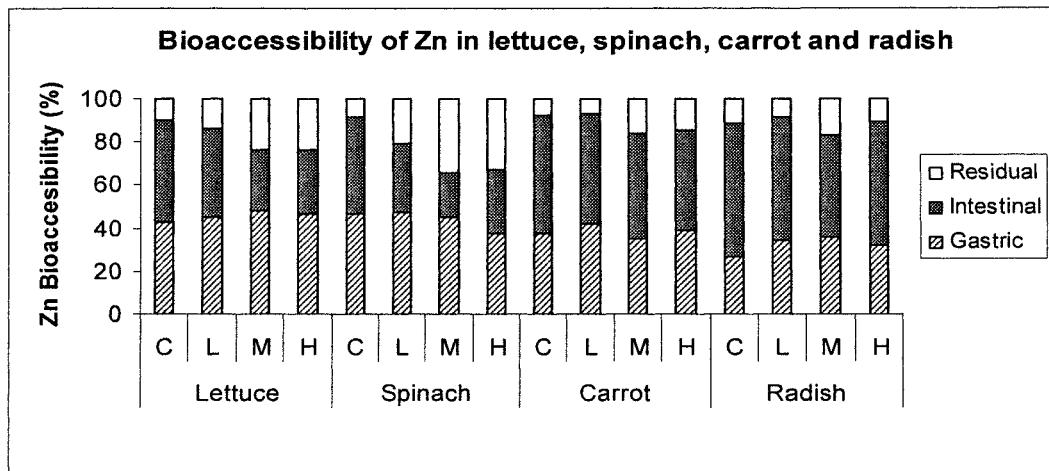


**(F) Copper**

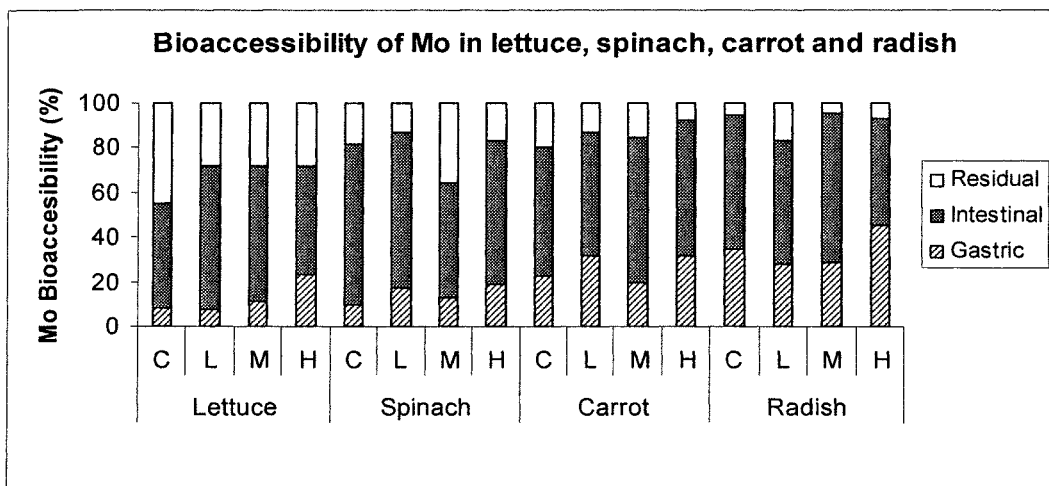


**Figure 7.1 (continued)**

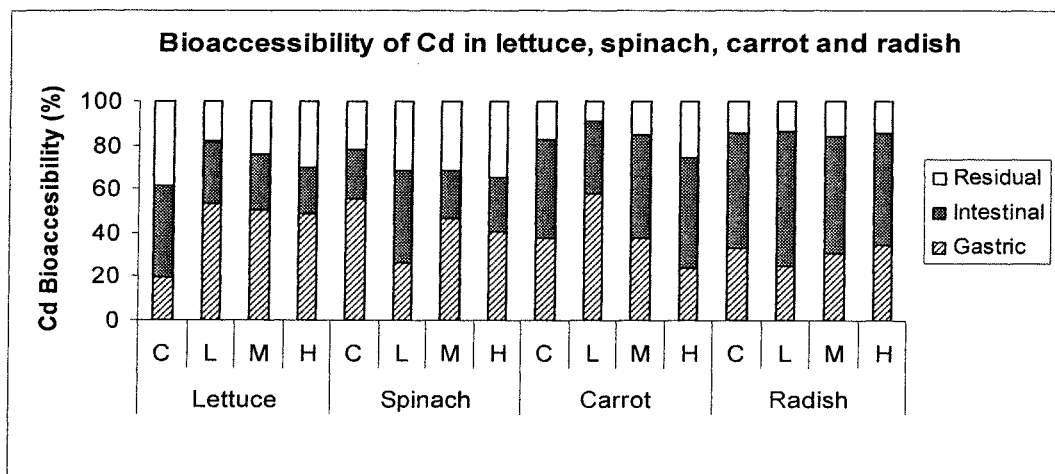
**(G) Zinc**



**(H) Molybdenum**



**(I) Cadmium**



### **Copper**

The bioaccessibility of Cu was high in all plants. For lettuce, spinach, carrot and radish, respectively, 22-35%, 19-38%, 36-45% and 27-33% (in gastric phase) and 38-49%, 37-61%, 34-48% and 41-48% (in intestinal phase) of the total Cu was found. In the residual fraction, 20-40%, 15-29%, 14-21% and 24-28% of the total Cu was recovered in lettuce, spinach, carrot and radish, respectively.

### **Zinc**

The major content of Zn was bioaccessible in all plants. In the gastric phase, 43-48%, 38-47%, 35-42% and 26-35% of the total Zn was extracted in lettuce, spinach, carrot and radish, respectively. In the intestinal phase, 29-47%, 21-45%, 47-55% and 48-62% of the total metal was found in lettuce, spinach, carrot and radish, respectively. Only a small fraction of Zn was left in the residual fraction; 10-24%, 9-34%, 7-16% and 8-17% in lettuce, spinach, carrot and radish, respectively.

### **Cadmium**

The percentage of soluble Cd measured in the gastric phase in lettuce, spinach, carrot and radish were 19-53%, 26-56%, 24-58% and 25-35%, respectively. In the intestinal phase, 21-42%, 22-42%, 33-51% and 51-62% of the total metal was found in lettuce, spinach, carrot and radish, respectively. The content measured in the residual phase was 18-38%, 22-35%, 9-25% and 14-16% of the total Cd in lettuce, spinach, carrot and radish, respectively.

### **Molybdenum**

The bioaccessibility of Mo was high in all plants but the amount extracted in the intestinal phase was always greater than that in the gastric phase. For lettuce, spinach, carrot and radish, this amounted to 8-24%, 10-19%, 20-32% and 28-45% (in the gastric phase), respectively and 47-65%, 52-72%, 55-65% and 48-66% (in the intestinal phase) of the total Mo was extracted. The content measured in the residual phase was 28-45%, 13-36%, 8-20% and 5-17% of the total Mo in lettuce, spinach, carrot and radish, respectively.



## **Iron**

Most of the Fe content was dissolved in the gastric and intestinal phases for carrot and radish, while there were slightly smaller amounts found in lettuce and spinach. In the gastric phase, 5-10%, 10-17%, 25-32% and 26-32% of the total Fe was extracted in lettuce, spinach, carrot and radish, respectively. In the intestinal phase, 38-47%, 29-41%, 39-55% and 40-45% of the total Fe was measured in lettuce, spinach, carrot and radish, respectively. The content remained in the residual fraction; 44-55%, 43-61%, 14-30% and 22-33% of the total metal was recovered in lettuce, spinach, carrot and radish, respectively.

### **7.3.5 Comparison of total metal analysis and PBET experiment**

In this PBET experiment, a mass balance can be made i.e. the amount of the metals in the plants before the start of the digestion (total metal) should be equal to the amount of metals released in the gastrointestinal extraction plus the amount of the metals left in the residual fraction. The statistical hypothesis test explained in section 7.3.3 can be used to check that the total metal analysis and the PBET result are not significantly different. The statistical data are presented in Tables 7.5-7.8 (A-D). It indicated that all elements determined in every plant type were not significantly different (at the 5% significance level) between the total metal and the PBET results i.e. the t-stat values lie within the interval (-4.303, 4.303). It is therefore concluded that the PBET results are in good agreement with the total metal analysis in terms of the mass balance.

**Table 7.3 (A-B) Bioaccessibility of the metals in plant CRMs**

**(A) Tea leaves**

Element	Certified values (mg/kg)	Physiologically-Based Extraction Test (PBET), mg/kg									
		Phase I			Phase II			Phase III (Residual)			Total I+II+III Mean ± SD, n = 3
		Mean ± SD, n = 3	%	Mean ± SD, n = 3	%	Mean ± SD, n = 3	%	Mean ± SD, n = 3	%		
Cr	1.91 ± 0.22	0.67 ± 0.13	32.57	0.73 ± 0.09	35.73	0.65 ± 0.09	31.70	2.04 ± 0.11			
Mn	1570 ± 110	998 ± 298	58	356 ± 231	21	360 ± 32	21	1714 ± 105			
Fe	(432)	1 ± 1	0.2	6 ± 2	1.5	429 ± 46	98.3	437 ± 43			
Ni	6.12 ± 0.52	2.68 ± 0.57	39.82	2.43 ± 0.24	36.05	1.63 ± 0.46	24.13	6.74 ± 0.43			
Cu	20.4 ± 1.5	3.7 ± 1.0	17.3	7.2 ± 0.5	33.3	10.7 ± 1.1	49.5	21.7 ± 0.4			
Zn	34.7 ± 2.7	17.0 ± 2.8	40.8	10.9 ± 1.3	26.2	13.7 ± 2.6	32.9	41.7 ± 4.9			
Mo	na	0.005 ± 0.003	6.13	0.024 ± 0.005	27.20	0.058 ± 0.002	66.67	0.087 ± 0.003			
Cd	0.0302 ± 0.004	0.0159 ± 0.0125	41.69	0.0038 ± 0.0027	9.91	0.0184 ± 0.0198	48.40	0.0381 ± 0.0116			
Pb	1.78 ± 0.24	0.13 ± 0.02	7.45	0.20 ± 0.02	11.51	1.40 ± 0.01	81.04	1.73 ± 0.05			

**Table 7.3 (continued)**

**(B) Spinach leaves**

Element	Certified values (mg/kg)	Physiologically-Based Extraction Test (PBET), mg/kg									
		Phase I			Phase II			Phase III (Residual)			Total I+II+III Mean ± SD, n = 3
		Mean ± SD, n = 3	%	Mean ± SD, n = 3	%	Mean ± SD, n = 3	%	Mean ± SD, n = 3	%		
Cr	na	0.15 ± 0.02	9.64	0.29 ± 0.07	18.54	1.11 ± 0.07	71.82	1.54 ± 0.08			
Mn	75.9 ± 1.9	39.0 ± 0.6	47.0	31.0 ± 4.9	37.3	13.0 ± 2.0	15.7	83.0 ± 4.0			
Fe	na	38 ± 3	20.2	63 ± 3	33.3	88 ± 5	46.5	189 ± 6			
Ni	2.14 ± 0.10	0.87 ± 0.06	42.13	0.73 ± 0.09	35.53	0.46 ± 0.18	22.33	2.06 ± 0.20			
Cu	12.2 ± 0.6	6.4 ± 0.1	44.7	5.7 ± 0.4	40.4	2.1 ± 0.5	14.9	14.2 ± 0.4			
Zn	82 ± 3	52 ± 2	57.1	30 ± 1	32.2	10 ± 0.4	10.7	92 ± 3			
Mo	na	0.206 ± 0.041	37.07	0.312 ± 0.052	55.99	0.039 ± 0.011	6.94	0.557 ± 0.086			
Cd	2.89 ± 0.07	1.02 ± 0.19	37.44	0.64 ± 0.11	23.42	1.07 ± 0.08	39.14	2.73 ± 0.37			
Pb	na	0.120 ± 0.068	30.68	0.110 ± 0.075	28.15	0.161 ± 0.083	41.17	0.392 ± .076			

**Table 7.4** The extraction equilibrium of the intestinal digestion phase

Element	Bioaccessible metals, mg/kg - Tea CRM				Bioaccessible metals, mg/kg - Spinach CRM							
	Phase IIA		Phase IIB		t-stat	P-value	Phase IIA		Phase IIB		t-stat	P-value
	Mean (n=3)	SD	Mean (n=3)	SD			Mean (n=3)	SD	Mean (n=3)	SD		
Cr	0.730	0.093	0.760	0.100	-0.512	0.660	0.286	0.073	0.302	0.098	-0.794	0.511
Mn	356.020	230.635	324.751	201.412	1.737	0.225	30.972	4.873	30.086	3.757	0.946	0.444
Fe	6.415	1.901	5.990	1.912	5.899*	0.028*	62.857	3.005	59.936	1.364	2.752	0.111
Ni	2.429	0.236	2.208	0.101	1.247	0.339	0.733	0.091	0.720	0.117	0.873	0.475
Cu	7.212	0.465	7.147	0.985	0.162	0.886	5.741	0.431	5.923	0.601	-0.773	0.520
Zn	10.934	1.264	10.832	1.304	0.191	0.866	28.621	1.011	28.731	2.432	-0.109	0.923
Mo	0.024	0.005	0.020	0.003	3.417	0.076	0.312	0.052	0.278	0.059	3.687	0.066
Cd	0.004	0.003	0.003	0.001	1.153	0.368	0.639	0.115	0.603	0.131	2.705	0.114
Pb	0.199	0.024	0.215	0.038	-1.019	0.415	0.110	0.075	0.115	0.078	-1.982	0.186

Note : t-critical (two-tail) is 4.303 and p-values are reported at 5% significance level. \* 1% significance level giving t-critical = 9.925.

**Table 7.5 (A – D)** Bioaccessible and total metal concentrations found in lettuce

**(A) Lettuce – control treatment** (statistical data are reported at 5% significance level)

Element	Total metal, mg/kg by acid digestion Mean $\pm$ SD, n = 3	Physiologically-Based Extraction Test (PBET), mg/kg						Total VS PBET		
		Phase I		Phase II		Phase III (Residual)		Total I+II+III Mean $\pm$ SD, n = 3	t-stat	P-value
		Mean $\pm$ SD, n = 3	%	Mean $\pm$ SD, n = 3	%	Mean $\pm$ SD, n = 3	%			
Cr	1.31 $\pm$ 0.50	0.09 $\pm$ 0.02	8.86	0.22 $\pm$ 0.18	21.28	0.74 $\pm$ 0.15	69.87	1.05 $\pm$ 0.31	-0.704	0.554
Mn	215 $\pm$ 18	105 $\pm$ 11	47	79 $\pm$ 9	35	40 $\pm$ 4	18	225 $\pm$ 5	1.376	0.303
Fe	82 $\pm$ 7	5 $\pm$ 3	6	39 $\pm$ 8	47	38 $\pm$ 2	47	82 $\pm$ 4	-0.270	0.812
Ni	2.04 $\pm$ 0.93	0.39 $\pm$ 0.13	28.57	0.48 $\pm$ 0.11	34.72	0.51 $\pm$ 0.16	36.71	1.38 $\pm$ 0.08	-1.352	0.309
Cu	7.91 $\pm$ 0.24	1.81 $\pm$ 0.14	22.78	3.92 $\pm$ 0.33	49.37	2.21 $\pm$ 0.01	27.85	7.94 $\pm$ 0.18	0.098	0.931
Zn	95 $\pm$ 14	45 $\pm$ 20	43	49 $\pm$ 19	47	10 $\pm$ 1.64	10	104 $\pm$ 3.02	1.005	0.421
Mo	0.46 $\pm$ 0.02	0.04 $\pm$ 0.01	8.57	0.2 $\pm$ 0.13	46.71	0.20 $\pm$ 0.16	44.73	0.44 $\pm$ 0.03	-1.848	0.206
Cd	0.13 $\pm$ 0.08	0.04 $\pm$ 0.06	19.25	0.09 $\pm$ 0.02	42.41	0.08 $\pm$ 0.02	38.34	0.21 $\pm$ 0.02	2.118	0.168
Pb	0.49 $\pm$ 0.18	0.06 $\pm$ 0.03	15.72	0.18 $\pm$ 0.04	49.58	0.12 $\pm$ 0.05	34.70	0.36 $\pm$ 0.04	-1.063	0.399

**Table 7.5 (continued)**

**(B) Lettuce – low treatment** (statistical data are reported at 5% significance level)

Element	Total metal, mg/kg by acid digestion Mean ± SD, n = 3	Physiologically-Based Extraction Test (PBET), mg/kg						Total VS PBET		
		Phase I		Phase II		Phase III (Residual)		Total I+II+III Mean ± SD, n = 3	t-stat	P-value
		Mean ± SD, n = 3	%	Mean ± SD, n = 3	%	Mean ± SD, n = 3	%			
Cr	0.96 ± 0.20	0.10 ± 0.03	9.15	0.13 ± 0.05	12.11	0.83 ± 0.25	78.74	1.06 ± 0.27	0.369	0.747
Mn	653 ± 50	336 ± 23	50	216 ± 37	32	114 ± 38	17	666 ± 37	1.780	0.217
Fe	69 ± 5	4 ± 1	5	28 ± 8	39	39 ± 7	55	70 ± 2	0.234	0.837
Ni	2.63 ± 0.44	1.10 ± 0.16	41.58	1.16 ± 0.13	43.86	0.39 ± 0.14	14.57	2.65 ± 0.14	0.068	0.952
Cu	9.06 ± 1.45	2.95 ± 0.56	30.21	4.22 ± 0.74	43.14	2.60 ± 0.58	26.64	9.77 ± 0.63	1.270	0.332
Zn	94 ± 18	44 ± 10	45	41 ± 11	41	14 ± 4	14	99 ± 12	0.408	0.723
Mo	0.98 ± 0.62	0.07 ± 0.04	7.41	0.60 ± 0.19	64.78	0.26 ± 0.11	27.81	0.93 ± 0.26	-0.136	0.904
Cd	3.03 ± 0.74	1.90 ± 0.24	53.38	1.01 ± 0.38	28.51	0.64 ± 0.33	18.10	3.55 ± 0.26	0.957	0.439
Pb	0.90 ± 1.10	0.03 ± 0.01	10.74	0.10 ± 0.05	31.67	0.18 ± 0.09	57.59	0.31 ± 0.07	-0.942	0.446

**Table 7.5 (continued)**

(C) Lettuce – medium treatment (statistical data are reported at 5% significance level)

Element	Total metal, mg/kg by acid digestion Mean ± SD, n = 3	Physiologically-Based Extraction Test (PBET), mg/kg						Total VS PBET		
		Phase I		Phase II		Phase III (Residual)		Total I+II+III Mean ± SD, n = 3	t-stat	P-value
		Mean ± SD, n = 3	%	Mean ± SD, n = 3	%	Mean ± SD, n = 3	%			
Cr	0.86 ± 0.31	0.05 ± 0.03	4.07	0.19 ± 0.11	16.97	0.87 ± 0.10	78.96	1.11 ± 0.12	1.075	0.395
Mn	1515 ± 58	718 ± 48	47	564 ± 28	37	230 ± 13	15	1513 ± 7	-0.081	0.943
Fe	68 ± 6	6 ± 1	9	27 ± 9	40	34 ± 7	51	67 ± 4	-0.411	0.721
Ni	5.01 ± 0.56	1.25 ± 0.30	24.24	2.77 ± 0.58	53.40	1.16 ± 0.07	22.36	5.18 ± 0.54	0.270	0.812
Cu	10.33 ± 0.21	3.60 ± 0.36	35.08	4.64 ± 0.48	45.21	2.02 ± 0.26	19.71	10.26 ± 0.38	-0.526	0.652
Zn	307 ± 36	144 ± 14	48	86 ± 4	29	70 ± 10	23	301 ± 15	-0.261	0.819
Mo	2.27 ± 0.89	0.35 ± 0.06	11.58	1.84 ± 0.28	60.76	0.84 ± 0.23	27.65	3.03 ± 0.04	1.441	0.286
Cd	6.92 ± 2.02	4.29 ± 0.32	50.23	2.21 ± 0.85	25.85	2.04 ± 0.61	23.92	8.54 ± 0.12	1.444	0.285
Pb	0.44 ± 0.59	0.05 ± 0.004	16.93	0.13 ± 0.10	44.11	0.11 ± 0.03	38.96	0.29 ± 0.07	-0.500	0.667

**Table 7.5 (continued)**

**(D) Lettuce – high treatment** (statistical data are reported at 5% significance level)

Element	Total metal, mg/kg by acid digestion Mean $\pm$ SD, n = 3	Physiologically-Based Extraction Test (PBET), mg/kg						Total VS PBET		
		Phase I		Phase II		Phase III (Residual)		Total I+II+III Mean $\pm$ SD, n = 3	t-stat	P-value
		Mean $\pm$ SD, n = 3	%	Mean $\pm$ SD, n = 3	%	Mean $\pm$ SD, n = 3	%			
Cr	0.70 $\pm$ 0.17	0.08 $\pm$ 0.07	8.18	0.23 $\pm$ 0.15	24.74	0.62 $\pm$ 0.12	67.08	0.93 $\pm$ 0.10	3.814	0.062
Mn	2613 $\pm$ 341	1327 $\pm$ 46	49	1038 $\pm$ 108	38	336 $\pm$ 36	12	2701 $\pm$ 45	0.438	0.704
Fe	206 $\pm$ 114	13 $\pm$ 8	10	62 $\pm$ 18	46	59 $\pm$ 13	44	134 $\pm$ 38	-0.886	0.469
Ni	10.96 $\pm$ 2.46	4.07 $\pm$ 0.46	31.32	7.17 $\pm$ 0.25	55.17	1.76 $\pm$ 0.31	13.51	13 $\pm$ 0.65	1.908	0.197
Cu	11.37 $\pm$ 0.46	2.58 $\pm$ 0.37	22.37	4.35 $\pm$ 0.38	37.64	4.62 $\pm$ 0.06	39.99	11.55 $\pm$ 0.38	0.473	0.683
Zn	525 $\pm$ 101	223 $\pm$ 11	47	139 $\pm$ 28	29	113 $\pm$ 9	24	475 $\pm$ 31	-0.683	0.565
Mo	2.08 $\pm$ 0.88	0.63 $\pm$ 0.55	23.65	1.29 $\pm$ 0.54	48.63	0.73 $\pm$ 0.27	27.71	2.65 $\pm$ 0.16	0.996	0.424
Cd	15.32 $\pm$ 5.32	8.97 $\pm$ 0.56	48.55	3.94 $\pm$ 0.95	21.31	5.57 $\pm$ 1.55	30.14	18.48 $\pm$ 1.34	0.996	0.424
Pb	0.12 $\pm$ 0.11	0.05 $\pm$ 0.04	25.57	0.08 $\pm$ 0.01	40.06	0.07 $\pm$ 0.04	34.37	0.20 $\pm$ 0.02	1.180	0.359



**Table 7.6 (A – D)** Bioaccessible and total metal concentrations found in spinach

**(A) Spinach – control treatment** (statistical data are reported at 5% significance level)

Element	Total metal, mg/kg by acid digestion Mean $\pm$ SD, n = 3	Physiologically-Based Extraction Test (PBET), mg/kg						Total VS PBET		
		Phase I		Phase II		Phase III (Residual)		Total I+II+III Mean $\pm$ SD, n = 3	t-stat	P-value
		Mean $\pm$ SD, n = 3	%	Mean $\pm$ SD, n = 3	%	Mean $\pm$ SD, n = 3	%			
Cr	0.60 $\pm$ 0.46	0.11 $\pm$ 0.05	15.75	0.19 $\pm$ 0.07	28.08	0.38 $\pm$ 0.23	56.17	0.68 $\pm$ 0.19	0.277	0.808
Mn	288 $\pm$ 24	122 $\pm$ 13	41	139 $\pm$ 7	47	34 $\pm$ 12	11	294 $\pm$ 9	0.368	0.748
Fe	49 $\pm$ 21	9 $\pm$ 1	16	23 $\pm$ 1	41	24 $\pm$ 5.80	43	57 $\pm$ 5	0.666	0.574
Ni	1.28 $\pm$ 0.59	0.38 $\pm$ 0.13	28.18	0.50 $\pm$ 0.08	36.76	0.48 $\pm$ 0.16	35.05	1.36 $\pm$ 0.24	0.311	0.785
Cu	4.92 $\pm$ 0.73	1.91 $\pm$ 0.50	37.93	2.40 $\pm$ 0.09	47.56	0.30 $\pm$ 0.17	14.51	5.05 $\pm$ 0.42	-1.115	0.381
Zn	65 $\pm$ 28	37 $\pm$ 10	46	36 $\pm$ 19	45	7 $\pm$ 1	9	79 $\pm$ 10	0.660	0.577
Mo	1.43 $\pm$ 0.46	0.15 $\pm$ 0.06	10.08	1.11 $\pm$ 0.37	72.09	0.27 $\pm$ 0.04	17.84	1.54 $\pm$ 0.30	0.866	0.478
Cd	0.14 $\pm$ 0.10	0.11 $\pm$ 0.01	55.73	0.05 $\pm$ 0.02	22.32	0.05 $\pm$ 0.01	21.95	0.21 $\pm$ 0.03	0.892	0.466
Pb	0.74 $\pm$ 0.89	0.07 $\pm$ 0.02	15.40	0.14 $\pm$ 0.04	30.18	0.25 $\pm$ 0.13	54.42	0.46 $\pm$ 0.13	-0.509	0.661

**Table 7.6 (continued)**

**(B) Spinach – low treatment** (statistical data are reported at 5% significance level)

Element	Total metal, mg/kg by acid digestion Mean $\pm$ SD, n = 3	Physiologically-Based Extraction Test (PBET), mg/kg						Total VS PBET		
		Phase I		Phase II		Phase III (Residual)		Total I+II+III Mean $\pm$ SD, n = 3	t-stat	P-value
		Mean $\pm$ SD, n = 3	%	Mean $\pm$ SD, n = 3	%	Mean $\pm$ SD, n = 3	%			
Cr	0.45 $\pm$ 0.34	0.08 $\pm$ 0.02	12.61	0.16 $\pm$ 0.03	26.54	0.37 $\pm$ 0.12	60.85	0.61 $\pm$ 0.10	0.628	0.594
Mn	1280 $\pm$ 220	523 $\pm$ 49	38	700 $\pm$ 90	50	167 $\pm$ 47	12	1390 $\pm$ 181	0.495	0.669
Fe	55 $\pm$ 22	7 $\pm$ 1	10	19 $\pm$ 4	29	39 $\pm$ 11	61	65 $\pm$ 7	0.795	0.510
Ni	2.55 $\pm$ 1.07	0.99 $\pm$ 0.18	28.85	1.84 $\pm$ 0.64	53.98	0.59 $\pm$ 0.27	17.17	3.42 $\pm$ 0.24	1.202	0.352
Cu	10.17 $\pm$ 1.91	2.12 $\pm$ 0.37	19.00	6.82 $\pm$ 0.35	60.96	2.24 $\pm$ 0.59	20.04	11.18 $\pm$ 1.10	-0.031	0.978
Zn	104 $\pm$ 19	50 $\pm$ 17	47	34 $\pm$ 2	32	21 $\pm$ 5	20	105 $\pm$ 15	2.820	0.106
Mo	4.19 $\pm$ 4.53	0.92 $\pm$ 0.86	17.66	3.65 $\pm$ 2.18	69.71	0.66 $\pm$ 0.26	12.63	5.23 $\pm$ 3.21	0.485	0.676
Cd	2.46 $\pm$ 0.65	0.76 $\pm$ 0.16	26.44	1.19 $\pm$ 0.33	41.75	0.91 $\pm$ 0.19	31.81	2.86 $\pm$ 0.33	1.406	0.295
Pb	0.40 $\pm$ 0.20	0.10 $\pm$ 0.06	26.89	0.07 $\pm$ 0.01	19.65	0.19 $\pm$ 0.14	53.46	0.36 $\pm$ 0.15	-0.177	0.876

**Table 7.6 (continued)**

**(C) Spinach – medium treatment** (statistical data are reported at 5% significance level)

Element	Total metal, mg/kg by acid digestion Mean $\pm$ SD, n = 3	Physiologically-Based Extraction Test (PBET), mg/kg						Total VS PBET		
		Phase I		Phase II		Phase III (Residual)		Total I+II+III Mean $\pm$ SD, n = 3	t-stat	P-value
		Mean $\pm$ SD, n = 3	%	Mean $\pm$ SD, n = 3	%	Mean $\pm$ SD, n = 3	%			
Cr	1.05 $\pm$ 1.00	0.09 $\pm$ 0.06	7.22	0.15 $\pm$ 0.05	11.88	1.04 $\pm$ 0.20	80.90	1.28 $\pm$ 0.25	0.511	0.660
Mn	2495 $\pm$ 191	1149 $\pm$ 138	46	894 $\pm$ 79	36	429 $\pm$ 11	17	2472 $\pm$ 66	-0.196	0.863
Fe	107 $\pm$ 41	12 $\pm$ 7	14	28 $\pm$ 10	33	46 $\pm$ 9	53	87 $\pm$ 9	-1.105	0.384
Ni	8.94 $\pm$ 1.70	2.53 $\pm$ 0.79	27.99	5.21 $\pm$ 0.81	57.66	1.30 $\pm$ 0.46	14.35	9.04 $\pm$ 1.06	0.162	0.886
Cu	15.43 $\pm$ 1.61	5.39 $\pm$ 0.70	34.42	5.80 $\pm$ 1.34	37.05	4.47 $\pm$ 1.07	28.53	15.65 $\pm$ 1.03	-1.895	0.199
Zn	342 $\pm$ 44	152 $\pm$ 11	45	69 $\pm$ 21	21	115 $\pm$ 31	34	336 $\pm$ 28	-0.159	0.888
Mo	3.58 $\pm$ 0.47	0.48 $\pm$ 0.07	12.65	1.97 $\pm$ 0.64	51.67	1.36 $\pm$ 0.49	35.69	3.82 $\pm$ 0.42	0.558	0.633
Cd	7.86 $\pm$ 1.86	3.82 $\pm$ 1.51	46.41	1.84 $\pm$ 0.46	22.34	2.58 $\pm$ 1.38	31.25	8.24 $\pm$ 0.92	0.248	0.827
Pb	0.44 $\pm$ 0.18	0.04 $\pm$ 0.03	14.44	0.05 $\pm$ 0.03	15.17	0.21 $\pm$ 0.08	70.39	0.30 $\pm$ 0.09	-0.912	0.458

**Table 7.6 (continued)**

**(D) Spinach – high treatment** (statistical data are reported at 5% significance level)

Element	Total metal, mg/kg by acid digestion		Physiologically-Based Extraction Test (PBET), mg/kg										Total VS PBET	
	Mean $\pm$ SD, n = 3	%	Phase I		Phase II		Phase III (Residual)		Total I+II+III		t-stat	P-value		
			Mean $\pm$ SD, n = 3	%	Mean $\pm$ SD, n = 3	%	Mean $\pm$ SD, n = 3	%	Mean $\pm$ SD, n = 3	%				
Cr	0.59 $\pm$ 0.37	24.08	0.16 $\pm$ 0.05	43.52	0.29 $\pm$ 0.22	43.52	0.22 $\pm$ 0.09	32.40	0.66 $\pm$ 0.23	0.226	0.842			
Mn	4336 $\pm$ 1071	41	1843 $\pm$ 364	42	1886 $\pm$ 380	42	739 $\pm$ 45	17	4468 $\pm$ 722	0.213	0.851			
Fe	88 $\pm$ 35	17	13 $\pm$ 4	40	31 $\pm$ 5	40	33 $\pm$ 11	43	77 $\pm$ 9	-0.714	0.549			
Ni	19.33 $\pm$ 3.45	28.33	5.87 $\pm$ 2.33	60.16	12.46 $\pm$ 0.38	60.16	2.38 $\pm$ 1.30	11.51	20.71 $\pm$ 1.32	0.502	0.666			
Cu	15.53 $\pm$ 1.79	27.97	4.77 $\pm$ 0.13	57.15	9.75 $\pm$ 0.51	57.15	2.54 $\pm$ 0.33	14.87	17.05 $\pm$ 0.64	-1.476	0.278			
Zn	592 $\pm$ 278	38	225 $\pm$ 27	29	175 $\pm$ 59	29	199 $\pm$ 25	33	600 $\pm$ 100	0.035	0.975			
Mo	4.00 $\pm$ 1.04	18.95	0.80 $\pm$ 0.08	64.72	2.75 $\pm$ 0.44	64.72	0.69 $\pm$ 0.44	16.33	4.24 $\pm$ 0.65	0.718	0.547			
Cd	18.44 $\pm$ 8.90	40.44	10.24 $\pm$ 4.42	24.92	6.31 $\pm$ 1.62	24.92	8.77 $\pm$ 5.06	34.64	25.32 $\pm$ 1.30	1.169	0.363			
Pb	0.68 $\pm$ 0.21	17.66	0.09 $\pm$ 0.03	24.41	0.13 $\pm$ 0.10	24.41	0.31 $\pm$ 0.10	57.93	0.53 $\pm$ 0.09	-0.992	0.426			

**Table 7.7 (A – D)** Bioaccessible and total metal concentrations found in carrot

**(A) Carrot – control treatment** (statistical data are reported at 5% significance level)

Element	Total metal, mg/kg by acid digestion		Physiologically-Based Extraction Test (PBET), mg/kg						Total VS PBET		
	Mean $\pm$ SD, n = 3	%	Phase I		Phase II		Phase III (Residual)		Total I+II+III Mean $\pm$ SD, n = 3	t-stat	P-value
			Mean $\pm$ SD, n = 3	%	Mean $\pm$ SD, n = 3	%	Mean $\pm$ SD, n = 3	%			
Cr	0.36 $\pm$ 0.21	20.34	0.09 $\pm$ 0.02	25.50	0.11 $\pm$ 0.03	25.50	0.23 $\pm$ 0.08	54.16	0.42 $\pm$ 0.09	0.724	0.544
Mn	19.14 $\pm$ 0.34	48.06	9.45 $\pm$ 0.67	43.07	8.47 $\pm$ 0.73	43.07	1.75 $\pm$ 0.61	8.87	19.67 $\pm$ 0.64	0.931	0.450
Fe	18.49 $\pm$ 1.45	31.95	5.81 $\pm$ 0.35	38.53	7.01 $\pm$ 1.22	38.53	5.37 $\pm$ 0.23	29.52	18.20 $\pm$ 1.38	-0.191	0.866
Ni	0.62 $\pm$ 0.07	15.51	0.09 $\pm$ 0.04	27.57	0.17 $\pm$ 0.03	27.57	0.34 $\pm$ 0.11	56.91	0.60 $\pm$ 0.09	-0.237	0.835
Cu	2.08 $\pm$ 0.19	36.38	0.80 $\pm$ 0.21	42.79	0.94 $\pm$ 0.23	42.79	0.46 $\pm$ 0.09	20.83	2.21 $\pm$ 0.31	0.484	0.676
Zn	20.82 $\pm$ 2.89	37.33	8.73 $\pm$ 1.86	54.73	12.81 $\pm$ 0.92	54.73	1.86 $\pm$ 0.96	7.95	23.40 $\pm$ 0.64	1.614	0.248
Mo	0.21 $\pm$ 0.08	22.71	0.06 $\pm$ 0.03	57.54	0.15 $\pm$ 0.08	57.54	0.05 $\pm$ 0.02	19.75	0.25 $\pm$ 0.07	0.507	0.663
Cd	0.06 $\pm$ 0.02	37.23	0.03 $\pm$ 0.01	45.23	0.03 $\pm$ 0.01	45.23	0.01 $\pm$ 0.01	17.54	0.07 $\pm$ 0.01	3.671	0.067
Pb	0.06 $\pm$ 0.02	15.43	0.01 $\pm$ 0.01	43.52	0.03 $\pm$ 0.01	43.52	0.03 $\pm$ 0.01	41.05	0.07 $\pm$ 0.002	1.332	0.314

**Table 7.7 (continued)**

**(B) Carrot – low treatment** (statistical data are reported at 5% significance level)

Element	Total metal, mg/kg by acid digestion Mean $\pm$ SD, n = 3	Physiologically-Based Extraction Test (PBET), mg/kg						Total VS PBET		
		Phase I		Phase II		Phase III (Residual)		Total I+II+III Mean $\pm$ SD, n = 3	t-stat	P-value
		Mean $\pm$ SD, n = 3	%	Mean $\pm$ SD, n = 3	%	Mean $\pm$ SD, n = 3	%			
Cr	0.30 $\pm$ 0.25	0.08 $\pm$ 0.03	17.07	0.17 $\pm$ 0.11	35.69	0.22 $\pm$ 0.16	47.23	0.47 $\pm$ 0.08	1.122	0.379
Mn	45.84 $\pm$ 11.75	24.31 $\pm$ 3.63	47.95	23.34 $\pm$ 3.13	46.04	3.05 $\pm$ 0.23	6.01	50.70 $\pm$ 5.26	0.610	0.604
Fe	13.08 $\pm$ 0.86	4.26 $\pm$ 0.32	31.44	7.43 $\pm$ 0.32	54.82	1.86 $\pm$ 0.37	13.73	13.55 $\pm$ 0.65	2.832	0.105
Ni	1.19 $\pm$ 0.14	0.46 $\pm$ 0.20	36.86	0.52 $\pm$ 0.16	41.70	0.27 $\pm$ 0.23	21.45	1.24 $\pm$ 0.12	0.536	0.646
Cu	2.71 $\pm$ 0.38	1.17 $\pm$ 0.09	37.23	1.51 $\pm$ 0.27	48.32	0.45 $\pm$ 0.10	14.44	3.13 $\pm$ 0.37	3.998	0.057
Zn	40.58 $\pm$ 14.30	21.03 $\pm$ 4.63	42.12	25.46 $\pm$ 3.46	51.00	3.44 $\pm$ 1.21	6.89	49.93 $\pm$ 3.52	0.912	0.458
Mo	1.07 $\pm$ 0.31	0.42 $\pm$ 0.13	31.97	0.72 $\pm$ 0.15	55.27	0.17 $\pm$ 0.05	12.76	1.31 $\pm$ 0.21	1.296	0.324
Cd	1.61 $\pm$ 0.49	1.12 $\pm$ 0.16	57.87	0.64 $\pm$ 0.29	32.84	0.18 $\pm$ 0.12	9.29	1.94 $\pm$ 0.14	1.074	0.395
Pb	0.08 $\pm$ 0.01	0.02 $\pm$ 0.02	19.64	0.03 $\pm$ 0.01	28.06	0.05 $\pm$ 0.02	52.30	0.10 $\pm$ 0.02	0.825	0.496

**Table 7.7 (continued)**

(C) Carrot – medium treatment (statistical data are reported at 5% significance level)

Element	Total metal, mg/kg by acid digestion Mean ± SD, n = 3	Physiologically-Based Extraction Test (PBET), mg/kg						Total VS PBET		
		Phase I		Phase II		Phase III (Residual)		Total I+II+III Mean ± SD, n = 3	t-stat	P-value
		Mean ± SD, n = 3	%	Mean ± SD, n = 3	%	Mean ± SD, n = 3	%			
Cr	0.35 ± 0.27	0.06 ± 0.03	13.52	0.12 ± 0.03	27.38	0.27 ± 0.15	59.10	0.45 ± 0.14	0.565	0.629
Mn	143.93 ± 37.17	66.00 ± 2.29	37.65	89.24 ± 8.50	50.92	20.03 ± 4.39	11.43	175.27 ± 6.09	1.255	0.336
Fe	19.69 ± 3.87	5.47 ± 0.82	25.11	10.13 ± 2.39	46.49	6.19 ± 1.95	28.40	21.80 ± 0.41	1.041	0.407
Ni	2.41 ± 0.26	0.72 ± 0.06	28.63	1.40 ± 0.10	55.71	0.39 ± 0.20	15.66	2.51 ± 0.32	0.553	0.636
Cu	6.80 ± 0.83	3.29 ± 0.39	44.83	2.55 ± 0.17	34.72	1.50 ± 0.25	20.45	7.35 ± 0.31	0.864	0.478
Zn	83.58 ± 7.66	28.59 ± 3.08	35.09	40.11 ± 3.67	49.21	12.79 ± 0.97	15.70	81.49 ± 6.34	-0.858	0.481
Mo	3.90 ± 2.71	0.72 ± 0.04	19.71	2.36 ± 1.20	65.15	0.55 ± 0.14	15.14	3.63 ± 1.12	-0.266	0.815
Cd	3.52 ± 0.53	1.40 ± 0.27	37.40	1.79 ± 0.52	47.71	0.56 ± 0.23	14.90	3.75 ± 0.32	0.606	0.606
Pb	0.06 ± 0.03	0.02 ± 0.01	20.63	0.03 ± 0.01	35.14	0.03 ± 0.01	44.24	0.08 ± 0.01	0.772	0.521

**Table 7.7 (continued)**

**(D) Carrot – high treatment** (statistical data are reported at 5% significance level)

Element	Total metal, mg/kg by acid digestion Mean $\pm$ SD, n = 3	Physiologically-Based Extraction Test (PBET), mg/kg						Total VS PBET		
		Phase I		Phase II		Phase III (Residual)		Total I+II+III Mean $\pm$ SD, n = 3	t-stat	P-value
		Mean $\pm$ SD, n = 3	%	Mean $\pm$ SD, n = 3	%	Mean $\pm$ SD, n = 3	%			
Cr	0.96 $\pm$ 0.61	0.13 $\pm$ 0.13	12.03	0.12 $\pm$ 0.07	11.24	0.84 $\pm$ 0.12	76.73	1.09 $\pm$ 0.29	0.493	0.671
Mn	214.83 $\pm$ 18.27	70.53 $\pm$ 4.42	31.73	113.37 $\pm$ 12.41	51.00	38.37 $\pm$ 4.90	17.26	222.27 $\pm$ 12.63	0.514	0.659
Fe	24.52 $\pm$ 9.88	9.29 $\pm$ 0.10	29.22	16.94 $\pm$ 3.25	53.26	5.57 $\pm$ 0.62	17.52	31.81 $\pm$ 3.78	1.310	0.321
Ni	4.88 $\pm$ 1.10	2.37 $\pm$ 0.22	50.68	1.70 $\pm$ 0.76	36.31	0.61 $\pm$ 0.28	13.00	4.67 $\pm$ 0.85	-0.972	0.434
Cu	9.58 $\pm$ 2.54	5.09 $\pm$ 0.55	44.78	4.28 $\pm$ 1.27	37.61	2.00 $\pm$ 0.24	17.61	11.37 $\pm$ 0.60	1.374	0.303
Zn	68.46 $\pm$ 16.29	33.70 $\pm$ 2.29	38.85	40.68 $\pm$ 6.11	46.89	12.37 $\pm$ 3.00	14.26	86.75 $\pm$ 5.97	1.799	0.214
Mo	3.17 $\pm$ 3.82	1.44 $\pm$ 0.60	31.51	2.79 $\pm$ 1.66	60.78	0.35 $\pm$ 0.16	7.70	4.58 $\pm$ 2.34	0.754	0.529
Cd	3.83 $\pm$ 0.94	1.03 $\pm$ 0.21	23.95	2.17 $\pm$ 0.41	50.63	1.09 $\pm$ 0.37	25.42	4.29 $\pm$ 0.43	1.195	0.355
Pb	0.20 $\pm$ 0.08	0.03 $\pm$ 0.02	10.85	0.12 $\pm$ 0.03	45.60	0.11 $\pm$ 0.02	43.54	0.25 $\pm$ 0.02	1.233	0.343



**Table 7.8 (A – D)** Bioaccessible and total metal concentrations found in radish

**(A) Radish – control treatment** (statistical data are reported at 5% significance level)

Element	Total metal, mg/kg by acid digestion Mean $\pm$ SD, n = 3	Physiologically-Based Extraction Test (PBET), mg/kg						Total VS PBET		
		Phase I		Phase II		Phase III (Residual)		Total I+II+III Mean $\pm$ SD, n = 3	t-stat	P-value
		Mean $\pm$ SD, n = 3	%	Mean $\pm$ SD, n = 3	%	Mean $\pm$ SD, n = 3	%			
Cr	0.74 $\pm$ 0.37	0.08 $\pm$ 0.03	12.13	0.14 $\pm$ 0.03	19.78	0.47 $\pm$ 0.16	68.09	0.69 $\pm$ 0.09	-0.191	0.866
Mn	16.13 $\pm$ 1.11	6.15 $\pm$ 0.94	37.60	8.87 $\pm$ 0.22	54.20	1.34 $\pm$ 0.24	8.20	16.36 $\pm$ 1.18	0.171	0.880
Fe	27.08 $\pm$ 8.28	9.54 $\pm$ 2.05	32.41	13.35 $\pm$ 3.84	45.34	6.55 $\pm$ 1.35	22.25	29.44 $\pm$ 5.80	0.539	0.644
Ni	2.07 $\pm$ 0.34	0.39 $\pm$ 0.15	20.67	0.51 $\pm$ 0.13	27.52	0.97 $\pm$ 0.22	51.81	1.87 $\pm$ 0.05	-1.065	0.399
Cu	2.75 $\pm$ 0.11	0.76 $\pm$ 0.04	27.16	1.29 $\pm$ 0.08	46.42	0.74 $\pm$ 0.25	26.42	2.79 $\pm$ 0.26	0.197	0.862
Zn	65.95 $\pm$ 13.54	15.25 $\pm$ 1.63	26.47	35.86 $\pm$ 3.33	62.23	6.51 $\pm$ 0.45	11.30	57.63 $\pm$ 4.82	-0.809	0.503
Mo	1.01 $\pm$ 0.19	0.41 $\pm$ 0.23	34.51	0.71 $\pm$ 0.34	60.17	0.06 $\pm$ 0.03	5.33	1.17 $\pm$ 0.17	1.858	0.204
Cd	0.06 $\pm$ 0.04	0.02 $\pm$ 0.01	33.23	0.04 $\pm$ 0.03	52.61	0.01 $\pm$ 0.004	14.16	0.07 $\pm$ 0.04	0.328	0.774
Pb	0.12 $\pm$ 0.07	0.02 $\pm$ 0.02	12.78	0.09 $\pm$ 0.02	60.69	0.04 $\pm$ 0.03	26.53	0.15 $\pm$ 0.02	0.525	0.652

**Table 7.8 (continued)**

**(B) Radish – low treatment** (statistical data are reported at 5% significance level)

Element	Total metal, mg/kg by acid digestion Mean $\pm$ SD, n = 3	Physiologically-Based Extraction Test (PBET), mg/kg						Total VS PBET		
		Phase I		Phase II		Phase III (Residual)		Total I+II+III Mean $\pm$ SD, n = 3	t-stat	P-value
		Mean $\pm$ SD, n = 3	%	Mean $\pm$ SD, n = 3	%	Mean $\pm$ SD, n = 3	%			
Cr	1.16 $\pm$ 0.60	0.09 $\pm$ 0.03	6.92	0.20 $\pm$ 0.08	14.88	1.03 $\pm$ 0.54	78.19	1.32 $\pm$ 0.50	0.772	0.521
Mn	49.40 $\pm$ 1.36	22.97 $\pm$ 3.17	46.84	21.24 $\pm$ 1.80	43.31	4.83 $\pm$ 0.65	9.84	49.03 $\pm$ 1.75	-0.839	0.490
Fe	25.25 $\pm$ 1.07	6.53 $\pm$ 1.32	26.56	10.89 $\pm$ 1.57	44.27	7.17 $\pm$ 1.16	29.17	24.60 $\pm$ 0.70	-1.240	0.341
Ni	4.16 $\pm$ 0.71	1.24 $\pm$ 0.14	33.20	1.33 $\pm$ 0.04	35.47	1.17 $\pm$ 0.33	31.33	3.74 $\pm$ 0.25	-0.986	0.428
Cu	3.22 $\pm$ 0.31	1.09 $\pm$ 0.13	33.27	1.41 $\pm$ 0.10	42.99	0.78 $\pm$ 0.08	23.75	3.27 $\pm$ 0.29	0.567	0.628
Zn	108.24 $\pm$ 8.15	34.50 $\pm$ 1.88	34.02	58.35 $\pm$ 2.16	57.53	8.58 $\pm$ 2.07	8.46	101.43 $\pm$ 2.06	-1.156	0.367
Mo	1.59 $\pm$ 0.63	0.57 $\pm$ 0.23	27.89	1.12 $\pm$ 0.23	55.33	0.34 $\pm$ 0.20	16.79	2.03 $\pm$ 0.27	1.327	0.316
Cd	0.46 $\pm$ 0.18	0.15 $\pm$ 0.10	24.69	0.37 $\pm$ 0.10	61.56	0.08 $\pm$ 0.03	13.75	0.60 $\pm$ 0.04	1.087	0.391
Pb	0.40 $\pm$ 0.25	0.02 $\pm$ 0.02	7.47	0.10 $\pm$ 0.01	33.25	0.18 $\pm$ 0.17	59.28	0.31 $\pm$ 0.19	-1.108	0.383

**Table 7.8 (continued)**

**(C) Radish – medium treatment (statistical data are reported at 5% significance level)**

Element	Total metal, mg/kg by acid digestion Mean $\pm$ SD, n = 3	Physiologically-Based Extraction Test (PBET), mg/kg						Total VS PBET		
		Phase I		Phase II		Phase III (Residual)		Total I+II+III Mean $\pm$ SD, n = 3	t-stat	P-value
		Mean $\pm$ SD, n = 3	%	Mean $\pm$ SD, n = 3	%	Mean $\pm$ SD, n = 3	%			
Cr	0.86 $\pm$ 0.31	0.14 $\pm$ 0.05	12.80	0.26 $\pm$ 0.11	24.48	0.67 $\pm$ 0.23	62.72	1.06 $\pm$ 0.12	0.797	0.509
Mn	228.07 $\pm$ 45.45	119.72 $\pm$ 15.58	48.56	106.62 $\pm$ 20.75	43.24	20.22 $\pm$ 4.95	8.20	246.56 $\pm$ 27.50	1.123	0.378
Fe	23.94 $\pm$ 7.63	8.68 $\pm$ 2.62	30.57	11.38 $\pm$ 1.60	40.10	8.33 $\pm$ 1.40	29.33	28.39 $\pm$ 2.42	0.768	0.523
Ni	5.47 $\pm$ 0.43	2.38 $\pm$ 0.22	45.41	2.08 $\pm$ 0.62	39.65	0.78 $\pm$ 0.79	14.95	5.24 $\pm$ 0.08	-0.826	0.496
Cu	5.84 $\pm$ 1.55	1.81 $\pm$ 0.24	30.17	2.49 $\pm$ 0.43	41.46	1.70 $\pm$ 0.15	28.37	6.00 $\pm$ 0.47	0.244	0.830
Zn	328.80 $\pm$ 96.31	92.94 $\pm$ 1.97	35.84	123.19 $\pm$ 24.06	47.51	43.17 $\pm$ 10.65	16.65	259.29 $\pm$ 28.03	-1.271	0.332
Mo	36.85 $\pm$ 6.21	10.77 $\pm$ 2.07	28.90	24.75 $\pm$ 5.59	66.41	1.75 $\pm$ 0.14	4.69	37.27 $\pm$ 7.47	0.058	0.959
Cd	1.81 $\pm$ 0.48	0.57 $\pm$ 0.28	30.59	1.00 $\pm$ 0.11	53.28	0.30 $\pm$ 0.15	16.13	1.87 $\pm$ 0.29	0.149	0.895
Pb	0.47 $\pm$ 0.24	0.08 $\pm$ 0.02	22.83	0.15 $\pm$ 0.04	43.45	0.12 $\pm$ 0.05	33.72	0.35 $\pm$ 0.10	-0.638	0.589

**Table 7.8 (continued)**

**(D) Radish – high treatment** (statistical data are reported at 5% significance level)

Element	Total metal, mg/kg by acid digestion Mean ± SD, n = 3	Physiologically-Based Extraction Test (PBET), mg/kg						Total VS PBET		
		Phase I		Phase II		Phase III (Residual)		Total I+II+III Mean ± SD, n = 3	t-stat	P-value
		Mean ± SD, n = 3	%	Mean ± SD, n = 3	%	Mean ± SD, n = 3	%			
Cr	1.08 ± 0.44	0.12 ± 0.02	11.85	0.28 ± 0.10	28.28	0.59 ± 0.21	59.87	0.99 ± 0.23	-0.246	0.829
Mn	315 ± 56	132 ± 6	41.11	162 ± 50	50.57	27 ± 7	8.32	320 ± 43	0.460	0.690
Fe	28.76 ± 12.52	7.67 ± 0.79	25.73	12.31 ± 4.24	41.33	9.81 ± 3.97	32.94	29.79 ± 8.51	0.088	0.938
Ni	9.20 ± 0.63	3.85 ± 1.34	40.85	4.76 ± 1.09	50.49	0.82 ± 0.05	8.66	9.43 ± 0.28	0.763	0.525
Cu	8.61 ± 0.31	2.37 ± 0.81	27.42	4.12 ± 0.42	47.75	2.15 ± 0.62	24.83	8.64 ± 0.21	0.180	0.874
Zn	471 ± 151	113 ± 3	32.35	200 ± 25	57.31	36.12 ± 3.60	10.34	350 ± 29	-1.416	0.293
Mo	41.91 ± 16.04	15.66 ± 4.69	45.28	16.63 ± 8.28	48.08	2.30 ± 1.12	6.64	35 ± 14	-0.524	0.653
Cd	3.66 ± 0.75	1.39 ± 0.18	34.76	2.05 ± 0.53	51.29	0.56 ± 0.41	13.95	3.99 ± 0.50	0.511	0.660
Pb	0.37 ± 0.07	0.03 ± 0.03	8.64	0.19 ± 0.05	51.83	0.15 ± 0.01	39.53	0.37 ± 0.07	0.049	0.966

#### 7.4 Summary

The PBET results of the plant CRMs (tea leaves and spinach leaves) were in good agreement with the total metal certified values and this indicates that the *in vitro* gastrointestinal extraction procedure carried out were validated for measuring bioaccessibility of metals in contaminated plant samples. During the intestinal compartment extraction where the absorption mostly takes place, it was proved that the digestion equilibrium had been reached after 2 h by applying the statistical hypothesis test. There was no significant difference between the amounts of metals found in the first 2 h intestinal extraction and the 4 h intestinal extraction.

The Cr and Pb bioaccessibility results of the plant samples were similar in the gastric phase i.e. relatively low amounts of the metals were extracted in all plants ranged from 4-24% and 11-27% for Cr and Pb, respectively. Whereas, there was greater bioaccessibility for both Cr and Pb in the intestinal extraction; 11-44% and 20-61% for Cr and Pb, respectively. The major content of Cr was present in the insoluble residual phase which is not available for absorption. For Fe, the high content was dissolved in the gastric and intestinal phases for carrot and radish, while there were slightly smaller amounts found in lettuce and spinach. Mn, Zn, Cu, Ni, Mo and Cd had similar bioaccessibility i.e. most of the metal contents were dissolved in the gastric and intestinal phase for every vegetable plant studied. This indicates the potential for absorption, e.g. Mn in lettuce (gastric phase: 47-50%, and intestinal phase: 32-38%), Ni in spinach (gastric phase: 28-29%, and intestinal phase: 37-60%), Cu in carrot (gastric phase: 36-45%, and intestinal phase: 34-48%), Zn in carrot (gastric phase: 35-42%, and intestinal phase: 47-55%), Cd in radish (gastric phase: 25-35%, and intestinal phase: 51-62%), and Mo in radish (gastric phase: 28-45%, and intestinal phase: 48-66%).

## 7.5 References

- Cabanero, A. I., Madrid, Y., and Camara, C. (2004). 'Selenium and Mercury Bioaccessibility in Fish Samples: An *in Vitro* Digestion Method', *Analytica Chimica Acta*, 526, 51-61.
- Cave, M. R., Wragg, J., Palumbo, B., and Klinck, B. A. (2002). '*Measurement of the Bioaccessibility of Arsenic in UK Soils*'. Bristol: British Geological Survey, Environmental Agency. (R & D Technical Report P5-062/TR02).
- Oomen, A. G., Hack, A., Minekus, M., Zeijdner, E., Schoeters, G., Verstraete, W., Wiele, T. V. D., Wragg, J., Rempelberg, C. J. M., Sips, A. J. A. M., and Wijnen, J. H. V. (2002). 'Comparison of Five *in Vitro* Digestion Models to Study the Bioaccessibility of Soil Contaminants', *Environmental Science and Technology*, 36, 3326-3334.
- Rauret, G., Lopez-Sanchez, J.-F., Sahuquillo, A., Barahona, E., Lachica, M., Ure, A. M., Davidson, C. M., Gomez, A., Luck, D., Bacon, J., Yli-Halla, M., Muntau, H., and Quevauviller, P. (2000). 'Application of a Modified BCR Sequential Extraction (Three-Step) Procedure for the Determination of Extractable Trace Metal Contents in a Sewage Sludge Amended Soil Reference Material (CRM 483), Complemented by a Three-Year Stability Study of Acetic Acid and EDTA Extractable Metal Content', *Journal of Environmental Monitoring*, 2, 228-233.
- Rodriguez, R. R., Basta, N. T., Casteel, S. W., and Pace, L. W. (1999). 'An *in vitro* Gastrointestinal Method to Estimate Bioavailable Arsenic in Contaminated Soils and Solid Media', *Environmental Science and Technology*, 33, 642-649.
- Ruby, M. V., Davis, A., Schoof, R., Eberle, S., and Sellstone, C. M. (1996). 'Estimation of Lead and Arsenic Bioavailability Using a Physiologically Based Extraction Test', *Environmental Science and Technology*, 30, 422-430.

Townsend, A. T. (2000). 'The Accurate Determination of the First Row Transition Metals in Water, Urine, Plant, Tissue and Rock Samples by Sector Field ICP-MS', *Journal of Analytical Atomic Spectrometry*, 15, 307-314.

Widmaier, E. P., Raff, H., and Strang, K. T. (2006). *Vander's Human Physiology: The Mechanism of Body Function*. 10th Ed. New York: McGraw-Hill.

Wragg, J., and Cave, M. R. (2002). '*In Vitro Methods for the Measurement of the Oral Bioaccessibility of Selected Metals and Metalloids in Soils: A Critical Review*'. Bristol: Environmental Agency (P5-062/TR/01).

## Chapter 8

### Conclusions and future work

#### 8.1 Conclusions

This research aimed to investigate the bioavailability of 9 metals (Cr, Mn, Fe, Ni, Cu, Zn, Mo, Cd, and Pb) to vegetable crops (spinach, lettuce, carrot and radish) cultivated in compost soils at different levels of metal contamination. The uptake and accumulation of these metals by the plants were examined. Furthermore, the elemental speciation has been performed to characterize the metal containing species induced in the plants exposed to metal stress. In order to evaluate health risks arising from ingestion of the metal contaminated plants, the oral bioaccessibility i.e. the use of an *in vitro* physiologically based extraction test (PBET) simulating the transition of the metal pollutants in the plants into the human gastrointestinal system was undertaken.

Four sub-experiments were designed to achieve the research aims. The first experiment dealt with total metal and extractable metal analysis of the metal contaminated soils which were used for growing plants. In addition, soil pH, organic matter contents, and CEC were measured. It was found that the soil total concentration varied widely from control-low-medium-high soil treatments as prepared for use in different levels of metal contamination. The control soil was considered as weakly acid (pH 5.25), the low (pH 4.51) and medium (pH 4.28) soil treatments were acid, and the high soil treatment (pH 4.01) was very acid. The OM percentages were similar in all soils ranging from 93.0 – 94.5%. The CEC of the control, low, medium and high soil treatment was 109, 98, 99 and 102 cmol<sub>c</sub>/kg, respectively. Extractions of heavy metals in the soils using a range of chemical selective extractants (EDTA, CH<sub>3</sub>COOH, CaCl<sub>2</sub>, H<sub>2</sub>O) indicated that the extractability percentages in all soil treatments applied with the extractants are ranked in descending orders as follows;

For Mn, Zn and Cd;                    EDTA >> CH<sub>3</sub>COOH > CaCl<sub>2</sub> > H<sub>2</sub>O

For Fe, Cu, Ni, Mo and Pb;        EDTA >> CH<sub>3</sub>COOH > CaCl<sub>2</sub> ≈ H<sub>2</sub>O



For Cr;

low extractability for all extractants

In the second experiment, the plants were cultivated in the metal contaminated soil under greenhouse conditions. The plant materials i.e. roots and leaves were acid digested and analysed by ICP-MS for total metal determination. It was found that, with the exception of Cr, metal concentrations (Mn, Fe, Ni, Cu, Zn, Mo and Cd) in lettuce, spinach, carrot and radish depended on the concentrations of the (total) metal in the soils in which the plants were grown i.e. the accumulated metal contents in the plants were increased when the higher levels of metal contamination in the soils were applied. For Pb, the amounts accumulated in the leafy vegetables also depended on their levels of contamination in the soils while the root vegetables had rather low uptake and the uptake levels did not increase when higher levels of contamination were applied. Mn, Fe and Zn were relatively easily mobilized from soils to plants; they tended to accumulate in all plants studied at high concentrations. The elements which were more enriched in leaves included Mn and Zn (in all plant types), and Fe and Cd (only in the root vegetables). In contrast, Fe, Ni, Cu, Mo and Pb were accumulated more in roots of the leafy vegetables. Among all plants studied, it was observed that carrot had low uptake for all elements (Cr, Ni, Cu, Mo, Cd and Pb), except for Mn, Fe, Zn which were found in all plants. The metal mobilised from soil to plant as indicated by the metal contents accumulated in the plants decreased in the order  $Mn \gg Zn > Fe > Cu > Mo > Ni > Cd > Pb \approx Cr$ .

From the first and second experiment studied, we can then assess metal bioavailability to plants by measuring transfer factor (TF) values of the metals based on total metal contents in the soils. It was found that the order of TF values was  $Mn > Zn \gg Cd > Ni > Cu > Mo \approx Pb > Cr \approx Fe$ . The mean TF values of each element irrespective of plant types were 1.93, 1.77, 0.485, 0.194, 0.111, 0.052, 0.045, 0.037 and 0.036 for Mn, Zn, Cd, Ni, Cu, Mo, Pb, Cr, and Fe, respectively. Hence, Mn and Zn were most bioavailable to plants i.e. they can be transferred from soils to plants more easily than Ni, Cu, Mo, Pb, Cr and Fe which are less bioavailable. Whereas, the bioavailability of Cd was relatively moderate. In addition, the results enabled the development of statistical regression models that are suited to predict metal uptake by plants. This was done by establishing the relationship between the extractable soil

metals which gave the greatest correlation with the metal contents accumulated in plants and the TF values of metals in plants. From the regression equations obtained for almost every case, it indicated that the relationship between the TF values and the extractable soil metals followed the power regression curve which has the general equation of  $y = ax^b$ ; where a, b are constants, x is the independent variable (extractable soil metal concentration), and y is the dependent variable (TF values). There were some cases in which it did not follow the power regression curve but a linear model ( $y = ax + b$ ), these are; Mn (for CR-L and RD-R), Mo (for SP-R and CR-R), and Cd (for LT-L, SP-R, SP-L and CR-R). However, it was observed that not all regression models are appropriate for prediction of the bioavailability of metals to plants as their powers of prediction were too low. These include the models for prediction of Mn (for CR-L, RD-R and RD-L), Cu (for RD-L), Mo (for RD-R and RD-L) and Cd (for LT-L, SP-R, SP-L and RD-R).

As it is known that metal containing species called phytochelatins (PCs) are induced in plants exposed to heavy metals, the third experiment was conducted in order to characterize these metal species in the plants using SEC-UV-ICP-MS and Electrospray MS. The SEC-UV-ICP-MS provided information on the distribution of different MW containing compounds in the plants. It was found that a common association of the metals (Cd, Cu, Mo, Pb, and Zn) to the high MW fractions (8160 Da) was observed in all plant extracts. The lower MW fractions of approximately 1000 – 3000 Da of Cd, Cu, Mo, Ni, Pb, and Zn containing compounds were found to be present in all plant extracts. Iron was not detected in the roots of carrot and radish, but present as both high MW (8200 Da) and low MW (2500 Da) compounds in the leaves of spinach and lettuce. To characterize the individual metal containing species present in the plant samples, the Nanospray MS detector was employed. Unfortunately, no evidence from this MS analysis can confirm that these compounds are related to the PC family.

Finally, the possible implications to human health associated with consumption of the contaminated vegetables were assessed using the PBET. The results indicated that the Cr and Pb bioaccessibility of the plant samples were similar in the gastric phase i.e. relatively low amounts of the metals were extracted in all plants ranged from 4-24%

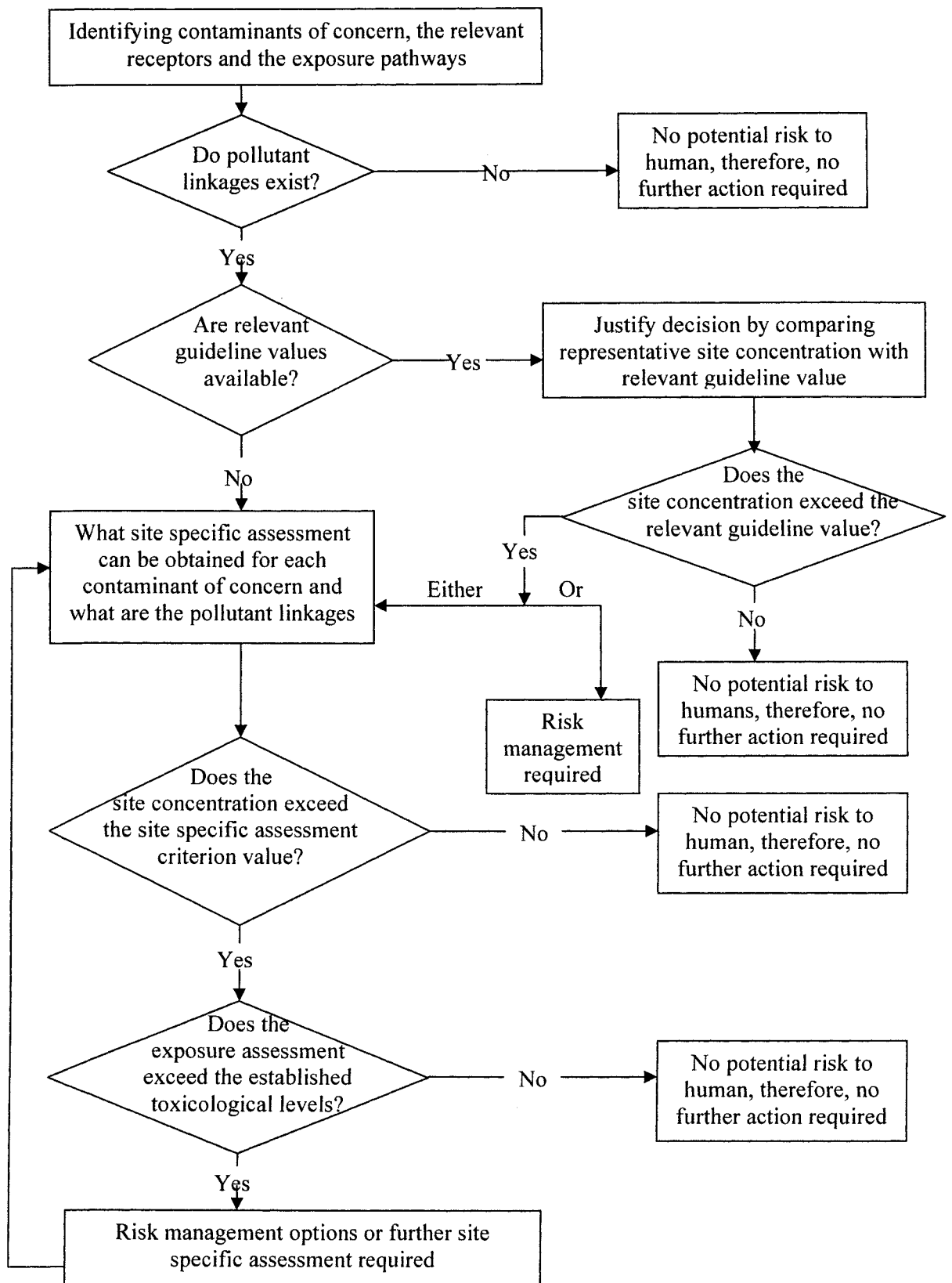
and 11-27% for Cr and Pb, respectively. Whereas, there was greater bioaccessibility for both Cr and Pb in the intestinal extraction; 11-44% and 20-61% for Cr and Pb, respectively. The major content of Cr was present in the insoluble residual phase which is not available for absorption. For Fe, the high content was dissolved in the gastric and intestinal phases for carrot and radish, while there were slightly smaller amounts found in lettuce and spinach. Mn, Zn, Cu, Ni, Mo and Cd had similar bioaccessibility i.e. most of the metal contents were dissolved in the gastric and intestinal phase for every vegetable plant studied. This indicates the potential for absorption, e.g. Mn in lettuce (gastric phase: 47-50%, and intestinal phase: 32-38%), Ni in spinach (gastric phase: 28-29%, and intestinal phase: 37-60%), Cu in carrot (gastric phase: 36-45%, and intestinal phase: 34-48%), Zn in carrot (gastric phase: 35-42%, and intestinal phase: 47-55%), Cd in radish (gastric phase: 25-35%, and intestinal phase: 51-62%), and Mo in radish (gastric phase: 28-45%, and intestinal phase: 48-66%).

The risk assessment to human health from metal contaminated soil is based on a comparison between the predicted exposure levels (total intake via all pathways) and the established toxicological levels set by regulatory agencies or environmental authorities. Under part IIA of the UK Environmental Protection Act 1990, soil is determined as contaminated if there is the likely presence and significance of a pollutant linkage i.e. a relationship between a contaminant and receptor by a pathway. After the introduction of part IIA, soil guideline values (SGVs) for 7 selected metals/metalloids were developed by DEFRA/EA in 2002 and are to be used to determine whether or not soil affected by contamination could be defined as contaminated soil. Consequently, the use of SGVs is restricted and not directly concerned with human health. Toxicological data for the metals/metalloids were published at the same time. The toxicological data aims to derive an oral tolerable daily intake and an inhalation index dose, which in turn are needed to derive SGVs for the specified substances. However, the interpretation of toxicological data is complex and it is crucial that mistakes are not made at this point.

In this research, the pollutants were the 9 metals, linked to the pathways (soils and plants) with the receptor being humans. Hence, the framework for risk assessment to

humans from the food chain exposure of metals via the soil-plant-human route could be established as shown in Figure 8.1. The key components of the framework include identifying of pollutant linkage existence, availability of relevant guideline values, site specific assessment criterion, exposure assessment values and established toxicological levels. Risk management options or further site specific assessment are required if guideline values/assessment criterion values exceed the relevant established assessment levels. The established toxicological levels may be obtained from bioaccessibility data e.g. bioaccessibility data are used in exposure modelling for human health risk assessment, but only when it can be adequately related to bioavailability i.e. there is robust supporting evidence from *in vivo* tests (DEFRA/EA, 2007). In addition, bioaccessibility data should be applicable to contaminants where ingestion is the only or main pathway of exposure. According to the current views of the land contamination policy team (DEFRA/EA, 2007), there are still considerable uncertainties to be able to use the bioaccessibility data with confidence. The reasons for this could include: results vary depending on the test method used, the soil types or plant type and the contaminant; a method developed and validated for one contaminant (or soil type or plant type) is not always appropriate for other contaminants (or soil types or plant types); and no standard reference materials either in the UK or abroad that can be used to validate results or check their reproducibility.

In addition, there are a number of parameter inputs to be considered for a risk assessment. These parameters could include: contaminant properties e.g. physico-chemical properties; representative site concentration; site conditions e.g. pH, SOM; depth of contamination; land use e.g. residential, allotment, commercial/industrial; and receptor characteristics e.g. body weight, contaminated soil/plant ingestion rates.



**Figure 8.1** Flow chart for risk assessment to human health from contaminated soil (adapted from Nathanail and Bardos, 2004)

## 8.2 Future work

Future work arising from these studies could include;

- Incorporation of plant health and biomass considerations into the plant uptake study e.g. a non-invasive measure of plant response to stress using a PAM (Pulse Amplitude Modulation) chlorophyll fluorometer to identify a link between plant real time response to pollutant uptake
- Application of the regression models modified with a larger number of plant and soil samples to obtain more robust models for better prediction of pollutant uptake by plants
- Investigation of the metal toxicity related to the oral bioaccessibility study e.g. using the reference nutrient intake (RNI) values provided by the UK Department of Health
- Verification of detected metal containing species involving preparative fractionation and electrospray (ESI) MS analysis

## 8.3 References

DEFRA/EA (Department for Environment, Food and Rural Affairs and the Environment Agency) (2007). '*Environmental Agency Views on Using an In Vitro Bioaccessibility Data in Land Contamination Risk Assessments for Human Health*', Available at: [http://www.environment-agency.gov.uk/commondata/acrobat/bioaccessibility\\_1796763.pdf](http://www.environment-agency.gov.uk/commondata/acrobat/bioaccessibility_1796763.pdf) (Accessed: 20 July 2007).

Nathanail, C. P. and Bardos, R. P. (2004). *Reclamation of Contaminated Land*. Chichester: John Wiley & Sons.

## List of Publications

- 1) Intawongse, M. and Dean, J. R. (2006). 'Uptake of Heavy Metals by Vegetable Plants Grown on Contaminated Soil and their Bioavailability in the Human Gastrointestinal Tract', *Food Additives and Contaminants*, 23, 36-48.
- 2) Intawongse, M. and Dean, J. R. (2006). 'In-vitro Testing for Assessing Oral Bioaccessibility of Trace Metals in Soil and Food Samples', *Trends in Analytical Chemistry*, 25, 876-886.
- 3) Intawongse, M. and Dean, J. R. 'Use of the Physiologically-Based Extraction Test to Assess the Oral Bioaccessibility of Metals in Vegetable Plants Grown on Contaminated Soil', *Environmental Pollution*, in press.
- 4) Intawongse, M., Ma, R. and Dean, J. R. 'Characterization of Metal-binding Phytochemical Species in Vegetable Plants by Size Exclusion Chromatography with UV and ICP-MS Detection', *Phytochemical Analysis*, submitted in May 2007.