



The role of prostaglandin F_{2α} on ovulation and LH release in cows

A função da prostaglandina F_{2α} na ovulação e na liberação de LH em vacas

Natália Ávila de Castro¹ ; Carlos Eduardo Porciuncula Leonardi²; Jaswant Singh²; Augusto Schneider¹; Paulo Bayard Gonçalves³; Fernando Caetano Oliveira¹; Camila Amaral D'Ávila¹; Rogério Ferreira⁴; Bernardo Garziera Gasperin¹; Elizângela Mírian Moreira⁵; Jéssica de Souza Andrade⁶; Luiz Francisco Machado Pfeifer⁵ 

¹ Universidade Federal de Pelotas, Pelotas – RS, Brazil

² University of Saskatchewan, Saskatoon – SK, Canada

³ Universidade Federal de Santa Maria, Santa Maria – RS, Brazil

⁴ Universidade Estadual de Santa Catarina, Chapecó – SC, Brazil

⁵ Embrapa-Empresa Brasileira de Pesquisa Agropecuária, Porto Velho – RO, Brazil

⁶ Bionorte-Rede de Biodiversidade e Biotecnologia da Amazônia Legal, Programa de Pós-graduação em Biodiversidade e Biotecnologia da Amazônia Legal, Porto Velho – RO, Brazil

ABSTRACT

This study aimed to evaluate the role of prostaglandin F_{2α} (PGF) on ovulation. In Experiment 1, cows were randomly allocated to two treatments to receive 150 µg of d-Cloprostenol (PGF Group, n = 12) or 2 mL of NaCl 0.9% (Control Group, n = 11) and CIDRs[®], were removed 4 days later. No cow ovulated in Control and PGF groups. In Experiment 2, cows were randomly separated into two experimental groups to receive 4 injections of 150 µg of d-Cloprostenol (n = 9) or 2 mL of NaCl 0.9% (n = 9). In this experiment, ovulation was not observed in any cows. In Experiment 3, ovariectomized cows receive three injections of 300µg of PGF analog (PGF Group, n = 5), 100µg of Lecirelin (GnRH Group, n = 5) or 2 mL of PBS (Control Group, n = 4). The LH concentration was higher (P <0.0001) in cows from the GnRH group than in the PGF and Control groups. In experiment 4, cows with preovulatory follicles (>11.5 mm) were treated with Saline (Control Group, n = 6); Lecirelin (GnRH Group, n = 7) or Cloprostenol Sodium (PGF Group, n = 6). There was a significant increase in the vascular area of follicles from 0 to 24 h in GnRH and PGF treatments. In conclusion, PGF was not able to induce ovulation in cows with high or low plasma progesterone concentration. Additionally, PGF alone was not able to induce LH release and follicle luteinization, but increased follicular vascularization.

Keywords: Cow. Ovary. Pituitary. Prostaglandin. Reproduction.

RESUMO

O objetivo deste estudo foi avaliar o papel da prostaglandina F_{2α} (PGF) na ovulação. No Experimento 1, as vacas foram alocadas aleatoriamente em dois tratamentos para receber 150 µg de d-Cloprostenol (Grupo PGF, n = 12) ou 2 mL de NaCl 0,9% (Grupo Controle, n = 11) e os CIDR[®], foram removidos 4 dias depois. Nenhuma vaca ovulou nos grupos Controle e PGF. No Experimento 2, as vacas foram separadas aleatoriamente em dois grupos experimentais para receber 4 injeções de 150 µg de d-Cloprostenol (n = 9) ou 2 mL de NaCl 0,9% (n = 9). Não foi observada ovulação em nenhum dos animais deste experimento. No Experimento 3, vacas ovariectomizadas receberam três injeções de 300µg de análogo de PGF (Grupo PGF, n = 5), 100µg de Lecirelina (Grupo GnRH, n = 5) ou 2 mL de PBS (Grupo Controle, n = 4). A concentração de LH foi maior (P <0,0001) nas vacas do grupo GnRH do que nos grupos PGF e Controle. No Experimento 4, vacas com folículos pré-ovulatórios (> 11,5 mm) foram tratadas com solução salina (Grupo Controle, n = 6), Lecirelina (Grupo GnRH, n = 7) ou Cloprostenol Sódico (Grupo PGF, n = 6). Houve um aumento significativo na área vascular dos folículos de 0 a 24h nos tratamentos com GnRH e PGF. Em conclusão, a PGF não foi capaz de induzir ovulação em vacas com alta ou baixa concentração plasmática de progesterona. Além disso, a PGF sozinha não foi capaz de induzir a liberação de LH e a luteinização do folículo, mas aumentou a vascularização folicular.

Palavras-chave: Vaca. Ovário. Pituitária. Prostaglandina. Reprodução.

Correspondence to:

Luiz Francisco Machado Pfeifer
Embrapa Rondônia
BR 364 - Km 5,5 - Zona Rural
Caixa postal: 127 CEP: 76815-800, Porto Velho – RO, Brazil
e-mail: luiz.pfeifer@embrapa.br

Received: September 22, 2020

Approved: December 23, 2020

How to cite: Castro NA, Leonardi CEP, Singh J, Schneider A, Gonçalves PB, Oliveira FC, D'Ávila CA, Ferreira R, Gasperin BG, Moreira EM, Andrade JS, Pfeifer LFM. The role of prostaglandin F_{2α} on ovulation and LH release in cows. *Braz J Vet Res Anim Sci.* 2021;58:e175001. <https://doi.org/10.11606/issn.1678-4456.bjvras.2021.175001>

Introduction

Prostaglandin F_{2α} (PGF) analogs are commonly used to induce luteolysis in estrous synchronization programs in cattle (Pursley et al., 1995; Weems et al., 2006; Colazo & Mapletoft, 2014). However, PGF is also able to hasten and synchronize ovulation in cattle (Pfeifer et al., 2014; Pfeifer et al., 2016; Castro et al., 2017) independent of its luteolytic action (Leonardi et al., 2012). Previously, we observed that d-Cloprostenol (PGF analog) had a similar ovulatory effect to that of estradiol benzoate in timed artificial insemination (TAI) protocols, resulting in similar ovulation and pregnancy rates in dairy (Pfeifer et al., 2016; Castro et al., 2017) and beef cows (Pfeifer et al., 2014; Pfeifer et al., 2018). Despite this, the mechanism of action for injectable PGF to induce ovulation in cattle is still unknown.

During a natural estrous cycle, the ovarian dominant follicle reaches ovulatory capacity after luteolysis and a consequent decrease in progesterone concentrations (Colazo & Mapletoft, 2014). In a TAI program, however, the use of GnRH can induce ovulation even in the presence of progesterone (Colazo et al., 2008), as it directly stimulates pituitary LH release (Halász et al., 1989). Furthermore, it was shown that estradiol can induce an LH surge in ovariectomized cows under high progesterone concentrations (Martínez et al., 2007). Although PGF injection has been associated with ovulation after progesterone insert removal during TAI, little is known about its hypothalamic effects and ability to trigger LH release.

The administration of PGF associated with GnRH can induce an increase in plasma LH levels in postpartum cows, suggesting that PGF increases the responsiveness to GnRH (Randel et al., 1996). Besides, in mice, prostaglandin E (PGE) is known to stimulate LH secretion while PGF inhibits it

(Murdoch et al., 1993) and the presence of both receptors was demonstrated in the pituitary gland (Naor et al., 2007).

Based on these considerations, we hypothesize that PGF treatment affects the hypothalamic-pituitary level to induce ovulation and luteinization in cattle. Therefore, this study aimed to evaluate: 1) the effect of PGF administered in different time points and doses on ovulation; 2) whether PGF can induce ovulation in cows with high and low serum progesterone concentrations; 3) the serum concentration of LH after PGF treatment and 4) the effect of PGF on steroidogenesis and vascularization of preovulatory follicles.

Materials and Methods

The Committee for Ethics in Animal Experimentation from the Brazilian Agricultural Research Corporation (Embrapa – Rondônia) approved all procedures performed in this experiment (Number F.02/2014).

Experiment 1. Effect of a single PGF dose in a high progesterone environment

Nonlactating crossbred dairy cows (Gyr x Holstein; n = 23) between 3 and 6 years old, parity between 2 and 4, body condition score (BCS) between 2.5 and 3.5 (1 = emaciated, 5 = obese) were used. Cows were maintained in a *Brachiaria brizantha* pasture, with free access to water and mineral supplement. Before the experiment, all cows were examined by transrectal ultrasonography (SIUI CTS-900 equipped with 5 MHz linear probe, Guangdong, China) twice, 11 days apart, to confirm that none had a uterine infection as well as to evaluate the presence of follicles and corpus luteum (CL). All cows presented a CL and/or a dominant follicle (DF; follicle ≥ 8mm) and were included in the study.

Cows were submitted to a pre-synchronization treatment as shown in Figure 1A. On Day 0, approximately 6 to 7 d after ovulation, cows were treated with two progesterone-releasing intravaginal implants devices (1.9 g progesterone each, CIDR[®], Zoetis, Campinas, Brazil), plus 2 mg of estradiol benzoate (EB, Bioestrogen[®], Biogénesis-Bagó, Curitiba, Brazil) i.m. On Day 8, cows received 300 IU of eCG (Novormon[®], Zoetis, Campinas, Brazil) i.m., and 24 h later were randomly separated into one of two experimental treatments to receive: 1) 150 µg of d-Cloprostenol (Croniben[®], Curitiba, Brazil; PGF Group, n = 12), or 2) 2 mL of NaCl 0.9% (Control Group, n = 11). The CIDR devices were removed on Day 13.

All cows were evaluated by transrectal ultrasonography once a day from Day 6 to Day 9 and every 12 h from Day 9 until ovulation, or five days after treatments in the absence of ovulation. Also, color Doppler ultrasonography (Mindray[®] M5 VET[®] equipped with 5 MHz linear probe) was used

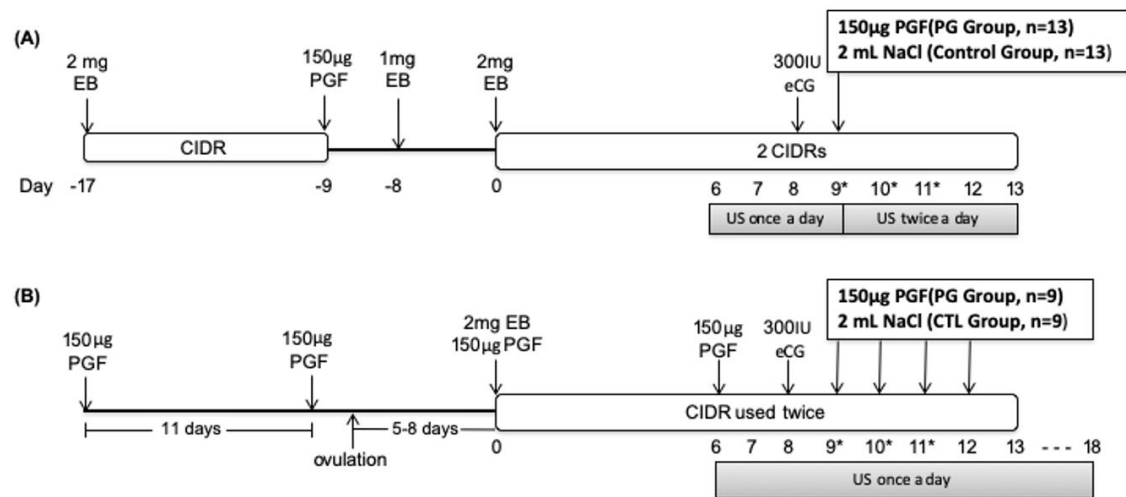

Figure 1 - Ovulation synchronization protocol used for cows in (A) Experiment 1 and (B) Experiment 2. *Blood collections for analysis of serum progesterone concentration. Abbreviations: EB: estradiol benzoate, PGF: prostaglandin F₂ α , ECP: estradiol cypionate, eCG: equine chorionic gonadotropin, US: ultrasound examination.

to evaluate the blood flow of the DF. Color gain settings were kept constant for all ultrasonic assessments. Images of the follicles were obtained from ultrasound assessments with maximum color intensity, focusing on the widest diameter of the follicle. When consistent Doppler signals were detected in the follicular wall, it was considered that the follicle had detectable blood flow. The intensity of follicular vascularization was expressed subjectively as the percentage of peri-follicular circumference enriched with Color Doppler signals as described elsewhere (Ginther, 2007; Satheshkumar, 2018).

Blood samples were collected on Days 9, 10, and 11 of the experiment, from the coccygeal vein, in vacuum tubes, without anticoagulant. Immediately after collection, samples were refrigerated at 4 °C, then centrifuged (3000 \times g for 15 min) and stored at -20 °C. Serum P4 concentrations were analyzed on D9, D10, and D11 of the experiment (Figure 2) assessed by chemiluminescence (ADVIA Centaur; Siemens; Ref. 01586287; sensitivity of 0.21 ng/mL), with intra- and inter-assay values lower than 12%.

Experiment 2. Effect of multiple PGF doses in a low progesterone environment

Nonlactating crossbred dairy cows (Gyr \times Holstein; n = 18) were given PGF i.m. twice, 11 days apart. Ten days after the second PGF (Day 0), approximately 5 to 8 days after ovulation, all cows received a hormonal treatment (Figure 1B). On Day 0, cows were treated with a twice-used CIDR device (CIDR[®], Zoetis, Campinas, Brazil), 2 mg of EB i.m. and 150 µg of a PGF analog (d-Cloprostenol, Croniben[®], Biogénesis-Bagó, Curitiba, Brazil) to induce luteolysis. On Day 6, cows received 150 µg of d-Cloprostenol i.m., and 48 hours later, 300 IU

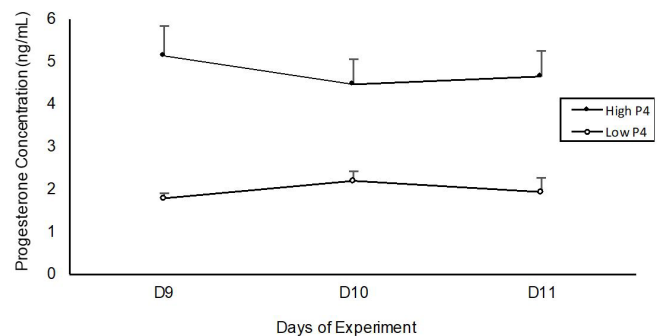

Figure 2 - Serum progesterone concentrations in cows exposed to high (Exp. 1 – two new CIDR[®]), and low (Exp. 2 – one twice used CIDR[®]), progesterone concentrations.

of eCG (Novormon[®], Zoetis, Campinas, São Paulo, Brazil) i.m. On Day 9, cows were randomly separated into two experimental treatments to receive: 1) 4 injections, once a day, of 150 µg of d-Cloprostenol (4xPGF Group, n = 9), or 2) 4 injections of 2 mL of NaCl (0.9%, Control Group, n = 9). The progesterone inserts were removed on Day 13. All cows were evaluated by transrectal ultrasonography, every 24 h from Day 9 until ovulation, or five days after CIDR[®] removal in the absence of ovulation. Blood collection and serum progesterone concentrations were performed as described for Experiment 1.

Experiment 3. LH release after PGF treatment

Ovariectomized crossbred cows (*B. taurus* \times *B. indicus*; n = 14) were randomly allocated to receive three i.m. injection (Hour 0, 1 and 2) of one of the following treatments: 300 µg of d-Cloprostenol (PGF analog; Croniben[®], Curitiba, Brazil; PGF Group, n = 5), 100 µg of Lecirelin (GnRH analog, Gestran plus[®], Tecnopec, São Paulo, Brazil; GnRH

Group, n = 5) or 2 mL of Saline (Control Group, n = 4). To determine the serum concentration of LH, blood samples were collected from all cows, as follows: 2 h before the injections, hourly from the moment of injections (Hour 0) to 6 h, and every 6 h from 6 h to 36 h after injections. Serum LH concentrations were analyzed by radioimmunoassay, adapted from Bolt & Rollins (1983) and Bolt et al. (1990). The minimum detection limit was 0.06 ng/mL. The intra-assay CVs were 4.9 and 7.4% for low- and high- reference samples, whereas interassay CVs were 21.9% and 7.2% for low- and high- reference samples.

Experiment 4. Effect of PGF on steroidogenesis and vascularization of pre-ovulatory follicles

Nonlactating dairy cows (Jersey and Holstein; n = 19) with a BCS between 2.5 and 3.5 were maintained in a natural pasture with free access to water and mineral supplement. On Day 0, cows were treated with 2 mg of EB i.m. (Gonadiol[®], Zoetis, Brazil) and 241 µg Cloprostenol i.m. (Estron[®], Agener, Brazil) simultaneously to the insertion of a progesterone-releasing intravaginal implant (1g progesterone; Sincrogest[®], Ourofino, Brazil). Furthermore, all follicles > 8mm were aspirated on Day 0. On Day 8, 241 µg cloprostenol i.m. (Estron[®], Agener, Brazil) was administered. All cows were evaluated by transrectal ultrasonography (SonoScape A6V equipped with 7.5 MHz linear probe), every 24 h from Day 7 to Day 11. On Day 9, the progesterone inserts were removed and, 12 h later, the cows were randomly allocated into three treatments: 2 mL of Saline i.m. (Control Group, n = 6); 100 µg of Lecirelin i.m. (GnRH analog, Gestran plus[®], Tecnopec, São Paulo, Brazil; GnRH Group, n = 7) or 500 µg Cloprostenol Sodium i.m. (Ciosin[®] - MSD, Brazil; PGF Group, n = 6).

All cows had a single follicle with a diameter greater than 11.5 mm at the moment of the treatment. Color Doppler ultrasonography (Mindray[®] M5 VET[®] equipped with 5 MHz linear probe) was used to evaluate blood flow of the pre-ovulatory follicle 0 and 24 h after treatment. Both ovaries were scanned, and the location of the dominant follicle was recorded for each cow. Then, B-mode and color-flow mode short videoclips (7s duration) were recorded. The intensity of follicular vascularization was blindly evaluated and objectively expressed as the percentage of the peripolar circumference that had signs of color Doppler. Thus, the circumference of the DF (CDF) was calculated using the internal calipers of the machine. To calculate the proportion of the peripolar circumference of the DF vascularized, three to four images that better represented the colored area surrounding the DF were chosen to calculate

the linear vascularized surface (LVS). The images were overlaid to obtain one single image and then, the LVS was calculated using the ImageJ software. To determine the proportion of colored pixels surrounding the DF, the LVS was divided by CDF.

Pre-ovulatory follicles were aspirated 24 h after treatments under caudal epidural anesthesia with 80 mg Lidocaine Chlorhydrate (Anestex Fagra[®] - Vêtoquinol, Brazil). Follicular aspiration was guided by transvaginal ultrasonography (PieMedical Esaote AguilaVet, equipped with a 6 MHz microconvex probe) using an ovum pick up the system with a 16G catheter (Jelco[®]) attached to a silicon tube and a 5 mL syringe. The follicular fluid samples were centrifuged and preserved in liquid nitrogen until estradiol and progesterone concentration analysis. Follicular fluid progesterone (P4) and estradiol (E2) concentrations were assessed by chemiluminescence (ADVIA Centaur; Siemens), as described in Experiment 1.

Statistical analysis

All statistical analyses were performed using SAS 9.0 (SAS, Cary, NC, USA). Continuous variables (diameter of the dominant follicle, time of ovulation and concentration of LH, follicular fluid estradiol and progesterone) were analyzed by one-way ANOVA, and means were compared between groups by the post-hoc Tukey test. Analyses involving repeated measures over time were compared by analysis of variance for repeated measures using the MIXED procedure to evaluate the main effects of treatment, time (sampling period), and their interaction (treatment vs. time). When the interaction was significant, means were compared among treatments using the Tukey post-hoc test. Ovulation rate was analyzed by the Chi-square test. Data from follicular vascularization had normal distribution according to the Shapiro-Wilk's test and were evaluated using paired data design into a parametric mixed model. Pairwise comparisons were performed using least square corrected means. Differences between groups were considered significant when the *P*-value was less or equal to 0.05.

Results

Experiment 1

No cow ovulated in Control and PGF groups when exposed to high progesterone concentrations. The average serum progesterone concentration was 4.7 ± 0.3 ng/mL (Figure 2). Follicular growth and follicular blood flow scores were shown in Figures 3A and 3B, respectively. Follicular growth was not different between groups (*P* = 0.32) from

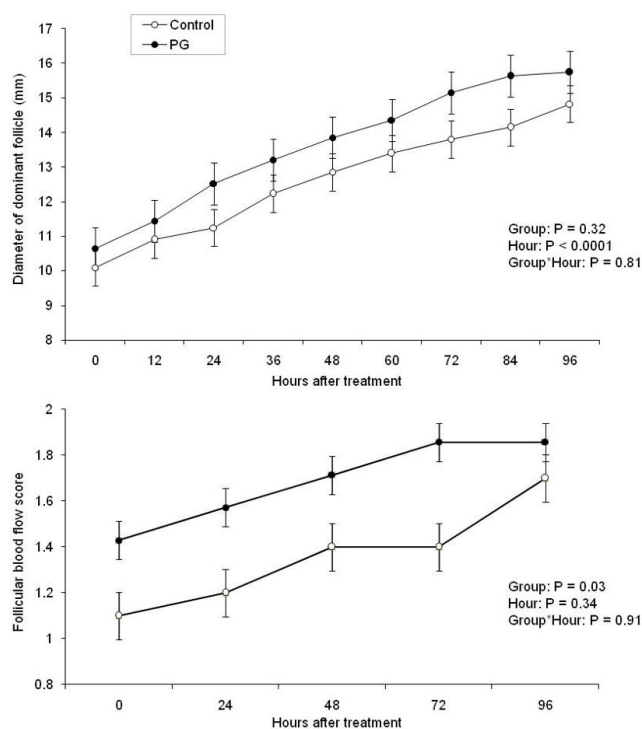

Figure 3 - (A) Diameter (Mean \pm SEM) of the dominant follicle and (B) blood flow score in cows treated with a single dose of 150 μ g of PGF analog (PGF Group, n = 12) or NaCL (Control Group, n = 11) on Day 9 of the estradiol-high progesterone-based protocol (Experiment 1). All cows received 2 new CIDR[®] devices, and 2 mg of EB i.m., in a presence of a CL on Day 0. On Day 8, cows received 300 IU of eCG. CIDR[®] devices were removed on Day 13 of the protocol.

day 6 to 13. However, there was an increase in the blood flow of the DF after PGF treatment ($P = 0.03$).

Experiment 2

No cow exposed to low progesterone ovulated in Control and 4xPGF groups. The average serum progesterone concentration was 1.9 ± 0.1 ng/mL (Figure 2). However, after CIDR[®] removal, all cows (9/9) from the Control group ovulated, and 78% (7/9) of the cows treated with PGF ovulated ($P = 0.13$). Follicular growth (Figure 4) was not different between groups ($P = 0.92$). However, after CIDR[®] removal, 57% (4/7) of PGF treated cows ovulated until 48 h, while in the Control Group, only 22% (2/9) ovulated in the same period ($P = 0.15$). The average interval from CIDR[®] removal to ovulation was 54.6 ± 3.5 h in Control and 42.6 ± 6.5 h in PGF group ($P = 0.12$).

Experiment 3

Serum LH concentrations after saline, GnRH, or PGF injection are shown in Figure 5. Prior to the injections (Hour 0), LH concentration was similar among groups ($P = 0.97$; 4.5 ± 0.3 ng/mL). However, 1 h after the first

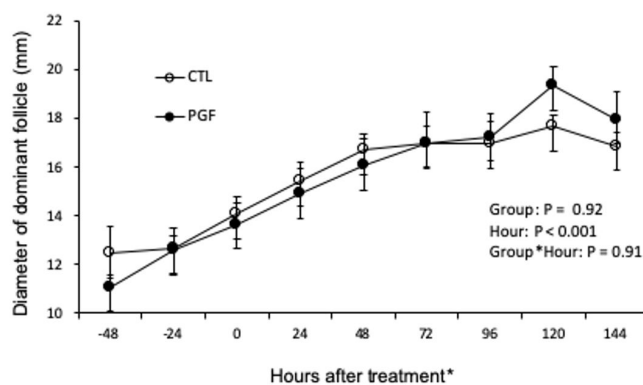

Figure 4 - Diameter (Mean \pm SEM) of the dominant follicle in cows treated with four doses of 150 μ g of PGF analog (PGF Group, n = 12) or NaCL (Control Group, n = 11) on Days 9 to 12 of the estradiol-low progesterone-based protocol (Experiment 2). All cows were synchronized with a twice-used CIDR[®] device, 2 mg of EB i.m., and 150 μ g of a PGF analog on Day 0. On Day 6, cows received 150 μ g of d-Cloprostenol, and 48 h later, 300 IU of eCG. CIDR[®] devices were removed on Day 13 of the protocol. *Time points relative to the first injection of the treatments.

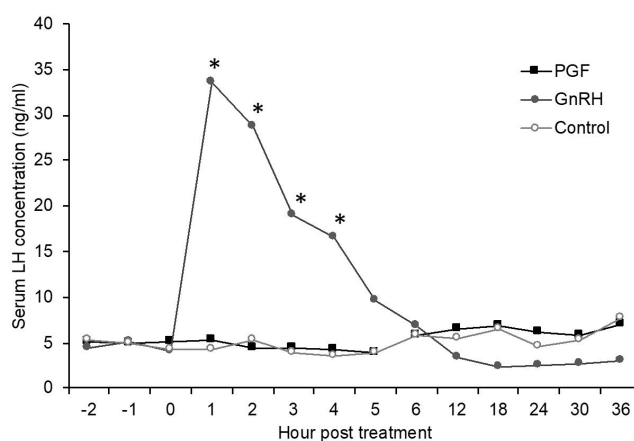

Figure 5 - Serum LH concentrations after injections of d-Cloprostenol (PGF Group, n = 5), Lecirelin (GnRH Group, n = 5), or Saline (Control Group, n = 4) in ovariectomized cows from Experiment 3.

injections, the LH concentration was higher ($P < 0.0001$) in cows from GnRH group (33.6 ± 13.2 ng/mL) compared to the PGF and Control groups (5.2 ± 0.5 and 4.2 ± 0.5 ng/mL, respectively). This difference persisted up to 4 h after the first injections ($P < 0.05$). After this period, LH concentrations returned to basal levels and were similar ($P > 0.05$) among groups. The LH secretion pattern was not different between PGF and Control groups ($P > 0.05$) and was maintained between 3 and 8 ng/mL throughout the study.

Experiment 4

Follicular fluid progesterone and estradiol concentrations in Control, GnRH, and PGF treatments are shown in Figure 6. Cows treated with GnRH had a significant decrease in follicular

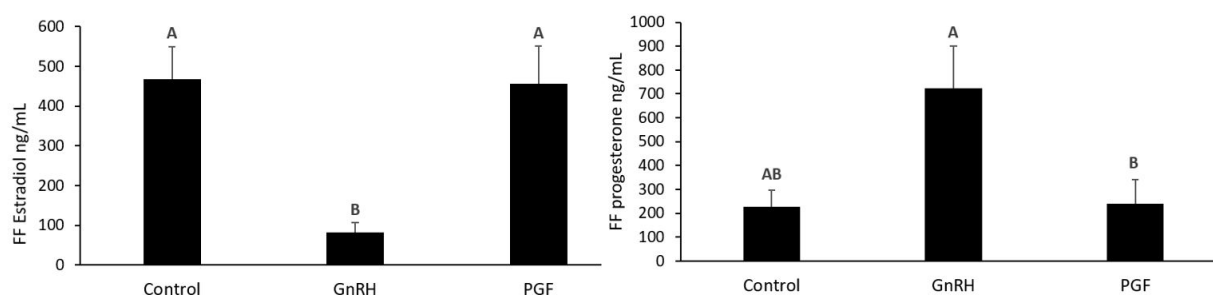

Figure 6 - Follicular fluid estradiol (A) and progesterone (B) concentration in preovulatory follicles from cows 24 h after treatment with Saline (Control Group, n=6); Lecirelin (GnRH Group, n = 7) or Cloprostenol Sodium (PGF Group, n=6). All the cows had a single follicle with a diameter greater than 11.5 mm at the moment of treatment. ^{A, B} Indicate significant difference among groups ($P < 0.05$).

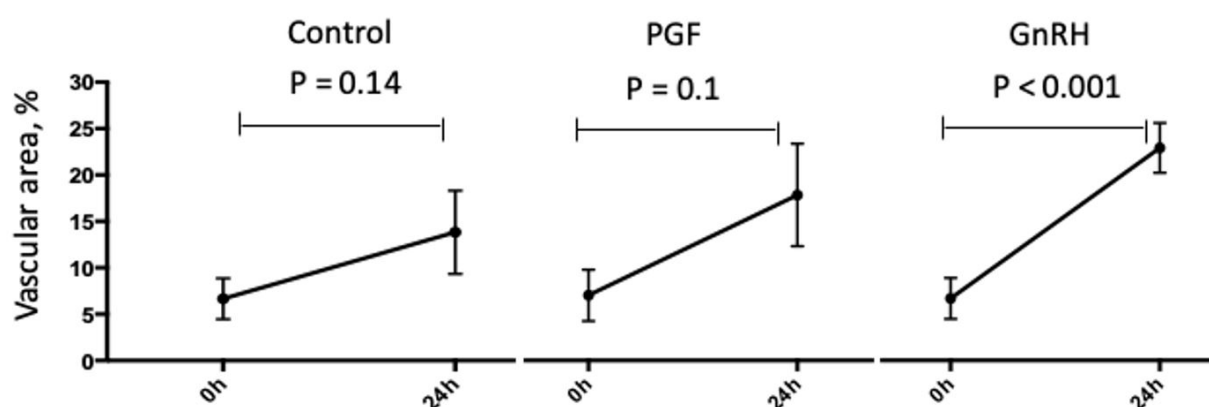

Figure 7 - Vascular area (%) in preovulatory follicles from cows before (0 h) and 24 h after treatment with Saline (Control Group, n=6); Cloprostenol Sodium (PGF Group, n=6); and Lecirelin (GnRH Group, n = 7). All the cows had a single follicle with a diameter greater than 11.5 mm at treatment.

fluid estradiol concentration and an increase in progesterone concentration, compared to the other treatments ($P < 0.05$). There was a significant increase in vascular area of follicles from 0 to 24 h in GnRH (three-fold; $P < 0.001$) and a tendency for PGF (two-fold; $P < 0.05$) treatments (Figure 7).

Discussion

The results of this study indicate that PGF is not able to stimulate LH release and ovulation in cattle. Although it was shown before that in association with GnRH, PGF can increase LH secretion in postpartum cows (Randel et al., 1996), our results did not confirm this finding. We demonstrated that intramuscular injection of PGF without any pretreatment (Exp. 3) or in the presence of low and high progesterone serum concentrations (Exp. 1 and 2) did not increase LH release nor induce ovulation. Also, PGF did not have any effect on steroidogenesis in preovulatory follicles (Exp. 4), providing further evidence that PGF does not act at the central level to control ovulation in cattle. However, the significant increase in follicular vascularization in preovulatory follicles suggests that systemic PGF administration may locally influence the ovulatory process.

Analogs of PGF are among the most used commercial products in estrous synchronization protocols (Lamb et al., 2010), besides being widely used in the treatment of reproductive tract disorders (Salasel & Mokhtari, 2011; Weems et al., 2006). Thus, understanding the role of PGF in ovulation is essential for the development of more efficient techniques and methods for the control of reproductive cycles in cows. In this sense, it is known that administration of commercial analogs of PGF results in ovulation in sheep (Davies et al., 2006) and cattle exposed to different ovulation synchronization protocols (Pfeifer et al., 2014; Pfeifer et al., 2016; Pfeifer et al., 2018; Castro et al., 2017). Additionally, the effect of PGF on ovulation is independent of its luteolytic action, since it is also able to induce ovulation in prepubertal heifers (Leonardi et al., 2012). Although the exact mechanism by which this occurs has not yet been elucidated, the results of our study indicate that PGF does not stimulate LH release, as observed for GnRH (Jaeger et al., 1987; Bolt et al., 1990), which induces an LH surge even in the presence of progesterone (Martínez et al., 2007).

The importance of prostaglandins in the cascade of events that precede ovulation has been demonstrated in

several species (Evans et al., 1983; Dhaliwal et al., 1991; Murdoch et al., 1993; Duffy & Stouffer, 2001; Bridges & Fortune, 2007). However, most of the reports about the action of endogenous PGF on periovulatory events in cattle are focused on its local action in the dominant follicle (Bridges & Fortune, 2007; Fortune et al., 2009; Willis et al., 2017). In response to GnRH, there is an increase in the PGF and PGE receptor expression in theca and granulosa cells of preovulatory follicles in cattle (Bridges & Fortune, 2007). Also, the pre-ovulatory LH surge induces granulosa cells cyclooxygenase-2 activity, which converts arachidonic acid to PGH₂, the precursor of prostaglandins E₂ and F_{2_α} (Sirois, 1994). The presence of these prostaglandins stimulates the activation of proteases in the granulosa (Fortune et al., 2009) and theca interna cells (Willis et al., 2017), promoting follicular rupture and extracellular matrix remodeling (Richards et al., 2005; Shozu et al., 2005). These reports demonstrated the importance of endogenous PGF in ovulation and support the hypothesis that PGF administration may directly alter the follicular environment. In our study, although PGF was not able to induce ovulation in cows with high progesterone levels, it improved follicular vascularization, suggesting a local action on the preovulatory follicle. Initially, we tested the effect of PGF in a high progesterone environment, and since PGF did not induce ovulation, we attempted to test multiple PGF injections in a low progesterone environment.

The presence of progesterone, even at low levels as observed in experiment 2, blocked the ovulatory action of PGF. However, after the progesterone source removal, almost 60% of PGF treated cows ovulated until 36 h, while only 22% of control cows ovulated in the same interval. In rhesus monkeys, LH increased PGE and PGF concentrations in follicular fluid about 10 h before ovulatory follicle rupture (Duffy & Stouffer, 2001). This suggests that PGs may modulate the effects of the LH surge in ovarian tissue remodeling, which is essential for follicle rupture and luteinization. These results, associated with our findings, suggest that PGF could have a local effect in the pre-ovulatory follicle.

In previous studies, we verified the ability of PGF to hasten ovulation when progesterone sources were removed before PGF treatment to induce ovulation (Leonardi et al., 2012; Pfeifer et al., 2014; Pfeifer et al., 2016; Castro et al., 2017). In the current study, to evaluate possible mechanisms of action, we maintained the source of progesterone during PGF injection. With this, we aimed to determine if, while pituitary gonadotropin release is inhibited by progesterone, PGF would still be able to induce ovulation. However, our results demonstrated that this did not happen, PGF did not induce ovulation in the presence of any level of progesterone.

Differently from observed in the cows of our experiments, exogenous PGF induced ovulation in anestrus ewes under the effect of medroxyprogesterone (Davies et al., 2006), suggesting a direct effect on the follicle, since circulating progesterone concentrations did not change and ovulation was not preceded by an LH or FSH surge. In our study, progesterone concentrations were high in Exp. 1 (around 5 ng/mL), and low in Exp. 2 (around 2 ng/mL), similar to those previously reported by Pereira et al. (2017), which induced endocrine profiles of high and low progesterone, respectively. It is known that serum progesterone concentrations around 2ng/mL can prevent the LH release necessary for ovulation of the dominant follicle in cattle (Kojima et al., 2003). It is possible, therefore, that even the low progesterone concentration can prevent the PGF stimulus on ovulation. This suggests that other periovulatory events need to be triggered to PGF have a stimulatory effect.

The results from our study also demonstrate that PGF alone is not able to stimulate the LH surge in cows, as low levels of LH were maintained even after three injections of PGF in ovariectomized cows. In postpartum cows, it was previously demonstrated that PGF increases LH secretion after GnRH injection (Randel et al., 1996), suggesting a direct effect of PGF on the anterior pituitary (Weems et al., 2006). However, the effect of PGF on LH secretion suggested by those authors was not confirmed in our current study using PGF alone. Besides inducing ovulation, the LH surge induced by GnRH promotes dramatic effects on follicular steroidogenesis, which initiates before follicular rupture and culminates with luteinization of the follicle (Komar et al., 2001).

Thus, we investigated if PGF administration in cows with preovulatory follicles during proestrus/estrus would induce such effects. As expected, GnRH treatment decreased estradiol synthesis and increased progesterone concentration (Komar et al., 2001; Santos et al., 2012), validating the luteinization model. However, PGF treatment did not promote luteinization, as estradiol and progesterone concentrations were similar to those observed in non-treated control cows, further confirming the absence of an indirect effect of PGF mediated by GnRH/LH. Interestingly, the evaluation of the preovulatory follicles by Color Doppler ultrasonography revealed that PGF treatment induced a significant increase in follicular vascularization, as observed in GnRH-treated, but not in control cows.

It was previously demonstrated that PGF induces a significant increase in vascularization at the periphery of the CL during both spontaneous and induced luteolysis, through inducing the expression of endothelial nitric oxide synthase (eNOS) (Shirasuna et al., 2008). However,

that effect seems to last only for 6 h, and in the present study, the evaluation was performed 24 h after treatment. Considering the short half-life of PGF, further studies are necessary to identify the mechanisms involved in the local action of PGF during ovulation.

Conclusion

Our results show that PGF did not induce ovulation under any serum progesterone level. Furthermore, PGF did not trigger an LH surge in ovariectomized cows and PGF alone was not able to induce follicle luteinization, although it increased follicular vascularization. Together, the results suggest that PGF may act locally to induce ovulation in cattle. Further studies are needed to understand its mechanism of action.

Conflict of interest

The authors declare no conflict of interest.

References

Bolt DJ, Rollins R. Development and application of a radioimmunoassay for bovine follicle-stimulating hormone. *J Anim Sci*. 1983;56(1):146-54. <http://dx.doi.org/10.2527/jas1983.561146x>. PMID:6402479.

Bolt DJ, Scott V, Kiracofe GH. Plasma LH and FSH after estradiol, norgestomet and Gn-RH treatment in ovariectomized beef heifers. *Anim Reprod Sci*. 1990;23(4):263-71. [http://dx.doi.org/10.1016/0378-4320\(90\)90040-M](http://dx.doi.org/10.1016/0378-4320(90)90040-M).

Bridges PJ, Fortune JE. Regulation, action and transport of prostaglandins during the periovulatory period in cattle. *Mol Cell Endocrinol*. 2007;263(1-2):1-9. <http://dx.doi.org/10.1016/j.mce.2006.08.002>. PMID:17064845.

Castro NA, Neves PMA, Cestaro JP, Melo VTO, Schneider A, Pfeifer LFM. Use of prostaglandin F2 α as ovulatory stimulus for synchronizing dairy cattle. *Res Vet Sci*. 2017;2018(118):151-4.

Colazo MG, Mapletoft RJ. A review of current timed-AI (TAI) programs for beef and dairy cattle. *Can Vet J*. 2014;55(8):772-80. PMID:25082993.

Colazo MG, Kastelic JP, Davis H, Rutledge MD, Martinez MF, Small JA, Mapletoft RJ. Effects of plasma progesterone concentrations on LH release and ovulation in beef cattle given GnRH. *Domest Anim Endocrinol*. 2008;34(1):109-17. <http://dx.doi.org/10.1016/j.domaniend.2006.11.004>. PMID:17210239.

Ethics Statement

The Committee for Ethics in Animal Experimentation from the Brazilian Agricultural Research Corporation (Embrapa – Rondônia) approved all procedures performed in this experiment (Number F.02/2014).

Acknowledgments

The authors are thankful to the National Council for Scientific and Technological Development (CNPq), Foundation of Research Support of the State of Rio Grande do Sul (Project n: 16/2551-0000494-3). This study was financed in part by the Coordenação de Aperfeiçoamento de Pessoal de Nível Superior - Brasil (CAPES) - Finance Code 001. This research was also supported by CNPq (Universal Project n: 407307/2016-8) and EMBRAPA (Project MP2 n 02.12.01.021.00.00).

Dhaliwal GS, Sharma RD, Prabhakar S. Ovarian changes in buffaloes following PGF 2 administration using two routes. *Buffalo Bull*. 1991;10:32-7.

Davies KL, Bartlewski PM, Epp T, Duggavathi R, Barrett DMW, Bagu ET, Cook SJ, Rawlings NC. Does injection of prostaglandin F2 α (PGF2 α) cause ovulation in anestrus Western White Face ewes? *Theriogenology*. 2006;66(2):251-9. <http://dx.doi.org/10.1016/j.theriogenology.2005.08.027>. PMID:16336995.

Duffy DM, Stouffer RL. The ovulatory gonadotrophin surge stimulates cyclooxygenase expression and prostaglandin production by the monkey follicle. *Mol Hum Reprod*. 2001;7(8):731-9. <http://dx.doi.org/10.1093/molehr/7.8.731>. PMID:11470860.

Evans G, Dobias M, King GJ, Armstrong DT. Production of Prostaglandins by Porcine Preovulatory Follicular Tissues and Their Roles in Intrafollicular Function 1. *Biol Reprod*. 1983;28(2):322-8. <http://dx.doi.org/10.1095/biolreprod28.2.322>. PMID:6404317.

Fortune JE, Willis EL, Bridges PJ, Yang CS. The periovulatory period in cattle: progesterone, prostaglandins, oxytocin and ADAMTS proteases. *Anim Reprod*. 2009;6(1):60-71. PMID:20390049.

- Ginther OJ. *Ultrasonic Imaging and Animal Reproduction: color-Doppler Ultrasonography*. 1. ed. Cross Plains: Equiservices Publishing; 2007.
- Halász B, Kiss J, Molnár J. Regulation of the gonadotropin-releasing hormone (GnRH) neuronal system: morphological aspects. *J Steroid Biochem*. 1989;33(4 Part 2):663-8. [http://dx.doi.org/10.1016/0022-4731\(89\)90475-5](http://dx.doi.org/10.1016/0022-4731(89)90475-5). PMID:2513450.
- Jaeger JR, Turner HA, Stormshak F. Gonadotropin releasing hormone-induced secretion of luteinizing hormone during the milk-ejection reflex in the postpartum Beef Cow2. *J Anim Sci*. 1987;65(2):543-7. <http://dx.doi.org/10.2527/jas1987.652543x>. PMID:3305457.
- Kojima FN, Bergfeld EGM, Wehrman ME, Cupp AS, Fike KE, Mariscal-Aguayo DV, Sanchez-Torres T, Garcia-Winder M, Clopton DT, Roberts AJ, Kinder JE. Frequency of luteinizing hormone pulses in cattle influences duration of persistence of dominant ovarian follicles, follicular fluid concentrations of steroids, and activity of insulin-like growth factor binding proteins. *Anim Reprod Sci*. 2003;77(3-4):187-211. [http://dx.doi.org/10.1016/S0378-4320\(03\)00038-1](http://dx.doi.org/10.1016/S0378-4320(03)00038-1). PMID:12695054.
- Komar CM, Berndtson AK, Evans ACO, Fortune JE. Decline in circulating estradiol during the periovulatory period is correlated with decreases in estradiol and androgen, and in messenger RNA for P450 aromatase and P450 17 α -hydroxylase, in bovine preovulatory follicles. *Biol Reprod*. 2001;64(6):1797-805. <http://dx.doi.org/10.1095/biolreprod64.6.1797>. PMID:11369611.
- Lamb GC, Dahlen CR, Larson JE, Marquezini G, Stevenson JS. Control of the estrous cycle to improve fertility for fixed-time artificial insemination in beef cattle: a review. *J Anim Sci*. 2010;88(13, Suppl.):E181-92. <http://dx.doi.org/10.2527/jas.2009-2349>. PMID:19783709.
- Leonardi CEP, Pfeifer LFM, Rubin MIB, Singh J, Mapletoft RJ, Pessoa GA, Bairy AM, Silva CAM. Prostaglandin F $_{2\alpha}$ promotes ovulation in prepubertal heifers. *Theriogenology*. 2012;78(7):1578-82. <http://dx.doi.org/10.1016/j.theriogenology.2012.06.030>. PMID:22925644.
- Martínez MF, Kastelic JP, Colazo MG, Mapletoft RJ. Effects of estradiol on gonadotrophin release, estrus and ovulation in CIDR-treated beef cattle. *Domest Anim Endocrinol*. 2007;33(1):77-90. <http://dx.doi.org/10.1016/j.domaniend.2006.04.009>. PMID:16797154.
- Murdoch WJ, Hansen TR, McPherson LA. A review - Role of eicosanoids in vertebrate ovulation. *Prostaglandins*. 1993;46(8):85-115. [http://dx.doi.org/10.1016/0090-6980\(93\)90037-8](http://dx.doi.org/10.1016/0090-6980(93)90037-8). PMID:8210447.
- Naor Z, Jabbour HN, Naidich M, Pawson AJ, Morgan K, Battersby S, Millar MR, Brown P, Millar RP. Reciprocal cross talk between gonadotropin-releasing hormone (GnRH) and prostaglandin receptors regulates GnRH receptor expression and differential gonadotropin secretion. *Mol Endocrinol*. 2007;21(2):524-37. <http://dx.doi.org/10.1210/me.2006-0253>. PMID:17138645.
- Pereira MHC, Sanches CP Jr, Guida TG, Wiltbank MC, Vasconcelos JLM. Comparison of fertility following use of one versus two intravaginal progesterone inserts in dairy cows without a CL during a synchronization protocol before timed AI or timed embryo transfer. *Theriogenology*. 2017;89:72-8. <http://dx.doi.org/10.1016/j.theriogenology.2016.10.006>. PMID:28043373.
- Pfeifer LFM, Leonardi CEP, Castro NA, Viana JHM, Siqueira LGB, Castilho EM, Singh J, Krusser RH, Rubin MIB. The use of PGF $_{2\alpha}$ as ovulatory stimulus for timed artificial insemination in cattle. *Theriogenology*. 2014;81(5):689-95. <http://dx.doi.org/10.1016/j.theriogenology.2013.11.016>. PMID:24412682.
- Pfeifer LFM, Siqueira LGB, Arashiro EKN, Castro NA, Viana JHM. Prostaglandin F $_{2\alpha}$ or estradiol benzoate to induce ovulation in timed artificially inseminated dairy cows. *Pesqui Agropecu Bras*. 2016;51(6):738-44. <http://dx.doi.org/10.1590/S0100-204X2016000600005>.
- Pfeifer LFM, Rodrigues WB, Silva KC, Anache NA, Castro NA, Castilho EM, Nogueira E. Different protocols using PGF $_{2\alpha}$ as ovulation inducer in Nelore cows subjected to estradiol-progesterone timed AI based protocols. *Theriogenology*. 2018;120:56-60. <http://dx.doi.org/10.1016/j.theriogenology.2018.06.030>. PMID: 30092375.
- Pursley JR, Mee MO, Wiltbank MC. Synchronization of ovulation in dairy cows using PGF $_{2\alpha}$ and GnRH. *Theriogenology*. 1995;44(7):915-23. [http://dx.doi.org/10.1016/0093-691X\(95\)00279-H](http://dx.doi.org/10.1016/0093-691X(95)00279-H). PMID:16727787.
- Randel RD, Lammoglia MA, Lewis AW, Neuendorff DA, Guthrie MJ. Exogenous PGF $_{2\alpha}$ enhanced GnRH-induced LH release in postpartum cows. *Theriogenology*. 1996;45(3):643-54. [http://dx.doi.org/10.1016/0093-691X\(95\)00410-A](http://dx.doi.org/10.1016/0093-691X(95)00410-A). PMID:16727826.
- Richards JAS, Hernandez-Gonzalez I, Gonzalez-Robayna I, Teuling E, Lo Y, Boerboom D, Falender AE, Doyle KH, LeBaron RG, Thompson V, Sandy JD. Regulated expression

- of ADAMTS family members in follicles and cumulus oocyte complexes: evidence for specific and redundant patterns during ovulation. *Biol Reprod.* 2005;72(5):1241-55. <http://dx.doi.org/10.1095/biolreprod.104.038083>. PMID:15659705.
- Salasel B, Mokhtari A. Effect of early postpartum PGF2 α treatment on reproductive performance in dairy cows with calving and puerperal traits. *Theriogenology.* 2011;76(9):1723-9. <http://dx.doi.org/10.1016/j.theriogenology.2011.07.004>. PMID:21872307.
- Satheshkumar S. Peri-follicular blood flow in the follicle from which ovulation occurs in cows. *Anim Reprod Sci.* 2018;198:154-9. <http://dx.doi.org/10.1016/j.anireprosci.2018.09.014>. PMID:30279026.
- Santos JT, Ferreira R, Gasperin BG, Siqueira LC, de Oliveira JF, Santos RA, Reis AM, Gonçalves PB. Molecular characterization and regulation of the angiotensin-converting enzyme type 2/Angiotensin-(1-7)/MAS receptor axis during the ovulation process in cattle. *J Renin Angiotensin Aldosterone Syst.* 2012;13(1):91-8. <http://dx.doi.org/10.1177/1470320311417273>. PMID:21824993.
- Shirasuna K, Watanabe S, Asahi T, Wijayagunawardane MPB, Sasahara K, Jiang C, Matsui M, Sasaki M, Shimizu T, Davis JS, Miyamoto A. Prostaglandin F2 α increases endothelial nitric oxide synthase in the periphery of the bovine corpus luteum: the possible regulation of blood flow at an early stage of luteolysis. *Reproduction.* 2008;135(4):527-39. <http://dx.doi.org/10.1530/REP-07-0496>. PMID:18296510.
- Sirois J. Induction of prostaglandin endoperoxide synthase-2 by human chorionic gonadotropin in bovine preovulatory follicles in vivo. *Endocrinology.* 1994;135(3):841-8. <http://dx.doi.org/10.1210/endo.135.3.8070377>. PMID:8070377.
- Shozu M, Minami N, Yokoyama H, Inoue M, Kurihara H, Matsushima K, Kuno K. ADAMTS-1 is involved in normal follicular development, ovulatory process and organization of the medullary vascular network in the ovary. *J Mol Endocrinol.* 2005;35(2):343-55. <http://dx.doi.org/10.1677/jme.1.01735>. PMID:16216914.
- Weems CW, Weems YS, Randel RD. Prostaglandins and reproduction in female farm animals. *Vet J.* 2006;171(2):206-28. <http://dx.doi.org/10.1016/j.tvjl.2004.11.014>. PMID:16490704.
- Willis EL, Bridges PJ, Fortune JE. Progesterone receptor and prostaglandins mediate luteinizing hormone-induced changes in messenger RNAs for ADAMTS proteases in theca cells of bovine periovulatory follicles. *Mol Reprod Dev.* 2017;84(1):55-66. <http://dx.doi.org/10.1002/mrd.22761>. PMID:27879029.

Financial Support: National Council for Scientific and Technological Development (CNPq), Foundation of Research Support of the State of Rio Grande do Sul (Project n: 16/2551-0000494-3). This research was also supported by CNPq (Universal Project n: 407307/2016-8) and EMBRAPA (Project MP2 n 02.12.01.021.00.00).