

**Univerzita Karlova v Praze  
Přírodovědecká fakulta**

Studijní program: Biologie  
Studijní obor: Ekologie



**Bc. Dovělě Barcytė**

**Zelené řasy dominující ve fytoplanktonu dvou kyselých jezer:  
taxonomické postavení, fylogenetické vztahy a odolnost vůči kovům**

**Taxonomic position, phylogenetic relationships and metal resistance  
of green algae dominating in phytoplankton of two acid lakes**

Diplomová práce

Vedoucí závěrečné práce: RNDr. Linda Nedbalová, Ph.D.

Praha, 2015



**Declaration:**

I hereby declare that this diploma thesis is entirely the result of my own work and I have acknowledged all the sources of information which have been used in it. This thesis has not been submitted in order to obtain the same or any other academic degree earlier.

In Prague, 14. 08. 2015

Signature

## Acknowledgments

Above all, I would like to thank my supervisor RNDr. Linda Nedbalová, Ph.D. for her help and support during all my study period. I have been extremely lucky to have such a positive supervisor who cared so much about me. It has been a great pleasure being a student of hers. Secondly, I would like to say thank you to RNDr. Jaromír Lukavský, CSc. (Institute of Botany of the ASCR) who has helped me with the experiments.

I would also like to express my sincere gratitude to Prof. Dr. Thomas Friedl (University of Goettingen, EPSAG, Germany) who let me to come to his laboratoty where I had the opportunity to learn the molecular methods. I am also saying a big thank you to Mgr. Ladislav Hodáč (University of Goettingen, Germany) for devoting his time and teaching me phylogenetic analyses and giving useful advices regarding my molecular results.

I should not, of course, forget RNDr. Jasna Vukič, Ph.D., who first introduced me to the work in the laboratory and had always a kind word to say. Also, I would like to thank Mgr. Jana Kvíderová, Ph.D. (Institute of Botany of the ASCR) who has helped me with the conversion equations.

Finally, I am very thankful to Mgr. Aivaras Žukauskas who encouraged me and has helped to start the studies at Charles University in Prague, where I have learned and experienced a lot.



## ABSTRAKT

Cílem této diplomové práce bylo objasnit taxonomické postavení a fylogenetické vztahy planktonních řas dominujících ve dvou kyselých jezerech s vysokou koncentrací kovů (Hromnické jezírko a Plešné jezero, Česká republika) a porovnat tyto izoláty s jinými blíže příbuznými kmeny s důrazem na toleranci k různým toxickým kovům (Cr, Al, Cu, Mn, Zn, Hg).

Fylogenetické analýzy ukázaly, že oba kmeny patří k druhu *Coccomyxa simplex*. Poprvé tak bylo prokázáno, že právě tento druh se může stát dominantní planktonní řasou v extrémním prostředí kyselých jezer se zvýšeným přísunem fosforu. Na základě analýzy 18S rDNA bylo možné v rámci rodu *Coccomyxa* rozlišit čtyři nezávislé fylogenetické linie, z nichž tři obsahují sladkovodní izoláty z kyselého prostředí. Z různých chemických roztoků byly získány nové kmeny nedávno popsáno druhu *Coccomyxa polymorpha*.

Z testů toxicity vyplynulo, že kmeny druhu *Coccomyxa simplex* vyizolované z Hromnického jezírka a z Plešného jezera nevykazují zvýšenou odolnost k vysoké koncentraci kovů. V případě hliníku byla reakce kmenů výrazně odlišná, ale nezávisela na koncentraci tohoto kovu v prostředí, odkud byl kmen vyizolován. Schopnost tohoto druhu přežít v extrémním prostředí je pravděpodobně daná jinými faktory, než je zvýšená tolerance k toxickým účinkům kovů.

**Klíčová slova:** Plešné jezero, Hromnické jezírko, acidifikace, ekologie, *Coccomyxa*, Trebouxiophyceae, 18S rDNA, ITS-2 rDNA, IC<sub>50</sub>, hliník, chrom, rtuť, měď, zinek, mangan

## ABSTRACT

The aim of this diploma thesis was to reveal the taxonomic position and phylogenetic relationships of the dominant planktonic algae in two acid metal-rich lakes (Hromnice Lake and Plešné Lake, Czech Republic) and to compare these isolates with other closely related strains with the focus on the tolerance to various toxic metals (Cr, Al, Cu, Mn, Zn, Hg).

The phylogenetic analyses showed that both strains belong to species *Coccomyxa simplex*. It was the first evidence that specifically this species is capable to become the dominant phytoplankton alga in the extreme environment of acid lakes with increased supply of phosphorus. Based on 18S rDNA analysis, four independent phylogenetic lineages were revealed within the genus *Coccomyxa* with three of them containing isolates from acid freshwaters. Furthermore, new strains of the recently described species *Coccomyxa polymorpha* were found growing in various chemical solutions.

The toxicity test revealed that *Coccomyxa simplex* strains isolated from Hromnice and Plešné lakes did not show any peculiar resistance to increased metal concentrations. A significantly strain-specific response was recorded in case of aluminum, however, it was not related to the concentration of this metal in the original habitat. The ability to thrive in extreme habitats is probably determined by other factors than the increased tolerance to toxic effects of metals.

**Key words:** Plešné Lake, Hromnice Lake, acidification, ecology, *Coccomyxa*, Trebouxiophyceae, 18S rDNA, ITS-2 rDNA, IC<sub>50</sub>, aluminum, chromium, mercury, copper, zinc, manganese

## TABLE OF CONTENTS

1. INTRODUCTION.....	8
2. LITERATURE REVIEW.....	11
2.1. Acidification of freshwater ecosystems .....	11
2.1.1 Atmospheric acidification .....	11
2.1.2 Acid mine drainage .....	14
2.3. The toxicity of heavy metals and aluminum to microalgae .....	19
2.4. Algal bioassay .....	21
2.5. Taxonomic position and ecology of genera <i>Coccomyxa</i> and <i>Pseudococcomyxa</i> .....	22
3. MATERIAL AND METHODS .....	26
3.1. Characteristics of the lakes.....	26
3.2. Algal strains.....	28
3.3. Molecular methods.....	29
3.4. Phylogenetic analyses .....	32
3.5. Light and electron microscopy.....	33
3.6. Toxicity test.....	34
4. RESULTS.....	37
4.1. Phylogenetic analyses .....	37
4.1.1. PCR amplification of 18S and ITS-2 rDNA .....	37
4.1.2. 18S rDNA phylogenetic analysis .....	38
4.1.3. Analysis of ITS-2 rDNA .....	45
4.2. Morphological characteristic of the strains .....	53
4.2.1. Light microscopy.....	53
4.2.2. Transmission electron microscopy.....	57
4.3. Effects of metals on growth of the strains.....	59
4.3.1. Growth curves .....	59
4.3.2. Toxicity curves.....	68
5. DISCUSSION .....	77
5.1. Phylogeny of the genus <i>Coccomyxa</i> .....	77
5.2. Taxonomic position of <i>Coccomyxa</i> strains isolated from acid lakes and chemical solutions .....	78
5.3. Morphology and ecology of <i>Coccomyxa</i> strains isolated from acid lakes and chemical solutions .....	79
5.4. Metal toxicity to the strains.....	81
7. REFERENCES.....	88
8. SUPPLEMENT .....	101

# 1. INTRODUCTION

Acidification of freshwater ecosystems is one of the major environmental and ecological problems nowadays. It changes chemical properties of water and thereby influences the biological structure and composition of communities (Hendrey et al., 1976a, b; Schindler, 1994, 1998; Driscoll, 2001). Acid habitats exhibit challenging conditions to most life forms and no higher organisms can thrive there. Extreme examples of acid lakes are mining lakes which originated in abandoned metal or coal mines (AMD lakes) (Geller et al., 2013).

During acidification biota can be influenced directly by changes in water quality or indirectly by disruption of ecosystem processes, e.g., alternations of acid-sensitive and acid-tolerant species at different trophic levels (Muniz, 1991). What is more, decreases in pH are usually accompanied by increased concentrations of various metals, especially aluminum, which becomes more soluble and, hence, more hazard to aquatic biota as it shifts to its toxic form ( $\text{Al}^{3+}$ ) under pH below 5.5 (Gensemer and Playle, 1999). In addition, increasing Al concentrations reduce dissolved phosphorus concentrations and may lead to oligotrophication of a water body (Kopáček et al., 2000). Furthermore, low pH limits the availability of dissolved inorganic carbon for primary producers (Gross, 2000).

Phytoplankton of acid lakes worldwide is usually dominated by flagellates from various taxonomic groups (Chlorophyta, Cryptophyta, Dinophyta, Euglenophyta, Chrysophyceae) (Almer et al., 1974, 1978; Lessmann et al., 2000; Nixdorf et al., 2001; Beulker et al., 2003). However, acid mining Lake **Hromnice** (Western Bohemia) and atmospherically acidified **Plešné** Lake in the Bohemian Forest (Šumava) are abundant in coccoid green algae with similar morphology, but without precise taxonomic affiliation. Both lakes are relatively rich in phytoplankton biomass due to increased input of phosphorus and low grazing pressure, but poor in species (Nedbalová et al., 2006; Hrdinka et al., 2013).

Hromnice Lake is the most acidified permanently meromictic lake in the Czech Republic which arose as a consequence of pyritic shale mining. Lake water is characterised by  $\text{pH} < 3$  and high concentrations of toxic metals, especially Al (up to  $176 \text{ mg L}^{-1}$ ) (Hrdinka et al., 2013). Plešné Lake, which is now recovering from strong atmospheric acidification, has surface water pH approaching 5 and Al concentration around  $0.5 \text{ mg L}^{-1}$  (Kopáček et al., 2000; Nedbalová et al., 2006).

Many studies have examined the effects of various metals on freshwater microalgae, however, a great deal of variability exists in the published data. Although certain generalizations could be made for a particular algal group or species (Gensemer and Playle, 1999), the information

about strain specific tolerance to various metals is still missing. Only few studies were carried out in order to assess the differences on metal toxicity among closely related algal strains isolated from different habitats (Gensemer, 1991; Hörnström, 1995; Olaveson and Nalewajko, 2000).

A green alga *Coccomyxa* is capable to colonize and thrive in completely different habitats what indicates a high plasticity of the genus and thus offers a platform for such comparative ecophysiological studies among different strains. Furthermore, the discovery of *Coccomyxa* in the chemical solutions (Sládečková, 1959) provides the knowledge about the actual tolerance limits of the genus to the metals.

## AIMS AND OBJECTIVES

The main hypothesis of my work is that strains isolated from acid environments with high concentration of metals are members of the same *Coccomyxa* lineage and can withstand higher concentrations of toxic metals than other closely related strains.

### Aims:

1. To assess taxonomic, phylogenetic, ecological and ecophysiological status of the strains isolated from Hromnice and Plešné lakes.
2. To compare the isolates from Hromnice and Plešné lakes with other *Coccomyxa/Pseudococcomyxa* strains with the focus on the tolerance to toxic metals.

### Objectives:

- To ascertain taxonomic position of the strains isolated from Hromnice and Plešné lakes.
- To find out whether the strains isolated from acid habitats with metal contamination are phylogenetically distinct or do they share a molecular basis for adaptation to extreme conditions.
- To assess phylogenetic relationships of isolates from acid habitats and *Coccomyxa/Pseudococcomyxa* strains isolated from other environment types.
- To evaluate patterns of ecological diversification within the *Coccomyxa/Pseudococcomyxa* lineage with the focus on acid habitats.
- To identify and assess phylogenetic relationships of the strains isolated from the chemical solutions.
- To assess if the tolerance to high metal concentrations of the strains isolated from Hromnice and Plešné lakes is increased in comparison with other closely related strains from circumneutral habitats.
- To find out what are the differences of toxic effects between different metals.
- To check whether the tolerance to metals reflect their original habitat.

## **2. LITERATURE REVIEW**

### **2.1. Acidification of freshwater ecosystems**

Freshwater ecosystems can be considered acid or slightly acid when pH of the water is below neutral ( $< 6.5$ ), while more evident biological consequences will develop at  $\text{pH} < 5.5$  (Gensemer and Playle, 1999). Decreasing pH affects the aquatic organisms at all major trophic levels not only by disturbing a range of their physiological functions but also considerably changing the environment they are exposed to, e.g. reduction of phosphorus availability, increased concentrations of toxic metals (Kopáček et al., 2000). The changes in ecosystem alter the life of species and the way they interact with each other. A severe acidification may result in species extinctions or shift to acid-tolerant organisms (Hendrey et al., 1976a, b; Schindler, 1994, 1998; Muniz, 1991; Driscoll, 2001).

Freshwater ecosystems can be acidified either by atmospheric deposition or acid mine drainage.

#### **2.1.1 Atmospheric acidification**

Atmospheric acidification of freshwater bodies can occur from anthropogenic and from natural sources. The most important anthropogenic source of acidifying compounds emitted to the air – sulphur dioxide ( $\text{SO}_2$ ) and nitrogen oxides ( $\text{NO}_x$ ) – is fossil fuel combustion (primarily coal and oil). Smelting of ores and other industrial activities also highly contribute to the pollution (Warfvinge and Bertills; 2000, Driscoll et al., 2001). Natural sources of atmospheric  $\text{SO}_2$  include volcanoes and algae in the oceans (S emissions are mainly in the form of dimethylsulphide). Biomass burning, lightning and microbial emissions from soils are the major natural processes involved in the production of  $\text{NO}_x$  (Bouwman and Van Vuuren, 1999). However, acidification of waters is associated with human activities much more often than with natural processes (Bricker and Rice, 1993; Rice and Herman, 2012).

Released to the atmosphere  $\text{SO}_2$  and  $\text{NO}_x$  are transported hundreds of kilometres and transformed by photo-oxidation to sulfuric and nitric acids (Lampert and Sommer, 2007) increasing the natural acidity of rainwater. Pure rain is slightly acidic ( $\text{pH}$  around 5.6) and, hence, acid rain is defined as rain with  $\text{pH}$  lower than 5.5 (Brönmark and Hansson, 2006). The acidifying pollutants return to the earth's surface not only dissolved in rain or snow, but also in the form of gases or airborne particles (Warfvinge and Bertills, 2000; Driscoll et al., 2001).

The transport of pollutants depends on wind, climate and meteorological conditions (Erisman and Draaijers, 1995).

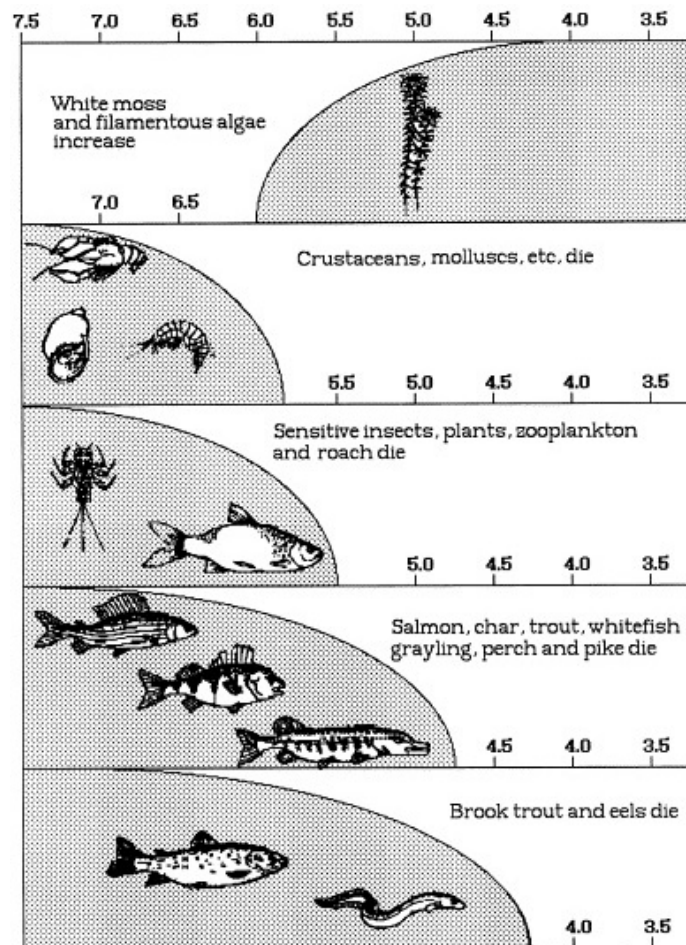
The harmful effects of acid rain on biota were already observed in the middle of the 17th century in England (Bricker and Rice, 1993). Nevertheless, emissions of acidic pollutants to the atmosphere kept increasing steadily, especially from the middle of the 19th century when the Industrial Revolution began, and reached the peak in Europe in the mid-1970s (Evans et al., 2001a). Building higher chimneys has helped to reduce local pollution in the industrialized countries but has transformed acid rain into a global problem (Bricker and Rice, 1993).

The first extensive studies of acid deposition and its effects were already made in the middle of the 19th century by English chemist R.A. Smith who first used the term “acid rain” (reviewed in Bricker and Rice, 1993), while scientific research of freshwater acidification started in 1920s. Experiments had shown that the trout populations were declining because of low pH of the water. Finally, in 1934 the relation between the acidity of freshwater and precipitation was suggested. The interest in the subject was renewed in Scandinavia and North America during 1970s and 80s when the obvious link between surface water acidification due to acid deposition and damage of thousands of streams, rivers and lakes with losses of fish populations was noted. The surprising was the fact that most acid compounds in Scandinavia came from continental Europe and Great Britain. It was the obvious evidence that pollutants can travel far away from their sources (reviewed in Erisman and Draaijers, 1995).

For acidification of inland waters to occur by precipitation three conditions must be met: the atmospheric deposition of acid anions must increase, the adjacent soils must not retain these anions and the aquatic ecosystem must have a low resistance to acidity or low alkalinity (Galloway, 1988). For example, in areas dominated by carbonate rocks no effects of acid rain are recorded due to the buffering capacity of the carbonates and high ecosystem alkalinity (Brönmark and Hansson, 2006; Lampert and Sommer, 2007). On the contrary, in regions where the bedrock weathering of minerals is slow (e.g. granites) or where the soils have been depleted of their original store of base cations (e.g. sandstones), anions together with  $H^+$  are transported into the aquatic ecosystem promoting the acidity of the surface water (Galloway, 1988; Evans et al., 2001b). Thus, the process of acidification occurs not only due to direct acid precipitation on the water surface but also as a result of the mobility of ions within the terrestrial environment, especially in the watershed. Furthermore, poorly buffered oligotrophic lakes are damaged the first (Lampert and Sommer, 2007).



Acidification caused by atmospheric inputs reduces phytoplankton and zooplankton diversity, but not necessary their productivity, whereas macrophytes usually decline both in diversity and abundance. Microbial detritus decomposition is greatly reduced in acid waters as well (Schindler, 1994). Filamentous algae (e.g. *Mougeotia* sp.) together with white moss *Sphagnum* sp. can increase in the shallow lakes, while benthic macroinvertebrates are very sensitive to the effects of increased acidity and rapidly disappear (Muniz, 1994) (Fig.1).



**Figure 1.** The elimination of organisms during acidification. Crustaceans react rapidly to changes in pH, whereas certain fish such as brook trout and eels do not die until acidification is far advanced. The abundance of white moss and filamentous algae indicates the ecological effects of acidification (taken and modified from Håkanson et al., 2000).

The reductions in emissions of the acidifying pollutants, especially  $\text{SO}_2$  concentrations, have decreased the rates of acidic deposition from the atmosphere across the large portions of North America and Europe throughout the 1980s and 1990s (Stoddard et al., 1999). As a

result, the partial recoveries of acidified surface waters were reported (Schindler, 1988; Evans et al., 2001a, b; Vrba et al., 2003; Nedbalová et al., 2006).

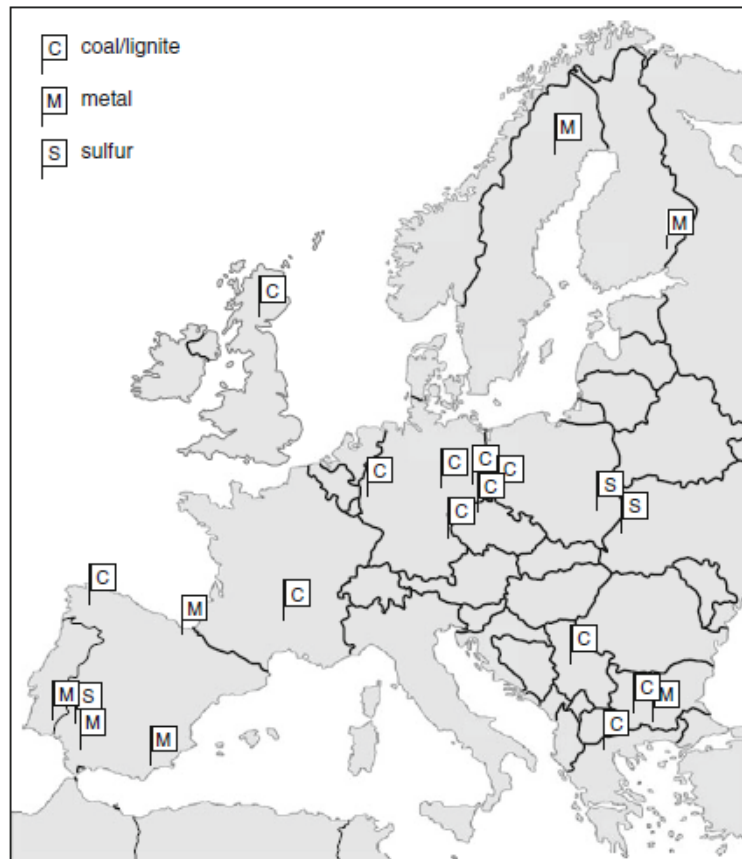
### 2.1.2 Acid mine drainage

Acid mine drainage (AMD) is an environmental impact of mining industry and a common problem of active and abandoned mine sites worldwide. AMD is formed when sulphide minerals are exposed to water and oxygen. Water serves not only as a reactant, but also as a reaction medium and the means of product transport. AMD may form in the mine shafts and adits, in spoil heaps and mineral tailings when the water flows through them or in groundwater of deep mines and later be discharged (Ferguson and Erickson, 1988; Salomons, 1995; Johnson and Hallberg, 2005). In this way, acid mine drainage can easily acidify and pollute freshwater bodies (Boult et al., 1994; Braungardt et al., 2003).

Oxidation of sulphide minerals and the formation of sulfuric acid is a part of natural weathering processes, therefore, the discharge of acid and metals from undisturbed metal ores or coals to aquatic ecosystems poses little threat. However, mining and milling processes accelerate the rate of oxidation reactions as the large masses of sulphide minerals are exposed to the atmosphere. Iron pyrite ( $\text{FeS}_2$ ) is the most abundant sulphide mineral causing AMD (Salomons, 1995). Moreover, many other sulphuric minerals are tend to be in association with it, e.g. chalcopyrite ( $\text{CuFeS}_2$ ), covellite ( $\text{CuS}$ ), galena ( $\text{PbS}$ ), sphalerite ( $\text{ZnS}$ ), etc. (Johnson and Hallberg, 2005). Pyrite oxidation is a complex hydrobiochemical process with the final precipitation of yellow, orange or red ferric oxyhydroxide ( $\text{Fe}(\text{OH})_3$ ) and the sulfate ( $\text{SO}_4^{2-}$ ) as the intermediate in the process (Johnson and Hallberg, 2005; ETIMC, 2010).

Oxygen, water, ferric iron ( $\text{Fe}^{3+}$ ) and iron-oxidizing bacteria (e.g., *Thiobacillus ferrooxidans*) play key roles in these reactions (Ferguson and Erickson, 1988). Other parameters such as pH, temperature and surface area of the exposed metal sulphides also determine the intensity of acid generation. What is more, biological parameters, e.g. biological activation energy, population density of bacteria, rate of bacterial growth, and supply of nutrients highly contribute as well (Salomons, 1995). The oxidation of sulphides proceeds rapidly in warm humid environments, while sulphide mineralogy (each sulphide mineral has a different oxidation rate) and grain size, the presence or absence of acid neutralizing minerals also influence the rate of AMD production (ETIMC, 2010). Water of AMD typically refers to pH 2–4.5, high concentrations of dissolved  $\text{SO}_4^{2-}$ , Fe and other metals (Rice and Herman, 2012).

A common situation in mining sites is a mine lake formation caused by the flooding of the mined out pit or rising ground water into the abandoned pits (Castro and Moore, 2000; Kalin et al., 2001; Beulker et. al., 2003). Pit lakes in former lignite, hard coal, and ore mines are affected by AMD in most of the cases (Geller et al., 2013) (Fig. 2).

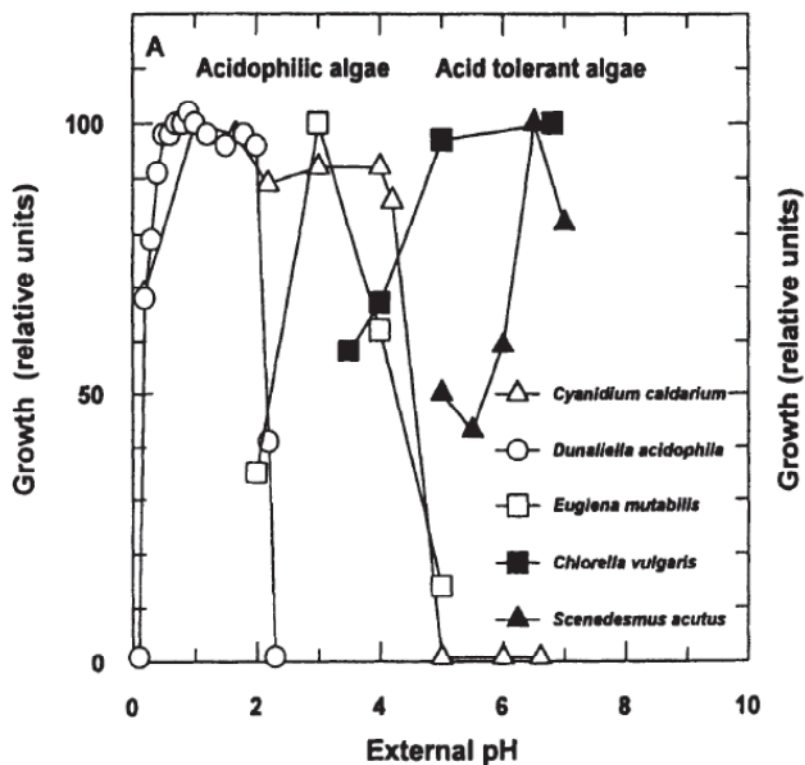


**Figure 2.** Occurrence of pit lakes in Europe. Flags show the mining regions and indicate the kind of mining causing the formation of the pit lakes (taken from Geller et al., 2013).

Acid mine lakes are unique habitats, which are typically narrow and deep without a littoral zone, enclosed by steep rock walls, and lacking a drainage basin (Kalin et al., 2001). The majority of these habitats are extremely acid with  $\text{pH} \sim 3$  and a water chemistry mainly dominated by sulphate and iron (Beulker et. al., 2003). The higher relative depth causes pit lakes to become stratified in many cases, and the water chemistry can vary greatly with depth. The values of the total dissolved solids and electrolytic conductivity tend to be several times higher near the bottom compared with those at the surface (Castro and Moore, 2000; Hrdinka et al., 2013). Furthermore, the acid pit lakes are often oligotrophic due to low concentrations of carbon and phosphorus (Nixdorf et al., 2001; Lessmann et al., 2003).

## 2.2. Influence of low pH on algae composition, abundance and biomass

The acidity of aquatic environments is one of the most important abiotic factors affecting the growth, physiology, and reproduction of aquatic organisms. Microorganisms that can grow below pH 4 but have growth optima in the neutral range are the acid-tolerant. Organisms that grow optimally at pH values smaller than 3 but are unable to thrive at neutral pH are the acidophilic (Fig. 3).



**Figure 3.** The acid tolerance of some microalgae (taken from Gimmer, 2001).

The pH of freshwater ecosystems may fluctuate daily and seasonally and thus many freshwater organisms are adapted to tolerate a relatively wide environmental pH range. Majority of algae grow in pH ranging from 4 to 9 but show optimal growth in circumneutral range. When exposed to pH extremes or rapid pH changes they can become stressed or die (Gimmer, 2001).

When organism is exposed to acid environment, the chemical gradient between cytoplasm and medium increases, resulting in higher  $H^+$  influx into the cell. Most of hydrogen ions must be removed, lest they interrupt metabolic processes (Visviki and Santikul, 2000; Nixdorf et al., 2001). Therefore, the reduction of proton influx and an increase in proton pump efficiency

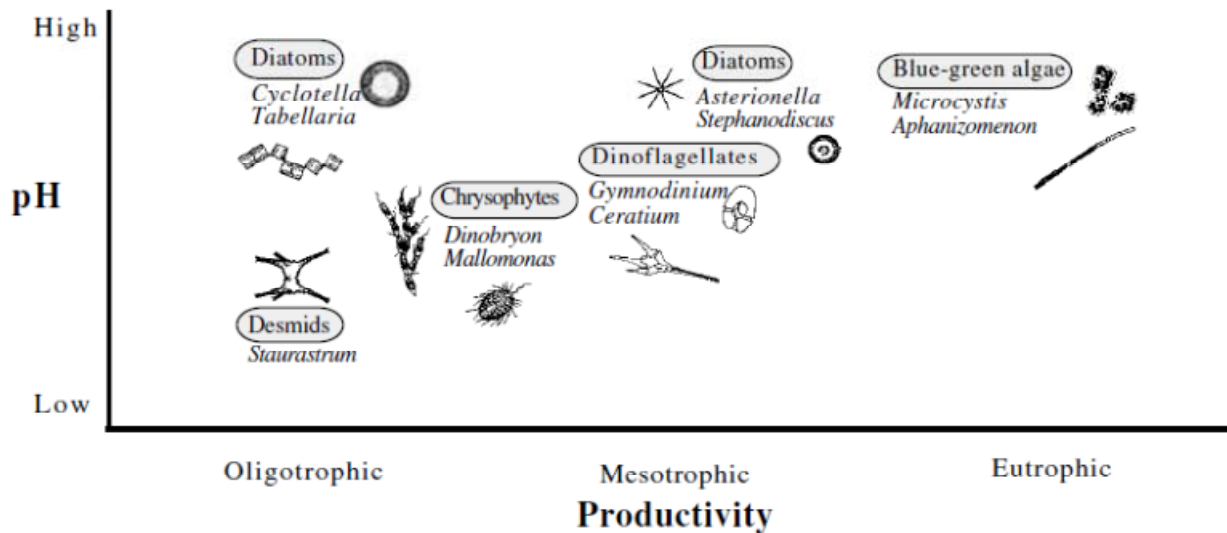
is the necessity for thriving at low pH (Gross, 2000). A cell wall expansion in low pH conditions is an additional problem for algae with cellulosic cell walls to cope (Gross, 2000). According to Coesel (1982), species with lower S/V ratio may be advantaged because of the reduced exposure with the acid environment.

Obvious changes occur in phytoplankton during acidification. As the pH declines, the species richness decreases and the species composition and dominance alter (Hendrey et al., 1976a, b; Brettum, 1996), because different algal groups and species tolerate different pH values. Green algae (Chlorophyta) tolerate a wide range of pH. *Dunaliella acidophila* is the most acidophilic green alga, growing optimally at pH 1 (Visviki and Santikul, 2000). Streptophyte algae *Mougeotia*, *Spirogyra*, *Zygnema* (Zygnematophyceae) occurs the best in slightly acidic waters (Stevenson, 1996). Diatoms (Bacillariophyceae) usually develop in alkaline waters (Kamat, 1965). According to DeNicola (2000) there is a threshold between pH 4.5 and 3.5 in which many species of diatoms are eliminated. On the other hand, the benthic genera *Eunotia*, *Frustulia* and *Pinnularia* are well represented in highly acidic environments. Siver and Hammer (1989) found a significant reduction of scaled chrysophytes below a pH 5–5.5. Euglenophyte *Euglena mutabilis* is well known to grow in extremely acid environments (Aquilera et al., 2006). Dinoflagellates *Gymnodinium* sp. and *Parvodinium umbonatum* were found in extremely acid mining lakes (Lessmann et al., 2000), while *Peridinium willei* was reported to tolerate a wide pH range (Niesel et al. 2007). Coccal cyanobacteria can only be found at pH > 4.5, while filamentous cyanobacteria, e.g. *Oscillatoria*, *Spirulina*, can tolerate much more lower pH values (Steinberg et al., 1998).

The modifications of structural composition of phytoplankton in lakes can already be observed in the pH range from 6 to 5 (Almer et al., 1974; Korneva, 1996). Cyanobacteria, diatoms and chlorophytes diminish (Hendrey et al., 1976a, b) and the algal flora becomes dominated by dinoflagellates, e.g. *Peridinium*, *Gymnodinium* (Almer et al., 1974), cryptomonads, e.g. *Cryptomonas* (Zytkowicz, 1982; Ojala and Jones, 1993), and chrysophytes, e.g. *Dinobryon* (Kwiatkowski et al., 1976). On the contrary, Albertano (1995) states that very acid locations are usually inhabited by rhodophytes, diatoms, chlorophytes, and euglenophytes.

The relationship between phytoplankton biomass and pH is still ambiguous. Some investigations indicate a positive correlation of algal biomass or chlorophyll *a* with pH (Bleiwias et al., 1984; Korneva, 1996) while others – opposite (Havens and DeCosta, 1987). Some authors did not find any relationship between pH and algal biomass (Yan, 1979). According to Schindler (1994) and Woelft et al. (2000), decrease of pH does not necessary

reduce the phytoplankton biomass. A low nutrient availability rather than high acidity limit the development of phytoplankton in many acidified lakes (Fig. 4).



**Figure 4.** The relative dominance of different algal groups in relation to productivity and pH (taken from Brönmark and Hansson, 2006).

Droop (1974) suggested that the intolerance shown by many algae to low pH is due to increased heavy metal concentrations and thus their toxicity. Besch et al. (1972) found that acid tolerant species were tolerant to high metal levels, but that the opposite was not true. So, it was proposed that pH is probably the primary factor affecting species distribution rather than heavy metals (Hargreaves and Whitton, 1976).

The algal floras in acid mining lakes with extremely low pH and high toxic metal concentrations have been examined in Germany (Lessmann et al., 2000; Woelft et al., 2000; Beulker et al., 2003), Austria (Moser and Weisse, 2011), Czech Republic (Hrdinka et al., 2013). In such extreme habitats, the diversity of the phytoplankton tends to be very low with species numbers about 10 from which only few periodically form dominant populations (Beulker et al., 2003). The phytoplankton of such lakes is generally dominated by flagellates belonging to the Chlorophyta (*Chlamydomonas*), Chrysophyceae (*Ochromonas*, *Chromulina*), Cryptophyta (*Cyathomonas*), Euglenophyta (*Lepocinclis*, *Euglena mutabilis*), Bacillariophyceae (*Eunotia*) (Lessmann et al., 2000; Nixdorf et al., 2001; Beulker et al., 2003). Chrysophytes and chlamydomonds are pioneer colonists of acidic waters (Nixdorf et

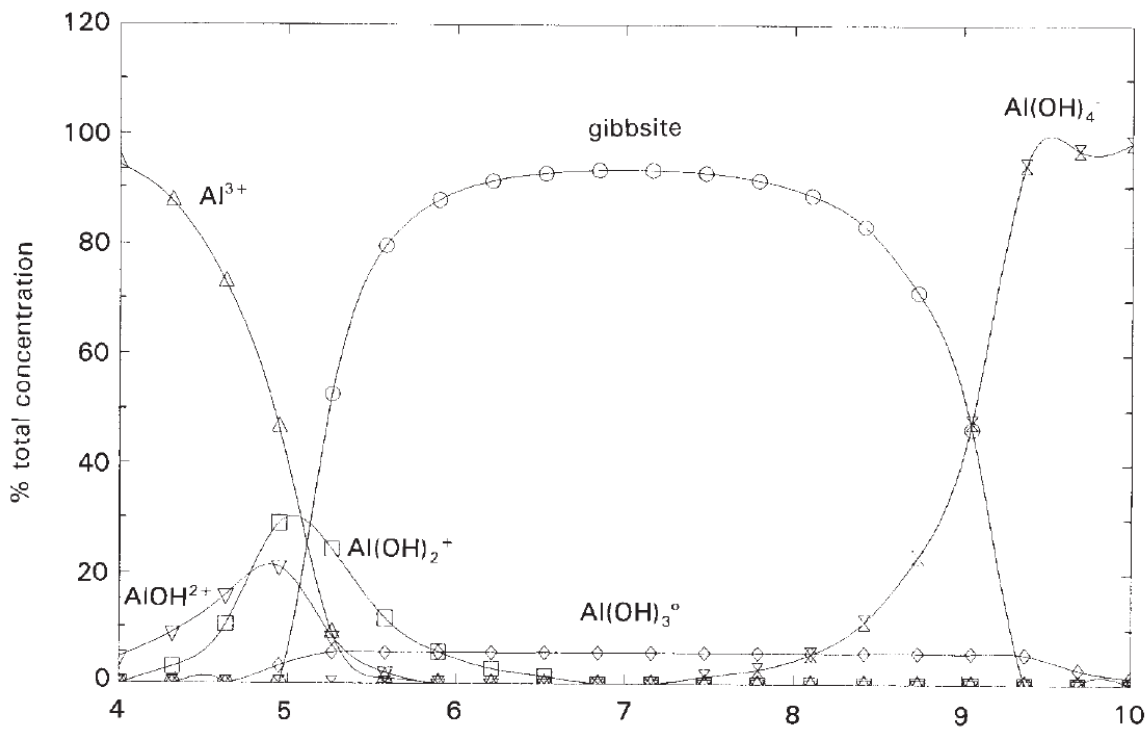
al., 1998). Flagella is one of the adaptations which give them the ability to migrate to nutrient rich places as AMD lakes are often limited by inorganic carbon and phosphorus (Nixdorf et al., 2001; Beulker et al., 2003). The algal mass development in the mining lakes usually occurs in the hypolimnion or near the sediments where production resources tend to accumulate (Nixdorf et al., 2003).

### **2.3. The toxicity of heavy metals and aluminum to microalgae**

Since heavy metals demonstrate toxic effects on living organisms, they are also termed as toxic metals (Kaplan, 2004). Some of them, e.g. Hg, Cd, As are highly toxic and even low concentrations of these compounds are poisonous. Other metals, e.g. Fe, Cu, Mn, Zn are essential micronutrients for algal metabolism, but can become toxic at concentrations higher than the amount required for normal growth (Reed and Gadd, 1990; Kaplan, 2004).

In aquatic environments metals may exist in different chemical forms. They may be present as insoluble inorganic complexes, suspended particles or in association with organic colloids in the sediments. They can also occur as free metal ions or as organic and inorganic complexes in the solution (Reed and Gadd, 1990; Kaplan, 2004). The solubility, mobility, availability and toxicity of heavy metals are determined by their speciation (Kaplan, 2004). Chemical forms of metals in the aquatic environments are controlled by many factors: temperature, salinity, pH, redox potential, organic and particulate content, biological activities, and metal properties. Hydrogen ion activity is probably the most important one. A small shift in pH can cause a sharp increase or decrease in the concentration of dissolved metal (Salomons, 1995). For example, aluminum, iron, copper, zinc, nickel, lead, and cadmium become more soluble when acidified. Thus, pH is an important factor affecting the toxicity of metals to microalgae (Aliotta et al., 1983). Hörnström et al. (1984) argued that the poor phytoplankton communities of acid lakes is not attributable to low pH as such but to an increased solubility of aluminum and its shift to the toxic  $Al^{3+}$  form (Fig. 5). The increased mobilization of aluminum causes precipitation of phosphorus and contributes to the tendency of acidified lakes to become oligotrophic (Kopáček et al., 2000). Moreover, acidified lakes often become more transparent due to the precipitation of humic substances by aluminum (Gensemer and Playle 1999; Lampert and Sommer, 2007).

Heavy metals are non-biodegradable pollutants that can be accumulated by some organisms either directly (e.g. in case of microalgae) or through the food chain (biomagnification). The most common overall toxicity sequence to algae is  $\text{Hg} > \text{Cu} > \text{Cd} > \text{Ag} > \text{Pb} > \text{Zn} > \text{Co} > \text{Mn}$  (Sorrentino, 1979; Sposito, 1986). Toxic effects of heavy metals to microalgae can be caused by various mechanisms (Reed and Gadd, 1990; Kaplan, 2004).



**Figure 5.** Aluminum speciation in varying water pH (taken from Gensemer and Playle, 1999).

Many studies of metal toxicity to freshwater microalgae have been published (Bartlett et al., 1974; Bonaly et al., 1978; Fargašová, 1993; Lukavský et al., 2003). A number of investigations have been done on pH-dependent metal toxicity as well (Aliotta et al., 1983; Peterson, 1984; Hörnström, 1984, 1995; Graham et al., 1996; Olaveson and Nalewajko, 2000; Fathi and Al-Omar, 2006). Different groups of algae exhibit various levels of tolerance to heavy metals. For example, desmids and diatoms are particularly sensitive to Al exposures, whereas chrysophytes along with some Chlorophyceae can tolerate Al concentrations up to  $400 \mu\text{g L}^{-1}$  at pH 5.5 (Hörnström, 1984). Takumara et al. (1989) observed that Cyanobacteria were much more sensitive to Cu, Cd and Zn than Chlorophyceae. Even very closely related species demonstrate different tolerance to toxic metals (Li et al., 2010) and even for the same species different tolerance limits can be reported (Bartlett et al., 1974; Bringmann and Kühn, 1980; Cain and Allen, 1980; Li et al., 2010).

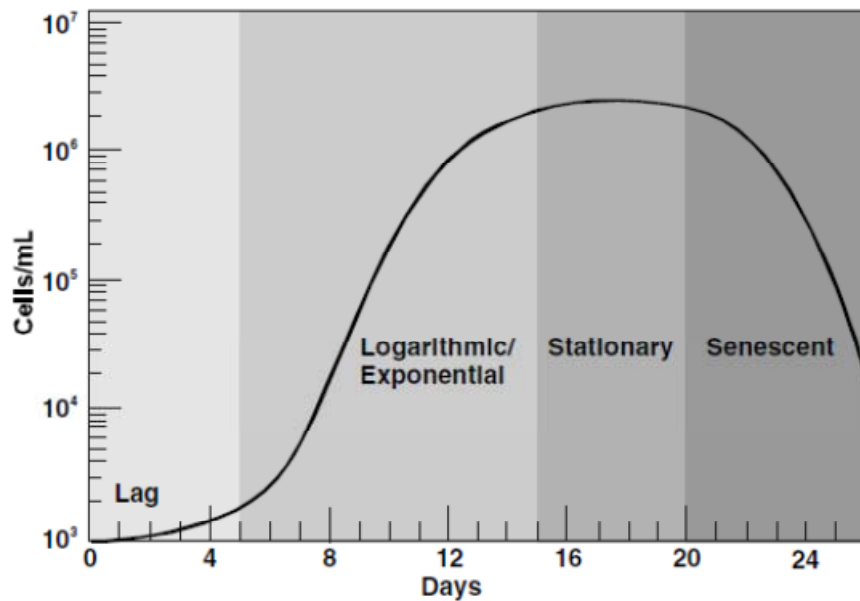


The different cultivation conditions, such as test medium, inoculum pretreatment, incubation conditions and test duration can highly affect the toxicity (Hörnström, 1990; Stauber, 1995) and influence the results. Moreover, resistance or sensitivity to metals is not only a species but a strain specific characteristic (Jin et al., 1996). Species living in more acidic and metals rich waters tend to be more tolerant to high concentrations of toxic metals. For instance, acidophilic diatom *Asterionella ralfsii* vs. circumneutral *A. formosa* (Gensemer, 1991), *Monoraphidium dybowskii* vs. *Monoraphidium griffithii* (Hörnström, 1995), *Euglena mutabilis* vs. *Euglena gracilis* (Olaveson and Nalewajko, 2000).

#### 2.4. Algal bioassay

Algal assay was originally developed to examine the potential of surface water eutrophication (Skulberg, 1964; USEPA, 1971). Later on, the method was adapted for the determination of toxicity to algae and, since then, algal bioassays have become a world-wide tool for the assessment of biostimulation and inhibition effects by a variety of test materials (Stauber, 1995; Albed-Hamid, 1996). Toxicity tests involving microalgae are simple, quick, do not require a lot of space or sophisticated equipment. Furthermore, algal growth bioassays are an efficient and effective way of ranking the relative toxicity of chemicals to a particular organism (Cairns et al., 1994).

Standar protocols for assessing the effects of metals on microalgae have been published by environmental protection agencies (USEPA, 1971; OECD, 1984; ISO, 1987) and a number of investigators, e.g. Blaise et al. (1986), Nyholm and Källqvist (1989), Lukavský (1992, 1995). The principal of the toxicity test using algal growth inhibition bioassay is that inoculum of exponentially growing algal cells (Fig. 6) are cultured for several generations in a defined medium containing a range of different concentrations of the toxicant. The test solutions are incubated for a period of time under controlled light and temperature conditions. Growth inhibition is measured as a reduction in growth or growth rate and compared to the control cultures under the identical conditions (Stauber, 1995; Albed-Hamid, 1996). Algal growth can be estimated by counting cells microscopically in a counting chamber or in an automatic particle counter. Biomass parameters such as cell fluorescence, optical density, turbidity, dry weight or chlorophyll *a* can be used as well. Finally, toxicity is expressed as an EC<sub>50</sub>/IC<sub>50</sub>, i.e. half maximal effective/inhibitory concentration to decrease growth by 50%.



**Figure 6.** Typical growth curve for algal culture in a nutrient-enriched medium (taken from Hoffman et al., 2003).

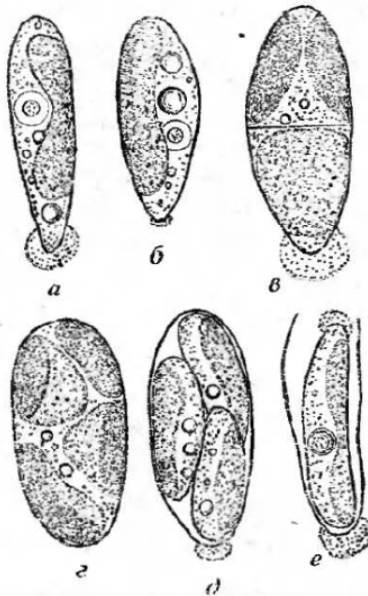
Traditionally toxicity tests have been carried out in standardized algal flasks with 50 ml to 500 ml test volume (USEPA, 1971; OECD, 1984). But recently microplate technique has changed the algal bottles and enabled more economic, accurate and rapidly reproducible algal toxicity assessment using a variety of species and chemical compounds (Blaise et al., 1986). The microplate technique involves the use of microlitre volumes of test solutions in 96-well microplates. The test solutions are prepared and dispense in a predetermined pattern into a microplate together with a defined volume of algal inoculum. Hereby prepared plates are kept under wanted conditions.

### 2.5. Taxonomic position and ecology of genera *Coccomyxa* and *Pseudococcomyxa*

Genera *Coccomyxa* Schmidle, 1901 and *Pseudococcomyxa* Korshikov, 1953 share the same morphological features: cells are ellipsoidal to slightly asymmetrical, rounded, often with one apex more rounded than the other; sometimes the cells are slightly curved; cell wall thin; chloroplast parietal, without pyrenoid; oil droplets may be present in the cytoplasm; reproduction by 2–4 autospores; no motile phases were observed (Komárek and Fott, 1983; Albertano et al., 1990; Ettl and Gärtner, 2014).

In his original description of *Coccomyxa* Schmidle (1901) pointed out a wide mucilaginous sheath around the cell wall, whereas Korshikov (1953) established a new genus *Pseudococcomyxa* with a single species *P. adhaerens* based on the presence of a mucilaginous basal disc at one end of the cell (Fig. 7). However, Mainx (1928) was the first

one to describe the species with a mucilaginous bung at one pole of the cell and named it *Coccomyxa simplex*. Fott (1981) retained the generic name *Pseudococcomyxa* for the algae with a mucilaginous basal disc at one end of the cell, but acknowledged the priority of the specific name *simplex* Mainx against *adhaerens* Korshikov, and established a new binomium *Pseudococcomyxa simplex* (Mainx) Fott, 1981 (reviewed in Albertano et al., 1990, Nemjová, 2009).



**Figure 7.** The original drawing of *Pseudococcomyxa adhaerens* (Korshikov, 1953).

During the 20th century there were about 40 taxa described within the genus *Coccomyxa* based on morphological characters, however, Ettl and Gärtner (2014) distinguish only seven species suitable for such identification as was also done by Komárek and Fott (1983). Originally, Komárek and Fott (1983) have assigned *Coccomyxa* to family Radiococcoideae in Chlorococcales order within the class Chlorophyceae. However, today *Coccomyxa/Pseudococcomyxa* belong to green algal class Trebouxiophyceae (Friedl, 1995) to *Elliptochloris* clade (Pröschold et al., 2011; Gustavs et al., 2013) (Fig. 8). What is more, recent studies of *Coccomyxa/Pseudococcomyxa* revealed that they cannot be differentiated into genera according to this traditional mucilage production criterion (Friedl et al., 2007; Darienko et al., 2015).

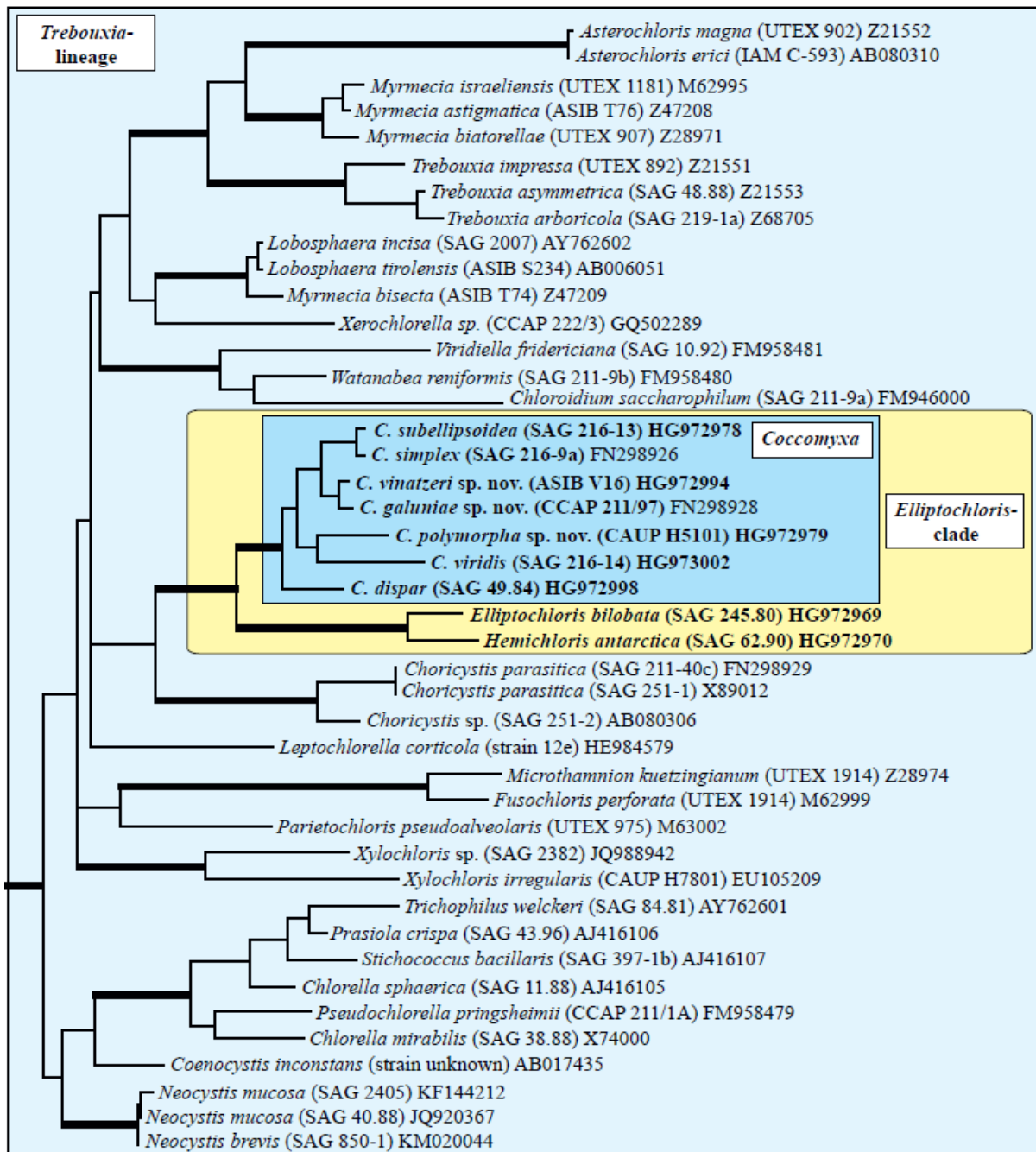
Some studies indicate the monophyly of *Coccomyxa/Pseudococcomyxa* (Nemjová, 2009; Darienko et al., 2015), while other studies confirm that these genera are a polyphyletic group of organisms (Muggia et al., 2010), including species from very different habitats and ecological conditions. *Coccomyxa/Pseudococcomyxa* occur as photobionts in lichens (Zoller and Lutzoni, 2003), as endosymbionts in protozoans (Hoshina and Imamura, 2008) and

*Ginkgo biloba* (Trémouillaux-Guiller et al., 2002; Trémouillaux-Guiller and Huss, 2007), as parasites in mussels (Syasina et al., 2012; Zuykov et al., 2014), or free living in various terrestrial (Lukešová, 2001) and aquatic (Verma et al., 2009; Hrdinka et al., 2013) habitats, including extreme environments (Broady, 1987; Bargagli et al., 1996).

Phylogenetic study of *Coccomyxa* by Zoller and Lutzoni (2003) revealed three main lineages within this genus, corresponding to free-living *Coccomyxa*, individuals isolated from basidiolichens *Omphalina* and *Coccomyxa* isolated from ascolichens belonging to the Peltigerales. The phylogenetic results of Gustavs et al. (2013) also showed three independent lineages of *Coccomyxa* within the *Elliptochloris*-clade of the Trebouxiophyceae. Two of these subclades contained strains of different habitats. Furthermore, based on both morphological features and molecular analyses Friedl et al. (2007) identified *Pseudococcomyxa* into two groups, designated as *Pseudococcomyxa* and *Avernensia*.

No doubts that taxonomy of *Coccomyxa*-like strains still remains ambiguous and the revision of these two genera is necessary and certainly should be based on molecular data and additional data sets (Neustupa and Nemjová, 2008).

As mentioned above, the genera *Coccomyxa*/*Pseudococcomyxa* are characterised by a wide ecological valence. *Pseudococcomyxa simplex* has been found as a contaminant in flasks with chemical solutions prepared for analytical purposes as well as in stock solutions used to prepare media for algal cultivation (Sládečková, 1959), and growing in distilled water in the laboratory (Taylor, 1965). A strain of *Coccomyxa* tolerant to low pH and 100 mM nickel was isolated from acid and metal contaminated Boomerang Lake in Ontario (Verma et al., 2009). Another metal-resistant *Coccomyxa* strain was isolated from extremely acid (pH 1.7–3.1) Tinto River in Spain (Garbayo, 2012). In addition to that, Falagán et al. (2014) isolated two *Pseudococcomyxa* strains from two stratified acid pit lakes located in Spain. Albertano et al. (1990) isolated 16 strains of *Pseudococcomyxa simplex* from very low pH (< 3) soils of Italy, whereas Lukešová (2001) found *Pseudococcomyxa simplex* both in very low and high pH soils of post-mining areas. In addition to that, Mohlová (2008) observed that *Pseudococcomyxa simplex* was able to growth in very acidic coal rich clays.



**Figure 8.** Taxonomic position of *Coccomyxa/Pseudococcomyxa* within the green algal class Trebouxiophyceae (taken and modified from Darienko et al., 2015).

### 3. MATERIAL AND METHODS

#### 3.1. Characteristics of the lakes

##### Plešné Lake

Plešné Lake (48°47' N, 13°52' E, 1090 m a.s.l.) is situated in the Bohemian Forest (Šumava Mountains), Czech Republic. The small lake is of glacial origin with area of 7.5 ha, volume 610 000 m<sup>3</sup>, maximum depth 18 m and theoretical water residence time of 0.8 yr. The lake lies in steep, forested (Norway spruce) geologically sensitive catchment (67 ha) on granitic bedrock (Veselý, 1994; Vrba et al., 2000). Plešné Lake is a dimictic, mesotrophic lake with anoxia in the hypolimnion during both winter and summer stratification periods and a thermocline depth of 4–5 m. The lake has two surface inlets and two known subsurface inlets (Kopáček et al., 2000, 2006). The shore of Plešné Lake is without aquatic vegetation, the only exception being *Carex* and *Isoetes* in shallow water (Pražáková et al., 2006).

In the early 1960s Plešné Lake was acidified by air pollution. Strong acidification progressed until the mid-1980s when pH of the water ranged between 4.4 and 4.7 (Veselý, 1994; Kopáček et al., 1998). Since late 1980s the lake started to recover (Veselý et al., 1998; Majer et al., 2003). However, Plešné Lake still remains strongly acidified with inlet water pH < 4.6, surface water pH ~ 5, depleted carbonate buffering system, the sulphate (SO<sub>4</sub><sup>2-</sup>) as the dominant anion and the increased concentrations of reactive Al (inlet water 613 µg L<sup>-1</sup>, surface water 361 µg L<sup>-1</sup>) (Kopáček et al., 2002; Nedbalová et al., 2006).

Acidification caused the extinction of fish and largely reduced the diversity and biomass of zooplankton in the Bohemian Forest lakes. However, Plešné Lake is unique in high phytoplankton biomass which comprises 80% of the total planktonic biomass. The reason for it is the higher inflow of phosphorus (TP = 12.3 µg L<sup>-1</sup>, SRP = 9.6 µg L<sup>-1</sup>) compared with the other lakes (Vrba et al., 2000; Nedbalová et al., 2006). In addition to that, the toxic effects of Al on the aquatic biota decreased during the chemical reversal of the lake (Vrba et al., 2003).

The most important component of phytoplankton biomass (> 95%) in Plešné Lake is a green coccoid alga, which was tentatively named according to its morphology *Monoraphidium dybowskii*, and filamentous cyanobacteria (*Limnothrix* sp., *Pseudanabaena* sp.) (Vrba et al., 2000, 2003; Nedbalová et al., 2006). Phytoplankton community also consists of acid-tolerant species of dinoflagellates (*Peridinium umbonatum*, *Katodinium planum*, *K. bohemicum*, *Gymnodinium* sp.), green algae (*Arthrodesmus incus*, *Carteria multifilis*, *Chlamydomonas* sp., *Chlorogonium fusiforme*, *Chloromonas angustissima*, *Kolliella corcontica*), cryptomonads (*Cryptomonas erosa*, *C. gracilis*, *C. marssonii*) and

chryomonads (*Bitrichia ollula*, *Dinobryon* spp., *Ochromonas* sp., *Spiniferomonas* sp.). Regarding zooplankton, five species of acid-tolerant rotifers (*Brachionus urceolaris* var. “*sericus*”, *Collotheca pelagica*, *Keratella serrulata*, *Microcodon clavus*, *Synchaeta tremula*) and two species of copepods (*Heterocope saliens*, *Acanthocyclops vernalis*) occur in Plešné Lake (Nedbalová et al., 2006).

### **Hromnice Lake**

Hromnice Lake (49°51'02.5" N, 13°26'39.3" E, 380 m a.s.l.) is located in the western part of the Czech Republic. It was formed as a consequence of the mining of pyritic shales, when the pit (approx. 50 m deep, 260 m x 150 m) was spontaneously flooded with acid rock drainage. This anthropogenic lake is the most acidified lake (pH ~ 2.6) in the Czech Republic with area of 0.974 ha, volume 60980 m<sup>3</sup> and maximal depth 14 m. The lake basin is formed by strongly inclined slopes with bare rock and shale debris. The surroundings are densely forested with a large area of arable land to the north of the pit. Hromnice Lake is a permanently meromictic lake with the chemocline lying at a depth of 3–3.5 m and has no surface inlet or outlet. The shore is without aquatic vegetation, the only exception being protonemata of a moss which was found at the bottom near the shore (Hrdinka et al., 2013).

The extreme chemical composition of lake water is characterized by high concentrations of SO<sub>4</sub><sup>2-</sup> (up to 6410 mg L<sup>-1</sup>), Fe (up to 2100 mg L<sup>-1</sup>), Al (up to 176 mg L<sup>-1</sup>) and increased concentrations of other heavy metals, e.g., Mn, Ni (up to 4.56 mg L<sup>-1</sup>), Cu (up to 1.52 mg L<sup>-1</sup>), Co (0.56 mg L<sup>-1</sup>) and Pb (0.13 mg L<sup>-1</sup>). The concentration of phosphorus (PO<sub>4</sub><sup>3-</sup>) ranges from 0.04 mg L<sup>-1</sup> at the surface and up to 1.6 mg L<sup>-1</sup> in the deeper layers (Hrdinka et al., 2013).

Hromnice Lake is poor in phytoplankton species composition but high in biomass. The values of chlorophyll *a* (20–50 µg L<sup>-1</sup>) are comparable with eutrophic lakes. The most abundant species is a coccal green trebouxioephycean alga *Coccomyxa* sp. occurring throughout the year together with an euglenoid flagellate *Lepocinclis* sp. Other flagellates *Chromulina* sp. and *Chlamydomonas* sp. were found in high abundance only during certain periods of a year. Regarding zooplankton, only two acid-tolerant rotifers *Cephalodella* sp. and *Elosa worallii* were found in this extreme lake (Hrdinka et al., 2013).

### 3.2. Algal strains

The strains used in this work were isolated from Hromnice and Plešné lakes and taken from the Culture Collection of Autotrophic Organisms in Třeboň (CCALA), the Culture Collection of Algae of Charles University in Prague (CAUP), Czech Republic, and the Culture Collection of Algae at Goettingen University (SAG), Germany (Table 1). Strains S1, S2, S3, S4, S5 and S6 were isolated from chemical solutions and received from Jaromír Lukavský (Table 2).

Phytoplankton samples from Hromnice Lake were taken in August 2012, samples from Plešné Lake in summer 2012 and 2014. The isolation of the target strains was done by serial dilution.

**Table 1.** List of strains from culture collections.

Strain number	Culture Collection	Species	Habitat
307	CCALA	<i>Coccomyxa gloeobotrydiformis</i>	soil
375	CCALA	<i>Monoraphidium griffithii</i>	fishpond
425	CCALA	<i>Pseudococcomyxa simplex</i>	hydrogeology bore
427	CCALA	<i>Pseudococcomyxa</i> sp.	pool
428	CCALA	<i>Pseudococcomyxa</i> sp.	thermal spring
905	CCALA	<i>Pseudococcomyxa simplex</i>	soil
912	CCALA	<i>Coccomyxa</i> sp.	soil
H 101	CAUP	<i>Pseudococcomyxa simplex</i>	stock media
216-9a	SAG	<i>Pseudococcomyxa simplex</i>	from culture of <i>Paramecium bursaria</i>

**Table 2.** Isolates from acid lakes and chemical solutions.

Strain	Isolated from	Concentration of chemical
Hromnice	Hromnice Lake	–
Plešné	Plešné Lake	–
S1	Phenol	100 mg L <sup>-1</sup>
S2	Aquaclean (algicide)	unknown
S3	Na <sub>3</sub> AsO <sub>4</sub>	207 mg L <sup>-1</sup>
S4	Al <sub>2</sub> (SO <sub>4</sub> ) <sub>3</sub>	100 mg L <sup>-1</sup>
S5	CsNO <sub>3</sub>	100 mg L <sup>-1</sup>
S6	FeSO <sub>4</sub>	100 mg L <sup>-1</sup>



### 3.3. Molecular methods

The isolation of genomic DNA was done using *Invisorb® Spin Plant Mini Kit* (STRATEC Molecular, Berlin, Germany). For the cell disruption the bead-beating method was applied: 100 µl of lysis buffer together with an equivalent amount of glass beads (425–600 µm in diameter) were added in the bead-beating tubes with the samples and "beaten" for 30 s at 5000 rpm in a bead-based homogenizer *PowerLyzer®* (MoBio, Carlsbad, CA). The samples were immediately placed on ice to minimize the activity of DNAses. 300 µl of lysis buffer was added and the extraction mixture was incubated for 40 min at 65 °C on the thermomixer. For further steps I followed the manufacturer's instructions, with the exception that no RNase A was added. The quality of the extracted genomic DNA and the amplified DNA after the PCR was checked via gel electrophoresis on a 1% agarose gel in 0.5 TBE buffer (140 V 30 min). The DNA isolates were stored at 4 °C.

For the small subunit (SSU) 18S rRNA gene and internal transcribed spacer 2 (ITS-2) amplification, the polymerase chain reaction (PCR) mixture and programs are given in the Tables 3–5. 18S rRNA genes were amplified using eukaryote specific primer 20F (Thüs et al., 2011) and CH1750R specific for green algae (Hallmann et al., 2013) (Fig. 9, Table 6). ITS-2 region was amplified using forward green algae specific primer AL1500af (Helms et al., 2001) and reverse eukaryote specific primer LR3 (Vilgalys and Hester, 1990) (Fig. 9, Table 6). PCR was performed in a thermocycler *TProfessional Basic* (Biometra, Goettingen, Germany). All PCR products were purified using the *MSB® Spin PCRapace* (STRATEC Molecular) kit.

**Table 3.** PCR master mix for amplification of 18S rRNA and ITS-2 concentration.

Chemicals	1 PCR reaction
5 x Buffer	10 µl
Forward primer (Fig. 9, Table 6)	0.5 µl
Reverse primer (Fig. 9, Table 6)	0.5 µl
My Taq	0.25 µl
HPLC H <sub>2</sub> O	37.75 µl
Final volume	49 µl
<b>+ Template</b>	<b>1 µl</b>

\*MgCl<sub>2</sub> was already added in the buffer

**Table 4.** PCR program for the 18S rRNA amplification.

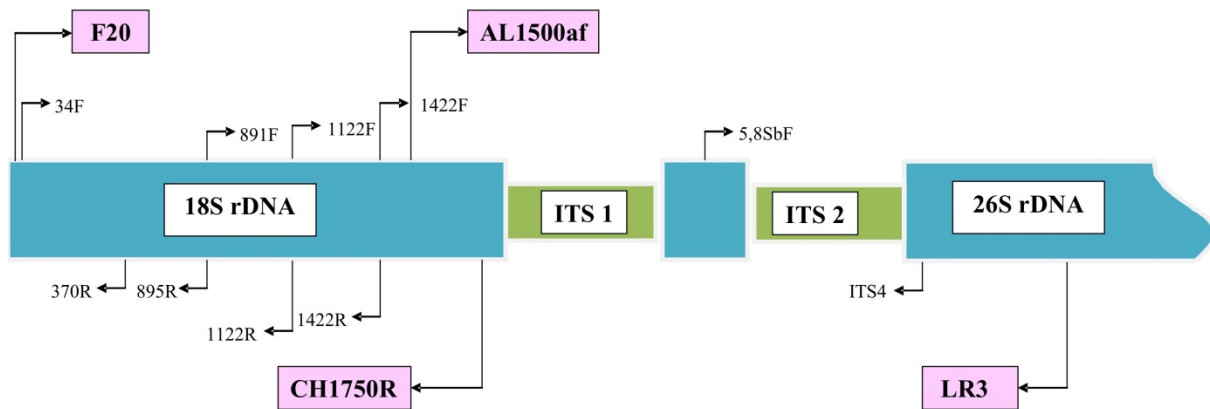
Reaction	Temperature	Time
Initial denaturation	95 °C	5 min
<b>Denaturation</b>	<b>94 °C</b>	<b>1 min</b>
<b>Annealing</b>	<b>54 °C</b>	<b>1 min</b>
<b>Elongation</b>	<b>72 °C</b>	<b>3 min</b>
Final Elongation	72 °C	10 min
Hold	10 °C	

} x 35

**Table 5.** PCR program for the ITS-2 amplification.

Reaction	Temperature	Time
Initial denaturation	95 °C	5 min
<b>Denaturation</b>	<b>95 °C</b>	<b>30 s</b>
<b>Annealing</b>	<b>54 °C</b>	<b>30 s</b>
<b>Elongation</b>	<b>72 °C</b>	<b>25 s</b>
Final Elongation	72 °C	5 min
Hold	10 °C	

} x 35



**Figure 9.** Overview of primers (taken and modified from EPSAG).

**Table 6.** PCR and sequencing primers.

Primer	Direction	Sequence 5' → 3'	Reaction
AL1500af	forward	GCG CGC TAC ACT GAT GC	PCR
LR3	reverse	GGT CCG TGT TTC AAG ACG G	PCR
F20	forward	GTA GTC ATA TGC TTG TCT C	PCR
CH1750R	reverse	CTT CCT CTA RTG GGG AGG	PCR
5.8SbF	forward	CGA TGA AGA ACG CAG CG	sequencing
ITS4	reverse	TCC TCC GCT TAT TGA TAT GC	sequencing
34F	forward	GTC TCA AAG ATT AAG CCA TGC	sequencing
370R	reverse	GGG TT(CT)GAT TCC GGA GAG GGA GCC T	sequencing
891F	forward	GTC AGA GGT GAA ATT CTT GGA	sequencing
895R	reverse	AAA TCC AAG AAT TTC ACC TC	sequencing
1122F	forward	GGC TGA AAC TTA AAG GAA TTG	sequencing
1122R	reverse	CAA TTC CTT TAA GTT TCA GCC	sequencing
1422F	forward	CAG GTC TGT GAT GCC CTT AG	sequencing
1422F	reverse	CTA AGG GCA TCA CAG ACC TG	sequencing

The sequencing reactions were performed using *BigDye® Terminator v3.1 Cycle Sequencing Kit* (Applied Biosystems, Darmstadt, Germany). The sequencing reaction mixture and program are demonstrated in the Tables 7–8. 18S rRNA gene was sequenced with standard sequencing primers 34F, 370R, 891F, 895R, 1122F, 1122R, 1422F, 1422R, for ITS-2 sequences primers 5.8SbF (Mikhailyuk et al., 2008) and ITS4 (White et al., 1990) were used (Fig. 9, Table 6). The DNA purification was done using ethanol and precipitated sequencing products were analyzed by the ABI Prism 3100 (Applied Biosystems) automated sequencer at the Experimental Phycology and Culture Collection of Algae at the University of Goettingen (EPSAG).

**Table 7.** The master mix for sequencing reaction.

Chemicals	Volume
T-Buffer 5x	1 µl
Terminator Ready Reaction Mix	2 µl
HPLC H <sub>2</sub> O	2 µl
Primer (Fig. 9, Tab. 6)	2 µl
Final volume	7 µl
<b>+ Purified PCR product</b>	<b>3 µl</b>

**Table 8.** Cycle sequencing program for 18S rRNA and ITS-2.

<b>Reaction</b>	<b>Temperature</b>	<b>Time</b>
Initial denaturation	96 °C	1 min
<b>Denaturation</b>	<b>96 °C</b>	<b>45 s</b>
<b>Annealing</b>	<b>50 °C</b>	<b>45 s</b>
<b>Elongation</b>	<b>60 °C</b>	<b>3 min</b>
Final Elongation	–	
Hold	4 °C	

} x 30

### 3.4. Phylogenetic analyses

The DNA sequences were assembled and edited in the program SeqAssem (Hepperle, 2004). For the alignment the homological sequences were taken from the GenBank (<http://www.ncbi.nlm.nih.gov/>), which were found using a sequence search algorithm BLAST (Basic Local Alignment Search Tool) (Altschul et al., 1990). All sequences were imported and stored as a preliminary alignment in BioEdit (Hall, 1999).

The 18S rRNA sequences were aligned with MAFFT (Multiple Alignment using Fast Fourier Transform) (Kato et al., 2002) available online ([mafft.cbrc.jp/alignment/server/](http://mafft.cbrc.jp/alignment/server/)). The alignment was obtained in FASTA format and adjusted manually with exclusion of any ambiguous regions.

The best-fit nucleotide substitution model for 18S rRNA sequences was estimated with Modeltest 3.7 (Posada and Crandall, 1998) in conjunction with a program PAUP\* 4.0b10 (Swofford, 2003). Model selection was conducted on the basis of hierarchical likelihood ratio tests (hLRT) and Akaike information criterion (AIC). Three types of phylogenetic analyses were used for 18S rDNA sequences: Bayesian Inference (BI), Maximum Likelihood (ML) and Maximum Parsimony (MP).

Bayesian analysis was conducted in MrBayes 3.2.4 (Huelsenbeck and Ronquist, 2001; Ronquist and Huelsenbeck, 2003). Two parallel Markov chain Monte Carlo (MCMC) runs for one million generations with one cold and three heated chains were conducted using general time reversible model with a proportion of invariable sites and a gamma-shaped distribution of rates across sites (GTR + I +  $\Gamma$ ), with trees sampled every 100 generations. The first 2500 generations were discarded as burn-in. Bayesian posterior probabilities were used to assess clade support.

Maximum likelihood (ML) analysis was performed with PhyML using the GTR model in the program SeaView 4 (Gouy et al., 2010). BioNJ method (an improved version of

Neighbor-Joining algorithm, Gascuel, 1997) was used to compute a full initial tree. One hundred bootstrap replicates were completed to evaluate branch support.

Maximum parsimony (MP) analysis was conducted in software program MEGA 6.0.6 (Tamura et al., 2013) using the Subtree-Pruning-Regrafting (SPR) algorithm (Nei and Kumar, 2000) with search level 1 in which the initial trees were obtained by 10 times randomization of the sequence and 1000 bootstrap replicates.

V4 region, which is the most variable region of the 18S rRNA molecule, was defined based on comparison of 18S rRNA secondary structure derived from *Chlamydomonas reinhardtii* (GenBank: M32703). This fragment was used for the analysis of the evolutionary distances among sequences which were computed as *p*-distances in MEGA 6 with all ambiguous alignment positions removed for each sequence pair.

The ITS-2 region was annotated using the online ITS-2 database (<http://its2.bioapps.biozentrum.uni-wuerzburg.de/>). The secondary structures for all ITS-2 sequences were folded using RNAstructure 5.4 (Reuter and Mathews, 2010). For the sequences where the structure model with minimal free energy did not correspond to the general structure, a model with a higher free energy was taken and manually modified to have the same structure as other sequences in the program 4SALE 1.7 (Seibel et al., 2006, 2008). Subsequently, the same program was used to derive the sequence-structure alignments and compensatory base change (CBC) matrices.

The primary sequences of ITS-2 region were also aligned with ClustalW in order to calculate the base composition and *p*-distances in MEGA 6.

Considering the primary sequence and secondary structure information, phylogenetic relationships between ITS-2 sequences were assessed using Profile Neighbor Joining (PNJ) analysis in ProfDistS 0.9.9 (Friedrich et al., 2005) through the use of an ITS-2 sequence-structure specific GTR model with 100 bootstrap replicates.

All computed trees were visualized using TreeView 1.6 (Page, 1996) or FigTree 1.4.2 (Rambaut, 2012) and modified by CorelDraw Graphics Suite X3. ITS-2 secondary structure illustrations were derived using VARNA (Darty et al., 2009) and 4SALE.

### **3.5. Light and electron microscopy**

Microscopic observations on the strains were done with Olympus BX-51 (Olympus C&S, Japan) and Nikon Eclipse E400 (Nikon Corp., Japan) light microscopes. Microphotographs were taken using an Olympus DP71 digital camera (Olympus C&S, Japan) and processed

using the Quick Photo Camera 2.3 software (Promicra, Czech Republic). The same software was used to measure the size (length and width) of the cells. Around 100 cells of each strain were measured to evaluate the morphology of the strains under identical conditions. All strains were grown in circumneutral Bold's Basal Medium (BBM) (Bischoff & Bold, 1963) for the morphological analysis.

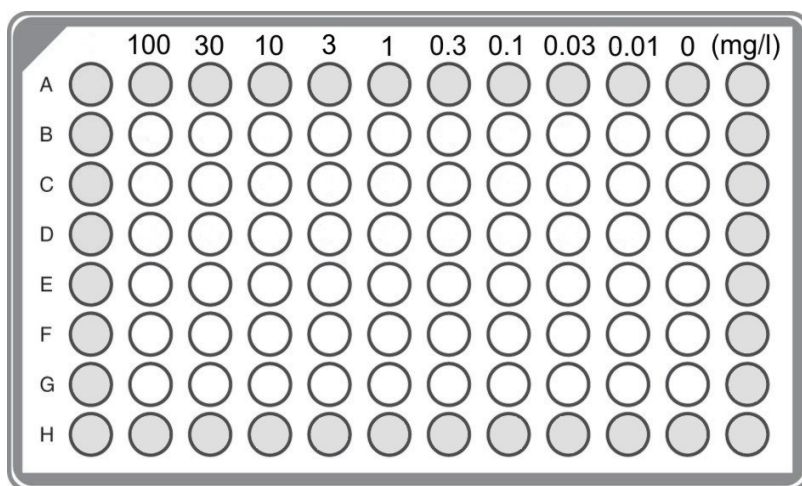
For transmission electron microscope (TEM) the cultures of strains Hromnice, Plešné and CAUP 101 were fixed for 24 h in 2.5% glutaraldehyde in 0.1 M cacodylate buffer (pH 7.2), and post-fixed in 2% OsO<sub>4</sub> in the same buffer. Fixed cells were dehydrated through an ascending ethanol and acetone series and embedded in Araldite and Poly/Bed<sup>®</sup> 812 mixture. Thin sections were cut on a Reichert-Jung Ultracut E ultramicrotome and stained using uranyl acetate and lead citrate. The TEM grids were examined with a JEOL 1011 transmission electron microscope. Photomicrographs were obtained using a Veleta CCD camera equipped with image analysis software (Olympus Soft Imaging Solution GmbH).

### 3.6. Toxicity test

Toxicity of metals to test strains was evaluated by miniaturised growth bioassay according to Lukavský (1992) in the Třeboň department of the Institute of Botany of the Academy of Science of the Czech Republic. Six metals (Al, Cr, Cu, Zn, Mn, Hg) at ten different concentrations (0, 0.01, 0.03, 0.1, 0.3, 1, 3, 10, 30, 100 mg L<sup>-1</sup>) were tested at pH 4.5.

Test solutions were prepared using BBM cultivation medium. The pH was adjusted using hydrochloric acid (HCl), and an appropriate amount of salt was added to get the right metal concentrations. Aluminum was added as AlK(SO<sub>4</sub>)<sub>2</sub>, chromium – K<sub>2</sub>Cr<sub>2</sub>O<sub>7</sub>, copper – CuSO<sub>4</sub>, zinc – ZnSO<sub>4</sub>·7H<sub>2</sub>O, manganese – MnCl<sub>2</sub>·4H<sub>2</sub>O, and mercury – HgCl<sub>2</sub>. Two hundred microliters of the test solution was pipetted to a single well according to a predetermined pattern in a 96-well microplate with a well volume of 250 µl. Six replicates of each metal concentration were used (Fig. 10). The plates were then sterilized under UV light for 1 hour.

For the toxicity tests the strains were cultivated in 100 ml of BBM medium at pH 4.5 in 250 ml Erlenmeyer glass flasks. Acid medium was obtained by the addition of HCl. Cultures were grown at room temperature. For inoculation exponentially growing cells of individual cultures of algae isolated from Hromnice and Plešné lakes and taken from the culture collections (CAUP H 101, SAG 216-9a, CCALA 427, CCALA 375) (Table 1) were used. Twenty microliters of inoculum (~ 20 x 10<sup>6</sup> cells mL<sup>-1</sup>) was added to every well within the test solution. The cell concentration was determined using Bürker's chamber.



**Figure 10.** Layout of a plate used for toxicity tests. Marginal wells were filled with distilled water to reduce evaporation (in grey). Six replicates of each metal concentration were used.

Microplates were closed with lids and covered with additional plastic film underneath the lids to reduce evaporation. The plates were then exposed in a cultivation unit after Lukavský (1992), irradiated with a constant fluorescent light of PAR  $97 \mu\text{mol m}^{-2} \text{s}^{-1}$  at temperature  $\sim 27^\circ\text{C}$ , and aerated with air containing  $\sim 2\%$  of  $\text{CO}_2$  (v/v). The cultures were grown until the stationary phase was achieved. Growth of the cultures was determined by measuring optical density at 750 nm ( $A_{750}$ ) by spectral scanning multimode reader *Varioskan™ Flash* (Thermo Scientific™, Finland).

Any ambiguous measurement values were excluded manually as well as subjected to K-criterion statistics to find the outliers; the K-criterion was performed for  $n=6$  and significance level of 0.05 (Likeš and Laga, 1978). The results of both data exclusion methods were compared and the consensus was found. Average value of  $A_{750}$  was calculated for each metal concentration after each measurement.

The average values of  $A_{750}$  were converted to cell concentration ( $\text{N mL}^{-1}$ ) according to conversion equations (see Supplement, S2). The conversion equation parameters were estimated according to the method described in Kvíderová (2010). The density of the undiluted culture was set to  $A_{750} \sim 1.0$  and then was diluted by factors of 0.5, 0.1, 0.05, 0.03, 0.01, 0.005, 0.003, 0.001, 0.0005, 0.0003 and 0.0001. BBM served as a blank. Cell concentration was counted using Bürker's chamber.

A one-way analysis of variance (ANOVA) followed by Dunnett's post hoc test was performed to test variations of growth between the control and algae exposed to different metal concentrations. A  $p$  value less than 0.05 was considered statistically significant.

Effects of metals on the cell concentration were evaluated from individual growth curves at early stationary phase and expressed as percentage over control, taking control as 100% (Lukavský et al., 1995).

The toxicity was also expressed as percent growth inhibition, calculated as:

$$\% \text{ Inhibition} = \frac{(\text{cell concentration of control}) - (\text{cell concentration of treatment})}{\text{cell concentration of control}} \times 100.$$

The half maximal inhibitory concentration ( $IC_{50}$ ) values were estimated using non-linear regression to fit data to a sigmoidal dose-response curve model (Variable slope model) and compared among data sets.

All data were analyzed and graphed using GraphPad Prism 5.03 (GraphPad Software, San Diego, CA).

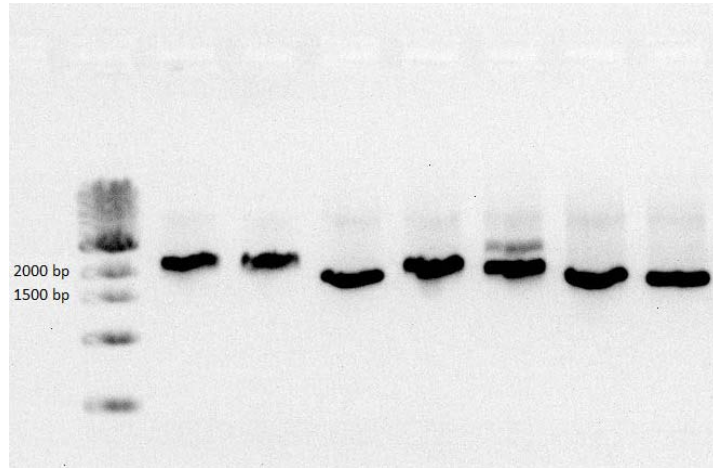


## 4. RESULTS

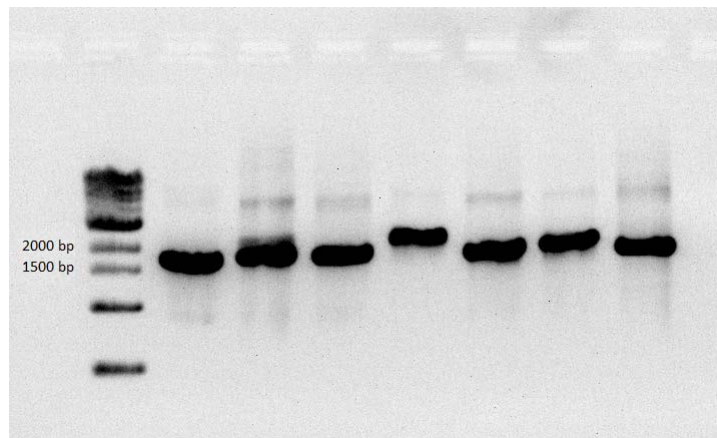
### 4.1. Phylogenetic analyses

#### 4.1.1. PCR amplification of 18S and ITS-2 rDNA

PCR products of the 18S rRNA gene displayed the size ranging from 1500 to 2000 base pairs (Fig. 11), the size of the ITS-2 PCR products was approximately the same (Fig. 12).



**Figure 11.** The size of 18S rDNA PCR products. 1 kb DNA ladder (Lambda DNA, New England Biolabs) was used to estimate the size.



**Figure 12.** The size of ITS-2 rDNA PCR products. 1 kb DNA ladder (Lambda DNA, New England Biolabs) was used to estimate the size.

#### 4.1.2. 18S rDNA phylogenetic analysis

The 18S rDNA data set used in this study contained 43 sequences (most of them assigned to *Coccomyxa*), including *Elliptochloris* as the closest relative of *Coccomyxa* (Friedl et al., 2007; Eliáš et al., 2008), and *Trebouxia* as an outgroup. Strains CCALA 307, CCALA 912 and S1 do not belong to *Coccomyxa/Pseudococcomyxa* complex and were excluded from the analysis (strains 307 and 912 belong to *Neocystis* sp., strain S1 to *Desmodesmus* sp.).

The final length of the alignment was 1708 base pairs with 1475 sites without polymorphism and 188 parsimony informative sites.

The Bayesian inference (Fig. 13) supported *Coccomyxa/Pseudococcomyxa* as a sister group of *Elliptochloris* within the class Trebouxiophyceae (Chlorophyta). *Coccomyxa/Pseudococcomyxa* monophyly was suggested by the tree topology but without statistical support (posterior probability (PP) = 0.52). The Bayesian tree topology recognized four distinct clades (marked as I–IV, Fig. 13) and three of them (i.e., clade II, III and IV) exhibited high statistical support (PP  $\geq$  0.98).

The maximum likelihood phylogenetic analysis revealed the same four clades of *Coccomyxa/Pseudococcomyxa* (Fig. 14), and confirmed *Elliptochloris* as a sister group. As in BI analysis, three of recognized clades (clade II, III and IV) displayed high statistical support (bootstrap value (BS)  $\geq$  97%). No robust support (BS = 56%) for *Coccomyxa/Pseudococcomyxa* monophyly appeared in ML analysis.

The maximum parsimony analysis (Fig. 15) yielded similar tree topology as generated in the previous analysis. *Elliptochloris* appeared as a sister group of *Coccomyxa/Pseudococcomyxa*, and again no statistical support (BS = 43%) was obtained for *Coccomyxa/Pseudococcomyxa* as a monophyletic group. In MP analysis the same three clades (clade II, III and IV) were highly statistically supported (BS  $\geq$  99%), and for the first time a moderate statistical support (BS = 86%) was proposed for the clade I.

#### Composition of the clades

##### Clade I

Clade I is the only of the four recognized *Coccomyxa/Pseudococcomyxa* clades which was not well supported by all the applied methods of analysis (PP = 0.78, BS = 62% in ML). The clade included newly sequenced strains taken from culture collections (Table 1), isolates from Hromnice and Plešné lakes and strain S3 isolated from a laboratory solution of sodium

arsenate ( $\text{Na}_3\text{AsO}_4$ ). Within this clade *Coccomyxa peltigerae-variolosae* SAG 216-6 and *Coccomyxa solorinae-bisporae* SAG 216-10 whose sequences were taken from GenBank formed a distinct supportive subclade in all analyses. However, their sequences were identical and this may have led to such clustering. The same situation was with sequences of *Coccomyxa elongata* SAG 216-36 (KF673385), Hromnice, CAUP H 101, CCALA 427 and S3, which appeared as a discrete subclade with a moderate support in ML and MP analyses (BS=68% and 76%, respectively). However, the sequences were identical and this may have influenced the results. Another noticeable supported subclade which arose in all three analysis included strain CCALA 905 and *Coccomyxa pringsheimii* (AY762603) (PP = 0.97, BS = 80% in ML and BS = 92% in MP).

### **Clade II**

Clade II was composed of two sequences (CCAP 211/97 and SAG 2254) and had a high statistical support in all analyses (PP = 0.98, BS = 97% in ML and BS = 100 % in MP).

### **Clade III**

Clade III included an isolate from acid lake (Boomerang Lake, Ontario, Canada) and various endosymbionts. The clade was supported by PP = 1, BS = 100% in ML and BS = 99% in MP.

### **Clade IV**

Clade IV, containing isolates from the chemical solutions (S2, S4, S5 and S6), was statistically supported by PP = 1 and BS = 99% in ML and MP analyses. In all three analyses two distinct subclades could be noted within clade IV. Subclade composed of strains S2 and S5 was highly supported in all the analyses (PP = 0.98, BS = 91% in ML, BS = 97% in MP), while subclade including strains S4 and S6 was well supported (BS = 81%) only in MP analysis. Nevertheless, sequences of strains S2 and S5 were identical, as well as the sequences of strains S4 and S6, and as mentioned above, this may have had the effect for such branching.

### ***P*-distances of 18S rRNA hypervariable V4 region**

The *p*-distance analysis of V4 region of 18S rRNA gene involved 32 nucleotide sequences. There were a total of 228 positions in the final dataset and overall mean distance among *Coccomyxa/Pseudococcomyxa* strains was 0.0212. The mean distance between clades I and II

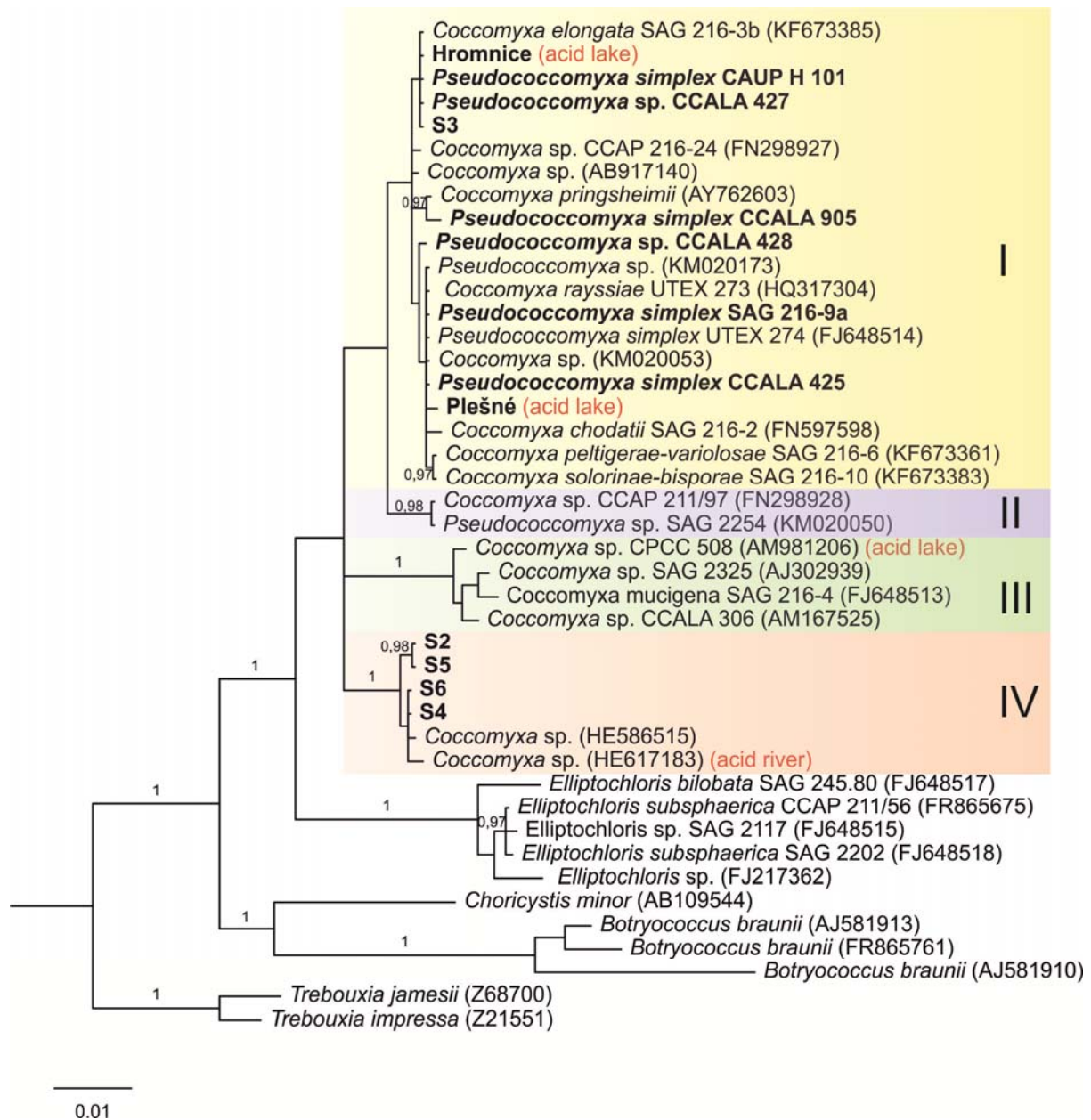
was 0.0164, between I and III 0.0463, and between I and IV 0.0232. The mean distance between clades II and III was 0.0307, II and IV 0.0300, and between III and IV 0.0548. Computed pairwise distances between the strains are shown in the Table 9. Clades II and III were excluded from this analysis as they did not contain any sequences involved in this work. The values of pairwise distances varied from 0 to 0.0359.

### **Clade I**

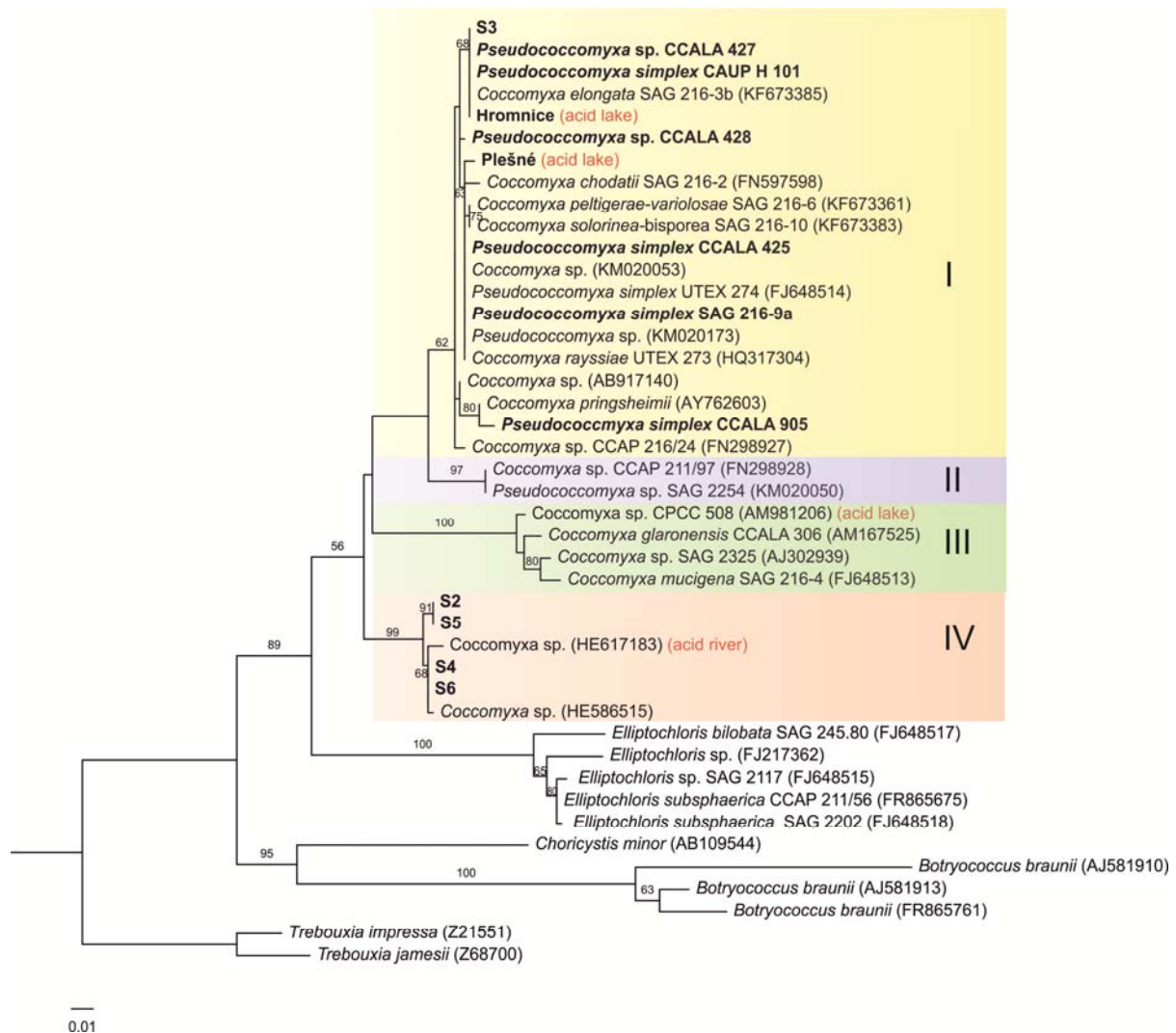
The calculated mean distance within the clade I was 0.0072. As mentioned above, sequences of Hromnice, CAUP H 101, CCALA 427 and S3 were identical to the SAG strain *Coccomyxa elongata* 216-3b, so respectively  $p$ -distance of V4 region was 0. V4 region of strain CCALA 905 differed from them only by 1 nucleotide ( $p = 0.0044$ ). Strain from Plešné Lake and strains CCALA 425 and SAG 216-9a shared the same V4 region which was also compatible with most of the reference strains within the first clade (Table 9). Strain CCALA 428 was different from them only by 1 nucleotide ( $p = 0.0044$ ).

### **Clade IV**

The calculated mean distance within clade IV was 0.0038. The comparison of V4 region of strains S4 and S6 revealed 100% identity and accordingly  $p = 0$  with *Coccomyxa* sp. (GenBank: HE586515), isolated from bark of *Cleistocalyx operculatus*, Indonesia, and was the only identical reference available in NCBI. The closest ally (HE617183) of these strains was isolate from Tinto River which is highly affected by AMD (Huelva, southwester Spain).

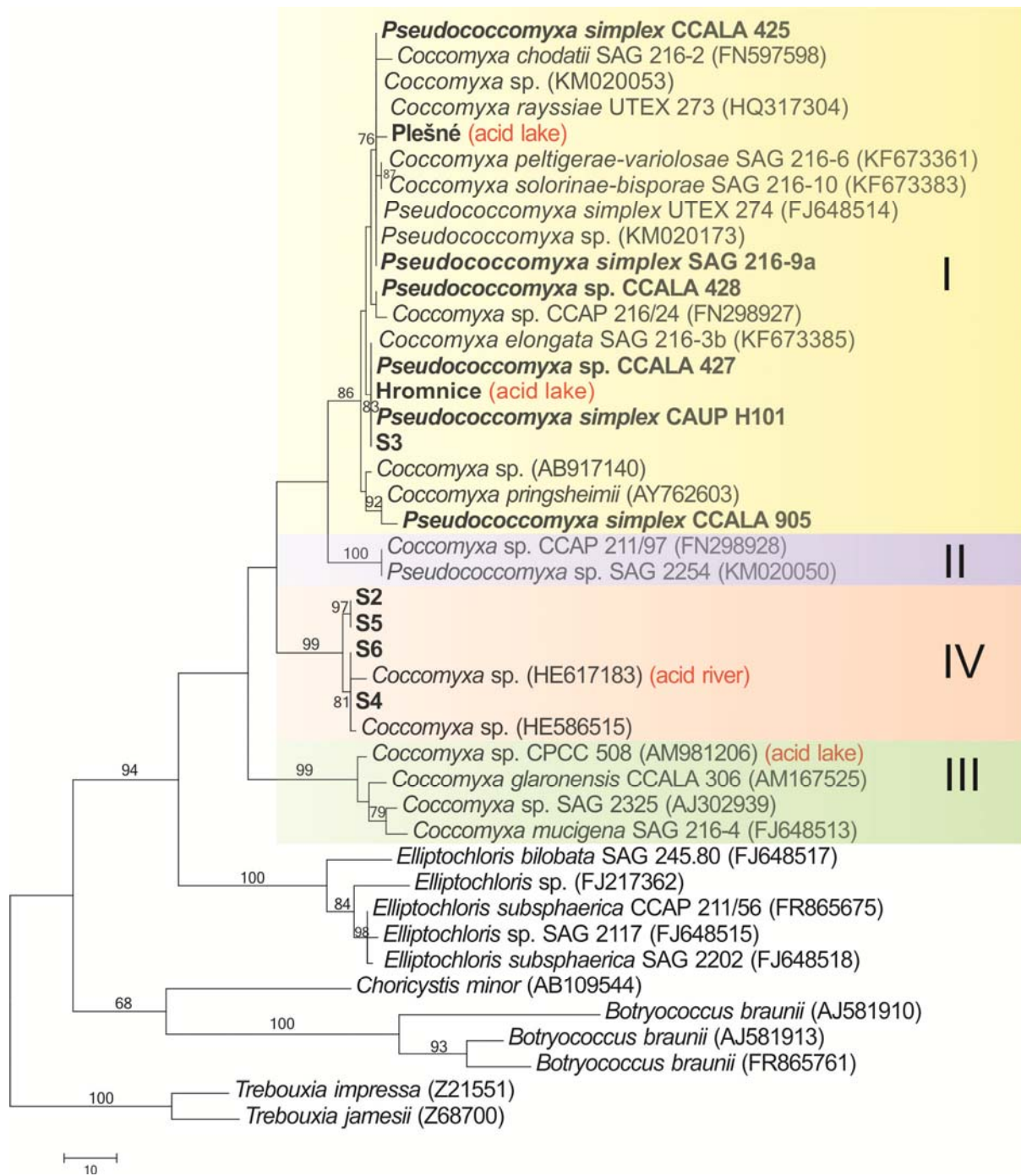


**Figure 13.** 18S rRNA based phylogenetic tree from Bayesian inference using GTR + I +  $\Gamma$  evolutionary model. Numbers near to branches indicate posterior probabilities (BI  $\geq$  0.97). The sequences in bold were obtained in this work, while sequences taken from NCBI are stated with the GenBank accession numbers (in brackets).



**Figure 14.** 18S rRNA based phylogenetic tree from Maximum Likelihood analysis. Bootstrap values greater than 50% are shown near to branches. Log-likelihood of the tree -4935.694806.





**Figure 15.** 18S rRNA based Maximum Parsimony tree. Numbers near to branches represent bootstrap support values > 75.

**Table 9.** *P*-distances of 18S rRNA hypervariable V4 region (length = 228 bp).

	[1]	[2]	[3]	[4]	[5]	[6]	[7]	[8]	[9]	[10]	[11]	[12]	[13]	[14]	[15]	[16]	[17]	[18]	[19]	[20]	[21]	[22]	[23]	[24]	[25]
[1] <i>Coccomyxa elongata</i> SAG 216-3b (KF673385)																									
[2] Hromnice Lake	0.0000																								
[3] CAUP H 101	0.0000	0.0000																							
[4] CCALA 427	0.0000	0.0000	0.0000																						
[5] S3	0.0000	0.0000	0.0000	0.0000																					
[6] CCALA 905	0.0044	0.0044	0.0044	0.0044	0.0044																				
[7] <i>Pseudococcomyxa simplex</i> UTEX 274 (FJ6485149)	0.0088	0.0088	0.0088	0.0088	0.0088	0.0132																			
[8] <i>Pseudococcomyxa</i> sp. (KM020173)	0.0088	0.0088	0.0088	0.0088	0.0088	0.0132	0.0000																		
[9] SAG 216-9a	0.0088	0.0088	0.0088	0.0088	0.0088	0.0132	0.0000	0.0000																	
[10] CCALA 425	0.0088	0.0088	0.0088	0.0088	0.0088	0.0132	0.0000	0.0000	0.0000																
[11] Plešné Lake	0.0088	0.0088	0.0088	0.0088	0.0088	0.0132	0.0000	0.0000	0.0000	0.0000															
[12] CCALA 428	0.0132	0.0132	0.0132	0.0132	0.0132	0.0175	0.0044	0.0044	0.0044	0.0044	0.0044														
[13] <i>Coccomyxa</i> sp. (AB917140)	0.0132	0.0132	0.0132	0.0132	0.0132	0.0132	0.0044	0.0044	0.0044	0.0044	0.0044	0.0088													
[14] <i>Coccomyxa</i> sp. (KM020053)	0.0088	0.0088	0.0088	0.0088	0.0088	0.0132	0.0000	0.0000	0.0000	0.0000	0.0000	0.0044	0.0044												
[15] <i>Coccomyxa</i> sp. CCAP 216-24 (FN298927)	0.0088	0.0088	0.0088	0.0088	0.0088	0.0132	0.0088	0.0088	0.0088	0.0088	0.0088	0.0044	0.0132	0.0088											
[16] <i>Coccomyxa rayssiae</i> (HQ317304)	0.0088	0.0088	0.0088	0.0088	0.0088	0.0132	0.0000	0.0000	0.0000	0.0000	0.0000	0.0044	0.0044	0.0000	0.0088										
[17] <i>Coccomyxa chodatii</i> SAG 216-2 (FN597598)	0.0175	0.0175	0.0175	0.0175	0.0175	0.0219	0.0088	0.0088	0.0088	0.0088	0.0088	0.0132	0.0132	0.0088	0.0175	0.0088									
[18] <i>Coccomyxa peltigerae-variolosae</i> SAG 216-6 (KF673361)	0.0088	0.0088	0.0088	0.0088	0.0088	0.0132	0.0000	0.0000	0.0000	0.0000	0.0000	0.0044	0.0044	0.0000	0.0088	0.0000	0.0088								
[19] <i>Coccomyxa solorinae-bisporae</i> SAG 216-10 (KF673383)	0.0088	0.0088	0.0088	0.0088	0.0088	0.0132	0.0000	0.0000	0.0000	0.0000	0.0000	0.0044	0.0044	0.0000	0.0088	0.0000	0.0088	0.0000							
[20] <i>Coccomyxa pringsheimii</i> (AY762603)	0.0044	0.0044	0.0044	0.0044	0.0044	0.0044	0.0132	0.0132	0.0132	0.0132	0.0132	0.0175	0.0088	0.0132	0.0132	0.0132	0.0219	0.0132	0.0132						
[21] S2	0.0132	0.0132	0.0132	0.0132	0.0132	0.0175	0.0219	0.0219	0.0219	0.0219	0.0219	0.0263	0.0263	0.0219	0.0219	0.0219	0.0307	0.0219	0.0219	0.0175					
[22] S5	0.0132	0.0132	0.0132	0.0132	0.0132	0.0175	0.0219	0.0219	0.0219	0.0219	0.0219	0.0263	0.0263	0.0219	0.0219	0.0219	0.0307	0.0219	0.0219	0.0175	0.0000				
[23] S4	0.0175	0.0175	0.0175	0.0175	0.0175	0.0132	0.0263	0.0263	0.0263	0.0263	0.0263	0.0307	0.0263	0.0263	0.0263	0.0263	0.0351	0.0263	0.0263	0.0175	0.0044	0.0044			
[24] S6	0.0175	0.0175	0.0175	0.0175	0.0175	0.0132	0.0263	0.0263	0.0263	0.0263	0.0263	0.0307	0.0263	0.0263	0.0263	0.0263	0.0351	0.0263	0.0263	0.0175	0.0044	0.0044	0.0000		
[25] <i>Coccomyxa</i> sp. (HE586515)	0.0175	0.0175	0.0175	0.0175	0.0175	0.0132	0.0263	0.0263	0.0263	0.0263	0.0263	0.0307	0.0263	0.0263	0.0263	0.0263	0.0351	0.0263	0.0263	0.0175	0.0044	0.0044	0.0000	0.0000	
[26] <i>Coccomyxa</i> sp. (HE617183)	0.0219	0.0219	0.0219	0.0219	0.0219	0.0175	0.0307	0.0307	0.0307	0.0307	0.0307	0.0351	0.0307	0.0307	0.0307	0.0307	0.0359	0.0307	0.0307	0.0219	0.0088	0.0088	0.0044	0.0044	0.0044



### 4.1.3. Analysis of ITS-2 rDNA

#### 4.1.3.1. ITS-2 rDNA phylogenetic analysis

##### ITS-2 alignment, its length and nucleotide composition

ITS-2 sequences of the studied strains fell within the range of 267 (S4, S6) to 284 (Plešné Lake) nucleotides in length. The base composition of ITS-2 region and the content of G+C are shown in Table 10. The content of base G and C was obviously higher than A and T (U). The content of G+C of ITS-2 region was about 62.5% in average in 12 strains. It varied from 59.2% to 63.7%.

**Table 10.** Nucleotide composition of ITS-2 rDNA region from *Coccomyxa* strains.

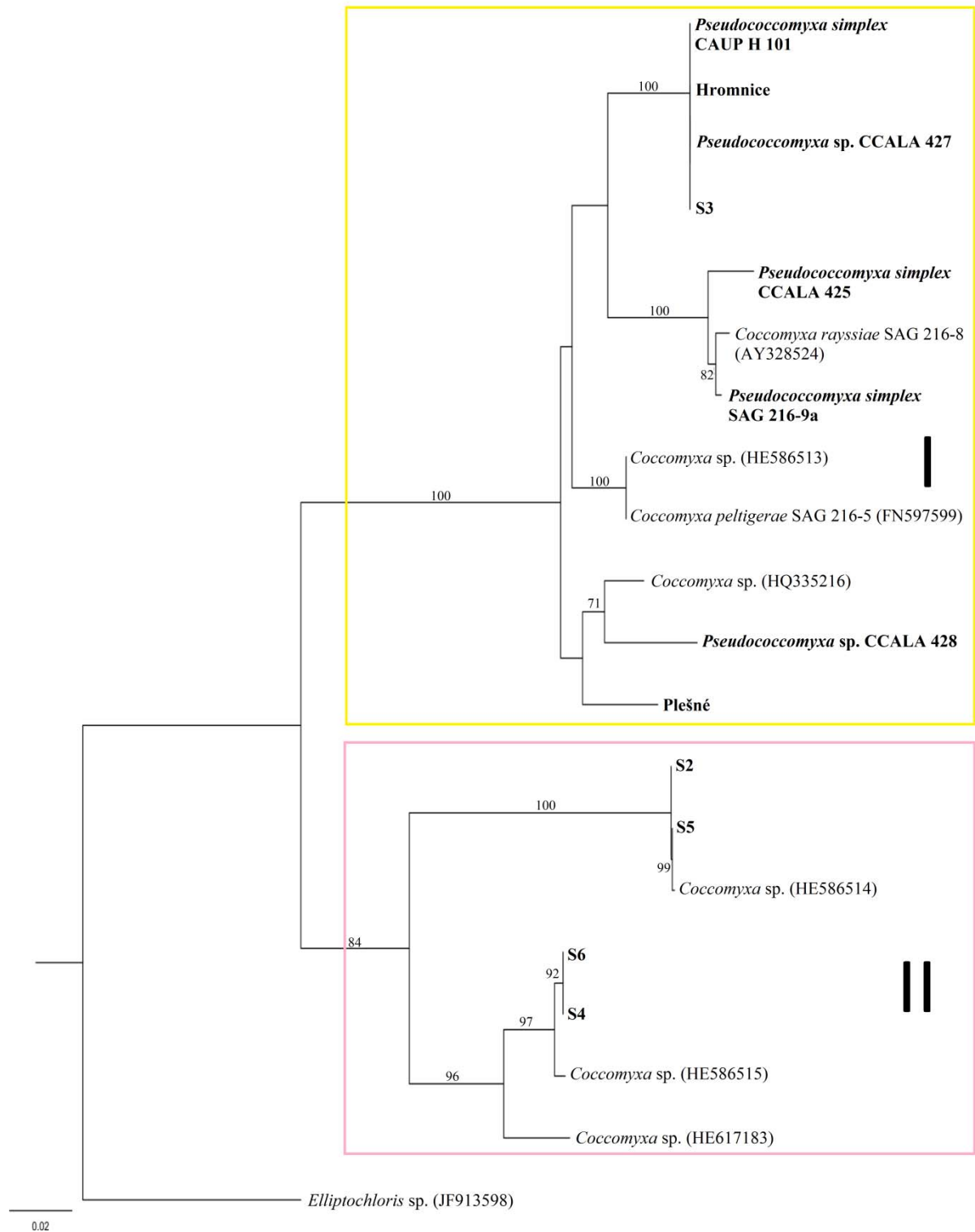
<b>Taxon</b>	<b>T (U) (%)</b>	<b>A (%)</b>	<b>G (%)</b>	<b>C (%)</b>	<b>G+C (%)</b>
Hromnice	18.4	20.2	30.1	31.2	61.3
CAUP H 101	18.4	20.2	30.1	31.2	61.3
CCALA 427	18.4	20.2	30.1	31.2	61.3
S3	18.4	20.2	30.1	31.2	61.3
SAG 216-9a	17.5	20.1	29.5	32.8	62.3
CCALA 425	18.2	19.3	29.4	33.1	62.5
CCALA 428	18.2	18.9	30.0	32.9	62.9
Plešné	19.4	21.5	28.9	30.3	59.2
S2	19.4	16.9	31.7	32.0	63.7
S5	19.4	16.9	31.7	32.0	63.7
S4	16.1	18.4	32.6	33.0	65.5
S6	16.1	18.4	32.6	33.0	65.5
Average	18.2	19.3	30.6	32.0	62.5

##### ITS-2 rDNA profile neighbor joining phylogeny

The analyzed *Coccomyxa/Pseudococcomyxa* strains clustered together into two clades (marked as I-II) (Fig. 16) showing the same pattern as in 18S rDNA analysis (Figs 13–15). The first clade was supported by BS = 100% while the second clade had BS = 84% support. Inside the first clade no significant subclades could be recognized while the second clade was composed of two subclades. The first subclade (BS = 100%) included strains S2 and S5, and strains S4 and S6 fell within the second subclade (BS = 96%).

### ***P*-distance analysis**

The *p*-distance analysis of ITS-2 region involved 19 nucleotide sequences with 293 positions in the final dataset, and computed overall mean distance was 0.1548. Hromnice Lake, CAUP H 101, CCALA 427 and S3 had identical sequences, as well as strain S2 with strain S5, and S4 with S6. No ITS-2 sequence was obtained for strain CCALA 905. The mean distance within the first clade was 0.0660, within the second 0.1168, and between clades 0.2340. Pairwise distances among the strains are shown in Table 11.



**Figure 16.** ITS-2 rDNA-based profile neighbor joining tree (with bootstrap values from 100 replicates) inferred from sequence-structure alignment.

**Table 11.** *P*-distances of ITS-2 rDNA region between new and reference strains of *Coccomyxa*.

	[1]	[2]	[3]	[4]	[5]	[6]	[7]	[8]	[9]	[10]	[11]	[12]	[13]	[14]	[15]	[16]	[17]	[18]
[1] Hromnice Lake																		
[2] CAUP H101	0.0000																	
[3] CCALA 427	0.0000	0.0000																
[4] S3	0.0000	0.0000	0.0000															
[5] <i>Coccomyxa</i> sp. (HE586513)	0.0427	0.0427	0.0427	0.0427														
[6] <i>Coccomyxa peltigerae</i> SAG 216-5 (FN597599)	0.0426	0.0426	0.0426	0.0426	0.0000													
[7] Plešné Lake	0.0786	0.0786	0.0786	0.0786	0.0538	0.0538												
[8] CCALA 428	0.0971	0.0971	0.0971	0.0971	0.0686	0.0683	0.0893											
[9] <i>Coccomyxa</i> sp. (HQ335216)	0.0688	0.0688	0.0688	0.0688	0.0545	0.0543	0.0580	0.0655										
[10] SAG 216-9a	0.0858	0.0858	0.0858	0.0858	0.0821	0.0821	0.0933	0.0933	0.0752									
[11] <i>Coccomyxa rayssiae</i> SAG 2016-8 (AY328524)	0.0933	0.0933	0.0933	0.0933	0.0896	0.0896	0.1007	0.1007	0.0827	0.0075								
[12] CCALA 425	0.0892	0.0892	0.0892	0.0892	0.0855	0.0855	0.0929	0.0929	0.0824	0.0299	0.0336							
[13] S2	0.2622	0.2622	0.2622	0.2622	0.2472	0.2472	0.2362	0.2416	0.2386	0.2557	0.2595	0.2586						
[14] S5	0.2622	0.2622	0.2622	0.2622	0.2472	0.2472	0.2362	0.2416	0.2386	0.2557	0.2595	0.2586	0.0000					
[15] <i>Coccomyxa</i> sp. (HE586514)	0.2649	0.2649	0.2649	0.2649	0.2500	0.2500	0.2390	0.2444	0.2415	0.2586	0.2624	0.2614	0.0000	0.0000				
[16] <i>Coccomyxa</i> sp. (HE586515)	0.2121	0.2121	0.2121	0.2121	0.2045	0.2045	0.2218	0.1992	0.2031	0.2222	0.2299	0.2328	0.1925	0.1925	0.0000			
[17] S4	0.2197	0.2197	0.2197	0.2197	0.2121	0.2121	0.2293	0.2068	0.2069	0.2261	0.2337	0.2366	0.1849	0.1849	0.1842	0.0112		
[18] S6	0.2197	0.2197	0.2197	0.2197	0.2121	0.2121	0.2293	0.2068	0.2069	0.2261	0.2337	0.2366	0.1849	0.1849	0.1842	0.0112	0.000	
[19] <i>Coccomyxa</i> sp. (HE617183)	0.2197	0.2197	0.2197	0.2197	0.2159	0.2159	0.2313	0.2256	0.2069	0.2299	0.2375	0.2375	0.2328	0.1852	0.1852	0.0637	0.0637	0.0637

#### **4.1.3.2. Analysis of ITS-2 rDNA secondary structure and compensatory base changes**

##### **Analysis of loop structures (helices)**

Helix I was composed of 9–12 pairings, while helix II consisted of 11–14 (S2, S5) pairings. Strains Hromnice Lake, CAUP H 101, CCALA 427, S3 (from now on abbreviated as A), CCALA 428 and Plešné Lake had the second helix composed of 11 pairings, whereas strains SAG 216-9a, CCALA 425 and S4 with S6 – 12 pairings. All the strains, except S2 and S5 (abbr. B) had two pyrimidine–pyrimidine mismatches (UxU and UxC) near the basis of the helix II, whereas strain B displayed only one pyrimidine–pyrimidine mismatch (UxU). Meanwhile, strains S4 and S6 (= C) had one pyrimidine–pyrimidine (UxU) and one purine–pyrimidine mismatch (AxC), forming a bulge in the stem. Helix III ranged from 33 to 35 pairings. Helix IV showed a great variability even within the same clade. Its length varied from 11 to 15 pairings.

##### **Comparison between the clades**

Six ITS-2 regions were well conserved in the secondary structure within the first clade: the stem of helix I with 9 base pairs, the spacer between helix I and helix II, helix II including 11 base pairs, spacer between helix II and helix III, helix III (excluding all the bulges in the stem and terminal loop), and the spacer between helix III and helix IV.

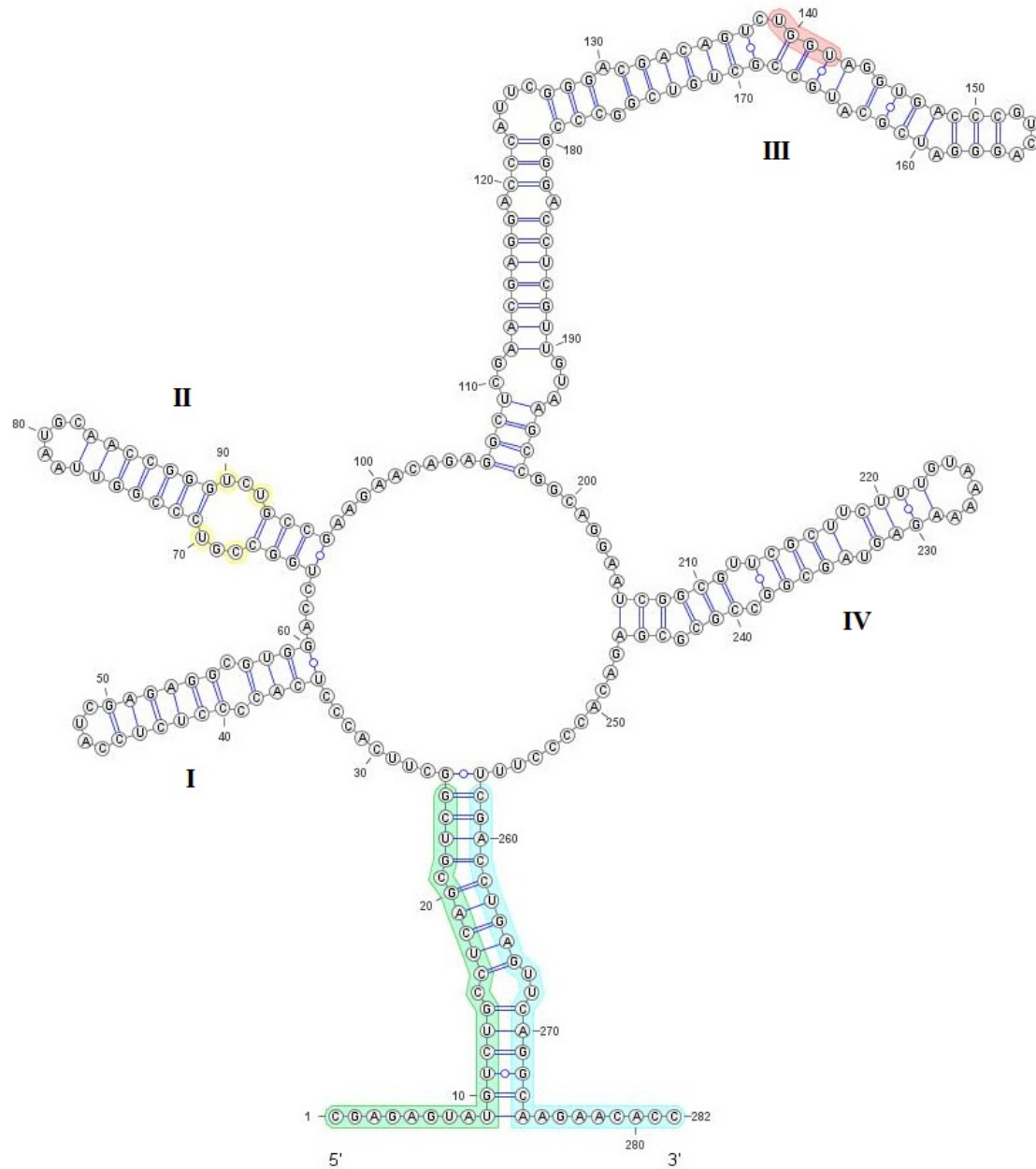
The strains of the second clade had conserved first 5 base pairs of helix I, 12 base pairs of helix II, the spacer between helix II and helix III, and helix III (excluding all the bulges in the stem and terminal loop).

##### **Compensatory base changes among the *Coccomyxa* strains**

Compensatory base changes (CBC) and hemi-CBC (hCBC) (where only one of two bases changes, but still preserves the pairing) are summarized in the Table 12. Helix I and IV were not included into analysis. There were no CBCs between the analyzed strains within the first clade and even no hCBCs were found between the group A and strains SAG 216-9a and CCALA 425. One hCBC was found in helix II of strains CCALA 428 and Plešné Lake when they were compared with the group A, while between strains CCALA 428 and Plešné Lake two hCBCs were observed (Fig. 18).

The analysis of ITS-2 secondary structure of strain SAG 216-9a revealed one hCBC with strain CCALA 425, CCALA 428 and Plešné Lake in helix II. Simultaneously, the comparison

of strain CCALA 425 with strain CCALA 428 and Plešné Lake unveiled one hCBC in both cases.



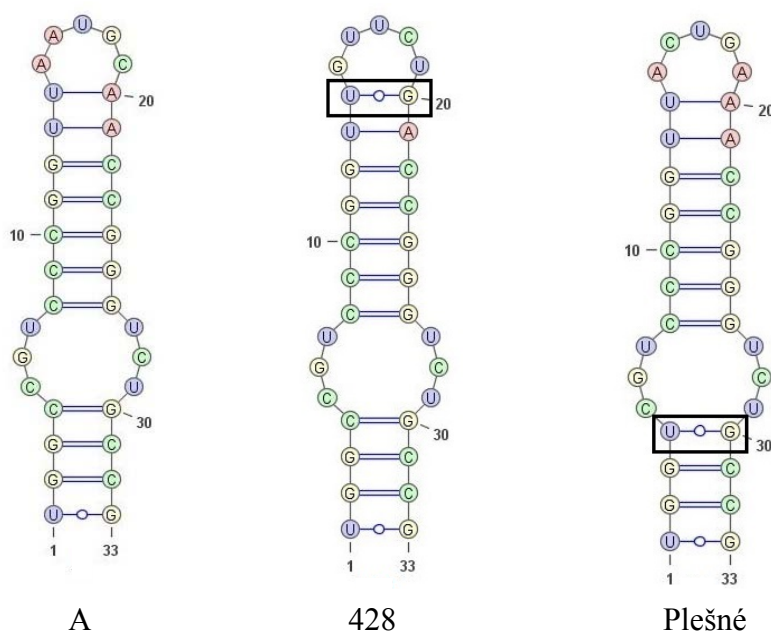
**Figure 17.** Diagram of secondary structure of ITS-2 transcript of strains Hromnice Lake, CAUP H 101, CCALA 427 and S3. The four helices, each with a stem-loop, are labeled I–IV. The model includes the 3' end of the 5.8S rRNA gene and the 5' end of the 26S rRNA gene. Typical ITS-2 motifs, a pyrimidine–pyrimidine mismatch in helix II and UGGU-motif 5' to the apex of helix III are marked.

The CBSs were found only when the strains from the first clade were compared with the strains from the second clade. In all the cases, two CBCs were found in helix III and at least one CBC – in helix II. Two CBCs in helix II were found in strain 216-9a.

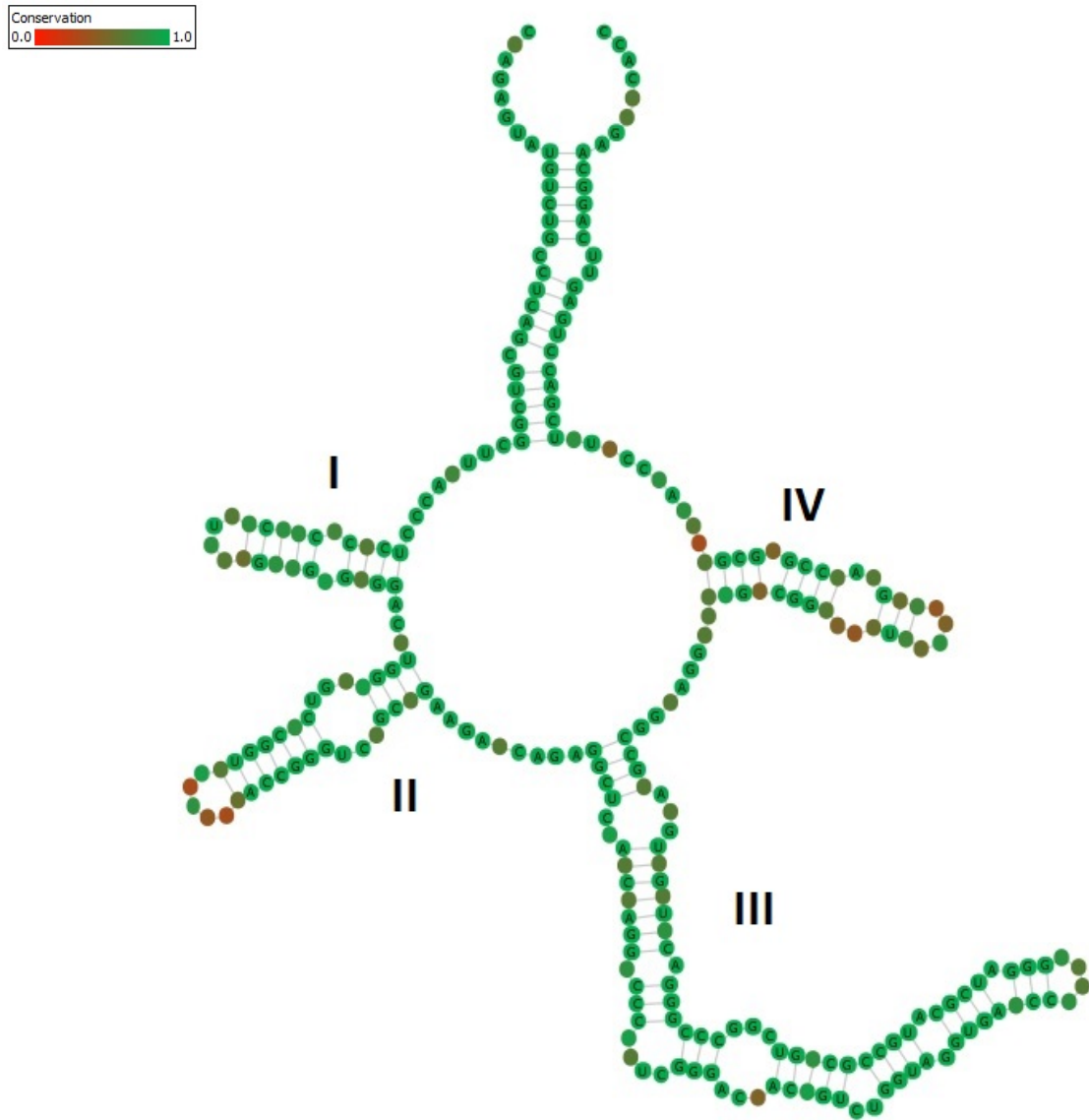
Strain from the groups B and C had no CBCs in the conserved regions but one hCBC (U-G x C-G) was found in helix II.

**Table 12.** Number of CBCs (first number) and hemi-CBCs (second number) in helices I, II and III among studied strains A = Hromnice Lake, CAUP H 101, CCALA 427, S3.

	[1]	[2]	[3]	[4]	[5]	[6]	[7]
[1] A		0+0	0+0	0 + 1	0 + 1	3 + 3	3 + 2
[2] SAG 216-9a	0+0		0 + 1	0 + 1	0 + 1	4 + 3	4 + 2
[3] CCALA 425	0+0	0 + 1		0 + 1	0 + 1	3 + 4	3 + 3
[4] CCALA 428	0 + 1	0 + 1	0 + 1		0 + 2	2 + 3	2 + 3
[5] Plešné	0 + 1	0 + 1	0 + 1	0 + 2		3 + 3	3 + 3
[6] S2,S5	3 + 2	4 + 2	3 + 3	2 + 3	3 + 3		1 + 1
[7] S4,S6	3 + 2	4 + 2	3 + 3	2 + 3	3 + 3	0 + 1	



**Figure 18.** The comparison of helix II between strains from the group A, 428 and Plešné Lake. Hemi-CBCs are marked in black rectangle.



**Figure 19.** 51% consensus ITS-2 secondary structure based on 12 studied strains. The four helices are numerated from I to IV. 100% conserved nucleotides are indicated by green circles. The less conserved nucleotides are indicated by brownish to red circles (see colour scale).



## 4.2. Morphological characteristic of the strains

### 4.2.1. Light microscopy

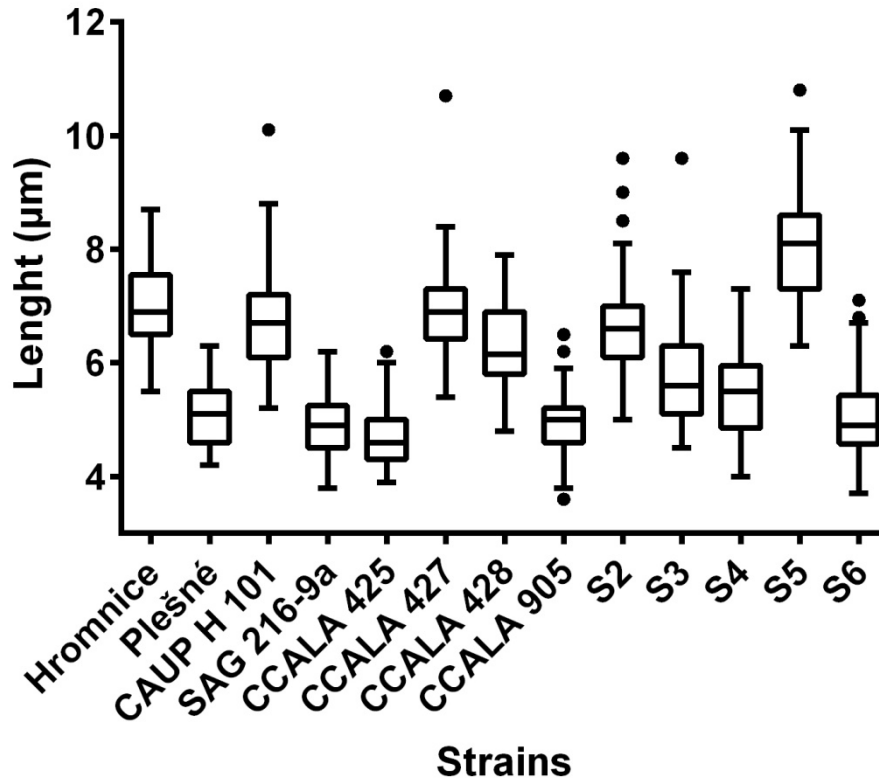
Morphological characteristics of the strains are demonstrated in the Table 13 and Figs. 20–22.

**Table 13.** Cell size of the strains.

Strain	Length ( $\mu\text{m}$ )			Width ( $\mu\text{m}$ )		
	Min	Max	Average $\pm$ SD	Min	Max	Average $\pm$ SD
Hromnice	5.50	8.70	7.00 $\pm$ 0.75	2.00	3.10	2.37 $\pm$ 0.28
Plešné	4.20	6.30	5.10 $\pm$ 0.55	2.00	3.10	2.47 $\pm$ 0.27
101	5.20	10.10	6.74 $\pm$ 0.82	1.80	3.30	2.57 $\pm$ 0.31
216	3.80	6.20	4.90 $\pm$ 0.53	1.80	3.20	2.37 $\pm$ 0.28
425	3.90	6.20	4.70 $\pm$ 0.49	1.80	3.10	2.46 $\pm$ 0.29
427	5.40	10.70	6.91 $\pm$ 0.80	1.70	2.70	2.08 $\pm$ 0.22
428	4.80	7.90	6.32 $\pm$ 0.81	1.70	2.80	2.14 $\pm$ 0.23
905	3.60	6.50	4.94 $\pm$ 0.49	3.00	4.30	4.07 $\pm$ 0.46
S2	5.00	9.60	6.59 $\pm$ 0.78	2.50	4.30	3.43 $\pm$ 0.36
S3	4.50	9.60	5.75 $\pm$ 0.83	2.40	3.60	3.05 $\pm$ 0.30
S4	4.00	7.30	5.44 $\pm$ 0.72	2.00	3.70	2.77 $\pm$ 0.32
S5	6.30	10.80	8.01 $\pm$ 0.94	2.70	5.10	3.41 $\pm$ 0.41
S6	3.70	7.10	5.03 $\pm$ 0.71	2.00	3.70	2.77 $\pm$ 0.32

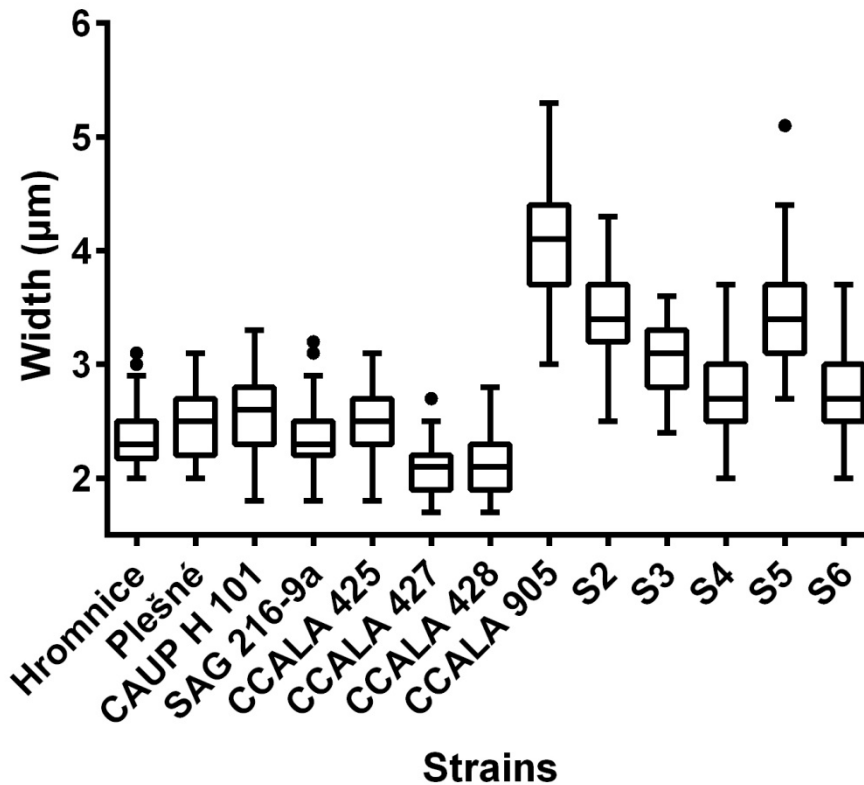
The length of the cells was much more variable between different strains than was the width. The strains with longest cells were S5, Hromnice, CCALA 427 and CAUP H 101, closely followed by S2 and CCALA 428. Plešné strain was approximately the same size as strains 216, 425, 905, S4 and S6, whereas the average length of strain S3 was considerably bigger than Plešné strain but much smaller than Hromnice strain. The cells of the strain CCALA 905 were almost spherical with the width very similar to their length in most of the cases, and thereby this strain had the highest width and the highest variability in it (Table 13, Fig. 21). According to their average cell length, the strains could be categorized into two groups: the ones with the average cell length 6  $\mu\text{m}$  and more (Hromnice, CAUP H 101, CCALA 427, CCALA 428, S2, S5) and the ones with average cell length up to 6  $\mu\text{m}$  (Plešné, SAG 216-9a, CCALA 425, CCALA 905, S3, S4, S6). When the statistical analysis (Kruskal Wallis test as data failed the normality test with Dunn's multiple comparison post test) was performed there was a statistically significant difference ( $p < 0.05$ ) in the cell length between Hromnice and Plešné strains. No statistically significant difference appeared in the measured

cell length between Hromnice strain and the strains (except strain CCALA 428) within the first group. When Plešné strain was compared with the strains within the second group, only the length of strain S3 appeared to be significantly different from the ones of Plešné strain (S3).



**Figure 20.** Cell length of the strains (whiskers and outliers plotted based on Tukey method (Tukey, 1977), the line inside box-plots indicates median).

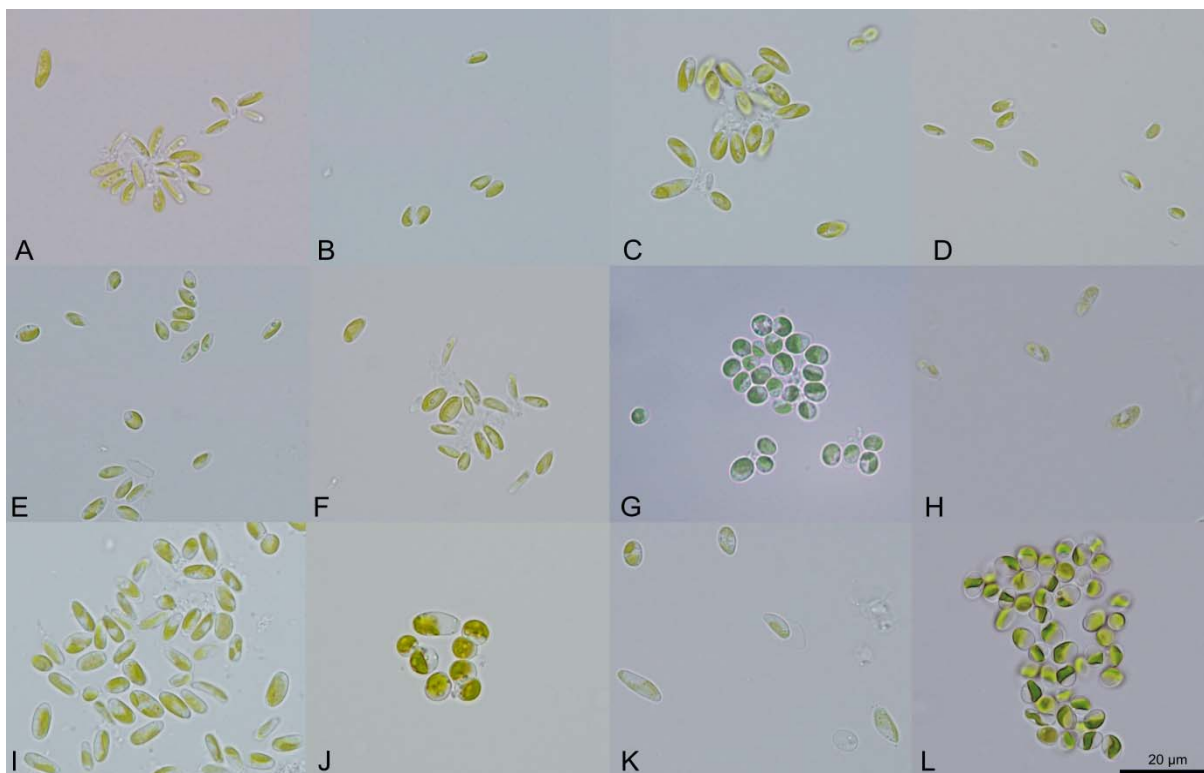
Looking at the box-plot of the width (Fig. 21) one can see a clear division in the width between strains isolated from Hromnice and Plešné lakes together with strains taken from the culture collections and the new isolates from the chemical solutions. It appeared that the strains isolated from the laboratory solutions tend to be much wider (with the exception of strain CCALA 905, discussed above) and also to have a greater variability in width. The statistical analysis confirmed such division in most of the cases (except strain CAUP H 101 vs. S4 and S6) (S3).



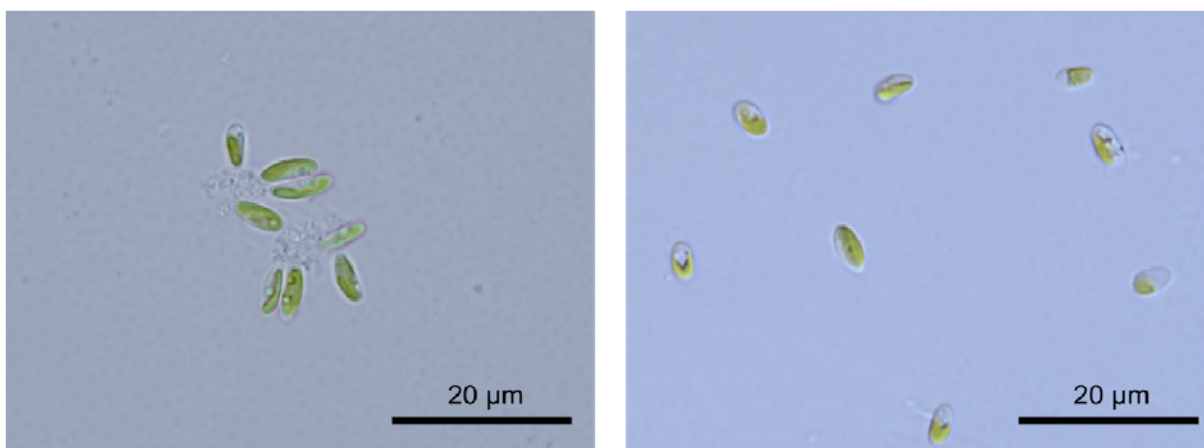
**Figure 21.** Cell width of the strains (whiskers and outliers plotted based on Tukey method (Tukey, 1977), the line inside box-plots indicates median).

Strain isolated from Hromnice Lake tended to be twice as long as narrow it was, while the mature cells of strain from Plešné Lake were rarely found in such appearance (Figs 22–23). It is interesting to notice that the newly isolated strains from the chemical solutions exhibited rather different size and shape characteristic when growing in BBM. For example, the cells of strain S3 were around 1.5  $\mu\text{m}$  longer and less than 1  $\mu\text{m}$  narrower while growing in  $\text{Na}_3\text{AsO}_4$  (Fig. 24) and a mucilaginous basal disc at one end of the cell was observed in such conditions (Fig. 25). The average length and width values (7.30  $\mu\text{m}$  x 2.1  $\mu\text{m}$ ) of this strain in sodium arsenate are very similar to ones got for Hromnice strain.

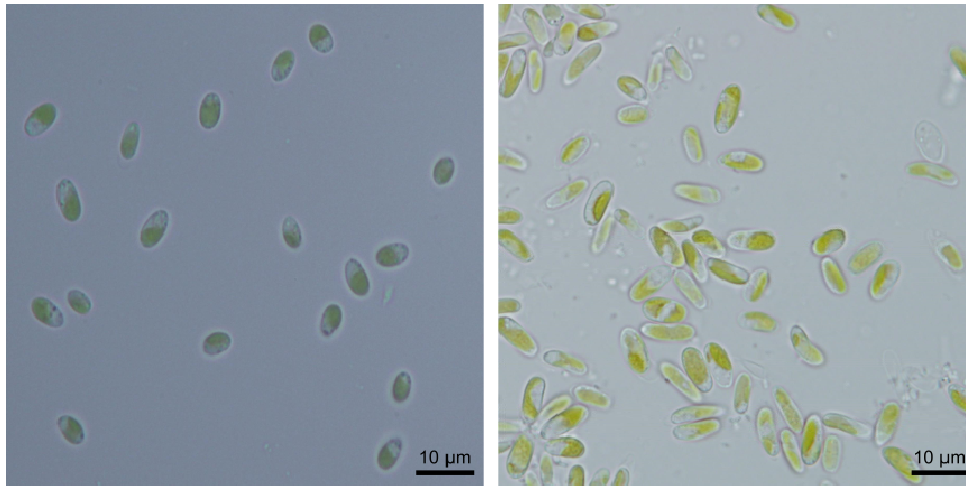
When based on molecular results (chapter 3) two groups of strains were compared (Hromnice, Plešné, CAUP H 101, SAG 216-9a, CCALA 425, CCALA 427, CCALA 428, CCALA 905, S3 vs. S2, S4, S5, S6) there was a statistically significant difference in cell length (Mann Whitney, two-tailed,  $p = 0.0038$ ). Cell width was also significantly different among these two groups of strains (Mann Whitney, two-tailed,  $p < 0.0001$ ).



**Figure 22.** Morphology of *Coccomyxa* strains. A – Hromnice, B – Plešné, C – CAUP H 101, D – SAG 216-9a, E – CCALA 425, F – CCALA 427, G – CCALA 905, H – S2, I – S3, J – S4, K – S5, L – S6. Strains S2–S6 in their original appearance when growing in various chemical solutions (Table 2).



**Figure 23.** Note the difference in the shape of mature cells of Hromnice Lake (on the left) and Plešné Lake (on the right).



**Figure 24.** The difference in strain S3 morphology when growing in BBM (on the left) and from the original solution (on the right).



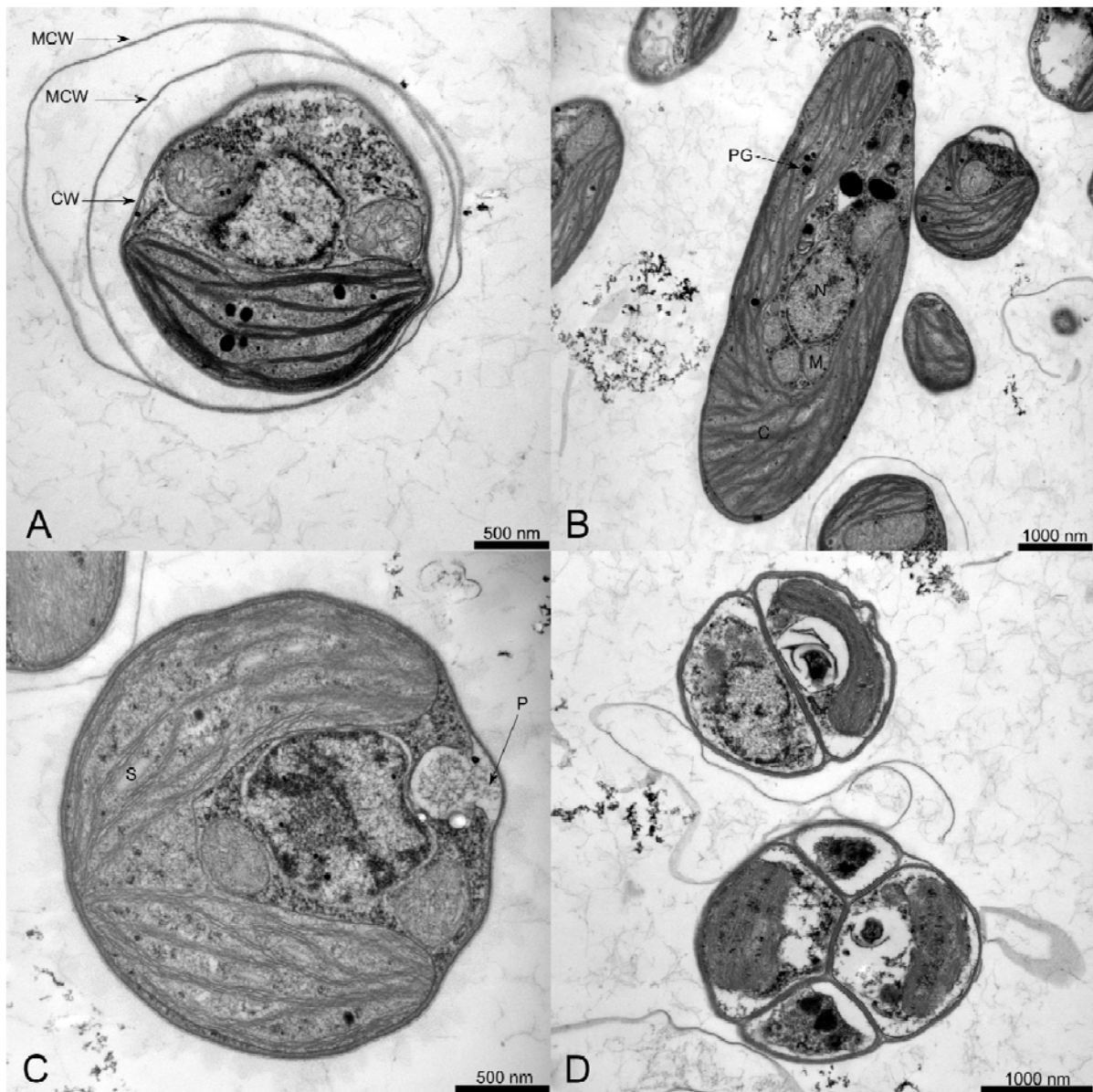
**Figure 25.** Cells of strain S3 isolated from sodium arsenate ( $\text{Na}_3\text{AsO}_4$ ). Arrows are pointing at a mucilaginous basal disc.

#### 4.2.2. Transmission electron microscopy

The ultrastructural investigations of Hromnice, Plešné and CAUP H 101 strains showed the presence of a distinct trilaminar cell wall (CW). One or more mother cell walls (MCW) of membrane-like appearance have been observed around spores or vegetative cells in all the samples (Fig. 26).

The cells contained a single parietal chloroplast with paired thylakoids and starch granules (S) inside the interthylacoidal space. Plastoglobules (lipoprotein particles inside chloroplasts) were also present in all strains. Nucleus, 2–4 mitochondria, endoplasmic reticulum, ribosomes and several vacuoles (V) full of electron dense material are visible in the cytoplasm. Papilla-

like structures (P) have been found in vegetative cells in all strains. The formation of 2 or 4 autospores inside the mother cell was observed as well (Fig. 26).



**Figure 26.** A – mature cell of Hromnice strain enclosed by two mother cell walls (MCW); B – the longitudinal section of Hromnice cell shows chloroplast (C), plastoglobules (PG), nucleus (N), mitochondria (M) and electrodense vacuoles (V) in the cytoplasm; C – Plešné strain, starch grain (S) and papilla-like structure (P) are indicated in the picture; D – Strain CAUP H 101, formation of autospores within the mother cell.

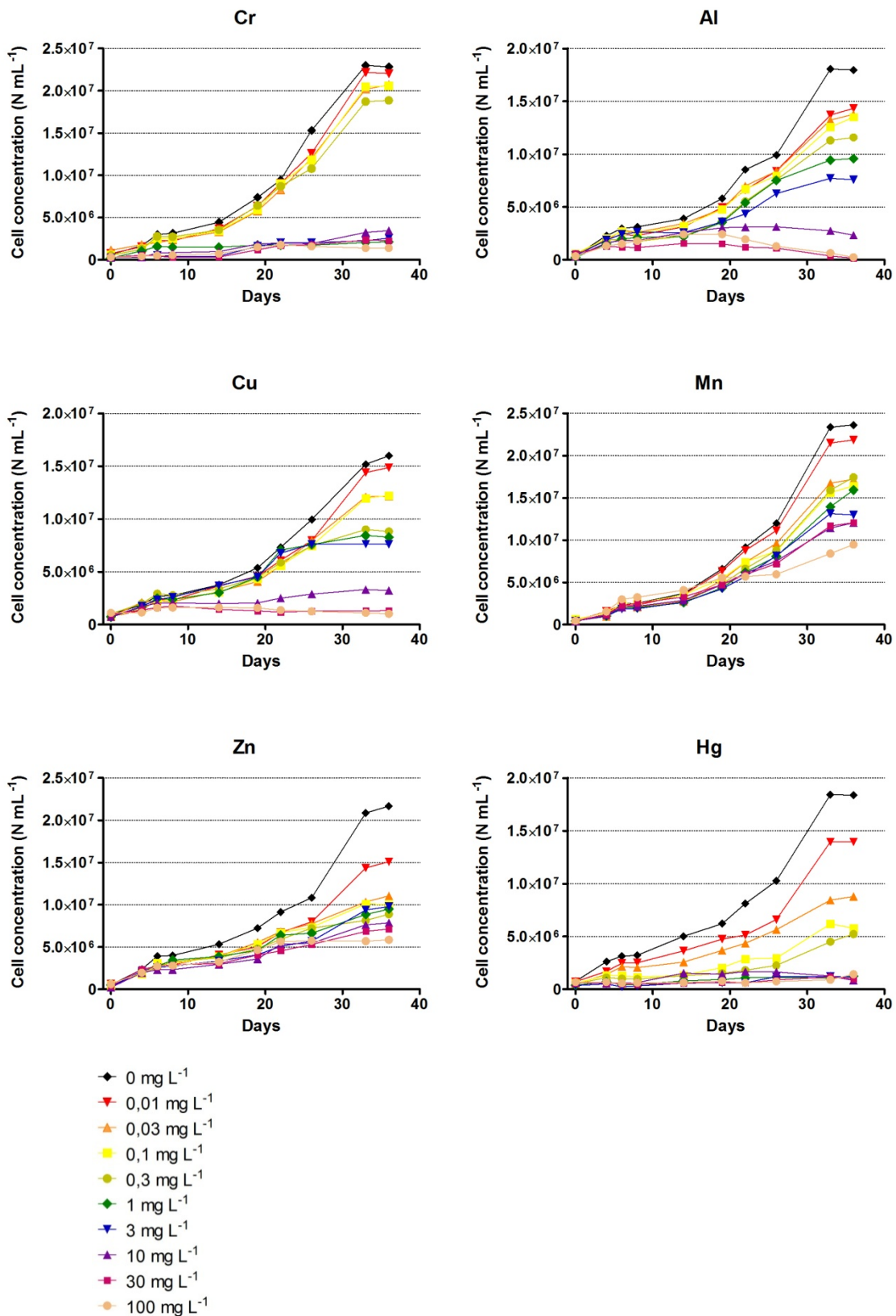
### 4.3. Effects of metals on growth of the strains

#### 4.3.1. Growth curves

The growth curves of selected *Coccomyxa simplex* strains (see chapter 4.1.: Hromnice, Plešné, CAUP H 101, SAG 216-9a and CCALA 427) cultivated in a gradient of Cr, Al, Cu, Mn, Zn and Hg concentrations are demonstrated in the Figs. 27–32. The stationary phases were reached at about 33<sup>rd</sup> day of the cultivation and lasted till ca. 36<sup>th</sup> day of the experiment. Strain CCALA 375 (*Monoraphidium griffithii*) used as reference strain reached a maximum cell concentration on the 22<sup>nd</sup> day which gradually decreased afterwards. The bioassay results showed differences in algal growth between control (in the absence of added metals) and treated ones. There was no statistically significant difference ( $p > 0.05$ ) in the growth of control in different plates, indicating that the growth of control of various strains was rather uniform in different treatments. The growth inhibition progressed with increasing metal concentrations in most of the cases and obvious difference between “low” (0–3 mg L<sup>-1</sup>) and “high” (10–100 mg L<sup>-1</sup>) concentrations can be noted.

#### **Hromnice strain**

The growth curves of Hromnice strain are demonstrated in the Fig. 27. Dunnett’s test showed a statistically significant difference ( $p < 0.05$ ) in the cell concentration of control and 0.3 mg L<sup>-1</sup> of Cr, while the growth of microalgae stopped at 1 mg L<sup>-1</sup>, clearly dividing tested Cr concentrations into non-toxic, toxic (0.3 mg L<sup>-1</sup>) and highly toxic (1–100 mg L<sup>-1</sup>) for the strain. In the case of Al, a significant growth reduction appeared at 1 mg L<sup>-1</sup> of the metal and any notable growth at 10 mg L<sup>-1</sup> of Al was observed. The strain exposed to different Cu concentrations did not show any growth at 10 mg L<sup>-1</sup> as well, and surprisingly, Dunnett’s test demonstrated no significant difference in the cell concentration of control and 3 mg L<sup>-1</sup> of Cu, indicating tested Cu concentrations as non-toxic (0–3 mg L<sup>-1</sup>) and highly toxic (10–100 mg L<sup>-1</sup>) for the strain. When the cell concentration of control was compared with 0.3 mg L<sup>-1</sup> of Mn, the statistically significant difference was got, but a slight growth of microalgae was seen even at 100 mg L<sup>-1</sup> of Mn. It is interesting to notice that the reduction of growth by Zn was already notable at 0.01 mg L<sup>-1</sup> and even so, a modest growth at 100 mg L<sup>-1</sup> of Zn was recorded. In the case of Hg, the growth of control and algae exposed to 0.01 mg L<sup>-1</sup> did not differ significantly, while other increasing concentrations caused a gradual decline of cell concentration with any visible growth at 1 mg L<sup>-1</sup>.



**Figure 27.** Growth curves of Hromnice strain when exposed to different concentrations of metals. Error in each point ranges from 1 to 34% in relative standard deviation (average 10–13% for individual metals).

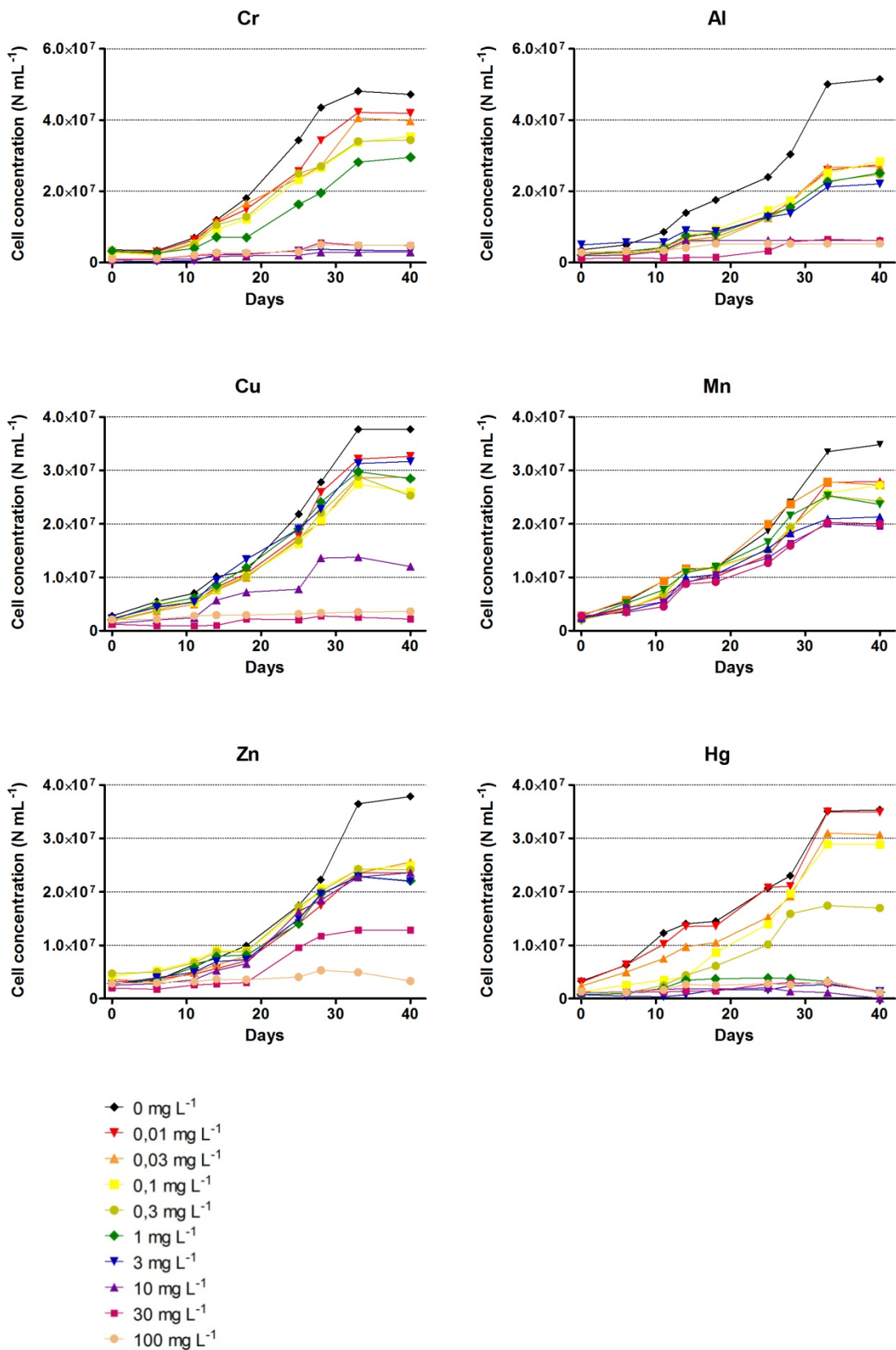


### **Plešné strain**

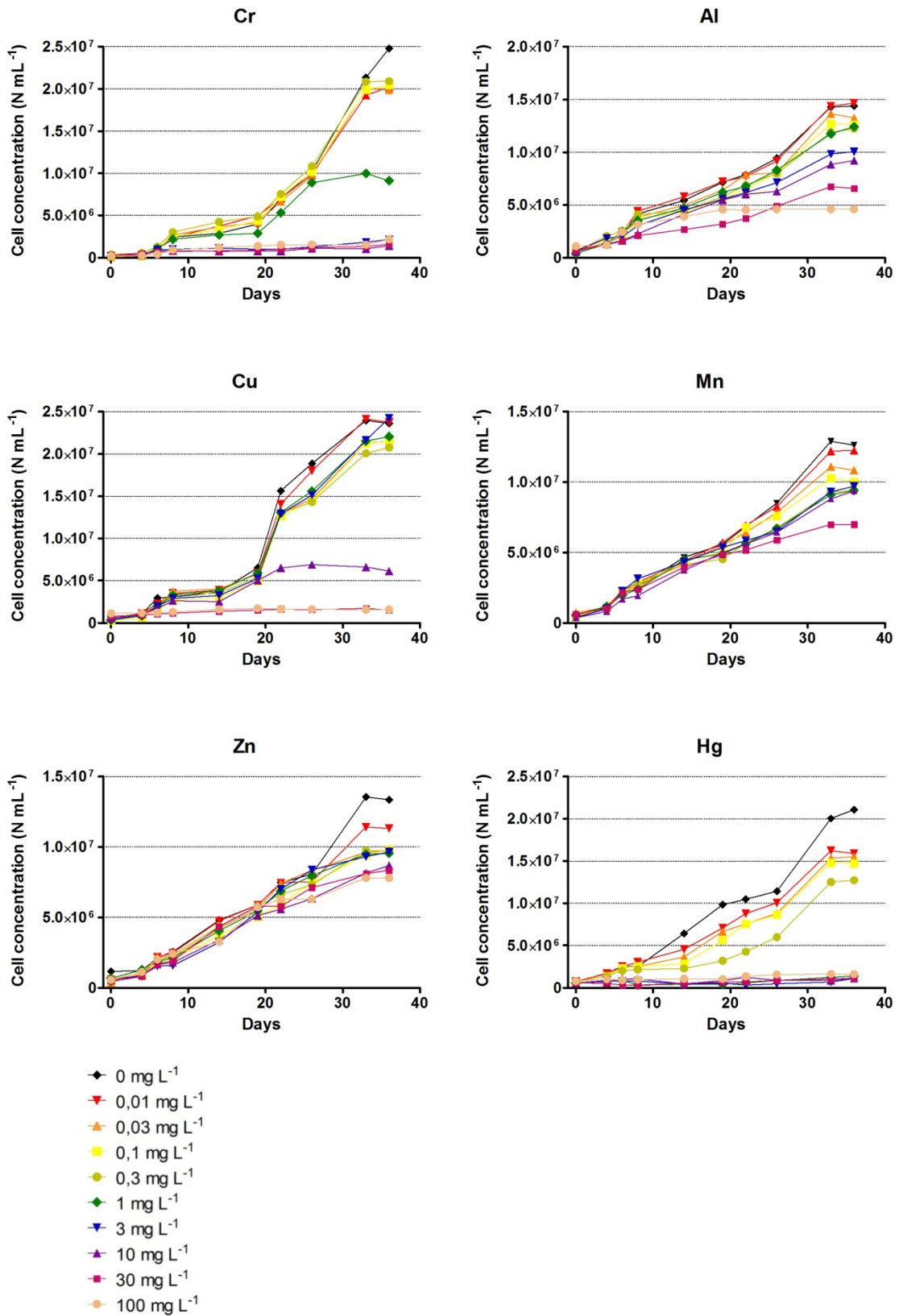
Growth inhibition of the strain increased with increasing metal concentration (Fig. 28). In the case of Cr, algae showed a statistically significant growth reduction (Dunnett's test,  $p < 0.05$ ) at  $1 \text{ mg L}^{-1}$  when compared with control, and a complete growth stop at concentration of  $3 \text{ mg L}^{-1}$ . For all tested Al concentrations,  $10 \text{ mg L}^{-1}$  was a threshold at which algae didn't show any growth, while in the case of Cu, just a reduced growth was demonstrated at the same concentration. Strikingly, the values of cell concentration formed a big gap between control and  $0.01 \text{ mg L}^{-1}$  concentration in Al testing. Microalgae exposed to Mn showed only a slight growth decrease with increasing concentrations (no data for  $100 \text{ mg L}^{-1}$ ). The growth at  $0.01$ – $10 \text{ mg L}^{-1}$  of Zn was rather stable as well. Slow growth of microalgae was noted at  $30 \text{ mg L}^{-1}$  of Zn, but no important growth was observed at  $100 \text{ mg L}^{-1}$  for the same metal. The plate with different Hg concentrations demonstrated a growth reduction already at  $0.3 \text{ mg L}^{-1}$  and the notable growth inhibition at  $1 \text{ mg L}^{-1}$ .

### **Strain CAUP H 101**

The growth curves (Fig. 29) at different Cr concentrations showed a clear transition from non-toxic to highly toxic concentrations with  $1 \text{ mg L}^{-1}$  as an intermediate. The similar situation occurred with Cu, but here the transition concentration was  $10 \text{ mg L}^{-1}$ . The apparent growth reduction was observed in  $3 \text{ mg L}^{-1}$  of Al and, surprisingly, microalgae grew at  $30 \text{ mg L}^{-1}$  of Al. The growth at such high concentration was also observed in the case of Mn (no data for  $100 \text{ mg L}^{-1}$ ), where the values of cell concentration of the control and algae growing at  $0.01$ – $0.1 \text{ mg L}^{-1}$  of Mn had no statistically significant difference and displayed a uniform growth. Dunnett's test revealed no significance of difference between the control and  $0.01 \text{ mg L}^{-1}$  of Zn, but the difference between the control and other Zn concentrations existed, revealing that the growth of the strain was already affected by  $0.03 \text{ mg L}^{-1}$  of Zn. However, with increasing Zn concentrations the growth did not change markedly and was rather uniform as it is seen from the growth curves (Fig. 29). The most toxic metal for this strain, as for all tested ones, was Hg with a significant reduction of cell concentration at  $0.3 \text{ mg L}^{-1}$  and a complete growth inhibition at  $1 \text{ mg L}^{-1}$ .



**Figure 28.** Growth curves of Plešné strain when exposed to different concentrations of metals. Error in each point ranges from 1 to 38% in relative standard deviation (average 10–18% for individual metals).



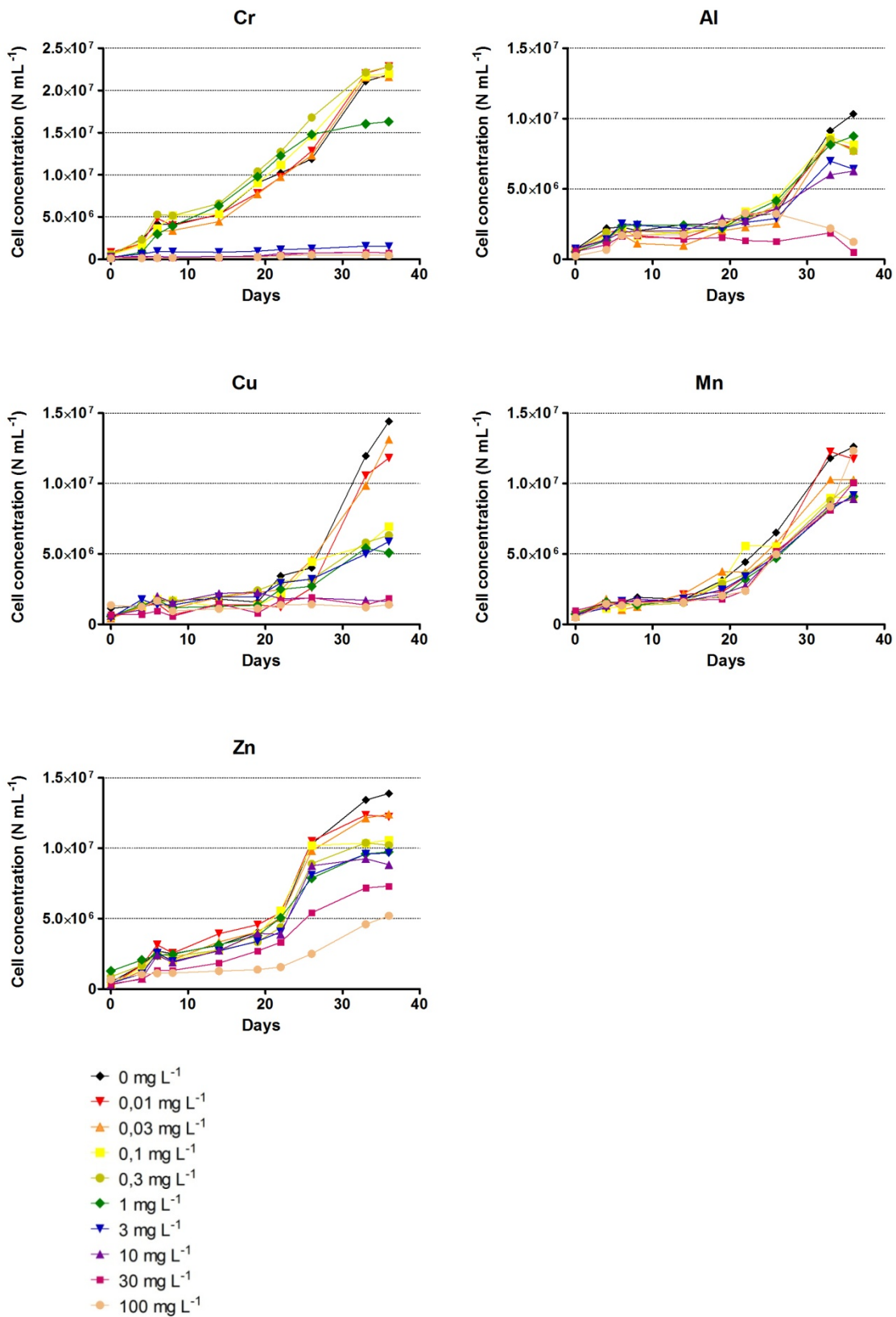
**Figure 29.** Growth curves of strain CAUP H 101 when exposed to different concentrations of metals. Error in each point ranges from 1 to 40% in relative standard deviation (average 12–14% for individual metals).

### **Strain SAG 216-9a**

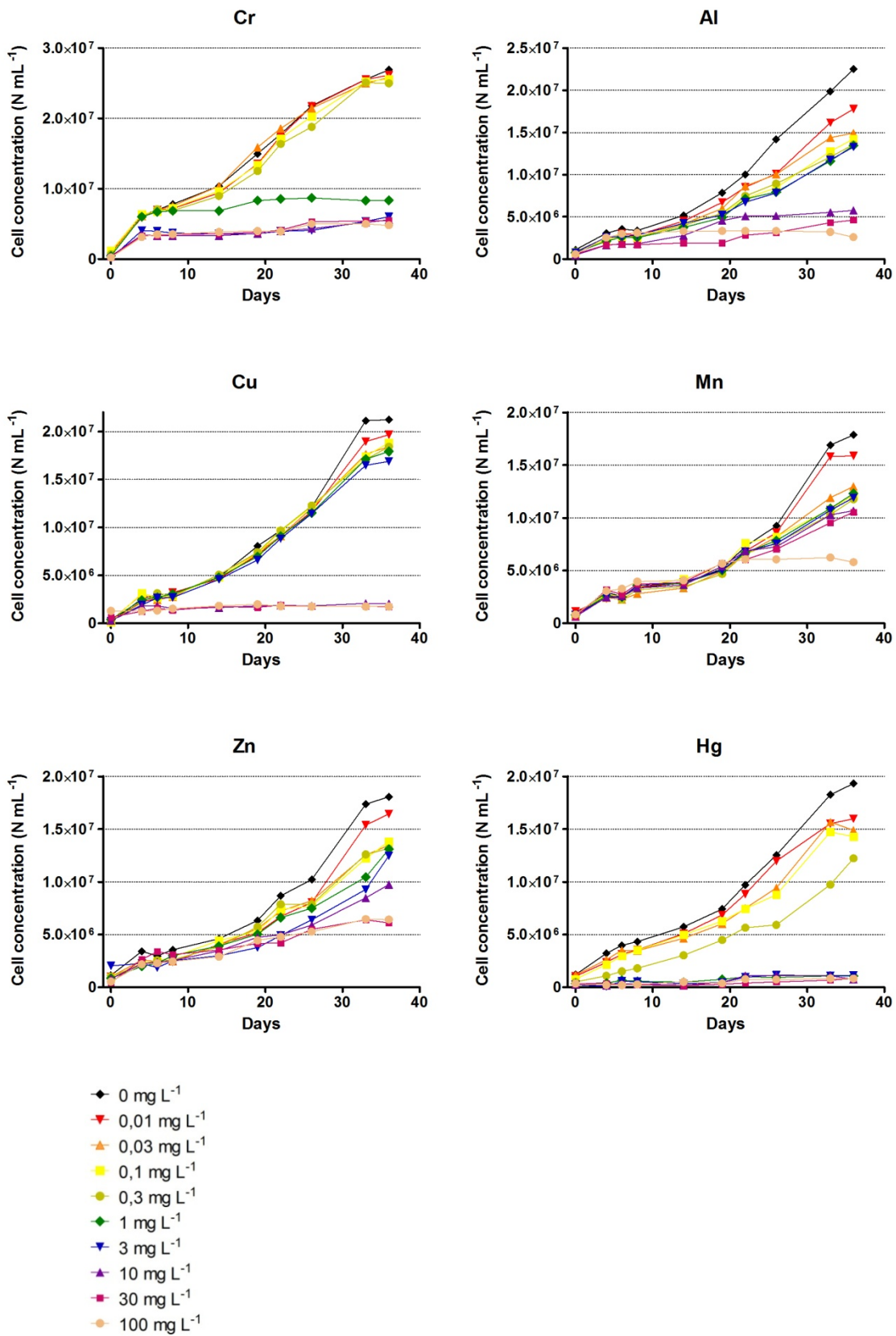
Three mg L<sup>-1</sup> of Cr was already a highly toxic concentration for the strain and at this or further following concentrations no growth was recorded. When the strain was exposed to different concentration of Al, only at 30 and 100 mg L<sup>-1</sup> of Al no growth occurred, and there was no statistically significant difference between the control and rest of the concentrations at which the growth was observed, indicating a uniform growth of the strain up to and including 10 mg L<sup>-1</sup> of Al. For Cu, the threshold concentration was 10 mg L<sup>-1</sup> at which no growth appeared. When looking at the growth curves of the strain exposed to Cu (Fig. 30), one could see a clear partition between the growth in 0–0.03 mg L<sup>-1</sup> of Cu and the rest of the “lower” concentrations, however, Dunnett’s test showed no significance for such pattern. The growth of the strain at different Mn concentrations showed only a minor decrease of cell concentration with increasing metal concentration, while exposure to different Zn concentrations led to a gradual reduction of cell concentration with increasing metal concentration.

### **Strain CCALA 427**

The strain showed a very similar growth response to different Cr concentrations as strain CAUP H 101 with a clear division into highly toxic and non-toxic concentrations with 1 mg L<sup>-1</sup> of Cr as an intermediate. The exposure to Cu demonstrated the same sharp partition: microalgae were well growing at 3 mg L<sup>-1</sup> but no growth was recorded at 10 mg L<sup>-1</sup> of Cu. In both cases, such growth pattern was statistically supported by Dunnett’s test. The growth of the strain affected by Al decreased with increasing metal concentrations. The strain did not grow at 100 mg L<sup>-1</sup> of Al, but a slight growth was noted at 10 and 30 mg L<sup>-1</sup> even though this is not very obvious from the growth curves (Fig. 31). Two levels of growth response of the strain could be noticed regarding Al: the slight influence on growth (0.03–3 mg L<sup>-1</sup>) and no growth (10–100 mg L<sup>-1</sup>). The algae exposed to Mn and Zn displayed the growth in all concentrations. There was a statistically significant growth reduction between the control and 10 mg L<sup>-1</sup> of Mn and between the control and 1 mg L<sup>-1</sup> of Zn. Nevertheless, noticeable growth appeared even within the highest metal concentrations. For Hg, already observed situation was noted: algae showed a reduced growth at 0.3 mg L<sup>-1</sup> and a full growth inhibition at 1 mg L<sup>-1</sup>.

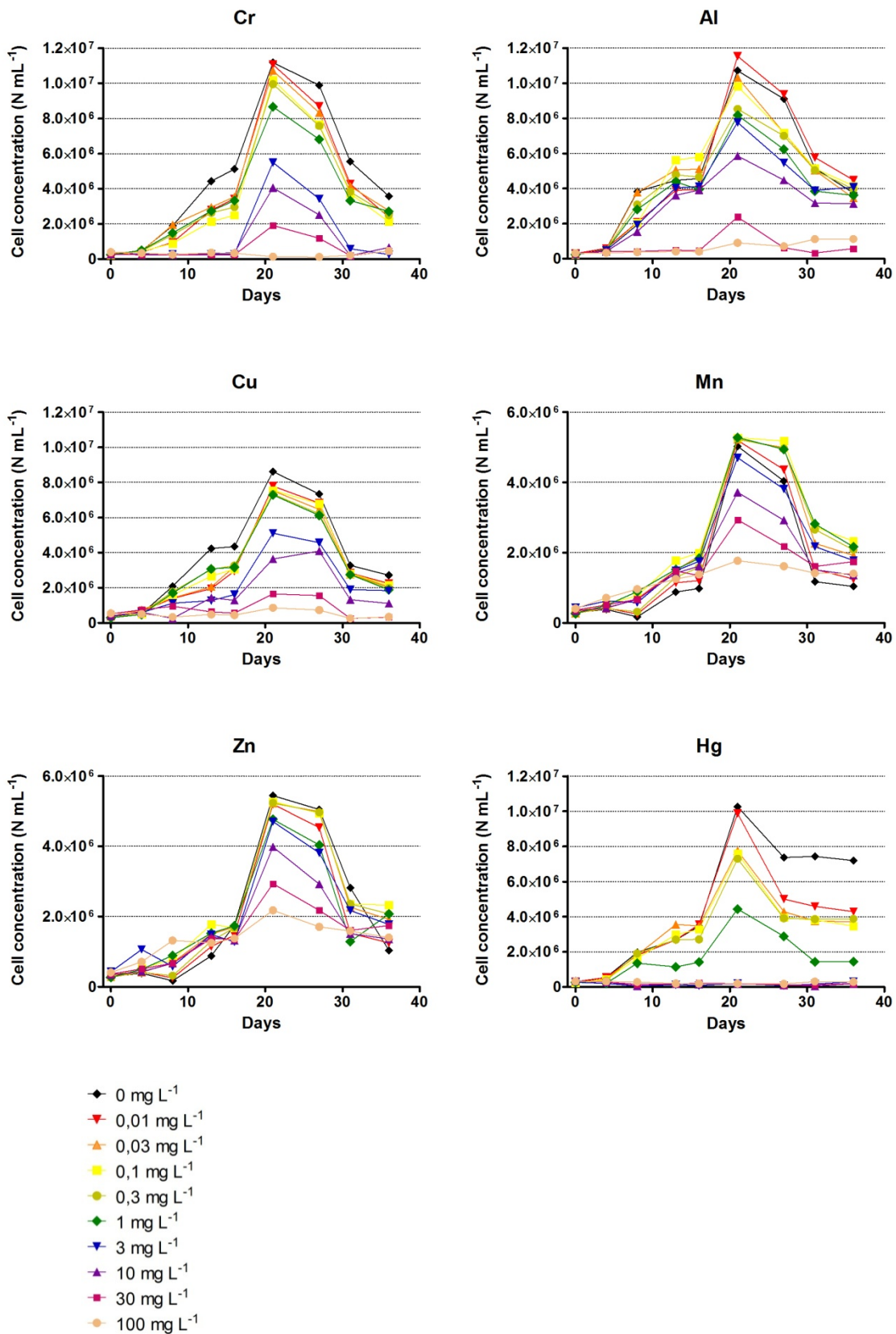


**Figure 30.** Growth curves of strain SAG 216-9a when exposed to different concentrations of metals (no data for Hg). Error in each point ranges from 1 to 40% in relative standard deviation (average 10–14% for individual metals).



**Figure 31.** Growth curves of strain CCALA 427 when exposed to different concentrations of metals. Error in each point ranges from 1 to 40% in relative standard deviation (average 10–12% for individual metals).





**Figure 32.** Growth curves of strain CCALA 375 (*Monoraphidium griffithii*) when exposed to different concentrations of metals. Error in each point ranges from 2 to 46% in relative standard deviation (average 14–17% for individual metals).

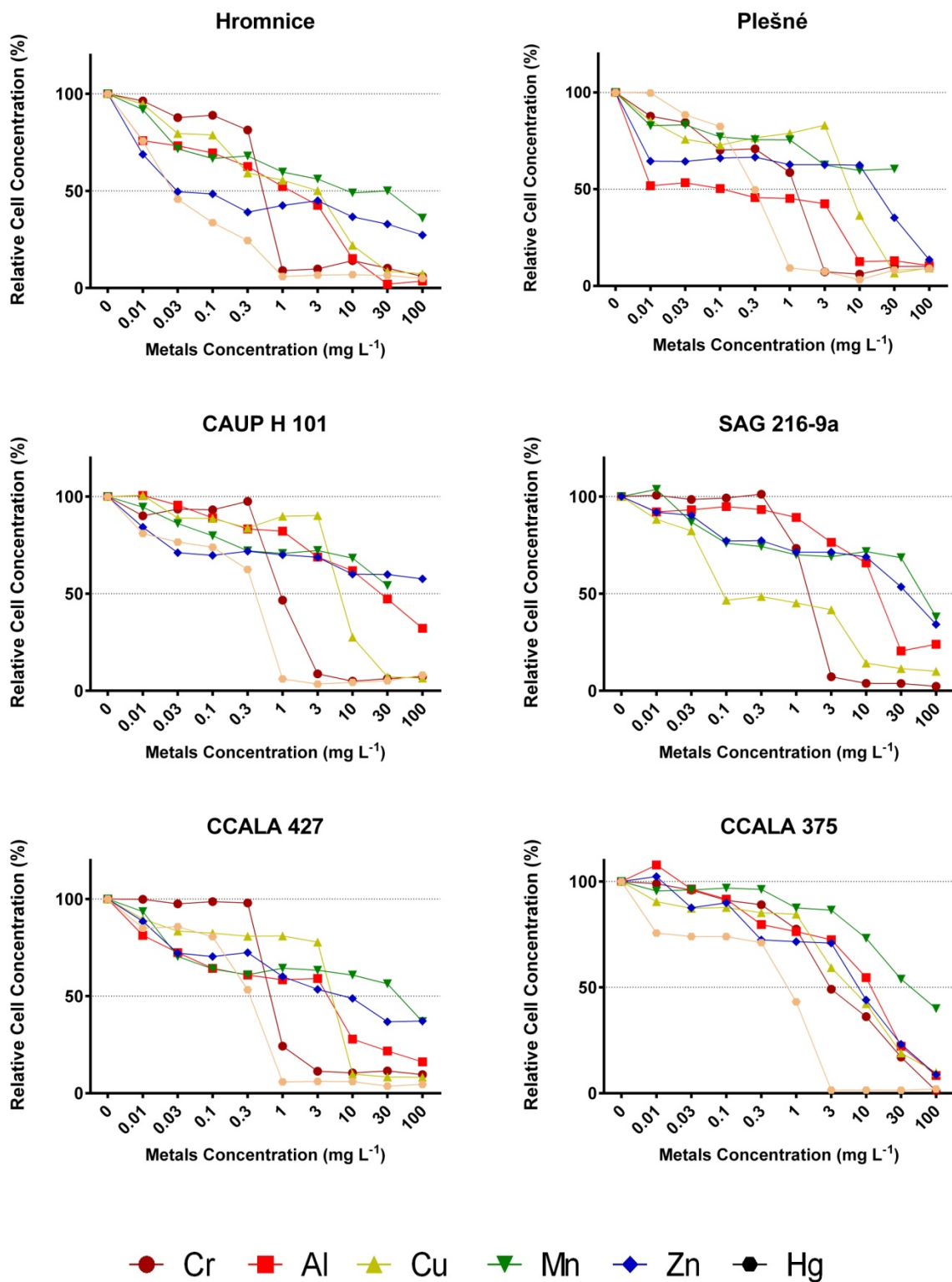
### **Strain CCALA 375**

In the case of Cr, the strain showed a statistically significant growth reduction at 3 mg L<sup>-1</sup> when compared with the cell concentration of control. It is the only strain which showed growth at such high Cr concentration. In tested Al and Cu concentrations, the statistical significant difference between the control and affected microalgae also appeared at 3 mg L<sup>-1</sup>. The growth curves (Fig. 32) of the strain exposed to different Mn and Zn concentrations proposed a gradual cell concentration decrease with increasing metal concentration, however, Dunnett's test did not provide any difference of significance between the control and the highest metal concentrations. This may be explained by the fact that the control in these plates had the lowest cell concentration. All above mentioned strains stopped growing at 1 mg L<sup>-1</sup> of Hg, whereas strain CCALA 375 showed just a reduced growth at this concentration and a complete growth inhibition at 3 mg L<sup>-1</sup>.

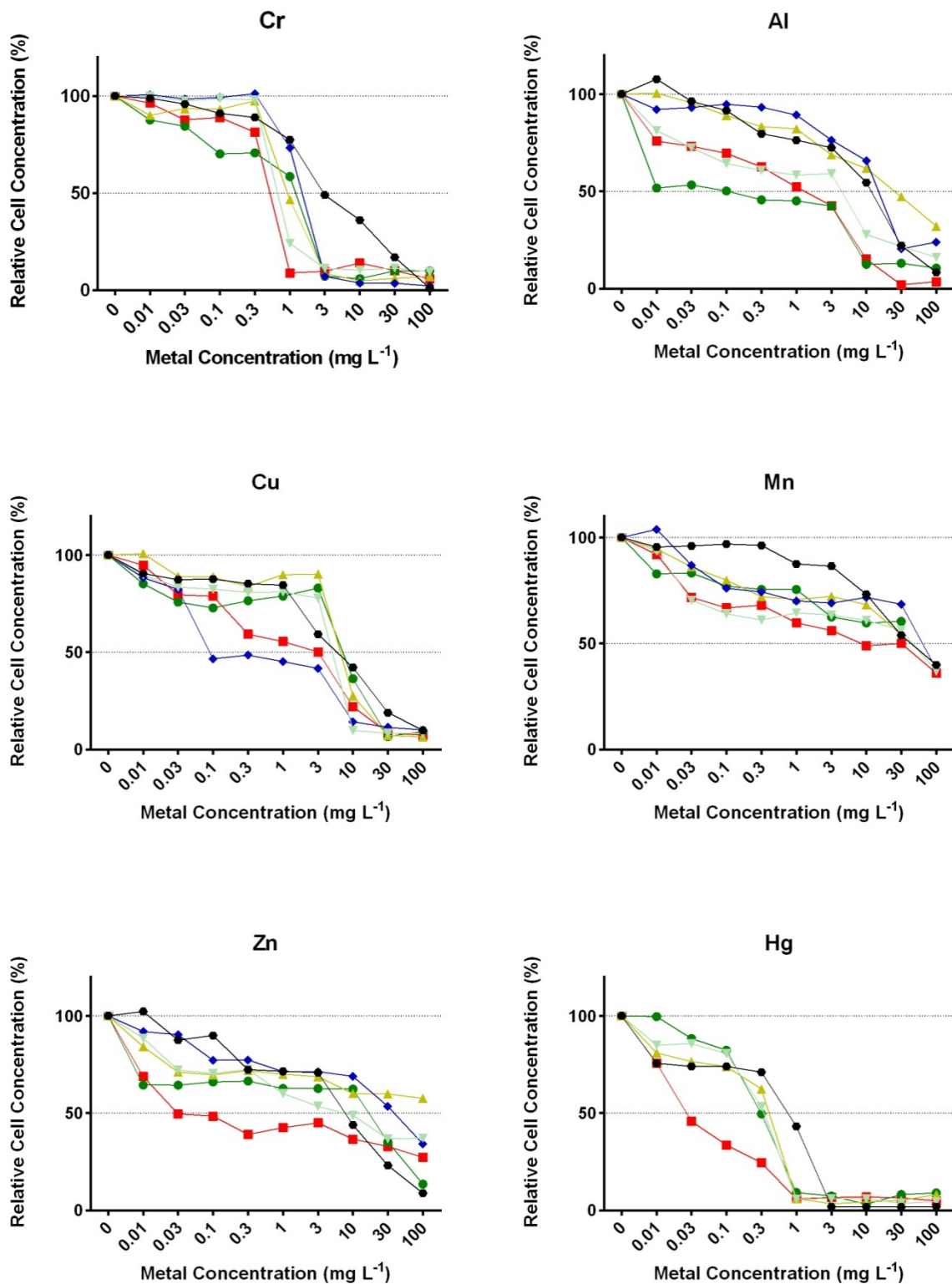
#### **4.3.2. Toxicity curves**

Figures 33 and 34 show the toxicity curves, which were constructed based on the data measured on 33<sup>rd</sup> day of the experiment (for strain CCALA 375 based on the data of 22<sup>nd</sup> day). The relative cell concentration (the ratio of the cell concentration in the presence of metal ions to that in the absence of the added metal) are plotted against metal concentration. In addition, graphs comparing growth inhibition at three metal concentrations were constructed from the toxicity curves to allow better comparison among strains (Figs 35–40). IC<sub>50</sub> values of Cr, Al, Cu and Hg and their 95% confidence intervals (Table 14) were also evaluated based on the toxicity curves.





**Figure 33.** Toxicity curves of *Coccomyxa* strains and *Monoraphidium griffithii* (CCALA 375) – comparison of metals. Error in each point ranges from 1 to 41% in relative standard deviation (average 7–20% for individual strains).



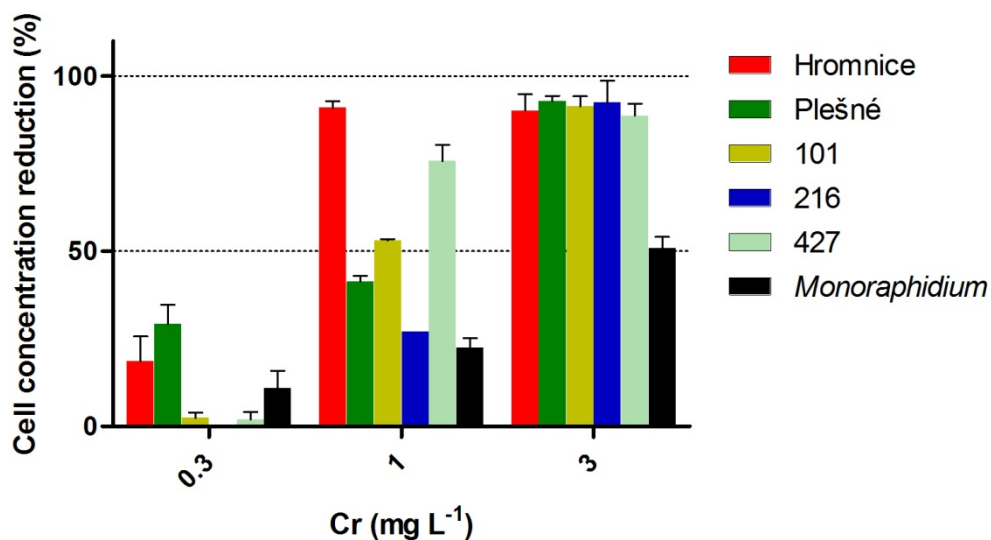
■ Hromnice   ● Plešné   ▲ 101   ◆ 216   ▼ 427   ● *Monoraphidium*

**Figure 34.** Toxicity curves of *Coccomyxa* strains and *Monoraphidium griffithii* (CCALA 375) – comparison of strains. Error in each point ranges from 1 to 41% in relative standard deviation (average 7–20% for individual metals).

## Comparison of strain sensitivity to metals

### Cr

Cr was the most toxic to Hromnice and Plešné strain based on growth reduction at  $0.3 \text{ mg L}^{-1}$ . Hromnice strain stopped growing at  $1 \text{ mg L}^{-1}$  of Cr, while cell concentrations of strain CCALA 427 and CAUP H 101 were reduced by 76% and 53 %, respectively, at the same metal concentration (Fig. 35). Three  $\text{mg L}^{-1}$  highly affected all the strains, except CCALA 375 (*Monoraphidium*) whose cell concentration was reduced only 51%, and thus this strain appeared to be the most resistant to Cr. This was reflected in the  $\text{IC}_{50}$  that reached the highest value for CCALA 375 (Table 14).

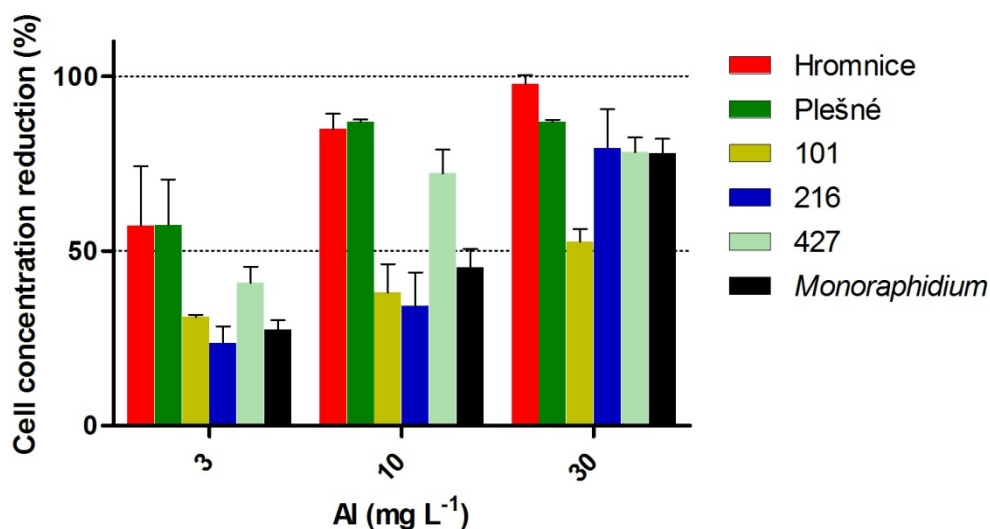


**Figure 35.** Growth inhibition of strains by Cr expressed as cell concentration reduction relative to control.

### Al

Surprisingly, the most sensitive to Al appeared strains isolated from Plešné and Hromnice lakes (Figs 34, 36). The reduction of cell concentration by half of Plešné strain occurred already at  $0.01 \text{ mg L}^{-1}$  of Al, however, the cell concentration afterwards stayed relatively stable up to  $3 \text{ mg L}^{-1}$  (Fig. 34). The cell concentration of Hromnice strain was reduced by 57% at  $3 \text{ mg L}^{-1}$ . Ten  $\text{mg L}^{-1}$  apparently affected strain CCALA 427, but for strains CAUP H 101, SAG 216-9a and *Monoraphidium* did not have a great impact on growth. Strain CAUP H 101 was the most resistant to Al with only 53% of growth reduction occurring at  $30 \text{ mg L}^{-1}$  of Al. A statistical comparison of  $\text{IC}_{50}$  values revealed three groups of strains regarding Al

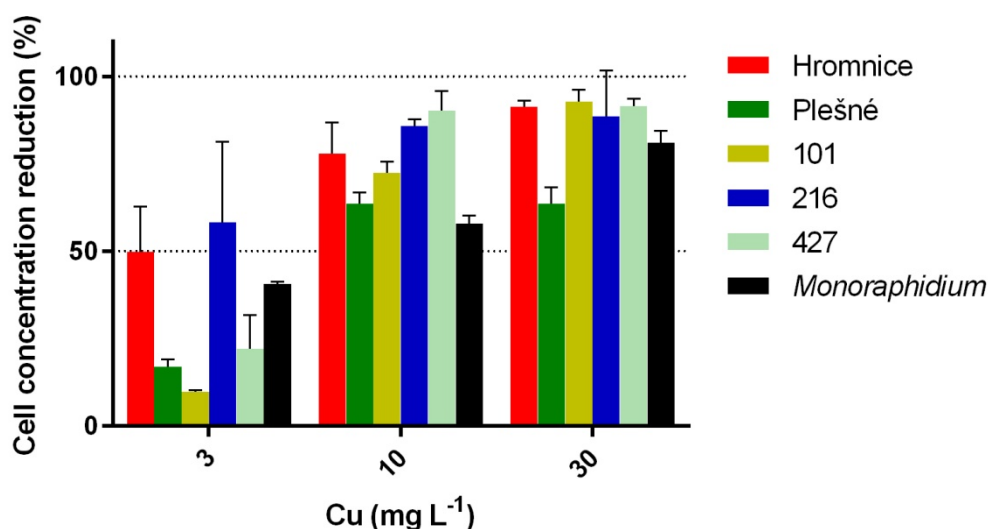
tolerance: 1) Plešné as the most sensitive strain, 2) Hromnice and CCALA 427 and 3) CAUP H 101, SAG 216-a and *Monoraphidium* as the most resistant strains (Table 14).



**Figure 36.** Growth inhibition of strains by Al expressed as cell concentration reduction relative to control.

## Cu

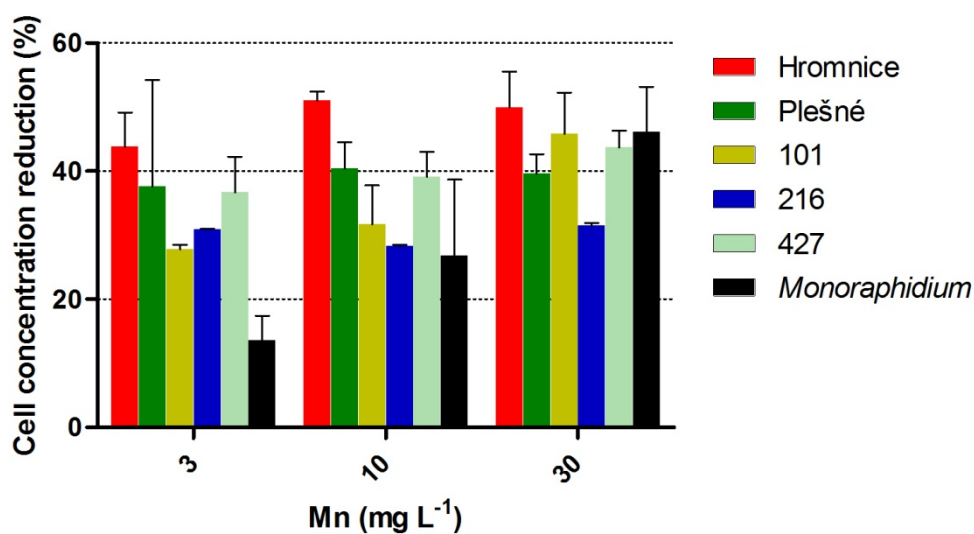
Being rather tolerant to above mentioned metals, strain SAG 216-9a was revealed to be the most sensitive to Cu with 58% reduction of cell concentration at 3 mg L<sup>-1</sup>. Hromnice strain was the second most sensitive strain with 50% reduction of cell concentration at the same concentration. Strain CCALA 427 was a little bit more sensitive than Plešné strain, but more resistant than Hromnice strain while growing at 3 mg L<sup>-1</sup> of Cu, however, it stopped growing at 10 mg L<sup>-1</sup>. The growth at such high Cu concentration was recorded for Plešné, CAUP H 101, and *Monoraphidium* strains. Thirty mg L<sup>-1</sup> of Cu was toxic concentration for all strains (Figs 34, 37). The comparison of IC<sub>50</sub> values identified Plešné, CAUP H101, CCALA 427 and *Monoraphidium* as the most resistant strains (Table 14).



**Figure 37.** Growth inhibition of strains by Cu expressed as cell concentration reduction relative to control.

### Mn

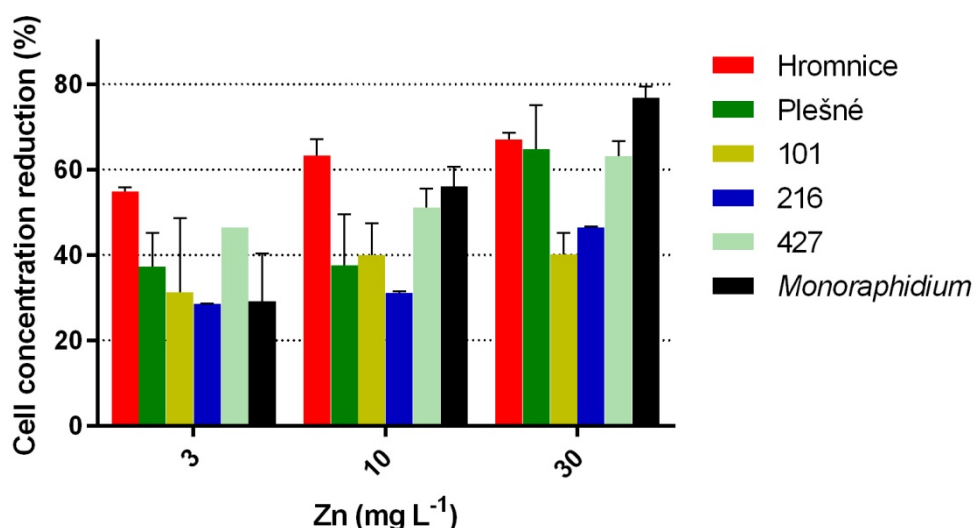
All the strains exposed to Mn showed just a slight growth inhibition with increasing metal concentration (Figs 34, 38). Hromnice strain demonstrated 50% reduction of cell concentration both at 10 and 30 mg L<sup>-1</sup> of Mn. The growth reduction of Plešné strain was also rather stable from 3 mg L<sup>-1</sup> (38%) to 30 mg L<sup>-1</sup> (40%). The similar observations was done for the rest of the strains, except *Monoraphidium* strain whose growth inhibition obviously increased with increasing metal concentrations (Fig. 38).



**Figure 38.** Growth inhibition of strains by Mn expressed as cell concentration reduction relative to control.

## Zn

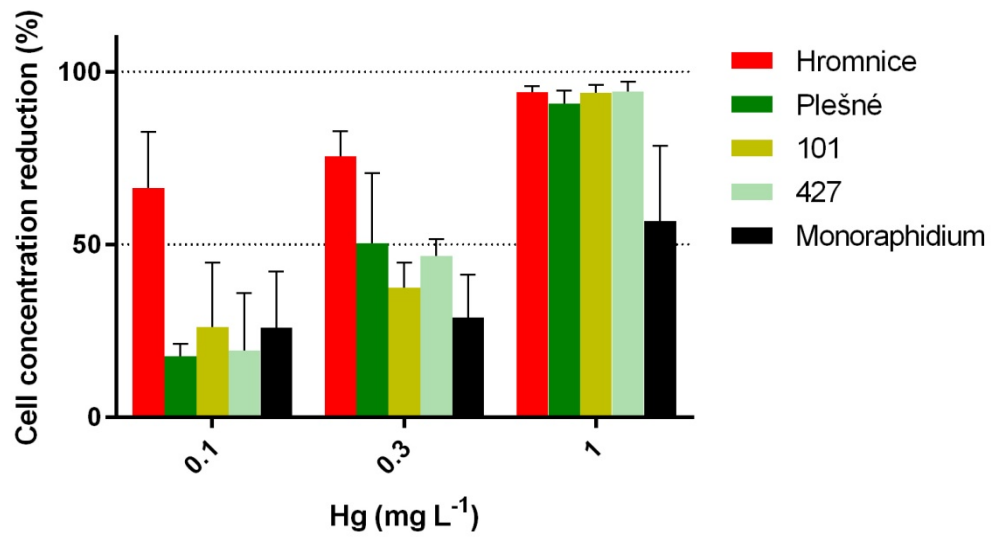
Based on 50% growth reduction, the strain isolated from Hromnice Lake demonstrated the highest sensitivity to Zn with such decrease occurring already at  $0.03 \text{ mg L}^{-1}$  of Zn. However, growth of this strain was rather stable at all tested metal concentrations. Plešné strain was observed to be quite resistant to Zn with approximately the same reduction of cell concentration (33– 38%) occurring at  $0.01\text{--}10 \text{ mg L}^{-1}$ . The same situation was noticed for strain SAG 216-9a: the reduction was quite stable from  $0.1 \text{ mg L}^{-1}$  (23%) to  $10 \text{ mg L}^{-1}$  (31%). The diminution of cell concentration of strain CAUP H 101 was the same (40%) at both 10 and  $30 \text{ mg L}^{-1}$  of Zn, while growth inhibition of strain CCALA 427 slowly increased with increasing Zn concentrations. At  $30 \text{ mg L}^{-1}$  *Monoraphidium* appeared to be the most sensitive to Zn with 77% growth reduction (Fig. 39).



**Figure 39.** Growth inhibition of strains by Zn expressed as cell concentration reduction relative to control.

## Hg

Mercury was the most toxic metal to all the strains (no data for strain SAG 216-9a) with any visible growth occurring at  $1 \text{ mg L}^{-1}$  (except *Monoraphidium*), as mentioned above. Hromnice strain appeared to be the most sensitive to Hg with 66% growth reduction already at  $0.1 \text{ mg L}^{-1}$  of Hg. The decrease of cell concentration by 50% and 47% was induced for Plešné strain and strain CCALA 427, respectively, at  $0.3 \text{ mg L}^{-1}$  of Hg. One  $\text{mg L}^{-1}$  of mercury diminished cell concentration of *Monoraphidium* only by 57%, and ranked this strain as the most resistant to Hg (Figs 34, 40). However, a statistical comparison of  $\text{IC}_{50}$  values revealed only Hromnice as significantly different from the other strains (Table 14).



**Figure 40.** Growth inhibition of strains by Hg expressed as cell concentration reduction relative to control.

**Table 14.** IC<sub>50</sub> values and 95% confidence intervals (mg L<sup>-1</sup>) based on toxicity curves (no data for Mn and Zn where low growth inhibition at high concentrations resulted in very wide confidence intervals). Values with distinct letters are significantly different.

		<b>Hromnice</b>	<b>Plešné</b>	<b>CAUP H 101</b>	<b>SAG 216-9a</b>	<b>CCALA 427</b>	<b><i>Monoraphidium</i></b>
<b>Cr</b>	IC50	0.48 <sup>a</sup>	0.63 <sup>a</sup>	0.97 <sup>a</sup>	1.37 <sup>b</sup>	0.74 <sup>a</sup>	3.75 <sup>c</sup>
	95% Conf. Int.	0.32 to 0.73	0.29 to 1.38	0.76 to 1.22	1.25 to 1.49	0.50 to 1.09	2.90 to 4.85
<b>Al</b>	IC50	0.60 <sup>a</sup>	0.07 <sup>b</sup>	22.36 <sup>c</sup>	13.47 <sup>c</sup>	0.71 <sup>a</sup>	7.77 <sup>c</sup>
	95% Conf. Int.	0.28 to 1.3	0.01 to 0.34	16.52 to 30.27	8.02 to 22.63	0.54 to 0.93	4.51 to 13.39
<b>Cu</b>	IC50	1.16 <sup>a,c</sup>	4.47 <sup>a,b</sup>	6.84 <sup>b</sup>	0.38 <sup>c</sup>	4.6 <sup>b</sup>	5.38 <sup>b</sup>
	95% Conf. Int.	0.66 to 2.03	1.20 to 16.73	4.64 to 10.10	0.16 to 0.91	2.52 to 8.37	3.37 to 8.58
<b>Hg</b>	IC50	0.04 <sup>a</sup>	0.28 <sup>b</sup>	0.25 <sup>b</sup>	–	0.27 <sup>b</sup>	0.40 <sup>b</sup>
	95% Conf. Int.	0.02 to 0.05	0.21 to 0.37	0.12 to 0.50	–	0.18 to 0.41	0.17 to 0.97



## 5. DISCUSSION

### 5.1. Phylogeny of the genus *Coccomyxa*

#### 18S rRNA

All analyses (BI, ML and MP) of the 18S rRNA gene data set produced phylogenetic trees with very similar topology and suggested *Coccomyxa/Pseudococcomyxa* as a monophyletic group within the Trebouxiophyceae, however, no statistical support was received by either method for the monophyly. The obtained phylogenetic trees revealed four independent clades of *Coccomyxa/Pseudococcomyxa* strains. All clades included strains from different habitats and even from completely different environmental types (e.g., freshwater, soil, phycobionts). The recent study of Darienko et al. (2015) revealed the same *Coccomyxa/Pseudococcomyxa* clades.

The closest known relative of *Coccomyxa/Pseudococcomyxa* is genus *Elliptochloris* (Friedl et al., 2007; Eliáš et al., 2008). This relationship was strongly supported by all the methods of analysis. Like *Coccomyxa/Pseudococcomyxa*, *Elliptochloris* species are coccoids with a single pyrenoidless chloroplast and reproduce by autospores. However, their cells are irregularly globular and chloroplast is lobate, and two types of asexual spores were reported for this genus (reviewed in Eliáš et al., 2008). As well as *Coccomyxa/Pseudococcomyxa*, *Elliptochloris* spp. have been found in different habitats ranging from free living in lakes and soils or on artificial substrates, to symbiotically in lichens and sea anemones (Letsch et al., 2009). Thus, rather similar morphological appearance and ubiquitous lifestyle consolidate the phylogenetic relationship of *Coccomyxa/Pseudococcomyxa* and *Elliptochloris* as sister groups.

Beyond question, the phylogenetic relationships among *Coccomyxa/Pseudococcomyxa* strains are not fully resolved and even more confusion interweaves in this matter as many different names for the same species exist. The study of Darienko et al. (2015) proved that name *Coccomyxa* should be used for the species previously designated as *Pseudococcomyxa*, because this monotypical genus is not valid. First of all, *Pseudococcomyxa* was originally described as producing mucilage only at one pole of the cell (Korshikov, 1953), however, mucilage production should not be taken as a criterion for separating genera and may simply be influenced by the environmental conditions as demonstrated in Darienko et al. (2015) and was also observed in this study. Secondly, in his original description Korshikov (1953) noted that unlike *Coccomyxa*, the cells of *Pseudococcomyxa* had resting stages – akinetes, however, no such evidence during 60 years was ever reported again. And finally, the phylogenetic trees do not demonstrate any separation between these two genera.

Four different clades which appeared in 18S rRNA analysis represent four different species of *Coccomyxa*. According to International Code of Nomenclature (ICN) for algae, fungi, and plants, also known as the Melbourne Code (McNeill et al., 2012), the correct scientific name is based on priority, meaning that the first scientific name proposed for species should be used. If so, *Coccomyxa simplex* Mainx, 1928 would be the right name for clade I, clade II contains newly described species *Coccomyxa galuniae* Darienko et Pröschold, 2015, clade III could be recognized as *Coccomyxa viridis* Chodat, 1913, and clade IV is recently described species *Coccomyxa polymorpha* Darienko et Pröschold, 2015 (Darienko et al., 2015).

The absence of any reasonable PP and BS values within clade I separating additional subclades, indicates that all the strains in this clade indeed belong to *Coccomyxa simplex*, based on phylogenetic species concept. What is more, *p*-distance analysis of V4 region, which is the most variable region of 18S rRNA gene, showed at the least 97.81% identity ( $p = 0.0219$ , Table 9). Thus, if such a variable region is so similar between different strains, it suggests that all the isolates may indeed represent single species (Zimmermann et al., 2011).

## ITS-2

The secondary structure of ITS-2 exhibited a common core of Eukaryota consisting of four helices, the third being the longest (Mai and Coleman, 1997; Schultz et al., 2005). Characteristically, the most variable region was helix IV, and the second most variable – helix I. Helix II, as usually, was relatively stable and had a pyrimidine–pyrimidine bulge. Helix III contained on the 5' side the single most conserved primary sequence, encompassing the UGGU (Fig. 17). The high degree of secondary structure conservation allowed the unambiguous alignment of most ITS-2 positions.

The analysis of ITS-2 sequence-structure alignment of newly sequenced *Coccomyxa* strains revealed two independent clades (*Coccomyxa simplex* and *Coccomyxa polymorpha*), and thus supported the results of 18S rRNA analysis.

## 5.2. Taxonomic position of *Coccomyxa* strains isolated from acid lakes and chemical solutions

### 18S rRNA

The strain isolated from Plešné Lake previously reported as *Monoraphidium dybowskii* (Woloszynska) Hindák & Komárkova Legnerová, 1969 was approved to belong to the genus *Coccomyxa* and taxonomic position of the dominant phytoplankton species both in Plešné and Hromnice lakes was finally confirmed.

Based on 18S rRNA analysis, the strains isolated from Hromnice and Plešné lakes together with strains S3, *Pseudococcomyxa simplex* CCALA 425, *Pseudococcomyxa* sp. CCALA 427, *Pseudococcomyxa* sp. CCALA 428, *P. simplex* CCALA 905, *P. simplex* CAUP H 101, and *P. simplex* SAG 216-9a belong to species *Coccomyxa simplex*, whereas S2, S4, S5 and S6 are new strains of *Coccomyxa polymorpha* (Darienko et al., 2015).

## ITS-2

The analysis of ITS-2 rDNA data echoed the 18S rRNA results: the isolates from the chemical solutions clustered together into a separate clade than the rest of the newly sequenced strains. Based on PNJ tree of ITS-2 sequence-structure data, strains S2 with S5 and S4 with S6 could even represent two different species, because the subclades were very well supported. However, when the secondary structures of ITS-2 were compared, there was no CBC found in the conserved regions within *Coccomyxa polymorpha* clade. The analysis of ITS-2 secondary structure within *Coccomyxa simplex* clade revealed no CBC in the conserved regions as well, and according to CBC species concept (Coleman, 2000), the strains which do not have any CBC in the conserved regions should certainly represent the same biological species. However, this conclusion is a bit tricky for *Coccomyxa* as it does not undergo sexual reproduction.

## 5.3. Morphology and ecology of *Coccomyxa* strains isolated from acid lakes and chemical solutions

### Morphological appearance

The isolates from Hromnice and Plešné lakes are two different populations of *Coccomyxa simplex* or they could even be called two different ecotypes of *Coccomyxa simplex* as they show some morphological differentiation between each other. Cells from Hromnice Lake were elongated in the same manner as strains CAUP H 101 and CCALA 427, whose sequences were identical to *Coccomyxa elongata* SAG 216-3b, where specific epithet *elongata* emphasized the morphological appearance of the cells. In contrast, strain isolated from Plešné Lake had more ellipsoidal cells. More precisely, the cells of *Coccomyxa simplex* from Hromnice Lake appeared to be twice as long as narrow, while cells from Plešné Lake were rarely found in such state.

The length of the cells did not show any clear trend between *Coccomyxa simplex* and *Coccomyxa polymorpha*, whereas the cells of the isolates of *Coccomyxa polymorpha* was considerably wider than the strains of *Coccomyxa simplex* while growing in BBM. Hence,

morphological investigation was in agreement with the genetic results, distinguishing these two species. Moreover, the morphological appearance of new strains of *Coccomyxa polymorpha* indeed matched the diagnosis of the species proposed by Darienko et al. (2015). However, the variation in the cells length and width is great even at the species level and suggests high intraspecific morphological variability of both species. Furthermore, the differences in the appearance of strain S3 while growing in its original solution and BBM clearly demonstrate the morphological plasticity of the genus *Coccomyxa* which depends on the environmental conditions they are exposed to, e.g. different salinity (Darienko et al., 2015).

The observation of *Coccomyxa* strains by transmission electron microscopy revealed the same features of the cells as described in Albertano et al. (1990).

### **Ecology**

The present study confirms that *Coccomyxa* is an ubiquitous genus capable to live in any continent and in a wide range of habitats including the most extreme ones, and no clear ecological requirements were noticed for a particular species. The capability of one species to colonize very different habitats indicates very broad ecological niche of the genus. Being so flexible and adaptable *Coccomyxa* may get the advantage when the conditions become extreme and become the dominant alga (Garbayo, 2012).

It is interesting to notice that *Coccomyxa* is not commonly reported occurring together with other phytoplankters in acid water bodies, but if present, so being the most abundant one (Nedbalová et al., 2006; Hrdinka et al., 2013) or even the only one (Falagán et al., 2014). This suggests that acid conditions may allow and promote the existence of *Coccomyxa* by reducing predation and interspecific competition for nutrients, light and space. This phenomenon was observed in Hromnice and Plešné lakes. Lacking grazing zooplankton and being rich in phosphorus (Hromnice Lake, Hrdinka et al., 2013), or with a relatively high input of phosphorus, but with depleted SRP in the water column (Plešné Lake, Nedbalová et al., 2006), these lakes offer a suitable habitat for such opportunistic species as *Coccomyxa simplex*, which immediately react to favorable conditions and quickly exploit the resources.

On the other hand, the occurrence of *Coccomyxa* in acid freshwaters may actually be more frequent than reported until now. First of all, if not being the most abundant one, *Coccomyxa* may sometimes be overlooked among the other algae because of its small size. Secondly, the small coccoid algae were always a problem for identification and misleading conclusions could have been made about algal composition in one or other acid lake in the past. For

example, some species of *Monoraphidium* have also been reported occurring in acid lakes in Scandinavia (Almer et al., 1978; Hörnström et al., 1995), as it was done for Plešné Lake (Nedbalová et al., 2006).

Apart from this, no studies were done summarizing the diversity of *Coccomyxa* regarding acid freshwater environments. Phylogenetic trees of 18S rRNA gene computed in this study show that the strains capable to live in acid habitats evolved within different *Coccomyxa* species and do not depend on the species *per se*. Different strains with distinct genetic variation may simply have adapted to the specific environmental conditions they were exposed to. Furthermore, I found out that the same species is capable to inhabit both acid lakes and laboratory solutions, and especially successful in extreme conditions can be the strains genetically identical to Hromnice strain (CAUP H 101, S3).

The discovery of *Coccomyxa* in the chemical solutions (Table 2) as previously reported by Sládečková (1959) is an important finding from the ecological and evolutionary points of view. First of all, strains S2, S4, S5 and S6 belong to newly described species *Coccomyxa polymorpha* (Darienko et al., 2015) with the only one publicly available strain previously designated as *Choricystis chodati* (CAUP H 5101, from an unknown habitat)<sup>1</sup>, and thereby these strains contribute to the knowledge of *Coccomyxa polymorpha* ecology. Secondly, it affirms the widespread distribution of *C. polymorpha* and its ability to occupy extreme environments. Until now only single strains of *C. polymorpha* were known from France, Spain (acid river) and Indonesia (tree bark), however their precise taxonomic affiliation was unknown or misleading. Finally, it provides further understanding about possible tolerance limits of the genus to stress factors, such as metal toxicity.

#### 5.4. Metal toxicity to the strains

Chromium, aluminum, copper, manganese, zinc and mercury had different effects on the growth of *Coccomyxa simplex* strains isolated from various habitats and the reference strain *Monoraphidium griffithii*. Overall, mercury was the most and zinc with manganese were the least toxic in all the cases. However, there was no such clear trend for the other metals, whose toxic effects on algae were ranked based on the growth inhibition by 50% and the shape of the toxicity curve. For example, in some cases the cell concentration was reduced by half at very low metal concentration, e.g. Zn Hromnice, Al Plešné, Cu SAG 216-9a, but the strain actually

---

<sup>1</sup> The relationship between the new strains of *C. polymorpha* and CAUP H 5101 is not shown in the phylogenetic trees.

kept growing well at very high metal concentrations. Thus, a steep or gradual decrease of the cell concentration with increasing metal concentration was taken in consideration as well.

The overall toxicity sequence obtained for Hromnice and Plešné strains was  $\text{Hg} > \text{Cr} > \text{Al} > \text{Cu} > \text{Zn} > \text{Mn}$ , for strain CAUP H 101  $\text{Hg} > \text{Cr} > \text{Cu} > \text{Al} > \text{Mn} \geq \text{Zn}$ , for strain SAG 216-9a  $\text{Cr} > \text{Cu} > \text{Al} > \text{Zn} > \text{Mn}$ , for strain CCALA 427  $\text{Hg} > \text{Cr} > \text{Cu} \geq \text{Al} > \text{Zn} > \text{Mn}$ , and for *Monoraphidium* it was  $\text{Hg} > \text{Cr} > \text{Cu} > \text{Zn} > \text{Al} > \text{Mn}$ . In principle, such sequences are compatible with the common toxicity sequences reported for algae (Sorentino, 1979; Sposito, 1986; Lukavský et al., 2003). However, an unavoidable interpretation and comparison problem exists since most toxicity tests have been carried out using different toxicity criteria, algal species, and experimental conditions compared to the present study.

No growth of *Coccomyxa simplex* strains was observed at  $1 \text{ mg L}^{-1}$  of Hg, while *M. griffithii* was a little bit more resistant to Hg with only 57% reduction of cell concentration at  $1 \text{ mg L}^{-1}$ . The obtained  $\text{IC}_{50}$  values for strains CAUP H 101, CCALA 427 and Plešné were almost identical (Table 14) showing very similar sensitivity to Hg as was also demonstrated by toxicity curves (Fig. 34). Hromnice strain appeared to be the most sensitive to mercury. Li et al. (2009) showed the 96 h  $\text{EC}_{50}$  of *Scenedesmus quadricauda* (Chlorophyceae) growth inhibition by mercury ( $\text{HgCl}_2$ ) at  $0.1401 \text{ mg L}^{-1}$ . The study of Gómez-Jacinto (2015) demonstrated that *Chlorella sorokiniana* (Trebouxiophyceae) was still growing at  $0.5 \text{ mg L}^{-1}$  of Hg but that the concentration of chlorophyll declined at  $1 \text{ mg L}^{-1}$ . Some older literature (Bringmann and Kühn, 1978, pH = 7.0) presents much lower Hg concentrations for survival. However, it is important to remember that mercury is one of the few metals whose solubility decreases when acidified (Lampert and Sommer, 2007), and thus at lower pH the same strains may be much more resistant to Hg than at neutral.

Chromium was the second most toxic metal for all the strains with the half reduction of growth occurring at less than (Hromnice, Plešné, CCALA 427) or around (CAUP H 101)  $1 \text{ mg L}^{-1}$ . For SAG 216-9a strain, the reduction of the cell concentration by 50% was between  $1\text{--}3 \text{ mg L}^{-1}$  of Cr ( $\text{IC}_{50} = 1.37 \text{ mg L}^{-1}$ ), while *M. griffithii* appeared to be the most resistant to Cr with half maximal inhibitory concentration at around  $3 \text{ mg L}^{-1}$ . To conclude, the obtained  $\text{IC}_{50}$  values did not differ significantly (Table 14) and the response of all *Coccomyxa* strains to Cr toxicity was relatively uniform. *Monoraphidium* demonstrated higher resistance to Cr than *Coccomyxa* strains as was also observed in the case of Hg. The results of Cr toxicity are compatible with the ones got by Bassi et al. (1990). The authors found that *Coccomyxa minor* was less tolerant to Cr (IV) than *Scenedesmus armatus* and that  $1 \text{ mg L}^{-1}$  of Cr is sufficient to induce alterations of chloroplast and cell wall in *C. minor*, while in *S. armatus* such

alterations were induced if Cr concentration was at least 5 mg L<sup>-1</sup>. Sánchez-Fortün et al. (2009) found that the 72 h median growth and photosynthetic performances of *Dictyosphaerium chlorelloides* (Trebouxiophyceae) were inhibited at 1.64 and 1.54 mg L<sup>-1</sup> of Cr, respectively, and that the complete stop of these processes occurred at 10 mg L<sup>-1</sup>. Nacorda et al. (2010) counted EC<sub>50</sub> of growth inhibition for *Chlorella vulgaris* at 1.76 mg/L of Cr (VI), while Ouyang et al. (2012) showed the strong suppression of growth and the photosynthetic mechanism already at 0.97 mg L<sup>-1</sup> for the same species.

In contrast to other metals *Coccomyxa* strains demonstrated a high variability of strain-specific response to aluminum. Surprisingly, strains Hromnice, Plešné and CCALA 427 were rather sensitive to aluminum (Figs. 34, 36). *Coccomyxa simplex* strains CAUP H 101 and SAG 216-9a were less sensitive to Al than strains Hromnice, Plešné and CCALA 427. *M. griffithii* also appeared to be rather resistant to Al with IC<sub>50</sub> at ~ 8 mg L<sup>-1</sup>. Hörnström et al. (1995) found that in nutrient-enriched humic lakewater with pH 4.8 the growth of *M. griffithii* was reduced by 75% already at 0.3 mg L<sup>-1</sup>, while for *M. dybowskii* at the same conditions 50% growth inhibition occurred at 2 mg L<sup>-1</sup> of Al. The strains tested in this study demonstrated greater resistance to Al when previously reported for other algae (reviewed in Gensemer and Playle, 1999).

Copper demonstrated moderate toxicity to the strains. The growth reduction of all strains (except strain SAG 216-9a) by half occurred at concentration higher than IC<sub>50</sub> = 1 mg L<sup>-1</sup>, but less than IC<sub>50</sub> = 7 mg L<sup>-1</sup>. Bozeman et al. (1989) reported 50% growth inhibition of *Selenastrum* (Chlorophyceae) at 6.7 mg L<sup>-1</sup> (BBM medium was used). This rather corresponds to the data obtained in this study.

All tested strains were rather tolerant to Zn and Mn. According to Vymazal (1986), algae could be classified as very resistant (> 10 mg L<sup>-1</sup>), resistant (2–10 mg L<sup>-1</sup>), moderately resistant (0.5–2 mg L<sup>-1</sup>), low resistant (0.1–0.5 mg L<sup>-1</sup>), and very low resistant (< 0.1 mg L<sup>-1</sup>) to Zn. All the strains in this study appeared to be very resistant to Zn as they demonstrated the growth at much higher concentrations than 10 mg L<sup>-1</sup> of Zn. Although the growth of Hromnice strain was already reduced by 50% at 0.03 mg L<sup>-1</sup>, the strain kept growing up to 100 mg L<sup>-1</sup> of Zn. The present results for such high Zn tolerance are in agreement with those obtained for *Monoraphidium* by Bácsi et al. (2015) who reported the 50 % growth inhibition within 72 h of *M. pusillum* and *M. griffithii* at 33.69 and 25.63 mg L<sup>-1</sup> of Zn, respectively.

*Coccomyxa simplex* strains demonstrated rather similar response to manganese with 50% growth inhibition occurring at more than 30 mg L<sup>-1</sup> of Mn. The observed such high resistance to the metal could be explained by the fact that in general algae are highly sensitive to Mn just

at high pH (Peters et al., 2011). Thus, the acidic pH of the medium they were exposed to should have not affected the growth of the strains even at highest concentrations of Mn. Moreover, Mn together with Zn are essential micronutrients for algal metabolism.

The present study demonstrates that strains of *Coccomyxa simplex* isolated from Hromnice and Plešné lakes do not show any peculiar resistance to various toxic metals and that they are just as sensitive to them as the strains that were not isolated from such extreme habitats, as circumneutral pool (CCALA 427) or from culture of *Paramecium bursaria* (SAG 216-9a). Surprisingly, the isolates from the acid lakes were in some cases even more sensitive than the rest of *Coccomyxa* strains included in this study. Remarkably, Plešné strain showed the lowest tolerance to Al, even though the concentrations of Al<sup>3+</sup> are still very high in the lake (Nedbalová et al., 2006). Furthermore, the tolerance to extremely high concentration of Al and increased concentrations of Cu and Mn in Hromnice Lake was also not reflected by the strain isolated from this lake. Therefore, my hypothesis that *Coccomyxa* strains isolated from acid environments with high concentration of metals could withstand higher concentrations of toxic metals than other closely related strains was denied. This is in contrast with some previous data demonstrating higher Al tolerance in algae living in more acidic Al rich waters (Gensemer, 1991).

On the other hand, the sensitivity of the strains was compared only based on growth inhibition, and if other toxicity evaluation criteria had been used, e.g., metabolic activity or photosynthesis, results may have looked a little bit different from the ones obtained.

*Coccomyxa* strains demonstrated rather similar response to all the metals, except aluminum, and certain generalizations could be made for one or another metal, e.g. 50% growth inhibition for *Coccomyxa* strains are likely to occur at ~ 0.3 mg L<sup>-1</sup> of mercury or ~ 1 mg L<sup>-1</sup> of chromium, which is in line with the published tolerance limits of other algae (Bassi et al., 1990; Sánchez-Fortün et al., 2009; Ouyang et al., 2012; Gómez-Jacinto, 2015). However, in the case of Al, a more strain-specific resistance was observed as was also demonstrated by Hörnström et al. (1995) or reviewed by Gensemer and Playle (1999). Thus, a strain-specific response to the metals could probably be observed only for those metals that are not extremely toxic for the organisms at very low concentrations.

Unfortunately, the question why *Coccomyxa simplex* strains are so successful in Hromnice and Plešné lakes still remains unresolved. However, few speculations could be proposed. First of all, the growth of such small-sized algae can be promoted by otherwise favorable environmental conditions (none or reduced grazing pressure, high supply of P), which counterbalance the influence of the toxic metals. Moreover, the resistance to low pH itself



rather than increased resistance to toxic metals may allow the growth of *Coccomyxa simplex* in Hromnice and Plešné lakes. Furthermore, presence of high H<sup>+</sup> activities (i.e. very low pH) and increased DOC concentrations that are found both in Hromnice and Plešné lakes may reduce the toxicity of Al (Gensemer and Playle, 1999).

The success of *Coccomyxa* in acid lakes could be also hidden in the morphology of the cells. *Coccomyxa simplex* cells are known to be covered by cellulosic cell wall containing sporopollenin (Gross, 2000), which is recognized to be beneficial in harsh environments. Sporopollenin has been also found in *Chlorella* where it is a component of trilaminar cell wall (Atkinson et al., 1972). For the first time the trilaminar cell wall in *Coccomyxa* was observed in the strains isolated from natural acidic environments (pH ~ 3) by Albertano et al. (1990). Interestingly, Burczyk and Hesse (1981) found that although *Chlorella fusca* was able to synthesize sporopollenin, the mutants derived from this strain were unable to do that. The constant cultivation of *Coccomyxa simplex* strains isolated from Hromnice and Plešné lakes in artificial circumneutral medium could have affected the actual physiology and morphology of the cells and hereby lead to the increased sensitivity to the metals. Therefore, the comparison of the cell morphology regarding cell wall from natural and laboratory conditions is urgent. The high morphological plasticity of *Coccomyxa* depending on environmental conditions (Darienko et al., 2015) may actually be the result of the changes in physiological apparatus inducing or preventing the production or cell wall associated substances, e.g. sporopollenin.

Regarding *Coccomyxa polymorpha*, unfortunately, the strains from the chemical solutions were isolated too late to include them in the growth inhibition bioassay and no conclusions can be made neither about metal toxicity to different *Coccomyxa* species, nor about strain-specific response.

## 6. CONCLUSIONS

- The phylogenetic analyses of 18S rRNA gene and ITS-2 rDNA sequences confirmed the taxonomic position of the majority of sequenced strains to the genus *Coccomyxa* belonging to *Elliptochoris* clade within the green algal class Trebouxiophyceae.
- The taxonomic position of the dominant planktonic alga in Hromnice and Plešné lakes (previously referred as *Coccomyxa* sp. and *Monoraphidium dybowskii*, respectively) was finally revealed. Both strains isolated from the lakes belong to the species *Coccomyxa simplex*;
- *Coccomyxa simplex* is a ubiquitous species capable to grow in very different environments and may get the advantage when the conditions become extreme. Strains genetically identical to Hromnice strain may be especially successful in extreme conditions;
- Species *Coccomyxa simplex* can be a dominant planktonic alga in acid lakes as it was never reported before;
- There is no clear trend between *Coccomyxa* species and their realized ecological niches. The strains capable to live in acid habitats evolved within different *Coccomyxa* species;
- New strains of a recently described species *Coccomyxa polymorpha* was found among the isolates from chemical solutions. *C. polymorpha* is also capable to colonize various habitats and this species might be particularly successful in metal contaminated sites;
- The most toxic metal for all the strains was mercury (Hg), the second most toxic – chromium (Cr). Copper (Cu) and aluminum (Al) had a moderate toxicity, while zinc (Zn) with manganese (Mn) were the least toxic metals for the strains;
- The isolates from Hromnice and Plešné lakes did not show any peculiar resistance to increased metal concentrations when compared with other closely related strains isolated from circumneutral habitats or *Monoraphidium griffithii* CCALA 375;
- Although Hromnice Lake is characterized by extremely high and Plešné Lake by high Al concentrations, *Coccomyxa* strains isolated from these habitats were rather sensitive to the exposure of the metal. The response to Al was rather strain-specific.

- Reference strain *Monoraphidium griffithii* CCALA 375 appeared to be more resistant to Cr, while the response to other metals (Al, Cu, Mn, Zn, Hg) was not markedly increased compared to *Coccomyxa* strains;
- The ability of *Coccomyxa* strains to tolerate low pH rather than increased resistance to high concentrations of metals allow them to dominate the phytoplankton in Hromnice and Plešné lakes;
- The reduced predation and increased supply of phosphorus promote the existence of *Coccomyxa* in the two acid lakes.

## 7. REFERENCES

- Abdel-Hamid, M.I. 1996. Development and application of a simple procedure for toxicity testing using immobilized algae. *Water Science and Technology* 33: 129–138.
- Aguilera, A., Manrubia, S., Gómez, F., Rodríguez N., Amils, R. 2006. Eukaryotic community distribution and its relationship to water physicochemical parameters in an extreme acidic environment, Río Tinto (southwestern Spain). *Applied and Environmental Microbiology* 72: 5325–5330.
- Albertano, P. 1995. Microalgae from sulphuric acid environments. In Wiessner, W., Schnepf, E., Starr, R.C. (Eds), *Algae, Environment and Human Affairs*. Bristol, Biopress, pp. 19–39.
- Albertano, P., Pinto, G., Pollio, A., Taddei, R. 1990. Morphology, ultrastructure and ecology of an acidophilic alga, *Pseudococcomyxa simplex* (Mainx) Fott (Chlorococcales). *Algological Studies* 59: 81–95.
- Aliotta, G., Pinto, G., Pollio, A. 1983. Observations on tolerance to heavy metals of four green algae in relation to pH. *Giornale Botanico Italiano* 117: 247–251.
- Almer, B., Dickson, W. T., Ekström, C., Hörnström, E., Miller, U. 1974. Effects of acidification on Swedish lakes. *Ambio* 3: 30–36.
- Almer, B., Dickson, W., Ekström, C., Hörnström, E. 1978. Sulphur pollution and the aquatic ecosystem. In Nriagu, J.O. (Ed.), *Sulphur in the Environment: Part II, Ecological Impacts*. New York, John Wiley & Sons, pp. 271–311.
- Altschul, S.F., Gish, W., Miller, W., Myers, E.W., Lipman, D.J. 1990. Basic local alignment search tool. *Journal of Molecular Biology* 215: 403–410.
- Atkinson, A.W., Gunning, B.E., John, P.C. 1972. Sporopollenin in the cell wall of *Chlorella* and other algae: ultrastructure, chemistry, and incorporation of (14)C-acetate, studied in synchronous cultures. *Planta* 107: 1–32.
- Bácsi, I., Novák, Z., Jánószky, M., B-Béres, V., Grigorszky, I., Nagy, S.A. 2015. The sensitivity of two *Monoraphidium* species to zinc: their possible future role in bioremediation. *International Journal of Environment Science and Technology* 12: 2455–2466.
- Bargagli, R., Broady, P.A., Walton, D.W.H. 1996. Preliminary investigation of the thermal biosystem of Mount Rittmann fumaroles (northern Victoria Land, Antarctica). *Antarctic Science* 8: 121–126.
- Bartlett, L., Rabbi, F.W., Funk W.H. 1974. Effects of copper, zinc and cadmium on *Selenastrum capricornutum*. *Water Research* 8: 179–185.
- Bassi, M., Corradi, M.G., Favali, M.A. 1990. Effects of chromium in freshwater algae and macrophytes. In Wang, W., Gorsuch, J.W., Lower, W.R. (Eds), *Plants for Toxicity Assesment*, American Society for Testing and Materials, Philadelphia, pp. 204–224.
- Besch, W.K., Richard, M., Castin, R. 1972. Benthic diatoms as indicators of mining pollution in the Northwest Miramichi River system, New Brunswick, Canada. *Internationale Revue der gesamten Hydrobiologie und Hydrographie* 57: 139–174.

Beulker, C., Dieter, L., Nixdorf, B. 2003. Aspects of phytoplankton succession and spatial distribution in an acidic mining lake (Plessa 117, Germany). *Acta Oecologica* 24: 25–31.

Bischoff, H.W., Bold, H.C. 1963. Phycological studies. IV. Some soil algae from Enchanted Rock and related algal species. *University of Texas Publications* 6318: 1–95.

Blaise, C., Legault, R., Bermingham, R., Van Coillie, R., Vaseur, P. 1986. A simple microplate algal assay technique for aquatic toxicity assessment. *Toxicity Assessment* 1: 261–281.

Bleiwas, A.S.H., Stokes, P.M., Olaveson, M.M. 1984. Six years of plankton studies in the La Cloche region of Ontario, with special reference to acidification. *Verhandlungen des Internationalen Verein Limnologie* 22: 332–337.

Bonaly, J., Delcourt, A., Mestre, J.C. 1978. The effects of some metallic ions on the growth of *Chlamydomonas variabilis* and *Euglena gracilis*. *Mitteilungen Internationale Vereinigung für Theoretische und Angewandte Limnologie* 21: 103–109.

Boult, S., Collins, D.N., White, K.N., Curtis, C.D. 1994. Metal transport in a stream polluted by acid mine drainage – the Afon Goch, Anglesey, UK. *Environmental Pollution* 84: 279–284.

Bouwman, A.F., Van Vuuren, D.P. 1999. Global assessment of acidification and eutrophication of natural ecosystems. United Nations Environment Programme, Division of Environmental Information, Assessment, and Early Warning (UNEP/DEIA&EW), Nairobi, Kenya, and National Institute of Public Health and the Environment (RIVM), Bilthoven, The Netherlands.

Bozeman, J., Koopman, B., Bitton, G. 1989. Toxicity testing using immobilized algae. *Aquatic Toxicology* 14: 345–352.

Braungardt, C.B., Achterberg, E.P., Elbaz-Poulichet, F., Morley, N.H. 2003. Metal geochemistry in a mine-polluted estuarine system in Spain. *Applied Geochemistry* 18: 1757–1771.

Brettum, P. 1996. Changes in the volume and composition of phytoplankton after experimental acidification of a humic lake. *Environmental International* 22: 619–628.

Bricker, O.P., Rice, K.C. 1993. Acid Rain. *Annual Reviews of Earth and Planetary Science* 21: 151–174.

Bringmann, G., Kühn, R. 1980. Comparison of the toxicity thresholds of water pollutants to bacteria, algae, and protozoa in the cell multiplication inhibition test. *Water Research* 14: 231–241.

Broadly, P.A. 1987. The morphology, distribution and ecology of *Pseudococcomyxa simplex* (Mainx) Fott (Chlorophyta, Chlorellaceae), a widespread terrestrial Antarctic alga. *Polar Biology* 7: 25–30.

Brönmark, C., Hansson, L.A. 2005. *The biology of lakes and ponds*. 2<sup>nd</sup> ed. Oxford, Oxford University Press.

Burczyk, J., Hesse, M. 1981. The ultrastructure of the outer cell wall-layer of *Chlorella* mutants with and without sporopollenin. *Plant Systematics and Evolution* 138: 121–137.

Castro, J.M, Moore, J.N. 2000. Pit lakes: their characteristics and the potential for their remediation. *Environmental Geology* 39: 1254–1260.

Cain, J.R., Allen, R.K. 1980. Use of a cell wall-less mutant strain to assess the role of the cell wall in cadmium and mercury tolerance by *Chlamydomonas reinhardtii*. *Bulletin of Environmental Contamination and Toxicology* 25: 797–801.

Cairns, J.Jr., McCormick, P.V., Niederlehner, B.R. 1994. Bioassay and field assessment of pollutant effects. In Rai, L.C., Gaur, J.P., Soeder, C.J. (Eds), *Algae and Water Pollution*. Stuttgart, E. Schweizerbart'sche Verlagsbuchhandlung, pp. 267–282.

Chodat, R. 1913. Monographies d'Algues en culture pure. *Mat Flore Cryptogam Suisse* 4: 1–266.

Coesel, P.F.M. 1982. Structural characteristics and adaptations of desmid communities. *Journal of Ecology* 70: 163–177.

Coleman, A.W., 2000. The significance of a coincidence between evolutionary landmarks found in mating affinity and a DNA sequence. *Protist* 151: 1–9.

Darty, K., Denise, A., Ponty, Y. 2009. VARNA: Interactive drawing and editing of the RNA secondary structure. *Bioinformatics* 25: 1974–1975.

Darienko, T., Gustavs, L., Eggert, A., Wolf, W., Pröschold, T. 2015. Evaluating the species boundaries of green microalgae (*Coccomyxa*, Trebouxiophyceae, Chlorophyta) using integrative taxonomy and DNA barcoding with further implications for the species identification in environmental samples. *PLoS ONE* 10: e0127838.

DeNicola, D.M. 2000. A review of diatoms found in highly acidic environments. *Hydrobiologia* 433: 111–112.

Driscoll, C.T., Lawrence, G.B., Bulger, A.J., Butler, T.J., Cronan, C.S. Eagar, C., Lambert, K.F., Likens, G.E., Stoddard, J.L., Weathers, K. C. 2001. Acidic deposition in the northeastern US: Sources and inputs, ecosystems effects, and management strategies. *BioScience* 51: 180–198.

Droop, M.R. 1974. Heterotrophy of carbon. In Stewart, W.D.P. (Ed.), *Algal Physiology and Biochemistry*, Oxford, Blackwell, pp. 530–559.

Eliáš, M., Neustupa, J., Škaloud, P. 2008. *Elliptochloris bilobata* var. *corticola* var. nov. (Trebouxiophyceae, Chlorophyta), a novel subaerial coccal green alga. *Biologia* 63: 791–798.

Erismann, J.W., Draaijers, G.P.J. 1995. Atmospheric deposition in relation to acidification and eutrophication. Amsterdam, Elsevier.

Ettl, H., Gärtner, G. 2014. *Syllabus der Boden-, Luft- und Flechtenalgen*. 2 Auflage. Berlin and Heidelberg, Springer Spektrum.

Evans, C.D, Jenkins, A., Helliwell, R., Ferrier, R., Collins, R. 2001a. Freshwater acidification and recovery in the United Kingdom. Wallingford, Centre for Ecology and Hydrology.

Evans, C.D, Cullen, J.M., Alewell, C., Kopáček, J., Marchetto, A., Moldan, F., Prechtel, A., Rogora, M., Veselý, J., Wright, R. 2001b. Recovery from acidification in European surface waters. *Hydrology and Earth System Sciences Discussions*, Copernicus Publications 5: 283–297.

Expert Team of the Inter-Ministerial Committee (ETIMC). 2010. Mine water management in the witwatersrand gold fields with special emphasis on acid mine drainage. Report to the inter-ministerial committee on acid mine drainage (December).

Falagán, C., Sánchez-Espana, J., Johnson, D.B. 2014. New insights into the biogeochemistry of extremely acidic environments revealed by a combined cultivation-based and culture-independent study of two stratified pit lakes. *FEMS Microbiology Ecology* 87: 231–243.

Fargašová, A. 1993. Effect of five toxic metals on the alga *Scenedesmus quadricauda*. *Biología* 48: 301–304.

Fathi, A.A., Al-Omair M.A. 2006. Effects of pH on toxicity of cadmium, cobalt and copper to *Scenedesmus bijuga*. *Protistology* 4: 221–226.

Ferguson, K.D., Erickson, P.M. 1988. Pre-Mine Prediction of Acid Mine Drainage. In Salomons, W., Forstner, U. (Eds), *Environmental Management of Solid Waste*, pp. 24–43.

Fott, B. 1981. Nomenklatorische änderungen bei einigen Chlorokokkalalgen. *Preslia* 53: 1–7.

Friedl, T. 1995. Inferring taxonomic positions and testing genus level assignments in coccoid green lichen algae: a phylogenetic analysis of 18S ribosomal RNA sequences from *Dictyochloropsis reticulata* and from members of the genus *Myrmecia* (Chlorophyta, Trebouxiophyceae cl. nov.), *Journal of Phycology* 31: 632–639.

Friedl, T., Kostikov, I., Müller, M., Beck A., Zufall-Roth, E., Hoffmann, L. 2007. A reinvestigation of *Pseudococcomyxa* (Chlorophyta, Trebouxiophyceae): morphology, rDNA sequencing and AFLP fingerprinting to define species. In Hindák, F. (Ed.), *Biology and Taxonomy of Green Algae V*, International Symposium, Programme and Abstracts, Bratislava, Slovak Botanical Society, p. 23.

Friedrich, J., Dandekar, T., Wolf, M., Müller, T. 2005. ProfDist: A tool for the construction of large phylogenetic trees based on profile distances. *Bioinformatics* 21: 2108–2109.

Galloway, J.N. 1988. Effects of acid deposition on tropical aquatic ecosystems. In Rodhe, H., Herrera, R. (Eds), *Acidification in Tropical Countries*. SCOPE Report 36, Chichester, John Wiley & Sons, pp. 141–164.

Garbayo, I., Torronteras, R., Forján, E., Cuaresma, M., Casal, C., Mogedas, B., Ruiz-Domínguez, M.C., Márquez, C., Vaquero I., Fuentes-Cordero, J.L., Fuentes, R., González-del-Valle, M., Vilchez, C. 2012. Identification and physiological aspects of a novel carotenoid-enriched, metal-resistant microalga isolated from an acid river in Huelva (Spain). *Journal of Phycology* 48: 607–614.

Gascuel, O. 1997. BIONJ: an improved version of the NJ algorithm based on a simple model of sequence data. *Molecular Biology and Evolution* 14: 685–695.

Geller, W., Schultze, M. 2013. Occurrence and distribution of pit lakes. In Geller, W., Schultze, M., Kleinmann, R., Wolkersdorfer, C. (Eds), *Acidic Pit Lakes – The Legacy of Coal and Metal Surface Mines*. Berlin, Springer.

Gensemer, R.W. 1991. The effects of pH and aluminum on the growth of the acidophilic diatom *Asterionella ralfsii* var. *americana*. *Limnology and Oceanography* 36: 123–131.

Gensemer, R.W., Playle R.C. 1999. The bioavailability and toxicity of aluminum in aquatic environments. *Critical Reviews in Environmental Science and Technology* 29: 315–450.

Gimmler, H. 2001. Acidophilic and acidotolerant algae. In Rai, L.C., Gaur, J.P. (Eds), *Algal Adaptations to Environmental Stresses*. Berlin, Springer, pp. 259–290.

Gómez-Jacinto, V., Garçça-Barrera, T., Gómez-Ariza, J.L., Garbayo-Nores, I., Vålchez-Lobato, C. Elucidation of the defence mechanism in microalgae *Chlorella sorokiniana* under mercury exposure. Identification of Hg-phytochelatins. *Chemico-Biological Interactions* 238: 82–90.

Gouy, M., Guindon, S., Gascuel, O. 2010. SeaView version 4: a multiplatform graphical user interface for sequence alignment and phylogenetic tree building. *Molecular Biology and Evolution* 27: 221–224.

Graham, J.M., Arancibia-Avila, P. Graham, L.E. 1996. Effects of pH and selected metals on growth of the filamentous green alga *Mougeotia* under acidic conditions. *Limnology and Oceanography* 41: 263–270.

Gross, W. 2000. Ecophysiology of algae living in highly acidic environments. *Hydrobiologia* 433: 31–37.

Gustavs, L., Darienko, T., Eggert, A., Wolf, W., Karsten, U., Pröschold, T. 2013. Variety of lifestyles – likeness of traits: an integrative case study on the genus *Coccomyxa* (Trebouxiophyceae, Chlorophyta). 10th International Phycological Congress. Abstract.

Håkanson, L., Gallego, E., Rios-Insua, S. 2000. The application of the lake ecosystem index in multi-attribute decision analysis in radioecology. *Journal of Environmental Radioactivity* 49: 319–344.

Hall, T. 1999. BioEdit: A user-friendly biological sequence alignment editor and analysis program for Windows 95/98/NT. *Nucleic Acids Symposium* 41: 95–98.

Hallmann, C, Stannek, L, Fritzlar, D, Hause-Reitner, D, Friedl, T, Hoppert, M. 2013. Molecular diversity of phototrophic biofilms on building stone. *FEMS Microbiology Ecology* 84: 355–375.

Hargreaves, J.W., Whitton, B.A. 1976. Effect of pH on tolerance of *Hormidium rivulare* to zinc and copper. *Oecologia* 26: 235–243.

Havens, K.E., DeCosta, J. 1987. Freshwater plankton community succession during experimental acidification. *Archiv für Hydrobiologie* 111: 37–65.

Helms, G., Friedl, T., Rambold, G., Mayrhofer, H. 2001. Identification of photobionts from the lichen family Physciaceae using algal-specific ITS rDNA sequences. *Lichenologist* 33: 73–86.

Hendrey, G.R., Baalsrud, K., Traaen, T.S., Laake, M., Raddum, G. 1976a. Acid precipitation: some hydrobiological changes. *Ambio* 5: 224–227.

Hendrey, G.R., Wright, R.F. 1976b. Acid precipitation in Norway: effects on aquatic fauna. *Journal of Great Lakes Research* 2: 192–207.



Hepperle, D. 2004. SeqAssem©. A sequence analysis tool, counting assembler and trace data visualization tool for molecular sequences. Win32-Version. Distributed by the author via: <http://www.sequentix.de/>.

Hoffman, D.J., Rattner, B.A., Burton, G.A. Jr., Cairns, J. Jr (Eds). 2003. Handbook of Ecotoxicology. 2<sup>nd</sup> ed. Boca Raton, Lewis Publishers.

Hörnström, E., Ekström, C., Duraini, M.O. 1984. Effects of pH and different levels of aluminum on lake plankton in the Swedish West Coast area. In Nyman, L., Ericsson, B. (Eds), Report No. 61, Institute of Freshwater Research, Drottingholm, pp. 115–127.

Hörnström, E. 1990. Toxicity test with algae – a discussion on the batch method. *Ecotoxicology and Environmental Safety* 20: 343–353.

Hörnström, E., Harbom, A., Edberg, F., Andrén C. 1995. The influence of pH on aluminium toxicity in the phytoplankton species *Monoraphidium dybowskii* and *M. griffithii*. *Water, Air and Soil Pollution* 85: 817–822.

Hoshina, R. Imamura, N. 2008. Multiple origins of the symbioses in *Paramecium bursaria*. *Protist* 159: 53–63.

Hrdinka, T., Šobr, M., Fott, J., Nedbalová, L. 2013. The unique environment of the most acidified permanently meromictic lake in the Czech Republic. *Limnologica* 43: 417–426.

Huelsenbeck, J.P, Ronquist, F. 2001. MRBAYES: Bayesian inference of phylogenetic trees. *Bioinformatics* 17: 754–755.

International Organization for Standardization (ISO). 1987. Water quality – algal growth inhibition test, No. 8692. ISO, Paris.

Jin, X., Nalewajko, C., Kushner, D.J. 1996. Comparative study of nickel toxicity to growth and photosynthesis in nickel-resistant and -sensitive strains of *Scenedesmus acutus* f. *alternans* (Chlorophyceae). *FEMS Microbiology Ecology* 31: 103–114.

Johnson, D.B., Hallberg, K.B. 2005. Acid mine drainage remediation options: a review. *Science of the Total Environment* 338: 3–14.

Kamat, M.D. 1965. Ecological notes on Kolhapur. *Journal of Biological Sciences* 8: 47–54.

Kalin, M., Cao, Y., Smith, M., Olaveson M.M. 2001. Development of the phytoplankton community in a pit-lake in relation to water quality changes. *Water Research* 35: 3212–3225.

Kaplan, D. 2004. Absorption and adsorption of heavy metals by microalgae. In Richmond, A. (Ed.), *Handbook of Microalgal Culture: Biotechnology and Applied Phycology*. Oxford, Blackwell Publishing, pp. 439–447.

Katoh, K., Misawa, K., Kuma, K., Miyata, T. 2002. MAFFT: a novel method for rapid multiple sequence alignment based on fast Fourier transform. *Nucleic Acids Research* 30: 3059–3066.

Komarék, J., Fott, B. 1983. Chlorophyceae (Grünalgen), Ordnung: Chlorococcales. In Huber-Pestalozzi, G. (Ed.), *Das Phytoplankton des Süßwassers; Systematik und Biologie*. Stuttgart, E. Schweizerbart'sche Verlagsbuchhandlung.

Komárková-Legnerová, J. 1969. The systematics and ontogenesis of the genera *Ankistrodesmus* Corda and *Monoraphidium* gen. nov. In Fott, B. (Ed.), Studies in Phycology, Stuttgart, Schweizerbart'sche, pp. 75–144.

Kopáček, J., Hejzlar, J., Stuchlík, E., Fott, J., Veselý, J. 1998. Reversibility of acidification of mountain lakes after reduction in nitrogen and sulphur emissions in Central Europe. *Limnology and Oceanography* 43: 357–361.

Kopáček, J., Hejzlar, J., Borovec, J., Porcal, P., Kotorová, I. 2000. Phosphorus inactivation by aluminum in the water column and sediments: Lowering of in lake phosphorus availability in an acidified watershed-lake ecosystem. *Limnology and Oceanography* 45: 212–225.

Kopáček, J., Stuchlík, E., Veselý, J., Schaumburg, J., Anderson, I.C., Fott, J., Hejzlar, J., Vrba, J. 2002. Hysteresis in reversal of Central European mountain lakes from atmospheric acidification. *Water, Air, and Soil Pollution* 2: 91–114.

Kopáček, J., Turek, J., Hejzlar, J., Kaňa, J., Porcal, P. 2006. Element fluxes in watershed-lake ecosystems recovering from acidification: Plešné Lake, the Bohemian Forest, 2001–2005. *Biologia, Bratislava* 61, Suppl. 20: S427–S440.

Korshikov, O. 1953. Vyznachnik prisnovodnihk vodorostey Ukrainsykoj RSR [Vyp] V. Pidklas Protokokovi (Protococcineae). Bakuol'ni (Vacuolales) ta Protokokovi (Protococcales) [The Freshwater Algae of the Ukrainian SSR. V. Sub-Class Protococcineae. Vacuolales and Protococcales]. Kyjv, Akad. NAUK URSR.

Korneva, L.G. 1996. Impact of acidification on structural organization of phytoplankton community in the forest lakes of the North-Western Russia. *Water Science and Technology* 33: 291–296.

Kvíděrová, J. 2010. Rapid algal toxicity assay using variable chlorophyll fluorescence for *Chlorella kesslerii* (Chlorophyta). *Environmental Toxicology* 25: 554–563.

Kwiatkowski, R.E., Roff, J.C. 1976. Effects of acidity on the phytoplankton and primary productivity of selected northern Ontario lakes. *Canadian Journal of Botany* 54: 2546–2561.

Lampert, V., Sommer, U. 2007. *Limnoecology: The ecology of lakes and streams*. 2<sup>nd</sup> ed. Oxford, Oxford University Press.

Lessmann, D., Fyson, A., Nixdorf, B. 2000. Phytoplankton of the extremely acidic mining lakes of Lusatia (Germany) with pH ≤ 3. *Hydrobiologia* 433: 123–128.

Lessmann, D., Fyson, A., Nixdorf, B. 2003. Experimental eutrophication of a shallow acidic mining lake and effects on the phytoplankton. *Hydrobiologia* 506–509: 753–758.

Letsch, M.R., Muller-Parker, G., Friedl, T., Lewis, L.A. 2009. *Elliptochloris marina* sp. nov. (Trebouxiophyceae, Chlorophyta), symbiotic green alga of the temperate Pacific sea anemones *Anthopleura xanthogrammica* and *A. elegantissima* (Anthozoa, Cnidaria). *Journal of Phycology* 45: 1127–1135.

Li, Y., Zhu, L., Liu, S. 2009. Individual and joint stress of lead and mercury on growth, glutathione and glutathione-related enzymes of *Scenedesmus quadricauda*. *Huan Jing Ke Xue* 30: 248–253.

Li, J.T., Duan, H.N., Li, S.P., Kuang, J.L., Zeng, Y., Shu, W.S. 2010. Cadmium pollution triggers a positive biodiversity-productivity relationship: evidence from a laboratory microcosm experiment. *Journal of Applied Ecology* 47: 890–898.

Likeš, J., Laga, J. 1978. *Základní Statistické Tabulky*. Praha, Státní nakladatelství technické literatury.

Lukavský, J. 1992. The evaluation of algal growth potential (AGP) and toxicity of water by miniaturized growth bioassay. *Water Research* 26: 1409–1413.

Lukavský, J., Maršálek B., Fremlová L. 1995. Mikrometoda stanovení toxicity a trofického potenciálu růstovým testem. *Odvětvová technická norma vodního hospodářství TNV 75 77 41*.

Lukavský, J., Furnadjieva, S., Cepák, V. 2003. Toxicity of metals, Al, Cd, Co, Cr, Cu, Fe, Ni, Pb and Zn on microalgae, using microplate bioassay 1: *Chlorella kessleri*, *Scenedesmus quadricauda*, *Sc. subspicatus* and *Raphidocelis subcapitata* (*Selenastrum capricornutum*). *Algological Studies* 110: 127–141.

Lukešová, A. 2001. Soil algae in brown coal and lignite post-mining areas in Central Europe (Czech Republic and Germany). *Restoration Ecology* 9: 341–350.

Mai, J.C., Coleman, A.W. 1997. The internal transcribed spacer 2 exhibits a common secondary structure in green algae and flowering plants. *Journal of Molecular Evolution* 44: 258–271.

Mainx, F. 1928. Einige neue Chlorophyceen (Tetrasporales und Protococcales). *Archiv für Protistenkunde* 64: 93–95.

Majer, V., Cosby, B.J., Kopáček, J., Vesely, J. 2003. Modelling reversibility of central European mountain lakes from acidification: Part I – The Bohemian Forest. *Hydrology and Earth System Sciences* 7: 494–509.

Mohlová, K. 2008. Algae and cyanobacteria colonizing toxic soils on coal-mining dumps. Master thesis, PšF JU, pp. 45.

Moser, M., Weisse, T. The most acidified Austrian lake in comparison to a neutralized mining lake. *Limnologia* 41: 303–315.

Muggia, L., Baloch, E., Stabentheiner, E., Grube, M., Wedin, Mats. 2010. Photobiont association and genetic diversity of the optionally lichenized fungus *Schizoxylon albescens*. *FEMS Microbiology Ecology* 75: 255–72.

McNeill, J., Barrie, F.R., Burdet, H.M., Demoulin, V., Hawksworth, D.L., Marhold, K., Nicolson, D.H., Prado, J., Silva, P.C., Skog, J.E., Wiersema, J.H., Turland, N.J. (Eds). 2006. *International Code of Botanical Nomenclature for algae, fungi, and plants (Melbourne Code)*. *Regnum Vegetabile* 154: 1–240.

Mikhailyuk, T.I., Sluiman, H.J., Massalski, A., Mudimu, O., Demchenko, E.M., Kondratyuk, S.Y., Friedl, T. 2008. New streptophyte green algae from terrestrial habitats and an assessment of the genus *Interfilum* (Klebsormidiophyceae, Streptophyta). *Journal of Phycology* 44: 1586–1603.

Muniz, I.P. 1991. Freshwater acidification: Its effects on species and communities of freshwater microbes, plants and animals. Proceedings of the Royal Society of Edinburgh, 97B, Royal Society of Edinburgh, Edinburgh, pp. 227–254.

Nacorda, J.O., Martinez-Goss, M.R., Torreta, N.K. 2010. Bioremoval and bioreduction of chromium (VI) by the green microalga, *Chlorella vulgaris* Beij., isolated from Laguna de Bay, Philippines. Philippine Journal of Science 139: 181–188.

Nedbalová, L., Vrba, J., Fott, J., Kohout, L., Kopáček, J., Macek, M., Soldán, T. 2006. Biological recovery of the Bohemian Forest lakes from acidification. Biologia, Bratislava 61, Suppl. 20: S453–S465.

Nei, M., Kumar, S. 2000. Molecular evolution and phylogenetics. Oxford, Oxford University Press.

Nemjová, K. 2009. Molekulárna fylogenetika a geometrická morfometrika aerofytických zelených rias komplexu *Coccomyxa/Pseudococcomyxa* s. I. Diplomová práca, PšF UK, pp. 91.

Neustupa, J., Nemjová, K. 2008. Quantitative assessment of morphological variation of six *Pseudococcomyxa* strains by geometric morphometric descriptors. Fottea 8: 111–116.

Niesel, V., Hoehm, E., Sudbrack, R., Willems, H., Chorus, I. 2007. The occurrence of the dinophyte species *Gymnodinium uberrimum* and *Peridinium willei* in German reservoirs. Journal of Plankton Research 29: 347–357.

Nixdorf, B., Wollmann, K., Deneke, R. 1998. Ecological potentials for planktonic development and food web interactions in extremely acidic mining lakes in Lusatia. In Geller W., Klapper, H., Salomons, W. (Eds), Acidic Mining Lakes. Berlin, Springer, pp. 147–167.

Nixdorf, B., Fyson, A., Krumbeck, H. 2001. Review: plant life in extremely acidic waters. Environmental and Experimental Botany 46: 203–211.

Nixdorf, B., Krumbeck, H., Jander, J., Beulker, C. 2003. Comparison of bacterial and phytoplankton productivity in extremely acidic mining lakes and eutrophic hard water lakes. Acta Oecologica 24: 281–288.

Nyholm, N., Källqvist, T. 1989. Methods for growth inhibition toxicity tests with freshwater algae. Environmental Toxicology and Chemistry 8: 698–703.

Organization for Economic Cooperation and Development (OECD). 1984. Alga, growth inhibition test, No. 201. OECD guidelines for testing of chemicals, Paris.

Ojala, A., Jones, R.I. 1993. Spring development and mitotic division pattern of a *Cryptomonas* sp. in an acidified lake. European Journal of Phycology 28: 17–24.

Olaveson, M.M., Nalewajko, C. 2000. Effects of acidity on the growth of two *Euglena* species. Hydrobiologia 433: 39–56.

Ouyang, H.L., Kong, X.Z., He, W., Qin, N., He, Q., Wang, Y., Wang, R., Xu, F. 2012. Effects of five heavy metals at sub-lethal concentrations on the reproduction and photosynthesis of *Chlorella vulgaris*. Chinese Science Bulletin 57: 785–793.

Page, R.D.M. 1996. TREEVIEW: An application to display phylogenetic trees on personal computers. Computer Applications in the Biosciences 12: 357–358.

Peters, S., Lofts, S., Merrington, G., Brown, B., Stubblefield, W., Harlow, K. Development of biotic ligand models for chronic manganese toxicity to fish, invertebrates, and algae. *Environmental Toxicology and Chemistry* 30: 2407–2415.

Peterson, H.G., Healey, F.P., Wagemann, R. 1984. Metal toxicity on algae: A highly pH dependent phenomenon. *Canadian Journal of Fisheries and Aquatic Sciences* 41: 974– 979.

Posada, D. Crandall, K.A. 1998. MODELTEST: testing the model of DNA substitution. *Bioinformatics* 14: 817–818.

Pražáková, M., Veselý, J., Fott, J., Majer, V., Kopáček, J. 2006. The long-term succession of cladoceran fauna and palaeoclimate forcing: A 14,600-year record from Plešné Lake, the Bohemian Forest. *Biologia, Bratislava* 61, Suppl. 20: S387–S399.

Pröschold, T., Darienko, T., Silva, P.C., Reisser, W., Krienitz, L. 2011. The systematics of “*Zoochlorella*” revisited employing an integrative approach. *Environmental Microbiology* 13: 350–364.

Rambaut, A. 2012. Figtree 1.4.0. Distributed by the author via: <http://tree.bio.ed.ac.uk/software/figtree/>.

Reed, R.H., Gadd, G.M. 1990. Metal tolerance in eukaryotic and prokaryotic algae. In Shaw, A.J. (Ed.), *Heavy Metal Tolerance in Plants: Evolutionary Aspects*. Boca Raton, CRC Press, pp. 105–118.

Reuter, J.S., Mathews, D.H. 2010. RNAstructure: software for RNA secondary structure prediction and analysis. *Bioinformatics* 11: 129.

Rice, K.C., Herman, J.S. 2012. Acidification on Earth: An assessment across mechanisms and scales. *Applied Geochemistry* 27: 1–14.

Ronquist, F., Huelsenbeck, J.P. 2003. MrBayes 3: Bayesian phylogenetic inference under mixed models. *Bioinformatics* 19: 1572–1574.

Salomons, W. 1995. Environmental impact of metals derived from mining activities: processes, predictions, prevention. *Journal of Geochemical Exploration* 52: 5– 23.

Sánchez-Fortün, S., López-Rodas, V., Navarro, M., Marvá, F., D'ors, A., Rouco, M., Haigh-Florez, D., Costas, E. 2009. Toxicity and adaptation of *Dictyosphaerium chlorelloides* to extreme chromium contamination. *Environmental Toxicology and Chemistry* 28: 1901–1905.

Schindler, D.W. 1994. Changes caused by acidification to the biodiversity, productivity and biogeochemical cycles of lakes. In Steinberg, C.E.W., Wright, R.F., (Eds), *Acidification of Freshwater Ecosystems: Implications for the Future*. Chichester, John Willey & Sons, pp.153–164.

Schindler, D.W. 1988. Effects of acid rain on freshwater ecosystems. *Science* 239: 149–157.

Schmidle, W. 1901. Über drei Algengenera. *Berichte der deutschen botanischen Gessellschaft* 19: 10–24.

Schultz, J., Maisel, S., Gerlach, D., Muller, T., and Wolf, M. 2005. A common core of secondary structure of the internal transcribed spacer 2 (ITS2) throughout the Eukaryota. *RNA* 11: 361–364.

Seibel, P.N., Müller, T., Dandekar, T., Schultz, J., Wolf, M., 2006. 4SALE – a tool for synchronous RNA sequence and secondary structure alignment and editing. *BMC Bioinformatics* 7: 498.

Seibel, P.N., Müller, T., Dandekar, T., Wolf, M., 2008. Synchronous visual analysis and editing of RNA sequence and secondary structure alignments using 4SALE. *BMC Evolutionary Biology* 1: 91.

Siver, P.A., Hamer, J.S. 1989. Multivariate statistical analysis of the factors controlling the distribution of scaled chrysophytes. *Limnology and Oceanography* 34: 368–381.

Skulberg, O.M. 1964. Algal problems related to the eutrophication of European water supplies and a bioassay method to assess fertilizing influences of pollution on inland waters. In Jackson, D.F. (Ed.), *Algae and Man*. New York, Plenum Press, pp. 262–299.

Sládečková, A. 1959. On the spontaneous growth of *Pseudococcomyxa adhaerens* (Chlorophyceae) in chemical solutions. *Ecology* 40: 732–733.

Sorentino, C. 1979. The effect of heavy metals on phytoplankton – a review. *Phykos* 18: 149–161.

Sposito, G. 1986. Distribution of potentially hazardous trace metals. In Siegel, H. (Ed.), *Metal Ions in Biological Systems*, vol. 20. New York, Marcel Dekker.

Stauber, J.L. 1995. Toxicity testing using marine and freshwater unicellular algae. *Australasian Journal of Ecotoxicology* 1: 15–24.

Steinberg, C.E.W., Schäfer, H., Beisker, W. 1998. Do acid-tolerant Cyanobacteria exist? *Acta Hydrochimica et Hydrobiologica* 26: 13–19.

Stevenson, R.J., Bothwell, M.L., Lowe, R.L. 1996. *Algal ecology – freshwater benthic ecosystems*. San Diego, Academic Press.

Stoddard, J.L., Jeffries D.S., Lükewille, A., Clair, T.A., Dillon, P.J., Driscoll, C.T., Forsius, M., Johannessen, M., Johannessen, M., Kahl, J.S., Kellogg, J.H., Kemp, A., Mannio, J., Monteith, D.T., Murdoch, P.S., Patrick, S., Rebsdorf, A., Skjelkvåle, B.L., Stainton, M.P., Traaen, T., Van Dam, H., Webster, K.E., Wieting, J., Wilander, A. 1999. Regional trends in aquatic recovery from acidification in North America and Europe. *Nature* 401: 575–578.

Swofford, D.L. 2003. PAUP\*. *Phylogenetic Analysis Using Parsimony (\*and Other Methods)*. Version 4. Sinauer Associates, Sunderland, Massachusetts.

Syasina, I.G., Kukhlevsky, A.D., Kovaleva, A.L., Vaschenko, M.A. 2012. Phylogenetic and morphological characterization of the green alga infesting the horse mussel *Modiolus modiolus* from Vityaz Bay (Peter the Great Bay, Sea of Japan). *Journal of Invertebrate Pathology* 111: 175–181.

Takamura, N, Kasai, F, Watanabe, M.M. 1989. Effects of Cu, Cd and Zn on photosynthesis of freshwater benthic algae. *Journal of Applied Phycology* 1: 39–52.

Tamura, K., Stecher, G., Peterson, D., Filipinski, A., Kumar, S. 2013. MEGA6: Molecular evolutionary genetics analysis version 6.0. *Molecular Biology and Evolution* 30: 2725– 2729.

Taylor, F.J. 1965. The growth of *Pseudococcomyxa adhaerens* Korshikov in distilled water. *Archiv für Mikrobiologie* 50: 378–381.

Thüs, H., Muggia, L., Pérez-Ortega, S., Favero-Longo, S.E., Joneson, S., O'Brien, H., Nelsen, M.P., Duque-Thüs, R., Grube, M., Friedl, T., Brodie, J., Andrew, C.J., Lücking, R., Lutzoni, F., Gueidan, C. 2011. Revisiting photobiont diversity in the lichen family Verrucariaceae (Ascomycota). *European Journal of Phycology* 46: 399–415.

Trémouillaux-Guiller, J., Rohr, T., Rohr, R., Huss, V.A.R. 2002. Discovery of an endophytic alga in *Ginkgo biloba*. *American Journal of Botany* 89: 727–733.

Trémouillaux-Guiller, J., Huss, V.A.R. 2007. A cryptic intracellular green alga in *Ginkgo biloba*: ribosomal DNA markers reveal worldwide distribution. *Planta* 226: 553–557.

Tukey, J.W. 1977. *Exploratory data analysis*. Massachusetts, Addison-Wesley Publishing Company.

United States Environmental Protection Agency (USEPA). 1971. Algal assay procedures: Bottle test. In Miller, W.E., Greene, J.C., Shiroyama, T. (Eds), National Eutrophication Program. Environmental Research Laboratory, U.S. Environmental Protection Agency, Corvallis.

Verma, V., Bhatti, S., Huss, V.A.R., Colman, B. 2009. Photosynthetic inorganic carbon acquisition in an acid-tolerant, free living species of *Coccomyxa* (Chlorophyta). *Journal of Phycology* 45: 847–854.

Veselý, J. 1994. Investigation of the nature of the Šumava lakes. A review. *Časopis Národního Muzea Praha, Řada přírodovědná* 163: 103–120.

Veselý, J., Hruška, J., Norton, S.A. 1998. Trends in water chemistry of acidified Bohemian lakes from 1984 to 1995: II. Trace elements and aluminum. *Water, Air, and Soil Pollution* 108: 425–443.

Vilgalys, R., Hester, M. 1990. Rapid genetic identification and mapping of enzymatically amplified ribosomal DNA from several *Cryptococcus* species. *Journal of Bacteriology* 172: 4238–4246.

Visviki, J., Santikul, D. 2000. The pH tolerance of *Chlamydomonas applanata* (Volvocales, Chlorophyta). *Archives of Environmental Contamination and Toxicology* 38: 147–151.

Vrba, J., Kopáček, J., Fott, J. 2000. Long-term limnological research of the Bohemian Forest lakes and their recent status. *Silva Gabreta* 4: 7–28.

Vrba, J., Kopáček, J., Fott, J., Kohout, L., Nedbalová, L., Pražáková, M., Soldán, M., Schaumburg, J. 2003. Long term studies (1871–2000) on acidification and recovery of lakes in the Bohemian Forest (Central Europe). *Science of the Total Environment* 310: 73–85.

Vymazal, J. 1986. Occurrence and chemistry of zinc in freshwaters – its toxicity and bioaccumulation with respect to algae: a review. Part 2: Toxicity and bioaccumulation with respect to algae. *Acta Hydrochimica et Hydrobiologica* 14: 83–102.

Warfvinge, P., Bertills, U. (Eds). 2000. Recovery from acidification in natural environment. Present knowledge and future scenarios, Report 5034, Swedish Environmental Protection Agency, Stockholm.

White, T.J., Bruns, T., Lee, S., Taylor, J. 1990. Amplification and direct sequencing of fungal ribosomal RNA genes for phylogenetics. In Innis, M.A., Gelfand, D.H., Sninsky, J.J., White,

T.J. (Eds), PCR Protocols: a Guide to Methods and Applications. New York, Academic Press, pp. 315–322.

Woelfl, S., Tittel, J., Zippel, B., Kringel, R. 2000. Occurrence of an algal mass development in an acidic (pH 2.5), iron and aluminium-rich coal mining pond. *Acta Hydrochimica et Hydrobiologica* 28: 305–309.

Yan, N. 1979. Phytoplankton community of an acidified, heavy metal-contaminated lake near Sudbury, Ontario: 1973–1977. *Water, Air, Soil Pollution* 11: 43–55.

Zimmermann, J., Jahn, R., Gemeinholzer, B. 2011. Barcoding diatoms: evaluation of the V4 subregion on the 18S rRNA gene, including new primers and protocols. *Organisms Diversity and Evolution* 11: 173–192.

Zoller, S., Lutzoni, F. 2003. Slow algae, fast fungi: exceptionally high nucleotide substitution rate differences between lichenized fungi *Omphalina* and their symbiotic green algae *Coccomyxa*. *Molecular Phylogenetic and Evolution* 29: 629–640.

Zuykov, M., Belzile, C., Lemaire, N., Gosselin, M., Dufresne, F., Pelletier, E. 2014. First record of the green microalgae *Coccomyxa* sp. in blue mussel *Mytilus edulis* (L.) from the Lower St. Lawrence Estuary (Québec, Canada). *Journal of Invertebrate Pathology* 120: 23–32.

Zytkowicz, R. 1982. Characteristics of the environment of the Jasne Lake. AUNC, *Limnological Papers* 13: 51–63.



## 8. SUPPLEMENT

### S1. List of abbreviations

Al – Aluminum

BI – Bayesian inference

bp – base pair

BS – Bootstrap

CAUP – Culture Collection of Algae of Charles University in Prague

CBC – Compensatory base change

CCALA – Culture Collection of Autotrophic Organisms in Třebon

CCAP – Culture Collection of Algae and Protozoa

Cr – Chromium

Cu – Copper

EPSAG – Experimental Phycology and Culture Collection of Algae at the University of Goettingen;

Hg – Mercury

ITS – Internal transcribed spacer

ML – Maximum likelihood

Mn – Manganese

MP – Maximum parsimony

NCBI – The National Center for Biotechnology Information

PCR – Polymerase chain reaction

PNJ – Profile neighbor-joining

PP – Posterior probability

rDNA – ribosomal deoxyribonucleic acid

rRNA – ribosomal ribonucleic acid

SRP – Soluble reactive phosphorus

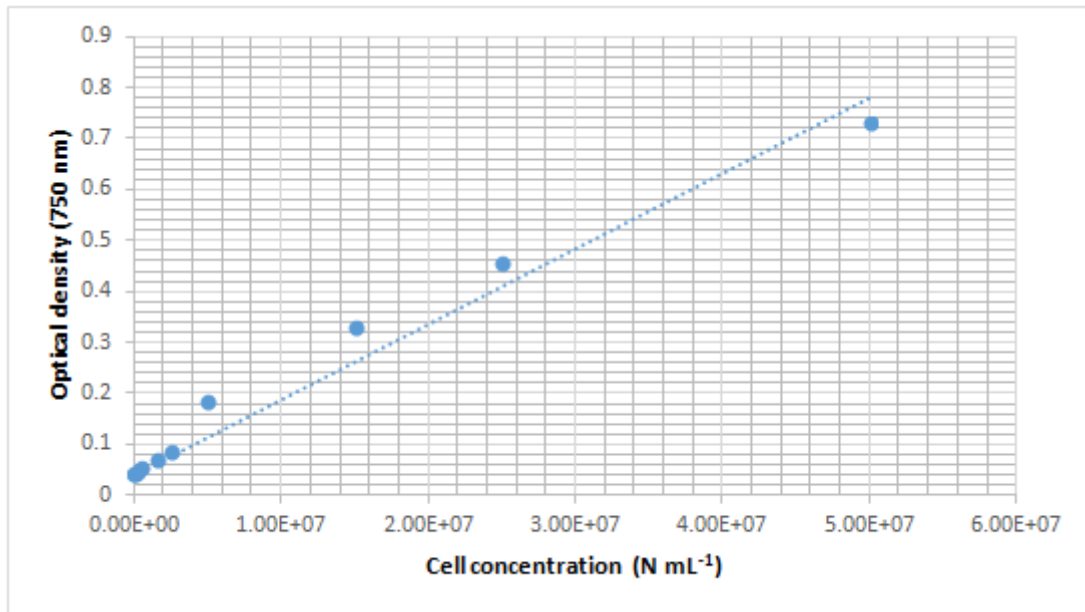
TP – Total phosphorus

Zn – Zinc

## S2. Conversion equations of the strains

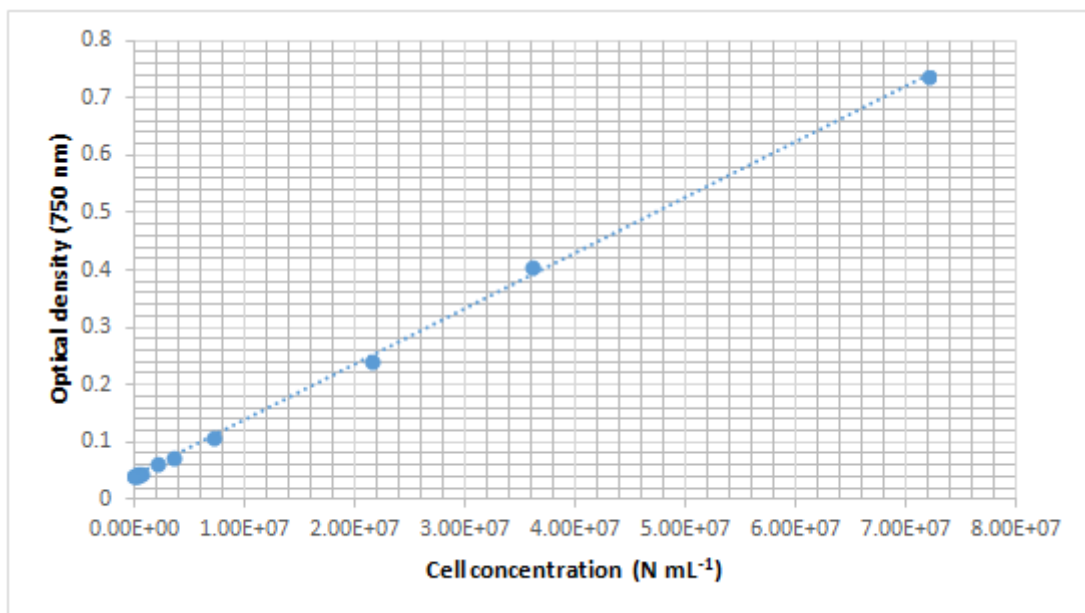
Hromnice strain:

$$\text{Cell concentration (N mL}^{-1}\text{)} = \frac{A_{750} - 0.040}{1.476\text{E-}08} \quad (r^2 = 0.9724)$$



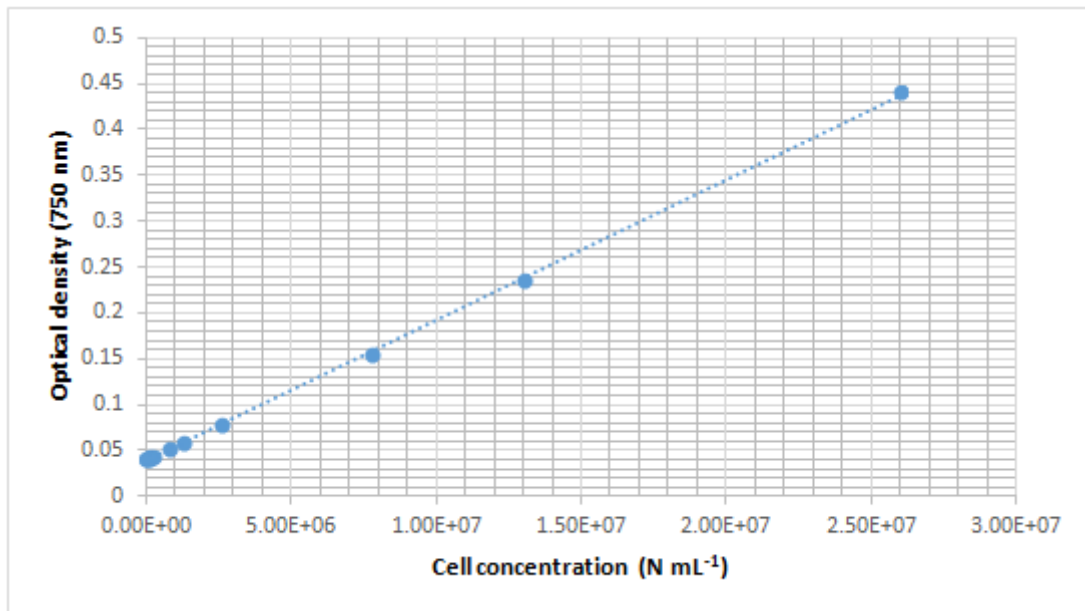
Plešné strain:

$$\text{Cell concentration (N mL}^{-1}\text{)} = \frac{A_{750} - 0.040}{9.730\text{E-}09} \quad (r^2 = 0.9994)$$



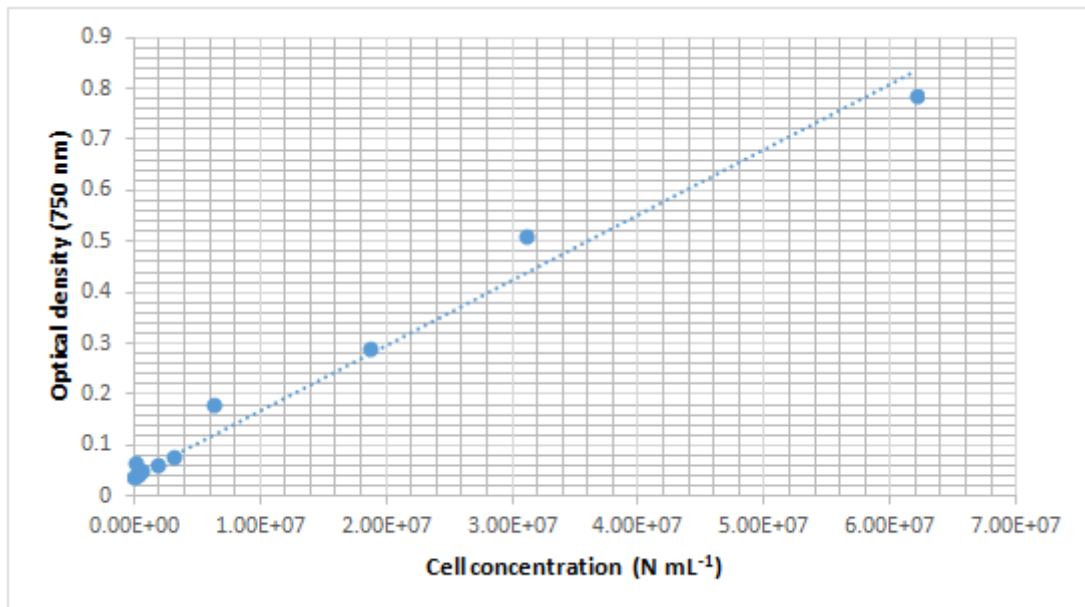
Strain CAUP H 101:

$$\text{Cell concentration (N mL}^{-1}\text{)} = \frac{A_{750} - 0.040}{1.525\text{E} - 08} \quad (r^2 = 0.9996)$$



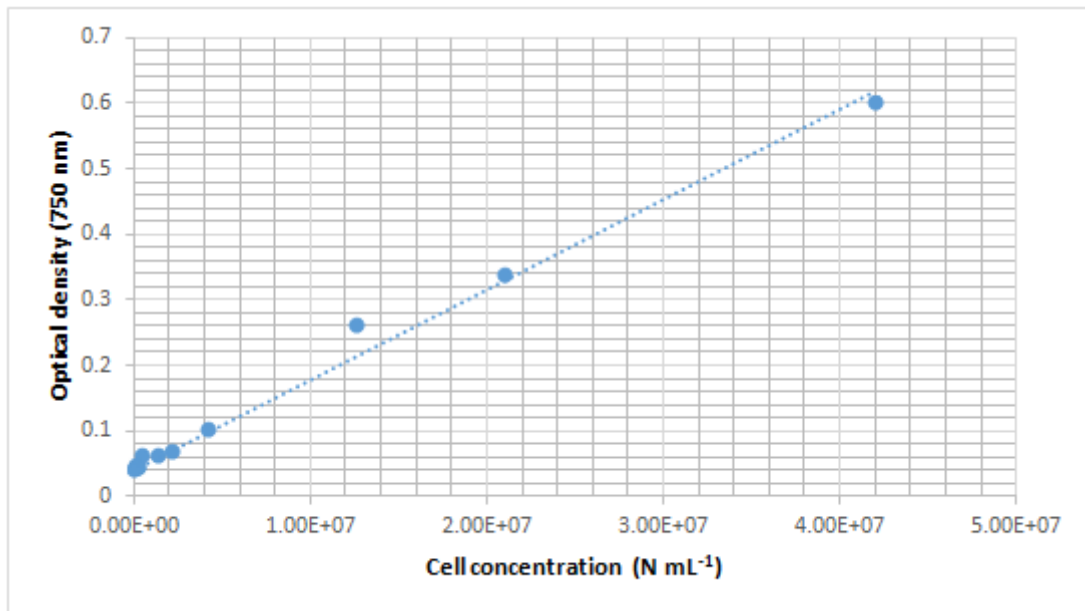
Strain SAG 216-9a:

$$\text{Cell concentration (N mL}^{-1}\text{)} = \frac{A_{750} - 0.040}{1.281\text{E} - 08} \quad (r^2 = 0.9781)$$



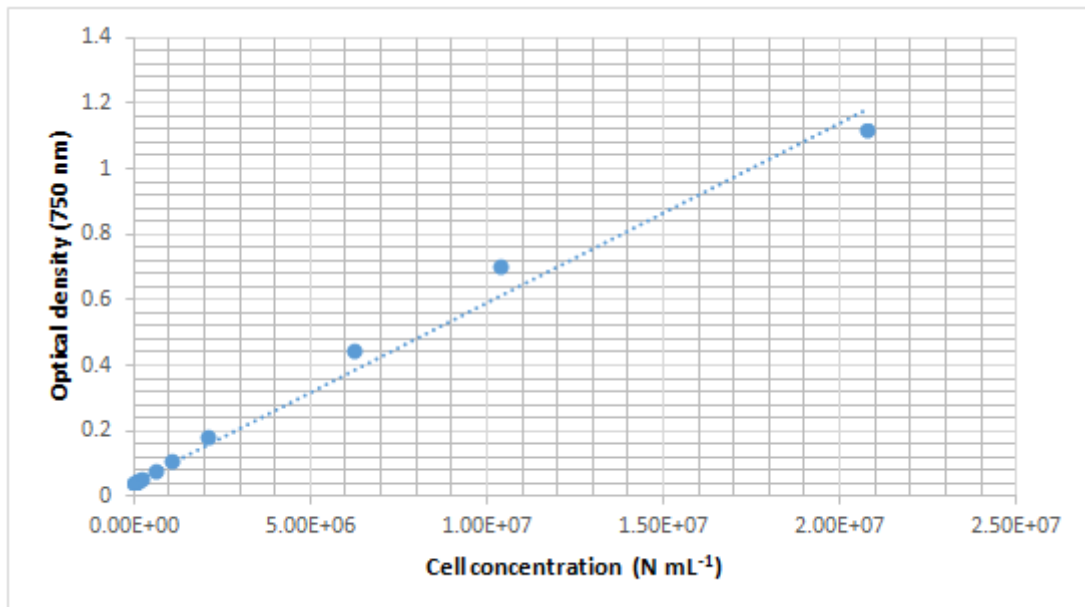
Strain CCALA 427:

$$\text{Cell concentration (N mL}^{-1}\text{)} = \frac{A_{750} - 0.040}{1.379\text{E-}08} \quad (r^2 = 0.9902)$$



Strain CCALA 375:

$$\text{Cell concentration (N mL}^{-1}\text{)} = \frac{A_{750} - 0.040}{5.500\text{E-}08} \quad (r^2 = 0.9866)$$



### S3. Statistical comparison of size between different strains

Dunn's multiple comparisons test	Length		Width	
	Significant?	Adjusted P Value	Significant?	Adjusted P Value
Hromnice vs. Plešné	Yes	< 0,0001	No	> 0,9999
Hromnice vs. CAUP H 101	No	> 0,9999	Yes	0,0402
Hromnice vs. SAG 216-9a	Yes	< 0,0001	No	> 0,9999
Hromnice vs. CCALA 425	Yes	< 0,0001	No	> 0,9999
Hromnice vs. CCALA 427	No	> 0,9999	Yes	0,004
Hromnice vs. CCALA 428	Yes	0,0273	No	0,0782
Hromnice vs. CCALA 905	Yes	< 0,0001	Yes	< 0,0001
Hromnice vs. S2	No	> 0,9999	Yes	< 0,0001
Hromnice vs. S3	Yes	< 0,0001	Yes	< 0,0001
Hromnice vs. S4	Yes	< 0,0001	Yes	< 0,0001
Hromnice vs. S5	No	0,1907	Yes	< 0,0001
Hromnice vs. S6	Yes	< 0,0001	Yes	< 0,0001
Plešné vs. CAUP H 101	Yes	< 0,0001	No	> 0,9999
Plešné vs. SAG 216-9a	No	> 0,9999	No	> 0,9999
Plešné vs. CCALA 425	No	0,173	No	> 0,9999
Plešné vs. CCALA 427	Yes	< 0,0001	Yes	< 0,0001
Plešné vs. CCALA 428	Yes	< 0,0001	Yes	< 0,0001
Plešné vs. CCALA 905	No	> 0,9999	Yes	< 0,0001
Plešné vs. S2	Yes	< 0,0001	Yes	< 0,0001
Plešné vs. S3	Yes	0,0003	Yes	< 0,0001
Plešné vs. S4	No	0,6247	Yes	0,0001
Plešné vs. S5	Yes	< 0,0001	Yes	< 0,0001
Plešné vs. S6	No	> 0,9999	Yes	0,0002
CAUP H 101 vs. SAG 216-9a	Yes	< 0,0001	Yes	0,0237
CAUP H 101 vs. CCALA 425	Yes	< 0,0001	No	> 0,9999
CAUP H 101 vs. CCALA 427	No	> 0,9999	Yes	< 0,0001
CAUP H 101 vs. CCALA 428	No	0,8616	Yes	< 0,0001
CAUP H 101 vs. CCALA 905	Yes	< 0,0001	Yes	< 0,0001
CAUP H 101 vs. S2	No	> 0,9999	Yes	< 0,0001
CAUP H 101 vs. S3	Yes	< 0,0001	Yes	< 0,0001
CAUP H 101 vs. S4	Yes	< 0,0001	No	0,0519
CAUP H 101 vs. S5	Yes	0,0002	Yes	< 0,0001
CAUP H 101 vs. S6	Yes	< 0,0001	No	0,0697
SAG 216-9a vs. CCALA 425	No	> 0,9999	No	> 0,9999
SAG 216-9a vs. CCALA 427	Yes	< 0,0001	Yes	0,002
SAG 216-9a vs. CCALA 428	Yes	< 0,0001	Yes	0,0476
SAG 216-9a vs. CCALA 905	No	> 0,9999	Yes	< 0,0001
SAG 216-9a vs. S2	Yes	< 0,0001	Yes	< 0,0001
SAG 216-9a vs. S3	Yes	< 0,0001	Yes	< 0,0001

SAG 216-9a vs. S4	Yes	0,002	Yes	< 0,0001
SAG 216-9a vs. S5	Yes	< 0,0001	Yes	< 0,0001
SAG 216-9a vs. S6	No	> 0,9999	Yes	< 0,0001
CCALA 425 vs. CCALA 427	Yes	< 0,0001	Yes	< 0,0001
CCALA 425 vs. CCALA 428	Yes	< 0,0001	Yes	< 0,0001
CCALA 425 vs. CCALA 905	No	> 0,9999	Yes	< 0,0001
CCALA 425 vs. S2	Yes	< 0,0001	Yes	< 0,0001
CCALA 425 vs. S3	Yes	< 0,0001	Yes	< 0,0001
CCALA 425 vs. S4	Yes	< 0,0001	Yes	< 0,0001
CCALA 425 vs. S5	Yes	< 0,0001	Yes	< 0,0001
CCALA 425 vs. S6	No	0,5985	Yes	< 0,0001
CCALA 427 vs. CCALA 428	No	0,1316	No	> 0,9999
CCALA 427 vs. CCALA 905	Yes	< 0,0001	Yes	< 0,0001
CCALA 427 vs. S2	No	> 0,9999	Yes	< 0,0001
CCALA 427 vs. S3	Yes	< 0,0001	Yes	< 0,0001
CCALA 427 vs. S4	Yes	< 0,0001	Yes	< 0,0001
CCALA 427 vs. S5	Yes	0,0354	Yes	< 0,0001
CCALA 427 vs. S6	Yes	< 0,0001	Yes	< 0,0001
CCALA 428 vs. CCALA 905	Yes	< 0,0001	Yes	< 0,0001
CCALA 428 vs. S2	No	> 0,9999	Yes	< 0,0001
CCALA 428 vs. S3	Yes	0,0108	Yes	< 0,0001
CCALA 428 vs. S4	Yes	< 0,0001	Yes	< 0,0001
CCALA 428 vs. S5	Yes	< 0,0001	Yes	< 0,0001
CCALA 428 vs. S6	Yes	< 0,0001	Yes	< 0,0001
CCALA 905 vs. S2	Yes	< 0,0001	No	0,6159
CCALA 905 vs. S3	Yes	< 0,0001	Yes	< 0,0001
CCALA 905 vs. S4	Yes	0,0083	Yes	< 0,0001
CCALA 905 vs. S5	Yes	< 0,0001	No	0,2647
CCALA 905 vs. S6	No	> 0,9999	Yes	< 0,0001
S2 vs. S3	Yes	< 0,0001	No	0,1187
S2 vs. S4	Yes	< 0,0001	Yes	< 0,0001
S2 vs. S5	Yes	< 0,0001	No	> 0,9999
S2 vs. S6	Yes	< 0,0001	Yes	< 0,0001
S3 vs. S4	No	> 0,9999	Yes	0,0041
S3 vs. S5	Yes	< 0,0001	No	0,3473
S3 vs. S6	Yes	< 0,0001	Yes	0,0074
S4 vs. S5	Yes	< 0,0001	Yes	< 0,0001
S4 vs. S6	No	0,0836	No	> 0,9999
S5 vs. S6	Yes	< 0,0001	Yes	< 0,0001

---