



University of HUDDERSFIELD

University of Huddersfield Repository

Lu, Wenlong

Modelling the Integration between the Design and Inspection Process of Geometrical Specifications for Digital Manufacturing

Original Citation

Lu, Wenlong (2011) Modelling the Integration between the Design and Inspection Process of Geometrical Specifications for Digital Manufacturing. Doctoral thesis, University of Huddersfield.

This version is available at <http://eprints.hud.ac.uk/14054/>

The University Repository is a digital collection of the research output of the University, available on Open Access. Copyright and Moral Rights for the items on this site are retained by the individual author and/or other copyright owners. Users may access full items free of charge; copies of full text items generally can be reproduced, displayed or performed and given to third parties in any format or medium for personal research or study, educational or not-for-profit purposes without prior permission or charge, provided:

- The authors, title and full bibliographic details is credited in any copy;
- A hyperlink and/or URL is included for the original metadata page; and
- The content is not changed in any way.

For more information, including our policy and submission procedure, please contact the Repository Team at: E.mailbox@hud.ac.uk.

<http://eprints.hud.ac.uk/>

Modelling the Integration between the Design and Inspection Process of Geometrical Specifications for Digital Manufacturing

Wenlong Lu

A thesis submitted to the University of Huddersfield
in partial fulfillment of the requirements for
the degree of Doctor of Philosophy

School of Computing & Engineering
The University of Huddersfield

December 2011

ABSTRACT

Geometrical Product Specifications (GPS) is a technical language which covers the standardization for micro/macro- geometry specifications. In today's environment of globalization, out-sourcing and sub-contracting is increasing. Geometrical specifications of a product need to be detailed to a degree where nothing is left open to interpretation. To fulfil this, and to meet the requirements of digital manufacturing, it is necessary to integrate the design and inspection process of a geometrical specification. At the technical level, many functional operator/operations are employed in a geometrical specification. These functional operators/operations are based on rigorous mathematics, and they are intricately related and inconvenient to be used directly. Consequently, it is of practical utility to build an integrated information system to encapsulate and manage the information involved in GPS. This thesis focuses on geometrical tolerancing, including form/orientation/ location tolerancing, and its integrated geometry information system. The main contributions are:

Firstly, a global data expression for modelling the integration between the design and inspection process of a geometrical tolerance is presented based on category theory. The categorical data model represents, stores and manipulates all the elements and their relationships involved in design and inspection process of a geometrical tolerance, by categories, objects and morphisms, flexibly; the relationships between objects were refined by pull back structures; and the manipulations of the model such as query and closure of query are realized successfully by functor structures in category theory.

Secondly, different categories of knowledge rules have been established to enhance the rationality and the intellectuality of the integrated geometry information system, such as the rules for the application of geometrical requirement, tolerance type, datum and datum reference framework and, for the refinement among geometrical specifications.

Finally, the host system for drawing indication of geometrical tolerances in the framework of GPS was established based on AutoCAD 2007 using ObjectARX.

RELATED PUBLICATIONS

1. **Wenlong Lu**, Xiangqian Jiang, Xiaojun Liu, Qunfen Qi and Paul Scott (2010). 'Modelling the integration between specifications and verification for cylindricity based on category theory', Measurement Science and Technology, 21(11): 115107-1~ 115107-12
2. **Wenlong Lu**, Xiangqian Jiang, Xiaojun Liu and Zhengao Xu (2008). 'Compliance uncertainty of diameter characteristic in the next-generation Geometrical Product Specifications and Verification', Measurement Science and Technology, 19(10): 105103-1~ 105103-8
3. **Wenlong Lu**, Xiaojun Liu, Xiangqian Jiang, Qunfen Qi and Paul Scott (2010). 'Categorical data model for Cylindricity Consistent with Geometrical Product Specifications Standard System', Proceedings of SPIE, Vol. 7544, 75446S
4. **Wenlong Lu**, Xiangqian Jiang, Paul Scott and Xiangqi Lan (2009). 'A Host System for Form Tolerance Specification in the Next-generation GPS based on AutoCAD', CIRP 2009 on CAT, B2-4, France
5. **Wenlong Lu**, Xiangqian Jiang, Paul Scott. 'An effective method for modelling complex orientation and location tolerancing data in the framework of GPS'. (Submitted to Expert Systems With Applications, Under Review)
6. Qunfen Qi, Xiangqian Jiang, Paul Scott, Xiaojun Liu, **Wenlong Lu**. 'Bridging the knowledge gap between surface texture specification and verification: Gap analysis and knowledge modelling'. (Submitted to Proceedings of the Institution of Mechanical Engineers, Part B: Journal of Engineering Manufacture, under review)
7. Qunfen Qi, Xiangqian Jiang, Paul Scott, Liam Blunt, **Wenlong Lu**. 'Surface texture specification, the more complete the better?' 12th CIRP Conference on Computer Aided Tolerancing, UK, accepted

ACKNOWLEDGEMENTS

I would like to express my sincere gratitude to my supervisor, Professor Xiangqian Jiang, for her kind help, advice, continued encouragement and support throughout the project.

Many thanks are devoted to my second supervisor, Professor Paul Scott, for his valuable guidance and in-depth knowledge in Category Theory and verifying the mathematics.

Many thanks give to my third supervisor, Professor Liam Blunt for his support, advice and kind help.

I would like to thank Professor Zhu Li, Professor Zhengao Xu and Professor Xiaojun Liu for their continuous support and help.

I would like to thank all my colleagues in the Centre for Precision Technologies, and my other friends in the University of Huddersfield for their kind help in my research and life.

I would like to thank Mr. David Brook, Dr. Wenhan Zeng, Dr. Tukun Li, and Ms. Qunfen Qi for their proof reading of the thesis.

I would like to thank Dr. Henrik Nielsen, Dr. Andrew Longstaff for their valuable suggestions for the thesis.

A great deal of considerations and thanks must go to my parents, my father in law and my mother in law. Without their encouragement, financial support, this thesis can never be finished.

Special thanks are given to my beloved wife, Ms. Zhonghua Tian. This thesis is finished saturating with her sweat.

CONTENTS

ABSTRACT	2
RELATED PUBLICATIONS	3
ACKNOWLEDGEMENTS.....	4
CONTENTS	5
LIST OF FIGURES	8
LIST OF TABLES	11
NOMENCLATURES	12
CHAPTER 1 INTRODUCTION	14
1.1 Background	14
1.2 Aim and Objectives	15
1.3 Methodology.....	15
1.4 Structure of the Thesis	16
CHAPTER 2 LITERATURE SURVEY	18
2.1 Introduction to GPS.....	18
2.2.1 A Brief History of Tolerancing.....	18
2.1.2 Motivation of GPS	18
2.1.3 Core ideas of GPS	21
2.1.3.6 GPS Matrix.....	26
2.2 Computer Aided Tolerancing Tools	29
2.2.1 Limits and fits software package	29
2.2.2 Tolerance Analyzing and Synthesizing Software Package	29
2.2.3 Geometrical Tolerance Software Packages	30
2.2.4 Surface Texture Software Package.....	31
2.2.5 Summary of Computer-aided Tolerance Tools.....	32
2.3 STEP-XML	33
2.4 Typical Data Models.....	34
2.5 Introduction to Category Theory [50-52]	35
2.6 Data Modelling Methodology Based on Category Theory	39
2.6.1 Representing relationships between inter/intra objects by pull back	40
2.6.2 Representing Query by Functor	41
2.6.3 Representing Query process by natural transform	42
2.6.4 Closure in queries	43
2.7 Comparison between Categorical Data Modelling Method and Other Data Modelling Methods	44
2.8 Summary.....	45

CHAPTER 3 DESIGN OF THE FRAMEWORK FOR THE INTEGRATED INFORMATION SYSTEM	46
3.1 Introduction	46
3.2 Framework of the Integrated Geometry Information System.....	46
3.2.1 The relationships between the system and other CAx systems	46
3.2.2 The Framework of the System	47
3.3 Framework of the Database Module.....	49
3.3.1 Function algorithms database subsystem	50
3.3.2 Measurement database subsystem	50
3.3.3 Information database subsystem	51
3.4 Framework of the Knowledge-based Module	51
3.5 Framework of the Host Module.....	52
3.5.1 Inner database of CAD subsystem.....	52
3.5.2 CAD user interface subsystem.....	52
3.6 Workflow of the Integrated Information System	53
3.7 Development Platform for the Integrated Information System.....	54
3.8 Summary	54
CHAPTER 4 REPRESENTATION OF GEOMETRICAL TOLERANCE KNOWLEDGE BY CATEGORICAL DATA MODEL	55
4.1 General Categorical Data Model of Geometrical Feature.....	55
4.2 General Categorical Data Model of Functional Operations	58
4.2.1 Partition	58
4.2.2 Extraction	58
4.2.3 Filtration	62
4.2.4 Collection	64
4.2.5 Association.....	64
4.2.6 Construction	66
4.2.7 Assessment.....	67
4.3 General Categorical Data Model of Parameter.....	68
4.4 Geometrical Requirement	68
4.5 Conclusion	69
CHAPTER 5 DATA MODELLING FOR GEOMETRICAL CHARACTERISTICS IN THE INTEGRATED INFORMATION SYSTEM	70
5.1 Form.....	70
5.1.1 Cylindricity.....	70
5.1.2 Roundness	85
5.1.3 Straightness	88
5.1.4 Flatness	97
5.2 Data Modelling for Orientation/Location Characteristics in the Integrated Information System	100
5.2.1 Correlation between Categorical Date Model for Orientation/ Location Tolerancing and that of Target and Datum Features	100
5.2.2 Categorical Data Modelling for Orientation/Location Tolerancing	103
5.3 Manipulations and Case Study	106

5.4 Conclusions.....	113
CHAPTER 6 KNOWLEDGE RULES DESIGN	114
6.1 Introduction	114
6.2 Design Rules for Type of Geometrical Characteristic	114
6.3 Design Rules for Geometrical Requirements	118
6.4 Design Rules for Datum and Datum Reference System	120
6.5 Design Rules for Refinement of Geometrical Characteristic	122
6.6 Conclusion	124
CHAPTER 7 PROTOTYPE DEVELOPMENT OF THE HOST SYSTEM OF THE INTEGRATED GEOMETRY INFORMATION SYSTEM	125
7.1 Introduction	125
7.2 Categorical Database Management System	125
7.3 Host System of the Integrated Information System— Combination with CAD System	127
7.3.1 Structure of the host system.....	127
7.3.2 Drawing Indication System of Geometrical Characteristic Consistent with GPS Based on AutoCAD2007	128
7.4 Functional Testing of the Host System [103]	132
7.4.1 Loading of the host system	132
7.4.2 Functional tesing of the host system	134
7.4.3 Unloading of the host system	135
7.4.4 Case study	135
7.5 Conclusion	137
CHAPTER 8 CONCLUSIONS AND FUTURE WORK	138
8.1 Summary and Conclusions	138
8.2 Future Work	139
REFERENCES.....	140

LIST OF FIGURES

Figure 2.1 An example of drawing indication of roundness	19
Figure 2.2 Measurement of roundness by different reference circles	20
Figure 2.3 Interrelationship of the geometrical feature definitions [65]	22
Figure 2.4 The relationships between geometrical feature, operator/operation and skin model [9]	23
Figure 2.5 Mirror between Specification and Measurement procedures [26].....	24
Figure 2.6 Relationships of various uncertainties in GPS [25-26].....	25
Figure 2.7 Relationships between various uncertainties and operators [24].....	26
Figure 2.8 Overview of the GPS Matrix Model [22]	27
Figure 2.9 The compressed “general GPS matrix” [20].....	28
Figure 2.10 Category	36
Figure 2.11 Product	36
Figure 2.12 Coproduct.....	37
Figure 2.13 Coproduct to represent inheritance.....	37
Figure 2.14 Pull back.....	38
Figure 2.15 Functor	38
Figure 2.16 Natural Transformation.....	39
Figure 2.17 The minor relationship is represented by pull back.....	41
Figure 2.18 Actual query process represented by transform between functors.....	43
Figure 3.1 Integration of the integrated geometry information system and CAx.....	47
Figure 3.2 Relationships among function, design, manufacture and verification of a product [105]	48
Figure 3.3 Framework of the Integrated Information System	49
Figure 3.4 Framework of the Database Module	50
Figure 3.5 Framework of the Knowledge-based Module.....	51
Figure 3.6 Framework of the Host Subsystem	52
Figure 4.1 The degrees of freedom of typical geometrical features.....	57
Figure 4.2 General categorical data model of geometrical feature	57
Figure 4.3 Several types of typical sampling strategy [68].....	60
Figure 4.4 General categorical data model of geometrical feature	62
Figure 4.5 General categorical data model of Filtration	63
Figure 4.6 An example of drawing indication for perpendicularity consistent with GPS	64
Figure 4.7 The association for perpendicularity assessment.....	65
Figure 4.8 General categorical data model of Association.....	66
Figure 4.9 General categorical data model of Association.....	67
Figure 4.10 General categorical data model of Evaluation	68
Figure 4.11 General categorical data model of Parameter	68
Figure 4.12 General categorical data model of Geometrical requirement	69

Figure 5.1 Drawing indication for cylindricity consistent with GPS.....	70
Figure 5.2 the categorical data model of cylindrical feature	71
Figure 5.3 the categorical data model for extraction of cylindrical feature (including the relationships between objects included in category Partition and category Extraction)	75
Figure 5.4 Style of using single long-pass filter along generatrix.....	76
Figure 5.5 Combination of a long-pass filter and a short-pass filter along generatrix.....	76
Figure 5.6 Style of using single long-pass filter for each circumferential section.....	76
Figure 5.7 Combination of a long-pass filter and a short-pass filter for each circumferential section.....	76
Figure 5.8 The categorical data model for filtration for cylindricity (including the relationships between objects included in category Partition , category Extraction and category Filtration).....	78
Figure 5.9 The categorical data model for evaluation operation for cylindricity	80
Figure 5.10 The categorical data model for evaluation operation for cylindricity	81
Figure 5.11 Categorical data modelling for Callout for Drawing Indication	82
Figure 5.12 The Categorical data modelling for Callout for Metrology	83
Figure 5.13 The Categorical data model for cylindricity(for Drawing Indication).....	84
Figure 5.14 The Categorical data model for cylindricity(for Metrology).....	85
Figure 5.15 Drawing indication for roundness consistent with GPS	86
Figure 5.16 The categorical data model of roundness (for Drawing Indication)	88
Figure 5.17 The categorical data model of roundness (for Metrology)	88
Figure 5.18 Partition to get the non-ideal cylinder surface	89
Figure 5.19 Obtain a set of ideal circles by appropriate association method.....	90
Figure 5.20 Collection.....	90
Figure 5.21 The minimum circumscribed cylinder enclosing the non-ideal line.....	90
Figure 5.22 Drawing indication for straightness for a central line consistent with GPS	91
Figure 5.23 The categorical data model of straightness of the central line (for Drawing Indication).....	92
Figure 5.24 The categorical data model of straightness of the central line (for Metrology) ...	93
Figure 5.25 Complete verification operator for straightness of the surface line	93
Figure 5.26 Drawing indication for straightness in a surface consistent with GPS	95
Figure 5.27 The categorical data model of straightness of the surface line (for Drawing Indication).....	96
Figure 5.28 The categorical data model of straightness of the surface line (for Metrology) ...	96
Figure 5.29 Complete verification operator for flatness.....	97
Figure 5.30 Drawing indication for flatness consistent with GPS	98
Figure 5.31 The categorical data model of flatness (for Drawing Indication).....	99
Figure 5.32 The categorical data model of flatness (for Metrology).....	100

Figure 5.33 The relationships of the complete verification operator of an orientation/location tolerance and the complete verification operators of the target feature and datum features	101
Figure 5.34 Drawing indication for perpendicularity based on conventional tolerancing	102
Figure 5.35 Drawing indications for perpendicularity consistent with GPS	102
Figure 5.36 Relationships between categorical data models of perpendicularity tolerancing in figure 5.35 and that for the central line and the plane A	103
Figure 5.37 Categorical data model for perpendicularity tolerancing consistent with GPS ..	105
Figure 5.38 The constraint among multi-categories in Arrow 8 is represented by pullback structure 8	106
Figure 5.39 The constraint in Arrow 24 is represented by pullback structure 24	107
Figure 5.40 The equivalency relationship in ②⑥, ③①, ③② and ③④ are represented by pullback structures	108
Figure 5.41 The equivalency relationship in ②⑦~③①, ③③ and ③⑤ are represented by pullback structures	108
Figure 5.42 The pullout structure of the Callout category	109
Figure 5.43 Obtaining the category C from pull back category p27 by forgetful functor F_{G-C}	111
Figure 6.1 Drawing indication for position characteristic consistent with GPS	115
Figure 7.1 Interface of the category database management system	126
Figure 7.2 Framework the host system	127
Figure 7.3 Function modules of prototype of the drawing indication system	128
Figure 7.4 man-machine interactive interface for flatness consistent with GPS	131
Figure 7.5 Structure of the classes involved in prototype of the drawing indication system.	132
Figure 7.6 Interface for loading the host system	133
Figure 7.7 Snapshot of AutoCAD2007	133
Figure 7.8 Snapshot of AutoCAD2007 after loading the GPS Indication	134
Figure 7.9 Dialog box of cylindricity configuration	134
Figure 7.10 Instance of cylindricity drawing indication	135
Figure 7.11 An example to illustrate the dragging function of the host system.....	135
Figure 7.12 4-stroke engine schematic[109]	136
Figure 7.13 An instance of specifying cylindricity drawing indication on cylinder of the 4-stroke engine	137

LIST OF TABLES

Table 2.1 The morphism types and their E-R Equivalent.....	40
Table 2.2 Relationship between student and minor course	40
Table 2.3 The comparison between the three typical data models.....	45
Table 4.1 Table of Invariance Class	56
Table 4.2 Sampling schemes for surfaces	60
Table 4.3 Filters in GPS.....	63
Table 5.1 The relationship between the diameter and stylus radius ratio and the cutoff frequency.....	73
Table 5.2 The relationship between the stylus radius ratio and the cutoff wavelength.....	73
Table 5.3 Cutoff wavelength (λ_c) series (mm) [95].....	76
Table 5.4 Cutoff frequency (f_c) series (UPR) [95].....	77
Table 5.5 Cutoff wavelength (λ_c) configured according to Length_G [94]	77
Table 5.6 Cutoff frequency (f_c) configured according to Ref_diameter [94]	77
Table 5.7 Relationship between parameter and association algorithm for cylindricity.....	80
Table 5.8 Relationship between parameter and reference datum	86
Table 5.9 Relationship between cutoff wavelength λ_c and the radius of probe stylus tip for surface line straightness (mm)	94
Table 5.10 Relationship between parameter and reference datum	94
Table 5.11 Relationship between parameter and reference datum	98
Table 6.1 Relative situations that situation feature represents	115
Table 6.2 Design rules for application of type of geometrical characteristic RI.....	116
Table 6.3 Knowledge rules for application of geometrical requirements RII.....	119

NOMENCLATURES

ANSI	American National Standards Institute
ASME	American Society of Mechanical Engineers
CAD	Computer-aided Design
CAPP	Computer-aided Process Planning
CAT	Computer-Aided Tolerancing
CAM	Computer Aided Manufacturing
CE	Concurrent Engineering
CIR	Circular run-out
CMM	Coordinate Measuring Machines
COA	Coaxiality
CON	Concentricity
C_S	Spherical Invariance Class
C_C	Cylindrical Invariance Class
C_P	Planar Invariance Class
C_H	Helical Invariance Class
C_R	Revolute Invariance Class
C_T	Prismatic Invariance Class
C_X	Complex Invariance Class
CYLt	Peak-to-Valley cylindricity deviation
CYLp	Peak-to-Reference cylindricity deviation
CYLv	Reference-to-Valley cylindricity deviation
CYLq	Root mean square cylindricity deviation
DOF	Degree of Freedom
DOI	Degree of Invariance
DIN	Deutsches Institut für Normung
DRF	Datum Reference Framework
E-R	Entity-Relationship
GD&T	Geometric Dimensioning and Tolerancing
GPS	Geometrical Product Specifications
IGES	Initial Graphics Exchange Specification
ISO	International Organization for Standardization
LSCI	Least Squares Reference Circle

LSCY	Least Squares Reference Cylinder
LSLI	Least Squares Reference Line
LSPL	Least Squares Reference Plane
NIST	National Institute for Standards and Technology
PAR	Parallelism
PER	Perpendicularity
PL	Plane
<i>PLNt</i>	Peak-to-Valley flatness deviation
<i>PLNp</i>	Peak-to-Reference flat deviation
<i>PLNv</i>	Reference-to-Valley flat deviation
<i>PLNq</i>	Root mean square flat deviation
POS	Position
PT	Point
PTB	Physikalisch-Technischen Bundesanstalt
RDOF	Rotational Degree of Freedom
<i>RONt</i>	Peak-to-Valley roundness deviation
<i>RONp</i>	Peak-to-Reference roundness deviation
<i>RONv</i>	Reference-to-Valley roundness deviation
<i>RONq</i>	Root mean square roundness deviation
<i>STRt</i>	Peak-to-Valley straightness deviation
<i>STRp</i>	Peak-to-Reference straightness deviation
<i>STRv</i>	Reference-to-Valley straightness deviation
<i>STRq</i>	Root mean square straightness deviation
TDOF	Translation Degree of Freedom
TTRS	Technologically and Topologically Related Surfaces
XML	Extensible Markup Language
2D	Two Dimensions
3D	Three Dimensions
Ⓜ	Maximum Material Requirement
Ⓡ	Reciprocity requirement
ⓕ	Free State Condition
Ⓟ	Project Tolerance Zone
Ⓛ	Least Material Requirement

CHAPTER 1 INTRODUCTION

1.1 Background

In the information age, the importance of digital manufacturing has been widely recognised. Digital manufacturing, in this context, is a method of production in which computer technology is used to manufacture products in a desired style or quantity with little or no involvement from humans [1]. The scope of digital manufacturing has evolved recently to include Computer-aided Design (CAD), Computer-Aided Tolerancing (CAT), Computer-aided Process Planning (CAPP), and so on [1].

GPS is an important fundamental standard system for digital manufacturing. The acronym GPS in this thesis stands for Geometrical Product Specifications, which is shortened from Dimensional & Geometrical Product Specifications and Verification. GPS is an internationally accepted concept (see ISO/TR 14638) covering all different requirements - indicated on a technical drawing - to the geometry of industrial workpieces (e.g. size, distance, radius, angle, form, orientation, location, run-out, surface roughness, surface waviness, surface defects, edges, etc.) and all related verification principles, measuring instruments and their calibration. GPS is in the charge of Technical Committee 213, in International Standard Organization (ISO/TC 213) [2][5].

It is of importance to reduce the uncertainty in the processes of design, manufacture and characterization, and to harmonize with the informatization of manufacturing industry. Therefore, many new concepts have been employed in GPS (e.g. specification/compliance uncertainty, operators, mathematical operations and so on), have been employed in GPS. However, these concepts are based on rigorous mathematics and, at the same time, intricately related, which makes them inconvenient to be used directly. Therefore, it is of practical importance to build an integrated geometry information system to encapsulate the knowledge in GPS.

Though there are a few groups have contributed on developing the software for the application of GPS [6-12], most of the geometrical tolerance specification

soft packages that dominate in the market or the software packages nested in CAD systems presently have been built upon the framework of the conventional GPS.

1.2 Aim and Objectives

This thesis focuses on the geometrical tolerancing and aims to save the product development time and cost by designing and developing an integrated geometry information system under the framework of GPS for supporting geometrical tolerance specifications and verification. The detailed objectives of the thesis are outlined as follows:

- (1) To undertake a literature review in the field of GPS, the conventional information system for geometrical tolerances and data modelling methods.
- (2) To design and develop a reliable and consistent framework for the integrated geometry information system which should be able to integrate with CAx (a broad term that means the use of computer technology to aid in the design, analysis, and manufacture of products [107]) systems.
- (3) To design a global data model to represent the information and its complex relations within geometrical product specifications and verification. The extensibility and flexibility are main consideration. Thus, new information should be able to be added to the system easily. At the same time, it does not reduce the reliability and consistence of existing knowledge within the system.
- (4) To develop the knowledge rules of the system. The knowledge rules are the special properties of the integrated geometry information system to differentiate with other software for geometrical tolerances.
- (5) To develop a host system for the applications of the integrated information system.

1.3 Methology

The integrated geometry information system can be decomposed into three

modules:

- (1) Database module: The database module is developed by modelling method based on category theory [13-18]. It not only can represent and manipulate the data structure flexibly, but also can maintain the coherence and reliability of the database.
- (2) Knowledge base module: The establishment of the function knowledge rules, specification knowledge rules and metrology knowledge rules will be the keys of the knowledge base module. It will be built on the knowledge through the communication with many experts in the field of geometrical precision design. Furthermore, the mechanical design handbook will be helpful. Production rules [16&19] will be selected for its knowledge representation for its wide use and its capability for representing various varieties of knowledge, and the inference mechanism of the knowledge base module will be devised according to the Bayesian algorithm and neural network algorithm [16&19].
- (3) The host subsystem: This project proposes the connection with CAD system for the application of geometrical tolerance.

1.4 Structure of the Thesis

This thesis is composed of five parts.

Chapter 2 reviews the background of GPS, together with a brief introduction to the popular Computer-Aided Geometry Information Systems. At the same time, the typical data models are analyzed, and the categorical data modelling method is detailed.

Chapter 3 details the functional requirements of integrated geometry information system, and develops the framework of such systems.

Chapter 4 develops the general categorical data model of the key elements involved in geometrical product specifications and verification. Chapter 5 documents the complete verification operators for geometrical tolerances, together with the data modelling for form characteristics in the integrated information system based on category theory.

Chapter 6 details different categories of knowledge rules for the integrated geometry information system to enhance the rationality and the intellectuality of the information system.

Chapter 7 presents the development and case studies of the host system.

CHAPTER 2 LITERATURE SURVEY

The chapter reviews current state and trends within the field of geometrical tolerancing. The objectives are to develop a better understanding about the issues of the existed systems, to identify the potential work and to introduce the main technique, i.e. modelling method based on category theory, into this field.

2.1 Introduction to GPS

2.2.1 A Brief History of Tolerancing

Tolerancing was initially brought about by the need for interchangeable parts in the late 1800s. In the beginning, only dimensional tolerances were used [20]. Engineers found that it is impossible to ensure the assemblability through the control of dimensional tolerance in some high-accuracy case. It was also an expensive way to control the assembly by subtracting the dimensional tolerance zone when it reaches to a very high-accuracy point. In 1940s, form, orientation and location tolerances, therefore, are introduced. In 1950, a draft standard is submitted to ISO (International Organization for Standardization) by America, Britain and Canada, on which the concept of geometrical tolerancing is proposed [104]. Along with the development of processing ability in manufacturing industry, we are now reaching the point where dimensional tolerances and geometrical tolerances have shrunk to a level where surface texture is significant. This is the point where conventional, zone-based tolerancing becomes inadequate. It is impossible for a designer using the current system – be it the ISO 1101 or the ANSI/ASME Y14.5 dialect – to express to which extent surface texture should be considered or ignored in geometrical tolerances [20].

2.1.2 Motivation of GPS

It is impossible to manufacture parts in exact shape. Parts always have deviations of size, form, orientation and location. And these deviations normally will have affect on the usability of the workpiece in some extent. Thereby, it is of necessary to specify appropriate geometrical tolerance on the geometrical elements of a workpiece to ensure its function.

In many cases, if the geometrical tolerance is too large, it will impair the function of the workpiece. And in other cases if the tolerance is too small, it will add cost of the workpiece and decrease its competitiveness in the market. Therefore, the design of geometrical tolerance should obey the rule of “meet the function requirement economically”.

With the improvement of manufacturing process and inspection ability, the wide applications of new technology, and the versatility of functional requirements, it has stricter requirement of drawing tolerances. In the past thirty years, the following problems have been confusing the design and inspection engineers.

- 1) For a drawing indication, different manufacture and inspection engineers have different explanations. Figure 2.1 is an example of drawing indication based on conventional tolerancing rules.

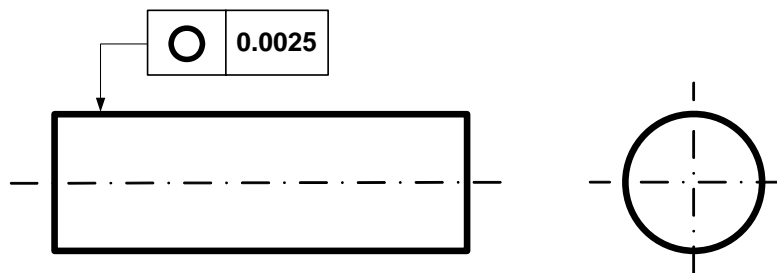

Figure 2.1 An example of drawing indication of roundness

As shown in Figure 2.1, only a final value “0.0025” is set in drawing indication for roundness. Obviously, this value is obtained through some experiments or experience. The evaluation process is that the measured value is less than 0.0025mm. However, the drawing indication does not specify how to get the measured value. Different metrologists can utilize different inspection processes. And even if the measured values obtained by different inspection engineers are the same, they are incomparable. Figure 2.2 shows the selection of reference circles will cause various results for the same workpiece, and the variation between the results can be more than 20% in this example.

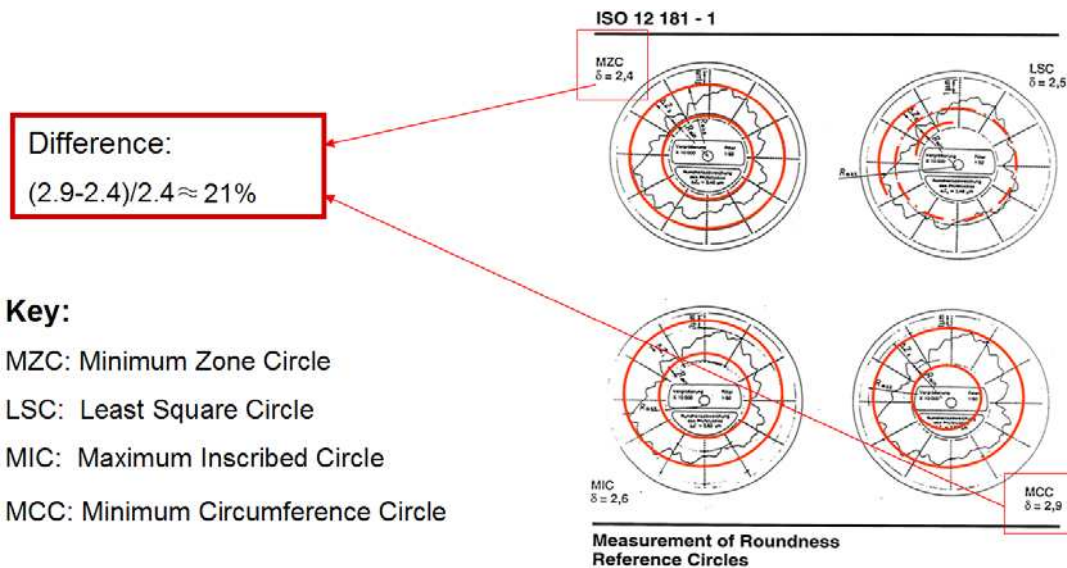

Figure 2.2 Measurement of roundness by different reference circles

Selection of the reference circle is just one step among other steps such as selection of filter, nesting indexes of filter, and so on.

- 2) Within the International Organization for Standardization, ISO, technical committees are established on an as-needed basis with little effort to coordinate the work of the committees. The standards of size, geometrical tolerance and surface texture were in different technical committees. Standards of size, geometrical tolerance and surface texture were in ISO/TC 3, ISO/TC10/SC5 and ISO/TC57 respectively. Because of this relatively loose planning structure, these technical committees were independent of each other, and their work may have had some repeatability and conflicts.
- 3) In today's environment of globalization, the use of out-sourcing and sub-contracting is increasing [2]. If problems emerged it is difficult for the designer and the producing engineers and metrologists to get together and solve the problem because of the spatial distance, the time difference, the language barrier, etc.
- 4) Versatile functional requirements central to modern industry (such as resistance to wear, eliminating leakage, etc.) cannot be expressed using conventional geometrical specifications. However, the only functional requirements that can be expressed precisely using the existing standards are the requirements related to assemblability [20].

To address those problems, a joint harmony group was established in 1993. After two years of work, a technical report named ISO/TR 14638 was published. And the technique committees ISO/TC3, ISO/TC10/SC5 and ISO/TC57 merged into one technique committee ISO/TC 213 in 1996 at Paris. ISO/TC 213 has focused its work on improving the GPS language. The improved GPS system with this improved GPS language will provide a broader variety of engineering tools necessary in order to express different functional requirements more precisely and with more complete and well-defined specification of workpieces. In the improved GPS language, many new terms and definitions such as duality principle, operation, operator, correlation/specification/method/ implementation uncertainty, skin model [21]-[26], etc. are developed to meet its various demands.

2.1.3 Core ideas of GPS

2.1.3.1 Skin Model

The designer first defines a "workpiece" of perfect form with shape and dimensions, which fit the functions of the mechanism. This "workpiece" of perfect form is called the nominal model. This first step establishes a representation of the workpiece with only nominal values, which is impossible to produce or inspect (each manufacturing or measuring process has its own variability or uncertainty).

The real surface of the workpiece, which is the physical interface of the workpiece with its environment, is imperfect geometry; it is impossible to completely capture the dimensional variation of the real surface of the workpiece to understand the complete extent of all variations.

From the nominal geometry, the designer imagines a model of this real surface, which represents the variations that could be expected on the real surface of the workpiece. This model representing the imperfect geometry of the workpiece is called the non-ideal surface model (skin model). The non-ideal surface model is used to simulate variations of the surface at a conceptual level. On this model, the designer will be able to optimize the maximum permissible limit values for which the function is downgraded but still ensured. Those maximum permissible limits define the tolerances of each characteristic of the workpiece.

2.1.3.2 Geometrical feature

Product consists of geometrical features, on which we specify geometrical characteristics to ensure the function. Geometrical feature is classified into two types, integral feature and derived feature. Where, integral is the surface or line on a surface, and the derived feature is centre point, median line or median surface from one or more integral features. According to the life period of the product, the integral feature is sorted into nominal integral feature, real integral feature, extracted integral feature and associated integral feature. The derived feature is sorted into nominal derived feature, extracted derived feature and associated derived feature. The structure of the interrelationship of the geometrical feature definitions is shown in Figure 2.3.

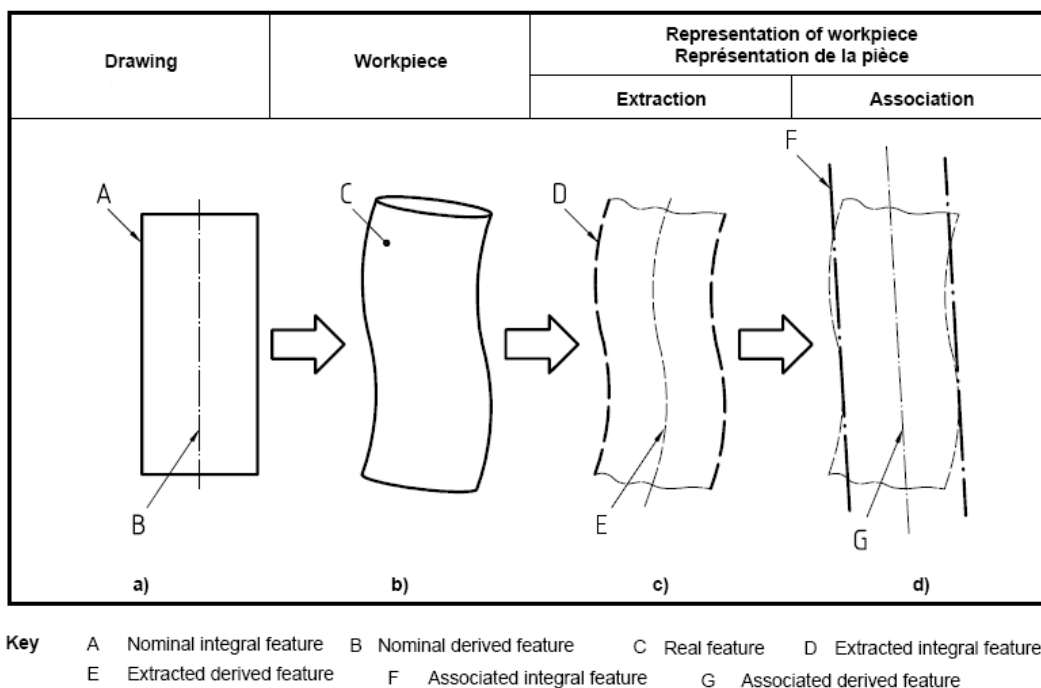

Figure 2.3 Interrelationship of the geometrical feature definitions [65]

2.1.3.3 Operation and Operator

The tools that are employed in the implementation of duality principle are operations and operators. ISO/TC213 has developed seven types (which are partition, extraction, filtration, association, collection, construction and evaluation) of operations to obtain the geometrical features or the values of characteristics, nominal values and limits in the improved GPS language, these seven types of operations will be implemented during measurement as the metrologist's activity according to the information from the designer. Operator is the ordered set of

some of these operations. According to the different phases along the entire production process of a part, ISO/TC213 defines three types of operators, which are functional operator, specification operator and verification operator. With the terms operation and operator, it is comparable between the value of the measurand which is specified by designer and the result of measurement, which is obtained by the metrologist.

The relationships between geometrical feature, operations and skin model are shown in Figure 2.4.

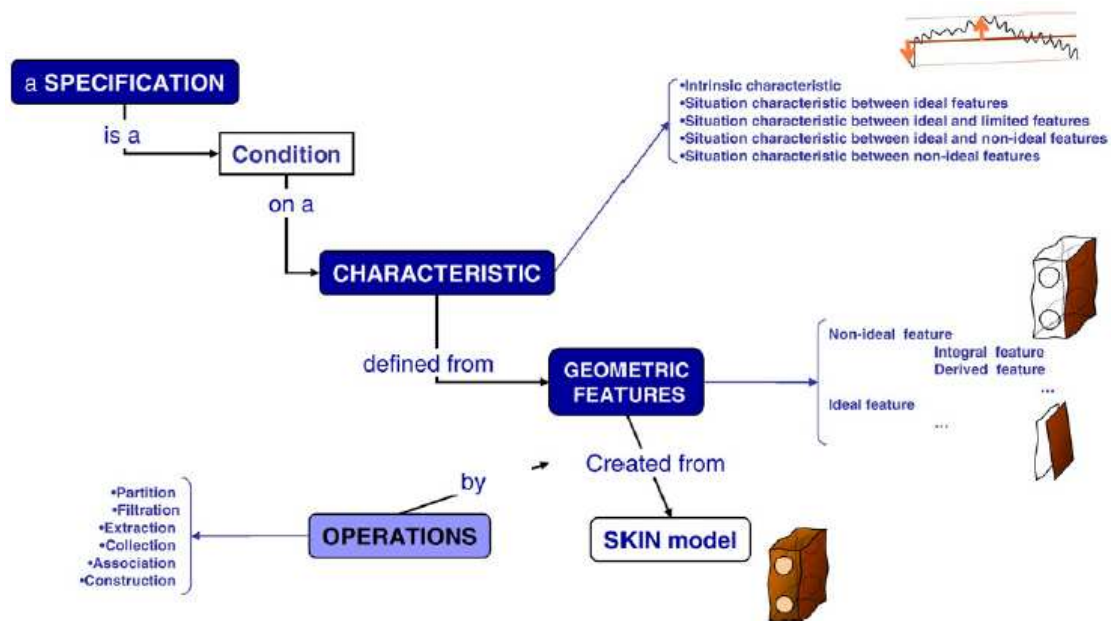

Figure 2.4 The relationships between geometrical feature, operator/operation and skin model [9]

2.1.3.4 Duality Principle

In the past, the specifications of geometrical characteristic and the verification of geometrical characteristic were in different Technical Committees of ISO, and many problems emerged.

Thanks to the tight relation between specification and verification both in the theory and in practice, the discrepancy is actually solved by the duality principle, which states that *a GPS specification defines a GPS specification operator independent of any measurement procedure or measurement equipment; and the GPS specification operator is realized in a verification operator which is independent of the GPS specification itself, but is intended to mirror the GPS specification operator* [91].

The mirror between “Design intent” and the “Verification of manufactured workpiece for compliance with design intent” is shown by Figure 2.5.

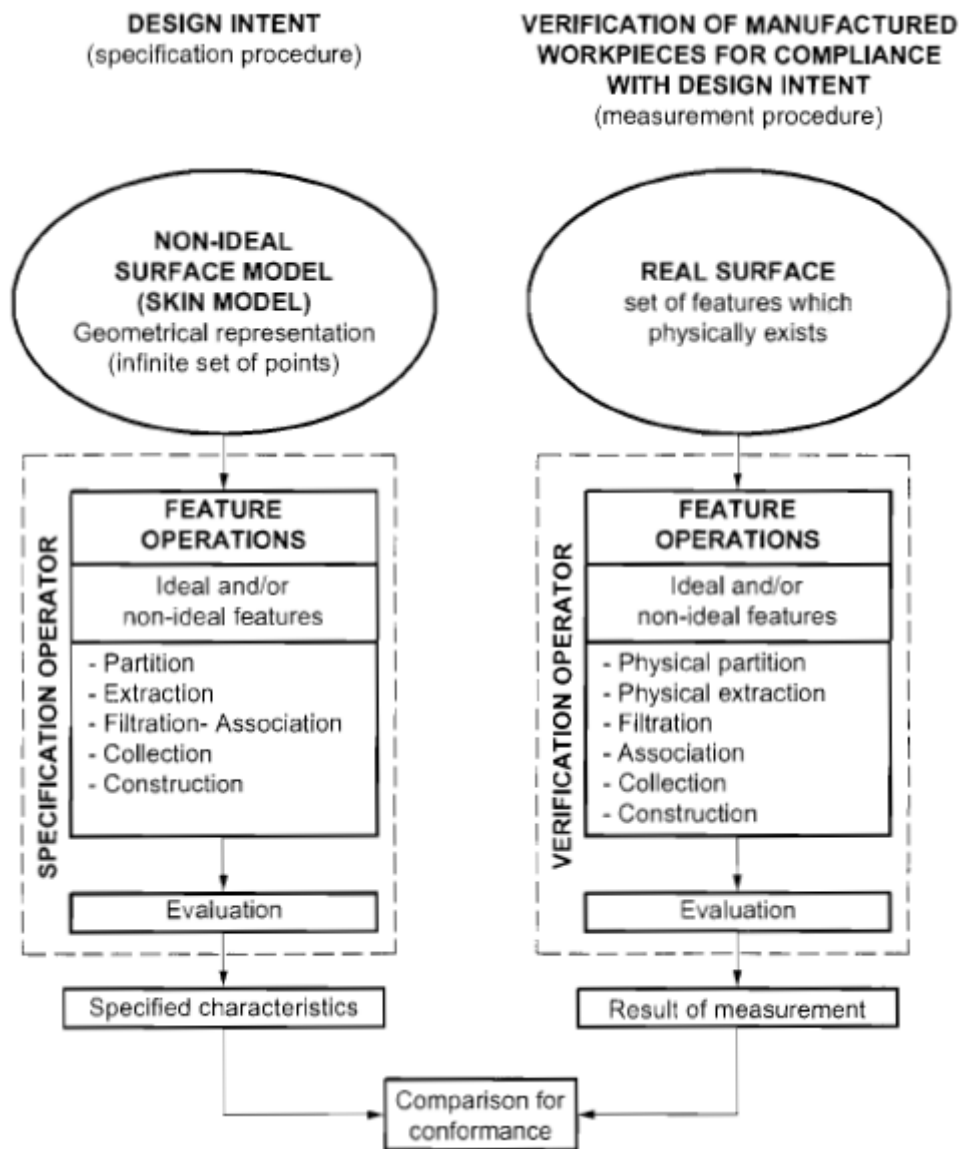

Figure 2.5 Mirror between Specification and Measurement procedures [91]

2.1.3.5 Extended Uncertainty system

The main work of ISO/TC 213 has been focusing on improving the GPS-language of GPS [3]. One of the most important concepts that are employed to improve GPS standards is ‘uncertainty’. It is generally realized that disagreements on the measurement values cannot always be explained by the presence of conventional measurement uncertainty only [25]. Actually, ‘Uncertainty’ is extended as an expression of “lack of information” in different stages of the entire product lifecycle more than measurement process.

Specification uncertainty, method uncertainty, implementation uncertainty and correlation uncertainty are four fundamental uncertainties in GPS. The combination of method uncertainty and implementation uncertainty is measurement uncertainty; and the combination of measurement uncertainty and specification uncertainty is compliance uncertainty. The relationships of various uncertainties are shown in Figure 2.6.

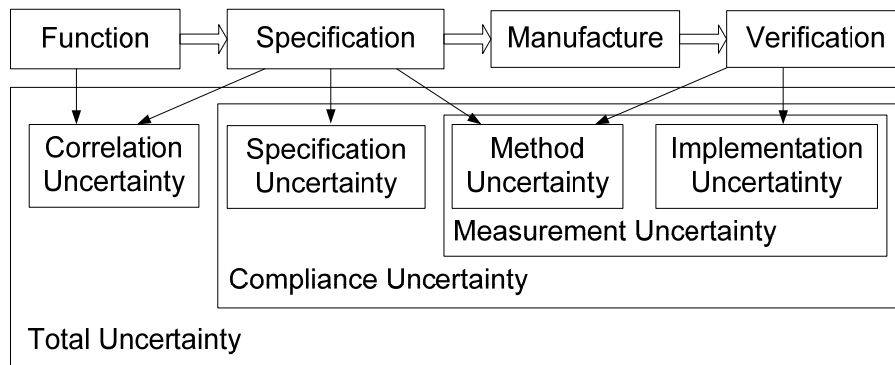

Figure 2.6 Relationships of various uncertainties in GPS [24]-[25]

Figure 2.6 implies that compliance uncertainty is one of the most important elements in GPS as it includes three of its four fundamental uncertainties. Specification uncertainty is defined to make geometrical specifications of the product more detailed and unambiguous, thereby helping to control the cost that is spent on design phase. Empiric data shows that almost 80% of the costs of a product are engaged during the design phase and initial production phase of that product [4]. In GPS, specification operator is regarded as a virtual instruction to the verification operator according to the duality principle [23], this can help to reduce method uncertainty. Implementation uncertainty is the uncertainty caused by metrologist, instruments and circumstances; it is the content that was considered conventionally in measurement uncertainty. Method uncertainty is caused by the difference of inspection method, which is specified by designer and that is selected by metrologist. Among the three components of compliance uncertainty, implementation uncertainty is the narrow sense content of conventional measurement uncertainty. Figure 2.7 is the relationship between various uncertainties and operators.

If everything is specified, the specification uncertainty is eliminated to zero, but this does not assure that the intended function of the part is described properly. If the function is not characterized by the specifications in accordance with the reality, the specifications may correlate badly to the intended function

and therefore, result in an uncertainty which is called correlation uncertainty. To reduce the correlation uncertainty, a complete, highly developed, systematic and standardized “language” is needed to express and translate the function of the workpiece into geometrical requirements on the drawing. It should be noted that the final performance of the machine/part depends not only on geometry of its parts but also on some other factors such as material properties and operating condition.

However, the extended uncertainty system only gives a method for analyzing and describing the problem. It cannot solve the problem intrinsically.

Figure 2.7 is the relationship between various uncertainties and operators.

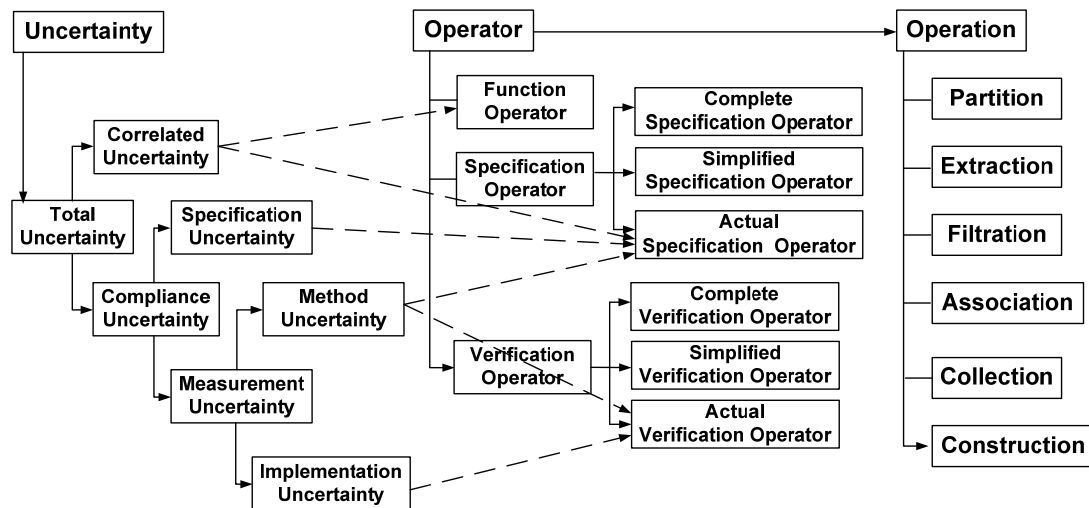

Figure 2.7 Relationships between various uncertainties and operators [24]

2.1.3.6 GPS Matrix

All the work that has been done by ISO/TC213 can be summarized as the development of the new GPS standards and the revision of the existing GPS standards. These GPS standards are under the framework of the GPS matrix model presented by ISO/TR 14638, which contains four matrices, i.e., four groups of standards, Fundamental GPS standards, Global GPS standards, General GPS standard and Complementary GPS standards. These GPS matrices are organized in a hierarchy. Principles and rules given in Fundamental standards apply for all other GPS standards, and that in Global standards apply for General and complementary standards, General standards cover the scope that Complementary standards apply for. The overview for GPS matrix model is presented in Figure 2.8.

Two fundamental concepts of chains and links of standards were formulated for General GPS standards matrix, which contains 18 chains and 7 links, by P. Bennich in 1994 [21], as shown in Figure 2.9. Each single standard in the chain affects the other standards, which have necessarily to be known, to understand and apply it properly. Therefore, every new GPS standard has to contain annex in which relation of the particular standard to the GPS matrix model is marked since 1996. Up to the 15th of November 2011, ISO/TC213 has published 113 new or thoroughly revised standards and about 35 documents are under development since 1996 [27].

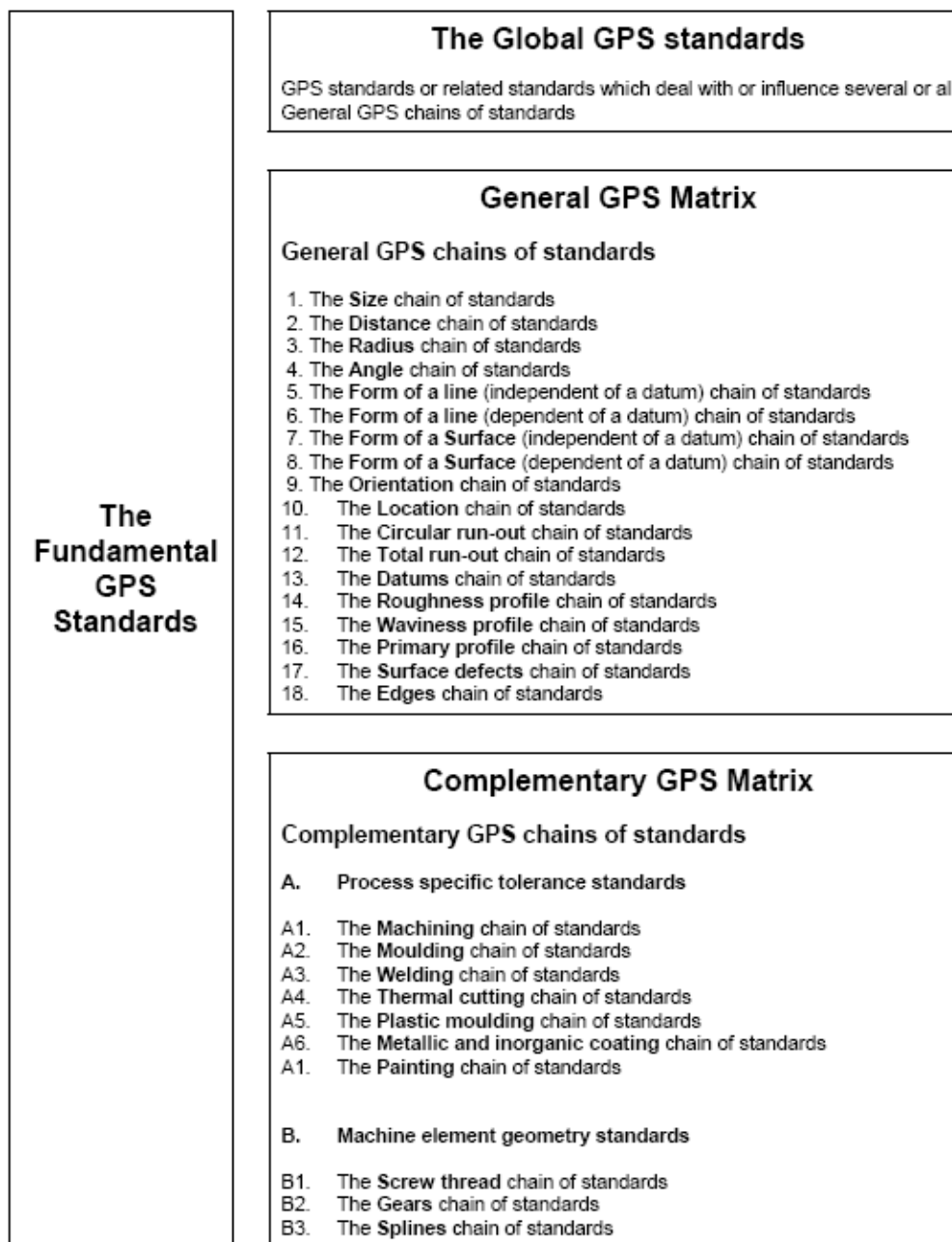

Figure 2.8 Overview of the GPS Matrix Model [22]

Chain link number		1	2	3	4	5	6
Geometrical characteristic of feature		Product documentation indication - Codification	Definition of tolerances - Theoretical definition and values	Definitions for actual feature - characteristic or parameter	Assessment of the deviations of the workpiece - Comparison with tolerance limits	Measurement equipment requirements	Calibration requirements - Measurements standards
1	Size						
2	Distance						
3	Radius						
4	Angle (tolerance in degrees)						
5	Form of a line independent of a datum						
6	Form of a line dependent of a datum						
7	Form of a surface independent of a datum						
8	Form of a surface dependent of a datum						
9	Orientation						
10	Location						
11	Circular run out						
12	Total run out						
13	Datums						
14	Roughness profile						
15	Waviness profile						
16	Primary profile						
17	Surface imperfections						
18	Edges						

Figure 2.9 The compressed “general GPS matrix” [20]

In summary, the goals of ISO/TC213 to solve the appeared problems can be summarized as the following:

- To reduce the correlation uncertainty by developing the necessary functional related “tools” facilitate the designers to express exactly their demand.
- To reduce the specification uncertainty by developing clear and unambiguous rules, stating default rules for operations, identifying and defining operations that have influence on a characteristic.
- To improve and enrich the GPS language and strive to keep it as simple as possible.
- To increase the utilization of computers and other advanced technologies in GPS and enable its better integration with CAD/CAM -systems [2].

The major work that should be accomplished by ISO/TC213 to reach the above goals includes:

- Harmonization of the terminologies;
- Preparation of a unified GPS-symbology, including improved harmonized symbology for the indication of surface texture (revision of ISO1302) and geometry (revision of ISO 1101);
- Reformation of requirements for measuring instruments;

- Mathematization of GPS-definitions in order to facilitate standardized inputs to software designers for computing algorithms in metrology, software designers for CAD-systems and standards on STEP, etc.

2.2 Computer Aided Tolerancing Tools

2.2.1 Limits and fits software package

Traditionally, engineers draw their limit and fit requirement by hand. In the Information age, computers are used as a general tool for drawing to replace hands. The computer-aided selection of limits and fits software package is focused on transferring dimensional tolerance into up/down dimensional deviation, calculating the clearance or coverage and determine the fit type.

- A typical example is the TOLPASS [28] software designed by HEXAGON Software. It is used by the designer for dimensioning of ISO fits to ISO 286. After input of nominal diameter, tolerance class and quality, TOLPASS calculates all tolerances as well as minimum/maximum clearance or coverage.
- Another example is KOK ISOTOL™ [29] soft package developed by Maryland Metrics and KOK Precision Tooling Co.. which provides instant display of limit dimensions for hole, shaft and fit, promotes specification of standard hole and shaft sizes and tolerance zones. It allows the user, if required, to modify the preferable fits to satisfy a special requirement.
- The software QMSys Tolerances and Fits [30] is a software which can be used to select appropriate sizes according to ISO 3 and suitable fits of machine parts according to ISO 286.

2.2.2 Tolerance Analyzing and Synthesizing Software Package

The computer-aided tolerance analyzing and synthesizing software packages can be utilized in the analysis and synthesis of dimensional tolerance. It is the dominant research field in computer-aided tolerancing. Many algorithms such as Worst Case, Six Sigma and Monte Carlo are used in the process.

- TASysWorld [31] provides a range of tolerance solutions in its TASysWorks Tolerance Solutions package, which includes PreTASysWorks for a tolerance assistant; TASysWorks for a tolerance analysis system; and

TASysWorks-INTOL, a tolerance optimizer. The software addresses the problem of tolerances in 3D mechanical assemblies.

- I-DEAS[®] VSA-3D [32] is a 3D tolerance analysis software application that is used to create a virtual prototype of geometry, tolerances, assembly process and measurements to simulate production, and predict the amounts and causes of variation in mechanical systems designed in I-DEAS before committing to tooling.
- MITCalc-Tolerance analysis [33] has two programs for the tolerance analysis of linear, 2D and 3D dimensional chains. 1) Tolerance analysis of linear dimensional chains. 2) Tolerance analysis of 2-D and 3-D dimensional chains. Data, methods, algorithms and information from professional literature and ANSI, ISO, DIN and other standards are used in calculation, such as ANSI B4.1, ISO 286, ISO 2768 and DIN 7186.
- VisVSA [34] is a dimensional analysis tool used to conduct the tolerance stack-up analysis for assemblies. It can deal with 3D parts and is able to integrate with most CAD systems. VisVSA performs the validations on the tolerance values, but there is no validation regarding DRF (Datum Reference Framework) conducted.
- The CATIA.3D FDT[™] tolerancing system developed by Dassault Systèmes is based on the TTRS (Technologically and Topologically Related Surfaces) model proposed by Clément et al [35]. The system automatically detected TTRS and combined TTRS pairs to specify a corresponding tolerance. However, the automatic specification was limited to situations involving mating conditions and was not applicable to tolerance within a part.

2.2.3 Geometrical Tolerance Software Packages

Geometrical tolerance is an important part of GPS. And it is also an accepted fact geometrical tolerance plays a more and more important role in ensuring product function in precision manufacturing.

- CE/TOL developed by Sigmetrix [36] not only includes the tolerance analysis module based on worst-case and statistical analysis, but also specifies default tolerances based on manufacturing and functional requirements..

The most common software for geometrical tolerance is the soft package for training. It mainly trains the engineers in the definition, indication format and application field, etc. of GD&T.

- The GD&T Trainer Professional Edition [37] is a comprehensive computer-based training program developed by Effective Training Incorporated that teaches the fundamentals of geometric dimensioning and tolerancing. It includes 28 lessons covering the basic rules, definitions, and concepts of GD&T. This new version of the classic training software adds features that make training more interactive, more professional, and more like an actual classroom setting.
- Tec-Ease Inc software packages [38] provides sources for GD&T training and materials. GeoTol Personal Trainer - Geometric Tolerancing Fundamentals computer based program (CBT) is an in-depth study designed to develop a basic working knowledge in GD&T.
- E-GAD™ Software (Electronic GD&T Aided Design) [39] is a multilingual, on-demand, e-learning/support software suite developed by Multi Metrics Inc.

There are some other geometrical tolerance software packages, which are embedded into CAD software for drawing indication, such as CATIA 3D Functional, SA-GDT, VisVSA, TI/TOL 3D and so on. These software packages can be used in the 3D CAD software, such as CATIA, UNIGRAPHICS, Pro/Engineer and I-DEAS and so on. Many geometrical tolerances are indicated on the drawing as text file and they are selected by users.

2.2.4 Surface Texture Software Package

There have been recent developments in the area of surface texture software development. The University of North Carolina at Charlotte has been contributing to the development of surface texture information system [40]-[43]. There are many other institutes are devoted to this area, and some results has been achieved.

- Sacerdotti et al. [44] have developed an open source universal toolbox – SCOUT. It aims to emphasizes freely sharing and developing code for surface texture analysis, to develop the relationship between friction, wear

and lubrication of surface texture with its 3D parameters. The toolbox was developed primarily for investigating the effect of surface texture on painting and pressing performance of auto body panels (AUTOSURF).

- A related project (SURFSTAND) [13,[45] on the development of 3-D parameters for areal characterization of surfaces has been completed and is currently a draft international standard before the ISO/TC 213 committee. These toolboxes have been developed to solve specific functional applications.
- Physikalisch-Technischen Bundesanstalt (PTB) in Germany is developing reference software for surface texture analysis [46].
- National Institute for Standards and Technology (NIST) in the US is currently commencing a project for developing reference software for surface texture and form analysis. While the focus of these tools is in evaluating the correctness of algorithms, the objective of these tools is on sharing information through the Internet and in developing a system for monitoring and performing remote diagnostics of the process.
- NPL has been developing reference software for surface texture together with Huddersfield, and the main outputs are focused on the development of softgauges for surface profile parameters defined within ISO 4287(1996) [106].
- The expert system for surface texture specification that has been developed by Charlmers University and Volvo Car UK Ltd, it regards 3D surface texture parameters as an effective tool to manage its functions.

2.2.5 Summary of Computer-aided Tolerance Tools

From the above analysis of the Computer-aided tolerance tools, we can know that: 1) many of the commercial CAT tools surveyed above support both dimensional and part of the geometrical tolerances. However, few of them have the ability to support all geometrical tolerance classes. Most of the CAT tools that prevail in the market are developed based on GD&T standard system, which has many differences to GPS standards. 2) The advanced functions of a CAT tool should have the ability to specify a default GPS scheme according to the functionality of the part and the good practice rules. And it can detect redundant-

dimensioning/tolerancing problems or under-dimensioning/tolerancing problems, check a GPS scheme corresponding to good practice rules. In addition, to have an advisory system to assist the designer in making decisions during specification stage, provide some manufacturing advisement and create advisement on inspection instruments and so on. Few of the surveyed computer aided tolerancing tools have the capabilities of these advanced functions.

2.3 STEP-XML

In design and manufacturing, many systems are used to manage technical product data. Each system has its own data formats so the same information has to be entered multiple times into multiple systems leading to redundancy and errors. The problem is not unique to manufacturing but more acute because design data is complex and in three dimensions, thus leading to increased scope for errors and misunderstandings between operators.

Many solutions have been proposed. The most successful ones are the standards for data exchange. The first ones were national and focused on geometric data exchange. They included SET in France, VDAFS in Germany and the Initial Graphics Exchange Specification (IGES) in the USA. Later a grand unifying effort was started under ISO to produce one International Standard for all aspects of technical product data and named STEP for the STandard for the exachange of Product Model Data [47].

IGES was developed primarily for the exchange of pure geometric data between CAD systems, STEP is intended to handle a much wider range of product-related data covering the entire life-cycle of a product. Typically, STEP can be used to exchange data between CAD, CAM, CAE and other CAX systems. STEP is addressing product data from mechanical and electrical design, Geometric dimensioning and tolerancing, analysis and manufacturing, with additional information specific to various industries such as automotive, aerospace, building construction, ship, oil and gas, process plants and others.

The Extensible Markup Language (XML) [47]-[48] is a general-purpose specification for creating custom markup languages. It is classified as an extensible language as it allows the user to define the mark-up elements. The purpose of XML is to aid information systems in sharing structured data,

especially via the Internet. It is easy for Java programming to output XML file data format. And the development of the standard STEP-XML, a short term for ISO 10303-28 [49], Industrial automation systems and integration -- Product data representation and exchange -- Part 28: Implementation methods: XML representations of EXPRESS schema (ISO 10303-11) and data, specifies the use of the XML to represent EXPRESS schema and the data that is governed by those EXPRESS schema. It is an alternative method to STEP-File for the exchange of data according to ISO 10303.

2.4 Typical Data Models

Managing large quantities of structured and unstructured data is a primary function of information systems. A data model in information systems is an abstract model that describes how data is represented and accessed. Data models formally define data objects and relationships among data objects for a domain of interest. There are types of data models, database model, Geographic data model, Generic data model, Semantic data model and so on.

A database model is a theory or specification describing how a database is structured and used. Several models have been suggested.

- Hierarchical model: In this model, data is organized into a tree-like structure, implying a single upward link in each record to describe the nesting, and a sort field to keep the records in a particular order in each same-level list.
- Network model: This model organizes data using two fundamental constructs, called records and sets. Records contain fields, and set to define one-to-many relationships between records: one owner, many members.
- Relational model: It is a database model based on first-order predicate logic. Its core idea is to describe a database as a collection of predicates over a finite set of predicate variables, describing constraints on the possible values and combinations of values.
- Entity-relationship model: It is an abstract conceptual representation of structured data, which produce a conceptual data model of a system, and its requirements in a top-down fashion.
- Object-relational model: Similar to a relational database model, but objects,

classes and inheritance are directly supported in database schemas and in the query language.

The indexes for evaluating a data model lie in two facts: the representation of a domain and the ability for the implementation of the data model.

2.5 Introduction to Category Theory [50]-[52]

Category theory arose in algebraic topology as a way to explain in what sense the passages from geometry to algebra in that field are 'natural' in the sense of reflecting underlying geometric reality rather than particular representations in that reality. At present, there is a large body of work in category theory ranging from purely categorical studies to applications of categorical principles in diverse fields. And its elegant style of expression attracts many researchers and applications in computer science as a language to represent the real world.

A **category \mathbf{C}** is given by a class of objects, denoted with $Ob_{\mathbf{C}}$, and a class \mathbf{C}_r of morphisms (normally called arrows), denoted with $Mor_{\mathbf{C}}$, which have the following structure.

- (1) Each arrow has a domain and a codomain which are objects; it is written as $f: X \rightarrow Y$ or $X \xrightarrow{f} Y$ if X is the domain of the arrow f and Y is its codomain. It can also be written as $X = \text{dom}(f)$ and $Y = \text{cod}(f)$, as shown in figure 2.10(a);
- (2) For every object X there is an identity arrow id_X , satisfying $\text{id}_X g = g$ for every $g: Y \rightarrow X$ and $f \text{id}_X = f$ for every $f: X \rightarrow Y$, as shown in figure 2.10(b);
- (3) Given two arrows f and g such that $\text{cod}(f) = \text{dom}(g)$, the composition of f and g , written as $g \circ f$, or gf , is defined and has a domain $\text{dom}(f)$ and a codomain $\text{cod}(g)$: $X \xrightarrow{f} Y \xrightarrow{g} Z$, as shown in figure 2.10(c);
- (4) Composition is associative, that is: given $f: X \rightarrow Y$, $g: Y \rightarrow Z$ and $h: Z \rightarrow W$, $h(gf) = (hg)f$, as shown in figure 2.10(d);

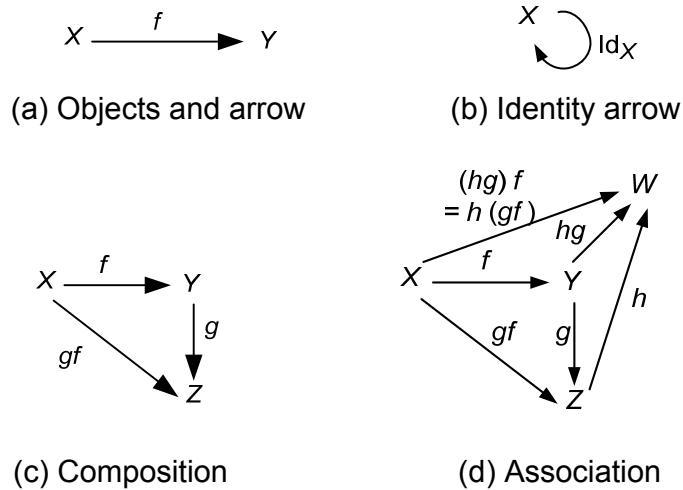

Figure 2.10 Category

There are many manipulations in category theory to implement its representative ability of the real world. Two main manipulations utilized in this thesis such as pull back, and functor transform are introduced.

Product:

Given a category C and two objects a, b in C , a product $a \times b$ is a triple (c, p, q) , where

There exists an object c in C ; $p: c \rightarrow a$ and $q: c \rightarrow b$ morphisms representing left and right projection from c to a and b respectively;

Universality property: for all $d \in C$ and $f: d \rightarrow a, g: d \rightarrow b$, There exists a unique morphism $h: d \rightarrow c$, satisfying $p \circ h = f$ and $q \circ h = g$.

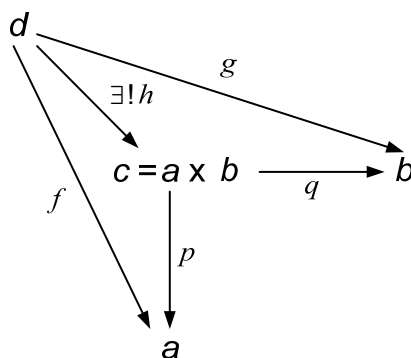

Figure 2.11 Product

Coproduct:

Given a category C and two object a, b in C , a coproduct $a + b$ is a triple (c, p, q) , where

There exists an object c in C ; $p: a \rightarrow c$ and $q: b \rightarrow c$ morphisms representing left and right projection from a and b to c respectively;

Universality property: for all $d \in C$ and $f: a \rightarrow d, g: b \rightarrow d$, There exists a unique morphism $h: c \rightarrow d$ satisfying $h \circ p = f$ and $h \circ q = g$.

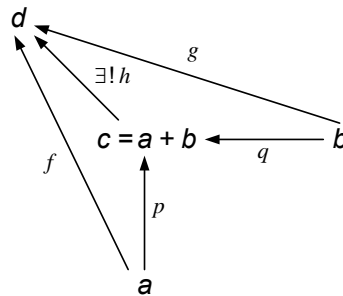

Figure 2.12 Coproduct

Coproduct is dual to product. The inherited property of categorical model can be realized by coproduct.

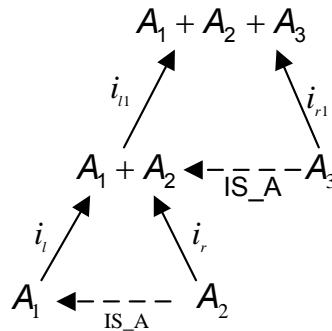

Figure 2.13 Coproduct to represent inheritance

Pull back

Given a category C and $\forall X, Y, Z \in Ob_C, \forall f \in hom(Y, X)$ and $\forall g \in hom(Z, X)$.

If $\exists M \in Ob_C, p: M \rightarrow Y$ and $q: M \rightarrow Z$ and satisfy:

- (1) $f \circ p = g \circ q$
- (2) For all $N \in Ob_C, \forall h \in hom(N, Y)$ and $\forall k \in hom(N, Z)$, If $g \circ k = f \circ h$, then $\exists! u: N \rightarrow M$ satisfy $p \circ u = h, q \circ u = k$

The triple (M, p, q) is called a pull back. The morphisms $p: M \rightarrow Y$ and $q: M \rightarrow Z$ represent the pull back of f along g and the pull back of g along f , as shown in figure 2.14.

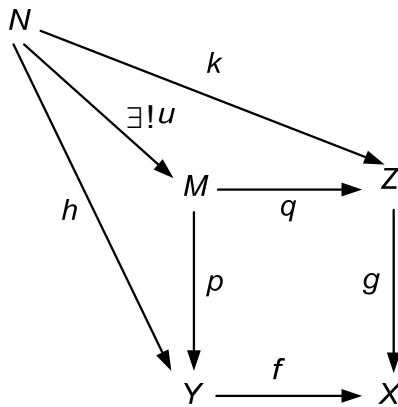

Figure 2.14 Pull back

From the definition of pull back, we know that it can represent and refine the relationships between categories clearly.

Functor

Let \mathbf{C} and \mathbf{D} be two categories. A functor F between \mathbf{C} and \mathbf{D} is:

- (1) $F: \mathbf{C} \rightarrow \mathbf{D}$ maps objects of \mathbf{C} to objects of \mathbf{D} and morphisms of \mathbf{C} to morphisms of \mathbf{D}
- (2) $f: X \rightarrow Y$ is mapped to $F(f): F(X) \rightarrow F(Y)$
- (3) $F(id_C) = id_{F(C)}$
- (4) \forall composable $f, g: F(f \circ g) = F(f) \circ F(g)$

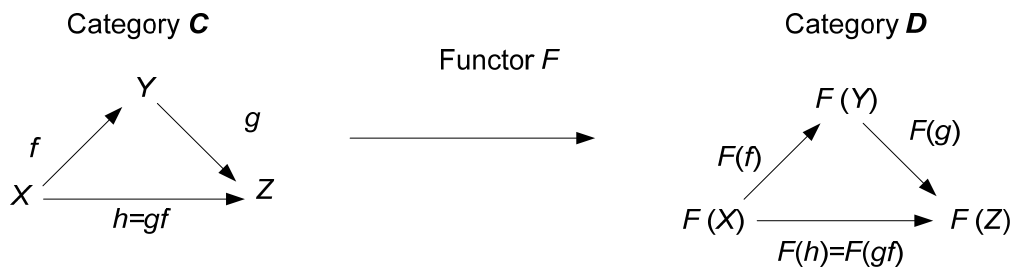

Figure 2.15 Functor

From the definition of functor, we can know that it is a morphism of categories that preserves structure.

Forgetful functor

Let F be a functor between two categories \mathbf{C} and \mathbf{D} . F is called a forgetful functor if some or all of the object's structures or morphisms in the category \mathbf{C} are 'forgotten' in the category \mathbf{D} .

From the definition of a functor, it is known that a functor is a transform

between categories that preserves structure. Query and Query with closure can be realized by the functor transform.

Natural transformation:

Given F and G are two functors between the categories A and B , a natural transformation $\alpha : F \rightarrow G$ between functors F and G is a function assigning to each object a of A an arrow of B , $\alpha(a) : F(a) \rightarrow G(a)$, such that, for every arrow $f : a \rightarrow a'$ in A the following square commutes.

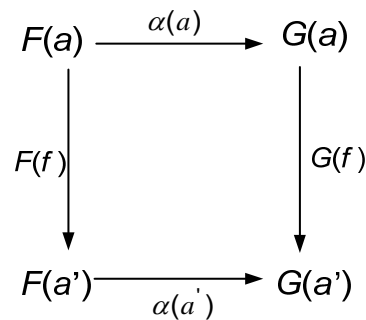

Figure 2.16 Natural Transformation

Message passing can be represented by natural transformations between methods. Query with closure are natural transformations between intension-extension functors and views with updating are pairs of dual natural transformations between intension-extension functors.

2.6 Data Modelling Methodology Based on Category Theory

From the definitions above we can know that a data modelling method based on category theory (categorical modelling method) will represent the real world by a homogeneous type, a category. All the elements and the complex relationships involved in geometrical tolerancing can be represented, stored and manipulated by different structures, such as categories, objects and morphisms in the categorical data model [53]-56]. And we can also know that there is a remarkable feature of categorical data method that it is not only focused on objects themselves, but more importantly also is focused on the relationships among objects, categories, and the relationships among categories and objects. A categorical data model can refine the relationships between objects/morphisms in different categories through construction of pull backs and various functors; the

construction of structures such as forgetful Functor and subcategory can deal with the query and its closure problems of the model successfully [57]-[64].

2.6.1 Representing relationships between inter/intra objects by pull back

We can know from the definition of morphism that it can represent the relationship of 1 to 1, 1 to many, many to 1, and it also can represent the relationship of more to more directly. The association abstraction between classes can be represented in object models by notation based on the entity-relationship (E-R) approach. In category theory, the E-R model can be represented by pullbacks, as shown in table 2.1.

Table 2.1 The morphism types and their E-R Equivalent [53]

Instances			Left projection		Right projection		Relationship			
b	c	a	Epic	Monic	Epic	Monic	Times of participation	Mapping	Membership class	
Entity	Entity	Relation					b : c	b : c	b	c
Supplier	Part	Order	N	N	N	N	m : n	m : n	N	N
Student	Course	Major	Y	N	N	N	m : n	m : n	Y	N
Country	District	Belong	Y	N	Y	Y	m : 1	1 : m	Y	Y
ID	Name	Status	Y	Y	N	N	1 : n	n : 1	Y	N
Car	License	Owe	Y	Y	Y	Y	1 : 1	1 : 1	Y	Y

① Note: N represents not sure.

where, Monic means *if $f \circ g_1 = f \circ g_2$ implies $g_1 = g_2$ for all morphisms $g_1, g_2 : x \rightarrow a$* ; and Epic means *if $g_1 \circ f = g_2 \circ f$ implies $g_1 = g_2$ for all morphisms $g_1, g_2 : b \rightarrow x$* [108].

The example of student minor course in table 2.1 can be represented by the table 2.2.

Table 2.2 Relationship between student and minor course

Student \ Course	Music	Mathematics	French
Jack		√	
Mike	√		
Peter	√		√

If we regard student and course as a category respectively, the initial object of these two categories can represent the major keys, i.e. SN and C# in the table. Subsequently, the minor relationship in table 2.2 can be represented by the pull back structure in Figure 2.17. The pull back structure is stored in the database system in an independent category, called pull back category. The pull back category consists of all the morphisms and objects involved in the morphisms, identifier of the correlated category and the constrained product between categories. Given category **Student** includes two objects, student ID, marked as SN and student name, marked as sname, and category course includes two objects, course ID, marked as C# and course name, marked as cname. Subsequently, the pull back category P consists of the following objects and morphisms:

$$Obj_P = \{SN^*P C\#, SN, C\#, sname, cname, grade\}$$

$$Mor_P = \{SN^*P C\#, SN, C\#, sname, cname, SN^*P C\# \rightarrow SN, SN^*P C\# \rightarrow C\#, SN \rightarrow sname, C\# \rightarrow cname\}$$

where $SN^*P C\#$ represents the product between category student and category course under the constrain minor. There is a new object in the pull back category P, which is the grade of the course that student minors.

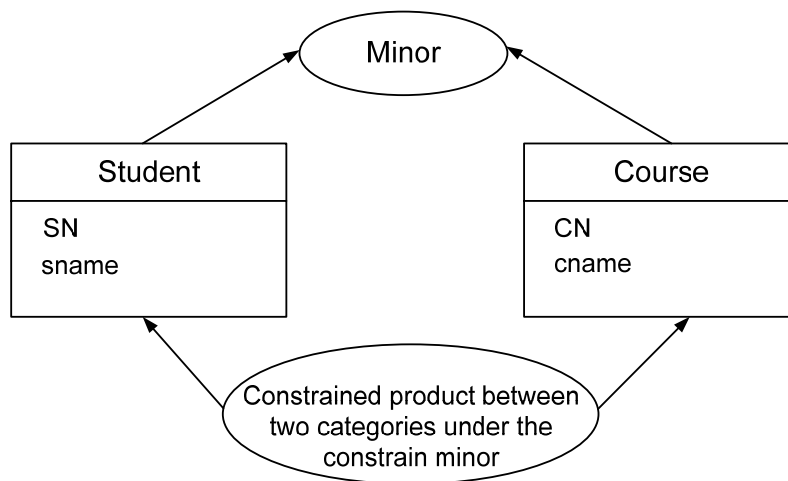

Figure 2.17 The minor relationship is represented by pull back

2.6.2 Representing Query by Functor

Categorical data model employs category, object, morphism, pull back and other structures to represent the entities and the relationships among them. And the result of the query is represented by a forgetful functor between categories. Eg,

'Please output the name of the students who minors mathematics and the grade is over 80'. The query for this process is:

STEP 1:

$A \rightarrow P$

$Mor_A = \{SN^*_pC\#, SN, C\#, sname, cname, SN^*_pC\# \rightarrow SN, SN^*_pC\# \rightarrow C\#,$

$SN \rightarrow sname, C\# \rightarrow cname \}$

$Ob_A = \{SN^*C\#, SN, C\#, sname, cname, grade \mid cname = 'mathematics', grade > 80\}$

/ A is the sub-category of category P, where cname = 'mathematics', and grade > 80 */*

STEP2:

$K \rightarrow A$

$Mor_K = \{ \}$

$Ob_K = \{sname\}$

/ Category K is the sub-category of category A, by forgetful functor */*

2.6.3 Representing Query process by natural transform

The above query process is just a transform in mode. The actual query process includes a functor, called faithful functor, to mapping a category mode to an instant category. For STEP1 in the above query process, there are two faithful functors:

$$F_{P-P} : INT_P \rightarrow EXT_P$$

$$F_{A-A} : INT_A \rightarrow EXT_A$$

Where, INT_P and EXT_P represents the category code and the instant category of pull back category P, F_{P-P} represents the transform between these two categories; INT_A and EXT_A represents the category code and the instant category of pull back category A, F_{A-A} represents the transform between these two categories.

The actual query process of STEP1 is the transform between functor F_{P-P} and F_{A-A} , $\sigma : F_{A-A} \rightarrow F_{P-P}$, as shown in Figure 2.18.

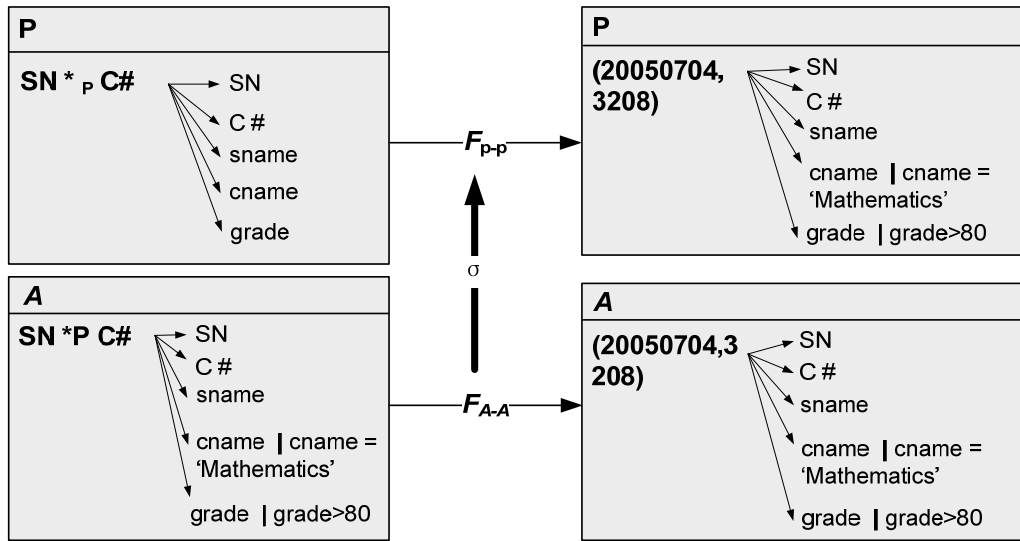

Figure 2.18 Actual query process represented by transform between functors

For $\forall f \in Mor_{INT_P}$, provided that

$$\sigma_a = F_{A-A}(\text{dom}(f)) \rightarrow F_{P-P}(\text{dom}(f))$$

$$\sigma_b = F_{A-A}(\text{cod}(f)) \rightarrow F_{P-P}(\text{cod}(f))$$

In the transform shown in figure 2.18, for $\forall f \in Mor_{INT_P}$, since $\text{dom}(\sigma_a \circ F_{A-A}(f)) = \text{dom}(F_{P-P}(f) \circ \sigma_b)$, $\text{cod}(\sigma_a \circ F_{A-A}(f)) = \text{cod}(F_{P-P}(f) \circ \sigma_b)$; then we can get the expressions $\sigma_a \circ F_{A-A}(f) = F_{P-P}(f) \circ \sigma_b$. It is obvious that every step in the actual query process can be regarded as a natural transform.

2.6.4 Closure in queries

From analysis of the above query process, it is obvious that query in mode can be conducted as the composition of a series of forgetful functors, and the result of each step is the sub-category of the original category. Since the structure of a sub-category is similar to the original category, the result of the query is closed. It means that the returned result of each query can be used either for further query, or can be stored in the database in their current form.

2.7 Comparison between Categorical Data Modelling Method and Other Data Modelling Methods

Databases have always had a formal background. This has had important advantages in proving that data operations are carried out rigorously in universality of applicability and in the agreement on common standards. The typical data model domains in the market are relational data model and objected-orientated data model. And the comparisons between the categorical data models with these two data model are listed as follows.

- 1) Objected-orientated data model has a very powerful structure to represent the real world. However, objected-orientated data model does not have its formal mathematical basis. The systematic management functions (such as query, closure of query, views and the update of views, and etc.) are very difficult to be realized. Whereas, the structures such as functor, natural transform and sub-category in the categorical data model solves these problems effectively.
- 2) The relational data model has very rigorous mathematical basis, relational algebra. However, the relational data model can only represent the world by relational tables. The relational table has an atomicity constraint (database modifications must follow an “all or nothing” rule). An entity may be represented by several tables. Time-consuming operation such as Join will be used in very high frequency, thereby to reduce the efficiency. In addition, the relational table has its limitations in representing the real world.

From the basic terms in category theory, it is known that there are two basic structures in a category, object and morphism. Object and morphism are one to one from the identify morphism. Therefore, the categorical data model is based on the morphisms and it has more rigorous mathematical foundation than a conventional object-oriented model. And it can represent the real world better than a relational model. Categorical data model composites the advantages of the relational data model and the object-oriented data model. The structures such as functor, natural transform and sub-category can deal with the query and closure in query problems, which are difficult in the object-oriented data model. The categorical data model support object nesting, so that an object in one

category can be another independent category, this avoids the atomic limitation in a relational model, therefore saves the storage space and improves the efficiency. Moreover, the multi level structure of the categorical data model can represent the entities and their relationships in different levels.

A comparison between the three typical data models is shown in table 2.3.

Table 2.3 The comparison between the three typical data models [55]

Type of model Representation and manipulation abilities	Relational data model	Object-oriented data model	Categorical data model
Relationship between objects in one category	Primary key/ Foreign key join	Method	Arrow
Relationship between objects in different categories	Functional dependency	Method transfer	Pull back
Reference Integrity	Foreign key	Object identifier	Initial Object
Identify of entity	Primary key, Foreign key	N/A	Initial Object
Normalization	Normal Atomic requirement	N/A	Composition of arrow No atomic requirement
Join between entities	Relational algebra	Object definition language	Pull back / Product
Product projection	Relational algebra	N/A	Product
Relational Projection	Relational algebra	N/A	Sub-category / Product Projection
View	Table	N/A	Sub-category
Aggression	Table join	YES	Pull back / Product
Inheritance	Table join	Sub-class	Coproduct
Object nesting	N/A	YES	YES
Multi level mapping	N/A	N/A	YES

2.8 Summary

This chapter presents a brief history of tolerancing, the motivation why GPS is generated, and the main task of it and the key concepts within it. Subsequently, some typical computer aided tolerancing tools, which prevail in the market are introduced and their features are analyzed and summarized. Then, the data representation standard 10303-28, marked as STEP-XML, is introduced. Finally, category theory and the data modelling method based on it (categorical data model) are presented. The comparisons between the categorical data model with the relational data model and the object-oriented data model are carried out.

CHAPTER 3 DESIGN OF THE FRAMEWORK FOR THE INTEGRATED INFORMATION SYSTEM

3.1 Introduction

As a part of information system within digital manufacturing, the integrated geometry information system is a separated system but not isolated. The system overcomes the shortcomings of the conventional geometrical specification system, which only considers the manufacturing process of product. The integrated geometry information system integrates the function, design, manufacturing and metrology of a product. For example, filter and its nesting indexes are considered in GPS specifications. Thereby, the integrated geometry information system is a concurrent design system.

3.2 Framework of the Integrated Geometry Information System

3.2.1 The relationships between the system and other CAx systems

The geometrical tolerances and surface texture play important roles during assembly, friction, wear and lubrication of parts. Thereby, design of geometrical tolerances is an important link after the structural design of a product. Computer aided tolerancing can help designer to make decisions in this process at a certain extent. CAPP bridges the design and manufacture, and it assigns geometrical tolerances to various processing steps in manufacturing process. The wide use of digital measurement equipment such as CMM (Coordinate Measuring Machine) was a revolution for measurement technique. Two important effects came out. Firstly, the consequent data processing with digital measurement technique is different with conventional one; this will force the assessment to change. Secondly, the software used in the digital measurement technique pushes forward the digitization of manufacturing industry. Then, the communication and exchange of data among different systems becomes another problem.

With the development of STEP, there is no need for direct communication and exchange of data among different systems such as CAD, CAPP and the integrated geometry information system. And this can be accomplished by STEP-

XML for product data representation and exchange.

In this thesis, CAD is used as the host system. And the popular CAD systems have interface for further development, such as ObjectARX for AutoCAD, UG/Open API for Unigraphics, and so on. The output of The Integrated Geometry Information System, which is the XML format, will be transformed to the inner format that the CAD system supports. The integrated framework of the integrated geometry information with other CAx software is presented in Figure 3.1.

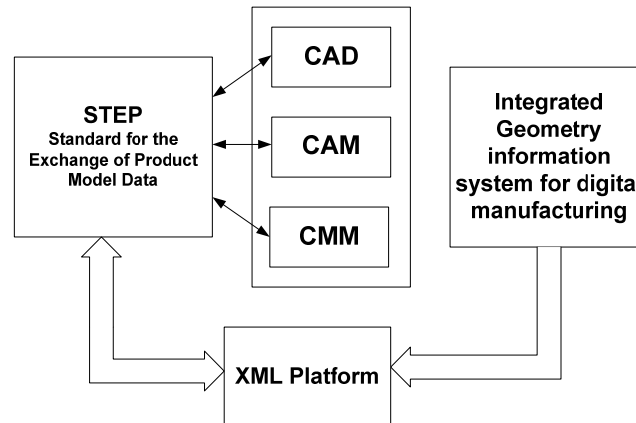

Figure 3.1 Framework of the integration between the integrated geometry information system with other CAx systems

3.2.2 The Framework of the System

In order to reduce the uncertainty during design and metrology process, thus to reduce specification uncertainty, method uncertainty and implementation uncertainty, GPS standard system aims to strengthen the completeness of geometrical specifications, i.e. to consider the function, type of geometrical specification, type of geometrical feature, geometrical requirement, and various operations and the nesting indexes to obtain the geometrical feature, evaluation parameter and so on.

It should be addressed that:

- (1) The comprehensive consideration of information related to geometrical product specifications above, it makes the geometrical product specifications more complete and unambiguous. However, if all this information is presented in one drawing indication, it will cause 'traffic jam', further to reduce the readability of the drawing indication.
- (2) Some components such as geometrical requirements, filtration and association algorithms, are easily to be determined in the process of design. However, some components are not suitable or should not be prescribed by

the drawing indication. For example, if particular inspection method is prescribed, this would force the manufacturer to provide inspection devices prescribed by the customer, although other sufficient inspection devices are already available, this will cause unnecessary cost.

- (3) One particular method that differs in assessment from the precise tolerance zone requires further specifications of the measuring conditions. Especially for the precise tolerance zone, further specifications of the measuring conditions should be specified.
- (4) The determination of the component involved in geometrical specifications should be user-machine interactive, and it can not be finished automatically.

CAD/CAM/CAPP/CMM-systems are the necessary tools for the implementation of Concurrent Engineering (CE). The integrated information system for GPS integrates the information of geometrical tolerancing, involving function, design, manufacture and verification, and it is an important component of CE. GPS standard system utilizes the enriched GPS language to express the GPS specifications complete, unique and unambiguous to meet the different functions of geometrical product. And, it makes the measured value of geometrical specifications and specified value to be comparable, thus to reduce the specification uncertainty, method uncertainty and implementation uncertainty.

Figure 3.2 shows the relationship between function, design, manufacture and verification of geometrical products.

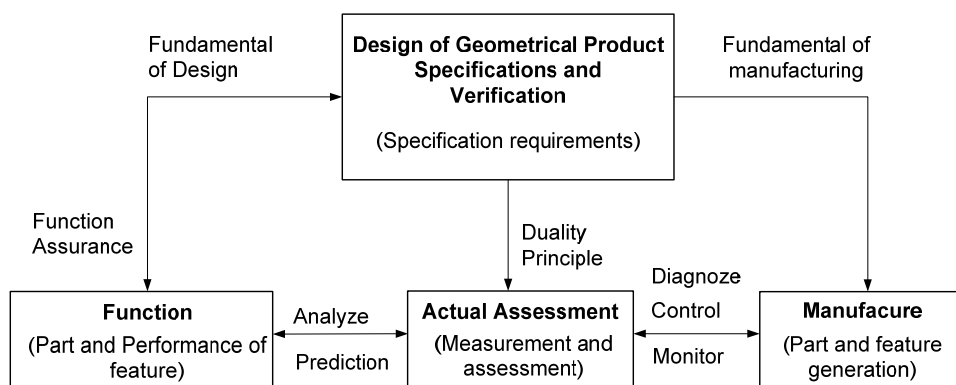

Figure 3.2 Relationships among function, design, manufacture and verification of a product [105]

The integrated geometry information system consists of three core modules: Database module, Knowledge base module and Host module. The Database module is the fundamental part of the system, and the knowledge base

subsystem is the key part for the intellectualization of the system. The entities in various phases of the product and their relationships are modelled in the database module. The running of the whole system relies on it. The Knowledge base module operates on the database module. It uses the knowledge rules stored in it to help the designer make decisions. The issues that should be solved in each part are the establishment of the computer representing model of the entities, their relationships and the establishment of the knowledge rules in different phases of product. One of the most common applications of the system is to combine it with CAD to visualize the geometrical specification of drawings. Consequently, the host module is another important part of the system. This project mainly combines the system with CAD software. The framework of the system is presented in Figure 3.3.

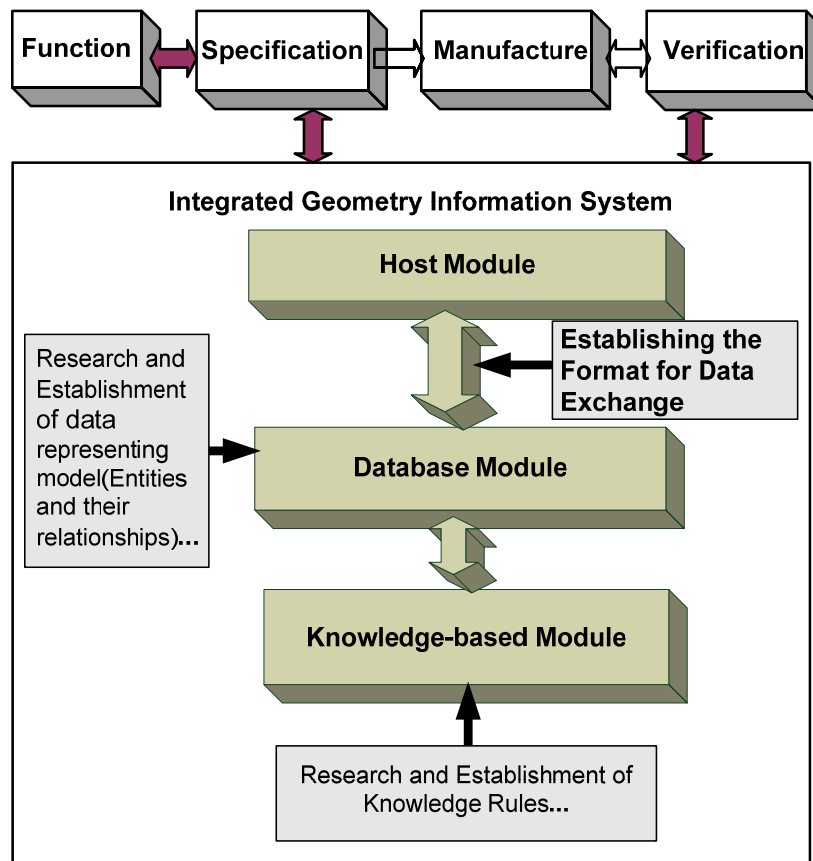

Figure 3.3 Framework of the Integrated Information System

3.3 Framework of the Database Module

The database Module is composed of six main parts. The functional algorithms base, the user interface, Measurement database, Information database, Outer

Interface and help system, which is demonstrated in figure 3.4.

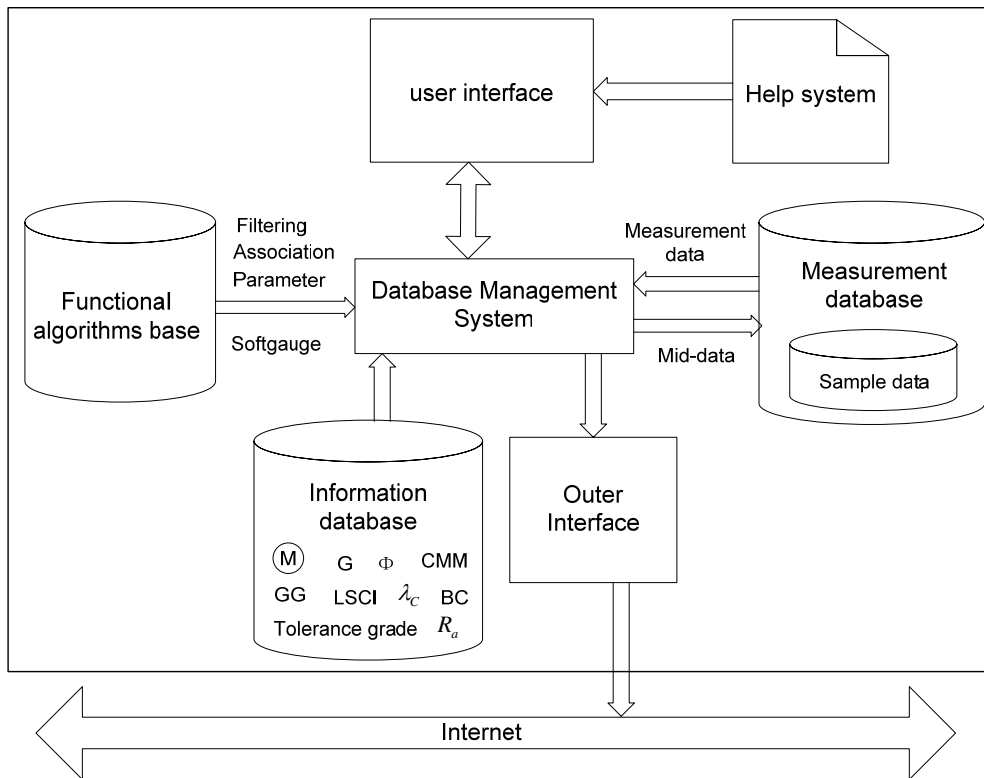

Figure 3.4 Framework of the Database Module

3.3.1 Function algorithms database subsystem

This subsystem integrates the various algorithms in GPS, such as the filtration algorithms, association algorithms, parameter evaluation algorithms, etc. This subsystem can be used as an independent cell, so it can be extended and revised flexibly with the development of GPS standard system. There are two kinds of function algorithms; one is for the practical engineering with some accuracy and high speed, the other is soft-gauge for the calibration of the commercial software, with high accuracy.

3.3.2 Measurement database subsystem

This subsystem is established mainly for metrology engineers. The raw data obtained by measurement is stored in this subsystem in some format such as SDF, SMD, etc.(It is outside the scope of this work). The system can read the file from this subsystem, and call the specified function algorithm from the function algorithm database subsystem to handle the raw data. The result of the processed data is sent to drawing indication/ or can be stored in the measurement database subsystem in the specified data format for later use. In

addition, the measurement database subsystem contains a sample database prepared for designers. Many typical data are stored in this database. If the designer wants to have a decision on selecting an operation from various operations (filtration, association and so on), she/he can use the system to call the operation from the function algorithm database subsystem, and load the sample data as input to find the result.

3.3.3 Information database subsystem

This subsystem includes the various codes needed in the drawing indication in GPS, such as tolerance grade of size, pre-fit database, filter, cut-off wavelength, sampling strategy, association operation, evaluation parameter, evaluation reference, instrument etc.

3.4 Framework of the Knowledge-based Module

The knowledge-based module consists of three main parts, knowledge rules base, infer engine and global database. The knowledge rules base is the key part of the subsystem. The infer engine uses some control strategy and search mechanism to match the specific rules with particular problems and thereby solve the particular problems. The global database stores some mid-data in the infer process. The framework of the knowledge-based subsystem is shown in Figure 3.5. The knowledge is classified into two groups, compatibility rules and cause-effect rules.

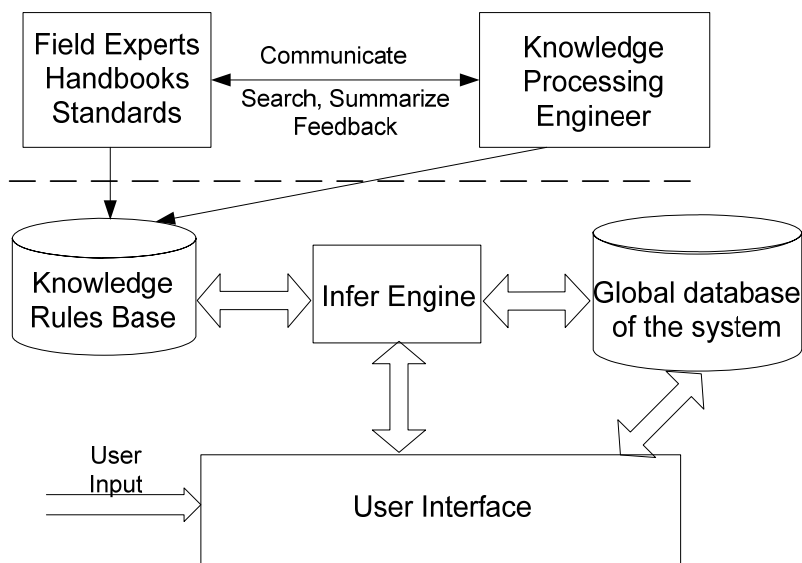

Figure 3.5 Framework of the Knowledge-based Module

3.5 Framework of the Host Module

The host module is composed of three main parts, CAD Inner database, CAD user Interface and Outer interface.

3.5.1 Inner database of CAD subsystem

The new generation GPS language is based on novel concepts operations and operator. It distinguishes the difference between the drawing indication for design and the drawing indication for metrology. And the drawing indication for metrology will be more detailed. Hence, the designer will use the system to define the codes that would be indicated in the drawing and the order of these codes as an entity. The entity will be stored in the inner database subsystem of CAD. Then, the entity will be mapped into different blocks according to different needs. These blocks will be indicated in design drawing and metrology drawing as the GPS specified format of data.

3.5.2 CAD user interface subsystem

The system will operate based on operation will rely on CAD system. The CAD user interface subsystem will read the information from this subsystem according to the input from the user, and then call the corresponding algorithms to handle it. The returned result will be user friendly.

This system integrates all the functional interfaces and the data, following by which the users (including designers and the metrology engineers) use the system. The framework of the host subsystem is demonstrated in Figure 3.6.

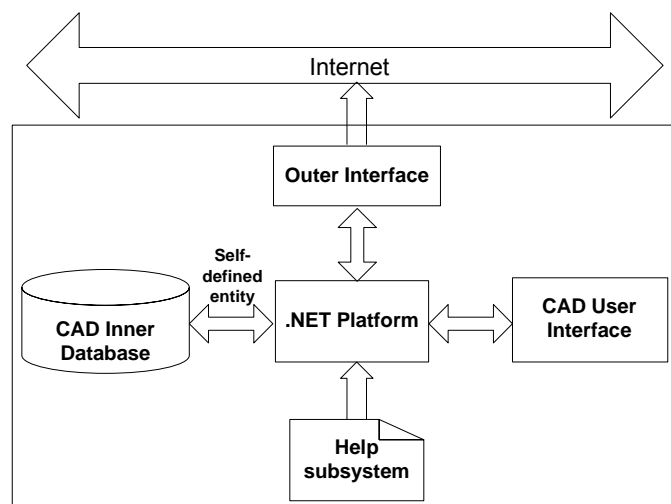

Figure 3.6 Framework of the Host Subsystem

3.6 Workflow of the Integrated Information System

The integrated geometry information system is user-machine interaction software. It has a unified user interface and utilizes the menu, button tools and dialog box to navigate the design. The designer analyzes the functions of the product and decomposes it into the detailed sub-functions as the input of the system. Afterwards, the designer will start the system. The workflow of the integrated information system is as follows:

- The system will check the compatibility between the geometrical characteristics and the geometrical features automatically.
- On condition that compatibility requirements are satisfied, the system will identify if the geometrical characteristics that are related to functions are defined from a single feature or relevant features. If a geometrical characteristic is defined from relevant features, the acquisition and subsequent data processing of the referenced datums is regarded as a normal feature.
- The system will recall the compatibility rules to check which tolerance requirements are compatible to the geometrical characteristics and features. It can provide a mechanism to help the designer decide whether it is reasonable or not to specify the tolerance requirement in his design.
- The designer can use the system to select the evaluation parameter (measurand) that is close to the function and thus can be used to evaluate it. Appropriate reference should also be selected for the parameter.
- For the comparability between the specified value and the measured value, the designer should specify a specification operator, which is a virtual instruction of a verification operator. Operations such as partition, extraction, filtration, association and their nested parameters and so on that make up the operator should be specified.
- During extraction operation in the previous step, measurement instrument should be considered based on the precision grade, measurement uncertainty and so on. Sampling strategy should be selected based on the determined measurement instrument and the type of the geometrical characteristic.
- The geometrical information of the geometrical specification output by the system will be stored into a XML data format file for the use by CAD host

system.

- The CAD host subsystem will map the geometrical specifications information into two blocks, one for the drawing indication for manufacturers, and the other is the referenced information for metrology engineers.
- The metrology engineers will use the referenced information provided by the designers and call the functional algorithms database to finish the measurement and the data process for geometrical specification. Then the evaluation operation will be used to evaluation the qualification of the product.

3.7 Development Platform for the Integrated Information System

The platforms such as Java, .Net, Microsoft SQL Server2000, ObjectARX and Visual C++ will be used to develop the different modules of the integrated information system. The system configurations are Microsoft windows 2000/XP, AutoCAD2007.

3.8 Summary

This chapter analyzed the functional requirements of the integrated geometry information system, and proposed the framework for its integration with other CAx systems. The inner framework of the information system has been designed, and the functions and detailed design of its three key modules have been stated.

CHAPTER 4 REPRESENTATION OF GEOMETRICAL TOLERANCE KNOWLEDGE BY CATEGORICAL DATA MODEL

A global data model, i.e., a data structure which is able to properly represent and store all the elements and the relationships between them involved in the integrated information system for the downstream analysis, is the key problem to be solved for the integrated geometry information system. For a complicated component, it may consist of tens of parts and a part will contain several to dozens of geometrical features. A geometrical feature is defined by a couple of geometrical specifications. Thousands of tables will be used if all the entities and the relationships between them are represented in the relational model. Thus inefficient conjunction operations will be used frequently. In addition, the tables in the relational model cannot represent the relationships involved in GPS characteristics very clearly.

As stated in [9], a geometrical specification is a condition on a characteristic defined from geometrical features which are created from the model of the non ideal surface of the part (skin model) by different operations. It is clear from the definition that the key elements involved in geometrical specifications are geometrical features, different types of functional operations and various conditions.

4.1 General Categorical Data Model of Geometrical Feature

Geometrical features are the point, line and surface that compose the part/workpiece. In ISO standards ISO 14660-1:1999 [65] and ISO 14660-2:1999 [66] about terms and definition of geometrical features, geometrical features is classified into two types, integral feature and derived feature. Integral feature is surface or line on a surface to make up of a part; and derived feature is centre point, median line or median surface from one or more integral features.

Geometrical feature plays an important role in design, manufacture and measurement process of geometrical product, because any geometrical

characteristic is specified on a geometrical feature. Srinivasan [67] shows a simple hierarchy of taxonomy that will be useful in understanding the product geometry specification. A product is recursively defined as an assembly of subassemblies and parts. Parts are composed of geometrical features, which are then subjected to various conditions (or, synonymously, constraints). The conditions, or constraints, on features are of two types: first is intrinsic, such as size and form, and these are on the features themselves; second is relational, such as position, and these are defined for two or more features.

Given that geometrical features are rigid body, through rigid motion, it contains a maximum of six degrees of freedom (DOF), i.e., three independent translations, marked as TDOF, and three independent rotations, marked as RDOF, in three-dimensional space. For some ideal geometrical feature, it has some intrinsic characteristic opposite to DOF, called invariance degree, marked as DOI, which means displacement(s) of the ideal feature for which the feature is kept identical in the space. Thereby, the following expression can be obtained.

$$DOI (Feat) \cup DOF (Feat) = \mathbf{I} = \{t_1, t_2, t_3, r_1, r_2, r_3\} \quad (4-1)$$

where, r_1, r_2, r_3 is the rotation degree respectively, t_1, t_2, t_3 is the translation degree respectively.

According to the DOF and DOI characteristics of rigid geometrical features, Srivinsan classifies the ideal geometrical features into seven Invariance classes, as shown in table 4.1 based on theory of symmetry group (provided that the coordinate system is established according to Figure 4.1).

Table 4.1 Table of Invariance Class [26]

Invariance Class	Code	Situation feature	DOI	DOF
spherical	C_S	point	r_1, r_2, r_3	t_1, t_2, t_3
cylindrical	C_C	straight line	t_3, r_3	t_1, t_2, r_1, r_2
planar	C_P	plane	t_2, t_3, r_1	t_1, r_2, r_3
helical	C_H	helical line	t_3, r_3	t_1, t_2, r_1, r_2
revolute	C_R	(point, straight line)	r_3	t_1, t_2, t_3, r_1, r_2
prismatic	C_T	(straight lin, plane)	t_3	t_1, t_2, r_1, r_2, r_3
complex	C_X	(point, straight line, plane)	—	$t_1, t_2, t_3, r_1, r_2, r_3$

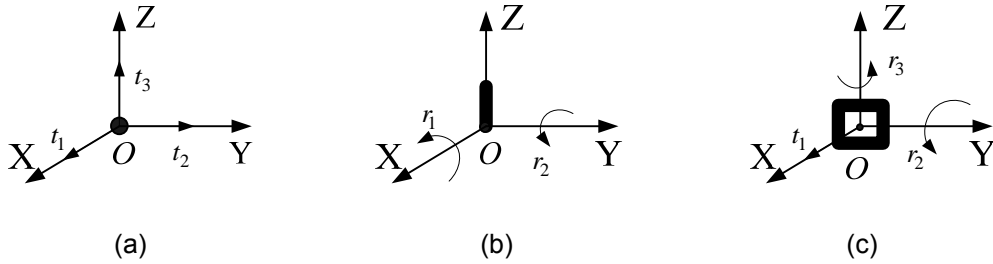

Figure 4.1 The degrees of freedom of typical geometrical features

And for the revolution and prismatic invariance class, their situation feature is the combination of point and straight line and combination of straight line and plane respectively, and then the following expressions can be obtained:

$$DOI(C_R) = DOI(C_C) \cap DOI(C_S) \quad (4-2)$$

$$DOI(C_T) = DOI(C_C) \cap DOI(C_P) \quad (4-3)$$

From the analysis above, the general categorical data model of geometrical feature, as shown in Figure 4.2, can be obtained. Where, rectangles represent category; the first line of Figure 4.2 represents the name of the category; the elements below the category name are the objects of the category; the initial internal object stores a unique system automatically generating an identifier value; and all the different morphisms are represented by arrows (the same below); $Fe\#$ represents the initial object of the category Geometrical Feature, which is the identifier of this category. $Obj(i)_{Feat}$ is the object involved in the category, and arrow represents the relationship among objects within the category. DOF is the degree of freedom of the geometrical feature.

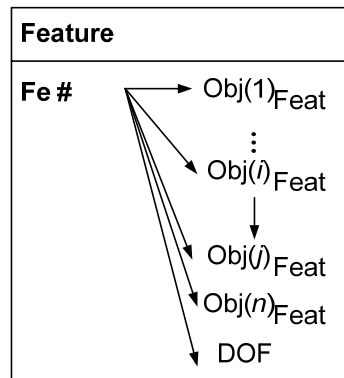

Figure 4.2 General categorical data model of geometrical feature

4.2 General Categorical Data Model of Functional Operations

Operations are used in GPS to identify geometrical features from the Skin model, they are divided into six classes, partition, extraction, filtration, association, collection and construction.

4.2.1 Partition

A partition is an operation used to identify bounded feature(s) from non-ideal feature(s) or from ideal feature(s) [26]. For example:

- A non-ideal surface nominally planar, identified by partition from the skin model;
- A section identified by partition from a non-ideal surface nominally planar (intersection of the non-ideal surface with an ideal plane).

Here the surface of a geometrical product is divided into independent surface portions for further analysis. The default partition, according to international standards, is that which divides the surface into maximal surface portions each of which belongs to one of the seven invariance classes of surfaces, (i.e. plane, sphere, cylinder, surface of revolution, prism, helix, and complex surface).

Algorithms exist that can implement the default partition, but they nearly all require a high density of sampled points on the surface to ensure an accurate estimate of the surface normal. ISO/TC 213 has been developing partitioning algorithms that do not require such a high density of surface points. One approach is to use interpolation methods to reconstruct a continuous surface from the discrete sampled points so that the surface normal can be accurately estimated from sparsely sampled points and then uses one of the existing algorithms.

4.2.2 Extraction

An extraction is an operation used to identify specific points from a feature. Extraction is typically used in metrology [26]:

- In coordinate metrology, points are extracted from the surface of the real part;
- In surface texture metrology, a surface indicator extracts points from in a profile (the measured section is only known by points; it is not a continuous

line).

Data acquisition is implemented by the measurement process. Some key factors are related to this, such as the circumstances, instrument, sampling strategy, sampling condition (sampling space, sampling number), metrology engineer and so on are critical to the measurement result. Some of these factors are subjective and some are objective.

(1) Sampling condition

The basic requirement that should be satisfied in the sampling process is Nyquist principle to keep the fidelity of geometrical feature. Then, the metrology engineers should use an optimized and simplified sampling strategy to reduce the measurement time and cost. Figure 4.3 are some typical sampling strategy for different types of geometrical features.

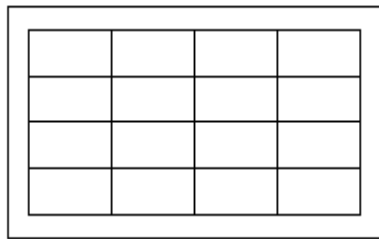

(a) Orthogonal grid

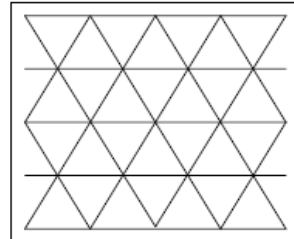

(b) triangle grid

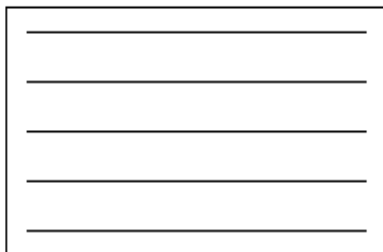

(c) parallel line

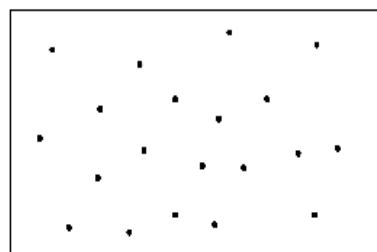

(d) points

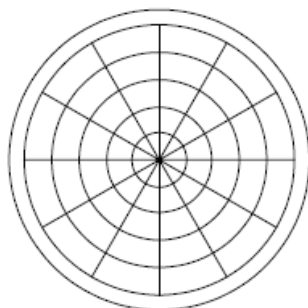

(e) polar grid

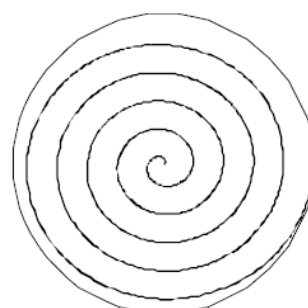

(f) Spiral

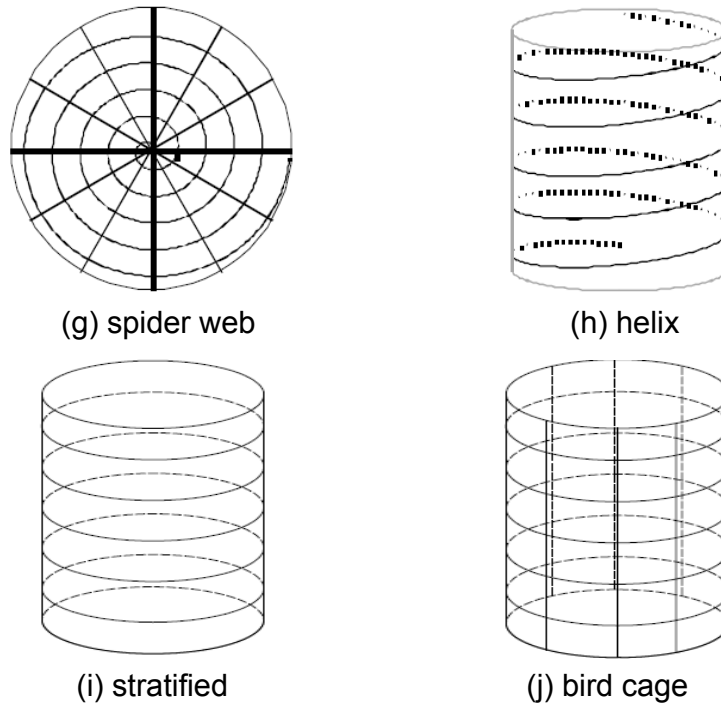

Figure 4.3 Several types of typical sampling strategy [68]

The relationships between the sampling strategy and the geometrical features are shown in table 4.2.

Table 4.2 Sampling schemes for surfaces ^①[68]

	Sphere	Plane	Cylinder	Surface of revolution	Prism	Helix Tube	Complex
Orthogonal grid	×	×	×	×	×	×	×
Bird Cage			×	×	×	×	
Polar Grid		×					
Specified Grid	×	×	×	×	×	×	×
Stratified	×	×	×	×	×	×	×
Helix	×		×	×	×	×	×
Spiral		×					
Spider Web		×					
Points	×	×	×	×	×	×	×
Parallel Line		×					

Notes ^①: 'X' represents the sampling scheme is suitable for the geometrical feature.

In addition, the parameters such as number of lines and circles in the “bird cage” strategy is determined by the metrologist according to the actual situation.

(2) Instrument

a. Inspection method

According to ISO 1101:2004 for the drawing indication of form tolerance, there is no need to prescribe the particular inspection methods on the drawing indication for the following reasons:

- The type and frequency of inspection to be used depend on the control of the manufacturing process (reliability).
- There are often different but equivalent correct inspection methods. Prescription of particular inspection methods would force the manufacturer to provide inspection devices prescribed by the customer, although other sufficient inspection devices are already available.
- Prescribing inspection methods that differ in assessment from the precise tolerance zone requires further specifications of the measuring condition. Inspection methods that differ from the precise tolerance zone and different measuring conditions would make the inspection of geometrical deviations obscure and prone to mistakes.

Though the reasons listed above, it is of practical meaning to provide some options for the metrology engineer or provide some recommendations to the metrology engineer to help them make decision, according to the range of tolerance of form and location tolerances and the systemic error and the uncertainty of the inspection method and so on.

b. Radius of probe stylus tip

For the contact measurement instrument, the radius of probe stylus tip has a great influence on the measurement results. If the radius of probe stylus tip is too large, it will cause the fidelity of measurement; if too small, λ_s will be small and a lot of sampling points are needed, and it will increase the measurement time and cost greatly. Thereby it is necessary to define the radius of probe stylus tip.

From the analysis above, we can obtain the general categorical data model of extraction, as shown in Figure 4.4.

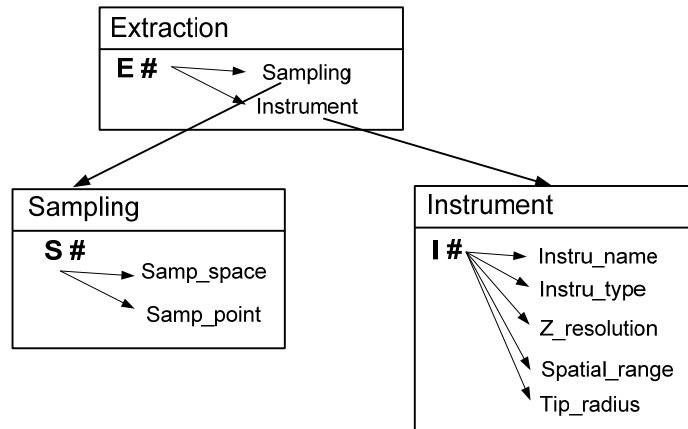

Figure 4.4 General categorical data model of geometrical feature

Where, E#, S# and I# represents the initial object of each category respectively; 'Samp_' is the abbreviation of 'Sampling_', and 'Instru_' is the abbreviation of 'Instrument_'; 'Z_' represents the Z direction.

4.2.3 Filtration

A filtration is an operation used to create a non-ideal feature by reducing the level of information of a non-ideal feature [26]. Generally, size deviation will influence the assembly property and the fit of parts; form and location tolerance will influence the assembly property, strength of structure, stiff, fit and sealing of parts; roughness will influence the fatigue strength, stiff, sealing, wear and so on of parts. It is clear that different types of geometrical deviations will cause different affections (sometimes we call it different functions) on parts. Therefore, it is important to obtain the function related information of a non-ideal feature through filtration.

Filtrations are typically used for surface texture specifications to separate the long and short wave content of a surface profile. For example, if only the long wave components are retained, the level of information is reduced as the short wave information is suppressed.

In order to solve the problems such as phase shift, edge deformation, deep valley corruption, the separation of information of micro structure and so on, ISO/TC 213 proposes a series of filters, such as Gaussian filter, Rk filter, Spline filter, Robust spline filter, Gaussian Regression filter, Wavelet filter, Morphologic filter and so on. The code of these filters are ISO/TS16610-x [69]-[82], and part of them are listed in table 4.3. Where, FA/FP means areal/ profile filter respectively;

-L/-M/-R represents linear/morphologic/robust filter respectively; code means the drawing indication of filter; nesting indexes is the parameter of filters.

Table 4.3 Filters in GPS

Filter Type	Filter Category	Filter Designation	Filter Name	Standard	Nesting Index
FA	FAL (Linear)	FALG	Gaussian	ISO/TS 16610-61	Cutoff wavelength, Cutoff Undulations Per Wave(UPR)
		FALS	Spline	ISO/TS 16610-62	
		FALW	Spline Wavelet	ISO/TS 16610-69	
	FAM (Morphological)	FAMCB	Closing Ball	ISO/TS 16610-81	Ball radius
		FAMCH	Closing Horizontal Segment	ISO/TS 16610-81	Segment length
		FAMOB	Opening Ball	ISO/TS 16610-81	Ball radius
		FAMOH	Opening Horizontal Segment	ISO/TS 16610-81	Segment length
		FAMAB	Alternating Series Ball	ISO/TS 16610-89	Ball radius
		FAMAH	Alternating Series Horizontal Segment	ISO/TS 16610-89	Segment length
	FAR (Robust)	FARG	Robust Gaussian	ISO/TS 16610-71	—
FARS		Robust Spline	ISO/TS 16610-72	—	
FP	FPL (Linear)	FPLG	Gaussian	ISO/TS 16610-21	Cutoff wavelength, Cutoff UPR
		FPLS	Spline	ISO/TS 16610-22	
		FPLW	Spline Wavelet	ISO/TS 16610-29	
	FPM (Morphological)	FAMCD	Closing Disk	ISO/TS 16610-41	Disc radius
		FPMCH	Closing Horizontal Segment	ISO/TS 16610-41	Segment length
		FAMOD	Opening Disk	ISO/TS 16610-41	Disc radius
		FPMOH	Opening Horizontal Segment	ISO/TS 16610-41	Segment length
		FPMAD	Alternating Series Disk	ISO/TS 16610-49	Disc radius
		FPMAH	Alternating Series Horizontal Segment	ISO/TS 16610-49	Segment length
	FPR (Robust)	FPRG	Robust Gaussian	ISO/TS 16610-31	—
		FPRS	Robust Spline	ISO/TS 16610-32	—
FP(special case)	F2RC	2RC	ISO3274	Cutoff wavelength, Cutoff UPR	

From the analysis above, we can know that the selection of probable filter and its nesting indexes according to the function of filter is the most important work in this step. Therefore, we can obtain the general categorical data model of extraction, as shown in Figure 4.5. Where, $F_i\#$ is the identifier of category Filtration; 'Filt_#' is the abbreviation of 'Filtration_#'.

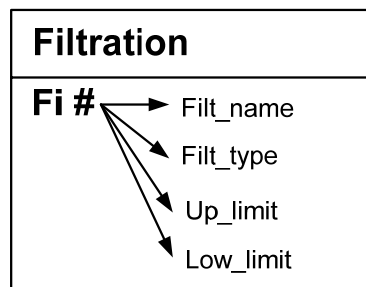

Figure 4.5 General categorical data model of Filtration

4.2.4 Collection

A collection is an operation used to consider several features together. For example:

- A plane pair (planes of a groove) formed by the collection of two planes;
- A median line which is the non-denumerable collection of section centres of a nominally cylindrical surface.

4.2.5 Association

An association is an operation used to fit ideal feature(s) to non-ideal feature(s) according to a criterion. For example:

- A plane fitted to a non-ideal surface according to the least-squares criterion;
- A cylinder fitted to a non-ideal surface according to the criterion of maximum diameter inscribed cylinder such that the cylinder is perpendicular to a datum plane.

Association is the task of associating ideal geometrical forms to non-ideal forms (for example, discrete set of points sampled on a manufactured surface).

Engineers are interested in association for the following reasons:

- Datum establishment: A datum is a reference geometrical object of ideal form established on one or more non-ideal geometrical forms on a manufactured part. Datums are used for relative positioning of geometrical objects in parts and assemblies of parts. Figure. 4.6 shows a datum indicated on a single part to specify perpendicularity.

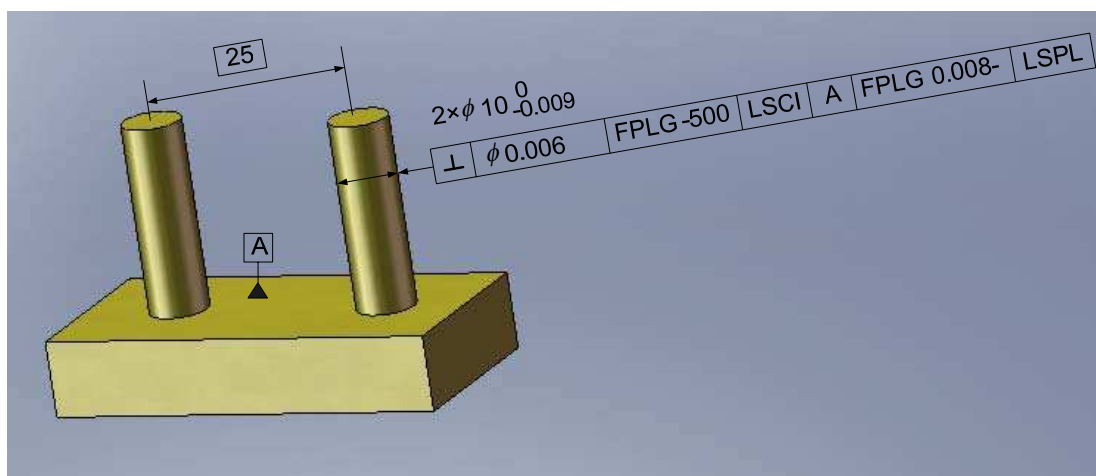

Figure 4.6 An example of drawing indication for perpendicularity consistent with

GPS

- Deviation assessment: It is often important to determine how far a specified geometrical feature manufactured has deviated from its intended ideal geometrical condition. Figure 4.7 specifies how much the specified derived central line can deviate from its ideal orientation. This deviation can be quantified by association.

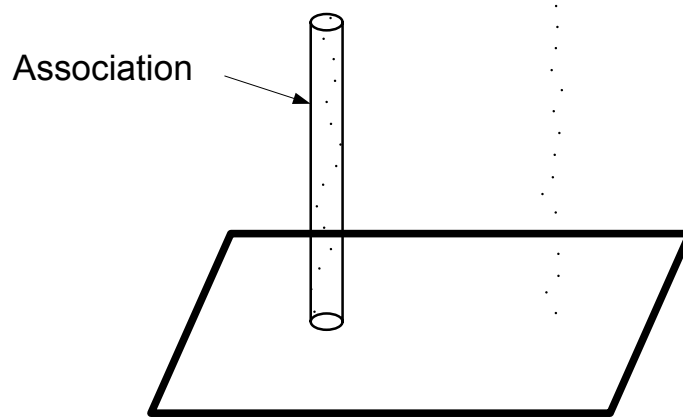

Figure 4.7 The association for perpendicularity assessment

Historically such fitting was accomplished by the use of surface plates, collets, mandrels and specialized measurement fixtures. More recently, manufacturing industry has started using modern measurement devices such as CMMs and optical scanners. This has accelerated the use of association by computation.

An association identifies one or more features, which maximize (or minimize) an objective subject to a set of constraints as shown in expression 4-4.

$$OP_{ASSO} (XX_i, i = 1, \dots, n) = \{XX_i, i = 1, \dots, n \} \begin{array}{l} C_1 \\ C_2 \\ \vdots \\ C_m \\ \max(\text{or min})O \end{array} \quad (4-4)$$

Where, XX_i are the fitted features, n is the number of fitted features, the C_j are the constraints, m is the number of constraints and O is the objective.

From the analysis above, we can know that the selection of probable association method and its constraints according to the function of association operation is the most important work in this step. Therefore, the general categorical data model of association can be obtained, as shown in Figure 4.8. Where, $A\#$ is the identifier of category Association; 'Asso_' is the abbreviation of

'Association_'.

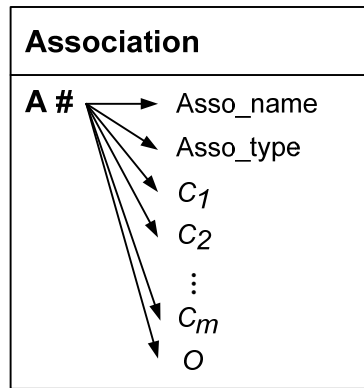

Figure 4.8 General categorical data model of Association

4.2.6 Construction

A construction is an operation used to build ideal feature(s) from other ideal features with constraints. For example:

- A plane such that it includes a datum point and is perpendicular to a datum straight line;
- A cone such that its summit is identical to a datum point, its axis is parallel to a datum straight line and its apex angle is equal to 45°.

A construction identifies one or more features, which satisfy a set of constraints, as shown in expression 4-5.

$$OP_{CONS}(XX_i, i = 1, \dots, n) = \{XX_i, i = 1, \dots, n\} \left| \begin{array}{c} C_1 \\ C_2 \\ \vdots \\ C_m \end{array} \right. \quad (4-5)$$

where the XX_i are the constructed features, n is the number of constructed features, the C_j are the constraints and m is the number of constraints.

From the analysis above, we can obtain the general categorical data model of construction, as shown in Figure 4.9. Where, Co# is the identifier of category Construction.

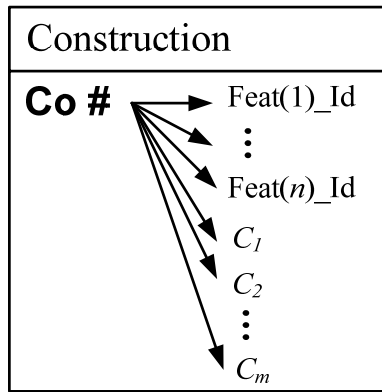

Figure 4.9 General categorical data model of Association

4.2.7 Assessment

An operation called evaluation is used to identify either the value of a characteristic or its nominal value and its limit(s). In dimensional and geometrical tolerance assessment by coordinate metrology, assessment algorithms play a key role in calculating a substitute feature from sampling data points and a deviation of the substitute feature from the nominal feature. A good algorithm must be functional, accurate, efficient, reliable and robust [65]-[67]. Since data analysis in tolerance assessment can be a significant source of errors [64], the development of algorithms has attracted much research. The types of algorithms can be classified by the fitting techniques used in the algorithms. These are least squares, minimum zone, circumscribed circle, inscribed circle and tangential contact. The development of quality algorithms for assessing various tolerances is not a trivial task because an algorithm is dependent upon the assessed characteristic, tolerance level, functional requirement, number of data points and the capability of metrology instrument.

An evaluation is denoted as constraints on a characteristic, and there are three types of expressions for evaluation operation, as shown in 4-6, according to the type of characteristic, the evaluation parameter and so on.

$$OP_{EVAL}(Char) = \begin{cases} l \leq char \\ l \geq char \\ l_1 \leq char \leq l_2 \end{cases} \quad (4-6)$$

where l , l_1 and l_2 are limits and “char” is a characteristic.

The evaluation is always used after the feature operation(s) defining one specification or one verification. And its general categorical data model is shown

in Figure 4.10. Where, Ev# is the identifier of category Evaluation; Meas_value means the measured value.

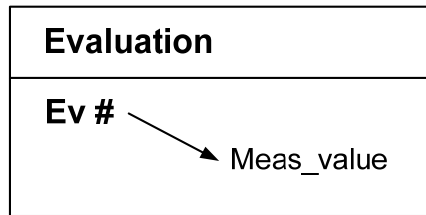

Figure 4.10 General categorical data model of Evaluation

4.3 General Categorical Data Model of Parameter

Data processing operations like filtration and association are first step for the measured data, and the selection of a proper parameter of characteristic to express the function requirement and for evaluation of the characteristic is the next important step. In GPS, standards for form tolerances such as ISO/TS 12780, 12781, 12181 and 12180 [83]-[90] define the parameter for straightness, flatness, roundness and cylindricity. The general categorical data model for parameter is shown in Figure 4.11. In order to make the category parameter to be generality, object 'evaluation_length' in surface texture is employed. Where, P# is the identifier of category parameter; 'Para_' is the abbreviation of 'Parameter_', and 'Spec_value' represents the specified value.

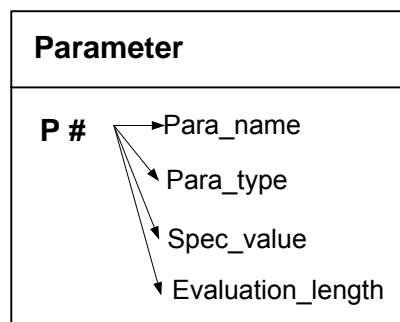

Figure 4.11 General categorical data model of Parameter

4.4 Geometrical Requirement

ISO/TC213 regards ISO 8015 [91]: Independency principle clearly as its fundamental geometrical tolerance requirements. Which means that each requirement must be indicated and respected respectively, unless relevant

requirements \textcircled{M} , \textcircled{L} , \textcircled{R} [92] etc. are indicated. After the application of independency principle, the application of \textcircled{M} , \textcircled{L} , \textcircled{R} in the design phase should be considered carefully and the manufacture and inspection should be done if and only if these codes are indicated on the drawing. The establishment of the rules of the relationships among these tolerance requirements and the relationships among the geometrical specifications are one of the important projects in the information system, which is stated in CHAPTER 5. The general categorical data model for geometrical requirement is shown in Figure 4.12. Where, Restriction is the name of the category, R# is the identifier of category Restriction; 'Rest_name' is the name of the geometrical requirement, and 'Instru_name' represents the type of the instrument to be recommended.

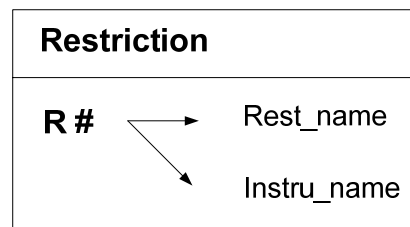

Figure 4.12 General categorical data model of Geometrical requirement

For the flexible extension of the information system, geometrical feature, various functional operation, geometrical requirement, parameter, and etc, should be treated as an independent category.

4.5 Conclusion

In view of the features of elements within geometrical product specifications and verification, and the relationship between the elements, categorical data modelling method is employed to construct a global data model. Subsequently, the general categorical models of geometrical features, the various functional operations and geometrical requirements have been established. The work in this chapter is fundamental to the complete data modelling for various geometrical characteristics.

CHAPTER 5 DATA MODELLING FOR GEOMETRICAL CHARACTERISTICS IN THE INTEGRATED INFORMATION SYSTEM

5.1 Form

5.1.1 Cylindricity

Cylindrical features play important roles when fitting shafts into holes in industry. Because of factors such as the transmission error of machine tools in the processing process, the distortion caused by the heating, pressure and other stress, vibration, wear, etc., the actual cylindrical features always have some process error, which is called cylindricity. In terms of the requirements of GPS, the evaluation of cylindricity should follow the procedure instructed in ISO/TS 17450-2:2005, which is partition → Association → Evaluation. In view of the specification operator and combine it with the practical measurement procedure, the actual verification operator for cylindricity is as follows: Partition→Extraction→Filtration→Association→Evaluation (+Parameter).

Based on the analysis of the verification operator of cylindricity, the complete format for the drawing indication for cylindricity is shown in Figure 5.1, which is different to the conventional ones based on [93].

<i>d</i>	0.01 (F)	FPLG 0.8-	FPLG -150	CYLt	LSCY	BC
-----------------	-----------------	------------------	------------------	-------------	-------------	-----------

Figure 5.1 Drawing indication for cylindricity consistent with GPS

Here, 'CYLt' is used to indicate the evaluation of cylindricity; '0.01' is the allowable value of the cylindricity; the first 'FPLG' is the linear profile Gaussian filter to obtain the generatrix profile; '0.8-' means that a single long-pass filter is used, the cutoff wavelength is 0.8mm, and the upper wavelength is ∞ ; the second 'FPLG' is the linear profile Gaussian filter to obtain the circumferential profile; '-150' means that a single long-pass filter is used, and the cutoff frequency is 150UPR(Undulations per Revolution); 'LSCY' means that the least

square association method is used to obtain the reference cylinder; 'BC' means that bird cage sampling strategy is used.

5.1.1.1 Complete verification operator

(1) Partition

Partition is a feature operation used to identify bounded features. After the analysis of the inherent characteristics of cylindrical feature, we know that a cylinder has an intrinsic characteristic, the diameter of each circumferential section, marked as Ref_diameter, and it has another geometry parameter, the length of generatrix, marked as Length_G. According to ISO/TS 17450-1, any geometrical feature belongs to an invariant type, marked as feat_type, which has its own DOF. Based on the above analysis, we can obtain the categorical data model of partition for cylindricity, as shown in figure 5.2.

Here, Fe# is the initial object for category **Feature**, and it is generated by the system automatically; 'arrow ①' means "From the analysis of geometrical features, it was classified into seven types, and each geometrical feature belongs to one of the seven types (which are prismatic, revolute, cylindrical, helical, planar, spherical and complex). Hence, DOF is determined by the type of geometrical feature".

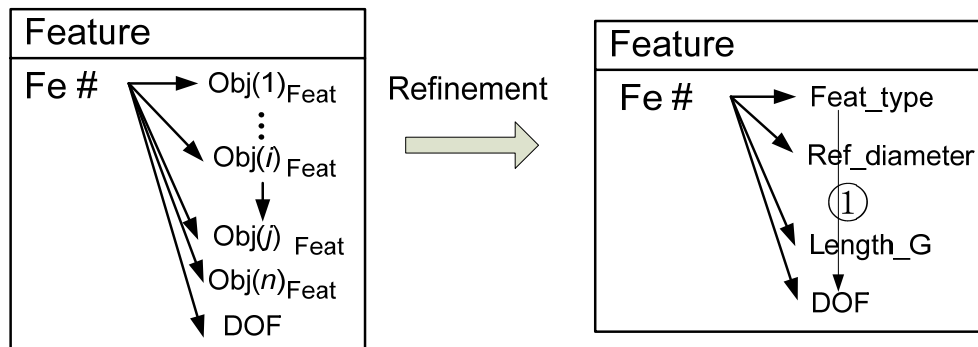

Figure 5.2 the categorical data model of cylindrical feature

(2) Extraction

Extraction is an operation used to identify a finite number of points from a feature, with specific rules [26]. Sampling and the instrument used in sampling are two factors that influence the results of extraction. Therefore, the category **Extraction** is divided into two categories, **Instrument** and **Sampling**. The factors that influence the metrology property of an instrument are spatial range, the revolution

in the z axis (displacement direction), the radius of tip and the type of instrument, marked as *Special_range*, *Z_revolution*, *Tip_radius* and *Instru_type* respectively. The nested indexes in the sampling process are sampling strategy, sampling length, sampling points, etc. Theoretically, the more sampling points, the higher precision can be achieved. However, it is not practical to do so in view of the time spent on sampling. Normally, the bird cage strategy is used. The actual number of sampling points of each circumferential section and the along generatrix direction should be considered according to the actual precision and sampling time. In order to assure the fidelity of sampling, the sampling process should meet the Nyquist sampling requirement.

The minimum number *Samp_point1* of sampling point in each generatrix is calculated as equation (5-1).

$$Samp_point1 = \frac{Length_G \times Num_cutoff_G}{\lambda_c} \quad (5-1)$$

Where, *Length_G* is the length of generatrix, λ_c is the cutoff wavelength, *Num_cutoff_G* is the number of sampling in each wave. In terms of sampling principle,

$$Num_cutoff_G \geq 7 \quad (5-2)$$

Then *Samp_point1* can be turned into $\left[\frac{Length_G \times Num_cutoff_G}{\lambda_c} \right]$, and

considering that the time spent in calculation is related to the matrix size of sampling data, the actual number of sampling points *samp_point_G* will normally be calculated according to equation (5-3).

$$Samp_point_G = 2^n \geq \left[\frac{Length_G \times Num_cutoff_G}{\lambda_c} \right] \quad (n \in N) \quad (5-3)$$

According to the circumferential cutoff frequency and the number of sampling points in each wave, marked as *Num_cutoff_R*, the minimum number of sampling points marked as *Samp_point2*, in each circumferential section, can be calculated through equation (5-4).

$$Samp_point2 = f_c \times Num_cutoff_R \quad (5-4)$$

where f_c is the cutoff frequency. In terms of sampling principle,

$$Num_cutoff_R \geq 7 \quad (5-5)$$

Then $Samp_point2$ is turned into $[f_c \times Num_cutoff_R]$, and the actual number of sampling points, marked as $Samp_point_R$, in each circumferential section will be calculated as

$$Samp_point_R = 2^m \geq [f_c \times Num_cutoff_R] \quad (m \in N) \quad (5-6)$$

The sampling space in each circumferential section and along the generatrix, marked as $Samp_space_R$ and $Samp_space_G$ respectively, can be calculated from $Ref_diameter$ and $Length_G$.

$$Samp_space_G = \frac{Length_G}{Samp_point_G} = \frac{Length_G}{2^n} \quad (5-7)$$

$$Samp_space_R = \frac{\pi \times Ref_diameter}{Samp_point_R} = \frac{\pi \times Ref_diameter}{2^m} \quad (5-8)$$

The magnitude of stylus radius is normally the same order as cutoff wavelength of filter. Following to ref[94] for radial section of cylindricity, the magnitude of stylus radius in each circumferential section and along the generatrix was configured according to table 5.1 and table 5.2 when the cutoff frequency and cutoff wavelength are selected as the series in line 1 in table 5.1 and table 5.2 respectively.

Table 5.1 The relationship between the diameter and stylus radius ratio and the cutoff frequency

f_c	...	15	50	150	500	1500	...
$\max \left\{ \frac{\pi \times Ref_diameter}{Tip_radius} \right\}$...	5	15	50	150	500	...

Table 5.2 The relationship between the stylus radius ratio and the cutoff wavelength

λ_c (mm)	...	0.08	0.25	0.8	2.5	8	...
$\max \{Tip_radius\}$...	0.05	0.15	0.5	1.5	5	...

If the metrologist cannot configure the stylus radius according to table 5.1 and 5.2, he/she is recommended to configure it according to $Ref_diameter$ by

$$Tip_radius = \begin{cases} \frac{\pi \times Ref_diameter}{24} & (Ref_diameter \leq 4\text{ mm}) \\ 0.5 & (Ref_diameter > 4\text{ mm}) \end{cases} \quad (mm) \quad (5-9)$$

Based on the detailed analysis for extraction, the categorical data model for extraction of cylindrical feature is established as shown figure 5.3.

Here E#, S# and I# are the initial objects for category **Extraction**, Sampling and Instrument respectively. The following are the explanations of each arrow shown in figure 5.3.

②: If a metrologist cannot make a decision on stylus radius according to cutoff wavelength or cutoff frequency, she/he can do it according to the nominal diameter *Ref_diameter* of the target cylinder.

③: The circumferential sampling length equals to the diameter *Ref_diameter* of cylinder.

④: The sampling length along generatrix is smaller than the generatrix length *Length_G* of the cylinder owing to the chamfer angle between its terminal and side surfaces.

⑤: In practical applications in industry, considering the time and cost spent on the measurement procedure, we select the bird cage sampling strategy to simplify the measurement.

⑥: The number of sampling points along generatrix should meet equation (3) according to sampling principle (optional rule).

⑦: The number of sampling points in each circumferential section should meet equation (6) according to sampling principle (optional rule).

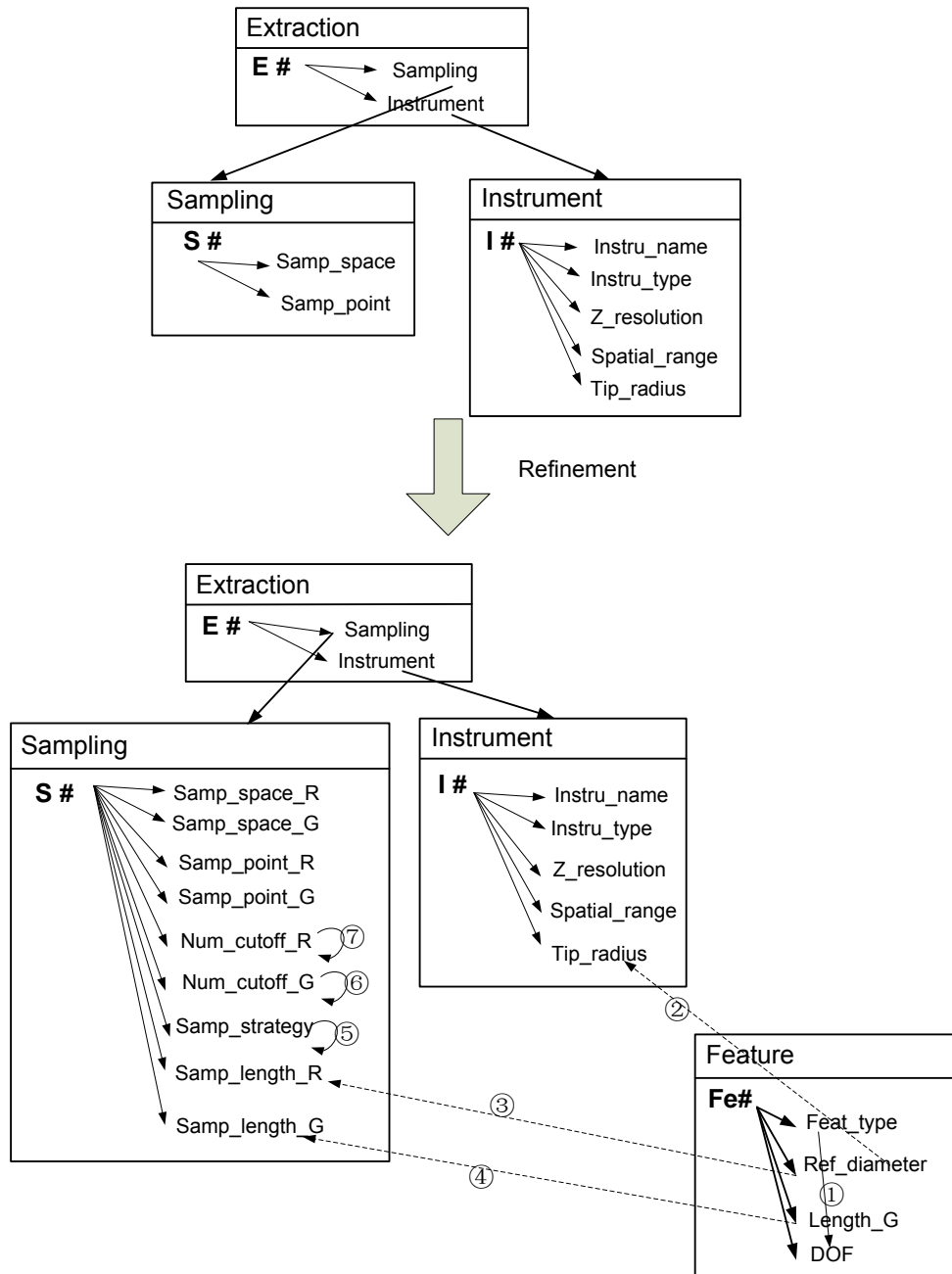

Figure 5.3 the categorical data model for extraction of cylindrical feature (including the relationships between objects included in category **Partition** and category **Extraction**)

(3) Filtration

Filtration is an operation used to remove the unwanted information and obtain the wanted information from the measured data [26]. The filters used to obtain the appropriate profile in circumferential and along generatrix from cylindrical feature are selected from ISO/TS16610-series standards according to their functions. The nested index for filters in each direction is cutoff frequency (f_c) and cutoff

wavelength (λ_c) respectively. Since there is no international standard for their default values, they have to be indicated in the drawing indication.

There are two styles for applications of filters in both circumferential and generatrix directions, as shown in Figures 4 to 7. One type is a single long-pass filter and the other is a set of a long-pass filter and a short-pass filter. When a long-pass filter is used, the upper limit of its nesting index for each generatrix is ∞ , and the lower limit of its nested index for circumferential section is 1UPR. When a short-pass filter is used, it must be the application of the set of a long-pass filter and a short-pass filter, so the long-pass filter should also be indicated.

Filter_name	Cutoff wavelength — ∞
-------------	------------------------------

Figure 5.4 Style of using single long-pass filter along generatrix

Filter_name	Cutoff wavelength_short pass — Cutoff wavelength_long pass
-------------	--

Figure 5.5 Combination of a long-pass filter and a short-pass filter along generatrix

Filter_name	1UPR - Cutoff frequency_Long pass
-------------	-----------------------------------

Figure 5.6 Style of using single long-pass filter for each circumferential section

Filter_name	Cutoff frequency_short pass - Cutoff frequency_long pass
-------------	--

Figure 5.7 Combination of a long-pass filter and a short-pass filter for each circumferential section

In practical applications in industry, nested indexes such as cutoff wavelengths (cutoff wavelength for short pass filter and long pass filter are marked as Lower-wavelength and Upper_wavelength respectively) and cutoff frequencies for filters (cutoff frequency for short pass filter and long pass filter are marked as Lowlimt_frequency and Uplimit_frequency respectively) are selected from table 3 and table 4 for convenient comparison of results according to ISO11562.

Table 5.3 Cutoff wavelength (λ_c) series (mm) [95]

...	0.008	0.025	0.08	0.25	0.8	2.5	8	...
-----	-------	-------	------	------	-----	-----	---	-----

Table 5.4 Cutoff frequency (f_c) series (UPR) [95]

...	15	50	150	500	1500	...
-----	----	----	-----	-----	------	-----

If the designers cannot decide which one is suitable for their situation, they can also select cutoff wavelength from table 5.5, according to the *Length_G* of cylindrical feature, and cutoff frequency from table 5.6 according to the *Ref_diameter*.

Table 5.5 Cutoff wavelength (λ_c) configured according to *Length_G* [94]

<i>Length_G</i> (mm)	λ_c (mm)
<i>Length_G</i> ≤ 240	0.8
240 < <i>Length_G</i> ≤ 750	2.5
<i>Length_G</i> > 750	8

Table 5.6 Cutoff frequency (f_c) configured according to *Ref_diameter* [94]

<i>Ref_diameter</i> (mm)	f_c (UPR)
<i>Ref_diameter</i> ≤ 8	15
8 < <i>Ref_diameter</i> ≤ 25	50
<i>Ref_diameter</i> > 25	150

Based on the analysis for filtration for cylindrical feature, its categorical data model is represented as figure 5.8. Where, F_i is the initial object for category **Filtration**.

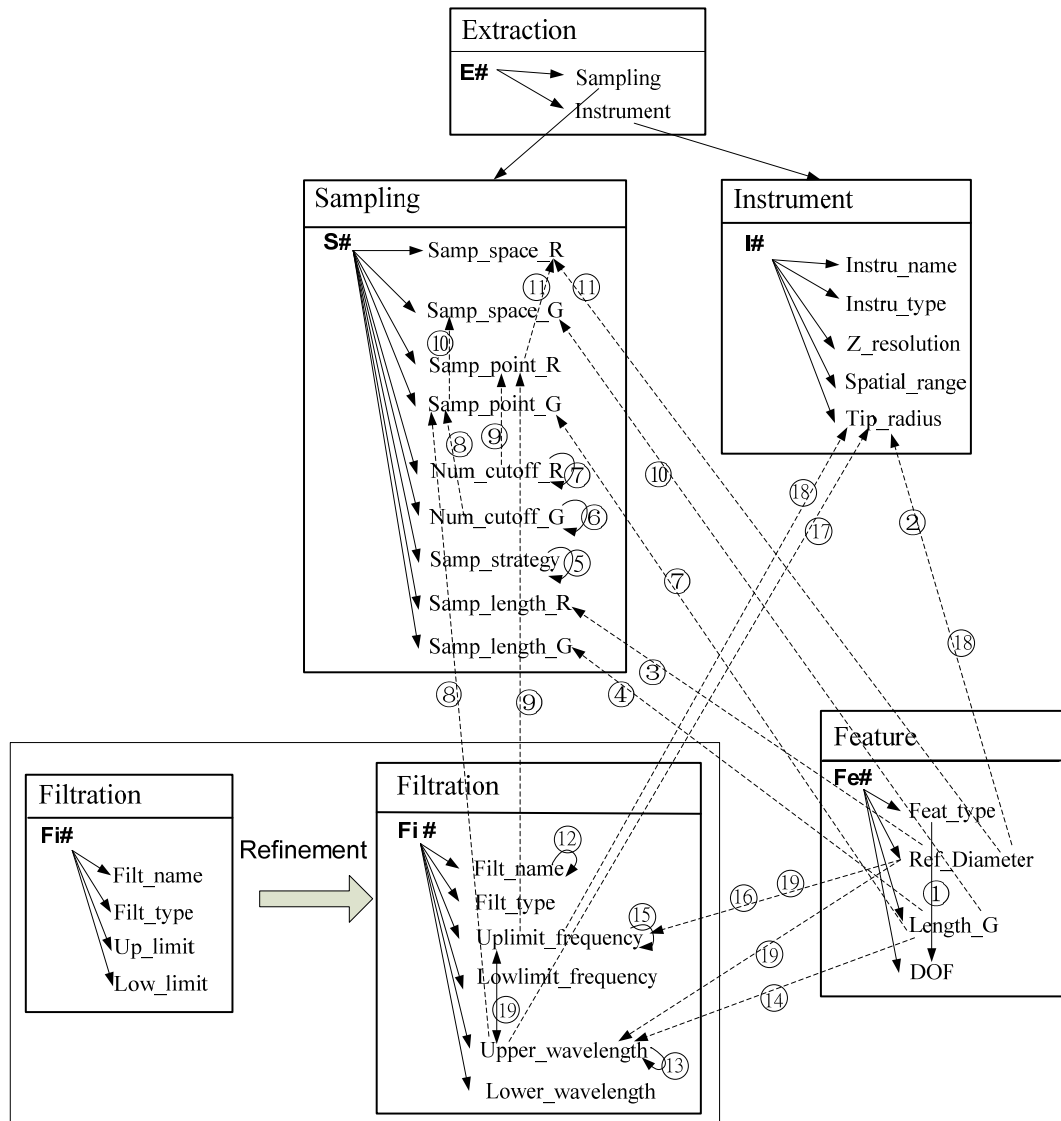

Figure 5.8 The categorical data model for filtration for cylindricity (including the relationships between objects included in category **Partition**, category **Extraction** and category **Filtration**)

- ⑧: To ensure the fidelity of sampling, the number of sampling points in each generatrix will be constrained by $Length_G$, Num_cutoff_G and λ_c according to equation (5-3), where n is the minimum natural number to meet equation 3. The actual sampling number in each generatrix is 2^n .
- ⑨: To ensure the fidelity of sampling, the number of sampling points in each circumferential section will be constrained by Num_cutoff_R and f_c according to equation (5-4), where m is the minimum natural number to meet equation 5-6. The actual sampling number in each generatrix is 2^m .
- ⑩: The sampling space in each generatrix $Samp_space_G$ is constrained by $Length_G$ and 2^n according to equation (5-7).

⑪: The sampling space in each circumferential section $Samp_space_R$ is constrained by $Ref_diameter$ and 2^m according to equation (5-8).

⑫: Filters will be selected from 16610-series according to their functions.

⑬: λ_c is set by designers according to actual situation. Normally, λ_c will be selected from series number in table 5.3 in convenient for comparison.

⑭: If the designers cannot distinguish the series values of λ_c listed in table 5.3, and then they can also be recommended to configure it from table 5.5 according to $Length_G$.

⑮: f_c was set by designers according to actual situation. Normally, f_c will be selected from series number in table 5.4 in convenient for comparison.

⑯: If the designers cannot distinguish the series values of f_c listed in table 5.4, they can also be recommended to select it from table 5.6 according to $Ref_diameter$.

⑰: To ensure the fidelity of sampling, the magnitude of radius of the probe stylus is constrained by λ_c , the detailed relationship is presented in table 5.2.

⑱: The magnitude of radius of the probe stylus is constrained by f_c and $Ref_diameter$, the detailed relationships are presented in table 5.1.

⑲: The cutoff frequency f_c , cutoff wavelength and nominal diameter should satisfy the relationship presented as $f_c = \frac{\pi \times Ref_diameter}{\lambda_c}$.

(4)Parameter

The parameter for evaluating cylindricity will also be selected from table 5.7. For the category **Parameter**, it contains five objects, $Para_name$, $Para_value$, $Evaluation_length_R$ and $Evaluation_length_G$, which refer to the name of parameter, the value of the parameter, the Evaluation length in each circumferential section, and the Evaluation length in generatrix direction respectively. Then the categorical data model for parameter for cylindricity is presented as figure 5.9.

Table 5.7 Relationship between parameter and association algorithm for cylindricity

Parameter \ Association	P-V	P-R	R-V	RMS
	CYLt	CYLp	CYLv	CYLq
Min. Zone Cylindricity	×			
Least Squa. Cylindricity	×	×	×	×
Min. Circum. Cyland.	×			
Max. Inscrib. Cyland.	×			

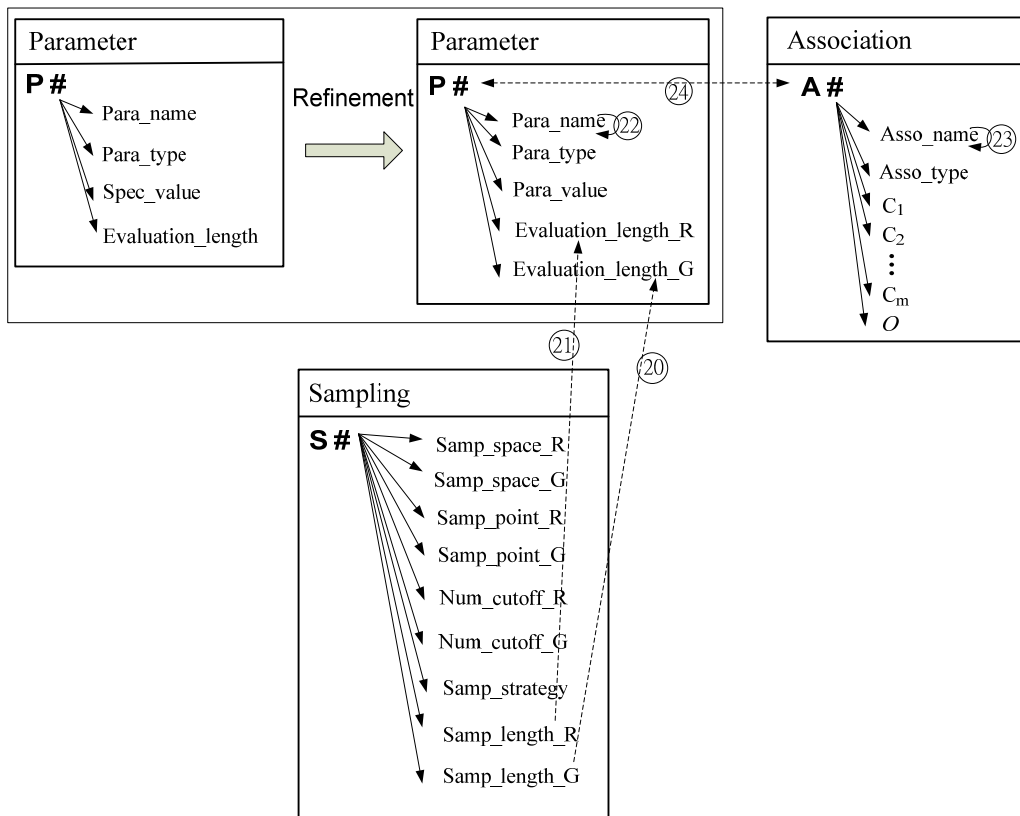

Figure 5.9 The categorical data model for evaluation operation for cylindricity
 Where, P# is the initial object for the category **Parameter**; arrow 20 means *The sampling length equals to evaluation length along generatrix*; arrow 21 means *The sampling length equals to evaluation length in each circumferential section*; arrow 22 means *Parameter should be selected from table 5.7 according to the functional requirement of product*; arrow 23 means *Association should be selected from table 5.7 according to the functional requirement of product*; and arrow 24 means *Parameter and association algorithms have the relationship*

presented in table 5.7.

(5) Evaluation

The cylindricity will be evaluated according to consistency between the measurement value and specified value of the parameter. The categorical data model for the parameter of cylindricity is presented in figure 5.10. (25) means *the result got by Measurement process should be less than the specified parameter value in evaluation.*

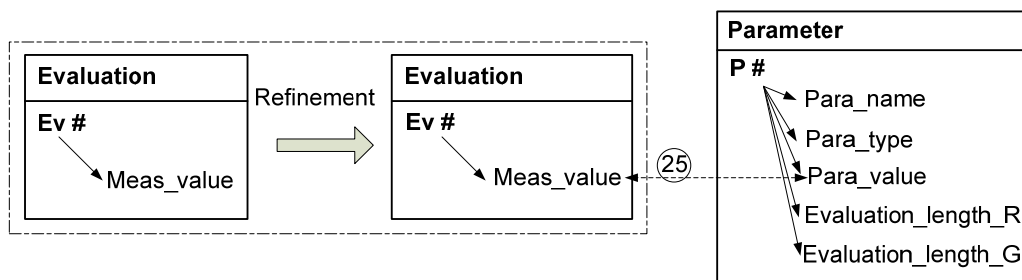

Figure 5.10 The categorical data model for evaluation operation for cylindricity

5.1.1.2 Geometrical requirements

Only Free State Requirement can be applied to cylindricity. Other geometrical requirements, such as maximum material requirement [90], can not be applied to cylindricity.

5.1.1.3 Relationships between cylindricity and other geometrical characteristics

If total radial runout is specified, we do not need to specify cylindricity on a cylindricity feature. If cylindricity is specified, there is no need to specify roundness normally on radial section, and straightness on generatrix. If these geometrical specifications are specified, it is reasonable that their value should be less than half the cylindricity [96], otherwise the integrated information system will give the designer a 'warning' for reminder.

5.1.1.4 Callout

From the typical and complete drawing indication for cylindricity in Figure 5.1, we can know that normally the callout for drawing indication for cylindricity has 11 elements, the symbol of cylindricity, the specified value, the parameter, the filter along generatrix, the nesting indexes of filter along generatrix (Lower wavelength and upper wavelength), the circumferential filter, the nesting indexes of

circumferential filter(Lower frequency and upper frequency), the association method and the sampling strategy, which are marked as Symbol, Spec_value, Filt_name_G, Lower_wavelength, Upper_wavelength, Filt_name_R, Upper_frequency, Lower_frequency, Asso and Para respectively. Considering that in some special conditions, the cylindrical geometrical feature is at Free State, therefore, category for **Callout for drawing indication** contains the above 11 objects and other 2 objects, Rest and C#, the initial object for the category **Callout for Drawing Indication**, as shown in figure 5.11.

A metrology engineer wants to know more information than above about cylindricity. Therefore, we can have a callout category for metrology, which is a nested category, i.e., each object in this category is the initial object (the indicator for a category) in other independent category. We can get the information for metrology by calling any object in the Callout for Metrology category, and the object has arrow to other object in its mapping category. Therefore, the Callout for metrology category contains 9 objects, C#, R#, S#, Ev#, I#, P#, Fe#, Fi# and A#, which are the initial object for the category **Callout for Metrology**, category **Restriction**, category **Sampling**, category **Evaluation**, category **Instrument**, category **Parameter**, category **Partition**, category **Filtration** and category **Association** respectively, as shown in figure 5.12.

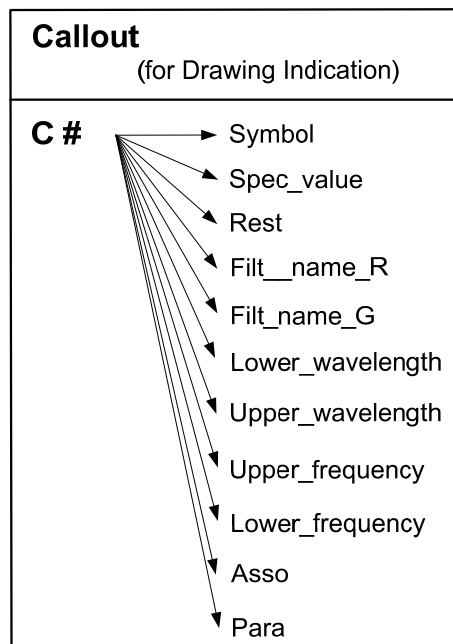

Figure 5.11 Categorical data modelling for **Callout for Drawing Indication**

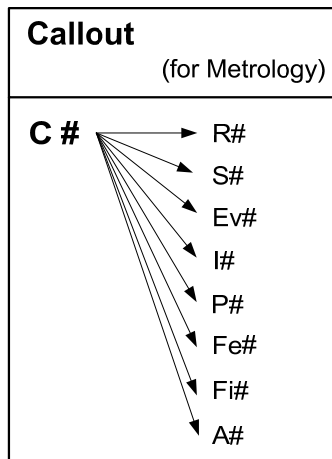

Figure 5.12 The Categorical data modelling for **Callout for Metrology**

5.1.1.5 The categorical data model for cylindricity

From the above analysis for the entities involved and the relationships between entities in cylindricity, and from the categories obtained for different operations in the operator, the categorical data model for drawing indication and the categorical data model for metrology are represented as figure 13 and figure 14 respectively.

In the categorical data model for cylindricity, the 43 arrows represent 43 different relationships. Some of these arrows are compulsory and some are optional (recommended); some of them are precise and some are approximate. If arrows are labelled with the same sequence number, they show that these multiple objects are combined in one relationship. If two or more arrows labelled with different numbers are shown between two objects, it means that there are different relationships between these two objects in different conditions. If the source and target of an arrow is the same object, this arrow is called a self-anti arrow. Except for the arrows that are explained in the analysis for the operations in the operator, the contents of all arrows are listed as follows:

Arrows ②⑥ ~ ③⑤ are the elements which are indicated in the drawing indication.

Arrows ③⑥ ~ ④③ are the elements which are contained in the complete verification operator. They are specified by designers according to the requirements.

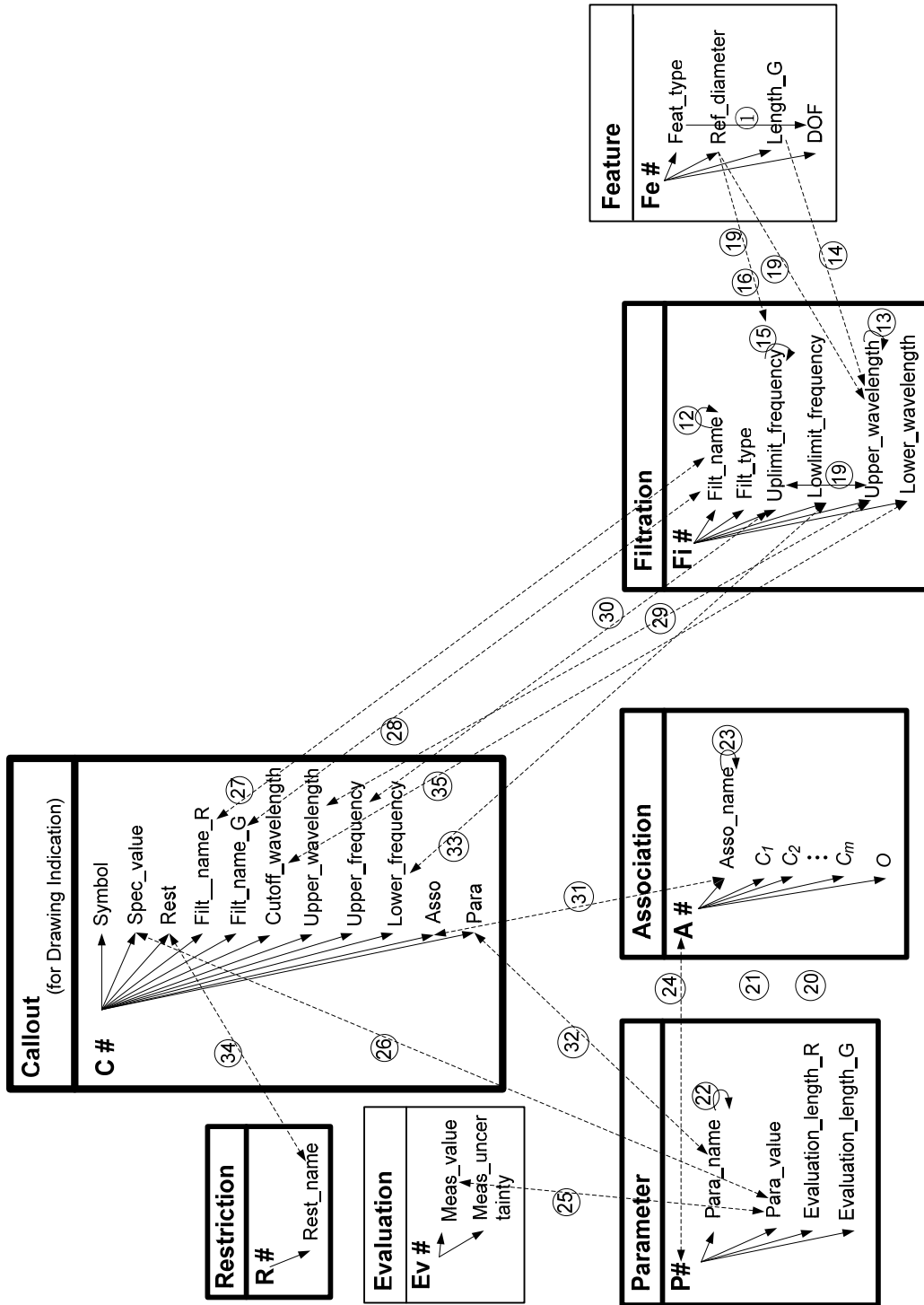

Figure 5.13 The Categorical data model for cylindricity(for Drawing Indication)

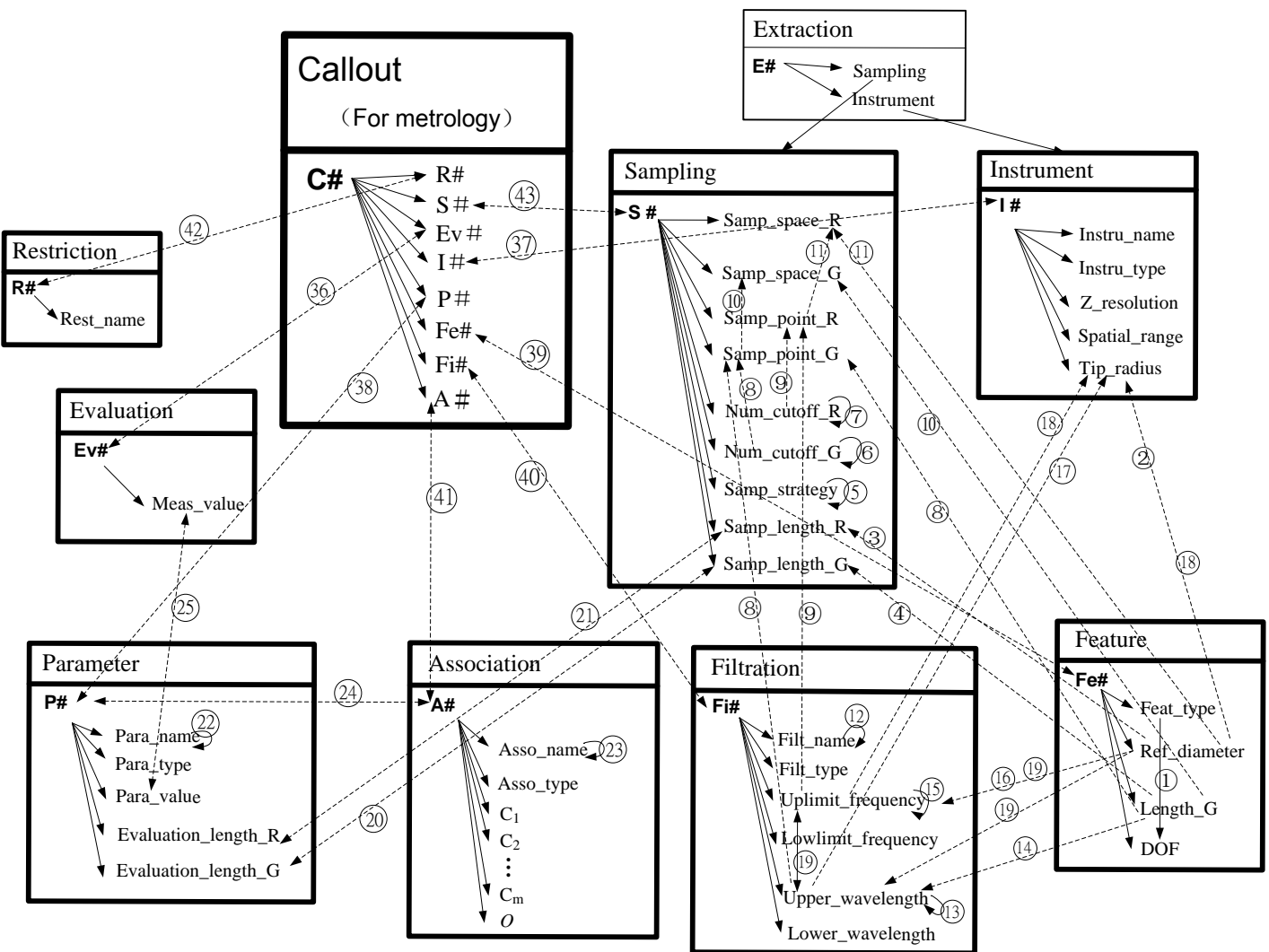

Figure 5.14 The Categorical data model for cylindricity(for Metrology)

5.1.2 Roundness

Roundness mainly applied to the radial section of geometrical features such as cylinder, cone, frustum of a cone, sphere and so on. After the analysis of geometrical specifications of cylindricity, cylindricity can be decomposed of roundness in radial section, straightness of the axis and the parallelism of a

generatrix related to the axis. Thereby, roundness can be treated as the radial component of cylindricity.

5.1.2.1 Complete verification operator of roundness

According to the requirement of GPS, the complete specification operator of roundness is partition→ association→ evaluation. Owing to the measurement error during the actual verification process, the complete verification operator of roundness is partition→ extraction→ filtration → association→ evaluation.

- (a) Extraction, the sampling condition in roundness can be configured referring to each circumference in radial section of cylindricity.
- (b) Filtration, according to the function that roundness defines in practical engineering, the filtration can be configured referring to each circumference in radial section of cylindricity.
- (c) Association, according to the function of the geometrical feature, the association algorithm, which is regarded as the reference datum, can be configured from table 5.8.

Table 5.8 Relationship between parameter and reference datum

Parameter \ Association	P-V	P-R	R-V	RMS
	<i>RONt</i>	<i>RONp</i>	<i>RONv</i>	<i>RONq</i>
Minimum Zone Circle	×			
Least Square Circle	×	×	×	×
Minimum Circum. Circle	×			
Maximum Inscribed Circle	×			

- (d) Evaluation, according to the function of the geometrical feature, the parameter for evaluation of roundness can be selected from table 4.8. Then the conformance of roundness can be decided according to the inequality.

$$\text{Measured data (roundness)} \leq \text{Specified value (roundness)}$$

Based on the analysis of the verification operator of roundness, the complete style for the drawing indication for roundness is shown in Figure 5.15.

○	0.03	ⓕ	FPLG -50	<i>RONt</i>	LSCI
---	------	---	----------	-------------	------

Figure 5.15 Drawing indication for roundness consistent with GPS

Where, 'RONt' is used to indicate parameter to evaluate roundness; '0.03' is the allowable value of the roundness; 'FPLG' is the linear profile Gaussian filter to obtain the profile; '-50' means that a single long-pass filter is used, and the cutoff frequency is 50UPR; 'LSCI' means that the least square association method is used to obtain the reference circle.

5.1.2.2 Geometrical requirements

According to the analysis in CHAPTER 6, only Free State Requirement (F) can be applied to roundness.

5.1.2.3 Relationships between roundness and other geometrical characteristics

If Circle runout is specified, there is no need to specify roundness on a geometrical feature. If cylindricity is specified, there is no need to specify roundness normally on radial section. If roundness is specified, it is reasonable that its value should be less than half the cylindricity [96].

5.1.2.4 The categorical data model for roundness

From the above analysis for the elements and the relationships between them involved in roundness, and referring to the categories obtained for different operations in the operator for cylindricity and referring to the categorical data model for cylindricity, the categorical data model for drawing indication and the categorical data model for metrology of roundness are represented as figure 5.16 and figure 5.17 respectively.

In the categorical data model for roundness, not every arrow is compulsory, some arrow is optional. For example, the nominal diameter of radial section of geometrical feature can not be obtained in cone and other cone like feature, in this situation, only if the sampling space is very important that we measure the diameter of the radial section, and then arrow 5 in figure 5.16 and 5.17 has its practical meaning. For the same reason, only if the designer can not determine, and distinguish the default value by the system, he/she can configure the cutoff frequency according to the measured diameter, and then arrow 5 in figure 5.16 and 5.17 has its practical meaning. The meaning of any other arrow in figure 5.16 and 5.17 can refer to the radial component of that of cylindricity.

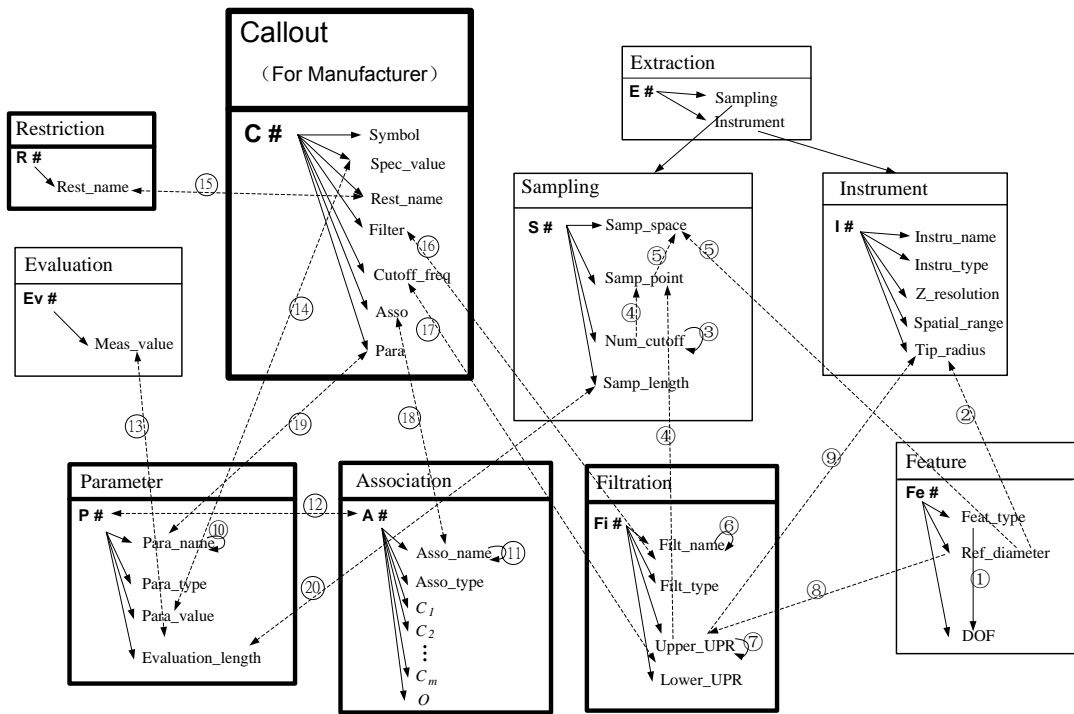

Figure 5.16 The categorical data model of roundness (for Drawing Indication)

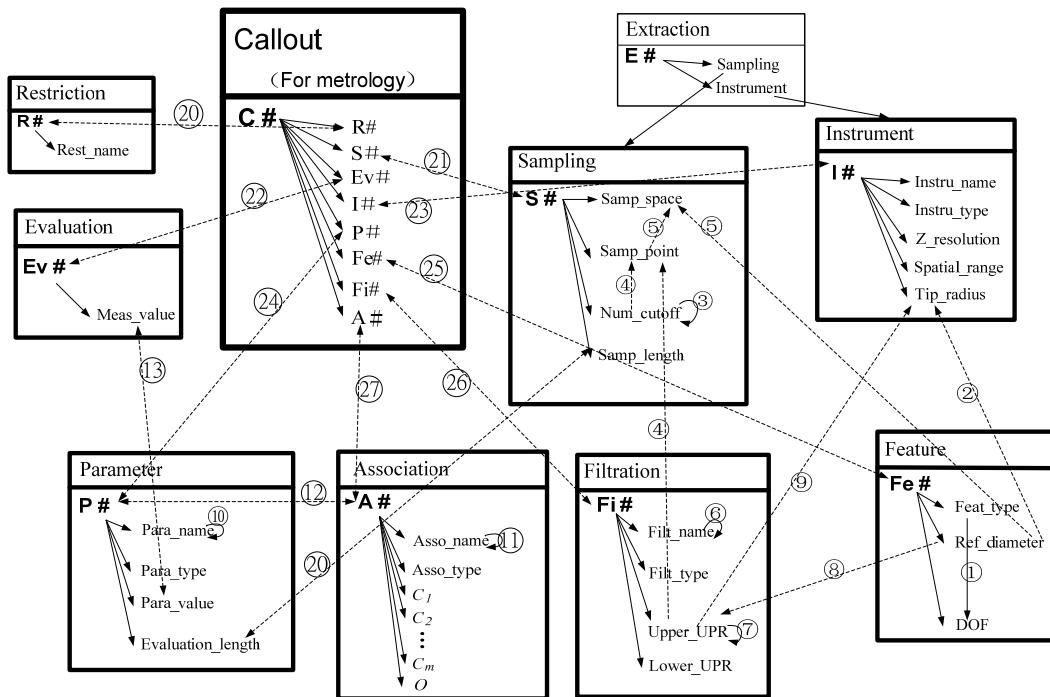

Figure 5.17 The categorical data model of roundness (for Metrology)

5.1.3 Straightness

There are two types of straight line, the central line (derived feature) and the surface line. Consequently, the straightness is analyzed according to the straight

line: straightness of a central line and straightness of a surface line.

5.1.3.1 Straightness of a central line

(1) Complete verification operator

According to the requirement of GPS, the complete specification operator of straightness of a central line is partition→ association→ collection → evaluation. Owing to the measurement error during the actual verification process, the complete verification operator is partition→ extraction→ filtration → association→ collection → evaluation. According to the definition of the central line (derived feature) in ISO 14660-2:1999, the central line mainly derives from a cylinder or cone, which are cylindrical feature in seven types of geometrical features. Take cylinder as an example to explain the complete verification operator of straightness of a central line.

- (a) Partition the non-ideal cylinder surface from specification surface model, as shown in Figure 5.18(a) and (b);

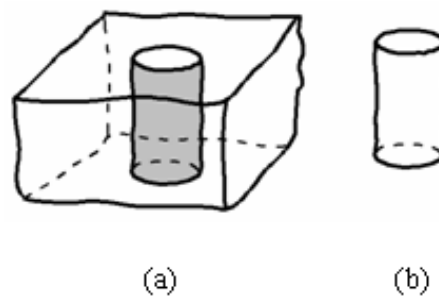

Figure 5.18 Partition to get the non-ideal cylinder surface

- (b) According to the functional and accuracy requirements of geometrical feature, and considering the time spent and cost, a set of radial sections is extracted from the partitioned cylinder surface by the sampling strategy;
- (c) Referring to the configuration of radial section of cylindricity, appropriate filtration method and its nesting indexes, stylus tip of the probe and etc, are selected;
- (d) According to the functional requirements of geometrical feature, we select association algorithm to get a set of ideal circles from the extracted non-ideal circles, as shown in Figure 5.19.

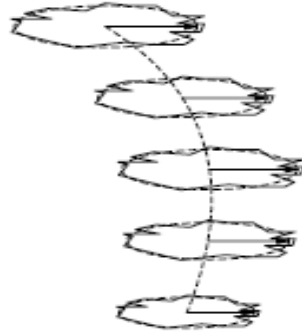

Figure 5.19 Obtain a set of ideal circles by appropriate association method

- (e) Collect all the centres of the circles to a non-ideal line, as shown in Figure 5.20(a) and (b);

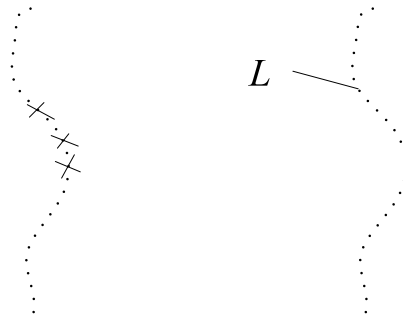

Figure 5.20 Collection

- (f) Enclosing the non-ideal line by a cylinder, diameter of the minimum circumscribed cylinder that totally encloses the extracted central line. As shown in Figure 5.21.

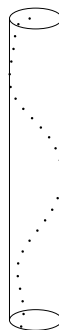

Figure 5.21 The minimum circumscribed cylinder enclosing the non-ideal line

- (g) Evaluation

The evaluation of conformance of the central line is carried out according to the following inequality.

$$\text{Diameter of the minimum circumscribed cylinder (central line of the cylinder)} \leq \text{specified value (straightness of the central line of the cylinder)}$$

Based on the above analysis of the verification operator, the complete style for the drawing indication for straightness for a central line is shown in Figure 5.22.

—	ϕ 0.01 CZ \textcircled{M} \textcircled{R}	FPLG -500	LSCI
---	--	-----------	------

Figure 5.22 Drawing indication for straightness for a central line consistent with GPS

Where, minimum parameter is used to evaluate straightness for a central line; '0.01' is the allowable diameter of the cylinder circumferential to the central line; 'FPLG' is the linear profile Gaussian filter to obtain the profile; '-500' means that a single long-pass filter is used, and the cutoff frequency is 500UPR; 'LSCI' means that the least square association method is used to obtain the reference circle.

(2) Geometrical requirements

According to the analysis in CHAPTER 6, geometrical requirements such as \textcircled{M} , \textcircled{L} , \textcircled{R} , \textcircled{P} and \textcircled{F} can be applied to straightness of the central line.

(3) Relationships between straightness of the central line and other geometrical characteristics

If cylindricity is specified on a geometrical feature, there is no need to specify straightness of the central line on it. If straightness of the central line is specified, it is reasonable that their value should be less than half the cylindricity [96].

(4) The categorical data model for straightness of the central line

After the above analysis for the elements and the relationships between them involved in straightness of the central line, and referring to the categories obtained for different operations in the operator and categorical data model for cylindricity, the categorical data model for drawing indication and the categorical data model for metrology of straightness of the central line are represented as figure 5.23 and figure 5.24 respectively.

In figure 5.23 and figure 5.24, it needs to be mentioned that the association method for the drawing indication is the association for the radial section, not for the straightness directly. And so does the filtration. The parameter for the central line, i.e., the arrow 10, only the diameter of minimum circumscribed cylinder is

recommended in ISO/TS 12180-1:2003. Arrow ② ⑤ ⑧ is similar to that in roundness. Since geometrical requirements such as \textcircled{M} , \textcircled{L} , \textcircled{R} can be used for the straightness of the central line, and the maximum material requirement has a few special instruments, thereby arrow ⑫ means that the instruments can be selected from the above special instruments. The meanings of other arrows in Figure 5.23 and 5.24 can refer that in roundness.

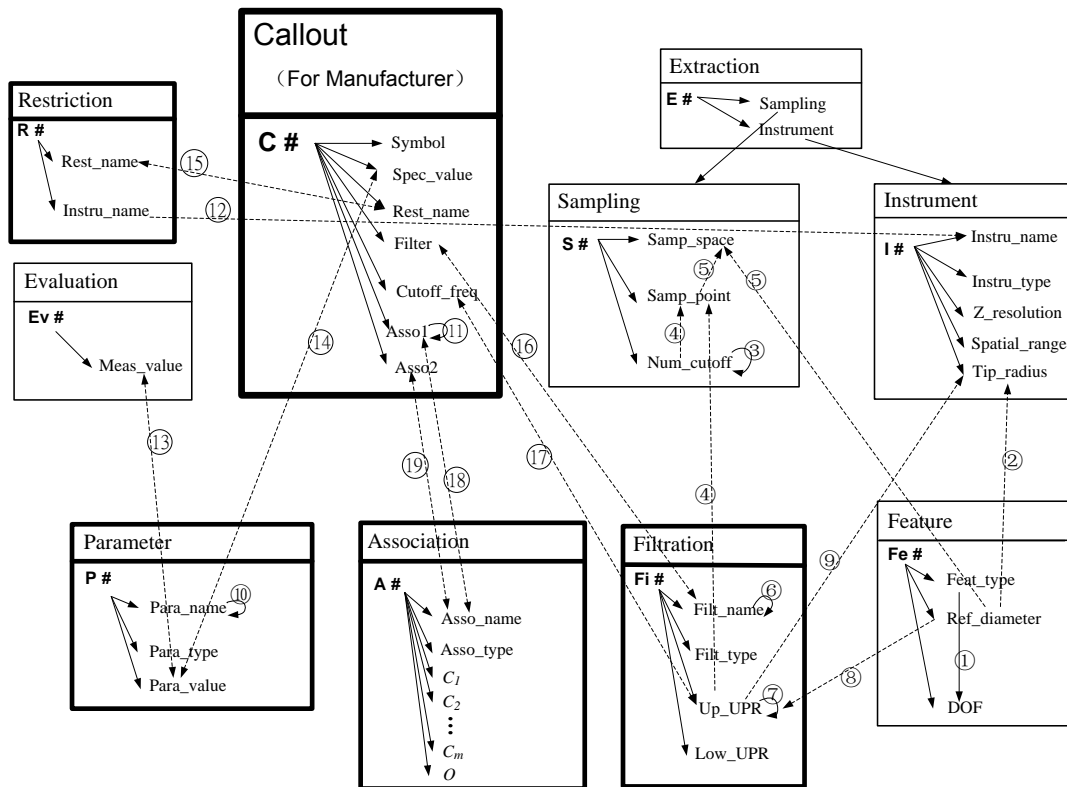

Figure 5.23 The categorical data model of straightness of the central line (for Drawing Indication)

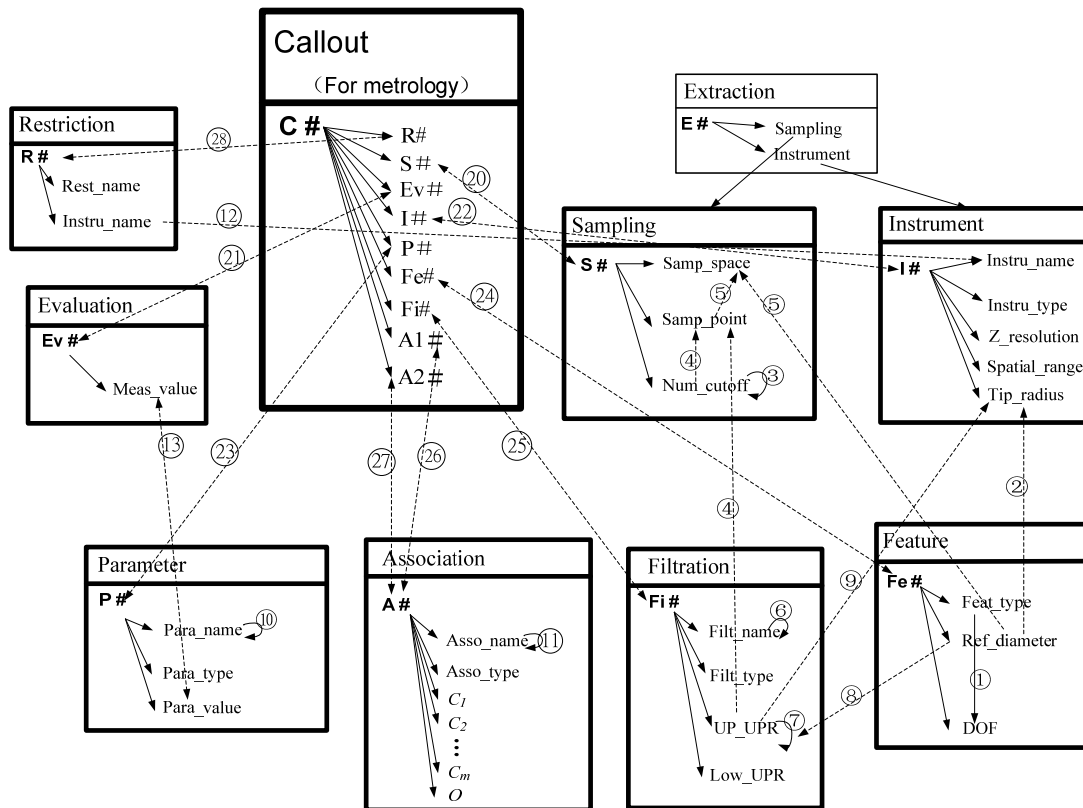

Figure 5.24 The categorical data model of straightness of the central line (for Metrology)

5.1.3.2 Straightness of a surface line

(1) Complete verification operator

According to the requirement of GPS, and considering the measurement error during the actual verification process, the complete verification operator for straightness of surface line is partition → extraction → filtration → association → evaluation, as shown in Figure 5.25.

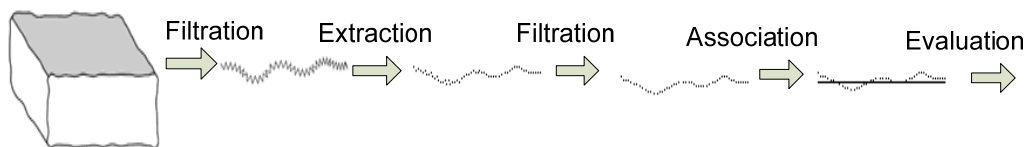

Figure 5.25 Complete verification operator for straightness of the surface line

(a) Partition

As shown in Figure 5.25, we can obtain geometrical feature on which straightness is specified by partition operation.

(b) Extraction

The configuration of sampling points and sampling space is carried out

referring to that in axial direction in cylindricity. The radius of probe stylus tip is configured according to the cutoff wavelength λ_c , as shown in table 5.9.

Table 5.9 Relationship between cutoff wavelength λ_c and the radius of probe stylus tip for surface line straightness (mm)

λ_c	Maximum stylus tip radius r
0.08	0.05
0.25	0.15
0.8	0.5
2.5	1.5
8	5

(c) Filtration

Filtration is configured referring to the axial filtration in cylindricity.

(d) Association

Based on the function of the geometrical feature, the association algorithm for the straightness of the surface line, which is regarded as the reference datum, can be configured according to table 5.10.

Table 5.10 Relationship between parameter and reference datum

Parameter Association	P-V	P-R	R-V	RMS
	STR_t	STR_p	STR_v	STR_q
Minimum zone reference lines	×			
Least square reference lines	×	×	×	×

(e) Parameter

Based on the function of the geometrical feature, the parameter for evaluation of the straightness of the surface line can be configured according to table 5.10.

(f) Evaluation

$$\text{Measured value (parameter for straightness of surface line)} \leq \text{Specified value (parameter for straightness of surface line)}$$

Based on the analysis of the verification operator of roundness, the complete style for the drawing indication for straightness for a central line is shown in

Figure 5.26.

—	0.1/100	FPLG 0.25-	STRp	LSLI
	0.3 CZ (F)			

Figure 5.26 Drawing indication for straightness in a surface consistent with GPS
 Where, 'STRp' is the parameter used to evaluate straightness in a surface; '0.3' is the allowable value of straightness in a surface; 'FPLG' is the linear profile Gaussian filter to obtain the generatrix profile; '0.25-' means that a single long-pass filter is used, the cutoff wavelength is 0.25mm, and the upper wavelength is ∞ ; 'LSLI' means that the least square association method is used to obtain the reference line; (F) is the requirement of free state; CZ means common zone; 0.1/100 every 100mm, the value of straightness in a surface should be less than 0.1mm.

(2) Geometrical requirements

According to the analysis in CHAPTER 6, only free condition state (F) and CZ can be applied to straightness of the surface line.

(3) Relationships between straightness of surface line and other geometrical characteristics

If cylindricity is specified on a cylindrical surface, there is no need to specify straightness of the generatrix on a cylindrical feature. If straightness is specified, it is reasonable that their value should be less than half the cylindricity. If flatness is specified on a plane, there is no need to specify straightness this geometrical feature in any direction. If straightness is specified, it is reasonable that their value should be less than half the flatness.

(4) The categorical data model for straightness of the surface line

From the above analysis for the elements and the relationships between them involved in straightness of the surface line, and referring to axial component of the categories obtained for different operations in the operator and the categorical data model for cylindricity, the categorical data model for drawing indication and the categorical data model for metrology of straightness of the surface line are represented as figure 5.27 and figure 5.28 respectively.

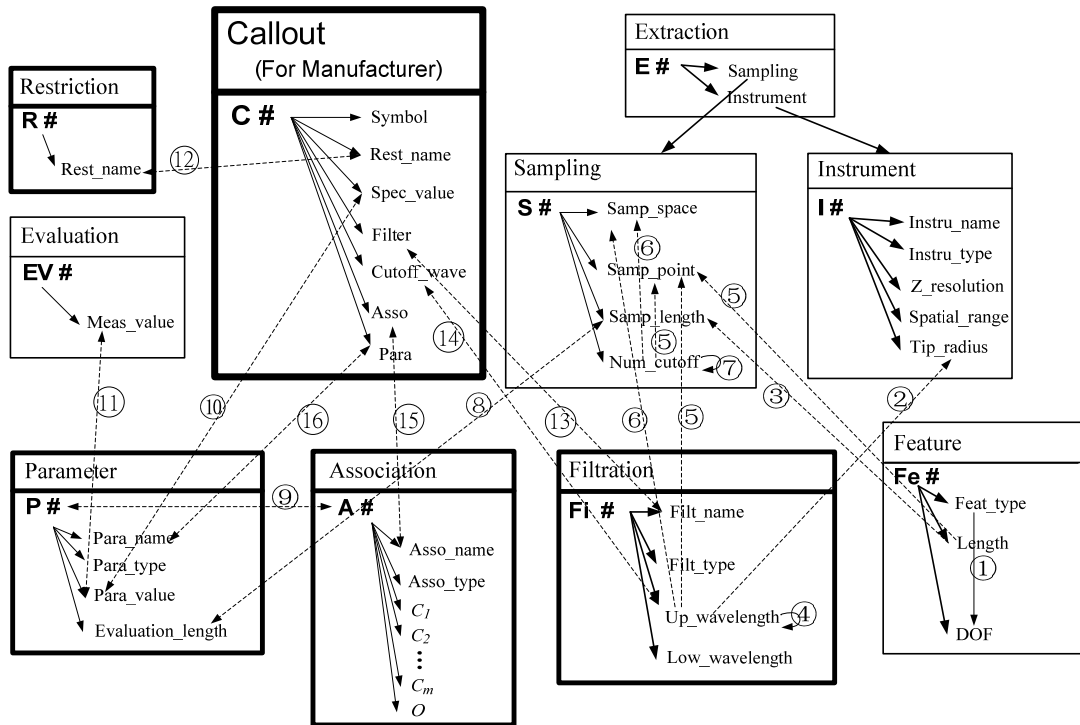

Figure 5.27 The categorical data model of straightness of the surface line (for Drawing Indication)

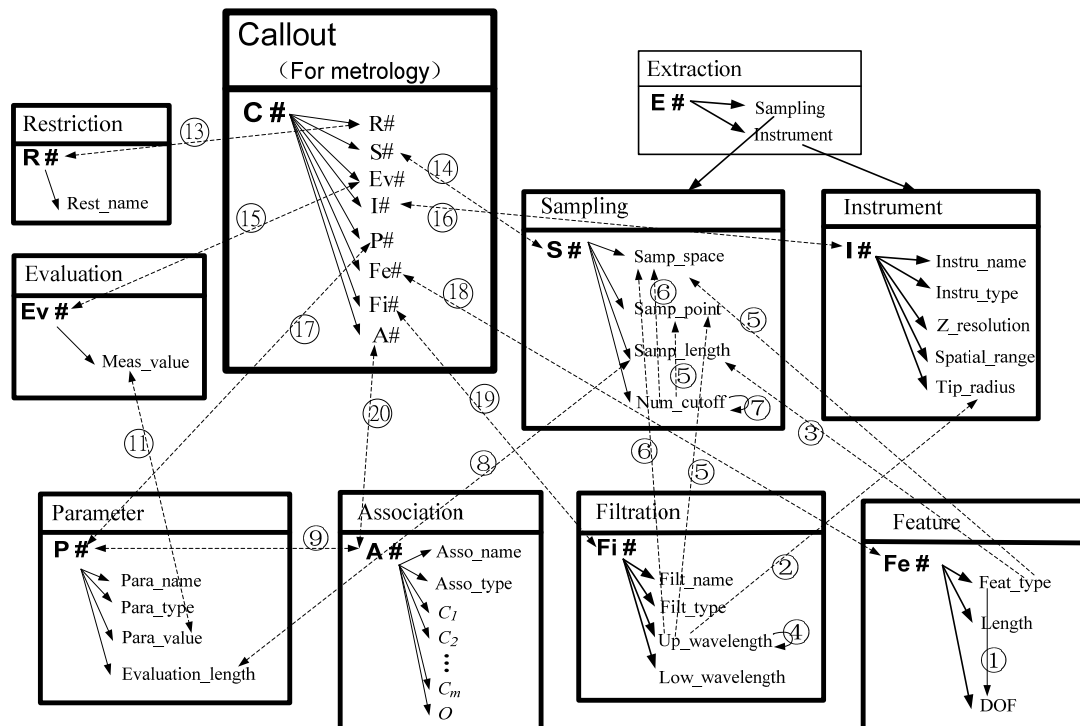

Figure 5.28 The categorical data model of straightness of the surface line (for Metrology)

5.1.4 Flatness

5.1.4.1 Complete verification operator

According to ISO/TS 12781-1:2003, 12781-2:2003 and ISO/TS 17450-2:2005, and considering the measurement error during the actual verification process, the complete verification operator for flatness is partition → extraction → filtration → association → evaluation, as shown in Figure 5.29.

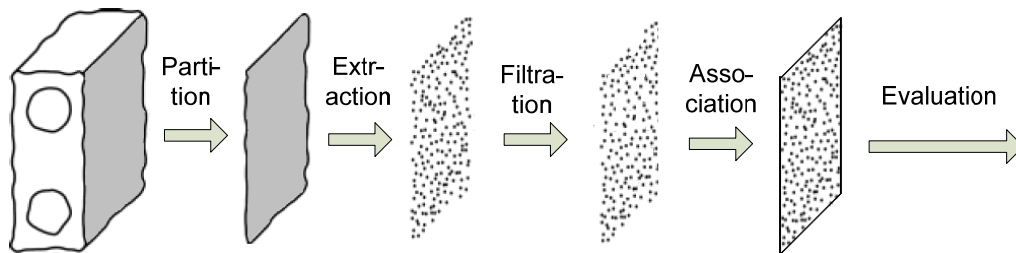

Figure 5.29 Complete verification operator for flatness

(i) Partition

As shown in Figure 5.29, geometrical feature on which straightness is specified can be obtained by partition operation.

(ii) Extraction

Sampling space in two directions is configured by cutoff wavelength λ_c and the number of sampling points in each wave, *Num_cutoff*. In order to keep the fidelity of sampling, *Num_cutoff* should be no less than 7. The sampling point in each measurement line is configured by sampling length, λ_c and *Num_cutoff*.

Sampling strategy for measuring plane can be configured considering the measurement accuracy, time spent and cost according to figure 4.3, on the basis of the function requirement.

The probe stylus tip is configured referring to that of straightness.

(iii) Filtration in two orthogonal directions can be configured referring to generatrix directions for cylindricity.

(iv) Association is configured according to table 5.11 based on the function requirement of plane.

Table 5.11 Relationship between parameter and reference datum

Parameter \ Association	P-V	P-R	R-V	RMS
	<i>PLNt</i>	<i>PLNp</i>	<i>PLNv</i>	<i>PLNq</i>
Minimum zone reference planes	×			
Least square reference planes	×	×	×	×

(v) Based on the function of the geometrical feature, the parameter for evaluation of the flatness can be configured according to table 5.11.

(vi) Evaluation is carried out according to the following inequality.

$$\text{Measured value (parameter for flatness)} \leq \text{Specified value (parameter for flatness)}$$

Based on the analysis of the verification operator of roundness, the complete style for the drawing indication for straightness for a central line is shown in Figure 5.30.

	0.1/100×70			
	0.3 NC (F)	FPLG 0.8-	<i>PLNt</i>	LSPL

Figure 5.30 Drawing indication for flatness consistent with GPS

Where, '*PLNt*' is the parameter used to evaluate flatness; '0.3' is the allowable value of flatness; 'FPLG' is the linear profile Gaussian filter to obtain the generatrix profile; '0.8-' means that a single long-pass filter is used, the cutoff wavelength is 0.8mm, and the upper wavelength is ∞ ; 'LSPL' means that the least square association method is used to obtain the reference plane; (F) is the requirement of free state; NC means the plane should be no convex; 0.1/100×70 means every 100mm×70 mm, the value of flatness should be less than 0.1mm.

5.1.4.2 Geometrical requirements

According to the analysis in CHAPTER 6, only free condition state (F) and CZ can be applied to flatness.

5.1.4.3 Relationships between flatness of surface line and other geometrical characteristics

If flatness is specified on a plane, there is no need to specify straightness this geometrical feature in any direction. If straightness is specified, it is

reasonable that their value should be less than half the flatness.

5.1.4.4 The categorical data model for flatness

From the above analysis for the elements and the relationships between them involved in flatness, and referring to axial component of the categories obtained for different operations in the operator and the categorical data model for cylindricity, the categorical data model for drawing indication and the categorical data model for metrology of flatness are represented as figure 5.31 and figure 5.32 respectively.

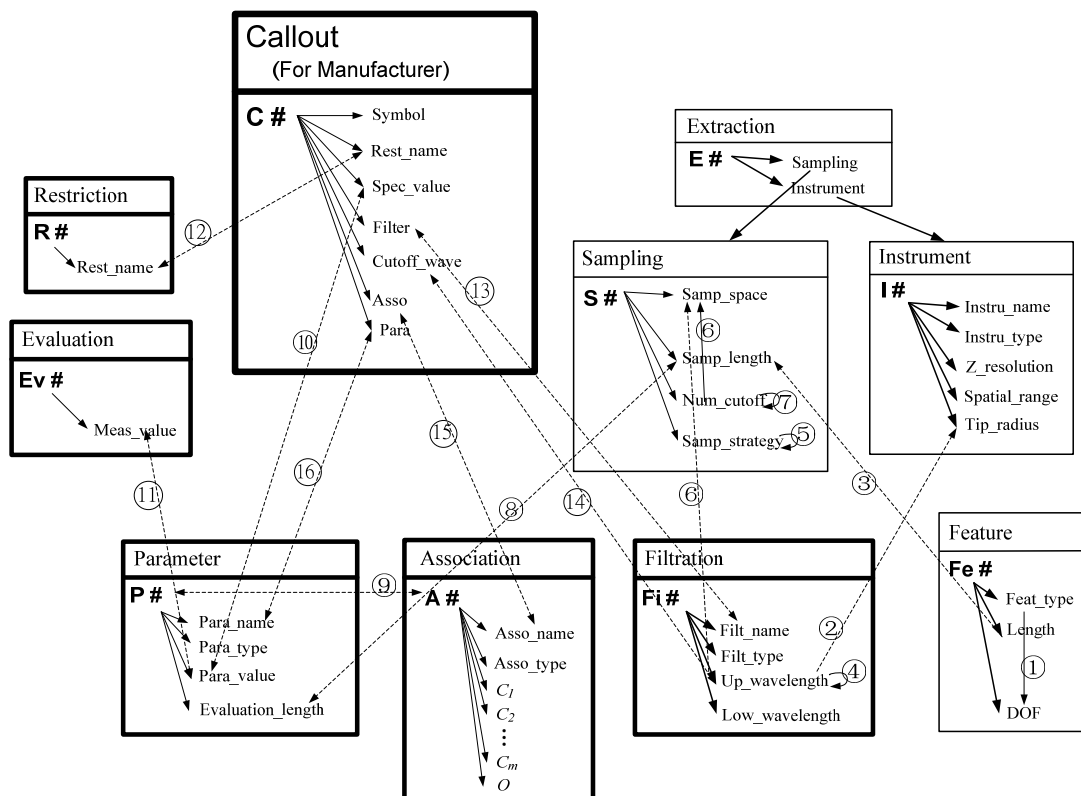

Figure 5.31 The categorical data model of flatness (for Drawing Indication)

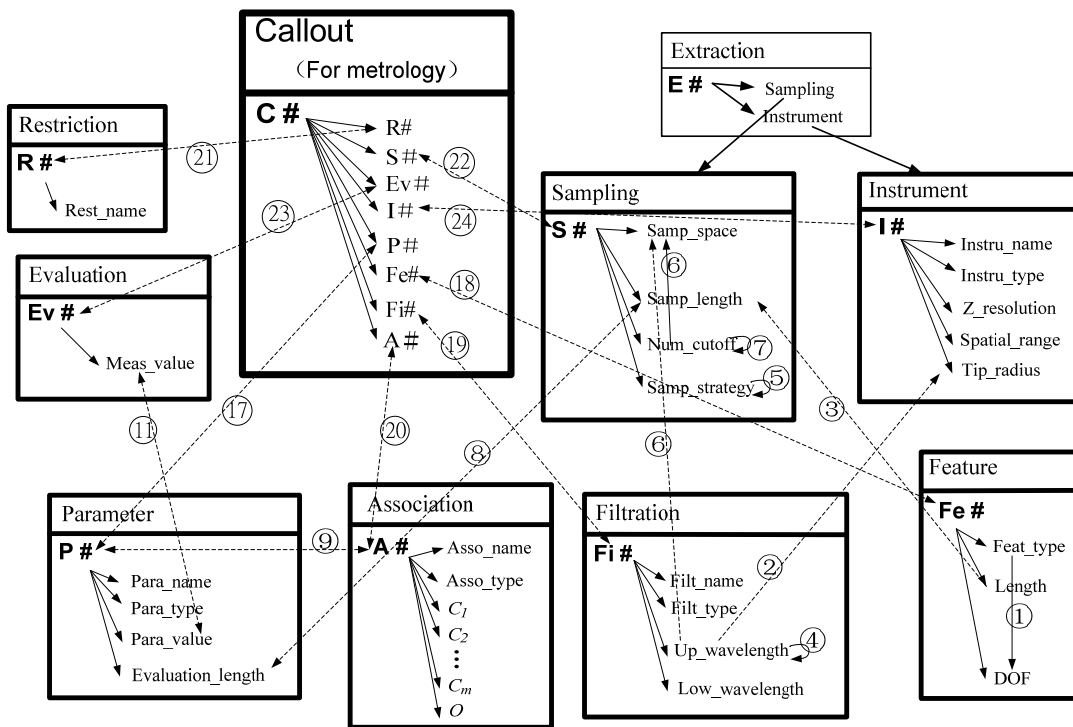

Figure 5.32 The categorical data model of flatness (for Metrology)

5.2 Data Modelling for Orientation/Location Characteristics in the Integrated Information System

5.2.1 Correlation between Categorical Date Model for Orientation/Location Tolerancing and that of Target and Datum Features

The difference between form tolerances and orientation/location tolerances is that the former is about the form of target feature itself while the latter is concerning about both the form of target feature and its situation in space relative to the datum features. According to ISO/TS17450-1 [26], the surface of a geometrical product is divided into independent surface portions, and any portion belongs to one of the seven invariance classes, which are prismatic, revolute, cylindrical, helical, planar, spherical and complex, and the target feature and the datum feature in orientation and location tolerances is no exception. Orientation/location tolerances mainly specify the situation relationships between geometrical features such as point, central line and plane. Point and plane belongs to the invariance class sphere and planar respectively. Central line is a derived feature, and it mainly belongs to invariance class cylindrical or revolute.

The verification operator of the target feature is the fundamental part of the verification operator of geometrical tolerancing, including form, orientation and location tolerances. Thereby, the relationships of the complete verification operator of an orientation/location tolerance and that of the target feature and datum features are shown in Figure 5.33, where condition1, condition 2 and condition 3 mean the reference orientation or location relationship between the target feature and each datum feature.

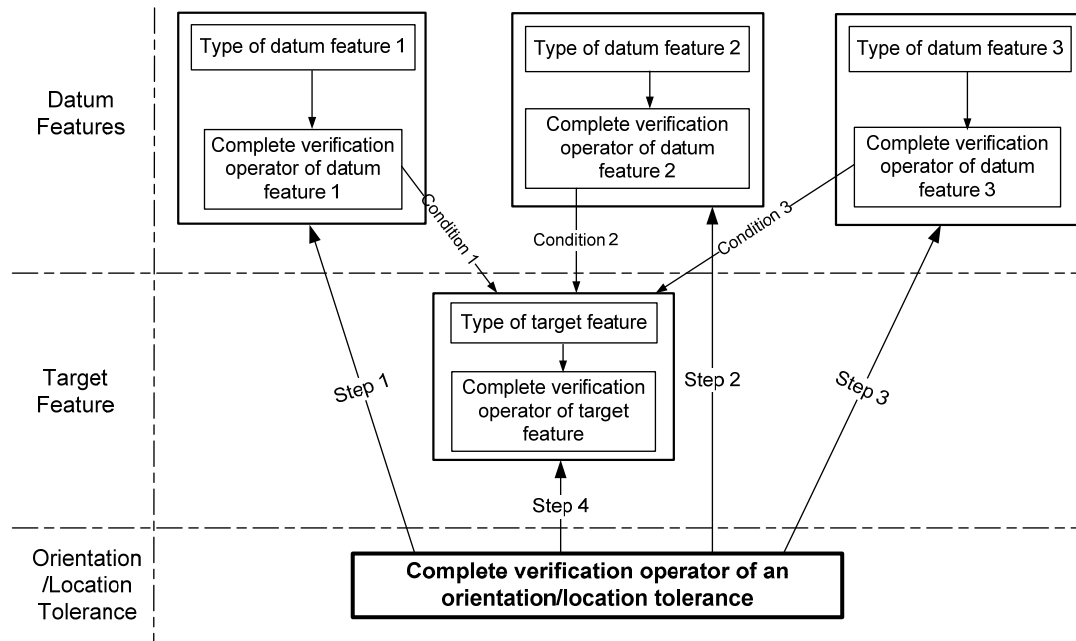

Figure 5.33 The relationships of the complete verification operator of an orientation/location tolerance and the complete verification operators of the target feature and datum features

Figure 5.34 is an example of a drawing indication for perpendicularity based on conventional GPS system. In order to meet the requirements of the GPS system, the drawing indication for perpendicularity has been improved, which is shown in figure 5.35, where the first 'FPLG' is the linear profile Gaussian filter to obtain the cylindrical profile; '-500' means that a single long-pass filter is used, and the cutoff frequency is 500UPR, 'LSCI' means that the least square association method is used to obtain the circumferential circle for cylinder; in the second indication, '0.8-' means that a single long-pass filter is used, the cutoff wavelength is 0.8mm, and the upper wavelength is ∞ ; 'LSPL' means that the least square association method is used to obtain the datum plane. This will be a complementation of ISO1101:2004 for geometrical tolerancing.

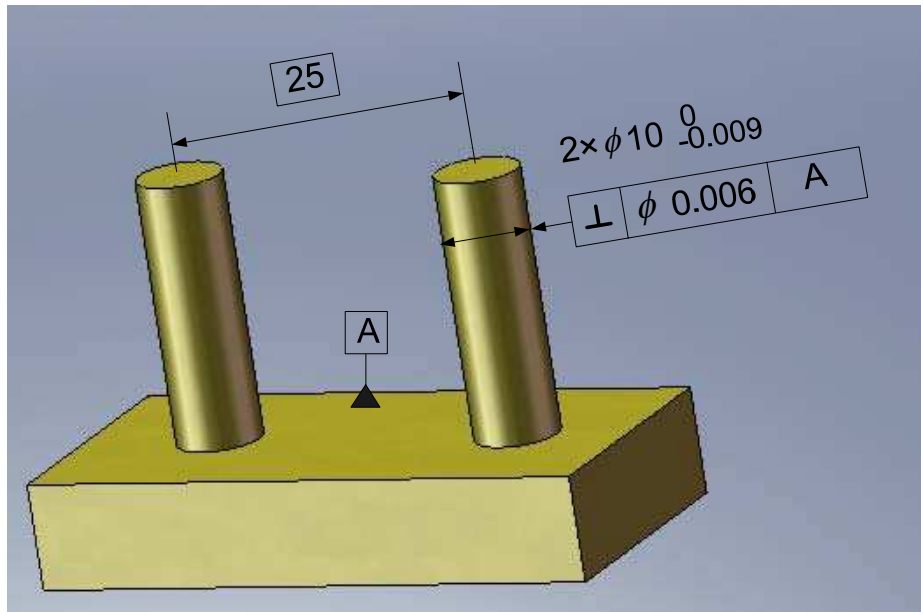

Figure 5.34 Drawing indication for perpendicularity based on conventional tolerancing

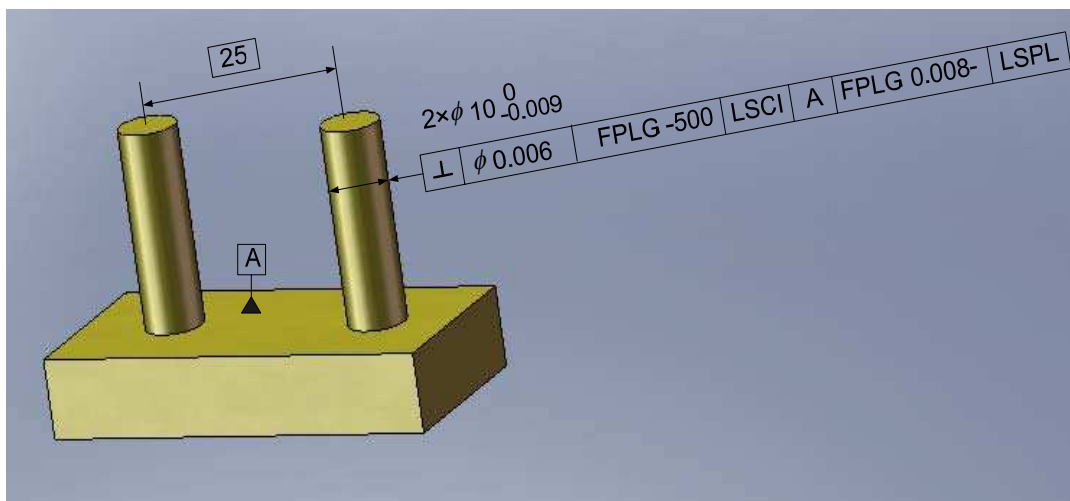

Figure 5.35 Drawing indications for perpendicularity consistent with GPS

For the perpendicularity shown in figure 5.35, its complete verification operator consists of two parts, one is the verification operator for target feature (the central line of the cylinder) and the other is the verification operator for datum feature A. The configuration of verification operator for datum A can be done based on a plane feature, as the following steps, partition→ extraction→ filtration→ association. There is a condition for the association operation in the verification operator for the central line, i.e., the associated straight line should be perpendicular to the associated datum plane A.

Based on the above analysis, the categorical data model for perpendicularity can be obtained based on that of central line and the plane, which are shown in

Figure 5.36.

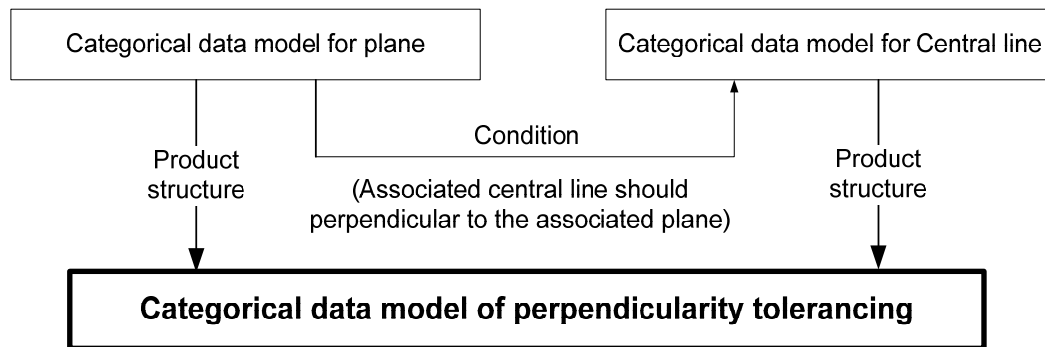

Figure 5.36 Relationships between categorical data models of perpendicularity tolerancing in figure 5.35 and that for the central line and the plane A

5.2.2 Categorical Data Modelling for Orientation/Location Tolerancing

According to Figure 5.36, the complete verification operator of perpendicularity consists of two parts. One is for the plane feature, which is a “Partition→ Extraction→ Filtration→ Association” process; and the other is that for the central line, which is a “Partition→ Extraction→ Filtration→ Association→ Collection→ Association→ (Parameter) →Evaluation” process. There is a condition on the association operation for central line based on the association operation on plane feature. Each operation is regarded as a **CATEGORY**.

The categorical data model of perpendicularity for drawing indication is shown in figure 5.37, where, rectangles represent category; the first line in a category represents the name of the category; the elements below the category name are the internal objects within the category; the object in this category with an arrow from itself to every other internal object in the category is called the initial internal object; the initial internal object stores in a unique system automatically generating an identifier value, and this ID value cannot be modified by applications and is independent of how an object is manipulated or structured. By modelling the database in this way, database users have no need to define keys (primary keys or candidate keys). All the different morphisms are represented by arrows (the same below). The top part of figure 5.37 is the categorical data model for DATUM FEATURE, i.e. plane, the meanings of all objects contained in it are as following: for category **Feature**, feat_type means the type of the datum feature, DOF means degrees of freedom of geometrical feature; for category **Filtration**, Filt_name and Filt_type represents the name and type of the filter respectively, Up_wavelength and Low_wavelength represents

the upper wavelength and lower wavelength for filter respectively; for category **Association**, Asso_name and Asso_type represent the name and type and C_m are the constraints, m is the number of constraints and O is the objective for association operation respectively; for category **Extraction**, since extraction is an operation used to identify a finite number of points from a feature, with specific rules. Sampling and the instrument used in sampling are two factors that influence the results of extraction. Therefore, the category **Extraction** is divided into two categories, **Instrument** and **Sampling**. The factors that influence the metrology property of an instrument are spatial range, the revolution in the z axis (displacement direction), the radius of tip and the type of instrument, marked as Spatial_range, Z_revolution, Tip_radius and Instru_type respectively, the nested indexes in the sampling process are sampling strategy, the number of sampling points in each wave (for fidelity), sampling space, etc., marked as Samp_strategy, Num_cutoff and Samp_space respectively. The bottom part of figure 5.37 is the categorical data model for TARGET FEATURE, i.e. the central line of the cylinder. The meanings of all objects contained in it are as following: For category **Feature**, Ref_diameter means the diameter of the cylinder; for category **Sampling**, samp_point means the sampling points in each radial section; for category **Evaluation**, Meas_value means the calculated value of perpendicularity; for category **Restriction**, Rest_name means the tolerancing principle; for category **Parameter**, Para_name, Para_type and Para_value represent the name, the type and specified value of the evaluation parameter respectively. Other objects within the categorical model for TARGET FEATURE are similar to that in DATUM FEATURE. Arrow 24 represents the condition that the associated central line should be perpendicular to the associated plane. Category **Callout for Drawing Indication** is the category of drawing indication for perpendicularity tolerancing. The meanings of 13 objects within category **Callout for Drawing Indication** are as following: Symbol means 'the symbol of perpendicularity', Spec_value means 'the specified value', Rest_name means 'the tolerancing principle for target feature', Filter means 'the circumferential filter', Low_frequency and Up_frequency mean 'the nesting indexes of circumferential filter', Asso1 means 'the association method in circumferential section for cylinder', Asso2 means 'the association for the central line', Symb_datum means 'the symbol of datum', Filter_datum means 'the filter of datum', Low_wave_datum and Up_wave_datum

mean 'the nesting indexes of filter for datum', and Asso_datum means 'the association method for datum'.

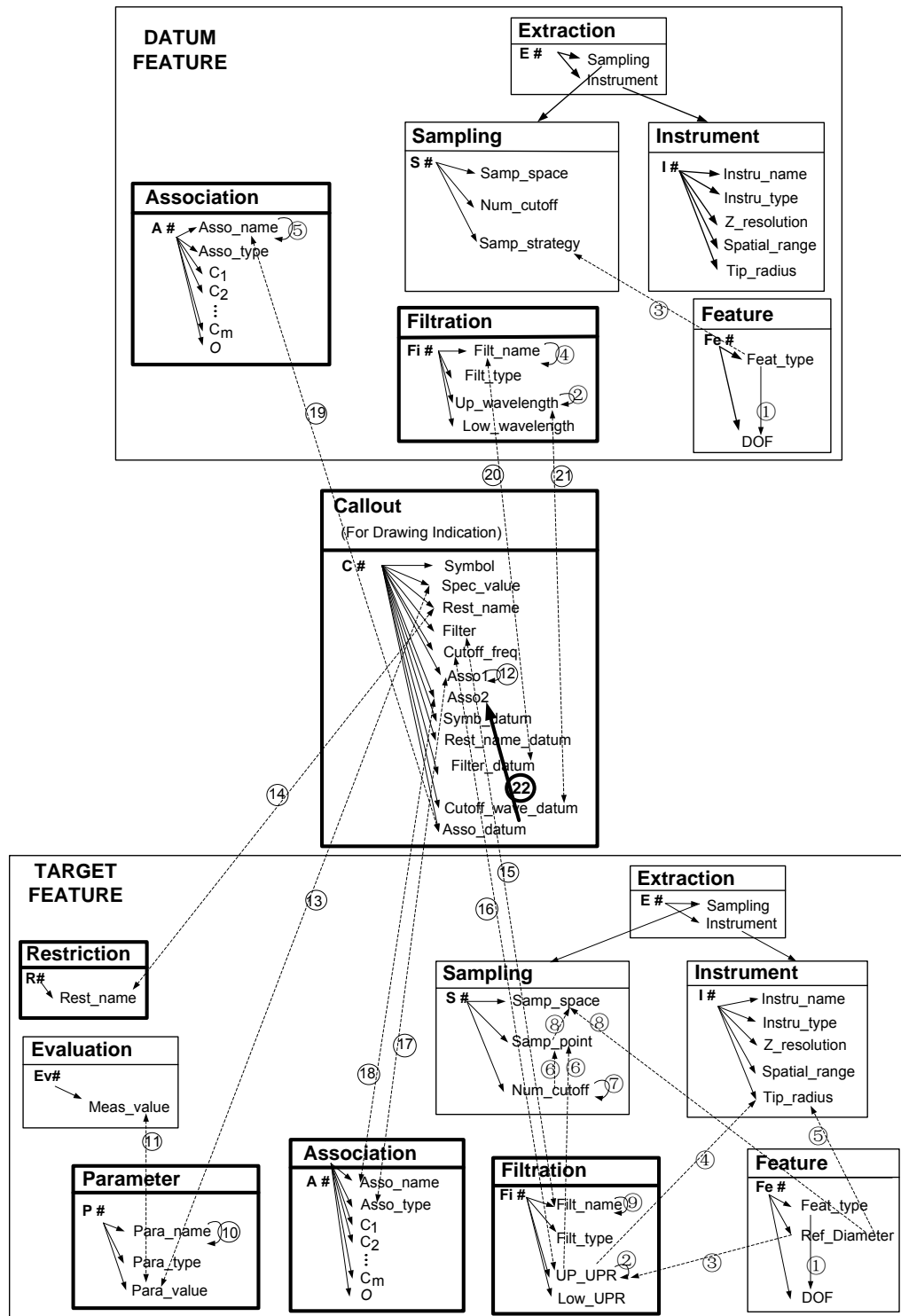

Figure 5.37 Categorical data model for perpendicularity tolerancing consistent with GPS

Bold rectangle means that the category has direct relationship to the callout for drawing indication.

The meaning of each arrow of the categorical data model for perpendicularity can refer to that of flatness and that of straightness of a central line.

The modelling of other geometrical tolerancing within orientation/location tolerances consistent with GPS is similar to that of perpendicularity.

5.3 Manipulations and Case Study

The arrow can represent the relationships between objects briefly. However, the detailed meaning of the relationships cannot be represented clearly. In categorical data modelling, the arrow that represents the relationship between two objects in different categories can be refined by the pull back structure in category theory. (Let's take the arrows in section 5.1(for cylindricity) as examples.) Thereby, arrow ⑧, which means the relationship between objects *Samp_point_R* and *Num_cutoff* in category **Sampling**, object *Length_G* in category **Feature** and object *Upper_wavelength* in category **Filtration**, was represented by pull back structure p_8 , as shown in figure 5.38.

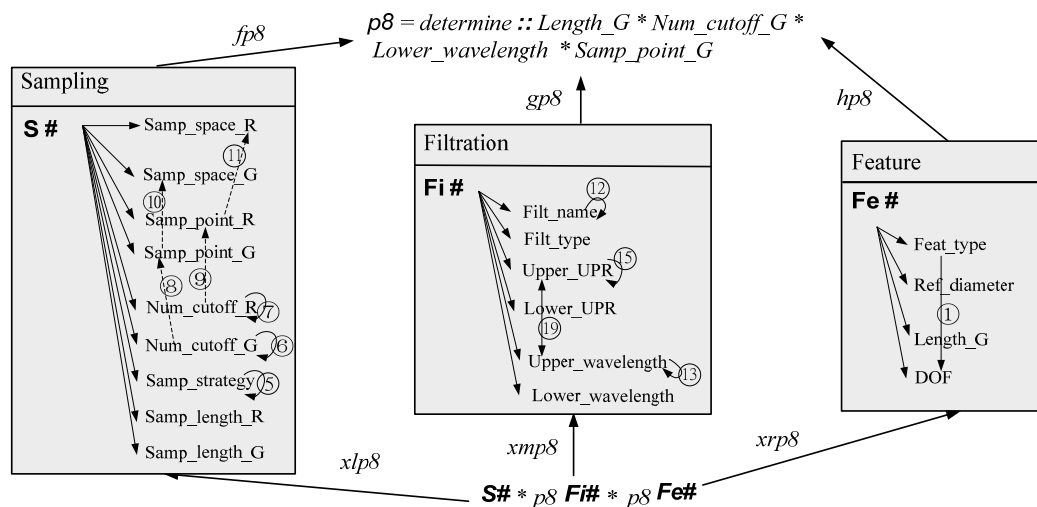

Figure 5.38 The constraint among multi-categories in Arrow 8 is represented by pullback structure 8

Arrow 24, which means relationship among objects in category parameter and object in category **Association** can be represented by pullback structure p_{24} , as shown in Figure 5.39.

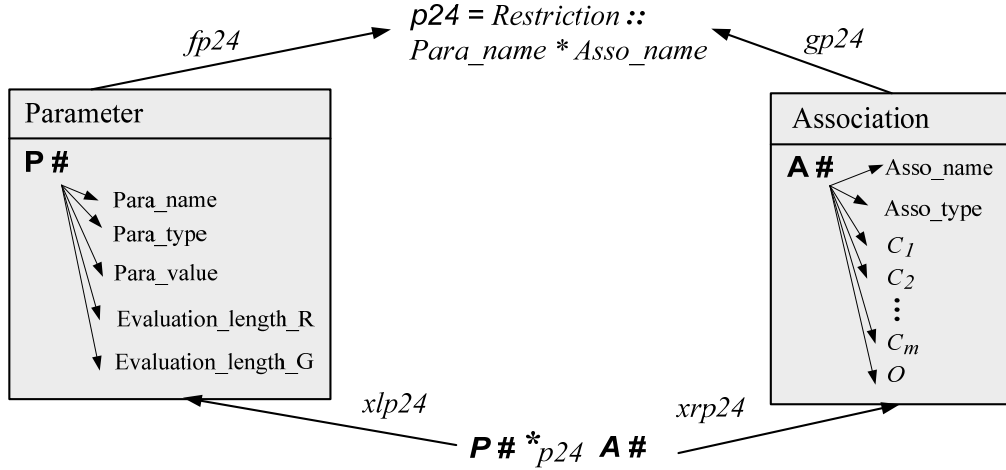

Figure 5.39 The constraint in Arrow 24 is represented by pullback structure 24

The pullback structures p_2 , p_8 and p_{24} are stored in the categorical database system in a category respectively, marked Cat_{p_2} , Cat_{p_8} and $Cat_{p_{24}}$, named pullback category. The objects that make up the pullback category are the arrows in pullback structure, the source and target objects in each arrow, the initial object in related categories and the constrained product of related categories.

Therefore, the objects in Cat_{p_2} are $Ob_{p_2} = \{I\#^*_{P_2} F\#, I\#, F\#, Ref_diameter, Tip_radius\}$; the morphisms in Cat_{p_2} are $Mor_{p_2} = \{xlp_2: I\#^*_{P_2} F\# \rightarrow F\#, xrp_2: I\#^*_{P_2} F\# \rightarrow I\#, \text{hom}(I\#, Tip_radius): I\# \rightarrow Tip_radius, \text{hom}(F\#, Ref_diameter): F\# \rightarrow Ref_diameter\}$. The objects in Cat_{p_8} are $Ob_{p_8} = \{S\#^*_{P_8} Fi\#^*_{P_8} Fe\#, S\#, Fi\#, Fe\#, Num_cutoff_G, Samp_point_G, Lower_wavelength, Length_G\}$; the morphisms in Cat_{p_8} are $Mor_{p_8} = \{xlp_8: S\#^*_{P_8} Fi\#^*_{P_8} Fe\# \rightarrow S\#, xmp_8: S\#^*_{P_8} Fi\#^*_{P_8} Fe\# \rightarrow Fi\#, xrp_8: S\#^*_{P_8} Fi\#^*_{P_8} Fe\# \rightarrow Fe\#, \text{hom}(S\#, Num_cutoff_G): S\# \rightarrow Num_cutoff_G, \text{hom}(S\#, Samp_point_G): S\# \rightarrow Samp_point_G, \text{hom}(Fi\#, Lower_wavelength): Fi\# \rightarrow Lower_wavelength, \text{hom}(Fe\#, Length_G): Fe\# \rightarrow Length_G\}$. The objects in $Cat_{p_{24}}$ are $Ob_{p_{24}} = \{P\#^*_{P_{24}} A\#, P\#, A\#, Para_name, Asso_name\}$; the morphisms in $Cat_{p_{24}}$ are $Mor_{p_{24}} = \{xlp_{24}: P\#^*_{P_{24}} A\# \rightarrow P\#, xrp_{24}: P\#^*_{P_{24}} A\# \rightarrow A\#, \text{hom}(P\#, Para_name): P\# \rightarrow Para_name, \text{hom}(A\#, Asso_name): A\# \rightarrow Asso_name\}$.

Arrows ②⑥ to ③⑤ mean the equivalency relationship between intra objects in Callout category and objects in categories Parameter, Filtration, Association and Restriction respectively, which is represented by pullback structures p_{26} to p_{35} respectively, as shown in Figures 5.40 and 5.41.

The pullback structures p_{26} to p_{35} are stored in the categorical database system as a category respectively, marked $Cat_{p_{26}}$ to $Cat_{p_{35}}$. There is a category

named *Callout* representing the drawing indication for cylindricity, and the objects in this category come from the pullback category Cat_{p26} to Cat_{p35} . Then, the category *Callout* (marked as Cat_{p1}) is the pullback category of the pullback structures which consist of these categories, which is shown in Figure 5.42.

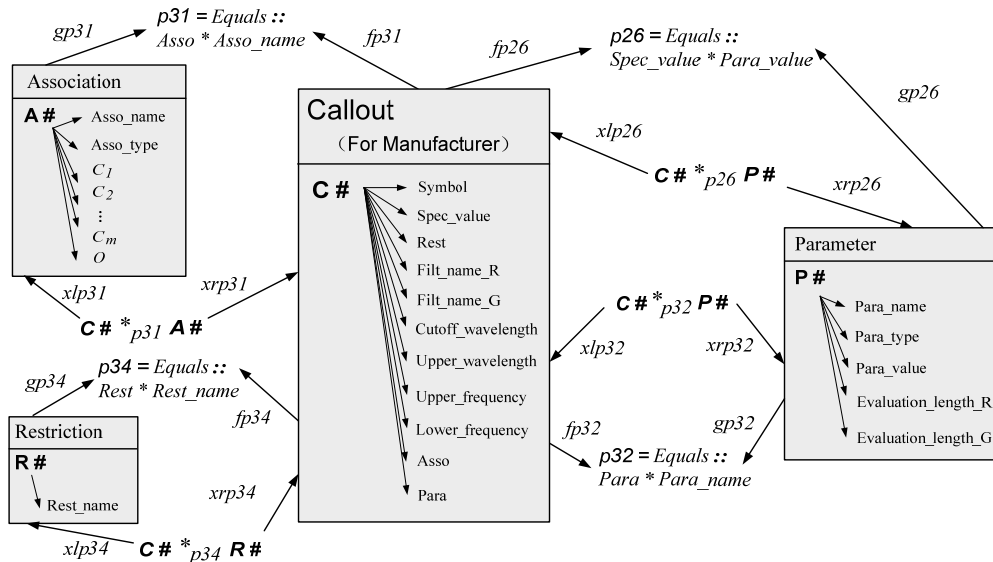

Figure 5.40 The equivalency relationship in ②⑥, ③①, ③② and ③④ are represented by pullback structures

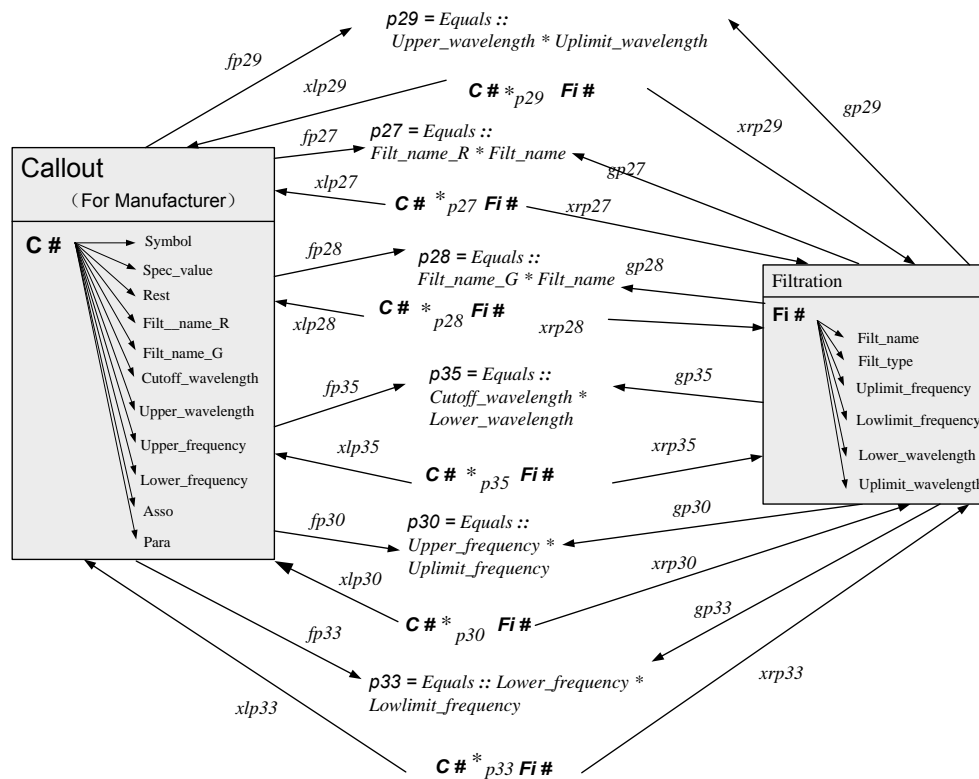

Figure 5.41 The equivalency relationship in ②⑦~③①, ③③ and ③⑤ are represented by pullback structures

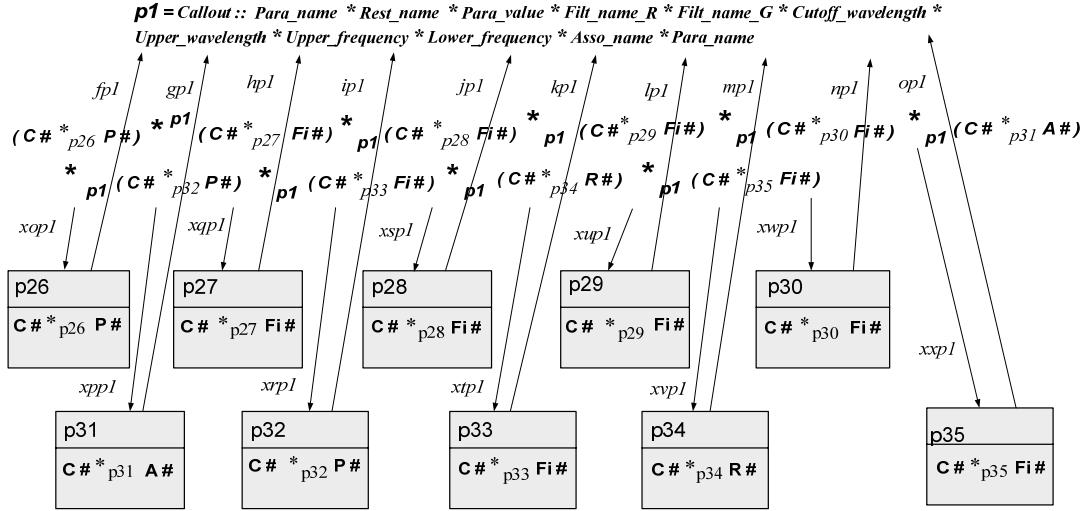

Figure 5.42 The pullout structure of the Callout category

In the category Cat_{p1} , the objects are $Ob_{p1} = \{(C\#^*_{p26}P\#)^*_{p1}(C\#^*_{p27}Fi\#)^*_{p1}(C\#^*_{p28}Fi\#)^*_{p1}(C\#^*_{p29}Fi\#)^*_{p1}(C\#^*_{p30}Fi\#)^*_{p1}(C\#^*_{p31}A\#)^*_{p1}(C\#^*_{p32}P\#)^*_{p1}(C\#^*_{p33}Fi\#)^*_{p1}(C\#^*_{p34}R\#)^*_{p1}(C\#^*_{p35}Fi\#), (C\#^*_{p26}P\#), (C\#^*_{p27}Fi\#), (C\#^*_{p28}Fi\#), (C\#^*_{p29}Fi\#), (C\#^*_{p30}Fi\#), (C\#^*_{p31}A\#), (C\#^*_{p32}P\#), (C\#^*_{p33}Fi\#), (C\#^*_{p34}R\#), (C\#^*_{p35}Fi\#), \text{Rest_name}, \text{Para_value}, \text{Filt_name_R}, \text{Filt_name_G}, \text{Cutoff_wavelength}, \text{Upper_wavelength}, \text{Upper_frequency}, \text{Lower_frequency}, \text{Asso_name}, \text{Para_name}\}$.

If the marking symbol in Cat_{p1} is marked as K_{P1} , then the morphisms are

$Mor_{p1} =$

$\{xop1:K_{P1} \rightarrow (C\#^*_{p26}P\#), xqp1:K_{P1} \rightarrow (C\#^*_{p27}Fi\#),$

$xsp1:K_{P1} \rightarrow (C\#^*_{p28}Fi\#), xup1:K_{P1} \rightarrow (C\#^*_{p29}Fi\#),$

$xwp1:K_{P1} \rightarrow (C\#^*_{p30}Fi\#), xpp1:K_{P1} \rightarrow (C\#^*_{p31}A\#),$

$xrp1:K_{P1} \rightarrow (C\#^*_{p32}P\#), xtp1:K_{P1} \rightarrow (C\#^*_{p33}Fi\#),$

$xvp1:K_{P1} \rightarrow (C\#^*_{p34}R\#),$

$xxp1:K_{P1} \rightarrow (C\#^*_{p35}Fi\#),$

$\text{hom}((C\#^*_{p26}P\#), \text{Para_value})(C\#^*_{p26}P\#) \rightarrow \text{Para_value},$

$\text{hom}((C\#^*_{p27}Fi\#), \text{Filt_name_R})(C\#^*_{p27}Fi\#) \rightarrow \text{Filt_name_R},$

$\text{hom}((C\#^*_{p28}Fi\#), \text{Filt_name_G})(C\#^*_{p28}Fi\#) \rightarrow \text{Filt_name_G},$

$\text{hom}((C\#^*_{p29}Fi\#), \text{Cutoff_wavelength})(C\#^*_{p29}Fi\#) \rightarrow \text{Cutoff_wavelength},$

$\text{hom}((C\#^*_{p30}Fi\#), \text{Upper_frequency})(C\#^*_{p30}Fi\#) \rightarrow \text{Upper_frequency},$

$$\begin{aligned}
&\text{hom}((C\#^*_{p31}A\#), \text{Asso_name}): (C\#^*_{p31}A\#) \rightarrow \text{Asso_name}, \\
&\text{hom}((C\#^*_{p32}P\#), \text{Para_name}): (C\#^*_{p32}P\#) \rightarrow \text{Para_name}, \\
&\text{hom}((C\#^*_{p33}Fi\#), \text{Lower_frequency}): (C\#^*_{p44}Fi\#) \rightarrow \text{Lower_frequency}, \\
&\text{hom}((C\#^*_{p34}R\#), \text{Rest_name}): (C\#^*_{p34}R\#) \rightarrow \text{Rest_name}, \\
&\text{hom}((C\#^*_{p35}Fi\#), \text{Upper_wavelength}): (C\#^*_{p35}Fi\#) \rightarrow \text{Upper_wavelength} \}.
\end{aligned}$$

The categorical data modelling method uses categories, objects, morphisms (arrows) and pull back structures to represent, refine and store the entities and the relationships between entities. However, how to realize the query in the integrated information system? And in addition, how to keep the closure for query? The categorical data model uses its functor transform to realize it, which is the forgetful functor.

For example, *Please output the elements of a drawing indication for a cylindricity, in which the specified value of cylindricity = '0.007 mm' and the parameter= 'CYLT'.*

This query will access the categories such as category **Restriction**, category **Parameter**, category **Association**, category **Filtration** and the **pull back** categories **p24**, **p26**, **p34** and **p35**. It is a complex process. The manipulation for this process is as follows:

Firstly, the system can derive a category **A** from the category **Parameter**, where **A** is a subcategory of the category **Parameter**;

Secondly, the system can derive the instant category **K** after a set of intermediate steps and get the pull back category **p1** from a general functor transform;

Finally, the system can derive the subcategory of category **K**, marked as category **L**, by a forgetful functor F_{L-K} .

STEP 1:

A \rightarrow **Parameter**

$$\text{Mor}_A = \{P\# \rightarrow \text{Para_name}, P\# \rightarrow \text{Para_value}\}$$

$$\text{Ob}_A = \{P\#, \text{Para_name}, \text{Para_value} \mid \text{Para_name} = \text{'CYLT'}, \text{Para_value} = \text{'0.007mm'}\}$$

*/** Category **A** is the subcategory of category **Parameter**, where

Para_name='CYLt' and Para_value='0.007'/*

STEP 2:

B → p24

$$Mor_B = \{x|p24\}$$

$$Ob_B = \{P\# * p24 A\#, P\#, Para_name, A\#, Asso_name \mid Para_name \in A\}$$

STEP 3:

C → p27

$$Mor_C = \{ \}$$

$$Ob_C = \{Filt_name_R\}$$

*/ * we can get pull back category p27 and its subcategory by forgetful functor F_{G-C} , as shown in Figure 5.43.*

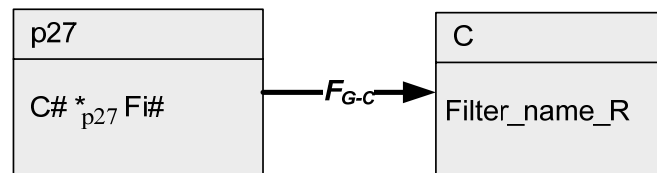

Figure 5.43 Obtaining the category C from pull back category p27 by forgetful functor F_{G-C}

**/*

STEP 4:

D → p28

$$Mor_D = \{ \}$$

$Ob_D = \{Filt_name_G\}$ */*Obtaining the subcategory from pull back category p28 */*

STEP 5:

E → p29

$$Mor_E = \{ \}$$

$Ob_E = \{Cutoff_wavelength\}$ */* Obtaining the subcategory from pull back category p29*/*

STEP 6:

F → p34

$$Mor_F = \{ \}$$

$Ob_F = \{Rest_name\}$ */* Obtaining the subcategory from pull back category p34 */*

STEP 7:

G → p30

$Mor_G = \{xrp30\}$

$Ob_G = \{C\# * p30 \text{ Fi\#, C\#, Upper_frequency, Fi\#, Cutoff_frequency} \mid$
 $Cutoff_frequency = '1500UPR'\}$

/ Congigure the subcategory from pull back category p30, where*
*Cutoff_frequency = '1500UPR' */*

STEP 8:

I → p43

$Mor_I = \{xrp29\}$

$Ob_I = \{C\# * p29 \text{ Fi\#, C\#, Upper_wavelength, Fi\#, Uplimit_wavelength} \mid$
 $Uplimit_wavelength = '\infty'\}$

/ Congigure the subcategory from pull back category p29, where*
*Uplimit_wavelength = '\infty' */*

STEP 9:

J → p33

$Mor_J = \{xrp33\}$

$Ob_J = \{C\# * p33 \text{ Fi\#, C\#, Lower_frequency, Fi\#, Lowlimit_frequency} \mid$
 $Lowlimit_frequency = '1UPR'\}$

/ Congigure the subcategory from pull back category p33, where*
*Lowlimit_frequency= '1UPR' */*

STEP10:

K → p1

$Mor_K = \{xop1, xpp1, xqp1, xrp1, xsp1, P\# \rightarrow Para_value, Fi\# \rightarrow$
 $Filt_name_R, Fi\# \rightarrow Filt_name_G, Fi\# \rightarrow Cutoff_wavelength, Fi\# \rightarrow$
 $Upper_frequency, A\# \rightarrow Asso_name, P\# \rightarrow Para_name, R\# \rightarrow Rest_name,$
 $Fi\# \rightarrow Upper_wavelength, Fi\# \rightarrow Lower_frequency\}$

$Ob_K = \{R\# * p1 P\# * p1 A\# * p1 Fi\# * p1 S\#, R\#, P\#, A\#, Fi\#, Rest_name,$
 $Para_name, Para_value, Filt_name_R, Lower_frequency, Upper_frequency,$
 $Filt_name_G, Cutoff_wavelength, Upper_wavelength, Asso_name \mid$
 $Rest_name \in F, Para_name \in A, Para_value \in A, Filt_name_R \in C,$
 $Lower_frequency \in J, Upper_frequency \in G, Filt_name_G \in D,$
 $Cutoff_wavelength \in E, Upper_wavelength \in I, Asso_name \in B\}$

STEP 11:

$$\mathbf{L} \xrightarrow{F_{L-K}} \mathbf{K}$$

$$Mor_L = \{ \}$$

$$Ob_L = \{ Rest_name, Para_name, Para_value, Filt_name_R, Lower_frequency, Upper_frequency, Filt_name_G, Cutoff_wavelength, Upper_wavelength, Asso_name \}$$

*/*Category L is the subcategory of category K , and it was obtained from category K by a forgetful functor F_{L-K} */*

5.4 Conclusions

The mathematical-based GPS system can be viewed as an operator-based system, and further on to be decomposed to an operation-based one. Firstly, this chapter refines the categorical data modelling for geometrical feature, various functional operations and etc. Secondly, the categorical data models for form tolerances have been established based on detailed analysis of its complete verification operator. Thirdly, this chapter presents the correlation between categorical data models of orientation/ location tolerancing and that of target and datum features, and then the categorical data models of orientation/location tolerancing has been constructed. Finally, the manipulations and case study of the categorical data model are presented.

CHAPTER 6 KNOWLEDGE RULES DESIGN

6.1 Introduction

The data elements in the integrated information system are organized in the structure of categories, and subsequently make up the framework of the whole system. In order to enhance the rationality of the design of geometrical characteristic, strengthen the intellectuality of the integrated geometry information system, and therefore to provide good recommendations for deeply and detailed design of elements involved in geometrical specifications, it is necessary to establish some knowledge rules for these geometrical specifications, such as the rules for application of various geometrical requirements, rules for the application of target geometrical feature and datum feature, rules for the application of datum reference framework, rules for the application of target geometrical feature and type of geometrical characteristic, etc. The rules need to be organized and represented in the system. And there are some typical representation methods, such as production rules, framework, logic, object-oriented and so on. Considering the Causal characteristics of knowledge rules involved in GPS information system, IF...THEN is employed to represent these rules [19]. No matter the rules are utilized either for checking the rationality of the designed geometrical characteristic or providing some recommendations for the design of geometrical characteristic, the inference strategy that the system employed is to match the information that the user provide with the condition of the rule from bottom to up until the current problem solution is obtained, i.e. forward inference mechanism. Since the application of forward inference mechanism is very mature, thus the work is focused on the design of the various rules. The knowledge rules consist of two types, one is the mandatory rules, which is consistent with the standard, and the other is optional rules, which come from the practical experience. This chapter is mainly focused on the mandatory rules; the optional rules will be supplemented in the future work.

6.2 Design Rules for Type of Geometrical Characteristic

The topological information defines the relative situation, such as distance and

angle, of two geometrical features in space. It is known from table 4.1 that the situation information of seven types of invariance is point, straight line and plane. The geometrical characteristic on a geometrical feature can be decomposed into the size and form characteristic of the feature itself and the topological constraints between geometrical features, i.e., the situation feature. Table 6.1 shows the different situation relationships between features based on various combinations of situation feature.

Table 6.1 Relative situations that situation feature represents

	Situation feature		Relative situation that situation feature represents	
	Target feature	Datum feature	location	orientation
1	PT	PT	Yes	No
2	PT	SL	Yes	No
3	PT	PL	Yes	No
4	SL	SL	Yes	Yes
5	SL	PL	Yes	Yes
6	PL	PL	Yes	Yes

Keys: PT-Point, SL-Straight Line, PL-Plane.

According to table 6.1, we can decompose the drawing indication in figure 6.1 into the topological relationships between the situation feature of each cylindrical invariances (the derived central line of cylindrical feature) and each of the three datum features (plane), i.e, the orientation relationship (perpendicular) between the derived central line and the plane C, the distance relationship between the derived central line and the plane A, and the distance relationship between the derived central line and the plane B.

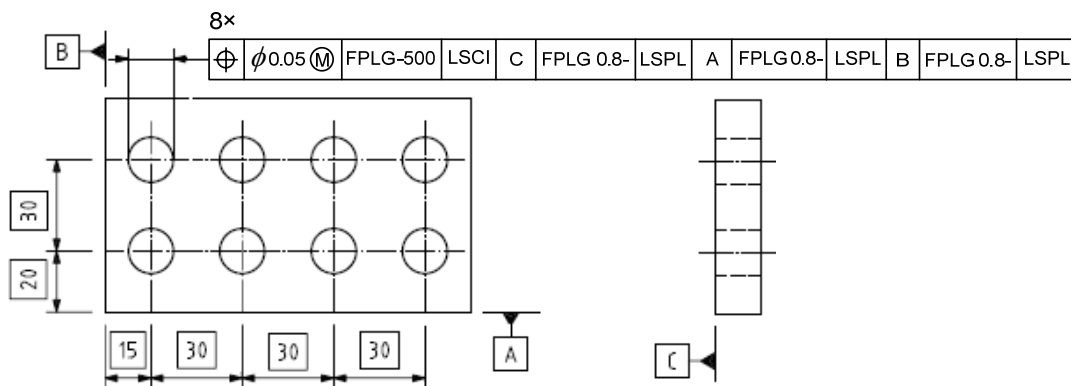

Figure 6.1 Drawing indication for position characteristic consistent with GPS

The composition of these three topological information is the position

characteristic. The composition of three situation feature, point, straight line and plane, can be used in different geometrical characteristics, as shown in table 6.2, where DOF is obtained in reference to coordinate system shown in Figure 4.1.

Table 6.2 Design rules for application of type of geometrical characteristic RI^①

Rule	Situation feature		Basic situation relationship	Constrained DOFs of target feature	Applicable geometrical characteristic type
	Target feature	Datum feature			
RI-1	<i>PT</i>	<i>PT</i>	Coincide	t_1, t_2, t_3	CON
RI-2	<i>PT</i>	<i>PT</i>	Non-coincide	t_1, t_2, t_3	POS
RI-3	<i>PT</i>	<i>SL</i>	PT on SL	t_1, t_2	POS
RI-4	<i>PT</i>	<i>SL</i>	PT not on SL	t_1, t_2	POS
RI-5	<i>PT</i>	<i>PL</i>	PT on PL	t_1, t_2	POS
RI-6	<i>PT</i>	<i>PL</i>	PT not on PL	t_1, t_2	POS
RI-7	<i>SL</i>	<i>PT</i>	PT on SL	t_1, t_2	POS
RI-8	<i>SL</i>	<i>PT</i>	PT not on SL	t_1, t_2	POS
RI-9	<i>SL</i>	<i>SL</i>	Coincide	t_1, t_2, r_1, r_2	COA, CIR, TOT
RI-10	<i>SL</i>	<i>SL</i>	SL and SL co-plane and parallel	t_1, t_2, r_1, r_2	PAR, POS
RI-11	<i>SL</i>	<i>SL</i>	SL and SL co-plane and perpendicular	t_1, r_1 (composed plane is perpendicular to t_1); t_2, r_2 (composed plane is perpendicular to t_2)	PER
RI-12	<i>SL</i>	<i>SL</i>	SL and SL co-plane and any angle	t_1, r_1, r_2 (composed plane is perpendicular to t_1); t_2, r_1, r_2 (composed plane is perpendicular to t_2)	ANG
RI-13	<i>SL</i>	<i>SL</i>	Not co-plane	t_2, r_2 (target is perpendicular to t_1); t_1, r_1 (target is perpendicular to t_2)	ANG, POS
RI-14	<i>SL</i>	<i>PL</i>	SL on PL	t_1, r_2	POS
RI-15	<i>SL</i>	<i>PL</i>	SL parallel to PL	t_1, r_3	PAR, POS
RI-16	<i>SL</i>	<i>PL</i>	SL perpendicular to PL	r_2, r_3	PER, POS, CIR, TOT
RI-17	<i>SL</i>	<i>PL</i>	SL and PL are in any angle	t_1, r_2, r_3	ANG
RI-18	<i>PL</i>	<i>PT</i>	PT on PL	t_1	POS
RI-19	<i>PL</i>	<i>PT</i>	PT not on PL	t_1	POS
RI-20	<i>PL</i>	<i>SL</i>	SL on PL	t_1, r_2	PER

Table 7.2 (Continued)

RI-21	PL	SL	SL parallel to PL	t_1, r_2 (PL perpendicular to t_1); t_2, r_1 (PL perpendicular to t_2)	PAR,POS
				t_1, t_2 (PL is not perpendicular to t_1 and t_2)	PAR
RI-22	PL	SL	SL perpendicular to PL	r_1, r_2	PER
RI-23	PL	SL	SL and PL are in any angle	r_2, r_3	ANG
RI-24	PL	PL	coincide	t_1, r_2, r_3	POS,SYM
RI-25	PL	PL	PL perpendicular to PL	r_3 (PL perpendicular to t_2); r_2 (PL perpendicular to t_1)	PER,POS
				r_2, r_3 (PL is not perpendicular to t_1 and t_2)	PER
RI-26	PL	PL	PL parallel to PL	t_1, r_2, r_3	PAR
RI-27	PL	PL	PL and PL are in any angle	r_2, r_3	ANG

Keys: PT-Point, SL-Straight Line, PL-Plane. PT, SL, PL does not represent single geometrical feature of point, straight line or plane, but have rich meaning. CON-Concentricity, POS-Position, COA-Coaxiality, CIR-Circular run-out, TOT-Total run-out, PAR-Parallelism, PER-Perpendicularity, ANG-Angularity, SYS-Symmetry.

Note ①: This rule is only applicable for a single datum.

It is obvious from table 6.2 that the design of type of geometrical feature is a comprehensive process, because it is related to the situation feature of target feature and datum feature and is very close to the relative situation information of them.

Therefore, the system will give some recommendations of the type of geometrical characteristic based on the type of situation feature of target and datum feature. For example,

IF {situation feature of target feature = PL & situation feature of datum feature = SL & $SL \subset PL$ }

THEN applicable geometrical characteristic type = PER

Since there is no rotational DOF of point, when point exists in situation feature, it can not be applied to orientation geometrical characteristic; it can only be applied to location geometrical characteristic. Thereby, we can get the general rule RI:

IF {(situation feature of target feature = PT || situation feature of datum feature = PT)}

& The basic situation relationship between target feature and datum feature ≠ 'coincide'}

THEN applicable geometrical characteristic type = POS

It should be mentioned that, for the above knowledge rules, no matter it provides recommendations for the preliminary design of designer, or it carries out the rationality checking for the designed geometrical characteristics, it can not get the conclusion that it must specify the corresponding geometrical characteristic on the geometrical feature, just only to verify that the specified geometrical characteristics **is applicable** to the geometrical feature. So does the following rules.

6.3 Design Rules for Geometrical Requirements

ISO/TC 213 independency principle as the fundamental geometrical requirement, i.e., all geometrical characteristic should be satisfied independently. Under the independency principle, the tolerance of form characteristic is not restrained by the dimensional tolerance, and vice versa. However, in many cases, there is some functional correlation between dimensional and geometrical tolerances. And to represent this correlation, some other geometrical requirements, such as \textcircled{M} , \textcircled{E} , \textcircled{L} and \textcircled{R} should be indicated [92]-[93],[96]-[97]. Where, \textcircled{E} is placed after the linear (size) tolerance, when applicable to a selected individual feature; \textcircled{M} , \textcircled{L} and \textcircled{R} are specified after the geometrical tolerance value. And these geometrical requirements are inspected only if it is specified in a functional need situation.

In contrast to all other principles of tolerancing in which deviation of form and location might be raised if tolerance of size is not exploited completely, reciprocity requirement \textcircled{R} permits raising the tolerance of sizes if deviations of form and location have not completely exploited their specified range. The reciprocity requirement can not used independently; it can only appear together with maximum material requirement \textcircled{M} or least material requirement \textcircled{L} , i.e., ' $\textcircled{M} \textcircled{R}$ ' or ' $\textcircled{L} \textcircled{R}$ '. Reciprocity requirement can only be used on central feature. Except for the above geometrical requirements, there are some other geometrical requirements for the special functional application. For example, in some cases of

function to void the interference in the assembly of the counterpart, the tolerances of location (position, coaxiality and symmetry) are not sufficient to ensure the function, projected tolerance zone \textcircled{P} is employed to give the possibility of indicating these functional demands clearly on the drawing. For some non-rigid parts, such as thin sheet metal, o-rings and so on, distort when they are taken out of their manufacturing surroundings. To limit the amount of distortion, it may be necessary to specify geometrical tolerances for the Free State, marked by the modifier \textcircled{F} .

According to ISO 1101:2004, though there are 19 geometrical characteristics (including form and location characteristics), the tolerance zones are limited to several ways, such as two parallel straight lines, two parallel curves(including two parallel concentric circles), two parallel planes, two parallel curved surfaces(including two coaxial cylindrical surfaces), cylindrical surface and spherical surfaces. For the round or cylindrical tolerance zone, ϕ is placed before the tolerance value, and so does $s\phi$ for spherical tolerance zone. Knowledge rules for application of different geometrical requirements are listed in table 6.3, in which geometrical feature type replace situation feature to make the meaning more clear.

Table 6.3 Knowledge rules for application of geometrical requirements **RII**

Rule	geometrical requirements	modifier	Type of geometrical feature ^①	Applicable geometrical characteristic types ^②
RII-1	Tolerance zone type	ϕ	cylindrical	STR,PAR,PER,ANG,POS,CON,COA
		$s\phi$	spherical	POS
RII-2	Maximum material requirement	\textcircled{M}	cylindrical	STR,PAR,PER,ANG,POS,CON,COA,SYM
RII-3	Least material requirement	\textcircled{L}	cylindrical	STR,PAR,PER,ANG,POS,CON,COA,SYM
RII-4	reciprocity requirement	\textcircled{M} \textcircled{R}	cylindrical	STR,PAR,PER,ANG,POS,CON,COA,SYM
		\textcircled{L} \textcircled{R}		
RII-5	projected tolerance zone	\textcircled{P}	cylindrical	PER, POS,SYM
RII-6	free state	\textcircled{F}	All geometrical types	All geometrical characteristics

Note ①, according to reference [67], there are seven types of geometrical feature, which are spherical, cylindrical, planar, helical, revolution, prismatic and complex.

②, geometrical characteristic is abbreviated as the first three characters.

The knowledge rules in table 6.3 is classified into two types, one is for the application of geometrical requirement and geometrical feature type, and the other is for the application of geometrical requirement and applicable geometrical characteristic type. There are two examples for the above two types of rules.

Example 1:

IF {geometrical feature type = planar &
applicable geometrical requirement = \textcircled{F} }

THEN the design is rational

Example 2:

IF {geometrical feature type = cylindrical &
applicable geometrical requirement = $s\phi$ }

THEN the design is not rational

6.4 Design Rules for Datum and Datum Reference System

The selection of datum will influence not only the verification process, but also the manufacturing process. Therefore, the design and choose of a rational datum is of great importance in geometrical characteristic design. The design of datum should follow the following application rules:

RULE III-1: In two correlated geometrical features, the one who has big area or the one who is planar or cylindrical geometrical feature is regarded as a datum feature.

In section 6.2, it states that the situation information of target feature is represented by the DOFs of its situation feature, however, in practical engineering, the DOFs of the situation feature of the target feature can not be constrained by one datum feature, and thereby the establishment of a datum reference framework is of necessary. Design rules of the datum reference framework will help to verify the validity of the design of datum, thus to reduce the problem of under-constrained or over-constrained.

RULE III-2: Redundancy of each datum in a datum reference framework is judged by the DOFs of the datum and the DOFs of the target feature.

The situation relationship between features can be represented by their situation feature. Subsequently, the datum reference framework can be substituted by the situation features of the datums. The DOFs of the datum framework is the union set of its composed datum, as shown in expression 6-1. The DOFs of the target feature that are constrained by the datum reference framework is the intersection of DOFs of them, as shown in expression 6-2.

$$DOF(R) = DOF(R_1) \cup DOF(R_2) \cup DOF(R_3) \quad (6-1)$$

$$DOF(T, R) = DOF(T) \cap DOF(R) \quad (6-2)$$

where $T \in \{PT, SL, PL\}$, and it represent target feature; $R \in \{PT, SL, PL\}$ and it represents datum reference framework; R_1, R_2 and R_3 represents the situation feature of the first, second and third datum; $DOF(T, R) \subseteq \{t_1, t_2, t_3, r_1, r_2, r_3\}$ and it is the collection of maximum common DOFs of datum reference framework and target feature; PT, SL and PL represents point, straight line and plane respectively.

The situation information between situation features of target and datum features including the orientation and location. To represent the location constrain of target feature in space, the theoretical exact dimensions are employed, as shown in expression 6-3.

$$T(O, L) = f(t_1, t_2, t_3, r_1, r_2, r_3, d_1, d_2, d_3, a_1, a_2, a_3) \quad (6-3)$$

Where, d_1, d_2, d_3 and a_1, a_2, a_3 are the theoretical exact distance or angle between the ideal position of target feature and the datum features respectively; O and L represent the orientation and location of the target feature respectively.

According to the above analysis, the orientation of target feature is constrained by the rotation DOFs of datum feature; the location of target feature is constrained by the translation DOFs of datum feature and the theoretical exact dimensions between the ideal position of target feature and the datum features. The redundancy judge of each datum in the datum framework can be carried out according to the following process:

STEP 1:

To judge the type of geometrical characteristic to make sure it is orientation or location characteristic;

STEP 2:

If it is an orientation geometrical characteristic, then obtain the common DOFs, marked as $DOF(T, R_i) (i \leq 3)$, of target feature and each datum feature, and then get the intersection of $DOF(T, R_i) \cap \dots \cap DOF(T, R_i) (i \leq 3)$. If the result is empty, then the system will return an error message;

STEP 3:

If it is a location geometrical characteristic, then obtain the common DOFs, marked as $DOF(T, R_i) (i \leq 3)$, of target feature and each datum feature, and then get the $DOF(T, R_2) - \{DOF(T, R_2) \cap DOF(T, R_1)\}$. If the result is empty, then the system will return a message to check whether there is a theoretical exact dimension between the ideal location of target feature and the secondary datum features, if the answer is no, then the system will return an error message, else if the answer is yes, then get $DOF(T, R_3) - \{DOF(T, R_3) \cap \{DOF(T, R_1) \cup DOF(T, R_2)\}\}$. If the result is empty, then the system will return a message to check whether there is a theoretical exact dimension between the ideal location of target feature and the third datum features, if the answer is no, then the system will return an error message, else if the answer is yes, it means that there is no redundant datum in the datum reference framework.

6.5 Design Rules for Refinement of Geometrical Characteristic

The relationship between different geometrical characteristics specified on the same target feature is called the refinement of geometrical characteristic. Since there are various constraints such as geometrical requirements, datum reference framework and other elements are involved in the geometrical characteristic, the refinement of geometrical characteristic is a complex procedure which contains DOF, geometrical requirement, type of geometrical characteristic, tolerance value, and datum reference framework and so on.

As stated in the above section, it is of great importance to consider the valid and redundancy of the design of geometrical characteristic. The refinement of geometrical characteristic is the foundation of the work. The refinement of geometrical characteristic is based on the classification of geometrical characteristic in ISO 1101:2004, which is that geometrical characteristic consists of form, orientation and location geometrical characteristic.

If there are two geometrical characteristic are specified on one target feature, three cases may emerge:

- (1) Two geometrical characteristic are within one category (here a category means form, orientation or location), but they defines different elements of the target feature (for example, diameter, central line or generatrix of the cylinder);
- (2) Two geometrical characteristic are within one category, and they defines the same elements of the target feature;
- (3) Two geometrical characteristic are within different categories.

From DOF of the target feature that are defined by geometrical characteristic, we can know that the defined DOF becomes less from location, orientation to form geometrical characteristic. Thereby, we can use the DOFs that the geometrical defines to state the above three cases.

For the case (1), the following rule is applied:

RULE IV-1: For two geometrical characteristic are within one category but they defines different elements of the target feature, the tolerance value of the one which controls more DOF should be larger.

IF { Category(geometrical characteristic 1) = Category(geometrical characteristic 2) & $T_1 \neq T_2$
& $\text{DOF}(\text{geometrical characteristic 1}) \supseteq \text{DOF}(\text{geometrical characteristic 2})$
THEN Para_value(geometrical characteristic 1) \geq Para_value(geometrical characteristic 2)

For the case (2), we should avoid it in most cases, if inevitable, the following rule should be applied.

RULE IV-2: For two geometrical characteristic are within one category, and they defines the same elements of the target feature, the tolerance value of the one which controls more DOF should be two times or more of the tolerance value of the one which controls less DOF.

IF {Category(geometrical characteristic 1) = Category (geometrical characteristic 2) & $T_1 = T_2$
& $\text{DOF}(\text{geometrical characteristic 1}) \supseteq \text{DOF}(\text{geometrical characteristic 2})$
THEN Para_value(geometrical characteristic 1) \geq
2 Para_value(geometrical characteristic 2)

For case (3), two geometrical characteristic are within different categories, the following rule is applied.

RULE IV-3: For two geometrical characteristic are within different categories, the tolerance value of the one which controls more DOF should be larger.

IF { Category(geometrical characteristic 1) \neq Category(geometrical characteristic 2)
& DOF(geometrical characteristic 1) \geq DOF(geometrical characteristic 2)}
THEN Para_value(geometrical characteristic 1) \geq Para_value(geometrical characteristic 2)

6.6 Conclusion

This chapter breaks through a single geometrical characteristic and sets up the knowledge rules for its design. The rules includes those for application of various geometrical requirements, for the application of target geometrical feature and datum feature, for the application of datum reference framework, and for the application of target geometrical feature and type of geometrical characteristic. These rules will enhance the rationality of the design of geometrical characteristic and strengthen the intellectuality of the information system. These rules are important of the system to show its intelligence which is different to other database system for geometrical characteristic.

CHAPTER 7 PROTOTYPE DEVELOPMENT OF THE HOST SYSTEM OF THE INTEGRATED GEOMETRY INFORMATION SYSTEM

7.1 Introduction

Database module is the framework of the integrated information system. The data involved in the system is organized and represented by categories; thereby the information system is built based on categorical data model. In convenient for the unified management and control of the GPS data, and to ensure the security and integrity of the database, it is of necessary to research and development of the corresponding category database management system. And the integrated information system is just an independent platform for design; its result should be output and combined with other host systems. The host system consistent with GPS, combining with CAD system, is developed.

7.2 Categorical Database Management System

In order to build, modify and access the database simultaneously or at different time in different methods by multiple application program or users, and to ensure the security and integrity of the database. The category database management system has been developed by our research group [60]. The correlated information and knowledge rules are stored in corresponding categories.

Figure 7.1 is the interface of the developed category database management system. Where the data involved in categorical data model for cylindricity is shown. Top left corner of the interface (zone ①) includes ten main categories involved in categorical data model of cylindricity, such as category **Association**, Calloutformanufacturer, Calloutformetrology, Evaluation, Extraction, Filtration, etc. Zone 1 is presented in a tree structure and each inner object in a category is visual. Top right corner of the interface (zone ②) presents the relationships between ten categories. Each inner object in a category can be defined and modified flexibly by the database management system.

The bottom of the interface (zone ③) is the query window of the database management system. Through the window, the user can use the queries in a SELECT...FROM... form. When the corresponding category in zone ③ is selected, the content after 'FROM...' is generated automatically. The bottom left of the interface (zone ④) is a statistical window for each category. For example, if category CalloutforManufacturer is selected, the category presented in query window (zone ③) is 'CalloutforManufacturer', and this window (zone ④) shows that this category has one instance category. The inner object in each category can be obtained from the statistical window.

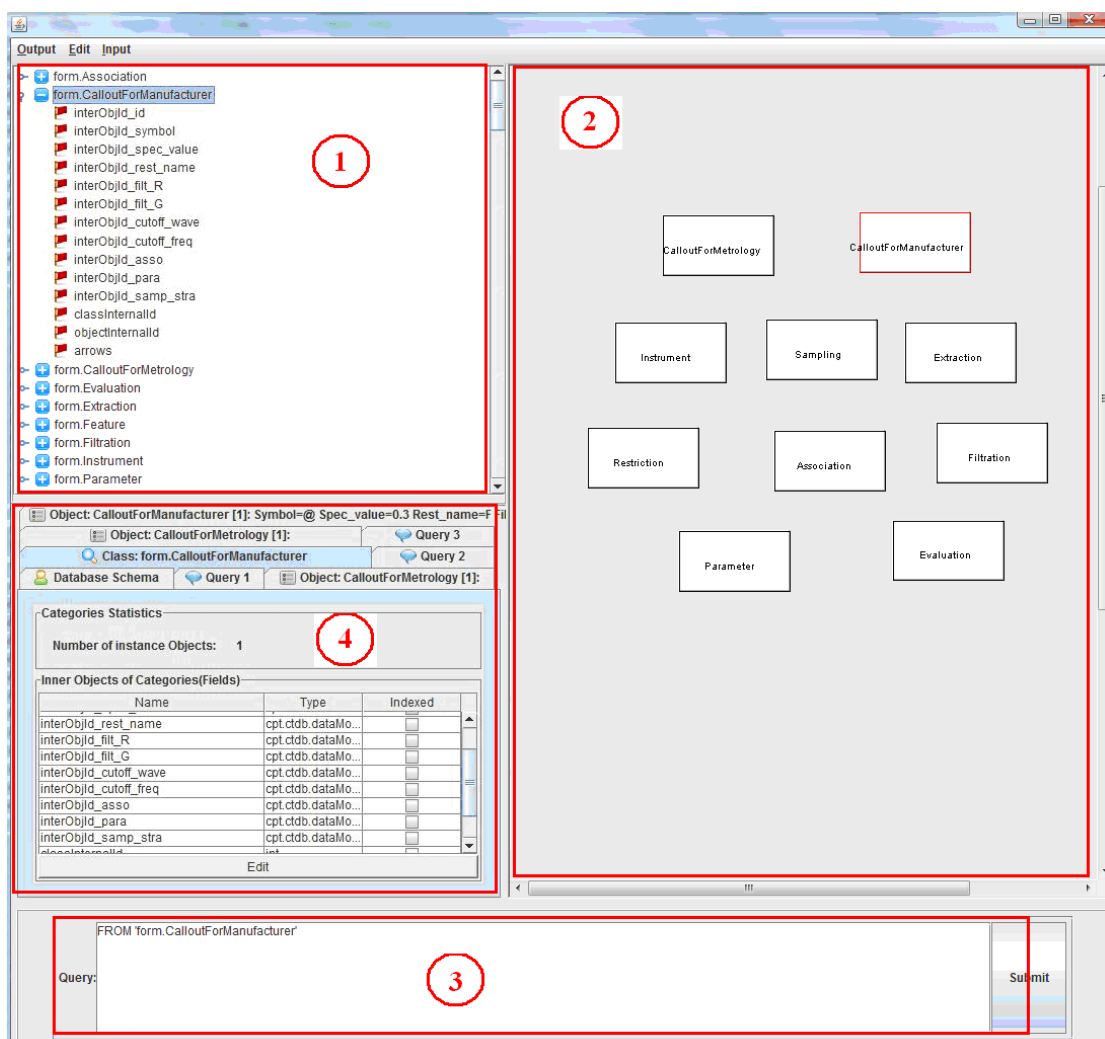

Figure 7.1 Interface of the category database management system

7.3 Host System of the Integrated Information System— Combination with CAD System

7.3.1 Structure of the host system

Host system of the integrated information system that combined with CAD system consists of information base, user interface, graphic interface and symbol storage of drawing indication, as shown in figure 7.2 [98].

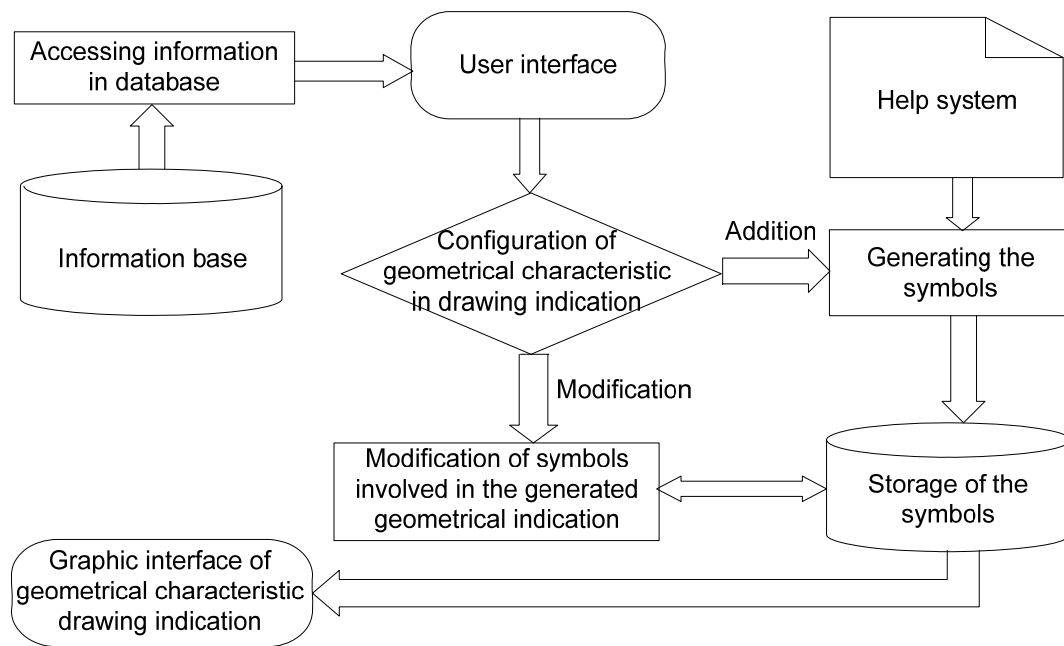

Figure 7.2 Framework the host system

The information base contains GPS characteristic drawing indication, such as parameter, type of association, geometrical requirement, filter and so on. It provides various kinds of information during operation of the prototype system. User interface is the man-machine interactive window. Through which the user can configure the drawing indication information based on the recommended options by the system or the user can input its own consideration. The generated geometrical indication can be modified or added. Subsequently, the generated drawing indication will be stored in the system and be specified on the drawing.

GPS characteristic drawing indication(abbreviated as GPS indication, the same below) system includes the generation of interface for drawing indication, the production of symbols of GPS indication and the drawing of symbols of GPS indication.

7.3.2 Drawing Indication System of Geometrical Characteristic Consistent with GPS Based on AutoCAD2007

Since the standard for indication of geometrical characteristic in 3D drawing has not been published yet, the development and realization of the drawing indication is based on AutoCAD2007.

7.3.2.1 Second development tools of AutoCAD

With the development of AutoCAD, its second development tools have been updating, such as ObjectARX, AutoLISP, ADS, VisualLISP and VBA. The advantages and disadvantages of various tools have been stated in [99]-[102]. In the above several development tools, in view of the fast speed and versatile functions of ObjectARX, it has been employed in the AutoCAD2007 system to establish the drawing indication system consistent with GPS.

7.3.2.2 Function modules of prototype of the drawing indication system

Based on the analysis of the function of the drawing indication system, a schema of the system is shown in figure 7.3, which consists of 6 modules, such as main program module, user interface module, database access module, generation of GPS characteristic in drawing indication module, modification of GPS characteristic in drawing indication module and drawing of GPS characteristic in drawing indication module.

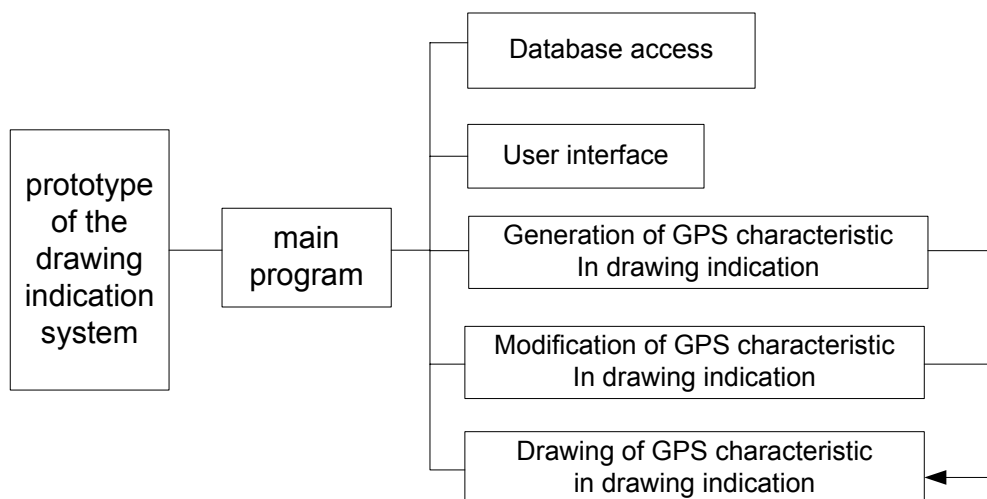

Figure 7.3 Function modules of prototype of the drawing indication system

Main program module is the kernel of the whole system. It includes the interface with AutoCAD2007 and it is responsible for the management of other modules and the information transmission between them. User interface module

is used to add the functional menu, man-machine interaction dialog box and so on. Database assess module is used to withdraw the correlated information from the information base, and to provide recommendations for the users to select or input appropriate geometrical characteristic drawing indication. Generation of GPS characteristic in drawing indication module will combine the input information from user and the corresponding standards for drawing indication of geometrical characteristic to generate the rational GPS characteristic in drawing indication. Modification of GPS characteristic in drawing indication module is used to modify the designed drawing indication, and drawing of GPS characteristic in drawing indication module is used to calculate the length that the characteristic in the geometrical characteristic in drawing indication possessions and drawing the geometrical characteristic in drawing indication in AutoCAD 2007.

7.3.2.3 Framework of the prototype system

The application program developed by ObjectARX is a windows dll in nature. Thereby, the information transmission between it with AutoCAD2007 and Windows can use Windows news transmission mechanism to realize the direct communication. ObjectARX application program calls `acrEntryPoint()` function to establish the entrance for information transmission with AutoCAD2007, and then use the switch statement in `acrEntryPoint()` function to deal with the various messages from AutoCAD2007. ObjectARX runs at the same address space with AutoCAD2007, and it uses the open architecture of AutoCAD 2007 to access it database, graphic system and the geometric modelling core directly. The external command registered by ObjectARX application program through `acedRegCmds()` macro can be regarded as the same as command in AutoCAD. ObjectARX 2007 is employed.

7.3.2.4 User interface design

To make the software easy to use, the system provides not only executive commands, but also menu bar. Subsequently, the edit of GPS characteristic in drawing indication can be done from both of them.

Firstly, a menu class `CGpsMenu` of the system is defined, and then add content of the menu from its construction function `CGpsMenu()` and connect the menu and the command.

```

CGpsMenu::CGpsMenu( )
{
//.....
CAcadPopupMenu IPopupMenuAdd(IPopUpMenu.AddSubMenu(index,
_T("add indication")));
CAcadPopupMenu IPopupMenuForm(IPopUpMenuAdd.AddSubMenu(index,
_T("form")));
IPopUpMenuForm.AddMenuItem(index,_T("straightness"),_T("StraightDimen
sion\n"));
V_I4(&index) = 1;
IPopUpMenuForm.AddMenuItem(index,_T("flatness"),_T("PlaneDimension\n
"));
V_I4(&index) = 2;
//... ..
V_I4(&index) = 1;
IPopUpMenu.AddMenuItem(index, _T("modify indication"),
_T("ModifyDimension\n"));
V_I4(&index) = 2;
IPopUpMenu.AddMenuItem(index, _T("help"), _T("GpsHelp\n"));
//... ..
}

```

If we call the function addGpsMenu() of the class CGpsMenu() while loading the application program, the menu bar can be uploaded, otherwise if we call the function deleteGpsMenu() of the class CGpsMenu() while unloading the application program, , the menu bar can be unloaded.

Except for menu bar, the user interface also provides the man-machine interactive interface for the user to input the information of GPS characteristic in drawing indication. Since the type of information involved in different GPS characteristics in drawing indication is different, the man-machine interactive interface will be designed independently. Figure 7.4 is the man-machine interactive interface for flatness consistent with GPS.

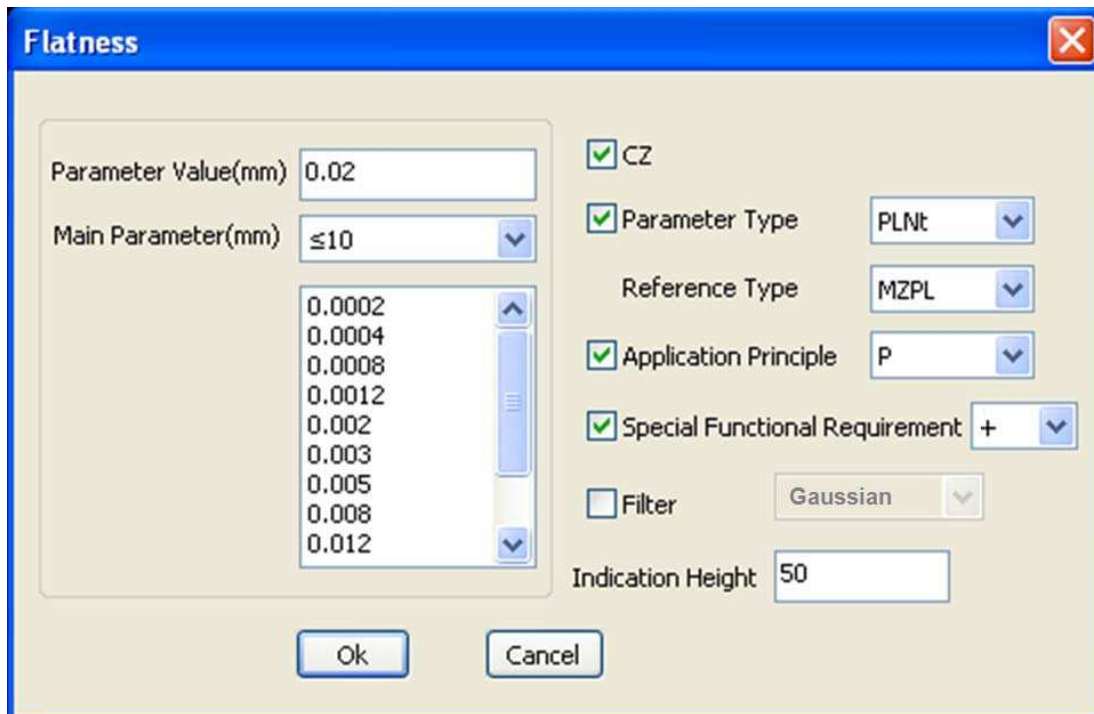

Figure 7.4 man-machine interactive interface for flatness consistent with GPS

7.3.2.5 Design and development of the self-defined blocks of indication symbol

If the symbols of GPS characteristic drawing indication drawn in AutoCAD 2007 are simply identified as points, line or characters, then each part of the symbols of GPS characteristic drawing indication is separated. And the whole GPS characteristic drawing indication can not change to suit the change of any part of the symbols of GPS characteristic drawing indication. Therefore, we should regard the GPS characteristic drawing indication as a whole. And it is an independent entity and can be regarded as the same as a straight line, circle. ObjectARX running environment includes several groups of class libraries, such as AcDb, AcEd, AcRx, AcGi, AcGe and so on. Where, AcDb is responsible for the management of the AutoCAD database class objects and its quote; AcEd includes a series of classes to define and register the new commands; AcRx is employed for real-time extensions of AutoCAD; AcGi is used to render AutoCAD entity of a graphical interface; AcGe class is tool libraries for general linear and geometric objects.

The user can not only uses AcDb to query and manipulate the entity/objects exists in AutoCAD, but also can create the new instance for the database objct. The self-defined class CDimensionof for GPS characteristic drawing indication, which is the abstract of symbols of various geometrical characteristic drawing

indication, is inherited from class AcDbEntity in AcDb, as shown in figure 7.5.

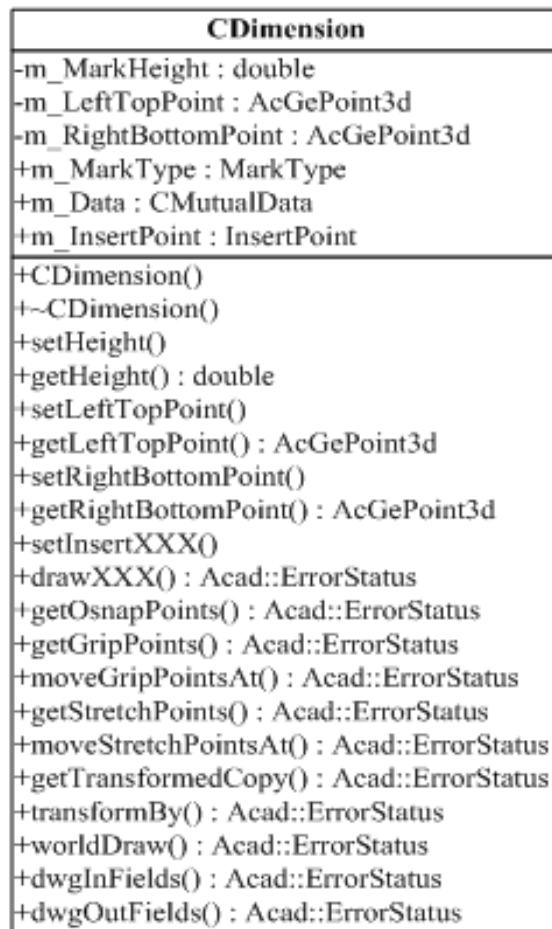

Figure 7.5 Structure of the classes involved in prototype of the drawing indication system

7.4 Functional Testing of the Host System [103]

Since the prototype of the drawing indication system is developed based on ObjectARX2007, the operation of the host system relies on AutoCAD2007.

7.4.1 Loading of the host system

After activating AutoCAD software, we can load the ASDKGpsMark.arx application program to start the prototype system by the following two methods:

One is through the menu Tools→Load Application to load the GPS characteristic drawing indication system, as shown in figure 7.6.

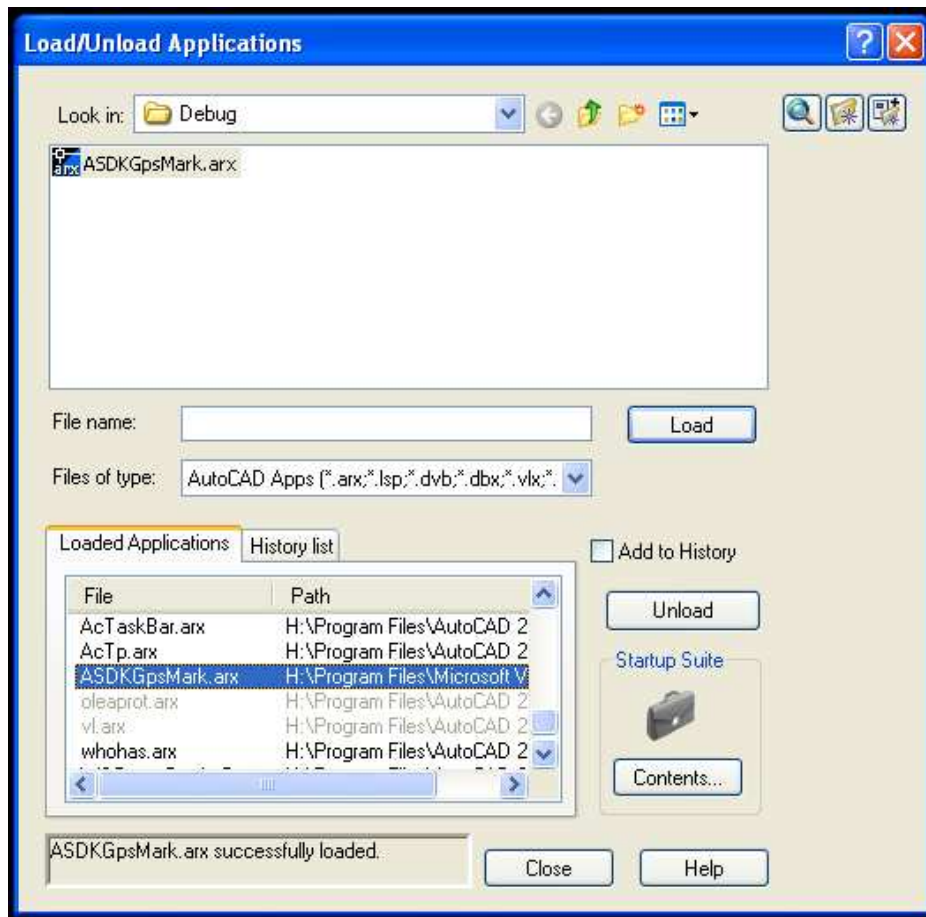

Figure 7.6 Interface for loading the host system

The other way is to type the command 'apload' in the arx command line, and then find the ASDKGpsMark.arx similar to the first method.

Figure 7.7 and Figure 7.8 are the snapshots for the AutoCAD2007 before and after the host system has been loaded respectively.

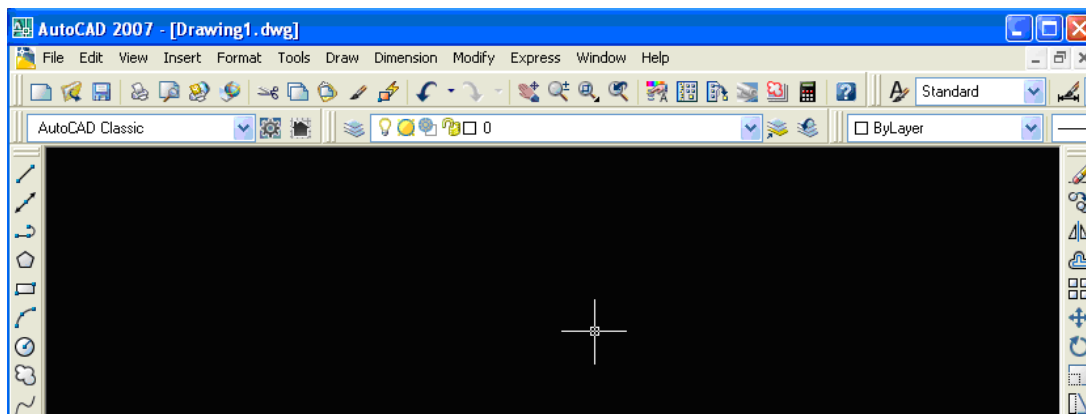

Figure 7.7 Snapshot of AutoCAD2007

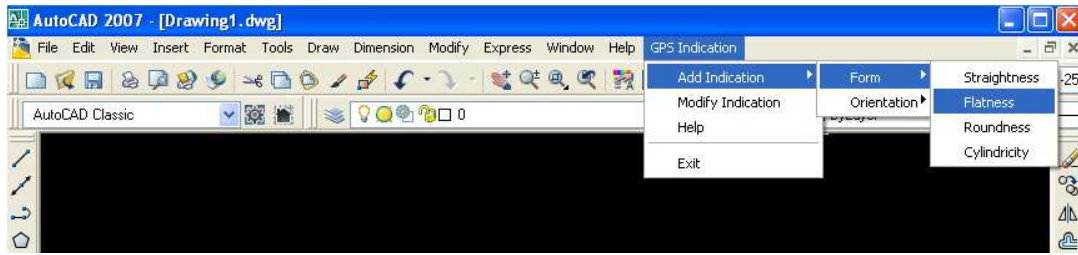

Figure 7.8 Snapshot of AutoCAD2007 after loading the GPS Indication

7.4.2 Functional testing of the host system

7.4.2.1 Addition of the GPS indication symbol

Take cylindricity as an example, we can select the cylindricity from the menu shown in figure 7.9, and then the popup dialog box in figure 7.9 will be shown. We can configure the cylindricity drawing indication according to functional requirements, and then click the OK button. Subsequently, the system will generate an object of drawing indication and prompting the designer to select a point to place the drawing indication, and the point is the left-top corner of the drawing indication, as shown in figure 7.10.

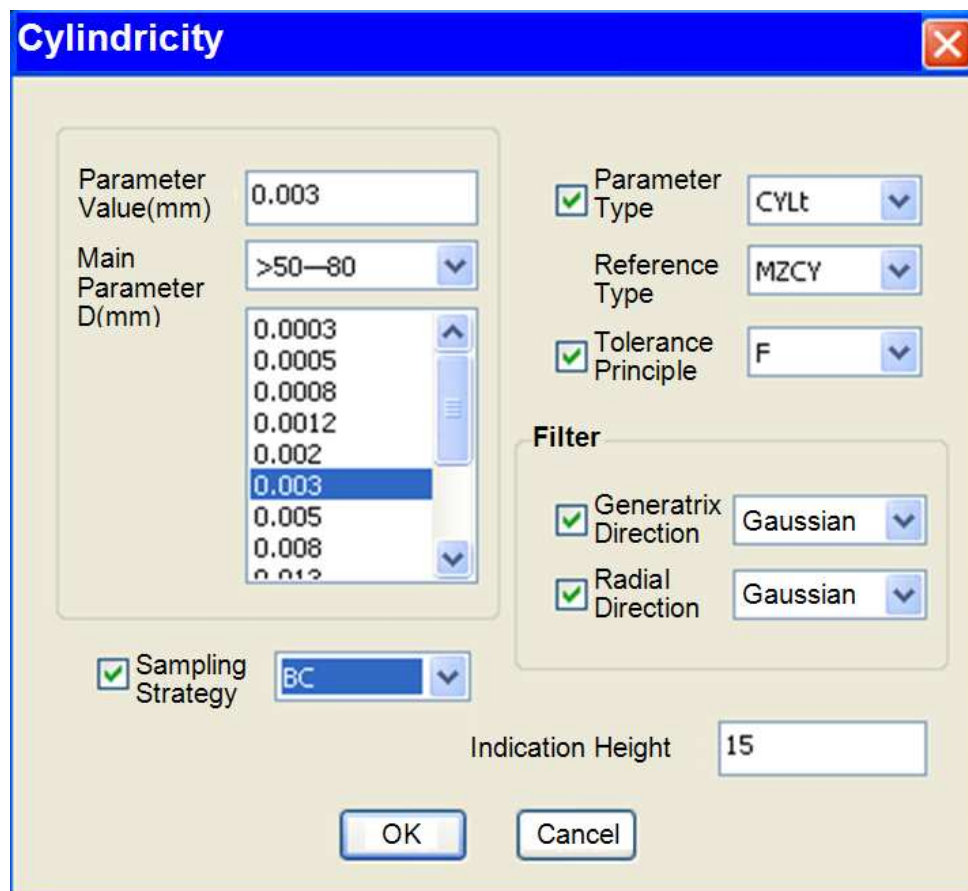

Figure 7.9 Dialog box of cylindricity configuration



Figure 7.10 Instance of cylindricity drawing indication

7.4.2.2 Modification of the GPS indication symbol

The system provides the mechanisms for modification of size and location of generated symbols involved in the geometrical characteristic drawing indication, one way is realized through the menu bar, GPS indication—> modify indication, which is shown in Figure 7.8. Furthermore, there are other tools that can be used for the specification framework, for example, the specification framework can be dragged by the point in its up-left corner, and its size can be resized by the points at right-bottom corner. Figure 7.11 is an example of cylindricity to illustrate the dragging function of the system.

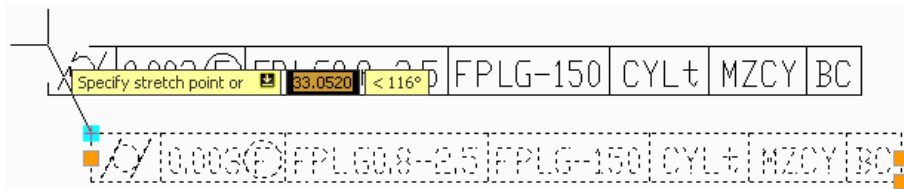

Figure 7.11 An example to illustrate the dragging function of the host system

7.4.3 Unloading of the host system

The GPS indication system can also be removed from AutoCAD2007 by using these optional ways:

- 1) One way is to use the Exit option in GPS indication menu.
- 2) The second way is to use the command line to input ASDKGpsMark.arx.
- 3) The thirdly way is to use menu bar to select GPS indication—>exit GPS indication.

The GPS indication can be saved and recognized by AutoCAD2007 after its being unloaded. The user has three options about this process, display proxy graphic, do not display proxy graphic, display proxy graphic border, according to the requirement.

7.4.4 Case study

Through the above function test of the prototype system, we can know that it

meets the expected goal. It can add, modify and access the geometrical characteristic drawing indication consistent with GPS. And the generated symbols can be resized and dragged. Figure 7.12 is the schematic of a 4-stroke engine and 7.13 is an instance of specifying cylindricity drawing indication on cylinder of the 4-stroke engine.

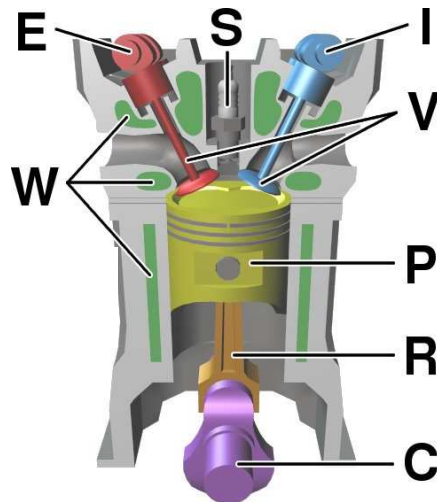

Keys:

C: Crankshaft, **E:** Exhaust camshaft, **I:** Inlet camshaft, **P:** Piston, **R:** Connecting rod, **S:** Spark plug, **V:** Valves. Red: exhaust, Blue: intake, **W:** Cooling water ducts

Figure 7.12 4-stroke engine schematic[ref 109]

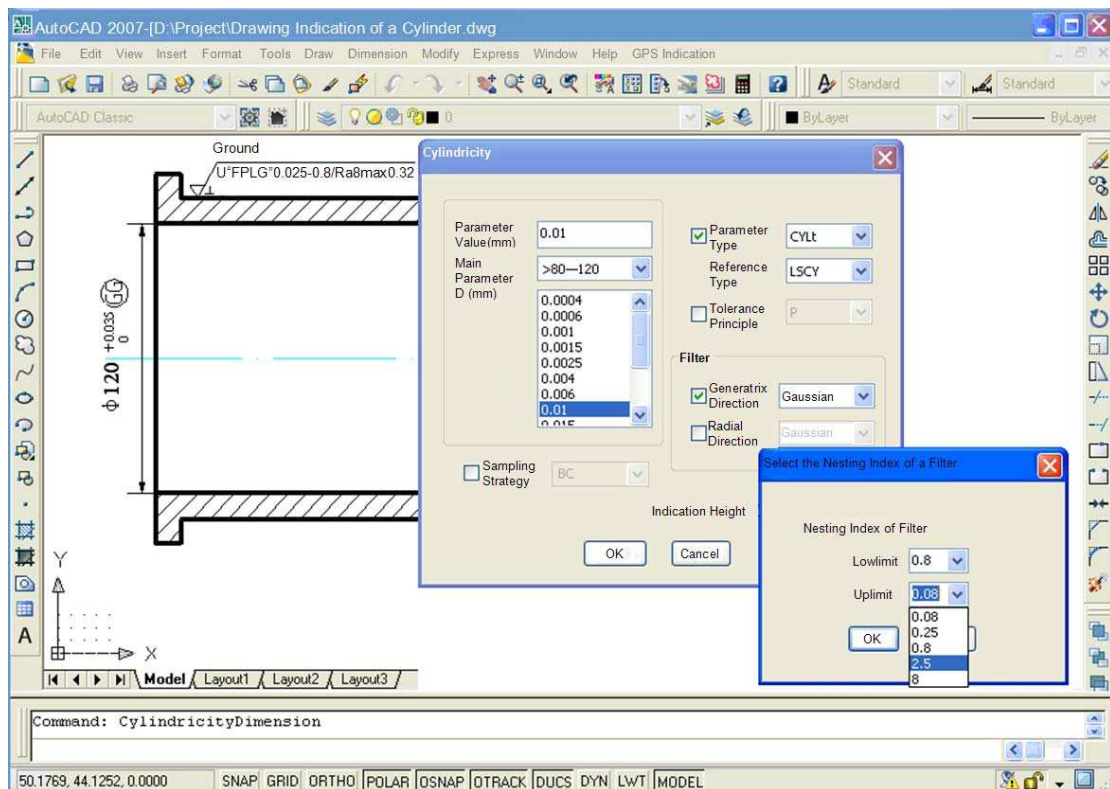

(a)

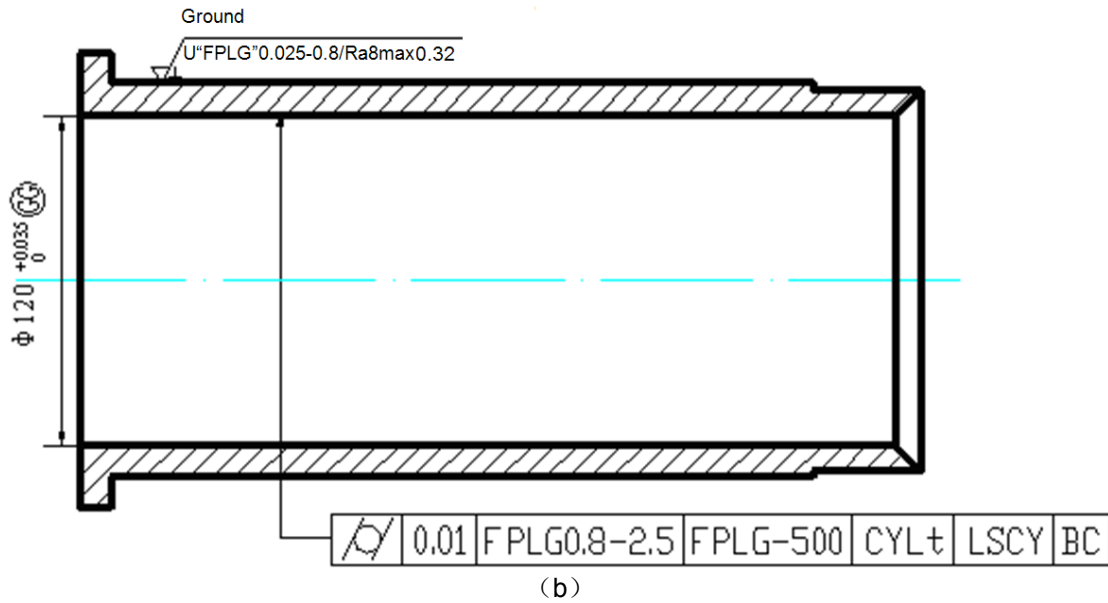

Figure 7.13 An instance of specifying cylindricity drawing indication on cylinder of the 4-stroke engine

It is obviously that the above cylindricity drawing indication consistent with GPS is more complete and clear than conventional ones.

7.5 Conclusion

The geometrical characteristic drawing indication prototype system has been developed based on AutoCAD 2007 by its second development tools ObjectARX. The design and implementation of the host system and its sub-modules has been explored. And the function test of the developed system has been carried out. The case study proves that the system can achieve the expected goal.

CHAPTER 8 CONCLUSIONS AND FUTURE WORK

This chapter summarises the outcomes of this thesis and highlights the contributions to the knowledge, together with a discussion of the future work.

8.1 Summary and Conclusions

This thesis has documented the design and development of an integrated geometry information system for digital manufacturing. This system aims to build an integrated information prototype system for geometrical tolerances which is consistent with Geometrical Product Specifications. The main contributions of the thesis are:

- 1) Proposed the categorical data modelling method to represent, store and manipulate all the elements and their relationships involved in design and inspection process of a geometrical tolerance, by categories, objects and morphisms flexibly.
- 2) Established different categories of knowledge rules to enhance the rationality and the intellectuality of the integrated geometry information system.

The main research work is summarised as the following:

- 1) A brief history of tolerance has been reviewed; the motivation why GPS was generated, the main task of GPS and the key concepts within it has been stated. The relationships between the key concepts of GPS have been analyzed. Some typical computer aided tolerancing tools have been reviewed, and their advantages and disadvantages have been analyzed.
- 2) The popular data modelling methods have been introduced and the categorical data model based on category theory has been investigated; the comparison between categorical data model and other data modelling method has been carried out.
- 3) The functional requirements of the Integrated Geometry Information System have been analyzed exhaustively, the whole framework for the integration between the Integrated Geometry Information System with other CAx systems

has been proposed, and the data exchange format has been defined. Under the outer integration environment of The Integrated Geometry Information System with other CAx systems, the inner framework of The Integrated Geometry Information System has been established, and the functions of three key modules have been stated. The two-layer model for geometry information of geometrical product has been proposed based on the CE motivation of GPS, and this model can meet different demands of designers, manufacturers and metrology engineers. And finally, the two-layer model can make the design of geometrical specifications more concise, complete and unique.

4) The categorical data models for the integration between specifications and verification for geometrical tolerances consistent with GPS framework have been established, which can represent and store all the elements and their relationships involved in specifications and verification process for geometrical tolerances, by categories, objects and morphisms, and the models can be extended flexibly.

5) Different categories of knowledge rules were established for the integrated geometry information system, such as the rules for the application of geometrical requirement, tolerance type, datum and datum reference framework and, for the refinement among geometrical specifications, etc. These rules will enhance the rationality of the design of geometrical characteristic and strengthen the intellectuality of the information system.

6) The host system for drawing indication of geometrical specifications based on GPS was established based on AutoCAD 2007 using ObjectARX has been developed.

8.2 Future Work

After the research work that has been done in the thesis, the author thinks that there are several things remains to be undertaken:

1) To add the practical knowledge rules (recommendations). The knowledge rules that have been established in the thesis are mainly based on standards, and most of them are mandatory rules. The practical knowledge rules will be established based on the experiences obtained in practical engineering for some special cases, such as gear, bearing, and so on.

2) To add and integrate the soft-gauges for the various algorithms, including filtration algorithms, association algorithms, parameter assessment algorithms, etc., to ensure the accuracy of the assessment.

REFERENCES

- [1] R G Brown(2000)
Driving digital manufacturing to reality, Proceedings of the 2000 Winter Simulation Conference,2000: 224-228
- [2] ISO/TC213(2004)
"Business Plan". <http://isotc213.ds.dk>
- [3] X Jiang (2002)
"Review of the Next Generation GPS", 2nd International Symposium on Instrumentation Science and Technology, Jinan, China.
- [4] Z Humienny (2007)
"State of art in Standardization in GPS Area"; the 10th CIRP Seminar on Computer Aided Tolerancing, Erlangen (Germany), CDRom paper, March 2007
- [5] Z Humienny, et al (2001)
"Geometrical Product Specifications", Warsaw University of Technology Printing House, ISBN 83-912190-8-9
- [6] A Ballu (2000)
A Ballu. Graphical language. ISO/TC213/WG14. Madrid, España, 2000
- [7] A Ballu, et al (1993)
Analysis of dimensional and geometrical specifications: standards and model. Proc. of 3rd CIRP Seminar on Computer Aided Tolerancing, Cachan, France, 1993:27-28
- [8] A Ballu, et al (1995)
Univocal expression of functional and geometrical tolerances for design, manufacturing and inspection. Proc. of 4th CIRP Seminar on Computer Aided Tolerancing, the University of Tokyo, JAPAN, 1995
- [9] J Y Dantan, et al (2008)
Geometrical product specifications – model for product life cycle. Computer-Aided Design, 40(4):493-501
- [10] A Ballu, et al (2001)
Global view of geometrical specifications. Geometric Product Specification and Verification: Integration of Functionality, 2001:13-24, ISBN 1-4020-1423-6
- [11] L Mathieu, et al (2003)
GEOSPELLING: a common language for Specification and Verification to express Method Uncertainty. Proc. of 8th CIRP Seminar on Computer Aided Tolerancing. The University of Charlotte, USA, 2003
- [12] L Mathieu, et al(2007)
"GPS card": a tool for univocal expression of geometrical specifications. the 10th CIRP Seminar on Computer Aided Tolerancing. Erlangen, Germany, CDRom, 2007:1-10
- [13] Barr, Michael; & Wells, Charles (1995)

- Category Theory for Computing Science, 2nd ed*, Prentice Hall, ISBN 0-13-323809-1.
- [14] A Hofstede, E Lippe, T P. Weide (1995)
 “A categorical framework for conceptual data modelling, definition, application, and implementation”, Technical Report CSI-R9512, Computing Science Institute. University of Nijmegen, Nijmegen, Netherland.
- [15] N N Rossiter, D A Nelson(1994)
 “The Functorial Data Model - An Extension to Functional Databases”, Technical Report of Department of Computing Science, University of Newcastle.
- [16] M Z Blwyberg(1992)
A Categorical View of Databases, Computing and Information Science Department, Kanas State University,
<http://www.cis.ksu.edu/~maria/papers/ara.ps>.
- [17] Y N Wang (1996)
Intelligent Control System-Fuzzy Logic, Expert system and Neural Network Control, Hunan University Press, Changsha, China. ISBN 7-81053-062-3/TP.6.
- [18] Y Wang(2006).
 A Knowledge-Based Intelligent System for Surface Texture (VirtualSurf). Mphil report. The University of Huddersfield
- [19] G Joseph, R G Raley(2002)
 Expert Systems Principles and Programming. China Machine Press, ISBN 7-111-10844-2.
- [20] H Nielsen. (2003)
 Specifications, operators and uncertainties. Proc. 8th CIRP Int. Seminar on Computer Aided Tolerancing (Charlotte, NC, USA)
- [21] P Bennich (1994)
 “Chains of Standards - A New Concept in GPS Standards”, Manufacturing review, The American Society of Mechanical Engineers, Vol. 7, No. 1, pp.29-38.
- [22] ISO/TR 14638 (1995)
Geometrical Product Specifications (GPS) ---Masterplan, International Organization for Standardisation, Geneva.
- [23] V Srinivasan(2001)
 "An integrated view of geometrical product specification and verification", Proc. of 7 th CIRP International Seminar on Computer Aided Tolerancing, Ecole Normale Supérieure de Cachan, 2001, France.
- [24] ISO/TS 17450-2(2002)
Geometrical Product Specifications (GPS) --General Concepts--Part 2: Basic tenets, specifications, operators and Uncertainties, International Organization for Standardisation.
- [25] H S Nielsen(2006)
 New concepts in specifications, operators and uncertainties and their impact on measurement and instrumentation. Meas. Sci. Technol, 17: 541–544.

- [26] ISO 17450-1(2011)
Geometrical product specification (GPS) – General Concepts – Part1:
Model for geometric specification and verification
- [27] ISO/TC 213(2011)
<http://isotc213.ds.dk>
- [28] http://www.hexagon.de/tolp_e.htm
- [29] <http://mdmetric.com/kok2.htm>
- [30] <http://www.qsyst.com/>
- [31] <http://www.ntcadcam.co.uk/solidworks-ana-tasysworks.htm>
- [32] www.ugs.it/pdf/fs_ideas_vsa_3d.pdf
- [33] <http://mitcalc-tolerance-analysis.lastdownload.com/>
- [34] http://www.ugs.com/products/efactory/docs/fs_visvsa.pdf
- [35] <http://www.ibm.com/solutions/engineering>
- [36] <http://www.sigmetrix.com/>
- [37] <http://www.etinews.com/products/software/trainer/>
- [38] www.tec-ease.com/software.htm
- [39] <http://www.multimetrix.com/software.aspx>
- [40] S H Bui, V Gopalan, J Raja(2001).
An Internet based Surface Texture Information System. *Int. J. Mach. Tools. Manuf.*, 41(13-14):2171-2177
- [41] R N Bhaskar, J Raja(1988).
A knowledge-based system for selection of surface texture parameters: a preliminary investigation. *Surface Topography*, 1:445-454
- [42] M Balasubramanian(2003).
Advanced Surface Texture Analysis for process diagnostic and function correlation. The university of North Carolina at Charlotte, Phd thesis
- [43] B G. Rosén, R Ohlsson, J Westberg(1995).
Interactive surface modelling, an implementation of an expert system for specification of surface roughness and topography. 1995, 35(2):317-324
- [44] F Sacerdotti, A Porrino, C Butler, et al(2002).
SCOUT–surface characterization open-source universal toolbox, *Meas Sci Techn*, 13: N21-N26
- [45] X Q Jiang(2004).
A Knowledge-Based Intelligent System for Engineering and Biomedical Engineering Surface Texture (VirtualSurf)', Research project report for University of Huddersfield.
- [46] L Jung, R Krüger-Sehm, B Spranger, L Koenders (2001)
"Reference software for roughness analysis"; Proceedings of the EUSPEN 2001, 27/05/01–21/05/01, Turin, pp. S500–503
- [47] ISO 10303-1(1994)
ISO 10303-1. Industrial automation systems and integration Product data representation and exchange – Overview and Fundamental Principles, Geneva

- [48] Bray, Tim; Jean Paoli, C. M. Sperberg-McQueen, Eve Maler, François Yergeau (2006)
"Extensible Markup Language (XML) 1.0 (Fourth Edition)-Origin and Goals". World Wide Web Consortium. Retrieved on October 29, 2006.
- [49] ISO/TS 10303-28(2003)
ISO/TS 10303-28. Industrial automation systems and integration – Product data representation and exchange – Part 28: Implementation methods: XML representations of EXPRESS schema and data, Geneva
- [50] J L Fiadeiro(2004).
Categories for Software Engineering. SpringerVerlag, 2004
- [51] J Guo (2002)
"Using Category Theory to Model Software Component Dependencies", Proceedings of the Ninth annual IEEE International Conference and Workshop on the Engineering of Computer-Based Systems, 185-192.
- [52] A Asperti(1990).
Categorical topics in computer science. Ph.D. Thesis, University of Pisa, 1990
- [53] B N Rossiter, D A Nelsen, M A Heather(1994).
The Categorical Product Data Model as a Formalism for Object-Relational Databases. Technical Report of Department of Computing Science, University of Newcastle, 1994
- [54] R M Colomb, et al (2001)
Category-Theoretic Fibration as an Abstraction Mechanism in Information Systems', Acta Informatica, 38(1):1-44..
- [55] B C Pierce (1991),
Basic Category Theory for Computer Scientists, MIT press, ISBN 0-262-66071-7
- [56] M Johnson, D Naumann and J Power (2001)
Category Theoretic Models of Data Refinement, Electronic Notes in Theoretical Computer Science 45
- [57] Yuanping Xu, Zhijie Xu, Xiangqian Jiang(2008)
Category theory-based Object-Oriented data management for Virtual Manufacturing, Int. J. Internet Manufacturing and Services, Vol. 1, No. 2.
- [58] Y Wang, P J.Scott, X Q Jiang(2005)
The Structure of Surface Texture Knowledge, Journal of Physics, conference series, 1-4.
- [59] Y Wang, P J Scott and X Q Jiang(2007)
"Structures of Specification and Verification Knowledge-base in Surface Texture Knowledge-based System"; the 10th CIRP Seminar on Computer Aided Tolerancing, Erlangen (Germany), CD Rom paper
- [60] Y Xu, Z Xu, X Jiang, P Scott(2011).
Developing a knowledge-based system for complex geometrical product specification (GPS) data manipulation. Knowl. Based Syst., 2011, 24(1),10-22
- [61] Q Qi, X Jiang, X Liu, P Scott(2010).

- An unambiguous expression method of the surface texture, Measurement, 43(10),1398-1403
- [62] W L Lu(2009).
Integrated Geometry Information System for Digital Manufacturing, 2nd Year report. The University of Huddersfield, 2006
- [63] W L Lu, X Q Jiang, X J Liu, et al (2010)
'Modelling the integration between specifications and verification for cylindricity based on category theory', Measurement Science and Technology, 21(11): 115107-1~ 115107-12
- [64] W L Lu, X J Liu, X Q Jiang, et al (2010)
'Categorical data model for Cylindricity Consistent with Geometrical Product Specifications Standard System', Proceedings of SPIE, Vol. 7544, 75446S
- [65] ISO 14660-1(1999)
Geometrical product specification(GPS) – Geometrical features – General terms and definitions
- [66] ISO 14660-2(1999)
Geometrical product specification(GPS) – Geometrical features – Extracted median line of a cylinder and a cone, extracted median surface, local size of extracted feature
- [67] V Srinivasan(1999).
A geometrical product specification language based on a classification of symmetry groups. Computer-Aided Design, 31: 659-668
- [68] ISO/DIS 14406(2008)
Geometrical product specification (GPS) – Data Extraction
- [69] ISO/TS 16610-01(2003)
Geometrical product specification (GPS) – Filtration – Part 1: Overview and basic terminology
- [70] ISO/TS 16610-20(2003)
Geometrical product specification (GPS) – Filtration – Part 20: Linear profile filters: Basic concepts
- [71] ISO/TS 16610-21(2003)
Geometrical product specification (GPS) – Filtration – Part 21: Linear profile filters: Gaussian filters
- [72] ISO/TS 16610-22(2003)
Geometrical product specification (GPS) – Filtration – Part 22: Linear profile filters: Spline filters
- [73] ISO/TS 16610-26(2003)
Geometrical product specification (GPS) – Filtration – Part 26: Linear profile filters: Filtration on nominally orthogonal grid planar data sets
- [74] ISO/TS 16610-27(2003)
Geometrical product specification (GPS) – Filtration – Part 27: Linear profile filters: Filtration on nominally orthogonal grid cylindrical data sets
- [75] ISO/TS 16610-29(2003)
Geometrical product specification (GPS) – Filtration – Part 29: Linear profile filters: Spline wavelets

- [76] ISO/TS 16610-30(2003)
Geometrical product specification (GPS) – Filtration – Part 30: Robust profile filters: Basic concepts
- [77] ISO/TS 16610-31(2003)
Geometrical product specification (GPS) – Filtration – Part 31: Robust profile filters: Gaussian regression filters
- [78] ISO/TS 16610-32(2003)
Geometrical product specification (GPS) – Filtration – Part 32: Robust profile filters: Spline filters
- [79] ISO/TS 16610-40(2003)
Geometrical product specification (GPS) – Filtration – Part 40: Morphological profile filters: Basic concepts
- [80] ISO/TS 16610-41(2003)
Geometrical product specification (GPS) – Filtration – Part 41: Morphological profile filters: Disk and horizontal line segment filters, 2003
- [81] ISO/TS 16610-42(2003)
Geometrical product specification (GPS) – Filtration – Part 42: Morphological profile filters: Motif filters
- [82] ISO/TS 16610-49(2003)
Geometrical product specification (GPS) – Filtration – Part 49: Morphological profile filters: Scale space techniques
- [83] ISO/TS 12180-1(2003)
ISO/TS 12180-1: Geometrical product specification (GPS) – Cylindricity – Part 1: Vocabulary and parameters of cylindricity form, 2003
- [84] ISO/TS 12180-2(2003)
ISO/TS 12180-2: Geometrical product specification (GPS) – Cylindricity – Part 2: Specification Operators, 2003
- [85] ISO/TS 12181-1(2003)
ISO/TS 12181-1: Geometrical product specification (GPS) – Roundness – Part 1: Vocabulary and parameters of roundness, 2003
- [86] ISO/TS 12181-2(2003)
ISO/TS 12181-2: Geometrical product specification (GPS) – Roundness – Part 2: Specification Operators, 2003
- [87] ISO/TS 12780-1(2003)
ISO/TS 12780-1: Geometrical product specification (GPS) – Straightness – Part 1: Vocabulary and parameters of straightness, 2003
- [88] ISO/TS 12780-2(2003)
ISO/TS 12780-2: Geometrical product specification (GPS) – Straightness – Part 2: Specification Operators, 2003
- [89] ISO/TS 12781-1(2003)
ISO/TS 12781-1: Geometrical product specification (GPS) – Flatness – Part 1: Vocabulary and parameters of flatness, 2003
- [90] ISO/TS 12781-2(2003)
ISO/TS 12781-2: Geometrical product specification (GPS) – Flatness – Part 2: Specification Operators, 2003

- [91] ISO 8015(2011)
Technical drawings-Fundamental tolerancing principles
- [92] ISO 2692(2006)
Geometrical product specifications (GPS) – Geometrical tolerancing – Maximum material requirement (MMR), least material requirement (LMR) and reciprocity requirement (RPR), 2006
- [93] ISO 1101 (2004)
Geometrical Product Specifications (GPS) -- Geometrical tolerancing -- Tolerances of form, orientation, location and run-out”; International Organisation for Standardization, 2004.
- [94] ISO, ISO/DIS 12180-2(1998)
Geometrical product specification (GPS) – Cylindricity – Part 2: Rules and procedures for the assessment of deviation from cylindrical form.
- [95] ISO, ISO 11562(1996)
Geometrical product specification (GPS)—surface texture: profile method—metrological characteristics of phase correct filters. Geneva: International Organization for Standardization
- [96] Georg Henzold(2010)
Geometrical Dimensioning and Tolerancing for Design, Manufacturing and Inspection, 2nd edition, Elsevier Ltd.
- [97] ISO 10579(1993)
Technical drawings-Dimensioning and tolerancing-Nonrigid parts.
- [98] W L Lu (2008)
“Integrated Geometry Information System for Digital Manufacturing”, Progress Report, Huddersfield, UK.
- [99] Y.Zhao, K.Ridgway& A.M.A.Al-Ahmari (2002)
Integration of CAD and a cutting tool selection system, Computers and Industrial Engineering, Vol.42, pp.17-34.
- [100] D Z Lao, Z Q Zhao(2001)
Case study of second development of AutoCAD 2000 by Object ARX, National Defence Industry Press, Beijing.
- [101] The Qinghong Computer Studio(2000)
Second development of AutoCAD. China Machine Press, Beijing
- [102] Li Changxun(2005)
Program development technology of AutoCAD ObjectARX, National Defence Industry Press, Beijing.
- [103] W L Lu, X Jiang, P J Scott and X Q Lan (2009)
‘A Host System for Form Tolerance Specification in the Next-generation GPS based on AutoCAD’, CIRP 2009 on CAT, B2-4, France.
- [104] K Wang(2004)
Form, orientation and Location tolerances. China Metrology Publishing House, Beijing.
- [105] L Blunt, et al.(1998)
The development methods for the characterization of roughness in three dimensions. Elsevier Science & Technology, United Kingdom.

- [106] *T Li* (2011)
Softgauges for Surface Texture, the University of Huddersfield, Phd thesis.
- [107] http://en.wikipedia.org/wiki/Computer-aided_technologies
- [108] http://en.wikipedia.org/wiki/Category_theory
- [109] http://en.wikipedia.org/wiki/File:Four_stroke_engine_diagram.jpg