

THE DEEP PHAEOPIGMENTS MAXIMUM IN THE OCEAN: REALITY OR ILLUSION?

A. Herbland
IFREMER
BP 1049
Nantes
France

ABSTRACT. The vertical distribution of phaeopigments in the ocean is traditionally interpreted as the result of the balance between two processes: (1) Grazing by herbivores (= production) and (2) photo-oxidation by excess of light (= degradation). If this interpretation is still correct for coastal and surface waters (e.g. spring bloom of phytoplankton and upwelled waters) there is today some evidence that the permanent (or seasonal) deep phaeopigment maximum layer in the bottom of the stratified euphotic zone (tropical and subtropical oceans) is largely overestimated. The artifact would be due to the presence of chlorophyll b which interferes with phaeopigments in the widely and routinely used acid fluorometric method for determination of Chla. The high concentration of Chlb relative to Chla at depth (and only at depth) suggests the existence, and probably the dominance, of shade adapted green algae (eukaryotes) in the deep chlorophyll maximum layer of the stratified euphotic zones. Recent direct observations and counting of cells support this hypothesis. The example in this paper shows that although they are irreplaceable, universal and simple techniques must be used with due considerations of their properties and limits when they are applied in structures where the conditions are expected to be very different from those where the method has been developed.

1. INTRODUCTION

Measurements of photosynthetic pigments have played an important role in studies of primary production in lakes and oceans. Among these pigments, chlorophyll a (Chla) was specially investigated because it is both the primary photosynthetic pigment in all oxygen evolving photosynthetic organisms (the other algal chlorophylls are considered as "accessory" or "secondary" photosynthetic pigments) and the most abundant: although Chla represents only about 1 % of the dry weight of a phytoplankton cell, in quite variable proportion (Strickland, 1965; Shuter, 1979) the concentration of Chla was and is still the best and the most practical chemical indicator of phytoplankton

13 NOV. 1995



biomass in natural samples (Cullen, 1982).

Yentsch (1965) and various authors cited by him have presented evidence that decomposition products of chlorophyll a can be present in natural-population extracts of phytoplankton, and one of the classical problems in the field of phytoplankton ecology has been to differentiate between "true" or "active" Chla and its degradation products in senescent phytoplankton and detritus.

The sequence of decomposition of Chla follows the pathways showed in Figure 1. Chla may lose the phytol (chlorophyllide a), only magnesium (Phaeophytin a or magnesium and phytol (phaeophorbide a). Prepared Chla extracts may easily be converted to magnesium-free products by the addition of acids and phytol may be removed by an enzyme, chlorophyllase. But since Chla and chlorophyllide a have identical visible absorption and fluorescence spectra, addition of acid only indicates whether the extract contains magnesium free products (phaeophorbide a and phaeophytin a) i.e. the phaeopigments.

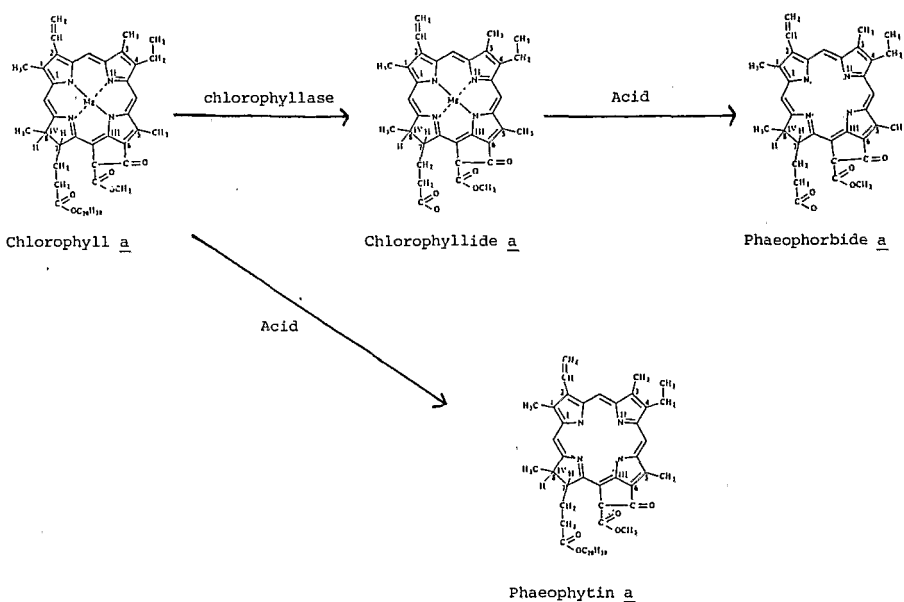

Figure 1. The principal steps in the decomposition of chlorophyll a. Phaeopigments = phaeophytin + phaeophorbide.

Accordingly a simple acidification step has been introduced to both the spectrophotometric (Lorenzen, 1967; Marker, 1972) and fluorometric (Yentsch and Menzel, 1963; Holm Hansen *et al*, 1965) techniques to help correct this source of error. In most works, it is the simple, rapid and sensitive fluorometric acidification technique which is used (Lorenzen and Jeffrey, 1980).

2. VERTICAL DISTRIBUTION OF PHAEOPIGMENTS AND THE CLASSICAL INTERPRETATION

A considerable amount of data exists on Chl_a and phaeopigment vertical distribution. In the permanent thermally stratified waters of the tropical ocean and in the seasonally stratified waters of the subtropical and temperate ocean, the vertical distribution of Chl_a and phaeopigments are closely related and show a typical pattern (Yentsch, 1965; Lorenzen, 1967; Soo-Hoo and Kiefer, 1982a and Figure 2):

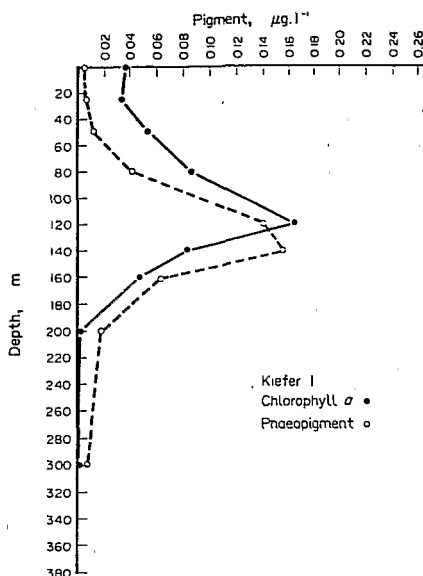

Figure 2. Vertical distribution, typical of open-ocean waters, of chlorophyll a and phaeopigments. Data are for $29^{\circ}00'00''\text{N}$ and $122^{\circ}31'12''\text{W}$. (From Soo Hoo and Kiefer, 1982).

At the surface, and in the warm, nutrient-poor mixed layer, values of Chl_a are low but phaeopigments are found at lower concentrations. Deeper down, in the deep chlorophyll maximum (DCM) generally located in the thermocline at the top of the nitracline (see the concept of Typical Tropical Structure by Herbland and Voituriez, 1979; Cullen, 1982) phaeopigments concentration increases, the maximum being reached systematically at a slightly deeper level than that of DCM. This phaeopigments decline but less than Chl_a . As a result the more or less constant percentage of phaeopigment in the mixed layer increases with depth.

2.1. How to explain such a wide-spread distribution?

Although the phaeopigments formation may result from a number pathways Chl_a degradation (bacterial and viral degradation, prolonged darkness, according to Yentsch, 1965, and nutrient deficiency according to Wolken *et al*, 1955) it is generally recognized that the most frequent fate of phytoplankton is to be grazed by herbivores, so that the primary source of chlorophyll break-down products in natural waters is in fecal materials. Currie, (1962); Lorenzen, (1967); Nemoto, (1968, 1972); Daley, (1973) and Jeffrey, (1974), all demonstrated that phaeopigments are abundant in the guts and fecal pellets of herbivorous zooplankton. Shuman and Lorenzen (1975) found a stoichiometric relationship between the ingestion of chlorophyll by grazing *Calanus* sp and the egestion of chlorophyll and phaeophorbide in fecal material.

It has also been known for a long time that phaeopigment quality is related to light : significant losses of phaeopigments were noted during photodegradation experiments by Lorenzen (1967), Moreth and Yentsch, 1970, Shuman (1978). The change in phaeopigment concentration follows a first-order decay kinetics that implies loss is proportional to the amount of radiation irrespective of exposure time.

The idea that the vertical distribution of phaeopigments represents a net result of grazing (= production of phaeopigments) and photooxidation (= destruction of phaeopigments) on short term scales in the water column was proposed by Yentsch (1965) and confirmed by Moreth and Yentsch (1970) and Lorenzen (1976).

In the former studies, most emphasis has been on copepods grazing. More recently, two papers have extended the concept to evaluate the role of microzooplankton grazing : Soo-Hoo and Kiefer (1982a, 1982b) considering the extreme small size of phaeopigment-containing particles suggested two pathways : a large particle pathway and small-particle pathway (see Figure 3a and its legend). Because feces of macrozooplankton are not quantitatively sampled by water bottles, patterns in vertical distribution of phaeopigments would result from processes affecting small particles.

In the same way, and more recently, Welschmeyer and Lorenzen (1985) constructed a model describing the dynamic budget of Chl_a and phaeopigments within the euphotic zone of two different oceanic areas (Figure 3b). The model, based on field measurements of the vertical distribution of pigments, the vertical flux of solar radiation through the water column, experimental photodegradation experiments and downwards flux of pigments provided estimates of phytoplankton growth rates and microzooplankton grazing intensity. For the North and South central Pacific gyre phytoplankton growth rates averaged 0.2 d^{-1} and 95 % of daily grazing was due to microzooplankton herbivores, and the model suggests that grazing and growth are in balance.

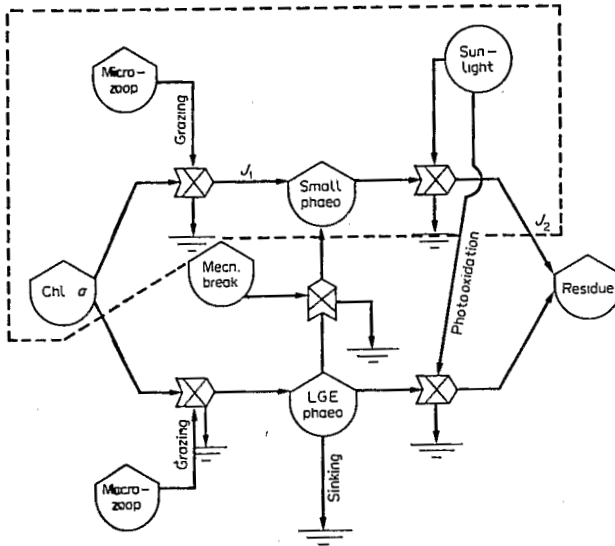

Figure 3a. Schematic representation of the major pathways of chlorophyll *a* degradation in the upper ocean. The part enclosed by the dashed lines describes the pathway attributed to microzooplankton grazing. The scheme is presented in the energy circuit language of Odum (1971).

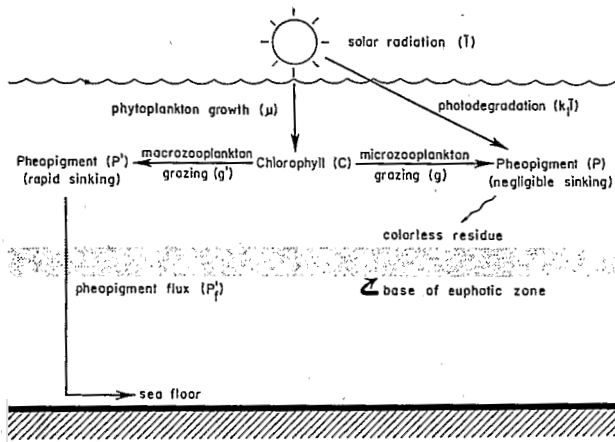

Figure 3b. Simplified diagram showing the dominant processes affecting the concentrations of chlorophyll and phaeopigments in the euphotic zone. (From Welschmeyer and Lorenzen, 1985).

To summarize, the vertical distributions of phaeopigments in the oceans and especially those in the stratified euphotic layer does not seem to raise a problem : *in situ* determinations, *in vitro* production and degradation experiments and models give, all together a coherent picture which agrees with the commonly accepted dynamics of the planktonic ecosystem. However, we shall see that there is to day some evidence that the deep phaeopigments maximum (DPM) is largely overestimated.

3. TOWARDS A NEW INTERPRETATION

3.1. Interference with chlorophyll b (Chlb)

It has been known for a long time that the fluorometric acidification techniques and specially those using filter instrument (the most commonly used) are affected to some degree by the presence of the other chlorophylls: Chlb and Chlc. Loftus and Carpenter (1971) noted that Chlb showed an acidification factor less than 1 (*i.e.* fluorescence of Chlb increases after acidification) and when Chlb is present in the extract, the decrease of fluorescence after acidification due to the phaeophytinisation of Chla is counteracted by the increase of fluorescence due to the formation of phaeophytin b. This results in a slight underestimation of Chla and calculation of significant quantities of phaeopigments even if none are present! The errors as a function of Chlc/Chla ratios are less severe than those associated with Chlb/Chla ratios.

In spite of the warning and the re-examination of the method by different authors (Holm-Hansen and Rieman, 1978; Gibbs 1979, Coveney 1982) the interference with Chlb was generally neglected because it was thought that Chlb concentrations are insignificant in the sea, particularly in the truly oceanic waters. In a study devoted to the presence of Chlb using the HPLC technique in the eastern North Pacific Ocean, Lorenzen (1981) found that although the pigment was detected in 72 % of samples, Chl(b)/Chl(a) ratios were less than 0.09 in 95 % samples. With such ratios the Chla underestimation is less than 5 % and the artificial phaeopigment /Chla ratio is less than 0.06. From the analysis of all the available data on Chlb distribution and relative abundance to Chla SOO-HOO and Kiefer (1982a) concluded : "until more data are reported as concentrations determined by separation techniques, evaluation of fluorometrically determined phaeopigments and Chla remains a consideration".

However, Jeffrey (1976) early demonstrated (with a thin layer chromatography technique), the presence of Chlb in significant proportion (ratios Chlb/Chla 0.5 at 100 m depths) in the Central North Pacific Gyre and Gieskes *et al.* (1978) found high ratios (0.2 to 0.56) for samples collected in the deep chlorophyll maximum layer of the Tropical North Atlantic. Today, more data exist and particularly on the vertical axis. Firstly, Neveux and De Billy (1986), using a modified spectrofluorometric method, have studied the distribution of

Chl_a, Chl_b, Chl_c of the Indian Ocean where oligotrophic conditions characterized most of the area. Vertical profiles showed typical DCM located at depth of 1 % of surface light. These DCM often were associated with high Chl_b/Chl_a ratio. More over, *spectrofluorometry* showed no significant increase in the percentage of phaeopigments a in the vicinity of the DCM, whereas such an increase was observed when *simultaneously using the traditional fluorometric method* : overestimations as much as 300 % of the value computed by spectrofluorometry were observed. The artifact was partially attributed to the relative abundance of Chl_b in the DCM.

To the contrary, in the upwelling region, an underestimation of phaeopigments concentration was observed, but always less than 50 %. This was related to the relative abundance of Chl_c which tends to underestimate phaeopigments (Loftus and Carpenter, 1971; Neveux, 1976).

Secondly, using reverse phase HPLC, Gieskes and Kraay (1986) have made the same observations in the stratified waters of the tropical Atlantic Ocean where a permanent DCM occurs in the bottom of the euphotic zone : At the depth of the DCM layer, Chl_b concentration was considerable (Chl_b/Chl_a ratios near 0.7) while near the surface only traces were found. They only detected traces of phaeoplytin a and phaeophorbide a with HPLC methodology in the deep samples and they concluded : "the abundance of phaeopigments measured in the conventional way near the bottom of the euphotic zone can therefore

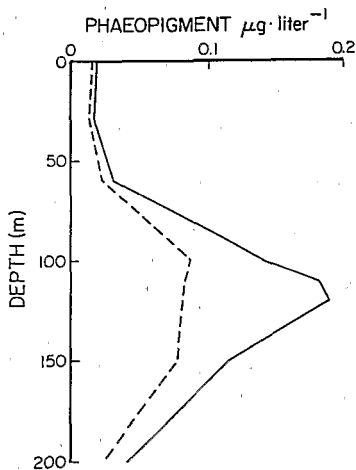

Figure 4. Vertical profile of phaeopigment concentration in tropical waters South of Hawaii. Composite profile for four stations ($n = 45$). Solid line: phaeopigments as estimated in the fluorometer; dashed lines: phaeopigment concentrations after correcting for chlorophyll b concentration in the sample. (From Vernet and Lorenzen, 1987).

not simply be used as an indicator of the presence of detritus or of grazing. *It may just be an artifact of the method used for its measurement reflecting the abundance of Chl b containing phytoplankton*".

Finally, and very recently Vernet and Lorenzen (1987), in a paper specially devoted to the problem of interference with Chlb, found consistently high concentrations of Chlb at the bottom of the euphotic zone in the tropical North Pacific Ocean (100-200 m) *but it was not detected in several samples of the mixed layer (0-60 m)*. The discrepancy between the phaeopigments concentration measured in the water column, by fluorometry and its Chlb corrected value (Figure 4) is most pronounced between 100 and 150 m, at the depth of phaeopigments maximum. If the Chlb correction, in that case, does not remove the feature, it decreases the overall concentration of phaeopigments suspended in the euphotic zone and flattens the deep phaeopigments maximum (DPM).

3.2. Field observations of Chlb containing algae

Now that there is some evidence that the DPM is largely overestimated by the presence of a Chlb rich layer, the question is : Are there field observations of vertical distribution of algae containing Chlb that support the pigment distribution? Chlb is an accessory pigment of algae belonging to the Chlorophyceae, Prasinophyceae and Euglenophyceae and is not found in other algal groups. (Jeffrey, 1976). These classes form the commonly designated "green algae". Although Allen (1961) listed green algae in records of Pacific phytoplankton, they were often regarded as being coastal and estuarine species and not present in truly oceanic waters (Butcher, 1959).

In fact, the absence of green algae in significant proportion in the stratified euphotic layer may be attributed to a lack of appropriate methodology : most of the studies devoted to the vertical distribution of phytoplankton have used the Utermöhl *settling technique* with an inverted microscope on *preserved samples*.

Recently, it has been noted that much of the photosynthetic activity and Chla of water samples (especially in oligotrophic waters) is contained in very small cells (less than few microns) which have remained largely ignored because they are so difficult to identify and count (Fogg, 1986). Because of their fragility, they are also selectively destroyed by the use of preservatives (Booth, 1987) : for example, even with the best known of preservatives (glutaraldehyde), Murphy and Haugen (1985) found that 15-20 % of the cells in prasinophytes (= green algae) cultures disintegrated immediately and another 35-40 % were lost within 8 days! It is only with the general and recent use of the epifluorescence microscopy - initially designed to count stained bacteria (Hobbie *et al.*, 1977) that it became evident that these very small phytoplankters (*i.e.* picoplankton and small nannoplankton) make a significant contribution to total phytoplankton (see for example LI *et al.* 1983; Platt *et al.* 1983).

Although the studies of the *in situ* size distribution of "Phaeopigments"-containing particles (that is Chlb - containing algae)

are less numerous than those of *Chla* containing particles, there is evidence that the small size categories dominate : Soo-Hoo and Kiefer (1982a) reported that "phaeopigments" passed through the 5 μm filter and were more usually found in particles smaller than those containing *Chla*. Herbland *et al.* (1985) found the same result in the whole equatorial Atlantic Ocean : the percentage of "Phaeopigments" was larger in the < 2 and < 1 fm fraction and the < 1 μm "Phaeopigments" showed a typical vertical pattern with a well defined maximum in the nitracline, slightly deeper than the *Chla* maximum. Are there recent reports of direct observations suggesting the presence, in significant proportions of small "green algae" in the vicinity of the DPM?

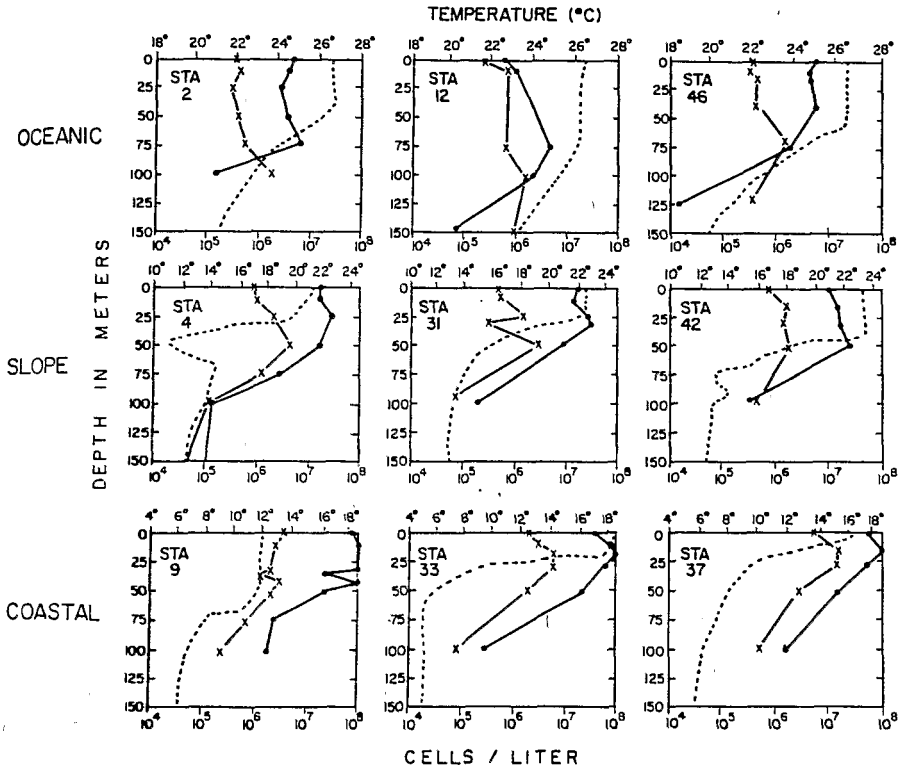

Figure 5. Comparison of the vertical distributions of cyanobacteria (o) and eucaryotes (x) in vertically stable water columns. (From Murphy and Haugen, 1985).

Murphy and Haugen (1985) compared the vertical distribution and abundance of procaryotic chroococcoid cyanobacteria and eucaryotic phototrophic ultraplankton at 50 stations in the North Atlantic. In the isothermal layer of the vertically stable waters, cyanobacteria outnumbered eucaryotes by roughly an order of magnitude (Figure 5). They reached a maximum at the thermocline at about the 1 % light level, and their abundance decreased rapidly below that. In contrast, the eucaryotic assemblage continued to increase for another 25 m (the maximum is at about the 0,5 % light level) and decreased less rapidly thereafter. Thus in the thermocline and below the eucaryotes equaled or exceeded the cyanobacteria. Glover *et al.* (1985) found similar results for the Sargasso Sea (Figure 6). Moreover, Glover *et al.*

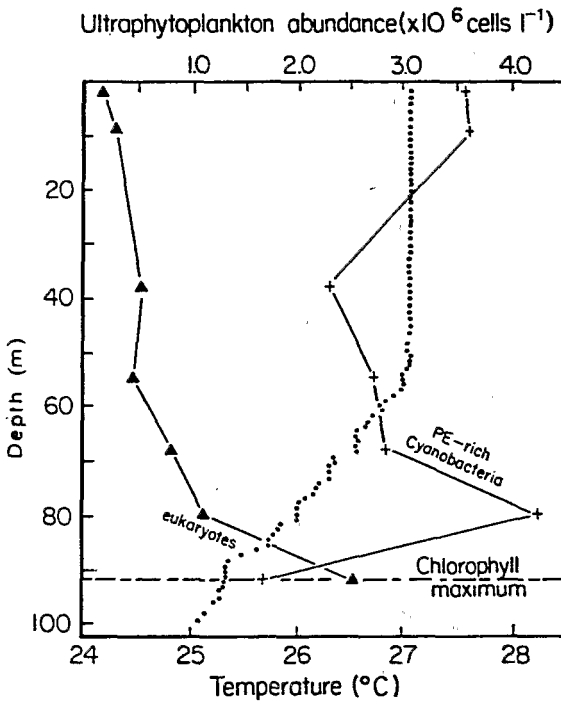

Figure 6. Depth profiles of phycoerythrin(PE)-rich *Synechococcus* (+), eukaryotic ultraplanktoners (Δ) and temperature ($^{\circ}$). Data were collected from the Sargasso Sea at $34^{\circ}49'N$, $66^{\circ}20.6'W$ in August 1983. Pump water was immediately filtered at <125 mm Hg through a $3\text{-}\mu\text{m}$ Nuclepore filter. The filtrate was passed through a $0.2\text{-}\mu\text{m}$ Nuclepore filter and cells were classified as either *Synechococcus* or eukaryotes. (From Glover *et al.*, 1985).

(1986), using photosynthesis and growth experiments with variable light quality and quantity found that eucaryotic ultraplankters have greater photosynthetic and growth efficiencies than *Synechococcus* in the dim-blue violet light occurring at the bottom of the euphotic layer (Figure 7).

Thus, the candidates for the validation of Chl_b distribution do exist, but they have been largely ignored because their smallness and fragility require new techniques of identification and counting. It remains to be unambiguously demonstrated that these small dominant eucaryotes are Chl_b containing algae.

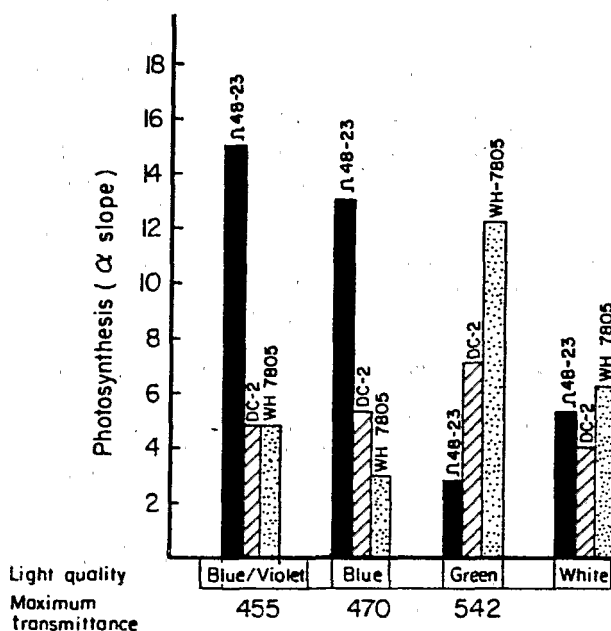

Figure 7. Photosynthetic efficiencies in different light qualities for an ultraplanktonic prasinophyte clone Ω48-23 (■). *Synechococcus* clone (DC-2 (▨) and *Synechococcus* clone WH 7805 (▩). Batch cultures were grown at 20°C, in 14/10 h light/dark cycles in blue-violet light at 1.6×10^{15} quanta $\text{cm}^{-2}\text{s}^{-1}$. In 'log-phase', we determine chlorophyll *a* concentrations²⁴ and photosynthetic rates²⁵ at four rate-limiting fluxes of blue-violet, blue, green or white light. (From Glover et al., 1986).

4. CONCLUSION

For the non-specialist, the "story of phaeopigments" may appear somewhat tedious, of limited interest, and irrelevant to the problem of biological-physical interactions in the ocean. If I concede that the matter is an affair of specialist I think on the opposite that this example concerns a general feature, with important ecological implications, including physical-biological interactions.

4.1. DPM or Chl_b layer : a general feature in the ocean

Relevante and Gilmartin (1973) and Shulenberger (1978) showed that the DCM crosses the Pacific Ocean at 28°N and that it is quasi-permanent between 40°N and 25°S in the eastern part of the Pacific. Similar observations have been made in the whole equatorial Atlantic and in the eastern part of the tropical Atlantic (Gieskes and Kraay, 1986; Herbland, 1983 and Herbland *et al.* 1985).

Accordingly, there is large amount of evidence that the DCM is a permanent feature in tropical and subtropical ocean and, if not fully explained, it is considered as a biological consequence of the presence of a thermocline in the euphotic zone (see Cullen, 1982). Although the vertical distribution of phaeopigments is less documented in the literature, it can be inferred from the available data that the DCM and DPM are often if not always, associated in the stratified euphotic zone (Figure 2). In consequence, the problem deals with about 40 % of the world ocean (or more if we take into account the seasonal thermocline in temperate waters). And if we are wrong, we are wrong at a large scale!

4.2. Physical - biological interactions : ecological consequences

It stands to reason that the vision of how the planktonic ecosystem in tropical and subtropical waters works will be different according to whether the DPM is actually a layer of detritus or a layer of active ultraplankton, perfectly adapted to the physical-chemical conditions that prevail at this level.

For example, light absorbed by Chl_b can promote photosynthesis at this depth : deep penetrating light in blue oceanic waters is near 480 nm (Jerlov, 1978 ; Morel and Prieur, 1977) ; it agrees well with *in vivo* absorption (470 nm : Yentsch and Guillard, 1969) and corrected excitation fluorescence peaks (486 nm : Neveux, 1982) of Chl_b.

The recent discovery of a deep Chl_b layer reinforces the concept of two superimposed layers of phytoplankton living in the stratified euphotic zone (Venrick, 1982) with different dominating pigments, different mean size and growth rates (Gieskes and Kraay, 1986) and probably different nutrients requirements (Fogg, 1986). It gives a new argument for the presence of a "shade flora" (Sournia, 1982), and the existence of closed interactions between physical forcing, (light spectrum) and biological response (pigments).

On the other hand, it implies that recent estimates of microzooplankton grazing from pigment budgets (Soo-Hoo and Kiefer,

1982a, Welschmeyer and Lorenzen, 1985) would be lower than previously believed for certain parts of the ocean, i.e. where a thermally stratified water column exists.)

Obviously, further investigations, with a new vision and new techniques, are necessary to complete the picture of a component of the ecosystem that may be responsible for most of the energy transformations and recycling of material taking place in the oceans (Fogg, 1986).

Three concluding remarks

1) The interference with Chl_b was neglected during 20 years principally because corrections found in surface samples were applied to deep samples. If comparison and extrapolation are two techniques which are widely used in the scientific approach, this example shows that they must be applied with care. One would make today the same mistake if we should consider that the existence of phaeopigments is doubtful in the old upwelled waters or after a spring bloom of diatoms in temperate waters. The concepts of Lorenzen (1967) relating the amount of phaeopigments to zooplankton grazing are still valid. It is only the generalization to any environmental conditions which is questionable.

2) Another cause of error is less the lack of a suitable method to detect the presence of Chl_b (as early as 1976 Jeffrey drew the attention upon the problem and wrote that thin layer chromatography was used in her laboratory as a routine method for field samples) - than the availability of a rapid, sensible and cheap method for measuring Chl_a. The attractive "easy to use" of the routine fluorometric technique has prevented the extension of more sophisticated and appropriate methods, more especially they give a smaller number of samples (quantity versus quality). However, a few profiles of precisely known different pigments in representative vertical structures far surpasses data obtained by some hundred profiles by the routine technique. Although, they are irreplaceable the *universal and simple methods should be used with due considerations of their properties and limits*. The controversy with the ¹⁴C method is an other important example of the necessity of such a caution.

3) Finally, for about 20 years (1965-1985) there was a kind of consensus (the word in vogue is "paradigm") on the phaeopigments status in the ocean: *in situ* observations, laboratory experiments and models agreed, even in case where it appears today that the presence of phaeopigments is doubtful! However, some observations (unpublished data of the author), were not, or hardly taken into account by the previous concepts: for example: how to explain the simultaneously short term increases of Chl_a and "phaeopigments" in certain low-lighted tamised cultures of natural phytoplankton of a deep chlorophyll maximum? Why use photo-oxidation properties of *in vivo* phaeopigments as an explanation for their vertical *in situ*

distribution and forget the same properties of *in vivo* chlorophyll ? These two inconsistencies are well explained by the new interpretation. Let us bet that now the old paradigm is attacked, many other unpublished contradictions will appear in the literature.

5. REFERENCES

- Allen, M.B.: 1961, 'Our knowledge of the kinds of organism in Pacific phytoplankton', *Proc. Pacif. Sci. Congr.* 10, 58-60.
- Booth, B.C.: 1987, 'The use of autofluorescence for analysing oceanic phytoplankton communities', *Bot. Marina* 30, 101-108.
- Butcher, R.W.: 1959, 'An introductory account of the smaller algae of British coastal waters. I. Introduction and chlorophyceae', *Fishery Invest.*, London (Ser. 4), 1-74.
- Coveney, M.: 1982, 'Elimination of chlorophyll b interference in the fluoremetric determination of chlorophyll a and phaeopigment a', *Arch. Hydrobiol. Beih. Ergebn. Limnol.*, 16, 77-90.
- Cullen, J.J.: 1982, 'The Deep chlorophyll Maximum : comparing vertical profiles of chlorophyll a', *Can J. Fish Aquat. Sci.* 39, 791-803.
- Currie, R.: 1962, 'Pigments in zooplankton faeces', *Nature* 193, 956-957.
- Daley, R.J.: 1973, 'Experimental characterization of lacustrine chlorophyll diagenesis : II. Bacterial, viral and herbivore grazing effects', *Archiv fur Hydrobiologie* 72, 402-439.
- Fogg, G.E.: 1986, 'Light and ultraphytoplankton', *Nature* 319, 96.
- Gibbs, C.F.: 1979, 'Chlorophyll b interference in the fluoremetric determination of chlorophyll a and phaeopigments', *Aust. J. Mar. Freshwater Res.* 30, 597-606.
- Gieskes, W.W.C., G.W. Kraay and S.B. Tijssen: 1978, 'Chlorophylls and their degradation products in the deep pigment maximum layer of the tropical North Atlantic', *Neth. J. Sea Res.* 12, 195-204.
- Gieskes, W.W. and G.W. Kraay: 1986, 'Floristic and physiological differences between the shallow and the deep nanophytoplankton community in the euphotic zone of the open tropical Atlantic revealed by HPLC analysis of pigments', *Mar. Biol.* 91, 567-576.
- Glover, H.E., A.E. Smith and L. Shapiro: 1985, 'Diurnal variations in photosynthetic rates : comparisons of ultraphytoplankton with a larger phytoplankton size fraction', *J. Plank. Res.* 7, 519-535.
- Herbland, A. and B. Voituriez: 1979, 'Hydrological structure analysis for estimating the primary production in the tropical Atlantic', *J. Mar. Res.* 37, 87-101.
- Herbland, A.: 1983, 'Le maximum de chlorophylle dans l'Atlantique tropical oriental : description, Ecologie, interpretation', *Oceanogr. Trop.* 18, 295-318.
- Herbland, A., A. Leboutteiller and P. Raimbault: 1985, 'Size structure of phytoplankton biomass in the equatorial Atlantic Ocean', *Deep Sea Res.* 32, 819-836.
- Hobbie, J.E., R.J. Daley and S. Jasper: 1977, 'Use of nucleopore filters for counting bacteria by fluorescence microscopy', *Appl. Environ. Microbiol.* 33, 1225-1228.

- Holm-Hansen, O. and B. Riemann: 1978, 'Chlorophyll a determination : improvements in methodology', *OIKOS* 30, 438-447.
- Holm-Hansen, O., C.J. Lorenzen, R.W. Holmes and J.D.H. Strickland: 1965, 'Fluoremetric determination of chlorophyll', *J. Cons. perm. Int. Explor. Mer.* 30, 3-15.
- Jeffrey, S.W.: 1974, 'Profiles of photosynthetic pigments in the ocean using thin layer chromatography', *Mar. Biol.* 26, 101-110.
- Jeffrey, S.W.: 1976, A report of green algal pigments in the Central North Pacific Ocean', *Mar. Biol.* 37, 33-37.
- Jerlov, N.G.: 1978, 'The optical classification of sea water in the euphotic zone', Rept nx 36 of the Inst. for fysik oceanografi, Kobenhauns Universitet.
- Li, W.K. and others: 1983, 'Autotrophic picoplankton in the tropical ocean', *Science* 219, 292-295.
- Loftus, M.C. and J.H. Carpenter: 1971, 'A fluoremetric method for determining chlorophylls a, b and c', *J. Mar. Res.* 29, 319-338.
- Lorenzen, C.J. and S.W. Jeffrey: 1980, 'Determination of chlorophyll in sea water', UNESCO technical papers in marine science, no. 35, 20 p.
- Lorenzen, C.J.: 1967, 'Determination of chlorophyll and phaeopigments: spectrophotometric equations', *Limnol. Oceanogr.* 12, 343-346
- Lorenzen, C.J.: 1967, 'Vertical distribution of chlorophyll and phaeopigments : Baja California', *Deep Sea Res.* 14, 735-745.
- Lorenzen, C.J.: 1976, 'Primary production in the sea', in D.H. Cushing and J.J. Walsh (eds.), *The ecology of the seas*, Saunders, London, 173-185.
- Lorenzen, C.J.: 1981, 'Chlorophyll b in the eastern North Pacific Ocean', *Deep Sea Res.* 28, 1049-1056.
- Marker, A.F.H.: 1972, 'The use of acetone and methanol in the estimation of chlorophyll in the presence of phaeophytin', *Freshwat. Biol.* 2, 361-385.
- Morel, A. et L. Prieur: 1977, 'Energie radiative disponible pour la photosynthese (PAR). Mesures du flux de photons et analyse spectrale', in B. Coste (ed.), *Campagne GUIDOME 1976, fasc. 2, Resultats des campagnes a la mer, no. 13* Publ. du GNEOX.
- Moreth, C.M. and C.S. Yentsch: 1970, 'The role of chlorophyllase and light in the decomposition of chlorophyll from marine phytoplankton', *J. exp. mar. Biol. Ecol.* 4, 238-249.
- Murphy, L.S. and E.M. Haugen: 1985, 'The distribution and abundance of phototrophic ultraplankton in the North Atlantic', *Limnol. Oceanogr.* 30, 47-58.
- Nemoto, T.: 1972, 'Chlorophyll pigments in the stomach and gut of some macrozooplankton species', in A.Y. Takenouty (ed.), *Biological Oceanography of the northern North Pacific Ocean*, Indemitsu Shoten, Tokyo, 411-418.
- Neveux, J. and G. de Billy: 1986, 'Spectrofluoremetric determination of chlorophylls and phaeophytins. Their distribution in the western part of the Indian ocean (July to August 1979)', *Deep Sea Res.* 33, 1-14.
- Neveux, J.: 1976, 'Dosage de la chlorophyll a et de la phaeophytine a par fluorimetrie', *Annales de l'Institut Oceanographique* 52, 165-174.

- Neveux, J.: 1982, 'Pigments du phytoplancton : composition et activite photochimique des chlorophylles', Signification Ecologique de la fluorescence *in vivo* de la chlorophylle a. Thse de Doctorat d'Etat, Univ. P. et M. Curie, Paris 146 p.
- Platt, T.D., V. Subbarao and B. Irwin: 1983, 'Photosynthesis of picoplankton in the oligotrophic ocean', *Nature* 301, 702-704.
- Relevante, N. and M. Gilmartin: 1973, 'Some observations on the chlorophyll maximum and primary production in the Eastern North Pacific', *Rev. ges. Hydrobiol.* 58, 819-834.
- Shulenberger, E.: 1981, 'The deep chlorophyll maximum and mesoscale environmental heterogeneity in the western half of the North Pacific Central Gyre', *Deep Sea Res.* 25, 1193-1208.
- Shuman, F.K. and C.J. Lorenzen: 1975, 'Quantitative degradation of chlorophyll by a marine herbivores', *Limnol. Oceanogr.* 2, 580-586.
- Shuman, F.K.: 1978, 'The fate of phytoplankton chlorophyll in the euphotic zone - Washington coastal waters', Ph. D. Dissertation, University of Washington, 125 pp.
- Shutter, B.: 1979, 'A model of physiological adaptation in unicellular algae', *J. Theor Biol.* 78, 519-552.
- Soo-Hoo, J.B. and D.A. Kiefer: 1982a, 'Vertical distribution of phaeopigments - I. A simple grazing and photo-oxydative scheme for small particles', *Deep Sea Res.* 29, 1539-1551.
- Soo-Hoo, J.B. and D.A. Kiefer: 1982b, 'Vertical distribution of phaeopigments. II. Rates of production and kinetics photo-oxidation', *Deep Sea Res.* 29, 1553-1563.
- Sournia, A.: 1982, 'Is there a shade flora in the marine plankton?', *J. Plank. Res.* 4, 391-399.
- Strickland, J.D.H.: 1965, 'Production of organic matter in primary stages of the marine food chain', in J.P. Rikley and G. Skirrow (eds.), *Chemical Oceanography*, Academic Press, London, pp. 447-610.
- Venrick, E.L.: 1982, 'Phytoplankton in an oligotrophic ocean : observations and questions', *Ecol. Monogr.* 52, 129-154.
- Vernet, M. And C.J. Lorenzen: 1987, 'The presence of chlorophyll b and the estimation of phaeopigments in marine phytoplankton', *J. Plank. Res.* 9, 255-265.
- Welschmeyer, N.A. and C.J. Lorenzen: 1985, 'Chlorophyll budgets : Zooplankton grazing and phytoplankton growth in a temperate fjord and the Central Pacific Gyres', *Limnol. Oceanogr.* 30, 1-21.
- Volken, J.J., A.D. Mellon and C.L. Greenblatt: 1955, 'Environmental Factors affecting growth and chlorophyll synthesis', *J. Protozool.* 2, 89-96.
- Yentsch, C.S.: 1965, 'Distribution of chlorophyll and phaeophytin in the open ocean', *Deep Sea Res.* 12, 653-666.
- Yentsch, C.S. and D.W. Menzel: 1963, 'A method for the determination of phytoplankton chlorophyll and phaeophytin by fluorescence', *Deep Sea Res.* 10, 221-231.
- Yentsch, C.S. and R.R.L. Guillard: 1969, 'The absorption of chlorophyll b *in vivo*', *Photochemistry and photobiology*, 9, 385-388.