



Open Archive Toulouse Archive Ouverte

OATAO is an open access repository that collects the work of Toulouse researchers and makes it freely available over the web where possible

This is a publisher's version published in: <https://oatao.univ-toulouse.fr/27262>

Official URL :

<https://doi.org/10.1016/j.dib.2020.106363>

To cite this version:

Prézélus, Flavie and Tiruta-Barna, Ligia and Guigui, Christelle and Remigy, Jean-Christophe *Modeling equations and dataset of model parameters for ultrafiltration membrane fabrication*. (2020) *Data in Brief*, 33. 106363. ISSN 2352-3409

Any correspondence concerning this service should be sent to the repository administrator: tech-oatao@listes-diff.inp-toulouse.fr



Data Article

Modeling equations and dataset of model parameters for ultrafiltration membrane fabrication



Flavie Prézélus^{a,b}, Ligia Tiruta-Barna^b, Christelle Guigui^b,
Jean-Christophe Remigy^{a,*}

^a Laboratoire de Génie Chimique, Université de Toulouse, CNRS, INPT, UPS, Toulouse, France

^b TBI, Université de Toulouse, CNRS, INRAE, INSA, Toulouse, France

ARTICLE INFO

Article history:

Received 8 August 2020

Revised 24 September 2020

Accepted 25 September 2020

Available online 2 October 2020

Keywords:

Process modeling

Membrane preparation

Ultrafiltration

Cellulose acetate

Life cycle assessment

Eco-design

ABSTRACT

In the related research article, entitled “A generic process modeling – LCA approach for UF membrane fabrication: Application to cellulose acetate membranes” [1], a generic model is described and used to obtain the list of material and energy flows as a function of operating conditions for ultrafiltration (UF) hollow fibers preparation by non-solvent induced phase separation. In this data article, equations of the model, a dataset of model parameters and modelled data are detailed. modeling equations are developed from material and energy balances for each unit operation (*i.e.* from polymer solution mixing to module conditioning) based on an industrial membrane fabrication process of UF cellulose acetate modules. These equations may be reused as such or adapted to other membrane materials and industrial practices. The dataset of model parameters relates to industrial on-site measurements and scientific literature for the existing cellulose-based module. The modelled data corresponds to a reference situation for which hollow fibers (inner and outer diameters equal to 0.93 mm and 1.67 mm, respectively) are fabricated from a polymer solution composition of 20 wt.% of cellulose triacetate, 78 wt.% N-methyl-2-pyrrolidone and 2 wt.% lithium chloride.

DOI of original article: [10.1016/j.memsci.2020.118594](https://doi.org/10.1016/j.memsci.2020.118594)

* Corresponding author.

E-mail address: remigy@chimie.ups-tlse.fr (J.-C. Remigy).

<https://doi.org/10.1016/j.dib.2020.106363>

2352-3409/© 2020 The Authors. Published by Elsevier Inc. This is an open access article under the CC BY license (<http://creativecommons.org/licenses/by/4.0/>)

© 2020 The Authors. Published by Elsevier Inc.
This is an open access article under the CC BY license
(<http://creativecommons.org/licenses/by/4.0/>)

Specifications Table

Subject	Chemical Engineering (General)
Specific subject area	Membrane filtration, Fabrication process
Type of data	Table, Figure, Equation, Raw data
How data were acquired	Industrial and literature data were used for model parameters, equations were developed from material and energy balances. Modelled data are obtained by applying model parameter values to the equations.
Data format	Raw, Analyzed
Parameters for data collection	Existing module (length 1.3 m, inner diameter 0.3 m) containing ultrafiltration hollow fibers (outer diameter 1.67 mm, inner diameter 0.93 mm).
Description of data collection	Industrial data relate to on-site measurements performed during a measurement campaign during an entire week (<i>i.e.</i> one batch of polymer solution, which corresponds to 10 modules), representative in terms of productivity. Flow rates, fluid temperatures and electric power of devices were measured.
Data source location	- Laboratoire de Génie Chimique, Université de Toulouse, CNRS, INPT, UPS, Toulouse, France - TBI, Université de Toulouse, CNRS, INRAE, INSA, Toulouse, France
Data accessibility	With the article
Related research article	F. Prézéus, L. Tiruta-Barna, C. Guigui, J.C. Remigy, A generic process modeling – LCA approach for UF membrane fabrication: Application to cellulose acetate membranes, <i>Journal of Membrane Science</i> , DOI: 10.1016/j.memsci.2020.118594 .

Value of the Data

- Equations and the dataset provided in this article give insight on the methodology used for model development and allow for reproducibility.
- This article helps researchers better understand how operating conditions can be considered for environmental assessment of membrane fabrication processes.
- The comprehensive detail of modeling equations and the dataset can be used to adapt the generic model to particular problems, such as other membrane materials or industrial practices.
- Industrial data on the preparation of ultrafiltration cellulose acetate membranes, often undisclosed, is given in this article.
- Flowsheets of the membrane fabrication process comprising detail on equipment are provided.

1. Experimental Design, Materials and Methods

The principles of the model development are detailed in the companion article [1]. To summarize, the generic model allows to obtain the list of material and energy flows as a function of operating conditions for ultrafiltration (UF) hollow fibers preparation by non-solvent induced phase separation. This fabrication process is modelled as a sequence of unit operations that can be divided into main steps: polymer solution and bore liquid mixing, degassing and extrusion, coagulation, rinsing, pre-conditioning, bundling, drying, module assembly, gluing, cutting, hydraulic testing and conditioning. For each unit operation, mass and energy balances carried out with model input parameters (operating conditions, engineering design facts, technical constraints and fluid properties) give consumptions per 1 m² of fabricated membrane.

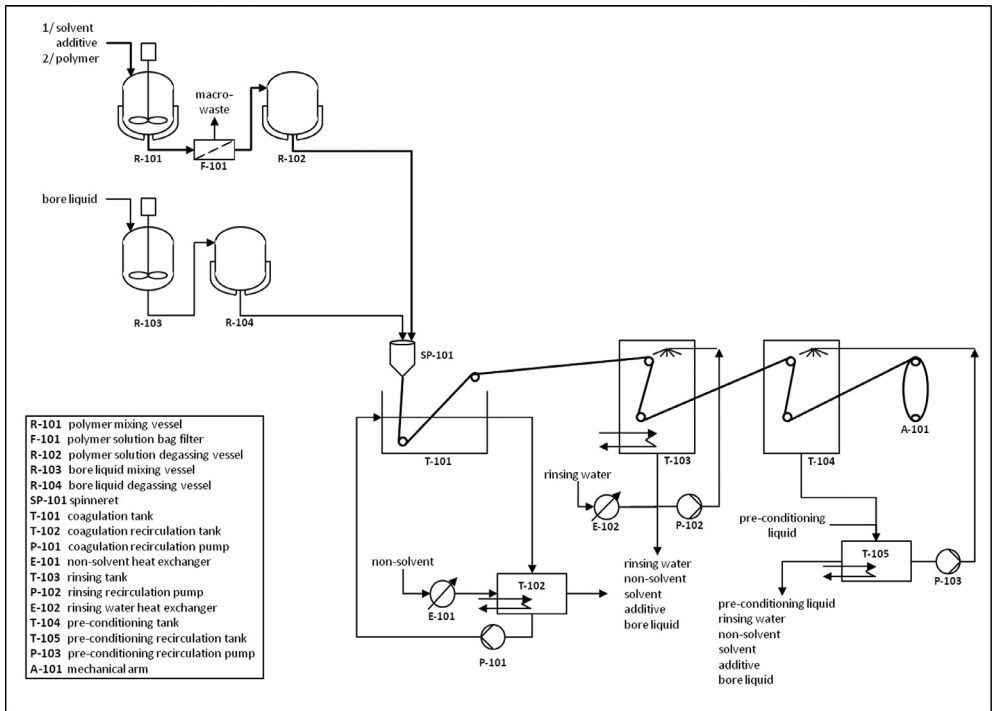

Fig. 1. Solution and hollow fiber preparation.

Flowsheets associated with the membrane fabrication process are presented in Fig. 1, and Fig. 2, as well as model assumptions in order to provide a comprehensive description of how the model equations in this article have been deduced.

1.1. Flowsheet of fabrication process

Figs. 1 and 2

1.2. General model assumptions

- A batch process is taken to model the membrane fabrication process; one polymer solution batch is the basis for the calculation of material and energy consumptions per m^2 of hollow fiber.
- Two parameters determined on the basis of a weekly production are used to calculate the production capacity (*i.e.* number of modules fabricated per polymer solution batch): number of polymer solution batches per week and number of modules fabricated per week. The production capacity is thus a variable.
- Batches follow one another without downtime, thus implying a continuous operation of the spinning chain.
- Tanks (*i.e.* coagulation, rinsing and pre-conditioning) are filled with the respective liquids at the desired temperature when spinning starts.

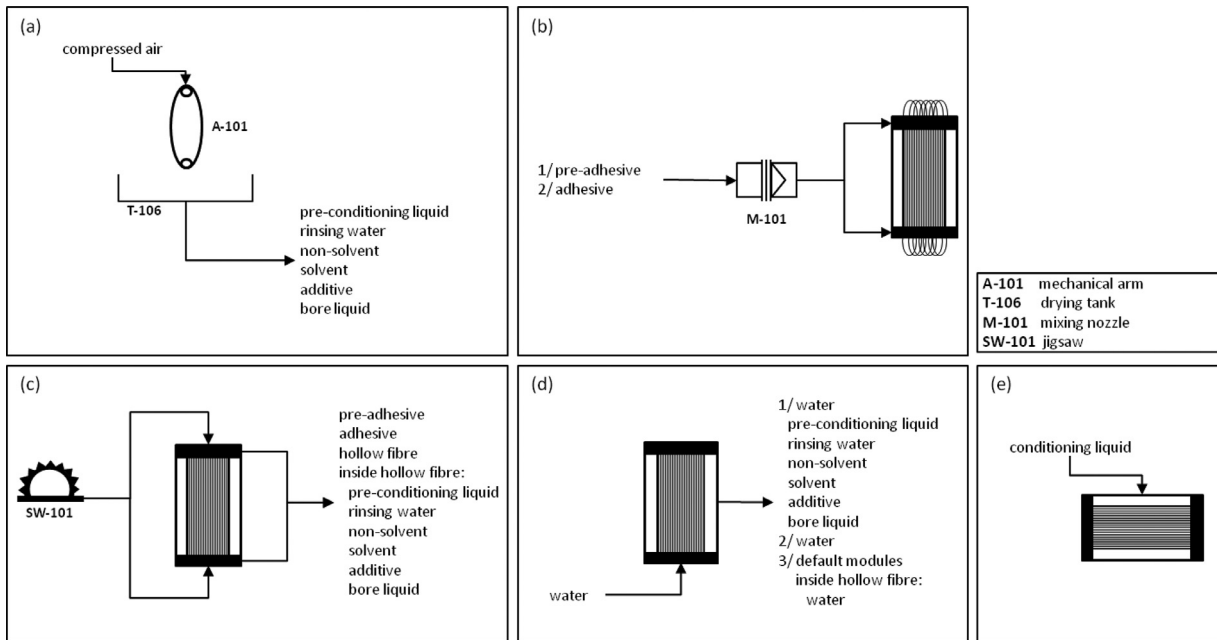

Fig. 2. Module preparation, testing and shipment preparation (a) drying, (b) gluing, (c) cutting, (d) hydraulic testing and (e) conditioning.

1.3. Model assumptions for material balance

Polymer solution and bore liquid preparation:

- Hollow fibers are composed of polymer material only.
- One batch of bore liquid is needed per batch of polymer solution.

Coagulation, rinsing and pre-conditioning:

- Tanks are modelled as continuous stirred tanks.
- Pores do not contract or expand.
- The pore volume is taken equal to the solvent volume at coagulation temperature.

Drying:

- The inside of fiber lumens is entirely emptied.

Cutting:

- All reject hollow fibers go to waste, including the liquid inside pores.

Hydraulic testing:

- Darcy's law is applied.
- Hollow fibers, adhesive and liquid included inside pores and lumens of defective modules are put to waste, whereas membrane housings, end caps, venting plugs and flanges are recycled.
- Integrity testing and quality control are neglected.

Conditioning:

- The conditioning liquid fills up the void volume between hollow fibers.

1.4. Model assumptions for energy balance

Polymer solution and bore liquid preparation:

- Constant power density dissipated by the stirrer is taken for scale-up.
- Neglected enthalpy of mixing.
- Dissipated mechanical energy from stirring.
- The global heat transfer coefficient is calculated by considering a standard Rushton vessel.

Coagulation, rinsing and pre-conditioning:

- Homogeneous temperature in the tanks are ensured by fluid recirculation.

Specific units:

- Energy consumptions of bundling, drying, gluing and cutting are not modelled.
- Neglected integrity testing and quality control.

1.5. Data collection

Values of parameters used in the below equations of material and energy balances are given in the [Section 1.5.1](#). Values of the model parameters are given: [Table 1](#) for dimensions and production, [Table 2](#) for polymer solution mixing, [Table 3](#) for bore liquid mixing, [Table 4](#) for de-gassing and extrusion, [Table 5](#) for coagulation, [Table 6](#) for rinsing, [Table 7](#) for pre-conditioning, [Table 8](#) for bundling, drying, module assembly, gluing, cutting and utilities, [Table 9](#) for hydraulic testing and [Table 10](#) for conditioning.

Table 1

Values for Module dimensions and production.

Operating conditions and/or engineering design facts				
Input parameter	Description	Unit	Literature reference	Reference situation
$\varphi_{HF,inner}$	Inner HF diameter	M	–	$9.30 \cdot 10^{-4}$
$\varphi_{HF,outer}$	Outer HF diameter	M	–	$1.67 \cdot 10^{-3}$
$\frac{\varphi_{spinneret,inner}}{\varphi_{HF,inner}}$	Ratio spinneret and HF inner diameters	–	1.5–4.4 [1], 1.1–1.4 [2]	1.1
$\frac{\varphi_{spinneret,outer}}{\varphi_{HF,outer}}$	Ratio spinneret and HF outer diameters	–	0.7–2.3 [1], 1.2–1.4 [2]	1.2
$L_{module,outer}$	Module outer length	M	–	1.3
$h_{adhesive,module}$	Adhesive height in module (both ends)	M	–	0.1
$\varphi_{module, inner}$	Module inner diameter	M	–	0.3
S_{module}	Filtration surface per module	m ²	–	55
n_{module} per week	Number of modules fabricated per week	–	–	28
n_{batch} per week	Number of PS batches fabricated per week	–	–	5

In particular, parameter values are given for the so-called reference situation, which is defined in the companion article. To summarize, the reference situation is defined as the fabrication of cellulose triacetate hollow fibers (inner and outer diameters equal to 0.93 mm and 1.67 mm, respectively) with a polymer solution composition of 20 wt.% of cellulose triacetate, 78 wt.% N-methyl-2-pyrrolidone and 2 wt.% lithium chloride.

Applying the parameter values of the reference situation to the modeling equations gives the modelled data of the reference situation, which are found in Section 1.5.2. Table 11 lists values of modelled data (other than material and energy balances), whereas Tables 12 and 13 explicit modelled data for material and energy balances, respectively, for one batch of polymer solution.

1.5.1. Model parameters

1.5.1.1. Dimensions and production. Table 1

1.5.1.2. Polymer solution mixing. Table 2

1.5.1.3. Bore liquid mixing. Table 3

1.5.1.4. Degassing and extrusion. Table 4

1.5.1.5. Coagulation. Table 5

1.5.1.6. Rinsing. Table 6

1.5.1.7. Pre-conditioning. Table 7

1.5.1.8. Bundling, drying, module assembly, gluing, cutting and utilities. Table 8

1.5.1.9. Hydraulic testing. Table 9

1.5.1.10. Conditioning. Table 10

1.5.2. Modelled data for the reference situation

Tables 11–13

Table 2

Values for the unit operation polymer solution mixing.

Operating conditions and/or engineering design facts					
Input parameter	Description	Unit	Literature reference	Suggested range	Reference situation
T_{mix}	S olvent and PS temperature during mixing	°C	70 [3], 25 [2], 70 [4]	25–70	60
T_{NS}	N S temperature during coagulation	°C	25 [5], 25–75 [2], 25 [4]	25–50	35
$W_{polymer,PS}$	Mass fraction polymer in PS	–	0.19 [5], 0.25 [2], 0.20 [4]	0.15–0.25	0.20
$W_{additive,PS}$	Mass fraction additive in PS	–	0–0.05 [6]	0–0.05	0.02 ^a
%defective module reject	Defective module reject rate after hydraulic testing	–	–	0–0.02	0.01
L_{bundle}	Bundle length during bundling	m	–	1.3–2.0	1.6
$\frac{P_{stir,solvent}}{V_{solvent}}$	Dissipated power density during solvent stirring	kW m^{-3}	0.5 ^b [7]	0–1.0	0.5
$\frac{P_{stir,PS}}{V_{PS}}$	Dissipated power density during PS stirring	kW m^{-3}	2–15 ^c [7]	2–15	15
$t_{stir,solvent}$	Stirring time for solvent	h	–	0–2	2
$t_{stir,PS}$	Stirring time for PS	h	24 [2]	20–24	22
T_{ref}	R eference temperature (e.g. of storage room)	°C	–	10–20	10

Technical constraints

Input parameter	Description	Unit	Literature reference	Suggested range	Reference situation
$EER_{air\ cooler}$	Air cooler energy efficiency ratio	–	2.5 [8]	1–5	2.5
$\eta_{compressor}$	Compressor efficiency	–	–	0.7–0.9 ^d	0.7 ^d
η_{stir}	Stirrer efficiency	–	0.7 [9]	0.7–0.9	0.7

^a Typical values for inorganic salts (e.g. LiCl). Values for polymeric additives (e.g. PEG) typically range from 0.10 to 0.15.^b Typical value for heat transfer and solid suspension for various industrial applications [7].^c Typical value in laminar regime for various industrial applications [7]: suspension polymerization 2 kW m^{-3} , gentle paste blending 5 kW m^{-3} , bulk polymerization 10–15 kW m^{-3} .^d Pump efficiency is taken.**Table 3**

Values for the unit operation bore liquid mixing.

Operating conditions and/or engineering design facts					
Input parameter	Description	Unit	Literature reference	Suggested range	Reference situation
$n_{spinneret}$	Number of spinnerets	–	–	0–10	8
$V_{spinning}$	Spinning speed	$m\ min^{-1}$	4–20 [10], 35 [2]	20–40	20.0
T_{BL}	S pinning temperature BL	°C	–	25–70	60
W_{BL1}	Mass fraction BL1 in BL	–	0 [2]	0–0.05	0.05
$\frac{P_{stir,BL}}{V_{BL}}$	Dissipated power density during BL stirring	kW m^{-3}	0.5 ^a [7]	0.5	0.5
$t_{stir,BL}$	Stirring time for BL	h	–	0–2	2

Technical constraints					
Input parameter	Description	Unit	Literature reference	Suggested range	Reference situation
η_{stir}	Stirrer efficiency	–	0.7 [9]	0.7–0.9	0.7

^a Typical value for heat transfer and solid suspension for various industrial applications [7].

Table 4

Values for the unit operation degassing and extrusion.

Operating conditions and/or engineering design facts					
Input parameter	Description	Unit	Literature reference	Suggested range	Reference situation
T_{air}	Air temperature	°C	20 [6], 25 [5]	20–25	20
$t_{degas,PS}$	PS degassing duration	H	–	19	19
$t_{degas,BL}$	BL degassing duration	H	–	0	0
$n_{filt,PS}$	Number of PS filtrations	–	2 [11]	0–2	2
Technical constraints					
Input parameter	Description	Unit	Literature reference	Suggested range	Reference situation
$x_{degas,PS}$	Thickness of PS degassing vessel	M	–	0–0.01	0.005
$x_{degas,BL}$	Thickness of BL degassing vessel	M	–	0–0.01	0.005
$\lambda_{degas,PS}$	PS vessel jacket thermal conductivity	$W m^{-1} K^{-1}$	14–16 [12]	14–16	15
$\lambda_{degas,BL}$	BL vessel jacket thermal conductivity	$W m^{-1} K^{-1}$	14–16 [12]	14–16	15
h_{air}	Convective heat transfer coefficient for air	$W m^{-2} K^{-1}$	2–25 [13]	2–25	15
$\eta_{thermal,discontinuous}$	Thermal transfer efficiency for discontinuous unit operations	–	–	0–1.0	0.15
Δh_{BL}	Total manometric head of BL pump	M	–	0–5	1 ^c
ΔP_{PS}	PS pump differential pressure	Pa	0.5–5 10^5 [1], 1 10^5 [2]	1–5 10^5	3 10^5
η_{pump}	Pump efficiency	–	0.7–0.9 [9]	0.7–0.9	0.7

Table 5

Values for the unit operation coagulation.

Operating conditions and/or engineering design facts					
Input parameter	Description	Unit	Literature reference	Suggested range	Reference situation
T_{NS}	N S temperature during coagulation	°C	25 [5], 25–75 [2], 25 [4]	25–50	35
$w_{solvent,coag}$	Mass fraction solvent in coagulation tank	–	–	0–0.05	0.03
$\frac{Q_{recirc,NS}}{Q_{input,NS}}$	Ratio NS recirculation flow: NS input flow	–	–	0–15	1.5
$\frac{Q_{input,NS}}{Q_{NS,output,coag}}$	Ratio NS input flow: NS coagulation output flow	–	–	0–100	40
Technical constraints					
Input parameter	Description	Unit	Literature reference	Suggested range	Reference situation
$\Delta h_{recirc,NS}$	Total manometric head of NS recirculation pump	M	–	0–5	1
η_{pump}	Pump efficiency	–	0.7–0.9 [9]	0.7–0.9	0.7
$\eta_{thermal,continuous}$	Thermal transfer efficiency for continuous unit operations	–	–	0–1.0	0.93

2. Data Description

modeling equations of material and energy balances and the corresponding model parameters are given. Table 11 summarises abbreviations specific to the equations. Whereas Fig. 3 illustrates geometrical dimensions of hollow fibers and the spinneret, Fig. 4 illustrates the generic

Table 6

Values for the unit operation rinsing.

Operating conditions and/or engineering design facts					
Input parameter	Description	Unit	Literature reference	Suggested range	Reference situation
$W_{\text{solvent,rins}}$	Mass fraction solvent in rinsing tank	–	–	0–0.05	0.015
T_{RW}	R W temperature during rinsing	°C	25 [5], 25–75 [2], 25 [4], 50 [3]	25–50	30
$\frac{Q_{\text{recirc RW}}}{Q_{\text{input RW}}}$	Ratio RW recirculation flow: RW input flow	–	–	0–15	10
$\frac{Q_{\text{input RW}}}{Q_{\text{RW.output rins}}}$	Ratio RW input flow: RW rinsing output flow	–	–	0–100	60
Technical constraints					
Input parameter	Description	Unit	Literature reference	Suggested range	Reference situation
$\Delta h_{\text{recirc RW}}$	Total manometric head of RW recirculation pump	M	–	0–20	10
η_{pump}	Pump efficiency	–	0.7–0.9 [9]	0.7–0.9	0.7

Table 7

Values for the unit operation pre-conditioning.

Operating conditions and/or engineering design facts					
Input parameter	Description	Unit	Literature reference	Suggested range	Reference situation
$W_{\text{solvent,precond}}$	Mass fraction solvent in pre-conditioning tank	–	–	0–0.05	0.01
W_{PRC1}	Mass fraction PRC1 in PRC	–	0.5 [2]	0–1.0	0.5
T_{PRC}	P RC temperature during pre-conditioning	°C	25 [2]	25–50	30
$\frac{Q_{\text{recirc PRC}}}{Q_{\text{input PRC}}}$	Ratio PRC recirculation flow: PRC1 input flow	–	–	0–500	350
$\frac{Q_{\text{input PRC}}}{Q_{\text{PRC.output precond}}}$	Ratio PRC input flow: PRC preconditioning output flow	–	–	0–15	5
Technical constraints					
Input parameter	Description	Unit	Literature reference	Suggested range	Reference situation
Δh_{PRC1}	Total manometric head of PRC1 pumping	M	–	0–5	1
$\Delta h_{\text{recirc PRC}}$	Total manometric head of PRC recirculation pumping	M	–	0–20	10
η_{pump}	Pump efficiency	–	0.7–0.9 [9]	0.7–0.9	0.7

module taken in the model. Table 12 lists model parameters associated with dimensions and production; Eqs. (1) to (13) are the corresponding equations.

For each unit operation of the membrane fabrication process, a figure describes its inputs and outputs, and a table lists the corresponding model parameters:

- Eqs. (14) to 29, Fig. 5 and Table 13 refer to polymer solution mixing;
- Eqs. (30) to 43, Fig. 6 and Table 14 refer to bore liquid mixing;
- Eqs. (44) to 59, Fig. 7 and Table 15 refer to degassing and extrusion;
- Eqs. (60) to 75, Fig. 8 and Table 16 refer to coagulation;
- Eqs. (76) to 92, Fig. 9 and Table 17 refer to rinsing;
- Eqs. (93) to 117, Fig. 10 and Table 18 refer to pre-conditioning;

Table 8

Values for the unit operations bundling, drying, module assembly, gluing, cutting and utilities.

Operating conditions and/or engineering design facts					
Input parameter	Description	Unit	Literature reference	Suggested range	Reference situation
L_{bundle}	Bundle length	M	–	1.3–2.0	1.6
$h_{\text{pre-adhesive, total}}$	Total pre-adhesive height (both ends)	M	–	0–0.1	0.04
$h_{\text{adhesive, total}}$	Total adhesive height (both ends)	M	–	0–0.2	0.16
$\%_{\text{defective module reject}}$	Defective module reject rate after hydraulic testing	–	–	0–0.02	0.01
n_{housing}	Number of membrane housings per module	–	–	1	1
n_{grid}	Number of grids per module	–	–	1–7	7
$n_{\text{end cap}}$	Number of end caps per module	–	–	0–2	2
$n_{\text{venting plug}}$	Number of venting plugs per module	–	–	0–2	2
n_{flange}	Number of flanges per module	–	–	0–1	1
$m_{\text{per housing}}$	Mass per membrane housing	Kg	–	0–20	14.0
$m_{\text{per grid}}$	Mass per grid	Kg	–	0–1.0	0.25
$m_{\text{per end cap}}$	Mass per end cap	Kg	–	0–1.0	0.2
$m_{\text{per venting plug}}$	Mass per venting plug	Kg	–	0–1.0	0.01
m_{flange}	Mass per flange	Kg	–	0–1.0	0.35
$W_{\text{PA1,pre-adhesive}}$	Mass fraction PA1 in pre-adhesive	–	–	0–1.0	0.30
$W_{\text{PA2,pre-adhesive}}$	Mass fraction PA2 in pre-adhesive	–	–	0–1.0	0.15
$W_{\text{A1,adhesive}}$	Mass fraction A1 in adhesive	–	–	0–1.0	0.65
P_{bundl}	Power of bundling machine	kW	–	0.1–0.2	0.14
P_{dry}	Power of compressors for drying	kW	–	0.75–1.1	0.9
P_{adh}	Power of adhesive blending and injection machine	kW	–	0.5–1.0	0.75
P_{cut}	Power of jig-saw for cutting	kW	–	4–12	8
$t_{\text{cut,module}}$	Cutting time per module	Min	–	5–15	10
P_{light}	Power of light bulbs	kW	–	5–15	10
$E_{\text{elec,heat/air cond}}$	Electricity consumption for heating and air conditioning per m^2 of spun HF	m^{-2}	–	0.30–0.50	0.40
$E_{\text{gas,heat/air cond}}$	Gas consumption for heating and air conditioning per m^2 of spun HF	m^3	–	0.04–0.08	0.06
k_{gas}	Gas conversion coefficient	kWh m^{-3}	–	9.0–12.0	11.34

Table 9

Values for the unit operation hydraulic testing.

Operating conditions and/or engineering design facts					
Input parameter	Description	Unit	Literature reference	Suggested range	Reference situation
T_{HTW}	H TW temperature during hydraulic testing	$^{\circ}\text{C}$	–	10–20	20
$\frac{V_{\text{HTW1}}}{V_{\text{pore}}}$	Ratio HTW1 vol: pore volume	–	–	0–200	120
L_p	Average module permeability	L m^{-2} h^{-1} bar^{-1}	230 [14]	230–300	230
t_{HT2}	Total hydraulic test duration	H	–	0–1.0	0.17
TMP_{HT1}	Transmembrane pressure of HT1 (rinsing)	Bar	–	0–2.0	1.0
TMP_{HT2}	Transmembrane pressure of HT2 (hydraulic test)	Bar	–	0–2.0	0.66
Technical constraints					
Input parameter	Description	Unit	Literature reference	Suggested range	Reference situation
η_{pump}	Pump efficiency	–	0.7–0.9 [9]	0.7–0.9	0.7

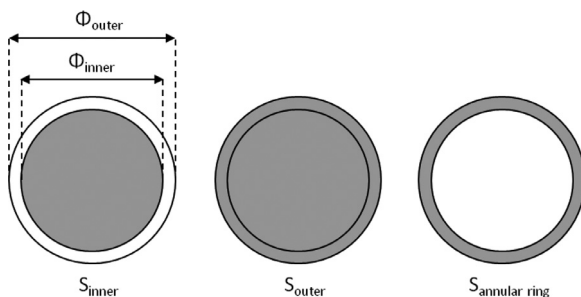

Fig. 3. Surfaces (i.e. shaded area) of an object made up of two concentric circles (e.g. hollow fiber, spinneret).

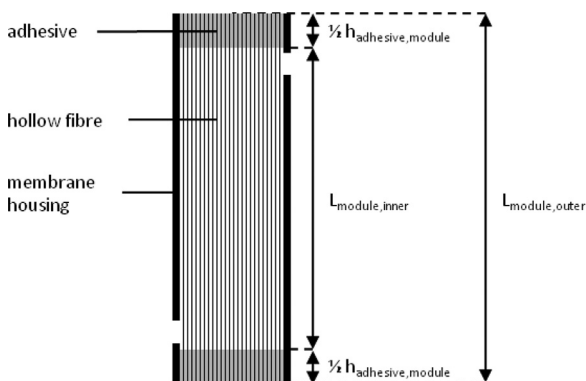

Fig. 4. Module lengths and heights.

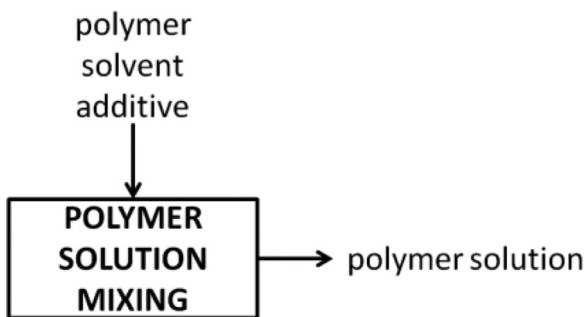

Fig. 5. Block diagram of Polymer solution mixing.

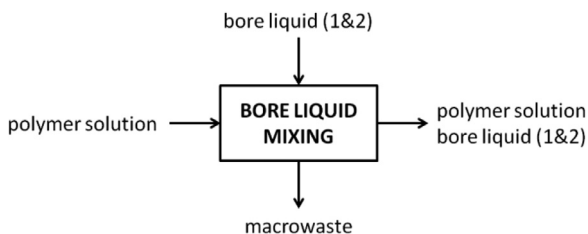

Fig. 6. Block diagram of the unit operation Bore liquid mixing.

Table 10

Values for the unit operation conditioning.

Operating conditions and/or engineering design facts					
Input parameter	Description	Unit	Literature reference	Suggested range	Reference situation
T _{CL}	C L temperature during conditioning	°C	–	10–20	20
w _{CL1}	Mass fraction CL1 in conditioning liquid	–	–	0–0.10	0.10

Table 11

Values of the modelled data (other than energy and mass balance).

Dimensions and production	
Spinneret inner diameter (m)	1.02 10 ⁻³
Spinneret outer diameter (m)	2.00 10 ⁻³
Spinneret annular ring surface (m ²)	2.33 10 ⁻⁶
Spinneret inner surface (m ²)	8.22 10 ⁻⁷
HF annular ring surface (m ²)	1.51 10 ⁻⁶
HF inner surface (m ²)	6.79 10 ⁻⁷
HF outer surface (m ²)	2.19 10 ⁻⁶
Module inner length (m)	1.20
Module inner surface (m ²)	0.07
Number HF per module	15,687.32
Module cross-section surface for adhesion (m ²)	0.04
Module volume for conditioning (m ³)	0.04
Number of modules per batch (-)	5.6
Polymer solution mixing	
Volume PS batch (m ³)	0.22
Bore liquid mixing	
PS extrusion flow (m ³ /h)	1.85 10 ⁻³
BL extrusion flow (m ³ /h)	8.26 10 ⁻⁴
Batch time (h)	15
Degassing and extrusion	
Diameter Rushton vessel for PS degassing (m)	0.7
Inner surface Rushton vessel for PS degassing (m ²)	1.3
Outer surface Rushton vessel for PS degassing (m ²)	1.4
Mean log surface Rushton vessel for PS degassing (m ²) (U.S) for PS (W/K)	1.3
Diameter Rushton vessel for BL degassing (m)	20.3
Inner surface Rushton vessel for BL degassing (m ²)	0.5
Outer surface Rushton vessel for BL degassing (m ²)	0.8
Mean log surface Rushton vessel for BL degassing (m ²) (U.S) for BL (W/K)	0.8
	11.9
Coagulation	
Volume pores+lumen during coagulation (m ³)	0.27
Density coagulation fluid (kg/m ³)	997
Rinsing	
Density rinsing fluid (kg/m ³)	995
Pre-conditioning	
Density PRC fluid in tank (kg/m ³)	1030

- Eqs. (118) to 157, Fig. 11 and Table 19 refer to bundling, drying, module assembly, gluing, cutting and utilities;
- Eqs. (158) to 162, Fig. 12 and Table 20 refer to hydraulic testing;
- Eqs. (163) to 166, Fig. 13 and Table 21 refer to conditioning;
- Eqs. (167) to 176 refer to waste.

Table 12
Values of the modelled data (mass balance for one batch of polymer solution).

Unit operation (i input, o output, w waste)	Composition	Polymer solution and bore liquid preparation		Coagulation		Rinsing			Coag & Rinsing waste
		l	i	o	wt.%	l	o	o	w liq
Material	wt%	Kg	kg	kg	wt.%	Kg	kg	wt.%	Kg
hollow fiber (HF) in inner m²	N/A	-	-	415	-	415	415	-	-
polymer (CTA)	0.20	46.4	-	-	-	-	-	-	-
solvent (NMP)	0.78	181.1	-	8.2	0.030	8.2	4.1	0.015	177.0
additive (LiCl)	0.02	4.6	-	0.2	0.001	0.2	0.1	0.000	4.5
polymer solution (PS)	N/A	-	232.2	-	-	-	-	-	-
bore fluid total	N/A	97.0	-	4.4	0.016	4.4	2.2	0.008	-
bore fluid 1 (glycerol)	0.05	4.9	-	0.2	0.001	0.2	0.1	0.000	4.7
bore fluid 2 (water)	0.95	92.2	-	4.2	0.015	4.2	2.1	0.008	90.1
coagulation non-solvent (water)	N/A	-	10 418	260.4	0.953	260.4	129.9	0.477	10 288
rinsing fluid (water)	N/A	-	-	-	-	8 179	136	0.500	8 043
pre-conditioning total	N/A	-	-	-	-	-	-	-	-
PRC1 (glycerol)	0.5	-	-	-	-	-	-	-	-
PRC2 (water)	0.5	-	-	-	-	-	-	-	-
membrane housing	N/A	-	-	-	-	-	-	-	-
Grid	N/A	-	-	-	-	-	-	-	-
end cap	N/A	-	-	-	-	-	-	-	-
venting plug	N/A	-	-	-	-	-	-	-	-
Flang	N/A	-	-	-	-	-	-	-	-
pre-adhesive 1 (resin)	0.30	-	-	-	-	-	-	-	-
pre-adhesive 2 (hardener)	0.15	-	-	-	-	-	-	-	-
pre-adhesive 3 (CaCO ₃)	0.55	-	-	-	-	-	-	-	-
adhesive 1 (resin)	0.65	-	-	-	-	-	-	-	-
adhesive 2 (hardener)	0.35	-	-	-	-	-	-	-	-
water for rinsing	N/A	-	-	-	-	-	-	-	-
water for hydraulic test	N/A	-	-	-	-	-	-	-	-
conditioning fluid total	N/A	-	-	-	-	-	-	-	-
conditioning 1 (Na bisulfite)	0.10	-	-	-	-	-	-	-	-
conditioning 2 (water)	0.90	-	-	-	-	-	-	-	-
module in units	N/A	-	-	-	-	-	-	-	-

Unit operation (i input, o output, w waste)	Pre-conditioning			Drying	Assembly & Glueing		Cutting
	l	o	o	o dry	i	o cut	w solid cut
Material	Kg	kg	wt.%	kg	kg	Kg	kg
hollow fiber (HF) in inner m²	415	415	-	415	415	337	78
polymer (CTA)	-	-	-	-	-	-	8.7
solvent (NMP)	4.1	2.8	0.010	1.8	1.8	1.5	0.3
additive (LiCl)	0.1	0.1	0.000	0.0	0.0	0.0	0.0
polymer solution (PS)	-	-	-	-	-	-	-
bore fluid total	2.2	1.5	0.005	1.0	1.0	0.8	-
bore fluid 1 (glycerol)	0.1	0.1	0.000	0.05	0.05	0.04	0.01
bore fluid 2 (water)	2.1	1.4	0.005	0.9	0.9	0.8	0.2
coagulation non-solvent (water)	129.9	89.7	0.318	58.1	58.1	47.2	10.9
rinsing fluid (water)	136.3	94.1	0.333	61.0	61.0	49.6	11.4
pre-conditioning total	470.6	94.1	0.333	61.0	61.0	49.6	-
PRC1 (glycerol)	235.3	47.1	0.167	30.5	30.5	24.8	5.7
PRC2 (water)	235.3	47.1	0.167	30.5	30.5	24.8	5.7
membrane housing	-	-	-	-	78.4	78.4	-
Grid	-	-	-	-	9.8	9.8	-
end cap	-	-	-	-	2.2	2.2	-
venting plug	-	-	-	-	0.1	0.1	-
Flang	-	-	-	-	2.0	2.0	-
pre-adhesive 1 (resin)	-	-	-	-	7.2	-	7.2
pre-adhesive 2 (hardener)	-	-	-	-	3.6	-	3.6
pre-adhesive 3 (CaCO ₃)	-	-	-	-	13.2	-	13.2
adhesive 1 (resin)	-	-	-	-	32.1	20.0	12.0
adhesive 2 (hardener)	-	-	-	-	17.3	10.8	6.5
water for rinsing	-	-	-	-	-	-	-
water for hydraulic test	-	-	-	-	-	-	-
conditioning fluid total	-	-	-	-	-	-	-
conditioning 1 (Na bisulfite)	-	-	-	-	-	-	-
conditioning 2 (water)	-	-	-	-	-	-	-
module in units	-	-	-	-	5.7	5.7	-

(continued on next page)

Table 12 (continued)

Unit operation	Hydraulic test		Preconditioning, drying, hydraulic test 1 waste		Hydraulic test 2 waste	Conditioning
	<i>l</i>	<i>o</i>	w liquid	w solid hydraulic test	w liquid	<i>i = o</i>
(i input, o output, w waste)	Kg	kg	kg	Kg	Kg	kg
hollow fiber (HF) in inner m ²	337	334	-	3	-	334
polymer (CTA)	-	-	-	0.4	-	-
solvent (NMP)	1.5	-	3.7	-	-	-
additive (LiCl)	0.0	-	0.1	-	-	-
polymer solution (PS)	-	-	0.0	-	-	-
bore fluid total	0.8	-	-	-	-	-
bore fluid 1 (glycerol)	0.04	-	0.1	-	-	-
bore fluid 2 (water)	0.8	-	1.9	-	-	-
coagulation non-solvent (water)	47.2	-	119.0	-	-	-
rinsing fluid (water)	49.6	-	124.9	-	-	-
pre-conditioning total	49.6	-	-	-	-	-
PRC1 (glycerol)	24.8	-	235.3	-	-	-
PRC2 (water)	24.8	-	235.3	-	-	-
membrane housing	78.4	78.4	-	-	-	78.4
Grid	9.8	9.8	-	-	-	9.8
end cap	2.2	2.2	-	-	-	2.2
venting plug	0.1	0.1	-	-	-	0.1
Flang	2.0	2.0	-	-	-	2.0
pre-adhesive 1 (resin)	-	-	-	-	-	-
pre-adhesive 2 (hardener)	-	-	-	-	-	-
pre-adhesive 3 (CaCO3)	-	-	-	-	-	-
adhesive 1 (resin)	20.0	19.8	-	0.2	-	19.8
adhesive 2 (hardener)	10.8	10.7	-	0.1	-	10.7
water for rinsing	17 289	-	17 086	-	-	-
water for hydraulic test	7 701	203	-	2.1	7 701	203
conditioning fluid total	-	-	-	-	-	251.9
conditioning 1 (Na bisulfite)	-	-	-	-	-	25.2
conditioning 2 (water)	-	-	-	-	-	226.7
module in units	5.7	5.6	-	-	-	5.6

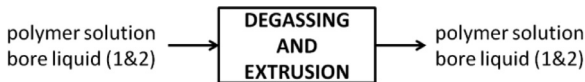

Fig. 7. Block diagram of the unit operations Degassing and extrusion.

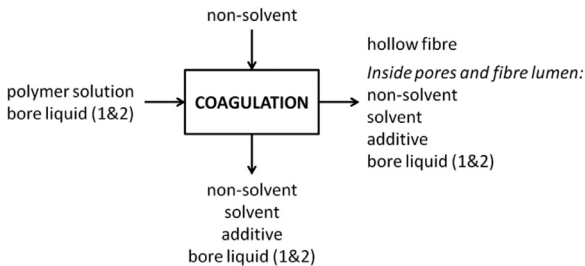

Fig. 8. Block diagram of the unit operation Coagulation.

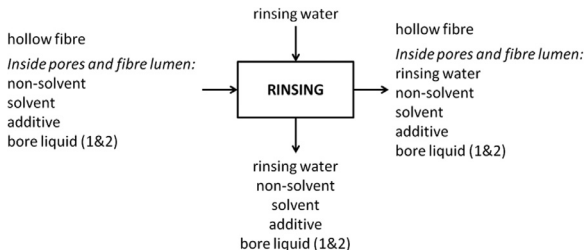

Fig. 9. Block diagram of the unit operation Rinsing.

Table 13

Values of modelled data (energy balance for one batch of polymer solution).

Parameter	mass kg	energy kWh
heat solvent	181.1	4.3
cool polymer solution	–	41.2
Degassing polymer solution	–	27.4
heat bore liquid	97.0	5.4
Degassing bore liquid	–	7.0
heat non-solvent	10 418	302.8
heat rinsing water	8 179	190.2
heat pre-conditioning 1 (glycerol)	235.3	3.2
heat loss, discontinuous	–	251.8
heat loss, input non-solvent	–	22.8
heat loss, input rinsing water	–	14.3
heat loss, input pre-conditioning 1	–	0.24

STIRRING	volume m ³	power kW	energy kWh
stir solvent + additive	0.18	0.09	0.3
stir polymer solution	0.22	3.28	103.0
stir bore liquid	0.10	0.05	0.1

PUMPING	volume m ³	mass Kg	energy kWh
pump polymer solution	0.22	N/A	5.2E-02
pump bore liquid	–	97.0	3.8E-04
recirculation pump non-solvent	–	15 627	0.06
recirculation pump rinsing water	–	81 794	3.18
pump pre-conditioning 1	–	235.3	9.2E-04
recirculation pump pre-conditioning	–	16 472	0.64
pump hydraulic test 1	17.32	–	0.69
pump hydraulic test 2	7.71	–	0.20

UTILITIES and OTHER UNIT OPERATIONS	energy kWh
Bundling	2
Drying	13
Glueing	11
Cutting	8
Lighting	148
elec: heating / air conditioning	166
gaz: heating / air conditioning	282

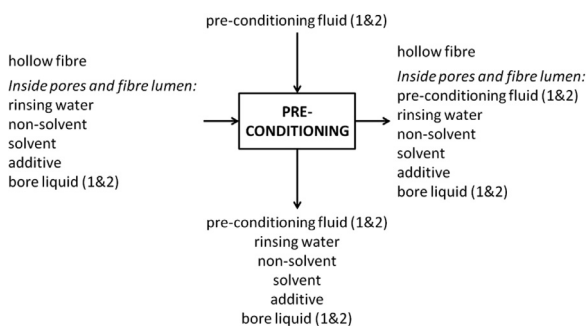
**Fig. 10.** Block diagram of the unit operation Pre-conditioning.

2.1. Modeling equations of material and energy balances

2.1.1. Abbreviations

Table 14

Table 14

Abbreviations specific to modeling equations of material and energy balances.

Fluid or compound		Unit operation	
A1	Compound 1 in adhesive	Adh	Adhesion
A2	Compound 2 in adhesive	Bundl	Bundling
BL	Bore liquid	Coag	Coagulation
BL1	Bore fluid 1 in bore liquid	Cond	Conditioning
BL2	Bore fluid 2 in bore liquid	Cut	Cutting
CL	Conditioning liquid	Degas	Degassing
CL1	Conditioning fluid 1 in conditioning liquid	Dry	Drying
CL2	Conditioning fluid 2 in conditioning liquid	Filt	Filtration
HF	Hollow fiber	Heat	Heating
HTW1	Hydraulic test water during step 1	Mix	Mixing
HTW2	Hydraulic test water during step 2	Precond	Pre-conditioning
NS	Non-solvent	Pump	Pumping
PA1	Compound 1 in pre-adhesive	Recirc	Recirculation
PA2	Compound 2 in pre-adhesive	Rins	Rinsing
PA3	Compound 3 in pre-adhesive	Spin	Spinning
PRC	Pre-conditioning liquid	Stir	Stirring
PRC1	Pre-conditioning fluid 1 in pre-conditioning liquid		
PRC2	Pre-conditioning fluid 2 in pre-conditioning liquid		
PS	Polymer solution		
RW	Rinsing water		

Calculated parameter		Unit	Calculated parameter		Unit
Cp	Specific heat capacity	$\text{kJ kg}^{-1} \text{K}^{-1}$	S	Surface	m^2
E	Energy	kWh	t	Time	h
L	Length	m	U	Global heat transfer coefficient	$\text{W m}^{-2} \text{K}^{-1}$
M	Mass	kg	V	Volume	m^3
M	Mass flow rate	kg h^{-1}	w	Mass fraction	no unit
N	Number	no unit	P	Density	kg m^{-3}
Q	Volume flow rate	$\text{m}^3 \text{h}^{-1}$	Φ	Diameter	M

Table 15

Parameters of module dimensions and production.

Operating conditions and/or engineering design facts		
Input parameter	Description	Unit
$\varphi_{\text{HF,inner}}$	Inner HF diameter	m
$\varphi_{\text{HF,outer}}$	Outer HF diameter	m
$\frac{\varphi_{\text{spinneret,inner}}}{\varphi_{\text{HF,inner}}}$	Ratio spinneret and HF inner diameters	-
$\frac{\varphi_{\text{spinneret,outer}}}{\varphi_{\text{HF,outer}}}$	Ratio spinneret and HF outer diameters	-
$L_{\text{module,outer}}$	Module outer length	m
$h_{\text{adhesive,module}}$	Adhesive height in module (both ends)	m
$\varphi_{\text{module,inner}}$	Module inner diameter	m
S_{module}	Filtration surface per module	m^2
$n_{\text{module per week}}$	Number of modules fabricated per week	-
$n_{\text{batch per week}}$	Number of PS batches fabricated per week	-

Table 16

Parameters of the unit operation polymer solution mixing.

Operating conditions and/or engineering design facts		
Input parameter	Description	Unit
T_{mix}	S olvent and PS temperature during mixing	°C
T_{NS}	N S temperature during coagulation	°C
$W_{polymer,PS}$	Mass fraction polymer in PS	-
$W_{additive,PS}$	Mass fraction additive in PS	-
%defective module reject	Defective module reject rate after hydraulic testing	-
L_{bundle}	Bundle length during bundling	m
$\frac{P_{stir,solvent}}{V_{solvent}}$	Dissipated power density during solvent stirring	$kW m^{-3}$
$\frac{P_{stir,PS}}{V_{PS}}$	Dissipated power density during PS stirring	$kW m^{-3}$
$t_{stir,solvent}$	Stirring time for solvent	h
$t_{stir,PS}$	Stirring time for PS	h
T_{ref}	Reference temperature (e.g. of storage room)	°C
Technical constraints		
Input parameter	Description	Unit
$EER_{air\ cooler}$	Air cooler energy efficiency ratio	-
$\eta_{compressor}$	Air cooler compressor efficiency	-
η_{stir}	Stirrer efficiency	-
Fluid properties		
Input parameter	Description	Unit
$\rho_{polymer,Tmix}$	Polymer density at T_{mix}	$kg m^{-3}$
$\rho_{additive,Tmix}$	Additive density at T_{mix}	$kg m^{-3}$
$\rho_{solvent,Tmix}$	Solvent density at T_{mix}	$kg m^{-3}$
$\rho_{polymer,TNS}$	Polymer density at T_{NS}	$kg m^{-3}$
$\rho_{additive,TNS}$	Additive density at T_{NS}	$kg m^{-3}$
$\rho_{solvent,TNS}$	Solvent density at T_{NS}	$kg m^{-3}$
$C_{Psolvent}$	Specific heat capacity solvent	$kJ kg^{-1} K^{-1}$

Table 17

Parameters of the unit operation bore liquid mixing.

Operating conditions and/or engineering design facts		
Input parameter	Description	Unit
$n_{spinneret}$	Number of spinnerets	-
$V_{spinning}$	Spinning speed	$m h^{-1}$
T_{BL}	S pinning temperature BL	°C
W_{BL1}	Mass fraction BL1 in BL	-
$\frac{P_{stir,BL}}{V_{BL}}$	Dissipated power density during BL stirring	$kW m^{-3}$
$t_{stir,BL}$	Stirring time for BL	h
Technical constraints		
Input parameter	Description	Unit
η_{stir}	Stirrer efficiency	-
Fluid properties		
Input parameter	Description	Unit
$\rho_{BL1,TBL}$	Density BL1 at T_{BL}	$kg m^{-3}$
$\rho_{BL2,TBL}$	Density BL2 at T_{BL}	$kg m^{-3}$
C_{PBL1}	Specific heat capacity BL1	$kJ kg^{-1} K^{-1}$
C_{PBL2}	Specific heat capacity BL2	$kJ kg^{-1} K^{-1}$

Table 18

Parameters of the unit operations degassing and extrusion.

Operating conditions and/or engineering design facts		
Input parameter	Description	Unit
T_{air}	Air temperature	°C
$t_{degas,PS}$	PS degassing duration	h
$t_{degas,BL}$	BL degassing duration	h
$n_{filt,PS}$	Number of PS filtrations	-
Technical constraints		
Input parameter	Description	Unit
$X_{degas,PS}$	Thickness of PS degassing vessel	m
$X_{degas,BL}$	Thickness of BL degassing vessel	m
$\lambda_{degas,PS}$	PS vessel jacket thermal conductivity	$W m^{-1} K^{-1}$
$\lambda_{degas,BL}$	BL vessel jacket thermal conductivity	$W m^{-1} K^{-1}$
h_{air}	Convective heat transfer coefficient for air	$W m^{-2} K^{-1}$
$\eta_{thermal,discontinuous}$	Thermal transfer efficiency for discontinuous unit operations	-
Δh_{BL}	Total manometric head of BL pump	m
ΔP_{PS}	PS pump differential pressure	Pa
η_{pump}	Pump efficiency	-

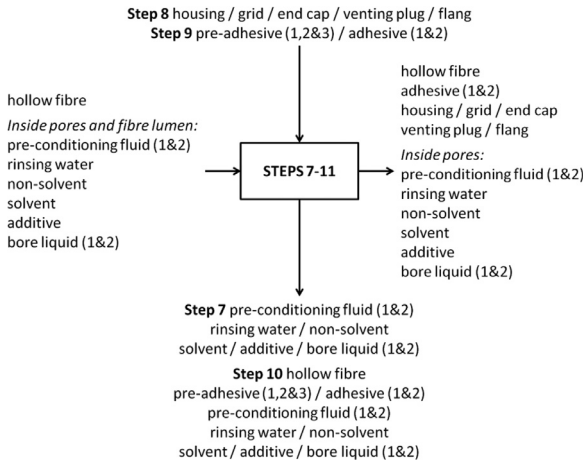
**Fig. 11.** Block diagram of the unit operations Bundling, Drying, Module assembly, Gluing, Cutting and Utilities.

2.1.2. Dimensions and production

Further consumption and waste calculations involve geometrical dimensions of modules, hollow fibers and the spinneret, which are illustrated in Fig. 3. and Fig. 4.

Spinneret diameters

$$\phi_{spinneret,inner} = \phi_{HF,inner} \cdot \frac{\phi_{spinneret,inner}}{\phi_{HF,inner}} \quad [m] \quad (1)$$

$$\phi_{spinneret,outer} = \phi_{HF,outer} \cdot \frac{\phi_{spinneret,outer}}{\phi_{HF,outer}} \quad [m] \quad (2)$$

Spinneret surfaces

$$S_{spinneret,annular\ ring} = \frac{\pi}{4} \cdot (\phi_{spinneret,outer}^2 - \phi_{spinneret,inner}^2) \quad [m^2] \quad (3)$$

Table 19
Parameters of the unit operation coagulation.

Operating conditions and/or engineering design facts		
Input parameter	Description	Unit
T_{NS}	N S temperature during coagulation	°C
$W_{solvent,coag}$	Mass fraction solvent in coagulation tank	-
$\frac{Q_{recirc,NS}}{Q_{input,NS}}$	Ratio NS recirculation flow: NS input flow	-
$\frac{Q_{input,NS}}{Q_{NS,output,coag}}$	Ratio NS input flow: NS coagulation output flow	-
Technical constraints		
Input parameter	Description	Unit
$\Delta h_{recirc,NS}$	Total manometric head of NS recirculation pump	m
η_{pump}	Pump efficiency	-
$\eta_{thermal,continuous}$	Thermal transfer efficiency for continuous unit operations	-
Fluid properties		
Input parameter	Description	Unit
$\rho_{NS,TNS}$	NS density at T_{NS}	kg m ⁻³
$\rho_{solvent,TNS}$	Solvent density at T_{NS}	kg m ⁻³
$\rho_{additive,TNS}$	Additive density at T_{NS}	kg m ⁻³
$\rho_{BL,TNS}$	BL density at T_{NS}	kg m ⁻³
$C_{Pinput,NS}$	Specific heat capacity NS	kJ kg ⁻¹ K ⁻¹

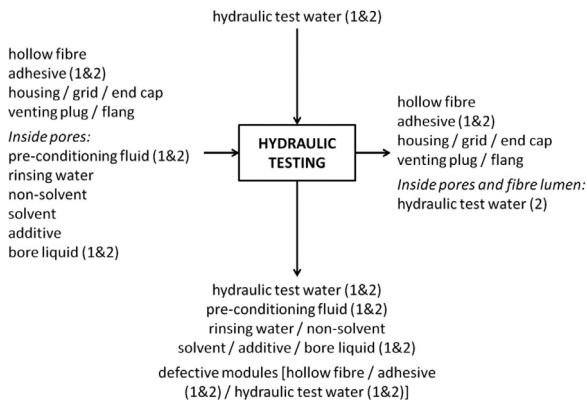

Fig. 12. Block diagram of the unit operation Hydraulic testing.

$$S_{(spinneret,inner)} = \frac{\pi}{4} \cdot \phi_{(spinneret,inner)}^2 \quad [m^2] \quad (4)$$

Hollow fiber surfaces

$$S_{HF,annular\ ring} = \frac{\pi}{4} \cdot (\phi_{HF,outer}^2 - \phi_{HF,inner}^2) \quad [m^2] \quad (5)$$

$$S_{HF,inner} = \frac{\pi}{4} \cdot \phi_{HF,inner}^2 \quad [m^2] \quad (6)$$

$$S_{HF,outer} = \frac{\pi}{4} \cdot \phi_{HF,outer}^2 \quad [m^2] \quad (7)$$

Module inner dimensions

Table 20

Parameters of the unit operation rinsing.

Operating conditions and/or engineering design facts		
Input parameter	Description	Unit
$W_{\text{solvent,rins}}$	Mass fraction solvent in rinsing tank	–
T_{RW}	R W temperature during rinsing	°C
$\frac{Q_{\text{recirc_RW}}}{Q_{\text{input_RW}}}$	Ratio RW recirculation flow: RW input flow	–
$\frac{Q_{\text{input_RW}}}{Q_{\text{RW,output_rins}}}$	Ratio RW input flow: RW rinsing output flow	–
Technical constraints		
Input parameter	Description	Unit
$\Delta h_{\text{recirc RW}}$	Total manometric head of RW recirculation pump	m
η_{pump}	Pump efficiency	–
Fluid properties		
Input parameter	Description	Unit
$\rho_{\text{RW,TRW}}$	RW density at T_{RW}	kg m^{-3}
$\rho_{\text{solvent,TRW}}$	RW density at T_{RW}	kg m^{-3}
$\rho_{\text{additive,TRW}}$	RW density at T_{RW}	kg m^{-3}
$\rho_{\text{BL,TRW}}$	RW density at T_{RW}	kg m^{-3}
$\rho_{\text{NS,TRW}}$	RW density at T_{RW}	kg m^{-3}
$C_{\text{P,input RW}}$	Specific heat capacity RW	$\text{kJ kg}^{-1} \text{K}^{-1}$

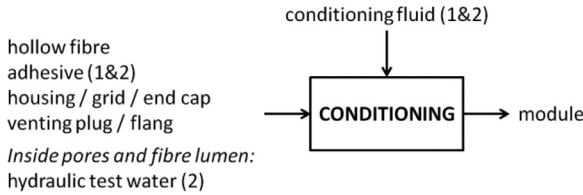
**Fig. 13.** Block diagram of the unit operation Conditioning.

$$L_{\text{module,inner}} = L_{\text{module,outer}} - h_{\text{adhesive,module}} \quad [\text{m}] \quad (8)$$

$$S_{\text{module,inner}} = \frac{\pi}{4} \cdot \phi_{\text{module,inner}}^2 \quad [\text{m}^2] \quad (9)$$

Number of hollow fibers per module

$$\eta_{\text{HF per module}} = \frac{S_{\text{module}}}{\pi \cdot \phi_{\text{HF,inner}} \cdot L_{\text{module,inner}}} \quad [\text{no unit}] \quad (10)$$

Module dimensions

The module cross-section containing adhesive ($S_{\text{module cross-section,adh}}$) and module volume filled with the conditioning liquid ($V_{\text{modul,cond}}$) are needed for consumption calculations during gluing and conditioning, respectively.

$$S_{\text{module cross-section,adh}} = S_{\text{module,inner}} - \eta_{\text{HF per module}} \cdot S_{\text{HF,outer}} \quad [\text{m}^2] \quad (11)$$

$$V_{\text{module,cond}} = L_{\text{module,inner}} \cdot S_{\text{module cross-section,adh}} \quad [\text{m}^3] \quad (12)$$

Module production capacity

Table 21
Parameters of the unit operation pre-conditioning.

Operating conditions and/or engineering design facts		
Input parameter	Description	Unit
$W_{\text{solvent,precond}}$	Mass fraction solvent in pre-conditioning tank	–
W_{PRC1}	Mass fraction PRC1 in PRC	–
T_{PRC}	PRC temperature during pre-conditioning	°C
$\frac{Q_{\text{recirc. PRC}}}{Q_{\text{input. PRC}}}$	Ratio PRC recirculation flow: PRC input flow	–
$\frac{Q_{\text{input. PRC}}}{Q_{\text{PRC.output. precond}}}$	Ratio PRC input flow: PRC preconditioning output flow	–
Technical constraints		
Input parameter	Description	Unit
Δh_{PRC1}	Total manometric head of PRC1 pumping	m
$\Delta h_{\text{recirc. PRC}}$	Total manometric head of PRC recirculation pumping	m
η_{pump}	Pump efficiency	–
Fluid properties		
Input parameter	Description	Unit
$\rho_{\text{solvent,TPRC}}$	Solvent density at T_{PRC}	kg m^{-3}
$\rho_{\text{solvent,TPRC}}$	Additive density at T_{PRC}	kg m^{-3}
$\rho_{\text{BL,TPRC}}$	BL density at T_{PRC}	kg m^{-3}
$\rho_{\text{NS,TPRC}}$	NS density at T_{PRC}	kg m^{-3}
$\rho_{\text{RW,TPRC}}$	RW density at T_{PRC}	kg m^{-3}
$\rho_{\text{PRC1,TPRC}}$	PRC1 density at T_{PRC}	kg m^{-3}
$\rho_{\text{PRC2,TPRC}}$	PRC2 density at T_{PRC}	kg m^{-3}
C_{pPRC1}	Specific heat capacity RW	$\text{kJ kg}^{-1} \text{K}^{-1}$

The production capacity is determined on the basis of the weekly production.

$$n_{\text{module per batch}} = \frac{n_{\text{module per week}}}{n_{\text{batch per week}}} \quad [\text{no unit}] \quad (13)$$

2.1.3. Polymer solution mixing

Hollow fibers are composed solely of polymer material. Polymer, additive and solvent inputs are determined with, among other model input parameters, the plant's production capacity.

Polymer solution density

$$\rho_{\text{PS,Tmix}} = \frac{1}{\frac{w_{\text{polymer,PS}}}{\rho_{\text{polymer,Tmix}}} + \frac{w_{\text{solvent,PS}}}{\rho_{\text{solvent,Tmix}}} + \frac{w_{\text{additive,PS}}}{\rho_{\text{additive,Tmix}}}} \quad [\text{kg m}^{-3}] \quad (14)$$

$$\rho_{\text{PS,TNS}} = \frac{1}{\frac{w_{\text{polymer,PS}}}{\rho_{\text{polymer,TNS}}} + \frac{w_{\text{solvent,PS}}}{\rho_{\text{solvent,TNS}}} + \frac{w_{\text{additive,PS}}}{\rho_{\text{additive,TNS}}}} \quad [\text{kg m}^{-3}] \quad (15)$$

Polymer solution mass per polymer solution batch

The boundary condition at the air – non-solvent interface during coagulation involves the conservation of polymer solution mass.

$$M_{\text{PS}} = M_{\text{HF}} \rightarrow \rho_{\text{PS,Tmix}} \cdot v_{\text{PS}} \cdot S_{\text{spinneret,annular ring}} = \rho_{\text{PS,TNS}} \cdot v_{\text{spinning}} \cdot S_{\text{HF,annular ring}} \quad [\text{kg h}^{-1}] \quad (16)$$

Eq. (16) can be expressed as Eq. (17).

$$\frac{v_{\text{PS}}}{v_{\text{spinning}}} = \frac{\rho_{\text{PS,TNS}} \cdot S_{\text{HF,annular ring}}}{\rho_{\text{PS,Tspinning}} \cdot S_{\text{spinneret,annular ring}}} \quad [\text{no unit}] \quad (17)$$

Table 22

Parameters of the unit operations bundling, drying, module assembly, gluing, cutting and utilities.

Operating conditions and/or engineering design facts		
Input parameter	Description	Unit
L_{bundle}	Bundle length	m
$h_{pre-adhesive, total}$	Total pre-adhesive height (both ends)	m
$h_{adhesive, total}$	Total adhesive height (both ends)	m
$\%defective\ module\ reject$	Defective module reject rate after hydraulic testing	-
$n_{housing}$	Number of membrane housings per module	-
n_{grid}	Number of grids per module	-
$n_{end\ cap}$	Number of end caps per module	-
$n_{venting\ plug}$	Number of venting plugs per module	-
n_{flange}	Number of flanges per module	-
$m_{per\ housing}$	Mass per membrane housing	kg
$m_{per\ grid}$	Mass per grid	kg
$m_{per\ end\ cap}$	Mass per end cap	kg
$m_{per\ venting\ plug}$	Mass per venting plug	kg
m_{flange}	Mass per flange	kg
$W_{PA1,pre-adhesive}$	Mass fraction PA1 in pre-adhesive	-
$W_{PA2,pre-adhesive}$	Mass fraction PA2 in pre-adhesive	-
$W_{A1,adhesive}$	Mass fraction A1 in adhesive	-
P_{bundl}	Power of bundling machine	kW
P_{dry}	Power of compressors for drying	kW
P_{adh}	Power of adhesive blending and injection machine	kW
P_{cut}	Power of jig-saw for cutting	kW
$t_{cut,module}$	Cutting time per module	min
P_{light}	Power of light bulbs	kW
$E_{elec,heat/air\ cond}$	Electricity consumption for heating and air conditioning per m^2 of spun HF	$kWh\ m^{-2}$
$E_{gas,heat/air\ cond}$	Gas consumption for heating and air conditioning per m^2 of spun HF	$m^3\ m^{-2}$
k_{gas}	Gas conversion coefficient	$kWh\ m^{-3}$

Fluid properties

Input parameter	Description	Unit
$\rho_{pre-adhesive}$	Pre-adhesive density at T_{ref}	$kg\ m^{-3}$
$\rho_{adhesive}$	Adhesive density at T_{ref}	$kg\ m^{-3}$

Table 23

Parameters of the unit operation hydraulic testing.

Operating conditions and/or engineering design facts		
Input parameter	Description	Unit
T_{HTW}	H TW temperature during hydraulic testing	$^{\circ}C$
$\frac{V_{HTW1}}{V_{pore}}$	Ratio HTW1 vol: pore volume	-
L_p	Average module permeability	$L\ m^{-2}\ h^{-1}\ bar^{-1}$
t_{HT2}	Total hydraulic test duration	h
TMP_{HT1}	Transmembrane pressure of HT1	Pa
TMP_{HT2}	Transmembrane pressure of HT2	Pa

Technical constraints

Input parameter	Description	Unit
η_{pump}	Pump efficiency	-

Fluid properties

Input parameter	Description	Unit
$\rho_{HTW,HTW}$	Density HTW at T_{HTW}	$kg\ m^{-3}$

Table 24
Parameters of the unit operation conditioning.

Operating conditions and/or engineering design facts		
Input parameter	Description	Unit
T _{CL}	C L temperature during conditioning	°C
W _{CL1}	Mass fraction CL1 in conditioning liquid	-
Fluid properties		
Input parameter	Description	Unit
ρ _{CL1,TCL}	Density CL1 at T _{cond}	kg m ⁻³

Polymer solution mass per polymer solution batch is calculated by converting the total fabricated length of hollow fiber into a total extruded length of polymer solution.

$$m_{\text{batch,PS}} = \frac{S_{\text{module}} \cdot n_{\text{module per batch}}}{(1 - \% \text{defective module reject})} \cdot \frac{L_{\text{module,outer}}}{L_{\text{module,inner}}} \cdot \frac{L_{\text{bundle}}}{L_{\text{module,outer}}} \cdot \frac{S_{\text{spinneret,annular ring}} \rho_{\text{PS,Tspinning}}}{\pi \phi_{\text{HF,inner}}} \cdot \frac{V_{\text{PS}}}{V_{\text{spinning}}} \quad [\text{kg}] \quad (18)$$

Eq. (18) can be simplified to Eq. (19).

$$m_{\text{batch,PS}} = \frac{S_{\text{module}} \cdot n_{\text{module per batch}}}{(1 - \% \text{defective module reject})} \cdot \frac{L_{\text{module,outer}}}{L_{\text{module,inner}}} \cdot \frac{L_{\text{bundle}}}{L_{\text{module,outer}}} \cdot \frac{S_{\text{HF,annular ring}} \rho_{\text{PS,TNS}}}{\pi \phi_{\text{HF,inner}}} \quad [\text{kg}] \quad (19)$$

Polymer solution volume per polymer solution batch

$$V_{\text{batch,PS}} = \frac{m_{\text{batch,PS}}}{\rho_{\text{PS,Tmix}}} \quad [\text{m}^3] \quad (20)$$

Input mass (i.e. polymer, solvent, additive)

$$W_{\text{solvent,PS}} = 1 - W_{\text{polymer,PS}} - W_{\text{additive,PS}} \quad [\text{no unit}] \quad (21)$$

$$m_{\text{polymer}} = W_{\text{polymer,PS}} \cdot m_{\text{batch,PS}} \quad [\text{kg}] \quad (22)$$

$$m_{\text{solvent}} = W_{\text{solvent,PS}} \cdot m_{\text{batch,PS}} \quad [\text{kg}] \quad (23)$$

$$m_{\text{additive}} = W_{\text{additive,PS}} \cdot m_{\text{batch,PS}} \quad [\text{kg}] \quad (24)$$

Energy required for solvent stirring and heating

$$E_{\text{stir,solvent}} = \frac{P_{\text{stir,solvent}}}{V_{\text{solvent}}} \cdot \left(\frac{m_{\text{solvent}}}{\rho_{\text{solvent,Tmix}}} + \frac{m_{\text{additive}}}{\rho_{\text{additive,Tmix}}} \right) \cdot \frac{t_{\text{stir,solvent}}}{\eta_{\text{stir}}} \quad [\text{kWh}] \quad (25)$$

$$E_{\text{heat,solvent}} = m_{\text{solvent}} \cdot C_{p\text{solvent}} \cdot (T_{\text{mix}} - T_{\text{ref}}) - E_{\text{stir,solvent}} \cdot \eta_{\text{stir}} \quad [\text{kWh}] \quad (26)$$

Energy required for polymer solution stirring and cooling

$$E_{\text{stir,PS}} = \frac{P_{\text{stir,PS}}}{V_{\text{PS}}} \cdot V_{\text{batch,PS}} \cdot \frac{t_{\text{stir,PS}}}{\eta_{\text{stir}}} \quad [\text{kWh}] \quad (27)$$

$$E_{\text{cool,PS}} = -E_{\text{stir,PS}} \cdot \eta_{\text{stir}} \quad [\text{kWh}] \quad (28)$$

Energy required for air cooler

Process water used to cool the polymer solution is cooled by an air cooler.

$$E_{\text{air cooler}} = -\frac{E_{\text{cool,PS}}}{\text{EER}_{\text{air cooler}} \cdot \eta_{\text{compressor}}} \quad [\text{kWh}] \quad (29)$$

2.1.4. Bore liquid mixing

One bore liquid batch is considered per polymer solution batch.

Polymer solution and bore liquid volumetric flow

The boundary condition at the air – non-solvent interface during coagulation involves the conservation of polymer solution and bore liquid masses.

$$M_{\text{PS}} = M_{\text{HF}} \rightarrow \rho_{\text{PS,Tmix}} \cdot V_{\text{PS}} \cdot S_{\text{spinneret,annular ring}} = \rho_{\text{PS,TNS}} \cdot V_{\text{spinning}} \cdot S_{\text{HF,annular ring}} \quad [\text{kg h}^{-1}] \quad (30)$$

$$M_{\text{BL}} = M_{\text{HF}} \rightarrow \rho_{\text{BL,Tspinning}} \cdot V_{\text{BL}} \cdot S_{\text{spinneret,inner}} = \rho_{\text{BL,TNS}} \cdot V_{\text{spinning}} \cdot S_{\text{HF,inner}} \quad [\text{kg h}^{-1}] \quad (31)$$

During extrusion, the polymer solution passes through the annular ring of the spinneret and the bore liquid inside the spinneret's lumen.

$$Q_{\text{PS}} = v_{\text{PS}} \cdot S_{\text{spinneret,annular ring}} \quad [\text{m}^3 \text{h}^{-1}] \quad (32)$$

$$Q_{\text{BL}} = v_{\text{BL}} \cdot S_{\text{spinneret,inner}} \quad [\text{m}^3 \text{h}^{-1}] \quad (33)$$

Eqs. (30) to (33) lead to Eqs. (34) and (33).

$$Q_{\text{PS}} = v_{\text{spinning}} \cdot S_{\text{HF,annular ring}} \cdot \frac{\rho_{\text{PS,TNS}}}{\rho_{\text{PS,Tmix}}} \quad [\text{m}^3 \text{h}^{-1}] \quad (34)$$

$$Q_{\text{BL}} = v_{\text{spinning}} \cdot S_{\text{HF,inner}} \cdot \frac{\rho_{\text{BL,TNS}}}{\rho_{\text{BL,TBL}}} \quad [\text{m}^3 \text{h}^{-1}] \quad (35)$$

Spinning time required per polymer solution batch

$$t_{\text{batch}} = \frac{V_{\text{batch,PS}}}{Q_{\text{PS}} \cdot n_{\text{spinneret}}} \quad [\text{h}] \quad (36)$$

Bore liquid input mass

$$\rho_{\text{BL,TBL}} = \frac{1}{\frac{w_{\text{BL1}}}{\rho_{\text{BL1,TBL}}} + \frac{(1-w_{\text{BL1}})}{\rho_{\text{BL2,TBL}}}} \quad [\text{kg m}^{-3}] \quad (37)$$

$$m_{\text{BL}} = \rho_{\text{BL,TBL}} \cdot Q_{\text{BL}} \cdot t_{\text{batch}} \cdot n_{\text{spinneret}} \quad [\text{kg}] \quad (38)$$

$$m_{\text{BL1}} = w_{\text{BL1}} \cdot m_{\text{BL}} \quad [\text{kg}] \quad (39)$$

$$m_{\text{BL2}} = (1 - w_{\text{BL1}}) \cdot m_{\text{BL}} \quad [\text{kg}] \quad (40)$$

Energy required for bore liquid stirring and heating

$$C_{\text{PBL}} = w_{\text{BL1}} \cdot C_{\text{PBL1}} + (1 - w_{\text{BL1}}) \cdot C_{\text{PBL2}} \quad [\text{kJ kg}^{-1}\text{K}^{-1}] \quad (41)$$

$$E_{\text{stir,BL}} = \frac{P_{\text{stir,BL}}}{V_{\text{BL}}} \cdot \frac{m_{\text{BL}}}{\rho_{\text{BL,TBL}}} \cdot \frac{t_{\text{stir,BL}}}{\eta_{\text{stir}}} \quad [\text{kWh}] \quad (42)$$

$$E_{\text{heat,BL}} = m_{\text{BL}} \cdot C_{\text{PBL}} \cdot (T_{\text{BL}} - T_{\text{ref}}) - E_{\text{stir,BL}} \cdot \eta_{\text{stir}} \quad [\text{kWh}] \quad (43)$$

2.1.5. Degassing and extrusion

Both PS and BL are degassed in separate vessels. Temperature is controlled. Both fluids are pumped to the spinneret for extrusion.

Energy required to maintain constant temperature of the polymer solution degassing vessel

Process water is used to maintain PS at the desired temperature during degassing and spinning. The heat transfer from PS to the air through the vessel's wall is compensated by process water. A standard Rushton vessel (i.e. vessel diameter equal to the liquid's height in the vessel) is considered to calculate the exchange surface.

$$\phi_{Rushton,degas PS} = \left(\frac{4 \cdot V_{batch,PS}}{\pi} \right)^{\frac{1}{3}} \quad [m] \tag{44}$$

$$S_{inner,degas PS} = \pi \cdot \phi_{Rushton,degas PS}^2 \quad [m^2] \tag{45}$$

$$S_{outer,degas PS} = \pi \cdot (\phi_{Rushton,degas PS} + 2 \cdot x_{degas PS}) \cdot \phi_{Rushton,degas PS} \quad [m^2] \tag{46}$$

$$S_{log\ mean,degas PS} = \frac{S_{inner,degas PS} - S_{outer,degas PS}}{\ln\left(\frac{S_{inner,degas PS}}{S_{outer,degas PS}}\right)} \quad [m^2] \tag{47}$$

The global heat transfer coefficient (U) considers conduction through the vessel wall's thickness and convection on the outside of the vessel, weighted by the heat exchange surfaces involved.

$$\frac{1}{(U \cdot S)_{PS}} = \frac{x_{degas PS}}{\lambda_{degas PS} \cdot S_{log\ mean,degas PS}} + \frac{1}{h_{air} \cdot S_{outer,degas PS}} \quad [K\ W^{-1}] \tag{48}$$

Eq. (48) can be expressed as Eq. (49).

$$(U \cdot S)_{PS} = \frac{1}{\left[\frac{x_{degas PS}}{\lambda_{degas PS} \cdot S_{log\ mean,degas PS}} + \frac{1}{h_{air} \cdot S_{outer,degas PS}} \right]} \quad [W\ K^{-1}] \tag{49}$$

$$E_{degas, PS} = (U \cdot S)_{PS} \cdot (T_{mix} - T_{air}) \cdot (t_{degas,PS} + t_{batch}) \quad [Wh] \tag{50}$$

Energy required to maintain constant temperature of the bore liquid degassing vessel

The same approach as for polymer solution degassing is taken for bore liquid degassing.

$$\phi_{Rushton,degas BL} = \left(\frac{4 \cdot Q_{BL} \cdot t_{batch} \cdot n_{spinneret}}{\pi} \right)^{\frac{1}{3}} \quad [m] \tag{51}$$

$$S_{(inner,degasBL)} = \pi \cdot \phi_{(Rushton,degasBL)}^2 \quad [m^2] \tag{52}$$

$$S_{outer,degas BL} = \pi \cdot (\phi_{Rushton,degas BL} + 2x_{degas BL}) \cdot \phi_{Rushton,degas BL} \quad [m^2] \tag{53}$$

$$S_{log\ mean,degas BL} = \frac{S_{inner,degas BL} - S_{outer,degas BL}}{\ln\left(\frac{S_{inner,degas BL}}{S_{outer,degas BL}}\right)} \quad [m^2] \tag{54}$$

$$(U \cdot S)_{BL} = \frac{1}{\left[\frac{x_{degas BL}}{\lambda_{degas BL} \cdot S_{log\ mean,degas BL}} + \frac{1}{h_{air} \cdot S_{outer,degas BL}} \right]} \quad [W\ K^{-1}] \tag{55}$$

$$E_{degas, BL} = (U \cdot S)_{BL} \cdot (T_{BL} - T_{air}) \cdot (t_{degas,BL} + t_{batch}) \quad [Wh] \tag{56}$$

Energy required to compensate for heat loss during polymer solution and bore liquid preparation

Heat loss $E_{heat,discontinuous}$ is calculated for polymer solution and bore liquid preparation together. It includes heat loss of the polymer solution and bore liquid during heating, stirring,

transfer, degassing and spinning.

$$E_{\text{heat loss, discontinuous}} = \frac{1 - \eta_{\text{thermal, discontinuous}}}{\eta_{\text{thermal, discontinuous}}} \cdot (E_{\text{heat, solvent}} + E_{\text{stir, solvent}} \cdot \eta_{\text{stir}} + E_{\text{heat, BL}} + E_{\text{stir, BL}} \cdot \eta_{\text{stir}} + E_{\text{degas, PS}} + E_{\text{degas, BL}}) \quad [\text{kWh}] \quad (57)$$

Energy required for bore liquid and polymer solution extrusion

$$E_{\text{pump, BL}} = \frac{m_{\text{BL}} \cdot g \cdot \Delta h_{\text{BL}}}{\eta_{\text{pump}}} \quad [\text{J}] \quad (58)$$

$$E_{\text{pump, PS}} = \frac{n_{\text{filt, PS}} \cdot V_{\text{batch, PS}} \cdot \Delta P_{\text{PS}}}{\eta_{\text{pump}}} \quad [\text{J}] \quad (59)$$

2.1.6. Coagulation

The coagulation tank is modelled as a **continuous stirred tank**. The polymer in the polymer solution coagulates whereas the solvent and additive diffuse in the non-solvent.

The volume of pores and fiber lumens remains unchanged and filled with liquid along the spinning process. The volume of pores is estimated to be equal to the volume of solvent at coagulation temperature and thus, any pore contraction or expansion is not taken into account.

Volume of fiber pores and lumen

The volume of pores is estimated to be equal to the volume of solvent at coagulation temperature (*i.e.* $\frac{m_{\text{solvent}}}{\rho_{\text{solvent, TNS}}}$). The volume of lumens is calculated from spinning conditions (speed, duration, number of spinnerets) and hollow fiber dimensions.

$$V_{\text{pores+lumen, coag}} = \frac{m_{\text{solvent}}}{\rho_{\text{solvent, TNS}}} + (S_{\text{HF, inner}} \cdot V_{\text{spinning}} \cdot t_{\text{batch}} \cdot n_{\text{spinneret}}) \quad [\text{m}^3] \quad (60)$$

Mass fraction in coagulation tank (including in hollow fiber)

Mass fractions in the coagulation tank are calculated according to the mass ratio between the solvent and chemical under consideration (*i.e.* additive or bore liquid).

$$w_{\text{additive, coag}} = w_{\text{solvent, coag}} \cdot \frac{m_{\text{additive}}}{m_{\text{solvent}}} \quad [\text{no unit}] \quad (61)$$

$$w_{\text{BL, coag}} = w_{\text{solvent, coag}} \cdot \frac{m_{\text{BL}}}{m_{\text{solvent}}} \quad [\text{no unit}] \quad (62)$$

$$w_{\text{NS, coag}} = 1 - w_{\text{solvent, coag}} - w_{\text{additive, coag}} - w_{\text{BL, coag}} \quad [\text{no unit}] \quad (63)$$

Mass inside pores and fiber lumen leaving the coagulation tank

$$\rho_{\text{coag}} = \frac{1}{\frac{w_{\text{solvent, coag}}}{\rho_{\text{solvent, TNS}}} + \frac{w_{\text{additive, coag}}}{\rho_{\text{additive, TNS}}} + \frac{w_{\text{BL, coag}}}{\rho_{\text{BL, TNS}}} + \frac{w_{\text{NS, coag}}}{\rho_{\text{NS, TNS}}}} \quad [\text{kg m}^{-3}] \quad (64)$$

Given the continuous stirred tank assumption, the mass fraction of a given chemical in fiber pores and lumen equals that in the coagulation tank.

$$m_{\text{solvent, output coag}} = w_{\text{solvent, coag}} \cdot \rho_{\text{coag}} \cdot V_{\text{pores+lumen, coag}} \quad [\text{kg}] \quad (65)$$

$$m_{\text{additive, output coag}} = w_{\text{additive, coag}} \cdot \rho_{\text{coag}} \cdot V_{\text{pores+lumen, coag}} \quad [\text{kg}] \quad (66)$$

$$m_{\text{BL, output coag}} = w_{\text{BL, coag}} \cdot \rho_{\text{coag}} \cdot V_{\text{pores+lumen, coag}} \quad [\text{kg}] \quad (67)$$

$$m_{\text{NS, output coag}} = w_{\text{NS, coag}} \cdot \rho_{\text{coag}} \cdot V_{\text{pores+lumen, coag}} \quad [\text{kg}] \quad (68)$$

$$m_{BL,output\ coag} = w_{BL1} \cdot m_{BL,output\ coag} \quad [kg] \quad (69)$$

$$m_{BL2,output\ coag} = (1 - w_{BL1}) \cdot m_{BL,output\ coag} \quad [kg] \quad (70)$$

Non-solvent mass

The factor $\frac{Q_{input\ NS}}{Q_{output\ NS,pores+lumen}}$ globally considers the convection and diffusion of the non-solvent from the coagulation tank in fiber pores and lumen.

$$m_{input\ NS} = m_{NS,output\ coag} \cdot \frac{Q_{input\ NS}}{Q_{output\ NS,pores+lumen}} \quad [kg] \quad (71)$$

Non-solvent recirculation ensures homogeneous temperature in the coagulation tank.

$$m_{recirc\ NS} = m_{input\ NS} \cdot \frac{Q_{recirc\ NS}}{Q_{input\ NS}} \quad [kg] \quad (72)$$

Energy required for non-solvent heating and pumping

$$E_{heat,input\ NS} = m_{input\ NS} \cdot C_{p,input\ NS} \cdot (T_{NS} - T_{ref}) \quad [kJ] \quad (73)$$

$$E_{heat\ loss,input\ NS} = E_{heat,input\ NS} \cdot \frac{(1 - \eta_{thermal,continuous})}{\eta_{thermal,continuous}} \quad [kJ] \quad (74)$$

$$E_{pump,recirc\ NS} = \frac{m_{recirc\ NS} \cdot g \cdot \Delta h_{recirc\ NS}}{\eta_{pump}} \quad [J] \quad (75)$$

2.1.7. Rinsing

The rinsing tank is modelled as a **continuous stirred tank**.

Mass fraction in rinsing tank (including in hollow fiber)

Mass fractions in the rinsing tank are calculated according to the mass ratio between the solvent and chemical under consideration (*i.e.* additive, bore liquid or non-solvent).

$$w_{additive,rins} = w_{solvent,rins} \cdot \frac{m_{additive,output\ coag}}{m_{solvent,output\ coag}} \quad [\text{no unit}] \quad (76)$$

$$w_{BL,rins} = w_{solvent,rins} \cdot \frac{m_{BL,output\ coag}}{m_{solvent,output\ coag}} \quad [\text{no unit}] \quad (77)$$

$$w_{NS,rins} = w_{solvent,rins} \cdot \frac{m_{NS,output\ coag}}{m_{solvent,output\ coag}} \quad [\text{no unit}] \quad (78)$$

$$w_{RW,rins} = 1 - w_{solvent,rins} - w_{additive,rins} - w_{BL,rins} - w_{NS,rins} \quad [\text{no unit}] \quad (79)$$

Mass inside pores and fiber lumen leaving the rinsing tank

$$\rho_{rins} = \frac{1}{\frac{w_{solvent,rins}}{\rho_{solvent,TRW}} + \frac{w_{additive,rins}}{\rho_{additive,TRW}} + \frac{w_{BL,rins}}{\rho_{BL,TRW}} + \frac{w_{NS,rins}}{\rho_{NS,TRW}} + \frac{w_{RW,rins}}{\rho_{RW,TRW}}} \quad [kg\ m^{-3}] \quad (80)$$

Given the continuous stirred tank assumption, the mass fraction of a given chemical in fiber pores and lumen equals that in the rinsing tank.

$$m_{solvent,output\ rins} = w_{solvent,rins} \cdot \rho_{rins} \cdot V_{pores+lumen,coag} \quad [kg] \quad (81)$$

$$m_{additive,output\ rins} = w_{additive,rins} \cdot \rho_{rins} \cdot V_{pores+lumen,coag} \quad [kg] \quad (82)$$

$$m_{BL,output\ rins} = w_{BL,rins} \cdot \rho_{rins} \cdot V_{pores+lumen,coag} \quad [kg] \quad (83)$$

$$m_{NS,output\ rins} = W_{NS,rins} \cdot \rho_{rins} \cdot V_{pores+lumen,coag} [\text{kg}] \quad (84)$$

$$m_{RW,output\ rins} = W_{RW,rins} \cdot \rho_{rins} \cdot V_{pores+lumen,coag} [\text{kg}] \quad (85)$$

$$m_{BL1,output\ rins} = W_{BL1} \cdot m_{BL,output\ rins} [\text{kg}] \quad (86)$$

$$m_{BL2,output\ rins} = (1 - W_{BL1}) \cdot m_{BL,output\ rins} [\text{kg}] \quad (87)$$

Rinsing water mass

The factor $\frac{Q_{input\ RW}}{Q_{RW,output\ rins}}$ globally considers the convection and diffusion of the rinsing water from the rinsing tank in fiber pores and lumen.

$$m_{input\ RW} = m_{RW,output\ rins} \cdot \frac{Q_{input\ RW}}{Q_{RW,output\ rins}} [\text{kg}] \quad (88)$$

Recirculation of rinsing water ensures homogeneous temperature in the rinsing tank.

$$m_{recirc\ RW} = m_{input\ RW} \cdot \frac{Q_{recirc\ RW}}{Q_{input\ RW}} [\text{kg}] \quad (89)$$

Energy required for rinsing water heating and pumping

$$E_{heat,input\ RW} = m_{input\ RW} \cdot C_{p,input\ RW} \cdot (T_{RW} - T_{ref}) [\text{kJ}] \quad (90)$$

$$E_{heat\ loss,input\ RW} = E_{heat,input\ RW} \cdot \frac{(1 - \eta_{thermal,continuous})}{\eta_{thermal,continuous}} [\text{kJ}] \quad (91)$$

$$E_{pump,recirc\ RW} = \frac{m_{recirc\ RW} \cdot g \cdot \Delta h_{recirc\ RW}}{\eta_{pump}} [\text{J}] \quad (92)$$

2.1.8. Pre-conditioning

The pre-conditioning tank is modelled as a **continuous stirred tank**.

Mass fraction in pre-conditioning tank (including in hollow fiber)

Mass fractions in the pre-conditioning tank are calculated according to the mass ratio between the solvent and chemical under consideration (*i.e.* additive, bore liquid, non-solvent or rinsing water).

$$W_{additive,precond} = W_{solvent,precond} \cdot \frac{m_{additive,output\ rins}}{m_{solvent,output\ rins}} [\text{no unit}] \quad (93)$$

$$W_{BL,precond} = W_{solvent,precond} \cdot \frac{m_{BL,output\ rins}}{m_{solvent,output\ rins}} [\text{no unit}] \quad (94)$$

$$W_{NS,precond} = W_{solvent,precond} \cdot \frac{m_{NS,output\ rins}}{m_{solvent,output\ rins}} [\text{no unit}] \quad (95)$$

$$W_{RW,precond} = W_{solvent,precond} \cdot \frac{m_{RW,output\ rins}}{m_{solvent,output\ rins}} [\text{no unit}] \quad (96)$$

$$W_{PRC,precond} = 1 - W_{solvent,precond} - W_{additive,precond} - W_{BL,precond} - W_{NS,precond} - W_{RW,precond} [\text{no unit}] \quad (97)$$

Mass inside pores and fiber lumen leaving the pre-conditioning tank

$$\rho_{PRC,TPRC} = \frac{1}{\frac{w_{PRC1}}{\rho_{PRC1,TPRC}} + \frac{(1 - w_{PRC1})}{\rho_{PRC2,TPRC}}} [\text{kg m}^{-3}] \quad (98)$$

$$\rho_{\text{precond}} = \frac{1}{\frac{w_{\text{solvent,precond}}}{\rho_{\text{solvent,TPRC}}} + \frac{w_{\text{additive,precond}}}{\rho_{\text{additive,TPRC}}} + \frac{w_{\text{BL,precond}}}{\rho_{\text{BL,TPRC}}} + \frac{w_{\text{NS,precond}}}{\rho_{\text{NS,TPRC}}} + \frac{w_{\text{RW,precond}}}{\rho_{\text{RW,TPRC}}} + \frac{w_{\text{PRC,rins}}}{\rho_{\text{RW,TPRC}}}} \quad [\text{kg m}^3] \quad (99)$$

Given the continuous stirred tank assumption, the mass fraction of a given chemical in fiber pores and lumen equals that in the pre-conditioning tank.

$$m_{\text{solvent,output precond}} = w_{\text{solvent,precond}} \cdot \rho_{\text{precond}} \cdot V_{\text{pores+lumen,coag}} \quad [\text{kg}] \quad (100)$$

$$m_{\text{additive,output precond}} = w_{\text{additive,precond}} \cdot \rho_{\text{precond}} \cdot V_{\text{pores+lumen,coag}} \quad [\text{kg}] \quad (101)$$

$$m_{\text{BL,output precond}} = w_{\text{BL,precond}} \cdot \rho_{\text{precond}} \cdot V_{\text{pores+lumen,coag}} \quad [\text{kg}] \quad (102)$$

$$m_{\text{NS,output precond}} = w_{\text{NS,precond}} \cdot \rho_{\text{precond}} \cdot V_{\text{pores+lumen,coag}} \quad [\text{kg}] \quad (103)$$

$$m_{\text{RW,output precond}} = w_{\text{RW,precond}} \cdot \rho_{\text{precond}} \cdot V_{\text{pores+lumen,coag}} \quad [\text{kg}] \quad (104)$$

$$m_{\text{PRC,output precond}} = w_{\text{PRC,precond}} \cdot \rho_{\text{precond}} \cdot V_{\text{pores+lumen,coag}} \quad [\text{kg}] \quad (105)$$

$$m_{\text{BL1,output precond}} = w_{\text{BL1}} \cdot m_{\text{BL,output precond}} \quad [\text{kg}] \quad (106)$$

$$m_{\text{BL2,output precond}} = (1 - w_{\text{BL1}}) \cdot m_{\text{BL,output precond}} \quad [\text{kg}] \quad (107)$$

$$m_{\text{PRC1,output precond}} = w_{\text{PRC1}} \cdot m_{\text{PRC,output precond}} \quad [\text{kg}] \quad (108)$$

$$m_{\text{PRC2,output precond}} = (1 - w_{\text{PRC1}}) \cdot m_{\text{PRC,output precond}} \quad [\text{kg}] \quad (109)$$

Pre-conditioning fluid mass

The factor $\frac{Q_{\text{input PRC}}}{Q_{\text{PRC,output precond}}}$ globally considers the convection and diffusion of the pre-conditioning fluid from the pre-conditioning tank in fiber pores and lumen.

$$m_{\text{input PRC}} = m_{\text{PRC,output precond}} \cdot \frac{Q_{\text{input PRC}}}{Q_{\text{PRC,output precond}}} \quad [\text{kg}] \quad (110)$$

$$m_{\text{input PRC1}} = w_{\text{PRC1}} \cdot m_{\text{input PRC}} \quad [\text{kg}] \quad (111)$$

$$m_{\text{input PRC2}} = (1 - w_{\text{PRC1}}) \cdot m_{\text{input PRC}} \quad [\text{kg}] \quad (112)$$

Recirculation of the pre-conditioning fluid ensures homogeneous temperature in the pre-conditioning tank.

$$m_{\text{recirc PRC}} = m_{\text{input PRC}} \cdot \frac{Q_{\text{recirc PRC}}}{Q_{\text{input PRC}}} \quad [\text{kg}] \quad (113)$$

Energy required for pre-conditioning fluid heating and pumping

$$E_{\text{heat,PRC1}} = m_{\text{PRC1,output precond}} \cdot C_{\text{P,PRC1}} \cdot (T_{\text{PRC}} - T_{\text{ref}}) \quad [\text{kJ}] \quad (114)$$

$$E_{\text{heat loss,PRC1}} = E_{\text{heat,PRC1}} \cdot \frac{(1 - \eta_{\text{thermal,continuous}})}{\eta_{\text{thermal,continuous}}} \quad [\text{kJ}] \quad (115)$$

$$E_{\text{pump,PRC1}} = \frac{m_{\text{PRC1,output precondition}} \cdot g \cdot \Delta h_{\text{PRC1}}}{\eta_{\text{pump}}} \quad [\text{kJ}] \quad (116)$$

$$E_{\text{pump,recirc PRC}} = \frac{m_{\text{recirc PRC}} \cdot g \cdot \Delta h_{\text{recirc PRC}}}{\eta_{\text{pump}}} \quad [\text{kJ}] \quad (117)$$

2.1.9. Bundling, drying, module assembly, gluing, cutting and utilities

During drying, fiber lumens are completely emptied. Pores remain filled with the pre-conditioning liquid. During cutting, liquid inside pores of reject hollow fibers goes to waste with the hollow fibers. The pre-adhesive and adhesive are made up of 3 and 2 compounds respectively. Utilities accounted for are the facility's lighting, heating and air conditioning.

Input mass (i.e. pre-adhesive, adhesive)

Pre-adhesive and adhesive input masses are calculated based on the total fabricated modules (including reject modules after hydraulic testing).

$$m_{\text{pre-adhesive}} = \rho_{\text{pre-adhesive}} \cdot S_{\text{module inner}} \cdot h_{\text{pre-adhesive,total}} \cdot \frac{n_{\text{module per batch}}}{1 - \% \text{defective module reject}} \quad [\text{kg}] \quad (118)$$

$$m_{\text{adhesive}} = \rho_{\text{adhesive}} \cdot S_{\text{module cross-section,adh}} \cdot h_{\text{adhesive,total}} \cdot \frac{n_{\text{module per batch}}}{1 - \% \text{defective module reject}} \quad [\text{kg}] \quad (119)$$

$$W_{\text{PA3,pre-adhesive}} = 1 - W_{\text{PA1,pre-adhesive}} - W_{\text{PA2,pre-adhesive}} \quad [\text{no unit}] \quad (120)$$

$$m_{\text{PA1,pre-adhesive}} = W_{\text{PA1,pre-adhesive}} \cdot m_{\text{pre-adhesive}} \quad [\text{kg}] \quad (121)$$

$$m_{\text{PA2,pre-adhesive}} = W_{\text{PA2,pre-adhesive}} \cdot m_{\text{pre-adhesive}} \quad [\text{kg}] \quad (122)$$

$$m_{\text{PA3,pre-adhesive}} = (1 - W_{\text{PA1,pre-adhesive}} - W_{\text{PA2,pre-adhesive}}) \cdot m_{\text{pre-adhesive}} \quad [\text{kg}] \quad (123)$$

$$m_{\text{A1,adhesive}} = w_{\text{A1,adhesive}} \cdot m_{\text{adhesive}} \quad [\text{kg}] \quad (124)$$

$$m_{\text{A2,adhesive}} = (1 - w_{\text{A1,adhesive}}) \cdot m_{\text{adhesive}} \quad [\text{kg}] \quad (125)$$

Input mass of module components

Since module components of reject modules are recycled, their respective input mass are calculated based on the module production capacity (i.e. $n_{\text{module per batch}}$).

$$m_{\text{housing}} = n_{\text{housing}} \cdot m_{\text{per housing}} \cdot n_{\text{module per batch}} \quad [\text{kg}] \quad (126)$$

$$m_{\text{grid}} = n_{\text{grid}} \cdot m_{\text{per grid}} \cdot n_{\text{module per batch}} \quad [\text{kg}] \quad (127)$$

$$m_{\text{end cap}} = n_{\text{end cap}} \cdot m_{\text{per end cap}} \cdot n_{\text{module per batch}} \quad [\text{kg}] \quad (128)$$

$$m_{\text{venting plus}} = n_{\text{venting plug}} \cdot m_{\text{per venting plus}} \cdot n_{\text{module per batch}} \quad [\text{kg}] \quad (129)$$

$$m_{\text{flange}} = n_{\text{flange}} \cdot m_{\text{per flange}} \cdot n_{\text{module per batch}} \quad [\text{kg}] \quad (130)$$

Mass inside pores and fiber lumen after drying

A material balance is carried out for each chemical under consideration during the drying operation (i.e. solvent, additive, bore liquid, non-solvent, rinsing water, pre-conditioning fluid).

$$m_{\text{solvent,output dry}} = m_{\text{solvent,output precondition}} \cdot \frac{m_{\text{solvent}}}{\rho_{\text{solvent,TNS}} \cdot V_{\text{pores+lumen,coag}}} \quad [\text{kg}] \quad (131)$$

$$m_{\text{additive,output dry}} = m_{\text{additive,output precondition}} \cdot \frac{m_{\text{solvent}}}{\rho_{\text{solvent,TNS}} \cdot V_{\text{pores+lumen,coag}}} \quad [\text{kg}] \quad (132)$$

$$m_{BL,output\ dry} = m_{BL,output\ precond} \cdot \frac{m_{solvent}}{\rho_{solvent,TNS} \cdot V_{pores+lumen,coag}} \quad [kg] \quad (133)$$

$$m_{NS,output\ dry} = m_{NS,output\ precond} \cdot \frac{m_{solvent}}{\rho_{solvent,TNS} \cdot V_{pores+lumen,coag}} \quad [kg] \quad (134)$$

$$m_{RW,output\ dry} = m_{RW,output\ precond} \cdot \frac{m_{solvent}}{\rho_{solvent,TNS} \cdot V_{pores+lumen,coag}} \quad [kg] \quad (135)$$

$$m_{PRC,output\ dry} = m_{PRC,output\ precond} \cdot \frac{m_{solvent}}{\rho_{solvent,TNS} \cdot V_{pores+lumen,coag}} \quad [kg] \quad (136)$$

$$m_{BL1,output\ dry} = w_{BL1} \cdot m_{BL,output\ dry} \quad [kg] \quad (137)$$

$$m_{BL2,output\ dry} = (1 - w_{BL1}) \cdot m_{BL,output\ dry} \quad [kg] \quad (138)$$

$$m_{PRC1,output\ dry} = w_{PRC1} \cdot m_{PRC,output\ dry} \quad [kg] \quad (139)$$

$$m_{PRC2,output\ dry} = (1 - w_{PRC1}) \cdot m_{PRC,output\ dry} \quad [kg] \quad (140)$$

Mass inside pores and fiber lumen after cutting

A material balance is carried out for each chemical under consideration during the cutting operation (*i.e.* solvent, additive, bore liquid, non-solvent, rinsing water, pre-conditioning fluid).

$$m_{solvent,output\ cut} = m_{solvent,output\ dry} \cdot \frac{L_{module,outer}}{L_{bundle}} \quad [kg] \quad (141)$$

$$m_{additive,output\ cut} = m_{additive,output\ dry} \cdot \frac{L_{module,outer}}{L_{bundle}} \quad [kg] \quad (142)$$

$$m_{BL,output\ cut} = m_{BL,output\ dry} \cdot \frac{L_{module,outer}}{L_{bundle}} \quad [kg] \quad (143)$$

$$m_{NS,output\ cut} = m_{NS,output\ dry} \cdot \frac{L_{module,outer}}{L_{bundle}} \quad [kg] \quad (144)$$

$$m_{RW,output\ cut} = m_{RW,output\ dry} \cdot \frac{L_{module,outer}}{L_{bundle}} \quad [kg] \quad (145)$$

$$m_{PRC,output\ cut} = m_{PRC,output\ dry} \cdot \frac{L_{module,outer}}{L_{bundle}} \quad [kg] \quad (146)$$

$$m_{BL1,output\ cut} = w_{BL1} \cdot m_{BL,output\ dry} \quad [kg] \quad (147)$$

$$m_{BL2,output\ cut} = (1 - w_{BL1}) \cdot m_{BL,output\ dry} \quad [kg] \quad (148)$$

$$m_{PRC1,output\ cut} = w_{PRC1} \cdot m_{PRC,output\ dry} \quad [kg] \quad (149)$$

$$m_{PRC2,output\ cut} = (1 - w_{PRC1}) \cdot m_{PRC,output\ dry} \quad [kg] \quad (150)$$

Energy required for bundling, drying, module assembly, cutting and utilities

$$E_{bundl} = P_{bundl} \cdot t_{batch} \quad [kWh] \quad (151)$$

$$E_{dry} = P_{dry} \cdot t_{batch} \quad [kWh] \quad (152)$$

$$E_{adh} = P_{adh} \cdot t_{batch} \quad [kWh] \quad (153)$$

$$E_{cut} = P_{cut} \cdot t_{cut,module} \cdot \frac{n_{module\ per\ batch}}{1 - \%defective\ module\ reject} \quad [kWh] \quad (154)$$

$$E_{\text{light}} = P_{\text{light}} \cdot t_{\text{batch}} \quad [\text{kWh}] \quad (155)$$

The electricity consumption for heating and air conditioning is proportional to the spinning duration and thus to the total fabricated length of hollow fiber.

$$S_{\text{HF,cut}} = S_{\text{module}} \cdot \frac{n_{\text{module per batch}}}{1 - \%_{\text{defective module reject}}} \cdot \frac{L_{\text{module,outer}}}{L_{\text{module,inner}}} \cdot \frac{L_{\text{bundle}}}{L_{\text{module,outer}}} \quad [\text{m}^2] \quad (156)$$

$$E_{\text{heat/air cond}} = \left(E_{\text{elec, heat air cond}} + k_{\text{gas}} \cdot E_{\text{gas, heat air cond}} \right) \cdot S_{\text{HF,cut}} [\text{kWh}] \quad (157)$$

2.1.10. Hydraulic testing

In a first step, fiber pores are rinsed with water. In a second step, permeability is measured. Darcy's law, applicable to incompressible fluids, is applied to determine water consumed during hydraulic testing.

After hydraulic testing, hollow fibers of defective modules go to waste along with the adhesive and liquid included inside pores and lumens. Membrane housings and auxiliary equipment (end caps, venting plugs, flange) are recycled and used for non-defective modules.

Input mass (i.e. water for hydraulic testing)

Fiber pores are first rinsed by a factor $\frac{V_{\text{HTW1}}}{V_{\text{pore}}}$.

$$m_{\text{HTW1}} = m_{\text{solvent}} \cdot \frac{V_{\text{HTW1}}}{V_{\text{pore}}} \cdot \frac{\rho_{\text{HTW,THT}}}{\rho_{\text{NS,TNS}}} \cdot \frac{L_{\text{module,outer}}}{L_{\text{bundle}}} \quad [\text{kg}] \quad (158)$$

Permeability is then measured. Darcy's law is applied.

$$m_{\text{HTW2}} = \rho_{\text{HTW,THT}} \cdot \frac{L_p}{10^3} \cdot t_{\text{HT2}} \cdot \text{TMP}_{\text{HT2}} \cdot S_{\text{module}} \cdot n_{\text{module per batch}} \cdot (1 - \%_{\text{defective module reject}}) \quad [\text{kg}] \quad (159)$$

Mass inside pores and fiber lumen after hydraulic testing

A material balance is carried out for water during hydraulic testing.

$$m_{\text{HTW2,output HT}} = \rho_{\text{HTW,THT}} \cdot V_{\text{pores+lumen,coag}} \cdot \frac{L_{\text{module,inner}}}{L_{\text{bundle}}} \cdot (1 - \%_{\text{defective module reject}}) \quad [\text{kg}] \quad (160)$$

Energy required for hydraulic water pumping

$$E_{\text{pump,HTW1}} = \frac{m_{\text{HTW1}}}{\rho_{\text{HTW,THT}}} \cdot \frac{\text{TMP}_{\text{HT1}}}{\eta_{\text{pump}}} \quad [\text{J}] \quad (161)$$

$$E_{\text{pump,HTW2}} = \frac{m_{\text{HTW2}}}{\rho_{\text{HTW,THT}}} \cdot \frac{\text{TMP}_{\text{HT2}}}{\eta_{\text{pump}}} \quad [\text{J}] \quad (162)$$

2.1.11. Conditioning

The void volume between hollow fibers inside each module is filled with the conditioning liquid. Pores and fiber lumens are filled with water from hydraulic testing.

Input mass (i.e. conditioning fluid)

$$\rho_{\text{CL,Tcond}} = \frac{1}{\frac{w_{\text{CL1}}}{\rho_{\text{CL1,Tcond}}} + \frac{(1-w_{\text{CL1}})}{\rho_{\text{CL2,Tcond}}}} \quad [\text{kg m}^{-3}] \quad (163)$$

$$m_{\text{CL}} = \rho_{\text{CL,TCL}} \cdot V_{\text{module,cond}} \cdot n_{\text{module per batch}} \quad [\text{kg}] \quad (164)$$

$$m_{\text{CL1}} = w_{\text{CL1}} \cdot m_{\text{CL}} \quad [\text{kg}] \quad (165)$$

$$m_{\text{CL2}} = (1 - w_{\text{CL1}}) \cdot m_{\text{CL}} \quad [\text{kg}] \quad (166)$$

2.1.12. Waste

Liquid waste: coagulation and rinsing

A material balance is carried out for liquid waste during coagulation and rinsing operations together.

$$m_{\text{waste,coag+rins}} = (m_{\text{solvent}} + m_{\text{additive}} + m_{\text{BL}} + m_{\text{input NS}} + m_{\text{input RW}}) - (m_{\text{solvent,output rins}} + m_{\text{additive,output rins}} + m_{\text{BL,output rins}} + m_{\text{NS,output rins}} + m_{\text{RW,output rins}}) \quad [\text{kg}] \quad (167)$$

Liquid waste: pre-conditioning, drying and hydraulic testing 1

A material balance is carried out for liquid waste during pre-conditioning, drying and the first step of hydraulic testing (*i.e.* rinsing step).

$$m_{\text{waste,precond+dry}} = (m_{\text{solvent,output rins}} + m_{\text{additive,output rins}} + m_{\text{BL,output rins}} + m_{\text{NS,output rins}} + m_{\text{RW,output rins}} + m_{\text{input PRC}}) - (m_{\text{solvent,output dry}} + m_{\text{additive,output dry}} + m_{\text{BL,output dry}} + m_{\text{NS,output dry}} + m_{\text{RW,output dry}} + m_{\text{PRC,output dry}}) + (m_{\text{solvent,output cut}} + m_{\text{additive,output cut}} + m_{\text{BL,output cut}} + m_{\text{NS,output cut}} + m_{\text{RW,output cut}} + m_{\text{PRC,output cut}}) + m_{\text{HTW1}} - m_{\text{HTW2,output HT}} \quad [\text{kg}] \quad (168)$$

Liquid waste: hydraulic testing 2

A material balance is carried out for liquid waste during the second step of hydraulic testing (*i.e.* permeability measurement).

$$m_{\text{waste,HT2}} = m_{\text{HTW2}} \quad [\text{kg}] \quad (169)$$

Solid waste: cutting

A material balance is carried out for each solid waste under consideration during the cutting operation (*i.e.* pre-adhesive, adhesive, hollow fibers).

$$m_{\text{waste,pre-adhesive,cut}} = m_{\text{pre-adhesive}} \quad [\text{kg}] \quad (170)$$

$$m_{\text{waste,adhesive,cut}} = m_{\text{adhesive}} \cdot \frac{h_{\text{adhesive,total}} - h_{\text{adhesive,module}}}{h_{\text{adhesive,total}}} \quad [\text{kg}] \quad (171)$$

$$m_{\text{waste,HF,cut}} = m_{\text{polymer}} \cdot \frac{1 - L_{\text{module,outer}}}{L_{\text{bundle}}} \quad [\text{kg}] \quad (172)$$

A material balance is carried out for liquid waste present in cut hollow fibers during the cutting operation.

$$m_{\text{waste,in pores,cut}} = (m_{\text{solvent,output dry}} + m_{\text{additive,output dry}} + m_{\text{BL,output dry}} + m_{\text{NS,output dry}} + m_{\text{RW,output dry}} + m_{\text{PRC,output dry}}) - (m_{\text{solvent,output cut}} + m_{\text{additive,output cut}} + m_{\text{BL,output cut}} + m_{\text{NS,output cut}} + m_{\text{RW,output cut}} + m_{\text{PRC,output cut}}) \quad [\text{kg}] \quad (173)$$

Solid waste: defective modules from hydraulic testing

Hollow fibers and liquid included in pores and lumens, pre-adhesive and adhesive of defective modules are put to waste. On the other hand, the membrane housing, flange, grids, end caps and venting plugs of defective modules are recycled for non-defective modules.

$$m_{\text{waste,HF,HT}} = m_{\text{polymer}} \cdot \frac{L_{\text{module,outer}}}{L_{\text{bundle}}} \cdot \%_{\text{defective module}} \quad [\text{kg}] \quad (174)$$

$$m_{\text{waste, adhesive, HT}} = m_{\text{adhesive}} \cdot \frac{h_{\text{adhesive, module}}}{h_{\text{adhesive, total}}} \cdot \%_{\text{defective module}} \quad [\text{kg}] \quad (175)$$

$$m_{\text{waste, in pores+lumen, HT}} = \rho_{\text{HTW, THT}} \cdot V_{\text{pores+lumen, coag}} \cdot \frac{L_{\text{module, outer}}}{L_{\text{bundle}}} \cdot \%_{\text{defective module reject}} \quad [\text{kg}] \quad (176)$$

Declaration of Competing Interest

The authors declare that they have no known competing financial interests or personal relationships which have, or could be perceived to have, influenced the work reported in this article.

Acknowledgments

The authors acknowledge the financial support of Université Fédérale de Toulouse (PRES) and Région Occitanie/Pyrénées-Méditerranée, France, and are grateful for the technical expertise of Aquasource (SUEZ). Special thanks to Dr. Philippe Aptel for his valuable comments.

References

- [1] F. Prézéus, L. Tiruta-Barna, C. Guigui, J.C. Remigy, A generic process modelling – LCA approach for UF membrane fabrication: application to cellulose acetate membranes, *J. Membr. Sci.* (2020) 118594 <https://doi.org/10.1016/j.memsci.2020.118594>.
- [2] J.M. Espenan, *Nouvelles Cartouches de Fibres Creuses Pour L'ultrafiltration: Fabrication, Propriétés de Transfert, Évaluation Économique*, Université Paul Sabatier de Toulouse, 1984.
- [3] W.L. Chou, D.G. Yu, M.C. Yang, C.H. Jou, Effect of molecular weight and concentration of PEG additives on morphology and permeation performance of cellulose acetate hollow fibers, *Sep. Purif. Technol.* 57 (2007) 209–219 <https://doi.org/10.1016/j.seppur.2007.04.005>.
- [4] A. Idris, A.F. Ismail, M.Y. Noordin, S.J. Shilton, Optimization of cellulose acetate hollow fiber reverse osmosis membrane production using Taguchi method, *J. Membr. Sci.* 205 (2002) 223–237 [https://doi.org/10.1016/S0376-7388\(02\)00116-3](https://doi.org/10.1016/S0376-7388(02)00116-3).
- [5] H. Waheed, F.T. Minhas, A. Hussain, Cellulose acetate/sericin blend membranes for use in dialysis, *Polym. Bull.* 75 (2018) 3935–3950 <https://doi.org/10.1007/s00289-017-2238-1>.
- [6] T.P.N. Nguyen, E.T. Yun, I.C. Kim, Y.N. Kwon, Preparation of cellulose triacetate/cellulose acetate (CTA/CA)-based membranes for forward osmosis, *J. Membr. Sci.* 433 (2013) 49–59 <https://doi.org/10.1016/j.memsci.2013.01.027>.
- [7] A. Bottino, G. Capannelli, S. Munari, A. Turturro, High performance ultrafiltration membranes cast from LiCl doped solutions, *Desalination* 68 (1988) 167–177 [https://doi.org/10.1016/0011-9164\(88\)80052-3](https://doi.org/10.1016/0011-9164(88)80052-3).
- [8] S.M. Kresta, A.W. Etchells III, D.S. Dickey, V.A. Atiemo-Obeng, *Advances in Industrial mixing: a Companion to the Handbook of Industrial Mixing*, John Wiley & Sons, Hoboken, 2015.
- [9] W. Pauchet, *La production de froid, techniques de l'ingénieur*, TBA2760, 2008.
- [10] Y. Mery, L. Tiruta-Barna, I. Baudin, E. Benetto, E. Igos, Formalization of a technical procedure for process ecodesign dedicated to drinking water treatment plants, *J. Clean. Prod.* 68 (2014) 16–24 <https://doi.org/10.1016/j.jclepro.2014.01.011>.
- [11] F. Ivaldi, *Fibres Creuses en Polysulfone: Fabrication, Propriétés de Transfert en Ultrafiltration*, Université Paul Sabatier de Toulouse, 1982.
- [12] I. Cabasso, E. Klein, J.K. Smith, Polysulfone hollow fibers. I. Spinning and properties, *J. Appl. Polym. Sci.* 20 (1976) 2377–2394 <https://doi.org/10.1002/app.1976.070200908>.
- [13] W.M. Hayes, D.R. Lide, T.J. Bruno, *CRC Handbook of Chemistry and Physics*, CRC Press, Boca Raton, 2016.
- [14] Y. Bessiere, *Filtration Frontale sur Membrane: Mise en Évidence du Volume Filtré Critique Pour L'anticipation et le Contrôle du Colmatage*, Université Paul Sabatier, Toulouse III, 2005.