



D7.2

System prototype demonstration

Project Acronym	TransAID	
Project Title	Transition Areas for Infrastructure-Assisted Driving	
Project Number	Horizon 2020 ART-05-2016 – GA Nr 723390	
Work Package	WP7 Real-World Prototype	
Lead Beneficiary	German Aerospace Center (DLR)	
Editor / Main Author	Julian Schindler	DLR
Reviewer	Robbin Blokpoel	DYN
	Xiaoyun Zhang	DYN
Dissemination Level	PU	
Contractual Delivery Date	First iteration: 30/06/2019 (M22)	
	Second iteration: 31/12/2020 (M40)	
Actual Delivery Date	17/02/2021	
Version	v2.0	



This project has received funding from the European Union’s Horizon 2020 research and innovation programme under grant agreement No 723390.

Document revision history

Version	Date	Comments
v0.1	2019-07-03	Initial draft version
v0.2	2019-08-07	Added vehicle and road side architecture
v0.3	2019-08-14	Added first iteration use cases and feasibility structure
v0.4	2019-08-26	Included several components' content, sent for review
v0.5	2019-08-29	Included several reviewer comments and updated several images.
v0.6	2019-08-30	Second review performed.
v1.0	2019-08-31	Final editing and submission.
v1.1	2020-11-16	Draft version of 2 nd iteration circulated
v1.2	2020-12-10	Input received and integrated
v1.3	2020-12-14	Added several tables and requirements for 2.2
v1.5	2020-01-21	Integrated final version
v1.6	2020-01-31	Full review performed
v2.0	2021-02-17	Final 2nd iteration version submitted

Editor / Main author

Julian Schindler (DLR)

List of contributors

Robert Markowski (DLR), Daniel Heß (DLR), Daniel Wesemeyer (DLR), Clarissa Böker (DLR), Baldomero Coll Perales (UMH), Gokulnath Thandavarayan (UMH), Miguel Sepulcre (UMH), Javier Gozalvez (UMH), Michele Rondinone (HYU), Dominik Matheis (HYU), Xiaoyun Zhang (DYN)

List of reviewers

Robbin Blokpoel (DYN), Xiaoyun Zhang (DYN)

Dissemination level:

PU : Public

RE : Restricted to a group specified by the consortium (including the Commission Services)

CO : Confidential, only for members of the consortium (including the Commission Services)

Table of contents

Document revision history	2
Table of contents	3
Executive Summary	6
1. Introduction	7
1.1 About TransAID	7
1.1.1 Iterative project approach	7
1.2 Purpose of this document	7
1.3 Structure of this document	8
1.4 General procedure of feasibility assessments in TransAID	9
1.5 Glossary	10
2 Full assessment of all use cases	12
2.1 Prototype architecture	12
2.1.1 Vehicles	12
2.1.1.1 CAVs	12
2.1.1.2 CVs	32
2.1.2 Road Side	34
2.2 Feasibility assessment	37
2.2.1 First iteration	37
2.2.1.1 General requirements assessment	37
2.2.1.2 Requirements of use case 1.1: Provide path around road works via bus lane	42
2.2.1.3 Requirements of use case 2.1: Prevent ToC/MRM by providing speed, headway and/or lane advice	51
2.2.1.4 Requirements of use case 3.1: Apply traffic separation before motorway merging/diverging	62
2.2.1.5 Requirements of use case 4.2: Safe spot in lane of blockage	67
2.2.1.6 Requirements of use case 5.1: Schedule ToCs before no AD zone	74
2.2.2 Second iteration	79
2.2.2.1 General requirements assessment	80
2.2.2.2 Requirements of use case 1.3: Queue spillback at exit ramp	84
2.2.2.3 Requirements of use case 2.1: Prevent ToC/MRM by providing speed, headway and/or lane advice	95
2.2.2.4 Requirements of use case 2.3: Intersection handling due to incident	107
2.2.2.5 Requirements of use case 4.2: Safe spot in lane of blockage & Lane change Assistant	119

2.2.2.6	Requirements of use case 4.1 + Service 5 (4.1-5): Distributed safe spots along an urban corridor.....	127
3	Public road assessment of highway entering	137
3.1	Prototype architecture.....	137
3.1.1	Public road setup.....	137
3.1.2	System architecture and components.....	140
3.1.3	Vehicles.....	144
3.1.3.1	Vehicle facilitation process.....	144
3.1.3.2	Sensors and Sensor Fusion	145
3.1.4	Road Side	146
3.1.4.1	Sensors and Sensor Fusion	146
3.1.4.2	Traffic Management System.....	147
3.1.5	Debugging HMI.....	149
3.1.6	Communication.....	150
3.2	Feasibility assessment	151
3.2.1	Public road use case 2.1 script and requirements overview.....	151
3.2.2	Feasibility results	153
3.2.2.1	Requirements verification.....	153
3.2.2.2	User experience	155
3.2.2.3	Check of overall feasibility.....	156
4	Detailed assessment of CAV behaviour at Safe Spots.....	157
4.1	Prototype architecture.....	157
4.1.1	Vehicle	158
4.1.1.1	Sensors and Sensor Fusion	158
4.1.1.2	Vehicle Automation.....	159
4.1.1.3	Communication.....	159
4.1.1.4	Debugging HMI.....	159
4.1.2	Road Side	160
4.1.2.1	Traffic Management and Monitoring System.....	160
4.1.2.2	Communication.....	160
4.2	Feasibility assessment	160
4.2.1	Requirements of use case 4.1-5: Distributed safe spots along an urban corridor	161
4.2.1.1	Description of the use case from D2.2.....	161
4.2.1.2	Use case setup.....	161
4.2.1.3	Feasibility results	166

5	Conclusion and outlook	170
	References	171
	Annex A: TransAID messages description	174
	Annex A1: MCM description (1 st iteration).....	174
	Annex A2: MCM description (2 nd iteration).....	178
	Annex B: TransAID messages ASN.1 specifications (1 st iteration)	184
	Annex B1: MCM ASN.1 specification	184
	Annex B2: CAM ASN.1 specification.....	193
	Annex B3: DENM ASN.1 specification	193
	Annex B4: MAP ASN.1 specification	193
	Annex B5: CPM ASN.1 specification	193
	Annex C: TransAID messages ASN.1 specifications (2 nd iteration)	194
	Annex C1: MCM ASN.1 specification	194
	Annex C2: CAM ASN.1 specification.....	205
	Annex C3: DENM ASN.1 specification	206
	Annex C4: MAP ASN.1 specification	206
	Annex C5: CPM ASN.1 specification	206

Executive Summary

This deliverable is a direct successor of Deliverable 7.1 [1] [2], which has introduced all vehicles, test tracks, used hardware, and proposed system architectures of the different used components. D7.1 has also introduced several system requirements for each component and for each use case described in D2.1 [3], which must be implemented.

D7.2 shows the system architecture implementation for the different components of the infrastructure part as well as for the vehicle part. It is shown how both parts communicate in the real-world following D5.2 [4] [5] by presenting the finally used ASN.1 message definitions (in the Annex) and details about the communication software.

In the project, real-world implementations have been performed at four partners. UMH was responsible for setting up the communication software required in all implementations. DLR assembled all use cases in several scenarios on the test track located in Peine-Eddesse in northern Germany. Dynniq implemented a C-ITS based highway merging as specified in use case 2.1 on public roads on the highway A13 in The Netherlands. HMETC finally took a closer look at ToC/MRM distribution in urban areas as specified in the combined use case 4.1-5 on a test track located in Griesheim, Germany.

Besides the implementation, feasibility assessments of all TransAID measures have been performed. For this, each use case has been divided into test scenarios, which have been implemented in the real-world prototypes, demonstrated and assessed.

Each test scenario is linked to related requirements set up in D7.1. During the feasibility assessment, the compliance with all requirements has been checked by project partner HMETC, who is taking the role of an OEM here. In addition, the overall “look and feel” of the prototype and the performance in each test scenario has been rated and described.

In summary, nearly all requirements were fully met. Only in few cases the implementation deviates from the earlier requirement specification, sometimes due to new findings in the project, sometimes as not all implementations could be showcased due to the COVID-19 pandemic.

Altogether, it could be shown that the TransAID measures can be put into real-world to help future automated vehicles to better cope with possible threats and to gain higher performance on the road. Nevertheless, further research is required to bring the measures to a higher Technology Readiness Level, up to series production. This is especially true for HMI design for vehicles and VMS (as this was not in scope of the project), vehicle automation behaviour in case of ToCs and MRMs, and I2V-MCM deconflicting.

1. Introduction

1.1 About TransAID

As the introduction of automated vehicles (AV) becomes feasible, even in urban areas, it will be necessary to investigate their impacts on traffic safety and efficiency. This is particularly true during the early stages of market introduction, when automated vehicles of different SAE levels, connected vehicles (able to communicate via V2X) and conventional vehicles will share the same roads with varying penetration rates.

There will be areas and situations on the roads where high automation can be granted, and others where it is not allowed or not possible due to missing sensor inputs, high complexity situations, etc. At these areas, many automated vehicles will change their level of automation. We refer to these areas as “Transition Areas”.

TransAID develops and demonstrates traffic management procedures and protocols to enable smooth coexistence of automated, connected, and conventional vehicles, especially at Transition Areas. A hierarchical approach is followed where control actions are implemented at different layers including centralised traffic management, infrastructure, and vehicles.

First, simulations are performed to examine efficient infrastructure-assisted management solutions to control connected, automated, and conventional vehicles at Transition Areas, taking the traffic safety and efficiency metrics into account. Then, communication protocols for the cooperation between connected/automated vehicles and the road infrastructure are developed. Measures to detect and inform conventional vehicles are also addressed. The most promising solutions are then implemented as real world prototypes and demonstrated at a test track and during the second iteration possibly on public roads. Finally, guidelines for advanced infrastructure-assisted driving are formulated. These guidelines also include a roadmap defining activities and needed upgrades of road infrastructure in the upcoming 15+ years to guarantee a smooth coexistence of conventional, connected, and automated vehicles.

1.1.1 Iterative project approach

The infrastructure-assisted management solutions are developed and tested in two iterations, each taking half of the project total duration. During the first iteration, the focus is on studying aspects of transition of control (ToC) and transition areas (TAs) through basic scenarios. This implies that realistic models for automated driving (AD) and ToC need to be developed and/or adopted. Using the basic scenarios, it is possible to run many simulations and focus in detail on the relatively new aspects of ToC, Transition Areas (TAs) and measures mitigating negative effects of TAs. The goal of the first iteration is to gain experience in modelling, simulation and real-world implementation with all aspects relevant to TAs and the mitigating measures.

During the second iteration, that experience is used to improve/extend the measures while at the same time increasing the complexity of the scenarios and/or selecting different (more complex) scenarios. Another possibility under consideration is the combination of multiple basic scenarios into one new more complex use case.

1.2 Purpose of this document

As a successor document of D7.1 (first iteration [1], second iteration [2]), this deliverable is describing all implementation actions for the real-world prototype. This second iteration version includes and extends the first iteration version and is based on findings of all other work packages.

Real-world implementations have been performed at three locations during the second iteration, with different foci. While DLR executed the full set of scenarios of all use cases (see Figure 1) on a test track in Peine-Eddesse, Dynniq conducted a public road highway merging experiment (use case 2.1) on the Dutch highway A13. In addition, HMETC conducted further investigations of ToC and MRM behaviour based on use case 4.1-5. Since V2X communication was developed by project partner UMH for all locations, a harmonized approach to real-world implementations of the TransAID measures is followed. Besides the implementations, a feasibility assessment of the developed prototypes has been performed by project partner HMETC. Therefore, each TransAID service and related use case (see D2.2, first iteration [6], second iteration [7]) has been transferred into test scenarios. The requirements for the different use cases, which have already been described in D7.1, are now related to the test scenarios and the compliance is discussed.

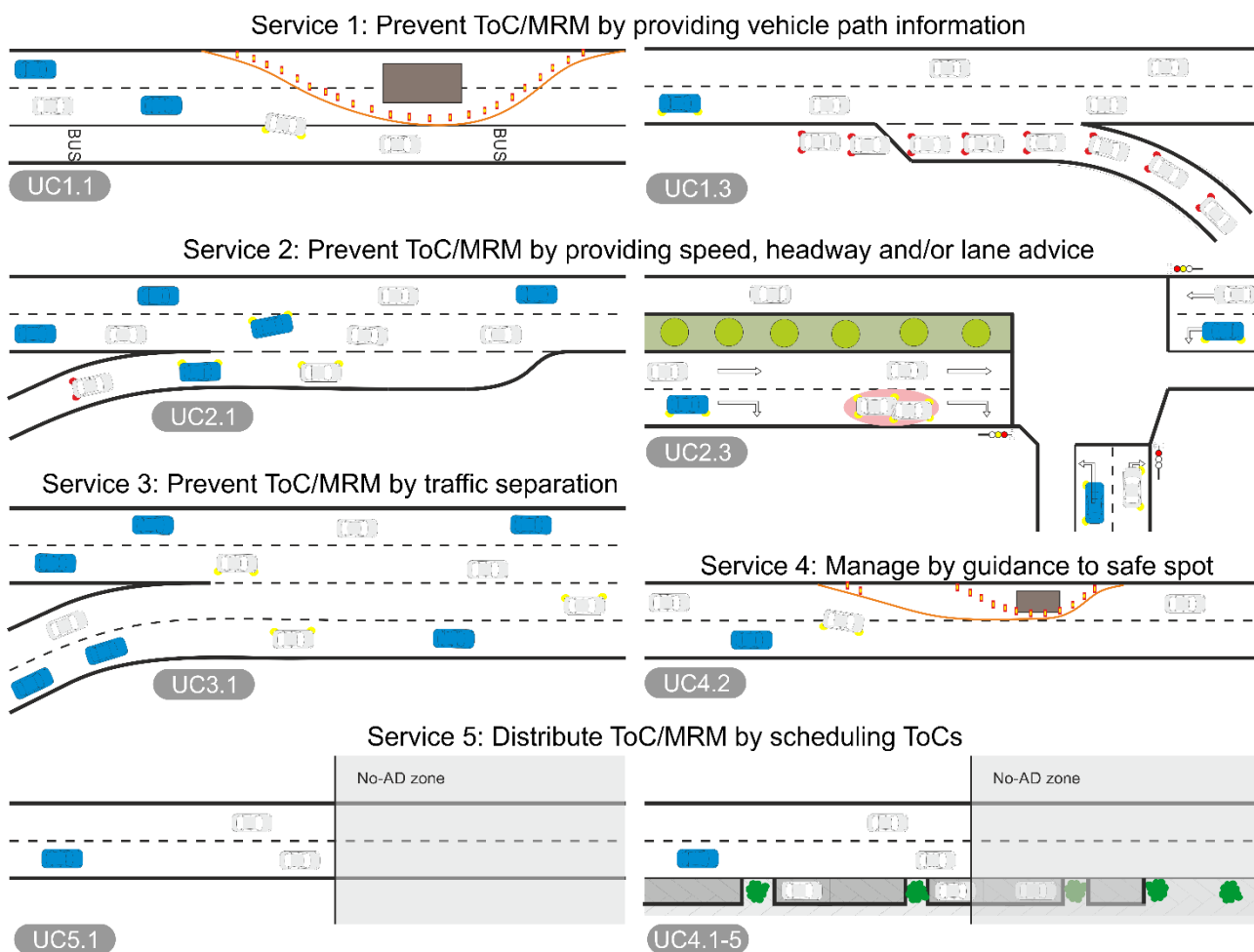


Figure 1: TransAID Services and Use Cases

Besides describing the procedures, a goal of this deliverable is to investigate which parts of the message definition (see D5.1 [8] [9] and D5.2 [4] [5]) and of the TransAID traffic management measures (see D4.2 [10] [11]) need to be adapted so that the system is not only performing in simulations (see D6.2 [12]) but also in the real world.

1.3 Structure of this document

This deliverable is first introducing the general procedure of feasibility assessments (section 1.4). In the following, the different assessments at the different locations are described. Here, first the full assessment at DLR is presented (section 2), followed by the public road assessment performed by Dynniq (section 3) and the detailed ToC/MRM analysis performed by HMETC (section 4). Each of

these sections follow the same structure, starting with the prototype architecture of the vehicles and the road side, and continuing with the detailed description of the performed feasibility assessment. The assessments include descriptions of the performed scenarios as well as requirement fulfillments and results.

Besides the conclusion in section 5, this deliverable also contains the ASN.1 message definitions of the used messages during the real world assessment in the Annexes A (MCM descriptions), B (ASN.1 definitions of first iteration) and C (ASN.1 definitions of second iteration).

1.4 General procedure of feasibility assessments in TransAID

In general, the feasibility assessment is prepared by the WP7 partners. While automated vehicles are prepared by DLR and HMETC, the road side equipment is prepared by DLR in the first iteration and by DLR and Dynniq in the second iteration. The communication aspects are developed by UMH.

Requirements which need to be fulfilled by the prototype (vehicle and infrastructure) have been proclaimed in D7.1. Basically, there are general requirements and requirements per use case.

After preparation, HMETC is visiting the test tracks and testing the prototypes in the different scenarios. In the second iteration, these visits had to be replaced by online events and video/data recordings due the pandemic. The feasibility assessment itself consists of

- a) Requirements verification
- b) User experience
- c) Summary of the overall feasibility

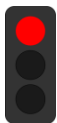
The requirements verification is done by rating the successfulness of each requirement. Therefore, each requirement is referenced from D7.1, rated and annotated. The rating follows this scheme:



The requirement is completely fulfilled.



The requirement is partially fulfilled. Details are given in the annotations.



The requirement is not fulfilled. Details are given in the annotations.

The given feasibility assessment steps are followed at each location.

1.5 Glossary

Abbreviation/Term	Definition
ACC	Adaptive Cruise Control
AD	Automated Driving
ADAS	Advanced Driver Assistance Systems
AV	Automated Vehicles (without cooperation abilities)
C-ITS	Cooperative Intelligent Transport Systems
C2C-CC	Car2Car Communication Consortium
CAM	Cooperative Awareness Message
CAV	Cooperative Automated Vehicle
CPM	Collective Perception Message
CV	Cooperative Vehicle
DENM	Decentralised Environmental Notification Message
DX.X	Deliverable X.X
ERTRAC	European Road Transport Research Advisory Council
HMI	Human Machine Interface
ITS	Intelligent Transport System
ITS-G5	Access technology to be used in frequency bands dedicated for European ITS
LOS	Level Of Service (from Highway Capacity Manual)
LV	Legacy Vehicle
MCM	Manoeuvre Coordination Message
MRM	Minimum Risk Manoeuvre
RSI	Road Side Infrastructure
RSU	Road Side Unit
SAE	Society of Automotive Engineers

SUMO	Simulation of Urban Mobility
TA	Transition area
TM	Traffic Management
ToC	Transition of Control
TransAID	Transition Areas for Infrastructure-Assisted Driving
V2I	Vehicle-to-infrastructure (communication)
V2V	Vehicle-to-vehicle (communication)
V2X	Vehicle-to-anything (communication)
VMS	Variable Message Signs
WP	Work Package

2 Full assessment of all use cases

2.1 Prototype architecture

In the following, the final prototype of the first project iteration is described. This section is based on section 4 of D7.1, and only adds more details to it.

2.1.1 Vehicles

During the tests performed a set of vehicles is used, including Cooperative Automated Vehicles (CAVs), Cooperative Vehicles without automation functionality (CVs) and legacy vehicles (LVs).

All CAVs and CVs are briefly described in the following.

2.1.1.1 CAVs

In the project, two CAVs have been used, DLR’s electric Volkswagen Golf “FASCarE” and DLR’s hybrid Volkswagen Passat “ViewCar2”. As both are from DLR, the internal setup is similar in both cars, with only minor differences in terms of used hardware revisions as the ViewCar2 is newer.

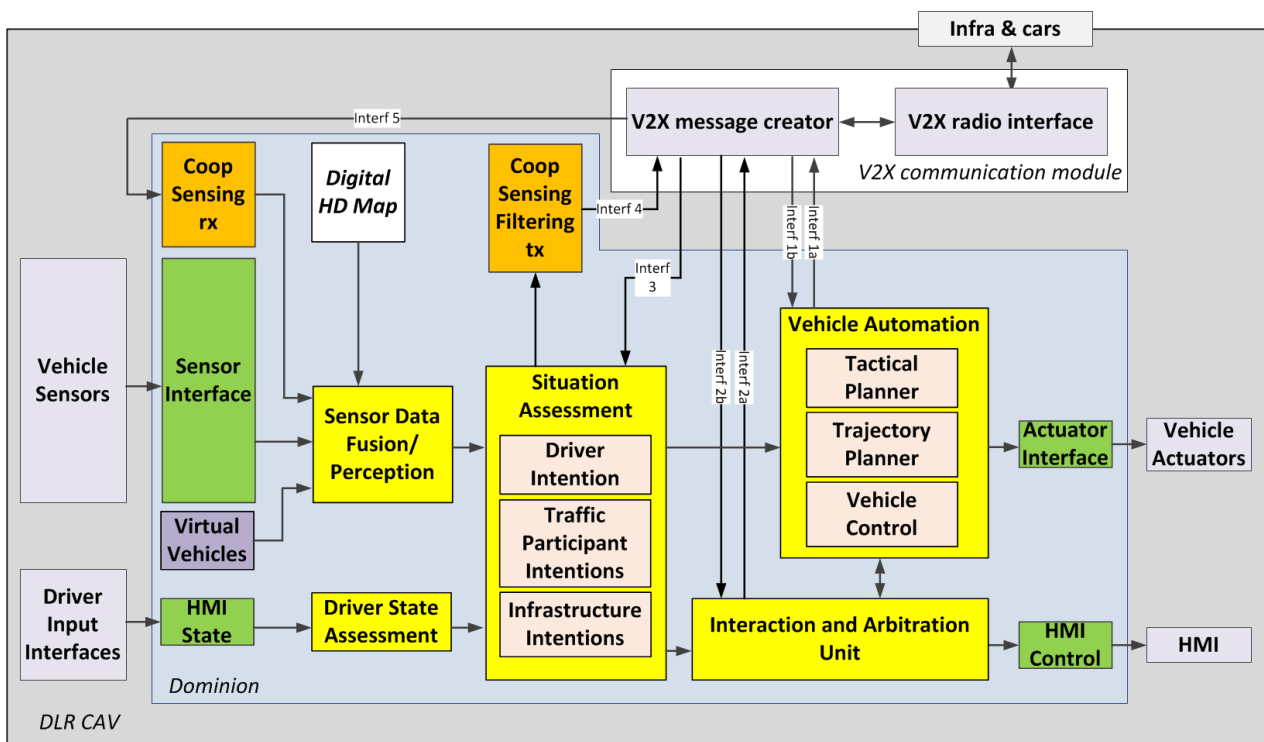


Figure 2: Initial CAV architecture

The CAVs basically follow the architecture shown in Figure 2 and described in D7.1. Only the component “Tactical Decision” has been renamed to “Tactical Planner”, and “Trajectory Planning” has been renamed to “Trajectory Planner”.

In the following, details about the sensors, sensor data fusion, vehicle automation and communication are given, which have been used during the first project iteration.

2.1.1.1.1 Sensors and Sensor Fusion

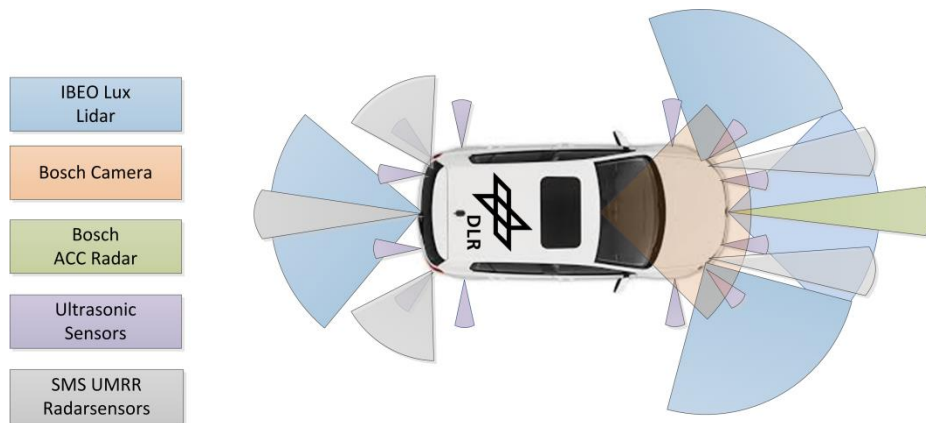


Figure 3: Sensor coverage of the FASCAR E

As shown in Figure 3 in the example of the FASCAR E, both research vehicles are equipped with multiple Ibeo laser scanners in the front and rear of each vehicle. The laser scanners are connected via Ethernet and integrated with the robot operating system (ROS). This is an open-source middleware framework comprising drivers for devices, message passing between processes implemented as nodes of a graph architecture, or implantations of frequently used functionalities (More information can be found on the ROS web page¹). The objects determined from the laser scanner points are sent via a custom interface between the ROS framework to the Dominion framework [13] of the automation. Before the detected and tracked objects are passed on, they are also fused with the received V2X messages. The in-vehicle sensor data fusion in the FASCAR E involves fusing the measurement data from the ego-vehicle sensors with the received infrastructure data, the CPMs and the data received from other vehicles, mainly CAMs. First, the tracks received via V2X and the tracks from the in-vehicle sensors go through a pre-processing step. In this process, clutter objects are filtered out from the sensor data of the ego-vehicle to avoid unnecessary calculations and, thus, computing time. Subsequently, all tracks are transformed into a common coordinate system. The next step in the fusion pipeline is prediction. This is necessary to compensate for the time that elapses between when an object is recorded by the infrastructure and when the CPM is received in the vehicle. The core of track-level fusion is the association of tracks from different sensor sources. The implementation of the association task is based on the solution described in [14] and establishes a track to track correspondence between the V2X messages and the in-vehicle sensors. The associated tracks are then fused using the Covariance Intersection algorithm [15]. The Covariance Intersection method computes an optimal estimate of the real state of an object given state estimates and covariance matrices of the estimation error of these state estimates. Tracks that cannot be associated cannot be fused. They are however added to the global track list because they extend the view of the environment perception. The entire fusion pipeline is described in D5.2 [5] section 2.3.1.2 in greater detail.

2.1.1.1.2 Vehicle Automation

The planning and decision-making modules for the TransAID CAVs have been implemented with the help of a vehicle automation library proposed in [16]. Accordingly, the CAV decision making is based on the four steps of environmental data aggregation, goal-oriented data abstraction in the so-called views, manoeuvre planning and manoeuvre selection. Environmental data is received from the Sensor Data Fusion/Perception block in the form of the estimated ego state, static obstacles

¹ <https://www.ros.org/>

perceived by the vehicle’s laser scanners, traffic participant information consolidated from CAM, CPM, and laser scanners, as well as road geometric and topological data from an HD digital map and a navigation component. The environmental data is abstracted in LaneFollowing-, LaneChange- and SafetyConstraintViews. The views allow formulating constraints for specific manoeuvre planning tasks. Each planned manoeuvre is rated by several different cost metrics. Decision making consists of selecting an appropriate, feasible and low-cost manoeuvre for execution by the Vehicle Control module. In addition to previous solutions, the project specific requirements relating to vehicle-driver, vehicle-infrastructure and vehicle-vehicle interactions are fulfilled by augmenting environmental data, manipulating constraint generation for the manoeuvre planners at the level of the goals of certain views and adjusting cost metrics.

As shown in Figure 2, the Tactical Planner component responsible for manoeuvre planning and plan selection receives input from the following components: Sensor Data Fusion/ Perception provides a list of static and dynamic objects and traffic participants. Map Provider sends geometric information about roads in the vicinity of the ego vehicle’s current position to the Tactical Planner. This enables the Tactical Planner to maintain an up-to-date, local subset of the HD map. At the same time, the Map Provider serves the purpose of decoupling the Tactical Planning component from the source of the geometric road information: The pre-defined map can be replaced by sensor detections of lane border markings. The Navigation component sends lane-specific navigation information to the Tactical Planner. A cost-to-go is provided for every individual lane to evaluate the utility of lane changes. The communication module directly interacts with the Tactical Planner to support vehicle-to-vehicle manoeuvre coordination and to address lane- and speed-advice from infrastructure-to-vehicle communication directly on the impacted tactical level. The Tactical Planner generates and selects viable manoeuvres for execution and sends the according vehicle trajectories to the Vehicle Control component, which in turn chooses control inputs (steering angle and acceleration) to minimize deviation from the trajectories.

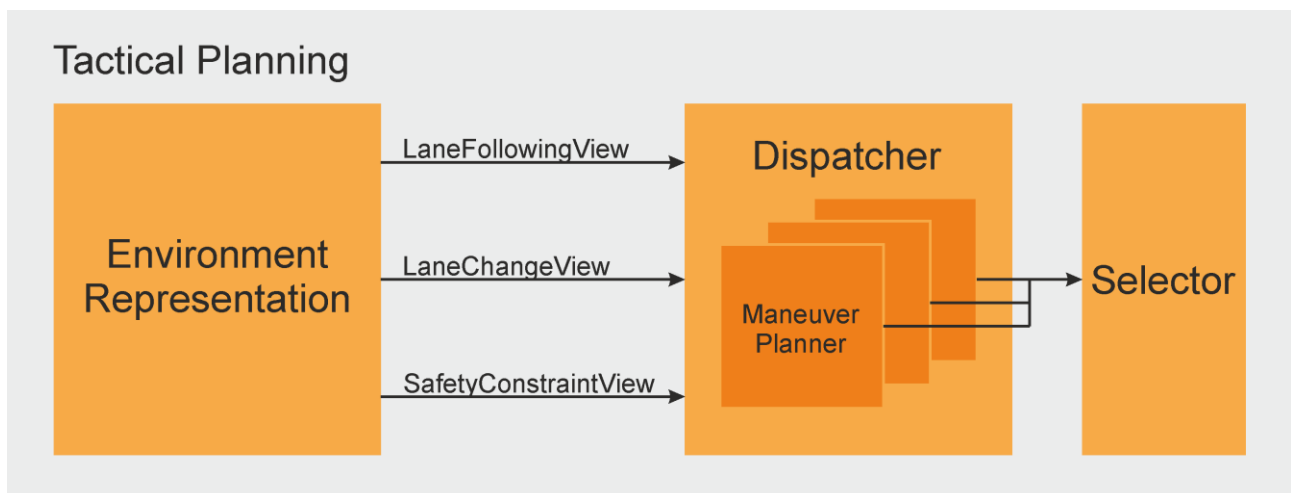


Figure 4: Tactical Planning with sub-components

The Tactical Planning component in turn consists of the following sub-components (Figure 4): Environment Representation aggregates data and generates LaneFollowing-, LaneChange- and SafetyConstraintViews. Several instances of Manoeuvre Planner convert constraints specified by the views into concrete trajectories. The Dispatcher sub-component defines goals and convex constraint regions for Manoeuvre Planner instances and selects instances for plan computation. The selector component determines cost metric values and finally selects a manoeuvre for execution. The solution set of the domain is non-convex (for example distinct gaps in traffic, lane selection) and a cost function modelling the desirable behaviour can be non-linear and complicated. As a computationally efficient approximation of the globally optimal solution under non-convex

constraints, the Dispatcher generates simple candidate solutions for promising, convex areas and the Selector evaluates the complicated, non-linear cost function only for the feasible candidates. Similar to [17], manoeuvre planning is formulated as a constrained, quadratic optimal control problem, which minimizes longitudinal and lateral acceleration and jerk as well as the deviation from a reference velocity and a reference position. While there are more involved approaches from multi-objective optimization theory, currently the simple strategy of selecting according to the weighted sum of the costs is applied. If a Manoeuvre Planner is provided with a LaneFollowingView, it applies the minimum of the appropriate distances to a currently preceding vehicle, a potentially merging vehicle, and the velocity constraints (speed limit, lane curvature) for generation of position and velocity reference. The lateral trajectory is constrained by the borders of the vehicle's current lane. If a Manoeuvre Planner is provided by a LaneChangeView, the longitudinal velocity and position reference is governed by the goal to align to a certain position in the traffic gap selected by the LaneChangeView. In the lateral direction, constraints are switched from the intermediate lane border to the target lane's outer border as soon as the longitudinal profile has reached sufficient alignment to the gap. The qpOASES [18] library is applied to solve the optimization problems. The standard metric for manoeuvre selection is based on the navigation information and the acceleration effort (fuel cost) of a manoeuvre. The cost-to-go for a position at the end of the manoeuvre is queried and the manoeuvre with the minimum trade-off between cost-to-go and acceleration effort is executed.

The requirements of the first iteration tests, which are shown in D7.1 [1] and also addressed in section 2.2 have been realized by additions to several sub-components. The modifications and their effects are described in the following:

Measure 1: Appropriate reaction to a notification of a road blockage or lane clearance by an RSU: An RSU may use a DENM message to declare individual lanes to be non-drivable. A reference geo location, a blocked distance interval and a bit-array indicating the state of individual lanes are provided by the message. The Map Provider component is modified to receive DENM messages. The referenced position in the DENM is matched to a lane cross section in the HD map. For that cross section, the bit-array is applied, closing lanes of the HD map in the process, updating its HD map representation of the according lanes. The Map Provider sends an update to the Tactical Planner, which removes the affected lane areas from the set of drivable lanes. The update is also sent to the Navigation component which then re-computes the cost-to-go values and sends updated cost-to-go values to the Tactical Planner component. An RSU may similarly modify the type of a lane with the help of a MAPEM message. For example, a road blockage may be circumnavigated by clearing a certain lane for regular passenger vehicle traffic. When a MAPEM is received, the Map Provider matches the lanes in the MAPEM to the lanes in the HD map. Furthermore, if a drivable lane is prohibited in the HD map but permitted in the MAPEM, the lane status is changed to "permitted" in the local HD map. Similar to the DENM approach, the Map Provider component is modified to monitor MAPEM messages and to send appropriate updates to the knowledge base of the Tactical Planner and Navigation. The Tactical Planner reacts to the updates in the next planning cycle with standard behaviours. The removal of drivable lanes induces the planner to avoid entering the given area, whereas the modification of the cost-to-go changes the manoeuvre selection and induces lane changes according to the given situation.

Measure 2: Execution of a Minimum Risk Manoeuvre as a reaction to a failed transition of control due to a blocked road or advice from an RSU (MCM-ToC): During automated driving, a human on the driver seat is not involved in the driving task. For several reasons, it can be necessary to transition back the control of the vehicle from the automation system to the human driver. In the TransAID project, two causes for a transition of control (ToC) are determined: The road operator/authority may decide to disallow automated traffic in a certain area. In this case an RSU can be employed to send MCM-ToC messages to individual vehicles. Another cause is the

limitation of the automated driving function: If the current goal becomes unattainable, the vehicle has to yield back control to the human driver. An orderly transition of control requires sufficient time for the human to regain situation awareness and physically take back the control. Therefore, each transition of control consists of three phases with the time intervals $[t_0, t_1]$, $[t_1, t_2]$ and $[t_2, t_3]$: Between t_0 and t_1 the driver is notified that a transition of control will have to be executed in the near future. Between t_1 and t_2 the driver is notified that he/she has to regain control in the next $t_2 - t_1$ seconds. If the driver has not taken over control until t_2 , a so-called Minimum Risk Manoeuvre (MRM) is automatically executed between t_2 and t_3 .

The vehicle has to automatically reach a safe state and standstill until t_3 . (During $[t_2, t_3]$ the driver may take over the control and thereby cancel the automatic execution of the MRM.) An MRM is defined as a manoeuvre, which uses zero velocity and the corresponding position profile as a reference for its optimization problem, in order to stop the vehicle as fast as possible while maintaining a certain acceleration bound. The acceleration bound is chosen as the usual, minimum acceleration for *nominal* automated operation. The MRM should be distinguished from emergency manoeuvres with full deceleration capability: During an MRM and in contrast to an emergency manoeuvre, the vehicle automation system is still fully operational and starts in an uncritical traffic situation. An abrupt deceleration could negatively impact the safety of the traffic situation and would not minimize the overall risk. (An MRM can still be replaced by an emergency manoeuvre with full deceleration capability should the situation deteriorate,.) The Dispatcher sub-component of the Tactical Planner is augmented to request planning of three additional manoeuvres: Lane following for the current lane and lane changes to both adjacent lanes, each manoeuvre with the objective of speed minimization, here denoted MRM. The Selector sub-component is modified to select only from the MRMs, if a ToC is active and in phase three, $t \in [t_2, t_3]$.

The Tactical Planner component is modified to receive MCM-ToC messages. The MCM-ToC message specifies a start position, an end position and a trigger time. Presumably, the three fields indicate the precise timing of the three phases of the ToC. It should be taken into account though, that important arguments can be made against an over-specification of the realization of such a ToC manoeuvre: First of all, the responsibility of an orderly transition of control is expected to be implemented within the vehicle, the automation system and the vehicle's manufacturer. Therefore, the AV should probably decide the timing and duration of the phases on its own. Furthermore, it is inconvenient to start the MRM at a predetermined position or time, if it has to end at a fixed position, e.g., the start of the No-AD-Zone. It was therefore determined to comply to the end position (start of the No-AD-Zone) only. The points of time t_1 , t_2 and t_3 are computed backwards from the end position defined by the MCM-ToC message, using minimum acceleration allowed for nominal operation during $[t_2, t_3]$ and the currently executed speed profile during $[t_0, t_2]$.

The second cause for the triggering of a ToC, an unattainable goal, is detected with the help of the Navigation component. If the minimum attainable cost-to-go is infinite, a ToC (including an MRM if driver is not responding) is scheduled. If a road blockage is detected inside the sensor range, it is used as the end point of the ToC/MRM. The remaining procedure equals the procedure for a message triggered MRM described above.

Measure 3: Changing lanes based on advice by an RSU (MCM-LA): An RSU may influence the merging behaviour of a CAV with the help of an MCM Lane Advice (MCM-LA), possibly selecting a merging strategy for multiple vehicles in a certain area, which is optimal for traffic flow. An MCM-LA message (see Annexes A1/B1) specifies the target lane ID, the station ID of a vehicle in front of a targeted gap, the station ID of a vehicle currently following the targeted gap, a lane change start position and a start time. Both station IDs and the start constraints are optional fields. The transmission of a single station ID is sufficient to uniquely identify a certain gap. No available station IDs is in the first project iteration interpreted as advice to change into any gap of the target

lane, with the gap selection strategy at the discretion of the recipient CAV. This is currently not in line with the definitions done so far, where the automation may stick to the lane change position and timing which is provided. If either the position or time constraint are unspecified, the according dimension is here interpreted to be unconstrained.

In order to model a proper reaction of the CAV to an MCM-LA reception, the Tactical Planner component is modified to receive the message. Furthermore, the Dispatcher sub-component is modified to pose the manoeuvre planning problems in such a manner that suitable trajectories are computed: If an LA with at least one valid station ID exists, the GapRatingView discounts all gaps with a constant cost offset, where either the leading or the following vehicle match the according station IDs. Lane change planners are parametrized to plan for the minimum cost gap, taking the discount into account. If the LA specifies constraints, these are added to the constraints of the lane change planning problems. In the Selector sub-component, a penalty for the discrepancy between advised lane ID of the MCM-LA i_{LA} and the goal point lane ID of a manoeuvre i_{MG} is introduced. With a penalty factor k_{LA} , the additional cost term $c_{LA} := k_{LA} \cdot |i_{LA} - i_{MG}|$ is considered for manoeuvre selection. Evidently, this strategy allows the CAV to execute multiple, consecutive lane changes to reach the advised lane.

Measure 4: Executing a Minimum Risk Manoeuvre into an assigned Safe Spot (MCM-ToC, MCM-LA, MAPEM): Using the MCM TransitionOfControl container, an RSU may set up a “No-AD” zone, with a transition area before it. Inevitably, a certain number of drivers will fail to re-gain control of their CAVs, leading to the execution of minimum risk manoeuvres. In such a situation, CAVs should not stop on a driving lane in order to avoid impacting the traffic flow. In many highway scenarios an emergency lane exists and CAVs could independently decide to finish MRMs on such an emergency lane. A possible strategy would be for the CAVs to queue up on the emergency lane, closing ranks at low speed if preceding vehicles exit the emergency lane, in order to clear the upstream part of the lane for other future MRMs. In urban scenarios, discrete parking boxes might replace an emergency lane. An RSU may monitor the occupancy of the parking boxes and advise CAVs which box to use in case of a failed transition. Using a MAPEM, parking boxes may be declared as lanes of type “park”. An MCM Lane Advice may be used to direct the vehicle onto a parking lane.

Measure 5: Changing speed based on advice by an RSU (MCM-SA): In order to influence the speed of a CAV, an RSU may send an MCM message with a CarFollowingAdvice (CFA) container. The message field “desiredBehavior” either contains a “TargetSpeed” or a “TargetGap”. Further, the message specifies an “advicePosition” and an “advisedLaneID”. The “advicePosition” indicates at which distance along the road the advice becomes active. It should be noted that the duration of the validity of the advice is not specifically upper bounded. Presumably, the speed advice ends when the lane with given ID ends. The Tactical Planner component is modified to receive MCM-CFA messages. On reception of a “TargetSpeed”, the speed-limit of each manoeuvre planner instance is upper-bounded by the specified value.

Measure 6: Opening a gap based on advice by an RSU (MCM-SA): As discussed in Measure 5, an MCM’s CarFollowingAdvice container may specify a “TargetGap”. Supposedly, the target gap size should be sent from an RSU to a CAV to support the merging of another vehicle in front of the CAV. Unfortunately, the specification heavily depends on the uninvolved vehicle initially in front of the CAV on the same lane. If the uninvolved vehicle does not exist, the gap size is undefined. If the uninvolved vehicle accelerates or “disappears” (by changing lanes), the CAV has no viable reference upon which to support the merging manoeuvre. Therefore, the value of “TargetGap” is interpreted as minimum target gap. If the vehicle in front is not available, compliance to the distance value is given. The ID of the merging vehicle is not transmitted in the current format. If a vehicle enters the lane in front of the CAV, the CAV cannot determine whether this was the

intended vehicle or whether the gap still has to be maintained. It is therefore recommended to modify the message by which an RSU may request a CAV to support a merging manoeuvre: A simple solution could be to specify the station ID of the merging vehicle and to broadcast CPM messages containing state information of the merging vehicle. In this way, the CAV is enabled to continuously and foresightedly adapt its speed to support the merging process. This approach would also solve the issues with Measure 5.

Measure 7: Sending and receiving planned manoeuvres via MCM (MCM-VMC): The Tactical Planner component is modified to send and receive MCM with a “VehicleManoeuvreContainer” (MCM-VMC). Each time a trajectory is selected for execution, an MCM-VMC is sent. On reception of an MCM-VMC, it is evaluated, whether the planned manoeuvre is useful for traffic prediction. A filter is applied, which determines, whether the sending vehicle is relevant and whether it has precedence over the ego vehicle. Irrelevant plans are discarded; relevant plans are maintained in a set C_p for a limited amount of time (or until they are replaced with a new message originating from the same station ID).

Measure 8: Detecting the necessity of cooperation and broadcasting a desired manoeuvre via MCM (MCM- VMC): The set C_p is applied for prediction of traffic participants. Predictions are used for the specification of constraints for the manoeuvre planners. To determine that the ego vehicle requires cooperation for a specific manoeuvre it is insufficient to know that a certain manoeuvre is infeasible under the current set of constraints/predictions. Additionally, the knowledge is required that the modification of the behaviour of another traffic participant enables the feasibility of a certain manoeuvre, or that it reduces its cost. To acquire that knowledge, the Dispatcher sub-component is modified to request planning of an additional, “hypothetical” manoeuvre: In this manoeuvre, the prediction of one or more traffic participants is replaced by a “hypothetical” cooperation behaviour. Such a manoeuvre is never selectable for execution and merely serves to compare cost and feasibility. If the necessity of cooperation is thus determined, the “hypothetical” manoeuvre is added to the MCM-VMC container as a desired manoeuvre.

Measure 9: Determining an appropriate reaction to the reception of an MCM desired manoeuvre (MCM-V2V): The reception of desired manoeuvres is handled similarly to the reception of planned manoeuvres described in Measure 7. In addition, the difference in required acceleration effort is estimated and only desired manoeuvres below a certain threshold are added to C_p . If a desired manoeuvre is added to C_p , the ego vehicle’s affected plans are “automatically” adapted to support the cooperation request. In that case, the own planned trajectory is updated in the MCM, allowing the vehicle which was expressing its desire to follow it.

2.1.1.1.2.1 Second iteration additions

In the second iteration, several new functionalities were introduced and needed implementation. In the following, the list of modifications from the first iteration is extended to include the new requirements specified in the second iteration version of D7.1 [2]. In addition to these functional extensions, the existing functions were further developed to increase stability, remove bugs, or adjust the intended behaviour.

Measure 10: Appropriate reaction to a blocked route: On the way to its destination, unforeseen incidents like car breakdowns or traffic jams can lead to a blockage of the desired route of the CAV. To prevent dangerous situation for the CAV, there are two ways to react to such a blockage: Either the CAV performs a ToC and lets the driver decide where to drive next; or the route is changed, enabling the CAV to continue driving in automated mode. Both reactions have been implemented in the second iteration of TransAID. When rerouting is not possible, the Map Provider closes the road, like how a DENM from an RSU would work in M1. This leads to the Tactical Planner triggering a ToC as described in M2, resulting in safe behaviour of the CAV as either the driver takes over or

the CAV safely stops through an MRM. Alternatively, the destination for the Navigation component is changed, leading to new costs-to-go for the Tactical Planner. The CAV then follows the new navigation, staying in the automated mode and without the necessity to activate the driver as the fallback level.

Measure 11: Encouraging certain reactions to the reception of an MCM desired manoeuvre (MCM-V2V): The possible reactions to receiving a desired manoeuvre as described in M9 are ignoring the desired manoeuvre as it is incompatible with the current state of the CAV, adapting the speed of the CAV and/or changing the lane to accept the desired trajectory of the other CV. In particular during preparation of the demonstrations it became apparent that finding and replicating the right conditions to induce the desired behaviour was nearly impossible. Thus, dynamic costs were introduced through which the likelihood of the desired cooperation could be increased, widening the range of acceptable conditions for each manoeuvre.

Measure 12: Appropriate reaction to traffic lights (MAPEM, SPATEM): When approaching a junction, it is important for the safety of everyone to comply with the traffic lights at that junction. To do so, a Traffic Light Provider combines MAPEM and SPATEM from the infrastructure to generate dynamic stop lines that feed into the different views the Tactical Planner uses. Each signal in the SPATEM has a corresponding connection between lanes in the MAPEM, thus controlling each connection between ingressing and egressing lanes separately. The stop lines for the traffic lights are generated at the closest point to the centre of the junction of the corresponding ingressing lane in the MAPEM. When approaching an impassable stop line (i.e., a yellow or red light), the trajectories generated by the Tactical Planner come to a stop in front of the stop line, respecting the traffic light. Once the traffic light shows green and the corresponding SPATEM is sent out, the stop line status is set to passable and the trajectory will continue past the stop line again.

Measure 13: Turn from straight lane at intersection (MAPEM): The concept from M1 was extended to not only include single segments from the HD map, but to use an intelligent connection algorithm to determine the correct segment sequence in the HD map. Both the starting and the end point of the respective lane in the MAPEM are matched onto the HD map and a connection is searched for between the two. When a connection is found, the types of all segments in that connection are changed, updating the navigation in the process. This enables a type change in the HD map for more complicated areas, in particular within intersections where many segments overlap and a clear assignment otherwise would be impossible.

2.1.1.1.3 Communication

The V2X communication module is logically divided into the V2X message creator and the V2X radio interface modules. The V2X radio interface is implemented in TransAID at the DLR prototypes by using the Cohda's MK5 On-board Unit (OBU), while the V2X message creator runs in the Car-PC where the Dominion Framework is installed. A wired Ethernet connection enables the communication between the V2X radio interface (i.e., Cohda's MK5 OBU) and the V2X message creator (i.e., Car-PC). Figure 5 shows the existing interfaces between the two modules.

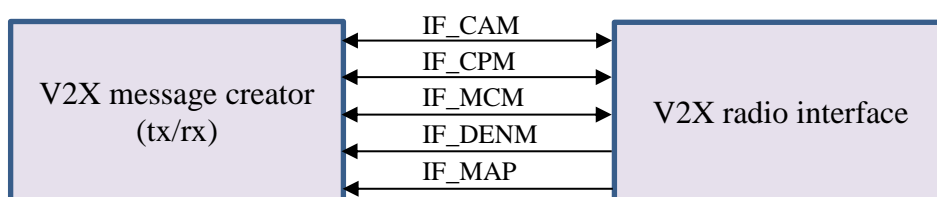


Figure 5: Architecture of the V2X communication module at the vehicle

2.1.1.1.3.1 V2X message creator

The V2X message creator module serves as a *middleware* to facilitate the integration between the Dominion software and the software running on the V2X radio interface. TransAID has followed this modular design approach to minimize the impact of substituting or evolving any of the two software the V2X message creator is connected to, and to facilitate the independent development of the different blocks. The communication between the dominion and the V2X message creator, and between the V2X message creator and the V2X radio interface, is enabled through UDP sockets.

The architecture of the V2X message creator module is represented in Figure 6 and Figure 7 from the transmission and reception point of view, respectively. At the transmission side (Figure 6), the information generated at the Dominion Framework and transmitted through the interfaces 1a, 2a and 4 (see Figure 2), is received at the UDP sockets and used to populate the CAM, CPM and MCM messages. Then, those messages are transmitted through other UDP sockets towards the V2X radio interface module. On the other hand, at the reception side (Figure 7) the V2X message creator module receives the content of the CAM, CPM, MCM, DENM and MAP messages through different interfaces, and after depopulating them, their content is transmitted through the interfaces 1b, 2b, 3, 5 towards the Dominion Framework (see Section 2.1 in D7.1). Both in the transmission and reception sides, some transformations of the messages' data are required in order to adapt them to the V2X radio interface and Dominion Framework requirements.

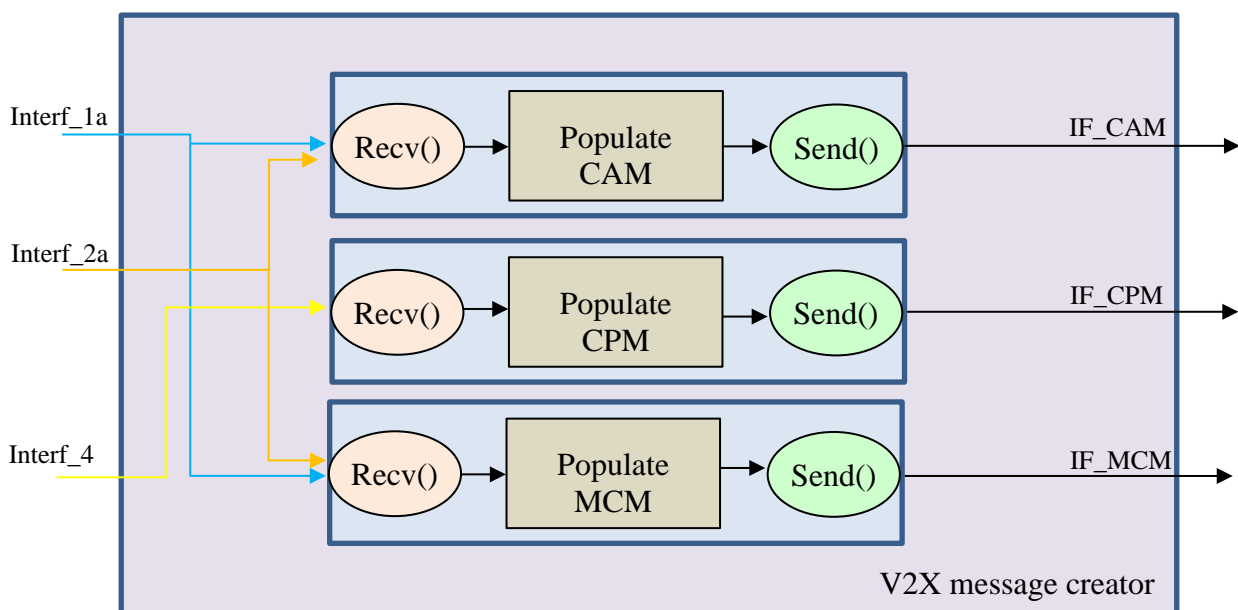


Figure 6: V2X message creator: transmission

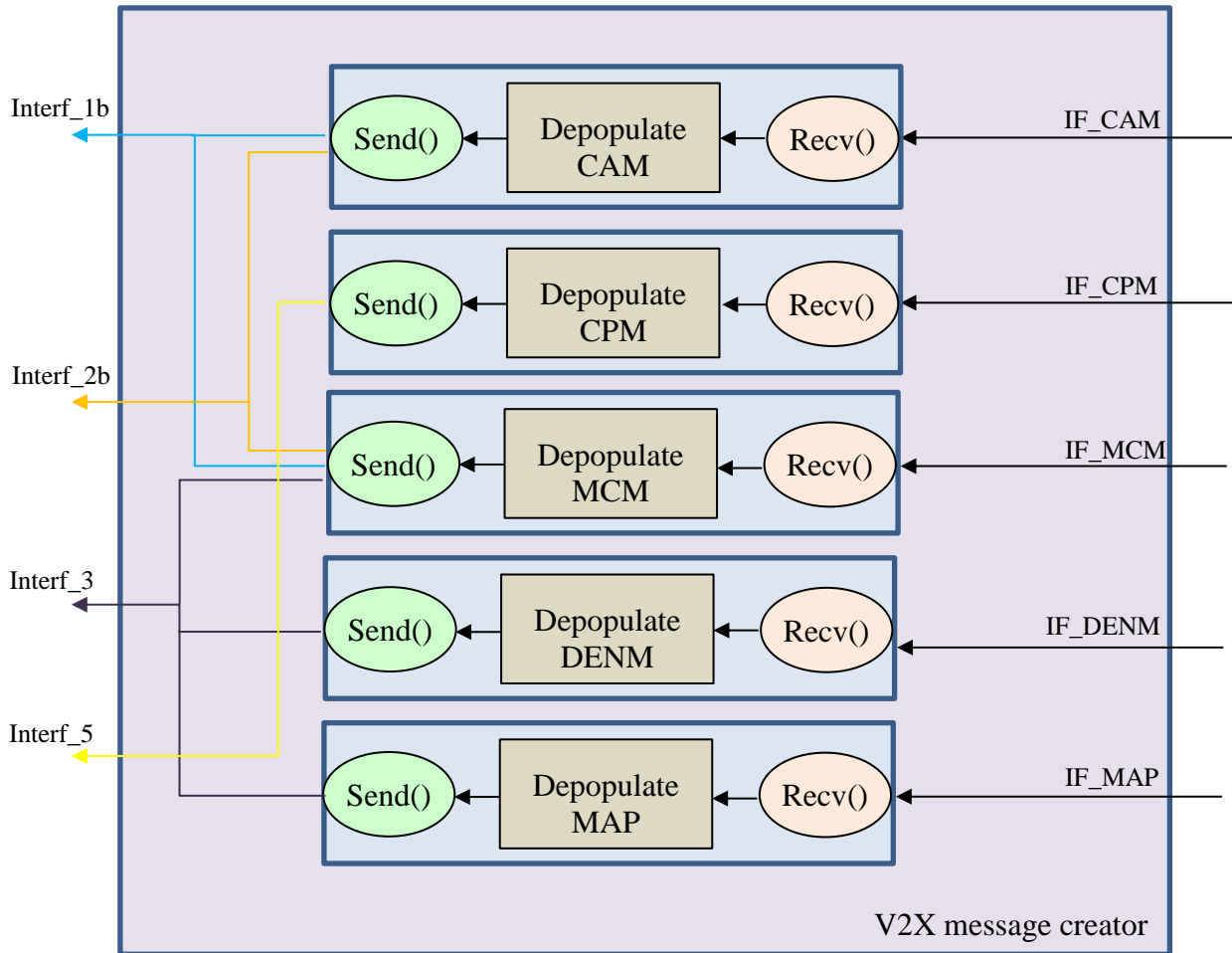


Figure 7: V2X message creator: reception

2.1.1.1.3.2 V2X radio interface

V2X communications in TransAID are enabled by the use of commercially available off-the-shelf (COTS) ETSI ITS G5 solutions compatible with the latest stable versions of the ETSI ITS and SAE DSRC standards [19] [20] [21] [22] [23] [24] [25] [26] [27] [28] [29]. TransAID has implemented its communication protocols and message sets on the top of these solutions thanks to the extensibility properties offered by them. In particular for the case of DLR, the Cohda's MK5 OBU has been selected which includes a Software Development Kit (SDK) that enables and facilitates modifications and customizations of the ETSI ITS G5. The resulting TransAID V2X radio interface module architecture is depicted in Figure 8. As it can be seen, a TransAID radio interface module is compliant to the standard ETSI ITS communication architecture [20] and supports transmission and reception of V2X messages over the ETSI ITS G5 radio technology as profiled in [28]. The adopted network and transport layer protocols are exactly the same as standardized in [23] - [27] and implemented in the commercially available V2X solutions, which provides a straightforward approach to bring TransAID implementations on real-road tests. In addition, the TransAID V2X radio interface module implements the Facility Layer's functional requirements and specifications as described in [23] including the support for DENM and CAM basic services, and the maintenance of the Local Dynamic Map and Vehicle State databases. On top of this, TransAID has extended the ITS G5 Applications to accommodate the needs of the TransAID use cases/services. Several V2X services have been created from scratch to manage the transmission and reception of MAP, CAM

and DENM messages (extending the Decentralized Environmental Notification and Cooperative Awareness services), and CPM and MCM messages to enable the Collective Perception and Manoeuvre Coordination services, respectively. This is represented in Figure 8 by the Application Layer’s CAM, MCM, CPM, DENM and MAP modules. These modules implement the functionalities to manage V2X messages to be transmitted and/or received, including UPER co/decoding and information processing.

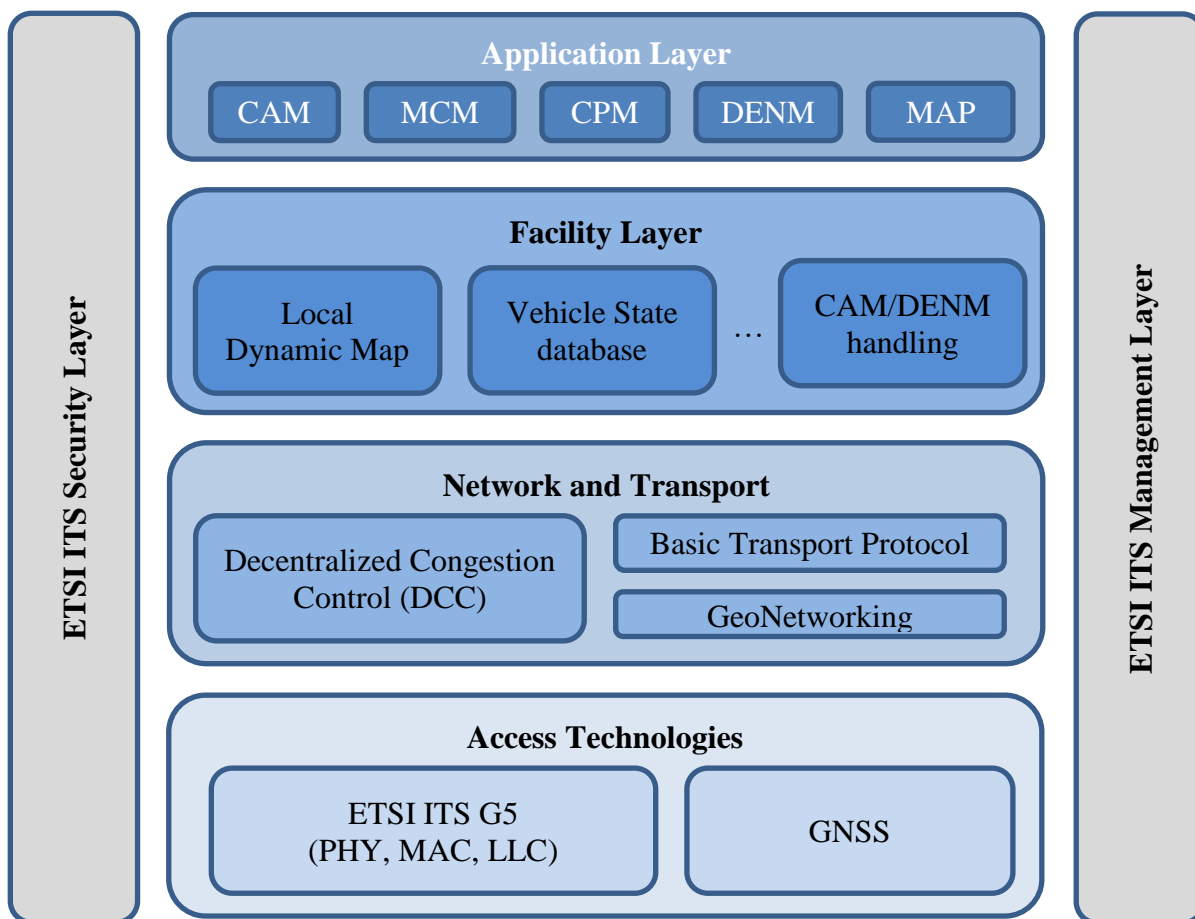


Figure 8: TransAID V2X radio interface architecture

Using as an example the MCM module of the ITS G5 Application Layer depicted in Figure 8, Figure 9 shows the processing of MCM messages on the transmission (see Figure 9.a) and reception (see Figure 9.b) path. On the transmission path, the MCM application takes the information of the IF_MCM interface coming from the V2X message creator module and depopulates it. Then, using the C structs that are created out of the MCM ASN.1 definition, the MCM message is populated and the BTP header is added. It is important to note that integrating the MCM ASN.1 definition in the MCM application module provides high flexibility to modify and adapt the message’s container to the TransAID requirements. The MCM ASN.1 definition is also used to generate the coding rules for the MCM’s UPER encoding. The resulting message is then transmitted to the Facility Layer. The MCM ANS.1 definition used during the first iteration of TransAID is included in “**Annex B1: MCM ASN.1 specification**” (the description of the different fields is in “**Annex A1: MCM description**”). On the reception path, messages arrive at the Application Layer through a callback function. All TransAID Application Layer’s modules use a similar callback function that is invoked when any of these messages is received. Therefore, the information of the BTP header needs to be accessed to identify the messages that are to be processed in this module, e.g., MCM. For example,

for the MCM message TransAID has set the BTP port 2010, while CAM and DENM messages are identified by the BTP port 2002 and 2001, respectively. The MCM ASN.1 definition is also used to create the UPER decoding rules that are used to get the information of the MCM message, and finally to populate the interface message to be transmitted through IF_MCM.

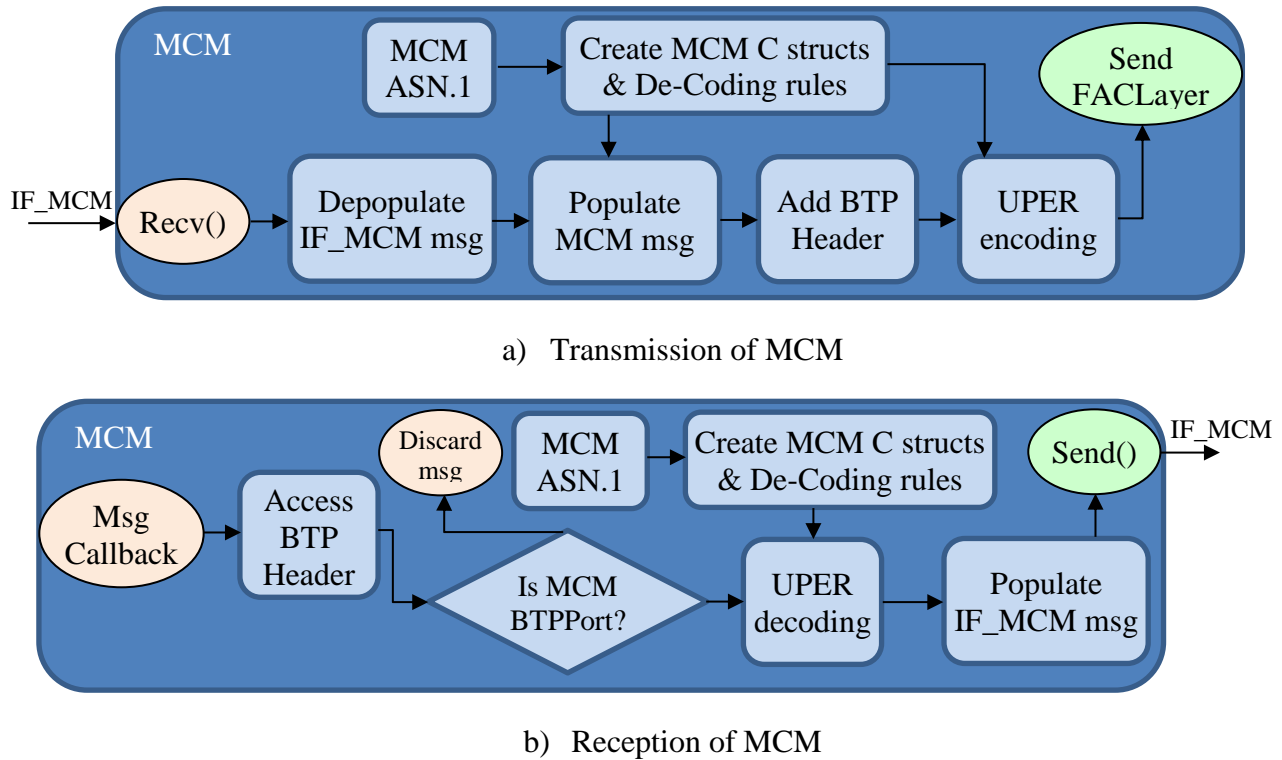


Figure 9: TransAID V2X radio interface architecture:

application layer a) transmission, b) reception (MCM used as an example; a similar approach used for other applications such as CPM, CAM, DENM, and MAP)

2.1.1.1.3.3 Second iteration additions

TransAID has followed during the second project iteration a similar philosophy for the implementation of the V2X communication module than during the first project iteration. Some modifications and adaptations were needed to fit the implementation to the new requirements of TransAID’s second iteration though. Figure 10 shows a graph diagram that shows some details of the V2X Application Layer implementation at the CAV in the 2nd project iteration. Note that the figure shows both the transmission and the reception path using different colours, and the interfaces to the AD Software or Dominion (Figure 2). As it has been introduced in Section 2.1.1.1.3, the Application Layer manages the transmission and reception of all V2X messages. On the reception path, the V2X’s Application Layer processes all the received V2X messages (i.e., MCMs, DENMs, CAMs, CPMs, SPATEMs, MAPEMs, etc.); note that in Figure 10 only some of the messages are illustrated for clarity. For example, in the case of MCMs, the V2X’s Application Layer accesses the ManeuverContainer to identify whether the message was originated by an RSU (i.e., I2V) or another CAV (i.e., V2V). If the MCM was originated by an RSU, then the RSUSuggestedManeuverContainer is analysed. This allows the CAV to identify whether the MCM includes advisories that it should take into account. If there are no advisories addressed to the CAV that receives the MCM, then MCM message is discarded. Otherwise, the relevant MCM information is transmitted through the IF1_MCM UDP interface that connects with the AD SW module. This is also the case when the MCM was originated by another CAV. In this case, the relevant information included in the VehicleManeuverContainer is transmitted through the

IF1_MCM UDP interface. Different processing is performed at the V2X Application Layer depending on the received V2X message. For example, when DENMs are received, the Application Layer could check the information included in the RWW (RoadWorks Warning) and identify whether it affects the CAV or not taking the CAV’s current location and distance to the event (among other things) into account. If the information included in the DENM is relevant for the CAV, the implemented V2X Application Layer forwards the DENM’s information that is of interest to the AD SW module through the IF_DENM UDP interface. Modifications have been also performed on the transmission path during the 2nd project iteration. In this case, the V2X Application Layer receives information from the AD SW module that is used to generate the V2X messages (e.g., CAM and MCM messages). For example, for the case of the CAM and MCM messages, this information is received at the V2X Application Layer from the AD SW module using UDP interfaces that are represented in Figure 10 as IF_CAM and IF2_MCM. The information included in the UDP interfaces is used to populate the V2X messages. For example, for the case of the CAM message, the IF_CAM includes information obtained from the vehicle’s CAN bus (e.g., speed, acceleration, heading and steering angle). The IF_CAM interface also includes relevant information that is used to populate the extended CAM message that is proposed in TransAID like the currently operated SAE automation level. Then, this CAM info is sent from the Application Layer to the Facility layer where the CAM is populated, i.e., regular CAM containers and the AutomatedVehicle container. For the case of the MCM message, the information necessary to populate them is received through the UDP interface that is referred to as IF2_MCM in Figure 10. In particular, the information included in the IF2_MCM is used to populate the VehicleManeuverContainer including planned and/or desired trajectories, and it might also include feedbacks about the advisories received from the RSU.

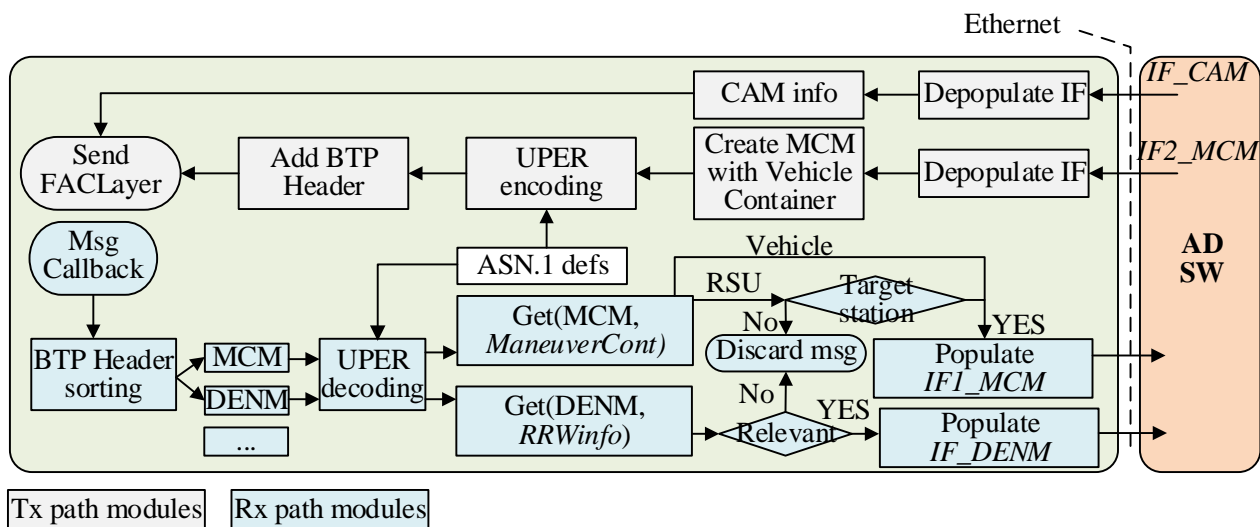


Figure 10: TransAID V2X radio interface architecture at the application layer (2nd project iteration)

2.1.1.1.4 HMI

2.1.1.1.4.1 First iteration debugging HMI

Although TransAID does not deal with HMI in general, it has been decided to implement a debugging HMI for testing and for demonstration of the behaviour. The HMI is not fulfilling current state-of-the-art HMI paradigms and is only for displaying the internals of the vehicle automation’s decisions and respected inputs.

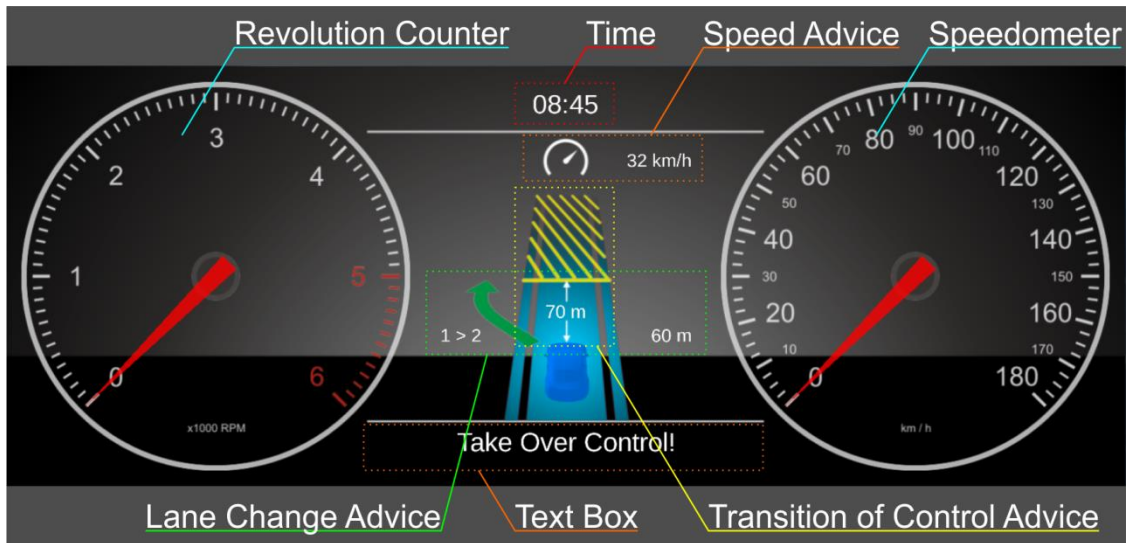


Figure 11: Debugging HMI overview

As shown in Figure 11, the HMI consists of standard elements like the revolution counter and the speedometer. The additional center part element consists of the following elements:

- Text Box: Here, additional text is shown.
- Speed Advice: Whenever a speed advice is received via MCM, it is directly shown here, converted to km/h.
- Lane Change Advice: Whenever a lane change advice is received via MCM, it is directly shown here. The Lane Change Advice consists of a couple of values: On the left, the current and desired lane ID is shown in the format “current > desired”. On the right side, the distance to the lane change position is shown. The arrow indicating the lane change direction is either turning left or right. Furthermore, it is either pulsing in case of a pending lane change or solid in case it is currently executed.
- Transition of Control Advice: This field is composed of a hatched area and the remaining distance in the current driving mode. The hatched area can be either yellow in case of a transition of control taking place or red in case of a minimum risk manoeuvre. The area is either pulsing when the advice is pending or solid when the advice is active. In case a minimum risk manoeuvre is executed, the hatched area is replaced by a warning message box, shown in Figure 12. A Transition of Control Advice is accompanied by the text message “Take Over Control!” shown in the Text Box. Therefore, a normal transition from automated control to human control without any action to take over by the driver consists of the following steps:
 1. Active transition of control: pulsing yellow hatched area and distance value
 2. Active minimum risk manoeuvre with overlay image.

All other combinations may only occur in case of wrongly used values. Being a debugging HMI, these cases nevertheless may occur.



Figure 12: HMI showing active Minimum Risk Manoeuvre

2.1.1.1.4.2 Second iteration HMI

Although HMI is not a topic of the TransAID project, it has been decided to use a more elaborate design to showcase the developments. As reference, DLR chose to use the general HMI framework developed in the TransAID sister project ADAS&me. More details about the design aspects of the original HMI can be found in [30]. The following subsections will briefly describe the HMI structure and the shown HMI sequences.

2.1.1.1.4.2.1 Structure

The used in-vehicle HMI is implemented on the cluster display. It consists of several parts, as described in Figure 13.

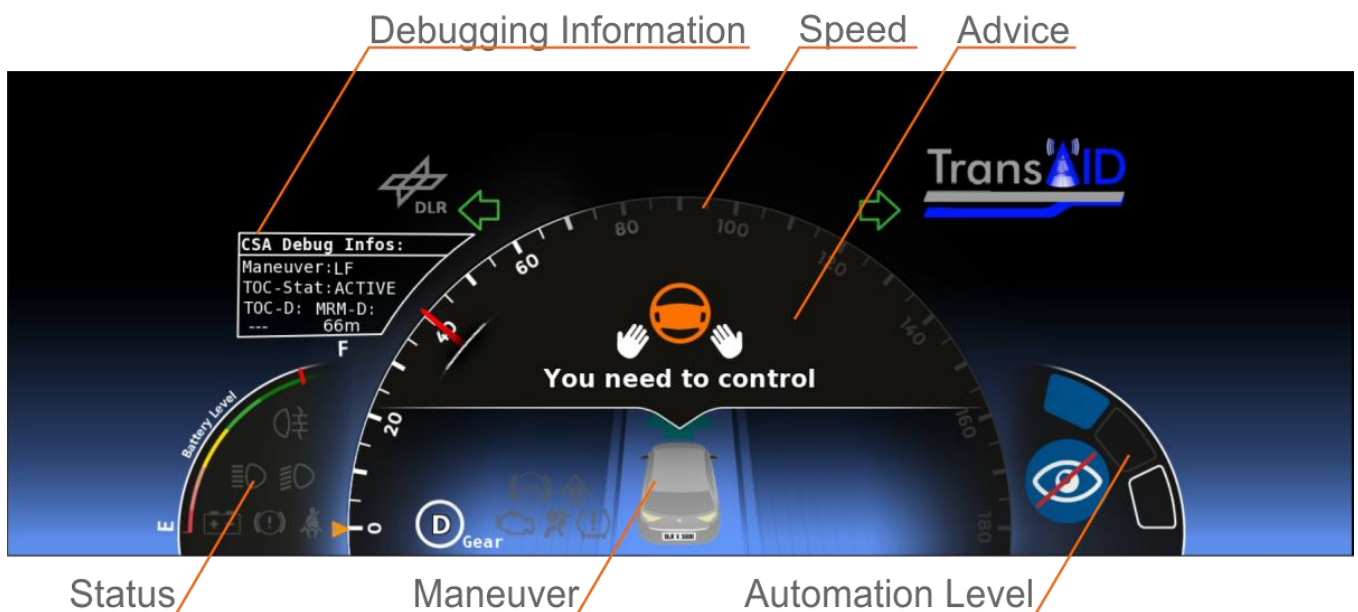


Figure 13: Structure of the second iteration HMI

Besides the central speedometer, the display consists of further standard components, like the current fuel/battery level, light and engine states and the currently chosen gear.

Further central components are:

- Maneuver section: A section in the center of the display showing the ego vehicle from a bird view perspective and the currently active manoeuvre, e.g., a straight arrow for lane following or an arrow indicating the lane change.
- Advice section: A section in the center of the display for any specific driver-system interaction.
- Automation Level section: This section on the bottom right of the display shows the currently chosen automation level and the availability of other levels. Existing levels are
 - o Manual driving: Here, the driver is in full control. In this level, different assistance systems are still active, e.g. lane keeping and speed advisory.
 - o Attentive driving: This level corresponds to an automated driving of SAE levels up to 3. The driver still needs to be attentive and needs to take over control at any time. This level has not been implemented in TransAID.
 - o Automated driving: This level corresponds to SAE level 4. Here, the driver does not need to monitor driving and can perform any secondary task.

The currently chosen level is indicated as a filled polygon. If a level is available, it is shown as a polygon frame. If not, also the frame is not visible. The chosen automation level is also shown as an icon, see Figure 14. To foster the awareness of the currently chosen automation level, also the backlight of the cluster display is coloured in the respective colour (white/grey: manual driving, orange: attentive driving, blue: automated driving).

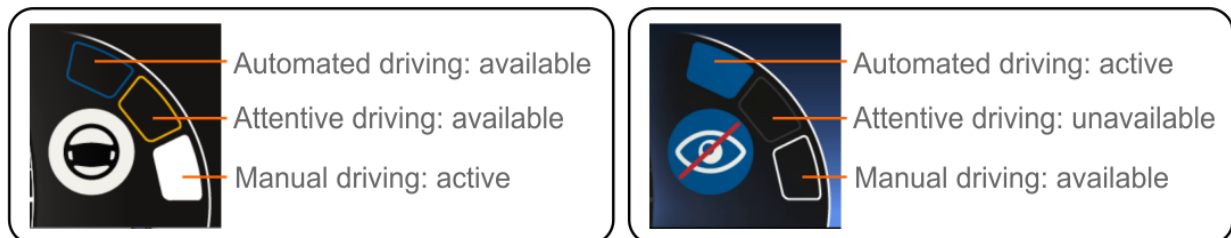


Figure 14: Detailed description of HMI for current automation level

- Debugging information: This section is used for debugging purposes for developers only. In the current design it shows the currently driven Maneuver as text (e.g., LF: Lane Following, LC: Lane Change), the current state of the ToC and the currently important distances until a ToC or MRM takes place. The example in Figure 13 shows an active ToC, with a distance of 66m until the MRM is triggered.

2.1.1.1.4.2.2 Transitions of Control

The driver is able to perform an upward ToC from manual driving to automated driving when automated driving is available (i.e., when the vehicle is on a driveable lane, sensors are working, when the ODD is met). To initiate the upward ToC, the driver needs to press a button on the right part of the steering wheel. If the vehicle is standing still, the driver also has to acknowledge by pressing the accelerator pedal once. Figure 15 shows the HMI presented during automation availability and upward transition. Each step of the ToC is accompanied by sounds presented in Table 1.

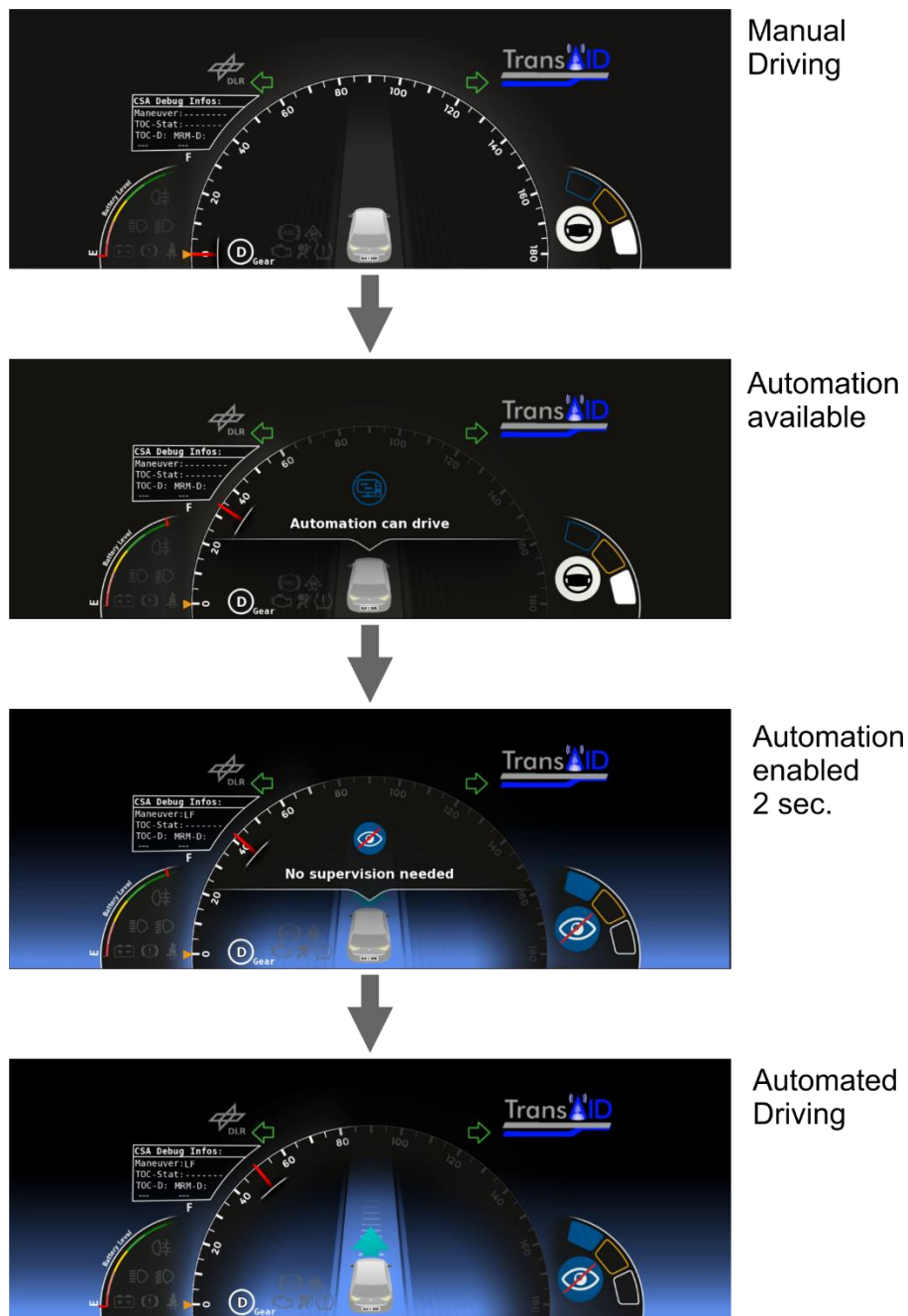


Figure 15: HMI presented when enabling automated driving







Downward ToCs to manual driving can be initiated by the driver at any time by pressing a button on the right side of the steering wheel, or by pressing the accelerator or brake pedal beyond a given threshold, or by steering intervention. If a downward ToC is triggered by the vehicle automation (e.g., after receiving a ToC advice from the infrastructure or when leaving the ODD), the driver is warned about this in an escalated way, as shown in Figure 16, accompanied by acoustic warnings as shown in Table 1.

As a first step, the driver is informed that a ToC is started, and that the driver has to take over. If the driver is not responding within a given range, or if the available time for a ToC is low, the HMI provides an escalation. The visual HMI gets more prominent and the acoustic HMI gets more intense. If also this escalation is ignored by the driver, the vehicle automation triggers the MRM at the last possible position required to stop the vehicle safely. The MRM is visualized in the cluster

display and accompanied by acoustic warnings. When an MRM is performed, the vehicle remains in a safe state.

If the driver is responding during the ToC escalation, a specific “You are in control” HMI is shown.

Table 1: Audio presented in case of a ToC

Upward ToC	Automation available	
	Automation activation	
Downward ToC	ToC Escalation 1	
	ToC Escalation 2	
	MRM	
	Automation deactivation	

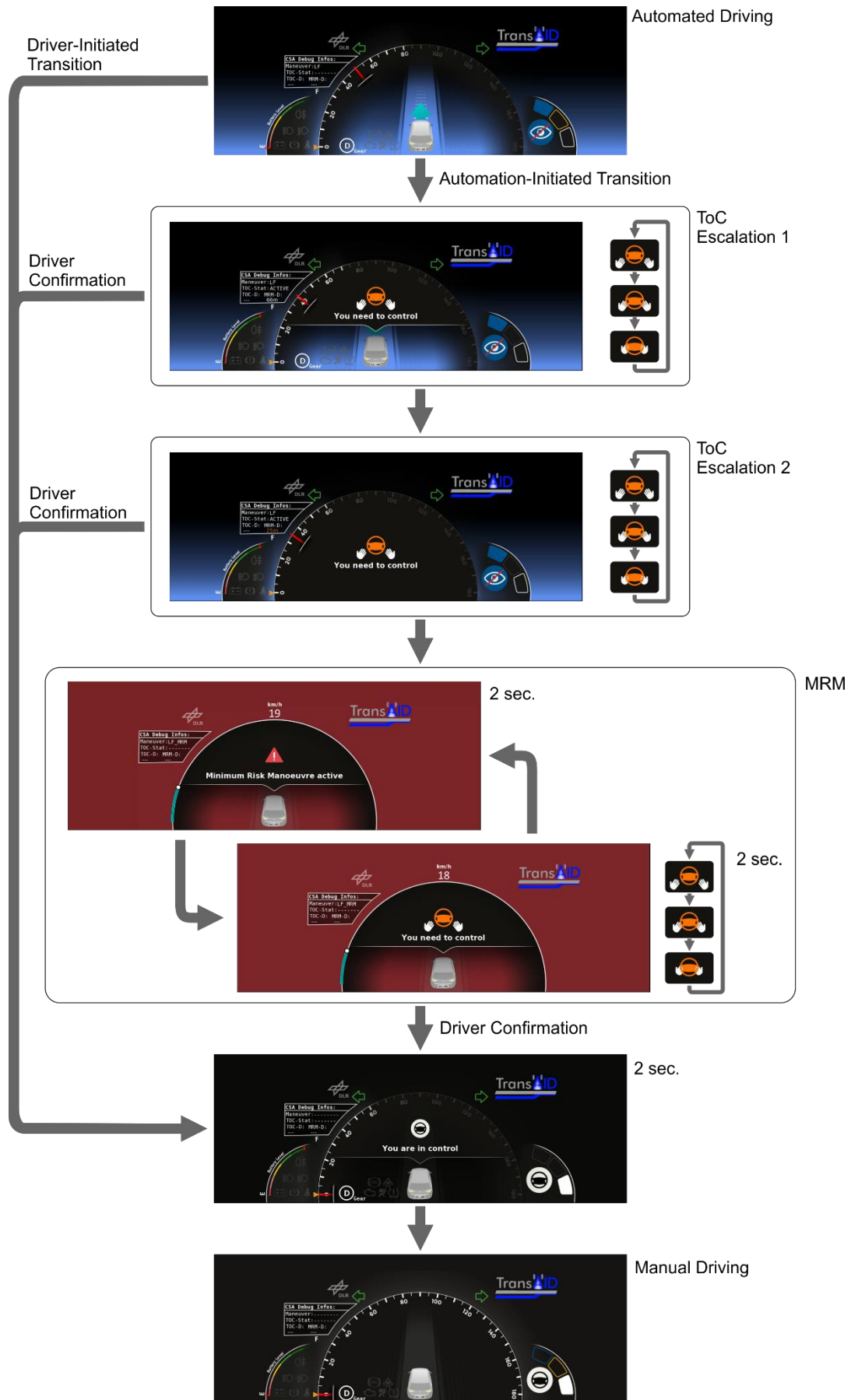


Figure 16: HMI presented in case of transition to manual driving

2.1.1.1.4.2.3 Lane changes

When the CAV is driving automatically, it also performs lane changes, which can be advised by the infrastructure or planned internally. Whenever a lane change is executed, a pulsing arrow is shown in the cluster display, see Figure 17. The lane change is accompanied by a triggered indicator.

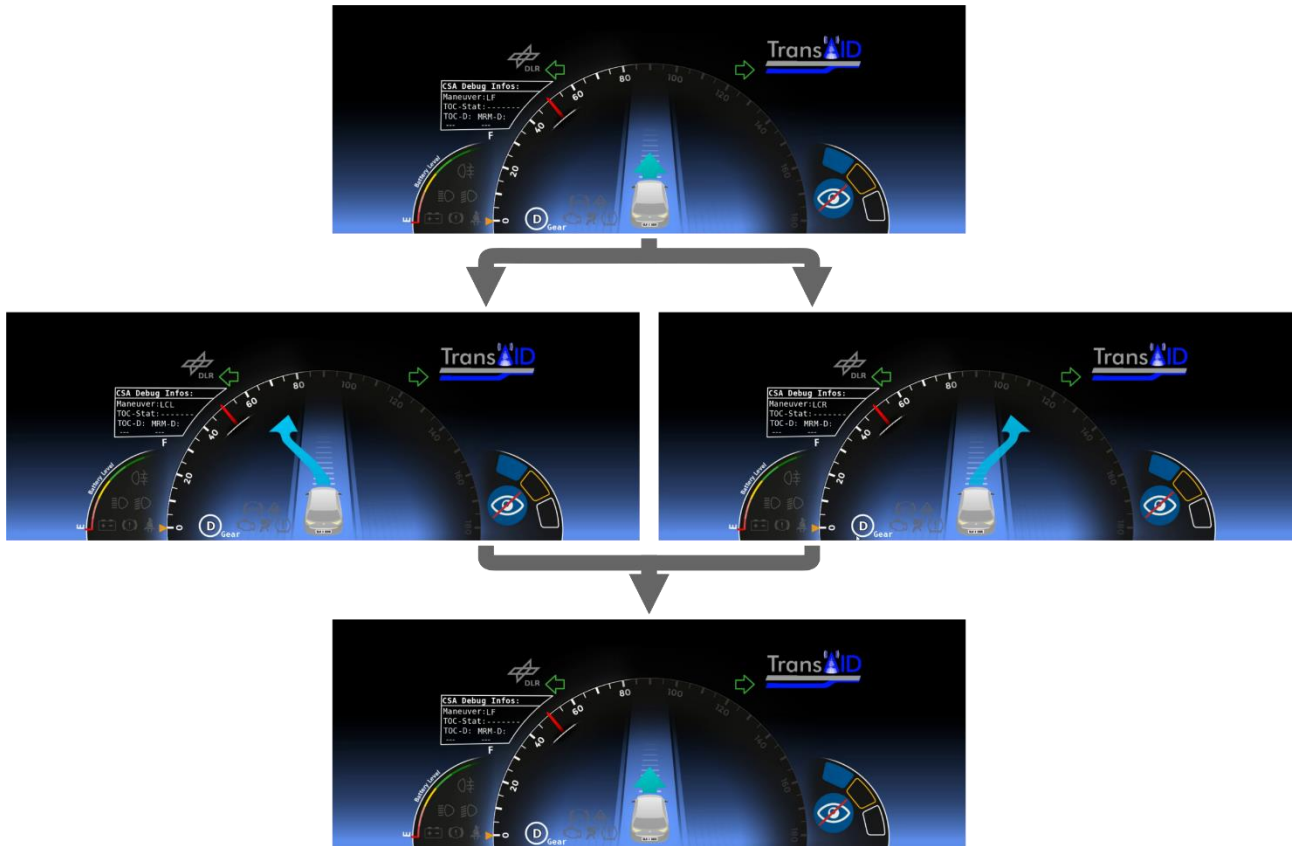


Figure 17: HMI presented when vehicle changes lane in automated driving

2.1.1.1.4.2.4 Detours

In case the vehicle is not able to follow the initially planned route, the respective information is shown on the cluster display. The provided HMI is shown in Figure 18.

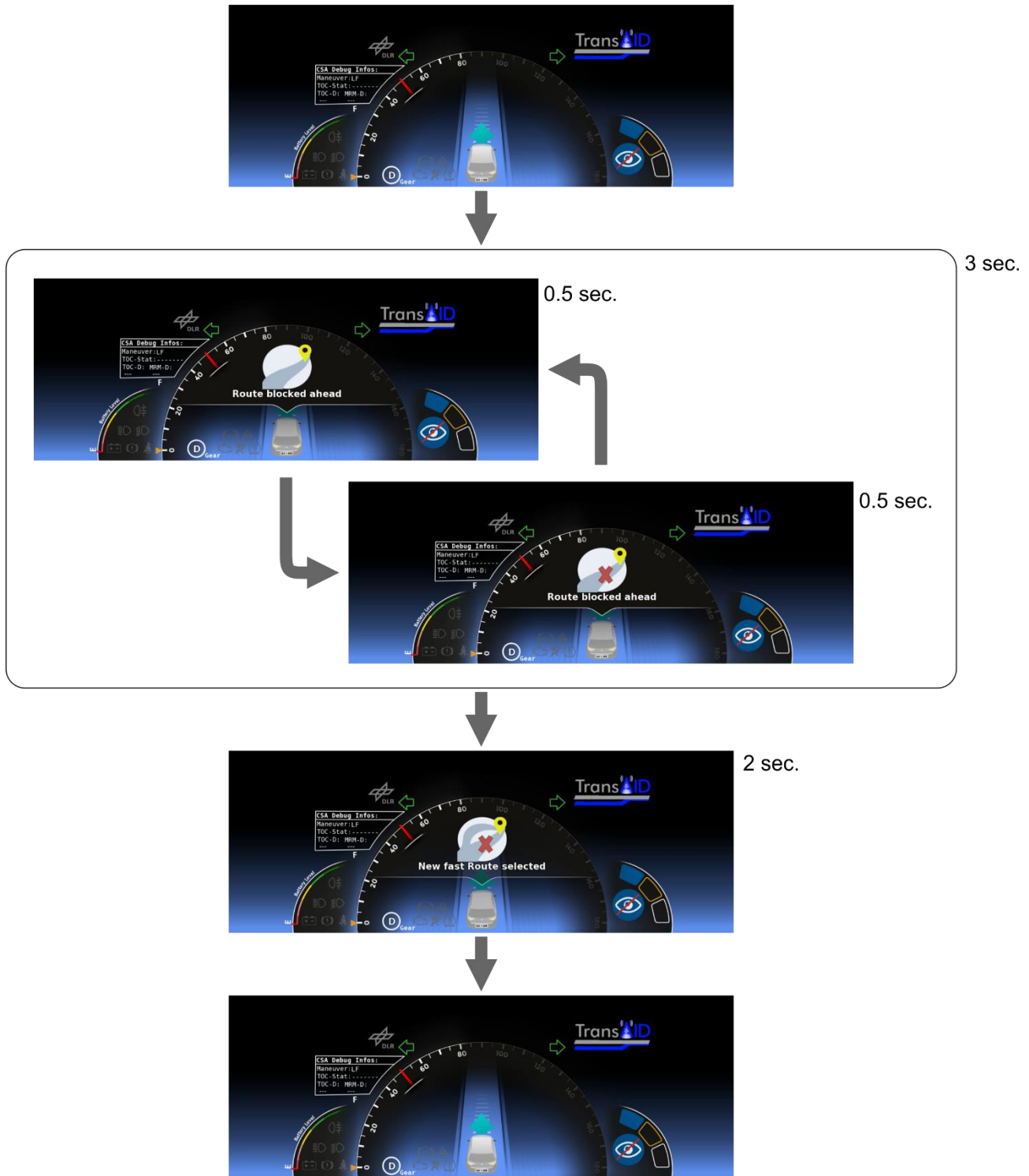


Figure 18: HMI presented in case of a required detour

2.1.1.2 CVs

In the first project iteration, only one single CV has been used, but only for testing the sensor data fusion in the CAVs of Lidar and CAM as described earlier.

The used car was a Volkswagen T5 bus, which used a Cohda V2X Box for communication. In addition, the bus includes an inertial measurement unit (IMU) coupled with a high-precision

satellite navigation system similar to those in the used CAVs. Therefore, the positioning data included in the CAMs was of high precision.



Figure 19: DLR's T5 bus used as a CV in TransAID

In the second project iteration, no CVs have been used in the full assessment.

2.1.2 Road Side

All tests in the first project iteration have been performed on the Peine-Eddesse test track already described in D7.1. In this iteration, a virtual road topology (Figure 20) has been placed on the test track which consists of a two-lane straight road which can be used as highway or rural road. It is accompanied by a merging lane used for the merging Service 2.1 (see D7.1 for details).

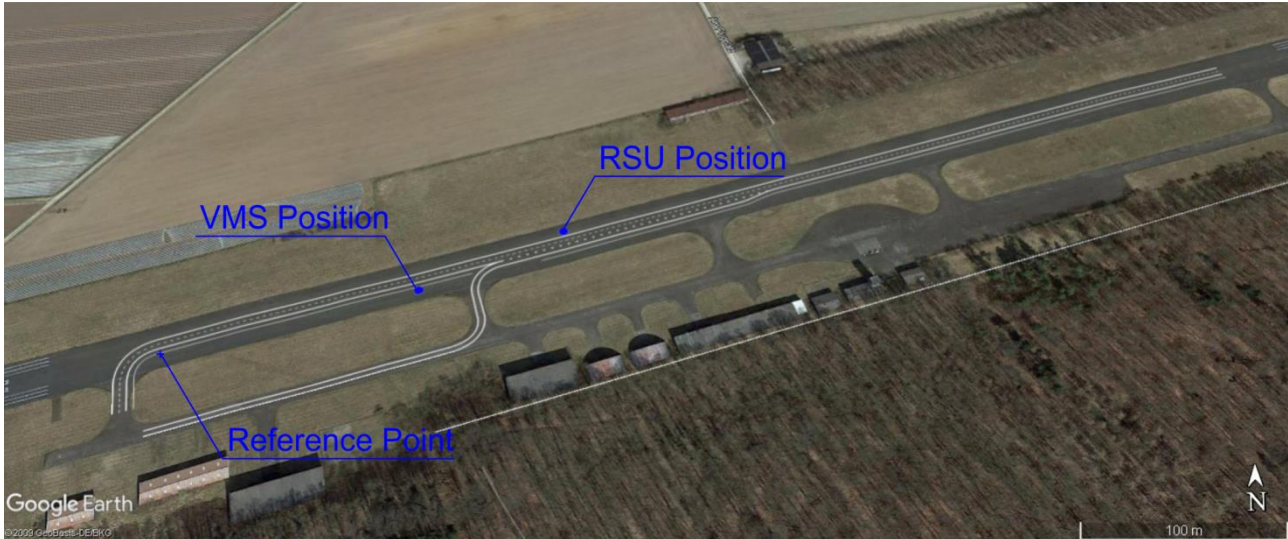


Figure 20: Used road topology on the Peine-Eddesse test track

In addition to the virtual parts, a variable message sign, and a pole with a mounted RSU and camera has been placed on the test track at the indicated positions.

Furthermore, a reference point was included in the first iteration trials. This reference point is used as local reference of lane, speed or ToC advice positions instead of using the content of a MAPEM, which will be used in future implementations.

In the following, all parts are explained in detail.

2.1.2.1.1 Sensors and Sensor Fusion

The mobile RSU used at the test track on Peine-Eddesse Air Field consists of a mobile retractable pole with an ACTi camera type B94 mounted at the top. This outdoor camera has a maximum resolution of 1.3 Megapixel and can record videos at 30 fps with a resolution of 1280x960 pixels. Furthermore, it is contained in a weatherproof casing and is equipped with a fan and heater that are like the camera powered by Power over Ethernet (PoE). The recorded data is processed on an ECX-1200 computer with an integrated NVIDIA GeForce GTX 1050 graphics card to allow for fast inference time of the subsequent object detection. The described setup is depicted in Figure 21.

Since the demonstration use cases within TransAID aim to leverage synergies between the infrastructure and automated vehicles, the videos recorded by the camera are further processed with the aim of providing relevant object information to the passing vehicles. This pipeline for further processing the recorded videos is implemented in ROS. Therefore, the video stream from the camera is first read into the format of a ROS message, before being passed to a node performing object detection. The object detection is performed by a neural network. Specifically, a TensorFlow implementation of a ResNet-50 network architecture comprising a Faster-R-CNN as detection algorithm is used. The network was trained on a manually labelled dataset acquired at the DLR reference track and is able to detect and classify cars, vans, trucks and their trailers as well as busses, motorbikes, pedestrians and bicycles. The detected objects are subsequently tracked over time in order to determine object velocities, reduce uncertainties and also provide object histories.

For this an adapted version of the approach presented in [31] is implemented. The tracking is based on a Kalman filter that performs the prediction step based on a constant velocity model. The predicted tracks are matched to the new detections with linear assignment based on a cost matrix. In doing so, confirmed tracks of objects that have already been tracked over multiple time steps are associated first, further processing consistently tracked objects prior to tracks with gaps in their tracking history. Matched tracks and detections are used to update the Kalman filter while unmatched detections generate new track candidates. The tracked bounding boxes in image coordinates are then transformed into the UTM coordinate system based on the calibrated inner and outer orientation and the known position of the camera. For the succeeding V2X message transfer, the data is formatted into a ROS message in the CPM format, ensuring the correct value ranges and units and handling invalid entries. In the final step these ROS messages are converted to UDP packets that are sent to a java application for further communication to the Cohda V2X box also mounted on the mobile RSU.



Figure 21: Mobile RSU with mounted ACTi Camera and ECX 1200 processing computer

2.1.2.1.2 Traffic Management System

The design of the traffic management system was scenario-driven at this stage of the tests. There is a receiver for CAMs from connected vehicles and there are senders for MCM, MAP and DENM running on the RSU. Depending on the scenario, each of the outgoing messages was either enabled or disabled (see Section 2.2 for more detailed information).

Each scenario was defined by a .conf file and a Java script containing the traffic management logic. In the .conf file, one can enable or disable the sending of specific messages, define the output ports

for each message type and define the identifiers of the vehicles involved in the scenario. The Java scripts ran specific instructions for the respective scenario, i.e., static messages were sent. Future works for the 2nd iteration on the traffic management system includes the generation of dynamic messages based on CAM data, CPM data for safe spot availability, and different acknowledgements for ToC/MRM performances, safe spot assignments or automation mode in order to emulate the services provided by the other work packages.

2.1.2.1.3 Communication

The design of the V2X communications module at the infrastructure is similar to the one implemented at the CAV (see Section 2.1.1.1). The Cohda solution used in this case is the MK5 RSU which is built with the same chipset as the MK5 OBU used in the vehicle (see Section 2.1.1.1.3) but housed in a waterproof enclosure. The DLR MK5 RSU solutions are also Power over Ethernet (PoE) capable.

In this case, the V2X message creator module is logically divided into the V2X message receiver and V2X message sender as depicted in Figure 5. Besides, the configuration files used for the V2X radio interface allow indicating whether the ETSI ITS G5 V2X solution should act as a passenger vehicle, or as an RSU.

2.1.2.1.4 Variable Message Sign

As variable message sign, a Niechoj electronics LUMEX full matrix sign compliant with EN 12966 has been used. For displaying, this device is receiving full colour bitmap files in the resolution of 39 x 40 pixels via Ethernet. During the integration of the first project iteration, an application has been developed which is updating the shown images frequently, according to the needs of the shown scenario. This approach also allows changing images or animations.

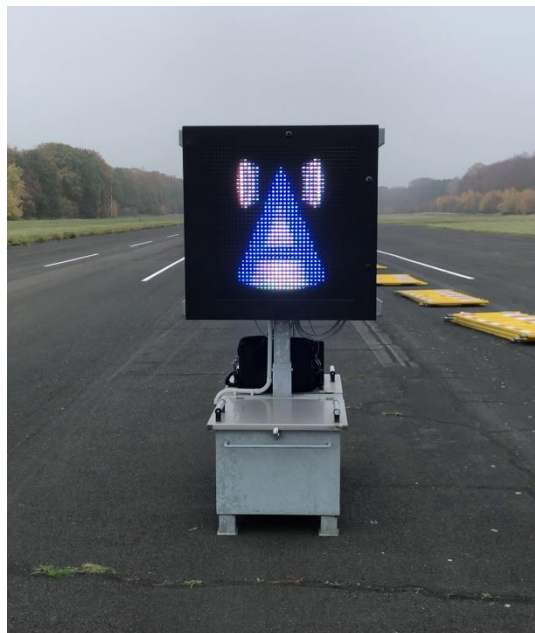


Figure 22: Variable message sign used during the test runs

2.2 Feasibility assessment

This chapter describes the general setup of the feasibility assessment.



2.2.1 First iteration






During the first project iteration, a set of use cases had to be tested. The use cases are introduced in D2.2 [6] and further specified in D7.1 [1] in terms of real-world assessment.







In the following, the feasibility assessment of the first iteration is shown. After dealing with the general requirements, the specific requirements for the first iteration use cases are described.


2.2.1.1 General requirements assessment

2.2.1.1.1 Requirements verification

General requirement description	Req. Name	Associated Test cases successfully executed	Notes
<p><i>Availability of cooperative automated vehicles:</i></p> <p>As TransAID deals with transition areas, all use cases include at least one cooperative automated vehicle. Therefore, cooperative automated vehicles need to be available for the feasibility assessment. The vehicles need to be able to drive longitudinally and laterally automated, independent of the SAE level of automation, as well as to cooperate via V2X.</p>	REQ_V_G_1		The minimum required number of CAVs was present during the tests
<p><i>Availability of transitions of control</i></p> <p>As TransAID focusses on SAE levels up to level 4, the automated vehicles need to have the ability to perform transitions of control to the driver and from the driver to the vehicle automation. The transitions need to be driver and automation initiated, meaning that the driver may decide which system is turned on (for each longitudinal and lateral control either manual driving with warnings or automated driving), but the automation itself may decide to not being able to keep the desired level of automation any longer.</p>	REQ_V_G_2		Transitions of control could be executed

<p><i>Availability of Minimum Risk Manoeuvres (MRM)</i></p>	<p>REQ_V_G_3</p>		<p>Standard and extended Minimum Risk Manoeuvres could be executed.</p>
<p><i>Availability of extensible sensor data fusion</i></p>	<p>REQ_V_G_4</p>		<p>The sensor data fusion is available and has included interfaces for CPM and CAM perception. Only CAM-Lidar fusion is currently used. In addition, map properties are changed according to DENM and MAPEM receptions. Nevertheless, the fusion with the CPM objects has not been implemented yet.</p>
<p><i>Communication and message sets</i></p>	<p>REQ_V_G_5</p>		<p>Communication is implemented following the designed message sets.</p>
<p><i>Cooperative lane changes</i></p>	<p>REQ_V_G_6</p>		<p>Cooperative lane changes in terms of V2V cooperation has only been tested in simulation, see sections 2.2.1.3.2.2 and 2.2.1.3.2.3</p>
<p><i>Local high definition map</i></p>	<p>REQ_V_G_7</p>		<p>A local high definition map was present. As mentioned in REQ_V_G_4, the map data is already dynamically changed on reception of DENM and MAPEM.</p>

	<p><i>HMI availability for CVs</i></p> <p>Task 5.5 describes signalling for legacy and cooperative vehicles, including signalling inside the vehicle. For this, the vehicle needs to have an HMI available. This will most likely be an Android smartphone connected to the OBU.</p>	REQ_V_G_8		As no CVs were present during the tests, also the CV HMI was not needed. Instead, a debugging HMI was used in the CAVs
Infrastructure requirements	<p><i>Communication and message sets</i></p> <p>It is a mandatory requirement for the infrastructure to be able to communicate advice to the vehicles by using ETSI ITS-G5 based V2X communication. In addition, the reception of messages is also needed to get a better image of the situation, e.g. by knowing the exact positions of cooperative vehicles and their plans, as well as knowledge of other non-cooperative vehicles' presence.</p> <p>To avoid extensive forwarding of messages, different road side units shall be linked to each other. While this is a general requirement, it will not be used during the feasibility assessment, as there will always be only one single road side unit available.</p> <p>Furthermore, the infrastructure needs the ability to communicate decisions to non-cooperative vehicles as well. This can be done by for instance Variable Message Signs. Possible additional methods are to be developed within WP4 and WP5.</p>	REQ_I_G_1		<p>The infrastructure was able to communicate messages in line with the defined message sets.</p> <p>As mentioned in the requirements, only one single RSU has been used.</p> <p>Communication to non-cooperative vehicles has been done by using a VMS, see REQ_I_G_6.</p>
	<p><i>Sensors</i></p> <p>In most cases, the infrastructure also needs to know where all non-cooperative vehicles are. Therefore, sensors to detect vehicle positions are a mandatory requirement. While the sensor can be of any kind, cameras are foreseen to be the best option, as they offer not only vehicle positions, but also more details, like the orientation and speed.</p>	REQ_I_G_2		A camera was able to detect and track objects.
	<p><i>Sensor data fusion</i></p> <p>As for the vehicles, also the infrastructure needs to perform a sensor data fusion, e.g. to understand that a vehicle detected by a camera is also transmitting messages.</p>	REQ_I_G_3		<p>In the first iteration, no sensor data fusion was present during the tests. This only affects Test 4.2_2, as in all other services no link between objects and message generation is required. Simulations for use case 2.1 have already demonstrated data fusion between sensors, CAM and CPM data. However, this will only be tested in the field in the second iteration.</p>
	<p><i>Processing capabilities</i></p> <p>The infrastructure needs to be able to compute several inputs to generate correct traffic management measures. Therefore, the infrastructure needs to include adequate processing capabilities.</p> <p>If the sensors need further processing capabilities e.g. to calculate object positions and dimensions, this needs to be included as well.</p>	REQ_I_G_4		Processing was possible without any shortcomings.
	<p><i>Road networks</i></p> <p>The different use cases will need different road network topologies to be taken into account. The road networks need to be available logically so that the infrastructure is able to plan on top of it.</p>	REQ_I_G_5		The used road network was included in the infrastructure as well.

<p><i>Signalling equipment</i></p> <p>The only method to reach non-cooperative legacy vehicles is through the road side equipment. Task 5.5 will investigate this further, but as there is no budget foreseen for Variable Message Signs (VMS), it is likely that this will be limited to existing infrastructure, e.g. traffic light signals, ramp meters, etc.</p>	<p>REQ_I_G_6</p>		<p>A VMS was available and used.</p>
--	------------------	---	--------------------------------------

2.2.1.1.2 Deviations to the final implementations planned in the second project iteration

Some deviations are existing by design in the first iteration. These are summarized in the following and are addressed in the second project iteration (see section 2.2.2.1.2):

- *Surrounding Traffic:* All tests have been performed with the minimum number of required participants in order to focus on the service implementations. Therefore, no LVs or additional CVs have been used during the trials.
- *Reference Position:* The TransAID message set includes several positions of actions in the MCM triggered by the Road Side. These positions are modelled as one-dimensional integers (see Annexes A1 and B1) referring to road segments identified in the MAPEM container. Since the MAPEM container needs an intersection with ingressing and egressing lanes, which is not present in the current road topology (see chapter 2.1.2) it has been decided to use a hard-coded reference point in the first iteration. All distances are measured along the lane from this point.
- *Camera integration:* The camera system used for the object detection was already successfully transmitting CPMs of all detected objects on the test track. Nevertheless, the object data has neither been used in the sensor data fusion of the vehicle (see chapter 0) nor in the road side (see chapters 2.1.2.1.1 and 2.1.2.1.2).
- *VMS images:* The images and animations have been created in correlation with Task 5.5 of the TransAID project. Nevertheless, it has to be said that the research in this task is not yet finished. Therefore, the images are not final.

2.2.1.1.3 User experience

This section explains what the general experience and feeling were when applying the services in real life from a car passenger/driver perspective, in order to understand if it is something that can be sold to OEMs customers.

It is important to highlight that the DLR test-vehicles are purely an experimental platform used to test and validate technical developments and not primarily meant to address perfect user experience. As mentioned before, in the performed integration sprint and demonstration, the main objective was to show primarily the cooperative interaction between an automated car and the road infrastructure as well as the automated implementation of infrastructure advice.

The test vehicle successfully drove automated and executed the required manoeuvres on the test track according to the scenarios. Being a careful reviewer as passenger in one of the back seats traveling with the test vehicle didn't feel different from a human driver. This can be already seen as a positive result of DLRs implementation, passengers don't feel unsafe while the car is traveling in automated mode. A successful ToC was not interrupted by a sudden change of vehicle speed or a

steering jerk. The test vehicles driving behaviour resulted in a safe and comfortable ride for passengers.

- In general, the applied acceleration and deceleration values were as expected comparable to a comfortable not aggressive driving style of a human driver
- Recognizable steering jerk while being in the curve sections before entering the ramp was noticed. This could be improved by applying slower steering angle changes and lower speed while traveling in the curved sections
- In general, the MRMs were recognizable but still had a smooth deceleration. As MRMs should be one of the last countermeasures before an accident, it is acceptable.
- Comfortable lateral and longitudinal speeds
- Messages received and processed in time
- Very smooth lane following on straight paths. The steering wheel was not jittering, vibrating or shaking
- In case of a requested/required lane change, a bit smoother trajectory should be planned (if possible), in terms of a not too abrupt change of lateral speeds to support a comfortable travel (this was noticeable especially when changing the lane from the ramp to one of the straight lanes). This can have influences on the path planning; a longer planned/calculated path (smaller lateral/longitudinal changes between single steps) compared to a human driver.
- Required V2X messages were transmitted and received properly to be taken into account for the individual test cases
- A HD map with overlays/status information of blocked or ending road segments was used to execute the test cases.

From an OEM perspective, potential areas for improvements can be seen in the HMI area, the reader should be aware that the used (debug) HMI is not in scope of TransAID:

- No indication of system status: automated driving vs. manual driving. A light blue colour inside of the cluster (background or as a thick borderline) could support indication of a CAV in automated driving mode. Additionally, the transition of control should be indicated using a short display pop-up message and/or audible output (text to speech function, beep, etc.).
- One or two buttons on the steering wheel (detection of driver's grip on steering wheel) could be an additional step to acknowledge transition of control.
- No turn light indicator used before and during lane change (at least inside of the vehicle not signaled using audio and/or cluster)
- Further investigations should be done for the cases where an MRM will be executed. Either before starting the MRM the driver must be warned (vibration, audible, visual with longer warning cycles) to take back control (cf. driver state monitoring) of the vehicle to reduce the number of MRMs, or after executing the MRM an emergency case strategy should be started (in case the driver is not able to react), starting with warning signals and ending with signalling that external help is required (e.g., hazard lights, horn, e-call). After executing the MRM vehicle, the engine should be stopped and all doors unlocked.
- Take over requests for drivers must be signaled much clearer (at least for first time users); a red flashing exclusion zone in cluster can be misinterpreted, starting with a light yellow fading to orange and red or a progress bar might help.
- Especially in case of lane changes, it will be more comfortable to indicate the next manoeuvre to prevent the driver from countermeasures resulting in unsafe behaviour and less comfortable travels.
- Another not yet verified solution could be the decoupling of steering and pedals while the vehicle is in automated driving mode.

2.2.1.1.4 Check overall feasibility

This section considers the results of the requirements verification and of the user experience and derive conclusion on overall feasibility. Also, it justifies if a given service is feasible/applicable in real-world implementation scenarios and why.

All test scenarios have been tested successfully and identified as mandatory baseline for following test scenarios. These base scenarios themselves are feasible and required for a real-world implementation (cf. L4 systems). A larger-scale test setup, using multiple CAV/CV as well as LV as mixed traffic environment, would be interesting especially when executing an MRM in order to assess the impact on traffic flow. Room for improvement is seen in the HMI area: Passengers of CAV/CV could be better informed before and while the vehicle is executing manoeuvres, resulting in a comfortable and safe travel (cf. travel sickness). This lack of information is related to the early stage of the prototype, which is not specifically designed to offer an end-customer HMI. TransAID lays down the focus in a proper function and manoeuvre implementation and not HMI at this stage of the project.

Overall, the implementation looks feasible from an OEMs point of view. Some test cases will be reviewed in the second test sprint to better judge the influence/impact of other road users (especially LV) and to get an impression from the outside monitoring the scenarios. ToC use cases were properly executed and implemented in a reasonable way. Further investigations could be done to select appropriate timings or distances for handing back the control to the driver.

2.2.1.2 Requirements of use case 1.1: Provide path around road works via bus lane

2.2.1.2.1 Description of the use case from D2.2

In most situations where road works block the normal lanes and there is a bus lane, that lane is provided as an alternative route to circumvent the road works. Automated vehicles might not have the (appropriate) logic to determine whether such an action is tolerated in the given situation (i.e., unable to detect the situation and corresponding correct lane markings) and need to perform a ToC. Also, especially in urban situations, such markings might not always be provided in every country). By explicitly providing a path around the road works from the road side infrastructure (RSI), CAVs can drive around the road works and maintain their automated driving (AD) mode (and thus preventing a ToC). That way, it is clear where the CAV is allowed to break the traffic rules and drive across the bus lane.

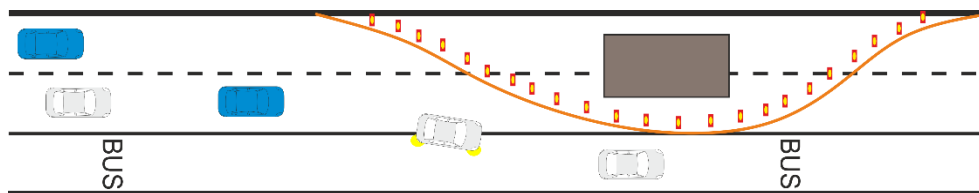


Figure 23: schematic overview of use case 1.1

In this use case, there are road works on a two-lane road with a bus lane next to it. The RSI has planned a path and is distributing it. Approaching CAVs receive the path from the RSI and use the path to drive around the road works.

The way the path is provided is to be determined in WP4. However, at the time of writing, the path is defined as a line with a starting point somewhere upstream of the road works, following the bus lane to the end point somewhere downstream of the road works. The RSI advises vehicles to start merging (find a gap) from the starting point onward. The distance (time) between the starting point

and beginning of the road works can be updated based on the Level of Service (LOS). When vehicles reach the end point, normal traffic operations can be resumed (i.e., merge back to the rightmost non-bus lane).

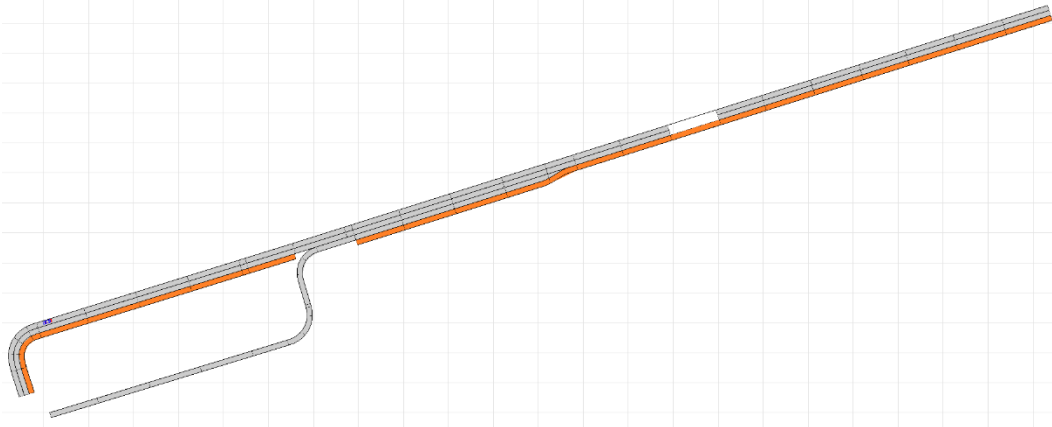

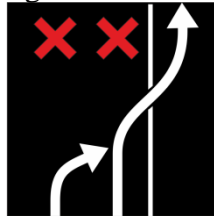
Note that a ToC will still occur since AVs cannot receive the path from the RSI (since AVs by definition are lacking the ability of cooperative behaviour using communication) and must give control to human drivers.

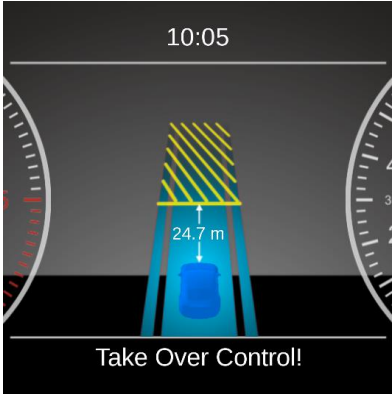
In general, all vehicles must be informed (through conventional signalling or ITS-G5) about the road works in advance to ensure there is enough time to execute lane changes and/or transitions of control without negatively affecting the traffic flow or safety.

2.2.1.2.2 Use case setup

For use case 1.1, three different tests are performed. They are summarized in the following.

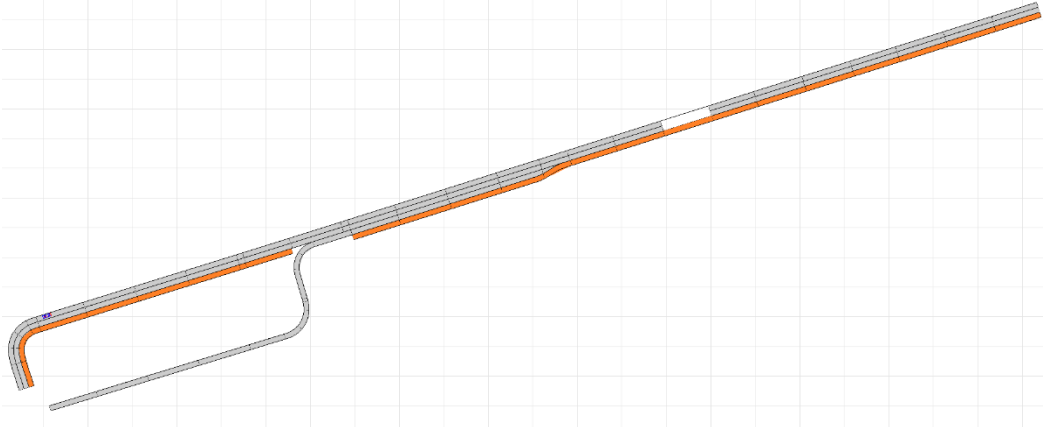
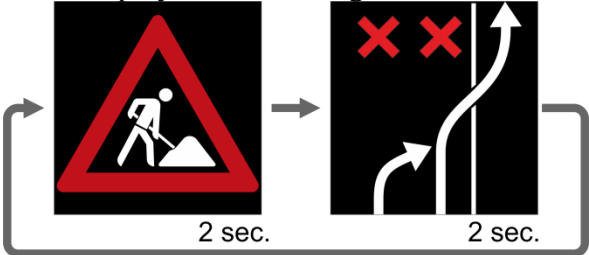
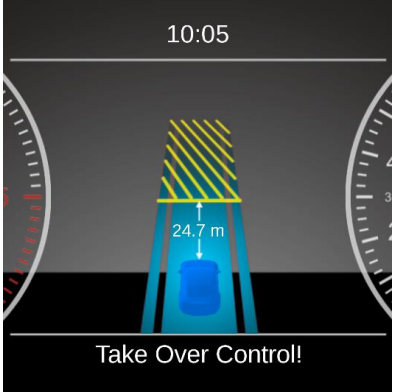
2.2.1.2.2.1 Test scenario 1.1_0: “Baseline: ToC in front of blockage”

Goal	Demonstrate negative effect of a ToC in front of the blockage when no TransAID measure is applied. Successful ToC to driver. This is a V2X Day-1 test case.
Used vehicles	ViewCar2
Used infrastructure	VMS, RSU
Used messages	DENM, CAM
Initial situation	ViewCar2 starts on two-lane rural road, heading for a road blockage covering both lanes. Emergency/restricted lane is existing. 
Scenario script	<ol style="list-style-type: none"> VMS displays the following animation: <div style="display: flex; align-items: center; justify-content: center; gap: 20px;"> <div style="text-align: center;">  <p>2 sec.</p> </div> <div style="text-align: center;">  <p>2 sec.</p> </div> </div> RSU broadcasts DENM::roadWorksAlert:: <ul style="list-style-type: none"> closedLanes

	<ul style="list-style-type: none"> • DrivingLanesStatus • EventPosition <ol style="list-style-type: none"> 3. The tactical planner draws conclusion that all lanes are blocked and ToC/MRM required. 4. AutomationLevelController triggers HMI  <ol style="list-style-type: none"> 5. Driver successfully takes over.
<p>Associated to Requirement(s) in addition to generic requirements</p>	<ul style="list-style-type: none"> • REQ_I_I1_S1.1_1 • REQ_I_I1_S1.1_3

2.2.1.2.2.2 Test scenario 1.1_1: “Baseline: MRM in front of blockage”

<p>Goal</p>	<p>Demonstrate negative effect of a ToC in front of the blockage when no TransAID measure is applied. ToC unsuccessful. This is a V2X Day-1 test case</p>
<p>Used vehicles</p>	<p>ViewCar2</p>
<p>Used infrastructure</p>	<p>VMS, RSU</p>
<p>Used messages</p>	<p>DENM, CAM</p>
<p>Initial situation</p>	<p>ViewCar2 starts on two-lane rural road, heading for a road blockage covering both lanes. Emergency/restricted lane is existing.</p>

	
<p>Scenario script</p>	<ol style="list-style-type: none"> VMS displays the following animation: <div data-bbox="475 705 1066 958" style="text-align: center;">  </div> RSU broadcasts DENM::roadWorksAlert:: <ul style="list-style-type: none"> closedLanes DrivingLanesStatus EventPosition The tactical planner draws conclusion that all lanes are blocked and ToC/MRM required. AutomationLevelController triggers HMI: <div data-bbox="475 1227 869 1617" style="text-align: center;">  </div> Since the driver is not responding, the Minimum Risk Manoeuvre is executed by ViewCar2, resulting in a stopped vehicle on the left lane. The following HMI is shown:

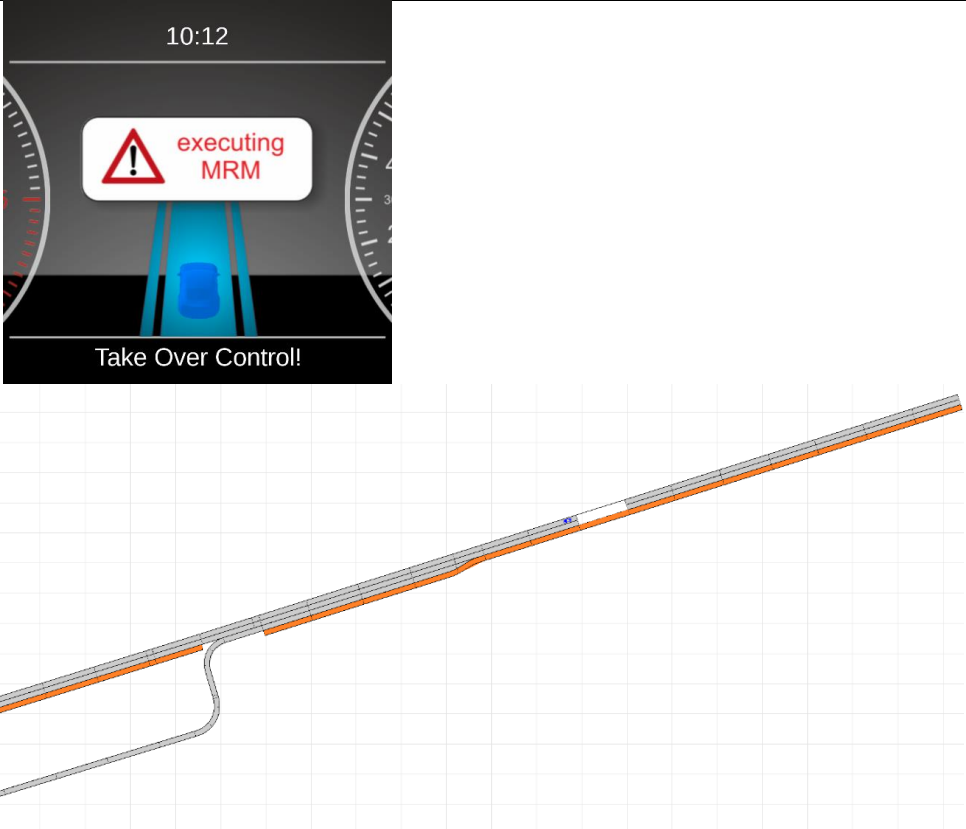
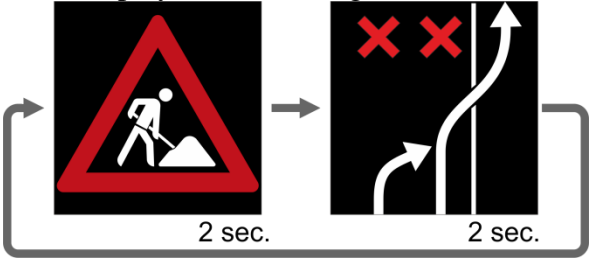
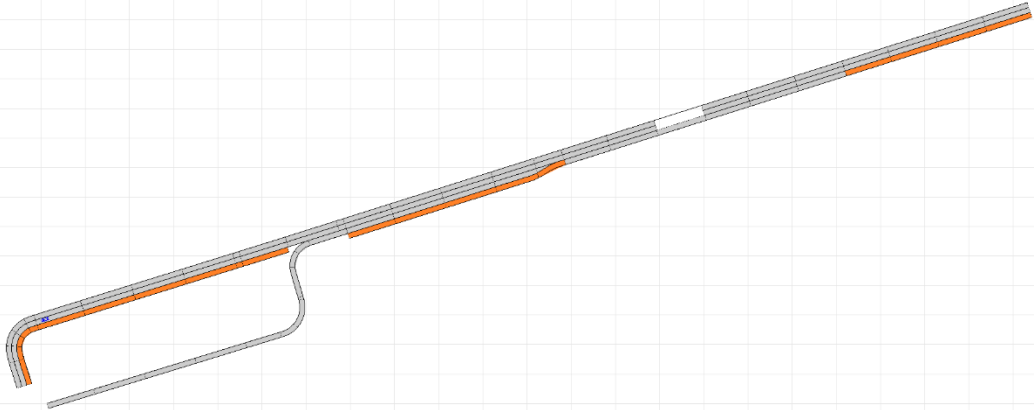
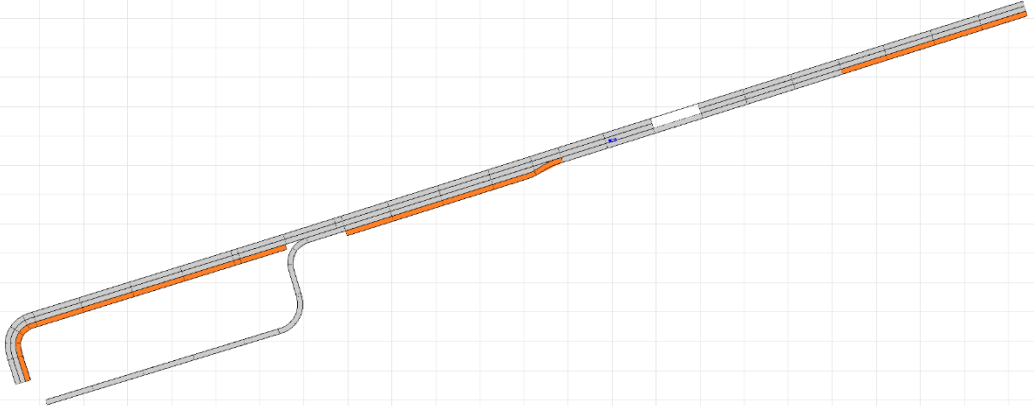
	
<p>Associated to Requirement(s) in addition to generic requirements</p>	<ul style="list-style-type: none"> • REQ_I_11_S1.1_1 • REQ_I_11_S1.1_3



Figure 24: Execution of the MRM inside the ViewCar2. Blockage indicated in digital map by DENM reception at the position of the cones on the road, left side.

2.2.1.2.2.3 Test scenario 1.1_2: “Path information around blockage”

Goal	Demonstrate that infrastructure advice allows CAV to continue driving without ToC around the obstacle.
Used vehicles	ViewCar2
Used infrastructure	VMS, RSU
Used messages	DENM, CAM, MAPEM
Initial situation	ViewCar2 starts on two-lane rural road, heading for a road blockage covering both lanes. Emergency/restricted lane is existing.

Scenario script	<p>1. VMS displays the following animation:</p>  <p>2. RSU broadcasts DENM::roadWorksAlert::</p> <ul style="list-style-type: none"> • closedLanes • DrivingLanesStatus • EventPosition <p>3. RSU sends MAPEM making emergency lane drivable in a specific area.</p>  <p>4. The digital map provider receives MAPEM, generates new borders and forwards this information to the vehicle automation</p> <p>5. The tactical planner draws conclusion that lane blocks can be avoided by newly available lane.</p> <p>6. ViewCar2 changes to the emergency lane and continues until the right lane of the road is available again and the allowed area ends.</p>  <p>7. ViewCar2 changes back to the right driving lane.</p>
-----------------	--

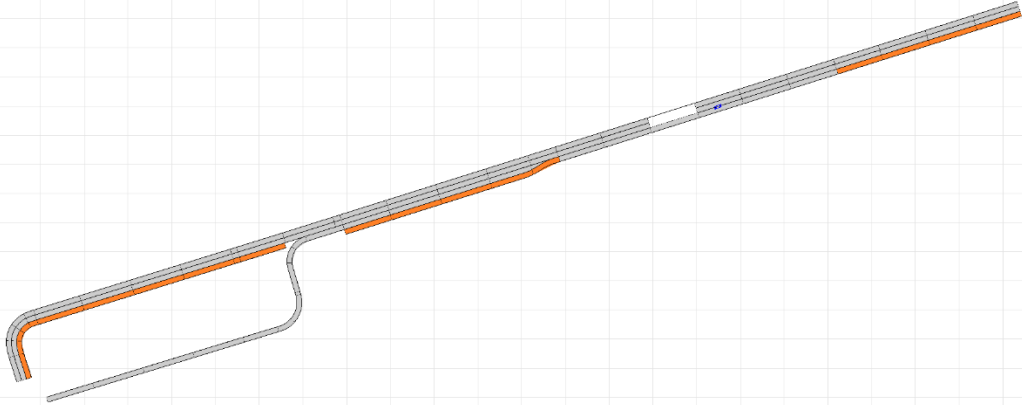
	
<p>Associated to Requirement(s) in addition to generic requirements</p>	<ul style="list-style-type: none"> • REQ_V_I1_S1.1_1 • REQ_I_I1_S1.1_1 • REQ_I_I1_S1.1_2 • REQ_I_I1_S1.1_3







Figure 25: ViewCar2 executing the lane change around the blockage.

2.2.1.2.3 Feasibility results

2.2.1.2.3.1 Requirements verification

In addition to the feasibility assessment of the general requirements shown in section 2.2.1.1 a few service-specific requirements needed to be verified:

Service-specific requirement description		Req. Name	Associated Test cases successfully executed	Notes
Vehicle requirements	<p><i>Path reception</i></p> <p>The vehicle automation shall be able to receive a path and to take it into account during trajectory planning. Of course, the final decision to follow the path is up to the automation itself. The path may be represented either as allowance to use the bus lane or as precise path containing points on the road the vehicle should pass. This will be defined later on in WP4, and WP5 is going to define the communication protocol to be used.</p>	REQ_V_II_S1.1_1		The path was correctly received in the format defined by D5.1. this guaranteed the successful execution all the associated test cases, hence the verification of this requirement
Infrastructure requirements	<p><i>Road network</i></p> <p>The road network needs to include an explicit bus lane. This lane must be marked as non-usable in the corresponding map. In addition, road works are needed, i.e. an area which is separated on the street</p>	REQ_I_II_S1.1_1		Inside of the map (debug screen) there was an explicit bus lane marked in orange that represents CAVs are not allowed to use it, and road works are marked as empty road segments (white blocks). In a series production visualization/HMI, different colours/markings and/or an annotation would be used to clearly distinguish those paths.
	<p><i>Sensors</i></p> <p>In order to plan valid paths it is recommended that the traffic is monitored. Positions of non-cooperative vehicles need to be included, and therefore corresponding sensors (i.e. a camera or induction loop sensors) should be used. This esp. includes the detection of stopped vehicles, either in case of Minimum Risk Manoeuvres or in case of simple traffic congestion.</p>	REQ_I_II_S1.1_2		RSU was equipped with a hemispherical camera, which runs an object detection algorithm to detect, classify and track objects. Transmitted CPMs were not used by the test vehicle in the first test case iteration.
	<p><i>Variable Message Signs (VMS)</i></p> <p>Variable Message Signs may be used to communicate the plans of the infrastructure to the non-cooperative vehicles. Those signs should be linked to the signs signalling the road works and the lane merging. In case a (C)AV is performing a Minimum Risk Manoeuvre in this area, the sign may also be used to show warning or jam messages, see Service 4.</p>	REQ_I_II_S1.1_3		A VMS installed on a trailer was used during all tests displaying different signs / messages according to the tested scenario.

Requirements were followed. The reception and transmission of required V2X message was verified using a V2X module (CohdaWireless mk5) present on the test track; an external one used to sniff all V2X messages in the test scenarios. The capture logs show that the RSU correctly formats DENM and MAPEM messages and the content of these messages fits to the specific requirements of the tests under evaluation. The capture logs also show that the vehicle transmits frequently CAM messages, which are formatted following ETSI ITS standards. The content of the CAM is not changing dynamically though, but this was not needed for the successful execution of the tests. The test vehicle was equipped with a system status display showing the current vehicle positions on a HD map which was generated by DLR for the test track.

2.2.1.2.3.2 User experience

User demands were fulfilled; all test scenarios were successfully executed and serve as baseline for following use cases. This was verified by traveling as passenger in the DLR test vehicle. General user experience comments and results are covered in section 2.2.1.1.3.

2.2.1.2.3.3 Check of overall feasibility

The tested scenarios in this section build a baseline, which perform the required tasks in a reasonable and efficient way. General feasibility results from section 2.2.1.1.4 also apply here.

2.2.1.3 Requirements of use case 2.1: Prevent ToC/MRM by providing speed, headway and/or lane advice

2.2.1.3.1 Description of the use case from D2.2

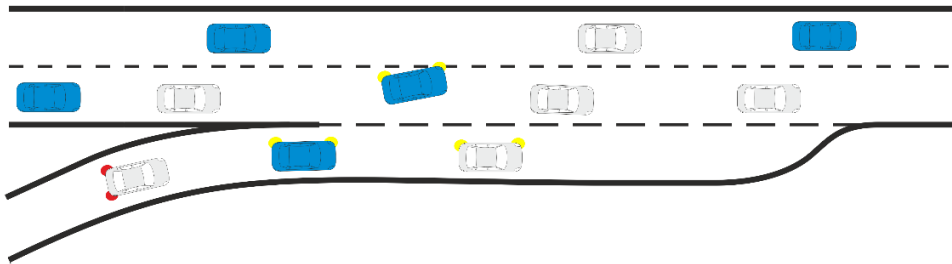


Figure 26: Schematic overview of use case 2.1

CAVs, AVs, CVs, and LVs drive along a motorway merge segment or enter the mainline motorway lanes through an on-ramp. The RSI monitors traffic operations along the motorway merge segment and detects the available gaps on the right-most mainline lane to estimate speed and lane advice for merging CAVs and CVs coming from the on-ramp. The use case assumes that CAVs and CVs continuously update their speed and lane information to the RSI (in a near-real-time fashion). In addition, the RSI also fuses this information with measurements obtained via available road-side sensors. The speeds and locations of AVs and LVs can be estimated based on the information gathered via the latter sensors and the location (and available sensing information) of the other vehicles (being CAVs or CVs). This use case necessitates the exchange of the required types of messages (i.e., CPM/CAM/MCM).

The central core of this use case is the guidance towards or creation of gaps in the motorway's right-most lane (that is not part of the on-ramp). If the available gaps there are not large enough to allow the safe and smooth merging of on-ramp vehicles, speed and lane advice are also provided to the CAVs and CVs driving there, thereby creating the necessary gaps in traffic to facilitate the smooth merging of on-ramp vehicles. Thus, gaps are created by the exchange of suitable lane change advices to these two kinds of vehicles; AVs and LVs do not receive information. Note that we do not adopt explicit ramp-metering algorithms to control the average in-flow of vehicles to the motorway. The ramp meter will only be used to assist vehicles in entering the motorway at the right moment, but not to restrict in-flow more than in the baseline. In addition, advice to vehicles is only given within a certain action-zone, i.e., upstream of and at the merge location. Beyond that, further downstream, vehicles can default back to their previous own behaviour.

Without the aforementioned measures vehicles might be impeded or involved in safety critical situations under specific traffic conditions (e.g. incidents) or automated driving operations (e.g., platooning at motorway merge/diverge segments). Under these circumstances, automated vehicles might request ToCs or execute MRMs for safety reasons.

Note: aggressive lane changes of human drivers can disturb traffic flow and cause emergency breaks or high decelerations. These do not pose great risks in free-flowing traffic, as the traffic streams remain locally and asymptotically stable (initial finite disturbances exponentially die out, even along CAV platoons). However, the more congested traffic becomes, the higher the instability of a traffic stream gets. Hence, such local disturbances are not smoothed out anymore, resulting in sudden and drastic changes in the speed profiles of upstream vehicles. Similarly, lane changes of

slow vehicles (e.g. trucks) have a higher impact, since they require larger gaps and can force other vehicles to suddenly break. Compared to cars, truck lane changes are minor in occurrence (if not forbidden by traffic law). However, in case they do occur, they typically lead to ‘moving bottlenecks’ due to their lower average speeds, especially in free-flow and synchronised traffic flows. Another situation, in which truck lane changes are more frequent, is when a truck enters the motorway via an on-ramp and trucks on the main motorway provide spacing by moving out of the way, creating again the aforementioned moving bottleneck.

2.2.1.3.2 Use case setup

For use case 2.1, six different tests are performed. They are summarized in the following. It has to be remarked that the original use case 2.1 does only include speed advice to the vehicle on the ramp (Test 2.1_5). Nevertheless, it was defined that advice could basically also be given to the vehicles on the highway, either for speed or for preferred lane usage. These aspects will be further investigated during the second project iteration, and also be covered in the simulation activities later on in the other work packages.

2.2.1.3.2.1 Test scenario 2.1_0: “Baseline: Ramp without communication”

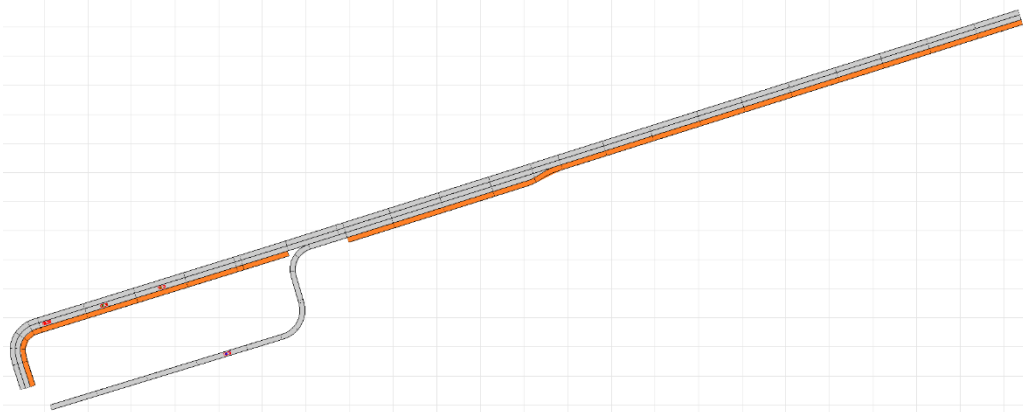
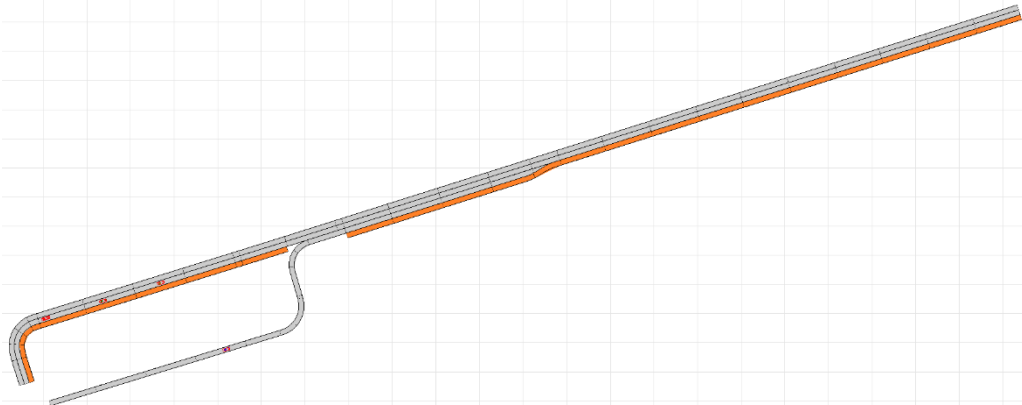
Goal	Demonstrate negative effect of a CAV not able to merge from a ramp to a highway.
Used vehicles	ViewCar2, FASCarE, T5 bus, optional legacy vehicle
Used infrastructure	None
Used messages	CAM
Initial situation	ViewCar2 starts on ramp entering highway. Several vehicles drive on the right lane of the highway close to each other 
Scenario script	1. When trying to enter the highway, no gap is found. Vehicle is braking and waiting until sufficient gap available
Associated to Requirement(s) in addition to generic requirements	Only generic requirements

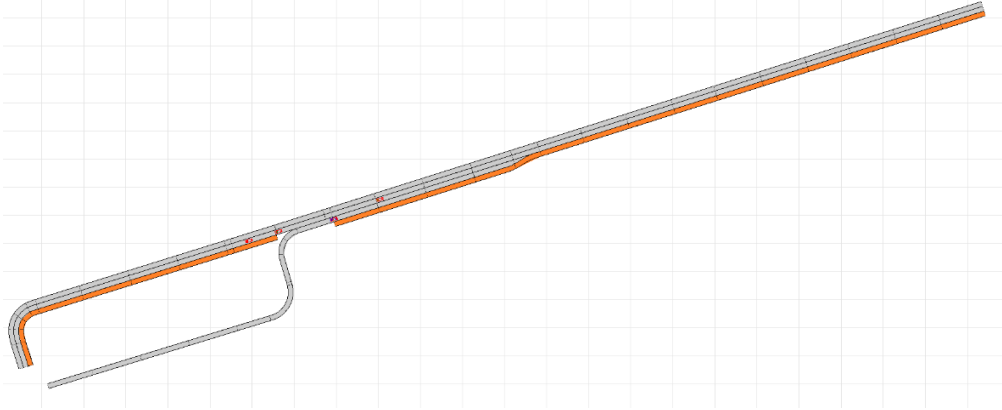


Figure 27: Blocked entrance, as manually driven FASCarE on adjacent lane does not allow merging (driving at the same speed). Lane change not possible, ViewCar2 stops.

2.2.1.3.2.2 Test scenario 2.1_1: “Cooperative lane change: Vehicle on highway opens gap”

Goal	Demonstrate abilities of cooperative lane change without infrastructure support. Here, the vehicle on the highway opens a gap by braking.
Used vehicles	ViewCar2, FASCarE, T5 bus, optional legacy vehicle
Used infrastructure	None
Used messages	CAM, V2V-MCM
Initial situation	ViewCar2 starts on ramp entering highway. Several vehicles, including FASCarE as other CAV drive on the right lane of the highway close to each other

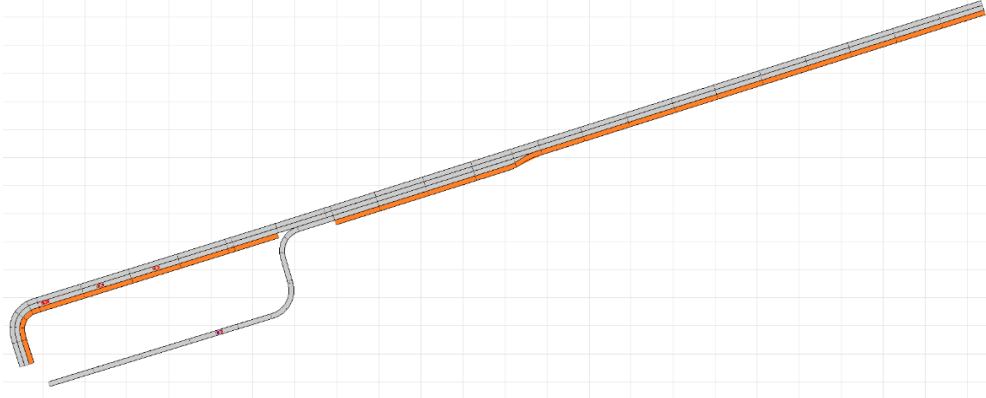
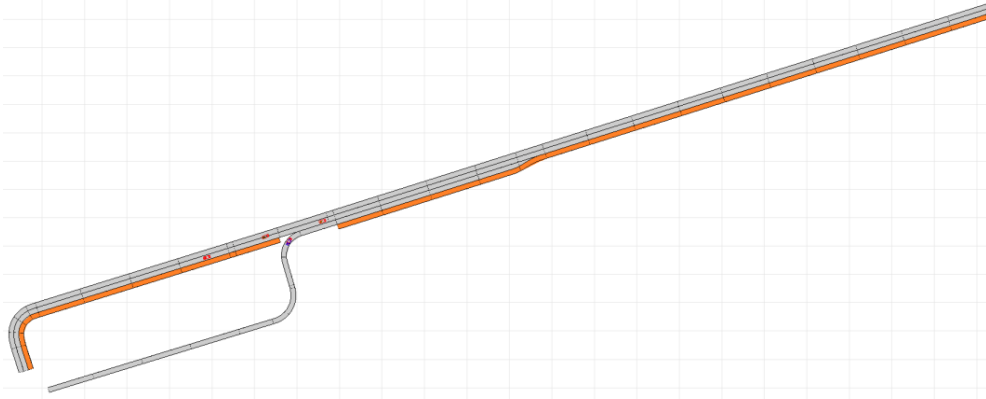


Scenario script	<ol style="list-style-type: none"> 1. When ViewCar2 arrives at the entrance, it indicates its desire to change to the right lane of the road via MCM::VMC::DesiredTrajectory 2. FASCarE on highway indicates cooperation by sending MCM::VMC::PlannedTrajectory containing a braking trajectory 3. FASCarE brakes  <ol style="list-style-type: none"> 4. ViewCar2 enters highway in new gap
Associated to Requirement(s) in addition to generic requirements	Only generic requirements.

Note: This test case has only been executed in simulation during the first iteration, since the message implementation at DLR was delayed and testing was impossible before deliverable submission. The tests will be repeated and the results included in the second iteration version of this deliverable.

2.2.1.3.2.3 Test scenario 2.1_2: “Cooperative lane change: Vehicle on highway changes lane”

Goal	Demonstrate abilities of cooperative lane change without infrastructure support. Here, the vehicle on the highway opens a gap by changing lane.
Used vehicles	ViewCar2, FASCarE, T5 bus, optional legacy vehicle
Used infrastructure	None
Used messages	CAM, V2V-MCM
Initial situation	ViewCar2 starts on ramp entering highway. Several vehicles, including FASCarE as other CAV drive on the right lane of the highway close to each other

	
<p>Scenario script</p>	<ol style="list-style-type: none"> 1. When ViewCar2 arrives at the entrance, it indicates its desire to change to the right lane of the road via <code>MCM::VMC::DesiredTrajectory</code> 2. FASCarE on highway indicates cooperation by sending <code>MCM::VMC::PlannedTrajectory</code> containing a lane change to the left 3. FASCarE changes lane  <ol style="list-style-type: none"> 4. ViewCar2 enters highway in new gap
<p>Associated to Requirement(s) in addition to generic requirements</p>	<p>Only generic requirements</p>

Note: This test case has only been executed in simulation during the first iteration, since the message implementation at DLR was delayed and testing was impossible before deliverable submission. The tests will be repeated and the results included in the second iteration version of this deliverable.

2.2.1.3.2.4 Test scenario 2.1_3: “Ramp assist: Infrastructure advises vehicle on highway to change lane”

<p>Goal</p>	<p>Demonstrate abilities of infrastructure support. Here, the infrastructure advises individual vehicles on the highway to change lane.</p>
<p>Used vehicles</p>	<p>ViewCar2, FASCarE, T5 bus, optional legacy vehicle</p>
<p>Used infrastructure</p>	<p>RSU, Camera</p>

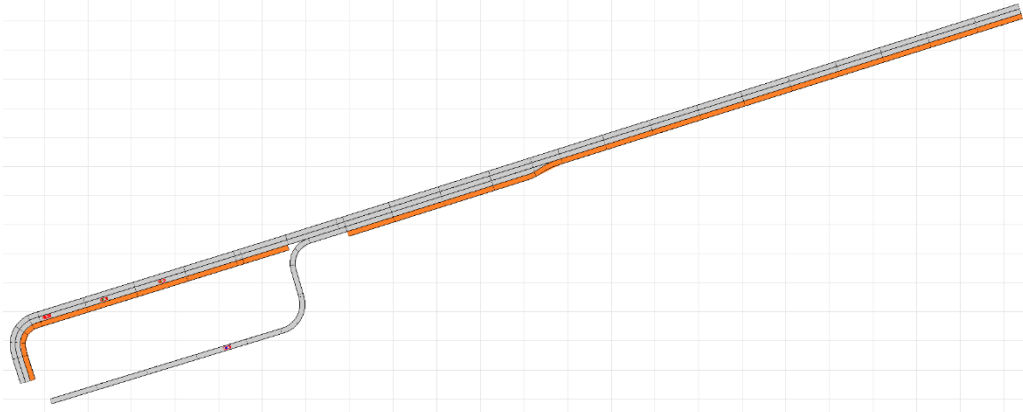
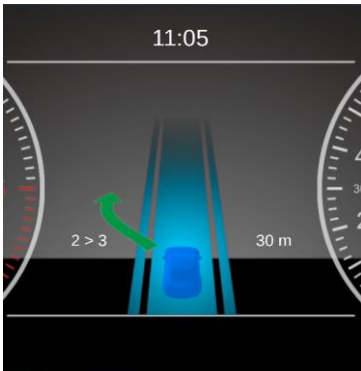
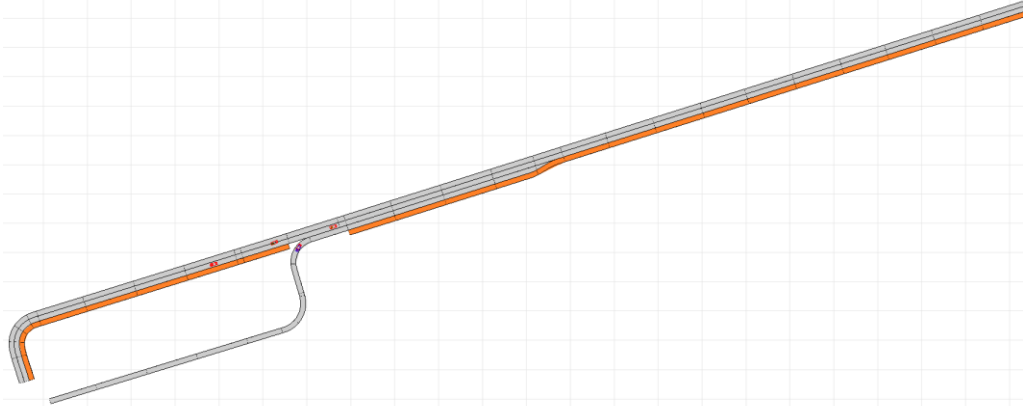
Used messages	CAM, I2V-MCM
Initial situation	<p>ViewCar2 starts on ramp entering highway. Several vehicles, including FASCarE as other CAV drive on the right lane of the highway close to each other</p> 
Scenario script	<ol style="list-style-type: none"> 1. RSU sends MCM::RSU_SMC::LaneAdvice::TargetLane=3 with LaneChangePosition=150 to FASCarE driving on right lane (=2) of the highway 2. FASCarE follows advice and changes lane. The following HMI is shown:  3. When ViewCar2 arrives at the entrance, it is able to perform the lane change into the new gap 
Associated to Requirement(s) in addition to generic requirements	<ul style="list-style-type: none"> • REQ_V_I1_S2.1_2 • REQ_I_I1_S2.1_1 • REQ_I_I1_S2.1_2



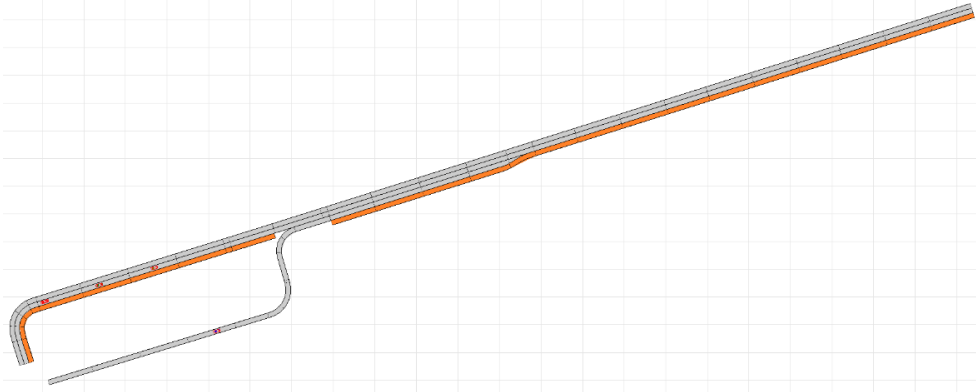
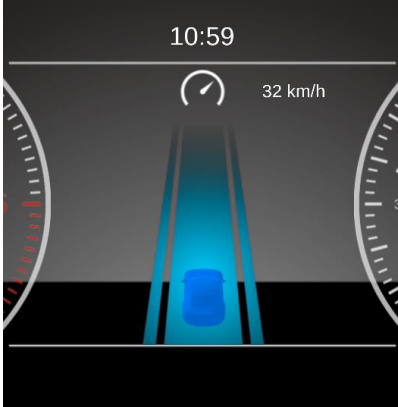
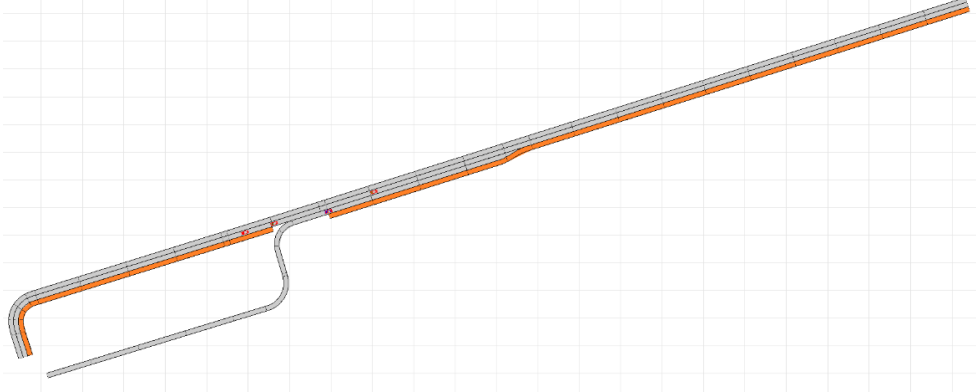
Figure 28: Image taken of the test while FASCarE automatically performs lane change.



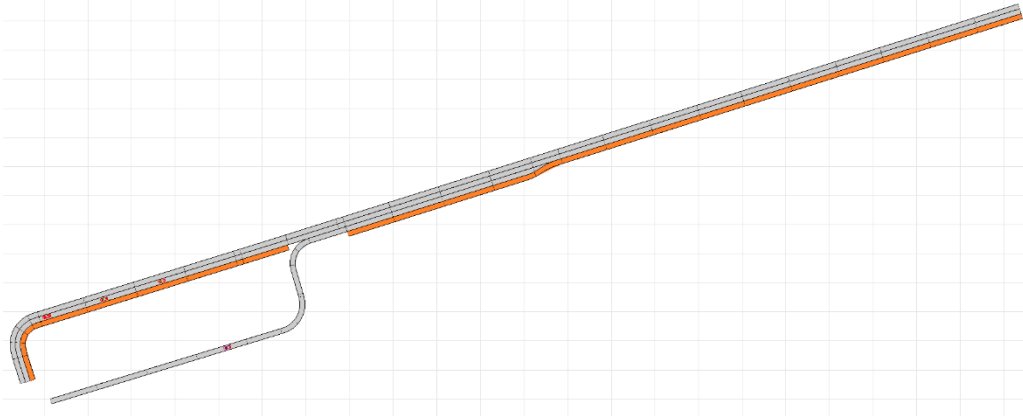
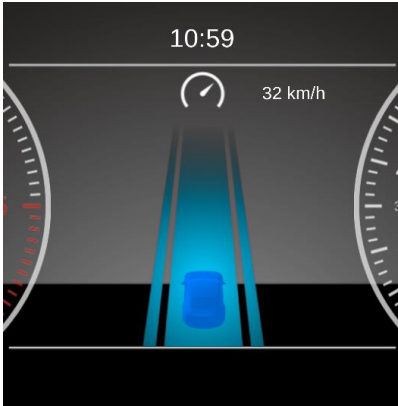
Figure 29: After successful lane change of the FASCarE, the ViewCar2 merges onto the highway.

2.2.1.3.2.5 Test scenario 2.1_4: “Ramp assist: Infrastructure advices vehicle on highway to change speed”

Goal	Demonstrate abilities of infrastructure support. Here, the infrastructure advices individual vehicles on the highway to change speed.
Used vehicles	ViewCar2, FASCarE, T5 bus, optional legacy vehicle
Used infrastructure	RSU, Camera

Used messages	CAM, I2V-MCM
Initial situation	<p>ViewCar2 starts on ramp entering highway. Several vehicles, including FASCarE as other CAV drive on the right lane of the highway close to each other</p> 
Scenario script	<ol style="list-style-type: none"> RSU sends MCM::RSU_SMC::CarFollowingAdvice::DesiredBehavior::TargetSpeed=9 to FASCarE driving on right lane of the highway FASCarE follows advice and slows down to open gap. The following HMI is shown:  When ViewCar2 arrives at the entrance, it is able to perform the lane change into the new gap in front of FASCarE. 
Associated to Requirement(s) in addition to generic requirements	<ul style="list-style-type: none"> • REQ_V_I1_S2.1_1 • REQ_I_I1_S2.1_1 • REQ_I_I1_S2.1_2

2.2.1.3.2.6 Test scenario 2.1_5: “Ramp assist: Infrastructure advises vehicle on ramp to change speed”

Goal	Demonstrate abilities of infrastructure support. Here, the infrastructure advises individual vehicles on the highway to change speed.
Used vehicles	ViewCar2, FASCarE, T5 bus, optional legacy vehicle
Used infrastructure	RSU, Camera
Used messages	CAM, I2V-MCM
Initial situation	<p>ViewCar2 starts on ramp entering highway. Several vehicles, including FASCarE as other CAV drive on the right lane of the highway close to each other</p> 
Scenario script	<ol style="list-style-type: none"> 1. RSU sends MCM::RSU_SMC::CarFollowingAdvice::DesiredBehavior::TargetSpeed=9 to ViewCar2 driving on ramp 2. ViewCar2 follows advice and slows down. The following HMI is shown:  3. When ViewCar2 arrives at the entrance, it is able to perform the lane change behind FASCarE.

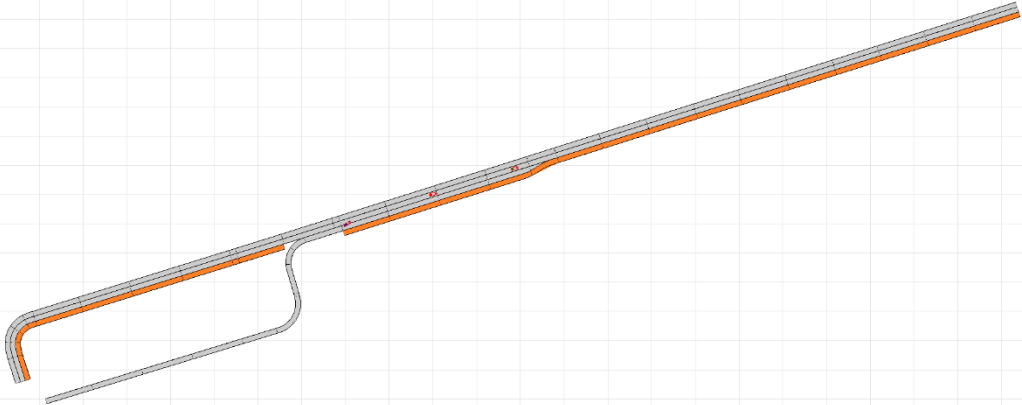
	
<p>Associated to Requirement(s) in addition to generic requirements</p>	<ul style="list-style-type: none"> • REQ_V_I1_S2.1_1 • REQ_I_I1_S2.1_1 • REQ_I_I1_S2.1_2







Figure 30: Successful lane change after speed adaptation of ViewCar2 on the ramp.

2.2.1.3.3 Feasibility results

2.2.1.3.3.1 Requirements verification

In addition to the feasibility assessment of the general requirements shown in section 2.2.1.1 a few service-specific requirements needed to be verified:

Service-specific requirement description		Req. Name	Associated Test cases successfully executed	Notes
Vehicle requirements	<p><i>Speed advice following</i></p> <p>The CAVs/CVs need to be able to receive speed advice from the infrastructure. In case of a CAV, the advice needs to be taken into account during trajectory planning, although the vehicle automation itself has the right to overrule the advice. In case of a CV, the speed advice is forwarded to the driver with an appropriate HMI.</p>	REQ_V_I1_S2.1_1		Speed advice received and followed by test vehicle.
	<p><i>Lane advice following</i></p> <p>Also, lane advice needs to be received and taken into account in the same way then speed advice.</p>	REQ_V_I1_S2.1_2		Lane advice received and followed. HMI shows target lane using moving arrows inside of the cluster display
Infrastructure requirements	<p><i>Speed and lane advice generation</i></p> <p>The infrastructure must be able to generate speed and lane advice based on the detected situation and disseminate them using an RSU.</p>	REQ_I_I1_S2.1_1		RSU generated advice that was received by test vehicle as well as other V2X receivers present on the test area. However, the advice was not generated based on the situation detected by the RSU.
	<p><i>Sensors</i></p> <p>This use case requires very precise detection of vehicles and vehicle behaviour, as probable gaps have to be estimated early enough to provide appropriate advice to the vehicles.</p>	REQ_I_I1_S2.1_2		RSU with dedicated camera detected surrounding objects (road users) and transmitted these using CPMs

For this set of tests, the reception and transmission of required V2X messages was also verified using the V2X module (CohdaWireless mk5) present on the test track. The capture logs show that the RSU correctly formats MCM messages following the TransAID MCM ASN.1 definition, and the content of these messages fits to the specific requirements of the tests under evaluation. In particular, the captured messages show the RSU’s lane change and car following advice that are addressed to the vehicle on the highway and/or ramp depending on the test.

2.2.1.3.3.2 User experience

As already mentioned in section 2.2.1.1.3 vehicle speeds and acceleration/deceleration are fine. Also, here a clear HMI supports travel comfort and perceived safety for passengers. Especially before and during lane changes (from ramp to highway) it must be easily recognizable that surrounding traffic is detected by the system (not leading to false impressions and counteractions by passengers/driver).

2.2.1.3.3.3 Check of overall feasibility

It can be clearly seen that advice applied to vehicles on the ramp is less disturbing the overall traffic flow compared to advice that affects vehicles traveling on the highway. For this reason, a higher priority should be given to advice at the on-ramp (which can be followed in less dense traffic). Lane changes of vehicles can have a higher impact on the overall traffic flow, which requires a constant

tracking of surrounding vehicles (especially non-cooperative LV). This might lead to the strict requirement of the presence of infrastructure sensing units supporting coordinated lane change advice or an exclusion of coordinated multiple vehicle lane changes in complex road architectures (e.g., sharp turns or multiple junctions/ramps in short distances).

2.2.1.4 Requirements of use case 3.1: Apply traffic separation before motorway merging/diverging

2.2.1.4.1 Description of use case from D2.2

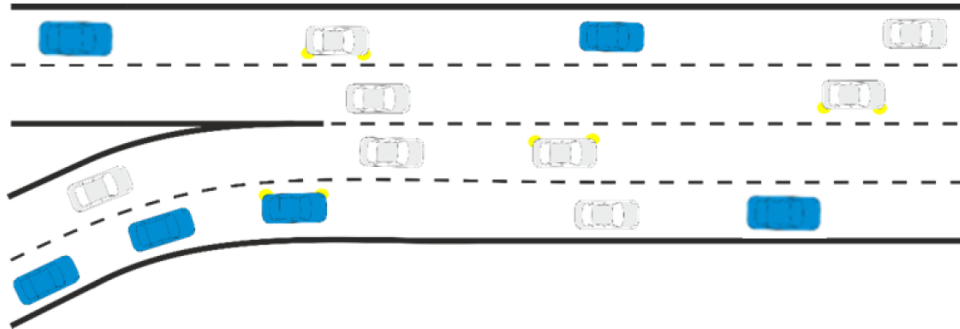


Figure 31: schematic overview of use case 3.1

CAVs, CAV platoons, CVs and LVs drive along two 2-lane motorways that merge into one 4-lane motorway. After the merging point, vehicles will drive to their target lane. RSI monitors the number of different types of vehicles upstream through collective perception but also via CAM receptions, and infra sensors.

Based on the provided traffic separation policy, CAVs and CAV platoons move to the left lane of the left 2-lane motorway and to the right on the right 2-lane motorway at some point upstream of the merging point (where merging usually starts). CVs move to the other lanes not allocated to CAVs and CAV platoons. CAVs and CAV platoons thus enter the 4-lane section on the outer lanes, giving space to manually driven vehicles (CVs and LVs) to occupy the central lanes (where human driving still may generate risky situations).

Following this approach, the overall number of risky situations will be reduced which will positively affect the number of ToCs in this area.

At some point downstream of the merging point, the traffic separation is disabled, and all vehicles can gradually start changing lanes to reach their target destination.

2.2.1.4.2 Use case setup

The effects of this use case can best be seen in traffic simulation. Nevertheless, the feasibility should be shown as well. Therefore, the use case is simplified, so that it focusses on traffic separation only. At this moment, it is not decided whether a full separation is targeted, meaning that also non-cooperative vehicles should change to their dedicated lane, or if the separation is only involving cooperative vehicles, separating CAVs and AVs to one lane and CVs and LVs to the other. A decision will be made after the baseline simulations have been performed.

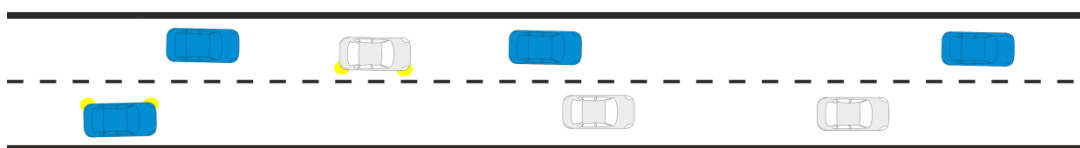


Figure 32: Schematic overview of the simplified use case 3.1



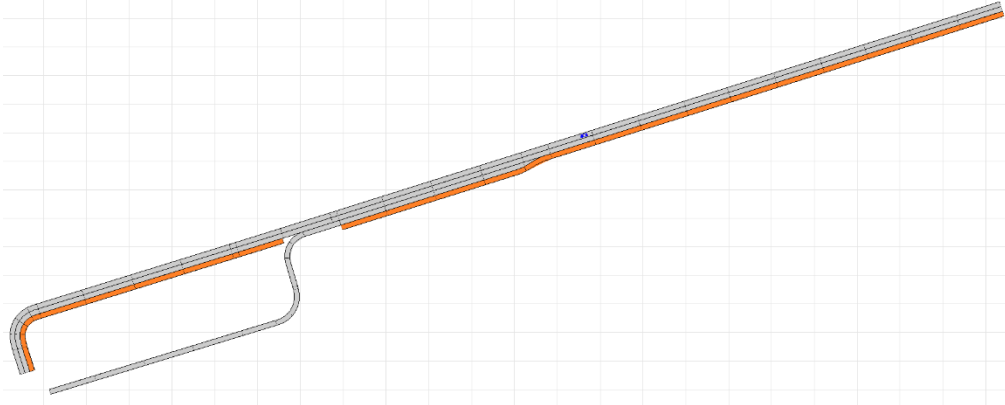
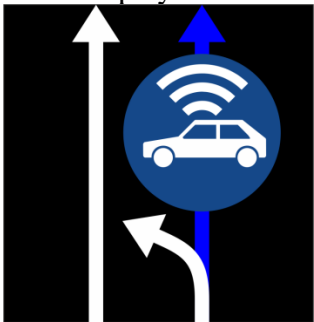
Figure 33: DLR's ViewCar2 executing the use case 3.1 tests

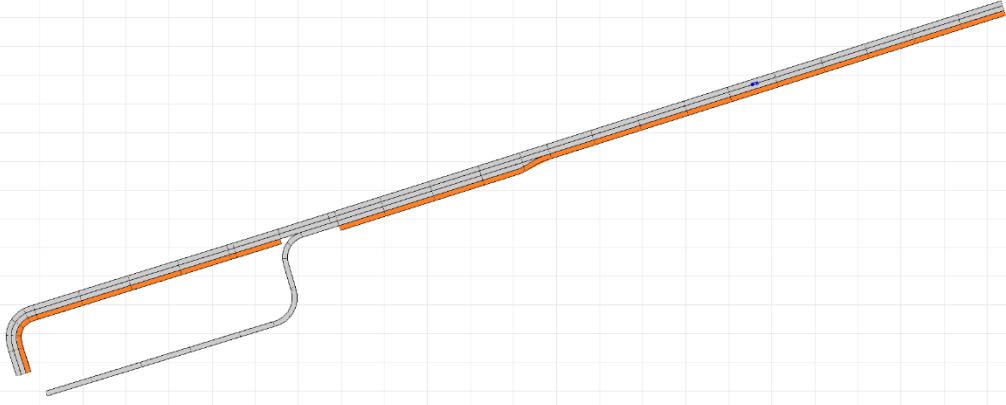


Figure 34: Internal view showing the received lane advice to the right lane in the cluster instrument

For the simplified use case 3.1, one single test is performed, described in the following.

2.2.1.4.2.1 Test scenario 3.1_0: “Traffic separation by lane advices”




Goal	Demonstrate the ability to perform traffic separation by receiving appropriate messages.
Used vehicles	ViewCar2
Used infrastructure	RSU, Camera, VMS
Used messages	CAM, I2V-MCM
Initial situation	<p>ViewCar2 starts on left lane of highway. Other legacy vehicles optionally drive on the right lane of the highway</p> 
Scenario script	<ol style="list-style-type: none"> 1. VMS displays the following sign: <div style="text-align: center;">  </div> 2. RSU sends MCM::RSU_SMC::LaneAdvice::TargetLane=2 with LaneChangePosition=500m to ViewCar2 3. ViewCar2 changes to right lane



	 <p>4. Legacy vehicle changes to left lane</p>
<p>Associated to Requirement(s) in addition to generic requirements</p>	<ul style="list-style-type: none"> • REQ_V_I1_S3.1_1 • REQ_V_I1_S3.1_2 • REQ_I_I1_S3.1_1 • REQ_I_I1_S3.1_2 • REQ_I_I1_S3.1_3

2.2.1.4.3 Feasibility results

2.2.1.4.3.1 Requirements verification

In addition to the feasibility assessment of the general requirements shown in section 2.2.1.1 a few service-specific requirements needed to be verified:

Service-specific requirement description	Req. Name	Associated Test cases successfully executed	Notes
<p><i>Separation advice following</i></p> <p>The CAVs/CVs need to be able to receive separation advice from the infrastructure. In case of a CAV, the advices need to be taken into account during trajectory planning, although the vehicle automation itself has the right to overrule the advice. This means that defined lanes should be marked as non-preferable. In case of a CV, the separation advice is forwarded to the driver with an appropriate HMI.</p>	REQ_V_I1_S3.1_1		Separation advice received and followed by test vehicle. HMI not showing the reason for trajectory changes.
<p><i>Lane advice following</i></p> <p>Also, lane advice needs to be received and taken into account.</p>	REQ_V_I1_S3.1_2		Test vehicle received lane change advice and followed them accordingly by changing lane if required.
<p><i>Separation advice generation</i></p> <p>The infrastructure needs to be able to generate separation advice. The advice may be simply switched on for areas on the road. No further detection capabilities are needed for the feasibility assessment, although the LOS needs to be determined to estimate whether separation needs to be done or not.</p>	REQ_I_I1_S3.1_1		The infrastructure-generated advice to request vehicles in a specific area to separate based on their automation level. Variable Message Sign (VMS) trailer was also used to generate separation advices for LVs.

<p><i>Lane advice generation</i></p> <p>The generation of lane advice is already covered in use case 2.1, but may also be useful in the context of use case 3.1, which has to be defined after the baseline simulations. Please note that separation itself is not needing lane advice capabilities, but those capabilities may be an adequate additional option for the implementation of separation.</p>	<p>REQ_I_I1_S3.1_2</p>		<p>RSU provided lane advices to present vehicles. For later test it might be interesting to execute tests with multiple CAV/CVs as well as LVs.</p>
<p><i>Variable message signs (VMS)</i></p> <p>In case non-cooperative vehicles need to be advised, variable message signs can be used to indicate the separation, e.g. by offering lane usage advices.</p>	<p>REQ_I_I1_S3.1_3</p>		<p>VMS showed a traffic separation advice sign to separate LVs and CAV/CVs.</p>

For this use case, the reception and transmission of required V2X message was also verified using the V2X module (CohdaWireless mk5) present on the test track. The capture log shows that the RSU correctly formats MCM messages following the TransAID MCM ASN.1 definition, and the content of these messages fits to the specific requirements of the use case under evaluation. In particular, the captured messages show the RSU’s lane change advice including the target station that should follow the advice, where the lane change should be performed, and what is the target lane.

2.2.1.4.3.2 User experience

General user experience results from section 2.2.1.1.3 also apply here. The usage of a VMS (as here done installed on a trailer) is a reasonable, easy understandable and cost effective solution to inform drivers of LV to change the lane (e.g. no need to install a V2X reception unit in LV). Slight adaptations of the lateral speed during lane change / merge could improve the safety impression of passengers while changing from the ramp to the straight road path (impression of a slight vehicle over swing).

2.2.1.4.3.3 Check of overall feasibility

Due to the lack of test vehicles, the use case couldn’t be tested to the full extent in the first iteration. Excluding the need to change the traffic regulations, the use case results will be implemented with a higher spread of CV/CAVs. For this reason, it seems right now not to be a feasible solution (drivers of LV could also force a breakup by intentionally using wrong lanes), but it can be forecasted to be a feasible solution in future.

2.2.1.5 Requirements of use case 4.2: Safe spot in lane of blockage

2.2.1.5.1 Description of use case from D2.2

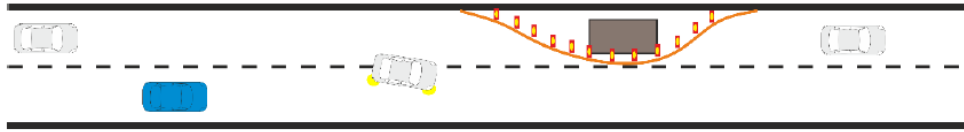


Figure 35: schematic overview of use case 4.2

There is a construction site covering one lane of the motorway road. The deployed RSI has information about the construction area and the vicinity of it and provides this information to the approaching CAVs.

Some CAVs are not able to pass the construction site without any additional guidance. Therefore, they need to perform a ToC. A ToC might be unsuccessful, so the respective CAV must perform an MRM. Without additional measures, the CAV would simply brake and stop on the lane it is driving, most likely disrupting the traffic flow when happening on the right lane (see figure),

To avoid this, the RSI also monitors the area just in front of the construction site and offers this place as a safe stop to the vehicle, if free. The CAV uses the safe spot information just in front of the construction site to come to a safe stop in case of an MRM.

Note: Service 4 basically is an additional measure to the other services, used when any ToC is about to fail (see D2.1 [3] for details) and the impact of MRMs should be reduced. In this specific case of use case 4.2, it can be seen as an extension to use case 1.1.

2.2.1.5.2 Use case setup

This use case will not be changed for the feasibility assessment. Nevertheless, discussions are going on focussing on the exact shape of safe spots. As a first idea, which is followed during the first iteration of the project, safe spots look as shown in Figure 36. Safe spots are separated areas on the road offering room for (C)AVs to stop and limited space to accelerate again. The number of the safe spots and the related size of the area are linked to the number of occurring Minimum Risk Manoeuvres, and needs to be estimated during the base line simulations. Nevertheless, it has been agreed that all safe spot related measures should include scalability, so that the derived measures apply for single safe spots as well as for larger areas.

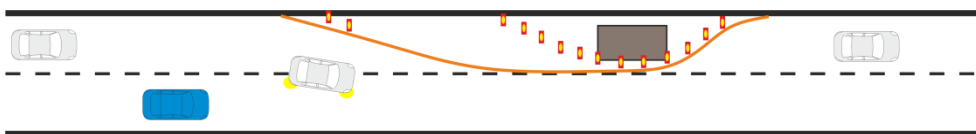


Figure 36: Safe spot design

Following the most recent discussions in WP5, an explicit reservation of safe spots is not envisioned. The infrastructure is only providing information about the free areas, and the vehicles may implicitly block the areas by sharing Manoeuvre Coordination Messages. The final decision is described in D5.1. In case two or more vehicles decide to make use of the same safe spot at the very same time, the conflict will be visible right after sharing the Manoeuvre Coordination Message. If one of the vehicles is not able to use another safe spot, or if there is no other available, the vehicle is going to stop on the road as it would do without the TransAID measure.

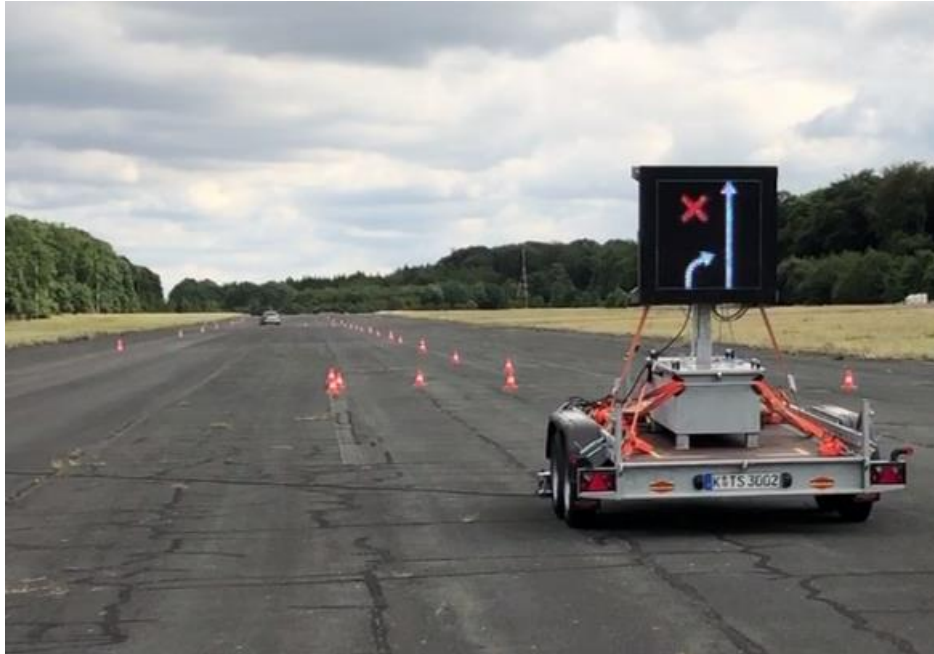
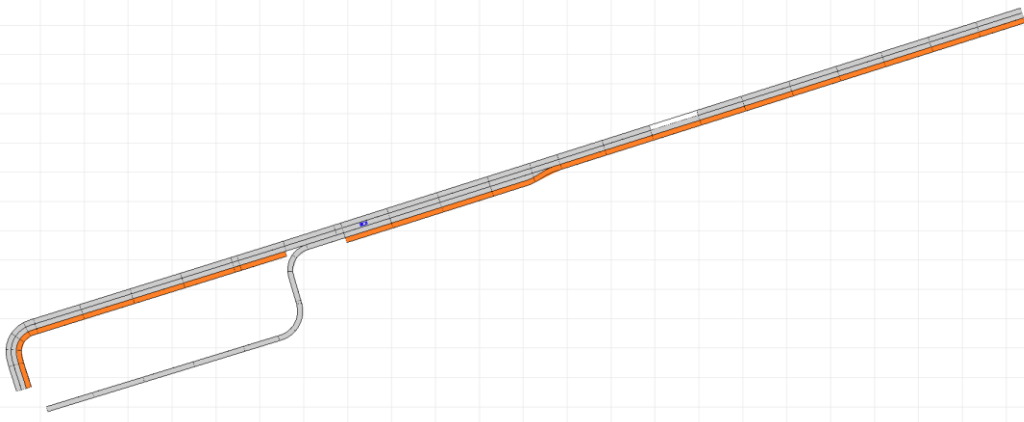
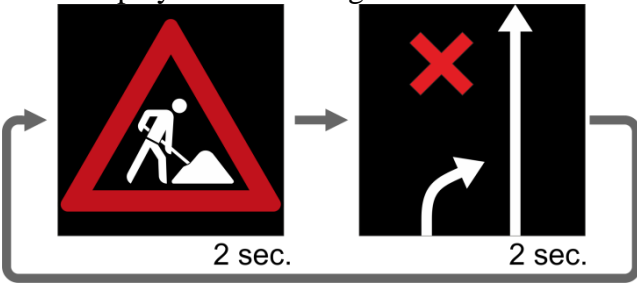


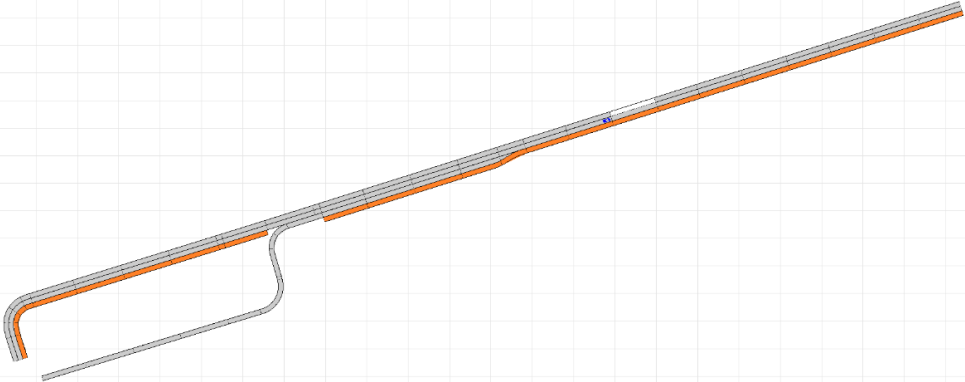


Figure 37: DLR's ViewCar2 executing the use case 4.2 tests.

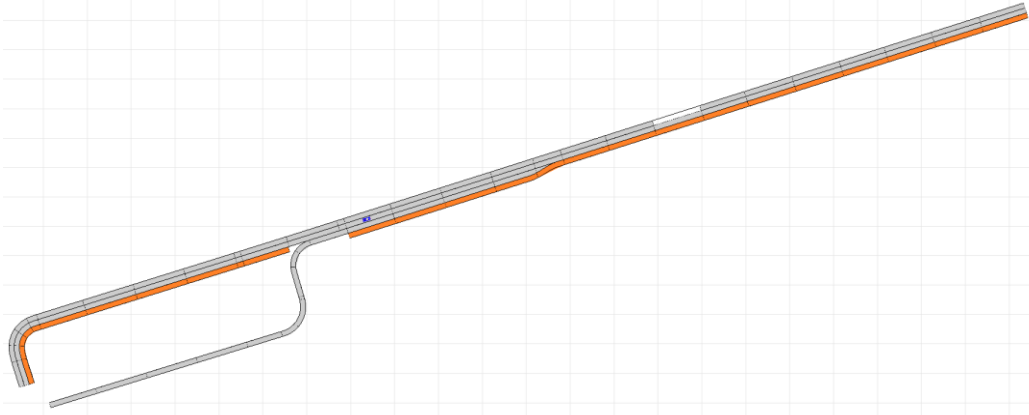
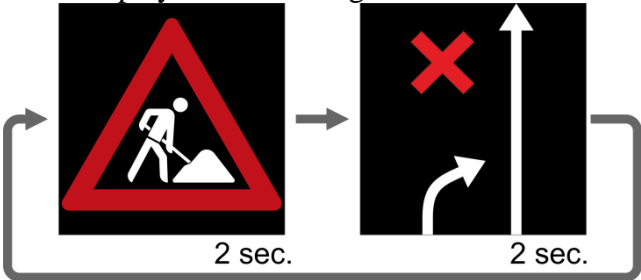
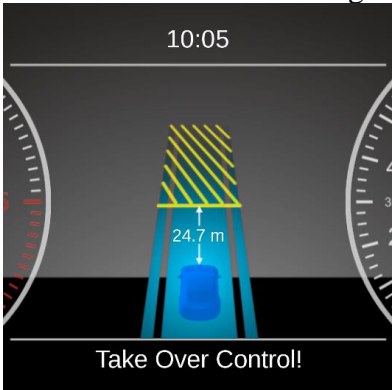
For use case 4.2, three tests are performed, described in the following.


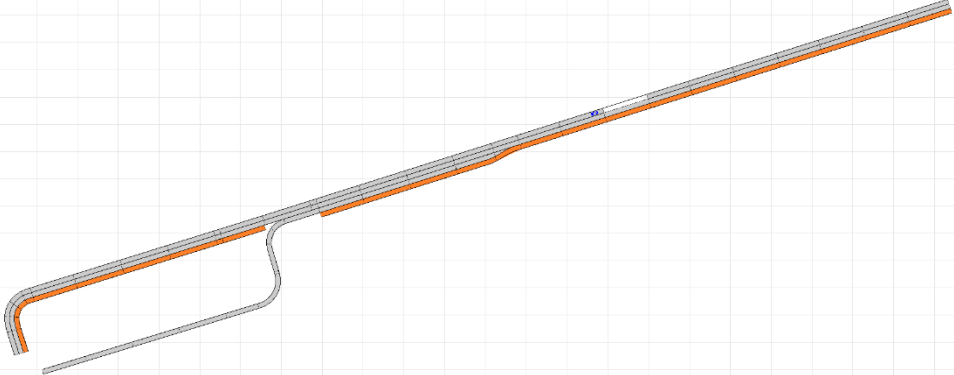
2.2.1.5.2.1 Test scenario 4.2_0: “Baseline: MRM on free lane”

Goal	Demonstrate negative effects of a ToC on the right lane in front of the blockage when no TransAID measure is applied. ToC unsuccessful, MRM executed.
Used vehicles	ViewCar2
Used infrastructure	RSU, VMS
Used messages	CAM, DENM
Initial situation	ViewCar2 starts on right lane of two-lane road, followed by a legacy vehicle. The left lane of the road is blocked by roadworks. The vehicle is by default not able to pass the roadworks on the right lane. 

<p>Scenario script</p>	<ol style="list-style-type: none"> 1. VMS displays the following animation <div style="text-align: center;">  <p>2 sec. 2 sec.</p> </div> 2. RSU broadcasts DENM::Roadworks 3. ViewCar2 issues ToC. The following HMI is shown: <div style="text-align: center;">  </div> 4. Driver does not take over control, standard MRM is executed. The following HMI is shown: <div style="text-align: center;">  </div> 5. ViewCar2 stops at entrance of roadworks area. <div style="text-align: center;">  </div>
<p>Associated to Requirement(s) in addition to generic requirements</p>	<ul style="list-style-type: none"> • REQ_V_I1_S4.2_1 • REQ_V_I1_S4.2_2 • REQ_I_I1_S4.2_1 • REQ_I_I1_S4.2_2

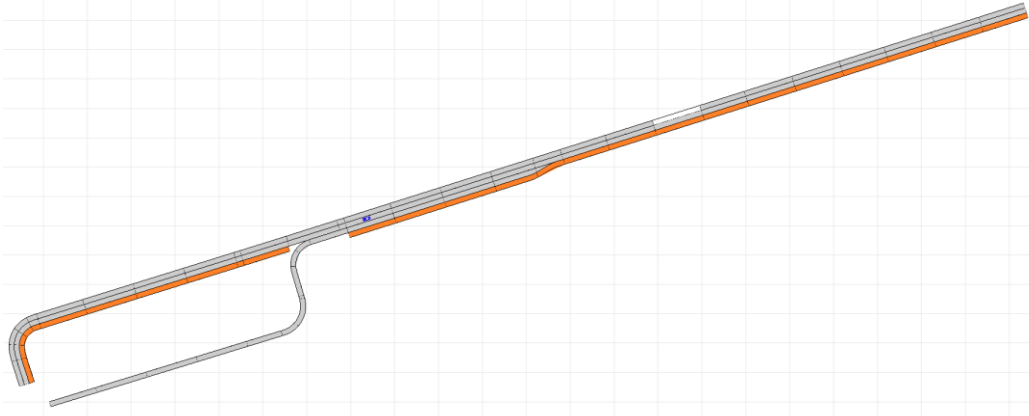
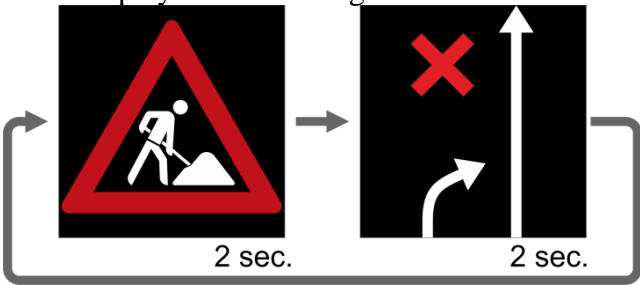


2.2.1.5.2.2 Test scenario 4.2_1: “MRM into SafeSpot on Left Lane”

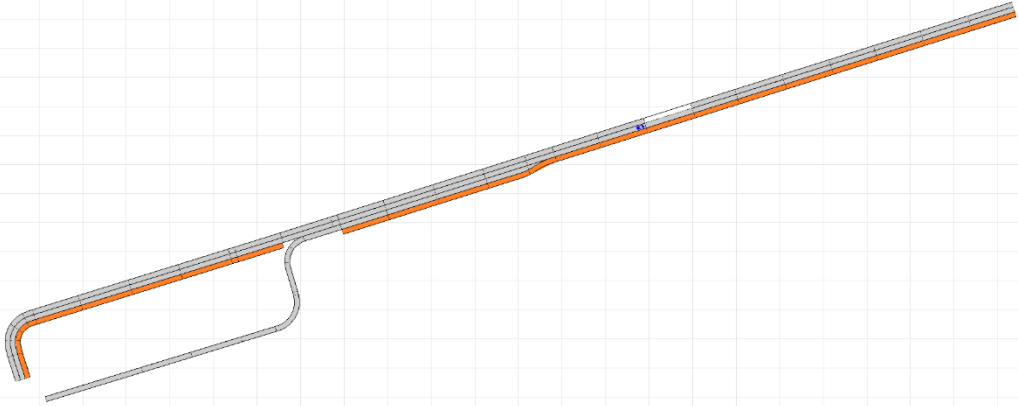
Goal	Demonstrate benefits of performing a Minimum Risk Manoeuvre into a Safe Spot in front of the roadworks area.
Used vehicles	ViewCar2
Used infrastructure	RSU, Camera, VMS
Used messages	CAM, DENM, I2V-MCM
Initial situation	<p>ViewCar2 starts on right lane of two-lane road, followed by a legacy vehicle. The left lane of the road is blocked by roadworks. The vehicle is by default not able to pass the roadworks on the right lane.</p> 
Scenario script	<p>1. VMS displays the following animation</p>  <p>2. RSU broadcasts DENM::Roadworks</p> <p>3. RSU sends MCM:: RSU_SMC ::ToCAdvice to ViewCar2</p> <p>4. ViewCar2 receives message, starts reducing speed with -0.5m/s^2 during ToC interval. The following HMI is shown:</p> 

	<p>5. Driver ignores ToC 6. RSU sends MCM::RSU_SMC::LaneAdvice::TargetLane=3(=SafeSpot position) to ViewCar2 7. MRM is executed. The following HMI is shown:</p>  <p>8. ViewCar2 performs lane change and stops in the SafeSpot,</p> 
<p>Associated to Requirement(s) in addition to generic requirements</p>	<ul style="list-style-type: none"> • REQ_V_I1_S4.2_1 • REQ_V_I1_S4.2_2 • REQ_I_I1_S4.2_1 • REQ_I_I1_S4.2_2

2.2.1.5.2.3 Test scenario 4.2_2: “MRM on current lane, SafeSpot occupied”

<p>Goal</p>	<p>Demonstrate infrastructure behaviour in case of an occupied safe spot. Minimum Risk Maneuver is performed on the driving lane.</p>
<p>Used vehicles</p>	<p>ViewCar2</p>
<p>Used infrastructure</p>	<p>RSU, Camera, VMS</p>
<p>Used messages</p>	<p>CAM, DENM, I2V-MCM</p>
<p>Initial situation</p>	<p>ViewCar2 starts on right lane of two-lane road, followed by a legacy vehicle. The left lane of the road is blocked by roadworks. The vehicle is by default not able to pass the roadworks on the right lane.</p>




	
<p>Scenario script</p>	<ol style="list-style-type: none"> 1. VMS displays the following animation <div style="text-align: center;">  </div> 2. RSU broadcasts DENM::Roadworks 3. RSU sends MCM:: RSU_SMC ::ToCAdvice to ViewCar2 4. ViewCar2 receives message, starts reducing speed with -0.5m/s^2 during ToC interval. The following HMI is shown: <div style="text-align: center;">  </div> 5. Driver ignores ToC 6. MRM is executed, ViewCar2 stops in right lane. The following HMI is shown: <div style="text-align: center;">  </div>


	
<p>Associated to Requirement(s) in addition to generic requirements</p>	<ul style="list-style-type: none"> • REQ_V_I1_S4.2_1 • REQ_V_I1_S4.2_2 • REQ_I_I1_S4.2_1 • REQ_I_I1_S4.2_2

2.2.1.5.3 Feasibility results

2.2.1.5.3.1 Requirements verification

In addition to the feasibility assessment of the general requirements shown in section 2.2.1.1 a few service-specific requirements needed to be verified:

	Service-specific requirement description	Req. Name	Associated Test cases successfully executed	Notes
Vehicle Requirements	<p><i>Safe spot advice following</i></p> <p>The CAVs need to be able to receive safe spot advices from the infrastructure. The advices need to be taken into account during trajectory and Minimum Risk Manoeuvre planning. It may be necessary, that the current level of automation is also communicated to the infrastructure.</p>	REQ_V_I1_S4.2_1		Safe spot advices received and followed using the lane change and ToC advices available in the MCM's RSU container.
	<p><i>Manoeuvre Coordination Message support</i></p> <p>The vehicles need to provide manoeuvre information in order to be able to implicitly block safe spots. Manoeuvres of the other vehicles shall be received and taken into account for the own trajectory and Minimum Risk Manoeuvre planning.</p>	REQ_V_I1_S4.2_2		MCM provided, but MCM-V2V support only tested in simulation.
Infrastructure requirements	<p><i>Safe spot availability detection</i></p> <p>The infrastructure needs the capability to always track the availability of the safe spots. This does not only include listening to appropriate messages indicating the blockage, but also the detection by using e.g. camera systems. This is necessary, as the safe spot areas may be also blocked by non-cooperative vehicles, e.g. due to a brake-down of a legacy vehicle.</p>	REQ_I_I1_S4.2_1		Safe spot availability was followed by using MCM. Nevertheless, the safe spot availability was not detected online by camera or message reception.

<p><i>Safe spot advice generation</i></p> <p>Whenever a safe spot is available, the infrastructure should forward this information to the vehicles.</p>	<p>REQ_I_11_S4.2_2</p>		<p>Safe spot advice was provided by RSU to receiving vehicles.</p>
---	------------------------	---	--

For this set of tests, the reception and transmission of required V2X message was also verified using the V2X module (CohdaWireless mk5) present on the test track. The capture log shows that the RSU correctly formats DENM and MCM messages, and the content of these messages fits to the specific requirements of the tests under evaluation. In particular, the DENM shows the event position of the roadworks and the lanes that are closed, and the MCM includes the ToC Advice and Lane Advice when required. The safe spot information to perform the MRM (Test scenario 4.2_1) is indicated by making the place of end transition to match the lane change position, so that if the driver does not take control, the MRM coincides with the lane change. Safe spot information will be an extension of the MCM message for the TransAID’s second iteration.

2.2.1.5.3.2 User experience

MRMs were successfully executed during the test cases. Deceleration speed was still acceptable from user’s point of view. A potential step before starting the MRM could be a minimal steering jerk and/or activation of the vehicles’ break system to trigger the driver’s attention that a vehicle control takeover is requested to reduce the chance a MRM must be triggered.

2.2.1.5.3.3 Check of overall feasibility

The bad impact of MRM was successfully demonstrated, which also leads to the conclusion that it is recommended to introduce safe spots (in areas where it is feasible, cf. road architecture). Additional space (safe spots) in front of road works could also have positive side-effects on the safety level of road workers: In case of accidents a safe spot can reduce the impact of vehicle accidents (speed mitigation before hitting objects of the road works).

2.2.1.6 Requirements of use case 5.1: Schedule ToCs before no AD zone

2.2.1.6.1 Description of use case from D2.2

After a transition of control (ToC) from automated to manual mode, an automated vehicle is expected to behave more erratically. The driving characteristics are different (e.g., different headway, different lateral movement variation, different overtaking behaviour, etc.). Because the driving behaviour during transitions and driving behaviour shortly thereafter are different, traffic flow and safety are disturbed. This effect is amplified when there are many ToCs in the same area. To prevent that amplification in mixed traffic scenarios, downward ToCs are distributed in time and space upstream of an area where there is no or limited automated driving (e.g., tunnel, geofence, complicated road works).

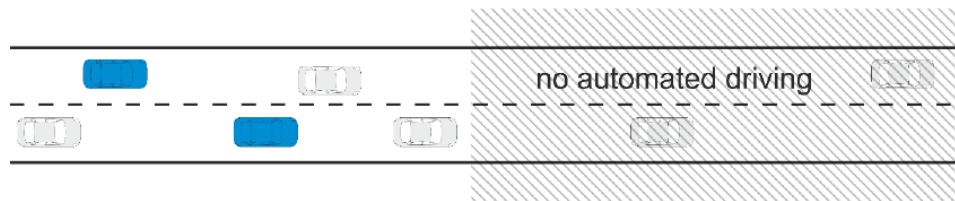


Figure 38: schematic overview of use case 5.1

Figure 38 shows the use case 5.1 where CAVs and other traffic are approaching a no AD zone with 2 lanes. Starting at some point upstream of the no AD zone, the RSI determines through collective

perception the positions and speeds of vehicles and determines the optimal location and moment for CAVs to perform a downward ToC. Subsequently, ToC requests are provided to the corresponding CAVs. Based on the ToC requests, the CAVs perform ToCs at the desired location and moment in time. CVs are warned about the ToCs and possible MRMs. In the no AD zone, the CAVs are in manual mode.

Note: the figure is schematic. The blue automated vehicles have performed ToCs further upstream than the picture might suggest.

2.2.1.6.2 Use case setup

The effects of this use case can best be seen in traffic simulation. Nevertheless, the feasibility should be shown as well. Therefore, ToC advice messages need to be implemented and tested. If the infrastructure needs more information to trigger the ToC advice messages, the use case can be extended accordingly.

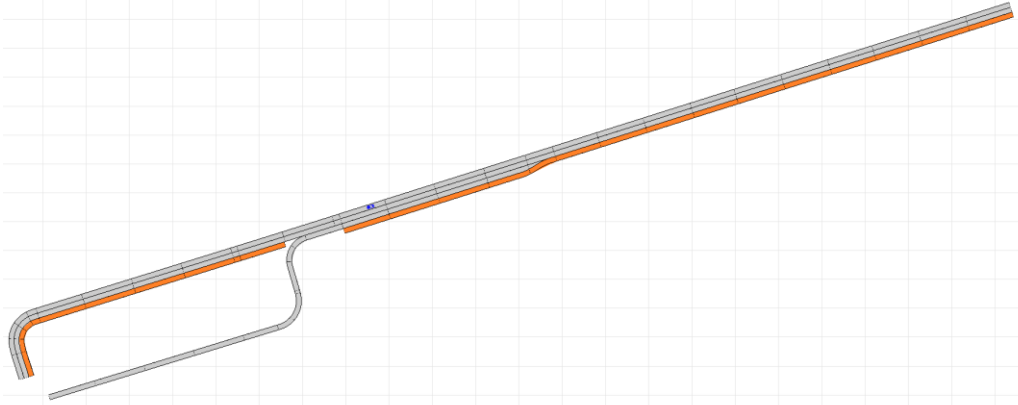

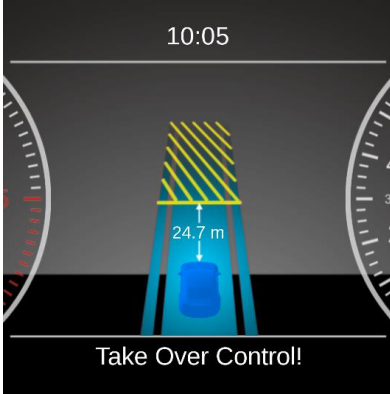


Figure 39: DLR's ViewCar2 executing the use case 5.1 tests.

For use case 5.1, two tests are performed, described in the following.

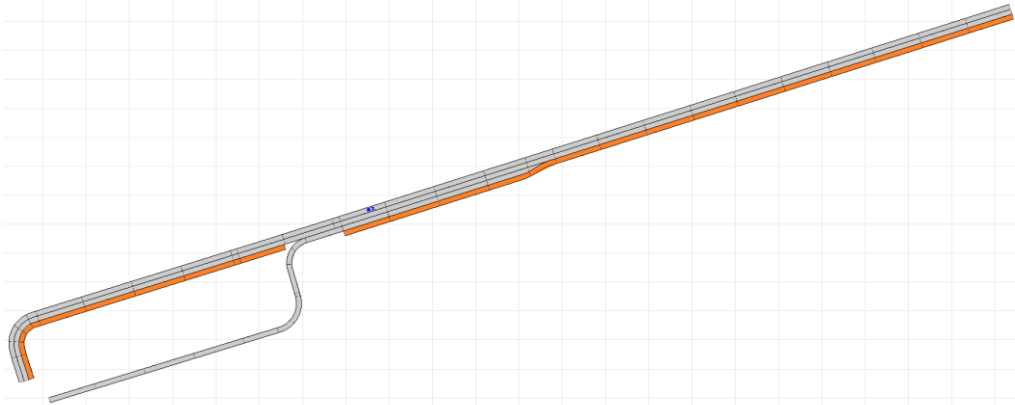

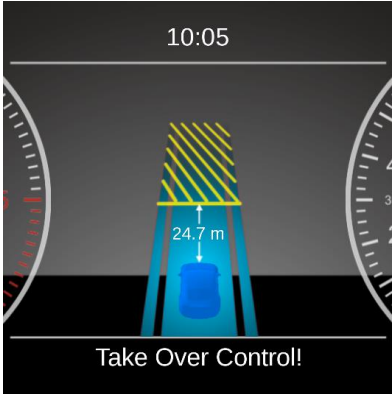
2.2.1.6.2.1 Test scenario 5.1_0: “Scheduled ToCs with driver’s response”


Goal	Demonstrate the possibility of scheduled ToCs. In this case, the driver is responding and the ToC is successful.
Used vehicles	ViewCar2
Used infrastructure	RSU, VMS
Used messages	CAM, DENM, I2V-MCM

<p>Initial situation</p>	<p>ViewCar2 starts on right lane of two-lane road. It approaches an area where no automated driving is possible or allowed</p> 
<p>Scenario script</p>	<ol style="list-style-type: none"> VMS displays the following sign:  RSU optionally broadcasts DENM::NoADZone RSU sends MCM::RSU_SMC::ToCAdvice (400m behind reference point) to ViewCar2 ViewCar2 issues ToC. The following HMI is shown:  Driver takes over control.
<p>Associated to Requirement(s) in addition to generic requirements</p>	<ul style="list-style-type: none"> • REQ_V_I1_S5.1_1 • REQ_I_I1_S5.1_1

2.2.1.6.2.2 Test scenario 5.1_1: “Scheduled ToCs without driver’s response”

<p>Goal</p>	<p>Demonstrate the possibility of scheduled ToCs. In this case, the driver is not</p>
-------------	---



	responding and the ToC is unsuccessful.
Used vehicles	ViewCar2
Used infrastructure	RSU, VMS
Used messages	CAM, DENM, I2V-MCM
Initial situation	<p>ViewCar2 starts on right lane of two-lane road. It approaches an area where no automated driving is possible or allowed</p> 
Scenario script	<ol style="list-style-type: none"> VMS displays the following sign:  RSU optionally broadcasts DENM::NoADZone RSU sends MCM:: RSU_SMC ::ToCAdvice (400m behind reference point) to ViewCar2 ViewCar2 issues ToC. The following HMI is shown:  Driver does not take over control, MRM is executed. ViewCar2 stops on current lane. The following HMI is shown:

	
<p>Associated to Requirement(s) in addition to generic requirements</p>	<ul style="list-style-type: none"> • REQ_V_I1_S5.1_1 • REQ_I_I1_S5.1_1

2.2.1.6.3 Feasibility results

2.2.1.6.3.1 Requirements verification

In addition to the feasibility assessment of the general requirements shown in section 2.2.1.1 a few service-specific requirements needed to be verified:

Service-specific requirement description	Req. Name	Associated Test cases successfully executed	Notes
<p><i>Vehicle requirements</i></p> <p><i>ToC advice following</i></p> <p>The CAVs need to be able to receive ToC advice from the infrastructure. The advice needs to be taken into account while driving. It may be necessary, that the current level of automation is also communicated to the infrastructure.</p>	REQ_V_I1_S5.1_1		ToC advice received and followed. The vehicles report the current level of automation to the infrastructure using an extended CAM container. This was not implemented by design for the TransAID first iteration.
<p><i>Infrastructure requirements</i></p> <p><i>ToC advice generation</i></p> <p>The infrastructure needs to be able to generate ToC advice. The exact requirements for this need to be derived from the baseline simulations and the envisioned traffic management procedures.</p>	REQ_I_I1_S5.1_1		ToC advice generated by present RSU.

For this set of tests, the reception and transmission of required V2X messages was also verified using the V2X module (CohdaWireless mk5) present on the test track. The capture log shows that the RSU correctly formats MCM messages, and that the content of these messages fits to the specific requirements of the tests under evaluation. In particular, the MCM includes two ToC advice entries. The advice is addressed to two different stations, and they indicate the place where the transition of control should be completed before executing the MRM.

2.2.1.6.3.2 User experience

A passenger of a CAV could not identify that the behaviour changed here (scheduling of ToC) compared to a fixed time or spot where the ToC is triggered (cf. Test scenario 1.1_0: “Baseline:

ToC in front of blockage”). Results and comments from previous ToC related scenarios also apply here. A proper HMI will have a high influence on the level of comfort and the perceived safety.

2.2.1.6.3.3 Check of overall feasibility

Feasibility of a scheduled ToC is expected to reduce the chance of stopped CAV/CV or generation of traffic jams. This was not verified in this first stage implementation due to the lack of test vehicles.

2.2.2 Second iteration

In the second project iteration, the set of use cases had changed. The new use cases are introduced in the second iteration version of D2.2 [7] and further specified in the second iteration version of D7.1 [2] in terms of real-world assessment. Compared to the first iteration, the second iteration use cases have a higher complexity. Some use cases are adding further components like a mobile traffic light, others are similar to before but add more implementation details.

Due to the outbreak of COVID-19 in Europe, HMETC personnel were not able to visit the DLR test-site for the feasibility assessment. Instead, both parties agreed to use a video live-stream (November 11th, 2020) and additional video and test data recordings of the test-site and the demo application to check and rate the implementation. Additional questions were raised and answered during the live-stream as well as after the event. With this in mind, HMETC did its best to overcome these limitations and to provide valuable results for the second iteration of the feasibility assessment.
















Figure 40: Impressions from the live-stream from DLR's proving ground in Peine-Eddesse


In the following, the feasibility assessment of the second iteration is shown. The structure is similar to the structure of the first iteration: After dealing with the general requirements assessment, the specific requirements for the second iteration use cases are discussed.

2.2.2.1 General requirements assessment

2.2.2.1.1 Requirements verification

General requirement description		Req. Name	Associated Test cases successfully executed	Notes
Vehicle requirements	<p><i>Availability of cooperative automated vehicles:</i></p> <p>As TransAID deals with transition areas, all use cases include at least one cooperative automated vehicle. Therefore, cooperative automated vehicles need to be available for the feasibility assessment. The vehicles need to be able to drive longitudinally and laterally automated, independent of the SAE level of automation, as well as to cooperate via V2X.</p>	REQ_V_G_1		CAVs have been present during the second iteration tests
	<p><i>Availability of transitions of control</i></p> <p>As TransAID focusses on SAE levels up to level 4, the automated vehicles need to have the ability to perform transitions of control to the driver and from the driver to the vehicle automation. The transitions need to be driver and automation initiated, meaning that the driver may decide which system is turned on (for each longitudinal and lateral control either manual driving with warnings or automated driving), but the automation itself may decide to not being able to keep the desired level of automation any longer.</p>	REQ_V_G_2		Transitions of control could be executed
	<p><i>Availability of Minimum Risk Manoeuvres (MRM)</i></p> <p>Whenever the automation is not able to continue driving at the desired level of automation, it has to try to give the control back to someone else, most likely (in SAE up to level 4) the driver of the car and sometimes a remote operator. Whenever this take-over-request (ToR) is not followed by the driver due to any reason (very distracted, fallen asleep, lost consciousness), the SAE4 vehicle has to reach a safe state. This is done by automatically triggering a Minimum Risk Manoeuvre. While this is especially true for SAE4 vehicles, it is foreseen that SAE3 vehicles will also offer light versions of such MRMs, e.g. decelerating to a full stop of the vehicle on the current lane. Nevertheless, current thoughts of MRMs also include lane changes to emergency lanes, and therefore more sophisticated behaviours. Vehicles driving in lower levels of automation do not have MRMs, as the driver always has to monitor the situation and as such is already in the loop. During the feasibility assessments of TransAID, Minimum Risk Manoeuvres need to be available in different kinds, so that different SAE levels can be tested.</p>	REQ_V_G_3		Standard and extended Minimum Risk Maneuvers could be executed.
	<p><i>Availability of extensible sensor data fusion</i></p> <p>The automated vehicles will need a sensor data fusion, which will fuse the data of the different sensors. This will need to be extensible, as it is foreseen that further data will be added to it, e.g. data related to map properties (availability of safe spots, see use cases 4.2 and 4.1-5), or data received by cooperative perception. The latter will include data from other vehicles' sensors or from infrastructure sensors.</p>	REQ_V_G_4		The sensor data fusion is available and has included interfaces for CPM and CAM perception. CAM and CPM object fusion is done. In addition, map properties are changed according to DENM and MAPEM receptions.
	<p><i>Communication and message sets</i></p> <p>As TransAID is relying on V2X communication based on the ETSI ITS-G5 radio access technology and its associated ETSI ITS standards, each cooperative vehicle has to be equipped with the appropriate hard- and software to receive and send dedicated messages on the given channels.</p>	REQ_V_G_5		Communication is implemented following the designed message sets.

	<p><i>Cooperative lane changes</i></p> <p>One of the key abilities repeated in several use cases is the ability to perform cooperative lane changes. While the precise communication for such cooperative lane changes is going to be studied in WP5, it is nevertheless a basic requirement for all cooperative automated vehicles to be able to perform cooperative lane changes.</p>	REQ_V_G_6		Cooperative lane changes in terms of V2V cooperation has been successfully tested.
	<p><i>Local high definition map</i></p> <p>The automated vehicles need to have a local high definition map of the use case area. This map needs to include a detailed representation of the road topology as required by automated vehicles implementations, and must be extensible to include additional dynamic data sent by the infrastructure, like road works areas, positions of safe spots etc.</p>	REQ_V_G_7		A local high definition map was present. As mentioned in REQ_V_G_4, the map data is already dynamically changed on reception of DENM and MAPEM.
	<p><i>HMI availability for CVs</i></p> <p>Task 5.5 describes signalling for legacy and cooperative vehicles, including signalling inside the vehicle. For this, the vehicle needs to have an HMI available. This will most likely be an Android smartphone connected to the OBU.</p>	REQ_V_G_8		As no CVs were present during the tests, also the CV HMI was not needed. Instead, a debugging HMI was used in the CAVs
Infrastructure requirements	<p><i>Communication and message sets</i></p> <p>It is a mandatory requirement for the infrastructure to be able to communicate advice to the vehicles by using ETSI ITS-G5 based V2X communication. In addition, the reception of messages is also needed to get a better image of the situation, e.g. by knowing the exact positions of cooperative vehicles and their plans, as well as knowledge of other non-cooperative vehicles' presence.</p> <p>To avoid extensive forwarding of messages, different road side units shall be linked to each other. While this is a general requirement, it will not be used during the feasibility assessment, as there will always be only one single road side unit available.</p> <p>Furthermore, the infrastructure needs the ability to communicate decisions to non-cooperative vehicles as well. This can be done by for instance Variable Message Signs. Possible additional methods are to be developed within WP4 and WP5.</p>	REQ_I_G_1		<p>The infrastructure was able to communicate messages in line with the defined message sets.</p> <p>In most of the use cases, only one RSU has been used. Only in the use cases requiring a traffic light (Use Case 2.3), a second RSU was used to propagate SPATEMs and MAPEMs.</p> <p>Communication to non-cooperative vehicles has been done by using a VMS, see REQ_I_G_6.</p>
	<p><i>Sensors</i></p> <p>In most cases, the infrastructure also needs to know where all non-cooperative vehicles are. Therefore, sensors to detect vehicle positions are a mandatory requirement. While the sensor can be of any kind, cameras are foreseen to be the best option, as they offer not only vehicle positions, but also more details, like the orientation and speed.</p>	REQ_I_G_2		A camera was able to detect and track objects.
	<p><i>Sensor data fusion</i></p> <p>As for the vehicles, also the infrastructure needs to perform a sensor data fusion, e.g. to understand that a vehicle detected by a camera is also transmitting messages.</p>	REQ_I_G_3		In the second iteration, the infrastructure was able to perform a sensor data fusion of camera-detected objects and CAM/CPM objects received by V2X.
	<p><i>Processing capabilities</i></p> <p>The infrastructure needs to be able to compute several inputs to generate correct traffic management measures. Therefore, the infrastructure needs to include adequate processing capabilities.</p> <p>If the sensors need further processing capabilities e.g. to calculate object positions and dimensions, this needs to be included as well.</p>	REQ_I_G_4		Processing was possible without any shortcomings.
	<p><i>Road networks</i></p> <p>The different use cases will need different road network topologies to be taken into account. The road networks need to be available logically so that the infrastructure is able to plan on top of it.</p>	REQ_I_G_5		The used road network was included in the infrastructure as well.

<p><i>Signalling equipment</i></p> <p>The only method to reach non-cooperative legacy vehicles is through the road side equipment. Task 5.5 will investigate this further, but as there is no budget foreseen for Variable Message Signs (VMS), it is likely that this will be limited to existing infrastructure, e.g. traffic light signals, ramp meters, etc.</p>	<p>REQ_I_G_6</p>		<p>A VMS was available and used.</p>
--	------------------	---	--------------------------------------

2.2.2.1.2 Existing deviations and addressing of first iteration deviations

As described in the previous section 2.2.2.1.1, nearly all deviations which occurred in the first project iteration have been solved. The only further existing deviation is that no specific CV HMI has been developed in the general assessment².

With regards to the first project iteration, the former deviations have been addressed as follows:

- *Surrounding Traffic:* In the second iteration, LVs have been present on the roads. CAVs had to react to LVs movements and plan their trajectories in a safe way through the dynamic situation. As consequence, complex scenarios with several vehicles (like use case 2.1 described in section 2.2.2.3) were not deterministic and highly related to the driving situation.
- *Reference Position:* In the second iteration, MAPEM have been used to identify the reference positions of MCMs. Nevertheless, this still is not unproblematic, e.g., the used hardware was only forwarding MAPEMs to the vehicle automation software when also SPATEMs have been received.
- *Camera integration:* Cameras have been fully integrated into the RSI, dynamically calculating the optimal advice for the vehicles based on current vehicle positions. Besides, CPMs have been broadcasted by the infrastructure.
- *VMS images:* The images and animations have been further updated in correlation with Task 5.5 of the TransAID project. As stated there, the images need to be seen as ideas for future standardization activities.

2.2.2.1.3 User experience

This section explains in general the experience collected during the tests and compares it with and expectations that the tested services would imply when applied in real life from a car passenger/driver perspective. This helps us to understand if and how the TransAID services can be marketed and offered to OEMs customers.

As already highlighted in the first feasibility assessment, it is important to remember that the DLR test-vehicles are purely an experimental platform used to test and validate technical developments and not primarily meant to address perfect user experience. In the performed integration sprint and demonstration, the main objective was to show primarily the cooperative interaction between automated vehicles and the road infrastructure as well as the automated implementation of infrastructure advices. The second iteration clearly showed exhaustive improvements and extensions of the first assessment in this direction.

The test vehicle successfully drove automated and executed the required manoeuvres on the test track according to the scenarios. Observing the vehicle behaviour didn't reveal large differences to

² Please note that the CV HMI has been developed for the public road assessment, see section 3.1.5

the behaviour of a human driver. This can be already seen as a first positive result for DLRs implementations, passengers are not perceived to be unsafe while the car is traveling in automated mode. A successful ToC was not interrupted by a sudden change of vehicle speed or a steering jerk. The test vehicles driving behaviour resulted in a perceived safe and comfortable ride for passengers.

- In general, the applied acceleration and deceleration values were as expected comparable to a comfortable and not aggressive driving style of a human driver in most of the cases.
- Steering jerk in curves seemed reduced compared to the first iteration.
- In general, the MRMs were recognizable but still had a smooth deceleration. As MRMs should be one of the last countermeasures before an accident, it is acceptable. Nevertheless, in some tests where the MRM is executed to reach a suggested safe spot on an adjacent lane (e.g. test 4.2.1), the vehicle keeps the cruise speed till the moment when the lane change starts. The CAV does not preventively decelerate to a lower MRM speed to take into account the possible presence of obstacles (e.g. other parked cars) adjacent to the suggested safe spot. Preventively decelerating would allow a more conservative planning to successfully execute the lane change and stop in these cases. Without a deceleration, the vehicle might arrive too fast and not have the time to execute the lane change hence stopping at the driven lane and blocking it. Also, if the car cannot execute the lane change and stop at the very last moment, the car would need to brake relatively strong, triggering an emergency manoeuvre that might not always be safe for the surrounding traffic.
- Very smooth lane following on straight paths. The steering wheel was not jittering, vibrating or shaking.
- In case of a requested/required lane change, a bit smoother trajectory should be planned (if possible), in terms of a not too abrupt change of lateral speeds to support a comfortable travel (this was noticeable especially when changing the lane from the ramp to one of the straight lanes). This can have influences on the path planning; a longer planned/calculated path (smaller lateral/longitudinal changes between single steps) compared to a human driver.
- Required V2X messages were transmitted and received properly to be taken into account for the individual test cases
- A HD map with overlays/status information of blocked or ending road segments was used to execute the test cases, but not visualized for the vehicle driver. The visualized map was used for test purposes only.

From an OEM perspective, potential areas for improvements can be seen in the HMI area, the reader should be aware that the used (debug) HMI is not in scope of TransAID:

- The transition of control was indicated in the second iteration using a short display pop-up message and audible signals so that the driver was informed about changes of the system status as well as the request to take over control to prevent an MRM execution. An animation in the cluster (hands moving towards the steering wheel and text, plus sound) is adopted. On the contrary, the moment when the control is back to the driver is indicated with a clear icon in the cluster and a sound. Nevertheless, the impression is that to avoid execution of MRM, ToR indications should be more visible or audible (voice/text to speech might be a solution here). Take-over requests for drivers should be signaled much clearer (at least for first time system users). A red flashing exclusion zone in cluster can be misinterpreted, starting with a light yellow fading to orange and red or a progress bar might help. A text to speech output could further improve the comfort by reducing the number of played beeps and chimes (in case time permits).
- One or two buttons on the steering wheel (detection of driver's grip on steering wheel) could be an additional step to acknowledge transition of control.

- Further investigations should be done for the cases where an MRM will be executed. For example, solutions to reduce the number of MRMs can be investigated: before starting the MRM, the driver could be more clearly warned (e.g., with vibration, audible, visual with longer warning cycles) to take back control (cf. driver state monitoring). Also, further study is needed to investigate the best strategies to undertake after executing the MRM. Possible solutions could be starting with warning signals and ending with signalling that external help is required (e.g., hazard lights, horn, e-call). After executing the MRM, the engine could be stopped and all doors unlocked. In the tests performed in the second iteration the MRM execution is more evident. Notice that in some tests, the MRM indication has not properly worked and the red MRM sign has not been shown. Consistency in the display strategy would be a key success factor for user-acceptance. In case of lane changes, the CAV system shall inform the driver about the next manoeuvre, also while performing an MRM. This can allow a better user acceptance, but mostly prevent unsafe driver reactions and uncomfortable driving experience. This has been partly addressed by the DLR CAV in the second iteration: lane change indications in the cluster are displayed before and during their execution (see test 2.3.3 in section 2.2.2.4.2.4 and the related HMI section 2.1.1.1.4.2.3) using arrows and displaying lanes.
- For the same reasons, a rerouting decision (e.g., in reaction to an obstacle in front blocking an allowed manoeuvre) or traffic rules violations (e.g. crossing a solid line) shall be clearly indicated and explained to the user. Although implemented in the HMI (see section 2.1.1.1.4.2.4), the rerouting information has not been visualized in all cases. Only the local HD map debugging visualization has correctly shown this information all times. Besides solving this issue, additional channels may be investigated, e.g., displaying on the navigation screen.
- Another not yet verified solution could be the decoupling of steering and pedals while the vehicle is in automated driving mode, as done e.g., in former research projects like EU-FP7-interactIVe.

2.2.2.1.4 Check overall feasibility

This section considers the results of the requirements verification and of the user experience and derive conclusion on overall feasibility. Also, it justifies if a given service is feasible/applicable in real-world implementation scenarios and why.

All test scenarios have been demonstrated successfully and constitute very promising proofs of feasibility for higher level CV/CAV functions in support to the TransAID traffic management strategies. Overall, the implementation looks feasible from an OEM's point of view provided that the necessary I2V functionalities and related V2X message get standardized.

2.2.2.2 Requirements of use case 1.3: Queue spillback at exit ramp

2.2.2.2.1 Description of the use case from D2.2

CAVs, AVs, CVs, and LVs approach an exit on a motorway. There is a queue on the exit lane that spills back onto the motorway. We consider a queue to spill back on the motorway as soon as there is not enough space on the exit lane to decelerate comfortably (drivers will start decelerating upstream of the exit lane). Vehicles are not allowed to queue on the emergency lane but queuing on right-most lane of the motorway will cause: a) a safety risk due to the large speed differences between the queuing vehicles and the regular motorway traffic and b) a capacity drop for all traffic (including vehicles that do not wish to use the exit). This use case assumes that the RSI will allow (and facilitate) vehicles to queue on a section of the emergency lane to avoid this capacity drop and safety risk.

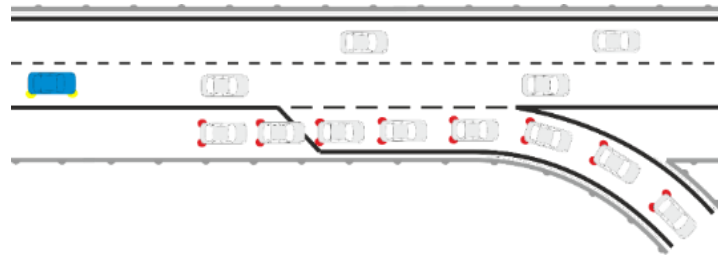


Figure 41: schematic overview of use case 1.3

The RSI will monitor the off-ramp and exit lane, and when a queue is detected, a section of the emergency lane will be opened. Vehicles that wish to exit the motorway will be able to decelerate and queue safely without interfering with the regular motorway traffic. The length of the section of the emergency lane that is opened for traffic will be determined dynamically by the RSI.

Traffic managers will try to avoid queuing on an exit ramp, usually by taking measures to improve the outflow of the exit. This use case looks into the behaviour of the RSI and the vehicles when the spillback of a queue on the motorway actually occurs. It does not discuss if, when, or how the traffic manager can avoid the spill-back of the queue on the motorway.

The RSI monitors traffic operations along the motorway and the exit ramp and detects the queue spillback. In order to ensure traffic safety, the speed limits of the different lanes are changed by the RSI as follows:

- The speed limit in the section of the motorway between the upstream end of the queue and the end of the off-ramp is reduced to 20 km/h above the speed limit of the adjacent lane to the left, while maintaining a minimum speed limit of 50 km/h.
- Upstream of this section, the speed limit is gradually reduced to improve safety and to avoid shock waves in the traffic flow. CVs and CAVs receive lane change advices, according to their desired route. Vehicles that intend to use the off-ramp are advised to use the right-most lane; the other vehicles are advised to use the other lanes.

The vehicles that wish to use the exit lane will be allowed to use the emergency lane at some distance upstream of the queue. The RSI will dynamically determine the length of the section where this is allowed, such that the vehicles leaving the motorway can safely and comfortably decelerate on the emergency lane (without disturbing the traffic that remains on the motorway).

It is possible that LVs and/or AVs will not use the emergency lane to decelerate and queue. In that case, the CVs and CAVs on the emergency lane should allow the LVs and AVs to merge into the queue on the exit lane.

If an AV or CAV does not manage to change into the exit lane, a TOR is offered (not forced) to the driver (more correctly, the driver should receive a signal that the vehicle cannot take the exit lane on its own). The driver can choose whether or not to accept the TOR, if the TOR is not accepted, the AV or CAV will keep on trying to merge into the exit lane for a short while (e.g., 10 seconds) and finally continue driving and change its route (it is assumed to reroute and use another exit).



Figure 42: Test vehicle ViewCar2 not able to take the off-ramp

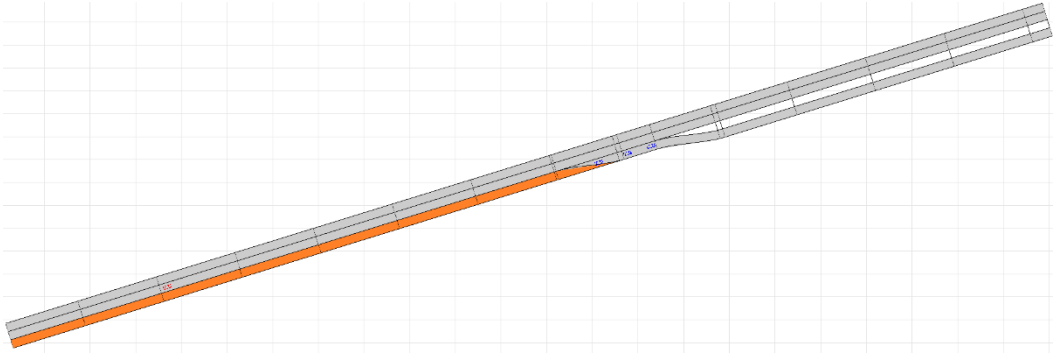
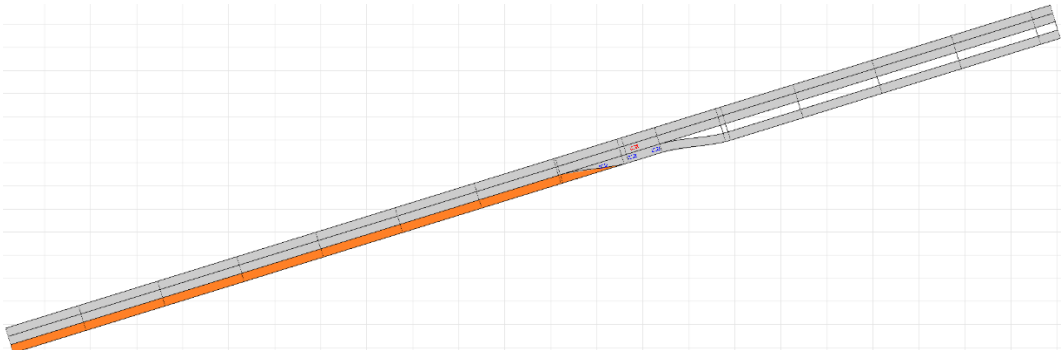


Figure 43: ViewCar2 using the emergency lane for queueing.

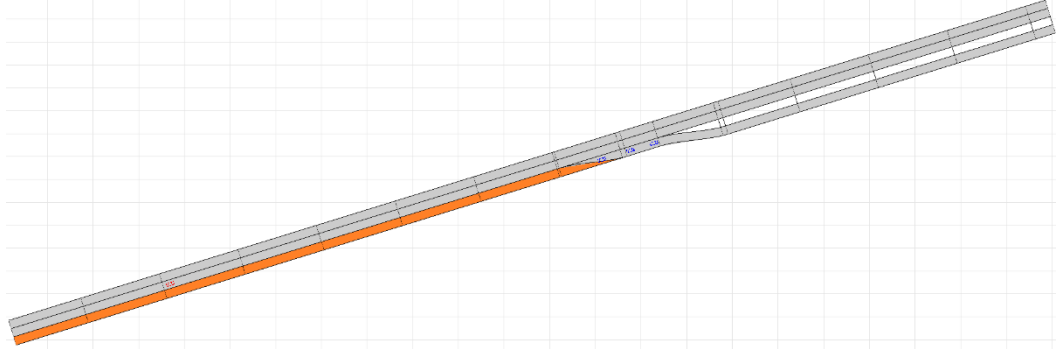
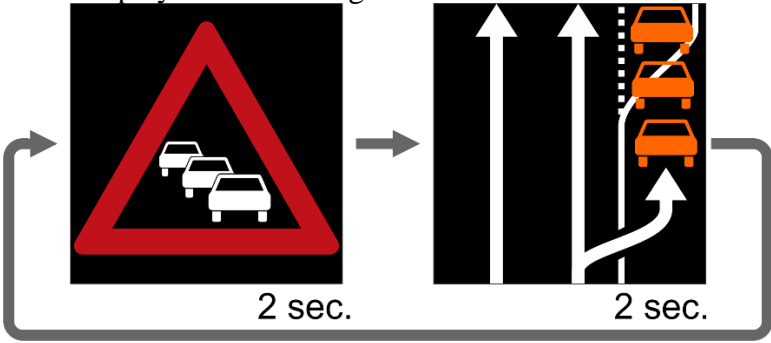
2.2.2.2.2 Use case setup

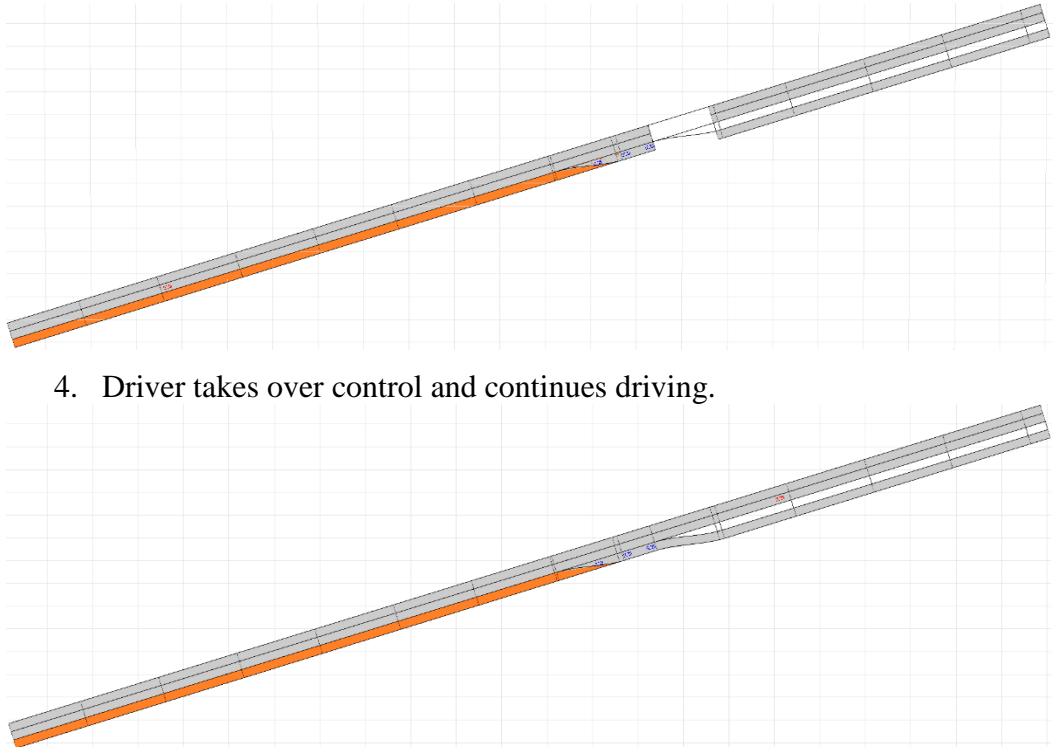
For use case 1.3, five different tests are performed. They are summarized in the following.

2.2.2.2.2.1 Test scenario 1.3_0: “Baseline: Stopping on highway”

Goal	Demonstrate negative effects of automated driving when no TransAID measure is applied. There is no ToC applied at the CAV, it is just stopping on the road as the off-ramp is blocked.
Used vehicles	ViewCar2, LVs blocking the off-ramp
Used infrastructure	None
Used messages	CAM
Initial situation	<p>ViewCar2 starts on two-lane highway. There is one single off-ramp, which is entirely blocked by vehicles. The desired route destination of the ViewCar2 is only reachable when the off-ramp is taken. An emergency/restricted lane is existing.</p> 
Scenario script	<ol style="list-style-type: none"> 1. ViewCar2 drives on highway and starts procedure taking the off-ramp. 2. ViewCar2 arrives at the off-ramp. Sensors recognize that it is blocked. 3. ViewCar2 decelerates and finally stops on the highway. Driver is not informed, as the behaviour is classified as standard procedure handling obstacles. 
Associated to Requirement(s) in addition to generic requirements	Only generic requirements

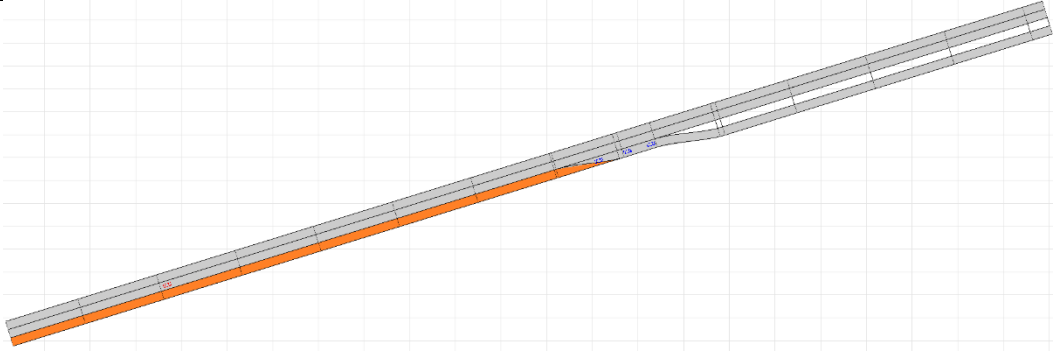
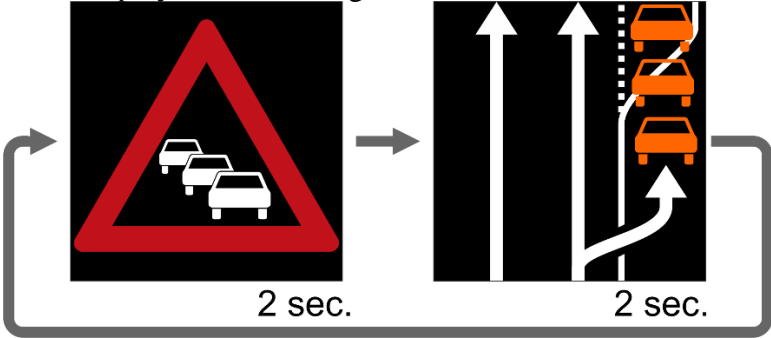
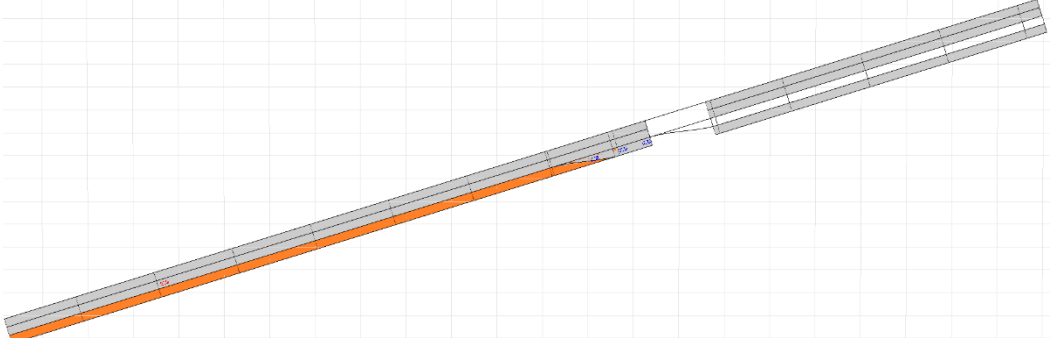
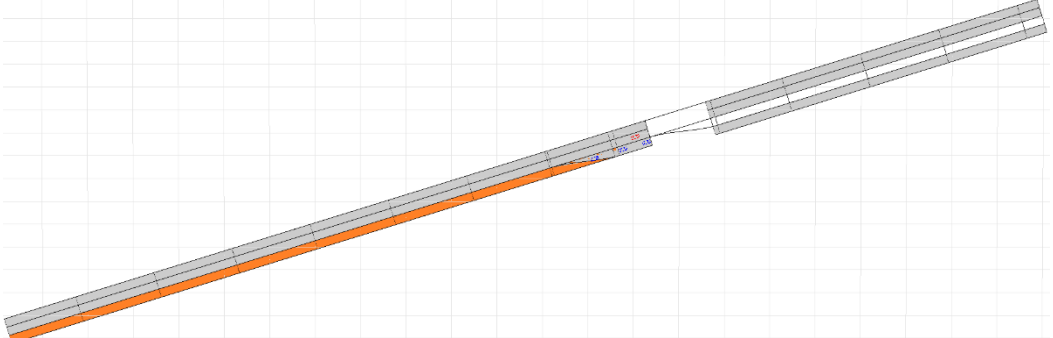
2.2.2.2.2.2 Test scenario 1.3_1: “Baseline: ToC on highway”

Goal	Demonstrate negative effects of automated driving when no TransAID measure is applied. The CAV performs a ToC, and the driver successfully takes over control.
Used vehicles	ViewCar2, LVs blocking the off-ramp
Used infrastructure	VMS
Used messages	CAM
Initial situation	<p>ViewCar2 starts on two-lane highway. There is one single off-ramp, which is entirely blocked by vehicles. The desired route destination of the ViewCar2 is only reachable when the off-ramp is taken. An emergency/restricted lane is existing.</p> 
Scenario script	<ol style="list-style-type: none"> ViewCar2 drives on highway. VMS displays the following animation: <div style="text-align: center;">  </div> Based on the VMS, the ViewCar2 tactical planner draws conclusion that taking the off-ramp will not be possible automated. A ToC is required and therefore a TOR is initiated and displayed as shown in 2.1.1.1.4.2.2. (Internally, the tactical planner marks the corresponding part of the road as “non-drivable”, resulting in the TOR)

	 <p>4. Driver takes over control and continues driving.</p>
<p>Associated to Requirement(s) in addition to generic requirements</p>	<p>Only generic requirements</p>

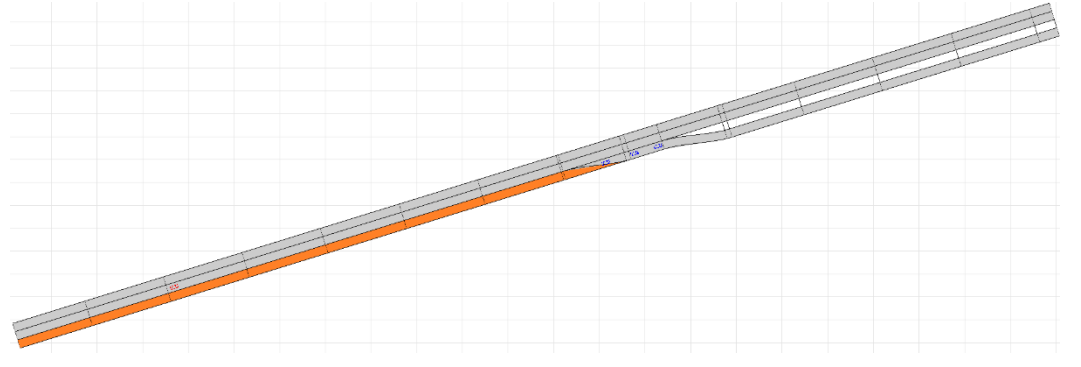
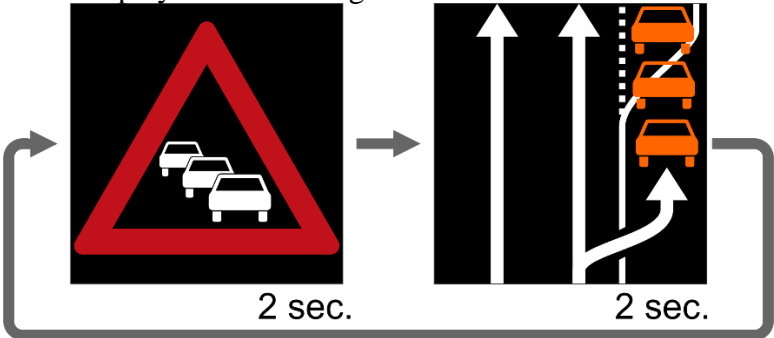
2.2.2.2.3 Test scenario 1.3_2: “Baseline: MRM on highway”

<p>Goal</p>	<p>Demonstrate negative effects of automated driving when no TransAID V2X measure is applied. The CAV performs a ToC. As the driver is not responding, an MRM is executed and the CAV is stopping on the highway.</p>
<p>Used vehicles</p>	<p>ViewCar2, LVs blocking the off-ramp</p>
<p>Used infrastructure</p>	<p>VMS</p>
<p>Used messages</p>	<p>CAM</p>
<p>Initial situation</p>	<p>ViewCar2 starts on two-lane highway. There is one single off-ramp, which is entirely blocked by vehicles. The desired route destination of the ViewCar2 is only reachable when the off-ramp is taken. An emergency/restricted lane is existing.</p>

	
<p>Scenario script</p>	<ol style="list-style-type: none"> 1. ViewCar2 drives on highway. 2. VMS displays the following animation: <div style="text-align: center;">  <p style="text-align: center;">2 sec. 2 sec.</p> </div> 3. Based on the VMS, the ViewCar2 tactical planner draws conclusion that taking the off-ramp will not be possible automated. A ToC is required and therefore a TOR is initiated and displayed as shown in 2.1.1.1.4.2.2. (Internally, the tactical planner marks the corresponding part of the road as “non-drivable”, resulting in the TOR)  <ol style="list-style-type: none"> 4. The driver is not taking over, an MRM is initiated. 5. The vehicle stops on the highway at the off-ramp. 
<p>Associated to Requirement(s)</p>	<p>Only generic requirements</p>

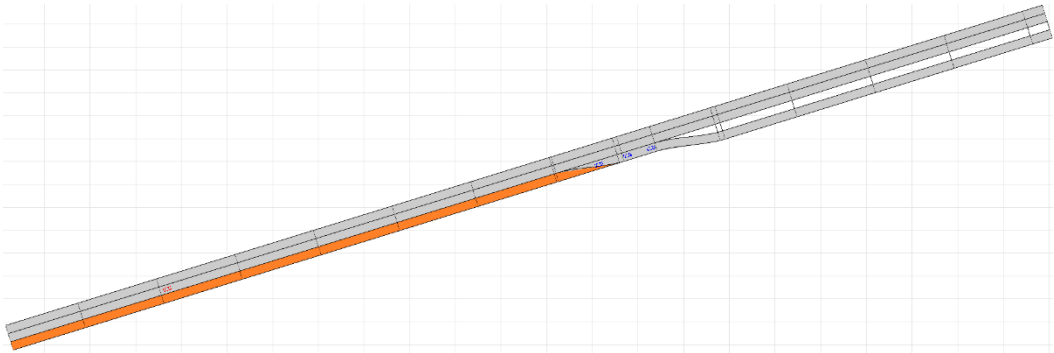
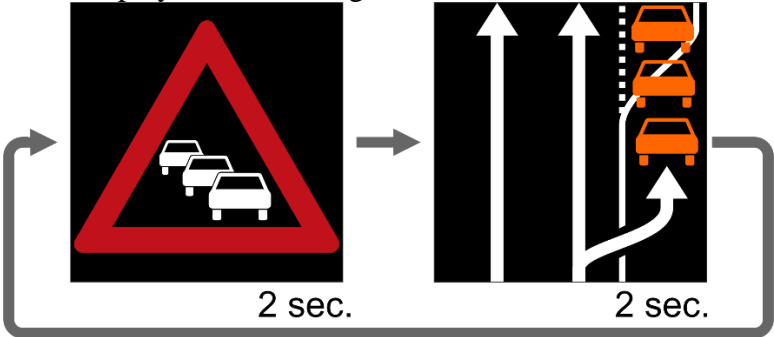
in addition to generic requirements	
-------------------------------------	--

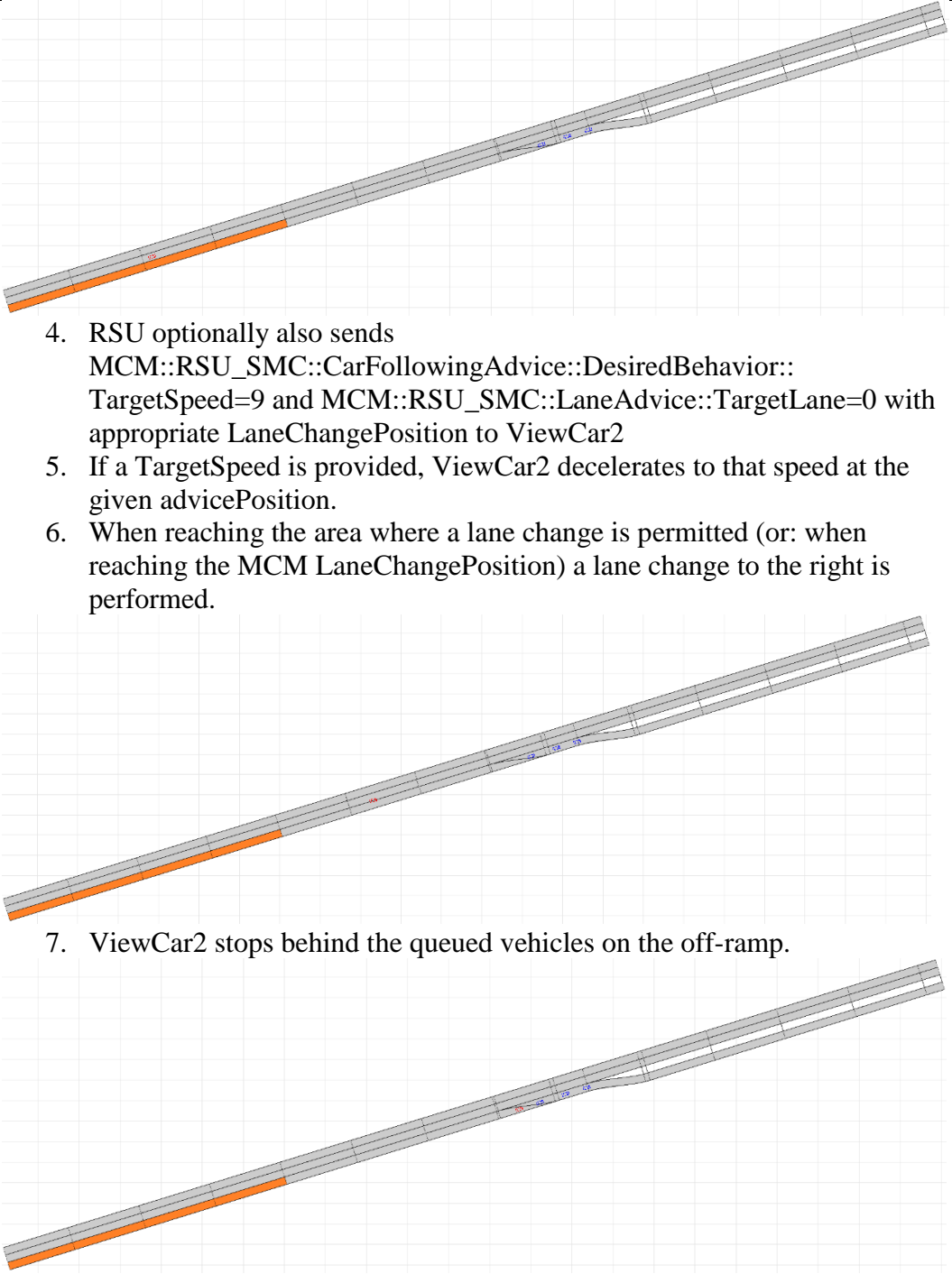
2.2.2.2.4 Test scenario 1.3_3: “Baseline: Detour”

Goal	Demonstrate negative effect of automated driving when no TransAID V2X measure is applied. A CAV arriving at the blocked off-ramp is planning a detour when it detected that taking the off-ramp is impossible.
Used vehicles	ViewCar2, LVs blocking the off-ramp
Used infrastructure	VMS
Used messages	CAM
Initial situation	<p>ViewCar2 starts on two-lane highway. There is one single off-ramp, which is entirely blocked by several vehicles. There are also other ways to reach the destination. An emergency/restricted lane is existing.</p> 
Scenario script	<ol style="list-style-type: none"> 1. ViewCar2 drives on highway and starts procedure taking the off-ramp. 2. VMS displays the following animation: <div style="text-align: center;">  </div> 3. ViewCar2 arrives at the off-ramp. Sensors recognize that it is blocked. 4. ViewCar2 decelerates, searching for an open gap. 5. At the end of the off-ramp, the tactical planner decides to use another route to the destination. The re-routing HMI described in 2.1.1.1.4.2.4 is shown. 6. ViewCar2 accelerates again, following the new route.
Associated to Requirement(s)	<ul style="list-style-type: none"> • REQ_V_I2_S1.3_2

in addition to generic requirements	
-------------------------------------	--

2.2.2.2.2.5 Test scenario 1.3_4: “Use of Emergency Lane”









Goal	Infrastructure provides allowance to use emergency lane. CAV uses it and queues behind the stopped vehicles on the off-ramp.
Used vehicles	ViewCar2, LVs blocking the off-ramp
Used infrastructure	VMS, RSU
Used messages	CAM, MAPEM, MCM
Initial situation	ViewCar2 starts on two-lane highway. There is one single off-ramp, which is entirely blocked by several vehicles. An emergency/restricted lane is existing. Infrastructure monitors the off-ramp and is able to provide dynamic advice. 
Scenario script	<ol style="list-style-type: none"> ViewCar2 drives on highway. VMS displays the following animation:  RSU sends MAPEM marking the last part of the emergency lane as drivable.

	 <p>4. RSU optionally also sends MCM::RSU_SMC::CarFollowingAdvice::DesiredBehavior::TargetSpeed=9 and MCM::RSU_SMC::LaneAdvice::TargetLane=0 with appropriate LaneChangePosition to ViewCar2</p> <p>5. If a TargetSpeed is provided, ViewCar2 decelerates to that speed at the given advicePosition.</p> <p>6. When reaching the area where a lane change is permitted (or: when reaching the MCM LaneChangePosition) a lane change to the right is performed.</p> <p>7. ViewCar2 stops behind the queued vehicles on the off-ramp.</p>
<p>Associated to Requirement(s) in addition to generic requirements</p>	<ul style="list-style-type: none"> • REQ_V_I2_S1.3_1 • REQ_V_I2_S1.3_3 • REQ_I_I2_S1.3_1 • REQ_I_I2_S1.3_2 • REQ_I_I2_S1.3_3 • REQ_I_I2_S1.3_4 • REQ_I_I2_S1.3_5

2.2.2.2.3 Feasibility results

2.2.2.2.3.1 Requirements verification

In addition to the feasibility assessment of the general requirements shown in section 0 a few service-specific requirements needed to be verified:

	Service-specific requirement description	Req. Name	Associated Test cases successfully executed	Notes
Vehicle requirements	<p><i>Path reception</i></p> <p>The vehicle automation shall be able to receive a path and to take it into account during trajectory planning. Of course, the final decision to follow the path is up to the automation itself. The path will be represented as allowance to use the emergency lane.</p>	REQ_V_I2_S1.3_1		The path was correctly received in the format defined by D5.1.
	<p><i>Speed advice following</i></p> <p>The CAVs/CVs need to be able to receive speed advices from the infrastructure. In case of a CAV, the advices need to be taken into account during trajectory planning, although the vehicle automation itself has the right to overrule the advices. In case of a CV, the speed advice is forwarded to the driver with an appropriate HMI.</p>	REQ_V_I2_S1.3_2		The successful reception of speed advices has been shown. Speed advice is esp. important for vehicles not taking the off-ramp, but passing it, as other vehicles may try to take the off-ramp late and therefore drive slowly.
	<p><i>Lane advice following</i></p> <p>Also, lane advices need to be received and taken into account in the same way then speed advices.</p>	REQ_V_I2_S1.3_3		Lane advice reception has been successfully shown, but not in this use case, as it has been found that proper lane changes only need the path reception formulated in REQ_V_I2_S1.3_1
Infrastructure requirements	<p><i>Road network</i></p> <p>The road network needs to include an explicit off-ramp and an emergency lane. The emergency lane must be marked as non-usable in the corresponding map</p>	REQ_I_I2_S1.3_1		Road network with off-ramp and emergency lane available.
	<p><i>Path generation</i></p> <p>The infrastructure/RSI needs to be able to generate a path or allowance to drive on normally not driveable lanes and communicate this to the C(A)V.</p>	REQ_I_I2_S1.3_2		The emergency lane has been successfully marked as driveable using MAPEM.
	<p><i>Speed and lane advice generation</i></p> <p>The infrastructure must be able to generate speed and lane advices based on the detected situation and disseminate them using an RSU.</p>	REQ_I_I2_S1.3_3		Speed and lane advices have successfully been generated, but only speed advices have been used in this use case.
	<p><i>Sensors</i></p> <p>This use case requires very precise detection of vehicles, esp. on the off-ramp and the emergency lane.</p>	REQ_I_I2_S1.3_4		Precise detection of vehicles on the off-ramp is successfully working.
	<p><i>Variable Message Signs (VMS)</i></p> <p>Variable Message Signs may be used to communicate the plans of the infrastructure to the non-cooperative vehicles. In case a (C)AV is performing a Minimum Risk Manoeuvre in this area, the sign may also be used to show warning or jam messages, see Service 4 of the first iteration.</p>	REQ_I_I2_S1.3_5		A VMS was used during all tests displaying different signs / messages according to the tested use case.

Predefined requirements were followed. The reception and transmission of required V2X message was verified using a V2X module (CohdaWireless mk5) present on the test track; an external one used to sniff all V2X messages in the test scenarios. The capture logs show that the RSU correctly formats DENM and MAPEM messages and the content of these messages fits to the specific requirements of the tests under evaluation. The capture logs also show that the vehicle transmits frequently CAM messages, which are formatted following ETSI ITS standards. The test vehicle was equipped with a system status display showing the current vehicle positions on a HD map which was generated by DLR for the test track.

2.2.2.2.3.2 User experience

All test scenarios were successfully executed. This was verified by observing the DLR test vehicle (inside and outside view) using the video stream and the recorded video material. Nevertheless, the behaviour of the CAV looked very sporty from the video streaming. Moreover, the HMI does not inform the driver/passenger about the reason for some decisions (e.g., violating the solid line). This needs to be addressed for real-life application scenarios. More general user experience comments and results are covered in section 2.2.2.1.3.

2.2.2.2.3.3 Check of overall feasibility

The tested scenarios in this section build a baseline, which perform the required tasks in a reasonable and efficient way. General feasibility results from section 2.2.2.1.4 also apply here.

Regarding the individual tests, the following remarks have to be given:

Test scenario 1.3_2: The CAV is obliged to perform an MRM in reaction to finding the exit lane fully occupied. It has to be remarked that the CAV did not activate the emergency lights during the assessment when standing on the highway after the MRM. This needs to be addressed for real-life application scenarios.

Test scenario 1.3_4: The CAV is suggested to make an early lane change to the hard shoulder before the exit lane and pile up behind the rest of the vehicles via an I2V-MCM. The CAV also receives a MAP message describing a modified road topology in order to allow occupying the hard shoulder lane where the solid line is present. It has to be remarked that the behaviour of the CAV looked very sporty from the video streaming. Moreover, the HMI does not inform the driver/passenger about the reason for violating the solid line. This needs to be addressed for real-life application scenarios.

2.2.2.3 Requirements of use case 2.1: Prevent ToC/MRM by providing speed, headway and/or lane advice

2.2.2.3.1 Description of the use case from D2.2

CAVs, AVs, CVs, and LVs drive along a motorway merge segment or enter the mainline motorway lanes through an on-ramp. The RSI monitors traffic operations along the motorway merge segment and detects the available gaps on the right-most mainline lane to estimate speed and lane advice for merging CAVs and CVs coming from the on-ramp. The use case assumes that CVs continuously update their speed and position information to the RSI (in a near-real-time fashion), while CAVs also update their current lane and share perception information of other vehicles around them. In addition, the RSI also fuses this information with measurements obtained via available road-side sensors. The speeds and locations of AVs and LVs can be estimated based on the information gathered via the latter sensors and the location (and available sensing information) of the other vehicles (being CAVs or CVs).

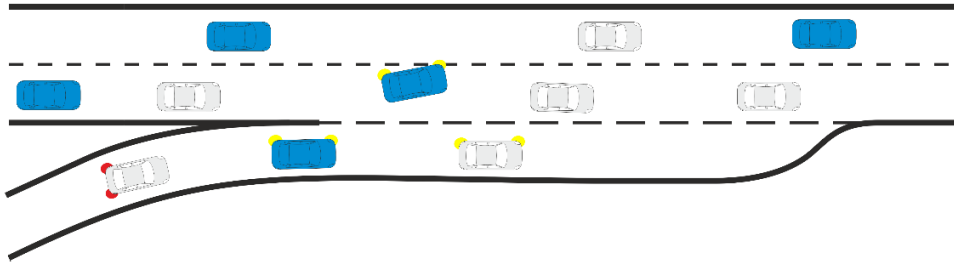


Figure 44: schematic overview of use case 2.1 (2nd Iteration)

The core of this use case is finding gaps in the motorway's right-most lane (that is not part of the on-ramp). C(A)V's are guided to these gaps with speed advice, because even with very low traffic volume they could arrive right next to other vehicles in the merging area by chance in the absence of guidance. If the available gaps are not large enough to allow the safe and smooth merging of on-ramp vehicles, speed and lane advices are also provided to the CAVs and CVs driving on the main road, thereby creating the necessary gaps in traffic to facilitate the smooth merging of on-ramp vehicles. Thus, gaps are created by the exchange of suitable lane change advices to these two kinds of vehicles; AVs and LVs do not receive information. In addition, advice to vehicles is only given within a certain action-zone, i.e., upstream of and at the merge location. Beyond that, further downstream, vehicles can default back to their previous own behaviour. Combining this with ramp-metering algorithms to control the in-flow of vehicles to the motorway, will open more possibilities for traffic management as the inflow can temporally be halted when the gap creation measures would be too disruptive.

Without the aforementioned measures vehicles might be impeded or involved in safety critical situations under specific traffic conditions (e.g. incidents) or automated driving operations (e.g. platooning at motorway merge/diverge segments). Under these circumstances automated vehicles might request ToCs or execute MRMs for safety reasons.



Figure 45: The CAV on the highway opens a gap for the merging vehicle by using V2V communication



Figure 46: Similar situation on-board

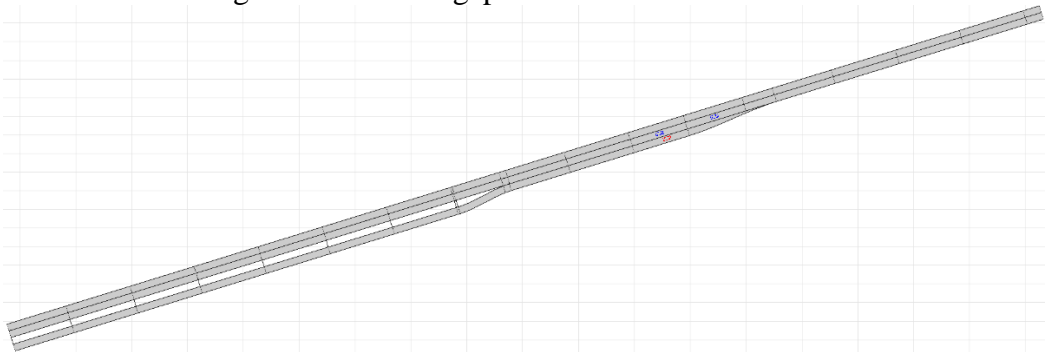
2.2.2.3.2 Use case setup

For use case 2.1, six different tests are performed. They are summarized in the following.

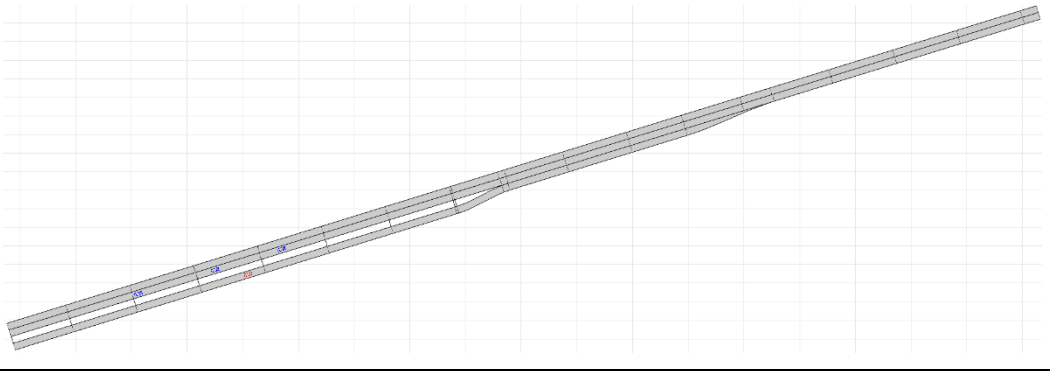
2.2.2.3.2.1 Test scenario 2.1_0: “Baseline: Ramp without communication”

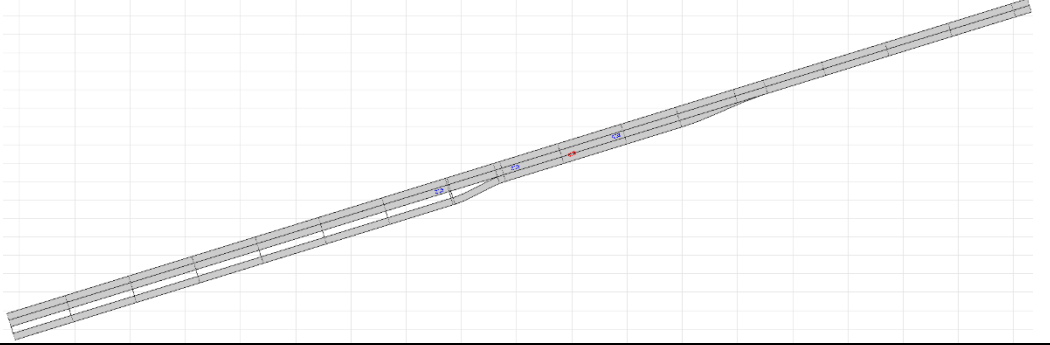
Goal	Demonstrate negative effect of a CAV not able to merge from a ramp to a highway.
Used vehicles	ViewCar2, FASCarE, legacy vehicle
Used infrastructure	None
Used messages	CAM
Initial situation	FASCarE starts on ramp entering highway. ViewCar2 and a legacy vehicle drive on the right lane of the highway close to each other

 A schematic diagram of a highway ramp merging into a main highway. The ramp starts from the bottom left and merges into the right lane of a two-lane highway. The diagram shows lane markings and the relative positions of vehicles as described in the table.

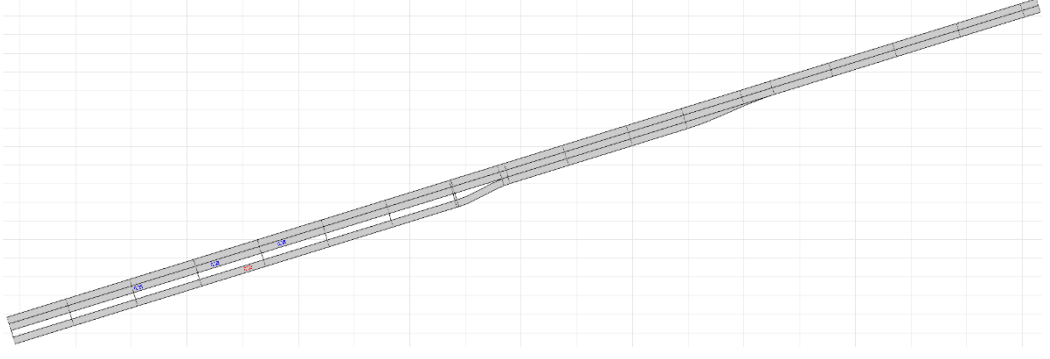
Scenario script	<p>1. When trying to enter the highway, no gap is found. FASCarE is braking and waiting until sufficient gap available</p> 
Associated to Requirement(s) in addition to generic requirements	Only generic requirements

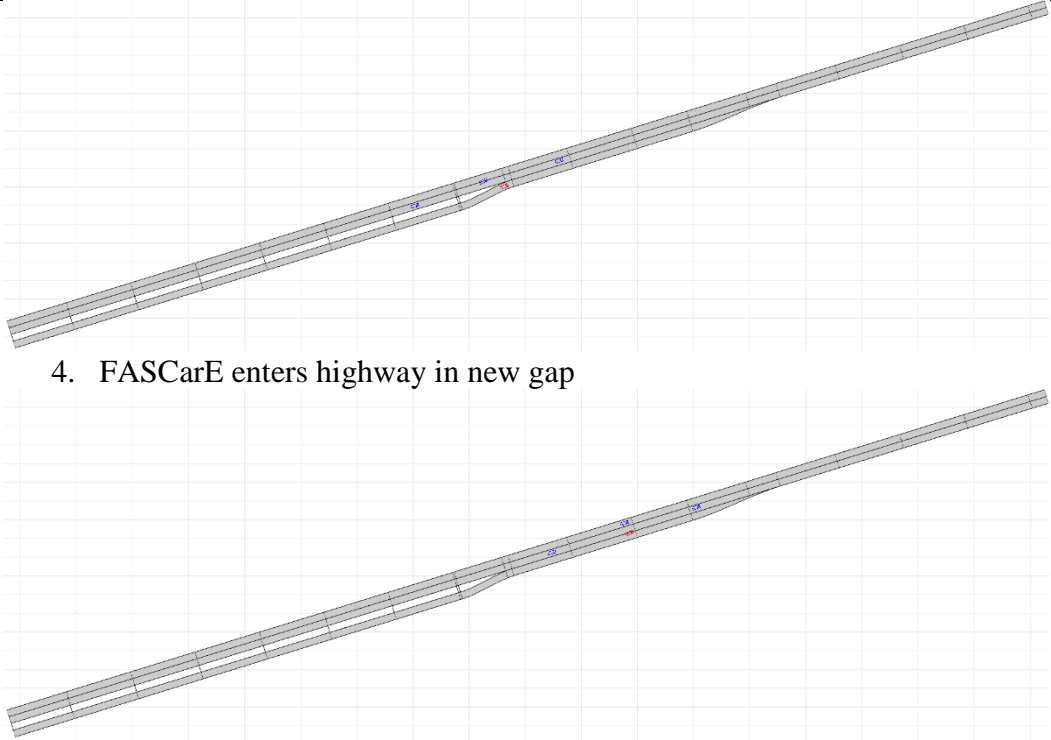
2.2.2.3.2.2 Test scenario 2.1_1: “Cooperative lane change: Vehicle on highway opens gap”

Goal	Demonstrate abilities of cooperative lane change without infrastructure support. Here, the vehicle on the highway opens a gap by braking.
Used vehicles	ViewCar2, FASCarE, legacy vehicle(s)
Used infrastructure	None
Used messages	CAM, V2V-MCM
Initial situation	<p>FASCarE starts on ramp entering highway. The ViewCar2 as other CAV and at least one legacy vehicle drive on the right lane of the highway close to each other.</p> 
Scenario script	<ol style="list-style-type: none"> 1. When FASCarE arrives at the entrance, it indicates its desire to change to the right lane of the road via MCM::VMC::DesiredTrajectory 2. ViewCar2 on highway indicates cooperation by sending MCM::VMC::PlannedTrajectory containing a braking trajectory 3. ViewCar2 brakes 4. FASCarE enters highway in new gap

	
Associated to Requirement(s) in addition to generic requirements	Only generic requirements.

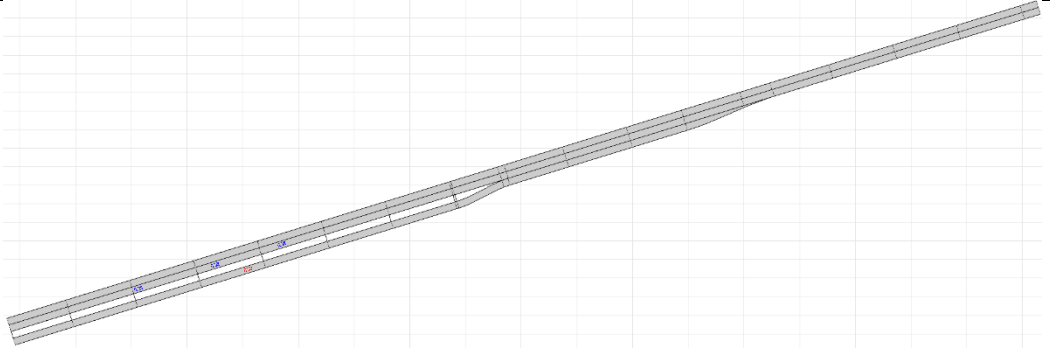
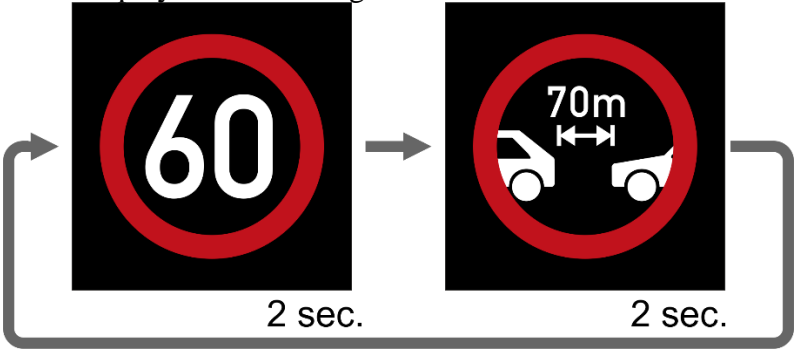
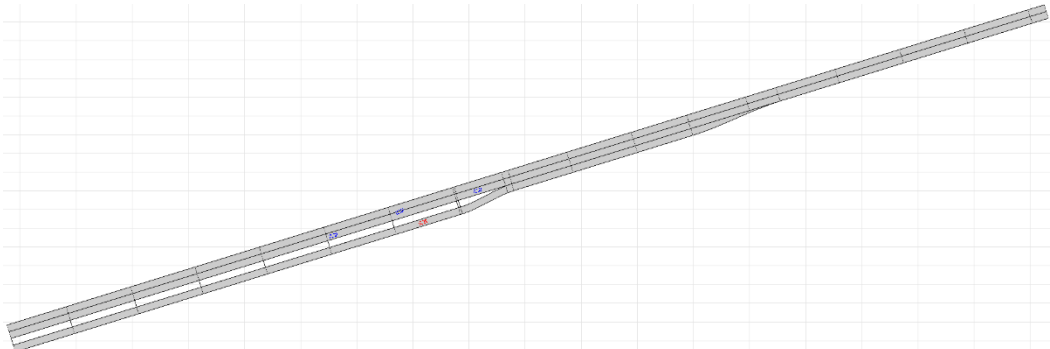
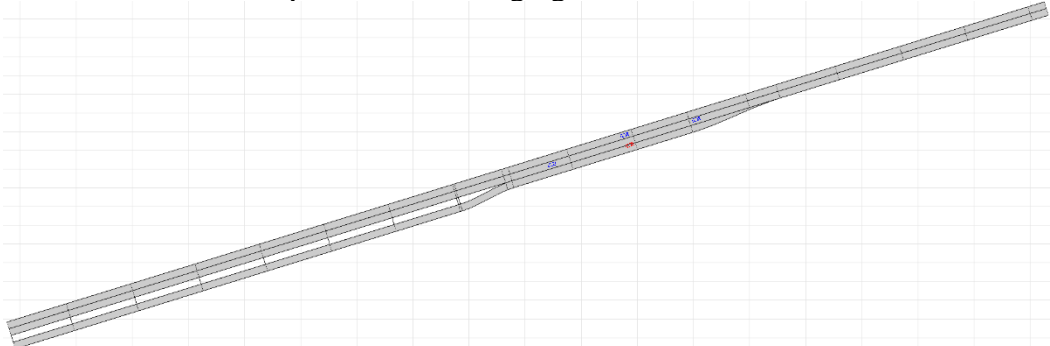
2.2.2.3.2.3 Test scenario 2.1_2: “Cooperative lane change: Vehicle on highway changes lane”

Goal	Demonstrate abilities of cooperative lane change without infrastructure support. Here, the vehicle on the highway opens a gap by changing lane.
Used vehicles	ViewCar2, FASCarE, legacy vehicle(s)
Used infrastructure	None
Used messages	CAM, V2V-MCM
Initial situation	<p>FASCarE starts on ramp entering highway. The ViewCar2 as other CAV and at least one legacy vehicle drive on the right lane of the highway close to each other.</p> 
Scenario script	<ol style="list-style-type: none"> 1. When FASCarE arrives at the entrance, it indicates its desire to change to the right lane of the highway via MCM::VMC::DesiredTrajectory 2. ViewCar2 on highway indicates cooperation by sending MCM::VMC::PlannedTrajectory containing a lane change to the left 3. ViewCar2 changes lane

	 <p>4. FASCarE enters highway in new gap</p>
<p>Associated to Requirement(s) in addition to generic requirements</p>	<p>Only generic requirements</p>

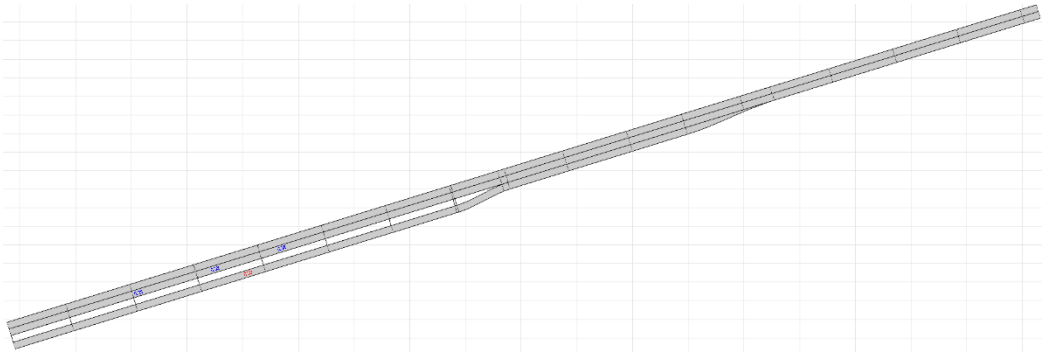
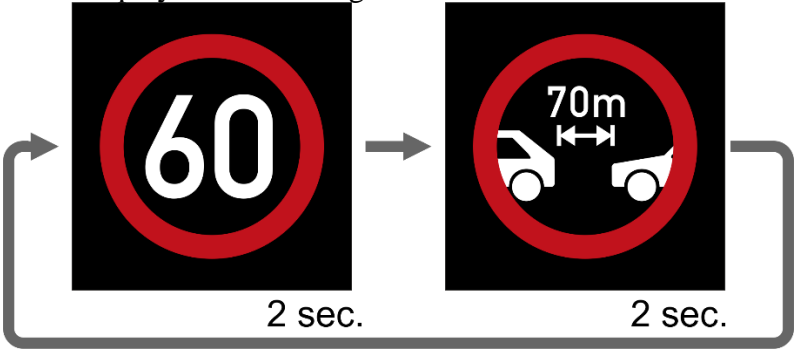
2.2.2.3.2.4 Test scenario 2.1_3: “Ramp assist: Infrastructure advises vehicle on highway to change lane”

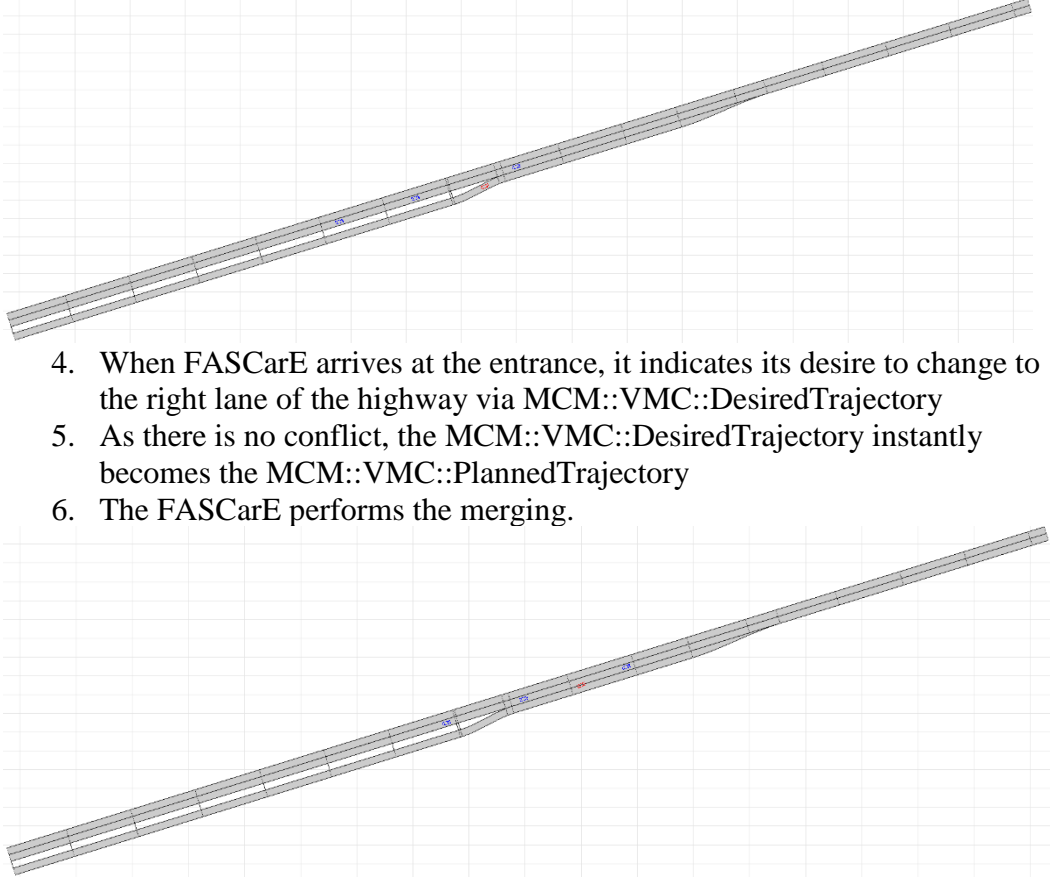
<p>Goal</p>	<p>Demonstrate abilities of infrastructure support, also in combination with V2V-communication. Here, the infrastructure advises individual vehicles on the highway to change lane early.</p>
<p>Used vehicles</p>	<p>ViewCar2, FASCarE, legacy vehicle(s)</p>
<p>Used infrastructure</p>	<p>RSU, Camera, VMS</p>
<p>Used messages</p>	<p>CAM, I2V-MCM, V2V-MCM</p>
<p>Initial situation</p>	<p>FASCarE starts on ramp entering highway. The ViewCar2 as other CAV and at least one legacy vehicle drive on the right lane of the highway close to each other.</p>

	
<p>Scenario script</p>	<ol style="list-style-type: none"> 1. VMS displays the following animation: <div style="text-align: center; margin: 10px 0;">  </div> 2. RSU sends MCM::RSU_SMC::LaneAdvice::TargetLane=3 with LaneChangePosition=150 to ViewCar2 driving on right lane (=2) of the highway 3. ViewCar2 follows advice and changes lane, showing the lane change left HMI described in 2.1.1.1.4.2.3.  <ol style="list-style-type: none"> 4. When FASCarE arrives at the entrance, it indicates its desire to change to the right lane of the highway via MCM::VMC::DesiredTrajectory 5. As there is no conflict, the MCM::VMC::DesiredTrajectory instantly becomes the MCM::VMC::PlannedTrajectory 6. The FASCarE performs the merging. 

Associated to Requirement(s) in addition to generic requirements	<ul style="list-style-type: none"> • REQ_V_I2_S2.1_2 • REQ_I_I2_S2.1_1 • REQ_I_I2_S2.1_2
--	---

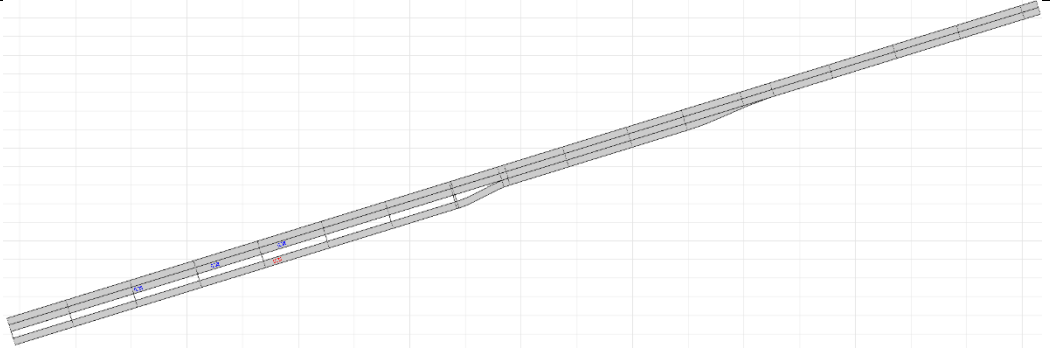
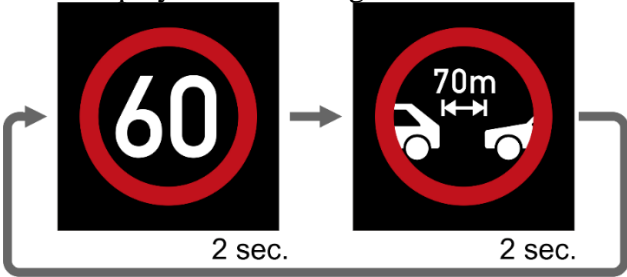
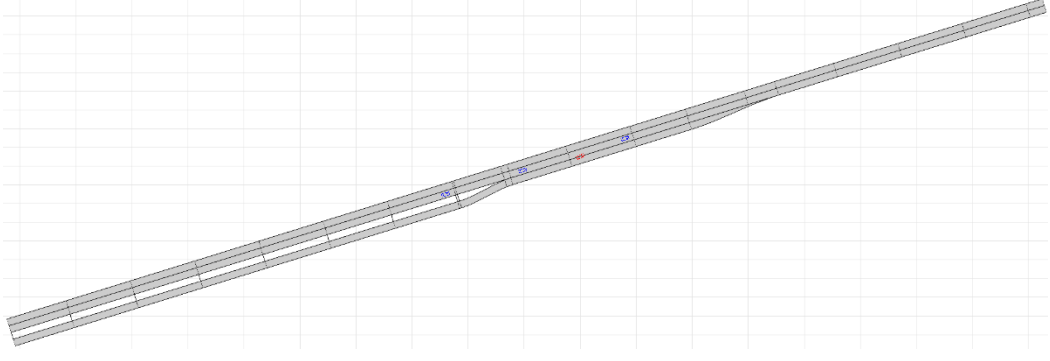
2.2.2.3.2.5 Test scenario 2.1_4: “Ramp assist: Infrastructure advices vehicle on highway to change speed”

Goal	Demonstrate abilities of infrastructure support. Here, the infrastructure advices individual vehicles on the highway to change speed.
Used vehicles	ViewCar2, FASCarE, legacy vehicle(s)
Used infrastructure	RSU, Camera, VMS
Used messages	CAM, I2V-MCM, V2V-MCM
Initial situation	<p>FASCarE starts on ramp entering highway. The ViewCar2 as other CAV and at least one legacy vehicle drive on the right lane of the highway close to each other.</p> 
Scenario script	<ol style="list-style-type: none"> 1. VMS displays the following animation: <div style="text-align: center;">  </div> 2. RSU sends MCM::RSU_SMC::CarFollowingAdvice::DesiredBehavior::TargetSpeed=9 to ViewCar2 driving on right lane of the highway 3. ViewCar2 follows advice and slows down to open gap.

	 <ol style="list-style-type: none"> 4. When FASCarE arrives at the entrance, it indicates its desire to change to the right lane of the highway via MCM::VMC::DesiredTrajectory 5. As there is no conflict, the MCM::VMC::DesiredTrajectory instantly becomes the MCM::VMC::PlannedTrajectory 6. The FASCarE performs the merging.
<p>Associated to Requirement(s) in addition to generic requirements</p>	<ul style="list-style-type: none"> • REQ_V_I2_S2.1_1 • REQ_I_I2_S2.1_1 • REQ_I_I2_S2.1_2

2.2.2.3.2.6 Test scenario 2.1_5: “Ramp assist: Infrastructure advises vehicle on highway to create gap and vehicle on ramp to change speed to catch the gap”





<p>Goal</p>	<p>Demonstrate abilities of infrastructure support. Here, the infrastructure advises individual vehicles on the ramp to change speed.</p>
<p>Used vehicles</p>	<p>ViewCar2, FASCarE, legacy vehicle(s)</p>
<p>Used infrastructure</p>	<p>RSU, Camera, VMS</p>
<p>Used messages</p>	<p>CAM, I2V-MCM, V2V-MCM</p>
<p>Initial situation</p>	<p>FASCarE starts on ramp entering highway. The ViewCar2 as other CAV and at least one legacy vehicle drive on the right lane of the highway close to each other.</p>

	
<p>Scenario script</p>	<ol style="list-style-type: none"> 1. VMS displays the following animation: <div style="text-align: center; margin: 10px 0;">  </div> 2. RSU sends MCM::RSU_SMC::CarFollowingAdvice::DesiredBehavior::TargetSpeed=9 to ViewCar2 driving on highway. 3. ViewCar2 follows advice (indicating this in a positive AdviceResponse) and slows down. 4. RSU calculates corresponding gap position based on received positions and advice acknowledgements. 5. RSU sends appropriate MCM::RSU_SMC::CarFollowingAdvice::DesiredBehavior::TargetSpeed to FASCarE driving on ramp 6. FASCarE follows advice and also slows down. 7. When FASCarE arrives at the entrance, it indicates its desire to change to the right lane of the highway via MCM::VMC::DesiredTrajectory 8. As there is no conflict, the MCM::VMC::DesiredTrajectory instantly becomes the MCM::VMC::PlannedTrajectory 9. The FASCarE performs the merging. 
<p>Associated to Requirement(s) in addition to generic requirements</p>	<ul style="list-style-type: none"> • REQ_V_I2_S2.1_1 • REQ_I_I2_S2.1_1 • REQ_I_I2_S2.1_2

2.2.2.3.3 Feasibility results

2.2.2.3.3.1 Requirements verification

In addition to the feasibility assessment of the general requirements shown in section 0 a few service-specific requirements needed to be verified:

Service-specific requirement description		Req. Name	Associated Test cases successfully executed	Notes
Vehicle requirements	<p><i>Speed advice following</i></p> <p>The CAVs/CVs need to be able to receive speed advice from the infrastructure. In case of a CAV, the advice needs to be taken into account during trajectory planning, although the vehicle automation itself has the right to overrule the advice. In case of a CV, the speed advice is forwarded to the driver with an appropriate HMI.</p>	REQ_V_I2_S2.1_1		Speed advice received and followed by test vehicle.
	<p><i>Lane advice following</i></p> <p>Also, lane advice needs to be received and taken into account in the same way then speed advice.</p>	REQ_V_I2_S2.1_2		Lane advice received and followed. HMI shows lane change in the cluster.
Infrastructure requirements	<p><i>Speed and lane advice generation</i></p> <p>The infrastructure must be able to generate speed and lane advice based on the detected situation and disseminate them using an RSU.</p>	REQ_I_I2_S2.1_1		RSU generated advice that was received by test vehicle as well as other V2X receivers present in the test area.
	<p><i>Sensors</i></p> <p>This use case requires very precise detection of vehicles and vehicle behaviour, as probable gaps have to be estimated early enough to provide appropriate advice to the vehicles.</p>	REQ_I_I2_S2.1_2		RSU with dedicated camera detected surrounding objects (road users) and used this information for advice calculation as well as transmitted these using CPMs

For this set of tests, the reception and transmission of required V2X messages was also verified using the V2X module (CohdaWireless mk5) present on the test track. The capture logs show that the RSU and the CAVs correctly format MCM messages following the TransAID MCM ASN.1 definition, and the content of these messages fits to the specific requirements of the tests under evaluation. In particular, the captured messages show the message exchanged for V2V coordination (planned and desired trajectories) as well as RSU’s lane change and car following advices that are addressed to the vehicle on the highway and/or ramp depending on the test. From an implementation feasibility point of view, it is interesting to further elaborate on the concurred reception of V2V and I2V MCMs at the test vehicles. The used implementation was not checking or deconflicting these messages with a dedicated logic. Instead, the I2V advice was followed whenever possible. V2V coordination is based on trajectories and therefore indirectly including adaptations performed due to I2V advices. In the showcased situations, the I2V and V2V advice have always been in line, although the I2V advice was received earlier and therefore used for long term planning while V2V advice was used on the on-ramp. Therefore, the following research questions should be answered after TransAID:

Does I2V coordination, if correctly applied, prevent the necessity for V2V coordination at the merging area? Should V2V coordination be applied if the I2V advices are not perfectly implemented, hence “refining” via V2V the coordination started via I2V? How shall vehicles react in case of contrasting advice by I2V and V2V? Which channel should have priority?

In addition, it is recognized that CAVs do not use MCMs to inform other vehicles about their current compliance to received I2V advices.

2.2.2.3.3.2 User experience

As already mentioned in section 2.2.2.1.3 vehicle speeds and acceleration/deceleration control seem suitable to the current test scenarios. Also, a clear and simple HMI supports travel comfort and perceived safety for passengers here. For drivers of surrounding vehicles (e.g., conventional vehicles), especially before and during lane changes (from ramp to highway) it shall be easily recognizable that these vehicles are detected by the CAV systems (not leading to false impressions and counteractions by passengers/driver), hence use of turning lights must be guaranteed at all time. Turning lights were not activated in some scenarios by the CAVs, and this is an important prerequisite for real-life adoption. For drivers of CAVs, it has been highlighted before that the HMI information provided is sufficient and exhaustive in the performed experiments.

2.2.2.3.3.3 Check of overall feasibility

It can be clearly seen that advices applied to vehicles on the ramp are less disturbing the overall traffic flow compared to advices that affect vehicles traveling on the highway. For this reason, a higher priority should be given to advices at the on-ramp (which can be followed in less dense traffic). Lane changes of vehicles can have a higher impact on the overall traffic flow, which requires a constant tracking of surrounding vehicles (especially non-cooperative LV). As already mentioned in the first iteration this might require the presence of infrastructure sensing units to support coordinated lane change advices or an exclusion of coordinated multiple vehicle lane changes in complex road architectures (e.g., sharp turns or multiple junctions/ramps in short distances).

Regarding the individual tests, the following remarks need to be given:

Test scenario 2.1_1: The CAV on the ramp does an early merging thanks to the speed reduction applied by the CAV on the highway. The driver of this CAV does not receive any HMI information of the underlying V2V coordination process, which is considered positive here. The smoothness of the driving experience cannot be perceived from the videos, yet the first impression is very positive and promising. From the V2X point of view, it is not clear here what is the need of CAMs exchange, except backwards compatibility. CAMs could also be used to trigger V2V coordination via MCM as soon as some CAM-information-dependent condition is met.

Test scenario 2.1_2: The feasibility of this use case was unfortunately not successfully demonstrated during the performed experiment runs. The CAV on the ramp merges on the highway thanks to the speed reduction applied by the CAV on the highway. This is said to be depending by the dynamic conditions of the two vehicles at the merging point, and the consequent cost function's output on the highway CAV generating a deceleration decision instead of a lane change in all the experiments runs.

Test scenario 2.1_3: The CAV on the ramp does an early merging thanks to the lane change applied by the CAV on the highway. The driver of this CAV does not receive any HMI information of the underlying I2V coordination process, which is considered positive here, he only receives an HMI notification of the upcoming lane change. The smoothness of the driving experience cannot be perceived from the videos, yet the first impression is very positive and promising.

Test scenario 2.1_4: The CAV on the ramp does an early merging thanks to the speed reduction applied by the CAV on the highway. The driver of this CAV does not receive any HMI information of the underlying I2V coordination process, which is considered positive here. The smoothness of

the driving experience cannot be perceived from the videos, yet the first impression is very positive and promising.

Test scenario 2.1_5: The feasibility of this use case was demonstrated during the experiments. The CAV on the ramp does a merging thanks to the speed variation advised by the RSI. The driver of the CAV on the highway does not receive any HMI information of the underlying I2V coordination process, which is considered positive here. The smoothness of the driving experience cannot be perceived from the videos, yet the first impression is very positive and promising.

2.2.2.4 Requirements of use case 2.3: Intersection handling due to incident

2.2.2.4.1 Description of the use case from D2.2

CAVs, AVs, CVs, and LVs are driving towards a 3-way signalised intersection. Each arm of the intersection consists of two entry lanes and one exit lane. The following describes the entry lanes of each arm. The east approach (A) has one lane for through traffic (1) and one lane for left turning traffic (2). The south approach (B) has one lane for right turning traffic (3) and one lane for left turning traffic (4). The west approach (C) has one lane for right turning traffic (5) and one lane for through traffic (6).

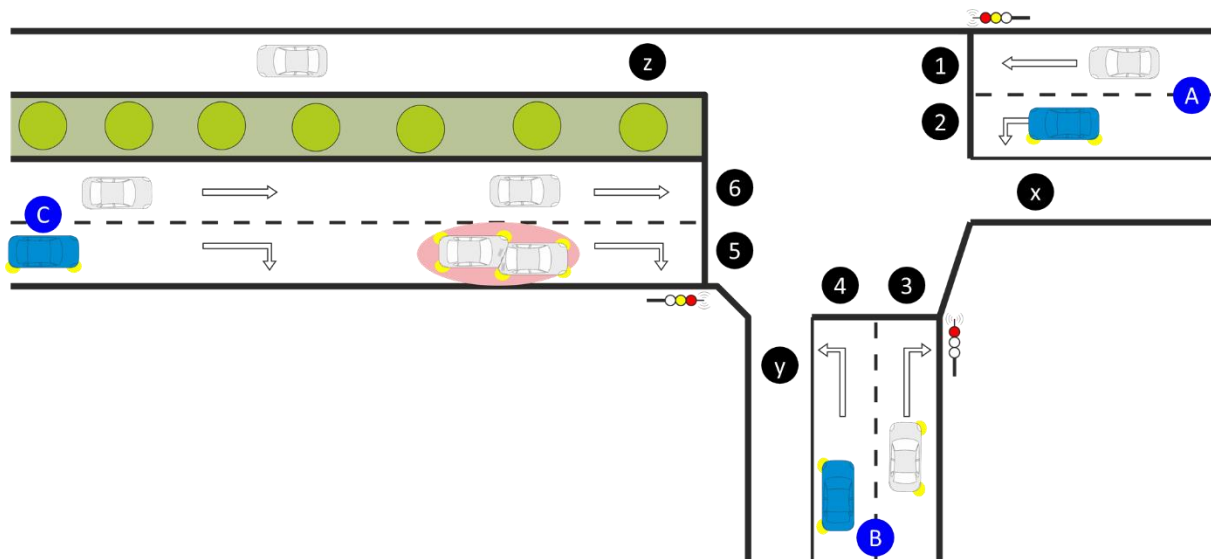


Figure 47: schematic overview of use case 2.3

An incident occurs just before the stop line of the right turning traffic lane on the west approach (approach C, lane 5). The incident is blocking lane 5 and therefore vehicles driving on this lane will need to use the through traffic lane (approach C, lane 6) to drive around the incident. Vehicles driving to the south also need to make their right turn from lane 6 to the exit lane of the south arm (lane y).

Vehicles approaching on lane 5 or lane 6, heading to the south arm of the intersection, will prepare for a right turn from lane 5 to the south arm of the intersection. Without measures a CAV:

- A. approaching on lane 5 will come to a stop in lane 5 before the incident. Depending on whether the CAV can recognise the situation, either a TOR is issued (CAV is able to identify the incident but has no solution) or the CAV will simply wait as if the incident is the end of a queue.
- B. approaching on lane 6 will try to merge to lane 5 and succeed (situation A is applicable) or cannot move to lane 5, because it is blocked by the incident or queuing vehicles before it.

The CAV will inform the driver it cannot make the right turn and continue straight ahead to lane x and follow an alternate route.

When the RSI receives information about an incident it will deploy all the following four counter measures. CAVs and CVs:

- A. will receive information about the incident itself (position, type, etc.).
 - i. In addition, CAVs and CVs will receive information to support (allow/enable) the right turn from lane 6 to the south arm of the intersection.

Note: Normally, vehicles at this intersection are not allowed to make a right turn from lane 6. Therefore, the MAP and SPAT messages do not facilitate such a manoeuvre. CAVs and CVs might require information to support this manoeuvre. How to facilitate this manoeuvre will be subject for study in WP4 and WP5.
- B. will receive a reduced speed advice.
- C. are advised to use lane 6 to prepare for the right turn to the south arm of the intersection. The lane advice will help CAVs to make the right turn while maintaining their automated driving (AD) mode (and thus preventing a ToC).
 - i. In case CAVs cannot cope with the situation they will drive straight ahead to find an alternate route.

Note: they will most likely not trigger a ToC in this situation, possibly resulting in an MRM, because a ToC when driving near or on the intersection is dangerous.

The traffic light control (TLC) program might also be updated to further support the measures in case of the incident. For example, the TLC-program could switch to a program with:

- an arm-by-arm control logic, or
- a combined straight and right turn control logic.

Note that AVs and LVs will not receive any information. Therefore, ToCs will occur for AVs.

2.2.2.4.2 Use case setup

The use case has been slightly adapted for the feasibility assessment, as no speed and lane advice is given by the infrastructure. The incidence itself is reported by DENM in some scenarios leading in conjunction to the changed MAPEM content to the desire to change lane. The CAV is responsible to perform lane changes accordingly, if possible by using V2V-MCM.

For use case 2.3, five different tests are performed. They are summarized in the following.

2.2.2.4.2.1 Test scenario 2.3_0: “Baseline: Stopping behind broken-down vehicle”

Goal	Demonstrate that a (C)AV is not able to correctly pass the situation. Here, the broken-down vehicle is not recognized as being broken-down, so the (C)AV is just queuing behind.
Used vehicles	ViewCar2, broken-down legacy vehicle
Used infrastructure	Traffic Light, RSU
Used messages	CAM, MAPEM, SPATEM
Initial situation	ViewCar2 starts on right lane of a two-lane rural road, which turns into a right-turn lane at the upcoming intersection. The ViewCar2 wants to perform a right-turn to reach its destination. Just in front of the intersection, a broken-down

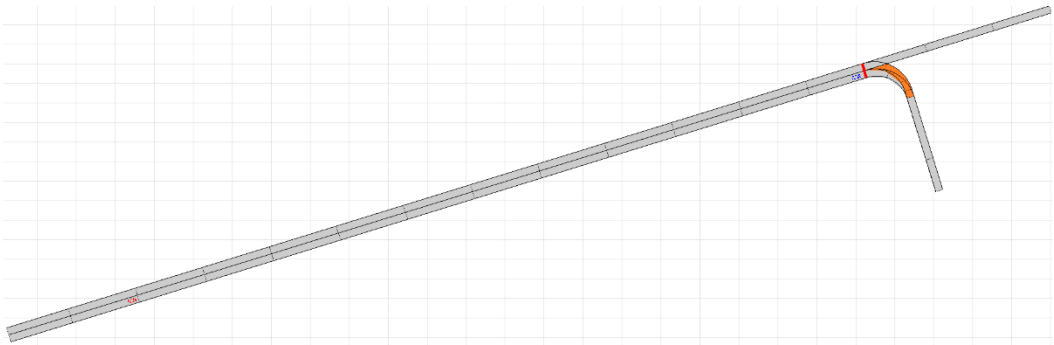
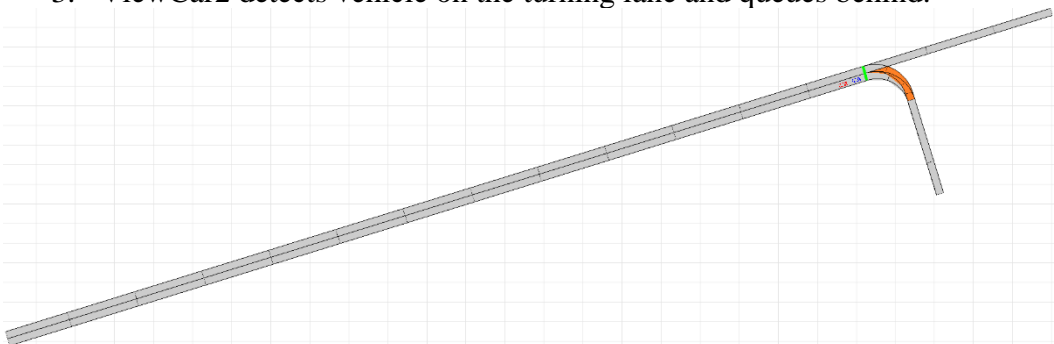
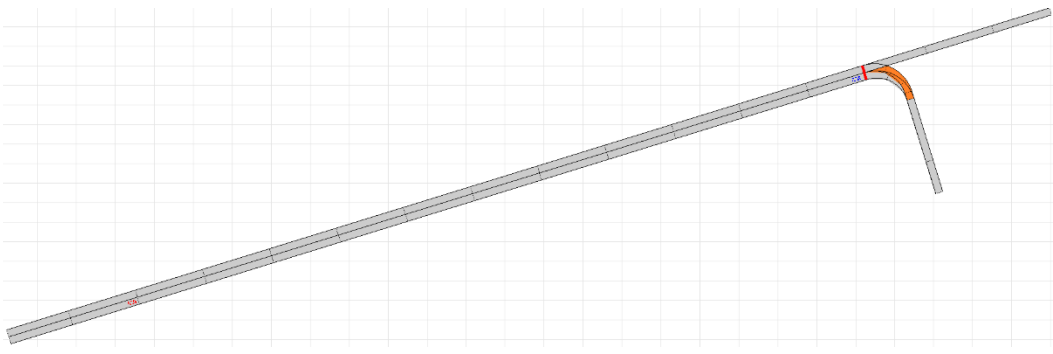
	<p>vehicle is blocking the right-turn lane.</p>  <p>The diagram shows a road with two lanes approaching an intersection. The right lane is turning right. A red car is positioned in the right-turn lane, blocking the path of the left lane. A blue car is in the left lane, approaching the intersection. A red arrow points to the red car, indicating it is blocking the right-turn lane.</p>
<p>Scenario script</p>	<ol style="list-style-type: none"> 1. ViewCar2 follows lane 2. When getting closer to the intersection, the right-turn manoeuvre is initiated, indicator is switched on, traffic light information is received in MAPEM and SPATEM. 3. ViewCar2 detects vehicle on the turning lane and queues behind.  <p>The diagram is identical to the one above, showing a red car in the right-turn lane blocking the path of a blue car in the left lane.</p>
<p>Associated to Requirement(s) in addition to generic requirements</p>	<ul style="list-style-type: none"> • REQ_I_I2_S2.3_1



Figure 48: ViewCar2 stopping behind broken-down vehicle.

2.2.2.4.2.2 Test scenario 2.3_1: “Baseline: ToC behind broken down vehicle”

Goal	Demonstrate that a (C)AV is not able to correctly pass the situation. Here, the broken-down vehicle is recognized as being broken-down, so the (C)AV is initiating a ToC. The driver takes over successfully.
Used vehicles	ViewCar2, broken-down legacy vehicle
Used infrastructure	Traffic Light, RSU
Used messages	CAM, MAPEM, SPATEM
Initial situation	ViewCar2 starts on right lane of a two-lane rural road, which turns into a right-turn lane at the upcoming intersection. The ViewCar2 wants to perform a right-turn to reach its destination. Just in front of the intersection, a broken-down vehicle is blocking the right-turn lane. 
Scenario script	<ol style="list-style-type: none"> 1. ViewCar2 follows lane 2. When getting closer to the intersection, the right-turn manoeuvre is

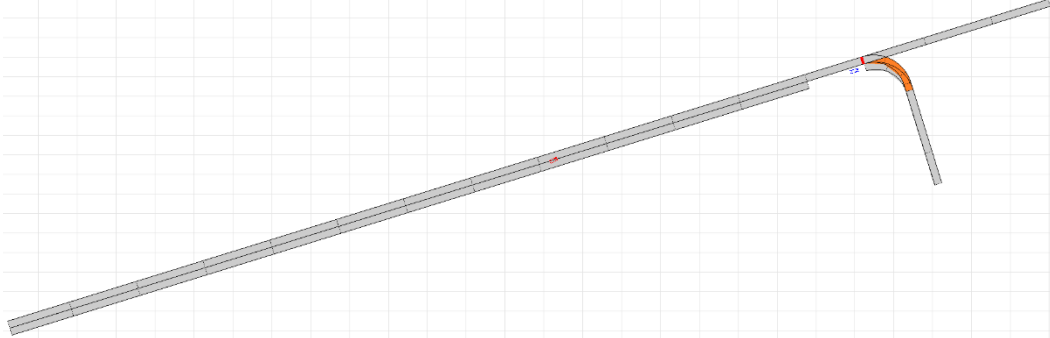
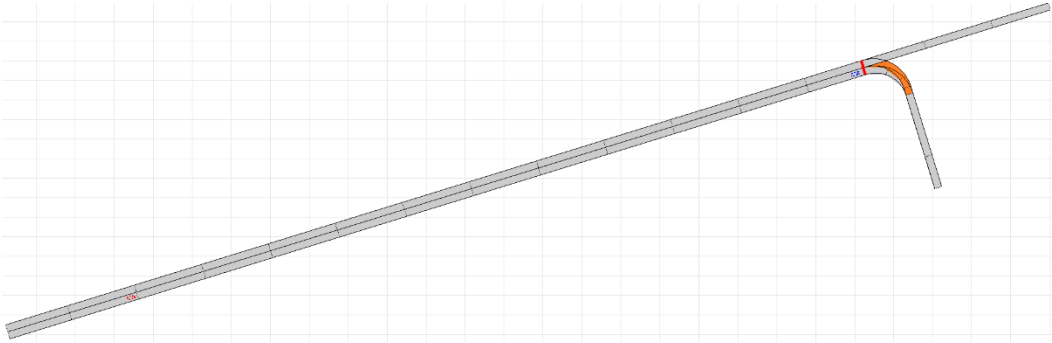
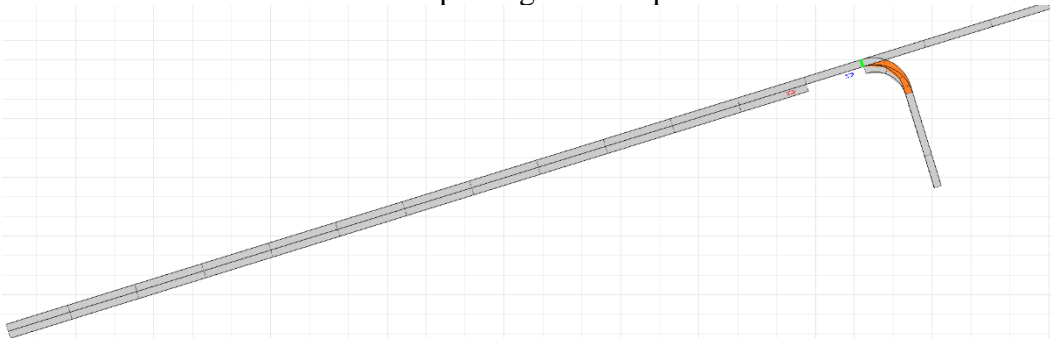
	<p>initiated, indicator is switched on, traffic light information is received in MAPEM and SPATEM.</p> <ol style="list-style-type: none"> 3. ViewCar2 detects broken-down vehicle on the turning lane (by recognizing emergency indicators or by receiving an appropriate DENM if the vehicle is a C(A)V). 4. ViewCar2 initiates a ToC. 5. The appropriate HMI as shown in 2.1.1.1.4.2.2 is shown. 6. The driver takes over and changes lane to pass the vehicle manually.  <ol style="list-style-type: none"> 7. The driver manually performs the turning at the intersection from the left lane, which is a through-lane only. 8. After the turn, the driver may switch on the automation again.
<p>Associated to Requirement(s) in addition to generic requirements</p>	<ul style="list-style-type: none"> • REQ_I_I2_S2.3_1



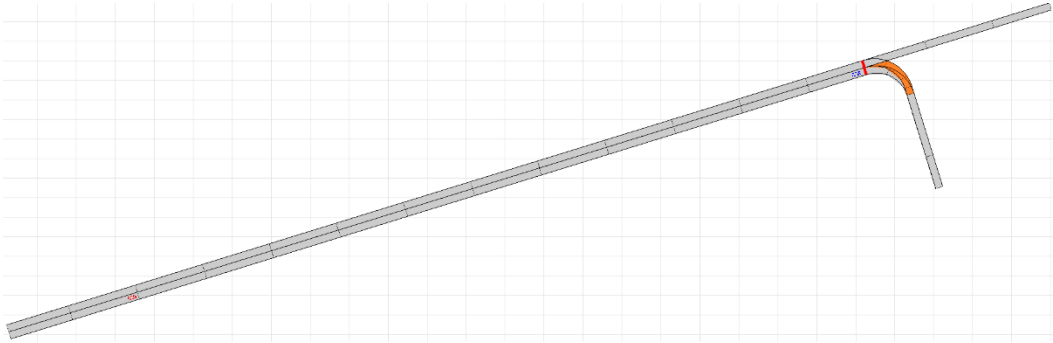
Figure 49: ViewCar2 performing ToC (see cluster instrument panel)

2.2.2.4.2.3 Test scenario 2.3_2: “Baseline: MRM behind broken down vehicle”

Goal	Demonstrate that a (C)AV is not able to correctly pass the situation. Here, the broken-down vehicle is recognized as being broken-down, so the (C)AV is initiating a ToC. The driver does not take over, so an MRM is triggered, stopping the (C)AV behind the broken-down vehicle.
Used vehicles	ViewCar2, broken-down legacy vehicle
Used infrastructure	Traffic Light, RSU
Used messages	CAM, MAPEM, SPATEM
Initial situation	<p>ViewCar2 starts on right lane of a two-lane rural road, which turns into a right-turn lane at the upcoming intersection. The ViewCar2 wants to perform a right-turn to reach its destination. Just in front of the intersection, a broken-down vehicle is blocking the right-turn lane.</p> 
Scenario script	<ol style="list-style-type: none"> 1. ViewCar2 follows lane 2. When getting closer to the intersection, the right-turn manoeuvre is initiated, indicator is switched on, traffic light information is received in MAPEM and SPATEM. 3. ViewCar2 detects broken-down vehicle on the turning lane (by recognizing emergency indicators or by receiving an appropriate DENM if the vehicle is a C(A)V). 4. ViewCar2 initiates a ToC. 5. The appropriate HMI as shown in 2.1.1.1.4.2.2 is shown. 6. The driver is not responding, an MRM is initiated 7. The ViewCar2 stops behind the broken-down vehicle with a distance, so that manual take-over and passing remains possible. 
Associated to	<ul style="list-style-type: none"> • REQ_V_I2_S2.3_1 • REQ_I_I2_S2.3_1

Requirement(s) in addition to generic requirements	
--	--

2.2.2.4.2.4 Test scenario 2.3_3: “Baseline: Detour”

Goal	Demonstrate that a (C)AV is not able to correctly pass the situation. Here, the broken-down vehicle is recognized as being broken-down, so the (C)AV is calculating a detour to avoid turning at the intersection.
Used vehicles	ViewCar2, broken-down legacy vehicle
Used infrastructure	Traffic Light, RSU
Used messages	CAM, MAPEM, SPATEM
Initial situation	<p>ViewCar2 starts on right lane of a two-lane rural road, which turns into a right-turn lane at the upcoming intersection. The ViewCar2 wants to perform a right-turn to reach its destination. Just in front of the intersection, a broken-down vehicle is blocking the right-turn lane.</p> 
Scenario script	<ol style="list-style-type: none"> 1. ViewCar2 follows lane 2. When getting closer to the intersection, the right-turn manoeuvre is initiated, indicator is switched on, traffic light information is received in MAPEM and SPATEM. 3. ViewCar2 detects broken-down vehicle on the turning lane (by recognizing emergency indicators or by receiving an appropriate DENM if the vehicle is a C(A)V). 4. ViewCar2 calculates that a detour is possible to reach the destination. 5. The HMI shows a detour advice as described in 2.1.1.1.4.2.4. 6. ViewCar2 performs lane change to the left through-lane. 7. ViewCar2 is following current signal phase, stopping when necessary.

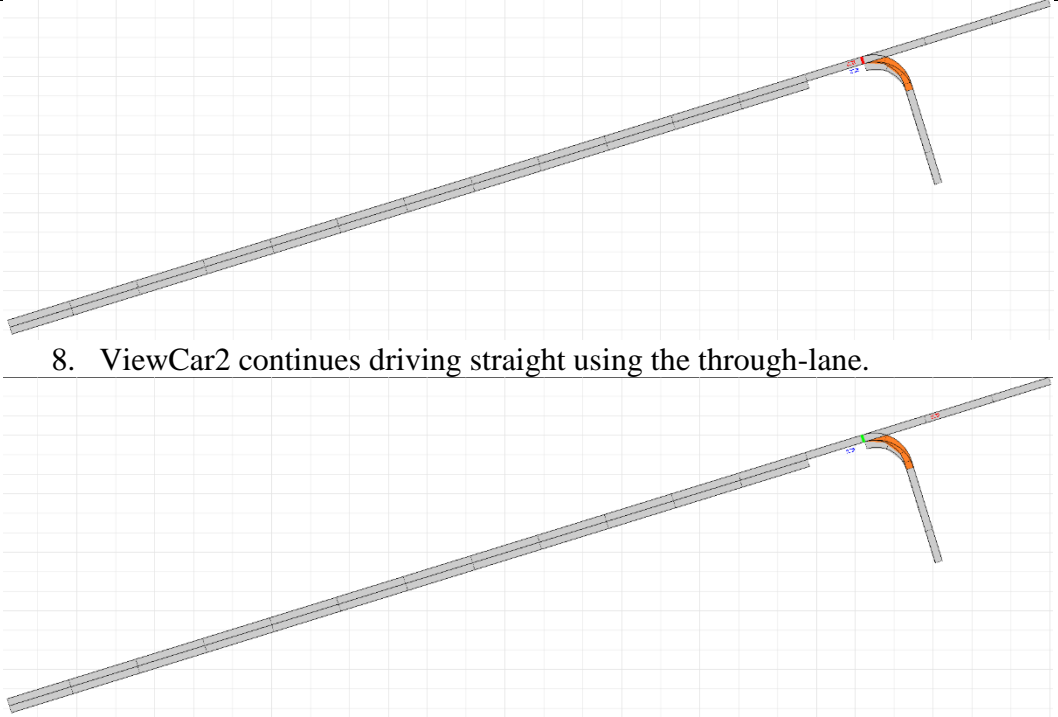
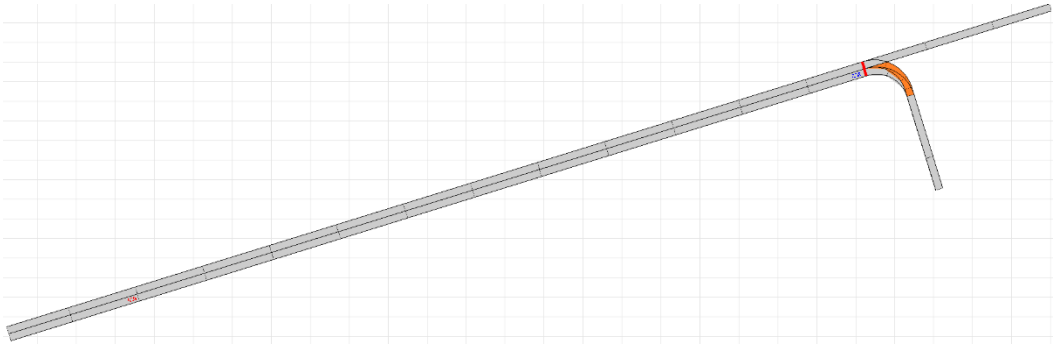
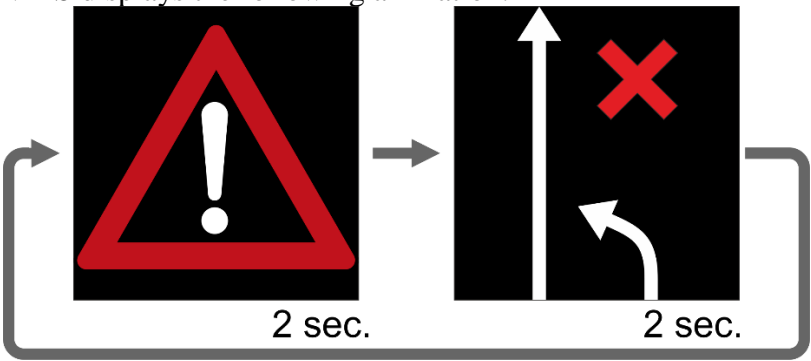
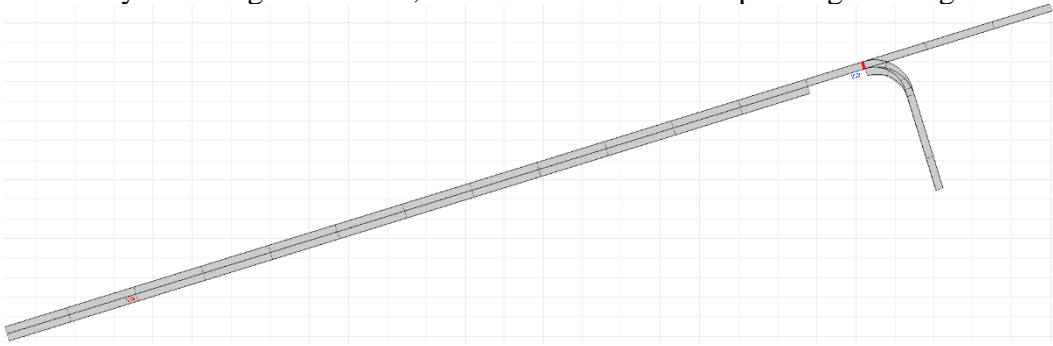
	 <p>8. ViewCar2 continues driving straight using the through-lane.</p>
<p>Associated to Requirement(s) in addition to generic requirements</p>	<ul style="list-style-type: none"> • REQ_V_I2_S2.3_1 • REQ_I_I2_S2.3_1



Figure 50: ViewCar2 performing a detour, driving straight on left lane.

2.2.2.4.2.5 Test scenario 2.3_4: “Turn from through-lane”

<p>Goal</p>	<p>Infrastructure detects broken-down vehicle (either by reception of a DENM if it is a C(A)V or by camera) and allows turning from the left through-lane.</p>
<p>Used vehicles</p>	<p>ViewCar2, broken-down legacy vehicle</p>

Used infrastructure	Traffic Light, RSU
Used messages	CAM, MAPEM, SPATEM, optionally DENM
Initial situation	<p>ViewCar2 starts on right lane of a two-lane rural road, which turns into a right-turn lane at the upcoming intersection. The ViewCar2 wants to perform a right-turn to reach its destination. Just in front of the intersection, a broken-down vehicle is blocking the right-turn lane.</p> 
Scenario script	<ol style="list-style-type: none"> 1. Infrastructure detects broken-down vehicle (by camera or DENM). 2. If the broken-down vehicle is not sending DENM, the infrastructure sends the appropriate DENM 3. VMS displays the following animation: <div style="text-align: center;">  <p>2 sec. 2 sec.</p> </div> 4. Infrastructure updates MAPEM, to allow right turns from the left through-lane 5. ViewCar2 follows lane 6. When getting closer to the intersection, traffic light information is received in the updated MAPEM and SPATEM. The corresponding intersection connection path is set to driving in the digital map. 7. By receiving the DENM, ViewCar2 blocks corresponding lane segment.  <ol style="list-style-type: none"> 8. Tactical planner of ViewCar2 decides to perform right turn from the left

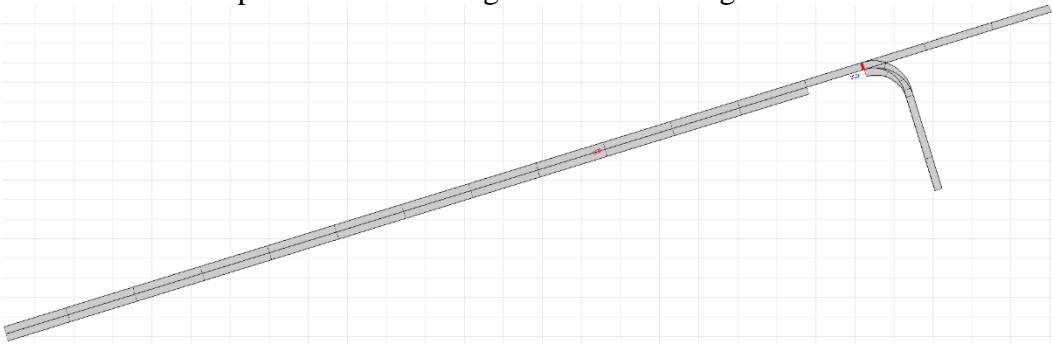
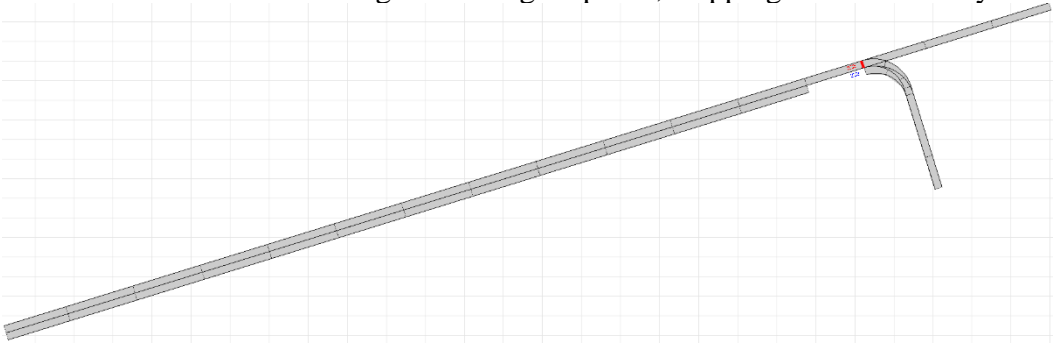
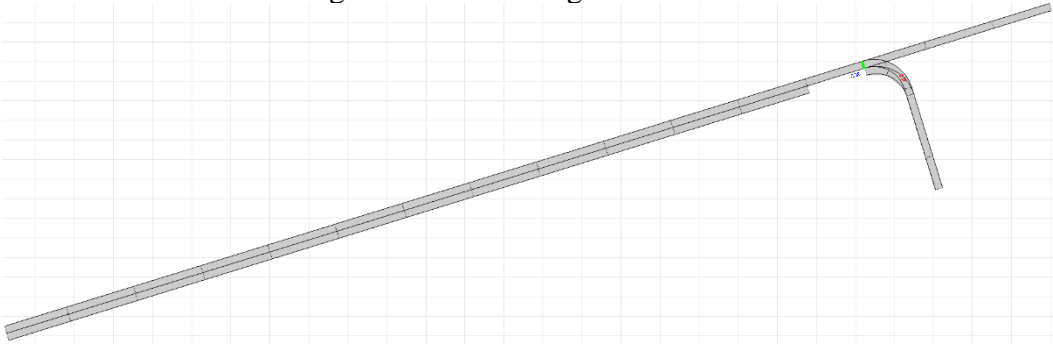
	<p>lane.</p> <p>9. ViewCar2 performs lane change to the left through-lane.</p>  <p>10. ViewCar2 is following current signal phase, stopping when necessary.</p>  <p>11. ViewCar2 turns right from left through-lane</p> 
<p>Associated to Requirement(s) in addition to generic requirements</p>	<ul style="list-style-type: none"> • REQ_V_I2_S2.3_1 • REQ_V_I2_S2.3_2 • REQ_V_I2_S2.3_3 • REQ_V_I2_S2.3_4 • REQ_I_I2_S2.3_1 • REQ_I_I2_S2.3_2 • REQ_I_I2_S2.3_3 • REQ_I_I2_S2.3_4 • REQ_I_I2_S2.3_5 • REQ_I_I2_S2.3_6









Figure 51: ViewCar2 performing the turning manoeuvre from the left lane.

2.2.2.4.3 Feasibility results

2.2.2.4.3.1 Requirements verification

In addition to the feasibility assessment of the general requirements shown in section 0 a few service-specific requirements needed to be verified:

Service-specific requirement description		Req. Name	Associated Test cases successfully executed	Notes
Vehicle requirements	<p><i>Incidence reception</i></p> <p>The vehicle automation shall be able to receive information about the incidence itself. The exact design of this information will be developed in WP5, but it may be similar to the DENM day-1 message.</p>	REQ_V_I2_S2.3_1		Incidence information is provided by DENM. The CAV is able to receive DENMs and react properly.
	<p><i>Path reception</i></p> <p>The vehicle automation shall be able to receive an alternative path, e.g. by a changed MAP topology and to take it into account during trajectory planning</p>	REQ_V_I2_S2.3_2		The path was correctly received in the format defined in D5.1, allowing a right-turn from the left lane.
	<p><i>Speed advice following</i></p> <p>The CAVs/CVs need to be able to receive speed advices from the infrastructure. In case of a CAV, the advices need to be taken into account during trajectory planning, although the vehicle automation itself has the right to overrule the advices. In case of a CV, the speed advice is forwarded to the driver with an appropriate HML.</p>	REQ_V_I2_S2.3_3		Speed advice is correctly received in other use cases. Nevertheless, it needs to be noted that there are only SPATEMs provided in this use case and no further speed advice is given.
	<p><i>Lane advice following</i></p> <p>Also, lane advices need to be received and taken into account in the same way then speed advices.</p>	REQ_V_I2_S2.3_4		Correct reaction of lane advice is shown in other use cases. In this use case, the lane advice is automatically triggered by the reception of a DENM blocking the own lane and by the RSI reaction of providing an alternative path.

Infrastructure requirements	<p><i>Road network</i></p> <p>The road network needs to include a signalized intersection with a dedicated turn lane.</p>	REQ_I_I2_S2.3_1		A road network with a signalized intersection was available.
	<p><i>Speed and lane advice generation</i></p> <p>The infrastructure must be able to generate speed and lane advices based on the detected situation and disseminate them using the RSU.</p>	REQ_I_I2_S2.3_2		Speed and lane advice are only generated implicitly. Speed advice is only given via SPATEM and signal phasing. Lane advice is the result of the available DENM blocking the lane and the provided additional path from the other lane. No further lane advice is needed to trigger automation behaviour.
	<p><i>Sensors</i></p> <p>This use case requires very precise detection of vehicles, esp. of the incidence. Alternatively, the incidence can be reported by the vehicle itself in case it is a (broken down) C(A)V. Nevertheless, it may be required to also monitor the adjacent lanes of the incidence to detect queued vehicles there.</p>	REQ_I_I2_S2.3_3		Infrastructure camera capabilities were showcased in other use cases. In UC 2.3 the incidence detection was done by sending/reception of DENMs
	<p><i>Variable Message Signs (VMS)</i></p> <p>Variable Message Signs may be used to communicate the plans of the infrastructure to the non-cooperative vehicles. In case a (C)AV is performing a Minimum Risk Manoeuvre in this area, the sign may also be used to show warning or jam messages, see Service 4 of the first iteration.</p>	REQ_I_I2_S2.3_4		A VMS installed was used during all tests displaying different signs / messages according to the tested scenarios.
	<p><i>Path generation</i></p> <p>The infrastructure/RSI needs to be able to generate a path or allowance to turn and communicate this to the C(A)Vs.</p>	REQ_I_I2_S2.3_5		The additional path to turn from the left lane was added in the RSI when an incidence was reported.
	<p><i>Adapted signalling</i></p> <p>Depending on the results of WP4 and the proposed traffic management measure, the traffic light needs to be able to change the signal plan to cope with the detected situation.</p>	REQ_I_I2_S2.3_6		The signalling used an adaptive process called AGLOSA which is automatically reacting to changed requirements/queues. Nevertheless, there was no special reaction implemented for broken-down vehicles.

Requirements were followed. The reception and transmission of required V2X message was verified using a V2X module (CohdaWireless mk5) present on the test track. The captured logs show that the RSU correctly formats DENMs. Nevertheless, the used DENM reflects a roadworks situation instead of a stationary broken-down vehicle (Even if from a functional point of view the CAV reaction would be similar in the experiment, in real world implementations, the CAV could react differently when receiving different types of DENMs). MAPEM messages could not be logged in the experiment, so their formatting could not be totally verified. Nevertheless, the logs show that the CAV correctly processes MAPEM information relevant for its position and heading during the tests. Moreover, the CAV was observed to react correctly depending on variation of the MAPEM configuration over different tests. The test vehicle was equipped with a system status display showing the current vehicle positions on a HD map which was generated by DLR for the test track.

2.2.2.4.3.2 User experience

User demands were fulfilled; all test scenarios were successfully executed. This was verified by traveling as passenger in the DLR test vehicle. General user experience comments and results are covered in section 2.2.2.1.3. It must be observed that the vehicle executed very quickly the lane

change manoeuvre after announcement, this might be helpful in dense traffic situations but could be more comfortable in less congested situations

2.2.2.4.3.3 Check of overall feasibility

The tested scenarios in this section build a baseline, which perform the required tasks in a reasonable and efficient way. General feasibility results from section 2.2.2.1.4 also apply here.

Regarding the individual tests, the following remarks need to be given:

Test scenario 2.3_2: The CAV executes an MRM stopping behind the broken-down vehicles and stays in this position as a result getting informed about the broken-down status of this vehicle via a DENM.

Test scenario 2.3_3: The CAV is informed about the broken-down car via DENM, it considers the HD map information to operate a detouring manoeuvre towards the straight direction at the intersection.

Test scenario 2.3_4: The CAV is informed about the broken-down car via DENM, it also receives a MAP message where the permission to turn right from the left lane is given. This allows the CAV to operate turn right at the intersection as initially planned.

2.2.2.5 Requirements of use case 4.2: Safe spot in lane of blockage & Lane change Assistant

2.2.2.5.1 Description of use case from D2.2

A construction site is covering one lane of a road (urban or motorway). The deployed RSI continuously collects information about the construction area and the vicinity of it and provides it to the approaching CAVs.

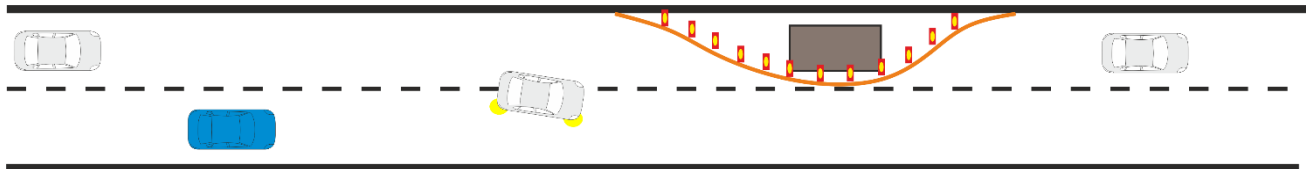


Figure 52: Schematic overview of use case 4.2 (2nd Iteration)

Some CAVs are not able to pass the construction site without human intervention due to system limitations. Therefore, system-initiated ToCs take place somewhere upstream of the construction site. If any ToCs are unsuccessful, the respective CAVs perform MRMs. Without additional measures, the CAV would simply brake and stop on the lane it is driving. Thus, if it stops on the right free lane it will majorly disrupt the traffic flow, while if it stops further upstream of the work zone on the left lane it will essentially create a second lane drop bottleneck.

To avoid the latter situations, the RSI which is monitoring the area just in front of the construction site, offers pre-determined spaces as safe stops to the vehicle, if they are not occupied by surrounding traffic. The CAV uses the safe spot location information to come to a safe stop in case of an MRM.

Additionally, the RSI uses cooperative awareness and collective perception services along with data fusion to acquire accurate knowledge regarding prevailing traffic conditions, and thus facilitate early merging of CAVs on the right free lane (Lane Change Assistant Service). To ensure smoother merging of the CAVs on the right free lane, the RSI schedules lane change advices so that they are distributed in space and time to prevent any likely local turbulence of traffic. The Lane Change

Assistant Service can be concurrently combined with cooperative manoeuvring to enhance its performance. Hence, the possibility that CAVs (which can overpass the work zone without disengagement of the driving automation system) stop in front of the work zone on the left lane and occupy safe spots that should be available for CAVs performing MRMs diminishes. Moreover, the average traffic flow performance is expected to improve in the absence of slow moving or stopped CAVs on the left lane in front of the work zone that attempt to merge onto the free right lane through cooperation.

2.2.2.5.2 Use case setup

This use case will not be changed for the feasibility assessment. Identical to the safe spot use case of the first iteration described in section 2.2.1.5, the safe spot design shown in Figure 53 is used including an explicit safe spot area.

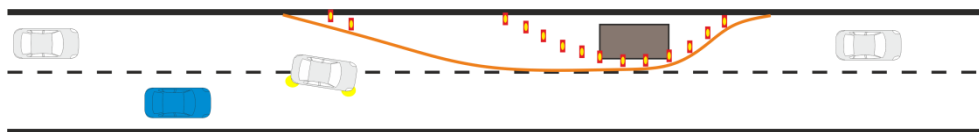


Figure 53: Safe spot design

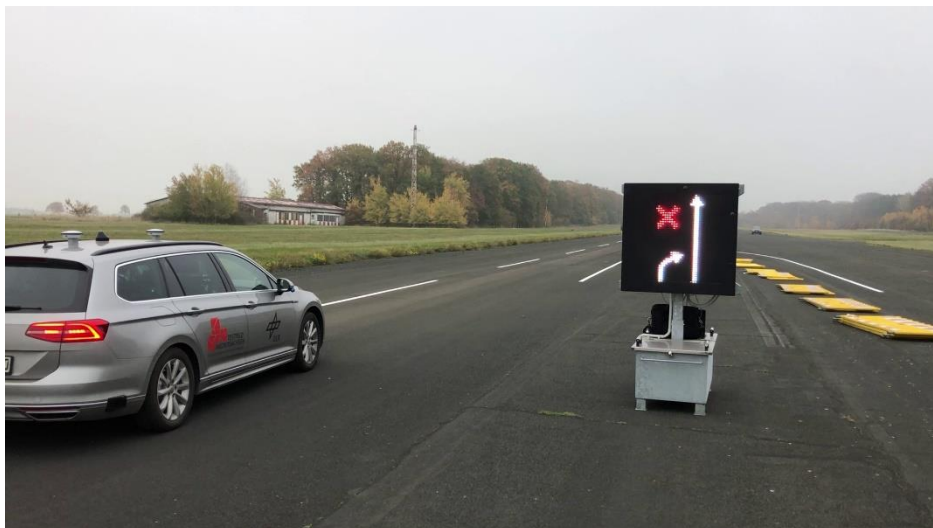


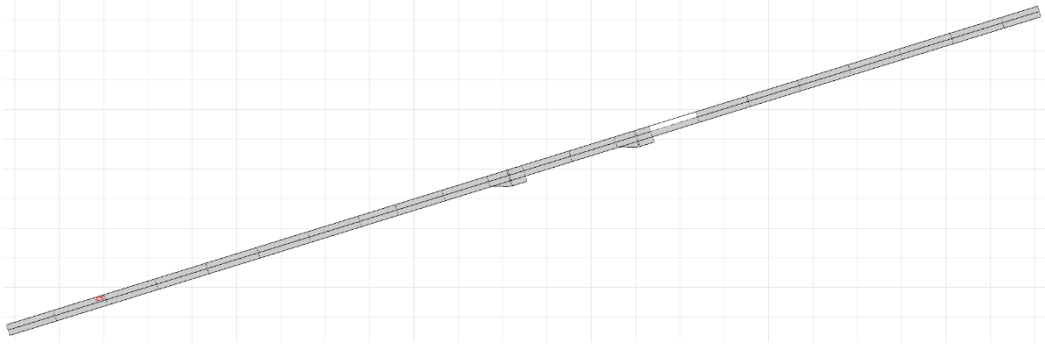
Figure 54: DLR's ViewCar2 executing the use case 4.2 tests.

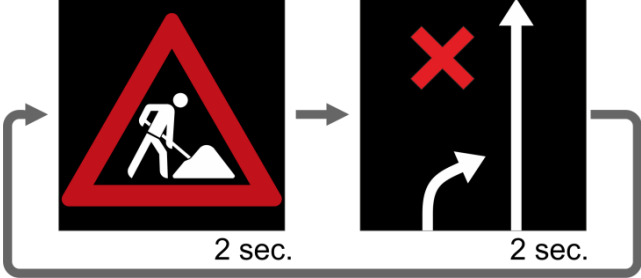


Figure 55: ViewCar2 performing the MRM in the safe spot on the left lane.

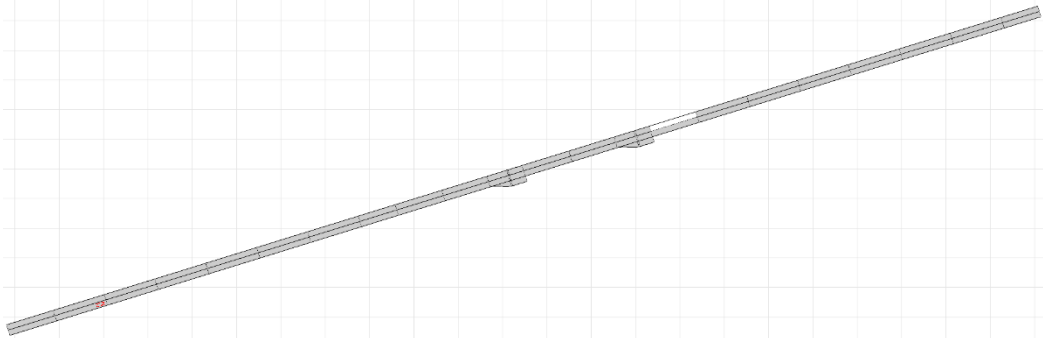
For use case 4.2, three tests are performed, described in the following.

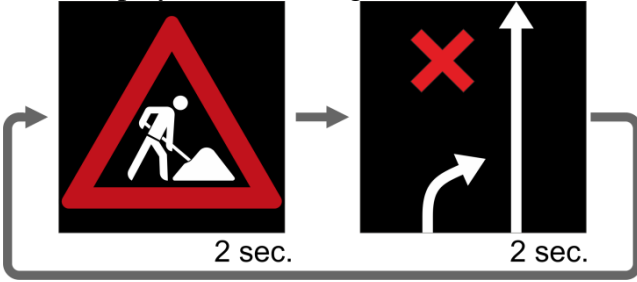
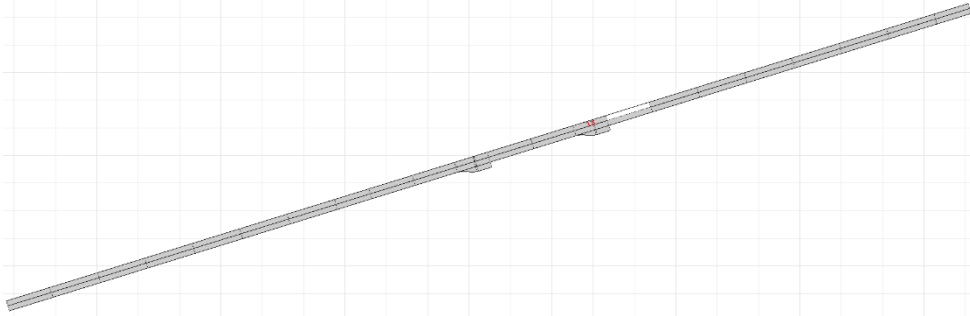
2.2.2.5.2.1 Test scenario 4.2_0: “Baseline: MRM on free lane”

Goal	Demonstrate negative effects of a ToC on the right lane in front of the blockage when no TransAID measure is applied. ToC unsuccessful, MRM executed.
Used vehicles	ViewCar2
Used infrastructure	RSU, VMS
Used messages	CAM, DENM
Initial situation	ViewCar2 starts on right lane of two-lane road, followed by a legacy vehicle. The left lane of the road is blocked by roadworks. The vehicle is by default not able to pass the roadworks on the right lane. 
Scenario script	1. VMS displays the following animation

	 <ol style="list-style-type: none"> 2. RSU broadcasts DENM::roadWorksAlert:: <ul style="list-style-type: none"> • closedLanes • DrivingLanesStatus • EventPosition 3. ViewCar2 initiates a ToC. 4. The appropriate HMI as shown in 2.1.1.1.4.2.2 is shown. 5. Driver does not take over control, standard MRM is executed. 6. ViewCar2 stops at entrance of roadworks area.
<p>Associated to Requirement(s) in addition to generic requirements</p>	<ul style="list-style-type: none"> • REQ_I_I2_S4.2_5

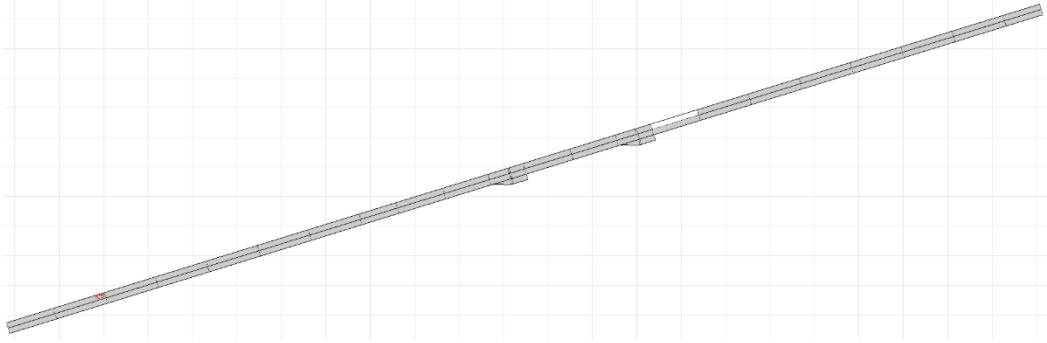
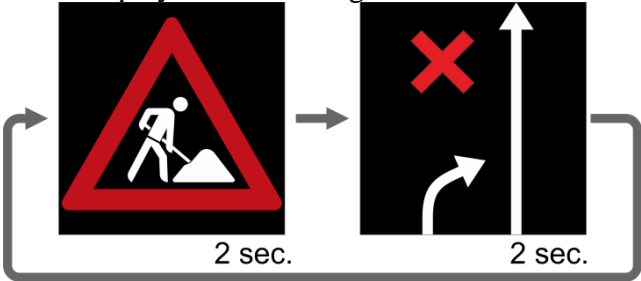
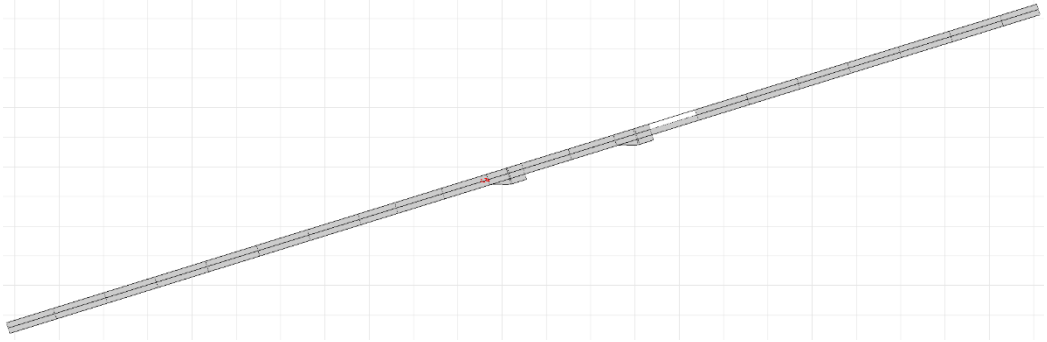
2.2.2.5.2.2 Test scenario 4.2_1: “MRM into safe spot on left lane”

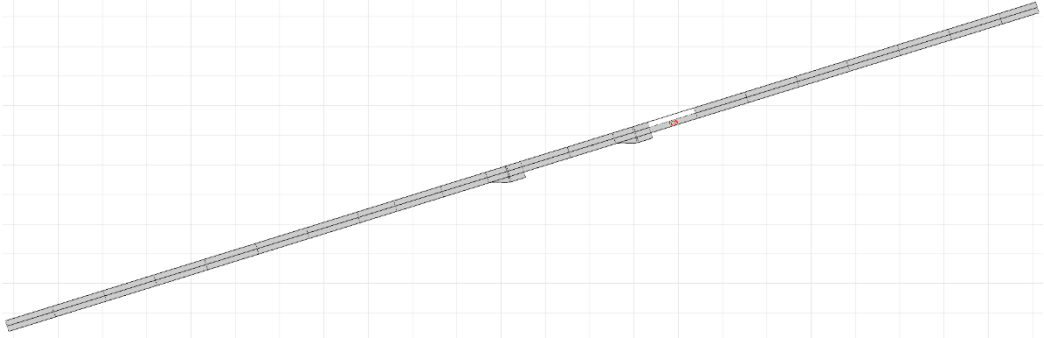
<p>Goal</p>	<p>Demonstrate benefits of performing a Minimum Risk Manoeuvre into a safe spot in front of the roadworks area.</p>
<p>Used vehicles</p>	<p>ViewCar2</p>
<p>Used infrastructure</p>	<p>RSU, VMS</p>
<p>Used messages</p>	<p>CAM, DENM, MAPEM, I2V-MCM</p>
<p>Initial situation</p>	<p>ViewCar2 starts on right lane of two-lane road, followed by a legacy vehicle. The left lane of the road is blocked by roadworks. The vehicle is by default not able to pass the roadworks on the right lane.</p> 

<p>Scenario script</p>	<ol style="list-style-type: none"> 1. VMS displays the following animation <div style="text-align: center;">  <p>The diagram shows a sequence of two VMS signs. The first sign is a triangular warning sign with a red border and a white background, depicting a worker with a shovel. Below it is the text '2 sec.'. An arrow points to the second sign, which is a rectangular sign with a black background, a red 'X' at the top, and a white arrow pointing upwards. Below it is the text '2 sec.'. A curved arrow at the bottom of the second sign indicates a loop or continuation.</p> </div> 2. RSU broadcasts DENM::roadWorksAlert:: <ul style="list-style-type: none"> • closedLanes • DrivingLanesStatus • EventPosition 3. RSU broadcasts MAPEM with possible safe spot positions 4. RSU sends combined MCM::RSU_SMC::ToCAdvice, MCM::RSU_SMC::LaneAdvice::TargetLane=3(=SafeSpot position) and MCM::RSU_SMC::SafeSpotAdvice to ViewCar2 5. ViewCar2 receives message, initiates ToC, starts reducing speed with - 0.5m/s² during ToC interval and prepares lane change. 6. The appropriate HMI as shown in 2.1.1.1.4.2.2 is shown. 7. Driver ignores ToC 8. MRM is executed together with the desired lane change into the safe spot 9. ViewCar2 stops in the safe spot. <div style="text-align: center;">  <p>The diagram shows a perspective view of a road with two lanes. A red dot on the right lane indicates a 'safe spot'. A white arrow points from the left lane towards this spot, indicating a lane change.</p> </div>
<p>Associated to Requirement(s) in addition to generic requirements</p>	<ul style="list-style-type: none"> • REQ_V_I2_S4.2_1 • REQ_V_I2_S4.2_2 • REQ_V_I2_S4.2_3 • REQ_I_I2_S4.2_1 • REQ_I_I2_S4.2_2 • REQ_I_I2_S4.2_3 • REQ_I_I2_S4.2_5

2.2.2.5.2.3 Test scenario 4.2_2: “CAV able to pass roadworks receives lane advice”

<p>Goal</p>	<p>Demonstrate how lane advice is given to a CAV which is able to pass the road works area.</p>
<p>Used vehicles</p>	<p>ViewCar2</p>
<p>Used infrastructure</p>	<p>RSU, VMS</p>


Used messages	CAM, DENM, I2V-MCM
Initial situation	<p>ViewCar2 starts on left lane of two-lane road. The left lane of the road is blocked by roadworks. The vehicle is by default able to pass the roadworks on the right lane.</p> 
Scenario script	<ol style="list-style-type: none"> VMS displays the following animation <div style="text-align: center;">  </div> RSU broadcasts DENM::roadWorksAlert:: <ul style="list-style-type: none"> closedLanes DrivingLanesStatus EventPosition RSU sends MCM::RSU_SMC::LaneAdvice::TargetLane=2(=right lane) to ViewCar2 ViewCar2 receives message, performs lane change to the right lane.  <ol style="list-style-type: none"> ViewCar2 passes road works area








	
<p>Associated to Requirement(s) in addition to generic requirements</p>	<ul style="list-style-type: none"> • REQ_V_I2_S4.2_2 • REQ_V_I2_S4.2_3 • REQ_I_I2_S4.2_3 • REQ_I_I2_S4.2_4 • REQ_I_I2_S4.2_5

2.2.2.5.3 Feasibility results

2.2.2.5.3.1 Requirements verification

In addition to the feasibility assessment of the general requirements shown in section 0 a few service-specific requirements needed to be verified:

	Service-specific requirement description	Req. Name	Associated Test cases successfully executed	Notes
<p>Vehicle Requirements</p>	<p><i>Safe spot advice following</i></p> <p>The CAVs need to be able to receive safe spot advices from the infrastructure. The advices need to be taken into account during trajectory and Minimum Risk Manoeuvre planning. It may be necessary, that the current level of automation is also communicated to the infrastructure.</p>	<p>REQ_V_I2_S4.2_1</p>		<p>Safe spot advices received and followed, also using the lane change and ToC advices available in the MCM's RSU container.</p>

	<p><i>Manoeuvre Coordination Message support</i></p> <p>The vehicles need to provide manoeuvre information in order to be able to implicitly block safe spots. Manoeuvres of the other vehicles shall be received and taken into account for the own trajectory and Minimum Risk Manoeuvre planning.</p>	REQ_V_I2_S4.2_2		CAVs were constantly sending V2V-MCMs.
	<p><i>Lane advice following</i></p> <p>The CAVs/CVs need to be able to receive lane advices from the infrastructure. In case of a CAV, the advices need to be taken into account during trajectory planning, although the vehicle automation itself has the right to overrule the advices. In case of a CV, the lane advice is forwarded to the driver with an appropriate HMI.</p>	REQ_V_I2_S4.2_3		CAVs were able to follow lane advice. If a lane advice was received, an appropriate indication has been given in the HMI independent of the current automation level.
Infrastructure requirements	<p><i>Safe spot availability detection</i></p> <p>The infrastructure needs the capability to always track the availability of the safe spots. This does not only include listening to appropriate messages indicating the blockage, but also the detection by using e.g. camera systems. This is necessary, as the safe spot areas may be also blocked by non-cooperative vehicles, e.g. due to a brake-down of a legacy vehicle.</p>	REQ_I_I2_S4.2_1		The road side infrastructure was able to detect the availability of safe spots by using its camera (see UC 4.1-5). During the feasibility assessment, the extra calibration for this use case has not been performed, thus leading to not using the camera as input here.
	<p><i>Safe spot advice generation</i></p> <p>Whenever a safe spot is available, the infrastructure should forward this information to the vehicles.</p>	REQ_I_I2_S4.2_2		Safe spot advice was provided by RSU to receiving vehicles.
	<p><i>Speed and lane advice generation</i></p> <p>The infrastructure must be able to generate speed and lane advices based on the detected situation and disseminate them using an RSU.</p>	REQ_I_I2_S4.2_3		Road side infrastructure was able to generate speed and lane advice.
	<p><i>Sensors</i></p> <p>This use case requires very precise detection of vehicles and vehicle behaviour, as probable gaps have to be estimated early enough to provide appropriate advices to the vehicles.</p>	REQ_I_I2_S4.2_4		Infrastructure was equipped with the camera and gaps have been estimated in UC 2.1. During the feasibility assessment, the extra calibration for this use case has not been performed, thus leading to not using the camera as input here.
	<p><i>Variable message signs (VMS)</i></p> <p>In case non-cooperative vehicles need to be advised, variable message signs can be used to indicate the separation, e.g. by offering lane usage advices.</p>	REQ_I_I2_S4.2_5		A VMS was showing an appropriate advice.

For this set of tests, the reception and transmission of required V2X message was also verified using the V2X module (CohdaWireless mk5) present on the test track. The capture log shows that the RSU correctly formats DENM, MAP and MCM messages, and the content of these messages fits to the specific requirements of the tests under evaluation. In particular, the DENM shows the event position of the roadworks and the lanes that are closed, and the MCM includes the ToC Advice and Lane Advice when required. The MAP message is also present, which is necessary to map the safe spot location on its topological description of the used road segment. The safe spot information to perform the MRM (Test scenario 4.2_1) is indicated by making the place of end transition to match the lane change position, so that if the driver does not take control, the MRM coincides with the lane change.

2.2.2.5.3.2 User experience

MRMs were successfully executed during the test cases. Deceleration speed seemed acceptable from user's point of view. Before starting the MRM the phase to take back control could be extended and a small steering jerk and/or activation of the vehicles break system could help to get the driver's attention that a vehicle control takeover is requested to reduce the chance a MRM must be executed.

2.2.2.5.3.3 Check of overall feasibility

The bad impact of MRM was successfully demonstrated, which also leads to the conclusion that it is recommended to introduce safe spots (in areas where it is feasible, cf. road architecture). Additional space (safe spots) in front of road works could also have positive effects on the safety level of road workers: In case of accidents a safe spot can reduce the impact of vehicle accidents (speed mitigation before hitting objects of the road works).

Regarding the individual tests, the following remarks need to be given:

Test scenario 4.2_0: The CAV is obliged to perform an MRM on the only free lane in reaction to not knowing about a safe spot location.

Test scenario 4.2_1: The CAV performs an MRM at the location of the advised safe spot, on the left lane before the roadworks, avoiding blocking the only free lane. It must be recognized that the CAV keeps the cruise speed up to the last moment before doing a lane change moment to occupy the safe spot. Since the CAV is in MRM at that moment, an alternative behaviour could be slowing down earlier before execution of the lane change and stop. This alternative behaviour would be probably more suitable in situations where other cars are parked before the free advised safe spot, as the CAV could better manoeuvre to fit in the safe spot and prevent stopping besides the parked cars, in case the lane change manoeuvre cannot be executed.

2.2.2.6 Requirements of use case 4.1 + Service 5 (4.1-5): Distributed safe spots along an urban corridor

2.2.2.6.1 Description of the use case from D2.2

On an urban two-lane road, LVs and C(A)V s are approaching a No-AD zone, where manual driving is obligatory. Therefore, all C(A)V s need to perform a transition, which occasionally may fail and lead to an MRM. Without further information, the vehicle would be expected to perform the MRM on the carriage way and interfere significantly with smooth and safe traffic operation.

However, upstream of the No-AD zone, several parking spaces are located on the road side, which could be used as safe spots. For the suitability of such a space it is assumed that the vehicle performing the MRM is able to enter it directly without further parking manoeuvres.

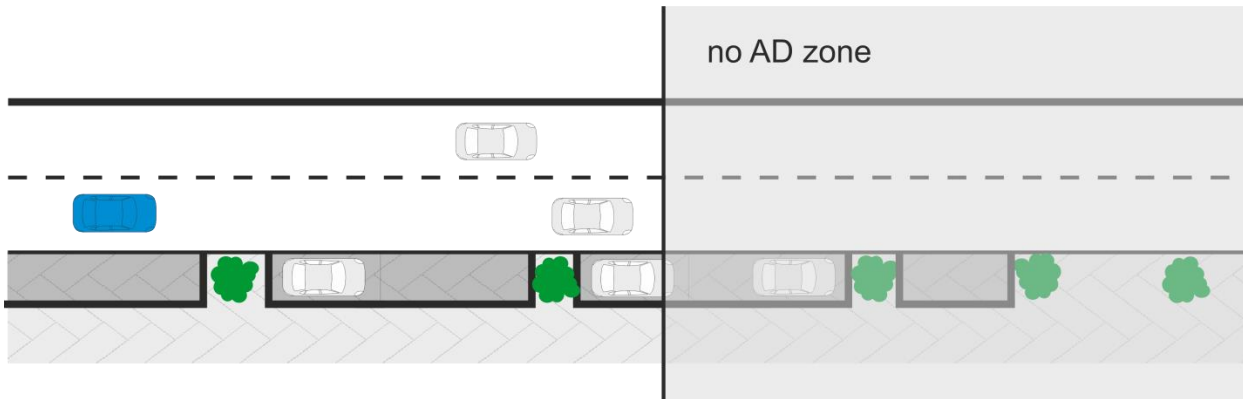


Figure 56: Schematic overview of use case 4.1-5

The RSI monitors the position and speed of the approaching vehicles and the availability of the safe spots (parked vehicles) and provides information about which spot to use in case of an MRM to the CAVs. Further, to raise the probability that a vehicle, that needs to perform an MRM, does this when a safe spot is in range, the RSI schedules and sends ToC advice and safe spot assignments for individual CAVs likely to perform an MRM.

C(A)V s that receive a ToC advice will initiate a takeover with a specified lead time. In case that the driver does not take over within this lead time the vehicle will try to steer towards its assigned safe spot and stop there.

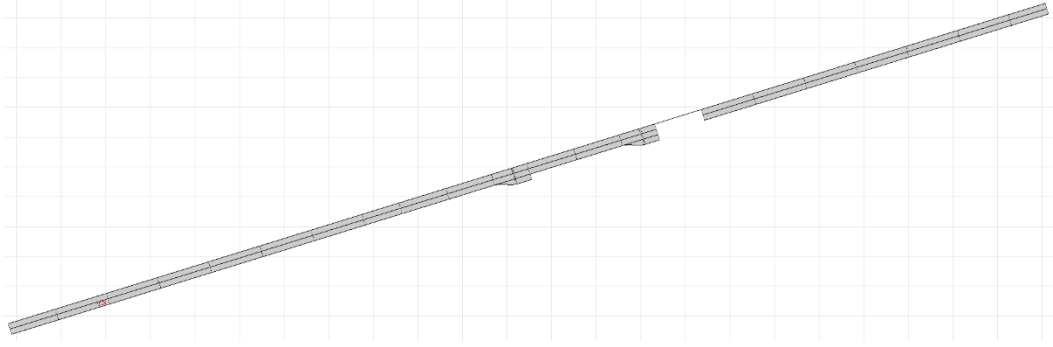
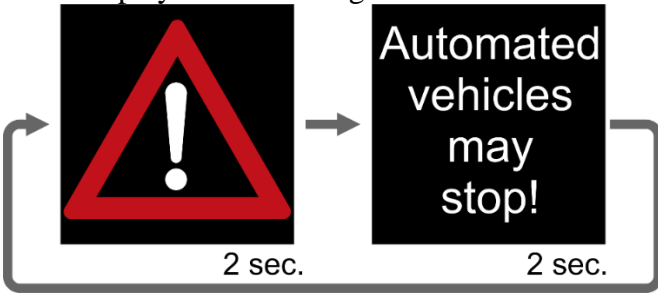


Figure 57: ViewCar2 taking the 2nd safe spot, as the first (right) is blocked.

2.2.2.6.2 Use case setup

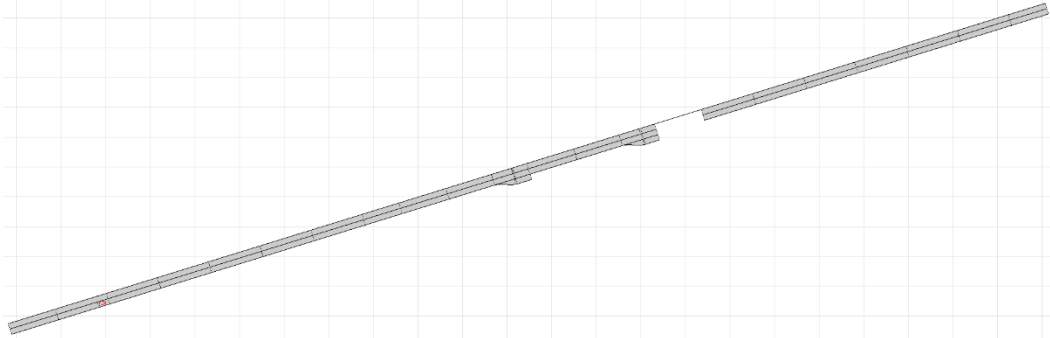
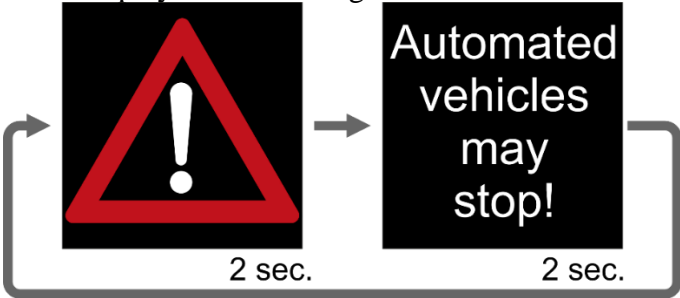
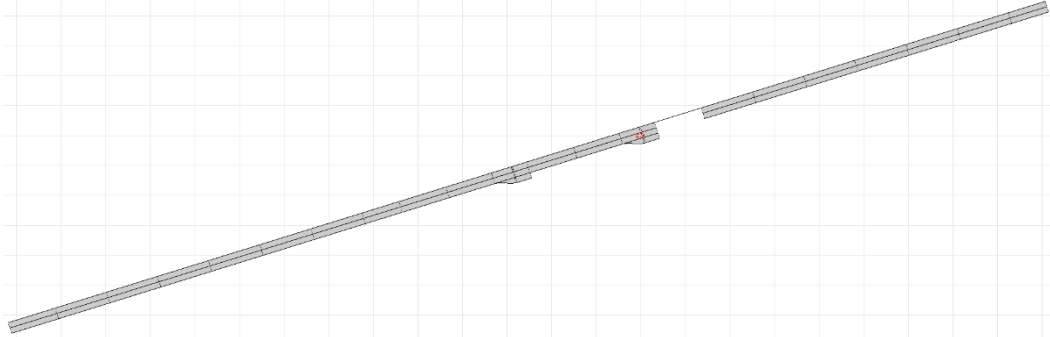
For use case 4.1-5, five different tests are performed. They are summarized in the following.

2.2.2.6.2.1 Test scenario 4.1-5_0: “Baseline: ToC on driven lane”

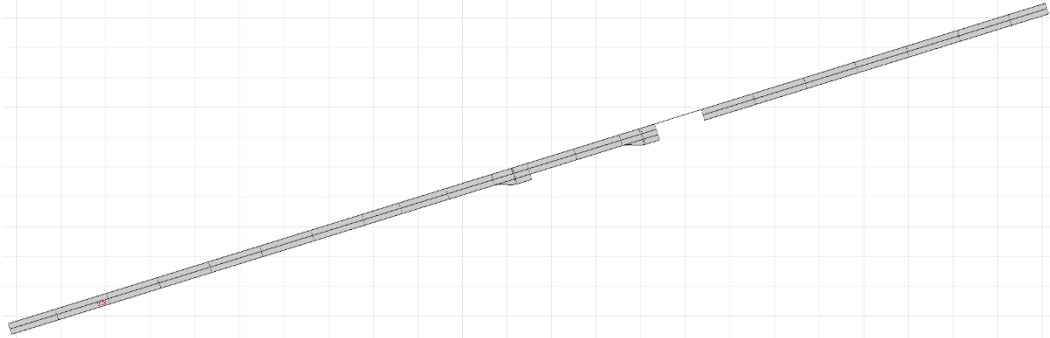
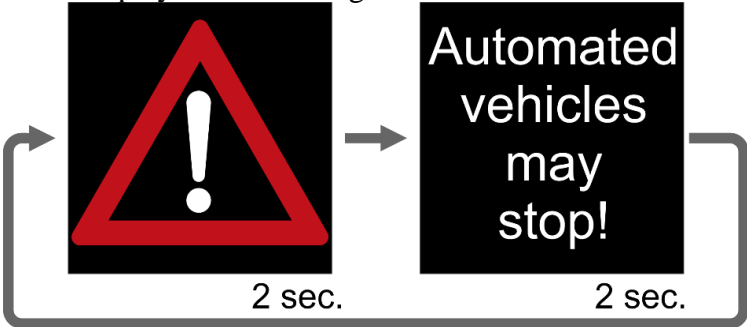
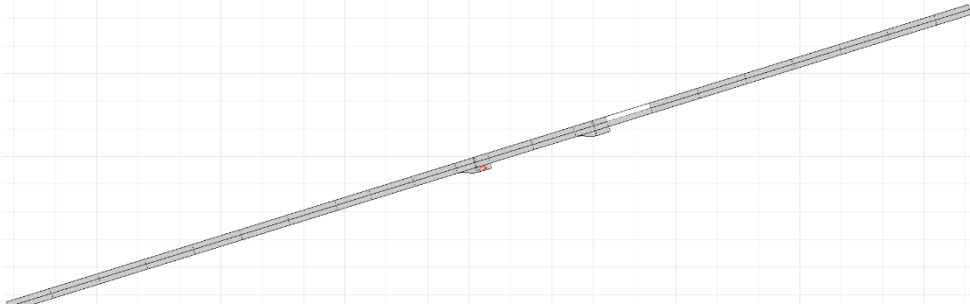
Goal	Demonstrate negative effects of a ToC on the road when no TransAID measure is applied. Driver takes over successfully.
Used vehicles	ViewCar2
Used infrastructure	VMS, RSU
Used messages	CAM
Initial situation	ViewCar2 starts on two-lane rural road, heading for a no-automated-driving-zone. 
Scenario script	<ol style="list-style-type: none"> VMS displays the following animation:  ViewCar2 initiates a ToC. The appropriate HMI as shown in 2.1.1.1.4.2.2 is shown. The driver takes over and continues driving manually.
Associated to Requirement(s) in addition to generic requirements	Only generic requirements.

2.2.2.6.2.2 Test scenario 4.1-5_1: “Baseline: MRM on driven lane”

Goal	Demonstrate negative effects of a ToC on the road when no TransAID measure is applied. Driver does not take over. MRM is initiated. Vehicle stops on the road.
------	--

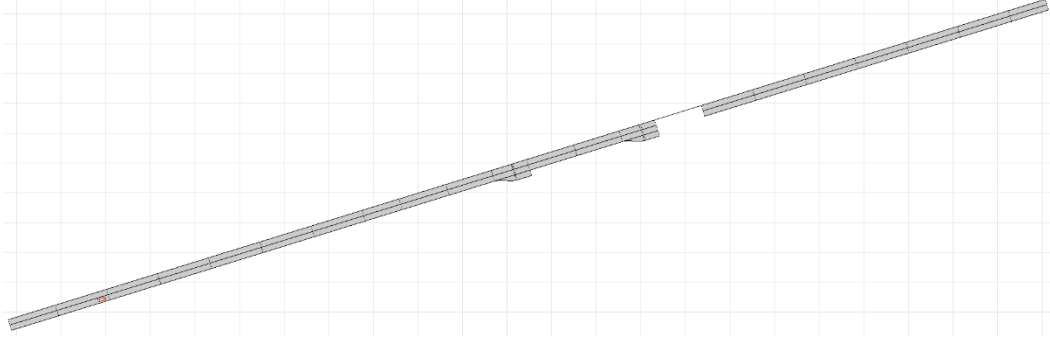
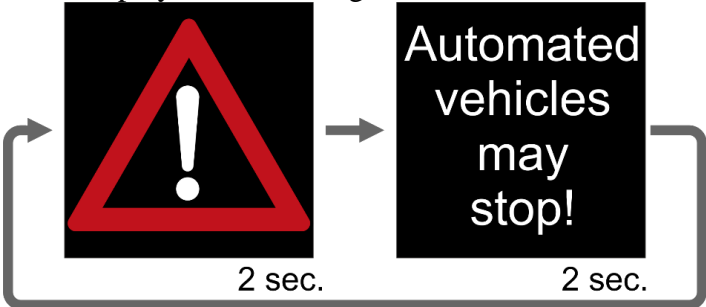
Used vehicles	ViewCar2
Used infrastructure	VMS, RSU
Used messages	CAM
Initial situation	<p>ViewCar2 starts on two-lane rural road, heading for a no-automated-driving-zone.</p> 
Scenario script	<ol style="list-style-type: none"> 1. VMS displays the following animation: <div data-bbox="475 931 1158 1227" style="text-align: center;">  <p>2 sec. 2 sec.</p> </div> 2. ViewCar2 initiates a ToC. 3. The appropriate HMI as shown in 2.1.1.1.4.2.2 is shown. 4. The driver is not responding, an MRM is executed. 5. ViewCar2 stops on the main road in front of the no-automated-driving-zone 
Associated to Requirement(s) in addition to generic requirements	Only generic requirements.

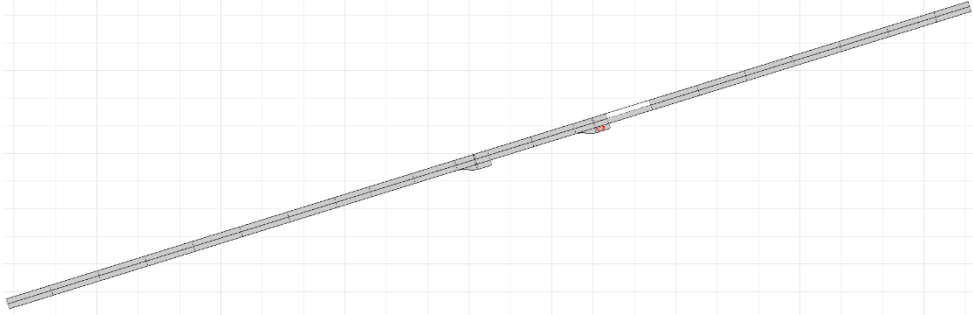
2.2.2.6.2.3 Test scenario 4.1-5_2: “Static advice to first safe spot”

<p>Goal</p>	<p>Demonstrate how infrastructure can avoid negative impacts by statically broadcasting SafeSpot Advice to the first safe spot out of two available, combined with an early ToC advice.</p>
<p>Used vehicles</p>	<p>ViewCar2</p>
<p>Used infrastructure</p>	<p>VMS, RSU</p>
<p>Used messages</p>	<p>CAM, MCM, MAPEM</p>
<p>Initial situation</p>	
<p>Scenario script</p>	<p>1. VMS displays the following animation:</p>  <p>2. RSU sends combined MCM::RSU_SMC::ToCAdvice (with an early ToC position), MCM::RSU_SMC::LaneAdvice::TargetLane=1(=SafeSpot lane) and MCM::RSU_SMC::SafeSpotAdvice to ViewCar2</p> <p>3. ViewCar2 receives message, initiates ToC, starts reducing speed with - 0.5m/s² during ToC interval and prepares lane change.</p> <p>4. The appropriate HMI as shown in 2.1.1.1.4.2.2 is shown.</p> <p>5. Driver ignores ToC</p> <p>6. MRM is executed together with the desired lane change into the safe spot</p> <p>7. ViewCar2 stops in the safe spot.</p> 

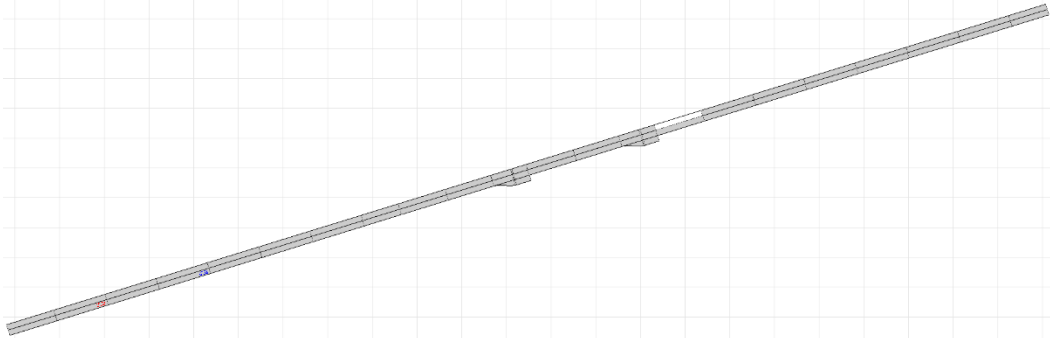
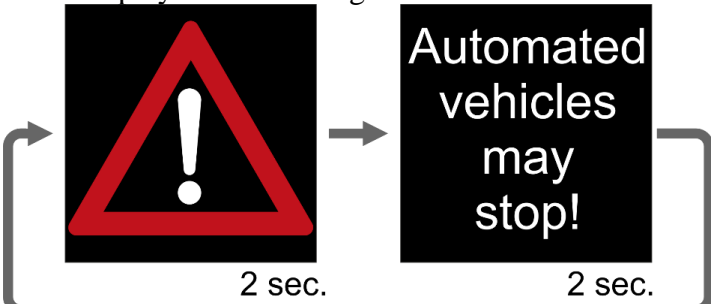
Associated to Requirement(s) in addition to generic requirements	<ul style="list-style-type: none"> • REQ_V_I2_S4.1-5_1 • REQ_V_I2_S4.1-5_3 • REQ_I_I2_S4.1-5_2 • REQ_I_I2_S4.1-5_3
--	--

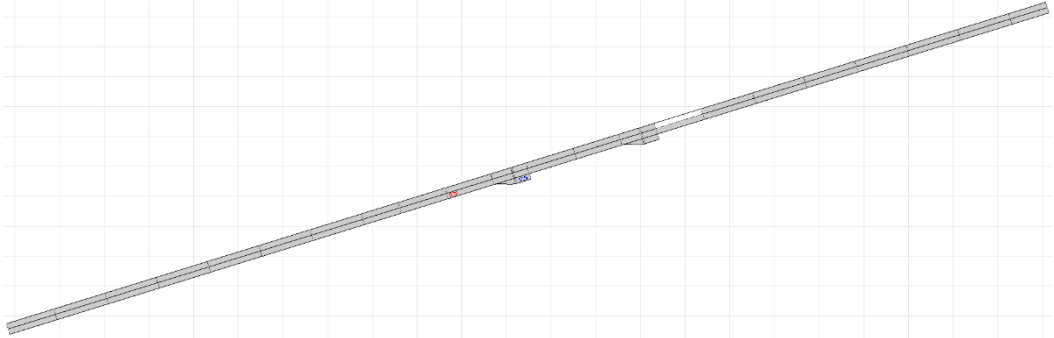
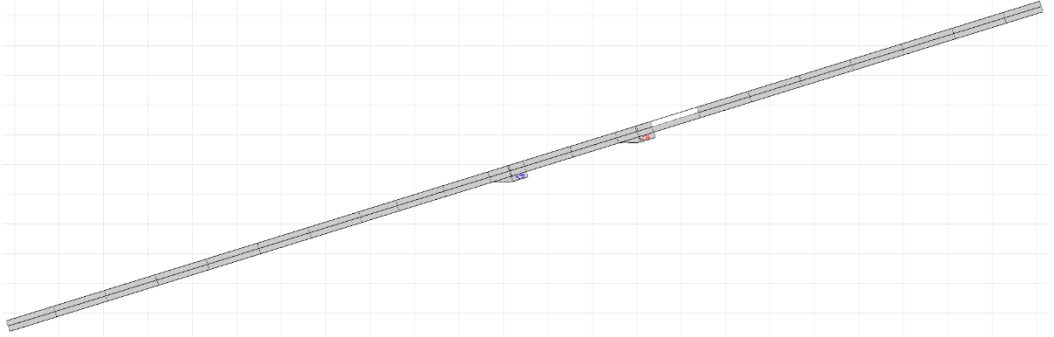
2.2.2.6.2.4 Test scenario 4.1-5_3: “Static advice to second safe spot”

Goal	Demonstrate how infrastructure can avoid negative impacts by statically broadcasting SafeSpot Advice to the second safe spot out of two available, combined with a late ToC advice.
Used vehicles	ViewCar2
Used infrastructure	VMS, RSU
Used messages	CAM, MCM, MAPEM
Initial situation	ViewCar2 starts on two-lane rural road, heading for a no-automated-driving-zone. 
Scenario script	<p>1. VMS displays the following animation:</p>  <p>2. RSU sends combined MCM::RSU_SMC::ToCAdvice (with a late ToC position), MCM::RSU_SMC::LaneAdvice::TargetLane=1(=SafeSpot lane) and MCM::RSU_SMC::SafeSpotAdvice to ViewCar2</p> <p>3. ViewCar2 receives message, initiates ToC, starts reducing speed with - 0.5m/s² during ToC interval and prepares lane change.</p> <p>4. The appropriate HMI as shown in 2.1.1.1.4.2.2 is shown.</p> <p>5. Driver ignores ToC</p> <p>6. MRM is executed together with the desired lane change into the safe spot</p> <p>7. ViewCar2 stops in the safe spot.</p>

	
<p>Associated to Requirement(s) in addition to generic requirements</p>	<ul style="list-style-type: none"> • REQ_V_I2_S4.1-5_1 • REQ_V_I2_S4.1-5_3 • REQ_I_I2_S4.1-5_2 • REQ_I_I2_S4.1-5_3

2.2.2.6.2.5 Test scenario 4.1-5_4: “Dynamic advice to free safe spot”







<p>Goal</p>	<p>Demonstrate how infrastructure can avoid negative impacts by dynamically broadcasting SafeSpot Advice to one of the two safe spots, when the other one gets blocked while the ToC is already in progress.</p>
<p>Used vehicles</p>	<p>ViewCar2, legacy vehicle</p>
<p>Used infrastructure</p>	<p>VMS, Camera, RSU</p>
<p>Used messages</p>	<p>CAM, MCM, MAPEM</p>
<p>Initial situation</p>	<p>ViewCar2 and a legacy vehicle start on two-lane rural road, heading for a no-automated-driving-zone.</p> 
<p>Scenario script</p>	<p>1. VMS displays the following animation:</p> 

	<ol style="list-style-type: none"> 2. RSU sends combined MCM::RSU_SMC::ToCAdvice (with a early ToC position), MCM::RSU_SMC::LaneAdvice::TargetLane=1(=SafeSpot lane) and MCM::RSU_SMC::SafeSpotAdvice to ViewCar2 3. ViewCar2 receives message, initiates ToC, starts reducing speed with - 0.5m/s² during ToC interval and prepares lane change. 4. The appropriate HMI as shown in 2.1.1.1.4.2.2 is shown. 5. Legacy vehicle stops in safe spot which has been used as target for ViewCar2  <ol style="list-style-type: none"> 6. Road side camera detects blockage of safe spot. 7. RSU sends combined MCM::RSU_SMC::ToCAdvice (with a late ToC position), MCM::RSU_SMC::LaneAdvice::TargetLane=1(=SafeSpot lane) and MCM::RSU_SMC::SafeSpotAdvice to ViewCar2 8. Driver ignores ToC 9. MRM is executed together with the desired lane change into the safe spot 10. ViewCar2 stops in the safe spot. 
<p>Associated to Requirement(s) in addition to generic requirements</p>	<ul style="list-style-type: none"> • REQ_V_I2_S4.1-5_1 • REQ_V_I2_S4.1-5_2 • REQ_V_I2_S4.1-5_3 • REQ_I_I2_S4.1-5_1 • REQ_I_I2_S4.1-5_2 • REQ_I_I2_S4.1-5_3

2.2.2.6.3 Feasibility results

2.2.2.6.3.1 Requirements verification

In addition to the feasibility assessment of the general requirements shown in section 0 a few service-specific requirements needed to be verified:

Service-specific requirement description		Req. Name	Associated Test cases successfully executed	Notes
Vehicle requirements	<p><i>Safe spot advice following</i></p> <p>The CAVs need to be able to receive safe spot advices from the infrastructure. The advices need to be taken into account during trajectory and Minimum Risk Manoeuvre planning. It may be necessary, that the current level of automation is also communicated to the infrastructure.</p>	REQ_V_I2_S4.1-5_1		CAVs have been able to follow safe spot advice, with and without combination with lane advice. CAVs were constantly transmitting their current automation level.
	<p><i>Manoeuvre Coordination Message support</i></p> <p>The vehicles need to provide manoeuvre information in order to be able to implicitly block safe spots. Manoeuvres of the other vehicles shall be received and taken into account for the own trajectory and Minimum Risk Manoeuvre planning.</p>	REQ_V_I2_S4.1-5_2		CAVs continuously are sending their planned and desired trajectory using V2V-MCM.
	<p><i>ToC advice following</i></p> <p>The CAVs need to be able to receive ToC advices from the infrastructure. The advices need to be taken into account while driving. As for safe spot advice following, it may be necessary, that the current level of automation is also communicated to the infrastructure.</p>	REQ_V_I2_S4.1-5_3		CAVs followed ToC advice from the infrastructure. CAVs were constantly transmitting their current automation level.
Infrastructure requirements	<p><i>Safe spot availability detection</i></p> <p>The infrastructure needs the capability to always track the availability of the safe spots. This does not only include listening to appropriate messages indicating the blockage, but also the detection by using e.g. camera systems. This is necessary, as the safe spot areas may be also blocked by non-cooperative vehicles, e.g. due to a brake-down of a legacy vehicle.</p>	REQ_I_I2_S4.1-5_1		A road side camera constantly monitored the safe spots. If a safe spot was blocked, this information has been used by the infrastructure logic and the SafeSpot advice has been adapted accordingly.
	<p><i>Safe spot advice generation</i></p> <p>Whenever a safe spot is available, the infrastructure should forward this information to the vehicles.</p>	REQ_I_I2_S4.1-5_2		The road side was able to generate a safe spot advice on static or dynamic basis, the latter using camera data as input.
	<p><i>ToC advice generation</i></p> <p>The infrastructure needs to be able to generate and send ToC advices.</p>	REQ_I_I2_S4.1-5_3		Infrastructure was able to provide ToC advice on static and dynamic basis, the latter using camera data as input.

Requirements were followed. The reception and transmission of required V2X message was verified using a V2X module (CohdaWireless mk5) present on the test track. The capture logs show that the RSU correctly formats MCM messages and the content of these messages fits to the specific requirements of the tests under evaluation. In particular, it can be observed that the safe spot advice dynamically changes in the MCM to indicate the location of the actually available safe spot.

Additionally, MAPEM receptions and processing is also visible in the V2X logs, which is necessary for mapping of the safe spot location mapping on the MAPEM topological representation. The test vehicle was equipped with a system status display showing the current vehicle positions on a HD map which was generated by DLR for the test track.

2.2.2.6.3.2 User experience

User demands were fulfilled; all test scenarios were successfully executed and serve as baseline for following use cases. This was verified by traveling as passenger in the DLR test vehicle. General user experience comments and results are covered in section 2.2.2.1.3.

The Minimum risk manoeuvre was highlighted with blinking red in the cluster when executed. The HMI also shows an indication of the lane change that is going to be performed as soon as the safe spot advice is received. It could be discussed if the HMI could let the driver be aware that in case of a blocked safe spot and another free one will be used (this would help to explain certain changes in the vehicle behaviour, when a given manoeuvre has been initiated and is modified later on).

2.2.2.6.3.3 Check of overall feasibility

The tested scenarios in this section build a baseline, which perform the required tasks in a reasonable and efficient way. General feasibility results from section 2.2.2.1.4 also apply here. It should be mentioned, that in these scenarios the test vehicles showed some intrinsic limitations in brake control capabilities which would not be present in a series production vehicle setup. So, all in all the results are satisfactory despite the implementation constraints.

Regarding the individual tests, the following remarks need to be given:

Test scenario 4.1-5_1: The CAV is obliged to perform an MRM on the driven lane in reaction to not knowing about a safe spot location.

Test scenario 4.1-5_2: The CAV performs an MRM at the location of the advised safe spot on the right, avoiding blocking the only free lane. It must be recognized that the CAV keeps the cruise speed up to the last moment before doing a lane change moment to occupy the safe spot. Since the CAV is in MRM at that moment, an alternative behaviour could be slowing down earlier before execution of the lane change and stop. This alternative behaviour would be probably more suitable in situations where other cars are parked car before the free advised safe spot, as the CAV could better manoeuvre to fit in the safe spot and prevent stopping besides the parked cars, in case the lane change manoeuvre cannot be executed.

Test scenario 4.1-5_3: The CAV performs an MRM at the location of the second advised safe spot.

Test scenario 4.1-5_4: The CAV dynamically reconsiders the planning for executing the MRM as the RSI safe spot advice received changes. Finally, the CAV executes the MRM at the location of the second advised safe spot.

3 Public road assessment of highway entering

This section describes the prototype design, the planned actions and execution of the public road prototype demonstration on A13 highway in the Netherlands. The demonstration took place during the second project iteration of TransAID (25th June 2020). In addition, a feasibility assessment of the developed prototype was conducted by the project partner HMETC afterwards.

The public road prototype demonstration of highway entering is based on use case 2.1: “Prevent ToC/MRM by providing speed, headway and/or lane advice”. Like other use cases, use case 2.1 and its TransAID traffic management (with and without communications) were simulated in WP3, WP4 and WP6 while sensors and signalling were studied in WP5. Standing on these foundations, a prototype architecture for use case 2.1 is designed, and a public road demonstration is performed in WP7 and reported in section 3.1 below. Due to the ongoing COVID-19 pandemic, the feasibility assessment was not carried out as planned on the field. Section 3.2 will discuss the results in more details and share some lessons learned.

3.1 Prototype architecture

3.1.1 Public road setup

For the TransAID prototype demonstration and the feasibility assessment, cooperative highway merging has been investigated in use case 2.1 (see Figure 58). Vehicles (LVs) are driving on the A13 mainline highway, and the test vehicle (CV) is driving on the on-ramp. Before the on-ramp/acceleration lane ends, the test vehicle needs to merge to the mainline highway safely.

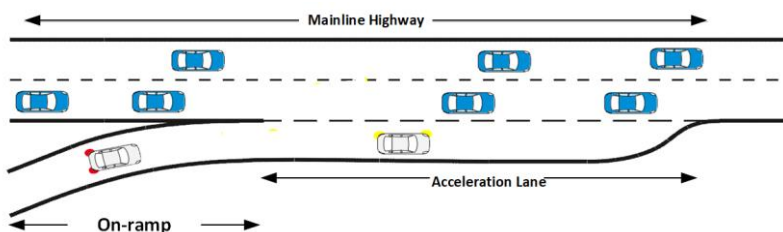


Figure 58: Use case 2.1 schematic layout

Figure 58 is the slightly adapted schematic layout of on-ramp/acceleration lane to highway merging. As can be seen, all vehicles on the A13 mainline highway currently are LVs. The white vehicle with left-turn indication lights is the test vehicle (CV). It is equipped with Dynniq’s research version

of an On-board Unit (OBU) for V2X communication, and electronic devices for navigation display and in-vehicle HMI. The speed advice provided by the core application - merging assistant (see D4.2 [11] section 3.1.2 and 3.2.2) is shown via the in-vehicle HMI to the driver and second driver. The need for this merging assistant originates from the lack of dynamic information hence merging gap prediction for CVs and (C)AVs, as they have limited traffic perception and possibly obscured field-of-view to merge safely onto the highway. If this information is insufficient, the CAV must request a Transition of Control (ToC) where the driver is asked to take back control. Use case 2.1 is designed with cooperative perception and V2X communication to augment its situational awareness for CVs and CAVs, and with the core application to calculate and provide speed advice intuitively via in-vehicle HMI, in order to postpone/reduce ToCs as much as possible.

As mentioned in the introduction, while most of the use cases in TransAID WP7 2nd iteration are demonstrated in closed roads/fields, use case 2.1 is sparing no effort towards a prototype demonstration on public road. The objectives of the demonstration are threefold:

1. Test the novel cooperative highway merging application under use case 2.1 with a CV merging to mainline highway. This application is based on the merging assistant algorithm.

The test vehicle (CV) on the on-ramp is informed about calculated speed advice to reach a gap on the highway.

2. The feasibility and impact of the demonstration will be investigated. The public road test is performed with one CV in this demonstration. The feasibility and impact of this demonstration leads to some insight of the application on other vehicle types: CVs and CAVs, for example, in the TA zone in the future.
3. The lessons learned from this demonstration could shed lights on the future studies and potential demonstrations. For example, adding an intelligent ramp metering to hold vehicles at the on-ramp when no suitable gap can be found, or when a certain traffic flow target can be set from the traffic management layer that dynamically increases the gap tolerances until the target flow is reached.

The public road setup roots from traffic safety, which is vital for a modified vehicle and a research phase application. The demonstration can only be performed under the following two test pre-conditions: First, the driver should be focusing on the driving task. Second, a second driver is sitting on the passenger seat with specific tasks, such as setting up application, reading speed advice and sending back feedbacks. According to the traffic intensity, the following three scenarios can be identified and performed:

Scenario 1 - The test vehicle driver should be informed about the speed advice provided by the application via the voice command from the second driver on the passenger seat. Based on the speed advice and traffic situation on the A13 mainline highway (over-the-left-shoulder in this case), the driver can decide between the options of acceptance and rejection:

Option 1 - Accept the speed advice, inform the acceptance to the second driver verbally and accelerate/ decelerate to reach the target speed as smooth and safe as possible. In this case, the traffic density is unsaturated (no traffic congestion on the mainline highway). The driver can easily identify the potential gaps (the intended one by the speed advice from the application), if he/she accelerates/decelerates to the targeted advised speed based on sufficient driving capability.

Option 2 - Decline the speed advice, inform the declination to the second driver verbally and drive according to strategic decisions based on his driving capability. This option can happen for the following reasons:

- The driver is not ready/comfortable (physically or mentally) to follow the speed advice and perform the driving task.
- A “present moment” assessment by the driver has led to insufficient confidence to follow the speed advice and perform the driving task according to the merging assistant application. The insufficient confidence to follow the speed advice could be caused by the malfunctioning, latency or inaccuracy of the merging assistant system, the sensor fusion or the vehicular communication system.

Scenario 2 - If this gap is not available due to onset of dense traffic, such as congestion forming on the highway, the test vehicle driver needs to perform driving tasks and make decision irrespective of the speed advice provided by the application. While approaching the end of acceleration lane, the driver assesses and decelerates for a possible gap to enter the mainline highway.

Scenario 3 - The demonstration must halt if recurrent or non-recurrent congestion on the on-ramp and mainline highway appears. The core application in this demonstration is designed for unsaturated traffic condition on the highway, targeting CVs, CAVs and even LVs (information provided via the road side speed advice matrix board/intelligent ramp metering).

The demo took place at the crossing of the A13 and the N209/S114³ near Rotterdam-The Hague Airport in the Netherlands (see Figure 59), which consists of a three-lane straight road and one-lane on-ramp/acceleration lane. The location was explicitly chosen due to the road layout resembling use case 2.1, the operation and execution possibility on the parallel service road next to the highway, and the curvature of the on-ramp, which could cause impeded perception of CAVs.

In order to perform the demonstration repeatedly (estimation of 10 runs based on the length of one test run), the test run route is designed as a closed circle trajectory. (see Figure 59, top: the blue trajectory). The route of one test run is defined as following (see Figure 59, top): the test vehicle drives on the curved-shaped on-ramp, merge onto A13 highway, drive straight on A13 highway until the next exit-ramp, get off the A13 highway, take a U-turn on the roundabout (see round circle at the bottom of Figure 59, top), get back on A13 highway, drive straight and get off the A13 highway and access N209/S114 to reach the beginning position on the on-ramp (see Figure 59, top: blue dot with “B”).

Figure 59, bottom, zooms in on the highway entering area and the merging area of the demonstration on google map. The one-lane, half-circle shaped on-ramp is approximately 200m and is followed by a straight one-lane acceleration lane of 465m. This lane merges into a three-lane highway (A13) with a speed limit of 100Km/h and 80Km/h (conveyed via LED matrix on the highway) on the test day.

Figure 59, bottom, shows the estimated positions of the two sets of inductive loop detectors, Mobile RSU station, TrafiRADAR camera and testing personnel (standing next to the Mobile RSU station or driving inside the test vehicle). Two sets of inductive loops are deployed in the highway that are used to collect information about the mainline vehicles. One of the inductive loops is 515m away to the first possible merging point (upstream), and the second one is 50m away from the first possible merging point (downstream). Additional data about the mainline highway is also detected using a radar camera. These two inputs data are fused in the implemented Mobile RSU station and utilized by the implemented merging assistant system to identify potential gaps in the right-most lane of the mainline highway.

As mentioned, the merging assistant system is the core component of the public road demonstration. In the next section, all components used in the demonstration and the interactions among them will be explained, followed by the system architecture design for this prototype.

³ The testing crew and filming crew will drive to 51°57'01.7"N 4°24'54.5"E (51.950475, 4.415139), see Figure 59, bottom, red dot. Before the demonstration day, the public road setup and preparation were executed on three separate dates in June 2020 and the process was compliant with safe work along the road, source: CROW 96b guideline. The testing crew have studied the course – safe work along the road before the demonstration as well.

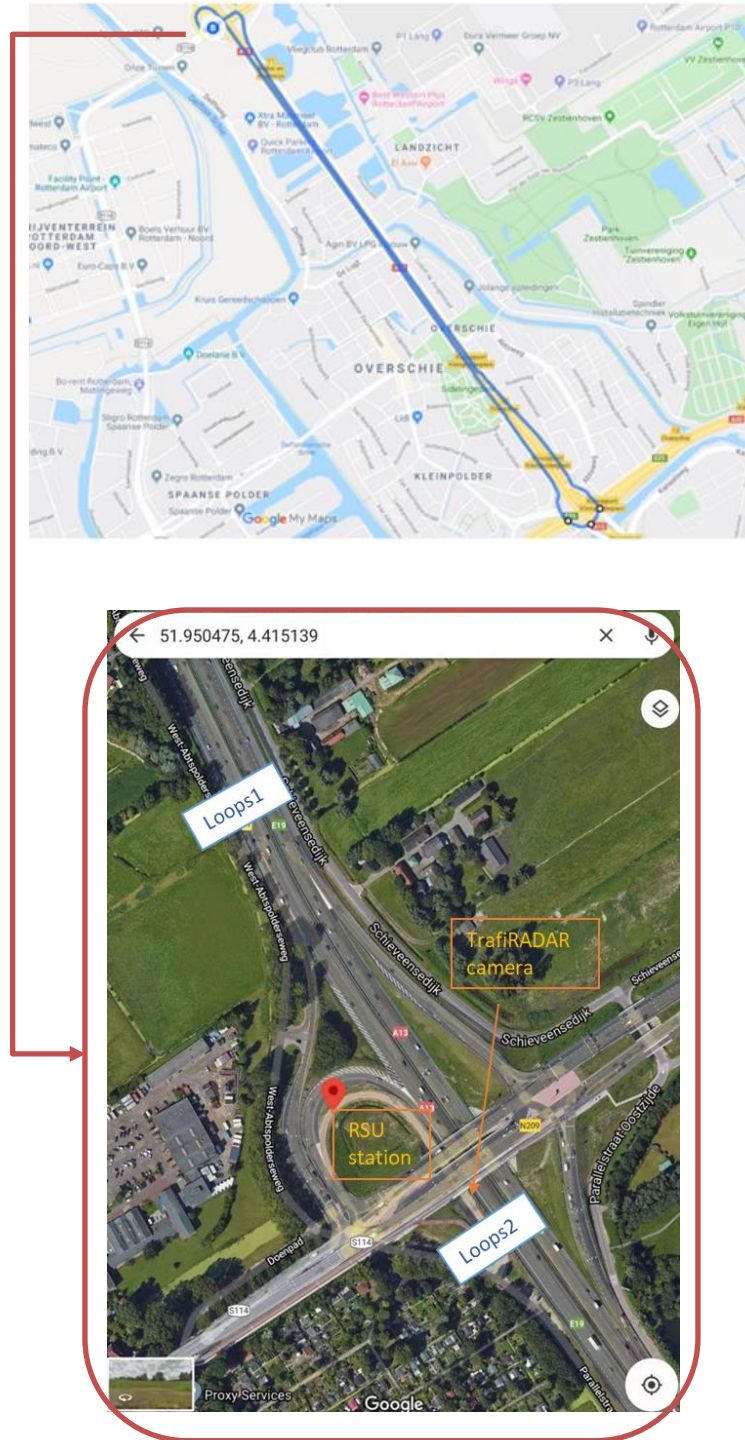


Figure 59: Top: Test run route on the A13, Bottom: Demonstration - on-ramp to A13 highway topology overview.

3.1.2 System architecture and components

Section 2 describes the use case prototypes by DLR in first and second iteration, Dynniq oversees and provides the infrastructure on the highway entering use case 2.1 during the second iteration additionally. Therefore, the prototype components and system architecture in use case 2.1 differed.

This section discusses first the entities, the components of each entity, and the message transmission with related hardware units (equipment) in the prototype demonstration. An overview is given in Table 2.

Table 2: Overview of Entities, components and equipment used in the demonstration

Entity	Component	Equipment-hardware units
<p>Traffic data infusion</p>	<p>MTM outstation: 1st set of loop detector</p>	<p>Inductive double loops detector upstream, network, data server</p>
	<p>MTM outstation: 2nd set of loop detector</p>	<p>Inductive double loops detector downstream, network, data server</p>
	<p>FLIR camera: A TrafiRADAR-like camera tracking vehicle speeds and positions</p>	<p>Light pole on the road side, battery, power supply, network Note: Aerial work platform is used during camera installation</p>
<p>The MergingAssistant calculates the speed advice, time-to-merge and distance-to-merge predictions based on the information it receives from the traffic loops and the camera.</p>	<p>Feature: advice speed, time-to-merge and distance-to-merge Application: Java code and its IDE</p>	<p>Laptop or other units with similar functions</p>
	<p>Feature: extracting inputs Application: Java code and its IDE</p>	<p>Laptop or other units with similar functions</p>
	<p>Feature: Communication to Geonet Daemon Application: Java code and its IDE</p>	<p>Laptop or other units with similar functions</p>
<p>TransAID RSU The TransAID RSU receives calculated data from the MergingAssistant and transmits it to the OBU. RSU also sends the received location, speed and heading updates from the OBU to the MergingAssistant. And RSU provides information to the GUI.</p>	<p>RSU GUI</p>	<p>Laptop, or any display devices suitable for displaying and debugging</p>
	<p>Geonet Daemon</p>	<p>MCM: The RSU sends MCM messages to the OBU. The MCM contains the speed advice, the distance and time countdowns to lane change manoeuvres. CPM: The RSU sends updates of the rightmost lane mainline highway vehicles (predicted) positions, based on the traffic</p>

		loop and camera data.
	Device driver (integrated test box)	ITS-G5 radio device Power Antenna
TransAID OBU The TransAID OBU displays information on the GUI among which the speed advice that the driver should follow.	OBU GUI	Laptop, or any display devices suitable for displaying and debugging
	Geonet Daemon	CAM: The OBU sends its location, speed and heading regularly via a CAM message. MavenCAM: is used to transmit the speed compliancy. The speed compliancy indicates whether the OBU intends to follow the speed advice it received from the RSU.
	Device driver (integrated test box)	ITS-G5 radio device Power Laptop GPS antenna: The OBU receives its location, speed and heading from the GPS

Besides a brief summary of each entity and its components, the overview table highlights two points: a) The merging assistant is the core application that fuses input data and calculates advice; b) The geonet daemon is an integral part of every Dynniq RSU and OBU, as well as for the research version TransAID RSU and TransAID OBU, which handle the geonet and lower layer protocols of the communication. This means services only need to send raw encoded application layer byte arrays and not need to worry about lower layer communication protocols.

The prototype demonstration system architecture of use case 2.1 was first presented in Figure 18, D7.1 [2]. This high-level architecture focuses on the road side and shows the sensor interfaces to retrieve and fuse sensor data. The sensor fusion model is running directly on the RSU instead of on a separate perception and fusion module, where the CAM messages are directly fused with the sensor data, such as loop detector data from MTM outstation and camera data.

To ensure the field integration of the merging assistant, the system architecture needs to add the component of V2I/I2V communication followed by the encoding and decoding of messages. Therefore, the new system architecture design targeting prototype demonstration on the public road is proposed in Figure 60. It provides a schematic overview of the OBU/RSU software components, hardware devices, the messages sent and received by the OBU/RSU, and the transmitted sensor data.

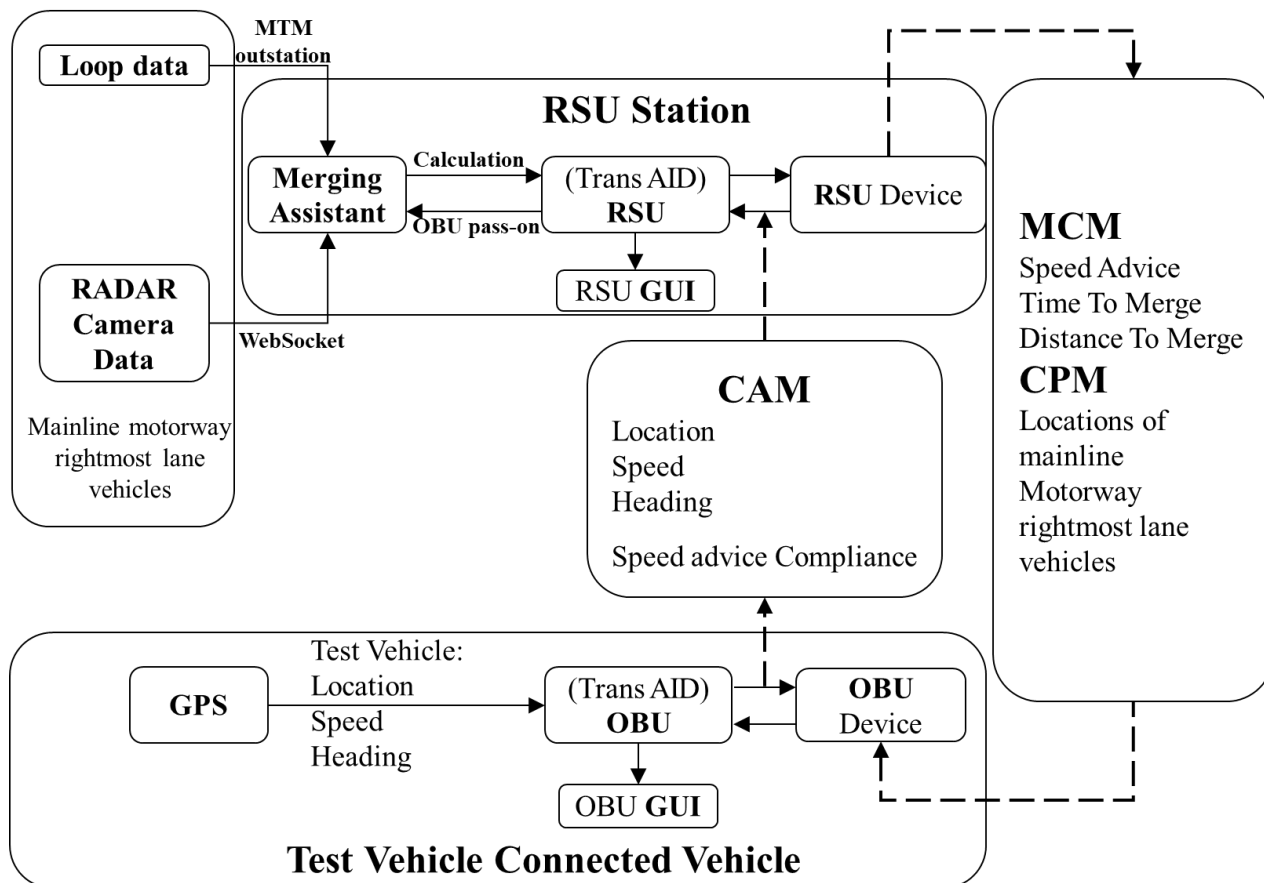


Figure 60: System architecture design presenting components interfaces

In Figure 60, the A13 mainline highway rightmost lane vehicles’ position and speed are detected from 1st and 2nd set of loops. These loop detector vehicle data are retrieved from the MTM outstation and among these data, the vehicle data on the mainline highway rightmost lane are passed onto the Merging Assistant. The mainline highway vehicle data are also detected later via virtual radar loops and virtual video loops of TrafirADAR camera. These two input data methods and the data fusion model (on the merging assistant end) aim to refine and augment the mainline highway vehicle data right before the first merging point, so that the accurate speeds and positions of the highway rightmost lane vehicles can be updated and therefore potential gaps can be precisely predicted by the Merging Assistant every timestep (100 ms).

The data flow between the Merging Assistant and the TransAID RSU is bidirectional. On the bottom, the test vehicle location, speed and heading originated from GPS are passed onto the TransAID OBU, encoded into CAM messages, sent to TransAID RSU (via 802.11p) and decoded for the Merging Assistant in order to take the concurrently updating test vehicle position, speed and heading into consideration.

With the test vehicle data and refined mainline highway vehicle data, the Merging Assistant application is able to calculate the speed advice, time-to-merge and distance-to-merge for the test vehicle. The merging assistant also calculates the speed advice, time-to-merge and distance-to-merge for the test vehicle. The speed advice is sent to TransAID RSU, encoded and transmitted to TransAID OBU in the form of MCM messages. The TransAID OBU receives the MCM messages, decodes them and shows the speed advice, time-to-merge and distance-to-merge on the in-vehicle HMI to the drivers, see Figure 66. The second driver shall feedback the first driver’s acceptance or rejection via the HMI. These feedbacks of speed advice compliance are conveyed to the TransAID RSU via CAM messages and passed onto the Merging Assistant to adjust the test vehicle positions

in the Merging Assistant calculation for the next time step, until the successful merge of the test vehicle.

3.1.3 Vehicles

During the prototype demonstration, two vehicles are directly used in the tests: a Cooperative Vehicle equipped with customised components (mentioned in section 3.1.2) driving the designed route (see Figure 59 in section 3.1.1), and a Legacy Vehicle (hosting mobile RSU station) in stationary position parallel to the highway.

This section briefly describes the sensors at the vehicle side and the temporarily equipped CV used as the test vehicle during the demonstration.

3.1.3.1 Vehicle facilitation process

Two of the distinct characters of use case 2.1 prototype demonstration are as follows: a) the tests are performed on public road (A13 Highway) with real time interactions with all other vehicle types (mostly LVs at the time of tests). Before and during the tests, the observed composition of vehicles is passenger car, heavy duty and light duty vehicles; b) use case 2.1 is envisioned as high-speed merging from on-ramp to highway. The speed limit on the A13 Highway is 100km/h and lowered to 80km/h in the month of the demonstration.

Based on these two characters, there are limitations to the type of vehicles that can be used during the highway entering manoeuvre. As consequence, an automated vehicle is excluded to be used for use case 2.1 as it is not allowed to perform high-speed merging task under automation mode. In addition, the disturbance caused by the driving behaviour of the test vehicle should be controlled within little to neglectable level.

Therefore, a Dymiq vehicle (Type: Passenger car, Ford Fiesta) undergoes facilitation process and equipped the test vehicle for the demonstration. Following the vehicle type discussion in TransAID, this vehicle (before facilitation process) should be categorized as LV since it is a passenger car with only human driver, no automation function and no V2X communication capability.

To prepare the test vehicle to a cooperative vehicle, it is then equipped with one integrated test box (including ITS-G5 research version OBU, antenna, laptops, inverters, cables etc.). The preparation aims to equip the test vehicle to a CV with capability of communicating its position, speed, acceleration, and direction via vehicular communication. So, the ITS-G5 OBU on the back of the test vehicle is responsible of sending, receiving and de/encoding messages with the ITS-G5 RSU (in the mobile RSU station) via device-to-device channel.

The GPS antenna is installed on the rooftop of the test vehicle and connected to the integrated test box on the backseat, see Figure 61. The connection establishment and functional range of the antenna were tested in the laboratory and on the public road during pre-test days.

On the passenger seat, a laptop is setup, connected to the integrated test box on the backseat and controlled by the second driver. The laptop display shows the in-vehicle HMI with speed advice, time to merge and distance to merge. The test vehicle is also equipped with cellular network and google map application for accurate speed and route following for the driver and second driver.



Figure 61: Vehicle facilitation details of the test vehicle (in/outside of the test vehicle, test day)

To serve as a mobile RSU station, a service van undergoes facilitation process to host RSI equipment. This vehicle is stationary during the test runs. It is located on the unpaved area behind the safety barriers of the acceleration lane. Therefore, the automotive properties of the vehicle are out of discussion scope. Entities mentioned in section 3.1.2, such as the merging assistant, the TransAID RSU, and the peripheral components are hosted in this vehicle. Figure 62 shows the relative location of the test vehicle and the RSU station during the demonstration.



Figure 62: A service van facilitated to a mobile RSU station

3.1.3.2 Sensors and Sensor Fusion

For the sensors on the vehicle side, no integration/modification to the vehicle sensors has been performed on the test vehicle. Since the test vehicle is not required to be an automated vehicle for use case 2.1 demonstration, vehicle sensors were not involved in the sensor fusion process.

As use case 2.1 is also designed for CAVs on the on-ramp and the merging assistant was targeting both CVs and CAVs on the on-ramp, it would be an interesting future research topic to use CAVs in automation mode on the public road for field demonstration, under the precondition of permission from road authority. In that case, the various sensors on a CAV could be instrumental for traffic

situational perception integration at the detection-level or track-level, hence for the cooperative behaviour of highway merging in TA zone as well.

One point that needs to be stressed is that the test vehicle is equipped with an On-board Unit and GPS antenna, see Figure 61. The GPS antenna is installed on the test vehicle rooftop for best signal reception. The GPS location of the test vehicle is therefore updated, sent via CAM messages every 100ms from the OBU on the test vehicle to the RSU. The test vehicle location data is fused with the loop detector data and the camera data, which generate the input for merging assistant calculation. The sensor fusion will be discussed in details in section 3.1.4.1.

3.1.4 Road Side

3.1.4.1 Sensors and Sensor Fusion

This section recapitulates the approach chosen in TransAID for the sensor fusion in use case 2.1 prototype demonstration. While details of sensor fusion for use case 2.1 simulation was discussed in section 2.2.1.1.1 in D5.2 [5], this section summarizes the operations and integrations of the road infrastructure at highways with C-ITS data, camera sensor fusion and inductive loop data.

As indicated in Figure 10 of D5.2, the base model of sensor fusion starts with creating vehicles once real traffic touches loop detectors on the mainline highway. The entry data was retrieved from MTM outstation - the operational system of the road network in the Netherlands. In most cases, these entry data are sent to a centralized traffic management system. Dynniq set up a connection from its data server centre to this system and the RSI (the mobile RSU station in the public road tests) subscribes the relevant data (the vehicle data passing the two sets loop detectors). In the public road demonstration, two sets of inductive loop detectors were used (positions in Figure 59, bottom), which were initially intended due to the long stretch of the highway merging area and the high-speed lane change manoeuvres.

The positions of the loop detectors are extremely important, especially the 2nd set of loops (50m to the first possible merging point) in these tests. Consider the traffic data from the 1st set of loops as entry data for creation of vehicles in the base queue model of the merging assistant, the traffic data from the 2nd set of loops are more accurate as there is only 50m left to reach the first merging point. And it creates/adjusts vehicle data in the enriched queue model. It is worth mentioning that the 1st set of loops is still important, as it provides the initial creation of vehicles and start the whole process of advice calculation and communication of the merging assistant, which is an essential “warming up” phase for the entire prototype system. Besides utilizing the loop detection data in the base model, the RSU also relies the highway vehicle data to the OBU via CPM messages, the positions of the mainline vehicles can be displayed on the in-vehicle HMI.

The on-ramp CV data such as position, speed etc. are already transmitted via CAM messages to the RSU once the CV on the on-ramp is within communication range of the RSU. The measured distance on the public road is 250 meters from the start of the on-ramp to the RSU location on the curvature topology, and 420 meters from the RSU to the end of acceleration lane. It is also observed during the tests that these distances are within the ITS-G5 communication range. The CV data is fused into the enriched model and from that point forward, the merging assistant can give sensible speed advice to the on-ramp CV.

The camera data was intended to be the last step to complete the enriched model and correct the data taken the speed change and lane change on the mainline highway into account. The results from the pre-test day shows that this part gave out sub-optimal data updates:

1. The position of the camera is originally chosen to be under the overpass bridge but didn't go through due to safety work regulation and none-closing of public highway commitment.

2. The camera is installed on the light pole besides the highway (20 meters upstream of the first possible merging point). Due to the installation height of the camera and height of HGV/LGV, it is observed that passenger cars' data is obscured when an HGV/LGV is passing at this location on the mainline highway rightmost lane.

3. To configure the camera before the test, some in-lab study has been performed which may cause the camera outside shield air leakage. It is also observed after installation on the public road that the lens begins to gradually form a fog layer that impede the process of camera data fusion to the enriched model.

Since the 2nd set of loop detectors are 30 meters upstream to the camera, and the loop detectors are more reliable, the final data fusion model during the test day was modified to be used but not to correct enriched model. As the loop detector is on average 95-99% accurate, a mitigation measure was taken to configure the potential gap to a conservative value of 2.8 second.

3.1.4.2 Traffic Management System

Considering the complexity of high-speed merging manoeuvre on this stretch of daily commute highway, we assume the CAVs cannot perform the task in automation mode without noticeable disturbance to the real traffic on the acceleration lane. If the CAV cannot autonomously perform the merging manoeuvre, it will issue a ToC that after a lead time of 10s will result in an MRM if the human driver does not take back control. The need for a centralized traffic management system is explained in detail in D4.2 [11].

The entire traffic management system of use case 2.1 is realised through the merging assistant system built from merging assistant algorithm. In the simulation studies of use case 2.1 in WP4 and WP6, the traffic management system is extended to target both C(A)V_s and LV_s (with intelligent ramp meter) on the on-ramp, and to even target C(A)V_s on the mainline highway for cooperative gap creation in the future. Figure 6 shows the schematic of mixed traffic highway merging under the highest-enforced traffic management control.

Adding an intelligent ramp metering to hold vehicles on the on-ramp is strong enforcement, it can be beneficial in the following situation:

1. TM assisting safe merging of C(A)V_s and LV_s when no suitable gap can be found a) via status quo traffic propagation, b) via speed and lane advice to the on-ramp vehicle, c) via speed and lane advice to the mainline rightmost lane vehicle.
2. TM reaching out to LV_s on the on-ramp and improving cooperative merging behaviour.
3. TM can set a certain traffic flow target that dynamically increases the gap tolerances until the target flow is reached.

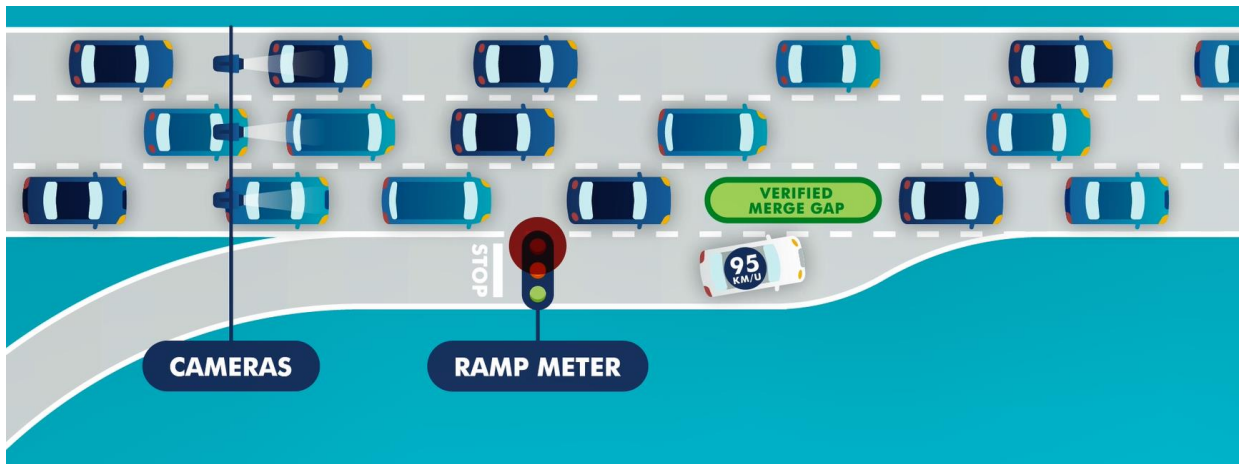


Figure 63: Visualisation of the highest-enforced traffic management system in TA zone.

For the public road implementation in WP7, the traffic management system has the following limitations to be carried out completely as it had in the simulations.

- a) The integration of merging assistant algorithm to a ramp meter still needs vast amount of work to bring out another prototype implementation element.
- b) The penetration of C(A)V's on the current public road (mainline highway) is nearly impossible without closing the A13 highway (therefore no real-time traffic).

The traffic management system undergoes several simplifications for public road prototype, see Figure 64. The system is a single code base (written in Java). The tracking sensor is designed as the road side camera, but the data fusion during public road tests only kept the checking function and not the data correction/augmentation function. The details of how to implement the traffic management system is explained in the upper half of Figure 60 in section 3.1.2.

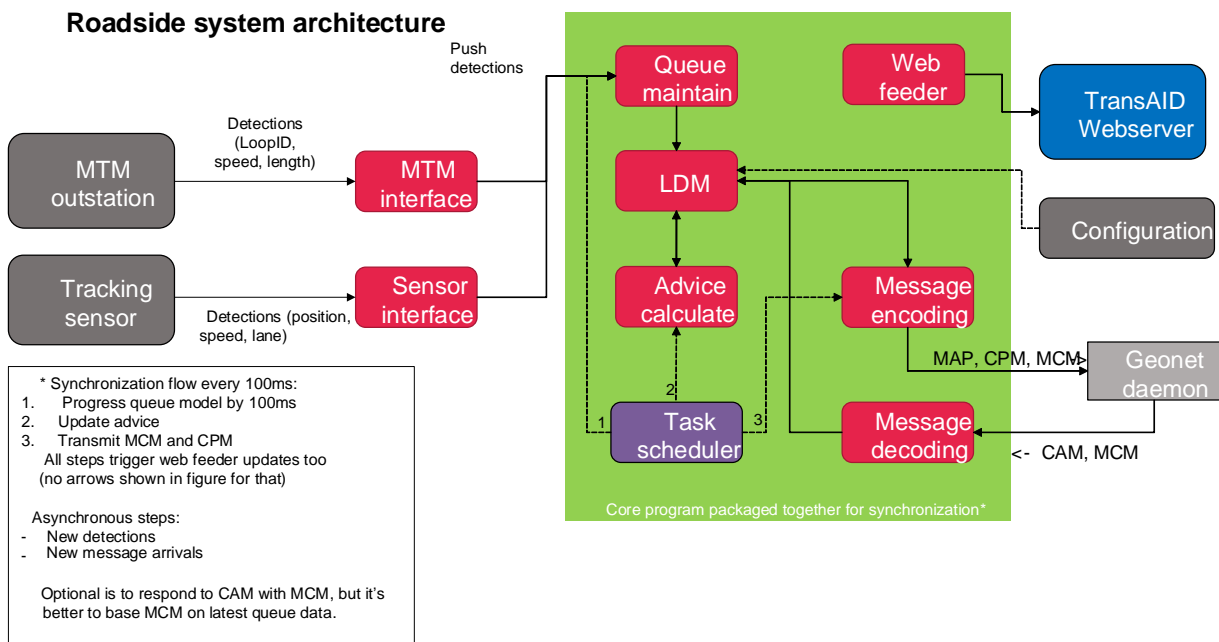


Figure 64: Road side architecture simplification of the merging assistant application

3.1.5 Debugging HMI

This section summarizes the debugging HMI methods designed for both simulation and prototype demonstration. Based on the user experience on the public road during the pre-testing and testing days, a general analysis will be given on the in-vehicle HMI and the road side HMI displays.

Figure 65 shows the debugging HMI on the road side computer. The upper graph shows a GUI with 2D vehicles (side view) representation on the on-ramp and on the mainline highway (lanes are grey colour with borrowed naming convention from the simulation: onramp, Outer and Inner). This was a snapshot of the test day, where only one test vehicle (CV) is showing on the onramp of the GUI and the vehicles on the three-lane mainline highway reflect real time traffic. The GUI was designed in simulations of WP4 and WP6, where its monitoring purpose was helpful in the merging assistant system development. Due to the single code character of the merging assistant, it was relatively easy to integrate to the prototype when traffic data is fused. The GUI is a simple tool to monitor the propagation of real time traffic including the on-ramp test vehicle. During the pre-test and test days, it was also used to counter the latency of network data and the adjustment of configuration onsite, in order to calculate an optimal speed/lane advice prediction by the merging assistant.

The lower graph of Figure 65 was designed for the prototype demonstration during the final event. It is a road side HMI showing the advice to the test vehicle, status of the test vehicle and merging manoeuvres of the on-ramp vehicle. On the bottom graph, all blue vehicles are real time traffic (retrieved from two sets of loop detectors and camera) on the highway rightmost lane and the only red vehicle on the acceleration lane is the test vehicle. Due to the COVID-19 pandemic, the demonstration during the final event was cancelled, and a video was produced instead. It was decided that the road side HMI showing on a LED board was not necessary with no audience and may even cause behaviours changes of real traffic on the public road. Instead, the road side HMI is shown on the road side computer to check if the merging assistant system was working and displaying as planned.

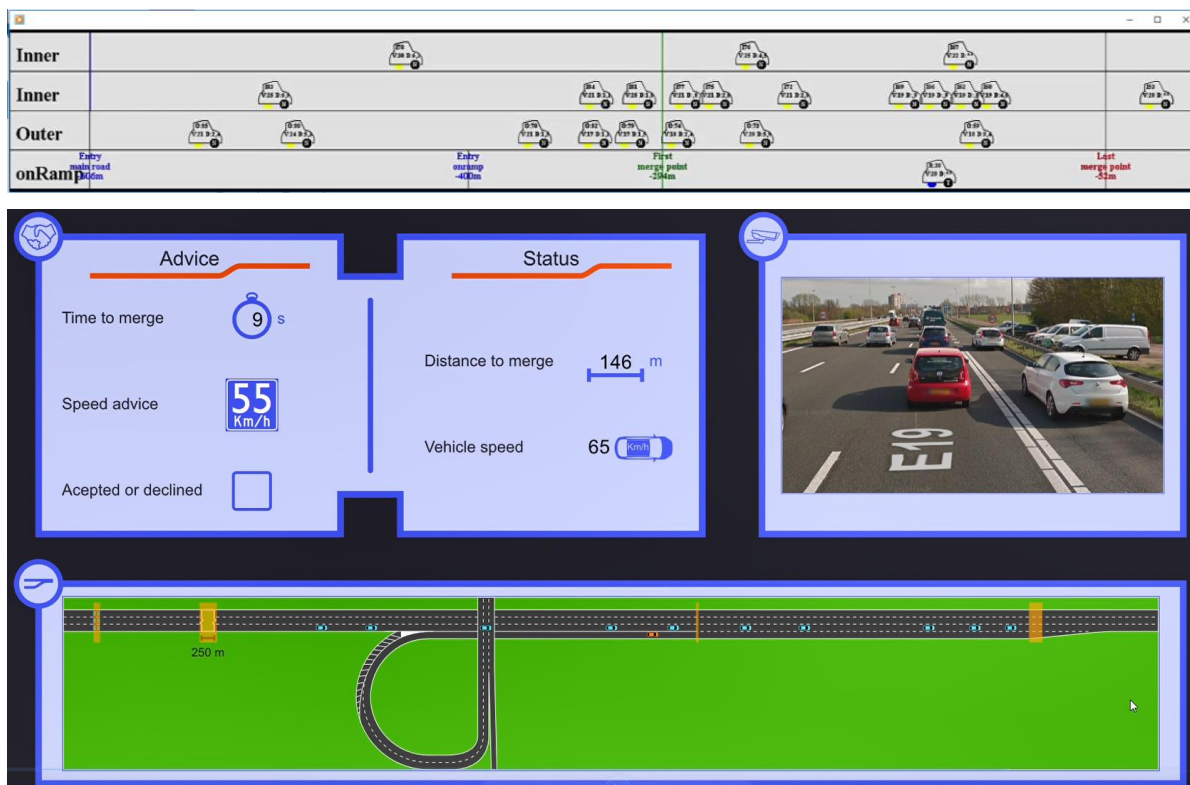


Figure 65: The road side HMI displaying on the road side computer

The experience from the pre-test and test days showed that these debugging HMIs are sufficient for implementation and operation for the public road prototype testing. It is visual friendly to check on the GUI and HMI displays instead of extrapolating needed information from the capture log afterwards.

At the CV side (see Figure 66), the merging assistant information is also displayed (time to merge, speed advice, and distance to merge). The driver can manually accept or reject the advice (one-push button, see mouse arrow in Figure 66) and this ACK/NACK is reported to the RSI via V2X messages. In addition, the HMI shows, using a vertical red bar, the current speed of the vehicle (yellow arrow) and whether it is within the suggested speed (green bar). Besides, a graphical representation of the zoomed-in merging segment (comparing to Figure 65) is displayed. Following the guidance of the In-vehicle HMI, the driver in the on-ramp test vehicle should aim for the middle of the green stripe.

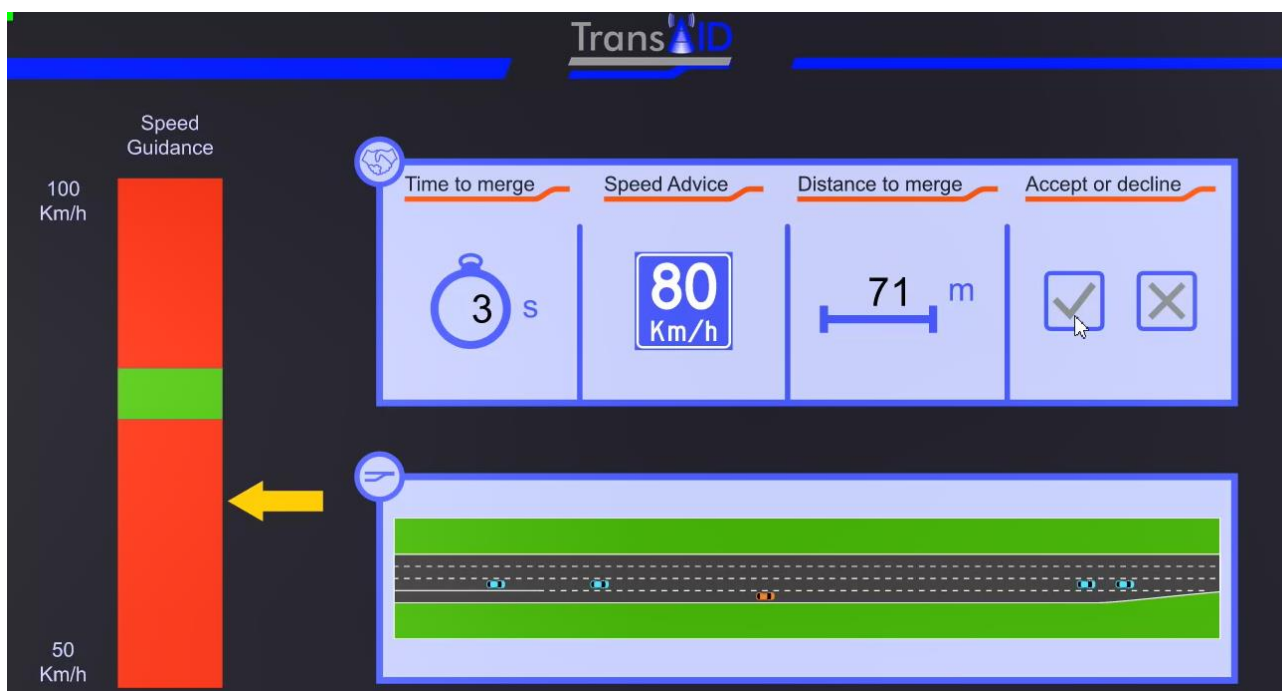


Figure 66: In-vehicle HMI displaying on in-vehicle computer

This In-vehicle HMI is the most intuitive representation to visualize the application on devices close to the road user/passenger. It is also helpful to use in the onsite setup, configuration and speed advice following tests. As TransAID is neither investigating state-of-the-art debugging HMI nor application display, the mentioned debugging methods are fast and intuitive onsite but strictly speaking, only works for functionality and feasibility checks and lacks precision.

3.1.6 Communication

Before integration of OBU and RSU radio into the use case 2.1 prototype, an emulation platform was built in-lab to check the communication mechanism in the prototype. This section explains how the communication mechanism of use case 2.1 was tested before field integration.

The communication channel was shown in the system architecture in section 3.1.2. To achieve and ensure its work mechanism in the field test, an emulation platform (see Figure 68) was created that integrates all software components into a virtual radio network. The hardware of OBU and RSU radio was substituted with docker platform running on laptops to mimic device units with communication capability. The objective is to test the integrated platform and modulated components' functionalities before setting up and configure the field test onsite. With live traffic

data (blue rectangles in Figure 67) from inductive loops on the highway, a key indicator is whether the message transmission is successful and MCM-based speed advice is accurate. Empirical results of the emulation showed the test vehicle (blue dot in Figure 67) was able to merge smoothly into the mainline highway without ToC/MRM if it follows the speed advice.



Figure 67: Use case 2.1 emulation platform display (road layout: OpenStreet map)

With proven feasibility in the emulation, the virtual radio network in the development phase is ported into field tests: laptop components in Figure 68 are swapped with OBU and RSU devices for the field test; they are then implemented on the test vehicle and RSU station. These OBU and RSU devices are ITS-G5 communication units with built-in communication engines and Geonet Daemons (supporting raw binary messages exchange).

The emulation platform is customised for the public road tests and sufficient to check the working mechanism of communication channel without labour onsite. It is sufficient in prototype of use case 2.1, but may not be applicable in other use cases when communication is much more complex.

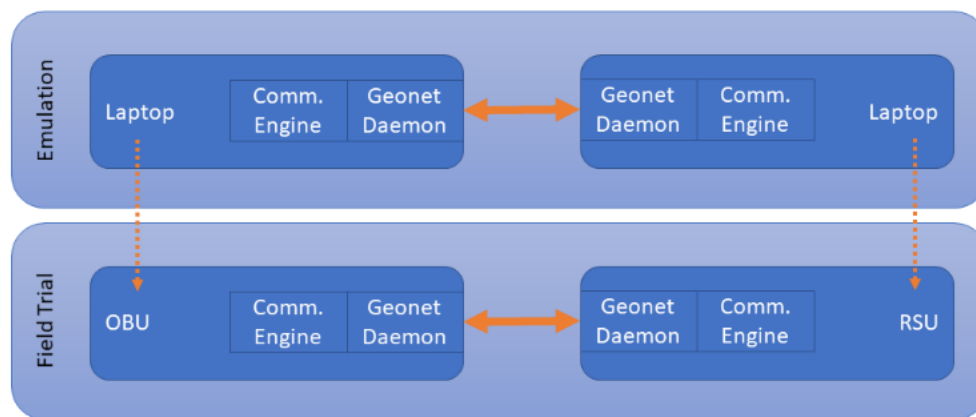


Figure 68: Emulation platform and public road test adaptation

3.2 Feasibility assessment

3.2.1 Public road use case 2.1 script and requirements overview

This section details the tests conducted to demonstrate the feasibility of the TransAID *Service 2 – Prevent ToC/MRM by providing speed, headway and/or lane advice*. In particular, the tests are conducted following the use case (UC) 2.1 that focuses on highway merge segments. Table 3

summarizes the test plan and present the scenario script. The possible requirements (general and use case specific) that are proposed in section 2.2 are also examined in this table.

Table 3: Use case 2.1 script and requirements overview

Goal	Demonstrate a test vehicle (CV) merging to mainline highway with the speed and lane advice provided by merging assistant application. The application targets potential merging gaps on the rightmost lane of mainline highway, and results to a smooth highway entering behaviour among all other real-time traffic.
Used vehicles	CV (DylnniqPoolAuto), Real-time traffic (All other vehicles passing through the highway entering area during the period of test vehicle merging)
Used infrastructure	Pole with FLIR camera (radar camera), mobile RSU station (DylnniqServiceVan)
Used messages	CAM, CPM, MCM
Risk Mitigation	CPM does not work → No variation necessary CAM, MCM do not work → The test vehicle driver performs driving task regardless of speed and lane provided by the application
Speed Limit	80km/h on the highway 0km/h ~ 80km/h on the on-ramp and acceleration lane (Test vehicle starts at the beginning point by the right-turn traffic light approximately at 0km/h ~ 30km/h. Considering conservative vehicle speed in curved-shape on-ramp, the test vehicle should accelerate gradually to the advised speed. When time-to-merge and distance-to-merge reach “0” (also confirmed by the lane advice), the test vehicle should perform lane change.)
Beginning point	Right-turn traffic light heads 61.1, 61.2, 61.4 (End of ViaductDoenkade/ X=0, on-ramp)
Initial situation	Test Vehicle waiting for traffic light turning green at X=0, on-ramp (51.949950, 4.415679), or test vehicle passing through green phase without stopping
Scenario script	<ol style="list-style-type: none"> 1. Dylnniq lab: Open black box and short explanation before setting them up in Mobile RSU station (DylnniqServiceVan) and Test vehicle (DylnniqPoolAuto). 2. Dylnniq office: Explain the test and the expected results using system architecture. 3. Test vehicle (DylnniqPoolAuto) and Mobile RSU station (DylnniqServiceVan) drive to the beginning location of highway entering scenario on A13 side road. 4. Setup and preparation on public road test location. 5. All system testing check and ready. 6. Loop data receiving and checking before used as inputs of merging assistant. 7. The test vehicle goes to the beginning point X=0, on-ramp. 8. RSU receives CAM from OBU and merging Assistant calculate speed







	<p>advice.</p> <p>9. MCM message is generated every 100ms with the speed and lane advice and sent from RSU to OBU.</p> <p>10. The second driver on the test vehicle communicates speed and lane advice with the driver; the driver makes decisions and communicates with the second driver.</p> <p>11. The three scenarios in section 3.1.1 (See the three possible scenarios identification in section 3.1.1) must be identified and performed under safety pre-conditions.</p> <p>12. The second driver feedbacks the verbal decision from the driver via in-vehicle HMI interface. CAM message is generated to be able to acknowledge the speed compliance.</p> <p>13. Merging task is being performed and being filmed from outside and inside. Voice-over for interface explanation is performed by the second driver and testing crew by the Mobile RSU station during the merging task.</p> <p>14. Repeat the test route.</p>
Repetitions	Plan to be ca. 10 times. (9 times during test day)
Video Recording	<p>Entire prototype testing period</p> <p>Inside/outside of the test vehicle (Go-pro camera)</p> <p>Outside Mobile RSU station (cameraman and TrafiRADAR camera)</p> <p>Dynniq office (black box opening shoot)</p>
Logging	<p>Testing process logging with camera</p> <p>Screen recordings of OBU and RSU (displaying laptops)</p>
Associated to Requirement(s) in addition to generic requirements	<p>General requirements: REQ_V_G_5, REQ_V_G_8, REQ_I_G_1, REQ_I_G_2, REQ_I_G_3, REQ_I_G_4, REQ_I_G_5</p> <p>Additional requirements (Use case specific): REQ_V_I2_S2.1_1, REQ_V_I2_S2.1_2, REQ_I_I2_S2.1_1, REQ_I_I2_S2.1_2</p>


3.2.2 Feasibility results

Due to the outbreak of Corona virus in 2020 HMETC personnel were not able to visit the Dynniq test-site for the feasibility assessment. Instead both parties agreed to use video recordings of the test-site and the demo application to check and rate the demo implementation. Additional questions were raised and answered after the video recordings were finalized. This limits the rating possibilities since a deeper-analysis of raw data is not possible when not being present on the test-site.





3.2.2.1 Requirements verification

The following table shows the verification of general requirements.

	General requirement description	Req. Name	Associated Test cases successfully executed	Notes
Vehicle requirements	<p><i>Communication and message sets</i></p> <p>As TransAID is relying on V2X communication based on the ETSI ITS-G5 radio access technology and its associated ETSI ITS standards, each cooperative vehicle has to be equipped with the appropriate hard- and software to receive and send dedicated messages on the given channels.</p>	REQ_V_G_5		Communication is implemented following the designed TransAID message sets.
	<p><i>HMI availability for CVs</i></p> <p>Task 5.5 describes signalling for legacy and cooperative vehicles, including signalling inside the vehicle. For this, the vehicle needs to have an HMI available. This will most likely be an Android smartphone connected to the OBU.</p>	REQ_V_G_8		A debugging HMI was used in the CV
	<p><i>Communication and message sets</i></p> <p>It is a mandatory requirement for the infrastructure to be able to communicate advice to the vehicles by using ETSI ITS-G5 based V2X communication. In addition, the reception of messages is also needed to get a better image of the situation, e.g. by knowing the exact positions of cooperative vehicles and their plans, as well as knowledge of other non-cooperative vehicles' presence.</p> <p>To avoid extensive forwarding of messages, different road side units shall be linked to each other. While this is a general requirement, it will not be used during the feasibility assessment, as there will always be only one single road side unit available.</p> <p>Furthermore, the infrastructure needs the ability to communicate decisions to non-cooperative vehicles as well. This can be done by for instance Variable Message Signs. Possible additional methods are to be developed within WP4 and WP5.</p>	REQ_I_G_1		<p>Communication is implemented following the designed TransAID message sets.</p> <p>Communications via VMS to legacy vehicle is out of scope for this demonstration</p>
Infrastructure requirements	<p><i>Sensors</i></p> <p>In most cases, the infrastructure also needs to know where all non-cooperative vehicles are. Therefore, sensors to detect vehicle positions are a mandatory requirement. While the sensor can be of any kind, cameras are foreseen to be the best option, as they offer not only vehicle positions, but also more details, like the orientation and speed.</p>	REQ_I_G_2		A camera was able to detect and track objects.
	<p><i>Sensor data fusion</i></p> <p>As for the vehicles, also the infrastructure needs to perform a sensor data fusion, e.g. to understand that a vehicle detected by a camera is also transmitting messages.</p>	REQ_I_G_3		The infrastructure data fusion worked correctly
	<p><i>Processing capabilities</i></p> <p>The infrastructure needs to be able to compute several inputs to generate correct traffic management measures. Therefore, the infrastructure needs to include adequate processing capabilities.</p>	REQ_I_G_4		Processing was possible without any shortcomings.

	If the sensors need further processing capabilities e.g. to calculate object positions and dimensions, this needs to be included as well.			
	<p><i>Road networks</i></p> <p>The different use cases will need different road network topologies to be taken into account. The road networks need to be available logically so that the infrastructure is able to plan on top of it.</p>	REQ_I_G_5		The used road network was included in the infrastructure as well

In addition, there are service-specific requirements which need to be fulfilled. The following table shows the service-specific requirements verification.

Service-specific requirement description		Req. Name	Associated Test cases successfully executed	Notes
<i>Vehicle requirements</i>	<p><i>Speed advice following</i></p> <p>The CAVs/CVs need to be able to receive speed advice from the infrastructure. In case of a CAV, the advice needs to be taken into account during trajectory planning, although the vehicle automation itself has the right to overrule the advice. In case of a CV, the speed advice is forwarded to the driver with an appropriate HMI.</p>	REQ_V_I2_S2.1_1		Speed advice received and followed by test driver.
	<p><i>Lane advice following</i></p> <p>Also, lane advice needs to be received and taken into account in the same way then speed advice.</p>	REQ_V_I2_S2.1_2		Lane advice received and followed by test driver
<i>Infrastructure requirements</i>	<p><i>Speed and lane advice generation</i></p> <p>The infrastructure must be able to generate speed and lane advice based on the detected situation and disseminate them using an RSU.</p>	REQ_I_I2_S2.1_1		RSU generated advices that was received by test vehicle.
	<p><i>Sensors</i></p> <p>This use case requires very precise detection of vehicles and vehicle behaviour, as probable gaps have to be estimated early enough to provide appropriate advice to the vehicles.</p>	REQ_I_I1_S2.1_2		RSU with dedicated camera detected surrounding objects (road users) and used this information for advice calculation as well as transmitted these using CPMs

3.2.2.2 User experience

This section explains what the general experience and feeling were when applying the services in real life from a car passenger/driver perspective, in order to understand if it is something that can be sold to OEMs customers.

It is important to highlight that Dynniq’s implementation is an experimental platform used to test and validate technical developments suitable for a CAV using a CV. As such it and not primarily meant to address perfect user experience. As mentioned before, in the performed integration sprint and demonstration the main objective was to show primarily the cooperative interaction between a connected car and the road infrastructure as well as emulation of an automated implementation of infrastructure advice.

The test vehicle successfully entered the highway and was able to communicate with the infrastructure to safely merge into the highway. Even in dense traffic situations, a safe highway

merge was possible. The test vehicles driving behaviour resulted in a safe and comfortable ride for passengers.

- In general, the suggested acceleration (or deceleration) values were as expected comparable to a (normal) comfortable not aggressive driving style.
- A debug HMI for the CV showing advices to the second driver executed by the driver (on behalf of an automated system) as well as an HMI for the road infrastructure to observe and monitor the CV reactions and other road users was used to execute the test cases.

From an OEM perspective, potential areas for improvements can be seen in the HMI area, the reader should be aware that the used (debug) HMI is not in scope of TransAID:

- No indication of system status: automated driving vs. manual driving. A light blue colour (background or as a thick borderline) could support indication of the system status (even if emulated) or and the availability of the lane merging system for the upcoming carriageway.
- For an in-vehicle usage an integration of messages is required (for example in the cluster display), were the driver is able to accept or reject the lane merge manoeuvre using a steering wheel button for example.
- A hysteresis should be applied where it is possible to avoid fast changes of the suggested speed.
- Audible commands or sounds could further improve the system usage

3.2.2.3 Check of overall feasibility

This section considers the results of the requirements verification and of the user experience and derive conclusion on overall feasibility. Also, it justifies if a given service is feasible/applicable in real-world implementation scenarios and why.

All test scenarios have been tested successfully and validate the feasibility of these functionalities in support to the TransAID traffic management strategy. A larger-scale test setup, using multiple CAVs/CVs, would be interesting in order to assess the impact on traffic flow. Room for improvement is seen in the V2X area. As highlighted above, not always the latest V2X specifications from TransAID are used.

Overall, the implementation looks feasible from an OEMs point of view with the due corrections in terms of V2X to guarantee interoperability.

4 Detailed assessment of CAV behaviour at Safe Spots

This section describes a detailed assessment of the TransAID combined services 4 and 5 (UC4.1-5) performed by HMETC in combination with UMH. The infrastructure uses MCM messages to assist CAVs with indications on where and when to execute a ToC, and with information about the presence and location of safe spots where to stop in case of MRM. The implemented prototypes are used to demonstrate the feasibility of integrating the TransAID communication protocols realized by UMH into an HMETC CAV prototype of much reduced automation capabilities with respect to the DLR ones. Yet this integration proves the effectiveness of TransAID’s “Distribute ToC and Manage ToC” traffic management measures, as well as their advantages compared to a baseline scheme where CAVs receive DENMs from the RSU with which they are only informed about the presence and location of a critical situation downstream.

4.1 Prototype architecture

In the following, the prototype for this evaluation is described. The evaluation platform consists of one RSI and one CAV (Figure 69).

Figure 70 shows the logical architecture of the platform.



Figure 69: CAV and RSI prototypes

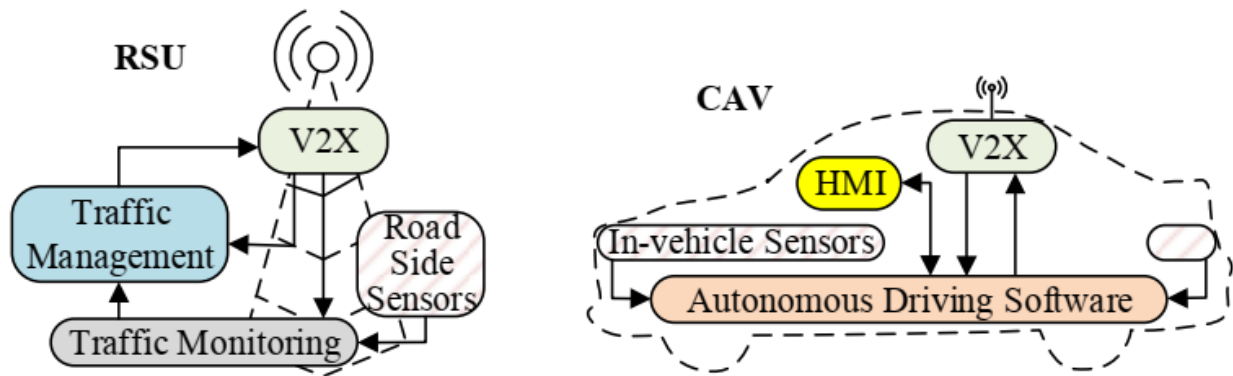


Figure 70: Prototype architecture

The RSI and CAVs communicate using commercial ITS-G5 enabled V2X devices. The RSI can fuse the information received through the V2X communication with other sensors to execute traffic monitoring. At the Traffic Management module, the RSI implements the traffic management measures. Via V2X, the Traffic Management module sends information (e.g. suggestions or advisories about how to handle a ToC) to create the V2X messages that are used to support the CAVs.

The CAV combines the V2X messages received from the RSI with the data collected from built-in sensors. This combination is performed at the Sensor Data Fusion module that provides the processed data to the Automated Driving Software (AD SW) module. The AD SW uses this input information as well as direct V2X information to interpret the environment and to plan the behaviour of the automation, including the planning of trajectories. These driving commands are implemented in the Actuators module. The developed platform includes also an interface between the driver and the AD SW. This is implemented through the Human-Machine-Interface (HMI) module that offers output of visual, acoustic and haptic feedback as well as input of manual control commands including the enabling and disabling of vehicle automation functions. Finally, the AD SW includes also an interface to the V2X Communications module. This interface is used to pass information that is used to create the V2X messages that the CAV will transmit together with the data gathered by other infrastructure.

4.1.1 Vehicle

A KIA Niro (Figure 69) already existing at HMETC is equipped with a reduced automation system. An OBU (On Board Unit) for V2X communications and a Mobileye camera system are integrating parts of it. The implemented CAV uses the Polysync DriveKit as the interface between the developed autonomous driving software and the vehicle. Through the Polysync interface, it is possible to control the vehicle's acceleration, braking and steering via CAN (Controller Area Network) messages. The Polysync DriveKit also allows a safety driver to take back the control of the vehicle as soon as it presses a pedal or turns the steering wheel. The autonomous operations of the CAV are also subject to the information received through the V2X module and HMI.

4.1.1.1 Sensors and Sensor Fusion

For the purpose of this study, the automated functionalities of the CAV prototype are not requested to cope with planning and control in reaction to surrounding objects' detection and tracking. Automated vehicle behaviour in terms of ToC and MRM management was isolated from possible implications deriving from object detection. To execute automated lateral and longitudinal control,

the CAV prototype mostly relies on the Mobileye EPM4 front camera system as environmental sensing source. The Mobileye EPM4 is capable of processing road lane markings and transmitting them over the CAN bus. This information is utilized by the AD SW to implement the vehicle lateral control.

4.1.1.2 Vehicle Automation

The AD SW installed in the CAV prototype is the ROS2-based platform for self-driving cars. For longitudinal control, the vehicle adapts to a given speed and controls the acceleration and deceleration without losing the ability to perform an emergency brake. For the lateral control of the vehicle, the main goal is to keep the vehicle in between the road's lane markings. Besides longitudinal and lateral control, the AD SW executes manoeuvres in reaction to received V2X information. The distributed ROS architecture passes the received information (for example, a ToC request) to the Planning node. This node then schedules a set of ToC related actions that depends on the information received and whether the driver reacts or not to the ToC request. The AD SW issues the TOR to the driver via the HMI Node at the time indicated by the received information from V2X. If the driver does not react within a given time threshold, an MRM is executed. The AD SW is requested to coordinate different manoeuvres for the execution of the MRM. This includes: speed adaptation to an objective MRM speed, lane change to the emergency lane, and stop in a safe spot.

4.1.1.3 Communication

The V2X module at the CAV is implemented using a Cohda Wireless's MK5 OBU. The main developments in the implemented CAV's V2X module have also focused on a specific Application Layer. This Application Layer manages the transmission and reception of all V2X messages that support the infrastructure-assisted ToC management measures.

On the reception path, the V2X module's Application processes the received V2X messages (e.g. MCMs or DENMs). For MCMs, the ManeuverContainer is accessed to identify whether the message was originated by an RSU or another CAV. If it was originated by the RSU, the RSU SuggestedManeuverContainer is analyzed to identify whether it includes advices addressed to the receiving CAV. If this is not the case, the MCM message is discarded. If there are advices addressed to the receiving vehicle, or if the MCM was originated by another CAV, the relevant information is transmitted to the AD SW module. When DENMs are received, the implemented Application accesses the information and checks whether it is relevant to the CAV. If this is the case, the information is forwarded to the AD SW module.

On the transmission path, the V2X Application Layer receives from the AD SW information used to generate CAM and MCM messages to be sent to the RSU.

4.1.1.4 Debugging HMI

The CAV prototype implementation includes a simple HMI that is used to inform the driver about the current and upcoming events. A ruggedized display was attached to the CAV dashboard, which enables the test driver to quickly check the current system status. The display runs a small application. The application does not fulfil all rules and design guidelines of a series product but already addresses the need to avoid overloading the driver with information. A CAN message sent by the AD SW and processed internally by the application in the display is used to visualize the system status (e.g., TOR to the driver, MRM in execution) using various text messages, a countdown timer and a progress bar.

4.1.2 Road Side

4.1.2.1 Traffic Management and Monitoring System

Figure 70 shows that the Traffic Management module takes as inputs the CAM- and MCM-related information from CAVs, respectively, and additional information obtained from the Traffic Monitoring module. This information is utilized to generate the MCM advices that the RSU transmits using the V2X module. The information reported by the Traffic Monitoring module can be utilized, for example, to identify the location of the safe spots. For this RSU prototype implementation, this information is considered available at this module even though the RSU is not equipped with the necessary sensors to detect this. We implement an UDP interface from the Traffic Management module to the V2X module to send the MCM advices to the V2X module. The MCM VehicleManeuverContainer received at the Traffic Management module can also include an AdviceResponseList that CAVs utilize to acknowledge the previously received advices from the RSU. If this is the case, this list is taken into account at the ‘Implement MCM advices’ module to remove the already acknowledged advices

4.1.2.2 Communication

The V2X module of the RSI is implemented using a standard compliant Coda Wireless MK5 RSU (see Figure 70). A specific Application Layer has been developed in this study and added to the RSU V2X Module. This Application Layer implements the two compared infrastructure-assisted traffic management schemes and, manages the transmission and reception of all V2X messages.

Upon receiving messages from the CAV (MCM and CAM) the application decodes them. When a CAM is decoded, the application forwards the ID of the CAV that generated the message, its SAE level and its location information to the Traffic Management and Traffic Monitoring modules. For the received MCM messages, the information included in the VehicleManeuverContainer is forwarded.

On the transmission path, the V2X module’s Application receives information coming from the TrafficManagement module and uses it used to create an MCM RSUSuggestedManeuverContainer whenever an MCM has to be sent to a specific vehicle. Similarly, the TrafficManagement module can configure the DENM messages that are periodically transmitted.

4.2 Feasibility assessment

The evaluation aims at showing the advantages of the TransAID’s ToC management scheme compared to a baseline approach where CAVs receive DENMs from the infrastructure and are only informed about the presence and location of the no-AD zone downstream. In this baseline approach a CAV issues a TOR when in the DENM relevance zone, that is at a distance to the no-AD zone equal to a ‘relevance distance’ indicated in the DENM. As the relevance distance is a fixed value for all the vehicles, nearby-driving vehicles approaching the no-AD zone would execute the ToCs at approximately the same location. Executing ToCs at close locations implies risks, since drivers need some time to control adequately the vehicle after a period of inactivity [32]. In case of an MRM, CAVs shall decelerate and stop. In some situations, it might happen that a CAV performing an MRM has no other option than stopping on the driving lane since there are no parking spots available. However, this can block traffic and generate significant traffic risks. The TransAID approach relies on MCM extensions with which individual advisories can be sent by the RSI to the CAVs to inform them how to more safely and efficiently manage ToCs and safe spots: the RSI not only notifies about an upcoming ToC but also suggests a spatial distribution of ToCs over a wider Transition Area. This minimizes the risks that drivers recover control of their vehicles at close

distances when they have still not recovered full attention and their driving performance is lower. The MCM-based ToC management scheme also constantly suggests CAVs road sections with safe spots where to stop if drivers fail to take over. With this information, the CAV implements an MRM guiding to a free section of the parking lane. This prevents risks and blockage of the driving lanes.

4.2.1 Requirements of use case 4.1-5: Distributed safe spots along an urban corridor

4.2.1.1 Description of the use case from D2.2

The generic description of this use case is exactly the same as in Section 2.2.2.6.1.

4.2.1.2 Use case setup

Many tests have been performed based on different configurations to generate ToC and MRM suggestions at the RSI, as well as and handle them at the CAV. A complete description of these tests can be found in [33]. In the following, two representative configurations for both the baseline and the TransAID approach are described.

Field trials have been conducted at the proving ground of the Griesheim airport (Figure 71). During the tests, the CAV uses the airport's main runway that has two lanes. The runway has a total length of approximately 1 km and it has been (virtually) divided into a 700-meter zone where the CAV can drive autonomously and a 300-meter zone where AD is not allowed (no AD zone in Figure 71). The RSU is located at the start of the no AD zone. Figure xx shows the initial location of the CAV when the tests start. The CAV drives autonomously from this location and it reaches a target speed of 60 Km/h when it is 700m away to the no AD zone. The RSU informs the CAV that it should perform a ToC before reaching the no AD zone via DENM or MCM messages, respectively. Safe spots are available on the emergency lane next to the driving runway. These safe spots reflect, for example, free spaces between parked cars as indicated in Figure 56 (Section 2.2.2.6.1). For the sake of safety during the tests, safe spots are not obtained by parking real cars. Instead, the emergency lane is virtually divided into 25m-length sections that are randomly chosen as free or occupied in each test run. This random use case configuration is made available to the CAV and RSU over subsequent test runs. A safe spot is made of three consecutive free sections that allow the CAV to safely perform a lane change from the driving runway to the emergency lane and stop in case of MRM. For each test run, at least a safe spot is available in the scenario. The scenario illustrated in Figure 71 shows an example with one safe spot available at [75m, 150m]. It should be noted that the free section at [350, 375] would not be considered a safe spot to perform the lane change and stop since it is not long enough to safely do the MRM manoeuvre.

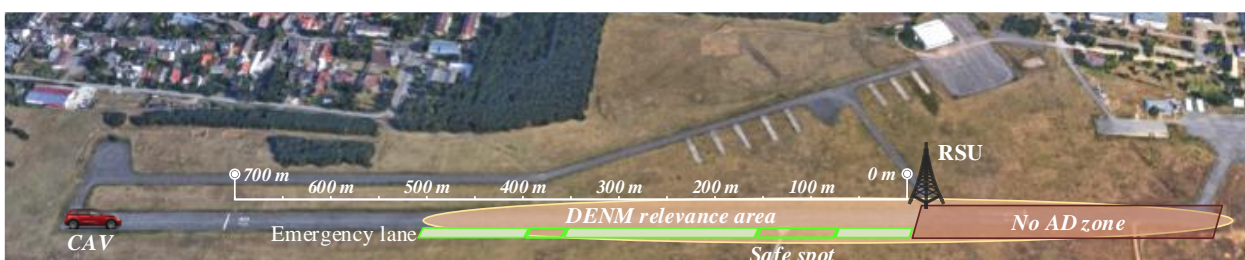


Figure 71: Aerial view of the Griesheim airport facilities in Griesheim (Hessen, Germany).

We consider that from the moment a ToC is requested, the driver has a lead time t_{TOR} of 10s to take over control before an MRM is executed. This is independent of the infrastructure-assisted

ToC management scheme under evaluation. During the TOR’s lead time, the CAV continues driving at 60 Km/h. This study considers that the driver does not intervene in time to a TOR and the CAV always executes an MRM. This is to investigate the impact on the traffic safety and efficiency of the execution of MRM when it is triggered by a DENM-based or MCM-based ToC management solutions. Another common configuration for the DENM-based and MCM-based ToC management schemes during the MRM is that the parking manoeuvre is performed at SpeedMRM that is set to 20Km/h. The CAV must slow-down from the driving speed (i.e., 60 Km/h) to SpeedMRM before executing the parking manoeuvre.

The RSI transmits DENMs periodically at 1Hz. A TOR is triggered at the receiving CAV upon entering the DENM relevance area (i.e., when reaching the 500m relevance distance). As the DENM does not indicate safe spot locations, this implementation assumes that the CAVs park on the emergency lane only if a safe spot is available when reaching the SpeedMRM. Otherwise, it stops on the driving lane. Besides DENMs, the RSI transmits MCMs including individual ToCAdvice and SafeSpot advisories to incoming CAVs to operate the MCM-based ToC management scheme. The RSI suggests a CAV to schedule the TOR execution so that it reaches the assigned safe spot driving the minimum possible distance at SpeedMRM. For doing this, the RSI first selects a safe spot for the CAV and considers its current location and driving speed (available through the CAMs) to identify the location where the TOR should be issued. When receiving the advisories, the CAV keeps its driving speed and triggers the TOR only at the advised ToC location. When the TOR’s lead time expires the CAV would slow down to SpeedMRM and drive a short distance before finding the suggested safe spot and smoothly executing the forward parking manoeuvre. Here, it is important to stress out that the RSI makes conservative calculations when selecting the locations where the TORs should be executed. It assumes an adequately large distance from the safe spot to account for the vehicle’s TOR lead time and deceleration profile.

4.2.1.2.1 Test scenario 4.1-5_0: “Baseline: ToC and MRM in reaction to DENM reception. No safe spot available when in MRM”

Goal	Demonstrate the effect of a ToC and MRM triggered in reaction to reception of a DENM informing about a non-AD zone ahead. This is a V2X Day-1 test case.
Used vehicles	HMETC Niro CAV
Used infrastructure	RSI
Used messages	DENM, CAM
Initial situation	HMETC Niro CAV starts on two-lane rural road, heading towards the no-AD zone at 60 Km/h.
Scenario script	<ol style="list-style-type: none"> 1. RSU broadcasts DENM::roadWorksAlert:: <ul style="list-style-type: none"> • RelevanceDistance • EventPosition 2. The CAV automation receives and processes the DENM and triggers a TOR upon entering the DENM relevance area (i.e. when reaching the 500m relevance distance from EventPosition).





	<div style="text-align: center;">  </div> <p>3. As the driver does not respond, the CAV triggers an MRM and slows down to speedMRM</p> <div style="text-align: center;">  </div> <p>4. As the CAV does not find a safe spot when reaching the speedMRM, it stops on the driving lane (see Figure 72).</p>
<p>Associated to Requirement(s) in addition to generic requirements</p>	<ul style="list-style-type: none"> • REQ_V_I2_S4.1-5_1 • REQ_I_I2_S4.1-5_2



Figure 72: Execution of a parking manoeuvre on the driven lane in reaction to a DENM reception when no safe spot is available

4.2.1.2.2 Test scenario 4.1-5_1: “Baseline: ToC and MRM in reaction to DENM reception. Safe spot available when in MRM”

Goal	Demonstrate the effect of a ToC and MRM triggered in reaction to reception of a DENM informing about a non-AD zone ahead. This is a V2X Day-1 test case.
Used vehicles	HMETC Niro CAV
Used infrastructure	RSI
Used messages	DENM, CAM
Initial situation	HMETC Niro CAV starts on two-lane rural road, heading towards the no-AD zone at 60 Km/h.
Scenario script	<ol style="list-style-type: none"> 1. RSU broadcasts DENM::roadWorksAlert:: <ul style="list-style-type: none"> • RelevanceDistance • EventPosition 2. The CAV automation receives and processes the DENM and triggers a TOR upon entering the DENM relevance area (i.e. when reaching the 500m relevance distance from EventPosition). <div data-bbox="475 1025 922 1326" style="text-align: center;">  </div> 3. As the driver does not respond, the CAV triggers a MRM and slows down to speedMRM <div data-bbox="475 1397 922 1697" style="text-align: center;">  </div> 4. As the CAV find a safe spot when reaching the speedMRM, it executes a lane change onto the emergency lane and stops
Associated to Requirement(s) in addition to generic requirements	<ul style="list-style-type: none"> • REQ_V_I2_S4.1-5_1 • REQ_I_I2_S4.1-5_2

4.2.1.2.3 Test scenario 4.1-5_2: “TransAID: ToC and MRM in reaction to MCM reception”

Goal	Demonstrate that infrastructure advice allows CAV to always execute an MRM more safely.
Used vehicles	HMETC Niro CAV
Used infrastructure	RSU
Used messages	CAM, MCM
Initial situation	HMETC Niro CAV starts on two-lane rural road, heading towards the no-AD zone at 60 Km/h.
Scenario script	<ol style="list-style-type: none"> 1. CAV sends CAM <ul style="list-style-type: none"> • Current automation level • stationID • current position and speed 2. RSU processes received CAM and sends MCM::RSU_SMC::VehicleAdviceList::VehicleAdvice <ul style="list-style-type: none"> • ToCAdvice(stationID) • SafeSpotAdvice(stationID) 3. The CAV automation receives the advices, processes them and triggers a TOR as specified in the ToCAdvice(StationID) <div data-bbox="475 1137 922 1440" data-label="Image"> </div> 4. As the driver does not respond, the CAV triggers an MRM and keep driving till the safe spot indicated SafespotAdvice(stationID) <div data-bbox="475 1514 922 1816" data-label="Image"> </div> 5. Right before the safe spot, the CAV slows down to speedMRM 6. When speedMRM is reached, it executes a lane change onto the emergency lane and stops (see Figure 73)
Associated to Requirement(s) in addition to	<ul style="list-style-type: none"> • REQ_V_I2_S4.1-5_1 • REQ_V_I2_S4.1-5_3 • REQ_I_I2_S4.1-5_1

generic requirements	<ul style="list-style-type: none"> • REQ_I_I2_S4.1-5_3
----------------------	---









Figure 73: Execution of a parking manoeuvre at a safe stop on the emergency lane in reaction to an MCM reception

4.2.1.3 Feasibility results

4.2.1.3.1 Requirements verification

As described above, the prototype used for this evaluation has limited capabilities in terms of RSI sensing and monitoring as well as CAV automation. As a result, many of the generic requirements indicated in Section xx cannot be fulfilled. Nevertheless, this does not affect the results of this evaluation, whose objectives are to verify the feasibility of integration of the TransAID communication protocols in a real-world I2V cooperative automation implementation and the advantages of the TransAID MCM- based traffic management measures compared to the baseline approach. In this context, the relevant requirements to be verified are:

	Service-specific requirement description	Req. Name	Associated Test cases successfully executed	Notes
Vehicle requirements	<p><i>Extended CAM information generation</i></p> <p>The vehicle automation generates information about the supported SAE level of the CAV, which shall be included in TransAID CAM extension and received by the infrastructure.</p>	REQ_V_I2_S4.1-5_1		The AD SW generated the CAV supported SAE level and included this information accordingly in the TransAID CAM extensions transmitted.

	<p><i>DENM information reception and consideration</i></p> <p>The vehicle automation shall be able to receive the MCM information indicating the point for triggering a ToC and the safe spot to use in case of MRM. This information has to be taken into account for triggering a TOR and eventually execute an MRM.</p>	REQ_V_I2_S4.1-5_2		The DENM information was correctly received in the format defined by D5.1. and processed. this guaranteed the successful execution the associated test cases, hence the verification of this requirement
	<p><i>ToC and safe spot advice reception and consideration</i></p> <p>The vehicle automation shall be able to receive the DENM information indicating the event position (start of the no AD zone) and the relevance distance to this position. This information has to be taken into account for triggering a TOR.</p>	REQ_V_I2_S4.1-5_3		The MCM information was correctly received in the format defined by D5.1. and processed. this guaranteed a timely TOR and a correct manoeuvre execution to the advised safe spot when in MRM.
Infrastructure requirements	<p><i>Extended CAM reception and consideration</i></p> <p>The RSU shall be able to receive the CAM extensions transmitted by the CAV indicating the currently supported SAE automation level and use this information to trigger dedicated MCM advices.</p>	REQ_I_I2_S4.1-5_1		The CAM information was correctly received in the format defined by D5.1. and processed. this guaranteed a timely generation of dedicated ToC and Safe spot advices
	<p><i>DENM info generation</i></p> <p>The infrastructure must be able to generate DENM information matching the actual features of the no AD zone and relevance distance and disseminate them using an RSU.</p>	REQ_I_I2_S4.1-5_2		The RSU generated the DENM information accordingly with the actual situation. As the no AD zone situation is artificially reproduced in this study, the DENM information is hard coded.
	<p><i>ToC and safe spot advice generation</i></p> <p>The infrastructure must be able to generate MCM ToC and safe spot advices matching the recipient vehicle ID and reflecting consistent points for triggering a ToC and eventually accommodating a MRM, respectively.</p>	REQ_I_I2_S4.1-5_3		The RSU generated the MCM information consistently with the actual situation. As free safe spots are generated randomly over subsequent runs in this study, a ToC point is suggested to the CAV in combination with a free safe spot that would allow the CAV to drive the minimum possible distance at speedMRM.

The requirements were met. Reception and transmission of required V2X messages was verified by the execution of related TOR and MRMs at the CAV at the correct points in time and space. Capture logs show that the RSU correctly formats DENM and MCM messages and the content of these messages is correctly used to execute TOR and MRM. The capture logs also show that the vehicle transmits CAM messages with meaningful TransAID extensions.

4.2.1.3.2 User experience

Even if not at a level expectable in series vehicles sold to customers, user demands were fulfilled. The ToR indications were functionally clear to the driver, and the MRM deceleration and lane change manoeuvres were optimized and fine-tuned to offer a comfortable driving experience. A video of the performed tests is available at the TransAID home page address⁴.

4.2.1.3.3 Check of overall feasibility

⁴ https://usercontent.one/wp/www.transaid.eu/wp-content/uploads/2017/Videos/transaid-mrm-toc_distributed_undefensive.mp4

The results in the tested scenarios demonstrate feasibility of integration of the TransAID communication protocols for operation of Infrastructure-assisted ToC management schemes even on a CAV prototype of reduced automation capabilities. In addition, the advantages of the MCM-based ToC management scheme were proven using the following indicators:

- Successful MRM: percentage of times the CAV executes a safe MRM (the CAV is able to make a lane change on the emergency lane and stop at a free safe spot).
- ToC Distribution: range of distances where the ToC is triggered.

The empirical results reported below are average values measured over 50 test runs under 8 different scenario configurations obtained by changing the location of the safe spots (at least one safe spot is available in each scenario). Table 4 compares the performance of the two infrastructure-assisted ToC management schemes in terms of successful MRM. The empirical results show that when the CAV follows the DENM-based ToC management scheme, it does not always successfully implement a safe MRM. It is important to recall that the DENM's relevant information is only available at the CAV once it is within the relevance distance (i.e. 500m away from the no-AD zone). At this point in time, the AD SW triggers the TOR and the CAV slows down from its driving speed to SpeedMRM. Therefore, the CAV misses any safe spot available from the start of the DENM's relevance area to the point at which it reaches SpeedMRM. In addition, the CAV is only allowed to park at the location where it reaches SpeedMRM since it does not have further information about the availability of safe spots downstream. In particular, CAVs using the DENM-based approach only find a safe spot 12.5% of the times. In turn, CAVs must stop on the driving lane in 87.5% of the tests. Table 4 shows that the MCM-based ToC management scheme always allows the CAV to perform a successful MRM. This is thanks to the MCM's ToCAdvice and SafeSpot advisories received from the RSI that informs when/where to execute the ToC for reaching the assigned safe spot and park in case of MRM.

Table 4: Successful MRM comparison

DENM-based ToC Management	MCM-based ToC Management
12.5%	100

The study in D4.2 [11] showed through simulations that traffic safety and efficiency is undermined when ToCs at multiple CAVs are concentrated at close locations. From this point of view, having a management scheme that spatially distributes the ToC points at multiple CAVs is preferable. To see how the compared schemes perform in this regard, Figure 74 shows the empirical distribution of the ToC points. In the case of the DENM-based scheme, CAVs issue the ToC as soon as they enter the DENM's relevance area at the exact same location that is 500m away from the no AD zone. Then, Figure 74 shows that the ToC range is of approximately 0m for all cases. The MCM-based ToC management scheme seeks minimizing the distance that the CAVs travel at SpeedMRM and at the same time distributing the ToC points. To this aim, it links each possible safe spot with a location where to issue the ToC. Considering that all potential safe spots are independent and equally usable, the distribution of the ToCs in this case depends on the length of the sections considered free on the emergency lane and the distance traveled by the CAV during the TOR's lead time and deceleration from driving speed to SpeedMRM. Since the emergency lane is divided in 25m-length sections where vehicles could stop, the distribution of ToC points is discrete and equally spaced as shown in Figure 74. Even if field tests were not conducted for all possible free safe spots locations, Figure 74 demonstrates that the MCM-based approach achieves a much better spatial distribution of ToC points.

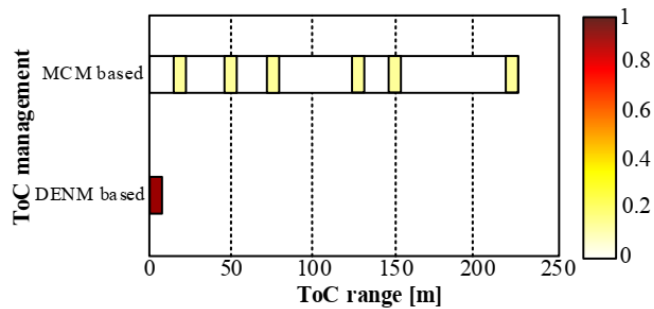


Figure 74: ToC distribution comparison

5 Conclusion and outlook

This deliverable describes the prototypical implementations done during TransAID. The prototypes consist of cooperative automated vehicles and different infrastructure components, as well as implementations of the message sets defined in D5.1. While all use cases and services described in D2.2 [6] [7] have been implemented on the test track in Peine-Eddesse, the highway merging described in use case 2.1 has also been implemented on public roads in The Netherlands. In addition, a closer look has been taken on the combined use case 4.1-5, with special focus on distribution of ToCs and MRMs using MCMs.

The feasibility of the real-world implementation of both the developed message sets and traffic management measures have been shown for all TransAID services and use cases. All TransAID services can be realized in the real-world, allowing the promised positive effects described in D6.2 [12].

Nevertheless, all that has been shown is a prototypic development, requiring a deeper investigation of some parts and further research. This is especially required in the definition of the behaviour at ToCs and MRMs. Although several studies exist dealing with ToCs and MRMs of individual vehicles, the combination of MRMs and infrastructure support as well as the availability and reservation of safe spots offer additional possibilities in the design of CAV behaviour and driver interaction. Valid questions here are, besides others:

- How should a CAV approach a provided safe spot?
- Can an MRM only be the final stopping of the car or can it include slow driving to achieve the optimal stopping position?
- How should a CAV deal with MRMs in urban areas, where safe parking spots may exist?
- How should a driver of a CAV be informed in case a dedicated safe spot is targetted?
- Should a driver of a CAV be informed differently when an MRM includes a lane change?

Since TransAID is not investigating HMI, several respective questions still need to be researched.

Similar to the ToC/MRM implementation, it is also required to take a closer look at the MCM exchange, especially when I2V and V2V MCMs are received:

- How will vehicles deal with contradictory advices?
- How can vehicles be rewarded when they behave cooperatively?

Further investigations may also go into the efficient usage of bandwidth in MCM communication. Instead of broadcasting MCMs all time (in the assessments, all CAVs constantly broadcasted their planned trajectories using V2V-MCM), more elaborate ways like enabling MCM sending only on CAM message reception may reduce the required bandwidth. Further filtering of relevant CAM messages (e.g., sender's automation level, matched position on the ego vehicle's HD map, further capabilities added to the CAM) may lead to further improvements.

In addition, the created software components need to be further enhanced to be able to cope with more (and more complex) situations, especially when thinking about large role-outs and series productions.

Since TransAID is about to end, all these aspects cannot be part of the project. Further research beyond the project scope is required.

References

- [1] J. Schindler, R. Markowski, F. Andert, A. Correa, M. Rondinone und R. Blokpoel, „TransAID Deliverable D7.1: System architecture for real world vehicles and road side,“ 2018.
- [2] J. Schindler, R. Markowski, F. Andert, A. Correa, M. Rondinone und R. Blokpoel, „TransAID Deliverable D7.1: System architecture for real world vehicles and road side (2nd iteration),“ 2019.
- [3] A. Wijbenga, E. Mintsis, J. Schindler, J. Vreeswijk, M. Rondinone, A. Correa, M. Sepulcre und S. Maerivoet, „TransAID Deliverable D2.1: Use cases and safety and efficiency metrics,“ 2018.
- [4] A. Correa, F. Andert, R. Blokpoel, N. Wojke, G. Thandavarayan, B. Coll, M. Sepulcre, J. Gozalvez, A. Wijbenga, J. Schindler und S. Maerivoet, „TransAID Deliverable D5.2: V2X-based cooperative sensing and driving in Transition Areas,“ 2019.
- [5] A. Correa, F. Andert, R. Blokpoel, N. Wojke, G. Thandavarayan, B. Coll, M. Sepulcre, J. Gozalvez, A. Wijbenga, J. Schindler, S. Maerivoet, X. Zhang, A. Leich und C. Böker, „TransAID Deliverable D5.2: V2X-based cooperative sensing and driving in Transition Areas (2nd iteration),“ 2020.
- [6] A. Wijbenga, E. Mintsis, J. Vreeswijk, A. Correa, L. Lücken, J. Schindler, M. Rondinone, S. Maerivoet, L. Akkermans, K. Carlier, I. Mayeres, E. Mitsakis, M. Sepulcre und R. Markowski, „TransAID Deliverable D2.2: Scenario definitions and modelling requirements,“ 2018.
- [7] A. Wijbenga, E. Mintsis, J. Vreeswijk, A. Correa, L. Lücken, J. Schindler, M. Rondinone, S. Maerivoet, L. Akkermans, K. Carlier, I. Mayeres, E. Mitsakis, M. Sepulcre und R. Markowski, „TransAID Deliverable D2.2: Scenario definitions and modelling requirements (2nd iteration),“ 2019.
- [8] M. Rondinone, A. Correa, R. Blokpoel, F. Andert, S. Khan, A. Wijbenga, J. Vreeswijk, M. Sepulcre und J. Gozalvez, „TransAID Deliverable D5.1: Definition of V2X message sets,“ 2018.
- [9] M. Rondinone, A. Correa, R. Blokpoel, F. Andert, S. Khan, A. Wijbenga, J. Vreeswijk, M. Sepulcre, J. Gozalvez, B. Coll-Perales und K. Carlier, „TransAID Deliverable D5.1: Definition of V2X message sets (2nd iteration),“ 2019.
- [10] S. Maerivoet, L. Akkermans, K. Carlier, Y.-P. Flötteröd, L. Lücken, R. Alms, E. Mintsis, D. Koutras, A. Wijbenga, J. Vreeswijk, A. Correa, X. Zhang und R. Blokpoel, „TransAID Deliverable D4.2: Preliminary simulation and assessment of enhanced traffic management measures,“ 2018.
- [11] S. Maerivoet, L. Akkermans, K. Carlier, P. Pápics, B. Ons, R. Alms, Y.-P. Flötteröd, L. Lücken, E. Mintsis, V. Karagounis, D. Koutras, A. Wijbenga, J. Vreeswijk, A. Correa, X. Zhang und R. Blokpoel, „TransAID Deliverable D4.2: Preliminary simulation and

assessment of enhanced traffic management measures (2nd iteration),“ 2020.

- [12] L. Lücken, M. Schwamborn, E. Mintsis, D. Koutras, A. Correa, M. Sepulcre, B. Coll, R. Blokpoel, G. Huisken, S. Maerivoet und J. Schindler, „TransAID Deliverable D6.2: Assessment of Traffic Management Procedures in Transition Areas,“ 2019.
- [13] M. Fischer, A. Richter, J. Schindler, J. Plättner, G. Temme, J. Kelsch, D. Assmann und F. Köster, „Modular and Scalable Driving Simulator Hardware and Software for the Development of Future Driver Assistance and Automation Systems,“ in *New Developments in Driving Simulation Design and Experiments*, Paris, 2014.
- [14] A. Houenou, P. Bonnifait, V. Cherfaoui und J.-F. Boissou, „A track-to-track association method for autonomous perception systems,“ in *2012 IEEE Intelligent Vehicles Symposium*, Alcalá de Henares, Spain, 2012.
- [15] F. Seelinger, „Fahrzeugübergreifende Informationsfusion für ein Kreuzungsassistenzsystem,“ Ph.D. dissertation, University of Ulm, Ulm, Germany, 2017.
- [16] D. Heß, S. Lapoehn, F. Utesch, M. Fischer, J. Schindler, T. Hesse und F. Köster, „Contributions of the EU Projects UnCoVerCPS and Enable-S3 to Highly Automated Driving in Conflict Situations,“ *AAET Automatisiertes und Vernetztes Fahren*, February 2019.
- [17] D. Heß, R. Lattarulo, P. Joshue, J. Schindler, T. Hesse und F. Köster, „Fast Maneuver Planning for Cooperative Automated Vehicles,“ *21st IEEE International Conference on Transportation Systems (ITSC)*, October 2018.
- [18] H. J. Ferreau, C. Kirsches, A. Potechka, H. G. Bock und M. Diehl, „qpOASES: A parametric active-set algorithm for quadratic programming,“ in *Mathematical Programming Computation*, 4 Hrs., Bd. 6, 2014, pp. 327-363.
- [19] *ETSI EN 302 637-2 Intelligent Transport Systems (ITS); Vehicular Communications; Basic Set of Applications; Part 2: Specification of Cooperative Awareness Basic Service, V1.3.2*, 2014.
- [20] *ETSI EN 302 665 Intelligent Transport Systems (ITS) Communication Architecture, v1.1.1*, 2010.
- [21] *ETSI EN 302 637-3 Intelligent Transport Systems (ITS) Vehicular Communications; Basic Set of Applications; Part 3: Specification of Decentralized Environmental Notification Basic Service, v1.2.2*, 2014.
- [22] *ETSI TS 102 894-2 Intelligent Transport Systems (ITS); Users and applications requirements; Part 2: Applications and facilities layer common data dictionary V1.2.1*, 2014.
- [23] *ETSI TS 102 894-1 Intelligent Transport Systems (ITS); Users and application requirements; Part 1: Facility layer structure, functional requirements and specifications v1.1.1*, 2013.
- [24] *ETSI EN 302 931 Intelligent Transport Systems (ITS) Vehicular Communications; Geographical Area Definition, v1.1.1*, 2011.

- [25] *ETSI EN 302 636-5-1 Intelligent Transport Systems (ITS) Vehicular Communications; GeoNetworking; Part 5: Transport protocols; Sub-part 1: Basic Transport Protocol, v1.2.1*, 2014.
- [26] *ETSI TS 103 248 Intelligent Transport Systems (ITS) GeoNetworking; Port Numbers for the Basic Transport Protocol (BTP), v1.0.1*, 2016.
- [27] *ETSI TS 103 301 Intelligent Transport Systems (ITS) Vehicular Communications; Basic Set of Applications; Facilities layer protocols and communication requirements for infrastructure services, v1.1.1*, 2016.
- [28] *ETSI TS 102 63-4-2 ITS Vehicular Communications; GeoNetworking; Part 4: Geographical addressing and forwarding for point-to-point and point-to-multipoint communications; Sub-part 2: Media-dependent functionalities for ITS-G5, v1.1.1*, 2013.
- [29] *ETSI ES 202 663 Intelligent Transport Systems (ITS); European profile standard for the physical and medium access control layer of Intelligent Transport Systems operating in the 5 GHz frequency band, V1.1.0*, 2010.
- [30] M. Wilbrink, J. Dodiya, F. A. A. Diederichs, L. M. A. Zanovello und A. Absér, „ADAS&me Deliverable D5.1 – HMI and automated functions,“ 2019.
- [31] N. Wojke, A. Bewley und D. Paulus, „Simple online and realtime tracking with a deep association metric,“ *IEEE International Conference on Image Processing (ICIP)*, pp. 3645-3649, September 2017.
- [32] A. Morando, T. Victor, K. Bengler und M. Dozza, „Users' Response to Critical Situations in Automated Drivign: Rear-Ends, Sideswipes, and False Warnings,“ *IEEE Transactions on Intelligent Transportation Systems*.
- [33] B. Coll-Perales, J. Schulte-Tigges, M. Rondinone, J. Gozálvez, M. Reke, D. Matheis und T. Walter, „Prototyping and Evaluation of Infrastructure-assisted Transition of Control for Cooperative Automated Vehicles,“ *IEEE Transactions on Intelligent Transportation System*, under review.
- [34] M. Rondinone, R. Blokpoel, J. Vreeswijk und J. Schindler, „MAVEN Deliverable D5.1: V2X communications for infrastructure-assisted automated driving,“ 2018.

Annex A: TransAID messages description

Annex A1: MCM description (1st iteration)

		Container	Data Frame	Opt.	Type	Description		
MCM	ITS PDU Header	Protocol version			Integer 0-255	version of the ITS message and/or communication protocol		
		Message id			Integer 0-255	Type of the ITS message		
		Station id			Integer 0-4294967295	Identifier for an ITS-S		
	Maneuver Coordination	MCM Parameters	Generation Delta Time			Integer 0-65535	Time corresponding to the time of the reference position in the MCM, considered as time of the MCM generation. The value of the DE shall be wrapped to 65 536. This value shall be set as the remainder of the corresponding value of Timestamps divided by 65 536 as below: generationDeltaTime = Timestamps mod 65 536	
			Basic Container	Station type			Integer 0-255	The type of technical context the ITS-S is integrated in. The station type depends on the integration environment of ITS-S into vehicle, mobile devices or at infrastructure. Types: unknown(0), pedestrian(1), cyclist(2), moped(3), motorcycle(4), passengerCar(5), bus(6), lightTruck(7), heavyTruck(8), trailer(9), specialVehicles(10), tram(11), roadSideUnit(15)
				Latitude			Integer 900000000-900000001	Latitude: oneMicrodegreeNorth(10), oneMicrodegreeSouth(-10), unavailable(900000001)
				Longitude			Integer -1800000000..1800000001	Longitude: oneMicrodegreeEast(10), oneMicrodegreeWest(-10), unavailable(1800000001)
				Position Confidence Ellipse			Sequence of semiMajorConfidence, semiMinorConfidence, semiMajorOrientation	The positionConfidenceEllipse provides the accuracy of the measured position with the 95 % confidence level. Otherwise, the positionConfidenceEllipse shall be set to unavailable.If semiMajorOrientation is set to 0° North, then the semiMajorConfidence corresponds to the position accuracy in the North/South direction, while the semiMinorConfidence corresponds to the position accuracy in the East/West direction. This definition implies that the semiMajorConfidence might be smaller than the semiMinorConfidence.
				Altitude	Value			Integer -100000-800001
			Conf			Enumerated 0-15	alt-000-01(0), alt-000-02(1), alt-000-05(2), alt-000-10(3), alt-000-20(4), alt-000-50(5), alt-001-00(6), alt-002-00(7), alt-005-00(8), alt-010-00(9), alt-020-00(10), alt-050-00(11), alt-100-00(12), alt-200-00(13), outOfRange(14), unavailable(15)	
			Maneuver Container			Choice	Choice between Vehicle Maneuver Container or RSU Suggested Maneuver containers	
			Vehicle Maneuver Container	Tolerated Distance Ahead			Integer 0-10000	The tolerated distance is the distance to the trajectory points that other vehicles have to respect when they want to accept a desired trajectory of someone else
				Tolerated Distance Behind			Integer 0-10000	The tolerated distance is the distance to the trajectory points that other vehicles have to respect when they want to accept a desired trajectory of someone else
				Planned Trajectory			Sequence size 1-30 of Trajectory Points	Future trajectory of the vehicle
				Trajectory Points	deltaXcm			Integer 0-10000
deltaYcm					Integer 0-10000	The reference position of the first point is the position and heading stated in the MCM		
deltaTimeMs			Integer 0-65535		Each following position (n) references to the former position (n-1)			

			Container	Data Frame	Opt.	Type	Description	
				absSpeed	X	Integer 0-16383	SpeedValue: standstill(0), oneCentimeterPerSec(1), unavailable(16383)	
				Longitudinal acceleration	X	Integer -160-161	LongitudinalAccelerationValue: pointOneMeterPerSecSquaredForward(1), pointOneMeterPerSecSquaredBackward(-1), unavailable(161)	
				Desired Trajectory	X	Sequence size 1-30 of Trajectory Points	Desired trajectory if other vehicles agree	
			Trajectory Points	deltaXcm		Integer 0-10000	The trajectory points are composed by delta-values in the vehicle coordinate system The reference position of the first point is the position and heading stated in the MCM Each following position (n) references to the former position (n-1)	
				deltaYcm		Integer 0-10000		
				deltaTimeMs		Integer 0-65535		
				absSpeed		Integer 0-16383		SpeedValue: standstill(0), oneCentimeterPerSec(1), unavailable(16383)
				Longitudinal acceleration		Integer -160-161		LongitudinalAccelerationValue: pointOneMeterPerSecSquaredForward(1), pointOneMeterPerSecSquaredBackward(-1), unavailable(161)
				RespectedDesiredTrajectoriesList		Sequence size 0-5 of RespectedDesiredTrajectory		
				RespectedDesiredTrajectory		Integer 0-4294967295	Reflects the vehicle ID which is respected in planning	
				TriggerTimeOfToC	X		Time when the ToC process starts	
				Minute		Integer 0-527040	Time when the ToC will be triggered in minutes since the start of the year	
				Milisecond		Integer 0-65535	Time when the ToC will be triggered in milicsecons since the start of the minute	
				TargetAutomationLevel	X	Enumerated	Level of automation of the vehicle after the ToC: saeLevel0 (0), saeLevel1 (1), saeLevel2 (2), saeLevel3 (3), saeLevel4 (4), saeLevel5 (5), ...	
				TriggerTimeOfMRM	X	Integer 0-65535	Time in milliseconds since the trigger of the ToC when the MRM will be triggered if the driver does not take control of the car	
				Heading				
				Value		Integer 0-3601	Orientation of a heading with regards to the WGS84 north: wgs84North(0), wgs84East(900), wgs84South(1800), wgs84West(2700), unavailable(3601)	
				Confidence		Integer 0-127	The absolute accuracy of a reported heading value for a predefined confidence level: equalOrWithinZeroPointOneDegree(1), equalOrWithinOneDegree(10), outOfRange(126), unavailable(127)	
				Speed				
				Value		Integer 0-16383	speed value: standstill(0), oneCentimeterPerSec(1), unavailable(16383)	
				Confidence		Integer 0-127	The absolute accuracy of a reported speed value for a predefined confidence level: equalOrWithinOneCentimeterPerSec(1), equalOrWithinOneMeterPerSec(100), outOfRange(126), unavailable(127)	
				Longitudinal Acceleration				
				Value		Integer -160-161	Vehicle acceleration at longitudinal direction in the centre of the mass of the empty vehicle	
				Confidence		Integer 0-102	The absolute accuracy of a reported acceleration value for a predefined confidence level: pointOneMeterPerSecSquaredForward(1), pointOneMeterPerSecSquaredBackward(-1), unavailable(161)	
				Lateral acceleration				
				Value		Integer -160-161	Vehicle acceleration at lateral direction in the centre of the mass of the empty vehicle: pointOneMeterPerSecSquaredToRight(-1), pointOneMeterPerSecSquaredToLeft(1), unavailable(161)	

			Container	Data Frame	Opt.	Type	Description		
			RSU Suggested	Confidence			Integer 0-102	The absolute accuracy of a reported acceleration value for a predefined confidence level: pointOneMeterPerSecSquared(1), outOfRange(101), asfaunavailable(102)	
				Vertical Acceleration		X			
				Value				Integer -160-161	Vehicle acceleration at vertical direction in the centre of the mass of the empty vehicle: pointOneMeterPerSecSquaredUp(1), pointOneMeterPerSecSquaredDown(-1), unavailable(161)
				Confidence				Integer 0-102	The absolute accuracy of a reported acceleration value for a predefined confidence level: pointOneMeterPerSecSquared(1), outOfRange(101), unavailable(102)
				Yaw Rate					
				Value				Integer -32766 - 32767	Vehicle rotation around z-axis of coordinate system centred on the centre of mass of the empty-loaded vehicle: straight(0), degSec-000-01ToRight(-1), degSec-000-01ToLeft(1), unavailable(32767)
				Confidence				Enumerated	The absolute accuracy range for reported yaw rate value for a predefined confidence level: degSec-000-01(0), degSec-000-05(1), degSec-000-10(2), degSec-001-00(3), degSec-005-00(4), degSec-010-00(5), degSec-100-00(6), outOfRange(7), unavailable(8)
				Curvature					
				Value				Integer -30000 - 30001	The inverse of a detected vehicle turning curve radius scaled with 30 000A curvature detected by a vehicle represents the curvature of the actual vehicle trajectory: straight(0), reciprocalOf1MeterRadiusToRight(-30000), reciprocalOf1MeterRadiusToLeft(30000), unavailable(30001)
				Confidence				Enumerated	The absolute accuracy range of a reported curvature value for a predefined confidence level: onePerMeter-0-00002(0), onePerMeter-0-0001(1), onePerMeter-0-0005(2), onePerMeter-0-002(3), onePerMeter-0-01(4), onePerMeter-0-1(5), outOfRange(6), unavailable(7)
				Curvature Calculation Mode				Enumerated	It describes whether the yaw rate is used to calculate the curvature for a reported curvature value: yawRateUsed(0), yawRateNotUsed(1), unavailable(2), ...
				Drive Direction				Enumerated	It denotes whether a vehicle is driving forward or backward: forward(0), backward(1), unavailable(2)
				Lane Position				Integer -1 - 14	the transversal position information on the road in resolution of lanes, counted from the outside border of the road for a given traffic direction: offTheRoad(-1), hardShoulder(0), outermostDrivingLane(1), secondLaneFromOutside(2)
				Steering Wheel Angle					
				Value				Integer -511 - 512	Steering wheel angle of the vehicle at certain point in time: straight(0), onePointFiveDegreesToRight(-1), onePointFiveDegreesToLeft(1), unavailable(512)
				Confidence				Integer 1 - 127	The Absolute accuracy for a reported steering wheel angle value for a predefined confidence level: equalOrWithinOnePointFiveDegree(1), outOfRange(126), unavailable(127)
				Advice Response List		X		Sequence size 0-3 of Advice Response	List of advice response objects
				Advice Response	Advice ID			Integer 0-255	Identifier for the acknowledgement
					Advice Followed			Bit String	Advice response: 1 followed, 0 not followed
							RSU Suggested	IntersectionReferenceID	X

			Container	Data Frame	Opt.	Type	Description
			Maneuver Container				intersection id
				RoadRegulatorID	X	Integer 0-65535	A globally unique regional assignment value typical assigned to a regional DOT authority. The value zero shall be used for testing needs
			IntersectionID		Integer 0-65535	A unique mapping to the intersection in question within the above region of use	
			RoadSegmentReferenceID	X		Specific lane ids are referring to this roadsegment id	
			RoadRegulatorID	X	Integer 0-65535	A globally unique regional assignment value typical assigned to a regional DOT authority. The value zero shall be used for testing needs	
			RoadSegmentID		Integer 0-65535	A unique mapping to the road segment in question within the above region of use during its period of assignment and use. Note that unlike intersectionID values, this value can be reused by the region	
			VehicleAdviceList	X	Sequence of size 8 of Vehicle Advice	List of lane advice objects, one per vehicle	
			Vehicle Advice	Target Station ID		Integer 0-4294967295	StationID of the vehicle the advice is targeted at
				Lane Advice	X		Single lane advice object
				Advice ID		Integer 0-255	Identifier for acknowledgement
				LaneAdviceReason		Enumerated	Indicates the reason why the CAV should perform the lane change: reason0 (0), reason1 (1), ...
				LaneChangePosition		Integer 0-10000	Position where the lane change should take place
				LaneChangeMoment			Time when the lane change should be performed
				Minute		Integer 0 - 527040	Time when the lane change should start in minutes since the start of the year
				Millisecond		Integer 0 - 65535	Time when the lane change should start in milliseconds since the start of the minute
				LaneChangeSpeed	X	Integer 0-500	Speed advice at the moment of the lane change
				LeadingVehicle	X	Integer 0-4294967295	StationID of the vehicle intended to be ahead of the target vehicle after merging
				FollowingVehicle	X	Integer 0-4294967295	StationID of the vehicle intended to be behind of the target vehicle after merging
				TargetLane		Integer 0-255	The lane number towards the target vehicle should move
				TriggeringPointOfToC	X	Integer 0-10000	Distance from the starting point where a ToC should be triggered if the lane change is not performed
				Car Following Advice	X		Single speed advice object
				Advice ID		Integer 0-255	Identifier for acknowledgement
				AdviceLaneID		Integer 0-255	LaneID to which the advice and position applies
				AdvicePosition		Integer 0-10000	Position where the target speed should be adhered
				DesiredBehaviour		Choice	Choice between TargetGap and TargetSpeed
				TargetGap		Integer 0-255	Target distance in m towards vehicle ahead
				TargetSpeed		Integer 0-255	Value of the speed advised to the target vehicle
				ToC Advice	X		
				Advice ID		Integer 0-255	Identifier for acknowledgement
				TocAdviceReason		Enumerated	Indicates the reason why the CAV should perform the ToC: reason0 (0), reason1 (1), ...
				PlaceOfStartTransition	X	Integer 0-10000	Position where the ToC should start
				TimeOfTriggerTransition	X		Time when the ToC should start
				Minute		Integer 0 - 527040	Time when the ToC should start in minutes since the start of the year
				Millisecond		Integer 0 - 65535	Time when the ToC should start in milliseconds since the start of the minute
				PlaceOfEndTransition	X	Integer 0-10000	Distance from the starting point where the ToC can be done

Annex A2: MCM description (2nd iteration)

		Container	Data Frame	Opt.	Type	Description		
MCM	Maneuver Coordination	ITS PDU Header			Integer 0-255	version of the ITS message and/or communication protocol		
					Integer 0-255	Type of the ITS message		
					Integer 0-4294967295	Identifier for an ITS-S		
	MCM Parameters	Basic Container	Generation Delta Time			Integer 0-65535	Time corresponding to the time of the reference position in the MCM, considered as time of the MCM generation. The value of the DE shall be wrapped to 65 536. This value shall be set as the remainder of the corresponding value of Timestamps divided by 65 536 as below: $generationDeltaTime = Timestamps \text{ mod } 65\ 536$	
			Reference position	Station type			Integer 0-255	The type of technical context the ITS-S is integrated in. The station type depends on the integration environment of ITS-S into vehicle, mobile devices or at infrastructure. Types: unknown(0), pedestrian(1), cyclist(2), moped(3), motorcycle(4), passengerCar(5), bus(6), lightTruck(7), heavyTruck(8), trailer(9), specialVehicles(10), tram(11), roadSideUnit(15)
				Latitude			Integer 900000000-900000001	Latitude: oneMicrodegreeNorth(10), oneMicrodegreeSouth(-10), unavailable(900000001)
				Longitude			Integer -1800000000..1800000001	Longitude: oneMicrodegreeEast(10), oneMicrodegreeWest(-10), unavailable(1800000001)
			Position Confidence Ellipse			Sequence of semiMajorConfidence, semiMinorConfidence, semiMajorOrientation	The positionConfidenceEllipse provides the accuracy of the measured position with the 95 % confidence level. Otherwise, the positionConfidenceEllipse shall be set to unavailable. If semiMajorOrientation is set to 0° North, then the semiMajorConfidence corresponds to the position accuracy in the North/South direction, while the semiMinorConfidence corresponds to the position accuracy in the East/West direction. This definition implies that the semiMajorConfidence might be smaller than the semiMinorConfidence.	
			Altitude	Value			Integer -100000-800001	Altitude: referenceEllipsoidSurface(0), oneCentimeter(1), unavailable(800001)
				Conf			Enumerated 0-15	alt-000-01(0), alt-000-02(1), alt-000-05(2), alt-000-10(3), alt-000-20(4), alt-000-50(5), alt-001-00(6), alt-002-00(7), alt-005-00(8), alt-010-00(9), alt-020-00(10), alt-050-00(11), alt-100-00(12), alt-200-00(13), outOfRange(14), unavailable(15)

			Container	Data Frame	Opt.	Type	Description		
MCM	Maneuver Coordination	MCM Parameters	Maneuver Container			Choice	Choice between Vehicle Maneuver Container or RSU Suggested Maneuver containers		
			Planned Trajectory			Sequence size 1-30 of Trajectory Points	Future trajectory of the vehicle		
			Trajectory Points		deltaXcm		Integer -10000 -10000	The trajectory points are composed by delta-values in the vehicle coordinate system The reference position of the first point is the position and heading stated in the MCM Each following position (n) references to the former position (n-1)	
					deltaYcm		Integer -10000 -10000		
					deltaTimeMs		Integer 0-65535		
					headingValue	X	Integer -160-161		wgs84North(0), wgs84East(900), wgs84South(1800), wgs84West(2700), unavailable(3601)
					absSpeed	X	Integer 0-16383		SpeedValue: standstill(0), oneCentimeterPerSec(1), unavailable(16383)
			Desired Trajectory			X	Sequence size 1-30 of Trajectory Points	Desired trajectory if other vehicles agree	
			Trajectory Points		deltaXcm		Integer 0-10000	The trajectory points are composed by delta-values in the vehicle coordinate system The reference position of the first point is the position and heading stated in the MCM Each following position (n) references to the former position (n-1)	
					deltaYcm		Integer 0-10000		
					deltaTimeMs		Integer 0-65535		
					headingValue	X	Integer -160-161		wgs84North(0), wgs84East(900), wgs84South(1800), wgs84West(2700), unavailable(3601)
					absSpeed	X	Integer 0-16383		SpeedValue: standstill(0), oneCentimeterPerSec(1), unavailable(16383)
			MinDistanceBehind			x	Integer 0 - 10000	Minimum distance to the centre front of the vehicle that other vehicles need to respect when they want to accept the desired trajectory	
			MinTimeHeadwayBehind			x	Integer 0 - 65535	Minimum time headway in milliseconds that need to be respected by a following vehicle when they want to accept the desired trajectory	
			Trigger Time of ToC			X		Time when the ToC process starts	
			Minute				Integer 0-527040	Time when the ToC will be triggered in minutes since the start of the year	
			Milisecond				Integer 0-65535	Time when the ToC will be triggered in milliseconds since the start of the minute	
			Target Automation Level			X	Enumerated	Level of automation of the vehicle after the ToC: saeLevel0 (0), saeLevel1LongAutom (1), saeLevel1LatAutom (2), saeLevel2 (3), saeLevel3 (4), saeLevel4 (5), saeLevel5 (6), mrm (7), ...	
			Trigger Time of MRM			X	Integer 0-65535	Time in milliseconds since the trigger of the ToC when the MRM will be triggered if the driver does not take control of the car	
			Vehicle Length					The length of the vehicle expressed in centimeters (LSB units of 0.01 m)	
Vehicle Length Value				Integer 0-1023	tenCentimeters(1), outOfRange(1022), unavailable(1023)				
Vehicle Length Confidence Indication				Enumerated	noTrailerPresent(0), trailerPresentWithKnownLength(1), trailerPresentWithUnknownLength(2), trailerPresenceIsUnknown(3), unavailable(4)				
Vehicle Width				Integer 0-62	The width of the vehicle expressed in centimeters (LSB units of 0.01 m): tenCentimeters(1), outOfRange(61), navailable(62)				

			Container	Data Frame	Opt.	Type	Description
MCM MCM	Maneuver Coordination	MCM Parameters	Vehicle Maneuver Container	Heading			
				Value		Integer 0-3601	Orientation of a heading with regards to the WGS84 north: wgs84North(0), wgs84East(900), wgs84South(1800), wgs84West(2700), unavailable(3601)
				Confidence		Integer 0-127	The absolute accuracy of a reported heading value for a predefined confidence level: equalOrWithinZeroPointOneDegree(1), equalOrWithinOneDegree(10), outOfRange(126), unavailable(127)
				Speed			
				Value		Integer 0-16383	speed value: standstill(0), oneCentimeterPerSec(1), unavailable(16383)
				Confidence		Integer 0-127	The absolute accuracy of a reported speed value for a predefined confidence level: equalOrWithinOneCentimeterPerSec(1), equalOrWithinOneMeterPerSec(100), outOfRange(126), unavailable(127)
				Longitudinal Acceleration			
				Value		Integer -160-161	Vehicle acceleration at longitudinal direction in the centre of the mass of the empty vehicle
				Confidence		Integer 0-102	The absolute accuracy of a reported acceleration value for a predefined confidence level: pointOneMeterPerSecSquaredForward(1), pointOneMeterPerSecSquaredBackward(-1), unavailable(161)
				Lateral acceleration			
				Value		Integer -160-161	Vehicle acceleration at lateral direction in the centre of the mass of the empty vehicle: pointOneMeterPerSecSquaredToRight(-1), pointOneMeterPerSecSquaredToLeft(1), unavailable(161)
				Confidence		Integer 0-102	The absolute accuracy of a reported acceleration value for a predefined confidence level: pointOneMeterPerSecSquared(1), outOfRange(101), asfaunavailable(102)
				Vertical Acceleration	X		
				Value		Integer -160-161	Vehicle acceleration at vertical direction in the centre of the mass of the empty vehicle: pointOneMeterPerSecSquaredUp(1), pointOneMeterPerSecSquaredDown(-1), unavailable(161)
				Confidence		Integer 0-102	The absolute accuracy of a reported acceleration value for a predefined confidence level: pointOneMeterPerSecSquared(1), outOfRange(101), unavailable(102)
				Yaw Rate			
				Value		Integer -32766 - 32767	Vehicle rotation around z-axis of coordinate system centred on the centre of mass of the empty-loaded vehicle: straight(0), degSec-000-01ToRight(-1), degSec-000-01ToLeft(1), unavailable(32767)
Confidence		Enumerated	The absolute accuracy range for reported yaw rate value for a predefined confidence level: degSec-000-01(0), degSec-000-05(1), degSec-000-10(2), degSec-001-00(3), degSec-005-00(4), degSec-010-00(5), degSec-100-00(6), outOfRange(7), unavailable(8)				
Curvature							
Value		Integer -30000 - 30001	The inverse of a detected vehicle turning curve radius scaled with 30 000A curvature detected by a vehicle represents the curvature of the actual vehicle trajectory: straight(0), reciprocalOf1MeterRadiusToRight(-30000), reciprocalOf1MeterRadiusToLeft(30000), unavailable(30001)				

			Container	Data Frame	Opt.	Type	Description		
MCM	Maneuver Coordination		Vehicle Maneuver Container	Confidence			Enumerated	The absolute accuracy range of a reported curvature value for a predefined confidence level: onePerMeter-0-00002(0), onePerMeter-0-0001(1), onePerMeter-0-0005(2), onePerMeter-0-002(3), onePerMeter-0-01(4), onePerMeter-0-1(5), outOfRange(6), unavailable(7)	
				Curvature Calculation Mode				Enumerated	It describes whether the yaw rate is used to calculate the curvature for a reported curvature value: yawRateUsed(0), yawRateNotUsed(1), unavailable(2), ...
				Drive Direction				Enumerated	It denotes whether a vehicle is driving forward or backward: forward(0), backward(1), unavailable(2)
				Lane Position				Integer -1 - 14	the transversal position information on the road in resolution of lanes, counted from the outside border of the road for a given traffic direction: offTheRoad(-1), hardShoulder(0), outermostDrivingLane(1), secondLaneFromOutside(2)
				Steering Wheel Angle					
				Value				Integer -511 - 512	Steering wheel angle of the vehicle at certain point in time: straight(0), onePointFiveDegreesToRight(-1), onePointFiveDegreesToLeft(1), unavailable(512)
				Confidence				Integer 1 - 127	The Absolute accuracy for a reported steering wheel angle value for a predefined confidence level: equalOrWithinOnePointFiveDegree(1), outOfRange(126), unavailable(127)
				Advice Response List			x		List of advice response objects
				Lane Advice Compliance			x	Integer 0-255	Single advice response object related with the RSU suggested Lane Advice
				Advice ID				Integer 0-255	Identifier for the acknowledgement
	LaneAdviceComplianceStatus				Enumerated	unknown (0), rejected (1), desired (2), planned (3), completed (4), ...			
	Car Following Advice Compliance			x		Single advice response object related with the RSU suggested Car following Advice			
	Advice ID				Integer 0-255	Identifier for the acknowledgement			
	CarFollowingComplianceStatus				Enumerated	unknown (0), notCompliant (1), compliant (2), ...			
	ToC Advice Compliance			x		Single advice response object related with the RSU suggested ToC Advice			
	Advice ID				Integer 0-255	Identifier for the acknowledgement			
	ToCAdviceComplianceStatus				Enumerated	unknown (0), rejected (1), planned (2), executing (3), completed (4), ...			
	Safe Spot Compliance			x		Single advice response object related with the RSU suggested Safe Spot Advice			
	Advice ID				Integer 0-255	Identifier for the acknowledgement			
	SafeSpotComplianceStatus				Enumerated	unknown (0), rejected (1), planned (2), executing (3), completed (4), ...			

			Container	Data Frame	Opt.	Type	Description
MCM	Maneuver Coordination	MCM Parameters	RSU Suggested Maneuver Container	IntersectionReferenceID	X		Specific lane ids are referring to this intersection id
				RoadRegulatorID	X	Integer 0-65535	A globally unique regional assignment value typical assigned to a regional DOT authority. The value zero shall be used for testing needs
				IntersectionID		Integer 0-65535	A unique mapping to the intersection in question within the above region of use
				RoadSegmentReferenceID	X		Specific lane ids are referring to this roadsegment id
				RoadRegulatorID	X	Integer 0-65535	A globally unique regional assignment value typical assigned to a regional DOT authority. The value zero shall be used for testing needs
				RoadSegmentID		Integer 0-65535	A unique mapping to the road segment in question within the above region of use during its period of assignment and use. Note that unlike intersectionID values, this value can be reused by the region
				VehicleAdviceList	X	Sequence of size 8 of Vehicle Advice	List of lane advice objects, one per vehicle
				Target Station ID		Integer 0-4294967295	StationID of the vehicle the advice is targeted at
				Advice Status		Enumerated	new (0), updated (1), cancelled (2), ...
				Lane Advice	X		Single lane advice object
				Advice ID		Integer 0-255	Identifier for acknowledgement
				Lane Advice Reason		Enumerated	Indicates the reason why the CAV should perform the lane change: reason0 (0), reason1 (1), ...
				Lane Change Advice Type		Choice	
				laneChangeAdviceDistanceRange			
				startingDistance		Integer 0-10000	Distance from the reference point the vehicle shall start requesting the driver to take control. Furthest distance the ToC can be executed, considering that reference point is downstream.
				endingDistance		Integer 0-10000	Distance from the reference point up to where the vehicle shall complete the ToC. Closest distance the ToC can be executed, considering that reference point is downstream.
				transitionAdviceTimeWindow			
				earliest			time when the vehicle shall start requesting the driver to take control. As a consequence it corresponds to the earliest possible time that ToC can be executed.
				Minute		Integer 0-527040	
				Milliseconds		Integer 0-65535	
				latest			time by when the vehicle shall complete the ToC. Latest moment the ToC can be executed.
				Minute		Integer 0-527040	
				Milliseconds		Integer 0-65535	
				LaneChangeSpeed	X	Integer 0-500	Speed advice at the moment of the lane change
				LeadingVehicle	X	Integer 0-4294967295	StationID of the vehicle intended to be ahead of the target vehicle after merging
				FollowingVehicle	X	Integer 0-4294967295	StationID of the vehicle intended to be behind of the target vehicle after merging
				TargetLane		Integer 0-255	The lane number towards the target vehicle should move
				TriggeringPointOfToC	X	Integer 0-10000	Distance from the starting point where a ToC should be triggered if the lane change is not performed
				Car Following Advice	X		Single speed advice object
				Advice ID		Integer 0-255	Identifier for acknowledgement
				AdviceLaneID		Integer 0-255	LaneID to which the advice and position applies
				AdviceDistanceRange			
				startingDistance		Integer 0-10000	Start position where the target speed/gap applies
endingDistance		Integer 0-10000	End position where the target speed/gap applies				
DesiredBehaviour		Choice					
TargetGap		Integer 0-255	Target distance in m towards vehicle ahead				
TargetSpeed		Integer 0-255	Value of the speed advised to the target vehicle				

			Container	Data Frame	Opt.	Type	Description			
MCM	Maneuver Coordination	MCM Parameters	RSU Suggested Maneuver Container	Vehicle Advice	ToC Advice		X	Single ToC advice object		
					Advice ID		Integer 0-255	Identifier for acknowledgement		
					TocAdviceReason			Enumerated	Indicates the reason why the CAV should perform the ToC: reason0 (0), reason1 (1), ...	
					targetAutomationLevel			Enumerated	saeLevel0 (0), saeLevel1LongAutom (1), saeLevel1LatAutom (2), saeLevel2 (3), saeLevel3 (4), saeLevel4 (5), saeLevel5 (6), mrm (7), ...	
					transitionAdviceType		X	Choice		
					transitionAdviceDistanceRange		X			
							startingDistance		Integer 0-10000	Distance from the reference point the vehicle shall start requesting the driver to take control. Furthest distance the ToC can be executed, considering that reference point is downstream.
							endingDistance		Integer 0-10000	Distance from the reference point up to where the vehicle shall complete the ToC. Closest distance the ToC can be executed, considering that reference point is downstream.
					transitionAdviceTimeWindow					
							Earliest			Time when the vehicle shall start requesting the driver to take control. As a consequence it corresponds to the earliest possible time that ToC can be executed.
							Minute		Integer 0-527040	
							Millisecond		Integer 0-65535	
							Latest			Time by when the vehicle shall complete the ToC. Latest moment the ToC can be executed.
							Minute		Integer 0-527040	
							Millisecond		Integer 0-65535	
					SafeSpotAdvice		X			Single Safe Spot advice object
							Advice ID		Integer 0-255	Identifier for acknowledgement
							Distance Range			
							startingDistance		Integer 0-10000	Distance to the start of the safe spot in meters
							endingDistance		Integer 0-10000	Distance to the end of the safe spot in meters

Annex B: TransAID messages ASN.1 specifications (1st iteration)

Annex B1: MCM ASN.1 specification

```

MCM-TransAID DEFINITIONS AUTOMATIC TAGS ::=
BEGIN

IMPORTS
ItsPduHeader, StationType, ReferencePosition, Heading, Speed,
LongitudinalAcceleration, LateralAcceleration, VerticalAcceleration, YawRate,
Curvature, CurvatureCalculationMode, DriveDirection, LanePosition,
SteeringWheelAngle, SpeedValue, LongitudinalAccelerationValue

FROM ITS-Container {itu-t(0) identified-organization(4) etsi(0) itsDomain(5)
wgl(1) ts(102894) cdd(2) version(1)};

MCM ::= SEQUENCE {
    header                ItsPduHeader,
    maneuverCoordination  ManeuverCoordination
}

ManeuverCoordination ::= SEQUENCE {
    generationDeltaTime  GenerationDeltaTime,
    mcmParameters        McmParameters
}

GenerationDeltaTime ::= INTEGER {
    oneMilliSec(1)
} (0..65535)

McmParameters ::= SEQUENCE {
    basicContainer        BasicContainer,
    maneuverContainer     ManeuverContainer
}

ManeuverContainer ::= CHOICE {
    vehicleManeuver      VehicleManeuver,
    rsuManeuver          RsuManeuver,
    ...
}

BasicContainer ::= SEQUENCE {
    stationType          StationType,
    referencePosition    ReferencePosition,
    ...
}

VehicleManeuver ::= SEQUENCE {
    toleratedDistanceAheadCmps  ToleratedDistance,
    toleratedDistanceBehindCmps ToleratedDistance,
    plannedTrajectory           PlannedTrajectory,
    desiredTrajectory           DesiredTrajectory OPTIONAL,
    respectedDesiredTrajectoriesList RespectedDesiredTrajectoriesList,
    triggerTimeOfToC           TriggerTimeOfToC OPTIONAL,
    targetAutomationLevel       TargetAutomationLevel OPTIONAL,
    triggerTimeOfMRM           TriggerTimeOfMRM OPTIONAL,
    heading                     Heading,
}

```



```

        speed                Speed,
        longitudinalAcceleration LongitudinalAcceleration,
        lateralAcceleration   LateralAcceleration,
        verticalAcceleration   VerticalAcceleration,
        yawRate               YawRate,
        curvature              Curvature,
        curvatureCalculationMode CurvatureCalculationMode,
        driveDirection        DriveDirection,
        lanePosition           LanePosition,
        steeringWheelAngle    SteeringWheelAngle,
        adviceResponseList    AdviceResponseList OPTIONAL
    }

ToleratedDistance ::= INTEGER (0..10000)

PlannedTrajectory ::= SEQUENCE SIZE (1..30) OF TrajectoryPoint

DesiredTrajectory ::= SEQUENCE SIZE (1..30) OF TrajectoryPoint

TrajectoryPoint ::= SEQUENCE {
    deltaXCm                DiffPosition,
    deltaYCm                DiffPosition,
    deltaTimeMs             DiffTime,
    absSpeed                 SpeedValue OPTIONAL,
    longitudinalAcceleration LongitudinalAccelerationValue OPTIONAL
}

DiffPosition ::= INTEGER (0..10000)

DiffTime ::= INTEGER (0..65535)

RespectedDesiredTrajectoriesList ::= SEQUENCE SIZE (0..5) OF
RespectedDesiredTrajectory

RespectedDesiredTrajectory ::= INTEGER (0..4294967295)

TriggerTimeOfToC ::= SEQUENCE {
    minute                Minute,
    millisecond            Millisecond
}

Minute ::= INTEGER (0..527040)

Millisecond ::= INTEGER (0..65535)

TargetAutomationLevel ::= ENUMERATED {
    saeLevel0 (0),
    saeLevel1 (1),
    saeLevel2 (2),
    saeLevel3 (3),
    saeLevel4 (4),
    saeLevel5 (5),
    ...
}

TriggerTimeOfMRM ::= INTEGER (0..65535)

```

```
AdviceResponseList ::= SEQUENCE SIZE (0..3) {
    adviceResponse      AdviceResponse
}

AdviceResponse ::= SEQUENCE {
    adviceID             AdviceID,
    adviceFollowed      AdviceFollowed
}

AdviceID ::= INTEGER (0..255)

AdviceFollowed ::= BIT STRING {
    notFollowed(0),
    followed(1)
}

RsuManeuver ::= SEQUENCE {
    intersectionReferenceID      IntersectionReferenceID OPTIONAL,
    roadSegmentReferenceID      RoadSegmentReferenceID OPTIONAL,
    vehicleAdviceList           VehicleAdviceList OPTIONAL
}

IntersectionReferenceID ::= SEQUENCE {
    region RoadRegulatorID OPTIONAL,
    id IntersectionID
}

RoadSegmentReferenceID ::= SEQUENCE {
    region RoadRegulatorID OPTIONAL,
    id      RoadSegmentID
}

RoadRegulatorID ::= INTEGER (0..65535)

IntersectionID ::= INTEGER (0..65535)

RoadSegmentID ::= INTEGER (0..65535)

VehicleAdviceList ::= SEQUENCE SIZE (1..8) OF VehicleAdvice

VehicleAdvice ::= SEQUENCE {
    targetStationID      TargetStationID,
    laneAdvice           LaneAdvice OPTIONAL,
    carFollowingAdvice   CarFollowingAdvice OPTIONAL,
    tocAdvice            TocAdvice OPTIONAL
}

TargetStationID ::= INTEGER (0..4294967295)
```

```
LaneAdvice ::= SEQUENCE {
    adviceID                AdviceID,
    laneAdviceReason        LaneAdviceReason,
    laneChangePosition      LaneChangePosition,
    laneChangeMoment        LaneChangeMoment,
    laneChangeSpeed         LaneChangeSpeed OPTIONAL,
    leadingVehicle          LeadingVehicle OPTIONAL,
    followingVehicle         FollowingVehicle OPTIONAL,
    targetLane              TargetLane,
    triggeringPointOfToC    TriggeringPointOfToC OPTIONAL
}

CarFollowingAdvice ::= SEQUENCE {
    adviceID                AdviceID,
    adviceLaneID            AdviceLaneID,
    advicePosition          AdvicePosition,
    desiredBehaviour        DesiredBehaviour
}

TocAdvice ::= SEQUENCE {
    adviceID                AdviceID,
    tocAdviceReason        TocAdviceReason,
    placeOfStartTransition  PlaceOfStartTransition OPTIONAL,
    timeOfTriggerTransition TimeOfTriggerTransition OPTIONAL,
    placeOfEndTransition    PlaceOfEndTransition OPTIONAL
}

RequestID ::= INTEGER (0..255)

LaneAdviceReason ::= ENUMERATED {
    reason0 (0),
    reason1 (1),
    ...
}

LaneChangePosition ::= INTEGER (0..10000)

LaneChangeMoment ::= SEQUENCE {
    minute                Minute,
    millisecond            Millisecond
}

LaneChangeSpeed ::= INTEGER (0..500)

LeadingVehicle ::= INTEGER (0..4294967295)

FollowingVehicle ::= INTEGER (0..4294967295)

TargetLane ::= INTEGER (0..255)

TriggeringPointOfToC ::= INTEGER (0..10000)

AdviceLaneID ::= INTEGER (0..255)

AdvicePosition ::= INTEGER (0..10000)
```

```
DesiredBehaviour ::= CHOICE {
    targetGap          TargetGap,
    targetSpeed       TargetSpeed
}

TargetGap ::= INTEGER (0..255)

TargetSpeed ::= INTEGER (0..255)

TocAdviceReason ::= ENUMERATED {
    reason0 (0),
    reason1 (1),
    ...
}

PlaceOfStartTransition ::= INTEGER (0..10000)

TimeOfTriggerTransition ::= SEQUENCE {
    minute          Minute,
    millisecond     Millisecond
}

PlaceOfEndTransition ::= INTEGER (0..10000)

END

ITS-Container {itu-t(0) identified-organization(4) etsi(0) itsDomain(5)
wgl(1) ts(102894) cdd(2) version(1)}

DEFINITIONS AUTOMATIC TAGS ::=
BEGIN

ItsPduHeader ::= SEQUENCE {
    protocolVersion INTEGER {
        currentVersion(1)
    } (0..255),
    messageID INTEGER {
        denm(1),
        cam(2),
        poi(3),
        spat(4),
        map(5),
        ivi(6),
        ev-rsr(7),
        cpm(32),
        mcm(33)
    } (0..255),
    stationID      StationID
}

StationID ::= INTEGER (0..4294967295)
```

```

StationType ::= INTEGER {
    unknown(0),
    pedestrian(1),
    cyclist(2),
    moped(3),
    motorcycle(4),
    passengerCar(5),
    bus(6),
    lightTruck(7),
    heavyTruck(8),
    trailer(9),
    specialVehicles(10),
    tram(11),
    roadSideUnit(15)
} (0..255)

ReferencePosition ::= SEQUENCE {
    latitude                Latitude,
    longitude               Longitude,
    positionConfidenceEllipse PosConfidenceEllipse,
    altitude                Altitude
}

Latitude ::= INTEGER {
    oneMicrodegreeNorth(10),
    oneMicrodegreeSouth(-10),
    unavailable(900000001)
} (-900000000..900000001)

Longitude ::= INTEGER {
    oneMicrodegreeEast(10),
    oneMicrodegreeWest(-10),
    unavailable(1800000001)
} (-1800000000..1800000001)

Altitude ::= SEQUENCE {
    altitudeValue           AltitudeValue,
    altitudeConfidence      AltitudeConfidence
}

AltitudeValue ::= INTEGER {
    referenceEllipsoidSurface(0),
    oneCentimeter(1),
    unavailable(800001)
} (-100000..800001)

AltitudeConfidence ::= ENUMERATED {
    alt-000-01(0), alt-000-02(1), alt-000-05(2), alt-000-10(3), alt-000-
    20(4), alt-000-50(5), alt-001-00(6), alt-002-00(7), alt-005-00(8), alt-010-
    00(9), alt-020-00(10), alt-050-00(11), alt-100-00(12), alt-200-00(13),
    outOfRange(14), unavailable(15)
}

PosConfidenceEllipse ::= SEQUENCE {
    semiMajorConfidence      SemiAxisLength,
    semiMinorConfidence      SemiAxisLength,
    semiMajorOrientation      HeadingValue
}

```

```
SemiAxisLength ::= INTEGER {
    oneCentimeter(1),
    outOfRange(4094),
    unavailable(4095)
} (0..4095)

Heading ::= SEQUENCE {
    headingValue          HeadingValue,
    headingConfidence     HeadingConfidence
}

HeadingValue ::= INTEGER {
    wgs84North(0), wgs84East(900), wgs84South(1800), wgs84West(2700),
    unavailable(3601)
} (0..3601)

HeadingConfidence ::= INTEGER {
    equalOrWithinZeroPointOneDegree(1),
    equalOrWithinOneDegree(10),
    outOfRange(126),
    unavailable(127)
} (1..127)

Speed ::= SEQUENCE {
    speedValue            SpeedValue,
    speedConfidence       SpeedConfidence
}

SpeedValue ::= INTEGER {
    standstill(0),
    oneCentimeterPerSec(1),
    unavailable(16383)
} (0..16383)

SpeedConfidence ::= INTEGER {
    equalOrWithinOneCentimeterPerSec(1),
    equalOrWithinOneMeterPerSec(100),
    outOfRange(126),
    unavailable(127)
} (1..127)

LongitudinalAcceleration ::= SEQUENCE {
    longitudinalAccelerationValue          LongitudinalAccelerationValue,
    longitudinalAccelerationConfidence     AccelerationConfidence
}

LongitudinalAccelerationValue ::= INTEGER {
    pointOneMeterPerSecSquaredForward(1),
    pointOneMeterPerSecSquaredBackward(-1),
    unavailable(161)
} (-160..161)

LateralAcceleration ::= SEQUENCE {
    lateralAccelerationValue          LateralAccelerationValue,
    lateralAccelerationConfidence     AccelerationConfidence
}
```

```

LateralAccelerationValue ::= INTEGER {
    pointOneMeterPerSecSquaredToRight(-1),
    pointOneMeterPerSecSquaredToLeft(1),
    unavailable(161)
} (-160..161)

VerticalAcceleration ::= SEQUENCE {
    verticalAccelerationValue VerticalAccelerationValue,
    verticalAccelerationConfidence AccelerationConfidence
}

VerticalAccelerationValue ::= INTEGER {
    pointOneMeterPerSecSquaredUp(1),
    pointOneMeterPerSecSquaredDown(-1),
    unavailable(161)
} (-160..161)

AccelerationConfidence ::= INTEGER {
    pointOneMeterPerSecSquared(1),
    outOfRange(101),
    unavailable(102)
} (0..102)

YawRate ::= SEQUENCE {
    yawRateValue YawRateValue,
    yawRateConfidence YawRateConfidence
}

YawRateValue ::= INTEGER {
    straight(0),
    degSec-000-01ToRight(-1),
    degSec-000-01ToLeft(1),
    unavailable(32767)
} (-32766..32767)

YawRateConfidence ::= ENUMERATED {
    degSec-000-01(0), degSec-000-05(1), degSec-000-10(2), degSec-001-
00(3), degSec-005-00(4), degSec-010-00(5), degSec-100-00(6), outOfRange(7),
unavailable(8)
}

Curvature ::= SEQUENCE {
    curvatureValue CurvatureValue,
    curvatureConfidence CurvatureConfidence
}

CurvatureValue ::= INTEGER {
    straight(0),
    reciprocalOf1MeterRadiusToRight(-30000),
    reciprocalOf1MeterRadiusToLeft(30000),
    unavailable(30001)
} (-30000..30001)

CurvatureConfidence ::= ENUMERATED {
    onePerMeter-0-00002(0), onePerMeter-0-0001(1), onePerMeter-0-
0005(2), onePerMeter-0-002(3), onePerMeter-0-01(4), onePerMeter-0-1(5),
outOfRange(6), unavailable(7)
}

```

```
CurvatureCalculationMode ::= ENUMERATED {
    yawRateUsed(0),
    yawRateNotUsed(1),
    unavailable(2),
    ...
}

DriveDirection ::= ENUMERATED {
    forward(0),
    backward(1),
    unavailable(2)
}

LanePosition ::= INTEGER {
    offTheRoad(-1),
    hardShoulder(0),
    outermostDrivingLane(1),
    secondLaneFromOutside(2)
} (-1..14)

SteeringWheelAngle ::= SEQUENCE {
    steeringWheelAngleValue          SteeringWheelAngleValue,
    steeringWheelAngleConfidence    SteeringWheelAngleConfidence
}

SteeringWheelAngleValue ::= INTEGER {
    straight(0),
    onePointFiveDegreesToRight(-1),
    onePointFiveDegreesToLeft(1),
    unavailable(512)
} (-511..512)

SteeringWheelAngleConfidence ::= INTEGER {
    equalOrWithinOnePointFiveDegree(1),
    outOfRange(126),
    unavailable(127)
} (1..127)

END
```


Annex B2: CAM ASN.1 specification

For the first iteration, TransAID is using the standard CAM ASN.1 definition [19].

Annex B3: DENM ASN.1 specification

For the first iteration, TransAID is using the standard DENM ASN.1 definition [21].

Annex B4: MAP ASN.1 specification

For the first iteration, TransAID is using the standard MAP ASN.1 definition.

Annex B5: CPM ASN.1 specification

For the first iteration, TransAID is using the CPM ASN.1 definition specified in MAVEN D5.1 [34].

Annex C: TransAID messages ASN.1 specifications (2nd iteration)

Annex C1: MCM ASN.1 specification

```

MCM-TransAID {
--   itu-t(0)
--   identified-organization(4)
--   etsi(0)
--   itsDomain(5)
--   wgl(1)
--   en(302637)
--   mcm (1)
--   version(2)
}

DEFINITIONS AUTOMATIC TAGS ::=
BEGIN

IMPORTS
    ItsPduHeader, StationType, ReferencePosition, VehicleLength, VehicleWidth,
    Heading, HeadingValue, Speed, LongitudinalAcceleration,
    LateralAcceleration, VerticalAcceleration, YawRate, Curvature,
    CurvatureCalculationMode, DriveDirection, LanePosition,
    SteeringWheelAngle, SpeedValue, LongitudinalAccelerationValue

FROM ITS-Container {itu-t(0) identified-organization(4) etsi(0) itsDomain(5)
wgl(1) ts(102894) cdd(2) version(1)};

MCM ::= SEQUENCE {
    header                ItsPduHeader,
    maneuverCoordination  ManeuverCoordination
}

ManeuverCoordination ::= SEQUENCE {
    generationDeltaTime    GenerationDeltaTime,
    mcmParameters          McmParameters
}

GenerationDeltaTime ::= INTEGER {
    oneMilliSec(1)
} (0..65535)

McmParameters ::= SEQUENCE {
    basicContainer        BasicContainer,
    maneuverContainer     ManeuverContainer
}

ManeuverContainer ::= CHOICE {
    vehicleManeuver      VehicleManeuver,
    rsuManeuver          RsuManeuver,
    ...
}

```

```

BasicContainer ::= SEQUENCE {
    stationType          StationType,
    referencePosition    ReferencePosition,
    ...
}

VehicleManeuver ::= SEQUENCE {
    plannedTrajectory    PlannedTrajectory,
    desiredTrajectory    DesiredTrajectory OPTIONAL,
    minDistanceBehind    MinDistanceBehind OPTIONAL,
    minTimeHeadwayBehind MinTimeHeadwayBehind OPTIONAL,
    triggerTimeOfToC     TimeDefinition OPTIONAL,
    targetAutomationLevel TargetAutomationLevel OPTIONAL,
    triggerTimeOfMRM     TriggerTimeOfMRM OPTIONAL,
    vehicleLength        VehicleLength,
    vehicleWidth         VehicleWidth,
    heading              Heading,
    speed                Speed,
    longitudinalAcceleration LongitudinalAcceleration,
    lateralAcceleration  LateralAcceleration,
    verticalAcceleration VerticalAcceleration,
    yawRate              YawRate,
    curvature             Curvature,
    curvatureCalculationMode CurvatureCalculationMode,
    driveDirection       DriveDirection,
    lanePosition         LanePosition,
    steeringWheelAngle   SteeringWheelAngle,
    adviceResponseList   AdviceResponseList OPTIONAL
}

PlannedTrajectory ::= SEQUENCE SIZE (1..30) OF TrajectoryPoint

DesiredTrajectory ::= SEQUENCE SIZE (1..30) OF TrajectoryPoint

TrajectoryPoint ::= SEQUENCE {
    deltaXCm             DiffPosition,
    deltaYCm             DiffPosition,
    deltaTimeMs          DiffTime,
    headingValue         HeadingValue OPTIONAL,
    absSpeed             SpeedValue OPTIONAL
}

DiffPosition ::= INTEGER (-10000..10000)

DiffTime ::= INTEGER (0..65535)

MinDistanceBehind ::= INTEGER (0..10000)

MinTimeHeadwayBehind ::= INTEGER (0..65535)

TimeDefinition ::= SEQUENCE {
    minute              Minute,
    millisecond         Millisecond
}

Minute ::= INTEGER (0..527040)

Millisecond ::= INTEGER (0..65535)

```

```
TargetAutomationLevel ::= ENUMERATED {
    saeLevel0 (0),
    saeLevel1LongAutom (1),
    saeLevel1LatAutom (2),
    saeLevel2 (3),
    saeLevel3 (4),
    saeLevel4 (5),
    saeLevel5 (6),
    mrm (7),
    ...
}

TriggerTimeOfMRM ::= INTEGER (0..65535)

AdviceResponseList ::= SEQUENCE {
    laneAdviceCompliance          LaneAdviceCompliance OPTIONAL,
    carFollowingAdviceCompliance  CarFollowingAdviceCompliance OPTIONAL,
    tocAdviceCompliance           ToCAdviceCompliance OPTIONAL,
    safeSpotAdviceCompliance      SafeSpotCompliance OPTIONAL,
    ...
}

AdviceID ::= INTEGER (0..255)

LaneAdviceCompliance ::= SEQUENCE {
    adviceID          AdviceID,
    laneAdviceComplianceStatus LaneAdviceComplianceStatus
}

LaneAdviceComplianceStatus ::= ENUMERATED{
    unknown (0),
    rejected (1),
    desired (2),
    planned (3),
    completed (4),
    ...
}

CarFollowingAdviceCompliance ::= SEQUENCE {
    adviceID          AdviceID,
    carFollowingComplianceStatus CarFollowingComplianceStatus
}

CarFollowingComplianceStatus ::= ENUMERATED{
    unknown (0),
    notCompliant (1),
    compliant (2),
    ...
}

ToCAdviceCompliance ::= SEQUENCE {
    adviceID          AdviceID,
    tocAdviceComplianceStatus ToCAdviceComplianceStatus
}
```

```
ToCAAdviceComplianceStatus ::= ENUMERATED{
    unknown (0),
    rejected (1),
    planned (2),
    executing (3),
    completed (4),
    ...
}

SafeSpotCompliance ::= SEQUENCE {
    adviceID                AdviceID,
    safeSpotComplianceStatus SafeSpotComplianceStatus
}

SafeSpotComplianceStatus ::= ENUMERATED{
    unknown (0),
    rejected (1),
    planned (2),
    executing (3),
    completed (4),
    ...
}

RsuManeuver ::= SEQUENCE {
    intersectionReferenceID IntersectionReferenceID OPTIONAL,
    roadSegmentReferenceID RoadSegmentReferenceID OPTIONAL,
    vehicleAdviceList       VehicleAdviceList OPTIONAL
}

IntersectionReferenceID ::= SEQUENCE {
    region RoadRegulatorID OPTIONAL,
    id     IntersectionID
}

RoadSegmentReferenceID ::= SEQUENCE {
    region RoadRegulatorID OPTIONAL,
    id     RoadSegmentID
}

RoadRegulatorID ::= INTEGER (0..65535)

IntersectionID ::= INTEGER (0..65535)

RoadSegmentID ::= INTEGER (0..65535)

VehicleAdviceList ::= SEQUENCE SIZE (1..8) OF VehicleAdvice

VehicleAdvice ::= SEQUENCE {
    targetStationID TargetStationID,
    adviceStatus     AdviceStatus,
    laneAdvice       LaneAdvice OPTIONAL,
    carFollowingAdvice CarFollowingAdvice OPTIONAL,
    tocAdvice        TocAdvice OPTIONAL,
    safeSpotAdvice   SafeSpotAdvice OPTIONAL
}

TargetStationID ::= INTEGER (0..4294967295)
```

```
AdviceStatus ::= ENUMERATED {
    new (0),
    updated (1),
    cancelled (2),
    ...
}

LaneAdvice ::= SEQUENCE {
    adviceID                AdviceID,
    laneAdviceReason        LaneAdviceReason,
    laneChangeAdviceType    LaneChangeAdviceType,
    laneChangeSpeed         LaneChangeSpeed OPTIONAL,
    leadingVehicle          LeadingVehicle OPTIONAL,
    followingVehicle         FollowingVehicle OPTIONAL,
    targetLane              TargetLane,
    triggeringPointOfToC    TriggeringPointOfToC OPTIONAL
}

CarFollowingAdvice ::= SEQUENCE {
    adviceID                AdviceID,
    adviceLaneID            AdviceLaneID,
    adviceDistanceRange     DistanceRange,
    desiredBehaviour        DesiredBehaviour
}

TocAdvice ::= SEQUENCE {
    adviceID                AdviceID,
    tocAdviceReason         TocAdviceReason,
    targetAutomationLevel   TargetAutomationLevel,
    transitionAdviceType    TransitionAdviceType OPTIONAL
}

SafeSpotAdvice ::= SEQUENCE {
    adviceID                AdviceID,
    safeSpotAdviceRange     DistanceRange
}

LaneAdviceReason ::= ENUMERATED {
    reason0 (0),
    reason1 (1),
    ...
}

LaneChangeAdviceType ::= CHOICE {
    laneChangeAdviceDistanceRange DistanceRange,
    laneChangeAdviceTimeWindow     TimeWindow
}

LaneChangeSpeed ::= INTEGER (0..500)

LeadingVehicle ::= INTEGER (0..4294967295)

FollowingVehicle ::= INTEGER (0..4294967295)

TargetLane ::= INTEGER (0..255)

TriggeringPointOfToC ::= INTEGER (0..10000)

AdviceLaneID ::= INTEGER (0..255)
```

```
DesiredBehaviour ::= CHOICE {
    targetGap          TargetGap,
    targetSpeed        TargetSpeed
}

TargetGap ::= INTEGER (0..255)

TargetSpeed ::= INTEGER (0..255)

TocAdviceReason ::= ENUMERATED {
    reason0 (0),
    reason1 (1),
    ...
}

TransitionAdviceType ::= CHOICE {
    transitionAdviceDistanceRange    DistanceRange,
    transitionAdviceTimeWindow        TimeWindow
}

TimeWindow ::= SEQUENCE {
    earliest    TimeDefinition,
    latest      TimeDefinition
}

DistanceRange ::= SEQUENCE {
    startingDistance    DistanceDefinition,
    endingDistance      DistanceDefinition
}

DistanceDefinition ::= INTEGER (0..10000)

END

ITS-Container {itu-t(0) identified-organization(4) etsi(0) itsDomain(5) wgl(1)
ts(102894) cdd(2) version(1)}

DEFINITIONS AUTOMATIC TAGS ::=
BEGIN

ItsPduHeader ::= SEQUENCE {
    protocolVersion INTEGER {
        currentVersion(1)
    } (0..255),

messageID INTEGER {
    denm(1),
    cam(2),
    poi(3),
    spat(4),
    map(5),
    ivi(6),
    ev-rsr(7),
    cpm(32),
    mcm(33)
} (0..255),

stationID    StationID
}
```

```
StationID ::= INTEGER (0..4294967295)

StationType ::= INTEGER {
    unknown(0),
    pedestrian(1),
    cyclist(2),
    moped(3),
    motorcycle(4),
    passengerCar(5),
    bus(6),
    lightTruck(7),
    heavyTruck(8),
    trailer(9),
    specialVehicles(10),
    tram(11),
    roadSideUnit(15)
} (0..255)

ReferencePosition ::= SEQUENCE {
    latitude                Latitude,
    longitude                Longitude,
    positionConfidenceEllipse PosConfidenceEllipse,
    altitude                Altitude
}

Latitude ::= INTEGER {
    oneMicrodegreeNorth(10),
    oneMicrodegreeSouth(-10),
    unavailable(900000001)
} (-9000000000..900000001)

Longitude ::= INTEGER {
    oneMicrodegreeEast(10),
    oneMicrodegreeWest(-10),
    unavailable(18000000001)
} (-18000000000..18000000001)

Altitude ::= SEQUENCE {
    altitudeValue           AltitudeValue,
    altitudeConfidence      AltitudeConfidence
}

AltitudeValue ::= INTEGER {
    referenceEllipsoidSurface(0),
    oneCentimeter(1),
    unavailable(800001)
} (-100000..800001)
```



```
AltitudeConfidence ::= ENUMERATED {
    alt-000-01(0),
    alt-000-02(1),
    alt-000-05(2),
    alt-000-10(3),
    alt-000-20(4),
    alt-000-50(5),
    alt-001-00(6),
    alt-002-00(7),
    alt-005-00(8),
    alt-010-00(9),
    alt-020-00(10),
    alt-050-00(11),
    alt-100-00(12),
    alt-200-00(13),
    outOfRange(14),
    unavailable(15)
}

PosConfidenceEllipse ::= SEQUENCE {
    semiMajorConfidence          SemiAxisLength,
    semiMinorConfidence          SemiAxisLength,
    semiMajorOrientation         HeadingValue
}

SemiAxisLength ::= INTEGER {
    oneCentimeter(1),
    outOfRange(4094),
    unavailable(4095)
} (0..4095)

VehicleLength ::= SEQUENCE {
    vehicleLengthValue           VehicleLengthValue,
    vehicleLengthConfidenceIndication VehicleLengthConfidenceIndication
}

VehicleLengthValue ::= INTEGER {
    tenCentimeters(1),
    outOfRange(1022),
    unavailable(1023)
} (1..1023)

VehicleLengthConfidenceIndication ::= ENUMERATED {
    noTrailerPresent(0),
    trailerPresentWithKnownLength(1),
    trailerPresentWithUnknownLength(2),
    trailerPresenceIsUnknown(3),
    unavailable(4)
}

VehicleWidth ::= INTEGER {
    tenCentimeters(1),
    outOfRange(61),
    unavailable(62)
} (1..62)

Heading ::= SEQUENCE {
    headingValue                 HeadingValue,
    headingConfidence            HeadingConfidence
}
```

```

HeadingValue ::= INTEGER {
    wgs84North(0),
    wgs84East(900),
    wgs84South(1800),
    wgs84West(2700),
    unavailable(3601)
} (0..3601)

HeadingConfidence ::= INTEGER {
    equalOrWithinZeroPointOneDegree(1),
    equalOrWithinOneDegree(10),
    outOfRange(126),
    unavailable(127)
} (1..127)

Speed ::= SEQUENCE {
    speedValue          SpeedValue,
    speedConfidence     SpeedConfidence
}

SpeedValue ::= INTEGER {
    standstill(0),
    oneCentimeterPerSec(1),
    unavailable(16383)
} (0..16383)

SpeedConfidence ::= INTEGER {
    equalOrWithinOneCentimeterPerSec(1),
    equalOrWithinOneMeterPerSec(100),
    outOfRange(126),
    unavailable(127)
} (1..127)

LongitudinalAcceleration ::= SEQUENCE {
    longitudinalAccelerationValue      LongitudinalAccelerationValue,
    longitudinalAccelerationConfidence AccelerationConfidence
}

LongitudinalAccelerationValue ::= INTEGER {
    pointOneMeterPerSecSquaredForward(1),
    pointOneMeterPerSecSquaredBackward(-1),
    unavailable(161)
} (-160..161)

LateralAcceleration ::= SEQUENCE {
    lateralAccelerationValue          LateralAccelerationValue,
    lateralAccelerationConfidence     AccelerationConfidence
}

LateralAccelerationValue ::= INTEGER {
    pointOneMeterPerSecSquaredToRight(-1),
    pointOneMeterPerSecSquaredToLeft(1),
    unavailable(161)
} (-160..161)

VerticalAcceleration ::= SEQUENCE {
    verticalAccelerationValue          VerticalAccelerationValue,
    verticalAccelerationConfidence     AccelerationConfidence
}

```

```
VerticalAccelerationValue ::= INTEGER {
    pointOneMeterPerSecSquaredUp(1),
    pointOneMeterPerSecSquaredDown(-1),
    unavailable(161)
} (-160..161)

AccelerationConfidence ::= INTEGER {
    pointOneMeterPerSecSquared(1),
    outOfRange(101),
    unavailable(102)
} (0..102)

YawRate ::= SEQUENCE {
    yawRateValue      YawRateValue,
    yawRateConfidence YawRateConfidence
}

YawRateValue ::= INTEGER {
    straight(0),
    degSec-000-01ToRight(-1),
    degSec-000-01ToLeft(1),
    unavailable(32767)
} (-32766..32767)

    YawRateConfidence ::= ENUMERATED {
        degSec-000-01(0),
        degSec-000-05(1),
        degSec-000-10(2),
        degSec-001-00(3),
        degSec-005-00(4),
        degSec-010-00(5),
        degSec-100-00(6),
        outOfRange(7),
        unavailable(8)
    }

Curvature ::= SEQUENCE {
    curvatureValue      CurvatureValue,
    curvatureConfidence CurvatureConfidence
}

CurvatureValue ::= INTEGER {
    straight(0),
    reciprocalOf1MeterRadiusToRight(-30000),
    reciprocalOf1MeterRadiusToLeft(30000),
    unavailable(30001)
} (-30000..30001)

CurvatureConfidence ::= ENUMERATED {
    onePerMeter-0-00002(0),
    onePerMeter-0-0001(1),
    onePerMeter-0-0005(2),
    onePerMeter-0-002(3),
    onePerMeter-0-01(4),
    onePerMeter-0-1(5),
    outOfRange(6),
    unavailable(7)
}
```

```
CurvatureCalculationMode ::= ENUMERATED {
    yawRateUsed(0),
    yawRateNotUsed(1),
    unavailable(2),
    ...
}

DriveDirection ::= ENUMERATED {
    forward(0),
    backward(1),
    unavailable(2)
}

LanePosition ::= INTEGER {
    offTheRoad(-1),
    hardShoulder(0),
    outermostDrivingLane(1),
    secondLaneFromOutside(2)
} (-1..14)

SteeringWheelAngle ::= SEQUENCE {
    steeringWheelAngleValue SteeringWheelAngleValue,
    steeringWheelAngleConfidence SteeringWheelAngleConfidence
}

SteeringWheelAngleValue ::= INTEGER {
    straight(0),
    onePointFiveDegreesToRight(-1),
    onePointFiveDegreesToLeft(1),
    unavailable(512)
} (-511..512)

SteeringWheelAngleConfidence ::= INTEGER {
    equalOrWithinOnePointFiveDegree(1),
    outOfRange(126),
    unavailable(127)
} (1..127)

END
```

Annex C2: CAM ASN.1 specification

For the second iteration, TransAID is using the standard CAM ASN.1 definition [19] with extensions to inform about current automation level. ASN.1 code for these extensions is detailed below:

```
SpecialVehicleContainer ::= CHOICE {
    publicTransportContainer PublicTransportContainer,
    specialTransportContainer SpecialTransportContainer,
    dangerousGoodsContainer DangerousGoodsContainer,
    roadWorksContainerBasic RoadWorksContainerBasic,
    rescueContainer RescueContainer,
    emergencyContainer EmergencyContainer,
    safetyCarContainer SafetyCarContainer,
    ...,
    mavenAutomatedVehicleContainer MavenAutomatedVehicleContainer
}

MavenAutomatedVehicleContainer ::= SEQUENCE {
    routeAtIntersection RouteAtIntersection,
    intersectionsRoute IntersectionsRoute,
    desiredSpeedRange DesiredSpeedRange,
    accelerationCapability AccelerationCapability,
    numberOfOccupants NumberOfOccupants OPTIONAL,
    distanceToFollowingVehicle VehicleDistance OPTIONAL,
    distanceToPrecedingVehicle VehicleDistance OPTIONAL,
    ableToPlatoon AbleToPlatoon,
    platoonId PlatoonId OPTIONAL,
    platoonParticipants PlatoonVehicles OPTIONAL,
    desiredPlatoonSpeed SpeedValue OPTIONAL,
    laneChanging LaneChanging OPTIONAL,
    ...,
    automationLevel AutomationLevel OPTIONAL
}

AutomationLevel ::= ENUMERATED {
    saeLevel0 (0),
    saeLevel1LongAutom (1),
    saeLevel1LatAutom (2),
    saeLevel2 (3),
    saeLevel3 (4),
    saeLevel4 (5),
    saeLevel5 (6),
    mrm (7),
    ...
}
```

Annex C3: DENM ASN.1 specification

For the second iteration, TransAID is using the standard DENM ASN.1 definition [21].

Annex C4: MAP ASN.1 specification

For the second iteration, TransAID is using the standard MAP ASN.1 definition.

Annex C5: CPM ASN.1 specification

For the second iteration, TransAID is using the CPM ASN.1 definition specified in MAVEN D5.1 [34].