

Title	Single-step generation of gene knockout-rescue system in pluripotent stem cells by promoter insertion with CRISPR/Cas9( Dissertation_全文 )
Author(s)	Matsunaga, Taichi
Citation	Kyoto University (京都大学)
Issue Date	2014-03-24
URL	<a href="http://dx.doi.org/10.14989/doctor.k18177">http://dx.doi.org/10.14989/doctor.k18177</a>
Right	
Type	Thesis or Dissertation
Textversion	ETD

Single-step generation of gene  
knockout-rescue system in pluripotent  
stem cells by promoter insertion with  
CRISPR/Cas9

(CRISPR/Cas9 を用いたプロモーター  
配列挿入による簡便なノックアウト・  
レスキューシステムの構築)

松永 太一

**Single-step generation of gene knockout-rescue system in pluripotent stem cells by promoter insertion with CRISPR/Cas9**

Authors:

Taichi Matsunaga <sup>a,b</sup>, Jun K. Yamashita <sup>a,b,\*</sup>,

Institutions:

<sup>a</sup> Department of Cell Growth and Differentiation, Center for iPS Cell Research and Application, Kyoto University, Kyoto 606-8507, Japan

<sup>b</sup> Department of Stem Cell Differentiation, Institute for Frontier Medical Sciences, Kyoto University, Kyoto 606-8507, Japan

\*Correspondence to:

Jun K. Yamashita, M.D., Ph.D.

Department of Cell Growth and Differentiation, Center for iPS Cell Research and Application, Kyoto University, 53 Shogoin Kawahara-cho, Sakyo-ku, Kyoto 606-8507, Japan

TEL: +81-75-751-3853, FAX: +81-75-751-4824

e-mail: juny@frontier.kyoto-u.ac.jp

## **Abstract**

Specific gene knockout and rescue experiments are powerful tools in developmental and stem cell biology. Nevertheless, the experiments require multiple steps of molecular manipulation for gene knockout and subsequent rescue procedures. Here we report an efficient and single step strategy to generate gene knockout-rescue system in pluripotent stem cells by promoter insertion with CRISPR/Cas9 genome editing technology. We inserted a tetracycline-regulated inducible gene promoter (tet-OFF/TRE-CMV) upstream of the endogenous promoter region of vascular endothelial growth factor receptor 2 (VEGFR2/Flk1) gene, an essential gene for endothelial cell (EC) differentiation, in mouse embryonic stem cells (ESCs) with homologous recombination. Both homo- and hetero-inserted clones were efficiently obtained through a simple selection with a drug-resistant gene. The insertion of TRE-CMV promoter disrupted endogenous Flk1 expression, resulting in null mutation in homo-inserted clones. When the inserted TRE-CMV promoter was activated with doxycycline (Dox) depletion, Flk1 expression was sufficiently recovered from the downstream genomic Flk1 gene. Whereas EC differentiation was almost completely perturbed in homo-inserted clones, Flk1 rescue with TRE-CMV promoter activation restored EC appearance, indicating that phenotypic changes in EC differentiation can be successfully reproduced with this knockout-rescue system. Thus, this promoter insertion strategy with CRISPR/Cas9 would be a novel attractive method for knockout-rescue experiments.

**Keywords:** CRISPR/Cas9 system, Endothelial cell differentiation, Knockout-rescue system, VEGFR2/Flk1, Promoter

## 1. Introduction

Loss-of-function studies of specific target genes such as gene knockout experiments are well-established basic strategies in biological research. Nowadays, gene knockout experiments are often followed by gene rescue experiments to confirm the specific function of target genes. However, to establish these experiments, multiple complicated steps are required; the generation of targeting vectors that often requires isolation and construction of long genomic fragments, mutagenesis with homologous recombination and clone selection for gene knockout, followed by cDNA isolation and plasmid construction, transfection, and clone selection for rescue experiments. These procedures are often hampered by various technical difficulties in cDNA isolation and plasmid construction of GC-rich or very large genes, homologous recombination efficiency and so on. To establish an efficient and simple method for knockout-rescue system in pluripotent stem cells, we employed an efficient genome editing technology, clustered regularly interspaced palindromic repeats/CRISPR-associated 9 (CRISPR/cas9) system and considered to insert only an inducible gene promoter to the endogenous promoter region, which would achieve both inactivation of endogenous gene with insertion (Knockout) and inducible expression of the target gene (Rescue), simultaneously.

CRISPR/Cas9 is a RNA-guided defense system in bacteria with a site-specific DNA double strand breaks (DSBs). CRISPR RNA and trans-activating CRISPR RNA recruit an endonuclease Cas9 to a specific genomic site and induce DSBs [1-4]. Co-existence of homology repair template for the target site induces highly efficient homologous recombination. This technology is now broadly applied to efficient and robust RNA-guided genome modifications [5-7]. By modifying not the gene body but only the promoter region using this technology, it will be possible to regulate gene

expression keeping the endogenous gene body intact. We hypothesized that insertion of a tetracycline-regulated inducible gene promoter (TRE-CMV) into the endogenous promoter region of target gene with CRISPR/Cas9 could offer an efficient and single-step strategy to generate a knockout-rescue (or overexpression) system in pluripotent stem cells.

In this study, we show the promising potential for this system using vascular endothelial growth factor receptor type 2 (VEGFR2/Flk1) as the target gene. Flk1 has an essential role in endothelial cell (EC) differentiation during embryogenesis [8]. We previously established a pluripotent stem cell differentiation system for cardiovascular cells, in which Flk1 appeared to be essential for EC differentiation [9-13]. Insertion of TRE-CMV promoter to endogenous Flk1 gene promoter region in a mouse embryonic stem cell (ESC) line (ESStA5-4) carrying tetracycline transactivator (tTA) gene efficiently worked to generate both homo- and hetero-Flk1 knockout clones. Inducible gene expression from genomic Flk1 gene was successfully achieved through activation of the inserted TRE-CMV promoter with doxycycline (Dox) depletion, resulting in the recovery of Flk1 expression as well as EC differentiation. Thus, the promoter insertion strategy would be a convenient and useful tool to show specific functional roles of target genes.

## 2. Materials and Methods

### 2.1. Antibodies

Monoclonal antibodies for murine Flk1 (AVAS12) and vascular endothelial (VE)-cadherin were described previously [14]. Monoclonal antibodies for murine CD31 and platelet-derived growth factor receptor alpha (PDGFR $\alpha$ ) were purchased from BD Biosciences (San Jose, CA, USA). Monoclonal antibodies for murine alpha-smooth muscle actin ( $\alpha$ SMA) and beta-actin ( $\beta$ -actin) were purchased from Sigma-Aldrich (St. Louis, MO, USA). Antibody for platelet-derived growth factor receptor-beta (PDGFR $\beta$ ) was purchased from eBioscience (San Diego, CA, USA).

### 2.2. Cell culture and differentiation

A mouse ESC line (ES $\dagger$ TA5-4) expressing tTA protein was a kind gift from Dr T. Era (Kumamoto University, Kumamoto, Japan) [15]. Undifferentiated ESCs were maintained on gelatin-coated dishes in maintenance medium (MM) (Glasgow minimum essential medium (GMEM; Life Technologies, Carlsbad, CA, USA) supplemented with 1% fetal bovine serum (FBS; SAFC Biosciences, Lenexa, KS, USA), 10% knockout serum replacement (Life Technologies), 1% MEM Non-Essential Amino Acids Solution (100 $\times$ ) (Life Technologies), 1mM Sodium pyruvate (Sigma-Aldrich), 0.1mM 2-mercaptoethanol (2-ME; Life Technologies) and  $2 \times 10^3$ U/mL leukemia inhibitory factor (LIF; Merck Millipore, Billerica, MA, USA)) as described previously [16]. Differentiation was induced using differentiation medium (DM) (Minimum Essential Medium Alpha (MEM $\alpha$ ; Life Technologies) supplemented with 10% FBS (Life Technologies) and 50 $\mu$ M 2-ME) as described previously [12]. Briefly, undifferentiated ESCs were plated on gelatin-coated dishes in DM with 1 $\mu$ g/mL Dox (Sigma-Aldrich) at

a cell density of  $0.75-1 \times 10^3$  cells/cm<sup>2</sup>. Cultured cells were harvested and subjected to Fluorescence-activated cell sorting (FACS; BD, Franklin Lakes, NJ, USA) purification (Day4.5). Purified mesodermal cells (PDGFR $\alpha^+$ ) were then plated on gelatin-coated dishes at a cell density of  $0.75-1 \times 10^4$  cells/cm<sup>2</sup> in DM containing 50ng/mL human VEGF<sub>165</sub> (WAKO, Osaka, Japan) with or without Dox. Three days after re-culture of mesodermal cells (Day4.5+d3), induced ECs and mural cells (MCs) were then examined by immunostaining and flow cytometry.

### 2.3. Plasmids and transfection

For construction of guideRNA-Cas9 plasmid, pX330 plasmid was obtained from addgene (<http://www.addgene.org/>). The target sequence for the promoter region of Flk1 gene (corresponding to +190 to +209 nucleotides from the transcriptional start site (TSS)) [17, 18] was synthesized using customized UCSC Genome Browser tracks for mouse genomes. The website predicted suitable seed sequences, 5'-NNNNNNNNNN-NGG-3', for SpCas9 target which was unique in the whole genome. ([http://www.genome-engineering.org/crispr/?page\\_id=41](http://www.genome-engineering.org/crispr/?page_id=41)). Two oligos (5'-CACCGCCCCCGCAGCGCAAGACCG-3' and 5'-AAACCGGTCTTGCGCTGCGGGGC-3') including the predicted target sequence were phosphorylated, annealed and inserted into pX330 vector using the *Bbs*I restriction enzyme site (Fig. S1A) [19]. For generation of targeting vector, we first inserted puromycin-resistant gene and TRE-CMV promoter into pcDNA3.1 (+) plasmid (Life Technologies) between *Bam*HI and *Eco*RV restriction enzyme sites. Then, both 5'- and 3'-homology arms were amplified by PCR from mouse ESC genome using primers (5'-arm; 5-AATTACGCGTCTATGGGTTTTCTGGACCGAGCC-3 and



5-ATATACTAGTGCACCGGCGCCCTGGCTCCAGC-3, 3'-arm;  
5-ATCGCCTCTGTGACTTCTTTGCGGGCCAGGG-3 and  
5-ATATGCGGCCGCGAGTGTGGGCCTAACCTTGAAG-3). Purified PCR amplicons were digested by *MluI* and *SpeI* (for 5'-arm) or *EcoRV* and *NotI* (for 3'-arm) and inserted into the targeting vector. Design of the targeting vector with homology arms (5'-arm; -653 to +176, 3-arm; +216 to +1090 from TSS) is schematically shown in Fig. S1B. An ESC line EStTA5-4 was transfected with pX330 plasmid and targeting vector using Mouse ES Cell Nucleofector Kit (Lonza, Valais, Switzerland). Cells were then plated on gelatin-coated dishes in MM containing Dox. After 2 days, the medium was changed with addition of 2µg/mL Puromycin (Nacalai Tesque, Kyoto, Japan) and Dox. Puromycin-resistant clones were picked after 7 days.

#### 2.4. Genomic PCR for evaluation of homologous recombination

Genomic DNA was isolated from ESC lines and amplified using KOD FX (Toyobo, Osaka, Japan), according to alkaline lysis method of the manufacturer's instructions. PCR analysis was performed using a mixture of primer1 (5'-ATAATCTTATCTCTTTGTCTGGCTGAAAGA-3';-1124 to -1095 from TSS), primer2 (5'-AACCAAGTCATTATGAGGAAAACCTCAATAG-3';+1397 to +1424 from TSS) and primer3 (5'-TATTGAATTCGGCGGCTCTAGAGTAGGCGC-3'; in transgene region).

#### 2.5. Sequencing analysis of PCR fragments

PCR fragments were electrophoresed, excised, and purified using QIAquick Gel Extraction Kit (QIAGEN, Valencia, CA, USA), according to the manufacturer's

instructions. Sequencing analysis of PCR fragments was performed using BigDye Terminator v3.1 Cycle Sequencing Kit (Applied Biosystems, Carlsbad, CA, USA) and specific sequencing primer (5'-CCTCAGGACCCCAAGAGAGT-3';+17 to +38 from TSS). Genomic DNA sequence was analyzed by ABI PRISM 3100 Genetic Analyzers (Applied Biosystems).

#### *2.6. RNA isolation and quantitative RT-PCR*

Undifferentiated ESCs were plated on gelatin-coated dishes in MM with or without Dox at a cell density of  $3-4 \times 10^3$  cells/cm<sup>2</sup>. After 3 days, total RNA was isolated from undifferentiated ESCs with RNeasy Mini Kit (QIAGEN), according to the manufacturer's instructions. Reverse-transcription was carried out with SuperScriptIII First-Strand Synthesis SuperMix for qRT-PCR (Life Technologies). Quantitative RT-PCR was performed using Power SYBR Green PCR Master Mix and a StepOnePlus system (Applied Biosystems). The amount of target RNA was normalized relative to the amount of Gapdh mRNA and calculated with the  $\Delta\Delta C_t$  method. Primer sequences for Flk1 and Gapdh gene are 5'-GGGATGGTCCTTGCATCAGAA-3', 5'-ACTGGTAGCACTGGTCTGGTTG-3' and 5'-TGTGTCCGTCGTGGATCTGA-3', 5'-TTGCTGTTGAAGTCGCAGGAG-3', respectively. Flk1 mRNA expression of homo-inserted ESC clone (#1) cultured in Dox (-) condition was set as 1.0.

#### *2.7. Immunoblotting*

Undifferentiated ESCs were plated on gelatin-coated dishes in MM with or without Dox at a cell density of  $3-4 \times 10^3$  cells/cm<sup>2</sup>. After 3 days, cells were harvested, suspended in phosphate buffered saline (PBS) and lysed with an equal volume of Sample Buffer

Solution with 2-ME (2×) (Nacalai Tesque). Cell lysates were boiled at 95 °C for 5 minutes. Samples were run on sodium dodecyl sulfate/polyacrylamide gel electrophoresis using gradient gel (Atto, Tokyo, Japan) followed by electrophoretic transfer onto polyvinylidene fluoride (PVDF) membranes. After the membranes were incubated for 30 minutes in blocking agents Blocking One (Nacalai Tesque), they were incubated for 90 minutes at room temperature with primary antibodies. Horseradish peroxidase (HRP)-conjugated anti-rat, or anti-mouse antibodies (Life Technologies) were used as secondary antibodies (1:20000). Can Get Signal Immunoreaction Enhancer solution kit (Toyobo) was used for signal enhancement. Immunoreactivity was detected with Immobilon Western Chemiluminescent HRP Substrate (Merck Millipore).

### *2.8. Cell sorting and flow cytometry*

Flow cytometry was performed as described [12]. Briefly, cultured cells were harvested and stained with allophycocyanin (APC)-conjugated monoclonal antibody for Flk1 or APC-conjugated antibody for VE-cadherin together with phycoerythrin (PE)-conjugated anti-PDGFR $\beta$  antibody, then subjected to analysis by FACS.

### *2.9. Immunostaining*

Immunostaining for cultured cells was carried out as described [12]. Briefly, 4% paraformaldehyde-fixed cells were blocked by 1% skim milk (BD Biosciences). Cells were stained with anti-CD31 antibody (1:500) and anti- $\alpha$ SMA antibody (1:1000), followed by a mixture of Alexa Fluor 488 Goat Anti-Rat IgG (H+L) Antibody (1:500) and Alexa Fluor 546 Donkey Anti-Mouse IgG (1:500) (Life Technologies). Nuclei were

visualized with DAPI (4, 6 diamidino-2-phenylindole; Life Technologies). Stained cells were photographed with inverted fluorescent microscopy, Eclipse TE2000-U (Nikon, Tokyo, Japan) and digital camera system AxioCam HRc with the use of AxioVision Software (Carl Zeiss, Oberkochen, Germany).

#### *2.10. Statistical analysis*

All values are expressed as the mean  $\pm$  SEM of at least three independent experiments. Statistical differences among groups were determined using one-way ANOVA. *p*-values of less than 0.05 were considered statistically significant.

### 3. Results

#### 3.1. Insertion of promoter sequence at *Flk1* locus in ESCs by CRISPR/Cas9

To generate and evaluate the promoter insertion strategy, we selected *Flk1* as a model gene. *Flk1* is a mesoderm or cardiovascular progenitor marker and essential for EC differentiation [8]. In our mouse ESC differentiation system, *Flk1* appeared approximately 4 days after differentiation of ESCs. Purified *Flk1*<sup>+</sup> cells were re-cultured and subsequently differentiated into ECs under VEGF<sub>165</sub> treatment. ECs did not appear in the absence of VEGF<sub>165</sub>, indicating the essential role of *Flk1* in EC differentiation in our system.

We tried to insert TRE-CMV promoter into the 5'-untranslated region (UTR) of the *Flk1* gene in an ESC line (ESStA5-4) [12, 15] with CRISPR/Cas9-mediated homologous recombination (Fig. 1A, Fig. S1A and B). We chose a DSB target site between +192 and +193 nucleotides from TSS, and generated a guideRNA-cas9 plasmid including complementary sequence of nucleotides from +190 to +209 (Materials and Methods, Fig. S1A). We also generated a target plasmid carrying a puromycin-resistant gene and TRE-CMV promoter with 5'- and 3'-homology arms (Fig. 1A, Fig. S1B). The guideRNA-cas9 and target plasmids were co-transfected to ESStA5-4 cell line, and puromycin-resistant cell clones were picked up. Genomic PCR analysis for the integration of TRE-CMV promoter into the *Flk1* locus demonstrated highly efficient recombination at the target site. Among 19 clones we examined, 4 homo-inserted clones (#1, 6, 8, and 17) and 11 hetero-inserted clones (#2, 3, 4, 7, 9, 10, 12, 13, 14, 15 and 19) were obtained (Fig. 1B). Sequencing analysis of the PCR-amplified fragments further confirmed that CMV-TRE promoter was correctly inserted into the DSB site on 5' UTR of *Flk1* gene with homologous recombination (Fig.

1C). Thus, we succeeded in efficiently obtaining both homo- and hetero-inserted clones with only one electroporation by the CRISPR/Cas9 system.

### *3.2. Inducible expression of genomic Flk1 gene in undifferentiated ESCs*

We next examined whether the introduced tet-OFF system is functional to successfully induce Flk1 gene expression from genomic Flk1 (Fig. 2A). First we examined this in undifferentiated ESCs. As endogenous Flk1 is not expressed in undifferentiated ESCs [20], induced gene expression would be specifically detected. Flk1 mRNA and protein were not expressed in WT cells and #5 clone (a negative control; unsuccessful homologous recombination) with or without Dox (Fig. 2B and 2C WT and #5). Whereas the expression of Flk1 mRNA and protein in #1, #2 and #8 clones were not detected in the presence of Dox (Fig. 2B #1, #2 and #8 Dox+), removal of Dox drastically promoted Flk1 mRNA and protein expression (Fig. 2B and 2C, #1, #2 and #8, Dox-). Furthermore, we confirmed the cellular surface expression of induced Flk1 protein with flow cytometry. WT and #5 clones did not express Flk1 at cell membrane with or without Dox (Fig. 2D WT, #5). While faint dull Flk1-positive populations were observed in #1, #2 and #8 clones even with Dox, the vast majority of cells turned to Flk1-high population with Dox depletion. (Fig. 2D, #1, #2 and #8). These results indicated that the inserted TRE-CMV promoter works highly specifically and successfully induces functional protein expression from genomic DNA in stem cells.

### *3.3. Knockout-rescue expression of genomic Flk1 gene in differentiating cells*

To confirm regulated expression of genomic Flk1 gene during differentiation, we differentiated these clones towards vascular lineages and analyzed Flk1 expression with

or without Dox. Withdrawal of LIF induced differentiation from undifferentiated ESCs (Fig. 3A). After 4.5 days, we purified a mesoderm population using anti-PDGFR $\alpha$  antibody. Purified mesoderm cells (PDGFR $\alpha$ <sup>+</sup>) were re-cultured with or without Dox together with VEGF<sub>165</sub> to induce EC differentiation. Three days after the re-culture, we performed flow cytometry with anti-Flk1 antibody (Fig. 3A). Approximately 20% of WT cells became Flk1-positive at this stage with or without Dox. A fewer percentage of cells (approximately 6%) from #2 hetero-inserted clone became Flk1<sup>+</sup> in the presence of Dox, suggesting a lower expression of endogenous Flk1 from the single allele (Fig. 3B, C WT, #2). On the other hand, almost no Flk1<sup>+</sup> cells appeared from homo-inserted #1 and #8 clones in the presence of Dox, indicating that Flk1 expression was completely knocked out. (Fig. 3B, C, #1 and #8, Dox+). When the inserted TRE-CMV promoter was activated with Dox depletion, Flk1<sup>+</sup> cells were dramatically increased in #1, #2 and #8 clones, indicating that Flk1 expression was successfully restored through genomic Flk1 gene expression with the activation of CMV-TRE promoter during differentiation (Fig. 3B, C #1, #2 and #8 Dox-). These results indicated that this inducible promoter insertion system can actually achieve hetero- and homo-knockout of target gene and rescue/overexpression from genomic DNA even in differentiating stem cells.

#### *3.4. Phenotypic regulation with the knockout-rescue system*

Finally, to confirm whether this knockout-rescue system can reproduce the biological phenotypes with the gene modification, we examined EC and MC differentiation from mesoderm cells with or without Dox. After 3 days culture of purified mesoderm cells (PDGFR $\alpha$ <sup>+</sup>) with VEGF<sub>165</sub>, we examined the appearance of ECs and MCs with flow cytometry and immunostaining (Fig. 4A). WT cells gave rise to

approximately 15% ECs (VE-cadherin<sup>+</sup>) and 70% MCs (PDGFR $\beta$ <sup>+</sup>), respectively, with or without Dox. Approximately half or less population of ECs appeared from hetero-inserted #2 clone with Dox. Furthermore, no ECs appeared and MCs became predominant from #1 and #8 homo-inserted clones with Dox, reflecting knockout phenotypes of the Flk1 gene [8] (Fig. 4B, C Dox+). Rescue/overexpression of Flk1 by Dox depletion completely restored EC differentiation from #1, #2 and #8 clones (Fig. 4B, C Dox-). Reciprocally, appearance of PDGFR $\beta$ <sup>+</sup> MC population was reduced with Flk1 induction in #1, #2 and #8 clones (Fig. 4B, C Dox-). Immunostaining for ECs (CD31<sup>+</sup>) and MCs ( $\alpha$ SMA<sup>+</sup>) further confirmed the results in EC and MC differentiation; few or no EC differentiation was observed with Dox in hetero-inserted (#2) or homo-inserted (#8) clones, respectively, but the depletion of Dox resulted in a drastic increase in ECs (Fig. 4D). All these results indicate that gene knockout and rescue of functional target genes can be precisely regulated, and phenotypic output of the target gene modification can be faithfully reproduced with this knockout-rescue system.



#### 4. Discussion

Here we demonstrated an efficient and single-step method to generate gene knockout-rescue systems in stem cells. The insertion of an inducible gene promoter upstream of the endogenous promoter region with CRISPR/Cas9 system was highly efficient to obtain hetero- and homo-inserted cell clones with a simple electroporation and drug-selection method. The inserted promoter functioned to knockout the target gene expression and to rescue with inducible expression of genomic DNA with high fidelity. Furthermore, this knockout and rescue experiment completely reproduced the phenotypes of the target gene modification. Thus, this method could be a novel potent tool for knockout-rescue experiments in the field of stem cell research.

Recently, a number of genome editing technologies such as zinc finger nucleases (ZFNs), transcription activator-like effector nucleases (TALENs), and CRISPR/Cas9, have emerged. Among them, the CRISPR/Cas9 system is rapidly expanding its variations and is now applied to various gene modifications with mutagenesis, homologous recombination, gene interference and gene activation [21-23]. CRISPR RNA-guided activator composed of an inactive Cas9 (dCas9) fused to VP64, a transcription activator, was reported to activate genomic expression in human cells [24-26]. Our promoter insertion method is another novel genomic gene expression system in an inducible fashion combined with gene disruption.

In this study, we established and examined the single-step generation of a knockout-rescue system by introducing CMV-TRE promoter into ESC lines expressing tTA protein. This single-step method would be also applicable to wild type ESCs by using a target vector which carries tTA gene. Furthermore, this efficient and simple strategy has a potential to be modified and extended for other gene modification

experiments. That is, insertion of the promoter not to 5'UTR but to translation start site region can provide variations in utility. For example, 5'-ends of induced genes can be modified by preparing appropriate target templates to generate various fusion proteins for labeling (adding tagged-peptides), chimera (adding other proteins) and location (adding specific localizing signal sequences). If some marker genes such as GFP gene followed by TRE-CMV promoter-driven endogenous target gene are inserted around the translation start site, tracing of endogenous gene activation through GFP expression would become possible in addition to knockout-rescue experiments.

Here, we showed an efficient single-step method for knockout and rescue/overexpression system in stem cells with inducible promoter insertion by CRISPR/Cas9. This system would be a powerful tool which could be broadly applied in the field of stem cell research and developmental biology.

### **Acknowledgments**

We are grateful to Dr. Feng Zhang (Massachusetts Institute of Technology, Cambridge, USA) for pX330 plasmids and Dr. Akitsu Hotta (Kyoto University, Kyoto, Japan) for his kind advice and suggestions. We thank Dr. Meiko Takahashi (Kyoto University) for her critical reading of the manuscript. This work was supported by JSPS KAKENHI Grant Number 24390197.

### **References**

- [1] Wiedenheft B., Sternberg S.H. & Doudna J.A, RNA-guided genetic silencing systems in bacteria and archaea. *Nature*. 482 (2012) 331-338.

- [2] Jinek M, Chylinski K, Fonfara I, *et al.* A programmable dual-RNA-guided DNA endonuclease in adaptive bacterial immunity. *Science*. 337 (2012) 816-21.
- [3] Cong L, Ran FA, Cox D, *et al.* RNA-guided genetic silencing systems in bacteria and archaea. *Science*. 339 (2013) 819-23.
- [4] Mali P, Yang L, Esvelt KM, *et al.* RNA-guided human genome engineering via Cas9. *Science*. 339 (2013) 823-6.
- [5] Hwang WY, Fu Y, Reyon D, Maeder ML, *et al.* Efficient genome editing in zebrafish using a CRISPR-Cas system. *Nat Biotechnol*. 31 (2013) 227-9.
- [6] Shen B, Zhang J, Wu H, *et al.* Generation of gene-modified mice via Cas9/RNA-mediated gene targeting. *Cell Res*. 23 (2013) 720-3.
- [7] Ding Q, Regan SN, Xia Y, *et al.* Enhanced efficiency of human pluripotent stem cell genome editing through replacing TALENs with CRISPRs. *Cell Stem Cell*. 12 (2013) 393-4.
- [8] Shalaby F, Ho J, Stanford WL, *et al.* A requirement for Flk1 in primitive and definitive hematopoiesis and vasculogenesis. *Cell*. 89 (1997) 981-90.
- [9] Yamashita J, Itoh H, Hirashima M, *et al.* Flk1-positive cells derived from embryonic stem cells serve as vascular progenitors. *Nature*. 408 (2000) 92-6.
- [10] Yurugi-Kobayashi T, Itoh H, Schroeder T, *et al.* Adrenomedullin/cyclic AMP pathway induces Notch activation and differentiation of arterial endothelial cells from vascular progenitors. *Arterioscler Thromb Vasc Biol*. 26 (2006) 1977-84.
- [11] Yamamizu K, Furuta S, Katayama S, *et al.* The kappa opioid system regulates endothelial cell differentiation and pathfinding in vascular development. *Blood*. 118 (2011) 775-85.

- [12] Yamamizu K, Kawasaki K, Katayama S, *et al.* Enhancement of vascular progenitor potential by protein kinase A through dual induction of Flk-1 and Neuropilin-1. *Blood*. 114 (2009) 3707-16.
- [13] Yamamizu K, Matsunaga T, Katayama S, *et al.* PKA/CREB signaling triggers initiation of endothelial and hematopoietic cell differentiation via Etv2 induction. *Stem Cells*. 30 (2012) 687-96.
- [14] Nishikawa SI, Nishikawa S, Hirashima M, *et al.* Progressive lineage analysis by cell sorting and culture identifies FLK1+VE-cadherin+ cells at a diverging point of endothelial and hemopoietic lineages. *Development*. 125 (1998) 1747-57.
- [15] Era T, Witte ON. Regulated expression of P210 Bcr-Abl during embryonic stem cell differentiation stimulates multipotential progenitor expansion and myeloid cell fate. *Proc Natl Acad Sci U S A*. 97 (2000) 1737-42.
- [16] Yamashita JK, Takano M, Hiraoka-Kanie M, *et al.* Prospective identification of cardiac progenitors by a novel single cell-based cardiomyocyte induction. *FASEB J*. 19 (2005) 1534-6.
- [17] Kappel A, Röncke V, Damert A, *et al.* Identification of vascular endothelial growth factor (VEGF) receptor-2 (Flk-1) promoter/enhancer sequences sufficient for angioblast and endothelial cell-specific transcription in transgenic mice. *Blood*. 93 (1999) 4284-92.
- [18] Kappel A, Schlaeger TM, Flamme I, *et al.* Role of SCL/Tal-1, GATA, and ets transcription factor binding sites for the regulation of flk-1 expression during murine vascular development. *Blood*. 96 (2000) 3078-85.
- [19] Ran FA, Hsu PD, Wright J, *et al.* Genome engineering using the CRISPR-Cas9 system. *Nat Protoc*. 8 (2013) 2281-308.

- [20] Yamaguchi TP, Dumont DJ, Conlon RA, *et al.* flk-1, an flt-related receptor tyrosine kinase is an early marker for endothelial cell precursors. *Development*. 118 (1993) 489-98.
- [21] Qi LS, Larson MH, Gilbert LA, *et al.* Repurposing CRISPR as an RNA-guided platform for sequence-specific control of gene expression. *Cell*. 152 (2013) 1173-83.
- [22] Bikard D, Jiang W, Samai P, *et al.* Programmable repression and activation of bacterial gene expression using an engineered CRISPR-Cas system. *Nucleic Acids Res*. 41 (2013) 7429-37.
- [23] Gilbert LA, Larson MH, Morsut L, *et al.* CRISPR-mediated modular RNA-guided regulation of transcription in eukaryotes. *Cell*. 154 (2013) 442-51.
- [24] Maeder ML, Linder SJ, Cascio VM, *et al.* CRISPR RNA-guided activation of endogenous human genes. *Nat Methods*. 10 (2013) 977-9.
- [25] Perez-Pinera P, Kocak DD, Vockley CM, *et al.* RNA-guided gene activation by CRISPR-Cas9-based transcription factors. *Nat Methods*. 10 (2013) 973-6.
- [26] Cheng AW, Wang H, Yang H, *et al.* Multiplexed activation of endogenous genes by CRISPR-on, an RNA-guided transcriptional activator system. *Cell Res*. 23 (2013) 1163-71.

## Figure Legends

### **Figure 1 Generation of promoter inserted ESC lines by CRISPR/Cas9.**

(A) Schematic model for insertion of promoter. Target sequence was set on 5'UTR region of mouse Flk1 gene (+190 to +209 from TSS). DSB site for Cas9 nuclease is between +192 and +193 in the target sequence. Targeting vector carries a puromycin-resistant gene and inducible promoter, TRE-CMV, between the 5'- and 3'-homology arms. Black arrows show the position of primers for PCR and sequencing analysis. (B) PCR analysis of genomic DNA. Upper bands (3.3kbp) indicate inserted allele. Shorter bands (2.5kbp) indicate no insertion (wt allele). (C) Nucleotide sequences of amplified PCR products. Representative sequences of intact or promoter-inserted allele are shown. Dotted line indicates recombination sites.

### **Figure 2 Induction of genomic Flk1 expression in undifferentiated ESCs.**

(A) Schematic model of tet-OFF system. Dox (+): no Flk1 expression. Dox (-): induction of genomic Flk1 gene expression from inserted TRE-CMV promoter. Undifferentiated ESCs were treated in Dox (-) condition for 3 days. (B) Quantitative RT-PCR showing mRNA expression of Flk1 in WT cells, a clone of unsuccessful homologous recombination (#5), a hetero-inserted clone (#2) and homo-inserted clones (#1 and #8) (n=3; \*\*\*P<.001, Dox (+) vs. Dox (-); N.S.: not significant). Flk1 mRNA was normalized to expression of #1 clone cultured in Dox (-) condition. (C) Immunoblotting for Flk1 and  $\beta$ -actin in undifferentiated ESCs (D) Representative results of flow cytometry. X-axis: blank; Y-axis: Flk1. Percentages of Flk1<sup>+</sup> cells among total cells are indicated.

**Figure 3 Flk1 expression in Flk1 knockout-rescue system during ESC differentiation**

(A) Experimental design for ESC differentiation. After induction, purification and re-culture of mesodermal cells (PDGFR $\alpha^+$ ), they were stimulated by addition of VEGF<sub>165</sub> with or without Dox for 3 days. (B) Representative results of flow cytometry. X-axis: blank; Y-axis: Flk1. Percentages of Flk1<sup>+</sup> cells among total cells are indicated. (C) Quantitative evaluation of percentages of Flk1<sup>+</sup> cells by flow cytometry. (n=3; \*\*\*P<.001, Dox (+) vs. Dox (-); N.S.: not significant).

**Figure 4 Endothelial cell differentiation in Flk1 knockout-rescue system**

(A) Experimental system for EC differentiation. Purified mesoderm cells were stimulated by addition of VEGF<sub>165</sub> with or without Dox for 3 days. (B) Representative results of flow cytometry at differentiation Day4.5+d3. X-axis: VE-cadherin. Y-axis: PDGFR $\beta$ . Percentages of VE-cadherin<sup>+</sup> ECs and PDGFR $\beta^+$  MCs among total cells are indicated, respectively. (C) Left panel; Quantitative evaluation of percentages of ECs among total cells. Right panel; MCs among total cells. (n=3; \*\*\*P<.001, Dox (+) vs. Dox (-); N.S.: not significant) (C) Immunostaining for CD31 (green),  $\alpha$ SMA (red) and DAPI (blue) at differentiation Day4.5+d3. Upper panels, Dox (+). Lower panels, Dox (-). Scale bars, 500 $\mu$ m.

**Supplemental Figure 1 The construction of guideRNA-Cas9 and targeting vector.**

(A) Schematic description of the guideRNA-Cas9 plasmid. Synthesized DNA oligonucleotides including the target sequence were annealed and inserted downstream of the U6 promoter in pX330 plasmids using *Bbs*I site. (B) Targeting vector as

homology template for DSB repair. Targeting vector has three cassettes; 5'-homology arm (-653 to +176 from TSS), 3'-homology arm (+216 to +1090 from TSS) and transgenes. Transgenes consist of EF-1 promoter-driven puromycin-resistant gene followed by pA and core insulator sequences of Chicken hypersensitivity site 4, and TRE-CMV promoter.



# Figure 1

A.

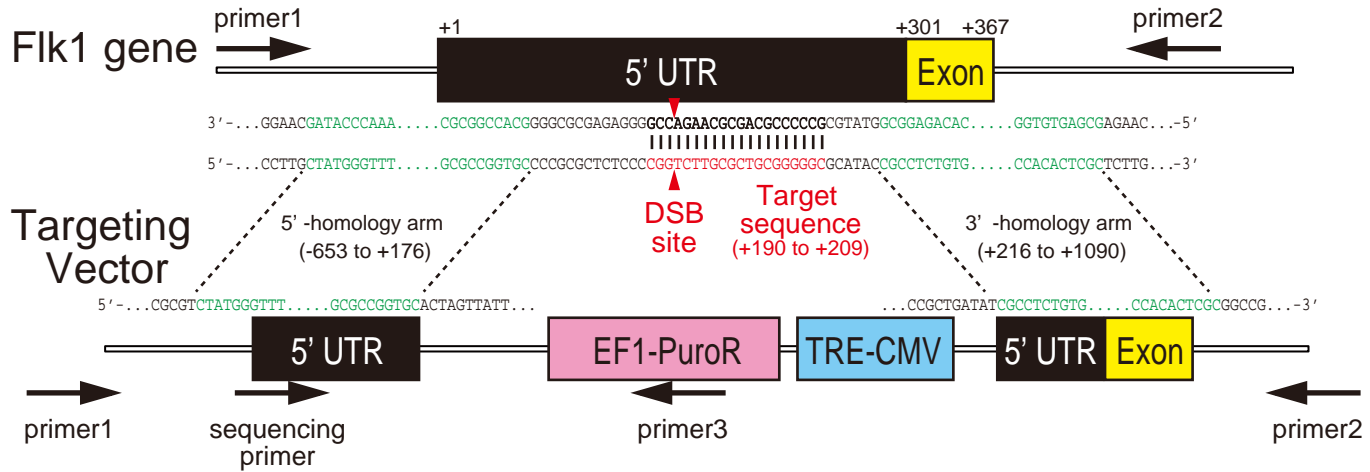

B.



C.

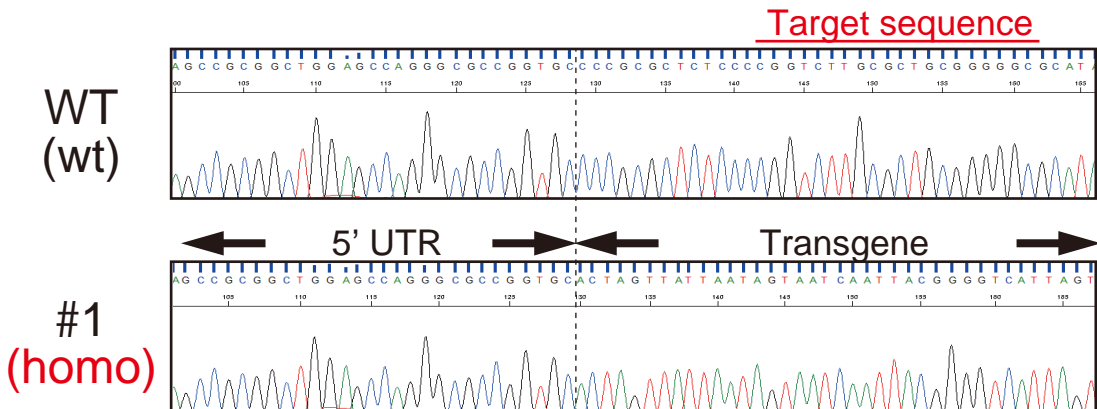

# Figure 2

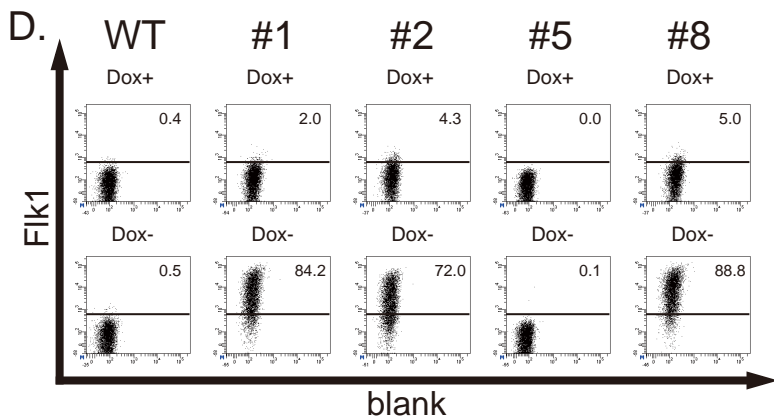
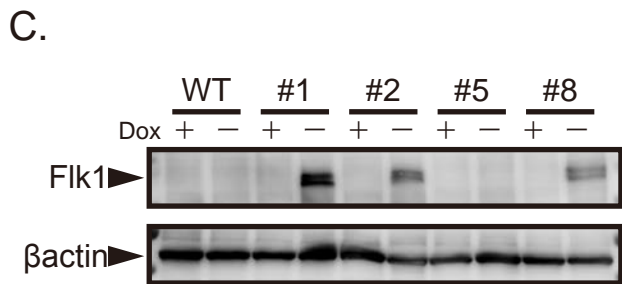
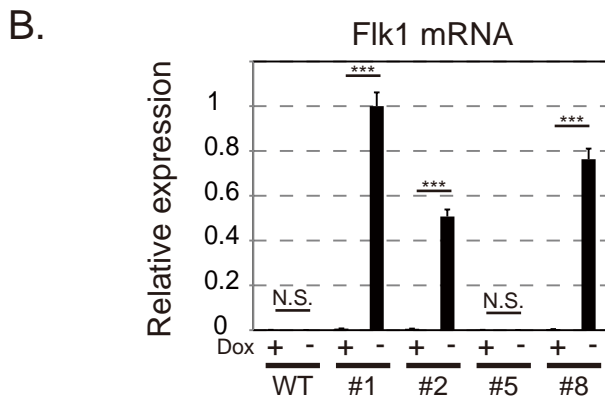
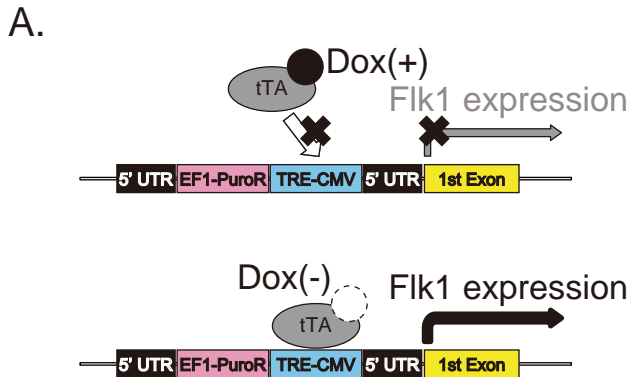

# Figure 3

A.

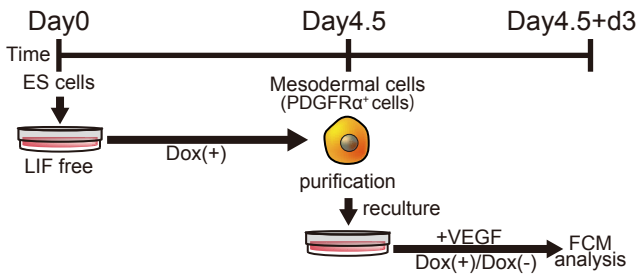

B.

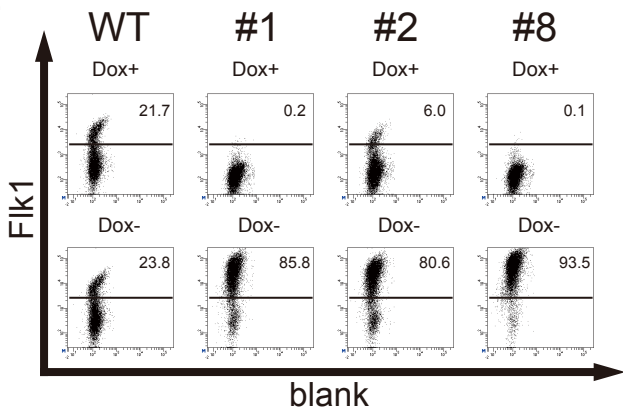

C.

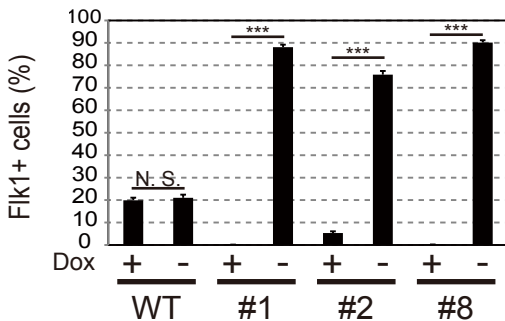

# Figure 4

A.

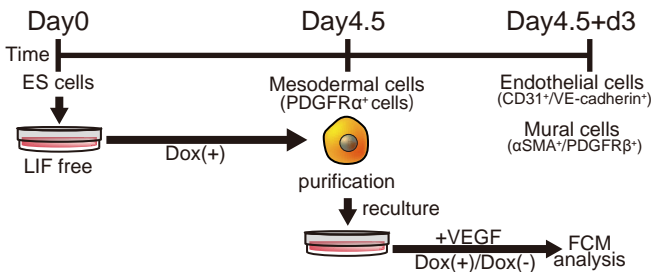

B.

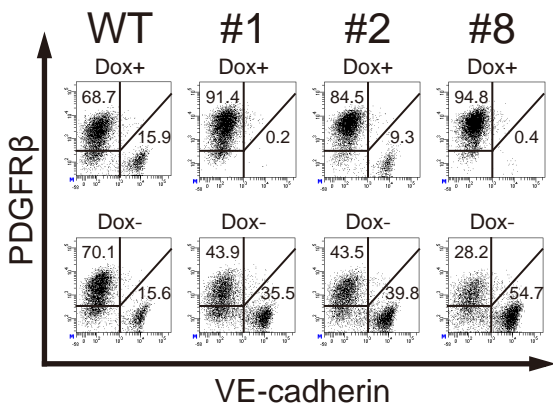

C.

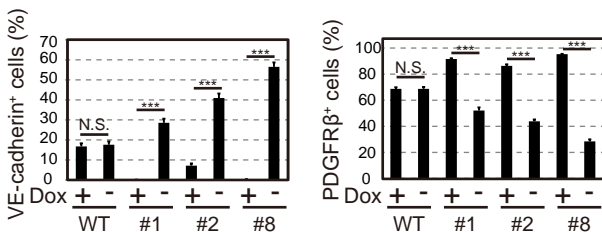

D.

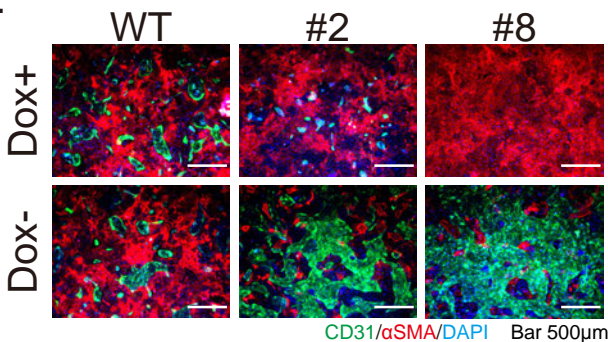

# FigureS.1

A.

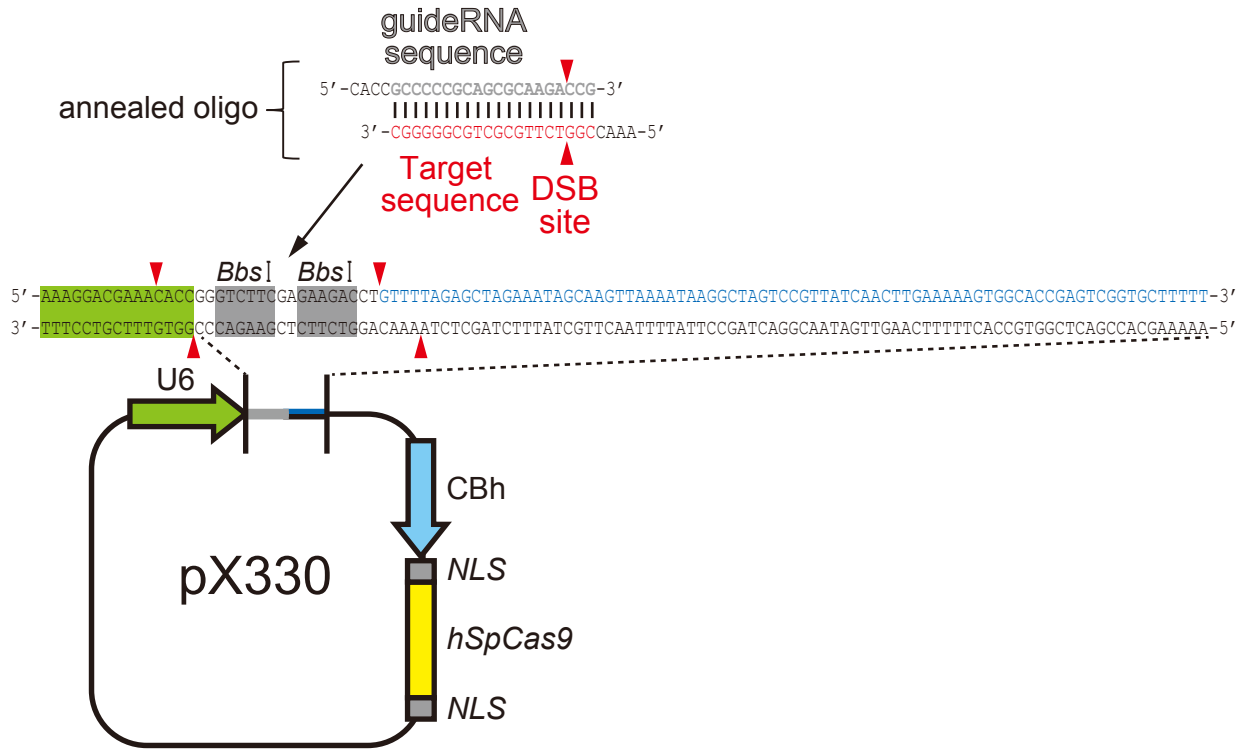

B.

