

Title	ON SOME PHYSIOLOGICAL ASPECTS IN THE DAILY RHYTHMIC ACTIVITY OF THE SEA-PEN, CAVERNULARIA OBESA VALENCIENNES
Author(s)	Imafuku, Michio
Citation	PUBLICATIONS OF THE SETO MARINE BIOLOGICAL LABORATORY (1973), 20: 431-454
Issue Date	1973-12-19
URL	http://hdl.handle.net/2433/175766
Right	
Type	Departmental Bulletin Paper
Textversion	publisher

ON SOME PHYSIOLOGICAL ASPECTS IN THE DAILY RHYTHMIC ACTIVITY OF THE SEA-PEN, *CAVERNULARIA OBESA VALENCIENNES*¹⁾

MICHIO IMAFUKU

Department of Zoology, Faculty of Science, Kyoto University

With 9 Text-figures

Abstract

Some efforts have been made in these experiments to see whether or not the fluctuation of hydrogen ion concentration of the body fluid can truly be a driving force of the rhythmic behavior, by injection of acidified sea water or changing of the metabolic rate by thermal treatments. The results are as follows: (1) A phase-shift was induced by the injection of acidified sea water. (2) The temperature coefficients of oxygen-consumption and the period of rhythm were 2.53 and 1.00 respectively from 20 to 30°C. (3) The phase of rhythm was shifted by a sudden temperature change in a certain range. (4) Rarely, an active expanded state was omitted without a phase-shift. As far as the results obtained are concerned it seems difficult to attribute the rhythmic behavior definitely to the fluctuation of hydrogen ion concentration of the body fluid.

Contents

Introduction	431
Material and methods	432
Results	433
Injection experiment	433
Temperature effect on oxygen-consumption	437
The effect of temperature on period	438
The effect of unsteady temperature	441
A. Effect of temperature change of the pulse type	441
B. Effect of temperature change of the step type	443
C. Effect of temperature cycle	446
Special behavior	447
Discussion	449
References	452

Introduction

It is widely known, in various kinds of organisms, that the behavioral or physiological activities are more or less regularly fluctuating with the time of day. Many of them maintain such periodicity even in some constant circumstances which are wholly devoid of natural light-dark alternation or temperature cycle. Therefore, the

1) Contributions from the Seto Marine Biological Laboratory, No. 572.

cause of the periodicity can not only be attributed to the direct effect of the ambient cycles, but to something involved in the organisms themselves. This is generally called the "biological clock", though the physiological or chemical basis has not yet been clarified even by the great efforts of many researchers.

In the present paper, is reported an attempt to see any physiological mechanism of the biological clock, by using the sea-pen, *Cavernularia obesa* VALENCIENNES, which shows a unique daily expansion-contraction rhythm.

The behavioral pattern of this sea-pen to bury itself in the sand by contraction during the daytime and to stand out of the sand by expansion at night was observed 75 years ago (MIYAJIMA, 1897; 1900). A series of works carried out by MORI (1943-1960) on the daily rhythmic behavior of this sea-pen have revealed the following aspects common to other animals. (1) The environmental factor controlling this behavior is the alternation of light and dark (MORI, 1943a; 1944a; 1960). (2) This rhythm persists in constant conditions for more than 100 days, retaining the period of approximately 24 h (MORI, 1947a), thus it is a kind of "circadian" (HALBERG, 1959) rhythm. (3) The period in constant conditions is temperature-independent, not affected by the temperature of the ambient water in the warmer season, but in the colder season the period is prolonged over 24 hours by lower temperature (MORI, 1943b; 1944b). (4) The rhythm is perfectly entrained to environmental light cycles so long as they are maintained between 18 to 30 h. However, when the animal is subjected to environmental light cycles of less than 6 or more than 48 h, it tends to disregard the environmental cycles and to show an endogenous circadian period or some irregular activity (MORI and ONDO, 1957; MORI, 1960). Further, MORI (1944c; 1945b; 1960) found that the daily change in the hydrogen ion concentration of the body fluid was closely correlated with the daily activity of the sea-pen. By an injection of acidic sea water into the sea-pen just having entered the resting contracted state he could make the sea-pen begin to expand. This injection technique was used in the present experiments in a hope to see the physiological mechanism of the "clock".

Material and Methods

All the experiments were carried out at the Seto Marine Biological Laboratory from August 1971 to September 1972, using sea-pens collected from Tanabe Bay. The animals were kept in glass cylinders containing a small amount of sand at the bottom, the water being always circulated. They were left unfed, but thought to take small plankton animals in the unfiltered inflowing sea water. The light-dark changes for entrainment were always done by alternation of 12 h light of 400 to 1600 lux (by a day-light fluorescent lamp) and 12 h dim light of less than 2 lux (by a pilot lamp). The light intensity was measured at the same level outside the cylinder as the sand surface in the cylinder. A constant condition was always of the continuous dim light. As the daily fluctuation of water temperature seldom exceeded 1°C in the warmer

season, the water temperature was not controlled generally, but in the colder season and in cases of temperature experiments. The expansion-contraction behavior was recorded on a kymograph by a method almost the same as devised by MORI (1945a), though only a single lever was used in the present experiments so that the troughs on the record showed the expanded state (Fig. 1). The onset of expansion was taken as the standard point of the rhythm with respect to the period and phase. A period means the time interval between the two consecutive expansions. The mean period is that of an average of 2 to 17 periods observed. In some experiments, a phase-shift was observed. The degree of the phase-shift was indicated by the deviation of the phase after the treatment from the previous one before treatment. In doing this, the period and phase were defined from a suspected ideal rhythm. The period of the ideal rhythm is the mean period of the actually observed rhythm, and the phase is determined when the sum of difference between each expanded state of the ideal rhythm and the corresponding one of the observed rhythm is minimum.

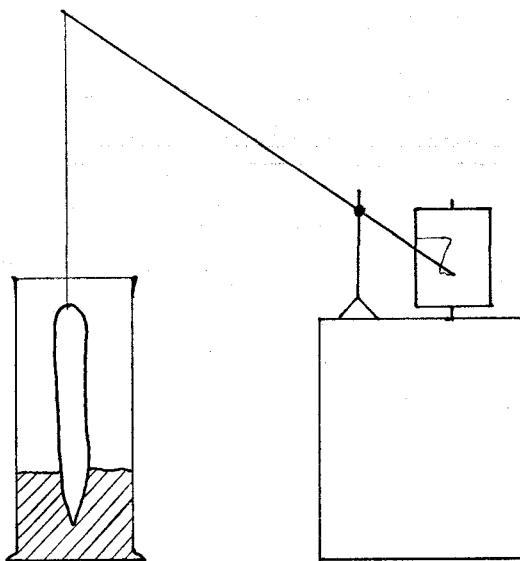

Fig. 1. Recording apparatus.

A piece of nylon thread is fixed through the tip of the sea-pen at one end and fastened to the end of the lever at the other end. The troughs on the record indicate the expanded states.

Results

Injection Experiment:

First, it was tested whether or not the change in hydrogen ion concentration of the body fluid takes part in the timing mechanism of the expansion-contraction rhythm of the sea-pen. If this is the case, a disturbance of the cycle by an injection of acidified sea water should cause a change in period, accompanied with a phase-shift. On the

other hand, in many other species, it is known that the circadian rhythm is very stable against various kinds of chemical treatments (*literature to be cited later*). Therefore, it was examined if any phase-shift could be induced by the injection of acidified sea water.

At first, the rhythm of a sea-pen, colony 1, was observed in the entraining light-dark cycle (Fig. 2a), in which the expanded state is perfectly synchronized with the environmental night phase. Then, the rhythm was recorded in constant dim light (Fig. 2b); it was regular and with a period of 23.6 h at the temperature of 25–28°C. The colony was again exposed to a light-dark cycle for the following three days, before it was returned to the condition of constant dim light. It was 14.4 hours after the onset of the first expansion when the colony in a contracted state had an injection of 6 ml of sea water acidified to pH 5.5 by dissolved carbon dioxide. This injection was 2 cm deep from the top of the colony (Fig. 2c). After the injection, the sea-pen began

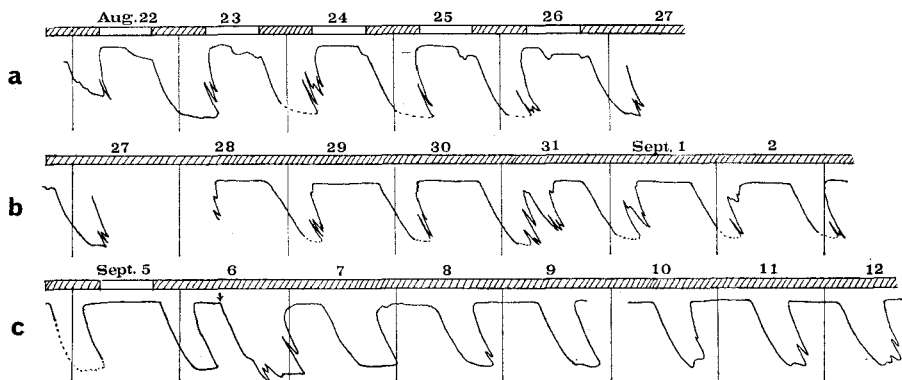

Fig. 2. Phase-shift induction by injection of acidified sea water in colony 1, which stood out of the sand by ca. 30 cm ($H=30$ cm) when expanded (at water temperature of 25–28°C).

a; In the light-dark cycle (lighted from 6 a.m. to 6 p.m.).

b; In constant dim light.

c; After the injection of acidified sea water (on Sept. 6, the moment of injection is shown by an arrow).

Bars above graphs show either lighted state (white) or state in dim-light (striped). Vertical lines indicate the midnight.

immediately to expand. The induced expansion was greater than the normal one, the animal body extended out of the sand attained more than 30 cm. This expanded state lasted for about 14.4 h, longer than the normal expanded state. However, a normal rhythm with a 23.0 h period followed this induced expansion. That is, the phase of the expansion-contraction rhythm of this sea-pen was advanced by 7.5 h through the injection of acidified sea water. This phase-shift was not so great as the theoretical shift (Table 1, *I*), which was estimated as the time span between the injection and the onset of the expected expansion that would appear if the injection was not made; the latter was deducible from the phase and period of the rhythm prior to the

injection. If the injection is the onset of a new rhythm, the phase should be shifted by hours shown by the theoretical shift.

To confirm the results of the above-mentioned preliminary experiment, the same experiment was repeated on several other colonies. There were some colonies which did not show a regular rhythm in constant conditions (Table 2 and Fig. 9) and they were excluded from the experiment. All the results of the injection experiments are summarized in Table 1, but a few excluded as the effect of the injection was imperfect, for instance expansion was much less. One such result is shown in Fig. 3e, in which the induced expansion was only about a half as large as the normal one. If this expansion is regarded as the first active phase of a new rhythm, then this phase must be considered to have appeared 14.4 h in advance to the expected usual phase. If the expansion of normal size next to the induced expansion is taken to be the first active phase of a new rhythm, then this phase must be regarded as delayed by 6.6 h from the expected usual phase.

Table 1. Phase-shift induced by injection of acidified sea water.

Weight: Wet weight of the contracted colony.

Period: A; After injection. B; Before injection. (The number of periods calculated in parentheses.)

Experiment	Colony	Weight (g)	Injected Sea Water		Period (hr)		Phase-Shift (hr)	
			pH	Vol. (ml)	B	A	Theoretical	Observed
1	1		5.5	6.0	23.6 (7)	23.0 (6)	9.2	7.5
2	14	9.5	4.60	4.8	23.6 (5)	24.0 (3)	3.8	4.6
3	50	57.9	5.15	5.0	24.9 (2)	26.2 (3)	19.5	17.4
4	2A	53.0	4.65	6.0	24.6 (3)	32.8 (3)	10.2	10.8
5	2A	53.0	5.50	5.0	24.4 (3)	24.6 (1)	11.8	11.8
6	2A	53.0	4.73	6.4	22.8 (1)	23.2 (3)	7.8	7.8
7	7A	24.2	4.74	2.0	23.0 (4)	23.9 (6)	11.6	11.7
8	7A	24.2	4.55	2.0	23.0 (3)	23.0 (7)	7.4	9.3
9	8A	11.7	4.74	2.5	24.2 (3)	18.9 (2)	9.2	8.6
10	9A	9.7	4.55	2.0	22.8 (3)	23.3 (4)	8.3	8.2

From Table 1, it is seen that when a full expansion is induced by the injection, a clear phase-shift occurs though it may be sometimes a little greater (Table 1, 2 and 8) or smaller (Table 1, 1, 3 and 9) than the theoretical shift. The greatest phase-shift (Table 1, 7) shown in Fig. 3a was observed on colony 7A which had been kept in constant dim light for a long time and maintained the active expanded phase in the later part of a day before injection. The injection induced this colony to a longer expanded state, followed by expanded phases shifted to the earlier part of a day.

In some cases, the rhythm after the injection was somewhat irregular. In colony 50 (Table 1, 3 and Fig. 3b), the injection immediately induced a rather formal expansion but it was followed by an evidently longer contracted state and then by a regular

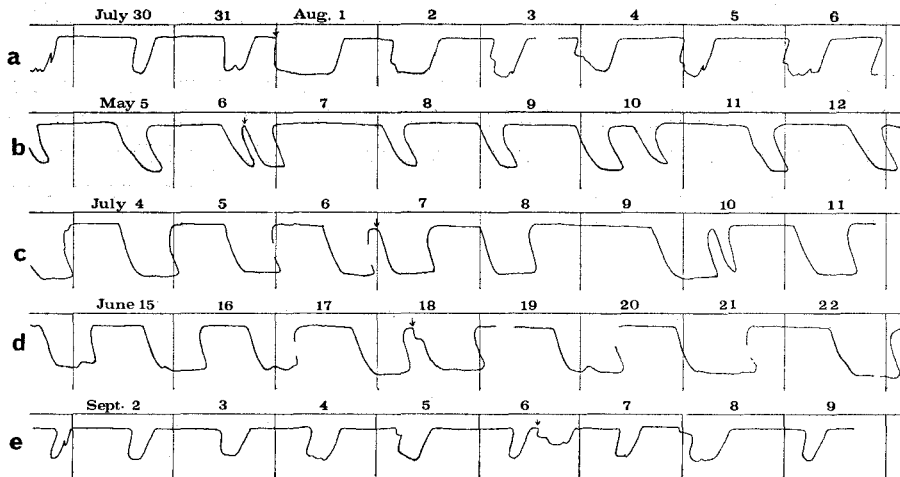

Fig. 3. Some rhythms after the injection of acidified sea water in constant dim light, the time of injection is shown by an arrow.

- a: With a typical phase-shift at 27–28°C (Table 1, 7). Colony 7A (H=23 cm).
 b: With a longer contracted state after the induced expansion and a sudden phase-shift later on May 10, at 20–22°C (Table 1, 3). Colony 50 (H=24 cm).
 c: With one normal cycle after the injection, but then followed by some cycles of irregular periods, at 25–26°C (Table 1, 5). Colony 2A (H=24 cm).
 d: With longer periods after the injection at 21–23°C (Table 1, 4). Colony 2A (H=24 cm).
 e: With lesser induced expansion at 27–29°C. Colony 7A (H=23 cm).

rhythm which was, however, interrupted suddenly two days later, on May 10, by a shorter period, though returned again to a steady regular rhythm of approximately 24 h. As it was unknown whether this intervening short period was the after-effect of injection or merely a spontaneous phase-shift rarely found in constant conditions (MORI, 1947a), only the first three regular cycles after the injection were taken into the calculation for the phase-shift.

Another irregular rhythm was observed on colony 2A (Table 1, 5 and Fig. 3c), there the injection induced two successive typical expansion of the normal size, followed by a longer contracted state and then by a somewhat longer period. In this case, only the first cycle was available to see the phase-shift.

An interesting phenomenon in the injection experiment is that sometimes the period is changed by the injection, somewhat lengthened (Table 1, 4 and Fig. 3d) or shortened (Table 1, 9).

The results obtained show that the expansion-contraction rhythm of the sea-pen is not so stable to chemical treatments as circadian rhythms of other animals to which various kinds of chemical agents have been known to be ineffective (BÜHNEMANN, 1955a; BALL and DYKE, 1956; BÜNNING, 1956; BÜNNING, 1957; HASTINGS, 1960). The following substances, as found recently, however, have some effect on the rhythmic

behavior: alcohol (KELLER, 1960; BÜNNING and BALTES, 1962; ENRIGHT, 1971b), heavy water (BRUCE and PITTENDRIGH, 1960; BÜNNING and BALTES, 1963; SUTER and RAWSON, 1968; PALMER and DOWSE, 1969; RICHTER, 1970; ENRIGHT, 1971a), cycloheximide (FELDMAN, 1967), lithium (ENGELMANN, 1972) and Valinomycin (BÜNNING and MOSER, 1972).

The carbonated sea water effective to the expansion-contraction rhythm of the sea-pen seems to affect as an acid substance rather than a solution of carbon dioxide, because acetic acid or lactic acid could induce the expansion, (MORI, 1945b; 1960), though the phase-shift has not yet been examined as to these two substances.

Only a few reports are available concerning the effect of pH change; in *Phaseolus* (pH=3.2 to 8, BÜNNING, 1956) and in *Euglena* (pH=3.5 to 7.1, BRUCE and PITTENDRIGH, 1960), though any clear effects were not observed yet in these cases. The effect of pH change may be something specific.

Though it is still unknown how the change of hydrogen ion concentration acts inside the sea-pen, a phase-shift can clearly be induced by the injection of acidified sea water.

Temperature Effect on Oxygen-Consumption:

According to the idea, as presented by MORI (see Discussion), that accumulation and excretion of metabolites take part in the timing mechanism, it is presumable that the period of the expansion-contraction rhythm is shortened by raising the environmental temperature, because the rate of hydrogen-ion accumulation should be increased at higher temperature.

Before this presumption is tested, firstly it may be necessary to see to what extent, if any, the metabolic rate is dependent on temperature. The oxygen-consumption rate was taken as the indicator of the metabolic rate. The parallellism between the rhythmic behavior and the rate of oxygen-consumption was already reported by MORI (1944c; 1960); much oxygen is consumed at night when the sea-pen is expanded, while almost none in the daytime when it is contracted. This was ascertained by the present author too. Then naturally the oxygen-consumption during the fully expanded state was measured at various temperatures from 20 to 30°C.

The colony B, weighing 53 g, was experimented with, under illumination by natural daylight through the room window and by a pilot lamp at night to enable one to work. The method was almost the same as that adopted by MORI (1944c). The measurements were made after the animal had been kept at respective adjusted temperatures for a few days, lest the animal should suffer sudden temperature changes. Three to six measurements were made for each temperature.

The results are shown in Fig. 4. The mean volumes of oxygen consumed at 29.6°C, 26.1°C, 23.1°C and 19.7°C were 2.54×10^{-2} ml/g/h, 1.78×10^{-2} ml/g/h, 1.70×10^{-2} ml/g/h, and 0.97×10^{-2} ml/g/h respectively. The Q_{10} was calculated to be 2.53 by drawing the regression line and using the next equation (PROSSER, 1952):

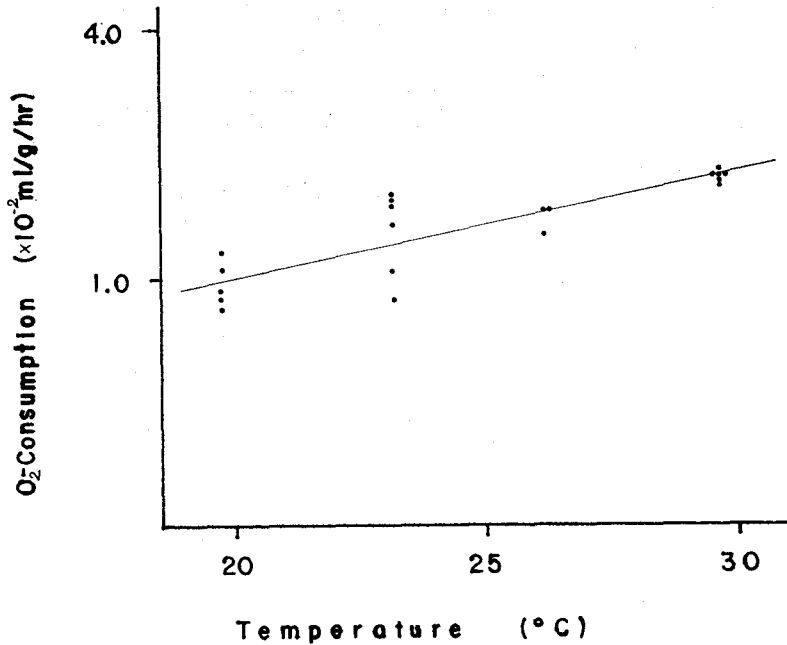

Fig. 4. Effect of temperature on oxygen-consumption.

Measurements were always made at night when the animal (Colony B, 53 g in weight in a contracted state) was fully expanded. Only in the ordinate, the scale is logarithmic. The temperature coefficient was calculated to be 2.53, from the regression line.

$$Q_{10} = (K_1/K_2)^{10/(t_1-t_2)}$$

where K_1 and K_2 are velocity constants corresponding respectively to temperatures t_1 and t_2 . This value falls within the usual range of Q_{10} for the metabolic rate, 2 to 3 (SOLLBERGER, 1965).

Though the temperature effect was rather small in the range from 23 to 26°C, it can be concluded from the present data that the oxygen-consumption rate of the sea-pen is temperature-dependent.

The Effect of Temperature on Period:

Now that the metabolic rate was shown to be temperature-dependent, the next step is to reveal whether the period is variable as the temperature changes. If the period is based directly on the metabolism having the rate which can be expressed for a considerably wide temperature ranges by $Q_{10}=2.53$, as estimated previously, then the period of 24 h at a certain temperature will be shortened to 9.5 h by increasing the temperature by 10°C or extended to 60.7 h by lowering the temperature by the same amount.

To test this, the behavior of 20 colonies, weighing from 9 to 60 g, was recorded

Table 2. Effect of temperature on period.

Period was measured at various temperatures in constant dim light.

(): The number of calculated periods.

[]: This period is excluded from Fig. 5.

Some of the irregular behavior are shown in Fig. 9.

Date	Colony	Temperature (°C)	Period (hr)	Remarks
'71 8/27-9/3	1	25-28	23.6 (7)	
10/23-28	1	22.0-22.8		irregular
11/16-24	1	20.7-22.8	23.2 (7)	
11/17-24	3	20.7-22.8		irregular, very long (Fig. 9, h)
12/12-22	21	19.5-22.5	[14.9 (17)]	short (Fig. 9, b)
12/12-23	22	19.5-22.5	22.8 (12)	given as a half of doubled,
12/12-23	24	19.5-22.5	23.2 (11)	45.7 h period (Fig. 9, c)
'72 2/8-13	11	22-23	25.0 (4)	
2/8-15	12	22-23		irregular
2/8-15	13	22-23	23.6 (7)	somewhat irregular
2/8-15	14	22-23	23.6 (7)	
3/25-28	34	25-26		irregular
3/25-31	11	25-26		irregular
3/25-31	12	25-26	22.4 (6)	somewhat irregular
4/17-5/2	50	24.9-25.2	23.3 (16)	
4/17-5/3	51	24.9-25.2		irregular
6/15-17	2A	21.1-21.3	24.6 (3)	
6/15-26	3A	21-23		irregular, very long
6/15-26	4A	21-23		irregular (Fig. 9, a)
6/15-7/27	1A	21-27		irregular
6/20-26	7A	22.9	22.6 (7)	
6/20-26	9A	22.9	22.6 (7)	
6/20-26	8A	22.9	23.0 (7)	
6/20-26	10A	22.9	26.4 (7)	
7/27-31	7A	27-28	23.0 (4)	
7/27-31	8A	27-28	24.2 (3)	
7/28-31	2A	27-28	24.0 (3)	
7/28-8/8	1A	27-28		irregular
7/28-8/8	10A	27-28	23.2 (3)	irregular in later part
8/20-21	8A	27.0-28.2	21.9 (2)	
8/20-22	7A	27.0-28.2	23.0 (3)	
8/20-22	9A	27.0-28.2	22.8 (3)	
8/20-22	10A	27.0-28.2	25.0 (3)	

in constant dim light at different constant temperatures from 20 to 30°C (Table 2). Sometimes the same colony was used repeatedly at different temperatures. Of 33 recordings, 22 were available for measurements of the period, but the remaining 11 were found too irregular to be used for period calculation; some of such irregular activities are shown in Fig. 9 and discussed later. Even in rather regular recordings an expanded state was eliminated from its expected situation or, rarely, an excessive

expansion was inserted between two regular consecutive expansions with about a 24 h interval (Fig. 9). In the former case, half of the long period that occurred by elimination of the expected expansion was taken as the regular period. In the latter case the excessive trough was neglected in calculating the period. The period was determined in each recording by averaging 2 to 17 periods. Thus the effect of temperature on the period is given in Fig. 5 which shows that the period was clearly

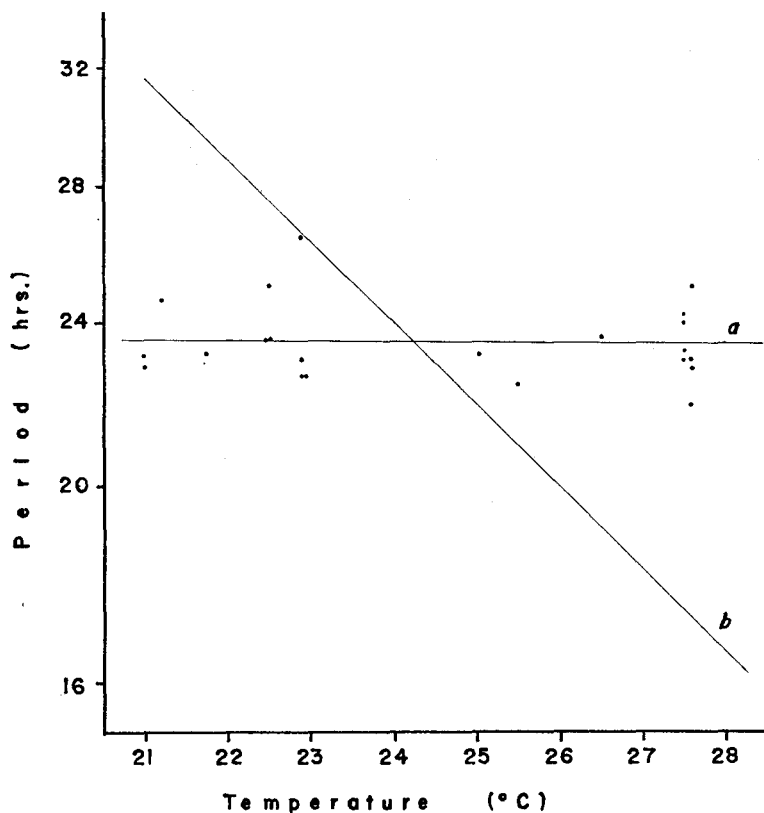

Fig. 5. Effect of temperature on the period. Only in the ordinate, the scale is logarithmic. Line a: the regression line of the period. Line b: the theoretical regression line of the period, if it were affected by temperature at $Q_{10}=2.53$.

almost unchanged from 20 to 30°C as dots showing periods are scattered between 22 and 26 h. To show this more simply, the regression line (line a) is drawn. If the periods were affected by temperature as well as oxygen-consumption, the regression line would run parallel to the line b. However, this was not the case. The actual regression line runs horizontally and this shows that Q_{10} is 1.00 as to the period. This value was calculated from the following equation (SOLLBERGER, 1965):

$$Q_{10} = (P_2/P_1)^{10/(t_1-t_2)}$$

where P_1 and P_2 are periods corresponding to temperatures t_1 and t_2 respectively.

The temperature coefficient of the period of the expansion-contraction rhythm of the sea-pen conforms well to that calculated in various kinds of other animals and plants as to their circadian rhythms, which ranges from 0.8 to 1.3 (SWEENEY and HASTINGS, 1960; BÜNNING, 1967).

The Effect of Unsteady Temperature:

The temperature-independence of the period at least between 20 and 30°C seems to suggest that the rhythmic behavior of the sea-pen is utterly indifferent to temperature changes. However, it may be supposed that some compensating mechanism works in the rhythmic process in a steady temperature condition to keep the period constant in a rather wide range of temperature. Such a compensating mechanism may get out of order if the animal is exposed to a sudden change in temperature, as the temperature-independence of circadian rhythms in many other animal and plant species (*references to be cited later*) is known to be temporarily affected by some types of sudden temperature changes: the pulse type, step type or cyclic type. Thus, the sea-pen was examined on this point.

A. Effect of temperature change of the pulse type

The interruption of an even temperature state by a certain duration of some different temperature is called here the change of the pulse type. If the rhythmic activity is really geared into the metabolism, then the period should be shortened by a pulse of significantly higher temperature.

The sea-pen, colony 50, kept in constant dim light at 25.6°C was exposed to higher temperature pulses of 29.0°C for 4 or 6 hours at a time. It took about 1 h to raise the sea water temperature to the pulse level or to lower to the previous temperature.

The treatments were given three times to the animal in the contracted state respectively on June 2 (a), 7 (b) and 11 (c) as seen in Fig. 6, which reveals some modifications in the activity pattern just after the treatments (b and c), but not the first treatment (a). In the second treatment (b), the duration of the expanded state was significantly

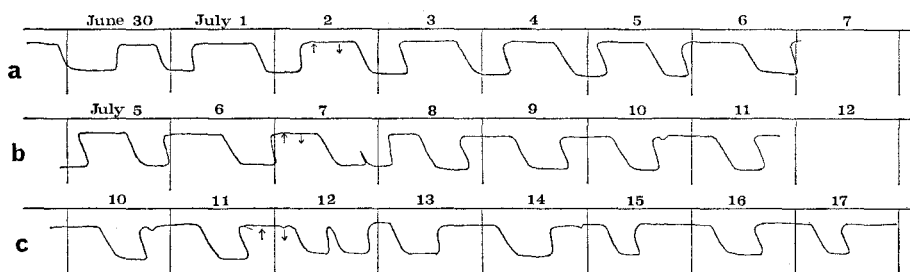

Fig. 6. Effect of the pulses of a higher temperature (29°C), under the constant dim light condition, on colony 50 (H=24 cm) kept at 25.6°C. The duration of successive pulses was 6 h for the first (a, on July 2), 4 h for the second (b, on July 7) and 6 h for the last (c, on July 11). ↑ : temperature rise, ↓ : temperature fall.

extended and in the third (c), two closely successive expanded states appeared; the latter may be explained as the occurrence of an additional expanded state. However, the treatments were seemingly almost ineffective on the following phase of the rhythm (Table 3).

Table 3. The pulse of a higher temperature (29°C) and its effects on the period and phase-shift (for the details, see Fig. 6).

Onset of treatment is given in hours from the beginning of the preceding expansion.

Period B: Before treatment and A: After treatment.

Of the period of the cycle under the treatment, Theoretical: the periods calculated theoretically at the temperature coefficient of 2.53, which are shorter than the actually observed periods. Phase-shift means the ultimate phase-shift; negative shows a delay and positive an advance.

Date	Treatment		Period (hr)		Period of the Cycle under Treatment (hr)		Phase-Shift (hr)
	Onset (hr)	Duration (hr)	B	A	Theoretical	Observed	
July 2	14.4	6	21.5 (2)	21.9 (4)	19.9	24.0	-3.7
July 7	14.4	4	21.9 (4)	22.8 (4)	20.8	22.2	-0.5
July 11	15.0	6	22.8 (4)	23.4 (7)	21.2	22.2	0.3

If the period is affected at the same rate as the metabolism by keeping the animal in the higher temperature of 29°C for some duration, the period of the cycle under treatment will be shortened to the theoretical period given in Table 3. The theoretical period (PT) was calculated from the relation:

$$PT = PB - S,$$

where PB is the period before the temperature treatment and S is the theoretical shift derivable from the following equation (RAWSON, 1960):

$$Q_{10} = \left(\frac{d}{d-s} \right)^{10/\Delta t},$$

where Q_{10} is the temperature coefficient of the metabolic rate and 2.53 for the present experiments, d is the pulse duration of 4 or 6 hours, and Δt is the amplitude of the pulse, 3.4°C. Unexpectedly, the period of the cycle under treatment was not shortened, but rather extended somewhat in the first treatment (a); this extension should have caused some delaying phase-shift in the following rhythm. On the other hand, the same treatment had practically no effect on the phase-shift in the last case (c). Thus, in this experiment, the metabolism was not directly reflected in the period length as in the previous one.

The result obtained here affirms the result of the same experiment performed by MORI (1943b). In other animals and plants on which the effect of the temperature pulse was studied, it has been shown that a pulse of extremely low temperature causes

a delaying phase-shift, the magnitude of which is sometimes dependent on the time when the organisms are exposed to the pulse, as seen in *Periplaneta* (BÜNNING, 1959), *Uca* (BROWN and WEBB, 1948), *Phaseolus* (LEINWEBER, 1956) and in *Oedogonium* (BÜNNING and RUDDAT, 1960). The effect of the temperature change in a moderate range seems rather different among species. In the sun orientation of *Talitrus*, a cold treatment (4–6°C) had no effect on the phase of the internal clock, but an exposure to higher temperature (35–37°C) caused a slight advancing phase-shift (PARDI and GRASSI, 1955). The case was found opposite in the time sense of bees; a low temperature pulse (4–7°C) had some effect, while a high temperature one (32–35°C) had no effect (KALMUS, 1934; RENNER, 1957). The effect of the temperature change of this type is closely studied in *Phaseolus* (LEINWEBER, 1956; BÜNNING and TAZAWA, 1957; MOSER, 1962), in which the effect of high temperature treatments depends on the time when plants were exposed to them. A treatment just after the subjective midnight will lengthen the period of the leaf movement rhythm and a treatment settled 5 hours later than this will shorten it, while the exposure during the subjective daytime will be ineffective on the period (MOSER, 1962). This result might suggest that the phase of the expansion-contraction rhythm of the sea-pen can be shifted by a high temperature treatment in the expanded state, instead of the contracted.

On the other hand, the active phase of activity rhythm of rat could not be changed by lowering the body temperature regardless of whether the treatment was given in the active hours or in the inactive hours (RAWSON, 1960). The effect of temperature pulses thus seems to be different among species studied. Further experiments are necessary to ascertain whether the sea-pen is utterly insensitive to any temperature changes, or whether the sensitivity of this animal is phase-dependent.

B. Effect of temperature change of the step type

A temperature change from a certain steady degree to another steady temperature is called the step type. The activities of 4 colonies (7A, 8A, 9A and 10A) were recorded concurrently under the same thermal treatment of this type in constant dim light (Fig. 7). The animals previously kept at a constant temperature of 23°C since June 12 were subjected to a temperature rise to 26°C (in one hour) on June 27, colonies 7A and 9A being in the expanded state, colony 8A at the beginning of expansion and colony 10A in the contracted state.

This temperature step-up had almost no influence on the period of colonies 7A, 8A and 10A (Table 4), if the remarkably longer period from June 28 to 30 in colony 10A is acceptable as representing only an omission of one expanded state as in some previous cases. On the other hand, the behavior of colony 9A was greatly affected, the period being shortened to 5.5 to 12.6 h for a few days, though a nearly normal period of slightly shorter than 24 h was recovered after this.

Again, the temperature of the circulating sea water was raised from 26°C to 30°C (in one hour) on July 2, when colonies 7A and 8A were just at the beginning of the contracted state, colony 9A at the beginning of the expansion and colony

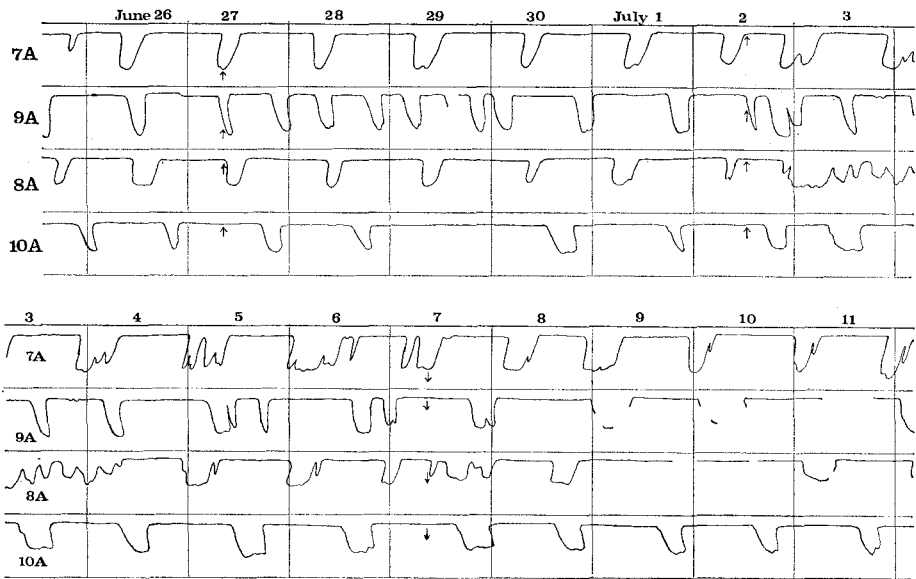

Fig. 7. Effect of temperature changes of the step type in constant dim light.

The temperature of circulating sea water was raised from 23°C to 26°C on June 27 (↑), from 26°C to 30°C on July 2 (↑), and then was dropped from 30°C to 26°C on July 7 (↓). Colony 7A: H=23cm, Colony 9A: H=16 cm, Colony 8A: H=15cm, Colony 10A: H=12cm.

Table 4. Effect of temperature changes of the step type in constant dim light.

Time of temperature change: hours after the onset of the previous expansion or just preceding one. The animal was expanded (E) or contracted (C) at the treatment.

Period B: before treatment. A: after treatment. T: period of the cycle under treatment. (Number of cycles calculated in parentheses) *Shortening to 15.0 h was observed in the next cycle.

Phase-shift: Negative, delaying phase-shift. Positive, advancing phase-shift.

Temperature Change	Colony	Time of Temp. Change	Period (hr)			Phase-Shift (hr)
			B	T	A	
23°C ↓ 26°C	7A	1.2 (E)	23.4 (1)	22.2	23.9 (5)	1.1
	9A	1.2 (E)	22.6 (7)	12.6		
	8A	0	22.2 (6)	24.0	23.7 (4)	0.3
	10A	14.4 (C)	24.0 (7)	22.8	23.3 (4)	2.3
26°C ↓ 30°C	7A	6.6 (C)	23.9 (5)	15.0	25.5 (4)	9.5
	9A	0.6 (E)	20.0 (3)	5.4		
	8A	5.4 (C)	23.7 (4)	13.2	24.3 (4)	9.4
	10A	19.2 (C)	24.3 (4)	23.4*	24.4 (3)	8.3
30°C ↓ 26°C	7A	9.4 (E)	25.5 (4)	24.0	22.8 (4)	-2.3
	9A	(C)			25.7 (4)	
	8A	10.8 (C)	24.3 (4)			
	10A	20.4 (C)	24.4 (3)	27.0	24.0 (4)	-2.9

10A in the contracted state. This temperature step-up by 4°C had greater effects on the behavior of all sea-pens. In colony 7A, the period of the cycle under the treatment was shortened to 15 h, but thereafter a period of slightly longer than 24 h soon appeared. Almost the same behavior as this was seen in colony 10A, though here shortening of the period occurred in the next cycle. The behavior of colony 9A became somewhat irregular. Colony 8A showed some extension, somewhat irregular, of the active (expanded) state especially on the two days after the treatment, immediately followed by a remarkable phase-shift by which the active state of the rhythm was moved to around midnight from the morning in the previous rhythm before the treatment.

In all colonies the period was shortened in the cycle just after this temperature change to a higher range, and a phase-shift was clearly induced, though obscurely in colony 9A. The magnitude of the shift was 9.5 h, 9.4 h and 8.3 h advancement in colonies 7A, 8A and 10A respectively (Table 4).

The animals kept at 30°C were then subjected to a fall in temperature to 26°C on July 7, when colony 7A was in the expanded state while the others were contracted. In colony 7A, the period was shortened from 25.5 h to 22.8 h by this treatment. The rhythm of colony 9A, which had been somewhat irregular after the treatment on July 2, returned to the normal form with a period of 25.7 h, though the period immediately after the temperature-fall was 29.4 h. The treatment induced a complex activity in colony 8A. The phase of the activity rhythm was slightly shifted in colony 10A (Table 4).

From the results obtained by this experiment it can be concluded that the sensitivity to temperature changes differs from colony to colony, colony 9A being the most sensitive especially to the temperature-rise, and that a temperature-rise is more effective in higher ranges (26°C to 30°C in this case) than in lower ranges (23°C to 26°C in this case), being accompanied with advancing effect. On the other hand, the temperature drop from 30°C to 26°C did not induce so much delaying phase-shift as expected from the result of temperature-rise treatment (Table 4).

The phenomenon that the period is temporarily affected by a sudden temperature change of this type has been observed in *Drosophila* (PITTENDRIGH, 1954) and in *Phaseolus* (BÜNNING, 1967). In these cases, a temperature drop caused some extension of the period, immediately followed, however, by a period shorter than 24 h and finally a circadian period was recovered. Such phenomenon could not be observed in this sea-pen; in this animal the period was shortened when it was exposed to the temperature-rise from 26°C to 30°C, but returned to a normal length without showing any longer period. In some organisms, the effect of temperature change of the step type on the phase-shift is shown to be phase-dependent, the magnitude and direction of the shift being determined by the phase in the activity cycle at the time of the treatment (MOSER, 1962; EHRET, 1959). However, this rule does not seem to be applicable to the rhythmic behavior of the sea-pen. When subjected to the temperature-rise from

26°C to 30°C, the period was always shortened regardless of the expanded and contracted states of the animals at the time of treatment. The difference may be attributable to an intrinsic specific nature.

Anyhow, the behavioral rhythm of the sea-pen is found to be not always insensitive to the temperature change, at least in a certain range of temperature.

C. Effect of temperature cycle

In various kinds of organisms, the circadian rhythm is found to be entrained to temperature cycles. The same colonies used in the preceding experiment were subjected to the alternation of two different temperatures in constant dim light (Fig. 8) for 15 days, from July 12 to 27, in which the temperature of circulating sea water was raised from 26°C to 30°C at 6 p.m. and dropped to the original temperature at 6 a.m. In the natural environments, the daily temperature fluctuation in the habitat area of the sea-pen in the vicinity of Seto is about 1°C in the warmer season and in winter. Then the temperature difference of 4°C must be very significant.

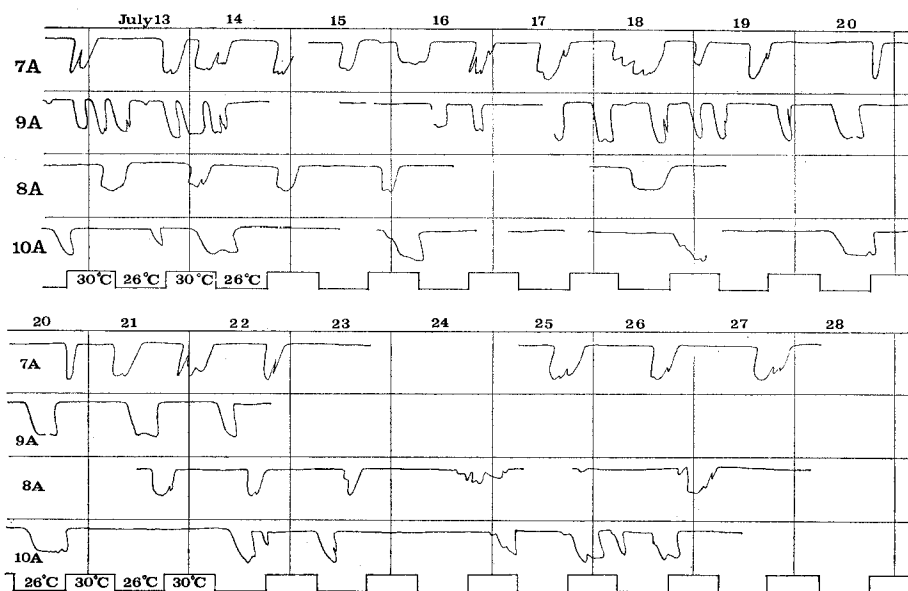

Fig. 8. Effect of temperature cycle of two different temperatures (26°C and 30°C) of equal duration (12 h) in dim light conditions for 15 days. Temperature cycle is shown at the bottom. For size of colonies, see Fig. 7.

In this temperature cycle, the behavior of colony 7A became somewhat irregular, without any tendency to expand only in one of the two temperature regimes, though the colony seemed to start the expansion in the lower temperature in the last three days (June 25–27). A more irregular activity was seen in colony 9A which had been found to be sensitive in the preceding experiment, though in the

last 3 days (July 20–22), the expansion seemed to be limited in the lower temperature. Colony 8A seemed to neglect the temperature cycle, keeping the original periodicity steadily but a little disturbed in the later part. In colony 10A, the behavior was somewhat irregular and the expansion was not restricted to either temperature.

From the behavior exhibited by these four colonies, it may safely be concluded that the sea-pen can not be easily entrained to the temperature cycle, but is not always utterly insensitive to this treatment. If the sea-pen were absolutely insensitive, it would keep the original periodicity steadily without showing any kind of irregularity.

This seemingly disagrees with many of the observations on other animals and plants. A temperature cycle with amplitude of 2.5 to 16°C could synchronize the activity rhythm of cockroaches (ROBERTS, 1962), the eclosion rhythm of *Drosophila* (PAUMING, quoted by BRUCE, 1960), the mating rhythm of *Paramecium aurelia* (KARAKASHIAN, 1968), the cell division rhythm of *P. bursaria* (VOLM, 1964) and the sporulation rhythm of *Pilobolus* (SCHMIDLE, 1951; UEBELMESSER, 1954) and of *Oedogonium* (BÜHNEMANN, 1955b). Even a difference of 1°C or less was effectual to the pedal movement rhythm of *Kalanchoe* (OLTMANN, 1960) and the leaf movement rhythm of *Phaseolus* (STERN and BÜNNING, 1929).

Thus, the synchronization with a temperature cycle is rather a common phenomenon among animals and plants, though not universal. The activity rhythm of the flying squirrel could not be synchronized with the temperature cycle of 25°C and 15°C, which was continued for 46 days; the animals maintained an endogenous circadian periodicity, neglecting the environmental temperature cycle (DECOURSEY, 1960). The behavior of the sea-pen may belong to the last case mentioned above, though it is not so persistent as in the flying squirrel; the expansion-contraction rhythm of the sea-pen was sometimes disturbed by the temperature changes.

Special Behavior:

Sometimes strange or irregular behavior was observed in constant dim light or even in light-dark cycle in the course of the present experiments. Some of them are thought to be very significant to see the mechanism of the rhythmic behavior of the sea-pen.

One of the examples met with most commonly is shown in Fig. 9a. Colony 4A exhibited an irregular behavior after the transfer to the constant dim light condition and was found ultimately to have extricated itself from the sand bed, though the irregular rhythm was not always followed by extrication in other colonies. Later, such an irregular rhythm could be easily entrained to light-dark cycles.

The next type of irregularity was a tendency to split some expanded state, for instance seen in colony 21 (Fig. 9b) which sometimes showed two closely consecutive expanded states in the dark regime of the light-dark cycle. This tendency was stronger in constant dim light.

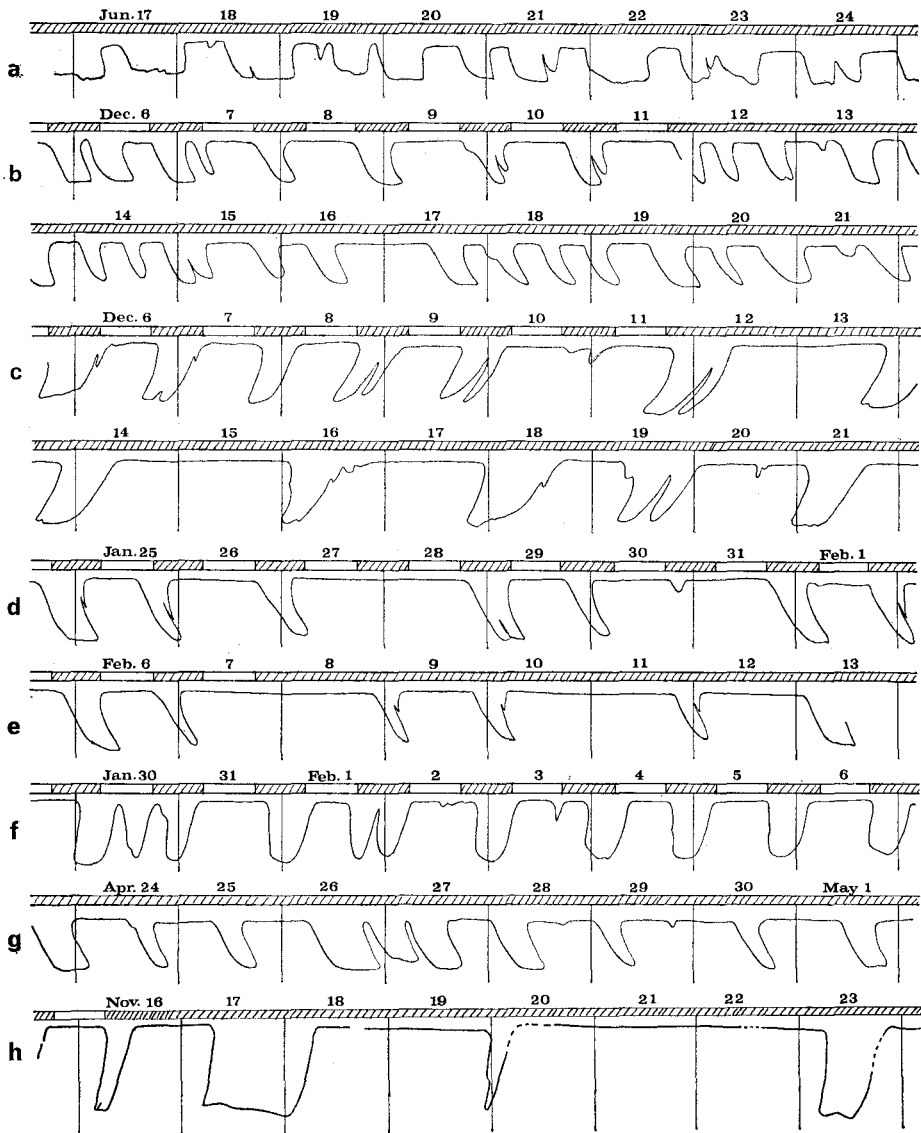

Fig. 9. Special behavior. a: Irregular rhythm of colony 4A ($W=40.7g$) at $21-23^{\circ}C$.
 b: Tendency to split the expanded state in colony 21 at $19.5-22.5^{\circ}C$, stressed especially in constant dim light.
 c: Tendency to double the period in colony 22 in constant dim light at $19.5-22.5^{\circ}C$.
 d and e: Omission of some expanded states in colony 11 ($H=27cm$) in light-dark cycle (d, Jan. 27), and in colony 11 ($H=27cm$) in constant dim light (e, Feb. 7 and 10) at $22-23^{\circ}C$.
 f and g: Insertion of additional expansion between two normal expanded states in colony 12 ($H=30cm$) in light-dark cycle at $22-23^{\circ}C$ (f, Jan. 30), and in colony 50 ($H=24cm$) in constant dim light at $24.9-25.2^{\circ}C$ (g, Apr. 26).
 h: Occurrence of markedly longer periods in colony 3 at $20.7-22.8^{\circ}C$.

A tendency in contrast with this was seen in the behavior of colony 22 (c), which was recorded in the same condition and simultaneously with the previous colony. The expanded state was restricted to the dark regime of the light-dark cycle, but in the constant dim light condition it was set at a period of 45.7 h. This might be accepted as the expansion being induced in every other cycle of the 22.8 h period, and then the behavior might be regarded as "regular" rather than "irregular" in a sense of the rhythm. As mentioned previously some expanded states were kept latent without any phase-shift even in the light-dark cycles (d) or in the constant condition (e, and see also Fig. 7, colony 10A on June 29). Thirteen of such cases occurred in the 349 colony-days (3.7%).

The behavior which may be contrasted with this was the displacement of the contracted state by the expanded one, without any phase-shift (f and g), as already shown in the observations made by MORI (1944b; 1960), in which the phase of the activity rhythm was maintained unchanged through a long expanded state covering 2 days.

Rarely some animal (colony 3) showed an enormously longer contracted state lasting for a few days (h). If the rhythmic behavior of this animal is simply exerted by the accumulation and excretion of metabolic hydrogen ions, then how can these behaviors of irregular types be explained?

Discussion

In the present paper, the physiological aspects of the rhythmic behavior of the sea-pen has been studied. MORI (1947b; 1960; personal communication) explained the daily expansion-contraction rhythm physiologically as follows; the increased hydrogen ion concentration of the body fluid caused by the accumulation of acidic metabolites induces the contracted animal to expand, then the expanded animal carries out the dilution of hydrogen ion concentration by the inflow of sea water through the process of expansion and subsequently the decreased concentration induces the animal to contract again.

Then, on MORI's working hypothesis the present author made some experiments in order to clarify the true mechanism of the expansion-contraction rhythm.

If the hydrogen ion concentration of the body fluid is closely related with the behavioral rhythm, the injection of carbonated sea water will induce a phase-shift. In fact, the phase of the expansion-contraction rhythm was shifted (Table 1). This fact supports that the rhythmic behavior is closely connected with the hydrogen ion of the body fluid, as suggested by MORI.

If it is correct, the period of the rhythm will be supposedly lengthened at a lower temperature and shortened at a higher one, because metabolic rates are generally temperature-dependent. Then, oxygen-consumption as metabolic rate and the period were measured at various temperatures around 20–30°C. The experimental

results revealed that the metabolic rate is not directly reflected in the period of the rhythm; the metabolic rate is temperature-dependent ($Q_{10}=2.53$, Fig. 4), while the period is temperature-independent ($Q_{10}=1.00$, Fig. 5). These results seem to suggest that the timing mechanism is independent of the metabolism. However, before this is accepted, it is necessary to test whether the rate of accumulation of the hydrogen ion concentration is affected by the ambient temperature.

The temperature-independence of the period seems to suggest that the sea-pen is utterly insensitive to temperature changes. But a sudden temperature change, especially of the step type (26 to 30°C), caused the temporarily shortening of the period (Fig. 7 and Table 4). Therefore, the temperature-independence of the expansion-contraction rhythm is not due to the nature that the sea-pen is insensitive to temperature but it seems to be attained by certain mechanism which is composed of a temperature-compensation system. The fact that the rhythmic behavior is greatly affected and the active period is extended even to 3 days or more under constant conditions at the environmental temperatures below 12–13°C (MORI, 1944b) indicates clearly the lower limit of temperature-independence.

The results of the injection experiments and measurement of the period at various temperatures do not always disagree with the working hypothesis proposed by MORI. However, some examples of special behavior are difficult to be explained by the working hypothesis. An expanded state is occasionally omitted or rarely excessively inserted without any phase-shifting in the constant condition (Fig. 9). In the case of the omission, the period of 48 h appears at the frequency of 3.7%; this value may be insignificant if the period takes various lengths at random, but because such a long period suddenly occurs in the course of regular circadian periodicity, this omission behavior may not be negligible.

This phenomenon should not be explained by the effect of such environmental factors as geomagnetism and barometric pressure, as BROWN (1960; 1970) considers, because in the present experiments there was no parallelism in the behavior among colonies whose recordings were made in the same concurrent experimental conditions, that is, if such stimuli were operating in the "constant" conditions, then the behavior of all the colonies would be synchronized with each other and would have the same period. Such individual difference in period is thought to be important evidence for endogenous rhythm as pointed by HARKER (1964). Therefore, the cause of the rhythm may be regarded as existing in the animal body itself.

This omission phenomenon is very difficult to be explained by the idea that one cycle, from an contraction to the next contraction through an expansion, is composed of the excretion and accumulation of acidic metabolites. It is important to detect whether or not any change in the hydrogen ion concentration of the body fluid occurs at the time when the expansion is omitted. If the hydrogen ion concentration is increased at the time of "omitted expansion", then the expansion-contraction behavior should not be closely connected with the hydrogen ion concentration. And if there

is no increase, the hydrogen ion concentration is closely correlated to the behavior, which is also supported by the injection experiment. In any case, it is hard to understand why such a long period is just twice a circadian period but not, for example, 30 h or 36 h.

A phenomenon similar to this is known in other organisms. In *Oedogonium*, the sporulation rhythm can be suppressed interruptedly for a few days by cyanide treatment without phase-shifting (BÜHNEMANN, 1955a). The nocturnal activity of *Gonyaulax* in flash light emission by stimulation was maintained steadily even in cells which had been forced to change the amount of luciferin quite artificially by bubbling prior to the beginning of the regular active phase (HASTINGS and SWEENEY, 1958). A temporary extinction of the mating reactivity by feeding could not shift the phase of the rhythm of the mating-type change in *Paramecium multimicronucleatum* (IMAFUKU, 1972). In higher animals, the active time in rats or hamsters is unchangable by keeping the animals inactive for some duration with electric shock or anesthetic (RAWSON, 1960; reviewed by TAKAGI, 1969). These facts suggest that the physiological or behavioral phenomena themselves do not take part in the timing mechanism but are controlled by some mechanism other than the actually observed rhythms, as described by BÜNNING (1960) and SWEENEY (1969).

These considerations lead the present author to the assumption that the expansion-contraction itself is not the timing mechanism but it is adjusted to be 24 h period or the multiple by a certain timing mechanism independent of the expansion-contraction behavior. The result of the injection experiment, that the phase-shift is induced by the injection of acidified sea water, can also be explained by supposing an independent clock if a running of the clock is affected by changing in the hydrogen ion concentration of the body fluid. Thus, the present author tends to the idea that the expansion-contraction rhythm of the sea-pen is also controlled by an independent clock. Of course, further examinations are necessary to confirm this, and further it should be clarified what kind of system the clock is composed of.

Acknowledgements

The present author wishes to express his sincere gratitude to Prof. Masaru KATO of Kyoto University, under whose supervision this work has been carried on, to Prof. Syuiti MORI of the same university, who gave the author many valuable advices and important suggestions through the course of this work, and to the staff of the Seto Marine Biological Laboratory for affording the author every facility for the works at the laboratory, especially to Prof. Takasi TOKIOKA for his help to complete the manuscript and also to Mr. Hidetomo TANASE for his assistance in collecting the material.

REFERENCES

- BALL, N. G. and DYKE, I. J. 1956. The effects of indole-3-acetic acid and 2:4-dichlorophenoxyacetic acid on the growth rate and endogenous rhythm on intact *Avena* coleoptiles. *J. exp. Bot.*, 7, 25-41.
- BROWN, F. A., Jr. 1960. Response to pervasive geophysical factors and the biological clock problem. *Cold Spring Harbor Symp. on Quant. Biol.*, 25, 57-71.
- , 1970. Hypothesis of environmental timing of the clock. In "The Biological Clock: Two Views". pp. 13-59. Academic Press: New York, London.
- BROWN, F. A., Jr. and WEBB, H. M. 1948. Temperature relations of an endogenous daily rhythmicity in the fiddler crab, *Uca*. *Physiol. Zool.*, 21, 371-381.
- BRUCE, V. G. 1960. Environmental entrainment of circadian rhythms. *Cold Spring Harbor Symp. on Quant. Biol.*, 25, 29-48.
- BRUCE, V. G. and PITTENDRIGH, C. S. 1960. An effect of heavy water on the phase and period of the circadian rhythm in *Euglena*. *J. cell. comp. Physiol.*, 56, 25-31.
- BÜHNEMANN, F. 1955a. Das endodiurnale System der Oedogoniumzelle. II. Der Einfluss von Stoffwechselfgiften und anderen Wirkstoffen. *Biol. Zbl.*, 74, 691-705.
- , 1955b. do. III. Über den Temperatureinfluss. *Z. Naturforsch.*, 10b, 305-310.
- BÜNNING, E. 1956. Versuche zur Beeinflussung der endogenen Tagesrhythmik durch chemische Faktoren. *Z. Bot.*, 44, 515-529.
- , 1957. Über die Urethan-Vergiftung der endogenen Tagesrhythmik. *Planta*, 48, 453-458.
- , 1959. Zur Analyse des Zeitsinns bei *Periplaneta americana*. *Z. Naturforsch.*, 14b, 1-4.
- , 1960. Opening address: Biological clocks. *Cold Spring Harbor Symp. on Quant. Biol.*, 25, 1-9.
- , 1967. "The Physiological Clock". Springer-Verlag: New York.
- BÜNNING, E. and BALTES, J. 1962. Wirkung von Äthylalkohol auf die physiologische Uhr. *Naturwissenschaften*, 49, 19.
- & ———, 1963. Zur Wirkung von schwerem Wasser auf die endogene Tagesrhythmik. *Ibid.*, 50, 622.
- BÜNNING, E. and MOSER, I. 1972. Influence of valinomycin on circadian leaf movements of *Phaseolus*. *Proc. nat. Acad. Sci.* 69, 2732-2733.
- BÜNNING, E. and RUDDAT, M. 1960. Weitere Experimente zur Deutung der physiologischen Uhr als Kippschwingungssystem. *Naturwissenschaften*, 47, 286.
- BÜNNING, E. and TAZAWA, M. 1957. Über den Temperatureinfluss auf die endogene Tagesrhythmik bei *Phaseolus*. *Planta*, 50, 107-121.
- DECOURSEY, P. J. 1960. Phase control of activity in a rodent. *Cold Spring Harbor Symp. on Quant. Biol.*, 25, 49-55.
- EHRET, C. F. 1959. Photobiology and biochemistry of circadian rhythms in non-photosynthesizing cells. *Fed. Proc.*, 18, 1232-1240.
- ENGELMANN, W. 1972. Lithium slows down the *Kalanchoe* clock. *Z. Naturforsch.*, 27b, 477.
- ENRIGHT, J. T. 1971a. Heavy water slows biological timing processes. *Z. vergl. Physiol.*, 72, 1-16.
- , 1971b. The internal clock of drunken isopods. *Ibid.*, 75, 332-346.
- FELDMAN, J. F. 1967. Lengthening the period of a biological clock in *Euglena* by cycloheximide, an inhibitor of protein synthesis. *Proc. nat. Acad. Sci.*, 57, 1080-1087.
- HALBERG, F. 1959. Physiologic 24-hour periodicity; General and procedural considerations with reference to the adrenal cycle. *Z. Vitam.- Horm.- u. Fermentforsch.*, 10, 225-296.
- HARKER, J. E. 1964. "The Physiology of Diurnal Rhythms." Cambridge Univ. Press.
- HASTINGS, J. W. 1960. Biochemical aspects of rhythms: Phase shifting by chemicals. *Cold Spring Harbor Symp. on Quant. Biol.*, 25, 131-143.
- HASTINGS, J. W. and SWEENEY, B. M. 1958. A persistent diurnal rhythm of luminescence in *Gonyaulax polyedra*. *Biol. Bull.*, 115, 440-458.

- IMAFUKU, M. 1972. A circadian rhythm of mating-type change and cell division in *Paramecium multimicronucleatum*, syngen 2. Zool. Mag., 81, 154–157. (in Japanese with English abstract).
- KALMUS, H. 1934. Über die Natur des Zeitgedächtnisses der Bienen. Z. vergl. Physiol., 20, 405–419.
- KARAKASHIAN, M. W. 1968. The rhythm of mating in *Paramecium aurelia*, syngen 3. J. cell. Physiol., 197–209.
- KELLER, S. 1960. Über die Wirkung chemischer Faktoren auf die tagesperiodischen Blattbewegungen von *Phaseolus multiflorus*. Z. Bot., 48, 32–57.
- LEINWEBER, F. J. 1956. Über die Temperaturabhängigkeit der Periodenlänge bei der endogenen Tagesrhythmik von *Phaseolus*. Ibid., 44, 337–364.
- MIYAJIMA, M. 1897. Ecological observations of a sea-pen (*Veretillum*). Zool. Mag., 9, 367–371. (in Japanese).
- , 1900. A sea-pen (*Cavernularia obesa* VAL.). Ibid., 12, 426–433. (in Japanese).
- MORI, S. 1943a. Daily rhythmic activity of the sea-pen, *Cavernularia obesa* VALENCIENNES. I. Observations in nature. Ibid., 55, 285–291. (in Japanese).
- , 1943b. do. II. Activities under constant darkness and constant illumination. Ibid., 55, 247–253. (in Japanese).
- , 1944a. do. III. Controlling of the activity by light (1). Ibid., 56/4·5·6, 1–5. (in Japanese).
- , 1944b. do. V. Activities under constant illumination and constant darkness in winter and influence of water temperature. Ibid., 56/4·5·6, 11–15. (in Japanese).
- , 1944c. do. VI. Analysis of the endogenous rhythm (1). Ibid., 56/4·5·6, 16–20. (in Japanese).
- , 1945a. Individuality of daily rhythmic activity and working hours. Kyodai Seiri Seitai, 18. (in Japanese).
- , 1945b. Daily rhythmic activity of the sea-pen, *Cavernularia obesa* VALENCIENNES. VIII. Endogenous daily rhythmic activity. Ibid., 19. (in Japanese).
- , 1947a. do. IX. Activity under constant darkness during 103 days. Physiol. and Ecol., 1, 8–14. (in Japanese with English résumé).
- , 1947b. A concept on mechanisms of the endogenous daily rhythmic activity. Mem. Coll. Sci., Kyoto Univ., Ser. B, 19, 1–4.
- , 1960. Influence of environmental and physiological factors on the daily rhythmic activity of a sea-pen. Cold Spring Harbor Symp. on Quant. Biol., 25, 333–344.
- MORI, S. and ONDO, Y. 1957. Daily rhythmic activity of the sea-pen, *Cavernularia obesa* VALENCIENNES. XV. Controlling of the activity by light (3). Publ. Seto Mar. Biol. Lab., 6, 79–98.
- MOSER, I. 1962. Phasenverschiebungen der endogenen Tagesrhythmik bei *Phaseolus* durch Temperatur- und Lichtintensitätsänderungen. Planta, 58, 199–219.
- OLTMANN, O. 1960. Über den Einfluss der Temperatur auf die endogene Tagesrhythmik und die Blühinduktion bei der Kurztagpflanze *Kalanchoe blossfeldiana*. Ibid., 54, 233–264.
- PALMER, J. D. and DOWSE, H. B. 1969. Preliminary findings on the effect of D₂O on the period of circadian activity rhythms. Biol. Bull., 137, 388.
- PARDI, L. and GRASSI, M. 1955. Experimental modification of direction-finding in *Talitrus saltator* (Montagu) and *Talorchestia deshayesei* (Aud.) (Crustacea-Amphipoda). Experimentia, 11, 202–205.
- PITTENDRIGH, C. S. 1954. On temperature independence in the clock system controlling emergence time in *Drosophila*. Proc. nat. Acad. Sci., 40, 1018–1029.
- PROSSER, C. L. 1952. Temperature: Metabolic aspects and perception. In "Comparative Animal Physiology", ed. C. L. Prosser, pp. 341–380, Saunders: Philadelphia and London.
- RAWSON, K. S. 1960. Effects of tissue temperature on mammalian activity rhythms. Cold Spring Harbor Symp. on Quant. Biol., 25, 105–113.
- RENNER, M. 1957. Neue Versuche über den Zeitsinn der Honigbiene. Z. vergl. Physiol., 40, 85–118.
- RICHTER, C. P. 1970. Blood-clock barrier: its penetration by heavy water. Proc. nat. Acad. Sci., 66, 244.

- ROBERTS, S. K. 1962. Circadian activity rhythms in cockroaches. II. Entrainment and phase-shifting. *J. cell. comp. Physiol.*, 59, 175-186.
- SCHMIDLE, A. 1951. Die Tagesperiodizität der asexuellen Reproduktion von *Pilobolus sphaerosporus*. *Arch. f. Mikrobiol.*, 16, 80-100.
- SOLLBERGER, A. 1965. "Biological Rhythm Research." Elsevier: Amsterdam-London-New York.
- STERN, K. and BÜNNING, E. 1929. Über die tagesperiodischen Bewegungen der Primärblätter von *Phaseolus multiflorus*. I. Der Einfluss der Temperatur auf die Bewegungen. *Ber. deutsch. bot. Ges.*, 47, 565-584.
- SUTER, R. B. and RAWSON, K. S. 1968. Circadian activity rhythm of the deer mouse, *Peromyscus*: effect of deuterium oxide. *Science*, 160, 1011-1014.
- SWEENEY, B. M. 1969. "Rhythmic Phenomena in Plants". Academic Press: London, New York.
- SWEENEY, B. M. and HASTINGS, J. W. 1960. Effects of temperature upon diurnal rhythms. *Cold Spring Harbor Symp. on Quant. Biol.*, 25, 87-104.
- TAKAGI, K. 1969. Endogenous clocks in human. *Shizen*, 24/10, 34-41. (in Japanese).
- UEBELMESSER, E. R. 1954. Über den endonomen Tagesrhythmus der Sporangienträgerbildung von *Pilobolus*. *Arch. f. Mikrobiol.*, 20, 1-33.
- VOLM, M. 1964. Die Tagesperiodik der Zellteilung von *Paramecium bursaria*. *Z. vergl. Physiol.*, 48, 157-180.

DISCUSSION

MÜLLER: 1) How did you calculate the theoretical phase-shift? 2) Did you perform the experiments on temperature changes at a constant illumination?

IMAFUKU: 1) Theoretically, the phase-shift would be due to the difference in time between the time of injection to be given and the onset of activity which could be expected under the condition of no injection. 2) All temperature experiments were performed under the condition of constant dim light less than 2 lux.

THIEL: 1) In which biotope do these sea-pens live? 2) Can you relate the behavior of the sea-pens to the natural environmental conditions (not only the day-night rhythm but also relation to pH in the water, O₂ rhythm, etc.)?

IMAFUKU: 1) They live on the sandy bottom of somewhat protected area from about 20 m deep to the low water mark. 2) The light-dark cycle is thought to be the most important environmental factor for the rhythmic behavior of the sea-pen. The effect of tide is generally remarkable to animals living in the intertidal zone, but seemingly insignificant to the expansion-contraction behavior of the sea-pen living mainly in the subtidal zone. Moreover, some colonies may be found exposed in the *expanded state* in the lowest water of the spring tide, which occurs at night in winter in this region. The changes in pH and O₂-concentration of the sea water in the region are too small to be effective to the expansion-contraction rhythm.