

Title	Development of Compact Synchrotron Radiation Facilities TELL-TERAS, NIJI-I-IV, at ETL (Commemoration Issue Dedicated to Professor Hidekuni Takekoshi On the Occasion of His Retirement)
Author(s)	Tomimasu, T.
Citation	Bulletin of the Institute for Chemical Research, Kyoto University (1990), 68(2): 86-102
Issue Date	1990-10-31
URL	<a href="http://hdl.handle.net/2433/77339">http://hdl.handle.net/2433/77339</a>
Right	
Type	Departmental Bulletin Paper
Textversion	publisher

## Development of Compact Synchrotron Radiation Facilities TELL-TERAS, NIJI-I~IV, at ETL

T. TOMIMASU

*Received June 28, 1990*

At the Electrotechnical Laboratory (ETL) four compact storage rings, TERAS, NIJI-I~III, have been already constructed and a compact storage ring, NIJI-IV, with long straight sections for a free electron laser (FEL) experiment will be completed in 1990. The 0.8-GeV ETL storage ring is called TERAS; Tsukuba Electron Ring for Accelerating and Storage. TERAS has been operated since Oct. 1981 for researches on radiometric standards, dissociative photoionization, photodissociation of sulfur containing molecules, solid state physics, ULSI lithography, generation of polarized SR and gamma-rays and for FEL experiment using an transverse optical klystron (TOK). A 10-T three pole wiggler will be installed in 1991 at the straight section where the TOK is installed. NIJI-I is a 0.27-GeV compact ring. NIJI is a Japanese verb meaning "rainbow" in English. It has been operated from Feb. 1986 to March 1989 for machine study of beam storage higher than 0.5A at low energies below 0.15-GeV. NIJI-II is a 0.6-GeV conventional type compact ring. It has been operated in Aug. 1989 and will be used for chemical vapor deposition (CVD) and polarized SR experiments.

NIJI-III is a 0.62-GeV superconducting type ring. It will be used for ULSI lithography experiments. Before the superconducting coils are installed, NIJI-III with conventional type magnets has been already constructed and operated in June 1989. NIJI-III with the superconducting ones is now operated in June 1990. NIJI-IV is a 0.5-GeV conventional type compact ring with straight sections longer than 7m where a 6.2-m long TOK is installed to achieve UV FEL experiment.

**KEY WORDS:** Synchrotron Radiation/Compact Rings/Linac/Magnetic Lattice/Lithography/FEL/Superconducting Coils/TOK/

### 1. Introduction

The wide applicability of synchrotron radiation (SR) depends on several of its important properties, such as high brightness and narrow divergence compared with conventional sources. Recently the HITACHI Corp. has succeeded in the test production of a piece of 64-Mbit DRAM<sup>1)</sup> and much attention has been paid to the use of SR in 0.2- $\mu$ m scale ULSI lithography for the development of 256-Mbit DRAM. The test producing of 64-Mbit DRAM in 1990 is one or two years earlier than the forecast generally done in Japan. On the other hand, with the increase of coronary heart disease in the industrial world, special attention has been also paid to the use of SR in medical diagnosis, specifically the use of human angiography. The sole drawback in these applications is that the SR facility including a storage ring, an electron injector and SR beam lines is much larger and more expensive than conventional X-ray sources. The SR facilities for these purposes must be compact, as shown in Fig. 1 and 2, easily operable, and capable of wide and uniform exposure of 8 inch-diameter Si wafers to

冨増多喜夫:Electrotechnical Laboratory, Umezono, Tsukuba, Ibaraki, 305 Japan.

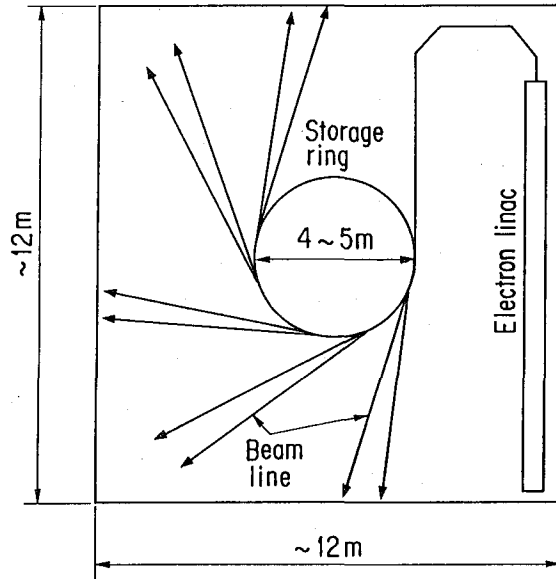

Fig. 1. A proposed compact SR facility for ULSI lithography.

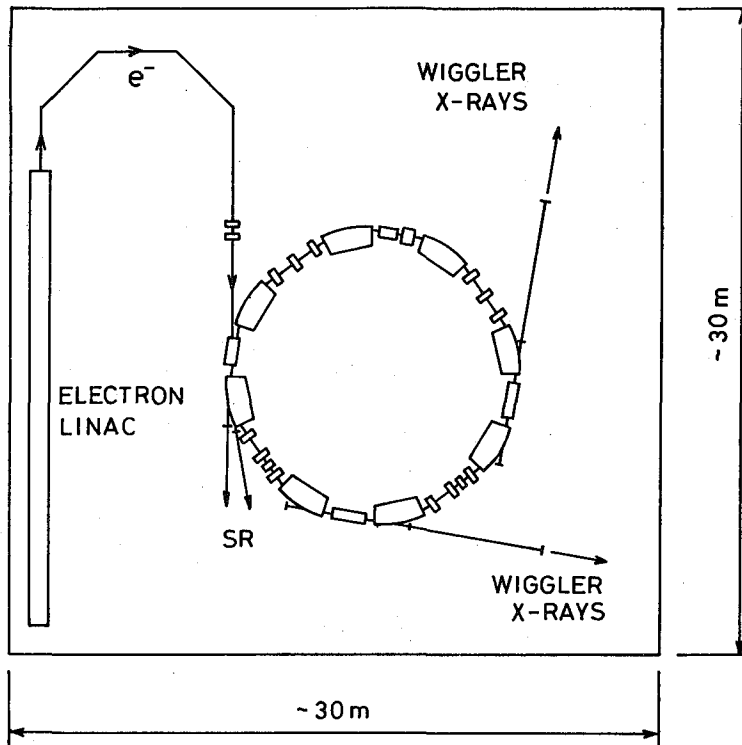

Fig. 2. A proposed compact SR facility for medical diagnosis.

soft X-rays and of wide and uniform exposure of the human heart to 33~34-KeV photons<sup>2)</sup>. A proposed compact SR facility for ULSI lithography shown in Fig. 1 includes a compact ring (about 4~5m diameter) using the electron undulating method<sup>3)</sup>, short SR beam lines used for uniform and wide exposure of SR and a short injector. The facility can be installed in a space of 12m. NIJI-I~III have been constructed as compact rings meeting the dimensions of the proposed compact SR facility shown in Fig. 1.

Another application of compact storage ring is as a high quality electron beam source with a potentiality of generating a FEL by use of the TOK<sup>4)</sup> like ACO<sup>5)</sup> and VEPP-3<sup>6)</sup>. We are developing a FEL facility using TERAS and a 1.45-m TOK. However, the FEL gain is roughly proportional to the square of the length of TOK<sup>7)</sup>, as far as its length is shorter than 10m and the energy spread of the electron beam is narrower than 0.1%. Therefore, NIJI-IV will be constructed in Nov. 1990 to have straight sections longer than 7m, where a 6.2-m TOK can be installed to achieve a high

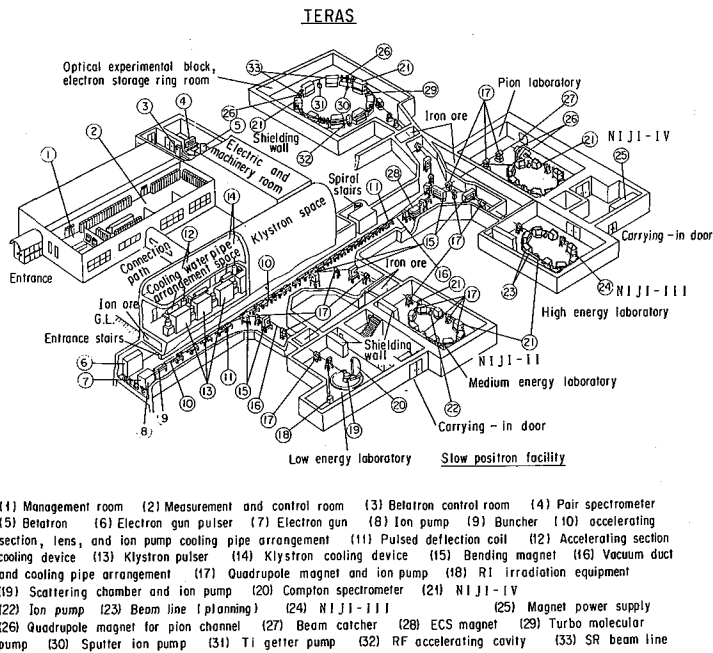

Fig. 3. ETL Linac and Storage Ring Facilities.

Table 1 Main parameters of rings developed for lithography and FEL experiment at ETL.

Machine and Laboratory	Size (m)	E (GeV)	R (m)	I (mA)	Ec (eV)
TERAS (Tsukuba. ETL)	10 $\phi$	0.8	2.0	250	568
NIJI-I (Tsukuba. ETL-SEI)	4 $\phi$	0.27	0.7	524	62
NIJI-II (Tsukuba. ETL-SEI)	4 $\times$ 6	0.6	1.4	120	342
NIJI-III (Tsukuba. ETL-SEI)	3.5 $\times$ 5	0.62	0.5	120	1057
NIJI-IV (Tsukuba. ETL-KHI)	4 $\times$ 13	0.5	1.2		231

gain FEL experiment. Of these rings, NIJI-I has been shut down on March 7, 1989. Figure 3 shows the ETL Linac<sup>8)</sup> and Storage Ring Facilities. The 500-MeV electron linac is called TELL; Tsukuba Electrotechnical Laboratory Linac. TELL can supply electrons to these four rings. Table I shows main parameters of the rings developed at ETL for lithography, FEL and CVD experiments.

## 2. 500-MeV ETL Linac "TELL"

TELL was assembled and adjusted in six months in Tsukuba in 1980. The main features of TELL are high efficiency, high current and high power beam acceleration and economical beam sharing.

1) The linac has been designed and constructed to provide high energy electrons in the energy range of 10-500 MeV. The electron beams are used for the generation of high intensity photons, slow positrons and pions, for the establishment of absorbed dose standards using electrons, photons and pions, for the studies on electronic structures of materials, radiation damage, radiation chemistry and nuclear data, for electron injection into four storage rings and for RI production. In order to satisfy these various requirements for the characteristics of the electron beams, the linac has three energy sections, that is, the low energy ( $\sim 100$  MeV), the medium ( $\sim 200$  MeV) and the high energy ( $\sim 400$  MeV) sections.

2) The linac is of medium duty ratio of 0.1% and high power of 50kW, not of high duty ratio of a few % and high power (100kW) like the three machines operated at Saclay, MIT and NIKHEF-K as shown in Fig. 4. The design approach to avoid the cumulative beam blow-up and to achieve a reasonable peak current of higher than 0.2A results in a configuration of twenty linearly tapered iris type accelerating waveguide, whose iris diameter is linearly tapered along the axis, and twelve quadrupole doublets or triplets, since the 2-mile Stanford linac and the 300-MeV Tohoku linac could not accelerate a peak current higher than 0.1A owing to the beam blow up effect.

3) The structure of the linearly tapered iris type accelerating waveguide (LTWG) is very simple as shown in Fig. 5 and the fabrication costs are certainly lower than those of the constant gradient type. An excellent merit of LTWG's is their ability to line up several kinds of the linearly tapered type accelerating waveguides so as to have as many as possible common cavities in their structures to reduce the fabrication cost, avoiding the beam blow up. We have designed five kinds of LTWG's. Fig. 6 shows the variation of their design parameters as a function of the iris diameter  $2a$  (cm) of the loading desk. The five kinds of the 3m long LTWG's are shown in Fig. 6 where they are designated A3 through E3. The final configuration of the linac consists of three kinds of LTWG's namely two of C3 and D3 type and one of C2 type, which is the 2.3m long input side part of C3 type. Four accelerating waveguides of C2 type used in the low energy section. Four ones of C3 type are used in the medium energy section, and the six ones of each C3 and D3 type are used in the high energy section. More than 210 accelerating waveguides of the ETL type LTWG were introduced in the 2.5-GeV PF linac of KEK<sup>9)</sup>, the 120-MeV JAERI linac<sup>10,11)</sup>, the 140-MeV ISIR linac of

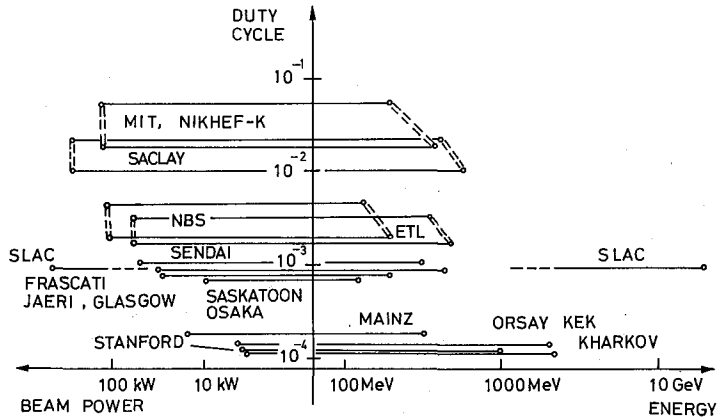

Fig. 4. Main medium and high energy electron linacs in operation.

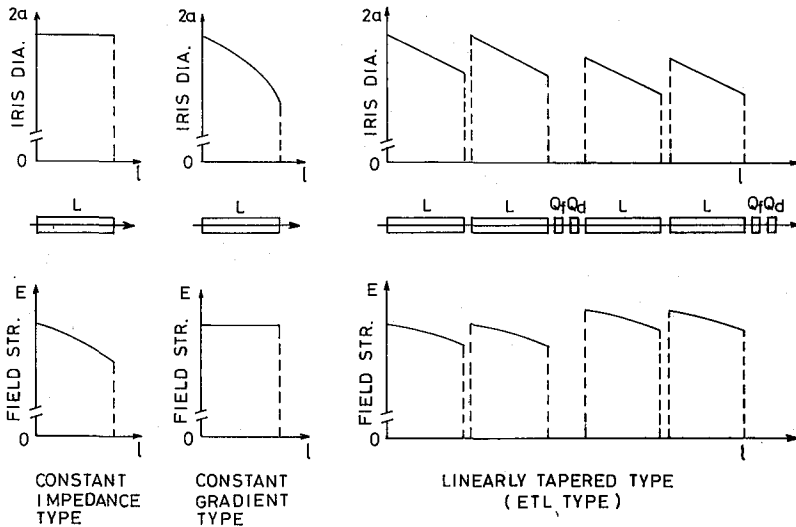

Fig. 5. Features of the linearly tapered iris type accelerating waveguides and their configuration.

Osaka Univ.<sup>12)</sup>, and the 40-MeV SORTEC linac<sup>13)</sup>. The maximum accelerating gradient of 19.3MV/m has been achieved in the 2-m accelerating waveguide of this type after the microwave aging of 20 hours.

Figure 7 shows a schematic layout of TELL and the research program in each laboratory. The maximum peak current so far obtained is 0.24A<sup>14)</sup>. The total length (77m) of TELL, including two pulsed deflection systems at the low and medium energy sections, has only 40% of the lengths (~200m) of the high duty ratio-low peak current machines operated at Saclay, MIT and NIKHEF-K. In this respect, the merit of the low duty ratio-high peak current like "TELL" is clear. TELL has the low, medium and high energy sections to satisfy the various requirements for the characteristics of electron beams, and five laboratories are arranged around the accelerator room. For economical beam sharing, the thinned out pulsed deflection system developed at ETL

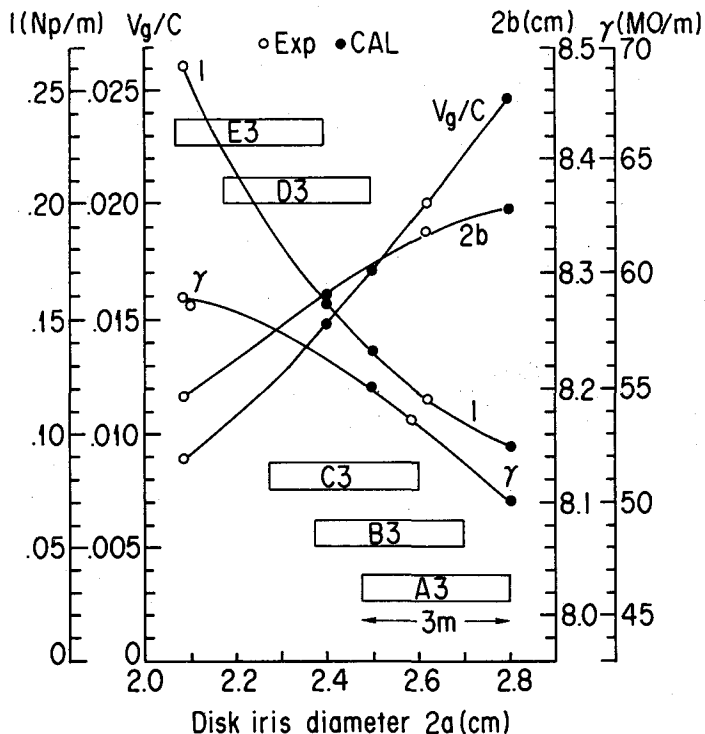

Fig. 6. Design parameters of the accelerating waveguides against iris diameter.

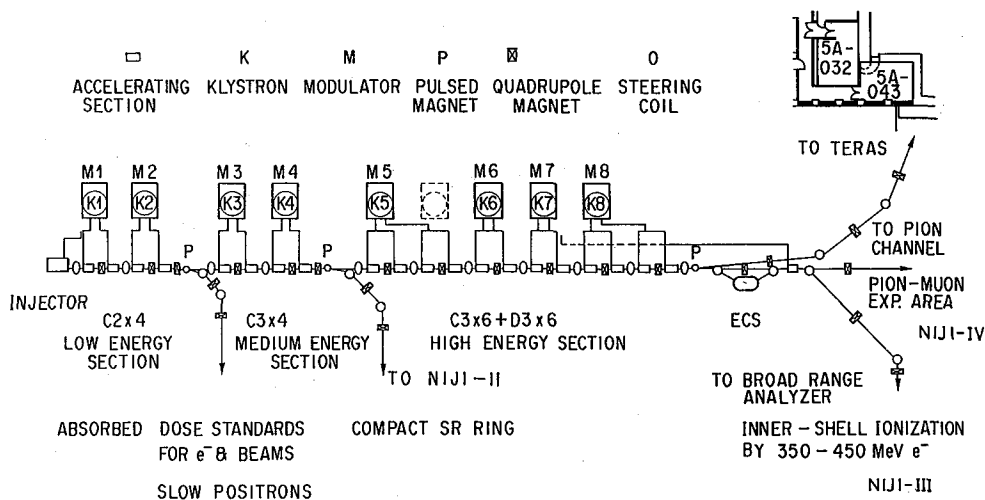

Fig. 7. Schematic layout of the beam centerline, klystrons, modulators, and beam transport systems.

is installed at each outlet of the low, medium and high energy sections<sup>15)</sup>. Figure 8 shows the beam sharing to each experimental room. The main parameters of TELL are shown in Tab. 2 and an energy spectrum of accelerated beam is Figure 9.

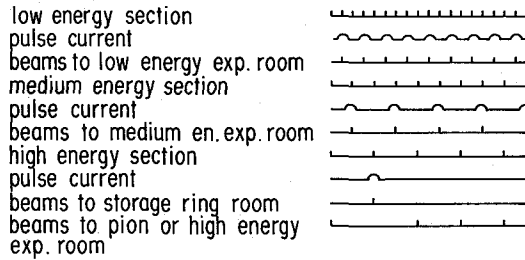

Fig. 8. Beam sharing to each experimental room.

Table 2 Main Parameters of TELL

Machine and Laboratory (Date of First Beam)	Accel. Type	Energy (MeV)	Duty Ratio(%)	peak Current
TELL (Tsukuba. ETL) (1980)	S-band TW	10~400	0.12	0.24A

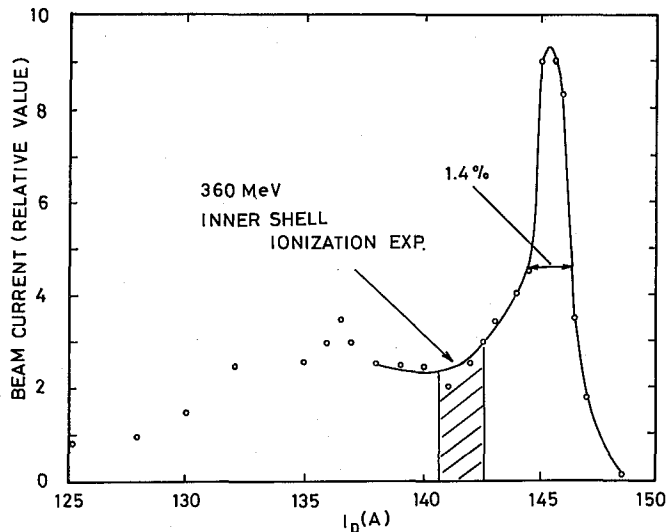

Fig. 9. Energy spectrum of accelerated beam.

TELL is using high-operation efficiency klystrons (E3776, efficiency 44~49%) developed with Toshiba Corp.. An operation efficiency of 50% is an important feature demanded for our klystrons to realize a high efficiency-low cost linac, since the high operation efficiency klystron enables us to use a smaller modulator.

The pulsed klystrons currently used in the world mostly have an efficiency of the order of only 35-40%. The improvement of the efficiency is an urgent requirement from the standpoint of energysaving and lower operation costs. The development of higher operation efficiency klystrons has been carried out since 1974 at ETL in cooperation with Toshiba. ETL has taken the initiative for the assignment of this project and both have played an important role in the development of high efficiency



pulsed klystrons<sup>16)</sup>.

### 3. 800-MeV ETL Storage Ring "TERAS"<sup>17)</sup>

The first beam storage was achieved on Oct. 7, 1981. The layout of TERAS and the SR beamlines are shown in Fig. 10. TERAS is a type of low energy injection. The magnet structure is a combination of eight 45° homogeneous-field magnets with the same entrance and exit of 11.7° and four triplet focusing systems. TERAS was designed in a year and assembled in ten months at a cost of 250 million yen at the ETL.

Since Oct. 1981, SR from TERAS has been used for researches on radiometric standards, dissociative photoionizations, photodissociations of sulfur containing molecules, solid state physics, and ULSI lithography technology. Figure 11 shows schematically the principle of the expansion of an exposed area of SR by using an undulating

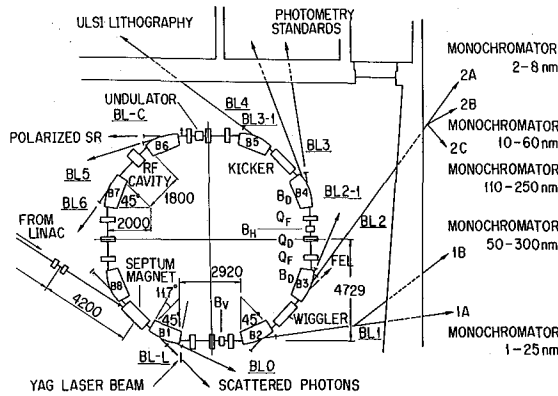

Fig. 10. Layout of TERAS and SR beam lines.

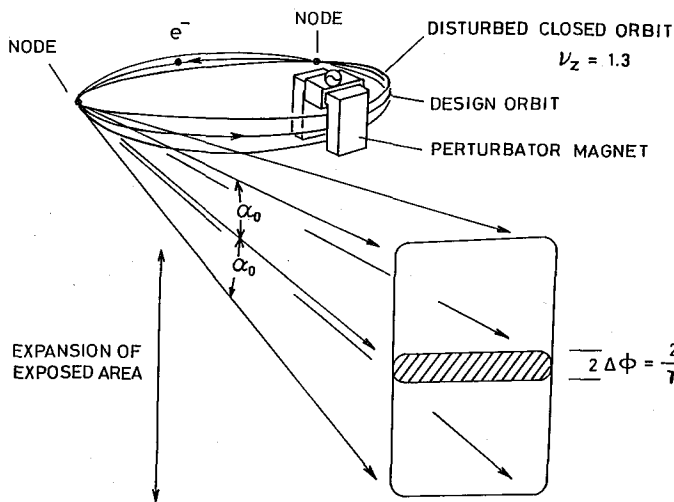

Fig. 11. Expansion of the exposed area of SR by the use of vertically undulating beam near a node. The tilt angle varies between  $\alpha_0$  and  $\alpha_0 + \Delta\alpha$ .

beam in TERAS<sup>3)</sup>. Because of the narrow vertical divergence of SR, ordinary rings can not achieve a uniform vertical exposure unless the beamline is longer than 10m for the several mm vertical area exposure. However, an electron undulating beam has made possible uniform wide-area exposure to SR increasing the vertical spread by a factor of more than five. Compared to the efforts paid to build more compact rings with superconducting magnets, it is more effective to shorten the SR beamlines to less than several meters by use of the undulating electron beam which allows a uniform wide-area exposure of 8-inch diameter Si wafers to SR.

The ETL's lithography group has constructed a prototype fine alignment system having vertical mask and wafer stages<sup>18)</sup>. In order to achieve an alignment accuracy of better than  $0.01\mu\text{m}$ , the group has developed a new interferometric optical heterodyne method that uses three symmetrically arranged gratings and detects the displacement between a mask and a wafer from the phases of beat signals. Using a  $0.76\text{-}\mu\text{m}$  period-grating system and a He-Ne transverse-mode Zeeman laser (wavelength= $0.632\mu\text{m}$ ), displacements smaller than 5nm were detected independently of the mask-wafer gap variations.

By using TERAS' electron beam, new radiation sources such as a backward Compton scattered laser beam (1.5-11-MeV  $\gamma$ -rays)<sup>19)</sup> and any kind of elliptically polarized radiation using a new type undulator<sup>20)</sup> have already been generated. The free electron laser experiment using an ETL TOK has been tried since 1989. In 1991, the TOK will be replaced by a 10-T three pole superconducting wiggler with iron cores produced on the basis of the design study of a 12-T superconducting wiggler<sup>21)</sup> for angiography and EXAFS. The Touschek effect and ion clearing in the TERAS ring have been also estimated by the decay rate plot method<sup>22)</sup>.

#### 4. NIJI-I

The design study of NIJI-I started in the summer of 1984 and in 1986 ETL and Sumitomo Electric Industries (SEI) completed NIJI-I whose layout is shown in Fig. 12<sup>23)</sup>. NIJI-I, measuring four meters in diameter, was installed in the medium energy laboratory of the Linac Facilities. An SR beamline shown in Fig. 12 was used for an SR CVD (Chemical Vapor Deposition) experiment. NIJI-I was operated on February 28, 1986, and was shut down on March 7, 1989. Electrons in an energy range of 80~180 MeV were injected into NIJI-I at a pulse rate of one per 0.32s from the linac, TELL.

The maximum stored current of 160-MeV electrons so far obtained is 524mA and the lifetime is about 70 min as shown in Fig. 13. This is the first data demonstrating the possibility of high current storage of more than 500mA at energies near 150 MeV<sup>24)</sup>.

#### 5. NIJI-II

NIJI-II is a 600-MeV conventional type ring. It has been constructed in the medium energy laboratory instead of NIJI-I by ETL and SEI and has been operated on August 3, 1989<sup>25,26)</sup>. The magnet structure is a combination of four 90° bending magnets ( $r=1.4\text{m}$ ,  $n=0$ ) with the same entrance and exit angle of 16° and six quadru-

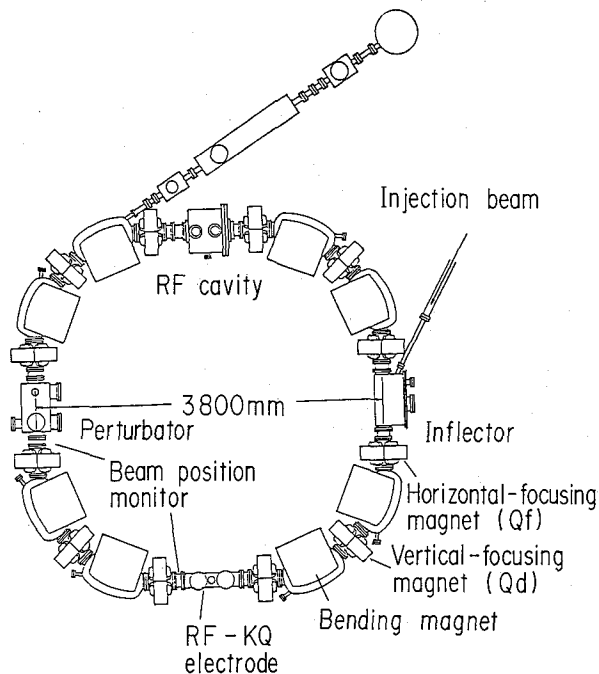

Fig. 12. Layout of NIJI-I and SR beam line.

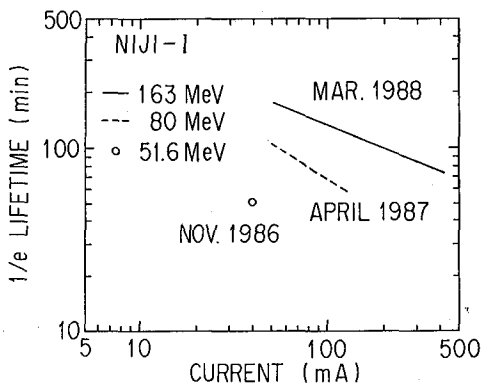

Fig. 13. Lifetime of stored beam current in NIJI-I.

ples magnets. The lattice order is  $0/2 Q_f B_d Q_f B_d Q_f 0/2$  and the periodicity is two. Two sextupole magnets are also installed. The configuration of the guide field elements is rectangular as shown in Fig. 14. The double bend achromat lattice structure, which can achieve dispersion free at long straight sections, can be also adopted for the FEL experiment. In the long straight sections, a septum magnet, a kicker coil, an RF cavity and a 1.36-m undulator for CVD experiments<sup>27)</sup> or a 1.3-m undulator with crossed and retarded magnetic fields are installed. The harmonic number is nine and the circumference is 17.04m. The maximum stored current so far

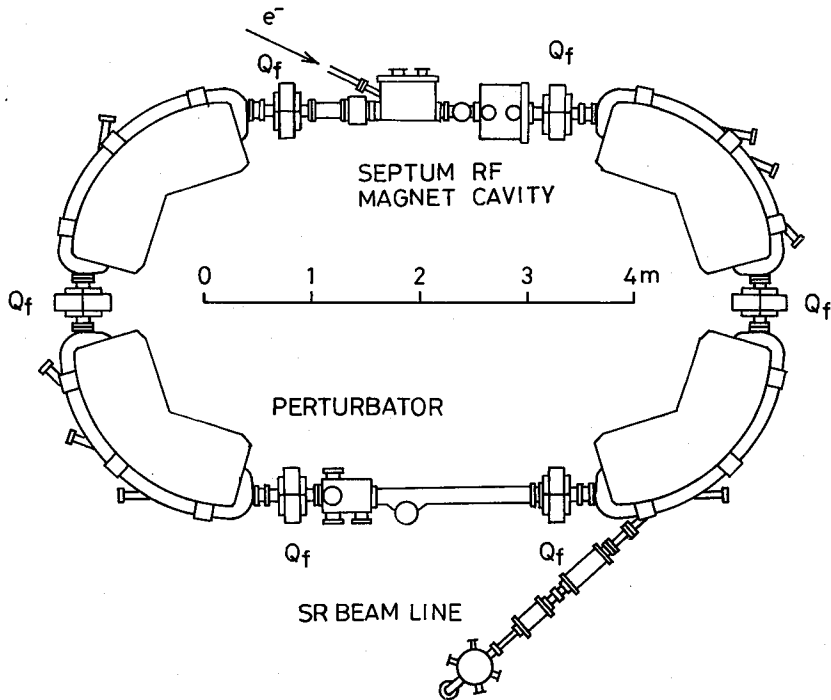

Fig. 14. Layout of NIJI-II.

obtained is 120mA.

## 6. NIJI-III

NIJI-III, a 620-MeV superconducting type ring, is being developed by SEI and ETL. The development of NIJI-III as a practical compact electron undulating ring for ULSI lithography are based on the studies on the expansion of the exposed area of SR at ETL<sup>3)</sup>. The development is commissioned to SEI by the Research Development Corporation sponsored by the Japanese Government from 1986 to 1990. The magnet structure is a combination of four superconducting magnets ( $r=0.5\text{m}$ ,  $n=0.5$ ) and eight quadrupole magnets. The configuration of the guide elements is of four-cornered type as shown in Fig. 15<sup>29)</sup>. The harmonic number is eight and the circumference is 15.54m. As the first stage of the construction of NIJI-III, NIJI-III with conventional type bending magnets has been already constructed and operated in June 1989 for machine study. As the second stage, four conventional type ones have been replaced by superconducting coils without ion yoke, starting in the fall of 1989 one by one, and NIJI-III with the superconducting ones is operated in June 1990. Figure 16 shows the cross section of the superconducting coil. The maximum stored current so far obtained is 120mA.

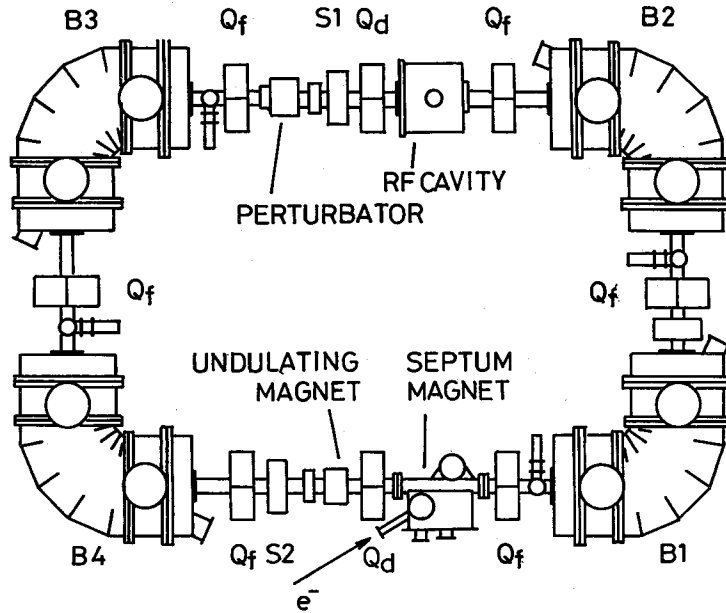

Fig. 15. Layout of NIJI-III.

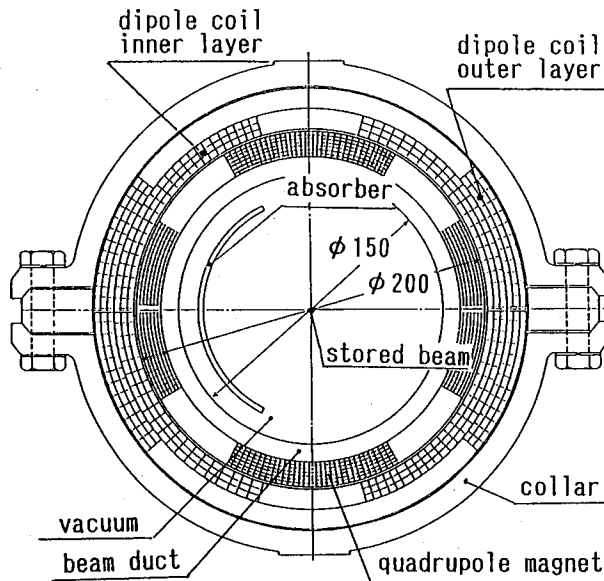

Fig. 16. Cross section of the superconducting coil.

### 7. NIJI-IV

NIJI-IV should be compact and its straight section where a TOK can be installed is long enough so as to generate the UV FEL. The choice of the magnetic lattice is

also important to achieve the beam storage of low emittance, small everygy spread, high current, and dispersion free at the TOK.

Figure 17 shows ratios of the length of straight section  $L_s$  to the cell length of the magnetic lattice  $L_c$  as a function of  $L_c$  of the main existing and planned storage rings. The closed circles show the storage rings of triple bend achromat lattice, the open circles double achromat lattice, the closed square FODO lattice, the open square triplet achromat lattice, and the closed triangle extended double bend achromat lattice. The solid line of  $L_s=6m$  indicates storage rings with a 6-m straight section. New storage rings of the third generation such as ALS, APS, ESRF, SPRING-8, SRRC (Taiwan), POHANG (Korea), TRIESTE (Italy) near this line can install many 5-m undulators to generate high brilliant radiations. The lattice of these rings is triple bend achromat type or double bend achromat rype. The both lattices can achieve dispersion free drift spaces for insertion devices. In the case of compact storage rings with two cell structure of these lattice, however, the triple bend achromat type can yield lower emittance beams because the emittance is inversely proportional to the cube of the

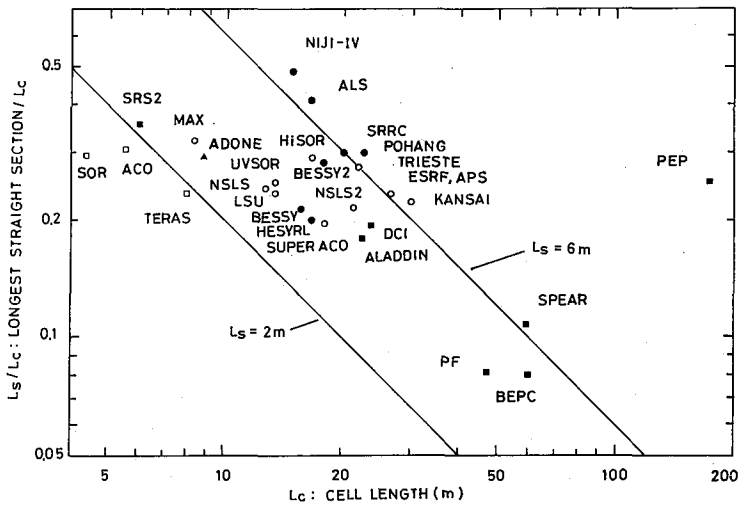
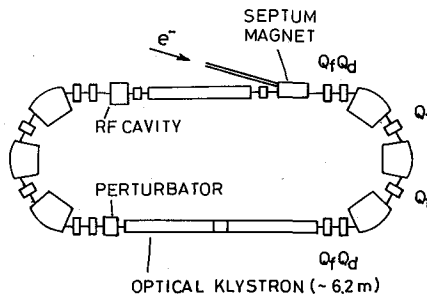

Fig. 17. Ratios of the length of straight section  $L_s$  to the cell length of the magnetic lattice  $L_c$  as a function of  $L_c$ .



NIJI-IV (ETL-KHI)  $C = 29.6\text{ m}$

Fig. 18. Layout of NIJI-IV.

number of dipole magnets.

Figure 18 shows a schematic layout of NIJI-IV<sup>29)</sup>. It is a 500-MeV conventional

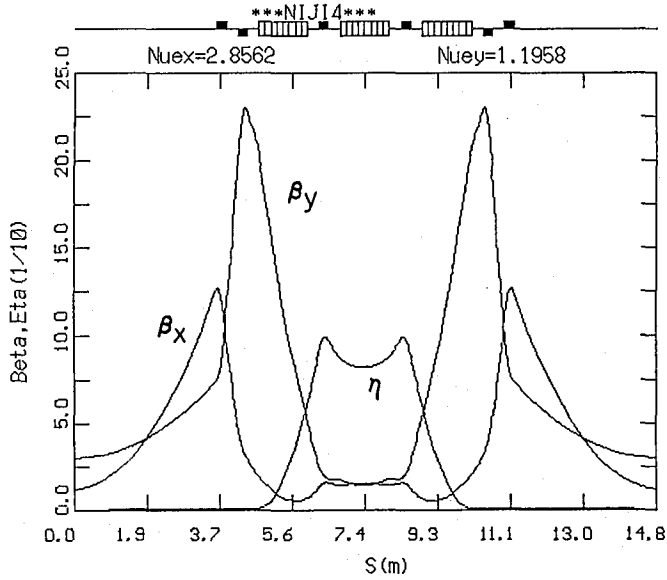

Fig. 19. Betatron and dispersion functions for one superperiod of lattice.

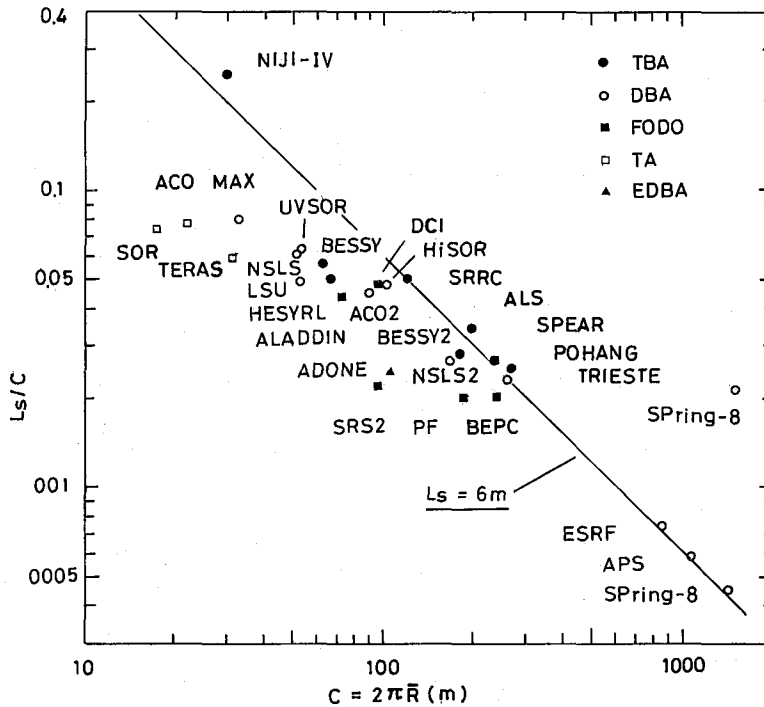

Fig. 20. Ratios of the length of straight section  $L_s$  to the circumference  $C$  as a function of  $C$ .

type compact ring with straight sections longer than 7m where a 6.2-m TOK can be installed to generate the UV FEL. NIJI-IV has a hexagonal configuration with a circumference of 29.6m, consisting of the two cell structure of the triple bend achromat lattice. The magnetic structure is a combination of six 60° dipole magnets ( $\rho=1.2\text{m}$ ,  $n=0$ ) with the same entrance and exit angle of 16.1° and twelve quadrupole magnets. The lattice order is 0/2 Qf Qd Bd Qf Bd Qf Bd Qd Qf 0/2 and the periodicity is two. The betatron and dispersion functions for one superperiod of the lattice are shown in Fig. 19. One of the long dispersion free spaces is used for the 6.2-m TOK. The 162.1MHz old RF cavity previously used for TERAS will be used as an RF cavity. The harmonic number is sixteen. A stored current higher than 60mA is expected at two bunch operation. The calculated beam emittance is  $5 \times 10^{-8}$  m. rad. at 350 MeV.

Figure 20 shows ratios of the length of straight section  $L_s$  to the circumference  $C$  as a function of  $C$  of the existing and planned storage rings worldwide except ones in the USSR. NIJI-IV is the most compact ring with 7-m long straight section.

### 8. 6.2-m TOK

The FEL wavelength  $\lambda_R$  is related to a wiggler magnet period  $\lambda_0$  of an insertion device and to the electron energy  $\gamma$  in units of rest mass  $m_0c^2$  by the resonance condition

$$\lambda_R = \lambda_0 (1 + K^2/2) / 2\gamma^2, \quad (1)$$

where  $K=93.4B$  (T)  $\lambda_0$  (m) with  $B$  being the peak magnetic field at the wiggler midplane. For instance,  $B=0.315\text{T}$ ,  $\lambda_0=0.07\text{m}$ ,  $\gamma=560$  (286.2 MeV) gives  $\lambda_R=348\text{nm}$  from Eq. (1). A gain per pass of the TOK for a wavelength  $\lambda_R$  given by Eq. (1) is<sup>30)</sup>

$$G^{\text{TOK}} = 1.12 \times 10^{-13} \lambda_0^2 (N + N_d) N^2 K^2 \gamma^{-3} (JJ)^2 f \rho F_t, \quad (2)$$

where  $N$  is the number of wiggler magnet periods,  $N_d$  the number of periods of light of wave length  $\lambda$  passing over an election in the dispersion section,  $JJ$  the Bessel function factor,  $f$  the modulation rate,  $\rho$  the peak electron density in  $\text{m}^{-3}$ , and  $F_t$  a filling factor due to the electron and light beams all along the TOK.

The maximum gain per pass of the optical klystron can be related to the maximum gain  $G_{2N}$  of a wiggler with  $2N$  periods by<sup>30)</sup>

$$G^{\text{TOK}} = G_{2N} 0.93 (N + N_d) f / N. \quad (3)$$

For an electron energy spread of  $5 \times 10^{-4}$ , the value of  $N_d$  attains 150. Therefore,  $G^{\text{TOK}}$  is roughly proportional to the square of the length of the TOK  $L_0$  for the length shorter than 10m since  $L_0 = 2N\lambda_0 + 3\lambda_0$ , where  $3\lambda_0$  is the length of the dispersion section.

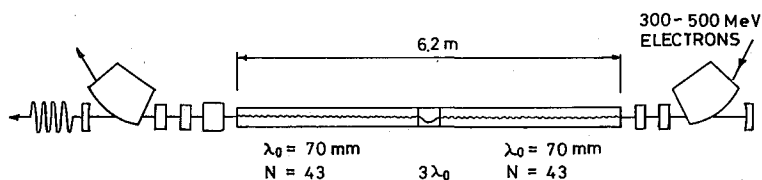

Fig. 21. Schematic layout of the 6.2-m TOK.



Figure 21 shows a schematic layout of the 6.2-m TOK, whose main parameters are as follows; the total length is 6.2m,  $\lambda_0$  is 70mm and  $N=43$ . Eq. (3) shows that  $G^{\text{TOK}}$  is larger than  $G_{2N}$  for  $f > 0.25$  at the condition of  $\lambda_0=70\text{mm}$ ,  $N=43$  and  $Nd=150$ . A gain per pass higher than 2.3% is expected for 350nm at 20mA bunch current from Eq. (2). A calculated horizontal tune shift due to the 6.2m optical klystron is +0.08 from 2.85. A sextupole correction can easily correct the tune shift and a decrease in dynamic aperture.

### Acknowledgements

The author is indebted to the members of the Linac and Storage-Ring Group, and Miss F. Takahashi for their constant and efficient assistance.

### REFERENCES

- (1) Y. Kawamoto, T. Kaga, T. Nishida, S. Iijima, T. Kure, F. Murai, T. Kisu, D. Hisamoto, H. Shinriki and Y. Nakagome: Digest of Technical Papers of 1990 Symp. on VLSI Technology (Honolulu, June 1990) p. 13.
- (2) T. Tomimasu: *Synchrotron Radiation News*, 1 (4), 28 (1988).
- (3) T. Tomimasu: *Jpn. J. Appl. Phys.*, 26, 741 (1987).
- (4) N. A. Vinokurov: Proc. 11th Intern. Conf. on High Energy Accelerators (Serpuukhov, 1977) 2, p. 455.
- (5) M. Billardon, P. Elleaume, J. M. Ortega, G. J. Ramian, M. Bergher, M. Velghe, Y. Petroff, D. A. G. Deacon, K. E. Robinson and J. M. Madey: *Phys. Rev. Lett.*, 51, 1652 (1983).
- (6) V. N. Litvinenko: *Synchrotron Radiation News*, 1, (5), 18 (1988).
- (7) T. Yamazaki, T. Nakamura, T. Noguchi, S. Sugiyama, T. Mikado, M. Chiwaki and T. Tomimasu: TELL-TERAS Activity Report 1980~1986, Electrotechnical Laboratory, March 1987, p. 25. T. Yamazaki, K. Yamada, S. Sugiyama, T. Tomimasu, T. Mikado, M. Chiwaki, R. Suzuki and H. Ohgaki: Proc. 2nd Symposium on Advanced Nuclear Energy Research (Mito, JAERI, Jan. 1990) p. 308.
- (8) T. Tomimasu, *IEEE Trans. Nucl. Sci.* NS-28 (3), 3523 (1981).
- (9) J. Tanaka: Proc. 7th Meeting on Linear Accelerator in Japan (KEK, Aug. 1982) p. 47.
- (10) H. Takekoshi: *Bull. Inst. Chem. Res. Kyoto Univ.*, 52 (1), 47 (1974); JAERI Report 6014 (1963) edited by H. Takekoshi.
- (11) Y. Kawarazaki, K. Mashiko, N. Akiyama, Y. Nobusaka, T. Shoji and M. Kitajima: Proc. 6th Meeting on Linear Accelerator in Japan (Electron Linac Lab., Hokkaido Univ., July 1981) p. 11.
- (12) K. Tsumori, J. Ohkuma, T. Sawai, N. Kimura, S. Okuda, T. Yamamoto, T. Hori, S. Suemine and S. Takamuku: Proc. 14th Intern. Conf. on High Energy Accelerators (Tsukuba, Aug. 1989) Vol. 27, p. 151.
- (13) M. Shiota, A. Hiraki, M. Mizota, T. Iida, M. Haraguchi, K. Kuno, S. Nakamura, M. Ohno and T. Tomimasu: Proc. 7th Symposium on Accelerator Science and Technology (RCNP, Osaka Univ. Dec. 1989) p. 10
- (14) T. Tomimasu: *Electronics Magazine*, 27 (13), 1249 (1982).
- (15) S. Sugiyama, T. Noguchi, T. Yamazaki, T. Mikado, M. Chiwaki and T. Tomimasu: Proc. 5th Symposium on Accelerator Science and Technology (KEK, Tsukuba, Sept. 1984) p. 169.
- (16) T. Tomimasu, K. Kadono, K. Ogura, T. Yamazaki, T. Okamoto, M. Hosoi, S. Miyake and Y. Unemura: Proc. 12th Meeting on Linear Accelerators in Japan (NERL, Tokyo Univ., Aug. 1987) p. 188.
- (17) T. Tomimasu, T. Noguchi, S. Sugiyama, T. Yamazaki, T. Mikado and M. Chiwaki: *IEEE Trans. on Nucl. Sci.* NS-30 (4), 3133 (1983).
- (18) J. Itoh, T. Kanayama, N. Atoda and K. Hoh: *Proc. Soc. Photo-Opt. Instrum. Eng.* 773, 7 (1987).
- (19) T. Yamazaki, T. Noguchi, S. Sugiyama, T. Mikado, M. Chiwaki and T. Tomimasu: *IEEE Trans. Nucl. Sci.* NS-32 (5), 3406 (1985).

T. TOMIMASU

- (20) H. Onuki, N. Saito and T. Saito: *Appl. Phys. Lett.* **52**, 173 (1988).
- (21) T. Keishi, Y. Hosoda, T. Tomimasu and S. Sugiyama: Proc. 7th Symposium on Accelerator Science and Technology (RCNP, Osaka Univ. Dec. 1989) p. 178.
- (22) T. Tomimasu, T. Noguchi, S. Sugiyama, T. Yamazaki, T. Mikado, M. Chiwaki, T. Nakamura and R. Suzuki: *Rev. Sci. Instrum.*, **60** (7), 1744 (1989).
- (23) H. Takada, K. Furukawa and T. Tomimasu: *Proc. Soc. Photo-Opt. Instrum. Eng.* **773**, 257 (1987).
- (24) T. Tomimasu: *Rev. Sci. Instrum.* **60** (7), 1622 (1989).
- (25) S. Sugiyama, T. Yamazaki, T. Mikado, M. Chiwaki, K. Yamada, H. Ohgaki, R. Suzuki, T. Tomimasu, T. Mitsui, H. Takada, Y. Tsutsui, Y. Oka and Y. Hirata: Proc. 7th Symposium on Accelerator Science and Technology (RCNP, Osaka Univ. Dec. 1989) p. 20.
- (26) Y. Oka, Y. Hirata, H. Takada and T. Tomimasu: *ibid.* p. 29.
- (27) T. Tomimasu: *Nucl. Sci. Appl.*, **3**, 29 (1987).
- (28) K. Emura, Y. Tsutsui, F. Miura, H. Takada and T. Tomimasu: Proc. 7th Symposium on Accelerator Science and Technology (RCNP, Osaka Univ. Dec. 1989) p. 344.
- (29) T. Tomimasu, S. Sugiyama, H. Ohgaki, T. Yamazaki, K. Yamada, T. Mikado, M. Chiwaki, R. Suzaki, S. Suse, M. Yoshiwa and A. Iwata: *ibid.* p. 347.
- (30) M. Billardon, P. Elleaume, J. M. Ortega, C. Bazin, M. Bergher, M. Velghe, D. A. G. Deacon and Y. Petroff: *IEEE J. of Quantum Electronics* **QE-21** (7), 805 (1985).