

Title	Effect of the Iodine Desorption Method on the Structure of Nylon 6 (Commemoration Issue Dedicated to Professor Keinosuke Kobayashi on the Occasion of His Retirement)
Author(s)	Kurokawa, Masataka; Konishi, Takashi; Tanei, Yoshiyuki
Citation	Bulletin of the Institute for Chemical Research, Kyoto University (1977), 55(2): 189-199
Issue Date	1977-08-31
URL	<a href="http://hdl.handle.net/2433/76729">http://hdl.handle.net/2433/76729</a>
Right	
Type	Departmental Bulletin Paper
Textversion	publisher

## Effect of the Iodine Desorption Method on the $\gamma$ Structure of Nylon 6

Masataka KUROKAWA, Takashi KONISHI\*, and Yoshiyuki TANSEI\*\*

*Received March 29, 1977*

Drawn filament of nylon 6 with  $\alpha$  structure was immersed in an iodine-potassium iodide aqueous solution and then the sorbed-iodine was washed out in an acetone-water, methanol-water and acetone-methanol solvents. The  $\gamma$  nylon filament obtained was investigated with the measurement of shrinkage, density, wide and small angle X-ray diffraction and thermal shrinkage stress in order to make clear the influence of wash solvent on the  $\gamma$  filament. Wide angle X-ray diffraction patterns showed that the crystal structure of  $\gamma$  filament was not affected by the character of wash solvents and the condition of washing and drying, but the density, small angle X-ray scattering and thermal shrinkage stress curves revealed that they caused the structural difference such as void formation, disorientation of the crystallites and the residual strain of the molecules in the amorphous regions. When the solvent-washed  $\gamma$  filament was further washed in water, there occurred that micro-voids disappeared, its density increased to the constant value of 1.134 (g/cm<sup>3</sup>), small angle scattering changed to distinct meridian interference patterns and its thermal stress curves varied to have the characteristic two stress peaks at 70°C and 210°C.

### INTRODUCTION

It is well known there takes place a crystalline transition from  $\alpha$  to  $\gamma$  form in an iodine treated nylon 6 filament.<sup>1,2)</sup> In the present work, the nylon 6 filaments were immersed in an iodine-potassium iodide aqueous solution and they were washed with an appropriate solvent to remove iodine. The solvents used in this experiments were sodium thiosulfate solution, acetone-water, methanol-water, and acetone-methanol mixture.

Many researchers had reported on the iodine sorption isotherms and their shrinking and swelling behavior.<sup>1,3,4)</sup> The measurements of IR absorption spectrum<sup>5~8)</sup> and X-ray diffraction<sup>2,9)</sup> of the  $\gamma$  structure of nylon 6 were carried out and the structural model of  $\gamma$  crystal has been discussed by many scholars.<sup>6,7)</sup> However, the detailed explanation of the structural changes in the  $\gamma$  form nylon 6 has not been yet understood.

The formation of hydrogen bonds has a great effect on the crystalline and amorphous states of polyamide. As a result of the formation of hydrogen bonds between the molecular chains of nylon 6, the structure of the amorphous region in  $\gamma$  nylon filament has a close relation with the property of washing solvent, washing temperature and drying condition after washing.

The object of this experiments is to investigate the effect of the washing solvent which is used to remove the iodine from the iodine-sorbed nylon filament, on the structure of  $\gamma$  nylon filaments. The  $\gamma$  structure was studied by the measurements of shrinkage, density,

\* 黒川昌孝, 小西 孝, 丹生由幸: Kyoto University of Industrial Arts and Textile Fibers, Matsugasaki Sakyo-ku, Kyoto 606, Japan.

\*\* Present address: Teijin Company, Ltd. Kitayoshida Matsuyama.

wide and small angle X-ray diffraction and thermal shrinkage stress during heating.

### EXPERIMENTAL AND MATERIALS

Commercial drawn nylon 6 monofilaments were used as samples for this experiment. The density and diameter were  $1.138(\text{g}/\text{cm}^3)$  and 0.5 mm respectively. Their X-ray diffraction patterns showed clear  $\alpha$ -form fiber diagrams. The filaments were immersed in the aqueous solution of 0.5 M  $\text{I}_2$ –1.0 M KI at  $30^\circ\text{C}$  for 24 hours. Iodine sorbed specimens were then immersed in washing solvent at  $30^\circ\text{C}$  for suitable length of time (5–10 days). The washing solvents were the mixture of methanol and water, acetone and water and acetone and methanol, and, 0.5 N sodium thiosulfate aqueous solution. The molar fraction of these mixed solutions were varied to investigate the effect of washing solvents on the formed  $\gamma$  structure of nylon 6.

After washing, some of the sample were washed in water at  $30^\circ\text{C}$  for 24 hours. The water drops were removed from the samples and then the samples were dried in a vacuum desiccator at  $30^\circ\text{C}$  for 2 days, in the constrained and unconstrained condition. From the X-ray diffraction patterns, they were found to be complete  $\gamma$  type nylon 6.

Wide and small angle X-ray diffraction data were obtained by the photographic method and recording diffractometer. SAXS (small angle X-ray scattering) curves were obtained at room temperature by using line collimation Shimadzu small angle diffractometer and point collimation Rigaku Denki small angle camera. The sample-film distance was 170 mm and Ni-filtered  $\text{Cu-K}\alpha$  X-ray was used. The density of the samples was measured using a density gradient column with n-heptane and carbon tetrachloride. The temperature of measurements was  $30 \pm 0.1^\circ\text{C}$ . The thermal shrinkage stress was calculated from the force of retraction, measured by using the apparatus which was made in our laboratory.

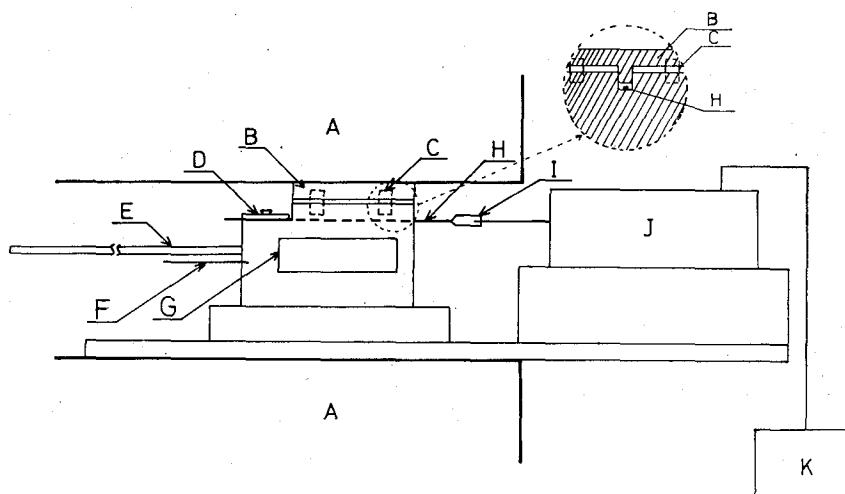

A: Press B: Compressing Plate C: Spring D: Clamp  
E: Thermometer F: Thermocouple G: Heater H: Sample  
I: Clamp J: Resistance Strain Gauge K: Recorder

Fig. 1. Schematic diagram of the apparatus for the measurement of thermal shrinkage stress.

Its schematic diagram is shown in Fig. 1. The sample length was 30 mm and an initial tension of 70 g/mm<sup>2</sup> was applied. The temperature of the sample was raised at a rate of 5°C/min.

The shrinkage  $S$  of the sample is represented by the following equation,

$$S(\%) = \{(1_0 - 1)/1_0\} \times 100$$

where  $1_0$ : the original,  $1$ : shrunk length.

The weight increase  $\Delta W$  of the  $\gamma$  filament is represented by

$$\Delta W(\%) = \{(W - W_0)/W_0\} \times 100$$

where  $W_0$ : the weight of the original  $\alpha$ -form nylon 6 filament,  $W$ : the weight of the iodine treated  $\gamma$  nylon filament.

### RESULTS AND DISCUSSION

The present experiments were carried out in order to investigate the influence of the washing solvent and condition of washing and drying, on the structure of  $\gamma$  nylon 6 obtained by treating with an aqueous solution of 0.5 M I<sub>2</sub>-1.0 M KI. Figure 2 shows the shrinkage of the  $\gamma$  nylon 6 filament before and after drying, as a function of the molar fraction of washing solvents: (a) CH<sub>3</sub>COCH<sub>3</sub>-H<sub>2</sub>O, (b) CH<sub>3</sub>OH-H<sub>2</sub>O and (c) CH<sub>3</sub>COCH<sub>3</sub>-CH<sub>3</sub>OH. The filament is lengthened by washing in water and shrunk again by drying. As shown in Fig. 2(a), the shrinkage of the samples increases as the molar fraction of H<sub>2</sub>O increases. It was found that the greater the molar fraction of CH<sub>3</sub>COCH<sub>3</sub> in the washing solvent becomes, the longer is the time for the complete removal of I<sub>2</sub>. Crystalline orientation of the samples is independent of the molar fraction of washing solvent. When CH<sub>3</sub>OH-H<sub>2</sub>O is used as the washing solvent, there is an increase of the shrinkage which is resulted from the drying of  $\gamma$  nylon filament after washing in water and a decrease of the orientation of  $\gamma$  crystallites, as the molar fraction of CH<sub>3</sub>OH increases. The time taken to remove I<sub>2</sub> completely is also found to become less. When the molar fraction of

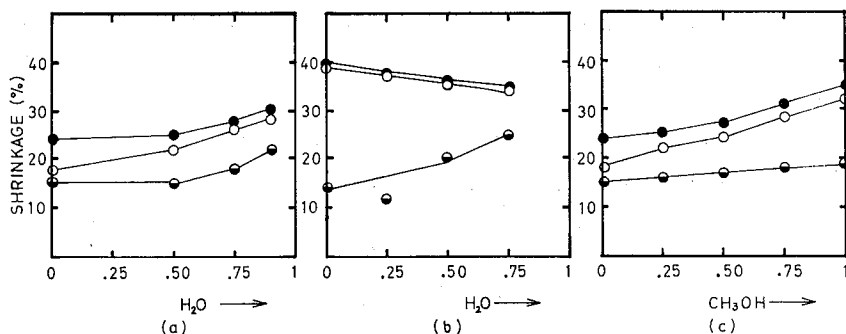

Fig. 2. The relation between the shrinkage of the  $\gamma$  filament and the molar fraction of the desorption solvents: (a) CH<sub>3</sub>COCH<sub>3</sub>-H<sub>2</sub>O, (b) CH<sub>3</sub>OH-H<sub>2</sub>O, (c) CH<sub>3</sub>COCH<sub>3</sub>-CH<sub>3</sub>OH. ○—○  $\gamma$  filament washed with desorption solvent (dry state); ◐—◐  $\gamma$  filament washed with desorption solvent, further washed in water (wet state); ●—●  $\gamma$  filament washed with desorption solvent, further washed and dried (dry state).

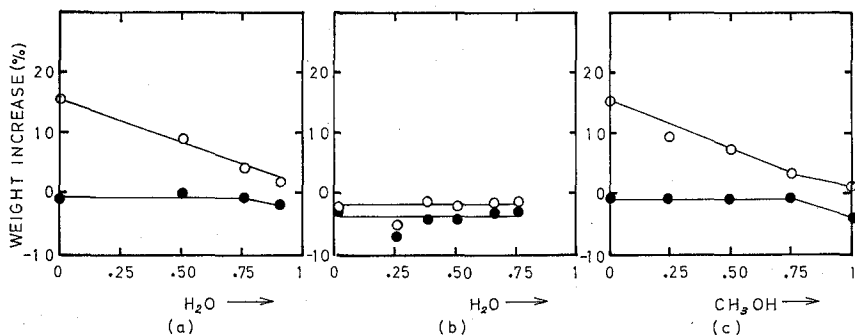

Fig. 3. The relation between the weight increase of the  $\gamma$  filament and the molar fraction of the desorption solvents: (a)  $\text{CH}_3\text{COCH}_3\text{-H}_2\text{O}$  (b)  $\text{CH}_3\text{OH-H}_2\text{O}$ , (c)  $\text{CH}_3\text{COCH}_3\text{-CH}_3\text{OH}$ . ○—○  $\gamma$  filament washed with desorption solvent and dried. ●—●  $\gamma$  filament washed with desorption solvent, further washed in water and dried.

$\text{CH}_3\text{OH}$  is large, large difference of shrinkage occurs between wet and dry state of water washed  $\gamma$  filament.

Figure 3 shows the weight changes of  $\gamma$  filaments.  $\gamma$  filament washed in  $\text{CH}_3\text{COCH}_3\text{-H}_2\text{O}$  and  $\text{CH}_3\text{COCH}_3\text{-CH}_3\text{OH}$  represent the weight increase which means that the removal of  $\text{I}_2\text{-KI}$  is incomplete and probably  $\text{KI}$  will be remained in the amorphous region. These remained  $\text{KI}$  may be almost completely washed out by further washing in water.

When  $\text{I}_2$ -removed specimens were further washed in water, the changes of shrinkage, density, SAXS and thermal shrinkage stress were observed while the change in the WAXS (wide angle X-ray scattering) patterns were negligibly small. The density of the filaments varied in the range from  $1.09 \text{ (g/cm}^3\text{)}$  to  $1.13 \text{ (g/cm}^3\text{)}$  according to the molar fraction of washing solution and the water treated specimens show a constant value of  $1.134 \text{ (g/cm}^3\text{)}$  in density. The SAXS of the specimen which was washed only with the solvent changes from a diffuse scattering to a distinct small angle diffraction patterns, as the molar fraction of  $\text{CH}_3\text{OH}$  increases. By washing in water, SAXS of the  $\gamma$  filament gave the distinct

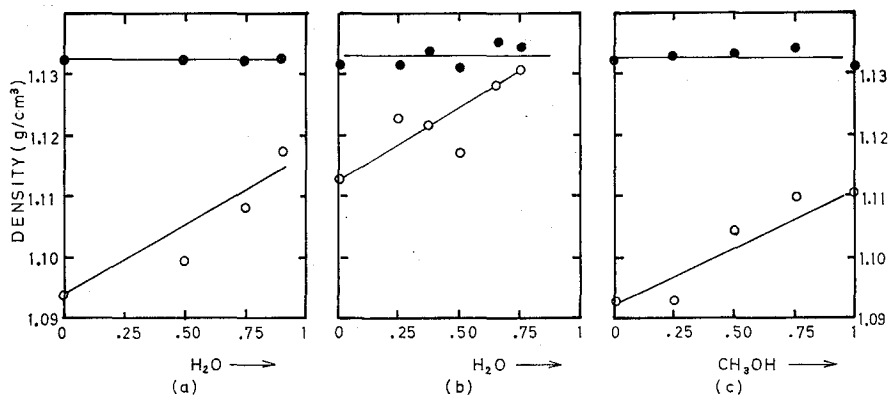

Fig. 4. The relation between the density of the  $\gamma$  filament and the molar fraction of the desorption solvents: (a)  $\text{CH}_3\text{COCH}_3\text{-H}_2\text{O}$ , (b)  $\text{CH}_3\text{OH-H}_2\text{O}$ , (c)  $\text{CH}_3\text{COCH}_3\text{-CH}_3\text{OH}$ . ○—○  $\gamma$  filament washed with desorption solvent and dried. ●—●  $\gamma$  filament washed with desorption solvent, further washed in water and dried.

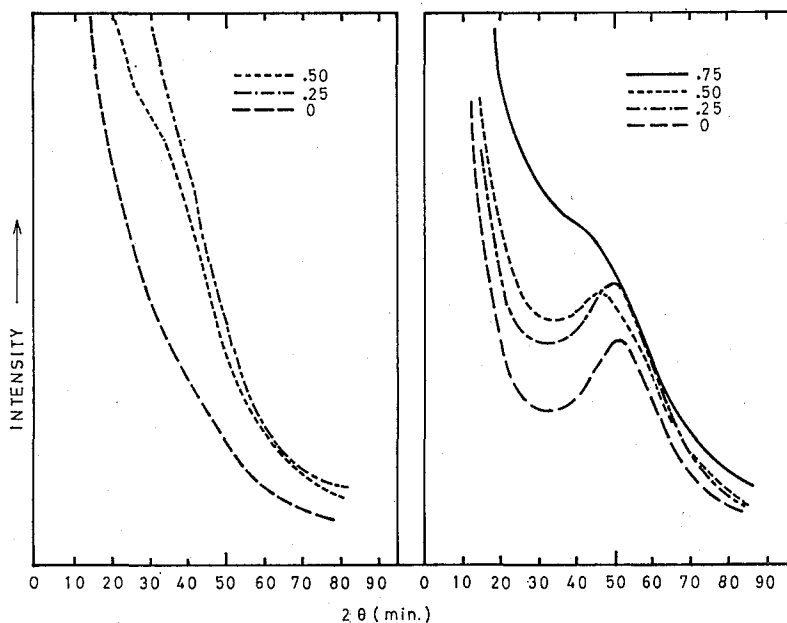

Fig. 5. Small angle X-ray scattering curves of the  $\gamma$  filament along the meridian. (a):  $\gamma$  filament washed with  $\text{CH}_3\text{COCH}_3\text{-CH}_3\text{OH}$  solution and dried. (b):  $\gamma$  filament washed with  $\text{CH}_3\text{COCH}_3\text{-CH}_3\text{OH}$  solution, further washed in water and dried. The molar fraction of  $\text{CH}_3\text{COCH}_3$  in the mixed solution: — .75, ---- .50, -.-.- .25, — 0.00.

meridian diffraction patterns from which the long period were calculated as  $114 \text{ \AA}$  for  $\text{CH}_3\text{OH-H}_2\text{O}$  and  $105 \text{ \AA}$  for  $\text{CH}_3\text{COCH}_3\text{-H}_2\text{O}$ . These values are independent of the molar fraction of the washing solutions. In the case of  $\text{CH}_3\text{COCH}_3\text{-CH}_3\text{OH}$  solution, the long period changes from the constant value of  $114 \text{ \AA}$  to  $105 \text{ \AA}$  according to the decrease of the fraction of  $\text{CH}_3\text{OH}$ , under 50%.

Figure 4 shows the density of  $\gamma$  nylon 6 filaments as a function of the molar fraction of the washing solution. Figure 5 shows the SAXS curves of the  $\gamma$  filaments. From these results, it can be concluded that micro-voids are easy to break out in the amorphous region of the  $\gamma$  filament, when the  $\text{CH}_3\text{COCH}_3\text{-H}_2\text{O}$  or  $\text{CH}_3\text{OH-H}_2\text{O}$  is used as the washing solution with a smaller fraction of  $\text{H}_2\text{O}$ . But, if the specimens are further washed in water and then dried, the micro-void disappears. According to their disappearance, the density increases and the diffuse small angle scattering changes to the distinct meridian interference patterns.

Figure 6 shows the effect of the concentration of  $\text{I}_2$  on the shrinkage, density and long period of the specimens which were immersed in the  $\text{I}_2\text{-KI}$  solution of various concentrations at  $30^\circ\text{C}$  for 24 hours and washed with  $\text{CH}_3\text{COCH}_3\text{-H}_2\text{O}$  (10/90) solution at  $30^\circ\text{C}$  for 5 days and then further washed in water at  $30^\circ\text{C}$  for 24 hours. Finally, the specimens were dried at an unconstrained condition. The change of the density and long period may be due to the  $\alpha\text{-}\gamma$  transition in the crystalline regions which is proved by wide angle X-ray diffraction patterns, and the most of the shrinkage would be caused by the structural changes in the amorphous regions because the specimen shrinks before the beginning of the  $\alpha\text{-}\gamma$  transition.

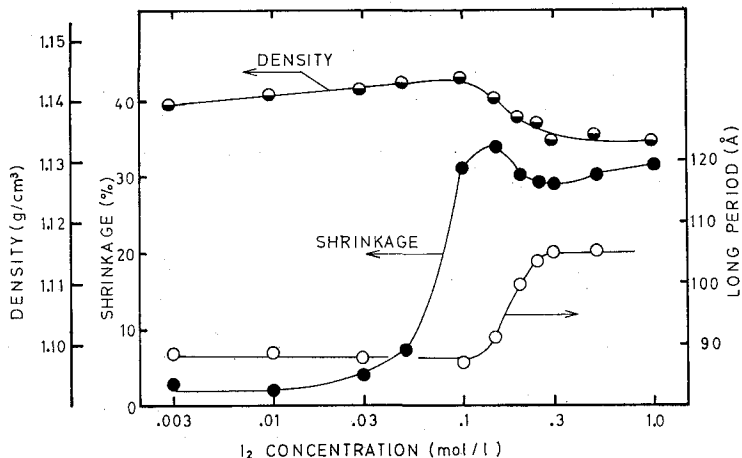

Fig. 6. I<sub>2</sub>-treated nylon 6 filament of the shrinkage, density and long period versus I<sub>2</sub> concentration. ●—● density, ○—○ long period and ●—● shrinkage.

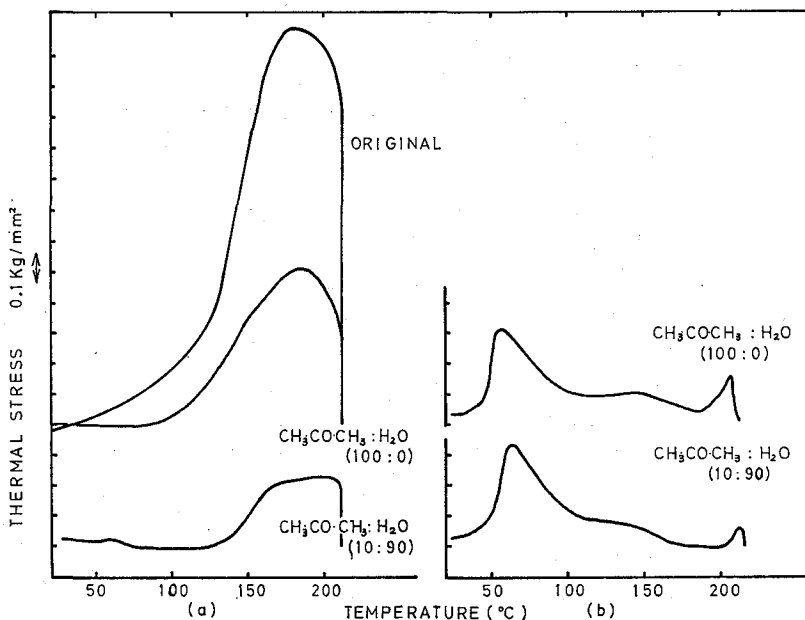

Fig. 7. Thermograms of the thermal shrinkage stress for the  $\gamma$  filament. (a):  $\gamma$  filament washed with CH<sub>3</sub>COCH<sub>3</sub>-H<sub>2</sub>O solution and dried. (b):  $\gamma$  filament washed with CH<sub>3</sub>COCH<sub>3</sub>-H<sub>2</sub>O solution, further washed in water and dried. In (a), the shrinkage stress curves of original  $\alpha$  filament is shown.

The thermal shrinkage stress curves of the  $\gamma$  nylon 6 filaments which were washed with CH<sub>3</sub>COCH<sub>3</sub>-H<sub>2</sub>O are shown in Fig. 7(a) and those of the specimens which were further washed in water are shown in Fig. 7(b). Thermal shrinkage stress curves of the  $\gamma$  filament washed in CH<sub>3</sub>COCH<sub>3</sub>-H<sub>2</sub>O are similar in shape to those of the original  $\alpha$  nylon filament, and its peak temperature of about 180°C corresponds to the annealing temperature

or the drawing temperature of the  $\alpha$  filament. But those of the specimens which were further washed in water are found to change as Fig. 7(b) and two peaks are observed at 70°C and 210°C respectively.

For the washing solution of  $\text{CH}_3\text{OH}-\text{H}_2\text{O}$ , the thermal shrinkage stress curves of the

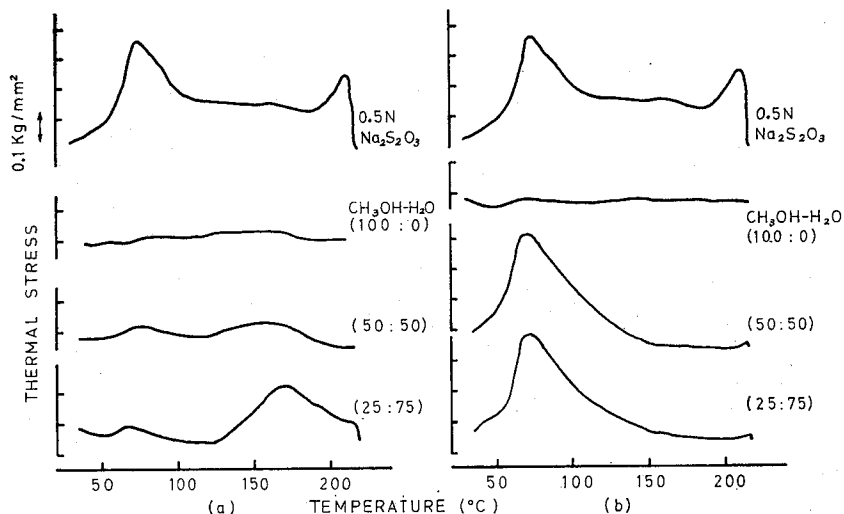

Fig. 8. Thermograms of the thermal shrinkage stress for the  $\gamma$  filament. (a):  $\gamma$  filament washed with  $\text{CH}_3\text{OH}-\text{H}_2\text{O}$  solution and dried. (b):  $\gamma$  filament washed with  $\text{CH}_3\text{OH}-\text{H}_2\text{O}$  solution, further washed in water and dried. Also thermograms for the  $\gamma$  filament washed with 0.5 N  $\text{Na}_2\text{S}_2\text{O}_3$  aqueous solution and dried (in (a)) and washed with 0.5 N  $\text{Na}_2\text{S}_2\text{O}_3$  solution, further washed in water and dried (in (b)) are shown.

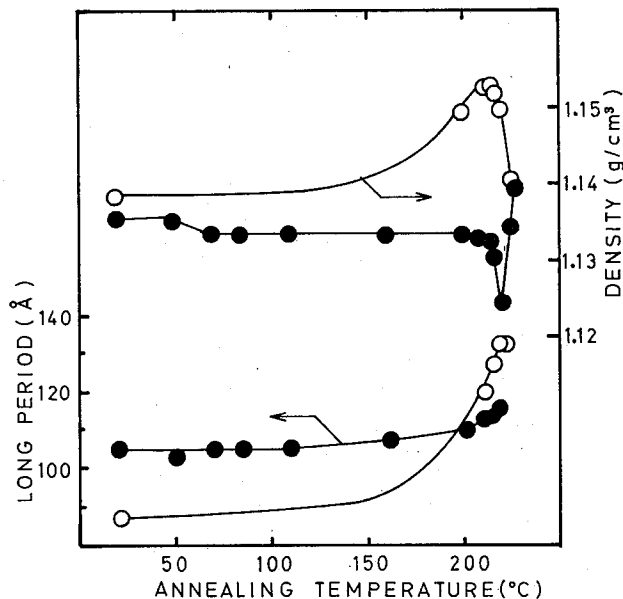

Fig. 9. Long period and density of the  $\alpha$  and  $\gamma$  nylon filament versus temperature of annealing:  $\bigcirc-\bigcirc$   $\alpha$  filament,  $\bullet-\bullet$   $\gamma$  filament.



$\gamma$  filament are shown in Figs. 8(a) and (b). In this case stress becomes weak as the molar fraction of  $\text{CH}_3\text{OH}$  increases because the disorientation of the crystallites takes place. When the specimens are washed with aqueous solution of sodium thiosulfate, the thermal shrinkage stress curves are the same as shown in Fig. 7(b) regardless of washing in water.

In order to investigate the details of the structure, the  $\gamma$  filaments were annealed in the free condition at various temperatures. Figure 9 shows the density and long period versus the annealing temperature. Both the density and long period are not changed by the annealing of  $\gamma$  nylon filament. Its structure is remarkably stable and further crystallization or the change in fine structure does not seem to take place up to  $200^\circ\text{C}$  above which the disorientation or partial melting and recrystallization at  $\gamma$  or  $\alpha$  crystal form starts.

During heating, the specimen shrinks up to  $70^\circ\text{C}$  and thereafter it begins to stretch out. The stretching ceases at  $200^\circ\text{C}$  and then it shrinks again rapidly. These shrinking behavior is in agreement with the result of thermal stress curves shown in Fig. 7(b). Due to the lack of accuracy in the measurements of the long period, it can not be confirmed whether this small dimensional change of 1% affects the long period or not. The long period of the fix-dried  $\gamma$  specimen is about  $15 \text{ \AA}$  greater than that of the relax-dried one and it decreases up to  $100^\circ\text{C}$ , approaching to the  $105 \text{ \AA}$  of the relaxed-dried specimen. Inter-Lamellar tie molecules are stretched when they are dried in the fixed condition and the relaxation occurs easily on annealing.

Figure 10 shows the changes of thermal shrinkage stress on annealing. Although the stress peak at  $210^\circ\text{C}$  does not change its position, that one at  $70^\circ\text{C}$  shifts to the temperature at which the specimen was annealed and its peak height decreases up to  $100^\circ\text{C}$  above which it rises again. The thermal shrinkage stress of the annealed  $\gamma$  filament at the lower

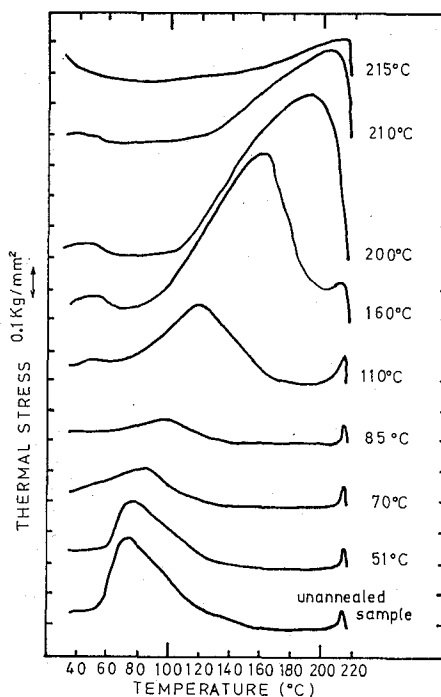

Fig. 10. Thermograms of the thermal shrinkage stress of the annealed  $\gamma$  filaments.

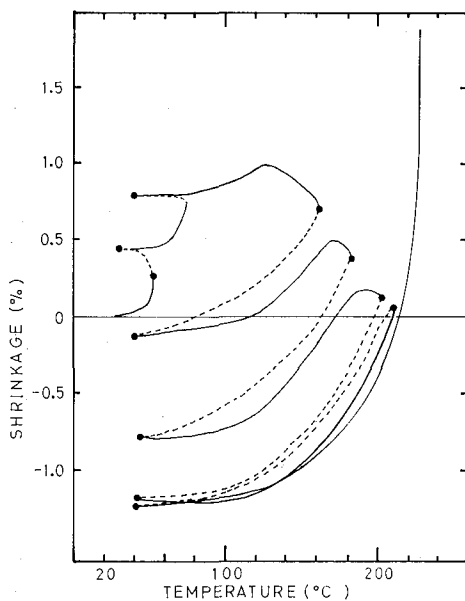

Fig. 11. Length changes of the  $\gamma$  filament during heating and cooling measured with TMA instrument (Shimazu TM-30). — during heating, ---- during cooling.

temperature has a close relation to the dimensional change of the specimen during heating. Therefore, the change in length of the specimen was measured during heating and cooling cycle and the results are shown in Fig. 11.

It is found that there exists the heat-setting effect in amorphous structure and the coefficient of linear thermal expansion is negative in spite of the annealing at the temperature as high as 210°C.

It can be considered that the thermal stress peak at 70°C corresponds to the configurational change of the molecular chain in the amorphous region of the  $\gamma$  nylon filament according to the formation or rupture of the hydrogen bonds during heating and that the peak at 210°C relates to the  $\gamma$  crystallites. The crystallites serve as the constraints to the segmental motion in the amorphous region, but when the segmental motion parallel to the chain axis through the crystallites becomes strong at elevated temperature, thermal shrinkage stress will be rapidly released through the crystallites.

The thermal shrinkage stress peak at 70°C is also observed in that of the drawn  $\alpha$  nylon filament hydrolyzed with HCl aqueous solution. It can be considered that the amorphous structure in the specimen treated with reagents which affects the hydrogen bond, is closely related to the condition of washing and drying, and the character of the reagents, because the structural changes may be affected by the formation or rupture of the hydrogen bond and strongly constrained by the crystallites.

From the results, it can be considered that a two phase model is appropriate to show the structure of  $\gamma$  nylon, while the heat-treated  $\alpha$  nylon 6 is represented by a para-crystalline model.

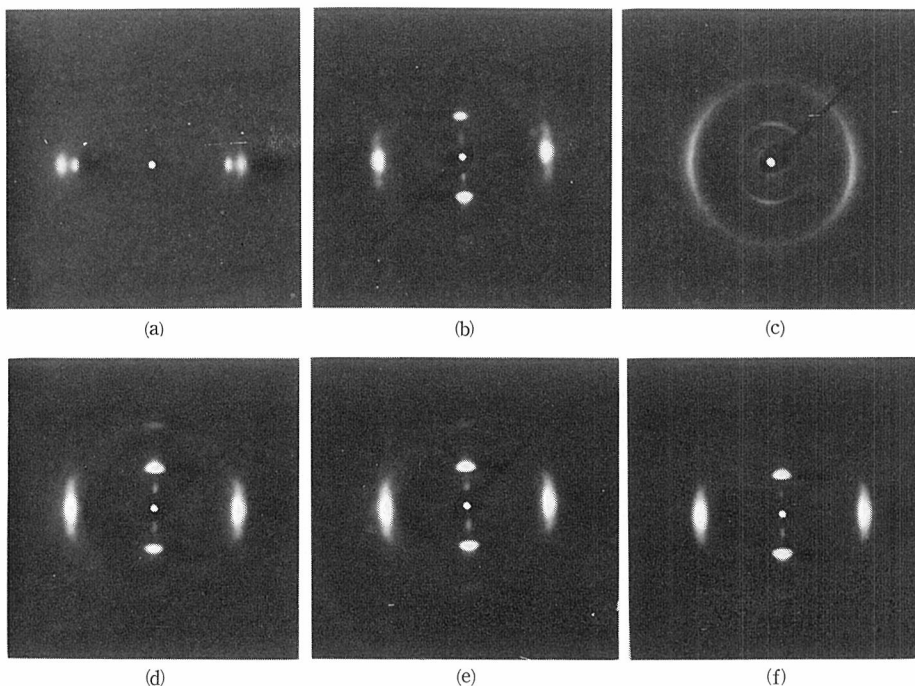

Photo 1. X-ray diffraction patterns of iodine-treated nylon 6 filaments.

- (a): Original drawn filament with  $\alpha$  structure.
- (b):  $\gamma$  filament washed with 0.5 N  $\text{Na}_2\text{S}_2\text{O}_3$  aqueous solution.
- (c):  $\gamma$  filament washed with  $\text{CH}_3\text{OH}$ .
- (d):  $\gamma$  filament washed with  $\text{CH}_3\text{OH}-\text{H}_2\text{O}$  (25: 75).
- (e):  $\gamma$  filament washed with  $\text{CH}_3\text{COCH}_3$ .
- (f):  $\gamma$  filament washed with  $\text{CH}_3\text{COCH}_3-\text{H}_2\text{O}$  (10: 90).

### CONCLUSION

By  $\text{I}_2$  treatment, a complex is formed between  $\text{I}_2$  molecules and the oxygen of the amide group of the molecular chains of nylon 6. When the sorbed  $\text{I}_2$  is removed by washing with the reagents, the hydrogen bonds are reformed between the amide groups. The structure and properties of the amorphous region will be related to the method of desorption of  $\text{I}_2$ , because the amount of hydrogen bonds may be affected by the character of the washing solvent, temperature of washing and the condition of drying. But the crystal structure is not affected by such treatment.

There can be formed a large number of micro-voids in the amorphous region of nylon filament, if the  $\text{CH}_3\text{COCH}_3-\text{H}_2\text{O}$ ,  $\text{CH}_3\text{OH}-\text{H}_2\text{O}$  and  $\text{CH}_3\text{COCH}_3-\text{CH}_3\text{OH}$  are used as the washing solvent, with a comparatively small component of  $\text{H}_2\text{O}$ . But when the  $\text{I}_2$ -desorbed nylon filament is further rinsed with water, these micro-voids disappear and as a result, the density increases and diffuse SAXS changes to the clear meridian interference patterns. These change in the amorphous region caused by washing in water is reflected in the thermal shrinkage stress curves. The thermal stress curves of the solvent washed  $\gamma$  filament are similar to that of the original  $\alpha$  nylon filament. But the thermal stress curves are found to change distinctly by further washing in water and drying the  $\text{I}_2$ -desorb-

ed  $\gamma$  filament at room temperature. The characteristic of this thermogram is the two stress peaks, one at 70°C and the other at 210°C. The former is related to the amorphous structure and the latter corresponds to the  $\gamma$  crystallites. The stress peak at 210°C is independent of the reannealing, but that one at 70°C shifts to the higher temperature on the reannealing. This means that the hydrogen bonds are built up in the amorphous region by annealing without the growth of  $\gamma$ -crystal. From these results, it can be concluded that the structural difference between the crystalline and amorphous regions in the  $\gamma$  nylon filament clearly exists and that the  $\gamma$  structure of nylon 6 obtained by the I<sub>2</sub>-treatment should be properly represented by the two phase model rather than para-crystalline model.

The authors wish to thank Mr. Kyaw Din of Master Course student in our laboratory for his valuable discussion.

#### REFERENCES

- (1) S. Ueda and T. Kimura, *Kobunshi Kagaku*, **15**, 243 (1958).
- (2) M. Tsuruta, H. Arimoto and M. Ishibashi, *Kobunshi Kagaku*, **15**, 619 (1958).
- (3) H. Arimoto, *Kobunshi Kagaku*, **19**, 101 (1962).
- (4) T. Kimura, *Kobunshi Kagaku*, **15**, 288 (1958).
- (5) H. Arimoto, *Kobunshi Kagaku*, **19**, 205 (1962).
- (6) H. Arimoto, *J. Polymer Sci.*, **A2**, 2283 (1964).
- (7) H. Arimoto, *Kobunshi Kagaku*, **19**, 456 (1962).
- (8) Ismat Abu-Isa, *J. Polymer Sci.*, **A1**, **9**, 199 (1971).
- (9) Y. Kinoshita, *Makromol. Chem.*, **33**, 1 (1959).