

Sheridan College

SOURCE: Sheridan Institutional Repository

Publications and Scholarship

Faculty of Humanities & Social Sciences
(FHASS)

1994

Were Dinosaurs Cold- or Warm-Blooded?: An Exercise in Scientific Inference

Grant R. Hurlburt

Sheridan College, grant.hurlburt@sheridancollege.ca

Follow this and additional works at: https://source.sheridancollege.ca/fhass_publications



Part of the [Paleontology Commons](#)

SOURCE Citation

Hurlburt, G. R. (1994). Were dinosaurs cold- or warm-blooded?: An exercise in scientific inference. In C. A. Goldman (Ed.), *Tested studies for laboratory teaching, volume 15. proceedings of the 15th annual workshop/conference of the association for biology laboratory education (ABLE)*(pp 181-214). New Haven, CT: Yale University, Dept. of Biology.



This work is licensed under a [Creative Commons Attribution-NonCommercial-No Derivative Works 4.0 License](https://creativecommons.org/licenses/by-nc-nd/4.0/). This Book Chapter is brought to you for free and open access by the Faculty of Humanities & Social Sciences (FHASS) at SOURCE: Sheridan Institutional Repository. It has been accepted for inclusion in Publications and Scholarship by an authorized administrator of SOURCE: Sheridan Institutional Repository. For more information, please contact source@sheridancollege.ca.

Chapter 11

Were Dinosaurs Cold- or Warm-Blooded?: An Exercise in Scientific Inference

Grant R. Hurlburt

Department of Zoology
University of Toronto
Toronto, Ontario M5S 1A1

Grant is a Ph.D. candidate in Zoology (Vertebrate Paleontology) at the University of Toronto. His research interests include the determination and study of relative brain size in recent and fossil vertebrates, and the interpretation of endocranial casts. His M.Sc. thesis was a detailed study of the endocranial cast of the domestic dog *Canis familiaris*.

Reprinted from: Hurlburt, G. R. 1994. Were Dinosaurs Cold- or Warm-Blooded?: An Exercise in Scientific Inference. Pages 181-214, in *Tested studies for laboratory teaching*, Volume 15 (C. A. Goldman, Editor). Proceedings of the 15th Workshop/Conference of the Association for Biology Laboratory Education (ABLE), 390 pages.

Although the laboratory exercises in ABLE proceedings volumes have been tested and due consideration has been given to safety, individuals performing these exercises must assume all responsibility for risk. The Association for Biology Laboratory Education (ABLE) disclaims any liability with regards to safety in connection with the use of the exercises in its proceedings volumes.

Contents

Introduction.....	182
Materials	183
Student Outline	184
Notes for the Instructor.....	198
Acknowledgements.....	201
Literature Cited and Further Reading.....	204
Appendix A: Drawings of Endocranial Casts.....	205
Appendix B: Natural History of Selected Dinosaurs.....	209
Appendix C: Resource Material	211

Introduction

This exercise introduces students to scientific inference. They will infer the mode of thermal regulation of dinosaurs (i.e., were they cold- or warm-blooded?) by comparing the relative brain size of dinosaurs to that of modern vertebrates. In the past 20 years, several lines of evidence have been introduced that suggest that dinosaurs were warm-blooded, not cold-blooded as traditionally thought. The size of the brain relative to the size of the body is one line of evidence. Modern mammals and birds are warm-blooded and have large brains relative to the size of their bodies, whereas reptiles are cold-blooded and have small brains relative to their body size (Martin, 1981). Thus, if we can estimate the relative brain size of dinosaurs we can make inferences as to their mode of thermal regulation; however, since dinosaurs are only known from fossilized specimens (except in *Jurassic Park!*), we must estimate this value.

In this exercise each student (1) estimates the relative brain size of a species of dinosaur, (2) compares this value to known values for extant warm-blooded (birds and mammals) and cold-blooded (reptiles) vertebrates, and (3) infers the mode of thermal regulation of their assigned species. Values for relative brain size are obtained using similar methods that are used by scientists who study the biomechanics and physiology of extinct vertebrates (Alexander, 1985, 1991; Colbert, 1962; Hopson, 1977, 1979; Jerison, 1973). To obtain an estimate of brain size students are provided with a drawing of a cranial endocast for their assigned species; the original endocast was made from a fossil specimen and a drawing of this endocast was published in the scientific literature. Students use a plastic scale model of their dinosaur to obtain an estimate of its body weight following the technique of water displacement used by Colbert (1962).

Because of the popular universal appeal of dinosaurs among the general public, this exercise is very popular with students. This 3-hour exercise has been taught at the University of Toronto to a class of 1,500 first-year biology students in a course that emphasizes evolution, ecology, and behaviour; these students all had taken biology in high school. It has also been successfully used in a biology course of 120 students, where these students had no prior background in biology. In both courses the students had been introduced to the concept of allometry; for allometry exercises see chapters in past ABLE chapters by Goldman et al. (1990) and Trombulak (1991).

Conceptually, this is not a difficult lab, although the calculations involved can be intimidating to some students. Overall, the students have fun in the lab and rank this exercise as one of their favourites.

A list of materials is provided below. Ideally, we have close to 20 species available for a class of 20 students. However, to conserve space in this chapter, I have provided materials for only eight species. These eight species are representatives of the major groups of dinosaurs. I suggest students work individually; if you have a class of 24 students then three students can work

independently on the same species (using their own materials) and can compare their results at the end of the class.

A Notes for the Instructor section is provided after the Student Outline and contains many practical tips for successfully completing this exercise, in addition to expected results. Master diagrams of the cranial endocasts for the eight species provided in this chapter are given in Appendix A. Natural history information for each of the major dinosaur groups is provided in Appendix B; students consult this information when interpreting their results. Additional resource material that students can consult is provided in Appendix C.

Materials

Dinosaur models (one per student; see Notes for the Instructor):

Diplodocus
Euoplocephalus
Lambeosaurus
Pachycephalosaurus
Stegosaurus
Stenonychosaurus
Triceratops
Tyrannosaurus

Materials for determining body mass (water displacement method): (per class)

Beakers, 2 liter (2)
 Large “wet weight” containers (e.g., pail) (2)
 Wooden dowel, 0.25 × 10 inches (3)
 Flasks, erlenmeyer, 2 liter (2)
 Masking tape (2 rolls)
 Meter sticks (5)
 Monofilament fishing line (1 spool)
 Pan balances (2)
 Plasticine, 20 g balls of different colours (1 per student)
 Rulers, 30 cm (1 per student)
 String (2 rolls)

Materials for determining brain size:

Endocast drawings (1 per species; see Appendix A)
 Tracing paper (1 per student)
 Pencil, HB (1 per student)
 Scotch tape (5 rolls)
 Ruler, 12" (1 per student)

Student Outline

Introduction

In this exercise you will infer the mode of thermal regulation of dinosaurs (i.e., were they cold- or warm-blooded?) by comparing the relative brain size of dinosaurs to that of modern vertebrates. In the past 20 years, several lines of evidence have been introduced that suggest that dinosaurs were warm-blooded, not cold-blooded as traditionally thought. The size of the brain relative to the size of the body is one line of evidence. Modern mammals and birds are warm-blooded and have large brains relative to the size of their bodies, whereas reptiles are cold-blooded and have small brains relative to their body size. Thus, if we can estimate the relative brain size of dinosaurs we can make inferences as to their mode of thermal regulation; however, since dinosaurs are only known from fossilized specimens (except in *Jurassic Park!*), we must estimate this value.

In this exercise you will (1) estimate the relative brain size of a species of dinosaur, (2) compare this value to known values for extant warm-blooded (birds and mammals) and cold-blooded (reptiles) vertebrates, and (3) infer the mode of thermal regulation of your assigned species. You will obtain the values for relative brain size using similar methods that are used by scientists that study the biomechanics and physiology of extinct vertebrates. An estimate of brain size will be determined using a drawing of a cranial endocast for your assigned species; the original endocast was made from a fossil specimen and a drawing of this endocast was published in the scientific literature. You will use a plastic scale model of your dinosaur to obtain an estimate of its body weight following the technique of water displacement used by Colbert (1962).

It is important to remember that the purpose of this exercise is to infer the mode of thermal regulation by comparing the relative brain size in extinct vertebrates to that of modern vertebrates. We are *not* trying to say that a particular dinosaur *was* a mammal, bird, or reptile. We *are* trying to suggest that, based on the relative size of its brain, its thermal regulation was like that of either warm- or cold-blooded modern vertebrates. An analogy would be determining whether the claws of a hypothetical dinosaur were wide and blunt like those of dogs, or narrow and curved those of a tree-climbing animal such as a squirrel. If the claw of our hypothetical dinosaur was narrow and blade-like, we could infer it might have climbed trees like modern squirrels; if blunt, we could assume it ran on the ground like dogs. In neither case would we be suggesting dinosaurs were related to dogs or squirrels — we would simply assume they possessed similar characters, developed through convergent evolution, for similar purposes.

Background Information

Warm- and Cold-Blooded Animals

Whether an animal is cold-blooded or warm-blooded can be termed its *mode of thermal regulation* (*thermal* referring to heat, body heat in this context). Warm-blooded animals have three defining characteristics: (1) constant body temperature, termed *homeothermy* (*homeo* = same); (2) internally generated heat, termed *endothermy* (*endo* = internal), produced by metabolic activity in the heart, liver, kidney, and brain; and (3) a metabolic rate about 10 times as high as cold-blooded animals. Cold-blooded animals have (1) body temperatures that vary with, and are often the same as, ambient (external) temperatures, termed *heterothermy* (*hetero* = different); (2) body heat from external sources, usually the sun, or *ectothermy* (*ecto* = external); and (3) low metabolic rates relative to warm-blooded animals. These characteristics are summarized in Table 11.1

Table 11.1. Characteristics of cold- and warm-blooded animals.

Mode of thermal regulation	Characteristic		
	Body temperature	Source of body heat	Metabolic rate
Cold-blooded	Varies, often the same as ambient (external) temperatures (= heterothermy)	From external sources, usually the sun (= ectothermy)	Low
Warm-blooded	Constant (= homeothermy)	Generated internally, by metabolic activity of heart, liver, kidney, and brain (= endothermy)	10X higher than cold-blooded animals

Metabolism can be defined as the sum of all chemical processes occurring within a cell. Metabolic *rate* is considered to be the energy output of an animal, and is commonly measured as oxygen (O₂) consumed or carbon dioxide (CO₂) produced.

Warm-blooded animals are *homeothermic endotherms*, and cold-blooded animals are *heterothermic ectotherms*. Sometimes homeotherm is used interchangeably with endotherm, and heterotherm interchangeably with ectotherm (poikilotherm), however strictly speaking is not accurate (see Table 11.1). Both modes have their advantages. Warm-blooded animals can exploit cool environments such as those found in the north and at night, which are not available to cold-blooded animals. Cold-blooded animals require only 1/10 the food of the former group and can therefore survive in sparse environments, and go without food for long periods.

Dinosaurs, Archosaurs, And Other Extinct Amniote Vertebrates

The vertebrate group called the Tetrapoda (*tetra* = four, *poda* = feet) includes all those animals we call amphibians, reptiles, birds, and mammals. It even includes some groups, like snakes and caecilians, that have no limbs. Within the tetrapods, there is a group of species (the Amniota) that all produce an extra embryonic membrane surrounding the embryo, called the amnion. Included within the living amniotes are mammals, turtles, birds, crocodilians, the enigmatic tuatara of New Zealand, snakes, and lizards. Available fossil evidence suggests that the evolutionary lineage giving rise to modern mammals had diverged from that giving rise to the rest of the amniotes by at least 300 million years ago. During the course of evolution in these early mammals (sometimes called “mammal-like reptiles”) many divergent, and now extinct species arose.

Dinosaurs, crocodilians, birds, and pterosaurs are included in the group Archosauria. Pterosaurs were flying creatures which were *not* dinosaurs or birds but were closely related to them. All dinosaurs and pterosaurs are extinct. Fossilized bones of dinosaurs (and other extinct creatures) found prior to the 1800s were often attributed to giants or dragons; indeed, the first scientific account of a dinosaur bone in 1677 identified it as the knee of a giant. Not until the 1820s were bones correctly attributed to animals called dinosaurs (*dino* = terrible, *saur* = lizard). The first bones found were recognized as being thigh or pelvic bones based on resemblances to modern animals.

Complete dinosaur skeletons were not found for many decades and the first reconstructions, based on a few bones of animals that had never been seen alive, were not always accurate. For

example, the bipedal (walking on two legs) *Iguanodon* was first reconstructed as a quadruped (four-legged), with what is now known to be the spike-like thumb bone placed on the nose. Further discoveries were made of dinosaurs in Europe and North America, and eventually on every continent. Complete and nearly complete specimens were sometimes found.

For many decades dinosaurs were considered to be functionally and physiologically similar to the modern cold-blooded amniotes: turtles, snakes and lizards, tuataras, and crocodylians. Based on bone structure, dinosaurs were classified as reptiles, and for this reason considered to be slow, sluggish, cold-blooded giants. Quadrupedal forms were reconstructed with their limbs splayed out to the side similar to the posture of modern reptiles (Figure 11.1), and the bipedal forms were pictured in nearly upright positions dragging heavy tails. The largest forms were thought to be so heavy that they had to spend much of their existence in the water, as can be seen in early illustrations.

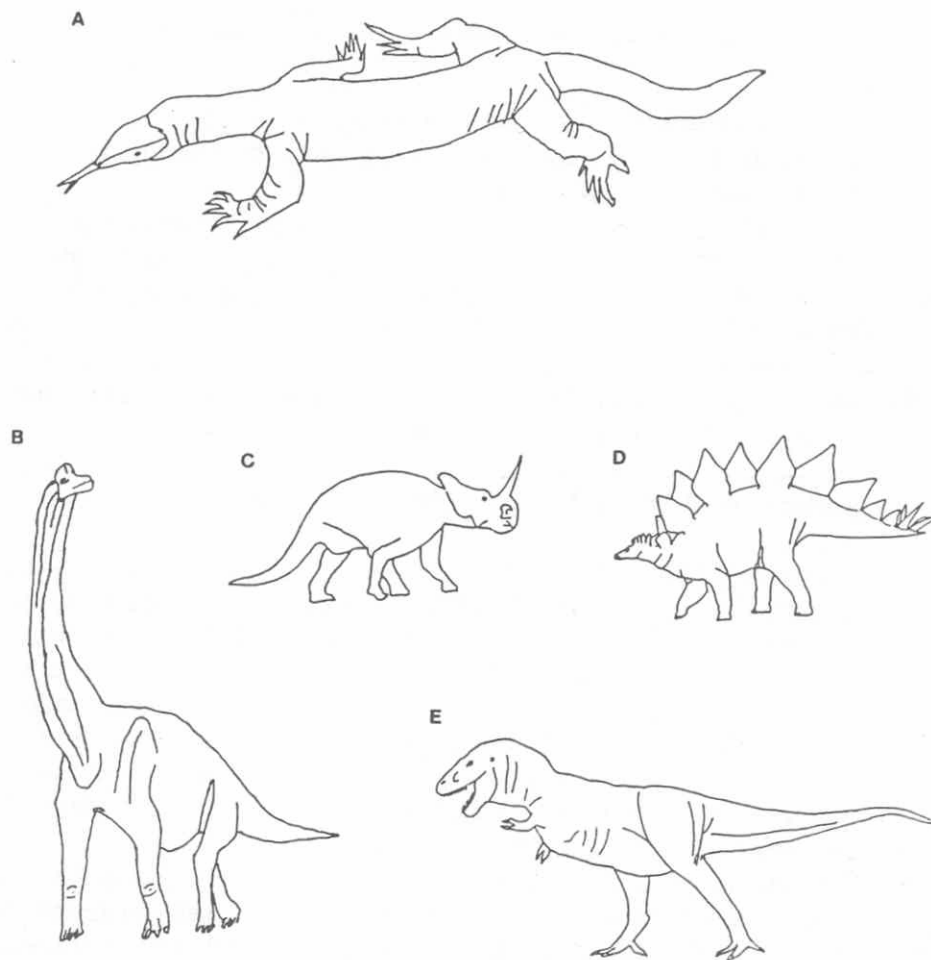

Figure 11.1. A varanid lizard (a), showing sprawled limb posture. Dinosaurs, with legs positioned vertically: (b) a sauropod brachiosaur, (c) the ceratopsian *Centrosaurus*, (d) a stegosaur, and (e) the carnivorous theropod *Albertosaurus*. Not drawn to scale.

Since about 1970 views of dinosaurs and pterosaurs have been changing, suggesting that both groups were different from any other group known. There is no evidence of insulation in dinosaurs. Analysis of footprints and functional anatomy has shown that dinosaurs walked with their legs straight beneath them (Figure 11.1). This makes a better weight-bearing arrangement and also means they were faster and more agile than once thought. Bipedal dinosaurs walked with their bodies oriented more horizontally than vertically, with tails extended behind them to counterbalance the weight of the body (Figure 11.1). The interpretations of dinosaurs as being more agile, and other evidence, has led some scientists, notably John Ostrom and Robert Bakker, to suggest that at least some if not all dinosaurs were warm-blooded.

Principles of the Procedure

Relative Brain Size

Relative brain size is the brain mass of an animal relative to its body mass. In this exercise we will compare the relative brain size of extinct vertebrates to that of modern vertebrates. Relative brain size in modern and extinct vertebrates is discussed below.

Modern Vertebrates

Brain size in amniote vertebrates is allometrically related with body size. Figure 11.2 shows a plot of the coordinates for brain and body size for cold-blooded and warm-blooded amniotes. For convenience, all cold-blooded amniotes are called reptiles, while warm-blooded amniotes are grouped separately as birds and as mammals. For birds and reptiles of the same body mass (x -axis), bird brains are 10 times the size of reptile brains, on average. (Figure 11.2 is a log-log plot, and a difference of 1 on the axis means a ten-fold difference). Similarly, mammal brains are 10 times the size of reptile brains of the same body mass. Some points are above and some below the slope for each relationship, indicating that some animals have a smaller brain, and others a larger brain for the body size than would be predicted by the equation for each slope. However, the brain-body points are clustered around the slope. Polygons have been drawn around the scatters of points to indicate the range of brain-body sizes. Notice that the shape of the polygon is oriented along the slope in each case. For each of mammals, birds, and reptiles, the regression equations describe the relationship between brain mass in milligrams (y -axis) and body mass in grams (x -axis).

Extinct Vertebrates

To determine relative brain size in extinct vertebrates, we need to determine their body mass and brain mass.

Body Size: In this exercise “size” is a general term, whereas “mass” is a more specific and exact concept that will be used in your calculations. Mass is measured in kilograms and is the same regardless of gravity. A 10 kg mass is the same on the moon or Earth. A 10 kg mass *weighs* 10 kg on Earth, but considerably less on the moon, since weight is a function of gravity. You should know that 1 ml (= cm³) of water weighs 1 g, and that 1 litre weighs 1 kg.

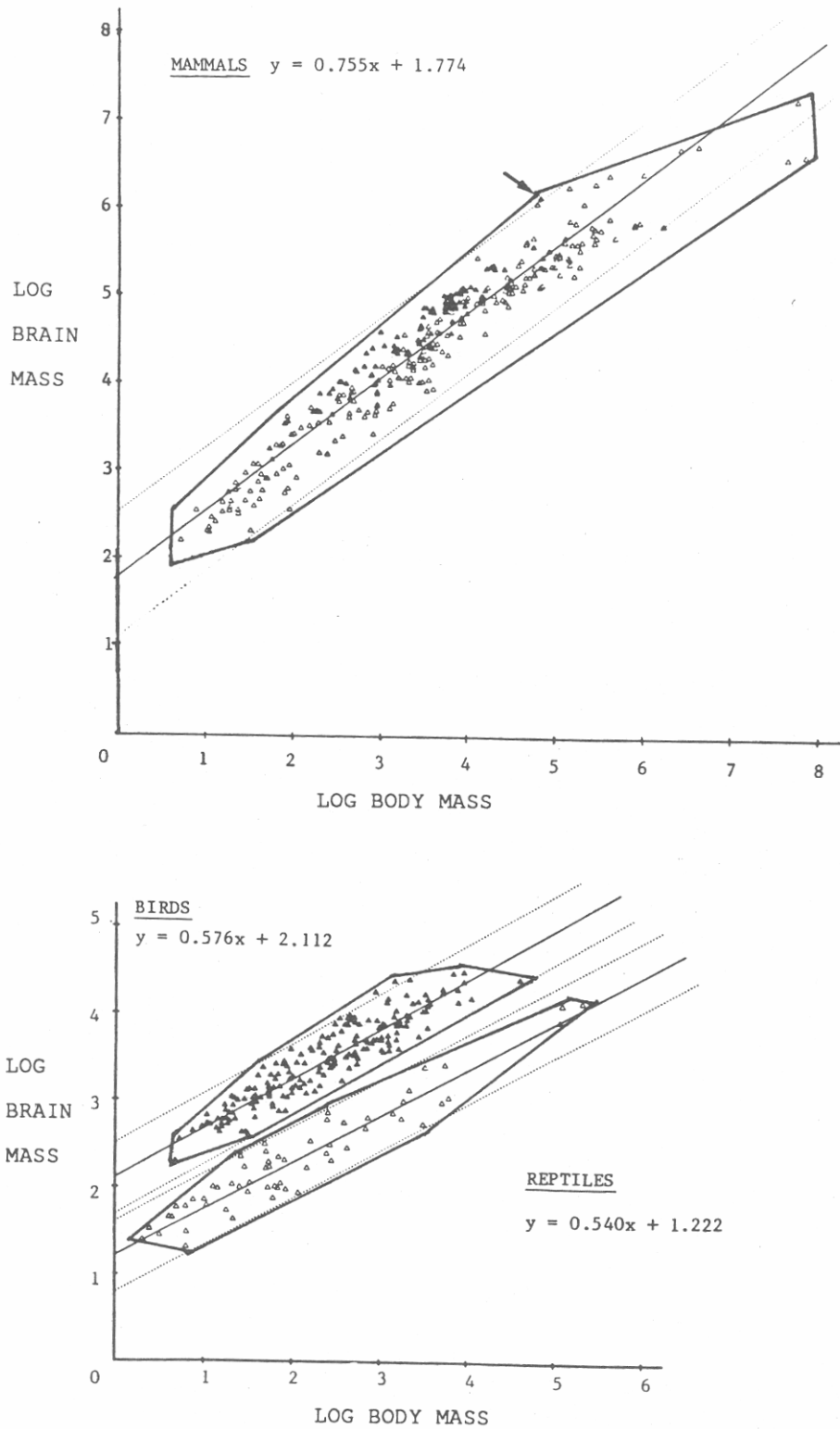

Figure 11.2. Allometric relationships between brain and body mass in 309 species of placental mammals (*top*; arrow = *Homo sapiens*) and 180 bird species and 59 reptile species (*bottom*). Adapted from Martin (1981).

Most, if not all animals, including humans, have a *specific gravity* (SG) of 1, meaning that, like water, 1 ml weighs 1 g. This is why you float with most of your body submerged. The force of buoyancy, which makes you float, is equal to the weight of the water a body displaces. A 70 kg body displaces 70 litres of water, which also weighs 70 kg. Thus the buoyancy force is 70 kg, so that a 70 kg body will float when nearly submerged. Alligators and crocodiles also float nearly submerged, which has led scientists to suggest that dinosaurs also had an SG of about 1. The brain also has an SG of 1. Thus in this exercise volume and weight can be used interchangeably as indicators of brain and body mass. These concepts are important for understanding the water displacement (Colbert) method outlined below.

It may surprise you that scientists do not agree on the actual body weight of dinosaurs. Weaver (1983) reported three different estimates of body weight obtained by three different authors for a single dinosaur: 15, 40, and 78 metric tons. Each author used different weight determination methods, one of which we will use in this exercise.

Scientists are interested in the body weight of extinct vertebrates for several reasons in addition to determining relative brain size. Weaver (1983) investigated whether the dinosaur he was studying could eat enough in one day to fuel a warm-blooded metabolism, given the size of the head and quality of vegetation. How fast a dinosaur could move also depended on body size. Estimating body size aids in estimating the amount of prey available to a predator, and how many herbivores could survive on available vegetation.

In this exercise you will use one (of several possible) methods for estimating body weight in extinct vertebrates, all of which have been used by scientists. The Colbert method entails calculation of the volume of a scale model of a dinosaur and using this information to determine the weight of the full-size animal. Scale models are made by reconstructing a dinosaur skeleton, making a model of the skeleton, then packing clay around it to correspond with muscles and organs and other soft tissues to obtain the proportions in life of the animal. This method was used by Colbert (1962) and Alexander (1985).

Brain Size and Endocranial Casts: In vertebrates, the brain occupies the cranial cavity which is a chamber in the part of the skull called the braincase. The brain occupies nearly all of this cavity in mammals and birds, but only about half the space or less in other vertebrates. We can determine the volume of the cranial cavity using endocranial casts (*endo* = inside; *cranial* = cranium or skull). Casts can be made by pouring liquid latex (rubber) into the cranial cavity, letting it set, and pulling it out, resulting in a model with the shape and volume of the cranial cavity. Natural endocasts (= endocranial casts) can also form where sediment has filled the cavity. Determining endocast volume gives the cavity volume, from which brain volume can be estimated. Jerison (1973) conducted a major investigation of endocasts, and Radinsky (1968) gives instructions on how to make endocasts.

Brains of modern reptiles do not fill the entire endocranial cavity. Much of the space is occupied by blood sinuses and a thick dura mater, a membrane lining the brain. Consequently, endocasts of these animals do not show clear details of the brain, such as the cerebrum, optic tectum, and cerebellum because these are partly or wholly surrounded by blood sinuses and the dura mater (Hopson, 1979). The available research suggests that brains in reptiles occupy approximately half the endocranial cavity (Hopson, 1979; Jerison, 1973). Endocasts of dinosaurs, with the exception of the small theropods, resemble endocasts of modern (and extinct) reptiles in that they show few details of the brain; consequently, the 50% relationship has been assumed to exist. The exception is the small theropod dinosaurs, including *Stenonychosaurus*, whose endocasts, like those of pterosaurs and *Archaeopteryx*, show features of the brain such as the optic tectum and cerebellum, as well as small blood vessels, and in this, they resemble endocasts of modern birds. In these forms, the brain has been assumed to fill the entire endocranial cavity (Hopson, 1979; Jerison, 1973), and thus endocast volume is equal to brain volume.

Figure 11.3 is a drawing of an endocranial cast of a dinosaur. The projections to the side of it are fillings of nerve canals which extend from the brain itself. The olfactory bulbs and nerves occupied the section represented by the anterior end of the cast.

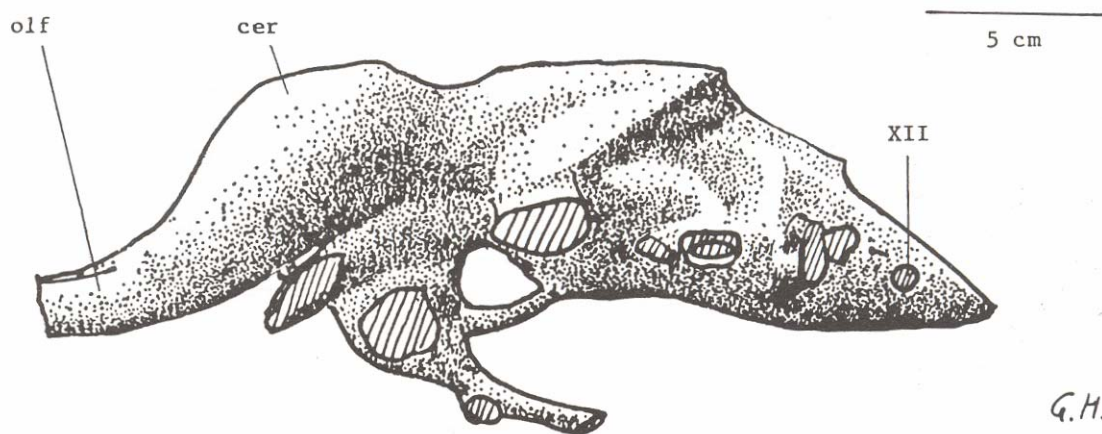

Figure 11.3. Endocranial cast of the duckbill dinosaur *Edmontosaurus* (ROM 1793, left lateral view). *Cer*, cerebral hemisphere; *olf*, olfactory bulbs and nerve; *XII*, stump of cranial nerve 12.

Materials

You will receive: (a) a dinosaur model to estimate body mass (MBd), (b) a drawing of an endocast in two views to determine brain mass (MBr), and (c) information obtained from your instructor to help you scale brain mass to lifestage.

Procedure

Determination of Body Weight

The Colbert method is based on the principle that an object immersed in water is buoyed up by a force equal to the weight of water displaced. Thus, the difference between the weights of an object weighed in air and weighed in water, is equal to the weight of water displaced. Since 1 g of water weighs 1 ml, this allows us to calculate the mass of water displaced, and therefore the mass of the immersed object. This gives us the mass of a scale model, which is then multiplied by a scale factor to give us an estimate of the body mass of the actual organism. You will obtain dry and wet weights of your models and of a plasticine model, and use them in your calculations.

- Figure 11.4 illustrates the arrangement of the apparatus to be used. A wooden dowel is taped to the left pan of the two-pan balance. The object to be weighed is suspended from the dowel with fishing line so it is suspended in a large container of water deep enough to completely immerse the model. Do not suspend the model without first supporting it with your hand or by floating it in water; the balance will be damaged if the model is suspended without support. Record the dry weight by placing the model on the balance pan.

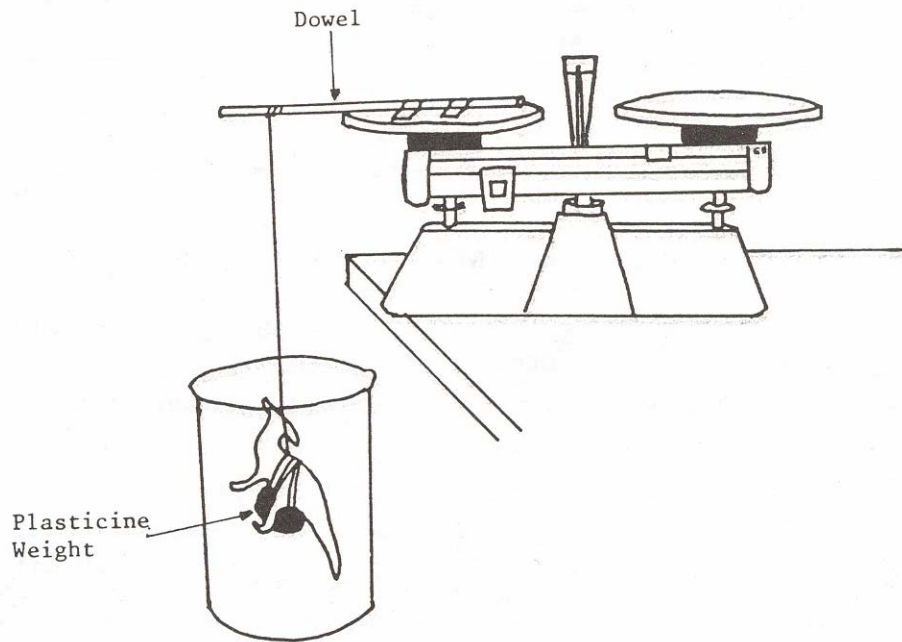

Figure 11.4. Colbert (water displacement) method. Suspend model in a container which already contains water so it is completely immersed. Do not allow model to rest against the sides of the container.

2. The models will usually float in water so you will use a lump of plasticine to weight the model and attach it to the fishing line.
3. Weight in air:
 - (a) Obtain the weight in air (in grams) for the plasticine (P_{air}) by weighing it on the balance together with the apparatus (dowel, fishing line, etc.). Do not suspend the plasticine in air. Enter this value in Table 11.2.
 - (b) Obtain the weight in air (in grams) for the model plus plasticine ($M+P_{\text{air}}$). Enter this value in Table 11.2.
4. Weight in water:
 - (a) Obtain the weight in water (in grams) for the plasticine (P_{water}) by suspending it so it is completely immersed in water. Enter this value in Table 11.2.
 - (b) Obtain the weight in water (in grams) for the model plus plasticine ($P+M_{\text{water}}$). Enter this value in Table 11.2.
5. Determine the volume of the model in millilitres using the following formula, and enter the result in Table 11.2:

$$\text{Model volume (ml)} = (P+M_{\text{air}} - P+M_{\text{water}}) - (P_{\text{air}} - P_{\text{water}})$$

Table 11.2. Determining volume of model.

Weight in air	Weight in water	Air - water
$P+M_{\text{air}}$	$P+M_{\text{water}}$	(A)
P_{air}	P_{water}	(B)
Model volume (ml) =		(A - B)

6. Determine the actual (lifesize) body mass (MBd) (in grams) by multiplying model volume by the volume scale factor for your assigned species (which you will determine). (Remember that 1 ml of water or body tissue weighs 1 g, so the terms are interchangeable.) Determine the volume scale factor as follows (record your values in Table 11.4):
- (a) Obtain an estimate of the length of an actual (lifesize) specimen for your assigned species from Table 11.3.

Table 11.3. Estimated body lengths of lifesize specimens.

Specimen	Life body length (mm)	Specimen	Life body length (mm)
<i>Diplodocus</i>	25,000	<i>Stegosaurus</i>	5,000
<i>Euoplocephalus</i>	8,000	<i>Stenonychosaurus</i>	8,000
<i>Lambeosaurus</i>	5,000	<i>Triceratops</i>	2,000
<i>Pachycephalosaurus</i>	5,000	<i>Tyrannosaurus</i>	12,000

- (b) Using a piece of string, measure the total length of the model in millimeters from the anteriormost part of the head to the tip of the tail. Be sure to lie the string along the smooth contours of the body; do not include spines or plates. Divide the value for model's length into the actual length in millimetres obtained from Table 11.3, to obtain the linear scale factor; remember to use the *same units* (i.e., millimeters).

Linear scale factor = (Length of actual (lifesize) specimen) \div (Length of model)

Table 11.4. Determining the body mass scale factor.

Length (same units)		Linear scale factor	Volume scale factor (linear scale) ³
Actual	Model		
(A)	(B)	(C = A \div B)	(C ³)

(c) Body mass (MBd) (g) = Model volume (ml) \times Volume scale factor. Complete Table 11.5.

Table 11.5. Determining body mass (MBd).

Model volume (ml)	Volume scale factor (C^3)	Body mass (MBd) (g)
(A)	(B)	(A \times B)

Determination of Brain Volume

In this section you will determine the volume of the endocast of your specimen using the “Double Graphic Integration” method, with dorsal and lateral views of the endocast (Jerison, 1973:50–51) as illustrated in Figure 11.5. The endocast will be treated as an elliptical cylinder, that is, a cylinder elliptical in cross section. The two diameters of the ellipse will be determined by calculating the average diameter of each of the dorsal and lateral views. In this exercise we will follow Jerison (1973) in not including the olfactory tract as part of the brain proper, and in considering the boundary between the posterior brain and the spinal cord to be where nerve XII exits the brain or endocast. The olfactory tract carries impulses from the olfactory bulb to the brain but it can be argued it does not participate in the integration functions of the brain. Moreover, in mammals, the correlation of the size of the olfactory bulbs and tracts with brain size is very low ($r = 0.350$), whereas the correlation is more than $r = 0.94$ for other parts of the brain with total brain mass (Jerison, 1973:72–73).

Obtain a sheet of white paper and follow the steps below:

- Trace the outlines of the dorsal and lateral views onto the paper. Follow the heavy lines (these exclude the olfactory tracts and spinal cord) as shown in Figure 11.5 (a and b).
- On both lateral and dorsal views, draw equally spaced vertical lines, as in Figure 11.5 (c and d). As in Figure 11.5, space your lines equally so that there are approximately 10 (8–12) on each view. (Measure the length of your endocast and divide by 10 to determine the approximate spacing). Ensure that the spacing between the lines is the same spacing in the dorsal and lateral views.
- Determine the average diameter of the dorsal view (D_d) by measuring the length in centimeters of each line drawn, summing these lengths, and dividing by the number of lines to obtain the average length. Enter this value in Table 11.6.
- Repeat step 3 for the lateral view to determine D_l in centimeters. Enter this value in Table 11.6.
- Measure the length (L) of the endocast (between the vertical lines) to determine L in centimeters. Use the longest length if the two views differ. Enter this value in Table 11.6.
- Determine the scale factor of the drawing. The scale factor for the drawing is calculated as the *actual* (lifesize) length divided by the *drawing* length. Use the scale bar on the drawing to determine the scale factor. The scale bar is a line with a length printed below it (e.g., 60 mm) and refers to the length in the actual (lifesize) specimen (it is not the length itself). Divide this amount (e.g., 60 mm) by the length of the line in the drawing (e.g., 20 mm) to determine the scale factor. Enter this value in Table 11.6.

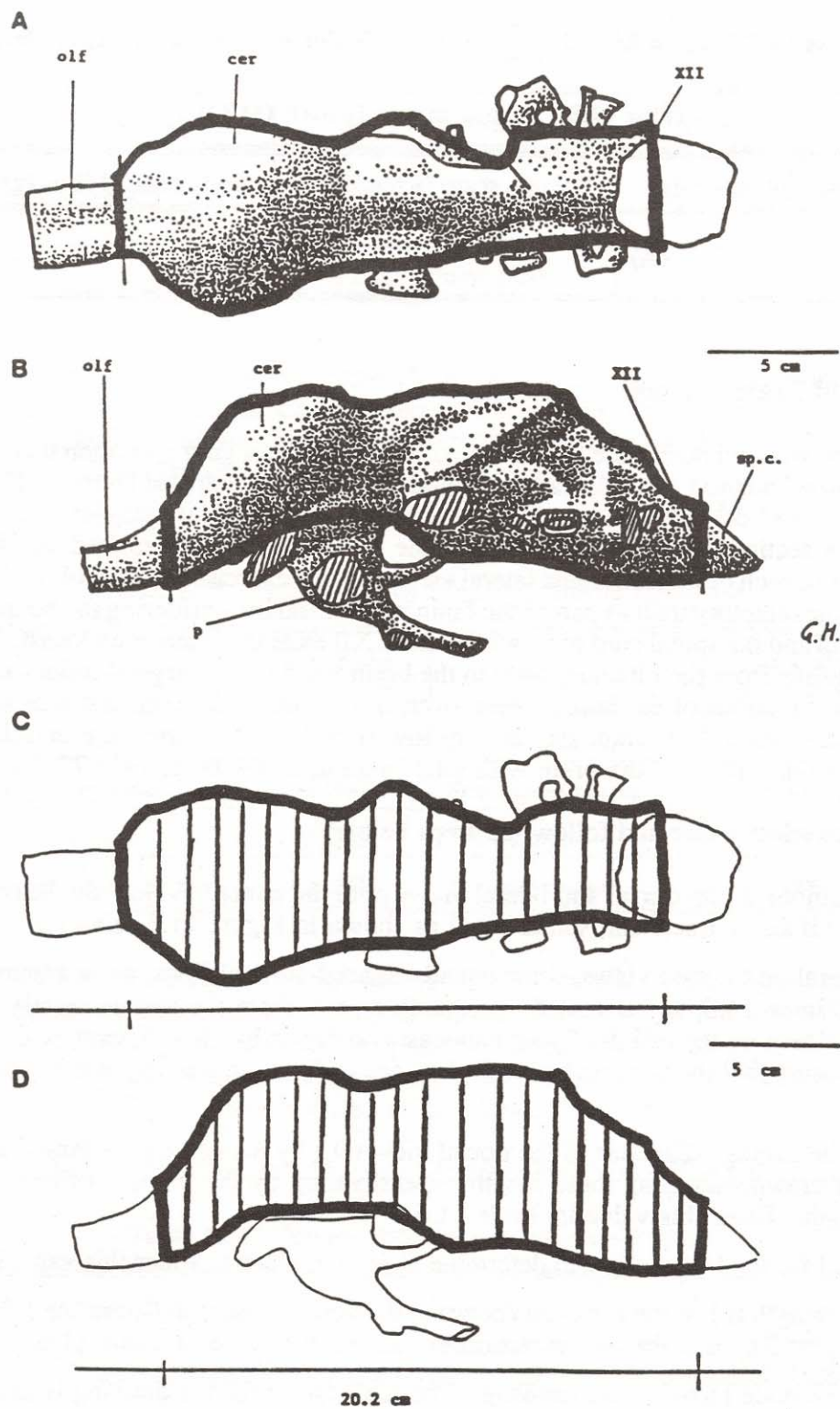

Figure 11.5. Endocranial cast of *Edmontosaurus*. (a, b) Dorsal and left lateral views, respectively, with olfactory bulb and spinal cord demarcated. (c, d) Dorsal and lateral views drawn at what would be 1-cm intervals in life. Length is 20.2 cm. *Cer*, cerebral hemispheres; *olf*, olfactory bulbs; *XII*, stump of cranial nerve 12.

Length written below scale bar	Length of scale bar in drawing	Scale factor of drawing
(A)	(B)	(A ÷ B)

7. The endocast drawing is not lifesize. To determine the actual (lifesize) volume, first multiply the values for D_d , D_l , and L (in cm) from the drawing (steps 4, 5, and 6) by the scale factor you calculated for the drawing. Enter the actual values for D_d , D_l , and L (in cm) in Table 11.6.

Table 11.6. Determining dimensions of actual endocast.

Drawing dimensions (cm)	Scale factor of drawing	Actual dimensions of endocast (cm)
D_d :		D_d :
D_l :		D_l :
L :		L :

8. Use the actual dimensions determined in step 7 for D_d , D_l and L (in cm) to determine the endocast volume (in ml) of your specimen. To determine endocast volume we will use the formula for the volume of an elliptical cylinder ($= r_1 \times r_2 \times L \times \pi$). (The typical formula uses the radii of the cylinder, r . Since the radius equals half the diameter, we multiply each of the two diameters by 0.5; $0.5 \times 0.5 = 0.25$, the value used in the equation below.) Complete Table 11.7.

$$\text{Endocast Volume (ml)} = 0.25 \times D_d \times D_l \times L \times \pi$$

Table 11.7. Determining endocast volume.

Actual dimensions (cm)				Endocast volume (ml)
D_d	D_l	L		
(A)	(B)	(C)	$0.25 \times \pi$ (D)	(A × B × C × D)

9. Lastly, you will recall from the discussion above in the Background Information, that in most dinosaurs the brain occupied only half of the endocranial chamber. Then divide your endocast volume (in ml) by 2 to obtain the brain mass (in g). Complete Table 11.8.
10. In order to make comparisons with the data provided by Martin (1981) in Figure 11.2, convert brain mass to milligrams (1 g = 1000 mg). Complete Table 11.8.

Table 11.8. Determining brain mass (MBr, in mg).

Endocast volume (ml)	Brain/endocast scale factor	Brain mass (g)	Brain mass (MBr) (mg)
(A)	(B)	$(A \times B = C)$	$(C \times 1000)$

Laboratory Report

- At the end of this laboratory, ensure that you have obtained body mass (MBd) in grams and brain mass (MBr) in milligrams. Calculate log values of these and give a copy of these to your instructor who will check that they are approximately correct.

Body mass (MBd) (g)	Log (MBd)

Brain mass (MBr) (mg)	Log (MBr)

- Plot the log values for MBd and MBr on the log-log graph of brain mass (y-axis) versus body mass (x-axis) in Figure 11.6 (which is based on the values in Figure 11.2). Where does the data point fall in relation to the polygons for reptiles, birds, and mammals? If it falls outside the polygons, would it fit in one if the polygon was extended along its slope?
- Applying the above information and the natural history information (and any additional information) provided by your instructor, what mode of thermal regulation might you infer for your specimen? Explain.

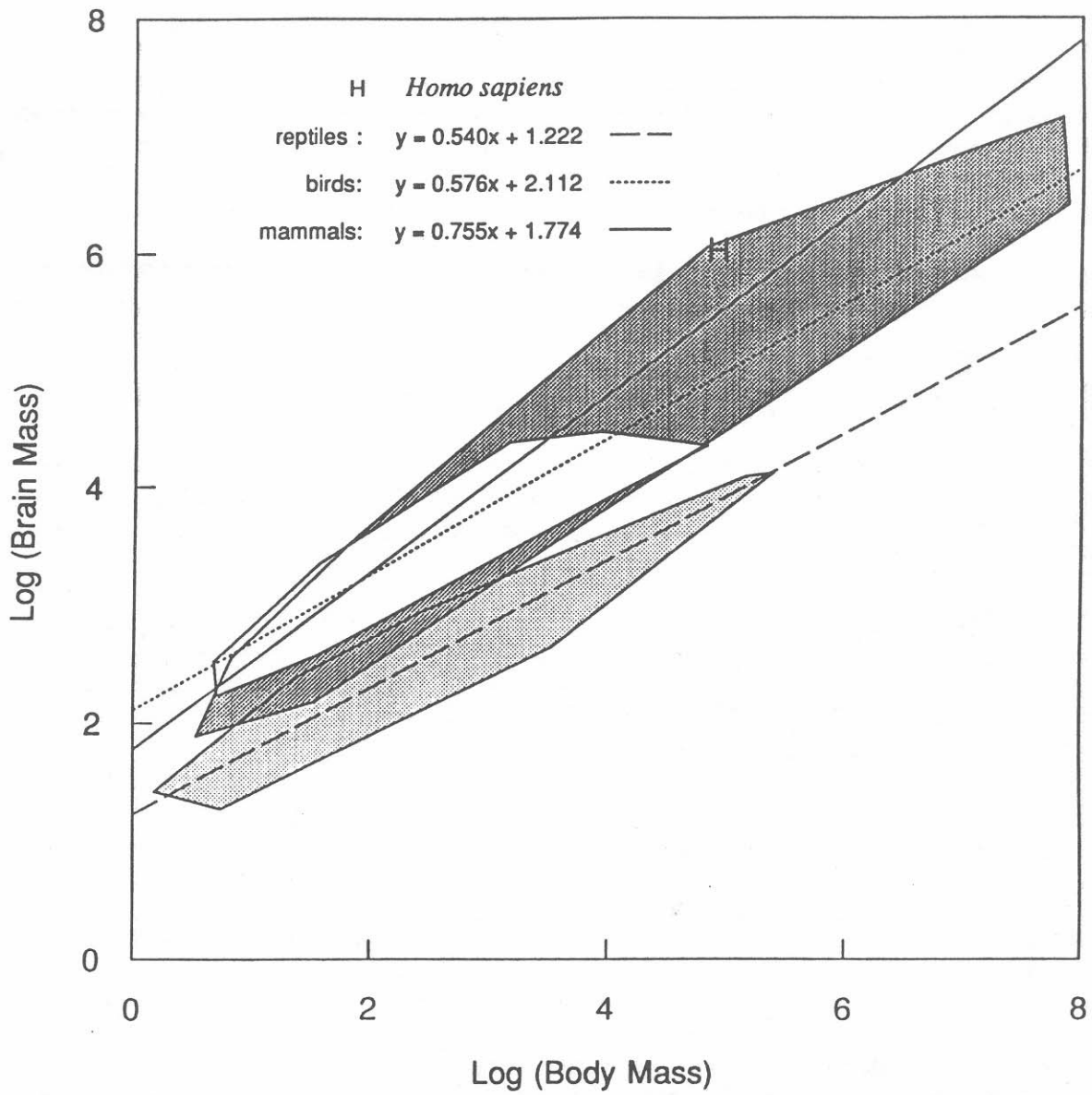

Figure 11.6. Log-log plot of brain mass versus body mass for mammals, birds, and reptiles. See text in Student Outline for details.

Notes for the Instructor

Dinosaur Models

In the original exercise developed at the University of Toronto we used 17 plastic dinosaur models from three sources: Carnegie Museum of Natural History (3), British Museum of Natural History (11), and the Royal Ontario Museum (3). This list is provided below (the eight indicated with an asterisk are used in the exercise presented in this chapter).

British Museum of Natural History (London, England):

*Diplodocus** (#3211)
Megalosaurus (#3213)
*Stegosaurus** (#3214)
*Triceratops** (#3217)
*Tyrannosaurus** (#3218)
Pteranodon (#3219)
Plesiosaurus (#3220)
Iguanodon (#3221)
Brachiosaurus (#3222)
Brontosaurus (#3225)
*Stenonychosaurus** (#3226)

Carnegie Museum of Natural History (Pittsburgh):

Dimetrodon
*Euoplocephalus**
*Pachycephalosaurus**

Royal Ontario Museum (Toronto):

Parasaurolophus
*Lambeosaurus**
Albertosaurus

In addition to using scale models, we also estimated body mass using (1) indicators of body length (drawings of animals, casts of fossil skeletons, and heads or casts of fossil skulls) following the method used by Jerison (1973); and (2) dimensions of the femur (drawing or cast of femur) following the method used by Alexander (1985).

Carnegie Models

Since we first developed this exercise the Carnegie Museum has produced a large assortment of multi-colored dinosaur models that are widely available from many sources (educational toy stores, natural science stores, etc.). These models are also available from Carolina Biological Supply Company (prices ranging from \$1.20 US to \$19.35 US each). Carnegie makes models of *Diplodocus*, *Stegosaurus*, *Triceratops*, and *Tyrannosaurus* (we use the British Museum models); you can use these models so long as they are not mounted on a permanent base (which interferes with weighing and will have to be removed).

In the U.S. these models can be obtained from: Safari Ltd., P.O. Box 630685, Miami, FL 33163, (305) 631-1000. In Canada: Party Pigs, 3258 Hawthorne Rd., Ottawa, Ont. K1G 3W9, (613) 739-8854. The most expensive model is about \$20 US for the largest species, *Brachiosaurus*.

The Carnegie models are reported to be 1/40 in linear scale, but when model volumes are multiplied by the corresponding volume scale (i.e., $40^3 = 64,000$), the body weights that are obtained are very inconsistent with weights reported in the scientific literature (see further comments under Scale Factors).

British Museum Models

The British Museum models have been available for many years and are very good replicas. They are now available as painted (multi-colored) and non-painted (one-colour) models. As with the Carnegie models, the largest models are about \$20 US each.

In the U.S. these models can be obtained from: Advancing Play, Inc., 1789 Maryland Ave., Niagara Falls, NY 14305, (800) 388-8362. In Canada: Quality International, Unit 12, 45A West Wilmot Rd., Richmond Hill, Ont. L4B 2P2, (905) 731-7600.

The British Museum models are reported to be 1/40 linear scale (Alexander, 1985), and when the volumes of the models are multiplied by the volume scale ($40^3 = 64,000$) the resultant body masses are consistent with values in the literature. *Stenonychosaurus* is an exception, and is scaled at 1/10.

ROM Models

Depending upon availability, the ROM models can be obtained (\$1.50–\$3.00 CDN each) from: ROM Little Shop, 100 Queen's Park, Toronto, Ont. M5S 2C6, (416) 586-5785.

If the ROM *Lambeosaurus* is not available, it can be substituted with another hadrosaur, for example, *Corythosaurus* or *Parasaurolophus* (both of which are available from the Carnegie Museum). These three hadrosaurs, and indeed most hadrosaurs (except the large *Edmontosaurus*), differed mainly in the shape of their crests — in body mass, brain mass, and head shape the three hadrosaurs were very similar. Thus, the body mass and the brain mass obtained for the *Lambeosaurus* endocast will be appropriate for either *Corythosaurus* or *Parasaurolophus*; the body length of 8 m should be similar as well (if a Carnegie model is used, try a body length of 7 m, since many of these models are not as consistently scaled as the British Museum models).

Endocast Drawings

Drawings of endocasts of representatives of the major dinosaur groups are provided in Appendix A. For each of the eight drawings both dorsal (top) and left lateral (bottom) views are provided. These are endocasts of the dinosaur species for which scale models have been made, or are endocasts of closely related species. All are adapted from Hopson (1979), except for the dorsal view of *Diplodocus* which is from Marsh (1895).

It is recommended that each pair of drawings be enlarged and presented on a sheet of 8.5" × 11" paper, retaining the scale bar in each. It is very important that you ensure that students remember that the size of the actual brain is less than that of the endocranial cast; in most cases it is one-half the size of the endocranial cast (with the exception of *Stenonychosaurus*, see comments below under Endocast Volume).

All pairs of drawings in Appendix A are shown with the dorsal view above and left lateral view below. Anterior is to the left. The vertical lines demarcate the boundary between the brain proper and the olfactory tract anteriorly and the spinal cord posteriorly. The heavy line outlines the brain and separates it from casts of nerves and the inner ear laterally, cartilage dorsally, and the pituitary body ventrally. Tracings should be made of the area within the heavy line only.

Scale Factors

It is important that students realize that the models and drawings must be scaled to approximate the actual (life) size for the specimen. It is obvious that the lifesize creatures are enormously larger than the models, but the actual endocranial casts are only 1.5 to 3 times larger than the drawings. The procedure for scaling the model is fairly straightforward; total body length is provided either on the model (BMNH models) or on an accompanying label (Carnegie models), or if any of these values are incorrect, they are provided in this chapter. The technique for establishing the scale factor for the endocast drawing is also straightforward; students use the scale bar provided on the drawing, remembering to convert from endocast volume to brain mass by multiplying by 0.5.

The lifesize body lengths provided in Table 11.3 are within the range of values in the literature; when these lengths are used to determine scale factors and then body weights, the resulting weights are consistent with values reported by Alexander, (1985, 1991), Colbert (1962), Hopson (1977,1979), Jerison (1973), and Lambert (1983). It is important to note that Table 11.3 provides lifesize body lengths different from those printed on the models for four of eight specimens: *Euoplocephalus* and *Pachycephalosaurus* (Carnegie models) and *Stegosaurus* and *Triceratops* (BMNH models).

The length of *Euoplocephalus* in Table 11.3 is 5 m; this value is 1 m shorter than the value given on the model tag (6 m), yet is consistent with the body weight reported by Lambert (1983). The length of *Pachycephalosaurus* is 5 m; this is the average of weight of 4.6 m reported by Lambert (1983) and the length on the model tag (6 m), and yields a weight consistent with the weight given on the model tag. The length for the BMNH *Stegosaurus* (6 m) is that given on a ROM model of *Stegosaurus*, and results in a linear scale closer to 1/40 than does the BMNH lifesize length of 5 m. The length for *Triceratops* of 8 m is from Lambert (1983) and yields a linear scale closer to 1/40 than does the BMNH lifesize length of “about 6 m.”

In general, the body lengths reported on the scale models should be used with caution. Scale models are not perfect and body lengths may not be exactly 1/40 of life lengths, which themselves are estimates. The Carnegie models do not appear to be scaled to the cube of 40, at least in volume, although they are reported to be 1/40 scale. Use of the cube of 40 provides weights greatly at variance with the literature, and use of the reported body lengths on the models does not give a value of 1/40. In addition, information on models may be inaccurate. For example, the tag on the Carnegie *Pachycephalosaurus* gives a length of 6 m, but the model base gives a life length of 8 m, whereas Lambert (1983) gives a life length of 4.6 m. All British Museum models are 1/40 linear scale (Alexander, 1985), except *Stenonychosaurus*, which is 1/10.

Lastly, the actual body masses of dinosaurs are not known, although approximations have been calculated by a number of methods. Alexander (1985) used hip height, not body length, to establish a linear scale, but hip heights are not used in this exercise because they are not widely reported in the literature and depend on the reconstruction of the particular dinosaur.

Performing Calculations

Tables have been provided to assist students to keep track of their measurements. It is important that they are conscious of the units that they are using (i.e., millimeters versus centimeters, and milligrams versus grams); this has been explicitly stated throughout the Student Outline, but seems to still cause problems.

Natural History and Resource Material

Natural history information for each of the major dinosaur groups is provided in Appendix B. This material can be printed in poster format and posted on a bulletin board in the lab room. Students consult this information when interpreting their results.

In addition to the natural history information for the major groups, we provide posters in the lab room that provide additional information that the students can consult when writing their report. This resource material is presented in Appendix C: Endothermy and Homeothermy in Large Ectothermic Heterotherms, The Heart of Amniote Vertebrates, Evidence for Warm-Blooded Dinosaurs, Brain Size: Metabolism and Behaviour, and The Mesozoic Era: Climate and Environment.

Expected Results

The expected results are presented in Tables 11.9 and 11.10. Log values of body mass and brain mass are plotted in Figure 11.7. These results suggest that the relative brain size for all species, except *Stenonychosaurus*, is what we would expect for reptiles of such large size (i.e., body mass). If we were to extend the reptile polygon in Figure 11.7 it would include all points except *Stenonychosaurus*. Thus we would infer that all species, with the exception of *Stenonychosaurus*, maintained a cold-blooded physiology. The species above the regression line have larger brains than those below the line. The data for species above the line and close to the mammal polygon may suggest either an ectothermic/heterothermic or endothermic/homeothermic physiology, or some unique physiology (e.g., mass homeothermy, a phenomena whereby large reptiles are thought to retain body heat solely by virtue of their size).

Stenonychosaurus is unique among the dinosaurs in this exercise in that its brain-body relationship falls within the range of bird and even mammal brain-body relationships; that is, it is comparable in terms of relative brain size to modern warm-blooded vertebrates. Among dinosaurs, this is only true of other small theropods, such as *Dromiceiomimus* and *Velociraptor*. Consequently, the possibility that small theropods were warm-blooded is not ruled out on the basis of relative brain size.

Acknowledgements

I wish to thank the 1500 introductory biology students at the University of Toronto in 1991 who were the first to use this exercise, and also the participants in this workshop at the 1993 ABLE conference for their interest and comments. Thanks are due also to McNeil Alexander and R. D. Martin for permitting use of their work. Finally, I owe a great debt of gratitude to Corey Goldman for the amount of time and effort he has invested in advising on, editing, re-writing, and improving this laboratory exercise. The final form of this exercise, and all intermediate incarnations, owe much to his enthusiasm, energy, interest, and good humor.

Table 11.9. Determining body mass.

Specimen/model	Life body length (m) (BL)	Model length (mm) (ML)	BL/ML (mm/mm)	Volume scale (BL/ML) ³	Model volume (ml)	Body mass (g)
<i>Diplodocus</i> BMNH	25 m	590	42.4	76,225	292.4	22,288,190
<i>Euoplocephalus</i> CARN	5 m	154	32.5	34,328	55.6	1,908,637
<i>Lambeosaurus</i> ROM	8 m	190	42.1	74,618	39.8	2,969,796
<i>Pachycephalosaurus</i> CARN	5 m	206	24.3	143,349	86.2	1,236,884
<i>Stegosaurus</i> BMNH	6 m	163	36.8	49,836	48.8	2,431,997
<i>Stenonychosaurus</i> BMNH	2 m	193	10.4	1,106	37.5	41,475
<i>Triceratops</i> BMNH	8 m	193	41.4	70,958	97.6	6,925,501
<i>Tyrannosaurus</i> BMNH	12 m	305	39.3	60,698	113.7	6,901,363

Table 11.10. Body mass and brain mass for eight dinosaur species, as plotted in Figure 11.7.

Specimen/model (# in Figure 11.7)	Log (Body mass)	Log (Brain mass)	Body mass (g)	Brain mass (mg)
<i>Diplodocus</i> BMNH (1)	7.3	4.8	22,300,000	57,000
<i>Euoplocephalus</i> CARN (2)	6.3	4.7	1,900,000	46,350
<i>Lambeosaurus</i> ROM (3)	6.5	5.3	3,000,000	200,000
<i>Pachycephalosaurus</i> CARN (4)	6.1	4.6	1,200,000	36,000
<i>Stegosaurus</i> BMNH (5)	6.4	4.4	2,400,000	22,500
<i>Stenonychosaurus</i> BMNH (6)	4.6	4.6	41,500	37,000
<i>Triceratops</i> BMNH (7)	6.8	4.9	6,900,000	79,400
<i>Tyrannosaurus</i> BMNH (8)	6.8	5.3	6,900,000	202,000

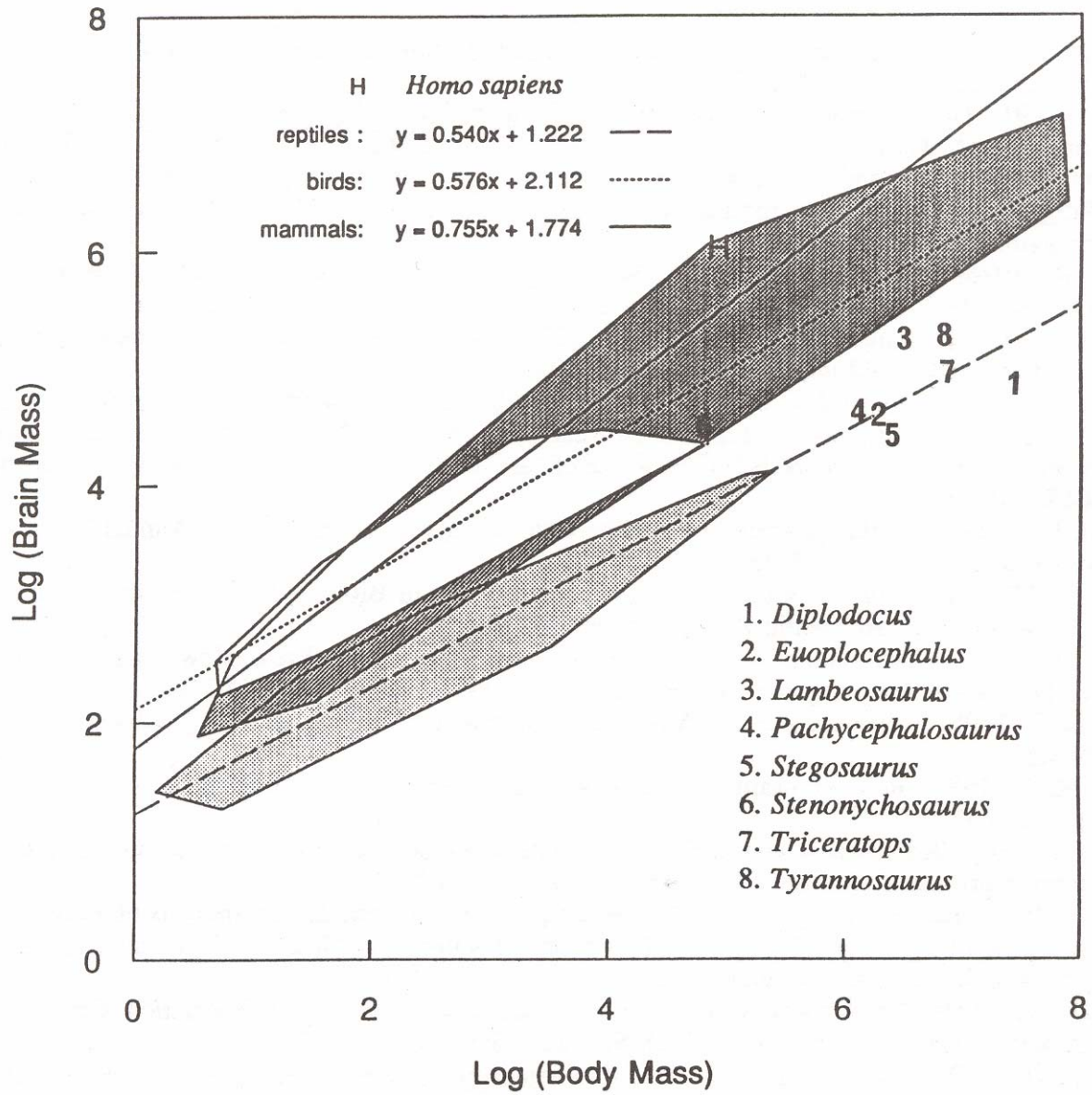

Figure 11.7. Log-log plot of brain mass versus body mass for mammals, birds, and reptiles, with values plotted for the eight dinosaur species in this chapter (data from Table 11.10).

Literature Cited and Further Reading

- Alexander, R. McN. 1985. Mechanics of posture and gait of some large dinosaurs. *Zoological Journal of the Linnean Society*, 83:1–25.
- . 1991. How dinosaurs ran. *Scientific American*, 264(4),130–136.
- Anderson, J. F., A. Hall-Martin, and D. A. Russell. 1985. Long-bone circumference and weight in mammals, birds, and dinosaurs. *Journal of Zoology, London (A)*, 207:53–61.
- Auffenberg, W. 1981. The behavioral ecology of the Komodo monitor. University Presses of Florida, Gainesville, 300 pages.
- Bakker, R. 1986. The dinosaur heresies. William Morrow, New York, 481 pages.
- Colbert, E. H. 1962. The weights of dinosaurs. *American Museum Novitates*, 2076:1–16.
- Frair, W., R. G. Ackman, and N. Mrosovsky. 1972. Body temperature of *Dermochelys coriacea*: Warm turtle from cold water. *Science*, 177:791–793.
- Goldman, C. A., R. R. Snell, J. J. Thomason, and D. B. Brown. 1990. Principles of allometry. Pages 43–71, *in* Tested Studies for Laboratory Teaching. Volume 11. (C. A. Goldman, Editor). Proceedings of the 11th Workshop/Conference of the Association for Biology Laboratory Education (ABLE), 195 pages.
- Hopson, J. A. 1977. Relative brain size and behavior in archosaurian reptiles. *Annual Review of Ecology and Systematics*, 8:429–448.
- . 1979. Paleoneurology (Chapter 2). Pages 39–146, *in* Biology of the Reptilia, Volume 9 (C. Gans, Editor). Academic Press, London, 462 pages.
- Jerison, H. J. 1973. Evolution of the brain and intelligence. Academic Press, New York, 482 pages.
- Lambert, D. 1983. A field guide to dinosaurs. Avon Books, New York, 256 pages.
- Marsh, O. C. 1895. Dinosaurs of North America. Department of the Interior, U.S. Geological Survey, 415 pages.
- Martin, R. D. 1981. Relative brain size and basal metabolic rate in terrestrial vertebrates. *Nature*, 292 (5827):57–60.
- Radinsky, L. B. 1968. A new approach to mammalian cranial analysis, illustrated by examples of prosimian primates. *Journal of Morphology*, 124:167–180.
- Regal, P. 1978. Behavioral differences between reptiles and mammals: An analysis of activity and mental capabilities. Pages 183–202, *in* Behavior and neurology of lizards (N. Greenberg, Editor). N.I.M.H. Publications, Rockville, Maryland.
- Russell, D. A. 1969. A new specimen of *Stenonychosaurus* from the Oldman Formation (Cretaceous) of Alberta. *Canadian Journal of Earth Sciences*, 6:595–612.
- . 1972. Ostrich dinosaurs from the late Cretaceous of Western Canada. *Canadian Journal of Earth Sciences*, 9:375–402.
- Trombulak, S. C. 1991. Allometry in biological systems. Pages 49–68, *in* Tested Studies for Laboratory Teaching. Volume 12. (C. A. Goldman, Editor). Proceedings of the 12th Workshop/Conference of the Association for Biology Laboratory Education (ABLE), 218 pages.
- Weaver, J. 1983. The improbable endotherm: The energetics of the sauropod dinosaur *Brachiosaurus*. *Paleobiology*, 9(2):173–182.

APPENDIX A
Drawings of Endocranial Casts

Key to endocranial casts on the following four pages:

1. Sauropod: *Diplodocus*
2. Ankylosaur: *Euoplocephalus*
3. Ornithopod hadrosaur: *Lambeosaurus*
4. Pachycephalosauria: *Pachycephalosaurus*
5. Stegosauria: *Stegosaurus*
6. Small theropod: *Stenonychosaurus* (= *Troodon*)
7. Ceratopsian: *Triceratops*
8. Large theropod: *Tyrannosaurus rex*

Reprinted from Hopson (1979), with permission from Academic Press Inc. (London) Ltd.

1

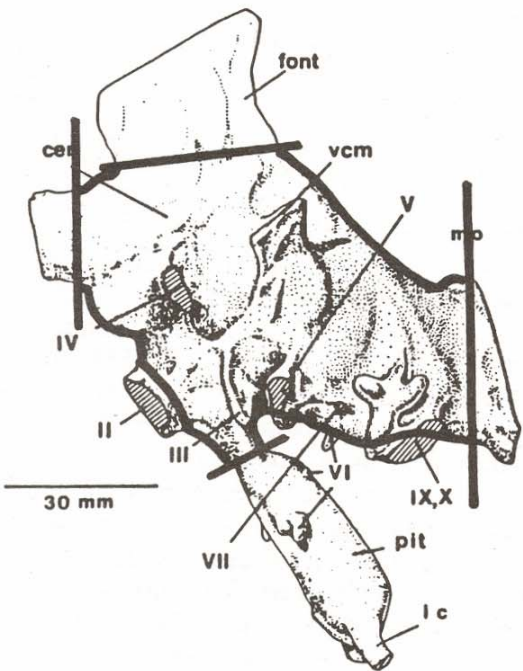
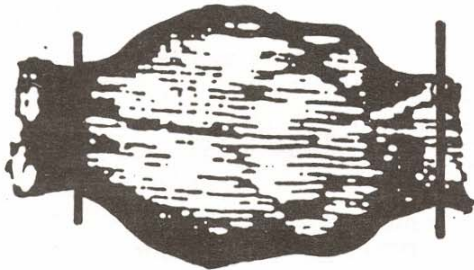

2

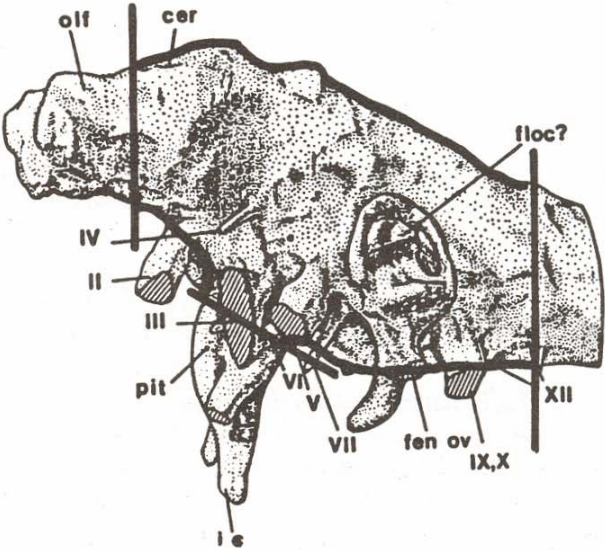
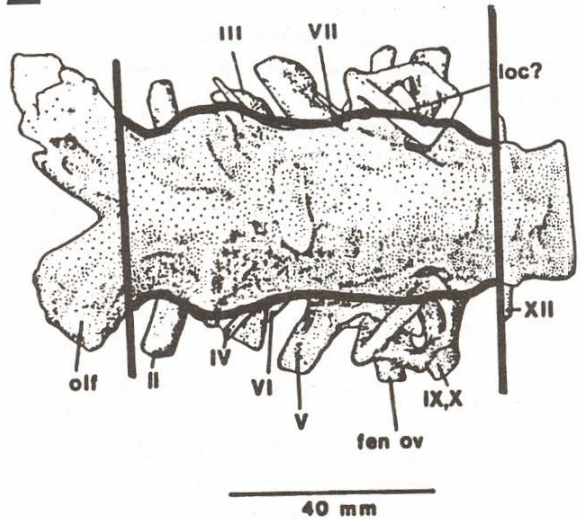

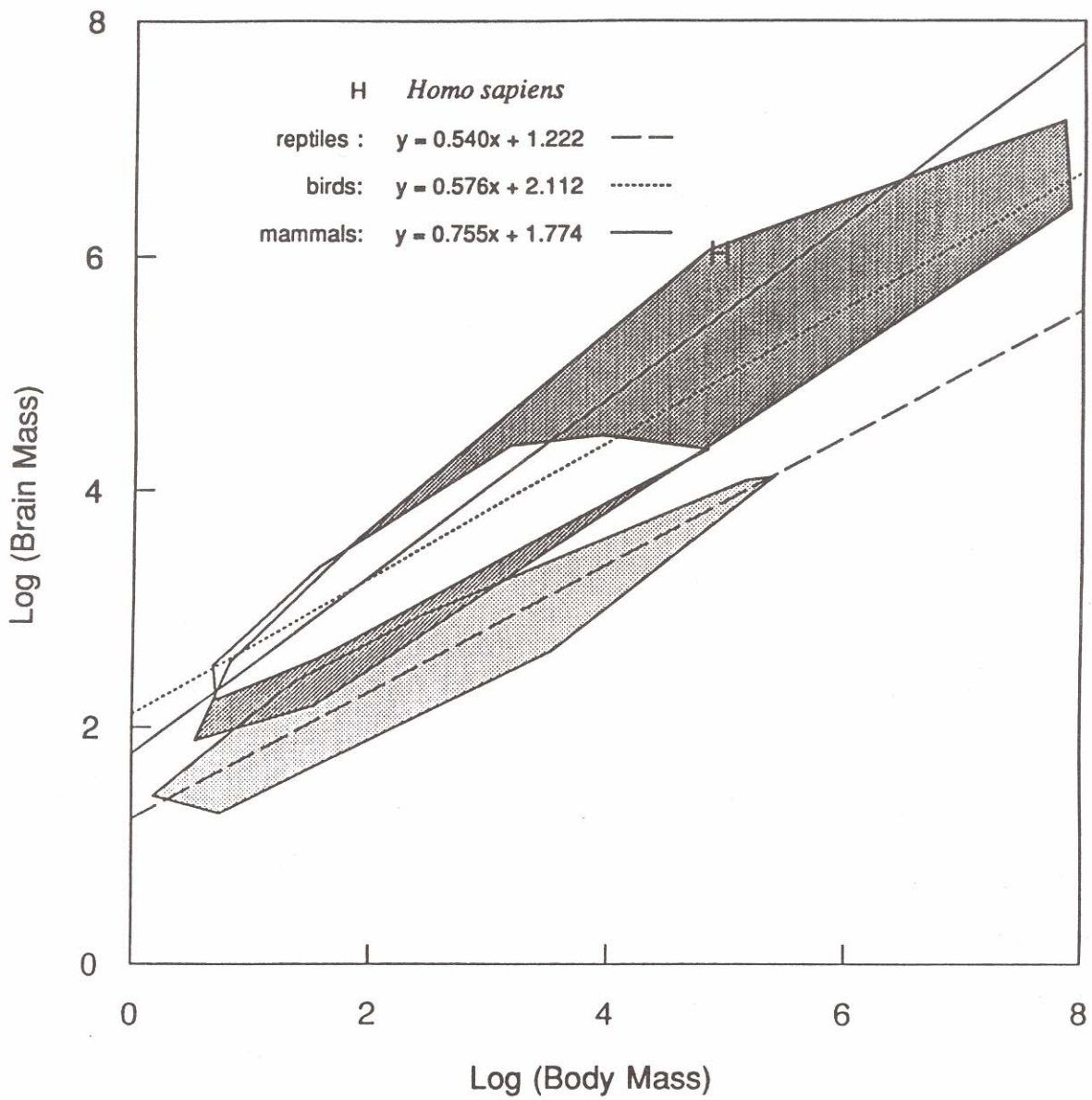
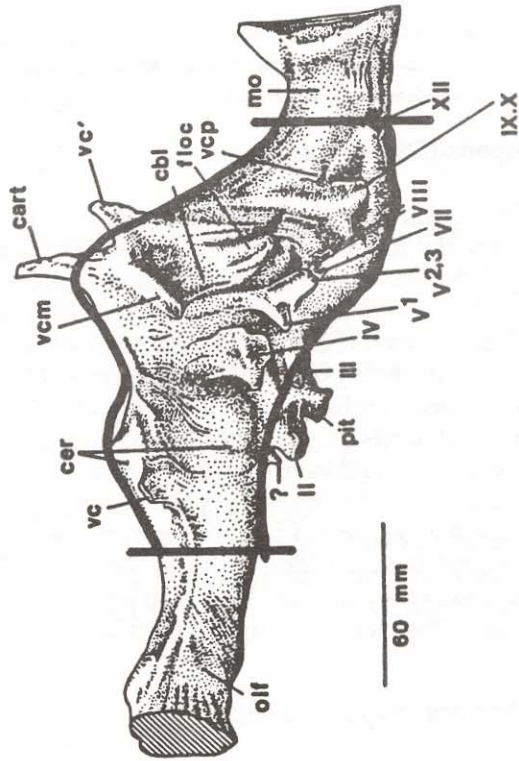
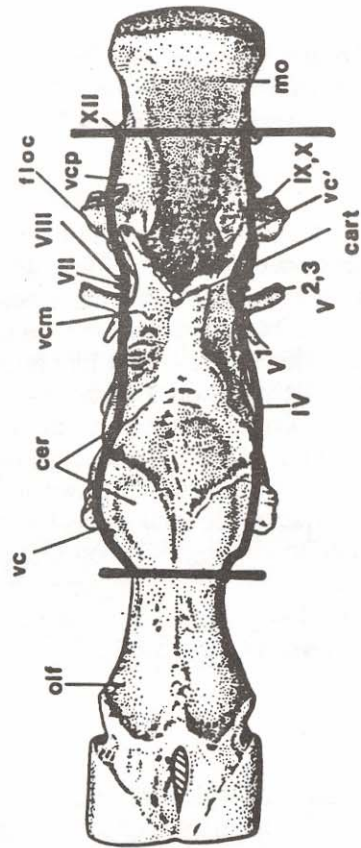
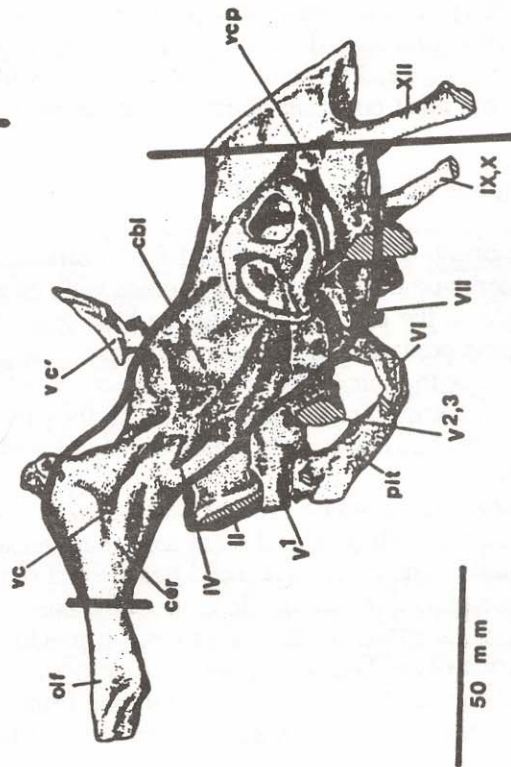
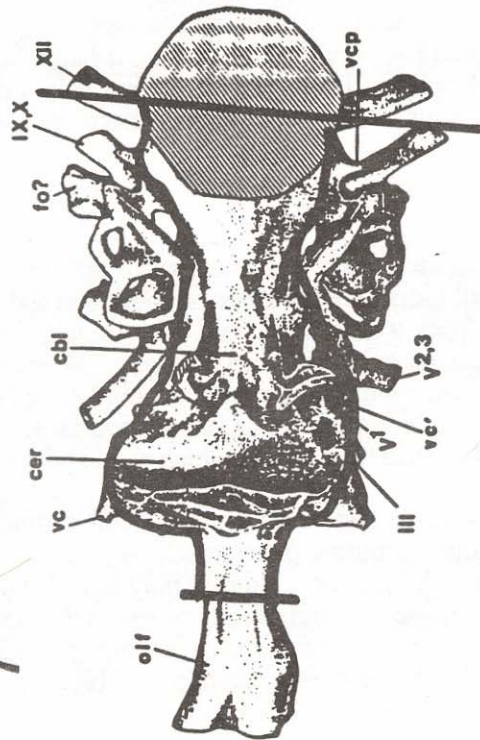

Figure 11.6. Log-log plot of brain mass versus body mass for mammals, birds, and reptiles. See text in Student Outline for details.

8



7



APPENDIX B
Natural History of Selected Dinosaurs

Sauropods (*Diplodocus*)

Sauropods were the largest animals ever to walk on earth, some the length of several buses. They were quadrupedal with pillar-like legs. Like theropods, their feet bore claws, not hooves, with a large claw on each thumb. They had extremely long tails and long necks with heads the size of a horse's head. Teeth were present only in the front of their mouths, but fossils of sauropods have been found with piles of smooth worn stones near their stomach region, where no other stones are found. This suggests that like birds and crocodiles, they had stones in their gizzard, a tough part of the stomach. Gizzard stones serve to grind food in birds and crocodiles and possibly did so in sauropods. Given the small size of sauropod teeth, it is not easy to imagine what kind of plants they ate although the gizzard stones would have been important, possibly vital, in digestion.

Their size would have been useful as a defense against predators, assisted by claws on their feet and swinging of the large tails. We know they walked on land from fossil tracks. Several forms had nostrils on top of their heads for reasons which are not clear, but which may relate to cooling of blood circulating in the head.

Sauropods were widespread and common in the Jurassic but declined in frequency through the Cretaceous. *Diplodocus*, a Late Jurassic form, had an extremely long whip-like tail and neck and may have been the longest dinosaur. However it was lightly built and less than half the weight of its well-known relative, *Brontosaurus*.

Ankylosaurs (*Euoplocephalus*)

Euoplocephalus was an ankylosaur, an armoured dinosaur, of which more than 30 different species are known. Ankylosaurs were quadrupedal, low, squat, heavy-bodied animals, with short massive limbs and barrel-shaped bodies. Some were 2 m long but most were larger, up to the length of a bus and the weight of a small elephant. Their backs were armoured by bony slabs and the bodies were guarded by rows of spikes along their sides and legs. Some had large bony clubs at the end of their tails. All had weak jaws and small teeth and probably ate low-growing vegetation. Their feet had small hoofs on the toes.

Euoplocephalus had blunt spines on its armoured back and on its forearm; it had a bony club at the end of its tail and a head resembling a square rock with spines. It was the length and height of a U.S. M47 tank and was the most common North American ankylosaur. Known fossils date from the Late Cretaceous.

Ornithopods (*Lambeosaurus*)

The ornithopod (literally, "bird foot") dinosaurs included a large number of different species. All were bipedal herbivorous dinosaurs which could walk on all fours. The toes bore small hooves and large tails balanced the weight of the body in front of the hind legs. They would have been fairly quick, a necessary adaptation for escaping predators, as none were armoured, unlike other herbivorous dinosaurs. When feeding, they could have stood with their bodies nearly vertical, but when running their bodies would have been parallel to the ground. We know from fossil tracks that they used their front feet. Like ceratopsians, ornithopods had no front teeth but had hundreds of small, closely packed teeth in their cheeks which would have made them efficient processors of food.

Lambeosaurus was a type of ornithopod known as a hadrosaur, the duck-billed dinosaurs, common in the Cretaceous. They lacked front teeth but had tough grinding plates resembling duck bills at the front of their mouths. The crest on its head had several possible functions. Sounds may have been produced through the air passages. Air breathed in through the nostrils passed through the chambers in the crests. The chambers would have increased the surface area of the area in which scent was detected, an important function in detecting the approach of predators. Air passing through chambers could have acted to cool blood in vessels circulating through the head. Exercise (such as running from carnivores) can quickly increase body temperature to levels which are dangerous unless the heat can be lost from the blood. (Blood vessels are close to the surface in your wrists and covering or uncovering them will, respectively, allow you to retain or

lose body heat.) With its body held parallel to the ground, *Lambeosaurus* may have travelled quadrupedally or bipedally, with the body in front balanced by the long tail behind the legs. Known fossils date from Late Cretaceous.

Pachycephalosaurs (*Pachycephalosaurus*)

Pachycephalosaurus was a member of an unusual group of ornithomimids which had skulls of thick bone often armoured with spikes. These were likely used in combat, either in defense or with other members of the same species. *Pachycephalosaurus* was the largest of the group, with the thickest skull, which had 25 cm of bone in the outer layer, set with small spikes. It was not a fast runner, and probably ate leaves, seeds, fruits, and possibly insects. Known fossils date from the Late Cretaceous of North America.

Stegosaurus (*Stegosaurus*)

This well-known quadrupedal dinosaur of Late Jurassic age had a row of plates incised with channels along its back. Blood vessels may have run through these, facilitating the loss of heat from blood close to the surface. This was a slow-moving, herbivorous dinosaur whose short, weak teeth could only have processed soft, lush vegetation. The plates would protect the backbone and the long tail spikes would have been swung for defense but its sides may have been vulnerable to attack.

Ceratopsians (*Triceratops*)

Ceratopsians (horned dinosaurs) were among the last dinosaurs to evolve, known mainly from the Late Cretaceous. They were quadrupeds with large heads bearing often large horns, and enormous bony frills extending back from the head protecting the neck, also sometimes armed with horns. Ceratopsians were plant-eaters, with powerful jaws, several hundred tightly packed teeth in the cheeks, and a tough, parrot-like beak. They would have been efficient processors of food. Some forms appear to have died in large groups, suggesting they may have occurred in large assemblages in life. Their feet had small hoofs on each toe.

Triceratops was one of the last dinosaurs and unlike some other ceratopsians, had a short, solid bony frill. It was one of the largest ceratopsians.

Theropods

Theropods were bipedal, carnivorous dinosaurs, including the large predator *Tyrannosaurus rex* and some small dinosaurs the size of chickens. Their three-toed hind feet, which bore all the weight, resemble those of birds and were armed with dangerous claws. Birds are considered to have descended from some small theropods, and one specimen of *Archaeopteryx*, the earliest known bird, was mistaken for a small theropod for almost two decades. Their teeth were arranged at the front and sides of the mouth and were often extremely large and sharp. The forelimbs had two or three fingers, often armed with sharp claws, but in some forms reduced in size. Most were active hunters, although some forms may have been scavengers.

Small Theropods (Stenonychosaurus)

The small theropods included forms with small heads at the end of long flexible necks — they resemble ostriches in many ways. The body in front of the hind legs was balanced by a long tail behind. Their long legs made them fast runners. They had large eyes and forelimbs with rudimentary grasping hands, and were quick, agile predators. *Stenonychosaurus* had a stronger grasping hand than some other small theropods, and small but sharp teeth unlike some of the toothless small theropods. It was a rapid runner and its large eyes suggest it may have hunted at twilight. Small mammals or insects may have been its prey. It is known from the Late Cretaceous of North America.

Large Theropods (Tyrannosaurus)

The largest theropods were perhaps as big as two-legged animals could get. The three-toed feet of their hind legs were armed with sharp dangerous claws and their forelimbs were similarly armed. The long, sharp, often serrated (like steak knives) teeth at the front and sides of their mouth were up to 3 cm in length. These enormous predators occurred from the Early Jurassic to the Late Cretaceous. Most large theropods were active predators but the largest forms may have been too big, slow, and clumsy to have been anything but scavengers. They moved with their bodies approximately parallel to the ground, their heavy bodies in front of their hind legs balanced by heavy tails extending behind.

Tyrannosaurus was the largest land predator known, with teeth up to 19 cm long, and enormous claws on its hind feet. Its large head was very heavy, unlike that of smaller relatives such as *Allosaurus* whose skull had many open spaces for lightness. Its two-fingered forelegs were too short to reach its mouth yet were quite strong. It may have been too slow and clumsy to have been an effective predator thus it may have been a scavenger (eater of dead meat). Alternately, it may have been a fearsome predator. We are not sure.

APPENDIX C
Resource Material

Endothermy and Homeothermy in Large Ectothermic Heterotherms

Some animals which are considered cold-blooded can maintain body temperatures above those of the ambient (air or water) temperature. The Galapagos tortoise weighs 170 kg or more, and the Komodo dragon can reach 100 kg. In both species body temperature drops slowly during the night yet stays higher than the air temperature, probably due to the low surface area to volume ratio resulting from their large size. Heat of muscular activity and the low thermal conductance of the tortoise shell may also contribute to this low rate of temperature loss.

Frair et al. (1972) reported a 400 kg marine leatherback turtle which maintained a body temperature of 18°C higher than the decreasing temperature of the surrounding water. It was suggested that body temperature was produced by the heat of muscular activity (swimming motions) and retained by the body covering and specialized circulatory patterns.

Other large vertebrates, such as the tuna, Porbeagle shark, and even python, can raise their body temperature above ambient levels through muscular action. So can invertebrates such as the sphinx moth and bumble bee, both of which are insulated.

In the above cases body temperature is generated internally by muscular action and *not* by the metabolic heat of internal organs, which heats true endotherms. Also, body temperature changes with ambient temperature although it remains above it. Large reptiles are known to retain body heat solely by virtue of their size, which some scientists have termed *mass homeothermy*.

The Heart of Amniote Vertebrates

The majority of cold-blooded tetrapod vertebrates (those having four limbs, at least primitively — remember snakes!), such as amphibians and amniotes other than birds and mammals, have 3-chambered hearts in which the flow of oxygenated and deoxygenated blood is mixed. The hearts of warm-blooded mammals and birds are 4-chambered resulting in the separation of oxygenated and deoxygenated blood. This separation of oxygenated blood results in increased metabolic efficiency in birds and mammals relative to other tetrapods. Mammalian and avian (bird) hearts are constructed differently, though, with mammals being “right-handed,” like amphibians, and birds being “left-handed,” like the remainder of the amniote vertebrates. Crocodiles, alligators, and gavials, which make up the Crocodylia, and birds are the only extant archosaurs. Like birds, crocodiles have a “left-handed” 4-chambered heart. However, the crocodylian heart is functionally 3-chambered, because there is a hole in the wall between two of the chambers. Both crocodylians and varanid lizards (such as Komodo Dragons) have complicated hearts which deliver low pressure blood to lungs (which high pressure would damage) and high pressure blood to their bodies.

Nevertheless oxygenated and deoxygenated blood is not separated in them. What might this mean about the hearts of other archosaurs, such as dinosaurs?

Evidence for Warm-blooded Dinosaurs

1. The similarity of dinosaur limb proportions to those of living mammals and birds suggested equally high running speeds and therefore similar metabolisms. However, the surfaces of the ends of bones where they form joints are smoother, better fitting, and more developed in mammals and birds than in dinosaurs. This suggests less dexterity, mobility, and flexibility in dinosaur movement — other qualities, such as cartilaginous bone surfaces, suggest less speed.
2. Predator-prey ratios in dinosaur communities were similar to ratios in modern mammals and fossil mammal assemblages. Because warm-blooded predators, such as lions, require 10 times the food of a cold-blooded carnivore of similar body weight, the ratio of predators to prey (e.g., lions to zebras) is 10 times as great in communities of cold-blooded animals as in those of warm-blooded animals; that is, 10 cold-blooded predators can survive on a food supply (prey species) that would support one warm-blooded predator of similar body weight.
3. Similar bone histology in dinosaurs and living endotherms indicates rapid, endothermic-level, growth rates. Today, only endothermic homeotherms grow as fast as dinosaurs appear to have grown. No living “cold-blooded” animals grow as quickly as did dinosaurs; it remains to be seen whether it is impossible to be cold-blooded and grow at such rates. Regularly fed turtles and alligators in farms grow almost at “warm-blooded” rates (Bakker, 1986).
4. Finally, it is important to understand that there are advantages to being “cold-blooded,” for instance, only one-tenth the food is required. Secondly, the large size of most dinosaurs may have helped retain heat. At body weights of 10 kg or over, the mass is so large relative to surface area that heat is retained in the body for some time. Only 20% of mammals are over 10 kg in body weight.

Brain Size, Metabolism, and Behaviour

The brain requires a lot of energy in the form of glucose. Large brains such as those of endotherms would require the energy produced by an active metabolism. Larger brains are also more complex and delicate, requiring the stable, constant environment present in a homeothermic physiology.

We are not yet sure about the relationship of brain size to an animal. However, it seems likely that larger brains occur in animals which are more active and which have more demanding activity patterns. We would expect large brains in faster animals than in slower ones, since running requires higher and faster levels of coordination of body parts, and faster animals would have included both those which relied on running to capture prey, and those who needed speed to escape predators. Flying animals would also require unusually large levels of coordination of body parts and high levels of muscular activity.

For carnivorous dinosaurs, the small and large theropods, finding and acquiring food (prey) may well have been more demanding in terms of behaviour, intelligence, aspects of balance of the body, and coordination and balance of the body than was the case for herbivorous dinosaurs. A similar situation seems to exist among mammals today.

For herbivorous mammals, demands on behaviour beyond food finding would have been connected to avoiding predation. The great size and claws of sauropod dinosaurs, and the armour and spikes of ankylosaurs, stegosaurs, and possibly pachycephalosaurs, may have meant their defense against predation would have been largely passive and therefore not requiring much intelligence.

The horned dinosaurs, the ceratopsians, had defensive structures on their heads (horns) and little protection for the rest of the body beyond that provided on the neck by the frill. It seems reasonable that ceratopsians would have actively used their horns in defense, implying a behaviour requiring more intelligence. Ornithomimids, including *Iguanodon* and the hadrosaurs, had neither armour nor weapons, and so would likely have required acute senses to detect predators and fast running speeds for escape.

Carnivorous animals usually are more mobile and intelligent than herbivorous animals. Carnivores need to stalk and capture prey, to select mobile prey and out-smart them. Several adaptations are employed by

potential prey animals to deter predation of herbivorous animals. Some run quickly to escape predators (antelopes) others employ body armour (ankylosaurs), or defensive structures (horns of ceratopsians and antelopes). Some animals use great size to deter attack (elephants, sauropods).

The Mesozoic Era: Climate and Environment

The Mesozoic Era extended from about 250 to 65 million years ago and included the Triassic Period (250–210), Jurassic Period (210–144) and Cretaceous Period (144–65 million years ago). The climate was significantly different from what it is today, with snakes, lizards, and probably forests occurring within 10° latitude of the North Pole. In the areas near the North and South Poles temperatures may have been 10–15°C warmer than today, while at the equator temperatures were only 5° higher than they are today. There was little seasonality in temperature, meaning winters were not much cooler than summers, in contrast to the situation in temperate regions today.

Mammals were quite small through the great portion of the Mesozoic, and were probably largely nocturnal (active at night). A great evolutionary event occurred in the early Cretaceous: the evolution of the angiosperms, or flowering plants. Angiosperms include grasses, wildflowers, and broadleaf trees (oaks, willows, maples). We also see many insects: bees, wasps, flies, butterflies, and beetles for the first time in the early Cretaceous.

Many angiosperms rely on insects for pollination by insects; that is, they could not reproduce without the participation of insects who in turn depend on flowering plants for food. Many birds, mammals, and reptiles rely on insects for food.