Aryu_Proceeding_2018-1.pdf

by

Submission date: 07-Feb-2021 10:35AM (UTC+0700)

Submission ID: 1503357104

File name: Aryu_Proceeding_2018-1.pdf (1.12M)

Word count: 3493

Character count: 16089

Simulation of Fuzzy Logic Based Energy Management for the Home with Grid Connected PV-Battery System

Aryuanto Soetedjo, Yusuf Ismail Nakhoda, Choirul Saleh
 Department of Electrical Engineering
 National Institute of Technology (ITN) Malang
 Indonesia
 e-mail: aryuanto@gmail.com

Abstract—This paper presents the energy management for the home with the grid connected PV-battery system. The fuzzy logic controller is employed to control the power flow delivered to the loads. The objective is to minimize the electricity cost by managing the energy penetration from the PV-battery system to the grid. The fuzzy logic controller is developed in distributed scheme where each load has its own controller. The fuzzy rule is designed by considering the availability of PV power, the state of charge of the battery and the total loads power consumption. The simulation results show that the proposed system achieves a cost reduction of 13.9% compared to the system without the fuzzy logic controller.

Keywords—energy management; grid connected; PV-battery; fuzzy logic controller

I. INTRODUCTION

Recently the smart grid, a new technology in electricity system, becomes the popular and challenging topics. The smart grid integrates the information communication technology, electronics, sensors, control system, renewable energies into the electricity system. The main components of smart grid are [1]: a) power grid; b) renewable energy generation; c) energy storage; d) demand side management.

From the view point of residential consumer, the smart grid enables us to manage the home energy consumption by considering the electricity costs, the availability of renewable energy and energy storage, and the characteristic of households. In [1], the Lyapunov optimization technique was employed to reduce the electricity cost for residential customer. The idea is by saving the surplus energy from PV to battery, charging the battery when the electricity price is low, and discharging the battery when the electricity price is high.

The energy management system for grid-connected hybrid PV-battery system was developed in [2]. The method consists of two control strategies, i.e. the open loop and closed loop. The open loop optimization control is employed to manage the hourly power flow over a day in order to minimize the electricity cost. The optimization problem is solved using the linear programming. The closed loop model predictive control is employed to handle the disturbances of predicted load demands.

A day-ahead energy management system was proposed in [3] for minimizing the total operating costs in the day-

ahead. The optimization problem is formulated using a mixed-integer nonlinear programming. The optimal solution is formed by load shifting and controlling the battery charging/discharging.

A method to predict the load power consumption and PV generation was developed in [4]. The prediction is employed in the house with storage controller for minimizing the peak load. The global approach is used to figure out the next charging/discharging scenario. To compensate for the prediction error, the local approach is adopted.

The energy management based-on the fuzzy logic controllers (FLCs) were proposed in [5-10] as summarized in Table 1.

TABLE I. FLC-BASED ENERGY MANAGEMENT SYSTEMS

No.	Objective	Fuzzy input variables	Fuzzy output variable	Ref.
1	Manage energy from PV according to load priority	Difference between PV power and consumption power, and state of charge (SOC) of battery	Probability to start the loads	[5]
2	Control power delivered from grid, PV and energy storage	Difference between generated power and consumption power, SOC of battery, and electricity price	Amount power extracted from grid	[6]
3	Minimize electricity cost while smoothing the peak load	Day, time, electricity consumption in the past, inside temperature in the past, outside temperature in the past, and predicted temperature.	Short term load consumption	[7]
4	Maximize energy consumption from PV and reducing energy supply from grid	Electricity price and load power	Signal control to switch-on/off grid and PV	[8]
5	Optimize charging/discharging time	Electricity price and the SOC of battery	Rate of battery charging/discharging	[9]
6	Reducing peak demand, minimizing electricity cost and increasing the comfort level	The scheduled time of appliances and the consumer feedback	The new scheduled time	[10]

As discussed previously, there is no general approach to apply the FLC in the home energy management system. Generally the FLC is developed according to the particular situation and the specific objective. In this paper, we deal with the home energy management system with the grid connected PV-battery system based-on the FLC. Our framework is similar to [5], however instead of controlling the group of loads according to the category, our approach treats the load individually. It provides more flexibility to control the load in the distributed control architecture. Fortunately, the FLC might be implemented in a low cost hardware mounted on each load.

The rest of paper is organized as follows. Section 2 presents the proposed system. Section 3 discusses the simulation results. Finally, conclusion is covered in Section 4.

II. PROPOSED SYSTEM

A. Overview of Proposed System

The architecture of our proposed system is illustrated in Fig. 1, in which only the electrical parts are shown. It consists of the grid, the PV-battery system, the grid-tie inverter, the loads, and the power switches. In this work it is assumed that the grid is always connected to the AC bus. The objective of energy management is to minimize the electricity cost by controlling the power from the PV-battery system. As shown in the figure, the PV-battery system adopted here is the cascade configuration, where the PV cannot inject the energy to the grid directly, but it is used to charge the battery. Then the battery delivers the energy to the grid through a grid-tie inverter.

The loads consist of the refrigerator, the lighting, the washing machine, the iron, the fan, and the TV. Since the operation time of refrigerator and lighting cannot be shifted, they are not controlled. Thus there are no power switches from the grid to them. As shown in the figure, there are five power switches, i.e. four power switches for controlling the power flow from the grid to the loads and one power switch for controlling the power flow from the battery to the grid.

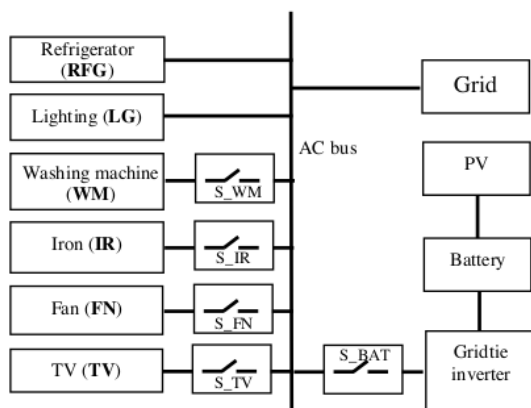

Figure 1. Architecture of proposed system – Electrical part.

The main idea of our proposed energy management is described as follows. In the grid connected PV-battery system, the energy from the battery is used to reduce the electricity cost from the grid. Since the battery is charged by the PV system, the battery charging/discharging should be controlled properly. For example, when the weather is sunny and all loads consume the power, i.e. all loads are switched-on, then the control decision should be made whether to charge the battery or discharge the battery. To accomplish this task, we employ the FLC as described in the next section.

B. Proposed Fuzzy Logic Controller (FLC)

The proposed FLC is illustrated in Fig. 2. In this work we only consider six loads as shown in Fig. 1. However the approach could be extended accordingly. As shown in the figure each module has its own FLC. The input variables of the FLC are the SOC of battery and the load power, while the output variable of FLC is the status of power switch.

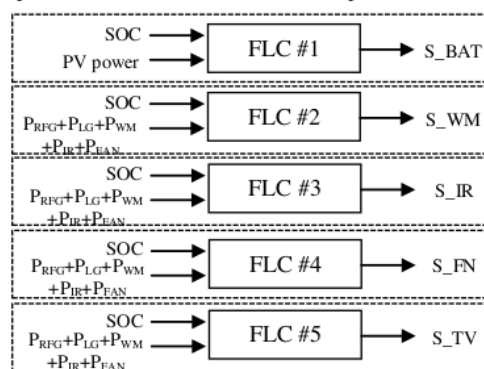

Figure 2. Architecture of proposed FLC.

The membership function of SOC variable is shown in Fig. 3. All SOC variables in the system (FLC #1 to FLC #5) use the same membership function. The membership function of PV power and S_BAT variables are shown in Fig. 4 and Fig. 5 respectively.

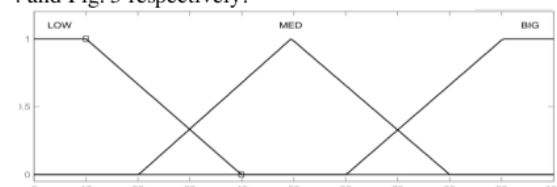

Figure 3. Membership function of SOC variable.

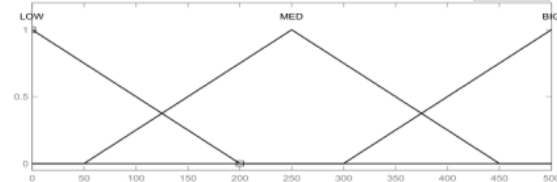

Figure 4. Membership function of PV power variable.

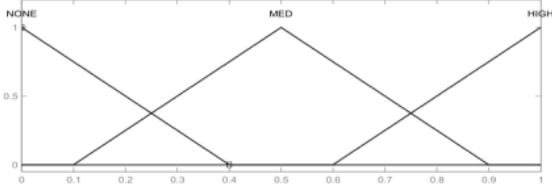

Figure 5. Membership function of S_BAT variable.

TABLE II. FUZZY RULE FOR FLC #1

PV power	SOC		
	Low	Med	Big
Low	None	Med	High
Med	Med	Med	High
Big	Med	High	High

The fuzzy rule for FLC #1 is given in Table 2. The rule is defined according to the objective as described previously. For examples:

- *IF PV power is Low AND SOC is Low THEN S_BAT is None.*
It means that when there is not enough power from the PV and the battery capacity is low (or empty) then the battery will be disconnected from the grid, i.e. power switch will be OFF.
- *IF PV power is Low AND SOC is Big THEN S_BAT is High.*
It means that when there is not enough power from the PV and the battery capacity is high (or full) then the power switch will be ON, i.e. battery is connected to the grid.

Since the FLC #2 to FLC #5 are developed in the similar fashion, only the FLC #2 is described here. The membership function of $(P_{RFG}+P_{LG}+P_{WM}+P_{IR}+P_{FAN})$ and S_WM variables are shown in Fig. 6 and Fig. 7 respectively. The $(P_{RFG}+P_{LG}+P_{WM}+P_{IR}+P_{FAN})$ variable is the total power consumed by the loads, except the TV. It is noted here that the power of TV is not considered as the input variable due to the fact the TV is a non-essential load.

The fuzzy rule for FLC #2 is given in Table 3. Some rules are discussed below:

- *IF $(P_{RFG}+P_{LG}+P_{WM}+P_{IR}+P_{FAN})$ is Low AND SOC is Big THEN S_WM is High.*
It means that when the total power consumption is low and the battery is full then the washing machine will be switched on.
- *IF $(P_{RFG}+P_{LG}+P_{WM}+P_{IR}+P_{FAN})$ is Big AND SOC is Big THEN S_WM is Med.*
It means that when the total power consumption is high and the battery is full then the probability to switch on the washing machine is medium because in this condition if the battery is connected to the grid then it will be discharged quickly due to the high power consumption.

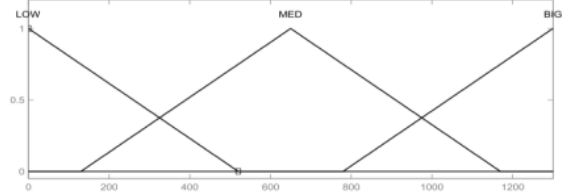

Figure 6. Membership function of $(P_{RFG}+P_{LG}+P_{WM}+P_{IR}+P_{FAN})$ variable.

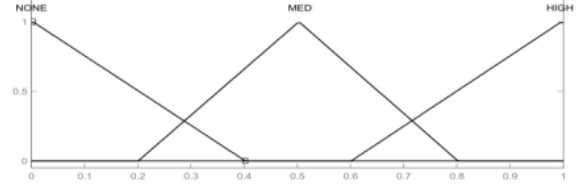

Figure 7. Membership function of S_WM variable.

TABLE III. FUZZY RULE FOR FLC #2

$P_{RFG}+P_{LG}+P_{WM}+P_{IR}+P_{FAN}$	SOC		
	Low	Med	Big
Low	None	Med	High
Med	None	Med	Med
Big	None	None	Med

III. SIMULATION RESULTS

The proposed system is simulated using MATLAB Simulink. In the simulation, the data of load profiles are given in Table 4. It is assumed here that for simplicity the iron is operated one hour every day. The capacities of the grid system, the PV system and the battery are 1300 Watt, 500 Watt and 100 Ampere hour (Ah) respectively. Three scenarios are used to verify the algorithm, where Scenario-1, Scenario-2 and Scenario-3 use the profile of PV power as given in Table 5, Table 6 and Table 7 respectively. In each scenario, we conduct two methods as below:

- **Without FLC:** The system runs without the FLC. The loads are assumed to be operated as follows. The washing machine (WM) is operated from 05:00 to 06:00. The iron is operated from 05:00 to 06:00. The fan is operated from 10:00 to 18:00 (80 Watt per hour). The TV is operated from 17:00 to 24:00 (40 Watt per hour). In this method, the PV will deliver the energy to the grid whenever available.
- **With FLC:** The system runs with the FLC. The operation times of the controlled loads are determined automatically by the FLC.

It is noted here that the refrigerator and the light are always switched on according to the specification given in Table 4. They are not controlled by the FLC. However their power consumptions are considered in the fuzzy inference. The starting time of the washing machine, the iron, the fan and the TV are determined by the FLC according to the current condition of the PV power, the SOC and the total power consumptions. However the duration of operation

follows the specification given in the table. In addition, the power consumed by the fan is determined by the FLC. In this case, it is divided into three conditions: low power (40 Watt), medium power (60 Watt) and high power (80 Watt).

TABLE IV. LOAD DATA

Load name	Consumption power	Duration of operation	Time range of operation
Refrigerator	100 Watt	24 hours	00:00-24:00
Lighting	200 Watt	12 hours	18:00-06:00
Washing machine	400 Watt	1 hour	05:00-21:00
Iron	350 Watt	1 hour	05:00-21:00
Fan	40 – 80 Watt	NA	00:00-24:00
TV	40 Watt	NA	00:00-24:00

To simplify the calculation of electricity cost, we only consider the cost of electricity, where the price of 1Watt hour is IDR 1.467. The calculation of electricity costs are given in Table 8, where the costs are calculated during a day.

TABLE V. THE PROFILE OF PV POWER IN SCENARIO-1

Time	PV Power	Time	PV Power	Time	PV Power
1	0 Watt	9	200 Watt	17	50 Watt
2	0 Watt	10	300 Watt	18	0 Watt
3	0 Watt	11	400 Watt	19	0 Watt
4	0 Watt	12	600 Watt	20	0 Watt
5	0 Watt	13	500 Watt	21	0 Watt
6	0 Watt	14	400 Watt	22	0 Watt
7	0 Watt	15	300 Watt	23	0 Watt
8	100 Watt	16	100 Watt	24	0 Watt

TABLE VI. THE PROFILE OF PV POWER IN SCENARIO-2

Time	PV Power	Time	PV Power	Time	PV Power
1	0 Watt	9	200 Watt	17	0 Watt
2	0 Watt	10	300 Watt	18	0 Watt
3	0 Watt	11	400 Watt	19	0 Watt
4	0 Watt	12	400 Watt	20	0 Watt
5	0 Watt	13	300 Watt	21	0 Watt
6	0 Watt	14	300 Watt	22	0 Watt
7	0 Watt	15	200 Watt	23	0 Watt
8	100 Watt	16	0 Watt	24	0 Watt

TABLE VII. THE PROFILE OF PV POWER IN SCENARIO-3

Time	PV Power	Time	PV Power	Time	PV Power
1	0 Watt	9	200 Watt	17	0 Watt
2	0 Watt	10	200 Watt	18	0 Watt
3	0 Watt	11	200 Watt	19	0 Watt
4	0 Watt	12	200 Watt	20	0 Watt
5	0 Watt	13	200 Watt	21	0 Watt
6	0 Watt	14	200 Watt	22	0 Watt
7	0 Watt	15	0 Watt	23	0 Watt
8	100 Watt	16	0 Watt	24	0 Watt

TABLE VIII. CALCULATION OF ELECTRICITY COST

	Scenario-1		Scenario-2		Scenario-3	
	No FLC	FLC	No FLC	FLC	No FLC	FLC
Energy Consumption - a day (Wh)	6470	6570	6470	6310	6470	5810
Energy from Grid - a day (Wh)	4860	4370	5190	4470	5370	4950
Energy from PV-Battery - a day (Wh)	1610	2200	1280	1840	1100	860
Total Cost (IDR)	7130	6410	7614	6557	7878	7262
Cost Reduction (%)	NA	10.1	NA	13.9	NA	7.8

From Table 8, it is obtained that the electricity costs of methods with the FLC (FLC) in three scenarios are lower than the ones without the FLC (No FLC). The highest cost reduction is achieved in Scenario-2, i.e. 13.9%. It is interesting to note that the energy consumption of the method with FLC conforms to the power generated by the PV. In the sense that when the energy from the PV decreases, i.e. from Scenario-1 to Scenario-3, then the energy consumption will decrease accordingly. It is done by switching off the TV (non-essential load) and lowering the power consumption of the fan. The result indicates that the proposed FLC works properly in minimizing the electricity cost.

The profiles of energy consumptions, the generated energy from the PV and battery, and the SOC of battery of Scenario-1 to Scenario-3 are illustrated in Fig. 8 to Fig. 10. Since the refrigerator and the lighting are not controlled by FLC (the energy consumptions are fixed), their profiles are not drawn in the figure.

By examining the figures, we can see that the washing machine and the iron are switched on once the SOC of battery is enough to discharge, thus it will reduce the power extracted from the grid. For example in Fig. 8, it occurs at 10:00. The ability of the FLC for controlling the power shiftable load (the fan) is clearly shown in the figures, where the power consumption of the fan varies according to the availability of PV power. In Fig. 10, since the TV is considered as the non-essential load, it is many switched off due to the fact that the energy from the PV is lower compared to the ones in Fig. 8 and Fig. 9.

IV. CONCLUSION

The home energy management system using the FLC is presented. The FLC is an effective method to handle the optimization problem such as for minimizing the electricity cost in the grid connected PV-battery system. The optimization could be made due to fact that the operation of some loads could be shifted in the time or the power rating. To manage such condition, the fuzzy rule is developed. From

the simulation, it is obtained that the objective of the home energy management could be achieved by the proposed FLC.

In future, the approach will be extended to the larger and complex systems. Further the real implementation will be carried out.

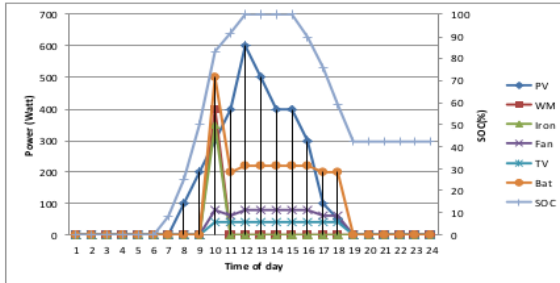

Figure 8. Energy consumption profile of Scenario-1.

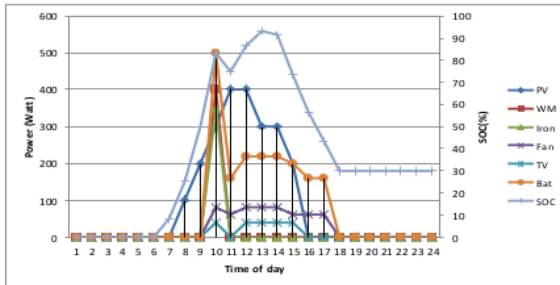

Figure 9. Energy consumption profile of Scenario-2.

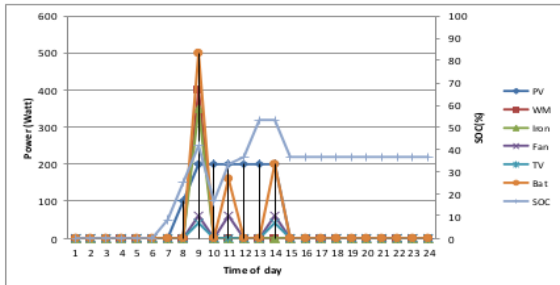

Figure 10. Energy consumption profile of Scenario-3.

1

ACKNOWLEDGMENT

This work is supported by the Research Grant, Excellent Basic Research on Higher Institution scheme from Directorate General of Higher Education, Ministry of Research and Technology and Higher Education, Republic of Indonesia (SP DIPA. 042.06.1.401516/2018)

REFERENCES

- [1] Y. Fang, M. Pan and Y. Guo, "Optimal power management of residential customers in the smart grid," IEEE Transactions on Parallel & Distributed Systems, vol. 23, no. 9, Sep. 2012, pp. 1593-1606, doi:10.1109/TPDS.2012.25.
- [2] Z. Wu, H. Tazvinga and X. Xia, "Demand side management of photovoltaic-battery hybrid system," Applied Energy, vol. 148, June 2015, pp. 294-304, doi:10.1016/j.apenergy.2015.03.109.
- [3] M. F. Shaaban, A. H. Osman and M. S. Hassan, "Day-ahead optimal scheduling for demand side management in smart grids," Proc. European Modelling Symposium (EMS), Nov. 2016, pp. 124-129, doi:10.1109/EMS.2016.031.
- [4] Y. Wang, X. Lin and M. Pedram, "Adaptive control for energy storage systems in households with photovoltaic modules," IEEE Transactions on Smart Grid, vol. 5, no. 2, pp. 992-1001, March 2014.
- [5] F. Chekired, A. Mahrane, Z. Samara, M. Chikh, A. Guenounou and A. Mefflah, "Fuzzy logic energy management for a photovoltaic solar home," Energy Procedia, vol. 134, Oct. 2017, pp. 723-730, doi:10.1109/TSG.2013.2292518.
- [6] L. Yao, C. C. Lai and W. H. Lim, "Home energy management system based on photovoltaic system," Proc. IEEE International Conference on Data Science and Data Intensive Systems, Dec. 2015, pp. 644-650, doi:10.1109/DSDIS.2015.42.
- [7] S. Bissey, S. Jacques and J.C.L. Bunetel, "The fuzzy logic method to efficiently optimize electricity consumption in individual housing," Energies, vol. 10, issue. 11, Oct. 2017, pp. 1-24, doi:10.3390/en10111701.
- [8] A. Chehri and H.T. Mouftah, "FEMAN: Fuzzy-Based Energy Management System for green houses using hybrid grid solar power," Journal of Renewable Energy, vol. 2013, pp. 1-6, 2013.
- [9] S. Zhou, Z. Wu, J. Li and X. Zhang, "Real-time energy control approach for smart home energy management system, Electric Power Components and Systems, vol. 42, issue. 3-4, Feb. 2014, pp. 315-326, doi:10.1080/15325008.2013.862322.
- [10] M. Collotta and G. Pau, "A solution based on bluetooth low energy for smart home energy management," Energies, vol. 8, issue 10, Oct. 2015, pp. 11916-11938, doi:10.3390/en81011916.

ORIGINALITY REPORT

4%

SIMILARITY INDEX

0%

INTERNET SOURCES

4%

PUBLICATIONS

%

STUDENT PAPERS

PRIMARY SOURCES

1

Aryuanto Soetedjo, Abraham Lomi, Yusuf Ismail Nakhoda. "Implementation of optimization technique on the embedded systems and wireless sensor networks for home energy management in smart grid", 2016 IEEE Conference on Wireless Sensors (ICWiSE), 2016

Publication

3%

2

Wu, Zhou, Henerica Tazvinga, and Xiaohua Xia. "Demand side management of photovoltaic-battery hybrid system", Applied Energy, 2015.

Publication

2%

Exclude quotes On

Exclude bibliography On

Exclude matches < 2%