

THE HARMONIZATION OF RED LISTS FOR THREATENED SPECIES IN EUROPE





# The harmonization of Red Lists for threatened species in Europe

Proceedings of an International Seminar in Leiden,  
27 and 28 November 2002

Editors

H.H. de longh  
O.S. Bánki  
W. Bergmans  
M.J. van der Werff ten Bosch

Mededelingen No. 38  
November 2003

**IUCN**  
The World Conservation Union

NETHERLANDS COMMITTEE FOR  
**IUCN**  
THE WORLD CONSERVATION UNION



**CML**  
Institute of Environmental Sciences

NEDERLANDSE COMMISSIE VOOR INTERNATIONALE NATUURBESCHERMING  
Netherlands Commission for International Nature Protection

Secretariaat: dr. H.P. Nooteboom  
National Herbarium of the Netherlands/Hortus Botanicus  
Einsteinweg 2  
POB 9514  
2300 RA Leiden  
The Netherlands

Mededelingen No. 38, 2003  
Editors: H.H. de longh, O.S. Bánki, W. Bergmans and M.J. van der Werff ten Bosch

Lay out: Sjoukje Rienks  
Cover design: Sjoukje Rienks  
Front cover photograph: Common crane (*Grus grus*): F. de Nooyer/Foto Natura  
Back cover photographs: *Tyto alba* (D. Nill/Foto Natura); *Barbus barbus* (W.A.M. Meinderts/Foto Natura); *Podarcis muralis* (W.H. Klomp/Foto Natura); *Cricetus cricetus* (R. Krekels/Foto Natura); *Martes martes* (D. Nill/Foto Natura); *Platalea leucorodia* (D. Elliger/Foto Natura); *Amanita solitaria* (J. Meijvogel/Foto Natura); *Pinguicula vulgaris* (C. Castelijns/Foto Natura)  
Photograph p. 1: *Usnea subflorida* (G.L. de Hoog/Foto Natura)

ISSN 0923-5981

This seminar was held on 27 and 28 November 2002 in Leiden, The Netherlands  
Organisation: Centre of Environmental Science of Leiden University in collaboration with the Netherlands Committee for IUCN and the IUCN Red List Programme  
Sponsors: Van Tienhoven Foundation, Ministry of Agriculture, Nature Management and Fisheries, Institute of Environmental Sciences

Address corresponding editor:  
Hans de longh  
Institute of Environmental Sciences  
POB 9518  
2300 RA Leiden  
The Netherlands  
Tel +31-71-5277431  
e-mail: longh@cml.leidenuniv.nl

## Foreword

Red Lists are a valuable part of our species protection policy. Not only are they important as indicators, they are also vital as a tool for sound and unambiguous communication between governments and all other parties involved in species protection. Dutch species protection policy and the protection plans resulting from it are for a large part based on these Red Lists and the studies underpinning them.

The Wild Birds Directive and the Habitats Directive have given species policy a clear European dimension. However, European species protection policy is impeded by the different ways these Red Lists are being used in the various EU Member States. According to this international seminar 'The Harmonization of Red Lists in Europe' some 3700 Red Lists are in use but the approach, aim and criteria used, vary widely. This does not help communication: it affects the communication between Member States and the communication between Member States and the European Commission. Because of these differences the Red Lists are hardly used during the regular reviews of the annexes to the Wild Birds Directive and the Habitats Directive. It is therefore of importance that the Red List criteria are being harmonised. I think that the new IUCN Categories and Criteria (version 3.1) will go a long way to bringing this harmonisation about. The Netherlands therefore intends to use these new IUCN Categories and Criteria in its future Red List reviews.

I hope that this seminar, the proceedings presented here and the new IUCN Categories and Criteria will lead to a better and more harmonised international species protection policy. The Netherlands would be very happy to contribute to this aim.

Cees Veerman  
Minister of Agriculture, Nature and Food Quality



## Preface



*Perdix perdix* (P.P. de Nooyer/Foto Natura)

The present Proceedings are the results of a European seminar on the harmonization of National Red Lists in Europe held on the 27th and 28th of November 2002, at the National Museum of Natural History (Naturalis) in Leiden, the Netherlands.

The seminar was organised by the Centre of Environmental Science in Leiden and the Netherlands Committee for IUCN in co-operation with the IUCN Red List Programme.

The seminar was attended by more than 90 participants from 23 European countries, most of them involved and interested in nature conservation in Europe, species specialists (botanists and zoologists) who are involved in Red Listing in Europe, European members of the SSC, European members of IUCN, policy makers and politicians.

The objectives of the seminar have been defined as follows:

- 1 to get acquainted with the revised IUCN Red List Categories and Criteria, and the regional application guidelines;
- 2 to exchange experiences with the application of the IUCN Categories and Criteria and the regional application guidelines;
- 3 to discuss recommendations for a better harmonisation of national Red Listing across Europe.

The first day of the seminar was largely devoted to the policy aspects of Red Listing in Europe, with a prominent attention for the European legislation, such

as the Birds and Habitat directives. A main outcome of this first day was, that the over 3,468 regional or national Red Lists identified in Europe show a high variability in purpose, composition, geographic coverage and Categories and Criteria used. Partly as a result of this variability and lack of a consistent approach, Red Lists species are rarely used for European ecological networks and play a modest role in the updating of the annexes of the Habitats and the Birds directives.

During the seminar it became obvious, that harmonization can only be reached on a voluntary basis. Red Lists are often embedded in local legislation and have great political and emotional significance. Changing this system from one day to the other may have large implications. In this context the use of pilots was recommended, to test the new IUCN Categories and Criteria (version 3.1.) on specific taxonomic groups.

During the second day the more technical sessions resulted in specific recommendations for the specialists working with Red Lists.

During the seminar all objectives have been reached and the number of participants resulted in the organisation of two parallel workshops on the second day. The seminar is therefore perceived as a successful meeting, which has contributed significantly to the ongoing discussion on the use of Red Lists for nature conservation in Europe. Special thanks are due to Craig Hilton Taylor and Caroline Pollock of the IUCN Red List Programme and Ulf Gärdenfors



*Calopteryx virgo* (C. Castelijns/Foto Natura)

for their support. I also want to thank the Ministry of Agriculture, Nature Management and Food Quality and the Van Tienhoven Foundation once again for their generous financial support and the organisers for their efforts to realise this event. I wish that a follow-up will be given to the recommendations of this seminar. NC-IUCN and CML will continue to work on the follow-up of these recommendations, with your support.

Doeke Eisma  
Chairman NC-IUCN



# Contents

## Introduction

- H.H. de Iongh, O.S. Bánki, W. Bergmans and  
M.J. van der Werff ten Bosch* 15

## PART I

### Red listing Policy in Europe; results of the plenary workshop

- 1 Opening address 21  
*D. Eisma*
- 2 Welcome address 23  
*H.A. Udo de Haes*
- 3 The relevance of Red Data lists for EU nature policy 25  
*M. O'Briain and A. Rubin*
- 4 The revised IUCN Red List Categories and Criteria: version 3.1 33  
*C. Pollock, G.M. Mace and C. Hilton-Taylor*
- 5 The regional application guidelines 49  
*U. Gärdenfors*
- 6 Inputs of the Netherlands Committee for IUCN and Dutch  
members in the Red List process 57  
*W. Ferwerda*
- 7 A statistical survey on European Red Lists 59  
*C. Köppel, F. Jansen, J. Burton, M. Schnittler and N. Hirneisen*
- 8 Red Listing in Portugal with the new IUCN criteria:  
state of the art 77  
*L. Rogado*
- 9 Red Listing policy in the Netherlands 87  
*P. Joop*

|    |   |    |
|----|---|----|
| 10 | Ecological networks and the protection of Red List species<br><i>G. Bennett</i> | 91 |
| 11 | Summary of discussion<br><i>O.S. Bánki and H.H. de Iongh</i>                    | 97 |

## PART II

### Workshop Session I

|    |  |     |
|----|--|-----|
| 12 | Threat descriptors and extinction risk – The Austrian Red List concept<br><i>K.P. Zulka, E. Eder, H. Höttinger and E. Weigaard</i>   | 103 |
| 13 | Red Lists in Flanders: scale effects and trend estimates<br><i>L. de Bruyn, A. Anselin, D. Bauwens, S. Colazzo, K. Devos, D. Maes, G. Vermeersch and E. Kuijken</i>          | 111 |
| 14 | Red List of reptiles and amphibians in the Netherlands<br><i>R. Creemers</i>   | 121 |
| 15 | Red Listing in Estonia<br><i>V. Lilleleht</i>  | 127 |
| 16 | Red Listing' birds in the UK: A provisional comparison of 'The population status of birds in the UK' with the IUCN regional guidelines<br><i>M.A. Eaton and R.D. Gregory</i> | 137 |
| 17 | Red Listing of birds in Germany<br><i>H.G. Bauer</i>   | 149 |
| 18 | Red Listing of freshwater fishes and lampreys in the Netherlands<br><i>H. de Nie</i>   | 159 |
| 19 | The Red List 2002 of Swiss dragonflies; First attempt to use IUCN Categories and Criteria for invertebrate species in Switzerland<br><i>Y. Gonseth</i>                       | 169 |
| 20 | Summary of discussion<br><i>H.H. de Iongh</i>  | 177 |

### **PART III**

#### **Workshop session II**

- 21 Possible consequences of the new IUCN regional guidelines for a Red List of vascular plant species in the Netherlands 181  
*W.L.M. Tamis, B. Odé and J.P.M. Witte*
- 22 Harmonization of Red Lists in Europe: some critical fungi species from Italy 195  
*G. Venturella, A. Bernicchia, V.F. Marchisio, A. Laganà, S. Onofri, G. Pacioni, C. Perini, C. Ripa, A. Saitta, E. Salerni, E. Savino, A. Vizzini, M. Zotti and L. Zucconi*
- 23 Demographic, phytogeographic and state-of-habitat study on eight Red-Listed taxa of central-southern Italian vascular flora: early data 205  
*E. Givó, G. Abbate and M. Iberite*
- 24 Applying Red List criteria in Flanders (North Belgium) 217  
*D. Maes, L. de Bruyn and E. Kuijken*
- 25 Red Lists and Red Data Books in North-West Russia: intents, approaches and realities! 225  
*A. Zavarzin, O. Krever, R. Sagitov and V. Petrov*
- 26 Basis of standard classification of habitat types and threats in Red Lists: Examples from Norway 235  
*F. Ødegaard*
- 27 A preliminary Red List of Sicilian bryophytes 241  
*P. Campisi, P. Aiello and M.G. Dia*
- 28 Summary of discussion 275  
*O.S. Bánki*

### **PART IV**

#### **Conclusions and recommendations**

- 29 Summary of plenary discussion, conclusions and recommendations 283  
*H.H. de Jongh, W. Bergmans, M.J. van der Werff ten Bosch and O.S. Bánki*

## **PART V**

### **Annexes**

- 1 The Context of Red Data books, with a complete bibliography  
of the IUCN publications 291  
*J.A. Burton*
- 2 Critical review of modern systems of biodiversity extinction  
risk categories and the problem of their adaptation 301  
*A.V.A. Kreuzberg*
- 3 Biodiversity status survey and extinction risk assessment in  
the Republic of Uzbekistan 313  
*A.V.A. Kreuzberg, A.E. Kreuzberg-Mukhina and A.E. Bykova*

## **PART VI**

**Overview of Red Lists** 319

**Progress on the European Red List of vascular plants** 329

**List of addresses of corresponding authors** 331



*Pinguicula vulgaris*  
(C. Castelijns/Foto Natura)



*Podarcis muralis* (W.H. Klomp/Foto Natura)



*Cricetus cricetus* (R. Krekels/Foto Natura)



*Bufo calamita* (C. Castelijm/Foto Natura)

# Introduction

*H.H. de Iongh, O.S. Bánki, W. Bergmans  
and M.J. van der Werff ten Bosch*

## BACKGROUND

In 1998 the Centre of Environmental Science (CML), together with the Netherlands Committee for IUCN (NC-IUCN), the Wageningen University Research Centre and the National Herbarium of the Netherlands, organised a seminar on Species Conservation, with the aim to discuss and review the new IUCN Categories and Criteria (C&C) of threatened species. Although this represented a modest contribution in the review process, some sixty experts took part in this workshop, among them were employees of ministries, institutes and universities, the Director-General and staff members of IUCN International and Dutch members of the Species Survival Commission (SSC).

Although the Red List Workshop of 1998 focused mainly on a review of the new global C&C of IUCN, a number of specific recommendations relevant for national and European Red Lists were also formulated (De Iongh and Prins 1999).

The Finnish National Committee for IUCN organised a first European workshop on Red List criteria on 1-3 October 2001, in Helsinki. An important conclusion of this workshop was the need for more harmonization within Europe, where many countries still use different Categories and Criteria for establishing the national Red Lists. The Seminar on 27 and 28 November in Leiden builds further on the results of the Helsinki workshop.

## NEW IUCN CRITERIA AND CATEGORIES

The reason for establishing Red Lists is to show the risk of extinction of a species. Since the new IUCN Categories and Criteria were developed in 1997 an extensive review has been done, and a considerable number of adjustments were made, partly as a result of a resolution of the World Conservation Congress in Amman (2000).

The IUCN Red List Programme in Cambridge indicated that IUCN, for the years to come, wants to hold on to the present set of categories and criteria, and does not want any changes for the sake of consistence and comparability. It is proposed to update the Global Red List every year. As for the Re-

gional Application Guidelines, simple definitions were chosen for concepts such as population, sub-population, generation, reduction, extreme fluctuations, area of residence etc. These guidelines are mainly intended to evaluate the position of species on a national Red List in the light of the status of that species in the region. In this case they are taking into account the populations in adjacent areas. By applying these guidelines an upgrading or downgrading of the species could be considered. For these regional application guidelines a protocol has been developed that consists of a number of steps. The existing status of a species is tested using criteria like life history, habitat specialisation and reproduction ecology in a regional or local setting and consequently upgrading or downgrading may take place.

## RESULTS OF THE RED LIST WORKSHOPS

In 1998 the Dutch Ministry of Agriculture, Nature Management and Fisheries had officially published five national Red Lists (*mammals, birds, butterflies, reptiles and amphibians*, and *mushrooms*). These Red Lists had been established on the basis of national criteria and categories (especially the occurrence in 'atlas quadrates' and 'trends' with reference to the 1994 IUCN C&C). In the Dutch workshop of 1998 it was therefore recommended that new Red Lists should be published, preferably with the use of the new IUCN C&C. Another four Red Lists were published in the Netherlands after 1998 (*lichens, dragonflies and grasshoppers* in April 1998 and *freshwater fish* in June 1998). For the evaluation of these Red lists also national criteria were used.

A pilot, to test the added value of the new IUCN C&C with the review of the Dutch Red List for birds is under way. Based on this pilot conclusions will be drawn on the feasibility to use the IUCN C&C for Dutch Red Listing.

At the time of the Dutch workshop of 1998 many national Red Lists in Europe were not acquainted with the use of the new IUCN C&C. During the European Red List workshop in 2001 it was suggested that the existing national Red Lists could be reviewed with the new IUCN C&C, aiming at a better qualitative support and harmonization with other national, regional and global Red Lists. Although in the meantime more and more European countries have started using the new IUCN C&C (for example Finland, Sweden, Switzerland, UK), a substantial number of countries, among them the Netherlands, still make use of their own criteria. The Netherlands at the moment follows a policy to use both Red Lists and target species and, as said earlier, have started a pilot to test the use of the new IUCN Categories and Criteria.

In practice problems are encountered with the species listed in the annexes of the EU Habitats and Birds Directives, which do not occur on some national



Red Lists in Europe. These annexes comprise several species which are common in some European countries and therefore are not found on the national Red Lists. A stronger link between species listed in the annexes of the Habitats and Birds Directives with national Red Lists can be achieved during the periodical review of the annexes. During the European Red List workshop in Helsinki a plea was made for more harmonization within Europe, under the present Conventions and with the European legislation.

For a number of species on national Red Lists the application of these new IUCN Categories and Criteria and the regional guidelines imply a change of status. Tests have been done on a pilot scale with individual species of mammals, birds, vascular plants, mosses and lichens, resulting in downgrading or upgrading on the existing Red Lists.

#### INTERNATIONAL HARMONIZATION OF RED LISTS

Because the Red Lists are often referred to in national legislation an international harmonization of these lists in the European framework will only become more important. However there is resistance as well and it can only be achieved on a voluntary basis and with convincing arguments. This harmonization can take place in several ways. 1) The present Red Lists can be tested to the international Categories and Criteria (as is already happening in a few European countries such as Norway, Sweden, Finland, Switzerland and others). 2) Additional lists can be established for populations of international (European) importance. 3) A third option would be the upgrading or downgrading of species on national Red Lists, depending on their status in Europe. IUCN has already developed a protocol for the latter. However, it should be avoided that nationally threatened species (and subspecies) lose their national Red List status and their protective measures with it because the species has several vital populations still elsewhere in Europe. In this respect the political significance of national Red Lists is stressed.

In practice, additional lists to a national Red List are being used already in some cases (e.g. the Netherlands, Germany, UK). As for the upgrading or downgrading of species, it is recommended that national Categories and Criteria will be updated and related to the newest IUCN Categories and Criteria in the near future. It is also recommended that, instead of reviewing the present Red Lists every 15 years, yearly updates will take place and the results made available on websites.

## REFERENCES

- IONGH, H.H DE and H.H.T. PRINS, 1999. International Seminar on Species Conservation; the IUCN Red List categories discussed. Nederlandsche commissie voor Internationale Natuurbescherming, Mededelingen No. 33.

## PART I

### Red Listing policy in Europe; result of the plenary workshop



Martes martes (D. Nill/Foto Natura)



# 1

## Opening address

*D. Eisma*

On behalf of the Netherlands Committee for IUCN, the Center for Environmental Science, and the IUCN Red List Programme, I would like to welcome you to this seminar. I not only welcome the participants of the 15 member states of the EU, but also give a hearty welcome to the participants from the accession countries. Together we are the future of Europe.

First of all I would like to thank the Dutch ministry of Agriculture, Nature Management and Fisheries and the Netherlands Foundation for International Nature Conservation (Van Tienhoven Foundation), who made this symposium possible.

Prof. Udo de Haes will take the floor after me and will explain you about the contribution of the Center of Environmental Science to this seminar.

I want to tell you something about the Netherlands Committee for IUCN, which is a platform for the Dutch members of IUCN and the Dutch members of the six International Commissions of IUCN, including the Species Survival Commission.

The Dutch State, as an IUCN member, has an observer status in the Committee.

If I would have more than 5 minutes, I would have spoken more in detail about the activities and the successes of our National Committee.

When Achim Steiner – Director General of IUCN – travelled from Gland (HQ) to visit Brussels and The Hague last October, he was convinced that the Red Lists in Europe must be harmonized.

In 1998 NC IUCN initiated together with CML, the Wageningen University and the National Herbarium of The Netherlands a Red List workshop, aimed at providing an input to revision of the global Categories and the Criteria of IUCN.

During this workshop also some recommendations were made for national and European Red Lists.

A workshop organized by the Finish National Committee for IUCN in 2001 addressed the European national Red Lists and one of the most important conclusions made was the necessity for more harmonization of Red Lists in Europe.

I would like to stress the tremendous importance of Red Lists for communication purposes for governments, the private sector and the wider pub-

lic, and I am confident that this symposium will bring the process of harmonization of Red Lists a step further.

Today we are focusing on the policy part of European harmonization of national Red Lists. Tomorrow there will be a more technical session. Please focus your remarks and questions in those different directions today and tomorrow.

The speakers will follow these guidelines and I hope that the participants will do the same.

We are very satisfied to have so many participants attending this seminar.

Not only the quantity, but above all the quality of the speakers makes me very eager to start this symposium.

I now give the floor to Helias Udo de Haes, who is Scientific Director of the Center of Environmental Science.

# 2

## Welcome address

*H.A. Udo de Haes*

Dear participants, keynote speakers and guests,

On behalf of the Centre of Environmental Science, together with the Netherlands Committee for IUCN and the IUCN Red List Programme the co-organiser of this international seminar, I would like to give you a warm welcome in Leiden.

Doeke Eisma, Chairman of NC-IUCN has already expressed his gratitude to the sponsors of this seminar and I would like to add my appreciation to the Director and staff of Naturalis, who have given us the opportunity to organise this seminar in the accommodation of the National Museum of Natural History, Naturalis.

I certainly hope that you will have an opportunity to explore the treasures of the museum, which was established on 9 August 1820, then including three existing collections: the old collection of Louis Napoleon, the taxonomic collection of Leiden University, the oldest university in the Netherlands, and a private bird and mammal collection of the founder of the museum, mr. C.J. Temminck.

These old collections are still preserved but of course were extended in the period that followed and the museum now also has a very attractive public display and a large international bookshop.

If you will attend the training workshop on Friday, you will also have an opportunity to visit the National Herbarium of the Netherlands, which also harbours the oldest herbarium collections in the Netherlands, with special reference to collections from South East Asia.

Leiden is called with right 'the museum city' and if you have more time, you may as well visit other museums such as the Museum of Anthropology and the Museum of Archeology.

The Centre of Environmental Science has been a member of the World Conservation Union since its early years and one of the founding fathers of CML, Prof. Kuenen, was also one of the first presidents of IUCN. In this spirit, CML has been an active member of the Netherlands Committee for IUCN, contributing to activities of the Committee and to the network of the Species Sur-

vival Commission in particular. CML co-hosted an international workshop as an input in the development of the new IUCN Categories and Criteria for Global Red Listing in 1998, together with NC-IUCN and the National Herbarium of the Netherlands. CML also contributes to the national monitoring programme of vascular plants of the Floron Foundation and is involved in several field programmes for the conservation of endangered species, for instance a strategy to protect the lion in West and Central Africa.

The main objective of this seminar is to discuss the application of the new IUCN Categories and Criteria for Red Listing and to achieve more harmonization of Red Listing in Europe. Observing that today some 90 participants from 19 European countries have gathered in Leiden to discuss these issues, I am convinced that some progress will be made for the benefit of Nature Conservation in Europe.

I wish you all a very fruitful seminar and I hope that you will enjoy your stay in Leiden.



# 3

## The relevance of Red Data Lists for EU nature policy

*M. O'Briain and A. Rubin*

Red Data Lists, which identify species of high conservation concern, are valuable tools to assist the setting of priorities for conservation action. IUCN has played the leading role in developing and refining these lists as well as the scientific criteria underpinning them. It is therefore important that there is good understanding of the new revised IUCN Red List Categories and Criteria and regional guidelines for their application. This should provide the basis for a more harmonized approach to the development of Red Lists at European, national and sub-national levels. The European Commission is an end user of Red Lists, which are very relevant to the evolving EU nature and biodiversity policy.

In this presentation the EU policy context for nature and biodiversity is outlined. The key role played by the Birds and Habitats Directives, together with the different listings of species and habitat types that they contain, is explained. The experiences in adapting these listings, including those linked to the present enlargement of the EU, is described. Current relevant priorities for the protection of species and habitats are highlighted. Some final considerations in relation to Red Lists are given.

### THE EU POLICY CONTEXT

Nature and Biodiversity represents a key component of EU environmental policy and has been identified as one of the four priorities under the 6th EU Environmental Action Programme.<sup>1</sup> This is in the context of the overall goal to halt the decline of biodiversity by 2010, established by the European Council at Göteborg, Sweden, in June 2001. The EU action programme also em-

---

<sup>1</sup> Environment 2010: Our future, our choice. The sixth EU environment action programme 2001-2010. Office of Official Publications of the European Communities. ISBN 92-894-0652-6. Decision No 1600/2002/EC of the European Parliament and of the Council of 22 July 2002 laying down the Sixth Community Environment Action Programme. Official Journal Series L No. 242 of 10/9/2002.

phases the need for a strong science base to inform the development of environment policy.

The key nature and biodiversity objectives listed under the programme include measures for the protection or restoration of nature and biodiversity from damaging pollution, for conservation of marine and wetland areas, for species and habitat conservation, especially to avoid habitat fragmentation and for the promotion of the sustainable use of soil.

These objectives are to be pursued by a series of priority actions, taking account of the principle of subsidiarity and based on existing global and regional conventions and strategies as well as the full implementation of the relevant EU acts. One of the priority actions is 'encouraging coherent assessment, further research and co-operation on threatened species'.<sup>2</sup>

The EU is a party to the Convention on Biological Diversity. With a view to fulfilment of its obligations under this convention an EU biodiversity strategy has been prepared as well as four EU action plans.<sup>3</sup> One of these plans is focused on natural resources; the others deal with integration of biodiversity into other relevant policy sectors, notably agriculture, fisheries and development aid.

The EU is also party to a number of other international conventions and derived agreements, including the Bern, Bonn and Washington (CITES) Conventions. The Member States and the Commission try to ensure that there is consistency at EU level between the listings under the different international agreements and EU Directives. Any changes to these conventions that may have implications for the EU are carefully examined.

## THE BIRDS AND HABITATS DIRECTIVES

The key instruments at EU level for nature protection are Council Directive 79/409/EEC on the conservation of wild birds<sup>4</sup> (commonly referred to as the 'Birds Directive') and Council Directive 92/43/EEC on the conservation of natural habitats and of wild fauna and flora<sup>5</sup> (the so called 'Habitats Directive'). Unlike some other international laws, which do not have a strong

---

<sup>2</sup> Article 6 paragraph 2 (a) of Decision No 1600/2002/EC.

<sup>3</sup> In February 1998, the European Commission adopted a Communication to the Council and the European Parliament on a European Community Biodiversity Strategy (COM(1998) 42 final). The Council endorsed the Strategy in June (Council Conclusions of 21 June 1998), as did the Parliament in October (European Parliament. Non legislative resolution A4-0347/98) of the same year. The Strategy foresaw the preparation of Action Plans of a sectoral and cross-sectoral nature to ensure implementation of the Strategy objectives. In March 2001, the Commission adopted a Communication to the Council and the European Parliament on Biodiversity Action Plans in the areas of Conservation of Natural Resources, Agriculture, Fisheries, and Development and Economic Co-operation (COM(2001)162 final. Volumes I-V).

<sup>4</sup> Official Journal No. L 103, 25.04.1979, p. 1.

<sup>5</sup> Official Journal No. L 204, 22.07.1992, p. 7.

enforcement basis, the nature directives are legally powerful tools for the integration of nature into other policy areas. The directives aim to conserve species and habitats that have been identified as being of European Conservation interest, especially through site protection under the NATURA 2000 ecological network. They also contain strict species protection provisions. A comparison of some of the key provisions of the two directives is given in Table 1.

**Table 1** – Some key provisions of the Birds and Habitats Directives

| <b>Birds Directive</b>  | <b>Habitats Directive</b>  |
|---|--|
| <ul style="list-style-type: none"> <li>• All bird species protected</li> <li>• No priority bird species (but indicative list for Life-Nature funding)</li> <li>• EU territory treated as a whole</li> <li>• Habitat conservation measures (including designation of Special Protection Areas)</li> <li>• Species protection provisions including regulated hunting and trade for a limited number of species</li> </ul> | <ul style="list-style-type: none"> <li>• Only species and habitat types of EU interest</li> <li>• Priority habitats/species - for which EU has particular responsibility</li> <li>• EU divided into different Biogeographical regions</li> <li>• Site protection measures (mainly through designation of Special Areas of Conservation)</li> <li>• Species protection and management provisions</li> </ul> |

Both directives are complemented by a set of annexes, which primarily relate to listings of taxa for which specific objectives are to be achieved under the directives (Table 2). As regards threatened and vulnerable species these are primarily covered by Annex I of the Birds Directive and Annexes II and IV of the Habitats Directive. Annex I of the Birds Directive lists 181 species. Annex II and IV of the Habitats Directive list about 700 and 820 species respectively.

Species are listed in Annex I of the Birds Directive and Annex II and IV of the Habitats Directive primarily because they are considered to have an unfavourable conservation status at European level by being endangered, vulnerable or rare. Article 4(1) of the Birds Directive and Article 1(g) of the Habitats Directive present definitions corresponding to these categories of interest (Table 3). Whereas the Birds Directive does not provide a category explicitly mentioning ‘endemic species’ a number of the endemic species and sub-species are listed in Annex I of this directive.

**Table 2 – Purpose of different Annexes to Birds and Habitats Directives**

| Birds Directive  | Habitats Directive   |
|--|--|
| <ul style="list-style-type: none"> <li>• <b>Annex I</b> – bird species in need of special habitat protection measures including site designation</li> <li>• <b>Annex II</b> – huntable birds (II.1 huntable in all Member States: II.2.in indicated Member States)</li> <li>• <b>Annex III</b> – tradable birds (III.1.in all Member States: III.2.only for indicated Member States)</li> <li>• <b>Annex IV</b> – prohibited methods of capture/killing/transport</li> </ul> | <ul style="list-style-type: none"> <li>• <b>Annex I</b> – habitat types in need of site protection</li> <li>• <b>Annex II</b> – species in need of site protection</li> <li>• <b>Annex III</b> – criteria for site selection</li> <li>• <b>Annex IV</b> – strictly protected species</li> <li>• <b>Annex V</b> – exploited species subject to management</li> <li>• <b>Annex VI</b> – prohibited methods of capture/killing/transport</li> </ul> |

**Table 3 – Definitions of species of European conservation interest in Birds and Habitats Directives**

| Birds Directive   | Habitats Directive   |
|---|--|
| <ul style="list-style-type: none"> <li>• in danger of extinction</li> <li>• vulnerable to specific changes in their habitat</li> <li>• rare because of small populations or restricted local distribution</li> <li>• requiring attention for reasons of the specific nature of their habitat</li> </ul> | <ul style="list-style-type: none"> <li>• endangered</li> <li>• vulnerable (likely to become endangered)</li> <li>• rare (small populations at risk)</li> <li>• endemic requiring particular attention</li> </ul> |

The listings in the annexes are mainly focused at the species level but do include sub-species, where it is considered that these are of particular conservation concern. Examples include the Greenland White-fronted Goose (*Anser albifrons flavirostris*) in Annex I of the Birds Directive and the Dutch sub-species of the Root Vole (*Microtus oeconomus arenicola*) in Annexes II and IV of the Habitats Directive. The lists in the annexes of the Habitats Directive in some cases focus on groups of species (e.g. bats are listed as Microchiroptera in Annex IV of the directive).

As regards the Habitats Directive certain species are only covered by Annex II (e.g. *Vertigo* snails) or Annex IV (many bat and cetacean species), underlining the different emphasis or possibilities for their conservation under the directive. Some species groups such as invertebrates are poorly repre-

sented or not covered at all under existing species lists. For example lichens and fungi do not feature under the Habitats Directive. Up to now the emphasis has been on the conservation of different listed habitat types as a basis for also conserving the habitats of these species groups.

The Habitats Directive also identifies species of 'priority' conservation interest in its Annex II. These are threatened species for which the European Union has particular responsibility given that a large proportion of their natural range falls within EU territory. Sites with priority habitat types and species are given a higher level of protection under the directive than non-priority interests. There is no legal priority list under the Birds Directive but an indicative list of species has been prepared for the purpose of defining priorities for funding under the LIFE Regulation.

There are also some limited geographical restrictions concerning the listing of a certain species under the annexes. For example the Wolf (*Canis lupus*) is listed under Annex IV of the Habitats Directive for some countries whereas in other Member States this species is listed instead under Annex V, which deals with exploitable species that may be subject to management measures to ensure their favourable conservation status.

Such differential listings can reflect the difficult process of negotiations leading to adoption and subsequent adaptations of the directive, where a species may be considered to be of conservation concern at European level but have a favourable conservation status in one or other Member State. However, from an EU perspective, it is generally emphasised that Member States hosting healthy populations of otherwise threatened species have a special contribution to make to their protection within the European framework.

#### ADAPTING THE ANNEXES OF THE NATURE DIRECTIVES

There have been several adaptations of the annexes to both directives, principally linked to the successive enlargements of the EU, but also taking into consideration new information on the scientific status and trends of species and habitat types in Europe.

Annex I of the Birds Directive, which originally contained 76 species and sub-species has been modified on four occasions. These changes have been mainly adaptations to successive enlargements, including the addition of endemic species for Macaronesia with the accession of Spain and Portugal to the EU. However, they have also taken into account changes in the conservation status of species. For example the Corncrake *Crex crex* was not listed in the original directive but was added to Annex I in 1986 due to increased recognition of its declining status in the Member States. There has only been one removal from list. This relates to the continental sub-species of the Cormorant (*Phalacrocorax carbo sinensis*) which was removed from Annex I in 1997

as its population was by then considered to have significantly recovered to a favourable conservation status.

For the Habitats Directive there have been two adaptations – one linked to the accession of Austria, Finland and Sweden to the EU in 1995. The other modification in 1997 aimed primarily to address gaps for Annexes I and II that were not adequately covered during the first update. There have been no deletions from the listings in this directive.

Further modifications have been prepared to adapt the directives for the accession of eight countries from Central and Eastern Europe as well as Cyprus and Malta, foreseen for 2004. All candidate countries were asked to make proposals for what they considered should be part of the annexes. Following detailed examination about 160 new species are to be listed under the Habitats Directive and 13 species under the Birds Directive. These new lists will take effect from the date of accession of these countries to the EU.

The following guidelines applied to the most recent adaptation of the annexes of the nature directives. This was not to be a general revision and only related to proposals from candidate countries. They needed to justify the scientific value of their proposals in a European context. Geographical restrictions were only to be granted in very exceptional circumstances. The balance and structure of the existing annexes was to be respected and no new taxonomic group of species was to be included in this exercise. Taxonomically disputed species and groups were to be avoided. Sub-species were to be avoided as far as possible. The addition of new habitat types was preferred to the listing of new species. The amendments to the annexes should not significantly change the obligations of existing Member States.

As regards the process of agreeing adaptations to the annexes the European Commission has worked closely with the Member States. This is primarily in the framework of their Habitats and Ornis Committees, which are committees legally established under the directives. Scientific Working Groups comprised of experts from the Member States' administrations advise these committees. There has been equally close collaboration with the competent authorities in the candidate countries, and with relevant expert groups.

For the latest adaptation the expert evaluation process also involved the European Topic Centre for nature protection and biodiversity of the European Environment Agency. Use was made of different information sources such as Bern Convention lists, IUCN Red Lists, BirdLife International references, and national Red Lists. However, the quality of the information available has varied considerably between different taxonomic groups and regions, especially in the absence of comprehensive Red Lists based on common approaches and methodologies at European level.

## SOME CURRENT RELEVANT PRIORITIES FOR SPECIES AND HABITAT PROTECTION

Whereas preparations for enlargement and finalising the establishment of the NATURA 2000 network are key priorities in EU nature policy other aspects, relevant to the implementation of the directives, are being developed for which the issue of Red Lists is pertinent.

One current priority is to develop better understanding as well as agreed approaches to monitoring and reporting under the nature directives. This includes the objective of providing an operational basis to determine if 'favourable conservation status' is being achieved for species and habitats of EU conservation concern, particularly with regard to the role played by NATURA 2000.

There is also increasing focus on the species protection provisions of Article 12 of the Habitats Directive. This has involved the establishment of a working group of experts from Member States and non governmental organisations as well as the Commission to examine the legal and technical principles underpinning species protection. This aims to provide better clarity as to what is meant by such concepts as 'breeding and resting places' and 'natural range' and how these can be applied to different species, in relation to their biological requirements. This work may prompt reflections on future amendments of the annexes of the directive.

The development of biodiversity indicators in association with the European Environment Agency is also an emerging priority. In this regard a project titled 'EU Bio-Imps' should help develop Biodiversity Implementation Indicators. This work on indicators should provide a tool for further integration of nature and biodiversity considerations into the implementation of other policy areas such as agriculture.

There is also increased attention to the integration of environmental considerations in the marine environment. This involves the development of a marine strategy with increased emphasis on the ecosystem approach towards management. A marine working group has been established to assist with implementation of the nature directives in the marine environment. Whereas in the short term the priority is on providing guidance to assist the selection of marine NATURA 2000 sites there is recognition that in the future the annexes of the Habitats Directive will need to be strengthened for habitat types and species to make it a more effective tool for marine conservation.

Finally, work on supporting species action plans continues. The EU has assisted the development by BirdLife International of plans for all globally threatened birds and other priority bird species. Plans are being finalised as a tool to assist the conservation and sustainable use of those huntable bird species under the Birds Directive, which are at present considered to have an unfavourable conservation status.

## SOME FINAL CONSIDERATIONS

Achieving the overall target of halting the decline of biodiversity in the European Union by 2010 will require a strong science based approach for policy development and implementation. The value and potential of Red Lists in this process needs to be fully realised.

From the point of view of the nature directives there will be a need to give further consideration as to how to update the Birds and Habitats Directive lists in the future. At present this is a heavy and complicated procedure, involving co-decision of the Council of Ministers, representing the Member States, as well as the European Parliament. In this regard the harmonizing and strengthening of national and European Red Lists could provide a valuable tool for assessments with a view to any future adaptations of the annexes.

Objective data relevant to the life histories of different species and status of habitats will not only help to categorise but to define priorities for future conservation action in the European Union. Particular emphasis needs to be given to strengthening the habitat dimension, which from a conservation policy perspective has frequently the added advantage of achieving multiple species benefits.

One of the key challenges is categorising and dealing with species and habitats that have an unfavourable conservation status. In this regard it will be particularly important to develop approaches and information systems that will enable us to determine when listed species and habitats no longer have an unfavourable conservation status in the EU.



# 4

## The Revised IUCN Red List Categories and Criteria: version 3.1

*C. Pollock, G. Mace and C. Hilton-Taylor*

### BACKGROUND TO THE CRITERIA REVIEW

In 1994, IUCN – The World Conservation Union adopted new criteria for assessing extinction risks to species (IUCN 1994). These criteria were used in several international publications, including *Birds to Watch 2* (Collar *et al.* 1994), the 1996 *IUCN Red List of Threatened Animals* (Baillie and Groombridge 1996), the *World List of Threatened Trees* (Oldfield *et al.* 1998), *Threatened Birds of the World* (BirdLife International 2000) and the 2000 *IUCN Red List of Threatened Species* (Hilton-Taylor 2000). The relative objectivity of the listings in these publications has made them an excellent tool for observing changes in status over time and this new method has attracted great interest from wildlife agencies and management authorities, as well as the media, and is increasingly being adopted as a global standard. Not surprisingly, there were also some controversial elements, particularly the listing in 1996 (Baillie and Groombridge 1996) of fisheries species, long-lived species such as elephants and marine turtles, and the status of some small and very narrowly distributed endemic molluscs and other invertebrates.

At the IUCN World Conservation Congress (WCC) held in Montreal in October 1996, the Species Survival Commission (SSC) was mandated under WCC Resolution 1.4 to:

‘within available resources, urgently to complete its review of the IUCN Red List Categories and Criteria, in an open and transparent manner, in consultation with relevant experts, to ensure the criteria are effective indicators of risk of extinction across the broadest possible range of taxonomic categories, especially in relation to:

- marine species, particularly fish, taking into account the dynamic nature of marine ecosystems;
- species under management programmes;
- the time periods over which declines are measured.’

Under the auspices of the IUCN SSC Red List Programme, SSC set up a Criteria Review Working Group. The task of this group was to respond to the mandate given to SSC at the World Conservation Congress and to report any proposed changes back to the SSC Executive Committee.

## THE PROCESS

The Criteria Review Working Group consisted of 25 members (see Appendix 1), representing a wide range of expertise on animal and plant taxa, and including people with technical knowledge about extinction risk assessments, as well as experience in applying the Red List Criteria. This Group oversaw the review and made the final recommendations to modify the categories and criteria.

The review was conducted in stages as outlined below.

| DATES              | ACTIVITY   |
|--------------------|--|
| Jan. - Dec. 1997   | Correspondence and seeking input from the members of IUCN and SSC.   |
| Jan. - Feb. 1998   | Planning for Scoping Workshop.   |
| March 1998         | <i>Scoping workshop</i> , London, UK. Funded by IUCN.  |
| March - Sept. 1998 | Planning and fund-raising for activities outlined by the Scoping Workshop.   |
| October 1998       | <i>Regional assessment working group</i> Montreal, Canada. The meeting contributed views on regional assessments. Funding from Canadian Wildlife Service.  |
| January 1999       | <i>Marine Workshop</i> . Tokyo, Japan. Funding from German Government. Evaluates issues related to marine species. Additional input from Japanese meeting on Risk Assessment.                                  |
| May 1999           | <i>Range Size, Habitat Areas and Dealing with Uncertainty Workshop</i> . Manly, Sydney, Australia. Funding from environment and technical agencies in New South Wales, Australia.                              |
| June 1999          | <i>Criterion A Workshop</i> . Cambridge, UK. Funding from Finnish Government.  |
| July 1999          | <i>Review Workshop</i> . Cambridge, UK. Criteria Review Working Group meeting to discuss recommendations from all workshop reports, and provide final set of recommendations. Funding from Finnish Government. |

|                   |  |
|-------------------|--|
| September 1999    | <i>Publication in Species</i> . Draft of revised criteria prepared and published in <i>Species</i> and sent to all SSC members for comment. The draft was translated into French and Spanish and circulated to all IUCN members for comment. |
| Sept. - Nov. 1999 | Correspondence and seeking input from the members of IUCN and SSC.   |
| December 1999     | Submission of re-drafted proposals to SSC Executive Committee.   |
| January 2000      | <i>Criteria B and D</i> . Workshop to resolve geographical scale issues. Uppsala. Sweden. Funding from three Swedish agencies.   |
| February 2000     | Submission of revised IUCN Red List Categories and Criteria to IUCN Council for approval   |
| January 2001      | <i>Publication of the revised IUCN Red List Categories and Criteria</i> : version 3.1 in three languages (English, French, and Spanish)  |

The workshops from January to July 1999 followed directly from specific issues outlined by the Scoping Workshop in March 1998. Participants at these workshops (see Appendix 1) were selected to reflect technical and practical expertise in the areas being discussed. All workshops addressed specific issues and attempted to deliver recommended courses of action through analysis and discussion. In order to provide continuity and coherence to the process, at least 4-5 members of the Criteria Review Working Group attended each topic-based workshop. In addition, each member of the group was requested to attend at least one of the workshops.

Written reports on the workshops provide all the supporting arguments and documentation for the final outcome of the review as presented here. All the workshop reports adhere to a common standard, are comprehensive and will be available as a package along with the final report from the Criteria Working Group. Copies of reports produced so far are available via the IUCN web site ([www.iucn.org/themes/ssc/red-lists.htm](http://www.iucn.org/themes/ssc/red-lists.htm)) or they can be ordered directly from the IUCN Red List Programme Officer. A full outline of the draft proposals for amending the criteria was published in *Species* 31-32, pages 43-57.

Over 60 people participated in the workshops. All review group members were involved in at least one of the topical workshops. As a result of the review process, several new topics have become the focus of active research and publication in the academic community, e.g. handling uncertainty (Akçakaya *et al.* 2000), scale and area measurement (Burgman and Fox 2003), life history impacts for threat status (Akçakaya 2002) and the nature of declining populations (Rodríguez 2002).

## CHANGES TO THE CATEGORIES AND CRITERIA

The changes described in this section follow the sequence in the IUCN rules (see *IUCN Red List Categories and Criteria: version 3.1* (IUCN 2001) also available at [www.iucn.org/themes/ssc/red-lists.htm](http://www.iucn.org/themes/ssc/red-lists.htm)).

### Introduction

The 1994 Categories and Criteria stated that the categories provide a method for highlighting those species under higher extinction risk, so as to focus attention on conservation measures designed to protect them. However, there was a need for a more explicit account of the role and purpose of the Red List (including the background and history to the current listing procedure). This should include an account of how a listing status should be interpreted, the relationship of the criteria to one another, their background in theoretical biology, and what they are and are not intended to indicate. The difference between measuring threats and assessing conservation priorities also needed to be expanded, as there are many people who interpret the Red List as a means of priority setting. The introduction was identified as one place where some of these issues should be dealt with in more detail; the remainder will be covered in detailed user guidelines that are now available from [www.iucn.org/themes/ssc/red-lists.htm](http://www.iucn.org/themes/ssc/red-lists.htm).

- **Outcome:**

A new introduction explains the role and appropriate uses for the categories and criteria. Particular emphasis is placed on the fact that while the Red List may focus attention on those taxa at highest risk, it is not the sole means of setting priorities for conservation measures for their protection. A new version numbering has also been added.

### Preamble

Various changes were made to the Preamble to reflect changes elsewhere in the document. An area of particular importance concerned the handling of uncertainty in the criteria. Despite the fact that the notes accompanying the 1994 criteria recognized the problem of data uncertainty, there was no clear guidance on how to deal with it in either the assessment of species or the interpretation of listings. This is an important problem that limits the use and interpretation of the Red List Categories and Criteria, and leads to irresolvable debates over particular issues. Many other problems with the criteria were related to this issue, e.g. the use of the Data Deficient category, the lack of criteria for Near Threatened, and the assessment of species whose status is

known only from one small part of its range. New methods and approaches developed during the review provide a better understanding of uncertainty and offer a way forward.

- **Outcome:**

- 1 Re-ordering of points for clarity.
- 2 A few small editorial changes have been made for clarity.
- 3 A new Figure 1 is included to reflect changes to categories (see below).
- 4 The section on uncertainty has been revised with the addition of a detailed Annex 1 which provides full guidance on dealing with uncertainty that is consistent with the methods implemented in the RAMAS<sup>®</sup> Red List software package (Akçakaya and Ferson 2001).
- 5 The minimum documentation requirements for assessments are fully specified in Annex 3 (IUCN 2001).
- 6 The section on regional level assessments has been revised to refer to the guidelines produced by the Regional Applications Working Group.

### Definitions

Many small changes were suggested in the review to improve clarity, consistency and/or accuracy in the definitions of terms used in the criteria.

- **Outcome:**

- 1 Slightly revised versions of most definitions.
- 2 New section to deal with scale problems under Area of Occupancy.
- 3 New wording for quantitative analysis to ensure that its use is clear for cases where the modelling is of environmental rather than population processes and is not directly equivalent to applying a full Population Viability Analysis (PVA).

### The categories

#### *Qualitative definitions*

The qualitative definitions for the threatened categories (Critically Endangered, Endangered and Vulnerable) tended to overstate the predictive accuracy of the system. They also did not adequately convey to the general reader the fact that it is the criteria that determine listing in the threatened categories and that this evaluation requires a scientifically based assessment. The difficulty was how to phrase them without using quantitative terms but still convey a sense of urgency.

- **Outcome:**

The wording for the qualitative definitions for threatened categories has been revised.

#### *Conservation dependent*

The use of Conservation Dependent as an independent Red List Category was not logically consistent as a taxon can be both threatened and conservation dependent. In addition assessors have used this category in a variety of contexts making it less useful than was hoped. More logically Conservation Dependent could be used as a flag under all the threatened categories but this is not a satisfactory solution, as it would require many difficult judgements to be made about the effectiveness of conservation programmes.

- **Outcome:**

The category 'Conservation Dependent' has been removed.

#### *Near threatened*

This category was increasingly being used more formally than was intended. In the 1994 categories it was very loosely defined so better guidance was required on when and how to use it. The development of criteria has been suggested, but this option would create many difficulties. The guidelines will provide practical and more consistent methods for determining when a species should be listed as Near Threatened. This might be where a taxon meets only some sub-criteria or where there is a plausible assessment of a threatened category but the assessment based on best estimates leads to Least Concern. In addition this category will include some taxa that previously would have been listed as Conservation Dependent.

- **Outcome:**

The Near Threatened category has been redefined to be more specific about when it should be used and that includes some species previously classified as Conservation Dependent.

#### *Least Concern*

This category was provided to differentiate species that had been evaluated, and found not to be threatened. This gives the impression that one is required to conduct a formal assessment for blatantly common (weedy) taxa. From basic observations it can be easily seen that most of these extremely common taxa would not qualify for listing even though they have not been put through a formal assessment.

- **Outcome:**

The Least Concern category has been redefined to make its role clearer. This has resulted in the old category of Lower Risk no longer being necessary.

The changes to the categories has resulted in a new figure for the structure of the IUCN Red List categories which is simplified compared to the 1994 version (see Figure 1).

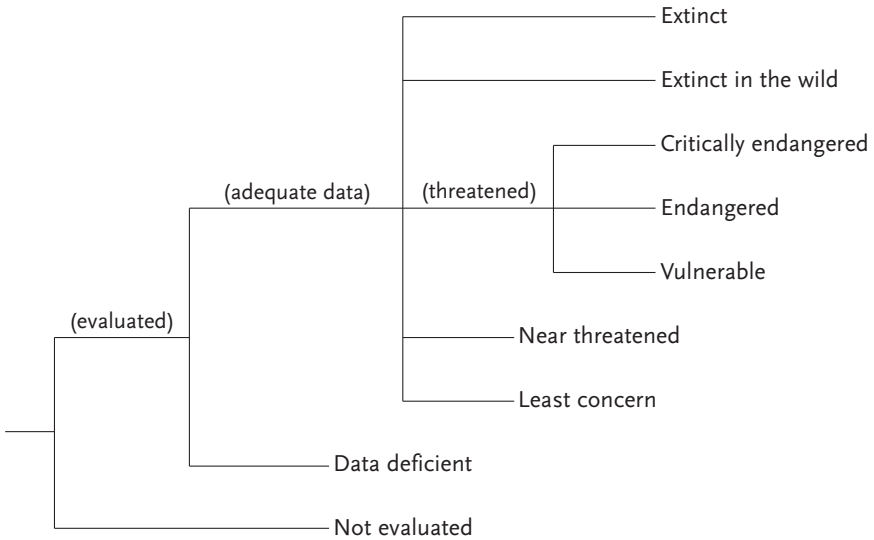

**Figure 1** – New structure for the IUCN categories and criteria

### Changes to the criteria

#### *Criterion A*

A number of problems with Criterion A were identified during the review process. The quantitative thresholds used in 1994, especially for Vulnerable, may have been too low. In addition, the rates of decline did not take into account managed populations that are being harvested down to levels at which higher yield is attained, or dramatic declines that occurred in the distant past but are now halted or even reversed. The criterion also did not provide guidance on projecting into the future, especially for long-lived species, where such assessments may be both unreliable and irrelevant. Greater clarity is also required on whether the criterion allows the use of a shifting time window for species where only a small amount of data is available. The confidence limits on declining population data are also an important issue as strict application of the precautionary principle could lead to over-listing under this criterion.

• **Outcome:**

- 1 A new subcriterion (A1) has been added to provide higher decline rate thresholds for species that have ceased declining.
- 2 A new subcriterion (A4) has been added to provide the opportunity for shifting time windows.
- 3 The decline thresholds for the Vulnerable category have been increased from 20% to 30%.
- 4 New threshold decline rates:

| Sub-criteria            | VU    | EN    | CR    |
|-------------------------|-------|-------|-------|
| A2, A3, A4              | > 30% | > 50% | > 80% |
| A1 (decline has ceased) | > 50% | > 70% | > 90% |

Figure 2 illustrates the principles behind the changes to Criterion A. The graph shows three kinds of decline. In (A) the population has declined rapidly but then stabilizes at a new much reduced level. This population would be assessed under the new Criterion A1 that has higher thresholds. Curves (B) and (C) show two different ways in which declines might proceed but where the decline is not halted. The thresholds in Criterion A2, A3 and A4 will apply to these.

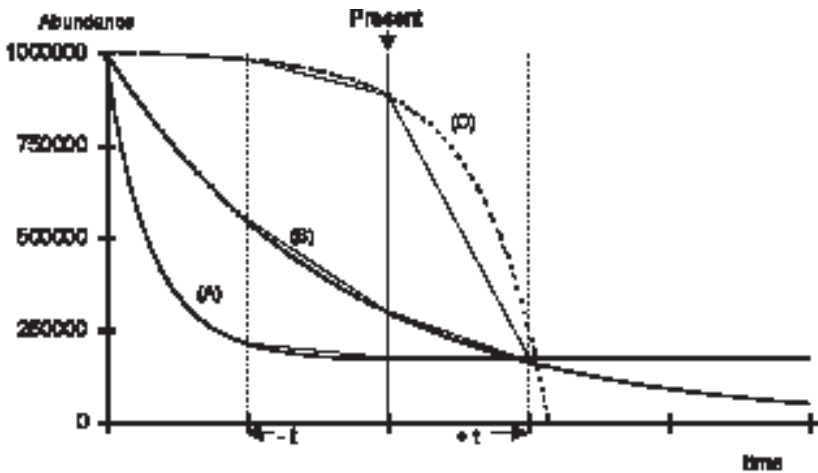

**Figure 2** – Patterns of population decline to which Criterion A might apply. In (A) the decline has ceased, in (B) the decline rate is reducing and in (C) the decline rate is increasing.



### *Criterion B*

The area-based thresholds under Criterion B do not scale well across all organisms. Most of the time this is not a problem since criterion B is only intended to be applicable to species for which range area and distribution characteristics are the cause of threatened status, and not those for which population size and structure are measurable and relevant. However, the relatively large thresholds could lead to over-listing of some locally abundant, micro-endemic taxa. Scale of measurement under Area of Occupancy also has a strong influence on the resulting area.

- **Outcome:**

- 1 A new structure for the criterion explicitly differentiates classifications made by Extent of Occurrence and Area of Occupancy.
- 2 Guidelines on choosing scales for measurement of grid-based areas have been added. This is further expanded on in the new user guidelines (see [www.iucn.org/themes/ssc/red-lists.htm](http://www.iucn.org/themes/ssc/red-lists.htm)).

### *Criterion C*

In the 1994 Criteria, under one of the qualifying subcriteria, all individuals have to be in a single subpopulation. This was too exclusive and did not allow the listing of very skewed populations where a small number of mature individuals exist outside the main population.

- **Outcome:**

A new form of sub-criterion C2 (ii) has been added to be more precautionary, and to allow a small proportion of the population to be distinct.

### *Criterion D*

Subcriterion D2 under Vulnerable, was intended to be used for species with very small distributions. However, the thresholds for Area of Occupancy and number of locations, although given as indicators, were frequently interpreted too literally. Some people have argued that the subcriterion is too inclusive and results in massive over-listing, whereas others argue that it is too exclusive (for many marine species) and so is under-listing. The threats aspect needs to be emphasized more than the restricted distribution.

- **Outcome:**

Subcriterion D2 under Vulnerable has been re-worded to indicate that the quantitative thresholds are for guidance only, to avoid over listing of micro-endemics.

## CONCLUSION

The revised *IUCN Red List Categories and Criteria: version 3.1* came into force in 2001 and the aim is to keep this revised system stable for several iterations of the IUCN Red List. This stability will enable genuine changes in the status of species to be detected rather than to have such changes obscured by the constant modification of the criteria.

As a result of the review process, several new topics have become the focus of active research and publication in the scientific community. As greater clarity emerges on tricky and unresolved issues, these will be addressed in a comprehensive set of user guidelines. The current draft of the guidelines incorporates elements from previous sets of guidelines (for marine fish, bryophytes, trees, and the use of Criterion A) along with extensive guidelines for the topics covered in the categories and criteria (e.g. dealing with uncertainty, the use of different scales of measurement when calculating range areas, guidelines on the use of Near Threatened, Data Deficient, and Not Evaluated). The user guidelines are intended to be a 'living document' in that they will be revised on a regular basis as new insights are gained on the application of the criteria to a wider range of taxonomic groups and as new developments in conservation biology theory emerge. The first draft version of the guidelines is available at [www.iucn.org/themes/ssc/red-lists.htm](http://www.iucn.org/themes/ssc/red-lists.htm).

## REFERENCES

- AKÇAKAYA, H.R., 2002. Estimating the variance of survival rates and fecundities. *Animal Conservation* 5: 333-336.
- AKÇAKAYA, H.R., S. FERSON, M.A. BURGMAN, D.A. KEITH, G.M. MACE and C.A. TODD, 2000. Making consistent IUCN classifications under uncertainty. *Conservation Biology* 14: 1001-1013.
- AKÇAKAYA, H.R. and S. FERSON, 2001. RAMAS<sup>®</sup> *Red List: Threatened Species Classifications under Uncertainty*. Version 2.0. Applied Biomathematics, New York.
- BAILLIE, J. and B. GROOMBRIDGE (compilers and editors), 1996. *1996 IUCN Red List of Threatened Animals*. IUCN, Gland, Switzerland and Cambridge, UK.
- BIRDLIFE INTERNATIONAL, 2000. *Threatened Birds of the World*. Lynx Edicions and BirdLife International, Barcelona and Cambridge, UK.
- BURGMAN, M.A. and J.C. FOX, 2003. Bias in species range estimates from minimum convex polygons: implications for conservation and options for improved planning. *Animal Conservation* 6 (1):
- COLLAR, N.J., M.J. CROSBY and A.J. STATTERSFIELD, 1994. *Birds to Watch 2: the World List of Threatened Birds*. BirdLife Conservation series No. 4. BirdLife International, Cambridge, UK.

- HILTON-TAYLOR, C. (compiler), 2000. 2000 *IUCN Red List of Threatened Species*. IUCN, Gland, Switzerland and Cambridge, UK.
- IUCN, 1994. *IUCN Red List Categories*. Prepared by the IUCN Species Survival Commission. IUCN, Gland, Switzerland.
- IUCN, 2001. *IUCN Red List Categories and Criteria: Version 3.1*. IUCN Species Survival Commission. IUCN, Gland, Switzerland and Cambridge, UK.
- OLDFIELD, S., C. LUSTY and A. MACKINVEN, 1998. *The World List of Threatened Trees*. World Conservation Press, Cambridge.
- RODRÍGUEZ, J.P., 2002. Range contraction in declining North American bird populations. *Ecological Bulletins* 48: 53-71.

### Appendix 1 – Criteria Review Working Group and Workshop Participants

The participants were selected because of (1) their experience in developing the criteria, (2) experience of using the criteria at regional, global or broad taxonomic levels, (3) technical skills in key areas of interest. The membership provided some regional balance as well as broad taxonomic and thematic balance. A # indicates that the participant was a member of the Criteria Review Working Group and an X indicates which workshops people attended.

| Name              | Country      | Expertise   | Scoping | Marine | Range Area | Criterion A | Review | Criteria B & D |
|-------------------|--------------|---|---------|--------|------------|-------------|--------|----------------|
| Alberto Abreu     | Mexico       | Application to marine turtles   |         |        |            | X           | X      |                |
| #Resit Akçakaya   | USA (Turkey) | Uncertainty, PVA's and development of Red List software               |         | X      | X          | X           | X      |                |
| Tony Auld         | Australia    | Application to Australian plants                                      |         |        | X          |             |        |                |
| #Jonathan Baillie | UK (Canada)  | Broad application experience. Co-editor of 1996 Animals Red List      | X       |        |            | X           | X      |                |
| #William Bond     | South Africa | Plants, sporadic threats, inter-specific dependencies, life histories | X       | X      |            |             |        |                |
| Amie Brautigam    | USA          | Marine species  |         | X      |            |             |        |                |
| Andrew Burbidge   | Australia    | Threatened Australian animals   |         |        | X          |             |        |                |
| Mark Burgman      | Australia    | Uncertainty, PVA's and application experience                         |         |        | X          |             |        |                |
| Alan Butler       | Australia    | Marine species  |         |        | X          |             |        |                |
| Doug Butterworth  | South Africa | Marine species, population modelling                                  |         | X      |            |             |        |                |
| Gregor Cailliet   | USA          | Marine species  |         | X      |            |             |        |                |

|                      |                   |   |   |   |   |   |   |   |   |
|----------------------|-------------------|---|---|---|---|---|---|---|---|
| Elvira Carrillo      | Cuba              | Marine species  | X |   |   |   |   |   |   |
| #Nigel Collar        | UK                | Drafting group member. Birds  | – | X | X | X | X | X | X |
| Peter De Lange       | New Zealand       | Plants and regional assessments   |   | X |   |   |   |   |   |
| Rainer Froese        | Philippines       | Marine species  | X |   |   |   |   |   |   |
| #Ulf Gärdenfors      | Sweden            | Chair Regional Assessment Working Group and broad application experience  | X | X | X | X | X | X | X |
| #Kevin Gaston        | UK                | Drafting group member. Abundance and distribution of species              |   | X | X | X | X | X | X |
| Tim Gerrodette       | USA               | Marine species  |   | X |   |   |   |   |   |
| David Given          | New Zealand       | Plants, general application, SSC Executive and Chair Plants Sub-committee |   | X |   |   |   |   |   |
| #Brian Groombridge   | UK                | Editor of 1994 and co-editor of 1996 Animals Red List                     |   |   |   |   |   |   |   |
| Tomas Hallingback    | Sweden            | Plants (Bryophytes), general application experience                       |   |   |   |   |   |   | – |
| #Craig Hilton-Taylor | UK (South Africa) | Broad application in southern Africa. Red List Programme Officer          |   | X | X | X | X | X | X |
| Stephen Hopper       | Australia         | Australian plant population dynamics                                      |   | X |   |   |   |   |   |
| #Elodie Hudson       | UK                | Marine species  | X |   | X | X | X | X | X |
| Hajime Ishihara      | Japan             | Marine species  | X |   |   |   |   |   |   |

| Name                           | Country                              | Expertise  | Scoping | Marine | Range Area | Criterion A | Review | Criteria B & D |
|--------------------------------|--------------------------------------|--|---------|--------|------------|-------------|--------|----------------|
| #Bob Irvin                     | USA                                  | Marine issues  | X       |        |            | X           | X      |                |
| Nick Isaac                     | UK                                   |  | X       |        |            |             |        |                |
| Yoshio Kaneko                  | Japan                                | Marine species   |         | X      |            |             |        |                |
| #David Keith                   | Australia                            | Plants, broad application experience   |         |        | X          | X           | X      | X              |
| Oskar Kindvall                 | Sweden                               | Insects, application in Sweden   |         |        |            |             |        | X              |
| Tatsu Kishida                  | Japan                                | Marine species   |         | X      |            |             |        |                |
| #Russell Lande                 | USA                                  | Drafting group member. Extinction theory   |         |        |            |             | X      | X              |
| #Nigel Leader-Williams         | UK                                   | Drafting group member. Exploitation and management issues  | X       |        |            | X           | X      | X              |
| #Charlotte Lusty               | UK                                   | Plants, especially trees. Extensive work on tree database and guidelines for trees                         | X       |        |            | X           | X      |                |
| #Georgina Mace                 | UK                                   | Chair Red List Standards Working Group and responsible for Criteria Review process. Drafting group member. | X       | X      | X          | X           | X      | X              |
| Berin Mackenzie<br>Sue Matinka | Australia<br>Switzerland<br>(Canada) | Australian plants<br>SSC representative  | X       |        | X          |             |        |                |
| Helene Marsh                   | Australia                            | Ecology & management of N. Australian marine, coastal and terrestrial wildlife species                     |         |        | X          |             |        |                |

|                      |                          |   |   |   |   |
|----------------------|--------------------------|---|---|---|---|
| #Larry Master        | USA                      | The Nature Conservancy representative   | X | X | X |
| Hiroyuki Matsuda     | Japan                    | Marine species  | X | X | X |
| #Michael Maunder     | UK                       | Plant Conservation Committee rep. Drafting group member                                 |   |   |   |
| Jessica Meeuwig      | Canada                   | Marine species (sea-horses)   | X |   |   |
| #E.J. Milner-Gulland | UK                       | Drafting group member. Harvesting and extinction theory                                 | X | X | X |
| #Sanjay Molur        | India                    | Extensive experience of application of criteria to a range of species at regional scale | X | X | X |
| Jack Musick          | USA                      | Marine species (sharks)   | X |   |   |
| John Paxton          | Australia                | Marine species  | X | X |   |
| Winston Ponder       | Australia                | Marine molluscs   |   | X |   |
| Hugh Possingham      | Australia                | PVAs, modelling, scaling issues   |   |   | X |
| #Howard Powles       | Canada                   | Marine fish issues  | X | X | X |
| #André Punt          | Australia (South Africa) | Fisheries, marine ecosystem and management  | X | X | X |
| John Reynolds        | UK                       | Marine species  | X |   | X |
| Callum Roberts       | UK                       | Marine species and extensive application of the criteria                                | X |   |   |

| Name                  | Country          | Expertise  | Scoping | Marine | Range Area | Criterion A | Review | Criteria B & D |
|-----------------------|------------------|--|---------|--------|------------|-------------|--------|----------------|
| #Jon Paul Rodríguez   | USA (Venezuela)  | Regional assessment as a contribution to global assessment. Range area and population size | X       |        |            | X           | X      |                |
| Yvonne Sadovy         | China            | Marine species (Groupers and Wrasse)   |         |        | X          |             |        |                |
| #Mary Seddon          | UK               | Invertebrates, especially molluscs. Extensive experience of application                    |         |        | X          |             |        |                |
| #Alison Stattersfield | UK               | Birds, documentation and databases   | X       |        |            | X           | X      | X              |
| #Simon Stuart         | Switzerland (UK) | Head IUCN/SSC Species Programme. Drafting group member                                     | X       | X      |            | X           | X      | X              |
| Barbara Taylor        | USA              | Marine species, PVA's  |         | X      |            |             |        |                |
| Amanda Vincent        | Canada           | Marine species (sea-horses)  |         | X      |            |             |        |                |
| John Wang             | USA (Canada)     | Marine issues (Center for Marine Conservation rep.)  |         |        | X          | X           | X      | X              |
| Grahame Webb          | Australia        | Marine turtles and crocodiles, population assessments                                      |         | X      |            |             |        |                |
| Chris Wood            | Canada           | Marine species   |         | X      |            |             |        |                |
| #Tetsukazu Yahara     | Japan            | Plants, extinction risk assessment   | X       | X      | X          | X           | X      | X              |



# 5

## The Regional Application Guidelines

*U. Gärdenfors*

### INTRODUCTION

There is a large and worldwide interest in producing national Red Lists or their expanded form, Red Data Books. Historically, these Red Lists have had different purposes and objectives in different countries, hence the adopted criteria have varied (Burto 2003). In several countries the Red List has served the purpose of identifying or listing species that would be encompassed by national legislation and/or action plans. In many other countries the Red List criteria have been set solely to identify species at risk of extinction or have reflected a combination of extinction risk and priority for species conservation, without any direct legislative implications. With the birth of the new generation of IUCN Red List Criteria (Mace and Lande 1991; IUCN 1994, 2001) the objective of the global Red List criteria was made clear: to reflect the relative risk of extinction without ogling at any other motives.

Not the least because the IUCN Red List Categories are defined by quantitative, clear-cut, and scientifically sound criteria, they are attractive and many countries have already adopted or considered to adopt these new criteria (Gärdenfors 2001). Still, there are issues to be discussed and solved if the IUCN Red List Criteria are to receive a wide acceptance and to be used in a consistent way at national and other sub-global scales (Gärdenfors 1996). Recognising these issues, the First World Conservation Congress held in Montreal in 1996, adopted a resolution to develop guidelines for using the IUCN Red List Categories at regional levels. As a result, a Regional Application Working Group (RAWG) was formed under the IUCN Species Survival Commission. The latest draft from the RAWG was recently published (Gärdenfors *et al.* 2001) and the work is to be finalized during the spring of 2003. In this paper, I will summarise the draft results (Gärdenfors *et al.* 2001) but also focus on the improvements that have taken place since that draft was published. For full details, please refer to the upcoming Regional Application Guidelines, which are planned to be published during the year 2003. It is also essential to carefully study the global IUCN Red List Criteria (IUCN 2001) and the global Guidelines for using the IUCN Red List Categories and Criteria (IUCN Red List Standards and Petitions Subcommittee 2003).

## SOME PREMISES AND CONCEPTS

For convenience, the word *regional* is used here to indicate any subglobal geographically defined area, such as continent, country, state, or province.

Provided that the regional population to be assessed is isolated from conspecific populations outside the region, the (global) IUCN Red List Criteria (IUCN 2001) can be used without modification within any geographically defined area. However, when those criteria are applied to part of a population defined by a geopolitical border, or to a regional population where individuals move to or from other populations beyond the border, the thresholds listed under each criterion may be incorrect, because the unit being assessed is not the same as the actual population. As a result, the estimate of extinction risk may be inaccurate. The problem cannot be solved through any general changes of the thresholds. Instead, the categorisation process must be conducted in a two-step procedure in which to provide a more accurate assessment of the extinction risk of the regional population, which will be explained below.

Even though the Guidelines may in principle be applied at any geographical scale, application within very restricted geographical areas is discouraged. The smaller the region, and the more wide-ranging the taxon under consideration, the more often the regional population will interchange individuals with neighbouring populations. Therefore the assessment becomes less reliable. Still, it is not possible to provide any general guidance on the precise lower limit for sensible application as this depends on the nature of the region, and especially the barriers to dispersal that exist.

## THE CATEGORIES

The IUCN Red List Categories (IUCN 2001) should be used unaltered at regional levels, with three exceptions or adjustments.

- 1 Taxa extinct within the region but extant in other parts of the world should be classified as *Regionally Extinct* (RE). A taxon is RE when there is no reasonable doubt that the last individual potentially capable of reproduction within the region has died or disappeared from the region or, in the case of a former visiting taxon, individuals no longer visit the region. It is up to the regional Red List authority to set a time limit for listing under RE, but should not normally precede 1500 AD.
- 2 The category of *Extinct in the Wild* (EW) should be assigned only to taxa that are extinct in the wild over their entire natural range, including the region, but that are extant in cultivation, in captivity, or as a naturalized population (or populations) outside the past range.

- 3 Taxa not eligible for assessment at a regional level should be assigned the category *Not Applicable* (NA). A taxon may be NA because it is not wild or not within its natural range in the region, or because it is a vagrant to the region. It may also occur at very low numbers in the region (if the region has decided to use a ‘filter’ before the assessment procedure) or the taxon may be classified at a lower taxonomic level (e.g. below the level of species or subspecies) than considered eligible by the regional Red List authority. In contrast to other Red List categories, it is not mandatory to use NA for all taxa to which it applies; but is recommended for taxa where it is informative.

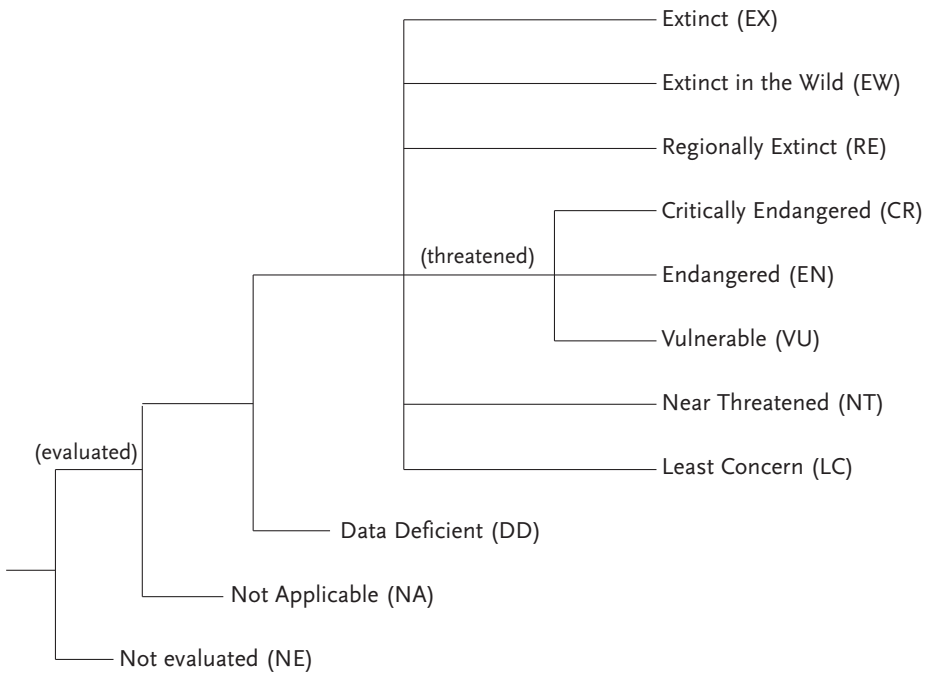

**Figure 1** – Structure of the categories on regional level.

### WHICH TAXA CAN BE ASSESSED?

The categorisation process should be applied only to wild populations inside their natural range and to populations resulting from benign introductions (IUCN 2001). A taxon that occasionally breeds under favourable circumstances in the region but regularly becomes (regionally) extinct should not be considered. Similarly, a taxon that is currently expanding its distributional range outside the region and appears to be in a colonisation phase within the region

should not be considered for regional assessment until the taxon has reproduced within the region for several years (typically for at least 10 consecutive years).

Taxa formerly considered Regionally Extinct (RE) that naturally re-colonise the region may be assessed after the first year of reproduction. Re-introduced, formerly RE taxa may be assessed as soon as at least a part of the population successfully reproduces without direct support.

Visiting taxa, i.e., such that regularly occur in the region but still do not breed, may be assessed against the criteria, but vagrant taxa should not be assessed.

The regional Red List authority may decide to apply a filter, e.g. a preset threshold of the global or continental population share, to the assessment of breeding and/or visiting taxa. For instance, a region may decide that it will not assess species that occur or have occurred within the last century in the region with less than 1% of the global population. When applied, any such filters must be clearly specified.

## THE ASSESSMENT PROCEDURE

Regional assessment should be carried out in a two-step process that is slightly different for breeding and non-breeding populations (Fig. 2).

### Breeding populations

In the first step, the criteria of the global IUCN Red List are applied to the regional population of the taxon (as specified by IUCN 2001) resulting in a preliminary categorization. All data used in this initial assessment – such as number of individuals and variables relating to area, reduction, decline, fluctuations, subpopulations, locations, and fragmentation – should be from the regional population, not the global population.

In the second step, the existence and status of any conspecific populations outside the region that may affect the risk of extinction within the region should be investigated. If the taxon is endemic to the region or the regional population is isolated, the Red List category defined by the criteria should be adopted unaltered. If, on the other hand, conspecific populations outside the region are judged to affect the regional extinction risk, the regional Red List category should be changed to a more appropriate level that reflects the extinction risk as defined by criterion E (IUCN 2001). In most cases, this will mean downgrading the category met by the global criteria, because populations within the region may experience a ‘rescue effect’ from populations outside the region. In other words, immigration from outside the region will tend to decrease extinction risk within the region.

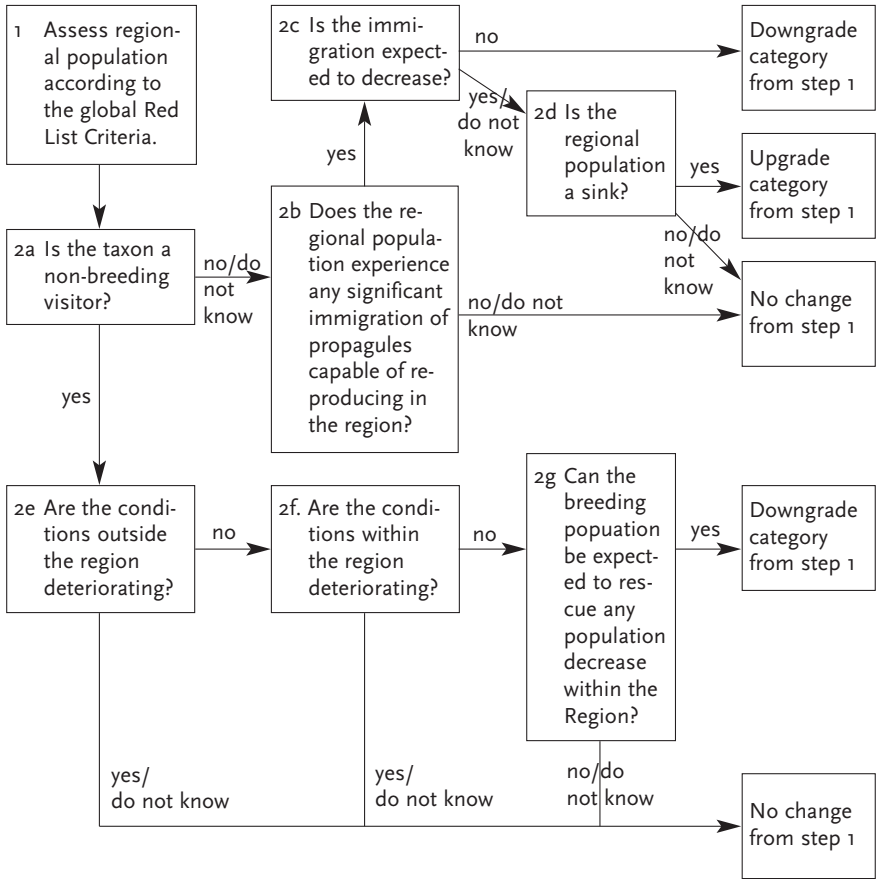

**Figure 2** – Conceptual scheme of the procedure for assigning an IUCN Red List category at a regional level. In step 1 all data used should be from the regional population, not the global population. The exception is when to evaluate a projected reduction or continued decline of a non-breeding population, in case conditions outside the region must be taken into account already in step 1. Likewise, breeding populations may be affected by events in, e.g., wintering areas, which must be considered already in step 1.

Normally, such a downgrading will involve a one-step change in category, such as moving the category from Endangered (EN) to Vulnerable (VU) or from VU to Near Threatened (NT). For expanding populations, whose global range barely touches the edge of the region, a downgrading of the category by two or even more steps may be appropriate. Likewise, if the region is very small and not isolated by barriers from surrounding regions, downgrading by two or more steps may be necessary.

Conversely, if the population within the region is a demographic sink (Puliam 1988) that is unable to sustain itself without immigration from populations outside the region, AND if the extra-regional source is expected to decrease, the extinction risk of the regional population may be underestimated by the criteria. In such exceptional cases, an upgrading of the category may be appropriate. If it is unknown whether or not extra-regional populations influence the extinction risk of the regional population, the category from step one should be kept unaltered.

### Visiting populations

As with breeding populations, data used in the initial step (box no. 1 in fig. 2) should be from the regional population, not the global population. To be able to correctly project a population reduction (criteria A3 and A4) or a continued decline (criteria B and C) it may, however, be necessary to examine the conditions outside the region, and particularly in the population's breeding area. It is also essential to distinguish true population changes and fluctuations from transient changes, which may be due to unsuitable weather or other factors and may result in visitors temporarily favouring other regions. Observed population numbers will expectedly fluctuate more in non-breeding than in breeding populations. This must be carefully considered when evaluating the criteria of reduction, continuing decline and extreme fluctuations.

In a second step, the environmental conditions outside (box 2e, fig. 2) and inside (box 2f) the region should be examined. Because past or projected population reductions outside the region, as well as deteriorating environmental conditions inside the region, already have been accounted for in the first step, such changes will not lead to any adjustments in the second step. There will be reasons to downgrade the category met in step one only when environmental conditions are stable or improving. Globally very rare taxa, e.g., such Red Listed under criterion D, should not be downgraded because a very small global population would not be expected to produce any notable rescue effect within the region.

Adjustments can be made to all the categories except for Extinct (EX), Extinct in the Wild (EW), Regionally Extinct (RE), Data Deficient (DD), Not Evaluated (NE), and Not Applicable (NA), which cannot be up- or downgraded.

### ADDITIONAL PARAMETERS

Assessment of extinction risk and setting conservation priorities are two related but different processes. Assessment of extinction risk, such as the assignment of IUCN Red List categories, generally precedes the setting of priorities. The latter normally includes the assessment of extinction risk, but also takes

into account a number of other factors (Milsap *et al.* 1990; Master 1991; Lamoreux *et al.* 2003). In the context of regional risk assessments, a number of additional pieces of information are valuable for setting conservation priorities. For example, it is important to consider not only conditions within the region but also the status of the taxon from a global perspective and the proportion of the global population that occurs within the region. Consequently, it is recommended that any publication that results from a regional assessment should include at least three measures: (1) the regional Red List category, (2) the global Red List category, and (3) an estimate of the proportion (%) of the global population occurring within the region.

## REFERENCES

- BURTON, J., 2003. The context of Red Data Books, with a complete bibliography of the IUCN publications. In: H.H. de Iongh, O.S. Bánki, W. Bergmans, and M.J. van der Werff (ed.) *Harmonization of Red lists in Europe*. Proceedings International Seminar, 27-28 November 2002, The Netherlands Foundation for International Nature Protection, Mededelingen No. 38, Leiden.
- KÖPPEL, C., F. JANSEN, J. BURTON, M. SCHNITTLER and N. HIRNEISEN, 2003. A Statistical Survey on European Red Lists. In: H.H. de Iongh, O.S. Bánki, W. Bergmans, and M.J. van der Werff (ed.) *Harmonization of Red lists in Europe*, pp. 55-71. Proceedings International Seminar, 27-28 November 2002, The Netherlands Foundation for International Nature Protection, Mededelingen No. 38, Leiden.
- GÄRDENFORS, U., 2001. Classifying threatened species at a national versus global level. *Trends in Ecology and Evolution* 16: 511-516.
- GÄRDENFORS, U., C. HILTON-TAYLOR, G.M. MACE and J.P. RODRÍGUEZ, 2001. The application of IUCN Red List Criteria at Regional levels. *Conservation Biology* 15 (5): 1206-1212.
- IUCN, 1994. *IUCN Red List categories*. Prepared by the IUCN Species Survival Commission. World Conservation Union, Gland.
- IUCN, 2001. *IUCN Red List categories. Version 3.1*. Prepared by the IUCN Species Survival Commission. IUCN, Gland and Cambridge.
- IUCN Red List Standards and Petitions Subcommittee, in preparation. *Guidelines for using the IUCN Red List Categories and Criteria*. IUCN, Gland.
- LAMOREUX, J., R. AKCAKAYA, L. BENNUN, L. BOITANI, D. BRACKETT, A. BRÄUTIGAM, T. BROOKS, N. COLLAR, G.A.B. DA FONSECA, U. GÄRDENFORS, C. HILTON-TAYLOR, G. MACE, R. MITTERMEIER, A. B. RYLANDS, B. STEIN and S. STUART (2003). Value of the IUCN Red List. *Trends in Ecology and Evolution* 18: 214-215.
- MACE, G.M. and R. LANDE, 1991. Assessing extinction threats: toward a reevaluation of IUCN threatened species categories. *Conservation Biology* 5: 148-157.
- MASTER, L.L., 1991. Assessing threats and setting priorities for conservation. *Conservation Biology* 5: 559-563.

MILSAP, B.A., J.A. GORE, D.E. RUNDE and S.I. CERULEAN, 1990. Setting priorities for the conservation of fish and wildlife species in Florida. *Wildlife Monographs* 111: 1-57.

PULLIAM, H.R., 1988. Sources, sinks, and population regulation. *The American Naturalist* 132: 652-661.



# 6

## The Red List and influencing Policy and Private Sector

*W. Ferwerda*

We all know that ecosystems decline because of human activities and population growth. More species disappear from our planet the last few hundreds of years than the thousands of years before. For the first time in its short history mankind is facing an extinction crisis, caused by mankind itself. The IUCN Red List of Threatened Species is the only existing instrument which enables us monitor this crisis. The status of the majority of vertebrate species is becoming more and more documented. We know more about the reasons why these species are in danger or why they became extinct. IUCN is internationally recognized because of the Red List of Threatened Species, which is the result of the tremendous effort of the (volunteer) members of the IUCN/Species Survival Commission and its Specialist Groups. The Red List is widely used by people and organizations, like NGOs, scientists and some governmental institutes. Unfortunately the 'real' world, the world of the financial markets, industry and business are not familiar with the Red List of Threatened Species and its meaning. How can we change this?

When we look closer to the major threats to threatened birds, mammals and plants, as mentioned in the 2000 Red List, we see habitat loss/degradation, direct loss/exploitation, invasive species and pollution. The extinction crisis is in fact closely related to economical activities, industrial development, increase of land use for agriculture and livestock, etc. For some years the Netherlands Committee for IUCN (NC-IUCN) worked on the impact of the Dutch economy to biodiversity worldwide. The conclusion was that a small country has a large impact on biodiversity and ecosystems worldwide and some Dutch industry and finances are direct or indirectly involved by causing those major threats. By using visual maps, like *The Netherlands and the World Ecology* map, the communication to policy makers and the private sector is stimulated and combined with a dialogue and meetings it may form a basis for a corporate responsibility strategy.

The Red List is a great tool to communicate to the private sector. Unfortunately, Chief Executive Officers (CEOs) of investment and transnational com-

panies, industrial complexes and high governmental officials are until now not or only slightly familiar with this important scientific document. Explaining people from the private sector about what the Red List is, and how their activities are related to it, would be an important first step. CEOs often understand the causes of the extinction crisis, but do not know how they may contribute as a company to counteract it. Communicating the Red List to the private sector and explaining how they could anticipate in certain 'species cases', would in my opinion be an additional goal of the IUCN, its members, Commissions and partners. As a scientific community we have many data and more data is produced every year. The question is how are do we communicate these data, if we want to support the *good will* in policy and private sector to decrease their impact on biodiversity by making the right decisions. Meanwhile we should continue in improving and harmonizing the IUCN/Red List of Threatened Species, but while doing so, efforts should also be put towards communication to policy makers and private sector to raise awareness and influence them with what is behind the Red List statistics. The Red List should play an important role in bringing together partnerships of *willing* companies, NGOs and governments in saving biodiversity using the Red List. It is the only way to realize the difficult target of the World Summit of Sustainable Development in Johannesburg: halting biodiversity loss in 2010.

# 7

## A Statistical Survey on European Red Lists

*C. Köppel, F. Jansen, J. Burton,  
M. Schnittler, N. Hirneisen*

### INTRODUCTION AND GEOGRAPHIC AREA OF RED LISTS

Red Lists are scientific reports about the status of wildlife. The first were published by the IUCN in 1966 under the name 'Red Data Book'. Currently, about 2.000 Red List publications exist for Europe and these can be subdivided as follows:

#### **World-wide including Europe**

Mostly published by the IUCN, e.g.

- 2002 IUCN Red List of Threatened Species – Hilton-Taylor (compiler) (2002).
- 1997 IUCN Red List of Threatened Plants – Walter and Gillett (eds.) (1998).

#### **Europe-wide**

A lot of European Red Lists are published by inter-governmental bodies, such as the Council of Europe (Strassbourg), e.g.

- Red Data Book of European Butterflies (Rhopalocera) – Swaay and Warren (1999).

or the United Nations (Geneva), e.g.

- European Red List of Globally Threatened Animals and Plants – Economic Commission for Europe (ed.) (1991).

but also from NGOs, such as BirdLife, e.g.

- Birds in Europe: their conservation status – Tucker, Heath, Tomialojc and Grimmett (1994).

or experts of special species groups, e.g.

- Red Data Book of European Bryophytes – European Committee for Conservation of Bryophytes (1995).

### **Supranational**

Examples of supranational Red Lists include:

*The Netherlands, Germany, Denmark:*

- Red Lists of Biotopes, Flora and Fauna of the Trilateral Wadden Sea Area, 1995 – Nordheim, Andersen and Thissen (1996).

*Denmark, Sweden, Finland, Russia, Estonia, Latvia, Lithuania, Poland, Germany:*

- Red List of marine and coastal biotopes and biotope complexes of the Baltic Sea, Belt Sea and Kattegat – Nordheim and Boedeker (1998).

*Lithuania, Latvia, Estonia:*

- Red Data book of the Baltic region. Part 1. Lists of threatened vascular plants and vertebrates – Ingelög, Andersson and Tjernberg (ed.) (1993).

*Spain, Portugal:*

- Red List of Bryophytes of the Iberian Peninsula – Sergio, Casas, Brugués and Cros (1994).

*Britain, Ireland:*

- Red Data book of Britain and Ireland: Stoneworts – Stewart and Church (1992).

### **National**

Examples of national Red Lists are:

- Polish Red Data Book of Animals. Vertebrates – Glowacinski (ed.) (2001).
- Red List of Plants and Animals of Slovakia – Baláz, Marhold and Urban (eds.) (2001).
- Red Data Book of Turkish Plants (Pteridophyta and Spermatophyta) – Ekim, Koyuncu, Vural, Duman, Aytaç and Adigüzel (2000).

## Regional

These can be subdivided as follows:

- a geographical region: naturally isolated areas, like islands, e.g.
  - Libro rojo de especies vegetales amenazadas de las Islas Canarias – Gómez Campo and Colaboradores (1996).  
[Remark: the Canary Islands are a part of Spain]
- b ecosystem level: Nature areas, like rivers and mountains, e.g.
  - Endangered fish species of the Danube river in Austria – Schiemer and Spindler (1989).
  - Threatened vascular flora of Sierra Nevada (Southern Spain) – Blanca, Cueto, Martíñex-Lirola and Molero-Mesa (1998).
- c administrative units: like Federal states (Bundesländer), Cantons, Districts, cities etc.
  - Atlas préliminaire des papillons de jour de Wallonie & Liste Rouge révisée – Goffart and De Bast (2000).
  - A documented Red List of the butterflies of Flanders – Maes and Van Dyck (1996).  
[Remark: Belgium has only 5 national Red Lists but 17 regional Red Lists of Wallonie and Flanders, e.g. the Butterflies; these may be very small, including only a few local populations of a given species, e.g. for a city.]
  - Regionale Rote Liste Lübeck – Amphibien und Reptilien – Lammert, Kahns and Niehus (1996).

## DEFINITION OF A RED LIST

What exactly is a Red List? How we can count them?

### Taxonomic circumscription

A Red List publication can contain a part of a taxonomic group or in an extreme case all major taxonomic groups of plants and animals.

Good examples of a 'part of a taxonomic group' are Crustacea and Insecta which are part of the Order Invertebrates. Because of their species richness scientists often work only on a part of a taxonomic group, such as a family e.g.

- Butterflies, Bombyces and Hawkmoths, Noctuid Moths, Geometrid Moths etc. of the order Lepidoptera,
- Ants, Spider Wasps, Digger Wasps, Humble Bees, Hive Bees etc. of the order Hymenoptera,
- Tiger Beetles, Ground Beetles, Water Beetles, Leaf Beetles, Longhorn Beetles etc. of the order Coleoptera.

These Red Lists can be published as single publications or together with other Red Lists in a special compilation. A good example for such a compilation is the Red List of endangered animals and plants, plant communities and habitats of Thuringia in Germany (Fritzlar and Westhuis 2001). In this compilation are 61 single Red Lists (e.g. single Red Lists with 11 Coleoptera, 9 Lepidoptera, 6 Diptera, etc.)

By contrast, there are also Red Lists which contain all major taxonomic groups of plants and animals in one single publication, e.g.

- 2002 IUCN Red List of Threatened Species – Hilton-Taylor (Compiler) (2002).
- European Red List of Globally Threatened Animals and Plants. – Economic Commission for Europe (ed.) (1991).

These facts make the comparison of Red Lists very difficult. But it gets even more complicated.

### Geographical consideration

In many Red Lists there are several columns for threat categories, since threat assessments are given for subregions, too. A good example for this is the Red List of vascular plants of Italy (Conti, Manzi and Pedrotti, 1997). This publication contains, beside the national threat classification, the Red List information for 20 districts (e.g. Toscana, Piemonte, Sicily) in 20 columns.

So, should this publication be handled as a single Red List or as 21 Red Lists?

A further geographical problem is that the Canaries, Madeira, and Azores are considered politically part of Europe, but are bio-geographically quite separate from Europe. The same applies to the possessions of France and other countries overseas. For purely arbitrary reasons, the Azores, Madeira and Canaries are included in this survey, but other overseas possessions of EU member states are not.

Finally, there is a presentational problem with the maps used to show the Red Lists in this paper. Because the data is presented in political units, islands such as those of the Balearics and Tyrrhenians are included with their political states, and Northern Ireland with mainland Britain, even though the data may not apply to those islands (or vice versa).

## Methodology

To arrive at a fast and practical solution, we adopted the following approach for the evaluation of Red List data:

- 1 Classifying all lists into 31 taxonomic groups of organisms (e.g. vascular plants, mosses and liverworts, mammals, birds, beetles and so on)
- 2 Analysing presence or absence of these taxonomic groups (the minimum was counted as one publication, the maximum as 31)
- 3 Analysing the number of regions and/or subregions covered by a list (if there is more than one Red List column, the publication was regarded as two or more separate lists, otherwise as one)

### NUMBER OF RED LISTS

More than 2,000 (current and historical) European Red List publications were evaluated in the way described above, resulting in a total of over 3,701 single Red Lists currently known to us. From these, 139 are world-wide lists including Europe, 94 cover the whole of Europe; the remaining 3,468 are regional or national lists.

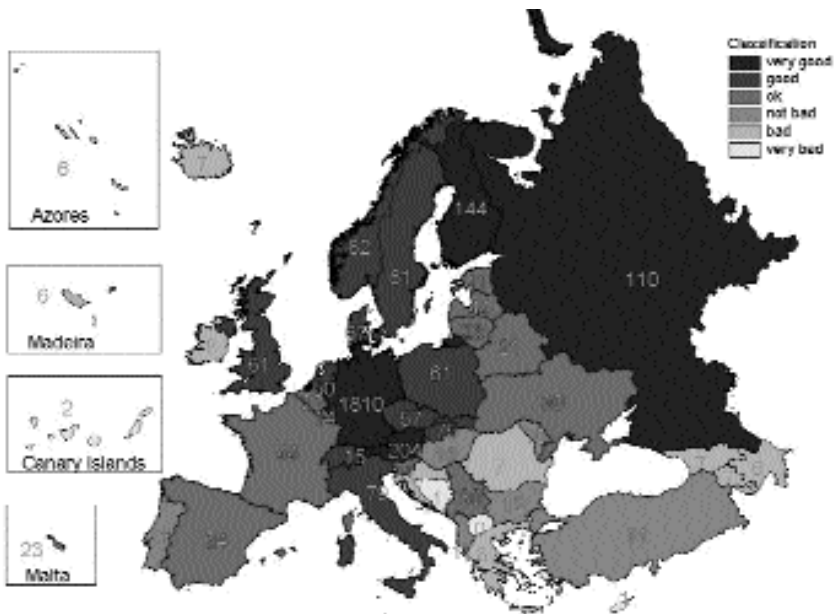
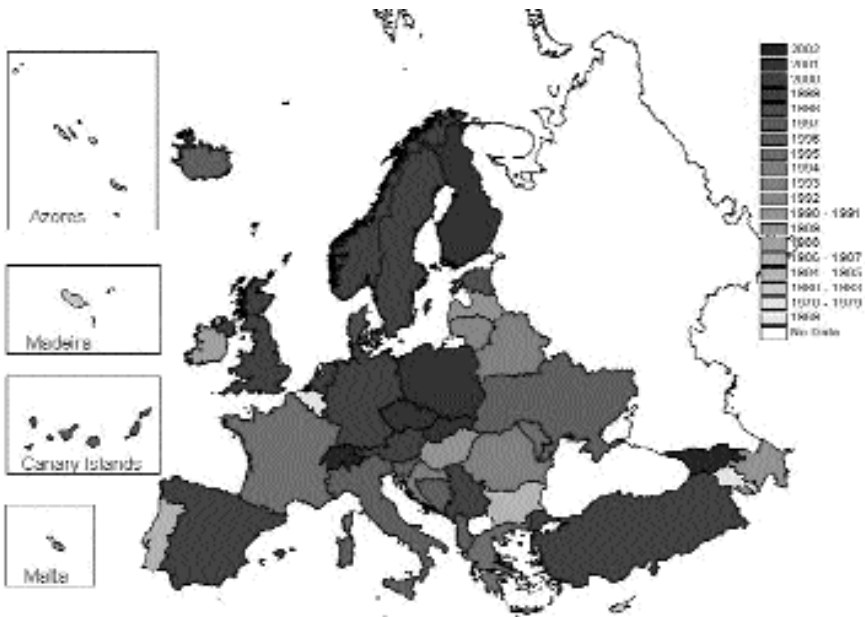

**Figure 1** – Number of current and historical Red Lists in the different states and regions of Europe.

From the 3,468 Red Lists of 49 European countries and regions, Germany has the highest proportion (1,810 lists, equalling 51.9 %), followed by UK (226 Red Lists), Austria (204 Red Lists) and Finland (144 Red Lists). On average, there are 71 Red Lists for each of the 49 evaluated European countries and regions (or 35 if we disregard Germany). Except for the former Yugoslav Republic of Macedonia, all European countries have at least one national Red List published. However, both the number of systematic groups covered as well as the number of regional Red Lists published varies widely: the 10 European countries and regions with the highest numbers of Red Lists make up 78.3 % (2,714) of all lists.

### DISTRIBUTION OF RED LIST ACTIVITIES

The lion's share of national and regional Red Lists comes from Central Europe, Fennoscandia and the Atlantic countries, whereas the largest gaps exist in the Mediterranean region, the Balkan peninsula and eastern Europe. In many of these countries, only vascular plants and vertebrates are covered by Red Lists.



**Figure 2** – Current national Red Lists of Vascular Plants – distribution and year of publication.





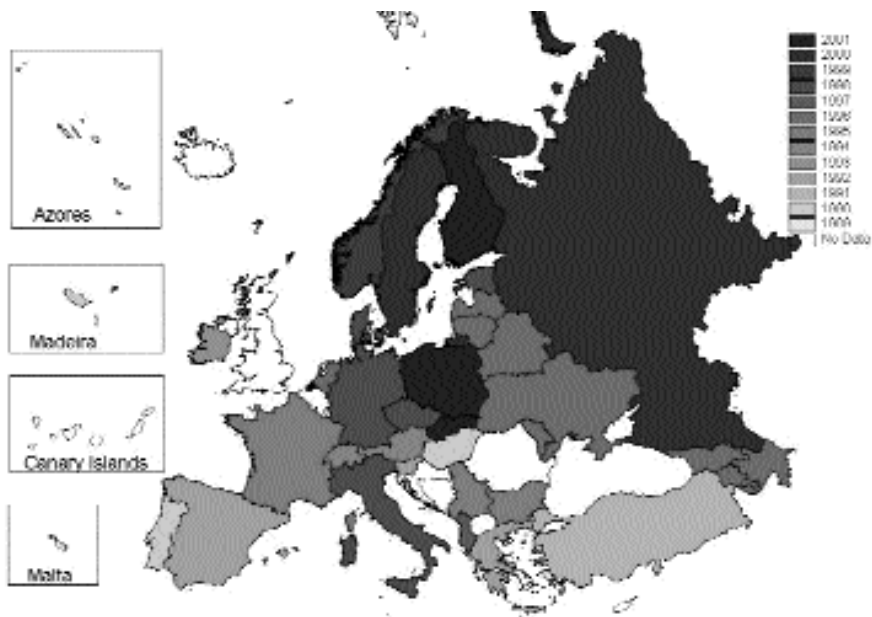

**Figure 5** – Current national Red Lists of Amphibia and Reptiles – distribution and year of publication.

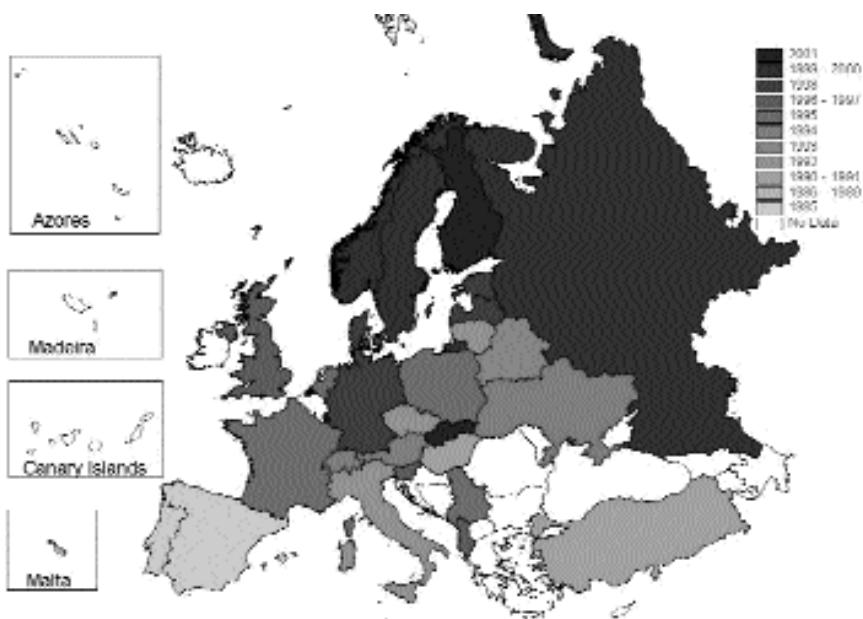

**Figure 6** – Current national Red Lists of Butterflies and Moths – distribution and year of publication.

Reviewing the time horizons of the Red Lists published, the Scandinavian countries have the most current Red Lists, followed by Central Europe, and also the states of the former Soviet Union. Except for the newly formed republics of former Yugoslavia, most European Red Lists for vascular plants, vertebrates but also some more conspicuous groups of insects were issued after 1992, thus being within the time span of one decade often considered as the time span where Red Lists should be updated in regular intervals. In these groups, a database of national Red Lists would find solid ground and would be a useful tool for analysing threat status and target regions for conservation of species at an European scale.



**Figure 7** – Number of current national and regional Red Lists of four vertebrate groups.

Germany produced by far more Red Lists than any other European country, which is in part caused by the federal organisation of nature conservation (the highest authority is with the states, not with the federal government). However, so far no efforts have been made by Germany to adopt the IUCN categories and Criteria for a national Red List, which is in part due to the long tradition and the well-elaborated national system of categories (Schnittler and Ludwig 1996).

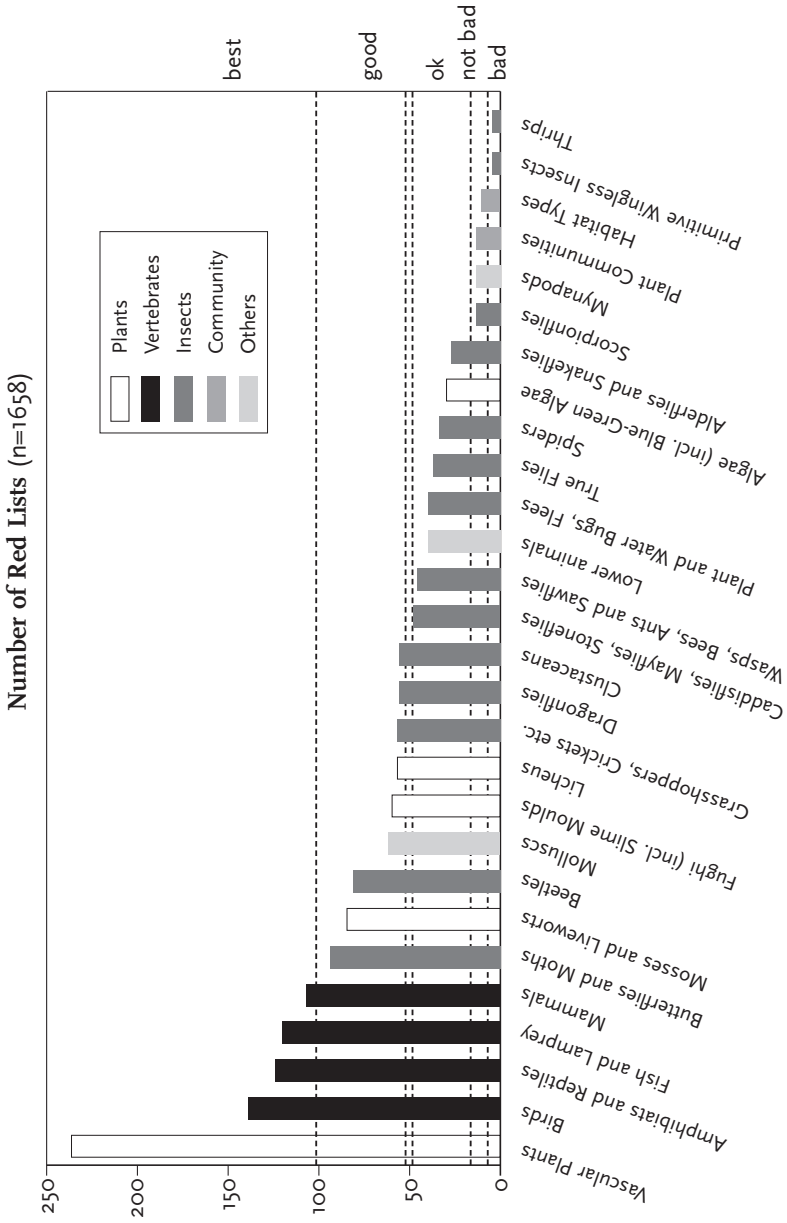

Figure 8 – Systematic groupings treated most frequently in national and regional Red Lists (excl. Germany).

## SYSTEMATIC GROUPINGS TREATED IN RED LISTS

Systematic groupings treated most frequently are: 1. Vascular plants, 2. Birds, 3. Amphibians and Reptiles, 4. Fish and Lampreys, 5. Mammals, 6. Butterflies and Moths, 7. Mosses and Liverworts, 8. Beetles, 9. Molluscs. The least information is available on Thrips and primitive wingless insects.

## REGIONAL RED LISTS

Twenty-four of the 49 European countries and regions (= 48.9 %) have published not only national but also regional Red Lists, e.g. the federal states in Germany and Austria, the Swiss cantons, or the French districts.

## UPDATING OF RED LISTS

Currently, we are aware of 579 national Red Lists in Europe. Most of these (83% = 481 Red Lists) were published during the last ten years (1992-2001), 16% (93 Red Lists) were published in the period 1982 to 1991. Belgium has the oldest still valid national Red List (although more recent publications exist for the regions of the country). It appeared in 1969 and treats the vascular plants (Lalwée and Delvosalle, 1969). That means: Belgian started very early (it is one of the oldest Red Lists in Europe of all). It did not pursue further efforts to update the national list, but publishes separate lists for Flanders and Wallonia.

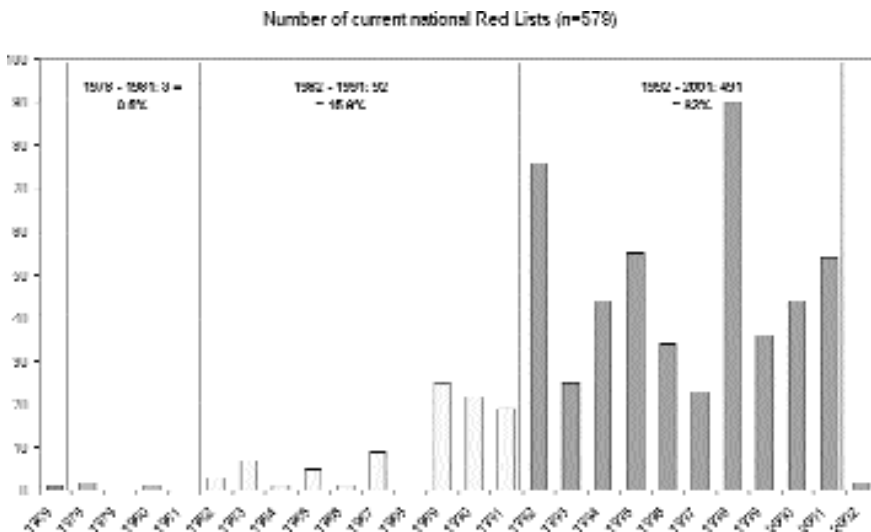

Figure 9 – Updating of national Red Lists in Europe (time period).

## RESPONSIBLE ORGANISATIONS

With respect to the organisations responsible for the publication of Red Lists there are three main groups: 1. Governmental bodies (about 90% of all publications), 2. NGOs (e.g., WWF, The Turkish Association for the Conservation of Nature, The Royal Society for the Protection of Birds; many Red Lists on birds are from NGOs), 3. Scientific institutions such as natural history museums or universities.

## CATEGORIES AND CRITERIA SYSTEM

In the categories and criteria systems used for Red Listing we find a very high variety, and this is also the most important obstacle to come to a consistent database of comparable European Red Lists (Köppel *et al.* 2000). Currently, most states still use their own categories and criteria system, some still valid lists use the pre-1994 IUCN categories, and even 'mixed' systems occur.

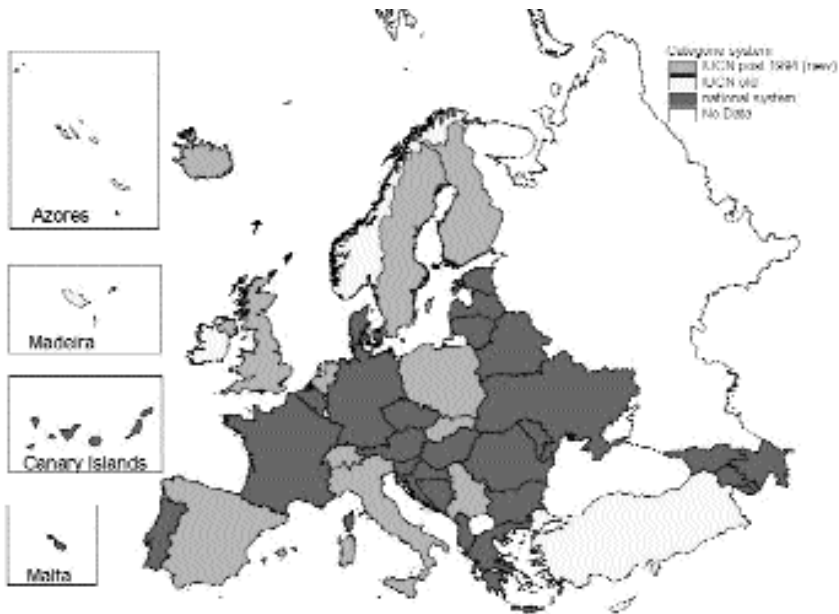

**Figure 10** – Used Category Systems at the example of the current national Red Lists of Vascular Plants in Europe.

To compare threat assessments made by different countries a true standardisation of categories (not only category names, but also criteria systems used!)

would be indispensable. Although being a huge challenge, it would be a very desirable goal to develop a criteria system applicable to all taxonomic groups (including both mosquito and elephant!) and regions (covering a city as well as a continent!). The new (2001) IUCN Categories and Criteria version 3.2. meet this requirement to a certain extent.

However, considerable differences still remain if one takes into account the intention of the different categories and criteria systems currently existing in Europe. The following table shows an example of this in a comparison of the German categories with those of the IUCN.

| IUCN                                 | German-speaking countries   |
|--------------------------------------|---|
| Focus on extinction probability<br>– | Can a species fulfil its role in Nature?<br>Additional category R (= rare)                      |
| Fixed thresholds                     | Variable thresholds:<br>in relation to geographical area<br>for the group of organisms assessed |

The main difference between the IUCN system and the system of German speaking countries is that the first focuses entirely on extinction probability. The German system asks if a species still can fulfil its role in nature. Therefore, taxa with populations stabilized at a very low level after severe decline will be listed under these criteria but not under the IUCN criteria.

A further difference is the existence of a category R (extremely rare) in the German system, designed to serve practical needs of nature conservation. This criterion establishes a watch list of extremely rare species not currently under threat and not showing signs of decline. They have to be monitored only since even small and local impacts can threaten the entire population of a country.

The criteria CR, EN, VU have fixed thresholds in the IUCN system (area of occupancy, extent of occurrence, number of mature individuals) but variable thresholds regarding decline (%). The system of the German-speaking countries works with scales, and the thresholds have to be defined for each group of organisms and area under consideration.

The fixed thresholds in the IUCN system often cause problems when applied to countries of different size. For example, for smaller regions the thresholds for the number of individuals can reach the carrying capacity for a healthy population, thus placing it in any case in a threat category, even if no threat factors can be seen. This has been the case for the eagle in Switzerland, a bird naturally requiring a large territory.

The solution offered for the regional application of the IUCN criteria is the up and downgrading process (Gärdenfors *et al.*, 2001). However, this solution has two drawbacks:

- it is a relatively rough tool compared with the very sophisticated system of the IUCN Categories and Criteria itself, since it offers only adjustment concerning the ‘whole’ categories, i.e. from CR to EN or vice versa
- it does not apply for sessile organisms.

For the lists published so far for vascular plants, an additional problem is posed by the fact that numbers of individuals are often impossible to count. Quite often, grid mapping data are used, and it is often difficult to achieve comparability if it comes to the grid size which was used to determine a criterion like ‘area of occupancy’. The currently published national Red Lists using the 1994 IUCN categories provide the following data:

| Country              | Used grid sizes  |
|----------------------|--|
| The Netherlands 2000 | the number of records presented are based on the 1 x 1 kilometer grid of the topographical map |
| UK 1999              | 10 x 10 kms  |
| Switzerland 2002     | no information   |
| Poland 2001          | no information   |
| Italy 1997           | no information   |

Using different grid sizes, problems like the contradiction between fixed thresholds for some criteria and the size of the country can be ‘creatively’ solved by using different ‘fringe criteria’ for the basic data used for the criteria. However, this undermines the comparability of national Red Lists, and the dangerous development would be that countries use the label ‘IUCN’ but in fact justify the ‘fringe criteria’ to obtain the results foreseeable by ‘common sense’.

To tackle this problem, it would be very desirable to agree about these ‘fringe criteria’ like counting units, grid sizes, or migration objects and rates used for different taxonomic groups of organisms.

The following publications explain in detail ‘how to use the criteria system’ in relation to the IUCN system (examples):

a National

- Rote Liste der gefährdeten Farn- und Blütenpflanzen der Schweiz. Ausgabe 2002 – Moser, Gyga, Bäumler, Wyler and Palese (2002).



- Lista Roja de la Flora Vascular Española – Lozano (ed.) (2000).
- Grundlagen zur Fortschreibung der Roten Listen gefährdeter Tiere Österreichs – Zulka, Eder, Höttinger and Weigand (2001).
- Schnittler, M. and G. Ludwig, 1996. Zur Methodik der Erstellung Roter Listen. In: Federal Agency for Nature Conservation (ed.): Rote Listen gefährdeter Pflanzen Deutschlands – Schriftenreihe für Vegetationskunde 28: 709-739.

#### b General

- The Application of IUCN Red List Criteria at Regional Levels – Gärdenfors, Hilton-Taylor, Mace and Rodríguez (2001).

#### c Special

- IUCN Red List Categories and Criteria. Version 3.1 – IUCN Species Survival Commission (2001).

## OUTLOOK

In 2003, V.I.M. (Verlag für interaktive Medien) will make the European Red Lists available on the web (see [www.s2you.com](http://www.s2you.com)).

## LITERATURE

- BALÁZ, D., K. MARHOLD and P. URBAN (eds.), 2001. *Cerveny Zoznam Rastlín a Zivočíchov Slovenska*. [Red List of Plants and Animals of Slovakia. Nature Conservation]. – Ochrana Prírody, Supplement 20, Štátna ochrana prírody Slovenskej republiky, Banská Bystrica.
- BLANCA, G., M. CUETO, M.J. MARTÍNEZ-LIROLA and J. MOLERO-MESA, 1998. Threatened vascular flora of Sierra Nevada (Southern Spain). *Biological Conservation* 85 (3): 269-285.
- CONTI, F., A. MANZI and F. PEDROTTI (coordination), 1997. *Libro rosso regionali delle piante d'Italia*. – WWF, Associazione Italiana per il World Wildlife Fund in collaborazione con la Società Botanica Italiana, Camerino.
- ECONOMIC COMMISSION FOR EUROPE (ed.), 1991. *European Red List of Globally Threatened Animals and Plants and recommendations on its application as adopted by the Economic Commission for Europe at its forty-sixth session (1991) by decision D (46)*. United Nations Publication, Economic Commission for Europe, Geneva.
- EKIM, T., M. KOYUNCU, M. VURAL, H. DUMAN, Z. AYTAÇ and N. ADIGÜZEL, 2000. *Türkiye Bitkileri Kırmızı Kitabı (Egrelti ve Tohumlu Bitkiler)*. *Red Data Book of Turkish*

- Plants (Pteridophyta and Spermatophyta)*. Türkiye Tabiatini Koruma Derneği (Turkish Association for the Conservation of Nature), Ankara.
- European Committee for conservation of Bryophytes, 1995. *Red Data Book of European Bryophytes*. Trondheim, Norway.
- FRITZLAR, F. and W. WESTHUS in Zusammenarbeit mit dem Fachbeirat für Arten- und Biotopschutz der TLUG Jena, 2001. *Rote Listen der gefährdeten Tier- und Pflanzenarten, Pflanzengesellschaften und Biotope Thüringens*. Naturschutz Report 18, Thüringer Landesanstalt für Umwelt und Geologie, Abteilung Ökologie und Naturschutz, Jena.
- GÄRDENFORS, U., C. HILTON-TAYLOR, G.M. MACE and J.P. RODRÍGUEZ, 2001. The Application of IUCN Red List Criteria at Regional Levels. *Conservation Biology* 15 (5): 1206-1212.
- GŁOWACINSKI, Z. (ed.), 2001. *Polska czerwona księga zwierząt. Kregowce. – Polish Red Data Book of Animals. Vertebrates*. Warszawa.
- GOFFART, P. and B. DE BAST, 2000. *Atlas préliminaire des papillons de jour de Wallonie & Liste Rouge révisée*. Ministère de la Région Wallone (Direction Générale des Ressources Naturelles et de l'Environnement), Bruxelles.
- GOMEZ CAMPO, C., 1996. *Libro rojo de especies vegetales amenazadas de las Islas Canarias*. Viceconsejería de Medio Ambiente, Consejería de Política Territorial, Gobierno de Canarias, Medio Ambiente Canarias, Canarias.
- HILTON-TAYLOR, C. (ed.), 2002. *2002 IUCN Red List of Threatened Species*. IUCN, The World Conservation Union, Gland.
- INGELÖG, T., R. ANDERSSON and M. TJERNBERG (eds.), 1993. *Red Data Book of the Baltic region*. Part 1. *Lists of threatened vascular plants and vertebrates*. Swedish Threatened Species Unit, Uppsala, in co-operation with Institute of Biology, Riga, Uppsala.
- KÖPPEL, C., M. SCHNITTLER, E. RENNWALD and N. HIRNEISEN, 2000. A database of European Red Lists as a tool for risk assessment in endangered Vascular Plants. *Zeitschrift für Ökologie und Naturschutz* 9: 119-126.
- LAMMERT, F.-D., R. KAHNS and O. NIEHUS, 1996. *Regionale Rote Liste Lübeck – Amphibien und Reptilien 2*, aktualisierte Fassung. Hansestadt Lübeck, Der Senat – Umweltamt, Lübeck.
- LAWALREE, A. and L. DELVOSALLE, 1969. Ptéridophytes et Spermatophytes rares, disparus ou menacés de disparition en Belgique. pp. 23-86. In: L. Delvosalle, F. Demaret, J. Lambinon and A. Lawalrée, *Plantes rares, disparues ou menacées de disparition en Belgique: L'appauvrissement de la flore indigène*. Travaux, Ministère de l'Agriculture. Administration des Eaux et Forêts. Service des Réserves Naturelles Domaniales et de la Conservation de la Nature.
- LOZANO, F.D. (ed.), 2000. *Lista Roja de la Flora Vascular Española – Red List of Spanish Vascular Flora*. Conservación Vegetal. Boletín de la Comisión de Flora del Comité Español de la Unión Mundial para la Conservación Naturaleza, 6.
- MAES D. and H. VAN DYCK, 1996. *Een gedocumenteerde Rode Lijst van de dagvlinders van Vlaanderen [A documented Red List of the butterflies of Flanders]*. Mededelingen van het Instituut voor Natuurbehoud 1, Brussels.
- MOSER, D.E., A. GYGAX, B. BÄUMLER, N. WYLER and R. PALESE, 2002. *Rote Liste der gefährdeten Farn- und Blütenpflanzen der Schweiz*. Ausgabe 2002. BUWAL-Reihe 'Voll-

- zug Umwelt'. Bundesamt für Umwelt, Wald und Landschaft (BUWAL), Bern; Zentrum des Datenverbundnetzes der Schweizer Flora (ZDSF/CRSF, Chambésy); Conservatoire et Jardin botaniques de la Ville de Genève (CJBG, Chambésy), Genève.
- NORDHEIM, H. VON and D. BOEDEKER, 1998. *Red List of marine and coastal biotopes and biotope complexes of the Baltic Sea, Belt Sea and Kattegat. Including a comprehensive description and classification system for all Baltic marine and coastal biotopes*. Baltic Sea Environment Proceedings 75, Helsinki Commission, Baltic Marine Environment Protection Commission, Helsinki, Finland.
- NORDHEIM, H. VON, O.N. ANDERSEN and J. THISSEN, 1996. *Red Lists of Biotopes, Flora and Fauna of the Trilateral Wadden Sea Area, 1995*. Schriftenreihe für Landschaftspflege und Naturschutz 47, Bundesamt für Naturschutz (BfN), Bonn-Bad Godesberg.
- SCHIEMER, F. and T. SPINDLER, 1989. Endangered fish species of the Danube river in Austria. *Regulated rivers: Research & Management* 4: 397-407.
- SCHNITTLER, M. and G. LUDWIG, 1996. Zur Methodik der Erstellung Roter Listen. In: Federal Agency for Nature Conservation (ed.), *Rote Listen gefährdeter Pflanzen Deutschlands*. *Schriftenreihe für Vegetationskunde* 28: 709-739.
- SERGIO, C., C. CASAS, M. BRUGUÉS and R.M. CROS, 1994. *Lista Vermelha dos Briófitos da Península Ibérica. Red List of Bryophytes of the Iberian Peninsula*. Instituto da Conservação da Natureza (ICN) & Museu, Laboratório e Jardim Botânico, Universidade de Lisboa (MLJB), Lisbon.
- STEWART, N.F. and J.M. CHURCH, 1992. *Red Data Book of Britain and Ireland: Stone-worts*. The Joint Nature Conservation Committee, Peterborough.
- SWAAY, C. VAN and M. WARREN, 1999. *Red Data Book of European Butterflies (Rhopalocera)*. *Nature and environment* 99: 1-260, Council of Europe Publishing, Strasbourg.
- TUCKER, G.M., M.F. HEATH, L. TOMIALOJC and R.F.A. GRIMMETT, 1994. *Birds in Europe: their conservation status*. BirdLife Conservation Series 3, Cambridge, U.K.
- WALTER, K.S. and H.J. GILLET (eds.), 1998. *1997 IUCN Red List of Threatened Plants*. Compiled by the World Conservation Monitoring Centre. IUCN, Gland and Cambridge.
- ZULKA, K.P., E. EDER, H. HÖTTINGER and E. WEIGAND, 2001. *Grundlagen zur Fortschreibung der Roten Listen gefährdeter Tiere Österreichs*. Monographien 131. Umweltbundesamt, Vienna.



# 8

## Red Listing in Portugal with the new IUCN Categories and Criteria: state of the art

*L. Rogado*

The actual project for revising the Portuguese Red Data List will assess the threat status of the following vertebrate groups: freshwater and migratory fishes, amphibians and reptiles, birds and mammals. This will be the first Red Data book in Portugal using the new IUCN Categories and Criteria (version 3.1) and so experience with and knowledge of the new concepts, and the use of the RAMAS Red List software (version 2.0) are being gathered, reviewed and discussed. For many species (in Portugal) there is a lack of data or an uncertainty with regard to data quality. However, with these limitations, the assessment will be done as much as possible using the available species data, although some field work is being done to cover some of the identified information gaps. The project runs from July 2001 until December 2003 and the end results will be published in 2004. It is expected that about 50% of the species will be assessed (first step) by the end of 2004. The second step, the application of the regional guidelines, has not started yet and is planned for a later stage.

With this paper it is intended to report on the methodological constraints and decisions taken in applying the new IUCN Categories and Criteria in Portugal and to launch some questions to be widely discussed between people working on these issues in different taxonomic groups and countries.

### INTRODUCTION

Red Lists in Portugal have no legal framework and are not covered by the national law but have a general acceptance and are widely used to support environmental policies, like setting priorities or performing environmental impact assessments.

The harmonization in the assessment of the species' threat status, within and between countries, is a very important issue, which is recognised in Portugal. In the past, when the previous IUCN criteria were used, it was also the intention to use a widely recognised system, although the scientific basis was

more narrow. It is my opinion that nevertheless the harmonization of National Red Lists in Europe needs to go far beyond the decision of the application of a common system. It demands an enormous amount of work to ensure the technical harmonization of the criteria application.

This paper is divided into four parts: 1) general information about the organisation of the species assessment process in Portugal, its schedules and frameworks; 2) decisions taken in the application of the criteria in Portugal; 3) doubts in applying some concepts; 4) problems in using the RAMAS Red List software.

## GENERAL INFORMATION

Revising Red Data Lists in Portugal is a task commissioned to the Nature Conservancy Institute (ICN) in Lisbon, which belongs to the Ministry of Urban Affairs, Spatial Planning and Environment. Nevertheless, many researchers from other institutes and universities from all over the country, were invited to work together to contribute to fulfilling this objective. The present project seeks to assess the threat status of the following vertebrates groups: 1) freshwater and migratory fishes, 2) amphibians and reptiles, 3) birds and 4) mammals.

It will be the first Red Data Book in Portugal using the new IUCN Categories and Criteria (version 3.1 – 2001) and so experience and knowledge on the new concepts and use of the RAMAS Red List software (version 2.0) are being gathered and discussed.

The working team is organised in three levels. The editor's level, co-ordinated by the ICN, is responsible for consistency in the procedures and the integration and implementation of all activities. This team, which consists of eleven researchers, reviews and approves the work program, the work schedule, the authors' lists, the species reference lists, the content of the Red List publication, the Red Listing methods and technical issues in the application of the IUCN Categories and Criteria, and the final validation of the Red List publication. The conceptual approach is taking into account suggestions from all participants of the different levels.

At the authors level there are four working groups with a total number of 50 researchers involved. Each working group has a co-ordinator from ICN, who also belongs to the editor group. The authors have to suggest and discuss the working methods, gather all available information, identify information gaps, propose and execute some data collection, to cover the most important data gaps, and assess the species against the IUCN criteria.

To the third organisational level belong the local collaborators (mainly volunteers), who are contacted by the authors to give relevant information on some species, to implement some fieldwork or to do any precise task. From

time to time, a national seminar invites all these groups to check progress and discuss common problems and solutions.

The project has started in July 2001 and will be finalised by December 2003. Publication of the results will take place in 2004. The programme will make use of the available knowledge, though some fieldwork is being done to cover some of the identified information gaps.

In order to support the work, some relevant documents have been produced and published, such as

- General Guidelines for the Application of the IUCN Categories and Criteria in Portugal;
- Guidelines for the application of the IUCN Categories and Criteria for fishes in Portugal and Guidelines for the use of RAMAS Red List software.

Some IUCN documents have been translated into Portuguese:

- Definitions of 'IUCN Red List Categories and Criteria' (version 3.1 - 2001);
- Definitions for 'The application of IUCN Red List Criteria at Regional Levels' (2001);
- Summary of the table of the categories; RAMAS Red List table of threats; and the RAMAS Red List table of conservation measures.

#### NATIONAL DECISIONS AND GUIDELINES IN APPLYING IUCN CRITERIA

During the assessment exercises, some problems in the application of the concepts and of the treatment of uncertainty of data were identified. The discussion continues, with the intention to search for solutions. In addition adjustments have been proposed which resulted in the design of some new procedures.

It was decided to assess the *taxa* at the species level and to perform different evaluations for the mainland of Portugal, Madeira and the Azores, which means that if a species occurs in all these regions, it will be assessed separately for each region. However species with distinct populations, resident and migratory ones like the European stork (*Ciconia ciconia*) and the salmon (*Salmo trutta*) should also be assessed separately.

#### Extent of Occurrence (EOO) and Area of Occupancy (AOO)

After intense discussions on the methods to calculate the EOO and AOO and taking into account that both have to be 'estimated' to be used under criteria B, it was decided to perform the calculations as follows.

For EOO it was decided that, if the area is known to be significantly larger than 20,000 km<sup>2</sup>, the area limited by the outer grid squares can be used. On the other hand, if the area is close to 20,000, 5,000 or 100 km<sup>2</sup>, then it is recommended to use a more precise calculation method, which can be applied by using the area limited by the minimum convex polygon. In both cases it has to be considered whether the data were collected with a systematic method for all the territory (for instance an atlas) or if they came from variable sampling, which can lead to an underestimate of the EOO. In any case, areas within neighbouring Spanish territory and unsuitable habitats at a coarse scale should be excluded. When data are scarce, the use of models should be avoided and models should only be used in special known cases.

For some particular taxons specific procedures have been agreed. For freshwater fishes only the freshwater area will be taken into account, as the continuous area (length x calculated width) in rivers where the species occurs. For migratory fishes the same reasoning will be used, which means the surface area (length x calculated width) in rivers is used until the first obstacle and for their marine habitat the Economic Exclusive Zone (EEZ) area is used as a limit. For marine species, like marine mammals and turtles, also the EEZ area will be used because it is impossible to set borders in their distribution. On the other side for migratory birds, which just pass through the country, only the area covering the used corridor will be used.

For taxonomic groups with a distribution atlas available (e.g. birds, reptiles and amphibians), the sum of the occupied grid squares will be used to calculate AOO. As this calculation will over-estimate the AOO for species specialised on certain habitats, the amount of suitable and available habitat (from land use maps) can be used to obtain a more reliable value. When no atlas is available, the AOO can only be calculated from the area of suitable habitat estimated within the EOO. Some species have an irregular and dynamic land occupation pattern, like *Microtus cabreræ*, which uses a patched and variable habitat due to crop rotation. In these cases not only the area used at a particular moment should be considered, but all areas potentially used if suitable conditions can be re-established within a short time period.

The calculation of the AOO also takes into account that in some particular situations AOO 'is the smallest area essential at any stage to the survival of existing populations of a taxon'. Therefore it was decided to exclude the corridors between critical habitats for migratory species. For migratory fishes, the marine area should be excluded, because the inland waters are under special threat and are essential to accomplish their life cycle. So the AOO will only be the area (length x calculated width) in rivers until the first obstacle. For freshwater fishes, the AOO is the area (length x calculated width) in rivers, where the species actually occurs. Semi-aquatic species, like amphibians, will be



treated as fishes and so, the AOO is the area (length x calculated width) in rivers where these species actually occur and often also the area in the margins with an adequate width. Other examples are some colonial nesting birds to which the AOO is the area of the nesting place (e.g. an islet) and for cave dwelling bats, the roosting areas are used for the AOO.

### Reversibility of reduction causes

To address this issue, negative impacts should be considered reversible, if it is known how to exclude them. Even if at the moment there is no budget for conservation action, but it is expected be available in the next 3 generations, they should be considered as reversible. On the other hand, if you know how to exclude the causes, but the solution is too difficult to implement, then the negative aspects should be taken as irreversible. Examples of this are dams that have an expected 'life' of a 100 years and a low probability to be removed, as well as the effects of introduced taxa (invasive species), whose eradication is unlikely.

### Location

According to the IUCN definition as 'a geographical or ecologically distinct area in which a single threatening event can rapidly affect all individuals of the taxon present' some reasoning was made in order to get a more precise interpretation of this concept. In this sense 'rapidly' means faster than the recovery capacity of the species. 'Affect' doesnot necessarily imply mortality, it can also refer to modification of the reproduction rate, which can significantly and negatively modify the species viability in that precise location. Species mobility and colonisation ability should also be taken into account. If the population can move to another place and maintain its viability, the threat should not be considered a 'serious' one.

Regarding the assessment of the number of locations it was considered that climatic changes at a global level should not count as a threatening event, as they occur at very large geographic and time scales and are difficult to measure. For migratory fishes, each watershed area where the species occur, should correspond to one location, because if a dam would be built downstream, it would prevent the access of the species to the whole watershed and vice versa.

## DOUBTS IN APPLYING SOME CONCEPTS AND IN THE TREATMENT OF UNCERTAIN DATA

Some doubts and difficulties in the application of the IUCN system are still present and the discussion is ongoing. With this paper it is expected that a wide discussion and exchange of experiences will bring some useful recommendations. The main problems are related to the following topics.

### Generation length

The most common method to calculate it will probably be:

Generation length = age of maturity + 0,5 \* (length of reproductive period in life cycle)

Nevertheless length of reproductive period in life cycle is difficult to know for many species of which the biology is poorly known. It is important to know if maximal longevity could be used and what kind of correction should be done.

### Scale correction factors

It is unclear if it is really necessary to standardise estimates between species with similar habitat requirements or to use the finest scale for species with better data (quantitative and qualitative). Another problem is to standardise estimates for species, where the AOO was not calculated, using grid squares but minimum convex polygons or linear area calculations (see above EOO and AOO), although grid squares could be projected over these maps

### Qualifiers

It is clear that the use of qualifiers is of extreme importance in the new IUCN criteria, because some criteria can only be applied if the data have a certain quality and precision.

For instance the number of mature individuals has to be estimated to be applied for criteria C and D. So it is important to clarify the adequate qualifier when using data resulting from inquiries, survey data, index of abundance or the total population size.

## Extreme fluctuations

There are some doubts how to deal with this subject.. This is a typical problem for freshwater fishes. For instance the Saramugo (*Anaecypris hispanica*) is a small endemic threatened freshwater fish species which occurs in intermittent small rivers in the Guadiana watershed, at the South of the Iberian Peninsula. During summers most of their populations stay confined to small pools. Sometimes these pools dry out completely and in this situation there are high local mortalities. This means that it can be considered an extreme fluctuation both in the number of mature individuals as in AOO. Another example is migratory fishes, as the Sea lamprey (*Petromyzon marinus*), which enter the freshwater systems during winter. There is a positive relationship between the number of animals entering the watersheds and the river flows, and so big variations can occur between years with heavy rainy and dry years. The question is if such seasonal and annual variations can be considered as extreme fluctuations.

## Extent of Occurrence and Area of Occupancy when data are scarce

This is a particular problem for freshwater fishes, especially because data are scarce and these parameters have to be estimated. One possibility is to use habitat extrapolation models, but there are no good habitat use models for fish, because data on ecological behaviour are missing for several species. Another possibility is to work at a sub-basin scale but this will result in an over-estimation, because the sampling grid is very broad.

## Other issues which need more discussion

This is the case for calculating reduction and continuing decline and the concept of 'Moving window' reduction.

## PROBLEMS IN APPLYING RAMAS RED LIST SOFTWARE

The RAMAS software (version 2.0) is a useful tool for assessing the species threat category under the IUCN system. However, some particularities must be well understood so that all users follow the same procedures.

### 'Unknown' *versus* the qualifier used

For almost every parameter, of which data are entered in RAMAS Red List software, it is requested to specify a qualifier describing the reliability of the value: if it is observed, estimated, projected, inferred or suspected. But instead of giving a value for the parameter it is also possible to say the value is 'unknown'. In this case different qualifiers applied to 'unknown' have different effects on the results: (1) if the qualifier is too weak for a given criterion it is the same as ignoring that parameter; (2) if the qualifier is enough to apply this specific criterion it will give all possibilities of threat categories because the program takes a precautionary approach. In fact, this is a question that needs more reasoning but it was advised by the IUCN Red List Programme to use very wide limits for the parameter instead of 'unknown' in order to allow the use of the qualifier 'estimated'.

### Logical parameters (True/False, Yes/No, 0-1)

When it is not possible to be certain about the answer, RAMAS allows to use a number between 0 (false) and 1 (true) reflecting one of the situations: the degree of plausibility in the statement or the reliability of the information about that aspect of the population. This can lead to some mixture of both situations. In this project it has been suggested to the authors, when using a value between 0 and 1, it should preferably reflect the biological situation of the species instead of percentage of authors who agree with the statement. In any case the value should be explained in the notes.

### Population

Under the tab population in RAMAS the past and future number of mature individuals can be specified. These parameters are not used directly but can be used to calculate past reduction automatically in the reduction tab. In this project it has been suggested that these values should only be filled in if there is enough data about the population itself and not if data is taken from other variables that are indirectly related to the number of mature individuals. In this case it was thought to be better to answer 'unknown' (with the qualifier estimated).

### All individuals in one sub-population?

The RAMAS uses the answer to this question under the 'Fragmentation' tab to evaluate criteria C2a(ii) 'at least (96%) of the mature individuals are in one sub-population'. The problem is that if you answer no to this question the software takes it as a zero and RAMAS does not apply the criteria C2a(ii). Nevertheless you can have 96% of the mature individuals in one sub-population and in fact they are not all in one population. In this case if you answer 0,96 then it applies criteria C2a(ii). In this situation the possibility that this percentage reflects the authors opinion is even more questionable.



# 9

## Red Listing Policy in the Netherlands

*P. Joop*

In the Netherlands the Ministry of Agriculture, Nature management and Fisheries is responsible for the release of Red Lists since the 1990's. A Red List gives an overview of species breeding in the Netherlands which are endangered. This can mean that a species has disappeared or that it is on the verge of disappearance.

The specific status of a species is determined by two parameters: trend and rarity. The used categories of status are: extinct, critically endangered, endangered, vulnerable, near threatened (and least concern, is: not threatened at the moment).

| TREND  |      |    |     |     |       |        |  |
|--------|------|----|-----|-----|-------|--------|--|
| –      | o/+  | –  | NT  | LC  | LC    | LC     |  |
| 25%    | t    | –  | VU  | VU  | VU    | LC     |  |
| 50%    | tt   | –  | EN  | EN  | VU    | NT     |  |
| 75%    | ttt  | –  | CR  | EN  | VU    | NT     |  |
| <100%  | tttt | EX | –   | –   | –     | –      |  |
| 100%   |      |    |     |     |       |        |  |
| RARITY |      | x  | rrr | rr  | r     | common |  |
|        |      | 0% | >0% | 1%  | 5%    | 12,5%  | Distribution plants and invertebrates    |
|        |      | 0% | >0% | 1%  | 5%    | 25%    | Distribution vertebrates                 |
|        |      | 0  | 1   | 250 | 2.500 | 25.000 | Number of individuals or breedings pairs |

Through the years the Red Lists have been considered as a thermometer for biodiversity in the Netherlands. It helps policymakers to focus political attention (preservation plans, budget) towards those species which need the attention most. This makes a Red List an interesting instrument: in itself it is a 100% ecological instrument, it can be considered as a shortlist of endangered species. Within active nature policy it is an instrument, which helps to divide available funds/budgets between different kinds of species, which are in some kind of (protectional) need. Within a more passive policy (protection, preservation), it gives politicians an instrument to value nature in general within the process of environmental planning. For instance the planning of a new Highway may take into account the distribution of the number of Red List species in the area.

The overall objective is to move species from a higher threat category to a lower threat category, or even get them removed from the list so in the end the Red List will get shorter.

Although Red Lists have been frequently used in nature conservation, nature development and environmental and spatial planning, the lists as such didn't have a formal status in the 1990's. With the new legislation of the Flora and Fauna Act in April 2002 however, the existence and purpose of 'lists' have been underlined, and the authorities are obliged to give special policy attention to the species on these lists (for instance: research to improve knowledge of the species). The Red List, as said, includes various threat categories: extinct, critically endangered, endangered, vulnerable, near threatened and least concern. At this moment (March 2003) the Ministry of Agriculture, Nature Management and Fisheries has a special policy attention for Red Lists and is preparing a methodology to implement the categories of the Red List within the intention of the Flora and Fauna Act.

#### POLICY APPROACH

The protection of nature in the Netherlands is set out on two tracks: protection of land (area) and protection of species. For the protection of land, a Main National Ecological Structure (EHS) is laid out over the country. Within this structure the emphasis lies on the development and conservation of nature values. Realising a structure like that is a process which takes decades. Meanwhile certain species have arrived in the danger zone and they can't simply wait for the realisation of a nation-wide safe heaven to be accomplished (the EHS): immediate action is needed. Here is one of the main reasons for the necessity of a specific policy on the protection of species. This is also the case for all species which are distributed mostly outside this structure and won't be protected by the realisation of the EHS. The Ministry of Agriculture, Nature management and Fisheries focuses on so-called 'target species' in their spe-



The government Red List program in the Netherlands (2002):

| Incorporated                   | Planned for incorporation | Planned for actualisation (incl. IUCN 2002 criteria) |
|--------------------------------|---------------------------|--|
| Mammals 1994                   | Fish (salt water)         | Birds  |
| Birds 1996                     | Caddisflies (Trichoptera) |  |
| Reptiles and Amfibians 1996    | Stoneflies (Plecoptera)   |  |
| Fish (fresh water) 1999        | Mayflies (Ephemeroptera)  |  |
| Butterflies 1995               | Flatworms (Tricladia)     |  |
| Grasshoppers and Crickets 1999 | Bryophytes                |  |
| Dragonflies 1999               | Vascular plants           |  |
| Fungii 1996                    | Mollusks (fresh water)    |  |
| Lichens 1998                   | Bees                      |  |

cies policy. These species can be considered both nationally and internationally endangered. Therefore the list of target species contains more species than the lists with Red List species. Target species are a compilation of:

- Species from the appendices of the European conventions for the protection of Birds (appendix 1) and Habitats (appendices 2 and 4) which occur in the Netherlands;
- IUCN global Red List species (2000);
- Species for which the Netherlands is important, although not as breeding ground;
- National Red List species.

#### IUCN INCORPORATED?

With the actualisation of the Red List of Birds in the Netherlands, the Ministry of Agriculture, Nature management and Fisheries is strongly motivated to make use of the IUCN criteria. Not only to make the Dutch Red Lists compatible with Red Lists of neighbouring countries, but also to add insight on the threat status of species on the national Red Lists as they already exist. The Red List of Birds, which will be completed in 2003, is considered as a pilot. It will make use of two methods and deliver two lists, one nationally oriented list which makes it possible to compare the list with the former Red List of Birds from 1996, and which makes it possible to compare the list with Red Lists of other European countries.

In my personal opinion, the use and application of the new (2001) IUCN Categories and Criteria is a matter of concern. The descriptions I have seen point out several ways to estimate the threat category of a species. Terms used here are: observed, estimated, inferred, suspected. This does not seem very accurate and either is not a very simple version of algebra. It seems like IUCN has confidence in the determination of the status of species with these criteria. To policy advisors like myself, it looks that with the new IUCN criteria researchers and others may get into a debate about the most realistic status of a species, without reaching agreement. The Dutch way to assess the status is more straight forward in the same order of one plus one makes two. I hope that the IUCN criteria turn out to be the same concerning complexity and even more concerning outcome. To accomplish this I make a plea for a closer cooperation between the two worlds of research and policy.

#### REFERENCES

- BAL, D., H.M.BEIJER, M.FELLINGER, R. HAVEMAN, A.J.F.M. VAN OPSTAL and F.J. ZADLHOFF, 2001. *Handboek Natuurdoeltypen*. Rapp. nr. 2001/020. Ministry of Agriculture, Nature management and Fisheries, Expertisecentrum LNV, Wageningen.
- MINISTRY OF AGRICULTURE, NATURE MANAGEMENT AND FISHERIES, 2000. *PSO en IPO. Meerjarenprogramma Uitvoering Soortenbeleid 2000-2004*. Ministry of Agriculture, Nature management and Fisheries, The Hague.

# 10

## Ecological networks and the protection of Red List species

*G. Bennett*

### INTRODUCTION

The development of the ecological network model has its origins in the growing awareness among those actively involved in the conservation of biodiversity that:

- the protection of individual biological elements – predominantly a limited number of exceptionally valuable natural areas and threatened species – is not succeeding in arresting the decline in the integrity of the protected areas and many species populations
- the viability of species populations is dependent on the existence of a particular complex of environmental elements, processes and conditions rather than on simply segregating and isolating the populations from human influences
- the increasing extent and intensity of human activities in the landscape and their impact on biodiversity cannot be compensated through additional site- or species-protection measures alone.

Efforts to meet these challenges have encouraged the development of models that extend the scope of conservation actions beyond the traditional emphasis on the protection of threatened species and valuable sites. Significantly, despite the wide diversity of situations, means and perspectives through which conservation actions are being taken, two generic goals can be discerned in many of the newer approaches, namely that (1) ecological functions are to be maintained and (2) natural resources are to be used sustainably.

Various operational models have been devised to meet these generic goals. These models are known by a variety of appellations. Most common are *ecological network*, *reserve network*, *bioregional planning* and *ecoregion-based conservation*. IUCN uses the term *ecological network*, which is the convention that will be used in this paper.

An ecological network can be regarded as: A coherent system of natural and/or semi-natural landscape elements that is configured and managed with the objective of maintaining or restoring ecological functions as a means to conserve biodiversity while also providing appropriate opportunities for the sustainable use of natural resources.

Note that, as discussed above, this definition has two key components: the maintenance of ecological functions as a means of conserving biodiversity and the sustainable use of natural resources. An ecological network aims to achieve these twin objectives by creating an infrastructure that facilitates ecological functioning but also accommodates a degree of human exploitation of the landscape where this is compatible with, or contributes to, the conservation of biodiversity.

To some extent the various approaches applied in different regions represent differences in scope or emphasis with regard to the balance between biodiversity conservation and the exploitation of natural resources. However, all of these models aim to achieve the two generic goals noted above and can therefore be regarded as comparable approaches. And although the emphasis of the initiatives varies, a number of elements can be discerned which are common to all the approaches. These are:

- a focus on conserving biodiversity at the ecosystem, landscape or regional scale
- an emphasis on maintaining or strengthening ecological coherence, primarily through providing for ecological interconnectivity
- ensuring that critical areas are buffered from the effects of potentially damaging external activities
- restoring where appropriate degraded ecosystems
- promoting complementarity between land uses and biodiversity conservation objectives, particularly by exploiting the potential biodiversity value of associated semi-natural landscapes.

These approaches do not, therefore, stake a claim to the landscape in a way that fences off the entire countryside from all human activities. They aim, rather, to focus conservation action on those areas and on those species communities that harbour environmental values which are crucial to the maintenance of ecological functions, and also to delineate human activities in such a way that they are both economically viable and ecologically sustainable.

Although the first manifestations of the ecological network model date from the 1970s, it was only during the 1990s that the approach attracted sufficient attention and credibility to become widely applied. Today, over 150 regional-scale networks are known to be under development or in the course of

implementation in both developed and developing countries, including over 50 in Europe. These initiatives can be found on all continents except Antarctica, in a wide range of biogeographic zones and in landscapes varying from highly exploited to virtually pristine. The network concept was originally conceived as a means of reconciling the needs of biodiversity conservation with those of economic development in man-exploited landscapes in the more developed countries. However, recent years have seen increased attention for the potential value of the model in developing countries where there is an urgent need to secure sustainable development in regions characterised by a rich biodiversity and economically valuable natural resources and where local populations are often dependent for their welfare on the continued functioning of ecosystems.

One of the most interesting aspects of the ecological network model is the variety of scales at which it is being applied. The majority of networks are applied to a geographical region, such as a watershed, a mountain range or a natural community, although in many of the cases where the initiative is part of government policy or planning, the region may be delineated by a sub-national administrative unit or even an entire country. However, the model is also being used to frame conservation actions at both lower and higher scales. At one extreme, networks are being developed to conserve biodiversity at the local level, such as the many municipal projects in Denmark and the Netherlands. At the other extreme are cases where the model is being used as the basis for a strategic approach to biodiversity conservation at the supra-continental scale, such as the Pan-European Ecological Network and the Western Hemisphere Shorebird Reserve Network.

#### ECOLOGICAL NETWORKS AND THE PROTECTION OF SPECIES POPULATIONS

Virtually all of the European ecological network initiatives aim to conserve both species populations and habitats. However, the criteria for selecting the priority species for protection vary substantially from network to network. Moreover, most European networks aim to conserve several categories of protected species, although in a few cases only a single type of priority species is identified for conservation action. Thus, the types of species protected through the networks include those identified as:

- endangered species (for example, the Swiss National Ecological Network)
- threatened, vulnerable and rare species, species that have seriously declined due to loss of biotope, and species for which a special international responsibility is carried (the Dutch Ecological Network)

- keystone species, focal species and ‘species of special concern’ (WWF’s Carpathian Ecoregion Initiative)
- flagship species (for example, the Transnational Ecological Network)
- endemic and relict species (for example, the Ecological Network of the Orenbourg Region)
- species of European importance (the Pan-European Ecological Network)
- in a few cases, national and regional Red Lists (for example, Ukraine’s National Ecological Network and the Heart of Russia network).

Given the fact that virtually all European ecological networks include species protection as one of their principal objectives, it is interesting that the networks apply such a wide range of criteria in selecting the priority species for conservation action and that so few networks explicitly use the Red Lists as a basis for identifying priority species.

There are three obvious reasons for this apparent anomaly:

- the primary focus of many networks is to conserve a particular habitat type rather than priority species populations as such, but conserving the habitats will serve to conserve the respective species populations, and particularly those species included in the Red Lists;
- some networks have a particular or a limited conservation objective (such as the Wallonian Ecological Network: ‘the overall improvement of the status of Wallonia’s biodiversity’);
- some networks are in an early phase of development and have not yet established the species protection criteria.

It should be noted that the failure of most ecological networks to explicitly include the Red Lists among their criteria for identifying priority species is not to say that populations of Red List species are not targeted for protection. However, it is not possible on the basis of the data assembled to date to assess to what extent the European ecological networks that do not explicitly use the Red Lists as a frame of reference to identify priority species do in fact aim to conserve these species populations through their other conservation criteria. This will certainly be very limited for some networks that focus on only a very limited number of species, such as the Transnational Ecological Network (one flagship species) and the PLANECO project in the Italian Appenines (the brown bear, the wolf and several ungulates) or very particular types of habitat (such as the European Coastal and Marine Ecological Network or the Forest Habitat Network in Scotland). However, in many cases there will almost certainly be a substantial degree of congruence or a close relationship simply because, on the basis of the criteria applied, large numbers of priority species have been identified. For example, the Volga-Ural ecological network has iden-

tified over 300 species for protection and both the Romanian and Slovakian networks are targeted at over 40 priority species.

## CONCLUSION

The ecological network is becoming increasingly applied in countries around the world as a model for reconciling the conservation of biodiversity with the exploitation of natural resources.

In Europe, ecological networks are being developed in most countries, and virtually all of these networks include species protection as one of their principal objectives. These initiatives go beyond the legislative requirements for species protection since they aim to conserve and, where appropriate, restore both habitats and ecological coherence. They therefore have the potential to make an important contribution to the conservation of species populations.

However, few networks use the respective Red Lists as an explicit criterion for identifying the species that are to be the target of conservation action. Although it seems, on the basis of existing information, that many of the networks target Red List species, it is not clear to what extent this is the case. It is nevertheless reasonable to assume that most networks will in practice make an important contribution to the conservation of Red List species populations.

It would therefore be instructive to carry out a detailed comparative analysis of the available data on ecological networks in order to determine which Red List species are being targeted by the existing networks as priority species and to identify important omissions for further action by IUCN. This relatively simple exercise would enable IUCN to establish a full picture of the extent to which Red List species are the subject of conservation action across the continent and to prioritise further actions to promote the conservation of Red List species populations in Europe.

## REFERENCE

BENNETT, G. and P. WIT, 2001. *The development and application of ecological networks: a review of proposals, plans and programmes*. IUCN, Gland & AIDEnvironment, Amsterdam.





# 11

## Summary of the discussion

*O.S. Bánki and H.H. de Iongh*

The first day of the seminar mainly focused on Red Listing Policy in Europe. It was agreed upon to discuss the technical aspects of the application of the IUCN Criteria and Categories (C&C) in more detail on the second day of the seminar.

During the morning session the representative of the Dutch Ministry of Agriculture, Nature Management and Fisheries stressed the importance of the harmonization of Red Lists in the case of supra-national ecosystems and the establishment of a European Ecological Network. In the Netherlands nine Red Lists have been published to date and these are used for priority setting for nature conservation in a multi annual plan until 2004. Dutch Red lists have a legal status (Flora and Fauna Act) and are used for national nature conservation policy. The existing Dutch Flora and Fauna Act also relates more directly to the European Habitat and Bird directives. The representative of the Netherlands Committee for IUCN (NC-IUCN) therefore proposed 1) to include for discussion the relevance of European legislation and 2) to discuss not only the harmonization process in terms of the European Union, but to extent the discussion to Europe as a geographical unit. Both these statements were endorsed by the participants.

Discussions proceeded on the role of the European Union in the Red Listing process in Europe. The representative of the European Union stressed the importance of European Red Lists as a means of communicating the status of the European nature to policymakers. This was seconded by the participants. Several questions were posed about the EU-Directives (Habitats and Birds) and the processes of updating and maintaining these. It was acknowledged that the Annexes of these Directives are not perfect and need regular updates. Red Lists can and should be used as an input for these updates, but they are not yet used in an optimal way, due to inconsistencies in the Red List methodology.

The Annexes of the Habitats Directive have been updated four times ( a.o. to fill gaps for the Boreal region in 1997), those of the Birds Directive have been updated two times. An example of changes in Annex I of the Bird direc-

tive is the removal of the cormorant (*Phalacrocorax carbo sinensis*) in 1997 and the addition of the corn crane (*Crex crex*) in 1986.

Usually, changes to the EU-Directives are made on the basis of proposals by member states. Networks like IUCN can also make proposals, but individuals are not eligible to propose changes. The timing of proposals is an important success factor, and should be taken into account. With respect to maintaining the EU-Directives, the possibilities for sanctions and compensations were put forward. When conflicts arise on the maintenance of the EU-Directives, these disputes can be addressed at the Court of Justice of the European Communities in Luxembourg. Sanctions could be a result of this legal process. The EU does not provide compensations for nature conservation in relation to agricultural subsidies and possible negative effects arising from these, but there are possibilities for co-financing of nature conservation activities. Overall, it is not a current strategy of the EU to develop new Red Lists, but the EU rather encourages others to do so. The EU-Environmental Agency could be a key strategic partner in the development of new European Red Lists. The morning session ended with a discussion on how to deal with Global Warming and small regions or countries with respect to the Regional Guidelines for applying IUCN Red List Criteria. In the case of changes caused by Global Warming it is agreed that the best thing to do is to re-evaluate the complete assessment, since many factors and ranges are affecting species change because of Global Warming. It is recognised that the new IUCN C&C may show a bias for species, which live in the edge of their range, which will in particular be relevant for small regions or countries. Politically the EU does not distinguish between smaller and larger countries.

In the afternoon session, participants commented on the large amount of Red Lists in Europe, with Germany being by far the country with the most Red Lists. The occurrence of taxonomic problems between lists is seen as one of the barriers for reaching harmonization. A proposal was made to follow the Flora and Fauna Europea, as well as to consult the European specialist groups, as a scientific sounding board if problems with scientific names and synonyms are encountered during comparisons of different Red Lists. Besides this, the existence of other systems for the establishment of Red Lists with a broader purpose than merely the estimation of extinction risk as is the aim of the IUCN C&C, was indicated as another barrier for harmonisation. Many of the current Red Lists in Europe are not solely aimed at estimating extinction risk, but include also priorities for conservation.

The objectivity and flexibility to changes of the IUCN C&C system was questioned. The representatives of the IUCN Red List programme indicated that there are approximately 140 persons involved in the development of the new IUCN C&C, and that there is objectivity in the application of the criteria because statements and documents on the status of species should always be

given, leaving little room for abuse and speculation. The status of a species can always be challenged through communication with the relevant specialist group.

During the panel discussion with the speakers of the first day the relevance of Red Lists for policy was discussed. Some participants stated that as long as Red Lists have no legal binding, their relevance for policy is of less importance. There was a plea for the establishment of a body that oversees if Nations are doing well with their species, and for the start of a process of translating Red Lists to legal instruments. Others argued that Red Lists, such as the Global IUCN Red List, are scientific lists which should be constantly updated, and should thus be flexible. By giving the Red Lists a legal character, conflicts between conservation and development efforts would only get more complicated. Moreover, not every conservation goal can be placed in a legal instrument. There are other instruments, such as voluntary initiatives, that could be more successful. The choice of instruments should depend on the particular circumstances involved.

The discussion proceeded on the effectiveness of Red Lists for biodiversity conservation.

The example was given of the Jehova witness who was impressed by reading the Bible, but questioned if the reading as such would bring him to heaven. What does it mean for conservation if one country has many Red Lists and another country has only a few? Has the existence of Red Lists proven to be effective for biodiversity conservation in those countries? Some stated the limited use of Red Lists for policy in this respect. Some questioned the effectiveness of Red Lists to conserve biodiversity in general. For example, in several countries, the existence of Red Lists for vascular plants did not protect certain species from disappearing. Trade-offs seem to be unavoidable; if you protect one group of organisms, you do not protect another. The issue whether to protect species and/or habitats was central in the discussion. Some thought a choice should be made between policy targeted on species or on habitats. Others argued that habitats are central to species protection, and habitats and species should be targeted at the same time. However, problems arise in the relation between a species and a habitat approach. An example was given from Eastern Europe, where 30% of the bird species are included in the important bird areas, indicating that 70% of the bird species are living outside these areas. Perhaps the relation between Red List species and the habitat approach should be reviewed. The concept of ecological coherence is seen as important to reduce problems between species and sites. In some cases the establishment of Ecological Networks might be an option, since protection of entire ecosystems is often not realistic. However, the concept of Ecological Networks is still seen as too philosophical by some. Besides this, what seems to work in e.g. the Netherlands, might not work in Eastern Europe. It was agreed that the

relevance of Red Lists for conservation should be maximized. It was also stated that of the more than 50 existing ecological networks in Europe do not target Red List species, while they have the potential to promote these Red List species. The reason may be the existing inconsistency in Red List methodology in the European region. NATURA 2000 is among these European networks.

Furthermore, the participants agreed that Red Lists serve as a starting point. Red Lists are important for communication purposes on biodiversity towards policy makers, but also to the wider public. Other initiatives, like the Global Biodiversity Information Facility, could also be vehicles for communication. For setting real priorities for conservation a broader scope, involving more issues and factors, is needed. Cross-compliance and integrating biodiversity conservation in other sectors, e.g. by the use of the ecological footprint concept, is needed to reduce negative effects. Red Lists could help in communicating this message. Overall, the participants endorsed a general plea for the establishment of more European Red Lists instead of only national Red Lists. However the two approaches are complementary. The new IUCN C&C could play an essential role in establishing harmonization for these Red Lists. At the moment, countries hardly use Red Lists of other (neighbouring) countries. However for supra-national ecosystems and the status of biodiversity in Europe, European Red Lists are highly relevant. Policy makers are confronted with a large set of Red Lists in Europe and a variety of discussions and issues involved with these. Specialists on biodiversity should realise that policy makers crave for simple concepts, and do not want to unravel all the difficult technical problems; 'they do not want to know how the car works, but just want to drive it'. For effective policy in the European region the development of European Red Lists would be the best option, although it was realised that the approximately 3700 Red Lists now existing in Europe have local legal, political and emotional importance.

## PART II

### Workshop Session I



Crex crex (D. Nill/Foto Natura)



# 12

## Threat descriptors and extinction risk – the Austrian Red List concept

*K.P. Zulka, E. Eder,  
H. Höttinger and E. Weigand*

### INTRODUCTION

Red Lists of threatened species are among the most important conservation tools. At the beginning, they were mainly political instruments to raise awareness of the problem of species extinction. Nowadays, they have become indispensable tools for environmental control, in particular on a national scale. Red List categorisations can be decisive for the allotment of financial means for species conservation programmes, they delineate sanctuaries and they substantiate environmental impact studies. With their increased scope, however, national Red Lists face new requirements with regard to consistency, categorisation accuracy, repeatability, data documentation and regional comparability.

When an update of Austrian Red Lists of threatened animals was due in 2000, two series of Red Lists had already appeared (Gepp 1983; 1994). For the new version, it was evident that the progress achieved during the IUCN discussion process (Mace and Lande 1991; IUCN 1994; Gärdenfors 2000) had to be reflected in a new Austrian concept for threat assessment. However, a direct adoption of the IUCN criteria was fraught with difficulties:

- 1 In 1999, guidelines for the national implementation of the IUCN criteria were still at a preliminary stage (Gärdenfors 2000);
- 2 Several problems, e. g. the question of grid cell scale for the application of IUCN criterion B, were not solved at that time (Palmer *et al.* 1997);
- 3 Invertebrate experts expected difficulties when applying the strict numerical threshold criteria, in particular with regard to population decline, in the light of the paucity of existing data. More flexibility with regard to the variety of data types would also have been desirable;
- 4 A more detailed data documentation system appeared to be necessary (cf. Mrosovsky 1997). On a national scale, explicit reference to existing faunal databases seemed a desirable goal.

During discussion with experts, it became increasingly evident that major inconsistencies in previous Red Lists were consequences of ambiguities in the meaning of ‘threat’. Depending on the organism, Red Lists displayed conservation value, rarity, population decrease, priorities, extinction risk or even beauty of an organism, most often a mixture of these properties. Already acknowledged by Mace and Lande (1991), Red List categorisations cannot be objectively achieved as long as value-laden components such as conservation priorities are part of the listing result.

However, even if such components are excluded, threat can be defined at three different logical levels (Harcourt and Parks, 2003; Harcourt, *in litt.*, 3 March 2002): (1) Causes of threat: habitat destruction, habitat fragmentation, hunting or anthropogenic pressure of any other kind. (2) The response to these threat causes, or ‘susceptibility to threat’ (Harcourt and Parks 2003): a scattered distribution, small and declining populations (cf. Caughley 1994). (3) The final consequence: extinction in the past or increased extinction risk in the future (Fig. 1).

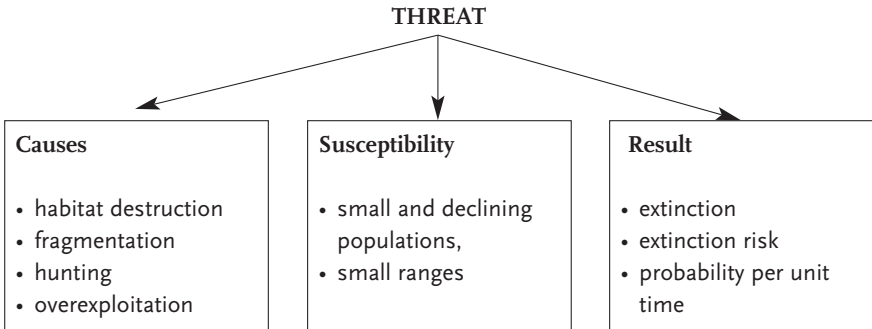

**Figure 1** – The logical levels of the meaning of ‘threat’.

The IUCN criteria A to D define threat in terms of level 2, in terms of threat correlates. Criterion E, by contrast, defines threat in terms of extinction probability per unit time. The advantage of such a definition is its generality. A probabilistic measure of threat can be compared across organism groups, life forms, old and new lists. It has a clear and unambiguous meaning. Extinction risk is the most relevant information for species conservation programmes. Among the five IUCN criteria, Criterion E assumes a special position, since it integrates information captured by the other criteria. As Keith *et al.* (2000) formulate: ‘The attributes in rules A-D serve as surrogates for extinction risk, which is addressed directly in rule E’. However, at present, categorisation using the IUCN criteria A to D frequently disagrees with a numerical analysis using criterion E (Gärdenfors 2000; T. Regan *in litt.*, 17 September 2002).



## CONCEPT

The main idea behind our Austrian concept is to use the relationship between various threat factors, correlates or threat indicators on the one hand and extinction probability on the other hand to substantiate the Red List categorisation. We use eight quantities, ‘abundance’, ‘abundance trend’, ‘range trend’, ‘habitat availability’, ‘habitat trend’, ‘direct human influence’, ‘immigration’ and ‘other risks’ and call them ‘threat descriptors’ without having to decide whether they are causal factors of extinction risks or just correlates. From a particular combination of these threat indicator values, we infer extinction risk, expressed in terms of extinction probability per unit time (Fig. 2).

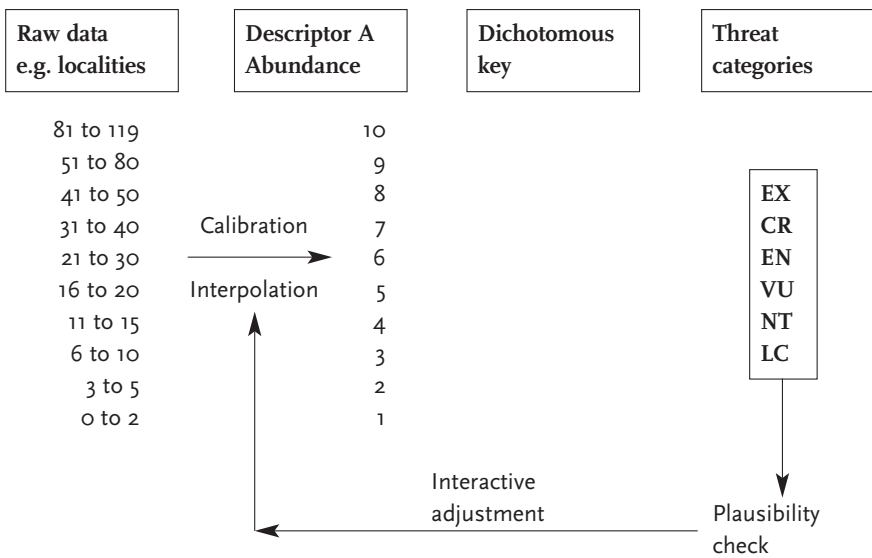

**Figure 2** – Calibration of threat descriptor scales and assessment procedure. In the first step, raw data are mapped on a uniform numeric scale. Then, data of eight descriptors are integrated using decision rules in a dichotomous key. The resulting categories are defined as in IUCN criterion E. The calibration can be improved by an iterative trial-and-error process. Well-known organisms or species for which population viability results are available are good starting points, other species can be integrated by interpolation.

The assessment process starts with an Austrian species checklist, which already exists or has to be compiled for the assessment process. For every species, relevant data are collected, e. g. by counting database records, by comparing older and recent record numbers to identify trends, by comparing

habitat requirements of the species with the availability of the habitat type. The next step is crucial: The raw data are mapped onto unified tenpartite descriptor scales, which have to be calibrated in an appropriate manner. Well-known species are a good starting point for calibration, e.g. species of which all existing populations including their prospects are known, species for which population viability analyses have been calculated, or species which are so abundant that they can be considered safe without reasonable doubt. These species span the descriptor scale in which other species can be integrated by interpolation according to their raw data values.

The combination of descriptor values then leads to a threat category by a set of decision rules. However, the large set of threat descriptors would make logical AND-OR decision rules very complicated. A dichotomous decision key is a more user-friendly way to integrate the information of various threat descriptors into the single quantity ‘threat’, which is defined as in IUCN criterion E. This serves two purposes: (1) it limits the infinite ways to calibrate abundance scales to a few meaningful ones, (2) it makes the final statement comparable across regions, organism groups, and Red Lists. Evidently, the scale calibrations need to be optimised in an iterative trial-and-error process. Descriptor scales can be linear or non-linear.

The dichotomous key is based on a simple model (Fig. 3). A monotonic relationship is assumed between abundance values and extinction risk. The key starts to categorise abundance values in a preliminary way. In a second

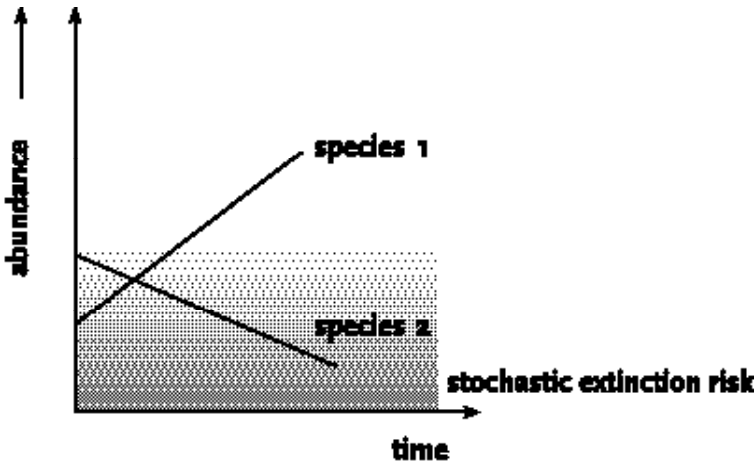

**Figure 3** – Model on which the categorisation key is based, integrating abundance and abundance trend (or similarly: habitat availability and habitat trend). A risk zone near small abundance values is assumed. Extinction risk depends on the length of the species’ trajectory within the risk zone.

step, trend data modify the preliminary categorisation. The model behind this step assumes a risk zone, where a species will plunge into or emerge from, depending on the trend. Species in the risk zone, but with a positive trend, will have a lower extinction risk than species without a positive trend. A similar consideration can be applied to habitat availability and habitat trend, which means that categorisation can be based on abundance data alone, or habitat data alone, or on both descriptor sets combined.

Other threat descriptors like ‘direct human influence’, ‘range trend’ or ‘immigration’ modify the categorisation obtained by the basic descriptors. A wide range of properties and threat scenarios can thus be incorporated into the assessment process.

The Red List contains the threat category, termed in international IUCN abbreviations, the scientific name, the authority of the species and the German name (Fig. 4). A status column indicates a specific checklist position, e.g. for introduced species or visitors. Then, values of the eight threat descriptors follow. Thus, determinants of threat are visible at a glance: the threat descriptor number sequence tells a short story about the nature of threat impinging on the species. The following column links to a text box in which in-

| Threat category | Species  | Status | Abundance | Abundance trend | Range trend | Habitat availability | Habitat trend | Direct human influence | Immigration | Other risks | Remarks | Responsibility | Call for action |
|-----------------|--|--------|-----------|-----------------|-------------|----------------------|---------------|------------------------|-------------|-------------|---------|----------------|-----------------|
| CR              | <i>Aulacochthebius narentinus</i> (Reitter),<br>Narenta-Zwerguferkäfer | 1      | 0         | 0               | 1           | -6                   | 0             | 0                      | 0           | 25          | !!      | !!             |                 |
| LC              | <i>Hydraena alpicola</i> Pretner,<br>Alpen-Zwergwasserkäfer            | 6      | -1        | -1              | 4           | -1                   | 0             | 0                      | 0           | 26          | !!      |                |                 |
| LC              | <i>Hydraena belgica</i> d'Orchymont,<br>Belgischer Zwergwasserkäfer    | 4      | -2        | 0               | 2           | -3                   | 0             | 0                      | 0           | 27          |         |                |                 |
| LC              | <i>Hydraena britteni</i> Joy,<br>Brittens Zwergwasserkäfer             | 4      | 0         | 0               | 2           | -1                   | 0             | 0                      | 0           | 28          | !       |                |                 |
| CR              | <i>Hydraena intermedia</i> Rosenhauer,<br>Mittlerer Zwergwasserkäfer   | 1      | -5        | -5              | 2           | -2                   | 0             | 0                      | 0           | 29          | !!      | !!             |                 |
| LC              | <i>Hydraena lapidicola</i> Kiesenwetter,<br>Stein-Zwergwasserkäfer     | 7      | 0         | 0               | 6           | -1                   | 0             | 0                      | 0           | 30          |         |                |                 |

Figure 4 – Layout of the Red List. For explanation of the columns, see text. Species in the threat categories EX to NT, species in the category DD and species with exclamation marks in the ‘responsibility’ or ‘action’ columns are printed in shaded rows.

formation of any kind can be entered to justify the categorisation, to compare current with previous categorisations or to provide biological information.

The last two columns are not part of the threat assessment process. The penultimate column lists national responsibility derived from the percentage of range situated within Austria. The last column, named 'call for action', displays priorities for those species that should receive special care in the future, be it because of high responsibility, flagship- or keystone status, data deficits, lack of knowledge or a high threat category. Which measures are necessary is detailed in the text box.

## DISCUSSION

A first series of Red Lists of threatened animals in Austria compiled according to the new scheme is presently in the press, namely lists on mammals, birds, grasshoppers, water beetles, neuropterids and butterflies. For almost all groups, sufficient data were available to assess the first threat descriptor 'abundance'. In most cases, the number of localities was used to calibrate the descriptor values. However, for birds, breeding pairs (reproduction units) provided a more accurate raw data set to enter the assessment process.

Difficulties were encountered with the second threat descriptor, abundance trend. Except for water beetles, where old collections provided an unbiased reference data set, expert opinion often had to replace trend calculations. Even for birds, trend estimations were only possible at a very crude scale. Likewise, habitat availability was difficult to determine. CORINE land cover data (Aubrecht 1998) permitted a first estimation, but habitat requirements never matched CORINE land cover types exactly. In most cases, threat assessment using abundance data was more accurate than threat assessment relying solely on habitat data.

However, even if all threat descriptors have to be based on expert opinion and no explicit data are available at all, the system provides a transparent and consistent way of threat categorisation within an group of organisms. Data improvements of any kind can be seamlessly integrated, as soon as they are available. Like in any measuring process, comparability is not so much a question of using precisely the same instruments and methods. This would be desirable, but is difficult to achieve and precludes any methodological improvements over time. Agreement on definitions and quantities to be assessed, by contrast, permits a variety of approaches to be compared within some limits.

Compared to the IUCN criteria, which define strict numerical thresholds to delineate threat categories, the Austrian system is fuzzier. However, the process is transparent and justification of every detail is provided. In particular, the group-specific calibration process has several advantages: (1) Data of any kind can be used. If breeding pair data are more accurate than grid cell occurrence data, there is no obstacle to use them; (2) Incomplete data can be

incorporated. Abundance records are never complete, they always constitute an unknown proportion of the true area of occupancy of a species. In invertebrate groups, this proportion can be very low; (3) The relationship between abundance, abundance trend and extinction risk can be fine-tuned according to the size, the trophic position, the survival strategy, and the life form of the organism. For a particular scale calibration, the IUCN criteria appear as a special case in the system; (4) A close connection between raw data and final categorisation result is an inevitable consequence of the calibration process. If necessary, any risk categorisation can be traced back to the original data, of which the source is indicated in a methods section.

In summary, the Austrian Red List assessment scheme can be regarded as a generalisation of the IUCN criteria A to D, aiming at a better correspondence between surrogate criteria (mainly based on abundance and abundance trend) and extinction risk. Alternatively, the categorisation system may be viewed as a very broad interpretation of the term 'numerical analysis' in IUCN criterion E, collecting data on various threat factors, quantifying them and integrating them into a single statement. In any case, the system is intended to produce categorisations that are compatible with IUCN standards while providing extensive documentation of the data sources available on a national scale

## REFERENCES

- AUBRECHT, P., 1998. *CORINE Landcover Österreich. Vom Satellitenbild zum digitalen Bodenbedeckungssatz*. Umweltbundesamt Monographie 93. Umweltbundesamt, Vienna.
- CAUGHLEY, G., 1994. Directions in conservation biology. *Journal of Animal Ecology* 63: 215-244.
- GÄRDENFORS, U., 2000. Population viability analysis in the classification of threatened species: problems and potentials. *Ecological Bulletin* 48: 181-190.
- GÄRDENFORS, U., J.P. RODRIGUEZ, C. HILTON-TAYLOR, C. HYSLOP, G. MACE, S. MOLUR and S. POSS, 1999. Draft guidelines for the application of IUCN Red List criteria at national and regional levels. *Species* 31/32: 58-70.
- GEPP, J. (ed.), 1983. *Rote Listen gefährdeter Tiere Österreichs. Grüne Reihe des Bundesministeriums für Gesundheit und Umweltschutz*, Band 2. Bundesministeriums für Gesundheit und Umweltschutz, Vienna.
- GEPP, J. (ed.), 1994. *Rote Listen gefährdeter Tiere Österreichs. Grüne Reihe des Bundesministeriums für Umwelt, Jugend und Familie*, Band 2. Styria, Graz.
- HARCOURT, A.H. and S.A. PARKS, 2003. Threatened primates experience high human densities: adding an index of threat to the IUCN Red List criteria. *Biological Conservation* 109: 137-149.
- IUCN, 1994. *IUCN Red List Categories*. Prepared by the IUCN Species Survival Commission. IUCN, Gland.

- KEITH, D.A., T.D. AULD, M.K.J. OOI and B.D.E. MACKENZIE, 2000. Sensitivity analyses of decision rules in World Conservation Union (IUCN) Red List criteria using Australian plants. *Biological Conservation* 94: 311-319.
- MACE, G.M. and R. LANDE, 1991. Assessing extinction threats: towards a reevaluation of IUCN threatened species categories. *Conservation Biology* 5: 148-157.
- MROSOVSKY, N., 1997. IUCN's credibility critically endangered. *Nature* 389: 436.
- PALMER, M.A., N.G. HODGETTS, M.J. WIGGINTON, B. ING and N.F. STEWART, 1997. The application to the British flora of the World Conservation Union's revised Red List criteria and the significance of Red Lists for species conservation. *Biological Conservation* 82: 219-226.

# 13

## Red Lists in Flanders: scale effects and trend estimation

*L. de Bruyn, A. Anselin, D. Bauwens, S. Colazzo,  
K. Devos, D. Maes, G. Vermeersch and E. Kuijken*

### INTRODUCTION

It is estimated that about 40,000 to 50,000 species (2.8% of the world's biodiversity) occur in Belgium (viruses, Bacteria, Protista, 'Algae' not included), 80% can be found in Flanders (Gysels 1999; Van Goethem 1998). Of these, 75% are invertebrates (insects, spiders, a.o.), 24% are 'plants' (vascular plants, mosses, lichens and fungi), whereas vertebrates (birds, mammals, reptiles and amphibians) constitute the remaining 1%. Most likely, the reported figures are substantial underestimations, especially for invertebrates. As an example we can cite the insect order Diptera (Flies, mosquitoes, midges). At present, about 4,500 species of Diptera are reported for the Belgian fauna (Grootaert *et al.* 1991). However, based on the checklists of the surrounding countries, it is estimated that the total species richness could amount to over 6,000 species. This implies that for about 1,500 to 2,000 species it is even uncertain whether or not they occur in Flanders. If we extrapolate this to the other insect orders and invertebrate groups, this would imply that thousands of organisms still remain to be discovered.

For Flanders, Red Lists have been compiled for mammals (Criel 1994), carabids and cicindelids (Desender *et al.* 1995), amphibians and reptiles (Bauwens and Claus 1996), dragonflies (De Knijf and Anselin 1996), spiders (Maelfait *et al.* 1998), freshwater fish (Vandelannoote *et al.* 1998), breeding birds (Devos and Anselin 1999), butterflies (Maes and Van Dyck 1999), mosses (Hoffmann 1999a), lichens (Hoffmann 1999b), mushrooms (Walley and Verbeke 2000), grasshoppers and crickets (Decler *et al.* 2000), long-legged flies (Pollet 2000) and vascular plants (Biesbroek *et al.* 2001). The Red List categories are those proposed by the IUCN Species Survival Commission (IUCN Species Survival Commission 1994), adapted for Flanders (Maes *et al.* 2003; Maes and Van Swaay 1997). The knowledge on the status of Flemish biodiversity is strongly biased towards vertebrates and vascular plants of which the status of respectively 100% and 58-70% of the species has

been established. On the other hand, the status for fungi and invertebrates is only known for respectively 10% and 5-6% (Table 1).

**Table 1** – Estimated number of species and number of species with known Red List status for the major taxa of Flemish flora and fauna

|                      | Estimated # species            | Red List status known       |                          |                              |
|----------------------|--------------------------------|-----------------------------|--------------------------|------------------------------|
|                      |                                | % of total fauna in Belgium | Number with known status | % of total with known status |
| Belgium              | 40 000-50 000 <sup>1</sup>     |                             |                          |                              |
| Flanders             | 32 000-40 000                  | 80%                         |                          |                              |
| Fungi                | 5000-6000                      | 16%                         | 552                      | 10%                          |
| 'Flora' <sup>2</sup> | 2 680-3 600                    | 8%                          | 2 089                    | 58-78%                       |
| Invertebrates        | 24 000-30 000                  | 75%                         | 1 365                    | 5-6%                         |
| Vertebrates          | 295 ( $\pm$ 500 <sup>3</sup> ) | 1%                          | 295                      | (100%)                       |

1 Not included: Virusses, Bacteria, Protista, 'Algae'

2 Flora includes vascular plants, mosses, lichens

3  $\pm$  500 species includes non breeding, migratory birds

Overall, for all Red-Listed taxa combined (4,264 species), one third is extinct in Flanders or threatened (Red List categories critically endangered, endangered and vulnerable) (Fig. 1, De Bruyn 2001). About 7.5% (319 species) are locally extinct, i.e. no records since 1980. About 30%, or 1,279 species (or 47% – 2004 species, if one includes susceptible species), are threatened in one way or an-other. When we extrapolate these relative figures to the estimated numbers of organisms that should occur in Flanders (taking into account the proportion of 'Belgian' species living in Flanders, and the number of 'undiscovered' invertebrates), we get a rough estimate on the status of biodiversity in Flanders. Of the 42,000 species occurring on the Flemish territory, about 14,000 should occur on the Red Lists, of which 5,000 are extinct in Flanders. This implies that many species went extinct before they were discovered in Flanders. In all probability, these figures are an underestimation of the real situation because groups such as algae, unicellular organisms ( $\pm$  5,000 in the Netherlands) or Bacteria (>1,000 in the Netherlands) were not taken into account.



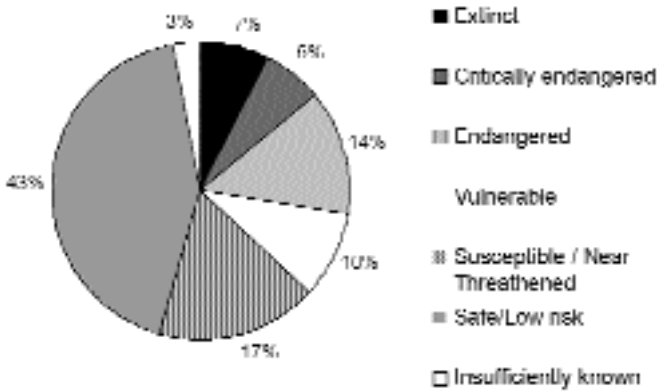

**Figure 1** – Relative distribution over Red List categories of the screened Flemish biota. Data are based on the Red Lists of mammals, breeding birds, amphibians, reptiles, fish, dolichopodids, butterflies, carabids, dragonflies, spiders, grasshoppers, vascular plants, mosses, lichens and a number of mushroom groups.

The previous paragraphs treated the state of nature based on long-term data collected during the previous century (since 1900). Trend analyses are based on relatively large sample surfaces (e.g. 4 x 4 km, 5 x 5 km UTM grids). However, it was shown that for common species, population losses fail to be detected on these grid maps. For species of intermediate rarity, grid maps may identify species decline, but usually underestimate population losses (Thomas and Abery 1995; Van Dyck 2000). Larger grid cells may contain several populations of a species. When some of these disappear, this is not reflected in the distribution maps since a grid square only becomes empty when the last population gets extinct. Therefore it is proposed to monitor changes of species status more intensely on a finer scale (Thomas and Abery 1995). The latter is illustrated with data from two vertebrate groups and one invertebrate, viz., breeding birds, amphibians and butterflies.

#### BREEDING BIRDS

In 1994, a project started to census rare (45 species) and colonial (15 species) breeding birds in Flanders (Devos and Anselin 1996). Since then, the target birds are monitored annually using the standardised and detailed territory mapping method as described in Hustings *et al.* (1985) and van Dijk (1993). The research areas are visited several times during the breeding season (March-July). All territories are mapped and the breeding pairs and/or nests are

counted. The results are reported at regular intervals (Anselin *et al.* 1998; Devos and Anselin 1996).

At present, 31 of the 62 species are only represented by less than 10 breeding pairs (Fig. 2a). Between 1994 and 1996, the number of breeding pairs decreased for 12 species, increased for 22 species, while it was stable or fluctuating for 28 species. Most species that were represented with only few breeding pairs in 1994 showed a decreasing trend (Fig. 2b) (examples are Great Grey Shrike – *Lanius excubitor*, Penduline tit – *Remiz pendulinus*) or showed no clear trend. However, many of the latter are already so rare (e.g. Wryneck – *Jynx torquilla*, Corncrake – *Crex crex*, Melodious warbler – *Hippolais polyglotta*) that the slightest decrease would wipe them out. For only few (e.g. Bittern – *Botauris stellaris*, Common gull – *Larus canus*, Little bittern – *Ixobrychus minutus*) the situation seems to improve. All birds with over 100 breeding pairs are stable or increase (Blue heron – *Ardea cinerea*, Rook – *Corvus frugilegus*, Cormorant – *Phalacrocorax carbo*, Herring gull – *Larus argentatus*). Important to notice is that for some of the more common colony breeders (e.g. Little Tern – *Sterna albifrons* and Sandwich Tern – *Sterna sandvicensis*) all breeding pairs are confined to a single colony, which also makes them vulnerable. For example, the Sandwich Tern decreased from over 1,500 breeding pairs in 2001 to  $\pm 40$  in 2002!

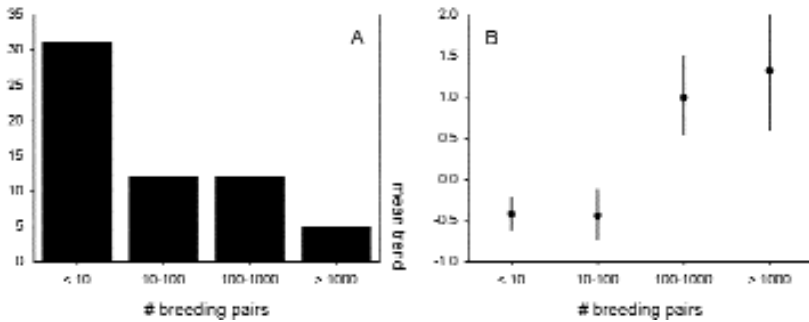
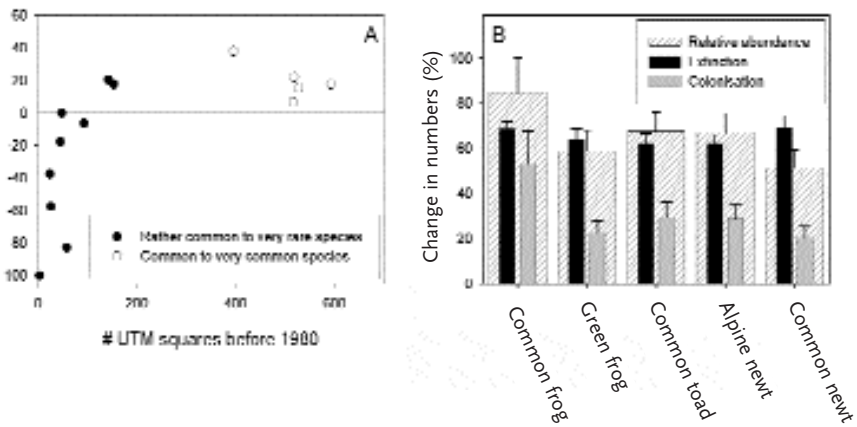

**Figure 2** – Breeding success of 62 monitored rare and colony breeding birds in Flanders. 2a – Breeding density frequency distribution (number of breeding pairs); 2b – Mean trend for the period 1994-1996 in the number of breeding pairs (data are mean  $\pm$  S.E.).

## AMPHIBIANS

Presence/absence data in 4 x 4 km Universal Transverse Mercator (UTM) squares of species distribution maps, showed that several species declined significantly or even became extinct during the last century (Bauwens and Claus

1996). The Yellow-bellied Toad – *Bombina variegata* is extinct since 1984, while only few populations (most very small with less than 10 calling males!) of the Tree Frog – *Hyla arborea* are left at present. The rare species such as Midwife Toad – *Alytes obstetricans* or Common Spadefoot – *Pelobates fuscus* were the first to show decline (except for Palmate Newt – *Triturus helveticus* and Great Crested Newt – *Triturus cristatus*, which show a modest upward trend). On the other hand, populations of species with relative wide distributions (e.g. Alpine Newt – *Triturus alpestris*, Common Newt – *Triturus vulgaris*) appear to show stable or even increasing numbers of occupied grid cells (Fig. 3a).



**Figure 3** – Distribution and trends for Flemish amphibian species. 3a – Relationship between abundance and trend (# 4 x 4 km UTM squares before and after 1980); 3b – Mean amphibian species specific turnover between 1975-1989 and 1999-2001 (detailed pool inventarisation) (data are mean ± S.E.).

In 1999-2001, a detailed inventory campaign was set up in Flanders (Colazzo *et al.* 2001). The research was focussed on areas for which detailed inventories from the near past were available (period 1975-1989; De Fonseca 1980; Sanders 1987). This made it possible to get well-documented abundance and distribution trends over the last decennium for a number of species (Colazzo *et al.* 2002). Overall, about 1600 ponds, scattered over 9 regions, were examined, of which 750 were visited during both time periods. Analyses of distribution changes were carried out only for common amphibian species, since these species were the most likely not to have shown significant changes with the grid counting method. The study focussed on the Common Toad – *Bufo*

*bufo*, the Green Frog – *Rana esculenta-synklepton*, the Common Frog – *Rana temporaria*, the Alpine Newt and the Common Newt.

The combined data for all species and regions showed that the actual number of local populations was only 64% of the formerly recorded number, which implies a reduction of about  $\frac{1}{3}$  over the past 15-25 years. All species studied show a decreasing trend (Fig. 3b). This trend was strongest for the Green Frog (-41%) and the Common Newt (-48%). The reduction for the Common Toad is only moderate (-15%) and does not indicate a significant reduction in the number of local populations.

## BUTTERFLIES

The Flemish butterfly atlas contains about 190,000 records, collected since 1830 (Maes and Van Dyck 1999; 2001). Butterfly presence is recorded in 5 x 5 km UTM squares. Distribution and trend analyses were performed with the year 1991 as a pivotal date. During the last century, butterfly diversity continuously decreased, at first slowly, but later much faster (8-fold!) during the second part of the 20th century (Maes and Van Dyck 2001). As a result, butterfly species richness declined with 30% from 62 in 1900 to 47 species at present. Another 50% is threatened (Maes and Van Dyck 2001). Compared to the period before 1991, the distribution range of 17 species shrunk (decline of at least one Red List category), 20 species were more or less stable (no category change) and 11 have extended their range (Maes and Van Dyck 1999). These changes are not equal for different Red List categories (Fig. 4a). In general, species that were common to very common in the past (e.g. Meadow Brown – *Maniola jurtina*, Holly Blue – *Celastrina argiolus*, Map – *Araschnia levana*), are stable, or even increase their distribution further (except for Small Copper – *Lycaena phlaeas*, Wall Brown – *Lasiommata megera* and Small Heath – *Coenonympha pamphilus*). On the other hand, rare species such as Queen of Spain Fritillary – *Issoria lathonia*, Purple Emperor – *Apatura iris*, or White Admiral – *Ladoga camilla*, further decline (except for Small Skipper – *Thymelicus sylvestris*, Brown Argus – *Aricia agestis* and Marbled White – *Melanargia galathea*).

The distribution of the Alcon blue, *Maculinea alcon*, is restricted to the Campine Region in Flanders (Maes and Van Dyck 2001). Before 1991, it occurred in 39 (20%) of the 194 5 x 5 km UTM squares of the Campine Region (Fig. 4b). Between 1991 and 1998 this reduced to 20 squares (10%). In 1999-2000 this species only occurred in 12 squares (6%). Overall, the distribution area of the Alcon blue declined by 69%. However, a recent study of the ecology and distribution of the Alcon blue showed that the situation is even worse (Van Reusel *et al.* 2000). During this study, all known existing populations were recorded. The distribution was assessed at three levels. On the 5 x 5 km scale, the butterfly occurs in 13 of the 644 Flemish UTM squares,

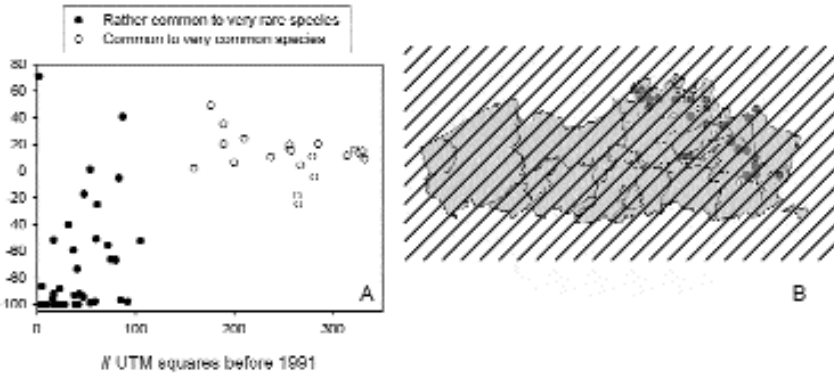

**Figure 4a** – Relationship between abundance and trend for Flemish butterfly species (ratio # 5 x 5 km UTM squares before and after 1991). **4b** – Distribution map of the Alcon Blue (white = before 1991, grey = 1991-1998, black = 1999-2000).

or 1.84%. On the 1 x 1 km scale, *M. alcon* occurs in 23 of the 14,325 UTM squares (or 0.16%). Finally, the effective number of populations (35) covers 42.33 ha of the total Flemish territory of 1,378,767 ha, or 0.003%. In other words, the distribution figure based on the 5 x 5 km squares (area of occupancy) overestimates the real distribution by 600% (area of occurrence).

The causes of the biodiversity crisis are well known and include human impacts on habitats (habitat destruction, degradation, fragmentation, and restructuring) and on organisms (overexploitation, introduction of exotic competitors, predators and parasites, and creating new pests) (Mooney and Cleland 2001; Pimm *et al.* 1995; Vitousek *et al.* 1996; Wilson 1991). For Flanders, the same disturbance factors were cited (e.g. Bauwens and Claus 1996; Dumortier *et al.* 2003; Kuijken *et al.* 2001; Maes and Van Dyck 2001). Environmental pressure on nature is strong in Flanders due to the high population densities, leaving only about 11% of the territory for nature (De Bruyn *et al.* 2002). The remaining surface suffers strongly due to environmental pressures (Van Steertegem 2001). One of the main impacts is from agricultural practice. Agriculture is extremely intensive in Flanders, emitting Europe's highest levels of nutrients into the environment (OECD database for 2001 at [www.oecd.org](http://www.oecd.org)). This over-fertilization is causing species extinctions; for example it is one of the main reasons why nearly a third of the area's butterfly species have been wiped out during the past century (Maes and Van Dyck 2001). The farming system also influences the distribution and abundance of farmland birds (Alford and Richards 1999; Chamberlain and Fuller 2001; Donald *et al.* 2001). For instance, agricultural intensification is blamed for the plummeting populations of the House Sparrow, *Passer domesticus*, in Western Europe in recent decades (Hole *et al.* 2002).

## REFERENCES

- ALFORD, R.A. and S.J. RICHARDS, 1999. Global amphibian declines: a problem in applied ecology. *Annual Review of Ecology and Systematics* 30: 133-165.
- ANSELIN, A., K. DEVOS and E. KUIJKEN, 1998. *Kolonievogels en zeldzame broedvogels in Vlaanderen in 1995 en 1996*. Rapport Instituut voor Natuurbehoud 98/09, Vlavico-rapport 98/1.
- BAUWENS, D. and K. CLAUS, 1996. *Verspreiding van amfibieën en reptielen in Vlaanderen*. De Wielewaal Natuurvereniging, Turnhout.
- BIESBROEK, B., K. ES, W. VAN LANDUYT, L. VANHECKE, M. HERMY and P. VAN DEN BREMPT, 2001. *Een ecologisch register voor hogere planten als instrument voor het natuurbehoud in Vlaanderen*. Rapport VLINA 2000.01, Brussel.
- CHAMBERLAIN, D.E. and R.J. FULLER, 2001. Contrasting patterns of change in the distribution and abundance of farmland birds in relation to farming system in lowland Britain. *Global Ecology and Biogeography* 10: 399-409.
- COLAZZO, S., P. BAERT, F. VALCK and D. BAUWENS, 2001. *Kwantificeren van recente veranderingen in status van amfibieën en hun biotopen in het landelijke gebied* (VLINA 00/02). Rapport Instituut voor Natuurbehoud R.2002.03, Brussel.
- COLAZZO, S., P. BAERT, F. VALCK and D. BAUWENS, 2002. Vindplaatsen van de algemene amfibieën in Vlaanderen: winst en verlies. *Natuurpunt. Focus* 1: 103-109.
- CRIEL, D., 1994. *Rode Lijst van de zoogdieren in Vlaanderen*. Ministerie van de Vlaamse Gemeenschap, Departement Leefmilieu en Infrastructuur (LIN), Administratie Milieu, Natuur en Landinrichting (AMINAL), Brussel.
- DE BRUYN, L., 2001. 4.2. Soorten. In: E. Kuijken, D. Boeye, L. de Bruyn, K. de Roo, M. Dumortier, J. Peymen, A. Schneiders, D. van Straaten and G. Weyembergh (eds.) *Natuurrapport 2001. Toestand van de natuur in Vlaanderen: cijfers voor het beleid*. Mededelingen van het Instituut voor Natuurbehoud 18: 28-39 ([www.nara.be](http://www.nara.be)).
- DE BRUYN, L., J. SCHEIRS and H. VAN GOSSUM, 2002. How affluence harms the environment in Europe. *Nature* 417: 485.
- DE FONSECA, P., 1980. *De herpetofauna in Oost- en West-Vlaanderen. Verspreiding in functie van enkele milieufactoren*. Doctoraatsverhandeling, RU Gent, Gent.
- DE KNIJF, G. and A. ANSELIN, 1996. *Een gedocumenteerde rode lijst van de libellen van Vlaanderen*. Mededelingen van het Instituut voor natuurbehoud 4.
- DECLER, K., H. DEVRIESE, K. HOFMANS, K. LOCK, B. BARENBURG and D. MAES, 2000. *Voorlopige atlas en 'Rode Lijst' van de sprinkhanen en krekels van België (Insecta, Orthoptera)*. Rapport van het Instituut voor Natuurbehoud 2000.10.
- DESENDER, K., D. MAES, J.P. MAELFAIT and M. VAN KERKVOORDE, 1995. *Een gedocumenteerde Rode Lijst van de zandloopkevers en loopkevers van Vlaanderen*. Mededelingen van het Instituut voor Natuurbehoud 1, Brussel.
- DEVOS, K. and A. ANSELIN, 1996. *Kolonievogels en zeldzame broedvogels in Vlaanderen in 1994*. Rapport Instituut voor Natuurbehoud 96/20, Vlavico-rapport 96/1, Brussel.
- DEVOS, K. and A. ANSELIN, 1999. 4. Broedvogels. In: E. Kuijken (ed.) *Natuurrapport 1999. Toestand van de natuur in Vlaanderen: cijfers voor het beleid*. Mededelingen van het Instituut voor Natuurbehoud 6: 48-51.

- DONALD, P.F., R.E. GREEN and M.F. HEATH, 2001. Agricultural intensification and the collapse of Europe's farmland bird populations. *Proceedings of the Royal Society London, Biological Sciences* 268: 25-29.
- DUMORTIER, M., L. DE BRUYN, K. DE ROO, J. PEYMEN, A. SCHNEIDERS, D. VAN STRAATEN, G. WEYEMBERGH and E. KUIJKEN, 2003. *Natuurrapport 2003. Toestand van de natuur in Vlaanderen: cijfers voor het beleid*. Mededelingen van het Instituut voor Natuurbehoud 21, Brussel (www.nara.be).
- GROOTAERT, P., L. DE BRUYN and M. DE MEYER, 1991. *Catalogue of the Diptera of Belgium*. Studiedokumenten van het K.B.I.N., Brussel.
- GYSELS, J., 1999. *Handboek biodiversiteit*. Natuurvereniging Wielewaal v.z.w., Turnhout.
- HOFFMANN, M., 1999a. 14. Mossen. In: E. Kuijken (ed.) *Natuurrapport 1999. Toestand van de natuur in Vlaanderen: cijfers voor het beleid*. Mededelingen van het Instituut voor Natuurbehoud 6: 1-92.
- HOFFMANN, M., 1999b. 15. Korstmossen. In: E. Kuijken (ed.) *Natuurrapport 1999. Toestand van de natuur in Vlaanderen: cijfers voor het beleid*. Mededelingen van het Instituut voor Natuurbehoud 6: 93-94.
- HOLE, D.G., M.J. WHITTINGHAM, R.B. BRADBURY, G.Q.A. ANDERSON, P.L.M. LEE, J.D. WILSON and J.R. KREBS, 2002. Widespread local house-sparrow extinctions. *Nature* 418: 931-932.
- HUSTINGS, F., R. KWAK, P. OPDAM and M. Reijnen, 1985. *Natuurbeheer in Nederland. Deel 3: Vogelinventarisatie. Achtergronden, richtlijnen and verslaggeving*. Pudoc Wageningen, Zeist.
- IUCN Species Survival Commission, 1994. *IUCN Red List categories*. IUCN, Gland.
- KUIJKEN, E., D. BOEYE, L. DE BRUYN, K. DE ROO, M. DUMORTIER, J. PEYMEN, A. SCHNEIDERS, D. VAN STRAATEN and G. WEYEMBERGH, 2001. *Nature Report 2001: Nutshell*. Institute of Nature Conservation, Brussel (www.nara.be).
- MAELFAIT, J.P., L. BAERT, M. JANSSEN and M. ALDERWEIRELDT, 1998. *A Red List for the spiders of Flanders*. Bulletin of the Royal Institute of Natural Sciences, Entomology 68: 131-142.
- MAES, D., L. DE BRUYN and E. KUIJKEN, 2003. Red List criteria in Flanders. In: H.H. de Iongh, O.S. Bánki, W. Bergmans, and M.J. van der Werff (ed.) *Harmonization of Red lists in Europe*. Proceedings International Seminar, 27-28 November 2002, The Netherlands Foundation for International Nature Protection, Mededelingen No. 38, Leiden.
- MAES, D. and H. VAN DYCK, 1999. *Dagvlinders in Vlaanderen – Ecologie, verspreiding en behoud*. Stichting Leefmilieu, Antwerpen.
- MAES, D. and H. VAN DYCK, 2001. Butterfly diversity loss in Flanders (North Belgium): Europe's worst case scenario? *Biological Conservation* 99: 263-276.
- MAES, D. and C.A.M. VAN SWAAY, 1997. A new methodology for compiling national Red Lists applied to butterflies (Lepidoptera, Rhopalocera) in Flanders (N-Belgium) and the Netherlands. *Journal of Insect Conservation* 1: 113-124.
- MOONEY, H.A. and E.E. CLELAND, 2001. The evolutionary impact of invasive species. *Proceedings of the National Academy of Science, USA* 98: 5446-5451.
- PIMM, S.L., G.J. RUSSELL, J.L. GITTLEMAN and T.M. BROOKS, 1995. The future of biodiversity. *Science* 269: 347-350.

- POLLET, M., 2000. *Een gedocumenteerde Rode Lijst van de slankpootvliegen van Vlaanderen*. Mededelingen van het Instituut voor Natuurbehoud 8.
- SANDERS, D., 1987. *Opstellen van beheersformules voor reptielen en amfibieën*. Deel 2. Rapport Universitaire Instelling Antwerpen, Wilrijk.
- THOMAS, C.D. and J.C.G. ABERY, 1995. Estimating rates of butterfly decline from distribution maps: the effect of scale. *Biological Conservation* 73: 56-65.
- VAN DIJK, A.J., 1993. *Handleiding SOVON Broedvogelonderzoek*. SOVON, Beek/Ubbergen.
- VAN DYCK, H., 2000. Natuurbehoud met een 'hokjesmentaliteit'. Glippen onze middenmoters door de mazen van het inventarisatienet? *Wielewaal* 66: 202-205.
- VAN GOETHEM, J., 1998. *First national report of Belgium to the Convention on biological diversity*. Royal Belgian Instituut of Natural Sciences, Staatssecretariaat voor Veiligheid, Sociale Integratie en Leefmilieu, Brussel.
- VAN REUSEL, W., D. MAES and H. VAN DYCK, 2000. *Soortbeschermingsplan gentiaanblauwtje*. Report MINA/120/98/SB01. University of Antwerp (UIA), Wilrijk.
- VAN STEERTEGEM, M, 2001. MIRA-T 2001. *Vlaamse Milieumaatschappij*, Mechelen.
- VANDELANNOOTE, A., R. YSEBOODT and J. COECK, 1998. *Atlas van de Vlaamse beek- en riviervissen*. *Water, Energie en Leefmilieu*, Wijnegem.
- VITOUSEK P.M., C.M. D'ANTONIO, L.I. LOOPE and R. WESTBROOKS, 1996. Biological invasions as global environmental change. *American Scientist* 84: 468-478.
- WALLEYN, R. and A. VERBEKE, 2000. *Een gedocumenteerde Rode Lijst van enkele groepen paddestoelen (Macrofungi) van Vlaanderen*. Mededelingen van het Instituut voor Natuurbehoud 7.
- WILSON, E.O., 1991. *The Diversity of Life*. Harvard University Press, Cambridge, USA.



# 14

## Red List of reptiles & amphibians in the Netherlands

*R. Creemers*

### INTRODUCTION

The latest official National Red List for reptiles and amphibians of the Netherlands has been published in 1996. It was the result of a project of four months, financed by the Dutch Ministry of Agriculture, Fisheries and Nature Management. This Ministry is responsible for the Red List program and its implementation in legislation and nature management.

This project was one of the first larger projects for the foundation RAVON. This foundation is supported by 800 volunteers, of whom 200 to 300 are actually active in field research in the Netherlands.

In the Red List project the first two months were spent on collecting data from 15 different data sets. Reporting took about 6 weeks, so there was little time left for the analysis of data. After consulting several Dutch herpetologists, we have chosen for a rather simple and straightforward interpretation of all available distribution data. Thus an estimate could be made for the nation-wide decline of species and their former and present distribution. Since old data are often incomplete or inaccurate, corrections of old data are inevitable but sometimes risky, especially for the most abundant species in the category safe/low risk. For vulnerable, endangered and critically endangered species, we made a realistic and conservative estimate of trends and decline.

### METHODS

Species were classified according to the IUCN categories defined in 1994. For the present purpose, the IUCN classification was modified slightly by the Dutch government. The status of species was defined by comparing the present distribution (1985-1994; abundance in 5 by 5 square kilometers) with the distribution before 1950. Trend was divided into 4 linear steps and abundance into 4 non-linear classes (<1%, 1-5%, 5-25% and > 25%). The combination of trend and abundance yields 15 possible combinations and 5 categories (Table 1).

**Table 1** – Possible combinations of trend and abundance

| abund. →<br>trend<br>↓ | <1%                 | 1-5%                    | 5-25%                   | >25%                    |
|------------------------|---------------------|-------------------------|-------------------------|-------------------------|
| 0-25%                  | Susceptible<br>(SU) | Safe/Low risk<br>(S/LR) | Safe/Low risk<br>(S/LR) | Safe/Low risk<br>(S/LR) |
| 25-50%                 | Vulnerable<br>(VU)  | Vulnerable<br>(VU)      | Vulnerable<br>(VU)      | Safe/Low risk<br>(S/LR) |
| 50-75%                 | Endangered<br>(EN)  | Endangered<br>(EN)      | Vulnerable<br>(VU)      | Susceptible<br>(SU)     |
| 75-100%                | Critical<br>(CR)    | Endangered<br>(EN)      | Vulnerable<br>(VU)      |                         |

The Red Data List for Reptiles and Amphibians of 1996 was based on 133,000 records. In 2002 this data set already contained 230,000 records. The status of different species was determined by comparing abundance and trend in 1986-1996 vs. the first half of the 20th century. A correction of the data was necessary to compensate for missing data in the period before 1950. Therefore we had to make some assumptions about the amount of habitat loss.

#### HABITAT LOSS

Large parts of the most important potential habitat (heathland and moors) for reptiles has gradually been converted into arable land and pastures. The remaining parts are degraded in suitability for reptiles. All seven reptile species have suffered substantial habitat losses. Within their natural range, there is hardly any new colonisation. Leading Dutch herpetologists are convinced that the recent distribution of most reptiles is confined to areas in which the species were already present in previous periods.

The main cause of declines of Amphibian populations in the Netherlands is the conversion of heathland and moors into arable land and pastures, urbanisation and direct habitat destruction in rural landscapes. For the Red List amphibians we also concluded that the recent distribution is confined to areas in which the species were already present in previous periods.

## RESULTS

Out of 23 species, fifteen were evaluated for the Red List. These fifteen species are, according to the (1994) IUCN criteria, classified as Red List species. Eight species are classified as 'safe' or 'at low risk'. Ordered by rate of decline these species are: *Rana temporaria*, *Bufo bufo*, *Rana esculenta*, *Triturus alpestris*, *Triturus vulgaris*, *Rana ridibunda*, *Lacerta vivipara* and *Bufo calamita*. The last two species will most probably enter the Red List within the next ten years.

'Vulnerable' species are *Rana lessonae*, *Triturus helveticus*, *Rana arvalis*, *Triturus cristatus*, *Alytes obstetricans*, *Anguis fragilis*, *Lacerta agilis*, *Natrix natrix* and *Vipera berus*.

Four species were classified 'Endangered': *Pelobates fuscus*, *Salamandra salamandra*, *Hyla arborea* and *Coronella austriaca*.

Two species (*Bombina variegata* and *Podarcis muralis*) are listed as 'Critically Endangered'. These species are extremely rare and have shown a decline in population size, which exceeds 75%. The numbers in which they occur are so marginal that extinction of the last natural populations is likely.

In general the Dutch reptiles are more seriously endangered than amphibians. Out of the seven indigenous reptiles, six are on this Red List. For the amphibians nine out of sixteen species were selected.

## POSITIVE TRENDS

As a result of habitat management and species conservation volunteers were able to stop (and even reverse) in some cases the decline of populations. The decline of populations of *Podarcis muralis*, *Hyla arborea* and *Alytes obstetricans* is, at least in some regions, stopped and in some cases populations are growing again. Examples of population growth for these rare species is given in Fig. 1 and 2. The lessons we learned about conservation of these species have been implemented for the habitat management of other populations in the Netherlands. Some endangered species have colonised some of their lost territory again. This proves that populations can grow as a result of good habitat management. These positive trends will be incorporated in the next Red List.

A new Red List is scheduled for 2006. This new List will be composed according to the new, revised IUCN criteria. Because of the immobility of most herpetofauna species we expect little changes in distribution ranges of species. However, application of the new IUCN Categories and Criteria could influence the status of species slightly. We expect the Red List will not be shortened and that two species (*Lacerta vivipara* and possibly *Bufo calamita*) will enter the list.

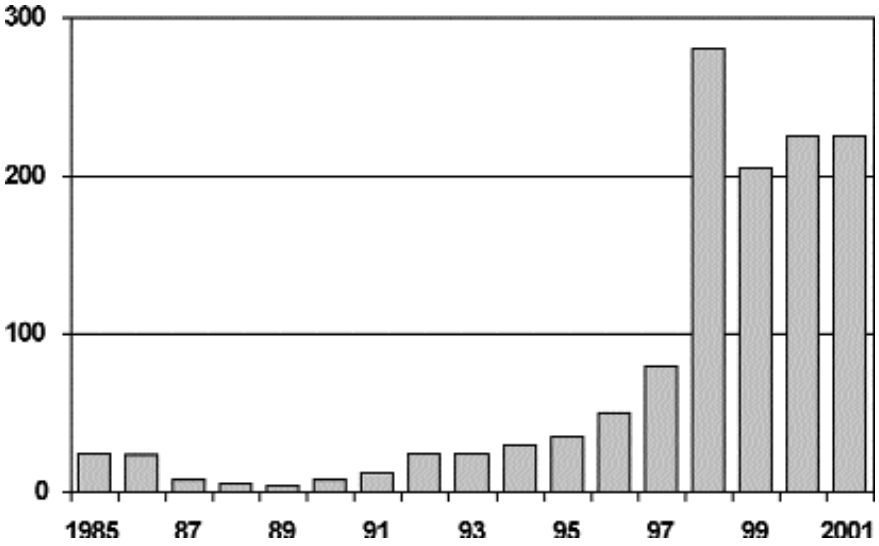

Figure 1 – Number of calling male common tree frogs (*Hyla arborea*) in Zuid-Eschmarke.

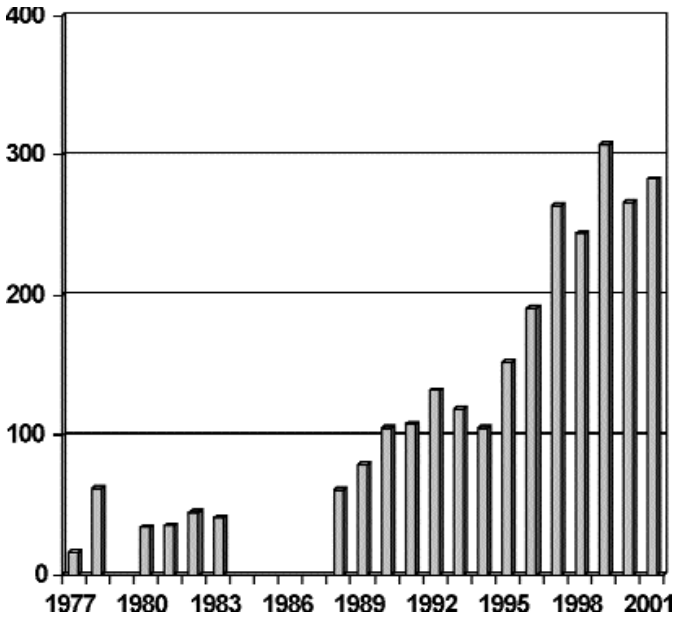

Figure 2 – Population-growth for common wall lizards (*Podarcis muralis*) in Maastricht (De Hoge Fronten, 1977-2001).

For the foundation RAVON the Red List is an important instrument to evaluate our species protection programme. We use it as a tool to set priorities in conservation efforts.

#### REFERENCES

- CREEMERS, R.C.M., 1996. *Bedreigde en kwetsbare Reptielen en Amfibieën in Nederland*. Basisrapport met voorstel voor de Rode Lijst. Stichting RAVON, Nijmegen.
- HOM, C.C., P.H.C. LINA, G. VAN OMMERING, R.C.M. CREEMERS and H.J.R. LENDERS, 1996. *Bedreigde en kwetsbare Reptielen en Amfibieën in Nederland. Toelichting op de Rode Lijst*. IKC Natuurbeheer, Ministerie van LNV.
- IUCN, 1994. *Red List Categories*. Prepared by the IUCN Species Survival Commission. World Conservation Union, Gland.
- MINISTERIE VAN LANDBOUW, NATUURBEHEER EN VISSERIJ, 1996. *Rode lijst van Reptielen en Amfibieën*. Expertise Centrum LNV, Wageningen.



# 15

## Red Listing in Estonia

*V. Lilleleht*

### INTRODUCTION

Despite the simplicity and a rather high level of unification of principles used for the compilation of Red Data Books these principles have changed quite a lot overtime. This is especially the case in Eastern Europe, where Red Data Books have even become legal state documents. The history of compiling Red Data Books in Estonia has also been complicated and controversial. Up to now, three Red Data Books (Red Lists) have been completed in Estonia. This article is meant to give an overview of the compilation process of these three Red Data Books.

### ESTONIAN RED DATA BOOKS

The introduction and maintenance of the Estonian Red Data Book was initiated by the Commission for Nature Conservation of the Estonian Academy of Sciences. The book was compiled during 1976-1979 in general accordance with the IUCN rules for Red Data Books at that time. As required, the instruction for compiling the Estonian Red Data Book was approved by the Council of Ministers. The book was issued in four copies, and it consisted of separate sheets containing information about the state of threatened taxa (species and subspecies), their distribution, population size, habitat and included also protection measures already undertaken or proposed to be taken in the near future. The book was designed for specialists to be used in professional work. The Red Data Book meant for a wider public was issued in 1982, and it contained brief data not only on threatened species but also on all species placed under full protection (Kumari 1982).

In 1981, the Law on the Protection and Utilization of Fauna, valid in the Soviet Union, was adopted, with slight modifications, in Estonia. According to this law, the maintenance of the Red Data Book was legitimized and all species included were consequently considered fully protected. At the same time, the Estonian Red Data Book was to comprise all species entered into the Red Data Book of the Soviet Union, which happened to occur (even occasionally) in Estonia. For revising and updating the lists of the Estonian Red Data

Book, a new list of threatened species occurring within the Estonian territory was drawn up in 1985-1988. The Commission of the Red Data Book of Estonia was established by the Government. In accordance with the instruction of the Red Data Book, suggestions about entering species into this book were to be made again by the Commission for Nature Conservation of the Estonian Academy of Sciences. Lists of species to be included into the new Estonian Red Data Book were compiled and approved by the Commission of the Red Data Book. Although the book was not fully legitimized because of large-scale reorganization activities that started after restoration of the independent state of Estonia, the lists of threatened species were published and can be very rightly regarded as the second Estonian Red Data Book (Red List). Since according to the law on the protection of fauna, enforced on the example of the respective Soviet law, full protection of species was possible only by entering them into the Red Data Book, the second Estonian Red Data Book contained, besides the lists of endangered species, also a separate supplement including two categories of species. This supplement contained a large number of species which had traditionally been fully protected or utilized in Estonia, despite the fact that their survival was not endangered.

During 1986-1993 Estonian specialists participated in the compiling of the Red Data Book of the Baltic Region. It contained, among other lists, also Estonian lists of threatened vascular plants, amphibians, reptiles, birds and mammals (Ingelög *et al.* 1993). They were based on the lists of the second Estonian Red Data Book with only a few specific alterations. Compilation of the new, third, Red Data Book, coordinated again by the Commission for Nature Conservation of the Estonian Academy of Sciences, started in 1995 when an expert group was formed. Lists of endangered species were drawn up largely in 1997 with a few alterations made as late as 1998 (Lilleleht 1998a, 1998b).

#### PRINCIPLES OF COMPILING ESTONIAN LISTS OF THREATENED SPECIES

As seen from the above overview, the principles of compiling lists of threatened species in Estonia have changed for various reasons during the period under discussion. Although the first Estonian Red Data Book was compiled by a non-governmental organization virtually independently, the instruction for compiling the book was approved by the government. Lists of threatened species and threat categories were drawn up by the non-governmental organization – Commission for Nature Conservation of the Estonian Academy of Sciences. The second list of threatened species was approved by the Commission of the Red Data Book set up by the government. The list itself required additional approval by the government, which was indispensable at that time because the species that were entered into the Red Data Book were consequently regarded as being under protection. The Law on the Protection



and Utilization of Fauna, valid at that time, did not foresee any other possibilities for placing species under protection. The list was again drawn up by specialists. The third Estonian Red Data Book as well as the instruction for compiling it, were completed independent of the government. The government supported its compilation and publication financially. The categories used in the Estonian Red Data Books and in the international IUCN Red Data Books are principally the same (Table 1). However, the new system of IUCN categories, approved in 1994, was not applied in Estonia. Instead, it was decided to adopt the system of categories used in the Red Data Book of the Baltic Region (Ingelõg *et al.* 1993). Thus the third Estonian Red Data Book introduces, following the example of the Red Data Books of the Nordic States and the Red Data Book of the Baltic Region, the category 'care demanding', which has rendered the system of categories more flexible. As far as the principles of compiling lists have not yet stabilized, the category 'out of danger' was not applied this time. The number of taxa entered into the Estonian Red Data Book has changed as well (Table 2).

Table 1 – Threat categories used in Estonian Red Data Books

|   | 1979                | 1988          | 1998           |
|---|---------------------|---------------|----------------|
| 1 | Endangered          | Endangered    | Endangered     |
| 2 | Vulnerable and rare | Vulnerable    | Vulnerable     |
| 3 |                     | Rare          | Rare           |
| 4 | –                   | –             | Care demanding |
| 5 | Indeterminate       | Indeterminate | Indeterminate  |

A general tendency is not only an increase in the number of taxa in different taxonomic groups that have been entered into the Estonian Red Data Book, but also the continuously growing number of new taxonomic groups and their more complete inclusion for assessment of threatened species, particularly in the latest list. In this context, general accents to be considered in maintaining Red Data Books have changed.

The Red Data Book is continuously supplemented with new ones, known only to a small circle of specialists, or those which are, in fact, very hard or impossible to protect directly, or those which need not even be protected (e.g. species known as pests), etc. Consequently, new Red Data Books cannot be regarded as the Red Data Books of endangered and protection demanding species as they traditionally used to be. Although one of the aims of the Estonian Red Data Book is still to make society aware of the taxa that are under threat of extinction, it is not necessary to distribute the complete list over a broader public; distributing a summary list may be sufficient. The last

**Table 2** – The number of taxa in Estonian Red Data Books

|                 | 1979 | 1988 | 1998 |
|-----------------|------|------|------|
| Fungi           | –    | 12   | 91   |
| Lichens         | –    | 40   | 110  |
| Algae           | –    | 5    | 14   |
| Bryophyta       | –    | 40   | 199  |
| Vascular plants | 155  | 169  | 309  |
| Invertebrates   | 4    | 20   | 490  |
| Vertebrates     | 100  | 69   | 105* |
| Total           | 259  | 355  | 1318 |

\*Including four variations of fishes.

Red Data Book presents a general estimate of the biological diversity of the Estonian territory, as well as an estimate of the probability and possibilities to preserve and conserve it. The list should serve not only as a basis of a more general assessment of both the state of the natural environment, the species living in it and the trends of changes taking place in it, but also as a basis for making proposals to improve the situation when needed.

Among the Estonian Red Data Books the first edition and, as was intended, also the second edition provided a data bank to be used for developing programmes for the protection and restoration of species. However, the second Red Data Book presented merely a list of threatened species. The third Red Data Book also contains lists of threatened species but, in addition, also habitats of endangered taxa and threat factors are included. Moreover, attention is drawn to gaps in the knowledge of certain taxonomic groups and some threatened species, as well as to the inadequacy in the evaluation of the situation in Estonia.

### THE ESTONIAN RED DATA BOOK 1998

Different taxonomic groups inhabiting the Estonian territory have been studied to a different extent for assessing the degree of threat to taxa belonging to them (Table 3). Full evaluation of single taxa has been carried out in the case of all macrofungi, macrolichens, Bryophytes, vascular plants and vertebrates. In the case of invertebrates, evaluation of threat covers only about one-fourth of the species and is complete in a few groups only. A number of invertebrate and algae groups, microfungi and microlichens have remained almost totally unevaluated. On the one hand, this is due to the poor knowledge of

many groups (in particular, invertebrate groups) in Estonia. On the other hand, the groups that have remained unevaluated, or prove inadequately evaluated, are predominantly formed by small-sized species which are hard to identify (microfungi, microlichens, algae, Protozoa etc.). As a result of this and proceeding from the specific features of their biology, the total distribution and abundance of such species and changes in population size, as well as the general state of the species are very hard to establish or estimate.

Table 3 – Threatened taxa in different groups of registered natural species in Estonia

|                        | Number of species | Evaluated       |                 | Threatened |              |
|------------------------|-------------------|-----------------|-----------------|------------|--------------|
|                        |                   | Number          | %               | Number     | %            |
| <b>Fungi</b>           | c. 4000           | c. 2500         | c. 62           | 91         | c. 3.6       |
| Macrofungi             | c. 2500           | c. 2500         | 100             | 91         | c. 3.6       |
| Microfungi             | c. 1500           | 0               | 0               | ?          | ?            |
| <b>Lichens</b>         | c. 785            | 337             | c. 43           | 110        | 32.6         |
| Macrolichens           | 337               | 337             | 100             | 110        | 32.6         |
| Microlichens           | c. 450            | 0               | 0               | ?          | ?            |
| <b>Algae</b>           | c. 2700           | >14             | >0.5            | 14         | ?            |
| <b>Bryophytes</b>      | <b>525</b>        | <b>525</b>      | <b>100</b>      | <b>199</b> | <b>37.9</b>  |
| Anthocerotopsida       | 2                 | 2               | 100             | 1          | 50           |
| Marchantiopsida        | 116               | 116             | 100             | 47         | 40.5         |
| Bryopsida              | 407               | 407             | 100             | 151        | 37.1         |
| <b>Vascular plants</b> | <b>1498</b>       | <b>1498</b>     | <b>100</b>      | <b>309</b> | <b>20,6</b>  |
| <b>Invertebrates</b>   | <b>13 621</b>     | <b>&gt;3421</b> | <b>&gt;25.1</b> | <b>490</b> | <b>ca 14</b> |
| <i>Protozoa</i>        | 346               | 0               | 0               | ?          | ?            |
| <i>Porifera</i>        | 3                 | 3               | 100             | 0          | 0            |
| <i>Coelenterata</i>    | 11                | 11              | 100             | 1          | 9.1          |
| <i>Ctenophora</i>      | 1                 | 1               | 100             | 0          | 0            |
| <i>Platyhelminthes</i> | 304               | 0               | 0               | ?          | ?            |
| <i>Nemathelminthes</i> | 452               | >4              | >0.9            | 3          | ?            |
| <i>Nemertini</i>       | 4                 | 0               | 0               | ?          | ?            |
| <i>Priapulida</i>      | 1                 | 1               | 100             | 0          | 0            |
| <i>Annelida</i>        | 143               | 141             | 98.6            | 13         | 9.2          |
| <i>Bryozoa</i>         | 7                 | 1               | 14.3            | ?          | ?            |
| <i>Mollusca</i>        | 155               | 155             | 100             | 39         | 25.2         |
| <i>Gastropoda</i>      | 129               | 129             | 100             | 35         | 27.1         |
| <i>Bivalvia</i>        | 26                | 26              | 100             | 4          | 15.4         |

|                            | Number<br>of species | Evaluated       |               | Threatened  |              |
|----------------------------|----------------------|-----------------|---------------|-------------|--------------|
|                            |                      | Number          | %             | Number      | %            |
| <i>Arthropoda</i>          | 12194                | 3104            | 25.5          | 434         | 14.0         |
| <i>Crustacea</i>           | 334                  | 319             | 95.5          | 115         | 36.0         |
| <i>Arachnida</i>           | 786                  | 8               | 1.0           | 5           | 62.5         |
| <i>Myriapoda</i>           | 38                   | 0               | 0             | ?           | ?            |
| <i>Tardigrada</i>          | 1                    | 0               | 0             | ?           | ?            |
| <i>Insecta</i>             | 11035                | 2777            | 25.2          | 314         | 11.3         |
| Vertebrates                | <b>355</b>           | <b>355</b>      | <b>100</b>    | <b>101</b>  | <b>28.4</b>  |
| <i>Cyclostomata+Pisces</i> | 61                   | 61              | 100           | 22          | 36.1         |
| <i>Amphibia</i>            | 11                   | 11              | 100           | 5           | 45.4         |
| <i>Reptilia</i>            | 5                    | 5               | 100           | 1           | 20           |
| <i>Aves</i>                | 218                  | 218             | 100           | 56          | 25.7         |
| <i>Mammalia</i>            | 60                   | 60              | 100           | 17          | 28.3         |
| <b>Total</b>               | <b>c. 23500</b>      | <b>&gt;8600</b> | <b>&gt;37</b> | <b>1314</b> | <b>c. 15</b> |

Altogether, as many as 8,600 species (i.e. at least 37% of all species registered in Estonia) were examined and their conservation status assessed. Of these, 1,314 species (i.e. about 15%) were declared extinct or endangered. The numbers and proportions of species in different taxonomic groups included in the Estonian Red Data Book is different. Of the greatest proportion of extinct or threatened species, more than one third occurs among evaluated mosses, one-third among macrolichens, more than one fourth, among vertebrates and one fifth, among vascular plants.

The latest Estonian Red Data Book of 1998 presents, for the first time, the list of threatened taxa in the form of a table where their habitats and threat factors are arranged in the order of importance. This circumstance allowed to summarize and generalize these data. Moreover, this makes it possible to detect probable future changes both in the distribution of threatened taxa between different habitats and in factors endangering them.

About one third of the Estonian threatened taxa (30.8% of all threatened species, see table 4) are associated with forests (particularly fungi, mosses and lichens) and one fourth (23.0%) are associated with waterbodies. The proportion of taxa inhabiting meadows (8.7%), shores and banks (7.5%) and cultivated landscape (6.2%) among the threatened taxa is smaller, forming less than one tenth. Of course, such a distribution reflects largely the distribution of all organism groups between different habitats. Of the threatened species, fungi are associated mostly with forests (84.6% of all threatened fungal spe-

**Table 4** – Number of threatened taxa in different habitats (excluding 14 species of algae)

|                           | Fungi     | Lichens    | Bryo-<br>phyta | Vascular<br>plants | Inverte-<br>brates | Verte-<br>brates | Total       | %          |
|---------------------------|-----------|------------|----------------|--------------------|--------------------|------------------|-------------|------------|
| Forests                   | 77        | 49         | 56             | 57                 | 133                | 29               | 401         | 30.8       |
| Bushes                    | 2         | –          | –              | 12                 | 2                  | 1                | 17          | 1.3        |
| Mires                     | 1         | 1          | 30             | 19                 | 12                 | 5                | 68          | 5.2        |
| Meadows                   | 3         | –          | 4              | 72                 | 27                 | 8                | 114         | 8.7        |
| Shores and<br>banks       | –         | 9          | 25             | 41                 | 10                 | 13               | 98          | 7.5        |
| Floodplains               | –         | –          | –              | 7                  | –                  | 3                | 10          | 0.8        |
| Rocks                     | –         | 23         | 32             | 15                 | 3                  | 1                | 74          | 5.7        |
| Alvars                    | –         | 23         | 17             | 16                 | 10                 | –                | 66          | 5.1        |
| Dunes and<br>sandy plains | 4         | 4          | 2              | 26                 | 24                 | 2                | 62          | 4.8        |
| Waterbodies               | –         | 1          | 16             | 26                 | 222                | 35               | 300         | 23.0       |
| Man-made<br>habitats      | 4         | –          | 17             | 18                 | 34                 | 8                | 81          | 6.2        |
| Habitat<br>unknown        | –         | –          | –              | –                  | 13                 | –                | 13          | 1.0        |
| <b>Total</b>              | <b>91</b> | <b>110</b> | <b>199</b>     | <b>309</b>         | <b>490</b>         | <b>105</b>       | <b>1304</b> | <b>100</b> |

cies) and lichens (44.5%); invertebrates (45.3%) and vertebrates (33.3%) are associated with waterbodies. Meadows as a habitat are preferred mostly by threatened vascular plants (23.3%). The proportion of threatened species preferring sea and lake shores is about one-tenth in the case of vascular plants (13.3%), mosses (12.6%), vertebrates (12.4%) and lichens (8.2%). In mires the proportion of threatened species is the highest in the case of mosses (15.1%). Among lichens and mosses a number of species inhabit rocks and boulders (20.9 and 16.1%, respectively). Fewer threatened species are found in other habitats.

Proceeding from the distribution of threatened species between different habitats, the first place among the factors endangering them is occupied by various forestry activities (affecting 27.3% of all threatened species), primarily clear cutting and unsustainable forest management. They are followed by threats to waterbodies (14.2%) and agricultural activities (13.0%). Very often, threat factors are unknown (14.9%) (Table 5).

**Table 5** – Primary factors threatening different species of the Estonian Red Data Book (excluding 14 species of algae)

|   | Fungi     | Lichens    | Bryo-<br>phyta | Vascular<br>plants | Inverte-<br>brates | Verte-<br>brates | Total       | %          |
|---|-----------|------------|----------------|--------------------|--------------------|------------------|-------------|------------|
| Exploitation  | 8         | –          | 1              | 7                  | 2                  | 15               | 33          | 2.5        |
| Disturbance<br>and traffic                                  | 3         | –          | –              | –                  | –                  | 17               | 20          | 1.5        |
| Mechanical<br>wear on<br>habitat                            | –         | 2          | 4              | 38                 | 9                  | –                | 53          | 4.1        |
| Construction  | 1         | 2          | –              | 19                 | 26                 | –                | 48          | 3.7        |
| Mining  | 1         | 2          | –              | –                  | 5                  | –                | 8           | 0.6        |
| Agricultural<br>activities                                  | 7         | 23         | –              | 97                 | 32                 | 11               | 170         | 13.0       |
| Forestry<br>activities                                      | 69        | 50         | 40             | 70                 | 117                | 10               | 356         | 27.3       |
| Drainage of<br>mires and<br>bogs, and<br>peat<br>harvesting | 2         | 1          | 34             | 23                 | 11                 | 6                | 77          | 5.9        |
| Threats to<br>waterbodies                                   | –         | 3          | 19             | 40                 | 109                | 14               | 185         | 14.2       |
| Environmental<br>toxins, air<br>pollution,<br>acidification | –         | –          | –              | –                  | 84                 | 1                | 85          | 6.5        |
| Other causes  | –         | 7          | –              | –                  | 40                 | 28               | 75          | 5.8        |
| Cause<br>unknown  | –         | 20         | 101            | 15                 | 55                 | 3                | 194         | 14.9       |
| <b>Total</b>  | <b>91</b> | <b>110</b> | <b>199</b>     | <b>309</b>         | <b>490</b>         | <b>105</b>       | <b>1304</b> | <b>100</b> |

Forestry activities occupy the first place among threat factors in the case of fungi (affecting 75.8% of all threatened fungal species), lichens (45.4%) and invertebrates (23.9%). Vascular plants are threatened mostly by agricultural activities (31.4%), particularly by overgrowing of meadows, pastures and other open spaces as a result of cessation of hay cutting or grazing. The second largest threat to vascular plants are forestry activities, changing first of all the composition of tree species in forests (22.6%). Forestry activities have also been regarded as most threatening in the case of invertebrates (23.9%). The

second place among threat factors is occupied by changes in waterbodies (22.2%). In the case of vertebrates, who are more mobile, other causes (changes taking place in other regions, climatic changes etc.) play the greatest role (26.7%); they are followed by disturbance and traffic (16.2%), and trapping and hunting (14.3%). Threat factors are not known for about half of the endangered moss species (50.8%).

#### PREPARATIONS FOR COMPILING OF THE FOURTH ESTONIAN RED DATA BOOK

Some preparations have been made for compiling a fourth Estonian Red Data Book. The Commission of the Red Data Book was again created by the Commission for Nature Conservation, and will be approved by the Ministry of Environment. It was decided to use the new Red List Categories and Criteria adopted by the IUCN Council in 1994. An attempt was made to apply the new Criteria to bird species breeding within the Estonian territory.

#### REFERENCES

- INGELÖG, T., R. ANDERSSON and M. TJERNBERG, 1993. *Red Data Book of the Baltic Region*. Part 1. *Lists of threatened vascular plants and vertebrates*. Swedish Threatened Species Unit, Uppsala.
- KUMARI, E. (ed.), 1982. *Punane raamat. Eesti NSV-s kaitstavaid taime- ja loomaliike*. Valgus, Tallinn (In Estonian with English summary 'The Red Data Book of the Estonian S.S.R.').
- LILLELEHT, V. (ed.), 1998a. *Eesti Punane raamat. Ohustatud seened, taimed ja loomad*. Tartu. (In Estonian with English summary 'Estonian Red Data Book. Threatened Fungi, Plants and Animals'.)
- LILLELEHT, V., 1998b. Estonian Red Data Book. *Estonia Maritima* 3: 137-149.





# 16

## **‘Red-Listing’ birds in the UK: A provisional comparison of ‘The Population Status of Birds in the UK’ with IUCN regional guidelines**

*M.A. Eaton and R.D. Gregory*

### INTRODUCTION

The first national assessment of status of conservation concern of birds in the UK was published in 1990 (Batten *et al.* 1990) as a collaboration between the Nature Conservancy Council, the then statutory conservation body for Britain, and the RSPB, the UK Birdlife partner. This venture used quantitative criteria to judge the conservation status of each species, including the international importance of populations, the rarity of breeding species, population decline, localised distribution, and special concern. The list was subsequently updated and expanded in 1996, and published as *Birds of Conservation Concern* (‘BoCC’: Gibbons *et al.* 1996a) and *Birds of Conservation Importance* (‘BoCI’: Nature Conservancy Council 1996), which considered a wider range of qualifying criteria by virtue of improved data availability in both the UK and continental Europe. The revised listing considered population size and geographical range decline, historical population decline, rarity of breeding species, localised distribution, international importance, and both global and European conservation concern. This listing became widely recognised and used as the principal assessment of the conservation status of birds in the UK, and found acceptance outside the organisations responsible for its creation.

The third assessment of the conservation status of birds in the UK was published in 2002: *The Population Status of Birds in the UK* (hereafter referred to as ‘PSoB’) (Gregory *et al.* 2002). This exercise maintained the same listing criteria as used in 1996, described below. The current paper describes the assessment procedure, and gives a brief overview of the results. While it is intended to continue with repeated assessments using the same methodology on a six-year period, the development of guidelines for implementing IUCN Red-Listing on a regional basis (Gärdenfors 2001; Gärdenfors *et al.* 2001) now offers an alternative methodology with the potential for alternative results. It is important, therefore, that a comparative assessment of the two processes is conducted. It is hoped that this will identify the strengths and weaknesses of

the two approaches, and may result in an improved unified system best suited to the needs of bird conservation in the UK. Work on IUCN Red-Listing is currently underway. A few examples of the provisional results of IUCN Red-Listing of UK birds are given in this paper, accompanied by discussion of the merits of the two approaches.

#### PSOB LISTING CRITERIA AND DATA SOURCES

PSoB uses a 'traffic-light' system, whereby birds of the highest conservation concern are classified as red (based on population trends), amber denotes those of medium concern (based both on population trends and the UK's international responsibility to conserve these species) and green indicates a generally favourable conservation status. Population status is determined by assessing species against seven quantitative criteria, based upon global conservation status, European conservation status, recent population decline, historical population decline, breeding rarity, localised distribution and international importance (see below). Summary details are given below, and at greater length in Gregory *et al.* (2002). As in IUCN Red-Listing procedures, species are assessed by every criterion, and placed in the highest category reached under any criteria.

#### Global conservation status – Red List

Species with IUCN Globally Threatened (Critically Endangered, Endangered or Vulnerable) status, as published in *Threatened Birds of the World* (Birdlife International, 2000), were Red-Listed.

#### European Conservation Status – Amber List

Species with unfavourable European conservation status, as reported in *Birds in Europe* (Tucker and Heath 1994), were placed on the Amber List. This included Species of European Conservation Concern (SPEC) categories 2 (unfavourable status and concentrated in Europe) and 3 (unfavourable status but not concentrated in Europe).

#### Recent population decline – Red and Amber Lists

Recent population decline was measured over a 25-year period, 1974-99. A variety of surveys and monitoring schemes were used as sources of population trends (see Gregory *et al.* 2002). The UK is well served by bird monitor-

ing, and has good quality data for many species reaching back over three decades or longer. Species that have undergone a greater than 50% decline over the 25 year period were red-listed, while those that decreased by between 25 and 49% were Amber-Listed. Range contraction was treated in an identical fashion, using data from the two atlases of breeding birds in Britain and Ireland (Sharrock 1976; Gibbons *et al.* 1993).

#### Historical population decline – Red and Amber Lists

Species that showed a severe decline between 1800 and 1995 were placed on the Red List, using a system of ordinal scoring over five periods since 1800, which is best described as semi-quantitative. This categorisation could result in species becoming ‘stuck’ on the Red-List for many subsequent periodic PSoB assessments. Therefore, a number of sub-criteria allowed for increases in population more recently to cause species to be moved from Red to Amber, and Amber to Green.

#### Breeding Rarity – Amber List

Data from sources such as Rare Breeding Bird Panel reports (Ogilvie *et al.*, 1998; 1999a and b; 2000; 2001) and statutory conservation agency/RSPB single species surveys were used to assess population size. Population size was taken as the mean of the maximum total number of pairs (or more relevant units, for example in the case of birds for which territorial males are the standard survey unit) during the five years 1995-1999. Species with fewer than 300 pairs in the UK were placed on the Amber List.

#### Localised distribution – Amber List

Separate analyses were conducted to determine how localised species were in the breeding and non-breeding seasons, when appropriate. In both cases, the proportion of the UK population occurring in the best ten sites was calculated, with sites defined as Important Bird Areas (IBAs) for the breeding season assessment and Special Protection Areas (SPAs) for non-breeding assessment (Heath and Evans 2000; Stroud *et al.* 2001). If more than 50% of the UK population bred or wintered at the ten most important sites the species was Amber-Listed.

## International importance – Amber List

Estimates of populations from *European Bird Populations: estimates and trends* (Birdlife International/European Bird Census Council 2000) were used to assess the percentage of the European breeding populations present in the UK in both the breeding and non-breeding season. If greater than 20% of the European population is present in the UK then a species was Amber Listed. For many species of wildfowl and waders European population sizes are not well known. Instead, Northwest European (wildfowl) and East Atlantic flyway (waders) population sizes were used (Rose and Scott 1997).

### RESULTS OF PSoB

Of the 247 species assessed by the PSoB, 40 (16%) were categorised as Red-List, 121 (49%) as Amber-List and 86 (35%) as Green-List. Eleven of the Green-Listed species were placed in this category due to insufficient data, rather than being classified separately as Data Deficient, as in the IUCN Red-Listing process. With one exception (Little Grebe *Tachybaptus ruficollis*), this species occurs on passage in the UK in relatively low numbers. In addition, a number of species were not considered because they have become extinct in the UK; one of these, the Great Auk *Pinguinus impennis*, is globally extinct. Full listings for each category, together with data used in the listing process and further explanation of rationale can be found in Gregory *et al.* (2002).

The species Red-Listed by PSoB include both ‘traditionally’ rare species such as Bittern *Botaurus stellaris*, Red-necked Phalarope *Phalaropus lobatus* and Cirl Bunting *Emberiza cirlus* that have been the focus of conservation effort in the UK for decades. Other species such as Red Kite *Milvus milvus*, Osprey *Pandion haliaetus* and Dartford Warbler *Sylvia undata* have moved from the Red List in 1996 to the Amber List in 2002, due at least in part to successful conservation action. The other main groups of species on the Red List are those that, while still widespread and considered common, have decreased massively in recent decades. These are principally birds of agricultural landscapes that have been adversely affected by intensification (Aebischer *et al.* 2000); Grey Partridge *Perdix perdix*, Turtle Dove *Streptopelia turtur*, Skylark *Alauda arvensis* and Yellowhammer *Emberiza citrinella* amongst them. In addition, new species added to the Red List in 2002, such as Marsh and Willow Tit *Parus palustris* and *P. montanus* and Lesser Spotted Woodpecker *Dendrocopos minor* point to a worrying decline in woodland birds in the UK.

## COMPARISON OF PSoB LISTINGS WITH THE PROVISIONAL RESULTS OF THE IUCN RED-LISTING EXERCISE

All 247 species assessed by PSoB are undergoing Red-Listing using IUCN regional guidelines, and data is being collated for this task. The same data sources are being used as for PSoB; in cases where new data has become available since that assessment it will be disregarded in order to make the two processes comparable. In many cases, new analyses are necessary to prepare the data, such as calculating species trends in terms of generation lengths rather than the 25-year time period used in PSoB. The most recent regional Red-Listing guidelines have been followed (Gärdenfors *et al.* 2001; Gärdenfors, pers. comm.). Bird populations in the UK have been well studied, resulting in a high level of knowledge on the population status of birds, and movements of birds to and from neighbouring regions (e.g. Wernham *et al.* 2002). Therefore, it has been possible to assess the majority of species under IUCN criteria A-D, and to follow the second step assessing the influence of conspecific populations outside of the UK, with reasonable confidence. No species has been designated as Data Deficient so far.

Tables 1 to 3 give *provisional* results from IUCN Red-Listing of UK bird species of twenty species from each of the three PSoB colour categories. For all species listed in Tables 1-3 the assessment is of the breeding population only; for some, such as Purple Sandpiper, the outcome of an assessment of the non-breeding population is likely to be different. For some species, assessment by IUCN criteria is inappropriate, due to their marginal status in the UK; species such as Hoopoe *Upupa epops* have been excluded from the assessment for not being regular breeders in the UK while others such as Little Egret *Egretta garzetta* have been excluded as recent colonisers.

The two Red-Listing processes discussed in this paper do not use the same listing categories. The IUCN criteria are intended solely to assess extinction risk, whereas the PSoB criteria are intended to assess changes in population status even if these have no bearing on the risk of extinction. However, it might be expected that there should be a degree of concordance between categories used by the two processes. The simpler design of PSoB inevitably means that PSoB categories will overlap more than one IUCN category. Table 4 illustrates a simple attempt to 'match up' categories.

An examination of Tables 1-3 shows that the assessments of many species does concur with this matching between PSoB and IUCN categories; Capercaillie *Tetrao urogallus*, for example, is Red-Listed by PSoB and (provisionally) designated as Critically Endangered in the UK under IUCN regional criteria. Most of the PSoB Green-Listed species have been provisionally placed in the IUCN Least Concern category (Table 3). However, the IUCN Red-Listing con-

**Table 1** – Examples of provisional results of applying IUCN Red-Listing criteria to species on PSoB Red-List.

| Species                   |                              | PSoB Red-List criteria <sup>1</sup> |    |     |     | Provisional IUCN listing |
|---------------------------|------------------------------|-------------------------------------|----|-----|-----|--------------------------|
|                           |                              | IUCN                                | HD | BDp | BDr |                          |
| Bittern                   | <i>Botaurus stellaris</i>    |                                     | *  | *   | *   | EN* C2a(i,ii); D         |
| Capercaillie              | <i>Tetrao urogallus</i>      |                                     |    | *   | *   | CR A2b                   |
| Grey Partridge            | <i>Perdix perdix</i>         |                                     |    | *   |     | EN A2b                   |
| Corncrake                 | <i>Crex crex</i>             | *                                   | *  |     | *   | VU D                     |
| Stone Curlew              | <i>Burhinus oedicephalus</i> |                                     |    |     | *   | NT* D                    |
| Roseate Tern              | <i>Sterna dougallii</i>      |                                     |    | *   | *   | CR A2a; C2a(ii)          |
| Turtle Dove               | <i>Streptopelia turtur</i>   |                                     |    |     | *   | VU A2b                   |
| Wryneck                   | <i>Jynx torquilla</i>        | *                                   | *  | *   |     | CR C2a(i,ii)             |
| Lesser Spotted Woodpecker | <i>Dendrocopos minor</i>     |                                     |    | *   |     | EN A2b                   |
| Skylark                   | <i>Alauda arvensis</i>       |                                     |    | *   |     | LC                       |
| Ring Ouzel                | <i>Turdus torquatus</i>      |                                     |    | *   |     | LC                       |
| Willow Tit                | <i>Parus montanus</i>        |                                     |    | *   |     | EN A2b                   |
| Red-backed Shrike         | <i>Lanius collurio</i>       | *                                   | *  | *   |     | CR C2a(i,ii); D          |
| Starling                  | <i>Sturnus vulgaris</i>      |                                     |    | *   |     | VU A2b                   |
| House Sparrow             | <i>Passer domesticus</i>     |                                     |    | *   |     | LC                       |
| Tree Sparrow              | <i>Passer montanus</i>       |                                     |    | *   |     | EN A2b                   |
| Scottish Crossbill        | <i>Loxia scotica</i>         | *                                   |    |     |     | LC                       |
| Bullfinch                 | <i>Pyrrhula pyrrhula</i>     |                                     |    | *   |     | LC                       |
| Yellowhammer              | <i>Emberiza citrinella</i>   |                                     |    | *   |     | VU A2b                   |
| Corn Bunting              | <i>Miliaria calandra</i>     | *                                   | *  |     |     | VU A2b                   |

<sup>1</sup> PSoB Red-List criteria. IUCN: Globally threatened under IUCN Red-Listing criteria. HD: Historical population decline during 1800-1995. BDp: 50% decline in breeding population over previous 25 years. BDr: 50% decline in breeding range over previous 25 years. WDp: 50% decline in non-breeding population over previous 25 years. Further details in Gregory *et al.* (2002).

\* denotes where categorisation was modified due to immigration from extralimital populations, as described in Gärdenfors *et al.* (2001).

**Table 2** – Provisional results of applying IUCN Red-Listing criteria to species on PSoB amber-list

| Species               | PSoB amber-list criteria <sup>1</sup> |      |      |     |     | Provisional IUCN listing <sup>2</sup> |              |
|-----------------------|---------------------------------------|------|------|-----|-----|---------------------------------------|--------------|
|                       | HDr                                   | BDMr | SPEC | LOC |     |                                       |              |
|                       |                                       | BDMp | WDMp | BR  | INT |                                       |              |
| Black-throated Diver  |                                       |      |      | *   | *   | VU D                                  |              |
| Red-necked Grebe      |                                       |      |      | *   | *   | EN* D                                 |              |
| European Storm-Petrel |                                       |      |      | *   | *   | LC                                    |              |
| Little Egret          |                                       |      |      | *   |     | not assessed                          |              |
| Honey Buzzard         |                                       | *    |      |     |     | EN D                                  |              |
| Montagu's Harrier     |                                       | *    |      | *   |     | CR D                                  |              |
| Purple Sandpiper      |                                       |      |      | *   |     | CR D                                  |              |
| Great Skua            |                                       |      |      |     | *   | *                                     | LC           |
| Mediterranean Gull    |                                       |      |      | *   |     |                                       | NT** D       |
| Stock Dove            |                                       |      |      |     | *   |                                       | LC           |
| Barn Owl              |                                       | *    | *    |     |     |                                       | LC           |
| Green Woodpecker      |                                       |      |      | *   |     |                                       | LC           |
| Barn Swallow          |                                       |      |      | *   |     |                                       | LC           |
| Tree Pipit            |                                       | *    |      |     |     |                                       | VU* A2b      |
| Yellow Wagtail        |                                       | *    |      |     |     |                                       | NT           |
| Hedge Accentor        |                                       |      |      |     |     |                                       | LC           |
| Fieldfare             |                                       | *    |      | *   |     |                                       | not assessed |
| Mistle Thrush         |                                       |      |      |     |     |                                       | LC           |
| Dartford Warbler      | *                                     |      | *    | *   |     |                                       | NT           |
| Serín                 |                                       |      |      | *   |     |                                       | not assessed |

<sup>1</sup> PSoB Amber-List criteria. HDr: historical population decline 1800-1995, followed by recovery over last 25 years. BDMp: decline of 25-49% in breeding population in last 25 years. BDMr: decline of 25-49% in breeding range over last 25 years. WDMp: decline of 25-49% in wintering population over last 25 years. SPEC: unfavourable European conservation status (SPEC2 and 3). BR: Breeding population 1-300 pairs. LOC: (50% of UK breeding and/or non-breeding population in (10 sites). INT: (20% of European (NW Europe – wildfowl, E Atlantic flyway – waders) breeding or non-breeding population in UK. Further details in Gregory *et al.* (2002). <sup>2</sup> See Table 1.

**Table 3** – Provisional results of applying IUCN Red-Listing criteria to species on PSoB Green-List.

| Species                |                                | PSoB green-list | Provisional IUCN listing <sup>2</sup> |
|------------------------|--------------------------------|-----------------|---------------------------------------|
| Little Grebe           | <i>Tachybaptus ruficollis</i>  | *               | LC                                    |
| Grey Heron             | <i>Ardea cinerea</i>           | *               | LC                                    |
| Tufted Duck            | <i>Aythya fuligula</i>         | *               | LC                                    |
| Sparrowhawk            | <i>Accipiter nisus</i>         | *               | LC                                    |
| Ptarmigan              | <i>Lagopus mutus</i>           | *               | LC                                    |
| Common Sandpiper       | <i>Actitis hypoleucos</i>      | *               | VU A2b                                |
| Long-eared Owl         | <i>Asio otus</i>               | *               | LC                                    |
| Hoopoe                 | <i>Upupa epops</i>             | *               | not assessed                          |
| Dipper                 | <i>Cinclus cinclus</i>         | *               | LC                                    |
| Robin                  | <i>Erithacus rubecula</i>      | *               | LC                                    |
| Whinchat               | <i>Saxicola rubetra</i>        | *               | LC                                    |
| Reed Warbler           | <i>Acrocephalus scirpaceus</i> | *               | LC                                    |
| Lesser Whitethroat     | <i>Sylvia curruca</i>          | *               | LC                                    |
| Pied Flycatcher        | <i>Ficedula hypoleuca</i>      | *               | LC                                    |
| Crested Tit            | <i>Parus cristatus</i>         | *               | LC                                    |
| Short-toed Treecreeper | <i>Certhia brachydactyla</i>   | *               | VU* D                                 |
| Jackdaw                | <i>Corvus monedula</i>         | *               | LC                                    |
| Greenfinch             | <i>Carduelis chloris</i>       | *               | LC                                    |
| Common Crossbill       | <i>Loxia curvirostra</i>       | *               | LC                                    |
| Lapland Longspur       | <i>Calcarius lapponicus</i>    | *               | not assessed                          |

\* See Table 1.

**Table 4** – Approximate predicted relationship between IUCN Red List categories and PSoB Categories

|                                   | PSoB         | IUCN                                   |
|-----------------------------------|--------------|--|
| Increasing conservation concern ↑ | Not assessed | Globally extinct<br>Regionally extinct |
|                                   | Red List     | Critically Endangered<br>Endangered    |
|                                   | Amber List   | Vulnerable<br>Near Threatened          |
|                                   | Green List   | Least Concern<br>Data Deficient        |



ducted so far has also highlighted a number of species for which the two categorisations are not similar. Five of the 20 PSoB red-listed species assessed by IUCN guidelines were assigned to the Least Concern category, as were eight of 17 amber-listed species. Conversely, two of 18 PSoB green-listed species were categorised in an IUCN threatened category.

## DISCUSSION

The disparities between the results of the two assessments described above have arisen due to differences in the criteria used. A number of particular differences between PSoB and IUCN criteria are highlighted below:

- 1 The trend period for recent decline: In the case of short-lived species, the ten-year period used in IUCN Red-Listing (when this is greater than three generation lengths of a species) is much shorter than the 25 years used in PSoB. Species that may have declined massively in recent years but then 'bottomed out' in the last decade may elude IUCN threatened categories. However, the use of generation length may be a more relevant measure of time over which to measure population trends.
- 2 Differing percentage thresholds for declines and range contractions are inevitably going to produce differences in assessment results.
- 3 The use of criteria from outside of the UK may influence PSoB inappropriately; Green Woodpecker is Amber-listed due to SPEC 2 status, but is common and increasing in most of the UK.
- 4 The use of historical data by PSoB means that species that have been stable in the UK for many years, but at much lower population levels than historically so, are still highlighted as being of conservation concern. This includes, for example, raptor species reduced to very low numbers by persecution in the 19th and early 20th century and yet to fully recover.
- 5 The PSoB assessment process automatically Red-Lists any species categorised as Globally Threatened under IUCN guidelines (Birdlife International 2000). IUCN regional guidelines do not require this, so somewhat perversely Globally Threatened species may be listed as being of Least Concern regionally.
- 6 The two procedures assess localised distribution in completely different ways. PSoB uses a simple measure of concentration at the most important sites, whereas IUCN listing includes measures of extent of occurrence, area of occupancy and restriction to a limited number of sites.

From the provisional IUCN Red-Listing of 60 species presented above, a few patterns can be identified in comparison with the PSoB listing. Principally, compared with PSoB, the results of assessing extinction risk with IUCN criteria appear to:

- I Understate the conservation concern regarding birds that have undergone major declines over the last three decades, but remained common and widespread. These include some of the suite of declining farmland birds, such as Skylark *Alauda arvensis*, that are currently the focus of considerable conservation action in the UK.
- II Exaggerate the conservation concern regarding edge-of-range species in the UK, including those that have never had more than a toehold in the UK (e.g. Montagu's Harrier *Circus pygargus*) and those that have colonised recently (e.g. Mediterranean Gull, *Larus melanocephalus*).

These differences are not surprising, given the different emphasis and aims of the two Red-Listing procedures. IUCN Red-Listing is intended to assess extinction risk, and does so well; for example, correctly identifying that despite the massive recent declines Skylark is unlikely to actually go extinct in the UK in the near future. However, it may be that the same would have been said if IUCN criteria had been applied to Red-backed Shrike *Lanius collurio* during early part of the twentieth century; it subsequently declined to such an extent that it only remains as a breeding bird in the UK due to occasional attempts to breed in the Scottish highlands. PSoB was designed to inform the setting of bird conservation priorities in the UK and so is not solely concerned with extinction risk. Declines in common birds are of great concern to both conservation bodies and the UK public. Conversely, the loss of breeding species that have never become fully established in the UK, while regrettable, could be regarded as being of lesser concern, and is often very difficult for UK conservation action to address.

While this interim report has revealed some interesting results, all 247 species must be fully assessed by all IUCN regional criteria before any conclusions can be made. The 'bespoke' PSoB process may prove to be of greater value to UK conservation, but it seems unlikely that it could not be improved by the use of elements of IUCN criteria: The use of generation lengths rather than a fixed term against which to measure population trends, for example. It is important that careful consideration is made to the release of the results of any IUCN Red-Listing exercise, as the promotion of a second, 'rival' conservation assessment may just serve to confuse the situation, leaving interested parties able to pick and choose from the two lists to suit their goals.

Finally, it must be stressed that processes such as IUCN Red-Listing and PSoB are assessments of some aspect(s) of population status, and not in themselves standalone methods for setting conservation priorities. Factors such as legal conservation frameworks, the availability of funds and the cost of conservation action, the likelihood of success of such action and the attendant benefits for other species and the ecological, phylogenetic, historical and cultural preferences for species should be considered in addition to the results of popula-

tion status assessments. Figure 1 suggests a simple framework for setting conservation priorities.

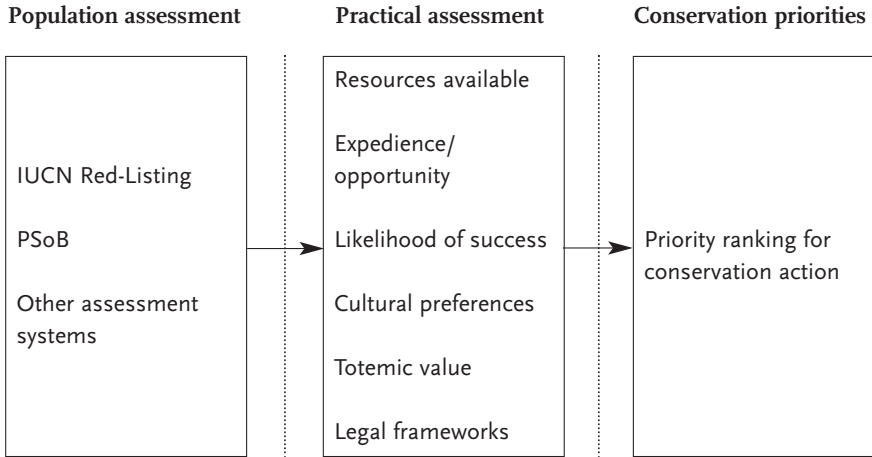

**Figure 1** – Framework for the setting of priorities for conservation action

#### ACKNOWLEDGEMENTS

The authors of this paper are heavily indebted to the authors of *The Population Status of Birds in the United Kingdom*: Richard Gregory, Nick Wilkinson, David Noble, James Robinson, Andrew Brown, Julian Hughes, Deborah Procter, David Gibbons and Colin Galbraith.

#### REFERENCES

- AEBISCHER, N.J., A.D. EVANS, P.V. GRICE and J.A. VICKERY, 2000. *Ecology and Conservation of Lowland Farmland Birds*. BOU, Tring.
- BATTEN, L.A., C.J. BIBBY, P. CLEMENT, G.D. ELLIOT and R.F. PORTER, 1990. *Red Data Birds in Britain*. Poyser, London.
- BIRDLIFE INTERNATIONAL, 2000. *Threatened Birds of the World*. BirdLife International, Barcelona & Cambridge.
- BIRDLIFE INTERNATIONAL/EUROPEAN BIRD CENSUS COUNCIL, 2000. *European bird populations: estimates and trends*. BirdLife International, Cambridge.
- GÄRDENFORS, U., 2001. Classifying threatened species at national versus global levels. *Trends in Ecology and Evolution* 16: 511-516.
- GÄRDENFORS, U., C. HILTON-TAYLOR, G.M. MACE and J.P. RODRIGUEZ, 2001. The application of IUCN Red List criteria at regional levels. *Conserv. Biol.* 15: 1206-1212.

- GIBBONS, D.W., M.I. AVERY, S.R. BAILLIE, R.D. GREGORY, J. KIRBY, R.F. PORTER, G.M. TUCKER and G. WILLIAMS, 1996a. Bird Species of Conservation Concern in the United Kingdom, Channel Islands and Isle of Man: revising the Red Data List. *RSPB Conservation Review* 10: 7-18.
- GIBBONS, D.W., J.B. REID and R.A. CHAPMAN, 1993. *The New Atlas of Breeding Birds in Britain and Ireland: 1988-1991*. Poyser, London.
- GREGORY, R.D., N.I. WILKINSON, D.G. NOBLE, J.A. ROBINSON, A.F. BROWN, J. HUGHES, D.A. PROCTER, D.W. GIBBONS and C.A. GALBRAITH, 2002. The population status of birds in the United Kingdom, Channel Islands and Isle of Man: an analysis of conservation concern 2002-2007. *Brit. Birds* 95: 410-450.
- HEATH, M.F. and M.I. EVANS (eds.), 2000. *Important Bird Areas in Europe: Priority sites for conservation. 1: Northern Europe*. BirdLife International, Cambridge.
- NATURE CONSERVANCY COUNCIL, 1996. *Birds of Conservation Importance*. JNCC, Peterborough.
- OGILVIE, M.A. and the Rare Breeding Birds Panel, 1998. Rare breeding birds in the United Kingdom in 1995. *Brit. Birds* 91: 417-447.
- OGILVIE, M.A. and the Rare Breeding Birds Panel, 1999a. Rare breeding birds in the United Kingdom in 1996. *Brit. Birds* 92: 120-154.
- OGILVIE, M.A. and the Rare Breeding Birds Panel, 1999b. Rare breeding birds in the United Kingdom in 1997. *Brit. Birds* 92: 389-428.
- OGILVIE, M.A. and the Rare Breeding Birds Panel, 2000. Rare breeding birds in the United Kingdom in 1998. *Brit. Birds* 93: 358-393.
- OGILVIE, M.A. and the Rare Breeding Birds Panel, 2001. Rare breeding birds in the United Kingdom in 1999. *Brit. Birds* 94: 344-381.
- ROSE, P.M. and D.A. SCOTT, 1997. *Waterfowl population estimates*. 2nd edn. Wetlands International Publ. 44, Wageningen.
- SHARROCK, J.T.R., 1976. *The Atlas of Breeding Birds in Britain and Ireland*. Poyser, Berkhamsted.
- STROUD, D.A., D. CHAMBERS, S. COOK, N. BUXTON, B. FRASER, P. CLEMENT, P. LEWIS, I. MCLEAN, H. BAKER and H. WHITEHEAD, 2001. *The UK SPA network – its scope and content*. Nature Conservancy Council, Peterborough.
- TUCKER, G.M. and M.F. HEATH, 1994. *Birds in Europe: Their Conservation Status*. BirdLife International, Cambridge.
- WERNHAM, C., M. TOMS, J. MARCHANT, J. CLARK, G. SIRIWARDENA and S. BAILLIE, 2002. *Migration Atlas: Movements of the Birds of Britain and Ireland*. A & C Black, London.

# 17

## Red-Listing of birds in Germany

*H.G. Bauer*

### HISTORICAL BACKGROUND

The German Red Lists of Birds date back to 1971 (DS/IRV 1971) when the very first German Red List of any taxonomic group was published by the West-German Section of former ICBP (now BirdLife International). This first Red List was mainly instigated by the publication of IUCN's 5th Red Data Book in 1970 (Köppel 1999) and was already subdivided in different threat categories.

Subsequently, a further five Red Lists were published in former West Germany in quick succession (see Table 1 for details), the last in 1987 (DDA & DS/IRV 1987). In former East Germany (GDR), on the other hand, threat status of breeding bird species was never assessed in Red Lists, but comparable threat status categories for all breeding birds (except for hunted species) had entered GDR legislation in 1984.

After re-unification, the first Red List of breeding birds in Germany was published in 1991 (DDA & DS/IRV 1991). Procedure and classification system were mostly identical to those of the 1987 West-German list, but again, as in virtually all lists before, slight alterations and amendments had been introduced, thus making comparison with precursor lists difficult.

Since nature conservation legislation and policy is – in general – the domain of German federal states, the Red-Listing process was quickly adopted by regional NGOs, too. From 1973 onwards, Red Lists were issued in all federal states of West Germany, mostly following the procedures adopted by the national NGO platform.

After a decade of 'unobtrusiveness', the Red Lists started to gain considerable political impact from the 1980s onwards, especially after the publication of the fourth edition of the German Red Data Book by Blab *et al.* (1984). And, despite the fact that Red Lists never became law in German – in contrast to Switzerland and Austria –, they developed into one of the most powerful political instruments of nature conservation. Among others, this is mirrored in the sheer number of national, regional or even subregional and local Red Lists published in Germany (over 1,800 according to Köppel *et al.* 2003), all designed and aimed to raise public awareness about biodiversity loss and the extinction risk many of Germany's birds were facing, as well as to influence policy and decision makers in order to take conservation action.

**Table 1** – Red Lists of Birds in Germany

---

| BRD          | DDR  |
|--------------|--|
| 1 1971       | none, but 4 threat categories in national conservation legislation (01.10.1984) ('CR', 'VU', 'Rare', 'others') |
| 2 31.12.1972 |  |
| 3 30.11.1974 |  |
| 4 01.01.1977 |  |
| 5 01.01.1982 |  |
| 6 01.01.1987 |  |

---

**Germany**

- 1 10.11.1991
  - 2 01.06.1996
  - 3 31.12.2001
- 

Federal state lists since 1973 (BE, SL); 1974 (BW, NI, HB); 1975 (He); 1976 (BY, HH, RP, SH); 1980 (NW) or after 1991 (BB, MV, SN, ST, TH)

---

German Federal States are abbreviated as follows: BB=Brandenburg, BE=Berlin, BW=Baden-Württemberg, BY=Bayern, HB=Bremen, HE=Hessen, HH=Hamburg, MV=Mecklenburg-Vorpommern, NI=Niedersachsen, NW=Nordrhein-Westfalen, RP=Rheinland-Pfalz, SH=Schleswig-Holstein, SL=Saarland, SN=Sachsen, ST=Sachsen-Anhalt, TH=Thüringen.

**CLASSIFICATION SYSTEMS**

Well into the 1990s all Red Lists of breeding birds in Germany were derived from expert opinions based on the collective knowledge of scientists on population size, trends and threat factors, rather than from a rigid classification system of set quantitative threshold levels. One of the main, and not completely unfounded, criticisms of these Red Lists, and any other purely 'qualitative' assessment system, was that the categorization process could at times be lacking in transparency. In order for Red Lists to be less prone to such criticism, a National Red List Committee (Birds) was founded in 1994 with the aim to develop an objective quantitative criteria system with many elements taken from the IUCN guidelines (IUCN 1994), but based on the conceptual framework developed by Schnittler *et al.* (1994), while integrating all national institutions (both GO's and NGO's) concerned with the science and policy of bird conservation.

Thus, in the second Red List of Birds of unified Germany (Witt *et al.* 1996) a set of quantitative criteria was used which corresponds mainly to the general criteria outlined by IUCN (1994) and Schnittler *et al.* (1994). With the (partial)

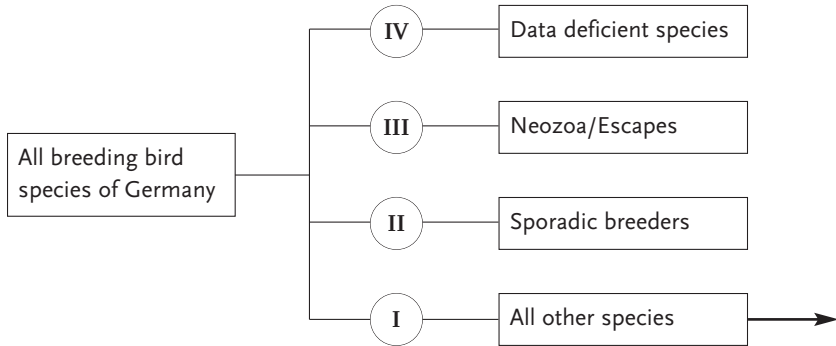
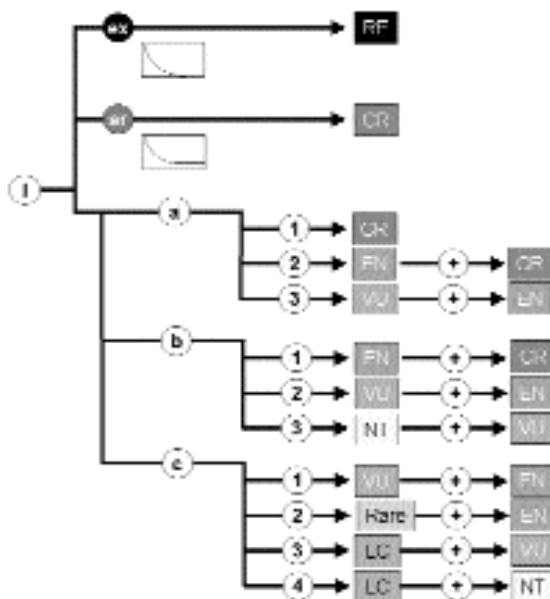

**Figure 1** – First step in red-listing birds in Germany. All breeding birds are assigned to four status categories, only those of category I enter the actual red-listing procedure.

adoption of IUCN’s more rigid categorization procedure, but particularly with the introduction of fixed quantitative criteria and threshold levels, the red-listing process in fact became more ‘objective’. This system was only slightly refined for the third Red List of German breeding birds (Bauer *et al.* 2002), therefore not adapting IUCN’s new (regional) guidelines developed and published almost concurrently with the German list (Gärdenfors 2001; IUCN 2001).

The German Red-Listing process for birds entails the following steps. First, all breeding bird species are categorized into four status categories (see Fig. 1), with status IV denoting data-deficient species (‘DD’ in IUCN terms) for which an assessment seems impossible on the basis of existing knowledge. Surprisingly, considering the huge amount of data available for this taxonomic group in Germany, there was indeed one species listed in this category, Scops owl, and two more contenders for this category which at present are kept under the ‘Regionally Extinct’ label, but whose actual status might be changed in the near future, if new data become available (Rock partridge and Rock thrush). The other two status categories outside the actual Red Listing system denote escapes or neozoa (status category III), and species which only sporadically breed in Germany (status category II), both not applicable in Red List assessment (‘NA’ in new IUCN terms). All other species, i.e. all regularly breeding native bird species in Germany (status category I), enter the actual assessment procedure outlined in Fig. 2.

In the procedure for the 2002 list the assessment period (ranging from 1975-1999) again embraced 25 years as in the precursor list, therefore differing from the 1994 IUCN procedure which used a ten year or three generation period. The first categorization step concerns former regular breeding birds that have not bred within the last ten years (see ‘ex’ in Fig. 2). These species are entered in Red-List category ‘Regionally Extinct’ (RE). In a second step



**Figure 2** – Red-Listing birds in Germany. Breeding birds of status category I are assessed according to decision rules ‘ex’, ‘ar’, and ‘a’, ‘b’, ‘c’ (for detailed description of decision rules see text) to reach IUCN threat categories RE= Regionally Extinct, CR= Critically endangered, EN= Endangered, VU= Vulnerable, former IUCN threat category ‘Rare’, or non-threat categories NT= Near-threatened and LC= Least concern. For most categories the assessment process also allows for adjustment (up-grading) by use of ‘threat factors’. For details see text.

species enter decision rule ‘ar’ which showed steep decline rates prior to the assessment period, but now have more or less stabilized on an extremely low population level (thus not qualifying for high threat categories according to the other assessment rules below). If such species face an undiminished extinction risk they are categorized in Red-List category ‘Critically Endangered’ (CR), otherwise they are treated under decision rule ‘cr’.

All other species are classified according to their decline rate or loss of area of occupancy. The latter argument was comparatively little used in the assessment process, however, since data quality was mostly insufficient for application of respective quantitative criteria (since there are no comparable breeding atlas data for all of Germany from two different time periods). In general, therefore, the current procedure treats different threshold levels of *decline rate* as the principal feature in the categorization process (decision rules ‘a’, ‘b’ or ‘c’ in Fig. 2). The subsets (‘1’, ‘2’, ‘3’, (‘4’)) under each decision rule mainly denote different quantitative population levels.



The highest threat categories are reached by species with decline rates of > 50% (or with drastic areal loss) under decision rule 'a', lower categories are reached by species with decline rates of > 20% (or respective areal losses) under decision rule 'b', the lowest or no threat categories are reached under decision rule 'c' by species showing decline rates below 20%, population stability, or population increases.

Under decision rules 'a' and 'b' species are grouped in three subsets according to their population levels, with 'a1' and 'b1' denoting populations of < 1,000 pairs or restricted range species with < 100 occupied sites or < 10 breeding colonies, 'a2' and 'b2' denoting uncommon species with populations of < 10,000 pairs, and 'a3' and 'b3' denoting common species with populations of > 10,000 pairs. Under decision rule 'c' species can only enter one of the threat categories (VU) if they are rare (i.e. with < 10,000 pairs in Germany) *and* if they are on a historical low considering population size or area of occupancy (decision rule 'c1'; compare to 'a1' above). For restricted-range species with populations of < 1,000 pairs former IUCN category 'Rare' is maintained in this system under criterion 'c2'. All other species do not reach a threat category under decision rule 'c', unless subject to up-grading in the final step (see below).

In a final step, categorization may be changed slightly according to specific 'threat factors' or 'risk factors' (decision rule '+'). A range of six different arguments, most of them also used by IUCN in its Red-Listing procedure, may serve to up-grade a species in order to take specifically higher extinction risks into account. The six factors altering – in actual fact: up-grading – preliminary categorization are: the species (i) is restricted to special, threatened habitats, (ii) is conservation dependent, (iii) is facing actual threats by human interference, (iv) will face considerable problems in future, (v) is highly dependent on immigration (sink-population), (vi) regionally shows a strongly reduced area of occupancy and/or considerable fragmentation. The up-grading generally involves one category, with 'Rare' species treated like those of category 'VU'.

## CONGRUENCE AND DIFFERENCES IN RED-LISTING PROCEDURES

There are apparent differences between IUCN and German assessors in the general aims of Red Lists and in the perception of their political 'applicability' (compare Köppel, 1999; Bauer *et al.* 2002). The 'philosophy' of IUCN centres on strict extinction risk assessment is based on a range of population-demographic data. The emerging Red Lists are therefore strongly focused on species faced with a more or less immediate extinction risk on population level. They are not or no longer concerned with the ensuing conservation action which in this concept is left to other instruments (see below). The 'philosophy' of German Red-Listing bodies, on the other hand, centres on the evaluation of the status of (regional) biodiversity and has a stronger focus on

historical processes. The corresponding German Red Lists consequently have a broader scope and show a strong focus on species faced with apparent threats which need to be politically addressed and remedied. In this approach it is stressed that the reduction in population size or the loss of well-adapted species or subspecies at habitat or regional levels alone may have a considerable negative impact on species communities and ecosystems, not only the final (regional) extinction process. Thus, the two concepts 'by definition' must lead to different categories and criteria, and subsequently to differing lists of threatened taxa. In consequence, they are based on different political aims.

Despite the principal differences outlined above, there are a range of congruent features in the Red-Listing process that are intrinsic to both sides. Strong congruence can be found in the use of quantitative data on population size, decline rate and changes in areal occupancy, and the fact that threshold values are used to reach the various threat categories during the assessment process. Furthermore, a common feature is the use of three main threat categories encompassing Critically endangered (CR), Endangered (EN), and Vulnerable (VU), as well as a Near-Threatened category (NT) for Red-List candidate species. The latter corresponds particularly well to the notion of Red Lists being 'alerting' systems to urge conservation action.

On the other hand, there are also several differences in the actual assessment procedure, the most important with respect to the Red List of German breeding birds being:

1 Time scale

German ornithologists adopted a 25 year period rather than the 3 generation/10 year period suggested by IUCN (1994) or the varying generation length procedure suggested by IUCN (2001), which at present is not generally established even for bird species, and still needs to be scientifically evaluated by BirdLife International (Eaton and Gregory 2003).

2 Decision rules and criteria used

There are considerable differences between the five decision rules A-E used by IUCN (Gärdenfors 2001) and the three main decision rules a-c used by German ornithologists, including the use of threat factors or risk factors outlined above. Furthermore, the preliminary categorization of species according to IUCN decision rules A-E have to be refined in a second step, as in e.g. the Red-Listing process in Switzerland (Keller *et al.* 2001). The procedure adopted by the German Red-List Committee for birds similarly includes a second refining step, but the actual process is quite different.

3 Categories used

There is one major difference between the categories concerning the use of former IUCN category 'Rare'. This category has been maintained in the German Red List of birds to certify Red-List status in a range of rare and threatened species that would otherwise not have qualified. In the IUCN

procedure, on the other hand, rarity is used as a criterion/decision rule, and not as a category.

#### CONCLUDING REMARKS

The German Red List Committee (Birds) favours any development that helps to improve the objectivity and scientific basis of Red-Listing procedures. However, when trying to follow the changes outlined by IUCN in its recent Regional Guidelines (Gärdenfors *et al.* 1999; Gärdenfors 2001) one is confronted with the dilemma that there are considerable differences in the intentions and objectives of the respective Red-Listing processes. IUCN's aims with its new Regional Guidelines are to establish status reports purely relating to extinction risk without incorporation of immanent conservation implications. These, in most cases, will require further processes of conservation assessment and prioritization on regional level, i.e. the development of additional lists in which 'priority species' for conservation action are identified and brought to public awareness. The German Red Lists, on the other hand, aim at documenting the conservation status of biodiversity at given scales (predominantly national or federal state level). Apart from pointing out immediate extinction risks, they are also designed to emphasize moderate declines in widespread species in order to help identify threat factors with large-scale environmental impact at an early stage. As such, these lists are well-established alerting systems and conservation instruments, which are more sensitive and with a broader scope compared to IUCN Regional Red Lists. Consequently, they are better suited to provide decision and policy makers with a wide range of baseline information for species and landscape conservation and management.

We argue that IUCN's categorization methods are essential in providing its governmental and NGO membership with a scientific framework for assessment of global extinction risk of species, which in a growing number of cases are followed up by SSC Surveys and Conservation Action Plans across (virtually) all taxonomic groups. However, as far as regional categorization is concerned, 'pure' extinction risk assessment may not be the best choice, especially in temperate regions, which may generally be poor in endemics or species in risk of global extinction.

The use of regional extinction risk assessment *sensu* IUCN may certainly be possible in states, where Red Lists might quickly find their way into national legislation together with additional lists of 'priority species for conservation action' (e.g. Switzerland: Keller and Bollmann 2001; Keller *et al.* 2001), or in those where Red Lists are not yet politically accepted instruments. But in other states, the introduction of an additional, separate list of threatened species in need of conservation action may counteract the political acceptance and power Red Lists have acquired over the last two decades. Moreover, since these new

lists lack the political impact of the well-established Red Lists, they might even weaken the existing instrument and thus harm the conservation cause in general.

Provided the new IUCN regional criteria are harmonized and generally adopted, another major obstacle has to be overcome. In order to be able to meet the complicated list of assessment criteria of IUCN (2001), the data sets have to be improved dramatically. Not even for the exceptionally well-covered group of birds do we have sufficient information to answer most of the questions necessary to adequately assess long-term extinction risk of bird species. Insufficient data quality (or availability!) may thus have to be outbalanced by a considerable increase in subjectivity. And finally, since IUCN gave only cursory outlines for some assessment procedures (especially for the 'second phase'; see Gärdenfors *et al.* 1999; Keller *et al.* 2001), another aspect of Red List improvement may be detrimentally affected: that of comparability. One important aim of IUCN's guidelines was to improve comparability between taxonomic groups as well as between different national lists. This aim can only be met, if questions of congruence and of data quality have highest priority throughout the whole harmonization process. However, in view of the massive range of 'national adaptations', we have to conclude that the intended aim to alleviate comparability is inadequately fulfilled by current IUCN regional guidelines.

In consequence, we propose that existing differences in criteria systems be maintained throughout Europe, provided that the intentions and aims of the instrument as well as the underlying data basis and the adopted categorization process are transparently and comprehensibly publicized. Multi-national compilations of Red Lists at larger geographic scales will be greatly facilitated if all the original information used in national Red-Listing procedures are being made available.

#### ACKNOWLEDGEMENTS

I wish to thank P. Berthold, M. Binot-Hafke, H. Haupt, H. Martens, and P. Südbeck for remarks and suggestions on an earlier draft of this paper, and M. Krome for technical assistance with the tables and figures.

#### REFERENCES

- BAUER, H.-G., P. BERTHOLD, P. BOYE, W. KNIEF, P. SÜDBECK and K. WITT, 2002. *Rote Liste der Brutvögel Deutschlands*. (3. Fassung, Stand 31.12.2001). Ber. Vogelschutz 39, in press.
- BLAB, J., E. NOWAK, W. TRAUTMANN and H. SUKOPP (eds.), 1984. *Rote Liste der gefährdeten Tiere und Pflanzen in der Bundesrepublik Deutschland*. Kilda-Verlag, Greven.

- DDA & DS/IRV [Dachverband Deutscher Avifaunisten & Deutsche Sektion des Internationalen Rates für Vogelschutz], 1987. Rote Liste der in der Bundesrepublik Deutschland und Berlin (West) gefährdeten Vogelarten. (6. Fassung, Stand 1.1.1987). *Ber. Dtsch. Sek. Int. Rat Vogelschutz* 26: 17-26.
- DDA & DS/IRV, (1991). Rote Liste der in Deutschland gefährdeten Vogelarten. (1. Fassung, Stand 10.11.1991). *Ber. Dtsch. Sek. Int. Rat Vogelschutz* 30: 15-29.
- DS/IRV, (1971). Die in der Bundesrepublik Deutschland gefährdeten Vogelarten und der Erfolg von Schutzmaßnahmen. *Ber. Dtsch. Sek. Int. Rat Vogelschutz* 11: 31-37.
- EATON, M.A. and D. GREGORY, 2003. 'Red Listing' birds in the UK: A provisional comparison of 'the population status of birds in the UK', with IUCN regional guidelines. In: H.H. de Iongh, O. Bánki, M.J. van der Werff ten Bosch and W. Bergmans, *Harmonization of Red Lists in Europe*. International Seminar 28 and 29 November 2003, Leiden.
- GÄRDENFORS, U., 2001. Classifying threatened species at national versus global levels. *TREE* 16: 511-516.
- GÄRDENFORS, U., J.P. RODRÍGUEZ, C. HILTON-TAYLOR, C. HYSLOP, G. MACE, S. MOLUR and S. POSS, 1999. Draft guidelines for the application of IUCN Red List criteria at national and regional levels. *Species* 31/32: 58-70.
- IUCN, 1994. *IUCN Red List Categories*. Prepared by the IUCN Species Survival Commission. IUCN, Gland.
- IUCN, 2001. *IUCN Red List Categories and Criteria. Version 3.1*. Prepared by the IUCN Species Survival Commission. IUCN, Gland & Cambridge.
- KELLER, V. and K. Bollmann, 2001. Für welche Vogelarten trägt die Schweiz besondere Verantwortung? *Ornithol. Beob.* 98: 323-340.
- KELLER, V., N. ZBINDEN, H. SCHMID and B. VOLET, 2001. *Rote Liste der gefährdeten Brutvogelarten der Schweiz*. Bundesamt f. Umwelt, Wald und Landschaft, Bern & Schweizerische Vogelwarte, Sempach.
- KÖPPEL, C., 1999. Rote Listen: Geschichte, Konzepte und Umsetzung sowie alternative Ansätze. *Öko-L* 21/3, 27-34.
- KÖPPEL, C., F. JANSEN, J. BURTON, M. SCHNITTLER and N. HIRNEISEN, 2003. A statistical survey on European Red Lists. In: H.H. de Iongh, O. Bánki, M.J. van der Werff ten Bosch and W. Bergmans, *Harmonization of Red Lists in Europe*. International Seminar 28 and 29 November 2003, Leiden.
- SCHNITTLER, M., G. LUDWIG, P. PRETSCHER and P. BOYE, 1994. Konzeption der Roten Liste der in Deutschland gefährdeten Tier- und Pflanzenarten unter Berücksichtigung der neuen internationalen Kategorien. *Natur u. Landschaft* 69: 541-549.
- WITT, K., H.-G. BAUER, P. BERTHOLD, P. BOYE, O. HÜPPOP and W. KNIEF, 1996. Rote Liste der Brutvögel Deutschlands. (2. Fassung, Stand 1.6.1996). *Ber. Vogelschutz* 34: 11-35.



# 18

## Red-Listing of freshwater fishes and lampreys in the Netherlands

*H. de Nie*

### GENERAL INTRODUCTION

The Dutch Red List of fishes was the last in a row which started with breeding birds, mammals, butterflies, reptiles and amphibians, fungi, lichens, dragonflies and grasshoppers. For all these organisms the same criteria were used to make them comparable to each other. De Dutch criteria have been based on the combination of rareness and rate of decrease. Therefore rareness alone, without a marked decrease, is not considered to be an argument to place a species on the Red List. The decrease in the case of freshwater fishes, is measured either as a decrease in the extent of occupancy (using 5 x 5 km squares) or as a decrease in parameters, like catch statistics, supposed to reflect the dynamics of the whole population (criteria A1 b and c, A2 b and c, IUCN 2001).

However, in the Dutch criteria, the decrease over a period of 50 years is considered, instead of the 10 years of 3 generations of the IUCN criteria. If we assume a smooth but exponential decrease in 50 years and compare the Dutch percentages (<25%, 25-50%, 50-75%, and >75%) with the percentages according to IUCN norms dealing with 10 years, this results in large differences. I therefore had to reformulate the Dutch criteria as percentages per 10 years as follows (see first column in Fig. 1).

| Occupancy                | Very rare        | Rare          | Fairly frequent | Common          |
|--------------------------|------------------|---------------|-----------------|-----------------|
| Pop. size/area reduction | <1% <sup>a</sup> | 1-5%          | 5-25%           | >25%            |
| <5.6%                    | Near Threatened  | Least Concern | Least Concern   | Least Concern   |
| 5.7 - 12.9%              | Vulnerable       | Vulnerable    | Vulnerable      | Least Concern   |
| 13.1 - 21.1%             | Endangered       | Endangered    | Vulnerable      | Near Threatened |
| >24.2%                   | Crit. Endangered | Endangered    | Vulnerable      | Near Threatened |

Figure 1 – The Dutch criteria for the red listing (reduction computed over 10 years).

| Name                     | latin                          | Name                                   | latin                       |
|--------------------------|--------------------------------|--|-----------------------------|
| <b>NEARLY THREATENED</b> |                                | <b>CRITICALLY ENDANGERED</b>           |                             |
| Chub                     | <i>Alburnoides bipunctatus</i> |  |                             |
| Ide                      | <i>Leuciscus idus</i>          |  |                             |
| Eel                      | <i>Anguilla anguilla</i>       |  |                             |
| <b>VULNERABLE</b>        |                                | <b>EXTINCT (river Rhine and Meuse)</b> |                             |
| Weatherfish              | <i>Misgurnus fossilis</i>      | Twaite shad                            | <i>Alosa fallax</i>         |
| Sea trout                | <i>Salmo trutta trutta</i>     | Sturgeon                               | <i>Acipenser sturio</i>     |
| Sunbleak                 | <i>Leucaspius delineatus</i>   | Salmon                                 | <i>Salmo salar</i>          |
| Crucian carp             | <i>Carassius carassius</i>     | Houting                                | <i>Coregonus oxyrinchus</i> |
| Bitterling               | <i>Rhodeus sericeus</i>        | Grayling                               | <i>Thymallus thymallus</i>  |
| River lamprey            | <i>Lampetra fluviatilis</i>    | Brown trout                            | <i>Salmo trutta fario</i>   |
| Dace                     | <i>Leuciscus leuciscus</i>     | Allis shad                             | <i>Alosa alosa</i>          |
| Chub                     | <i>Leuciscus cephalus</i>      |  |                             |
| <b>ENDANGERED</b>        |                                |  |                             |
| Nase                     | <i>Chondrostoma nasus</i>      |  |                             |
| Brook lamprey            | <i>Lampetra planeri</i>        |  |                             |
| Barbel                   | <i>Barbus barbus</i>           |  |                             |
| Sea lamprey              | <i>Petromyzon marinus</i>      |  |                             |
| Minnow                   | <i>Phoxinus phoxinus</i>       |  |                             |
| Burbot                   | <i>Lota lota</i>               |  |                             |

**Figure 2** – The Dutch red list of freshwater fishes and lampreys.

As summarised in Fig. 2, according to the Dutch norms, in total 24 species out of a list of 46 indigenous species (subspecies in the case of brown trout and sea trout) were listed (De Nie and Van Ommering 1998).

Applying the new IUCN categories and criteria (version 3.1), seven species have to be expelled from the list, because their rate of decrease was beyond IUCN criteria (Fig. 3). Three species have to move from Endangered to Vulnerable, while one species has to be moved from Near Threatened to Vulnerable, because the actual extent of occupancy is no longer relevant for it being Red-Listed.

On both lists most Red List species are species from streaming water (rheophilic).



| Name                     | latin                       | Name                                   | latin                          |
|--------------------------|-----------------------------|--|--------------------------------|
| <b>NEARLY THREATENED</b> |                             | <b>CRITICALLY ENDANGERED</b>           |                                |
|                          |                             | Chub                                   | <i>Alburnoides bipunctatus</i> |
| <b>VULNERABLE</b>        |                             | <b>EXTINCT (river Rhine and Meuse)</b> |                                |
| Sea lamprey              | <i>Petromyzon marinus</i>   | Twaite shad                            | <i>Alosa fallax</i>            |
| Minnow                   | <i>Phoxinus phoxinus</i>    | Sturgeon                               | <i>Acipenser sturio</i>        |
| Burbot                   | <i>Lota lota</i>            | Salmon                                 | <i>Salmo salar</i>             |
| Eel                      | <i>Anguilla anguilla</i>    | Houting                                | <i>Coregonus oxyrinchus</i>    |
| River lamprey            | <i>Lampetra fluviatilis</i> | Grayling                               | <i>Thymallus thymallus</i>     |
| Dace                     | <i>Leuciscus leuciscus</i>  | Brown trout                            | <i>Salmo trutta fario</i>      |
| Chub                     | <i>Leuciscus cephalus</i>   | Allis shad                             | <i>Alosa alosa</i>             |
| <b>ENDANGERED</b>        |                             |  |                                |
| Nase                     | <i>Chondrostoma nasus</i>   |  |                                |
| Brook lamprey            | <i>Lampetra planeri</i>     |  |                                |
| Barbel                   | <i>Barbus barbus</i>        |  |                                |

**Figure 3** – The Dutch Red List of freshwater fishes and lampreys after application of IUCN-criteria.

## EXAMPLES

### The burbot *Lota lota* (Linnaeus)

This is a freshwater species from a family of mainly marine species. This family is part of the well known order Gadiformes, cods and haddocks. The extent of occupancy from 1900-1950 compared with the occupancy in 5 x 5 km squares during 1980-1995 is given in Fig. 4. The decrease in occupancy is 28%, calculated by interpolation over a period of 10 years, hardly good enough to qualify for ‘Vulnerable’.

### The Chub *Alburnoides bipunctatus* (Bloch)

The Chub was supposed to be lost for the Dutch ichthyofauna. There were unconfirmed observations from the 19th and early 20th century. The only confirmed observation was an individual caught in 1931 in the River Meuse near Roermond. Just during the preparation of the Dutch Red Listing, members of the Natuurhistorisch Genootschap in Limburg (Limburg Naturalists’ Society) caught several Schneiders in a tributary of the river Meuse, a stream called De Geul, one of the very few relatively unspoiled streams in The Nether-

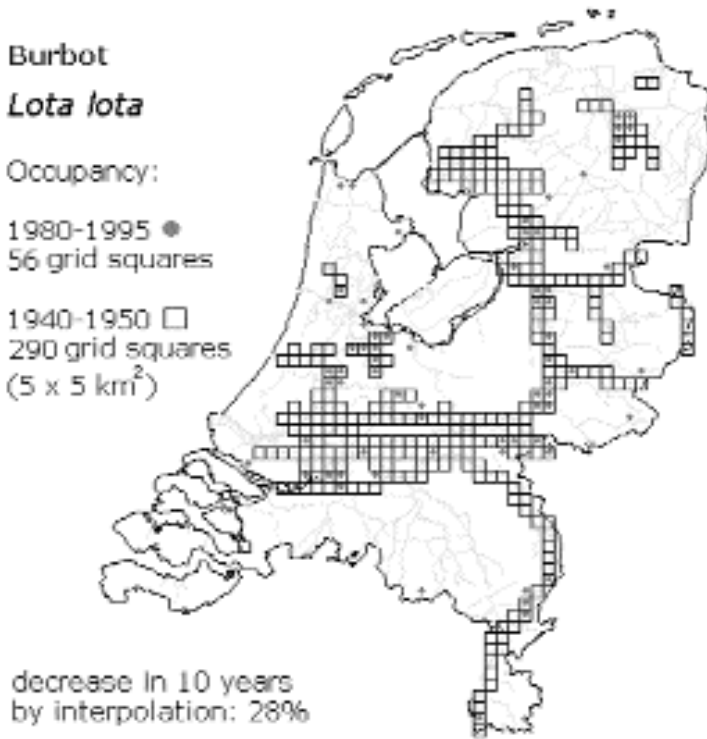

**Figure 4** – The extent of occupancy of the Burbot (*Lota lota*) based on observations from 1900-1950 and 1980-1995 (De Nie 1997a and b).

lands. Maybe the fishes caught are individuals coming from streams in Belgium. There are no indications for reproduction. Thus, likely there are no streams where the Schneider can complete its whole life cycle (De Nie 1997b). However, potential habitat may be present if attempts to further improve the Geul show to be successful. The minimal extent of proper habitat will be only a few hectares. So this species can be listed as critically endangered.

#### The European Eel (*Anguilla anguilla*)

The eel is still common in The Netherlands; the fish is widely distributed throughout the country. This is a catadromous species, spawning in the Atlantic ocean; after a larval phase in salt water, elvers (juvenile eels, or glass eels) migrate to freshwater. This immigration is monitored since 1938 by standardized catches in the sluices of the IJsselmeer. The immigration of elvers is very erratic. During the 1940s there was a period with a very low influx, followed by periods with a high influx. However, since the late 1980s recov-

ery holds off. This does not only apply to the situation in The Netherlands, but also to that in other countries of North and South Europe. The present levels are about 10% of the average level during the period before 1980, implying more than 60% decrease in 10 years (Dekker 2002).

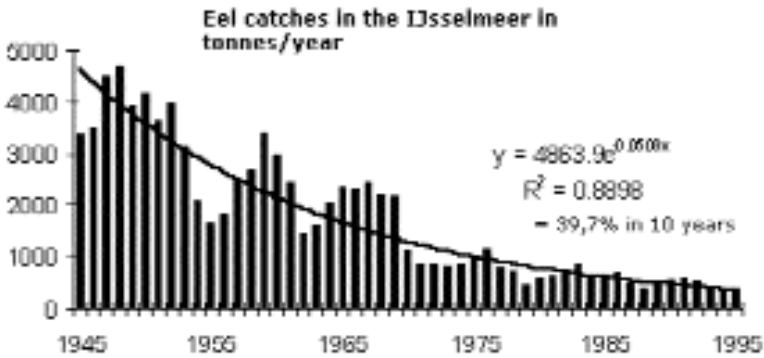

**Figure 5** – Eel catch statistics 1945-1995 in the IJsselmeer. Source: Willem Dekker, RIVO Netherlands Institute for Fisheries Research.

The amount of eel caught in the IJsselmeer (Lake IJssel) decreased since 1945, interpolating with a simple exponential function yields a decrease of 39.7% in 10 years. (De Nie 1997b). The Red List status Vulnerable for this species is important, also because the cause of this decrease is unclear.

Sea trout *Salmo trutta trutta* Linnaeus and Salmon *Salmo salar* Linnaeus

Other remarkable species are salmon and sea trout. The sea trout may be considered as an anadromous form of the brown trout (*Salmo trutta fario*) which is extinct in the Netherlands. The catch statistics of the sea trout in the lower stretches of the river Rhine and Meuse do not show a clear decrease. It is supposed that individuals, wight are offspring from (often artificially ‘improved’) populations in the upper stretches of the river Rhine and Meuse (and tributaries) may develop a sea migrating form (induced by habitat deterioration!). These sea going fishes stay more in coastal waters, while salmon migrate over long distances in the Atlantic. On the other hand, sea trout lack the strong homing ability of salmon, so they can travel upstream in any river. Therefore, in spite of the poor water quality of the rivers Rhine and Meuse, sea trout did not evidently decrease in the lower stretches of these rivers.

In higher stretches of the river Rhine (river Waal near Nijmegen) and also according to German sources the sea trout was supposed to be extinct as a self reproducing population in the river Rhine (Steinberg and Lubieniecki 1991)

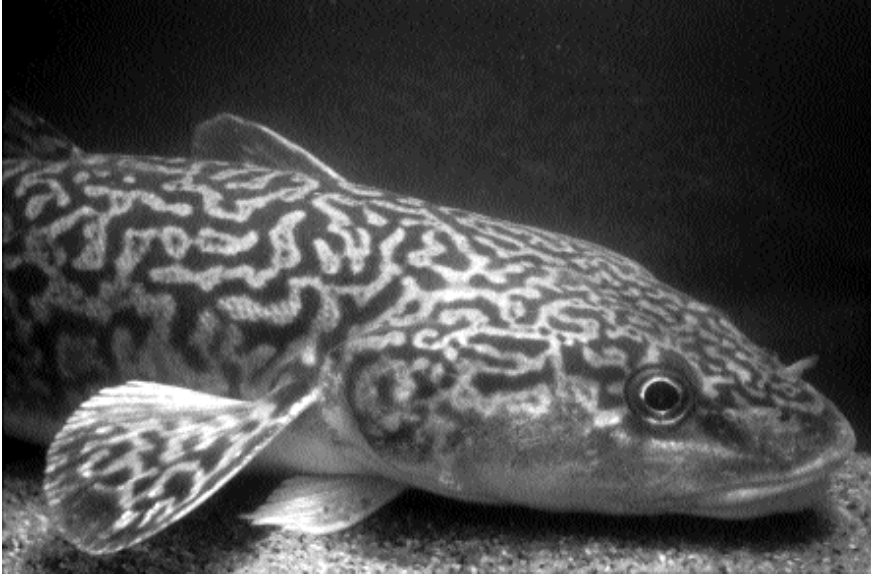

The bullhead *Cottus gobio*.

However this decrease in The Netherlands was poorly documented and tentatively estimated as more than 50% in 50 years. This may be 13% in 10 years, not enough to qualify for a Red List status.

The same is true for the salmon, which became extinct in the river Rhine and Meuse. Because the salmon fishery was an important activity in the 19th century and beginning of the 20th century, we have accurate catch statistics. If we analyze these statistics with a very simple model of decrease (exponential), in retrospect we can conclude that the mean rate of decrease was about 6.6% per year and 49% per 10 years (Fig. 6).

A time-analysis model was applied to these data (Fig. 7). Auto Regressive Integrated Moving Average using a moving average on log-transformed data over 10 years, supposing a 5 years cycle in the catches between 1885 tot 1930 and 1885 to 1940 yielded promising results to predict the probability of extinction within a certain time range. However, with a very wide range of probabilities. Even an increase in population was possible within the 95% range. The results are strongly influenced by the choice of the model and the parameters used. The use of this kind of models may be helpful. Being not an expert on time series analysis, I cannot be more specific.

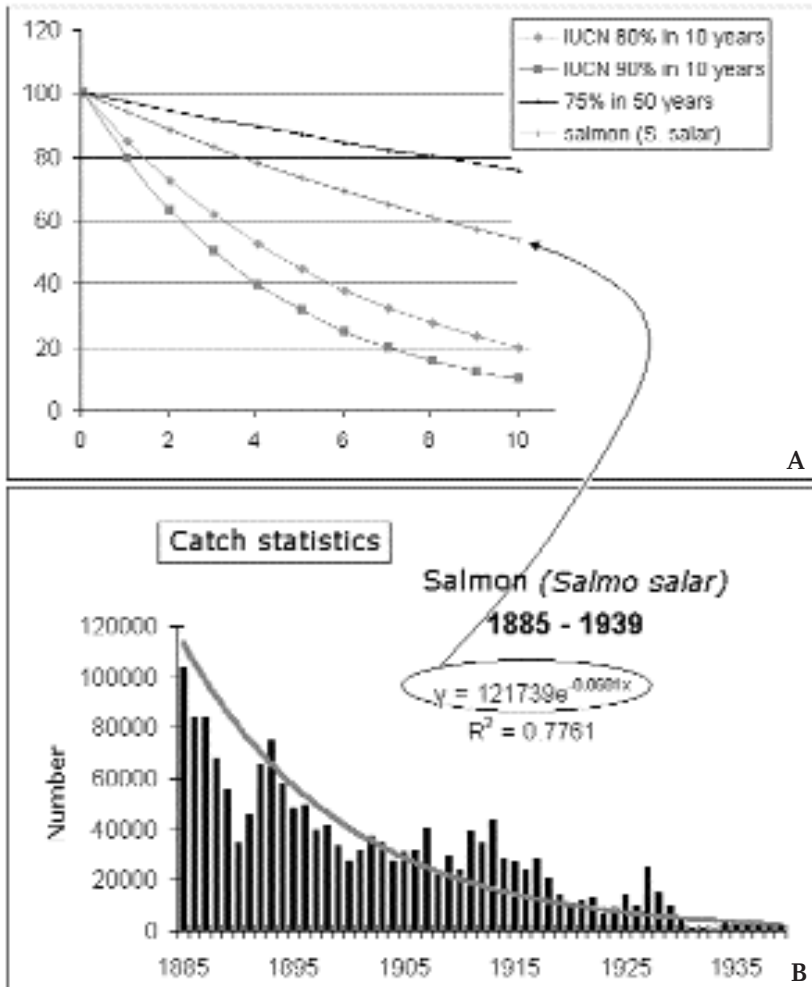
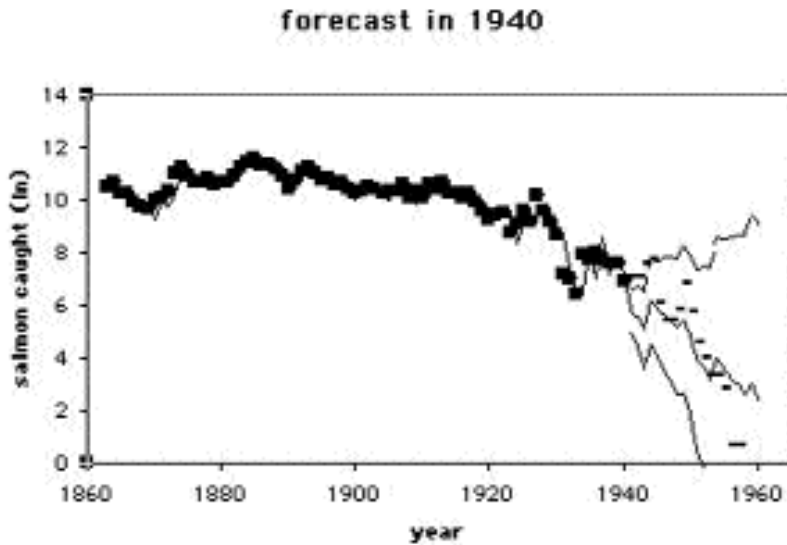

Figure 6 – Catch statistics of the Salmon (*Salmo salar*) during 1885-1935 (B) and protected rate of decline over 10 years (A).

### Bullhead *Cottus gobio* Linnaeus

This species is a fresh water species related to many marine fish species from the order of Scorpion fishes. This species is fairly common in the greater water bodies as lakes, canals and big rivers. Even in some of the smaller but non-streaming waters typically for The Netherlands. On the other hand, this species is rare in streams. Therefore, this species is not on the red list, but a 'target species'. Target species are selected species, typically for an ecosystem.



**Figure 7** – Auto Regressive Integrated Moving Average with catch statistics on salmon (1885-1940) to predict extinction.

The ecosystem quality is measured by monitoring a set of typical species. This method is similar to that of economic indicators, such as the retail price index, a representative selection of products monitored in a subset of stores. The quality of ecosystems, the loss or gain in biodiversity, is measured in a parsimonious way, to make this procedure practical and affordable.

## CONCLUSIONS

- According to the Dutch criteria 24 species of freshwater fish (53% of 45 species) have a Red List status. When applying IUCN criteria 18 species (40%) have a Red List status. In both cases nearly all species are rheophilic.
- The rate of decrease to qualify for a Red List status was too low for 7 species. The actual distribution alone (rareness) is not an argument (the Schneider had Red List status Nearly Threatened). A rapid rate of decrease of a common species does not yield a high Red List status (e.g. Red List status of the Eel is Nearly Threatened in spite of a strong decline).
- The rate of decrease chosen to obtain a Red List status may be too high, other statistical mathematical techniques may be of use to estimate the probability of extinction (e.g. for the salmon).

- Monitoring the population of species with a Near Threatened or carefully chosen species without a Red List status is a means to measure ecosystem quality (concept: target species).

#### ACKNOWLEDGEMENTS

I thank dr. A. ter Maat for the ARIMA analysis on the salmon data.

#### REFERENCES

- DEKKER, W., 2002. *De toestand van de Europese aalstand en -visserij* (Press release in Dutch. [www.rivo.wag-ur.nl/index3/index.htm](http://www.rivo.wag-ur.nl/index3/index.htm)).
- DE NIE, H.W., 1997a. *Atlas van de Nederlandse zoetwatervissen*, Media Serv' Doetinchem.
- DE NIE, H.W., 1997b. *Threatened and vulnerable freshwater fish species in The Netherlands. Proposal for a red list* (in Dutch – with English summary). St. Atlas Verspreiding Zoetwatervissen ([home.wxs.nl/~hwdenie/redlist.htm](http://home.wxs.nl/~hwdenie/redlist.htm)).
- DE NIE, H.W. and G. VAN OMMERING, 1998. *Bedreigde en kwetsbare zoetwatervissen in Nederland. Toelichting op de rode lijst*. Rapport IKC Natuurbeheer 33. Wageningen.
- IUCN, 2001. *IUCN Red List Categories and Criteria; version 3.1*, IUCN Species Survival Commission IUCN, Gland, (IUCN\_2001.pdf).
- STEINBERG, L. and B. LUBIENIECKI, 1991. Die Renaissance der Meerforelle (*Salmo trutta trutta* L.) und erste versuche zur Wiedereinbürgerung des Lachses (*Salmo salar* L.) in Nordrhein-Westfalen. *Fischökologie* 5: 19-33.





# 19

## The Red List 2002 of Swiss Dragonflies First attempt to use IUCN Categories and Criteria to assess the Red List status of invertebrate species in Switzerland

*Y. Gonseth*

### INTRODUCTION

In 1998, the Swiss Center for the Cartography of Fauna (CSCF) was contracted by the Swiss Agency for Environment, Forest and Landscape (SAEFL) to develop a strategy and propose a programme for a periodical reassessment of threatened invertebrate species in Switzerland. The defined strategy, accepted in 1999 by the SAEFL, was based on the following postulates:

- First: Animal groups having priority must be representative of the main macrohabitats of Switzerland, that means running and stagnant waters, wet and dry grasslands and forests;
- Second: Fieldwork has to be done to ensure the proper publication of new Red Lists or to update already existing ones. In other words, the whole procedure represents a great opportunity to gather new information about the concerned animal groups;
- Third: IUCN Categories and Criteria have to be used to evaluate the status of concerned species. For us this postulate meant that the gathering of quantitative data was mandatory and that expert's opinion had only to be used to evaluate the final result of a step by step procedure.

In our initial proposal the following groups were considered as coming first:

- For running and stagnant waters: stoneflies, mayflies, caddishflies, aquatic molluscs and dragonflies;
- For dry- and wetlands: grasshoppers and butterflies;
- For forests: saproxylic beetles like longhorn beetles, Scarabaeidae, Buprestidae and Lucanidae.

To fulfil our objectives the fieldwork had to be focused on the re-sampling of already visited sites and on the prospective sampling of new ones. The maps presented here (Fig. 1 and 2) concern the re-sampled and newly sampled sites

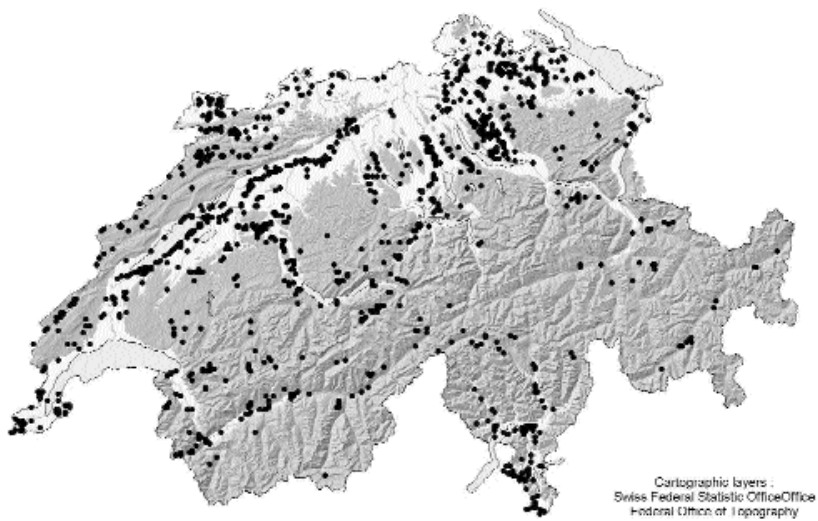

**Figure 1** – Square kilometers revisited between 1999 and 2000.

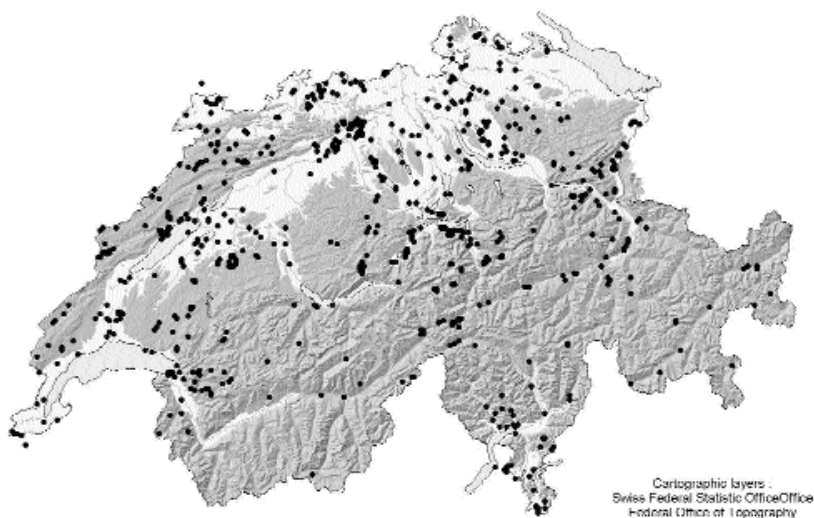

**Figure 2** – Square kilometers visited for the first time between 1999 and 2000.

of our first test group, the dragonflies. The project concerned, named *Odonata 2000*, began in 1999 and ended in 2001.

This project could not have been carried to a successful conclusion without the financial support of the SAEFL (nearly 200.000 Swiss francs), the

help of the seven odonatologists of our accompanying group and the huge work of our 55 field collaborators.

In two years no less than 35,405 field observations concerning 75 species were gathered, 1282 km<sup>2</sup> were re-sampled and 623 km<sup>2</sup> were visited for the first time. Combined with the 80,900 field observations gathered since 1850 until 1998, these results allowed us to evaluate trend and frequency, extent of occurrence and area of occupancy for every species of the Swiss dragonfly fauna.

#### MAIN OBJECTIVES

The Red List evaluation procedure we have chosen could not be understood without taking our main objectives into account (Gonseth and Monnerat 2002). This procedure has to be:

- Identical for the whole or at least for most of the species of the chosen taxonomic groups;
- As objective as possible and thus easily reproducible;
- Quantitative but reasonable in terms of human and financial investments;
- Applicable to other invertebrate groups without great modifications.

#### CHOSEN CATEGORIES

The third postulate of our strategy implied that the chosen procedure had to be compatible with the IUCN ones. Thus, the first step was the adoption of the proposed IUCN Red List Categories. We did not have any problem at this level. The only liberty we took was to adopt other possibilities of French and German translations of the English concepts as proposed by Keller *et al.* (2001).

RE (Regionally Extinct – éteint régionalement): ***éteint en Suisse / in der Schweiz ausgestorben***

CR (Critically Endangered – en danger critique d'extinction): ***au bord de l'extinction / vom Aussterben bedroht***

EN (Endangered – en danger): ***en danger / stark gefährdet***

VU (Vulnerable – vulnérable): ***vulnérable / verletzlich***

NT (Near Threatened – quasi menacé): ***potentiellement menacé / potenziell gefährdet***

LC (Least Concern – préoccupation mineure) ***non menacé / nicht gefährdet***

DD (Data Deficient – données insuffisantes): ***données insuffisantes / ungenügende Datengrundlage***

NE (Not Evaluated – non évalué): ***non évalué / nicht beurteilt***

## TAXONOMIC LEVEL

The IUCN directives concerning the taxonomic level that have to be adopted for Red Lists are very flexible. For the new Swiss Odonata Red List, we generally adopted the species level and kept the subspecies level only for three taxa of the Southern Alps: *Calopteryx virgo meridionalis*, *Calopteryx splendens caprai* and *Onychogomphus forcipatus unguiculatus*. The reason of this choice is linked with the different ecological requirements of these southern subspecies. It is moreover evident that the adopted procedure only focuses on native species. In other words, migrant and irregularly or doubtfully observed species have not been assessed.

## CHOSEN CRITERIA

The IUCN Red List criteria are divided into five different groups (IUCN 2001) that are obviously more suitable for Vertebrates than for Invertebrates. In our case, the use of A, C, D and E groups, which implies gathering quantitative data on the population's size and/or population's dynamic of every species, had to be rejected for logistical and financial reasons. Only the use of the B criterion, that implies to estimate the size, respectively the changes of the size, of species occupancy area or extent of occurrence, has been retained.

We thus only focused our attention on the evolution of the geographical range of every species in Switzerland. To compensate for the loss of flexibility, implied by the restriction to only a limited number of criteria, we decided that at least one of the three complementary requirements (a-c) proposed by IUCN had to be fulfilled to classify a species in a threatened category.<sup>1</sup>

## CHOSEN PROCEDURE

After having chosen Red List Categories and Criteria, we decided to adopt the two-step procedure proposed by Gärdenfors *et al.* (2001) to edit our new Odonata Red Lists.

The first step of this procedure implied the evaluation of the area of occupancy of every species (AO; product of its frequency and the surface of the country compatible with dragonflies' reproduction: 37,500 km<sup>2</sup>) and the classification of the species in the IUCN categories using the following criteria:

<sup>1</sup> It is important to stress here that only two of these three subcriteria were applicable with the available data. We lack indeed the mandatory long temporal series of data to evaluate the third one (extreme fluctuation of extent occurrence, area of occupancy, number of locations or subpopulations or number of individuals).

CR: AO between one and ten km<sup>2</sup>  
EN: AO between 11 and 500 km<sup>2</sup>  
VU: AO between 501 and 2000 km<sup>2</sup>.

The second step of this procedure implied the reassessment of the status of every species using:

- The calculated trend;
- The fragmentation and isolation levels of the Swiss populations;
- The habitat rarity and/or sensibility.

In some rare cases we also used the decline of the population size of the species deducted from the decline of the number of their Swiss populations. This exercise led to the upgrading of 18 species, the downgrading of nine species, and 45 species remaining in their initial category.

Trend evaluation was based on the comparison of the number of sites where a given species reproduced during the first period (1970-1998) and the number of sites where it has been found again during the second period (1999-2001), with or without proof of reproduction. As a weighing criterion, we used the number of positive sites of the second period, which had been unsuccessfully visited in the first one. This measure, which integrates possible modifications of local species distribution, was selected because it was proven to be efficient at recapturing stable trends for very common species (Monnerat and Gonseth, in press).

$$\text{Trend formula: } \text{trend}_i = [(p21_i - p1r_i) + n2_i] / p1r_i * 100$$

where for species i:

p1: between 1970-1998

p2: resampling in 1999/2001

p21: both in p1 and p2

trend<sub>i</sub> = trend (in %)

p1r<sub>i</sub> = number of presences in period 1 revisited in period 2

p21<sub>i</sub> = number of presences in both periods (p21<sub>i</sub> is a subset of p1r<sub>i</sub>)

n2<sub>i</sub> = number of new presences among sites already visited for any species in period 1 (weighing index)

At the end of the whole process, the repartition of the different species in the IUCN Red List categories was the following:

- Two species were considered regionally extinct;
- 12 as critically endangered;
- Seven as endangered and;
- Five as vulnerable.

In other words, 36% of the Swiss dragonfly fauna are on the new Red List. Moreover, 12 species are near threatened, and the remaining 34 species, 47% of the Swiss fauna, are Least Concern.

### CONCLUSION

The acquired experience shows that the use of the IUCN procedure, Categories and Criteria could be applied to update old or edit new Red Lists for invertebrate groups. At the end of 2001, the Swiss Ministry of the Environment therefore decided to support other projects dealing with our initial postulates. Thus a four-year project devoted to Orthoptera, a five-year project devoted to aquatic organisms and a two-year pilot study devoted to saproxylic Coleoptera could begin in 2002.

**Table 1** – Planned activities to upgrade already existing Red Lists or to edit new ones in Switzerland (based on IUCN Categories and Criteria \*)

| Already existing Red Lists                | First edition | First Revision | Second revision |
|---|---------------|----------------|-----------------|
| Lichen                                    | 2002*         | 2015?          | ?               |
| Macromyceta                               | 1997          | ?              | ?               |
| Bryophyta                                 | 1991          | 2003           | 2013*           |
| Spermaphyta                               | 1991          | 2002*          | 2012*           |
| Mammalia                                  | 1994          | 2003-2008*     | 2018*           |
| Aves                                      | 1994          | 2001*          | 2011*           |
| Reptilia                                  | 1994          | 2003-2005*     | 2015*           |
| Amphibia                                  | 1994          | 2003-2005*     | 2015*           |
| Pisces                                    | 1994          | 2004-2006*     | 2016*           |
| Mollusca                                  | 1994          | 2002-2006*     | 2015*           |
| Ephemeroptera                             | 1994          | 2002-2006*     | 2015*           |
| Odonata                                   | 1994          | 2002*          | 2012*           |
| Orthoptera                                | 1994          | 2002-2005*     | 2015*           |
| Lepidoptera Rhopalocera<br>+ Hesperioidea | 1994          | 2005-2010*     | 2020*           |

|                          |        |       |       |
|--------------------------|--------|-------|-------|
| Coleoptera Carabidae     | 1994   | ?     | ?     |
| Coleoptera Hydradephaga  | 1994   | ?     | ?     |
| Diptera Tipulidae        | 1994   | ?     | ?     |
| Hymenoptera Apoidea      | 1994   | ?     | ?     |
| Hymenoptera Formicoidea  | 1994   | 2008* | ?     |
| <b>Planned Red Lists</b> |        |       |       |
| Plecoptera               | 2006*  | 2016* | 2026* |
| Trichoptera              | 2006*  | 2016* | 2026* |
| Saproxylic Coleoptera    | 2010?* | ?     | ?     |

---

As can be gleaned from Table 1, the projects lead by the CSCF are only a part of the whole Red List reassessment strategy engaged by the SAEFL. The main problem at the moment is to know if in the future the financial and human means will be equal to this very ambitious initiative.

#### REFERENCES

- DUELLI, P., 1994. *Listes rouges des espèces animales menacées de Suisse*. Office fédéral de l'environnement, des forêts et du paysage, OFEFP, Bern.
- GÄRDENFORS, U., J.P. RODRÍGUEZ, C. HILTON-TAYLOR and G. MACE, 2001. The application of IUCN Red List Criteria at regional level. *Conservation Biology* 15: 1206 - 1212.
- GONSETH, Y. and C. MONNERAT, 2002. *Liste Rouge des Libellules menacées en Suisse*. Série OFEFP: L'environnement pratique. Office fédéral de l'environnement, des forêts et du paysage, Bern and Centre Suisse de cartographie de la faune, Neuchâtel.
- IUCN, 2001. *IUCN Red List Categories: Version 3.1*. Prepared by the IUCN Species Survival Commission. IUCN, Gland.
- KELLER, V., N. ZBINDEN, H. SCHMID and B. VOLET, 2001. *Liste Rouge des oiseaux nicheurs menacés de Suisse*. OFEFP – Série: L'environnement pratique. Office fédéral de l'environnement, des forêts et du paysage, Bern and Station ornithologique Suisse, Sempach.
- MONNERAT, C. and Y. GONSETH, in press. *Recent changes in distribution of Odonata in Switzerland*. Proceedings of the 13th International Colloquium of the European Invertebrate Survey.





# 20

## Summary discussion Workshop I

*H.H. de Iongh*

With regard to the Red Listing in Austria, it is stated that use is made of different Categories and Criteria (C&C), but with reference to the IUCN system, the system makes use of an expert opinion system. The Austrian system uses less numerical thresholds than the IUCN C&C, but it is transparent and provides justification. Not enough attention has been paid to monitoring aspects so far.

In Belgium Flanders uses the old (1994) IUCN C&C. So far only a small part of the overall biodiversity has been assessed. In general a strong increase is observed in the number of alien invasive species. Monitoring programmes of breeding bird species and amphibians and butterflies show a general decline in species numbers

In the Netherlands the assessment methodology refers also to the 1994 IUCN C&C, but an adapted version is in use, with correction factors for specific taxonomic groups. It is the intention to update the Dutch Red List of Birds and of Amphibians and Reptiles within two years time, using the new IUCN C&C (as a pilot). Of the total number of Dutch freshwater fish species, 50% has been Red Listed. When applying the new 2001 IUCN C&C (version 3.1), the Dutch Red List for freshwater fish species is expected to reduce from 24 to 18 species.

In Estonia only three Red Data Books have been prepared so far. The Categories and Criteria in use, make reference to the 1994 IUCN C&C, but are an adapted version. So far 15% of the known taxa have been Red Listed in Estonia.

It is the intention to update the existing Red Data Books in Estonia within the coming years, using the new 2001 IUCN C&C (version 3.1).

Switzerland applies the old (1994) IUCN C&C for the Red Listing of dragonflies. Regarding the possible application of the new IUCN C&C, it is thought that only the A and B Criteria are feasible for dragonflies.

In the UK the Birds in Europe II Project (Species of European Conservation Concern; SPECS) works on Red Lists within the framework of the Population Status of Birds in the UK (PSoB). Use is made of specific Criteria and three different lists; Red, Amber and Green. The direct aim of these listings is the setting of conservation priorities. Seven so called PSoB Criteria are used to prepare these lists. Vagrants, rare migrants and recently introduced

species are not included in the lists. It is also concluded that some species are misclassified with the PSoB criteria, due to exceptional circumstances which may also happen when using the new IUCN C&C. The PSoB criteria do not prioritise 'Edge of Range Scarce Breeders', which is the case with the new IUCN C&C. A constraint encountered is the calculation of the Generation Time. Problems are also encountered with species which have an impossible status: e.g. species which are threatened globally, but which are not threatened regionally.

In Germany all breeding bird species have been evaluated for their Red List status. The categories used are similar as the 1994 IUCN Categories, but the criteria are different. In general there is a concern with the subjectivity of the new IUCN C&C.

It is concluded that Red Listing in Europe helps with the identification of priority sites and also helps with the updating of the Species Lists of the Habitats and Birds Directives. In addition, European Red Listing may also contribute to the monitoring of individual species in this region. A conclusion is, that for birds it is not recommended to make assessments at the sub-species level.

It is observed that in most presentations in this workshop reference is made to the (1994) IUCN C&C, while the new (2001) IUCN C&C (version 3.1) have only been applied for pilots, most presentations refer to adapted versions for national use.

A constraint identified during the discussion is that the calculated order of rarity of a particular species is clearly affected by grid size because also the area of occupancy will change with grid size. In general problems are encountered especially when scaling down rarity from larger to smaller grid size. The need is expressed to develop adapted software to deal with this problem.

Another concern with the new IUCN C&C is, that species, which show a moderate decline, are not identified by the new IUCN criteria. Occasionally mis-evaluation may take place, due to exceptional circumstances, such as extreme mild winters. It is also suggested that the application of the new IUCN C&C may lead to shorter Red Lists, which may affect the political credibility of the existing Red Lists.

Future declines, which are used in the new IUCN C&C, are still very difficult to predict.

The use of the IUCN Red Lists for monitoring purposes is also questioned since habitat data may serve the purpose of monitoring often better than data on specific Red List species.

## PART III

### Workshop session II



*Agaricus geesterani* (J. Meyvogel/Foto Natura)



# 21

## Possible consequences of the new IUCN regional guidelines for a Red List of vascular plant species in the Netherlands

*W.L.M. Tamis, B. Odé and J.P.M. Witte*

### INTRODUCTION

The national policy for nature conservation in the Netherlands has two main approaches: an ecosystem protection approach and a species protection approach (LNV 2000, Bal *et al.* 2001). Species protection of vascular plants in the Netherlands is regulated by several national and European policy instruments. There is a certain overlap in species protected by the different instruments and there is no relation between actual threat and legal protection of species. At this moment (autumn 2002) the Netherlands has not an official Red List for vascular plants. In May 2000 a report has been published with a proposal for an official Red List for vascular plants in the Netherlands (Van der Meijden *et al.* 2000); in this article we refer to it as the 2000 Red List. It is based on interpretations by the Dutch Ministry of Agriculture, Nature Management and Fisheries of the 1994 Red List guideline of the IUCN. The official publication of the proposed Red List for vascular plants is delayed, mainly by political and judicial barriers.

Meanwhile IUCN published new guidelines with adapted categories and criteria for Red Lists (IUCN 2001). Separate guidelines for application of the categories and criteria on regional levels (Gärdenfors *et al.* 2001) were also published. There are two important parts in the regional guidelines. In the first part the global criteria and categories have to be applied and then in the second part of extraregional influx of species is assessed and accordingly categories can be adapted, e.g. downgrading. The formalisation of the use of Red List categories and criteria on a regional scale is a formidable step forwards in creating more reliable information. Despite this formalisation quite a number of issues remain open for discussion, e.g. the application of the criteria in case of small countries, where by definition the abundance of most species is small and the influx of neighbouring countries (if present) is presumably large.

In the Netherlands a large amount of distribution data on vascular flora has been sampled by volunteer botanists and by governmental organisations in the 20th century. These data were already used for the 2000 Red List on the

basis of some simple criteria (Van der Meijden *et al.* 2001). In this article we used these data again and applied the new IUCN regional guidelines with some adaptations: instead of individual evaluation of all known biological, ecological and distributional data of each species, we applied some simple rules of thumb. The interpretations and adaptations of the new IUCN regional guidelines are described and the results evaluated. In this article we refer further to this new list as the provisional IUCN Red List. The 2000 Red List is compared to the provisional IUCN Red List. In order to study the robustness of the new IUCN regional guidelines we studied also some alternative scenarios with smaller country size and different country borders.

**Table 1** – The two published Red Lists of vascular plants in The Netherlands.

|            | 1990 Red List   | 2000 Red List   |
|------------|---|---|
| Grid       | 5x5 km  | 1x1 km  |
| Periods    | before 1950 -> 1980-1990  | 1935 -> 2000  |
| Categories | IUCN, 1983 (partly)   | IUCN, 1994  |
| Criteria   | rarity and decline, based on grid data (Korneck and Sukopp, 1988) | rarity and decline, based on grid data (guidelines from the Dutch government) |

#### THE 2000 RED LIST

In 1990 a first preliminary Red List of vascular plants has been published (Weeda *et al.* 1990). Although IUCN-categories (1983) have been used, criteria have been based on Korneck and Sukopp (1988). It was the first quantitative attempt to gain attention for plant species with a strong decline throughout the past century. Since its publication in 1990, this Red List has been adopted by nature conservation organisations as being the official Red List, though it was never approved by the Dutch government.

The 1990 Red List has been updated in 2000, using guidelines of the Ministry of Agriculture, Nature management and Fisheries that include an analysis of actual rarity and of decline in the past century but on a much finer scale (Table 1, Van der Meijden *et al.* 2000). The criteria used are quite simple (Table 2). This resulted in the proposal of the 2000 Red List, that was approved by the Ministry of Agriculture, Nature management and Fisheries but has not yet officially been published. The delay is probably induced by political and judicial problems. Nevertheless it already has been widely adopted as the new official Red List. Even the Dutch government itself has used the 2000 Red List for its assignment of so-called Target species, which play a major role in nature conservation policy.

**Table 2** – Criteria for categorisation, based on rarity and decline, as used in the 2000 Red List.

| Occupancy (sq. km) | Decrease |        |        |                |
|--------------------|----------|--------|--------|----------------|
|                    | 75-100%  | 50-75% | 25-50% | < 25% decrease |
| 1-36               | CR       | EN     | VU     | NT             |
| 37-190             | EN       | EN     | VU     | LC             |
| 191-551            | VU       | VU     | VU     | LC             |
| > 551              | NT       | VU     | LC     | LC             |

#### APPLICATION AND INTERPRETATION OF THE NEW IUCN REGIONAL GUIDELINES

The new IUCN regional guidelines comprise several steps. First the global criteria are applied, which results in a list of species in several categories. Then in a second step the possible influence of extraregional populations on the risk of extinction is evaluated and this may result in an upgrading or downgrading of the category for individual species. The result of the first two steps is a national Red List. In a last step the global Red List categories for the national Red List species are extracted and the international importance of the national population is estimated and this information is combined together. The way the new IUCN regional guidelines were applied and interpreted for the analysis for the Dutch vascular plants is described in the Appendix 1.

At this point we want to make the explicit statement that we do not propose a new Dutch Red List for vascular plant species based on the new IUCN regional guidelines, nor shall we present a new list of Red-List plant species. In this article we will point to differences between the 2000 Red List and the provisional IUCN Red List, and discuss the importance of each criterion, the results of the downgrading, the Red-List categories related to commonness and (inter)national importance of Red-List categories. We end with some scenarios in order to investigate the sensitivity of the new IUCN procedure for country size and country border effects.

**Table 3** – Number of vascular plant species in the Netherlands on the Red List; 2000 Red List; IUCN = provisional IUCN Red List for the whole country (o), with exclusion of the most southern part of the most southern province Zuid-Limburg (ZL; scenario 1), for an area of 10,000 km<sup>2</sup> (scenario 2) and one of 300 km<sup>2</sup> (scenario 3).

|                           | 2000 | IUCN | NL-ZL | NL-10 | NL-3 |
|---------------------------|------|------|-------|-------|------|
| scenario                  |      | o    | 1     | 2     | 3    |
| area NL %                 | 100  | 100  | 98.2  | 27    | 8    |
| ZL                        | +    | +    | –     | +     | +    |
| evaluated                 | 1328 | 1308 | 1280  | 1252  | 1194 |
| not evaluated (NE)        | 162  | 182  | 182   | 182   | 182  |
| (not present in scenario) | –    | –    | 28    | 56    | 114  |
| least concern (LC)        | 829  | 873  | 877   | 804   | 701  |
| near threatened (NT)      | 114  | 133  | 144   | 183   | 222  |
| threatened                |      |      |       |       |      |
| vulnerable (VU)           | 136  | 118  | 102   | 116   | 140  |
| endangerd (EN)            | 102  | 110  | 83    | 81    | 64   |
| critically endangerd (CR) | 97   | 37   | 37    | 31    | 30   |
| regionally extinct (RE)   | 50   | 37   | 37    | 37    | 37   |
| total threatened          | 335  | 265  | 222   | 228   | 234  |
| total Red List            | 499  | 435  | 397   | 451   | 490  |

#### THE PROVISIONAL IUCN RED LIST VERSUS THE 2000 RED LIST

After application of the new IUCN regional guidelines, the provisional IUCN Red List contains 435 species, which is 33% of all evaluated species, and 265 threatened (combination of the categories VU, EN and CR) species which is 20% of all evaluated species (Table 3). on The provisional IUCN Red List has 5% (64 species) less species than the 2000 Red List. This is mainly caused by a much lower number of species in the category CR. The difference in total number of threatened species on both lists is about 20% (Table 4): 166 species of the 2000 Red List would not reappear on the provisional IUCN Red List, the latter, however, comprising 100 species not included in the 2000 Red List.



**Table 4** – Comparison of the 2000 Red List with the provisional IUCN Red List; shifts in numbers between Red List categories and not-Red List categories and between threatened categories and not-threatened categories.

|                    | both – | only 2000 | only IUCN | both + | total |
|--------------------|--------|-----------|-----------|--------|-------|
| Red List species   | 728    | 165       | 101       | 334    | 1328  |
| Threatened species | 61     | 61        | 59        | 153    | 334   |

#### THE PROVISIONAL IUCN RED LIST IN DETAIL

In Table 5 detailed results are presented of the number of species for each category for each criterion and the number of downgradings after having applied the global criteria. The species in the categories NT and VU have on average 1.9 criterion for their designation. For the species in the EN and CR categories this average value is 1.5. The application of the B2 criterion resulted in no species in the NT category. The reason for this is that more common species have less fragmented populations because they are more common and only 3 species were actually classified as VU using this criterion and remain vulnerable after downgrading. A total of 274 downgradings have been applied, but only 48 species disappear from the provisional IUCN Red List by this downgrading.

**Table 5** – Provisional IUCN Red List: number of classifications per criterion (after downgrading), average number of criteria classifying the species per category and number of downgradings per category.

| Categorie                  | criterion |     |     | nr. spec. total | nr. spec. classif. | average nr. criteria applied | nr. spec. downgraded |
|----------------------------|-----------|-----|-----|-----------------|--------------------|------------------------------|----------------------|
|                            | A2        | B2  | D2  |                 |                    |                              |                      |
| Near threatened (NT)       | 118       | 0   | 116 | 234             | 133                | 1.8                          | 48                   |
| Vulnerable (VU)            | 121       | 45  | 53  | 219             | 118                | 1.9                          | 104                  |
| Endangered (EN)            | 76        | 86  | 0   | 162             | 110                | 1.5                          | 67                   |
| Critically endangered (CR) | 19        | 31  | 0   | 50              | 37                 | 1.4                          | 55                   |
| Total                      | 334       | 162 | 169 | 665             | 398                | 1.7                          | 274                  |

In Figure 1 the relation between Red List categories and commonness of the species is presented. All species with a distribution of 20 km<sup>2</sup> or less are per definition on the provisional IUCN Red List, and about 70% of these species

are classified as threatened. All species classified as CR are found in this commonness class only. In the following commonness classes the percentage of threatened species declines to 30%, 15% and eventually 5% of the total number of species.

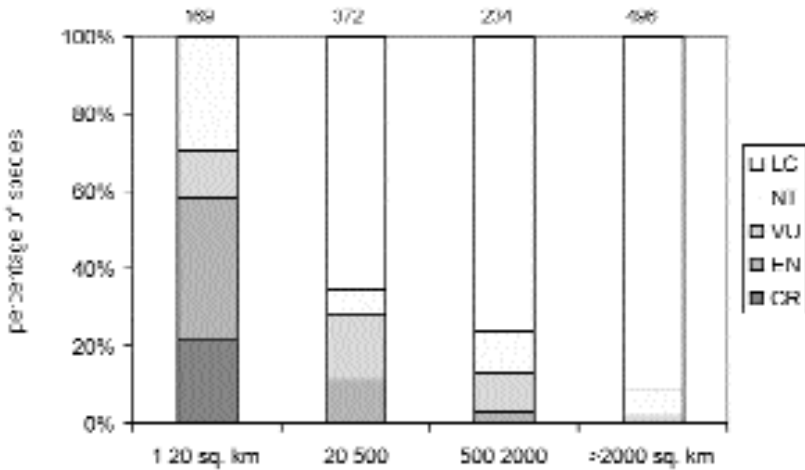

**Figure 1** – Distribution of categories for different commonness classes of vascular plants in the Netherlands after application of the new IUCN regional guidelines. At the top of each bar the number of species of that class is shown.

#### IMPORTANCE OF PROVISIONAL IUCN RED LIST SPECIES

The last step in the regional guidelines is the addition of information on the global Red List and information about the international importance. None of the Dutch vascular plant species on the provisional IUCN Red List is present on the global IUCN Red List (IUCN 2002).

In table 6 the international importance of the national populations of vascular plant species in the Netherlands is presented. Overall, only about 2% of

**Table 6** – Percentages of vascular plant species in the Netherlands per Red List category of which the national distribution is important in international context (class IV and V, see box 1).

|                             | Red List categories |     |     |     |     |     | threat. | RL  | all species |
|-----------------------------|---------------------|-----|-----|-----|-----|-----|---------|-----|-------------|
|                             | LC                  | NT  | VU  | EN  | CR  | RE  |         |     |             |
| internationally important % | 1.6                 | 1.6 | 1.8 | 8.7 | 0.0 | 5.9 | 4.5     | 3.7 | 2.3         |

the Dutch species are important in the international context, and this is still an overestimation. This percentage is about 2 times higher for the provisional IUCN Red List species.

#### ALIEN SPECIES ON THE PROVISIONAL IUCN RED LIST

If we consider in detail the 'alien' species on the provisional IUCN Red List, 4% of these species are classified as threatened. Examples of alien species on the provisional IUCN Red List are *Azolla mexicana* (RE) and *Elodea canadensis* (CR). The Dutch trivial name of the last species, Canadian Pondweed, is 'waterpest', which name can also be easily understood by non-Dutch people. Though these 'alien' species are classified as Red List species according to the new IUCN regional guidelines, there is a strong difference of opinion on the question whether alien species may occur on a Red List or not.

#### HOW ROBUST ARE THE NEW IUCN REGIONAL GUIDELINES?

An important question is whether the new regional guidelines lead to different results for countries of different sizes. At present, the only large country with a national IUCN Red List of vascular plants is Sweden. From the comparison of the Dutch provisional list and the Swedish list it appears that the percentage of threatened vascular plant species is twice as high in the smaller Netherlands than in the larger Sweden. In order to investigate whether this is an artefact of the new method, or a realistic result, we developed some scenarios in which we created smaller versions of the Netherlands (scenario 2 and 3 in Table 3). To our surprise the proportion of threatened species is only 12-14% lower in these smaller scenarios, whereas the proportion of Red List species is only 4 and 13% higher (Table 3). This indicates the proportions of the listed species are more or less independent of the size of the country. Thus, we may tentatively conclude that the new regional IUCN guidelines can be used for countries of different sizes.

Another point of debate is the role of the national boundary in relation to natural boundaries of species. We developed a scenario (scenario 1 in Table 3) in which we excluded the most southern part of the Netherlands (1.8% of the total area). This part of the Netherlands has a different landscape and flora, and belongs to the Central-European botanical region. The virtual exclusion of this small but floristically different part of the Netherlands results in a 16% lower number of threatened species for the rest of the country. So, the IUCN regional procedure is more sensitive for small changes in regional borders.

## DISCUSSION

The new IUCN regional guidelines lean heavily on detailed population-ecological and distributional knowledge of species, especially the criteria C, D and E. For floral and faunal groups with a large number of species it is in our opinion not feasible to collect this information. If this knowledge is not present an expert opinion approach is possible, but in this approach non-reproducible results and subjectivity are risks. The 2000 Red List for vascular plants in the Netherlands is based on some simple criteria in combination with distributional data on a scale of 1 km<sup>2</sup>. We adapted the new IUCN regional guidelines for the Dutch vascular flora by using some simple rules of thumb in combination with distributional data on a scale of 1 km<sup>2</sup> applied to all plant species. In our opinion this approach is more objective and reproducible than the species by species evaluation by experts on basis of population numbers. We admit that some rules of thumb could be replaced in the future by better ones, e.g. the measure of fragmentation (Witte and Torfs 2002).

Nevertheless the new IUCN regional guidelines are an important step forward in protecting species. By formalising the guidelines and criteria a lot of issues of debate become apparent. With regard to vascular plants there are a large number of problems to resolve yet: e.g. how to define individual and generation, when are populations fragmented etc. etc. There are two important aspects in the procedure we want to discuss now. The first point is that more common species with a population reduction of less than 20% can be halved in thirty years, without ever appearing on a national Red List. This could be resolved by the further lowering of the lower limit of the category Near Threatened or by increasing the period in which population reduction is measured. The second point is that the presence of 'alien' species needs to be evaluated. The criterion now proposed by IUCN is to consider all species, regardless of their origin, which were present before 1900 (or 1800). A possible solution is to exclude all species which do not belong to the floral region of the country.

The new IUCN regional guidelines propose to add information about international importance after having created a national IUCN Red List, in order to make further national priorities possible. We feel that also the national importance for characteristic landscapes should be used. National Red Lists give a very strong signal towards the public and national governments. But is this signal not too strong if the list contains a relatively large number of regionally less important or several 'alien' species? A possible improvement of the IUCN regional procedure could be to add the third step of determining international importance before assigning the definitive Red List categories.

A proposal for a Red List for vascular plants in the Netherlands has been published in 2000 and is still waiting for official publication by the national government. The application of the new IUCN regional guidelines would result in a large number of changes. Should the proposed Red List of 2000

be updated now? In our experience it is not wise to change important lists too often. The least that could be done is to come to a national agreement about the interpretation of the criteria and the way to implement them. As a consequence of this the 100 species new on the provisional IUCN Red List could be proposed for publication and might be added to the published 2000 Red List.

In our opinion the Red List should play a central role in species protection. However, in the present Dutch situation there is no relation between actual threat and protection of species; the 2000 Red List species are only partly listed as protected species. The legally protected species comprise a list of 104 in number, among which species that may even be classified as Least Concern, while unprotected species may be classified as Endangered. This is broadly regarded as a problem. Furthermore, species protection is restrained as long as the proposed 2000 Red List for vascular plants in the Netherlands is still waiting for official publication by the national government and as long as the judicial status of the species of the 2000 Red List is unclear. Furthermore, the 2000 Red List reflects the fact that in Dutch nature policy Red List species are a part of the ecosystem protection approach. Regarding the long period over which decline is measured, a relatively large amount of still quite common species occur on the 2000 Red List. It therefore appears that the Dutch guidelines are not automatically suitable for selecting protected species.

Nevertheless, Dutch nature conservation policy does have targets, concerning species protection. In a recent publication, the Dutch ministry for Agriculture, Nature management and Fisheries (LNV 2000) has formulated that the conditions for conservation of all species and populations as present in the Netherlands in 1982 have to be sustainable in 2020.

We would suggest to choose one out of two options to solve the problems and actualise the list of protected species. One option is to simply protect the most threatened species on the 2000 Red List (RE, CR and EN). Alternatively, using the IUCN criteria could help in assigning the species with a high extinction risk and high national and international importance.

As a result of European legislation, the protected species at present do include the internationally important species of the Habitats Directive. We would be in favour of making an IUCN European Red List, to evaluate and actualise the need to protect species on a European scale, resulting in effective legislation for international species protection.

## REFERENCES

- BAL, D., H.M. BIJE, M. FELLINGER, R. HAVEMAN, A.J.F.M. VAN OPSTAL and F.J. VAN ZADELHOFF, 2001. *Handboek Natuurdoeltypen*. Rapport nr. 2001/20, Expertisecentrum LNV, Wageningen.
- GÄRDENFORS, U., 2001. Classifying threatened species at a national versus global level. *Species* 16: 511-516.
- GÄRDENFORS, U., C. HILTON-TAYLOR, G.M. MACE and J.P. RODRIGUEZ, 2001. The application of IUCN Red List criteria at regional levels. *Conservation Biology* 15: 1206-1212.
- IUCN, 2001. *IUCN Red List Categories and Criteria: Version 3.1*. IUCN Species Survival Commission, Gland, Switzerland & Cambridge, UK
- IUCN, 2002. *2002 IUCN Red List of Threatened Species*. www.redlist.org.
- KORNECK, D. and H. SUKOPP, 1988. Rote Liste der in der Bundesrepublik Deutschland ausgestorbenen, verschollen und gefährdeten Farn- und Blütenpflanzen und ihre Auswertung für den Arten- und Biotopschutz, *Schriftreihe für Vegetationskunde* 19: 1-210.
- LNv, 2000. *Natuur voor mensen, mensen voor natuur*. *Nota natuur, bos en landschap in de 21e eeuw*. Ministerie van Landbouw, Natuurbeheer en Visserij, 's Gravenhage.
- SCHAMINÉE, J.J., L. VAN DUUREN and A.J. DE BAKKER, 1992. Europese en mondiale verspreiding van Nederlandse vaatplanten. *Gorteria* 18: 57-96.
- VAN DER MEIJDEN, R., B. ODÉ, C.L.G. GROEN, J.P.M. WITTE and D. BAL, 2000. Bedreigde en kwetsbare vaatplanten in Nederland; Basisrapport met voorstel voor de Rode Lijst. *Gorteria* 26: 85-208.
- WEEDA, E.J., R. VAN DER MEIJDEN and P.A. BAKKER, 1990. FLORON-Rode Lijst 1990; Rode Lijst van de in Nederland verdwenen en bedreigde planten (Pterophyta en Spermatophyta) over de periode 1.1.1980-1.1.1990. *Gorteria* 16: 2-26.
- WITTE, J.P.M. and R. VAN DER MEIJDEN, 2000. Mapping ecosystem types by means of ecological species groups. *Ecological engineering* 16: 143-152.
- WITTE, J.P.M. and P.J.J.F. TORFS, 2002 (in press). Scale dependency and fractal dimension of rarity, *Ecography*.

**APPENDIX I**  
DESCRIPTION OF THE APPLICATION OF THE NEW IUCN  
REGIONAL GUIDELINES FOR THE VASCULAR PLANT  
SPECIES IN THE NETHERLANDS

Data

Records were extracted from the flora database FLORBASE from 1975-2000. In this periode c. 8 million records of plant species were sampled by volunteer botanists, organised by FLORON ([www.FLORON.nl](http://www.FLORON.nl)), and by governmental organisations. Data were sampled on a grid scale of 1 km by 1 km. The total land surface area in the Netherlands is about 36,750 km<sup>2</sup>. A total of 1490 plant taxa (species and subspecies) were taken into consideration.

The data were split into two periods of 13 and 12 year respectively. The spatial coverage of the observations was not complete and differs for the different regions in the Netherlands. Therefore the total expected presence of each plant species is calculated for each period with a weighing procedure. Change in occurrence was calculated between the two periods. To avoid calculation problems, a value of 1/2 was added to each number of observations when calculating the change in occurrence between the two periods

Not evaluated taxa (NE)

A number of 182 species (12%) were excluded from evaluation:

- all species ('alien species') introduced after 1900;
- other new species, which have not yet been found reproducing in the wild;
- some species which are deliberately sown or planted for non-conservational purposes;
- species whose natural area lies at least 100 km from the Dutch border ('voorpost');
- hybrids, varieties and cultivars;
- species already extinct before 1900.

Categories

Regionally extinct (RE): 37 species (2.5%) were not found in either period and were considered as regionally extinct (RE). If a species was absent in just one period, it was always classified as critically endangered (CR).

Near threatened (NT): all species with a decline between 20% and the lower limit for decline for the category vulnerable, were considered as near threatened, unless they were classified in a higher category by criteria B or D2.

### Criteria

Population reduction (A): we used the conservative A2 criterion based on our data and approach, because in our opinion it is almost impossible to have a reliable knowledge for all 1490 species for both the periods and for the whole country about causes of decrease.

Small distribution, decline or fluctuation (B): we used the B2 criterion based on our data and approach in combination with a criterion on population reduction (decrease of at least 20%) and a measure of fragmentation (fragmented if on average present in 3 km<sup>2</sup> within a grid cell of 5 km by 5 km). Reliable information on strong fluctuations is not available.

Small population size & decline (C): not used.

Very small or restricted (D): only the D2 criterion was used: vulnerable if present in at least 20 1 km x 1 km grid cells.

Quantitative analysis (E): not used.

The criteria as applied for the Dutch vascular plant species are summarized in the following table.

| Occupancy      | Decrease<br>km <sup>2</sup><br>80-100% | Decrease<br>km <sup>2</sup><br>50-80% | Decrease<br>km <sup>2</sup><br>30-50% | Decrease<br>km <sup>2</sup><br>20-30% | Decrease<br>km <sup>2</sup> less<br>than 20% |
|----------------|--|---------------------------------------|---------------------------------------|---------------------------------------|--|
| 1-10(20) frag. | CR                                     | CR                                    | CR                                    | CR                                    | VU   |
| Idem not frag. | CR                                     | EN                                    | VU                                    | VU                                    | VU   |
| 11-500 frag.   | CR                                     | EN                                    | EN                                    | EN                                    | LC   |
| Idem not frag. | CR                                     | EN                                    | VU                                    | NT                                    | LC   |
| 501-2000 frag. | CR                                     | EN                                    | VU                                    | VU                                    | LC   |
| Idem not frag. | CR                                     | EN                                    | VU                                    | NT                                    | LC   |
| >2000          | CR                                     | EN                                    | VU                                    | NT                                    | LC   |

CR = critically endangered; EN = endangered; VU = vulnerable; NT = near threatened; LC = least concern; 1-10(20) combination of criterion B2 and D2; each class of small distribution is divided into fragmented (frag.) and not fragmented (not frag.).



## Downgrading

Some simple rules of thumb are used to downgrade the classifications after step 1 in the new IUCN regional guidelines. The following species groups were downgraded 1 class:

- riverine species
- saline species
- marginal species.

## Presence on global Red List

Information on which Dutch species is present on the global Red List has been checked in the most recent version of the List on [www.redlist.org](http://www.redlist.org) on 21th November 2002 (IUCN 2002). Not one species of the provisional IUCN Red List is present on the global Red List.

## Assessment of international importance

Information is used about the European distribution published in Schaminée *et al.* (1992). The Netherlands lies wholly in the maritime (western) region of Europe, so we calculated the western position of a population as the fraction of the distribution which can be found in the western region. Fractions were classified as: I: 0-0.20; II: 0.20-0.40; III: 0.40-0.60, IV: 0.60-0.80 and V: 0.80-1.00.

## Summarizing the main differences with the IUCN regional guidelines

- difference between periods is not 10 years but 12.5 years and the change is measured not in the last 10 years, but in the last 25 years;
- only distributional data were used based on a grid of 1 km<sup>2</sup>; no information was used on the number of individuals;
- benign introductions of some species were excluded;
- criterion B: the subcriterion of strong fluctuation is not taken into account, because of lack of reliable data;
- criteria C and E: these criteria not used; in our opinion reliable information on population numbers and ecological characteristics of species is not available;
- downgrading: in our opinion it is not feasible to have a reliable assessment of the influx from extraregional populations for a large number of species. The risk of unreliable subjective assessments is, in our opinion, less pre-

ferable than the profit of applying simple and ecological sound rules of thumb.

- Assessment of international importance: the used 'western index' is an approximation of the international importance of the Netherlands for vascular plant species. The index overestimates the international importance.

# 22

## Harmonization of Red Lists in Europe: some critical fungi species from Italy

G. Venturella, A. Bernicchia, V.F. Marchisio, A. Laganà,  
S. Onofri, G. Pacioni, C. Perini, C. Ripa, A. Saitta, E. Salerni,  
E. Savino, A. Vizzini, M. Zotti and L. Zucconi

### INTRODUCTION

Fungi are currently distinguished in microfungi and macrofungi on the basis of the fruiting bodies' size (Arnolds, 1981). The basidiomata and ascomata of macrofungi are easy to detect, being immediately visible with the naked eye, and they are considered by researchers as useful tools for biodiversity studies. Besides, fungal biodiversity studies provide the basis for conservation action plans for fungi species.

Biodiversity studies are still very unbalanced, in many European countries. For example, Italy boasts a long tradition of mycological studies, but some areas are still unexplored and the number of fungi is clearly underestimated.

A check-list project was recently funded by the Italian Ministry of the Environment in order to assess fungal diversity and obtain useful information on the rarity of the species.

### UP-TO-DATE FUNGAL DIVERSITY IN ITALY

According to Onofri *et al.* (in press), 4,296 taxa belonging to the class *Basidiomycetes* are listed in the provisional check-list of Italian fungi. This very significant, but still approximate, number of fungi is going to be increased as soon as the second part of the check-listing project will start and new records of *Basidiomycetes*, *Ascomycota*, *Zygomycota*, *Chytridiomycota* and the remaining classes of *Basidiomycota* will be listed. The elaboration of all available data showed the presence in the Italian territory of 55 taxa which are possibly endemic at different levels (local, regional, national, biogeographical), 13 exotic taxa, and 87 probably rare and/or endangered taxa.

## TOWARDS A RED LIST FOR FUNGI IN ITALY

The idea that fungi may be threatened and deserve special attention to their conservation is now well established in Europe (Courtecuisse 2001). However, currently no Red Data Book of fungi exists in southern Europe.

In the Italian Red Data Book, published by Conti *et al.* (1992), 458 taxa of vascular plants, 267 lichens and 496 bryophytes are reported while algae and fungi are not considered at all.

The Working Group for Mycology of the Italian Botanical Society (Venturella *et al.* 1997) proposed a preliminary list of 23 species of macrofungi believed to be rare and/or endangered in Italy: *Amanita eliae* Quél., *Antrodiella onychoides* (Egeland) Niemelä, *Battarrea phalloides* Dicks. : Pers., *Boletus junquilleus* (Quél.) Boud., *Cortinarius herculeus* Malençon, *Cortinarius orellanus* (Fr.) Fr., *Dendrothele incrustans* (P.A. Lemke) P.A. Lemke, *Entoloma madidum* (Fr.) Gillet, *Gyrodontium sacchari* (Spreng.) Hjortstam, *Hebeloma hiemale* Bres., *Hebeloma remyi* Bruchet, *Hygrocybe calyptriformis* (Berk. & Broome) Fayod, *Hygrocybe spadicea* (Scop. : Fr.) P. Karst., *Inocybe tricolor* Kühner, *Junghuhnia semisupiniformis* (Murr.) Ryvarden, *Leucopaxillus lepistoides* (Maire) Singer, *Lycoperdon mammiforme* Pers., *Melanophyllum eyrei* (Massal.) Singer, *Panaeolus dunensis* Bon & Courtec., *Rhodotus palmatus* (Bull.: Fr.) Maire, *Russula seperi-na* Dupain, *Torrendia pulchella* Bres., *Trametes ljubarskyi* Pilát. These taxa were referred to the IUCN 'Data Deficient' category (DD) (IUCN 1994).

Comparing the above mentioned list with taxa included in the provisional European Red List of Endangered Macrofungi (Ing 1993), nine taxa belong to one of the four categories proposed by Ing. In particular to category A (widespread losses, rapidly declining populations, many national extinctions, high-level concern), in which *Boletus junquilleus* and *Hygrocybe spadicea* are included. *Entoloma bloxamii* (Berk. & Br.) Sacc. (reported sub *E. madidum*), *Melanophyllum eyrei* and *Rhodotus palmatus* belong to category B (widespread losses, evidence of steady decline, some national extinctions, medium-level concern). In the C category (widespread, but scattered populations, fewer extinctions, lower-level concern) fall *Cortinarius orellanus* and *Lycoperdon mammiforme*, while *Battarrea phalloides* and *Torrendia pulchella* belong to the D category (local losses, some extinctions but mainly at edge of geographical range). The remaining taxa proposed by the Working Group for Mycology of the Italian Botanical Society (Venturella *et al.* 1997) were included in the list since they are infrequent or rare in the Mediterranean area, where ecological conditions limit their growth and appearance.

The elaboration of new data arising from the Italian Check-list of *Basidiomycetes* shows a different situation. In fact, among the 23 fungi included in the previous list (Venturella *et al.* 1997) only for *Inocybe tricolor* the status of threatened species can be confirmed. Besides, on the basis of the increase of the mycological exploration of the Italian territory *Dendrothele incrustans* is not confirmed as rare in Italy while *Antrodia albobrunnea*, *Crepidotus cinnabarinus*

(Bernicchia, *in verbis*), *Rhodotus palmatus*, *Chalciporus amarellus* (Fig. 1) and *Suillus flavidus* (Fig. 2) should be included in the list of taxa rare in Italy proposed in this paper. In particular, the mycorrhizal species in association with *Pinus* ssp., *C. amarellus* and *S. flavidus*, recorded in subalpine forest in few localities of the Italian territory, seem to be threatened by air pollution and certain forest management activities. The information on ecology and distribution of these species is still inadequate and the status of Data Deficient (DD) is here proposed. The saprotrophic *Hygrocybe calyptriformis* (Fig. 3), just included at a European level in the IUCN category as 'Critically Endangered (CR)', confirms its status also in Italy where it was found in few localities of Tuscany, Veneto and Lombardy.



Figure 1 – *Chalciporus amarellus*



Figure 2 – *Suillus flavidus*



Figure 3 – *Hygrocybe calyptriformis*

Finally, as previously reported by Venturella (1999), *Pleurotus nebrodensis* (Inzenga) Quél. (Fig. 4) should be raised to the status of threatened species. In the Mediterranean area, *Pleurotus* species growing on different umbelliferous plants and characterized by entirely white basidiomata are often classified as *P. nebrodensis* or *P. eryngii* var. *nebrodensis* or *P. eryngii* subsp. *nebrodensis*. Comparing morphological, distributional and ecological data with molecular studies through isozyme and RAPD analysis, the presence of *P. nebrodensis* is only restricted to Sicily. The remaining populations of white *Pleurotus* species growing on umbelliferous plants should be considered as varieties of *P. eryngii* (Zervakis *et al.* 2001). In Sicily *P. nebrodensis* show a very punctiform distribution and a high risk of extinction mainly due to the economic value of its basidiomata. Notwithstanding the habitat of growth is included in a protected area, in the absence of any rule enforcement for fungi, the gatherers collect many unripe basidiomata of *P. nebrodensis* every year. During the last ten years, the occurrence of this taxon decreased dramatically. According to the IUCN Red List Categories (IUCN 2001) the status of Critically Endangered (CR) for *P. nebrodensis* is here proposed. In particular *P. nebrodensis* is submitted to a high level of exploitation, the extent of its occurrence is less than 100 km<sup>2</sup> and the number of mature individuals is very low. Notwithstanding the difficulty to apply the term ‘population’ to fungi, in the case of *P. nebrodensis* it is evident that this taxon belongs to a well characterized population delimited inside the plant association *Cachryetum ferulaceae* Raimondo, 1980. The size of



Figure 4 – *Pleurotus nebrodensis*

the *P. nebrodensis* population is estimated to number fewer than 250 mature individuals. *Ex situ* conservation strategies, carried out through the cultivation of this interesting basidiomycete, also reduce the anthropic pressure on the sites of growth (Perini 1998). As reported by Courtecuisse (2001), *P. nebrodensis* cultivation in Sicily (Venturella and Ferri 2001) and culture collections of basidiomycetes by Homolka *et al.* (1999) are, for the time being, the only examples of *ex situ* conservation of fungi at the European level. Recently the Mycotheca Universitatis Taurinensis (MUT) in the Department of Plant Biology of the University of Turin has also been devoted to *ex situ* conservation of basidiomycetes mycelia (Varese *et al.* 2001). In accordance with the new data, presently 93 taxa in Italy have the status of rare and/or endangered fungi (Table 1).

Recently, the European Council for the Conservation of Fungi [ECCF] & Koune (2001) proposed to include in Annex 1 of the Bern Convention a list of 30 basidiomycetes and 3 ascomycetes threatened at the European level. It should be noted that 22 of them are included in the Italian Check-list of *Basidiomycetes*. The diagram reports the presence of these taxa in the Italian Regions (Fig. 5).

**Table 1** – List of 93 fungi considered rare and/or endangered in Italy.

|  |   |
|--|---|
| <i>Aleurodiscus botryosus</i> Burt                                   | <i>C. colus</i> Fr.   |
| <i>A. cerussatus</i> (Bres.) Höhn. & Litsch.                         | <i>C. croceoconus</i> Fr.   |
| <i>A. dextrinoideocerussatus</i> G. Moreno, M.N. Blanco & Manjon     | <i>C. fuscoperonatus</i> Kühner                                   |
| <i>Alnicola sphagneti</i> (P.D. Orton) Romagn.                       | <i>C. gentilis</i> (Fr.) Fr.                                      |
| <i>A. tantilla</i> (J. Favre) Romagn.                                | <i>C. helobius</i> Romagn.  |
| <i>Amphinema diadema</i> K.H. Larss. & Hjortstam                     | <i>C. hillieri</i> Rob. Henry                                     |
| <i>Amyloathelia amylacea</i> (Bourdot & Galzin) Hjortstam & Ryvarden | <i>C. ionosmus</i> M.M. Moser, Nespiak & Schwöbel                 |
| <i>Amylocorticium subincarnatum</i> (Peck) Pouzar                    | <i>C. latobalteatus</i> (Schaeff. apud M.M. Moser) M.M. Moser     |
| <i>A. subsulphureum</i> (P. Karst.) Pouzar                           | <i>C. leochrous</i> Schaeff.                                      |
| <i>Antrodia albobrunnea</i> (Romagn.) Ryvarden                       | <i>C. magicus</i> Eichhirn  |
| <i>A. radiculosa</i> (Peck) Gilb. & Ryvarden                         | <i>C. orellanoides</i> Rob. Henry                                 |
| <i>Botryobasidium botryoideum</i> (Overh.) Parmasto                  | <i>C. papulosus</i> Fr.   |
| <i>B. candicans</i> J. Erikss.                                       | <i>C. paracephalix</i> Bohus                                      |
| <i>B. conspersum</i> J. Erikss.                                      | <i>C. parvannulatus</i> Kühner                                    |
| <i>Brevicellicium exile</i> (H.S. Jacks.) K.H. Larss. & Hjortstam    | <i>C. patibilis</i> Brandud & Melot                               |
| <i>Bulbillomyces farinosus</i> (Bres.) Jülich                        | <i>C. pluvius</i> (Fr. : Fr.) Fr.                                 |
| <i>Ceraceomyces borealis</i> (Romell) J. Erikss. & Ryvarden          | <i>C. porphyropus</i> (Alb. & Schwein.) Fr.                       |
| <i>C. sulphurinus</i> (P. Karst.) J. Erikss. & Ryvarden              | <i>C. praestans</i> (Cordier) Gillet                              |
| <i>Cerinomyces crustulinus</i> (Bourdot & Galzin) Martin             | <i>C. psammocephalus</i> (Bull.) Fr.                              |
| <i>Ceriporia excelsa</i> (S. Lundell) Parmasto                       | <i>C. pulchripes</i> J. Favre                                     |
| <i>Ceriporiopsis pannocincta</i> (Romell) Gilb. & Ryvarden           | <i>C. pygmaeus</i> (Velen.) M.M. Moser                            |
| <i>Chalciporus amarellus</i> (Quél.) Singer                          | <i>C. scaurotraganooides</i> Rob. Henry                           |
| <i>Clavulicium delectabile</i> (H.S. Jacks.) Hjortstam               | <i>C. subporphyropus</i> Pilát                                    |
| <i>C. macounii</i> (Burt) J. Erikss. & Boidin                        | <i>C. terpsichores</i> Melot var. <i>calosporus</i> Melot         |
| <i>Cortinarius aurantiomarginatus</i> Jul. Schäff.                   | <i>C. uliginosus</i> Berk.  |
| <i>C. badiovinaceus</i> M.M. Moser                                   | <i>Crepidotus cinnabarinus</i> Peck                               |
| <i>C. bibulus</i> Quél.  | <i>Cristinia gallica</i> (Pilát) Jülich                           |
| <i>C. caesiocinctus</i> Kühner                                       | <i>C. rhenana</i> Grosse-Brauckm.                                 |
| <i>C. calopus</i> P. Karst.  | <i>Crustoderma dryinum</i> (Berk. & M.A. Curtis) Parmasto         |
| <i>C. canabarba</i> M.M. Moser                                       | <i>Crustomyces expallens</i> (Bres.) Hjortstam                    |
|  | <i>C. subabruptum</i> (Bourdot & Galzin) Jülich                   |
|  | <i>Cyphellostereum laeve</i> (Fr. : Fr.) D.A. Reid                |
|  | <i>Cystostereum murrarii</i> (Berk. & M.A. Curtis) Pouzar         |
|  | <i>Dentipellis fragilis</i> (Pers. : Fr.) Donk                    |
|  | <i>Erythricium hypnophilum</i> (P. Karst.) J. Erikss. & Hjortstam |
|  | <i>Fibricium rude</i> (P. Karst.) Jülich                          |



|  |   |
|--|---|
| <i>F. subceraceum</i> (Hallenb.) Bernicchia                | <i>I. glabrescens</i> Velen.                                      |
| <i>Fomitopsis cajanderi</i> (P. Karst.) Kotl. & Pouzar     | <i>I. huijsmannii</i> Kuyper                                      |
| <i>Gloeocystidiellum karstenii</i> (Bourdot & Galzin) Donk | <i>I. leptophylla</i> G.F. Atk.                                   |
| <i>Hebeloma funariophilum</i> M.M. Moser                   | <i>I. oreina</i> J. Favre   |
| <i>H. pyrophilum</i> G. Moreno & M.M. Moser                | <i>I. piceae</i> Stangl & Schwöbel                                |
| <i>Hygrocybe calyptriformis</i> (Berk. & Broome) Fayod     | <i>I. tricolor</i> Kühner   |
| <i>Hyphoderma litschaueri</i> (Burt) J. Erikss. & Å. Strid | <i>Inonotus dryophilus</i> (Berk.) Murrill                        |
| <i>Hypochnicium polonense</i> (Bres.) Å. Strid             | <i>Mucronella flava</i> Corner                                    |
| <i>Inocybe albomarginata</i> Velen.                        | <i>Oxyporus corticola</i> (Fr. : Fr.) Ryvarden                    |
| <i>I. albovelutipes</i> Stangl                             | <i>Phanerochaete aff. avellanea</i> (Bres.) J. Erikss. & Ryvarden |
| <i>I. amblyspora</i> Kühner                                | <i>Phlebia chrysocreas</i> (Berk. & M.A. Curtis) Burds.           |
| <i>I. fuscescentipes</i> Kühner                            | <i>Pleurotus nebrodensis</i> (Inzenga) Quéf.                      |
| <i>I. geraniodora</i> J. Favre                             | <i>Rhodotus palmatus</i> (Bull. : Fr.) Maire                      |
|  | <i>Suillus flavidus</i> (Fr. : Fr.) Singer                        |

---

As clearly shown in Fig. 5, many species listed in the report of the European Council for the Conservation of Fungi (ECCF) & Koune (2001) as threatened in Europe were recorded in several Italian Regions: based on this fact, some Italian Regions or, in selected cases, Italy as a whole, could be considered sites for conservation of threatened European fungi.

#### REGIONAL RED LISTS FOR FUNGI IN ITALY

Among cases studied at the regional level an attempt to propose conservation action for fungi growing in certain threatened habitats, was recently carried out in Tuscany. According to Antonini and Antonini (1999) two species until now found only in autochthonous spruce forest in the northern Apennine (Mount Abetone), *Gomphus clavatus* (Pers.: Fr.) Gray and *Porphyrellus porphyrosporus* (Fr.) Gilbert, considered as endangered and vulnerable respectively, were proposed to be protected in Tuscany. Mycological research confirmed the phytogeographic and ecological value of relict mountain peat bogs in the Northern Apennine, few in number and small in extension habitats, recording the presence of interesting and rare fungi worthy of conservation. Among saprotrophic fungi linked to this environment, the species *Arrhenia lobata* (Pers.: Fr.) Redhead, *Entoloma poliopus* (Romagn.) Noordel., *Galerina paludosa* (Fr.) Kühner, *Gymnopilus bellulus* (Peck) Murrill, *Hygrocybe coccineocrenata* (P.D. Orton) M.M. Moser, *H. laeta* (Pers.: Fr.) P. Kumm., *Pholiota myosostis* (Fr.: Fr.) Sing. and *Psilocybe elongata* (Pers.: Fr.) J. Lange are noteworthy (Perini *et al.* 2002). *Helvella juniperi* Filippa & Baiano, *Hygrocybe conicoides* (P.D.

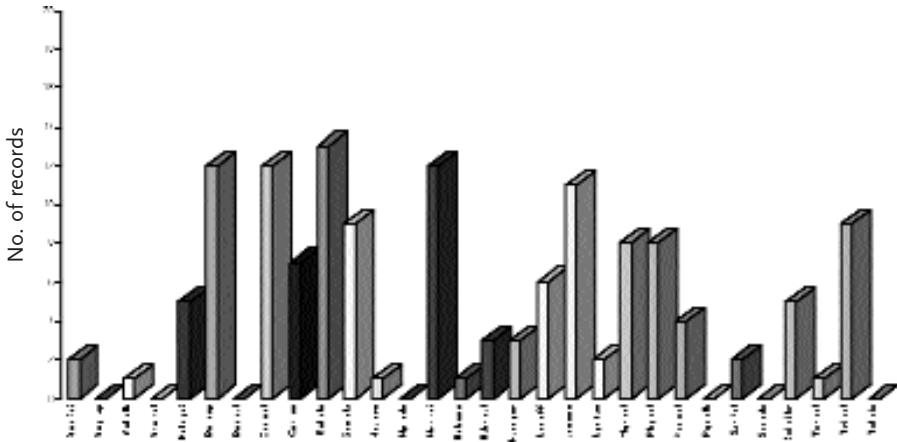

**Figure 5** – List of taxa proposed by ECCF to be included in Annex 1 of the Bern Convention compared with taxa reported in the Italian check-list (\*). Ama fri = *Amanita friabilis*, Amy lap = *Amylocystis lapponica*, Ant alb = *Antrodia albobrunnea*, Arm ect = *Armillaria ectypa*, Bolp gri = *Boletopsis grisea*, Bol dup = *Boletus dupainii*, Bov pal = *Bovista paludosa*, Can mel = *Cantharellus melanoxeros*, Cor ion = *Cortinarius inochlorus*; Ent blo = *Entoloma bloxamii*, Gom cla = *Gomphus clavatus*, Hpa cro = *Hapalopilus croceus*, Hpl odo = *Haploporus odoratus*, Her eri = *Hericium erinaceum*, Hoh cum = *Hohenbuehelia culmicola*, Hbe cal = *Hygrocybe calyptriformis*, Hus pur = *Hygrophorus purpurascens*, Lar off = *Laricifomes officinalis*, Leu com = *Leucopaxillus compactus*, Lyo fav = *Lyophyllum favrei*, Myr col = *Myriostoma coliforme*, Phy pel = *Phylloporus pelletieri*, Pod mul = *Podoscypha multizonata*, Pyc alb = *Pycnoporellus alboluteus*, Sar ful = *Sarcodon fuligineoviolaceus*, Ske odo = *Skeletocutis odora*, Sui si he = *Suillus sibiricus* ssp. *helveticus*, Tor pul = *Torrendia pulchella*, Tri col = *Tricholoma colossus*, Tul niv = *Tulostoma niveum*.

Orton) P.D. Orton & Watling, *H. olivaceonigra* (P.D. Orton) M.M. Moser, *Macrolepiota phaeodisca* Bellù, *Oudemansiella mediterranea* (Pacioni & Lalli) E. Horak, *Psathyrella ammophila* (Durieu & Lév.) P.D. Orton and *Tulostoma giovannellae* Bres., growing in sandy coastal dunes, should also be included in the Tuscany Red List for fungi (Antonini *et al.* 2002).

## REFERENCES

- ANTONINI, D. and M. ANTONINI, 1999. Due taxa da inserire nella red-list dei macromiceti della Toscana. *Parliamo di funghi* 1: 15-19. Gruppo Micologico Camaiolese, Lucca.
- ANTONINI, D., M. ANTONINI, A. LAGANA' and C. PERINI, 2002. *Macrofungal species proposed for a Tuscan red-list (Italy)*. IMC7 – Book of abstracts 7th International Mycological Congress, Oslo, 11-17 August 2002. IMC7 Organizing Committee, Oslo.
- ARNOLDS, E., 1981. Ecology and coenology of macrofungi in grasslands and moist heathlands in Drenthe, Netherlands. *Bibl. Mycol.* 1 (83).
- CONTI, F., A. MANZI and F. PEDROTTI, 1992. *Libro rosso delle piante in Italia*. Associazione Italiana WWF Italia, Ministero dell'Ambiente, Camerino.
- COURTECUISSÉ, R., 2001. Current trends and perspectives for the global conservation of fungi, pp. 7-18, in: D. Moore, M.M. Nauta, S.E. Evans and M. Rotheroe (eds.), *Fungal Conservation. Issues and Solutions*. Cambridge University Press, Cambridge.
- EUROPEAN COUNCIL FOR THE CONSERVATION OF FUNGI [ECCF] and J.P. KOUNE, 2001. *Data sheets of threatened mushrooms of Europe, candidates for listing in Appendix 1 of the Convention*. ECCF, Strasbourg.
- HOMOLKA, L., L. LISA, I. STOYTICHEV and F. NERUD, 1999. Culture collection of Basidiomycetes (CCBAS) – A tool for ex situ conservation of Basidiomycetes, p. 53, in: *Abstracts XIIIth Congress of European Mycologists*, 21-25 September 1999, Alcalá de Henares, Madrid.
- ING, B., 1993. Towards a Red List of endangered European macrofungi, pp. 231-237, in: D.N. Pegler, L. Boddy, B. Ing and P.M. Kirk (eds.), *Fungi of Europe: Investigations, Recording and Conservation*. Royal Botanical Gardens, Kew.
- IUCN, 1994. *IUCN Red List Categories*. Prepared by the IUCN Species Survival Commission. IUCN, Gland.
- IUCN, 2001. *IUCN Red List categories and criteria. Version 3.1*. Prepared by the IUCN Species Survival Commission. IUCN, Gland and Cambridge.
- ONOFRI, S., A. BERNICCHIA, V. FILIPELLO MARCHISIO, C. PERINI, G. VENTURELLA, L. ZUCCONI and C. RIPA, (in press). *La biodiversità fungina in Italia. Sistema Biodiversità Italia – stato attuale delle conoscenze sulla biodiversità in Italia*. Società Botanica Italiana, Firenze e Ministero dell'Ambiente, Servizio Conservazione della Natura, Roma.
- PERINI, C., 1998. Different aspects of the activities done for the conservation of macrofungi in Italy: 86-90, in: C. Perini (ed.), *Conservation of fungi in Europe*. Proceedings of the 4th Meeting of the European Council for the Conservation of Fungi. ECCF, Vipiteno.
- PERINI, C., I. BONINI, P. ROMAGNOLI, D. ANTONINI and M. ANTONINI, 2002. Macrofungi and bryophytes of montane mires (Tuscany, Italy): organisms worthy of conservation. *Feddes Repertorium* 113 (1-2): 152-160.
- VENTURELLA, G., 1999. *The conservation of Pleurotus nebrodensis through its cultivation*. Abstracts XIIIth Congress of European Mycologists, 21-25 September 1999, Alcalá de Henares, Madrid, p. 131.

- VENTURELLA, G. and F. FERRI, 2001. *Progetto FUNGIS. Progetto di sviluppo per la funghicoltura in Sicilia*, 118 pp. Dipartimento di Scienze Botaniche, Università di Palermo, Palermo.
- VENTURELLA, G., C. PERINI, C. BARLUZZI, G. PACIONI, A. BERNICCHIA, F. PADOVAN, L. QUADRACCIA and S. ONOFRI, 1997. Towards a Red Data List of fungi in Italy. *Bocconea* 5: 867-872.
- VARESE, G., S. SCANNERINI and V. FILIPELLO MARCHISIO, 2001. *La Mycotheca Universitatis Taurinensis (MUT) per la conservazione ex situ della biodiversità fungina e le applicazioni biotecnologiche*. Abstracts 96th Congresso della Società Botanica Italiana, 26-28 September 2001, Varese: 118. Università degli Studi dell'Insubria, Varese.
- ZERVAKIS, G., G. VENTURELLA and K. PAPADOPOULOU, 2001. Genetic polymorphism and taxonomic infrastructure of the *Pleurotus eryngii* species-complex as determined by RAPD analysis, isozyme profiles and ecomorphological characters. *Microbiology* 147: 3183-3194.

# 23

## Demographic, phytogeographic and state-of-habitat study on eight Red-Listed taxa of central-southern Italian vascular flora: early data

*E. Giovi, G. Abbate and M. Iberite*

### INTRODUCTION AND AIMS OF RESEARCH

During the last decades the topic of biological diversity and its conservation gained a central position within the international environmental debate. In this scenario, the first comprehensive Plant Red Data Book published by IUCN (Lucas and Singe 1978) came also as the first concrete methodological approach in defending threatened plants.

Italy had to wait a long time before having such a tool for vascular plants: the Red Book of Italian Plants (*Libro Rosso delle Piante d'Italia*) was edited only in 1992 (Conti *et al.* 1992). It was based on monographs and, though it is now old, it still is the only reference for Italy to address the problem of taxa threatened at the national level in a comprehensive way (Fig. 1). In this book the authors selected 458 taxa in need of conservation efforts.

In 1997 the same authors published the Regional Red Lists of Italian Plants (*Liste Rosse Regionali delle Piante d'Italia*), taking the 1994 IUCN categories as a reference (IUCN 1994; Rizzotto 1995). This, as the Red Book before, contains the major regional botanists' contributions (mostly by the authors of the regional floras) and represents the most up-to-date data source on threatened flora. This new checklist is however extremely poor in structure and consists only of tables. If we consider yet how complex and abundant Italian vascular flora is, a synthesis in reporting regional data is necessary.<sup>1</sup> At the same time this conciseness dramatically restricted the List's availability both as a field tool and as a legal reference. For each taxon, the Lists quote only the IUCN category, both at national level and for each one of the 20 Italian administrative regions (Fig. 2); on the other hand they completely lack information on biology, ecology and appropriate safeguard measures. But we know that extinction risk is the result of many biotic and abiotic factors which we hardly can estimate properly: therefore the more we will know about a species, the more effective its safeguard strategy will be. Regional Red Lists number 1011 taxa threatened at national scale and 3179 at regional level.<sup>2</sup>



rience and knowledge of the regional authorities. This approach can easily produce mistakes and moreover it does not follow IUCN/SSC guidelines which recommend to base one's evaluations on field observations for a sufficient period of time.

In the framework of the actions promoted by the Italian Society of Botany (S.B.I.) in order to study and safeguard threatened flora, the present research has the priority objective to apply, for the first time in Italy, IUCN-established criteria, checking the actual conservation status of 8 Red-Listed taxa standing for different plant life forms, risk categories, chorotypes, taxonomic groups and environments of some central-southern Italian regions. By this we intend to deduce further guidelines drawn up *ad hoc* for the principal groups of vascular plants, in agreement to and supplementing IUCN criteria, to serve as an aid in effective assessing of risk categories.

In this paper we present some early results of a two year research activity and some remarks on Red-Listing experience in Italy.

## MATERIALS AND METHODS

### Selection criteria and selected taxa<sup>3</sup>

The preliminary operation for the selection of the taxa to study was a thorough analysis of the Regional Red Lists of Italian Plants. To reach an adequate compromise between significance and feasibility of the research, the candidate taxa should:

- be included in the national list of threatened taxa (see footnote 2);
- occur in at least one of the following regions: Lazio, Abruzzo, Molise, for logistic reasons;
- occur in few regions, preferably one, to make it easier to compare different populations;

1 According to the most recent data, Italian vascular flora consists of 6516 species and 7429 taxa (including subspecies), turning out as the richest in Europe. These data are quoted from the *Database of Italian Vascular Flora*, which is right now being completed: it is a comprehensive project started by the Plant Biology Department of the University of Rome 'La Sapienza' in 1999, following a convention funded by the Ministry of the Environment and Territorial Defence - Nature Conservation Department (Abbate *et al.* 2001).

2 Regional Red Lists of Italian Plants report both the taxa threatened at national level (stating the IUCN category also for each one of the 20 regions) and those taxa which are threatened in one or more regions but not at risk at national scale. For these taxa a blank box could mean: 1) occurring but not threatened in that region or 2) not occurring at all in that region; this ambiguity seriously limits the applicability of the Red Lists. Red Lists of other nations clearly distinguish the two cases; therefore Italian Red Lists need to be adapted in this sense.

3 Nomenclature follows Liste Rosse Regionali delle Piante d'Italia (Conti *et al.* 1997).

- not belong to taxonomically critical groups of Italian flora, and to be easily recognised in nature;
- stand for different chorotypes and plant life forms;
- not occur in places too difficult to be reached – habitats that are, so to speak, protected by themselves. Environments which are somehow threatened are instead much more interesting, because they allow us to estimate the effects resulting from protection actions or interferences or stress ceasing.

Based on these criteria we selected eight taxa (Table 1).

### Experimental plan

While drawing our experimental plan, we felt the need for easy techniques, requesting not so many years of observation. This will be all the more important if we intend to reach conclusions regarding many taxa, especially for those nations having rich floras, such as Italy.

So we adopted a quantitative population study approach. This has been scarcely applied in Italy so far, both for its theoretical difficulties and for the long data collecting phases. While for animals the functional unity – that is what makes the species reproduce and spread – usually corresponds to the individual, for plants it is often hard to identify the functional unity and a precise knowledge is required of the species' reproductive biology. When vegetative propagation prevails over sexual reproduction, it becomes hard to assess the vitality of a population in terms of genetic variability.

For the eight selected taxa, together with a demographic study, we perform basic genetic research and state-of-habitat analysis.

#### *Population study*

The population study of the selected taxa is the main feature of this research. For each taxon we perform field surveys in preliminarily selected sites and make observations aimed at assessing the vitality of natural populations. The method is the following:

- building permanent sample plots or transects for data collecting for an *in situ* population dynamics study. The size of the plots or transects relates to: plant size, reproductive biology and arrangement of the individuals within the population;
- field monitoring of the individuals included in the plots. Counting involves the number of individuals and, when it is possible, the number of mature reproductive structures.



**Table 1** – The eight selected taxa, standing for different taxonomic groups, families, plant life forms, chorotypes and risk categories at national level (according to Conti *et al.* 1997); for an explanation of the abbreviations used, the reader is also referred to that source).

|                                     | Taxon   | Family                | Plant life form | Chorotype          | IUCN category |
|-------------------------------------|---|-----------------------|-----------------|--------------------|---------------|
| <b>Pteridophyta</b>                 | <i>Isoetes velata</i> A.<br><i>Braun</i> subsp. <i>velata</i>     | <i>Isoëtaceae</i>     | I rad           | Medit.-Atl.        | VU            |
| <b>Angiospermae dicotyledones</b>   | <i>Adonis vernalis</i> L.   | <i>Ranunculaceae</i>  | H scap          | Eurosib. (steppic) | CR            |
|                                     | <i>Malcolmia littorea</i> (L.) R. Br.                             | <i>Brassicaceae</i>   | Ch suffr        | W-Medit. (Steno)   | EN            |
|                                     | <i>Astragalus aquilanus</i> Anzalone                              | <i>Fabaceae</i>       | H scap          | Endem.             | VU            |
|                                     | <i>Vicia sativa</i> L. subsp. <i>incisa</i> (M. Bieb.) Arcang.    | <i>Fabaceae</i>       | T scap          | Pontic             | VU            |
|                                     | <i>Acer cappadocicum</i> Gled subsp. <i>lobelii</i> (Ten.) Murray | <i>Aceraceae</i>      | P scap          | Endem.             | LR            |
|                                     | <i>Goniolimon italicum</i> Tammaro, Frizzi et Pignatti            | <i>Plumbaginaceae</i> | H ros           | Endem.             | VU            |
| <b>Angiospermae monocotyledones</b> | <i>Iris setina</i> Colasante                                      | <i>Iridaceae</i>      | G rhiz          | Endem.             | CR            |

### Chromosome number

Chromosome number is nowadays considered a useful tool in understanding phylogenetic links between taxonomically related taxa; at the same time it can help explain the relationships between populations living in different sites (Stace 2000). In this part of the research we make use of classic techniques as follows:

- field collecting of plant parts to be cultivated in laboratory;
- separating tissues to be put through karyologic analyses;
- metaphase freezing by use of colchicine and chromosome counting.

### *Reference coenoses*

Plant conservation goes hand in hand with conservation of related coenoses: the more the plant community is altered in structure and composition from its optimum, the more threatened we must consider a species and the more urgent are protection measures. This part of the research follows the classic Braun-Blanquet phytosociological method:

- collecting references to verify if the taxa are already included in described phytocoenoses. If we deal with a characteristic or differential species of a syntaxon, we already know something about its synecology and have a reference coenosis;
- performing phytosociological surveys in order to test the state of the coenosis or else to define the synecology of our taxon, if there were no references.

## RESULTS<sup>4</sup>

### *Isoetes velata* A. Braun subsp. *velata*

This is an amphibian Pteridophyte occurring in humid sites; we are studying it in a *Quercus frainetto* Ten.-rich community (named Foglino wood) situated near the Tirrenian coast in Southern Lazio region. Nowadays, these habitats are very rare, and in Lazio they sometimes survive as a witness of the past, before the drainings which took place. Here *I. velata* ssp. *velata* is widespread on clayey soils overlaying fossil dunes on which water persists only during the winter. We built two sample plots 1 m x 1 m each, the first one (P1) in a more disturbed site than the second one (P2), but both on hardly grazed grounds. The number of individuals was always high, especially if we consider that the taxon never performs vegetative propagation. We are also cultivating some individuals, which showed great vitality, on which we are counting the number of leaves per rosette, measuring the corm diameter (to see if a correlation does exist) and preparing the chromosome analyses. *I. velata* ssp. *velata* was reported as I rad (Pignatti, 1982), but our observations showed that it might rather be considered G bulb (though the corm cannot be properly defined a bulb).

<sup>4</sup> The small maps report the IUCN category for each studied *taxon* in the 20 Italian regions; in the grey box the *status* at national scale is given (Conti *et al.*, 1997).

**Table 2** – Countings in the two *I. velata* ssp. *velata* plots.

|    | N. of individuals |       |       |
|----|-------------------|-------|-------|
|    | 09/01             | 02/02 | 03/02 |
| P1 | 44                | 231   | 134   |
| P2 | –                 | 284   | 216   |



*Adonis vernalis* L.

This species has been considered extinct in Italy for many years, until it was rediscovered in 1995 (Frattaroli 1996) in a small Karstic valley at 1200 m a.s.l. in Abruzzo region, on the southern border of Gran Sasso and Laga Mountains National Park. The plants are often very large (up to 1 m high and crown diameter 50 cm), so we built a circular sample plot with a radius of 4 m in which we counted 90 individuals, quite a high number. On the other hand the whole population occurs in a restricted and distinctly bounded area, as large as a football field, on the valley floor. Outside this area the species is very sporadic, though it seems to be spreading a little. We propose to change the plant life form from H scap (Pignatti 1982) to G rhiz; this takes into account that the plant has many more chances to spread by vegetative means.



*Malcolmia littorea* (L.) R. Br.

This is a coastal dune plant occurring in Italy only in a restricted area in the Southern Lazio region, next to Circeo National Park, a plain disjunction from Iberic and French stands. It was not reported for about 35 years. Then, in 2001, we found it again in a rectangular 70 m<sup>2</sup> area directly on the beach (P1). In 2002 we found two other sites where we built sample areas (P2, P3) with the same size as P1. We performed preliminary phytosociological surveys and

**Table 3** – Countings in the three *M. littorea* plots.

|    | N. of individuals |       |       |
|----|-------------------|-------|-------|
|    | 09/01             | 03/02 | 06/02 |
| P1 | 12                | 13    | 14    |
| P2 | –                 | 14    | 14    |
| P3 | –                 | 40    | 43    |



cultivated some specimens which later flowered and fructified. We did not observe vegetative propagation.

*Astragalus aquilanus* Anzalone

**Table 4** – Countings in the two *A. aquilanus* plots.

|    | N. of individuals |       |
|----|-------------------|-------|
|    | 07/01             | 08/02 |
| P1 | 11                | 27    |
| P2 | 7                 | 6     |



Though included as priority species in many conventions and directives, we found that this species is more widespread than had been assumed. It is an endemic species discovered in the late 60s in the Abruzzo region (Anzalone 1970) and recently found in Calabria too (Bernardo 1996). In Abruzzo we investigated two stands near L’Aquila in xeric pastures. We built two sample plots 1 m x 1 m each; populations are not very abundant, but the species often occurs in the region: while performing the surveys for *Adonis vernalis* L., we accidentally found *A. aquilanus* in the same place.

*Vicia sativa* L. subsp. *incisa* (M. Bieb.) Arcang

This species occurs in Italy only near Rome (Castelli Romani), far away from most of its distribution area (Crimea, Bulgaria, Greece, Turkey). It lives in very disturbed stands (uncultivated lands, road edges). It probably established itself in Italy during the stay of *Septimius Severus* Legions, coming from Mesopotamia through today's Romania. If this hypothesis can be confirmed, we will have to consider if the active protection of an alien species thought of as indigenous should be recommended.



*Acer cappadocicum* Gled. subsp. *lobelii* (Ten.) Murray

**Table 5** – Countings in the three *A. cappadocicum* ssp. *lobelii* transects.

| Transect              | M    | B1    | B2   |
|-----------------------|------|-------|------|
| N. of individuals     | 7    | 4     | 6    |
| Average diameter (cm) | 9.28 | 25.48 | 20.7 |



This is one of the few Italian endemic trees, infrequently occurring in beech forests along the central-southern Apennines. We did surveys in the Molise region (the northern part of the distribution area) within the Biosphere Reserve 'Collemeluccio-Montedimezzo' and in the Basilicata region near Potenza. We counted individuals occurring over three transects of 100 m each, one (M) in Molise, the others (B1, B2) in Basilicata. We also measured the stem diameter at 1,30 m from ground level. Populations from Basilicata proved to be much healthier than those from Molise. On the other hand we observed that most populations from Basilicata do not fit the original description drawn by Italian botanist Michele Tenore in 1835. They seem to show intermediate features between *A. cappadocicum* ssp. *lobelii* and the *A. opalus* complex, often occurring in central-southern Apennines in similar habitats. It is possible that these populations are derived from a hybridization between the

two taxa. If this hypothesis can be confirmed, all the distribution area of *A. cap-padocicum* ssp. *lobelii* will have to be reviewed.

*Goniolimon italicum* Tammaro, Frizzi et Pignatti

This species, the only representative of the genus *Goniolimon* in Italy, was discovered in the Karstic complex of Ocre, near L'Aquila, in Abruzzo (Tammaro *et al.*, 1982). A few other stands have been recorded in the past but, as some surveys have shown, the species seems to occur there no longer, due to human activities. During our studies, the population of the locus classicus looked very poor; over a 250 m transect only 6 individuals occurred. Based on these early data, while considering the fact that this species never performs vegetative propagation, *G. italicum* seems to be really threatened, even more than the VU status reported by the Red Lists.



*Iris setina* Colasante

This is an endemic *Iris*, occurring only in a restricted area in Southern Lazio (Colasante, 1989; Colasante and Sauer, 1993). During the 70s a residential neighbourhood was built right over its locus classicus; here the species survives today only in a few flowerbeds. We found few seemingly natural small populations and we started a study of one of them. Since this species, like many irises, performs a massive vegetative propagation, one cannot tell one individual from another, and so we counted the number of flowering stems. In a 1 m x 1 m sample plot we found 56 flowering stems and 150 flowers; we returned later in the same place to observe that not one of those flowers had produced a capsule. Massive vegetative propagation may help a *taxon* surviving but at the same time it may have serious consequences for its genetic variability; if the population of *I.*



*setina* under study will prove to be a clone, the loss of genetic diversity would be dramatic.

## CONCLUSIONS

During the first two years of this research, some trends came out in the study of Red-Listed taxa. We selected both endemic and non-endemic taxa, with more or less large distribution areas. The most interesting situations soon appeared to be the cases of non-endemic taxa occurring in Italy only in very restricted stands. Two of the studied taxa, *Malcolmia littorea* and *Vicia sativa* ssp. *incisa*, clearly reflect this: in both cases their Italian stands are but small parts of their total distribution areas and in both cases they occur in degraded environments. So we may ask: why do they not occur in other regions in similar habitats? An easy answer to this question may be that they accidentally penetrated in historical times. But how? And when? In most cases we cannot find historical documentation to strengthen or refute such a hypothesis. In the future we will need more and more integration of different branches of research, such as the karyological analyses we carried out.

Italy is still far behind in Red-Listing activities, mainly because of its complex and rich flora, which even today is not well known. The Database of Italian Vascular Flora will be completed only after the present study but from a comparison between the present data and those in the the Regional Red Lists some matters are already emerging: there are probably many misunderstood taxa that will eventually be deleted from the Red Lists. Only when that has been accomplished, will conservation efforts finally be directed towards effective biodiversity conservation.

## REFERENCES

- ABBATE, G., A. ALESSANDRINI, F. CONTI, A. LA POSTA, I. RONCHIERI, N. TARTAGLINI and C. BLASI, 2001. La banca dati della flora vascolare italiana. *Inform. Bot. Ital.* 33 (2): 417-420.
- ANZALONE, B., 1970. Su un nuovo 'Astragalus' scoperto in Abruzzo e osservazioni su 'Astragalus vesicarius' L. (*sensu lato*). *Webbia* 24: 723-734.
- BERNARDO, L., 1996. Segnalazioni floristiche italiane: 837. *Inform. Bot. Ital.* 28: 267-268.
- COLASANTE, M., 1989. On the three misunderstood wild bearded irises: *I. bicapitata* nom. nov., *I. relicta* nom. nov., *I. setina* sp. nov. *Giorn. Bot. Ital.* 123, Suppl. 1: 52.
- COLASANTE, M. and W. SAUER, 1993. The genus *Iris* L. in Latium (Central Italy): General remarks on the morphological and karyological differentiation as well as on the ecological adaptation and flowering periods. *Linzer biol. Beitr.* 25(2): 1189-1204.
- CONTI, F., A. MANZA and F. PEDROTTI, 1992. *Libro Rosso delle Piante d'Italia*. Ministero dell'Ambiente, WWF Italia & Società Botanica Italiana, Rome.

- Conti, F., A. Manza and F. PEDROTTI, 1997. *Liste Rosse Regionali delle Piante d'Italia*. WWF Italia & Società Botanica Italiana, Camerino.
- FRATTAROLI, A.R., 1996. Segnalazioni floristiche italiane: 843. *Inform. Bot. Ital.* 28: 270-271.
- IUCN, 1994. *IUCN Red List Categories*. Prepared by the IUCN Species Survival Commission. IUCN, Gland.
- LUCAS, G. and H. SYNGE, 1978. *The IUCN Plant Red Data Book*. IUCN, Morges.
- PIGNATTI, S., 1982. *Flora d'Italia*. 3 volumes. Edagricole, Bologna.
- RIZZOTTO, M., 1995. Le categorie IUCN per la compilazione delle 'Liste Rosse' e l'attività della S.B.I. per la conservazione della flora. *Inform. Bot. Ital.* 27: 315-338.
- STACE, C.A., 2000. Cytology and cytogenetics as a fundamental taxonomic resource for the 20th and 21st centuries. *Taxon* 49: 451-478.
- TAMMARO, F., S. PIGNATTI and G. FRIZZU, 1982. 'Goniolimon italicum' (Plumbaginaceae), una nuova specie rinvenuta nei pressi di L'Aquila (Appennino Centrale). *Webbia* 36(1): 39-46.



# 24

## Applying Red List criteria in Flanders (North Belgium)

*D. Maes, L. de Bruyn and E. Kuijken*

### INTRODUCTION

Red Lists are compiled for three main reasons: 1) To assess potentially adverse impacts on species, 2) to help inform conservation priorities and to promote research on threatened species or 3) as a component of State of the Environment Reports (Possingham *et al.* 2002). Another important use of Red Lists is to enlarge the awareness of the public about the decline of biodiversity in general (Blab *et al.* 1984). In the past most of the Red Lists were compiled on a 'best professional judgement' basis. In 1994, the IUCN promoted the use of quantitative criteria for the compilation of international (Mace and Stuart 1994; IUCN Species Survival Commission 1994) and national or regional Red Lists (Gärdenfors *et al.* 2001; e.g. Schnittler *et al.* (1994) in Germany; Maes *et al.* (1995) in Flanders – North Belgium; Van Ommering (1994) in the Netherlands).

In this contribution, we will illustrate the criteria and Red List categories that are applied for the compilation of Red Lists in Flanders (North Belgium) and we will demonstrate that the proposed IUCN criteria for use on the regional scale are inappropriate in small countries or regions.

### RED LISTS IN FLANDERS

Flanders (total area 13,512 km<sup>2</sup>) is the northern, Dutch speaking part of Belgium. It exhibits the typical features of a western industrialised region: Extensive industry, infrastructure, house building and agriculture, and a human population density of 431 citizens/km<sup>2</sup> (De Bruyn *et al.* 2002; Van Hecke and Dickens 1994). Nature conservation policy is the responsibility of the regional governments (Flanders, Wallonia and Brussels) and it is therefore appropriate to compile Red Lists per region rather than for Belgium as a whole. Flanders developed Red List Categories and Criteria in 1995 (Maes *et al.* 1995; Maes and van Swaay 1997) that were based upon the IUCN criteria (IUCN Species Survival Commission 1994) and on Categories and Criteria used in

The Netherlands (Van Ommering 1994) and in Germany (Schnittler *et al.* 1994). Flemish Red List categories are based on two criteria: A trend criterion (change in the extent of distribution between two compared periods) and a rarity criterion (the number of sites, populations, grid squares, etc. of a species). The application of the Red List criteria in Flanders is summarised in Table 1. Additional Red List categories, not shown in Table 1, are ‘Probably threatened’ (i.e., studies on single or few populations indicate that the species is threatened in its entire range) and ‘Data deficient’ (i.e., insufficient data are available for correct assessment, for example because of the inconspicuousness of species or an unclear taxonomy).

**Table 1** – Classification scheme for the Red Lists of Flanders; the % that determine rarity (% grid squares, populations, etc.) and trend (decline in the number of grid cells, populations, etc.) are indicative.

| Trend                    | Rarity        |                       |              |                      |                  |
|--------------------------|---------------|-----------------------|--------------|----------------------|------------------|
|                          | Extinct<br>0% | Very rare<br><2%      | Rare<br>2-5% | Fairly rare<br>5-15% | Not rare<br>>15% |
| Very strong decline >75% | Extinct       | Critically Endangered | Endangered   | Vulnerable           | Near threatened  |
| Strong decline 50-75%    | –             | Endangered            | Endangered   | Vulnerable           | Near threatened  |
| Moderate decline 25-50%  | –             | Vulnerable            | Vulnerable   | Vulnerable           | Near threatened  |
| No decline <25%          | –             | Rare                  | Rare         | Rare                 | Not threatened   |

Since 1994, 16 Red Lists have been compiled in Flanders: Five vertebrate groups, nine invertebrate groups, higher plants and a selected group of fungi (Table 2).

**Table 2** – Published Red Lists in Flanders together with their reference and the total number of species per taxonomic group.

| Group                   | Reference                           | Number of species |
|-------------------------|-------------------------------------|-------------------|
| <b>Vertebrates</b>      |                                     |                   |
| Mammals                 | Criel (1994)                        | 59                |
| Amphibians & Reptiles   | Bauwens and Claus (1996)            | 19                |
| Fish                    | Vandelannoote and Coeck (1998)      | 55                |
| Birds                   | Devos and Anselin (1999)            | 163               |
| <b>Invertebrates</b>    |                                     |                   |
| Carabid beetles         | Desender <i>et al.</i> (1995)       | 352               |
| Butterflies             | Maes and Van Dyck (1996)            | 64                |
| Dragonflies             | De Knijf and Anselin (1996)         | 58                |
| Spiders                 | Maelfait <i>et al.</i> (1998)       | 607               |
| Grasshoppers            | Decler <i>et al.</i> (2000)         | 39                |
| Dolichopodid flies      | Pollet (2000)                       | 260               |
| Empidid flies           | Grootaert <i>et al.</i> (2001)      | 258               |
| Water bugs              | Bosmans <i>et al.</i> (in prep.)    | 57                |
| Land snails             | Backeljauw <i>et al.</i> (in prep.) | 104               |
| <b>Plants and fungi</b> |                                     |                   |
| Fungi                   | Walley and Verbeken (1999)          | 552               |
| Higher plants           | Biesbrouck <i>et al.</i> (2001)     | 1028              |

A digital list of all species for which a Red List has been compiled together with their threat status in Flanders can be found on [ftp://ftp.instat.be/Users/Dirk\\_M/RedListsFlanders.xls](ftp://ftp.instat.be/Users/Dirk_M/RedListsFlanders.xls) or on [www.nara.be](http://www.nara.be).

## DISCUSSION

Flanders is a small region (13,512 km<sup>2</sup>) which makes a straightforward application of the regional IUCN Red List criteria inappropriate. Table 3 shows the Red List of butterflies (Maes and Van Dyck 1999; 2001) based on the IUCN Red List criteria. This exercise clearly shows that many Flemish butterfly species would appear in the most threatened IUCN Red List category (based on criterion 'B1ab' in the guidelines of Gärdenfors *et al.* (2001)) simply due to the limited area of Flanders. Even smaller European countries or regions (e.g., Luxembourg, Liechtenstein, Andorra, or the different German 'länder', etc.) would have all their species, even the most widespread ones, in the category 'Critically endangered' on the basis of this limited 'extent of occurrence' cri-

terion. This does not allow prioritisation of threatened species because they appear all equally threatened.

**Table 3** – Number of butterfly species in Flanders using the Flemish Red List criteria compared to the IUCN Red List criteria.

| Red List category     | Number of species |                           |
|-----------------------|-------------------|---------------------------|
|                       | RL criteria       | Flanders RL Criteria IUCN |
| Extinct               | 19                | 19                        |
| Critically endangered | 5                 | 14                        |
| Endangered            | 6                 | 4                         |
| Vulnerable            | 7                 | 3                         |
| Rare                  | 3                 | –                         |
| Data deficient        | 1                 | 1                         |
| Not threatened        | 23                | 23                        |
| <b>Total</b>          | <b>64</b>         | <b>64</b>                 |

Since much more data are available on vertebrates and on vascular plants, the proposed IUCN criteria are more easily applicable to these groups than to lower organisms, such as invertebrates [dolichopodid – Pollet (2000) or empidid flies – Grootaert *et al.* (2001)] or lower plants (Hallingbäck *et al.* 1995)]. Their distribution and certainly their population numbers are only vaguely known, let alone changes in the area of extent or the number of populations.

Comparability of Red Lists among countries or regions is, in our opinion, of secondary importance to comparability among taxa within a country or region. Nature conservation is the competence of local or national governments and should therefore focus on the local scale. Listing priorities within a region or country should be based on comparable categories and criteria within the region rather than between countries or regions. Recently, techniques have been developed to compare trends among species of different taxonomic groups within a country or region (Telfer *et al.* 2002). As an example, we compared trends of butterflies and dragonflies in Flanders. Among the ten most declining species of both groups, nine are butterflies and only one is a dragonfly (Table 4); this means that butterflies have declined stronger than dragonflies (Maes and Van Dyck 2001). Extending such trend calculations to other taxonomic groups will result in an objective priority list for the compilation of national or regional species action plans.

**Table 4** – Comparing trends of two taxonomic groups (butterflies and dragonflies) in Flanders (north Belgium) using Telfer *et al.* (2002).

| Species                                    | Trend  |
|--|--------|
| 1 <i>Polyommatus semiargus</i> (butterfly) | -3.290 |
| 2 <i>Issoria lathonia</i> (butterfly)      | -2.720 |
| 3 <i>Melitaea cinxia</i> (butterfly)       | -2.807 |
| 4 <i>Pyrgus malvae</i> (butterfly)         | -2.446 |
| 5 <i>Leptidea sinapis</i> (butterfly)      | -2.428 |
| 6 <i>Satyrrium w-album</i> (butterfly)     | -1.320 |
| 7 <i>Hesperia comma</i> (butterfly)        | -1.234 |
| 8 <i>Coenagrion hastulatum</i> (dragonfly) | -1.055 |
| 9 <i>Plebeius argus</i> (butterfly)        | -0.971 |
| 10 <i>Limenitis camilla</i> (butterfly)    | -0.576 |

#### FUTURE USE OF RED LISTS IN FLANDERS

In the future, the use of Red Lists and the ‘follow-up’ of Red List species in Flanders will probably change; the compiled information in the present Red Lists is usually rapidly out of date because many threatened species decline at such speeds that one can only confirm its extinction in a next Red List published 10-15 years later. Threatened species should therefore be monitored on a year to year basis so that species declines are detected early enough to undertake conservation actions. Since it will not be feasible to monitor all threatened species, a well selected set of species from different taxonomic groups and habitats (a so called multi-species approach) is more appropriate (Lambeck 1997; Van Dyck *et al.* 2001).

#### REFERENCES

- BACKELJAUW, T. *et al.*, in prep. *Gedocumenteerde Rode Lijst van de landslakken van Vlaanderen*. Institute of Nature Conservation, Brussels.
- BAUWENS, D. and K. CLAUS, 1996. *Verspreiding van amfibieën en reptielen in Vlaanderen*. De Wielewaal, Turnhout.
- BIESBROUCK, B., K. ES, W. VAN LANDUYT, L. VANHECKE, M. HERMY and P. VAN DEN BREMT, 2001. *Een ecologisch register voor hogere planten als instrument voor het natuurbehoud in Vlaanderen*. Institute of Nature Conservation, National Botanic Garden of Belgium, Brussels and Katholieke Universiteit Leuven.
- BLAB, J., E. NOWAK, W. TRAUTMAN and H. SUKOPP, 1984. *Rote Liste der gefährdeten Tiere und Pflanzen in der Bundesrepublik Deutschland*. Kilda, Greven.

- BOSMANS, R. *et al.*, in prep. *Gedocumenteerde Rode Lijst van de water- en oppervlaktewantsen van Vlaanderen*. Institute of Nature Conservation, Brussels.
- CRIEL, D., 1994. *Rode lijst van de zoogdieren in Vlaanderen*. AMINAL, Brussels.
- DE BRUYN, L., J. SCHEIRS and H. VAN GOSSUM, 2002. How affluence harms the environment in Europe. *Nature* 417: 485.
- DE KNIJF, G. and A. ANSELIN, 1996. *Een gedocumenteerde Rode lijst van de libellen van Vlaanderen*. Institute of Nature Conservation, Brussels.
- DECLER, K., H. DEVRIESE, K. HOFMANS, K. LOCK, B. BARENBURG and D. MAES, 2000. *Voorlopige atlas en 'rode lijst' van de sprinkhanen en krekels van België (Insecta, Orthoptera)*. SALTABEL, Brussels.
- DESENDER, K., D. MAES, J.-P. MAELFAIT and M. VAN KERCKVOORDE, 1995. *Een gedocumenteerde Rode Lijst van de zandloopkevers en loopkevers van Vlaanderen*. Institute of Nature Conservation, Brussels.
- DEVOS, K. and A. ANSELIN, 1999. Broedvogels. In: Kuijken, E. (ed.) *Natuurrapport 1999*. Toestand van de natuur in Vlaanderen: cijfers voor het beleid. Institute of Nature Conservation, Brussels.
- GÄRDENFORS, U., C. HILTON-TAYLOR, G.M. MACE and J.P. RODRÍGUEZ, 2001. The application of IUCN Red List criteria at regional levels. *Conserv. Biol.* 15: 1206-1212.
- GROOTAERT, P., M. POLLET and D. MAES, 2001. A Red Data Book of Empidid Flies of Flanders (northern Belgium) (Diptera, Empididae s.l.): constraints and possible use in nature conservation. *J. Insect Conserv.* 5: 117-29.
- HALLINGBÄCK, T., N.G. HODGETTS and E. URMI, 1995. How to apply the new IUCN Red List Categories to Bryophytes. *Species* 24: 37-41.
- IUCN Species Survival Commission, 1994. *IUCN Red List Categories*. IUCN, Gland.
- LAMBECK, R.J., 1997. Focal species: A multi-species umbrella for nature conservation. *Conserv. Biol.* 11: 849-56.
- MACE, G.M. and S. STUART, 1994. Draft IUCN Red List Categories, Version 2.2. *Species* 21: 13-24.
- MAELFAIT, J.-P., L. BAERT, M. JANSSEN and M. ALDERWEIRELDT, 1998. A Red list for the spiders of Flanders. *Entomologie* 68: 131-42.
- MAES, D., J.-P. MAELFAIT and E. KUIJKEN, 1995. Rode lijsten: een onmisbaar instrument in het moderne Vlaamse natuurbehoud. *Wielewaal* 61: 149-56.
- MAES, D. and H. VAN DYCK, 1996. *Een gedocumenteerde Rode lijst van de dagvlinders van Vlaanderen*. Institute of Nature Conservation, Brussels.
- MAES, D. and H. VAN DYCK, 1999. *Dagvlinders in Vlaanderen – Ecologie, verspreiding en behoud*. Stichting Leefmilieu, in co-operation with the Institute of Nature Conservation and the Vlaamse Vlinderwerkgroep, Antwerp/Brussels.
- MAES, D. and H. VAN DYCK, 2001. Butterfly diversity loss in Flanders (north Belgium): Europe's worst case scenario? *Biol. Conserv.* 99: 263-76.
- MAES, D. and C.A.M. VAN SWAAY, 1997. A new methodology for compiling national Red Lists applied on butterflies (Lepidoptera, Rhopalocera) in Flanders (N.-Belgium) and in The Netherlands. *J. Insect Conserv.* 1: 113-24.
- POLLET, M., 2000. *Een gedocumenteerde Rode lijst van de slankpootvliegen (Dolichopodidae) van Vlaanderen*. Institute of Nature Conservation, Brussels.

- POSSINGHAM, H.P., S.J. ANDELMAN, M.A. BURGMAN, R.A. MEDELLÍN, L.L. MASTER and D.A. KEITH, 2002. Limits to the use of threatened species lists. *Trends in Ecology & Evolution* 17: 503-7.
- SCHNITTNER, M., G. LUDWIG, P. PRETSCHER and P. BOYE, 1994. Konzeption der Roten Listen der in Deutschland gefährdeten Tier- und Pflanzenarten – unter Berücksichtigung der neuen internationalen Kategorien. *Natur und Landschaft* 69: 451-9.
- TELFER, M.G., C.D. PRESTON and P. ROTHERY, 2002. A general method for measuring relative change in range size from biological atlas data. *Biol. Conserv.* 107: 99-109.
- VAN DYCK, H., D. MAES and I. BRICHAU, 2001. *Toepassen van een multi-soortenbenadering bij planning en evaluatie in het Vlaamse natuurbehoud*. Report of the University of Antwerp (in assignment of the Ministry of the Flemish Community, Department of Nature), Wilrijk.
- VAN HECKE, E. and C. DICKENS, 1994. Bevolking, pp. 45-61. In: A. Verbruggen (ed.), *Leren om te keren, Milieu- en natuurrapport Vlaanderen*. Vlaamse Milieumaatschappij en Garant Uitgevers N.V., Leuven/Apeldoorn
- VANDELANNOOTE, A. and J. COECK, 1998. Rode lijst van de inheemse en ingeburgerde zoet- en brakwatersoorten en van de rondbekken in Vlaanderen, pp. 259-264. In: A. Vandelanootte, R. Yseboodt, B. Bruylants, R.F. Verheyen, J. Coeck, J. Maes, C. Belpaire, G. Van Thuyne, B. Denayer, J. Beyens, D. De Charleroy and P. Vandenabeele (eds.), *Atlas van de Vlaamse beek- en riviervissen*. Water-Energik-vLario, Wijnegem.
- VAN OMMERING, G., 1994. *Notitie Kategorieën, Criteria en Normen voor Rode Lijsten*, opgesteld conform besluiten van de klankbordgroep Rode Lijsten, ingesteld door NBLFF. Ministry of Agriculture, Nature Management and Fisheries, 's Gravenhage.
- WALLEYN, R. and A. VERBEKEN, 1999. *Een gedocumenteerde Rode Lijst van enkele groepen paddestoelen (macrofungi) van Vlaanderen*. Institute of Nature Conservation, Brussels.





# 25

## Red Lists and Red Data Books in Northwest Russia: intents, approaches and realities

*A. Zavarzin, O. Krever, R. Sagitov and V. Petrov*

### INTRODUCTION AND THE HISTORY OF RED LISTING IN RUSSIA

Intensive and widely spread activities in red listing and compilation of Red Lists and Red Data Books indicate the concern of the human civilisation in preserving the essential elements of 'Life on Earth': all the existing species of organisms. This largely comes from the understanding that only maintaining the organisms' (genetic) diversity can help to conserve the ecological processes forming the life support system on earth. Accordingly, the Red Listing activities themselves help to monitor changes in the human impact on biological diversity globally and locally, while the outcome of this work also leads to the understanding of the magnitude of this human impact.

Throughout the history of species conservation in Russia, starting with the Russian Empire (followed by the Soviet Union and further by the Russian Federation), Russia has actively participated in this process, in several ways. In 1911 Russia, together with USA, Japan and Great Britain signed the Washington International Convention on the conservation of seals. Later in the 20th century the IUCN approach in collecting and analysing data on rare and endangered species world-wide, was accepted, and Russian zoologists compiled the first data base of rare mammal and bird species for the Global Red List of IUCN during 1961-1964. In the next ten years the 'Red Data Book of Rare and Endangered Species of Animals and Plants of the Soviet Union' was prepared and officially adopted by the Ministry of Agriculture of USSR on March 12, 1974. The first edition of this book was published in 1978 and the second, revised one – in 1984. The first edition contained data on 62 species and subspecies of mammals, 63 species of birds, 8 species of amphibians, 21 species of reptiles and 444 species of vascular plants, all of them being officially recognised as either being in danger of extinction or rare in the whole area of the Soviet Union (Red Data Book of USSR 1978).

In the course of compiling the 'Red Data Book of the USSR' it became obvious that, due to the size of the country and diversity of the climatic zones sim-

ilar compilations were necessary for the units (Republics) in order to ensure both a better preservation of the species included in the Union's Red Data Book and special conservation measures for those species that were already threatened locally but not yet nationally. Based on that assumption the Soviet Republics were obliged to prepare their own Red Data books. The Red Data Book of the Russian Soviet Federative Socialist Republic (RSFSR) was compiled during the 80-s. Its volume on animals was published in 1983 in accordance with the Republican Law 'On the Conservation and Use of the Animal World' (1980) and following the decision by the Republican Supreme Council to establish the Red Data Book (1982). Structurally the Red Data Book of RSFSR is similar to the third edition of the IUCN Red Data Book and second edition of the USSR Red Data Book (Red Data Book of USSR 1984). It contains data on 245 species and subspecies of animals (Table 1) including 49 invertebrates (15 molluscs and 34 insects) and 196 vertebrates (9 fishes, 4 amphibians, 11 reptiles, 107 birds and 65 mammals). The taxa were split into five categories:

- I *species and subspecies facing extinction*: those which declined to critical numbers or of which habitats had been destroyed to the extent that they will get extinct in the nearest future.
- II *species and subspecies significantly decreasing in numbers*: those that were rare or even common in the past but are constantly decreasing and requiring special measures, or otherwise will be subjects for the category I.
- III *rare species and subspecies*: those that are not facing extinction but occur in such low numbers or encountered in such limited areas that any threat may lead them towards extinction.
- IV *species and subspecies of undetermined status*: insufficiently known and poorly studied species that may be endangered but require further investigations for exact conclusions to be made.
- V *restored species and subspecies*: those that started to recover after measures taken having been but are still requiring monitoring of their status.

**Table 1** – Number of species and subspecies of animals, assigned to different categories in the Red Data Book of the RSFSR (1983)

| Cat.         | Mammals   | Birds      | Reptiles  | Amphibians | Fishes   | Invertebrates | Total | %          |
|--------------|-----------|------------|-----------|------------|----------|---------------|-------|------------|
| I            | 22        | 25         | 1         |            | 3        | 16            | 67    | 27,0       |
| II           | 17        | 24         | 3         | 4          | 4        | 21            | 73    | 29,4       |
| III          | 18        | 40         | 5         |            | 1        |               | 64    | 25,8       |
| IV           | 7         | 18         | 2         |            | 1        | 12            | 40    | 16,2       |
| V            | 4         |            |           |            |          |               | 4     | 1,6        |
| <b>Total</b> | <b>68</b> | <b>107</b> | <b>11</b> | <b>4</b>   | <b>9</b> | <b>49</b>     |       | <b>100</b> |

Similarly to the one on animals 'The Red Data Book of the RSFSR: plants' was published in 1988 and contained data on 533 species of plants including 465 species of vascular plants, 22 species of bryophytes, 29 species of lichens and 17 species of fungi. In this volume the species were classified according to the categories adopted in the 'List of Rare, Threatened and Endemic Plants in Europe' (1977) and the first 'IUCN Plant Red Data Book' (1978) and included the following categories:

- 0 (Ex) – *probably extinct species (subspecies)*
- 1 (E) – *species (subspecies) facing extinction*: survival is not possible if the impacting threats remain.
- 2 (V) – *endangered species (subspecies)*: those that will soon be shifted to the category 1 if threats to them remain.
- 3 (R) – *rare species (subspecies)*: those that are represented by small populations and are not endangered but are facing the risk of being endangered.
- 4 (I) – *undetermined species (subspecies)*: those that are presumably belonging to the categories 0-3, but are insufficiently known and poorly studied to make conclusions about their state.

**Table 2** – Number of species and subspecies of plants, assigned to different categories in the Red Data Book of the RSFSR (1988)

| Category     | Vascular plants | Bryophytes | Algae    | Lichens   | Fungi     | Total      | %          |
|--------------|-----------------|------------|----------|-----------|-----------|------------|------------|
| 0            | 8               |            |          |           |           | 8          | 1          |
| 1            | 74              |            |          |           |           | 74         | 15         |
| 2            | 118             |            |          | 8         |           | 126        | 25         |
| 3            | 245             | 22         |          | 21        | 16        | 304        | 57         |
| 4            | 10              |            |          |           | 1         | 11         | 2          |
| <b>Total</b> | <b>465</b>      | <b>22</b>  | <b>0</b> | <b>29</b> | <b>17</b> | <b>533</b> | <b>100</b> |

Resulting from the Red Listing process 20% of the fauna and 2,5% of the flora of Russia was considered to be rare or endangered.

#### THE PRESENT STATE OF RED LISTING IN THE RUSSIAN FEDERATION AND IT'S REGIONS

After the collapse of the Soviet Union and during the period of social and economic instability the species conservation activities have still been in place in modern Russia. Vast areas of the Russian Federation have maintained natural processes in major ecosystems and nowadays there are over 1,800 species

of vertebrates, approximately 150 000 species of invertebrates, and over 22,000 species of vascular plants reported from the country. Among those, 418 species are included in the global IUCN Red List (Table 3).

**Table 3** – Numbers of species from selected taxonomic groups reported from the territory of the Russian Federation, listed in the national Red Data Book and in the global IUCN Red List (data compiled by O. Krever and V. Gorbatovsky).

| Group           | No. of species | Red listed in Russian Federation |              | Red listed by IUCN |              |
|-----------------|----------------|----------------------------------|--------------|--------------------|--------------|
|                 |                | No.                              | % from total | No.                | % from total |
| Mammals         | 320            | 65                               | 20           | 51                 | 16           |
| Birds           | > 730          | 123                              | 17           | 57                 | 8            |
| Reptiles        | 75             | 21                               | 28           | 6                  | 8            |
| Amphibians      | 27             | 8                                | 30           | 4                  | 15           |
| Fishes          | >650           | 33                               | 5            | 50                 | 8            |
| Vascular plants | >20 000        | 440                              | 2            | 250                | 1            |

Both the Constitution of the former Soviet Union and the present Constitution of the Russian Federation consider the necessity of nature protection and sustainable use of natural resources. International treaties and the system of federal environmental legislation intend to provide a sufficient basis for identification, preservation and monitoring of rare species of plants, animals and fungi and allow to scale this process down to the regional level to ensure better conservation of biological diversity of Russia.

The present legal framework for species conservation on the federal level consists of the Constitution of the Russian Federation (RF; 1993), the Law on the Animal World (1995), the Law on the Protection of the Environment (2002) and others. The Red Data Book of the RF is the main direct legal document that lists the endangered and rare species and supposes to regulate activities related to or affecting these species. The Red Data Book of the RF is scientifically based on the Red Data Book of the RSFSR, but was prepared and has to be revised according to the Decision of the Government ‘On the Red Data Book of the Russian Federation’ from 19.02.1996. The revised list of animals was legally adopted in 1997 and ‘The Red Data Book of the Russian Federation: Animals’ was published in 2001. The system of categories remains in principle like it was in the one of the RSFSR but a new category (0 – probably extinct) was added. The new list now contains 415 taxa (including 260 vertebrate and 155 invertebrate species and subspecies). The new list of rare and endangered plants (including fungi) is still under discussion thus

leaving the Plant volume of the Red Book of the RSFSR to be the valid reference (see above).

Compared to the situation in many other countries, the Russian Red Data Books are not only resulting from and promoting further activities in the areas of conservation biology, public awareness and environmental lobbying, but also intend to serve as a legal basis for species protection. Therefore considering the size of the country when its regions often exceed territories of the largest European states, it is essential to downscale this process to the regional level to ensure practical preservation of populations and habitats of the rare and endangered taxa and enforce federal legislation. Accordingly the 'Subjects of Federation' (the Regions of the Russian Federation) have also started the process of identifying and legalising the means to conserve species through preparing and adopting regional Red Lists and Red Books. Initially this process has been started by the research institutions that have maintained and constantly compiled data on the regional biological diversity, thus also obtaining information on the status of different taxa. Taking into consideration the increased level of regional economic independence, the intention was to use the available legislation and scientific data to produce regional lists of rare species, to identify the existing threats to these species, to promote monitoring and conservation measures to be taken through adoption of Red Lists as the regional legal acts. However, the absence of specified federal regulation caused the process of regional Red Listing to turn out to be chaotic and uncontrolled. At the moment there are 37 regional Red Data Books covering 42 out of 89 regions of Russia. Regrettably most of these Red Data Books do not meet federal requirements for such publications to be regional legal acts (i.e. published after the regional legal act on the Red Data Book has been approved). These Red Data Books have only scientific or awareness value and do not constitute the basis for direct protection of the listed species and forms on site.

#### NORTH-WEST RUSSIA AS A CASE STUDY OF THE INITIAL PHASE OF REGIONAL RED LISTING PROCESS IN THE RUSSIAN FEDERATION

Among the seven super-regions into which the Russian Federation was recently divided the region of North-West Russia is a good example to analyse the strengths and weaknesses of developing regional Red Data Books. The selected region is comparatively advanced both in terms of scientific potential and socio-economic development. Furthermore it is subjected to direct economic and social influence from European countries that also facilitates possibilities for the development of international species conservation approaches.

The region of NW Russia covers 1.7 millions km<sup>2</sup> (about 10% of Russia and 16% of Europe) and consists of 11 administrative regions. Part of the Arctic and most of Kola-Karelian and eastern European forest bioregions are

within the borders of NW Russia. The area is important to maintain populations of several endemic plants and animals as well as over 20 globally threatened species from the IUCN Global Red List. Large numbers of species of international concern (e.g. 79 bird species of European Conservation Concern) are widespread here, and the region also contains viable populations of nearly all large European mammals (such as brown bear, lynx, wolverine, otter, elk, , etc) threatened elsewhere. The main threats to the rare species are coming both from the direct impact of unregulated exploitation and from the indirect impact of growing urbanisation, pollution and habitat destruction. Therefore there is an urgent need to specify and implement measures to maintain and preserve regionally rare or endangered species.

**Table 4** – Numbers of species listed in the regional Red Books in NW Russia

| RDB                          | Vertebrates       | Invertebrates     | Vascular plants | Bryophytes | Algae | Fungi | Lichens |
|------------------------------|-------------------|-------------------|-----------------|------------|-------|-------|---------|
| RDB of Archangel Region      | 70                | 51                | 216             | 2          | –     | 11    | 2       |
| RDB of Republic of Karelia   | 104               | 259               | 205             | 86         | –     | 23    | 77      |
| RDB of St. Petersburg Region | under preparation | under preparation | 201             | 56         | 71    | 151   | 49      |

Recognising the need to preserve biological diversity the Red Listing process was started in most of the regions of NW Russia as early as in the beginning of the 90s. Since then four out of the eleven regions have published their Red Data Books:

- The Red Data Book of the Archangel region. Rare and Protected Plant and Animal Species. 1995
- The Red Data Book of the Republic of Karelia. Rare Plants and Animals and those in Need of Protection. 1995
- The Red Data Book of the Republic of Komi. Rare and Endangered Species of Plants and Animals. 1998
- The Red Data Book of the St. Petersburg region. Vol. 1 Protected Areas. 1999; Vol. 2 Plants. 2000; Vol. 3 Animals (in press).

As appears from the Red Listing approach in Russia the Red Data books are intended to be sources for scientific research in conservation biology, to serve as educational and awareness material for the general public and to provide a

legal framework for species conservation. Therefore the evaluation of the first regional Red Data Books is to be done in relation to the stated principles.

The scientific value of the above mentioned compilations firstly comes from the fact that most of them contain data not only on mammals, birds and flowering plants, but on all major groups of organisms (plants, animals and fungi) that are considered to be rare (Table 4). Secondly, the process of compiling the lists of rare taxa required the assessment of existing data, thus resulting also in the identification of 'gaps' in our knowledge and creating a platform for regional species inventory projects. Thirdly, the layout and structure of descriptive articles are generally following the one from the Red Data Book of the Russian Federation, rendering the resulting data comparable between the regions.

However, the overall problem for the compilation of scientifically significant and applicable Red Data books in the region is coming firstly from the unequal distribution of knowledge of the regions' biological diversity and the uneven distribution of its scientific potential. This leads to unequal and inadequate representation of the different macrotaxa in the regional lists. Furthermore this problem is coupled with the lack of standardised principles for (i) selecting species to be included in the Red List, (ii) describing those that were selected, (iii) categorising the list, (iv) establishing monitoring of the species' population status. All the Red Data Books in the region are applying similarly named categories of rarity into which the species are categorised. These categories intend to follow those adopted in the federal Red Data Book and are referred to as 'the IUCN categories'. However in reality the categories used are not equal in meaning and are corresponding to the 'old' categories adopted by the IUCN SSC a long time ago and not in use any longer. Furthermore specified criteria for the application of the categories are lacking, leaving only the experts' 'common sense' as the driving source to include or not include particular species and groups in the lists. Therefore, scientifically the data from these books is hardly comparable. Another obvious problem is the lack of co-ordination between the regions in the Red Listing process that often results in illogical differences in the contents of the Red Lists and the proposed conservation measures. Such differences have negative consequences when practical conservation activities are designed.

From the educational point of view most of the Red Data Books published so far have been nicely designed, well illustrated and contain detailed descriptive articles for each taxon. However, because of the price and the limited number of copies published, these books are hardly available for the public. Also, no additional educational material has ever been prepared and published to disseminate this information on rare species and their habitats to different social groups, including schoolchildren. The characteristic situation is that most of the people in the region know about 'the Red Data Book' in general, but are not aware of what kind of Red Data Books exists and they can rarely mention any example of a species from any of the Red Data Books.

The third criterion – the legal functioning of the regional Red Data Book – is by no means fulfilled by the Red Data Books published in NW Russia. So far only the Red Data Book of Karelia was compiled according to the adopted regional law. The Red Data Book of Archangel has been considered to be just a scientific publication from the very beginning and there was no legislation making reference to the Red Data Book ever prepared for the region. The remaining two official Red Data Books had been compiled before the legal acts were drafted and thus are still lacking legal support. Unfortunately, even for the Red Data Book of Karelia, the law had been adopted before the federal legislative framework was set, resulting in the former becoming outdated and being in need of serious revision by now.

Thus neither of the existing regional Red Data Books in NW Russia is fully meeting the criteria of the ‘Red Listing intent’ and some are rather negative examples that must be accounted for in order not to be repeated. But the main question now is how the identified problems can be overcome when new Red Lists are prepared and how we can develop better examples within the region?

The serious problem of the inequality of data for different groups of organisms probably will not be solved in the near future, though joint regional inventory programmes should be developed and implemented. Most of the solutions to the other problems mentioned above, have already been proposed by the IUCN CIS Office in ‘Strategy for Conservation of Rare Species in Russia’. This implies *inter alia* that:

- the structure of regional Red Data Book must follow that of the federal Red Data Book ;
- categories and criteria used in the federal Red Data Book must be applied for the compilation of the regional Red Data Books;
- recommended conservation measures related to the different regional Red Data Books must be effectuated in order to ensure preservation of e.g. migrating species;
- the regional Red Data Book must be revised every time when new information on rare species becomes available;
- the regional Red Data Book must be the legal instrument to ensure efficient species conservation at the regional level.

The last solution is the most difficult one due to the generally insufficient knowledge of legal practices by biologists who are mainly involved in Red Listing. Simplified classification of legal documents includes three categories:

- *declarational legal acts* – those that contain principles that form the basis for the regulation of relations within this area of legislation (telling ‘what would be good to do’). These legal acts can operate on their own in the absence of legal acts that would specify them and only if there are people responsible and interested in implementing those principles.



- *procedural legal acts* – those that regulate the order of implementing regulations within the area of legislation, specifying rights and responsibilities of participating parties (telling ‘what, is to be done and how, when, and by whom and what is the order of steps to be taken’).
- *physical legal acts* – those that are explaining to which extent the relations are implemented (telling ‘what exactly and to which extent it is to be done’).

Practically only those legal institutions that contain all three categories of the legal instruments are effective. Therefore compilation of the new regional Red Data Books requires specific attention to the legal acts to be adopted beforehand. A positive example is also coming from NW Russia where the Murmansk region has introduced a document about such requirements, as a basis for the Red Data Book.

Firstly, the regional Law ‘On the Red Data Book of the Murmansk region’ clearly identifies types of decisions to be taken after a rare species from the defined category is found. Secondly, the categories are not only identified by the scientific means but also by the set of conservation measures that they require. Thirdly, the document defines the legal meaning of such terms as ‘habitat’, ‘critical ecotope’, ‘fitting in the landscape’ that have to be specified in the description of each species included in the Red Data Book. Implementation of this law remains to be started, but the example of conservationists and regional authorities who were able to find a compromise is promising and provides a good basis for developing common principles in legalising regional Red Lists.

Though even the most difficult problems seem to have solutions, successful implementation of the proposed measures cannot be achieved just within one region and efforts are required on three different levels: regional, national and international.

At the regional level it is important that the legal acts are adopted, specifying procedures to be followed and measures to be secured before the Red List is compiled (see above). Furthermore, the compilation must start with the production of a Red List which after a certain period of revision and data accumulation can be transformed into a Red Data Book. It is also necessary to keep in mind that Red Listing must not only lead to the publication of a Red Data Book, but also must create a sufficient basis for developing regional Action Plans for species conservation which include both inventories and monitoring, and public awareness programmes.

Regional activities are to be supported at the national level. This support must come primarily from the co-ordination of species conservation efforts in different regions and may also consist of the development of exemplary legal acts (including definitions and criteria) to be adopted, which the regions will be obliged to follow. It is also necessary that particular species conservation strategies are discussed and developed at the national level. Only in this case

further revision of the federal Red Data Book will be based on data from the regional ones, not vice versa.

The next level – international co-operation – is also essential for successful species conservation. On this level the rarity categories and framework criteria for them are to be agreed upon, and further made applicable on different scales. Such work has been undertaken by IUCN, though it is still far from complete. Unfortunately, IUCN criteria and guidelines for their application are poorly known and rarely implemented in Russia, and more effort is to be made to introduce the IUCN approach at the regional level. The overall conclusion from the brief analysis of Red Listing in Russia shows the high potential of the IUCN network to facilitate and co-ordinate this process and positively affect species conservation in Russia in general.

#### REFERENCES

- IUCN, 1978. *The IUCN Plant Red Data Book*. IUCN, Morges.
- MINISTRY OF AGRICULTURE, 1978. *The Red Data Book of USSR. Rare and Endangered Species of Animals and Plants*. Krasnaya Kniga SSSR. Lesnaya Promyshlennost Publishers, Moscow.
- MINISTRY OF AGRICULTURE, 1984. *The Red Data Book of USSR*. Second Edition revised and enlarged. Krasnaya Kniga SSSR. Lesnaya Promyshlennost Publishers, Mosco.
- RSFSR, 1983. *The Red Data Book of the RSFSR: Animals*. Krasnaya Kniga RSFSR. Zhivotnye. Rosselkhozizdat, Moscow.
- RSFSR, 1988. *The Red Data Book of the RSFSR: Plants*. Krasnaya Kniga RSFSR. Rastenia. Rosagropromizdat, Moscow.

# 26

## Basis for standard classification of habitat types and threats in Red lists

### Example from Norway

*F. Ødegaard*

#### INTRODUCTION

The main aims of this pilot project were to develop a standard hierarchical list for reporting habitat types and threat types of Red-Listed species based on existing classification systems of nature types in Norway, and to test these systems for selected groups of Red-Listed species within beetles, butterflies and vascular plants. The long term aim was, through extension, being able to apply the system for all species across taxonomic groups.

The project was initiated as a part of an adaptation of the Norwegian Red List for information and management purposes. The Norwegian Red List contains 3,060 species belonging to 27 different taxonomic groups. A safe management of the Red-Listed species demands proper knowledge about habitats and threats for each species. Easy and flexible access to existing knowledge is a key qualification for obtaining precise management. Then, one of the first requirements is a standard system for reporting habitats and threats across taxonomic groups.

#### STANDARDIZATION OF HABITAT TYPES

The first part of this study was to develop a standard hierarchical system for reporting habitat types for all organisms across all taxonomic groups. Originally, the Norwegian Red Data List distinguished only six main types of habitats. Thus, there was a need for more detailed reporting of habitat types for each species in order to produce Red Lists as a tool for management of areas. The two existing systems for classification of nature types: 'Norwegian vegetation types' (Fremstad 1997), and 'Mapping of nature types' (Directorate for Nature Management 1999) were assessed as a basis for a new system.

Habitat units of 'Norwegian vegetation types' are defined through the composition of plant species (e.g. lichen woodland, alpine ridge vegetation). The advantage of that system is that units are consistently area covering without

overlap, and the system works well for producers and herbivorous species. It is also an advantage that the units are mainly defined based on species composition, because our basis is that species themselves are the most important factors for categorization of habitat types. On the other hand, vegetation types poorly reflect specialised organisms living in general habitat types. The same is true for species belonging to functional groups other than producers and herbivores (e.g. decomposers, predators, fungivores). Such organisms are better classified in systems based on their substrata or keystone factors. Habitats without vegetation, for instance caves and sterile gravel fields, are poorly classified in terms of vegetation types.

‘Mapping of nature types’ is a system developed for municipalities in Norway as a tool for mapping their areas of concern regarding biological diversity. Important criteria for the classification of habitat types in that system are the presence of Red-Listed species, important substrata and keystone habitats. Several problems are met when the system is extended to a unified system for all taxonomic groups. Firstly, there are serious problems with scale, because hierarchical units can not be consistently nested. Secondly, some units are overlapping and not consistently area covering.

In total, a unified system of habitat types should consider scale in a hierarchical way, area cover and overlapping units should be separated, the system should be based on species composition of all taxonomic groups, and finally, habitats, substrata, and keystone factors should be treated separately.

A unified system for Norway could be based on ‘Norwegian vegetation types’, including areas without vegetation. In addition, it is necessary to specify substratum-based point habitats. In this way, the decomposers, fungivores, and predators receive a precise and descriptive habitat category, without being too detailed. It is therefore proposed to report habitat characterization in a three step system. The first step is the habitat type which consists of hierarchical, completely area covering units, based on species composition of organisms (e.g. hierarchical from Woodland – pine forest – poor pine forest). Habitat types of organisms are reported as detailed as necessary according to the level of confidence.

The second step is the reporting of point habitats. These are substratum based units in the broad sense. For instance, the point habitats for herbivores would be their host plants, while for the predators, it would be their prey. More conventional, the point habitats of lichens and mosses would be stones, logs, dung etc. Point habitats could be reported as hierarchical units independent of area and time (e.g. hierarchical from ‘dead wood, bark or fungi’ to ‘dead wood, bark or fungi on pine’). It is not necessary to report point habitats for producers like vascular plants, because they are properly covered by habitat types. Exceptions would be for epiphytes and parasitic plants. Details of the hierarchical subdivision of habitat types and point habitats are reported in Ødegaard *et al.* (2001).

Finally, species-based ecological keystone factors should be reported (e.g. dependence on fire, old trees, nutrient composition, micro-climate). A standard list of keystone factors should be developed along with thorough testing of many taxonomic groups.

#### STANDARDIZATION OF THREAT TYPES

The second part of this study was to assess the meaning of, and the connection between, different human activities that threaten species diversity in Norway. There are 50 different threat types in the Norwegian Red List. These are described in very general ways, and they are not consistent across taxonomic groups. A survey of different definitions of threat types in the Nordic countries revealed differences in the meaning and in the degree to which they were worked out. In many cases the effects of the threats and the processes that cause the threats were mixed up. The hierarchical connections between the threats were not always clear, partly because several threat types relate to situations at different scales. This situation complicates the use of threats in reporting and management.

A survey of the human induced threats to species diversity was performed. Based on threat types used in the other Nordic countries, we tried to elucidate the relation between causes, processes and effects of threats for Red-Listed species (Box 1). With regard to the requirements in Red Lists, we found it important to divide threats into three different topics.

Human activities of impact were separated from the effects and processes observed in nature. Such kind of activities are for instance destruction of natural habitats, emission of chemicals or over-exploitation of vulnerable populations. This type of categorization harmonizes very well with the DPSIR-system (driving forces, pressures, states, impacts, responses) which is the causal framework for describing the interactions between society and the environment adopted by the European Environment Agency (EEA). In that system 'driving forces' and 'pressures' would be synonymous with 'human activities of impact' (see European Environment Agency 2002). When the human activities of impact are identified, it may facilitate the implementation of proper action plans aimed to reduce the threats, and also an easier allocation of responsibilities of sectoral ministries. These threats could be subdivided into 'pressure against areas/habitats', which include long series of different threat types (see Ødegaard *et al.* 2001 for detailed subdivision units). Further, emission of chemicals, pressure against individual organisms, impact of introduction and use of alien species, and impact of other and unknown activities could be reported (Box 2).

**Box 1** – Relation between causes, processes and effects of threat types for red-listed species.

physical, chemical and ecophysiological processes

Human activity of impact (cause) ♦ environmental effects ♦ individual effects ♦ population effects

*Example 1 – Overfertilizing*

increased drainage of nutrients, eutrophication, competition

Overfertilizing in agriculture ♦ increased nutrient status ♦ oxygen deficit ♦ reduced populations

*Example 2 – Climatic change*

atmospheric processes, physiological processes competition

emission of climate gases ♦ e.g. increase of temperature ♦ changed conditions of competition ♦ community changes

The second main topic of threat is ‘environmental changes’. This threat type includes all types of processes caused by human activities of impact. This could be chemical processes, climatic change or changes of physical environment. The categorization of these threats harmonizes very well with EEA’s ‘states’ in the DPSIR-system (European Environment Agency 2002). Environmental changes could be divided into 3 subcategories related to chemical processes, climatic change, and changes of physical environment, respectively. Further subdivision is proposed in Ødegaard *et al.* (2001).

Finally, impacts on individuals, populations or species should be reported. The categorization of these threats harmonizes well with EEA’s ‘impacts’ in the DPSIR-system (European Environment Agency 2002). The subdivisions in this category involve threats against populations on different scales which may be reported synchronously. These are: impact by fragmentation; critical shortage of habitat; interactions between species; changes in population structure; physiological effects; indirect effects (Box 2).

The presented system of threat types should be clear and consistent at least at the two uppermost levels in the hierarchy (Box 2). Further subdivision of categories are reported in Ødegaard *et al.* (2001).

## Box 2 – Systematic arrangement of threat types for Red-Listed species

### Human activity of impact

- Pressure on areas/habitats
- Emission of chemicals
- Pressure on individual organisms
- Impact of introduction and use of alien species
- Impact of other and unknown activities

### Environmental changes

- Chemical processes
- Climatic changes
- Changes of physical environment

### Impacts on populations

- Impact by fragmentation
- Critical shortage of habitat
- Interactions between species
- Changes in population structure
- Physiological effects
- Indirect effects

This proposal for standard reporting of habitat types and threats in Red Lists is tested for a selected number of taxa in the Norwegian Red List, in total 373 species. The system works well on the two upper hierarchical levels. However, it should be tested for more taxonomic groups to obtain a more complete hierarchical structure of habitat types, point habitats, keystone factors, human activities of impact, environmental change and impacts on populations.

## SPECIES INFORMATION REQUIREMENTS IN NATIONAL RED LISTS

To meet the needs for proper management, communication, and information about Red-Listed species, it is proposed that Red Lists should include the following information regarding each species. Species information should start with the scientific name, names of higher taxonomic categories, preferably order- and family name, and the common name. Secondly, the IUCN Red List Categories and Criteria should be assessed according to IUCN (2001). Further, it is proposed above that habitat characteristics of each species should be reported in terms of habitat types, point habitats and keystone factors. Further, the national distribution of the species should be cited or reported as some kind of regional pattern in order to identify the areas of concern in the given country. As proposed above, threat types should be divided into impacts

of human activities, environmental change, and impacts on populations, all of which work as reporting units. To fulfil the aim of being a tool for management authorities, the Red Lists may also include some kind of management proposal (e.g. reference to an action plan) for each species. Red Lists may also be a tool for conservation priorities. In this regard, species of national responsibility would be important. Other groups of species could be sorted out based on actual national priorities.

#### ACKNOWLEDGEMENTS

I want to thank the Directorate for Nature Management (DN) in Norway which financially supported the project. Great thanks to Kaare Aagaard, Per Arild Aarrestad, Oddvar Hanssen and Bjørn Åge Tømmerås at the Norwegian Institute for Nature Research, and Sissel Rübbergt at DN for fruitful discussions and written contributions.

#### REFERENCES

- DIRECTORATE FOR NATURE MANAGEMENT, 1999. *Mapping og nature types. The value of biodiversity*. DN-håndbok 13.1999. Directorate for Nature Management, Oslo. In Norwegian.
- EUROPEAN ENVIRONMENT AGENCY, 2002. [themes.eea.eu.int/all\\_indicators\\_box?sort\\_by=dpsir](http://themes.eea.eu.int/all_indicators_box?sort_by=dpsir)
- FREMSTAD, E., 1997. *Vegetation types in Norway*. NINA Temahefte 12. Norwegian Institute for Nature Research, Trondheim (in Norwegian).
- IUCN, 2001. *IUCN Red List Categories and Criteria. Version 3.1*. IUCN, Gland.
- ØDEGAARD, F., O. HANSSSEN, K. AAGAARD and P.A. AARRESTAD, 2001. *Basis for standard classification of habitat types and threats in the Norwegian Red List. A test of the system based on three taxonomic groups*. NINA Fagrapport 47. Norwegian Institute for Nature Research, Trondheim. In Norwegian.



# 27

## A preliminary Red List of Sicilian Bryophytes

*P. Campisi, P. Aiello and M.G. Dia*

### INTRODUCTION

Recently Red Lists of bryophytes have been compiled for territories ranging from continental to those of small geographic regions (European Committee for Conservation of Bryophytes [ECCB], 1995; Office Fédéral de l'Environnement, de la Forêt et du Paysage [OFEFP], 1991; Puche and Gimeno, 2001; Schumacker and Vá\_a 2000; Sérgio *et al.* 1994). In Italy, a first list was drawn up by Cortini Pedrotti and Aleffi (1992) with reference to both hepatics and mosses, which was followed by a list by Aleffi and Schumacker (1995) which refers to hepatics only. These lists regard the whole country while no Red List has been prepared for smaller territories.

Consequently we have started the compilation of a Red List of the bryophytes of Sicily, which for its insularity and geographic position is one of the most interesting regions in Italy, as it is situated in the centre of the Mediterranean Basin and is relatively close to the African continent. The establishment of a Red List in Sicily is also important because it is an Italian region with legislative and administrative autonomy in the field of environmental conservation. Moreover, we think that data collected from Sicily may be useful for the Red List assessment of the Mediterranean region.

Consisting of around 600 taxa, the Sicilian bryoflora is fairly rich (c. 50% of the whole Italian bryoflora) thanks to the very high environmental diversity of the island. It includes numerous phytogeographically interesting taxa, the importance of which is emphasized by the fact that they grow in this isolated region. It also includes several taxa requiring a relatively unpolluted environment, which can be found in Sicily as it is sparsely industrialized.

Despite being of remarkable interest, hitherto no conservation measures have specifically been introduced to protect this component of the Sicilian flora and it is exposed to numerous risk factors. Regarding this matter it should be remembered that in Sicily the environment has suffered profound transformations in the course of its long history and is also seriously threatened at present. Unregulated construction in natural and semi-natural areas, fires (the frequency of which has increased considerably over the past decades), the abandonment of cultivation, the canalisation of water courses and the capture of springs constitute the principle causes of risk and contribute to the start of

a process of desertification, also clearly connected to variations in climate at this time. Nevertheless, many places of particular environmental interest still occur in Sicily and for their conservation the Sicilian Regional Administration has already established 3 Parks and other Natural Reserves. However, regarding bryophytes, these protected areas are insufficient to protect the threatened species. In fact, on the one hand, as has already been observed, no protection measure is specifically applied to bryophytes, on the other hand many interesting species occur in territories which are not at all protected, where they occupy particular niches.

On account of this situation, the need to establish a Red List for conservation programmes for Sicilian bryophytes is evident. Nevertheless we should stress that the knowledge of the bryoflora and of the taxa distribution must even now be considered incomplete, above all owing to discontinuous bryological research, which suffered a long period of stasis in the last century (Raimondo and Dia 1997). Moreover, in most cases, the research carried out did not supply the population data that are absolutely necessary for the application of the IUCN criteria. These gaps lengthen the classification process of threatened taxa and thus their assessment within threat categories (Critically Endangered, Endangered and Vulnerable) is still in progress. However, since the compilation of a Red List is urgent because various scenarios predict considerable changes for bryophyte habitats, we thought it expedient to publish preliminary data supplying an annotated list of Threatened, Near Threatened, Least Concern and Data Deficient taxa.

## MATERIAL AND METHODS

The territory of Sicily and surrounding isles amounts to 25,707 km<sup>2</sup>. Data concerning taxa, retrieved from literature and herbaria of the Botanical Department of Catania (CAT), of the Botanical Department of Messina (MS) and of Herbarium Mediterraneum of Palermo (PAL) are included in a Data Bank on the Sicilian bryoflora. They concern general and Sicilian distribution, habitat, ecological behaviour, and threat categories assigned by ECCB (1995) and Schumacker and Vá\_a (2000) for Europe (with regard to mosses and hepatics respectively), by Cortini Pedrotti and Aleffi (1992) for Italian mosses and by Aleffi and Schumacker (1995) for Italian hepatics. Following instructions given by the 3.1 version of IUCN Red List Categories (IUCN, 2001), as well as guidelines for applying threat categories to bryophytes suggested by Hallingbäck *et al.* (1998), threatened taxa and taxa qualified as Least Concern and Near Threatened have been listed. The first group includes rare taxa only known in five or fewer Sicilian locations (some of which were no longer recorded after 1950) and taxa growing in greatly threatened habitats. Additionally, a list of Data Deficient taxa is reported. This includes taxa recorded in more than five locations, which have not been found after 1950 and require further field work, as

well as taxa whose known distribution is in our opinion inadequate and taxa of uncertain presence or taxonomy. Therefore, their assessment is to be considered provisional, awaiting further data.

Until now, we have not applied the IUCN regional application guidelines for downgrading or upgrading, because the territory is surrounded by the sea and because the diaspore inflow from neighbouring territory cannot be valued. At present, in fact, the distribution and the reproductive capacity of the taxa in Southern Italy and in Northern Africa is still insufficiently known.

Nomenclature follows Cortini Pedrotti (2001) for mosses and Grolle and Long (2000) for hepatics.

The occurrence of taxa in Italy is based on Aleffi and Schumacker (1995) and Cortini Pedrotti (2001).

For present purposes the term 'location' is used to indicate a topographically and ecologically characterized site such as a single relief, a forest, a valley.

Chorological elements are in accordance with Düll (1983, 1984-85, 1992), and they are used with the same abbreviations. In order to obtain a synthesis of chorological characters, the threatened taxa have been assigned to the following phytogeographical patterns, obtained from their chorological elements:

|                               |   |
|-------------------------------|---|
| <b>arctic-alpine:</b>         | arc-alp, subarc-subalp  |
| <b>boreal:</b>                | bor, subbor, bor-mont, bor-mont/dealp   |
| <b>continental:</b>           | kont, subkont, subkont-mont, subkont-med,<br>n. subkont   |
| <b>mediterranean:</b>         | med, submed, submed-mont, med-subalp,<br>w.submed-mont, e.submed  |
| <b>oceanic-mediterranean:</b> | oc-med, oc-med-mont, s. oc-med, s.oc-w.med,<br>suboc-submed, suboc-submed-mont, submed-oc,<br>submed-suboc, med-suboc |
| <b>oceanic:</b>               | n.oc, n.oc-mont, suboc, n.suboc, suboc-mont,<br>n.suboc-mont;   |
| <b>temperate:</b>             | temp, temp-mont, w.temp;  |
| <b>tropical:</b>              | subtrop-oc, oc-med/trop, oc-med/paleotrop.  |

In order to analyse the distribution of threatened taxa in the different habitats, these have been grouped into the 13 broad categories reported in Fig. 2 (see p. 269). Some threatened taxa occur in more than one of these categories and are therefore considered more than once.

## RESULTS

Until now, the research has allowed to list 182 threatened, 93 Near Threatened, 16 Least Concern and 85 Data Deficient taxa reported in Tables 1-4. Moreover Table 1 reports chorological elements, threat categories in Europe and Italy and some observations about threatened taxa.

**Table 1** – Threatened taxa

| <b>HEPATICIS</b>  | <b>Chorological element</b> | <b>Status in Italy</b><br>(Aleffi and Schumacker 1995) | <b>Status in Europe</b><br>(Schumacker and Vá_a 2000) | <b>Notes</b>   |
|---|-----------------------------|--|---|--|
| <i>Apometzgeria pubescens</i> (Schrank) Kuwah.            | bor-mont                    | –  | –   | Recorded only in one location.   |
| <i>Athalamia spathysii</i> (Lindenb.) S. Hatt.            | s.oc-med                    | E <sup>1</sup>   | R   | Unknown in northern and central Italy.   |
| <i>Barbilophozia barbata</i> (Schmidel ex Schreb.) Loeske | subbor-mont                 | –  | –   | Recorded only in one location, unknown in southern Italy, in Sicily at the southern limit of its global range. |
| <i>Barbilophozia floerkei</i> (F. Weber & D. Mohr) Loeske | bor-mont                    | –  | –   | Unknown in southern Italy.   |
| <i>Barbilophozia hatcheri</i> (A. Evans) Loeske           | bor-mont                    | –  | –   | Recorded only in one location, in Sicily at the southern limit of its global range.                            |
| <i>Bazzania trilobata</i> (L.) Gray                       | subbor(-mont)               | –  | –   | Unknown in southern Italy.   |

<sup>1</sup> E: Endangered; Ev: Vanished; Ex: Extinct; K: Unknown; R: Rare; RT: Regionally threatened taxa; V: Vulnerable.

|   |                   |   |   |  |
|---|-------------------|---|---|--|
| <i>Calypogeia muelleriana</i> (Schiffn.) Müll.Frib.   | subbor-mont       | – | – | Recorded only in two locations.  |
| <i>Cephaloziella dentata</i> (Raddi) Steph.           | oc-med            | R | R | Recorded only in two locations, unknown in southern Italy.                                       |
| <i>Cololejeunea minutissima</i> (Sm.) Schiffn.        | oc-med            | – | – | Very rare, also in southern Italy.   |
| <i>Cololejeunea rossettiana</i> (C. Massal.) Schiffn. | w.submed-mont     | – | – | Recorded only in one location.   |
| <i>Exormotheca pustulosa</i> Mitt.                    | suboc-med         | E | R | Unknown in northern and central Italy.   |
| <i>Fossombronia crozalsii</i> Corb.                   | euoc              | – | R | Unknown in the Italian peninsula.  |
| <i>Fossombronia husnotii</i> Corb.                    | oc-med            | – | – | Recorded only in two locations, unknown in southern Italy.                                       |
| <i>Frullania fragilifolia</i> (Taylor) Gottsche & al. | suboc-mont        | – | – | Endemic species unknown in southern Italy. Not reported since 1950, could be regionally extinct. |
| <i>Frullania microphylla</i> (Gottsche) Pearson       | suboc-dealp       | – | – | Recorded only in one location. Not reported since 1950, could be regionally extinct.             |
| <i>Frullania parvistipula</i> Steph.                  | r-submed-mont     | V | E | Recorded only in one location, unknown in central and southern Italy.                            |
| <i>Jungermannia atrovirens</i> Dumort.                | w.temp-mont/dealp | – | – | Very rare in Sicily, lives in threatened habitats.   |

| HEPATICES<br>(continued)   | Chorological<br>element | Status in<br>Italy<br>(Aleffi and<br>Schumacker<br>1995) | Status in<br>Europe<br>(Schumacker<br>and Vá_a<br>2000) | Notes  |
|--|-------------------------|--|---|--|
| <i>Jungermannia<br/>exsertifolia</i> ssp.<br><i>cordifolia</i> (Dumort.)<br>Vá_a | subarc-<br>subalp       | V  | –   | Recorded only in one<br>location, unknown in<br>central and southern<br>Italy. Not reported<br>since 1950, could be<br>regionally extinct. |
| <i>Jungermannia<br/>obovata</i> Nees   | bor-mont                | V  | –   | Unknown in central<br>and southern Italy.  |
| <i>Jungermannia<br/>pumila</i> With.   | w.temp-<br>mont         | –  | –   | Recorded only in one<br>location, unknown in<br>southern Italy. Not<br>reported since 1950,<br>could be regionally<br>extinct.             |
| <i>Jungermannia<br/>sphaerocarpa</i> Hook.                                       | bor-mont                | –  | –   | Recorded only in two<br>locations.   |
| <i>Lophocolea minor</i><br>Nees  | e.temp                  | –  | –   | Recorded only in one<br>location.  |
| <i>Lophozia collaris</i><br>(Hook.) Jörg.  | bor-mont/<br>dealp      | –  | –   | Recorded only in one<br>location, unknown in<br>southern Italy.  |
| <i>Lophozia excisa</i><br>(Dicks.) Dumort  | arc-alp                 | –  | –   | Recorded only in one<br>location.  |
| <i>Lophozia ventricosa</i><br>(Dicks.) Dumort                                    | bor                     | –  | –   | Recorded only in one<br>location.  |
| <i>Mannia fragrans</i><br>(Balbis) Frye &<br>L. Clark                            | e.submed                | E  | –   | Recorded only in two<br>location.  |

|   |                    |    |   |   |
|---|--------------------|----|---|---|
| <i>Microlejeunea ulicina</i> (Taylor)<br>A. Evans     | suboc              | –  | – | Unknown in central and southern Italy.  |
| <i>Nardia geoscyphus</i> (De Not.) Lindb.             | bor                | –  | – | Recorded only in one location, unknown in southern Italy. Not reported since 1950, could be regionally extinct. |
| <i>Pedinophyllum interruptum</i> (Nees) Kaal.         | suboc-dealp        | –  | – | Recorded only in one locations. Not reported since 1950, could be regionally extinct.                           |
| <i>Porella arboris-vitae</i> (With.) Grolle           | w.submed-mont      | –  | – | Recorded only in one location.  |
| <i>Preissia quadrata</i> (Scop.) Nees                 | bor-mont/<br>dealp | –  | – | Recorded only in two location. Not reported since 1950, could be regionally extinct.                            |
| <i>Radula linden-bergiana</i> Gottsche<br>ex C.Hartm. | w.submed-mont      | –  | – | Unknown in southern Italy.  |
| <i>Riccia bifurca</i> Hoffm.                          | submed             | –  | – | Recorded only in one location.  |
| <i>Riccia cavernosa</i> Hoffm.                        | s.temp             | –  | – | Recorded only in one location.  |
| <i>Riccia trabutiana</i> Steph.                       | s.oc-med           | R  | R | Recorded only in two locations, unknown in the Italian peninsula.   |
| <i>Riella notarisii</i> (Mont.) Mont.                 | med                | Ev | E | Recorded only in one location, unknown in the Italian peninsula.  |
| <i>Scapania aequiloba</i> (Schwägr.) Dumort.          | bor-mont           | –  | – | Recorded only in one location.  |

| <b>HEPATICES</b><br>(continued)                         | <b>Chorological element</b> | <b>Status in Italy</b><br>(Aleffi and Schumacker 1995)        | <b>Status in Europe</b><br>(Schumacker and Vá_a 2000) | <b>Notes</b>   |
|---|-----------------------------|---|---|--|
| <i>Scapania aspera</i><br>Bernet and M. Bernet          | n.subocmont                 | –   | –   | Recorded only in two locations, unknown in southern Italy.                                 |
| <i>Scapania curta</i><br>(Mart.) Dumort.                | subbor-mont                 | –   | –   | Recorded only in one location. Not reported since 1950, could be regionally extinct.       |
| <i>Scapania nemorea</i><br>(L.) Grolle                  | w.temp-mont                 | –   | –   | Recorded only in two locations.  |
| <i>Scapania subalpina</i><br>(Nees ex Lindenb.) Dumort. | subarc-subalp               | –   | –   | Recorded only in one location, unknown in central and southern Italy.                      |
| <b>MOSSES</b>   | <b>Chorological element</b> | <b>Status in Italy</b><br>(Cortini Pedrotti and Aleffi, 1992) | <b>Status in Europe</b><br>(ECCB, 1995)               | <b>Notes</b>   |
| <i>Acaulon fontiquerianum</i><br>Casas & Sérgio         | oc-med                      | –   | R   | Endemic species recently recorded only in two locations, unknown in the Italian peninsula. |
| <i>Acaulon muticum</i><br>(Hedw.) Müll.                 | temp                        | E   | –   | Recorded only in two locations, unknown in southern Italy.                                 |
| <i>Amphidium mougeotii</i><br>(Bruch & Schimp.) Schimp. | subocmont                   | –   | –   | Unknown in southern Italy.   |



|  |                 |   |   |  |
|--|-----------------|---|---|--|
| <i>Anacolia webbii</i><br>(Mont.) Schimp.                  | oc-med-<br>mont | R | R | Recorded only in three locations, in Italy known only from Sardinia and Calabria.  |
| <i>Antitrichia californica</i> Sull.                       | med             | E | – | Recorded only in one location, unknown in southern Italy. Not reported since 1950, could be regionally extinct.            |
| <i>Aulacomnium androgynum</i><br>(Hedw.) Schwägr.          | temp            | – | – | Recorded only in two locations.  |
| <i>Aulacomnium palustre</i> (Hedw.) Schwägr.               | bor             | – | – | Its habitat is heavily threatened.   |
| <i>Bartramia pomiformis</i> var.<br><i>elongata</i> Turner | bor-mont        | – | – | Recorded only in two locations.  |
| <i>Brachythecium campestre</i> (Müll. Hal.) Bruch & al.    | subkont         | – | – | Recorded only in two locations.  |
| <i>Brachythecium collinum</i> (Müll. Hal.) Bruch & al.     | arc-alp         | – | – | Recorded only in one location, unknown in central and southern Italy, in Sicily at the southern limit of its global range. |
| <i>Brachythecium reflexum</i> (Starke) Bruch & al.         | bor-mont        | – | – | Recorded only in one location.   |
| <i>Brachythecium starkei</i> (Brid.) Bruch & al.           | bor-mont        | – | – | Very rare in Sicily due to its ecological requirements.  |

| <b>MOSSES</b><br>(continued)                      | <b>Chorological element</b> | <b>Status in Italy</b><br>(Cortini, Pedrotti and Aleffi 1992) | <b>Status in Europe</b><br>(ECCB 1995) | <b>Notes</b>   |
|---|-----------------------------|---|--|--|
| <i>Bryum cellulare</i><br>Hook.                   | oc-med/<br>paleotrop.       | Ex  | V                                      | Not reported since 1950, could be regionally extinct. Unknown in southern Italy. |
| <i>Bryum elegans</i><br>Nees                      | bor-mont                    | –   | –                                      | Recorded only in two locations.  |
| <i>Bryum funckii</i><br>Schwägr.                  | s.temp                      | –   | –                                      | Recorded only in one location, unknown in southern Italy.                        |
| <i>Bryum intermedium</i><br>(Brid.) Blandow       | subbor                      | –   | –                                      | Recorded only in one location.   |
| <i>Bryum klinggraeffii</i><br>Schimp. in Klinggr. | suboc                       | –   | –                                      | Recorded only in two locations.  |
| <i>Bryum pallens</i> Sw.                          | bor                         | –   | –                                      | Recorded only in two locations.  |
| <i>Bryum schleicheri</i><br>Lam. & DC             | bor-mont                    | –   | –                                      | Recorded only in one location.   |
| <i>Bryum subapiculatum</i><br>Hampe               | suboc                       | –   | –                                      | Recorded only in two locations.  |
| <i>Bryum tenuisetum</i><br>Limpr.                 | suboc-<br>mont              | –   | –                                      | Recorded only in one location, unknown in the Italian peninsula.                 |
| <i>Bryum veronense</i><br>De Not.                 | arc-alp                     | E   | –                                      | Recorded only in one location, unknown in central and southern Italy.            |
| <i>Calymperes erosum</i><br>Müll.Hal.             | oc-med/<br>trop             | R   | V                                      | Unknown in the Italian peninsula.  |

|   |               |    |   |   |
|---|---------------|----|---|---|
| <i>Campylopus oerstedianus</i> (Mull. Hal.) Mitt.                                     | submed – oc   | –  | – | Recently recorded only in one location, unknown in the Italian peninsula.                                       |
| <i>Campylopus pilifer</i> ssp. <i>vaporarius</i> (De Not) Brullo, Privitera & Puglisi | c. med        | –  | – | Endemic taxon recorded in a very rare habitat only in two locations.  |
| <i>Campylopus pyriformis</i> (Schultz) Brid.  | suboc         | –  | – | Recorded only in one location, unknown in central and southern Italy.   |
| <i>Campylostelium pitardii</i> (Corb.) E. Maier                                       | med           | –  | – | Recently recorded only in one location, unknown in the Italian peninsula.                                       |
| <i>Cinclidotus aquaticus</i> (Hedw.) Bruch & Schimp.                                  | submed-mont   | –  | – | Recorded only in two locations.   |
| <i>Cirryphyllum cirrosum</i> (Schwägr. ex Schult.) Grout                              | subarc-subalp | –  | – | Recorded only in one location, unknown in southern Italy. Not reported since 1950, could be regionally extinct. |
| <i>Cirryphyllum tommasinii</i> (Sendtn. ex Boulay) Grout                              | temp-mont     | –  | – | Recorded only in one location, unknown in southern Italy. Not reported since 1950, could be regionally extinct. |
| <i>Cratoneuron curvicaule</i> (Jur.) G. Roth  | subarc-subalp | Ex | – | Recorded only in one location. Not reported since 1950, could be regionally extinct.                            |

| <b>MOSSES</b><br>(continued)                            | <b>Chorological element</b> | <b>Status in Italy</b><br>(Cortini, Pedrotti and Aleffi 1992) | <b>Status in Europe</b><br>(ECCB 1995) | <b>Notes</b>  |
|---|-----------------------------|---|--|---|
| <i>Cryphaea heteromalla</i> (Hedw.)<br>D. Mohr          | suboc-med                   | –   | –                                      | Species living in relatively unpolluted environments.   |
| <i>Cynodontium bruntonii</i> (Sm.)<br>Bruch & al.       | suboc-mont                  | –   | –                                      | Unknown in southern Italy.  |
| <i>Desmatodon latifolius</i> (Hedw.)<br>Brid.           | subarc-subalp               | –   | –                                      | Recorded only in one location, unknown in southern Italy.   |
| <i>Dichodontium pellucidum</i> (Hedw.)<br>Schimp.       | bor-mont                    | –   | –                                      | Not reported since 1950, could be regionally extinct. Unknown in southern Italy.                                |
| <i>Dicranella humilis</i><br>R. Ruthe                   | bor                         | E   | R                                      | Recorded only in one location, unknown in southern Italy. Not reported since 1950, could be regionally extinct. |
| <i>Dicranella rufescens</i> (Dicks.) Schimp.            | temp (-mont)                | –   | –                                      | Recorded only in one location, unknown in southern Italy.   |
| <i>Dicranella schreberiana</i> (Hedw.) Dicks.           | subbor                      | –   | –                                      | In Sicily at southern limit of its global range.  |
| <i>Dicranoweisia cirrata</i> (Hedw.)<br>Lindb. ex Milde | suboc                       | –   | –                                      | Recorded only in one location.  |

|  |               |   |   |   |
|--|---------------|---|---|---|
| <i>Dicranoweisia crispula</i> (Hedw.) Milde          | bor-mont      | – | – | Recorded only in two locations.   |
| <i>Dicranum bonjeanii</i> De Not.                    | bor           | – | – | Recorded only in one location, unknown in southern Italy. Not reported since 1950, could be regionally extinct. |
| <i>Diphyscium foliosum</i> (Hedw.) D. Mohr           | suboc-mont    | – | – | Recorded only in two locations.   |
| <i>Distichium inclinatum</i> (Hedw.) Bruch & al.     | subarc-subalp | – | – | Recorded only in one location, unknown in southern Italy.   |
| <i>Ditrichum cylindricum</i> (Hedw.) Grout           | subbor        | – | – | Recorded only in two locations, unknown in southern Italy.  |
| <i>Ditrichum pallidum</i> (Hedw.) Hampe              | submed        | – | – | Recorded only in one location.  |
| <i>Ditrichum pusillum</i> (Hedw.) Hampe              | temp          | – | – | Recorded only in one location.  |
| <i>Drepanocladus polycarpus</i> (Voit) Warnst.       | bor           | – | – | Recorded only in one location. Not reported since 1950, could be regionally extinct.                            |
| <i>Drepanocladus polygamus</i> (Bruch & al.) Hedenäs | bor           | – | – | Unknown in southern Italy.  |
| <i>Encalypta rhaptocarpa</i> Schwägr.                | subarc-subalp | – | – | Not reported since 1950, could be regionally extinct. Unknown in southern Italy.                                |

| <b>MOSSES</b><br>(continued)                       | <b>Chorological element</b> | <b>Status in Italy</b><br>(Cortini, Pedrotti and Aleffi 1992) | <b>Status in Europe</b><br>(ECCB 1995) | <b>Notes</b>  |
|--|-----------------------------|---|--|---|
| <i>Entodon concinnus</i><br>(De Not.) Paris        | suboc<br>(-mont)            | –   | –                                      | Recorded only in one location. Not reported since 1950, could be regionally extinct.                            |
| <i>Entosthodon hungaricus</i> (Boros)<br>Loeske    | subkont-med                 | –   | R                                      | Recorded only in two locations, unknown in the Italian peninsula.   |
| <i>Ephemerum recurvifolium</i><br>(Dicks.) Boulay  | submed                      | –   | –                                      | Recorded only in one location, unknown in southern Italy.   |
| <i>Ephemerum sessile</i> (Bruch)<br>Müll. Hal.     | suboc                       | E   | R                                      | Recorded only in one location, unknown in southern Italy. Not reported since 1950, could be regionally extinct. |
| <i>Eurhynchium flotowianum</i><br>(Sendtn.) Kartt. | subkont-mont                | E   | –                                      | Not reported since 1950, could be regionally extinct. Unknown in southern Italy.                                |
| <i>Fissidens curnovii</i><br>Mitt.                 | oc-med                      | V   | –                                      | Recorded only in two locations, unknown in southern Italy.  |
| <i>Fissidens exiguus</i><br>Sull.                  | suboc-submed                | Ex  | R                                      | Recorded only in one location, unknown in southern Italy. Not reported since 1950, could be regionally extinct. |

|  |                   |    |   |  |
|--|-------------------|----|---|--|
| <i>Fissidens fontanus</i><br>(La Pyl.) Steud.                | submed            | –  | – | Recorded only in two locations, unknown in southern Italy.                           |
| <i>Fissidens gracili-<br/>folius</i> Brugg-Nann.<br>& Nyholm | temp-mont         | –  | – | Recorded only in two locations.  |
| <i>Fissidens limbatus</i><br>Sull.                           | oc-med            | E  | – | Unknown in southern Italy.   |
| <i>Fissidens<br/>ovatifolius</i><br>R. Ruthe                 | med-suboc         | E  | R | Recorded only in one location. Not reported since 1950, could be regionally extinct. |
| <i>Funaria micro-<br/>stoma</i> Bruch<br>ex Schimp.          | dealp             | E  | K | Not reported since 1950, could be regionally extinct. Unknown in southern Italy.     |
| <i>Gigaspermum<br/>mouretii</i> Corb.                        | oc-med            | –  | R | Recorded only in one location, unknown in the Italian peninsula.                     |
| <i>Grimmia affinis</i><br>Hornsch.                           | bor-mont          | E  | – | Recorded only in one location, unknown in central and southern Italy.                |
| <i>Grimmia curvata</i><br>(Brid.) De Sloover                 | bor-mont          | –  | – | Recorded only in two locations.  |
| <i>Grimmia donniana</i><br>Sm.                               | n.suboc-<br>mont  | –  | – | Recorded only in one location, unknown in southern Italy.                            |
| <i>Grimmia elatior</i><br>Bruch ex Bals. &<br>De Not.        | subarc-<br>subalp | Ex | – | Not reported since 1950, could be regionally extinct. Unknown in southern Italy.     |
| <i>Grimmia montana</i><br>Bruch & Schimp.                    | suboc-<br>mont    | E  | – | Recorded only in one location.   |

| <b>MOSSES</b><br>(continued)                          | <b>Chorological element</b> | <b>Status in Italy</b><br>(Cortini, Pedrotti and Aleffi 1992) | <b>Status in Europe</b><br>(ECCB 1995) | <b>Notes</b>  |
|---|-----------------------------|---|--|---|
| <i>Grimmia tergestina</i><br>Tomm. ex Bruch & Schimp. | submed-suboc-mont           | –   | –                                      | Recorded only in one location.  |
| <i>Grimmia torquata</i><br>Hornsch. ex Grev.          | subarc-subalp               | –   | –                                      | Recorded only in two locations.   |
| <i>Homalia besseri</i><br>Lobartz                     | subkont-mont                | E   | –                                      | Recorded only in one location.  |
| <i>Homalia lusitanica</i><br>Schimp.                  | oc-med-mont                 | –   | –                                      | Recorded only in two locations.   |
| <i>Hygrohypnum luridum</i> (Hedw.)<br>Jenn.           | bor(-mont)                  | E   | –                                      | Recorded only in one location. Not reported since 1950, could be regionally extinct.          |
| <i>Hylocomium splendens</i> (Hedw.)<br>Bruch. & al.   | subbor                      | –   | –                                      | Recorded only in one location. Not reported since 1950, could be regionally extinct..         |
| <i>Hypnum jutlandicum</i> Holmen & E. Warncke         | suboc                       | –   | –                                      | Sporophyte not observed in Sicily.  |
| <i>Hypnum vaucheri</i><br>Lesq.                       | bor-mont                    | –   | –                                      | Recorded only in two locations, unknown in southern Italy. Sporophyte not observed in Sicily. |
| <i>Isopterygiopsis pulchella</i> (Hedw.)<br>Z. Iwats. | bor-mont                    | –   | –                                      | Recorded only in one location, unknown in southern Italy.                                     |



|  |                  |    |   |   |
|--|------------------|----|---|---|
| <i>Isothecium alopecuroides</i> var. <i>robustum</i> (Bruch. & al.) Düll | subkont-mont     | –  | – | Unknown in southern Italy.  |
| <i>Lescurea saxicola</i> (Bruch & al.) Milde                             | subarc-subalp    | E  | – | Recorded only in one location, unknown in southern Italy. Not reported since 1950, could be regionally extinct. |
| <i>Mielichhoferia elongata</i> (Hoppe & Hornsch. ex Hook.) Hornsch.      | subarctic-alpine | –  | K | Recorded only in one location, unknown in southern Italy.   |
| <i>Mielichhoferia mielichhoferiana</i> (Funk) Loeske                     | subarc-subalp    | E  | K | Recorded only in one location, unknown in southern Italy.   |
| <i>Mnium stellare</i> Hedw.  | bor-mont         | –  | – | Recorded only in one location. Not reported since 1950, could be regionally extinct.                            |
| <i>Orthothecium intricatum</i> (C.Hartm.) Bruch. & al.                   | bor-mont         | –  | – | Recorded only in one location. Not reported since 1950, could be regionally extinct.                            |
| <i>Orthotrichum alpestre</i> Hornsch. ex Bruch & al.                     | subarc-subalp    | Ex | – | Unknown in central and southern Italy.  |
| <i>Orthotrichum obtusifolium</i> Brid.                                   | n.subkont        | E  | – | Recorded only in one location, unknown in southern Italy. Not reported since 1950, could be regionally extinct. |
| <i>Orthotrichum pal-lens</i> Bruch ex Brid.                              | subbor (-mont)   | E  | – | Unknown in southern Italy.  |

| <b>MOSSES</b><br>(continued)                             | <b>Chorological element</b> | <b>Status in Italy</b><br>(Cortini, Pedrotti and Aleffi 1992) | <b>Status in Europe</b><br>(ECCB 1995) | <b>Notes</b>  |
|--|-----------------------------|---|--|---|
| <i>Orthotrichum pulchellum</i> Brunt.                    | n.oc                        | V   | –                                      | Recorded only in one location, unknown in the Italian peninsula.                      |
| <i>Orthotrichum scanicum</i> Grönvall                    | submed-suboc                | E   | Ex                                     | Recorded only in one location, unknown in central and southern Italy.                 |
| <i>Oxystegus tenuirostris</i> (Hook. & Taylor) A.J.E.Sm. | suboc-mont                  | –   | –                                      | Recorded only in two locations.   |
| <i>Philonotis caespitosa</i> Jur.                        | bor                         | –   | –                                      | Recorded only in one location. Not reported since 1950, could be regionally extinct.  |
| <i>Plagiomnium elatum</i> (Bruch & Schimp.) T.J. Kop.    | bor                         | –   | –                                      | Recorded only in two locations.   |
| <i>Plagiomnium medium</i> (Bruch & Schimp.) T.J. Kop.    | subarc-alp                  | –   | –                                      | Recorded only in two locations. Not reported since 1950, could be regionally extinct. |
| <i>Plagiothecium cavifolium</i> (Brid.) Z. Iwats         | bor(-mont)                  | –   | –                                      | Recorded only in two locations, unknown in southern Italy.                            |
| <i>Plagiothecium undulatum</i> (Hedw.) Bruch & al.       | n.oc(-mont)                 | –   | –                                      | Recorded only in one location, unknown in southern Italy.                             |
| <i>Platydicta subtilis</i> (Hedw.) Crum                  | subkont-mont                | –   | –                                      | Recorded only in one location, unknown in southern Italy.                             |

|  |            |   |   |  |
|--|------------|---|---|--|
| <i>Pohlia elongata</i><br>Hedw.                                      | bor-mont   | – | – | Recorded only in two locations.  |
| <i>Pohlia lutescens</i><br>(Limpr.) Lindb.                           | temp       | E | – | Recorded only in one location, unknown in central and southern Italy.  |
| <i>Pohlia proligera</i><br>(Lindb. ex Breidl.)<br>Lindb. ex Arnell   | bor-mont   | E | – | Recorded only in two locations, in Sicily at the southern limit of its global range.                           |
| <i>Polytrichastrum longisetum</i> (Brid.)<br>G.L. Smith              | bor        | – | – | Recorded only in one location.   |
| <i>Polytrichum commune</i> var. <i>perigoniale</i><br>(Michx.) Hampe | subbor     | – | – | Recorded only in one location.   |
| <i>Polytrichum strictum</i> Brid.                                    | bor        | – | – | Its habitat is heavily threatened.   |
| <i>Pottia pallida</i><br>Lindb.                                      | oc-med     | E | – | Unknown in southern Italy.   |
| <i>Pseudoleskea radicata</i> (Mitt.)<br>Mönk.                        | subarc-alp | E | – | Recorded only in one location, unknown in southern Italy, in Sicily at the southern limit of its global range. |
| <i>Pseudoleskeella nervosa</i> (Brid.)<br>Nyholm                     | bor-mont   | – | – | Recorded only in two locations.  |
| <i>Pseudotaxiphyllum elegans</i> (Brid.)<br>Z. Iwats.                | suboc      | – | – | Unfrequent also in Italy.  |
| <i>Pterygoneurum lamellatum</i><br>(Lindb.) Jur.                     | submed     | E | V | Unknown in southern Italy.   |

| <b>MOSSES</b><br>(continued)                                | <b>Chorological element</b> | <b>Status in Italy</b><br>(Cortini, Pedrotti and Aleffi 1992) | <b>Status in Europe</b><br>(ECCB 1995) | <b>Notes</b>   |
|---|-----------------------------|---|--|--|
| <i>Ptychomitrium nigrescens</i> (Kunze) Wijk & Margad.      | oc-med                      | Ex  | RT                                     | Endemic species recorded only in one location, unknown in the Italian peninsula.     |
| <i>Pyramidula tetragona</i> (Brid.) Brid.                   | submed-suboc                | Ex  | V                                      | Not reported since 1950, could be regionally extinct. Unknown in southern Italy.     |
| <i>Racomitrium affine</i> (Weber & D. Mohr) Lindb.          | bor-mont                    | –   | –                                      | Unfrequent also in Italy.  |
| <i>Racomitrium ericoides</i> (Weber ex Brid.) Brid.         | n.oc                        | –   | –                                      | Recorded only in two locations.  |
| <i>Racomitrium sudeticum</i> (Funk) Bruch & Schimp.         | subarc-subalp               | –   | –                                      | Recorded only in one location. Not reported since 1950, could be regionally extinct. |
| <i>Rhabdoweisia fugax</i> (Hedw.) Bruch & al.               | bor-mont                    | –   | –                                      | Not reported since 1950, could be regionally extinct. Unknown in southern Italy.     |
| <i>Rhynchostegium strongylense</i> (Bott.) Buck & Privitera | med                         | R   | R                                      | Endemic species recorded in a very rare habitat only in two locations.               |
| <i>Rhytidiadelphus squarrosus</i> (Hedw.) Warnst.           | subbor                      | –   | –                                      | Recorded only in one location. Not reported since 1950, could be regionally extinct. |

---

|   |                    |   |   |  |
|---|--------------------|---|---|--|
| <i>Sanionia uncinata</i><br>(Hedw.) Loeske  | bor(-mont)         | – | – | Recorded only in one location. Not reported since 1950, could be regionally extinct. |
| <i>Schistidium confertum</i> (Funck)<br>Bruch & Schimp.                             | subbor-mont        | – | – | Unfrequent also in Italy.  |
| <i>Schistidium flaccidum</i> Bruch<br>& Schimp.                                     | submed-mont        | E | – | Recently recorded only in one location. Rare also in Italy.                          |
| <i>Schistidium rivulare</i><br>(Brid) Podp. ssp.<br><i>rivulare</i>                 | bor-mont           | – | – | Unknown in central and southern Italy.   |
| <i>Schistidium rivulare</i><br>ssp. <i>latifolium</i> (J.E.<br>Zetterst.) B. Bremer | bor-mont           | – | – | Recorded only in one location, unknown in central and southern Italy.                |
| <i>Scleropodium cespitans</i> (Mull.Hal.)<br>L.F.Koch                               | oc-submed          | – | – | Unknown in southern Italy.   |
| <i>Scorpiurium deflexifolium</i> (Solms)<br>M. Fleisch. & Loeske                    | temp               | – | – | Recorded only in one location.   |
| <i>Scorpiurium sendtneri</i> (Schimp.)<br>M. Fleisch.                               | submed<br>(-suboc) | – | – | Recorded only in one location.   |
| <i>Sematophyllum substrumulosum</i><br>(Hampe) E. Britton                           | s.oc-med           | – | – | Recorded only in two locations, unknown in southern Italy.                           |
| <i>Sphagnum subsecundum</i> var. <i>contortum</i><br>(Schultz) Huebener             | bor(-mont)         | – | – | Its habitat is heavily threatened. Local populations very small.                     |

---

| <b>MOSSES</b><br>(continued)  | <b>Chorological element</b> | <b>Status in Italy</b><br>(Cortini Pedrotti and Aleffi, 1992) | <b>Status in Europe</b><br>(ECCB, 1995) | <b>Notes</b>   |
|---|-----------------------------|---|---|--|
| <i>Sphagnum subsecundum</i> var. <i>inundatum</i> (Russow) C.E.O.Jensen       | bor                         | –   | –                                       | Its habitat is heavily threatened. Local populations very small. |
| <i>Sphagnum subsecundum</i> var. <i>rufescens</i> (Nees ex Hornsch.) Huebener | n.suboc                     | –   | –                                       | Its habitat is heavily threatened. Local populations very small. |
| <i>Syntrichia bolanderi</i> (Lesq. & James) R.H. Zander                       | oc-med                      | –   | V                                       | Recorded only in one location, unknown in the Italian peninsula. |
| <i>Syntrichia handelii</i> (Schiffn.) Bach.                                   | med-subalp                  | –   | V                                       | Recorded only in one location, unknown in the Italian peninsula. |
| <i>Syntrichia latifolia</i> (Bruch ex C.Hartm.) Huebener                      | temp                        | –   | –                                       | Recorded only in two locations, unknown in southern Italy.       |
| <i>Syntrichia norvegica</i> Web.  | subarc-subalp               | –   | –                                       | Recorded only in one location, unknown in southern Italy.        |
| <i>Syntrichia papillosa</i> (Wilson) Jur.                                     | w.temp                      | –   | –                                       | Recorded only in one location, unknown in southern Italy.        |
| <i>Thamnobryum cossyrense</i> (Bott.) A.J.E.Sm.                               | med                         | Ex  | Ex                                      | Unknown in the Italian peninsula.                                |
| <i>Timmiella flexisetata</i> (Bruch) Limpr.                                   | s.oc-w.<br>med-mont         | R   | R                                       | Unknown in southern Italy.                                       |

|   |                        |    |   |  |
|---|------------------------|----|---|--|
| <i>Tortula brevissima</i><br>Schiffn.                               | kont                   | –  | R | Recorded only in two locations.  |
| <i>Tortula revolvens</i><br>(Schimp.) G.Roth                        | submed                 | –  | K | Unfrequent also in Italy.  |
| <i>Tortula solmsii</i><br>(Schimp.) Limpr.                          | oc-med                 | –  | R | Recorded only in one location.   |
| <i>Tortula subulata</i><br>var. <i>subinermis</i><br>Schwäger.      | suboc-sub-<br>med-mont | –  | – | Unfrequent also in Italy.  |
| <i>Trematodon</i><br><i>longicollis</i> Michx.                      | subtrop                | R  | R | Recorded only in two locations.  |
| <i>Trichostomopsis</i><br><i>aaronis</i> (Lor.)<br>Agnew & Townsend | subkont-<br>med        | –  | R | Recorded only in two locations, unknown in the Italian peninsula.                    |
| <i>Ulotia crispa</i> (Hedw.)<br>Brid.                               | temp                   | –  | – | Recorded only in two locations.  |
| <i>Warnstorfia</i><br><i>exannulata</i>                             | bor                    | –  | – | Recorded only in one location. Not reported since 1950, could be regionally extinct. |
| <i>Weissia levieri</i><br>(Limpr.) Kindb.                           | oc-med                 | Ex | R | Unknown in southern Italy.   |

**Table 2 – Near Threatened taxa.**

**HEPATICES**

*Aneura pinguis* (L.) Dumort.  
*Anthoceros agrestis* Paton  
*Calypogeia fissa* (L.) Raddi  
*Cephaloziella calyculata* (Durieu & Mont.)  
 Müll.Frib  
*Cephaloziella divaricata* (Sm.) Schiffn.  
*Cephaloziella rubella* (Nees) Warnst.  
*Cephaloziella turneri* (Hook.) Müll.Frib.  
*Chiloscyphus pallescens* (Ehrh. ex Hoffm.)  
 Dumort.  
*Chiloscyphus polyanthos* (L.) Corda  
*Diplophyllum albicans* (L.) Dumort.  
*Jungermannia hyalina* Lyell  
*Marchantia paleacea* Bertol.  
*Marchantia polymorpha* ssp. *ruderalis*  
 Bischl. & Boisselier  
*Metzgeria furcata* (L.) Dumort  
*Nardia scalaris* Gray  
*Petalophyllum ralfsii* (Wils.) Nees &  
 Gottsche  
*Plagiochila asplenoides* (L. emend. Taylor)  
 Dumort.  
*Plagiochila porelloides* (Torrey ex Nees)  
 Lindenb.  
*Porella obtusata* (Taylor) Trevis.  
*Riccardia chamaedryfolia* (With.) Grolle  
*Riccia bicarinata* Lindb.  
*Riccia ciliata* Hoffm.

**MOSESSES**

*Amblystegium varium* (Hedw.) Lindb.  
*Anomobryum julaceum* (P.Gaertn. & al.)  
 Schimp.  
*Anomodon viticulosus* (Hedw.) Hook. &  
 Taylor  
*Atrichum undulatum* (Hedw.) P.Beauv.  
*Barbula convoluta* var. *commutata* (Jur.)  
 Husn.

*Barbula ehrenbergii* (Lorentz) M.Fleisch.  
*Bartramia ithyphylla* Brid.  
*Bryum canariense* var. *provinciale*  
 (H.Philib.) Husn.  
*Bryum capillare* var. *platyloma* Schimp.  
*Bryum creberrimum* Taylor  
*Calliargonella cuspidata* (Hedw.) Loeske  
*Cinclidotus mucronatus* (Brid.) A.L.M.  
 Guim.  
*Cinclidotus riparius* (Brid.) Arn.  
*Coscinodon cribrosus* (Hedw.) Spruce  
*Dicranum scoparium* Hedw.  
*Didymodon spadiceus* (Mitt.) Limpr.  
*Distichium capillaceum* (Hedw.) Bruch &  
 al.  
*Ditrichum flexicaule* (Schwägr.) Hampe  
*Ditrichum subulatum* Hampe  
*Encalypta ciliata* Hedw.  
*Encalypta streptocarpa* Hedw.  
*Eurhynchium striatulum* (Spruce) Bruch &  
 al.  
*Fissidens crassipes* var. *philibertii* (Fleisch.)  
 Brugg.-Nann.  
*Fontinalis hypnoides* var. *duriaei* (Schimp.)  
 Husn.  
*Fontinalis hypnoides* var. *duriaei* (Schimp.)  
 Husn.  
*Funariella curviseta* (Schwägr.) Sérgio  
*Grimmia hartmanii* Schimp.  
*Grimmia ovalis* (Hedw.) Lindb.  
*Gyroweisia reflexa* (Brid.) Schimp.  
*Hedwigia ciliata* (Hedw.) P.Beauv.  
*Hedwigia stellata* Hedenäs  
*Hypnum andoi* A.J.E.Sm.  
*Hypnum cupressiforme* var. *subjulaceum*  
 Molendo  
*Hypnum resupinatum* Taylor  
*Leptodictyum humile* (P.Beauv.) Ochyra  
*Lescurea mutabilis* (Brid.) Lindb. ex  
 I.Hager  
*Mnium hornum* Hedw.  
*Neckera crispa* Hedw.



*Neckera pumila* Hedw.  
*Neckera pumila* Hedw.  
*Orthotrichum acuminatum* H. Philib.  
*Orthotrichum philibertii* Venturi  
*Orthotrichum schimperi* Hammar  
*Orthotrichum shawii* Wilson in Schimp.  
*Orthotrichum speciosum* Nees in Sturm.  
*Orthotrichum speciosum* Nees in Sturm.  
*Orthotrichum stramineum* Hornsch. ex  
Brid.  
*Palustriella commutata* (Hedw.) Ochyra  
*Palustriella falcata* (Brid.) Hedenäs  
*Philonotis arnellii* Husn.  
*Philonotis calcarea* (Bruch & Schimp.)  
Schimp.  
*Philonotis marchica* (Hedw.) Brid.  
*Philonotis rigida* Brid.  
*Plagiomnium affine* (Blandow) T.J.Kop.

*Plagiothecium denticulatum* (Hedw.)  
Bruch & al.  
*Pogonatum aloides* var. *minimum* (Hedw.)  
P. Beauv.  
*Pogonatum nanum* (Hedw.) P.Beauv.  
*Pohlia nutans* (Hedw.) Lindb.  
*Polytrichum commune* Hedw.  
*Polytrichum piliferum* Hedw.  
*Pseudoleskea incurvata* (Hedw.) Loeske  
*Pylaisia polyantha* (Hedw.) Schimp.  
*Racomitrium canescens* (Hedw.) Brid.  
*Racomitrium lanuginosum* (Hedw.) Brid.  
*Rhizomnium punctatum* (Hedw.) T.J.Kop.  
*Rhizomnium punctatum* (Hedw.) T.J.Kop.  
*Rhytidadelphus triquetrus* (Hedw.) Warnst.  
*Syntrichia calcicolens* Amann  
*Tortella tortuosa* var. *fragilifolia* (Jur.)  
Limpr.

---

**Table 3** – Least Concern taxa.

| HEPATICS  | Status in Europe<br>(Schumacker and Vá_a,<br>2000) | Status in Italy<br>(Aleffi and Schu-<br>macker 1995)      |
|---|--|---|
| <i>Fossombronia wondraczekii</i> (Corda) Lindb.     | NT   | R   |
| <i>Mannia androgyna</i> (L.) A.Evans                | NT   | E   |
| <i>Oxymitra incrassata</i> (Brot.) Sérgio & Sim-Sim | NT   | R   |
| <i>Riccia crozalsii</i> Levier                      | NT   | E   |
| MOSSSES   | Status in Europe<br>(ECCB 1995)                    | Status in Italy<br>(Cortini, Pedrotti<br>and Aleffi 1992) |
| <i>Aschisma carniolicum</i> (Weber & D.Mohr) Lindb. | R  | Ex  |
| <i>Bryum dunense</i> A.J.E.Smith ex Whitehouse      | –  | R   |
| <i>Crossidium crassinerve</i> (De Not.) Jur.        | –  | E   |
| <i>Dicranella howei</i> Renauld & Cardot            | –  | E   |
| <i>Entosthodon durieui</i> Mont.                    | K  | V   |
| <i>Funaria pulchella</i> H.Philib.                  | –  | E   |
| <i>Grimmia crinita</i> Brid.                        | R  | Ex  |
| <i>Gymnostomum viridulum</i> Brid.                  | –  | R   |
| <i>Pleuridium acuminatum</i> Lindb.                 | –  | E   |
| <i>Pottia crinita</i> Wilson                        | –  | E   |
| <i>Pottia intermedia</i> (Turner) Fürnr.            | K  | V   |
| <i>Pterygoneurum ovatum</i> (Hedw.) Dixon           | –  | E   |

E: Endangered; Ex: Extinct; K: Insufficiently known; NT: Not Threatened; R: Rare; V: Vulnerable.

Table 4 – Data Deficient taxa.

---

HEPATICS

---

*Blasia pusilla* L.  
*Calypogeia azurea* Nees & Mont.  
*Fossombronia pusilla* var. *decipiens* Corb.  
*Fossombronia wondraczekii* var. *loitlesbergeri* (Schiffn.) Chalaud  
*Marsupella boeckii* (Austin) Kaal.  
*Porella Xbaueri* (Schiffn.) C. E.O. Jensen  
*Riccia atromarginata* Levier  
*Riccia ciliifera* Link ex Lindenb.  
*Riccia gougetiana* Durieu & Mont.  
*Riccia macrocarpa* Levier  
*Riccia papillosa* Moris  
*Targionia lorbeeriana* Müll. Frib.

---

MOSSES

---

*Acaulon triquetrum* (Spruce) Müll.Hal.  
*Atrichum angustatum* (Brid.) Bruch  
*Brachythecium albicans* (Hedw.) Bruch & al.  
***Brachythecium populeum*** (Hedw.) Bruch & al.  
***Brachythecium rutabulum*** var. *flavescens* Bruch & al.  
***Brachythecium velutinum*** var. *salicinum* (Bruch & al.) Mönk.  
***Bryoerythrophyllum recurvirostre*** (Hedw.) P.C.Chen  
*Bryum algovicum* Sendtn.  
*Bryum imbricatum* (Schwägr.) Bruch & Schimper  
***Bryum mildeanum*** Jur.  
*Bryum pallescens* Schleich. ex Schwägr.  
*Bryum ruderale* Crundw. & Nyholm  
*Bryum turbinatum* (Hedw.) Turner  
***Cratoneuron filicinum*** var. *atrovirens* (Brid.) Ochyra  
*Ctenidium molluscum* var. *condensatum* (Schimp.) E.Britton  
*Didymodon cordatus* Jur.  
***Encalypta rhaptocarpa*** var. *trachymitria* (Ripart) Wijk & Margad.  
*Ephemerum serratum* var. *minutissimum* (Lindb.) Grout  
*Ephemerum serratum* var. *rutheanum* Jur.  
***Eurhynchium pulchellum*** var. *diversifolium* (Bruch. & al.) C.E.O.Jensen  
***Eurhynchium pulchellum*** var. *praecox* (Hedw.) Dixon  
*Fabronia pusilla* Raddi  
***Fissidens adianthoides*** Hedw.  
***Fissidens incurvus*** var. *tamarindifolius* (Turn.) Braithw.  
*Fissidens limbatus* var. *bambergeri* (Schimp. ex Milde) Düll

*Funaria hygrometrica* var. *calvescens* (Schwägr.) Mont.  
*Funaria hygrometrica* var. *muralis* Huebener  
***Grimmia anodon*** Bruch & Schimp.  
***Gymnostomum aeruginosum*** Sm.  
***Gymnostomum calcareum*** var. *intermedium* Schimp.  
***Gymnostomum calcareum*** var. *muticum* (Boulay) Boulay  
***Hedwigia ciliata*** var. *leucophaea* Bruch & al.  
***Homalothecium sericeum*** var. *meridionale* Schimp.  
*Leptobarbula berica* (De Not.) Schimp.  
*Leptobryum pyriforme* (Hedw.) Wilson  
***Lescuraea mutabilis*** (Brid.) Lindb. ex I.Hager  
*Leskea polycarpa* Hedw.  
***Phascum curvicolle*** Hedw.  
***Physcomitrium pyriforme*** (Hedw.) Brid.  
***Plagiomnium affine*** (Blandow) T.J.Kop.  
***Plagiomnium rostratum*** (Schrad.) T.J.Kop.  
***Plagiomnium undulatum*** (Hedw.) T.J.Kop.  
***Plagiothecium denticulatum*** (Hedw.) Bruch & al.  
***Plagiothecium nemorale*** (Mitt.) Jäggli  
***Pogonatum nanum*** (Hedw.) P.Beauv.  
***Pohlia annotina*** (Hedw.) Lindb.  
***Pohlia atropurpurea*** (Wahlenb.) Lindb.  
***Polytrichastrum alpinum*** (Hedw.) G.L.Smith  
***Polytrichum commune*** var. *humile* Sw.  
*Pottia bryoides* (Dicks.) Mitt.  
***Pterigynandrum filiforme*** var. *majus* (De Not.) De Not.  
***Rhynchostegiella teesdalei*** (Bruch & al.) Limpr.  
*Rhynchostegium megapolitanum* var. *meridionale* Schimp.  
*Rhynchostegium rotundifolium* (Brid.) Bruch & al.  
*Schistidium crassipilum* Blom  
*Schistidium singarense* (Schiffn.) Laz.  
*Scleropodium touretii* var. *colpophyllum* (Sull.) E.Lawton ex H.A.Crum  
*Sphagnum subsecundum* Nees ex Sturm  
***Syntrichia laevipila*** var. *laevipiliformis* (De Not.) Limpr.  
*Syntrichia pagorum* (Milde) Amann  
*Syntrichia ruraliformis* (Besch.) Cardot  
***Tortella flavovirens*** var. *viridiflava* (De Not.) Casares-Gil.  
*Tortella humilis* (Hedw.) Jenn.  
*Tortula freibergii* Dixon & Loeske  
*Tortula subulata* var. *angustata* (Schimp.) Limpr.  
*Tortula vahliana* (Schultz) Mont.  
*Trichostomopsis australasiae* (Hook. & Grev.) Robins.  
*Trichostomopsis umbrosa* (Müll.Hal.) Robins  
***Trichostomum brachydontium*** var. *cuspidatum* (Braithw.) Sav.

*Trichostomum brachydontium* var. *densum* (Bruch & al.) Düll  
*Weissia controversa* var. *densifolia* (Bruch & al.) Wilson  
*Weissia triumphans* var. *pallidisetum* (H.Müll.) Düll

In boldface: taxa not found in Sicily after 1950, requiring further field work.

## DISCUSSION

The threatened taxa constitute 30.3% of the bryophyte flora of Sicily. Among them 141 (29.7%) are mosses and 41 (32.5%) hepatics (Table 5). It is a noteworthy percentage and the incidence of Near Threatened taxa is also not negligible (15.4%).

Regarding threatened taxa, among mosses 28 (19.8%) and 39 (27.6%) taxa have also been classified in threat categories in the Red List of Europe (ECCB, 1995) and Italy (Cortini Pedrotti and Aleffi, 1992) respectively. Among hepatics 7 (17%) taxa are also listed as threatened by Schumacker and Vá\_a (2000) in Europe and 9 (22%) by Aleffi and Schumacker (1995) in Italy (Table 1).

Some taxa, such as the endemic *Rhynchostegium strongylense* and *Thamnobryum cossyrense* are very important. In fact their global range is very small and all or most of their populations live in isles surrounding Sicily. In particular, *Thamnobryum cossyrense* only occurs in Ustica and Pantelleria, *Rhynchostegium strongylense* lives in Pantelleria, Stromboli and Ischia, a small island near Naples.

A survey of Table 1 also shows that 88 threatened taxa occur in only one location, 9 of them are unknown in the Italian peninsula, 10 are unknown in both central and southern Italy and 27 in southern Italy.

Table 5 – Distribution of Red Listed taxa in the IUCN categories.

|                 | Mosses |                | Hepatics |                | Bryophytes |      |
|-----------------|--------|----------------|----------|----------------|------------|------|
|                 | n.     | % <sup>1</sup> | n.       | % <sup>2</sup> | n.         | %    |
| Threatened      | 141    | 29.7           | 41       | 32.5           | 182        | 30.3 |
| Near Threatened | 69     | 14.5           | 22       | 17.4           | 93         | 15.4 |
| Least Concern   | 12     | 2.52           | 4        | 3.1            | 16         | 2.7  |
| Data Deficient  | 73     | 15.4           | 12       | 9.5            | 85         | 14.1 |

1 of total number of mosses;

2 of total number of hepatics.

Some taxa occur in a few locations concentrated in a small area. For example *Sphagnum* taxa and *Aulacomnium palustre* inside the Madonie Mountains territory and *Amphidium mougeotii*, *Dicranoweisia crispula*, *Fissidens gracilifolius*, *Grimmia montana* and *Pyramidula tetragona* on Mount Etna.

On the whole, 16 Sicilian threatened taxa are unknown in the rest of the Italian territory. They are: *Fossombronia crozalsii*, *Riccia trabutiana*, *Riella notarisii*, *Acaulon fontiquerianum*, *Bryum tenuisetum*, *Calymperes erosum*, *Campylosetelium pitardii*, *Enthostodon hungaricus*, *Gigaspermum mouretii*, *Orthotrichum pulchellum*, *Ptychomitrium nigrescens*, *Syntrichia bolanderi*, *Syntrichia handelii* and *Trichostomopsis aaronis*. Moreover, 61 of the taxa are unknown in southern Italy .

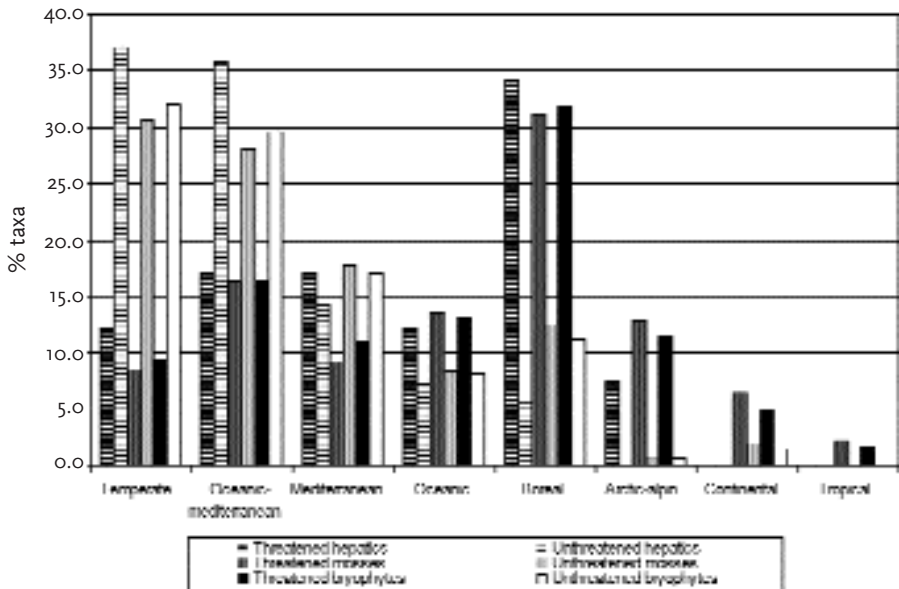

Figure 1 – Distribution of threatened and unthreatened taxa in main phytogeography.

Figure 1 shows the arrangement of threatened and unthreatened taxa in main patterns of distribution. Among threatened bryophytes the incidence of boreal taxa is very high (31.9%), while that of temperate (9.3%) and oceanic-mediterranean (16.5%) taxa is very low with respect to unthreatened taxa (32.0% and 29.6% respectively). Moreover, among threatened taxa the occurrence of oceanic (13.2%) and of arctic-alpine (11.5%) taxa is significant. Likewise, continental and tropical taxa are more represented in threatened (4.9% and 1.6%) than unthreatened (1.5% and 0%) taxa.

Among threatened taxa the occurrence of montane taxa (inclusively 69) is noteworthy, and some of them, such as *Barbilophozia barbata*, *Barbilophozia hatcheri*, *Brachythecium collinum*, *Dicranella schreberiana*, *Pohlia prolifera* and *Pseudoleskea radicata* are also important from the phytogeographical point of view, because in Sicily they are at the southern limit of their global range.

It is also interesting to note that the list of threatened taxa includes some strictly Mediterranean taxa such as *Riella notarisii* and *Campylostelium pitardii*, therefore they are rare in the middle of their distribution area too.

As pointed out in Table 1, some taxa have only been recorded from 1 or 2 locations before 1950, therefore such taxa are surely at least threatened, but they could be extinct in our region.

With regard to the distribution of threatened taxa in the different habitats, Fig. 2 shows that most of them grow in forests or maquis (28.1%). Among these, several taxa are montane and exclusive for this habitat such as *Diphyscium foliosum*, *Homalia besseri* and *Hypnum vaucheri*.

Also high is the percentage of taxa occurring on cliffs and outcrops (20.9%), habitats smaller and more fragmented compared to the former. Habitats relatively well represented are also freshwater habitats, slopes and paths and mountain summits. This mainly includes arctic-alpine and boreal-montane taxa. Moreover, the incidences of caves (6.5%), peatlands (3.9%), fumaroles (3.2%) and anthropogenic environment (3.9%) are significant. The first three of them are very specialized, rare and threatened habitats. On the contrary,

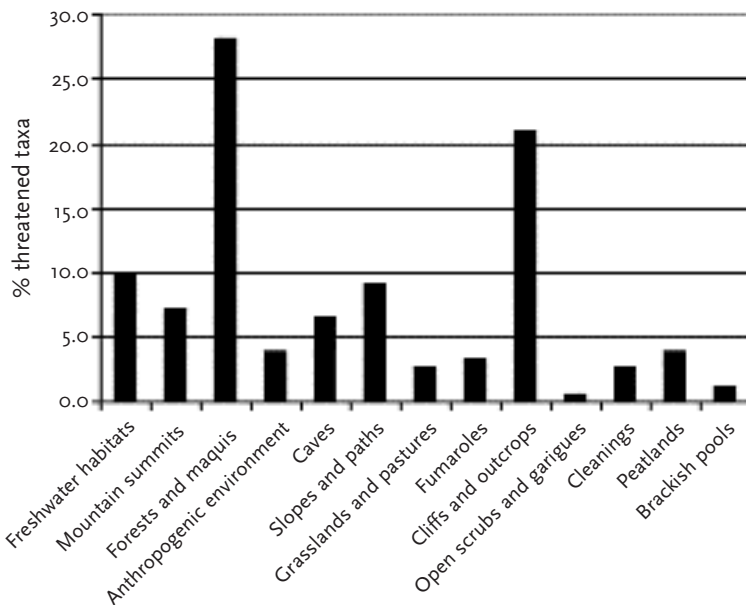

Figure 2 – Distribution of threatened taxa in the different habitat types.

anthropogenic environment is naturally widespread but it includes habitats that are more or less dynamic as a consequence of human activities. Poorly represented habitats include grassland and pastures, open scrubs and garrigues, brackish pools. Among these, the latter, contrary to the others, has become very rare in Sicily.

Most of the threatened taxa live in the northern orographic systems, on Mount Etna and in some isles. Many locations are placed within regional parks and other areas officially protected, but no conservation measure is specifically applied to bryophytes; moreover, several locations occur in territories not protected at all. Some sites of particular importance for the conservation of the Sicilian bryoflora have also been reported in ECCB (1995).

We hope that this list will be useful as a basis to complete the Sicilian Red List and that it will help to improve the knowledge of rare and threatened taxa in our region.

#### ACKNOWLEDGMENTS

The authors wish to thank prof. René Schumacker for his helpful comments on the manuscript and dr. Wim Bergmans for linguistic revision. Financial support by the University of Palermo ('Progetto Giovani Ricercatori') is gratefully acknowledged.

#### REFERENCES

- ALEFFI, M. and R. SCHUMACKER, 1995. Check-list and red-list of the liverworts (*Marchantiophyta*) and hornworts (*Anthocerotophyta*) of Italy. *Fl. Medit.* 5: 73-161.
- CORTINI PEDROTTI, C., 2001. New check-list of the mosses of Italy. *Fl. Medit.* 11: 23-107.
- CORTINI PEDROTTI, C. and M. ALEFFI, 1992. Lista rossa delle Briofite d'Italia, pp. 559-637. In: F. Conti, A. Manzi, F. Pedrotti, *Libro rosso delle piante d'Italia*. W.W.F. Italia.
- DÜLL, R., 1983. Distribution of the European and Macaronesian liverworts (Hepaticophytina). *Bryol. Beitr.* 2: 1-115.
- DÜLL, R., 1984-85. Distribution of European and Macaronesian mosses (Bryophytina). *Bryol. Beitr.* 4/5: 1-232.
- DÜLL, R., 1992. Distribution of European and Macaronesian Mosses – Annotations and progress. *Bryol. Beitr.* 8/9: 1-225.
- ECCB (European Committee for Conservation of Bryophytes), 1995. *Red Data Book of European bryophytes*. ECCB, Trondheim.
- GROLLE, R., and D.G. LONG, 2000. An annotated check-list of the Hepaticae and Anthocerotae of Europe and Macaronesia. *J. Bryol.* 22: 103-140.



- HALLINGBÄCK, T., N. HODGETTS, G. RAEYMAEKERS, R. SCHUMACKER, C. SÉRGIO, L. SÖDERSTRÖM, N. STEWART and J. VÁ\_A, 1998. Guidelines for application of the revised IUCN threat categories to bryophytes. *Lindbergia* 23: 6-12.
- IUCN, 2001. *IUCN Red List Categories: Version 3.1*. Prepared by the IUCN Species Survival Commission. IUCN, Gland & Cambridge.
- OFEFP (Office Fédéral de l'Environnement, de la Forêt et du Paysage). 1991. *Liste Rouge. Les bryophytes menacés ou rares de la Suisse*. OFEFP, Berne.
- PUCHE, F. and C. GIMENO, 2001. The Red Data List of Bryophytes of Valencia County (East Spain). *Fl. Medit.* 11: 11-22.
- RAIMONDO F.M. and M.G. DIA, 1997. Nouvel inventaire de la bryoflore sicilienne, actualisé sur la base de contributions récentes. *Bocconeia* 5 : 885-894.
- SCHUMACKER, R. and J. VÁ\_A, 2000. *Identification keys to the liverworts and hornworts of Europe and Macaronesia (distribution & status)*. Documents de la Station scientifique des Hautes – Fagnes 31.
- SÉRGIO, C., C. CASAS, M. BRUGUÉS and R.M. Cros, 1994. *Lista Vermelha dos Briófitos da Península Ibérica*. Instituto da Conservação da Natureza. Museu, Laboratório e Jardim Botânico, Universidade de Lisboa, pp. 45.



# 28

## Summary of the Discussion of Workshop II

*O.S. Bánki*

The second parallel workshop session was more or less aimed at discussions related to plants, bryophytes, fungi, mosses, lichens, etc. The chairs during the discussions were Pieter Baas in the morning and Avi Shmida in the afternoon. A first observation put forward after the presentations in the discussion was that the IUCN Categories and Criteria are not used everywhere. It was followed by a short discussion on the practical use of the IUCN Categories and Criteria, which is not perceived as evident by some. Some argued that Red Lists should be aimed at estimating the risk of extinction in such a way that priority actions for conservation can be identified. Others argued that Red Lists should already combine estimated risks of extinction and conservation priorities in their methodologies. There were also pleas to not assign legal status to Red Lists, because it must remain easy to update these regularly, and to separate Red Lists from lists with legally protected species.

The presentations during the workshop also made clear that when working with the taxa under discussion problems arise with the application of the IUCN Categories and Criteria, and with the IUCN terminology when dealing with small-sized organisms (such as bryophytes, mosses, fungi, lichens, and herbs). One of the largest problems concerns sample sizes. There was a short discussion if the application of the IUCN Categories and Criteria is better applicable for Fauna groups than it is for Flora groups. Originally, the IUCN Categories and Criteria were created to describe the extinction risks of larger animals although presently they are supposed to be applicable to any species. The participants did not reach agreement on the question whether application proved to be more practical for Fauna groups. The participants acknowledged however, that making separate IUCN Categories and Criteria for different groups of organisms is not feasible for the IUCN Red List Programme. Instead, specialist groups should aim to agree in discussions with the IUCN Red List Programme, how to use notions like sample size on how to handle terminologies in respect to special groups of organisms. The European Committee for the Conservation of Bryophytes has accomplished this for bryophytes, where European standards for species assessments were created in dialogue with specialists and the IUCN Red List Programme. This example could pres-

ent a standard for other groups, like for instance fungi. Participants agreed that such standardisation should be established on a European and not only a national level.

Concerning both European and national Red Lists, it was indicated that the information coming from national Red Lists could at the moment not be incorporated in European Red Lists, because of differences in the categories and criteria used. Also, a nationally important species may not be as important for Europe as a whole. Someone proposed that the problems with scale and different methodologies in Europe seem to be similar in Russia in relation to the federal states, and perhaps there are lessons to be learned from both cases.

Several technical problems in methodology were discussed. For a number of countries, the occurrence of species that belong to a flora that, in those countries, is on the periphery of its distribution, gives a distorted picture of the total of national Red List species. Although there was a general discussion if peripheral flora should be subtracted from Red Lists, the participants agreed that its value for nations should not be underestimated and that in fact biodiversity as a whole should be protected. Also the problem of introduced species and invasive alien species was shortly discussed. These species sometimes appear on Red Lists or lists of protected species. There was no conclusive agreement on the best threshold to use in these cases, although someone proposed to include species that exist in an area for more than one hundred years. Apparently different thresholds are used at the moment.

Several participants requested a better communication of the IUCN Categories and Criteria by the IUCN Red List Programme. Since there are no user guidelines available at the moment (November 2002), people are obliged to make their own interpretations. Carolyne Pollock of the IUCN Red List Programme indicated the lack of capacity of the programme to provide more training workshops than currently are given. The programme has now adopted the 'training the trainers' concept, to increase the amount of workshops. It was also stated that the user guidelines for the new IUCN Categories and Criteria should be available soon.

It was acknowledged by the participants that several countries lack up to date information on their biological diversity. It is highly important that inventories in the field in Europe, should be encouraged to provide reliable information. From the presentations it became clear that there is a lack of taxonomists and specialists in several countries, especially in Southern and Eastern Europe, which greatly hampers the development of knowledge on several groups of organisms. Some even went so far as to state that taxonomists belong to the most endangered species in Europe and maybe even worldwide. The subject of parataxonomy was shortly discussed, including the use of volunteer groups. In the Netherlands the role of voluntary groups of non-professionals was and still is of crucial importance in assessing and monitoring

its biological diversity. The participants expressed a general plea for a European Taxonomic Initiative to address the taxonomic impediment in Europe.

In conclusions, participants noted that there are large differences in data quality and abundance between different countries as well as between different taxonomic groups in Europe. This is also indicated by the large variation in numbers of endangered species between countries. For example, while in some countries 10% of the plant species are endangered, others report 25% of endangered species. The participants agreed that it is very important for communication strategies on the status of biological diversity in Europe where conflicting messages should be avoided. The participants further endorsed the conclusion that there is too little progress in the harmonisation and acceptance of IUCN Categories and Criteria. It was observed that there is an urge to proceed with more speed, and periodical seminars like the current one in Leiden could help to improve this process.



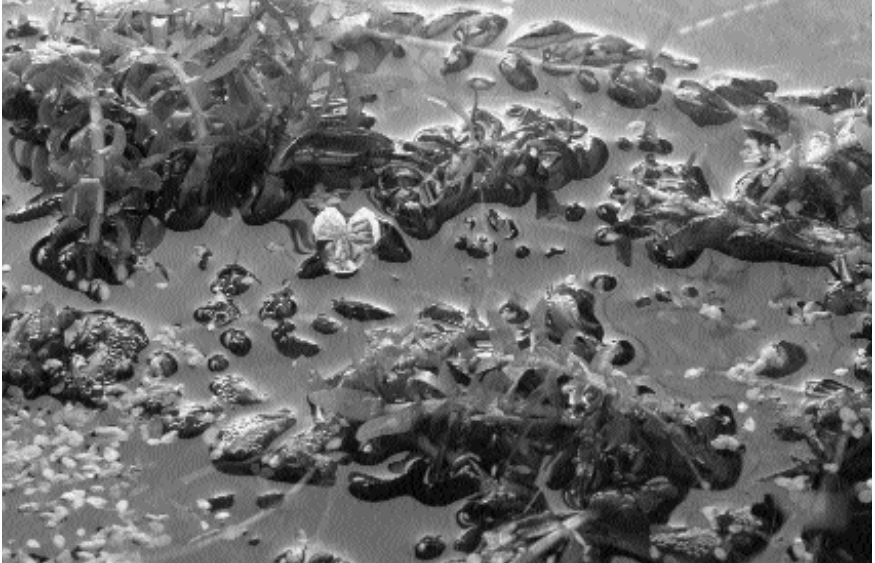

*Elodea canadensis* (J. van Arkel/Foto Natura)



*Vipera berus* (R. Krekels/Foto Natura)



*Platalea leucorodia*  
(D. Ellinger/Foto Natura)



*Mitrula paludosa* (C. Castelijns/Foto Natura)



## PART IV

### Summary of Plenary Discussion, Conclusions and Recommendations

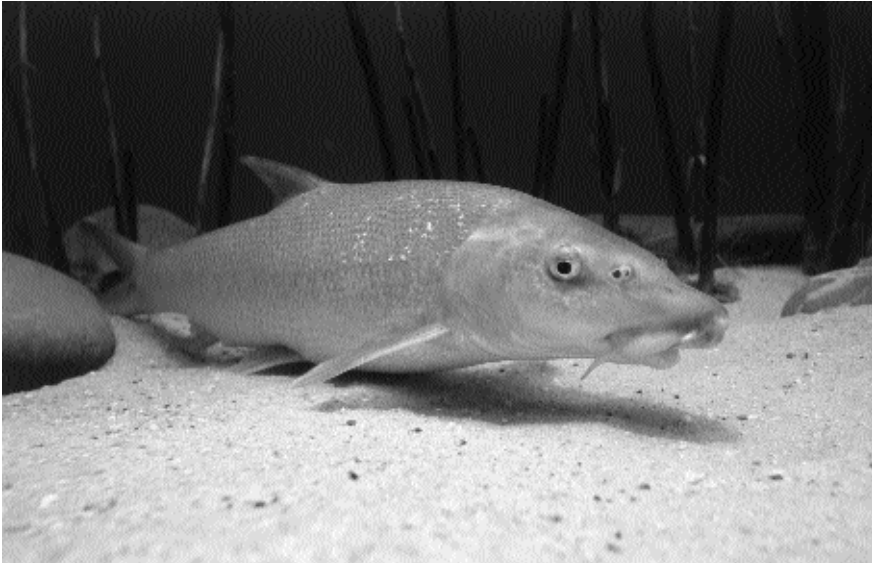

Barbus barbus (W.A. Meinderts/Foto Natura)



# 29

## Summary of Plenary Discussion, Conclusions and Recommendations of the Seminar ‘On the Harmonisation of National Red Lists in Europe’

*H.H. de Iongh, O. Bánki, W. Bergmans and  
M.J. van der Werff ten Bosch*

During the final plenary discussion the results of the parallel workshops were presented and discussed. The principal question was raised, whether the new IUCN Categories and Criteria (C&C) really contribute to saving more species from extinction. It was mentioned that this is a rhetoric question, which is very difficult to answer. The added value of the new C&C is at least its higher transparency in terms of accuracy and reliability of data and the scientific methodology applied in general. The new IUCN C&C should also be observed within the context of the policy objective of the Earth Summit in Johannesburg, to bring to a halt the global loss of biodiversity in 2010, being one of the instruments which may contribute to reach this objective.

The importance of the support function of the IUCN Red List programme in Cambridge was emphasised. This support function comprises a.o. new guidelines for specific taxonomic groups and stand alone training packages. There is also a need for maps indicating the geographical coverage and availability of Red Lists in Europe, the paper of Köppel *et al.* (Chapter 7, this volume) will partly address this need.

With regard to the scale issue, the importance of Red Lists on a smaller scale for local nature conservation policy was emphasised. Examples mentioned were the County Red Lists in the UK and the Provincial Red Data Books in Spain. Red Lists also contribute to effective nature conservation legislation on these smaller scales. It was also realised that at smaller scales the issues ‘edge effects’ and of the ‘area of occupancy’ will play a greater role, causing a bias in Red Listing, but the regional application guidelines may compensate partly for this bias.

Red Lists on smaller scale levels are complementary to Red Lists of larger scale levels, such as the European region, both as an input in the periodical updating process of the annexes of the Birds and Habitats directives, and as an early warning system for species at risk of extinction in the region.

Finally the question was raised who (which institutions) had expressed a need for harmonization of Red Lists and even whether there was a need for harmonization at all. In response reference was made to the recommendations of the Helsinki workshop in 2002, which emphasised the importance of harmonization for the European region. Also it was mentioned that policy makers are difficult to be convinced on the importance of Red Lists in Europe for nature conservation policy, if a large variety of methods and approaches are used. Greater harmonization in methodology and approaches of Red Lists is expected to enhance therefore the impact on European policy.

The following conclusions and recommendations have been prepared through a consultative process with the participants of the Red List Seminar. Feedback of the seminar participants was incorporated in the text, but the final formulation remains the responsibility of the Editors.

- 1 The participants of the Red List seminar in Europe, held in Leiden on 27 and 28 November 2002 endorse and support the policy objective with regard to the reduction of biodiversity loss in 2010 as defined by the World Summit in Johannesburg and expect that the following conclusions and recommendations will contribute to the implementation of this policy within the European region. In this respect it is concluded that Red List species are presently not explicitly targeted by the existing ecological networks in Europe.

*It is recommended to the European Commission to develop policy, which explicitly addresses the problems of Red-Listed species in the development and establishment of European ecological networks.*

- 2 It is concluded that according to the global Red List, since 1500 AD, as far as known, a total of 14 globally threatened species have gone extinct in the European region (2 mammals, 2 birds, 1 fish, 5 freshwater molluscs, 2 insects, and 1 bryophyte), while presently in Europe 43 mammals, 15 birds, 9 amphibians and 64 freshwater fish are globally threatened. With the global Red List based on the new Categories and Criteria only recently published (2001 and updated in 2002), it is too early to draw conclusions with regard to trends in species globally threatened. However the publication of the global Red List in 2004 may reveal more meaningful information on trends.

*It is recommended to IUCN to consider the possibility to use the regular updates of the global Red List for the monitoring of status and trends of European species, which are globally threatened and to make this information available on the web.*

- 3 With regard to the need for harmonization of Red Listing Categories and Criteria it is concluded that presently in Europe some 3,468 regional or national Red Lists have been identified using a variety of categories and criteria, but that not all Red Listing authorities in Europe have expressed the need for harmonization. Several countries have good working systems, most of which make reference to the IUCN Categories and Criteria of 1994. Sometimes additional criteria are used, which do not reflect extinction risk per se. It is concluded that, although the new IUCN Categories and Criteria (version 2001) are globally accepted and supported, the overall application can only be achieved on a voluntary basis and may not be feasible for the whole European region.

At present countries in the IUCN regions of West, Central and Eastern Europe, which started the application of the 2001 version (or slightly modified versions) of the IUCN Red List Categories and Criteria for national Red Listing are: Norway, Denmark, Sweden, Finland, Iceland, Russia, Spain, Portugal, Czech Republic, Slovakia, Switzerland, Serbia, Croatia and the UK.

*In order to help achieve more harmonization, it is recommended that Red Listing authorities in all countries in the IUCN European regions will be informed about the 2001 IUCN Red List Categories and Criteria (version 3) and the regional application guidelines and, if need exists, should get access to the training modules developed by IUCN for the compilation of their national Red Lists in order to help ensure the harmonization of Red Lists across Europe.*

4. It is recognized that the Council of Europe has published a limited number of European Red Lists (a.o. Birds, Mushrooms, Butterflies, Macrolichens), and some European Red Lists ( a.o. vascular plants) are in preparation.

*It is recommended to the Council of Europe to continue the preparation and publication of other European Red Lists, considering (subject to discussion) the use of the 2001 IUCN Red List Categories and Criteria and the regional guidelines, to regularly update them and to make them available to the public on the world wide web.*

*In general, co-operation with other bodies that have produced European Red Lists (e.g. bryophytes by the European Committee for Conservation of Bryophytes) is recommended.*

- 5 It is recognised that the recommendations made to the IUCN/SSC Red List Programme during the Helsinki workshop on European Red Listing in November 2001, namely to further develop and adapt the regional application guidelines, to develop guidelines for using the Red List Categories and Criteria with examples from difficult taxonomic groups, to en-

courage multilateral consultations (a.o. on further harmonization) and to provide training in the use of the Red List criteria, have all been followed-up:

- The regional application guidelines have been further adapted and developed.
- New guidelines on using the IUCN Red List Categories and Criteria, with specific taxonomic examples to illustrate particular problems are in the process of being drafted.
- This Seminar in Leiden can be considered as a follow up on the recommendation to hold multi-national consultations.
- A stand-alone training package on the Red List Categories and Criteria and the regional application guidelines is being developed by the IUCN Red List Programme. This package will include a manual and a series of PowerPoint Presentations that can be used individually or by other trainers to train large groups. The package will be tested at a series of training workshops in 2003 before it is made more widely available.

*This meeting encourages the IUCN/SSC Red List Programme to continue work on the recommendations from the Helsinki workshop, and of other relevant workshops (such as the NATURA 2000 workshop held in Germany), including a follow-up on the recommendations regarding further harmonization of Red Lists in Europe (No. 3), and to keep the wider IUCN network informed on progress.*

- 6 It is recommended that the explicit inclusion of the IUCN Red List Categories and Criteria (and the regional application guidelines) in national or regional legislation should be avoided. It is recognized that such legislation is generally intended to set conservation priorities and action, whereas the IUCN Red List Categories and Criteria are intended to estimate the risk of extinction of species. It is acknowledged that the IUCN Red List Categories should feed into any priority setting system used, but they should not be used as the sole determinants.

*It is recommended not to encourage the explicit inclusion of the IUCN Red List Categories and Criteria in local, national or European legislation.*

- 7 The application of the new IUCN Categories and Criteria and the regional application guidelines should be adapted to the levels of existing appropriate legislation, which may be on the level of the European Community, nations in the European region, federal states within nations, provinces or even municipalities. On levels where no appropriate legislation is available or on smaller scale levels problems may occur with reference to legislative backing or scale and extent of occurrence and/or area of occupan-

cy of populations, but Red Lists may still have a symbolic or political function.

*It is recommended not to prioritise the use of the new IUCN Categories and Criteria for the establishment of Red Lists on scale levels where no appropriate legislation is available and/or in smaller states or provinces, but to encourage the use of these Categories and Criteria for Red Listing on levels where appropriate legislation is available and which are compatible to the area of occupancy/extent of occurrence of viable populations.*

*In general legislation with regard to Red Lists should allow for response times which are no longer than 10 years or three generations of the species assessed, for updates.*

- 8 It is concluded that the use of the regional application guidelines has resulted in constraints with respect to the application for specific taxonomic groups, such as insects, bryophytes or lichens.

*The regional application guidelines have to be adapted for the use in Red Listing of specific taxonomic groups.*

- 9 In some countries, where presently different criteria are used for Red Listing, the application of the IUCN Red List Categories and Criteria may lead to shorter or longer Red Lists. The political impact of this should be considered, when applying the new IUCN Categories and Criteria.

*It is recommended, when applying the IUCN Red List Categories and Criteria, to start pilots in order to evaluate the impact of the new methodology.*

- 10 It is recognized that the IUCN Red List system states that species categorised as 'Not Evaluated' or 'Data Deficient' can be included in a Red List as a separate category.

*It is recommended to carefully consider the conservation status of species which are classified as 'Not Evaluated' or 'Data Deficient' and to consider inclusion in a Red List as a separate category if there are indications for the need of a precautionary approach (e.g. for fungi).*

- 11 It is recognized that the new (2001) IUCN Red List Criteria do not detect species that have undergone longer lasting moderate declines or declines in the past, but are still widespread and relatively common, while in some other Red List systems these are recognised.

*It is recommended to carefully evaluate the results of Red Listing when applying the new IUCN Categories and Criteria, and not to exclude a priori species*

*from conservation action when they are not listed as threatened (see also recommendation 10).*

- 12 It is recognized that Red Lists per se are not sufficient to set conservation priorities alone.

*It is recommended that for the setting of conservation priorities, other factors should be considered including the use of human threat factors, additional lists reflecting the importance of migratory species, species of regional or global concern, CITES listed species, flagship species, keystone species, costs of conservation action etc. etc. This should be embedded in local, national and regional legislation (see recommendation No. 6).*

- 13 It is concluded that for some taxonomic groups (e.g. fungi) due to insufficient knowledge of the numbers of species involved, Red Lists do not reflect the true extinction risk of the existing species.

*It is recommended to policy makers at all levels to halt the ongoing dismantling of taxonomic research institutions and instead prioritise the reinforcement of the capacity of taxonomic institutions involved in species inventories, identifications and descriptions within the European region.*



## PART V

### Additional Papers



*Decticus verrucivorus* (C. Castelijns/Foto Natura)



# 1

## The Context of Red Data Books, with a Complete Bibliography of the IUCN Publications

*J.A. Burton*

Sir Peter Scott is generally credited with inventing the Red Data Book (RDB) concept in 1963 (Fitter 1978; Anonymus 1986; Scott *et al.* 1987; Huxley 1993; Collar 1996), and this concept involved technical data sheets to be published in loose leaf form, together with a popular edition published in a conventionally bound book form. Only one 'official' version<sup>1</sup> of the latter was ever published (Fisher *et al.* 1969), but the publication of the loose-leaf RDBs extended from 1966 until 1978.<sup>1</sup> However from the late 1960s onwards, popular, national and local RDBs have proliferated, and from 1979 until 1991 IUCN continued to publish the technical sheets for some international RDBs. These were in a similar layout to the earlier loose-leaf versions, but conventionally bound. BirdLife (formerly International Council for Bird Preservation, ICBP) continued publishing the technical international RDBs with further volumes appearing in 1985 and 1992, but apparently 'the international Red Data Book programme is effectively, if unofficially, at an end; indeed as a coherent endeavour it has been over since the late 1980's (Collar 1996). The early loose-leaf RDBs have never been catalogued, and it is now very difficult to establish which species were published in what order. Indeed it is difficult to ascertain exactly how many editions/revisions were published, and when. The purpose of this review is to establish the chronology of publication and prepare the ground for a more comprehensive review listing the species and the dates when they were revised. The majority of publications, including those of IUCN and ICBP usually gloss over the complications of references by simply referring to

1 In fact another version was published in 1972, authored by Kai Curry-Lindahl, the vice chairman of the Species Survival Commission. Despite the fact that the book is dedicated to Peter Scott, and published three years after *The Red Book*, no reference is made to the latter publication. In fact the history of this version is somewhat complicated, and the manuscript was completed in 1966 (see p. xi): 'The text of this book was completed in 1966. Its publication has been delayed owing to technical circumstances (the planned artwork took a very long time to produce and did not turn out satisfactorily, so it was finally abandoned)....'. Crowe (1970) shed further light on the origin of the Red Data Books, but is not in itself a Red Data Book. However, much of the information comes from sources related to the RDBs, and it is an important book in understanding the history of RDBs.

Vincent 1966-1971 (cf. Collar *et al.* 1994), or not using them as sources (cf. Baillie and Groombridge 1996). Collar (1996) gives a review of the decline in IUCN's publishing programme for RDBs, which has virtually ground to a halt (Collar 1996). This review also mentions the unpublished (but apparently completed) volume on North American and Mexican fish, compiled in the 1980s, but does not mention another volume on the fish of Sri Lanka that was being prepared by IUCN (Evans, n.d.). Like Collar (*op. cit.*) I believe that it is of utmost importance that the publication of the IUCN RDBs is revitalised and continued.

#### THE PROTO-RED DATA BOOK

Such appears to be the generally accepted official history but, despite the fact that the late Sir Peter Scott was one of the authors of the history quoted above (Scott *et al.*, *op. cit.*), it is in error. The Red Book (Fisher *et al.* 1969) does not record the history of the Red Data Books in any detail. In April 1964, Fitter published a short report on the activities of the IUCN Survival Service Commission – now the Species Survival Commission – in *Oryx*, in which he mentioned that the Red Data Book of IUCN for mammals was reasonably complete, and sheets for birds were under active preparation and a few reptiles would also be included. This makes clear that the preparations for the RDBs had started in 1963 or earlier. The date of 1963 seems to be first mentioned in Fitter (1978), which stated that 'Not until Peter Scott became Chairman of the IUCN Survival Service Commission in 1963 did a systematic study of the endangered species problem begin. The Red Data Books (RDBs) are his brainchild...' The RDBs may well have been Peter Scott's brainchild, and the title almost certainly was, but they were certainly being researched and available in red plastic binders a considerable time before he became Chairman of the SSC in 1963. But memory can be unreliable. Sir Peter Scott later wrote that '...I became Chairman of the SSC... in 1961...' (in Stonehouse, 1981). Sir Peter's authorised biography (Huxley 1993) recorded that his 'major achievement while working for IUCN was the creation of the Red Data Books.' And Huxley (*op. cit.*) dates their origination as 1962.

Both the IUCN/WCMC Library in Cambridge and the Linnaean Society in London hold copies of a duplicated two-volume set of data sheets. These are loose-leaf, in red plastic binders, derived from a typed manuscript, and very similar to the final printed version, except that they have larger page dimensions and contain maps. These volumes are dated 1962 and titled *Animals and plants threatened with extinction*. And they have red covers. As already mentioned, a note by Fitter published in April 1964 makes it quite clear that draft Red Data Books were in existence (mammals) or in preparation (birds and reptiles), and were already in use. It is this draft that was in circulation and is

preserved in the Linnaean and IUCN/WCMC libraries (and doubtless elsewhere). The draft was 'not available for general circulation, being confined to officers and members of the executive organs of IUCN and WWF, to members of the Survival Service Commission, and to a very limited number of private individuals who make substantial donations towards the cost.' Precisely how many copies of these proto-RDBs now survive is unknown, but it is not likely to be very many, since only about 50 were ever produced. A list of the recipients was included with Volume 1 (Appendix 1). Updates were circulated, but unfortunately it is unlikely that many complete sets of these or the original sheets now exist. As the updates were received, the recipients usually did what they were instructed to do, and removed and destroyed the out of date sheets. It is possible that a few recipients transferred the obsolete sheets to the back of the loose-leaf volume, but so far I have been unable to locate such a set. In order to locate remaining copies the recipients of the draft RDB are given in Appendix I. Volume 1 contained the following sections A: Mammals; B Birds (this is a list compiled by James Fisher, but no data sheets); C: Reptiles; D: Amphibians (empty); E: Fish (empty); F Invertebrates (empty); G: Plants (a report on Cycads by Richard Melville); H: Recently extinct species. Volume 2 contains Bird data sheets. The data sheets were circulated between 1962 and 1965; but at present it has not been possible to compile a list of the dates of circulation.

The revisions circulated in March 1964 included for the first time data sheets printed on coloured paper indicating degree of threat, which was to remain a feature of all the loose-leaf versions. In all at least 60 interim reports and updating issues were circulated. The authors included J.H. Calaby, J. Fisher, R. Melville, N. Simon and J. Vincent.

However, in the course of researching the early history, it became apparent that the early loose leaf RDBs were in direct descent from the card index system that Col. Leofric Boyle had initiated in about 1959. The Report of the SSC to the IUCN General Assembly in 1960, not only includes the first comprehensive categorised list of endangered species, but it also includes extracts from Col. Boyle's card index. At the following General Assembly in 1963, the categories for classifying endangered species was finalised. The step from a card index to a loose leaf volume was important, in that it enabled the data to be circulated, and this was initiated shortly after. The only post 1970s reference to the card index located by the present author is in Thornback and Jenkins (1982). In the Introduction Thornback records that 'By the early 1960s the information so far collected had been stored on data cards amalgamated into a loose-leaved book. Sir Peter Scott, then Chairman of the SSC, had the idea of publishing this information as a Red Data Book series aimed at drawing public attention to the global threats to species in order to gain support, funds, and most important, action in the fight to save them.'

It is worth noting at this point, that almost simultaneously with IUCN's publication of the RDBs, the United States Committee on Rare & Endangered

Wildlife Species was developing its own loose-leaf publication. Sheets were printed during the course of 1964, and circulated by Daniel Janzen of the Fish & Wildlife Service of the United States Department of the Interior (USDI), with a request for comments by December 1 1964; this was finally published in 1966, on coloured loose-leaf sheets. Orange-red for mammals, green for birds and yellow for amphibians and reptiles. I can find no trace of any mention of IUCN or its publications in the US version, and it appears the compilers were working in isolation. Interestingly, as far as I can ascertain, the term Red Data Book has never been used in the USA for any of the numerous publications on threatened wildlife, even though most conform with the generally accepted design and presentation of data, and despite the widespread use of the term in almost all other parts of the world, and in translation as well. It is also worth noting that in the US both the technical 'RDB' and a 'popular' version had been produced over 50 years ago. Allen (1942) is effectively an RDB for New World mammals, and this was followed by Harper (1945) for Old World mammals, and Greenaway (1958; consulted: The revised edition of 1967) for birds of the world. These works are well known, but less well known – in fact largely overlooked – is the popular version, complete with attractive illustrations, also produced under the auspices of a Committee of the USDI, title 'Fading Trails: The story of endangered American wildlife' (Beard 1942). According to Hal Coolidge, the first Chairman of the SSC, (in the foreword to Allen 1942), this series of books was the result of an initiative in 1936 of John C. Phillips, who should perhaps therefore be credited with the concept of Red Data Books, but not the title.

#### PUBLISHED IUCN RDBS

In 1987 a review of RDBs, resulting from a symposium held at the Madrid Meeting of the SSC in 1984, was published (Fitter and Fitter 1987). Although this provides a useful overview, as mentioned above, there is much detail missing from the review of the history of RDBs, particularly the section dealing with IUCN's Red Data Books (Scott *et al.* 1987). Earlier, the present author had attempted to collate all known Red Data Books dealing with animal species (Burton 1984), but this attempt, in common with almost all other publications, failed to present the detailed history of IUCN's Red Data Books accurately. Indeed Simon (1966) is missing, because in the copy consulted it had been subsumed into Goodwin and Holloway (1972) with the original title pages missing. The bibliographic history of plant RDBs is less confusing and a comprehensive review was carried out by Jarvis *et al.* (1981). From about 1975 onwards, the bibliographic history is fairly straightforward, since most were published conventionally. However, there were still some notable exceptions, such as the individual sheets for the Northern Square-lipped Rhino and Black Rhino, published in February 1981 (Thornback 1981a, 1981b); these are

often overlooked, and rarely referred to. There are also some quasi-published RDBs such as that of Wells (1981), and Anonymus (1982). These were circulated, but never properly published; however since they often differ markedly from the final published form, they are important research material. There appears to be no record of how many of these extracts were issued.

To state that the bibliographic history of the IUCN RDBs is confusing is an understatement, and research is hindered by the fact that no single library appears to own a complete set, despite their recent origin. The confusion over the bibliographic history of the RDBs derives mostly from the fact that they were issued in loose-leaf format (often described as a librarian's nightmare) over an extended period of time (1966-1979). The intention was that the issues of loose-leaf updates should be inserted into the binder, and replace out of date sheets. Instructions sent with the sheets suggested that the recipients should destroy the old sheets. Librarians dislike loose-leaf books, mostly because of the ease that single sheets can be removed; moreover an instruction to destroy material goes against their training. Furthermore, in the case of the IUCN RDBs, not all recipients remembered to put the updating sheets in binders and they often became separated. And consequently very few complete sets are now available for consultation. One of the few relatively complete sets of (animal) Red Data Books that I have located is that held in the Zoology Library of the Natural History Museum (NHM) in London. However, at the time I consulted them (February 1998) some of the sheets were misplaced, a few had been torn in two and repaired with sellotape (presumably when a librarian had rescued them) and some of the preambles and other supplementary materials were completely missing, presumed destroyed. Despite these shortcomings, the NHM copy does appear to be the most comprehensive that is readily available in the UK. However, it should be borne in mind that this set is of the published RDBs and does not include the 'Proto-RDBs'. As is apparent from the IUCN Catalogue (Grose 1993), no complete sets are currently in the possession of IUCN either in Gland or Cambridge. A further factor adding to the confusion, is that the method of publishing was not conventional. The sheets were not produced by the main publications division of IUCN, but under the auspices of the Survival Service Commission (now Species Survival Commission), and the sheets were issued and distributed, by mail, in small batches at approximately six-monthly intervals. The dates printed on the sheets do not always reflect accurately the date of publication or circulation, as delays were not uncommon. ICBP (now BirdLife International) provided the data for the early bird volumes (Aves), but they were published by IUCN, with ICBP copyright. The 1978-79 volume was reprinted in 1985 by the Smithsonian Institution, but it was not until 1985 that ICBP published the RDB under its own imprint, and even this was jointly with IUCN. In 1992 the Bird RDB still bears IUCN's name, but it was published solely by ICBP (N.J. Collar, in lit. 1998).

The first attempt at a comprehensive listing of IUCN publications, including RDBs, occurred in 1993 when IUCN published a list of the publications from 1948-1992 held in the IUCN Library in Gland (Grose 1993), and it was this listing that first drew my attention to the need for a systematic review of IUCN's RDBs. The listing below is the result and it provides the following data:

- 1 This Catalogue number; \* indicates 'seen by author'; \*\* indicates 'in author's library'.
- 2 Reference number from IUCN Catalogue (Grose, 1993).
- 3 Date of publication, including month if known; the sheets were often issued/published the month following the month cited.
- 4 IUCN Issue number, where relevant.
- 5 Author(s)/ Editors.
- 6 Number of species involved; N = new sheets; UD= up dated sheets.

Column 6 lists the numbers of species treated in each publication/revision. It is outside the scope of the present review to list these, but it is important to note that some species were revised on several occasions, while others were never changed. When reference is made to these data sheets future researchers should be careful to ensure they are citing the year of the reference accurately. A comprehensive tabulation of the data sheets and their revisions is planned as part of a more comprehensive review of RDB listings.

#### OTHER RED DATA BOOKS AND THE RELEVANCE OF RDBS

While there have been various publications which listed endangered species before the publication of the RDBs, the publication of the IUCN RDBs changed the perceptions of endangered species and introduced for the first time a degree of consistency in the categorisation; the history and various other aspects of the categorisations are discussed in Fitter and Fitter (1987). The publication of the IUCN RDBs led directly to the publication of numerous national RDBs, and over the subsequent years RDBs have been published at more detailed levels, both geographically and taxonomically. I estimate that over 500 RDBs and related documents have been published, of which I have examined over 400 (Burton, unpublished manuscript); since each RDB may contain several Red Lists relating to different taxa, written by different authors, some listings give a much greater number of red lists (cf. [www.vim.de](http://www.vim.de)). Another important indirect result of the publication of the RDBs was the successful development and conclusion of the Convention on International Trade in Endangered Species of Wild Fauna and Flora (CITES). Without the existence of the international RDBs and the concepts embodied in it, it is doubtful if CITES could have been developed. It is now one of the most widely accepted international Treaties in existence, with, in January 2003, 161



**Table 1** – Chronological Catalogue and details of publication of IUCN Red Data Books, 1966-1997, including interim revisions

| Country                                       | Is a national Red List available? |                        | Are the new IUCN Criteria used? | Notes   | Information source (pers comm 2002)    |
|---|-----------------------------------|------------------------|---------------------------------|---|--|
|   | Breeding <sup>1</sup>             | Wintering <sup>1</sup> |                                 |   |  |
| Albania                                       | Yes (1997)                        | Yes (1997)             | Yes                             | Update planned for 2003 will also use the IUCN criteria   | Taulant Bino                           |
| Andorra                                       | Yes (1998)                        | No                     | No                              |   | Jordi Pálu                             |
| Armenia                                       | Yes (1987)                        | Yes (1987)             | No                              | Birds included within a Red Data Book of all fauna.   | Luba Balyan                            |
| Austria                                       | Yes (2002)                        | No                     | Yes                             |   | Michael Dvorak                         |
| Azerbaijan                                    | Yes (1989)                        | Yes (1989)             | No                              |   | Elchin Sultanov                        |
| Belarus                                       | Yes (1993)                        | No                     | No                              | New Red List to be published during 2003-2005 will use IUCN Red List Criteria.  | Lyubasha Vergeichik                    |
| Belgium                                       | Yes (1999)                        | No                     | Yes                             | Available for Flanders region only  | Anny Anselin                           |
| Bosnia & Herzegovina                          | No                                | No                     | -                               | A proposed Red List was published in 1989 but no final list exists.   | Drazen Kotrošan                        |
| Bulgaria                                      | Partial (1985)                    | Partial (1985)         | No                              | Birds included in national Red List of all animals, but are covered very poorly. A new Red List is in the early planning stages but use of IUCN Criteria is as yet unclear. | Dimiter Georgiev                       |
| Croatia                                       | Yes (2002)                        | Yes (2002)             | Yes                             |   | Andreja Radovic                        |
| Cyprus  | No                                | No                     | -                               |   | Peter Flint                            |
| Czech Republic                                | Yes (2003)                        | Yes (2003)             | Yes                             |   | Karel Stastrny                         |
| Denmark                                       | Yes (2003)                        | Yes (2003)             | Yes                             |   | Michael Grell                          |
| Estonia                                       | Yes (1998)                        | Yes (1998)             | Yes                             |   | Jaanus Elts                            |
| Faroe Islands                                 | No                                | No                     | -                               |   | Bergur Olsen                           |
| Finland                                       | Yes (2000)                        | No                     | Yes                             |   | Teemu Lehtiniemi                       |
| France  | Yes (1999)                        | Yes (1999)             | No                              |   | Bernard Decueningk                     |
| Georgia                                       | No                                | No                     | -                               |   | Ramaz Gokhelashvili                    |
| Germany                                       | Yes (2002)                        | No                     | Partially                       |   | Hans-Gunther Bauer                     |
| Gibraltar                                     | No                                | No                     | -                               |   | John Cortes                            |
| Greece  | Yes (1992)                        | Yes (1992)             | No                              | A proposal to develop a new Red List using the IUCN criteria has been prepared recently   | Claire Papazoglou & Stavroula Papoulia |
| Greenland                                     | No                                | No                     | -                               |   | David Boertman                         |
| Hungary                                       | Yes (2000)                        | Yes (2000)             | Yes                             |   | Zsolt Nagy                             |
| Iceland                                       | Yes (2000)                        | No                     | Yes                             |   | Olafur Einarsson                       |
| Ireland                                       | Yes (1993)                        | Yes (1999)             | No                              |   | Steve Newton                           |
| Italy   | Yes (1999)                        | No                     | Yes                             |   | Marco Gustin                           |
| Latvia  | Yes (2000)                        | Partial (2000)         | No                              |   | Edmunds Racinskis                      |
| Liechtenstein                                 | Yes (1997)                        | No                     | Partially                       |   | Georg Willi                            |
| Lithuania                                     | Yes (2002)                        | Partial (2002)         | No                              |   | Liutauras Raudonikis                   |
| Luxembourg                                    | Yes (2003)                        | No                     | Yes                             |   | Patric Lorgé                           |
| Macedonia                                     | Yes (2004)                        | Yes (2004)             | Yes                             |   | Emilian Stoynov                        |
| Malta   | Yes (1989)                        | No                     | No                              |   | John Borg                              |
| Moldova                                       | Yes (2001)                        | ?                      | Yes                             |   | Nicolaj Zubcov                         |
| Netherlands                                   | Yes (2003)                        | No                     | ?                               | New Red List in preparation and may use IUCN Criteria   | Johanna Winkelman & Eduard Osieck      |
| Norway (inc Svalbard & Jan Mayen)             | Yes (1998)                        | No                     | Yes                             |   | Ingar Øien                             |
| Poland  | Yes (2001)                        | No                     | Partially                       |   | Maria Wieloch                          |
| Portugal (inc Azores & Madeira)               | Yes (2003)                        | ?                      | Yes                             |   | Helder Costa                           |
| Romania                                       | Yes (2003)                        | Yes (2003)             | Yes                             |   | Dan Munteanu                           |
| Russia  | Yes (2000)                        | Yes (2000)             | Yes                             |   | Alexander Mischenko                    |
| Slovakia                                      | Yes (2001)                        | Yes (2001)             | Yes                             |   | Pavol Kanuch                           |
| Slovenia                                      | Yes (2000)                        | No                     | No                              |   | Tomaz Jancar                           |
| Spain (inc Canary Is)                         | Yes (2003)                        | Yes (2003)             | Yes                             |   | Ramon Marti                            |
| Sweden  | Yes (2000)                        | ?                      | Yes                             |   | Bjorn Welander                         |
| Switzerland                                   | Yes (2001)                        | No                     | Yes                             |   | Verena Keller                          |
| Turkey  | Yes (2003)                        | Yes (2003)             | Yes                             |   | Guven Eken                             |
| Ukraine                                       | Yes                               | Yes                    | No                              |   | Oleg Dudkin                            |
| United Kingdom (inc Channel Is & Isle of Man) | Yes (2002)                        | No                     | No                              | Application of the IUCN Criteria is being investigated currently  | Richard Gregory & Debbie Proctor       |
| Yugoslavia                                    | No                                | No                     | -                               |   | Predrag Dukic                          |

<sup>1</sup>Date of publication is shown in parenthesis

countries signatory to it. In the early days of CITES very few non-government organisations (NGOs) took part in the Meetings of the Parties to CITES, and IUCN played a leading role, the original draft Treaty having been prepared by IUCN's legal experts. Over 20 years after CITES came into force, IUCN and in particular the SSC and its Specialist Groups still play a major role in advising the technical meetings of CITES. National RDBs have also played a similar role in influencing national legislation in many parts of the world, and several states have ongoing programmes monitoring endangered species and maintaining up to date RDBs. While many scientists and naturalists dispute the validity of biodiversity hotspot analyses, nonetheless, RDBs play an important role in assessing them. Finally, local RDBs play an important role in helping NGOs develop their priorities, as well as influencing national agencies, and national legislatures.

#### BIBLIOGRAPHY

N.B. The references marked \* are not cited in the text of this paper but were used in the compilation of this report, and are important works in the history of the Red Data Books.

- ALLEN, G.M., 1942. *Extinct and vanishing mammals of the Western Hemisphere*. Special Publication 11. American Committee for International Wild Life Protection, New York.
- ANONYMUS, 1982. *The Conservation Status of the Great Apes*. Unpublished manuscript. IUCN, Gland.
- ANONYMUS, 1986. *1986 IUCN Red List of Threatened Animals*. IUCN, Gland/Cambridge.
- BAILLIE, J. and B. GROOMBRIDGE (compilers and editors), 1996. *1996 IUCN Red List of threatened animals*. IUCN, Gland/Cambridge.
- BEARD, D.B., 1942. *Fading Trails: The story of endangered American wildlife*. Macmillan, New York.
- BURTON, J. A., 1984. A bibliography of Red Data Books (Part 1: Animal Species). *Oryx* 18: 61-64.
- \*BURTON, J.A., 2000. *List of Red Data Books held in library of John A. Burton*. Unpublished manuscript.
- \*COLLAR, N.J., L.P. GONZAGA, N. KRABBE, A. MADROÑO NIETO, L.G. NARANJO, T.A. PARKER and D.C. WEGE, 1992. *Threatened Birds of the Americas: The ICBP/IUCN Red Data Book*. Smithsonian Institution, Washington & International Council for Bird Preservation, Cambridge.
- \*COLLAR, N. and S. STUART, 1985. *Threatened birds of Africa & related islands*. ICBP, Cambridge/IUCN, Gland/Cambridge
- COLLAR, N., 1996. The reasons for Red Data Books. *Oryx* 30 (2): 121-130.
- COLLAR, N.J., M.J. CROSBY and A.J. STATTERSFIELD, 1994. *Birds to watch 2: The world list of threatened birds*. Birdlife Conservation Series 4. Birdlife International, Cambridge.
- \*COLLINS, N.M. and M. MORRIS, 1985. *Threatened swallowtail butterflies of the World*. IUCN, Gland/Cambridge.

- CROWE, P.K., 1970. *World wildlife: The last stand*. Charles Scribner's Sons, New York.
- CURRY-LINDAHL, K., 1972. *Let them Live*. William Morrow, New York.
- EVANS, D. (n.d.). *Red Data Book of the fish of Sri Lanka*. Unpublished manuscript. IUCN/WCMC library.
- FISHER, J., N. SIMON and J. VINCENT, 1969. *The Red Book*. Collins, London.
- \*FITTER, R.S.R., 1964. The Survival Service Commission. *Oryx* 7 (4): 157-159
- FITTER, R.S.R., 1978. *The penitent butchers: The Fauna Preservation Society 1903-1978*. Fauna Preservation Society & Collins, London.
- FITTER, R.S.R. and M.S. FITTER, 1987. *The road to extinction*. IUCN, Gland.
- \*GREENAWAY, J.C., [1958] 1967 (second revised edition). *Extinct and vanishing birds of the World*. Dover, New York.
- GOODWIN, H. and C. HOLLOWAY, 1972-1976. *IUCN Red Data Book*, Vol. 1. *Mammalia*. IUCN, Morges.
- \*GROOMBRIDGE, B., 1982. *The IUCN Amphibia-Reptilia Red Data Book* part 1. IUCN, Gland/Cambridge.
- GROSE, K., 1993. *IUCN publications 1948-1992*. IUCN, Gland.
- \*HARCOURT, C., 1990. *Threatened African Primates*. IUCN, Gland & Cambridge
- \*HARPER, F., 1945. *Extinct and vanishing mammals of the Old World*. Special Publication 12. American Committee for International Wild Life Protection, New York.
- \*HONEGGER, R., 1968-1979. *IUCN Red Data Book*, Vol. 3. *Reptilia-Amphibia*. IUCN, Morges.
- HUXLEY, E., 1993. *Peter Scott*. Faber & Faber, London.
- \*KING, W., 1977-1981. *IUCN/ICBP Red Data Book Birds*. Smithsonian Institution, Washington.
- \*KLINOWSKI, M., 1991. *Threatened dolphins, porpoises and whales of the world*. IUCN, Gland & Cambridge.
- \*LUCAS, G.L. and H. SYNGE, 1978. *IUCN Plant Red Data Book*. IUCN, Morges.
- \*MELVILLE, R., 1970-71. *IUCN Red Data Book*, Vol. 5. *Angiospermae*. IUCN, Morges.
- \*MILLER, R.R., 1968-77. *IUCN Red Data Book*, Vol. 4. *Pisces*. IUCN, Morges.
- SIMON, N., 1966-1971. *IUCN Red Data Book*, Vol. 1. *Mammalia*. IUCN, Morges.
- SCOTT, P., J.A. BURTON and R.S.R. FITTER, 1987. Red Data Books: The historical background. In: R.S.R.F. Fitter and M.S. Fitter, *The road to extinction*. IUCN, Gland/Cambridge.
- \*STONEHOUSE, B., 1981. *Saving the animals: The World Wildlife Fund book of conservation*. Weidefeld & Nicolson, London.
- THORNBACk, L.J., 1981a. *Northern square-lipped rhino: 1-4*. IUCN, Gland/Cambridge.
- THORNBACk, L.J., 1981b. *Black rhino: 1-6*. IUCN, Gland/Cambridge.
- THORNBACk, J. and M. JENKINS, 1982. *The IUCN Mammal Red Data Book Part 1*. IUCN, Gland/Cambridge.
- \*VINCENT, J., 1966-1971. *IUCN/ICBP Red Data Book*, Vol. 2. *Aves*. IUCN, Morges.
- WELLS, S., 1981. *Extracts from the IUCN Red Data Book for invertebrates*. Unpublished manuscript. IUCN/WCMC library, Cambridge.
- \*WELLS, S., R.M. PYLE and N.M. COLLINS, 1983. *IUCN Invertebrate Red Data Book*. IUCN, Gland/Cambridge.

## ACKNOWLEDGEMENTS

I would like to thank Nigel Collar for his stimulating paper on the need for RDBs, Elaine Shaughnessy (IUCN Publications) for first suggesting that I undertake this review, and helping supply some of the material and Kevin Grose (IUCN Library), for publishing the IUCN catalogues that stimulated my interest in locating 'missing' material, who together with Cecile Thiery of IUCN helped research materials held in the IUCN library and archives. Thanks are also due to Ann Datta (Zoology Librarian, Natural History Museum, London), Gina Douglas (Linnean Society Librarian) and Mary Cordiner (IUCN/WCMC Librarian) for providing access to and help with important collections of publications. Richard Fitter and Vivien Burton as well as several of the aforementioned, commented on various drafts of the manuscript. Finally, together with IUCN staff mentioned above, Simon Stuart, Kevin Grose, Jeff McNeely, and Sue Rallo of IUCN also provided valuable advice and comment. Craig Hilton-Taylor and Christian Köppel have provided many additional references to Red Data Books.

Postscript: After this paper had been completed I found a list of Extinct and threatened species, using categories very similar indeed to those of the early IUCN categories, as an appendix to Cabrera's *Mammals of South America*. This was published in 1940, over two decades before the publication of the first Red Data Book.

## APPENDIX I

### LIST OF RECIPIENTS OF ORIGINAL DRAFT RED DATA BOOK

F.J. Appelman, J.G. Baer, R. Bigalke, F. Bourliere, C.L. Boyle, W. Burhenne, J.H. Calaby, H. Coolidge, M. Cowie, A. Daubercies, J. Dorst, The Duke of Edinburgh, H. Elliott, C.V. Elst, I. Gabrielson, E.H. Graham, E.P. Gee, J.P. Greenaway, L. Hoffmann, S. Horstadius, H. Hussey, Boonsong Lekagul, I.S. MacPhail, G. Mountfort, H.R.H. Prince Bernhard of the Netherlands, M. Nicholson (now in Library of Linnean Society), P. Scott, L.K. Shaposhnikov, J. Verschuren, F. Vollmar and two copies each to the national appeals of WWF in UK, US, Netherlands and Switzerland.

## 2

# Critical Review of Modern Systems of Biodiversity Extinction Risk Categories and the Problem of Their Adaptation

*A. V.-A. Kreuzberg*

### DEVELOPMENT OF THE SYSTEM OF EXTINCTION RISK CATEGORIES IN THE REGION OF THE FORMER USSR (FSU)

For more than the quarter-century-long history of the compiling of Red Data Books, a comprehension of the system of categories based not so much on the objective evaluation of the inventory data (quantitative criteria) and monitoring, but rather on quite subjective understanding of the dynamics of extinction risk (qualitative criteria) has evolved in the FSU territory.

If in the first edition of the Red Data Book of the USSR (1978, established in 1974) only two categories were adopted (Category A – species under the threat of extinction and Category B – rare species), the 1984 edition (Borodin 1984), which had the widest response in the USSR and beyond, there were already five categories. They took their origin in the system of the IUCN categories and had both numerical (I-V) and context designations. The latter largely contained qualitative dynamic assessments, such as ‘Extinct’, ‘Vanishing’, ‘Declining’, ‘Rare’, ‘Indeterminate’, and ‘Rehabilitated.’ The qualitative data on the state of numbers and ranges were, at best, adequate for mammals and birds; however, they were not estimated on a principal basis, due to the absence of a system of assessment (with objective criteria).

Both the definitions of categories and the terminology used were not perfect. Indeed, ‘vanishing’ (endangered) taxa are also declining; ‘rare’ taxa, without an indication of their natural rarity, but with the indication of the potential risk of extinction in the future, can hardly be distinguished from the artificially or anthropogenically rare ‘Vanishing’ and ‘Declining’ taxa; ‘Indeterminate’ without the area in which the taxon occurs is too loose a notion; fully ‘Rehabilitated’, as well as ‘naturally (itself) rehabilitated’ taxa are the subject of concern of the nature protection agencies, but not of the Red Data Books, from which they, reasonably, should be withdrawn.

Practically all the regional Red Data Books published since 1978 in the FSU territory used the same national categories (with slightly better or worse variations of their numbers, numerical and terminological definitions). Sub-

jectivism was considerably high in the 1984 publication, which predetermined a large number of mistakes in it (Nekrutenko 1987). The Red Data Books published by the Soviet republics and later by the CIS states (Anonymous 1985; Abdusalyamov 1988; Kovshar 1991) copied the same mistakes and, as a result, contained a large number of taxa of which the status did not cause any alarm in the respective regions. Despite the variety of opinions among the specialists compiling Red Data Books, on the whole one has to admit the prevalence of the traditional 'qualitative' way of thinking, which completely ignores the methods of the quantitative assessments of the status of taxa.

#### DEVELOPMENT OF THE IUCN SYSTEM OF CATEGORIES AND ITS APPLICATION AT A REGIONAL LEVEL

The history of the development of the IUCN system of Categories and Criteria until 1994 was fairly well exposed in its brief review, many times published both in the form of a separate booklet (IUCN 1994; Karaganda 1997), and in the Preamble to the IUCN Red Lists of 1996-1998 (Baillie and Groombridge 1996; Walter and Gillett 1998). Until then, published versions of the system did not apply the more objective criteria. The vague definitions of most categories allowed a rather loose interpretation of the status of this or that taxon. A typical example of this is the 1994 IUCN Red list (Groombridge 1993), which contained taxa of six categories: Extinct (Ex), Endangered (E) (corresponding to 'Vanishing' in the Russian version), Vulnerable (V) (corresponding to 'Declining' in the Russian version), Rare (R) (without definition of their natural rarity, but with the indication of the presence of risk of extinction), Indeterminate (I), and Insufficiently known (K) (both corresponding to 'Indeterminate' in the Russian version). Principally, this system was not so different from that used in the FSU.

A modern system of IUCN Categories and Criteria of the extinction risk of wild taxa has existed in the form of a project since 1993 (IUCN, 1993) and officially since late 1994 (Mace and Stuart 1994). In the original form it was used only globally and only twice: in the publication of the 1996 IUCN Red List (animals) and in 2000 (animals and plants) (Baillie and Groombridge 1996; Hilton-Taylor 2000). In them, the taxa are assigned to the following categories: Extinct in the world (EX), Extinct in the Wild (EW), Regionally Extinct (RE), Critically Endangered (CR), Endangered (EN), Vulnerable (VU) [corresponding to 'Declining' in the Russian version], Lower Risk-Conservation Depended (LR-CD) [by definition corresponding to 'Rehabilitated' in the Russian version]; Lower Risk – Near Threatened (LR-NT) [by definition corresponding to 'Rare' in the Russian version particularly, including criteria VU: D], Data Deficient (DD) [corresponding to 'Indeterminate' in the Russian version]. Apart from these, the system contains two more categories, the taxa of

which are included in the Red List, but to different degrees represent future candidates to it: Lower Risk – Least Concern (LR-LC), Not Evaluated (NE). The hierarchical scheme of this system of categories is represented in Fig. 1.

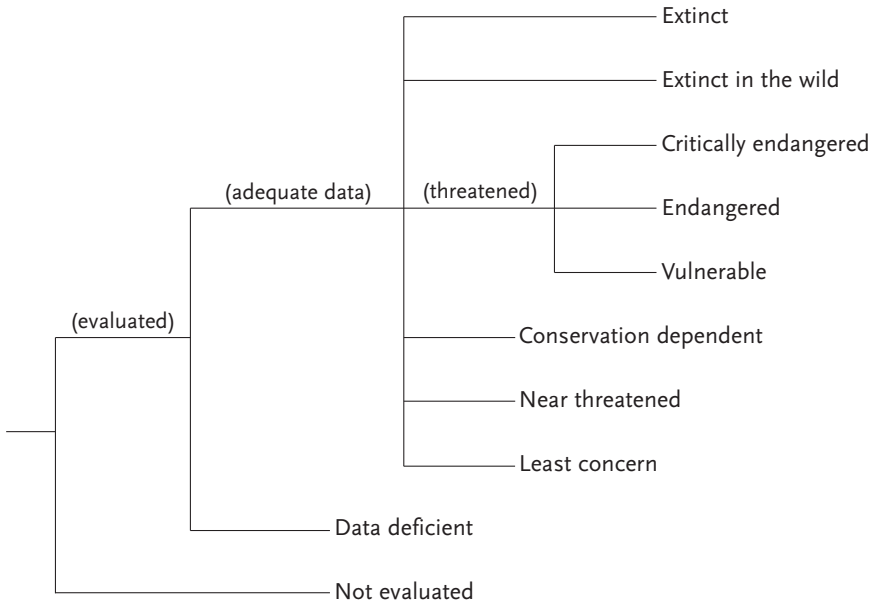

**Figure 1** – Hierarchical scheme of the IUCN system of categories adopted in 1994.

As compared to the previous system of IUCN Categories and Criteria, some conceptual changes to the system on the whole have been made. First, a rather vague defined category ‘Rare’ was excluded (see text above) – the taxa from this category of the 1994 IUCN Red List (Groombridge 1993) were distributed in the next edition (Baillie and Groombridge 1996) between the categories ‘Vulnerable’ (criteria VU; D) and ‘Lower Risk – Near Threatened’. However, this resulted in more confusion, for taxa which have the determined risk of extinction by the criteria of the system (‘Vulnerable’ without the criterion VU; D) and uncertain (lower) risk currently and potential in the future, not defined by these criteria at all (‘Vulnerable’ – criterion VU; D), have been found in one and the same category. The split up of the category ‘Extinct’ and ‘Endangered’ had a positive function for the users. The introduction of the category ‘Lower Risk – Conservation Dependent’ was intended to strengthen the attention for working on the conservation of a number of taxa. However, it has not always reflected the real status and was not formulated specifically (which also can be said about all the other categories but ‘Extinct’) because the principle of ex-



cluding (tesa – antitesa), based on a scale of criteria, was used for its semantical definition.

The main feature of the new system distinguishing it from the previous analogues is the availability of the scale of criteria (A-E), which are intended to identify objectively and universally the status of a taxon in the most important Categories: 'Critically Endangered', 'Endangered' and 'Vulnerable'. Formally, the way of presenting the information on the status of a taxon was chosen quite well: the category assigned to a taxon was followed by code designations of criteria and subcriteria, as well as specialists or organizations (by list), which implemented this analysis (e.g. VU 23 B1+2a-c). Practically, the scale handles the notions responsible for the decrease in two parameters: numbers and range. Quantitative data on the decrease of these parameters serve as the basis of identification of the corresponding criterion of threat. Strictly speaking, this is wrong from the methodological standpoint. The state of the extinction threat to a population is determined by the closeness of such parameters, which are critical for the values of survival. The latter can be quite different for different taxa or their systematic groups. The thing is that the survival, which means the minimal threshold of the numbers of populations of birds and mammals, depends on many factors (social, migrational, etc.), which are practically of no value for the identification of such values for invertebrates. The methods of the modelling of the process of a decrease in vertebrates and invertebrates are considerably different. Therefore, it is incorrect, both biologically and mathematically, to propose some absolute 'key' parameters of the process of decrease (e.g. 50% in 10 years or three generations) applicable to all taxa and obtained on the basis of the correlation analysis of some groups of mammals and birds. Thus, one of the main problems of application of the criterion scale in its original form is the *absence of universality* and the complexity of analysis of the state of populations of many invertebrate animals with a short reproductive cycle and large vertebrate animals with a long life history (reptiles and mammals). Another problem is the unavailability of data on the status of numbers and range of a taxon in a significant territory (e.g. the former USSR – 1/6 of the whole mainland) and, as a result, inadequate choice of one of the criteria, has led to a highly *subjective* bias in the global status of a taxon (Kuzmin *et al.* 1998). It should be said that cases where the status of European populations was applied to the whole range of a taxon were almost a common rule in the 1996 IUCN Red List. Certain difficulties for those not speaking English were, and still are, posed by the English terms of categories. Thus, the terms Threatened and Endangered are synonymous (cf. CITES); Critically Endangered cannot be translated without a partial loss in the key meaning; Vulnerable – are there populations that are absolutely invulnerable? Near Threatened (how near and by what?) is too loose a notion. And finally, all the remaining biodiversity can be assigned to the category Not Evaluated. It is not clear why the authors of the system refused to choose from the widely and traditionally used terms in the English literature, such as the



more specific 'Vanishing', 'Rare... [naturally]', 'Indeterminate... [in status]'. The category 'Regionally Extinct -RE' recommended for regional Red Lists has no meaning in general because all categories of regional Red Lists are regional. Nor can it be said that the application of the English abbreviated terms is very felicitous, for they are too different from the meant categories and sub-categories (EX – RE, CR – EN) and look too much like the other categories (EW – EN, EN – NE, NE – RE), which complicates the comprehension.

Attempts to use the new IUCN system at the regional level as, e.g., in current editions of 'Africa's Vanishing Wildlife' (Stuart and Stuart 1998) or the China Red Data Book (Wang Sung 1998) etc., have only resulted in a significant reduction in the number of categories applied, and often in a change in their meaning and/or their terminological designations. For instance, the category 'Rare', which includes only potentially threatened local or mosaic-like distributed taxa, was present in such publications just because in these regions such taxa were always naturally rare. Therefore, to identify them as 'threatened or near threatened' would be utterly incorrect. The scale of the quantitative criteria for the assessment of the risk of extinction (as well as the system of information coding) has never been used at the national level: the material was presented more extensively aiming at its comprehension by a wider audience.

As a result of a series of meetings and discussions of all drawbacks of this system held by the working group on revision of the criteria, set up by the SSC of IUCN, in 1998-2000, it was recommended to adopt certain changes and to simplify the system.

First and foremost, it was recommended to exclude the notion Lower Risk: Conservation Dependent from the system of categories as rather ambiguous. Practically, the taxa of this category are to be reassigned to the category Near Threatened (NT) after concretisation and expanding its definition. It was also recommended not to use the term Lower Risk. Thus, the scheme above (Fig. 1) in the recommended version is to have two parallel branches in the section Adequate Data: Near Threatened (NT) – Least Concern (LC). Besides, some additional stylistic and semantic amendments were made to the definition of Categories and Criteria. Criterion A was subject to most changes, where two subcriteria describing the past and future state of the population of a taxon were further subdivided into two more subcriteria depending on the clarity of comprehension (!) of the status of a decrease in population number (IUCN/SSC/Criteria Review Working Group 1999). This criterion was also subject to quantitative changes (Mace 2000). However, most of them where upon to mis-interpretation due to the lack of concreteness, contributed to the growth of subjectivism. To a certain degree, this adversely affects the comprehension of the system at a regional level, which was proved in practice later (Gardenfors 1999).

However, the working group on the regional application of categories (RAWG), set up within the subcommittee of the IUCN Red List Programme,

as a result of its activities in 1998-2000 prepared a number of clear definitions of terms, to be applied at the regional level, as well as valuable methodical recommendations on such activities (Gardenfors 1999). In particular, a two-stage procedure of the assessment of the risk of extinction of a taxon from the region was put forward: (i) application of the global criteria for such an assessment of a taxon in the region; (ii) a correcting assessment of immigration links with conspecific populations beyond the region. However, the procedure of the regional assessment of the extinction risk is recommended to start from the classification of the share (percentage) of its regional population in the global one (I-III or I-V classes, depending on a region and expertise).

#### EXPERIENCE OF ADAPTATION OF THE IUCN SYSTEM OF CATEGORIES AND THE REGION OF THE FORMER USSR

The question of the compliance of the regional system of categories and the global system of IUCN is very important and timely. For in case of a positive solution, it will provide sole, or at least convertible approaches to the assessment of the taxon extinction risk from the wild, irrespective of the level of territoriality or national notions. However, as observed above, there are certain difficulties in the way.

In this connection, we have undertaken an attempt to make a critical synthesis of the various approaches to the creation and the application of the system of Categories and of the assessment Criteria of the risk of taxon extinction in the wild. Therefore, in the new edition of the Red Data Book of the Republic of Uzbekistan the national system is used, which combines both the elements of the traditional comprehension of the extinction of taxa in the wild (qualitative or dynamic aspect), typical of the number of regional Red Data Books and lists in the territory of the former USSR, and the most important features of the 1994 IUCN system (a quantitative aspect) taking into consideration the latest recommendations on its improvement.

As a matter of principle, after taking into consideration all traditional approaches (both in the territory of the former USSR, the other regions of the world, and by IUCN) and summarizing all mentioned afore, it is now possible to suggest a scheme of adaptation of the regional system of categories (with respect to the traditional designation of the latter) and the IUCN system (Fig. 2).

In the new edition of the Red Data Book of the Republic of Uzbekistan, a system of figures and letter-symbol designations (in English) for the different categories of threat to wildlife is applied. These categories are traditional for a number of such national publications that are close or in conformity with the global categories of IUCN; they are given in square brackets.

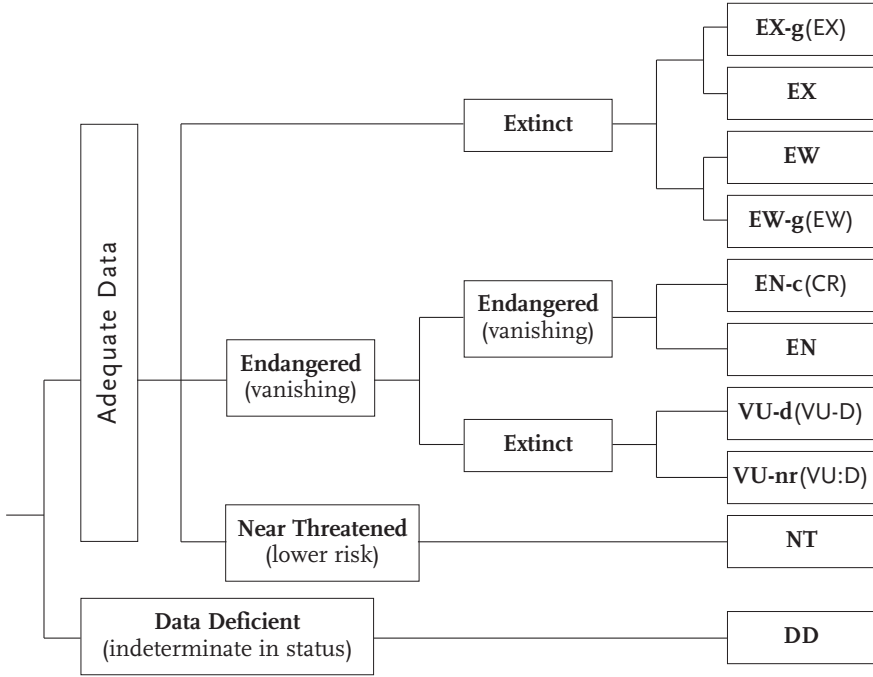

**Figure 2** – A possible hierarchic scheme of the regional system of categories when adapted to the IUCN system.

In order to avoid too loose an interpretation of terms, which frequently takes place while translating them into local languages, the Latin (which are the root words for most West European languages) designations of the key definitions, as well as some Russian and English synonymous names of categories typical of some regional editions are provided.

*Category of extinction* defines taxa as ‘Extinct’ or probably<sup>1</sup> extinct in the world, wildlife, country, region (at the national and regional levels during the last 100 years, and at the global level during the last 400 years).

o category: ‘EXTINCT’. Taxa that are not found in the wild (in the world or in the country, region) at least for many years, or survived only in cultivation, captivity or as naturalized or semi-captive populations well outside of the past natural range. There are 4 subcategories:

<sup>1</sup> In applying the term ‘probably extinct’, an interrogation mark has been added to the according abbreviation (EX?, EX-w?, EX-r?).

- ‘Extinct in the world (globally)’ – (EX-g) [*Extinct in the world* (EX)];
- ‘Extinct in the Wild (globally)’ – (EW-g) [*Extinct in the Wild* (EW)];
- ‘Regionally Extinct’ – (*regionalis exstincti*) – (EX) [*Regionally Extinct* (RE)], (‘Extirpated’).
- ‘Regionally Extinct in the Wild ‘ – (*in naturae regionalis exstincti*) – (EW).

The following two categories of threat or danger define taxa as ‘Threatened’ having an extremely high and very high risk of extinction in the wild in immediate or near future (1st category) or the risk of extinction in the wild a medium in the medium-term future (2nd category). As a rule, the former has a low number in few local populations and narrow present ranges, and the latter has a higher number and relatively wide and severely fragmented ranges.

In reality, the former and the latter represent taxa which have become rare as a result of direct or indirect effect of anthropogenic factors (‘artificially rare’).

*Category 1: ‘VANISHING’, ‘ENDANGERED’*

Taxa that are under threat (danger) of immediate risk of extinction, their number and range have considerably declined to the critical level or close to it.

2 subcategories:

- ‘Critically Vanished’ or ‘Critically Endangered’ (*vanesci in stato critico*) (EN-c) [*Critically Endangered* (CR)], i.e. on the brink of extinction now;
- ‘Vanishing: in danger’ or ‘Endangered’ (*vanesci in stato periculoso*) – EN [*Endangered* (EN)], i.e. those vanishing (approaching the brink of extinction in the near future).

*Category 2: ‘VULNERABLE (‘Declining’) – (vulnerabilis (declivis) – VU*  
[*‘Vulnerable’ (VU), except criteria (VU:D)]*

Taxa with continuously reducing number and range over the last years, which can approach critical levels of survival in the near future.

The next category of potential threat or ‘Lower Risk’ of extinction defines taxa as ‘Near Threatened’ having insufficient determined lower risk of extinction in the wild at present and rather high risk of extinction in the future under pressure of new adverse factors. Taxa listed in this category connected with their natural low number in few local or mosaic-like distributed populations (‘naturally rare’) and, as a rule, narrow ranges that are accounted for by a particular ecological specialization.

*Category 3: ‘NATURALLY RARE’ – (rarae naturaliter) – NR* [*‘Near Threatened’ (NT) particularly, on determination, including criteria VU:D]*

Taxa having a local or severely fragmented area of occupancy and a low number, which are relatively stable, but which can decrease to the critical level of survival under unfavourable changes of environmental conditions.

Next category of information deficient ('Data Deficient') defines taxa as having insufficiently determined risk of extinction in the wild owing to lack of adequate data on number and range of status for its direct or indirect assessment. This category confirms the possibility of their status change in the future.

*Category 4: 'INDETERMINATE IN STATUS' – (indeterminati in stato) – DD ['Data Deficient' (DD)], ('Indeterminate')*

Taxa having such number and range, which can offer some concern; however, appropriate data on abundance and/or distribution to indicate their definite category are lacking.

For the definition of categories, based on the system of criteria, a principle of data obtained as a result of the survey is used. Properly speaking, the notion 'critical values for survival' used for the designation of the category of threat of extinction is particular, absolute and static for individual taxa or their groups. General indices, which can be indirectly used in a relative assessment of the risk of a taxon's extinction and the definition of categories, are the characteristics (criteria) of the dynamics of the process of extinction.

For the inclusion of taxa into Categories 1 and 2, there is a rich range of quantitative criteria connected with conditions of the number fluctuation and range dynamics. Each taxon was evaluated by all criteria, and presence of any of them was a basis for the inclusion of the taxon into one of these categories. It was supposed that all data for the total range or all the populations of species that would be necessary for the formulation of clear conclusions concerning their status are available only in separate cases. In case, when there was a wide range of assessments for the degree of threat the preventive principle was chosen and a taxon was included in the highest deserved category. When there were evident threats for a taxon, for example, declining natural habitats or such habitats being destroyed, it was included into one of the categories even though there may be little direct information on the biological status of the taxon itself.

Summarizing the afore-mentioned information, we shall pay attention to some structural peculiarities of the national system of categories:

- 1 The used categories are grouped in Section 'Extinct', 'Endangered' or artificially rare (as a result of human activity), 'Vanishing and declining', under the potential threat of extinction, or 'Lower risk of extinction' ('Naturally rare'). 'The criterion 'Data Deficient' predetermines the category 'Indeterminate in Status'. The list of taxa of the special regime of use and requiring special attention is published as an appendix to the Red Data Book of the Republic of Uzbekistan. It includes the directly protected taxa not included into the Red Data Book and those corresponding to the cate-

- gories 'Rehabilitated', Least Concern (LC), Not Evaluated (NE), as well as the key monitoring taxa.
- 2 In order to include taxa into separate categories, a relative assessment is made of the risk of their extinction by using the scale of quantitative and qualitative characteristics (criteria A-E) of the dynamics of numbers and ranges of taxa. In comparison to the scale of 1994 IUCN Criteria and recommendations of 1999, an additional subdivision of Criterion A for all categories and criteria C2b, D for Category 2 (VU), as well as temporary indices connected with the number of generations for the criteria A and C2 is not used here. In compliance with the IUCN recommendation of 1999, corrections to Criterion A for Category 2 (VU) and criterion E for Categories 1(EN-c), 1(EN) are used.
  - 3 The names of the categories are adopted taking into account the national vocabulary and an opportunity to use an easy conversion of notions between the regional systems and that of IUCN.
  - 4 Difficulties in application of criteria for taxa of Invertebrates

For the first time, rare and threatened invertebrate species and subspecies have been included in the Red Data Book of Uzbekistan (in press), most of them insects. However, the application of many criteria for the determination of the degree of threat applied to invertebrate animals, particularly to insects, is difficult as it renders objective problems. On the one hand, annual fluctuations in numbers of the insect populations of hundred and even thousand times are a rather usual phenomenon and it is sometimes difficult to distinguish them from an intensive continuous decline (Category 2). On the other hand, numbers of many insects are difficult to assess due to the peculiarities of their biology (they often cannot be found even if a special survey is provided, but this cannot always be interpreted as a threat for the species' existence). The rarity of insect species in the wild (but not their rarity in collections, which can be explained by the lack of specialized collectors), a limited range, and, above all, the real threats to their existence as a result of changes of their habitats (Category 3) should be confirmed by means of scientific data.

Certainly, there is no sense in including into Category 3 a great number of taxa of insects, which are believed to be rare just because they are poorly studied – only those taxa are included that have been studied well enough and inhabit areas exposed to intensive anthropogenic pressure. One also should be prudent while including these taxa into Category 4. It is, at least, necessary to record an obvious decrease in the population. Such an analysis can be made on the basis of long-term observations in different points of the range and a comparison of climatic and ecological factors. Making an assessment on the basis of such criteria of the large numbers of insect species in Uzbekistan, when the local entomological fauna is not well known yet, is practically impossible in the near future. But even now there are some numbers of threatened taxa that can be included in one of the above-mentioned cate-

gories. However, from the ecological point of view, protection of separate invertebrate species, in particular insects, has little sense, because it is practically impossible to implement it without conservation of their habitats – and that is the main problem. Taking into account all arguments mentioned above, a small group of invertebrates typical for the threatened ecosystems (biocoenose) of Uzbekistan, was included in the present edition of the Red Data Book when protection of separate species involves conservation of all their ecological association.

Thus, our experience of adaptation of the global system of categories in Uzbekistan has shown a complete absence of principal barriers between the regional and global level of understanding of the process of taxa extinction in the wild. In fact, there is no ground to presume that the modern IUCN system should be duplicated in the national perception – this is hardly possible due to the traditional notions in this sphere. In our opinion, it is quite sufficient to reach a mutual conversion of systems; however, not only at the ‘global-regional’ level, but also, which is very important, at the ‘regional-regional (national-national)’ levels.

#### ACKNOWLEDGEMENTS

The critical review of modern systems of biodiversity extinction risk categories and the analysis of their apply at the regional and national level were made during the implementation of the INTAS project 1483 ‘Correlates of the extinction risk for the threatened biodiversity in Central Asia’. Therefore I would like to express my gratitude to INTAS for the opportunity to implement this important work. Also, I would like to thank all my colleagues and partners in the project and especially to the project leader Dr. Eleanor J. Milner-Gulland, to our moderators of the Red-Listing process at the regional level Dr. Craig Hilton-Taylor, Dr. Ulf Gärdenfors and Dr. Mariano Gimenez-Dixon, to our neighbour Prof. Wang Sung who presented the view on the Red-Listing process in China, to our intern Ms. Elena Bykova and all participants of the Tashkent meeting on the Red-Listing process in Central Asia (2001) who discussed their understanding of the Red-Listing process at the national, regional and global levels. I am also very grateful to our Russian colleagues Dr. Olga Krever, Dr. Sergey Kuzmin and Dr. Nikolai Formozov for our discussion during the round table at the IUCN Moscow office for NIS. Special thanks I would like to express to my wife Dr. Elena Kreuzberg-Mukhina for her support, patient and care.

## REFERENCES

- ABDUSALYAMOV, I.A. (ed.), 1988. *Red Data Book of Tajik SSR*. Donish Publishers, Dushanbe.
- ANONYMOUS, 1985. *Red Data Book of Kyrgyz SSR. Rare and Endangered Species of Animals and Plants*. Kyrgyzstan, Frunze.
- BORODIN, A.M. (ed.), 1984. *Red Data Book of the USSR. Rare and Endangered Species of Animals and Plants*, Vol. 1. Lesnaya Promyshlennost' Publishers, Moscow.
- BAILLIE, J. and B. GROOMBRIDGE (eds.), 1996. *1996 IUCN Red List of Threatened Animals*. IUCN, Gland and Cambridge; Conservation International, Washington.
- GARDENFORS, U., 1999. Draft Guidelines for the Application of IUCN Red List Criteria at National and Regional Levels. *Species* 31-32: 58-70.
- GROOMBRIDGE, B (ed.), 1993. *1994 IUCN Red List of Threatened Animals*. IUCN, Gland and Cambridge.
- IUCN, 1993. *Draft IUCN Red List Categories*. IUCN, Gland.
- IUCN, 1994. *IUCN Red List Categories*. IUCN, Gland.
- IUCN/SSC CRITERIA REVIEW WORKING GROUP, 1999. IUCN Red List Criteria Review Provisional Report: Draft of the Proposed Changes and Recommendations. *Species*.
- KARAGANDA, 1997. *IUCN categories for inclusion of species into the Red Data Book*. IUCN, Gland.
- KUZMIN, S.L., 1998. The state and prospects of development of the IUCN Red Data Book of animals. *Zoological Journal* 77 (10): 1093-1102.
- MACE, G.M., 2000. Summary of the results of the review of IUCN Red List Categories and Criteria 1996-2000: 57-61. In: C. Hilton-Taylor (comp.), *2000 IUCN Red List of Threatened Species*. IUCN, Gland and Cambridge.
- MACE, G.M. and S.N. STUART, 1994. Draft IUCN Red List Categories, Version 2.2. *Species* 21-22: 13-24.
- NEKRUTENKO, Yu.P., 1987. Insects in the Red Data Book of the USSR. *Zoological Journal* 66 (2): 198-210.
- KOVSHAR, A.F. (ed.), 1991. *Red Data Book of Kazakh SSR. Rare and Endangered species of Animals and Plants*. Vol. 1 *Animals*. Gylym, Alma-Ata.
- STUART, Ch. and T. STUART, 1998. *Africa's Vanishing Wildlife*. Smithsonian Institution Press, Washington.
- WALTER, K.S. and H. GILLET (eds.), 1998. *1997 IUCN Red List of Threatened Plants*. IUCN, Gland and Cambridge.
- WANG SUNG (ed.), 1998. *China Red Data Book of Endangered Animals*, Vol. 1-4. Science Press, Beijing.



# 3

## **Biodiversity Status Survey and Extinction Risk Assessment in the Republic of Uzbekistan**

*A.V.-A. Kreuzberg, E.A. Kreuzberg-Mukhina, E.A. Bykova*

### THE CURRENT STATUS OF BIOLOGICAL DIVERSITY IN THE REPUBLIC OF UZBEKISTAN

The particular geographical position of Uzbekistan within the Centralasian region on a junction of several biogeographical provinces has caused a significant richness of its animal world. At the same time, the biodiversity of Uzbekistan reflects the exceptional difference of natural conditions of this state. Vast plains occupied by different kinds of deserts, mountain grasslands (steppes), forests and alpine meadows, gallery poplar forests along river-beds, wetlands and water-reservoirs, and oases all represent typical ecosystems with their characteristic faunistic complexes.

The fauna of Uzbekistan has an ancient history and complex genetic relations. A significant role belongs to Turan and Turkestan endemic and autochthon species. Besides, in Uzbekistan groups of animals are found, which in the historical past migrated here from other regions: from Central Asian deserts and mountains, Indo-China, grasslands of Kazakhstan, from Siberia, South Europe and North Africa. Part of the fauna, especially that of wetlands, consists of introduced and occasional settlers from the Far East, China, the Caucasus, Baltic countries, Middle Russia, North America and other regions. On the whole, the present fauna of vertebrate animals includes 664 species: among them 97 mammalian species, 424 birds, 58 reptiles, 2 amphibians and 83 fishes. The fauna of invertebrate animals can be evaluated as comprising an estimated 15,000 species.

During the past decades, resulting from intensive economical development, many species of wild animals in Uzbekistan have been subject to a considerable human pressure that has led to a decrease in ranges and numbers of individuals of many species and total extinction of some of them. The main threats are posed to big mammals and birds that are of practical value as game (commercial) species. Endemic and locally distributed species with a narrow range are also under threat of extinction due to the vulnerable character of ecosystems intensively impacted by human development. Such species as the Caspian Tiger, Asiatic Cheetah, Turkmen Kulan (Wild Ass), and Aral Trout

have gone completely extinct from the territory of Uzbekistan. Other species such as the North Persian Leopard, Striped Hyena, Great Bustard, Big Amu-Darya Shovelnose, Little Amu-Darya Shovelnose, Syr-Darya Shovelnose, Ship Sturgeon (Aral Sea stock) are near extinction (critically endangered). The third group of animals such as Ustyurt and Bukhara Urinals, Markhor, Snow Leopard, Caracal, Iranian (Centralasian) Otter, Marbled Teal, Houbara Bustard, Pin-tailed Sandgrouse, Khentau Toad Agama, Strauch's Toad Agama, Sand Racerunner, Aral Barber, Pike Asp, several mollusc and insect species are endangered or vulnerable. A number of animal species has not reached critical levels yet, but a steady decline in their numbers has been observed, resulting from over-hunting and trapping, industrial and agricultural development of land and pollution of the environment.

Irrigated agriculture is the main form of land use in Uzbekistan. Irrigation has dramatically changed the ecological situation in different regions, which rendered the survival of many desert animals impossible under the new ecological conditions. In the last decades in Uzbekistan, Golodnaya, Karshi, Surkhan-Sherabad steppes, the central part of the Fergana valley, the stripe of foothills along the western outskirts of Tien-Shan and the Pamiro-Alay mountain systems have been developed for agriculture, thus leading to a decrease of habitats for Goitered (Persian) Gazelle, wild mountain sheep, Houbara Bustard, Pin-tailed Sandgrouse and other animal species. Considerable changes in the valleys of the great plain rivers led to a decline of gallery poplar ('tugai') forests that were cut or degraded as a result of water-flow volume loss. Owing to these changes and to a direct threat posed by human activities, the ranges of Bukhara deer, a local endemic pheasant subspecies and other inhabitants of river forests decreased.

Resulting from extensive hydrological constructions, salinization, and a decrease of the Aral Sea level, the indigenous ichthyofauna of the Aral Sea became extinct or near extinct; many endemic species of molluscs and crustaceans became critically endangered or near extinct. Regulation of great rivers' water-flows, appearance of new water-reservoirs, large scale development of irrigation networks, industrial pollution of water-areas, mountain-mining exploitation of the upper reaches of rivers and the influence of introduced species of fish have produced a negative effect on the existence of many species of the indigenous ichthyo- and malacofaunas.

Owing to changes of ecological conditions in the Aral Sea region, the wetlands in the delta of the River Amu-Darya have lost much of their rich avian diversity. The breeding habitats of the Mute Swan, Dalmatian and Great White Pelicans, Pygmy Cormorant and other threatened bird species have declined.

Transformation of mountain ecosystems as a result of human activity, live-stock overgrazing, cutting trees and bushes, and the development of mountain-mining industry have led to soil erosion, and the impact of mass-recreation predetermined the destruction of habitats for many invertebrate species.

Many wild plants play a role in the selection work for the creation of new economically viable cultivation and improvement of the existing ones. There are more than 4500 wild species of higher plants in the territory of Uzbekistan. Among them there are many rare, endemic and relict ones (more than 400) for the protection of which efficient measures are required. About 10-12% of the local flora falls under these categories. In spite of the fact that the status of plants protected in the natural reserves is relatively good, many species of plants have abruptly reduced their areas of occupancy (for instance, tulips and peonies, soapy stem, *Lagochilus inebrians* Bng., some onion species like *Allium stipitatum* Rgl, etc.). A considerable number of plant species is on the verge of extinction. A lot of damage to the wild flora is done by uncontrolled picking of rare medicinal and food plants (especially bulbous, bulbotuber and rhizomatous plants dug up together with underground organs).

It is clear that direct threats of extinction are posed to many wild animal species and their habitats if special legislative measures aimed at their protection are not taken. At the same time, it is known that any animal species is a genetically unique and non-recurrent phenomenon of nature, occupying its own place in the biological community. The Red Data Book of Rare and Threatened Animals is one of the important national legislative documents in the area of nature conservation in the Republic of Uzbekistan. During the past and at present, the work on the compiling of the Red Data Book of Uzbekistan is connected with similar work on other national Red Data Books and it is especially related to the IUCN Red List system.

#### RED LISTING PROCESS AS A BIODIVERSITY EXTINCTION RISK ASSESSMENT

The first books about extinct and vanishing animals of the world have been published since 1945. The primacy in the creation and the update of Red Data Books and Red Lists of threatened animals belongs to the the World Conservation Union (IUCN) founded in 1948. Since 1949, at the initiative of this organization an enormous work on the composition and analyses of lists of threatened animals has been made. The Species Survival Commission of IUCN (SSC/IUCN), in co-operation with other international and national nature conservation agencies, has been publishing issues of an international 'Red Data Books' dedicated to vertebrates (1963, 1966-1971, 1972-1974, 1978-1980) and other taxonomic groups of animals of the world or regional faunas (Fishes, Amphibians and Reptiles, Birds, Mammals of America and Australasia, Invertebrates, Swallowtail Butterflies and others). More complete information on threatened animal species and taxonomic groups has been published since 1986 in special series of books under the general title: 'SSC/IUCN Action Plans for the Conservation of Biological Diversity' ('Status Survey and Conservation Action Plan'). Up to date, about 40 such books (Antelopes, Wild

Sheep and Goats, Wild Cats, Otters, Pheasants, Cranes, Swallowtail Butterflies, Dragonflies, Conifers, Cactuses and Succulents, Palms and others) have been published. Such issues (1-19) have been published since 1989 in series of 'Occasional Papers of the SSC/IUCN' (Rodents, African Antelopes and Elephants, Turtles, Sharks, Molluscs, Blue Butterflies and many others).

Publications of the IUCN Red Lists of Threatened Animals in 1988, 1990, 1993, 1996, the IUCN Red List of Threatened Plants (1998), the World List of Threatened Trees (1998) and Threatened Species (2000) became significant events. The IUCN published a periodically updated global catalog of species, subspecies and populations of animals assigned to different categories of threat, with the indication of the main criteria of their status. During the whole history of compiling Red Data Books and Red Lists of Threatened species, the Species Survival Commission has been improving the system of Categories and Criteria, in order to include the truly threatened species. The last version of this system of Categories was published in 2001.

The IUCN Red List of Threatened Animals was compiled on the basis of the new IUCN Categories and Criteria. An analysis of impoverishment processes occurring in the world fauna cited in the IUCN Red Lists has shown that during the last four centuries a large number of species have gone extinct in the wild: 83 mammal species, 128 birds, 21 reptiles, 5 amphibians, 81 fishes, 291 molluscs, 8 crustaceans, 72 insects, 3 onychophorans, 1 turbellaria and 73 plants. Besides these numbers, 33 animal species have gone extinct from the wild and are only conserved in captivity. The extinction rate of species in the wild has dramatically accelerated since the end of the last century and it still continues. Presently, 1,130 mammal species, 1,183 birds, 296 reptiles, 146 amphibians, 751 fishes, 938 molluscs, 408 crustaceans, 10 spiders, 555 insects and about 20 other invertebrate animals and 5611 plant species are under the threat of extinction or experiencing a decline of range and numbers.<sup>1</sup>

The publication of the first issues of the International Red Data Book produced a powerful incentive to the creation of national and regional Red Data Books and Lists. Currently, such issues are being published in many states of Europe and Central Asia, Turkey, USA, Brazil, Southern Africa, Japan, Vietnam, Thailand, Taiwan, Korea, Australia, New Zealand, China and including others.

In 1983, the Red Data Book of the Uzbek SSR (Animals) including 63 species of vertebrate animals, and in 1984 the Red Data Book of Plants including 163 species of vascular plants were published. The further order of composition and publication of the Red Data Book was regulated by Resolution No. 109 of 9 March 1992 of the Cabinet of Ministers of the Republic of Uzbekistan and by the Statute 'On the Red Data Book of the Republic of Uzbekistan' of 17 June 1992. The Uzbek Academy of Sciences took responsibility for the

<sup>1</sup> The 1997 IUCN Red List of Threatened Plants (1998) cited 380 EX, 371 EX/EN, 33, 418 EN+VU (threatened) plant species.

implementation of the Red Data Book. The Red Data Book, as defined in the Statute, is a permanent publication which by the regulation must be reviewed at least once every 10 years. During this time the status of several species can change – some of them can be restored in numbers as a result of special conservation measures; others can decline to levels of a higher degree of threat. To date, the Uzbek Academy of Sciences and the Uzbekistan Zoological Society, the latter a member of IUCN since December 1997, have collected ample information, which allowed to evaluate the present state and status of many plant and animal species in the flora and fauna of Uzbekistan. Included in the Red Data Book of Uzbekistan are 24 taxa (species and subspecies) of mammals, 53 birds, 16 reptiles, 18 fishes, 3 annelids, 14 molluscs, 63 arthropods and 301 vascular plant species. The preparation of this book is a result of the current analysis of the status of rare and threatened plant and animal species in Uzbekistan.

The Red Data Book presents the documented illustration of the process of species extinction and serves as a basis for action plans for species conservation. Its role consists of the attraction of public attention to the need for the protection of the national fauna and flora. It is addressed to governmental and non-governmental organizations, scientific institutes and the broad community. The publication of a new edition of this Red Data Book of Uzbekistan in 2000 used the new IUCN Criteria and Categories and will initiate the realization of concrete measures for the protection and restoration of some threatened species, additional research on the current distributions, and a number of others actions.



## PART VI

### Overview of Red Lists\*



*Philomachus pugnax* (D. Ellinger/Foto Natura)

\*Source: Dr. Christia Köppel, V.I.M.-Verlag für interaktive Medien GbR, Germany, [postmaster@vim.de](mailto:postmaster@vim.de), [www.vim.de](http://www.vim.de).

**European Red Lists**  
Number of current and historical Red Lists

**Phytogeographical Groups**  
Nordic Baltic Central Europe

| Systematic groups                    | WORLD |        | Nordic  |        |        |         |         | Baltic |           |        | Central Europe |                |         |         |               |             |         |
|--------------------------------------|-------|--------|---------|--------|--------|---------|---------|--------|-----------|--------|----------------|----------------|---------|---------|---------------|-------------|---------|
|                                      | WORLD | EUROPE | ICELAND | NORWAY | SWEDEN | FINLAND | ESTONIA | LATVIA | LITHUANIA | POLAND | SLOVAKIA       | CZECH REPUBLIC | HUNGARY | AUSTRIA | LIECHTENSTEIN | SWITZERLAND | GERMANY |
| Vascular Plants                      | 8     | 10     | 3       | 5      | 8      | 13      | 3       | 4      | 3         | 8      | 9              | 11             | 3       | 30      | 4             | 13          | 182     |
| Mosses and Liverworts                | 1     | 3      | 1       | 5      | 5      | 8       | 2       | 1      | 3         | 9      | 6              | 1              | 4       |         | 3             | 45          |         |
| Lichens                              | 1     | 1      | 1       | 4      | 3      | 5       | 2       | 1      | 2         | 4      | 1              |                | 10      |         | 2             | 32          |         |
| Fungi (incl. Slime Moulds)           |       |        |         | 6      | 5      | 8       | 1       | 1      | 3         | 4      | 3              |                | 2       |         | 1             | 50          |         |
| Algae (incl. Blue-Green Algae)       |       |        | 1       | 2      |        | 5       | 1       | 1      | 2         | 2      | 2              |                | 2       |         |               | 36          |         |
| Plant Communities                    |       |        |         |        |        |         | 1       |        | 1         | 3      |                |                | 4       |         | 1             | 36          |         |
| Habitat Types                        |       | 2      |         |        | 1      | 1       | 1       | 1      | 1         |        |                |                | 2       |         |               | 23          |         |
| Soils                                |       |        |         |        |        |         |         |        |           |        |                |                |         |         |               | 1           |         |
| Cultivated Plants                    |       |        |         |        |        |         |         |        |           |        |                |                |         |         |               | 1           |         |
| Domestic Animals                     |       |        |         |        |        |         |         |        |           |        |                |                |         |         |               | 11          |         |
| Mammals                              | 8     | 9      |         | 6      | 3      | 7       | 3       | 4      | 3         | 5      | 4              | 3              | 1       | 6       | 5             | 82          |         |
| Birds                                | 13    | 12     | 1       | 5      | 3      | 7       | 3       | 4      | 3         | 6      | 4              | 3              | 1       | 21      | 4             | 10          | 156     |
| Amphibians and Reptiles              | 10    | 8      |         | 5      | 3      | 7       | 4       | 4      | 3         | 5      | 3              | 3              | 1       | 8       | 2             | 12          | 125     |
| Fishes and Lampreys                  | 7     | 7      |         | 6      | 2      | 6       | 2       |        | 1         | 5      | 5              | 7              | 2       | 18      | 1             | 6           | 94      |
| Molluscs                             | 8     | 5      |         | 3      | 2      | 6       | 2       | 3      | 1         | 3      | 1              | 2              | 1       | 6       |               | 5           | 68      |
| Butterflies and Moths                | 8     | 8      |         | 3      | 2      | 8       | 2       | 3      | 1         | 3      | 2              | 1              | 1       | 16      | 2             | 5           | 146     |
| Beetles                              | 8     | 4      |         | 4      | 2      | 6       | 1       | 4      | 1         | 2      | 2              | 1              | 1       | 19      |               | 3           | 176     |
| Grasshoppers, Crickets, Earwigs, ... | 8     | 4      |         | 3      | 2      | 4       | 1       | 1      | 1         | 3      | 3              | 1              | 1       | 5       |               | 4           | 74      |
| Dragonflies                          | 8     | 3      |         | 4      | 2      | 5       | 1       | 1      | 1         |        | 2              | 2              | 1       | 7       |               | 6           | 79      |
| Wasps, Bees, Ants and Sawflies       | 8     | 2      |         | 1      | 2      | 5       | 2       | 1      | 1         | 3      | 2              | 1              | 1       | 7       |               | 3           | 116     |
| True Flies                           | 3     |        |         | 2      | 2      | 7       | 1       | 1      |           | 2      | 1              |                | 1       |         | 1             | 65          |         |
| Alderflies and Snakeflies            | 5     | 2      |         | 3      | 2      | 3       | 1       | 1      |           | 2      | 1              |                | 6       |         | 1             | 17          |         |
| Plant and Water Bugs, Flees          | 3     |        |         | 4      | 2      | 8       | 1       | 1      |           | 2      | 1              |                | 3       | 1       |               | 32          |         |
| Caddisflies, Mayflies, Stoneflies    | 5     |        |         | 4      | 2      | 8       | 1       | 3      | 1         | 2      | 3              | 1              | 1       | 5       |               | 1           | 56      |
| Scorpionflies                        |       |        |         | 2      |        | 3       | 1       |        |           | 1      | 1              |                | 4       |         |               | 5           |         |
| Thrips                               |       |        |         |        |        |         |         |        |           |        |                |                | 1       |         |               | 3           |         |
| Primitive Wingless Insects           |       |        |         |        |        |         |         |        |           |        |                |                |         |         |               |             |         |
| Crustaceans                          | 8     | 4      |         | 1      | 2      | 4       | 1       | 2      | 1         | 3      | 2              | 1              |         | 11      | 1             | 43          |         |
| Spiders                              | 8     | 6      |         |        | 2      | 4       | 1       | 1      |           | 1      | 3              | 1              |         | 4       |               | 42          |         |
| Myriapods                            | 3     |        |         |        | 2      | 4       |         |        |           | 2      |                |                |         |         |               | 1           |         |
| Lower animals                        | 8     | 4      |         | 4      | 2      | 2       | 2       | 3      |           | 1      | 1              |                | 2       |         |               | 13          |         |
|                                      | 139   | 94     | 7       | 82     | 61     | 144     | 41      | 44     | 26        | 61     | 75             | 57             | 16      | 204     | 15            | 82          | 1810    |



| Atlantic |             |         |            | Mediterranea   |         |               |        |         |                |          |           |       |        | Balcanic |       |        |        |        | Easte    |         |           |         |                     |                        |         |          |                      |         |
|----------|-------------|---------|------------|----------------|---------|---------------|--------|---------|----------------|----------|-----------|-------|--------|----------|-------|--------|--------|--------|----------|---------|-----------|---------|---------------------|------------------------|---------|----------|----------------------|---------|
| DENMARK  | NETHERLANDS | BELGIUM | LUXEMBOURG | UNITED KINGDOM | IRELAND | FAROE ISLANDS | AZORES | MADEIRA | CANARY ISLANDS | PORTUGAL | GIBRALTAR | SPAIN | FRANCE | ITALY    | MALTA | GREECE | CYPRUS | TURKEY | BULGARIA | ROMANIA | MACEDONIA | ALBANIA | SERBIA & MONTENEGRO | BOSNIA AND HERZEGOWINA | CROATIA | SLOVENIA | MOLDOVA, REPUBLIC OF | UKRAINE |
| 8        | 5           | 3       | 3          | 10             | 2       | 1             | 1      | 1       | 2              | 3        | 1         | 10    | 5      | 9        | 3     | 3      | 1      | 3      | 3        | 5       |           | 3       | 3                   | 1                      | 2       | 1        | 4                    | 4       |
|          | 1           | 1       | 2          | 1              |         |               |        |         |                | 5        |           | 2     |        | 2        | 1     |        |        | 1      | 1        |         |           | 1       | 2                   |                        |         | 1        |                      | 1       |
| 2        | 1           |         |            | 2              |         |               |        |         |                |          |           |       | 2      | 1        | 1     |        |        |        |          |         |           | 1       | 1                   |                        |         |          |                      | 1       |
| 3        | 5           | 1       |            |                |         |               |        |         |                |          |           |       |        | 1        | 1     |        |        |        |          |         |           | 1       | 1                   |                        |         |          |                      | 1       |
| 2        | 2           |         |            | 1              | 1       |               |        |         |                |          |           |       | 1      |          | 1     |        |        |        |          |         |           | 1       | 1                   |                        |         |          |                      | 1       |
| 1        | 1           |         |            |                |         |               |        |         |                |          |           |       |        |          |       |        |        |        |          |         | 1         |         |                     |                        |         |          |                      | 1       |
| 1        | 2           |         |            |                |         |               |        |         |                |          |           |       |        |          |       |        |        |        |          |         |           |         |                     |                        |         |          |                      |         |
| 5        | 5           | 2       |            | 3              | 1       |               | 1      | 1       |                | 1        |           | 2     | 4      | 6        | 1     | 1      |        | 1      | 2        |         |           | 1       | 1                   |                        | 2       | 1        | 1                    | 2       |
| 5        | 6           | 1       | 2          | 2              | 1       |               | 1      | 1       |                | 1        |           | 2     | 7      | 9        | 1     | 1      |        | 2      | 2        | 1       |           | 1       | 1                   |                        | 2       | 2        | 2                    | 2       |
| 6        | 3           | 1       |            | 1              | 1       |               | 1      | 1       |                | 1        |           | 2     | 5      | 6        | 1     | 1      |        | 1      | 2        |         |           | 1       | 1                   |                        | 3       | 2        | 3                    |         |
| 4        | 3           | 1       |            | 2              | 2       |               | 2      | 2       |                | 2        |           | 2     | 7      | 4        | 1     | 2      |        | 1      | 2        | 1       |           | 1       | 1                   |                        | 2       | 2        | 1                    | 1       |
| 2        | 2           | 1       |            | 2              |         |               |        |         |                |          |           |       | 2      | 3        | 1     |        |        |        |          |         |           | 1       | 1                   |                        | 2       |          | 1                    |         |
| 4        | 2           | 2       | 2          | 5              |         |               |        |         | 2              |          | 3         | 1     | 6      | 1        | 1     |        |        | 1      |          |         | 1         | 1       |                     |                        | 3       |          | 2                    |         |
| 4        |             | 4       | 1          | 4              |         |               |        |         |                | 1        |           | 1     | 3      | 1        | 1     |        |        |        |          |         |           | 1       | 1                   |                        |         |          |                      | 2       |
|          | 3           | 1       | 2          | 2              |         |               |        |         | 1              |          | 1         | 1     | 4      | 1        | 1     |        |        |        |          |         |           |         | 1                   |                        | 1       |          | 2                    |         |
| 2        | 1           | 3       | 2          | 2              |         |               |        |         |                |          |           | 1     | 2      | 1        | 1     |        |        | 1      |          |         |           | 1       |                     |                        | 1       |          | 1                    | 1       |
|          |             |         |            | 5              |         |               |        |         |                |          |           |       | 2      | 1        | 1     |        |        |        |          |         |           | 1       |                     |                        |         |          |                      | 1       |
| 4        |             | 1       |            | 3              |         |               |        |         |                |          |           | 3     | 1      | 1        | 1     |        |        |        |          |         |           | 1       |                     |                        |         |          |                      | 1       |
|          |             |         |            | 1              |         |               |        |         |                |          |           |       |        | 2        | 1     |        |        |        |          |         |           | 1       |                     |                        |         | 1        |                      | 1       |
| 2        |             |         |            | 3              |         |               |        |         |                |          |           |       | 3      | 1        | 1     |        |        |        |          |         |           | 1       |                     |                        |         | 1        |                      | 1       |
| 4        |             |         |            | 4              |         |               |        |         |                |          |           |       | 1      | 1        | 1     |        |        |        |          |         |           | 1       |                     |                        |         | 2        |                      | 1       |
|          |             |         |            |                |         |               |        |         |                |          |           |       | 1      | 1        | 1     |        |        |        |          |         |           | 1       |                     |                        |         | 1        |                      | 1       |
|          |             |         |            |                |         |               |        |         |                |          |           |       | 2      | 1        | 1     |        |        |        |          |         |           | 1       | 3                   |                        |         | 4        |                      | 1       |
| 2        | 2           |         |            | 2              |         |               |        |         |                |          |           | 2     | 3      | 1        | 1     |        |        |        |          |         |           | 1       | 3                   |                        |         | 4        |                      | 1       |
| 4        | 4           |         |            | 2              |         |               |        |         |                |          |           |       | 4      |          |       |        |        |        |          |         |           | 1       |                     |                        |         | 1        |                      |         |
|          |             |         |            | 2              |         |               |        |         |                |          |           |       | 1      |          |       |        |        |        |          |         |           |         | 1                   |                        |         | 2        |                      |         |
| 2        | 2           |         |            | 2              |         |               |        |         |                |          |           | 2     | 2      | 1        | 1     |        |        |        |          |         |           | 1       | 4                   |                        | 4       |          | 4                    | 1       |

0 67 50 22 14 61 8 1 6 6 2 16 1 24 44 79 23 8 1 11 12 7 0 17 30 1 8 33 10 30

European Red Lists  
National and regional Red Lists

Phytogeographical Groups  
Nordic Baltic Central Europe

Atlantic

Systematic groups

|                                      | WORLD | EUROPE | ICELAND | NORWAY | SWEDEN | FINLAND | ESTONIA | LATVIA | LITHUANIA | POLAND | SLOVAKIA | CZECH REPUBLIC | HUNGARY | AUSTRIA | LIECHTENSTEIN | SWITZERLAND | GERMANY | DENMARK | NETHERLANDS | BELGIUM | LUXEMBOURG | UNITED KINGDOM |
|--------------------------------------|-------|--------|---------|--------|--------|---------|---------|--------|-----------|--------|----------|----------------|---------|---------|---------------|-------------|---------|---------|-------------|---------|------------|----------------|
| Vascular Plants                      | 0     | +      | 0       | 0      | +      | +       | +       | +      | +         | +      | 0        | +              | 0       | +       | 0             | +           | +       | +       | +           | +       | 0          | +              |
| Mosses and Liverworts                | 0     | 0      | 0       | 0      | 0      | 0       | 0       | 0      | 0         | 0      | 0        | +              | 0       | +       | 0             | +           | +       | +       | 0           | 0       | 0          | +              |
| Lichens                              | 0     | 0      | 0       | 0      | 0      | 0       | 0       | 0      | 0         | 0      | 0        | 0              | 0       | +       | 0             | 0           | +       | 0       | 0           | 0       | 0          | 0              |
| Fungi (incl. Slime Moulds)           |       |        |         | 0      | 0      | 0       | 0       | 0      | 0         | 0      | 0        | +              |         | +       |               | 0           | +       | 0       | 0           | -       |            | 0              |
| Algae (incl. Blue-Green Algae)       |       |        | 0       | 0      |        | 0       | 0       | 0      | 0         | 0      | 0        | 0              |         | 0       |               | 0           | +       | -       | -           | -       | -          | 0              |
| Plant Communities                    |       |        |         |        |        |         | 0       |        |           | 0      | 0        | 0              |         |         |               |             |         |         |             |         |            |                |
| Habitat Types                        |       |        |         |        |        |         |         |        |           |        |          |                |         |         |               |             |         |         |             |         |            |                |
| Soils                                |       |        |         |        |        |         |         |        |           |        |          |                |         |         |               |             |         |         |             |         |            |                |
| Cultivated Plants                    |       |        |         |        |        |         |         |        |           |        |          |                |         |         |               |             |         |         |             |         |            |                |
| Domestic Animals                     |       |        |         |        |        |         |         |        |           |        |          |                |         |         |               |             |         |         |             |         |            |                |
| Mammals                              | 0     | +      |         | 0      | +      | +       | +       | +      | +         | +      | 0        | 0              | 0       | +       |               | +           | +       | +       | +           | +       |            | +              |
| Birds                                | 0     | +      | 0       | 0      | +      | +       | +       | +      | +         | +      | 0        | 0              | 0       | +       | +             | +           | +       | +       | +           | -       | 0          | +              |
| Amphibians and Reptiles              | 0     | +      |         | 0      | +      | +       | +       | +      | +         | +      | 0        | 0              | 0       | +       | 0             | +           | +       | +       | +           | -       | -          | 0              |
| Fishes and Lampreys                  | 0     | +      |         | 0      | 0      | 0       | 0       | 0      | 0         | 0      | 0        | +              | 0       | +       | 0             | +           | +       | +       | +           | -       | -          | +              |
| Molluscs                             | 0     | +      |         | 0      | 0      | 0       | 0       | 0      | 0         | 0      | 0        | 0              | 0       | +       |               | +           | +       | -       | -           | -       | -          | +              |
| Butterflies and Moths                | 0     | 0      |         | 0      | 0      | 0       | 0       | 0      | 0         | 0      | 0        | 0              | 0       | +       | 0             | +           | +       | +       | 0           | -       | 0          | +              |
| Beetles                              | 0     | +      |         | 0      | 0      | 0       | 0       | 0      | 0         | 0      | 0        | 0              | 0       | +       |               | +           | +       | +       | +           | -       | 0          | +              |
| Grasshoppers, Crickets, Earwigs, ... | 0     | +      |         | 0      | 0      | 0       | 0       | 0      | 0         | 0      | 0        | 0              | 0       | +       |               | +           | +       | +       | +           | 0       | 0          | +              |
| Dragonflies                          | 0     | 0      |         | 0      | 0      | 0       | 0       | 0      | 0         | 0      | 0        | 0              | 0       | -       |               | +           | +       | 0       | 0           | -       | 0          | +              |
| Wasps, Bees, Ants and Sawflies       | 0     | 0      |         | 0      | 0      | 0       | 0       | 0      | 0         | 0      | 0        | 0              | 0       | +       |               | +           | +       | +       | +           | -       | -          | +              |
| True Flies                           | 0     |        |         | 0      | 0      | 0       | 0       | 0      | 0         | 0      | 0        | 0              |         | -       |               | 0           | +       | 0       |             | -       |            | +              |
| Alderflies and Snakeflies            | 0     | 0      |         | 0      | 0      | 0       | 0       | 0      | 0         | 0      | 0        | 0              |         | +       |               | +           | +       | 0       |             |         |            | 0              |
| Plant and Water Bugs, Flees          | 0     |        |         | 0      | 0      | 0       | 0       | 0      | 0         | 0      | 0        | 0              |         | +       | 0             |             | +       | 0       |             |         |            | +              |
| Caddisflies, Mayflies, Stoneflies    | 0     |        |         | 0      | 0      | 0       | 0       | 0      | 0         | 0      | 0        | 0              | 0       |         |               | +           | +       | 0       |             |         |            | +              |
| Scorpionflies                        |       |        |         | 0      |        | 0       | 0       |        |           |        | 0        | 0              |         |         | +             |             |         | -       |             |         |            |                |
| Thrips                               |       |        |         |        |        |         |         |        |           |        |          |                |         |         | +             |             |         | +       |             |         |            |                |
| Primitive Wingless Insects           |       |        |         |        |        |         |         |        |           |        |          |                |         |         |               |             |         |         |             |         |            |                |
| Crustaceans                          | 0     | +      |         | 0      | 0      | 0       | 0       | 0      | 0         | 0      | 0        | 0              |         | +       | 0             |             | +       | -       | -           |         |            | +              |
| Spiders                              | 0     | +      |         |        | 0      | 0       | 0       | 0      |           | 0      | 0        | 0              |         | +       |               |             | +       | -       | -           |         |            | +              |
| Myriapods                            | 0     |        |         |        | 0      | 0       |         |        |           |        | 0        |                |         | -       |               |             | -       | -       |             |         |            | +              |
| Lower animals                        | 0     | +      |         | 0      | 0      | 0       | 0       | 0      |           | 0      | 0        |                |         | -       |               |             | +       | -       | -           |         |            | +              |

MACEDONIA = MACEDONIA, THE FORMER YUGOSLAV REPUBLIC OF

- 0 = only national Red List(s)
- + = national and regional Red List(s)
- = only regional Red List(s)

| Mediterranea           |   |  |  |  |  |  |  |  |  | Balcenic |  |  |  |  |  |  |  |  |  | Eastern Continental |  |  |  |  |  |  |  |  |  | Number of countries or regions |
|------------------------|---|--|--|--|--|--|--|--|--|----------|--|--|--|--|--|--|--|--|--|---------------------|--|--|--|--|--|--|--|--|--|--------------------------------|
| IRELAND                | 0 |  |  |  |  |  |  |  |  | 0        |  |  |  |  |  |  |  |  |  | 0                   |  |  |  |  |  |  |  |  |  |                                |
| FAROE ISLANDS          | 0 |  |  |  |  |  |  |  |  |          |  |  |  |  |  |  |  |  |  |                     |  |  |  |  |  |  |  |  |  | 32                             |
| AZORES                 | 0 |  |  |  |  |  |  |  |  |          |  |  |  |  |  |  |  |  |  |                     |  |  |  |  |  |  |  |  |  | 27                             |
| MADEIRA                | 0 |  |  |  |  |  |  |  |  |          |  |  |  |  |  |  |  |  |  |                     |  |  |  |  |  |  |  |  |  | 22                             |
| CANARY ISLANDS         | 0 |  |  |  |  |  |  |  |  |          |  |  |  |  |  |  |  |  |  |                     |  |  |  |  |  |  |  |  |  | 21                             |
| PORTUGAL               | + |  |  |  |  |  |  |  |  |          |  |  |  |  |  |  |  |  |  |                     |  |  |  |  |  |  |  |  |  | 10                             |
| GIBRALTAR              | 0 |  |  |  |  |  |  |  |  |          |  |  |  |  |  |  |  |  |  |                     |  |  |  |  |  |  |  |  |  | 12                             |
| SPAIN                  | + |  |  |  |  |  |  |  |  |          |  |  |  |  |  |  |  |  |  |                     |  |  |  |  |  |  |  |  |  | 1                              |
| FRANCE                 | + |  |  |  |  |  |  |  |  |          |  |  |  |  |  |  |  |  |  |                     |  |  |  |  |  |  |  |  |  | 1                              |
| ITALY                  | + |  |  |  |  |  |  |  |  |          |  |  |  |  |  |  |  |  |  |                     |  |  |  |  |  |  |  |  |  | 41                             |
| MALTA                  | 0 |  |  |  |  |  |  |  |  |          |  |  |  |  |  |  |  |  |  |                     |  |  |  |  |  |  |  |  |  | 46                             |
| GREECE                 | 0 |  |  |  |  |  |  |  |  |          |  |  |  |  |  |  |  |  |  |                     |  |  |  |  |  |  |  |  |  | 41                             |
| CYPRUS                 | 0 |  |  |  |  |  |  |  |  |          |  |  |  |  |  |  |  |  |  |                     |  |  |  |  |  |  |  |  |  | 42                             |
| TURKEY                 | 0 |  |  |  |  |  |  |  |  |          |  |  |  |  |  |  |  |  |  |                     |  |  |  |  |  |  |  |  |  | 27                             |
| BULGARIA               | 0 |  |  |  |  |  |  |  |  |          |  |  |  |  |  |  |  |  |  |                     |  |  |  |  |  |  |  |  |  | 33                             |
| ROMANIA                | + |  |  |  |  |  |  |  |  |          |  |  |  |  |  |  |  |  |  |                     |  |  |  |  |  |  |  |  |  | 28                             |
| MACEDONIA              |   |  |  |  |  |  |  |  |  |          |  |  |  |  |  |  |  |  |  |                     |  |  |  |  |  |  |  |  |  | 30                             |
| ALBANIA                | 0 |  |  |  |  |  |  |  |  |          |  |  |  |  |  |  |  |  |  |                     |  |  |  |  |  |  |  |  |  | 28                             |
| SERBIA & MONTENEGRO    | 0 |  |  |  |  |  |  |  |  |          |  |  |  |  |  |  |  |  |  |                     |  |  |  |  |  |  |  |  |  | 22                             |
| BOSNIA AND HERZEGOWINA | 0 |  |  |  |  |  |  |  |  |          |  |  |  |  |  |  |  |  |  |                     |  |  |  |  |  |  |  |  |  | 21                             |
| CROATIA                | 0 |  |  |  |  |  |  |  |  |          |  |  |  |  |  |  |  |  |  |                     |  |  |  |  |  |  |  |  |  | 18                             |
| SLOVENIA               | 0 |  |  |  |  |  |  |  |  |          |  |  |  |  |  |  |  |  |  |                     |  |  |  |  |  |  |  |  |  | 19                             |
| MOLDOVA, REPUBLIC OF   | 0 |  |  |  |  |  |  |  |  |          |  |  |  |  |  |  |  |  |  |                     |  |  |  |  |  |  |  |  |  | 21                             |
| UKRAINE                | 0 |  |  |  |  |  |  |  |  |          |  |  |  |  |  |  |  |  |  |                     |  |  |  |  |  |  |  |  |  | 10                             |
| BELARUS                | 0 |  |  |  |  |  |  |  |  |          |  |  |  |  |  |  |  |  |  |                     |  |  |  |  |  |  |  |  |  | 3                              |
| RUSSIAN FEDERATION     | . |  |  |  |  |  |  |  |  |          |  |  |  |  |  |  |  |  |  |                     |  |  |  |  |  |  |  |  |  | 2                              |
| GEORGIA                | 0 |  |  |  |  |  |  |  |  |          |  |  |  |  |  |  |  |  |  |                     |  |  |  |  |  |  |  |  |  | 27                             |
| ARMENIA                | 0 |  |  |  |  |  |  |  |  |          |  |  |  |  |  |  |  |  |  |                     |  |  |  |  |  |  |  |  |  | 19                             |
| AZERBAIJAN             | 0 |  |  |  |  |  |  |  |  |          |  |  |  |  |  |  |  |  |  |                     |  |  |  |  |  |  |  |  |  | 11                             |
|                        |   |  |  |  |  |  |  |  |  |          |  |  |  |  |  |  |  |  |  |                     |  |  |  |  |  |  |  |  |  | 22                             |
|                        |   |  |  |  |  |  |  |  |  |          |  |  |  |  |  |  |  |  |  |                     |  |  |  |  |  |  |  |  |  | 689                            |



# European Red Lists Part 1

## Phytogeographical Groups

### Nordic

### Baltic

### Central Europe

| Systematic groups                    | WORLD |        | NORDIC  |        |        |         |         | BALTIC |           |        | CENTRAL EUROPE |                |         |         |               | SWITZERLAND |
|--------------------------------------|-------|--------|---------|--------|--------|---------|---------|--------|-----------|--------|----------------|----------------|---------|---------|---------------|-------------|
|                                      | WORLD | EUROPE | ICELAND | NORWAY | SWEDEN | FINLAND | ESTONIA | LATVIA | LITHUANIA | POLAND | SLOVAKIA       | CZECH REPUBLIC | HUNGARY | AUSTRIA | LIECHTENSTEIN |             |
| Vascular Plants                      | 2002  | 1992   |         |        |        |         |         |        |           |        |                |                |         |         |               |             |
| Mosses and Liverworts                | 2002  | 1995   | 1996    | 1999   | 2000   | 2001    | 1998    | 1991   | 1992      | 1992   | 2001           | 1995           | 1999    |         |               | 1991        |
| Lichens                              | 1989  | 1989   | 1996    | 1999   | 2000   | 1998    | 1998    | 1996   | 1992      | 1992   | 2001           | 1995           |         | 1999    |               | 1996        |
| Fungi (incl. Slime Moulds)           |       |        |         | 1999   | 2000   | 2001    | 1998    | 1996   | 1992      | 1992   | 2001           | 1995           |         | 1999    |               | 1997(A)     |
| Algae (incl. Blue-Green Algae)       |       |        | 1996    | 1999   | 2000   | 2001    | 1998    |        | 1992      | 1992   | 2001           | 1996           |         | 1999    |               |             |
| Plant Communities                    |       |        |         |        |        |         | 1998    |        |           |        | 1986           | 1995           |         |         |               | 1998(A)     |
| Habitat Types                        |       |        |         |        |        |         |         |        |           |        |                |                |         |         |               |             |
| Soils                                |       |        |         |        |        |         |         |        |           |        |                |                |         |         |               |             |
| Cultivated Plants                    |       |        |         |        |        |         |         |        |           |        |                |                |         |         |               |             |
| Domestic Animals                     |       |        |         |        |        |         |         |        |           |        |                |                |         |         |               |             |
| Mammals                              | 2002  | 1997   |         | 1999   | 2000   | 2001    | 1998    | 2000   | 1997      | 2001   | 2001           | 1989           | 1990    | 1994    |               | 1994        |
| Birds                                | 2002  | 1997   | 2000    | 1999   | 2000   | 2001    | 1998    | 2000   | 1993      | 2001   | 2001           | 1989           | 1990    | 1994    | 1998          | 2001        |
| Amphibians and Reptiles              | 2002  | 1997   |         | 1999   | 2000   | 2001    | 1998    | 1996   | 1996      | 2001   | 2001           | 1998           | 1990    | 1994    | 1993          | 1994        |
| Fishes and Lampreys                  | 2002  | 1997   |         | 1999   | 2000   | 2001    | 1998    |        | 1992      | 2001   | 2001           | 1998           | 1996    | 1997    | 1991(A)       | 1994        |
| Molluscs                             | 2002  | 1992   |         | 1999   | 2000   | 2001    | 1998    | 1998   | 1992      | 1995   | 1992           | 1995           | 1990    | 1994    |               | 1998        |
| Butterflies and Moths                | 2002  | 1999   |         | 1999   | 2000   | 2001    | 1998    | 1998   | 1992      | 1995   | 2001           | 1992           | 1990    | 1994    | 1996          | 1994        |
| Beetles                              | 2002  | 1992   |         | 1999   | 2000   | 2001    | 1998    | 1998   | 1992      | 1992   | 2001           | 1992           | 1990    | 1998    |               | 1994        |
| Grasshoppers, Crickets, Earwigs, ... | 2002  | 1992   |         | 1999   | 2000   | 2001    | 1998    | 1998   | 1992      | 1995   | 2001           | 1992           | 1990    | 1994    |               | 1997        |
| Dragonflies                          | 2002  | 1992   |         | 1999   | 2000   | 2001    | 1998    | 1998   | 1992      |        | 2001           | 1999           | 1990    |         |               | 1994        |
| Wasps, Bees, Ants and Sawflies       | 2002  | 1992   |         | 1999   | 2000   | 2001    | 1998    | 1998   | 1992      | 1995   | 2001           | 1992           | 1990    | 1994    |               | 1994        |
| True Flies                           | 2002  |        |         | 1999   | 2000   | 2001    | 1998    | 1998   |           |        | 2001           | 1992           |         |         |               | 1994        |
| Alderflies and Snakeflies            | 2002  | 1992   |         | 1999   | 2000   | 2001    | 1998    | 1998   |           |        | 2001           | 1992           |         | 1994    |               | 1994        |
| Plant and Water Bugs, Fleas          | 2002  |        |         | 1999   | 2000   | 2001    | 1998    | 1998   |           |        | 2001           | 1992           |         | 1983    | 1995(A)       |             |
| Caddisflies, Mayflies, Stoneflies    | 2002  |        |         | 1999   | 2000   | 2001    | 1998    | 1998   | 1992      | 1995   | 2001           | 1992           | 1990    | 1994    |               | 1994        |
| Scorpionflies                        |       |        |         | 1999   |        | 1992    | 1998    |        |           |        | 2001           | 1992           |         | 1994    |               |             |
| Thrips                               |       |        |         |        |        |         |         |        |           |        |                |                |         | 1994    |               |             |
| Primitive Wingless Insects           |       |        |         |        |        |         |         |        |           |        |                |                |         |         |               |             |
| Crustaceans                          | 2002  | 1992   |         | 1999   | 2000   | 2001    | 1998    | 1998   | 1992      | 1995   | 2001           | 1992           |         | 1994    | 1991(A)       |             |
| Spiders                              | 2002  | 1992   |         |        | 2000   | 2001    | 1998    | 1998   |           | 1995   | 2001           | 1992           |         | 1994    |               |             |
| Myriapods                            | 2002  |        |         |        | 2000   | 2001    |         |        |           |        | 2001           |                |         |         |               |             |
| Lower animals                        | 2002  | 1992   |         | 1999   | 2000   | 2001    | 1998    | 1998   |           | 1995   | 2001           |                |         |         |               |             |

MACEDONIA = MACEDONIA, THE FORMER YUGOSLAV REPUBLIC OF

### Responsible Organisation:

without marking = official Red List (governmental bodies)

N = NGOs (e.g. WWF)

A = scientific author (institutions)

Current national Red Lists (year of publication) / responsibility (part 1)

Atlantic

Mediterranea

| GERMANY | DENMARK | NETHERLANDS | BELGIUM | LUXEMBOURG | UNITED KINGDOM | IRELAND | FAROE ISLANDS | AZORES | MADEIRA | CANARY ISLANDS | PORTUGAL | GIBRALTAR | SPAIN | FRANCE | ITALY   | MALTA | GREECE | CYPRUS | TURKEY |
|---------|---------|-------------|---------|------------|----------------|---------|---------------|--------|---------|----------------|----------|-----------|-------|--------|---------|-------|--------|--------|--------|
| 1999    | 1998    | 2000(A)     | 1983(A) | 1999(A)    | 1999           | 1988    | 1983          | 1983   | 1983    | 1996           | 1985     | 1983      | 2000  | 1995   | 1997    | 1989  | 1995   | 1983   | 2000   |
| 1998    | 1998    | 1992        | 1984(A) | 1987(A)    | 2001           |         |               |        |         |                | 1994     |           | 1994  | 1987   | 1995(A) | 1989  |        |        | 1991   |
| 1998    | 1998    | 1998        |         |            | 1996           |         |               |        |         |                |          |           |       | 1987   | 1992    | 1989  |        |        |        |
| 1998    | 1998    | 1996        |         |            |                |         |               |        |         |                |          |           |       |        | 1997(A) | 1989  |        |        |        |
| 1998    |         |             |         |            | 1992           | 1992    |               |        |         |                |          |           |       | 1987   |         | 1989  |        |        |        |
| 2000    |         |             |         |            |                |         |               |        |         |                |          |           |       |        |         |       |        |        |        |
| 1996(A) |         |             |         |            |                |         |               |        |         |                |          |           |       |        |         |       |        |        |        |
| 1999(N) |         |             |         |            |                |         |               |        |         |                |          |           |       |        |         |       |        |        |        |
| 1998    | 1998    | 1994        | 1994(A) |            | 1993(A)        | 1993    |               | 1990   | 1990    |                | 1990     |           | 1992  | 1995   | 1998    | 1989  | 1992   |        | 1991   |
| 1998    | 1998    | 1996        |         | 1995(A)    | 1990(N)        | 1993    |               | 1990   | 1990    |                | 1990     |           | 1992  | 1999   | 1998    | 1989  | 1992   |        | 1993   |
| 1998    | 1998    | 1996        |         |            |                | 1993    |               | 1990   | 1990    |                | 1990     |           | 1992  | 1995   | 1998    | 1989  | 1992   |        | 1991   |
| 1998    | 1998    | 1998        |         |            | 1996           | 1996    |               | 1993   | 1993    |                | 1993     |           | 1992  | 1996   | 1998    | 1989  | 1995   |        | 1991   |
| 1998    |         |             |         |            | 1991           |         |               |        |         |                |          |           |       | 1995   | 1992    | 1989  |        |        |        |
| 1998    | 1998    | 1995        |         | 2001(A)    | 1997           |         |               |        |         |                | 1985     |           | 1985  | 1995   | 1992    | 1989  |        |        | 1991   |
| 1999    | 1998    |             |         | 1996(A)    | 1994           |         |               |        |         |                |          |           |       | 1995   | 1992    | 1989  |        |        |        |
| 1998    | 1998    | 1999        | 2000(A) | 2000(A)    | 1987           |         |               |        |         |                | 1985     |           | 1985  | 1995   | 1992    | 1989  |        |        |        |
| 1998    | 1998    | 1998        |         | 1998(A)    | 1987           |         |               |        |         |                |          |           |       | 1995   | 1992    | 1989  |        |        | 1991   |
| 1998    |         |             |         |            | 1991           |         |               |        |         |                |          |           |       |        | 1992    | 1989  |        |        |        |
| 1998    | 1998    |             |         |            | 1992           |         |               |        |         |                |          |           |       | 1998   | 1992    | 1989  |        |        |        |
| 1998    |         |             |         |            | 1991           |         |               |        |         |                |          |           |       |        | 1992    |       |        |        |        |
| 1998    | 1998    |             |         |            | 1992           |         |               |        |         |                |          |           |       |        | 1992    |       |        |        |        |
| 1998    | 1998    |             |         |            | 1991           |         |               |        |         |                |          |           |       |        | 1992    |       |        |        |        |
| 1998    | 1998    |             |         |            | 1992           |         |               |        |         |                |          |           |       |        | 1992    | 1989  |        |        |        |
| 1998    | 1998    |             |         |            | 1991           |         |               |        |         |                |          |           |       |        | 1992    | 1989  |        |        |        |
| 1998    |         |             |         |            | 1991           |         |               |        |         |                |          |           |       |        | 1992    |       |        |        |        |
| 1998    |         |             |         |            | 1991           |         |               |        |         |                |          |           |       |        | 1992    |       |        |        |        |
| 1998    |         |             |         |            | 1991           |         |               |        |         |                |          |           |       |        | 1992    |       |        |        |        |
| 1998    |         |             |         |            | 1991           |         |               |        |         |                |          |           |       |        | 1992    | 1989  |        |        |        |
| 1998    |         |             |         |            | 1991           |         |               |        |         |                |          |           |       | 1995   | 1992    | 1989  |        |        |        |
| 1998    |         |             |         |            | 1991           |         |               |        |         |                |          |           |       |        | 1992    |       |        |        |        |
| 1998    |         |             |         |            | 1991           |         |               |        |         |                |          |           |       |        | 1992    |       |        |        |        |
| 1998    |         |             |         |            | 1991           |         |               |        |         |                |          |           |       | 1995   | 1992    | 1989  |        |        |        |

**European Red Lists  
Part 2**

**Phytogeographical Groups**

**Current  
Eastern**

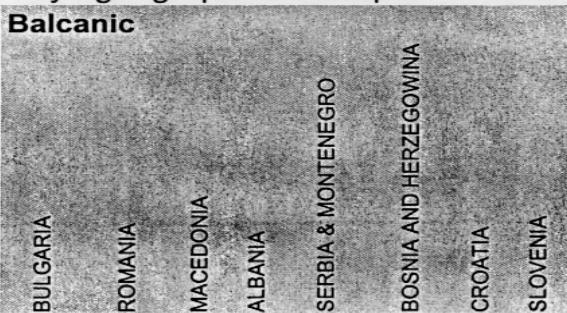

**Systematic groups**

|                                      | BULGARIA | ROMANIA | MACEDONIA | ALBANIA | SERBIA & MONTENEGRO | BOSNIA AND HERZEGOWINA | CROATIA | SLOVENIA | MOLDOVA, REPUBLIC OF | UKRAINE |
|--------------------------------------|----------|---------|-----------|---------|---------------------|------------------------|---------|----------|----------------------|---------|
| Vascular Plants                      | 1987     | 1994(A) |           | 1997    | 1999                | 1996(A)                | 1994    | 1996     | 1995                 | 1995    |
| Mosses and Liverworts                | 1998(A)  |         |           | 1997    | 1998(A)             |                        |         | 1992     |                      | 1995    |
| Lichens                              |          |         |           | 1997    | 1995(A)             |                        |         |          |                      | 1995    |
| Fungi (incl. Slime Moulds)           |          |         |           | 1997    | 1995(A)             |                        |         |          |                      | 1995    |
| Algae (incl. Blue-Green Algae)       |          |         |           | 1997    | 1995(A)             |                        |         |          |                      | 1995    |
| Plant Communities                    |          |         |           | 1997    |                     |                        |         |          |                      |         |
| Habitat Types                        |          |         |           |         |                     |                        |         |          |                      |         |
| Soils                                |          |         |           |         |                     |                        |         |          |                      |         |
| Cultivated Plants                    |          |         |           |         |                     |                        |         |          |                      |         |
| Domestic Animals                     |          |         |           |         |                     |                        |         |          |                      |         |
| Mammals                              | 1995     |         |           | 1997    | 1995(A)             |                        | 1994    | 1992     | 1978                 | 1995    |
| Birds                                | 1995     | 1983(A) |           | 1997    | 1995(A)             |                        | 1998    | 1992     | 1989                 | 1995    |
| Amphibians and Reptiles              | 1995     |         |           | 1997    | 1995(A)             |                        |         | 1992     | 1996(A)              | 1995    |
| Fishes and Lampreys                  | 1995     | 1994(A) |           | 1997    | 1995(A)             |                        | 1995    | 1996     | 1978                 | 1995    |
| Molluscs                             |          |         |           | 1997    | 1995(A)             |                        |         | 1992     |                      | 1995    |
| Butterflies and Moths                |          |         |           | 1997    | 1995(A)             |                        |         | 1996     |                      | 1995    |
| Beetles                              |          |         |           | 1997    | 1995(A)             |                        |         |          |                      | 1995    |
| Grasshoppers, Crickets, Earwigs, ... |          |         |           |         | 1995(A)             |                        |         | 1992     |                      | 1995    |
| Dragonflies                          |          |         |           |         | 1995(A)             |                        |         | 1997     |                      | 1995    |
| Wasps, Bees, Ants and Sawflies       |          |         |           |         | 1995(A)             |                        |         |          |                      | 1995    |
| True Flies                           |          |         |           |         | 1995(A)             |                        |         |          |                      | 1995    |
| Alderflies and Snakeflies            |          |         |           |         | 1995(A)             |                        |         | 1992     |                      | 1995    |
| Plant and Water Bugs, Fleas          |          |         |           |         | 1995(A)             |                        |         | 1992     |                      | 1995    |
| Caddisflies, Mayflies, Stoneflies    |          |         |           |         | 1995(A)             |                        |         | 1992     |                      | 1995    |
| Scorpionflies                        |          |         |           |         |                     |                        |         | 1992     |                      | 1995    |
| Thrips                               |          |         |           |         |                     |                        |         |          |                      | 1995    |
| Primitive Wingless Insects           |          |         |           |         |                     |                        |         |          |                      | 1995    |
| Crustaceans                          |          |         |           | 1997    | 1995                |                        |         | 1992     |                      | 1995    |
| Spiders                              |          |         |           |         | 1995                |                        |         | 1992     |                      | 1995    |
| Myriapods                            |          |         |           |         |                     |                        |         | 1992     |                      | 1995    |
| Lower animals                        |          |         |           | 1997    | 1995                |                        |         | 1992     |                      | 1995    |

MACEDONIA = MACEDONIA, THE FORMER YUGOSLAV REPUBLIC OF

**Responsible Organisation:**

without marking = official Red List (governmental bodies)

N = NGOs (e.g. WWF)

A = scientific author (institutions)



national Red Lists (year of publication) / responsibility (part 2)  
Continental

|         | UKRAINE | BELARUS | RUSSIAN FEDERATION | GEORGIA | ARMENIA | AZERBAIJAN | Number of countries or regions |
|---------|---------|---------|--------------------|---------|---------|------------|--------------------------------|
| 1996    |         | 1993    |                    | 2002(A) | 1990    | 1989       | 50                             |
| 1996    |         | 1993    |                    |         |         |            | 31                             |
| 1996    |         | 1993    |                    |         |         |            | 26                             |
| 1996    |         | 1993    |                    |         |         |            | 20                             |
| 1996    |         | 1993    |                    |         |         |            | 18                             |
|         |         |         |                    |         |         |            | 6                              |
|         |         |         |                    |         |         |            | 1                              |
|         |         |         |                    |         |         |            | 0                              |
|         |         |         |                    |         |         |            | 0                              |
|         |         |         |                    |         |         |            | 1                              |
| 1994    |         | 1993    | 2000               | 1982    | 1987    | 1989       | 41                             |
| 1994    |         | 1993    | 2000               | 1982    | 1987    | 1989       | 45                             |
| 1996(A) | 1996(A) | 2000    | 1996(A)            | 1996(A) | 1996(A) | 1996(A)    | 40                             |
| 1994    |         | 1993    | 2000               | 1982    | 1987    | 1989       | 41                             |
| 1994    |         | 1993    | 2000               |         |         |            | 26                             |
| 1994    |         | 1993    | 2000               |         |         |            | 32                             |
| 1994    |         | 1993    | 2000               |         |         |            | 27                             |
| 1994    |         | 1993    | 2000               |         |         |            | 30                             |
| 1994    |         | 1993    | 2000               |         |         |            | 26                             |
| 1994    |         | 1993    | 2000               |         |         |            | 22                             |
| 1980    |         | 1993    |                    |         |         |            | 18                             |
| 1994    |         |         |                    |         |         |            | 17                             |
|         |         | 1993    |                    |         |         |            | 18                             |
|         |         |         |                    |         |         |            | 20                             |
|         |         |         |                    |         |         |            | 8                              |
|         |         |         |                    |         |         |            | 3                              |
|         |         |         |                    |         |         |            | 2                              |
| 1994    |         | 1993    | 2000               |         |         |            | 25                             |
|         |         |         |                    |         |         |            | 16                             |
|         |         | 1993    | 2000               |         |         |            | 8                              |
| 1994    |         |         |                    |         |         |            | 19                             |





## Progress on the European Red List of vascular plants

Within the framework of the Euro+med Plantbase ([www.euromet.org.uk](http://www.euromet.org.uk)), funded by the European Union, V.I.M. (Verlag für interaktive Medien, Gagenau, Germany) and the Institute of Plant Sciences and Botanical Garden of the University of Bern, Switzerland, are establishing a website of plant conservation data for Europe ([www.s2you.com/euromed](http://www.s2you.com/euromed)).

So far the following information has been loaded: 54 citations of national and regional Red Lists of vascular plants, more than 700 links to websites of protected areas from 40 countries and over 550 links to botanic garden websites of 32 countries in Europe and the Mediterranean region. A list of plant biodiversity and genetic information resources has also been compiled, leading more than 100 websites and documents in this controversial debate. The emphasis is on information on gene flow from crops to their wild relatives. These link collections are updated weekly. In addition, detailed conversation datasets are being prepared on selected taxonomic groups such as *Galanthus* and *Brassica*. This part of the website is a work in progress, and currently only data on a few selected taxonomic groups are available to show how the data will be presented in future.

The next important step will be to add the synonyms of all names of vascular plants taxa in national Red Lists. The intention is to get feedback and thus to enhance the reliability of these data and to produce a new and authoritative European Red List.

The project depends heavily on the mobilization of up-to-date local, regional and national knowledge. It needs the collaboration of all specialists (both academic and amateur) working in the European and Mediterranean region. The Internet publication is the starting point of an interactive collaboration in Europe among experts, for instance the European Plant Specialist Group within the IUCN Species Survival Commission. Experts on vascular plant taxonomy and conservation are most welcome to contact the undersigned.

Prof.dr. Klaus Ammann, University of Bern, Institute of Plant Sciences and Botanical Garden, [Klaus.Ammann@ips.unibe.ch](mailto:Klaus.Ammann@ips.unibe.ch), [www.botany.unibe.ch](http://www.botany.unibe.ch), [www.botany.unibe.ch](http://www.botany.unibe.ch)

Dr. Christian Köppel, V.I.M.-Verlag für interaktive Medien GbR, Germany, [postmaster@vim.de](mailto:postmaster@vim.de), [www.vim.de](http://www.vim.de)



## List of addresses of corresponding authors

- BÁNKI, O.S. – Netherlands Committee for IUCN, Plantage Middenlaan 2b, 1088 DD Amsterdam, The Netherlands, t +3120 626 1732, f +3120 627 9349, banki@nciucn.org
- BAUER, H.-G. – Max-Planck Research Centre for Ornithology, Vogelwarte Radolfzell, Schlossallee 2, D-78315 Radolfzell, Austria, t +49 7732 150 150, f +49 7732 150 142, bauer@vowa.ornithol.mpg.de
- BENNETT, G. – Syzygy, PO Box 412, 6500 AK Nijmegen, The Netherlands, t +3124 684 444, f +3124 684 4406, bennett@syzygy.nl
- BURTON, J. – Consultant, World Land Trust, Blyth House, Bridge Street, Hales-worth, Suffolk IP19 8AB, United Kingdom, t +44 1986 874422, f +44 1986 874425, john.a.burton@lineone.net, worldlandtrust@btinternet.com, www.worldlandtrust.org
- CAMPISI, P. – Dipartimento di Scienze Botaniche dell'Università degli Studi di Palermo, v. Archirafi, 38 – 90100 Palermo, Italy, t +39 0916238216; f +39 0916238203, pcampisi@unipa.it
- CREEMERS, R. – Stichting RAVON, P.O. Box 1413, 6501 BK Nijmegen, The Netherlands, t +3124 365 3270, kantoor@ravon.nl, www.ravon.nl
- DE BRUYN, L. – Institute of Nature Conservation, Kliniekstraat 25, 1070 Brussels, Belgium, t +3225 288 888, f +3225 581 805, luc.de.bruyn@instnat.be
- DE IONGH, H.H. – Institute of Environmental Sciences, P.O. Box 9518, 2300 RA Leiden, The Netherlands, t +3171 527 7431, f +3171 527 7496, iongh@cml.leidenuniv.nl
- DE NIE, H. – Organization for Improvement of Inland Fisheries (OVBI) and Foundation for Field Research on Reptiles, Amphibians and Freshwater Fishes (RAVON), P.O. Box 1413, 6501 BK Nijmegen, The Netherlands, t +3124 365 3270, hwdenie@planet.nl
- DEVOS, K. – Institute of Nature Conservation, Kliniekstraat 25, 1070 Brussel, Belgium
- EATON, M.A. – Royal Society for the Protection of Birds, The Lodge, Sandy, Bedfordshire, SG19 2DL, United Kingdom, t +44 (0)1767 680551, f +44(0)1767 692365, mark.eaton@rspb.org.uk
- EISMA, D. – Netherlands Committee for IUCN, Plantage Middenlaan 2b, 1088 DD Amsterdam, The Netherlands, t +3120 626 1732, f +3120 627 9349, nciucn@nciucn.nl
- FERWERDA, W. – Netherlands Committee for IUCN, Plantage Middenlaan 2B, 1018 DD Amsterdam, The Netherlands, t +3120 626 1732, f +3120 627 9349, willem.ferwerda@nciucn.nl

- GÄRDENFORS, U. – Swedish Species Information Centre, P.O. Box 7007, SE-75007 Uppsala, Sweden, t +4618 672 689, f +4618 673 480, Ulf.Gardenfors@ArtData.slu.se
- GIOVI, E. – Dipartimento di Biologia Vegetale, Università degli Studi di Roma 'La Sapienza', Piazzale Aldo Moro, 5, 00185 Roma, Italy, t +39 0649912828, f +39 0649912957, emanuela.giovi@uniroma1.it
- GONSETH, Y. – Centre Suisse de Cartographie de la Faune (CSCF), Terreaux 14, C H-2000 Neuchâtel, Switzerland, t +4132 57257, yves.gonseth@cscf.unine.ch
- JOOP, P. – National Reference Centre, Ministry of Agriculture Nature Management and Fisheries, National Red List Program, P.O. Box 20401, 2500 EK The Hague, The Netherlands, t +3170 378 5626, f +3170 378 6144, p.joop@eclnv.agro.nl
- KÖPPEL, C. – Verlag für interaktiven medien GbR (VIM), Orchideenweg 12, 76571 Gaggenau, Germany, t +49 7225-79137, f +49 7225-79132, postmaster@vim.de, www.vim.de
- KREUZBERG, A.V.-A. – Institute of Zoology of Uzbek Academy of Sciences, Niyasov str. 1, Tashkent, 700095, Republic of Uzbekistan, t +9987 1121 6185, f +9987 1120 6791, iucn\_uz@comuz.uz
- LILLELEHT, V. – Estonian Agricultural University, Institute of Zoology and Botany, Riia 181, EE51014 Tartu, Estonia, t +372-7-383012, f. +372-7-383013, vilju.lilleleht@zbi.ee
- MAES, D. – Institute of Nature Conservation, Kliniekstraat 25, 1070 Brussel, Belgium, t +3225 521 837, f +3225 581 205, dirk.maes@instnat.be
- O'BRIAIN, M. – Nature & Biodiversity Unit, DG Environment, B2, European Commission, Nature Protection and Biodiversity Unit, 200, Rue de la Loi, B-1049 Brussels, Belgium, micheal.O'Briain@cec.eu.int
- ØDEGAARD, F. – Norwegian Institute for Nature Research, Tungasletta 2, NO-7485, Trondheim, Norway, t +47 73 80 15 55, f +47 73 801401, frode.odegaard@nina.no
- POLLOCK, C. – IUCN SSC Red List Programme, 219c Huntingdon Road, Cambridge, CB3 0DL, United Kingdom, t +4412 2327 7966, f +4412 2327 7845, caroline.pollock@ssc-uk.org
- ROGADO, L. – Instituto da Conservação da Natureza, Rua Filipe Folque 46 - iffl. 1050-114 Lisboa, Portugal, t +351.21 351 0440, f + 351.21 357 47 71, rogado@icn.pt
- TAMIS, W.L.M. – Nationaal Herbarium Nederland, branch Leiden University, P.O. Box 9514, 2300 RA Leiden, The Netherlands, t 031-71-5273546, f 031-71-5275611, tamis@cml.leidenuniv.nl
- UDO DE HAES, H.A. – Centre of Environmental Science, Leiden University, POB 9518, 2300 RA Leiden, The Netherlands, t +3171 527 7488, f +3171 527 7496, udodehaes@cml.leidenuniv.nl
- VENTURELLA, G. – Dipartimento di Scienze Botaniche, Via Archirafi 38, I-90123 Palermo, Italy, t +3909 1623 8203, f +3909 1623 8203, gvent@unipa.it
- ZULKA, K.P. – Federal Environment Agency Austria, Spittelauer Lände 5, A-1090 Vienna, Austria, t 0043/1/31304/3130, f 0043/1/31304/3400, zulka@ubavie.gv.at
- ZAVARZIN, A. – St.Petersburg Naturalists Society and St.Petersburg State University, Universitetskaya emb., 7/9, St.Petersburg, 199034, Russia. t +7(812)3289620, f +7(812)3289753; baltic@teai.org