

**CML**

Institute of Environmental Sciences

# Life cycle approaches for Conservation Agriculture

**Part I: A definition study for data analysis**

**Part II: Report of the Special Symposium on  
Life Cycle Approaches for Conservation  
Agriculture on 8 May 2006 at the SETAC-Europe  
16<sup>th</sup> Annual Meeting at The Hague**

Jeroen Guinée  
Lauran van Oers  
Arjan de Koning  
Wil Tamis

CML report 171 – Department of Industrial Ecology & Department of  
Environmental Biology

June 2006



Universiteit Leiden



# **Life cycle approaches for Conservation Agriculture**

## **Part I: A definition study for data analysis**

## **Part II: Report of the Special Symposium on Life Cycle Approaches for Conservation Agriculture on 8 May 2006 at the SETAC-Europe 16<sup>th</sup> Annual Meeting at The Hague**

Final report, June 2006

Jeroen Guinée  
Lauran van Oers  
Arjan de Koning  
Wil Tamis

Institute of Environmental Sciences  
Leiden University  
PO Box 9518  
2300 RA Leiden  
the Netherlands

CML report 171  
Department of Industrial Ecology & Department of Environmental Biology

***Copies can be ordered as follows:***

by telephone: +31 71 5277485

by writing to: CML library, P.O.Box 9518, 2300 RA Leiden, the Netherlands

by fax: +31 71 5275587

by e-mail: [eroos@cml.leidenuniv.nl](mailto:eroos@cml.leidenuniv.nl)

Please mention report number, and name and address to whom the report is to be sent.

Concurrent spreadsheets can be downloaded from

<http://europa.eu.int/comm/environment/natres/> and from [www.leidenuniv.nl/cml/ssp/](http://www.leidenuniv.nl/cml/ssp/)

Contact: CML, P.O.Box 9518, 2300 RA Leiden, the Netherlands

+31 71 5277477, +31 71 5277434, [guinee@cml.leidenuniv.nl](mailto:guinee@cml.leidenuniv.nl)

ISBN-10: 90-5191-148-3

ISBN-13: 978-90-5191-148-0

Printed by: Institute of Environmental Sciences, Leiden.

© Institute of Environmental Sciences, Leiden, 2006.

## Foreword

This report gives account of the study on life cycle approaches for conservation agriculture that the Institute Environmental Sciences (CML) of Leiden University has done for Syngenta Crop Protection AG, Switzerland. The study consisted of two parts that are reported separately.

Part I reports on a definition study considering a life cycle framework for a methodological consistent environmental and economic analysis of alternative agricultural management systems, focusing especially on these impact categories that have not yet maturely developed within LCA but are of particular importance in agricultural studies.

Part II reports on a workshop that has been held in conjunction with the 16th annual SETAC-symposium in The Hague 2006. During this workshop, different impact assessment methods dealing with conservation agriculture measures were presented and discussed.

We hereby like to acknowledge Syngenta Crop Protection AG for sponsoring this work and for supporting the debate on LCA and conservation agriculture.

Leiden, June 2006



# Part I

## A definition study for data analysis

### Contents

Executive summary.....	1
1 Introduction.....	3
1.1 The SOWAP/ProTerra projects.....	3
1.2 Problem description.....	3
1.3 Solution.....	3
1.4 Goal of this study.....	4
2 Definition of Life Cycle Framework.....	5
2.1 LCA methodology.....	6
2.1.1 Introduction.....	6
2.1.2 Framework.....	8
2.1.3 Goal and scope definition.....	9
2.1.4 Inventory analysis.....	12
2.1.5 Impact assessment.....	27
2.1.6 Interpretation.....	33
2.2 LCC methodology.....	35
2.2.1 Overview.....	35
2.2.2 Goal and Scope definition.....	36
2.2.3 Inventory analysis.....	36
2.3 Discussion.....	37
3 LCA impact assessment methods for land use related impacts.....	39
3.1 Introduction.....	39
3.2 General issues existing land use impact assessment methods.....	41
3.2.1 Description of existing land use impact methods.....	41
3.2.2 Discussion of land use impact methods.....	44
3.2.3 Conclusion.....	45
3.3 Existing single indicator impact assessment methods.....	46
3.3.1 Biodiversity impact through direct physical interventions.....	46
3.4 Existing multi indicator impact assessment methods.....	50
3.4.1 Introduction.....	50
3.4.2 Erosion.....	51
3.4.3 Hydrology.....	52
3.4.4 Soil fertility.....	54
3.5 Conclusions on practical and sensible methods for land use related impacts.....	56
4 Finding LCA and LCC data.....	58
4.1 Introduction.....	58
4.2 Data for LCA.....	58
4.2.1 LCI data needs.....	58
4.2.2 LCIA data needs.....	61
4.3 Data for LCC.....	62
4.4 Data available from SOWAP/ProTerra projects.....	63
4.5 Overview.....	64
5 Conclusions.....	65
5.1 Goal, scope, functional unit and system boundary.....	65
5.2 Impact Assessment.....	65
5.3 Life cycle costing.....	65
5.4 Data.....	65
6 References.....	67





## Executive summary

In the area of Conservation Agriculture, Syngenta is involved in two major projects testing alternative soil and weed management methods for arable respectively perennial crops: SOWAP and ProTerra. Both projects are producing numerous useful results e.g. data on soil erosion, water use, nutrients use, quality of the crop, biodiversity, etc. at the experimental farms. Key challenge for these projects now is to bring these data in an encompassing framework for further assessment and decision support.

Since each alternative particularly involves different upstream (and possibly also downstream) processes and may involve impacts related to different environmental problems, it is desirable that the framework will have a life-cycle basis. The study consisted of two parts that are reported separately.

Part I reports on a definition study considering a life cycle framework for a methodologically consistent environmental and economic analysis of alternative agricultural management systems as defined in the ProTerra and SOWAP projects, focusing especially on these impact categories that have not yet maturely developed within LCA but are of particular importance in agricultural studies.

The study did not concern a specific LCA case-study, but a definition study aiming to present a life-cycle framework for further assessment and decision support regarding the comparison of various management methods in SOWAP and ProTerra projects.

Life Cycle Assessment (LCA) and Life-Cycle Costing (LCC) methods have been taken as basis for the framework. Both tools are extensively described and illustrated with specific agriculture examples on functional units, system boundaries, flow charts and allocation. Subsequently, the focus has been on land use related impact and their assessment within LCA. Based on an inventory of existing and evolving LCA impact assessment methods for these land use related impacts, methods have been screened on their compliance with the general structure of life cycle impact assessment (LCIA), and the data needs of these methods have been analysed and compared to the data available from the SOWAP and ProTerra projects. General conclusion is there is no consensus yet on what are the best and most practical land use related life cycle impact assessment methods, that methods are still developing fast and that various methods have problems complying with the general LCIA structure.

Part II reports on a workshop that has been held in conjunction with the 16th annual SETAC-symposium in The Hague 2006. During this workshop, different impact assessment methods dealing with conservation agriculture measures were presented and discussed. Similar discussions and conclusions were drawn as in Part I, but also recommendations were made. In summary these recommendations are:

- Apply operative land-use related impact assessment methods in a case-study in order to initiate a constructive debate on the level of concepts and methodology. This will enable us to identify the key differences between a variety of methods which are currently being practised;
- Develop a scientific framework for Conservation Agriculture defining what it means and how it can best be measured (indicators);
- Learn from the LCIA experiences with the toxicity categories in defining best practice for LCIA of land use related impacts.



# 1 Introduction

## 1.1 The SOWAP/ProTerra projects

In the area of Conservation Agriculture, Syngenta is involved in several research projects aiming to protect the European agricultural soils against erosion. SOWAP (Soil and Water Protection) is such a project (<http://www.sowap.org/>). This project partly financed by Syngenta and partly by the EU Life program, focuses on agricultural practices in arable crops with pilot sites in the UK, Belgium, Hungary, France, and the Czech Republic in maize, wheat, sugar beet, beans and sunflowers. The SOWAP members are testing the impact of a range of site-specific soil and weed management methods, such as conventional tillage vs. conservation- and/or zero-tillage practices on the economics of the operations as well as effects on soil erosion and pesticide and fertiliser run-off. Also, some biodiversity indicators are monitored like birds, earthworms and aquatic invertebrates in order to better understand potential side-effects of the chemical inputs needed for conservation and zero tillage.

Another Syngenta financed project is ProTerra, focusing on soil protection in perennial crops with experimental sites in Mediterranean olive plantations and vineyards (<http://www.proterra.eu.com/>). The key challenge is that growers of Mediterranean olives and vines historically prefer to keep the soil bare during the summer in order to reduce competition for water and nutrients. The resulting soil structure is extremely vulnerable to heavy rain bursts in autumn and winter, washing away the soil and the residual herbicides used to keep the soil bare. A possible solution is the introduction and management of cover crops. This alternative has a number of advantages:

- it helps improving infiltration rates, which reduces the risk of flash flooding;
- it possibly also helps increasing the water holding capacity of the soil;
- it helps stabilising the surface and holding the soil in place during the autumn and winter rains through the crop's root structure.

The project partners are testing a range of different cover crops appropriate for the local conditions (e.g. with relatively low evapotranspiration in summer) and annual management of the cover crops to minimise competition for water. Several cover crop management systems are compared, ranging from low-tillage to chemical control with several non-residual herbicides.

## 1.2 Problem description

Both projects are producing numerous useful results e.g. data on soil erosion, water use, nutrients use, quality of the crop, biodiversity, etc. at the experimental farms. The key challenge now is to bring these data in an encompassing framework for further assessment and decision support.

## 1.3 Solution

There is a solution for each problem; the main question is how to select the proper solution for the problem described above. The LCA method yields a location-independent, time-integrated, generic analysis of all potential environmental impacts associated with a product or product system. It is important to realise given a specific question whether this indeed is the appropriate approach or whether a more site-specific and time-dependent approach like Environmental Risk Assessment would be more appropriate (for more discussion on this, see e.g. Guinée *et al.*, 2002). In this case, because each alternative particularly involves different upstream (and possibly also downstream) processes and may involve impacts related to different environmental problems, it is desirable that the framework will have a life-cycle basis. This life-cycle basis is not restricted to LCA, but also other life-cycle approaches may be relevant in this framework, such as Life-Cycle Costing (LCC). However, it should also be realised that LCA may not be able to properly deal with all types of impacts. There may still remain aspects that cannot (sensibly) be covered with LCA and that should be addressed with other tools. The proposed contribution of LCA to land use should be embedded in a broader approach of more types of tools and approaches, which all have to play their role. Of particular interest seem to be:

- Environmental Risk Assessment (ERA), with attention for local conditions
- Ecological modelling, investigating the sustainability of given activities being part of a value chain.
- Certification of sustainable land use (with attention for local characteristics, aspects in terms of activities (instead of environmental processes), and pass/fail criteria (instead of quantitative indicators), see Udo de Haes (2006).

Aspects that cannot (sensibly) be covered with LCA and that should be addressed with other tools, will be identified in this study but not further elaborated.

LCA will thus be the core of the framework. LCA consists of four phases: goal & scope definition; inventory analysis; impact assessment; and interpretation. For this study on the comparison of different agricultural management systems, the third phase is of particular importance and will receive extensive attention:

- impact assessment: the classification and characterisation of interventions (e.g. emissions of substances) into specific environmental impact categories and optionally the normalisation, grouping and/or weighting of characterisation results.

The classification and characterisation is based on a balance of scientific knowledge and best available practice in the scientific community, while the weighting between environmental problems is a political choice based on subjective arguments. This project will focus on the gathering and processing of data for the impact assessment. Procedures for the subjective weighting between environmental problems are beyond the scope of the project. Furthermore this project will focus especially on these impact categories that have not yet maturely developed but are at the same time of particular importance in agricultural studies, such as erosion, soil quality impacts, hydrology related impacts, direct biodiversity impacts and remaining land use related impacts.

## **1.4 Goal of this study**

The goals of this study can thus be described as:

- The definition of a life cycle framework for a methodological consistent environmental<sup>1</sup> and economic analysis of alternative agricultural management systems as defined in the ProTerra and SOWAP projects, focusing especially on these impact categories that have not yet maturely developed within LCA but are of particular importance in agricultural studies.
- Given this framework, identify data gaps in the collected data within the ProTerra and SOWAP projects.

Note that this report does not concern a specific LCA case-study, but a definition study aiming to present a life-cycle framework for further assessment and decision support regarding the comparison of various erosion management methods in SOWAP and ProTerra projects.

---

<sup>1</sup> Analysis on the level of separate impact categories, i.e. global warming, eutrophication, toxicity etc., not aggregated into one impact score.

## 2 Definition of Life Cycle Framework

A concept that is closely related to this definition study is the triple-P approach: Planet, Profit, and People. This project will focus on the framework for “planet” (environmental) and “profit” (economic) analysis of the management systems. The “people” (social) aspects of the different systems will not be identified, but may be included in follow-up work.

For “planet”, the key tool to be applied will be the environmental life cycle assessment (LCA) approach. LCA is an approach that strives to be encompassing in relation to both the phases of a product (cradle-to-grave) as also the wide range of possible environmental problems related to the product (i.e. global warming, eutrophication, toxicity etc.). It is a very useful tool for the integral (in time, space and issues covered<sup>2</sup>) comparison of alternative systems on the basis of a similar function or service that is fulfilled by these systems. As basis for this comparison a so-called functional unit is defined and all economic and environmental inputs and outputs are modelled in a linear way to this functional unit. Due to this input-output character, LCA also has its limitations. For example, LCA can address many flow-related environmental issues usefully in a time-integrated way and on the basis of a functional unit. LCA cannot really deal sensibly with non-flow related issues, such as one time transitions (e.g. logging of rainforest for agricultural land). Such important issues need to be handled separately from LCA. The same holds true for site-specific and time dependent impacts as approached in Environmental Risk Assessment.

“Profit”-issues, i.e. the economic aspects of the different alternative systems, will be addressed through a LCC approach. LCC is a method of calculating the total life cycle costs and proceeds of a product, i.e. a crop, thus from cradle to grave. Many different approaches and variants of life cycle costing methods exist. In this study we will apply LCC that is aligned with LCA (see Huppes *et al.*, 2004).

The life-cycle framework that we propose for this study is summarised in Figure 1 below and will be elaborated in subsequent chapters. *In this definition study we will try and include all relevant environmental and economic aspects within this LCA-LCC framework as far as possible and sensible, and we will identify those aspects that cannot be brought into this framework in a practical and/or sensible way and should be dealt with otherwise.* Below, LCA and LCC will be first described two separate sections.

---

<sup>2</sup> The USDA-NRCS Energy Consumption Awareness Tool for different tillage practices that is available on the web (<http://ecat.sc.egov.usda.gov/>), is also a sort of life-cycle based tool, although focusing on energy only. A full-fledged LCA as referred to in this study would e.g. not only focus on energy but would quantify all relevant environmental impacts of specific energy use such as resource depletion, global warming, stratospheric ozone depletion, acidification, etc.

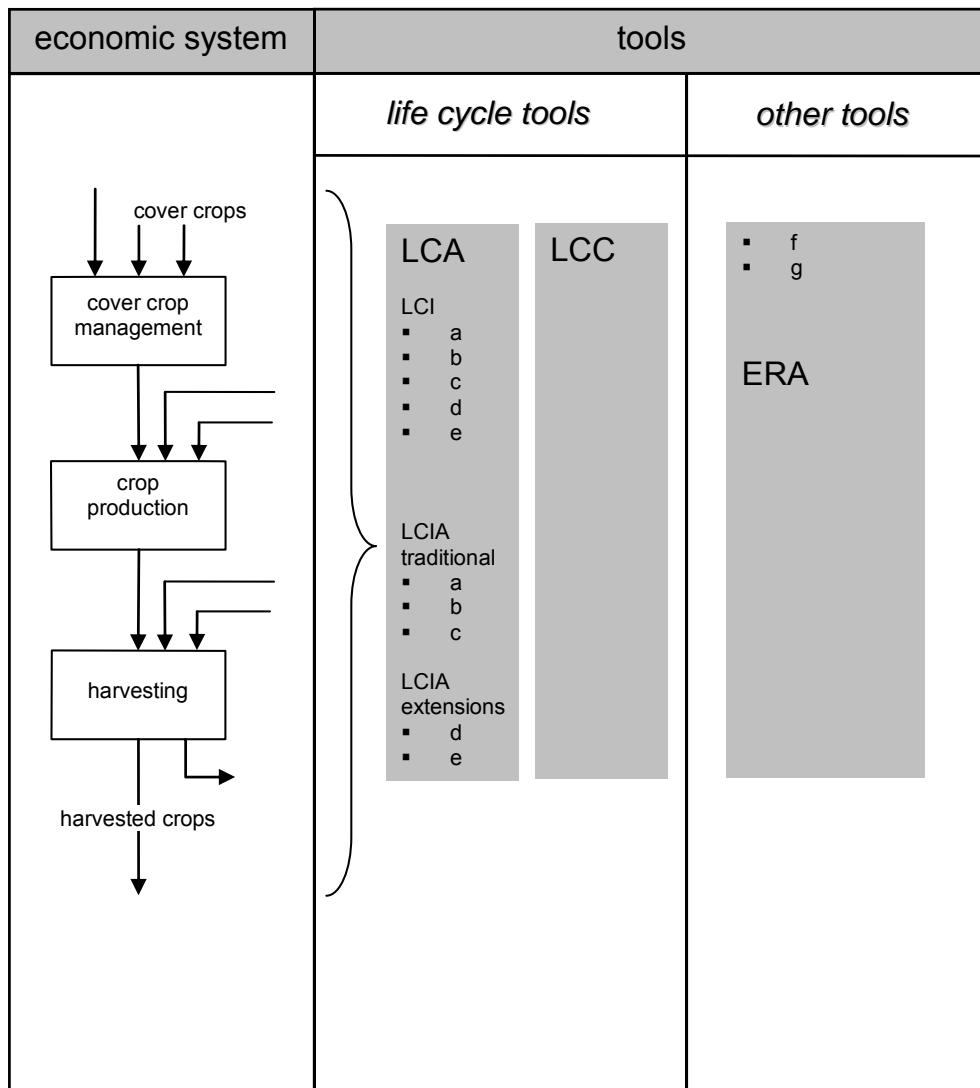

Figure 1: Life-cycle framework for assessing Conservation Agriculture alternatives, elaborated for a hypothetical agriculture system. LCI = Life Cycle Inventory, LCIA = Life Cycle Impact Assessment, a - e are environmental interventions, the impact of a - c can be assessed using the 'traditional' impact assessment methods used in LCA's, d & e need to be assessed with impact assessment methods specially designed for agricultural LCA's, f & g are environmental interventions that cannot be assessed by the life cycle tools.

## 2.1 LCA methodology

### 2.1.1 Introduction

Environmental policy today focuses at the transition to sustainable production and consumption patterns. This is taking place in various ways and at various levels. Knowledge of the environmental impacts of production and consumption patterns are indispensable for improving the performance of industries and consumers in this area. Integrated assessment of all environmental impacts from cradle to grave is the basis for achieving more sustainable products and services. One of the assessment tools widely used for this is environmental Life Cycle Assessment, abbreviated LCA. One of LCA's Leitmotivs is to get a full

picture of a product's impacts in order to find best solutions for their improvement without shifting impacts to other fields.

LCA has become a core topic in the field of environmental management. The International Organisation for Standardisation (ISO) has played and still is playing a role in the formal task of methodology standardisation. Within the ISO 14040 series, several international standards have been published by ISO on the topic of LCA. The central one is ISO 14040 (1997): 'Environmental management – Life cycle assessment – Principles and framework', which specifies the main idea of LCA. These ideas have been elaborated in further international standards and technical reports, like ISO 14041 (1998), 14042 (2000a) and 14043 (2000b). These standards are currently under revision and will be replaced by a new single document ISO 14044, which only includes editorial changes but no changes with respect to the technical content.

According to ISO 14040, Life Cycle Assessment is a "compilation and evaluation of the inputs and outputs and the potential environmental impacts of a product system throughout its life cycle". It is moreover stated that "A product system is a collection of unit processes connected by flows of intermediate products which perform one or more defined functions. [...] The essential property of a product system is characterised by its function, and cannot be defined solely in terms of the final products". Products include goods and services providing a given function. In the following we will speak, however, of a product as *pars-pro-toto* for all objects of LCA, if not specified differently.

LCA takes as its starting point the function fulfilled by a product system. In principle, it encompasses all the environmental impacts of resource use, land use and emissions associated with all the processes required by this product system to fulfil this function – from resource extraction, through materials production and processing and use of the product during fulfilment of its function, to waste processing of the discarded product. This means that ultimately all environmental impacts are related to this function, being the basis for comparisons to be made.

LCA as defined here deals only with the environmental impacts of a product (system), thus ignoring financial, political, social and other factors (e.g. costs, regulatory matters or Third World issues). This does not, of course, imply that these other aspects are less relevant for the overall evaluation of a product, but merely delimits the scope of LCA. In practice, LCA seldom deals with all environmental impacts, e.g. biotic resources are often not included.

A prime purpose of LCA is to support the choice of different (technological) options for fulfilling a certain function by compiling and evaluating the environmental consequences of these options. It should indicate the effects of choices in a way that prevents problem shifting. Problem shifting can occur when analysing only one activity, one area, one substance, one environmental problem or effects over a limited period of time. So the LCA model tries to cover all activities related to a product or function; stating effects anywhere in the world; covering all relevant substances and environmental themes; and having a long time horizon<sup>3</sup>. This encompassing nature of LCA in place, time and effect mechanisms has as a corollary that the model used should be relatively simple to keep the analysis feasible.

Carrying out an LCA for a specific product or set of product alternatives requires several things:

---

<sup>3</sup> So an ascertained productivity (soil fertility) - taking into account the consequences of erosion over the long term - should be part of the functional unit. Otherwise it is necessary to measure the change of productivity over time, i.e. the change in economic outputs (harvested crops) and inputs (fertiliser, pesticides, energy etc.).

- data on the production, use and disposal of the product, the materials it is made from, the energy it requires, and so on;
- a method to combine all these data in the appropriate way;
- software, in which all these methodological rules have been implemented
- a procedural context in which the process of doing LCA and using its results is embedded.

In the following, the emphasis is on shortly explaining the method. A discussion of other aspects can be found in e.g. Guinée *et al.* (2002).

Applying LCA to agricultural systems without due consideration to the specific characteristics of agriculture may raise problems. In the past, several studies have been performed to identify these problems and propose solutions. Building on Audsley *et al.* (1994), Wegener Sleeswijk *et al.* (1996) and Weidema and Meeusen (2000), specific problems and issues encountered when applying LCA to agricultural systems, will be highlighted below (in text boxes).

## 2.1.2 Framework

The complexity of LCA requires a fixed protocol for performing an LCA study. Such a protocol has been established by the ISO and is generally referred to as the methodological framework. ISO distinguishes four phases of an LCA study (see Figure 2):

- goal and scope definition;
- inventory analysis;
- impact assessment;
- interpretation.

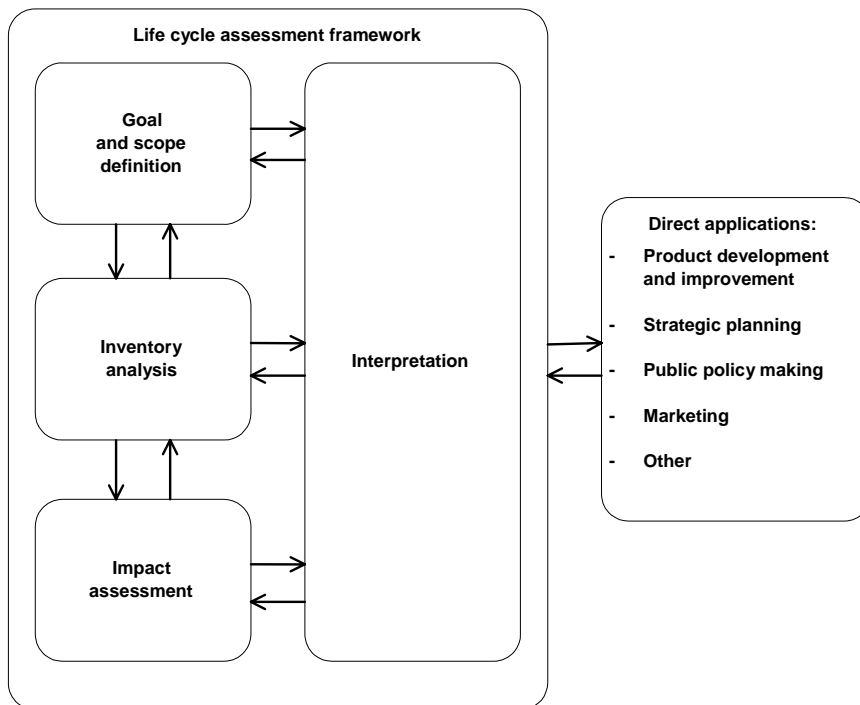

Figure 2: Methodological framework of LCA: phases of an LCA (source: ISO 14040, 1997).

From Figure 2, it is apparent that LCA is not a linear process, starting with the first and ending with the last phase. Instead it follows an iterative procedure, in which the level of detail may subsequently be increased. Despite the iterative character of LCA, most important methodological aspects of the different phases and steps within these phases will be discussed in a sequential mode, below.



The ISO International Standards mentioned are important in providing an international reference with respect to principles, framework and terminology for conducting and reporting LCA studies. The ISO standards do not, however, provide a 'cookbook' of step-by-step operational guidelines for conducting an LCA study. Several guidebooks have been published to support the execution of LCA's with more concrete guidelines, decision trees, tables with conversion factors and mathematical equations. Some key guidebooks are listed in Table 1. The guidelines given by Guinée *et al.* (2002) will be used in this study.

Table 1: Some key guidebooks on LCA.

Commissioner / Publisher	Publication date	Reference
Society of Environmental Toxicology and Chemistry (SETAC)	1991	(Fava <i>et al.</i> , 1991)
Nordic Council of Ministers	1992	(Anonymous, 1992)
Dutch government	1992	(Heijungs <i>et al.</i> , 1992)
SETAC	1993	(Consoli <i>et al.</i> , 1993)
US-Environmental Protection Agency (US-EPA)	1993	(US EPA, 1993)
Nordic Council of Ministers	1995	(Lindfors <i>et al.</i> , 1995)
McGraw-Hill	1996	(Curran, 1996)
Danish government	1998	(Hauschild & Wenzel, 1998)
Dutch government	2002	(Guinée <i>et al.</i> , 2002)
Asia-Pacific Economic Cooperation (APEC)	2004	(Lee & Inaba, 2004)
Chalmers University of Technology	2004	(Baumann & Tillman, 2004)

### 2.1.3 Goal and scope definition

The Goal and Scope Definition phase is the first phase of an LCA, establishing the aim of the intended study, the functional unit, the reference flow, the product system(s) under study and the breadth and depth of the study in relation to this aim.

First, the goal of the LCA study is stated and justified, explaining the goal (aim or objective) of the study and specifying the intended use of the results (application), the initiator (and commissioner) of the study, the practitioner, the stakeholders and for whom the study results are intended (target audience).

The goal of a particular LCA-study on the SOWAP or ProTerra Conservation Agriculture (CA) projects could be something like the comparison on long term life cycle environmental and economic impacts of alternative site-specific soil and weed management methods, such as conventional tillage, conservation- and zero- tillage practices.

Next, the main characteristics of an intended LCA study are established, covering such issues as temporal, geographical and technology coverage, the mode of analysis employed and the overall level of sophistication of the study (scope definition). Particularly two points need further explanation here: mode of analysis and level of sophistication.

The prime purpose of LCA as stated above leaves room for, at least, two quite distinct interpretations, or modes of analysis; descriptive LCA and change-oriented LCA.

- Descriptive LCA answers the question of accounting: what is the share or contribution of one particular way of fulfilling a certain function in the entire set of environmental problems that currently exist? Descriptive LCA can be used as a starting point for an improvement analysis.
- Change oriented LCA puts an emphasis on change. The analysis then addresses the environmental implications of a change from or to one particular way of fulfilling a certain function. This change may assume a variety of forms, which may be illustrated as "drinking one more beer" and "drinking a

different brand of beer". Within the change-oriented LCA we distinguish between three main types of questions, related to three main types of choice:

1. Occasional choices related to one-time functions or small-scale optimisations: e.g., should I take the high-speed train or the plane to my meeting in Paris next week?
2. Structural choices related to a function to be delivered regularly: e.g., should I take the high-speed train or the plane to my weekly meetings in Paris?
3. Strategic choices, binding the choice on how to supply a function for a long, or even indefinite period of time: e.g., should the government invest in high-speed railroads or in airports?

All three questions require their own modelling set-up. In most guidebooks on LCA, the focus is on structural choices. The approaches that have been developed by Azapagic (1996) and by Weidema *et al.* (1999) may particularly be useful for LCA's with occasional choices as a starting point.

There are various levels of sophistication of LCA possible. Two levels are often distinguished and sometimes elaborated in separate sets of guidelines (Guinée *et al.*, 2002): a simplified and a detailed level. The simplified level has been introduced for making faster and cheaper LCA's compared to detailed level LCA's. The guidelines for simplified LCA largely comply with the ISO standards but not completely. The guidelines given for detailed LCA fully comply with the various ISO Standards as mentioned. It is evident that the results of simplified analysis will generally be less certain and robust than those of detailed LCA.

A crucial element of the Goal and Scope definition phase concerns the definition of the function, functional unit, alternatives and reference flows. The functional unit describes the primary function(s) fulfilled by a (product) system, and indicates how much of this function is to be considered in the intended LCA study. It will be used as a basis for selecting one or more alternative (product) systems that might provide these function(s). The functional unit enables different systems to be treated as functionally equivalent and allows reference flows to be determined for each of them. For instance, one could define a functional unit for wall colouring in terms of the area to be covered, the type of wall, the ability of the paint to hide the underlying surface and its useful life. In a real example, then, the functional unit of a wall covering would be "20 m<sup>2</sup> wall covering with a thermal resistance of 2 m<sup>2</sup> K/W, with a coloured surface of 98% opacity, not requiring any other colouring for 5 years" (ISO, 2000c). In this functional unit, thermal resistance is included as a second function besides colouring. One can define the function of a given product system as precisely as one wishes. However, the more strictly the functional unit is described, the fewer alternatives will be left to compare.

Defining the *functional unit* for agricultural economic systems requires particular attention. Agricultural processes are strongly influenced by environmental conditions like climate and properties of the soil. The condition of the soil might change over time due to management of the land. Specifically in the case of the SOWAP/ProTerra projects that compare crop-soil management systems with different magnitude of soil erosion, the ascertained steady state level of crop productivity per hectare is an important inclusion into the functional unit definition. After all, due to soil erosion the productivity of the soil on the long term will decrease. There are different possibilities to include these long term effects into the functional unit. Three main different options can be distinguished:

1. Extend the economic system with restoration processes for soil erosion, i.e. including dredging of ditches and supplement of soil to eroded areas (see flow charts) to keep the crop productivity per hectare at the ascertained steady state level.
2. Define an additional impact category for reduced harvest. As will be discussed in Section 2.1.4 the harvest is part of the economic system. This option is thus not recommended as a decreasing yield (economic effect) is now assessed as an environmental effect.
3. Monitor loss of harvest per hectare and define the functional unit as a fixed amount of harvest which means that in case of loss of soil productivity the area planted with the crop under consideration has to be expanded (see unit process data, Section 2.1.4).

Sometimes, the comparison can be limited to a difference analysis. For example, if after harvesting of the crops the different systems are the same, the processes related to transport, consumption and waste treatment of the consumed crops would be of no relevance for the comparison and the study could be limited to a cradle-to-harvesting study. This is, however, not necessarily true. Harvested crops from the different management systems may have different moisture contents and so require more/less drying as applicable. So the functional unit most likely will be defined as 1 kg of a dried, specific harvested crop and will include the whole life-cycle from cradle-to-grave. From the perspective of the farmer the functional unit is not necessarily related to the mass yield of crops but rather the income-yield (€). The best basis of comparison could rather be a certain income yield.

Defining the *functional unit* for foodstuffs is a matter requiring particular attention. The main reason for this is that providing humans with nutrients is not the sole function of foodstuffs. Foodstuffs also fulfil an important practical, psychological and social function. This is particularly true in the industrialised world, since people there actually consume more than sufficient nutrients. The basic point of departure in comparing food products is real substitution. Moreover, differences in spillage and decay of foodstuffs due to e.g. different packaging systems for the foodstuff may also be relevant to include. Last but not least, the quality aspects of a product are a recognised problem in the definition of a functional unit. However, in this project these special and important aspects in the definition of the functional unit will not be elaborated any further.

On the basis of the functional unit, a number of alternative product systems may be declared functionally equivalent and reference flows will be determined for these systems. The reference flow is a measure of the needed outputs from processes in a given (product) system which are required to fulfil the function expressed by the functional unit. For example, the above functional unit for wall covering might be fulfilled by 20 m<sup>2</sup> wall covered with paint A and this is therefore the reference flow for the product system that corresponds to paint A. Paint A might be compared to paint B providing the same coverage of the 20 m<sup>2</sup> wall but requiring a different amount. For example, 10 litre of paint A and 15 litre of paint B might be needed to provide the specified function.

Note that no calculations are made and no data are collected in the Goal and Scope Definition. It really is a place for initial reflection: what exactly will the calculations be about.

The functional unit, system coverage and type of LCA in the SOWAP/ProTerra projects can be chosen in different ways:

- We advice to cover the impacts in the system from cradle-to-harvesting.
  - the study includes up stream processes
  - the study includes dredging of ditches and supplement of soil to eroded areas or changes in productivity over time
  - consumption and waste treatment are considered the same for alternatives and thus cut off.
- The type of LCA is likely change oriented, i.e. a difference analysis between management options for one chosen crop rotation system<sup>4</sup> or a specific crop
- Functional unit: sustainable long term production of 1 kg of a dried, specific harvested crop.
- Rotation systems are compared, so no allocation necessary

Note: in SOWAP no information is gathered on:

- drying and storage of crops
- dredging of ditches
- soil restoration processes

## 2.1.4 Inventory analysis

### 2.1.4.1 Basics

In the inventory analysis, often referred to as LCI, the life-cycle of the product (alternatives) analysed is determined, first qualitatively and then quantitatively.

The basis of the inventory analysis is the unit process. This is an elementary operation, like rolling of steel, the generation of electricity through coal gasification, ploughing, making a tractor. The aggregation level of a unit process will differ in practice from LCA to LCA and even within one LCA. Sometimes a whole refinery is considered as unit process, while in other study such a refinery is stripped into 50 separate sub-processes. An average LCA may comprise about 50-500 unit processes. A number of unit processes linked together may constitute a system that can be assessed by LCA. The general structure of a unit process is shown in Figure 3. Four main groups of flows can be discerned:

- economic inflows, e.g. steel required to make a tractor;
- environmental (or elementary) inflows, e.g., the ores and fossil fuels absorbed by a material production process;
- economic outflows, e.g. the tractor produced by the tractor factory;
- environmental (or elementary) outflows, e.g. the emissions to air and water by the tractor factory.

---

<sup>4</sup> There are several typical crop rotation systems represented in the SOWAP monitoring sites, like

- maize - winter wheat
- maize - winter wheat - oil seed rape
- winter wheat - spring beans
- sugar beet - winter wheat

To develop a concrete LCA case, in terms of necessary economic inputs and typical emissions, one of the systems should be chosen and elaborated.

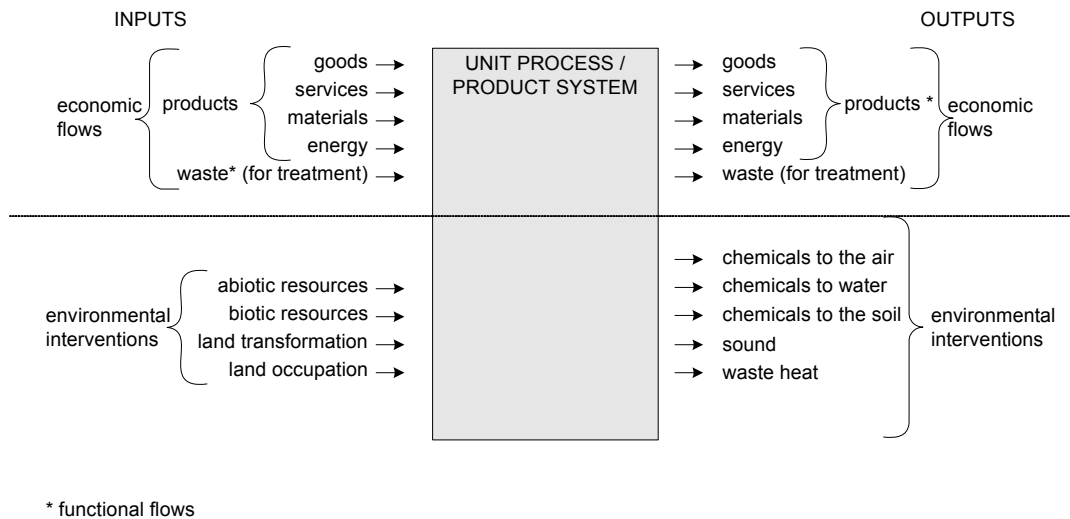

Figure 3: Data categories distinguished by Guinée *et al.* (2002).

In the categorisation of flows, one should observe that waste flows are economic flows. The meaning of the term “economic” has no connection with the value or price of the commodity, and neither does it point to the objective of a process. It only indicates that this flow connects two unit processes: it is an inflow for one process and an outflow for another process. This is in contrast with the situation for environmental flows that are only connected to one unit process: environmental inflows flow from the environment to the unit process, and environmental outflows flow from the unit process to the environment.

#### 2.1.4.2 System boundaries

Before defining a system of unit processes, the system boundaries have to be defined between the product system (as part of the physical economy) and the environment. Or put in other terms: it has to be defined which flows cross this boundary and are environmental interventions (i.e. resources extractions, emissions and land use). An example of confusion on this point are forests and other biological production systems (see Figure 4). Do they belong to the environment and is wood a resource coming into the physical economy (natural forest)? Or is the forest already part of the economy and are solar energy, CO<sub>2</sub>, water and minerals to be regarded as the environmental interventions passing the boundary between environment and economy (forestry)? Another example concerns the other end of the life cycle: is a landfill to be regarded as part of the environment or still as part of the physical economy? In the first case all materials which are brought to the landfill have to be regarded as emissions into the environment; in the latter case this will only hold for the emissions from the landfill to air and groundwater. In order to make the results of different studies comparable there is a great need for harmonisation here. An element may well be the degree to which the processes involved are steered by human activities. Forestry can be regarded as part of the socio-economic system. But wood extracted from a natural forest will have to be regarded as a critical resource taken from the environment. Likewise a landfill, managed without any control measures should be regarded as part of the environment, with all discarded materials to be regarded as emissions. If the landfill is a well controlled site, separated from groundwater and with cleaning of the percolation water, one may well regard this as part of the product system with only the emissions from the landfill to be considered as burdens to the environment. Clear guidelines for including processes within the economic system are available: landfill and forestry should be included. Nevertheless, one should be aware of specific details that may differ between studies, e.g. the depth of the (agricultural) soil demarcating which part is included and which not.

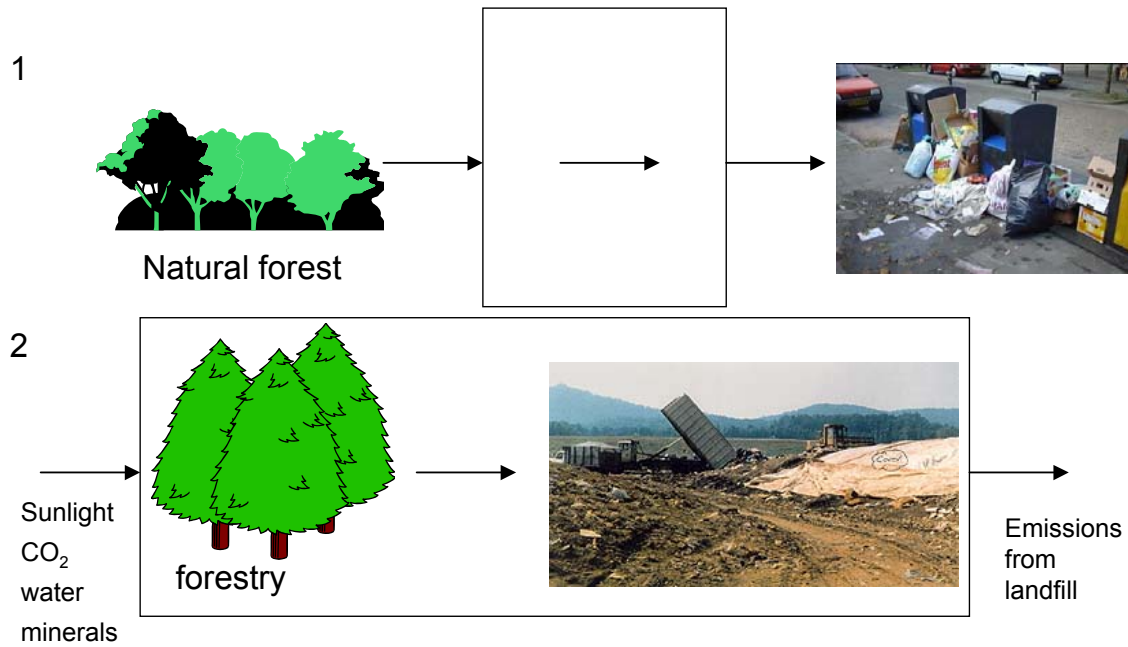

Figure 4: Two ways of defining system boundaries between physical economy and environment in LCA; a) with narrow system boundaries, b) with extended boundaries. The economy is indicated by the black box. In the first case the forest from which the timber is harvested, is considered to be part of the environment and logging is an environmental resource extraction. Throwing away a paper bag is considered an environmental emissions out of the economy. In the second case the forest is considered to be part of the economic system and the resources taking up by the forest (CO<sub>2</sub>, water, sunlight etc.) is the environmental resource extraction. Also in the second case the landfill is considered part of the economic system Only the emissions emanating from the landfill are environmental interventions.

With respect to the *economy-environment boundary* in agriculture there have been several developments in the past decade. The report 'Application of LCA to Agricultural Products' (Wegener Sleeswijk *et al.*, 1996) focused on LCAs for agricultural products. One of the subjects discussed in this report was the boundary between the product system and the environment. There it was opted to include the agricultural soil in the environment system, for the main reason that damage to the soil should be regarded as an environmental impact in order to differentiate between systems differing in their impact on soil quality. Furthermore, it was opted to regard the harvested portion of the crop as an economic output of arable farming and thus as part of the economic system, with the remaining portion being regarded as part of the environment system. Horticultural production in which no natural soil is used for production belongs entirely to the economy, except for the soil itself, which remains part of the environment system. Another argument for defining the soil as part of the environment stems from the principle of 'multifunctionality'. This principle, regularly applied in the context of public policy, implies that the quality of, say, agricultural soil should be maintained at such a level that it can also fulfil other functions, including ecological functions. If land is taken out of agricultural use, the quality of the soil should be such as to permit other types of land use. Other choices are possible here. Audsley *et al.* (1994), for example, opted to regard soil as part of the economy, right down to the depth of the water table, because soil is an integral part of farming systems. In specific agricultural studies, the analysis of the top layer may be of importance. In general LCA a simple system boundary excluding soil from economy seems adequate enough.

This reasoning is thus adopted here. Thus, agriculture (and similarly forestry) are taken to be economic processes, agricultural and forestry soils remain part of the environment system, the harvested portion of the crop flows to other processes in the economic system while the non-harvested portion remains in the environment system. A consequence of this choice is that use of pesticides is regarded as an emission to the environment, except for pesticides which end up on the harvested crop. Also the application of nutrients in fertilisers is considered an emission to the soil, while the uptake of nutrients by the harvested crops is considered an extraction from the environment. Strictly erosion of the soil in this option is not an environmental intervention. After all soil is considered environment and thus erosion of the soil is a flow within the environment, not crossing the economy-environment boundary. In other words erosion is a natural process. However, unquestionably erosion is re-enforced by human influences. These human influences probably are a set of direct physical, chemical and biological interventions on the land. Together with environmental conditions, like climatic circumstances and slope, these human influences will determine the amount of erosion. Practically spoken however it is easier to measure soil loss than it is to measure all these parameters and estimate erosion, using a (characterization) model. So for erosion a more pragmatic approach is chosen to measure instead of estimate the amount of soil loss.

### 2.1.4.3 Flow charts

A next step concerns drawing the flow diagram of the system studied. It constitutes the basis for the whole analysis and it identifies all relevant processes of the product system with their interconnections. The functional unit delivered by the system is the central element; starting from here, the processes ramify "upstream" up to the different resources used, and "downstream" to the different ways of waste management involved.

Figure 5 and Figure 6 show the flowcharts of some agricultural systems compared in the ProTerra and SOWAP projects. The data in the ProTerra project relate to perennial farming systems producing different crops (e.g. olives and vines) using different management systems (i.e. bare soil and cover crops). The data in the SOWAP project relate to arable farming systems producing different crops (e.g. maize, sugar beet and wheat) using different management systems (i.e. conventional ploughing, non inversion tillage, no tillage). The figures also illustrate the relation between the processes that are studied in the ProTerra and SOWAP projects and the upstream processes, like the production of energy, fertilisers, pesticides, and possible downstream processes, like the treatment of agricultural waste (composting or feed production) (shaded process trees in Figure 5 and Figure 6).

In Figure 5 and Figure 6, boxes are unit processes and arrows are economic flows. A flow chart illustrates the processes and their qualitative connections. The connections are the economic flows. To keep the flow chart focused and readable, environmental flows and quantitative information are often left out.

#### Flowchart for production system of perennials

The production system of perennials mainly consists of two parts, management between the rows and within the rows. For the bare soil alternative, soil between the rows is kept bare with the help of herbicides and there is no cultivation between the rows. The rows itself are cultivated up to 5 times per year. During cultivation of the rows, herbicide is only applied to the soil between the rows. For the cover crop alternative, the soil between the rows has a cover crop. Ancillary materials include equipment and machines. The upstream process chains connected to products, like fertilisers, pesticides and seeds, include all the materials, energy and capital goods that are necessary for the application and production of these products. For olives and grapes in particular, the crop needs a lot of processing. However, these downstream processes will be the same for both alternatives. Harvest in the alternative having a cover crop between the rows is more labour intensive.

#### Flowchart for production system of arable crops (e.g. maize – wheat rotation system)

In the production of arable crops generally several subsystems can be distinguished: establishing, maintenance, harvesting and drying/storage. The subsystem “establishing” includes processes like tillage with a plough, seed application (including seed treatment), pesticides application and fertilisers application. “Maintenance” includes the application of pesticides, growth regulators and fertilisers. Sometimes there are two more activities that are carried in the non-inversion tillage and no-tillage systems:

1. Stale seedbed preparation, i.e. encourage weed to grow, so you can kill it with a herbicide, before the crop starts to grow.
2. Cover crop management, i.e. planting of a cover crop and application of a herbicide to kill cover crop before crop planting.

However these operations are not always done and therefore not elaborated in the flowchart. Ancillary materials include equipment and machines. The upstream process chains connected to products, like fertilisers, pesticides and seeds, include all the materials, energy and capital goods that are necessary for the application and production of the products. Drying and storage are not presented in the flowchart. For the moment it is assumed that these processes will be the same for the different alternatives. However this might not be the case if the moisture content of crops tends to be different for different alternatives.

Note that the economic system in the presented flowcharts is exclusive restoration processes for soil erosion, like dredging of ditches and supplement of soil to eroded areas. As stated above under the heading of “functional unit definition” the presented economic systems therefore do not present comparable functions, because possible economic consequences of erosion are not internalised in the description of the economic system. After all, the functional unit definition it is proposed to include a sustainable constant level of crop production. Erosion will make a more frequent maintenance of ditches necessary and on the long term also supplement of soil to eroded areas is necessary to combat the decrease in productivity of the soil.

So ideally the restoration processes for soil erosion should be part of the description of the economic system. However, in the SOWAP and ProTerra projects this kind of information is not gathered. Nonetheless changes in productivity are monitored over the short time period (3-4 years) and also the amount of soil loss is monitored for the different alternatives. So information about the loss of productivity between alternatives over time might be used to correct for an increase in economic inputs that is necessary to produce a constant amount of crop comparable between the alternatives. One should keep in mind however that this loss of productivity due to erosion is not always apparent on the short or mid



term<sup>5</sup>. So a practical solution might be to use the amount of soil loss as (part of) an indicator for the need to intensify digging and dredging of ditches on the mid term and the loss of productivity on the long term. As stated before loss soil and the economic consequences like loss of productivity ideally should not be part of the environmental analysis but for pragmatic reasons one might propose an additional impact category to account for this economic loss of value (see also Section 2.1.5 on impact categories).

---

<sup>5</sup> For example in Belgium soil erosion can go on for hundreds of years without substantial decrease in productivity of the soil, because the soil is very deep. However the decrease in productivity in other regions, like Spain, is much faster. Thus productivity measurement over a longer period alone is not (always) the appropriate parameter for a correct sustainable FU comparison.

## Perennials (olives and wines)

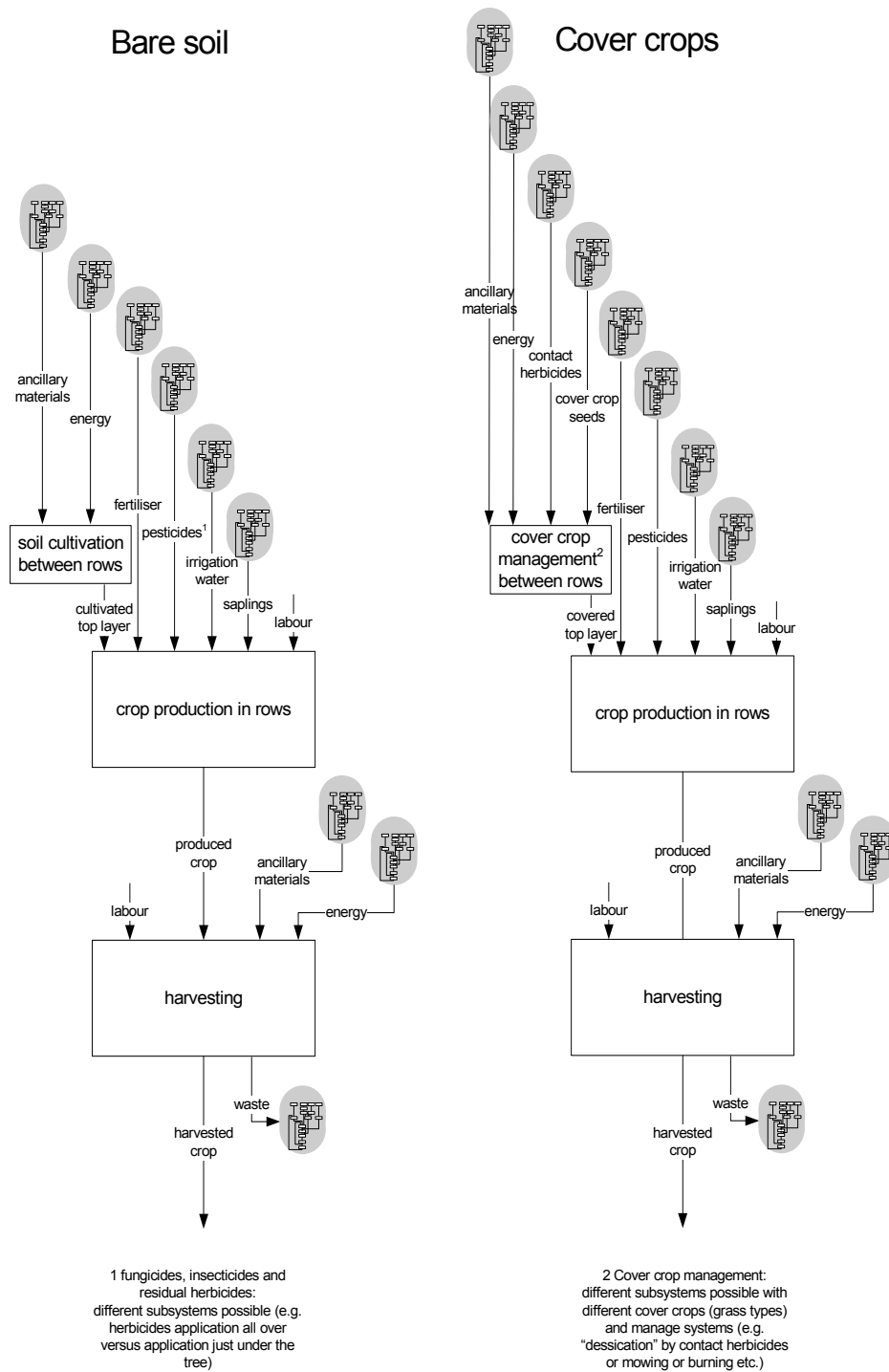

Note: different alternatives may differ in amounts of inputs (fertiliser consumption etc.)

Figure 5: Rough outline of economic processes (boxes) and the consumed and produced materials for perennials, i.e. economic in- and outputs (arrows) of the different alternative perennial systems.

## Arable crops (maize, wheats)

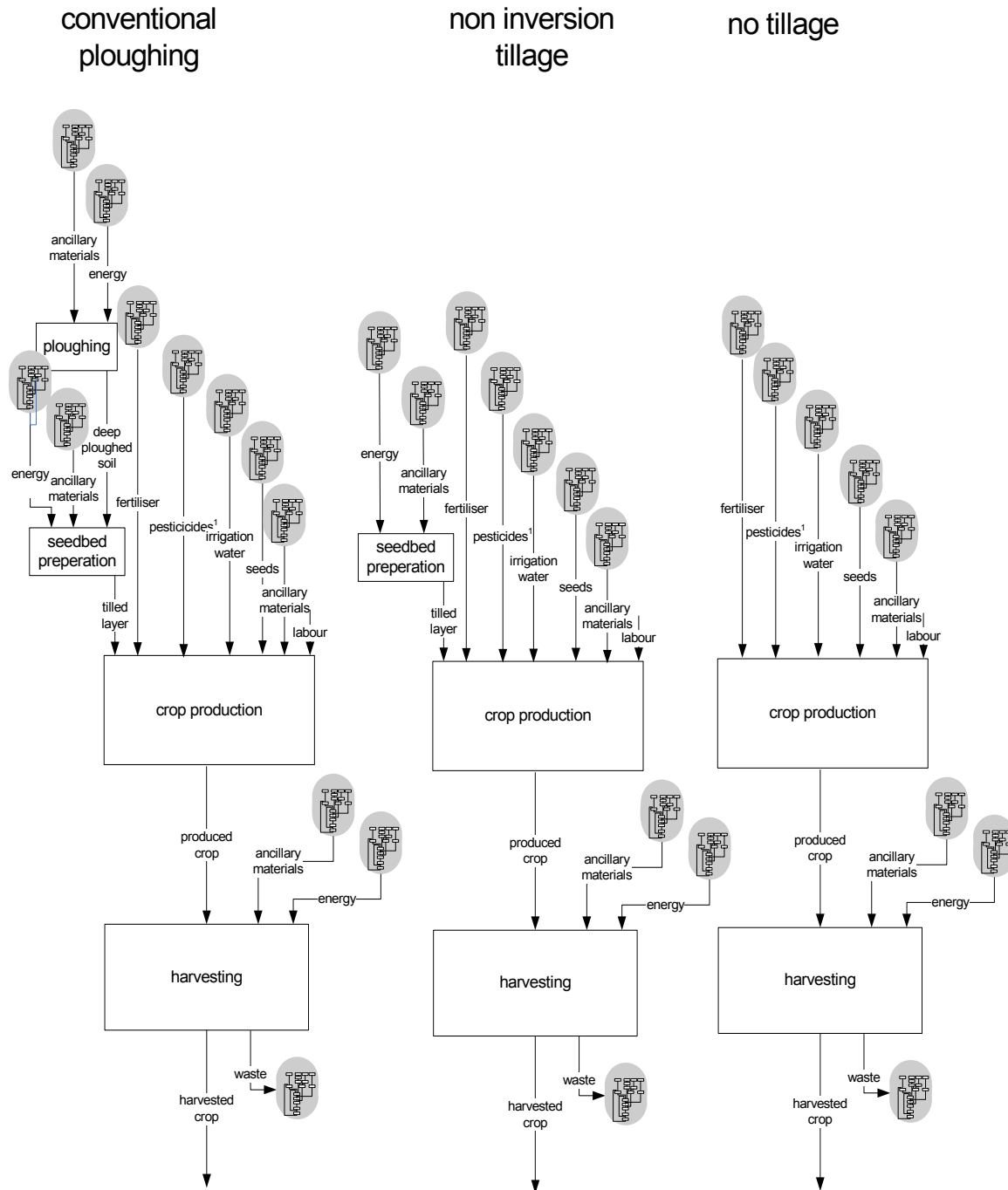

Figure 6: Rough outline of economic processes (boxes) and the consumed and produced materials, for arable crops i.e. economic in- and outputs (arrows) of the different alternative arable crops systems.

A flow diagram can become quite huge when applying the life-cycle concept in a strict sense. In the refinery there is a lot of machinery that need cleansing and lubricants and needs maintenance and replacements, and in addition to this offices and office equipment are needed. Intuitively, one would say that the impacts of the office and office equipment will be negligible compared to the production of naphtha and kerosene. In other words, the flow diagram might be cut off at several places. If all goes well, cut-offs are only made for processes that indeed have a negligible contribution to the total impact. Extreme care should be taken when applying cut-offs.

By making cut-offs in flow diagrams, the impacts of the neglected processes are not taken into account anymore. The main problem behind the cut-off issue of the flow diagram is often the fact that one cannot draw a flow diagram of 500 or more unit processes anymore. In practice the criteria for making cut-offs in the flow diagrams, is a lack of readily accessible data. Gathering these data would imply a disproportionate expenditure of funds and effort on data collection. However, the outcome of an LCA study, may substantially be influenced by cut-offs. Simple LCA's therefore come at a price. Today, the cut-off problem can be handled better by estimating the environmental interventions associated with flows for which no readily accessible data are available using environmentally extended Input-Output Analysis (Suh *et al.*, 2004).

#### 2.1.4.4 Data collection

After the qualitative flow diagram, a quantification of the diagram follows. Data collection is a core issue in LCA. Data need to be collected for each unit process of the flow diagram. Two types of data need to be gathered for each unit process: environmental flows and economic flows (Figure 3). Generally, process characteristics are reported as averages (CO<sub>2</sub>-emission per 1000 MJ of electricity, iron used per ton of steel, etc.). The number of process data can easily mount up to several hundreds or thousands.

Data on 'generic' background processes like production of electricity, gasoline, building materials, transport, packaging materials, can be found in LCA databases. LCA databases that are best consulted for these 'generic' background processes are:

- ecoinvent (ecoinvent Centre, 2004)
- Buwal ([http://www.umwelt-schweiz.ch/buwal/eng/fachgebiete/fg\\_produkte/umsetzung/oekobilanzen/index.html](http://www.umwelt-schweiz.ch/buwal/eng/fachgebiete/fg_produkte/umsetzung/oekobilanzen/index.html))
- GABI ([www.gabi-software.com](http://www.gabi-software.com))

LCA data on agricultural background processes have been compiled by several authors in specific case studies:

- LEI agricultural database (Weidema & Meeusen, 2000)
- Novel-Protein Food (Berg *et al.*, 1995);
- DK LCAfood project ([www.lcafood.dk](http://www.lcafood.dk)).

A problem with the compilations from individual studies is that the economy-system boundary could have been defined differently. Furthermore using LCA data gathered on an individual farm may not be representative for all farms.

The previous eight LCA data sources might provide data for the background processes but do not provide data for the farming system under study in the ProTerra/SOWAP projects. For these data have to be gathered 'on-site' which needs some attention, especially for agricultural processes, as discussed below. Practical guidelines for the use of data gathered in the Proterra/SOWAP projects in an LCA are discussed in Section 5.4.

For LCA models, like any other model, data quality may have a major influence on results and proper evaluation of data quality is therefore an important step in every LCA. The data used in a given case study should, for instance, be representative for that particular study. Various partial methods are available for data quality assessment in LCA, but a generally agreed standardised method for overall assessment of data quality is lacking as yet.

As mentioned above, process characteristics are reported as averages in the LCA. In the case of industrial processes this might be a valid procedure. However, compared to industrial processes, the agricultural processes tend to be far more dependent on environmental circumstances, like weather conditions and soil properties etc. The yield and necessary inputs for production (e.g. fertilisers, pesticides etc.) will differ between different geographical regions. And also within one region the productivity will fluctuate or change over time due to fluctuating or changing environmental circumstances. So for agricultural processes it is very important to indicate that the averages represent a specific geographical region and time span. So process data for agricultural processes are site and time specific.

Emissions and resource uses can be quite different depending on local circumstances. The influence of site specific conditions is much larger for agricultural processes than for industrial processes. The type and size of economic and environmental in- and outputs of agricultural processes, are very much determined by geographical environmental conditions, such as climate, hydrology, soil type, slope, etc. This high dependency of the inventory on site specific conditions makes a spatial differentiation of processes for agricultural production necessary, although not often done in agricultural LCA-studies.

Generally spoken there are three options for data collection for agricultural LCA's:

- measure the actual intervention (transformation, extraction, emission, erosion) ;
- use models that estimate interventions using site specific information (e.g. USLE model for erosion; see <http://topsoil.nserl.purdue.edu/usle/>; <http://www.fao.org/docrep/t1765e/t1765e0e.htm>)
- use generic average interventions.

Which data to take also depends on the goal of a specific study<sup>6</sup>.

In LCA often generic inventory data are used either based on averages or (site specific) models. In general these generic data are sufficient for LCA. However, in the case of the SOWAP and ProTerra projects many site specific field data are gathered for different types of management, and thus better data will probably become available and the use of generic data will probably not be necessary for, at least, the agricultural field processes.

The economical and environmental data for agricultural processes are also time specific. As already mentioned the productivity of an agricultural process may fluctuate due to for example fluctuating weather conditions or nutrient availability. If the productivity fluctuates around a stable level this type of differences in process data in time may very well be neutralised by calculating averages over a sufficient long time span (e.g. several years).

However, in agricultural processes the productivity may also change in a specific direction, i.e. increase or decrease, mostly due to management of the land. Ideally the aim of land management for crop production is to ensure a constant crop production. In other words the land is managed to influence the economic output. For instance fertilisers are applied to the land to supplement the nutrients that are extracted by the harvested crops (Figure 7). However, if for instance no preventing or restoration measures are taken erosion may, on the mid- or long-term, also lead to a reduced productivity of the soil. Which process data should be used in these cases (t1, t2, t3, integral)?

---

<sup>6</sup> If the goal of the study is to obtain an idea of the environmental impacts associated with milk sold in supermarkets, use can be made of average data on milk production. If various different current milk-production methods are being compared, use can be made of average data on the companies applying the various production methods. A milk producer who wishes to know which elements of his product (system) have the greatest bearing on the environmental impacts he causes will obviously choose data specific to his own product (system). If the government wishes to use LCA to back up a policy to encourage or discourage a given production method, use can be made of normative data that are specific to companies applying the production method in question (Wegener-Sleeswijk *et al.*, 1996).

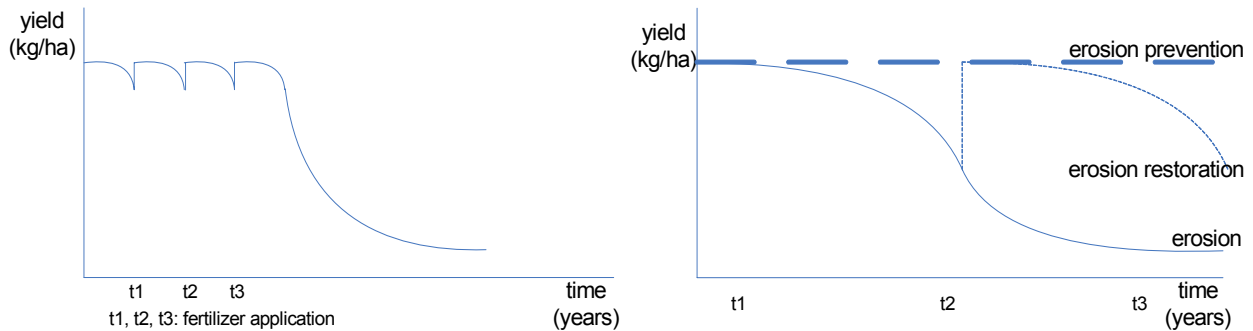

Figure 7: Fluctuation and change of productivity over time.

In the quantification of processes, as described above, all processes are reported in their characteristic quantities. Subsequently, the processes must be scaled in the inventory analysis to the actual quantities needed for the product system studied: if not 1000 MJ but 67 MJ of electricity are needed for that product system, all in- and outputs of that process need to be multiplied by 67/1000. The functional unit sets the conditions here: if the analysis is about painting 10 square metres of wall for ten years, this  $100 \text{ m}^2 \times \text{year}$  determines how much paint, and thus how much electricity, and thus how much coal and  $\text{CO}_2$  is related to that.

#### 2.1.4.5 Allocation

In scaling the process data to the actual quantities needed, the problem of multiple processes and allocation frequently comes up. As allocation is an important issue in the LCA debate, this issue will be discussed here a bit more extensively. The problem lies in processes which are part of more than one product system, the so-called “multifunctional processes”. How should the environmental impacts of these processes be allocated to the different product systems involved? If a product, for example, contains PVC, chlorine is needed to produce the PVC. Chlorine is generally co-produced with caustic soda in one process. It is evident to partition all other flows of this process (the sodium chloride input, the electricity use, the emissions) over the co-products, viz. chlorine and caustic soda, in one way or another. This partitioning step is called allocation. Allocation is often done based on the relative mass, energy-content or economic value of the co-products.

There are three basic types of multifunctional processes that require partitioning (Figure 8): multi-output processes (co-production, e.g. the chlorine and caustic soda production process), multi-input processes (combined waste processing, e.g. a waste incinerator incinerating various different waste flows simultaneously) and recovery and recycling processes (where a waste flow is upgraded to a useful material).

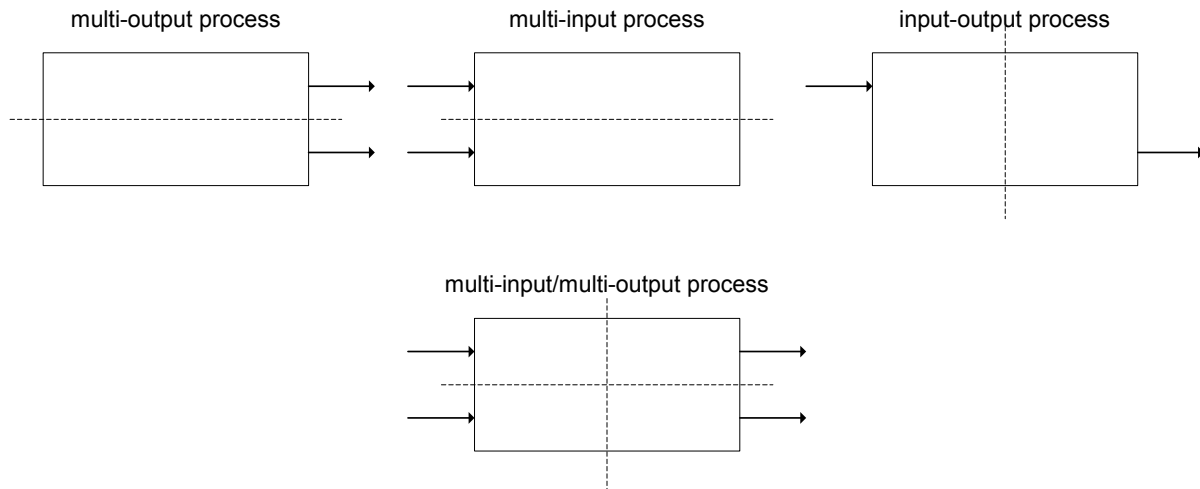

Figure 8: Basic types of multifunctional processes, and their combination. Functional flows to which all other flows are to be allocated are shown as arrows. Other flows have been omitted from the figure. System boundaries (for allocation) are depicted as dotted lines.

Co-production means that one unit process produces more than one functional output. The question is: how should the environmental burdens (the environmental interventions from and to the environment) be allocated to these different functional outputs? Traditionally this is done on a mass basis. But the example of diamond production which goes together with the production of a great bulk of stones as a by-product shows that this may not be equitable: all burdens would be allocated to the stones and not to the diamonds, although the latter are the reasons for the existence of the mine. Another principle concerns allocation on basis of economic value, as the key steering factor for all production processes. It may be noted that it is also an economic principle which determines what has to be allocated to what: as wastes have to be allocated to products, only an economic principle can decide which output is waste and which is product or by-product.

With combined waste treatment the problem is that emissions from an incineration plant will contain a broad spectrum of materials, which will definitely not be included in a great deal of the burned wastes. Allocating the emission of cadmium to the waste management of a polyethylene (PE) bottle again is not equitable. The procedure should begin here with a causality principle linking as far as possible materials to different fractions of the waste.

With recycling we can distinguish between closed loop and open loop situations. In a fully closed loop situation there is no allocation problem, because there is only one product at stake. Generally loops will in part or in total be open: the wastes from one product system will be used as a secondary resource for another. In this situation we deal with a multiple process for which an allocation rule has to be defined. In present practice often a “50% rule” is used, giving an equal share to the two product systems involved, but also more sophisticated logic may be applied. In addition to this, one may also want to allocate part of the resource needs for product system A to product system B, because the latter also makes use of the resources, and part of the wastes from product system B to product system A, because system B also solves the waste problem for system A.

ISO 14041 (1998) has proposed a preference order of different options to be checked on their applicability one after the other. In short, this preference order consists of the following steps:

- allocation by dividing processes into sub-processes
- allocation by expanding the boundaries of the system (system expansion);
- apply principles of physical causality for allocation of the burdens;
- apply other principles of causality, for instance economic value.

According to ISO 14041 (1998), the first two options can be interpreted as avoiding allocation.

Although the different options of this preference order themselves are clear, the practical implementation differs between practitioners. Some authors (Ekvall, 1999; Weidema, 2001) have elaborated system expansion (also called 'substitution', 'subtraction' and 'avoided burden' method) as allocation method. The concept behind system expansion is that the production of a co-product by a process causes that another process for another product is avoided. For example, if the production of chlorine also co-produces caustic soda, another process producing the same caustic soda needs to produce less caustic soda to fulfil the same demand of caustic soda. Therefore, it is argued, we may subtract the avoided emissions, resources, electricity use, etc. from the life cycle interventions of the product system for which the chlorine is needed. Like in other allocation methods, problems rise when elaborating this method into practice. If a waste incinerator co-produces a certain amount of electricity, which type of electricity generation is then avoided? Electricity from natural gas, from uranium, from wind, or from a mixture of these?

Others (Guinée *et al.*, 2002; Guinée *et al.*, 2004) have elaborated economic allocation as a methodology which can be applied consistently for all types of allocation situations.

It must be stressed that such choices (partitioning versus system expansion, mass versus energy-content versus economic value, electricity production from gas versus uranium versus wind) may significantly influence the results of a specific LCA-study.



Allocation is an important subject within LCA and also often needed in agricultural LCA-studies, e.g. in cases of co-production. Crop rotation systems can be considered as multi-output processes that produce several different crops.

If a comparison is being made between different crop-rotation schemes, this will cause no extra allocation problems. In practice, though, such a comparison will not often be useful, for LCA is a tool designed for comparing the environmental impacts of various different products. What will most frequently be compared are a product from one crop-rotation scheme and one from another scheme. This gives rise to difficulties, because the various crops and the activities performed in cultivating these crops often also have consequences for the crops grown later in the rotation scheme. Examples include:

- soil fumigation carried out for potatoes, but also benefiting other crops;
- application of organic fertilisers in a given crop, with some fraction of the minerals being used by the next sown crop.

These allocation problems cannot simply be ignored in an LCA. The basic point of departure in allocation is: 'Why is a given activity performed?'.

For example: the soil fumigants applied in potato cultivation would not be used if potatoes were not included in the crop-rotation scheme. The environmental interventions associated with the soil fumigants should therefore be allocated entirely to the potatoes, even if benefits accrue to other crops, too. On these grounds, in the case of application of nitrogen fertiliser the associated environmental interventions are allocated to the crop to which the fertiliser dressing is applied as the nitrogen is applied to stimulate the growths of the current crop on the land. Its effect is short-lived. In contrast the environmental interventions associated with application of phosphate and potassium are divided over the crops on the basis of the recommended dressings for each individual crop as the application of these fertilisers are meant to improve soil productivity on a longer term. The same holds for organic matter which is allocated on the basis of the share of the various crops in the crop rotation scheme (expressed in terms of space requirements: ha-yr). When multiple fertilisers (manure and other animal wastes, in particular) are applied, the emissions occurring up until the moment the minerals reach the soil (emissions during storage, transport and application) are divided over the various crops on the basis of the mineral content of the fertilisers.

In the previous examples the allocation problem could be solved using physical-causal relationships, however that is not always possible. One of the alternative approaches is economic allocation based on the value of all resulting functions. In the case of crop production this means that economic inflows and environmental interventions are allocated to the different crops that are produced in the rotation system over a given time period by ratio of proceeds of each crop (yield (kg) x price (€/kg)). For example: when ploughing benefits both the summer and winter crop, the emissions associated with ploughing (direct plus emissions in the chain of making the plough & tractor) are allocated according the proceeds of each crop.

Given the importance of the crop-rotation scheme for further choices within an LCA, it is of major importance that the crop-rotation scheme being used to cultivate the products in question already be indicated in the goal definition. (Source: Wegener-Sleeswijk *et al.*, 1996; see also Cowell & Clift, 2000). For the SOWAP/Protterra where crop-rotation schemes are compared we advice to asses the agricultural process as a single output system with one economical outflow of two or more combined crops. Allocation of the environmental impacts to a single crop is thus not necessary.

There are also special cases of co-production (multi-output processes) possible in agricultural LCAs. For example, while the primary function of the agricultural processes is the production of crops, meat and dairy, the agricultural sector provides more services, at least in the Netherlands, like for instance the conservation of species like meadow birds and plant species. To perform this task the agricultural management is adapted. This adaptation of the management might lead to a reduction of the productivity of the primary function. For this reason the farmers in the Netherlands are subsidized to perform these conservation tasks. In this case the agricultural process is a multi-output process delivering at least two functions, e.g. crop production and nature conservation. In this case crop production and nature conservation are considered economic outputs and economic inputs and interventions should be allocated to the different economic outputs, either by causal allocation or simple allocation methods (e.g. economic allocation). Definition of the system boundaries in both options has no influence on this allocation problem. In both options the primary function is crop production and the co-product is "nature conservation".

In the end, when all allocation issues are resolved and process data have been scaled to the actual quantities needed for the product system studies, all economic intermediary flows (paint, electricity, oil) are transposed into flows from and flows to the environment. The result of this is a potentially long list of resource extractions and emissions associated to a functional unit of the product studied. This list is often called the inventory table. An inventory table of 300 different substances is not unusual. In the computation process care must be taken that loops of flows are taken into account properly; for instance: electricity production requires steel and the production of steel requires electricity. Computational details are specified by Heijungs & Suh (2002). In Table 2 the inventory results are shown for the hypothetical system of PE throw-away bags.

Table 2: Inventory results for the hypothetical system of PE throw-away bags.

<b>intervention</b>	<b>product system</b>
<b>resources</b>	
crude oil	8.1 kg
<b>emissions to air</b>	
1-butene	$7.8 \times 10^{-7}$ kg
benzene	$9.9 \times 10^{-7}$ kg
carbon dioxide	2.2 kg
dioxins (unspecified)	$8.1 \times 10^{-14}$ kg
ethylene	$1.2 \times 10^{-4}$ kg
nitrogen oxides	$3.7 \times 10^{-3}$ kg
Sulphur dioxide	$2.0 \times 10^{-2}$ kg
<b>emissions to water</b>	
benzene	$1.2 \times 10^{-9}$ kg
cadmium	$4.4 \times 10^{-8}$ kg
Lead	$3.0 \times 10^{-9}$ kg
mercury	$2.8 \times 10^{-9}$ kg
Phenol	$2.4 \times 10^{-8}$ kg
<b>economic inflows not followed to the system boundary</b>	
lubricants	2.4 kg
<b>economic outflows not followed to the system boundary</b>	
used plastic bag	1000
Residue to dump	0.08 kg
recovered energy	0.0008 MJ

Apart from the quantitative entries, the inventory results may also include qualitative issues and flags, points which cannot be dealt with in a quantitative way but which have to be considered in the final appraisal of the results.

### **2.1.5 Impact assessment**

As discussed, the final result of the inventory analysis is a long list of resource extractions and emissions which can easily mount up to a couple of hundreds of entries. Comparing product alternatives and finding options of product improvements based on this long list is difficult if not impossible. A further interpretation and aggregation of this list is therefore very desirable.

The basic idea is simple. The inventory table sometimes includes ten or more heavy metals (lead, mercury, chromium, cadmium), and these are substances that are toxic to a more or lesser level. In addition, the inventory may include a number of acidifying substances and a dozen of CFCs known for their contribution to climate change impacts. It thus seems obvious to sort together all substances that contribute to a particular type of environmental impact, and to aggregate substances within such an impact type according to their toxicity, acidifying potential, etc.

The impact assessment phase, often referred to as LCIA, deals with this topic. According to ISO 14040 (1998), impact assessment is a “phase of life cycle assessment aimed at understanding and evaluating the magnitude and significance of the potential environmental impacts of the product system”. Within the impact assessment phase several steps may be distinguished:

- selection of impact categories;
- selection of characterisation methods: category indicators, characterisation models and factors;
- classification (assignment of inventory results to impact categories);
- characterisation;
- normalisation;
- grouping;
- weighting.

According to ISO the first four steps are mandatory and the last three are optional.

In the first step relevant impact categories are defined. There are various ways to do this. Some consider toxicity, e.g., as an impact category while others will split this category up into carcinogenicity, mutagenicity, neurotoxicity, allergenicity, and many other possible toxic impacts. It will be clear that the first approach will result in a shorter list of impact categories than the second approach, but the results of the first approach will be subject to more debate. After all, combining allergic reactions and life-shortening diseases often includes an explicit or implicit weighting of the relative seriousness of allergies compared to e.g. cancer. Nevertheless, the first approach, an drastic aggregation of inventory results to 10-15 impact categories, is currently dominant. Even more drastic approaches have already been developed even, aggregating inventory results into three impact categories: human health, ecosystem health and resources (Hofstetter, 1998; Goedkoop & Spriensma, 1999; Steen, 1999).

Table 3 illustrates which impact categories are typically addressed in an LCA.

Table 3: Common impact categories and subcategories

impact category	single baseline characterisation method provided in the Handbook?	other characterisation method(s) available in the Handbook?
<b>A. Baseline impact categories</b>		
Depletion of abiotic resources	yes	yes
Impacts of land use		
Land competition	yes	yes
Climate change	yes	yes
Stratospheric ozone depletion	yes	yes
Human toxicity	yes	yes
Ecotoxicity		
freshwater aquatic ecotoxicity	yes	yes
marine aquatic ecotoxicity	yes	yes
Terrestrial ecotoxicity	yes	yes
Photo-oxidant formation	yes	yes
Acidification	yes	yes
Eutrophication	yes	yes
<b>B. Study-specific impact categories</b>		
Impacts of land use		
Loss of life support functions	no	yes
Loss of biodiversity	no	yes
Ecotoxicity		
freshwater sediment ecotoxicity	yes	yes
marine sediment ecotoxicity	yes	yes
Impacts of ionising radiation	yes	yes
Odour		
malodorous air	yes	no
Noise	yes	no
Waste heat	yes	no
Casualties	yes	no
<b>C. Other impact categories</b>		
Depletion of biotic resources	no	yes
Desiccation	no	no
Odour		
malodorous water	no	no
...	...	...

The list in Table 3 is based on a so-called midpoint approach. The methods proposed by Hofstetter (1998), Goedkoop & Spriensma (1999) and Steen (1999) are often called endpoint-oriented approaches. The key difference between midpoint and endpoint approaches is the point in the environmental mechanism (i.e. the chain of environmental processes linking interventions to impacts; modelled in LCA (usually only partially) to one or more category endpoints by means of a characterisation model) at which the category indicators are defined. They may be defined close to the intervention (the midpoint, or problem-oriented approach), or they may be defined at the level of category endpoints (the endpoint, or damage approach). A cluster of category endpoints of recognisable value to society is referred to as an “area of protection”, e.g. human health, natural resources, the natural environment and the man-made environment. Midpoint and endpoint indicators may not be mixed. However it is possible to use both types of impact assessment methods separately to examine the sensitivity of the LCA-results for the chosen impact assessment method. Work is underway to align midpoint and endpoint indicators (Heijungs *et al.*,

2003). Note that there is a relation between the discussion on the economy-environment system boundaries (see Section 2.1.4) and the definition of areas of protection

Energy use is sometimes also mentioned as an impact category. However, in LCA the focus is on the impacts that are the consequence of the production and use of energy, e.g. electricity, due to emissions (CO<sub>2</sub>, SO<sub>2</sub>, PAHs) and resource use (coal, gas, oil). The same reasoning applies to waste (in kg or m<sup>3</sup>) as separate impact category: in LCA the focus is on impact that are the consequence of waste management processes, be it landfill, incineration etc. and not the inflow stream of waste to be processed by these techniques. Some of the above categories are not yet calculated in practice, particularly due to a lack of (proper) data and/or methods. This is particularly true for radiation, horizon pollution, warming of river water through waste heat and land use.

Table 3 shows that some issues that are relevant for the ProTerra and SOWAP projects are not covered yet by an impact category and/or baseline characterisation method, like erosion, desiccation / hydrology, soil fertility, biodiversity impact through direct physical interventions (i.e. impact of ploughing etc. on earthworms). In the following chapter we will particularly focus on these lacking issues, that is make an inventory of available impact assessment methods and review if these methods can sensibly and practically be integrated in the LCA method.

Subsequently, the interventions recorded in the inventory table are quantified in terms of a common category indicator. To this end characterisation models are used, from which characterisation factors are derived for individual pollutants and so on. The factors translating emissions into contributions to impact categories are called characterisation factors. These are often based on complex environmental models comprising of transport processes through the environment, degradation, intake and impacts of substances. For each impact category listed in Table 3, a characterisation method comprising a category indicator, a characterisation model and characterisation factors derived from the model, should thus be available or developed. For the impact category climate change, a characterisation method may resemble the example given in Table 4.

Table 4: Illustration of the concepts involved in characterisation.

impact category	climate change
LCI results	emissions of greenhouse gases to air (in kg)
characterisation model	the model as developed by the Intergovernmental Panel on Climate Change (IPCC) defining the global warming potential of different greenhouse gases
category indicator	infrared radiative forcing (W/m <sup>2</sup> )
characterisation factor	global warming potential for time horizon of 100 years (GWP100) for each greenhouse gas emission to air (in kg carbon dioxide/kg emission)
unit of indicator result	kg (carbon dioxide eq)

Examples of characterisation factors and models for a number of baseline impact categories are listed in Table 5.

Table 5: Examples of characterisation models and factors for a number of important impact categories.

impact category	characterisation factor	characterisation model
Abiotic depletion	ADP	Ultimate reserves and extraction rates (Guinée & Heijungs, 1995)
Climate change	GWP	IPCC model
Stratospheric ozone depletion	ODP	WMO model
Human toxicity	HTP	Multimedia model, e.g. EUSES, CalTox
Ecotoxicity (aquatic, terrestrial etc.)	AETP, TETP, etc.	Multimedia model, e.g. EUSES, CalTox
Photo-oxidant formation	POCP	UNECE Trajectory model
Acidification	AP	RAINS
Eutrophication	EP	Biomass formation (Heijungs <i>et al.</i> , 1992)
Etc.	...	...

ADP = abiotic depletion potential

ODP = ozone depletion potential

AETP = aquatic ecotoxicity potential

AP = acidification potential

EP = eutrophication potential

GWP = global warming potential

HTP = human toxicity potential

TETP = terrestrial ecotoxicity potential

POCP = photochemical ozone creation potential

It is generally recognised today that characterisation methods for assessing chemical releases should include a measure of both fate (including exposure/intake where relevant) and effect of the substances. The fate aspect involves the distribution over and persistence within the different environmental media. For toxic releases, fate may be modelled by e.g. multimedia models and effect may be expressed by e.g. a so-called PNEC (Predicted No-Effect Concentration) or similar effect indicator.

Most characterisation methods are globally oriented but refinements are possible here, of course. This is not necessary for global categories, including climate change and stratospheric ozone depletion, but may be relevant for categories like acidification and eutrophication. Another refinement concerns the possible inclusion of anthropogenic background levels. This may for instance be relevant for the assessment of toxic releases and is already used in the assessment of photo-oxidant forming releases.

Similar to the discussion on the dependence of emissions and resource uses on local circumstances in Section 2.1.4, the environmental impacts of agricultural processes may also be dependent on local circumstances. In case of impacts, this may be due to site specific differences in distribution, fate and exposure processes influencing the impact assessment. This is a well known problem in LCA. The impact of a given intervention will depend on the (local) environmental conditions that determine the distribution, fate, exposure of the emitted substance and the sensitivity to the damage. This aspect is valid for interventions of both agricultural as well as industrial processes. The problem may be solved by using characterization models that take into account site dependent parameters so several sets of site specific characterization factors can be calculated. Such site-dependent models have been developed for some impact categories, but need further development in terms of geographic areas covered, impact categories covered and data needed.

It should be noted however that characterisation modelling is by no means without obstacles. Due to the fact that many categories are quite heterogeneous with respect to their underlying mechanisms, such characterisation models (and their derived factors) cannot be defined on the basis of scientific knowledge alone, but will to a smaller or larger extent also be based on value judgments. In fact, this is also the case - although to a minor degree -, with the well accepted global warming models and GWP values (Hertwich *et al.*, 2001).

In the classification step the environmental interventions qualified and quantified in the Inventory analysis are assigned on a purely qualitative basis to the various pre-selected impact categories. Thus, CH<sub>4</sub> and CO<sub>2</sub> are for example assigned to climate change. A possible double-counting may occur, e.g. for a

chemical like NO<sub>x</sub> that reacts to contribute to acidification and is then not available anymore to cause toxic impacts.

In the characterisation step the environmental interventions assigned qualitatively to a particular impact category in classification are quantified in terms of a common unit for that category by their respective characterisation factors, allowing aggregation into a single number: the indicator result. The resulting number for one particular impact category is referred to as a category indicator result, and the complete set of category indicator results as the environmental profile. For example, if the global warming potential for time horizon 100 years (GWP<sub>100</sub>) of CO<sub>2</sub> equals 1 and the GWP<sub>100</sub> of CH<sub>4</sub> equals 21, the indicator result for an emission of 2 kg CO<sub>2</sub> and an emission of 3 kg CH<sub>4</sub> for climate change using the GWP<sub>100</sub> characterisation factors becomes :

$$1 \times 2 + 21 \times 3 = 65 \text{ kg CO}_2 \text{ - equivalents}$$

In Table 6 the environmental profile is shown for the hypothetical system of PE throw-away bags.

Table 6: Environmental profile for the hypothetical system of PE throw-away bags.

Impact category	Value
<b>indicator results</b>	
depletion of abiotic resources	3.5 kg antimony eq
photo-oxidant formation	1.2×10 <sup>-4</sup> kg ethene eq
climate change	2.2 kg CO <sub>2</sub> eq
freshwater aquatic ecotoxicity	0.013 kg 1,4DCB eq
terrestrial ecotoxicity	2.6×10 <sup>-6</sup> kg 1,4DCB eq
human toxicity	0.0088 kg 1,4DCB eq
Acidification	0.033 kg SO <sub>2</sub> eq
Eutrophication	4.8×10 <sup>-4</sup> kg PO <sub>4</sub> eq
<b>interventions of which characterisation factors are lacking</b>	
emission to air: dioxins (unspecified)	8.1×10 <sup>-14</sup> kg
<b>Economic outflows not followed to system boundary</b>	
used plastic bag	1000
residue to dump	0.08 kg
Recovered energy	0.0008 MJ

The indicator results are expressed each in their own units, e.g., kg climate change equivalents, kg 1,4-DCB equivalents, etc. A further weighting of these scores is thus difficult without a prior processing, the so-called normalisation. Normalisation is an optional step of Impact assessment in which the indicator results are expressed relative to well-defined reference information. The reference information may relate to a given community (e.g. The Netherlands, Europe or the world), person e.g. a Danish citizen (Hauschild & Wenzel, 1998) or other system, over a given period of time. Other reference information may also be adopted, of course, such as a future target situation. Every indicator result is thus expressed as a contribution to the total environmental problem for a given year and a given geographic area, e.g. 1999 for the Netherlands. In this way, one may encounter a contribution of 10<sup>-12</sup> by a certain product to the total acidification problem in the Netherlands in 1999, and 10<sup>-9</sup> to smog. These numbers have no absolute meaning and can be re-scaled to other metrics and scales (see above).

The main aim of normalising the category indicator results is to better understand the relative importance and magnitude of these results for each product system under study, providing information on the relative significance of the category indicator results. Normalisation can also be used to check for inconsistencies.

In

Table 7 the normalised environmental profile is shown for the hypothetical system of PE throw-away bags.

Table 7: Normalised environmental profile for the hypothetical system of PE throw-away bags.

Impact category	Value
normalised indicator results	
depletion of abiotic resources	$2.2 \times 10^{-11}$ yr
photo-oxidant formation	$2.6 \times 10^{-15}$ yr
climate change	$5.7 \times 10^{-14}$ yr
freshwater aquatic ecotoxicity	$6.7 \times 10^{-15}$ yr
terrestrial ecotoxicity	$6.8 \times 10^{-18}$ yr
human toxicity	$1.8 \times 10^{-16}$ yr
Acidification	$1.1 \times 10^{-13}$ yr
Eutrophication	$3.7 \times 10^{-15}$ yr
interventions of which characterisation factors are lacking	
emission to air: dioxins (unspecified)	$8.1 \times 10^{-14}$ kg
economic outflows not followed to system boundary	
used plastic bag	1000
residue to dump	0.08 kg
recovered energy	0.0008 MJ

Grouping is another optional step of Impact assessment in which impact categories are aggregated in one or more sets defined in the Goal and scope definition phase. It may take the form of sorting - whereby impact categories are sorted on a nominal basis, e.g. by characteristics such as emissions and resource use, or global, regional and local spatial scales -, and/or ranking - whereby impact categories are hierarchically ranked (e.g. high, medium, and low priority), applying value choices. Little work has yet been done on operationalisation of this step (Schmitz & Paulini, 1999).

A last optional step of the impact assessment is weighting in which the (normalised) indicator results for each impact category calculated are assigned numerical factors according to their relative importance, multiplied by these factors and possibly aggregated. This may include a formalised weighting procedure, resulting in one environmental index. The weighting can be done case by case, or on basis of a generally applicable set of weighting factors. For the latter, three different lines can be distinguished, which are in part interconnected and which may to some extent be combined: a monetary approach, in which a translation into monetary values is being performed; a distance-to-target approach, in which the weighting factors are in some way related to given reference levels; and societal approach, in which the weighting factors are set in a authoritative procedure, comparable to the setting of standards. Although all steps of LCA contain value choices, weighting par excellence is based on value-choices. The weighting factors are highly subjective as they are based on perceptions of what is worse: dead forests or dead fish, etc. Therefore, ISO 14042 (2000a) states that "weighting shall not be used for comparative assertions disclosed to the public". Outside ISO, however, weighting methods have received extensive attention since 1992. For an overview, see for example Finnveden (1999).

In Table 8 weighting results using a further unspecified weighting method are shown for the hypothetical system of PE throw-away bags. Note that the weighting factors in this example are purely fictitious and should not be used in any real-world application.



Table 8: Weighting results for the hypothetical system of PE throw-away bags.

Impact category	Weight	Value
<b>weighted indicator results</b>		
depletion of abiotic resources	0.01	$2.2 \times 10^{-13}$ yr
photo-oxidant formation	0.8	$2.1 \times 10^{-15}$ yr
climate change	2.4	$1.4 \times 10^{-13}$ yr
freshwater aquatic ecotoxicity	0.2	$1.3 \times 10^{-15}$ yr
terrestrial ecotoxicity	0.4	$3.9 \times 10^{-18}$ yr
human toxicity	1.1	$1.9 \times 10^{-16}$ yr
Acidification	1.3	$1.4 \times 10^{-13}$ yr
Eutrophication	1.0	$3.7 \times 10^{-15}$ yr
<b>weighting result</b>		
Total	–	$5.1 \times 10^{-13}$ yr
<b>interventions of which characterisation factors are lacking</b>		
Emission to air: dioxins (unspecified)		$8.1 \times 10^{-14}$ kg
<b>economic outflows not followed to system boundary</b>		
used plastic bag	–	1000
residue to dump	–	0.08 kg
recovered energy	–	0.0008 MJ

## 2.1.6 Interpretation

Where goal and scope definition sets the focus and inventory analysis and impact assessment comprise data collection and calculations, a final place for analysing and interpreting the results is needed. This place is provided by the fourth phase of the LCA framework, the interpretation. It basically is concerned with three different types of activities:

- an evaluation of the results obtained so far;
- an analysis of these results;
- drawing conclusions and making recommendations.

Below, these three activities will be discussed.

It will be clear that the results of an LCA are not completely certain. Large amounts of data are needed, and some of these data may be of poor quality. Moreover, cut-offs have been made and other simplifications and assumptions may have been introduced to make the analysis feasible. For some data items, there may be a range of values available, for instance because different databases contradict each other. Methodological choices can be debated; the principles used for allocating multi-functional processes are just one example here. Finally, normative choices, for instance as to the use of weighting factors, can be present at a number of places. All in all, an analysis of the quality of the analysis and the robustness of the results is an essential part of a sound decision-making. It is for this reason that the interpretation phase is a place par excellence to address uncertainty. A number of steps are possible for the interpretation phase (Guinée *et al.*, 2002):

- consistency check;
- completeness check;
- contribution analysis;
- perturbation analysis;
- sensitivity and uncertainty analysis.

Interpretation is a relatively new phase of LCA and has not yet received as much attention as the other LCA phases. Preliminary proposals for operationalising the above listed Interpretation steps have been elaborated (ISO 14043, 2000b; Guinée *et al.*, 2002). New approaches continue to be published, and the

usefulness of the different approaches is being investigated, also aided by developments in software. Below, a few examples of approaches will be given.

In a contribution analysis, the results of LCA are divided into contributing unit processes and/or environmental flows. In Table 9 the results of a contribution analysis for the emission of cadmium to fresh water yielding a decomposition into the main contributing processes, are shown for the hypothetical system of PE throw-away bags<sup>7</sup>.

Table 9: Main contributing processes to the emission of cadmium to fresh water for the hypothetical system of PE throw-away bags<sup>7</sup>.

Process	Contribution
Electricity production	56%
Refining; allocated to naphtha	25%
Incineration of chemical waste	19%

A perturbation analysis is a systematic method to study the influence of changes of data items. Such changes may be introduced due to statistical variation, or deliberately by product or process improvement. An example of the result of a perturbation analysis is in Table 10. This table can be read as follows: if the coefficient for the output of ethylene of the process production of ethylene is increased by 1%, the system-wide emission of benzene to fresh water is decreased by 1.15%. Note that only a small number of coefficients exhibit such large sensitivities.

Table 10: Result of a perturbation analysis for the emission of benzene to fresh water.

Process	Flow	Multiplier
production of ethylene	output of ethylene	-1.15
production of PE	input of ethylene	0.92
production of PE	output of PE	0.92
production of plastic bags	input of PE	0.92
production of plastic bags	output of plastic bags	0.92
packaging a loaf	output of loaves packaged	0.92
Refining	output of naphtha	0.90
production of ethylene	input of naphtha	0.90
packaging a loaf	input of plastic bags	0.70
rest (19 items)		<0.1

Sensitivity and uncertainty analysis address inherent uncertainties in data and different scenarios, assumptions and choices. Typical forms may address

- parameter variation, i.e. the recalculation of results with modified data and/or choices;
- Monte Carlo analyses, for instance leading to results with error bars;
- ranking of alternatives on the basis of the number of runs for which a certain alternative ranks best or worst.

Sensitivity and uncertainty analysis are becoming accessible by the development of LCA software that supports the required calculations, the availability of databases containing uncertainty information, and methods to support the interpretation of advanced statistical methods.

The approaches mentioned often serve a double purpose: evaluation of the results and analysis of the results. For instance, a perturbation analysis will provide an indication of the robustness of the results, but

<sup>7</sup> Thus, a large part (56 per cent) of the emission of cadmium to surface water is caused by electricity production. Note that the contribution of 25 per cent by refining is only the part that is allocated to production of naphtha, and that this excludes the production of fuel oil and other co-products. If the emission of cadmium to surface water is a major concern in the study, it is clear that the process data for the electricity production should be checked carefully.

also shows where improvements may be introduced. Another example is the contribution analysis: it can serve the purpose of evaluation by pointing out unexpected and therefore suspicious results, and it helps to locate key issues for improvement of products.

A final activity in the interpretation is the drawing of conclusions and the making of recommendations. Although no formal methods can be specified here, the main concern in the LCA framework is to safeguard the consistency with the goal and scope of the study, the procedural embedding and the justification of the conclusions and recommendations.

## **2.2 LCC methodology**

### **2.2.1 Overview**

LCC is a method of calculating the total life cycle cost of a product (covering both goods and services) induced throughout its life cycle. It is an analytical tool that belongs to the group of the life cycle approaches. Many different approaches and variants of LCC methods exist. An overview of LCC methods is given in Huppes *et al.* (2004). In this paper we will only be concerned with LCC to be used in conjunction with LCA also called LCA-type LCC.

The LCC methodology will not be discussed as extensively as the LCA methodology as - in principle - it is a more simple (it lacks an impact assessment, normalisation & weighting phase) and some of the issues like goal & scope definition, allocation are the same in LCA which have been discussed already. Moreover the current study is more focussed on LCA issues.

The LCA-type LCC has only recently been given more attention in scientific literature. As a result basic methodology is still under discussion and no databases exist yet that contain LCC data of general processes which can be used in the LCC of agricultural systems. (For LCA very large databases exist that contain the environmental and economic input and outputs of thousands of processes). Application of the LCC methodology is therefore hampered by lack of data in the background system. There is a 'work-around' to plug this data-gap, but it means that the LCC cannot be carried out in a fully consistent manner. On the other hand data gathering for LCC can be much more easy than data gathering in LCA because all money transfers are already recorded. These matters are explained in more detail in 2.2.3. Having indicated some of the current limitations of the LCC methodology we proceed by explaining the set-up of a LCA-type LCC.

The main question to be answered when using the LCC tool, is the reason for which it is going to be applied. Three sub- questions can be derived from this.

1. For which actors are we going to calculate the cost? Actors could for instance be a country, government body, a private firm or individual consumer.
2. Which cost are going to be taken into account? Examples could be budget cost, market cost or social cost. Social cost would include all market related items plus external effects.
3. Which cost measures are going to be applied? Existing approaches are average yearly cost, steady state cost, net present value etc.

In the following sections each sub question will be elaborated upon.

#### 1) Cost bearer?

For the LCC to be aligned with LCA, the system boundaries should be the same for the LCA and the LCC. We define the cost bearer in the LCC as the actor that is directly responsible for providing the functional unit. In the SOWAP/Proterra projects, it would be the farmer. Logically the system boundaries of the LCC are similar to those in the LCA.

## 2) Which cost?

Social costs, which would include all market related items plus external effects, should not be used in this LCC because it leads to double counting. External effects like environmental pollution are already being accounted for in the LCA.

Budget costs are the costs that directly come out-of-the pocket, whatever it's legal or tax status. For a comparison of different alternatives in a LCC, budget costs would only be of relevance in the most simple cases. Investment costs are not considered in this cost category, because the cost of borrowing and depreciation are rarely paid out of the pocket.

Market costs are relatively simple but includes the cost of borrowing, depreciation and all direct taxes and subsidies. In principle for an equal comparison of alternatives, taxes and subsidies should not be included in the comparison.

Alternative costs are market costs that are corrected for account price distortions, market imperfections and also transfer payments are left out of account. Transfer payments are not paid in return for a good or service delivered, like taxes, subsidies, or gifts.

Alternative costs are chosen for use in this LCC as it provides the best way of comparing the alternatives on an equal basis. If in practice it is possible to correct for account price distortions and market imperfections remains to be seen.

## 3) Which cost measure?

LCA uses steady state modelling for the calculation of the environmental interventions. In this LCC we chose to do the same for the life cycle cost. The steady state models lack a time specification. The steady state costs are calculated as the sum of the yearly costs of a product or service divided by it's functional running time. No discounting is involved.

To be able to calculate the life cycle cost for the cost bearer in principle we would need to calculate the value added for all the processes, using alternative costs and steady state modelling, for all the unit processes in the whole agricultural production chain. However this would be an impossible task given that no LCC databases exist yet. Luckily there is a work-around this problem which makes it possible to be concerned with costs in the fore-ground system only, see section 2.2.3.

## 2.2.2 Goal and Scope definition

The goal & scope of the LCC should be the same as the LCA. This means that the system boundaries should be the same in the LCA and LCC. Flows cut-off in the LCA are also not accounted for in the LCC. The functional unit in the LCC and LCA are also the same. The allocation methods used in the LCA are also being used in the LCC.

However, due to the premature nature of the LCC methodology, we are sometimes forced to do things differently than in the LCA methodology.

## 2.2.3 Inventory analysis

As discussed in the overview of the LCC methodology in principle we need to gather the value added for all the unit processes in the agricultural production chain. No databases exist yet that contain these LCC data so for the system under consideration we would have to gather them ourselves for all the unit processes. That is impossible.

We solve this problem by assuming that the price (ex VAT) of a product or service paid for by the cost bearer is the sum of all values added in the chain of unit processes used to create this product or service. This relieves us of the need to gather data on value added in the production chain. Inconsistencies in the LCC introduced by this simplification are:

1. the price of a product or service also includes taxes paid by the producers.

2. the capital cost of investments in the production chain of a certain product or service which finally ends-up in the price of a product is likely not calculated in a steady state way (but likely includes discounting).
  3. subsidies and taxes have influenced the price of a product or service.
- Thus there is an inconsistency between the foreground and background system in the way cost are calculated.

Summarising the above discussion, from a practical point of view the following cost will be taken into account for the foreground system:

- value added within the foreground system;
- external purchases;
- including purchases of capital goods;
- including overheads and services;
- excluding payments on borrowed capital;
- excluding VAT.

We do not have to deal with processes in the background system as the value added in the background system are assumed to be the same as the external purchases.

## 2.3 Discussion

LCA and LCC are powerful tools when it comes to integrated life cycle-based comparisons of alternative systems to fulfil one specific function. In order to keep LCA/LCC practical and feasible, a number of model simplifications are often made (although no always explicitly stated):

- Near-complete omission of spatial detail, by not distinguishing between emissions near different kinds of ecosystem, for example. The only default spatial details that are retained are those specified by a short list of environmental media: air, surface water, soil, sea and sediment. There are ongoing developments aiming to include more spatial characteristics, however.
- Complete omission of temporal detail. Among other things, this means that emissions are specified as total (infinite) time-integrated emissions.
- Complete omission of non-linearities.<sup>8</sup> This means, for example, that if the production of 1 kg steel is associated with an emission of 5 kg of a substance, the production of 2 kg steel is assumed to be associated with an emission of 10 kg of that substance (hence, fixed input-output coefficients).
- Omission or extreme simplification of most economic, socio-cultural and technological mechanisms influencing operation of the processes considered in the Inventory analysis. For example, the most common economic response to a rise in demand for a product brought about by adopting a certain option for supply of a functional unit is a rise in price and certain buyers of that product leaving the market. This market mechanism is virtually ignored. Income effects are likewise ignored. For instance, if product A is more expensive than product B, switching to B will mean the consumer has more money to spend on other (polluting) activities. Such shifts are not generally taken into account (Guinée *et al.*, 2002).

LCA and LCC are system analysis approaches. Such approaches generally imply numerous choices to be made with a high level of freedom. To be useful and comparable, these choices need to be made and implemented in a consistent way. For example, system boundaries between economy and environment as to e.g. the soil (which has been taken as part of the environment, see above) need to be handled consistently throughout all agricultural LCAs in order to allow inter-comparison of the results of the LCA-studies.

---

<sup>8</sup> In this context, neglecting non-linearity means that the model structure is linear, in the sense of twice as much product requiring twice the amount of materials, leading to twice the emissions and to twice the environmental impact. It may still be the case that the simple coefficients used in the model are derived from highly non-linear models, as with global warming potential, for example.

LCA and LCC are tools integrating all environmental/economic aspects of a system and can easily become too complex to handle. That's why amongst others simplifications have been made in the past (see above). The LCA/LCC tools have therefore a specific application domain and cannot replace tools that assess time- and site dependant environmental impacts and specific economic tools. For instance an LCA cannot predict if at a certain moment at a certain place some environmental standards will be exceeded. LCA can thus never replace e.g. Risk Assessment and thus for some decisions, information from both these (and other) tools needs to be taken as input to a decision-making process.

In this definition study we adopt the solutions proposed by Wegener Sleeswijk *et al.* (1996) and we will further focus on the core problems related to the impact assessment, particularly those impact categories that are of special interest for the SOWAP and ProTerra projects but for which no operational and "accepted" methods exist in LCA:

- hydrology (desiccation);
- erosion;
- soil fertility;
- biodiversity.

Based on an inventory of existing and evolving LCA impact assessment methods for land use related impacts, the data needs of these methods will be analysed and compared to the data available from the SOWAP and ProTerra projects;

## 3 LCA impact assessment methods for land use related impacts

### 3.1 Introduction

In recent years studies have been performed to extend LCIA, with impact categories related to issues as erosion, desiccation, land use, biodiversity, for example to assess the sustainability of agricultural systems. These topics are still under discussion in the LCA community as is shown by the ongoing work of the taskforce on natural resources and land use in the UNEP/SETAC life cycle initiative (Milà i Canals *et al.*, 2006). In this chapter, we report the main results of an inventory that we have made of existing and developing LCA impact assessment methods for land use related impacts, their data needs and how these data needs compare to data available from the SOWAP and ProTerra projects.

As a first step, we have subdivided the land use related impact assessment methods into two categories:

1. *Single indicator*: a single indicator like area occupied, area transformed or thermodynamics of an ecosystem is used as indicator for effects on biodiversity/natural biotic environment.
2. *Multi indicator*: several indicators are being used to assess the effects on the soil quality which by way of a cause-effect chain can affect biodiversity.

At this point it is convenient to discuss the cause-effect chain of land use interventions. A schematic overview of the cause-effect chains of land use interventions is shown in Figure 9. Note that Figure 9 is not a comprehensive description of all relations in the cause-effect chain of land use impacts, but is only meant as illustration of the concept of cause-effect chains. The cause-effect chain starts with land use related interventions like area occupied, use of fertiliser, effects on vegetation cover, use of agrochemicals etc. In turn these interventions have an effect on water infiltration, soil organic matter content, soil compaction. These affected parameters may be called state (or midpoint in LCIA terminology) indicators as they describe the state of the system. The effects on soil compaction, soil organic matter, hydrology in turn affects the erosion rate. Further along the cause-effect chain the biodiversity is affected which finally can be considered as category indicator for the category endpoint or area of protection “natural biotic environment”.

When developing a set of impact assessment indicators to assess the sustainability of agricultural systems, it is important to choose the indicators with care. The impact categories chosen should together permit an all-encompassing assessment of the land use related impacts (completeness). Furthermore the chosen categories should have minimum overlap and avoid double counting. For instance, it would be unwise to use both as indicator soil compaction, soil surface sealing and water infiltration as the first two indicators affect water infiltration. Also overlap with the other impact category indicators should be avoided. For instance the application of agro-chemicals is already assessed in the ecotoxicity impact categories and should not be assessed again in a land use related impact category. This issue is further discussed in Section 3.2.2.4.

The SOWAP and ProTerra projects focus on issues like erosion, hydrology, soil fertility and biodiversity. Therefore, as a second step, we will further focus in this definition study on the following issues:

- erosion
- hydrology/desiccation
- soil fertility

These indicators are state indicators at the beginning of the cause effect chain. They can be used as indicator for separate impact categories or can be weighted to obtain a single impact category.

The selected single indicators, further up the cause-effect chain and better described as impact indicators are:

- biodiversity as assessed in terms of land occupation/land transformation or
- ecosystem health in terms of cooling capacity.

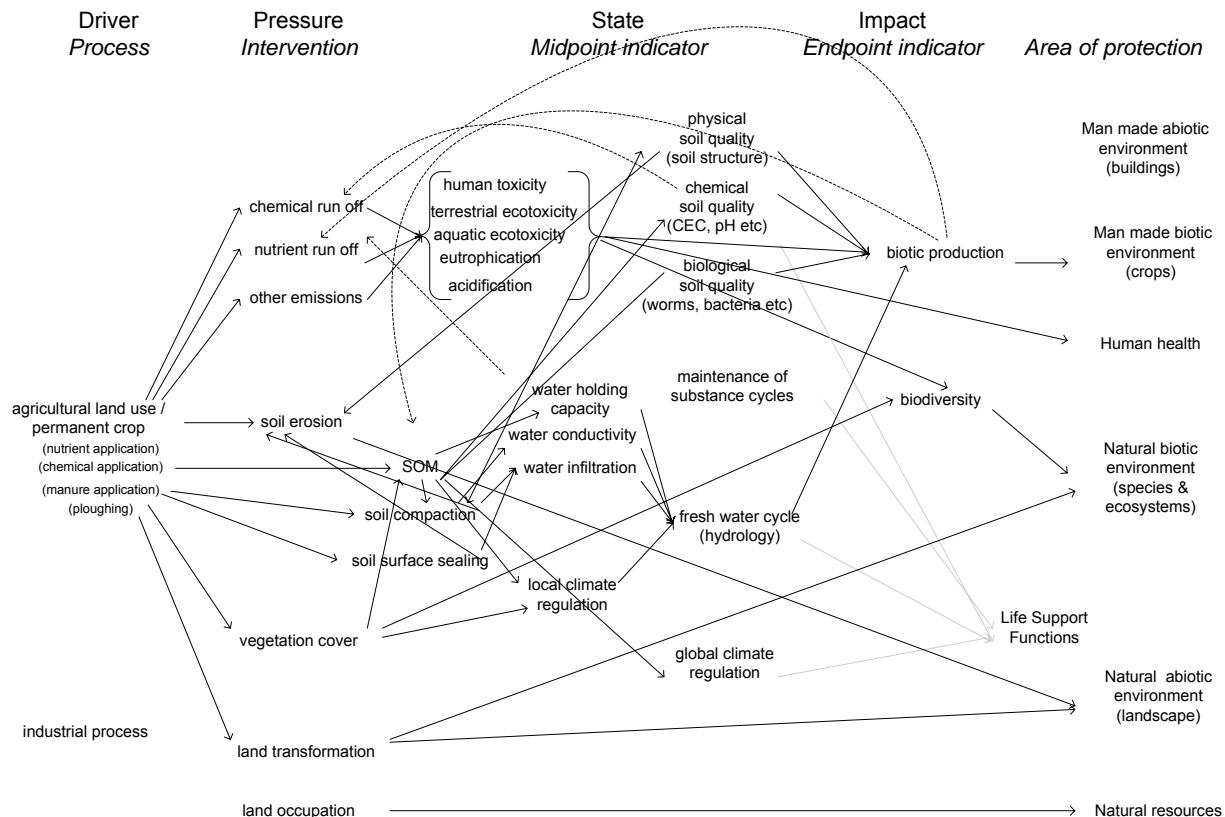

Figure 9: Schematic overview of the cause effect chains of land use related interventions (Adapted from Milà i Canals, 2003; Cowell & Lindeijer, 2000).

In the following sections, first a general overview is given of existing land use related impact assessment methods and their possible short-comings. Then the existing single indicator methods or separate indicators of multi indicator methods which are most promising (in practical and scientific terms) are discussed in more detail. After this discussion, then data available in the SOWAP and ProTerra projects are compared with the data needs of these most promising indicators.

Leitmotiv in the evaluation of the method identified in this definition study is to analyse if it is possible to include these impacts by these method in a useful (“does it make sense”) and practical (“are the data needed available”) manner in LCA.

In inventorying and exploring the “new” methods for land use related impacts, we will match the characteristics of the new methods with the obligatory characteristics of LCA impact assessment methods:

- Which intervention(s) are characterised?
- Which indicator is used and does it appropriately reflect the problem that is assessed?
- Which characterisation model is being used to calculate the influence of the interventions on the selected indicator?
- Are operative characterisation factors available?
- What is the indicator result?

As an example of the structure of a life cycle impact assessment method in the following box the well known impact assessment method for climate change is shown.



General structure of life cycle impact assessment illustrated by the impact category climate change.

Impact category	Climate change
intervention	emissions of greenhouse gases to air (kg)
indicator	infrared radiative forcing ( $W \cdot m^{-2}$ )
characterisation model	IPCC model defining the GWP's of different greenhouse gases
characterisation factor	GWP <sub>100</sub>
indicator result	kg (CO <sub>2</sub> -equivalent)

The calculation of the indicator result for climate change is as follows:  
 2 kg CO<sub>2</sub> (GWP<sub>100</sub> = 1) + 3 kg CH<sub>4</sub> (GWP<sub>100</sub> = 11) gives  $2 \times 1 + 3 \times 11 = 35$  kg CO<sub>2</sub>-equivalent.

For the land use related impact assessment methods the structure should be defined as clear and unambiguous as it is defined for climate change. Unfortunately this is not always the case as will be shown later.

## 3.2 General issues existing land use impact assessment methods

### 3.2.1 Description of existing land use impact methods

The use of land has substantial impacts on the environment. LCA strives to assess the impacts for a wide variety of processes (i.e. land use types by agriculture, forestry, mining, industry etc.). Most of the present land use impact methods assess the impacts on indicators related to biodiversity (e.g. Lindeijer *et al.*, 1998; Köllner, 2000; Mattsson *et al.*, 2000) and life support functions (e.g. Lindeijer *et al.*, 1998; Wagendorp *et al.*, 2006 in terms of ecosystem thermodynamics) or soil quality, as a supplier of life support functions. Soil quality is mostly expressed in terms of soil fertility for (future) crop production (e.g. Cowell & Clift, 2000; Milà i Canals, 2003; Mattsson *et al.*, 2000). Some methods specifically try to assess impacts on hydrology (Heuvelmans *et al.*, 2004; Heuvelmans *et al.*, 2005; see also Ek *et al.*, 2002). An overview of methods reviewed in this study is given in Table 11.

This overview does not represent a complete inventory of available methods for land use related impact categories but represent the most important developments in this research field which is sufficient for this study. Methods not discussed include those of Baitz *et al.* (1998), Schweinle (1998) and Müller-Wenk (1998). More complete inventories of land use related impact categories can for instance be found in Lindeijer (2000b).

Methods can be divided into multi indicator methods and single indicator methods. In multi indicator methods the impact of land use is assessed using, sometimes a large, set of separate indicators, like soil compaction, soil erosion, surface run off, crop biomass, number of plant species etc. (e.g. Muys & Garcia Quijano, 2002; Baitz *et al.*, 1998; Mattsson *et al.*, 2000) or subcategory indicators are aggregated into one indicator (Brentrup *et al.*, 2002). In single indicator methods only one key indicator is measured (e.g. Lindeijer *et al.*, 1998; Köllner, 2000). The number of indicators distinguished in the diverse land use related impact assessment methods is also given in Table 11.

Many methods only describe the indicators to assess land use, but the development into a complete impact assessment method for LCA is not further elaborated. For example it is not clear what type of inventory data will be used (land use classes?, specified physical or chemical interventions?) and no characterisation factors, normalisation factors and weighting factors for subcategory indicators are elaborated (Muys & Garcia Quijano, 2002; Heuvelmans *et al.*, 2005, Cowell & Clift, 2000; Milà i Canals,

2003). Many of the land use impact assessment methods seem to propose indicators that are suitable for site-specific Environmental Impact Assessment (EIA instead of LCA). The indicators describe the state of the soil or ecosystem without relating the state to specific interventions but only classifying the type of land use. Such indicators are very useful to compare the quality of different sites, with different uses. However for LCA purposes the relation of the state of the environment, i.e. soil and ecosystem, with the direct interventions that cause the state should be quantified in a characterisation model.

Most methods use a limited number of land use types (classes of land use for different biogeographical regions) as inventory data together with the size and duration of the land use (Lindeijer *et al.*, 1998; Köllner, 2000; Brentrup *et al.*, 2002). The resolution of these classes is likely too low to distinguish between alternative systems in the SOWAP/ProTerra project. Some methods propose to use specified interventions, like erosion, application of organic matter or water extraction (Cowell & Clift, 2000; Milà i Canals, 2003), see also Table 11.

In the assessment of land use impacts a distinction is made between changes of land properties (transformation) and maintenance of land properties (occupation). The size of the damage is often defined as the difference between the effect due to the studied land use type and a reference land use type in the same area. Because the effect of land use depends on site specific situations the effect of the damage is often presented relative to biogeographical conditions.

Table 11: Overview of land use impact assessment methods further assessed in this study.

Reference	Inventory		Indicators							Operational	
	Direct physical interventions	Land types	resources	Ecosystem health (biotic natural and man made environment)						Characterisation factors	Normalisation factors
				Hemeroby	Biodiversity	soil fertility (life support function)	hydrology	Exergy (life support function)	multi-indicator		
Brentrup <i>et al.</i> , 2002		11 classes		Naturalness index					no	yes	yes
Lindeijer <i>et al.</i> (1998); Lindeijer (2000a, 2002); Weidema & Lindeijer (2001)					vascular plant species density					limited <sup>3</sup>	?
Lindeijer <i>et al.</i> (1998)		x				(f)NPP					
Köllner, 2000; Goedkoop & Spriensma, 1999 <sup>8</sup>		x			vascular plant species density				no	limited <sup>4</sup>	?
Milà i Canals, 2003	4 types <sup>1</sup>					soil organic matter				no	no
Cowell & Clift, 2000	loss of soil mass		Soil static reserve life							preliminary	no
Cowell & Clift, 2000	added organic matter					organic matter				no <sup>2</sup>	no
Cowell & Clift, 2000	vehicle operation on land					soil compaction				no	no
Heuvelmans <i>et al.</i> , 2005	water use		Dynamic water reserve life							no	no
Heuvelmans <i>et al.</i> , 2005	land use type	? <sup>5</sup>					Changes in regional water balance			no	no
Wagendorp <i>et al.</i> , 2006		?						Cooling capacity of an ecosystem	no	no	no
Muys & Garcia Quijano, 2002		?							17 indicators <sup>6</sup>	no	no
Mattsson <i>et al.</i> , 2000									9 indicators <sup>7</sup>	no, mainly qualitative description	no

1 emission of crop residues, emission of organic residues, erosion and increased aeration

2 it is not clear how characterisation factors should be elaborated

3 no operational list of factors available, however some basic data available from case studies, mainly concerning mining activities and forestry

4 characterisation factors available for 16 land use types, representative for the Swiss lowlands (and probably comparable regions)

5 These methods claim to be LCA impact assessment methods, however they more resemble ERA, using a large amount of site specific information on soil, hydrological and weather conditions etc.

6 Seventeen indicators are proposed for land use impacts distinguished into 4 themes soil, water, vegetation structure and biodiversity

7 nine indicators are proposed for land use impacts distinguished into 3 themes soil fertility (7 indicators), biodiversity and landscape

8 Method proposed by Köllner (2000) and operationalised by Goedkoop and Spriensma (1999) in the Ecoindicator '99 impact assessment method.

## 3.2.2 Discussion of land use impact methods

### 3.2.2.1 Scope of LCA determines the resolution of analysis, i.e. type of inventory data and IA

The level of detail by which the 'intervention' use of land should be described depends on the scope of the LCA (e.g. land use part of background vs foreground processes etc.) For background processes a mere classification of a limited number of archetypical land use types (and the associated characterisation factors) might be sufficient, while for a comparison of land management types, e.g. in crop production, a detailed distinction between activities and their direct physical interventions are necessary.

### 3.2.2.2 System boundary: economic system and environmental system

The quality of the land can be judged by functional values for humans and intrinsic values (Udo de haes *et al.*, 2002). Changes in the quality defined in functional terms have economic consequences and should ideally be internalised within the economic system. In LCA this means that changes in land quality that influence the present production (soil fertility) should not be assessed separately in the environmental impact assessment, because the economic output, i.e. the amount of produced crop (crop yield), is already defined in the functional unit (see discussion in Mattsson *et al.*, 2000). Also the economic sustainability, i.e. future soil fertility, should not be part of an environmental impact assessment but should be treated in the definition of the functional unit, the process tree should be extended with restoration activities and/or allocation principles should be applied when soil quality improvement is considered an economic service (see Cowell & Clift, 2000; Milà i Canals, 2003). However the non-economic values of functions, i.e. intrinsic value, are by definition not considered in the economic system and changes in these 'environmental' or 'ecological' functions should be part of the environmental impact assessment. Ideally the land use impact assessment should only assess changes in environmental functions. However some of the suggested indicators for land use impact assessment relate to functional valuation of the land properties for humans (economic valuation) (e.g. soil fertility for crop production).

### 3.2.2.3 Inventory data

The following LCI-data for land use can in general be distinguished:

- type of land use (e.g. forest, cropland, grassland, settlement etc.)
- management activities (type and amount of fertiliser use, % of surface sealed etc)
- area size and location of land use
- duration of land use

In most land use methods the land use is classified in land use types, like e.g. forest, cropland, grassland, settlement etc. In fact a land use type is not a pressure indicator, like other interventions (e.g. emissions and extractions) registered in LCI. A land use type is a driver indicator for which in many cases a set of interventions can be distinguished (physical, chemical and biological).

So a land use type often refers to a set of physical, chemical and biological interventions related to the management of the land. For example a land use type 'permanent pasture' or 'arable crop production' might refer to a set of interventions like emissions of nutrients and toxics due to the application of fertilisers, manure and pesticides, and direct physical interventions due to drainage and ploughing etc. To relate the separate interventions to impact categories the interventions and the accompanying impacts related to a land use type should be disentangled. If not treated in this way the different geographical conditions and the possible alternations of land management types will lead to numerous land use types.

Furthermore the land use types will not only refer to direct physical interventions but also to interventions that are already accounted for in other (conventional) impact categories (see below)

#### 3.2.2.4 Land use impacts in relation to other impact categories: cause-effect chain

Impacts of land use are often expressed using indicators for biodiversity or soil quality. However, conventional impact categories, like eutrophication, acidification and ecotoxicity, are also related to these (end and midpoint) indicators. So the impact of many of the land management activities like application of fertilisers, organic matter, lime and pesticides, are already accounted for in the environmental assessment.

In some land use impact methods the intervention model and characterisation model are integrated. To avoid double counting of impacts therefore the land use impact should only deal with impacts related to direct physical interventions of land use. In some of the at present suggested methods for land use impact assessment it is not clear to which extent the effect of the land use type is related to these direct physical changes of the environment or to the chemical changes that are already considered in conventional impact categories.

Some of the land use impact category indicators are measured state or endpoint indicators. However the quality of the land in an area is not only determined by the direct chemical and physical interventions in the area but is also determined by impacts due to transboundary pollution or other indirect effects related to processes in other areas. So the quality of measured state and endpoint indicators can not directly be related to the direct interventions in the area.

So the link of the different indicators to the endpoints needs to be elaborated. This is necessary to avoid double counting, to get scientific basis to weight the different functions and to find relations with existing impact categories, like acidification, eutrophication and ecotoxicity.

#### 3.2.2.5 Normalisation

Most methods do not provide normalisation data. Actually, only Brentrup *et al.* (2002) provide normalisation data, see also Table 11. The reference situation for normalisation data is something different than the reference situation as described as part of the characterisation model. In normalisation the reference situation refers to the present land use situation in the region and year of reference. In the characterisation models for land use impacts the reference situation refers, in most cases, to the (past or future) natural climax vegetation for that region. The reference situation is often used to estimate the size of the damage due to the actual land use ( $Quality_{reference} - Quality_{actual}$ ) or as a correction of the site dependency of the characterisation factor for climatic and other geographical conditions ( $Quality_{reference} - Quality_{actual} / Quality_{reference}$ ).

### 3.2.3 Conclusion

The general conclusion of the overviews by Lindeijer (2000b) and Cowell & Lindeijer (2000) is that, until 2000, there was no generally accepted methodology for the assessment of land use impacts due to methodological dispute and the lack of data to make the methods operational. Also many methods described in recent publications, between 2000 and 2005, are not developed into operational methods and/or still face methodological problems (e.g. Heuvelmans *et al.*, 2004, 2005; Milà i Canals, 2003., Muys & Garcia Quijano, 2002; Wagendorp *et al.*, 2006) and/or are not suited to distinguish between detailed land management as described in the alternatives of the SOWAP and ProTerra projects (e.g. Brentrup *et al.*, 2002; Lindeijer *et al.*, 1998; Köllner, 2000).

Some methods however contain promising indicators that might be used as such or be further elaborated into meaningful indicators. These are described more thoroughly and compared to the general structure of LCIA (see Section 3.1) in the following section, first discussing the single (all encompassing) indicators and then discussing the sub-indicators taken from the multi-indicator impact assessment methods.

## 3.3 Existing single indicator impact assessment methods

### 3.3.1 Biodiversity impact through direct physical interventions

#### 3.3.1.1 General

Of the land use impact methods listed in Table 11 there are two methods that deal with the impacts due to land use on biodiversity (Lindeijer, 2000a; Lindeijer *et al.*, 2002 & 1998; Köllner, 2000). The methods are elaborated in a limited set of characterisation factors. Another methodology related to the intensity of land use on, amongst others, biodiversity is the hemeroby concept (Brentrup *et al.*, 2002). For this method a set of characterisation and normalisation factors is available. Wagendorp *et al.* (2006) uses exergy analysis as a measure for biodiversity.

#### 3.3.1.2 Lindeijer, biodiversity

In the method of Lindeijer (Lindeijer *et al.*, 2002 & 1998; Lindeijer, 2000a) vascular plant species diversity is taken as a proxy for species diversity in general. Differences in vascular plant species density depend on the type of land use of the area involved.

The crucial issue in the method is the species density under various land use regimes. The species diversity may be measured on different scales (so called mapping areas) and need to be calibrated to one parameter i.e. the species accumulation rate  $\alpha$ . Lindeijer chooses a logarithmic function to describe this relation. The formula is  $S_{\text{map}} - S_{\text{ref cell}} = \alpha \log (A_{\text{map}}/A_{\text{ref cell}})$ , with S the number of species and A the surface area,  $_{\text{map}}$  stand for the situation in the mapping area in which data are collected, and  $_{\text{ref cell}}$  is a reference mapping cell of 1m<sup>2</sup> stated to contain 10 species ( $S_{\text{ref cell}} = 10$ ,  $A_{\text{ref cell}} = 1$ ). This relation allows for comparison of data from various data collection schemes. The differences between ecosystems (both natural and cultural) are expressed in the  $\alpha$  constant, which is taken as the measure for defining characterisation factors.

The characterisation factors are derived from the equation describing the relation between species density and area. Not the species density S but the constant  $\alpha$ , the species accumulation rate, is used. The factors are calculated as follows:

- for transformation:  $(\alpha_{\text{ini}} - \alpha_{\text{fin}}) / \alpha_{\text{ref}}$
- for occupation:  $(\alpha_{\text{ref}} - \alpha_{\text{act}}) / \alpha_{\text{ref}}$

For each case study (land use type) therefore 4  $\alpha$ 's must be established: (1) the reference situation  $\alpha_{\text{ref}}$ , representing the potential natural ecosystem, (2) the situation before the transformation  $\alpha_{\text{ini}}$ , (3) the situation during occupation  $\alpha_{\text{act}}$  and (4) the situation after termination of human activity  $\alpha_{\text{fin}}$  which may or may not be equal to the reference situation, depending on the irreversibility of the damage done by human intervention.

The method makes a distinction between land occupation and land transformation. The necessary inventory data to calculate the impact score is respectively m<sup>2</sup>.yr and m<sup>2</sup> of specific land use types.

A list of operational characterisation factors does not exist. In Lindeijer *et al.*, 1998 & 2002 some basic data (S,  $\alpha$ ) are available for climate zones and some land use types. For other combinations of land use and regions, data must be gathered and characterisation factors must be developed case by case. The  $\alpha$  in the reference situations for different regions worldwide required for calculation of these factors are already available in the form of two maps and two tables. Lindeijer proposes to use an existing vegetation database (Floron database) to determine  $\alpha$  values for important cultural ecosystems in the Netherlands (Lindeijer *et al.*, 2002). The result is possibly useful for the Netherlands but has a limited relevance for the rest of the world.

### 3.3.1.3 Köllner: biodiversity

As in Lindeijer (see above) also the method of Köllner (2000) takes vascular plant species diversity as a proxy for species diversity in general. Differences in vascular plant species density depend on the type of land use of the area involved. Besides transformation and occupation the method also incorporates a correction factor for regional impacts of land use in the region surrounding the local area where the actual intervention takes place. The method makes a distinction between land occupation and land transformation. The necessary inventory data to calculate the impact score is respectively  $\text{m}^2 \cdot \text{yr}$  and  $\text{m}^2$  of specific land use types.

Köllner too uses a function describing the relation between the number of species and the surface area. The function is different from the one used in the methods of Lindeijer i.e.  $S = aA^b$ , or the logarithmic variant  $\ln S = \ln a + b \ln A$ , with  $S$  the number of species,  $A$  the surface area,  $a$  a constant representing the typical species richness and  $b$  the “species accumulation rate”. Köllner also discusses other functions but selected the one he uses as the best fit to his data.  $S$  is then specified for 30 ecosystems, for a standard surface of  $100 \text{ m}^2$  and compared to a reference, being the Swiss situation in 1850. Species density for various types of land use is calculated as  $S_{\text{occ}} / S_{\text{ref}}$ . The inverse  $(1 - S_{\text{occ}} / S_{\text{ref}})$  is called  $S_{\text{lost}}$ , or species potentially lost.

The characterisation factor for the impact on biodiversity is SPEP, which stands for Species-Pool Effect Potential. Each type of land use has its own  $\text{SPEP}_{\text{local, occ}}$ , which is based on the ratio between the number of plant species found in the area occupied for a specific type of land use and the average number of plant species found in the region as a reference. The relationship between SPEP and the relative number of species for a land use type is described as a negative log-curve. The method is thus a marginal approach, determining the slope of a species-area curve for each land use type.

Data were gathered on  $\text{SPEP}_{\text{local}}$  and  $\text{SPEP}_{\text{regional}}$  for 16 land use types, taking the average species richness of the present Swiss Lowlands as a reference. Some land use types score positively, to be interpreted as a positive effect on (present) species richness.

### 3.3.1.4 Brentrup: hemeroby

According Brentrup *et al.* (2000), land use by humans leads to a degradation of naturalness of the land (e.g. decreasing availability of habitats and diversity of wildlife species, but more). The naturalness of an area is defined as the sum of land actually not influenced by humans and the remaining naturalness of a land that is influenced by humans. To classify the remaining naturalness of land the Hemeroby concept is used. The hemeroby classes describe the degree of human activities that prevent the ecosystem from developing towards a natural endpoint situation (Kowarik, 1999). The Hemeroby concept describes 11 levels of intensity of land use, from no human influence at all to purely artificial and the related ecosystems and vegetation. Characterisation factors are defined for the different intensities of land use, using a cardinal scale from 0, 0.1... to 1, the so called Naturalness Degradation Potentials (NDP). The assessment of land use is regionalised because on a large geographical scale the types of ecosystems are far from homogeneous. So the impact category is divided in impact sub-categories ‘land use in European biogeographical regions’. For this purpose ecologically homogeneous units for Europe are defined based on the natural vegetation in 11 biogeographic regions (EEA, 1998a, 1998b), like Alpine, Atlantic, Mediterranean etc.

Normalisation values for the sub-categories are calculated based on the inventory of land cover data (Satellus, 2000) of the European Topic Centre on Land Cover (ETC/LC). Weighting factors for the sub-categories are suggested, based on the distance-to-target approach and the assumption that the current land use pattern in the European biogeographical regions is acceptable.

An operational method including characterisation factors, normalisation factors and a procedure for weighting of the impact sub-categories is available. However at this moment the method is to a large extent subjective, e.g. cardinal scale of classes and equal weighting of sub-categories. In the future scientific research might allow for a more scientific transformation of classes into characterisation factors.

Normalisation factors are only available for the European region while the processes of many product systems often stretch out all over the world and so the inventory results of many product systems might contain land use data outside Europe.

The hemeroby concept is a rough classification of human influence on land. By definition this classification does not allow for a detailed quantification of impacts of interventions by of human activities. The resolution of this characterisation model is too low to discriminate between the alternatives in the SOWAP and Proterra projects on environmental problems.

### 3.3.1.5 *Wagendorp: exergy, ecosystem health, Life support*

According Wagendorp *et al.* (2006), the cooling capacity of an ecosystem, or the loss of cooling due to disturbance (e.g. decreasing evapotranspiration), is a measure of overall ecosystem functioning and health. Remote sensing derived parameters are proposed as indicators of land use impacts. It is stated however that thermal remote sensing has still a lot of methodological problems.

The indicators are site specific, that is the value is influenced by characteristics like soil type, climate and other abiotic growth factors. Therefore the value of the indicator is expressed as a percentage of the site specific reference system, e.g. the climax vegetation. Three indicators are briefly described in the article of Wagendorp *et al.* (2006):

1. Surface temperature of an ecosystem or
2. Thermal response number (TRN) or
3. Solar exergy dissipation (SED)

In the proposed land use impact method the intervention model and characterisation model seem to be integrated.

The indicator described above is a state indicator. It is proposed to link this measured state indicator to specific land use types. So the land use classes are the inventory data (e.g. referring to direct physical interventions of a crop production process). However the state of the area is not only affected by direct physical interventions. The state also will be determined by other environmental mechanisms, that are already described by other (conventional) impact categories, like acidification, eutrophication, ecotoxicity and global warming. Furthermore the state of an area is determined by impacts due to transboundary pollution and indirect effects related to other processes in other areas.

The inventory data of a land use type refers to a set of physical, chemical and biological interventions related to a set of management drivers. For example a land use type 'permanent pasture' or 'arable crop production' might refer to a set of interventions like emissions of nutrients and toxics due to the application of fertilisers, manure and pesticides, and direct physical interventions due to drainage and ploughing etc. To relate the separate interventions to impact categories the interventions and the accompanying impacts related to a land use type should be disentangled. If not treated in this way the different geographical conditions and the possible alternations of land management types will lead to numerous land use types.

The method described by Wagendorp *et al.* (2006) is not yet operational and no characterisation factors or normalisation factors have been calculated yet. The proposals are still developing and thermal remote sensing has still a lot of methodological problems. A more fundamental problem is that the proposed does not refer to direct physical interventions in the area only. A natural decrease may also affect the cooling capacity of an ecosystem. From a practical point of view a problem is the low resolution of the land use types which will never be high enough to distinguish between management types in the SOWAP/ProTerra projects.



### 3.3.1.6 Suggestions for possible approaches

Table 12: Overview of the methods proposed for the impact assessment category biodiversity in LCA and their placement within the LCIA structure.

	Lindeijer	Köllner	Brentrup	Wagendorp
Impact category	biodiversity	biodiversity	hemeroby	exergy
intervention	m <sup>2</sup> .yr (occupation) m <sup>2</sup> (transformation) specific land use types	m <sup>2</sup> .yr (occupation) m <sup>2</sup> (transf) specific land use types	m <sup>2</sup> .yr (occupation)	m <sup>2</sup> .yr (occup. ?)
Indicator	vascular plant species diversity; separate indicators for occupation and transformation	vascular plant species diversity	naturalness degradation potential (NDP)	surface temperature of ecosystem; thermal response number; solar exergy dissipation
Characterisation model	vegetation maps + equation	vegetation maps + equation	hemeroby classes with cardinal scores	in development
Characterisation factor	n.a.	16 SPEP's	NDP's for 11 European regions	in development

SPEP: species-pool effect potential

Table 12 illustrates the compliance of the various biodiversity methods with the general structure of LCIA. The methods generally comply well to this structure but operative characterisation factors are only available for a limited set of land use types and calculating new factors often requires data that are hard to get or not available at all. If applied to the SOWAP/ProTerra plots, the default land use related impact assessment methods are too coarse. The different management practices as examined by the SOWAP/ProTerra projects likely fall into one class making a differentiation between the management practices on the basis of land use related impacts impossible using these methods.

Another problem is that it is quite difficult to get clear insights in the key differences and similarities between these methods; creating a full and thorough overview of these key differences and similarities exceeded the project's capacity. All proposals have pros and cons in their contents, raising new proposals again and in this way further complicating the discussion. A discussion is thus needed on what are the most relevant and practical indicators and related approaches. The UNEP-SETAC Taskforce 2 on natural resources and land use may hopefully be able to give clarification to these difficult contents discussions (see also Part II of this report) in the further future, but for the short term a more simple and practical approach is needed. For the moment, the most feasible approach is to use land occupation in square meters year as most basic indicator for suppressing biodiversity. Inventory data for this are available from for example the ecoinvent database.

### 3.3.1.7 Transformation and occupation

Both Lindeijer *et al.* and Köllner take land occupation and land transformation impacts into account. In the method of Lindeijer *et al.* this results in two separate impact categories, one for land transformation impacts and one for land occupation impacts. Köllner aggregates both impacts into one impact category indicator. Brentrup and Wagendorp discuss occupation only.

Attributing a certain area land occupation to the functional unit is straightforward as land occupation just like the rest of the interventions can be considered as a steady state interventions.

In our opinion, land transformation should not be treated as an intervention or impact (category), but as an economic process. The term itself –transformation – refers to a human activity (land transformed by mankind). The economic process land transformation then has to be allocated to a functional unit, but as an economic process it has a regular process description like any other economic process, for example logging of a forest with economic inputs as machinery and fossil fuels for saws and trucks; economic outputs as wood and agricultural area; interventions as CO<sub>2</sub> due to a reduction of organic carbon content

of the soil (increased degradation through higher aeration) and related impacts on climate change, occupation, erosion, biodiversity etc.

As an example of a land transformation that generates environmental interventions that have to be ascribed to a functional unit are those related to the transformation of long-standing grassland into arable land. Grassland soil has a higher organic matter content than arable soil. When transforming the grassland soil, the organic matter will decompose which results in large CO<sub>2</sub> emissions during several years after the transformation. This issue is a particular importance in LCA's of biofuels (Edwards *et al.*, 2003).

Direct physical interventions on biodiversity of this transformation process should be treated in the same way as discussed before, but it should probably be linked to a reference situation. This reference situation should not reflect what it was (as for most European cultural soils, that is so long ago and has become quite unimportant), but to what it could become if left over to “mother nature”. If no reference at all would be included, agricultural soil would be agricultural soil, no matter if it was transformed from tropical forest or from pristine grasslands/mix forests.

For transformation a distinction should subsequently be made between one-time transformation events and continuous transformation events like in slash and burn agriculture. The latter perfectly fits into LCA and can be handled a flux ( $X \text{ m}^2/\text{day}$  forest cultivated for agricultural soil). The one-time transformation event is much more difficult to handle.

Attributing one-time land transformation events to functional units is problematical, as the relationship between the two is generally anything but transparent. What will be the agricultural output from an area of cleared forest, and what proportion of the clearing is to be attributed to one kilogram of any one of these crops? The transformation process needs to be written-off just like that is done for capital goods in LCA. But this allocation issue may also be the real problem: if the land transformation process results in a land type that is used infinitely or undetermined, then allocation is problematic AND the resulting impacts will converge to zero. This is for example the case with a one-time transformation of forest into agricultural land that is used perpetually. It is fully similar to the difficulties of handling high impact-low risk events, like the Tsjernobyl accident, in LC(I)A. For this, other tools are needed or agreement is needed on a shorter time calculation ground (for example, one time-events are allocated over 100 years).

### **3.4 Existing multi indicator impact assessment methods**

#### **3.4.1 Introduction**

In the previous section we discussed in detail the ‘holistic’ single indicator land use impact assessment methods that use an indicator that is quite far in the cause-effect chain. In this section we will select and discuss indicators from the multi-indicator land use impact assessment methods as given in Table 11. These indicators stand typically at the beginning of the cause-effect chain of land use related impacts. Indicators for the following impacts are discussed:

- erosion
- hydrology/desiccation
- soil fertility

First, a quick overview of the current impact assessment methods is given for each issue. Then the current impact assessment methods are discussed in more detail and finally possible implementation of an indicator in LCA in general and SOWAP/ProTerra projects in particular is discussed.

## 3.4.2 Erosion

### 3.4.2.1 Existing methods

Of the land use impact methods listed in Table 11 there are several methods that deal with the issue of erosion in the environmental impact assessment (Cowell & Clift, 2000; Muys & Garcia Quijano, 2002; Mattsson, 2000). However none of the methods is elaborated in an operational set of characterisation factors.

### 3.4.2.2 Cowell & Clift: loss of soil mass as sub-indicator of the multi-indicator approach

According to Cowell & Clift (2000) the Loss of soil mass is an indicator for depletion of resources (soil as a resource). As a characterisation model the soil static reserve life is proposed ( $SSRL = R/E$ ). So the soil static reserve life is a function of global reserves of agricultural soil (i.e. total topsoil in the world)(tonnes)(R) and current annual global net loss of topsoil mass by erosion (tonnes/year)(E). The necessary inventory data to calculate the impact score is the loss of soil mass (in tonnes), either measured or estimated (e.g. using erosion models like USLE; see <http://topsoil.nserl.purdue.edu/usle/>; <http://www.fao.org/docrep/t1765e/t1765e0e.htm>).

At this moment no operational factors are available. To derive such a set information is necessary on the reserve of the topsoil, i.e. area and depth of topsoil suitable for agriculture. Furthermore also worldwide erosion data should be available. Finally because soil is not globally available (i.e. not shipped all over the world like ores and fossil fuels) a differentiation of the factors for different regions is recommendable, using regional reserves and regional erosion rates.

### 3.4.2.3 Muys & Garcia Quijano: erosion as sub-indicator of the multi-indicator approach

The method of Muys & Garcia Quijano (2002) describes the land use impact by 17 quantitative indicators divided over 4 impact sub- categories: soil, water, vegetation structure and biodiversity. The indicator soil erosion is a sub-indicator in the sub-impact category soil. In this method it is proposed to transform the loss of soil mass into a loss of soil depth (in m) using the bulk density of the soil. Finally, the loss of soil depth over a period of 100 years is compared to the total rootable soil depth up to 1m. A complete loss of the soil within a period of less than 100 years leads to the maximum impact score. (Erosion risk factor =  $E \text{ (kg/ha/yr)} \times 100 \text{ yr} / \text{Total Rootable Soil Depth (1m)}$ ). The necessary inventory data to calculate the impact score is the loss of soil mass (in tonnes), either measured or estimated (e.g. using erosion models like USLE).

At this moment no operational factors are available. To derive such a set information more or less the same information is necessary as described for the method of Cowell & Clift, (2000).

### 3.4.2.4 Mattsson: erosion as sub-indicator of the multi-indicator approach

The method of Mattson *et al.* (2000) describes the land use impact by 9 indicators for 3 impact sub categories soil fertility (7), biodiversity (1) and landscape (1). Most indicators are described qualitative. The indicator soil erosion is a sub-indicator in the impact sub category soil fertility. In this method it is proposed to use the loss of soil mass (kg) as an indicator for erosion impact without using characterisation factors.

### 3.4.2.5 Suggestions for possible approaches

Table 13 illustrates the compliance of erosion methods with the general structure of LCIA. Key point of discussion for erosion is the intervention “loss of soil”. Erosion basically is a natural phenomenon that will occur any way. Human activities may due to their nature and intensity, enhance erosion. In a systems

analysis as LCA, soil is considered to be environment by most practitioners as also done in toxicity models. When soil is part of the environment system, soil loss cannot be the intervention, as it doesn't cross the economy-environment boundary.

Table 13: Overview of the methods proposed for the impact assessment category erosion in LCA and their compliance with the LCIA structure.

	Cowell & Clift	Mattson	Muys & Garcia Quijano
Impact category	depletion of soil	soil fertility	soil
intervention	loss of soil (kg/ha/yr)	loss of soil (kg/ha/yr)	loss of soil (kg/ha/yr)
Indicator	soil static reserve life (SSRL)	loss of soil	soil erosion
Characterisation model	SSRL = R/E	unweighted aggregation	soil depth loss over 100 yr compared to total rootable soil depth
Characterisation factor	n.a.	1 for all interventions	n.a.

Similar to global warming, the impact category should actually be something as “enhanced erosion or soil loss”. Then, the proper interventions still need to be determined. Man can enhance erosion by removing terraces, cutting hedgerows on steep slopes, by deep ploughing and other agricultural practices. Interventions could thus be soil disturbance by ploughing or cutting hedgerows. What one needs to know is thus extent of natural loss of soil as a reference and the marginally increased loss of soil (kg/ha/yr) due to all kinds of soil disturbance interventions (ploughing, cutting hedgerows etc.). All these different interventions should be linked to characterisation factors indicating the marginally increased soil loss due to that specific intervention, fully comparable to global warming, for example. To what extent this would be possible in practice, remains to be investigated but the erosion models mentioned and the report by Delbaere & Serradilla (2004) can certainly help here.

Referring back to earlier discussions on erosion (see Sections 2.1.3 and 2.1.4.2) we see the following different possibilities to deal with soil erosion in LCA:

1. expand the economic system (see Section 2.1.3). keeping the productivity of the soil at constant level by carrying out counter measures like:
  - clean up processes (dredging of ditches etc.)
  - restoration processes for agricultural soil.
2. Measure change of economic in- and outputs for the unit processes over (long) time period (erosion as loss of productivity; see Section 2.1.4.2).
3. Define an additional impact category for erosion adopting the interventions definition discussed above.

As implementing option 1 and 2 will probably raise many practical problems (see discussions in Sections 2.1.3 and 2.1.4.2), option 3 is the only realistic one. However, to elaborate option 3 in a decent way, quite some work is needed as indicated above. The more “quick and dirty” approach using loss of soil as indicator would however match currently collected data in the SOWAP and ProTerra projects and just for this reason, it may be useful to adopt this “quick and dirty” approach as long as better and more decent methods are still lacking.

### 3.4.3 Hydrology

#### 3.4.3.1 Existing methods

Of the land use impact methods listed in Table 11 one author proposes two indicators for assessing impacts on hydrology (Heuvelmans *et al.*, 2005). One indicator is a measure of the depletion of water due to water use (water as a resource). The other indicator evaluates the impacts of different land use types on the regional water balance<sup>9</sup>. We will discuss both indicators separately.

<sup>9</sup> Ek *et al.* (2002) adopt a quite similar approach but for practical reasons we have focused here on the proposals by Heuvelmans *et al.* (2005).

### 3.4.3.2 Heuvelmans: Impacts on the water balance due to land use

The described methodology for the assessment of impacts on the water balance due to land use is not as such suitable for LCA purposes. It proposes to assess effects on the water balance for the indicators: evapotranspiration, surface run off, discharge, groundwater recharge and soil loss through water erosion using a hydrological model SWAT. Also some derived indicators are proposed like infiltration minus evapotranspiration, precipitation surplus and daily and monthly stream flows. These indicators represent risks of flooding and drought and so may affect several areas of protection like biodiversity and man made environment. The calculations for the land use types require a set of site specific input data of the area (in GIS format), like elevation data, weather data, soil characteristics and land use data (e.g. detailed vegetation parameters). Therefore the method more seems to be a site specific Environmental Impact Assessment instead of a methodology to derive generic (non site specific) characterisation factors for LCIA.

The use of the SWAT model to derive characterisation factors for LCA is not elaborated. Given the site dependency of the effects of the land use on hydrology it is disputable whether a development of a generic set of characterisation factors is possible at all.

### 3.4.3.3 Heuvelmans: Impacts on the water balance due to water use

In Heuvelmans *et al.* (2005) also an indicator is proposed for depletion of resources (water as a resource). As a characterisation model the dynamic water reserve life is proposed ( $DWRL = R/(U-P)$ ). Thus the dynamic water reserve life is a function of regional reserves of water (R) and current regional consumption (U) and precipitation (P). The necessary inventory data to calculate the impact score is the consumption of water (kg).

At this moment no operational factors are available. To derive such a set, information on the reserve fresh water is necessary. Furthermore, also worldwide evapotranspiration and precipitation data should be available. Finally, because water is not globally available (i.e. not shipped all over the world like ores and fossil fuels) a differentiation of the factors for different regions is recommendable, using regional reserves, regional evapotranspiration and precipitation rates.

### 3.4.3.4 Suggestions for possible approaches

Table 14: Overview of the methods proposed for the impact assessment category hydrology in LCA and their compliance with the LCIA structure.

	Heuvelmans	Heuvelmans
Impact category	depletion (water)	regional water balance
intervention	water use (kg)	land use (m <sup>2</sup> .yr)
Indicator	dynamic water reserve life (DWRL)	streamflow: average downstream water availability and drought risk
Characterisation model	$DWRL = R/(U-P)$	SWAT model
Characterisation factor	n.a.	n.a.

Table 14 illustrates the compliance of the two hydrology related methods with the general structure of LCIA. Main discussion point for these methods is the operationalisation of the characterisation models and related characterisation factors. They both need further elaboration into lists of CFs linked to clearly defined interventions, comparable again to global warming. This will probably be feasible for the resource indicator, but not for the regional water balance indicator on the short term. To prevent not taking into account water related impacts at all, the most practical thing to do right now is to collect data on water use and aggregate these without further weighting (1 to 1; CF = 1). These can then always be used as input for more sophisticated approaches.

### 3.4.4 Soil fertility

#### 3.4.4.1 Existing methods

Of the land use impact methods listed in Table 11 there are several methods that deal with the impacts due to land use on soil fertility or productivity (Milà i canals, 2003; Cowell & Clift, 2000; Muys & Garcia Quijano, 2002; Mattson *et al.*, 2000 and Lindeijer *et al.*, 1998). However the methods are not elaborated in an operational set of characterisation factors.

It is disputable whether impacts on soil fertility for crop production should be assessed in an environmental impact assessment. After all, the fertility of the soil is an economic valuation of the system, the productivity of a process is already part of the definition of the unit process and is expressed in the ratio between the economic inputs and outputs. Directional changes in productivity of the soil will become visible when monitoring economic in- and outputs of an agricultural process over a (long) time period, see also section 2.1.4 on inventory analysis.

#### 3.4.4.2 Lindeijer *et al.*: free net primary production

Lindeijer *et al.* (1998) operationalises an indicator for life support functions making a distinction between occupation and transformation impacts based on free net primary biomass productivity (fNPP). This is simply the total biomass dry matter grown on a ha in a year (NPP), minus the biomass removed from the field in harvest. Lindeijer *et al.* (1998) have proposed to use fNPP as an indicator for the potential of nature development, as it expresses the amount of biomass free for development of higher species. The formula for ecosystem occupation as a measure for life support functionality is:

$$\text{loss of life support functions} = A \times t \times (\text{fNPP}_{\text{ref}} - \text{fNPP}_{\text{act}})$$

where:

A = area of land used

t = occupation time (e.g. 1 year)

fNPP<sub>ref</sub> = free net primary productivity of reference system (Mg/ha.yr)

fNPP<sub>act</sub> = free net primary productivity in the actual system (Mg/ha.yr)

The impacts due to occupation are calculated relative to a reference system.

The formula for ecosystem transformation as a measure for life support functionality is:

$$\text{loss of life support functions} = A \times (\text{fNPP}_{\text{ini}} - \text{fNPP}_{\text{act}})$$

,where:

fNPP<sub>ini</sub> = free net primary productivity of the system before transformation (Mg/ha.yr)

Aggregation of the occupation and transformation impacts is discouraged, as this would require the assumption that all land transformations can be reversed within a certain (to be estimated) recovery time.

#### 3.4.4.3 Milà I Canals: soil organic matter

According to Milà i Canals (2003) the Soil Organic Matter content (SOM) is an indicator for the long term effects on soil quality and the life support functions of the soil. It is proposed to use a SOM model to calculate characterisation factors for several interventions affecting SOM, like emission of crop residues, emission of organic residues (manure etc.) that have a positive effect on SOM and erosion and increased aeration that have a negative effect on SOM.

There are yet no operational characterisation factors. To derive an operational set of characterisation factors a SOM model should be selected, that takes into account climate, soil properties, soil management, vegetation type. Furthermore data should be gathered for model parameters and input. These data can be site specific measurements but probably (partly) also default values for soil orders or life zone groups can be used.

Note that in this method the area of protection is crop production (man made environment) in the long term. Changes in the (future) crop production can be considered as an economic problem, i.e. related to the functional valuation for mankind of the land quality, and not an environmental problem, i.e. related to the intrinsic valuation of the land quality. For this reason it is disputable whether this assessment should be part of the environmental assessment.

#### *3.4.4.4 Cowell & Clift: Organic matter*

Cowell & Clift (2000) suggest to use the organic matter applied to the soil as an indicator for the long term effects on soil quality and productivity of the soil. The amount of organic matter in the soil (SOM) improves the chemical, physical and biological quality of the soil for crop production. It is argued that for crop production the organic matter content of the soil should be maintained as high as possible. The characterisation model that is proposed is OM Indicator (tonnes<sup>-1</sup>) = M<sup>-1</sup>, in which OM=tonnes of organic matter added to soil system under analysis (above ground matter, roots, and other organic matter such as manure). The indicator is expressed in this way so that a higher number indicates a greater impact, that is a large number means a large negative impact on future soil fertility. Note that the indicator is the reciprocal of the intervention, that is amount of organic matter added to the soil.

#### *3.4.4.5 Muys & Garcia Quijano: vegetation structure*

The method of Muys & Garcia Quijano (2002) describes the land use impact by 17 quantitative indicators divided over 4 impact sub- categories: soil, water, vegetation structure and biodiversity. The impact subcategory “vegetation structure” contains some indicators related to productivity, like

- total above-ground biomass
- leaf area index,
- vegetation height,
- free net primary production, i.e. that part of the primary production which is not harvested but left on the land to sustain life support functions.
- crop biomass

It is proposed to aggregate the indicator scores into the impact subcategory “vegetation structure” by averaging the indicators, which means that implicitly equal weights are given to every indicator. Note, however that the indicators do not seem to be independent. The publication gives a mere description of indicators to monitor the state of the vegetation structure. However the elaboration into characterisation models and a description of characterisation factors and necessary intervention data is not clearly described.

#### *3.4.4.6 Mattsson et al.: the multi-indicator approach*

The method of Mattsson *et al.* (2000) describes the land use impact by 9 indicators for 3 impact sub categories soil fertility (7), biodiversity (1) and landscape (1). Mattsson suggests to describe the indicators for the impact category soil fertility, like soil organic matter, soil structure, soil pH, in a qualitative way. LCA strives to quantify the environmental assessment as much as possible so this method is not further discussed.

#### *3.4.4.7 Suggestions for possible approaches*

Table 15 illustrates the compliance of soil fertility methods with the general structure of LCIA. The main discussion point for soil fertility is whether in agricultural LCA studies soil fertility should be an impact category at all. In agro-LCA studies soil fertility is part of the economic goal of the agro-system (fertilizers and manure are e.g. applied for that) as only a fertile soil can assure a good crop produce. Soil fertility in agricultural LCA studies is thus rather an economic than an environmental problem. It could be a relevant

impact category, however, for non-agricultural LCA studies, but then, as also explained for soil erosion, unambiguous relations between characterisation models/factors and interventions need to be established, comparable to for example global warming.

Table 15: Overview of the methods proposed for the impact assessment category soil fertility in LCA and their compliance with the LCIA structure.

	Lindeijer	Cowell & Clift	Mattsson <i>et al.</i>	Muys & Garcia Quijano	Mila i Canals
Impact category	soil life support functions	soil quality and productivity	soil fertility	soil fertility	soil life support functions
intervention	land occupation (m <sup>2</sup> .yr), land transformation (m <sup>2</sup> )	organic matter (kg)	ha or n.a. ?	land occupation (m <sup>2</sup> .yr)	change in soil organic matter content
Indicator	free Net Primary Production (fNPP)	1/OM	3 indicators: SOM, soil structure, soil pH	5 indicators: biomass, leaf area, height, fNPP, crop biomass,	soil organic matter content
Characterisation model	empirical or model	unweighted aggregation	qualitative	5 equations give, no data	unweighted aggregation
Characterisation factor	7 available for a rough classification, more CF's case by case	1 for all interventions	n.a.	n.a.	1 for all interventions

### 3.5 Conclusions on practical and sensible methods for land use related impacts

Having discussed in detail the impact assessment methods related to land use we summarise the conclusions here for the four impact categories identified:

1. biodiversity
  - none of the biodiversity impact assessment methods seem to be suitable directly.
  - in the short term use m<sup>2</sup>yr as most basic indicator for suppressing biodiversity.
  - transformation impacts must be accounted for by describing it as an economic process with it's own interventions.
2. hydrology
  - the impact assessment method by Heuvelmans *et al.* (2005) for water use seems promising.
  - in the short term collect data on water use and aggregate these without further weighting.
3. soil fertility
  - soil fertility should not be an impact category in agricultural LCA studies as it represents an economic asset and should be reflected as such.
4. erosion
  - soil loss as such cannot be the intervention as erosion is a natural phenomenon that happens without any human intervention. Enhanced soil loss is the impact to assess and should be linked to interventions such as cutting hedgerows and ploughing at different depths.
  - in the long term perhaps enhanced erosion can be taken up in LCIA, for the short term the “quick and dirty” approach in terms of soil loss may be adopted.

Furthermore, land transformation should be treated as an economic process, rather than as an environmental impact.



As to the discussion which impacts fit in LCA and which not, it can be concluded that basically any impact fits that is accountable in a (linear) quantitative<sup>10</sup> way to an economic input or output, and for which operative methods and data are readily available.

In this line of reasoning there will also be issues that can be included into LCA, although not completely satisfactorily. This is, for example, also the case for emissions of toxic heavy metals and emissions with predominantly acute effects. These emissions and their impact can and should be included in LCA, but for a full appropriate assessment, other tools need to be applied in addition to LCA (e.g. Risk Assessment).

---

<sup>10</sup> Qualitative aspects thus basically fall outside the scope of LCA and can better be addressed by other tools as it is impossible to relate these to an input or output (or FU).

## 4 Finding LCA and LCC data

### 4.1 Introduction

In this chapter we discuss in detail where life cycle data can be found that can be used in the ProTerra, SOWAP projects. We will consider both life cycle assessment and life cycle costing data, the first category being the most demanding. Particularly attention will be paid to data gathering in the SOWAP Proterra projects for land use related impact categories and the integration of these in the life-cycle framework.

### 4.2 Data for LCA

#### 4.2.1 LCI data needs

##### 4.2.1.1 Foreground system

Hypothetical examples of the life cycle inventory of two foreground processes are shown in Table 16 and Table 17. Both economical and environmental in- and outflows are recorded. Taking a closer look at Table 16 describing the unit process “wheat production - conventional ploughing”, the given economic in- and outflows are obvious. Some attention should be paid to the units. Is the wheat production specified on a dry weight basis or on some reference moisture content or just on the basis of its weight whatever its moisture content.

In the ProTerra/SOWAP the foreground system typically consists of the agricultural measures on the farm which are carried out by the farmer.

Furthermore care should be given to the numbers specified. Is it an average measured over many years or is it a single measurement for one year. For instance application of pesticides or the yield can depend on the particular weather conditions in a certain year, therefore an average over more years is likely to be more meaningful. It is important not to record the exceptional cases in your LCI. In the same way, exceptional events like an accidental spillage should not be recorded in the LCI. It is also important to note how the values were obtained and the time & geography details.

The environmental resource use and environmental outflows are less intuitive. The uptake of nutrients and CO<sub>2</sub> by the crop have been recorded here. Crops (the parts that are removed during harvest) have been attributed to the economic system while the soil is part of the environmental system (see Section 2.1.4.2). Therefore the uptake of nutrients is environmental resource use. Values for the uptake of nutrients can be estimated from C, N & P content of the harvest and the crop yield.

When specifying environmental resource use or environmental outflow the depleted compartment (for resource use) or receiving compartment (air, water, soil etc.) should be given. Recording the compartment information is important for the next stage of the LCA, the impact assessment. The compartment classification should follow the compartment classification of the impact assessment method. It is also important to specify the cas-no/code of the environmental interventions in the same way as in the life cycle impact assessment method. This makes it possible to connect the environmental interventions automatically to the characterisation factors by the LCA-software. Choosing before hand the life cycle impact assessment method can in this way save time.

For the foreground system it will likely be possible to gather the necessary data for the land use related impact categories which can be used meaningful in the ProTerra/SOWAP projects as discussed in Chapter 3. As an example of environmental resource use, “land occupied” is recorded here.

As a last point, all the values given for a unit process should relate to the economical outflow of the process.

In the ProTerra/SOWAP projects it is likely that the system of interest is not the production of a single crop but the production of a crop rotation scheme, see discussion in box on page 23. The economical outflow from the agricultural process is thus a single flow consisting of two (or more) crops. A hypothetical simplified life cycle inventory table could be as follows:

name	class/compartiment	value	unit
<b>economic inflow</b>			
paraquat used	pesticide	$5.74 \times 10^{-5}$	kg
NPK (15-15-15) used	art. fertiliser	$1.40 \times 10^{-2}$	kg
<b>economic outflow</b>			
wheat/barley (30/70)	crops	1	kg
<b>environmental resource use</b>			
land occupied	-	100	m <sup>2</sup> .yr
<b>environmental outflow</b>			
nitrogen	agr. soil	$4.59 \times 10^{-3}$	kg
phosphorous	agr. soil	$5.64 \times 10^{-4}$	kg

where for instance the NPK fertiliser input is all the fertiliser used in the complete crop rotation cycle which may span more years and produces wheat/barley in a 30:70 weight percent distribution.

#### 4.2.1.2 Background system

In detailed LCA's, those who perform the LCA will also gather detail LCI data on processes that are more in the background of the system under consideration. This means that suppliers of products and services used in the foreground system have to be contacted to obtain data on economic & environmental in- and outflows of their production processes. As an example the manufacturer of the fertiliser (See example in Table 16) could be contacted by the LCA practitioner to obtain data on the environmental emissions during the production of the NPK fertiliser.

Often problems will be encountered when trying to obtain these LCI data of background systems in this way because:

- the data are not available;
- the data are not public;
- it is not even known where or who is the producer or service e.g. electricity.

These problems make the do-it-yourself background data gathering very time-consuming and is not advisable for only the most extensive LCA-studies.

Background data can also be obtained from more readily available sources:

- LCA databases;
- IOA-tools;
- Other LCA studies
- or as last resort, are cut-off.

References to several LCA database were already given in Section .2.1.4.4. In these sources the 'standard' environmental interventions, like emissions to air that affect global warming, ozone layer destruction or freshwater emissions, can be found. The area and type of land use, although coarsely classified, is also often given in LCA-databases.

Table 16: Example life cycle inventory table for the economic process "wheat production - conventional ploughing".

name	code/cas-no	class/compartment	value	unit	price (€/unit)
<b>economic inflow</b>					
diesel	xxx-455	energy	$1.35 \times 10^{-3}$	kg	
electricity	Sgf-672	energy	$8.06 \times 10^{-2}$	MJ	
paraquat used	bbg-584	pesticide	$5.74 \times 10^{-5}$	kg	
NPK (15-15-15) used	ffr-396	art. fertiliser	$1.40 \times 10^{-2}$	kg	
manure	fgr-256	org. fertiliser	$7.24 \times 10^{-1}$	kg	
<b>economic outflow</b>					
wheat	bbg-585	crops	1	kg	
<b>environmental resource use</b>					
agricultural land	-	occupation	$8.84 \times 10^{-2}$	m <sup>2</sup> .yr	
<b>environmental outflow</b>					
carbon dioxide	124-38-9	air	$1.31 \times 10^{-1}$	kg	
nitrogen	7727-37-9	agr. soil	$4.59 \times 10^{-3}$	kg	
phosphorous	7723-14-0	agr. soil	$5.64 \times 10^{-4}$	kg	

Table 17: Example life cycle inventory table for the economic process "fertiliser application - NPK (15-15-15)".

name	code/cas-no	class/compartment	value	unit	price (€/unit)
<b>economic inflow</b>					
diesel	xxx-455	energy	$1.8 \times 10^{-5}$	kg	
NPK (15-15-15)	ffr-396	art. fertiliser	1.02	kg	
<b>economic outflow</b>					
NPK (15-15-15) used	bbg-585	art. fertiliser	1	kg	
<b>environmental resource use</b>					
none	-	-	-	-	
<b>environmental outflow</b>					
nitrogen	7727-37-9	agr. soil	$1.5 \times 10^{-1}$	kg	
phosphorous	7723-14-0	agr. soil	$6.5 \times 10^{-2}$	kg	
cadmium	7440-43-9	agr. soil	$3.5n^{-8}$	kg	

If we take a closer look at the ecoinvent database, probably the largest existing database, several environmental interventions related to land use have been recorded for every unit process in the database: land occupation, land transformation and water use. It is noted that these two impact categories are mainly indicators for 'Degradation of biodiversity' and partly 'Degradation of life support functions'.

For land occupation the area as well as the duration required for the production of a certain amount of products and services are important and therefore recorded in square metres times time ( $m^2 \text{yr}$ ). Land occupation classes used in the ecoinvent database are based on the CORINE land cover classes classification. Forty different classes are distinguished.

The land cover classes classification does not include regional differentiation. However as ecoinvent records the geographical location of every unit process, combining this information with the land cover classification classes makes regionalisation possible.

Besides land occupation data also land transformation data are recorded in ecoinvent. Land transformation entries consist of:

1. land transformation, from *land use type X*, and
2. land transformation, to *land use type Y*.

The amount of land is recorded in square metre ( $m^2$ ) and the *land use type X* and *Y* are again classified according the CORINE land cover classes classification. Suggestions are provided to attribute the land formation to the total amount of products and services provided by the process using standard depreciation periods. These suggestions can be used to treat land transformation as an economic process, as recommended before. However, other interventions for the economic process of land transformation are not provided by ecoinvent.

Thus the ecoinvent database provides some basic data about land use related impact categories which can be used in LCAs. It is advisable to use the same classification scheme in the description of the foreground processes.

Other land use related categories like erosion rate are typically not recorded in LCA databases.

## 4.2.2 LCIA data needs

### 4.2.2.1 'Standard' environmental interventions

As discussed in Section 2.1.5 many different impact assessment methods exist for the 'standard' environmental interventions. Section 2.1.5 mainly discussed the impact assessment methods as used in the CML 2002 method. Other impact assessment methods (without being complete) are:

- IMPACT 2002+ (Jolliet *et al.*, 2003; Pennington *et al.*, 2005)
- EDIP'97 (Hauschild and Wenzel, 1998)
- EcoIndicator (Goedkoop & Spriensma, 1999)
- TRACI (Bare *et al.*, 2003)

All of these methods use lists of characterisation factors that should be multiplied with the inventory items listed in Section 4.2.1.

In practice the impact assessment methods and their characterisation factors have been incorporated in LCA software. Using the one or other impact assessment is not more work than selecting the method in the software.

#### 4.2.2.2 Land use related environmental interventions

As extensively discussed in Chapter 3, characterisation of the land use related interventions is difficult and we have recommended - for the time being - a very simple aggregation of the m<sup>2</sup>yr (as most basic indicator for suppressing biodiversity) and water use (as most basic indicator for hydrology related impacts) over the life cycle of the products. The related interventions are thus m<sup>2</sup>yr land and m<sup>3</sup> water. If additionally inventory data on soil loss (kg/ha/yr) can be collected, the “quick and dirty” approach for soil erosion can also be applied.

The SOWAP/Proterra projects can in principle provide LCI data on land occupation which can be used together with the land occupation data as available in the ecoinvent database using the CORINE land type classification.

### 4.3 Data for LCC

Using the simple approach for LCC as described in Section 2.2, the data needs for LCC are quite modest. Only the expenditures in the foreground system should be known which are typically recorded on farm level for accounting purposes.

Summarising our data needs for the foreground system:

- value added within the foreground system;
- external purchases;
- including purchases of capital goods;
- including overheads and services;
- excluding payments on borrowed capital;
- excluding VAT.

In a practical sense the costs in the foreground system can be broken down into:

- capital costs for
  - farm buildings
  - machinery
  - land
  - etc.

Notice that the capital costs are calculated as steady state costs. The steady state cost is the investment cost divided by running lifetime of the capital good. For instance a tractor has a price of 100000 € and its running lifetime is 20 years the steady state cost are  $100000/20 = 5000$  €/yr.

- operational costs
  - fertiliser
  - agro-chemicals
  - seeds
  - tillage operations (e.g. cost of contract firm)
  - fuel
  - labour
  - etc
- disposal costs
  - disposal of organic waste
  - etc

## **4.4 Data available from SOWAP/ProTerra projects**

In the SOWAP project a database is in development containing data for specific fields and plots in fields. The database contains information for the different fields and plots in the fields, like plot characteristics (soil type, slope) and information on the economic inflows (plough/seed/harvest, pesticide use, fertiliser use) and outflows (yield) of different phases in the land use management. Data are given in physical units (kg/ha, tonnes/ha) and monetary units (local currency euros, pounds,...). Costs are given for materials and contractor's costs (incl. labour, materials). The structure of the database is set up. At the moment the data are implemented.

### *Data at present available in the SOWAP database*

#### Economic inputs (physical and monetary units):

Use of machinery: available but not in the database.

Use of diesel: available but not in the database.

Soil management costs: local currency per ha

Harvest costs: local currency per ha

Plant rate: Seeds per ha (treated/non treated) for both cover crops and produced crops.

Use of pesticide:

- name
- active ingredient
- costs (product costs and labour costs): local currency per ha
- rate: kg per ha or l per ha

Use of fertiliser:

- type (slurry, manure, inorganic, incl. lime etc.)
- N, P, K: %
- application method (injection, spraying etc.)
- costs (product costs and labour costs): local currency per ha
- rate: kg per ha or l per ha

#### Economic outputs (physical and monetary units):

- yield: tonnes (fresh weight) per ha
- price: local currency per ha
- moisture content: %

#### Environmental data

- physico-chemical properties of the soil, which are measured annually
- weight and quality of the soil eroded

## 4.5 Overview

In Table 18 a short overview is given of the data availability in the SOWAP/Proterra projects and remaining data gaps.

Table 18: Overview of available LCI, LCIA and LCC data for the LCA and LCC of the various conservation agricultural production schemes.

Life cycle tool/stage	Availability	Gap
<b>LCI</b>		
'standard' interventions		
foreground system	yes	no
background system	yes	no
land use related interventions <sup>1</sup>		
foreground system	yes	no
background system	yes	no
<b>LCIA</b>		
'standard' impact categories	yes	no
land use related impact categories	classification	yes/no <sup>2</sup>
<b>LCC</b>		
foreground system	yes	no
background system	yes from price	no

<sup>1</sup> land use related interventions as proposed to use in the SOWAP/ProTerra projects: land occupation and water use.

<sup>2</sup> Using a very simple aggregation of the intervention of the land use related interventions as proposed in Chapter 3 for the time being no data gap exists in the life cycle impact assessment. However, if a characterisation method for land occupation of water use is required, no ready available characterisation factors exist.



## 5 Conclusions

### 5.1 Goal, scope, functional unit and system boundary

The functional unit is best chosen as the long-term output of a crop rotation scheme expressed in terms of kg dried crops of specific composition. In this way no (difficult) allocation to a specific crop type is necessary. As an alternative the revenues from the crops of a particular crop rotation scheme may be used as comparative basis. The type of LCA is likely change oriented.

We advice to cover the impacts in the system from cradle-to-harvesting.

- including up stream processes
- including dredging of ditches and supplement of soil to eroded areas or changes in productivity over time
- excluding consumption and waste treatment because these can be considered the same for alternatives

The agricultural soil is assumed to be part of the environment. Farming is considered to be an economic process. The harvested portion of the crop is attributed to the economic system and flows to other processes in the economic system while the non-harvested portion remains in the environment.

### 5.2 Impact Assessment

It is recommend taking into account the 'standard' impact categories as described in Section 2.1.5.

Impacts of land use related interventions are currently difficult to include into the life cycle impact assessment framework. It is proposed - on the short term - to use  $m^2yr$  as most basic indicator for suppressing biodiversity and water use as most basic indicator for hydrology related impacts. For these two, inventory data can be extracted from existing databases. If the user is able to additionally collect data on soil loss, a "quick and dirty" approach in terms of soil loss may be adopted for soil erosion impacts, as long as better and more appropriate methods are lacking.

### 5.3 Life cycle costing

It is advised to use a rather specific kind of life cycle costing when it will be used in conjunction with LCA which are the steady state, alternative cost for those who provide the functional unit. In principle this would mean that for all upstream processes the value added of a particular process should be calculated/looked up. This is avoided by stating the price of a product or service is the sum the value added of all the economic processes used in the delivery of the service or product. Thus, from a practical point of view the following cost will be taken into account for the foreground system:

- value added within the foreground system;
- external purchases;
- including purchases of capital goods;
- including overheads and services;
- excluding payments on borrowed capital;
- excluding VAT.

### 5.4 Data

Life cycle inventory data for the background system can in many cases be taken from LCA databases. 'Traditional' environmental interventions are covered rather well, although in generic way. Given the proposed land use related impact categories also data for the background system are available in the LCA databases. Thus no major data gaps exist in principal when an LCA is carried for the agricultural systems researched in the SOWAP/ProTerra projects.

No data gaps seem to be present for a life cycle costing study except that ownership of the land has not been recorded.

## 6 References

1. Anonymous, Product Life Cycle Assessment - Principles and Methodology. Nord 1992:9, Nordic Council of Ministers, Copenhagen, 1992.
2. Audsley E., S Alber, R. Clift, S. Cowell, P. Crettaz, G. Gaillard, J. Hausheer, O. Jolliet, R. Kleijn, B. Mortensen, D. Pearce, E. Roger, H. Teulon, B. Weidema & H. van Zeijts. 1994. Harmonisation of environmental life cycle assessment for agriculture. Final report of EU concerted action AIR3-CT94-2028. European Commission DG VI Agriculture. Brussels.
3. Azapagic, A. Environment system analysis: the application of linear programming to life cycle assessment, Volume I, Ph.D.-thesis University of Surrey, Guildford, 1996.
4. Baitz, M., J Freißig & C. Schöch, 1998. Method to Integrate Land Use in Life Cycle Assessment. Institut für Kunststoffprüfung (IKP), University of Stuttgart, Stuttgart.
5. Bare J.C., Norris G.A., Pennington D.W., McKone T., 2003. TRACI: The Tool for the Reduction and Assessment of Chemical and Other Environmental Impacts. Journal of Industrial Ecology 6 (3) 49–78.
6. Baumann, H. and A.-M. Tillman, The Hitch hiker's Guide to LCA - An orientation in life cycle assessment methodology and application, Studentlitteratur, Lund (Sweden), 2004.
7. Berg, Nico van den, Gjal Huppes and Bernard van der Ven, 1995. Milieu-analyse Novel Protein Foods. DTO-werkdocument VN4, Delft.
8. Brentrup, F., J. Küsters, J. Lammel, H. Kuhlmann. 2002. Life Cycle Impact Assessment of Land Use Based on the Hemeroby Concept. Int J LCA 7 (6): 339-348.
9. Consoli, F., D. Allen, I. Boustead, N. de Oude, J. Fava, W. Franklin, B. Quay, R. Parrish, R. Perriman, D. Postlethwaite, J. Seguin and B. Vigon (eds) Guidelines for life-cycle assessment: a 'Code of Practice', Society of Environmental Toxicology and Chemistry (SETAC), Brussels, 1993.
10. Cowell S.J. & R. Clift, 2000. A methodology for assessing soil quantity and quality in life cycle assessment. J. Cleaner Production 8: 321-331
11. Cowell, S.J. & E. Lindeijer, 2000. Impacts on ecosystems due to land use: biodiversity, life support, and soil quality in LCA. In: Agricultural data for Life Cycle Assessments. B.P. Weidema & M.J.G. Meeusen (eds.). Agricultural Economics Research Institute (LEI), The Hague.
12. Curran, M.A., Environmental Life-Cycle Assessment, McGraw-Hill, New York, 1996.
13. Delbaere B. & A. N. Serradilla (eds.), 2004, Environmental risks from agriculture in Europe: environmental risk zones in Europe using agri-environmental indicators. Tilburg, European centre for nature conservation (ECNC).
14. ecoinvent Centre (2004): ecoinvent data v1.1, Final reports ecoinvent 2000 No. 1-15. CD-ROM, ISBN 3-905594-38-2. Swiss Centre for Life Cycle Inventories <<http://www.ecoinvent.ch>>, Dübendorf, Switzerland.
15. EEA (1998a): Europe's Environment: The Second Assessment. EEA (European Environment Agency), Copenhagen, Denmark
16. EEA (1998b): Europe's Environment: Statistical Compendium for the Second Assessment. EEA (European Environment Agency), Copenhagen, Denmark
17. Ek van, R., E. Lindeijer, L. van Oers, E. van der Voet & J. Witte, 2002. Towards including desiccation in LCA. TNO report 42/02.002943. TNO Industrial Technology, Eindhoven.
18. Ekvall, T., System Expansion and Allocation in Life Cycle Assessment with Implications for Wastepaper Management, PhD dissertation, Chalmers University of Technology, Gothenburg, Sweden, 1999.
19. Fava, J.A., R. Denison, B. Jones, M.A. Curran, B. Vigon, S. Selke and J. Barnum (eds), A technical framework for life-cycle Assessments, Report of the workshop organised by the Society of Environmental Toxicology and Chemistry, 18-23 August 1990, Vermont, Smugglers Notch, 1991.
20. Finnveden, G., 1999. A critical review of operational valuation/weighting methods for life cycle assessment, AFR-report 253, AFN (Swedish Waste Research Council), Swedish EPA, Stockholm.
21. Goedkoop, M. & R. Spriensma, 1999. The Eco-indicator 99 - A damage oriented method for life cycle Impact assessment. PRé Consultants, Amersfoort.
22. Guinée J.B. & R. Heijungs (1995) A proposal for the definition of resource equivalency factors for use in product life cycle assessment. Environ. Toxicol. Chem. 14(5):917-925.
23. Guinée, J.B. (Ed.), M. Gorrée, R. Heijungs, G. Huppes, R. Kleijn, A. de Koning, L. van Oers, A. Wegener Sleeswijk, S. Suh, H.A. Udo de Haes, J.A. de Bruijn, R. van Duin & M.A.J. Huijbregts,

- Handbook on Life Cycle Assessment: Operational Guide to the ISO Standards, Kluwer Academic Publishers. Dordrecht (Hardbound, ISBN 1-4020-0228-9; Paperback, ISBN 1-4020-0557-1), 2002.
24. Guinée, J.B., R. Heijungs & G. Huppes, 2004 Economic Allocation: Examples and Derived Decision Tree Int. J. LCA 9 (1), 23-33.
  25. Hauschild, M. and H. Wenzel, Environmental Assessment of products. Volume 2: Scientific background / Volume 1: Methodology, tools and case studies in product development. Chapman & Hall, London, 1998.
  26. Heijungs, R. & S. Suh. 2002. The computational structure of life cycle assessment. Kluwer Academic Publishers, Dordrecht.
  27. Heijungs, R., J.B. Guinée, G. Huppes, R.M. Lankreijer, H.A. Udo de Haes, A. Wegener Sleeswijk, A.M.M. Ansems, P.G. Eggels, R. van Duin and H.P. de Goede, Environmental Life Cycle Assessment of products: Guide and Backgrounds, CML, Leiden University, Leiden, 1992
  28. Heijungs, R., M. Goedkoop, J. Struijs, S. Effting, M. Sevenster, G. Huppes 2003. Towards a life cycle impact assessment method which comprises category indicators at the midpoint and the endpoint level. Report of the first project phase: Design of the new method VROM report.
  29. Hertwich, E.G., J.K. Hammit and W.S. Pease, A Theoretical Foundation for Life-Cycle Assessment: Recognizing the Role of Values in Environmental Decision Making J. Ind. Ecol. 4 (1): 13–28 (2001).
  30. Heuvelmans G. J. Garcia, B. Muys, J. Feyen, 2004. Up- and down stream water quantity conflicts in land use impact assessment. Poster presentation SETAC 2004.
  31. Heuvelmans G., B. Muys & J. Feyen, 2005. Extending the life cycle methodology to cover impacts of land use systems on the water balance. Int J LCA 10 (2) 113 – 119.
  32. Hofstetter, P., Perspectives in life cycle Impact assessment: A structured approach to combine models of the technosphere, ecosphere and valuesphere, Ph.D. Thesis. Kluwer Academic Publishers, Dordrecht, 1998.
  33. Hubbell S.P. (2001) The unified neutral theory of biodiversity and biogeography. monographs in population biology 32, Princeton University Press isbn 0661021287.
  34. Huppes, G., M. van Rooijen, J.B. Guinée, R. Kleijn, R. Heijungs, A. de Koning & L. van Oers, 2004. Life Cycle Costing and the Environment. CML-report, Institute of Environmental Sciences (CML), Leiden University.
  35. Huppes, G., M. van Rooijen, R. Kleijn, R. Heijungs, A. de Koning & L. van Oers. Life cycle costing and the environment. CML report 2004.
  36. ISO International Standard 14040, Environmental management – Life cycle assessment – Principles and framework, International Organisation for Standardisation (ISO), Geneva, 1997.
  37. ISO International Standard 14041, Environmental management - Life cycle assessment - Goal and scope definition and Inventory analysis, International Organisation for Standardisation (ISO), Geneva, 1998.
  38. ISO International Standard 14042, Environmental management - Life cycle assessment - Life cycle Impact assessment, International Organisation for Standardisation (ISO), Geneva, 2000a.
  39. ISO International Standard 14043, Environmental management - Life cycle assessment - Life cycle Interpretation, International Organisation for Standardisation (ISO), Geneva, 2000b.
  40. Jolliet O., Margni M., Charles R., Humbert S., Payet J., Rebitzer G., Rosenbaum R., 2003. IMPACT 2002+: A new life cycle impact assessment methodology. Int J LCA 8 (6) 324-330.
  41. Köllner, T., 2000. Species-pool effect potentials (SPEP as a yardstick to evaluate land-use impacts on biodiversity. J Cleaner production 8: 293-311.
  42. Kowarik I (1999): Natürlichkeit, Naturnähe und Hemerobie als Bewertungskriterien. in: Konold W, Böcker R, Hampicke U (1999): Handbuch Naturschutz und Landschaftspflege. ecomed, Landsberg, Germany, Germany
  43. Lee, K.-M. and A. Inaba, Life Cycle Assessment - Best Practices of ISO 14040 Series. Asia-Pacific Economic Cooperation, Ministry of Commerce, Industry and Energy Republic of Korea ([http://ecodesign.ajou.ac.kr/apec/trainingmanual/apec\\_read.php?number=33](http://ecodesign.ajou.ac.kr/apec/trainingmanual/apec_read.php?number=33)), 2004.
  44. Lindeijer E.W., M. van Kampen, P.J. Fraanje, H.F. van Dobben, G.J. Nabuurs, E.P.A.G. Schouwenburg, A.H. Prins, N. Dankers & M.F. Leopold, 1998, Biodiversity and life support indicators for land use impacts in LCA. Report W-DWW-98-059. Publication series raw materials 1998/7. Ministry of transport, public works and water management, Delft.
  45. Lindeijer, E., 2000a. Biodiversity and life support impacts of land use in LCA. J Cleaner production 8: 313-319

46. Lindeijer, E., 2000b. Review of land use impact methods. *J. Cleaner Production* 8: 273-281
47. Lindeijer, E., I. Kok, P. Eggels & A. Alferts, 2002. Improving and testing a land use methodology for LCA. Including cases-studies on bricks, concrete and wood. RWS DWW, Delft.
48. Lindfors, L.-G., K. Christiansen, L. Hoffman, Y. Virtanen, V. Juntilla, O-J Hanssen, A. Rønning, T. Ekvall G. Finnveden, Nordic Guidelines on Life-Cycle Assessment, Nord 1995:20. Nordic Council of Ministers, Copenhagen, 1995.
49. Mattsson, B., C. Cederberg & L. Blix, 2000. Agricultural land use in life cycle assessment (LCA): case studies of three vegetable oil crops. *J Cleaner Production* 8: 283-292.
50. Milà i Canals. L., 2003. Contributions to LCA methodology for agricultural systems. Site-dependency and soil degradation impact assessment. Chapter IV, Soil Quality in Land Use impacts. Doctoral thesis Universitat Autònoma de Barcelona, Barcelona.
51. Milà i Canals. L., Bauer C., Depestele J., Dubreuil A., Freiermuth Knuchel R., Gaillard G., Michelsen O., Müller-Wenk R., Rydgen B., 2006. Key-elements in a framework for land use impact assessment within LCA. Discussion paper for the land use sub-taskforce within life cycle initiative programme on LCIA, Taskforce 2 on natural resources and land use.
52. Müller-Wenk R. 1998. Land use - the main threat to species. IWÖ-Diskussionsbeitrag nr. 64 St. Gallen, Switzerland: IWÖ-HSG.
53. Muys, B. & J. Garcia Quijano, 2002. A new method for Land Use Impact Assessment in LCA based on ecosystem exergy concept. internal report. Laboratory for Forest, Nature and Landscape Research, KU., Leuven.
54. Pennington D.W., Margni M., Ammann C., Jolliet O., Pennington D.W., 2005. Multimedia fate and human intake modeling: Spatial versus nonspatial insights for chemical emissions in Western Europe. *Environmental Science and Technology* 39 (4): 1119.
55. Satellus (2000): CORINE Land Cover, 250m raster data, V06/00, CD-ROM. Satellus (Swedish Space Corporation Group), Kiruna, Sweden. <http://etc.satellus.se/>
56. Schweinle 1998. Integration of land use into Life Cycle Assessment. In: Presentation at the 2nd international symposium on LCA of Agriculture and Forestry
57. Steen, B. 1999 A systematic approach to environmental priority strategies in product development (EPS), Version 2000, Centre for Environmental assessment of products and material systems, Chalmers University of Technology, Technical Environmental Planning, Gothenburg.
58. Suh, S., M. Lenzen, G.J. Treloar, H. Hondo, A. Horvath, G. Huppes, O. Jolliet, U. Klann, W. Krewitt, Y. Moriguchi, J. Munksgaard and G. Norris, 2004. System Boundary Selection in Life-Cycle Inventories Using Hybrid Approaches. *Environ.Sci. & Technol.* 38 (3) 657-664.
59. Udo de Haes H.A., Finnveden G., Goedkoop M., Hauschild M., Hertwich E.G., Hofstetter P., Jolliet O., Klöpffer W., Krewitt W., Lindeijer E., Müller-Wenk R., Olsen S.I., Pennington D.W., Potting J., Steen B. (eds.), 2002, Life cycle impact assessment: striving towards best practice. Published by the Society of Environmental Toxicology and Chemistry (SETAC), Pensacola FL, USA.
60. Udo de Haes, H.A. 2006. Sustainable management of natural resources in a life cycle perspective. *Int. J. LCA* 11(1) 2-2.
61. US Environmental Protection Agency, 1993. Life-Cycle Assessment: Inventory Guidelines and Principles, EPA/600/R-92/245, Washington DC, USA.
62. Wagendorp, T., H. Gulinck, P. Coppin & B. Muys, 2006. Land use impact evaluation in life cycle assessment based on ecosystem thermodynamics. *Energy* 31: 112-125
63. Wegener Sleeswijk A., R. Kleijn, M.J.G. Meeusen - van Onna, H. Leneman, H.H.W.J.M. Sengers, H. van Zeijts, J.A.W.A. Reus 1996. Toepassing van LCA voor agrarische produkten. 1: Methodische kernpunten 2: Aanvulling op de handleiding LCA 3: Methodische achtergronden. Den Haag, Centrum voor Milieukunde Leiden, centrum voor Landbouw en Milieu, Landbouw-Economisch Instituut (LEI-DLO) isbn 90-5242-326-1.
64. Weidema, B.P. 2001. Avoiding co-product allocation in life cycle assessment *J. Ind. Ecol.* 4 (3): 39-61
65. Weidema, B.P., N. Frees & A.-M. Nielsen. 1999. Marginal production technologies in life cycle inventories *Int. J. LCA* 4 (1): 48-56.
66. Weidema B.P. & M.J.G. Meeusen, 2000. Agricultural data for life cycle assessments. The Hague, Agricultural economics Research Institute (LEI). Report 2.00.01 isbn 90-5242-563-9.
67. Weidema B.P. & E. Lindeijer, 2001. Physical impacts of land use in product life cycle assessment. Final report of the EURENVIRON-LCAGAPS sub-project on land use. Dept. of Manufacturing Engineering and Management, Technical University of Denmark.



## PART II

### Report of the Special Symposium on Life Cycle Approaches for Conservation Agriculture on 8 May 2006 at the SETAC-Europe 16<sup>th</sup> Annual Meeting at The Hague

#### Contents

1	Introduction.....	1
1.1	Backgrounds .....	1
1.2	Special Symposium.....	2
2	Abstracts of presentations .....	3
2.1	Platform presentations .....	3
2.2	Posters .....	5
3	Discussion and recommendations.....	8
3.1	Summary of the discussion of the Special Symposium.....	8
3.2	Outlook for future research.....	9
4	Appendix.....	11
4.1	Integral versions of platform presentations.....	11
4.2	Integral version of posters.....	66

#### 1 Introduction

##### 1.1 Backgrounds

Production in primary sectors like agriculture is associated with additional environmental impacts very different from those occurring in energy and chemical industries, being related to such issues as species depletion (with biodiversity impacts), erosion and hydrological changes. Some of these issues can be quantitatively addressed within the standard structure of LCA impact assessment, while others remain at the level of qualitative flagging or secondary assessment of relevant mechanisms and conditions.

Soil erosion in cropland is an increasing problem, not only in developing countries but also in Europe. Most conspicuous are the gullies in olive- and vineyards and the brown rivers in the South of Europe. Bare soil under the trees is required in summer in order to minimise evapotranspiration. The rains in winter then cause vehement silt transport. But also annual crops in Mid-Europe can lead to soil erosion, particularly in hilly regions after removal of natural barriers such as hedgerows. There are various measures to tackle this problem. These include: physical barriers like the (re-)planting of hedgerows to stop the run-off; improved farm management like contour-ploughing; zero-tillage; sowing of cover crops; careful crop protection (herbicide use); and surely others. These measures differ in effectiveness and have also side effects, either positive or negative. Important issues include: reduction of soil erosion, level of toxic residues in soil and run-off water; impacts on biodiversity, carbon sequestration, and quality and quantity of the crop.

## 1.2 Special Symposium

A Special Symposium about Life Cycle Approaches for Conservation Agriculture was organised at the SETAC-Europe 16<sup>th</sup> Annual Meeting at The Hague, The Netherlands (7-11 May 2006). This Special Symposium was commissioned by Syngenta and organised by The Institute of Environmental Sciences of Leiden University (CML), in close co-operation with Syngenta. The Special Symposium was held in the afternoon of the 8. May and was chaired by Mike Lane (Syngenta) and Wil Tamis (CML). The Special Symposium was very well visited, -about 150 people attended the platform presentation-, and there was a lively discussion after the finalization of the platform presentations.

At this Special Symposium five platform presentations and seven posters were brought together. The subjects and speakers of the platform presentations were:

- 1) Life cycle impact approaches for conservation agriculture (J. Guinée)
- 2) A framework for land use impact assessment in LCA (L. Mila i Canals)
- 3) Innovations in land use impact assessment for LCA (B. Muys)
- 4) Assessment of agricultural management impacts on soil quality in Life Cycle Assessment (H.R. Oberholzer)
- 5) Life Cycle Impact Approaches for Conservation Agriculture - framework for the discussion (H.A. Udo de Haes)

The abstracts of these platform presentations are included in par. 2.1 and the integral PowerPoint presentations are included in the appendix (par. 4.1) of the report of this Special Symposium.

For the poster session the following eight posters were submitted (subject and first author):

- 1) Development of a method for identifying marginal suppliers of agricultural crops in consequential LCA of biobased products (J Kløverpris)
- 2) Life Cycle Assessment of a poplar energetic crop system (C. Martinez)
- 3) Environmental Impact Assessment of orange juice and energy exploitation of the solid wastes (C. Koroneos)
- 4) A universal method to assess functional and structural impacts of human-induced land use and land use change: integrating ecosystem concepts and LCA principles (J. Garcia-Quijano)
- 5) Integration of biodiversity as life cycle impact category for LCA in agriculture (P. Jeanneret)
- 6) Balancing carbon emission and sequestration fluxes of forest land based on a LCI-approach (R. Wollenman)
- 7) LCA of horticultural crops including impacts on soil quality and pesticide rating (L. Mila i Canals)
- 8) Analysis of environmental performance indicators for forestry and agricultural production systems on the northern slopes of the Swiss Alps (H. Heinemann)

Two posters (3 and 4) were not presented during the SETAC-Europe 16<sup>th</sup> Annual Meeting (and one poster was send after), but we included all poster contributions in order to get a more or less complete picture of the scientific field. All abstracts are included in par. 2.2 and the available integral posters are included in the appendix (par. 4.2) of the report of this Special Symposium.

The focus of this Special Symposium was to analyse conservation-agriculture measures in a life cycle, with special attention for conservation of soil, water and biodiversity. In LCA, aspects like biodiversity, hydrology and soil quality are generally aggregated under the heading 'land use'. At this Special Symposium we tried on focusing on impact assessment methods dealing with these aspects separately and on the constraints to such approaches.



## **2 Abstracts of presentations**

### *2.1 Platform presentations*

#### 2.1.1 Life cycle impact approaches for conservation agriculture

Authors: J.B. Guinée, L. van Oers, W.L.M. Tamis, M. Lane, J.F. Gonzalez-Valero  
Address first author: [guinee@cml.leidenuniv.nl](mailto:guinee@cml.leidenuniv.nl), CML, P.O. Box 9518, 2300 RA Leiden, The Netherlands

In the area of Conservation Agriculture, Syngenta is involved in several research projects aiming to protect the European agricultural soils against erosion (e.g. SOWAP and ProTerra). These projects are producing useful data on soil erosion, water use, nutrients use, quality of the crop, biodiversity, etc. Because each alternative involves different upstream processes, impacts and costs, these data should be brought together in a life-cycle framework for further assessment and decision support. For this, a life-cycle framework for a methodologically consistent environmental impact assessment and economic analysis of alternative agricultural management systems has been defined. Subsequently, it has been analysed which of the traditionally difficult impacts for LCIA (erosion, desiccation, soil fertility and biodiversity) would fit in this framework in a useful and practical manner, and which not. For this, an inventory and assessment of existing LCIA methods for these impacts has been made. In addition, the data produced in the ProTerra and SOWAP projects have been matched with the data needs of identified existing LCIA methods for these impacts.

#### 2.1.2 A framework for land use impact assessment in LCA

Authors: L. Mila i Canals, R. Mueller-Wenk, O. Michelsen, C. Bauer, B. Rydgren, G. Gaillard  
Address first author: [lmic@surrey.ac.uk](mailto:lmic@surrey.ac.uk), Centre for Environmental Strategy (D3), University of Surrey Guildford, Surrey GU2 7XH United Kingdom

Land use by agriculture, forestry, house-building or industry leads to substantial impacts, particularly on biodiversity and on soil quality as a supplier of life support functions. Unfortunately there is no widely accepted assessment method so far for land use impacts. Within the UNEP-SETAC LC Initiative, key issues in LCIA of land use have now been treated. This framework describes the selected impact pathways, linking the land use types registered in LCI to the damage categories, like human health, natural environment and natural resources. Such damage occurs if the land properties are modified (transformation) and also if the current man-made properties are maintained (occupation). The time lag between land use intervention and the damage may be large. The size of damage is the difference between the effect from the studied case of land use and a suitable reference land use on the same area. Damage depends not only on the type of land use (coverage and intensity) but is also heavily influenced by the bio-geographical conditions of the area.

#### 2.1.3 Innovations in land use impact assessment for LCA

Authors: B. Muys, J.F. Garcia-Quijano, G. Heuvelmans  
Address first author: [bart.muys@biw.kuleuven.be](mailto:bart.muys@biw.kuleuven.be), Forest Ecology and Management, Laboratory for Forest, Nature and Landscape Research KULeuven Vital Decosterstraat 102 B - 3000 Leuven, Belgium

Several improvements in land use impact assessment for LCA are presented: (1) a theoretical basis for indicator selection, (2) a related reference system, (3) an integrating land use impact

indicator, (4) a modeling approach for integration over time and space and for uncertainty analysis, and (5) a way of dealing with off-site impacts. We propose the ecosystem exergy theory as a solid thermodynamic basis for indicator selection. It is a succession model in which ecosystems tend to maximize dissipation of exergy flows by maximizing exergy content. The maximum level is site specific and reached in the climax system (also called Potential Natural Vegetation or PNV). Impact assessment is done by comparing exergy content and dissipation of the actual system with the PNV. A fully operational land use method was developed and applied by Garcia-Quijano et al. (see posters). A powerful single indicator for land use impact is the surface temperature of the ecosystem. It is a cost-efficient measure of solar exergy dissipation and has a strong correlation with the soil, water, vegetation structure and biodiversity indicators of Garcia Quijano et al. For the water balance indicators we demonstrate the power of spatially explicit modeling with SWAT (Soil and Water Assessment Tool), the strengths and weaknesses of model parameter transfer from calibrated catchments to areas with low data availability and a procedure to distinguish between input data, model and scenario uncertainty. In order to account for the off site effects of land use activities on water quantity, being average discharge, floods and droughts, we introduced a new impact category regional water balance. Since trade-offs in water flux dissipation exist between land use systems and downstream ecosystems a joint minimization of both impact categories is necessary.

#### 2.1.4 Assessment of agricultural management impacts on soil quality in Life Cycle Assessment

Authors: H.R. Oberholzer, P. Weisskopf, G. Gaillard, R. Freiermuth, T. Nemecek  
Address first author: [hansrudolf.oberholzer@fal.admin.ch](mailto:hansrudolf.oberholzer@fal.admin.ch), Agroscope FAL Reckenholz, Station fédérale de recherches en agroécologie et agriculture, Reckenholzstrasse 191. 8046 Zurich, Switzerland.

Agroscope FAL-Reckenholz developed an impact assessment category for soil quality (SALCA-SQ) for enabling a comprehensive assessment for land use impacts in LCIA of agricultural activities. The method characterises the impact of land management practices on the quality of arable soil by means of nine indicators covering soil physics, chemistry and biology. The method considers management practices such as crop rotation, amount and type of fertilizers, soil tillage and wheeling. SALCA-SQ enables a differentiated assessment of management practices by aggregating positive as well as negative effects of each management practice on each indicator. In case studies the applicability and significance of the method was tested. Positive effects observed as a consequence of sufficient addition of organic matter and optimal crop rotation as well as the negative impacts induced by wheeling and intensive soil cultivation resulted in plausible changes of the indicators. This indicates the importance of a detailed inventory of agricultural management activities for the assessment of land use impacts rather than a simplified evaluation on the management systems level.

#### 2.1.5 Life Cycle Impact Approaches for Conservation Agriculture - framework for the discussion

Author: H.A. Udo de Haes  
Address first author: [udodehaes@cml.leidenuniv.nl](mailto:udodehaes@cml.leidenuniv.nl), CML, P.O. Box 9518, 2300 RA Leiden, The Netherlands.

This paper will present a framework for the discussion in the special symposium on Conservation Agriculture. Conservation Agriculture aims to conserve water and soil, and to enhance biodiversity in current agricultural practice. In the present session this will be discussed in a life cycle management context. The discussion will deal with the question to

which extent the related environmental changes can be characterized in LCIA, and what other impact approaches are needed. On the one hand, LCIA may well be able to deal with non-current types of impact, like release of acids and nutrients from the soil to the ground water and the run-off of soil particles. The goal here is to discuss examples, both from a theoretical and practical point of view. On the other hand LCIA has limitations with one-time transitions, with local characteristics and with impacts which cannot be quantified in relation to a functional unit. Examples include replacement of forest by agriculture, soil fertility, desiccation and biodiversity. The aim here is to discuss other life cycle impact approaches which can cope with the relevant types of impact, like ERA and certification of companies.

## 2.2 Posters

### 2.2.1 Development of a method for identifying marginal suppliers of agricultural crops in consequential LCA of biobased products

Authors: J. Kløverpris, H. Wenzel, P.H. Nielsen

Address first author: [jk@ipl.dtu.dk](mailto:jk@ipl.dtu.dk), Technical University of Denmark, Dept. of Manufacturing Engineering and Management, Produktionstorvet 424, DK-2800 Lyngby, Denmark.

The global demand for crops is increasing due to increasing food demand for a growing population and increasing markets for biobased non-food products. This underpins the need for LCA methodology to handle consumption of crops correctly. Building on the concept of consequential LCA, the present study aims at extending existing methodology to enable identification of marginal suppliers of specific crops to regional and global markets. In each case, it also addresses whether increased crop production is achieved by extensification (more land) or intensification (more fertilizers, pesticides and/or water). This is of crucial importance for the inventory analysis. The developed methodology relies on projections of future agricultural production and trade as well as geographical data on current changes in global land use. As an example, preliminary testing of the method indicates that increased consumption of maize in China leads to expansion of croplands in Argentina.

### 2.2.2 Life Cycle Assessment of a poplar energetic crop system

Authors: C. Martinez, G.X. Gabarell, A.A. Assumpció, R.M. Rigola, C.J Carrasco, S.M.I. Solano, C.P. Ciria, R.J. Rieradevall

Address first author: [carles.martinez@uab.es](mailto:carles.martinez@uab.es), Institut de Ciència i Tecnologia Ambientals (ICTA), Universitat Autònoma de Barcelona, 08193 Bellaterra, Barcelona, Spain.

In the frame of the Evaluation of the Environmental Sustainability of Energetic Crops project funded by the Spanish Ministry of Science and Technology (CTM2004-06800-C03-01), a Life Cycle Assessment (LCA) study is performed to assess the environmental performance of hybrid poplar (*Populus x euroamericana*) crop biomass production in short rotation coppice. The main aim of this study is to calculate the energy balance of the biomass production stage and to identify the most environmentally critical stages. Data for the biomass production system studied is obtained from a trial field located in Soria (Castilla y Leon region, Northern of Spain). The assessment takes into account of all stages of the most important agricultural operations (field preparation, planting, agrochemical control, harvest and stool elimination) as well as the extraction of raw materials (e.g. fossil fuel, mineral) and the production of the farming inputs (e.g. fertilizers). Life Cycle Impact Assessment (LCIA) is realized including midpoints impacts categories. The results will show if poplar biomass crops are energetically efficient and environmentally sustainable.

### 2.2.3 Environmental Impact Assessment of orange juice and energy exploitation of the solid wastes

Authors: C. Koroneos, D. Rovas, N. Tzanis

Address first author: [koroneos@aix.meng.auth.gr](mailto:koroneos@aix.meng.auth.gr), Laboratory of Heat Transfer and Environmental Engineering, Aristotle University of Thessaloniki, Box 483, 54124 Thessaloniki, Greece.

The overall aim of this study is to evaluate the environmental impacts of the whole orange juice production process, as well as the energy exploitation of the solid wastes that result from the citrus processing industries via anaerobic digestion. Life Cycle Assessment (LCA) is the tool that is utilized. The whole life cycle of orange juice processing is considered, taking into consideration the following steps: cultivation of orange trees, the transportation of oranges into the citrus-processing industry, the production of juice and the transportation of solid wastes into the suggested anaerobic reactor. Also, there is taken into consideration the energy used that is mainly electricity from lignite plus the energy that is derived from the anaerobic digestion of the waste. The functional unit is taken to be the processing of one ton of oranges. The inventory analysis is analyzed, and at the same time the flows of energy and material are investigated at all stages of the production. The environmental impact at each stage of the production is calculated using eco-indicator 95, and very important conclusions are drawn on the steps needed to be taken for the optimization of the process and the utilization of solid waste.

### 2.2.4 A universal method to assess functional and structural impacts of human-induced land use and land use change: integrating ecosystem concepts and LCA principles

Authors: J.F. Garcia-Quijano, B. Muys

Address first author: [juan.garcia@biw.kuleuven.be](mailto:juan.garcia@biw.kuleuven.be), Division Forest, Nature and Landscape Research Celestijnenlaan 200 E. B-3001. Leuven, Belgium.

Assessment of human land use and land use change requires a versatile method applicable in a broad range of spatio-temporal contexts. We present a method combining a theoretical basis in ecosystem thermodynamics for the indicator selection with life cycle assessment (LCA) as an operational methodology for impact calculation. The theoretical basis is the ecosystem exergy concept, which states the ecosystem tends to maximize exergy content and dissipation. The method uses 16 indicators distributed over 4 themes soil, water, vegetation structure and biodiversity. It evaluates the impact of human activities on the ecological quality of the land against a reference system. For a given site, the potential natural vegetation, i.e. the climax system under present site conditions was selected as the reference system with the highest exergy level content and the highest exergy dissipation capacity. The general formula for indicator calculation has three components. The first part is the indicator score, which is essential for any land use impact study and sufficient for Environmental Impact Assessment (EIA). The second part is the LCA component, which allows to express the impact per functional unit of the production system in order to compare between scenarios, technologies and regions. The third component allows time integration in the case of dynamic systems. Finally a method of indicator value aggregation into a land use impact score is proposed for land occupation and for land use change separately. Results obtained from different land use systems in Belgium, Spain; Cameroon and South Africa show that the method is universally applicable and sufficiently sensitive to detect differences in impacts between typical local land use systems.

### 2.2.5 Integration of biodiversity as life cycle impact category for LCA in agriculture

Authors: P. Jeanneret, D. Baumgartner, R. Freiermuth, G. Gaillard, O. Huguenin, T. Nemecek, P. Weibel

Address first author: [philippe.jeanneret@fal.admin.ch](mailto:philippe.jeanneret@fal.admin.ch), Agroscope FAL Reckenholz, Station fédérale de recherches en agroécologie et agriculture, Reckenholzstrasse 191. 8046 Zurich, Switzerland.

Agroscope FAL-Reckenholz developed a method which allows the integration of biodiversity (organismal diversity) as an impact category of LCA for agricultural production (SALCA-Biodiversity). First, a list of indicator-organisms was established considering ecological and LCA (ISO-norm) criteria. The indicator-organisms are flora, birds, mammals, amphibians, molluscs, spiders, carabids, butterflies, wild bees, and grasshoppers. Second, inventory data about agricultural practices including relevant criteria for biodiversity were specified. Beside typical agricultural practices like pesticide use and tillage, semi-natural habitats, e.g. set aside fields, were integrated. Third, a notation system was evolved to estimate every indicator-organism reaction regarding agricultural activities (characterization) followed by an aggregation step. In a specific case study, several scenarios representing options for grassland management were calculated. The results show the dominant influence of management intensity on most indicator-organisms. The range of indicator values is much higher for grassland than in arable crops.

### 2.2.6 Balancing carbon emission and sequestration fluxes of forest land based on a LCI-approach

Authors: R.A. Wollenmann

Address first author: [regina.wollenmann@env.ethz.ch](mailto:regina.wollenmann@env.ethz.ch), ETH Zürich, Professur forstliches Ingenieurwesen, CHN K 75.1, Universitätsstrasse 16, CH-8092 Zürich, Switzerland.

Environmental analysis tools such as LCA or ecological footprint assessment consider land use twofold: First as land to provide sink capacity, and second as area occupied by production activities and facilities. However, even intensively managed ecosystems act as a source and a sink. Our investigation aims (1) at balancing carbon sequestration and emission fluxes of forest land use and (2) to evaluate the methodology for a close-to-nature and a plantation regime. The regimes have a positive sequestration capacity of about 85 kg C·m<sup>-3</sup> (plantation) and about 180 kg C·m<sup>-3</sup> (close-to-nature), respectively. Assuming a given area of forest cover, a division of “ecological labor” between plantation forest and forest reserve provides a net carbon sink capacity of 0.18 kg C·m<sup>-2</sup>·a<sup>-1</sup> compared to 0.14 kg C·m<sup>-2</sup>·a<sup>-1</sup> for the close-to-nature regime. The results clearly indicate that the management regime determines the net carbon sink capacity and that “ecological labor division” between intensively and unmanaged forests offer opportunities to maximize carbon sequestration.

### 2.2.7 LCA of horticultural crops including impacts on soil quality and pesticide rating

Authors: L. Milà i Canals, S.J. Cowell, A. Hospido, D. Jones, G. Koerber, P. Cross, B. Hounsome, G. Edwards-Jones

Address first author: [l.mic@surrey.ac.uk](mailto:l.mic@surrey.ac.uk), Centre for Environmental Strategy (D3), University of Surrey Guildford, Surrey GU2 7XH United Kingdom

LCA is being used to assess the environmental benefits or otherwise of producing horticultural crops in the UK and alternative supplying countries (Spain, Kenya). Field emissions (CO<sub>2</sub>; CH<sub>4</sub>; N<sub>2</sub>O; NO<sub>3</sub>-) are being measured and modelled as part of the project,

providing accurate LCI information for many of the common impact categories (global warming; acidification; eutrophication). In addition, two new impact categories relevant for agriculture are being assessed: soil organic matter is used as an indicator for the impacts on the resource aspect of soil quality; and a novel approach to pesticide toxicity based on ratings is applied. The results from British farms are presented for some of the studied crops, and the usefulness and relevance of the new impact categories is discussed

### 2.2.8 Analysis of environmental performance indicators for forestry and agricultural production systems on the northern slopes of the Swiss Alps

Authors: H.R. Heinimann, R.A. Wollenmann, N. Knechtle

Address first author: [hans.heinimann@env.ethz.ch](mailto:hans.heinimann@env.ethz.ch), ETH Department of Environmental Sciences, ETH-Zentrum CHN K 72.2, CH-0892 Zurich, Switzerland.

There is a recent trend to develop environmental performance metrics according to the ISO 14'030 standards. However, there is little knowledge about environmental performance of different production systems used in forestry and agriculture on similar sites. The present study aims (1) to develop a standardized input-output model to analyze environmental inputs and outputs, and (2) to evaluate environmental performance for seven forestry and six agricultural production systems. The analysis consisted of two environmental indicators, energy consumption on the input-side and greenhouse gas on the emission-side, the functional unit was 1 kg of dry matter of biomass (DMB). The emission of carbon dioxide equivalents varies between 0.01 and 0.07 kg per kilogram of DMB, whereas the wood production systems are in the lower and the agricultural systems in the higher area of the range. Energy consumption varies between 0.1 and 1.2 MJ per kilogram of DMB, which correspond to a share on the heating value (17.5 MJ) of about 1% to 7%. The results clearly demonstrate that environmentally sound production of biomass is even possible under mountainous terrain conditions.

## 3 Discussion and recommendations

### 3.1 *Summary of the discussion of the Special Symposium*

Conservation agriculture could be simply defined as agriculture aiming at the best possible balance of the practical conservation of soil, water and biodiversity, and profitable agricultural production. Two presentations focused on the inclusion of land-use aspects in LCA, but the development of these methods is still in its infancy, despite the fact that this is already a long existing topic. From the presentations it became clear that not all land-use related problems could be solved and that the data requirements are relatively high for such an analysis to succeed. Another presentation focused on the description and aggregation of soil quality (and biodiversity, see posters) in different agricultural scenarios, but no clear procedure on how to include these analyses into a LCA framework was presented. So, the key topic during the general discussion was what should be included in LCA and what should be treated by other tools and approaches. Two opposite opinions were expressed:

1. Don't squeeze all land-use related impacts within the framework of LCA;
2. Include any land-use related impact in LCA that fits within the general LCIA structure of intervention – indicator - characterization model / factor – indicator result.

The general opinion was that it is not credible to leave out land-use related effects in an LCA, as land-use effects are too important to omit. Generally, it was also concluded that simple solutions like qualitative flagging do not work in practice. Focus points for future research are: 1) the possible alternative methods to describe effects on soil and water quality and

quantity and biodiversity and 2) the combination or aggregation of the results of these alternative methods within LCA. These issues are further discussed in the following section. Currently there is thus no single and simple method to compare and to communicate the environmental performance of different agricultural scenarios.

### 3.2 Outlook for future research

It seems that there is a requirement to develop a scientific framework for Conservation Agriculture, defining what Conservation Agriculture means, providing a comprehensive set of indicators covering all relevant impacts and thus offering a consistent basis for interpretation of various land use practices. The discussion at the Special Symposium illustrated that it is important to clarify the mutual relation between analytical and procedural tools (like certification, see figure). The link between indicators and analytical tools has to be a continuous improvement loop. Only then the indicators can become credible measures for certification standards. A scientific basis for these standards is desperately needed. From the discussions it became clear that opinions diverge on this point but opinions seem to converge that a framework for Conservation Agriculture should at least meet two requirements:

1. It should include LCA but it should not be limited to LCA only;
2. It should have an analytical basis, and not start from a management tool such as certification, for example:

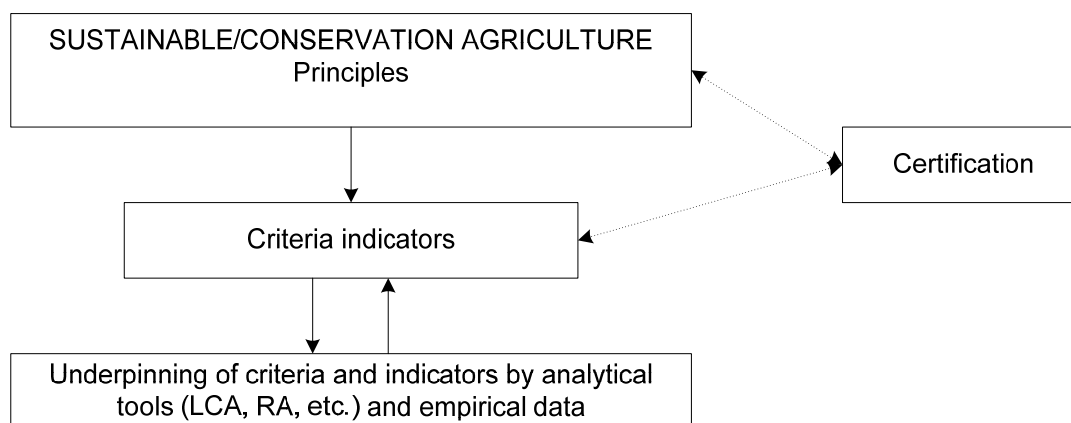

One of the goals of this Special Symposium was to initiate a broad discussion on the topic of Conservation Agriculture, its principles and indicators and how it can be addressed in LCA. From the presentations it became clear that Task Force 2 of the UNEP-SETAC LC-Initiative would be the most appropriate forum for this discussion. However, it also appeared that the discussions in this forum progress very slowly and that they get stuck at a conceptual and theoretical level. Support from agro-industry (like Syngenta) could certainly help to enhance the work of the Task Force 2 of the UNEP-SETAC LC-Initiative by e.g. financing the application in a case-study of operative land-use related impact assessment methods to lift of the discussion over the level of concepts and methodological debates and to enable finding out what the key differences between methods in practice are. This could then be the starting point of a debate and consensus process on most representative indicators and related operative methods for impact assessment of land use related impacts in LCA.

One of the conclusions from the definition study (Part I) may well be that certain impacts do not fit in the LCIA structure or cannot satisfactorily be addressed by LCIA (similar to acute

toxic impacts). For these impacts then recommendations should be formulated as to how these could additionally be addressed by other (analytical) tools, in a similar way as it is recommended to apply RA in addition to LCA, particularly for local threshold passing assessments.

For impacts that do fit in the LCIA structure, there is a discussion on the most relevant and operative indicators for Life Cycle Impact Assessment (LCIA) of land use related interventions. We observe an analogy between the treatment of toxicity impact in LCIA and the treatment of land use related impacts. Also with respect toxicity, there has been an intensive debate on the usefulness of including toxic impact in LCIA. The debate was initiated from scientists and stakeholders that were particularly active in the field of Risk Assessment. They argued that as they 1) performed RA-studies already, 2) complied with chemical legislation, 3) did not surpass any thresholds locally; and 4) LCA could not deal with thresholds and acute effects, it made no sense to include toxicity into LCIA. Many discussions followed focusing on the added value of LCIA to RA and vice versa and in the end there was quite broad consensus that it was useful to also look at toxicity from an LCA perspective. The way toxic impact were assessed in LCA at that time was, however, very simplistic. Toxic emissions were divided by a standard and then aggregated (“critical volumes approach”). After that, the multi-media modelling based approaches have been introduced, better reflecting the behaviour of chemicals through the environment but at the same time initiating long and as yet unresolved scientific debates on best multi-media modelling and effect assessment practices. It is just this Spring, that within TaskForce 3 (TF3) of the UNEP-SETAC LC-Initiative, it has been decided to build a much simpler multi-media *consensus* model – independent of any of the existing models. This consensus model will be used as best practice for given periods of time and at the same time it will be the starting point for further model improvements. New developments from existing (scientific, non-consensus based) multi-media models will be submitted for discussion and brought into the consensus model when consensus is reached on these developments. This foreseen future for the TF3 work resembles much of the way the IPCC works and how their (consensus / policy) GWPs are accomplished. We suggest that land-use impact assessment modellers could learn from this. They could even try to skip the part during which intense debates were held while little progress was made by starting with a simple  $m^2 \cdot yr$  and simultaneously start working on a better and more sophisticated but operative approach (without bothering the average LCA practitioner too much with these difficult discussion as we don’t bother them either with difficult GWP-model inner side discussions).

In summary the recommendations are:

- Apply operative land-use related impact assessment methods in a case-study in order to initiate a constructive debate on the level of concepts and methodology. This will enable us to indentify the key differences between a variety of methods which are currently being practised;
- Develop a scientific framework for Conservation Agriculture defining what it means and how it can best be measured (indicators);
- Learn from the LCIA experiences with the toxicity categories in defining best practice for LCIA of land use related impacts.



## **4 Appendix**

### *4.1 Integral versions of platform presentations*

Without further comments we present the integral versions of the platform presentations in the following order:

- 1) Life cycle impact approaches for conservation agriculture (J. Guinée)
- 2) A framework for land use impact assessment in LCA (L. Mila i Canals)
- 3) Innovations in land use impact assessment for LCA (B. Muys)
- 4) Assessment of agricultural management impacts on soil quality in Life Cycle Assessment (H.R. Oberholzer)
- 5) Life Cycle Impact Approaches for Conservation Agriculture - framework for the discussion (H.A. Udo de Haes)

# Life Cycle Impact Approaches for Conservation Agriculture

Jeroen Guinée, Laurant van Oers,  
Arjan de Koning and Wil Tamis  
CML - Department of Industrial Ecology  
Leiden University

Mike Lane<sup>1</sup>  
Juan Gonzalez-Valéro<sup>2</sup>  
<sup>1</sup> Syngenta UK Ltd, Bracknell, UK  
<sup>2</sup> Syngenta International AG, Basel, CH

 syngenta

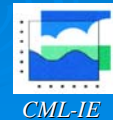

## Contents of this presentation

- SOWAP/ProTerra: what is it about?
- Aim of this study
- Brief introduction on LCA
- Main SOWAP/ProTerra environmental issues
- Existing *land use* LCIA methods
- Conclusions

 syngenta

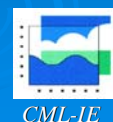

## SO<sub>il</sub>WA<sub>ter</sub>P<sub>rotection</sub>: what is it about?

(<http://www.sowap.org/>)

- Sponsors: Syngenta and EU “Life-Environment”
- Aim: help improve the economics of operations while reducing effects on soil erosion and pesticide / fertiliser run-off
  - Testing site-specific soil and weed management methods, such as conventional tillage vs. conservation- and/or zero- tillage practices on agricultural practices in arable crops (e.g. maize, wheat, sugar beet, beans and sunflowers)



## ProTerra: what is it about?

(<http://www.proterra.eu.com/> )

- Sponsor: Syngenta
- Aim: help reduce extreme soil losses occurring under conventional soil management
  - Testing management approaches (e.g. cover crops) for soil and water conservation in Mediterranean perennial cropping systems (e.g. olives and vines)



## Aim of this study

- Life cycle framework for assessing sustainability of alternative agricultural management systems
  - focusing on LCIA issues important for SOWAP/ProTerra but not yet maturely developed within LCIA
  - distinguishing between what fits within LCIA and what not
- Definition study
- No development of new methods

 syngenta



## LCA: key characteristics

- *Product & service systems*
- *Life Cycle (from cradle to grave)*
- *Quantitative*
- *Environmental*
- *Systems analysis*
- *Integrated (over time, place)*

 syngenta



# Process inputs and output and definition of system boundaries

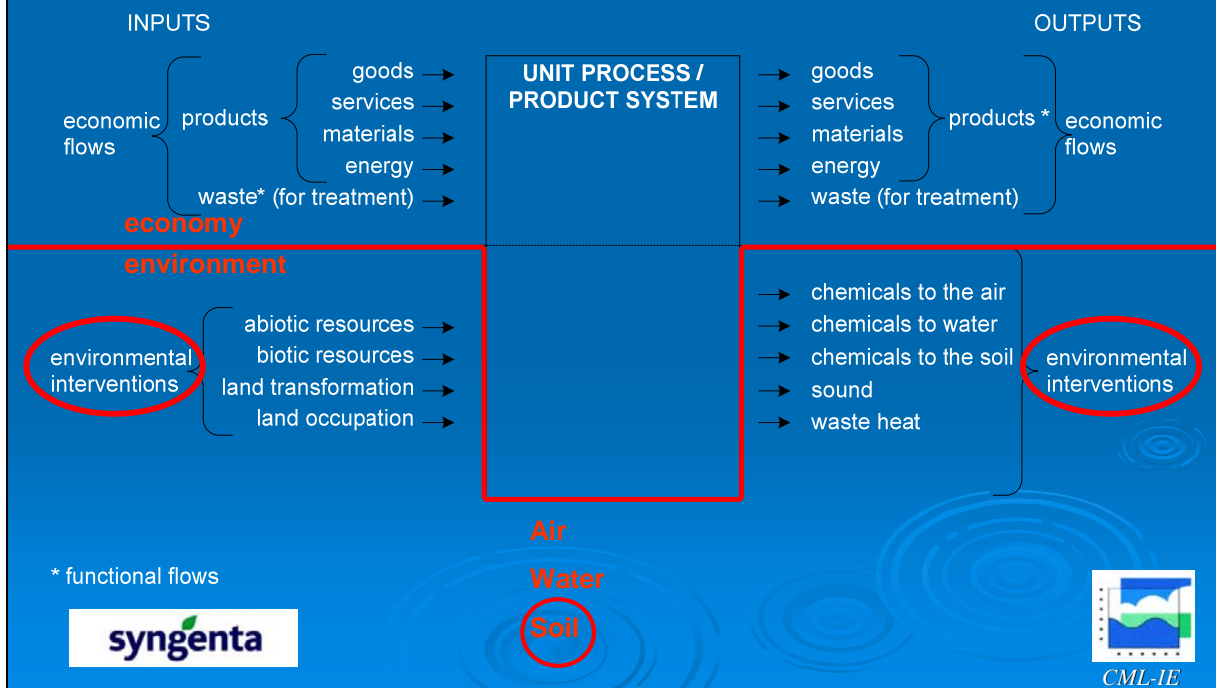

## General structure of LCIA exemplified by the GWP

Impact cat	Climate change
Intervention	emissions of greenhouse gases to the air (kg)
Indicator	Infrared radiative forcing ( $W/m^2$ )
Char.model	IPCC model defining the GWPs of different greenhouse gases
Char.factor	$GWP_{100}$
Indicator result	kg ( $CO_2$ -equivalents)

Example Calculation:

$2 \text{ kg } CO_2 \text{ (GWP = 1)} + 3 \text{ kg } CH_4 \text{ (GWP = 21)}$  gives  $1 \times 2 + 11 \times 3 = 65 \text{ kg } CO_2 \text{ - equivalents}$

syngenta

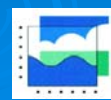

it gives you the broader picture

# LCA useful as integration framework

but to assess the sustainability of agricultural systems, appropriate impact indicators are needed

ancillary materials, energy, sowing, deep tillage, seedbed preparation, tilled layer, crop, harvesting, harvested crop, waste

syngenta

CML-IE

## Causal-effect chain (sources: various references)

Driver Process	Pressure Intervention	State Midpoint indicator	Impact Endpoint indicator	Area of protection
agricultural land use / permanent crop (nutrient application) (chemical application) (manure application) (ploughing)	chemical run off, nutrient run off, other emissions, soil erosion, soil compaction, soil surface sealing, vegetation cover	human toxicity, terrestrial ecotoxicity, aquatic ecotoxicity, eutrophication, acidification, water holding capacity, water conductivity, water infiltration, fresh water cycle (hydrology), local climate regulation, global climate regulation	physical soil quality (soil structure), chemical soil quality (CEC, pH etc), biological soil quality (worms, bacteria etc), biotic production, biodiversity, Life Support Functions	Man made abiotic environment (buildings), Man made biotic environment (crops), Human health, Natural biotic environment (species & ecosystems), Natural abiotic environment (landscape)
industrial process	land transformation, land occupation			Natural resources

syngenta

CML-IE

# Criteria

- Completeness
- Minimum overlap and double-counting
- Consistent with LCA key characteristics, system boundaries etc.
- Practical

 syngenta

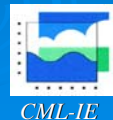

## SOWAP and ProTerra issues

- Erosion, hydrology, soil fertility and biodiversity
  - Inventory of existing land use LCIA methods
  - Discussion of methods
    - (how) do they fit in general structure of LCIA ?

 syngenta

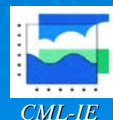

# Erosion

	Cowell & Clift, 2000	Mattsson et al., 2000	Muys & Garcia Quijano, 2002
Impact cat	depletion (soil)	soil erosion	soil erosion
Intervention	loss of soil (kg/ha/yr)	loss of soil (kg/ha/yr)	loss of soil (kg/ha/yr)
Indicator	soil static reserve life (SSRL)	loss of soil	soil erosion
Char.model	SSRL=R/E	unweighted aggregation	soil depth loss over 100 yr compared to total rootable soil depth
Char.factor	n.a.	1 for all int.	n.a.

➤ Discussion:

- Soil loss is no intervention as soil = environment !!
- Proper interventions still to be determined
- Practical applicability



# Hydrology

	Heuvelmans et al., 2005	Heuvelmans et al., 2005
Impact cat	depletion (water)	regional water balance
Intervention	water use (m <sup>3</sup> or m <sup>3</sup> /m <sup>2</sup> .yr ??)	land use (m <sup>2</sup> .yr)
Indicator	dynamic water reserve life (DWRL)	streamflow: average downstream water availability and drought risk
Char.model	DWRL=R/(U-P)	SWAT model
Char.factor	n.a.	n.a.

➤ Discussion:

- Promising approaches, but data intensive (practical applicability)!
- Characterisation factors needed for set of land use types





# Soil fertility

	Lindeijer (1998)	Cowell & Clift, 2000	Mattsson et al., 2000	Muys & Garcia Quijano, 2002	Milà i Canals, 2003
Impact cat	soil life support functions	soil quality and productivity	soil fertility	soil fertility	soil life support functions
Intervention	land occupation (m <sup>2</sup> .yr)	organic matter (OM; kg)	ha or n.a.?	land occupation (m <sup>2</sup> .yr)	decrease SOM due to erosion, aeration (tillage); increase SOM due to emission crop residues, manure
Indicator	free Net Primary Production (fNPP)	1/OM	3: SOM, soil structure, soil pH	5: biomass; leaf area; height; fNPP; crop biomass	Soil Organic Matter (SOM)
Char.model	?	unweighted aggregation	qualitative	5 equations given: no data up to the user !	unweighted aggregation
Char.factor	7; rough data; more CFs case by case	1 for all int.	n.a.		1 for all int.

## Discussion:

- Qualitative indicators; operationalisation left to LCA practitioner; (S)OM as intervention
- Soil fertility in agro-LCAs: goal of agro-system AND impact category ?

syngenta



CML-IE

# Biodiversity

	Lindeijer, 2002, 2000, 1998 (also Weidema & Lindeijer, 2001)	Köllner, 2000	Brenttrup, 2000	Wagendorp, 2005
Impact cat.	biodiversity	biodiversity	hemeroby	exergy
Intervention	m <sup>2</sup> .yr (occup) & m <sup>2</sup> (transf) specific land use types	m <sup>2</sup> .yr (occup) specific land use types	m <sup>2</sup> .yr (occup)	m <sup>2</sup> .yr (occup) ?
Indicator	vascular plant species diversity; separate indicators for occupation and transformation	vascular plant species diversity	Naturalness Degradation Potential (NDP)	surface temperature of ecosystem; thermal response number; solar exergy dissipation
Char.model	vegetation maps + equation	vegetation maps + equation	Hemeroby classes with cardinal scores	developing
Char.factor	n.a.	16 SPEPs	NDPs for 11 European regions	developing

## Discussion:

- Insight in methods remains difficult
- Occupation (m<sup>2</sup>.yr) as most basic indicator for the time being

syngenta

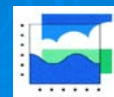

CML-IE

# Land occupation & transformation

- Occupation: included as  $m^2.yr$ 
  - extended with biodiversity indication
  - either or not with reference situation
- Transformation:
  - Economic process; no impact category or intervention
    - e.g. logging of a forest for wood and/or agricultural soil with:
      - economic inputs: machinery and fossil fuels for saws and trucks
      - economic outputs: wood and agro-area
      - interventions:  $CO_2$  due to reduction of organic carbon content
      - impacts: climate change, occupation, erosion, biodiversity etc.
    - One-time transformation vs. continuous transformation events
      - allocation of one-time transformations problematic

 syngenta

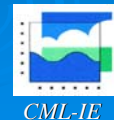

## Overall conclusions

- Do fits:
  - Theoretical: anything that can be allocated to an economic input or output and related to intervention
  - Practical: anything with readily available methods & data are readily available
- Don't fits:
  - Impacts with no related interventions
  - One-time transformations to land type with infinite use

 syngenta



# Research outlook

- Applicable without any further work:
  - Hydrology (resource depletion)
  - Land occupation / biodiversity (simple  $m^2 \cdot yr$  approach)
  - Erosion in terms of soil loss (practical but inconsistent with LCA system boundaries)
  - Land transformation as economic process
  
- Applicable only after further work:
  - Hydrology (regional water balance)
  - Erosion: better approach
  - Biodiversity more sophisticated approach (discussion of relevant indicators, approaches and applicability needed)

 syngenta





## Land use impacts in LCA: a framework from the UNEP/SETAC Life Cycle Initiative

SETAC Europe 16<sup>th</sup> Annual Meeting  
The Hague, 8<sup>th</sup> May 2006

*Llorenç Milà i Canals, CES, University of Surrey*

*C Bauer, J Depestele, A Dubreuil, R Freiermuth Knuchel, G  
Gaillard, O Michelsen, R Müller-Wenk, B Rydgren*

\*Based on the discussion paper available in  
<http://www.lci-network.de/cms/content/pid/591>

## Contents

- Context
  - What is the UNEP/SETAC LC Initiative?
  - Relevance of land use impacts
- Main impact pathways from land use
  - Biodiversity (intrinsic value)
  - Bio-productivity
  - Substance cycling
- Environmental mechanism
  - Transformation/Occupation: process; intervention; impact
- Considerations for the application of the framework
  - Reference situation
  - Future impacts and Time frame
  - Bio-geographical differentiation for land use impacts
  - Impact indicators
- Conclusions and Implementation: situation vs. spatial differentiation

SETAC-Europe 16<sup>th</sup> Annual Meeting. LC Initiative land use impact assessment framework



# The UNEP/SETAC Life Cycle Initiative

<http://lcinitiative.unep.fr/>

- **Mission:** *“to develop and disseminate practical tools for evaluating the opportunities, risks, and trade-offs associated with products and services over their entire life cycle to achieve sustainable development”*
- **LCIA Programme:** *“to establish and provide guidance on models and characterisation factors for the different impact categories”*
- **TF2 on resources and land use:**

<http://www.lci-network.de/cms/content/pid/591>

Context

SETAC-Europe 16<sup>th</sup> Annual Meeting, LC Initiative land use impact assessment framework



## Relevance of land use impacts

- Production of raw materials often takes place in ecologically fragile areas:
  - agriculture; forestry; mining
- Land use by humans exerts considerable damages on land functions
  - the decline of Europe's biodiversity in many regions [...] derives mainly from highly intensive, partially industrial forms of agricultural and silvicultural land use, from an increased fragmentation of remaining natural habitats by infrastructure and urbanisation [...] (The Dobris Assessment, 1995)
  - soil degradation has been often driven by increasing demand for food production (UNEP's GEO-3, 2002)
  - greenhouse gas emissions caused by land cover changes are of the same order of magnitude as those derived from combustion (IPCC 2001)

... and yet they are not commonly included in LCA!

Context

SETAC-Europe 16<sup>th</sup> Annual Meeting, LC Initiative land use impact assessment framework



# Impact pathways from land use processes

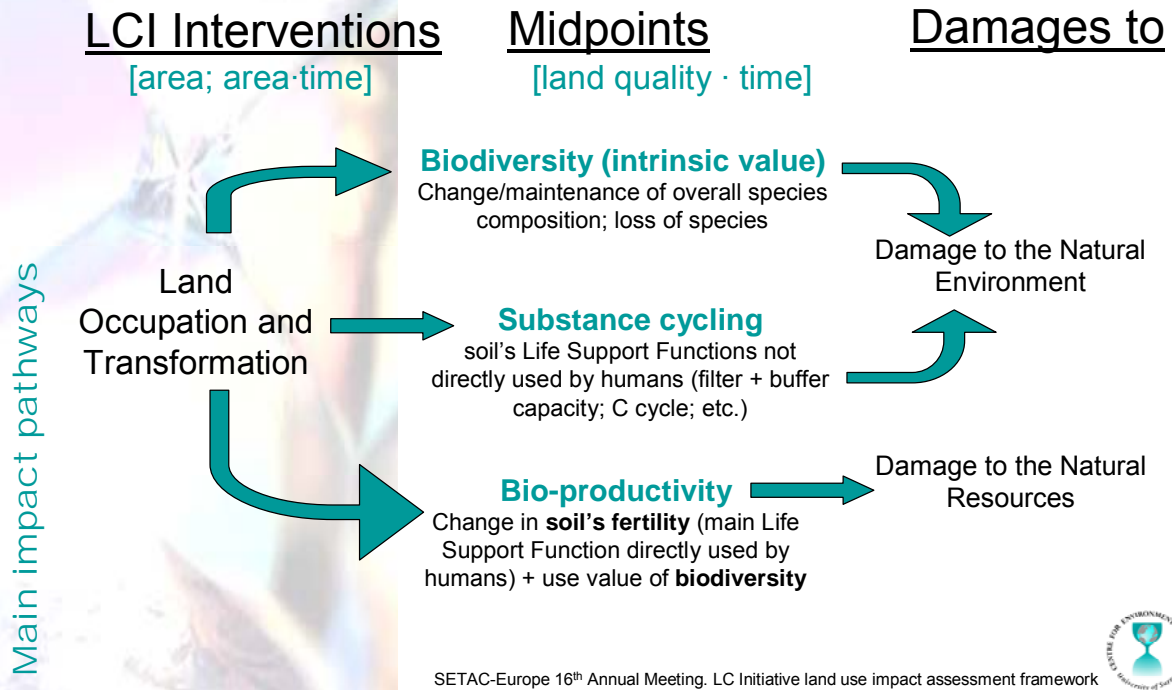

## Transformation: process; intervention; impact

- *Transformation process*: change of properties in a land area to fit a new type of human use
- *Transf. intervention*: when listed in LCI [m<sup>2</sup>]
- *Transf. impact*: amount of [land quality · time] not available due to a transformation intervention (shaded)

Environmental mechanism

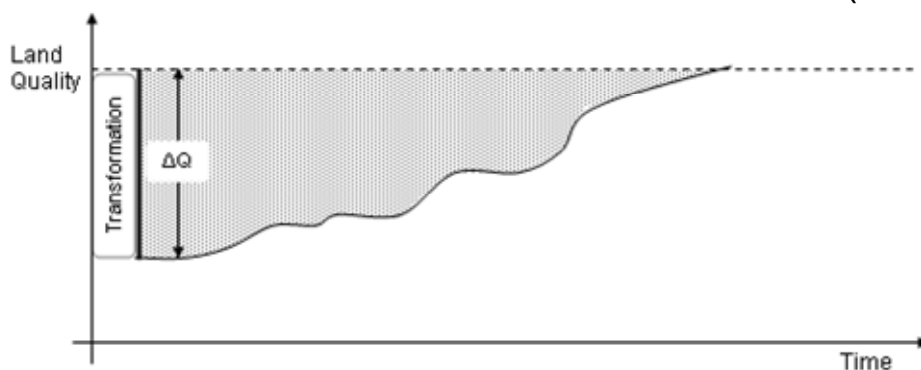

SETAC-Europe 16<sup>th</sup> Annual Meeting. LC Initiative land use impact assessment framework

# Occupation: process; intervention; impact

- *Occupation process*: maintenance of properties in a land area to keep a human use (no intended transf.)
- *Occup. intervention*: when listed in LCI [**m<sup>2</sup> · time**]
- *Occup. impact*: amount of [**land quality · time**] not available due to an occupation intervention (shaded)

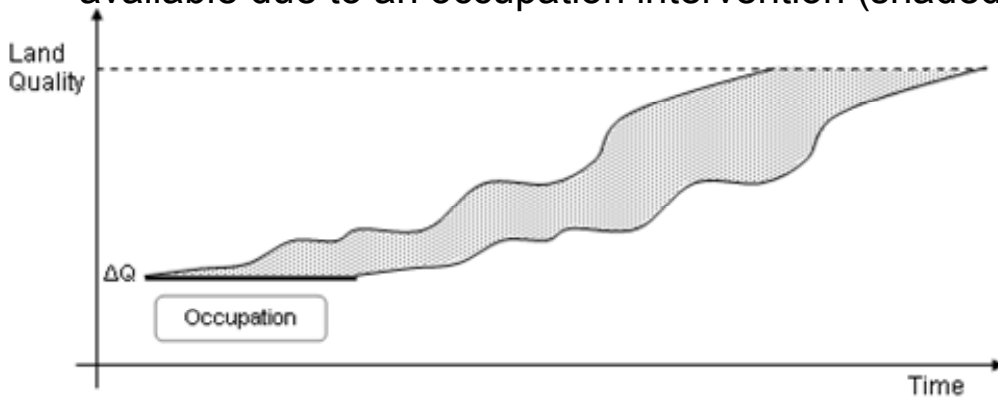

SETAC-Europe 16<sup>th</sup> Annual Meeting, LC Initiative land use impact assessment framework



# LCI modelling parameters

- Quantitative description of land use process: change in land quality (different parameters for each impact)
- Time
- Area

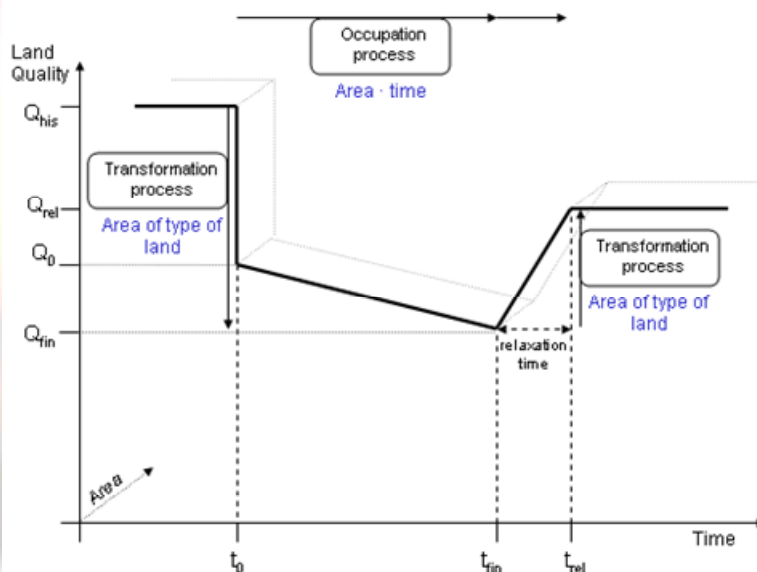

SETAC-Europe 16<sup>th</sup> Annual Meeting, LC Initiative land use impact assessment framework



# Dynamic Reference Situation

- Default: natural relaxation
- Consequential LCA: most likely alternative land use

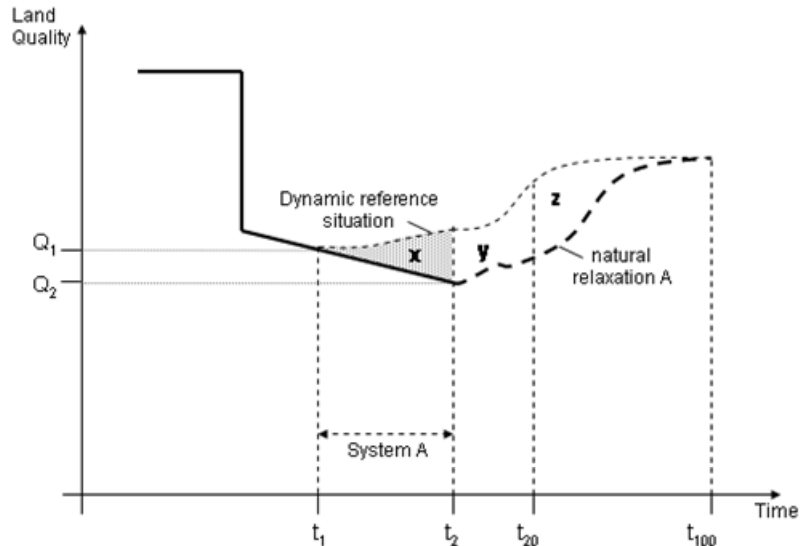

SETAC-Europe 16<sup>th</sup> Annual Meeting. LC Initiative land use impact assessment framework



# Time Frame for impacts after land use intervention

- Default: model impacts until  $\infty$  or new steady state
- Huge uncertainties on future events! 2 alternative approaches: pulse vs. continued occupation:

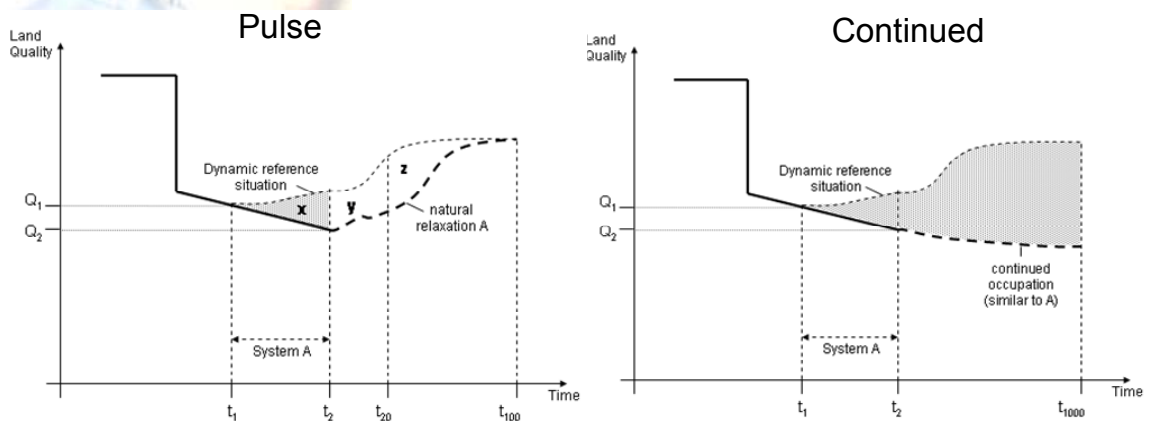

SETAC-Europe 16<sup>th</sup> Annual Meeting. LC Initiative land use impact assessment framework





# Time Frame for impacts after land use intervention

- Non reversed impacts must be red-flagged! (interpretation)
- ... OR consider a large virtual relaxation time (e.g. 10,000 years)

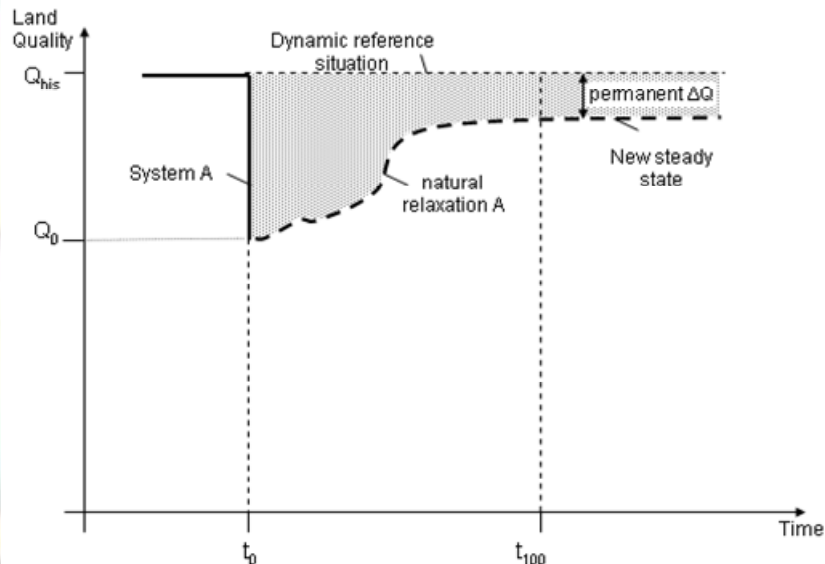

SETAC-Europe 16<sup>th</sup> Annual Meeting. LC Initiative land use impact assessment framework



# Bio-geographical differentiation for land use impacts

- Land use impacts require bio-geographical differentiation:
  - ‘The same land use intervention has different consequences depending on the sensitivity and inherent land quality of the environment where it occurs’
- Dependent on impact pathway!
- Options to contextualise impacts:
  - thresholds;
  - ‘distance to climax’;
  - dose-response functions?
- A consistent approach needs to be derived with other impact categories (eutrophication; acidification; toxicity)

SETAC-Europe 16<sup>th</sup> Annual Meeting. LC Initiative land use impact assessment framework



## Indicators for land use impacts (i.e. how do we assess land quality?)

- Different indicators for each impact pathway
- Differences at midpoint / damage level
- Possibly opposite signs! ('what is good for bio-productivity may be bad for biodiversity')
- Still under development (examples in the discussion paper)
  - Expert workshop organised by CES, 12-13 June 2006:  
<http://www.soc.surrey.ac.uk/ias/workshops/DEFNBEST/cfp.php>



SETAC-Europe 16<sup>th</sup> Annual Meeting, LC Initiative land use impact assessment framework

## A need and a (possible) way forward

- Land use impacts on (at least) biodiversity, bio-productivity and substance cycling need to be included in LCA, otherwise many applications of LCA will lose credibility and usefulness: (bio)energy; food; forestry; mining; waste treatment; etc.
- Bio-geographical differentiation needs to be included in land use impact assessment or the results will be meaningless
- How?
  - *Situation differentiation*: definition of land use archetypes with relevant information for user of LCA results (e.g. purchaser of land-based products)
  - *Spatial differentiation*: provision of relevant parameters with the LCI information for a detailed assessment of the effects of land management practices (e.g. for land manager)



SETAC-Europe 16<sup>th</sup> Annual Meeting, LC Initiative land use impact assessment framework



THANK YOU!

Any questions?

Land use impacts in LCA:  
a framework from  
the UNEP/SETAC Life Cycle Initiative

<http://www.lci-network.de/cms/content/pid/591>

You can also send further comments to  
Llorenç ([L.MiC@surrey.ac.uk](mailto:L.MiC@surrey.ac.uk))

SETAC-Europe 16<sup>th</sup> Annual Meeting. LC Initiative land use impact assessment framework



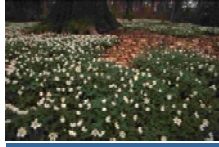

[www.biw.kuleuven.be/lbh/lbnl/forecoman/eng/index.asp](http://www.biw.kuleuven.be/lbh/lbnl/forecoman/eng/index.asp)



## Innovations in land use impact assessment for LCA

Bart MUYS, Juan GARCIA-QUIJANO and Griet HEUVELMANS  
Dept. of Land Management and Economics

KATHOLIEKE UNIVERSITEIT  
**LEUVEN**  
WWW.KULEUVEN.BE

### Land use in LCA



- **poorly developed** impact category
- essential for products with part of their life cycle in a land-intensive sector (**mining, forestry, agriculture**)
- two activities: land **occupation** and land **transformation**
- typical is the impact in **time** and **space**
- Land is more than area; it has certain site-specific **qualities**

KATHOLIEKE UNIVERSITEIT  
**LEUVEN**  
WWW.KULEUVEN.BE

## Challenges for land use in LCA

- Lack of generic framework for indicator selection
- Lack of an unequivocal reference system
- Lack of a universally applicable indicator set
- How to integrate over time and space?
- How to account land use impact?
- How to differentiate between land use and land use change?
- How to cope with off-site effects?
- How to deal with uncertainty?



## Aim

Contribute to a **universally applicable** land use impact assessment method

Specific objectives:

- propose **good practice** answers to each of the challenges
- test and apply the proposed methodologies



## Generic framework



**The model of self-organization in living systems:  
Complex open systems tend to maximize their exergy content**

Four key elements:

1. Ecosystems are open systems that **receive external exergy** fluxes (mainly solar exergy);
2. Ecosystems use part of that external exergy to **increase their internal exergy level** in terms of biomass, structure and information (*order from disorder*);
3. Ecosystems maintain and increase their capability to build up order through **genetic selection and transfer** and other **learning** processes (*order from order*);
4. Ecosystems with high exergy level are more successful in dissipating external exergy flows; it means that they are better buffered and thus have **higher stability**.

Wagendorp et al., 2006

KATHOLIEKE UNIVERSITEIT  
**LEUVEN**  
WWW.KULEUVEN.BE

## Generic framework



	<b>Ecosystem</b>	<b>Human society</b>
<b>Goal function</b>	max[buffer exergy flows] by max[exergy level]	max[buffer exergy flows] by max[exergy level]
<b>Exergy build-up</b>	biomass, structure, DNA	food reserves, houses, bank accounts, other comforts
<b>Buffering activity</b>	Radiation gradients, temperature change, nutrient loss, water run-off, sediment loss, wind damage	external threats in terms of climate, hunger, war, natural and technical disasters
<b>Main exergy source</b>	solar radiation	Ecosystems, fossil fuels, nuclear
<b>Memory</b>	Mainly DNA	DNA, oral and written information, bits and bytes

WWW.KULEUVEN.BE

## Generic framework

*Definition of Sustainable development:* Increasing the exergy level of the human society not provoking a significant decrease of ecosystem exergy level

*Definition of land use impact:* decrease of the ecosystem exergy level caused by human activity

Muys, 2006

WWW.KULEUVEN.BE



## Reference system

The **potential natural vegetation** (PNV or climax system) is the system with highest natural exergy level and highest control over fluxes of energy and materials.

The PNV is **site-specific** (climate, soil, topography, available regional species pool)

Muys, 2002

KATHOLIEKE UNIVERSITEIT  
**LEUVEN**  
WWW.KULEUVEN.BE



## Reference system

Stratification of the land in homogeneous [site x land use] units

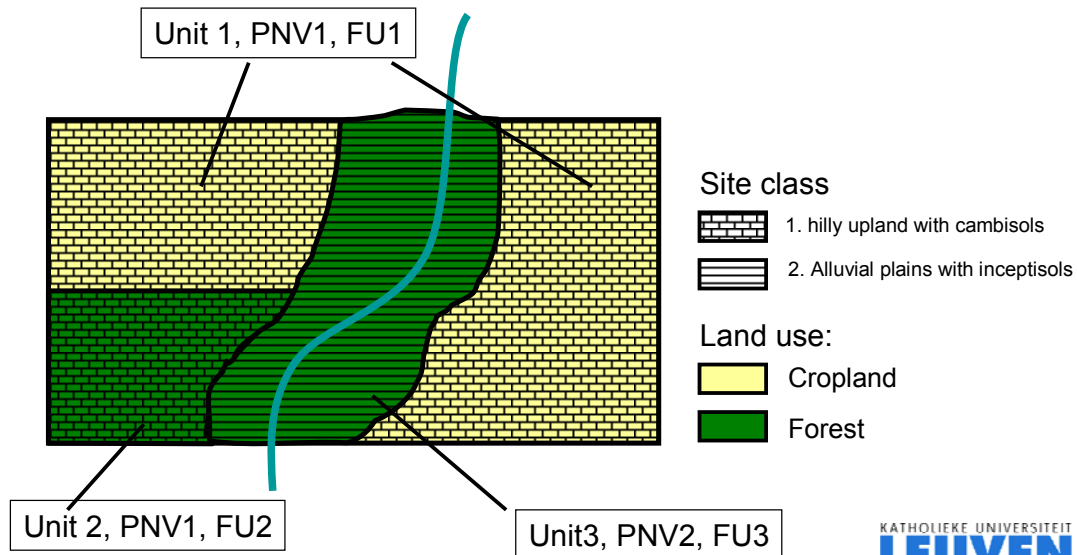

## Indicator set

17 quantitative indicators divided over 4 themes: Vegetation, Biodiversity, Soil and Water

Exergy content {  
- Vegetation (biomass & structure)  
- Biodiversity (genetic information)

Exergy dissipation {  
- Soil (sediment and nutrient flow buffering)  
- Water (water flow buffering)

Muys & Garcia, 2002



## Indicator set

Indicator scores ( $\Delta Q$ ) indicate difference in quality between actual land use and reference state

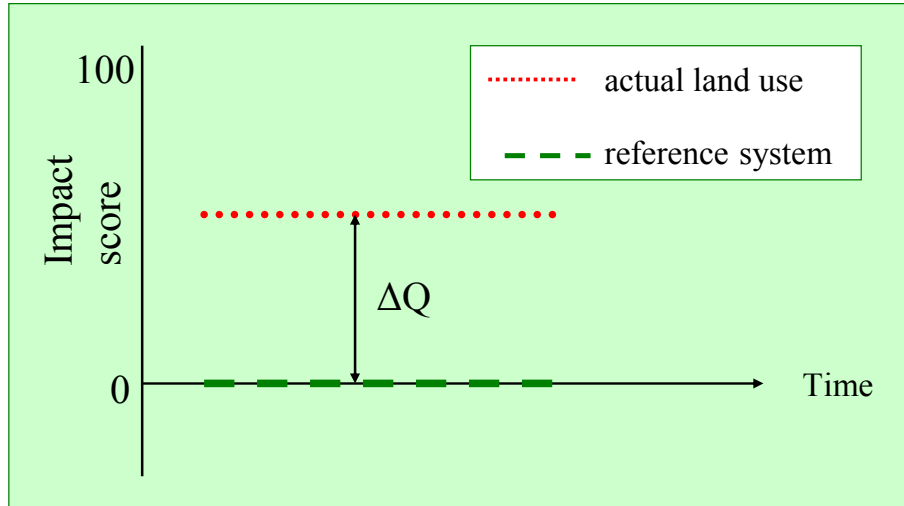

KATHOLIEKE UNIVERSITEIT  
**LEUVEN**  
WWW.KULLEUVEN.BE

## Vegetation indicators

Code	Indicator	Calculation	Reference state	Alternatives
V1	Total living Biomass (TB)	$\left(1 - \frac{TB_{act}}{TB_{ref}}\right) * 100$	$TB_{ref}$	Total above-ground living biomass
V2	Canopy fractal dimension (FD)	$\left(1 - \frac{FD_{act}}{FD_{ref}}\right) * 100$	$FD_{ref}$	Leaf area index, canopy height, root FD
V3	Free Net Primary Production (fNPP)	$\left[1 - \left(\frac{NPP_{act} - harvest}{NPP_{ref}}\right)\right] * 100$	No harvest	Crop biomass

Peters et al., 2004

KATHOLIEKE UNIVERSITEIT  
**LEUVEN**  
WWW.KULLEUVEN.BE

## Biodiversity indicators



Code	Indicator	Calculation	Reference state	Alternatives
B1	Shannon Diversity index (SI)	$\left(1 - \frac{SI_{act}}{SI_{ref}}\right) * 100$	SI <sub>ref</sub>	Number of species compared to regional species pool
B2	Exotic species cover (EX)	$EX_{act} * 100$	No exotics	
B3	Use of biocides	$\left(\frac{A_{aff} * N}{A_{tot}}\right)$ N=number of applications per decade; A=area	No biocides	

WWW.KULEUVENBE

## Soil indicators



Code	Indicator	Calculation	Reference state
S1	Loss of permeability (PE)	$\left(\frac{A_{aff} * (PE_{ref} - PE_{act})}{A_{tot} * PE_{ref}}\right) * 100$	PE <sub>ref</sub>
S2	Disturbance of structure	$\left(\frac{A_{aff} * D * N}{A_{tot}}\right)$ A=area; D= depth in m; N=number of applications	No disturbance
S3	Soil erosion	$\left(1 - \frac{USLE_{act}}{USLE_{ref}}\right) * 100$	USLE <sub>ref</sub>

## Soil indicators



Code	Indicator	Calculation	Reference state
S4	Cation Exchange Capacity (CEC)	$\left(1 - \frac{CEC_{act}}{CEC_{ref}}\right) * 100$	$CEC_{ref}$
S5	Base saturation (BS)	$\left(1 - \frac{BS_{act}}{BS_{ref}}\right) * 100$	No disturbance
S6	Fertilization, impoverishment	$\left(\frac{A_{aff}}{A_{tot}} * N\right)$ A=area; N=number of applications	No application

## Water indicators



Code	Indicator	Calculation	Reference state
W1	Evapotranspiration (ET)	$\left(1 - \frac{ET_{act}}{ET_{ref}}\right) * 100$	$ET_{ref}$
W2	Surface runoff (RO)	$\left(1 - \frac{RO_{act}}{RO_{ref}}\right) * 100$	$RO_{ref}$
W3	Drainage, irrigation	$\left(\frac{A_{aff}}{A_{tot}}\right) * 100$ A=area	No artificial change of water balance

## Accounting *land use impact*



1. Indicator calculation per land unit
2. Aggregation per theme

$$\Delta Q_V = \frac{\sum_{i=1}^n \Delta Q_{Vi}}{N} \quad \text{where} \quad N = 3$$
$$\Delta Q_B = \frac{\sum_{j=1}^m \Delta Q_{Bj}}{M} \quad \text{where} \quad M = 3$$
$$\Delta Q_S = \frac{\sum_{p=1}^x \Delta Q_{Sp}}{X} \quad \text{where} \quad X = 6$$
$$\Delta Q_W = \frac{\sum_{q=1}^y \Delta Q_{Wq}}{Y} \quad \text{where} \quad Y = 3$$

Peters et al., 2004

KATHOLIEKE UNIVERSITEIT  
**LEUVEN**  
WWW.KULEUVEN.BE

## Accounting *land use impact*



3. Impact per FU

$$S_V = \Delta Q_V * (area \times time)_{FU} * FU^{-1}$$

$$S_B = \Delta Q_B * (area \times time)_{FU} * FU^{-1}$$

$$S_S = \Delta Q_S * (area \times time)_{FU} * FU^{-1}$$

$$S_W = \Delta Q_W * (area \times time)_{FU} * FU^{-1}$$

4. Spatial upscaling of land units (weighted averaging with area)

Peters et al., 2004; Heuvelmans et al., 2005b

KATHOLIEKE UNIVERSITEIT  
**LEUVEN**  
WWW.KULEUVEN.BE

## Accounting *land use change impact*

1. Indicator calculation per land use change unit
2. Aggregation per theme
3. Impact per FU

$$S_i = [\Delta Q_2 - \Delta Q_1] * (area \times time)_{FU} * FU^{-1}$$

for i = soil, water, vegetation and biodiversity

4. Spatial upscaling of land units (weighted averaging with area)



## Results

### land use impact per unit of area

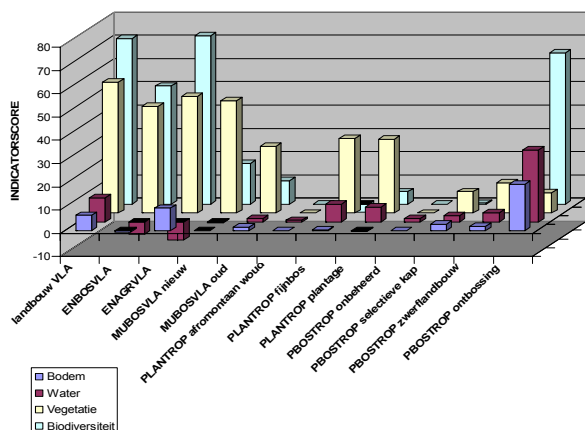

- any land use type around the globe can be compared
- Impact of forestry land use on soil and water is low, except for tropical deforestation
- natural systems have lowest impact
- intensively managed plantations systems have higher impact than multifunctional forests
- impact of selective logging and shifting cultivation in tropical forest is low



## Results

### Land use impact per FU of 1 ton CO<sub>2</sub>

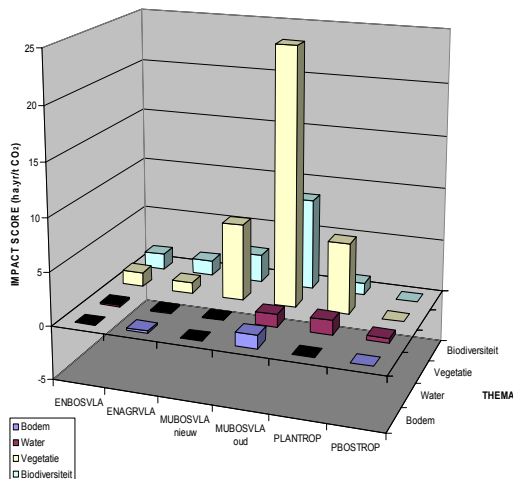

- result of multiplying land use impact with area\*time needed to produce 1 FU

- intensive energy crops have a very low impact, because their time\*space requirement per ton CO<sub>2</sub> emission reduction is very low

- multifunctional forests have a high impact, because their time\*space requirement per FU is very high

## Single indicator

- **Hypothesis:**

- The exergy dissipation of an ecosystem can be measured by the produced heat, using thermal remote sensing

- **Candidate single indicators**

- Surface Temperature(Ts):

- Lower in PNV

- Spatial variation Ts:

- Lower in PNV

- Thermal Buffer Capacity (TBC =  $\Delta Ts / \Delta t$ )

- Lower in PNV

- Thermal Response Number (TRN =  $(Rn \cdot \Delta t) / \Delta Ts$ ):

- Larger in PNV

- Solar Exergy Dissipation (SED): Net-radiation / net-short wave radiation ( $Rn/K^*$ ): Larger in PNV

## Single indicator

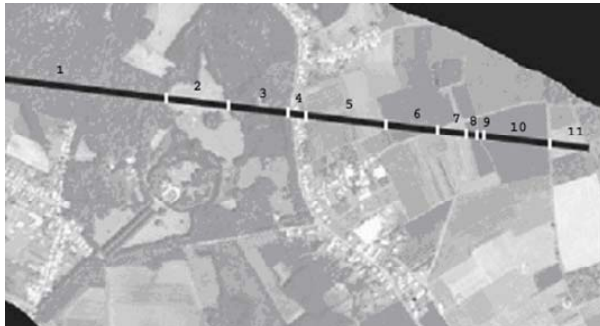

Surface type	Ts (°C)	TRN (kJm <sup>-2</sup> C <sup>-1</sup> )	SED (%)
Forest plantation *	29.5	1631	85
Douglas fir forest *	24.7	1549	90
Regenerating forest *	29.4	788	79
Cleareut *	51.8	406	65
Rock quarry *	50.7	168	62
Young forest*	14.2	863	89
Meadow*	13.8	502	84
Potato cropland	13.3	360	83
Lawn*	15.7	318	73
Forest*	22.4	1400	67
Cereal crop	23.5	1173	66
Water*	24.0	1211	65
Orchard*	24.2	1154	65
Grassland	23.4	924	66
Urban*	26.4	309	63

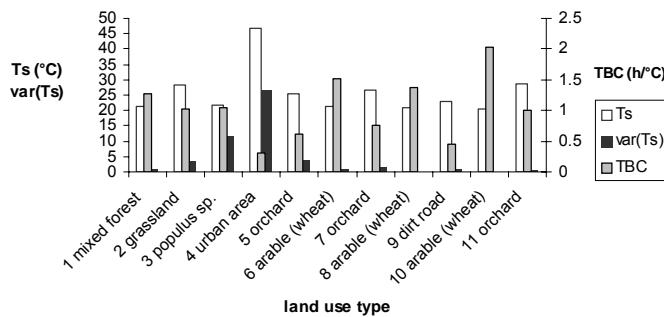

Ts shows strong correlations with V,B,S & W indicators!

Wagendorp et al., 2003

## Integration over time and space through modelling

Time series of water fluxes (stream flow and others) are generated with the hydrological model SWAT

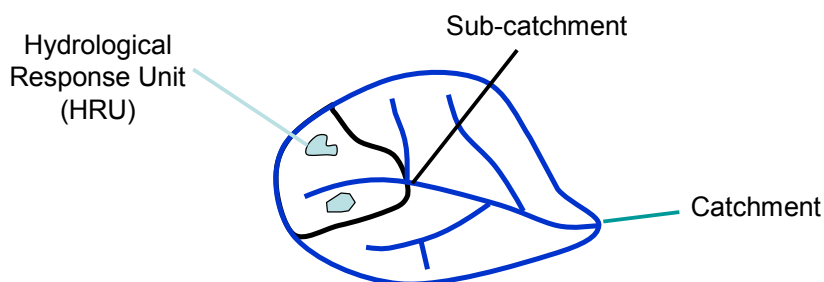

SWAT simulates the land phase of the hydrological cycle for each HRU (land use / soil unit)

The hydrological response of a subcatchment is the weighted average of the responses of its composing HRUs

Heuvelmans et al., 2005b

KATHOLIEKE UNIVERSITEIT  
**LEUVEN**

## Integration over time and space through modelling



Water indicators can be derived with a hydrological model, though such a model requires some kind of calibration

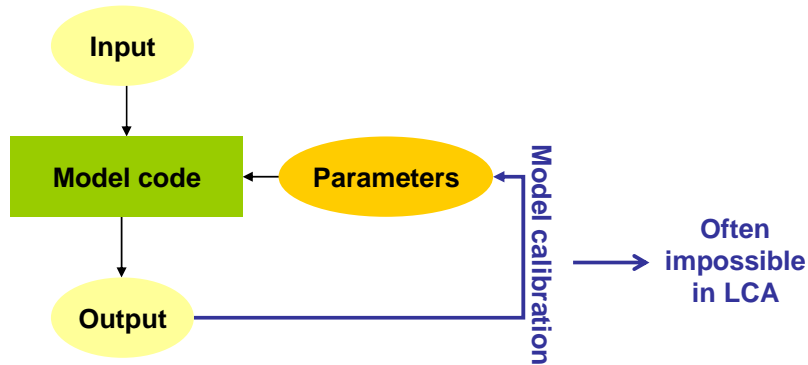

Data for a site-specific calibration are usually not available in LCA. How can model parameters be estimated in this case?

KATHOLIEKE UNIVERSITEIT  
**LEUVEN**

## Integration over time and space through modelling



LCAs often relate to ungauged sites or to hypothetical scenarios of environmental change, so that a site-specific optimisation of parameters is not possible

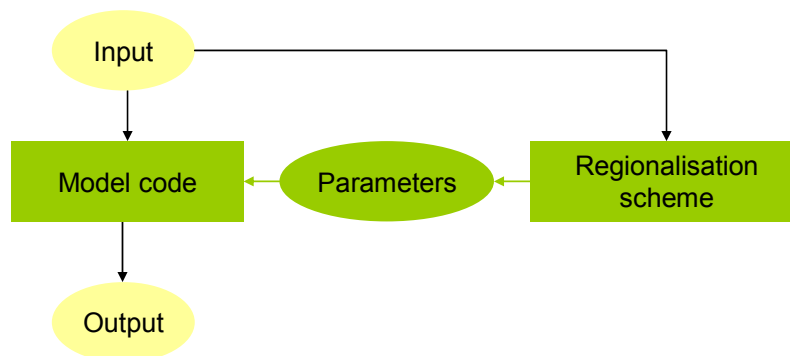

Regionalisation models link model parameters to more readily available data and can therefore be used for estimating parameters in ungauged catchments

Heuvelmans et al., 2006

KATHOLIEKE UNIVERSITEIT  
**LEUVEN**



## Integration over time and space through modelling



Six types of regionalisation models, having a varying degree of complexity were considered:

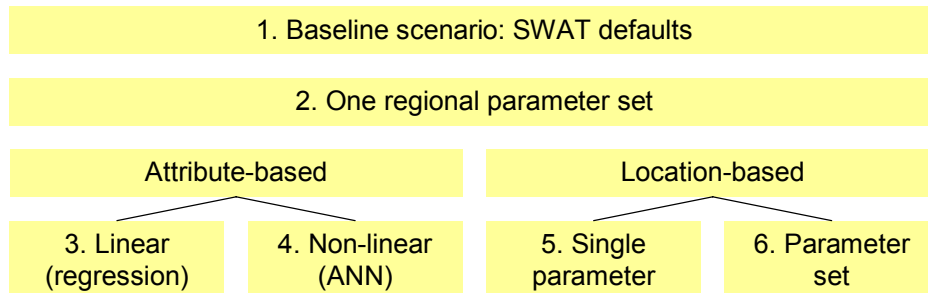

SWAT defaults are assumed to result in the poorest model performance, site-specific parameter optima are assumed to give the best performance

KATHOLIEKE UNIVERSITEIT  
**LEUVEN**

## Integration over time and space through modelling



How can water indicators for LCA be calculated with SWAT?

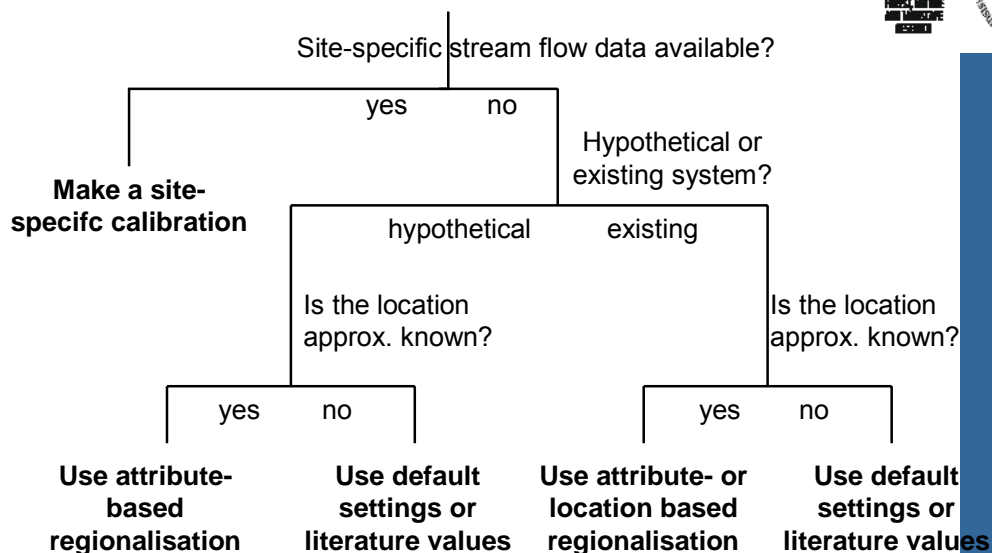



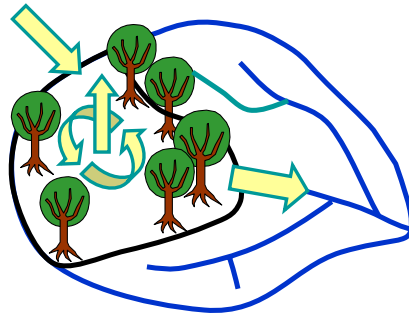

The most suitable method depends on the decision-making context

## Off-site effects

Water flows passing land use systems can be represented as:



 System boundary  
 Catchment boundary

-  Impact on water resources consumption
  -  Impact on hydrological properties of the site
  -  Impact on the stream flow regime
- } Included in existing methods  
 } Currently not considered

Heuvelmans et al., 2005a

## Off-site effects

Regional water balance impact category: selection of indicators

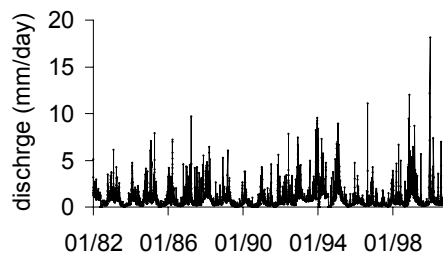
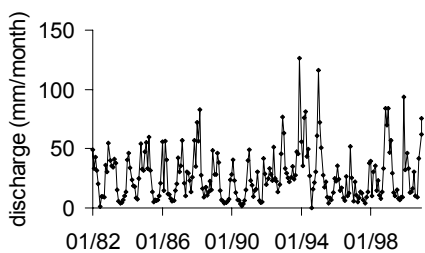

Rank stream flow observations from low to high values

Rank stream flow observations from low to high values

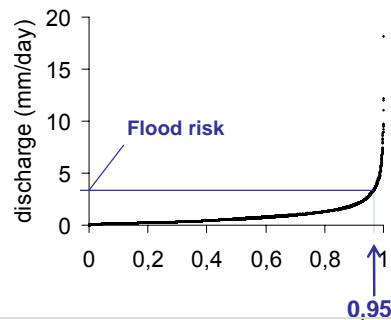
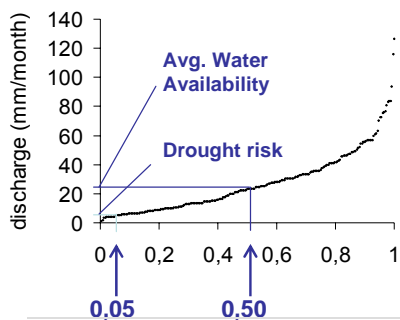

## Off-site effects

The proposed regional water balance indicators might conflict with existing water indicators for terrestrial ecosystem functioning

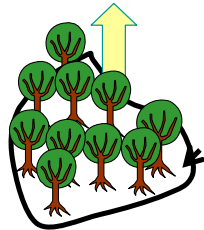

Evapotranspiration is positively correlated with terrestrial ecosystem health (land use impact category)

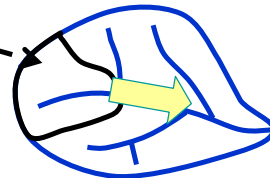

Downstream water availability is positively correlated with functioning of downstream systems (regional water balance impact category)

How can we make trade-offs between upstream and downstream interests?

Heuvelmans, 2005

KATHOLIEKE UNIVERSITEIT  
**LEUVEN**

## Off-site effects

A top-down approach can facilitate the joint interpretation of conflicting or interrelated water indicators

To this end, a (conceptual) measure or goal function of ecosystem health is needed that is applicable to terrestrial as well as aquatic ecosystems

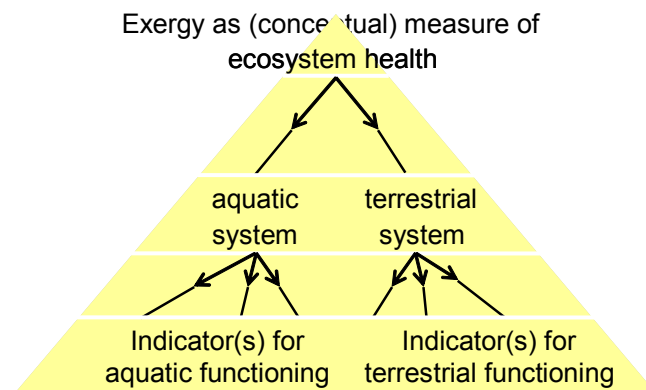

KATHOLIEKE UNIVERSITEIT  
**LEUVEN**

## Off-site effects

Exergy levels change during natural succession: earlier stages have a relatively larger aquatic exergy level, the latest stages have the highest terrestrial exergy

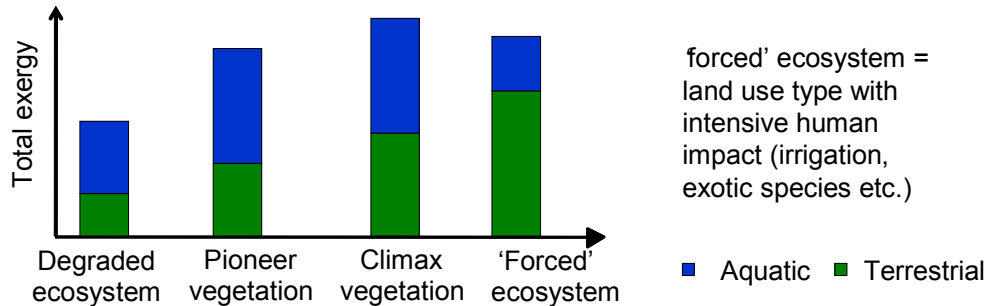

The terrestrial exergy level of forced ecosystems might surpass the terrestrial exergy level of the climax vegetation, but only at the expense of downstream ecosystem functioning

→ express impacts relative to natural climax (= reference system)

## Off-site effects

Environmental impact is measured as the deviation of the water fluxes in the present situation and in the reference system, so that systems under different abiotic conditions can be compared

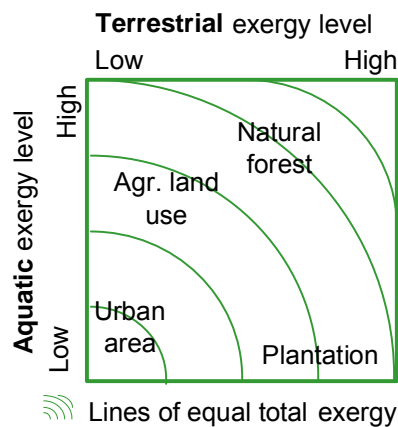

## Uncertainty analysis

Sources of uncertainty when modelling the impact of land use systems on the stream flow regime:

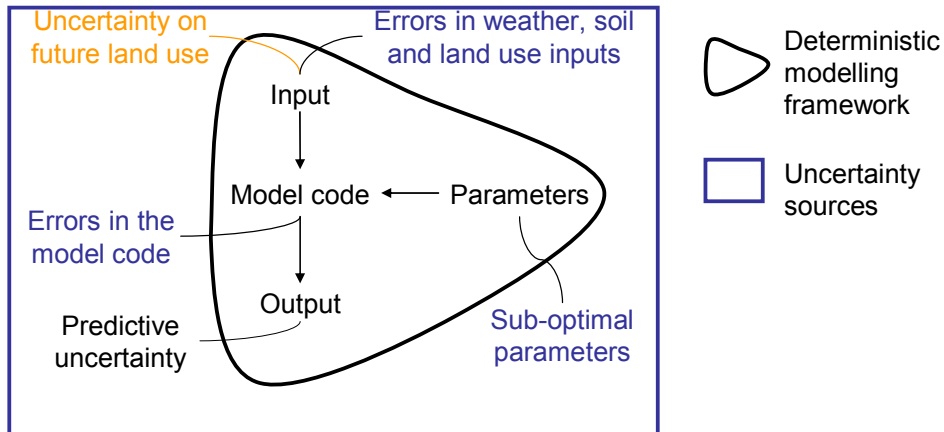

Uncertainty inherent in using a hydrological model: assessed with GLUE (General Likelihood Uncertainty Estimation)

Uncertainty on the future land use: assessed by scenario analysis

Heuvelmans, 2005

## Uncertainty analysis

In LCA one usually distinguishes 3 x 3 sources of uncertainty: data, models and choices can be missing, inappropriate or unreliable

	Missing	Inappropriate	Unreliable
Data	Regionalisation models	Sensitivity analysis and model validation	GLUE
Models	New impact category		
Choices	Scenario analysis		

These different uncertainty sources were dealt with for water quantity impacts using a variety of tools: revision of the impact description method, model calibration, validation, regionalisation, sensitivity analysis, uncertainty analysis and scenario analysis

KATHOLIEKE UNIVERSITEIT  
**LEUVEN**

## Uncertainty analysis



In an LCA study, two sources of model uncertainty are considered:

- (1) Linking interventions with indicators
- (2) Linking indicators with an 'area of protection'

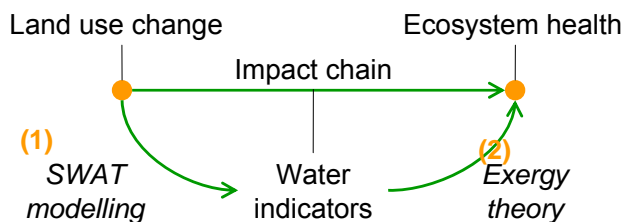

The uncertainty on (1) was assessed with GLUE

The uncertainty on (2) was not considered in this study, and could be examined in future research (validation by expert consensus, comparing different qualitative modelling approaches)

KATHOLIEKE UNIVERSITEIT  
**LEUVEN**

## References

- Wagendorp, T., H. Gulinck, P. Coppin and B. Muys, 2006. Land use impact evaluation in life cycle assessment based on ecosystem thermodynamics. *Energy* 31: 112-125.
- Muys, B. and J. Garcia, 2002. Conceptual framework for choosing indicators. In: Schweinle, J. (ed.). The assessment of environmental impacts caused by land use in the life cycle assessment of forestry and forest products. Final report Working group 2 "land use" of COST Action E9. *Mitteilungen der Bundesforschungsanstalt für Forst- und Holzwirtschaft* 209, 15-20.
- Muys, B. 2002. Reference systems. In: Schweinle, J. (ed.). The assessment of environmental impacts caused by land use in the life cycle assessment of forestry and forest products. Final report Working group 2 "land use" of COST Action E9. *Mitteilungen der Bundesforschungsanstalt für Forst- und Holzwirtschaft* 209, 56-59.
- Peters, J. J. Garcia Quijano, T. Content, G. Van Wyk, N.M. Holden, S.M Ward and B. Muys, 2004. A new land use impact assessment method for LCA: theoretical fundamentals and field validation. In: N. Halsberg (ed.) *Life Cycle Assessment in the Agri-food sector. Proceedings from the 4th International Conference*, October 6-8 2003, Bygholm, Denmark. DIAS report Animal Husbandry no. 61, 143-156.
- Wagendorp, T., B. Muys and H. Gulinck, 2003. Thermal indicators based on the ecosystem exergy concept as tool for land use impact assessment: preliminary results. In: S. Ulgiati, M.T. Brown, M. Giampietro, R.A. Herendeen, K. Mayumi (eds.). *Reconsidering the Importance of Energy. Proceedings of the third Biennial International Workshop of Advances in Energy Studies*, Porto Venere, Italy, September 24/28 2002, 305-314.
- Heuvelmans, G., J.F. Garcia-Quijano, B. Muys, J. Feyen and P. Coppin, 2005b. Modelling the water balance with SWAT as part of the land use impact evaluation in a life cycle study of CO<sub>2</sub> emission reduction scenarios. *Hydrological Processes* 19: 729-748.

# References

- Garcia-Quijano, J.F., G. Deckmyn, E. Moons, S. Proost, R. Ceulemans and B. Muys, 2005. An integrated decision support framework for the prediction and evaluation of efficiency, environmental impact and total social cost of domestic and international forestry projects for greenhouse gas mitigation: description and case studies. *Forest Ecology and Management* 207: 245-262.
- Heuvelmans, G., B. Muys and J. Feyen, 2005a. Extending the Life Cycle Methodology to Cover Impacts of Land Use Systems on the Water Balance. *International Journal of Life Cycle Assessment* 10 (2): 113-119.
- Heuvelmans, G., Muys, B., Feyen, J., 2006. Regionalisation of the parameters of a hydrological model: Comparison of linear regression models with artificial neural nets. *Journal of Hydrology* 319: 245-256.
- Heuvelmans, G., 2005. Catchment scale water quantity impact analysis related to life cycle assessment for forestry and agriculture. PhD dissertation Katholieke Universiteit Leuven. *Dissertationes de Agricultura* 676, 165p.

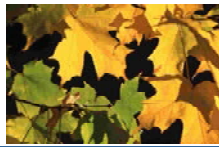
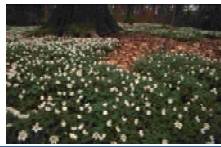

## Thank you for your attention!

Onderzoeksgroep Ecologie en Beheer van Bossen  
[www.biw.kuleuven.be/lbh/lbni/forecoman/ned/index.asp](http://www.biw.kuleuven.be/lbh/lbni/forecoman/ned/index.asp)  
[bart.muys@biw.kuleuven.be](mailto:bart.muys@biw.kuleuven.be)

KATHOLIEKE UNIVERSITEIT  
**LEUVEN**  
WWW.KULEUVEN.BE



# Assessment of agricultural management impacts on soil quality in Life Cycle Assessment (SALCA-SQ)

**Hans-Rudolf Oberholzer**  
**Peter Weisskopf**  
**G rard Gaillard**  
**Ruth Freiermuth**  
**Thomas Nemecek**

Swiss Federal Research Station for Agroecology  
and Agriculture FAL-Reckenholz, Zurich



## Framework

- System limits
  - spatial: farm
  - temporal: middle-term = 6-8 years
- Management data of all plots of a farm in a single year is representative for a whole crop rotation
- Only influences of agricultural management practices are included, not immission
- Changes of properties due to this activities are assessed, not absolute states
- The method is based on expert knowledge and bibliographical references

SETAC Meeting The Hague  
08.05.2006

Soil quality assessment (SALCA-SQ) Oberholzer et al. 2006





## Background of soil quality assessment

- **Definition of soil quality (according to OIS 1998)**
  - Site specific soil characteristics and functions, biodiversity, plant production and plant quality
- **Assessment according to concept of soil quality, based on**
  - Soil properties related to soil functions

OIS: Swiss Ordinance on Impact on Soil, 1998

SETAC Meeting The Hague  
08.05.2006

Soil quality assessment (SALCA-SQ) Oberholzer et al. 2006

 **agroscope**  
FAL RECKENHOLZ

## Impact assessment (1) Selection of direct indicators of soil quality

**Soil properties**

**Criteria**

**Direct  
Indicators**

According to ISO  
14040 and ISO 14042

Depending on the  
question of the Life  
Cycle Assessment

= measurable  
soil properties  
fulfilling all  
criteria

SETAC Meeting The Hague  
08.05.2006

Soil quality assessment (SALCA-SQ) Oberholzer et al. 2006

 **agroscope**  
FAL RECKENHOLZ

## Impact assessment (2)

### Selected direct indicators

Soil property categories	Direct indicator
Physical	Rooting depth of soil
	Macropore volume
	Aggregate stability
Chemical	Soil organic matter
	Inorganic pollutants
	Organic pollutants
Biological	Earthworm biomass
	Microbial biomass
	Microbial activity

SETAC Meeting The Hague  
08.05.2006

Soil quality assessment (SALCA-SQ) Oberholzer et al. 2006

 **agroscope**  
FAL RECKENHOLZ

## Inventory analysis and classification (1)

### Using the application of slurry as an example

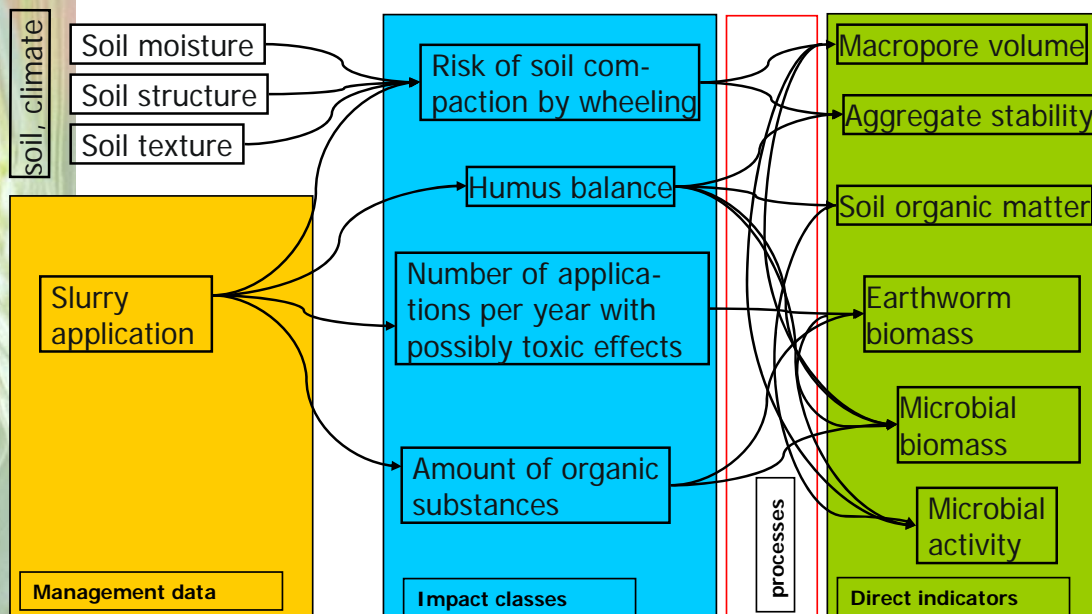

SETAC Meeting The Hague  
08.05.2006

Soil quality assessment (SALCA-SQ) Oberholzer et al. 2006

 **agroscope**  
FAL RECKENHOLZ

## Inventory analysis and classification (2) For agricultural management practices in general

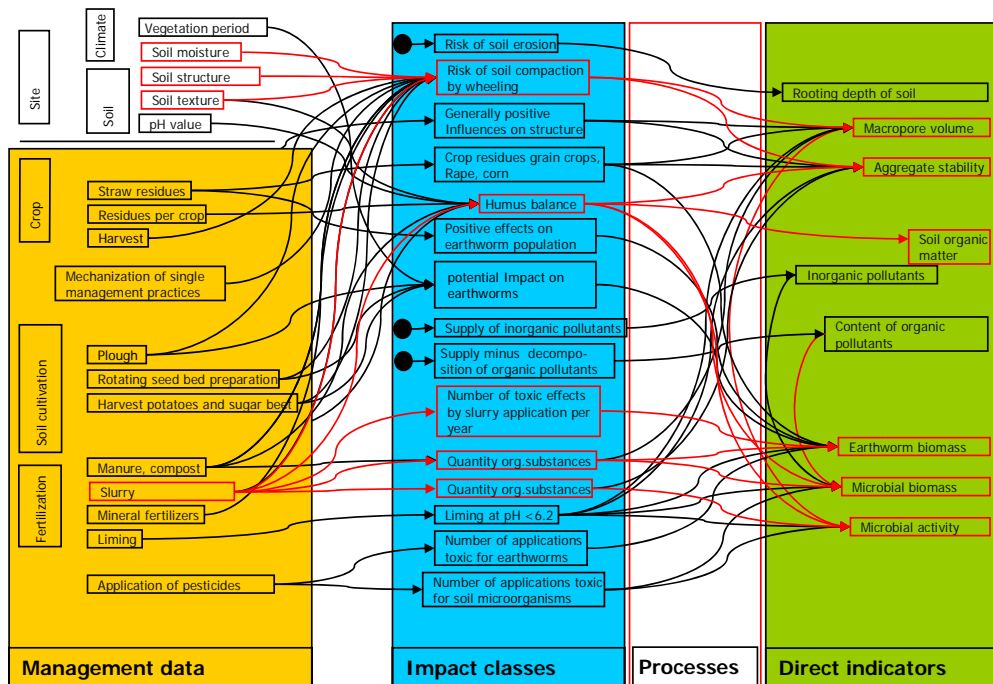

SETAC Meeting The Hague  
08.05.2006

Soil quality assessment (SALCA-SQ) Oberholzer et al. 2006

agroscope  
FAL RECKENHOLZ

## Impact assessment (3) Characterization of a single direct indicator

Impact classes	Value	Weighting	Weighted value
Impact class 1	S 1	g 1	W 1
<i>Risk of soil compaction</i>			W 2
<i>Crop residues</i>	S 3	g 3	W 3
Impact class n	S n	g n	W n
Sum of all impacts			$\Sigma(W)$

SETAC Meeting The Hague  
08.05.2006

Soil quality assessment (SALCA-SQ) Oberholzer et al. 2006

agroscope  
FAL RECKENHOLZ

## Interpretation scheme for a single direct indicator, example macropore volume

Balance of all effects on macropore volume $\Sigma(W)$	Assessment
Balance of all effects on macropore volume $> 2$	++
Balance of all effects on macropore volume $> 1$	+
Balance of all effects on macropore volume $> -1$	0
Balance of all effects on macropore volume $> -3$	-
Balance of all effects on macropore volume $\leq -3$	--

SETAC Meeting The Hague  
08.05.2006

Soil quality assessment (SALCA-SQ) Oberholzer et al. 2006

 agroscope  
FAL RECKENHOLZ

## Interpretation of impact assessment for the whole set of soil quality indicators: Main rules

- The influences on single direct indicators are not directly comparable because of:
  - different scaling schemes
  - the fact that mostly several soil functions are concerned
  - soil quality may be at risk if a single direct indicator is damaged

➤ Aggregation cannot be justified by soil science

SETAC Meeting The Hague  
08.05.2006

Soil quality assessment (SALCA-SQ) Oberholzer et al. 2006

 agroscope  
FAL RECKENHOLZ

## Scenarios for plausibility test

### Crop rotations

- **Crop rotation 1:** Monoculture silage maize
- **Crop rotation 2:** Winter wheat – winter rape - potatoes – winter barley – meadow - meadow
- **Crop rotation 3:** sugar beet – winter wheat – winter barley – winter rape – winter wheat – winter rape

### Fertilization

- **D2:** Optimum N-fertilization with ammonia nitrate
- **D3:** 70 % of D2: 90 kg N slurry + ammonia nitrate)
- **D4:** 70 % of D2: 40 kg N manure + 50 kg N slurry, + ammonia nitrate
- **D6:** 40 kg N manure and 50 kg N slurry
- **D8:** 72 kg N manure and 90 kg N slurry

- **Climatic region** with long and short vegetation period respectively

- **lightweight and heavy mechanisation**



SETAC Meeting The Hague  
08.05.2006

Soil quality assessment (SALCA-SQ) Oberholzer et al. 2006

FAL RECKENHOLZ

## Results of plausibility test: Crop rotation 2, heavy clay soil, climatic zone D (wet climate)

Direct indicators	D2	D3	D4	D6	D8
Rooting depth of soil	0	0	0	0	0
Macro pore volume	0	0	0	0	+
Aggregate stability	-	0	+	+	++
Soil organic matter	--	0	+	+	+
Inorganic pollutants	0	0	0	0	0
Organic pollutants	0	0	0	0	0
Earthworm biomass	-	-	-	-	+
Microbial biomass	-	0	0	0	+
Microbial activity	-	0	0	0	+



SETAC Meeting The Hague  
08.05.2006

Soil quality assessment (SALCA-SQ) Oberholzer et al. 2006

FAL RECKENHOLZ

## Results of comparison between management systems: Organic – Conventional farming (DOK trial, Oberwil/Switzerland)

### Treatments

- D0: unfertilized control
- D2: biodynamic management system
- O2: bioorganic management system
- K2: conventional management system
- M: minerally fertilized control

SETAC Meeting The Hague  
08.05.2006

Soil quality assessment (SALCA-SQ) Oberholzer et al. 2006

 **agroscope**  
FAL RECKENHOLZ

## Results of comparison between management systems: Organic – Conventional farming (DOK trial, Therwil/Switzerland)

Direct indicators	D0	D2	O2	K2	M
Rooting depth of soil	0	0	0	0	0
Macropore volume	-	+	+	+	-
Aggregate stability	-	+	+	+	-
Soil organic matter	--	+	+	+	--
Inorganic pollutants	0	0	0	0	0
Organic pollutants	0	0	0	0	0
Earthworm biomass	-	+	+	+	-
Microbial biomass	-	+	+	+	-
Microbial activity	-	+	+	+	-

SETAC Meeting The Hague  
08.05.2006

Soil quality assessment (SALCA-SQ) Oberholzer et al. 2006

 **agroscope**  
FAL RECKENHOLZ



## Conclusions

- First results indicate the importance of a detailed inventory of agricultural management activities for the assessment of land use impacts rather than a simplified evaluation on the management systems level.
- The method represents an objective, comprehensible possibility for the impact assessment of agricultural management practices on soil quality. It is compatible with LCA and soil sciences.
- The method is implemented in an Excel File, so that its complexity should not be a problem for the LCA practitioner.
- The results are also useful for agricultural consulting services on the farm level (“weak point analysis”).
- The single components can (and should!) be completed, improved and regularly updated.

SETAC Meeting The Hague  
08.05.2006

Soil quality assessment (SALCA-SQ) Oberholzer et al. 2006

 **agroscope**  
FAL RECKENHOLZ

## Thank you for your attention

**Detailed report of the method SALCA-SQ:**

**[www.reckenholz.ch/doc/de/forsch/control/bilanz/salca-sq.pdf](http://www.reckenholz.ch/doc/de/forsch/control/bilanz/salca-sq.pdf)**

# Life Cycle Approaches for Conservation Agriculture

Helias A. Udo de Haes  
Den Haag, 8 May 2006



## Land use in Life Cycle Impact Assessment (LCIA)

- ongoing efforts in SETAC to include land use impacts in LCIA (as part of LCA)
- for studies on agriculture and forestry these are of greatest importance
- not always easy, due to specific modelling structure of LCA
- alternative of “flagging” non-fitting impacts does not work in practice
- what to do?





## Analytical approach

- main question: which aspects of land use do fit in LCA, which aspects problematic?
- choice of an analytical approach:
  - distinction between different aspects of land use
  - analyse per aspect whether it fits in LCI/LCIA modelling structure
  - if problematic, try to find other solution



## Aspects of Land Use

- LCI-phase: interventions
  - chemical management measures
  - physical management measures
- LCIA-phase: environmental impacts
  - impacts at midpoint level
  - impacts on Life Support Functions
  - impacts at damage level



## Management measures

- Chemical
  - use of fertilizers and pesticides
  - use of fossil fuels
- Physical
  - terrassing of croplands, removal of terrasses
  - restoration of eroded fields
  - irrigation and drainage
  - type of harvesting (by hand, mechanical)
  - use of intercrop species
  - ploughing, removal of weed vegetation
  - conservation of patches of wild vegetation



## Midpoint impacts

- surface needed for crops
- organic carbon content of soil
- release/fate/effect of CO<sub>2</sub>, N<sub>2</sub>O, CH<sub>4</sub>
- release/fate/effect of nutrients
- release/fate/effect of pesticides
- salinization
- land use (standing crop)



# Impacts on Life Support Functions

- soil erosion
- soil fertility loss
- disturbance of hydrology



## Impacts at damage level

- habitat loss / impacts on biodiversity
- loss in yield



## Conditions for good fit in LCI/LCIA

- quantitative
- relation to functional unit (input or output character)
- generic regarding space (not site specific)
- steady state or fleet-based analysis, no one-time transitions

## Potentials of LCI

- use of flow chart to identify relevant impacts
- management measures related to material and/or energy flows



## Potentials of LCIA

- surface needed for crops (current)
- carbon sequestration (current)
- release of CO<sub>2</sub>, N<sub>2</sub>O, CH<sub>4</sub> (current)
- water use (in development)
- nutrients, acids, metal ions and pesticides to groundwater (extended fate modelling) (new)
- salinization of soil (new)



## Problematic to include in LCI/LCIA

- physical management measures (terrassing, choice tree species, etc.)
- impacts on hydrology
- soil erosion
- loss of soil productivity
- one-time habitat loss
- concomitant biodiversity



## Can it still be done?

- increasingly efforts are being made
- possibilities after transformations
- scientific challenge
- but results far removed from common understanding
- support for decision making questionable
- other possibilities?



## What other tools to be used?

- analytical tools:
  - environmental risk assessment (local effects toxics)
  - ecological modelling (soil fertility, soil erosion)
- procedural tools:
  - certification of resource production / extraction
  - Type I and Type III labelling of products



## Examples of certification

- Forestry: Forest Stewardship Council (FSC)
  - forestry management
  - Chain of Custody (Type III)
- Fisheries: Marine Stewardship Council (MSC)
- Agriculture: Organic farming; SAI
- Mining: Sustainable Mining ?
- statement: this approach more productive than squeezing *all* impacts in LCA jacket



## Conclusions on land use in LCA

1. LCI flow chart remains basis
2. quite some criteria for land use can be underpinned by LCI/LCIA
3. some additional LCIA impacts (impact categories) possible
4. a number of criteria problematic to fit in LCA
5. these preferably dealt with in other tools
6. then still contributions from LCA possible



## 4.2 *Integral version of posters*

Without further comments (and page numbers) we present the integral versions of the poster in the following order:

- 1) Development of a method for identifying marginal suppliers of agricultural crops in consequential LCA of biobased products (J Kløverpris)
- 2) Life Cycle Assessment of a poplar energetic crop system (C. Martinez)
- 3) Environmental Impact Assessment of orange juice and energy exploitation of the solid wastes (C. Koroneos) (Summary of manuscript)
- 4) A universal method to assess functional and structural impacts of human-induced land use and land use change: integrating ecosystem concepts and LCA principles (J. Garcia-Quijano)
- 5) Integration of biodiversity as life cycle impact category for LCA in agriculture (P. Jeanneret)
- 6) Balancing carbon emission and sequestration fluxes of forest land based on a LCI-approach (R. Wollenman)
- 7) LCA of horticultural crops including impacts on soil quality and pesticide rating (L. Mila i Canals)
- 8) Analysis of environmental performance indicators for forestry and agricultural production systems on the northern slopes of the Swiss Alps (H. Heinemann).

The readability of some posters is low; please ask authors to send the original files for full details!



# Model for the Identification of Marginal Crop Production in LCA

- a pre-requisite for land use impact assessment of crop use

The present industrial PhD project addresses the consequences of using a given crop in the life cycle of a product, e.g. wheat for ethanol production.

Increased demand for the crop of interest (i) leads to increased world market prices and, thereby, incentives to produce more in different regions. The increased production caused by the increased demand is designated the marginal production. This derives from either intensification (higher yield), expansion of the area planted (at the expense of natural areas) and/or displacement of other crops on existing agricultural land.

The reduced supply of these crops leads to increased prices on carbohydrates, protein and oil depending on the market. This will stimulate the production of carbohydrate, protein and oil crops leading to replacement of the displaced crops. Once again, the increased production will come from intensification, expansion and/or displacement. The latter will displace other crops and so on.

At some point, the displacement will become negligible and all increased production will have been divided between intensification and expansion in different countries. For each country, the impacts can then be assessed.



Jesper Kløverpris<sup>1,2</sup>  
Henrik Wenzel<sup>1</sup>  
Per H Nielsen<sup>2</sup>

<sup>1</sup>Department of Manufacturing Engineering and Management  
Technical University of Denmark

<sup>2</sup>Novozymes A/S

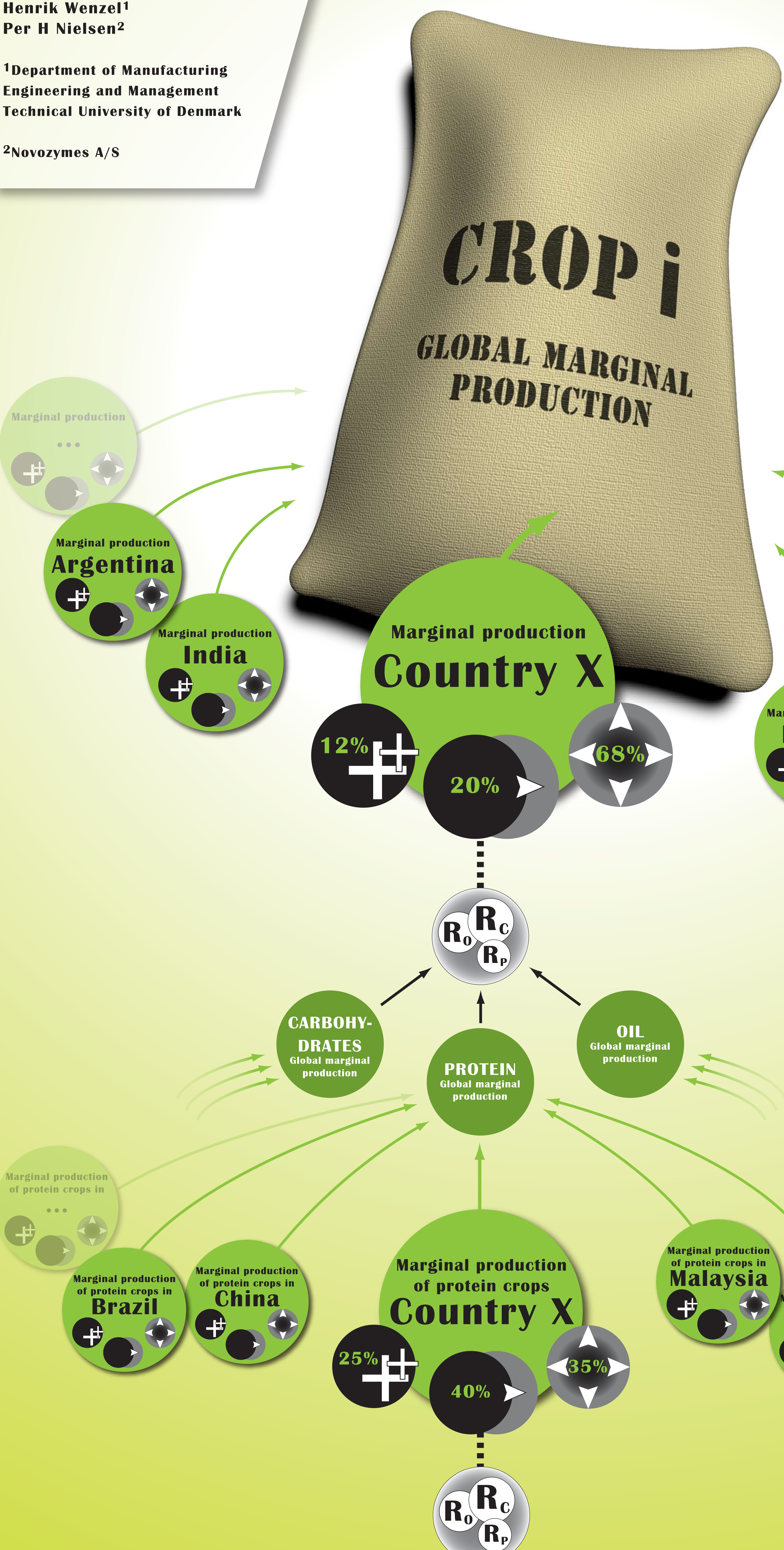

## Global Marginal Production of Crop i

So far, life cycle impact assessment of crop production has mainly been based on the production method of the immediate crop supplier. Unfortunately, this does not reflect the actual consequences of using a crop-based product instead of a conventional. If gasoline is displaced by ethanol produced from wheat grown in Denmark, this will only have a small effect on the agricultural system in the country. The most prominent effect is likely to be a decrease in the Danish exports of wheat. In other words, the consequences will lie outside of Denmark. The decreased supply on the world market will stimulate production in other countries and this is the consequence on which the impact assessment should be based. The increased production caused by the increased demand and distributed geographically is designated the global marginal production.



## National Marginal Production of Crop i

Increased production of a crop can be achieved by the following three processes:

### Intensification Higher Yield

There are several ways to achieve higher yields. Some of them are mentioned here:

- Increased application of fertilizers
- Increased application of pesticides
- Increased levels of irrigation
- Use of improved crop strains
- Improved agricultural practice

In some countries of the world, intensification does not occur as a result of increased demand but due to internal competition between farmers. Such intensification is not considered part of the marginal production since it is not caused by increased demand. The intensification measures are important in the impact assessment.



### Expansion into natural areas

In some parts of the world, deforestation is a common example of this process. The impact assessment of increased crop production must account for the fraction of marginal production achieved by expansion. Indicators may be erosion and loss of biodiversity.

### Displacement of other crops

This process takes place on existing agricultural land. When displacement occurs, it is necessary to consider the service previously provided by the crops displaced. At the present stage of the project, this is considered to be animal feed. This service must be replaced in the system modeling.

### Replacement of the service provided by the crop displaced

When some crops are not grown due to displacement by crop i, their service must be provided in another way. Based on the assumption, that the crops displaced were previously used for animal feed, their service was to provide carbohydrates, protein and oil (fat) for the animals. Protein must now be provided by an increased global production of protein crops. These are defined as crops primarily grown for their content of protein. However, they will also contain carbohydrates and oil, which will displace global marginal production of these substances. This has not been indicated in the diagram to the left, but is included in the computer simulations of the systems. The increased production of protein crops will occur by intensification, expansion and/or displacement. Likewise for carbohydrate and oil crops. This means that other crops will be displaced again. This is accounted for in a next iteration and so on.

## Computer Simulations of the System

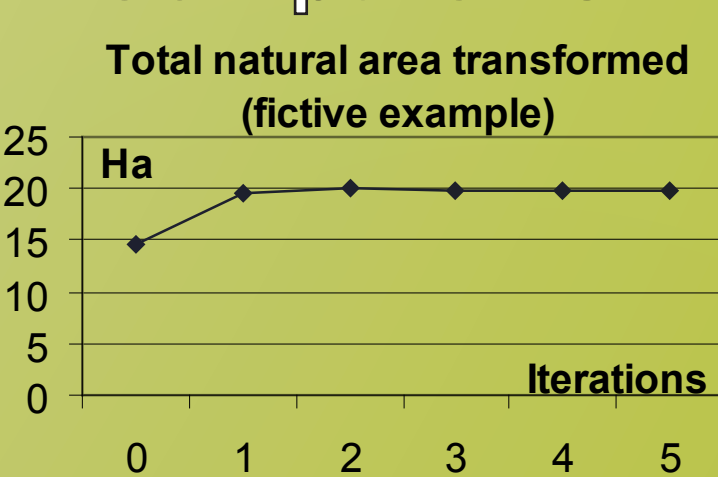

The system demonstrated to the left has been implemented in a spreadsheet model with fictive data. This model is iterative due to the continued displacement of crops in the system. However, the model reaches a steady result after just a few iterations. This can be seen in the graph to the left, which demonstrates the calculation of the total natural area transformed due to an increased production of the crop i. The system has also been implemented in the LCA software SimaPro where the results from the spreadsheet model have been reproduced.

## Results and outlook

So far, this study has only handled the consequences of increased crop production at a theoretical level. The next step in the project will be to retrieve concrete data for the modeling of the system described. For this purpose, output from a global economic equilibrium model will be used. If successful, this study will provide a result in the format shown below. This will form the basis for an impact assessment of increased crop production indicating the actual consequences. The suggested analysis is difficult to perform but once it has been carried out, it can be used in any LCA involving consumption of major crops. The input parameters will just have to be updated from time to time.

1000 kg Crop i

Inventory			
Country	Intensification	Expansion	Natural area transformed
Argentina	23 kg	30 kg	42 m <sup>2</sup> tropical dry forest
Brazil	40 kg	21 kg	70 m <sup>2</sup> tropical rainforest
China	148 kg	5 kg	10 m <sup>2</sup> grassland
Country X	4 kg	17 kg	68 m <sup>2</sup> temperate forest
India	17 kg	0 kg	(no expansion)
Malaysia	1 kg	3 kg	10 m <sup>2</sup> tropical rainforest
Russia	4 kg	0 kg	(no expansion)
Ukraine	8 kg	0 kg	(no expansion)
USA	190 kg	0 kg	(no expansion)
...	...	...	...

FICTIVE DATA

## Impact Assessment

### Acknowledgements

The authors are grateful to the Danish Ministry of Science, Technology and Innovation, which is partly funding the project and to professor Anette Reenberg from the Institute of Geography at the University of Copenhagen who serves as co-advisor.

# LIFE CYCLE ASSESSMENT OF A POPLAR ENERGETIC CROP SYSTEM.



## ABSTRACT

A LCA study is performed to assess the environmental and energy performance of hybrid poplar crop biomass production in short rotation coppice in southern Europe.

The results show that cultivated poplar as biomass energy crop in southern Europe is energetic efficient and environmental sustainable.

Carles Martínez<sup>1</sup>, Xavier Gabarrell<sup>1,2</sup>, Assumpció Anton<sup>3</sup>, Miquel Rigola<sup>4</sup>, Pilar Ciria<sup>5</sup>, Juan Carrasco<sup>5</sup>, Joan Rieradevall<sup>1,2</sup>

<sup>1</sup>Institut de Ciència i Tecnologia Ambientals (ICTA). SosteniPrA. Universitat Autònoma de Barcelona, 08193 Bellaterra (Barcelona), Spain.

<sup>2</sup>Departament d'Enginyeria Química. Universitat Autònoma de Barcelona 08193 Bellaterra (Barcelona), Spain.

<sup>3</sup>Institut de Recerca i Tecnologies Agroalimentaries, Centre de Cabriels. Carretera de cabriels s/n 08348. Barcelona (Spain)

<sup>4</sup>Institut del Medi Ambient. Universitat de Girona. Campus Montilivi M24. 17071. Girona (Spain).

<sup>5</sup>Centro de Investigaciones Energéticas, Medioambientales y Tecnológicas (CIEMAT), Avda Complutense, 22. 28040 Madrid (Spain).

\*e-mail: [carles.martinez@uab.es](mailto:carles.martinez@uab.es); [www.sostenipra.cat](http://www.sostenipra.cat)

## INTRODUCTION AND OBJECTIVES

The poplar as energy crop has been deeply analysed in northern and centre Europe [1]. However, in European southern countries, this crop is just being developed as a source of renewable energy.

The main objective of this study is to demonstrate poplar's high potentialities in European southern countries as a renewable energy. In order to analyse the energetic and environmental performance of this energy crop, a Life Cycle Assessment has been carried out.

## MATERIAL & METHODS

Location of the Experimental Parcels



The poplar agricultural production uses field data collected during the establishment of four parcels in the region of Soria (northern Spain) in 1999. The parcels have an extension of 0,65 ha with a plantation density of 10000 plants/ha. The environmental impact of the poplar system is analysed following the Life Cycle assessment methodology [2].

The software used was SimaPro V.6.0. developed by Pré Consultants [3].

**Functional Unit:** the production of 1 tone of the poplar dry matter.

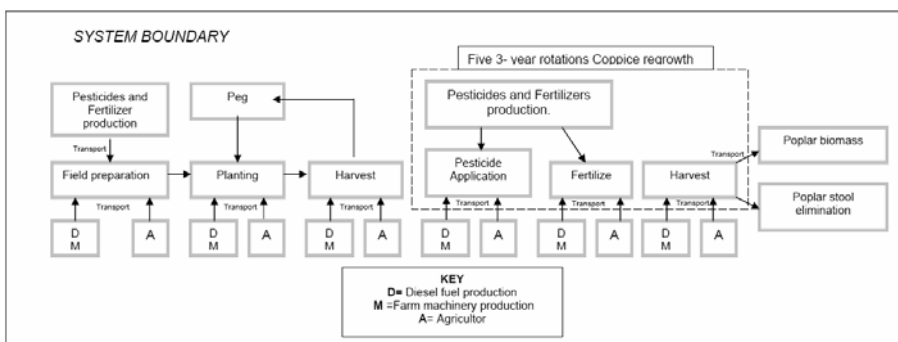

## RESULTS & DISCUSSION

### •Energy balance

Type of energy	MJ Produced	MJ Consumed	Net Energy Ratio
Direct energy stored in biomass	18,200	368	98%
Calorific energy production (85%)	15,470		97%
Electric energy production (27%)	4,910		93%

The net energy ratios (energy outputs divided the primary energy consumed) demonstrate the high energy efficient of this system.

### •Energy Consumption of the system.

The main consumption stages of the system are the production of agrochemicals and the transport phases. The first one represents a 42% and the second a 39% of the total energy consumption of the system.

MJ consumed by poplar biomass crop system

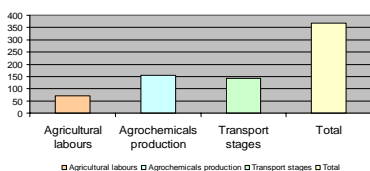

### •Environmental impacts

	AB	GW	OLD	HT	FWAE	MAE	TE	PO	A	E
Agricultural labours	0.5	78.9	0.000009	83.6	8.8	18,981	0.5	0.02	0.6	0.1
Agrochemicals production	1.1	247.7	0.000017	82.3	15.2	58,649	1.1	0.03	0.9	0.2
Agrochemicals application	0	73.2	0	5.2	192.7	0	3.7	0	1.3	0.3
Transport stages	0.08	13.4	0.000016	2.9	0.2	687	0.006	0.008	0.02	0.0005
<b>TOTAL</b>	<b>1.68</b>	<b>413.2</b>	<b>0.000042</b>	<b>174</b>	<b>216.9</b>	<b>78,317</b>	<b>5.3</b>	<b>0.06</b>	<b>2.8</b>	<b>0.6</b>

AB: Abiotic Depletion (kg. SB eq.), GW: Global Warming (kg. CO<sub>2</sub> eq.), OLD: Ozone Layer Depletion (kg. CFC-11 eq.), HT: Human Toxicity (kg. DB eq.), FWAE: Fresh Water Aquatic Ecotox (kg. DB eq.), MAE: Marine Aquatic Ecotox (kg. DB eq.), TE: Terrestrial Ecotox (kg. DB eq.), PO: Photochemical Oxidation (kg. C<sub>2</sub>H<sub>2</sub>), A: Acidification (kg. SO<sub>2</sub>), E: Eutrophication (kg. PO<sub>4</sub>).

The production of agrochemical have the highest impact in 5 of the 10 categories analysed and the use in 4 of the 10.

The use of mineral fertilizers and herbicides ( production and application) are the most critical environmental actions of the system. Itself represent between 96-40%.

## CONCLUSIONS

The energy and environmental results obtained show that poplar crops used to obtain biomass have a high implementation potential in southern Europe.

Furthermore, the strategic planning of the transport and the use of other kind of fertilizers can lead to a reduction of the environmental impacts of the system analysed.

Other impact categories such as water consumption and soil erosion, which are very vulnerable environmental aspects in Southern Europe, should be studied in order to achieve a more accurate analysis of the environmental performance of poplar crops.

## ACKNOWLEDGEMENTS

This project was funded by the Ministry of Science and Technology, through the project "Evaluation of the Environmental Sustainability of Energetic crops (CTM2004-06800-C03-01)" and SosteniPrA Reserch Group. Dursi (SGR2005-00007).

## BIBLIOGRAPHY

- [1]Venendaal R, Jorgensen U, Fosters C.A. European energy crops: a Synthesis. Biomass an Bioenergy 1997; 13: 147-185.
- [2]JAENOR 2000. "Gestión Medioambiental. Análisis de Ciclo de Vida. Evaluación de impacto del Ciclo de Vida". (ISO14042:2000)
- [3] Pré Consultants. [www.pre.nl](http://www.pre.nl)

# ENVIRONMENTAL IMPACT ASSESSMENT OF ORANGE JUICE PRODUCTION

C. Koroneos\*, D. Rovas, N. Tzanis  
Laboratory of Heat Transfer and Environmental Engineering,  
Aristotle University of Thessalonica,  
P.O. Box 483, GR 54124, Thessalonica, Greece

---

## Abstract

Life Cycle Assessment (LCA) is a useful tool to assess the environmental impact of a product, process or service and it can be very useful to the comparison of similar products. Life Cycle Assessment methodology can lead to interventions that minimize the magnitude of pollution, conserve fossils and ecological systems, develop and utilize cleaner technologies and maximize recycling. Although LCA is a relatively new method it has been accepted and used by industries worldwide. LCA is a tool that is very central to the eco-design of products and processes.

The overall aim of this work is to evaluate the environmental impacts of the orange juice production at all life cycle stages as well as examine the energy exploitation of the solid wastes that results from the citrus processing industries via anaerobic digestion.

The life cycle of the orange juice production constitutes of the cultivation of orange trees, the transportation of oranges into the citrus-processing industry, the production of juice and the transportation of solid wastes into the suggested anaerobic reactor. The functional unit is taken to be the treatment of one ton of oranges. The inventory analysis is presented, while at the same time the flows of energy and material are investigated at all stages of the production. For the investigation of environmental effects of the system, the impact of the emissions of all stages were evaluated and various conclusions have been drawn.

*Keywords: Anaerobic Fermentation; Cultivation; Energy; Life Cycle Assessment; Orange Juice Production; Solid Wastes;*

---

\*Christopher J. Koroneos : Tel no. (2310)/995968, FAX:(2310)/996012, Email: [koroneos@aix.meng.auth.gr](mailto:koroneos@aix.meng.auth.gr)

## ***Orange juice production system***

The system under study is made up of the following parts: cultivation, juice industrial processing, anaerobic digestion (Figure 1)

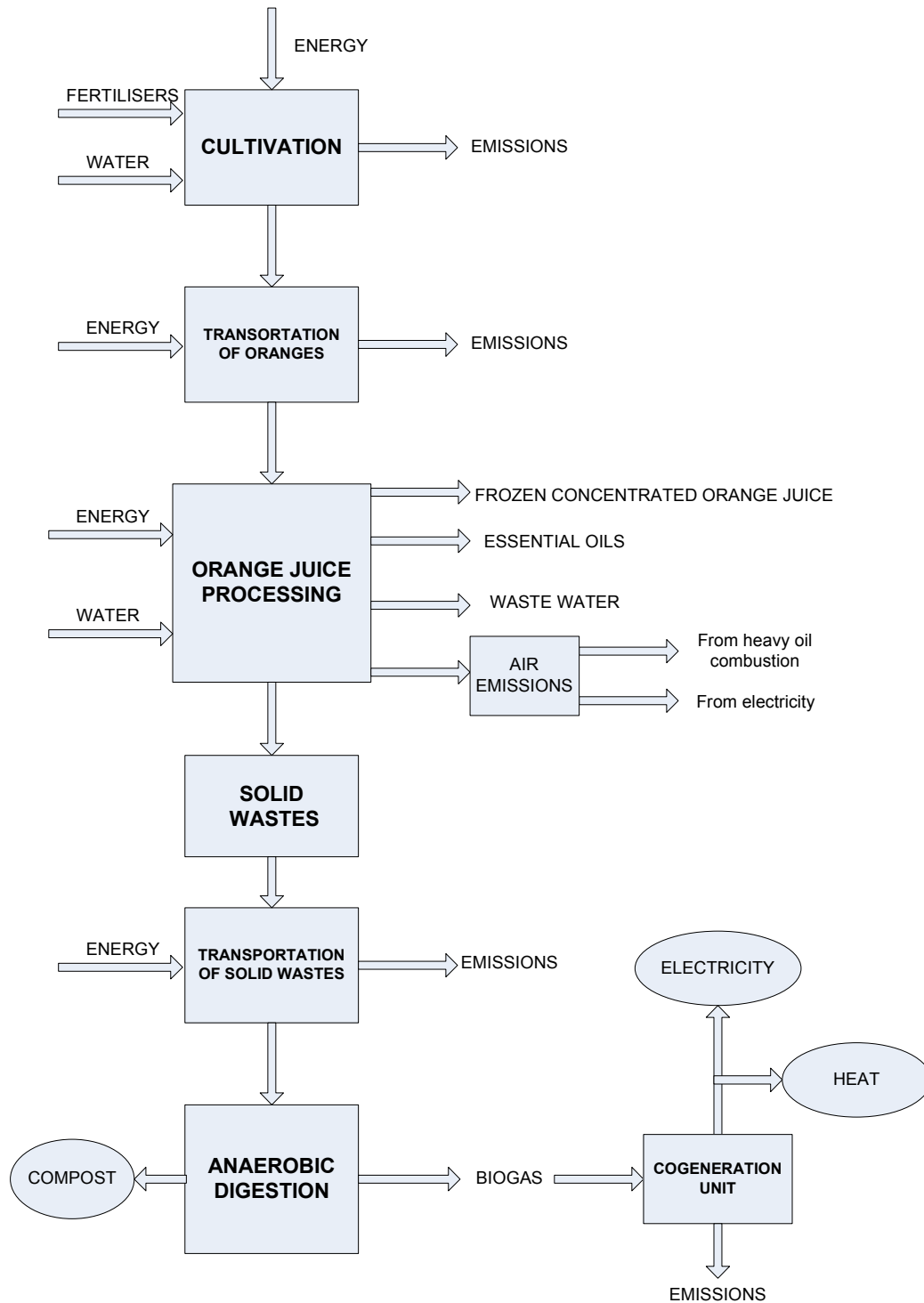

Figure 1. Life cycle of orange juice production

Based on the data of the Greek Ministry of Agriculture the total production of citrus fruits in Greece is approximately 1.300.000 ton per year and only the 1/3 of the production is processed for juice extraction from 18 units from which the 11 are located in the Peloponnese area. From these quantities the 80% of citrus concern oranges, 12.4% lemons, 6.2% mandarines and roughly 1% grape fruit (data of 1999).

The quantities of treatment of oranges in average values of three-year period 1998-2000 are given in table 1.

Table 1. Quantities of treatment of by-products and wastes from oranges in Greece (tons) average values (1998 – 2000)

Type	Processed	Juice	Ess. oils	Solid Waste	Waste Water	Total Waste
Oranges	300.000	90.000	300	160.000	50.000	210.000

Thus from 1000 kg oranges, there are 300kg of juice, 533 kg solid wastes, 166 kg waste water and 1 kg essential oils produced (figure 2)

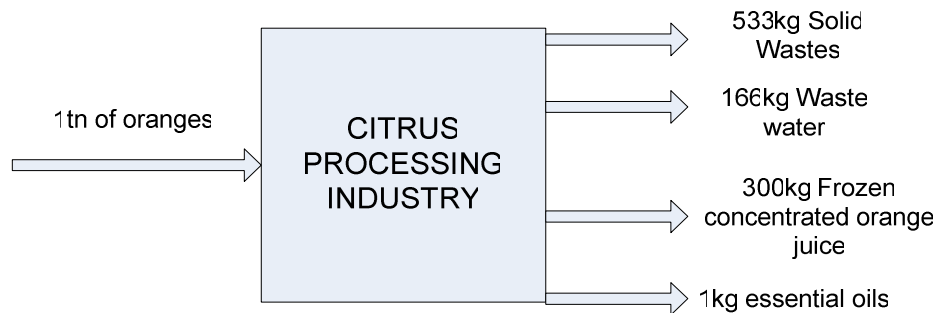

Figure 2. Flowsheet of the citrus processing industry.

The processing of one ton of oranges with the outputs resulting is shown on table 2.

Table 2. Consumptions of resources and energy from the treatment of 1 ton of oranges in the industry

Citrus processing Industry	Water consumption	Electricity Consumption	Fuel Consumption (heavy oil)
1 ton of oranges	2,3 m <sup>3</sup>	11,82kWh	2,86kg

The anaerobic digestion is based on the major by-products and waste streams during citrus juice and concentrate processing, namely juice extractor residues, press liquors from the dewatering of citrus peel prior to drying and the effluent of mill centrifuges. A reference citrus waste composition is presented in Table 3.

Table 3. Citrus waste composition[1]

<i>Citrus waste composition</i>	
<b>TS (%)</b>	<i>17.9</i>
<b>VS (%TS)</b>	<i>96.1</i>
<b>N (%TS)</b>	<i>1.06</i>
<b>P (%TS)</b>	<i>0.121</i>
<b>K (%TS)</b>	<i>1.18</i>
<b>COD (%TS)</b>	<i>114</i>
<b>BOD (%TS)</b>	<i>56</i>

The flows of energy for the anaerobic digestion of the solid waste from the processing of one ton of oranges is shown in figure 4..

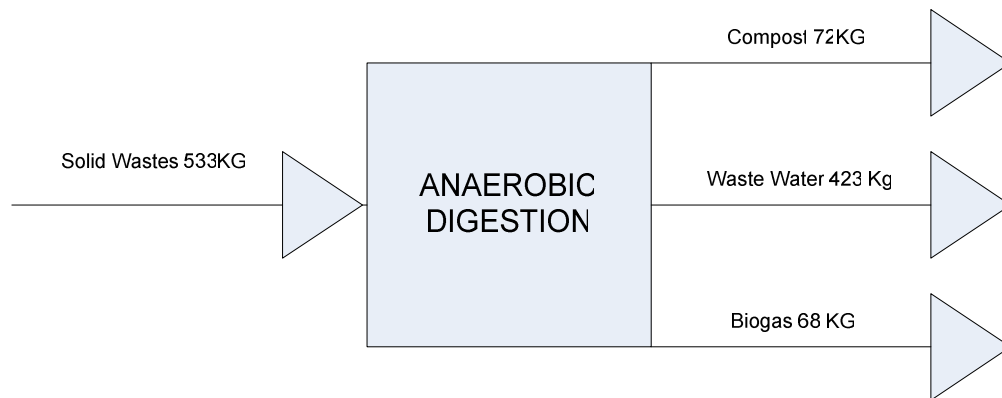

Figure 3. Quantitative flows of functional unit at the stage of anaerobic fermentation

## Environmental Impact Assessment

The environmental Impact assessment is calculated using Eco-Indicator 95 methodology and the results are shown in figure 4

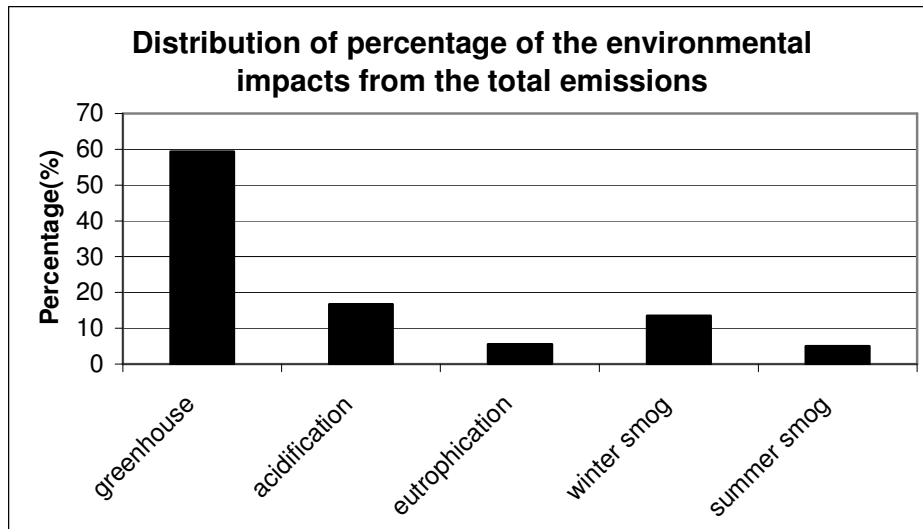

Figure 4. Column diagram of evaluated values from the environmental impacts of total emissions from all the stages of the current LCA

1. Graumlich T.R., (1983), Potential fermentation products from citrus processing wastes, Food Technology, 12/1983.



# A top-down approach to land quality evaluation in life cycle assessment based on close-to-criticality-operation state of the ecosystem and exergy concept

Juan F. Garcia-Quijano<sup>1</sup> ([juan.garcia@agr.kuleuven.ac.be](mailto:juan.garcia@agr.kuleuven.ac.be)), Griet Heuvelmans<sup>2</sup> and Bart Muys<sup>1</sup>

<sup>1</sup>K.U.Leuven, Division for Forest, Nature and Landscape, Celestijnenlaan 200 E, B-3001 Leuven, Belgium; <sup>2</sup>Ecorem, Antwerp, Belgium



## 1. Introduction

The Kyoto Protocol of the UNFCCC allows the Clean Development Mechanism (CDM) afforestation and reforestation (AR) projects in developing countries to reduce GHG in the atmosphere and supporting sustainable development at the same time.

Socio-economic, institutional and environmental aspects must be taken into account from the designing phase throughout the implementation and monitoring phases of the project.

Annex B of the Modalities and Procedures for CDM-AR projects approved at the Conference of Parties of the UNFCCC (CoP9 in Milan, Italy 2003), states that Project Design Documents (PDD) of CDM-AR projects should describe the project activity and the present environmental conditions (i.e. climate, hydrology, soils, ecosystems and endangered species and their habitats, analysis of the environmental impact including biodiversity, natural ecosystems, and off site impacts).

Planning and design phases needs instruments (e.g. Environmental Impact Assessment (EIA) and Risk Analysis) which are aimed at identifying possible negative impacts and at elaborating alternative course of actions or control measures. For the implementation and monitoring phase, tools [e.g. Life Cycle Assessment (LCA) among others] aim at surveying the environmental state of sites & ecosystems.

## 2. ENCOFOR project (see section 4A)

**Philosophy:** Maximizing synergies between the sequestration of carbon and the generation of benefits for the environment and local stakeholders.

**Audience:** Governments, local communities, NGOs, as well as project managers, investors and certifiers.

**Partners:** Face Foundation, KU Leuven, Joanneum Research, B.S.S. economic consultants, ICRAF, FIS Ltd/Unique, CETEFOR, Prof. J. Kuylenstierna.

**Overall objective:** Development of framework to design sustainable CDM AR projects taking into account the interest of all stakeholders and to test it in 4 case studies in 4 non – Annex I countries (Bolivia, Ecuador, Kenya & Uganda).

## 3. Proposal

We propose the use of Environmental Impact Assessment (EIA) methods for the planning and design phases and a new Land Use Impact Assessment method based on LCA and exergy concepts for the implementation and monitoring phases. EIA leads to an Environmental Impact Statement (EIS), a document meeting government requirements and added as part of the Project Design Document (PDD).

The ENCOFOR project is designed in three steps (section 4A) where among other analyses, a full EIA is developed (section 4B & 4C). During the prefeasibility step of the ENCOFOR, the two first phases of an EIA, i.e. project proposal and scoping, are carried out by means of a land and socio-economic suitability analyses. After this, the first draft of the EIS is prepared. During the second step of the ENCOFOR project, this EIS draft is discussed with local stakeholders in order to improve the initial identification of possible problems with local knowledge. Baseline assessments and greenhouse gases balance are carried out, upon which the proper environmental and socio-economic impact assessment will be executed. Results of these analyses will be submitted for public review and comments. As consequence of this interaction in the final level of the feasibility level, the final project design, assembles all the analysis, inputs and feedbacks to prepare, first, the final EIS that will be part of the PDD; second, decisions about the best project type to be carried out and the measures to avoid or to mitigate negative effects derived from the execution of the CDM-AR project; and third, the basic plan to evaluate and monitor if the decisions and measures taken are accomplishing with their objectives.

In order to accomplish with the last phase of an EIA, i.e. evaluation and monitoring, we propose a new Land Use Impact Assessment Method that compares the quality of the actual land use with the quality of the Potential Natural Vegetation of the site over the actual conditions (see figure in section 4D1). Assessment is carried out by means of 17 indicators in order to improve the initial identification of possible problems with local knowledge. Baseline assessments and greenhouse gases balance are carried out, upon which the proper environmental and socio-economic impact assessment will be executed. Results of these analyses will be submitted for public review and comments. As consequence of this interaction in the final level of the feasibility level, the final project design, assembles all the analysis, inputs and feedbacks to prepare, first, the final EIS that will be part of the PDD; second, decisions about the best project type to be carried out and the measures to avoid or to mitigate negative effects derived from the execution of the CDM-AR project; and third, the basic plan to evaluate and monitor if the decisions and measures taken are accomplishing with their objectives.

The method is scale independent and applies to all land uses in the world. Indicators were chosen because they identify changes in the flow & storage of energy and matter pointing out modifications of the dissipation capacity of the ecosystem. Impacts of each indicator are expressed by functional unit (i.e. 1 tonCO<sub>2</sub> emission reduction).

## 6. Conclusion:

The proposed EIA method measures the difference in quality between the actual land use or production system and a reference natural system representative of the project area. 17 indicators divided into 4 themes measure the changes in flux and storage of matter and energy, taking into account the time-space needs of the production system and allocating impacts to the functional units of the production system. Aggregations of the indicators by themes allows to identify problematic areas and therefore the appropriate measures can be taken. Addition of local indicators are allowed according the EIS.

## 4. Structure of the proposal, ENCOFOR and land occupation & land use cases

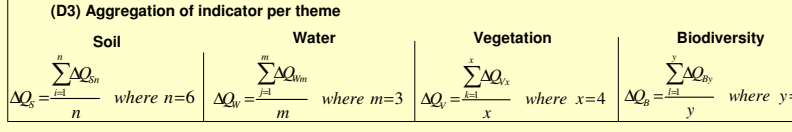
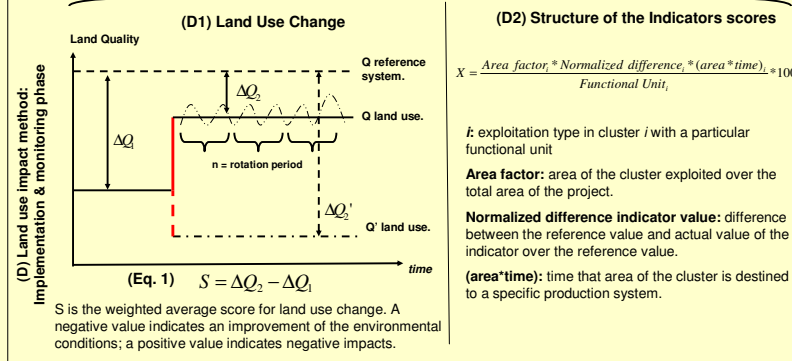
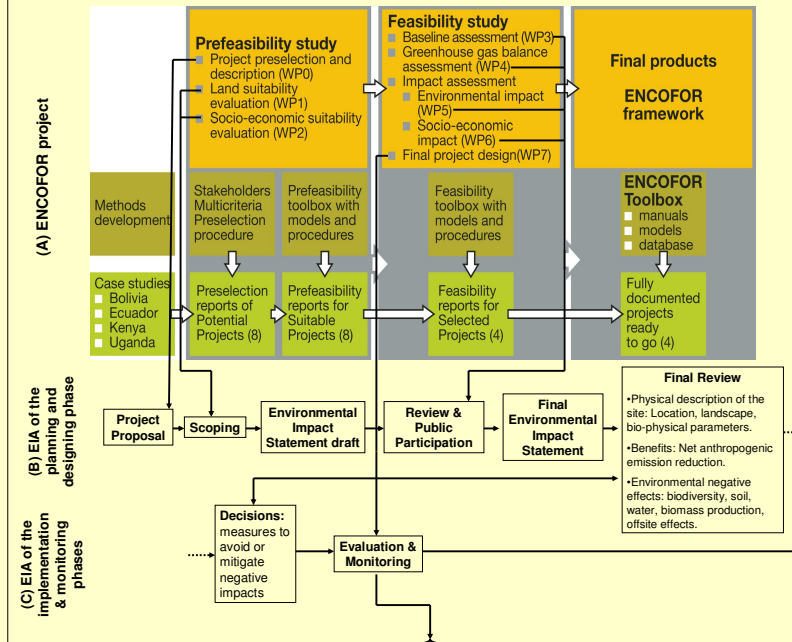

## 5. Indicators for Environmental Performance

Every indicator described below will be multiplied by the following factor

$$F = \frac{(time * area)_i}{Functional Unit_i} * 100$$

In addition to the proposed indicators, other indicators for key factors locally identified during the preparation of the EIS and land suitability analysis can be incorporated

<b>Infiltration</b> $S1 = \sum_i \left( \frac{A_i * (I_{ref} - I_{act})}{A_i * I_{ref}} \right)$	<b>Cation Exchange Capacity</b> $S4 = \sum_i \left( \frac{A_i * (CEC_{ref} - CEC_{act})}{A_i * CEC_{ref}} \right)$
<b>Soil structure disturbance</b> $S2 = \sum_i \left( \frac{A_i * d_{act}}{A_i * d_{ref}} \right)$	<b>Base Saturation</b> $S5 = \sum_i \left( \frac{A_i * (BS_{ref} - BS_{act})}{A_i * BS_{ref}} \right)$
<b>Soil Erosion</b> $S3 = \sum_i \left( \frac{A_i * \left[ \frac{soil_{ref}}{A_i} \right] / d_{ds}}{A_i * \left[ \frac{soil_{act}}{A_i} \right] / d_{ds}} \right)$	<b>Liming, fertilizing &amp; impoverishment</b> $S6 = \sum_i \left( \frac{A_{lim}}{A_i} \right)$

*I*: infiltration; *CEC*: cation exchange capacity; *d*: soil depth; *BS*: base saturation; *soil<sub>ref</sub>*: soil, soil eroded; *ρ*: bulk density; *A<sub>i</sub>*: area; *t*: recovery time of the system; *R<sub>p</sub>*: rotation period; *FU*: functional unit; *i*: cluster; *A<sub>lim</sub>*: limed, fertilized or impoverished area.

<b>Evapotranspiration</b> $W1 = \sum_i \left( \frac{A_i * (E_{ref} - E_{act})}{A_i * E_{ref}} \right)$	<b>Artificial change of water balance</b> $W3 = \sum_i \left( \frac{A_{irrig} + A_{drain}}{A_i} \right)$
<b>Surface Runoff</b> $W2 = \left( \frac{Q}{P - E_{avg-act}} \right)$	<i>E</i> : evapotranspiration; <i>Q</i> : surface runoff; <i>P</i> : precipitation; <i>avg</i> : average of the whole project site; <i>ref</i> : reference; <i>act</i> : actual; <i>A<sub>irrig</sub></i> : area irrigated; <i>A<sub>drain</sub></i> : area drained.

<b>Total Aboveground Biomass</b> $V1 = \sum_i \left( \frac{A_i * (TAB_{ref} - TAB_{act})}{A_i * TAB_{ref}} \right)$	<b>Vertical Space Structure</b> $V3 = \sum_i \left( \frac{A_i * \left[ 1 - \frac{H_{act}/St_{act}}{H_{ref}/St_{ref}} \right]}{A_i * \left[ 1 - \frac{H_{ref}/St_{ref}}{H_{ref}/St_{ref}} \right]} \right)$
<b>Leaf Area Index</b> $V2 = \sum_i \left( \frac{A_i * (LAI_{ref} - LAI_{act})}{A_i * LAI_{ref}} \right)$	<b>Free Net Primary Production</b> $V4 = \sum_i \left( \frac{A_i * [NPP_{ref} - (NPP_{act} - Ht)]}{A_i * NPP_{ref}} \right)$

<b>Simpson's Diversity Index</b> $B1 = \sum_i \left( \frac{A_i * (D_{ref} - D_{act})}{A_i * D_{ref}} \right)$	<b>Biocides</b> $B3 = \sum_i \left( \frac{A_b}{A_i} \right)$
<b>Simpson's Evenness Index</b> $B2 = \sum_i \left( \frac{A_i * (E_{d-ref} - E_{d-act})}{A_i * E_{d-ref}} \right)$	<b>Cover of Exotic Species</b> $B4 = \sum_i \left( \frac{A_{ex-sp}}{A_i} \right)$

**Acknowledgement:** ENCOFOR project is funded by EuropeAid from Sept 2003 – May 2007. Contract B7-6200/2002/069-203/TPS. For more information visit <http://www.joanneum.at/encofor/>





# INTEGRATION OF BIODIVERSITY AS IMPACT CATEGORY FOR LCA IN AGRICULTURE

Jeanneret Ph., Baumgartner, D., Freiermuth Knuchel, R., Gaillard, G., Huguenin-Elie, O., Nemecek, Th., Weibel, P.

Agroscope FAL Reckenholz, Swiss Federal Research Station for Agroecology and Agriculture, CH-8046 Zurich, www.reckenholz.ch

## Abstract

SALCA-Biodiversity integrates selected indicator species groups for biodiversity in LCA methodology for agricultural production. Agricultural activities receive scores according to their impact on the selected indicators. A case study with grassland and winter wheat management systems, shows that scores considerably differ between low input and organic fields, and intensively used fields.

## Introduction

In the framework of the **Swiss Agricultural Life Cycle Assessment (SALCA)** methodology, a method was developed which allows the integration of biodiversity (organismal diversity) as an impact category of LCA for agricultural production, **SALCA-Biodiversity**. The impact of agricultural activity on biodiversity is evaluated at the level of plot/crop and can be aggregated for the levels crop rotation, production branch and farm. By means of a case study, the significance and practicability of the new impact assessment method for biodiversity is demonstrated.

## Results and Discussion

Production system	Biodiversity scores							
	Grassland				Winter Wheat			
	(A)	(B)	(C)	(D)	(A)	(B)	(C)	(D)
<b>Overall species diversity</b>	<b>6.2</b>	<b>6.4</b>	<b>13.8</b>	<b>21.3</b>	<b>7.7</b>	<b>7.5</b>	<b>8.4</b>	<b>8.7</b>
Grassland flora	3.7	3.9	11.4	18.5				
Crop flora					15.2	15.1	16.0	17.3
Birds	6.4	6.7	13.8	22.0	5.3	5.0	6.2	6.4
Mammals	7.3	7.3	11.1	11.1	4.6	4.6	4.6	4.6
Amphibians	2.1	2.1	5.2	9.5	1.7	1.7	1.8	1.8
Molluscs	5.4	5.6	5.8	11.3	2.2	2.2	2.2	2.2
Spiders	9.1	9.3	15.8	22.4	8.2	8.0	10.5	10.7
Carabid Beetles	7.0	7.4	13.6	21.0	10.9	10.6	11.7	11.9
Butterflies	6.8	7.0	20.0	36.0				
Wild Bees	7.4	7.6	18.6	23.0	5.2	4.9	5.0	4.8
Grasshoppers	6.9	6.9	19.4	33.1				
<b>Ecologically demanding species</b>								
Amphibians	0.8	0.8	2.9	4.8	1.5	1.4	1.6	1.6
Spiders	8.9	9.0	15.3	21.6	8.0	7.8	10.3	10.5
Carabid Beetles	7.0	7.3	13.4	20.6	10.6	10.1	11.2	11.3
Butterflies	6.7	6.8	19.4	36.0				
Grasshoppers	6.8	6.8	19.3	32.9				

### Grassland management systems :

- Less numerous cuts and low fertiliser inputs (C and D systems) are advantageous for most of the indicator species groups with inflection point between 4 to 3 cuts/year and slurry fertilisation to solid manure.

### Winter wheat management systems :

- Low pesticide inputs and low fertilisation in extensive and organic production systems (C and D systems) positively influence most of the indicator species groups.

## Conclusions

**SALCA-Biodiversity** method allows (1) to define the inflection point of management from which large impacts on biodiversity are to be expected for a production system, (2) to compare between production systems (e.g. grassland vs. crops), and (3) to investigate the reaction of different organisms to different management systems.

Contact: [philippe.jeanneret@fal.admin.ch](mailto:philippe.jeanneret@fal.admin.ch)

PDF-Report: : <http://www.reckenholz.ch/doc/fr/forsch/control/bilanz/salca-bd.pdf>

## Materials and Methods

**First**, **indicator species groups** were determined considering ecological and LCA criteria: flora, birds, mammals, amphibians, molluscs, spiders, carabids, butterflies, wild bees, and grasshoppers.

**Second**, extensive **inventory data about agricultural practices** susceptible to cause biodiversity changes were specified: occupation, emissions, farming intensity indicators (e.g. number of cuts) and process figures (e.g. herbicide type). Beside typical cultivated fields, semi-natural habitats were integrated.

**Third**, a **characterisation based on notes system** was evolved to estimate every indicator species group reaction regarding agricultural activities followed by an aggregation step resulting in **scores**. In addition to the **overall species diversity** of the indicator species groups, **ecologically demanding species** were considered for some of them.

### Case study

Four **grassland** and **winter wheat** management systems are compared at the plot level for typical Swiss conditions.

**Table 1: Results of SALCA-Biodiversity.** Biodiversity scores are given per ha cultivated crop. A, B, C, D are management systems with main characteristics :

### Grassland systems (hay production):

(A) 5 cuts/year, fertilised with slurry; 11t DM/ha

(B) 4 cuts/year, fertilised with slurry; 9t DM/ha

(C) 3 cuts/year, fertilised with solid manure; 5.6t DM/ha

(D) 1 cut/year, no fertilisation; 2.7t DM/ha

### Winter wheat systems:

(A) Conventional production; 5.8t DM/ha

(B) Integrated production – intensive; 5.5t DM/ha

(C) Integrated production – extensive; 4.5t DM/ha

(D) Organic production; 3.5t DM/ha

Scores of **grassland (A)** and **winter wheat (B)** systems are set as **reference scores**. Color codes are given for rough comparison:

- similar to the reference (95%<score<104%)
- better than the reference (105%<score<114%)
- much better than the reference (score >115%)
- no relevance for the considered system

### Grassland vs. winter wheat :

- Because extensively used grasslands are considerably less disturbed by agricultural activities than arable extensive and organic winter wheat fields, they are more suitable habitats for most of the indicator species groups, and therefore show largely higher scores.

### Overall species diversity vs. ecologically demanding species :

- Overall species diversity and ecologically demanding species show the same general pattern of reaction to the investigated management systems.

# BALANCING CARBON EMISSION AND SEQUESTRATION FLUXES OF FOREST LAND, BASED ON A LCI-APPROACH

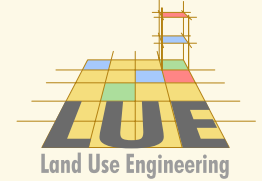

Regina A. Wollenmann

ETH Zurich, CHN K 75.1, Universitaetsstrasse 16, CH- 8092 Zurich, +41446323254, wollenmann@env.ethz.ch

## Abstract

Environmental analysis tools such as LCA or ecological footprint assessment consider land use twofold: First as land to provide sink capacity, and second as area occupied by production activities and facilities. The investigation aims (1) at balancing carbon sequestration and emission fluxes of forest land use and (2) to evaluate the methodology for a close-to-nature and a plantation regime. The regimes have a positive sequestration capacity of about  $85 \text{ kg C}\cdot\text{m}^{-3}$  (plantation) and about  $180 \text{ kg C}\cdot\text{m}^{-3}$  (close-to-nature), respectively. Assuming a given area of forest cover, a division of "ecological labor" between plantation forest

and forest reserve provides a net carbon sink capacity of  $0.18 \text{ kg C}\cdot\text{m}^{-2}\cdot\text{a}^{-1}$  compared to  $0.14 \text{ kg C}\cdot\text{m}^{-2}\cdot\text{a}^{-1}$  for the close-to-nature regime. The results clearly indicate that the management regime determines the net carbon sink capacity and that "ecological labor division" between intensively and unmanaged forests offer opportunities to maximize carbon sequestration.

## Introduction

- The increasing world population and the finite character of the resource land requires an increase of land productivity both to provide resources and to recycle waste.
- Unsealed and uncovered primary production areas of all intensivities act at the same time as a source and a sink.
- Current environmental assessment tools see land either as a source (LCA)<sup>1</sup> (=> increase productivity) or as a sink (Ecological Footprint)<sup>2</sup> (=> decrease productivity)
- Eco-efficient land-use innovation is looking for a new generation of land-use technologies that creates more value with less use of energy, materials and space.

## Problem and Hypotheses

- How to increase land productivity while
- keeping source and sink flow capacities for biogeochemical cycles in balance.
- Hypothesis 1: A mix of extensive and intensive land-use regimes provides a higher environmental land-use performance than the concept of multifunctional land-use.
- Hypothesis 2: Sink capacity of primary production areas will not be sufficient to sequester emissions of all downstream activities.

## Methods

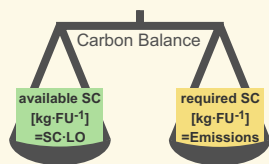
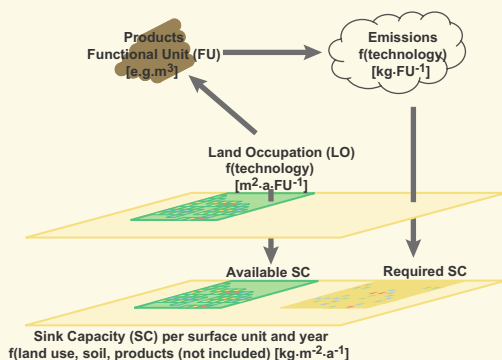

**Land occupation data:**  
Assessing direct and indirect land use:  
Using land use data of LCI EcoInvent<sup>3</sup> provides such data divided in land occupation and land transformation  
Excellent as land transformation has a crucial impact on the C-balance  
For this study only direct land use and land occupation was considered.

**Sink Capacity data:**  
See Results

**Emission data:**  
Assessing direct and indirect emissions:  
Data of LCI EcoInvent<sup>3</sup> database was used  
The amount of released carbon was extracted (Carbon mono- and dioxide, biogenic and fossil, and carbon soil)  
The assessment of roundwood production in both regimes bases on own calculations. See Poster "Environmental performance analysis of forest and agricultural production systems".

## Results

### Mix of land use regimes

- Plantation (Eucalyptus)  
SC land use, soil [ $2.6 \text{ Mg C}\cdot\text{ha}^{-1}\cdot\text{a}^{-1}$ ]<sup>4</sup>
- Close-to-Nature (Beech)  
SC land use, soil [ $1.4 \text{ Mg C}\cdot\text{ha}^{-1}\cdot\text{a}^{-1}$ ]<sup>5</sup>
- Conservation area  
SC land use, soil [ $1.4 \text{ Mg C}\cdot\text{ha}^{-1}\cdot\text{a}^{-1}$ ]<sup>6</sup>

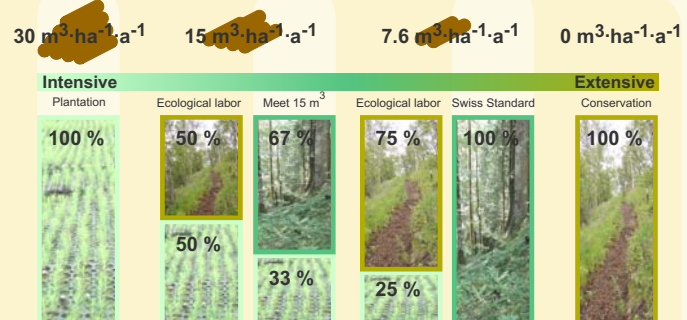

### Ecological performance (Carbon balance) over area

- Downstream processing:  
Roundwood [diagonal lines]  
Newspaper [horizontal lines]

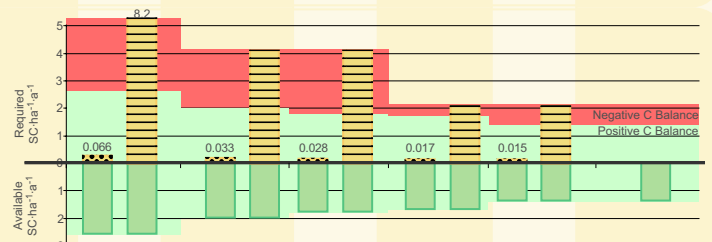

### Ecological performance (Carbon balance) per m³

- Downstream processing:  
Roundwood [diagonal lines]  
Newspaper [horizontal lines]

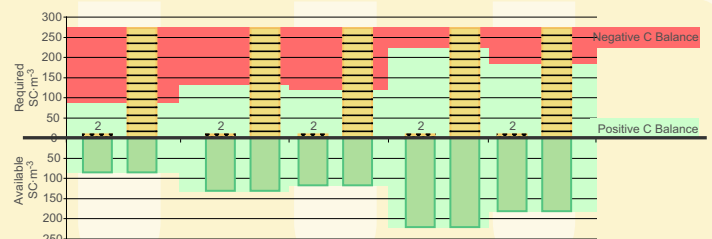

## Discussion and Conclusions

With equal productivity, ecological labor division provides higher carbon SC per area and  $\text{m}^3$  than extensive land use.

- The sequestration potential for ecological labour division is  $0.18 \text{ kg C}\cdot\text{m}^{-2}\cdot\text{a}^{-1}$  compared to  $0.14 \text{ kg C}\cdot\text{m}^{-2}\cdot\text{a}^{-1}$  for the close-to-nature regime.
- High conservation area share. We create a wilderness with spots of highly intensive land use.
- The life cycle of wood influence the carbon cycles more heavily than intensity of land use.
- The carbon balance is positive for a carbon release of  $85 \text{ kg}\cdot\text{m}^{-3}$  for plantations and  $180 \text{ kg}\cdot\text{m}^{-3}$  for close-to-nature regimes respectively.
- Intensive production of energywood has a high sequestration potential, products with a higher carbon release, need more extensive production methods for a positive carbon balance.

## References and Remarks

- Jungbluth, N. and R. Frischknecht (2001). Arbeitspapier: Qualitätsrichtlinien ECOINVENT 2000: Landnutzung und -umwandlung.
- Wackernagel, M. and W. Rees (1996). Our Ecological Footprint: Reducing Human Impact on the Earth. Gabriola Island, BC, New Society Publishers.
- Frischknecht, R., H.-J. Althaus, et al. (2004). Overview and Methodology. ecoinvent report No. 1. Duebendorf, Swiss Centre for Life Cycle Inventories.
- Giardina, C. P. R., Michael G. (2002). "Total Belowground Carbon Allocation in a Fast-growing Eucalyptus Plantation Estimated Using a Carbon Balance Approach." Ecosystems 5: 487-499.
- Schulze, E.-D., Ed. (2000). Carbon and Nitrogen Cycling in European Forest Ecosystems. Ecological Studies. Berlin, Springer.
- Assumption: same as close to nature

Llorenç Milà i Canals<sup>1</sup>, Sarah J Cowell<sup>1</sup>, Almudena Hospido<sup>1</sup>, Davey Jones<sup>2</sup>, Georgia Koerber<sup>2</sup>, Paul Cross<sup>2</sup>, Barry Hounsome<sup>2</sup>, Gareth Edwards-Jones<sup>2</sup>

<sup>1</sup>Centre for Environmental Strategy, University of Surrey, Guildford GU2 7XH (UK), [L.MiC@surrey.ac.uk](mailto:L.MiC@surrey.ac.uk)

<sup>2</sup>School of Agricultural and Forest Sciences, University of Wales, Bangor LL57 2UW (UK)

## ABSTRACT

LCA is being used to assess the environmental benefits or otherwise of producing horticultural crops in the UK and alternative supplying countries (Spain, Uganda). Field emissions (CO<sub>2</sub>; CH<sub>4</sub>; N<sub>2</sub>O; NO<sub>x</sub>; NH<sub>3</sub>; NO<sub>3</sub>; PO<sub>4</sub><sup>3-</sup>) have been estimated using literature models. In addition, one new impact indicator relevant for agriculture has been used: a novel approach to pesticide toxicity based on ratings. Land occupation is used as an interim indicator of land use impacts while data on soil organic matter are collected to be used in a more sophisticated model for impacts on soil quality. The results from British farms are presented for some of the studied crops (potatoes and lettuces), and the usefulness and relevance of the new impact indicator is discussed.

## INTRODUCTION

•Project goal: assess the benefits or otherwise of increased local production of vegetables, compared to increased importation from overseas.

•Life Cycle Assessment (LCA) is used to combine all the environmental information. This needs to be combined with effects on the local level: soil emissions are being measured in the studied supplying farms.

•This poster presents some preliminary results for UK crops, including an indicator of the hazards posed by the pesticides used.

## MATERIALS & METHODS

UK farms from three different counties supplying the main retailers have been selected for this study. These results include:

- Potatoes: 4 farms in 2 counties: Pot1; Pot2; Pot3; Pot4
- Lettuces: 2 farms in 2 counties, each producing 2 crops per year: LetA,1st; LetA,2nd; LetB,1st; LetB,2nd

A **cradle to gate LCA** has been used:

- Functional Unit (FU): **1,000 kg produce at the farm gate**: On-farm refrigeration in LetA and LetB. No storage of potatoes
- LCI information is derived from farm accountancy books and spray diaries for the season 2004-2005
- Soil emissions derived from literature; soil emissions measurements are being taken to compare with literature estimates
- **LCIA**: CML2001 (Guinée *et al.* 2002): Acidification Potential (AP); Eutrophication Potential (EP); Global Warming Potential (GWP 100yr); Human Toxicity Potential (HTP inf.)
- **Land use**: occupation is measured per FU as m<sup>2</sup>-yr

A **Pesticide Hazard indicator** based on the Environmental Impact Quotient (EIQ; Kovach *et al.* 1992; Cross and Edwards-Jones 2006) has been used to score the different products:

- Dimensionless factor derived from published toxicity data, including effects on farm worker, consumer and environment
- Used to characterise the sprayed doses stated in spray diaries

## RESULTS

	Pot1	Pot2	Pot3	Pot4
AP [kg SO <sub>2</sub> -Eq.]	0.9	1.1	0.6	4.8
EP [kg PO <sub>4</sub> <sup>3-</sup> -Eq.]	0.3	0.4	0.3	1.1
GWP 100 years [kg CO <sub>2</sub> -Eq.]	140.9	82.6	90.9	230.4
HTP inf. [kg DCB-Eq.]	65.3	54.3	50.1	57.5

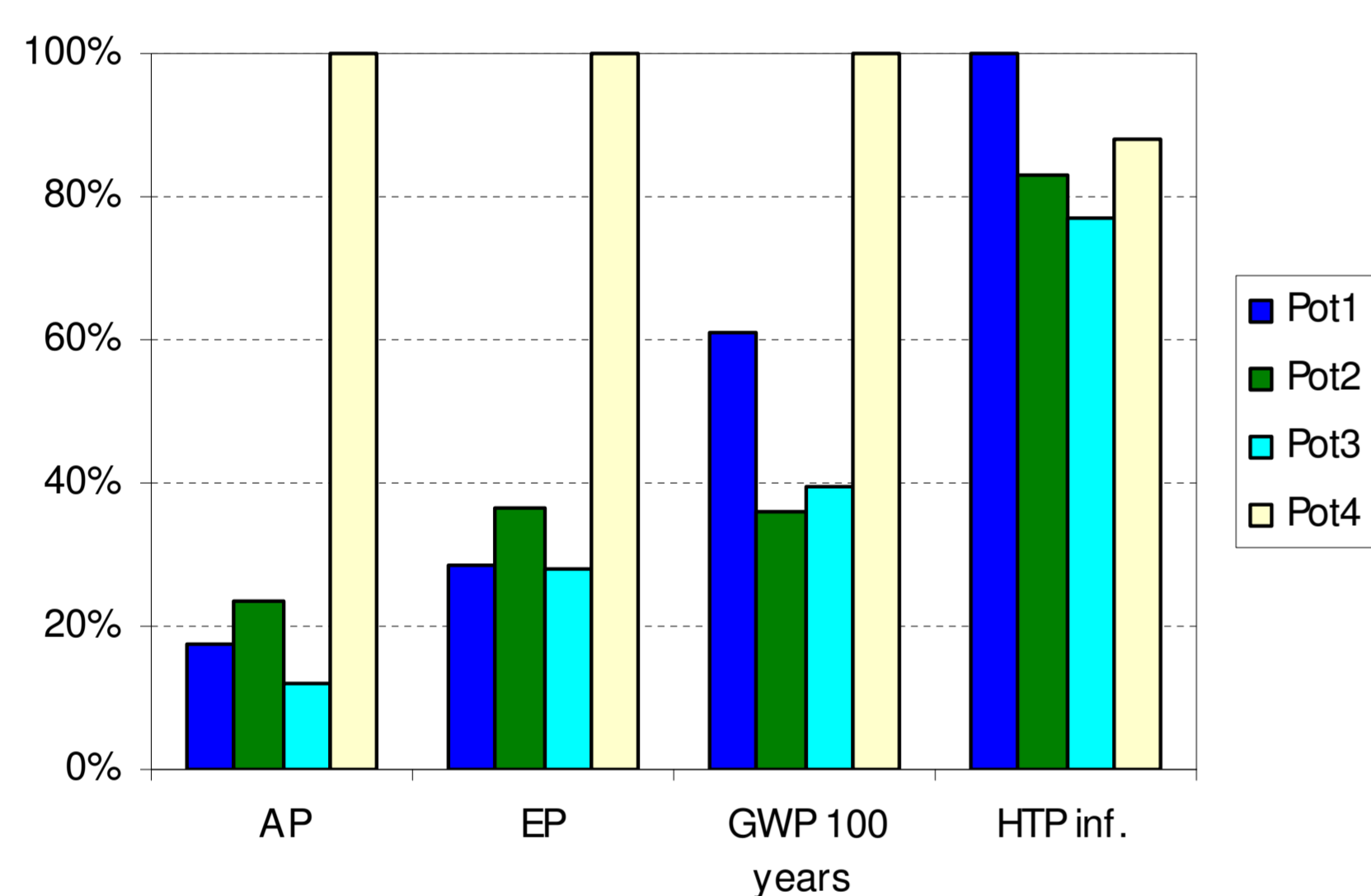
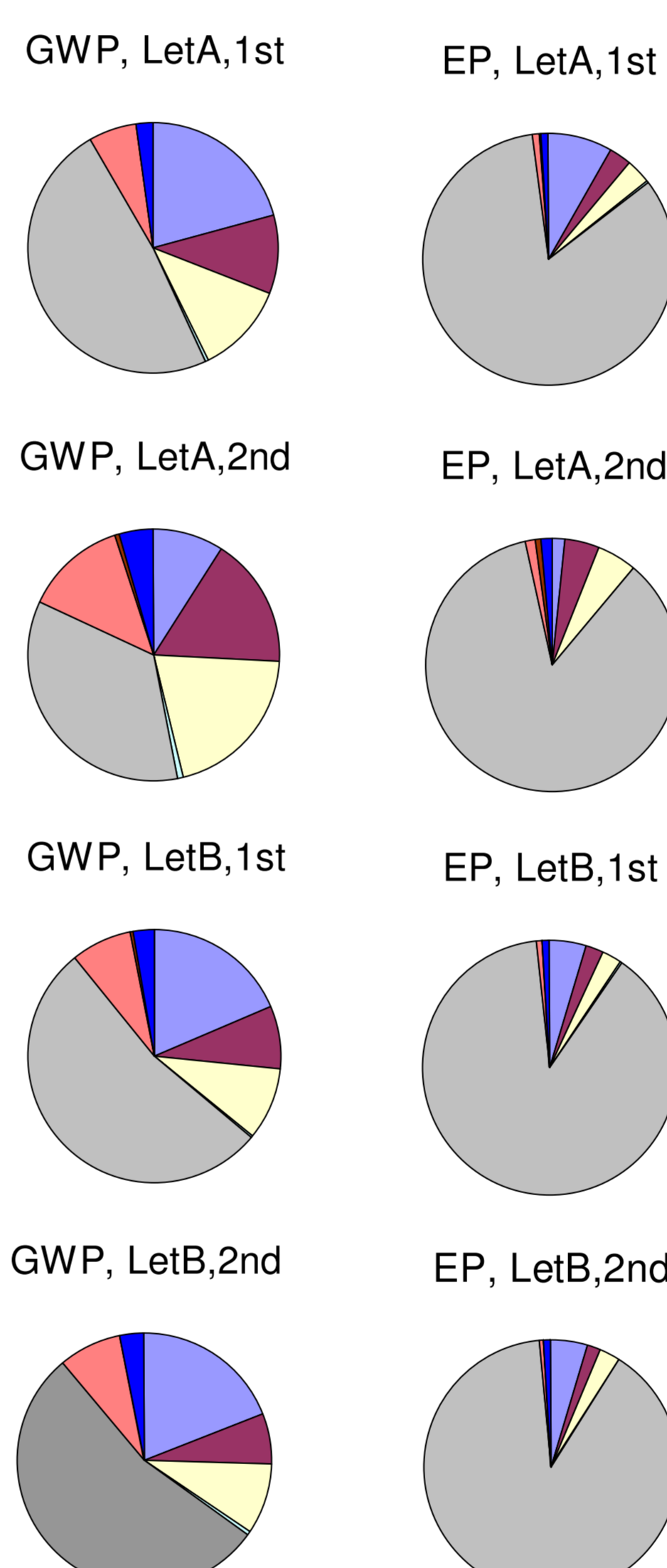
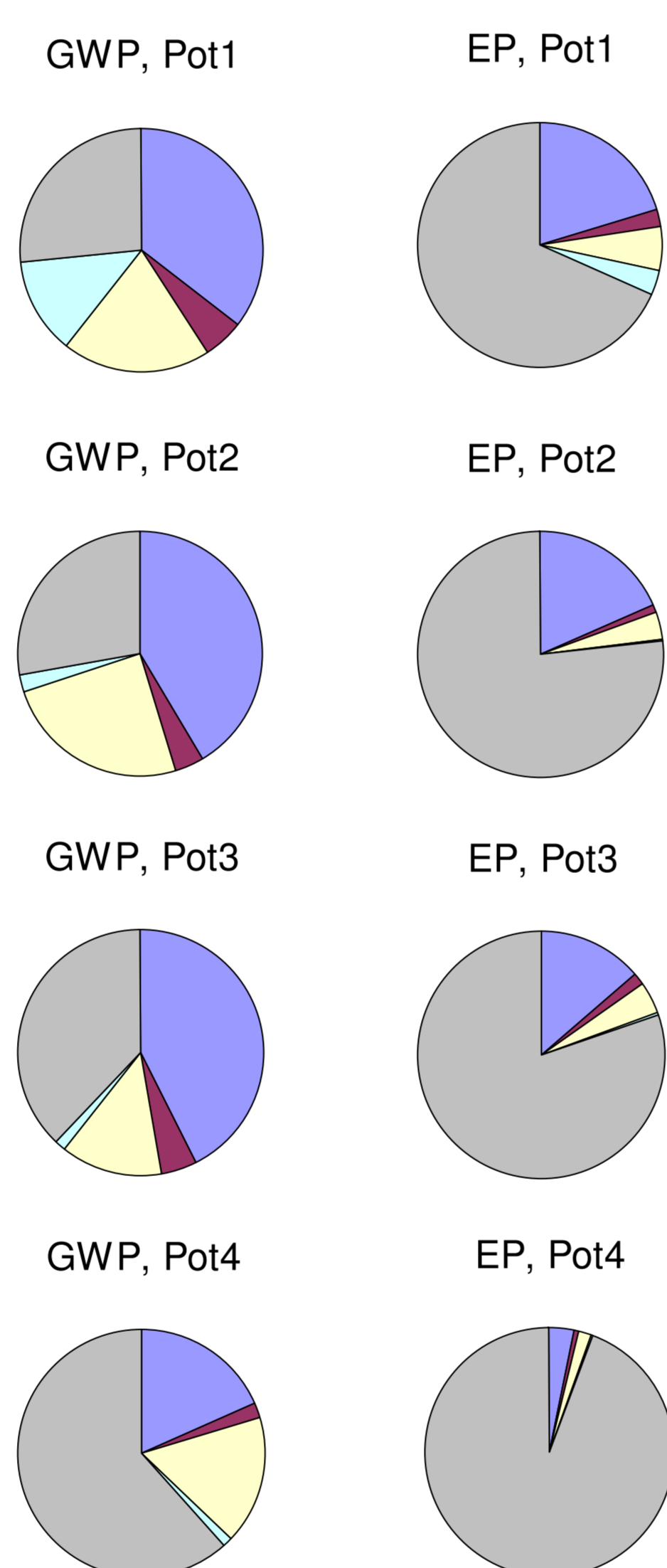

Figure 1: LCA results for the production of **1,000kg potatoes** in 4 UK farms. Acidification Potential (AP); Eutrophication Potential (EP); Global Warming Potential (GWP 100 years); Human Toxicity Potential (HTP inf.). Absolute values are shown in the Table. Pie charts on the right show relative contributions from different items.



	LetA,1st	LetA,2nd	LetB,1st	LetB,2nd
AP [kg SO <sub>2</sub> -Eq.]	4.1	1.4	3.7	3.7
EP [kg PO <sub>4</sub> <sup>3-</sup> -Eq.]	1.3	0.7	1.3	1.3
GWP 100 years [kg CO <sub>2</sub> -Eq.]	500.0	228.8	379.3	372.3
HTP inf. [kg DCB-Eq.]	209.3	135.7	125.2	118.3

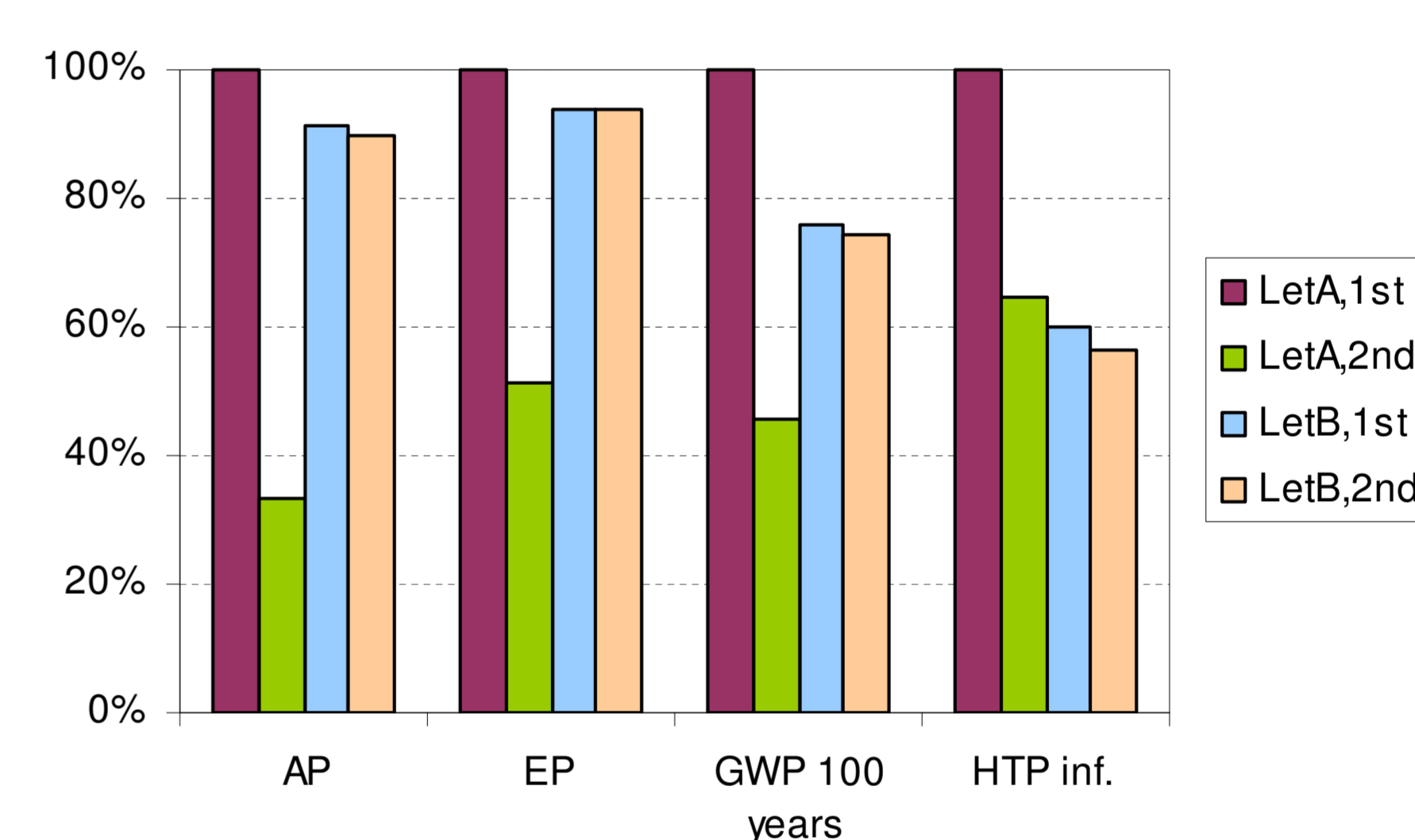

Figure 2: LCA results for the production of **1,000kg lettuces** in 2 UK farms, for 1st and 2nd crops. Acidification Potential (AP); Eutrophication Potential (EP); Global Warming Potential (GWP 100 years); Human Toxicity Potential (HTP inf.). Absolute values are shown in the Table. Pie charts on the left show relative contributions from different items.

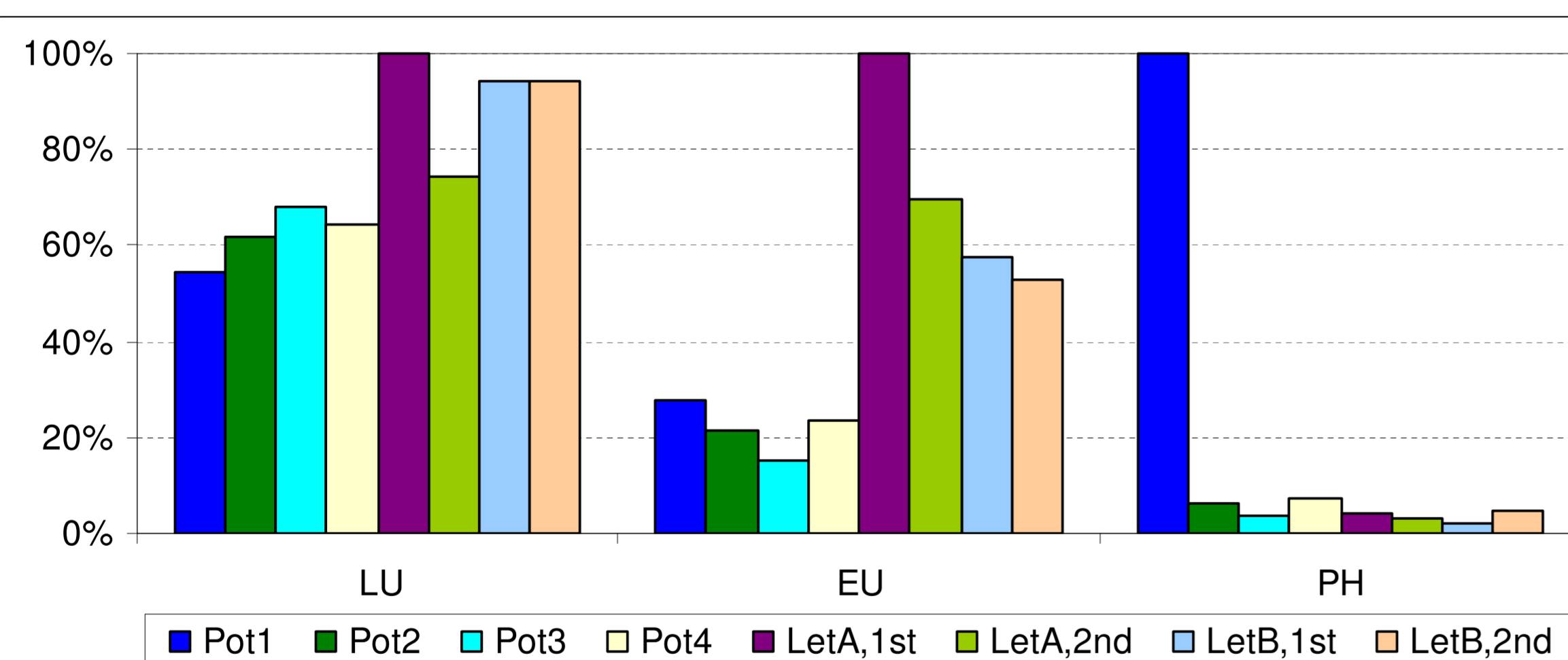
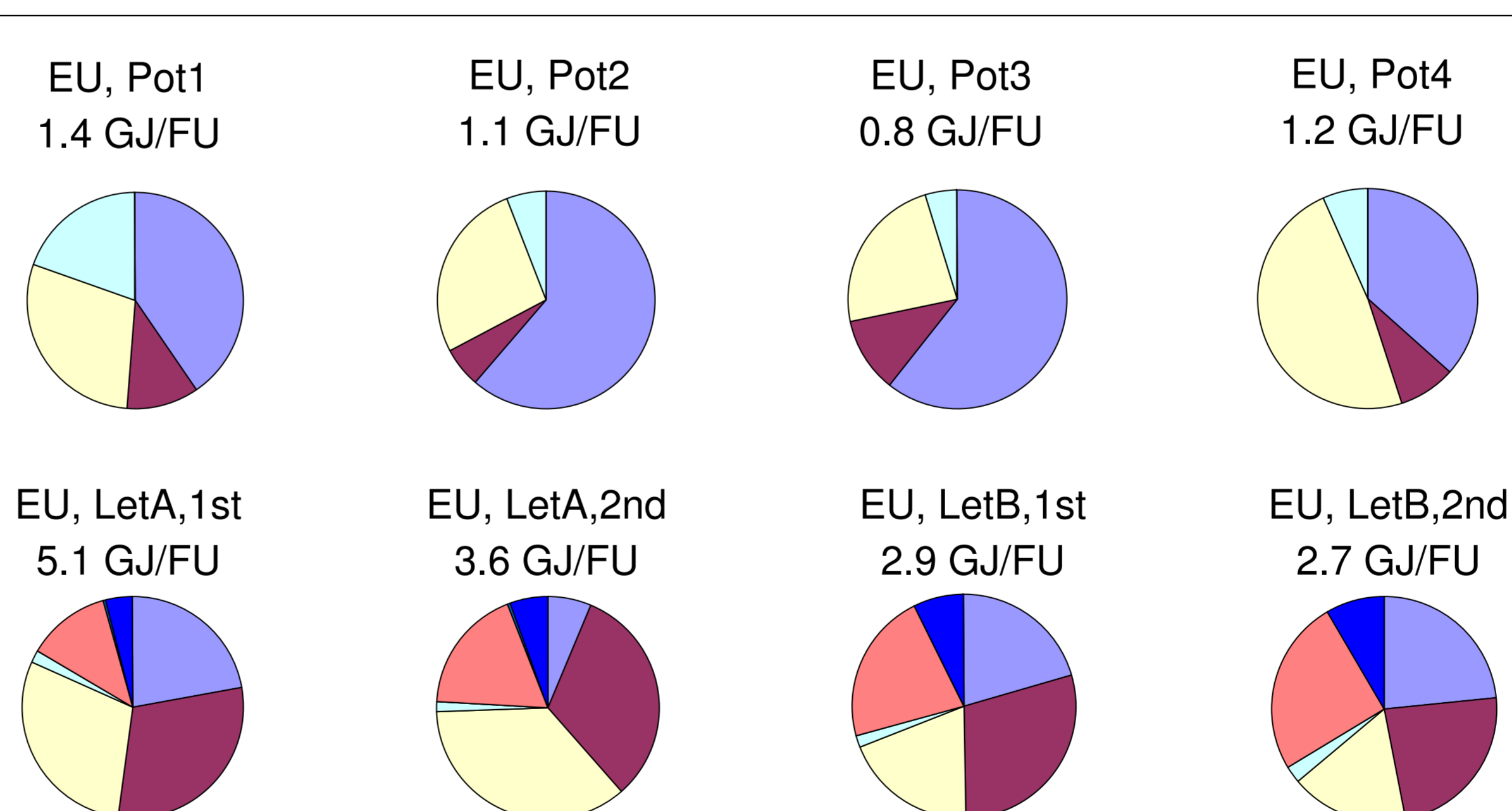

Figure 3: LCA results for the production of 1,000kg produce in 6 UK farms. Land Use, occupation (LU); Primary Non-renewable Energy Use (EU); Pesticide Hazard (PH). Pie charts on the right show relative contributions from different items in the system.



Legend to all pie charts:

- Fertiliser production
- Machinery production
- Mechanisation
- Pesticide production
- Soil emissions
- Storage
- Waste treatment
- Water production

## DISCUSSION

### Key findings:

- All results vary significantly between farms, and between first and second crops of lettuce within one farm
- Soil emissions play a crucial role in GWP (25-60%) and EP (68-94%)
- Fertiliser production is very relevant particularly for potato production

### Pesticide rating:

- Results are dominated by bulk substances: sulphuric acid (desiccant); 1,3-dichloropropene (soil sterilant)
- The use of this indicator is very straightforward, requiring only data present in the spray diaries apart from the EIQ ratings of the used active ingredients

## OUTLOOK

- Check correlation of measured soil emissions with literature values
- Study the correlation of Pesticide Hazard results with more sophisticated methods to assess pesticide toxicity
- Include soil quality indicator to characterise land use impacts

## REFERENCES

- Cross PA, Edwards-Jones G (2006) Variation in pesticide hazard from vegetable production in Great Britain from 1991 to 2003. *Pest Management Science*. In press.
- Kovach J, Petzoldt C, Degnij J et al. (1992) A method to measure the environmental impact of pesticides. *New York's Food and Life Sci. Bull.* 139: 1-8.
- Guinée J (ed.), Gorée M, Heijungs R, Huppes G, Kleijn R, de Koning A, van Oers L, Wegener Sleeswijk A, Suh S, Udo de Haes H.A, de Bruijn H, van Duin R, Huijbregts MAJ, Lindeijer E, Roorda AAH, van der Ven BL, Weidema BP (2002) Life cycle assessment. An operational guide to the ISO standards. VROM & CML, Leiden University (The Netherlands)

# Environmental Performance Analysis of Forest and Agricultural Production Systems

Hans R. Heinemann, Regina A. Wollenmann, Norbert Knechtle

## Abstract

Environmental performance metrics have been emerging since the introduction of the ISO 14030 standard. However, there is only limited knowledge about environmental performance of forest and agricultural production systems. The study hierarchically mapped the flows of economic goods, environmental resources, and emissions by using input-output models. A set of forest and agricultural production systems that are typical for the Northern Slopes of the Swiss Alps was evaluated for two performance parameters: (1) energy flow, including grey energy, and (2) carbon dioxide emissions.

The study normalized the results to the output of 1 kg of dry matter of biomass DBM. The emission of greenhouse gases varies between 0.01 and 0.06 kg of carbon dioxide equivalents per kilogram of dry biomass, whereas the forest tree production systems are in the lower and the agricultural systems in the higher area of the range. Energy consumption varies between 0.1 and 1.2 MJ per kilogram of dry biomass. Compared with the heating value of about 17.5 MJ per kilogram the share of energy consumption in the heating value is only a between 0.5% and 7%. The results clearly demonstrate that environmentally sound production of biomass is even possible under mountainous terrain conditions.

## Introduction

Environmental performance metrics have been emerging since the introduction of a the ISO 14030 standard. However, there is only limited knowledge about how to evaluate environmental performance of forest and agricultural production systems. The study aimed:

- to develop a standardized process-based input-output model to analyze the flows of environmental inputs and outputs,
- to evaluate environmental performance indicators of selected forestry and agricultural biomass production systems that are typical for the Northern Slopes of the Alps.

The study was part of the PRIMALP project that investigated options of sustainable land use in the Swiss Alps [2].

## Method

"Cradle to grave" flows of (1) economic goods, (2) environmental resources, and (3) emissions to the environment may be represented as flows on mathematical graphs [3, 5]. The edges carry the flows, and the nodes represent the processes that convert inputs into outputs. Mathematically, a "flows in networks" problem may be analyzed by a system of linear equations for which matrix notation has been widely used.

Production systems of primary production (forestry and agriculture) are hierarchically organized (Fig. 1, from left to right). The highest level of organization is (a) the production system level consisting of a network of humans, machinery, and facilities. The next hierarchical level is (b) the machine level mapping manufacturing processes and the flow of raw materials, fuels, lubricants and other forms of energy. The next lower level is (c) the raw material and energy systems level, mapping the extraction and production processes of the materials and energy sectors. We used the Ecoinvent life cycle inventory data for the raw materials and energy systems [1]. Data had to be gathered and analyzed for seven components (green boxes of Fig. 1). Engine combustion required special attention, because the corresponding emissions have a big influence on the results. Material profiles required original work [4], emissions from combustion were taken from test reports, where available, whereas production system knowledge was a result of meta-analysis.

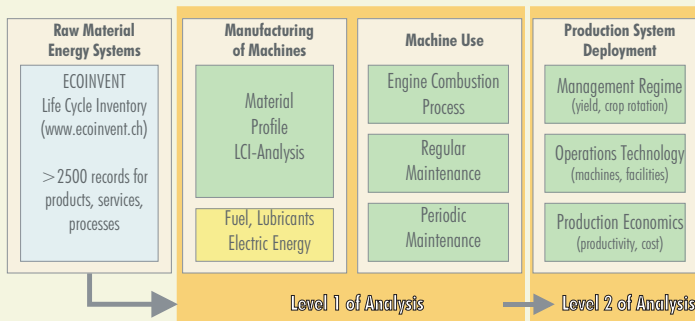

Fig. 1 Components of the analytical framework. The production system is the highest hierarchical level consisting of components of the next lower level, the machine. There are three types of data: (1) own original data and meta-data [green boxes], (2) standard life cycle inventory data Ecoinvent [blue box], and (3) data that were not available [yellow box].

## Contact

Hans R. Heinemann, ETH Zurich  
Forest Engineering Group  
ETH Zentrum CHN K72.2  
CH-8092 Zurich  
Switzerland  
hans.heinemann@env.ethz.ch  
http://www.lue.ethz.ch

## Results

The indicator for energy flow (Fig.2) covers a range of 0.1 to 1.2 MJ·kg<sup>-1</sup><sub>DBM</sub>, corresponding to a share in the heating value of the produced biomass of about 0.5% to 7%. The CO<sub>2</sub>-emission indicator (Fig. 3) varies between 0.005 and 0.06 kg·kg<sup>-1</sup><sub>DBM</sub>. 0.005 to 0.04 kg of biomass have to be grown to sequester this amount of emissions, corresponding to a share in the extracted biomass of about 0.5% to 4%.

A fully mechanized forest harvesting system (CTL) showed the best environmental performance, together with the motor-manual system and the grazing system on steep slopes. The agricultural intensive forage system and the combined forage-grazing system had the lowest environmental performance, about 1.5 to 2 times lower than the forest helicopter logging system.

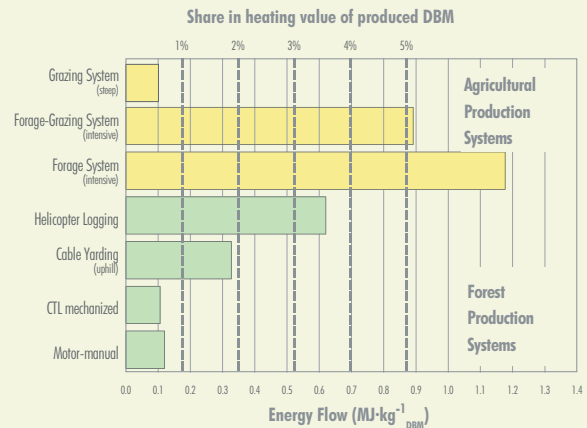

Fig. 2 Energy throughput of production systems. Throughput consists of both process and grey energy. Total energy throughput equals a share in the heating value of the produced biomass of 0.5% to 7%.

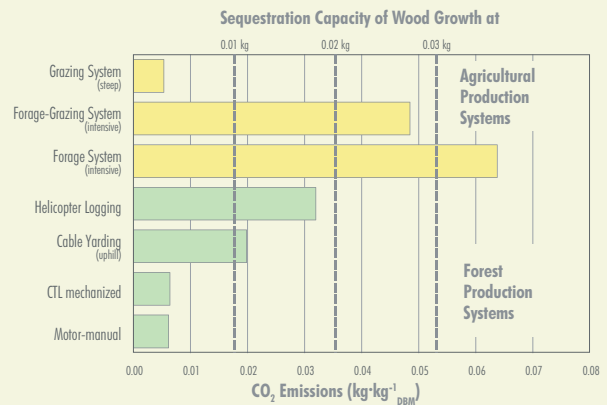

Fig. 3 CO<sub>2</sub> emission of production systems. The growth of 0.005 to 0.06 kg DBM provides the capacity to sequester CO<sub>2</sub> emissions. Therefore, 0.5% to 4% of the produced biomass volume has to regrow to provide CO<sub>2</sub> neutrality.

## Conclusions

- Hierarchical mapping of economical and environmental flows with input-output models proved to be highly flexible.
- Fully-mechanized forest harvesting systems for trafficable terrain (CTL Harvester-Forwarder) have the same environmental performance as motor-manual systems that are considered environmentally superior.
- Environmental performance of forest harvesting systems (CTL) for trafficable terrain equals to the most extensive agricultural production system, grazing on steep slopes.
- Helicopter logging, which is often considered environmentally evil has about half of the environmental burden of an intensive agricultural forage production system.

## References

- [1] Ecoinvent online. ecoinvent 2000 life cycle inventory database V 1.2 [Accessed May-1 2006]. Swiss Center for Life Cycle Inventories. Available from www: (http://www.ecoinvent.ch/en/index.htm)
- [2] GOTSCH, N., C. FLURY, M. KREUZER, P. RIEDER, H.R. HEINMANN, A.C. MAYER, and H.-R. WETSTEIN. 2004. Land- und Forstwirtschaft im Alpenraum - Zukunft im Wandel. Karl. Wissenschaftsverlag Vauck Kall We. 305 p.
- [3] HEIJUNGS, R., et al. 1992. Environmental Life Cycle Assessment of Products. Backgrounds LCA. Centre for Environmental Science. Leiden, NL, 9267. 96 p.
- [4] KNECHTLE, N. 1997. Materialprofile von Holzmesstechniken - Analyse ausgewählter Beispiele als Grundlage für eine forsttechnisches Ökoinventar. ETH, Professur forstliches Ingenieurwesen. Zürich. Diplomarbeit, un veröffentlicht.
- [5] LEONTIEF, W. 1970. Environmental repercussions and the economic structure: an input-output approach. Review of Economics and Statistics. 52: 262-271.