

**The research-teaching nexus  
in the sciences**  
*Scientific research dispositions  
and teaching practice*

# ico

The research was carried out in the context of the *Dutch Interuniversity Centre for Educational Research*

Title: The research-teaching nexus in the sciences: Scientific research dispositions and teaching practice

Titel: De verwevenheid van onderzoek en onderwijs in de Natuurwetenschappen: wetenschappelijke onderzoekende houding en de onderwijspraktijk

ICLON, Leiden University Graduate School of Teaching

Print: Mostert & Van Onderen! Leiden

Cover design: Gerda Visser-Wijnveen

Cover illustration: René Wouters

ISBN/EAN: 978-94-90383-01-5

© 2009, Roeland M. van der Rijst

All rights reserved. No part of this thesis may be reproduced, stored in retrieval systems, or transmitted in any form, or by any means, electronic, mechanical, photocopying, recording, or otherwise, without the prior written permission of the author.

**The research-teaching nexus  
in the sciences:  
Scientific research dispositions and teaching practice**

Proefschrift

ter verkrijging van

de graad van Doctor aan de Universiteit Leiden,

op gezag van Rector Magnificus prof.mr. P.F. van der Heijden,

volgens besluit van het College voor Promoties

te verdedigen op woensdag 23 september 2009

klokke 15.00 uur

door

Roeland Matthijs van der Rijst

geboren te Utrecht

in 1975

*Promotiecommissie*

*Promotores*

Prof.dr. N. Verloop

Prof.dr. J.W. Kijne

Prof.dr. J.H. van Driel

*Overige leden*

Prof.dr. J. Elen, Katholieke Universiteit Leuven

Prof.dr. M.J. Goedhart, Rijksuniversiteit Groningen

Dr. J.W.F. van Tartwijk, Universiteit Leiden





# Table of contents

<b>1. General introduction</b>	<b>13</b>
<b>1.1 Introduction</b>	<b>13</b>
<b>1.2 The research-teaching nexus</b>	<b>14</b>
1.2.1 <i>Higher education and society</i>	14
1.2.2 <i>Studies on the integration of research in teaching</i>	15
<b>1.3 Teaching in higher education</b>	<b>17</b>
1.3.1 <i>Higher education as a separate field of research</i>	17
1.3.2 <i>Research on teaching in secondary education</i>	19
<b>1.4 Relevance of the studies</b>	<b>21</b>
1.4.1 <i>Scientific research dispositions in university education</i>	21
1.4.2 <i>Tangible and intangible elements of the research-teaching nexus</i>	22
1.4.3 <i>Teachers' intentions and approaches to teaching</i>	22
1.4.4 <i>Students' perceptions of learning environments</i>	23
<b>1.5 Context and research questions</b>	<b>24</b>
1.5.1 <i>Research context</i>	24
1.5.2 <i>Research questions</i>	24
<b>1.6 Outline of the thesis</b>	<b>26</b>
<b>2. Exploring scientific research disposition from the perspective of academics</b>	<b>31</b>
<b>2.1 Introduction</b>	<b>32</b>
2.1.1 <i>Scientific research dispositions in literature</i>	32
2.1.2 <i>Nature of science and scientific inquiry</i>	34
2.1.3 <i>Context and research question</i>	36
<b>2.2 Methods</b>	<b>36</b>
2.2.1 <i>Participants</i>	36
2.2.2 <i>Procedure</i>	37
2.2.3 <i>Qualitative analysis of interview data</i>	39
2.2.4 <i>Quantitative analysis of codes</i>	40
<b>2.3 Results</b>	<b>41</b>
2.3.1 <i>Six aspects of scientific research dispositions</i>	41
2.3.2 <i>Percentage distribution of codes among participants</i>	46
2.3.3 <i>Hierarchical cluster analysis and principal component analysis</i>	46
2.3.4 <i>Relationship between clusters and background variables</i>	50
<b>2.4 Conclusions and discussion</b>	<b>51</b>
2.4.1 <i>Scientific research dispositions</i>	51
2.4.2 <i>Implications for research and teaching</i>	54

<b>3. Towards an empirically based notion of the concept of disposition</b>	<b>59</b>
<b>3.1 Introduction</b>	<b>60</b>
3.1.1 <i>Dispositions of substances in modern philosophy</i>	61
3.1.2 <i>Three principles for the concept of disposition</i>	62
3.1.3 <i>Dispositions of subjects in educational research</i>	63
3.1.4 <i>Habitus as a system of dispositions</i>	64
3.1.5 <i>Thinking dispositions</i>	66
3.1.6 <i>Teacher dispositions</i>	67
3.1.7 <i>Research question</i>	68
<b>3.2 Methods</b>	<b>68</b>
3.2.1 <i>Three instruments to assess scientific research dispositions of academics</i>	68
3.2.2 <i>Participants</i>	69
3.2.3 <i>Instrument 1: Semi-structured open-ended interview</i>	69
3.2.4 <i>Instrument 2: Hierarchical ordering task</i>	69
3.2.5 <i>Instrument 3: Structured mapping task</i>	70
<b>3.3 Results</b>	<b>74</b>
3.3.1 <i>Results instrument 1: Semi-structured open-ended interview</i>	74
3.3.2 <i>Results instrument 2: Hierarchical ordering task</i>	74
3.3.3 <i>Results Instrument 3: Structured mapping task</i>	74
<b>3.4 Conclusions and discussion</b>	<b>78</b>
3.4.1 <i>Differences and similarities between the instruments</i>	78
3.4.2 <i>Implications for an empirically based notion of the concept of disposition</i>	80
3.4.3 <i>Suggestions for further research</i>	81
<b>4. Speech act theory as an instrument to capture university science teachers' discourse</b>	<b>85</b>
<b>4.1 Introduction</b>	<b>86</b>
4.1.1 <i>Discourse analysis and speech act theory</i>	86
4.1.2 <i>Methods of instruction</i>	88
4.1.3 <i>Approaches to teaching</i>	88
4.1.4 <i>Research questions</i>	89
<b>4.2 Methods</b>	<b>89</b>
4.2.1 <i>Sample and research context</i>	89
4.2.2 <i>Procedure</i>	90
4.2.3 <i>Analysis of teachers' speech acts</i>	90
4.2.4 <i>Post-course administration of the ATI</i>	91
4.2.5 <i>Analysis of typical speech act sequences</i>	93
<b>4.3 Results</b>	<b>94</b>
4.3.1 <i>Teachers' speech acts</i>	94
4.3.2 <i>Typical speech act sequences</i>	98
4.3.3 <i>Groups of typical speech act sequences</i>	98
4.3.4 <i>Characteristics of the typical speech act groups</i>	102



<b>4.4 Conclusions and discussion</b>	<b>103</b>
4.4.1 <i>Assertive and directive speech acts</i>	103
4.4.2 <i>Limitations and suggestions for further research</i>	104
<b>5. Associations between teachers' intentions and students' perceptions of the research intensiveness of learning environments</b>	<b>109</b>
<b>5.1 Introduction</b>	<b>110</b>
5.1.1 <i>Intangible elements in the research-teaching nexus</i>	111
5.1.2 <i>Modes of integration of disciplinary research into teaching</i>	111
5.1.3 <i>Students' perceptions of the research intensiveness of learning environments</i>	114
5.1.4 <i>Research question</i>	115
<b>5.2 Methods</b>	<b>115</b>
5.2.1 <i>Sample</i>	115
5.2.2 <i>Procedure</i>	116
5.2.3 <i>Interview about teachers' intentions</i>	117
5.2.4 <i>Student questionnaire on research intensiveness of learning environments</i>	117
5.2.5 <i>Analysis</i>	119
<b>5.3 Results</b>	<b>120</b>
5.3.1 <i>Teaching research-led courses</i>	121
5.3.2 <i>Teaching research-tutored courses</i>	122
5.3.3 <i>Teaching research-oriented courses</i>	122
5.3.4 <i>Teaching research-based courses</i>	124
5.3.5 <i>Congruence between teachers' intentions and students' perceptions</i>	124
5.3.6 <i>Aspects of scientific research disposition</i>	125
<b>5.4 Conclusions and discussion</b>	<b>128</b>
5.4.1 <i>Congruence between teachers' intentions and students' perceptions</i>	128
5.4.2 <i>Limitations and suggestions for further research</i>	129
<b>6. General conclusions and discussion</b>	<b>133</b>
<b>6.1 Introduction</b>	<b>133</b>
<b>6.2 Links between research and teaching</b>	<b>133</b>
<b>6.3 Findings with regard to the research questions</b>	<b>135</b>
6.3.1 <i>Research question 1a</i>	135
6.3.2 <i>Research question 1b</i>	135
6.3.3 <i>Research question 2</i>	135
6.3.4 <i>Research question 3a</i>	136
6.3.5 <i>Research question 3b</i>	137
6.3.6 <i>Research question 4</i>	137
<b>6.4 General conclusions</b>	<b>138</b>
6.4.1 <i>Research dispositions of academics</i>	138
6.4.2 <i>Evaluation of research dispositions</i>	138
6.4.3 <i>Teachers' speech acts</i>	139

6.4.4 <i>Teachers' intentions regarding research in teaching</i>	139
<b>6.5 Strengths and limitations of the studies</b>	<b>139</b>
6.5.1 <i>Strengths</i>	139
6.5.2 <i>Limitations</i>	141
<b>6.6 Suggestions for further research into higher education</b>	<b>143</b>
6.6.1 <i>Further development of the research instruments</i>	143
6.6.2 <i>Student evaluation of research-intensive learning environments</i>	145
<b>6.7 Recommendations for teaching practice in higher education</b>	<b>145</b>
6.7.1 <i>Educational policy and consultancy</i>	145
6.7.2 <i>Teaching practice and teacher training</i>	147
6.7.3 <i>Student learning</i>	147
<b>References</b>	<b>149</b>
<b>Summary</b>	<b>165</b>
<b>Samenvatting</b>	<b>173</b>
<b>Publications</b>	<b>183</b>
<b>Curriculum Vitae</b>	<b>187</b>
<b>Dankwoord</b>	<b>189</b>
<b>ICLON PhD dissertation series</b>	<b>191</b>



## Chapter 1

### General introduction



# 1. General introduction

## 1.1 Introduction

This thesis reports on four studies aimed at improving our understanding of how to bridge the gap between research and teaching in undergraduate university science education. A rationale behind strengthening the link (nexus) between research and teaching is to enhance student understanding of science and scientific inquiry (Boyer Commission, 1998 and 2002; Jenkins, Healey, & Zetter, 2007; Zubrick, Reid, & Rossiter, 2001). To obtain literacy in science and scientific inquiry, students need to acquire disciplinary knowledge and skills, and they also need to develop appropriate scientific research dispositions (cf. American Association for the Advancement of Science, 1990 and 1993). In the studies reported in this thesis, scientific research dispositions were explored, and potential methods to evaluate these dispositions were examined. Next, in order to understand how research and teaching can be linked in science courses, teaching practices at research universities were investigated. Associations were examined between teachers' intentions and approaches to teaching, and between teaching behaviour and students' perceptions of the research intensiveness of the learning environments. Academics were examined, who taught undergraduate university science courses of the bachelor's programmes of the Faculty of Science at Leiden University in the Netherlands. The labels 'teachers', 'teaching staff', and 'academics' are used interchangeably below. The participating academics were involved in both research and teaching. The label 'academics' is used in this thesis to emphasise the scholarly nature of the profession, while the labels 'teachers' and 'teaching staff' refer specifically to the teaching profession.

Debates about the research-teaching nexus originated, among other things, from the desire of policy makers in higher education to promote the research identity of the institutes (Barnett, 2005; Elen & Verburgh, 2008; Jenkins et al., 2003; Simons & Elen, 2007); for other stakeholders, such as curriculum developers, teacher trainers, and teachers, different practical reasons for a focus on the research-teaching nexus can be discerned. Curriculum developers, for example, continually need to re-think the construction and content of the curriculum, especially when this curriculum needs to promote, and not hinder, close ties between staff research, teaching, and learning. Teacher trainers wish to know which competencies teachers need to develop and to strengthen links between research and teaching during their courses. Furthermore, teachers at higher education institutes are important stakeholders in strengthening research in teaching, because they put the integration of research and teaching into action

during their courses. Throughout the years teachers develop a broad variety of teaching experiences in which research is integrated in teaching. By reflecting on these experiences and sharing ideas about teaching with colleagues, teachers in higher education can increase their teaching repertoire and expand their ideas on linking research and teaching. At the end of this thesis several recommendations for teaching practice in higher education are presented. This first chapter describes the context, the relevance, the research questions, and the design of the studies.

### **1.2 The research-teaching nexus**

#### ***1.2.1 Higher education and society***

In recent decades, changes in society led to a process of transformation in higher education institutes. Technological developments, globalization, and increased international competition altered university life. Although the rise of the so-called 'knowledge society' did not affect their overall civic function as 'knowledge institutes', it did alter universities' organisational structures. In the literature on higher education at least three changes in higher education institutes can be detected. First, the change from an elite system to a mass system affected the internal structures of higher education institutes (Scott, 1995). Especially the teaching function became subject to re-organization. Student-staff ratios changed drastically over the last 50 years, as more and more students needed to be taught. Second, owing to globalization and increased international competition in research, institutes had to change their focus from local to global (Barnett, 2000). A similar development from a local to a global orientation followed for the teaching function of higher education institutes. Finally, a more recent change forced institutes to reflect on quality standards of staff (Ramsden, 2003). Changes to mandatory pedagogical and educational training for academics result from the increased demands from society. Many governments endeavoured to increase the number of graduates from higher education, and many companies set more specific requirements for the competencies of graduates. The idea was that through better teachers and more effective teaching methods more students could be guided by fewer teaching staff. In sum, higher education was becoming 'big business' (Barnett, 2000). Nowadays, stakeholders in higher education request to know if funds are being used effectively, and policy makers require clear evidence-based answers from research in general, and from research into higher education in particular. Therefore, higher education institutes are encouraged to continually explore ways to adjust, in order to prepare for potential changes in society and the demands put forward by various

stakeholders. In this global, changing society, higher education institutes have to continually re-negotiate their position to meet the demands. A clear and distinctive identity can be a strong basis for deciding how to react to changes and demands. The identity of research-intensive universities, such as Leiden University, rests strongly on the importance of research with a strong theoretical relevance, while professional or vocational universities stress the importance of research with practical relevance. The kind of research with which a higher education institute is associated seems to typify the identity of that institute. Recent debates about enhancing links between research, teaching, and learning can be understood from the perspectives described above. The aim of this thesis was to contribute to recent debates about enhancing connections between research, teaching, and learning by investigating academics' views and their teaching practice at a research-intensive university.

### ***1.2.2 Studies on the integration of research in teaching***

In recent decades, the aim of strengthening links between research and teaching attracted a great deal of attention from policy makers, curriculum developers, teachers, and researchers in the field of higher education (Barnett 2005; Griffiths, 2004; Healey, Jordan, Pell, & Short, in press; Jenkins, Healey, & Zetter, 2007; Zubrick, Reid, & Rossiter, 2001). The debates were sometimes confused, because the subject of linking research and teaching has many perspectives and many stakeholders (cf. Turner, Wuetherick, & Healey, 2008). Concepts are used differently among different stakeholders, and perspectives are not always understood clearly in debates between stakeholders. For the clarification of the present situation, many studies are focused, as a first step, on defining the research-teaching nexus and describing stakeholders' conceptions about the nexus. Some researchers describe the misunderstandings of the relationship between research and teaching at university in the form of myths (Hughes, 2005; Kinchin & Hay, 2007); others describe philosophical perspectives (Simons, 2006) or examine the conceptions of stakeholders, such as academics (cf. Visser-Wijnveen, Van Driel, Van der Rijst, Verloop, & Visser, in press), policy makers (cf. Neumann, 1992), or students (cf. Turner et al., 2008). Although Hattie and Marsh (1996; 2002) showed that there seems to be no relationship between being an effective researcher and being a good teacher, many teachers at higher education institutes explicitly value the integration of research and teaching at their institutes (Elen & Verburch, 2008; Elton, 1986; Jensen, 1988; Neumann, 1992). Jensen (1988), for example, showed that although academics in higher education institutes in Denmark reported some reservations, such as a perceived difficulty in

combining the twofold task of research and teaching, all preferred to work in an institute in which research as well as teaching was present. Academics have multiple professional roles, of which teaching is often neither the role with the highest priority, nor that with the highest regard among peers and superiors (Colbeck, 1998; Serow, 2000; Young, 2006). Similarly, Gottlieb and Keith (1997) found in an internationally comparative survey study that research was perceived to positively affect teaching, but that aspects of teaching (e.g., course load, student demands) had a negative impact on research. A growing body of research supports the suggestion that the integration of research in teaching is good for student motivation and student learning (Durning & Jenkins, 2005; Elton, 1986; Healey, 2005a; Hunter, Laursen, & Seymour, 2006; Jenkins, Blackman, Lindsay, & Paton-Saltzberg, 1998; Lindsay, Breen, & Jenkins, 2002; Turner et al., 2008). Students perceive many benefits to their learning when research is strongly integrated in their courses (Seymour, Hunter, Laursen, & Deantoni, 2004; Van der Rijst, Visser-Wijnveen, Verstelle, & Van Driel, 2009). Seymour and colleagues (2004) examined student experiences of research activities in the undergraduate phase of university science education, and presented positive student experiences, such as students' increased self-confidence for doing research, increased motivation for the discipline, enhanced understanding of what it means to be a scientist, improved critical thinking skills, and increased knowledge about the scientific process. Robertson and Blackler (2006) found in an interview study that students experienced pride and were motivated by the enthusiasm of their teachers. Students were challenged because they were engaged in research-related activities. Healey and colleagues (in press) showed that, according to the students, the main advantage of enhanced links between research and teaching was that their teachers were enthusiastic and that having a well-known researcher as a teacher excited them (Healey et al., 2003; Turner et al., 2008). Therefore, many higher education institutes in various countries have put much time and effort into bridging the gap between research, teaching, and learning (Elsen, Visser-Wijnveen, Van der Rijst, & Van Driel, 2009; Healey 2005b; Jenkins, Breen, & Lindsay, 2003; Leisyte, Enders, & De Boer, in press). The emphasis in this thesis was on empirically describing what teaching staff at universities can do to enhance links between research and teaching which support student learning about research at universities.



### **1.3 Teaching in higher education**

#### ***1.3.1 Higher education as a separate field of research***

In 1990, McKeachie showed that research on teaching in higher education had developed a distinctive knowledge base in the course of the previous decades (McKeachie, 1990). Over the years the field of research on teaching in higher education became a distinct area in the educational sciences (cf. Durkin & Barnes, 1986; Forest, 2006; Trent & Cohen, 1973). In the *Handbook of Research on Teaching*, Menges (2000, p. 1122) presented some remarkable and substantial differences between teaching in higher education and teaching in secondary education. Firstly, the function of higher education institutes within society is different from that of schools of secondary education. Higher education institutes often have a research function alongside their teaching function. Additionally, the purpose of higher education differs from that of secondary education in many ways, among which that secondary education has the objective of providing a broad basic (compulsory) education, while higher education institutes offer specialised (optional) training for students. Furthermore, teaching staffs in higher education institutes have much experience in research or in a profession, but often have limited pedagogical and educational training. Therefore, teachers in higher education, more so than teachers in secondary education, are often oriented towards their discipline rather than towards the scholarship of teaching. Other responsibilities than teaching usually prevail for teachers in higher education.

Academics in higher education have different professional roles (Colbeck, 1998; Martin, 1997); the teaching role is not always the most essential part of their professional identity (cf. Beijaard, Meijer, & Verloop, 2004; McAlpine, Jazvak-Martek, & Gonsalves, 2007). Boyer (1997) described four scholarships, four fields of the academic profession: the scholarships of discovery, integration, application, and teaching. The purpose of the scholarship of discovery is to build new knowledge through research. Academics who write textbooks or comprehensive literature reviews in which they interpret the use of knowledge across disciplines work in the scholarship of integration. Academics working in the scholarship of application aid society and the professions in addressing problems. And the purpose of the scholarship of teaching is to 'study teaching models and practices to achieve optimal learning'. This can be done, among other things, through developing and testing instructional materials and through advancing learning theory using classroom research. Over the last decade the scholarship of teaching has become more and more a topic of interest in research on higher education, in which conceptual as well as empirical manuscripts on various issues

in teaching practice in higher education are disseminated (Healey, 2000; Kreber, 2002; Kreber & Cranton, 2000; Trigwell et al., 2000; Trigwell & Shale, 2004). These studies can be found in the regular peer-reviewed scientific journals in the field of research on higher education, and much of the small-scale teacher research of own practice can be found in the numerous (online) journals on the scholarship of teaching and learning (to name a few, *International Journal for the Scholarship of Teaching and Learning*, *International Journal of Teaching and Learning in Higher Education*). Development in this area can be expected in the coming years, because of the large number of disseminated articles. Especially reviews and meta-studies in which small-scale empirical classroom studies are thematically clustered have the potential to produce new and interesting results about teaching in higher education.

The afore-mentioned studies on the scholarship of teaching are all aimed at contributing to debates about excellence in teaching in higher education through describing and explaining the teaching practice (Kane, Sandretto, & Heath, 2004; Sherman, Armistead, Fowler, Barksdale, & Reif, 1987; Shulman, 2002). Shulman (2002) described six goals of excellent teaching in higher education. First, teachers should ensure that students are engaged and motivated. Second, teachers need to help students acquire knowledge and develop understanding; and third, they need to enable them to demonstrate their knowledge and understanding through performance and action. Fourth, students must be encouraged during their studies to engage in critical reflection of the world; and fifth, they must develop their ability to navigate through the complexities of the world in formulating their own designs for action. Finally, teachers need to foster a lifelong commitment to critical examination and self-development. These goals for teaching in higher education can only be achieved when academics become excellent in their teaching profession. Sherman and colleagues (1987) showed that in theories about the development of excellence in teaching two elements seem to indicate excellent stages of functioning, namely, increased levels of complexity and a wider repertoire of action strategies. Furthermore, according to Sherman and colleagues (1987), awareness and reflection seem to be elements which can strengthen the experience and deepen the learning effect of the teaching experience (cf. Alexander, 2005; Korthagen, 2004; Pickering, 2006). In institutes that aim to support teaching staff in becoming excellent in teaching, professional development trajectories might focus on promoting awareness and reflection in order to improve teaching actions. Professional development trajectories can facilitate teachers by providing, for example, training to become aware of the influence of their approach on student

learning, or to use student evaluation for redesigning of the course content. Research instruments developed and used in the studies reported in this thesis can also be used by teachers and teacher trainers to become aware of factors related to the integration of research in teaching, such as research dispositions, and, subsequently, to monitor these factors during teaching practice.

### ***1.3.2 Research on teaching in secondary education***

Although the field of teaching in higher education is a distinct field, relationships with other fields of research in the educational sciences exist. The field of teaching in higher education has close ties with the field of research in teacher education for secondary education. Many results from research in secondary teacher education can be of significant value to teaching in higher education, and some clearly distinct themes in teacher education can also be discerned in the field of teaching in higher education.

Although many differences can be distinguished between teaching in higher and in secondary education, methods to investigate teachers and teaching in secondary education (Verloop, Van Driel, & Meijer, 2001; Shulman, 1986; Shulman, 1987) can also be used for research on teaching in higher education. Note that the knowledge base of teachers in higher education is different from that of teachers in secondary education. A notable difference between teachers in secondary education and those in higher education is that many teachers in higher education institutes have experience in non-teaching professions. Especially teachers in vocational areas of higher education are often familiar with the profession in which they teach courses. Teachers at research universities have experience of scientific research and the academic professional area. Although these professional experiences are not always directly linked to teaching and learning, they are an important element in the knowledge base of teachers in higher education. Teachers can provide students with examples from lived experiences of the profession or of research. Therefore, every effort to bridge gaps between research and teaching can be perceived as an effort to make teachers in higher education aware of the value of their professional research experiences for student learning.

A part of the knowledge base of teachers in higher education which is not often researched in the field of teaching in higher education is domain-specific knowledge, such as pedagogical content knowledge, which is the knowledge necessary to teach specific topics effectively to students (Berry, Loughran, & Van Driel, 2008). There is a growing body of literature about pedagogical content knowledge in secondary education (cf. Abell, 2007; De Jong, Van Driel, & Verloop,

2005; Major & Palmer, 2006; Nilsson, 2008; Van Driel, Verloop, & De Vos, 1998). A notable example of research on pedagogical content knowledge in higher education is the study by Padilla, Ponce-de-León, Rembado, and Garritz (2008) on the chemical notion of 'amount of substance'. The parts of the knowledge base of teaching that are domain specific are of special relevance to academics beginning their teaching careers, because they have not yet acquired an extensive teaching experience in that domain.

An underrepresented element in the research into teaching in higher education is the interpersonal relationship between academics and students. Research into interpersonal relationships has provided much understanding about classroom situations and many useful results for teachers in secondary education (cf. Van Tartwijk, Brekelmans, & Wubbels, 1998; Wubbels, Brekelmans, & Hooymayers, 1992). Interpersonal relationships in higher education are often rather different from the interpersonal relationships developed in secondary education. Therefore, the results cannot be transferred directly from one context to the other, but instruments can be adapted to the context and used to gather data about the various relationships. A notable example is the adaptation to the doctoral research context of a questionnaire often used to measure interpersonal relationships in secondary education, in order to measure the interpersonal relationship between supervisors and PhD students (Mainhard, Van der Rijst, Van Tartwijk, & Wubbels, 2009).

Another topic of interest for teaching in higher education is the assessment of teaching. In the fields of secondary education (cf. Nijveld, Beijaard, Brekelmans, Verloop, & Wubbels, 2006) and vocational education (cf. Bakker, Sanders, Beijaard, Roelofs, Tigelaar, & Verloop, 2008), a broad knowledge base has been developed about issues in the assessment of teaching. Studies have also been reported on the assessment of teaching in higher education, which can support teachers and teacher trainers as well as consultants in the field of higher education (cf. Tigelaar, Dolmans, Wolfhagen, & Van der Vleuten, 2004).

The professional development of teachers in higher education is a broad field (e.g., Eggins & MacDonald, 2003; Hoogveld, Paas, & Jochems, 2005; Stes, Min-Leliveld, Gijbels, & Van Petegem, in press), which is closely connected with the field of secondary teacher education (e.g., Cochran-Smith & Zeichner, 2005; Meirink, Meijer, Verloop, & Bergen, 2009; Tillema & Orland-Barak, 2006). Action research, for example, is a domain of knowledge which can be profitable for the professional development of teachers in higher education (Kember, 2000). Much knowledge about how to guide teachers in action research projects has already

been developed in secondary educational contexts (cf. Ax, Ponte, & Brouwer, 2008; Platteel, Hulshof, & Van Driel, 2008)

In sum, the field of research into teaching in higher education is a separate field, which can build further on knowledge from research conducted in the context of secondary education and teacher education. By fostering the mutual beneficial ties between research on teaching in higher education, teacher education and teaching in secondary education, the field of research on teaching, in general, can grow. Researchers in the field of teaching in higher education can build on previously developed knowledge about the knowledge base of teaching in secondary education and on knowledge from other fields of research in the educational sciences. While the impact of the results from other fields on teaching in higher education is re-negotiated, the specific context factors of teaching and teachers in higher education need to be kept in mind.

#### **1.4 Relevance of the studies**

##### ***1.4.1 Scientific research dispositions in university education***

In many science courses explicit attention is given to knowledge and research skills appropriate to the discipline. However, less explicit attention is given to intangible elements of research, such as scientific research dispositions (Elen & Verburgh, 2008). The underlying rationale of the study of scientific research dispositions is that science teaching and student learning of science in research-intensive environments might be positively influenced by explicit attention to research dispositions in undergraduate science curricula (McLean & Barker, 2004; Elen & Verburgh, 2008; Elen, Lindholm-Ylänne, & Clement, 2007). In this thesis, personal combinations of tendencies to act during research activities are labelled 'research dispositions'. These research dispositions are related to a person's character as well as to a person's contextual situation and circumstances, such as work environment, cultural background, and learning atmosphere. A person's tendencies to act can develop during infancy or later in life, as a result of educational experiences or experiences at work, and can also change according to particular circumstances in the learning environment or working environment. For every person involved in research, a set of personal tendencies to act while undertaking research can be discerned, for instance, a tendency to seek understanding, and a tendency to innovate. Some scientists might focus strongly on critically observing the outcomes of their experiment. Others are relatively more inclined towards developing innovative ideas. Focusing explicitly on a variety of aspects of research dispositions could make it possible for students to develop a realistic and mature picture of scientific practice.

### **1.4.2 Tangible and intangible elements of the research-teaching nexus**

In university teaching, knowledge of concepts, principles, and theories are important elements of scientific literacy, but knowledge about the processes of scientific inquiry can not be neglected (American Association for the Advancement of Science, 1990; 1993). The university curriculum should pay attention to the processes of scientific inquiry when preparing students to be scientifically literate with a mature epistemological disposition (Elen et al., 2007; Elen & Verburgh, 2008). The process of scientific inquiry can be emphasised in multiple ways in university curricula in which research and teaching are integrated. However, scientific inquiry cannot be described as a fixed set of general rules or steps that scientists follow. Which steps and procedures are followed within a particular scientific inquiry depends largely on the individual, the context, and the particular investigation (American Association for the Advancement of Science, 1993; chapter 'The scientific enterprise'). Neumann (1992; 1994) suggested a distinction between 'tangible' and 'intangible' ways of integrating research and teaching at universities. The tangible nexus shows how the clearly visible, explicit integration of research in teaching is organised, such as through a research internship or a research practical. The intangible nexus concerns the more tacit, not directly observable integration of research and teaching, such as through developing an inquisitive atmosphere, stimulating critical thinking, or supporting the development of research dispositions. Both tangible and intangible elements in university education are relevant when designing curricula, and when teaching courses, to give students a complete picture of what it means to do scientific research and to be a researcher.

### **1.4.3 Teachers' intentions and approaches to teaching**

According to Norton, Richardson, Hartley, Newstead, and Mayes (2005), teachers' intentions reflect a compromise between teachers' conceptions of teaching and their academic and social contexts. On the one hand, teachers' intentions are influenced by abstract conceptions of what teaching and learning should involve, conceptions of the context in which teachers teach, and perceived control over the teaching practice; on the other hand, intentions determine a person's actions (Ajzen & Fishbein, 2005). This intervening position between teachers' conceptions and teaching practice makes teachers' intentions a relevant object of research. Furthermore, in the field of higher education, many studies have been reported on approaches to teaching (cf. Gregory & Jones, in press; Kember 1997; Kember & Kwan, 2002; Prosser, Trigwell, & Taylor, 1994; Postareff & Lindblom-Ylänne, 2008; Stes, De Maeyer, & Van Petegem, 2008; Stes, Gijbels, & Van Petegem, 2008). The

approach of a teacher gives a characterisation of his/her typical teaching style, similar to how a student's approach to learning describes the student's learning style (Kember, 1997). Teachers' approaches to teaching are context dependent and can, for example, change between courses taught by the same teacher. The Approaches to Teaching Inventory (ATI; Prosser et al., 1994) is frequently used to examine teachers' approaches in higher education. The inventory is often administered to teachers in retrospect of a particular course in order to retrieve the teachers' approach to teaching during that course. Broadly two types of approaches to teaching can be distinguished in the research literature in higher education, a student-focused/learning-oriented and a teacher-focused/content-oriented approach (Kember, 1997; Prosser et al., 1994). The student-centred/learning-oriented approach is characterised by a focus of the teacher on changing students' conceptions, while a teacher-centred/content-oriented approach is characterised by a focus of the teachers on transmitting information to students.

#### ***1.4.4 Students' perceptions of learning environments***

Several studies into the quality of student evaluations of learning environments show that students' perceptions are a valid source of data about teachers and teaching (Abrami, d'Apollonia, & Cohen, 1990; Braskamp & Ory, 1994; Cashin & Downey, 1992; Marsh & Roche, 1997). The teacher is an important element of the learning environment, and often its organiser and constructor. Students' perceptions of elements of the learning environment, such as availability of supervision or possibilities for feedback from peers, are a rating, not only of the learning environment itself, but also of the teacher. The teacher constructed this environment, within certain constraints, and guided the students through the environment. In their study of postgraduate student evaluations, Marsh, Rowe, and Martin (2002) concluded that student evaluations of learning environments are a reliable source of information. Therefore, students' perceptions of learning environments are an effective method to gather data about teachers and teaching (Abrami et al., 1990; Mainhard et al., 2009). Studies into students' perceptions of learning environments in which research and teaching are closely integrated show that students' perceptions are a relevant resource, not only for the purposes of constructing learning theories, but even more so for curriculum development and teacher development purposes (Jenkins et al., 2003; Van der Rijst et al. 2009).

## **1.5 Context and research questions**

### **1.5.1 Research context**

Leiden University was founded in 1575, and is the oldest university in the Netherlands. Recently, together with other eminent research universities in Europe, Leiden University took the initiative to join forces in a collaborative group labelled the League of European Research Universities. One of the aims of this league is to collaborate and share ideas about research and teaching (Boulton & Lucas, 2008). Since the Bologna declaration, emphasis is put on the internationalisation of national higher educational systems (De Wit, 2006; Elen & Verburgh, 2008; European Ministers of Education, 1999). Because of this declaration, among other reasons, the universities in the Netherlands underwent some rather far-reaching innovations, such as the change of the credit system for the study load of courses (European Credit Transfer System), the introduction of the bachelor's-master's structure, and the introduction of English as the first language of instruction in master's programmes. These innovations have led to a more accessible higher education system for international students and staff members in the Netherlands. A new innovation specific to Dutch universities is the prominence given to the professional pedagogical development of teaching staff. Since 2008, the universities in the Netherlands have agreed to initiate a common mandatory pedagogical training course for new staff at universities (Vereniging van Samenwerkende Nederlandse Universiteiten, 2008). Many universities in the Netherlands, including Leiden University, are currently working towards introductory pedagogical training facilities for university staff.

University teachers from the Faculty of Science of Leiden University participated in the studies presented in this thesis. This science faculty comprises eight bachelor's programmes, Astronomy, Biology, Computer Sciences, Life Science & Technology, Mathematics, Molecular Science & Technology, Bio-Pharmaceutical Sciences, and Physics, and twelve master's programmes. Around 1600 students are enrolled in these programmes. The programmes are offered by eleven research institutes, including Leiden Institute of Physics, Leiden Observatory, Leiden Institute of Chemistry, and Institute of Biology Leiden. In these institutes together, an average of 300 PhD candidates conducts their research projects, and up to 350 scientific staff members, from post-doctoral fellows to full professors, and up to 340 other staff members are employed.

### **1.5.2 Research questions**

The studies presented in this thesis were focused on the individual level of teaching and learning: academics' characteristics, such as research dispositions



and teaching intentions, were examined. The central aim of the studies presented in Chapters 2 and 3 was to improve understanding of the scientific research dispositions of experts in the field of scientific research. The overarching aim of the studies presented in Chapters 4 and 5 was to identify patterns between science academics' teaching intentions and their actual teaching practice.

As discussed above, research dispositions are relevant elements of the intangible nexus, and are also an under-emphasised theme in education and in educational research. Therefore, in the first two studies, the nature of scientific research dispositions as intangible elements of the research-teaching nexus was considered. During the first study, aspects of scientific research dispositions of academics were inferred from interviews. Academics were clustered in groups with comparable research dispositions. The main research questions in the first study were the following:

***1a) What aspects can be distinguished in the ways science academics conceive of their scientific research dispositions?***

***1b) What are the differences and similarities between groups of academics with comparable research dispositions?***

The research aim of the second study was to develop an empirically based notion of disposition through the evaluation of three instruments to assess the concept of disposition. The question posed in this study was:

***2) Which instruments or combination of instruments can best be used to investigate a person's research disposition?***

The third and fourth studies were focused on associations between, on the one hand, teachers' approaches and intentions and, on the other hand, actual teaching practice in research-intensive environments. In the third study, academics' approaches were measured using a questionnaire and their teaching practices were investigated through a study of teachers' speech during courses. The central research questions of this study were the following:

***3a) What typical sequences can be recognised in individual teachers' speech during course meetings?***

***3b) Are teachers' typical speech act sequences associated with their approaches to teaching and the method of instruction used during science courses?***

Finally, in the fourth study, academics' teaching intentions were inferred through interviews, and their teaching practices were examined through the students' perceptions of the constructed learning environments. The central question in the fourth and final study was:

***4) What associations can be identified between teachers' intentions and students' perceptions of the research intensiveness of university science courses?***

**1.6 Outline of the thesis**

In Chapters 2 and 3, two studies are presented which were aimed at gaining a comprehensive understanding of academics' scientific research dispositions. In Chapters 4 and 5, two studies are presented which were aimed at gaining a deeper understanding of associations between teachers' approaches, teachers' intentions, and teaching practice. In Figure 1.1 an overview of all instruments used in this thesis is presented. The instruments are categorized into three groups, representing the underlying variables.

Chapter 2 presents the first study. In this study, academics (n=23) of the science faculty at Leiden University were interviewed about their research dispositions. The participants had different backgrounds in terms of discipline, research experience, and teaching experience. The analysis of the interview data was analogous to procedures of the grounded theory approach; themes and categories were recognised based on participants' responses in the interviews (Bryant & Charmaz, 2007). A hierarchical cluster analysis provided insight into subgroups of participants with similar scientific research dispositions. A principal component analysis of categorical data was performed to explore latent variables underlying these subgroups. Combination of results from the hierarchical cluster analysis with the principal component analysis allowed the clusters to be interpreted in terms of similarities in research dispositions between cases within clusters (Greenacre, 2007).

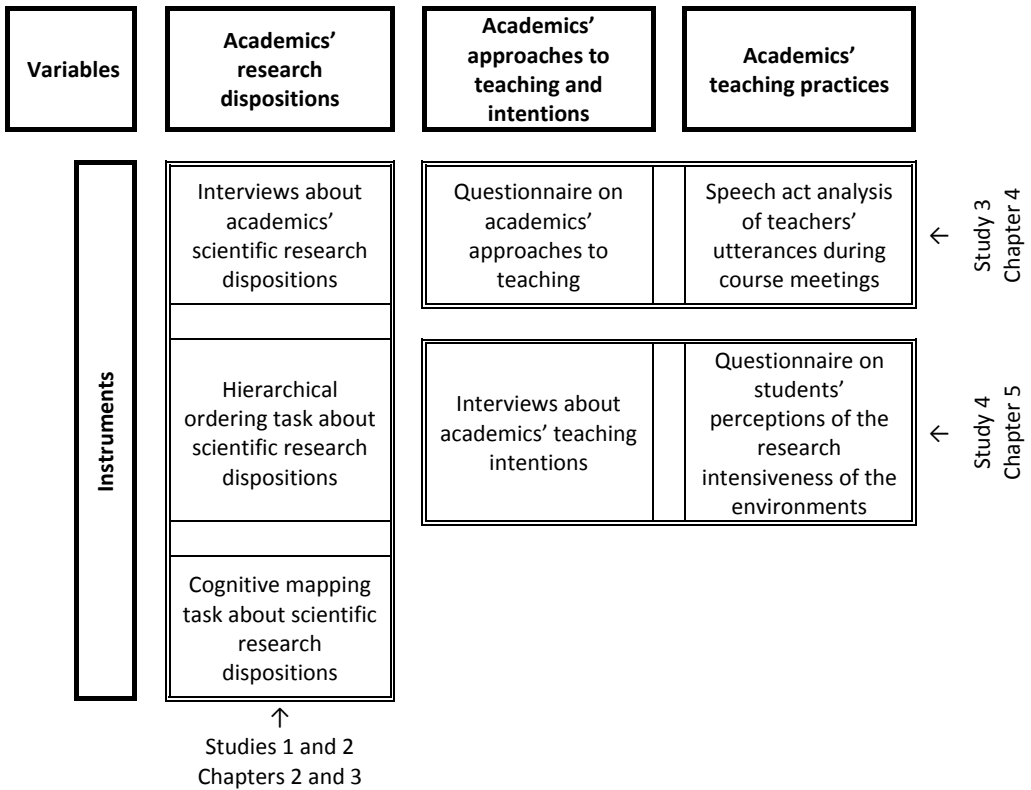

Figure 1.1 Overview of instruments used in the studies, categorised into academics' research dispositions, approaches to teaching and intentions, and teaching practices

The second study is described in Chapter 3. In this study three instruments were compared to identify a person's scientific research disposition. These instruments differed in their latitude for the respondents: a semi-structured open-ended interview, a hierarchical ordering task, and a structured mapping task. The aim of this study was, first, to increase understanding of the concept of research disposition by developing an empirically based notion of disposition, and second, to identify which instrument, or combination of instruments, was most effective in evaluating a person's research disposition.

Chapter 4 describes the third study. Here, a new analysis tool in the field of teaching in higher education, speech act analysis, was developed to investigate teachers' speech during course meetings and to gather information about academics' teaching practice. This analytical framework was based on speech act

theory; it provides a method to investigate teachers' speech repertoires. Typical speech act sequences of the participants were identified, and similar patterns were clustered. Associations between speech acts of academics (n=12) and their approaches to teaching were examined in a mixed method design in this study.

In Chapter 5, associations between teachers' intentions and students' perceptions were identified through the comparison of results from interviews with teachers (n=11) and a student questionnaire (n=104). The analysis of the interview data was analogous to procedures of classic content analysis; existing categories from the literature were used to analyse interview transcripts (Krippendorff, 1980; Ryan & Bernard, 2000). Students' perceptions of the learning environment were used as a window into academics' teaching practice. Associations between students' responses to the questionnaire and teachers' intentions are presented.

In Chapter 6, the main findings and conclusions of the four studies are summarised, discussed, and related to each other. Suggestions for further studies and implications for the practice of teaching in higher education are described.



**Chapter 2**

**Exploring scientific research disposition  
from the perspective of academics**



## 2. Exploring scientific research disposition from the perspective of academics<sup>1</sup>

In many science departments at universities, academics are searching for ways to strengthen links between research, teaching and learning. By making intangible elements of research practice, such as scientific research disposition, a more explicit part of the science curriculum these connections could be made stronger. Understanding differences and similarities between academics' scientific research dispositions could help to enhance intangible links between research, teaching and learning. These dispositions are personal mixtures of tendencies to act while performing research. The aim of the present study is to explore scientific research dispositions of academics. A semi-structured open-ended interview was administered to 23 academics from the Faculty of Science of Leiden University. The participants had different backgrounds in terms of discipline, research experience and teaching experience. Six different aspects were identified in a qualitative analysis which reflected the variety of the academics' scientific research dispositions: inclination to (1) achieve, (2) be critical, (3) be innovative, (4) know, (5) share and (6) understand. A hierarchical cluster analysis provided insight into subgroups of participants with similar scientific research dispositions. A principal component analysis of categorical data was performed to explore latent variables underlying these subgroups. Combining results from the hierarchical cluster analysis with the principal component analysis allowed the clusters to be interpreted in terms of similarities between cases within clusters. Implications for teaching and learning at universities are explored.

---

<sup>1</sup> This chapter has been submitted in an adapted form as:  
Van der Rijst, R.M. Visser-Wijnveen, G.J., Kijne, J.W., Verloop, N., & Van Driel, J.H.  
*Exploring scientific research disposition from the perspective of academics.*

## **2.1 Introduction**

A profound understanding of scientific research practice is needed to teach students to undertake scientific research at universities. The call for the enhancement of links between research, teaching and learning at universities has been answered recently in many studies in various countries (cf. USA: Boyer, 1990; Boyer Commission, 1998 and 2002; Australia: Brew, 2006; UK: Barnett, 2005; Griffiths, 2004; Healey, 2005b; Jenkins et al., 1998; Continental Europe: Van der Rijst et al., 2009). These studies present positive views on stimulating student learning by developing pedagogies and instructional approaches aimed at enhancing these links in higher education institutions. Knowledge of scientific research practice can be helpful when looking for ways to strengthen the link between research, teaching and learning in science departments.

Studies into scientific research practice have shown that the idea of a common single scientific method is overly misleading. Scientific inquiry cannot be characterised as a fixed set of steps that all scientists follow (American Association of the Advancement of Science (AAAS), 1993). Many scholars have described the phenomenon of scientific inquiry in ways which deviate from the idea of a single scientific method (cf. Bauer, 1992; Latour, 1987; Latour & Woolgar, 1979; Rowbottom & Aiston, 2006). Generally, these studies were undertaken to provide a better understanding of research practice as can be seen from the actions undertaken by the scientists themselves. It has become apparent that processes of inquiry are highly dependent on the specific context of a particular investigation, on the discipline in which a study is performed, and on personal characteristics of the scientists involved. However, these studies also show that general principles to describe the different processes of scientific inquiry can be distinguished. Latour (1987), for example, described six principles underlying science in action from a sociological perspective. These kinds of principles provide deeper understanding of the variety of processes in scientific research.

### ***2.1.1 Scientific research dispositions in literature***

Every scientist has a personal tendency to act in a specific way when undertaking scientific research, for instance, a tendency to innovate, to seek understanding, to share new insights or new ideas. Some scientists might focus strongly on critically observing the outcomes of their experiment. Others, however, might tend more towards developing new innovative ideas. We label these personal combinations of tendencies to act as 'dispositions'. A scientist's research disposition is his or her individual mixture of tendencies to act while performing scientific research. Although scientific research dispositions are individual characteristics, similarities



between aspects within dispositions can be expected. Although shared aspects of these dispositions provide understanding of research practice, no systematic investigations into scientists' dispositions in their research practice have been carried out. The aim of the present study is to categorize a variety of aspects within scientists' research dispositions.

In line with psychological literature (Albarracin, Johnson & Zanna, 2005), we refer to the changeable and intentional tendencies to act in practice as the disposition of an individual. We first note that this concept is different from the concept of 'attitude' used in psychological literature, which contemporarily is defined as 'a psychological tendency that is expressed by evaluation a particular entity with some degree of favor or disfavour' (sic.) (Albarracin et al., 2005: p. 4). In science education research literature the concept 'attitude towards science' is used (e.g. Lichtenstein, Owen, Balalock, Liu, Ramirez, Pruski, Marshall, & Toeperwein, 2008; Caleon & Subramaniam, 2008) to express a bi-polar feeling towards science. Furthermore, we note that the concept of 'attitude towards something' should be discriminated from the broader intuitive notion of an 'attitude while performing something', in the sense that commonly an 'attitude while performing something' is considered to be a characteristic way of behaving, while a 'attitude towards something' is a positive or negative feeling towards something. For example an 'attitude towards science' is not the same as a 'scientific attitude', because a student can have very negative feelings towards doing scientific lab-work (attitude as a concept in psychology), while being very critical when performing a lab-work assignment (attitude as a notion daily life). Finally, we note that the concept of 'disposition' is strongly related to Bourdieu's (1977, 1988) use of his notion of 'habitus'.

The concept of 'disposition' has been used in educational research before but not always in a consistent way. Katz and Rath (1985) defined a disposition in teacher education as referring to 'a pattern of acts that were intentional on the part of the teacher in a particular context and at particular times' (p. 303). This definition interprets the concept of disposition in a strongly behavioural sense. However, from philosophical debates about the concept of disposition (as a conditional property of material, like fragility or solubility), it becomes clear that a disposition is not always 'a summary of actions observed'. For example, a glass vase still has the disposition to be fragile, even though I hold it in my hands unbroken. Similarly, an individual who is irascible does not need to be angry constantly. On the other hand, however, a single observed action does not need to be 'caused' by a disposition; it could be just an uncharacteristic event. For example, we cannot infer that a person is characteristically hot-tempered if he

leaves the room angry after an unpleasant incident, he might be intrinsically rather mild-natured. Dispositions are, in some significant way, an intrinsic matter. To cut the philosophical debate short for now, we therefore propose, in line with Fara (2005), that an individual is disposed to *M* when *C* if and only if he has an intrinsic property in virtue of which he does *M* when *C* occurs, where *M* is a verb related to psychological disposition (e.g. to get angry, be critical, or be innovative) and *C* is a sentence stating the condition (e.g. people shout at him, he reads a manuscript from a colleague, or is writing a research proposal). That is why in this study we use the term disposition to refer to tendencies to act, rather than to the actual actions observed.

A study by Neumann showed that academics conceive relations between research and teaching in three distinct ways: (1) global connection, (2) tangible connection, and (3) intangible connection (Neumann, 1992). The global connection describes the nexus at departmental level and relates to research activity in the department, which can guide teaching activities in university courses. The tangible and intangible connections describe the relations on an individual level. Neumann defined the intangible connection between research and teaching as being related to students developing approaches and attitudes towards knowledge development and research. While the tangible connection emphasizes the transmission of advanced knowledge and results from recent research, the intangible connection relates to more implicit relations between research, teaching and learning. Scientific research dispositions are mostly related to these intangible connections between research and teaching at universities. However, it is possible to reflect on scientific research dispositions explicitly, by making it part of explicit curriculum messages, rather than giving students only implicit curriculum messages about aspects of scientific research dispositions (Ryder, Leach & Driver, 1999). Underlying aspects of scientific research dispositions can be made explicit by academics during teaching practice, for example, by guiding students with their reflections on the processes of inquiry in specific authentic research situations.

### **2.1.2 Nature of science and scientific inquiry**

Alongside knowledge of concepts, principles and theories, one of the elements of scientific literacy is to understand the processes of scientific inquiry (American Association for the Advancement of Science, 1990; 1993; Laugksch, 2000). The university curriculum should pay attention to these processes of scientific inquiry, when preparing scientifically literate students. Naturally, a scientifically literate student should develop a functional understanding of the nature of science and

scientific inquiry (NOS) (Abd-El-Khalick & Lederman, 2000; Abd-El-Khalick, 1998). However, scientific inquiry cannot be described as a fixed set of general rules or steps that scientists follow. Which steps and procedures are followed within a particular scientific inquiry depends greatly on the individual, the context, and the particular investigation (AAAS, 1993, chapter 'The scientific enterprise'). University curricula should, therefore, emphasize both discipline-independent factors and individual-scientist factors which influence the processes of inquiry. Aspects of the NOS are typically described in terms that are independent of discipline, i.e. in terms specific to the domain of science but not specific to a particular discipline within science (Schwartz & Lederman, 2008). Factors specific to the individual scientist, which influence and might explain the processes of inquiry he or she applied, have not been highlighted in literature. This means that individual choices cannot always be understood fully by scrutinizing the scientist's knowledge and beliefs about the NOS. For example, there might be two scientists who have the same knowledge and similar beliefs about the NOS but who approach the same problems quite differently. While both, for example, express similar beliefs about social-cultural influences on the processes of science, one scientist might still choose to scrutinize the problem on his own first, while the other might be more inclined to discuss the problem with colleagues abroad. Knowledge and beliefs about the NOS as well as an individual's scientific research disposition are both elements which can help us to understand the processes of scientific inquiry. Furthermore, Samarapungavan, Westby, & Bodner (2006) showed that 'immersion in authentic research experiences provides students with important opportunities to learn about the processes of scientific inquiry specific to their discipline'. More than that, the level of research expertise is a predictor of the sophistication and consistency of scientists' and students' conceptions about the processes of scientific inquiry. Learning about the characteristics of scientific inquiry, such as the NOS and scientific research dispositions, can therefore best be situated in authentic research practice where students play central participatory roles (Samarapungavan et al., 2006; Schwartz et al., 2004).

In many science courses explicit attention is given to knowledge of the discipline and research skills appropriate to the discipline. However, less attention is given to the dispositions that students need to become proficient researchers. Furthermore, every academic has certain preferred dispositions, like an inclination to be critical, to be curious or to be innovative. Although science staffs at universities have much experience in research as well as in teaching, they rarely explicitly express their inclinations to act. The idea underlying the present study is that university science teaching and student learning of science in research-

intensive environments might be positively influenced by giving explicit attention to scientific research dispositions in science curricula. Focusing explicitly on aspects of scientific research dispositions could provide students with a more realistic picture of scientific practice. Understanding differences and similarities between the various tendencies to act during research activities could be helpful when developing pedagogies and approaches to enhance links between research, teaching and learning, for example, by emphasizing what teachers need to focus on when improving students' understanding of scientific research practice. This study aims to provide academics with knowledge about the nature of scientific research practice, which could be valuable when they are trying to enhance student research competence. The implications for teaching practice at universities are anticipated.

### **2.1.3 Context and research question**

The present study was conducted at the science faculty of a research-intensive university in the Netherlands. Academics at this faculty are involved in both research activities, and teaching. Their skills, knowledge and dispositions towards research influence their teaching in one way or another. The aim of present study was first to identify the variety of aspects of scientific research disposition from the perspective of science academics, and secondly, to describe differences and commonalities between their preferred dispositions. The guiding research questions were *what aspects can be distinguished in the ways science academics conceive of their scientific research dispositions* and *what are the differences and similarities between groups of academics with comparable research dispositions*.

## **2.2 Methods**

To identify the qualitative variation in aspects of scientific research disposition, a semi-structured open-ended interview was designed and administered to science academics. Aspects of the academics' scientific research dispositions were categorised qualitatively. Commonalities and differences between participants were identified quantitatively.

### **2.2.1 Participants**

Before selecting participants two issues were considered. Firstly, the sample should cover the variety of research institutes present at the Faculty of Science of Leiden University. Secondly, participants with a large variety of experience in research as well as in teaching should be included in the sample.

Academics at different research institutes of the faculty were asked to participate. During the time in which the interviews were held, a pedagogical training for university science teachers was taking place. All academics, who had subscribed to this training, were asked to participate. Altogether, 41 faculty members were sent an email to ask for their cooperation, of whom 23 (56%) were able to be interviewed during the interview period. The main reasons given for not participating were 'staying abroad' and 'no available time' to be interviewed. Six of the participants (26%) were female. The participants held positions ranging from full professor (6), associate professor (3), assistant professor (9), lecturer (4), and post-doctoral researcher (1). All participants in this study were PhD graduates and were participating, or had participated, in research areas similar to the areas in which they taught their courses. This sample was representative of the population of faculty members of the faculty of science, in the sense that it contained members (a) from all disciplines within the Science Faculty, (b) from all levels of positions, and (c) with a variety of experience in research and teaching. The disciplines of the participants can be grouped into 5 sets; chemistry (30%), astrophysics (22%), mathematics and computational sciences (22%), physics (17%), and biology (9%).

### **2.2.2 Procedure**

Open-ended interview questions were designed to be flexible, offering participants opportunities to raise matters they considered to be important. The interview questions were tested in a pilot study with educational experts in the fields of science teaching and science research. The main aim was to find out whether the interview questions stimulated participants to explain ideas about scientific research dispositions. The wording of the questions was adapted slightly in response to their comments. Participants in the pilot interviews were excluded from the main study.

The semi-structured interview consisted of two parts. In the first part of the interview, general questions were asked about research activities, teaching activities, and background variables. The background variables were gender, position, educational experience, research institute, research orientation and research strategy. The research orientation was defined as pure or applied. When the research was described by the participant as focusing on improving scientific theory or models, the research orientation was labelled as pure, while research described as focusing on improving practice was labelled as applied. This demarcation relates to the categorization of disciplines in higher education from Becher's adaptation (Becher, 1989) of Biglan's categorization (Biglan, 1973).

Becher categorised research disciplines on two dimensions, namely pure-applied and hard-soft. While all natural science disciplines can be categorised as hard disciplines in the Becher categorization, the pure-applied dimension was used in this study to define the academics' research orientation. Furthermore, the background variable 'research strategy' related to the principle strategy academics used in their daily practice. Two strategies were considered, namely theoretical or experimental.

Part two of the interviews included questions about scientific research dispositions of academics and students and their behaviour related to these dispositions. When answering questions about their own scientific research dispositions, participants were encouraged to reflect on their current or previous research activities. Interviews took approximately 70 minutes and transcripts were sent to participants for member checking to establish data credibility (Janesick, 1994). In this study we only report on the four questions about academics' scientific research dispositions that are relevant to the aim in this study. The interviews were held in the first language of the interviewees. The questions and answers were translated from Dutch.

- a) *Can you describe which attitudes/dispositions are necessary to do scientific research?*
- b) *Picture a 'good scientist'. Explain why, according to you, this scientist is a 'good scientist'?*
- c) *Which attitudes/dispositions best fit your description of a good scientific researcher?*
- d) *Can you describe which attitudes/dispositions are necessary when conducting research in your field of study?*

Participants responded to these questions differently, for example some responded at length to questions *a* and *b*, while only referring to their earlier answers at questions *c* and *d*. Others were rather brief at question *a* and elaborated their answers at questions *b* and *d*. When selecting interview fragments for the analysis, we left out the fragments where interviewees only referred to their earlier answers on these four questions. This resulted in 72 interview fragments, consisting of question and answer, of approximately 296 words each. These interview fragments were used in the further analysis.

### **2.2.3 Qualitative analysis of interview data**

The aim of the qualitative analysis of the interview data was to capture the variation in aspects of scientific research dispositions conceptualised by academics in science and mathematics. An open coding approach was followed when analyzing the data. 'During open coding the data are broken down into discrete parts, closely examined, compared for similarities and differences, and questions are asked about the phenomena as reflected in the data' (Strauss & Corbin, 1990, p. 62). The analysis of the interview data consisted of five steps, analogous to procedures of the grounded theory approach (Bryant & Charmaz, 2007; Strauss & Corbin, 1990). The first step in the analysis process was to analyze interview transcripts to create a preliminary list of 'in-vivo codes', in which words and phrases used by the participants were applied as code labels (Strauss & Corbin, 1990, p. 69). Secondly, similar in-vivo codes were clustered creating a list of meaningful descriptive categories. Codes which initially seemed to portray a new theme were assigned to new categories. In the open coding process of qualitative analysis the point when no new categories appear, the data saturation point is typically reached after 12 participants (Guest, Bunce, & Johnson, 2006; Straus & Corbin, 1990). Short definitions and demarcation rules for each category were added based on underlying in-vivo codes. Interview fragments, in which participants did not refer to the subject of scientific research disposition or anything related to the subject were labelled as 'no code'. In the third step a research assistant was involved to verify whether the meaningful descriptive categories could be applied by a person not familiar with the data. Half of all interview fragments (n=36) were coded independently by the author and the research assistant using the list of meaningful descriptive categories, definitions and demarcation rules generated in the previous step. Categories, definitions and demarcation rules were refined, based on negotiated consensus between raters, creating the final list of meaningful descriptive categories, definitions and demarcation rules. In the fourth step of the analysis procedure all other interview fragments (n=36) were coded independently by a first and a second rater using the final list. The inter-rater reliability with two raters was 0.77 (Cohen's  $\kappa$ ), and 78.4% agreement based on 36 interview fragments and 28 meaningful descriptive categories. The first and second rater reached consensus on all codes during discussion and re-reading of interview fragments. Subsequently, descriptive categories were assigned to all 72 interview transcripts using Atlas-ti, a software program for qualitative analysis (Muhr, 1997). Finally, all descriptive categories were clustered into groups with similar meaning, creating the main aspects of scientific research dispositions.

### **2.2.4 Quantitative analysis of codes**

To study commonalities within the distribution of aspects in interview transcripts, a hierarchical cluster analysis (HCA) and a principal component analysis for categorical data (PRINCALS) were performed on the distribution of the six aspects of all 23 participants in our sample (see Table 2.2 for the percentage distributions of the codes). A hierarchical cluster analysis was carried out to explore whether relatively homogenous subgroups could be identified, based on the distribution of codes in their interviews. Pearson correlations were calculated as a measure of distance, and between-groups linkage was used as a clustering method. This clustering method is based on the average distance between all inter-cluster pairs. Secondly, a PRINCALS was carried out to explore how the subgroups of participants were related. This exploratory technique is related to Principal Component Analysis in that it allows loadings to be calculated for variables on the same dimensions, i.e. latent variables. PRINCALS, as opposed to Principal Component Analysis, can be applied to categorical data (De Heus, Van Leeden, & Gazendam, 1995). Furthermore, PRINCALS allows a plot of an n-dimensional manifold to be generated, in which both cases and variables are represented by 'points' and 'vectors' respectively (Gifi, 1990; Van Driel, Bulte, & Verloop, 2007). In the present study the cases were the distribution of codes in participants' interviews and the vectors were the aspects of scientific research dispositions. The relative distance between points within this manifold represents the relative similarity between cases. Furthermore, the position of the points with respect to a vector indicates the score on that variable represented by that vector. Points on the positive side of a vector score above average on the scale, while points on the negative side score below average.

Combining the clusters from the HCA and the manifold from the PRINCALS analysis allowed an interpretation of the clusters in terms of similarities between cases within clusters. By labelling all cases with cluster numbers from the HCA, cluster areas could be identified within the PRINCALS manifold. A 'cluster area' is the space on the manifold in which all cases from a particular cluster are present, and which could overlap other cluster areas. These areas allowed similarities and differences to be distinguished between clusters from the HCA based on identified dimensions (i.e. latent variables) and vectors (i.e. variables) from PRINCALS. To study cluster areas more deeply, 'cluster-cores' and 'cluster-boundaries' can be recognised. The cluster-core is that part of the cluster area in which only cases from a single cluster are present and which does not overlap with other cluster areas, while the cluster boundary is that part of the cluster area in which cases from other clusters are present or which does overlap with other cluster areas.



Cases within the cluster-cores can be used to give a qualitative description of common characteristics of cases in that particular cluster, while cases within the cluster-boundaries share characteristics of cases from the adjacent cluster.

Because the number of participants in this exploratory study was low, no statistical measures could be used to explore significant correlations between background variables of participants and clusters. To explore possible relations between the background of participants and the identified clusters, all cases are presented with their background variables and their cluster in Table 2.2. Some noteworthy relations between clusters and background variables will be presented at the end of the Results section.

All statistical analyses were performed using SPSS software, version 14.0.1 [note that in this version, PRINCALS is part of the optimal scaling technique 'Categorical Principal Components' (CATPCA); see also Statistical Package for the Social Sciences Incorporated, 1990: chap.8].

## **2. 3 Results**

### **2.3.1 Six aspects of scientific research dispositions**

Six qualitatively different aspects were distinguished from the interview transcripts: (1) inclination to achieve, (2) inclination to be critical, (3) inclination to be innovative, (4) inclination to know, (5) inclination to share, and (6) inclination to understand. Based on the qualitative analysis of the interview data these six aspects were interpreted as the core aspects of a scientific research disposition. These six aspects reflect the qualitative variation in the academics' conceptualization of scientific research disposition within the data. In the following sections the content of each aspect will be described in words. These descriptions are based on the underlying codes, which are presented in the first column of Table 2.1. Table 2.1 also presents two quotes to illustrate each aspect of scientific research disposition. The research institute and all codes assigned to the fragment from which this quote originates are shown in brackets.

#### *Explanation of 'inclination to achieve'*

Many of the participants described their scientific practice as 'hard work and very time-consuming'. They described outstanding scientists as having strong elements of discipline, persistence and perseverance. When describing an inclination to achieve as one of the aspects of a scientific research disposition, academics put emphasis on the *ambition* and *drive to completely devote oneself* to the issues under study. Being *passionate* and *persistent* were characteristic features within this aspect. A considerable amount of *personal discipline* was considered

necessary: not giving up before you are satisfied and keeping up the effort even when it becomes difficult. *Patience* was considered crucial when conducting scientific research. Those academics, which put emphasis on this aspect, evaluated themselves as *full of initiative* and referred to the importance of bearing in mind the final goal of the project. Often this aspect was related to *passion* and *putting all of your energy into the project*. The inclination to *persist until you are satisfied* was found to be important, but should be balanced by the need to keep in mind the construction of an appropriate end, even when you still know so little about the phenomenon under study.

Table 2.1 Underlying codes with illustrative quotes of the six aspects of scientific research disposition (translated from Dutch by the author; between brackets: research institute and codes assigned to the fragment)

Aspect (with underlying codes)	Example Quote 1	Example Quote 2
To Achieve - ambition - discipline - full of initiative - patience - passionate - persistent	'To concentrate, to focus, that's something central to this profession. It [research] is no hocus-pocus, it isn't very extraordinary. You just need a certain routine and discipline'. (Chem; <i>discipline</i> )	'I consider thoroughness important. As I already said, dummies are unacceptable. You can have innovative ideas but you have to put these ideas into practice in a scientifically correct and theoretically sound way, and if your ideas do not seem to work afterwards, you just have to dismantle them'. (Astro; <i>discipline</i> )
To be Critical - critical (general) - critical towards others - honesty - observing - self-critical	'Being critical, being independent, and having the ability to present well are the core aspects, I believe, especially being critical'. (Chem; <i>critical (general), skilled communicator, choosing own path</i> )	'To be critical is most important. They [students] have to weigh all the information they receive, not only from literature, but also the results from their own experiments. [...] many things can be related to that, open attitude, open towards other ideas and towards different results, [...] but all is closely related to being critical.' (Phys; <i>self-critical, critical towards others</i> )

Table 2.1 (continued)

Aspect (with underlying codes)	Example Quote 1	Example Quote 2
To be Innovative - anticipating - associative - choosing own path - creative - original - unconventional	'A good study has some innovative element. Many articles are produced which just present small technical steps. Anyone with brains can write these. A good study needs at least one original thought.' (Math; <i>original</i> )	'The ability to ask exciting new questions and to create new mental images, originality is important. Some people are good researchers, but they follow standard procedures. Others are better, recognizing new areas of research.' (Bio; <i>original</i> )
To Know - curious - excitement	'On the one hand, getting curious, while on the other hand, not getting too excited. So, being enthusiastic on the one hand, and yet keeping disciplined, keeping calm to proceed by conveniently arranged steps'. (Chem; <i>curiosity and discipline</i> )	'Curiosity, in particular within science, I suppose, but that might be my limited perception. Curiosity is a major motive, should be the most important motive'. (Astro; <i>curiosity</i> )
To Share - explaining - openness towards others - persuasive - skilled communicator - working together	'Presenting, naturally, if it all goes well, is an archetypical form, it includes aspects such as being independent, being critical, showing drive, passion, it includes all these aspects, doesn't it?' (Chem; <i>skilled communicator, choosing own path, critical (general), passionate</i> )	'Nowadays, as a researcher, it won't do anymore to withdraw yourself to your room, to think it all out on your own. Interaction with other groups can't be underestimated nowadays, that's how you will make progress.' (Chem; <i>working together</i> )
To Understand - overview - scrutinizing - solving problems	'The drive to understand a phenomenon, to feel the inner joy when you understand the issues, when you solve a problem, but then again, it isn't just about solving puzzles. It is about the joy of understanding issues in a way nobody else understands them. That is so special, that is what you have to experience'. (Astro; <i>scrutinizing</i> )	'Yes, the desire to understand how something works and to experience the thrill when you understand it, when you solve the issue.' (Astro; <i>solving problems</i> )

### *Explanation of 'inclination to be critical'*

Many participants perceived 'being critical' as the core issue in scientific practice. When describing an inclination to be critical as one of the aspects of a scientific research disposition, academics put emphasis on a *critical attitude towards others*, for example, articles, colleagues, but also *toward the observations from experiments*. A *self-critical attitude*, being critical of one's own ideas and own work, also fits within this aspect. Generally speaking, issues within this aspect all boiled down to sophisticated doubt, which initiates critical questioning of all kinds of issues. Academics who emphasised this aspect often talked about critically observing the experimental setup and data. Continuously *being attentive and open towards strange incidents and observations*, which ask for critical reflection, was essential to most of these academics. Always double checking the set-up and considering issues of accuracy were connected with this aspect. Furthermore, part of this inclination revolved around *critically honest* management and presentation of your data, such as meticulously avoiding plagiarism and twisting data to suit your private opinion.

### *Explanation of 'inclination to innovate'*

Good science was perceived by the participants as an innovative endeavour. Originality and creativity are elements of this. Participants acknowledged that not all scientific projects are highly innovative, but creating innovative ideas and practices was perceived as an aspect of scientific research practice. When describing an inclination to innovate as one of the aspects of a scientific research disposition, academics put emphasis on *originality, creativity* and *choosing their own line of research*. Many academics referred to the benefit of '*unconventional behaviour*', which was explained as behaviour that contradicted, for example, the conventions within the research group, or within the field of research as a whole. To do this, a certain amount of courageousness or naivety is necessary. Some paid tribute to the naivety of, for example, new scientists, who can be innovative because they are not yet inhibited by various conventions in the field. Developing new instruments and explaining innovative ideas was reported as a major drive. A degree of creativity and following your intuition was felt to be necessary. *Associative thinking* and combining various issues, for example from diverse fields of research, was considered very beneficial. Academics who put a strong emphasis on this aspect might be perceived as ahead of times, or having an outlook that anticipates future studies.

*Explanation of 'inclination to know'*

When describing an inclination to know as one of the aspects of a scientific research disposition, academics put emphasis on *curiosity* and being knowledge-thirsty. Scientists exhibiting this inclination were highly motivated to read about new issues and listen to new ideas. Their attention was drawn towards phenomena and perspectives, which were novel to them. They were motivated to gain knowledge of more facts about new issues. Their broad interest made them curious about various topics. These topics were not only related to their own field of study, but could also be related to other fields. This inclination was strongly associated with a basic interest in and curiosity about the unknown. Issues such as *motivation* with an intrinsic orientation and *excitement* when the curiosity was fed, were often reported.

*Explanation of 'inclination to share'*

Research results are disseminated among others within the scientific community on a regular basis. Some participants highlighted sharing results as an element of a scientific research disposition. When describing an inclination to share as one of the aspects of a scientific research disposition, academics put emphasis on *explaining, convincing others* and *openness towards other ideas* and conclusions. These other ideas and conclusions may come from immediate colleagues and students, from international contacts, from conferences, or from journals. Academics emphasizing this aspect often reported that *interdisciplinary exchange of knowledge, methods and ideas* is rather important. Academics acknowledged benefiting from an *open-mind towards others*. This aspect was said to often co-occur with becoming a *skilled communicator*, being good at creating social contacts, not only in *working together with colleagues*, but also being good at assembling people around your ideas and generating funding for further research. Certain intrinsic characteristics, such as optimism, empathy, and strategic sensitivity, were considered to be very helpful.

*Explanation of 'inclination to understand'*

When describing an inclination to understand as one of the aspects of a scientific research disposition, academics put emphasis on the inclination to *scrutinize underlying causes* and meaning of phenomena and facts around us. These academics put emphasis on a search for *deep understanding*, to get to the bottom of the issue. They were not satisfied with only knowing the facts, but wanted to understand how the facts are connected to each other. They often stressed the inclination to seek the *broad view* and to *relate facts to the bigger picture*. An

inclination to develop a *broad-minded view of their subject area* and to unite the various findings and results from individual studies was often reported by academics, which emphasised this aspect.

One might tend to read the aspects 'inclination to know' and 'inclination to understand' as being similar. However, the differences between these two aspects can be explained in terms of the underlying codes, which are presented in the first column of Table 2.1. The demarcation criteria were deduced from the underlying codes. Underlying codes of 'to know' were assigned to fragments in which participants talk about their initial curiosity about a subject, the curiosity which focuses the motivation to learn more about a topic, which excites you as a scientist. The underlying codes of 'to understand' were assigned to interview fragments in which participants talk about scrutinizing phenomena, the drive to understand the issue in depth, to create an overview of the facts and the relations between facts related to a specific topic. Some participants related this aspect to a kind of internal frustration, whereas the aspect 'to know' did not generally involve any frustration.

### **2.3.2 Percentage distribution of codes among participants**

Table 2.2 presents the percentage distribution of the main aspects of scientific research disposition. The distribution of codes is presented as a percentage of occurrences of codes within the interview per participant. Background variables (educational experience, gender, position in department, and affiliation with educational institution) are also presented in Table 2.2. The distribution percentages were used as indicators of the 'amount of attention or the degree to which an attitude or belief permeates a population' (Krippendorff, 1982, p. 109). These distributions indicate the 'amount of attention' given to that particular aspect in the interview.

### **2.3.3 Hierarchical cluster analysis and principal component analysis**

To study commonalities within the distribution of aspects in the interview transcripts, a hierarchical cluster analysis (HCA) and a principal component analysis for categorical data (PRINCALS) were performed on the percentage distribution of the six aspects of participants. Five clusters were defined from the hierarchical cluster analysis. The number of clusters was estimated by the demand that every case was included in a cluster and there was a reasonable increase in the clustering criterion (Everitt, Landau & Leese, 2001).

The five clusters identified by the HCA can be interpreted through a PRINCALS analysis. Combining the results from the hierarchical cluster analysis

and the PRINCALS analysis allowed the clusters to be interpreted in terms of similarities between cases within clusters. Figure 2.1 shows all cases on a two-dimensional manifold calculated by PRINCALS.

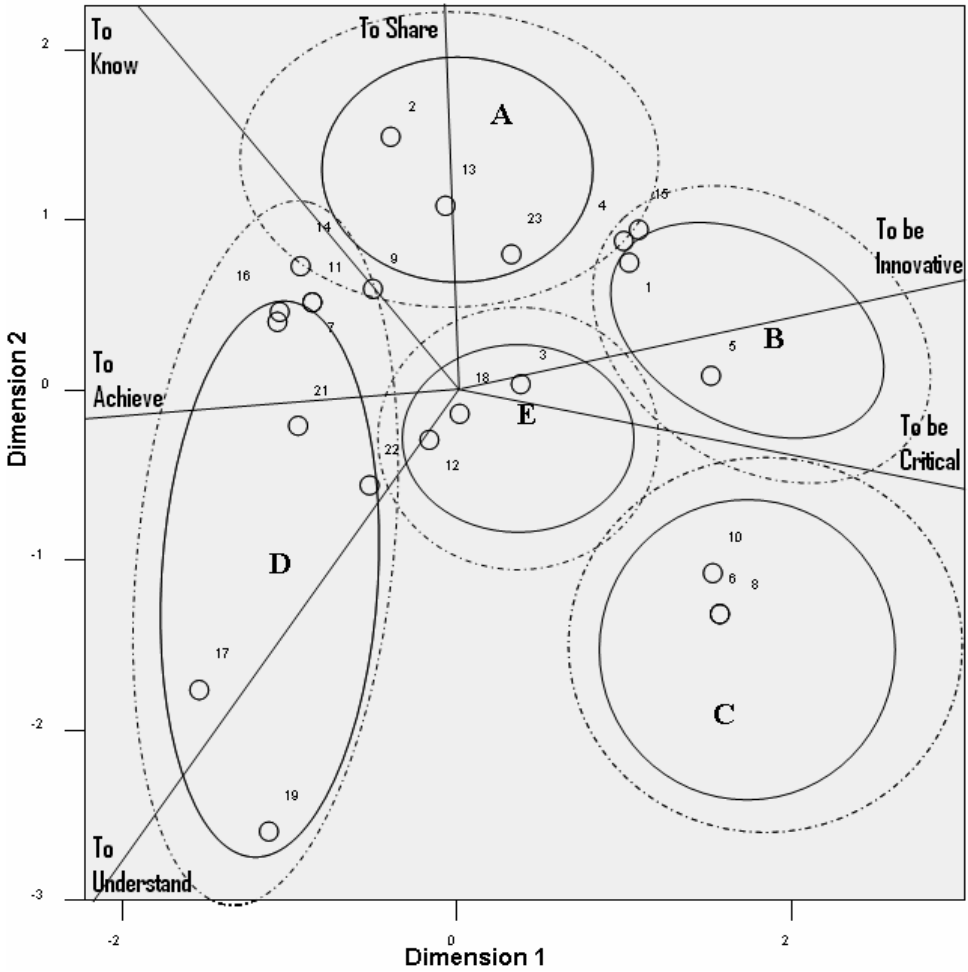

*Figure 2.1 Cases plotted on a two dimensional manifold and labelled with case numbers from the cluster analysis (vectors of the six aspects of scientific research dispositions are plotted on the manifold)*

*Table 2.2 Percentage distribution of the aspects of scientific research disposition*

Cluster (from HCA)	Case number	Educational experience (years)	Gender	Position	Institute	Orientation	strategy	To Achieve	To be Critical	To be Innovative	To Know	To Share	To Understand	No Code	Total number of codes
A	2	15	male	Full	Chem	applied	Exp	25	0	13	50	13	0	0	8
	7	40	female	Lectu	Biol	applied	Exp	20	0	0	40	20	20	0	5
	11	2	male	Assist	Phys	pure	Exp	20	0	0	40	20	20	0	5
	13	6	male	Assist	Astro	pure	Exp	20	0	20	40	20	0	0	5
	15	20	male	Assist	Math	applied	Theo	0	18	18	36	18	0	9	11
B	23	10	male	Assist	Chem	pure	Theo	0	0	14	29	29	14	14	7
	Mean values cluster A														
	1	1	male	Assist	Phys	applied	Exp	9	36	9	18	27	18	0	11
	4	30	male	Assoc	Chem	applied	Exp	0	25	13	25	38	25	0	8
	5	15	female	Assoc	Chem	applied	Exp	0	20	20	0	60	0	0	5
Mean values cluster B															
C	6	20	male	Full	Biol	applied	Exp	0	30	40	10	0	10	10	10
	8	30	female	Lectu	Chem	applied	Exp	0	40	0	0	20	20	20	5
	10	8	male	Assist	Phys	pure	Exp	10	70	10	10	0	0	0	10
Mean values cluster C															
								3.3	46.7	16.7	6.7	6.7	10.0	10.0	8.3



Table 2.2 (continued)

Cluster (from HCA)	Case number	Educational experience (years)	Gender	Position	Institute	Orientation	strategy	To Achieve	To be Critical	To be Innovative	To Know	To Share	To Understand	No Code	Total number of codes
D	9	5	male	Full	Phys	pure	Exp	33	0	11	22	11	22	0	9
	14	10	male	Assist	Astro	pure	Exp	43	0	0	14	43	0	0	7
	16	21	female	Full	Chem	applied	Theo	33	0	0	22	33	11	0	9
	17	20	male	Lectu	Math	pure	Theo	33	0	0	33	0	33	0	3
	19	22	male	Lectu	Math	pure	Theo	33	0	0	0	0	33	33	3
	20	10	male	Post-D	Math	pure	Theo	43	0	0	14	29	14	0	7
	21	20	male	Full	Astro	pure	Theo	60	0	0	40	0	0	0	5
	22	2	male	Assist	Astro	pure	Theo	36	14	7	29	0	14	0	14
Mean values cluster D															
								39.3	1.8	2.3	21.8	14.5	15.9	4.1	7.1
E	3	25	male	Full	Chem	applied	Exp	41	12	29	12	6	0	0	17
	12	8	male	Assoc	Astro	pure	Exp	22	0	33	33	0	11	0	9
	18	10	female	Assist	Math	pure	Theo	50	17	17	17	0	0	0	6
Mean values cluster E															
								37.7	9.7	26.3	20.7	2.0	3.7	0.0	10.7
Total mean values															
								19.5	17.6	14.0	20.5	17.0	10.6	3.6	8.2

The two dimensions are the latent variables identified by PRINCALS, which together account for 73.1 % of the variation in the data. The five 'cluster areas', from the clusters identified in the HCA, are plotted on the manifold to provide an indication of how the clusters are related. The 'cluster-cores', represented by dotted lines, and 'cluster-boundaries', represented by closed lines, are presented in Figure 2.1. Cases 4 and 15 are positioned within cluster-boundaries of cluster A and B, and so can be documented as mixed cases, having characteristics of cluster A and characteristics of cluster B. Cases 7, 9, 11, and 14 are positioned in the boundaries of cluster A and D. The directions of the vectors on the two-dimensional manifold were calculated, and are presented in Figure 2.1. These vectors represent the arrangement of the six aspects of scientific research dispositions (variables) towards the two identified dimensions (latent variables).

The vectors of the six aspects of scientific research dispositions presented in Figure 2.1 provide an interpretation of the two dimensions of the manifold. Dimension 1 runs from 'to achieve' on one side to 'to be innovative' and 'to be critical' on the other side. Dimension 2 divides cases between scoring high on 'to understand' and scoring high on 'to share' and 'to know'.

Cases, which score low on 'to achieve' and high on 'to be critical' and 'to be innovative', are positioned on the right hand side of Figure 2.1 (high on dimension 1), while cases, scoring low on 'to understand' and high on 'to share' and 'to know', are positioned on the top half of Figure 2.1 (high on dimension 2). We can now interpret the clusters based on the dimensions defined by the vectors of the six aspects of scientific research dispositions. For example, cases in cluster D all score relatively high on 'to achieve', while cases in cluster C score relatively high on 'to be critical'. By combining the results from HCA and PRINCALS, we identified five clusters of participants, which have more or less similar scientific research dispositions. Table 2.3 presents short descriptions of each cluster, based on similarities and differences between cases in cluster-cores using the distribution of codes from Table 2.2. These cluster descriptions are based on the cases in the cluster-cores, because these cases best represent the characteristics of each cluster. We refer to distribution frequencies greater than or equal to 27% as 'high' scores and distribution frequencies less than or equal to 18% as 'low' scores.

### ***2.3.4 Relationship between clusters and background variables***

Possible relations between the clusters and the background variables of the participants were explored by examining patterns of background variables within the clusters. The idea behind this step was that differences of culture between

disciplines within an institute could have an important influence on participants' personal research dispositions. Table 2.2 presents the background variables of all cases within each cluster. Interestingly, cases in clusters B and C generally had an applied research orientation and an experimental research strategy, while cases in clusters D and E had a pure research orientation. Table 2.2 and 2.3 indicate, based on visually examining of the results, that academics from more applied and experimental fields of study (Cluster B and C) tend to put more emphasis on the aspects 'to be innovative' and 'to be critical', while academics from fields with a theoretical research orientation (Cluster D) tend to focus more on the aspects 'to achieve' and 'to understand'. Furthermore, all participants from the mathematics institute are in clusters D and E, while no participants from astrophysics are in clusters B and C. Visually, no patterns between cluster and gender, position or educational experience were recognised in the data.

*Table 2.3 Descriptions of clusters based on cases in cluster-cores and the vectors of the aspects of scientific research dispositions*

---

Cluster	Cases in 'cluster-core'	Description
		<i>The scientific research dispositions of persons who are positioned in the core of this cluster typically consist of...</i>
<b>Cluster A</b>	2, 13, 23	... high scores on 'to know' and low scores on 'to understand' and 'to be critical'.
<b>Cluster B</b>	1, 5	... high scores on 'to share' and low scores on 'to achieve' and 'to understand'.
<b>Cluster C</b>	6, 8, 10	... high scores on 'to be critical' and low scores on 'to achieve' and 'to know'.
<b>Cluster D</b>	17, 19, 21	... high scores on to achieve and low scores on 'to be critical' and 'to be innovative'.
<b>Cluster E</b>	3, 12, 18	... both similar scores on 'to achieve' and 'to be innovative' and/or similar scores on 'to understand' and 'to share'.

---

## **2.4 Conclusions and discussion**

### **2.4.1 Scientific research dispositions**

The results of this study present a diverse picture of how science academics conceptualize their scientific research disposition. The analysis of the interview

transcripts distinguished six qualitatively different aspects of scientific research disposition: inclination (1) to achieve, (2) to be critical, (3) to be innovative, (4) to know, (5) to share knowledge, and (6) to understand. Three of these aspects, *inclination 'to know', 'to be critical', and 'to share'*, resemble aspects in literature on research dispositions and scientific attitudes (De Vos & Gensenberger, 2000), but they have never been verified in an empirical study of the research practice of academics. Three aspects, *inclination 'to achieve', 'to understand', and 'to be innovative'*, were new to our understanding of scientific research dispositions and provided new insights into scientific practice.

The six aspects found in this study can also be compared to the classes described by Thagard (2005). Thagard discussed a broad range of factors for scientific success, based on a short survey and written advice to young scientists from three Nobel Prize laureates in the field of biology. 'Six classes of successful habits' emerged from this discussion; (1) make new connections, (2) expect the unexpected, (3) be persistent, (4) get excited, (5) be sociable, and (6) use the world. Although Thagard uses the term 'habit', he does not make a distinction between incidental actions and habitual actions of an individual. A 'disposition', as defined earlier in this manuscript, is not characterised by 'accidental' behaviour, but is characterised by an intentional behavioural pattern. The 'actions' of successful scientists, described by Thagard can therefore be considered to be 'dispositions', if an individual intentionally follows a pattern of actions in similar situations. Habits classified by Thagard within the class 'making new connections' can be interpreted as analogous to elements in our main category 'to be innovative'. Similarly, elements in our category 'to achieve' resemble habits classified as 'be persistent'. However, a clear difference in interpretation is apparent when we look at the aspects 'to know' and 'to understand'. Thagard does not make any distinction between habits related to 'knowing' and habits related to 'understanding'. Elements from the class 'get excited', like 'never do anything that bores you' and 'have devotion for truth', are similar to elements of our aspect 'to know', like 'excitement' and 'curiosity'. Other elements from this class, like 'have a strong desire to comprehend' incline more towards 'to understand'. Likewise, actions in the class 'be sociable' can be mapped onto the inclination 'to share', and actions in the class 'expect the unexpected' can be interpreted as part of an inclination 'to be critical', in the sense that scientists who tend to critically scrutinize observational data are receptive to unexpected trends in the data. We can conclude from this that although not much has been written in research literature about the research disposition of academics, some similar aspects do emerge in different studies.

Before discussing the statistical procedures, identifying clusters and relating these clusters to background variables of academics, we will first discuss the assumptions underlying the present study. Firstly, the analyses are based on the percentage distribution of the six aspects in interviews with academics. The relationship between the distribution of aspects and the actual research disposition of academics was not always very straightforward. To put it another way, we did not necessarily expect to find a one-to-one correlation between what academics say in an interview and their actual dispositions. To overcome this difficulty, multiple opportunities were presented to the participants during the interviews to say whatever they perceived to be related to the topic under debate. Secondly, we had to be careful to define the aspect with the highest percentage distribution as being the most central or most important aspect within a participant's research disposition. This assumption behind the analysis used in this study might limit the conclusions. However, the interview consisted of multiple questions and responses, and during the qualitative analysis of the fragments each code could only be assigned once to each interview fragment. This means that an aspect with a high percentage distribution must be interpreted as an aspect that was mentioned by the participant in different interview fragments, and therefore in response to different interview questions. Finally, in any interview procedure it is difficult to determine the extent to which the responses to interview questions are being influenced by perceived social desirability. However, all participants were informed about the complete confidentiality of the interview, and no possible reasons for socially desirable responses could be identified in the interview scheme. Nevertheless, we have to be careful when drawing general conclusions from this data alone. Further research on academics' scientific research dispositions should be done to verify the results in other contexts.

Furthermore, some differences and similarities in the background variables of the participants were observed between the identified clusters. From the differences and similarities in this sample we were able to draw the conclusions that 1) academics from more applied and experimental fields of study tended to put more emphasis on 'to be innovative' and 'to be critical', while academics from fields with a pure research orientation tended to focus more on 'to achieve' and 'to understand'; and 2) academics in mathematical sciences tended to focus more on aspects 'to achieve' and 'to understand', while astrophysicists often put less stress on aspects 'to be innovative' and 'to be critical', relative to other groups of academics. These final observations indicate that disciplinary differences and/or institutional cultures might have had an

influence on the scientific research dispositions of these academics. However, these observations should not be overstated, as they do not show unambiguous relationships between investigative disciplines and research dispositions. Studies presenting possible relationships between the investigative context and academics' views on the nature of science and scientific inquiry (Schwartz & Lederman, 2008) also did not show unequivocal results.

### **2.4.2 Implications for research and teaching**

We anticipate three implications for university science education: helping university science teachers with scaffolding and supervising research-intensive education, improving student learning about research practice, and supporting the professional development of university teachers.

Firstly, university science teachers scaffolding research activities and supervising students participating in research activities need to understand the diversity in research approaches. As scientific research dispositions are essential for understanding the underlying mechanisms of scientific practice, university teachers should at least be aware that differences in research dispositions do exist. If university science teachers are able to discriminate between the six aspects, it should become possible for them to scaffold the development of students' research dispositions on science courses. Furthermore, by explaining scientific research dispositions, university science teachers should be able to encourage students to consider aspects of research dispositions and offer students opportunities to develop a realistic understanding of scientific research practice. Finally, to provide university teachers with tools to identify scientific research dispositions in educational settings, the aspects of research dispositions should be 'translated' into observable behavioural patterns which can be observed in student activities. This means that for each aspect a description should be generated of the related behavioural pattern. Such a description can then be used in educational settings to identify the research disposition, for example, of students undergoing research activities in their curriculum. Further studies are needed to identify which observable behavioural patterns are related to each of the six aspects of scientific research dispositions.

Secondly, science students learn about research practice both implicitly and explicitly. Academics giving an explicit account of their research practice experiences as part of their university teaching can be of great value to student learning in research-intensive environments (Seymour et al., 2004). A unique feature of research practice is that there are different approaches to research and that all scientists will choose their approach based on their dispositions. Although,

dispositions towards scientific research are acquired by students during their university study, there are relatively few moments during university courses when students explicitly reflect on the nature of knowledge development. As with their learning about the nature of science (Abd-El-Khalick et al., 1998), students do not learn about scientific research dispositions implicitly by doing science. Students could use the framework of six aspects of a research disposition presented here to understand implicit aspects of research practices more deeply. Furthermore, science students should be acquainted with the diversity of processes of inquiry to develop a realistic picture of research practice. A possible approach to accomplishing this is to arrange multiple ways to come into contact with different research groups within the science curriculum.

Thirdly, an understanding of scientific research disposition can be helpful for the professional development of university science teachers. Encouraging teachers to reflect on implicit aspects of their own and their peers' research practice, such as scientific research dispositions, is likely to help them become more receptive to student conceptions and misconceptions about research practice. Although these student conceptions about research could be informative when designing and teaching university science courses, especially at research-intensive universities, academics rarely explicitly use knowledge about students' conceptions. Aspects of scientific research dispositions, such as those defined in this study, could help university science teachers to understand students' conceptions and misconceptions about scientific practice, for example by identifying missing aspects of scientific research disposition within students' conceptions about research.

Although knowledge about scientific research dispositions can support both university science teaching and student learning, academics rarely reflect explicitly on preferred aspects of scientific research dispositions in their discipline (cf. Neumann, 1992). Results from this study provide us with new perspectives on academics' practice. The framework of six aspects of scientific research dispositions presented in this study could be helpful in university science teaching, learning, and professional development of academics.







## Chapter 3

### Towards an empirically based notion of the concept of disposition



### **3. Towards an empirically based notion of the concept of disposition<sup>2</sup>**

Debates on the concept of disposition in educational research are theoretically oriented, and show limited empirical applicability. The aim of this study was to evaluate a set of instruments to assess the concept of disposition empirically. In this study scientific research dispositions of academics were considered. We examined three instruments, which differed in their latitude for the respondents: a semi-structured open-ended interview, a hierarchical ordering task, and a structured mapping task. The results show that the semi-structured interview and the hierarchical ordering task enabled assessment of the tacit research dispositions, while the structured mapping task facilitated assessment of the respondents' explicit ideas about their research dispositions. Hence, we suggest for future research to utilize a combination of the instruments.

---

<sup>2</sup> This chapter has been submitted in an adapted form as:  
Van der Rijst, R.M., Visser-Wijnveen, G.J., Van Driel, J.H., Kijne, J.W., & Verloop, N. *Towards an empirically based notion of the concept of disposition in educational research.*

### 3.1 Introduction

The concept of disposition can be identified in various bodies of literature within the educational sciences (Barak, Ben-Chaim, & Zoller, 2007; Bourdieu, 1989; Damon, 2007; Diez & Rath, 2000; Dottin, 2009; Facione, Facione, & Giancarlo, 2000; Laird, 2005; Murray, 2007; Perkins, Tishman, Ritchart, Doris & Andrade, 2000; Pithers & Soden, 2000; Schussler, 2006; Stupnisky, Renaud, Daniels, Haynes, & Perry, 2008). However, there has been little conceptual debate about the concept of disposition in educational research, as the concept is still in a developmental phase (Dottin, 2009). In order to improve the quality of the conceptual debate more attention should be given to the definition of and the ideas behind the concept of disposition. Conceptual misunderstandings are prolonged when concepts remain unclear. In some fields of educational research, for example, the words *disposition* and *attitude* are used interchangeably. Although these concepts are closely related, they are not the same. The concept of attitude used in the psychological literature is contemporarily defined as ‘a psychological tendency that is expressed by evaluating a particular entity with some degree of favor or disfavor’ (sic.) (Eagly & Chaiken, 1993, cited in Albarracín et al., 2005, p. 4, italics in original), while the concept of disposition can be more broadly defined as a person’s individual mixture of inclinations to act under certain conditions (Siegel, 2005; Van der Rijst, Van Driel, Kijne, & Verloop, 2007). Situational inducements, such as social norms, group pressure, time on task, or task difficulty, are often opposed to dispositional attributes, such as motives, personality traits, or abilities, in the classification of causes of behaviour in psychology (Trope, 1986). Therefore, the psychological concept of attitude, as in *attitude towards something*, should be discriminated from the broader ordinary notion of *having an attitude*, in the sense that an attitude is commonly considered to be a characteristic way of behaving, while the psychological notion of attitude towards something is a positive or negative feeling towards something. For example, a *scientific attitude* is not the same as an *attitude towards science*. A student can have a positive feelings towards doing laboratory work (attitude as a concept in psychology), while being very critical when performing a lab-work assignment (attitude as a notion in daily life). Bearing in mind this difference, we note that the concept of disposition is more closely related to the commonly received notion of attitude than to the psychological concept of attitude, in the sense that the commonly received notion of attitude and the concept of disposition can both be broadly defined as a person’s mixture of inclinations to act under certain conditions.

Few interdisciplinary debates about the concept of disposition exist within educational research, but within philosophy the concept has been overly discussed in recent decades (cf. Fara, 2005; see Malzkorn, 2001 for an overview). Although this debate involves *dispositions of substances*, many arguments also reverberate upon the use of the concept in the social sciences, the *disposition of subjects*. Since the concept of disposition faces similar problems in both fields, the arguments from the debate on dispositions of substances are potentially helpful when considering dispositions of subjects.

### **3.1.1 Dispositions of substances in modern philosophy**

The debate about dispositions in modern philosophy can support academics working with the concept in educational research, especially at the present time, as no commonly accepted notion of the concept of disposition is present in educational research. Because the arguments in the philosophical debate are rather technical and diverse, we are not able to give a full account. For an attractive overview of the debate in modern philosophy, see Fara, 2005 and Malzkorn, 2001. Below, we present the basic arguments from this debate, and deduce three principles of the concept of disposition which are potentially helpful when working towards an empirically based notion of the concept of disposition in educational research.

Dispositional properties of substances, such as solubility or fragility, only relate to *possible* behaviour under certain specified conditions. Categorical properties, such as shape and mass, on the other hand, can be observed directly from actual behaviour. For example, sugar has categorical properties, such as its colour and crystalline shape. These properties can be observed and measured under normal conditions. Its dispositional property cannot be measured under normal conditions, but only under certain specified conditions. A dispositional property is distinct from a categorical property in that it needs specific conditions under which the manifestation of the dispositional property can be observed. For example, we only know that a glass vase has the tendency “to break (dispositional property) when it falls on a solid floor (condition C)”, if and only if (iff) it breaks when it falls on a solid floor (manifestation M)’. This description gives an idea of the Simple Conditional Analysis of dispositional properties, which is generally stated as follows: An object is disposed to M when C iff it would M if it were the case that C. However, this definition of disposition faces several counterexamples, most of which are special cases of the *conditional fallacy* of contemporary philosophy (cf. Bonevac, Dever, & Sosa, 2008; Shope, 1978). The conditional fallacy roughly states that one ignores the fact that the truth of a

statement sometimes depends on whether a particular state of affairs actually occurs, while it should only depend on the assumptions or the definitions, which, therefore, permits several counterexamples. Here we describe only two counterexamples to the Simple Conditional Analysis, which are not directly related to this conditional fallacy. Johnston (1992) described the situation in which a glass vase, which is disposed to shatter when dropped, is carefully covered with packing material. The glass vase still has the disposition to be fragile, but it does not shatter when it is dropped. The disposition of the vase is masked by the external packing material. A similar counterexample was described in Bird's (1998) antidote example. A poison is disposed to kill when ingested, but when an antidote is administered in time the manifestation of the disposition will not be present. In both counterexamples, the packing material and the antidote are items external to the substances, and should, according to our common sense, not eliminate the dispositional property. It seems that a disposition should be related, in one way or another, to some intrinsic property of that substance. Thus, as Fara (2005) puts it, an object "*N* is disposed to *M* when *C*" is true iff *N* has an intrinsic property in virtue of which it *M*s when *C*'. Thus, there must be an intrinsic property which can serve as an explanatory basis for the disposition. This means that the label of the disposition, e.g., fragility or solubility, does not explain anything in the sense that if we ask why that glass vase is disposed to break when dropped on a solid floor, the answer, because it has the disposition to be fragile, is not adequate. This is similar to the explanation given by Molière's doctor about the dispositional property of opium; it has a *virtus dormitiva* whose nature it is to put the senses to sleep. An adequate answer might be that there is an intrinsic property which causes the manifestation of the disposition. For example, the irregular atomic structure of the vase will not hold owing to the force of the fall. Note, that different intrinsic properties might be considered as a causal basis for the same disposition. For example, fragility might be explained by weak intermolecular bounds or by instability of larger parts (Fara, 2005). Therefore, the causal efficacy of a disposition is debatable. However, in everyday life, the concept of disposition is applied in an explanatory way, often with an implicit assumption of the existence of an intrinsic property as explanatory base.

### **3.1.2 Three principles for the concept of disposition**

From the above discussion on the debate about the concept of disposition in modern philosophy, we can deduce three main principles relevant to this concept. The first principle is that dispositions only become apparent or observable under specific circumstances. Analogous to the fact that the dispositions of substances,

such as the solubility of sugar, only become apparent in specific environments, such as in tea or coffee, dispositions of subjects, such as being critical, most often become apparent in a competitive environments. Furthermore, the simple conditional analysis showed that we have to be specific in describing the exact conditions of a certain disposition. And even if we are, several counterexamples, such as masks or antidotes, can be proposed. These counterexamples do not negate the existence, but merely restrain the manifestation of a particular disposition. Hence, dispositions should always have an explanatory basis which refers to some intrinsic properties.

The second principle, therefore, states that dispositions always have an explanatory basis, which can be found in the intrinsic attributes of the substance or the subject under investigation. These intrinsic properties are durable and stable. Even then, the causal efficacy of dispositions of subjects can not be guaranteed; at least, some debate remains possible about the explanatory value of dispositions. We can, for example, use the concept of disposition to explain behavioural tendencies, but we face the same dilemma as with the concept of dispositions of substances. The concept of disposition labels the presence of an intrinsic property which can appear in a behavioural pattern. The label itself does not explain any characteristic features. However, by labelling something as a *disposition*, we acknowledge that it has characteristics similar to those of other dispositions. This is analogous to labelling an animal as a *vertebrate*. The label only explicates that the animal has the same characteristics as other members of that subphylum. Therefore, the concept of disposition has the potential to support the categorization and understanding of the behavioural patterns of subjects.

The third principle, which can be drawn from the previous discussion about the concept in modern philosophy, is that dispositions can be evaluated empirically. If dispositions of subjects are durable and stable attributes, similar to dispositions of substances, they need an explanatory basis in some intrinsic property of the subject, such as experiences, motives, personality traits, attitudes, skills, or abilities. Since such intrinsic properties are theoretically assessable, it is possible to empirically assess dispositions of subjects. From here we can develop an empirically based notion of the concept of disposition in educational research.

### ***3.1.3 Dispositions of subjects in educational research***

Before we continue, we must reflect on a remarkable difference between the dispositions of substances and the dispositions of subjects. Subjects, in contrast to substances, can reflect on their own dispositional attributes. This means that a

subject knows its behavioural tendencies and might choose not to behave according to that specific disposition. For example, a subject who is disposed to be highly critical of the work of others might choose not to be critical of the work of a first-year student. The actual disposition might be masked by the subject's intentions. In the philosophy of the social sciences, the notion that subjects have their own understanding of phenomena which affects the understanding of others is described as the *double hermeneutics* in social sciences (Giddens, 1987). This double hermeneutics restricts the interpretation of the results about dispositions and of matching behavioural patterns of subjects considerably. As described in the following section, we used the three principles to briefly evaluate three bodies of literature in which the concept of disposition has a central place. In these bodies of literature the contexts in which the concept of disposition is used differ. The dispositions of academics, of teachers, and of students have been examined and described in these bodies of literature.

### **3.1.4 *Habitus as a system of dispositions***

Bourdieu described the word *disposition* as particularly suited to express what is covered by his concept of habitus. The habitus of a person designates a way of being, a habitual state, and, in particular, a tendency, propensity, or inclination (Bourdieu, 1977). Bourdieu's ideas have been used widely in the field of educational research, especially concerning topics in the sociology and anthropology of education, such as social capital. Bourdieu's *Outline of a theory of practice* (1977) was written as a reaction against the structure-agency debate, at that time, between subjectivists and objectivists, as Bourdieu called them. Subjectivists explained social behaviour from the interpretations of the agents, or actors, while objectivists described social behaviours from abstract structures, external to the domain of the individual agents. Bourdieu attempted to dissolve the debate through a Hegelian dialectic of synthesizing these seemingly opposite ideas. First, Bourdieu noted that social behaviour is not determined by rational thoughts, but by practical logic, the not fully conscious or goal-directed thoughts and feelings of the actors. Therefore, according to Bourdieu, social behaviour is directed not by conscious mental states of agents, nor by abstract theoretical structures transcending individual agents, but by the rather unconscious system of values and dispositions towards specific behaviours. This 'system of durable, and transposable dispositions' is labelled as the habitus of an agent (Bourdieu, 1977). While Bourdieu's ethnographic fieldwork in Kabylia (Algeria) provided the basis for the development of his ideas, French Academia provided Bourdieu with a test case for his theory. The habitus of French academics, for example, is



described as the beliefs, assumptions, and dispositions of scholarship. The concept of habitus provided Bourdieu with a foundation to examine processes of socialization that individual academics experienced in particular research and teaching groups (Bourdieu, 1988; Bourdieu, 1989). In this way, Bourdieu provides an explanation for the existence of research groups and disciplines, which comprise actors who have similar dispositions. The habitus of a researcher can be understood through the system of dispositions, which develops over time in the interaction with other agents in the social field, for example, the other academics in the research group. In this sense, processes of socialization are processes of change of the habitus of an individual agent towards the habitus of other agents in a group. Academics develop their systems of dispositions throughout their academic careers, and when working in new research groups they slowly and unconsciously change their habitus. In this way, researchers tend to develop similar dispositions. Academics also have a teaching task, in which they train students to design, conduct, and report about scientific studies. In teaching students about doing science, academics intentionally, although mostly implicitly, aim to change the habitus of the students towards the teacher's system of dispositions. In a certain way the students are socialised in doing research in a manner similar to that of the particular academic. The ideas of habitus as a system of dispositions can be seen as an alternative sociological or anthropological lens through which social behaviour can be investigated. Bourdieu's ideas are still used by educational researchers to analyze issues in teaching in higher education (Deem & Lucas, 2007; Noyes, 2008).

The system of dispositions of actors are rather stable and durable, but also change over time as a result of experiences, among other things. This provides the intrinsic attributes of the subjects as a strong explanatory basis for the dispositions. Therefore, this body of literature recognizes the second principle. However, the first principle, which states that dispositions become apparent under specific circumstances, cannot be directly related to Bourdieu's use of the concept of disposition. Although Bourdieu describes specific contexts in which actors interact with each other, such as rural areas of Algeria or French academia, he does not explicitly demonstrate which dispositions become apparent under which circumstances. Furthermore, from Bourdieu's theoretical observation that the habitus comprises stable and durable dispositions, we can infer that, in principle, these dispositions are open to empirical assessment. However, Bourdieu does not explicitly refer to instruments, such as surveys or interview schemas, which can be used to evaluate dispositions in educational settings.

### 3.1.5 Thinking dispositions

Critical thinking dispositions have been of interest to researchers in the field of education because these dispositions potentially provide an explanatory basis for student behaviour. In this body of literature, thinking dispositions have been broadly defined as tendencies toward particular patterns of intellectual behaviour (Perkins et al., 2000; Perkins, Jay, & Tishman, 1993). Perkins and colleagues (1993) put forward a *triadic conception* of thinking dispositions. In their view, three elements, (1) ability, (2) sensitivity, and (3) inclination, should be present in order to induce dispositional behaviour, such as critical thinking. First, a person should have the basic capacities or skills to perform certain behaviour (ability). Second, this person should perceive this behaviour to be appropriate in that particular situation (sensitivity). Third, this person should have the tendency, or drive, to carry out the behaviour (inclination). These three elements are essential for dispositional behaviour to occur, while a particular disposition can be associated with an inclination, tendency, or drive of a person. Facione & Facione (1992) developed a questionnaire to measure critical thinking dispositions. The findings of studies in which this California Critical Thinking Disposition Questionnaire (Facione & Facione, 1992; Facione et al., 2000) were used suggest several sub-dispositions, such as open-mindedness, inquisitiveness, systematicity, and truth-seeking (Facione, Sanchez, Facione, & Gainen, 1995). In this body of literature the disposition to think critically is related to a spirit of inquiry, drawing unwarranted assumptions cautiously, and weighing the credibility of evidence (Barak et al, 2007; Pithers & Soden, 2000). Less clear, however, is the influence of the disposition or sub-dispositions on psychological attributes or educational outcome variables, such as self-efficacy, motivation, or academic achievement (Laird, 2005; Stupnisky et al, 2008).

The triadic conception of dispositional behaviour, described in this body of literature on thinking dispositions, is an interesting example of how to comprehensibly describe specific circumstances under which dispositional behaviours become apparent (first principle). Although no intrinsic attributes could be identified in this body of literature, some psychological attributes were mentioned, such as self-efficacy and motivation. These attributes can potentially serve as an exploratory basis for dispositions (second principle). Furthermore, the questionnaire developed in this body of literature illustrates that dispositions can be assessed empirically. However, the advantages and disadvantages of the evaluation of dispositions through survey techniques were only tacitly touched upon (third principle).

### **3.1.6 Teacher dispositions**

In 2000, the American National Council for Accreditation of Teacher Education (NCATE) published a new set of standards for the evaluation of teacher candidates' performances (Damon, 2007). These standards not only focused on the knowledge and skills required for teaching, but also on teachers' professional dispositions. These teacher dispositions were rather loosely defined issues associated with teacher beliefs, attitudes, and behaviours. Logically, debates arose about the definition of 'teacher dispositions' (described by Damon, 2007; Dottin, 2009; Murray, 2007; Schussler, 2006, among others). In 1985, Katz & Raths already defined teacher disposition as "an attributed characteristic of a teacher, one that summarizes the trend of a teacher's action in a particular context" (p. 301), and contrasted this definition with other constructs, such as habits, skills, attitudes, and traits. Throughout the years, the concept of teacher disposition has been described in different ways. However, a common element can be distinguished, that dispositions describe a pattern of intentional acts in a particular context and at a particular time (Diez & Raths, 2000). The definition of the concept as a pattern of acts does indeed contrast it with the psychological concept of attitude, which is a bi-polar feeling towards something. However, it also indicates that disposition in this sense is a behavioural concept. The definition seems to encourage counting of teacher behaviours to find behavioural patterns and thus teacher dispositions, while the concept of disposition as a tendency to act does not necessarily mean that a disposition results in observable behaviours. This illustrates that in the body of literature on teacher dispositions the concept is observed through a behavioural lens, rather than through a cognitive lens. The debate about the definition and value of the concept of teacher dispositions is unresolved and ongoing in the literature on teaching and teacher education (cf. Damon, 2007; Dottin, 2009; Murray, 2007; Schussler, 2006).

When we compare the body of literature on teacher dispositions to the three principles of the concept of disposition, we firstly notice that the concept is defined through a behavioural lens, and therefore, inevitably, no intrinsic properties are attributed to provide an explanatory basis for the patterns of intentional acts. Therefore, the second principle is not satisfied. Furthermore, teachers' dispositions become apparent under specific circumstances (first principle), for example, during *bumpy moments* in classroom experiences (cf. Kan, Verloop, & Ponte, 2008; Romano, 2006). However, which dispositions or sub-dispositions become apparent during these specific 'bumpy moments' should be identified in future research. Finally, related to the third principle, empirical

measurement techniques which are appropriate to describe teacher dispositions remain to be identified.

### **3.1.7 Research question**

From the previous discussion about the concept of disposition, it is clear that in the social and educational sciences the boundaries for the concept are not yet clearly defined. The debate about dispositions of substances provides three principles, which are potentially useful to define the concept of disposition of subjects. These three principles can set the ground rules to construct a suitably strong notion of dispositions in educational research. One of the gaps identified in the literature on the concept of dispositions in educational research is the empirical foundation of the concept. The aim of this study was to develop an empirically based notion of disposition of subjects through the evaluation of a set of three instruments to assess the concept. The guiding question was *which instruments or combination of instruments can best be used to investigate a persons' research disposition*. Comprehension of the concept improves when more is known about the instruments through which we can measure or assess the dispositions of the participants in our studies.

## **3.2 Methods**

### **3.2.1 Three instruments to assess scientific research dispositions of academics**

In this section, a study of three instruments to assess dispositions, specifically scientific research dispositions of academics, is described. Recently, we carried out a study which showed that scientific research dispositions of academics comprised of six aspects, namely, inclination (1) to achieve, (2) to be critical, (3) to be innovative, (4) to know, (5) to share, and (6) to understand (Van der Rijst et al., 2007). The three considered instruments differed in their degrees of freedom, or latitude, for the participants (Meijer, 1999): (1) a semi-structured open-ended interview, (2) a hierarchical ordering task, and (3) a structured mapping task. Awareness of the tension between latitude for participants in the research instruments and the complexity of the interpretations was expected to generate an improved understanding of the limitations and advantages of specific methods and instruments. For example, the structured questions in a survey should be considered as having a less extended degree of freedom than open-ended questions, while interpretation of the results of the open-ended questions is more complex. The latitude of the semi-structured open-ended interview method was reasonably large, as participants could raise any issue concerning their dispositions towards research whenever they thought it necessary. The

hierarchical ordering task restricted the participants in their freedom to raise issues concerning their research dispositions, in the sense that they only could react to the presented six aspects. Compared to the other two instruments, the structured mapping task had the narrowest latitude. Participants were restricted to reacting to two aspects at a time in a multiple-choice format. Thus, the latitude decreased from interview, via ordering task, to mapping task.

### **3.2.2 Participants**

To investigate the similarities and differences, the three instruments were presented to three participants, Steven, Roger, and David. The names are fictitious in order to preserve anonymity. Steven was full professor at a research institute of chemistry, Roger an associate professor at a research institute of astronomy, and David an assistant professor at a research institute of astronomy. All three participants were academics at a Faculty of Science of Leiden University.

### **3.2.3 Instrument 1: Semi-structured open-ended interview**

The first instrument was aimed at identifying aspects of the participants' scientific research dispositions through coding of the transcripts of the interviews with the participants. A semi-structured open-ended interview was designed and administered, providing the participants with multiple opportunities to raise matters considered to be important. Participants were asked to relate all questions to their daily research practice. General questions, such as "what are the most important aspects of your research attitude," were asked as well as more specific questions probing participants' research dispositions during research, such as, "which dispositions do you embrace during your research activities?" In this instrument participants received a reasonably large degree of freedom. The frequencies of the codes in the interview fragments were counted and recalibrated to unity, which is the total number of assigned codes, to make comparison with other instruments possible. Hence, aspects close to 1 could be interpreted as mentioned most often, while aspects close to 0 were mentioned least. The interviews took place during the summer of 2006, were transcribed verbatim, and were analysed using codes described in a previous study on the scientific research dispositions of academics (Van der Rijst et al., 2007). For an explanation of the six aspects, see Chapter 2.

### **3.2.4 Instrument 2: Hierarchical ordering task**

The second instrument was designed to identify participants' scientific research dispositions using a structured task. After reading the descriptions of all aspects of

scientific research dispositions, the participants were asked to hierarchically order the six aspects in order of preference, as perceived in their everyday research practice. The aspects were put into a linear order, from the aspect which was most often present to the aspect which was least present. The order was explicitly not interpreted using a normative value by the participants. Participants could react to the presented six aspects and put these aspects in a hierarchical order. The compulsory hierarchical ordering was a additional restriction of freedom. The aspect highest on the preference list was assigned '6'; the aspect lowest on the list was assigned 1. The preferences were recalibrated to unity, which was defined as 21 (6+5+4+3+2+1), so that aspects close to 1 could be interpreted as *high* in the hierarchical order, and aspects close to 0 as *low* in the hierarchical order. The hierarchical ordering tasks as well as the structured mapping tasks, which are explained below, were presented to participants during the fall of 2007.

**3.2.5 Instrument 3: Structured mapping task**

With the third instrument, all aspects were presented pair-wise to the participants. After re-reading the descriptions of the aspects of scientific research dispositions, the participants were asked (i) if they perceived a clear relationship between the two aspects presented, (ii) if they perceived any direction between the presented aspects, and (iii) if they could rate the strength of the relationship on a three-point scale. A direction was interpreted as causal direction between two aspects. For example, a respondent might indicate that he/she, in general, has an initial drive or tendency to understand a phenomenon, after which he gradually develops a tendency to critically examine that phenomenon. Participants were restricted to reacting to two aspects at a time through multiple-choice-like questions. Based on the data from step two (ii) in the interview scheme, cognitive graphs were constructed and analysed, using concepts from Graph Theory and (social) network analysis (Borgatti, Everett, & Freeman, 1999; Huisman & Van Duijn, 2003). The nodes in a cognitive graph represent the cognitive aspect, whereas the ties between the nodes represent the relationships between the cognitive aspects. Since these cognitive graphs have the same architecture as mathematical graphs, the same mathematical techniques can be deployed, using concepts such as density, centrality, and degree. Similar to Graph Theory, the properties of the nodes (e.g., in-degree and out-degree) as well as the properties of the total graph (e.g., density and reciprocal density) can be applied to assess the metric of these graphs using quantifiable measures. Previous study findings have shown that techniques from Graph Theory can be applied successfully to assess the structural properties of conceptions (Bakkenes,

Vermunt, Wubbels, & Imants, 2007; Wassink, Slegers, & Imants, 2003). In instrument 3, we applied five concepts from Graph Theory, two to characterize aspects on a global level, namely, (1) global density and (2) reciprocal density, and three to assess properties on an individual node level, namely, (3) overall degree, (4) in-degree, and (5) out-degree.

1. The global density of a graph is defined as the ratio between the number of present ties and the number of possible ties. This is a measure of the completeness of a graph. A complete graph will have global density 1, while a graph without any ties between the nodes will have a density 0. The density can be calculated for directed as well as undirected graphs. To investigate whether the direction influenced the centrality of the nodes in the graphs of the participants, degrees for both the undirected and the directed representation of the graphs were calculated.
2. A second graph property, reciprocal density, is a property of directed graphs. The reciprocal density of a graph is the ratio between the present number of reciprocal ties and the possible number of reciprocal ties. A complete graph, with only reciprocal relations between nodes, has reciprocal density 1, while a graph without any reciprocal relationships has reciprocal density 0. The degree of individual nodes is used to characterize the centrality of nodes within a graph.
3. The overall degree of a node in a directed graph is the sum of incoming and outgoing ties. If we neglect the directions of the ties between nodes we can also calculate the overall degree for the undirected graphs. Within a directed graph we can discriminate between in-degree and out-degree.
4. The in-degree is the number of relations directed towards a node.
5. The out-degree is the number of relations directed away from a node towards other nodes.

For all aspects, the directed overall degree, undirected overall degree, in-degree, and out-degree were calculated. The degree was calculated for both the undirected and the directed representation of the graphs, to investigate if the direction influenced the centrality of nodes. All properties were recalibrated to unity, in order to allow cross-instrument comparisons. Aspects close to 1 can be interpreted as having a central position in the graph, while aspects close to 0 were more peripheral.

*Table 3.1 Brief illustrations of participants' verbalizations of their scientific research dispositions (between brackets the absolute frequencies of the codes)*

	Steven	Roger	David
To Achieve - ambition - discipline - full of initiative - patience - passionate - persistent	'To concentrate, to focus, that's something central to this profession. It [research] is no hocus-pocus, it isn't very extraordinary. You just need a certain routine and discipline'. (8)	'You can have innovative ideas; however, you have to put these ideas into practice in a scientifically correct and theoretically sound way, and if the ideas do not seem to work afterwards, you just have to dismantle them'. (2)	(0)
To be Critical - critical (general) - critical towards others - honesty - observing - self-critical	'Being critical, being independent, and having the ability to present nicely are the core aspects, in my view, in particular being critical'. (2)	(0)	(0)
To be Innovative - anticipating - associative - choosing own path - creative - original - unconventional	'My intuition tells me how certain processes will evolve. And if I am wrong, I will adapt my hypothesis. Being afraid does not help! On the other hand, doing research is formulating a work hypothesis and then testing this hypothesis. And then you verify or adapt your hypothesis. [...] Intuition that relates to experience and also a kind of creativity'. (6)	'Personally, I consider originality important; however it does not always emerge spontaneously. [...]. I have much respect for researchers who have different ideas, which might not be so fashionable at a particular time. Though they have made a lot of considerations, few others came to similar results'. (3)	'It is possible to do predictable as well as unpredictable research, choosing a direction in which the chances of succeeding are limited; however, if you succeed it will be a major breakthrough. On the other hand, it isn't possible to work on such risky research projects throughout your career: the chances are too large nothing will come out, a subtle balance is essential'. (1)



*Towards an empirically based notion of the concept of disposition*

---

Table 3.1 (continued)

	Steven	Roger	David
<p>To Know</p> <ul style="list-style-type: none"> <li>- curiosity</li> <li>- excitement</li> </ul>	<p>'On the one hand, being curious, while on the other hand, not being nervous. Thus, being enthusiastic, on the one hand, and yet again keeping disciplined, and taking the time to proceed by conveniently arranged steps'. (2)</p>	<p>'Curiosity, in particular within science, I suppose, however, that might be my limited perception. Curiosity is a major motive, should be the most important motive'. (3)</p>	<p>'There is a difference between people with a kind of energy, with passion, or love for, oh, wow lets do this, and people showing no passion at all, oh do I have to do this before March 25, okay, I'll think about it on the 24th'. (3)</p>
<p>To Share</p> <ul style="list-style-type: none"> <li>- explaining</li> <li>- openness to others</li> <li>- persuasive</li> <li>- skilled communicator</li> <li>- working together</li> </ul>	<p>'Presenting is, naturally, if it all goes well, an archetypical form, it includes aspects such as being independent, being critical, showing a drive, a passion, it includes all these aspects, doesn't it?' (1)</p>	<p>(0)</p>	<p>'They [good researchers] keep on doing work on their own. They are not only engaged in science policy issues,[...] they [...] do their own work, their own calculations, keep thinking about issues, and not just pointing out the direction to go, while others do the hard work'. (1)</p>
<p>To Understand</p> <ul style="list-style-type: none"> <li>- overview</li> <li>- scrutinizing</li> <li>- solving problems</li> </ul>	<p>(0)</p>	<p>'The drive to understand a phenomenon, to feel the inner joy when they understand the issues, when they solve a case, and again, it isn't about just solving puzzles. It is about the joy of understanding issues in a way nobody else understands them'. (1)</p>	<p>(0)</p>

---

### 3.3 Results

#### **3.3.1 Results instrument 1: Semi-structured open-ended interview**

In total, 19 codes were assigned to Steven's interview fragments, 9 codes to Roger's fragments, and 5 codes to David's fragments. The participants' fragments varied in length. Therefore, the ratios of words per code were calculated to indicate possible differences in global features of the interview transcripts. David had the highest ratio, with 158.8 words per code; Steven had 94.8 words per code; and Roger had 71.8 words per code. Table 3.1 presents, for each participant, a quote illustrating the participant's verbalization of the aspects of his scientific research disposition. The absolute frequency of each code is also presented between brackets in Table 3.1.

From the results presented in Table 3.1, we can judge that Steven most often spoke about the aspects 'to achieve' and 'to be innovative', while aspects 'to understand' and 'to share' were least mentioned during the interview. Roger showed a different picture, when mentioning the aspects 'to be innovative' and 'to know' most frequently, 'to share' and 'to be critical' were not referred to at all. David referred to the aspect 'to know' relatively frequently, while he did not mention 'to achieve', 'to be critical', and 'to understand'. Each of the three participants put emphasis on different aspects of a scientific research disposition.

#### **3.3.2 Results instrument 2: Hierarchical ordering task**

All participants were asked to hierarchically order the six aspects in a linear order of their preference in their everyday research activities. In Table 3.2, the orders of preference of the participants are presented, alongside results from the other instruments. Table 3.2 shows that the aspects 'to be innovative' and 'to achieve' were most important to Steven, while the aspects 'to understand' and 'to be critical' were least important, according to the hierarchical ordering task. Roger put most emphasis on the aspects 'to know' and 'to understand' and less emphasis on 'to achieve' in his daily research practice. David, on the other hand, viewed the inclination 'to be innovative' and 'to share' as most preferred in his daily research practice, while the aspects 'to understand' and 'to achieve' scored low on his preference list.

#### **3.3.3 Results Instrument 3: Structured mapping task**

With instrument 3, a total of 15 pairs of aspects were presented to each participant. Figure 3.1 presents the graphical representation of the participants' responses to the pair-wise presentation of the aspects of scientific research dispositions. The global density of the undirected graphs ranged from Steven with

0.73, to David with 0.53, and Roger with a density of 0.40. A similar order of the participants was found after the determination of the global density of the directed graphs: Steven with 0.57, David with 0.37, and Roger with 0.23. Global properties of graphs are illustrative when graphs are compared. However, when characteristics of individual graphs are being explored, it is necessary to calculate the properties of individual nodes. Table 3.2 presents the properties of the individual aspects in the graphs of the participants derived from all four properties of the nodes, i.e., undirected overall degree, directed overall degree, in-degree, and out-degree.

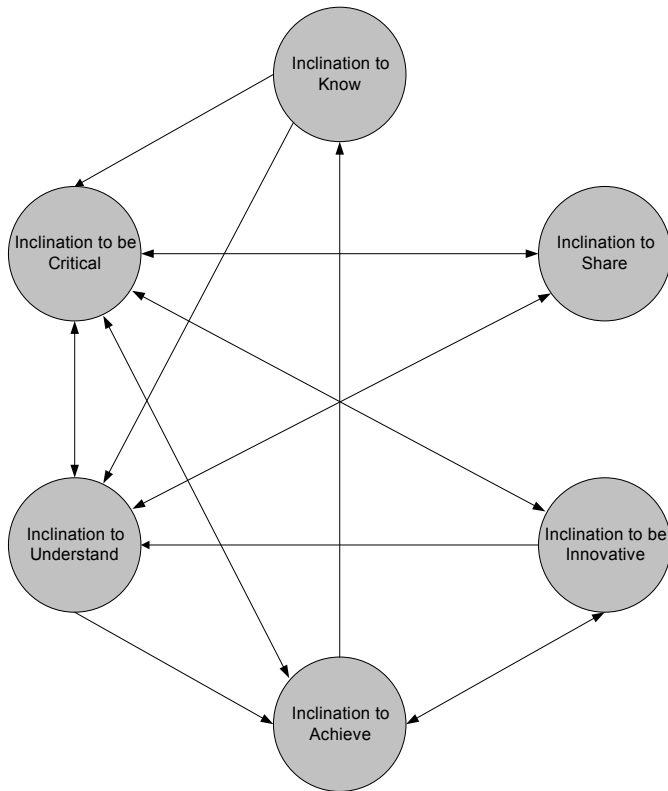

*Figure 3.1a Directed graph representation of Steven's scientific research disposition*

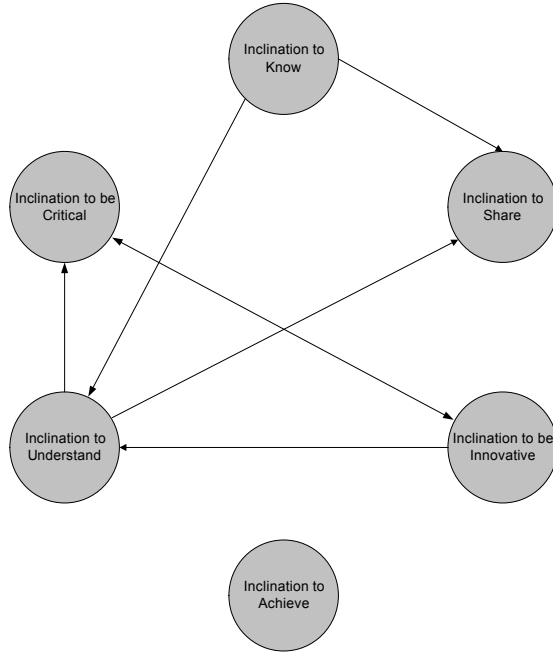

Figure 3.1b Directed graph representation of Roger's scientific research disposition

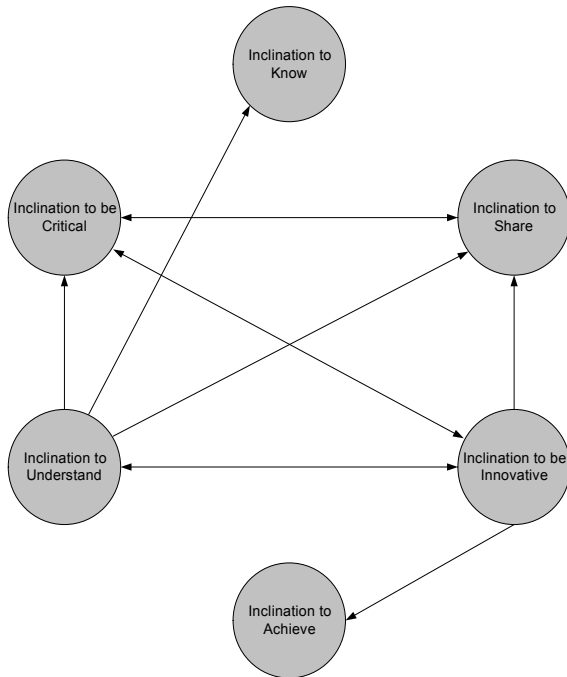

Figure 3.1c Directed graph representation of David's scientific research disposition

*Table 3.2. Properties of individual aspects of participants' scientific research dispositions deduced from the cognitive graphs normalised to unity (between brackets: Instrument 1 is a semi-structured open-ended interview, instrument 2 is a hierarchical ordering task, and instrument 3 is a structured mapping task)*

		To Achieve	To be Critical	To be Innovative	To know	To Share	To Understand
Steven	Interview (1)	0.42	0.11	0.32	0.11	0.05	0
	Hierarchical order (2)	0.24	0.10	0.29	0.19	0.14	0.05
	Un-directed degree (3)	0.18	0.23	0.14	0.14	0.09	0.23
	Directed degree (3)	0.18	0.26	0.15	0.09	0.12	0.21
	In-degree (3)	0.18	0.29	0.12	0.06	0.12	0.24
	Out-degree (3)	0.18	0.24	0.18	0.12	0.12	0.18
Roger	Interview (1)	0.22	0	0.33	0.33	0	0.11
	Hierarchical order (2)	0.10	0.05	0.19	0.29	0.14	0.24
	Un-directed degree (3)	0	0.17	0.17	0.17	0.17	0.33
	Directed degree (3)	0	0.21	0.21	0.14	0.14	0.29
	In-degree (3)	0	0.29	0.14	0	0.29	0.29
	Out-degree (3)	0	0.14	0.29	0.29	0	0.29
David	Interview (1)	0	0	0.20	0.60	0.20	0
	Hierarchical order (2)	0.10	0.14	0.29	0.19	0.24	0.05
	Un-directed degree (3)	0.06	0.19	0.25	0.06	0.19	0.25
	Directed degree (3)	0.05	0.23	0.27	0.05	0.18	0.23
	In-degree (3)	0.09	0.27	0.18	0.09	0.27	0.09
	Out-degree (3)	0	0.18	0.36	0	0.09	0.36

Table 3.2 shows, among other things, the centrality of aspects in Steven's graph according to the structured mapping task. The aspects 'to be critical' and 'to understand' had the most ties with other aspects in Steven's graph; the aspects 'to know' and 'to share' had the least number of ties with other aspects. The number of ties with other nodes is a measure of centrality in a graph. Therefore, the aspects 'to be critical' and 'to understand' could be interpreted as central nodes, while the aspects 'to know' and 'to share' were interpreted as peripheral nodes in Steven's graph according to the results from the structured mapping task. In Roger's graph, the aspect 'to understand' had the most ties with other aspects, while the aspect 'to achieve' had no ties with other aspects. Therefore, the aspect 'to understand' could be interpreted as most central, and the aspect 'to achieve' was interpreted as most peripheral in Roger's graph. David's graph showed that 'to be innovative' and 'to understand' had the most ties, while the aspects 'to know' and 'to achieve' had the least number of ties. Thus, the aspects 'to be innovative' and 'to understand' could be interpreted as most central, while the aspects 'to know' and 'to achieve' were interpreted as most peripheral in David's graph.

### **3.4 Conclusions and discussion**

#### ***3.4.1 Differences and similarities between the instruments***

The results, presented in Table 3.2, can be used to compare the three instruments which assess academics' scientific research dispositions. Note that the results from the three instruments do not always coincide. For example, Steven's interview transcripts and his order of preference give similar results: both instruments present 'to achieve' and 'to be critical' as the most important aspects, but the results for his graph deviate strongly. Although there are differences between the results of the three instruments, we also observe some similarities on which we can base our conclusions about the instruments.

First, we notice that the interviews and the hierarchical ordering task show similar results for all three participants. The aspects which are most frequently mentioned in the interviews are also the aspects which appear high in the hierarchical order. For Steven the aspects 'to achieve' and 'to be innovative', for Roger the aspects 'to know' and 'to be innovative', and for David the aspects 'to know', 'to be innovative', and 'to share' are most important. This indicates that the interview and the ordering task can be used to gauge a similar feature of the concept of disposition.

Second, we notice that for all three participants, the results from the interview do not match with the results from the structured mapping task. For

example, in Steven's research disposition the aspects 'to be critical' and 'to understand' are more central according to the results from the structured mapping task, while 'to know' and 'to share' are more peripheral, i.e., closer to 0. A possible explanation can be found in the crucial differences between the instruments. The degree of freedom within these three instruments decreases from the interview, via the ordering task to the mapping task. The semi-structured interview and the hierarchical ordering gave the participants full insight into what they presented as their scientific research dispositions. The structured mapping task was explicitly designed in such a way that the academics could not easily recognize patterns in their own dispositions. The participants were presented with 15 pairs of aspects in a row. While this task was perceived as cognitively intensive, we can assume that the academics could not easily influence the data towards their explicit ideas about scientific research dispositions. Throughout instrument 3, the academics were repeatedly required to focus on their daily research practices, to ensure that they were relating their answers to their own dispositions in research. Therefore, we assume that the results from the structured mapping task indicate the *implicit*, or tacit, scientific research disposition, while the results from the interview and the hierarchical ordering task represent academics' *explicit* ideas about their scientific research disposition.

Third, the in-degree and out-degree tend to follow the results from the interviews. In most cases, aspects that have an out-degree which is higher than the in-degree are also mentioned relatively frequently in the interviews. Although degrees calculated for undirected graphs are similar to degrees calculated for directed graphs, differences between in-degree and out-degree might indicate more detailed properties of graphs which cannot be gauged using undirected graphs only. Therefore, properties of directed graphs display additional and relevant information with respect to undirected graphs. The observation that the in- and out-degree follow the interview results, and the assumption that the interview gauges explicit ideas about dispositions, indicate that a possible relationship exists between explicit conception of a research disposition and a high out-degree of an aspect within a graph. If this holds in future research, then we can assume that aspects with a higher out-degree than in-degree are fundamental aspects in a person's disposition. In Roger's case, for example, the aspects 'to know' and 'to be innovative' both have higher out-degrees than in-degrees, while the aspects 'to be critical' and 'to share' have high in-degrees. This might indicate that the inclinations to know and to be innovative are fundamental aspects of Roger's disposition. First, he has a passion for knowing and being innovative; second, he is critical and wants to share his ideas.

Fourth, the semi-structured open-ended interview is time-consuming in its data-collection and its data-analysis procedures, especially when more than three participants are involved. The hierarchical ordering task and the structured mapping task are more time-efficient. When the hierarchical ordering task and the structured mapping task are combined, both explicit preference and implicit centrality of aspects can be examined collectively and succinctly.

Finally, the techniques from Graph Theory used in instrument 3 effectively discriminate between characteristics of individual nodes within graphs as well as between structural global properties of academics' cognitive graphs. This comparison shows that analysis techniques from Graph Theory can be used in empirical studies into people's conceptions and cognitions, such as scientific research dispositions.

### ***3.4.2 Implications for an empirically based notion of the concept of disposition***

The findings presented here show, among other things, that a distinction can be made between respondents' implicit conceptions about research dispositions and their actual research disposition. The open-ended interview study showed the more explicit conceptions, while the structured mapping tasks represented the tacit conceptions, of academics' scientific research dispositions. In drawing conclusions from this observation, we must pay attention to the differences between the instruments before considering the nature of the concept itself. First, the instruments used in this study differ in the degree of freedom presented to the respondents. Second, a characteristic distinction between instruments can be related to respondents' overview of their previous reactions to the instrument. For example, when completing a survey, respondents are able to re-view previous answers, while during an interview participants have to re-call their previous answers from memory. It is reasonable to assume that respondents were more limited in their awareness of their previous answers in the structured mapping task than during the interview or the hierarchical ordering task. Furthermore, consciously or unconsciously, respondents often try to make their reactions correspond with earlier reactions. Therefore, we can draw the conclusion that the interview and the hierarchical ordering task both assessed the perceived value of respondents to scientific research dispositions. The mapping task was less open to manipulation by the respondents and was more likely to assess respondents' actual scientific research dispositions.



### **3.4.3 Suggestions for further research**

Future research using the instruments presented in this study can potentially identify relationships between properties of academics' dispositions and background variables. Furthermore, we presented a tool to identify various properties of academics' graphs. Although this novel technique is rarely used in educational research (cf. Bakkenes et al., 2007; Wassink et al., 2003), the results presented here appear promising for future research. However, more research is needed, for example, to reveal possible relationships between global properties of graphs and interview results. Further research is also needed to identify fields of research in which this technique can be applied, and to develop the conceptual framework of techniques from Graph Theory. Finally, the validity and the reliability of instruments to assess dispositions in other contexts should be a constant concern to researchers.

Enhancing university teachers' awareness of the influence of their research dispositions on their teaching intentions and behaviours might induce them to more explicitly reflect on the scholarship of teaching (Boyer, 1990; Neumann, 2006). Thus, university teachers should attach high value to their own ideas, experiences, and research dispositions when teaching students how to become scholars in their field of expertise, and should not merely rely on the teaching tradition of the institute. For example, Borda (2007) provides some interesting suggestions for the cultivation and assessment of dispositions in questions, careful use of language, and discourse analysis.

The findings of this study show that the concept of disposition is still in a developmental phase in the educational research literature. Three general principles were identified as potentially supportive to improving the concept of disposition in educational research. We built towards an empirically based notion of the concept of disposition in educational research, by the evaluation of three instruments to assess scientific research dispositions. A combination of the hierarchical ordering task and the structured mapping task provided us with an effort-result efficient combination, in the sense that it produced relevant results and was more time-efficient than the open-ended interview methodology. Generally, to correctly interpret empirical results, there should be a strong relationship between the way concepts are defined and the methods used to assess them. For future research on the concept of disposition in the educational sciences, we recommend to use a combination of these instruments while paying attention to the effects of the different features of the instruments on the results, for example, the latitude of the instrument, or participants' overview of their responses.





**Chapter 4**

**Speech act theory as an instrument to capture  
university science teachers' discourse**



## 4. Speech act theory as an instrument to capture university science teachers' discourse<sup>3</sup>

The findings of studies on classroom discourse suggest that teachers' speech influences student learning. Although university teachers have diverse ways of lecturing, not many have a broad speech act repertoire. Patterns of 12 university science teachers' speech acts sequences were examined. Teachers with similar patterns were clustered, and associations with the methods of instruction and approaches to teaching were analysed. University teachers, whose approaches to teaching showed a high emphasis on student learning, used many directive speech acts such as questions and instructions. Teachers, who focused on transmitting ideas, used more assertive acts such as giving information and predictions. The presented framework can be applied as a window into teachers' speech act repertoires.

---

<sup>3</sup> This chapter has been submitted in an adapted form as:  
Van der Rijst, R.M., Visser-Wijnveen, G.J., Verloop, N., & Van Driel, J.H. *Speech act theory as an instrument to capture university science teachers' discourse*.

### **4.1 Introduction**

The findings of studies on classroom discourse suggest that teachers' speech has a persistent influence on students' learning and on their perceptions of the learning environment (cf. Rogers, Malancharuvil-Berkes, Mosley, Hui, & Joseph, 2005; Roth & Roychoudhury, 1994; Scott & Mortimer, 2006; Walshaw & Anthony, 2008). Academic staff at higher education institutes, and especially at research universities, professionally develop multiple scholarships, including the scholarship of development and the scholarship of teaching (Boyer, 1990; Healey, 2000; Trigwell, Martin, Benjamin, & Prosser, 2000). Many issues are relevant to the professional development of a university teacher in the scholarship of teaching, such as knowledge of student learning, knowledge of assessment, and knowledge of method of instructions. Knowledge of teachers' speech acts, as an element of knowledge of classroom discourse, also belongs to university teachers' knowledge base of teaching (Verloop et al., 2001). Teaching about scientific research, its methods, processes, and products, is an important content element of university courses. University teachers have many different ways of starting a discourse or monologue about research (cf. Elsen et al., 2009), but not many teachers are aware of their own speech act repertoire. For example, a science teacher may instruct students about what they should or should not do when working in a laboratory. Another teacher may describe how a research study is normally conducted in a laboratory. Both teachers might utter similar words, but convey a distinct message. Often, teachers do not explicitly select a particular way of addressing the students, but use a single personal style for uttering propositions during course meetings. A broad speech act repertoire can be helpful to motivate diverse students and to stimulate the multiple intelligences and learning styles of students. The aim of this study was twofold: first, to identify patterns in teachers' speech acts during courses, and second, to unravel associations between university teachers' speech acts, their approaches, and the methods of instruction. This study is relevant to teachers and teacher educators at higher education institutes who work on strengthening the scholarship of teaching and learning and for the improvement of teachers' speech act repertoires as an element of their knowledge base of teaching.

#### ***4.1.1 Discourse analysis and speech act theory***

Analysis of speech acts is one of the several forms of discourse analysis used to improve our understanding of issues in learning and instruction (e.g., Huisman, 2006; Karasavvidis, Pieters, & Plomp, 2000; Rogers et al., 2005; Roth & Roychoudhury, 1994; Saarinen, 2008). Speech act theory was first developed by

Austin (1962), and later by Searle (1969), as a part of the philosophy of language which was concerned not with what is *said*, but with what is *meant* by a particular expression (Bach & Harnish, 1979). Austin (1962) and Searle (1969) developed the idea that the meaning of a word is its use in language, into speech act theory. In their view, language is more than simply the transmission of information. Each lingual expression or utterance has a particular intent and, therefore, has an illocutionary point. The illocutionary point of a speech act refers to the communicative intention which is included in the act. The illocutionary point of an act is often indicated by performative verbs, such as to inform, to claim, to state, to demand, or to advise. Although these verbs may occur in specific speech acts, this is not a requirement. The speech act with the intention of demanding something, for example, can be expressed by saying, 'I hereby demand that you do this exercise', but also by saying 'Do this exercise' or 'Finish the exercise, please'. Performative verbs are indicators of the illocutionary point of the acts, but not necessary elements in these speech acts. Examples of other illocutionary indicators are the position of the verb, intonation, and gesture (Roth & Lawless, 2002). Note that these illocutionary indicators are not always to be found in transcriptions of spoken language. From the theories of speech acts, five main speech act types based on the purpose of the act can be distinguished: acts with assertive, commissive, declarative, directive, and expressive points (Austin, 1962; Bach & Harnish, 1979; Searle, 1969). An assertive act, described by some authors as a constative act, expresses the speaker's belief and intention that the hearer forms a similar belief. Examples of performative verbs describing assertive speech acts are the following: to inform, to reflect, to dispute, or to predict. Commissive acts express the speaker's intention and belief that his utterance obligates himself or herself to do something, and are accompanied by verbs, such as to promise, to offer, or to guarantee. When a speaker utters a declarative speech act, which some authors call effectives or verdicts, the utterance changes a state of affairs, such as when a vicar states, 'I declare you man and wife' or when the prime minister states, 'I hereby veto this bill.' Directive speech acts express the speaker's intention that the hearer takes action. Directive acts are, therefore, accompanied by verbs, such as to question, to ask, to advise, or to instruct. Expressive acts, or acknowledgements, express the speaker's feelings regarding the hearer, through verbs, such as to greet, to accept, to apologize, or to thank. Thus, expressive acts articulate an emotional state of the speaker towards the hearer. In educational contexts, speech acts with declarative purposes are expected to occur only in very specific situations, such as graduation ceremonies, and not often during the day-to-day course meetings.

### **4.1.2 Methods of instruction**

University teachers can select different methods of instruction for their courses. Most university courses can be broadly divided into three types of instruction: lectures, seminars, and practicals. This categorization is rather abstract. Within each type, sub-divisions are possible; for example, during the first course meeting of a practical, the teacher might first give a lecture about the content of the research assignments. Or during a typical lecture course a teacher might ask the students to reflect on the topic through discussing some issues with their peers. In each method of instruction the teacher has a distinct role. During a lecture, the teacher has the role of the 'expert', during a practical the teacher has the role of a 'guide', and during a seminar the teacher is more or less a 'discussion leader'. Teachers behave differently in different roles, and, therefore, it is plausible that teachers' speech acts diverge between methods of instruction and teacher roles. In this study, we examined associations between teachers' speech acts and methods of instruction.

### **4.1.3 Approaches to teaching**

In the field of higher education, many studies have been reported on approaches to teaching (cf. Gregory & Jones, in press; Kember 1997; Kember & Kwan, 2002; Prosser et al., 1994; Postareff & Lindblom-Ylänne, 2008; Stes, Gijbels, & Van Petegem, 2008). The discussion about approaches to teaching is more multifaceted than presented here; we present only those aspects which are necessary to this study. The Approaches to Teaching Inventory (ATI; Prosser et al., 1994) is frequently used to examine teachers' approaches in higher education, and its items are composed from the idea that teachers have both an intention and a strategy when teaching university courses. Different teaching intentions were identified, including conceptual-change and information-transmission intentions. Teaching strategies were also identified, including teacher-focused and student-focused strategies. Factor analysis showed that the ATI distinguishes two types of approaches to teaching: conceptual-change/student-focused (CCSF) and information-transmission/teacher-focused (ITTF). Stes, De Maeyer, and Van Petegem (2008) recently translated the ATI and tested its validity in the context of higher education in Flanders, Belgium. The results indicate that the instrument is rather context-dependent. Stes, De Maeyer, and Van Petegem (2008), therefore, recommend adapting the formulation of the items to the context in which the questionnaire is used. Furthermore, Martin, Prosser, Trigwell, Ramsden, and Benjamin (2000) showed that university teachers' approaches in a *specific* course are consistent with their teaching practices. Teachers' approaches, however, can



be inconsistent with their teaching practices when the *general* approaches of university teachers are considered (cf. Murray & McDonald, 1997). Therefore, regarding *specific* teaching situations, we expected a high correspondence between teachers' approaches and the actual teaching practice. In their review study of research on teachers' beliefs and practices, Kane, Sandretto, and Heath (2002) present the risk of telling half the story when only paying attention to the teachers' perspective. They call for studies in which associations are drawn between observations of teaching practice and what teachers say about their teaching: it is important to be aware that teachers' self reports about their teaching might not be as close to their actual teaching practice as is often assumed. In the present study, this was done by relating teachers' speech acts to teachers' approaches to teaching.

#### **4.1.4 Research questions**

In this study, we focused on teachers' speech acts as an element of their teaching practice, and investigated associations between teachers' speech acts, their approaches to teaching, and the methods of instruction of the courses. The two leading research questions in this study were *what typical sequences can be recognised in individual teachers' speech during course meetings, and are teachers' typical speech act sequences associated with their approaches to teaching and the method of instruction used during science courses?*

## **4.2 Methods**

### **4.2.1 Sample and research context**

The participants were 12 university science teachers, 2 female and 10 male, of the Faculty of Science of Leiden University. All participants volunteered to participate in a larger research project which focused on the research-teaching nexus in the sciences. The participants ranged in position from assistant professor to full professor, and taught courses in various sub-disciplines. In one way or another, all courses of the participants were research intensive (Elsen et al., 2009). Furthermore, a variety of methods of instruction was present in the courses. These methods of instruction were categorised into three main groups: lectures, seminars, and practicals. These methods of instruction are characterised by differences in typical group size: large, medium, and small groups, respectively. In this sample, lectures had typical group sizes of 15 students or more, seminars had group sizes between 7 and 15 students, and the group size during practicals was fewer than 7 students. The amount of time students were to spend on each course ranged between 28 and 196 hours of study load.

### **4.2.2 Procedure**

During the autumn and winter of 2007, the participants' classes were audio-tape recorded using a tie-clip microphone. The first 15 minutes of the course meetings were recorded and transcribed verbatim, with transcription accuracy confirmed by the author. After the final meetings, the teachers were presented with the Dutch version of the Approach to Teaching Inventory (ATI; Stes, De Maeyer, & Van Petegem, 2008).

### **4.2.3 Analysis of teachers' speech acts**

Teachers' speech acts were analysed using categories retrieved from the literature. Speech act analysis is basically a qualitative method, in which particular speech acts are analysed individually. The individual utterances are classified and their semantic relationships taken into consideration to categorize their intention. In this study, the method was also used in a more quantitative fashion through the determination of the frequency of the speech act types and the calculation of typical speech act sequences of each participant. The analysis procedure can be divided into three phases: (1) development of a codebook, (2) determination of the inter-rater reliability, (3) establishment of agreement. These phases are similar to classic content analysis or related qualitative methodologies in which a pre-developed coding scheme based on findings of previous studies are used (Krippendorff, 1980; Ryan & Bernard, 2000). We explain each phase of the analysis procedure in some detail.

Phase 1, development of a codebook: Speech act types and matching performative verbs were collected from the literature on the philosophy of language (Austin, 1962; Searle, 1969). Five main speech act types are distinguished in the literature, namely, assertive, commissive, declarative, directive, and expressive speech acts. Especially in educational contexts, also utterances with an evaluative intent occur. For example, in explaining to students the most effective way to solve a problem, a teacher may say, "That's a good way to approach the problem" or "You are doing very well, now." Therefore, evaluative acts were categorised as specific codes. Expressive speech acts articulate an emotional state of the speaker, while evaluative acts articulate the speakers' normative values. The six primary codes were discussed by the research team and applied to a sample of transcripts, resulting in a preliminary codebook. Each single sentence uttered was coded. Compound sentences were separated. This resulted in a total of 1870 fragments from 12 teachers. Based on the initial reading of the fragments, several sub-categories were proposed and negotiated by the research team. As a result, three types of directive speech acts were

distinguished: question, advice, and instruct. The assertive acts were sub-categorised into inform, predict, and reflect. Student talk was coded as 'student speech acts.' These student speech acts were not divided into separate speech act codes, because the focus of this study was on teachers' utterances. The codebook was applied to a sample of four transcripts and adapted according to the results. Demarcation rules were described to distinguish between categories. Table 4.1 depicts the categories of speech acts with illustrative quotes. Phase 2, determination of the inter-rater reliability: An independent rater was consulted to verify if the codebook could be used by people other than members of the research team. First, a sample of four transcripts was coded independently by the independent rater and the author. The codes, the demarcation rules, and all differences in assigned codes were discussed. The demarcation rules were modified according to the results of the discussion. Finally, the inter-rater reliability was determined based on the codes assigned by both raters to a sample of 4 new transcripts. Inter-rater agreement on the level of the sub-categories was Cohen's Kappa .69; on the level of the main categories, Cohen's Kappa was .73. Student talk was excluded from the calculation of inter-rater agreement, because no dissimilarities between raters could occur.

Phase 3, establishment of agreement: Agreement on the codes of all transcripts was established by the independent rater and the author following negotiation of the differences between codes. The dissimilarity between raters could be related to at least two points. First, most of the dissimilarities were found within assertive speech acts, thus between assertive-inform, assertive-predict, and assertive-retrospect. Second, some fragments had dual illocutionary points, such as a directive act with an evaluative point. For example, the utterance 'Don't do that foolish thing' includes both an evaluative and an instructional point. This sometimes occurred with evaluative illocutionary points which were incorporated within assertive or directive acts.

#### **4.2.4 Post-course administration of the ATI**

The language and vocabulary of the ATI version of Stes, De Maeyer, and Van Petegem (2008) were adapted to the Dutch higher education context. The questionnaire consisted of 22 items, which could be sub-divided into two main scales, conceptual-change/student-focus (CCSF) and information-transmission/teacher-focused (ITTF). We followed the proposal of Stes, De Maeyer, and Van Petegem (2008) for the item distribution in the scales. Cronbach's alpha reliabilities of the two scales for the sample in this study were

.98 (CCSF) and .87 (ITTF). For all participants, the scores on the two scales CCSF and ITTF were calculated.

*Table 4.1 Categories and explanations of illocutionary points of teachers' speech acts*

Categories of speech acts	Explanation of illocutionary point of speech act
Assertive acts	Assertive speech acts express the speaker's belief and his intention or desire that the hearer have or form a similar belief. An utterance that asserts a thing that can be judged as true or false. The illocutionary point of an assertive act focuses on persuading the hearer to form a parallel belief. Assertive acts are divided into three sub-categories: 1) Inform: speaker articulates assertions about factual situations or phenomena at this moment. 2) Predict: speaker talks about expectations for future situations, or asserts consequences or predictions. 3) Reflect: speaker formulates assertions about past situations, and reflects in a non-normative way.
Commissive acts	Commissive speech acts express the speaker's intention and belief that his utterance obligates him to do something. The illocutionary point of a commissive act focuses on the behaviour and cognition of the speaker.
Declarative acts	Declarative speech acts are judgments that by convention have official, binding import in the context of the institution in which they occur. For example, the speaker utters a thing as part of his function or position. The effect of a declarative act changes an institutional state of affairs. The illocutionary point of a directive act focuses on change of a current situation.
Directive acts	Directive speech acts express the speaker's attitude toward some prospective action by the hearer and his intention that his utterance, or the attitude it expresses, be taken as a reason for the hearer's action. The illocutionary point of a directive act focuses on the hearer's behaviour. Directive acts are divided into three sub-categories: 1) Question: speaker formulates questions. In transcripts often, but not always, indicated with a question mark. 2) Instruct: speaker gives instructions to the hearer. 3) Advise: speaker formulates a recommendation.
Evaluative acts	Evaluative speech acts express the speaker's perceived evaluation of a thing. This expressed value is clearly the main point of the utterance; thus, the act comprises a normative load. Speech acts including words such as 'better', 'more effective', or 'nicer' are often evaluative. The illocutionary point of an evaluative act focuses on communication of a perceived value or norm of the speaker.
Expressive acts	Expressive speech acts express the speaker's feelings regarding the hearer or, where the utterance is clearly perfunctory or formal, the speaker's intention that his utterance satisfies a social expectation of expression of certain feelings and his belief that it does so. The illocutionary point of an expressive act focuses on communication of an emotional state of the speaker.

**4.2.5 Analysis of typical speech act sequences**

To enable recognition of characteristic patterns in teachers' utterances, participants were grouped with respect to similarities in their speech acts. Similarities were then identified within these groups with respect to method of instruction and approach to teaching. Frequencies of speech acts only give information about the occurrence of the individual acts, and not about successive acts. Information about successive utterances would improve our understanding of teachers' speech acts during course meetings. Therefore, not only were the frequencies determined, also the transitional frequencies for four successive speech acts were calculated. These transitional frequencies are called lag sequential acts. A lag  $n$  speech act is the  $n$ th speech act that precedes or follows a particular act. Figure 4.1 visually presents the sequence of four successive speech acts and the lag 1, lag 2, and lag 3 acts. Lag 1 acts ( $X_1X_2$ ,  $X_2X_3$ , and  $X_3X_4$ ) are those acts which directly follow a particular act; lag 2 acts ( $X_1X_3$  and  $X_2X_4$ ) are the second succeeding acts; and the lag 3 act ( $X_1X_4$ ) is the third succeeding act. To determine transitional frequencies, SPSS syntax for analysing lag-sequential categorical data (O'Conner, 1999) was used.

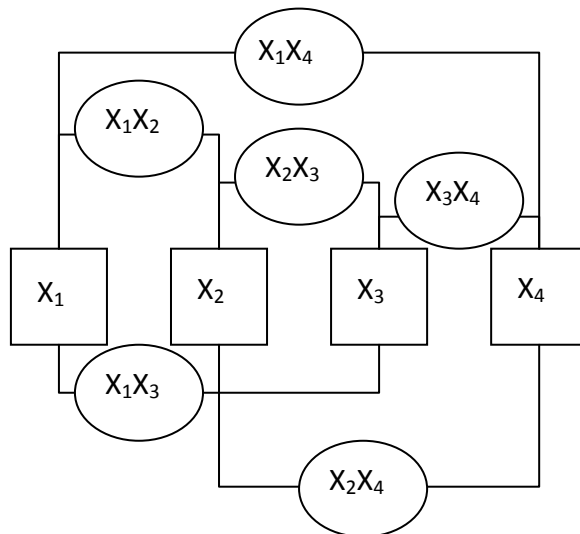

*Figure 4.1 Sequence of successive speech acts with lag 1, lag 2, and lag 3 successors*

First, the frequencies were determined of the original arrays of teachers' speech acts. Second, frequencies and transitional frequencies were calculated for reduced arrays in which similar successive acts were deleted. Similar acts were

deleted in order to create arrays in which successive acts were always different from previous acts. This was done to identify changes in types of speech acts in the lag sequential analysis. To identify the typical sequence of speech acts during the classroom activities of the participants, which consisted of four consecutive codes, a quantitative measure for typical sequences was developed. This measure consisted of weighted probabilities of the frequencies and the transitional frequencies, namely, (1) the weighted probability of the frequencies of the four individual codes ( $X_i$ ) with respect to the total number of codes ( $Total$ ), (2) the weighted probability of the frequencies of the three lag 1 sequences ( $X_iX_{i+1}$ ), (3) the weighted probability of the frequencies of the two lag 2 sequences ( $X_iX_{i+2}$ ), and (4) the weighted probability of frequency of the lag 3 sequence ( $X_iX_{i+3}$ ).

$$TypicalSequence := \left( \frac{X_1 + X_2 + X_3 + X_4}{4 \cdot Total} \right) + \left( \frac{X_1X_2 + X_2X_3 + X_3X_4}{3 \cdot (Total - 1)} \right) + \left( \frac{X_1X_3 + X_2X_4}{2 \cdot (Total - 2)} \right) + \left( \frac{X_1X_4}{(Total - 3)} \right) \quad (4.1)$$

$$(\Delta TypicalSequence)^2 = \left( \frac{1}{(Total)^2} \right) + \left( \frac{1}{(Total - 1)^2} \right) + \left( \frac{1}{(Total - 2)^2} \right) + \left( \frac{1}{(Total - 3)^2} \right) \quad (4.2)$$

The addition of these four elements resulted in a quantity which could be used to determine the most typical speech act sequence (see Formula 4.1). If  $Z = A + B$ , then the error in  $Z$  equals  $(\Delta Z)^2 = (\Delta A)^2 + (\Delta B)^2$ . Therefore, if we estimated the measurement errors in the subsequent frequencies on 1, then the standard errors in the typical sequences ( $\Delta TypicalSequence$ ) could be estimated as  $\frac{2}{Total}$  (see Formula 4.2 for exact error in typical sequence). The standard errors in the typical sequences were used as a criterion to determine the most typical sequences of the participants.

### 4.3 Results

#### 4.3.1 Teachers' speech acts

In total, more than half of teachers' speech acts were assertive speech acts (60%), roughly 20 percent were directive acts, and 8% consisted of evaluative acts. Five percent of teachers' speech acts consisted of commissive acts, and two percent were expressive acts. Only 10 percent were student speech acts. No declarative acts were found in this sample. Table 4.3 depicts the frequencies of the speech act types per participant before similar successive acts were deleted, and shows the

actual uttered acts of the participants during class. The names of the participants are fictitious to preserve anonymity. Assertive-inform speech acts were coded most often in the fragments; they made up 39% of the 1870 coded fragments. Table 4.2 depicts the speech act sequences which scored highest on the typical measure calculated using Formula 4.1.

*Table 4.2 Participants' typical speech act sequences*

Participant	Typical Speech act Sequence			
	X1	X2	X3	X4
Dr. Simon	Inform	Predict	Inform	Predict
	Question	Inform	Question	Inform
Dr. Paul	Inform	Question	Inform	Question
	Question	Student	Question	Student
Dr. Nathan	Question	Inform	Commissive	Inform
Dr. Susan	Instruct	Inform	Instruct	Inform
	Inform	Instruct	Inform	Instruct
Dr. Charles	Inform	Student	Inform	Student
	Inform	Question	Student	Inform
Dr. Adam	Inform	Evaluative	Inform	Evaluative
Dr. Edward	Reflect	Inform	Reflect	Inform
Dr. Adrian	Inform	Reflect	Inform	Reflect
	Reflect	Inform	Reflect	Inform
Dr. Carlos	Inform	Predict	Inform	Predict
Dr. Tanya	Inform	Evaluative	Inform	Evaluative
	Predict	Inform	Predict	Inform
Dr. Howard	Inform	Predict	Instruct	Inform
	Predict	Inform	Predict	Inform
Dr. Eliot	Inform	Predict	Inform	Predict
	Predict	Inform	Predict	Inform

Table 4.3 Frequencies of speech acts before similar successive acts were deleted

Participant	Sub-discipline	Total Number	Assertive			Directive			Evaluative	Commissive	Expressive	Student act
			Inform	Predict	Reflect	Question	Instruct	Advise				
Dr. Simon	Chem	174	114	17	8	18	5	3	5	1	0	
Dr. Paul	Chem	178	29	11	8	29	6	11	1	7	64	
Dr. Nathan	Astro	110	57	8	1	14	2	5	14	2	1	
Dr. Susan	Bio	125	31	17	23	2	24	5	1	8	3	
Dr. Charles	Compu	189	53	16	9	21	12	18	7	6	32	
Dr. Adam	Astro	148	63	24	2	15	4	15	6	4	8	
Dr. Edward	Chem	103	21	23	26	4	1	7	4	2	10	
Dr. Adrian	Chem	285	111	21	29	32	13	22	16	6	24	
Dr. Carlos	Math	62	27	10	10	1	1	7	4	0	1	
Dr. Tanya	Bio	120	41	14	30	10	1	16	4	1	1	
Dr. Howard	Compu	176	60	27	15	8	21	9	12	3	4	
Dr. Eliot	Phys	200	126	26	6	11	0	11	14	2	2	
<b>Total</b>		<b>1870</b>	<b>733 (.39)</b>	<b>214 (.11)</b>	<b>167 (.09)</b>	<b>165 (.09)</b>	<b>90 (.05)</b>	<b>129 (.07)</b>	<b>88 (.05)</b>	<b>42 (.02)</b>	<b>150 (.08)</b>	



*Table 4.4 Lag frequencies and typical measure for participants' speech act sequences*

Participant	Total number of codes	Typical speech act sequence								Lag 1 frequencies			Lag 2 frequencies		Lag 3 frequencies	Typical Measure (S.E.)
		X1		X2		X3		X4		X1-X2	X2-X3	X3-X4	X1-X3	X2-X4	X1-X4	
		X1	X2	X2	X3	X3	X4	X4	X1-X2	X2-X3	X3-X4	X1-X3	X2-X4	X1-X4		
Dr. Simon	97	41	17	41	17	41	17	41	17	13	10	13	27	3	11	0.70 (.02)
		16	41	16	41	16	41	16	41	11	13	11	4	27	12	0.71 (.02)
		41	16	41	16	41	16	41	16	13	11	13	27	4	10	0.69 (.02)
Dr. Paul	147	28	51	28	51	28	51	28	51	25	16	25	8	30	19	0.58 (.01)
Dr. Nathan	75	13	28	11	28	11	28	11	28	9	5	10	6	18	10	0.68 (.03)
Dr. Susan	84	16	21	16	21	16	21	16	21	6	5	6	5	11	6	0.46 (.02)
		21	16	21	16	21	16	21	16	5	6	5	11	5	4	0.43 (.02)
Dr. Charles	149	34	24	34	24	34	24	34	24	6	6	6	9	8	5	0.33 (.01)
		34	19	24	34	19	24	34	19	6	8	6	2	5	10	0.32 (.01)
Dr. Adam	100	34	14	34	14	34	14	34	14	12	9	12	21	7	10	0.60 (.02)
Dr. Edward	74	16	16	16	16	16	16	16	16	6	7	6	6	10	8	0.55 (.03)
Dr. Adrian	218	62	26	62	26	62	26	62	26	11	12	11	23	6	9	0.37 (.01)
		26	62	26	62	26	62	26	62	12	11	12	6	23	9	0.37 (.01)
Dr. Carlos	37	14	7	14	7	14	7	14	7	5	5	5	6	2	4	0.65 (.06)
Dr. Tanya	73	22	13	22	13	22	13	22	13	7	3	7	10	5	7	0.52 (.03)
		12	22	12	22	12	22	12	22	8	6	8	4	10	4	0.49 (.03)
Dr. Howard	134	37	20	37	20	37	20	37	20	8	6	10	7	7	9	0.39 (.02)
		20	37	20	37	20	37	20	37	6	8	6	3	13	6	0.37 (.02)
Dr. Eliot	110	45	22	45	22	45	22	45	22	19	14	19	31	7	10	0.73 (.02)
		22	45	22	45	22	45	22	45	14	19	14	7	31	10	0.72 (.01)

**4.3.2 Typical speech act sequences**

Table 4.4 shows the frequencies of all variables in Formula 4.1 and 4.2. Some teachers have more than one sequence with similar typical measures, or at least within the standard error. This means that those speech act sequences are equally typical of the speech acts during that particular class. Often the orders of two individual speech acts change within the sequences, for example, in the sequences of Dr. Eliot, Dr. Adrian, and Dr. Susan. However, some speech acts which equal typical measures are differently organised. For example, the sequences of Dr. Charles show a sequence with directive-question acts and a sequence with student speech acts. Both sequences of Dr. Charles are, intuitively, related, in the sense that the questions are directed to students, and student speech acts in the typical sequence reflect a classroom discourse with teacher-student dialogue. In this perspective it is interesting to note that the directive-questions in the sequence of Dr. Paul can be interpreted as different acts from the directive-question acts in the sequence of Dr. Charles. The directive-question acts of Dr. Charles are not typically followed by student answers, but by assertive-inform acts by the teacher. These directive-questions could, for example, have been posed to stimulate student thinking more than to stimulate student responses. Thus, in speech act sequences the interpretation of acts depends on the consecutive order of the acts. Generally, assertive-inform is part of the sequences, except in the typical sequence of Dr. Paul, which consists of directive-question and student acts.

**4.3.3 Groups of typical speech act sequences**

Two groups of typical speech act sequences can be broadly recognised in the data in university courses: sequences with assertive acts and sequences with directive acts. The assertive speech act sequences can be sub-divided into two groups, one with assertive-predict acts and the other with assertive-reflect acts. The directive sequence group can be divided into a group with directive-question acts and a group with directive-instruct speech acts. The typical speech act sequences of Dr. Charles and Dr. Adam are special cases, in the sense that neither sequence can be incorporated into the two larger groups. Dr. Adam typically uses evaluative acts, and Dr. Charles typically involves students during his teaching. Table 4.5 shows the typical sequence groups. Dr. Nathan's typical sequence is the only sequence which consists of commissive speech acts, such as promises or offers. Dr. Nathan also uses directive-question acts and, therefore, has been assigned to the directive-question group. Furthermore, the speech act sequences of Dr. Simon draw attention because one of the sequences belongs to the assertive-predict

group, while the other two belong to the directive group. We position Dr. Simon in the directive–question group, because two of his typical sequences consist of question acts. In the discussion we present explanations as to why some teachers have more typical sequences than other teachers.

To illustrate the differences between the groups of typical speech act sequences, fragments from participants' course meetings are presented. For presentation purposes, original fragments in Dutch were translated by the author. The first fragment illustrates a typical assertive speech act sequence. This fragment, with assertive-reflect acts, was taken from the course transcripts of Dr. Adrian.

Dr. Adrian: In the last meeting we discussed the benefits of alternative splicing, a single gene produces multiple products. (Assertive-reflect)

Dr. Adrian: We will talk again about transposons, cell-typical structures of proteins, which we've already seen. (Assertive-reflect)

Dr. Adrian: And, ladies and gentleman, here we are again, are you male or female? (Directive-question)

Dr. Adrian: We often have this kind of conversation in this room, that's not my fault, it's part of the course content. (Assertive-reflect)

Dr. Adrian: Yesterday, we talked about why female genes are more often used in offspring than male genes. (Assertive-reflect)

Dr. Adrian: And after the meeting, one of the men came up to me and said, "Sir, are we going to get some bonus points in the final test, because we got so depressed during your course?" (Assertive-reflect)

This sequence illustrates how assertive-reflect acts are used in lecture-type courses. The next fragment illustrates the use of evaluative acts during a course meeting; it was selected from the transcripts of Dr. Tanya.

Dr. Tanya: Actually, almost nobody had noticed it. (Assertive-reflect)

Dr. Tanya: It was so subtle; the horse went on tipping until he got the sign. (Assertive-reflect)

Dr. Tanya: This, now, is known as the Hans effect. (Assertive-inform)

Dr. Tanya: That really is the well-known name of these kinds of phenomena. (Assertive-inform)

- Dr. Tanya: So, Hans could not count, but very remarkable it was. (Evaluative act)
- Dr. Tanya: And that's what many forget, it was a remarkably clever horse, because it completed the task in a very innovative way. (Assertive-inform)
- Dr. Tanya: He likely didn't have any clue whatsoever, (assertive-reflect)
- Dr. Tanya: But it was an extremely good pupil. (Evaluative act)
- Dr. Tanya: He knew that in many different tasks and many different contexts, and so on, that he just had to pay close attention to what his boss did (Assertive-reflect)
- Dr. Tanya: And he learned in an associative way what the sign was for when to stop, when his boss looked happy and when he was going to receive his award. (Assertive-reflect)
- Dr. Tanya: It really is a magnificent example in two ways. (Expressive act)
- Dr. Tanya: One is how to pay close attention when training animals. (Assertive-inform)
- Dr. Tanya: Very close, actually, because you almost never know what you do (Evaluative act)
- Dr. Tanya: And when you have all your procedures, the people who train the animals do not know what the actual goal is, if that is possible, often not. (Assertive-predict)

Throughout Dr. Tanya's course meeting, evaluative acts and assertive-reflect acts are iterated using assertive-inform acts. Furthermore, Dr. Tanya, like Dr. Adam, typically uses evaluative acts. For example, "That is a good question!" or "Generally, that is good for the observations". These evaluative speech acts can be broadly divided into two categories, first, sharing of teachers' opinions about course content or methodologies and, second, evaluating the learning processes of students. Although the previous examples illustrate an element habitually present in teachers' daily talk, namely, assertive speech acts, directive speech acts also play an important role in teachers' discourse. The following fragment illustrates directive acts selected from the transcripts of Dr. Susan.

- Dr. Susan: So, I mean, as long as we have enough, check and see how many seawater plates there are before you do anything. (Directive-instruct)

Dr. Susan: Because everybody needs to make at least one fresh plate for next week, but if there are more than that, then try other temperatures if you can. (Directive-instruct)

Dr. Susan: Sometimes they won't. (Assertive-inform)

Dr. Susan: Most bugs got a plus or minus 15 degrees around their optimum. (Assertive-inform)

Dr. Susan: But some of these bugs seem to grow quite happily from room temperature down to almost freezing. (Assertive-inform)

Dr. Susan: So check this and see, because it would be nice to have some bugs growing at room temperature or at 18 degrees, just so we can pack them all in. (Directive-instruct)

Dr. Susan: Otherwise we have to turn the 18 degrees stove down I think. (Assertive-predict)

Dr. Susan: Also, now that I have a brand new 18-degree shaker, it would be nice to be able to use it. (Assertive-predict)

Dr. Susan clearly provides students with helpful instructions for getting through the practical laboratory assignments. She gives instructions and explains to the students some of the consequences if the instructions are not followed. During practicals these strict instructions are often necessary, not only with regard to completion of the assignments, but also in relation to the strict safety regulations when working with living organisms ('bugs'). These instructions are important during laboratory classes, but questions are also often posed by teachers. The following fragment illustrates a speech act sequence during a lecture-type course in which the teacher asks questions of the students. This fragment with directive-question comes from Dr. Simon.

Dr. Simon: Eventually, you need an equal amount of E2's and E3's as you have proteins to eliminate. (Assertive-inform)

Dr. Simon: Do you get this? (Directive-question)

Dr. Simon: Okay, to what do E2's and E3's bond? (Directive-question)

Dr. Simon: The two larger ones ..., the categories are hydrophobic patches in proteins. (Assertive-inform)

Dr. Simon: Hydrophobic means that they do not like water. (Assertive-inform)

Dr. Simon: That's what my colleague probably explained in the last meeting; if not, then please pay attention. (Assertive-reflect)

Dr. Simon: Hydrophobic means that it does not like water. (Assertive-inform)

Dr. Simon: The protein molecule is the driving force behind protein folding.  
(Assertive-inform)

Dr. Simon: There are electrostatic charges in a protein molecule related the hydrophobic places in the amino acid. (Assertive-inform)

Dr. Simon: What is the protein going to do? (Directive-question)

Dr. Simon: Just chemistry, the electrostatic charges are going outside, because they want to have contact with the water and the hydrophobic part will turn inside (Assertive-inform)

Dr. Simon: The protein folds into a certain form. (Assertive-inform)

Dr. Simon: That is why the protein folds in another order of charges  
(Assertive-inform)

Clearly, the questions in Dr. Simon's monologue were posed as a rhetorical tool to stimulate students cognitively and to motivate students to listen. Directive-question speech acts, naturally, can also be used differently, as questions in order to elicit direct student responses.

#### **4.3.4 Characteristics of the typical speech act groups**

In Table 4.5, the method of instructions, divided into three types, lecture, seminars, and practicals, are presented alongside the typical speech act groups. Among other things, Table 4.5 shows that teachers use directive speech acts most often during practicals, while they use more assertive acts during lectures. The typical speech act of Dr. Edward is an anomaly for this statement. The meetings in the particular phase of the practicals at the moment of tape-recording were more similar to lectures than were other meetings later in the course curriculum, in the sense that the teacher reflected on previous work and talked about what to do next. Therefore, it is conceivable that Dr. Edward used more assertive-reflect speech acts than he would have done in a different practical course meeting.

Table 4.5 also depicts the score of each participant on the two ATI scales conceptual-change/student-focused (CCSF) and information-transmission/teacher-focused (ITTF). On the whole, the overall means show that participants in this sample score slightly higher on the CCSF scale (3.58) than on the ITTF scale (3.08). The speech acts of participants with approaches high on the CCSF scale (Dr. Simon, 4.70; Dr. Paul, 4.30) both have typical sequences with directive and student acts. These participants often asked questions and encouraged students to react. The speech acts of the two participants with approaches to teaching high on the ITTF scale (Dr. Adrian, 4.73; Dr. Howard, 3.82) are both characterised by a combination of assertive-inform and assertive-predict in their typical sequences.

Dr. Susan scores high on ITTF scale (3.91), but she also scores high on the CCSF scale. Finally, Dr. Charles is remarkable with respect to his approach, because both his CCSF score and his ITTF score are rather low. This may be related to the method of instruction, a seminar, or it may be interpreted as showing that the respondent found few links between the ATI items and his particular course.

*Table 4.5 Distribution of the variables method of instruction and approach to teaching among speech act groups and participants*

Group	Participant	Method of instruction	Approaches to Teaching	
			CCSF	ITTF
Directive-question	Dr. Simon	Practical	4.70 (.48)	2.18 (.87)
Directive-question	Dr. Paul	Practical	4.30 (.68)	2.91 (1.30)
Directive-question	Dr. Nathan	Seminar	3.70 (.68)	3.18 (1.40)
Directive-instruct	Dr. Susan	Practical	4.00 (1.63)	3.91 (1.30)
Student	Dr. Charles	Seminar	2.20 (1.23)	2.45 (1.13)
Evaluative	Dr. Adam	Seminar	3.90 (1.29)	2.73 (1.27)
Assertive-reflect	Dr. Edward	Practical	3.80 (1.03)	3.00 (1.10)
Assertive-reflect	Dr. Adrian	Lecture	3.50 (1.18)	4.73 (.47)
Assertive-predict	Dr. Carlos	Lecture	4.10 (.74)	2.27 (.47)
Assertive-predict	Dr. Tanya	Lecture	3.60 (.84)	2.91 (1.45)
Assertive-predict	Dr. Howard	Seminar	2.70 (1.06)	3.82 (.87)
Assertive-predict	Dr. Eliot	Lecture	2.40 (1.51)	2.91 (1.22)
			<b>3.58 (.77)</b>	<b>3.08 (.74)</b>

## 4.4 Conclusions and discussion

### 4.4.1 Assertive and directive speech acts

To answer the first research question, regarding the characteristic patterns recognisable in teachers' speech acts, we clustered teachers into groups characterised by sequences with assertive acts and sequences with directive acts. The assertive-sequence group was sub-divided into two groups, typical sequences with assertive-reflect acts and typical sequences with assertive-predict acts. The directive-sequence group was sub-divided into sequences with questions and sequences with instructions. Below, we summarize the characteristic features of the typical speech act sequences of the participants, and turn to the second research question, about the associations between speech act groups, methods of instruction, and approaches to teaching.

Seven of the twelve teachers had more than one typical speech act sequence. Often these sequences were mirrored versions; however, sometimes two or more typical speech acts of a single teacher were qualitatively different.

This means that the different speech act sequences were typically present in the uttered arrays during the course meeting, which can be interpreted as showing that the particular teacher had a broad repertoire of speech acts. For example, Dr. Simon used two different typical speech act sequences in his course meetings, one with directive-question acts and the other with assertive-predict acts. Both sequences were equally typical during the course meetings. Thus, Dr. Simon gave information to students followed by questions of the students, as well as making predictions, such as stated in a speculative format (if-then). That these sequences had an equally high typical measure (see Table 4.4) shows that they were equally present during his course meeting, which represents the repertoire of speech acts used. In this way, the typical measure can illuminate the applied speech act repertoires of university teachers.

From the analysis of teachers' speech acts during university courses, we first observed that assertive-inform speech acts were most frequently present in the typical sequences. From this we conclude, with respect to the first research question, that speech acts in which the teacher has the intention to inform students are most often present in teachers' utterances. Whatever method of instruction or approach a teacher uses, he/she always inform students, for example, about course content or about assignments. Second, we conclude, with respect to the second research question, that during lectures teachers mostly used assertive speech acts, while during laboratory courses they more often used directive speech acts. During lectures teachers primarily explained course content, while during laboratory courses teachers more often gave students instructions on how to proceed with the inquiry. Finally, related to the second research question, we conclude that teachers who scored high on the CCSF approach more often used directive speech acts, such as questions or instructions, while teachers who scored high on the ITTF approach more often used assertive acts. It is plausible that teachers who put emphasis on conceptual change engage in dialogue with students more often than do teachers who put emphasis on information transmission.

### ***4.4.2 Limitations and suggestions for further research***

Although we did not focus on the content of the discourse between teachers and students in this study, it was possible to use the categorisation of speech acts developed for teachers to analyse the discourse during course meetings. The theoretical foundation and the possibility of empirically locating types of speech acts are the advantages of the categorisation presented in this study. However, some limitations should be noted. First, during the development of the speech



acts categorisation scheme, we noted that speech acts with an evaluative illocutionary point often seemed to co-occur in assertive or directive speech acts. This means that the category of evaluative speech act was not always clearly demarcated from other types of speech acts. Therefore, we suggest that, in future research using this method of speech act analysis, the use of evaluative acts should be re-evaluated as a distinct speech act category. When evaluative acts are disregarded, it might be expected that inter-rater reliabilities will increase. Second, we found associations between teachers' speech acts and the methods of instruction; however, teacher roles might be an underlying variable which explains teachers' variety in speech acts better than methods of instruction can explain. Further studies in which teacher roles are related to teachers' speech acts might give a better understanding of the discourse phenomena during university courses. Furthermore, we did not sub-divide student speech acts in this study. The presented method of speech act analysis provides us with a tool to analyse students' speech acts in combination with teachers' speech acts. Further research in which students' as well as teachers' speech acts are analysed will provide a better understanding of discourse between student and teacher in university courses. Finally, teachers' speech acts related to student understanding and students' perceptions of the learning environment are of interest to educational researchers in the field of learning and instruction.

The method of speech act analysis presented in this study can uncover teachers' speech act repertoires, and thus can be used in multiple ways in professional development programmes for teachers, or as a self-reflection tool in educational practice. Speech act theory provides teachers with a method to reflect on their own speech act repertoire, and with a framework to expand their repertoire. When university teachers and teacher trainers recognise that teachers' speech acts play a relevant role in educational practice in higher education, and that it is possible to expand one's speech act repertoire, teachers might become more inclined to work on the scholarship of teaching and learning, and their knowledge base of teaching (Verloop et al., 2001).





**Chapter 5**

**Associations between teachers' intentions and  
students' perceptions of the research intensiveness of  
learning environments**



## 5. Associations between teachers' intentions and students' perceptions of the research intensiveness of learning environments<sup>4</sup>

Many factors have already been recognised as possible explanations of why teachers in higher education teach the way they do. Teaching intentions are additional explanatory factors for differences in teaching; these are especially of interest, because intentions initiate teachers' actions. In this study, we examined in what ways specific teachers' intentions regarding the integration of research in teaching are related to students' perceptions of the learning environments. Interviews were held with university science teachers (n=11), and a questionnaire was presented to their students (n=104). The results show that teachers' intentions related to tangible elements of the integration of research in teaching, such as the use of academics' own research during the courses, are relatively more congruent with students' perceptions than are intangible elements, such as stimulating the development of research dispositions. The results indicate that if students are to perceive and appreciate the intangible elements of research, academics need, first, to become more aware of these elements and, second, to take more care in explicitly drawing students' attention to these elements during science courses.

---

<sup>4</sup>This chapter is to be submitted in an adapted form as:

Van der Rijst, R.M., Visser-Wijnveen, G.J., Kijne, J.W., Van Driel, J.H., & Verloop, N. *Associations between teachers' intentions and students' perceptions of the research intensiveness of learning environments.*

### 5.1 Introduction

Many factors influence the way teachers at university teach their courses. In research into teaching in higher education, much attention has been given to factors such as conceptions of teaching and learning (Kember 1997; Oolbakkink-Marchand, Van Driel, & Verloop, 2006; Pajares, 1992; Visser-Wijnveen, et al., in press), orientations towards teaching (Kember & Gow, 1994; Samuelowicz & Bain, 2001), and approaches to teaching (Stes, Gijbels, & Van Petegem, 2008; Trigwell & Prosser, 2004). Other factors which have been recognised as explanations of why different teachers teach differently include teachers' pedagogical repertoire, teaching skills, and the sophistication of their subject matter knowledge. Although this listing of elements of the knowledge base of teachers (Verloop et al., 2001) in higher education is not exhaustive, it provides multiple explanations for differences in teaching in higher education. In a study among university teachers, Martin and colleagues (2002) discussed a critical issue in why teachers teach differently, namely, the differences in their goals and objectives for teaching and learning in their courses. According to Norton and colleagues (2005), teachers' intentions reflect a compromise between teachers' conceptions of teaching and their academic and social contexts. On the one hand, teachers' intentions are influenced by their abstract notions of what teaching and learning should involve; on the other hand, their intentions are also influenced by the context in which they teach their courses. The factors which influence intentions are also reflected in the Theory of Planned Behaviour (Ajzen & Fishbein, 2005). In this model of human behaviour, three kinds of cognitive factors determine a person's intention to act: attitude towards the action, the subjective norm, and perceived control over the action. Intentions initiate the actions of a person. This intervening position between conceptions and actions makes teachers' intentions a valuable object of research. Many research findings on conceptions of teaching and learning show an ambiguous relationship between conceptions and teaching practice (Murray & MacDonald, 1997; Samuelowicz & Bain, 1992); others show a strong congruence between teachers' intentions and their teaching practice when the context of teaching is clearly defined (Martin et al., 2002; Norton et al., 2005; Prosser, Martin, Trigwell, Ramsden, & Middleton, 2008). Teachers' intentions can give us more insight into the relationships between teachers' cognitions and teaching practice. In this study, we considered university teachers' intentions regarding the nexus between research and teaching in their courses.

### **5.1.1 Intangible elements in the research-teaching nexus**

Neumann (1994) distinguished between the 'tangible nexus' and the 'intangible nexus' in the integration of research and teaching at universities. In the tangible nexus, the clearly visible, explicit forms of integration of research and teaching are categorised, such as teaching 'research practicals'. In the intangible nexus, the more tacit, not directly observable forms of integration of research and teaching are grouped, such as creating an inquisitive research climate, fostering an innovative atmosphere, or stimulating the development of students' research dispositions. Intangible elements have often been denoted by teachers and by educational researchers as relevant elements of learning to do research, but few researchers (McLean & Barker, 2004; Elen & Verburgh, 2008; Elen et al., 2007) have addressed the relation between these intangible elements of the research-teaching nexus and student experiences of courses. Research dispositions are an element of the intangible nexus. In Chapter 2, six qualitatively different aspects of the scientific research disposition of academics were presented: inclination (1) to achieve, (2) to be critical, (3) to be innovative, (4) to know, (5) to share knowledge, and (6) to understand (Van der Rijst, Kijne, Verloop, & Van Driel, 2008). Table 5.1 presents the six aspects with an illustrative quote from university teachers about each aspect. The research dispositions of academics are different from the research dispositions of students. Academics are experts in research and often have a well-explicated research disposition, while students have less experience and may have ambiguously expressed, or underdeveloped, research dispositions. Although the research dispositions of academics and students may be different, we assumed that the research dispositions of both groups would comprise the same six aspects.

### **5.1.2 Modes of integration of disciplinary research into teaching**

Healey (2005b) and Jenkins and colleagues (2007) suggest that the possibilities of integrating research in teaching can be described according to two dimensions: (1) running from emphasis on research products to emphasis on research process, and (2) running from students as an audience to students as participants of research activities. These dimensions divide the two-dimensional plane into four quadrants, which have been characterised as four qualitatively different approaches to integrating research into university teaching. Figure 5.1 shows the four quadrants, in which the vertical axis depicts the student role, and the horizontal axis shows on which research aspect the emphasis is put in a course.

*Table 5.1 Categories of scientific research dispositions illustrated with quotes*

---

Aspect of scientific research disposition	Illustrative quote
Inclination to achieve	Dr. Susan: But some people just can't, it is insecurity; research, there is an awful lot of insecurity in research. Some people just can't take it.
Inclination to criticize	Dr. Simon: Being critical of oneself, and of the sources: 'Is it correct what I argue?' So, what are the proper sources, which sources are trustworthy, and even when a source is trustworthy, read it again.
Inclination to innovate	Dr. Susan: And two students actually asked if they could come in the next day and do their experiment, because they didn't have everything they wanted, and they turned up with old stuff to make bread and they put my yeast into this mix to see if they were going to get bread or not. This is probably one of the most original solutions that anybody has come up with. So I liked that one.
Inclination to know	Dr. Nathan: But you really have to try hard to stimulate their curiosity and their inquisitive attitude.
Inclination to share	Dr. Carlos: Although they just study well-known mathematical maxims, by studying for themselves they create an attitude similar to the attitude of a researcher in the field of mathematics. In research you have to read articles and explain your ideas to come to new suggestions as to how to solve your problem. In that sense a research attitude is created among students or researchers.
Inclination to understand	Dr. Charles: You always need to ask yourself if you really understood what was going on in such a situation. It does depend how broadly you define 'research', but I believe that this aspect is part of this more practically oriented student research project.

---



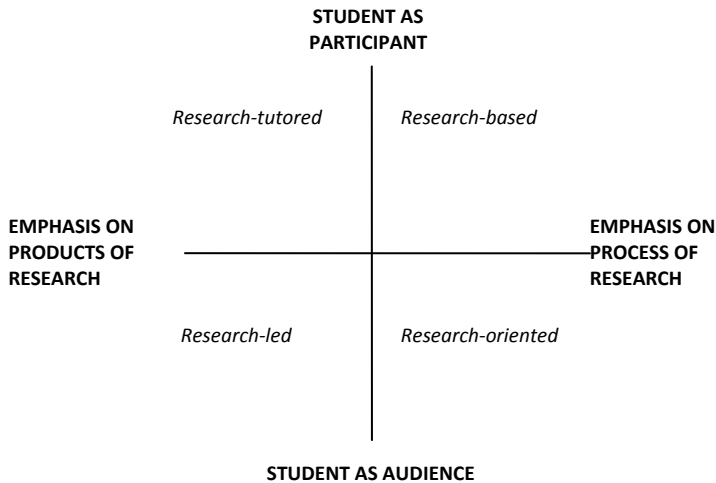

*Figure 5.1 The four modes of the research-teaching nexus (cf. Healey, 2005b)*

Healey (2005b) labelled the two bottom quadrants of this model as 'research-led' and 'research-oriented'. In these two modes, students are perceived as an audience in research activities, in the sense that they do not directly contribute to the development of scientific knowledge. Neither end of the scale, 'students as audience' or 'students as participants', should be interpreted as passive or active student engagement; they should be regarded as related to students working on developing their own knowledge and skills, or on developing new knowledge in the discipline, respectively (Elsen et al., 2009). Students might work actively on improving their own knowledge and skills, without aiming to contribute new knowledge to the discipline, and thus still score high on the element 'student as audience'. The 'research-led' and 'research-oriented' modes can be discerned in the difference between emphasizing research products and emphasizing the research process. In the 'research-tutored' and 'research-based' modes, students participate in research while focusing on the development of new knowledge in the discipline. This heuristic model provides us with a tool to broadly understand the main orientation towards the nexus of research and teaching in the courses, but we have to keep in mind that each course can be subdivided into smaller units, such as assignments, assessments, and instructions, which in their turn can deviate from the overarching general mode of the course. For example, in a course with an overall emphasis on the process of research,

such as a research practical on thermodynamics in which students examine the behaviour of gases, the teacher can choose to insert a lecture on the behaviour of ideal gases as a product of research. In this study, therefore, we kept in mind the ambiguity in the dimensions of this heuristic model, and considered the four modes as qualitatively distinct ways to consider the emphasis in courses on the integration of research into teaching. Healey's four quadrants provide an indication of how to categorize courses based on their general emphasis (Elsen et al., 2009).

### ***5.1.3 Students' perceptions of the research intensiveness of learning environments***

Several studies into the quality of student evaluations of learning environments show that students' perceptions are a valid and reliable source of data about teachers and teaching (Braskamp & Ory, 1994; Cashin & Downey, 1992; Marsh & Roche, 1997). Marsh and colleagues (2002) conclude that student evaluations of research environments are reliable and stable, and that, therefore, students' perceptions of learning environments are an effective method for gathering data about characteristics of learning environments (cf. Mainhard et al., 2009). Additionally, how students perceive the learning environment largely determines the final effect of a course. For example, when a student perceives an assignment as irrelevant, it is likely that this student does not exploit the full learning opportunity. In an overview of research into students' perceptions of learning environments in which a strong integration exists between research and teaching, Jenkins and colleagues (2003) show that students are more motivated when they encounter staff research at the institute at an early stage in their studies. Students experience courses as up to date and intellectually stimulating when teachers bring into play elements of their own research during their courses. According to the students, teachers become more enthusiastic when bringing up their own studies (Jenkins et al., 2003). The credibility of the staff and the institute increases when teachers have research responsibilities as well (Jenkins et al., 1998). Furthermore, students perceive a positive relationship between doing research projects and their learning (Turner et al., 2008). Finally, students appreciate being socially and intellectually involved in a research group (Healey, 2005b). Robertson and Blackler (2006) showed in an interview study that students in a research-intensive learning environment experienced 'pride', and were motivated by the enthusiasm of their teachers. Students are intellectually challenged by close involvement with research-related activities. Healey and colleagues (in press) summarised the main findings of studies into students' perceptions of the

relevance of research for their learning. The advantages of a close connection between research and teaching, according to the students, are the enthusiasm of the teachers, the credibility of the staff, and the stimulus of being taught by a 'well-known' scientist. Furthermore, students experience that being actively involved in research activities increases their development of skills and their awareness of the research process (Healey et al., in press; Turner et al., 2008). An important disadvantage of the involvement of teachers in research activities was the decline in availability of the staff. Additionally, when students are only partially involved in the research projects of their teachers, they do not always develop a sense of ownership of the project (Healey et al., in press). Thus, research-intensive learning environments have advantages for student learning, but they also have some disadvantages.

#### **5.1.4 Research question**

The aim of this study was to identify associations between teachers' intentions related to the research-teaching nexus and the students' perceptions of the research intensiveness of the learning environments. The rationale behind this aim was to gain a greater understanding of the associations between teachers' intentions which are put into practice and students' perceptions. We considered teachers' intentions regarding the emphasis on research in their courses; we were interested in their intentions regarding both tangible and intangible elements of the research-teaching nexus. Therefore, the central question in this study was *what associations can be identified between teachers' intentions and students' perceptions of the research intensiveness of university science courses?*

## **5.2 Methods**

### **5.2.1 Sample**

The participants were university science teachers (n=11) and their students (n=104) from the Faculty of Science of Leiden University. Teaching staff with a research task as well as involvement in courses with a research component were asked to participate. The participating teachers volunteered to contribute to this study. The positions of the teachers varied from assistant to full professor, and represented six sub-disciplines within the natural sciences and mathematics, namely, astrophysics, biology, chemistry, computer science, mathematics, and physics. The term course was used in this study to indicate a curricular unit for which students get a certain number of credits, such as a series of lectures, practicals, or group-work sessions. The contents of the courses reported in this study were related to research in very diverse ways. Some courses were directly

related to doing research, such as research practicals or research internship; others were more focused on listening to researchers, such as lectures from visiting professors or seminars about current research topics. The amount of time students were supposed to invest in each course varied between 28 hours and 196 hours of study load.

**5.2.2 Procedure**

During fall and winter 2007, the courses of the participating teachers were followed as part of a larger project which was focused on the research-teaching nexus in the sciences. Before the courses started, the participating teachers were interviewed about their intentions for the particular courses. During the last meetings of the courses, students were asked to complete a questionnaire about the research intensiveness of the learning environment (Van der Rijst et al., 2009). In total 69% (104) of the students who followed the courses completed the questionnaire. The response rates of individual courses varied between .25 and 1.00. Table 5.2 depicts the educational institutes, the method of instruction, and the response rates of the questionnaire per course.

*Table 5.2 Background information of courses and response to the questionnaire*

Teacher	Educational institutes	Year of study (bachelor's phase)	Method of instruction	Absolute response (response rate)
Dr. Adam	Astrophysics	2	Seminar	9 (.75)
Dr. Nathan	Astrophysics	1	Practical	18 (.90)
Dr. Tanya	Biology	2	Lecture	2 (.25)
Dr. Susan	Biology	1	Practical	10 (1.00)
Dr. Simon	Chemistry	1	Practical	2 (.33)
Dr. Paul	Chemistry	2	Practical	2 (1.00)
Dr. Edward	Chemistry	2	Practical	3 (1.00)
Dr. Charles	Computer Science	2	Seminar	8 (.53)
Dr. Howard	Computer Science	1	Seminar	39 (.87)
Dr. Carlos	Mathematics	3	Lecture	3 (.38)
Dr. Eliot	Physics	1	Lecture	8 (.53)

104 (.69)

### **5.2.3 Interview about teachers' intentions**

The aim of the pre-course semi-structured interviews with the participating teachers was to retrieve their intentions before teaching the courses. The interviews comprised four structured questions, which were used to guide the conversation between interviewer and interviewee. The teachers were given multiple opportunities to raise matters which they considered to be important, and were asked to explain issues which were unclear to the interviewer or to give clearer explanation of the rationale behind a statement. Two questions were asked about general goals and objectives for the course. The teachers were asked, first, to give a general explanation of the course ('Can you give a general description of the course?') and, second, to explain more specifically what they aimed to achieve during the course and how ('Explain what you intend to achieve during the course and how you intend to achieve that'). The third and fourth questions related to the intended support of the development of students' research dispositions, such as critical thinking, curiosity, or creativity ('In what way is research present in the course?', and 'In what way are you going to stimulate or support students' attitude, inclination or manner in these research activities?'). In the responses during this interview, both tangible and intangible elements of teachers' intentions were present. Teachers' intended modes of the research-teaching nexus and their intentions to arrange research were considered tangible elements of the nexus, while support of students' research dispositions in the courses was considered an intangible element.

### **5.2.4 Student questionnaire on research intensiveness of learning environments**

In order to measure students' perceptions of the learning environments, we used a previously developed questionnaire on the research intensiveness of learning environments (Van der Rijst et al., 2009). Three sources can be distinguished as the origins of the items in this questionnaire. First, the heuristic model of Healey (2005b) about modes of the research-teaching nexus was used to find indications of tangible elements of the research-teaching nexus. Second, from the *Postgraduate Research Evaluation Questionnaire* (PREQ; Marsh et al., 2002), items which focused on intangible elements of the nexus and research facilities, such as infrastructural needs or availability of staff, were retrieved. Third, items from the questionnaire of Verburgh and Elen (2006) about the research-teaching nexus were used to inform items in the student questionnaire about both tangible and intangible elements. The questionnaire used in this study consisted of three parts related to both intangible and tangible aspects of research in university courses. Part A of the questionnaire included the tangible attention paid to research during

*Table 5.3 Scales of the student questionnaire with Cronbach’s alphas and exemplary items*

Scale	Alpha	Exemplary item
<i>A1 – Attentiveness to doing research</i> (11 items) concerns the extent to which research was addressed during the course according to the students.	.95	During this course clear relationships were drawn between research and teaching content.
<i>A2 – Becoming acquainted with recent research</i> (5 items) concerns the amount of attention for recent research problems and results.	.89	During this course my awareness grew about the problems researchers struggle with at this moment.
<i>A3 – Participating in research</i> (5 items) concerns the extent to which students were involved in and/or contributed to research.	.90	During this course we searched for answers to as yet unresolved scientific questions.
<i>A4 – Using research of teacher</i> (4 items) concerns the amount of attention given to research activities of the particular teacher.	.91	During this course I got acquainted with the research of my teacher(s).
<i>B1 – Stimulating a scientific research disposition</i> (7 items) concerns the extent to which students were stimulated to develop a critical, scientific research disposition.	.86	During this course the teacher(s) urged us to ask critical questions about our work.
<i>B2 – Integration in a research community</i> (3 items) describes to what extent students were socially engaged in the research environment and appreciated the research climate of the educational institute.	.82	During this course I had opportunities for social interaction with researchers of the institute.
<i>B3 – Motivation for research activities</i> (3 items) concerns the extent to which students were stimulated to develop academically.	.85	During this course I felt stimulated to engage in further study in this research domain.
<i>C – Quality of learning environment</i> (10 items) describes the overall student satisfaction with the quality of the course, concerning issues such as availability of supervision and quality of ancillary facilities.	.90	During this course the teacher(s) taught me in an adequate way.

the course; it consisted of four scales, 'becoming acquainted with recent research', 'participating in research', 'attentiveness to doing research', and 'using research of teacher'. Part B contained three scales about intangible research elements: whether students perceived themselves to be involved in the research community, whether their motivation for research had increased, and whether the development of their scientific research disposition had been stimulated. Part C, a single scale, covered the ancillary facilities, such as the availability of supervision, the quality of infrastructural elements, and the clarity of learning goals. Students were asked to score the items according to how relevant they thought the statement was to the course. The five-point Likert scale ran from 'almost never' (1), through 'hardly ever' (2), 'sometimes' (3), and 'reasonably often' (4), to 'almost always' (5). For every scale, Cronbach's alpha, means, and standard deviations were calculated for the present sample of science students (n=104) of the participating teachers. Reliabilities of the scales, measured using Cronbach's alpha, varied between .82 and .95. Table 5.3 shows the eight scales from the questionnaire with reliabilities and illustrative example items.

### **5.2.5 Analysis**

The analysis of the interview data resembled classic content analysis (Krippendorff, 1980; Ryan & Bernard, 2000, p. 785), in the sense that we worked with pre-developed categories to code the data. Four phases can be distinguished in the analysis procedure. The *first* phase consisted of the development of a codebook. The categories used to code the data originated from three sources. (1) The scales of the questionnaire about the research intensiveness of learning environments (Van der Rijst et al., 2009) were used to identify teachers' intentions regarding the emphasis on research in their courses, in fragments of the responses to the first two questions of the interview. (2) The six aspects of scientific research dispositions (Van der Rijst et al, 2008) were used to identify in the responses to the third and fourth questions of the interview which aspects of students' research dispositions teachers intended to encourage. (3) The four modes of the research-teaching nexus (Healey, 2005b) were used to categorise how research was integrated in course activities. During the *second* phase, the interview questions were coded using ATLAS-ti as an electronic tool for qualitative analysis (Muhr, 1997). The transcripts of interview questions 1 and 2 were analysed using the part of the code book about the scales of the questionnaire, while interview questions 3 and 4 were coded using the part of the codebook about the aspects of research dispositions. The complete transcript was coded to retrieve the mode of the research-teaching nexus. During the *third* phase of the

analysis procedure, a qualitative data analysis matrix was composed with the teachers on the rows and average students' perceptions scores in the columns (cf. Table 5.5). In this matrix, those scales which were explicitly identified as intended in a course were highlighted, to identify congruency between teachers' intentions and students' perceptions. If an element was explicitly mentioned as intended in the course, and students rated that particular element high, congruence was assumed between teachers' intentions and students' perceptions. Similarly, if an element was explicitly mentioned as *not* intended in a course and students rated that particular element low, congruence was also assumed between teachers' intentions and students' perceptions. When the teacher did not mention an element, no assumption was made about intentions for the course concerning this element. This means that congruency could be determined only for those elements which were explicitly referred to during the interview. Congruency was assumed with students' perceptions larger than 3.50 for intended elements, and smaller than 2.50 for elements which were not explicitly part of teachers' intentions. Teachers who taught courses with similar modes of the nexus were clustered into groups to enable consideration of similarities between intentions to stimulate the development of research dispositions. In the *fourth* phase, teachers' intentions regarding the emphasis on research in their courses, and their intentions regarding the development of aspects of students' research dispositions, were combined with the mode of the nexus and with students' perceptions of the research intensiveness of the courses elicited from the questionnaire in a narrative way. These narrative descriptions were composed by first reading the transcript, and then listing all codes and inferring the teachers' intentions. Each course was characterised by one of the four modes of the research-teaching nexus (Healey, 2005b). The scale averages of the students' perceptions per teacher were added to the narrative descriptions to support a qualitative visual examination of correspondence between the variables. The overall means of all students per scale were calculated using the complete dataset, neglecting the nesting of students in classes.

### 5.3 Results

Teachers' intentions regarding their courses were described in a narrative format. The descriptions were clustered in groups according to mode of the research-teaching nexus. The descriptions are presented below, with fragments in *italics* for those codes which are characteristic of teachers' intentions identified in the interviews. The scale averages of students' perceptions per teacher were added to the narratives and can also be found in Table 5.5 (p. 127).



### **5.3.1 Teaching research-led courses**

In a course with a research-led mode of the nexus, the emphasis is put on research products, such as the understanding of theories or models. Students are 'observers' involved in scientific research activities, such as in listening to a lecture by a researcher, or observing a simulation of an experiment.

Dr. Carlos's intentions for the course were mostly content-focused. The central issue in his lecture-type course was the transmission of understanding of the 'flavour' of mathematical argumentations. According to Dr. Carlos, this issue is the most relevant, and an important *disposition for research in that discipline*. This course consisted of lectures in which Dr. Carlos conveyed and explained some mathematical argumentations relevant to the course theme. At the end of the course, each student was asked to give a presentation about a topic from disciplinary research related to the theme of the course. Dr. Carlos explicitly did *not intend to ask for any participation in research activities from the students* other than sharing of ideas. Dr. Carlos's account of the course mode can be characterised as research-led. The students scored moderately low on all scales. Remarkably, the scale 'quality of the learning environment' (C; 4.60) was scored high. Furthermore, the students scored moderately high on stimulation to develop their research disposition (B1; 3.19), and were strongly motivated to pursue research (B3; 3.67).

Dr. Eliot's general intention for his course was to present students with invited speakers lecturing about *recent research*. Dr. Eliot perceived his role as that of 'chairman', who introduced the speakers and described the relations between the various topics. The most important goal for Dr. Eliot was to *motivate students for disciplinary research* by presenting research conducted within the institute. The description Dr. Eliot gave of this course can be characterised as research-led teaching. The students perceived a strong motivation for research (B3; 4.00) during the course meetings, and scored moderately high on the scale 'attention to research' (A1; 3.20). Furthermore, participation in research was scored very low (A3; 1.52).

According to Dr. Tanya, the focus of her lecture-type course was to *acquaint students with recent research*. Dr. Tanya planned to describe and explain the concepts in current theories and the most widely used research methods. Her students mostly listened actively to Dr. Tanya; *participation in research activities was not expected*. Dr. Tanya explicitly explained that one of her objectives was to *stimulate the development of students' dispositions* to think critically about the literature, hypotheses, and research questions. Dr. Tanya's description of the mode for this course can be characterised as research-led. The students did not

perceive themselves as participants in research (B3; 1.70) during this course, but were highly motivated to pursue research (B3; 4.50). Furthermore, the students perceived a strong stimulation to develop their research dispositions during this course (B3; 3.93).

### **5.3.2 Teaching research-tutored courses**

In a course with a research-tutored mode of the nexus, the emphasis is put on research products, such as the understanding of theories or models. Students are 'participants' involved in research activities, such as in writing about theories and models, or by giving presentations about a topic of interest.

According to Dr. Simon, *not much attention would be given to scientific research* during his course. Dr. Simon explained that he *always tries to integrate own research of the faculty/institute* into his courses, and believes that this is not done enough. During this course, the *students would participate in literature studies, and not in empirical or experimental studies*. The students would present their findings to their peers in a conference format. Dr. Simon considered the study of the literature an essential part of scholarly activity. During his course, Dr. Simon planned to focus on argumentation skills and competencies. This description was in line with a research-tutored mode of the nexus. The students in this course scored high on the scales 'motivation for research' (B3; 4.00), 'recent research' (A2; 3.90), and 'stimulation of research disposition' (B3; 3.43). None of the scales were scored low compared to the other courses.

### **5.3.3 Teaching research-oriented courses**

In a course with a research-oriented mode of the nexus, the emphasis is put on research processes, such as the gathering and analysis of data. Students are involved as 'observers' of the research activities, such as in repeating well-known experiments to develop certain research skills.

Dr. Charles explained that during his seminar, a combination of lecture and project, he planned to accustom students with and evaluate those *elements of recent research* which they would encounter during their professional careers. Dr. Charles explained that *his own fundamental mathematically oriented research would not be appropriate to discuss* during this practice-oriented course. Dr. Charles' description of his course resembled the research-oriented teaching mode of the nexus. Students scored low on almost all scales, except for the scales 'stimulation of research disposition' (B1; 3.04) and 'quality of teaching' (C; 3.55). The scale 'own research of teacher' (A4; 1.35) was scored lowest of all scales and of all courses by the students.

Dr. Howard explained that his course would focus on the development of practical skills. According to Dr. Howard, *scientific research will not be part of this course*. Only on second thoughts did Dr. Howard explain that the assignments would, in fact, have various research contexts. However, Dr. Howard said that although the assignments would be contextualised, the problems would be more general disciplinary problems. And the problems were designed to allow students to develop their problem-solving skills. Some issues, which were *still open questions in the field of disciplinary research*, were presented to the students in an adapted form. This course had a research-oriented teaching mode of the nexus. The students in this course judged the intensiveness of research in education as low (A1; 1.95).

Dr. Nathan explained that his seminar was intended to integrate teaching of skills with lecture-type activities. According to Dr. Nathan, during each component of his course, the level of *attention given to research will be high*. Dr. Nathan illustrated this with examples in which students were presented with assignments from the context of disciplinary research, for example, with research data from earlier research. Students were expected to use this existing data to train their analyzing skills. He stated explicitly that the focus would *not be on recent research or the research of the teacher*. An explicit learning goal in this course was to *stimulate the development of a research disposition* while working on the interpretation of data. The explanation Dr. Nathan gave about the mode of this course could be characterised as research-oriented. The student scores on the questionnaire showed that this course scored high on the scale 'attention to research' (B3; 3.77). Furthermore, according to the students, the development of their research disposition was stimulated to a moderately high degree (B3; 3.17). Students scored low on the scale of 'own research of the teacher' (A4; 2.12).

In her practical course, Dr. Susan planned to pay explicit *attention to bringing fun back into the practicals*. Dr. Susan aimed to achieve this through contextualization of the assignments, demonstration of novel experiments using materials from the laboratory, and description of the links with her own research experiences. Dr. Susan paid much *attention to explaining and showing how to do disciplinary research*. Dr. Susan's account of her course can be identified as research-oriented mode. All scores on the student questionnaire were moderately high, ranging from 3.82 (C) up to 2.52 (B2). Motivation for research scored moderately high (B3; 3.50), as did attention to research (A1; 3.55).

### **5.3.4 Teaching research-based courses**

In a course with a research-based mode of the nexus, the emphasis is put on research processes, such as the gathering and analysis of data. Students are 'participants' in research activities, such as in research internships or open experiments during research practicals.

Dr. Adam explained that the focus of his course was *to prepare and conduct scientific observations* using methods commonly applied in the discipline. *Student participation in research activities was central.* Students made observations to solve a more or less open problem. An important teaching goal was that the development of students' *research disposition was provoked and stimulated.* Dr. Adam explicitly explained his awareness that each student (and each scholar) needed to develop his/her own research disposition. Therefore, he perceived a need to differentiate between students in order to provide each student with the correct feedback during the course. A research-based mode characterised this course best. Students scored moderately high on the scale 'attention to research' (A1; 3.62), and very low on the scale of 'own research of teacher' (A4; 1.87). The students in this course scored relatively low on the scale 'stimulating a research disposition' (B1; 2.70). Students scored the quality of teaching in this course high (C; 3.82).

According to Dr. Edward, many *research elements would be intertwined in this course.* The *students participated* in parts of Dr. Edward's *own research activities.* He aimed to give students the chance to practice with all kinds of experimental research practices in the discipline. His course resembled a research-based mode. The students (n=3) scored high on 'recent research' (A3; 4.40) and on 'own research' (A4; 4.38).

According to Dr. Paul, *research was an essential part of this course.* *Students participated* in the research of a PhD candidate studying under the supervision of Dr. Paul, and thus were working on *recent issues in the disciplinary research field.* Dr. Paul emphasised the relevance of the experiments to the students, explicitly stating the goal *to increase student motivation for research.* This description of Dr. Paul's resembled the research-based mode of the nexus. Students (n=2) scored high on all scales. The scale 'quality of teaching' (C; 3.55) scored lowest of all the scales of this courses; the rest of the scores were all above 3.80.

### **5.3.5 Congruence between teachers' intentions and students' perceptions**

Table 5.5 depicts the average scores of the students' perceptions per teacher and per scale. Those elements to which the participating teachers explicitly referred in

their interviews as intentions for their courses and the elements which the teachers explicitly identified as not intended for the course are distinguished using separate symbols in Table 5.5. Congruent elements are marked with a plus sign, incongruent elements with a minus sign. Generally, the results presented in Table 5.5 reveal that 19 out of the 29 (66%) teachers' intentions related to the research-teaching nexus which were explicitly mentioned were in line with students' perceptions of the learning environment. Overall, based on the consistency rate presented in Table 5.5, consistency in teachers' intentions and students' perceptions can be discriminated. Three scales show consistency between teachers' intentions and students' perceptions, namely, 'participating in research' (A3; 4 out of 5), 'using research of teacher' (A4; 4 out of 5), and 'motivation for research' (B3; 3 out of 4). Two scales show low consistency, namely, 'becoming acquainted with recent research' (A2; 2 out of 4) and 'stimulation of research dispositions' (B1; 1 out of 4). The scale 'attentiveness to doing research' (A1; 5 out of 7) shows limited consistency. The scales which were, on average, rated highest by the students are 'motivation for research activities' (B3; 3.12) and 'quality of the learning environment' (C; 3.75). Notably, the two courses which scored highest on the scale 'quality of the learning environment' (C) are two research-led courses. Furthermore, the results on the scale 'participating in research' (A3) are notable, because all research-led courses show scores lower than average, while research-based courses show scores higher than average. This is in line with the 'student participation' versus 'student observation' dimension described by Healey (2005b), on which research-based education scores high on student participation in research activities, whereas research-led courses score high on student observation of research.

### ***5.3.6 Aspects of scientific research disposition***

In the interviews, the teachers were asked to explain which elements of students' research dispositions they intended to encourage. This provided in-depth information about teachers' intentions regarding issues related to the scale 'stimulation of research dispositions' (B1). In this section, we describe the aspects of research dispositions which teachers intended to emphasise in their courses. Furthermore, differences and similarities between the teachers in the four modes of the nexus are described. Various aspects were identified in the teachers' interviews, of which the 'inclination to criticize' was mentioned most often. The aspects of research disposition which the teachers intended to encourage among their students are presented in Table 5.4. Aspect 1 represents the first-mentioned aspect in the interview; aspect 2, the second. Most of the teachers referred to

two aspects; some only mentioned a single aspect of a research disposition. In Table 5.4, the aspects of research disposition to which the teachers referred in the interview are presented adjacent to the modes of the nexus. Below, five observations are described concerning the information about aspects of research disposition presented in Table 5.4. First, the aspect ‘to innovate’ was mentioned only by teachers with a research-oriented mode. Second, teachers with a research-based mode all mentioned at least one of the aspects ‘to know’ or ‘to understand’. Third, note that the three teachers with a research-led mode all referred to the aspect ‘to criticize’. Fourth, the aspect ‘to share’ was only present among teachers who taught courses in which emphasis was put on products of research (research-led and research-tutored mode). Finally, students’ perceptions of the stimulation of the development of their research disposition (B1) were on average lowest among the group of teachers with a research-oriented mode of the nexus.

*Table 5.4 Teachers’ intentions to the development of students’ research dispositions*

Teacher	Mode of the nexus	Teachers’ intention related to scientific research dispositions	
		Aspect 1 (inclination to)	Aspect 2 (inclination to)
Dr. Carlos	Led	Criticize	Share
Dr. Eliot	Led	Criticize	--
Dr. Tanya	Led	Criticize	--
Dr. Simon	Tutored	Share	Criticize
Dr. Charles	Oriented	Criticize	--
Dr. Howard	Oriented	Know	Criticize
Dr. Nathan	Oriented	Innovate	Know
Dr. Susan	Oriented	Innovate	Achieve
Dr. Adam	Based	Know	Achieve
Dr. Edward	Based	Achieve	Understand
Dr. Paul	Based	Know	Understand

*Table 5.5 Teachers' intended mode and students' perceptions of the research intensiveness of the learning environment*

Teacher	Mode of the nexus	Students' perceptions of the research intensiveness of learning environments							
		Attentiveness to doing research (A1)	Acquainting with recent research (A2)	Participating in research (A3)	Using research of teacher (A4)	Stimulating scientific research dispositions (B1)	Integration in a research community (B2)	Motivation for research activities (B3)	Quality of learning environment (C)
Dr. Carlos	Led	2.95 (1.32)	3.33 (1.27)	2.00 (.87)† +	2.25 (.50)	3.19 (.73)## -	2.67 (.01)	3.67 (.58)	4.20 (.35)
Dr. Eliot	Led	3.20 (.70)## -	3.79 (.75)## +	1.52 (.52)	2.94 (.96)## -	2.88 (.75)	3.00 (.90)	4.00 (.91)## +	3.56 (.81)
Dr. Tanya	Led	3.09 (.64)	3.60 (1.13)## +	1.70 (.71)† +	2.75 (1.41)	3.93 (.30)## +	2.50 (1.18)	4.50 (.24)	4.60 (.57)
Dr. Simon	Tutored	3.77 (.84)† -	3.90 (1.00)	2.20 (1.13)	3.75 (1.06)## +	3.43 (1.01)	3.33 (.94)	4.00 (.94)	3.80 (.42)
Dr. Charles	Oriented	2.57 (.48)	2.10 (.94)## -	2.83 (.59)	1.53 (.82)† +	2.76 (.52)	2.33 (.71)	3.04 (.79)## -	3.55 (.50)
Dr. Howard	Oriented	1.95 (.75)† +	2.10 (.72)	1.43 (.55)	1.35 (.45)	2.02 (.74)	1.76 (.75)	2.32 (1.00)	3.75 (.84)
Dr. Nathan	Oriented	3.95 (.47)## +	3.61 (.51)† -	2.31 (.92)	2.12 (.60)	3.17 (.67)## -	2.65 (.97)	3.77 (.70)	3.77 (.71)
Dr. Susan	Oriented	3.55 (.88)## +	3.20 (.73)	2.60 (1.01)	2.90 (.65)	2.87 (.57)	2.52 (1.02)	3.50 (.77)## +	3.82 (.45)
Dr. Adam	Based	3.62 (.70)	2.53 (.69)	2.20 (.72)## -	1.87 (.53)	2.70 (.35)## -	2.04 (.54)	3.11 (.44)	3.83 (.34)
Dr. Edward	Based	3.82 (.18)## +	3.87 (.58)	3.67 (.42)## +	3.83 (.88)## +	3.19 (.59)	3.11 (.84)	3.56 (.38)	3.77 (.32)
Dr. Paul	Based	4.14 (.19)## +	3.80 (.28)	4.40 (.57)## +	4.38 (.53)## +	3.93 (.30)	4.00 (.47)	3.83 (.24)## +	3.55 (.07)
<b>Overall mean</b>		<b>2.92 (1.07)</b>	<b>2.82 (1.01)</b>	<b>2.04 (.96)</b>	<b>2.04 (.98)</b>	<b>2.65 (.84)</b>	<b>2.30 (.94)</b>	<b>3.12 (1.05)</b>	<b>3.77 (.68)</b>
<b>Consistency Rate</b>		<b>5 out of 7</b>	<b>2 out of 4</b>	<b>4 out of 5</b>	<b>4 out of 5</b>	<b>1 out of 4</b>	<b>--</b>	<b>3 out of 4</b>	<b>--</b>

# strongly part of intention of the teacher; † not part of intention of the teacher

+ congruent; perceptions larger than 3.50 for elements being intended and smaller than 2.50 for elements which are not intended

- incongruent; perceptions smaller than 3.50 for elements being intended and larger than 2.50 for elements which are not intended

## 5.4 Conclusions and discussion

### 5.4.1 Congruence between teachers' intentions and students' perceptions

The central research aim was to establish associations between teachers' intentions and students' perceptions of the research intensiveness of university science courses. Generally, the results indicate that teachers' intentions are moderately congruent (66%) with students' perceptions of the research intensiveness of the learning environments. Teachers' intentions regarding the participation of students in research activities (A3) and using own research during the course (A4) were most often coherent with students' perceptions, while the stimulation of the development of research dispositions (B1) was least often coherent with students' perceptions. Participation in research activities and using research of the teacher during a course can both be categorised as tangible elements of the research-teaching nexus; stimulation of the development of students' research dispositions is an intangible element of the nexus. This result indicates that intentions about tangible elements are more coherent with students' perceptions than intangible elements. This can be explained in at least two ways. First, intangible elements are more difficult for students to perceive than are tangible elements. Second, intangible elements might be more difficult for teachers to emphasise. Therefore, teachers' intentions such as the stimulation of the development of research dispositions or the creation of an inquisitive atmosphere are more likely to be incongruent with students' perceptions than are teachers' intentions such as participation in research or using own research. In a recent study, it was found that students reported more learning outcomes on a dispositional level than explicitly intended by their teachers (Visser-Wijnveen, Van Driel, Van der Rijst, Verloop, & Visser, in press). The findings of that study and of the present study indicate that potential misunderstandings between teachers and students about intangible elements of the research-teaching nexus are latent. This suggests that misunderstandings about intangible elements of the research-teaching nexus are more likely to occur than misunderstandings about tangible elements of the nexus. It is advisable for teachers to keep in mind that such misunderstandings about the intangible elements might lead to unexpected and diffuse notions of the nature of scientific inquiry (cf. Abd-El-Khalick & Lederman, 2000).

These results also suggest that students perceive the development of their research dispositions less clearly during courses with a research-oriented mode than in courses with other modes of the nexus. A possible explanation is that when a student is following a course aimed at improving skills, it is more difficult for him or her to reflect on research processes or on research



dispositions. Reflection on research processes and dispositions might be stimulated best through observation of others, such as peers and experts, or through conducting authentic research in which the focus lies on the development of new knowledge, such as in courses with a research-based mode. In research-oriented courses the development of students' research dispositions might be stimulated through the creation of a critical and innovative atmosphere. Attention should be paid to the fact that when students are actively involved in the training of research skills the stimulation of the development of their research dispositions might not be perceived by them, although the teacher works on it constantly. Here, we assumed that both explicit attention of the teacher and awareness of the students are necessary for the development of appropriate research dispositions. Students' reflection on aspects of their own research dispositions can help them to focus on tacit elements of research, and can probably best be done before or after the assignments.

Some teacher intentions, which were perceived clearly by the students, were not mentioned by the teachers during the interviews as explicit intentions for the course. Dr. Simon, for example, did not explicitly intend to acquaint students with recent research (A2), nor did he explicitly intend to motivate students to pursue research (B3), but his students perceived both elements clearly in the course (A2, 3.90; B3, 4.00). Some teachers possibly did not consider it worthwhile to mention that specific intention during the interviews because they may have perceived it as obvious to have that intention, or that particular intention was not explicitly a learning goal or teaching goal for the teacher, but a thing he/she did implicitly pay attention to.

#### ***5.4.2 Limitations and suggestions for further research***

Student scores on the questionnaire depend not only on students' perceptions, but also on their expectations (Könings, 2007). This might give an explanation of the result that students in a research-led course perceived the quality of the course and their motivation for research very clearly, while we expect that a course in which the teacher transmits knowledge by direct instruction would not always stimulate motivation for research, nor be considered a high-quality learning environment. It is possible that the students had low expectations of the quality and the stimulation of their motivation for research, but were pleasantly surprised by the actual design of the course. Thus, the results of this study can not be used to compare between cases, but they may provide information about associations within cases. Furthermore, it might be interesting, in future research, to relate teachers' intentions to a combined measurement of students'

perceptions and expectations, in order to gain a greater understanding of possible associations between teachers' intentions and overall student experiences.

Students' perceptions of different kinds of learning environments were investigated in this study. The results suggest that there are differences and similarities in students' perceptions of learning environments. The evaluation of students' perceptions of the constructed learning environments can be an effective tool to stimulate teachers to reflect on their own teaching practices. The questionnaire used in this study might be used as an evaluation tool for teachers to become aware of students' perceptions of the constructed learning environment, and specifically to become aware of students' perception of research activities in their courses.

The results of this study show that teachers' intentions related to tangible elements of the nexus are relatively more coherent with students' perceptions than teachers' intentions regarding intangible elements of the nexus. This invites us to stimulate awareness among academics that the development of students' research dispositions, as an intangible element of the research-teaching nexus, needs explicit attention if we want students to perceive and appreciate research dispositions in their studies and later in their careers.



## Chapter 6

### General conclusions and discussion



## **6. General conclusions and discussion**

### **6.1 Introduction**

In this chapter, the main findings with regard to the research questions are summarised and general conclusions based on the findings of the studies presented in this thesis are described. Furthermore, the strengths and limitations of this thesis are considered and suggestions for further research into higher education are presented. This chapter concludes with recommendations for three categories of stakeholders in higher education: policy makers, teachers, and students.

### **6.2 Links between research and teaching**

Many issues need to be considered when enhancing links between research and teaching in higher education. These issues can be divided along the organisational levels, ranging from government policy on higher education and institutional policies to curriculum development and implementation by individual teachers (cf. Elsen et al., 2009; Jenkins et al., 2003; Clark, 1997). One of the aims of strengthening the research-teaching nexus is to improve student understanding of science and scientific research (cf. Jenkins et al., 2007; Zubrick et al., 2001). The studies presented in this thesis were focused on the level of teaching and learning; academics' characteristics, such as research dispositions and teaching intentions, were examined. The central aim of the studies presented in Chapters 2 and 3 was to improve understanding of the research dispositions of experts in the field of scientific research. The overarching aim of the studies presented in Chapters 4 and 5 was to identify patterns between science academics' teaching intentions and their actual teaching practice. The teachers' intentions investigated in this thesis were intentions regarding research activities for students in their courses and regarding the stimulation of the development of students' research dispositions. The findings of the studies reported in Chapters 1 and 2 provided a categorisation of aspects of research dispositions; this was used in Chapter 5 to investigate teachers' intentions regarding the development of students' research dispositions. Furthermore, teachers' actual teaching practices were explored by analysing their discourse during course meetings, their methods of instruction, and students' perceptions of the learning environments.

In the research literature about higher education, research dispositions have been identified as relevant elements of the intangible nexus; they have also been recognised as an under-emphasised theme in education and in educational research (cf. McLean & Barker, 2004; Elen & Verburgh, 2008). In the first two

studies, therefore, the nature of scientific research dispositions was considered. The main research aim of the first study, reported in Chapter 2, was to identify aspects of science academics' research dispositions, and to describe the differences and similarities between the individual research dispositions of the participants. An interview study was performed among academics (n=23) from the Faculty of Science of Leiden University. The interviews were analysed, and the *in vivo* responses of the participants about their research dispositions were identified and categorised. Academics with similar research dispositions were clustered using a hierarchical cluster analysis, combined with a principal components analysis, with the objective of finding differences and similarities between participants' research dispositions and their background variables. This study resulted in a classification of aspects of research dispositions and in the identification of similarities and differences between academics. This classification of aspects of research dispositions (for a description see Chapter 2) was later, in the study reported in Chapter 5, used to identify teachers' intentions regarding the stimulation of the development of students' research dispositions.

The research aim of the second study, described in Chapter 3, was to examine potential ways to describe a person's research disposition. In this study, first, the concept of disposition found in the research literature was described to identify principles which may be useful for the development of an empirically based notion of disposition. Second, three instruments to assess a person's research disposition were investigated in a case-study approach (n=3): a semi-structured open-ended interview, a hierarchical ordering task, and a cognitive mapping task.

The third and fourth studies, described in Chapters 4 and 5, respectively, were focused on associations between teachers' intentions and actual teaching practice in research-intensive learning environments. The central research aim of the third study was to identify and describe typical sequences in individual teachers' speech during course meetings, and to draw associations between these typical sequences of speech and teachers' approaches to teaching. University science teachers' (n=12) discourse during course meetings was recorded. An analysis scheme was developed to identify the underlying rationale behind teachers' spoken language. This scheme was based on speech act theory from the field of philosophy of language. The teachers were also asked to complete a questionnaire, in retrospect, on their approaches to teaching. The central aim in the fourth study was to identify associations between teachers' intentions concerning, on the one hand, the emphasis on research in their courses and students' research dispositions, and on the other hand, students' perceptions of

the research intensiveness of university science courses. Pre-course interviews were held with university science teachers (n=11) to gather information about their intentions regarding the implementation of research in their courses and the stimulation of the development of students' research dispositions. The students (n=104) were asked to complete a questionnaire about the research intensiveness of the learning environment (Van der Rijst et al., 2009). Associations between teachers' intentions and students' perceptions of the learning environments were described and related to results from previous research findings.

### **6.3 Findings with regard to the research questions**

#### **6.3.1 Research question 1a**

*What aspects can be distinguished in the ways science academics conceive of their scientific research dispositions? (Chapter 2)*

The result of this study is a classification of aspects of academics' scientific research dispositions. The findings of the analysis of the interview transcripts enabled us to distinguish six qualitatively different aspects of scientific research disposition: inclination (1) to achieve, (2) to be critical, (3) to be innovative, (4) to know, (5) to share knowledge, and (6) to understand. See Section 2.3 for an overview of the aspects of scientific research dispositions.

#### **6.3.2 Research question 1b**

*What are the differences and similarities between groups of academics with comparable research dispositions? (Chapter 2)*

Possible associations between the differences and similarities of academics' research dispositions and their background variables were explored by examining patterns of background variables within clusters of academics with similar research dispositions. The differences and similarities in the sample indicate that academics from more applied and experimental fields of study tend to put more emphasis on the aspects 'to be innovative' and 'to be critical', while academics from fields with a theoretical research orientation tend to focus more on the aspects 'to achieve' and 'to understand'. These observations suggest that disciplinary differences or institutional cultures, or both, have an influence on the scientific research dispositions of academics.

#### **6.3.3 Research question 2**

*Which instruments or combination of instruments can best be used to investigate a person's research disposition? (Chapter 3)*

The exploration of the educational research literature about dispositions described in Chapter 3 shows that the concept of disposition is still in a developmental stage. Three general principles were identified as potentially supportive in clarifying the concept of disposition in educational research. First, dispositions only become apparent under specific circumstances. Second, dispositions always have an explanatory basis, which can be found in intrinsic attributes. Third, dispositions can be investigated empirically. A combination of a hierarchical ordering task and a structured mapping task provided an adequate combination, in the sense that it produced relevant results and was more time-efficient than a semi-structured open-ended interview method. The findings presented in Chapter 3 show, among other things, that a distinction can be made between respondents' implicit conceptions of research dispositions and their explicit research dispositions. A first observation was that the interviews and the hierarchical ordering task showed similar results. The aspects which were most frequently mentioned in the interviews were also the aspects which appeared high in the hierarchical order. This indicates that the interview and the ordering task can be used to discern a similar feature of the concept of disposition. A second observation was that the results from the interview did not match with the results from the structured mapping task. A possible explanation was found in the crucial differences between the instruments. The degree of freedom within these three instruments decreases from the interview, via the ordering task, to the mapping task. The semi-structured open-ended interview and the hierarchical ordering task gave the participants insight into what they presented as their scientific research dispositions. The structured mapping task was explicitly designed in such a way that the academics could not easily recognize patterns in their answers. Therefore, the conclusion was drawn that the results from the structured mapping task indicate the *implicit*, or tacit, scientific research disposition, while the results from the interview and the hierarchical ordering task represent academics' *explicit* ideas about their scientific research disposition.

### **6.3.4 Research question 3a**

*What typical sequences can be recognised in individual teachers' speech during course meetings? (Chapter 4)*

To answer this research question regarding the characteristic patterns recognisable in teachers' speech acts, teachers were clustered into groups characterised by their speech sequences. Broadly two groups were identified, one using relatively more assertive speech, such as giving information or drawing predictions, and the other using relatively more directive speech acts, such as



giving instructions or posing questions. The assertive-sequence group was subdivided into two groups, one group determined by assertive reflection acts and the other by assertive prediction acts. The directive-sequence group was subdivided into a group of teachers who used questions relatively more frequently and a group who uttered instructions relatively more frequently. The speech act sequences which were typically present during course meetings were identified as potential determinants of the applied repertoire of speech of individual teachers.

### **6.3.5 Research question 3b**

*Are teachers' typical speech act sequences associated with their approaches to teaching and the method of instruction used during science courses? (Chapter 4)*

The findings from the analysis of teachers' speech acts during university courses illustrate that speech acts in which teachers assertively informed students were most frequently present in teachers' sequences. The conclusion based on this finding was that whatever the method of instruction or whatever the approach, the teacher always informs students, for example, about course content or about assignments. Second, the findings show that during lectures teachers mostly used assertive speech acts, while during laboratory courses teachers relatively more often used directive speech acts. In a lecture-type method of instruction teachers primarily explained course content, while during laboratory courses teachers more often gave students instructions, for example, on how to proceed with the inquiry. This finding relates to the common perceptions of lecture and practicals, and provides us with evidence that the analysis of teachers' speech acts is a valid research method. Finally, the conclusion was drawn that teachers who emphasised conceptual changes of students (conceptual change/student-focused approach) in their approach more often used directive speech acts, such as questions or instructions, while teachers who emphasised knowledge transfer (information transmission/teacher-focused approach) more often used assertive acts. Teachers who put emphasis on conceptual change engaged in dialogue with students more often than did teachers who emphasised information transmission.

### **6.3.6 Research question 4**

*What associations can be identified between teachers' intentions and students' perceptions of the research intensiveness of university science courses? (Chapter 5)*

The aim of the study presented in Chapter 5 was to identify associations between teachers' intentions with respect to emphasis on research during courses and students' perceptions of the research intensiveness of university science courses.

Generally, the results show that teachers' intentions were moderately congruent with students' perceptions of the research intensiveness of the learning environments. Teachers' intentions related to the tangible elements of research were relatively more often congruent with students' perceptions, while intentions related to intangible elements of research were relatively more often incongruent with students' perceptions. This was explained in two ways. First, intangible elements are more difficult for students to perceive than are tangible elements. Second, intangible elements are more difficult for teachers to emphasise during university courses. It is, therefore, likely that teachers' intentions such as working towards the development of students' research dispositions or the creation of an inquisitive atmosphere are more often incongruent with students' perceptions than are teachers' intentions such as letting students participate in research or using the teachers' own research.

### **6.4 General conclusions**

The general conclusions can be categorised into conclusions about scientific research dispositions, evaluation of research dispositions, teachers' speech acts, and teachers' intentions regarding research in teaching. Although the conclusions in this section are presented as solitary units, they can only be interpreted properly and understood in combination with the information presented in the chapters of this thesis.

#### **6.4.1 Research dispositions of academics**

- Six aspects are fundamental to research dispositions of academics in the sciences: inclination (1) to achieve, (2) to be critical, (3) to be innovative, (4) to know, (5) to share knowledge, and (6) to understand (Chapter 2).
- Academics from more applied and experimental fields of study tended to put more emphasis on 'to be innovative' and 'to be critical', whereas academics from fields with a theoretical research orientation tended to focus more on 'to achieve' and 'to understand' (Chapter 2).

#### **6.4.2 Evaluation of research dispositions**

- A distinction can be made between academics' explicit conceptions and their tacit conceptions of their research dispositions (Chapter 3).
- Semi-structured open-ended interviews and hierarchical ordering tasks showed explicit conceptions, whereas structured mapping tasks represented the tacit conceptions of academics' research dispositions (Chapter 3).

### **6.4.3 Teachers' speech acts**

- The typical sequences of teachers' speech acts illuminate their speech act repertoires in action (Chapter 4).
- Teachers who emphasised conceptual changes of students more often use directive speech acts, such as questions or instructions, whereas teachers who emphasised knowledge transfer more often use assertive speech acts (Chapter 4).

### **6.4.4 Teachers' intentions regarding research in teaching**

- Teachers' intentions are moderately congruent with students' perceptions of the research intensiveness of the learning environments (Chapter 5).
- Teachers' intentions related to tangible elements of the nexus are relatively more coherent with students' perceptions than are teachers' intentions regarding intangible elements of the nexus (Chapter 5).

## **6.5 Strengths and limitations of the studies**

### **6.5.1 Strengths**

#### *Broader applicability of aspects of research dispositions*

The classification of aspects of research dispositions was developed through the analysis of interviews with 23 academics who had a great deal of experience in doing scientific research. Through these interviews with experts on scientific research, a complete picture of aspects of research dispositions emerged. The results of a methodological study of the saturation point in qualitative interview studies show that, in general, after 12 transcripts most of the categories (>90%) are identified in interview transcripts (Guest et al., 2006). We can assume that the classification of aspects developed in the study reported in Chapter 2 is adequate for describing scientific research dispositions. Individuals with less experience in doing research, such as students, can develop their research dispositions, analogous to students developing their skills or knowledge about the process and products of research. It is plausible that individuals who have less experience in doing research have similar aspects, but ambiguously expressed, or underdeveloped. For example, a person who has not yet encountered academic debate through peer-reviewed feedback on manuscripts for scientific journals might be less inclined to consider collegial feedback an essential part of research. This person might express a weak correlation between the inclinations 'to share' information and 'to be critical' when asked to express an opinion. The development of a person's research disposition can be measured in at least three ways, through examining the number of aspects which are explicitly part of the

disposition, the number of relationships between these aspects, and the personal hierarchical order of aspects (cf. Chapter 3). In the studies presented in Chapters 2 and 3, academics showed aspects which were more prominently present and aspects which were peripherally present in their personal research dispositions. The development of students' research dispositions is also a personal matter, in the sense that no single constitution of aspects can be considered to be the ideal disposition for doing scientific research. When examining the development of students' research dispositions, at least three points are necessary to consider: students' 1) awareness of the potential aspects and relations between aspects, 2) awareness of their own research disposition and of those of others, and 3) awareness of individuals' personal choice in developing their own research disposition. The strength of the classification scheme of aspects of research dispositions is that it can be used to identify aspects and create awareness among academics and among less experienced groups of researchers, such as students.

### *A diverse set of research tools*

In the study reported in Chapter 3, an analysis tool from social network theory was used to evaluate academics' research dispositions. In the study presented in Chapter 4, a 'theoretical' framework from the philosophy of language was re-evaluated and re-developed into an empirically useful instrument to assess teachers' classroom discourse. Remodelling theoretical frameworks from other disciplines for empirical use in the field of educational research might improve the applicability and reliability of the results of educational studies. Various authors in the field of teaching and teacher education have revealed the complexity of 'teaching' (cf. Verloop et al., 2001; Shulman, 1986; Borko & Putman, 1996). This complexity can only be properly analysed and understood when the phenomena are investigated from different perspectives and by using various research tools. Researchers who investigate teachers and teaching in higher education should thus have a strong inclination to look over the disciplinary fence, to borrow ideas, models, and research tools from fields close to educational research, such as psychology, sociology, pedagogy, or philosophy, and also from more distant domains, such as mathematics, economy, or linguistics. The studies presented in Chapter 3 and in Chapter 4 show examples of how ideas from other fields can improve the analysis of phenomena in the field of education.

### *Combination of teachers' conceptions and teaching practice*

In early research on teaching, much emphasis was put on teaching effectiveness. Studies were predominantly focused on a description of what teachers did and

what the effect was on the students (Gage, 1963; Rosenshine, 1971; Shulman, 1986). Although this behavioural process-product line of research was recognised as the most vigorous and productive programme of research on teaching at that time, in recent decades studies on teacher cognitions have become a central focus in the field of research on teaching (Floden, 2001). At this moment, the pendulum is swinging back towards more effectiveness studies, as can be seen, for example, in the evidence-based programmes, in which evidence is seen as ‘scientifically proven’ effectiveness of teaching. In the studies presented in Chapters 4 and 5 elements of teacher cognitions, namely, teachers’ orientations (Chapter 4) and teachers’ intentions (Chapter 5), were examined in combination with measures of teacher behaviour, namely, teachers’ speech acts and students’ perceptions of the constructed learning environment. The strength of future research on teaching lies in the design of studies in which teachers’ cognitions and teachers’ behaviours are investigated in concert. These studies should stand on the shoulders of previous programmes and paradigms, for example, by intelligently using research design and methods from previous studies or through reflection on the current usefulness of the results from previous programmes. For example, in the sixties and seventies studies were designed concerning the topic of teacher classroom talk (Rosenshine & Furst, 1973). At first, the proportion of teacher talk to total classroom speech or the proportion of teacher talk to student talk were determined. Later on, more sophisticated observation schemes were designed in which, e.g., teachers’ approval and disapproval were discerned. These studies yielded consistent, low positive correlations with student achievement, which were often not significant (Rosenshine, 1971). In the study reported in Chapter 4, a more refined analysis tool was developed to examine teacher talk, use of which made it possible to discern determinants of teacher talk per method of instruction.

### **6.5.2 Limitations**

#### *Considerations concerning the samples*

The participants in the studies presented in this thesis were all affiliated with the Faculty of Science of Leiden University. This means that, strictly speaking, only conclusions can be drawn about academics of the science faculty at Leiden University. The findings presented in Chapter 2 showed that disciplinary and cultural differences can be expected in academics’ research dispositions. Although the differences between research universities in the Netherlands are much smaller than are the similarities, differences in the ways academics teach in the various teaching cultures at higher education institutions can be expected.

Therefore, when applying findings from these studies to other research cultures or teaching cultures, one has to pay attention to relevant differences.

Only academics from science domains participated in the studies presented in this thesis. Therefore, the conclusions drawn in this thesis are applicable to academics who teach 'science' courses. In these studies, the sample consisted of academics from different disciplines within the sciences, such as physics, chemistry, biology, and mathematics. Within these disciplines, large differences between participants in approaches to scientific research were present. For example, academics in theoretical physics may have more in common with mathematics than with academics working in experimental physics. Likewise, experimental physicists might be more similar in their research dispositions to experimental chemists. Therefore, disciplinary differences become ambiguous, and the traditional disciplinary boundaries become inadequate demarcation lines, when examining research dispositions (Brew, 2008). Nevertheless, attention should be paid to differences in research and teaching cultures. Conclusions drawn in this thesis can not be transferred directly to other disciplines without further consideration.

All participating academics were selected on a voluntary basis. It can be expected that the participating academics were, more than average, open to reflecting on educational issues, such as pedagogy, the curriculum, and student learning, and they might already have developed more sophisticated ideas about teaching and learning. The findings described in this thesis might be limited by this selection of participants. This needs to be taken into consideration when these conclusions are transferred to situations in which participants are present who have less clear ideas about teaching and learning.

### *Considerations concerning students' research dispositions*

Students' research dispositions were not directly measured in the studies reported in this thesis; the study presented in Chapter 5 was focused on the stimulation of the development of students' research dispositions. Academics' research dispositions and students' research dispositions are not the same, and the aspects of research dispositions found in Chapter 2 cannot be used for both groups without further consideration. A further study should be undertaken, with the aim of verifying the applicability of the aspects to students. In the studies reported in this thesis, academics' research dispositions were considered to be characteristics of experts in the field of scientific research. In their studies, students are working towards achieving more developed research dispositions. The research dispositions of final-year students are more developed than those of

first-year students. A plausible relation between academics' research dispositions and students' research dispositions is that academics have more developed research dispositions than students.

Further research is needed to examine the value of the development of students' research dispositions for student learning. Borda (2007) provided some interesting suggestions for the cultivation and assessment of research dispositions in college science classroom settings, such as open-ended styles of inquiry, raising appropriate research questions, and careful use of language. It might be interesting to examine the influence of such approaches on students' learning and development of research dispositions.

A rationale behind these studies is that the research experiences and research dispositions of academics can support them in teaching students about science and scientific inquiry. For example, an academic who in his/her daily research continuously works on creative, innovative solutions, can stimulate students to work on their creative skills and reflect on the innovative aspects of their research dispositions. Although it is acknowledged in the research literature that professional experience and craft knowledge are important elements of the knowledge base of teaching in higher education (cf. Van Driel, Verloop, Van Werven, & Dekkers, 1997), academics who teach courses in higher education do not always know how to apply their professional experience effectively during teaching. During the pedagogical training of teachers in higher education it might be beneficial to put explicit emphasis on links between professional knowledge and teaching students about science and scientific inquiry. Future research on methods to stimulate the development of students' research dispositions may provide relevant and valuable findings for teaching practice in higher education.

## **6.6 Suggestions for further research into higher education**

### ***6.6.1 Further development of the research instruments***

In the studies presented in this thesis, innovative research tools were developed. In the study presented in Chapter 2, a categorisation scheme to examine the aspects of a person's research disposition was developed; in the study reported in Chapter 3, a cognitive mapping task (cf. Bakkenes et al., 2007; Wassink et al., 2003) based on Graph Theory was used; in the study reported in Chapter 4, an analysis tool to examine teachers' classroom talk was constructed; and in the study presented in Chapter 5, a questionnaire to evaluate students' perceptions of the research intensiveness of learning environments was constructed and administered (cf. Van der Rijst et al., 2009). Four suggestions for further research using tools developed and used in this thesis are put forward below.

First, further research is needed to explore the applicability of the categorisation of aspects of research dispositions for groups other than science academics at research universities. Studies using other groups, such as academics in disciplines other than mathematics and the sciences, teachers in vocational higher education institutes, teachers in secondary and primary education, students at universities (research, vocational, or applied universities), pupils in secondary education, and pupils in primary schools, can lead to new conceptual insights.

Second, the techniques from Graph Theory used in Chapter 3 effectively discriminate between characteristics of individual nodes within graphs as well as between structural global properties of academics' cognitive graphs. More research is needed to examine the validity and the reliability of this instrument, to assess dispositions in other contexts, and to identify other fields of educational research in which this technique can be used. Furthermore, the mathematical possibilities of this Graph Theory framework are large, and need further development to uncover their full potential.

Third, use of the speech act analysis tool described in Chapter 4 has shown that it is possible to determine typical sequences in teachers' speech acts. Further research is needed to examine the applicability of this tool to identifying students' speech acts. A possible following step is to design studies on classroom discourse in which the speech acts of both teachers and students are examined with the aim of identifying interaction patterns and relating these patterns to, for example, the interpersonal relationships between students and teacher (Wubbels et al., 1992; Wubbels, Brekelmans, Den Brok, & Van Tartwijk, 2006). Studies in which students' as well as teachers' speech acts are analysed might provide a better understanding of the discourse between student and teacher (cf. Rogers et al., 2005; Saarinen, 2008; Scott & Mortimer, 2006). Further research on speech acts related to student understanding and students' perceptions of the learning environment would be of interest to those aiming to improve teaching practice in higher education; this might be done, for example, by providing teachers with tools to evaluate their actions and become aware of how their speech acts on the students.

Finally, in the study described in Chapter 5, students' perceptions were evaluated in relation to teachers' intentions. It might be interesting in future research to relate teachers' intentions to a combination of students' perceptions and students' expectations. Students' experiences of course meetings depend not only on their perceptions, but also on their expectations (Könings, 2007). Students with low expectations of the forthcoming research activities during a course could



have different perceptions of the research activities than have students with high expectations. A research design in which both perceptions and expectations are evaluated can provide an understanding of the influence of the created learning environment on students' experiences.

### ***6.6.2 Student evaluation of research-intensive learning environments***

In Chapter 5, a study is described in which students' perceptions of different kinds of learning environments were investigated. The differences were categorised into three methods of instruction, namely lectures, seminars, and practicals, and into the four modes of the research-teaching nexus proposed by Healey (2005b). The results suggest that there are differences and similarities between these kinds of learning environments in students' perceptions. Future studies in which the student questionnaire on the research intensiveness of learning environments (Van der Rijst et al., 2009) is administered to students following various courses, can provide valuable information about the differences and similarities in students' experiences of these different learning environments. Studies in which the questionnaire is used should be focused not only on large-scale and longitudinal administration, but also on the applicability of the questionnaire to other higher education institutes, such as vocational universities, or universities of applied sciences. The findings from large-scale questionnaire studies will give teachers as well as curriculum developers in higher education information about the potential strengths and weaknesses of the various kinds of learning environments with respect to the purpose of the teaching programme.

## **6.7 Recommendations for teaching practice in higher education**

Possible implications for higher education are discussed in this section. Recommendations are made for various stakeholders in higher education, such as policy makers, educational developers, teacher trainers, teachers, and students.

### ***6.7.1 Educational policy and consultancy***

This thesis focuses on teaching and on learning environments. Therefore, recommendations for educational policy makers are presented at the level of curricula and the learning environments. In the research literature on higher education, many suggestions can be found for strengthening the research-teaching nexus at the institutional policy level (cf. Boyer Commission, 1998; 2002; Deem & Lucas, 2007; Durning & Jenkins, 2005; Elsen et al., 2009; Jenkins et al., 2003; Zubrick, et al., 2001; Leisyte et al., in press). More evidence-based literature on higher educational policy can be found in higher education research journals,

such as *Higher Education Policy*, *Higher Education Quarterly*, or *Higher Education Research and Development*.

The findings of the studies presented in this thesis show variation among academics in their scientific research dispositions and in their teaching practice. Awareness of this variety in higher education leads to the idea that each teacher has personal strengths. For example, some teachers are strong in giving lectures, others are better in guiding students through research internships; some academics are strong in the innovative aspects of scientific research, while others excel in the critical aspects. In situations which are not hindered by practical or financial constraints, policy makers might consider assigning teaching staff to activities which are in line with their strengths. Furthermore, to foster their mature epistemological dispositions (Elen et al., 2007) and to develop a sophisticated notion of the nature of science and scientific inquiry (Abd-El-Khalick & Lederman, 2000), students need to come in contact with a variety of research activities as well as with a diversity of research dispositions, modelled by the teachers who teach them. This implies that when policy makers at higher education institutes are aware of the human resources in their teaching staff, they might manage these resources, taking into account possible constraints, in such a way that students get as many learning opportunities as possible and get acquainted with a broad variety of researchers and research practices during their studies. This awareness of the variation among academics might also influence the policy for contracting new faculty, in the sense that it is valuable for an educational organisation to have as much variation in teaching staff as possible.

A well-considered design of the programme and curriculum can be of great help in providing students with learning opportunities regarding research. Throughout the programme learning tracks, or educational trajectories, about research can be designed, in which students gradually develop individual competences in doing research. Well-designed parallel learning tracks, for example, a theoretical track and a practical track, can stimulate students to apply theoretical knowledge in actual research activities (cf. Ruis, 2007; Van der Rijst & Jacobi, 2009). In this thesis, scientific research dispositions are presented as relevant elements for doing research (Chapters 2, 3, and 5). For educational consultants, who advise higher education institutes about curriculum design, the idea of the development of students' research dispositions throughout the programme is of interest. The categorisation of aspects of research dispositions can be of assistance to educational consultants and curriculum developers in considering the design of curricula in higher education.

### **6.7.2 Teaching practice and teacher training**

In this section three recommendations are presented which endorse awareness of and encourage reflection on and monitoring of scientific research dispositions and teaching practice in order to promote further professional development to improve the pedagogical quality of teachers in higher education. In the following sections three examples are described, which follow directly from the findings of the studies presented in this thesis.

First, an understanding of scientific research dispositions can be helpful for university teachers when teaching students about research. Teachers in higher education, who scaffold research activities and supervise students in research activities, need to know a variety of ways to effectively teach students about research. If university science teachers are able to discriminate between the six aspects of research dispositions, it is possible for them to scaffold the development of students' research dispositions during science courses. Encouraging teachers to reflect on implicit aspects of their own and their peers' research practices, such as scientific research dispositions (Chapters 2 and 3), is likely to help them become more receptive to student conceptions and misconceptions about research practice, and support them in guiding students to develop adequate conceptions about scientific research.

Second, the method of speech act analysis presented in Chapter 4 can uncover teachers' speech act repertoires, and can be used in professional development programmes for teachers. Speech act theory provides teachers with a method to reflect on their own speech act repertoires, and with a framework to expand their repertoires. When university teachers and teacher trainers recognise that teachers' speech acts play a relevant role in educational practice in higher education, and that it is possible to expand one's speech act repertoire, teachers might become more inclined to work on the scholarship of teaching and learning, and on their knowledge base of teaching (Verloop et al., 2001).

Third, evaluation of students' perceptions of the constructed learning environments can be an effective tool to stimulate teachers to reflect on their own teaching practices. The questionnaire used in Chapter 5 can be used as an evaluation tool for teachers to become aware of students' perceptions of the constructed learning environment, and specifically of their perceptions of research activities in the courses.

### **6.7.3 Student learning**

Although knowledge about scientific research dispositions has the potential to support student learning about research, academics do not frequently stimulate

students to reflect explicitly on aspects of these dispositions. The categorisation of six aspects of scientific research dispositions presented in Section 2.3 can be helpful when encouraging student learning about research. During their studies, students learn about both implicit and explicit elements of research practice. The aspects of research dispositions can be used by students to reflect on specific implicit elements of research in order to gain a deeper understanding of research practices. For example, through reflection on the research dispositions of others, scientists and peers, students might come to understand the unique feature of research practice that there are different ways to do research.

The findings presented in Chapter 5 also suggest that reflection on scientific research dispositions might be stimulated most through observation of others, such as peers, experts, or the teacher, while doing research activities, and sharing ideas through discussions about research. It might be more difficult for students to reflect on the research process and research disposition when they are actively involved in improving their research skills. It might be more profitable for student learning about the processes of science to stimulate students' reflection on the process afterwards.



References



- Abd-El-Khalick, F., & Lederman, N.G. (2000). Improving science teachers' conceptions of nature of science: A critical review of the literature. *International Journal of Science Education*, 22, 665-701.
- Abd-El-Khalick, F., Bell, R.L., & Lederman, N.G. (1998). The nature of science and instructional practice: Making the unnatural natural. *Science Education*, 82, 417-436.
- Abell, S.K. (2007). Research on science teacher knowledge. In S.K. Abell & N.G. Lederman (Eds.), *Handbook of research on science education* (pp. 1105-1149). Mahwah, NJ: Lawrence Erlbaum Associates.
- Abrami, P.C., d'Apollonia, S., & Cohen, P. (1990). The validity of student ratings of instruction: What we know and what we do not. *Journal of Educational Psychology*, 82, 219-231.
- Ajzen, I., & Fishbein, M. (2005). The influence of attitudes on behavior. In D. Albarracín, B.T. Johnson, & M.P. Zanna (Eds.), *The handbook of attitudes* (pp. 173-221). Mahwah, NJ: Lawrence Erlbaum Associates.
- Albarracín, D., Johnson, B.T., Zanna, M.P., & Kumkale, G.T. (2005). Attitudes: Introduction and scope. In D. Albarracín, B.T. Johnson, & M.P. Zanna (Eds.), *The Handbook of Attitudes* (pp. 3-20). Mahwah, NJ: Lawrence Erlbaum Associates.
- Alexander, P.A. (2005). Teaching towards expertise. *British Journal for Educational Psychology*, 3, 29-45.
- American Association for the Advancement of Science (1990). *Science for all Americans*. New York: Oxford University Press.
- American Association for the Advancement of Science (1993). *Benchmarks for science literacy: A project 2061 report*. New York: Oxford University Press.
- Austin, J.L. (1962). *How to do things with words*. Oxford, UK: Oxford University Press.
- Ax, J., Ponte, P., & Brouwer, N. (2008). Action research in initial teacher education: An explorative study. *Journal of Educational Action Research*, 16, 55-72.
- Bach, K., & Harnish, R.M. (1979). *Linguistic communication and speech acts*. Cambridge, Mass: MIT Press.
- Bakkenes, I., Vermunt, J.D.H.M., Wubbels, Th., & Imants, J. (2007, April). *Towards a model for teachers' learning at the workplace*. Paper presented at the Annual Meeting of the American Educational Research Association, Chicago, USA.
- Bakker, M.E.J., Sanders, P., Beijaard, D., Roelofs, E., Tigelaar, D., & Verloop, N. (2008). De betrouwbaarheid en generaliseerbaarheid van competentiebeoordelingen op basis van een videodossier [The reliability and general applicability of competence assessment based on a video portfolio]. *Pedagogische Studiën*, 85, 240-260.
- Barak, M., Ben-Chaim, D., & Zoller U. (2007). Purposely teaching for the promotion of higher-order thinking skills: A case of critical thinking. *Research in Science Education*, 37, 353-369.
- Barnett, R. (2000). *Realizing the university in an age of supercomplexity*. Buckingham, UK: Open University Press/SRHE.
- Barnett, R. (Ed.) (2005). *Reshaping the university: New relationships between research, scholarship and teaching*. Maidenhead, UK: McGraw Hill/Open University Press.

## References

---

- Bauer, H.H. (1992). *Scientific literacy and the myth of the scientific method*. Urbana, IL: University of Illinois Press.
- Becher, T. (1989). *Academic tribes and territories: Intellectual enquiry and the cultures of disciplines*. Buckingham, UK: Open University Press/SRHE.
- Becher, T. (1990). Physicists on physics. *Studies in Higher Education*, 15, 3-20.
- Beijaard, D., Meijer, P.C., & Verloop, N. (2004). Reconsidering research on teachers' professional identity. *Teaching and Teacher Education*, 20, 107-128.
- Berry, A., Loughran, J.J., & Van Driel, J.H. (2008). Revisiting the roots of Pedagogical Content Knowledge. *International Journal of Science Education*, 30, 1271-1279.
- Biglan, A. (1973). Relationships between subject matter characteristics and the structure and output of university departments. *Journal of Applied Psychology*, 57, 204-213.
- Bird, A. (1998). Dispositions and antidotes. *The Philosophical Quarterly*, 48, 227-234.
- Bonevac, D., Dever, J., & Sosa, D. (2008). The conditional fallacy. *The Philosophical Review*, 115, 273-316.
- Borda, E.J. (2007). Applying Gadamer's concept of disposition to science and science education. *Science and Education*, 16, 1027-1041.
- Borgatti, S.P., Everett, M.G., & Freeman, L.C. (1999). *UCINET 5.0 version 1.00*. Natick, MA: Analytic technologies.
- Borko, H., & Putnam, R. (1996). Learning to teach. In D.C. Berliner & R.C. Calfee (Eds.), *Handbook of educational psychology* (pp. 673-707). New York: MacMillan.
- Bourdieu, P. (1977). Outline of a theory of practice (R. Nice, Trans.). New York: Cambridge University Press. (Original work published 1972)
- Bourdieu, P. (1988). *Homo academicus* (P. Collier, Trans.). Stanford, CA: Stanford University Press. (Original work published 1984)
- Bourdieu, P. (1989). For a socio-analysis of intellectuals: On homo academicus. *Berkeley Journal of Sociology*, 34, 1-29.
- Boyer Commission on Educating Undergraduates in the Research University (1998). *Reinventing undergraduate education: A blueprint for America's research universities*. Stony Brook, NY: State University of New York at Stony Brook for the Carnegie Foundation for the Advancement of Teaching.
- Boyer Commission on Educating Undergraduates in the Research University (2002). *Reinventing undergraduate education: three years after the Boyer report*. Stony Brook, NY: State University of New York at Stony Brook for the Carnegie Foundation for the Advancement of Teaching.
- Boyer, E.L. (1990). *Scholarship reconsidered: Priorities of the professoriate*. San Francisco CA: Jossey-Bass.
- Braskamp, L.A., & Ory, J.C. (1994). *Assessing faculty work: Enhancing individual and institutional performance*. San Francisco, CA: Jossey-Bass.
- Brew, A. (2001). Conceptions of research: A phenomenographic study. *Studies in Higher Education*, 26, 271-285.
- Brew, A. (2006). *Research and teaching: Beyond the divide*. New York: Palgrave MacMillan.
- Brew, A. (2008). Disciplinary and interdisciplinary affiliations of experienced researchers. *Higher Education*, 56, 423-438.



- Bryant, A., & Charmaz, K. (Eds.) (2007). *The Sage handbook of grounded theory*. Los Angeles: Sage Publications.
- Caleon, I.S., & Subramaniam, R. (2008). Attitudes towards science of intellectually gifted and mainstream upper primary students in Singapore. *Journal of Research in Science teaching*, *45*, 940-954.
- Cashin, W.E., & Downey, R.G. (1992). Using global student ratings for summative evaluation. *Journal of Educational Psychology*, *84*, 563-572.
- Clark, B.R. (1997). The modern integration of research activities with teaching and learning. *The Journal of Higher Education*, *68*, 241-255.
- Cochran-Smith, M., & Zeichner, K.M. (2005). *Studying teacher education: The report of the AERA panel on research and teacher education*. Mahwah, NJ: Lawrence Erlbaum Associates.
- Colbeck, C.L. (1998). Merging in a seamless blend: How faculty integrate teaching and research. *The Journal of Higher Education*, *69*, 647-671.
- Damon, W. (2007). Dispositions and teacher assessment: The need for a more rigorous definition. *Journal of Teacher Education*, *58*, 365-369
- De Heus, P., Van Leeden, R., & Gazendam, B. (1995). *Toegepaste data analyse* [Applied data Analysis]. Amsterdam: Reed Elsevier.
- De Jong, O., Van Driel, J.H., & Verloop, N. (2005). Preservice teachers' pedagogical content knowledge of using particle models in teaching chemistry. *Journal of Research in Science Teaching*, *42*, 947-964.
- De Vos, W., & Genseberger, R. (2000). 'Onderzoek doen' in de natuurwetenschappelijke vakken ['Doing research' in science subjects]. *Tijdschrift voor Didactiek der Bètawetenschappen*, *17*(1), 4-13.
- De Wit, H. (2006). European integration in higher education: The Bologna process towards a European higher education area. In J.J.F. Forest & P.G. Altbach (Eds.), *International handbook of higher education* (pp. 461-482). Dordrecht, NL: Springer.
- Deem, R., & Lucas, L. (2007). Research and teaching cultures in two contrasting UK policy contexts: Academic life in education departments in five English and Scottish universities. *Higher Education*, *54*, 115-133.
- Diez, M.E., & Raths, J. (Eds.) (2007). *Dispositions in teacher education*. Charlotte, NC: Information Age Publishing.
- Dottin, E.S. (2009). Professional judgment and dispositions in teacher education. *Teaching and Teacher Education*, *25*, 83-88.
- Durkin, M.J., & Barnes, J. (1986). Research on teaching in higher education. In M.C. Wittrock (Ed.), *Handbook of research on teaching* (3rd ed., pp. 754-777). New York: MacMillan Publishing Company.
- Durning, B., & Jenkins, A. (2005). Teaching/research relations in departments: The perspectives of build environment academics. *Studies in Higher Education*, *30*, 407-426.
- Eggs, H., & MacDonald, R. (2003). *The scholarship of academic development*. Buckingham, UK: Open University Press/SRHE.

## References

---

- Elen, J., Lindholm-Ylänne, S., Clement, M. (2007). Faculty Development in research-intensive universities: The role of academics' conceptions on the relationship between research and teaching. *International Journal for Academic Development*, 12(2), 123-139.
- Elen, J., & A. Verburgh, A. (2008). *Bologna in European research-intensive universities: Implications for bachelor and master programs*. Antwerp, Belgium: Garant.
- Elsen, G.M.F., Visser-Wijnveen, G.J., Van der Rijst, R.M., & Van Driel, J.H. (2009). How to strengthen the connection between research and teaching in undergraduate university education. *Higher Education Quarterly*, 63, 64-85.
- Elton, L. (1986). Research and teaching: Symbiosis or conflict. *Higher Education*, 15, 299-304.
- European Ministers of Education. (1999). *The Bologna declaration of 19 June 1999*.
- Everitt, B.S., Landau, S., & Leese, M. (2001). *Cluster analysis* (4<sup>th</sup> ed.). New York: Oxford University Press.
- Facione, N.C., & Facione, P.A. (1992). *CCTDI: The California Critical Thinking Disposition Inventory*. Millbrae, CA: California Academic Press.
- Facione, P.A., Facione, N.C., & Giancarlo, C.A. (2000). *California Critical Thinking Disposition Inventory*. Millbrae, CA: California Academic Press.
- Facione, P.A., Sanchez, C.A., Facione, N.C., & Gainen, J. (1995). The disposition towards critical thinking. *Journal of General Education*, 44(1), 1-25.
- Fara, M. (2005). Dispositions and habituals. *Noûs*, 39, 43-82.
- Forest, J.J.F. (2006). Teaching and learning in higher education. In J.J.F. Forest & P.G. Altbach (Eds.), *International handbook of higher education* (pp. 347-375). Dordrecht, NL: Springer.
- Gage, N.L. (1963). Paradigms for research on teaching. In N.L. Gage (Ed.), *Handbook of research on teaching* (pp. 94-141). Chicago: Rand McNally Company.
- Giddens, A. (1987). *Social theory and modern sociology*. Cambridge: Polity Press.
- Gifi, A. (1990). *Nonlinear multivariate analysis*. Chichester, UK: John Wiley & Sons Ltd.
- Gottlieb, E.E., & Keith, B. (1997). The academic research-teaching nexus in eight advanced-industrialized countries. *Higher Education*, 34, 397-420.
- Greenacre, M. (2007). *Correspondence analysis in practice* (2<sup>nd</sup> ed.). New York: Chapman & Hall.
- Gregory, J., & Jones, R. (in press). 'Maintaining competence': A grounded theory typology of approaches to teaching in higher education. *Higher Education*.
- Griffith, R. (2004). Knowledge production and the research-teaching nexus: The case of build environment disciplines. *Studies in Higher Education* 29, 709-726.
- Guest, G., Bunce A., & Johnson, L. (2006). How many interviews are enough? An experiment with data saturation and variability. *Field Method*, 18, 59-82.
- Halliwell, J. (2008). *The nexus of teaching and research: Evidence and insights from literature*. Toronto, CA: Higher Education Quality Council of Ontario.
- Hattie, J., & Marsh, H.W. (1996). The relationship between research and teaching: A meta-analysis. *Review of Educational Research*, 66, 507-542.

- Healey, M. (2000). Developing the scholarship of teaching in higher education: A discipline-based approach. *Higher Education Research and Development, 19*, 169-189.
- Healey, M. (2005a). Linking research and teaching to benefit student learning. *Journal of Geography in Higher Education, 29*, 183-201.
- Healey, M. (2005b). Linking research and teaching: Exploring disciplinary spaces and the role of inquiry-based learning. In R. Barnett (Ed.), *Reshaping the university: New relationships between research, scholarship and teaching* (pp. 67-78). London: McGraw Hill / Open University Press.
- Healey, M., Jordan, F., Pell, B., & Short, C. (in press). The research-teaching nexus: a case study of students' awareness, experiences and perceptions of research. *Innovations in Education and Teaching International*.
- Hoogveld, A.W.M., Paas, F., & Jochems, W.M.G. (2005). Training higher education teachers for instructional design of competency-based education: Product-oriented versus process-oriented worked examples. *Teaching and Teacher Education, 21*, 287-297.
- Hughes, M. (2005). The mythology of research and teaching relationships in universities. In R. Barnett (Ed.), *Reshaping the university: New relationships between research, scholarship and teaching* (pp. 14-26). Maidenhead, UK: McGraw Hill/Open University Press.
- Huisman, J. (2006). *Analysing university welcome addresses: A linguistic turn*. Paper presented at the annual meeting of the Society for Research into Higher Education, Brighton, UK.
- Huisman, M., & Van Duijn, M.A.J. (2003). Software for social network analysis. In P. J. Carrington, J. Scott, & S. Wasserman, *Models and methods in social network analysis* (pp. 270-316). Cambridge, UK: Cambridge University Press.
- Hunter, A.B., Laursen, S.L., & Seymour, E. (2006). Becoming a scientist: The role of undergraduate research in students' cognitive, personal, and professional development. *Science Education, 91*, 36-74.
- Janesick, V.J. (1994). The dance of qualitative research design: Metaphor, methodolatry, and design. In N.K. Denzin & Y.S. Lincoln (Eds.), *Handbook of Qualitative Research* (pp. 209-219). London: Sage Publications.
- Jenkins, A., Blackman, T., Lindsay, R., & Paton-Saltzberg, R. (1998). Teaching and research: Student perspectives and policy implications. *Studies in Higher Education, 23*, 127-141.
- Jenkins, A., Breen, R., & Lindsay, R. (2003). *Reshaping teaching in higher education: Linking teaching with research*. London: Kogan Page Limited.
- Jenkins, A., Healey, M., & Zetter, R. (2007). *Linking teaching and research in departments and disciplines*. York, UK: The Higher Education Academy.
- Jensen, J.-J. (1988). Research and teaching in the universities of Denmark: Does such an interplay really exist? *Higher Education, 17*, 17-28.
- Johnston, M. (1992). How to speak of the colors. *Philosophical Studies, 68*, 221-263.

## References

---

- Kan, C., Verloop, N., & Ponte, P. (2008, September). *Use of the repertory grid technique for eliciting teachers' moral constructs*. Paper presented at the annual meeting of the European Educational Research Association, Göteborg, Sweden.
- Kane, R., Sandretto, S., & Heath, C. (2002). Telling half the story: A critical review of research on the teaching beliefs and practices of university academics. *Review of Educational Research, 72*, 177-228.
- Kane, R., Sandretto, S., & Heath, C. (2004). An investigation into excellent tertiary teaching: Emphasising reflective practice. *Higher Education, 47*, 283-310.
- Karasavvidis, I., Pieters, J.M., & Plomp, T. (2000). Investigating how secondary school students learn to solve correlational problems: Quantitative and qualitative discourse approaches to the development of self-regulation. *Learning and Instruction, 10*, 267-292.
- Katz, L.G., & Rath, J.D. (1985). Dispositions as goals for teacher education. *Teaching and Teacher Education, 1*, 301-307.
- Kember, D. & Gow, L. (1994). Orientations to teaching and their effect on the quality of student learning. *Journal of Higher Education, 65*, 58-74.
- Kember, D. (1997). A reconceptualisation of the research into university academics' conceptions of teaching. *Learning and Instruction, 7*, 255-275.
- Kember, D. (2000). *Action learning and action research: Improving the quality of teaching and learning*. London: Routledge Falmer.
- Kember, D., & Kwan, K. (2002). Lecturers' approaches to teaching and their relationship to conceptions of good teaching. In N. Hativa, & P. Goodyear (Eds.), *Teacher thinking, beliefs and knowledge in higher education* (pp. 219-240). Dordrecht, NL: Kluwer Academic Publishers.
- Kinchin, I.M., & Hay, D.B. (2007). The myth of the research-led teacher. *Teachers and Teaching: Theory and Practice, 13*, 43-61.
- Könings, K.D. (2007). *Student perspectives on education: Implications for instructional design*. Unpublished doctoral dissertation, Open University, Heerlen, The Netherlands.
- Korthagen, F.A.J. (2004). In search of the essence of a good teacher: Towards a more holistic approach in teacher education. *Teaching and Teacher education, 20*, 77-97.
- Kreber, C. (2002). Controversy and consensus on the scholarship of teaching. *Studies in Higher Education, 27*, 151-167.
- Kreber, C., & Cranton, P.A. (2000). Exploring the scholarship of teaching. *The Journal of Higher Education, 71*, 476-495.
- Krippendorff, K. (1980). *Content analysis*. London: Sage Publications.
- Kyvik, S., & Smeby, J.-C. (1994). Teaching and Research: The relationship between the supervision of graduate students and faculty research performance. *Higher Education, 28*, 227-239.
- Laird, T.F.N. (2005). College students' experiences with diversity and their effects on academic self-confidence, social agency, and disposition towards critical thinking. *Research in Higher Education, 46*, 365-387.

- Laugksch, R.C. (2000). Scientific literacy: A conceptual overview. *Science Education, 84*, 71-94.
- Latour, B. (1987). *Science in action*. Cambridge, MA: Harvard University Press.
- Latour, B., & Woolgar, S. (1979). *Laboratory life: The social construction of scientific facts*. Los Angeles: Sage Publications.
- Leisyte, L., Enders, J., & De Boer, H. (in press). The balance between teaching and research in Dutch and English universities in the context of university governance reforms. *Higher Education*.
- Lichtenstein, M.J., Owen, S.V., Balalock, C.L., Liu, Y., Ramirez, K.A., Pruski, L.A., Marshall, C.E., & Toepperwein, M.A. (2008). Psychometric reevaluation of the scientific attitude inventory-revised (SAI-II). *Journal of Research in Science Teaching, 45*, 600-616.
- Lindsay, R., Breen, R., & Jenkins, A. (2002). Academic research and teaching quality: The views of undergraduate and postgraduate students. *Studies in Higher Education, 27*, 309-327.
- Mainhard, T.M., Van der Rijst, R.M., Van Tartwijk, J.W.F., & Wubbels, Th. (2009). Studying the supervision of doctoral students from an interpersonal perspective. *Higher Education, 85*, 359-373.
- Malzkorn, W. (2001). Defining disposition concepts: A brief history of the problem. *Studies in History and Philosophy of Science, 32*, 335-353.
- Marsh, H.W., & Hattie, J. (2002). The relation between research productivity and teaching effectiveness. *The Journal of Higher Education, 73*, 603-641.
- Marsh, H.W., & Roche, L.A. (1997). Making students' evaluations of teaching effectiveness effective. *American Psychologist, 52*, 1187-1197.
- Marsh, H.W., Rowe, K.J., & Martin, A. (2002). PhD students' evaluations of research supervision. *The Journal of Higher Education, 73*, 313-348.
- Martin, E., Prosser, M., Trigwell, K., Ramsden, P., & Benjamin, J. (2002). What university teachers teach and how they teach it. In N. Hativa & P. Goodyear (Eds.), *Teacher thinking, beliefs and knowledge in higher education* (pp. 103-126). Dordrecht, NL: Kluwer Academic Publishers.
- Martin, G.A. (1997). Teachers or researchers? The perceptions of professional role among university lecturers. *Innovations in Education and Teaching International, 34*, 154-159.
- Mayor, C.H., & Palmer, B. (2006). Reshaping teaching and learning: the transformation of faculty pedagogical content knowledge. *Higher Education, 51*, 619-647.
- McAlpine, L., Jazvak-Martek, M., & Gonsalves, A. (2007). The question of identity: Negotiating roles and voices in evolving academic systems. In R. Barnett & R. Di Napoli (Eds.), *Changing identities and voices in higher education* (pp. 113-123). London: Routledge Falmer.
- McKeachie, W.J. (1990). Research on college teaching: The historical background. *Journal of Educational Psychology, 82*, 189-200.
- McLean, M., & Barker, H. (2004). Students making progress and the 'research-teaching nexus' debate. *Teaching in Higher Education, 9*, 407-419.

## References

---

- Meijer, P.C. (1999). *Teachers' practical knowledge: Teaching reading comprehension in secondary education*. Unpublished doctoral dissertation, ICLON – Leiden University Graduate School of Teaching, Leiden, The Netherlands.
- Meirink, J.A., Meijer, P.C., Verloop, N., & Bergen, Th.C.M. (2009). Understanding teacher learning in secondary education: The relations of teacher activities to changed beliefs about teaching and learning. *Teaching and Teacher Education, 25*, 89-100.
- Menges, R.J., & Austin, A.E. (2001). Teaching in higher education. In V. Richardson (Ed.), *Handbook of research on teaching* (4<sup>th</sup> ed., pp. 1122-1156). Washington, DC: American Educational Research Association.
- Miles, M.B., & Huberman, A.M. (1994). *Qualitative data analysis*. London: Sage Publications.
- Moses, I. (1990). Teaching, research and scholarship in different disciplines. *Higher Education, 19*, 351-375.
- Muhr, T. (1997). *ATLAS.ti: the knowledge workbench: visual qualitative data analysis, management, model building: short user's manual*. Berlin: Scientific Software Development.
- Murray, F.B. (2007). Disposition: A superfluous construct in teacher education. *Journal of Teacher Education, 58*(5), 381-387.
- Murray, K., & MacDonald, R. (1997). The disjunction between lecturers' conceptions of teaching and their claimed educational practice. *Higher Education, 33*, 331-349.
- Neumann, A. (2006). Professing passion: Emotion in the scholarship of professors at research universities. *American Educational Research Journal, 43*, 381-424.
- Neumann, R. (1992). Perceptions of the teaching-research nexus: A framework for analysis. *Higher Education, 23*, 159-171.
- Neumann, R. (1994). The teaching-research nexus: Applying a framework to university students' learning experiences. *European Journal of Education, 29*(3), 323-338.
- Neumann, R., Parry, S., & Becher, T. (2002). Teaching and learning in their disciplinary contexts: A conceptual analysis. *Studies in Higher Education, 27*, 405-417.
- Nijveld, M.J., Beijaard, D., Brekelmans, J.M.G., Verloop, N., & Wubbels, Th. (2006). Assessing the interpersonal competence of beginning teachers: The quality of assessors' judgement processes. *International Journal of Educational Research, 43*, 89-102.
- Nilsson, P. (2008). Teaching for understanding: The complex nature of PCK in pre-service teacher education. *International Journal of Science Education, 30*, 1281-1299
- Norton, L, Richardson, J.T.E., Hartley, J., Newstead, S., & Mayes, J. (2005). Teachers' beliefs and intentions concerning teaching in higher education. *Higher Education, 50*, 537-571.
- Noyes, A. (2008). Choosing teachers: Exploring agency and structure in the distribution of newly qualified teachers. *Teaching and Teacher Education, 24*, 674-683.
- O'Conner, B. (1999). Simple and flexible SAS and SPSS programs for analyzing lag-sequential categorical data. *Behavior Research Methods, Instruments, & Computers, 31*(4), 718-726.

- Oolbakkink-Marchand, H.W., Van Driel, J.H., & Verloop, N. (2006). A breed apart? A comparison of secondary and university teachers' perspectives on self-regulated learning. *Teachers and Teaching: Theory and Practice*, 12, 593-614.
- Padilla, K., Ponce-de-León, A.M., Rembado, F.M., & Garritz, A. (2008). Undergraduate Professors' Pedagogical Content Knowledge: The case of 'amount of substance'. *International Journal of Science Education*, 30, 1389-1404.
- Pajares, M.F. (1992). Teachers' beliefs and educational research: Cleaning up a messy construct. *Review of Educational Research*, 62, 307-332.
- Perkins, D., Jay, E., & Tishman, S. (1993). Teaching thinking: From ontology to education. *Educational Psychologist*, 28(1), 67-85.
- Perkins, D., Tishman, S., Ritchhart, R., Donis, K., & Andrade, A. (2000). Intelligence in the wild: A dispositional view of intellectual traits. *Educational Psychology Review*, 12(3), 269-293.
- Pickering, A.M. (2006). Learning about university teaching: Reflections on a research study investigating influences for change. *Teaching in Higher Education*, 11, 319-335.
- Pithers, R.T., & Soden, R., (2000). Critical thinking in education: A review. *Educational Research*, 42, 237-249.
- Platteel, T., Hulshof, H., & Van Driel, J.H. (2008). Teachers of mother-tongue education in action: Teachers designing concept-context-enriched education in an action research setting. *L1- Educational Studies in Language and Literature*, 8(4), 85-105.
- Postareff, L., & Lindblom-Ylänne, S. (2008). Variation in teachers' descriptions of teaching: Broadening the understanding of teaching in higher education. *Learning and Instruction*, 18, 109-120.
- Prosser, M., & Trigwell, K. (1997). Relations between perceptions of teaching environment and approaches to teaching. *The British Journal of Educational Psychology*, 67, 25-35.
- Prosser, M., Trigwell, K., & Taylor, P. (1994). A phenomenographic study of academics' conceptions of science learning and teaching. *Learning and Instruction*, 4, 217-231.
- Prosser, M., Martin, E., Trigwell, K., Ramsden, P., & Middleton, H. (2008). University academics' experiences of research and its relationship to their experience of teaching. *Instructional Science*, 36, 3-16.
- Ramsden, P. (2003). *Learning to teach in higher education*. London: Routledge Falmer.
- Reeder, G.D., & Brewer, M.B. (1979). A schematic model of dispositional attribution in interpersonal perception. *Psychological Review*, 86, 61-79.
- Reeder, G.D., Vonk, R., Ronk, M.J., Ham, J., & Lawrence, M. (2004). Dispositional attribution: Multiple inferences about motive-related traits. *Journal of Personality and Social Psychology*, 86, 530-544.
- Robertson, J., & Blackler, G. (2006). Students' experiences of learning in a research environment. *Higher Education Research and Development*, 25, 215-229.
- Rogers, R., Malancharuvil-Berkes, E., Mosley, M., Hui, D., & O'Garro Joseph, G. (2005). Critical discourse analysis in education: A review of the literature. *Review of Educational Research*, 75, 365-416.

## References

---

- Romano, M.E. (2006). "Bumpy moments" in teaching: Reflections from practicing teachers. *Teaching and Teacher Education*, 22, 973–985.
- Rosenshine, B. (1971). *Teaching behaviours and student achievement*. London: NFER.
- Rosenshine, B., & Furst, N. (1973). The use of direct observation to study teaching. In R.M.W. Travers (Ed.), *Second handbook of research on teaching* (pp. 122-183). Chicago: Rand McNally College Publishing Company.
- Roth, W.-M., & Lawless, D. (2002). Scientific investigations, metaphorical gestures, and the emergence of abstract scientific concepts. *Learning and Instruction*, 12, 285-304.
- Roth, W.-M., & Roychoudhury, A. (1994). Science discourse through collaborative concept mapping: New perspectives for the teacher. *International Journal of Science Education*, 16, 437-455.
- Rowbottom, D.P., & Aiston S.J. (2006). The myth of 'scientific method' in contemporary educational research. *Journal of Philosophy of Education*, 40, 137-156.
- Ruis, P. (2007). *Praktijkvoorbeelden van researchintensief onderwijs aan de Universiteit Leiden [Exemplary practices of research-intensive education at Leiden University]*. Memorandum: 1232. Leiden, NL: ICLON – Leiden University Graduate School of Teaching.
- Ryan, G.W., & Bernard, H.R. (2000). Data management and analysis methods. In N.K. Denzin & Y.S. Lincoln (Eds.), *Handbook of Qualitative Research* (2nd ed., pp. 769-802). London: Sage Publications.
- Ryder, J., Leach, J., & Driver, R. (1999). Undergraduate science students' images of science. *Journal of Research in Science Teaching*, 36, 201-219.
- Saarinen, T. (2008). Position of text and discourse analysis in higher education. *Studies in Higher Education*, 33, 719-728.
- Samarapungavan, A., Westby, E.L., & Bodner, G.M. (2006). Contextual epistemic development in science: A comparison of chemistry students and research chemists. *Science Education*, 90, 468-495.
- Samuelowicz, K., & Bain, J.D. (1992). Conceptions of teaching held by academic teachers. *Higher Education*, 24, 93-111.
- Samuelowicz, K., & Bain, J.D. (2001). Revisiting academics' beliefs about teaching and learning. *Higher Education*, 41, 299-325.
- Samuelowicz, K., & Bain, J.D. (2002). Identifying academics' orientations to assessment practices. *Higher Education*, 43, 173-201.
- Schussles, D. L. (2006). Defining dispositions: Wading through murky waters. *The Teacher Educator*, 41(4), 251-268.
- Schwartz, R.S., & Lederman, N.G. (2008). What scientists say: Scientists' views of nature of science and relation to science context. *International Journal of Science Education*, 30, 727-771.
- Schwartz, R.S., Lederman, N.G., & Crawford, B.A. (2004). Developing views of nature of science in an authentic context: An explicit approach to bridging the gap between nature of science and scientific inquiry. *Science Education*, 88, 610-645.
- Scott, P. (1995). *The meanings of mass higher education*. Buckingham, UK: Society for Research into Higher Education.



- Scott, P.H., & Mortimer, E.F. (2006). The tension between authoritative and dialogic discourse: A fundamental characteristic of meaning making interactions in high school science lessons. *Science Education, 90*, 605-631.
- Searle, J.R. (1969). *Speech Acts*. Cambridge, UK: Cambridge University Press.
- Serow, R.C. (2000). Research and teaching at a research university. *Higher Education, 40*, 449-463.
- Seymour, E., Hunter, A.B., Laursen, S.L., & Deantoni, T. (2004). Establishing the benefits of research experiences for undergraduates in the sciences: First findings from a three-year study. *Science Education, 88*, 493-534.
- Sherman, T.M., Armistead, L.P., Fowler, F., Barksdale, M.A., & Reif, G. (1987). The quest for excellence in university teaching. *Journal of Higher Education, 48*, 66-84.
- Shope, R.K. (1978). The conditional fallacy in contemporary philosophy. *The Journal of Philosophy, 75*, 397-413.
- Shulman, L.S. (1986). Paradigms and research programs in the study of teaching: A contemporary perspective. In M. C. Wittrock (Ed.), *Handbook of research on teaching* (3<sup>rd</sup> ed., pp. 3-36). New York: MacMillan Publishing Company.
- Shulman, L.S. (1987). Knowledge and teaching: Foundations of the new reform. *Harvard Educational Review, 57*, 1-22.
- Shulman, L.S. (2002). Making differences: A table of learning. *Change, 34*, 36-44.
- Siegel, H. (2005). What (good) are thinking dispositions? *Educational Theory, 49*, 207-221.
- Simons, M. (2006). 'Education through research' at European universities: Notes on the orientation of academic research. *Journal of Philosophy of Education, 40*, 31-50.
- Simons, M., & Elen, J. (2007). The 'research-teaching nexus' and 'education through research': An exploration of ambivalences. *Studies in Higher Education, 32*, 617-631.
- Statistical Package for the Social Sciences Incorporated (1990). *SPSS Categories*®. Chicago: SPSS Inc.
- Stes, A., De Maeyer, S., & Van Petegem, P. (2008). Een Nederlandstalige versie van de ATI: Een valide instrument om onderwijsaanpak van docenten in het hoger onderwijs te meten? [A Dutch version of the ATI: A valid instrument to measure approaches to teaching in higher education?]. *Pedagogische Studiën, 85*, 95-106.
- Stes, A., Gijbels, D., & Van Petegem, P. (2008). Student-focused approaches to teaching in relation to context and teacher characteristics. *Higher Education, 55*, 255-267.
- Stes, A., Min-Leliveld, M.J., Gijbels, D., & Van Petegem, P. (in press). The impact of instructional development in higher education: A state-of-the-art of the research. *Educational Research Review*.
- Strauss, A., & Corbin, J. (1990). *Basics of qualitative research: Grounded theory procedures and techniques*. London: Sage Publications.
- Stupnisky, R.H., Renaud, R.D., Daniels, L.M., Haynes, T.L., & Perry, R.P. (2008). The interrelation of first-year college students' critical thinking disposition, perceived academic control, and academic achievement. *Research in Higher Education, 49*, 513-530.

## References

---

- Thagard, P. (2005). How to be a successful scientist. In M. E. Gorman, R. D. Tweney, D. C. Gooding, & A. P. Kincannon (Eds.), *Scientific and technological thinking* (pp. 159-1771). Mahwah, NJ: Laurence Erlbaum Associates.
- Tigelaar, D.E.H., Dolmans, D.H.J.M., Wolfhagen, I.H.A.P., & Van der Vleuten, C.P.M. (2004). The development and validation of a framework for teaching competencies in higher education. *Higher Education, 48*, 253-268.
- Tillema, H., & Orland-Barak, L. (2006). Constructing knowledge in professional conversations: The role of beliefs on knowledge and knowing. *Learning and Instruction, 16*, 592-608.
- Trent, J.W., & Cohen, A.M. (1973). Research on teaching in higher education. In R.M.W. Travers (Ed.), *Second handbook of research on teaching* (pp. 997-1071). Chicago: Rand McNally College Publishing Company.
- Trigwell, K., & Prosser, M. (1996). Changing approaches to teaching: A relational perspective. *Studies in Higher Education, 21*, 275-284.
- Trigwell, K., & Shale, S. (2004). Student learning and the scholarship of university teaching. *Studies in Higher Education, 29*, 534-536.
- Trigwell, K., Martin, E., Benjamin, J., & Prosser, M. (2000). Scholarship of teaching: A model. *Higher Education Research and Development, 19*, 155-168.
- Trope, Y. (1986). Identification and inferential processes in dispositional attribution. *Psychological Review, 93*, 239-257.
- Turner, N., Wuetherick, B., & Healey, M. (2008). International perspectives on student awareness, experience and perceptions of research: Implications for academic developers in implementing research-based teaching and learning. *International Journal for Academic Development, 13*, 199-211.
- Van der Rijst, R.M., & Jacobi, R.K. (2009). *Verwevenheid van onderzoek in het onderwijs aan de Universiteit Leiden: Curriculumanalyses van bacheloropleidingen Criminologie, Archeologie en MST* [The research-teaching nexus at Leiden University: Curriculum analysis of the bachelor programmes Criminology, Archaeology, and Molecular Science & Technology]. Rapport 191. Leiden, NL: ICLON – Leiden University Graduate School of Teaching.
- Van der Rijst, R.M., Kijne, J.W., Verloop, N., & Van Driel, J.H. (2008, April). *Exploring scientific research dispositions from the perspective of academics: A case study approach*. Paper presented at the annual conference of the National Association of Research in Science Teaching, Baltimore, USA.
- Van der Rijst, R.M., Van Driel, J.H., Kijne, J.W., & Verloop, N. (2007, August). *Scientific research dispositions in research, teaching and learning*. Paper presented at the biennial conference of European Association of Research in Learning and Instruction, Budapest, Hungary.
- Van der Rijst R.M., Visser-Wijnveen, G.J., Verstelle, T., & Van Driel, J.H. (2009). Studentbeleving van de onderzoeksintensiviteit van universitaire leeromgevingen [Student experience of the research intensiveness of learning environments at university]. *Pedagogische Studiën, 86*(3), 214-229.

- Van Driel, J.H., Beijaard, D., & Verloop, N. (2001). Professional development and reform in science education: The role of teachers' practical knowledge. *Journal of Research in Science Teaching*, 38, 137-158.
- Van Driel, J.H., Bulte, A.M.W., & Verloop, N. (2007). The relationship between teachers' general beliefs about teaching and learning and their domain specific beliefs. *Learning and Instruction*, 17, 156-171.
- Van Driel, J.H., Verloop, N., & De Vos, W. (1998). Developing science teachers' pedagogical content knowledge. *Journal of Research in Science Teaching*, 35, 673-695.
- Van Driel, J.H., Verloop, N., Van Werven, H.I., & Dekkers, H. (1997). Teachers' craft knowledge and curriculum innovation in higher education. *Higher Education*, 34, 105-122.
- Van Tartwijk, J., Brekelmans, M., & Wubbels, Th. (1998). Students' perceptions of teacher interpersonal style: The front of the classroom as the teachers' stage. *Teaching and Teacher Education*, 14, 607-617.
- Verburgh, A., & Elen, J. (2006, December). *The influence of discipline and experience on students' perception of the relationship between teaching and research*. Paper presented at the annual conference of the Society of Research into Higher Education, Brighton, UK.
- Verloop, N., Van Driel, J.H., & Meijer, P. (2001) Teacher knowledge and the knowledge base of teaching. *International Journal of Educational Research*, 35, 441-461.
- Visser-Wijnveen, G.J., Van Driel, J.H., Van der Rijst, R.M., Verloop, N., & Visser, A. (in press). The relationship between academics' conceptions of knowledge, research and teaching – a metaphor study. *Teaching in Higher Education*.
- Visser-Wijnveen, G.J., Van Driel, J.H., Van der Rijst, R.M., Verloop, N., & Visser, A. (in press). The ideal research-teaching nexus in the eyes of academics – building different profiles. *Higher Education Research and Development*.
- Vereniging van Samenwerkende Nederlandse Universiteiten (2008). *Overeenkomst inzake wederzijdse erkenning basiskwalificatie onderwijs* [agreement on mutually excepted basic teaching qualification].
- Walshaw, M., & Anthony, G. (2008). The teacher's role in classroom discourse: A review of recent research into mathematics classrooms. *Review of Educational Research*, 78, 516–551.
- Wassink, H., Slegers, P., & Imants, J. (2003). Cause maps and school leaders' tacit knowledge. *Journal of Educational Administration*, 41, 524-546.
- Wubbels, Th., Brekelmans, M., & Hooymayers H.P. (1992). Do teacher ideals distort the self-reports of their interpersonal behavior? *Teaching and Teacher Education*, 8, 47-58.
- Wubbels, Th., Brekelmans, M., Den Brok, P., & Van Tartwijk, J. (2006). An interpersonal perspective on classroom management in secondary classrooms in the Netherlands. In C. Evertson & C. Weinstein (Eds.), *Handbook of classroom management: Research, practice, and contemporary issues* (pp. 1161–1191). Mahwah, NJ: Lawrence Erlbaum Associates.

- Young, P. (2006). Out of balance: Lecturers' perceptions of differential status and reward in relation to teaching and research. *Teaching in Higher Education, 11*, 191-202.
- Zubrick, A., Reid, I., & Rossiter, P. (2001). *Strengthening the nexus between teaching and research*. Canberra: Commonwealth of Australia.



Summary



## Introduction

Although policy makers, as well as academics and students, show a positive appreciation for the nexus between research and teaching at universities, it is not always self evident for academics how to organize courses that positively influence a close connection between research, teaching and learning. The studies in this dissertation examine academics, affiliated with the Faculty of Sciences of Leiden University, who have both a research task and a teaching task. Central in these studies are three themes: research dispositions, teaching intention and teaching practice. In research literature on higher education, research disposition is recognized as a relevant but often underrepresented theme. Examples of aspects of a research disposition are: to critically observe research data, to share new findings and to be curious about new models and theories. The first two studies specifically address the identification of underlying aspects of the scientific research dispositions of academics. The central aim of the last two studies is to identify associations between on the one hand the teaching intentions and approaches and on the other hand current teaching practice of academics with respect to connections between research and teaching.

## Chapter 2: Aspects of scientific research dispositions

In Chapter 2, an interview study is described in which academics (n=23) were asked about their scientific research dispositions. The interviews were analyzed and participants' responses about their research dispositions were categorized. In this study, two research questions were central. The first research question was: *What aspects can be distinguished in the ways science academics conceive of their scientific research dispositions?* The analysis of the response to the interview questions led to a categorization of six qualitatively different aspects of scientific research dispositions, namely the inclinations (1) to achieve, (2) to be critical (3) to be innovative, (4) to know, (5) to share knowledge, and (6) to understand.

The second research question was: *What are the differences and similarities between groups of academics with comparable research dispositions?* Similarities and differences in the background variable of groups of academics were described. Academics with similar scientific research dispositions were grouped through a combination of a hierarchical cluster analysis and a principle components analysis, with the aim to identify similarities and differences in background variables between groups. The results suggested that academics within applied and experimental research domains more often put emphasis on the inclination 'to be innovative' and 'to be critical', whereas academics from research domains with a theoretical orientation, such as theoretical physics or

mathematics, relatively more often put emphasis on the inclination 'to achieve' and 'to understand'. This finding suggests that disciplinary, institutional and/or scientific culture differences have an influence on the scientific research disposition of academics.

### **Chapter 3: Methods for the measurement of research dispositions**

After the identification of different aspects of research dispositions, as described in Chapter 2, potential ways to study dispositions of persons were examined into more detail. In the study described in Chapter 3, first the notion of 'disposition' in the research literature is described, with the aim to identify principles to be used for the development of an empirical basis of 'disposition'. Next, three instruments to study the research disposition of individuals have been studied in a case study approach (n=3). The instruments which were examined are a semi-structured interview with open questions, a hierarchical ordering task and a cognitive mapping task. During the hierarchical ordering task the participants were asked to give a linear ordering of the six aspects related to their own research disposition, ranging from 'most applicable' to 'least applicable'. During the cognitive mapping task, the aspects of a research disposition were presented pair wise, and the academics were asked to explain the relation between each couple of the two aspects.

The central research question in this chapter was: *Which instruments or combination of instruments can best be used to investigate a person's research disposition?* It was demonstrated that the concept of disposition in the research literature still is in the making. In many scientific studies the notion of disposition is not primarily based on experimental data, but on theoretical assumptions. Three general principles were identified that are potentially supportive to an empirically based notion of disposition. The first is that a disposition only becomes visible under specific circumstances. Secondly, explanations for specific aspects of a disposition can in principle be found in somebody's intrinsic qualities. And thirdly, a disposition can in principle be studied empirically. Three potential methods to measure the disposition of a person were described in this chapter. A combination of the hierarchical ordering task and the structured cognitive mapping task turned out to be useful in the sense that this combination revealed relevant results and was more time efficient than a semi-structured interview method with open questions. The results suggest that a difference can be made between implicit and explicit views of academics about their research dispositions. Furthermore, the results suggest that the interview and the ordering task gauge a similar characteristic of the notion of disposition, namely the explicit



views of the participants. The structured cognitive mapping task suggested that implicit or tacit scientific research dispositions can be identified.

#### **Chapter 4: Speech acts**

The central aims of Chapter 4 are to recognize and describe sequences of speech acts that characterize the language of the teacher and to describe associations between these typical sequences and the approaches to teaching during the courses, in which research and teaching were connected. In this study, the speech acts of the participating teachers (n=12) were audio taped during the course meetings. An analysis scheme was developed to characterize the rationale behind the speech acts. The teachers were also asked, in retrospect, to fill out a questionnaire about their approach to teaching.

In this study, the first research question was: *What typical sequences can be recognised in individual teachers' speech during course meetings?* The transcripts of the interviews were analyzed with the coding scheme, based on the speech act theory from language philosophy, developed by John L. Austin and John R. Searle. This theory describes the intentionality behind speech expressions and gives a categorization in types of speech act. For example, the speaker of an assertive speech act (such as to inform or to reflect) has the intention to convince the listener and to give the listener an equal opinion in accordance with the content of the expression, whereas the speaker of a directive speech act (such as to advise or to instruct) has the intention to persuade the listener to perform an act in accordance with the content of the expression. Two groups of teachers were identified on basis of the sequences of their speech acts, one group using relatively more assertive speech acts, the other group using relatively more directive speech acts.

The second research question central in this chapter was: *Are teachers' typical speech act sequences associated with their approaches to teaching and the method of instruction used during science courses?* The analyses of the speech acts of teachers in course meetings showed that during lectures teachers mainly use assertive speech acts, whereas during practicals teachers relatively more often use directive speech acts. During lectures teachers mainly explained and gave overviews of the course content, whereas during practicals teachers more often gave instructions to students, for instance about how to proceed with the assignments. This result resembles the general perception of lectures and practicals at universities and indicates that this type of analysis gives a realistic characterization of the language behaviours of teachers during course meetings. Associations between the speech acts and the teachers' self-report of their

approach to teaching were analysed through comparing teachers' speech acts with results from a questionnaire about approaches to teaching. Teachers who put emphasis on students' conceptual change, more often used directive speech acts, such as asking questions and giving advice, whereas teachers who put emphasis on knowledge transfer more often used assertive speech acts, such as giving information and making predictions. Apparently, teachers who put emphasis on students' conceptual change seek a dialogue with the students, in which questions and advices have a dominant role, whereas teachers who put emphasis on knowledge transfer often explain and give information to the students.

### **Chapter 5: Teachers' intentions**

The central aim in Chapter 5 is to describe associations between the teachers' intentions and students' perceptions of research intensive learning environments. During interviews with university science teachers (n=11) prior to their courses, teachers were asked to describe their intentions towards the role of research in their courses and their intentions towards the development of research dispositions of their students. After the courses the students (n=104) were asked to complete a questionnaire about the research intensiveness of the learning environments. The research question central in this chapter was: *What associations can be identified between teachers' intentions and students' perceptions of the research intensiveness of university science courses?* The results showed that the teachers' intentions were only partially congruent with the perceptions of their students. The results suggested a difference in congruency of the teachers' intentions and the students' perceptions between 'tangible' and 'intangible' elements of research in the courses. The tangible nexus between research and teaching is expressed in elements such as the use of data of the research of the teacher during students' assignments, whereas the intangible nexus is expressed in less visible elements of the curriculum such as the creation of a research atmosphere or the stimulation of the development of students' research dispositions. The congruence between teachers' intentions and students' perceptions appeared stronger for the visible elements of the nexus. Possibly, the implicit parts of research are more difficult for students to perceive than are the visible elements. Incongruence between teachers' intentions and students' perceptions can yield misunderstandings, unfavourable for the learning process of the students in the sense that students might develop unrealistic notions of the nature of science and scientific investigation or a less limited research disposition.

The results suggested that intangible elements of the nexus between research and teaching deserve explicit attention of the teacher and the students.

### **Chapter 6: Conclusions and discussion**

In Chapter 6 the conclusions are summarised, the strengths and the limitations of the studies are described, and recommendations for further research and for teaching practice are given. The general conclusions can be summarized in four points: aspects of the research dispositions of academics, methods for the evaluation of research dispositions, teachers' speech acts and teachers' intentions regarding research in teaching.

#### *Research dispositions of academics*

- Six aspects are fundamental to research dispositions: inclination (1) to achieve, (2) to be critical, (3) to be innovative, (4) to know, (5) to share knowledge, and (6) to understand (Chapter 2).
- Academics from more applied and experimental fields of study tend to put more emphasis on 'to be innovative' and 'to be critical', whereas academics from fields with a theoretical research orientation tend to focus more on 'to achieve' and 'to understand' (Chapter 2).

#### *Evaluation of research dispositions*

- A distinction can be made between academics' explicit conceptions and their tacit conceptions of their research dispositions (Chapter 3).
- Semi-structured open-ended interviews and hierarchical ordering tasks show explicit conceptions, whereas structured mapping tasks represent the tacit conceptions of academics' research dispositions (Chapter 3).

#### *Teachers' speech acts*

- The typical sequences of teachers' speech acts illuminate their speech act repertoires in action (Chapter 4).
- Teachers who emphasised conceptual changes of students more often use directive speech acts, such as questions or instructions, whereas teachers who emphasised knowledge transfer more often use assertive speech acts (Chapter 4).

#### *Teachers' intentions regarding research in teaching*

- Teachers' intentions are moderately congruent with students' perceptions of the research intensiveness of the learning environments (Chapter 5).

- Teachers' intentions related to tangible elements of the nexus are relatively more coherent with students' perceptions than are teachers' intentions regarding intangible elements of the nexus (Chapter 5).

### *Practical and theoretical implications*

At the end of Chapter 6 recommendations for further research and implications for teaching practice are discussed.

In relation to further research, it was recognised that new research instruments have been developed and applied during the studies, such as a categorization of the aspects of research dispositions, a method for the analysis of teachers' speech acts, and a questionnaire to evaluate students' perceptions of research activities during course meetings. These research instruments were developed in the context of university science education and can potentially also be made applicable for other contexts.

Implications for teaching practice are discussed for policy makers, teachers, and students. The results from the studies suggest that the categorization of aspects of research dispositions can be helpful for the design and re-design of educational programmes at universities. Students can profit from the acquaintance with a variety of research dispositions of their teachers. A design of the curriculum in which attention is drawn towards the development of research dispositions can be of help for offering additional learning possibilities to students. Furthermore, appreciation of the variation between academics, such as variation in research dispositions and speech repertoire, can be helpful for educational policy makers when considering human resource management.

Some of the instruments, which are used in the studies, can also be made applicable for practice. For example, the method of analysis of speech acts also offers teachers and teacher trainers in higher education the possibility to evaluate and reflect on their speech act repertoire. Previous studies showed that student evaluations of learning environments are an effective instrument for teachers to reflect on their own teaching practice. A second example can be found in the questionnaire about students' perceptions of the research intensiveness of learning environments. This questionnaire can be applied as an evaluation instrument to improve the understanding of how students perceive the learning environments and specifically the research activities during the course meetings.



**Samenvatting**



## Introductie

Zowel beleidsmakers, als docenten en studenten tonen een positieve waardering voor de verwevenheid van onderzoek in het universitair onderwijs. Toch is het, ook voor docenten die zelf onderzoek doen, niet altijd evident op welke manier cursussen ingericht kunnen worden zodanig dat het onderzoek het onderwijs positief beïnvloedt. De studies in dit proefschrift betreffen wetenschappers die zowel een onderzoekstaak als een onderwijstaak hebben en verbonden zijn aan de Faculteit der Wiskunde & Natuurwetenschappen van de Universiteit Leiden. Hierbij staat een drietal thema's centraal: onderzoekende houding, onderwijsintentie en onderwijspraktijk. Al eerder werd 'onderzoekende houding' ('research disposition') erkend als een relevant, maar vaak onderbelicht thema in de onderzoeksliteratuur over het hoger onderwijs. Het kritisch observeren van onderzoeksgegevens, het doorzetten als de dataverzameling tegenzit en het nieuwsgierig zijn naar nieuwe modellen zijn drie voorbeelden van aspecten van een onderzoekende houding. De eerste twee studies richten zich specifiek op de identificatie van onderliggende aspecten van de wetenschappelijke onderzoekende houding van wetenschappers. Het centrale doel van de laatste twee studies is om verbanden te herkennen tussen aan de ene kant de onderwijsintenties en onderwijsaanpak van docenten en aan de andere kant hun actuele onderwijspraktijk aan de universiteit.

## Hoofdstuk 2: Aspecten van een onderzoekende houding

In Hoofdstuk 2 is een interviewstudie beschreven waarin wetenschappers (n=23) werden bevroegd op aspecten van hun onderzoekende houding. De interviews werden geanalyseerd, waarbij de letterlijke reacties van de deelnemers over hun onderzoekende houding werden gecategoriseerd. Wetenschappers met gelijksoortige onderzoekende houding werden gegroepeerd met behulp van hiërarchische clusteranalyse en principale componentenanalyse, met als doel verschillen en overeenkomsten tussen de onderzoekende houding van deelnemers en achtergrondvariabelen te vinden. In deze studie staan twee onderzoeksvragen centraal. De eerste onderzoeksvraag was: *welke aspecten kunnen onderscheiden worden in de manieren waarop universitaire docenten hun eigen onderzoekende houding concipiëren?* De analyse van de respons uit de interviews leidde tot een categorisatie van de aspecten van wetenschappelijke onderzoekende houding van wetenschappers. Er werden zes kwalitatief verschillende aspecten van wetenschappelijke onderzoekende houding onderscheiden namelijk een neiging om (1) te willen begrijpen, (2) te willen bereiken, (3) kennis te willen delen, (4) kritisch te willen zijn, (5) vernieuwend te

willen zijn en (6) te willen weten. Deze aspecten van een wetenschappelijke onderzoekende houding werden beschreven met behulp van de gegevens uit te interviews met de wetenschappers.

De tweede onderzoeksvraag luidde: *wat zijn de verschillen en overeenkomsten in de onderzoekende houding van groepen wetenschappers met gelijksoortige onderzoekende houdingen?* Overeenkomsten en verschillen in de achtergrondvariabelen van groepen van wetenschappers met gelijksoortige onderzoekende houding werden beschreven. De verschillen en overeenkomsten suggereerden dat wetenschappers binnen toegepaste en experimentele onderzoeksdomeinen vaker geneigd zijn nadruk te leggen op de aspecten 'vernieuwend zijn' en 'kritisch zijn', terwijl wetenschappers uit onderzoeksdomeinen met een meer theoretische onderzoeksoriëntatie, zoals theoretische natuurkunde of wiskunde, vaker geneigd zijn nadruk te leggen op de aspecten 'te bereiken' en 'te begrijpen'. Deze uitkomst wekt de suggestie dat disciplinaire, institutionele en/of culturele verschillen invloed hebben op de wetenschappelijke onderzoekende houding van wetenschappers.

### **Hoofdstuk 3: Methoden voor het meten van een onderzoekende houding**

Nadat de aspecten van een onderzoekende houding geclassificeerd zijn in Hoofdstuk 2, bestaat de behoefte om in meer detail te onderzoeken op welke manier de onderzoekende houding van personen gemeten kan worden. In deze studie is eerst beschreven hoe het 'houdingsbegrip', ofwel 'dispositiebegrip', voorkomt in verschillende bronnen in de onderzoeksliteratuur, met als doel principes te vinden die nuttig kunnen zijn bij het ontwikkelen van een op empirie gebaseerd begrip van 'houding'. Ten tweede zijn drie instrumenten om de onderzoekende houding van individuen te meten bestudeerd in een gevalstudie benadering (n=3), namelijk een semi-gestructureerd interview met open vragen, een hiërarchische ordeningstaak en een cognitieve afbeeldingstaak. Tijdens de hiërarchische ordeningstaak werd aan de participerende wetenschappers gevraagd om de zes aspecten lineair te ordenen van 'meest van toepassing' tot 'minst van toepassing' op de eigen onderzoekspraktijk. Tijdens de cognitieve afbeeldingstaak werden alle aspecten van een onderzoekende houding paarsgewijs aangeboden aan de wetenschappers met de vraag om de relatie tussen de twee aspecten te expliciteren. De analyse van de gegevens uit deze cognitieve afbeeldingstaak maakt gebruik van een theorie die ook wordt toegepast bij het analyseren van sociale netwerkstructuren.

In dit hoofdstuk staat de vraag centraal *welke instrumenten of combinatie van instrumenten het beste kunnen worden gebruikt om de onderzoekende*



*houding van een persoon te bestuderen*. Eerst werd aangetoond dat het begrip 'onderzoekende houding' in de literatuur over onderwijsonderzoek nog steeds in ontwikkeling is. In veel wetenschappelijke rapportages is het houdingsbegrip niet gebaseerd op empirische feiten, maar vooral op theoretische aannames. Drie algemene principes werden geïdentificeerd die mogelijk ondersteunend zijn bij het zoeken naar een meer empirische notie van het houdingsbegrip in onderwijsonderzoek. Het eerste geïdentificeerde principe was dat een houding alleen zichtbaar wordt onder specifieke omstandigheden. Een creatieve houding komt bijvoorbeeld minder gemakkelijk tot uiting in een overgestructureerde omgeving. Ten tweede kan voor een specifieke houding in principe altijd een verklaring of uitleg worden gevonden in iemands intrinsieke karaktereigenschappen. Zo kan een onderzoekende houding van een persoon verklaard worden vanuit het nieuwsgierige karakter van die persoon. Ten derde kan een houding in principe empirisch worden bestudeerd. Drie potentiële methoden om de onderzoekende houding van personen te bestuderen werden onderzocht. Een combinatie van de hiërarchische ordeningstaak en de gestructureerde cognitieve afbeeldingstaak zorgde voor een efficiënte combinatie, in de zin dat deze combinatie relevante resultaten produceerde en meer tijdefficiënt was dan een semi-gestructureerde interviewmethode met open vragen. De bevindingen tonen onder meer dat een verschil kan worden gemaakt tussen de impliciete opvattingen van wetenschappers over hun onderzoekende houding en hun expliciete onderzoekende houding. De resultaten suggereerden dat het interview en de ordeningstaak kunnen worden gebruikt om een gelijksoortig kenmerk van het dispositiebegrip te bestuderen, namelijk de expliciete opvattingen van de respondenten. De resultaten van de gestructureerde cognitieve afbeeldingstaak duiden erop dat daarmee de impliciete of stilzwijgende wetenschappelijke onderzoekende houding werd weergegeven.

#### **Hoofdstuk 4: Taalhandelingen**

Het centrale onderzoeksdoel in Hoofdstuk 4 is het herkennen en beschrijven van opeenvolgingen in de taalhandelingen die typerend zijn voor de gesproken taal tijdens cursusbijeenkomsten, en het beschrijven van associaties tussen de typerende sequenties van taalhandelingen en de onderwijsbenadering van docenten. In deze studie werden de taalhandelingen tijdens cursusbijeenkomsten van docenten (n=12) opgenomen op geluidstape. Een analyseschema werd ontwikkeld om de rationale achter de taalhandelingen te karakteriseren. Dit analyseschema is gebaseerd op de taalhandelingstheorie uit de taalfilosofie,

onder anderen ontwikkeld door John L. Austin en John R. Searle. Aan de docenten werd ook, in terugglans, gevraagd om een vragenlijst over hun onderwijsaanpak in te vullen. In deze studie staan twee onderzoeksvragen centraal.

De eerste onderzoeksvraag luidde: *welke typerende sequenties zijn te onderscheiden in de discours van universitaire docenten tijdens het lesgeven?* De uitgeschreven transcripten van de interviews werden geanalyseerd met een coderingsschema, ontwikkeld met behulp van de taalhandelingstheorie. Deze taalhandelingstheorie beschrijft de rationale achter taaluitingen en geeft daarvoor een categorisering in typen taalhandeling. Zo heeft de spreker van een assertieve taalhandeling (zoals informeren of reflecteren) de intentie om de luisteraar te overtuigen en daarmee een gelijke mening te laten krijgen in overeenstemming met de inhoud van de uiting, terwijl de spreker van een directieve taalhandeling (zoals adviseren of instrueren) de intentie heeft dat de luisteraar een handeling gaat verrichten in overeenstemming met de inhoud van de taaluiting. Er werden twee groepen geïdentificeerd op basis van de sequenties van de taalhandelingen van de docenten, de ene gekenmerkt door 'assertieve' taalhandelingen, de andere groep door 'directieve' taalhandelingen.

De tweede onderzoeksvraag die centraal stond in dit hoofdstuk luidde: *hangen de typerende sequenties in de taalhandelingen van docenten samen met de onderwijsaanpak en de instructiemethode tijdens natuurwetenschappelijke cursussen?* De analyse van de taalhandelingen van docenten tijdens de cursusbijeenkomsten laten zien dat ten eerste assertieve informerende taalhandelingen het meest frequent voorkwamen. De bevindingen illustreerden dat tijdens hoorcolleges docenten voornamelijk assertieve taalhandelingen gebruikten, terwijl tijdens practica docenten relatief vaker directieve taalhandelingen gebruikten. In een hoorcollege legden docenten hoofdzakelijk cursusinhoud uit, terwijl tijdens practica docenten vaker instructies aan studenten gaven, bijvoorbeeld instructies over hoe het onderzoek aan te pakken. Aangezien dit overeenkomt met de algemeen gedeelde perceptie van wat er gebeurt tijdens hoorcolleges en practica, geven deze resultaten aan dat de sequenties op een adequate en valide manier het taalgedrag van docenten typeren. Tenslotte werd de relatie gelegd tussen de taalhandelingen van docenten en de door henzelf gerapporteerde onderwijsaanpak, gemeten met een vragenlijst. Het bleek dat docenten die in hun onderwijsaanpak streven naar een conceptuele verandering bij studenten, meer gebruik maakten van directieve taalhandelingen, zoals vragen of geven van advies. Terwijl docenten die in hun onderwijsaanpak de nadruk leggen op kennisoverdracht vaker assertieve taalhandelingen laten zien, zoals informeren of voorspellen. Een verklaring hiervoor kan zijn dat docenten die de

nadruk leggen op cognitieve verandering bij studenten zoeken naar een dialoog waarin vragen en adviezen de boventoon voeren, terwijl docenten die de nadruk leggen op kennisoverdracht vaker gebruikmaken van informeren en uitleggen.

### **Hoofdstuk 5: Onderwijsintenties**

Het centrale doel van Hoofdstuk 5 was het verband te onderzoeken tussen de onderwijsintenties en studentpercepties van de leeromgevingen. Tijdens interviews met universitaire docenten (n=11), gehouden voordat de cursussen begonnen, werd ingegaan op de intenties van docenten voor de rol van onderzoek in hun cursussen en hun intenties voor het stimuleren van de ontwikkeling van de onderzoekende houding van studenten. De studenten (n=104) werd gevraagd om een vragenlijst over de onderzoeksintensiviteit van de leeromgeving in te vullen. De onderzoeksvraag in deze studie was: *welke samenhang kan geïdentificeerd worden tussen de onderwijsintenties van docenten en de studentpercepties van de onderzoeksintensiviteit van universitaire natuurwetenschappelijke cursussen?* De resultaten tonen aan dat intenties van docenten over het algemeen beperkt congruent zijn met de percepties van studenten. De resultaten suggereren een verschil in congruentie van docentintenties en studentpercepties tussen 'zichtbare' en 'verborgen' elementen van onderzoek in het onderwijs. In bestaand onderzoek werd al eerder het onderscheid gemaakt tussen de 'zichtbare' en 'verborgen' verwevenheid van onderzoek en onderwijs. De zichtbare verwevenheid komt tot uiting in elementen zoals het gebruik van onderzoeksgegevens van het eigen onderzoek van de docent tijdens de cursus, terwijl de verborgen verwevenheid tot uitdrukking komt in niet direct zichtbare elementen van het curriculum zoals het creëren van een onderzoeksatmosfeer of het stimuleren van de ontwikkeling van een onderzoekende houding. De congruentie tussen docentintenties en studentpercepties bleek sterker bij zichtbare elementen van de verwevenheid. Een mogelijke uitleg is dat voor studenten de impliciete onderdelen van onderzoek lastiger waar te nemen zijn dan expliciete, zichtbare onderdelen. Potentiële misverstanden die kunnen ontstaan door incongruentie tussen docentintenties en studentpercepties zijn ongunstig voor het leerproces van de studenten, in de zin dat studenten een onrealistisch begrip van de aard van wetenschap en wetenschappelijk onderzoek en/of een beperkte onderzoekende houding kunnen ontwikkelen. Het resultaat suggereert dat verborgen onderdelen van de verwevenheid tussen onderzoek en onderwijs expliciet aandacht verdienen van wetenschappers en studenten.

## Hoofdstuk 6: Conclusies en discussie

In Hoofdstuk 6 worden de conclusies samengevat, de sterke kanten en de beperkingen van de studies besproken en aanbevelingen beschreven voor verder onderzoek en voor de onderwijspraktijk. De algemene conclusies kunnen samengevat worden in een viertal punten: aspecten van de onderzoekende houding van wetenschappers, methoden voor het meten van onderzoekende houding, taalhandelingen van docenten, en intenties van docenten met betrekking tot onderzoek in het onderwijs.

### *Aspecten van de onderzoekende houding*

- Aan de onderzoekende houding kunnen zes aspecten onderscheiden worden, namelijk de neiging hebben om (1) te willen begrijpen, (2) te willen bereiken, (3) kennis te willen delen, (4) kritisch te willen zijn, (5) vernieuwend te willen zijn en (6) te willen weten (*Hoofdstuk 2*).
- Wetenschappers werkzaam in meer toegepaste en experimentele domeinen van onderzoek zijn geneigd meer nadruk op leggen op de aspecten 'vernieuwend zijn' en 'kritisch zijn', terwijl wetenschappers in domeinen met een meer theoretische onderzoeksoriëntatie vaker geneigd zijn zich te concentreren op de aspecten 'bereiken' en 'begrijpen' (*Hoofdstuk 2*).

### *Methoden voor het meten van een onderzoekende houding*

- Een verschil kan worden gemaakt tussen expliciete opvattingen van wetenschappers en hun impliciete opvattingen over de aspecten van hun onderzoekende houding (*Hoofdstuk 3*).
- Interviews met open vragen en hiërarchische ordeningstaken zijn adequate instrumenten voor het onderzoeken van de expliciete opvattingen, terwijl gestructureerde cognitieve afbeeldingstaken geschikt zijn voor het in kaart brengen van de impliciete opvattingen over de aspecten van een onderzoekende houding (*Hoofdstuk 3*).

### *Taalhandelingen van docenten*

- Het toegepaste handelingsrepertoire van docenten kan gerepresenteerd worden in enkele typische sequenties van de taalhandelingen (*Hoofdstuk 4*).
- Docenten die een *cognitieve-verandering/studentgerichte* onderwijsaanpak laten zien, gebruiken vaker directieve taalhandelingen, zoals vragen stellen, geven van instructies of adviezen, terwijl docenten met een *informatie-transmissie/inhoudgerichte* benadering vaker assertieve taalhandelingen gebruiken, zoals informeren, voorspellen of reflecteren (*Hoofdstuk 4*).

*Intenties van docenten ten aanzien van onderzoek in het onderwijs*

- De intenties van docenten zijn beperkt congruent met studentpercepties van de onderzoeksintensiviteit van de leeromgevingen (*Hoofdstuk 5*).
- De intenties van docenten die betrekking hebben op zichtbare onderdelen van de verwevenheid tussen onderzoek en onderwijs, zijn relatief meer samenhangend met studentpercepties dan de intenties van docenten die betrekking hebben op verborgen onderdelen (*Hoofdstuk 5*).

*Praktische en theoretische implicaties*

De nieuwe onderzoeksinstrumenten ontwikkeld en toegepast in de studies, waaronder een categorisering van de aspecten van een onderzoekende houding, een analyseschema voor de taalhandelingen van docenten en een vragenlijst om de studentpercepties van onderzoek te evalueren werden ontwikkeld in de context van universitaire bètaopleidingen, maar kunnen eventueel ook toepasbaar gemaakt worden voor andere contexten. Verder wordt beschreven dat de categorisatie van aspecten van onderzoekende houdingen behulpzaam kan zijn voor onderwijsadviseurs en curriculumontwikkelaars bij het aanpassen en ontwerpen van een onderwijsprogramma. Studenten kunnen namelijk profiteren van het in contact komen met een verscheidenheid aan onderzoekende houdingen die door de docenten worden gemodelleerd. Een weloverwogen ontwerp van het curriculum kan hierbij een hulp zijn voor het aanbieden van leermogelijkheden aan de studenten. Ook wordt beschreven dat voor beleidsmakers het begrip van de variatie tussen individuele docenten in het hoger onderwijs met betrekking tot de onderzoekende houding en de taalhandelingen behulpzaam kan zijn bij het personeelsbeleid. Verder worden aanbevelingen gedaan met betrekking tot de methode van analyse van taalhandelingen. Zo wordt beschreven dat deze methode de mogelijkheid biedt voor docenten en docenttrainers in het hoger onderwijs om het taalhandelingsrepertoire te evalueren en uit te breiden. Tevens is het reeds bekend dat studentevaluaties van leeromgevingen een doeltreffend instrument kunnen zijn voor docenten om te reflecteren op hun eigen onderwijspraktijk. De vragenlijst over de studentperceptie van de onderzoeksintensiviteit van leeromgevingen, zoals beschreven in Hoofdstuk 5, kan worden ingezet als een evaluatie-instrument voor docenten om inzicht te krijgen in de manier waarop studenten de onderwijsomgeving en specifiek de onderzoeksactiviteiten in de cursus percipiëren. Verder werd in de implicaties onder andere beschreven dat studenten de categorisatie van de aspecten van een onderzoekende houding kunnen gebruiken om de verborgen, impliciete elementen van de praktijk van

wetenschappelijk onderzoek beter te begrijpen. Een uniek kenmerk van de onderzoekspraktijk is dat er vele verschillende benaderingen voor het doen van onderzoek bestaan en dat wetenschappers de benadering kiezen die het meest past bij hun persoonlijke houding. Indien docenten op universiteiten de aspecten van een onderzoekende houding kunnen onderscheiden, zou het mogelijk kunnen worden om studenten te begeleiden in de ontwikkeling van een eigen onderzoekende houding.

## Publications

### *Scientific publications as first author*

Van der Rijst, R.M., Visser-Wijnveen, G.J., Verstelle, T., & Van Driel, J.H. (2009). Studentbeleving van de onderzoeksintensiviteit van universitaire onderwijsomgevingen [Student experience of the research intensiveness of learning environments at universities]. *Pedagogische Studiën*, 86(3), 214-229.

### *Scientific publications as co-author*

Elsen, G.M.F., Visser-Wijnveen, G.J., Van der Rijst, R.M., & Van Driel, J.H. (2009). How to strengthen the connection between research and teaching in undergraduate university education. *Higher Education Quarterly*, 36(1), 64-85.

Mainhard, M.T., Van der Rijst, R.M., Van Tartwijk, J.W.F., & Wubbels, Th. (2009). Development, reliability and validity of the questionnaire on supervisor-doctoral student interaction. *Higher Education*, 85(3), 359-373.

Visser-Wijnveen, G.J., Van Driel, J.H., Van der Rijst, R.M., Verloop, N., & Visser, A. (in press). The relationship between academics' conceptions of knowledge, research and teaching – a metaphor study. *Teaching in Higher Education*.

Visser-Wijnveen, G.J., Van Driel, J.H., Van der Rijst, R.M., Verloop, N. and Visser, A. (in press). The ideal research-teaching nexus in the eyes of academics – building different profiles. *Higher Education Research and Development*.

### *Manuscripts submitted for publication*

Van der Rijst, R.M., Visser-Wijnveen, G.J., Kijne, J.W., Verloop, N., & Van Driel, J.H. (submitted). Exploring scientific research disposition from the perspective of academics.

Van der Rijst, R.M., Visser-Wijnveen, G.J., Van Driel, J.H., Kijne, J.W., & Verloop, N. (submitted). Towards an empirically based notion of the concept of disposition in educational research.

Van der Rijst, R.M., Visser-Wijnveen, G.J., Verloop, N., & Van Driel, J.H. (submitted). Speech act theory as an instrument to capture university science teachers' discourse.

Van der Rijst, R.M., Visser-Wijnveen, G.J., Kijne, J.W., Van Driel, J.H., & Verloop, N. (submitted). Associations between teachers' intentions and students' perceptions of the research intensiveness of learning environments.

*Other publications*

- Elsen, G.M.F., Van Driel, J.H., Groot, C.G., Vaatstra, H.F., Van der Rijst, R.M., Visser-Wijnveen, G.J., Nedermeijer, J., & Verloop, N. (2006). *Researchintensief onderwijs: hoe kan de Universiteit Leiden zich hierbinnen profileren?* Rapport nr. 166. Leiden: Universiteit Leiden, ICLON.
- Van der Rijst, R.M. (Ed.) (2007). Conferentieverlag: Zorgvuldig en Veelbelovend Onderwijs, de 34<sup>ste</sup> Onderwijs Research Dagen, 6-8 juni 2007, Groningen. *Pedagogische Studiën*, 84(6), 476-491.
- Van der Rijst, R.M., & Jacobi, R.K. (2009). *Verwevenheid van onderzoek in het onderwijs aan de Universiteit Leiden: Curriculumanalyses van bacheloropleidingen Criminologie, Archeologie en MST*. Rapport nr. 191. Leiden: Universiteit Leiden, ICLON.
- Van der Rijst, R.M. (Ed.) (2009). Conferentieverlag: Licht op Leren, de 35<sup>ste</sup> Onderwijs Research Dagen, 18-20 juni 2008 te Eindhoven. *Pedagogische Studiën*, 86(3), 246-258.

*Symposia and individual paper presentations*

- Van der Rijst, R.M., & Van Driel, J.H. (2005, December). *The role of science faculty's epistemological beliefs in enhancing the research-teaching nexus*. Paper presented at the annual Postgraduate and Newer Researchers Conference of the Society for Research into Higher Education, Edinburgh, Scotland.
- Van der Rijst, R.M. (2006, October). *Exploring Scientific Research Disposition from the perspective of science academics*. Paper presented at the ICO Toogdag, the annual meeting of the Netherlands Interuniversity Centre for Educational Research, Amsterdam, The Netherlands.
- Van der Rijst, R.M., Van Driel, J.H., Kijne, J.W., & Verloop N. (2006, December). Teachers' and researchers' conceptions of scientific inquiry attitudes. In J.H. Van Driel (chair), *Strengthening the link between research, teaching and learning*. Symposium conducted at the annual meeting of the Society for Research into Higher Education, Brighton, UK.
- Van der Rijst, R.M., Van Driel, J.H., Kijne, J.W., & Verloop, N. (2007, June). Wetenschappelijke onderzoekende houdingen in natuurwetenschappelijk onderzoek en onderwijs [Scientific research dispositions in science education and research]. In J. Elen (chair), *Perspectieven op de relatie onderwijs en onderzoek*. Symposium conducted at the Onderwijs Research Dagen, the annual meeting of the Flemish Educational Research Association and the Netherlands Educational Research Association, Groningen, The Netherlands.



- Van der Rijst, R.M., Mainhard, M.T., Van Tartwijk, J.W.F., & Wubbels, Th. (2007, June). *Begeleidingsstijlen van dagelijks begeleiders van promovendi vanuit interpersoonlijk perspectief [Understanding the supervision of doctoral students from an interpersonal perspective]*. Paper presented at the Onderwijs Research Dagen, the annual meeting of the Flemish Educational Research Association and the Netherlands Educational Research Association, Groningen, The Netherlands.
- Van der Rijst, R.M., Van Driel, J.H., Kijne, J.W., & Verloop, N. (2007, August). scientific research dispositions in research, teaching and learning. In J.H. Van Driel (chair), *University teachers' conceptions of relations between teaching and disciplinary research*. Symposium conducted at the biennial meeting of the European Association of Research in Learning and Instruction, Budapest, Hungary.
- Van der Rijst, R.M. (2008, January). *Exploring Scientific Research Disposition from the perspective of science academics*. Paper presented at the Winter School of the Netherlands Interuniversity Centre for Educational Research, Jyväskylä, Finland.
- Mainhard, M.T., Van der Rijst, R.M., Tartwijk, J.W.F., & Wubbels, Th. (2008, March). *Studying the supervision of doctoral students from an interpersonal perspective*. Paper presented at the annual meeting of the American Educational Research Association, New York, USA.
- Van der Rijst, R.M., Kijne, J.W., Verloop, N., & Van Driel, J.H. (2008, April). *Exploring scientific research dispositions from the perspective of academics: A case study approach*. Paper presented at the annual international meeting of the National Association of Research in Science Teaching, Baltimore, USA.
- Van der Rijst, R.M., Visser-Wijnveen, G.J., Verstelle, T., & Van Driel, J.H. (2008, June). *Studentbeleving van research intensieve onderwijsomgevingen bij 'harde' en 'zachte' disciplines [Student experience of research intensive learning environments in 'hard' and 'soft' disciplines]*. Paper presented at the Onderwijs Research Dagen, the annual meeting of the Flemish Educational Research Association and the Netherlands Educational Research Association, Eindhoven, The Netherlands.
- Van der Rijst, R.M. (2008, July). *Comparing three methods to explore scientific research disposition from the perspective of academics*. Paper presented at the meeting of the Junior Researchers of the European Association of Research in Learning and Instruction, Leuven, Belgium.
- Visser-Wijnveen, G.J., Van Driel, J.H., Van der Rijst, R.M., & Verloop, N. (2009, April). *The benefits of integrating disciplinary research in teaching*. Paper

presented at the annual meeting of the American Educational Research Association, San Diego, CA, USA.

- Van der Rijst, R.M., Van Driel, J.H., & Verloop, N. (2009, May). *De invloed van taalhandelingen van docenten op de studentpercepties van research intensieve leeromgevingen [The influence of teachers' speech acts on student perceptions of research intensive learning environments]*. Paper presented at the Onderwijs Research Dagen, the annual meeting of the Flemish Educational Research Association and the Netherlands Educational Research Association, Leuven, Belgium.
- Van der Rijst, R.M., Van Driel, J.H., & Verloop, N. (2009, August). The influence of teachers' speech acts on students' perceptions of research intensive learning environments. In A. Verburgh (chair), *The student experience of the research-teaching nexus*. Symposium conducted at the biennial meeting of the European Association of Research in Learning and Instruction, Amsterdam, The Netherlands.
- Van der Rijst, R.M., Verloop, N., Van Driel, J.H., & Kijne, J.W. (2009, September). Congruence between university science teachers' intentions, approaches, and teaching behaviours. In J.H. Van Driel (chair), *Promoting high quality in undergraduate university science teaching*. Symposium conducted at the meeting of the European Science Education Research Association, Istanbul, Turkey.

*Poster and round-table presentations*

- Elsen, G.M.F., & Van der Rijst, R.M. (2005, March). *Leiden University and the concept of research-based education: A case about policy, research and education*. Round-table presented at the Seminar on Research-Based Teaching in Higher Education, Helsinki, Finland.
- Van der Rijst, R.M., Van Driel, J.H., Kijne, J.W., & Verloop, N. (2006, May). *Opvattingen van universitaire docenten over onderzoekende houding in natuurwetenschappelijk onderzoek en onderwijs [University teachers' conceptions about research dispositions in science education and research]*. Poster presented at the Onderwijs Research Dagen, the annual meeting of the Flemish Educational Research Association and the Netherlands Educational Research Association, Amsterdam, The Netherlands.
- Van der Rijst, R.M. (2007, August). *Construction Research Intensive Learning Environments*. Poster presented at the meeting of the Junior Researchers of the European Association of Research in Learning and Instruction, Budapest, Hungary.

## Curriculum Vitae

Roeland van der Rijst was born in Utrecht, the Netherlands on June 16<sup>th</sup>, 1975. He attended secondary education at the Zeldenrust College in Terneuzen, where he graduated in 1994. Afterwards he studied Physics and Astronomy at Utrecht University, and specialised in the history and foundations of physics. He earned his master degree in Physics and Astronomy in 2003. During this period, he also studied Philosophy at Utrecht University, and specialised in the philosophy of science. In 2003 he completed the master programme in Philosophy. In 2003 he was admitted to the Bilingual and International Teacher Education Programme at IVLOS, Utrecht University. During this programme he taught science classes at schools for secondary education in Zwolle, the Netherlands, and in Pretoria, South Africa. After graduation in June 2004, he was appointed as a teacher at the Vechtstede College in Weesp. At this school he taught science subjects in various streams, VMBO-t, HAVO, and bilingual VWO.

From 2005 to 2009 he worked as a PhD candidate at ICLON, Leiden University Graduate School of Teaching. His PhD research project focused on *the research-teaching nexus in the sciences* and aimed at improving our understanding of how to bridge the gap between research and teaching in undergraduate university science education. This research was linked to a project in the humanities. Besides attending courses and master classes relevant to the study of teachers and teaching in higher education, he presented his research at both national and international conferences. Additionally, he was president of the board of the national PhD student council (VPO) of the Netherlands Educational Research Association (VOR).

He is currently employed as a researcher and educational consultant at the department of higher education of ICLON, Leiden University Graduate School of Teaching. The focus of his research is on teachers and teaching in higher education.



# Dankwoord

De periode waarin ik aan mijn proefschrift heb gewerkt zie ik als een zeer waardevolle tijd. De ideeën verwoord in dit proefschrift zijn tot stand gekomen en aangescherpt door gesprekken met vele mensen. In dit dankwoord wil ik graag enkele personen in het bijzonder bij name noemen.

Allereerst wil ik het College van Bestuur van de Universiteit Leiden bedanken voor het mogelijk maken van dit promotieproject. Ik bedank ook de personen, die direct betrokken waren bij het project. Nico, de gesprekken met jou waren voor mij altijd intellectueel zeer inspirerend en van blijvende waarde. Jan K., ik heb jou leren kennen als een bevlogen wetenschapper en onderwijsman. Ik heb bewondering voor jouw heldere visie op de universitaire onderwijspraktijk. Jan vD., verkozen tot 'begeleider van het jaar 2008'. Ik kan niet anders dan beamen dat jij die prijs verdient hebt. Jouw begeleidingsstijl, waaronder het samen optrekken in het promotieproject spreekt mij zeer aan. Gerda, wij hebben de afgelopen vier jaar intensief samengewerkt en daarbij heb ik je leren kennen als nauwkeurig en consciëntieus; zeer goede eigenschappen voor een wetenschapper. Ik bewonder de manier hoe jij je tijd inplant en je ook vasthoudt aan die planning.

Mijn collega's van de ICLON onderzoeksgroep dank ik voor de prettige samenwerking. De discussies in de onderzoeksgroep en de individuele gesprekken waren voor mij zeer waardevol en hebben mij ingewijd in de geheimen van het onderwijskundig onderzoek. In het bijzonder wil ik mijn medepromovendi noemen waarmee ik de hoogtepunten en dieptepunten door de jaren heen heb gedeeld: Carlos, Chantal, Christel, Dirk, Helma, Jacobiene, Mariska K., Mariska M-L., Marjolein, Michiel, Mirjam B., Mirjam N., Nienke, Romi, Tamara en Wu Wei. Ik wil specifiek Ben Smit bedanken voor alle hulp bij de analyses en de intensieve bijeenkomsten waarin we ons samen hebben gebogen over de transcripten.

Ook de collega's van de afdeling Hoger Onderwijs ben ik dank verschuldigd. Tijdens het promotietraject heb ik vaak het gevoel gehad dat ik me niet volledig kon inzetten voor de afdeling. In de komende jaren zal ik dat proberen goed te maken. De medewerkers van het ondersteunend bureau. Jullie wil ik specifiek bedanken, omdat jullie altijd openstonden voor de korte vragen en voor de grotere klussen.

In de jaren tijdens het promotiewerk heb ik mijn ideeën ook gescherpt in gesprekken met collega's in het land. De bijeenkomsten van de ICO themagroep Teacher and Teacher Education en de VOR divisies Hoger Onderwijs en Lerarenopleiding en Leraarsgedrag waren altijd inspirerend. Ik hoop dat ik mijn

bijdrage aan deze bijeenkomsten kan blijven leveren. Mijn medepromovendi uit het VPO bestuur wil ik in het bijzonder noemen, Amber Walraven, Bas Kollöffel, Ellen Rohaan, Femke Kirschner, Liesbeth Baartman, Reyn van Ewijk en Rosanne Zwart. Ik wil jullie bedanken voor de waardevolle discussies tijdens de bestuursvergaderingen. Helaas kan ik niet iedereen noemen waarmee ik de afgelopen periode heb samengewerkt. Tim, Jan en Theo, jullie hebben laten zien hoe effectief en spontaan een samenwerking tussen collega's kan verlopen.

Tot slot wil ik mijn vrienden en familie bedanken voor de interesse, steun en toeverlaat in de afgelopen periode. Mijn ouders, Evert en Alien, dit is de plek om jullie te bedanken voor het mogelijk maken van mijn opleiding, maar ik wil jullie nog veel meer bedanken voor al jullie lieve zorgen en het bieden van een luisterend oor. Mijn zusje en paranimf, Else Lotte, naast al de gezellige momenten weet ik dat ik met jou ook over de onderwijskundige inhoud kan praten. De dinsdagen met Isa Noa waren voor mij een rustpunt in de week. Maar de mooiste momenten heb ik beleefd met z'n drieën. Arianne, jij hebt me altijd gesteund en open en kritisch meegelezen. Bedankt dat jij begrijpt wat er niet gezegd wordt.

*Roeland van der Rijst  
Leiden, juli 2009*

## ICLON PhD dissertation series

- Hoeflaak, A. (1994). *Decoderen en interpreteren: een onderzoek naar het gebruik van strategieën bij het beluisteren van Franse nieuwsteksten.*
- Verhoeven, P. (1997). *Tekstbegrip in het onderwijs klassieke talen.*
- Meijer, P.C. (1999). *Teachers' practical knowledge: Teaching reading comprehension in secondary education.*
- Zanting, A. (2001). *Mining the mentor's mind: The elicitation of mentor teachers' practical knowledge by prospective teachers.*
- Uhlenbeck, A.M. (2002). *The development of an assessment procedure for beginning teachers of English as a foreign language.*
- Oolbekkink-Marchand, H.W. (2006). *Teachers' perspectives on self-regulated learning: An exploratory study in secondary and university education.*
- Henze-Rietveld, F.A. (2006). *Science teachers' knowledge development in the context of educational innovation.*
- Mansvelder-Longayroux, D.D. (2006). *The learning portfolio as a tool for stimulating reflection by student teachers.*
- Meirink, J.A. (2007). *Individual teacher learning in a context of collaboration in teams.*
- Nijveldt, M.J. (2008). *Validity in teacher assessment: An exploration of the judgement processes of assessors.*
- Bakker, M.E.J. (2008). *Design and evaluation of video portfolios: Reliability, generalizability, and validity of an authentic performance assessment for teachers.*
- Oonk, W. (2009). *Theory-enriched practical knowledge in mathematics teacher education.*
- Visser-Wijnveen, G.J. (2009). *The research-teaching nexus in the humanities: Variations among academics.*
- Van der Rijst, R.M. (2009). *The research-teaching nexus in the sciences: Scientific research dispositions and teaching practice.*