

# **The evolving genetic and pathophysiological spectrum of migraine**

Boukje de Vries

Boukje de Vries

The evolving genetic and pathophysiological spectrum of migraine

PhD thesis, Leiden University, 20 januari, 2011

ISBN: 978-94-90371-61-6

© Boukje de Vries

Except (parts of):

Chapter 2: John Wiley & Sons, Inc.

Chapter 3: American Academy of Neurology Enterprises, Inc.

Chapter 4: American Medical Association

Chapter 5: BMJ Publishing Group Ltd.

Chapter 5 and 6: Nature Publishing Group

No part of this thesis may be reproduced in any form, by print, photocopy, digital file, internet, or any other means without written permission of the copyright owner.

Printed by: Off Page

Cover Design: A. Portier

# **The evolving genetic and pathophysiological spectrum of migraine**

**Proefschrift**

ter verkrijging van

de graad van Doctor aan de Universiteit Leiden,

op gezag van Rector Magnificus prof. mr. P.F. van der Heijden

volgens besluit van het College voor Promoties

te verdedigen op donderdag 20 januari 2011

klokke 15:00 uur

door

Boukje de Vries

geboren te Noordoostpolder

in 1979

---

## **Promotiecommissie**

### **Promotores:**

Prof. dr. M.D. Ferrari

Prof. dr. R.R. Frants

### **Co-promotor:**

Dr. A.M.J.M. van den Maagdenberg

### **Overige leden:**

Prof. dr. G.J.B. van Ommen

Prof. dr. R.A. Roos

Prof. dr. C.M. van Duijn (Erasmus MC, Rotterdam)

Prof. dr. A. Palotie (Sanger Institute, Cambridge, United Kingdom; University of Helsinki, Finland)

The studies presented in this thesis were performed at the Department of Human Genetics of the Leiden University Medical Center (LUMC). This work was supported by grants of the Netherlands Organisation for Scientific Research (NWO) (VICI 918.56.602); the EU sixth framework programme (FP6) "EUROHEAD" (grant LSHM-CT-2004-504837); and the Centre for Medical Systems Biology within the framework of the Netherlands Genomics Initiative (NGI)/Netherlands Organisation for Scientific Research (NWO).

Financial support for the publication of this thesis has been provided by the J.E. Jurriaanse Stichting, Nederlandse Hoofdpijn Vereniging, Menarini Farma Nederland and Allergan.

<b>Chapter 1</b>	General Introduction .....	7
<b>Chapter 2</b>	Genetic and functional analysis of FHM gene mutations .....	29
<b>2.1</b>	<i>CACNA1A</i> mutation linking hemiplegic migraine and alternating hemiplegia of childhood .....	31
	<i>Cephalalgia</i> 2008 28:887-891	
<b>2.2</b>	Familial hemiplegic migraine is associated with febrile seizures in an FHM2 family with a novel <i>de novo</i> <i>ATP1A2</i> mutation .....	39
	<i>Epilepsia</i> 2009 50:2503-2504	
<b>2.3</b>	The novel p.L1649Q mutation in the <i>SCN1A</i> epilepsy gene is associated with familial hemiplegic migraine: genetic and functional studies .....	45
	<i>Human mutation</i> 2007 28:522	
<b>Chapter 3</b>	Systematic analysis of three FHM genes in 39 sporadic patients with hemiplegic migraine .....	57
	<i>Neurology</i> 2007 4:2170-2176	
<b>Chapter 4</b>	Episodic ataxia associated with <i>EAT1</i> mutation C186S affecting glutamate reuptake .....	73
	<i>Archives of Neurology</i> 2009 66:97-101	
<b>Chapter 5</b>	Mutations in <i>TREX1</i> play a role in disorders comorbid with migraine .....	85
<b>5.1</b>	C-terminal truncations in human 3'-5' DNA exonuclease <i>TREX1</i> cause autosomal dominant retinal vasculopathy with cerebral leukodystrophy .....	87
	<i>Nature Genetics</i> 2007 39:1068-1070	
<b>5.2</b>	<i>TREX1</i> gene variant in neuropsychiatric systemic lupus erythematosus .....	103
	<i>Annals of the Rheumatic Diseases</i> 2010 69:1886-1887	
<b>Chapter 6</b>	Genome-wide association studies in migraine .....	109
<b>6.1</b>	Genome-wide association study of migraine implicates a common susceptibility variant on 8q22.1 .....	111
	<i>Nature Genetics</i> 2010 467:52-58	
<b>6.2</b>	Genome-wide association study for migraine in a Dutch genetic isolate and meta-analysis with other population-based cohorts .....	137
	<i>In preparation</i>	
<b>Chapter 7</b>	RNA expression profiles of familial hemiplegic migraine type 1 mouse models with relevance to migraine-associated cerebellar ataxia .....	161
	<i>In preparation</i>	
<b>Chapter 8</b>	General Discussion .....	179
<b>Summary</b>	.....	208
<b>Nederlandse samenvatting</b>	.....	211
<b>List of abbreviations</b>	.....	215
<b>Dankwoord</b>	.....	217
<b>List of publications</b>	.....	219
<b>Curriculum Vitae</b>	.....	223



---

# 1.0

**General introduction  
& scope of the thesis**

---

---

## 1.1. Migraine

Migraine is an episodic neurovascular disorder that is characterized by attacks of severe, unilateral, pulsatile headache that is often accompanied by nausea, vomiting, photo- and/or phonophobia. Typical migraine attacks last a few hours to several days.<sup>1</sup> Migraine can start at any age, but the age at onset usually is before the age of 50 years. The peak age at onset is between 10 to 12 years of age for males and between age 14 to 16 for females.<sup>2</sup> Migraine is a very common disease that is more prevalent in women than in men. The one-year overall prevalence of migraine in Western countries is around 11%; with 6-8% in men and 15-18% in women.<sup>3-6</sup> The median attack frequency is 1.5 per month. Approximately ten percent of migraineurs have weekly attacks.<sup>6</sup> The World Health Organisation (WHO) rates severe migraine among the most disabling chronic disorders.<sup>7</sup>

## 1.2. Migraine with and without aura

Migraine can be subdivided in migraine without aura (MO) and migraine with aura (MA), based on the absence or presence of an aura phase preceding the headache phase (Table 1). About one-third of the migraine patients experience an aura. The aura phase generally lasts 20-60 minutes and includes mostly visual symptoms, but symptoms can also be sensory or speech related.<sup>8</sup>

Currently no reliable biological markers are available for the diagnosis of migraine. Therefore, the diagnosis depends on the patient's symptom description, using the Diagnostic and Classification Criteria of the International Headache Society.<sup>1</sup> Patients are characterised by the recurrence of their migraine attacks (Table 1).<sup>1</sup> To classify as an MO patient, the patient needs to have had at least five MO attacks. An MA patient has had at least two MA attacks. Current treatment options for migraine are far from optimal and effective in only about half of the patients.<sup>9</sup>

**Table 1.** *International headache criteria for migraine without and migraine with aura*<sup>1</sup>

---

### **Migraine without aura**

---

- A. At least five attacks fulfilling criteria B-D
  - B. Headache attacks lasting 4 to 72 hours (untreated or unsuccessfully treated)
  - C. Headache has at least two of the following characteristics:
    - 1. Unilateral location
    - 2. Pulsating quality
    - 3. Moderate or severe pain intensity
    - 4. Aggravation by or causing avoidance of routine physical activity (e.g., walking or climbing stairs)
  - D. During headache at least one of the following;
    - 1. Nausea and/or vomiting
    - 2. Photophobia and phonophobia
  - E. Not attributed to another disorder
-



---

**Migraine with aura**

---

- A. At least two attacks fulfilling criteria B-D
  - B. Aura consisting of at least one of the following, but no motor weakness:
    - 1. Fully reversible visual symptoms including positive features (e.g., flickering lights, spots, or lines) and/or negative features (i.e., loss of vision)
    - 2. Fully reversible sensory symptoms including positive features (i.e., pins and needles) and/or negative features (i.e. numbness)
    - 3. Fully reversible dysphasic speech disturbance
  - D. Headache fulfilling criteria B-D for migraine without aura begins during the aura or follows aura within 60 minutes
  - E. Not attributed to another disorder
- 

**1.3. Migraine is a genetic disorder**

Migraine has a strong genetic component. Many patients have first-degree relatives who also suffer from migraine.<sup>10</sup> Population-based family studies showed that the familial risk of migraine is increased.<sup>11,12</sup> First-degree relatives of probands with MO have an almost 2-fold increased risk to also suffer from this disorder, but had only 1.4 times the risk of MA, compared with the general population. Instead, first-degree relatives of probands with MA had a nearly 4-fold increased risk for MA, but no increased risk for MO.<sup>11</sup> Studies of mono- and dizygotic twin pairs are the classical method to investigate the relative importance of genetic and environmental factors. Migraine concordance rates are between 1.5 and 2 times higher in monozygotic twins than in dizygotic twins for both MO and MA<sup>13,14</sup>, indicating that genetic factors are important in migraine susceptibility. A large population-based twin study comprising of some thirty thousand twin pairs revealed that genetic and environmental factors had an almost equally large contribution.<sup>15</sup> Shared environmental factors seemed to play a minor role as shown by studies comparing twins that were raised together or apart.<sup>16,17</sup>

**1.4. Hemiplegic migraine**

An often-used approach to find genes for complex genetic disorders is to study monogenic subtypes of these disorders. A monogenic subtype of migraine with aura exists and is called familial hemiplegic migraine (FHM). FHM is characterized by transient hemiparesis during the aura phase (Table 2)<sup>1</sup>, which may last from several minutes to several hours or even days. FHM patients have at least one additional first-degree family member that has identical hemiplegic migraine attacks.<sup>1</sup> FHM can be associated with additional neurological features, including cerebellar dysfunction, epilepsy and mental retardation.<sup>18-20</sup>

---

A sporadic form of hemiplegic migraine does exist and is called sporadic hemiplegic migraine (SHM). These patients do not have affected family members.<sup>1</sup> The estimated population prevalence for SHM is similar to that of FHM; approximately 0.01%. The clinical symptoms of SHM patients are identical to those of FHM.<sup>21</sup> It is unknown whether FHM and SHM share biological pathways and genetic factors.

**Table 2.** *International Headache Society Criteria for Familial Hemiplegic Migraine<sup>1</sup>*

---

### **Familial hemiplegic migraine**

---

- A. At least two attacks fulfilling criteria B and C
  - B. Aura consisting of fully reversible motor weakness and at least one of the following;
    - 1. Fully reversible visual symptoms including positive features (e.g., flickering lights, spots, or lines) and/or negative features (i.e., loss of vision)
    - 2. Fully reversible sensory symptoms including positive features (i.e. pins and needles) and/or negative features (i.e., numbness)
    - 3. Fully reversible dysphasic speech disturbance
  - C. At least two of the following:
    - 1. At least one aura symptoms develops gradually over  $\geq 5$  minutes, and/or different aura symptoms occur in succession over  $\geq 5$  minutes
    - 2. Each symptom lasts  $\geq 5$  and  $\leq 24$  hours
    - 3. Headache fulfilling criteria B-D for migraine without aura begins during the aura or follows aura within 60 minutes
  - D. At least on first-or second-degree relative has had attacks fulfilling these criteria A-E
  - E. Not attributed to another disorder
- 

### **1.5. Hemiplegic migraine as a model for common migraine**

A considerable proportion of the FHM and SHM patients also has attacks of common migraine with or without aura, not associated with hemiparesis.<sup>22,18,23</sup> Furthermore, the main clinical symptoms of the headache and aura phase are similar in HM and common migraine.<sup>24</sup> Therefore, FHM is believed to be part of the migraine spectrum and is considered a suitable model to study the pathophysiology of common migraine. Thus, genes and pathways involved in HM can be considered candidate genes and pathways for the common forms of migraine.

### **1.6. Hemiplegic migraine genes**

So far, three genes have been identified in families with FHM. The first FHM gene identified is *CACNA1A* (FHM1) that is located on chromosome 19p13.<sup>25</sup> *CACNA1A* encodes the  $\alpha 1$  subunit of neuronal  $Ca_v2.1$  (P/Q-type) voltage-gated calcium channels that are widely expressed throughout the central nervous system (CNS)<sup>26</sup> and the neuromuscular junction.<sup>27</sup> FHM1 mutations are

associated with a broad spectrum of clinical features besides hemiplegic migraine.<sup>18</sup> Cerebellar ataxia<sup>28-31</sup> and epilepsy, both during severe FHM attacks<sup>32</sup> or independent of FHM attacks<sup>33,34</sup>, are not uncommon. FHM1 mutations are also identified in some sporadic patients with hemiplegic migraine.<sup>35</sup>

Mutations in the *CACNA1A* gene can also cause episodic ataxia type-2 (EA2)<sup>25</sup> and spinocerebellar ataxia type-6 (SCA6).<sup>36</sup> EA2 is characterized by recurrent episodes of ataxia often associated with vertigo and migrainous headache and can be triggered by exercise, fatigue, and stress.<sup>37</sup> Whereas FHM1 is mainly caused by missense mutations, EA2 is mostly caused by nonsense, frameshift, splice site, and sometimes missense mutations.<sup>38</sup> SCA6 resulting in late onset ataxia is characterized by atrophy of cerebellar Purkinje cells. SCA6 is a polyglutamine disorder caused by small extensions of a CAG repeat that is located in the 3'-end of the *CACNA1A* gene.

The second FHM gene, *ATP1A2* (FHM2), is located on chromosome 1q23.<sup>39</sup> It encodes the  $\alpha 2$  subunit of sodium-potassium pumps. Most of the *ATP1A2* mutations are associated with pure FHM without additional clinical symptoms.<sup>39-42</sup> However, over the years, a number of FHM2 mutations have been reported that are associated with FHM and cerebellar problems<sup>43</sup>, childhood convulsions (BFIC)<sup>19</sup>, and epilepsy.<sup>41</sup> Interestingly, certain *ATP1A2* mutations were shown to be associated with non-hemiplegic migraine phenotypes, such as basilar migraine<sup>44</sup> and even common migraine.<sup>45</sup> A specific *ATP1A2* mutation was identified in a family with atypical alternating hemiplegia of childhood (AHC)<sup>46,47</sup>, a rare brain disorder that is characterized by hemiplegia, quadriplegia and other paroxysmal phenomena, including choreoathetotic movements and nystagmus. Age at onset in AHC is typically before 18 months (but later in the AHC family with the *ATP1A2* mutation) and symptom cessation often occurs after falling asleep.<sup>48</sup>

The most recently identified FHM gene is the *SCN1A* (FHM3) gene, which is located on chromosome 2q24<sup>49</sup> and encodes the  $\alpha 1$  subunit of neuronal voltage-gated  $\text{Na}_v 1.1$  sodium channels. *SCN1A* is a well-known epilepsy gene with over 150 truncating and missense mutations that are associated with childhood epilepsy (i.e., severe myoclonic epilepsy of infancy (SMEI) or generalized epilepsy with febrile seizures (GEFS+)).<sup>50,51</sup> The fact that not all FHM families are linked to one of the three known FHM loci implies that there are additional FHM genes to be identified.

### 1.7. Monogenic and complex disorders in which migraine is prevalent

Over the past years, several biological pathways have been suggested to play a role in migraine pathophysiology. Most prevailing hypotheses suggest that migraine has a vascular, a neuronal or inflammatory origin. Interestingly, migraine patients have an increased risk (comorbidity) for several diseases in which these pathways also play a role.

---

### *Vascular pathway*

A vascular component in the etiology of migraine has been debated for many years<sup>52,53</sup> and several vascular disorders show an increased prevalence of migraine. A clear example of a monogenetic vascular disorder in which migraine can be considered part of the clinical spectrum is the autosomal dominant disorder Cerebral Autosomal Dominant Arteriopathy with Subcortical Infarcts and Leukoencephalopathy (CADASIL).<sup>54</sup> CADASIL is caused by mutations in the *NOTCH3* gene, which encodes the Notch3 receptor that plays a key role in vascular smooth muscle cell function in small arteries and arterioles of the brain.<sup>55</sup> Up to one-third of CADASIL patients suffer from migraine with aura, where migraine often is the presenting clinical symptom.<sup>56</sup> Another example of a vascular monogenic disorder in which migraine is highly prevalent is Hereditary Vascular Retinopathy (HVR).<sup>57</sup> HVR is primarily characterized by progressive blindness due to vascular retinopathy and can be associated with a wide range of systemic and cerebral symptoms, including cerebral infarcts and white matter hyperintensities, vascular dementia, liver and kidney dysfunction, Raynaud's phenomenon, and migraine. Two additional North American families with similar symptoms were reported<sup>58,59</sup>, which like the Dutch HVR family were linked to the same 3p21.1-p21.3 region.<sup>60</sup> A family-based genetic association analysis between the 3p21 locus and migraine and Raynaud's phenomenon showed that the HVR locus gives a higher susceptibility for migraine and Raynaud's phenomenon in the Dutch HVR family.<sup>61</sup> Furthermore, also non-genetic vasculopathies, such as ischemic stroke and ischemic heart disease can be comorbid with migraine.<sup>62,63</sup>

### *Neuronal pathway*

Especially genetic studies in monogenic FHM showed evidence for involvement of neuronal hyperexcitability pathways in migraine.<sup>64,65</sup> Two other common brain disorders in which neuronal hyperexcitability pathways seem to play a role are epilepsy and depression. The shared neuronal hyperexcitability pathway, may well explain why both epilepsy and depression are bi-directionally comorbid with migraine.<sup>66,67</sup> The association between migraine and epilepsy is particularly evident for FHM. Epilepsy often observed in carriers of FHM gene mutations, and as mentioned earlier, the FHM3 *SCN1A* gene is also a well-known epilepsy gene. Moreover, six percent of patients with common migraine have epilepsy<sup>68</sup> and patients with epilepsy have a 2.4 times increased risk to also suffer from migraine.<sup>69</sup> Migraineurs also have increased risk for major depression; population-based odds ratios (ORs) range from 2.0 to 5.8, with strongest associations for MA.<sup>70</sup> Patients with depression have a 2.8-3.4 times increased risk for migraine.<sup>71</sup> The bi-directional comorbidity for these disorders suggests that epilepsy and depression have, at least in part, a shared etiology with migraine. This is strengthened by the fact that anti-epileptic and antidepressant drugs are effective in migraine patients.<sup>72</sup>

### *Inflammatory pathway*

During the headache phase of a migraine attack several vasoactive neuropeptides are released in the brain. It is hypothesized that these neuropeptides can cause neurogenic inflammation.<sup>73,74</sup> An example of an inflammatory disorder in which migraine is prevalent is systemic lupus erythematosus (SLE). SLE is a relapse-remitting autoimmune disorder that may affect multiple organs including the brain. About 40% of SLE patients have migraine, mostly migraine with aura.<sup>75</sup> Studying the genetics and molecular pathways of the disorders that are comorbid with migraine may provide valuable insights in molecular mechanisms involved in migraine.

### **1.8. Migraine mechanisms**

Although it was previously thought that migraine either had a vascular or a neurogenic origin, the current view is that migraine has a neurovascular origin (for review see Goadsby 2007).<sup>76</sup> Headache is not merely the consequence of painful vasodilatation, but is due to the activation of the trigeminovascular system (TGVS) that consists of meningeal and superficial cortical blood vessels that are innervated by the trigeminal nerve. The TGVS projects to the trigeminal nucleus caudalis in the brainstem, which transfers abnormal pain signals to higher order central nervous system centers giving rise to the headache. It is now well accepted that the migraine aura is not due to reactive vasoconstriction, but is neurally derived and most likely caused by the human equivalent of the cortical spreading depression (CSD) of Leao.<sup>77,78</sup> In experimental animals, CSD is characterized by a short-lasting, intense wave of neuronal and glial cell depolarization that starts in the occipital (visual) cortex and spreads slowly to frontal regions of the cortex at a rate of approximately 2-5 mm/min and that is accompanied by massive fluxes of ions ( $\text{Ca}^{2+}$ ,  $\text{Na}^+$ , and  $\text{K}^+$ ) followed by a longer-lasting inhibition of spontaneous and evoked neuronal activity (for review see Somjen 2002).<sup>79</sup> The electrophysiological changes are associated with changes in cerebral blood flow (CBF). There is a considerable body of clinical evidence that CSD is the likely basis of the migraine aura. Visual aura symptoms in humans<sup>80-82</sup> typically spread from the centre of the visual field to the periphery with a propagation rate comparable to CSD evoked in experimental animals. Positive (e.g. scintillations, paraesthesia's) and negative (e.g. scotomata, paresis) phenomena of the migraine aura can be explained by the initial transient hyperexcitation front of CSD followed by neuronal depression. Most importantly, however, functional neuroimaging studies in humans using blood-oxygen level dependent (BOLD) signals have convincingly demonstrated that CBF changes that occur during a migraine aura are very similar to those observed in experimental animals during CSD.<sup>83</sup>

---

Animal studies have shown that CSD can activate the TGVS, and thus might trigger headache mechanisms.<sup>84</sup> However, the connection between CSD and headache in patients remains an open question.<sup>85,86</sup> For instance, it would not explain how the headache phase is triggered in the majority of migraine patients that never experience an aura. Also, the fact that ketamine treatment can reduce aura symptoms but fails to prevent the headache<sup>87</sup> would argue against a key role of CSD in triggering the headache. Although one can hypothesize that spreading depression may occur in these patients in clinically silent subcortical areas of the brain without propagating to the visual cortex<sup>5,88</sup>, this has never been demonstrated.

### **1.9. Functional consequences of FHM mutations**

#### *Functional effects of FHM1 mutations on Ca<sub>v</sub>2.1 Ca<sup>2+</sup> channels*

Electrophysiological methods have been used to study the effect of FHM1 mutations on calcium channel functioning. Multiple aspects of the calcium channel are of importance for its function: expression of the channel, localization on the cell membrane, conductance of the channel, voltage-dependence of opening, closing and reopening, and duration of the open state. For electrophysiological studies of FHM1 mutations, heterologous expression systems (without endogenous expression of Ca<sub>v</sub>2.1- $\alpha_{1A}$ ) were transfected with recombinant Ca<sub>v</sub>2.1 channel components. Calcium channel parameters were measured using whole cell or single channel electrophysiology to assess the consequence of FHM1 mutations on the cellular level (i.e., the combined effect of all Ca<sub>v</sub>2.1 channels at the plasma membrane) or on the single channel, respectively (for review see Pietrobon 2007). At the single channel level, FHM1 mutations open at more negative voltages and have an enhanced channel open probability, compared to wild-type channels.<sup>90-92</sup> This *gain-of-function* consequence FHM1 mutations results in increased neuronal Ca<sup>2+</sup> influx, which would predict increased neurotransmission. At the whole cell level, however, neurons from Ca<sub>v</sub>2.1- $\alpha_{1A}$  knockout mice<sup>93,94</sup> that were transfected with either wild-type or mutant Ca<sub>v</sub>2.1- $\alpha_{1A}$  cDNA constructs, all seem to indicate a *loss-of-function* effect of FHM1 mutations.<sup>90-92,96</sup> Hippocampal neurons derived from Ca<sub>v</sub>2.1- $\alpha_{1A}$  knockout mice, that were transfected with wild-type or mutant Ca<sub>v</sub>2.1- $\alpha_{1A}$  cDNA constructs revealed a reduced neurotransmitter release and a decreased contribution of P/Q-type channels controlling neurotransmitter release.<sup>95,96</sup>

#### *Functional effects of FHM2 mutations on Na,K ATPases*

The functional consequences of *ATP1A2* mutations have been investigated by using various in vitro assays. The cell survival assay is a frequently used functional test that gives an indication of disease causality of *ATP1A2* mutations. Na<sup>+</sup>,K<sup>+</sup>-ATPase activity is necessary for cell survival. In the cell survival assay, endogenous sodium potassium pumps are inactivated by application of the drug ouabain to HeLa cells that express either wild-type or mutant  $\alpha 2$  Na<sup>+</sup>,K<sup>+</sup>-ATPase cDNAs that are made insensitive to ouabain.<sup>97</sup> The assay tests whether transfected wild-type

or mutant  $\alpha 2$  Na<sup>+</sup>,K<sup>+</sup>-ATPase cDNAs are able to rescue cell survival. Several *ATP1A2* mutations are tested using this cell survival assay and many showed mutations that have an effect on cell survival. For a few *ATP1A2* mutations, Segall and colleagues studied additional parameters, such as catalytic turnover, extracellular K<sup>+</sup> affinity and Na<sup>+</sup>,K<sup>+</sup> ATPase kinetics.<sup>98,99</sup> These studies showed that certain mutations, such as FHM2 mutation T345A, that were fully functional in the cell survival assay, could show an effect on other parameters.

#### *Functional effects of FHM3 mutations on sodium channels*

Similar to functional studies for FHM1 mutations, electrophysiological methods were used to determine the functional effect of the first FHM3 mutation. FHM3 mutation p.Gln1489Lys was cloned into the highly homologous heart-specific *SCN5A* cDNA due to apparent cloning difficulties with the brain-specific *SCN1A* cDNA. Wild-type or mutant *SCN5A* cDNA was transfected into human tsA201 cells.<sup>49</sup> Electrophysiological measurements (whole cell recordings) revealed a 2-4-fold accelerated recovery from fast inactivation for mutant Na<sub>v</sub>1.5 sodium channels compared to wild-type<sup>49</sup>, indicating increased firing capacity of the mutant neuron.

### **1.10. Common pathway and increased neurotransmission**

The three FHM genes fit in a common neuronal pathway. Mutations in all three FHM genes affect the transport of ions and lead to increased levels of glutamate and K<sup>+</sup> ions in the synaptic cleft. This may lead to an increased susceptibility for CSD.<sup>79</sup> Increased susceptibility for CSD could well explain the aura phase of migraine attacks. Another gene that would perfectly fit this neuronal pathway is the *SLC1A3* gene, encoding EAAT1 the excitatory amino acid transporter type 1. EAAT1 is involved in glutamate removal from the synaptic cleft.<sup>100,101</sup> Mutations in EAAT1 could, like the known FHM mutations, affect the glutamate levels in the synaptic cleft.

Several additional observations point at a potentially pivotal role of enhanced brain glutamate levels in the triggering of migraine attacks. For instance, (i) glutamate receptor antagonists may have acute anti-migraine activity<sup>102</sup>; (ii) noxious dural stimulation, as an experimental animal model for acute migraine, increases glutamate release from trigeminal ganglion neurons<sup>103</sup>; (iii) plasma<sup>104</sup> and cerebrospinal fluid<sup>105</sup> levels of glutamate are increased in migraineurs with and without aura in between attacks, further rising during attacks.

### **1.11. Migraine mouse models**

#### *Natural mouse mutants*

Different natural mouse mutants with mutations in the *Cacna1a* gene exist, such as *Tottering*, *Leaner*, *Rolling Nagoya* and *Rocker*.<sup>106-109</sup> Missense *Cacna1a* mutations are present in the *Tottering*, *Rolling Nagoya* and *Rocker* mutants (i.e., P601L, R1262G and T1310K, respectively).<sup>106,110,111</sup>

---

The *Leaner* mutant has a rather complex *Cacna1a* mutation leading to exon skipping and the inclusion of intronic sequences in the aberrantly spliced *Cacna1a* gene.<sup>112</sup> These natural mouse mutants all exhibit some degree of ataxia, and except for *Rocker*, several seizure types are also present. Furthermore, dyskinesia and dystonia are part of the phenotype of *Tottering* and *Leaner*, respectively.<sup>113,107</sup>

### *Transgenic mouse models*

*Cacna1a*-deficient knock-out mice ( $\alpha_{1A}$ -/-) that do not express  $\text{Ca}_v2.1$   $\text{Ca}^{2+}$  channels initially appear healthy. However, at approximately 10 days after birth, these mice develop a rapidly progressive neurological deficit with specific characteristics of ataxia and dystonia, and after 3-4 weeks after birth they die.<sup>93,94</sup> These knock-out mice are perhaps not very useful to study migraine for several reasons: i) whereas neurotransmission in the NMJ in heterozygous seems unaffected<sup>114</sup>, the homozygous mice have a lethal phenotype very different from migraine, ii) the knockout mutation is a *loss-of-function* mutation, unlike FHM1 mutations that are considered *gain-of-function mutations*.<sup>89</sup> Therefore, it seems more appropriate to study migraine pathophysiology using knock-in migraine mouse models that carry human pathogenic FHM1 mutations.

Two transgenic knock-in (KI) mouse models harbouring either the R192Q or the S218L FHM1 mutation were generated by introducing the respective mutation into the orthologous *Cacna1a* gene by homologous recombination.<sup>115,116</sup> These mutations were previously identified in FHM1 patients.<sup>25,117</sup> Whereas the R192Q mutation causes a relatively mild form of FHM, the S218L mutation is associated with a more severe form of FHM with additional neurological features (i.e., cerebellar ataxia, epilepsy and brain edema after mild head trauma). Interestingly, S218L KI mice show a complex phenotype that is very similar to that observed in S218L patients, whereas R192Q KI mice show no overt phenotype. These migraine mice models are considered valuable models to study migraine pathophysiology.



### 1.12. Scope and outline of the thesis

Identification and characterization of migraine susceptibility genes and pathways that are involved in the disease mechanisms are very important for understanding the pathophysiology of migraine. It may also give new insights that can be useful for drug development and treatment of migraine. Studies in this thesis focus on genetic factors and molecular pathways involved in FHM, SHM, other monogenic diseases in which migraine is prevalent, as well as the common forms of migraine. As HM is considered a suitable model for the common forms of migraine, the identification of mutations in FHM genes and investigating their functional consequences is also relevant to increase insights in the genetic and molecular background of the common forms of migraine. At the start of the thesis, three FHM genes had been identified: *CACNA1A*, *ATP1A2* and *SCN1A*.

In **Chapter 2**, several mutations in the three known FHM genes are presented with a functional characterisation using cellular assays or electrophysiological studies in cell systems. The mutations are associated with a broad spectrum of clinical symptoms, ranging from FHM and epilepsy to atypical AHC.

In **Chapter 3**, the involvement of the FHM genes in 39 sporadic patients with HM is studied. Although SHM patients are clinical indistinguishable from FHM patients, it has not been extensively studied whether FHM genes may play a major role in this form of hemiplegic migraine. The mutation scan resulted in the identification of several novel DNA variants. For all variants, functional studies were performed.

**Chapter 4** describes the involvement of the excitatory amino acid transporter EAAT1 in EA2 patients that were negative for mutations in the *CACNA1A* gene. EAAT1 fits the same cortical glutamate-related pathway of the three known FHM gene products. Previously, a mutation in this gene had been identified in a patient with a particularly severe clinical phenotype that included episodic ataxia and hemiplegic attacks. A novel EAAT1 mutation is identified in a EA2 patient and associated clinical and functional characteristics are described.

Previously, a Dutch family with a vascular monogenic disorder; Hereditary Vascular Retinopathy (HVR), was together with two additional North American families with similar symptoms linked to chromosome 3p21. In **Chapter 5.1**, the *TREX1* gene is identified as the causative gene in these three families. Retinal Vasculopathy with Cerebral Leukodystrophy (RVCL) is the novel name for this vascular disorder with autosomal dominant inheritance, that is characterized by progressive blindness due to vascular retinopathy that can be associated with a wide range

---

of clinical symptoms, including migraine. *TREX1* mutations are also identified in several other vascular and immune-related disorders, including Systemic Lupus Erythematosis (SLE). **Chapter 5.2** describes the first *TREX1* mutation in a patient with *neuropsychiatric* SLE (NPSLE).

The rapid development of high-throughput genotyping during the last years made genome-wide association studies (GWAS) a feasible and attractive method to identify genetic factors for genetically complex disorders, such as migraine. Large clinic-based migraine cohorts from various European headache clinics (**Chapter 6.1**) and population-based cohorts from the Dutch Icelandic (DICE) consortium (**Chapter 6.2**) were used for these GWA studies. The most significantly associated SNP in the clinic-based migraine GWAS was tested in several independent MA and MO replication cohorts encompassing a total amount of over 3,000 migraine patients. For the population-based study first a GWAS was performed in a large genetically isolated population from the south of the Netherlands (ERF) that was followed by meta-analysis of GWAS data from five additional cohorts.

The identification of FHM genes gave the opportunity to generate transgenic mouse models. Two *Cacna1a* knock-in migraine mouse models with specific FHM1 mutations (i.e. S218L and R192Q) were generated. These knock-in mice are considered useful tools to study migraine. In **Chapter 7**, we study the RNA expression profiles of cerebellum and occipital cortex of FHM1 knock-in mice under basal (i.e. un-triggered) conditions, to investigate whether and to which extent neurobiological differences in these migraine mice were regulated at the gene expression level.

**Chapter 8** provides a general discussion of the thesis, reviewing the results and discussing future possibilities for research in migraine genetics.

## References

1. Headache classification subcommittee of the international headache society. The international Classification of Headache Disorders. 2nd Edition. *Cephalalgia* 2004;24:1-160.
2. Haut SR, Bigal ME, Lipton RB (2006) Chronic disorders with episodic manifestations: focus on epilepsy and migraine. *Lancet Neurol.* 5:148-157.
3. Rasmussen BK, Jensen R, Schroll M, Olesen J (1991) Epidemiology of Headache in General-Population – A prevalence Study. *J Clin Epidemiol* 44:1147-1157.
4. Launer LJ, Terwindt GM, Ferrari MD (1999) The prevalence and characteristics of migraine in a population-based cohort: the GEM study. *Neurology* 53:537-542.
5. Lipton RB, Stewart WF (1998) Migraine headaches: Epidemiology and comorbidity. *Clin Neurosci* 5:2-9.
6. Goadsby PJ, Lipton RB, Ferrari MD (2002) Migraine--current understanding and treatment. *N Engl J Med.* 346:257-270.
7. Menken M, Munsat TL, Toole JF (2000) The global burden of disease study. Implications for Neurology. *Arch Neurol* 57:418-420.
8. Russell MB, Olesen J (1996) A nosographic analysis of the migraine aura in a general population. *Brain* 119:355-361.
9. Ramadan NM, Schultz LL, Gilkey SJ (1997) Migraine prophylactic drugs: proof of efficacy, utilization and cost. *Cephalalgia* 17:73-80.
10. Russell MB, Olesen J (1993) The genetics of migraine without aura and migraine with aura. *Cephalalgia* 13:245-248.
11. Russell MB, Olesen J (1995) Increased familial risk and evidence of genetic factor in migraine. *BMJ* 311:541-544.
12. Stewart WF, Staffa J, Lipton RB, Ottman R (1997) Familial risk of migraine: a population-based study. *Ann Neurol* 41:166-172.
13. Ulrich V, Gervil M, Kyvik KO, Olesen J, Russell MB (1999) Evidence of a genetic factor in migraine with aura: a population-based Danish twin study. *Ann Neurol* 45:242-246.
14. Gervil M, Ulrich V, Kyvik KO, Olesen J, Russell MB (1999) Migraine without aura: a population based twin study. *Ann Neurol* 46:606-611.
15. Mulder EJ, Van Baal C, Gaist D, Kallela M et al (2003) Genetic and environmental influences on migraine: a twin study across six countries. *Twin Res* 6:422-431.
16. Ziegler DK, Hur YM, Bouchard TJ jr, Hassanein RS, Barter R (1998) Migraine in

- 
- twins raised together and apart. *Headache* 38:417-422.
17. Svensson DA, Larsson B, Waldenlind E, Pedersen NL (2003) Shared rearing environment in migraine: results from twins reared apart and twins reared together. *Headache* 43:235-244.
18. Ducros A, Dernier C, Joutel A, Cecillon M et al (2001) The clinical spectrum of familial hemiplegic migraine associated with mutations in a neuronal calcium channel. *N Engl J Med* 354:17-24.
19. Vanmolkot KR, Kors EE, Hottenga JJ, Terwindt GM et al (2003) Novel mutations in the Na<sup>+</sup>, K<sup>+</sup>-ATPase pump gene ATP1A2 associated with familial hemiplegic migraine and benign familial infantile convulsions. *Ann Neurol* 54:360-366.
20. Vanmolkot KR, Stroink H, Koenderink JB, Kors EE et al (2006) Severe episodic neurological deficits and permanent mental retardation in a child with a novel FHM2 ATP1A2 mutation. *Ann Neurol* 59:310-314.
21. Thomsen LL, Ostergaard E, Olesen J, Russell MB (2003a) Evidence for a separate type of migraine with aura: sporadic hemiplegic migraine. *Neurology* 60:595-601.
22. Terwindt GM, Ophoff RA, Haan J, Vergouwe MN et al (1998a) Variable clinical expression of mutations in the P/Q-type calcium channel gene in familial hemiplegic migraine. Dutch Migraine Genetics Research Group. *Neurology* 50:1105-1110.
23. Thomsen LL, Ostergaard E, Romer SF, Andersen I et al (2003b) Sporadic hemiplegic migraine is an aetiologically heterogeneous disorder. *Cephalalgia* 23:921-928.
24. Thomsen LL, Eriksen MK, Roemer SF, Andersen I et al (2002) A population-based study of familial hemiplegic migraine suggests revised diagnostic criteria. *Brain* 125:1379-1391.
25. Ophoff RA, Terwindt GM, Vergouwe MN, van Eijk R et al (1996) Familial hemiplegic migraine and episodic ataxia type-2 are caused by mutations in the Ca<sup>2+</sup> channel gene CACNL1A4. *Cell* 87:543-552.
26. Westenbroek RE, Sakurai T, Elliott EM, Hell JW et al (1995) Immunochemical identification and subcellular distribution of the alpha 1A subunits of brain calcium channels. *J Neurosci* 15:6403-6418.
27. Uchitel OD, Protti DA, Sanchez V, Cherksey BD et al (1992) P-type voltage-dependent calcium channel mediates presynaptic calcium influx and transmitter release in mammalian synapses. *Proc Natl Acad Sci USA* 89:3330-3333.
28. Ducros A, Denier C, Joutel A, Vahedi K et al (1999) Recurrence of the T666M

- calcium channel CACNA1A gene mutation in familial hemiplegic migraine with progressive cerebellar ataxia. *Am J Hum Genet* 64:89-98.
29. Battistini S, Stenirri S, Piatti M, Gelfi C et al (1999) A new CACNA1A gene mutation in acetazolamide-responsive familial hemiplegic migraine and ataxia. *Neurology* 53:38-43.
30. Kors EE, Haan J, Giffin NJ, Pazdera L et al (2003) Expanding the phenotypic spectrum of the CACNA1A gene T666M mutation: a description of 5 families with familial hemiplegic migraine. *Arch Neurol* 60:684-688.
31. Alonso I, Barros J, Tuna A, Seixas A et al (2004) A novel R1347Q mutation in the predicted voltage sensor segment of the P/Q-type calcium-channel alpha-subunit in a family with progressive cerebellar ataxia and hemiplegic migraine. *Clin Genet* 65:70-72.
32. Vahedi K, Denier C, Ducros A, Bousson V et al (2000) CACNA1A gene de novo mutation causing hemiplegic migraine, coma, and cerebellar atrophy. *Neurology* 55:1040-1042.
33. Kors EE, Melberg A, Vanmolkot KR, Kumlien E et al (2004) Childhood epilepsy, familial hemiplegic migraine, cerebellar ataxia, and a new CACNA1A mutation. *Neurology* 63:1136-1137.
34. Beauvais K, Cavé-Riant F, De Barace C, Tardieu M et al (2004) New CACNA1A gene mutation in a case of familial hemiplegic migraine with status epilepticus. *Eur Neurol* 52:58-61.
35. Terwindt G, Kors E, Haan J, Vermeulen F et al (2002) Mutation analysis of the CACNA1A calcium channel subunit gene in 27 patients with sporadic hemiplegic migraine. *Arch Neurol* 59:1016-1018.
36. Zhuchenko O, Bailey J, Bonnen P, Ashizawa T et al (1997) Autosomal dominant cerebellar ataxia (SCA6) associated with small polyglutamine expansions in the alpha 1A-voltage-dependent calcium channel. *Nat Genet.* 15:62-69.
37. Jen JC (2008) Hereditary episodic ataxias. *Ann N Y Acad Sci.*1142:250-253.
38. Jen JC, Graves TD, Hess EJ, Hanna MG et al (2007) Primary episodic ataxias: diagnosis, pathogenesis and treatment. *Brain* 130:2484-2493.
39. De Fusco M, Marconi R, Silverstri L, Atorino L et al (2003) Haploinsufficiency of ATP1A2 encoding the Na<sup>+</sup>/K<sup>+</sup> pump alpha2 subunit associated with familial hemiplegic migraine type 2. *Nat Genet* 33:192-196.
40. Riant F, De Fusco M, Aridon P, Ducros A et al (2005) ATP1A2 mutations in 11 families with familial hemiplegic migraine. *Hum Mutat* 26:281.

- 
41. Jurkat-Rott K, Freilinger T, Dreier JP, Herzog J et al (2004) Variability of familial hemiplegic migraine with novel A1A2 Na<sup>+</sup>/K<sup>+</sup>-ATPase variants. *Neurology* 62:1857-1861.
42. Kaunisto MA, Harno H, Vanmolkot KR, Gargus JJ et al (2004) A novel missense ATP1A2 mutation in a Finnish family with familial hemiplegic migraine type 2. *Neurogenetics* 5:141-146.
43. Spadaro M, Ursu S, Lehmann-Horn F, Veneziano L et al (2004) A G301R Na<sup>+</sup>/K<sup>+</sup>-ATPase mutation causes familial hemiplegic migraine type 2 with cerebellar signs. *Neurogenetics* 5:177-185.
44. Ambrosini A, D'Onofrio M, Grieco GS, Di Mambro A et al (2005) Familial basilar migraine associated with a new mutation in the ATP1A2 gene. *Neurology* 65:1826-1828.
45. Todt U, Dichgans M, Jurkat-Rott K, Heinze A et al (2005) Rare missense variants in ATP1A2 in families with clustering of common forms of migraine. *Hum Mutat* 26:315-321.
46. Bassi MT, Bresolin N, Tonelli A, Nazos K et al (2004) A novel mutation in the ATP1A2 gene causes alternating hemiplegia of childhood. *J Med Genet.* 41:621-628.
47. Swoboda KJ, Kanavakis E, Xaidara A, Johnson JE et al (2004) Alternating hemiplegia of childhood or familial hemiplegic migraine? A novel ATP1A2 mutation. *Ann Neurol.* 55:884-887.
48. Aicardi J, Bourgeois M, Goutieres F (1995) Alternating hemiplegia of childhood: clinical findings and diagnostic criteria. In: Andermann F, Aicardi J, Vigeveno F (eds). *Alternating Hemiplegia of Childhood*. New York: Raven Press 3-18.
49. Dichgans M, Freilinger T, Eckstein G, Babini E et al (2005) Mutation in the neuronal voltage-gated sodium channel SCN1A in familial hemiplegic migraine. *Lancet* 336:371-377.
50. Meisler MH, Kearney JA (2005) Sodium channel mutations in epilepsy and other neurological disorders. *J Clin Invest* 115:2010-2017.
51. Mulley JC, Scheffer IE, Petrou S, Dibbens LA et al (2005) SCN1A mutations and epilepsy. *Hum Mutat* 25:535-542.
52. Wolff HG, Marcussen RM, Kunkle EC (1948) Studies on headache; analysis of the contractile state of the cranial vascular tree in migraine. *Trans Am Neurol Assoc.* 73:14-17.
53. Goadsby PJ (2009) The vascular theory of migraine--a great story wrecked by the facts. *Brain* 132:6-7.

54. Gladstone JP, Dodick DW (2005) Migraine and cerebral white matter lesions: when to suspect cerebral autosomal dominant arteriopathy with subcortical infarcts and leukoencephalopathy (CADASIL). *Neurologist* 11:19-29.
55. Joutel A, Corpechot C, Ducros A, Vahedi K et al (1996) Notch3 mutations in CADASIL, a hereditary adult-onset condition causing stroke and dementia. *Nature* 383:707-710.
56. Dichgans M, Mayer M, Uttner I, Brüning R et al (1998) The phenotypic spectrum of CADASIL: clinical findings in 102 cases. *Ann Neurol* 44:731-739.
57. Terwindt GM, Haan J, Ophoff RA, Groenen SM et al (1998b) Clinical and genetic analysis of a large Dutch family with autosomal dominant vascular retinopathy, migraine and Raynaud's phenomenon. *Brain* 121:303-316.
58. Jen J, Cohen AH, Yue Q, Stout JT et al (1997) Hereditary endotheliopathy with retinopathy, nephropathy, and stroke (HERNS). *Neurology* 49:1322-1330.
59. Grand MG, Kaine J, Fulling K, Atkinson J et al (1988) Cerebroretinal vasculopathy. A new hereditary syndrome. *Ophthalmology* 95:649-659.
60. Ophoff RA, DeYoung J, Service SK, Joosse M et al (2001) Hereditary vascular retinopathy, cerebroretinal vasculopathy, and hereditary endotheliopathy with retinopathy, nephropathy, and stroke map to a single locus on chromosome 3p21.1-p21.3. *Am J Hum Genet* 69:447-453.
61. Hottenga JJ, Vanmolkot KR, Kors EE, Kheradmand Kia S et al (2005) The 3p21.1-p21.3 hereditary vascular retinopathy locus increases the risk for Raynaud's phenomenon and migraine. *Cephalalgia* 25:1168-1172.
62. Etminan M, Takkouche B, Isorna FC, Samii A (2005) Risk of ischaemic stroke in people with migraine: systematic review and meta-analysis of observational studies. *BMJ* 330:63.
63. Kurth T, Gaziano JM, Cook NR, Logroscino G et al (2006) Migraine and risk of cardiovascular disease in women. *JAMA* 296:283-91.
64. Moskowitz MA, Bolay H, Dalkara T (2004) Deciphering migraine mechanisms: clues from familial hemiplegic migraine genotypes. *Ann Neurol* 55:276-280.
65. Barrett CF, van den Maagdenberg AM, Frants RR, Ferrari MD (2008) Familial hemiplegic migraine. *Adv Genet* 63:57-83.
66. Breslau N, Schultz LR, Stewart WF, Lipton RB et al (2000) Headache and major depression: is the association specific to migraine? *Neurology* 25:308-313.

- 
67. Fasmer OB (2001) The prevalence of migraine in patients with bipolar and unipolar affective disorders. *Cephalalgia* 21:894-899.
68. Andermann F, Andermann E (1992) Migraine and epilepsy, with special reference to the benign epilepsies of childhood. *Epilepsy Res Suppl* 6:207-214.
69. Ottman R, Lipton RB (1994) Comorbidity of migraine and epilepsy. *Neurology* 44:2105-2110.
70. Lipton RB, Hamelsky SW, Kolodner KB, Steiner TJ, Stewart WF (2000) Migraine, quality of life, and depression: a population-based case- control study. *Neurology* 55:629-635.
71. Breslau N, Davis GC, Schultz LR, Peterson EL. (1994) Joint 1994 Wolff Award Presentation. Migraine and major depression: a longitudinal study. *Headache* 34:387-393.
72. Sacco S, Olivieri L, Bastianello S, Carolei A (2006) Comorbid neuropathologies in migraine. *J Headache Pain* 7:222-230.
73. Moskowitz MA (1992) Neurogenic versus vascular mechanisms of sumatriptan and ergot alkaloids in migraine. *Trends Pharmacol Sci* 13:307-311.
74. Johnson KW, Bolay H (2006) Neurogenic inflammatory mechanisms. In: Olesen J, Goadsby PJ, Ramadan NM, Tfelt-Hansen P, Welch KMA. editors. The headaches, 3rd edn. Philadelphia: Lipincott Williams & Wilkins 309-319.
75. Glanz BI, Venkatesan A, Schur PH, Lew RA, Khosbin S (2001) Prevalence of migraine in patients with systemic lupus erythematosus. *Headache* 41:285-289.
76. Goadsby PJ (2007) Recent advances in understanding migraine mechanisms, molecules and therapeutics. *Trends Mol Med* 13:39-44.
77. Leao AA (1944) Spreading depression of activity in the cerebral cortex. *J Neurophysiol* 7:359-390.
78. Lauritzen M (1994) Pathophysiology of the migraine aura. The spreading depression theory *Brain* 17:199-210.
79. Somjen GG (2002) Ion regulation in the brain: implications for pathophysiology. *Neuroscientist* 8:254-267.
80. Lashley KS (1941) Patterns of cerebral integration indicated by the scotomas of migraine. *Arch Neurol Psychiatry* 46: 331-339.
81. Milner PM (1958) Note on a possible correspondence between the scotomas of migraine and spreading depression of Leão. *Electroencephalogr Clin Neurophysiol* 10:705.



82. Russell MB, Iversen HK, Olesen J (1994) Improved description of the migraine aura by a diagnostic aura diary. *Cephalalgia* 14:107-117.
83. Hadjikhani N, Sanchez Del Rio M, Wu O, Schwartz D et al (2001) Mechanisms of migraine aura revealed by functional MRI in human visual cortex. *Proc Natl Acad Sci USA* 98:4687-4692.
84. Bolay H, Reuter U, Dunn AK, Huang Z et al (2002) Intrinsic brain activity triggers trigeminal meningeal afferents in a migraine model. *Nat Med* 8:136-142.
85. Blau JN (1992) Classical migraine: symptoms between visual aura and headache onset. *Lancet* 340:355-356.
86. Goadsby PJ (2001) Migraine, aura, and cortical spreading depression; why are we still talking about it. *Ann Neurol* 49:4-6.
87. Kaube H, Herzog J, Käufer T, Dichgans M, Diener HC (2000) Aura in some patients with familial hemiplegic migraine can be stopped by intranasal ketamine. *Neurology* 55:139-141.
88. Haerter K, Ayata C, Moskowitz MA (2005) Cortical spreading depression: a model for understanding migraine biology and future drug targets. *Headache Currents* 2:97-103.
89. Pietrobon D (2007) Familial hemiplegic migraine. *Neurotherapeutics* 4:274-284.
90. Hans M, Luvisetto S, Williams ME, Spagnolo M et al (1999) Functional consequences of mutations in the human alpha1A calcium channel subunit linked to familial hemiplegic migraine. *J Neurosci* 19:1610-1619.
91. Tottene A, Fellin T, Pagnutti S, Luvisetto S et al (2002) Familial hemiplegic migraine mutations increase Ca(2+) influx through single human CaV2.1 channels and decrease maximal CaV2.1 current density in neurons. *Proc Natl Acad Sci USA* 99:13284-13289.
92. Tottene A, Pivotto F, Fellin T, Cesetti T et al (2005) Specific kinetic alterations of human Ca<sub>v</sub>2.1 calcium channels produced by mutation S218L causing familial hemiplegic migraine and delayed cerebral edema and coma after minor head trauma. *J Biol Chem* 280:17678-17686.
93. Jun K, Piedras-Rentería ES, Smith SM, Wheeler DB et al (1999) Ablation of P/Q-type Ca(2+) channel currents, altered synaptic transmission, and progressive ataxia in mice lacking the alpha(1A)-subunit. *Proc Natl Acad Sci USA* 96:15245-15250.
94. Fletcher CF, Tottene A, Lennon VA, Wilson SM et al (2001) Dystonia and cerebellar atrophy in Cacna1a null mice lacking P/Q calcium channel activity. *FASEB J* 15:1288-1290.

- 
95. Cao YQ, Piedras-Renteria ES, Smith GB et al (2004) Presynaptic Ca<sup>2+</sup> channels compete for channel type-preferring slots in altered neurotransmission arising from Ca<sup>2+</sup> channelopathy. *Neuron* 43:387-400.
96. Barrett CF, Cao YQ, Tsien RW (2005) Gating deficiency in a familial hemiplegic migraine type 1 mutant P/Q-type calcium channel. *J Biol Chem* 280:24064-24071.
97. Koenderink JB, Zifarelli G, Qiu LY, Schwarz W et al (2005) Na,K-ATPase mutations in familial hemiplegic migraine lead to functional inactivation. *Biochim Biophys Acta* 1669:61-68.
98. Segall L, Scanzano R, Kaunisto MA, Wessman M et al (2004) Kinetic alterations due to a missense mutation in the Na,K-ATPase alpha2 subunit cause familial hemiplegic migraine type 2. *J Biol Chem* 279:43692-43696.
99. Segall L, Mezzetti A, Scanzano R, Gargus JJ et al (2005) Alterations in the alpha2 isoform of Na,K-ATPase associated with familial hemiplegic migraine type 2. *Proc Natl Acad Sci USA* 102:11106-11111.
100. Kanner BI, Schuldiner S (1987) Mechanism of transport and storage of neurotransmitters. *CRC Crit Rev Biochem* 22:1-38.
101. Attwell D, Mobbs P (1994) Neurotransmitter transporters. *Curr Opin Neurobiol* 4:353-359.
102. Andreou AP and Goadsby PJ (2009) Therapeutic potential of novel glutamate receptor antagonists in migraine Expert opinion on investigational drugs 18(6):789.
103. Goadsby PJ and Classey JD (2000) Glutamatergic transmission in the trigeminal nucleus assessed with local blood flow. *Brain Res* 875(1-2):119.
104. Ferrari MD, Odink J, Bos KD, Malessy MJ, Bruyn GW (1990) Neuroexcitatory plasma amino acids are elevated in migraine. *Neurology* 40(10),1582-1586.
105. Martínez F, Castillo J, Rodríguez JR, Leira R, Noya M. (1993) Neuroexcitatory amino acid levels in plasma and cerebrospinal fluid during migraine attacks. *Cephalalgia* 13 (2), 89-93.
106. Green MC, Sidman RL (1962) Tottering -a neuromuscular mutation in the mouse. And its linkage with oligosyndacylism. *J Hered* 53:233-237.
107. Meier H, MacPike AD (1971) Three syndromes produced by two mutant genes in the mouse. Clinical, pathological, and ultrastructural bases of tottering, leaner, and heterozygous mice. *J Hered* 62:297-302.

108. Oda S (1973) [The observation of rolling mouse Nagoya (rol), a new neurological mutant, and its maintenance (author's transl)] *Jikken Dobutsu* 22:281-288.
109. Zwigman TA, Neumann PE, Noebels JL, Herrup K.J (2001) Rocker is a new variant of the voltage-dependent calcium channel gene *Cacna1a*. *Neurosci* 15;21:1169-1178.
110. Fureman BE, Jinnah HA, Hess EJ (2002) Triggers of paroxysmal dyskinesia in the calcium channel mouse mutant tottering. *Pharmacol Biochem Behav* 73:631-637.
111. Mori Y, Wakamori M, Oda S, Fletcher CF et al (2000) Reduced voltage sensitivity of activation of P/Q-type Ca<sup>2+</sup> channels is associated with the ataxic mouse mutation rolling Nagoya (tg(rol)). *J Neurosci* 20:5654-5662.
112. Fletcher CF, Lutz CM, O'Sullivan TN, Shaughnessy JD Jr et al (1996) Absence epilepsy in tottering mutant mice is associated with calcium channel defects *Cell* 87:607-617.
113. Noebels JL, Sidman RL (1979) Inherited epilepsy: spike-wave and focal motor seizures in the mutant mouse tottering. *Science* 204:1334-1336.
114. Kaja S, Van De Ven RC, Frants RR, Ferrari MD et al (2008) Reduced ACh release at neuromuscular synapses of heterozygous leaner Ca(v)2.1-mutant mice. *Synapse* 62:337-344.
115. van den Maagdenberg AM, Pietrobon D, Pizzorusso T, Kaja S et al (2004) A *Cacna1a* knockin migraine mouse model with increased susceptibility to cortical spreading depression. *Neuron* 41:701-710.
116. van den Maagdenberg AM\*, Pizzorusso T\*, Kaja S\*, Terpolilli N\* et al (2010) High CSD susceptibility and migraine-associated symptoms in CaV2.1 S218L mice *Ann of Neuro* 67(1):85-98.
117. Kors EE, Terwindt GM, Vermeulen FL et al (2001) Delayed cerebral edema and fatal coma after minor head trauma: role of the CACNA1A calcium channel subunit gene and relationship with familial hemiplegic migraine. *Ann Neurol* 49:753-760.



---

# 2

## Genetic and functional analysis of FHM gene mutations

---



---

# 2.1

## **CACNA1A mutation linking hemiplegic migraine and alternating hemiplegia of childhood**

---

B de Vries<sup>1\*</sup>, AH Stam<sup>2\*</sup>, F Beker<sup>3\*</sup>, AMJM van den Maagdenberg<sup>1,2</sup>, KRJ Vanmolkot<sup>1</sup>, LAEM Laan<sup>2</sup>, IB Ginjaar<sup>4</sup>, RR Frants<sup>1</sup>, H Lauffer<sup>5</sup>, J Haan<sup>2,6</sup>, JP Haas<sup>3</sup>, GM Terwindt<sup>2</sup> & MD Ferrari<sup>2</sup>

*<sup>1</sup>Department of Human Genetics, <sup>2</sup>Department of Neurology, <sup>4</sup>Centre for Human and Clinical Genetics, Leiden University Medical Centre, Leiden, and <sup>6</sup>Department of Neurology, Rijnland Hospital, Leiderdorp, the Netherlands, <sup>3</sup>Department of Paediatrics, Division of Neonatology and Paediatric Intensive Care and <sup>5</sup>Department of Paediatrics, Division of Neuropaediatrics and Metabolic Diseases, University of Greifswald, Greifswald, Germany*

*\* These authors contributed equally.*

**Cephalalgia 2008;28:887–891.**

---

## Abstract

Familial hemiplegic migraine (FHM) and alternating hemiplegia of childhood (AHC) are severe neurological disorders that share clinical features. Therefore, FHM genes are candidates for AHC. We performed mutation analysis in the *CACNA1A* gene in a monozygotic twin pair with clinical features overlapping with both AHC and FHM and identified a novel *de novo* *CACNA1A* mutation. We provide the first evidence that a *CACNA1A* mutation can cause atypical AHC, indicating an overlap of molecular mechanisms causing AHC and FHM. These results also suggest that *CACNA1A* mutation scanning is indicated in patients with a severe neurological phenotype that includes paroxysmal (alternating) hemiplegia.

## Introduction

Alternating hemiplegia of childhood (AHC) and familial hemiplegic migraine (FHM) are clinically very similar disorders.<sup>1,2</sup> AHC is typically characterized by episodes of alternating hemiplegia or quadriplegia and progressive neurological features beginning before the age of 18 months.<sup>1</sup> FHM is a rare subtype of migraine with aura associated with hemiparesis and in some cases ataxia, mental retardation, movement disorders or other neurological abnormalities.<sup>3</sup> For FHM, three genes have been identified: *CACNA1A*, *ATP1A2* and *SCN1A*, which all play a role in ion transport.<sup>4-6</sup>

Except for one Greek family with atypical AHC and an *ATP1A2* mutation, no genes have been identified for AHC.<sup>7,8</sup> Here we describe a monozygotic twin pair suffering from a complex phenotype of early-onset ataxia, alternating hemiplegia, epilepsy, migraine-like attacks and mental retardation, which clinically overlaps with both AHC and FHM. We identified a novel *de novo* *CACNA1A* mutation in both patients, confirming a genetic overlap between AHC and FHM.

## Subjects and methods

### *Subjects*

Standardized criteria were used for the diagnosis of FHM<sup>3</sup> and AHC.<sup>1</sup> All subjects gave informed consent. This study was approved by the local ethics committee of the University of Greifswald.

### *Genetic analysis*

Genomic DNA was isolated from peripheral leucocytes using a standard salting out extraction method.<sup>9</sup> The 47 coding exons and adjacent sequences of the *CACNA1A* gene were scanned for mutations by direct sequencing. In brief, all exons were amplified by polymerase chain reaction, using genomic DNA as a template. Direct sequencing was done by Cycle Sequencing (Prism Big Dye Terminators Cycle Sequencing kit; Applied Biosystems, Foster City, CA, USA) using the dideoxy termination method and an ABI3700 automated sequencer (Applied Biosystems). One hundred healthy controls were screened by direct sequencing. Detailed information is available from the authors upon request.



## Results

The monozygotic German twin brothers, now aged 17 years, were spontaneously born at term after an uneventful pregnancy. Their complex clinical features are summarized in the Table 1. One twin brother (patient I in Table 1) was severely affected and had a delayed psychomotor development. He is still not able to walk without support and is not able to speak. Between the ages of 2 and 7 years he suffered from generalized atonic seizures up to three times daily, often followed by unconsciousness lasting from seconds to several hours. Subsequently, he developed mental and psychomotor regression with ataxic and athetotic limb movements. At age 11 years, when he was hospitalized because of severe constipation and abdominal pain, episodes of abrupt stops in movement, tachycardia and swallowing automatisms were observed. Ictal EEG recordings showed mainly occipitotemporal bilateral synchronic sharp-slow wave activity (not shown). At the age of 12 years he experienced a period of alternating hemiplegia, starting on the left side and accompanied by fever. Cerebral magnetic resonance imaging (MRI) showed ictal right cortical swelling (Fig. 1). After 12 days the left-sided symptoms resolved, but there after right-sided weakness occurred, which lasted for days. EEG revealed slow wave activity over the left hemisphere (data not shown). As he is still not able to express himself, the presence and severity of migraine symptoms (headache, phonophobia, photophobia, nausea) are difficult to assess. At present, he is tetrapastic with athetotic and ataxic movements, and has intermittent convergent strabismus.

**Table 1** Clinical features of monozygotic twins compared with alternating hemiplegia of childhood (AHC) and familial hemiplegic migraine (FHM)

	AHC	FHM1	Patient I	Patient II
Onset of (alternating) hemiplegic attacks	0–18 months*	> 2 years to adolescence†	12 years	10 years
Hemidystonic spells	+	-	-	-
Quadriplegia	+	-	+	-
Choreoathetosis	+	-	+	-
Ataxia	+	+	+	+
Nystagmus	+	+	-	-
Strabismus	+	-	+	+
Mental retardation	+	-	+	+
Autonomic symptoms	+	+	+	+
Positive effect of sleep	+	-	-	-
Epilepsy	+	+	+	+
Aura symptoms	-	+	NA	+
Migrainous headache	-	+	NA	+

(+) or (-) indicates presence or absence of a symptom, respectively. NA indicates not applicable due to inability of verbal expression of the patient. \*Typically alternating hemiplegia. †Typically non-alternating hemiplegia.

The other twin brother (patient II in Table 1) was delivered shortly after his twin brother. Early infant psychomotor development was delayed. At the age of 1.5 years he was able to speak single words. Between the ages of 3 and 8 years he suffered twice a year from atonic episodes accompanied by loss of consciousness for 1 h, followed by ataxia. Ictal EEGs showed no signs of epilepsy (data not shown).

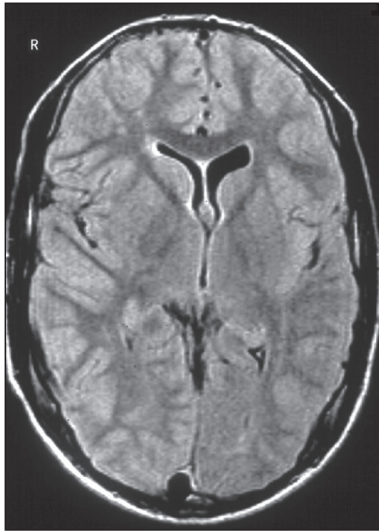

**Figure 1** Fluid-attenuated inversion recovery (FLAIR) image shows ictal diffuse cortical swelling of the right hemisphere of patient I.

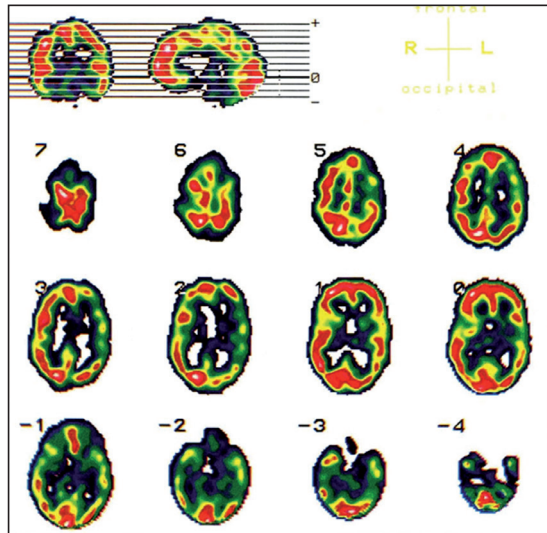

**Figure 2** Single photon emission computed tomography scan shows ictal left-sided hypoperfusion contralateral to the hemiparesis in the parieto-frontal (severe) and temporal (mild) cortex of patient II.

Since the age of 10 years he has experienced several episodes of right- or left-sided hemiplegia, and one episode with alternating hemiplegia for several days. One of the hemiplegic episodes was accompanied by reduced consciousness and fever and lasted several weeks. Cerebral single photon emission computed tomography showed ictal left-sided hypoperfusion in the parieto-fronto-temporal cortex (Fig. 2). At the age of 12 years, treatment with flunarizine was started, with doubtful effect. During hemiplegic attacks he complained of frontal throbbing headache with nausea, sometimes accompanied by phonophobia. Ophthalmic examination shows a strabismus. Except for the twin pair, no other family members suffer from attacks of hemiplegia, epilepsy or migraine. Monozygosity of the twins was confirmed and false paternity was excluded by genetic, multimarker analysis (data not shown). Extensive metabolic screening in both twins revealed no abnormalities. Cerebral MRI, showing diffuse ictal swelling in patient I (see above), was without severe abnormalities in either of the twins, and did not reveal cerebellar atrophy.

Direct sequencing of all 47 exons of the *CACNA1A* gene revealed a heterozygous 5361 G>T substitution (Genbank Ac. no. X99897) in exon 33 in both twins. This point mutation resulted in an amino acid change from a valine to a phenylalanine at position 1696. The mutation is located within the transmembrane segment S5 of the fourth domain, which together with segment S6 forms the inner part of the pore of the Ca<sub>v</sub>2.1- $\alpha$ 1 subunit. The parents did not carry the mutation, indicating that V1696F is a *de novo* mutation. Screening of 100 subjects from the general Dutch population with no history of migraine or epilepsy was performed by sequence analysis of exon 33 and was negative.

## Discussion

We have identified a novel *de novo* *CACNA1A* V1696F mutation in two monozygotic twin brothers with complex clinical features in part fulfilling the criteria of both AHC<sup>1</sup> and FHM<sup>3</sup> (Table 1). The presence of hemiplegia and other aura symptoms as well as migrainous headache are in favour of FHM. Episodes of alternating hemiplegia, developmental delay, mental retardation, choreoathetotic movements, strabismus and chronic ataxia are supportive of AHC. The severity of the phenotype, interictal symptoms and the relatively young age at onset of these patients are, in particular, very rare for FHM1 and more common in AHC. As no positive effect of sleep was observed and the age at onset was after 18 months, we name this overlap syndrome 'atypical AHC'. Although both monozygotic twin brothers are genetically identical, their clinical symptoms and attack frequency vary in severity, with patient I being more severely affected.

Several lines of evidence indicate that V1696F is the disease-causing mutation in this family. Val<sup>1696</sup> is highly conserved across multiple calcium channel homologues and across species (data not shown). The mutation was not identified in a large number of control chromosomes. The mutation occurred *de novo*, thus strengthening the evidence that it is the V1696F mutation that caused the disease. In a French FHM family another mutation affecting the same residue Val<sup>1696</sup> (V1696I) caused hemiplegic migraine without cerebellar signs.<sup>10</sup> Finally, electrophysiological analysis of mutant Ca<sub>v</sub>2.1- $\alpha$ 1 containing Iso<sup>1696</sup> has revealed that loss of the valine residue is associated with altered channel kinetics compatible with a phenotype of an increased Ca<sup>2+</sup> influx.<sup>11</sup> Notably, change of Val<sup>1696</sup> to a phenylalanine (V1696F) or an isoleucine (V1696I) causes phenotypes of different severity. Two out of three V1696I mutation carriers had hemiplegic migraine without cerebellar signs or other severe neurological features.<sup>10</sup> Both V1696F mutation carriers, however, had a very severe phenotype of atypical AHC. Apparently, substitution of the valine residue for a bulky phenylalanine in the transmembrane domain has a more dramatic effect on channel functioning.

---

Previously, sporadic patients with typical AHC have been scanned for mutations in the *CACNA1A* (FHM1), *ATP1A2* (FHM2) and *SLC1A3* genes, but no mutations were found.<sup>12-14</sup> Now, we present the first *CACNA1A* mutation in patients with atypical AHC. Previously an *ATP1A2* mutation was identified in a Greek family with atypical AHC, with a similar overlapping FHM/AHC phenotype.<sup>7,8</sup> Of note, both *CACNA1A* and *ATP1A2* are involved in ion transport, and mutations in these genes are predicted to increase concentrations of K<sup>+</sup> and glutamate in the synaptic cleft as a result of either increased neurotransmitter release (*CACNA1A* mutations) or impaired removal of K<sup>+</sup> and neurotransmitter (*ATP1A2* mutations).<sup>15,16</sup> Elucidating the molecular basis in this German family with complex clinical features strengthens the evidence for a common pathogenesis of FHM and AHC. Our results suggest that in severely affected paroxysmal (alternating) hemiplegic patients with mental retardation and an age at onset of alternating episodes beyond 18 months, *CACNA1A* mutation scanning is indicated.

### Acknowledgements

The authors thank Professor N. Hosten and M. Kirsch, MD (Institute for Diagnostic Radiology, University of Greifswald) for providing Figures 1 and 2. This work was supported by grants of the Netherlands Organization for Scientific Research (NWO) (903-52-291, M.D.F, R.R.F.; Vici 918.56.602, M.D.F), The Migraine Trust (R.R.F., M.D.F.), the EU 'Eurohead' grant (LSHM-CT-2004-504837; M.D.F., R.R.F., A.M.J.M.v.d.M.), EU FP6 ENRAH (LSSM-CT-2005-516513; A.M.J.M.v.d.M., L.A.E.M.L.) and the Centre of Medical System Biology (CMSB) established by the Netherlands Genomics Initiative/Netherlands Organisation for Scientific Research (NGI/NWO).

### References

- 1 Bourgeois M, Aicardi J, Goutieres F. Alternating hemiplegia of childhood. *J Pediatr* 1993; 122:673-9.
- 2 Haan J, Kors EE, Terwindt GM, Vermeulen FL, Vergouwe MN, van den Maagdenberg AM et al. Alternating hemiplegia of childhood: no mutations in the familial hemiplegic migraine CACNA1A gene. *Cephalalgia* 2000; 20:696-700.
- 3 Headache Classification Committee of the International Headache Society. The International Classification of Headache Disorders, 2nd edn. *Cephalalgia* 2004; 24:1-160.
- 4 Ophoff RA, Terwindt GM, Vergouwe MN, van Eijk R, Oefner PJ, Hoffman SM et al. Familial hemiplegic migraine and episodic ataxia type-2 are caused by mutations in the Ca<sup>2+</sup> channel gene CACNL1A4. *Cell* 1996; 87:543-52.

- 5 De Fusco M, Marconi R, Silverstri L, Atorino L, Rampoldi L, Morgante L et al. Haploinsufficiency of ATP1A2 encoding the Na<sup>+</sup>/K<sup>+</sup> pump alpha2 subunit associated with familial hemiplegic migraine type 2. *Nat Genet* 2003; 33:192–6.
- 6 Dichgans M, Freilinger T, Eckstein G, Babini E, Lorenz-Depiereux B, Biskup S et al. Mutation in the neuronal voltage-gated sodium channel SCN1A in familial hemiplegic migraine. *Lancet* 2005; 336:371–7.
- 7 Swoboda KJ, Kanavakis E, Xaidara A, Johnson JE, Leppert MF, Schlesinger-Massart MB et al. Alternating hemiplegia of childhood or familial hemiplegic migraine? A novel ATP1A2 mutation. *Ann Neurol* 2004; 55:884–7.
- 8 Bassi MT, Bresolin N, Tonelli A, Nazos K, Crippa F, Baschiroto C et al. A novel mutation in the ATP1A2 gene causes alternating hemiplegia of childhood. *J Med Genet* 2004; 41:621–8.
- 9 Miller SA, Dykes DD, Polesky HF. A simple salting out procedure for extracting DNA from human nucleated cells. *Nucleic Acids Res* 1988; 16:181–4.
- 10 Ducros A, Denier C, Joutel A, Cecillon M, Lescoat C, Vahedi K et al. The clinical spectrum of familial hemiplegic migraine associated with mutations in a neuronal calcium channel. *N Engl J Med* 2001; 345:17–24.
- 11 Mullner C, Broos LAM, Van den Maagdenberg AMJM, Striessnig J. Familial hemiplegic migraine type 1 mutations K1336E, W1684R, and V1696I alter Cav2.12+ channel gating. *J Biol Chem* 2004; 279:51844–50.
- 12 Haan J, Kors EE, Terwindt GM, Vermeulen FL, Vergouwe MN, Van den Maagdenberg AMJM et al. Alternating hemiplegia of childhood: no mutations in the familial hemiplegic migraine CACNA1A gene. *Cephalalgia* 2000; 20:696–700.
- 13 Kors EE, Vanmolkot KRJ, Haan J, Kheradmead Kia S, Stroink H, Laan LAEM et al. Alternating hemiplegia of childhood: no mutations in the second familial hemiplegic migraine gene ATP1A2. *Neuropediatrics* 2004;35:293–6.
- 14 De Vries B, Haan J, Stam AH, Vanmolkot KRJ, Stroink H, Laan LAEM et al. Alternating hemiplegia of childhood: no mutations in the glutamate transporter gene EAAT1. *Neuropediatrics* 2006; 37:302–4.
- 15 Sanchez-del-Rio M, Reuter U, Moskowitz MA. New insights into migraine pathophysiology. *Curr Opin Neurol* 2006; 19:294–8.
- 16 Van den Maagdenberg AM, Haan J, Terwindt GM, Ferrari MD. Migraine: gene mutations and functional consequences. *Curr Opin Neurol* 2007; 20:299–305



---

# 2.2

## **Familial hemiplegic migraine is associated with febrile seizures in an FHM2 family with a novel *de novo* ATP1A2 mutation**

---

Boukje de Vries<sup>1</sup>, Anine H. Stam<sup>2</sup>, Martin Kirkpatrick<sup>3</sup>, Kaate R.J. Vanmolkot<sup>1</sup>, Jan B. Koenderink<sup>4</sup>, Jeroen J.M.W. van den Heuvel<sup>4</sup>, Bas Stunnenberg<sup>4</sup>, David Goudie<sup>5</sup>, Jay Shetty<sup>3</sup>, Vivek Jain<sup>3</sup>, Judith van Vark<sup>1</sup>, GiselaM. Terwindt<sup>2</sup>, Rune R. Frants<sup>1</sup>, Joost Haan<sup>2,6</sup>, Arn M.J.M. van den Maagdenberg<sup>1,2</sup>, Michel D. Ferrari<sup>2</sup>

<sup>1</sup>Department of Human Genetics, Leiden University Medical Centre, Leiden, The Netherlands

<sup>2</sup>Department of Neurology, Leiden University Medical Centre, The Netherlands

<sup>3</sup>Department of Paediatrics, Tayside Children's Hospital, Dundee, United Kingdom

<sup>4</sup>Department of Pharmacology and Toxicology, Nijmegen Centre for Molecular Life Sciences, Radboud University Nijmegen Medical Centre, Nijmegen, The Netherlands

<sup>5</sup>Department of Clinical Genetics, Tayside Children's Hospital, Dundee, United Kingdom

<sup>6</sup>Department of Neurology, Rijnland Hospital, Leiderdorp, The Netherlands

**Epilepsia 2009;50:2503-2504**

## Introduction

Febrile seizures are the most common form of convulsions between the age of 6 months and 5 years<sup>1</sup>, but genetic factors have not been identified. Here we investigated the molecular basis of febrile seizures in a small family with co-occurring hemiplegic migraine<sup>2</sup> and febrile seizures (Fig. 1). Intermittent ataxia and diffuse encephalopathic episodes are also present in this family.

## Results

Using direct sequencing (see Vanmolkot et al., 2003)<sup>3</sup>, we identified a novel *de novo* heterozygous 2563 G>A substitution in exon 18 resulting in an amino acid change from a glycine to an arginine at position 855 in the *ATP1A2* FHM2 gene<sup>4</sup> that encodes the  $\alpha 2$  subunit of  $\text{Na}^+$ ,  $\text{K}^+$ -ATPase pumps. Only, the proband (III-1), the affected mother (II-2), and affected brother (III-2) carry this *ATP1A2* mutation. Gly855 is evolutionary conserved (Fig. 2A), and the mutation was not identified in 300 control chromosomes. An ouabain challenge assay (see Vanmolkot et al., 2006)<sup>5</sup> for the mutant p.Gly855Arg construct, unlike wildtype, showed complete loss of cell survival, indicating that the mutation has functional consequences at the protein level (Fig. 2B).

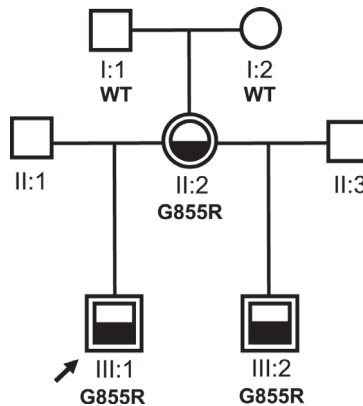

**Figure 1** Pedigree of the FHM2 family. The arrow indicates the proband. Squares indicate male subjects and circles indicate female subjects. To indicate clinical diagnosis; with lower-half-filled symbols represent FHM and double-lined symbols represent febrile seizures. Individuals heterozygous for the *ATP1A2* mutation are indicated by G855R. Wild-type (WT) indicates that the individual does not have the mutation.



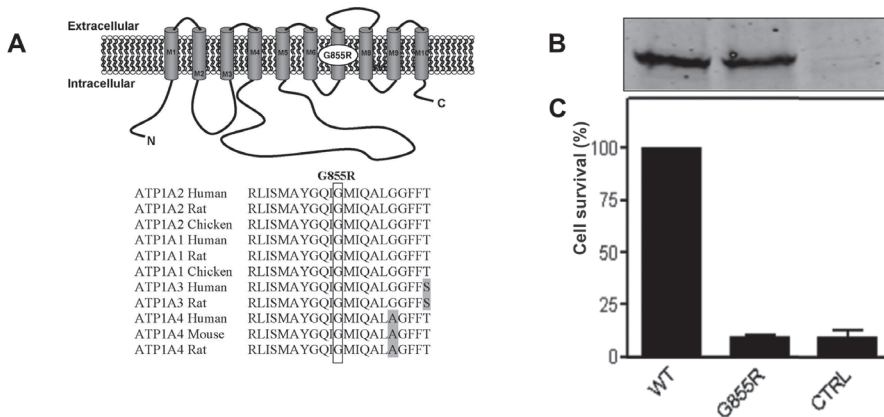

**Figure 2** Genetic and functional data on mutant *p.Gly855Arg*. **(A)** Alignment of amino acid sequences of several vertebrate sodium-potassium ATPase  $\alpha$ -subunits; Gly855 is represented as a black box. **(B)** Upper panel shows Western blot analysis of transfected HeLa cells. Lower panel shows graphic representation of ouabain cell survival assay. Bars represent cell survival after 5 days of ouabain treatment [error bars indicate standard error of the mean (SEM)].

### Clinical descriptions

This now 13-year-old proband (III-1) (Fig. 1) experienced, from the age of 9 months to 3 years, five complex febrile seizures and one simple febrile seizure. The complex seizures either lasted more than 15 min or started focally. There were also episodes of several seizures occurring sequentially. From the age of 7 months to 5 years, he also experienced several nonfebrile seizures, which typically had a focal onset and were secondary generalized. These seizures usually lasted up to 5 min, but sometimes were prolonged (up to 40 min), and at times occurred in clusters. Seizures stopped at age 5. From age 2.5, he experienced headache attacks accompanied by transient hemiparesis as well as frequent unprovoked episodes of ataxia lasting a few minutes to days. In addition, he had episodes of rapidly progressive drowsiness down to Glasgow Coma scale (GCS) 6–7, without any focal neurologic deficits or epilepsy. The patient has ongoing behavioral problems and mild learning difficulties. His now 3-year-old half-brother (III-2) had one complex (focal) febrile seizure lasting 15 minutes when he was 7 months old. Since the age of 21 months he had episodes of hemiplegia, and recurrent encephalopathic episodes often preceded by headache and hemiplegia, and one episode of unsteadiness after minor head injury. The mother (II-2), now age 31 years, had two simple febrile seizures at age 2 and also had attacks of hemiplegic migraine. The father of the proband (II-1) and the father (II-3) of his halfbrother and their grandparents (I-1 and I-2) never had hemiplegic migraine, ataxia, or seizures.

---

## Conclusion

We feel that the *ATP1A2* p.Gly855Arg mutation is the causal mutation in this family for a number of reasons: (1) FHM and febrile convulsions were present only in the three mutation carriers and not in non-mutation carriers; (2) the mutation was not identified in a panel of 150 healthy control individuals, and (3) functional studies revealed that the mutant has a deleterious effect on cell survival. Febrile seizures are reported in only some mutation carriers of three FHM2 families.<sup>3,6,7</sup> Future identification of additional families with co-occurring hemiplegic migraine and febrile seizures may shed light on the association between *ATP1A2* gene mutations and febrile seizures. We, therefore, recommend genetic analysis of the *ATP1A2* gene in patients with febrile seizures.

## Acknowledgments

We thank Dr. Thomas A. Pressley (the University of Texas Medical School, Lubbock, TX, U.S.A.) for providing anti-HERED antibody and L. Broos for technical assistance. This work was supported by grants of the Netherlands Organization for Scientific Research (NWO) (907-00-217 G.M.T, and Vici 918.56.602, M.D.F), and the Center of Medical System Biology (CMSB) established by the Netherlands Genomics Initiative/Netherlands Organisation for Scientific Research (NGI/NWO).

## Disclosure

We confirm that we have read the Journal's position on issues involved in ethical publication and affirm that this report is consistent with those guidelines. None of the authors has any conflict of interest to disclose.

## References

1. Leviton A, Cowan LD. (1982) Epidemiology of seizure disorders in children. *Neuroepidemiology* 1:40–83.
2. Headache Classification Committee of the International Headache Society. (2004) The international classification of headache disorders, 2nd edition. *Cephalalgia* 24:1–160.
3. Vanmolkot KRJ, Kors EE, Hottenga JJ, Terwindt GM, Haan J, Hoefnagels WA, Black DF, Sandkuijl LA, Frants RR, Ferrari MD, Van den Maagdenberg AMJM. (2003) Novel mutations in the Na<sup>+</sup>,K<sup>+</sup>-ATPase pump gene ATP1A2 associated with familial hemiplegic migraine and benign familial infantile convulsions. *Ann Neurol* 54:360–366.
4. De Fusco M, Marconi R, Silverstri L, Atorin L, Rampoldi L, Morgante L, Ballabio A, Aridon P, Casari G. (2003) Haploid insufficiency of ATP1A2 encoding the Na<sup>+</sup>/K<sup>+</sup> pump alpha 2 subunit associated with familial hemiplegic migraine type 2. *Nat Genet* 33:192–196.
5. Vanmolkot KR, Kors EE, Turk U, Turkdogan D, Keyser A, Broos LA, Kia SK, van den Heuvel JJ, Black DF, Haan J, Frants RR, Barone V, Ferrari MD, Casari G, Koenderink JB, van den Maagdenberg AM. (2006) Two *de novo* mutations in the Na,K-ATPase gene ATP1A2 associated with pure familial hemiplegic migraine. *Eur J Hum Genet* 14:555–560.
6. Deprez L, Weckhuysen S, Peeters K, Deconinck T, Claeys KG, Claes LR, Suls A, Van Dyck T, Palmmini A, Matthijs G, Van Paesschen W, De Jonghe P. (2008) Epilepsy as part of the phenotype associated with ATP1A2 mutations. *Epilepsia* 49:500–508.
7. Fernandez DM, Hand CK, Sweeney BJ, Parfrey NA. (2008) A novel ATP1A2 gene mutation in an Irish familial hemiplegic migraine kindred. *Headache* 48:101–108.



---

# 2.3

## **The novel p.L1649Q mutation in the *SCN1A* epilepsy gene is associated with familial hemiplegic migraine: genetic and functional studies**

---

Kaate R. J. Vanmolkot<sup>1\*</sup>, Elena Babini<sup>2\*</sup>, Boukje de Vries<sup>1</sup>, Anine H. Stam<sup>3</sup>, Tobias Freilinger<sup>4</sup>, Gisela M. Terwindt<sup>3</sup>, Lisa Norris<sup>5</sup>, Joost Haan<sup>3,6</sup>, Rune R. Frants<sup>2</sup>, Nabih M. Ramadan<sup>5</sup>, Michel D. Ferrari<sup>3</sup>, Michael Pusch<sup>2</sup>, Arn M. J. M. van den Maagdenberg<sup>1,3</sup>, and Martin Dichgans<sup>4</sup>

<sup>1</sup>Department of Human Genetics, Leiden University Medical Centre, Leiden, The Netherlands; <sup>2</sup>Istituto di Biofisica, Genova, Italy; <sup>3</sup>Department of Neurology, Leiden University Medical Centre, Leiden, The Netherlands; <sup>4</sup>Department of Neurology, Klinikum Großhadern, Ludwig-Maximilians-Universität, München, Germany; <sup>5</sup>Department of Neurology, Chicago Medical School at Rosalind Franklin University of Medicine and Science, North Chicago, Illinois; <sup>6</sup>Department of Neurology, Rijnland Hospital, Leiderdorp, The Netherlands

\*These authors contributed equally to this paper.

**Human Mutation 2007;28:522**

---

## Abstract

Familial hemiplegic migraine (FHM) is a severe subtype of migraine with hemiparesis during attacks. We scanned 10 families with FHM without mutations in the *CACNA1A* (FHM1) and *ATP1A2* (FHM2) genes. We identified the novel p.L1649Q mutation (c.4946T>A) in Na<sub>v</sub>1.1 sodium channel gene *SCN1A* (FHM3) in a North American kindred with FHM without associated ataxia or epilepsy. Functional analysis of the mutation, introduced in the highly homologous human *SCN5A*, revealed markedly slowed inactivation and a two-fold faster recovery from fast inactivation predicting enhanced neuronal excitation. Our findings establish the role of neuronal Na<sub>v</sub>1.1 sodium channels in FHM and reinforce the involvement of ion channel dysfunction in the pathogenesis of this episodic brain disorder.

## Introduction

Familial hemiplegic migraine (FHM) is a rare monogenic form of migraine with hemiparesis during aura. Mutations in three genes for FHM have been identified, in the *CACNA1A* calcium channel gene (MIM# 601011) for FHM1 (MIM# 141500)<sup>1</sup>, the *ATP1A2* Na,K-ATPase gene (MIM# 182340) for FHM2 (MIM# 602481)<sup>2</sup> and, recently, the p.Q1489K mutation (c.4465C>A; p.Gln1489Lys) in the *SCN1A* sodium channel gene (MIM# 182389) for FHM3 (MIM# 609634)<sup>3</sup>. All three gene products are intimately involved in the modulation of ion fluxes across neuronal and glial cell membranes, suggesting that FHM, and possibly also common types of migraine, are cerebral ionopathies.<sup>4</sup> The p.Q1489K *SCN1A* mutation is remarkable as it represents the first among more than 150 mutations in this gene that is not associated with either severe myoclonic epilepsy of infancy (SMEI, MIM# 607208) or generalized epilepsy with febrile seizures (GEFS+, MIM# 604233).<sup>5,6</sup> The mutation spectrum in SMEI differs from that in GEFS+ as the majority of SMEI mutations occurred *de novo*. Approximately half of the SMEI mutations are nonsense or frameshift mutations resulting in protein truncation and consequent loss-of-function. Almost 40% of SMEI mutations are missense mutations, with functional consequences that range from complete loss-of-function, gain-of-function to minimal functional effects.<sup>7</sup> The milder GEFS+ phenotype is associated with missense mutations only, showing either loss- or gain of-function effects.<sup>8,9</sup> Functional studies of the p.Q1498K mutation expressed and analyzed in the highly homologous human *SCN5A* revealed a more rapid recovery from fast inactivation (Dichgans et al., 2005). A limitation in that study was that the mutation was found in three families of common ancestry leaving the possibility of an isolated finding rather than a prominent FHM gene. In order to firmly establish the *SCN1A* gene as a gene for FHM3, independent confirmation in other families is necessary.

Here we performed mutation scanning in the *SCN1A* gene in 10 FHM families that were negative for mutations in the *CACNA1A* and *ATP1A2* genes. We identified the novel *SCN1A* p.L1649Q mutation (c.4946T>A) in a large kindred with pure FHM without epilepsy and show that this mutation severely interferes with voltage-gated sodium channel functioning.

## Subjects and methods

### *Patients*

We investigated 10 families with pure FHM (without associated epilepsy or ataxia) and without mutations in the *CACNA1A* (FHM1) and *ATP1A2* (FHM2) genes. Two to seven affected members were available per family. Diagnoses were made according to the IHS criteria.<sup>10</sup> All subjects gave written informed consent. Detailed information on the clinical characteristics of the *SCN1A* mutation carriers is shown in Table 1. Clinical diagnosis was made blinded for the genetic data.

### *Genetic analysis*

Genomic DNA was isolated from peripheral blood using a standard salting out extraction method.<sup>11</sup> All 26 exons of *SCN1A* were amplified by polymerase chain reaction (PCR), and primer details are available from the authors upon request. For several exons, primers were improved compared to our original paper<sup>3</sup>, for instance the alternatively spliced exon 5N, reported by Tate et al.<sup>12</sup> is now included in the scan. All PCR products were analyzed for mutations by direct sequencing. DNA numbering for *SCN1A* is based on cDNA reference sequence AB093548.1. Nucleotide numbering uses the A of the ATG translation initiation codon as nucleotide +1. Mutation nomenclature follows guidelines of the Human Genome Variation Society (<http://www.hgvs.org/mutnomen/>).

### *Mutagenesis, Cell Culture, and Electrophysiology*

As in the first study, we used the closely related *SCN5A* cDNA because of known difficulties in stability of recombinant bacteria with *SCN1A* cDNA.<sup>3</sup> p.L1636Q, which corresponds to p.L1649Q in *SCN1A* was introduced by site-directed mutagenesis into full-length human *SCN5A* cDNA subcloned in pCDNA3.1 (QuikChange XL Kit, Stratagene, La Jolla, CA, USA). *SCN5A-L1636Q* and *SCN5A-WT* cDNA constructs were transfected into human tsA201 cells using the calcium phosphate method and were each coexpressed with accessory human sodium channel subunit  $\beta$ 1 (ratio of cDNA 2:1) and CD8 cDNA. Before recording, DMEM medium was exchanged with bath solution and anti-CD8 coated microbeads (Dynabeads M-450 CD8, Oxoid, Basingstoke, UK) were added to the cell suspension. The bath solution contained (in mM): 110 Naglutamate, 35 NaCl, 4 KCl, 1 MgCl<sub>2</sub>, 1.8 CaCl<sub>2</sub>, 10 mM HEPES (pH 7.3). Macroscopic sodium currents were recorded using the whole-cell configuration of the patch clamp technique, filtered at 10 kHz by a low-pass Bessel filter, and acquired by a patch clamp L/M-EPC7 amplifier (List Medical Electronics, Darmstadt, Germany) interfaced with a National Instruments interface (PCI-6052E) and a custom acquisition program

---

(GePulse). Temperature was controlled ( $20 \pm 0.5$  °C) with a Peltier device. Patch pipettes were pulled from aluminium silicate glass (Hilgenberg GmbH, Malsfeld, Germany) and fire polished with a microforge. Electrode resistance was 1.5-2.0 M $\Omega$  with a pipette solution containing (in mM): 110 CsGlu, 30 NaCl, 2 MgCl<sub>2</sub>, 5 Cs-EGTA, 10 mM HEPES (pH 7.3). Access resistance was between 2 and 5 M $\Omega$ , and the cell capacitance was between 5 and 15 pF, as measured by the compensating circuit of the amplifier. Data from cells with a current amplitude of 0.5-1.5 nA were used for the analysis of the voltage-dependent parameters. Thus, the series resistance error was less than 4 mV. The holding-potential was -120 mV and steady state activation, steady-state inactivation, time constants of inactivation (e.g. time constants  $\tau_{fast}$  and  $\tau_{slow}$ ), and recovery from inactivation were measured using protocols, as described before.<sup>3</sup> Data analysis was performed using the program Ana (available at [http://www.ge.cnr.it/ICB/conti\\_moran\\_pusch/programs-pusch/software-mik.htm](http://www.ge.cnr.it/ICB/conti_moran_pusch/programs-pusch/software-mik.htm)), and Sigma Plot (SPSS Inc., Chicago, IL, USA).

## Results

### *Clinical genetic analysis of FHM families*

Mutation scanning of the *SCN1A* gene in the probands of the 10 families revealed one mutation in a North American family of Caucasian descent (Fig. 1A). Clinical details of mutation carriers from this family are shown in Table 1. The proband (III-4), aged 51 years, has hemiplegic migraine attacks since the age of 10 with a frequency that varies from twice a month to once a year. The attacks always start with blurred vision with dark spots, followed within minutes by spreading hemiparasthesia and hemiparesis with dysarthria and dysphasia. After 20-30 minutes, this is followed by a hemicranial throbbing headache, which is always located on the side opposite to the hemiparesis and is accompanied by nausea, vomiting, photo- and phonophobia. Six additional family members suffer from typical hemiplegic migraine attacks as well, with an age of onset varying from 11 to 24 years. We classified individual IV-3 also as affected, despite the fact that he only has had one attack of FHM so far. We feel that because of his young age (22) subsequent attacks are still likely to occur. Besides hemiplegic attacks, individual III-2 suffers from migraine with and without aura and individual IV-3 suffers from migraine without aura. No cerebellar signs or epilepsy symptoms were reported in this family.



Mutation analysis in the proband revealed a heterozygous point mutation in exon 26 (c.4946T>A; p.L1649Q), resulting in an amino acid substitution of glutamine for leucine. The mutation co-segregated completely with the hemiplegic migraine phenotype in this family and was not found in a panel of 400 control chromosomes. Sequence alignments indicated high conservation of Leucine<sup>1649</sup> among several vertebrate sodium channel  $\alpha 1$  subunits (Fig. 1B). Mutation p.L1649Q is located in the S4/D4 domain that is implicated in voltage sensing of fast inactivation (Fig. 1C-D).

**Table 1.** Clinical Characteristics of *SCN1A* Mutation Carriers

ID	Age at onset (yrs)	Aura symptoms during hemiplegic attacks				Hemiplegic attacks		Headache characteristics during hemiplegic attacks			
		H	S	V	A	Duration Hemiplegia	Frequency	Duration	Side	Character	Nausea/vomiting/photophobia/phonophobia
II-1	12	+	+	+	+	1-6 h	2/week	24-48 h	Both sides	Throbbing	+/+/+/+
II-2	11	+	+	+	+	10-60 min	4-5/year	4-72 h	Unilateral	Nagging	+/+/+/-
III-2*	21	+	+	+	+	1-14 h	3-4/year	2 days	Both sides	Pulsating	+/+/+/+
IV-2	15	+	+	+	+	10-60 min	2/year	4-72 h	Both sides	Throbbing	+/+/+/+
III-4	10	+	+	+	+	>60 min	2/month-1/year	24 h	Unilateral	Throbbing	+/+/+/+
III-5	24	+	+	+	+	15 min	5/life	3 h	Both sides	Pounding	-/-/-/-
IV-3**	19	+	+	+	+	45 min	1 till present	1.5 h	Unilateral	Throbbing	+/+/+/+

*H*: hemiparesis or hemiplegia; *S*: sensory disturbance; *V*: visual disturbance; *A*: aphasia; +: symptom consistently present in all or most attacks; -: symptom never present; \*Patient III-2 also suffers from migraine with and without aura attacks. \*\*Patient IV-3 also suffers from migraine without aura attacks.

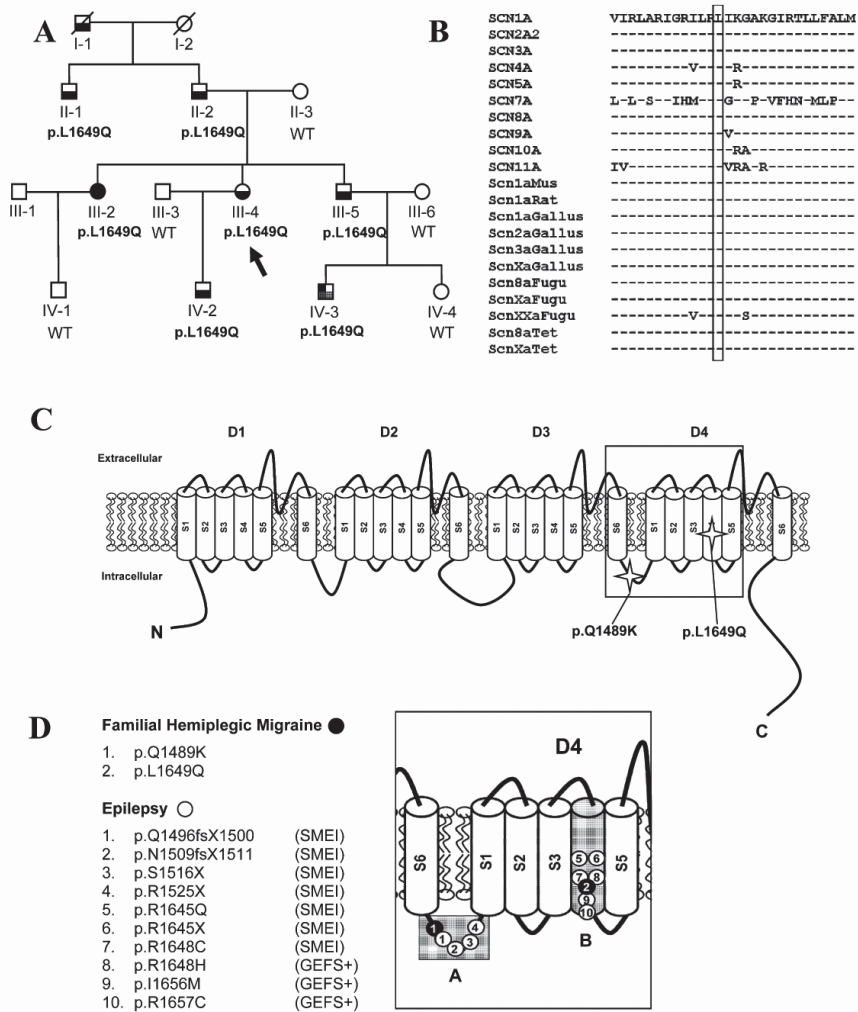
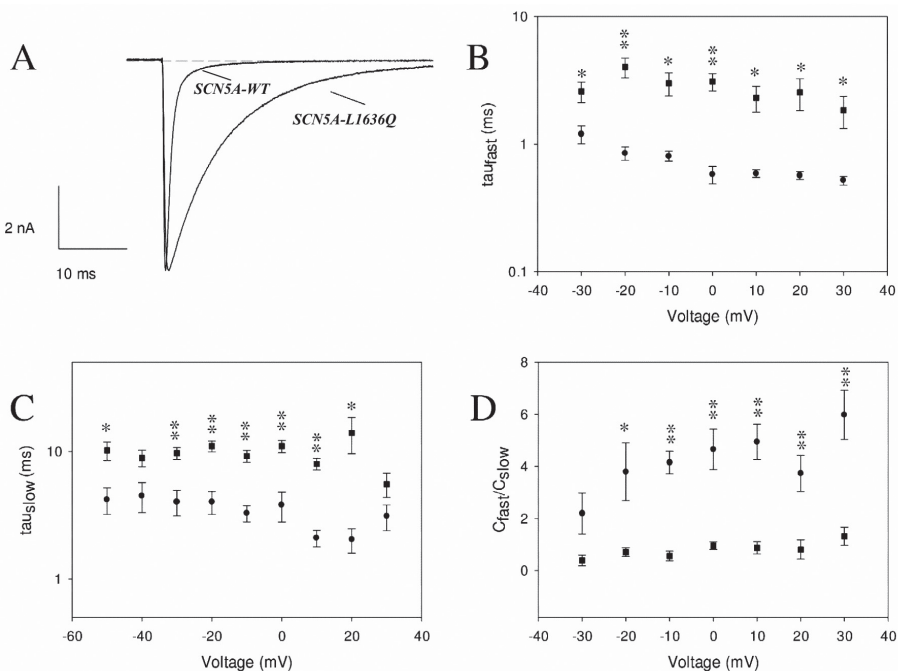

**Figure 1. A:** Pedigree of the *FHM3* p.L1649Q family. The arrow indicates the proband. Symbols present: *FHM*: black lower half; *MA* (migraine with aura): right upper square; *MO* (migraine without aura): left upper square; *WT*: wild-type; p.L1649Q heterozygous carrier of the pathogenic *SCN1A* mutation. Patient IV-3 (aged 22, gray lower half) had one typical (fulfilling the *IHS* criteria) hemiplegic migraine attack until present. **B:** Alignment of the amino acid sequence from several vertebrate sodium channel  $\alpha$  subunits, showing complete conservation of the mutated amino acid Leucine<sup>1649</sup>. **C:** Topology of *SCN1A*, encoding the  $\alpha 1$ -subunit of a neuronal *Na<sub>v</sub>1.1* sodium channel. The subunit consists of 4 repeat domains (D1-D4), which contain 6 transmembrane domains (S1-S6). The location of the novel mutation p.L1649Q in the voltage sensor domain S4/D4 is depicted, as well as the previously identified p.Q1489K *FHM3* mutation. **D:** Over 150 mutations have been identified for severe myoclonic epilepsy in infancy (SMEI) or generalized epilepsy with febrile seizures plus (GEFS+). For clarity, only SMEI and GEFS+ mutations are shown that are located in the (A) inactivation gate and (B) S4/D4 voltage sensor domain where *FHM3* mutations were identified (all mutations are based on *SCN1A* cDNA reference sequence: AB093548.1). For review papers with all *SCN1A* epilepsy mutations see Meisler et al. (2005)<sup>5</sup> and Mulley et al. (2005)<sup>6</sup>.

### Functional Consequences of the *FHM3* Mutation

TsA201cells expressing construct *SCN5A-L1636Q*, which is equivalent to mutation p.L1649Q in *SCN1A* showed typical voltage-dependent sodium inward currents, similar to cells trans-

fectured with construct *SCN5A-WT* (Fig. 2A), and with similar current density (Table 2). Mutant channels activated with the same voltage dependence as WT channels (Table 2). However, the time course of inactivation was slower for the mutant (Fig. 2A). Quantitative analysis of the inactivation time-course revealed that, at all tested voltages (-50 mV to 30 mV), both time constants of the double exponential fits ( $\tau_{fast}$  and  $\tau_{slow}$ ) were two- to four-fold larger for the mutant compared to wild-type (Fig. 2B-C). The contribution of the fast component relative to the slow component (also expressed as the ratio  $C_{fast}/C_{slow}$ ) of inactivation was reduced (Fig. 2D). Both effects lead to an overall slower fast inactivation of mutant channels (Fig. 2A). On the other hand, slow inactivation was unaffected (Table 2). The voltage dependence of steady state fast inactivation was shifted by  $\sim 10$  mV towards more positive voltages and recovery from fast inactivation, measured after a 500 ms conditioning pulse to  $-10$  mV, was 150% faster in the mutant than in the wild-type channels. Altogether, these functional analyses show that this mutation severely interferes with the fast inactivation process.



**Figure 2.** Electrophysiological properties of wild-type and mutant sodium channels. **A:** Macroscopic sodium currents were recorded using the whole-cell configuration of the patch clamp technique. Depicted are current traces recorded at  $-10$  mV showing slowed inactivation of mutant channels. **B-D:** Time constants of inactivation ( $\tau_{fast}$  and  $\tau_{slow}$ ) and their respective contributions ( $C_{fast}$  and  $C_{slow}$ ) were obtained from a bi-exponential fit to the decaying current phase as described earlier (Dichgans et al., 2005). **B:** fast time constant of inactivation ( $\tau_{fast}$ ). **C:** slow time constant of inactivation ( $\tau_{slow}$ ). **D:** ratio of the contribution of the fast and the slow component of inactivation ( $C_{fast}/C_{slow}$ ). At  $-50$  mV and  $-40$  mV the fast component was negligible. Mean values  $\pm$  SEM are given for *SCN5A-WT* (filled circles;  $n=6$ ) and mutant *SCN5A-L1636Q* (filled squares;  $n=6$ ). Values marked with asterisks are significantly different between wild-type and mutant (\*  $p<0.05$ ; \*\*  $p<0.01$ ) with Student's unpaired t-test.

**Table 2.** Activation and Inactivation Parameters for Wild-type and Mutant Sodium Channels

<b>Parameters</b>	<b>SCN5A-WT</b>	<b>SCN5A-L1636Q</b>
Current density (nA/pF)	0.24 ± 0.04 (30)	0.21 ± 0.03 (28)
<b>Steady-state activation</b>		
Voltage of half maximal activation ( $V_a$ , mV)	-44.2 ± 5.1 (7)	-41.4 ± 1.5 (6)
Slope factor ( $k_a$ )	6.1 ± 1.8	6.0 ± 1.5
Reversal potential ( $V_{rev}$ , mV)	45.6 ± 5.2	41.7 ± 7.0
<b>Steady-state fast inactivation</b>		
Voltage of half maximal inactivation ( $V_{fi}$ , mV)	-77.4 ± 3.1 (8)	-67.8 ± 2.7 (5) **
Slope factor ( $k_{fi}$ )	7.2 ± 1.4	7.5 ± 1.1
<b>Steady-state slow inactivation</b>		
Voltage of half maximal slow inactivation ( $V_{si}$ , mV)	-99.1 ± 10.2 (3)	-92.8 ± 0.7 (3)
Slope factor ( $k_{si}$ )	12.6 ± 3.3	13.0 ± 2.1
<b>Recovery from inactivation (-120 mV)</b>		
Fast time constant ( $\tau_{fast}$ ) (ms)	7.1 ± 1.6 (4)	4.6 ± 1.0 (5) *
Slow time constant ( $\tau_{slow}$ ) (ms)	322 ± 200	108 ± 48
<b>Onset of slow inactivation</b>		
Fast time constant ( $\tau_{fast}$ ) (s)	3.8 ± 1.4 (9)	5.1 ± 0.9 (4)
Slow time constant ( $\tau_{slow}$ ) (s)	302 ± 105	217 ± 98

Data are mean ± SD. Numbers in brackets indicate number of experiments. Values marked with asterisks are significantly different between wild-type and mutant (\*  $p < 0.05$ ; \*\*  $p < 0.01$ ) with Student's unpaired t-test.

## Discussion

We here firmly establish that certain mutations in the *SCN1A* epilepsy gene may cause FHM. First, the p.L1649Q *SCN1A* mutation completely co-segregated with a pure FHM phenotype (without epilepsy) in our family (Fig. 1A) and was not found in the control panel. Second, Leucine<sup>1649</sup> is highly conserved among several vertebrate sodium channel  $\alpha 1$  subunits (Fig. 1B). Third, the mutation is located in the S4 segment of domain 4 that acts as a voltage sensor and is known to play an important role in channel gating (Fig. 1C-D).<sup>13,14</sup> Finally, our functional studies of the mutation introduced in the highly homologous human *SCN5A* revealed clear functional effects: i) an overall slower inactivation of sodium channels; ii) a depolarizing shift by ~ 10 mV in the voltage dependence of the steady state inactivation; and iii) an accelerated recovery from fast inactivation (Table 2). Most likely, the p.L1636Q *SCN5A* mutation directly interferes with the inactivation process, as do other mutations in the S4/D4 domain<sup>14</sup>, even though we cannot fully exclude a contribution of an altered interaction with the  $\beta 1$  subunit.<sup>15</sup> Although this study convincingly showed causality for p.L1649Q in FHM3, in future studies, these findings should be confirmed in *SCN1A*, or even better in a knockin mouse model.

The previously identified FHM3 mutation p.Q1489K<sup>3</sup> was also introduced in the highly homologous *SCN5A* cDNA, which allows comparison of the functional consequences of both FHM3 mutations. This mutation is located in the cytoplasmic linker between domains III and IV (Fig. 1C-D) and revealed a two-fold to four-fold accelerated recovery from fast inactivation.<sup>3</sup> Thus, both the p.Q1489K and the p.L1649Q mutation lead to impaired fast inactivation and predict enhanced neuronal excitation. This fits very well with our current understanding of the pathogenesis of FHM.<sup>16,4</sup> The *CACNA1A* gene encodes neuronal Ca<sub>v</sub>2.1 calcium channels that modulate the release of neurotransmitters. FHM1 *CACNA1A* mutations were shown to cause gain-of-function effects in cellular models<sup>17,18</sup> and in a knockin mouse model.<sup>19</sup> In the transgenic model, FHM1 mutations increase the release of glutamate and other neurotransmitters (A. Tottene, A. van den Maagdenberg, and D. Pietrobon, unpublished observations) and reduce the threshold for cortical spreading depression (CSD).<sup>19</sup> CSD has been convincingly shown to be the underlying mechanism for the migraine aura<sup>20</sup> and, based on animal experiments, may also be responsible for triggering the headache phase of migraine attacks by activating the trigeminovascular system.<sup>21</sup> The *ATP1A2* gene encodes a Na,K-ATPase in glial cells. FHM2 *ATP1A2* mutations were shown to have altered kinetics or loss-of-function effects in cellular studies, predicting reduced re-uptake of both K<sup>+</sup> and glutamate from the synaptic cleft into glial cells.<sup>2,22</sup> Voltage-gated sodium channels are involved in the generation and propagation of action potentials in excitable tissues. FHM3 *SCN1A* mutations changed Na<sub>v</sub>1.1 channel inactivation kinetics, predicting enhanced neuronal excitation leading to increased release of neurotransmitters, including glutamate. The common overall effect of FHM mutations in all three FHM genes seems to be an increase of the concentration of K<sup>+</sup> and glutamate in the synaptic cleft. This should translate into an enhanced propensity for CSD and may thus be responsible for triggering FHM, and possibly “normal” migraine attacks.

Migraine and epilepsy are comorbid disorders and seem to have some overlapping mechanisms related to dysfunction of ion transportation.<sup>23</sup> It is remarkable that the vast majority of *SCN1A* mutations are associated with severe forms of epilepsy, whilst the p.Q1489K and p.L1649Q mutations cause pure FHM. The p.L1649Q FHM3 mutation is even adjacent to two “epilepsy” mutations that affect Arginine<sup>1648</sup>, the p.R1648C mutation causing SMEI<sup>24</sup> and p.R1648H causing GEFS+.<sup>25</sup> Both mutations have been examined in several expression systems with different outcomes all affecting channel inactivation.<sup>5</sup> From these and our studies it is evident that the voltage sensor in domain 4 (S4/D4) is pivotal to the fast inactivation of sodium channels but that there is no simple correlation between clinical phenotype and biophysical changes induced by *SCN1A* mutations. Dedicated functional studies comparing epilepsy and migraine mutations in the same gene may further the insight into both episodic brain disorders.

---

## References

1. Ophoff RA, Terwindt GM, Vergouwe MN, van Eijk R et al (1996) Familial hemiplegic migraine and episodic ataxia type-2 are caused by mutations in the Ca<sup>2+</sup> channel gene CACNL1A4. *Cell* 87:543-552.
2. De Fusco M, Marconi R, Silvestri L, Atorino L et al (2003) Haploinsufficiency of ATP1A2 encoding the Na<sup>+</sup>/K<sup>+</sup> pump alpha 2 subunit associated with familial hemiplegic migraine type 2. *Nat Genet* 33:192-196.
3. Dichgans M, Freilinger T, Eckstein G, Babini E et al (2005). Mutation in the neuronal voltage-gated sodium channel SCN1A in familial hemiplegic migraine. *Lancet* 366:371-377.
4. Ferrari MD, Goadsby PJ. (2006) Migraine as a cerebral ionopathy with abnormal central sensory processing. In: Gilman S, editor. *Neurobiology of Disease*. New York: Elsevier. p 333-348
5. Meisler MH, Kearney JA. (2005) Sodium channel mutations in epilepsy and other neurological disorders. *J Clin Invest* 115:2010-2017.
6. Mulley JC, Scheffer IE, Petrou S, Dibbens LA et al (2005) SCN1A mutations and epilepsy. *Hum Mutat* 25:535-542.
7. Rhodes TH, Lossin C, Vanoye CG, Wang DW, George AL Jr. (2004) Noninactivating voltage-gated sodium channels in severe myoclonic epilepsy of infancy. *Proc Natl Acad Sci USA* 101:11147-11152.
8. George AL Jr. (2005) Inherited disorders of voltage-gated sodium channels. *J Clin Invest* 115:1990-1999.
9. Barela AJ, Waddy SP, Lickfett JG, Hunter J, et al (2006) An epilepsy mutation in the sodium channel SCN1A that decreases channel excitability. *J Neurosci* 26:2714-2723.
10. Headache classification subcommittee of the international headache society (2004) The international classification of headache disorders. 2nd Edition. *Cephalalgia* 24(supplement 1):1-160.
11. Miller SA, Dykes DD, Polesky HF (1988) A simple salting out procedure for extracting DNA from human nucleated cells. *Nucleic Acids Res* 16:1215.
12. Tate SK, Depondt C, Sisodiya SM, Cavalleri GL et al (2005) Genetic predictors of the maximum doses patients receive during clinical use of the anti-epileptic drugs carbamazepine and henytoin. *Proc Natl Acad Sci USA* 102: 5507-5512.
13. Kuhn FJP, Greeff NG (1999) Movement of voltage sensor S4 in domain 4 is tightly coupled to sodium channel fast inactivation and gating charge immobilization. *J Gen Physiol* 114:167-183.

14. Ulbricht W (2005) Sodium channel inactivation: molecular determinants and modulation. *Physiol Rev* 85:1271-1301.
15. Ko S-H, Lenkowski PW, Lee HC, Mounsey JP, Patel MK. (2005) Modulation of Na(v)1.5 by beta1-- and beta3-subunit coexpression in mammalian cells. *Pflügers Arch-Eur J Physiol* 449:403-412.
16. Moskowitz MA, Bolay H, Dalkara T (2004) Deciphering migraine mechanisms: Clues from familial hemiplegic migraine genotypes. *Ann Neurol* 55:276-280.
17. Plomp JJ, Van den Maagdenberg AM, Molenaar PC, Frants RR, Ferrari MD (2001) Mutant P/Q-type calcium channel electrophysiology and migraine. *Curr Opin Investig Drugs* 2:1250-1260.
18. Pietrobon D (2005) Migraine: New molecular mechanisms. *Neuroscientist* 11:373-386
19. Van den Maagdenberg AM, Pietrobon D, Pizzorusso T, Kaja S et al (2004) A *Cacna1a* knockin migraine mouse model with increased susceptibility to cortical spreading depression. *Neuron* 41:701-710.
20. Lauritzen M. (1994) Pathophysiology of the migraine aura. The spreading depression theory. *Brain* 117:199-210.
21. Bolay H, Reuter U, Dunn AK, Huang ZH, et al (2002) Intrinsic brain activity triggers trigeminal meningeal afferents in a migraine model. *Nat Med* 8:136-142.
22. Segall L, Mezzetti A, Scanzano R, Gargus JJ et al (2005) Alterations in the alpha2 isoform of Na,K-ATPase associated with familial hemiplegic migraine type 2. *Proc Natl Acad Sci USA* 102:11106-11111.
23. Haut SR, Bigal ME, Lipton RB (2006) Chronic disorders with episodic manifestations: focus on epilepsy and migraine. *Lancet Neurol* 5:148-157.
24. Ohmori I, Ouchida M, Ohtsuka Y, Oka E, Shimizu K (2002) Significant correlation of the *SCN1A* mutations and severe myoclonic epilepsy in infancy. *Biochem Biophys Res Commun* 295:17-23.
25. Escayg A, MacDonald BT, Meisler MH, Baulac S et al (2000) Mutations of *SCN1A*, encoding a neuronal sodium channel, in two families with GEFS+2. *Nat Genet* 24:343-345.





---

# 3.0

## **Systematic analysis of three FHM genes in 39 sporadic patients with hemiplegic migraine**

---

B. de Vries, MSc\*, T. Freilinger, MD\*, K.R.J. Vanmolkot, MSc, J.B. Koenderink, PhD, A.H. Stam, MD, G.M. Terwindt, MD, PhD, E. Babini, PhD, E.H. van den Boogerd, BSc, J.J.M.W. van den Heuvel, BSc, R.R. Frants, PhD, J. Haan, MD, PhD, M. Pusch, PhD, A.M.J.M. van den Maagdenberg, PhD, M.D. Ferrari, MD, PhD, M. Dichgans, MD, PhD

*From the Departments of Human Genetics (B.d.v., K.R.J.V., E.H.v.d.B., R.R.F., A.M.J.M.v.d.M.) and Neurology (A.H.S., G.M.T., J.H., A.M.J.M.v.d.M., M.D.F.), Leiden University Medical Centre, Leiden, The Netherlands; Department of Neurology, Klinikum Großhadern, Ludwig-Maximilians-Universität, München, Germany (T.F., M.D.); Department of Pharmacology and Toxicology, Centre for Molecular Life Sciences, University Medical Centre St. Radboud, Nijmegen, The Netherlands (J.B.K., J.J.M.W.v.d.H.); Istituto di Biofisica, Consiglio Nazionale delle Ricerche, Genoa, Italy (E.B., M.P.); and Department of Neurology, Rijnland Hospital, Leiderdorp, The Netherlands (J.H.).*

*\*These authors contributed equally.*

**Neurology 2007;69:2170-2176**

---

## Abstract

**Background:** Familial (FHM) and sporadic (SHM) hemiplegic migraine are severe subtypes of migraine associated with transient hemiparesis. For FHM, three genes have been identified encoding subunits of a calcium channel (*CACNA1A*), a sodium–potassium pump (*ATP1A2*), and a sodium channel (*SCN1A*). Their role in SHM is unknown. Establishing a genetic basis for SHM may further the understanding of its pathophysiology and relationship with common types of migraine. It will also facilitate the often difficult differential diagnosis from other causes of transient hemiparesis.

**Methods:** We systematically scanned 39 well-characterized patients with SHM without associated neurologic features for mutations in the three FHM genes. Functional assays were performed for all new sequence variants.

**Results:** Sequence variants were identified in seven SHM patients: one *CACNA1A* mutation, five *ATP1A2* mutations, and one *SCN1A* polymorphism. All six mutations caused functional changes in cellular assays. One SHM patient later changed to FHM because another family member developed FHM attacks.

**Conclusion:** We show that FHM genes are involved in at least a proportion of SHM patients without associated neurologic symptoms. Screening of *ATP1A2* offers the highest likelihood of success. Because FHM gene mutations were also found in family members with “nonhemiplegic” typical migraine with and without aura, our findings reinforce the hypothesis that FHM, SHM, and “normal” migraine are part of a disease spectrum with shared pathogenetic mechanisms.

## Introduction

Hemiplegic migraine is a rare, often severe subtype of migraine with aura in which attacks are associated with hemiparesis.<sup>1</sup> Otherwise, the aura and headache symptoms are identical to those of common types of migraine.<sup>2</sup> Hemiplegic migraine may run in families (familial hemiplegic migraine [FHM]) or may be sporadic (SHM).<sup>1</sup> Clinically, FHM and SHM attacks are indistinguishable, and the majority of patients also have common attacks of migraine with or without aura, not associated with hemiparesis.<sup>3</sup>

Thus far, three genes for FHM have been identified. The *CACNA1A* gene (FHM1)<sup>4</sup> encoding the pore-forming subunit Ca<sub>v</sub>2.1 of neuronal P/Q-type calcium channels, the *ATP1A2* gene (FHM2)<sup>5</sup> encoding the  $\alpha$ 2 subunit of sodium–potassium pumps, and the *SCN1A* gene (FHM3)<sup>6</sup> encoding the  $\alpha$ 1 subunit of neuronal sodium channels.

Although clinically indistinguishable,<sup>3</sup> it is unknown whether and to what extent SHM and FHM are pathophysiologically related and whether and to what extent FHM genes are also involved

in SHM. Previous studies identified mutations in the *CACNA1A* gene in SHM patients.<sup>7-11</sup> Most of these patients showed cerebellar signs, suggesting an involvement of the *CACNA1A* gene in SHM with associated cerebellar and other neurologic signs or symptoms, such as cerebral edema and coma after minor head trauma. In contrast, the role of the FHM genes in “pure” SHM without associated neurologic symptoms is less clear. One *CACNA1A* mutation (R583Q)<sup>8</sup> and one *ATP1A2* mutation (R383H)<sup>12</sup> were reported in such patients.

Investigating the involvement of FHM genes in sporadic patients with hemiplegic migraine is important because it may further the insight into the pathophysiology of SHM and the relationship with other types of migraine. Moreover, understanding and establishing the genetic basis of SHM may help clinicians in diagnostic and therapeutic decision making. Many patients are initially misdiagnosed and mistreated. We therefore set out to search systematically for mutations in the known FHM genes in a large set of 39 clinically well-characterized patients with “pure” SHM, who had no interictal neurologic symptoms.

## Methods

### *Patients*

Sporadic hemiplegic migraine was diagnosed according to the criteria of the International Headache Society (IHS).<sup>1</sup> Patients with interictal neurologic symptoms, in particular ataxia, were excluded because these patients have a high a priori probability of carrying a *CACNA1A* mutation.<sup>7-11</sup> All available family members were directly interviewed, and their headache was diagnosed according to the IHS criteria. In addition to newly recruited SHM patients, we included 25 of the 27 patients from our previous study in which only the FHM1 *CACNA1A* gene was investigated.<sup>8</sup> Two patients from that study were excluded because of associated symptoms; one had ataxia and carried the T666M mutation, the other patient had childhood epilepsy and did not carry a *CACNA1A* mutation. Approval was obtained by local ethical committees in accordance with national legislation; all patients gave informed consent.

### *Mutation scanning*

Genomic DNA was isolated from peripheral leukocytes using a standard salting out extraction method. The *CACNA1A*, *ATP1A2*, and *SCN1A* genes were screened for mutations by sequencing.<sup>6,8,13</sup> In brief, all exons and flanking intronic regions were amplified by PCR, using genomic DNA as a template. Direct sequencing was performed with Cycle Sequencing (Prism Big Dye Terminators Cycle Sequencing kit, Applied Biosystems, Foster City, CA) using the dideoxy termination method and an ABI3700 automated sequencer (Applied Biosystems). For each exonic variant identified, 150 healthy controls were screened, by restriction enzyme analysis or direct sequencing. Detailed information is available from the authors on request.

---

### *Functional analysis.*

Functional analysis of mutations in the  $\text{Ca}_v2.1\text{-}\alpha 1$  calcium channel subunit was not performed because the single *CACNA1A* mutation found in this study was thoroughly investigated before.<sup>14</sup> Functional analysis of *ATP1A2* variants was performed by survival assays. Human Na,K-adenosine triphosphatase (ATPase)  $\alpha 2$ -subunit complementary DNA (cDNA) was subcloned into a modified pCDNA3.1 vector.<sup>15</sup> To distinguish endogenous Na,K-ATPase activity from that of transfected Na,K-ATPase, we used a cDNA construct encoding ouabain-resistant wildtype (*ATP1A2-WT*).<sup>15,16</sup> Mutations E120A, E492K, P786L, R834X, and R908Q were introduced in the ouabain-resistant wild-type  $\alpha 2$ -subunit construct by site-directed mutagenesis (Quikchange, Stratagene, La Jolla, CA). HeLa cells ( $5 \times 10^5$ ) were transfected with plasmid DNA of either *ATP1A2-WT* or *ATP1A2*-mutant (*ATP1A2-E120A*, *ATP1A2-E492K*, *ATP1A2-P789L*, *ATP1A2-R834X*, *ATP1A2-R908Q*) using Lipofectamine 2000 Transfection Reagent (Invitrogen, Carlsbad, CA). Two days after transfection, two-thirds of the cells were harvested for immunoblotting, and the  $\alpha 2$ -subunit protein was detected using the specific polyclonal antibody HERED.<sup>15,16</sup> The remaining one-third of the cells was seeded on 10-cm petri dishes, and subsequently  $1 \mu\text{M}$  ouabain was added to the culture medium. After 5 days of ouabain challenge, colonies were stained with 1% methylene blue in 70% methanol, scanned, and analyzed with Image Pro Plus (MediaCybernetics, Silver Spring, MD). Each transfection was performed 7 to 15 times. In case of partial survival, statistical significance was tested using Student *t*-test ( $p < 0.05$ ).

For functional analysis of the *SCN1A* variant, we used the closely related *SCN5A* cDNA, because of the known stability problems of recombinant bacteria with *SCN1A* cDNA.<sup>6,17</sup> R1914G, which corresponds to *SCN1A* R1928G, was introduced by site-directed mutagenesis into full-length human *SCN5A* cDNA subcloned in pCDNA3.1 (QuikChange XL Kit, Stratagene). *SCN5A-R1914G* and *SCN5A-WT* cDNAs were transfected into human tsA201 cells and were each coexpressed with accessory human sodium channel subunit  $\beta 1$ .<sup>6</sup> Macroscopic sodium currents were recorded using the whole-cell configuration of the patch clamp technique.<sup>6</sup> Steady state activation, steady state inactivation, time constants of inactivation (e.g., time constants  $\tau_{\text{fh}}$  and  $\tau_{\text{sh}}$ ), and recovery from inactivation (e.g.,  $\tau_{\text{fast}}$  and  $\tau_{\text{slow}}$  time constants) were measured using protocols, as described before.<sup>6</sup>

## **Results**

### *Patients*

Thirty-nine patients with “pure” SHM were included; 37 originated from Western Europe (mostly The Netherlands or Germany) and 2 came from the United States (table 1). As expected,<sup>3,18</sup> some of the patients exhibited basilar-type migraine symptoms during the attacks, but they were all free of interictal signs or symptoms. Age at onset of hemiplegic attacks ranged from 4 to 42 years. The number of attacks varied from 2 per lifetime to more than 200 per year. Likewise, duration of hemiparesis was variable, from several minutes to 1 week. Four patients reported loss of consciousness during attacks; 2 patients reported triggering of attacks by minor head trauma. In 1 patient, the initial diagnosis was later changed to FHM, when a family member developed hemiplegic migraine attacks. Notwithstanding, this patient was kept in the SHM group because he fulfilled the inclusion criteria of SHM at the time of clinical presentation. In approximately 70% of the families of our 39 SHM patients, attacks of common nonhemiplegic migraine with aura (one-third), without aura (one-third), or both (one-third) were present in one or more first-degree relatives.

Table 1 Clinical and genetic characteristics of SHM patients

Patient	Mutation in HM gene	Age at onset, y	Frequency of attacks, per y	Total duration of attack	Duration of paresis	BAM symptoms	Unconsciousness during attacks	Attacks triggered by minor head trauma	MO or MA in first-degree family members
1	No	27	3	1-2 d	Min	No	No	No	MO
2	No	20	4	0.5-2 d	0.5-2 h	No	No	No	MA
3	No	12	?	Days	Hrs	No	No	No	MA
4	No	18	24	15-60 min	15 min	No	No	No	MO
5	No	20	0-3	8 h	1 h	No	No	No	No
6	ATP1A2-R834X	10	1	4 d	2 d	No	No	Yes	MO
7	No	22	12	12 h	0.5-2 h	No	No	No	MO and MA
8	No	9	12-30	1-3 d	1 h-1 d	No	No	No	MA
9	No	25	24	Hrs-3 d	0.5-1 h	Yes	No	No	MO
10	No	12	4-36	1-2 d	5-10 min	No	Yes	No	No
11	No	19	2 in lifetime	20 min-1 h	20 min	No	No	No	MA
12	ATP1A2-E120A	13	12-250	1 d	1 h	No	No	No	No
13	No	25	48	10-24 h	?	?	No	No	MO and MA
14	No	13	2-6	Few hrs	0.5 h	No	No	No	MO and MA
15	No	29	2-100	Min-hrs	Min-hrs	Yes	Yes	Yes	No
16	No	4	24	1 d	Few hrs	Yes	No	No	MA
17	No	10	Once	1 d	1 h	No	No	No	MO and MA
18	No	20	0-2	1 wk-1 mo 1	1 wk-1 mo	?	No	No	MO
19	ATP1A2-P786L	5	0.5	3 wk	6 d	No	No	No	No
20	No	16	12	1 d	1 h	No	No	No	MO and MA
21	No	13	Once	Few days	Few days	No	No	No	MO and MA
22	No	13	2-52	1 d	0.5-1 h	No	No	No	MO and MA
23	ATP1A2-E492K	19	2	?	?	No	No	No	MA
24	No	32	2-12	Days	Hrs-days	No	No	No	MA
25	CACNA1A-R583Q	13	2	1 d	0.5 h	No	No	No	MA
26	No	34	8	0.5?	Hrs?	No	No	No	No
27	No	37	36-48	3-48 hrs?	Hrs-48 h	No	No	No	MO or MA?
28	SCN1A-R1928G	38	2 in lifetime	Few hrs	1.5 h	No	Yes	No	MO and MA
29	No	42	2 in lifetime	3-4 hrs	0.5 h	No	No	No	Migraine unspecified
30	No	11	30 in lifetime	Hours	1 h	No	No	No	MA and migraine unspecified
31	No	17	24	Up to 4 h	3-4 h	No	No	No	MA in grandmother
32	No	22	up to 50	Hours	Hours	No	No	No	No
33	No	15	4 to 10	1 h	15-30 min	No	No	No	Migraine unspecified
34	ATP1A2-R908Q	5	2 to 5	2 h	30-90 min	Yes	No	No	No
35	No	27	5 in lifetime	Up to 7 h	Up to 7 h	No	No	No	MO and MA
36	No	16	4	1.5-3 h	1-3 h	No	No	No	No
37	No	4	4	Hours	24-72 h	No	No	No	No
38	No	8	2-12	Hours	15-60 min	No	No	No	No
39	No	35	5	Few hours	15 min-3 h	No	Yes	No	MA

SHM = sporadic hemiplegic migraine; HM = hemiplegic migraine; BAM = basilar artery migraine; MO = migraine without aura; MA = migraine with aura.

*Genetic and functional findings.*

Sequencing of all exons and flanking intronic sequences in the 39 index cases revealed seven different sequence variants which were present in seven probands (table 2 and figure 1): one in *CACNA1A*, five in *ATP1A2*, and one the *SCN1A* gene. None of the sequence variants was present in 150 healthy controls (data not shown).

**Table 2** DNA variants identified in pure SHM patients

<b>Gene</b>	<b>Amino acid change</b>	<b>Nucleotide change</b>	<b>Abnormality in functional test</b>
<i>CACNA1A</i>	R583Q	nt2021GA	Electrophysiologic consequence
<i>ATP1A2</i>	E120A	nt463AC	Partial cell survival
<i>ATP1A2</i>	E492K	nt1578GA	Partial cell survival
<i>ATP1A2</i>	P786L	nt2604CT	No cell survival
<i>ATP1A2</i>	R834X	nt2461CT	No cell survival
<i>ATP1A2</i>	R908Q	nt2827GA	No cell survival
<i>SCN1A</i>	R1928G	nt5782CG	No electrophysiologic consequence

SHM: sporadic hemiplegic migraine.

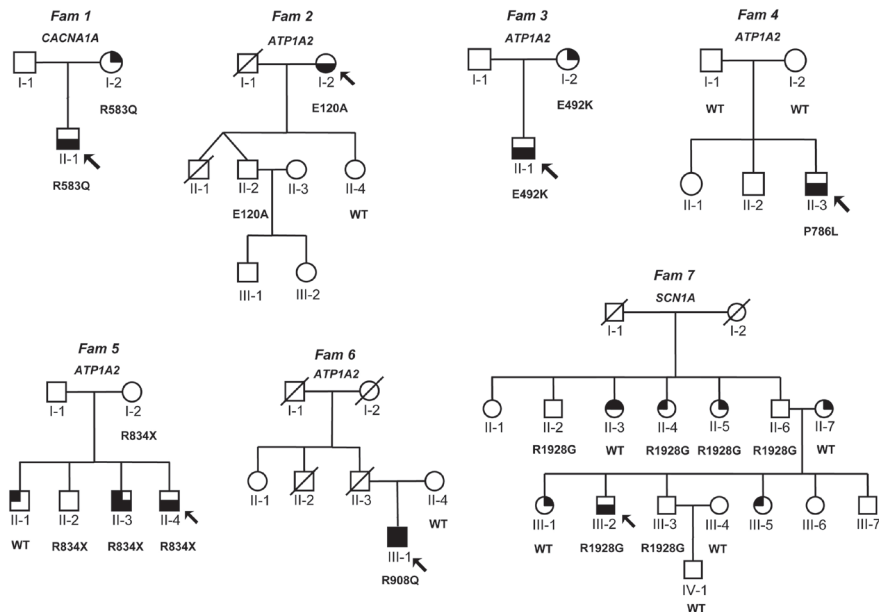

**Figure 1** Pedigrees of sporadic hemiplegic migraine cases with a mutation in one of the familial hemiplegic migraine genes (*CACNA1A*, *ATP1A2*, and *SCN1A*). The following symbols are used to indicate the diagnosis: filled lower half = familial hemiplegic migraine; right upper quadrant = migraine with aura; left upper quadrant = migraine without aura. Circle = female; square = male. Arrows indicate probands. Individuals homozygous for the wild-type allele are indicated by WT; individuals heterozygous for a DNA variant are indicated by the respective variant. Fam = family.

## CACNA1A

The single variant in the *CACNA1A* gene (R583Q) has been reported as part of our earlier study.<sup>8</sup> R583Q was present in the index case and his unaffected mother, who had migraine with aura but no hemiplegic attacks indicating incomplete penetrance. R583Q has previously been identified in families with FHM and shown to affect Ca<sub>v</sub>2.1 Ca<sup>2+</sup> channel gating in functional studies.<sup>14</sup> Thus, R583Q can be considered causative in our case.

## ATP1A2

The five DNA variants in *ATP1A2* included four missense variants (E120A, E492K, P786L, R908Q) and one nonsense mutation (R834X). P786, R908, and R834 are completely conserved across multiple homologs and orthologs, whereas E120 and E492 are less well conserved (figure 2). The P786L mutation was not present in the proband's parents. False paternity was excluded in this case. Thus, P786L represents a *de novo* mutation. E120A, E492K, and R834X were all present in one or more relatives who had no hemiplegic attacks, thus suggesting incomplete penetrance. R908Q was not present in the proband's mother, but DNA from additional family members was not available (figure 1).

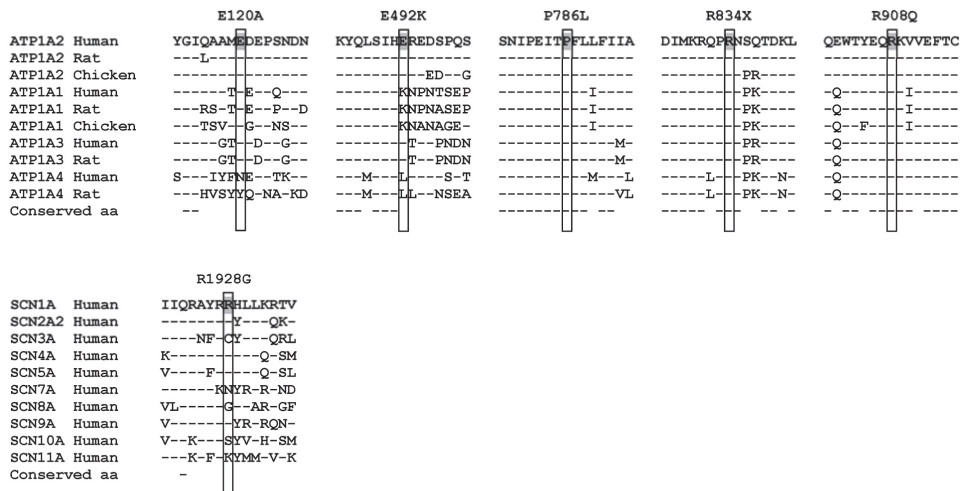

**Figure 2** Alignments of novel *ATP1A2* and *SCN1A* DNA variants identified in SHM patients. Conservation of mutated amino acids (highlighted in gray) is depicted in boxes. Dashed lines indicate conserved amino acids. Proteins were obtained from GenBank. Human: P50993 (*ATP1A2*), P05023 (*ATP1A1*), P13637 (*ATP1A3*), Q13733 (*ATP1A4*); Rat: P06686 (*ATP1A2*), P06685 (*ATP1A1*), P06687 (*ATP1A3*), Q64541 (*ATP1A4*); Chicken: P24797 (*ATP1A2*), P09572 (*ATP1A1*). Human: P35498 (*SCN1A*), Q99250 (*SCN2A2*), Q9NY46 (*SCN3A*), P35499 (*SCN4A*), Q14524 (*SCN5A*), Q01118 (*SCN7A*), Q9UQD0 (*SCN8A*), Q15858 (*SCN9A*), Q9Y5Y9 (*SCN10A*), Q9UI33 (*SCN11A*).



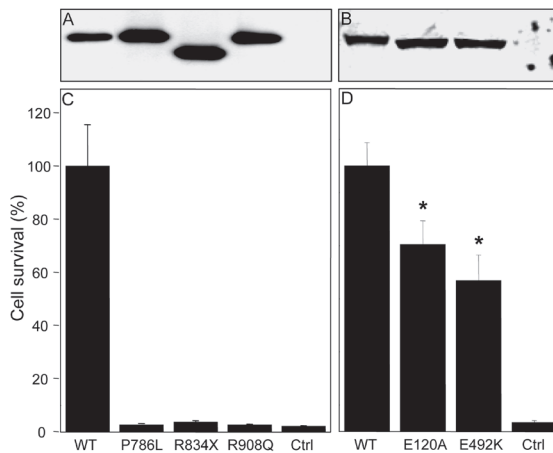

**Figure 3** Ouabain survival assay of novel *ATP1A2* DNA variants identified in sporadic hemiplegic migraine patients (**A** and **B**) Western blot analysis of HeLa cells transfected with wild-type (WT) or mutant *ATP1A2* complementary DNA (cDNA). (**C** and **D**) Ouabain sensitivity of cells transfected with either wild-type or mutant *ATP1A2* cDNA. Bars represent cell survival after 5 days of ouabain treatment (error bars SEM). \* Partial survival is significantly lower than for WT ( $p < 0.05$ ). Mutants P786L, R834X, and R908Q gave no survival. Ctrl control.

Functional consequences of all five *ATP1A2* variants were investigated using survival assays in HeLa cells as previously reported for FHM2 mutations.<sup>5,16</sup> The survival assays test for the ability of mutant protein to compensate for the loss of endogenous Na,K pump function, as achieved by ouabain treatment (figure 3, C and D). Because of an altered ouabain binding site, the transfected wild-type (*ATP1A2*-WT) and mutant (*ATP1A2*-E120A, *ATP1A2*-E492K, *ATP1A2*-P786L, *ATP1A2*-R834X, *ATP1A2*-R908Q) Na,K-ATPase  $\alpha 2$  subunits are ouabain insensitive. Western blot analysis showed that the constructs were expressed at comparable levels (figure 3, A and B). In the survival assay, cells expressing the wild-type construct survived ouabain treatment. In contrast, *ATP1A2* mutants gave no (*ATP1A2*-P786L, *ATP1A2*-R834X, *ATP1A2*-R908Q) or partial (*ATP1A2*-E120A [ $p = 0.03$ ], *ATP1A2*-E492K [ $p = 0.002$ ]) cell survival, indicating a clear functional consequence for all mutants (figure 3, C and D).

### *SCN1A*.

DNA variant R1928G in the *SCN1A* gene was present in the index case and five additional family members, two of whom had nonhemiplegic migraine. R1914G (which is equivalent to *SCN1A*-R1928G) was introduced to highly homologous human *SCN5A* (*SCN5A*-R1914G) and functionally tested for its biophysical properties by patch clamp experiments in transiently transfected human tsA201 cells.<sup>6</sup> Cells expressing the *SCN5A*-R1914G showed no significant difference in current density, steady state activation, steady state inactivation, and recovery from inactivation when compared with wild-type (table 3). These results indicate that the variant may be a DNA variant without a biologically significant effect on  $\text{Na}_v 1.1$  channel functioning.

**Table 3.** Activation and inactivation parameters for wild-type and mutant sodium channel subunit

	SCN5A/WT	SCN5A/R1914G
Current density (nA/pF)	0.24 ± 0.04 (30)	0.14 ± 0.09 (15)
<b>Steady state activation</b>		
Voltage of half maximal activation ( $V_a$ , mV)	-44.2 ± 5.1 (7)	-40.4 ± 3.7 (5)
Slope factor ( $k_a$ )	6.1 ± 1.8	6.2 ± 0.78
Reversal potential ( $V_{rev}$ , mV)	45.6 ± 5.2	35.4 ± 3.2
<b>Steady-state inactivation</b>		
Voltage of half maximal fast inactivation ( $V_{fi}$ , mV)	-77.4 ± 3.1 (8)	-76.5 ± 5.9 (5)
Slope factor ( $k_{fi}$ )	7.2 ± 1.4	8.1 ± 1.5
<b>Recovery from inactivation (-120 mV)</b>		
Fast time constant ( $\tau_{fj}$ ) (ms)	7.1 ± 1.7 (4)	0.6 ± 2.1 (4)
Slow time constant ( $\tau_{rs}$ ) (ms)	323 ± 200	310 ± 144

Electrophysiology was performed for wild-type SCN5A-WT and mutant SCN5A-R1914G, equivalent to SCN1A R1928G, in transiently transfected tsA201 cells. Values are mean ± SD. In brackets the number of recorded cells is given.

## Discussion

We screened 39 patients with “pure” SHM without ataxia or other additional neurologic features for mutations in the three known FHM genes. In 7 patients, we found a sequence variant (table 2). None was found in 300 control chromosomes. Six of these showed obvious functional changes and can be considered causal mutations. These results indicate that genes for FHM are involved in at least a proportion of patients with “pure” SHM. Our findings have important pathogenetic, clinical, and diagnostic implications.

With our findings, a sensible approach to genetic testing in SHM has become available to confirm the often difficult and clinically important diagnosis of SHM.<sup>19</sup> Because SHM patients with *de novo* mutations may represent the founder of a new family with highly disabling FHM, genetic confirmation of the diagnosis may have consequences for genetic counseling. When genetic testing is considered in a patient with “pure” SHM, the *ATP1A2* gene should be screened first. We found an *ATP1A2* sequence variant in five of the seven SHM cases with a confirmed sequence variant corresponding to 13% of the overall SHM sample. This is a strikingly higher prevalence compared with a previous study of the *ATP1A2* gene that included patients with SHM but provided no specific clinical details.<sup>12</sup>

Our findings are in line with earlier smaller studies showing that the yield of *CACNA1A* mutations in SHM patients is low in the absence of ataxia.<sup>20,21</sup> In contrast, *CACNA1A* mutations were found in

50% of SHM patients with associated cerebellar signs.<sup>7,9</sup> The present study is the first to evaluate the role of the recently identified FHM3 gene<sup>6</sup> in SHM. The likelihood of finding *SCN1A* mutations in “pure” SHM, however, seems very low.

Most *ATP1A2* mutations in this study were also found in asymptomatic relatives and in relatives with nonhemiplegic migraine. They thus showed reduced penetrance, as has also been noticed for *ATP1A2* mutations associated with FHM2.<sup>22-24</sup> This might explain why mutations in the *ATP1A2* gene are relatively common among sporadic patients. In contrast, all *SCN1A* mutations previously identified in FHM families showed complete penetrance.<sup>6,17</sup> This might relate to the low yield of mutations in this gene in our sample of sporadic cases.

Although we found FHM gene mutations in 18% of our patients with pure SHM, we did not find mutations in the majority of our patients. It is likely that when additional genes for FHM are discovered, greater proportions of patients with SHM will prove to have mutations in FHM genes. Until then, a diagnosis of SHM remains based on the exclusion of other causes of recurrent hemiparesis, careful physical examination, detailed personal and family history, and regular follow-up. In one patient (with *ATP1A2* mutation R834X; Family 5: figure 1), we had to change the initial diagnosis of SHM to FHM when an additional family member developed hemiplegic migraine attacks several years after our initial investigation. A diagnosis of pure SHM is likely when transient hemiparesis occurs in the course of a typical attack of migraine with aura, when there are no interictal abnormalities, and when “normal” attacks of migraine with or without aura are present in first-degree relatives.<sup>25</sup> Approximately 70% of pure SHM cases and 60% of the mutation carriers had first-degree relatives with common types of migraine.

Our findings provide genetic evidence that FHM genes are also involved in SHM and thus extend and reinforce the growing clinical, epidemiologic, genetic, and pathophysiologic evidence that FHM and SHM share neurobiological mechanisms.<sup>26</sup> Moreover, because the majority of hemiplegic migraine patients also have “normal” attacks of migraine without hemiparesis, both diseases can be considered extremes of the pathogenetic migraine spectrum with shared common pathways with “normal” migraine with and without aura.<sup>26-29</sup>

We identified five sequence variants in *ATP1A2* (figure 1; Families 2-6). All conferred reduced survival in cellular assays (figure 3) and therefore are likely to be causative mutations. P786L occurred *de novo* and could thus be the founder of a new FHM family. R908Q was found in a patient whose mother did not carry the mutation. Because DNA from the father was not available, it could not be established whether the mutation had occurred *de novo*. E120A and E492K

---

showed partially reduced survival (figure 3D). Both mutations were identified in other family members who were unaffected or had nonhemiplegic migraine with aura. The single *CACNA1A* mutation (R583Q) we found was previously shown to affect  $Ca_v2.1$   $Ca^{2+}$  currents in cellular models by changing channel gating.<sup>14</sup> The mutation was inherited from the mother, who has attacks of nonhemiplegic migraine with aura. The R1928G DNA variant that was identified in the *SCN1A* gene did not reveal significant effects on channel properties as investigated by electrophysiologic recordings. Also, this variant poorly segregates with the migraine phenotype. It was present in five nonhemiplegic family members; only one of them has migraine with aura, and another has migraine without aura. R1928G may therefore be a rare sequence variant without functional consequences.

Screening of FHM genes in sporadic patients with hemiplegic migraine may help to establish the diagnosis, enable counseling, and prevent unnecessary diagnostic and therapeutic trial with potentially harmful drugs. Scanning of the FHM2 *ATP1A2* gene seems to offer the highest likelihood of success. Because FHM mutations were also found in SHM and common types of migraine with or without aura, our findings reinforce the growing evidence that FHM, SHM, basilar-type migraine, and “normal” migraine are part of a disease spectrum with at least some shared pathogenetic pathways. Unraveling these pathways may help to identify novel migraine prophylactic drugs.

### **Acknowledgements**

The authors thank Dr. Thomas A. Pressley (The University of Texas Medical School, Lubbock, TX) for providing anti-HERED antibody; L. Bouti, L. Broos, and B. Stunnenberg for their technical assistance; and Prof. Dr. Thomas Friedrich (Technische Universität Berlin) for providing the *ATP1A2*-R908Q cDNA.

## References

1. Headache Classification Subcommittee of the International Headache Society. The international classification of headache disorders: 2nd edition. *Cephalalgia* 2004;24:1–160.
2. Ferrari MD. Migraine. *Lancet* 1998;351:1043–1451.
3. Thomsen LL, Ostergaard E, Olesen J, Russell MB. Evidence for a separate type of migraine with aura: sporadic hemiplegic migraine. *Neurology* 2003;60:595–601.
4. Ophoff RA, Terwindt GM, Vergouwe MN, et al. Familial hemiplegic migraine and episodic ataxia type-2 are caused by mutations in the Ca<sup>2+</sup> channel gene CACNL1A4. *Cell* 1996;87:543–552.
5. De Fusco M, Marconi R, Silverstri L, et al. Haploinsufficiency of ATP1A2 encoding the Na<sup>+</sup>/K<sup>+</sup> pump alpha2 subunit associated with familial hemiplegic migraine type 2. *Nat Genet* 2003;33:192–196.
6. Dichgans M, Freilinger T, Eckstein G, et al. Mutation in the neuronal voltage-gated sodium channel SCN1A in familial hemiplegic migraine. *Lancet* 2005;336:371–377.
7. Ducros A, Denier C, Joutel A, et al. The clinical spectrum of familial hemiplegic migraine associated with mutations in a neuronal calcium channel. *N Engl J Med* 2001;345:17–24.
8. Terwindt G, Kors E, Haan J, et al. Mutation analysis of the CACNA1A calcium channel subunit gene in 27 patients with sporadic hemiplegic migraine. *Arch Neurol* 2002;59:1016–1018.
9. Ducros A, Denier C, Joutel A, et al. Recurrence of the T666M calcium channel CACNA1A gene mutation in familial hemiplegic migraine with progressive cerebellar ataxia. *Am J Hum Genet* 1999;64:89–98.
10. Vahedi K, Dernier C, Ducros A, et al. CACNA1A gene de novo mutation causing hemiplegic migraine, coma, and cerebellar atrophy. *Neurology* 2000;55:1040–1042.
11. Curtain RP, Smith RL, Ovcaric M, Griffiths LR. Minor head trauma-induced sporadic hemiplegic coma. *Pediatr Neurol* 2006;34:329–332.
12. Jurkat-Rott K, Freilinger T, Dreier JP, et al. Variability of familial hemiplegic migraine with novel A1A2 Na<sup>+</sup>/K<sup>+</sup>-ATPase variants. *Neurology* 2004;62:1857–1861.
13. Vanmolkot KRJ, Kors EE, Hottenga JJ, et al. Novel mutations in the Na<sup>+</sup>, K<sup>+</sup>-ATPase pump gene ATP1A2 associated with familial hemiplegic migraine and benign familial infantile convulsions. *Ann Neurol* 2003;54:360–366.
14. Kraus RL, Sinnegger MJ, Koschak A, et al. Three new familial hemiplegic migraine

- 
- mutants affect P/Q-type Ca<sup>2+</sup> channel kinetics. *J Biol Chem* 2000;13:9239– 9243.
15. Koenderink JB, Zifarelli G, Qiu LY, et al. Na,KATPase mutations in familial hemiplegic migraine lead to functional inactivation. *Biochim Biophys Acta* 2005; 1669:61–68.
16. Vanmokat KRJ, Kors EE, Turk U, et al. Two de novo mutations in the Na,K-ATPase gene ATP1A2 associated with pure familial hemiplegic migraine. *Eur J Hum Genet* 2006;14:555–560.
17. Vanmolkot KRJ, Babini E, De Vries B, et al. The novel L1649Q mutation in the SCN1A epilepsy gene is associated with familial hemiplegic migraine: genetic and functional studies. *Hum Mutat* 2007;28:522.
18. Haan J, Terwindt GM, Ophoff RA, Frants RR, Ferrari MD. Is familial hemiplegic migraine the hereditary form of basilar artery migraine? *Cephalalgia* 1995;15: 477–481.
19. Black DF. Sporadic hemiplegic migraine. *Curr Pain Headache Rep* 2004;8:233–238.
20. Thomsen LL, Olesen J. Sporadic hemiplegic migraine. *Cephalalgia* 2004;24:1016–1023.
21. Carrera P, Piatti M, Stenirri S, et al. Genetic heterogeneity in Italian families with familial hemiplegic migraine. *Neurology* 1999;13:26–33.
22. Ducros A, Joutel A, Vahedi K, et al. Mapping of a second locus for familial hemiplegic migraine to 1q21-q23 and evidence for further heterogeneity. *Ann Neurol* 1997;42:885–890.
23. Gardner K, Barmada M, Ptacek L, et al. A new locus for hemiplegic migraine maps to chromosome 1q31. *Neurology* 1997;49:1231–1238.
24. Riant F, De Fusco M, Aridon P, et al. ATP1A2 mutations in 11 families with familial hemiplegic migraine. *Hum Mutat* 2005;26:281.
25. Thomsen LL, Ostergaard E, Romer SF, et al. Sporadic hemiplegic migraine is an aetiologically heterogeneous disorder. *Cephalalgia* 2003;23:921–928.
26. Ferrari MD, Goadsby PJ. Migraine as a cerebral ionopathy with abnormal central sensory processing. In: Gilman S, Pedley T, eds. *Neurobiology of disease*. New York: Elsevier, 2006:333–348.
27. May A, Ophoff RA, Terwindt GM, et al. Familial hemiplegic migraine locus on 19p13 is involved in the common forms of migraine with and without aura. *Hum Genet* 1995;96:604–608.
28. Terwindt GM, Ophoff RA, van Eijk R, et al. Involvement of the CACNA1A gene containing region on 19p13 in migraine with and without aura. Dutch Migraine Genetics Research Group. *Neurology* 2001;56: 1028–1032.

29. Moskowitz MA, Bolay H, Dalkara T.  
Deciphering migraine mechanisms:  
clues from familial hemiplegic migraine  
genotypes. *Ann Neurol* 2004;55:276–280.





---

# 4.0

## **Episodic ataxia associated with EAAT1 mutation C186S affecting glutamate reuptake**

---

Boukje de Vries\*, MSc; Hafsa Mamsa\*, MSc; Anine H. Stam\*, MD; Jijun Wan, PhD; Stef L. M. Bakker, MD, PhD; Kaate R. J. Vanmolkot, PhD; Joost Haan, MD, PhD; Gisela M. Terwindt, MD, PhD; Elles M. J. Boon, PhD; Bruce D. Howard, MD; Rune R. Frants, PhD; Robert W. Baloh, MD; Michel D. Ferrari, MD, PhD; Joanna C. Jen, MD, PhD; Arn M. J. M. van den Maagdenberg, PhD

*Author Affiliations: Departments of Human Genetics (Ms de Vries and Drs Vanmolkot, Frants, and van den Maagdenberg), Neurology (Drs Stam, Haan, Terwindt, Ferrari, and van den Maagdenberg), and Clinical Genetics (Dr Boon), Leiden University Medical Centre, Leiden, the Netherlands; Departments of Neurology (Ms Mamsa and Drs Wan, Baloh, and Jen), Biological Chemistry (Dr Howard), and Surgery (Dr Howard), School of Medicine, University of California, Los Angeles; Department of Neurology, St. Franciscus General Hospital, Rotterdam, the Netherlands (Dr Bakker); and Department of Neurology, Rijnland Hospital, Leiderdorp, the Netherlands*

*\*These authors contributed equally.*

**Archives of Neurology 2009;66:97-101**

---

## Abstract

**Background:** Episodic ataxia (EA) is variably associated with additional neurologic symptoms. At least 4 genes have been implicated. Recently, a mutation in the *SLC1A3* gene encoding the glutamate transporter EAAT1 was identified in a patient with severe episodic and progressive ataxia, seizures, alternating hemiplegia, and migraine headache. The mutant EAAT1 showed severely reduced uptake of glutamate. The syndrome was designated EA6 and shares overlapping clinical features with EA2, which is caused by mutations in *CACNA1A*.

**Objective:** To test the role of the *SLC1A3* gene in EA.

**Design:** Genetic and functional studies. We analyzed the coding region of the *SLC1A3* gene by direct sequencing.

**Setting:** Academic research.

**Patients:** DNA samples from 20 patients with EA (with or without interictal nystagmus) negative for *CACNA1A* mutations were analyzed.

**Main Outcome Measures:** We identified 1 novel EAAT1 mutation in a family with EA and studied the functional consequences of this mutation using glutamate uptake assay.

**Results:** We identified a missense C186S mutation that segregated with EA in 3 family members. The mutant EAAT1 showed a modest but significant reduction of glutamate uptake.

**Conclusions:** We broadened the clinical spectrum associated with *SLC1A3* mutations to include milder manifestations of EA without seizures or alternating hemiplegia. The severity of EA6 symptoms appears to be correlated with the extent of glutamate transporter dysfunction.

## Introduction

Episodic ataxias (EAs) are rare genetic disorders characterized by recurrent episodes of cerebellar ataxia variably associated with additional neurologic features. Different subtypes of EA are defined on the basis of genetic loci and clinical manifestations.<sup>1</sup>

The most common and best characterized subtypes of EA are EA1 and EA2. EA1 is caused by missense mutations in the *KCNA1* gene encoding a subunit of neuronal  $K_v1.1$   $K^+$  channels.<sup>2</sup> EA1 usually presents with short-lasting attacks that often are triggered by exertion, stress, or startle. Patients show persistent interictal motor unit activity (myokymia). EA2 is caused by mutations in the *CACNA1A* gene encoding the pore-forming subunit of neuronal  $Ca_v2.1$   $Ca^{2+}$  channels.<sup>3</sup> Mostly, non-sense, frameshift, splice site, and missense mutations have been described, resulting in either a complete loss<sup>4</sup> or partial impairment<sup>5,6</sup> of  $Ca_v2.1$  channel function. The episodes in EA2 last longer than in EA1, up to several hours,<sup>7</sup> and are often associated with vertigo and migrainous headache and can be triggered by exercise, fatigue, and stress.<sup>8</sup> Acetazolamide may prevent attacks.<sup>9</sup> Between attacks, nystagmus usually occurs. Many patients have interictal ataxia in addition to the attacks. The EA3, EA4, and EA5 subtypes are rarer and less well-defined disorders compared with EA1 and EA2.<sup>1</sup>

The EA6 subtype was identified in a 10-year-old patient with a severe phenotype of episodic and progressive ataxia, seizures, alternating hemiplegia, and migraine headache.<sup>10</sup> A heterozygous *de novo* P290R missense mutation was identified in the *SLC1A3* gene by use of a candidate gene approach. *SLC1A3* encodes the glial excitatory amino acid transporter EAAT1, which is involved in glutamate removal from the synaptic cleft.<sup>11,12</sup> Functional analysis of the mutant EAAT1 protein showed marked reduction of glutamate uptake *in vitro*.<sup>10</sup> In the present study, we performed a mutation analysis of the *SLC1A3* gene (OM/M 600111) in 20 patients with EA2-like symptoms but without *CACNA1A* mutations. In 1 family, we found an EAAT1 mutation that segregated with the disease in 3 patients. Functional studies revealed a moderate impairment of glutamate reuptake.

## Methods

### Patients

We investigated 20 patients who were referred for molecular confirmation of EA2 in whom no mutations were found in the *CACNA1A* gene. These patients showed typical EA2-like symptoms, including interictal nystagmus but no myokymia, attacks of mild ataxia with a duration of several hours, and a positive response to acetazolamide. Except for 2 patients from the United States, all patients came from Europe, mostly the Netherlands. Family members of the proband with the *SLC1A3* mutation (Figure 1) underwent neurologic examination by experienced neurologists (S.L.M.B. and A.H.S). All patients gave informed consent, and the study was approved by the local review board.

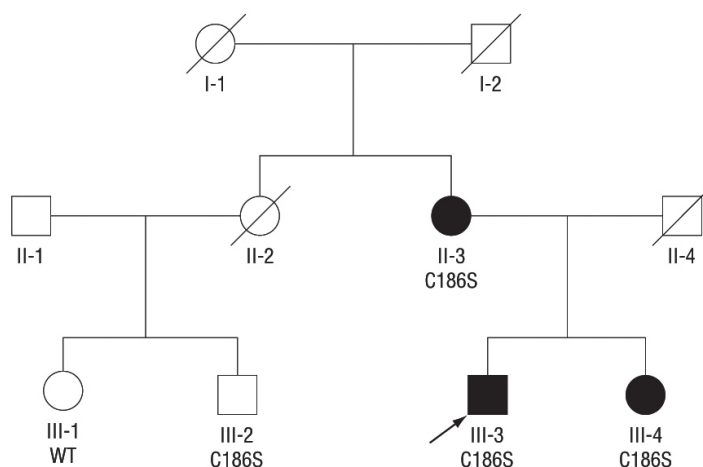

**Figure 1.** Pedigree of the episodic ataxia family with the EAAT1 C186S mutation. Episodic ataxia is indicated by a filled black square or circle for males or females, respectively. C186S indicates heterozygosity for the mutation. WT indicates homozygosity for the wild-type allele.

---

### *Genetic studies*

Genomic DNA was isolated from peripheral leukocytes using a standard salting out extraction method.<sup>13</sup> All exons and flanking intronic regions of the *SLC1A3* gene were amplified by polymerase chain reaction (PCR), using genomic DNA as a template. Direct sequencing was performed by cycle sequencing (Prism Big Dye Terminators Cycle Sequencing kit; Applied Biosystems, Foster City, California) using the dideoxy termination method and an ABI3700 automated sequencer (Applied Biosystems). Two hundred healthy controls were screened for the mutation by PCR analysis of exon 5 and subsequent restriction digestion of PCR products with restriction enzyme *AluI*.

### *Functional studies*

Functional studies<sup>10</sup> on glutamate uptake of wild-type and mutant EAAT1 were performed as described previously. In brief, full-length wild-type complementary DNA (EAAT1-WT) was cloned into a mammalian expression vector pcDNA3.1 (Invitrogen; Carlsbad, California). The mutant construct (EAAT1-186S) was generated by performing sitedirected mutagenesis (QuikChange; Stratagene; La Jolla, California). For functional analyses of the *SLC1A3* C186S mutation, 2 µg of wild-type (EAAT1-WT) or mutant (EAAT1-186S) EAAT1 complementary DNA constructs were transfected into COS7 cells. One day after transfection, the cells were dissociated and plated onto 60-mm-diameter tissue culture dishes. The cells were incubated with 1.5 mL of 1µM L-glutamic acid containing 1 µCi/mL of L-[3,4-<sup>3</sup>H]-glutamic acid for 2 minutes at room temperature. A total of 4 independent and masked experiments were performed, each in triplicate.

## **Results**

### *Genetic studies and clinical features associated with EAAT1 mutation*

Mutation analysis of the *SLC1A3* gene in 20 patients revealed in 1 patient a heterozygous c.556 T>A substitution (*SLC1A3* reference sequence; GenBank NM004172) that changed a cysteine to a serine at position 186 (C186S) of the EAAT1 protein (Figure 2A and 2B). The mutation was absent in 200 Dutch control individuals. C186S was identified in the proband (III-3), clinically affected family members II-3 and III-4, and 1 asymptomatic family member (III-2) (Figure 1).

Clinical information of the affected family members is summarized in the Table. The proband (III-3) is a 35-year-old man who has had episodes of ataxia since early childhood. Attacks gradually changed over time. Initially, vertigo, nausea, and vomiting were the most bothersome symptoms. Later in life, truncal and gait ataxia during the attacks became more prominent. Attacks are often associated with nausea, vomiting, photophobia, phonophobia, vertigo, diplopia, slurred speech, and blurred vision. No headache was reported. Typically, attacks were provoked by emotional stress, fatigue, or consuming alcohol or caffeine. Attack duration was usually

between 2 and 3 hours. Currently, his average attack frequency is once a month. Interictal neurologic examination revealed a horizontal gaze-evoked nystagmus without gait or truncal ataxia. Interictal electroencephalographic recording revealed no epileptic activity, and magnetic resonance imaging revealed no abnormalities (data not shown).

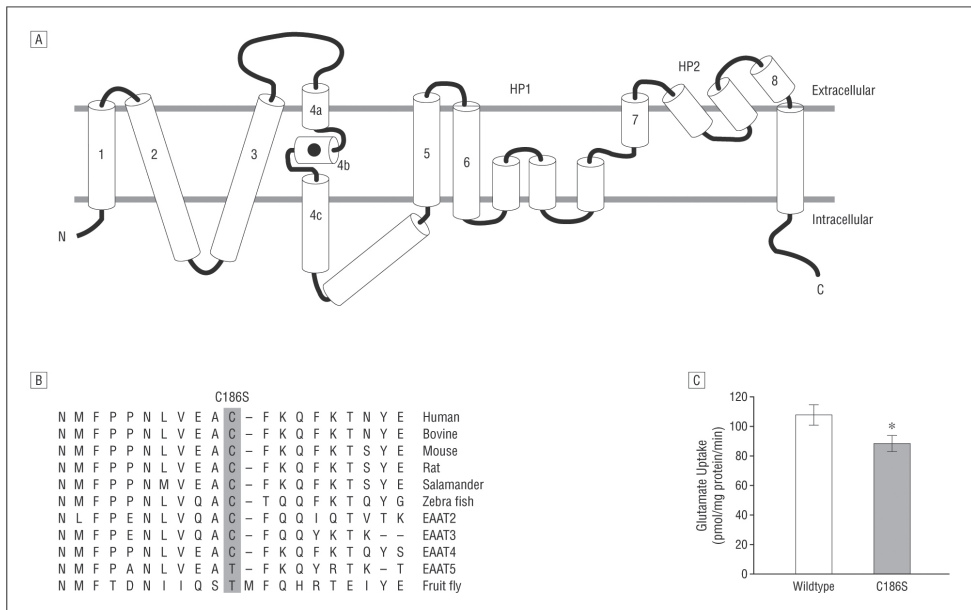

**Figure 2** EAAT1 C186S mutation. **A**, Schematic representation of the EAAT1 protein and the location of the mutated Cys186 amino acid in transmembrane segment 4B (indicated by a black dot) (the structure is adapted from Yernool et al<sup>64</sup>). **B**, Conservation of the mutated residue Cys186 highlighted in gray. The protein sequences were obtained from GenBank (homo sapiens, NP\_004163; Bos taurus, NP\_46411; Mus musculus, NP\_683740; Rattus norvegicus, NP\_062098; salamander, 057321; Danio rerio, NP\_997805; Drosophila melanogaster, NP\_477428; human EAAT2, AY066021; human EAAT3, NP\_004161; human EAAT4, NM\_005062; human EAAT5, NP\_006662). **C**, Glutamate uptake assay in COS7 cells expressing mutant EAAT1-186S (mean [SEM], 88.2[5.5]) or wild-type EAAT1-186C (mean [SEM], 107.8[6.9]). The results are the mean (SEM) of the 4 experiments, each in triplicate. The values are picomoles of glutamate transported per milligram of protein per minute of incubation. Asterisk indicates significant reduction of glutamate uptake compared with wild type ( $P=0.029$ ). Error bars indicate SEM. HP indicates helical hairpin.

His mother (II-3) and sister (III-4) were also diagnosed as having EA. The 56-year-old mother (II-3) has had episodes of ataxia similar to those of the proband since elementary school. Her attacks are also associated with vertigo, nausea, vomiting, photophobia, phonophobia, and slurred speech. The attacks were not associated with headache. She now has approximately 10 attacks per year, which may last for several hours and can be triggered by stress. The 28-year-old sister (III-4) has had episodes of ataxia since the age of 14 years. Associated symptoms include vertigo, nausea, vomiting, and mild photophobia. Sometimes, the day after an attack, she experiences

bilateral headache not associated with nausea, vomiting, phonophobia, or photophobia. Reported triggers are exercise, fatigue, and stress. Currently, she has on average 6 attacks a year. Typically, attacks last several hours. Acetazolamide significantly reduced the frequency of attacks in all 3 affected family members.

His 40-year-old cousin (III-2) is an asymptomatic carrier of the C186S EAAT1 mutation. He experienced 4 attacks of migraine without aura and has tensiontype headache, but does not exhibit signs or symptoms related to ataxia. Individuals I-1, I-2, and II-2 were considered healthy based on limited heteroanamnestic information. His grandfather had died at the age of 98 years. His grandmother had complained about dizziness, but no neurologic examination was performed during her lifetime. No relevant clinical information is available for individual II-2, who died of an unrelated cause. Non-mutation carrier III-1 is asymptomatic.

**Table.** Summary of Clinical Features of Patients With Episodic Ataxia Carrying the EAAT1 C186S Mutation

<b>Clinical Feature</b>	<b>Mother (II-3)</b>	<b>Proband (III-3)</b>	<b>Sister (III-4)</b>
Age at examination, y	56	35	28
Age at onset, y	<10	3	14
Ataxia	+	+	+
Vertigo	+	+	+
Diplopia/visual blurring	-/-	+/+	-/-
Nausea/vomiting	+/+	+/+	+/+
Photophobia/phonophobia	+/+	+/+	+/-
Attack duration	Hours	Hours	Hours
Attack frequency	~10 y	1-2 mo	~6 y
Triggers	Emotional stress	Emotional stress, fatigue, alcohol, caffeine	Emotional stress, fatigue, exercise
Response to acetazolamide	+	+	+
Interictal gaze-evoked nystagmus	-	+	-
Headache	-	-	+

Abbreviations: +, presence; -, absence.

### *Functional study of EAAT1 mutation C186S*

To investigate the functional consequences of the EAAT1 C186S mutation, radioactive glutamate uptake assays were performed in COS7 cells. The low level of endogenous glutamate uptake activity has long established the COS7 cells as being well suited for functional studies of glutamate transporters.<sup>15</sup> We measured glutamate uptake in COS7 cells transfected with the

wild-type (EAAT1-186C) or the mutant construct (EAAT1-186S). An 18% reduction in glutamate uptake was observed in cells expressing the mutant (mean [SEM], 88.2[5.5]) compared with the wild-type (mean [SEM], 107.8[6.9]) EAAT1, measured in picomoles per milligram of total protein per minute of incubation ( $P=0.029$ ; Figure 2C).

### Comment

We scanned the *SLC1A3* gene for mutations in 20 patients with EA2-like symptoms without *CACNA1A* mutations because of overlapping clinical features between EA2 and EA6. We found a novel nucleotide change c.556TA in the *SLC1A3* gene, resulting in EAAT1 mutation C186S, in a family with EA and interictal nystagmus but without migraine, seizures, cerebellar atrophy, or alternating hemiplegia.

Our genetic and functional data suggest that mutation C186S is pathogenic. First, the mutation C186S segregated with all 3 symptomatic family members but was not identified in a large panel of controls. The asymptomatic mutation carrier (III-2) had migraine without aura, but given the relatively high prevalence of migraine it is unlikely that these attacks are caused by the EAAT1 mutation. Therefore, he likely represents a nonpenetrant case of EA. Second, Cys186 is highly conserved among species (Figure 2B). Our functional studies revealed a reduced glutamate reuptake for the mutant EAAT1 (Figure 2C). Cys186 resides in transmembrane segment 4B (Figure 2A) on the outer perimeter of the human EAAT1 transporter protein that is implicated in intersubunit contact.<sup>15</sup> The 4B-4C loop was recently shown to undergo substrate-dependent conformational changes and has been hypothesized to be important in stabilizing the trimeric structure of the transporter and coordinating the cooperativity for sodium binding.<sup>16</sup>

Clinical severity of EA6 appears to be well correlated with glutamate reuptake capability of mutant EAAT1. The P290R mutation leads to a complete loss of glutamate reuptake and is associated with a severe EA phenotype with months-long attacks, seizures, and alternating hemiplegia.<sup>10</sup> In contrast, the C186S mutation has a mild effect on glutamate reuptake and is correlated with a milder EA phenotype. Although it is hard to predict from cellular studies how a mild increase in extracellular glutamate will affect cerebellar functioning in patients, it is well known that ion and neurotransmitter pathways are complex and tightly regulated. Subtle changes in these pathways have been associated with clinical manifestations.<sup>17,18</sup>

Since we found a mutation in only 1 of 20 patients with *CACNA1A*-negative EA2-like symptoms, other genes must be involved. Likely candidate genes are components of ion and neurotransmitter pathways involved in the regulation of cerebellar neuronal excitability.

---

### **Funding/Support**

This work was supported by grants U54 NS059065 and P50 DC05224 from the National Institutes of Health (Dr Baloh), grants 903-52-291 (Drs Ferrari and Frants) and Vici 918.56.602 (Dr Ferrari) from the Netherlands Organization for Scientific Research, The Migraine Trust (Drs Ferrari and Frants), grant LSHM-CT-2004-504837 from the European Union “EUROHEAD” (Drs Ferrari, Frants, and van den Maagdenberg), and the Center for Medical System Biology in the framework of the Netherlands Genomics Initiative.

Financial Disclosure: None reported.



## References

1. Jen JC, Graves TD, Hess EJ, et al. Primary episodic ataxias: diagnosis, pathogenesis and treatment. *Brain*. 2007;130(pt 10):2484-2493.
2. Browne DL, Gancher ST, Nutt JG, et al. Episodic ataxia/myokymia syndrome is associated with point mutations in the human potassium channel gene, KCNA1. *Nat Genet*. 1994;8(2):136-140.
3. Ophoff RA, Terwindt GM, Vergouwe MN, et al. Familial hemiplegic migraine and episodic ataxia type-2 are caused by mutations in the Ca<sup>2</sup> channel gene CACNL1A4. *Cell*. 1996;87(3):543-552.
4. Guida S, Trettel F, Pagnutti S, et al. Complete loss of P/Q calcium channel activity caused by a *CACNA1A* missense mutation carried by patients with episodic ataxia type 2. *Am J Hum Genet*. 2001;68(3):759-764.
5. Jen J, Wan J, Graves M, et al. Loss-of-function EA2 mutations are associated with impaired neuromuscular transmission. *Neurology*. 2001;57(10):1843-1848.
6. Wappl E, Koschak A, Poteser M, et al. Functional consequences of P/Q-type Ca<sup>2+</sup> channel Cav2.1 missense mutations associated with episodic ataxia type 2 and progressive ataxia. *J Biol Chem*. 2002;277(9):6960-6966.
7. Denier C, Ducros A, Vahedi K, et al. High prevalence of *CACNA1A* truncations and broader clinical spectrum in episodic ataxia type 2. *Neurology*. 1999;52 (9):1816-1821.
8. Dressler D, Benecke R. Diagnosis and management of acute movement disorders. *J Neurol*. 2005;252(11):1299-1306.
9. Griggs RC, Moxley RT III, Lafrance RA, McQuillen J. Hereditary paroxysmal ataxia response to acetazolamide. *Neurology*. 1978;28(12):1259-1264.
10. Jen JC, Wan J, Palos TP, Howard BD, Baloh RW. Mutation in the glutamate transporter EAAT1 causes episodic ataxia, hemiplegia, and seizures. *Neurology*. 2005; 65(4):529-534.
11. Kanner BI, Schuldiner S. Mechanism of transport and storage of neurotransmitters. *CRC Crit Rev Biochem*. 1987;22(1):1-38.
12. Attwell D, Mobbs P. Neurotransmitter transporters. *Curr Opin Neurobiol*. 1994; 4(3):353-359.
13. Miller SA, Dykes DD, Polesky HF. A simple salting out procedure for extracting DNA from human nucleated cells. *Nucleic Acids Res*. 1988;16(3):1215.

- 
14. Yernool D, Boudker O, Jin Y, Gouaux E. Structure of a glutamate transporter homologue from *Pyrococcus horikoshii*. *Nature*. 2004;431(7010):811-818.
15. Arriza JL, Fairman WA, Wadiche JI, Murdoch GH, Kavanaugh MP, Amara SG. Functional comparisons of three glutamate transporter subtypes cloned from human motor cortex. *J Neurosci*. 1994;14(9):5559-5569.
16. Koch HP, Hubbard JM, Larsson HP. Voltage-independent sodium-binding events reported by the 4B-4C loop in the human glutamate transporter excitatory amino acid transporter 3. *J Biol Chem*. 2007;282(34):24547-24553.
17. Cannon SC, Brown RH Jr, Corey DP. A sodium channel defect in hyperkalemic periodic paralysis: potassium-induced failure of inactivation. *Neuron*. 1991;6(4):619-626.
18. Imbrici P, D'Adamo MC, Kullmann DM, Pessia M. Episodic ataxia type 1 mutations in the KCNA1 gene impair the fast inactivation properties of the human potassium channels Kv1.4-1.1/Kvbeta1.1 and Kv1.4-1.1/Kvbeta1.2. *Eur J Neurosci*. 2006;24(11):3073-3083.





---

# 5

**Mutations in *TREX1* play a role in disorders comorbid with migraine**

---



# 5.1

## C-terminal truncations in human 3'-5' DNA exonuclease TREX1 cause autosomal dominant retinal vasculopathy with cerebral leukodystrophy

Anna Richards<sup>1,\*</sup>, Arn M J M van den Maagdenberg<sup>2,3,\*</sup>, Joanna C Jen<sup>4,\*</sup>, David Kavanagh<sup>1,\*</sup>, Paula Bertram<sup>1</sup>, Dirk Spitzer<sup>1</sup>, M Kathryn Liszewski<sup>1</sup>, Maria-Louise Barilla-LaBarca<sup>5</sup>, Gisela M Terwindt<sup>3</sup>, Yumi Kasai<sup>6</sup>, Mike McLellan<sup>6</sup>, Mark Gilbert Grand<sup>7</sup>, Kaate R J Vanmolkot<sup>2</sup>, Boukje de Vries<sup>2</sup>, Jijun Wan<sup>4</sup>, Michael J Kane<sup>4</sup>, Hafsa Mamsa<sup>4</sup>, Ruth Schäfer<sup>4</sup>, Anine H Stam<sup>3</sup>, Joost Haan<sup>3</sup>, Paulus T V M de Jong<sup>8-10</sup>, Caroline W Storimans<sup>11</sup>, Mary J van Schooneveld<sup>12</sup>, Jendo A Oosterhuis<sup>13</sup>, Andreas Gschwendter<sup>14</sup>, Martin Dichgans<sup>14</sup>, Katya E Kotschet<sup>15</sup>, Suzanne Hodgkinson<sup>16</sup>, Todd A Hardy<sup>17</sup>, Martin B Delatycki<sup>18,19</sup>, Rula A Hajj-Ali<sup>20</sup>, Parul H Kothari<sup>1</sup>, Stanley F Nelson<sup>21</sup>, Rune R Frants<sup>2</sup>, Robert W Baloh<sup>4</sup>, Michel D Ferrari<sup>3</sup> & John P Atkinson<sup>1</sup>

<sup>1</sup>Dept. of Medicine, Division of Rheumatology, Washington University School of Medicine, St. Louis, Missouri 63110, USA.

<sup>2</sup>Dept. of Human Genetics, and <sup>3</sup>Dept. of Neurology, Leiden University Medical Centre, 2300 RC Leiden, The Netherlands.

<sup>4</sup>Dept. of Neurology, University of California at Los Angeles, Los Angeles, California 90095, USA. <sup>5</sup>Dept. of Medicine, Division of Rheumatology, North Shore Long-Island Jewish Health System, Lake Success, New York 11030, USA. <sup>6</sup>Genome Sequencing Center, and <sup>7</sup>Department of Ophthalmology, Washington University School of Medicine, St. Louis, Missouri 63110, USA. <sup>8</sup>Dept. of Ophthalmogenetics, Netherlands Institute for Neuroscience, Royal Netherlands Academy of Arts and Sciences, 1000 GC Amsterdam, The Netherlands. <sup>9</sup>Dept. of Ophthalmology, Academic Medical Centre, 1100 DD Amsterdam, The Netherlands. <sup>10</sup>Dept. of Epidemiology and Biostatistics, Erasmus Medical Centre, 3000 CA Rotterdam, The Netherlands. <sup>11</sup>Meander Medical Centre, 3800 BM Amersfoort, The Netherlands. <sup>12</sup>Dept. of Ophthalmology, University Medical Centre, 3508 GA Utrecht, The Netherlands. <sup>13</sup>Dept. of Ophthalmology, Leiden University Medical Centre, 2300 RC Leiden, The Netherlands. <sup>14</sup>Dept. of Neurology, Klinikum Grosshadern, Universität München, D-81377 München, Germany. <sup>15</sup>Dept. of Neurology, Monash Medical Centre, Clayton, Victoria 3168, Australia. <sup>16</sup>Dept. of Neurology, Liverpool Hospital, Liverpool, New South Wales 2170, Australia. <sup>17</sup>Dept. of Neurology, Concord Repatriation General Hospital, Concord, New South Wales 2139, Australia. <sup>18</sup>Bruce Lefroy Centre for Genetic Health Research, Murdoch Childrens Research Institute, and <sup>19</sup>Dept. of Paediatrics, University of Melbourne, Royal Children's Hospital, Parkville, Victoria 3052, Australia. <sup>20</sup>Dept. of Rheumatic and Immunologic Diseases, Cleveland Clinic Foundation, Cleveland, Ohio 44195, USA. <sup>21</sup>Dept. of Human Genetics, University of California at Los Angeles, Los Angeles, California 90095, USA.

\*These authors contributed equally to this paper

---

Autosomal dominant retinal vasculopathy with cerebral leukodystrophy is a microvascular endotheliopathy with middle-age onset. In nine families, we identified heterozygous C-terminal frameshift mutations in *TREX1*, which encodes a 3'-5' exonuclease. These truncated proteins retain exonuclease activity but lose normal perinuclear localization. These data have implications for the maintenance of vascular integrity in the degenerative cerebral microangiopathies leading to stroke and dementias.

We have previously described three families sharing common features of retinal and cerebral dysfunction. Visual loss, stroke and dementia begin in middle age, and death occurs in most families 5 to 10 years later. These diseases map to 3p21.1–p21.3 (ref. 1) and are called cerebretinal vasculopathy (CRV)<sup>2</sup>, hereditary vascular retinopathy (HVR)<sup>3,4</sup> and hereditary endotheliopathy, retinopathy, nephropathy and stroke (HERNS)<sup>5</sup>. We now designate these illnesses as autosomal dominant retinal vasculopathy with cerebral leukodystrophy (RVCL) (OMIM 192315). The neurovascular syndrome features a progressive loss of visual acuity secondary to retinal vasculopathy, in combination with a more variable neurological picture<sup>1-7</sup>. In a subset of affected individuals, systemic vascular involvement is evidenced by Raynaud's phenomenon and mild liver (micronodular cirrhosis)<sup>2,5</sup> and kidney (glomerular) dysfunction<sup>5</sup>.

This retinal vasculopathy is characterized by telangiectasias, microaneurysms and retinal capillary obliteration starting in the macula. Diseased cerebral white matter has prominent small infarcts that often coalesce to pseudotumors. Neuroimaging studies demonstrate contrast-enhancing lesions in the white matter of the cerebrum and cerebellum. Histopathology shows ischemic necrosis with minimal inflammation and small blood vessels occluded with fibrin<sup>5</sup>. The white matter lesions resemble post-radiation vascular damage<sup>2</sup>. Ultrastructural studies of capillaries show a distinctive, multilamellar subendothelial basement membrane<sup>5</sup>.

By combining haplotypes in the three RVCL families, we narrowed the disease gene to a 3-cM region between markers D3S1578 and D3S3564 that encompassed ~10 Mb, containing over 120 candidate genes<sup>1</sup>. We then sequenced the full coding region and intron-exon boundaries of 33 candidate genes within this region (Supplementary Table 1).

Here we report the identification of mutations in *TREX1* (NM\_033627), encoding DNA-specific 3' to 5' exonuclease DNase III. In the CRV<sup>2</sup> and HVR<sup>3,4</sup> pedigrees, a heterozygous 1-bp insertion (3688\_3689insG) leads to V235fs and a consequent premature stop. In HERNS<sup>5</sup>, a heterozygous 4-bp insertion (3727\_3730dupGTCA) results in a frameshift at T249 (Fig. 1a,b).



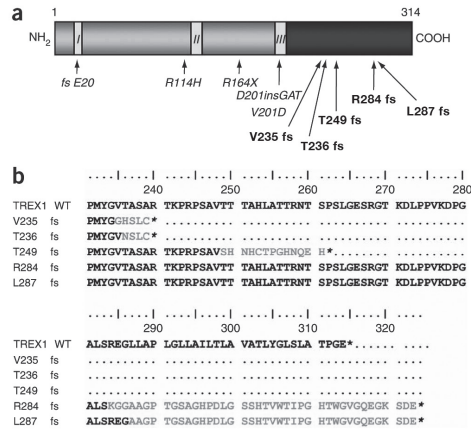

**Figure 1** Diagram of *TREX1* protein. **a**) *TREX1* has three exonuclease domains. Mutations in *italics* are associated with AGS<sup>13</sup>, and those in *boldface* at the C terminus are associated with RVCL. **b**) Comparison of the amino acid sequence of the C terminus of wild-type (WT) *TREX1* with RVCL associated mutations. The abnormal sequence introduced by the frameshifts is depicted in gray.

Next, we examined six families with putative RVCL (Supplementary Table 2)<sup>2,6,7</sup>. In each, we identified frameshift mutations affecting the C terminus of *TREX1*. In three, the alteration was V235fs, the same as that in the CRV and HVR pedigrees. Haplotype analysis suggests that they are not related (data not shown). We did not detect any of the mutations in panels of chromosomes matched by ancestry or location (Supplementary Methods). In the CRV and HERNS families, all affected individuals over the age of 60 (but none of the unaffected individuals over the age of 60) carried a *TREX1* mutation (100% penetrance). In the HVR<sup>3,4</sup> family, 10 of the 11 mutation carriers over 60 years of age have retinopathy.

*TREX1* (DNase III) is a DNA-specific 3' to 5' exonuclease ubiquitously expressed in mammalian cells<sup>8–10</sup>. It is thought to function as a homodimer, with a preference for single-stranded DNA and mispaired 3' termini<sup>8</sup>. *TREX1* is a part of the SET complex<sup>11</sup> that normally resides in the cytoplasm but translocates to the nucleus in response to oxidative DNA damage<sup>12</sup>.

Recently, homozygous mutations in *TREX1* have been reported to cause Aicardi-Goutiere syndrome (AGS)<sup>13</sup>. AGS is a rare, familial, early-onset progressive encephalopathy featuring basal ganglia calcifications and cerebrospinal fluid lymphocytosis, mimicking congenital viral encephalitis<sup>14</sup>. Notably, mutations associated with AGS disrupt the enzymatic sites in *TREX1*. This loss of exonuclease function<sup>13</sup> (Fig. 1) is hypothesized to cause the accumulation of altered DNA that triggers a destructive autoimmune response<sup>13</sup>. No phenotype was reported for the heterozygous carriers of these mutations; however, a heterozygous mutation in *TREX1* causing familial chilblain lupus has been reported recently<sup>15</sup>.

The distinctive clinical course and pathology of RVCL compared with AGS suggests separate disease mechanisms. The frameshift mutations observed in RVCL are downstream of the regions encoding the catalytic domains, whereas in AGS, homozygous mutations occur that alter exonuclease function. The heterozygous mutations observed in RVCL did not impair the enzymatic activity of TREX1 (Fig. 2a), in comparison with the R114H substitution in AGS<sup>13</sup>.

To investigate how the RVCL TREX1 proteins differ from the wild-type, we performed expression studies using confocal microscopy on cells transfected with TREX1 tagged with a fluorescent protein (Fig. 2b and Supplementary Fig. 1). The wild-type TREX1 labeled with fluorescent protein (FP-TREX1) localized to the perinuclear region. In contrast, the TREX1 proteins FP-V235fs and FP-T249fs were diffusely distributed in the cytoplasm and the nucleus, as was the case for the fluorescent protein alone (Fig. 2b and Supplementary Videos 1–4 online). Protein blotting confirmed that the expressed proteins were of the correct size (Fig. 2c). These results suggest a perinuclear targeting signal within the C terminus of TREX1. Consequently, we generated a construct containing the C-terminal 106 amino acid residues of TREX1 (FP-C-106). This protein showed a perinuclear localization pattern identical to that of the wild-type TREX1 protein (Fig. 2b). The TREX1 protein containing amino acid change R114H, found in AGS, also had the same pattern as the wild-type protein. In contrast, the protein with the alteration closest to the C terminus of TREX1, FP-287fs, was diffusely distributed, like the other two truncated proteins (data not shown).

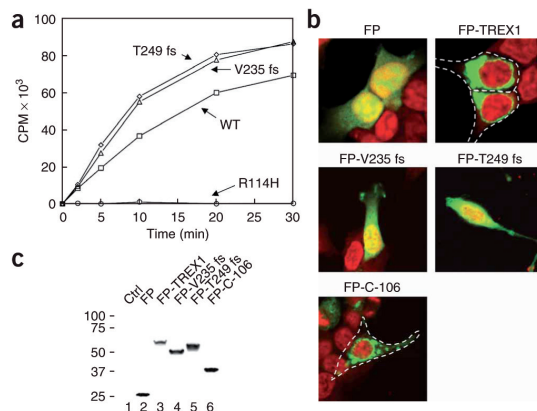

**Figure 2** Functional consequences of RVCL associated TREX1 mutations. **a)** Assessment of 3'-5' exonuclease activity using equivalent amounts of purified recombinant proteins expressed in *E. coli*. **b)** Confocal microscopy of HEK293T cells showing transiently expressed fluorescent protein (FP)-tagged TREX1 proteins (green), TOPRO3 staining of nuclei (red) and overlay (yellow). Similar expression patterns were obtained for wild-type protein and for proteins derived from constructs containing mutations associated with AGS and RVCL in CHO, HL-60 and HeLa cells (data not shown). **c)** Protein blot analysis of untransfected cells (1) and cells transfected with enhanced yellow fluorescent protein (eYFP) (2), wild-type TREX1 (3), TREX1 mutants (4,5) and the C-terminal 106 amino acids (6), all linked to eYFP.

The TREX1 proteins found in individuals with RVCL lack part of the C terminus. In haploinsufficient individuals, this may prevent an interaction with the SET proteins and therefore may prevent formation of the SET complex. The SET complex is hypothesized to target DNA repair factors, including TREX1, to damaged DNA under conditions of oxidative stress<sup>11,12</sup>. Lack of sufficient TREX1 associated with the SET complex may result in failure of granzyme A-mediated cell death<sup>12</sup>. Alternatively, the dissemination of untethered TREX1 in the nucleus and cytoplasm may have detrimental effects, especially on endothelial cells.

The clinical syndromes in these families and the study of their mutations should deepen our understanding of exonuclease function, homeostasis of the endothelium and events leading to premature vascular aging. RVCL and cerebral autosomal dominant arteriopathy with subcortical infarcts and leukoencephalopathy (CADASIL) represent two examples of monogenic disease featuring a cerebral microangiopathy for which the genetic defects are now known and from which we can gain new insights into the origin of strokes and dementia.

We obtained consent from all participants in this study, and the study was approved by the Office for Protection of Research Subjects at UCLA and the Human Research Protection Office at Washington University School of Medicine.

### **Acknowledgements**

We appreciate the cooperation of the participating families. We thank M. RBogacki, E. van den Boogerd, J. van Vark and S. Keradmand-Kia. A.R. is a 2005/2006 Fulbright Distinguished Scholar. D.K. is a Kidney Research UK clinical training fellow. A.R. and D.K. are recipients of Peel Medical Trust Travel Fellowships. At Washington University in St. Louis, this study has been funded by the Center for Genome Sciences Pilot-Scale Sequencing Project Program and by the Danforth Foundation. The Netherlands Organization for Scientific Research (NWO) (Vici 918.56.602), the European Union "Eurohead" grant (LSHMCT- 2004-504837) and the Center of Medical System Biology established by the Netherlands Genomics Initiative/NWO supported the work in the Netherlands. US National Institutes of Health (NIH)/National Institute on Deafness and Other Communication Disorders (NIDCD) grant P50 DC02952 (R.W.B.), NIH/National Eye Institute grant R01 EY15311 and a Stein-Oppenheimer Award (J.C.J.) supported the work at University of California, Los Angeles. R.S. is the recipient of a scholarship from the German National Scholarship Foundation.

### **Competing interests statement**

The authors declare no competing financial interests. Published online at <http://www.nature.com/naturegenetics>

Note: Supplementary information is available on the Nature Genetics website.

---

## References

1. Ophoff RA, DeYoung J, Service SK, et al (2001) Hereditary vascular retinopathy, cerebretinal vasculopathy, and hereditary endotheliopathy with retinopathy, nephropathy, and stroke map to a single locus on chromosome 3p21.1-p21.3. *Am. J. Hum. Genet.* 69, 447–453.
2. Grand MG, Kaine J, Fulling K et al (1988) Cerebretinal vasculopathy. A new hereditary syndrome. *Ophthalmology* 95, 649–659.
3. Storimans CW, Van Schooneveld MJ, Oosterhuis JA, Bos PJ (1991) A new autosomal dominant vascular retinopathy syndrome. *Eur. J. Ophthalmol* 1, 73–78.
4. Terwindt GM, Haan J, Ophoff RA et al (1998) Clinical and genetic analysis of a large Dutch family with autosomal dominant vascular retinopathy, migraine and Raynaud's phenomenon. *Brain* 121, 303–316.
5. Jen J, Cohen AH, Yue Q et al (1997) Hereditary endotheliopathy with retinopathy, nephropathy, and stroke (HERNS). *Neurology* 49, 1322–1330.
6. Cohn AC, Kotschet K, Veitch A et al (2005) Novel ophthalmological features in hereditary endotheliopathy with retinopathy, nephropathy and stroke syndrome. *Clin. Experiment. Ophthalmol.* 33, 181–183.
7. Weil, S, Reifenberger G, Dudel C et al (1999) Cerebretinal vasculopathy mimicking a brain tumor: a case of a rare hereditary syndrome. *Neurology* 53, 629–631 (1999).
8. Mazur DJ & Perrino FW (2001) Excision of 3' termini by the Trex1 and TREX2 3'→5' exonucleases. Characterization of the recombinant proteins. *J. Biol. Chem.* 276, 17022–17029.
9. Mazur DJ & Perrino FW (1999) Identification and expression of the TREX1 and TREX2 cDNA sequences encoding mammalian 3'→5' exonucleases. *J. Biol. Chem.* 274, 19655–19660.
10. Hoss M, Robins P, Naven TJ et al (1999) A human DNA editing enzyme homologous to the Escherichia coli DnaQ/MutD protein. *EMBO J.* 18, 3868–3875.
11. Chowdhury D, Beresford PJ, Zhu P et al (2006) The exonuclease TREX1 is in the SET complex and acts in concert with NM23-H1 to degrade DNA during granzyme A-mediated cell death. *Mol. Cell* 23, 133–142.
12. Martinvalet D, Zhu P & Lieberman J (2005) Granzyme A induces caspase-independent mitochondrial damage, a required first step for apoptosis. *Immunity* 22, 355–370.

13. Crow YJ, Hayward BE, Parmar R et al (2006) Mutations in the gene encoding the 3'-5' DNA exonuclease *TREX1* cause Aicardi-Goutières syndrome at the *AGS1* locus. *Nat. Genet.* 38, 917-920.
14. Goutieres F (2005) Aicardi-Goutières syndrome. *Brain Dev.* 27, 201-206.
15. Rice G, Newman WG, Dean J et al (2007) Heterozygous mutations in *TREX1* cause familial chilblain lupus and dominant Aicardi-Goutieres syndrome. *Am. J. Hum. Genet.* 80, 811-815.

## Supplementary Material

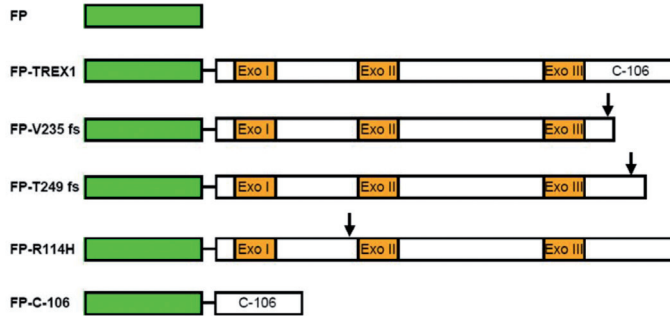

**Supplementary Fig. 1.** Schematic representation of FP constructs expressed in mammalian cells. The FP was cloned at the amino-terminus of TREX1 and mutants. A carboxyl-terminal segment of the last 106 amino acids of wild-type TREX1 was also prepared (C-106). The arrow indicate approximate sites of the mutations.

**Supplementary Table 1.** The 32 candidate genes sequenced prior to the discovery of TREX1 as the causative gene for RVCL.

Gene	Name	Gene ID	OMIM
<i>AMIGO3</i>	Adhesion molecule with Ig-like domain 3	386724	N/A
<i>ATRIP</i>	ATR interacting protein	11277	606605
<i>CACNA1D</i>	Voltage-dependent L-type calcium channel subunit alpha-1D	776	114206
<i>CACNA2D2</i>	Calcium channel voltage dependent, alpha- 2/ Delta Subunit 2	9254	607082
<i>CCR1</i>	Chemokine (C-C motif) receptor 1	1230	601159
<i>CCR2</i>	Chemokine (C-C motif) receptor 2	1231	601267
<i>CCR3</i>	Chemokine (C-C motif) receptor 3	1232	601268
<i>CCR9</i>	Chemokine (C-C motif) receptor 9	10803	604738
<i>CELSR3</i>	Cadherin, EGF LAG seven-pass G-type receptor 3	1951	604264
<i>CSPG5</i>	Chondroitin sulfate proteoglycan 5	10675	606775
<i>CTNNB1</i>	Catenin (cadherin-associated protein), beta 1	1499	116806
<i>CX3CR1</i>	Chemokine (C-X3-C motif) receptor 1	1524	601470
<i>CXCR6</i>	Chemokine (C-X-C motif) receptor 6	10663	605163
<i>DAG1</i>	Dystroglycan 1 (dystrophinassociated glycoprotein 1)	1605	128239
<i>ENTPD</i>	Ectonucleoside triphosphate diphosphohydrolase 3	956	603161
<i>GNAT1</i>	Guanine nucleotide binding protein, alpha transducing activity polypeptide 1	2779	139330

<i>GPX1</i>	Glutathione peroxidase 1	2876	138320
<i>LAMB2</i>	Laminin, beta 2 (laminin S)	3913	150325
<i>MAP4</i>	Microtubule-associated protein 4	4134	157132
<i>PH4</i>	PH-4 hypoxia-inducible factor prolyl 4-hydroxylase	54681	N/A
<i>PLXNB1</i>	Plexin B1	5364	601053
<i>RASSF1</i>	Ras association (RalGDS/AF-6) domain family 1	11186	605082
<i>RHOA</i>	Ras homolog gene family, member A	387	165390
<i>RIS1</i>	TMEM158 transmembrane protein 158 (RIS-1 Ras-induced senescence 1)	25907	N/A
<i>RPL29</i>	Ribosomal protein L29	6159	601832
<i>RPSA</i>	Ribosomal protein SA	3921	150370
<i>SEMA3F</i>	Semaphorin 3F	6405	601124
<i>Scotin</i>	Scotin	51246 6	07290
<i>SEMA3B</i>	Sema domain, immunoglobulin domain (Ig), short basic domain, secreted, (semaphoring) 3B	7869	601281
<i>STAB1</i>	Stabilin 1	23166	608560
<i>TRAIIP</i>	TRAF interacting protein	10293	605958
<i>VIPR1</i>	Vasoactive intestinal peptide receptor 1	7433	192321

N/A, not applicable. GeneID, and OMIM identities are indicated.

**Table 2.** Mutations identified in *TREX1* in RVCL.

#	Mutation	Frameshift	Reference	Geographical (Background)
1	3688_3689insG	V235	Grand et al	North America (European)
2	3688_3689insG	V235	Storimans et al Terwindt et al	Netherlands
3	3727_3730dupGTCA	T249	Jen et al	North America (Chinese)
4	3688_3689insG	V235	Grand et al	North America (Ashkenazi-Jewish)
5	3691_3692insA	T236	Weil et al	Germany
6	3835_3836insA	R284	Cohn et al	Australia
7	3688_3689insG	V235	Unpublished	North America
8	3688_3689insG	V235	Unpublished	Australia
9	3843_3844insG	L287	Unpublished	Netherlands

---

## **Supplementary Videos 1-4 Legends.**

### *Supplementary Video 1*

Confocal microscopy video showing functional consequences of RVCL associated *TREX1* mutations as modeled in transiently expressed HEK293T cells. Fluorescent protein (green) and TOPRO3 stained nuclei (blue). Fluorescence expression pattern of fluorescent protein (FP) alone. The protein is diffusely distributed in the cytoplasm and in the nucleus.

### *Supplementary Video 2*

Confocal microscopy video showing functional consequences of RVCL associated *TREX1* mutations as modeled in transiently expressed HEK293T cells. Fluorescent protein (green) and TOPRO3 stained nuclei (blue). Fluorescence expression pattern of wild type *TREX1* tagged with the fluorescent protein (FP-*TREX1*). This fusion protein is found in a perinuclear compartment and is excluded from the nucleus.

### *Supplementary Video 3*

Confocal microscopy video showing functional consequences of RVCL associated *TREX1* mutations as modeled in transiently expressed HEK293T cells. Fluorescent protein (green) and TOPRO3 stained nuclei (blue). Fluorescence expression pattern of mutant *TREX1*, tagged with the fluorescent protein (FP-V235 fs). The mutant form of *TREX1* exhibits an expression pattern identical to the fluorescent protein (FP) alone.

### *Supplementary Video 4*

Confocal microscopy video showing functional consequences of RVCL associated *TREX1* mutations as modeled in transiently expressed HEK293T cells. Fluorescent protein (green) and TOPRO3 stained nuclei (blue). Fluorescence expression pattern of carboxylterminal 106 amino acids of *TREX1* tagged with the fluorescent protein (FP-C-106). This fusion protein is found in a perinuclear compartment and is excluded from the nucleus. This pattern is identical to the native exonuclease, implicating this short stretch of amino acids in mediating the perinuclear localization of the protein.

## **Supplemental Methods**

### *Samples*

We analyzed DNA samples from nine families with clinical symptoms of RVCL (Supplementary Table 2). Informed consent was obtained from all patients, in accordance with procedures and regulations of the Institutional Review Boards.



*Mutation detection*

Genomic DNA was isolated from peripheral blood leukocytes or immortalized cell lines from consenting subjects as approved by IRB. In specific cases (Washington University Genome Sequencing Center), Phi29-based whole genome amplification was performed on genomic DNA samples. Gene sequences of candidate genes were extracted from GenBank ([www.ncbi.nlm.nih.gov](http://www.ncbi.nlm.nih.gov)) and Ensembl ([www.ensembl.org](http://www.ensembl.org)) databases. Primers to amplify the coding exons and exon-intron boundaries of candidate genes were designed with the PrimerDesign script that is based on the use of the Primer 3 program. Universal (forward and reverse) tails were added to the 5' ends of amplification primers to serve as the sequencing primer sites (primer sequences and PCR conditions are available on request). Direct sequencing of purified PCR products was done by using dye-terminator chemistry and electrophoresed on a MegaBase500 (Amersham Biosciences, Princeton, NJ) capillary sequencer or either the ABI3700 or ABI3730 automated sequencer (Applied Biosystems, Foster City, CA). The sequence traces were assembled and scanned for variations from the reference sequence using the PolyScan informatics suite or Vector NTI suite 9.0.0 program (Invitrogen, Carlsbad, CA). The tagged variations were then manually reviewed. All detailed protocols are available on request.

For further mutational analysis of *TREX1*, primers were designed to amplify the coding exons of *TREX1* (Supplementary Table 3). Purified PCR amplification products were sequenced using dye-terminator chemistry and electrophoresed on a MegaBase500 (Amersham Biosciences, Princeton, NJ) capillary sequencer or an ABI3700 sequencer (Applied Biosystems, Foster City, CA). Sequencing was analyzed using PolyPhred. Anonymized control samples were screened by sequencing. Controls were matched with the ethnic origins of the mutations. The RVCL *TREX1* mutations were not detected in 192 Caucasian (HD100CAU, Coriell), 192 Chinese (HD100CHI, Coriell) and 300 Dutch control alleles.

**Supplementary Table 3.** Primers and PCR conditions for *TREX1* exon.

Primer	Primer Sequence Forward	Primer Sequence Reverse
1	tgtaaacgacgcccagatggtggtgagaggacagacc	caggaaacagctatgaccaaatgagggctctgcatggg
2	tgtaaacgacgcccagtgatgtgctggtcccactaagg	caggaaacagctatgaccaaggctaggagcaggttggc
3	tgtaaacgacgcccagctctctcctgtgtgtgctcc	caggaaacagctatgacctgtgacagcagatggtcttgg
4	tgtaaacgacgcccagctctaggcagcatctacactcgc	caggaaacagctatgaccatcctgctaggaaagtggg

The appropriate universal sequencing primer was used for either reading the forward or reverse strand of all amplicons. Forward sequencing primer (5'-TGTAACGACGCCAGT-3'); reverse sequencing primer (5'-CAGGAAACAGCTATGACC-3'). Incubation conditions: temperature, 60°C; Mg<sup>2+</sup> concentration, 1.5 mM.

---

### *Haplotype analysis*

For 20 microsatellite markers in the chromosome 3p21.1-p21.3 region, standard PCRs were performed using a PTC200 thermal cycler (Bio-Rad Laboratories, Foster City, CA). PCR products were analyzed on an ABI3700 sequencer (Applied Biosystems, Foster City, CA) and genotypes were assigned using GENESCAN and GENOTYPER software (Applied Biosystems, Foster City, CA). Two investigators scored genotypes independently. In addition, 13 SNPs in the region closely flanking *TREX1* were typed by direct sequencing. Disease haplotypes were constructed by inspection of segregation.

### *Molecular cloning, mutagenesis, expression, and purification of E. coli proteins*

Mutations (V235fs, T249fs and R114H) were constructed using the cDNA clone encoding *TREX1* variant 1 (Origene TC304415) as a template for site-directed mutagenesis. Oligos used for mutagenesis were as follows:

V235fs (5' CATGTATGGGGGTACAGCCTCTG 3' and 5' CAGAGCGTGTGACCCCATACATG 3')

T249fs (5' TCTGCTGTCAAGTACAACCACTGC 3' and 5' GCAGTGGTTGTGACTGACAGCAGATG 3')

R114H (5' AGCCTTCCTGCGGCACCAGCCACAGCCCTGG and 3' ACCAGGGCTGTGGCTGGTCCCGAGGAAGGC).

In the case of *TREX1*, V235fs, T249fs and R114H, the inserts were subcloned by PCR using the *TREX1* cDNA clone as a template into the *E. coli* expression vector pET28a+1 {a derivative of pET28a+ (Novagen) created in house} containing an Nterminal 6x His epitope tag. Correct clones were transformed into the *E. coli* strain BL21CodonPlus (DE3)-RIL (Stratagene, La Jolla, CA). Cells containing the *TREX1* plasmids were grown at 37°C to an Absorbance<sub>600</sub> of 0.6. Isopropyl-1-thio-β-D galactopyranoside was added to a final concentration of 1 mM and the cultures incubated at 37°C for an additional 3h. Cells were then harvested and the pellets were stored at -80°C. For purification of recombinant proteins, cells were resuspended in cold sonication buffer (50 mM Tris pH 8.0, 500 mM NaCl, 10% glycerol, 5 mM beta mercaptoethanol, 1 mM imidazole, and 1mM PMSF). The cell suspension was sonicated and centrifuged at 15,000 g at 4°C for 20 min to obtain a cleared lysate. Histagged proteins were batch adsorbed to Ni-NTA Agarose (Qiagen, Valencia, CA) for 1 h at 4°C. The beads were washed extensively in wash buffer (sonication buffer containing 25 mM imidazole) and packed into a 5 ml polypropylene (Qiagen) column. After additional washes, fractions were collected during elution with five column volumes of elution buffer (sonication buffer containing 250 mM imidazole). Fractions containing His-*TREX1* proteins were identified by SDS-PAG electrophoresis and Western blotting with an anti-HIS-HRP conjugated antibody (Clontech, Mountain View, CA) or, alternatively, with Coomassie Brilliant Blue staining. The samples were pooled, concentrated and aliquots of the purified proteins frozen at -80°C.

### *Exonuclease assays*

1  $\mu\text{g}$  of Poly(dA) (GE Healthcare, Princeton, NJ) was labeled at the 3' end with  $^{32}\text{P}$  dATP (GE Healthcare) using Terminal Transferase (Roche Diagnostic Corp., Indianapolis, IN). Reactions containing 50 mM Tris pH 8.5, 4 mM  $\text{MgCl}_2$ , 1 mM DTT, 10  $\mu\text{g}$  BSA, 0.01 g radiolabeled poly(dA) substrate, and recombinant exonuclease TREX1 protein were incubated in a total volume of 100  $\mu\text{l}$  at 37°C. Aliquots were removed at the indicated times and ethanol precipitated in the presence of 50  $\mu\text{g}$  denatured calf thymus DNA (Sigma-Aldrich, St. Louis, MO). Ethanol-soluble radioactivity released into the supernatant was measured by scintillation counting.

### *Generation of N-terminally-tagged TREX1 constructs*

To directly visualize TREX1 within the living cell, all TREX1 forms were N-terminally tagged with the enhanced yellow fluorescent protein (eYFP). For clarity, the epitope tag is designated hereafter as fluorescent protein (FP) tag. At the wavelength employed it gives green fluorescence. The FP coding sequence was excised via EcoRI/BsrGI from sT-DAF-eY<sup>1</sup>. This fragment was utilized in a three-fragment ligation with EcoRI/XbaI-digested CD59dGPI<sup>2</sup> and the respective BsrGI/XbaI-digested PCR-derived TREX1 forms (see below). This resulted in aminoterminal tagging of TREX1 FP-TREX1, FP-V235fs and FP-T249fs). Wild-type FP was expressed from the second cistron of sT-DAF. Wild-type TREX1 (FP-TREX1) was used as a template DNA to generate the Aicardi-Goutieres R114H mutant (FP-R114H) by site-directed mutagenesis as described above. To study the effect on cellular localization of the carboxyl-terminus of TREX1, a FP-tagged fusion protein containing the last 106 amino acids of native TREX1 was generated (FPC106). A 646 bp BsrGI/BsaI fragment was excised from FP-TREX1, to remove the entire aminoterminal including all exonuclease sites. The cohesive ends were then blunted and the linearized 4532 bp fragment religated, resulting in FP-C106. All PCR-derived DNA fragments and ligation products were verified by DNA sequencing.

### *Confocal Microscopy*

HEK293T cells ( $7 \times 10^5$  on cover slides in 6-well plates) were transiently transfected overnight with 1.5  $\mu\text{g}$  of each construct using TransIT-293 (Mirus, Madison, WI), according to manufacturer's directions. Following two washes in PBS, the cells were fixed for 30 min at room temperature (RT) in PBS containing 2% paraformaldehyde. Following two washes in PBS, the cover slides were incubated for 30 min at RT in PBS containing a 1/2000 dilution of Topro3 (Molecular Probes, Carlsbad, CA) to visualize the nuclei, washed again with PBS and mounted on slides overnight with ProLong Gold (Molecular Probes). Samples were examined using a Zeiss LSM 510 laser scanning confocal microscope and images were processed using Image Examiner Software (Zeiss, Jena, Germany).

---

### *Expression, SDS-PAGE, and Western blotting*

Following overnight transient transfection of HEK293T cells (described above), cells were washed with PBS, lysed with 1% Nonidet P-40, 0.05% SDS in PBS with 2 mM PMSF for 15 min at 4°C, and centrifuged at 12,000 g for 10 min. Supernatants were immediately evaluated or frozen at -80 °C. The Western blot was loaded with  $5 \times 10^5$  cell equivalents per lane on non-reduced and electrophoresed (10% SDS-PAGE). Following transfer to nitrocellulose, the blots were probed with 1:4000 dilution of monoclonal anti-GFP antibody JL-8 that recognizes both GFP and YFP (Clontech Laboratories) and then HRP donkey anti-mouse IgG (Amersham Biosciences).

### *References*

1. Spitzer D et al (2004) *Molecular Immunology* 40, 911-919.
2. Spitzer D, Hauser H & Wirth D (1999) *Human Gene Therapy* 10, 1893.

### *Accession codes*

GenBank: cDNA and amino acid numbering was determined using the TREX1 protein AAK07616 and nucleotide sequence NM\_033627 (with the A at 2986 as the first base of the initiating ATG codon).

### *URLs*

The UCSC Genome Browser is available at <http://genome.ucsc.edu/>.

The Marshfield chromosome 3 genetic map is found at <http://research.marshfieldclinic.org/genetics>.





---

# 5.2

## **TREX1 gene variant in neuropsychiatric systemic lupus erythematosus**

---

B de Vries<sup>1</sup>, G M Steup-Beekman<sup>2</sup>, J Haan<sup>3,4</sup>, E L Bollen<sup>3</sup>, J Luyendijk<sup>5</sup>,  
R R Frants<sup>1</sup>, G M Terwindt<sup>3</sup>, M A van Buchem<sup>5</sup>, T W J Huizinga<sup>2</sup>,  
A M J M van den Maagdenberg<sup>1,3</sup> & M D Ferrari<sup>3</sup>

<sup>1</sup>*Department of Human Genetics, Leiden University Medical Center, Leiden, The Netherlands*

<sup>2</sup>*Department of Rheumatology, Leiden University Medical Center, Leiden, The Netherlands*

<sup>3</sup>*Department of Neurology, Leiden University Medical Center, The Netherlands*

<sup>4</sup>*Department of Neurology, Rijnland Hospital, Leiderdorp, The Netherlands*

<sup>5</sup>*Department of Radiology, Leiden University Medical Center, Leiden, The Netherlands*

**Annals of the Rheumatic Diseases 2010;69:1886-1887**

---

## Introduction

Systemic lupus erythematosus (SLE) is an autoimmune disorder with a complex genetic background. Some 14–75% of SLE patients report neurological and psychiatric symptoms and are diagnosed with neuropsychiatric-SLE (NPSLE).<sup>1</sup> Many of these patients also have cerebral white matter hyperintensities (WMH). The aetiology and genetic background of NPSLE is largely unknown.

In 2007, mutations in the *TREX1* gene, encoding the major mammalian 3'-5' DNA exonuclease, were identified in nine out of 417 SLE patients.<sup>2</sup> In addition, *TREX1* has been associated with disorders that are often associated with cerebral WMH, migraine(-like symptoms) and other manifestations of brain disease.<sup>3,4</sup> Consequently, we considered *TREX1* an excellent candidate for NPSLE.

## Results

We scanned genomic DNA of 60 NPSLE patients (table 1) for exonic *TREX1* mutations using direct sequencing,<sup>5</sup> and identified a novel heterozygous p.Arg128His mutation in one NPSLE patient. This DNA belonged to a postmenopausal woman who was admitted to our hospital because of lethargy and progressive migraine-like headache for 2 weeks. Previously, she was diagnosed with SLE<sup>6</sup> associated with pleuritis, Coombs positive autoimmune haemolytic anaemia, thrombopenia, and tested positive for antinuclear antibody (ANA) and anti-dsDNA antibodies. SLE manifestations were successfully treated with corticosteroids. Two years before admission, she was treated with prostacyclin infusions, corticosteroids and azathioprine for severe Raynaud's phenomenon with imminent gangrene of the fingers. On admission, she became increasingly confused and obtunded. Neurological examination revealed aphasia and bilateral Babinski signs. General physical examination and cerebrospinal fluid analysis were normal. Laboratory tests for ANA, anti-ENA, anticardiolipin IgM, anti-SSA and anti-SSB were positive. Brain MRI showed generalised atrophy, extensive symmetric cerebral WMH and cerebellar infarcts (figure 1A,B) without evidence for recent ischaemia. She was diagnosed with NPSLE<sup>7</sup> and treated for 3 days with daily doses of 1000 mg intravenous methylprednisolone and recovered after a few days. One year later she developed lupus nephritis class IV as confirmed by kidney biopsy.



**Table 1** Characteristics of neuropsychiatric systemic lupus erythematosus patients (n=60), of which 25 patients had white matter hyperintensities

	n (%)		n (%)
Female	56 (93)	APS	16 (27)
Age (years)		aCL_IgM*	29 (48)
Mean±SD	37.2±13.4	aCL_IgG*	39 (65)
Median	37.1	LAC†	16 (27)
SLE duration (years)		Active NPSLE	45 (75)
Mean±SD	6.4±5.5	Inactive NPSLE	15 (25)
Median	5.2	Aseptic meningitis	2 (3)
NPSLE duration (years)		Cerebrovascular disease	24 (40)
Mean±SD	1.9±3.8	Headache	15 (25)
Median	0.1	Mononeuropathy	2 (3)
Malar rash	21 (35)	Movement disorder	1 (2)
Discoid rash	26 (43)	Myelopathy	3 (5)
Photosensitivity	18 (30)	Cranial neuropathy	4 (7)
Oral ulcers	12 (20)	Plexopathy	1 (2)
Arthritis	42 (70)	Polyneuropathy	1 (2)
Serositis	33 (55)	Seizures	12 (20)
Renal disorder	28 (47)	Acute confusional state	4 (7)
Haematological disorder	36 (60)	Cognitive dysfunction	19 (32)
Immunological disorder	57 (95)	Mood disorder	4 (7)
ANF	58 (97)	Psychosis	4 (7)

\*Data unavailable for one patient, †data unavailable for seven patients. aCL, anticardiolipin; ANF, antinuclear factor; APS, antiphospholipid syndrome; LAC, lupus anticoagulans; NPSLE, neuropsychiatric-SLE; SLE, systemic lupus erythematosus.

## Discussion

We suggest that mutation p.Arg128His is causing NPSLE in the patient for several reasons. The mutation was not found in 400 control chromosomes, nor in 1712 healthy individuals, previously screened by Lee-Kirsch *et al.*<sup>2</sup> Furthermore, the mutation is located within the highly conserved second exonuclease domain (figure 1C). Notably, a crystallisation study of TREX1 by de Silva and colleagues<sup>8</sup> showed that specific hydrogen bonds of Arg<sup>128</sup> are involved in the destabilisation of double-stranded DNA to provide single-stranded DNA for the enzyme active site. Ultimate proof of pathogenicity should be provided by future functional studies.

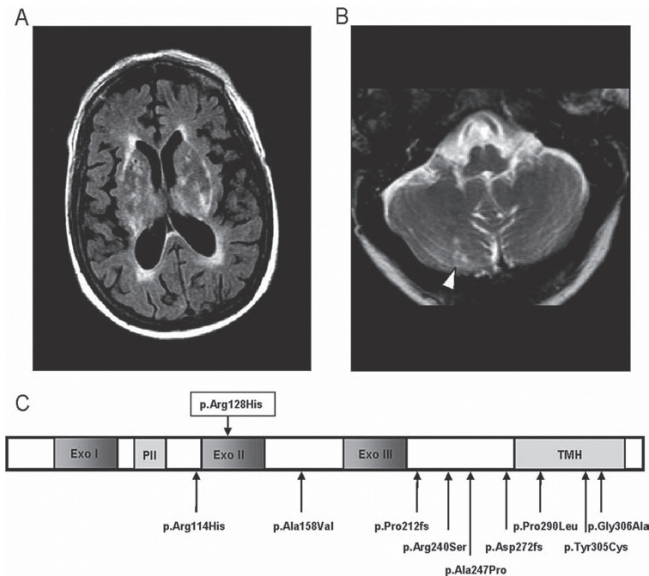

**Figure 1** MRI abnormalities in the *p.Arg128His* *TREX1* mutation carrier with neuropsychiatric systemic lupus erythematosus. (A) FLAIR image shows symmetric white matter hyperintensities in the capsula interna, capsula externa and periventricular white matter. (B) T2-weighted image shows three small infarcts in the right cerebellar hemisphere as indicated by the white arrow. (C) Schematic representation of the *TREX1* protein, showing the position of *p.Arg128His* as well as previously identified SLE mutations. 2 Exo I, II and III represent the exonuclease regions. PII represents the polyproline II motif and TMH the transmembrane helix.

Here we confirm *TREX1* as a genetic factor in SLE. Moreover, we were able to show involvement of *TREX1* in one out of 60 NPSLE patients, of which 25 had extensive WMH. Clinical characteristics of NPSLE patients with or without WMH were not different, except perhaps for a higher occurrence of cognitive dysfunction in the group with WMH (52 vs 17%) (data not shown). No exonic *TREX1* DNA variants were identified in the other 59 NPSLE patients reflecting the genetic heterogeneity in NPSLE.

### Acknowledgements

The authors thank all participants for taking part in the study. The authors also thank Kaate Vanmolokot and Judith Vark for their technical assistance.

### Funding

This work was supported by grants of the Netherlands Organisation for Scientific Research (NWO) (903-52-291, MDF, RRF, and Vici 918.56.602, MDF), and the Center of Medical Systems Biology (CMSB) within the framework of the Netherlands Genomics Initiative (NGI)/NWO.

## References

1. Bruns A, Meyer O (2006) Neuropsychiatric manifestations of systemic lupus erythematosus. *Joint Bone Spine* 73:639–45.
2. Lee-Kirsch MA, Gong M, Chowdhury D, et al (2007) Mutations in the gene encoding the 3'-5' DNA exonuclease TREX1 are associated with systemic lupus erythematosus. *Nat Genet* 39:1065–7.
3. Crow YJ, Hayward BE, Parmar R, et al (2006) Mutations in the gene encoding the 3'-5' DNA exonuclease TREX1 cause Aicardi-Goutières syndrome at the AGS1 locus. *Nat Genet* 38:917–20.
4. Kavanagh D, Spitzer D, Kothari PH, et al (2008) New roles for the major human 3'-5' exonuclease TREX1 in human disease. *Cell Cycle* 7:1718–25.
5. Richards A, van den Maagdenberg AM, Jen JC, et al (2007) C-terminal truncations in human 3'-5' DNA exonuclease TREX1 cause autosomal dominant retinal vasculopathy with cerebral leukodystrophy. *Nat Genet* 39:1068–70.
6. Tan EM, Cohen AS, Fries JF, et al. The 1982 revised criteria for the classification of systemic lupus erythematosus. *Arthritis Rheum* 1982;25:1271–7.
7. The American College of Rheumatology nomenclature and case definitions for neuropsychiatric lupus syndromes. *Arthritis Rheum* 1999;42:599–608.
8. de Silva U, Choudhury S, Bailey SL, Harvey S et al (2007) The crystal structure of TREX1 explains the 3' nucleotide specificity and reveals a polyproline II helix for protein partnering. *J Biol Chem.* 6;282(14):10537-10543.



---

# 6

## Genome-wide association studies in migraine

---



---

# 6.1

## Genome-wide association study of migraine implicates a common susceptibility variant on 8q22.1

---

V. Anttila<sup>1,2,\*</sup>, H. Stefansson<sup>3</sup>, M. Kallela<sup>4</sup>, U. Todt<sup>5,6</sup>, G. M. Terwindt<sup>7</sup>, M. S. Calafato<sup>1,8</sup>, D.R. Nyholt<sup>9</sup>, A.S. Dimas<sup>1,10,11</sup>, T. Freilinger<sup>12</sup>, B. Müller-Myhsok<sup>13</sup>, V. Artto<sup>4</sup>, M. Inouye<sup>1,14</sup>, K. Alakurtti<sup>1,2</sup>, M.A. Kaunisto<sup>2,15</sup>, E. Hämäläinen<sup>1, 2</sup>, B. de Vries<sup>14</sup>, A.H. Stam<sup>7</sup>, C.M. Weller<sup>14</sup>, A. Heinze<sup>16</sup>, K. Heinze-Kuhn<sup>16</sup>, I. Goebel<sup>5,6</sup>, G. Borck<sup>5,6</sup>, H. Göbel<sup>16</sup>, S. Steinberg<sup>3</sup>, C. Wolf<sup>13</sup>, A. Björnsson<sup>3</sup>, G. Gudmundsson<sup>17</sup>, M. Kirchmann<sup>18</sup>, A. Hauge<sup>18</sup>, T. Werge<sup>19</sup>, J. Schoenen<sup>20</sup>, J.G. Eriksson<sup>15,21,22,23</sup>, K. Hagen<sup>24</sup>, L. Stovner<sup>24</sup>, H.-E. Wichmann<sup>25,26,27</sup>, T. Meitinger<sup>28,29</sup>, M. Alexander<sup>30,31</sup>, S. Moebus<sup>32</sup>, S. Schreiber<sup>33</sup>, Y. S. Aulchenko<sup>34</sup>, M.M.B. Breteler<sup>34</sup>, A.G. Uitterlinden<sup>35</sup>, A. Hofman<sup>34</sup>, C. M. van Duijn<sup>34</sup>, P. Tikka-Kleemola<sup>36</sup>, S. Vepsäläinen<sup>4</sup>, S. Lucae<sup>13</sup>, F. Tozzi<sup>37</sup>, P. Muglia<sup>37,38</sup>, J. Barrett<sup>1</sup>, J. Kaprio<sup>2,23,39</sup>, M. Färkkilä<sup>4</sup>, L. Peltonen<sup>1, 2,40,\*</sup>, K. Stefansson<sup>3</sup>, J.-A. Zwart<sup>23,41</sup>, M.D. Ferrari<sup>7</sup>, J. Olesen<sup>18</sup>, M. Daly<sup>40</sup>, M. Wessman<sup>2,15</sup>, A.M.J.M. van den Maagdenberg<sup>7, 14</sup>, M. Dichgans<sup>12</sup>, C. Kubisch<sup>5,6,42</sup>, E.T. Dermitzakis<sup>11</sup>, R.R. Frants<sup>14</sup>, A. Palotie<sup>1,2, 40</sup> on behalf of the International Headache Genetics Consortium

*\* A full list of author affiliations appears at the end of the paper.*

**Nature Genetics 2010;42:869-873**

---

## Abstract

Migraine is a common episodic neurological disorder, typically presenting with recurrent attacks of severe headache and autonomic dysfunction. Apart from rare monogenic subtypes, no genetic or molecular markers for migraine have been convincingly established. We identified the minor allele of rs1835740 on chromosome 8q22.1 to be associated with migraine ( $P = 5.38 \times 10^{-9}$ , odds ratio = 1.23, 95% CI 1.150–1.324) in a genome-wide association study of 2,731 migraine cases ascertained from three European headache clinics and 10,747 population-matched controls. The association was replicated in 3,202 cases and 40,062 controls for an overall meta-analysis  $P$  value of  $1.69 \times 10^{-11}$  (odds ratio = 1.18, 95% CI 1.127–1.244). rs1835740 is located between *MTDH* (astrocyte elevated gene 1, also known as AEG-1) and *PGCP* (encoding plasma glutamate carboxypeptidase). In an expression quantitative trait study in lymphoblastoid cell lines, transcript levels of the *MTDH* were found to have a significant correlation to rs1835740 ( $P = 3.96 \times 10^{-5}$ , permuted threshold for genome-wide significance  $7.7 \times 10^{-5}$ ). To our knowledge, our data establish rs1835740 as the first genetic risk factor for migraine.

## Introduction

The recent boom of genome-wide association studies (GWAS) has had a major impact on our current view of genetic susceptibility to common traits and complex disorders. However, central nervous system disorders are under-represented among the conditions for which such associations have been found<sup>1</sup>. To our knowledge, no GWAS or common, robustly established linked genetic variants have been reported for major episodic neurological disorders (ICD-10 codes G40–G44, migraine, epilepsy and ataxias). However, there is substantial genetic information for rare Mendelian forms of migraine, epilepsy and ataxia, which classifies them as channelopathies associated with compromised neurotransmitter homeostasis<sup>2</sup>. So far, there is no evidence for the contribution of ion channel variants in common forms of these diseases<sup>3,4</sup>.

Migraine is an episodic neurological disorder with complex pathophysiology, affecting 8% of males and 17% of females<sup>5</sup> in the European population. Migraine ranks among the 20 most disabling diseases and has been estimated as the most costly neurological disorder, with a considerable impact on public health<sup>6</sup>. Clinically, the International Classification of Headache Disorders (ICHD-II<sup>7</sup>) recognizes two main common forms of migraine: migraine with aura and migraine without aura. The two forms are distinguished from each other based on the presence of aura, a period of variable and diverse neurological symptoms that precede the headache phase. Individuals may have attacks of only migraine without aura, or only migraine with aura, or they may have a combination of both types in variable proportions. There is debate among the scientific community whether migraine with aura and migraine without aura attacks represent



two distinct disorders or if they are merely variations of a single disease having a common complex genetic background. Migraine headache is believed to be caused by activation of the trigeminovascular system and the aura by cortical spreading depression, a slowly propagating wave of neuronal and glial depolarization<sup>8-10</sup>. However, these are considered to be downstream events, and it is unknown how migraine attacks are initiated.

To identify variants associated with the common forms of migraine, we carried out a two-stage GWAS in seven European migraine case collections (six clinic-based and one population-based) (Supplementary Fig. 1). In the discovery stage, we studied 3,279 migraineurs (1,124 Finnish, 1,276 German and 879 Dutch individuals) recruited from headache clinics and genotyped using Illumina arrays against population-matched controls (10,747 individuals) recruited from preexisting population-based GWAS (Supplementary Note). In the replication stage, a further 3,202 cases and 40,062 population-matched controls from Iceland, Denmark, The Netherlands and Germany were studied.

## Results

Diagnoses were made by headache experts using a combination of questionnaires and individual interviews that were based on the ICHD-II guidelines<sup>7</sup>. Due to the overlap between individuals having migraine with aura and those having migraine without aura, we analyzed the following diagnostic subgroups: (i) 'all migraine', defined as all individuals with migraine irrespective of subtype; (ii) 'migraine with aura only', defined as individuals who only have attacks where aura is present; (iii) 'both migraine with aura and migraine without aura', defined as individuals with attacks both with and without aura; and (iv) 'migraine without aura only', defined as individuals with only attacks of migraine without aura.

We used a multipopulation Cochran-Mantel-Haenszel (CMH) association analysis and a significance threshold of  $P \leq 5 \times 10^{-8}$  in our analyses. In the discovery sample, 2,731 cases and 10,747 controls (Table 1) passed quality control steps, and 429,912 markers were successfully genotyped (Online Methods). A quantile-quantile plot of the CMH analysis (Supplementary Fig. 2) and an overall inflation factor ( $\lambda$ ) of 1.08 were used as final quality control measures.

**Table 1** Study populations used in the two stages of the study

		Total	Men (%)	Women (%)	Individuals with both MA and MO (%)	Individuals with MA only (%)	Individuals with MO only (%)
<b>Discovery stage</b>							
Finland	Cases	1,064	19.8	80.2	94.4	5.6	0.0
	Controls	3,513	47.4	52.6	–	–	–
Germany	Cases	1,029	18.9	81.1	70.2	29.8	0.0
	Controls	2,317	45.1	54.9	–	–	–
The Netherlands	Cases	655	17.2	82.8	65.9	34.1	0.0
	Controls	4,917	41.7	58.3	–	–	–
Total GWAS							
	Cases	2,731	18.8	81.2	78.5	21.5	0.0
	Controls	10,747	44.3	55.7	–	–	–
<b>Replication stage</b>							
Iceland	Cases	900	22.5	77.5	63.0	21.8	15.2
	Controls	35,221	57.4	42.6	–	–	–
Denmark	Cases	1,116	22.4	77.6	26.3	43.3	30.5
	Controls	1,353	44.5	55.5	–	–	–
The Netherlands	Cases	349	18.3	81.7	59.8	40.2	0.0
	Controls	2,082	43.9	56.1	–	–	–
Germany	Cases	837	11.6	88.4	0.0	0.0	100.0
	Controls	1,406	37.3	62.7	–	–	–
Total replication	Cases	3,202	19.1	80.9	33.8	25.6	41.0
	Controls	40,062	55.6	44.4	–	–	–
<b>Overall</b>	Cases	5,933	19.0	81.0	54.4	23.7	22.1
<b>meta-analysis</b>	Controls	50,809	53.2	46.8	–	–	–

MA, migraine with aura; MO, migraine without aura.

Only one marker, rs1835740 on chromosome 8q22.1, showed significant association with migraine in the multipopulation CMH analysis (Fig. 1 and Supplementary Fig. 3). Eleven further loci were found with  $P \leq 5 \times 10^{-5}$  (Supplementary Table 1). The minor allele (A) of marker rs1835740 was associated with migraine with  $P = 5.38 \times 10^{-9}$  and odds ratios ranging between 1.21 and 1.33 (Table 2). Two nearby markers with the highest linkage disequilibrium (LD) to rs1835740 (rs982502,  $r^2 = 0.59$ ,  $P = 1.34 \times 10^{-4}$  and rs2436046,  $r^2 = 0.69$ ,  $P = 1.78 \times 10^{-5}$ ) also showed association with migraine (Supplementary Table 2). Haplotype analysis detected a 27-kb haplotype ( $P = 5.35 \times 10^{-8}$ ) (Supplementary Fig. 4 and Supplementary Table 3). In the HapMap Phase II data<sup>11</sup>, the variant is located between two close recombination hotspots, and analysis using the ssSNPer program<sup>12</sup> demonstrated that no long-range LD to rs1835740 exists within a 5-Mb window, strongly suggesting that the causative variant in this region is tagged by the minor allele of rs1835740 (Fig. 1). The 2-Mb window around rs1835740 was also imputed against the 1000 Genomes data (August 2009 release), but no other marker showed evidence of association exceeding that for rs1835740 (Fig. 1). Conditional analysis of the SNPs around rs1835740 showed no additional

independent signals (Supplementary Table 2). The proportion of genetic variance explained by the rs1835740 variant was estimated to be between 1.5% and 2.5%, depending on the heritability estimate used, and the population attributable risk was estimated to be 10.7% using previous methodology<sup>13</sup>.

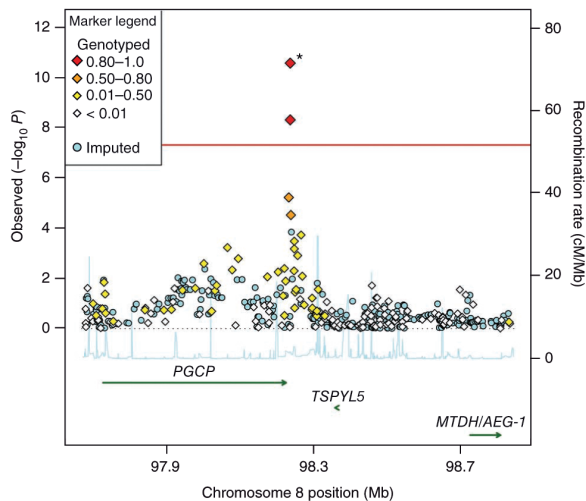

**Figure 1** Cochran-Mantel-Haenszel association results for combined analysis of the three study populations between 97.5 Mb and 99.0 Mb on chromosome 8q22.1. Diamonds show the position and P value for each marker in the region, with colors representing the extent of linkage disequilibrium (measured in  $r^2$ ) with the marker rs1835740, and blue circles indicate the locations and P-values of the imputed markers. For rs1835740, P-values are shown for both the original GWAS and the meta-analysis of all migraine samples in the study (denoted by asterisk). The blue graph shows the local recombination rate based on HapMap Phase II data<sup>11</sup>. The red line denotes the threshold for genome-wide significance ( $P \leq 5 \times 10^{-8}$ ). This figure was generated using a modified version of the script available at <http://www.broadinstitute.org/node/555>.

To confirm and extend our results, we performed a replication study on the only marker with genome-wide significance in the discovery stage: rs1835740. The diagnostic subgroups used in the discovery stage were also applied to the replication stage. Replication was successful in two ‘migraine with aura only’ subsets (Danish,  $P = 0.015$ , OR = 1.29 and Icelandic,  $P = 0.038$ , OR = 1.36), in the Icelandic ‘migraine without aura’ set ( $P = 0.0292$ , OR = 1.18) and in the Icelandic ‘all migraine’ group ( $P = 0.010$ , OR = 1.18) (Table 2). Overall, the A allele of marker rs1835740 was overrepresented (OR = 1.05–1.36; Table 2) in each subset of all replication samples except in the Danish ‘both migraine with aura and migraine without aura’ group (OR = 0.99). The effect was consistently stronger in the ‘migraine with aura only’ groups than other migraine subgroups (Fig. 2). It should be noted that the majority of the groups that did not reach formal replication were small and had limited power. Meta-analysis was conducted using the CMH test for each diagnosis subgroup alone as well as for all migraine samples together, with the latter group showing a final  $P = 1.69 \times 10^{-11}$  (Table 2).

**Table 2** Association results for marker rs1835740 using the CMH test

	Diagnosis	n (cases)	n (controls)	Case alleles (MAF)	Control alleles (MAF)	P-value	OR (95% CI)
<b>GWAS</b>							
Finland	All migraine	1,064	3,513	548/1,576 (0.258)	1,553/5,461 (0.221)	0.000447	1.22 (1.093–1.368)
Germany	All migraine	1,029	2,317	515/1,537 (0.251)	998/3,632 (0.216)	0.00142	1.22 (1.079–1.378)
The Netherlands	All migraine	655	4,917	329/963 (0.255)	2,086/7,742 (0.212)	0.000876	1.26 (1.098–1.437)
<b>Discovery stage</b>							
	MA only	589	10,747	313/859 (0.267)	4,637/16,385 (0.216)	<b>3.07</b> $\times 10^{-5}$	1.33 (1.164–1.528)
	Both MA & MO	2,142	10,747	1,071/3,193 (0.251)	4,637/16,385 (0.216)	<b>2.69</b> $\times 10^{-6}$	1.21 (1.115–1.304)
	All migraine	2,731	10,747	1,384/4,052 (0.255)	4,637/16,385 (0.216)	<b>5.38</b> $\times 10^{-9}$	1.23 (1.150–1.324)
<b>Replication stage</b>							
Denmark	MA only	483	1,353	244/722 (0.253)	562/2,144 (0.208)	<b>0.015</b>	1.29 (1.050–1.583)
	Both MA & MO	293	1,353	121/465 (0.206)	562/2,144 (0.208)	0.951	0.99 (0.785–1.255)
	MO only	340	1,353	153/527 (0.225)	562/2,144 (0.208)	0.333	1.11 (0.900–1.362)
	All migraine	1,116	1,353	518/1,714 (0.232)	562/2,144 (0.208)	0.069	1.15 (0.989–1.344)
Iceland	MA only	137	35,221	70/204 (0.255)	14,212/56,230 (0.202)	<b>0.0380</b>	1.36 (1.017–1.812)
	Both MA & MO	196	35,221	82/310 (0.209)	14,212/56,230 (0.202)	0.7256	1.05 (0.812–1.350)
	MO only	567	35,221	261/873 (0.230)	14,212/56,230 (0.202)	<b>0.0292</b>	1.18 (1.017–1.376)
	All migraine	900	35,221	413/1,387 (0.229)	14,212/56,230 (0.202)	<b>0.010</b>	1.18 (1.041–1.334)
The Netherlands	MA only	212	2,082	100/324 (0.236)	909/3,255 (0.218)	0.406	1.11 (0.873–1.399)
	Both MA & MO	137	2,082	66/208 (0.241)	909/3,255 (0.218)	0.382	1.14 (0.853–1.513)
	All migraine	349	2,082	166/532 (0.238)	909/3,255 (0.218)	0.250	1.12 (0.925–1.350)
Germany	MO only	837	1,406	396/1,278 (0.240)	629/2,183 (0.224)	0.3206	1.08 (0.932–1.241)
	MO only <sup>a</sup>	837	541	396/1,278 (0.240)	218/864 (0.201)	<b>0.0307</b>	1.23 (1.019–1.480)
<b>Meta-analysis</b>							
	All "MA only"	1,421	49,403	727/2,109 (0.256)	20,320/78,464 (0.206)	<b>6.98</b> $\times 10^{-8}$	1.29 (1.173–1.408)
	All "Both MA & MO"	2,768	49,403	1,340/4,176 (0.243)	20,320/78,464 (0.206)	<b>1.09</b> $\times 10^{-5}$	1.17 (1.089–1.248)
	All "MO only"	1,744	37,980	810/2,678 (0.232)	15,403/60,557 (0.203)	0.0105	1.12 (1.028–1.230)
	All "All migraine"	5,933	50,809	2,877/8,963 (0.243)	20,949/80,647 (0.206)	<b>1.69</b> $\times 10^{-11}$	1.18 (1.127–1.244)

MA, migraine with aura; MO, migraine without aura. Genome-wide significant values and successful replications are shown in boldface. <sup>a</sup>Values in this row were calculated after excluding an outlier control sample. The German replication control set consisted of several small samples. The largest of these had a considerably deviating minor allele frequency (MAF) (MAF = 0.238, n = 865) compared to other German (average MAF = 0.216, n = 3,260) and Central European control sets (average MAF = 0.212, n = 9,560). Thus, values with both including and excluding the outlier control sample are presented in the case allele and control allele columns. The meta-analysis value includes all control samples (without the outlier control group, "all migraine without aura samples," P = 0.00107, OR = 1.18, 95% CI 1.068–1.298 and "all migraine samples," P =  $8.43 \times 10^{-13}$ , OR = 1.20, 95% CI 1.143–1.264.

Marker rs1835740 is located between two potentially interesting candidate genes, *MTDH* and *PGCP*. We analyzed the effect of this marker's genotype on the expression of genes within a 2-Mb window in fibroblasts, primary T cells and lymphoblastoid cell lines (LCL) obtained from umbilical cords<sup>14</sup>. In the expression quantitative trait locus (eQTL) analysis, the rs1835740 genotype was found to have significant correlation to the transcript levels of the nearby *MTDH* gene in LCLs (Table 3 and

Supplementary Table 4), with the risk allele A being associated with higher expression levels (Fig. 3). This is in line with previous studies, which have proven that expression analyses in LCL cells are informative in neurological and neuropsychiatric traits<sup>15–17</sup>. No significant association was detected in fibroblasts or primary T cells. The eQTL analysis suggested that rs1835740 is a cis regulator of MTDH in LCLs.

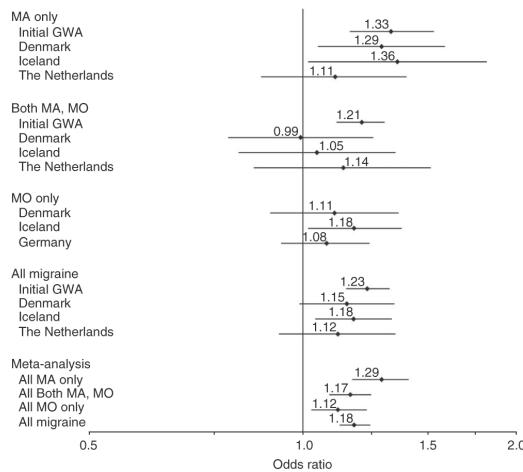

**Figure 2** For each dataset, the horizontal line indicates the 95% CI, and the number above the line indicates the point estimate of the odds ratio. MA only, individuals whose attacks are always accompanied with aura; both MA, MO, individuals with attacks with and without aura; MO only, individuals whose attacks never include aura.

**Table 3** Association of rs1835740 genotype with gene expression levels

SNP	Gene	Strand	SNP coordinate	Gene start	Distance	SRC P
rs1835740	UQCRB	–	98,236,089	97,311,911	924,178	0.0013226
rs1835740	MTDH	+	98,236,089	98,725,583	489,494	0.0000396 <sup>a</sup>
rs1835740	HRSP12	–	98,236,089	99,183,743	947,654	0.0028748

Genes with nominal or higher P values of expression association to rs1835740 genotype in the Spearman rank correlation test are shown.

<sup>a</sup>This value surpassed the significance threshold  $7.7 \times 10^{-5}$  (corresponding to a 0.001 permutation threshold after 10,000 permutations). Gene start refers to the location of 5' end of the gene if on the positive strand and the 3' end if on the negative strand. Locations and distances are given in base pairs and are according to NCBI build 36. SRC, Spearman rank correlation.

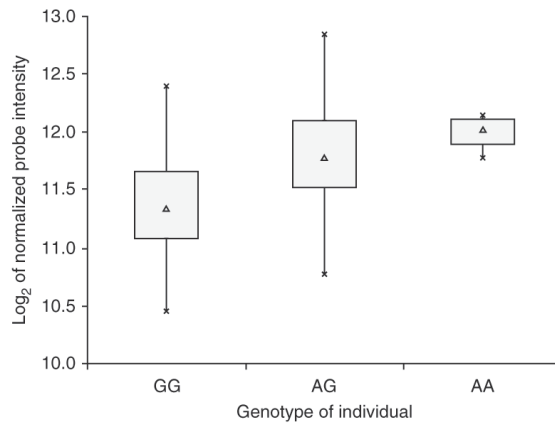

**Figure 3.** A box-plot of the quantified expression values for *MTDH/AEG-1*, ordered based on sample genotype of *rs1835740*. Normalised expression levels in lymphoblastoid cell lines using Illumina's WG-6 v3 Expression BeadChip array shown. In each group, the small pyramid indicates median value, the shaded area represents the lower and upper quartiles, and the crosses show the minimum and maximum values in the expression data.

## Discussion

The location of the associating sequence variant, *rs1835740*, between two genes involved in glutamate homeostasis, *PGCP* and *MTDH*, suggests that this region contains elements that could regulate either or both of these flanking genes; the eQTL analysis pointed to the latter. Although *MTDH* has mainly been studied in relation to carcinogenesis<sup>18</sup>, previous studies in cultured astrocytes have shown that *MTDH* downregulates *SLC1A2* (also known as *EAAT2* and *GLT-1*)<sup>18-22</sup>, the gene encoding the major glutamate transporter in the brain. Furthermore, knock-out mice lacking the *EAAT2* protein from their brains have been shown to suffer from lethal spontaneous epileptic seizures<sup>23</sup>. Despite the limitations in extrapolating eQTL findings from LCL cells directly to brain tissue, these data suggest a plausible link between the identified variant and glutamate regulation. This is a tempting hypothesis, as this neurotransmitter has long been suspected to play a key role in migraine pathophysiology<sup>24</sup>.

Although the evidence provided here is indirect, accumulation of excess glutamate in the synaptic cleft through downregulation of *EAAT2* or an increase in *PGCP* activity (or both) would provide a putative mechanism for the occurrence of migraine attacks. It is reasonable to speculate that this accumulation can increase susceptibility to migraine through increased sensitivity to cortical spreading depression, the likely mechanism for the migraine aura<sup>9,10</sup>, as well as through glutamate involvement in central sensitization, which has been postulated to be the underlying mechanism of allodynia during a migraine attack<sup>25</sup>.

Neither this study nor our previous study<sup>3</sup> yielded evidence for association of ion channel genes to common forms of migraine. Thus, even if the contribution of ion channel genes is well established in Mendelian forms of paroxysmal neurological disorders, such as familial hemiplegic migraine (FHM)<sup>26–29</sup>, their direct role in more common forms of paroxysmal neurological disorders remains open. Interestingly, previous studies suggested that the imbalance of glutamate release and clearance is a key component of the pathogenesis of FHM; the underlying mutation in FHM lies in *CACNA1A*, *ATP1A2* or *SCN1A*<sup>30,31</sup>. The results of the present study support the hypothesis that complementary pathways such as the glutamate system may tie the Mendelian channelopathies with the pathogenetic mechanisms of more common forms of episodic neurological disorders, such as migraine. Alterations in the functionally related EAAT1 transporter have been identified in other episodic phenotypes (such as episodic ataxia 6 (ref. 32) and a phenotype with episodic ataxia, hemiplegia and seizures<sup>33</sup>), providing an example of the link between EAAT transporters and episodic disorders. Future studies should be conducted to specifically test this hypothesis.

In summary, to our knowledge, we have identified the first robust genetic association to migraine. As our cases were mainly selected from specialized headache clinics, subsequent studies are needed to establish the contribution of rs1835740 in population-based migraine cohorts. These population-based cohorts may represent a different severity spectrum and possibly also a somewhat different underlying combination of genetic susceptibility variants. The effect of rs1835740 is stronger in individuals with migraine with aura than in those with migraine without aura, but further studies are needed to confirm the role of the variant in different migraine subgroups. This variant explains only a small fraction of the overall genetic variance in migraine, and future GWAS, perhaps with different ascertainment schemes, will likely identify additional loci explaining more of the genetic variance.

## Methods

Methods and any associated references are available in the online version of the paper at <http://www.nature.com/naturegenetics/>.

*Note: Supplementary information is available on the Nature Genetics website.*

---

## Acknowledgments

We wish to thank all individuals in the respective cohorts for their generous participation. This work was supported by the Wellcome Trust (grant number WT089062) and, among others, by the Academy of Finland (200923 to AP, 00213 to M.W.); the Helsinki University Central Hospital (to M. Kallela, M.F., V. Artto and S.V.); the Academy of Finland Center of Excellence for Complex Disease Genetics; the EuroHead project (LSM-CT-2004-504837); the Helsinki Biomedical Graduate School (to V. Anttila, P.T.-K.); the Finnish Cultural Foundation (to V. Anttila); the Finnish Neurology Foundation, Biomedicum Helsinki Foundation (to V. Anttila, P.T.-K. and V. Artto); the Cambridge Biomedical Research Centre (to S.C.); the Australian National Health and Medical Research Council Fellowship (339462 and 613674) and the Australian Research Council Future Fellowship (FT0991022) schemes (to D.R.N.); the German Federal Ministry of Education and Research (BMBF) (grant 01GS08121 to M. Dichgans, along with support to H.E.W. in the context of the German National Genome Research Network (NGFN-2 and NGFN-plus) for the Heinz Nixdorf Recall study, and to C.K. (EMINet - 01GS08120) for the National Genome Research Network (Germany; NGFN-1 and NGFN-Plus)); the Center for Molecular Medicine Cologne (to C.K.); the Heinz Nixdorf Foundation for the Heinz Nixdorf Recall study, Deutsche Forschungsgemeinschaft (DFG; to C.K. and H.G.); the Netherlands Organization for the Health Research and Development (ZonMw) no. 90700217 (to G.M.T.) and to the Rotterdam Study (RIDE1 and RIDE2); the Netherlands Organisation for Scientific Research (NWO) VICI (918.56.602) and Spinoza (2009) grants (to M.D.F.); and the Center for Medical Systems Biology (CMSB) established by the Netherlands Genomics Initiative/Netherlands Organisation for Scientific Research (NGI/NWO), project no. 050-060-409 (to C.M.v.D., R.R.F., M.D.F. and A.M.J.M.v.d.M.) and project nos. 050-060-810 and 175.010.2005.011, 911-03-012 (to the Rotterdam Study). We thank the Health 2000 study for providing Finnish control genotypes. The Broad Institute Center for Genotyping and Analysis is supported by a grant from the National Center for Research Resources (US). The KORA research platform was initiated and financed by the Helmholtz Center Munich, German Research Center for Environmental Health, which is funded by the German Federal Ministry of Education and Research and by the State of Bavaria and is supported within the Munich Center of Health Sciences (MC Health) as part of LMUinnovativ. The Rotterdam Study is funded by Erasmus Medical Center and Erasmus University, Rotterdam, Netherlands Organization for the Health Research and Development (ZonMw), the Research Institute for Diseases in the Elderly (RIDE), the Ministry of Education, Culture and Science, the Ministry for Health, Welfare and Sports, the European Commission (DG XII) and the Municipality of Rotterdam. We wish to thank S. Hunt, R. Gwillian, P. Whittaker, S. Potter and A. Tashakkori-Ghanbarian, as well as P. Marin-Garcia, for their invaluable help with this study. Finally, we wish to collectively thank everyone who has contributed to the collection, genotyping and analysis of the individual cohorts.



## References

1. Hindorff, L.A., Junkins, H.A., Mehta, J.P. & Manolio, T.A. A catalog of published genome-wide association studies (accessed 16 February 2010). <<http://www.genome.gov/gwastudies>>.
2. Hanna, M.G. (2006) Genetic neurological channelopathies. *Nat. Clin. Pract. Neurol.* 2, 252–263.
3. Nyholt, D.R. et al. (2008) A high-density association screen of 155 ion transport genes for involvement with common migraine. *Hum. Mol. Genet.* 17, 3318–3331.
4. Frankel, W.N. (2009) Genetics of complex neurological disease: challenges and opportunities for modeling epilepsy in mice and rats. *Trends Genet.* 25, 361–367.
5. Stovner, L.J., Zwart, J.A., Hagen, K., Terwindt, G.M. & Pascual, J. (2006) Epidemiology of headache in Europe. *Eur. J. Neurol.* 13, 333–345.
6. Stovner, L. et al. (2007) The global burden of headache: a documentation of headache prevalence and disability worldwide. *Cephalalgia* 27, 193–210.
7. International Headache Society. (2004) The international classification of headache disorders: 2nd edition. *Cephalalgia* 24, Suppl 1, 9–160.
8. Goadsby, P.J., Lipton, R.B. & Ferrari, M.D. (2002) Migraine—current understanding and treatment. *N. Engl. J. Med.* 346, 257–270.
9. Lauritzen, M. (1994) Pathophysiology of the migraine aura. The spreading depression theory. *Brain* 117, 199–210.
10. Hadjikhani, N. et al. (2001) Mechanisms of migraine aura revealed by functional MRI in human visual cortex. *Proc. Natl. Acad. Sci. USA* 98, 4687–4692.
11. Frazer, K.A. et al. (2007) A second generation human haplotype map of over 3.1 million SNPs. *Nature* 449, 851–861.
12. Nyholt, D.R. et al. (2004) A simple correction for multiple testing for single-nucleotide polymorphisms in linkage disequilibrium with each other. *Am. J. Hum. Genet.* 74, 765–769.
13. Risch, N.J. (2000) Searching for genetic determinants in the new millennium. *Nature* 405, 847–856.
14. Dimas, A.S. et al. (2009) Common regulatory variation impacts gene expression in a cell type-dependent manner. *Science* 325, 1246–1250.
15. Hu, V.W. et al. (2009) Gene expression profiling differentiates autism case-controls and phenotypic variants of autism

- 
- spectrum disorders: evidence for circadian rhythm dysfunction in severe autism. *Autism Res.* 2, 78–97.
16. Nishimura, Y. et al. (2007) Genome-wide expression profiling of lymphoblastoid cell lines distinguishes different forms of autism and reveals shared pathways. *Hum. Mol. Genet.* 16, 1682–1698.
17. Martin, M.V. et al. (2009) Exon expression in lymphoblastoid cell lines from subjects with schizophrenia before and after glucose deprivation. *BMC Med. Genomics* 2, 62.
18. Emdad, L. et al. (2009) Astrocyte elevated gene-1 (AEG-1) functions as an oncogene and regulates angiogenesis. *Proc. Natl. Acad. Sci. USA* 106, 21300–21305.
19. Kang, D.C. et al. (2005) Cloning and characterization of HIV-1-inducible astrocyte elevated gene-1, AEG-1. *Gene* 353, 8–15.
20. Noch, E. & Khalili, K. (2009) Molecular mechanisms of necrosis in glioblastoma: the role of glutamate excitotoxicity. *Cancer Biol. Ther.* 8, 1791–1797.
21. Boycott, H.E., Wilkinson, J.A., Boyle, J.P., Pearson, H.A. & Peers, C. (2008) Differential involvement of TNF alpha in hypoxic suppression of astrocyte glutamate transporters. *Glia* 56, 998–1004.
22. Dallas, M. et al. (2007) Hypoxia suppresses glutamate transport in astrocytes. *J. Neurosci.* 27, 3946–3955.
23. Tanaka, K. et al. Epilepsy and exacerbation of brain injury in mice lacking the glutamate transporter GLT-1. *Science* 276, 1699–1702.
24. Goadsby, P.J., Charbit, A.R., Andreou, A.P., Akerman, S. & Holland, P.R. (2009) Neurobiology of migraine. *Neurosci.* 161, 327–341.
25. Burstein, R., Cutrer, M.F. & Yarnitsky, D. (2000) The development of cutaneous allodynia during a migraine attack clinical evidence for the sequential recruitment of spinal and supraspinal nociceptive neurons in migraine. *Brain* 123, 1703–1709.
26. Ophoff, R.A. et al. (1996) Familial hemiplegic migraine and episodic ataxia type-2 are caused by mutations in the Ca<sup>2+</sup> channel gene CACNL1A4. *Cell* 87, 543–552.
27. De Fusco, M. et al. (2003) Haploinsufficiency of ATP1A2 encoding the Na<sup>+</sup>/K<sup>+</sup> pump alpha2 subunit associated with familial hemiplegic migraine type 2. *Nat. Genet.* 33, 192–196.
28. Dichgans, M. et al. (2005) Mutation in the neuronal voltage-gated sodium channel SCN1A in familial hemiplegic migraine. *Lancet* 366, 371–377.

29. Pietrobon, D. (2007) Familial hemiplegic migraine. *Neurotherapeutics* 4, 274–284.
30. de Vries, B., Frants, R.R., Ferrari, M.D. & van den Maagdenberg, A.M. (2009) Molecular genetics of migraine. *Hum. Genet.* 126, 115–132.
31. Tottene, A. et al. (2009) Enhanced excitatory transmission at cortical synapses as the basis for facilitated spreading depression in Ca(v)2.1 knockin migraine mice. *Neuron* 61, 762–773.
32. de Vries, B. et al. (2009) Episodic ataxia associated with EAAT1 mutation C186S affecting glutamate reuptake. *Arch. Neurol.* 66, 97–101.
33. Jen, J.C., Wan, J., Palos, T.P., Howard, B.D. & Baloh, R.W. (2005) Mutation in the glutamate transporter EAAT1 causes episodic ataxia, hemiplegia, and seizures. *Neurology* 65, 529–534.

## Affiliations

<sup>1</sup>Wellcome Trust Sanger Institute, Wellcome Trust Genome Campus, Cambridge, UK. <sup>2</sup>Institute for Molecular Medicine Finland (FIMM), University of Helsinki, Helsinki, Finland. <sup>3</sup>Department of Population Genomics, deCODE genetics, Reykjavik, Iceland. <sup>4</sup>Department of Neurology, Helsinki University Central Hospital, Helsinki, Finland. <sup>5</sup>Institute of Human Genetics, University of Cologne, Cologne, Germany. <sup>6</sup>Institute for Genetics and Center for Molecular Medicine Cologne, University of Cologne, Cologne, Germany. <sup>7</sup>Department of Neurology, Leiden University Medical Centre, Leiden, The Netherlands. <sup>8</sup>National Institute for Health Research, Cambridge Biomedical Research Centre, Cambridge University Hospitals National Health Service Foundation Trust, Cambridge, UK. <sup>9</sup>Neurogenetics Laboratory, Queensland Institute of Medical Research, Brisbane, Australia. <sup>10</sup>Wellcome Trust Center for Human Genetics, University of Oxford, Oxford, UK. <sup>11</sup>Department of Genetic Medicine and Development, University of Geneva Medical School, Geneva, Switzerland. <sup>12</sup>Department of Neurology, Klinikum Großhadern, Ludwig-Maximilians-Universität München, Munich, Germany. <sup>13</sup>Institute for Stroke and Dementia Research, Klinikum der Universität München, Munich, Germany. <sup>14</sup>Max Planck Institute of Psychiatry, Munich, Germany. <sup>15</sup>Department of Human Genetics, Leiden University Medical Centre, Leiden, The Netherlands. <sup>16</sup>Folkhälsan Research Center, Helsinki, Finland. <sup>17</sup>Kiel Pain and Headache Center, Kiel, Germany. <sup>18</sup>Department of Neurology, Landspítali University Hospital, Reykjavik, Iceland. <sup>19</sup>Department of Neurology, Glostrup Hospital and the Danish Headache Center, Glostrup, Denmark. <sup>20</sup>Research Institute of Biological Psychiatry, University of Copenhagen, Roskilde, Denmark. <sup>21</sup>Headache Research Unit, Department of Neurology and Groupe Interdisciplinaire de Génomprotéomique Appliquée (GIGA)-Neurosciences, Liège University, Liège, Belgium. <sup>22</sup>Department of General Practice, Helsinki University Central Hospital, Helsinki, Finland. <sup>23</sup>Vaasa Central Hospital, Vaasa, Finland. <sup>24</sup>National Institute for Health and Welfare, Helsinki, Finland. <sup>25</sup>Department of Neuroscience, Norwegian University of Science and Technology, Trondheim, Norway. <sup>26</sup>Institute of Epidemiology, Helmholtz Center Munich, Neuherberg, Germany. <sup>27</sup>Institut für Medizinische Informationsverarbeitung, Biometrie und Epidemiologie, Ludwig-Maximilians-Universität München, Munich, Germany. <sup>28</sup>Klinikum Großhadern, Ludwig-Maximilians-Universität München, Munich, Germany. <sup>29</sup>Institute of Human Genetics, Helmholtz Center Munich, Neuherberg, Germany. <sup>30</sup>Institute of Human Genetics, Klinikum Rechts der Isar, Technische Universität München, Munich, Germany. <sup>31</sup>Department of Genomics, Life and Brain Center, University of Bonn, Bonn, Germany. <sup>32</sup>Institute of Human Genetics, University of Bonn, Bonn, Germany. <sup>33</sup>Institute of Medical Informatics, Biometry and Epidemiology, University Hospital of Essen, University Duisburg-Essen, Essen, Germany. <sup>34</sup>Department of Clinical Molecular Biology, Christian Albrechts University, Kiel, Germany. <sup>35</sup>Department of Internal Medicine I, Christian Albrechts University, Kiel, Germany. <sup>36</sup>Department of Epidemiology, Erasmus University Medical Center, Rotterdam, The Netherlands. <sup>37</sup>Department of Internal Medicine, Erasmus University Medical Center, Rotterdam, The Netherlands. <sup>38</sup>Research Program in Molecular Medicine, University of Helsinki, Helsinki, Finland. <sup>39</sup>Drug Discovery, GlaxoSmithKline Research and Development, Verona, Italy. <sup>40</sup>Centre for Addiction and Mental Health, Department of Psychiatry, University of Toronto, Toronto, Ontario, Canada. <sup>41</sup>Department of Public Health, University of Helsinki, Helsinki, Finland. <sup>42</sup>The Broad Institute of MIT and Harvard, Boston, Massachusetts, USA. <sup>43</sup>Department of Neurology, Oslo University Hospital and University of Oslo, Oslo, Norway. <sup>44</sup>Cologne Excellence Cluster on Cellular Stress Responses in Aging-Associated Diseases (CECAD), University of Cologne, Cologne, Germany. <sup>45</sup>Institute of Human Genetics, University of Ulm. <sup>46</sup>Department of Medical Genetics, University of Helsinki, Helsinki, Finland. <sup>47</sup>Department of Medical Genetics, Helsinki University Central Hospital, Helsinki, Finland. <sup>48</sup>Deceased.

---

## Online Methods

### *Study design*

We jointly analyzed samples from three migraine with aura collections from Finland, Germany and The Netherlands with population-matched controls obtained from preexisting studies. This discovery phase was followed by a replication study of the top SNP, rs1835740, in samples from individuals with migraine from Denmark, Iceland, The Netherlands and Germany. Characteristics of each study sample are described in Table 1, and the recruitment and ascertainment of cases and controls are described in the Supplementary Note.

### *Discovery stage genotyping*

DNA was extracted from the subjects' blood samples using standard methods. Genotyping of the GWAS samples was done at the Wellcome Trust Sanger Institute on the Illumina 610K (for the Finnish and German samples) and the Illumina 550K (for the Dutch samples) SNP microarrays following the Infinium II protocol from the manufacturer (Illumina Inc.). Genotype calling was performed using the Illuminus software<sup>34</sup>.

### *Replication stage genotyping*

For the replication study, all Danish cases and 459 migraine-free controls were genotyped using the Centaurus platform (Nanogen Inc.), and 904 additional controls were genotyped at deCODE genetics using the Illumina HumanHap650 BeadArray. The Icelandic cases and controls were genotyped using the Illumina HumanHap 317K, 370K, 610K or 1M bead arrays at deCODE genetics. The Dutch replication cohort was genotyped using the TaqMan technology (Applied Biosystems, Life Technologies) at Leiden University Medical Center. The German replication cases were genotyped using Illumina HumanHap 610K array at the Institute of Human Genetics at the Helmholtz Zentrum, Munich.

### *Expression study*

The GenCord resource, a collection of cell lines derived from umbilical cords of 75 newborns of Western European origin born at the maternity ward of the University of Geneva Hospital, was used for the expression study. Sample collection was performed on full-term or near-full-term pregnancies to ensure homogeneity for sample source age. Three cell types were derived: (i) primary fibroblasts, (ii) LCLs and (iii) primary T cells<sup>14</sup>. Total RNA was extracted from these cells and two one-quarter-scale MessageAmp II reactions (Ambion) were performed for each extraction with 200 ng of total RNA. 1.5 µg of cRNA was hybridized to Illumina's WG-6 v3 Expression BeadChip array to quantify transcript abundance<sup>35</sup>. Intensity values were log<sub>2</sub> transformed and normalized independently for each cell type using quantile normalization for sample replicates

and median normalization across all individuals. Each cell type was renormalized using the mean of the medians of each cell type's expression values. DNA samples were extracted from umbilical cord tissue LCLs with the Puregene cell kit (Gentra-Qiagen), and genotyping was performed using the Illumina 550K SNP array (Illumina Inc.) to obtain the SNP genotypes for the samples.

#### *Statistical analysis of the genome-wide scan data*

Stringent per-SNP and per-sample limits were implemented in order to obtain high-quality data. Quality control measures were as follows: exclusion of samples with call rates <97%, non-comparable ancestry as measured using multidimensional scaling plots from PLINK<sup>36</sup>, possible contamination as identified by being an extreme heterozygosity outlier and cryptic relatedness (low-level relatedness to a large number of samples) and non-cryptic relatedness of  $\pi^{\wedge} > 12.5\%$ . From the initial 3,279 cases and 12,369 controls, 2,731 cases and 10,747 controls passed all quality control criteria, and 531 cases and 1,622 controls were excluded. The majority of case exclusions were due to quality issues on the 550K chips, and the majority of control exclusions were due to low-level relatedness in the Dutch control set. SNPs were excluded for having a minor allele frequency of <1% or for departing from Hardy-Weinberg equilibrium with  $P < 10^{-6}$  in cases or controls. Only completely overlapping SNPs from the three populations were used, leaving a total of 429,912 SNPs for analysis. To ascertain whether the control samples were properly matched to the cases, a population-specific inflation factor and an overall genomic inflation factor ( $\lambda$ ) were estimated using the median  $\chi^2$  value from a 1 degree-of-freedom allelic  $\chi^2$  test. For the Finnish samples,  $\lambda = 1.05$ ; for the German samples,  $\lambda = 1.07$ ; for the Dutch samples,  $\lambda = 1.09$ ; and the overall  $\lambda = 1.08$ , suggesting reasonably well matched controls in each case. Differences between cases and controls were assessed between each SNP and disease status using a two-tailed CMH test for  $2 \times 2 \times K$  stratified data (where  $K = 3$ ), as implemented in PLINK v1.06. To exclude long-range LD for the identified variant, we used the program ssSNPer<sup>12</sup> to demonstrate that no SNP within a 5-Mb window had high LD to rs1835740 in HapMap Phase II data.

#### *Conditional analysis for secondary effects*

In addition to rs1835740, two other SNPs on 8q22.1, rs2436046 and rs982502, showed a CMH  $P < 10^{-3}$  (Table 2 and Fig. 2). Based on our data, rs2436046 ( $r^2 = 0.68$ ) and rs982502 ( $r^2 = 0.59$ ) are in moderate LD with rs1835740. To evaluate whether these signals were independent from the top SNP association signal, the association between migraine and SNP alleles was tested using logistic regression, conditioning on rs1835740 as implemented in PLINK v1.06. Conditioning on rs1835740, no evidence of additional independent signals was found either for rs2436046 or rs982502 ( $P = 0.89$  and  $P = 0.47$ ) (Supplementary Table 3), suggesting that the moderate association of rs2436046 and rs982502 observed in the CMH test is the result of these SNPs being in LD with rs1835740.

---

### *Meta-analysis of discovery and replication samples*

The CMH test was used for the meta-analysis, with a nominal covariate used to distinguish each sample collection from the others. For the replication in Icelandic and Danish samples, association analysis was carried out using a likelihood procedure<sup>37</sup>, and results were adjusted for relatedness by dividing the  $\chi^2$  statistics by an inflation factor estimated through simulation<sup>38</sup>.

### *Imputation*

For each cohort, imputation of the untyped markers in the 2-Mb region around rs1835740 was carried out using IMPUTE v2 with the recommended options<sup>39</sup>. Haplotypes from the 1000 Genomes Project (August 2009 release) and haplotypes from HapMap Phase 3 were used as reference panels.

### *eQTL analysis*

Association between genotypes and expression was analyzed using Spearman rank correlation for all SNPs with a 2-Mb window centered on the transcription start site of the gene. Significance was assessed by comparing the observed P values at a 0.001 threshold with the minimum P values from each of 10,000 permutations of the expression values relative to genotypes<sup>35</sup>.

### *URLs*

Control populations: Finland—Health2000 study, <http://www.nationalbiobanks.fi>; Finland—Helsinki Birth Cohort study, <http://www.nationalbiobanks.fi>; Germany—KORA S4/F4 study, <http://www.helmholtz-muenchen.de/kora>; Germany—PopGen study, <http://www.popgen.de>; Germany—HNR study, [http://www.recall-studie.uni-essen.de/recall\\_info.html](http://www.recall-studie.uni-essen.de/recall_info.html); Illumina iControlDB, <http://www.illumina.com>; The Netherlands—Rotterdam I and III studies, <http://www.epib.nl/research/ergo.htm>; the Netherlands—Lumina study, <http://www.lumc.nl/hoofdpijn>. Other URLs: International Headache Genetics Consortium, <http://www.headachegenetics.org>; ssSNPer, <http://gump.qimr.edu.au/general/daleN/ssSNPer/>; GWAS plotter, <http://www.broadinstitute.org/node/555>; HapMap Phase 2 and 3 data, <http://www.hapmap.org>.

**References**

34. Teo, Y.Y. et al. (2007) A genotype calling algorithm for the Illumina BeadArray platform. *Bioinformatics* 23, 2741–2746.
35. Stranger, B.E. et al (2007) Population genomics of human gene expression. *Nat. Genet.* 39, 1217–1224.
36. Purcell, S. et al (2007) PLINK: a tool set for whole-genome association and population-based linkage analyses. *Am. J. Hum. Genet.* 81, 559–575.
37. Gretarsdottir, S. et al (2003) The gene encoding phosphodiesterase 4D confers risk of ischemic stroke. *Nat. Genet.* 35, 131–138.
38. Grant, S.F. et al (2006) Variant of transcription factor 7-like 2 (TCF7L2) gene confers risk of type 2 diabetes. *Nat. Genet.* 38, 320–323.
39. Howie, B.N., Donnelly, P. & Marchini, J (2009) A flexible and accurate genotype imputation method for the next generation of genome-wide association studies. *PLoS Genet.* 5, e1000529.

## Supplementary Material

Initial study

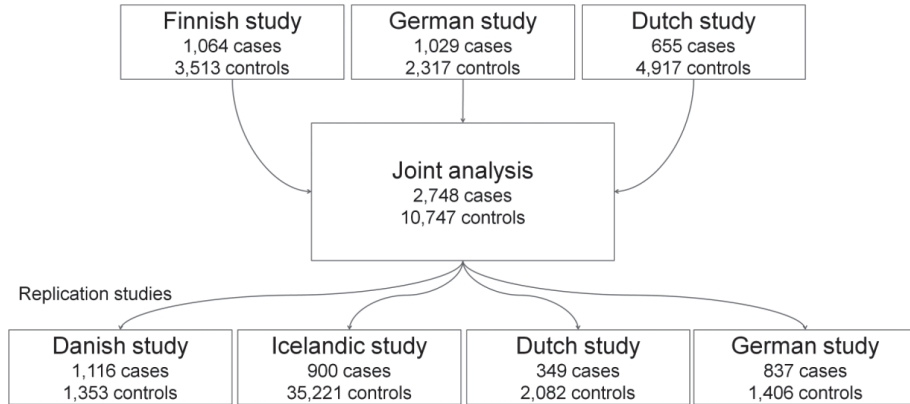

**Supplementary Figure 1.** Study design. In the initial study, migraine with aura (MA) patients from three clinic-based collections were analyzed in a joint genome-wide association analysis. The most significant association signal was replicated in an independent Danish clinic-based sample and an Icelandic population-based sample, containing MA and migraine without aura (MO) samples, as well as in a German clinic-based MO-specific sample.

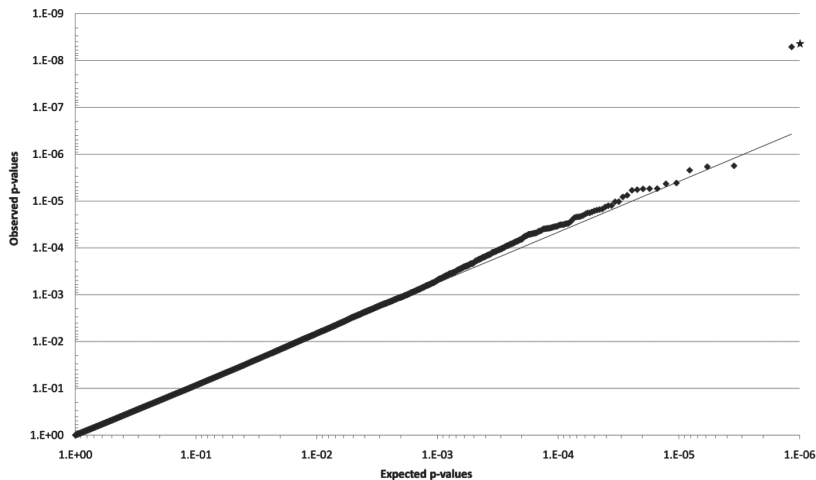

**Supplementary Figure 2.** Quantile-quantile plot of the results in the Cochran-Mantel-Haenszel analysis. Asterisk denotes marker rs1835740. Black line represents the distribution of p-values under the null given study inflation factor lambda of 1.08.



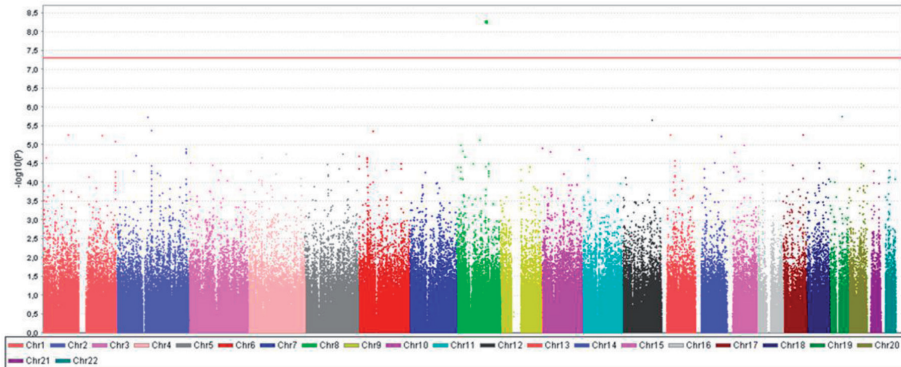

**Supplementary Figure 3.** Genome-wide Cochran-Mantel-Haenszel results for association between each marker and migraine with aura in the combined analysis of the three initial study populations. Red line denotes the threshold of genome-wide significance ( $p \leq 5 \times 10^{-8}$ ). Only marker rs1835740 on 8q22.1 exceeded this threshold.

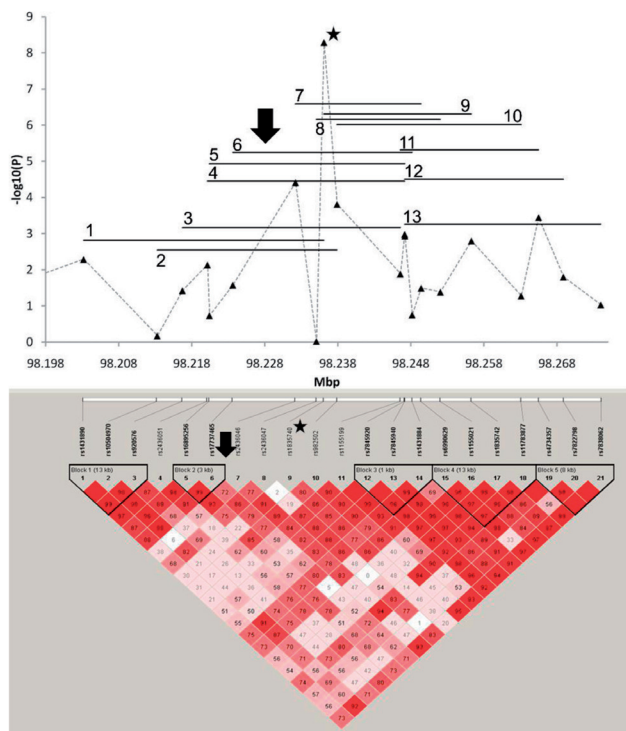

**Supplementary Figure 4.** Nine SNP sliding window haplotype analysis and local haplotype structure around marker rs1835740 on chromosome 8q22.1. In the upper part of the figure, the black pyramids show single-marker association results for each marker. The horizontal lines show the length and overall P-values for the nine marker sliding windows in the haplotype analysis. The lower part of the figure shows the Haplotype  $D'$  matrix in the GWA study analysis data, with estimated LD blocks using the Gabriel et al. method1. Black stars denote the location of rs1835740 and the black arrows denote the 3' end of PGCP in either part of the figure

## Supplementary tables

**Supplementary Table 1.** Association signals with  $p \leq 5 \times 10^{-5}$  and with multiple nearby associating SNPs

SNP	Chr	Location	P-value	OR	95% CI	Location	Gene
rs12084862	1	244269837	$8.20 \times 10^{-6}$	1.17	1.09-1.25	intragenic	<i>SMYD3</i>
rs17528324	2	118572626	$4.13 \times 10^{-6}$	1.27	1.15-1.41	intragenic	<i>INSIG2</i>
rs17862920	2	234492734	$1.26 \times 10^{-5}$	0.776	0.693-0.870	intragenic	<i>TRPM8</i>
rs2038761	6	2625766	$2.02 \times 10^{-5}$	0.865	0.809-0.925	intragenic	<i>MYLK4</i>
rs6456880	6	29071227	$2.18 \times 10^{-5}$	0.873	0.819-0.929	intragenic	<i>ZNF311</i>
rs7753655	6	49644523	$4.29 \times 10^{-6}$	0.852	0.796-0.912	intergenic	-
rs10888075	8	13804790	$1.04 \times 10^{-5}$	1.21	1.11-1.31	intergenic	near <i>SGCZ</i>
rs10111769	8	21003036	$1.49 \times 10^{-5}$	1.15	1.08-1.23	intergenic	-
rs2042600	11	19709275	$2.28 \times 10^{-5}$	0.876	0.824-0.932	intragenic	<i>NAV2</i>
rs3794331	13	44951545	$2.70 \times 10^{-5}$	1.28	1.14-1.43	intragenic	<i>COG3</i>
rs473422	15	56453633	$1.03 \times 10^{-5}$	0.864	0.820-0.922	intergenic	near <i>AQP9</i>

Footnote: Locations and distances in basepairs, according to NCBI build 36. Only the SNP with the lowest p-value is reported for each locus.

**Supplementary Table 2.** Conditional analyses for the two SNPs with moderate linkage disequilibrium to rs1835740 in chromosome 8q22.1

Chr	SNP A	SNP B	r <sup>2</sup>	SNP A P-value	SNP B P-value	SNP B given A
8	rs1835740	rs2436046	0.69	$5.12 \times 10^{-9}$	$1.78 \times 10^{-5}$	0.892
8	rs1835740	rs982502	0.59	$5.12 \times 10^{-9}$	$1.34 \times 10^{-4}$	0.4

**Supplementary Table 3.** Nine SNP sliding window haplotype analysis on the chromosome 8q22.1 associated region from Supplementary Figure 2

Haplotype	First SNP	Last SNP	Chi-sq.	D.f.	Overall P-value
1	rs1431890	rs1835740	43.07	16	2.730x10 <sup>-04</sup>
2	rs10504970	rs982502	43.10	17	4.643x10 <sup>-04</sup>
3	rs920576	rs1155199	41.37	13	8.291x10 <sup>-05</sup>
4	rs2436051	rs7845920	48.48	14	1.093x10 <sup>-05</sup>
5	rs16895256	rs7845940	47.68	12	3.553x10 <sup>-06</sup>
6	rs17737465	rs1431884	46.52	10	1.156x10 <sup>-06</sup>
<b>7</b>	<b>rs2436046</b>	<b>rs6990629</b>	<b>51.62</b>	<b>9</b>	<b>5.327x10<sup>-08</sup></b>
8	rs2436047	rs1155021	48.93	10	4.196x10 <sup>-07</sup>
9	rs1835740	rs1835742	53.46	10	6.107x10 <sup>-08</sup>
10	rs982502	rs11783877	45.23	8	3.327x10 <sup>-07</sup>
11	rs1155199	rs4734357	41.91	8	1.410x10 <sup>-06</sup>
12	rs7845920	rs7822798	39.34	9	9.995x10 <sup>-06</sup>
13	rs7845940	rs7838062	32.98	8	6.208x10 <sup>-05</sup>

The nine SNP window in bold is the one referred to in the text. N.B. haplotype value shown in text is for the single haplotype, above values for the association of the whole haplotype distribution.

**Supplementary Table 4.** SNPs with nominal or higher p-values for association with expression levels of MTDH/AEG-1

SNP	Gene SNP	coordinate	Gene start	Distance	SRC P-value
rs11783750	MTDH/AEG-1	98 865 219	98 725 583	139 636	0.0018741
rs10105830	MTDH/AEG-1	98 307 895	98 725 583	417 688	0.0004235
rs1835740	MTDH/AEG-1	98 236 089	98 725 583	489 494	<b>0.0000396*</b>
rs7845920	MTDH/AEG-1	98 247 132	98 725 583	478 451	0.0014652

Footnote: \* indicates surpassing the significance threshold  $7.7 \times 10^{-5}$  (corresponding to a 0.001 permutation threshold after 10,000 permutations). SRC = Spearman rank correlation. Locations and distances in basepairs, according to NCBI build 36. Numbers in bold are statistically significant.

---

## Supplementary Note: Clinical subject ascertainment and control samples

### *Ethical aspects*

Written informed consent was obtained from all participants, and the study was approved by the respective local research ethics committees of the Helsinki University Central Hospital, Pain Clinic Kiel in Kiel, the Department of Neurology at Klinikum Großhadern, Ludwig-Maximilians-University in Munich, and the University of Leiden Medical Centre. Informed consent was obtained from all patients.

### *Initial study*

The initial genome-wide association study consisted of three patient samples, collected from headache clinics in Finland, Germany and the Netherlands.

In Finland, 1,124 Finnish migraine with aura (MA, and MA/MO) patients were recruited. Each patient belongs to a multigenerational family with at least three family members with migraine. Patients were examined by a neurologist, and fulfilled the validated Finnish Migraine Specific Questionnaire for Family Studies (FMSQ<sub>FS</sub><sup>2</sup>). In cases of insufficient or conflicting information, a follow-up interview was conducted by telephone. All patients were diagnosed by the same headache specialist (M. Kallela) according to the current International Headache Society diagnostic criteria (ICHD-II)<sup>3</sup>.

In Germany, patient recruitment was done at two sites, in Kiel and in Munich. At the Pain Clinic in Kiel, a total of 994 German MA and MA/MO patients were recruited to a patient collection maintained at the Universities of Bonn and Cologne. All patients were diagnosed according to the ICHD-II<sup>3</sup> by headache specialists<sup>4</sup>. The detailed migraine anamnesis was obtained either by face-to-face interviews or by telephone interviews standardized by using a comprehensive migraine questionnaire. The second German set of 282 MA and MA/MO cases were recruited and examined by a headache specialist at the Klinikum Großhadern of the Ludwig-Maximilians-University, Munich. Phenotyping was based on a German translation of the FMSQ<sub>FS</sub><sup>2</sup>. Whenever the information was insufficient or conflicting, an additional telephone interview was performed. Information was obtained on all aspects of the ICHD-II<sup>3</sup> criteria as well as on other aspects (such as age at onset, prodromal symptoms, triggers, acute and prophylactic medication, family history, general past medical history, co-morbidity and place of birth).

In the Netherlands, 879 MA and MA/MO patients were available from the clinic-based Leiden University Migraine Neuro Analysis (LUMINA) study. Self-reported migraineurs were recruited via the project's website. A set of screening questions validated previously in a population-based study<sup>5</sup>

was used first. Participants fulfilling the screening criteria completed then the extended questionnaire focusing on signs and symptoms of migraine headache and aura as outlined in ICHD-II<sup>3</sup>. Individual diagnoses were made using an algorithm based on these criteria. The algorithm diagnosis was validated by a semi-structured telephone interview performed by experienced study physicians or by well-trained medical students. Specific attention was paid to migraine aura. A subset of the patients was asked to participate upon visiting the outpatient clinic.

### *Replication studies*

The replication phase of the study consisted of four separately recruited migraine patient samples from Denmark, Iceland, the Netherlands and Germany.

The Danish replication sample comprised 825 MA subjects of which 776 were successfully genotyped. Of these, 483 patients suffered from only MA attacks and 293 from both MA and MO attacks. Patients were selected from the Danish National Patient Register and from case files from neurological clinics, 1,365 took part in a screening telephone interview. If the proband was diagnosed with MA, the proband and selected relatives were diagnosed according to the ICHD-I<sup>6</sup> in a validated telephone interview (M. Kirchmann or A.H.). 305 Danish MO patients were selected from case files at the Danish Headache Center and diagnosed as mentioned above (ICHD-II<sup>3</sup>) in an extensive semi-structured telephone interview performed by trained physicians. In addition 81 MO subjects were identified during recruitment of the MA families. Thus, 386 MO patients were recruited and 340 successfully genotyped.

The Icelandic replication samples were recruited from three sources: first, a list of patients provided by two neurologists (401 potential participants), second, responses to an advertisement in the newsletter of the Icelandic Migraine Society (137 participants), and third, responses to a brief screening questionnaire mailed to a random sample of 20,000 Icelanders, aged 18–50 years and living in the Reykjavik area. All Icelandic recruits were asked to answer the comprehensive validated deCODE Migraine Questionnaire 2 or 3 (DMQ2 or DMQ3<sup>7</sup>). The questionnaire was designed based on ICHD-II<sup>3</sup>. The reliability of the MA and MO diagnoses based on the DMQ3 was assessed using a physician-conducted interview as an empirical index of validity. In total 1,612 subjects reporting five or more headache attacks were genotyped. Of them, 712 subjects reported atypical symptoms, preventing reliable IHS classification through questionnaire data only, and were excluded from the analysis. In total, the Icelandic sample consists of 567 MO patients, and 333 MA patients either with or without the MO attacks.

The German replication cohort includes 837 MO cases from the Department of Neurology of the Ludwig-Maximilians-University, Munich, Germany. Phenotyping followed the same protocol as

---

described for the Munich patient sample. The Dutch replication sample includes 356 Dutch MA or MA/MO patients that were recently recruited through the clinic-based Leiden University Migraine Neuro Analysis (LUMINA) study. The diagnosis and classification followed the same procedure as in the initial Dutch sample. *Nature*

### *Control samples*

Population-matched control samples were obtained from previously genotyped studies (for links to studies, see URL section of Online Methods). 1,881 Finnish controls originated from the Helsinki Birth Cohort study<sup>8</sup> and 2,173 controls from the Health2000 study, genotyped on the Illumina 660K or 610K platforms. 840 German controls were obtained from the KORA S4/F4 study<sup>9</sup>, 380 controls from the HNR study<sup>10</sup> and 677 from PopGen study<sup>11</sup>, all genotyped on the Illumina 550K platform. In addition, 444 controls were obtained from Illumina iControlDB by querying all Caucasian samples genotyped on the Illumina 550K platform on June 30th, 2008 and filtering these samples based on stratification as observed from multidimensional scaling plots of all existing German samples, and keeping only those identified as being of German descent. 974 Dutch controls were obtained from the Rotterdam study I<sup>12</sup>, genotyped on the Illumina 550K platform and imputed to cover all markers on the 610K platform. For each replication study, the group providing a replication dataset supplied a matched control cohort; the controls for the Danish and Icelandic replications were provided by deCODE, and German controls were obtained from the MARS study<sup>13</sup> and from GlaxoSmithKline<sup>14</sup> and Rotterdam study III.

## Reference

1. Gabriel SB et al (2002) The structure of haplotype blocks in the human genome. *Science* 296(5576): 2225-2229.
2. Kallela M, Wessman M & Färkkilä M (2001) Validation of a migraine specific questionnaire for use in family studies. *Eur J Neurol* 8, 61-66.
3. International Headache Society (2004) The International Classification of Headache Disorders: 2nd edition. *Cephalalgia* 24 Suppl 1, 9-160.
4. Todt U et al (2006) Variation of the serotonin transporter gene SLC6A4 in the susceptibility to migraine with aura. *Neurology* 67, 1707-1709.
5. Launer LJ, Terwindt, GM & Ferrari MD (1999) The prevalence and characteristics of migraine in a population-based cohort: The GEM Study. *Neurology* 5 537-542.
6. Headache Classification Committee of the International Headache Society (1988) Classification and diagnostic criteria for headache disorders, cranial neuralgias and facial pain. *Cephalalgia* 8 Suppl 7, 1-96.
7. Kirchmann M et al (2006) Validation of the deCODE Migraine Questionnaire (DMQ3) for use in genetic studies. *Eur J Neurol* 1 1239-44.
8. Barker DJ, Osmond C, Forsen TJ, Kajantie E & Eriksson JG (2005) Trajectories of growth among children who have coronary events as adults. *N Engl J Med* 35 1802-1809.
9. Wichmann HE, Gieger C & Illig T (2005) KORA-gen-resource for population genetics, controls and a broad spectrum of disease phenotypes. *Gesundheitswesen* 67 Suppl 1, S26-30.
10. Schmermund A et al (2002) Assessment of clinically silent atherosclerotic disease and established and novel risk factors for predicting myocardial infarction and cardiac death in healthy middle-aged subjects: rationale and design of the Heinz Nixdorf RECALL Study. Risk Factors, Evaluation of Coronary Calcium and Lifestyle. *Am Heart J* 144, 212-218.
11. Krawczak M et al (2006) PopGen: population-based recruitment of patients and controls for the analysis of complex genotype-phenotype relationships. *Community Genet* 9, 55-61.
12. Hofman A et al (2007) The Rotterdam Study: objectives and design update. *Eur J Epidemiol* 22, 819-829.
13. Heck A et al (2009) Polymorphisms in the angiotensin-converting enzyme gene region predict coping styles in healthy adults and depressed patients. *Am J Med Genet B Neuro-psychiatr Genet* 150B, 104-114.
14. Muglia P et al (2010) Genome-wide association study of recurrent major depressive disorder in two European case-control cohorts. *Mol Psychiatry* 15(6):589-601.





---

# 6.2

## Genome-wide association study for migraine in a Dutch genetic isolate and meta-analysis with other population-based cohorts

---

B. de Vries,<sup>1\*</sup> L. Ligthart,<sup>2\*</sup> N. Amin,<sup>3</sup> A.H. Stam,<sup>4</sup> P. Henneman,<sup>1</sup> B.A. Oostra,<sup>3</sup> Y.S. Aulchenko,<sup>3</sup> A.V. Smith,<sup>5</sup> M.A. Ikram,<sup>6</sup> J.J. Hottenga,<sup>2</sup> V.M. Kattenberg,<sup>2</sup> M.H.M. de Moor,<sup>2</sup> C. Janssens,<sup>3</sup> E.C.J. de Geus,<sup>2</sup> F.G. Zitman,<sup>8</sup> A.G. Uitterlinden,<sup>7</sup> A. Hofman,<sup>6</sup> G. Willemsen,<sup>2</sup> V. Gudnason,<sup>5</sup> B.W.J.H. Penninx,<sup>8</sup> Breteler,<sup>6</sup> L. Launer,<sup>6</sup> R.R. Frants,<sup>1</sup> G.M. Terwindt,<sup>4</sup> C.M. van Duijn,<sup>3</sup> D.I. Boomsma,<sup>2</sup> M.D. Ferrari,<sup>4</sup> A.M.J.M. van den Maagdenberg<sup>1,4</sup>

<sup>1</sup>Department of Human Genetics, Leiden University Medical Centre, Leiden, The Netherlands

<sup>2</sup>Department of Biological Psychology, Vrije Universiteit, Amsterdam, The Netherlands

<sup>3</sup>Genetic Epidemiology Unit, Departments of Epidemiology and Clinical Genetics, Erasmus University Medical Centre, The Netherlands

<sup>4</sup>Department of Neurology, Leiden University Medical Centre, Leiden, The Netherlands

<sup>5</sup>Laboratory of Epidemiology, Demography and Biometry, Intramural Research Program, National Institute on Aging, Bethesda, MD, USA

<sup>6</sup>Department of Epidemiology, Erasmus MC University Medical Center Rotterdam, The Netherlands

<sup>7</sup>Department of Internal Medicine, Erasmus Medical Center, Rotterdam, The Netherlands

<sup>8</sup>Department of Psychiatry, Leiden University Medical Centre, Leiden, The Netherlands

\*Both authors contributed equally

**Manuscript in preparation**

---

## Abstract

Migraine is a common neurovascular disorder with a genetically complex pattern of inheritance. Linkage and association studies in the common forms of migraine have had limited success as they lacked robust replication of initial findings. Recent availability of high-throughput genotyping methodology makes genome-wide association studies (GWAS) feasible and provided a much better opportunity for identifying gene variants for complex diseases, including migraine. Here we first performed a GWAS on 330 migraine cases and 1,216 controls of the Erasmus Rucphen Family (ERF) study population, a Dutch genetically isolated population. The most significant association was observed with single nucleotide polymorphism (SNP) rs7200027 ( $P$ -value  $1.34 \times 10^{-7}$ ), an intergenic SNP on chromosome 16. Another 220 SNPs in the ERF GWAS had a  $P$ -value below  $10^{-4}$ . A subsequent meta-analysis of migraine GWA data from five additional population-based cohorts of the Dutch-Icelandic (DICE) consortium indicated that rs7200027 only showed a significant signal in ERF. In fact, of the SNPs in the ERF GWAS with a  $P$ -value  $< 10^{-4}$ , only rs11636768 reached that significance level in the meta-analysis. Rs11636768 resides in an intergenic region on chromosome 15 between the ATP/GTP binding protein-like 1 (*AGBL1*) gene and the non-protein coding RNA 52 (*NCRNA00052*) gene. In addition, the meta-analysis itself gave unique opportunities to search for migraine variants that surface in this large set of 10,980 individuals (2,446 cases and 8,534 controls). The strongest association in the meta-analysis was observed with rs9908234 ( $P$ -value  $8.0 \times 10^{-8}$ ) that is located in the nerve growth factor receptor (*NGFR*) gene. Notably, *NGFR* was previously considered a strong candidate for migraine due to its involvement in the trigeminal pain system. Future studies will have to show the relevance of these findings as GWAS and meta-analysis signals need to be replicated and the functionality of gene variants needs to be investigated with functional studies.

## Introduction

Migraine is a common neurovascular brain disorder that is characterized by attacks of severe unilateral, often pulsating headache.<sup>1</sup> Two main types of migraine are distinguished based on the presence of an aura that can precede the headache: migraine with aura (MA) or without aura (MO). Although MA and MO have been considered distinct disease entities<sup>2,3</sup>, it is now more and more accepted that they do present different expression forms of the same disease.<sup>4-6</sup>

Gene identification in the common forms of migraine has been notoriously difficult. Except for a genetic association with a single nucleotide polymorphism (SNP) in the 5',10'-methylentetrahydrofolate reductase (*MTHFR*) gene, no genetic factors have been identified for common migraine; likely because most association studies were underpowered and therefore replicated poorly (for review see De Vries et al. 2009)<sup>7</sup>. Thus far, successes in migraine genetics

come primarily from studies in familial hemiplegic migraine (FHM), a rare monogenic subtype of MA that is considered a suitable model for common migraine.<sup>8</sup> Three genes were identified, all encoding ion transporters.<sup>9-11</sup> Functional research on FHM gene mutations indicated that abnormal neurotransmission of glutamatergic neurons in the cortex plays an important role in FHM and possibly the common forms of migraine.<sup>12</sup>

Here we performed a genome-wide association study (GWAS) which tests for association between a trait and hundreds of thousands of SNPs in the genome. Recently, the first GWAS of migraine was performed using clinic-based cohorts.<sup>13</sup> The present study is the first GWAS in migraine using population-based cohorts. We first performed a GWAS in the Erasmus Rucphen Family (ERF) study, a genetic isolate in the Southwest of the Netherlands, in which we identified 360 migraine cases and 617 non-headache controls.<sup>14</sup> Gene identification is expected to be easier in genetically isolated populations as, i) these populations have limited genetic heterogeneity due to a relatively small number of founders and genetic drift, and ii) environmental factors may be more homogeneous.<sup>15</sup> Subsequently, we performed a meta-analysis by combining migraine GWAS data of, in total, six population-based cohorts (2,446 cases and 8,534 controls) of the Dutch-Icelandic (DICE) consortium.

## **Materials and Methods**

### *Design*

Our study has a two-step design. First, we performed a GWAS on 330 migraine cases from the ERF population. In the second step, we performed a meta-analysis on 2,446 migraine cases from six different population-based cohorts (i.e., ERF, AGES, the Rotterdam study, NESDA, NTR1, and NTR2) of the DICE consortium. Details on the populations and genotyping are described in the following paragraphs.

### *Populations: Subjects and phenotypes*

Six different population-based migraine cohorts (ERF, AGES, the Rotterdam study, NESDA, NTR1, and NTR2) were included in this study (Table 1). Of them, only the ERF population is a genetically isolated population and contains related individuals. In the ERF, AGES, the Rotterdam study, NESDA, NTR1, and NTR2; 330, 357, 349, 756, 378 and 276 migraine cases were included for this study, respectively. Migraine in all populations was diagnosed based on the ICHD-II criteria of the International Headache Society.<sup>1</sup> However, in the NESDA, NTR1 and NTR2 cohorts, migraine diagnoses were determined by means of latent class analysis (LCA) of IHS migraine symptoms.<sup>16</sup> The ERF cohort is a population-based cohort that was not selected based on specific phenotypes. In stead, the NESDA, NTR1 and NTR2 cohorts were initially collected to study major depressive

disorder (MDD). Therefore, MDD is enriched compared to the other cohorts. The AGES cohort and the Rotterdam study were initially collected to study risk factors for disease at older age. A detailed description on the populations and migraine case finding is provided below. All individual GWA studies were approved by local ethics committees.

**Table 1** Descriptives for the samples included in the meta-analysis.

	ERF	AGES	NESDA	NTR1	NTR2	Rotterdam
<b>Subjects</b>						
Total N	1546	3219	1530	1593	1094	1998
N cases (♂, ♀)	330 (81, 249)	357 (71, 286)	756 (165, 591)	378 (69, 309)	276 (59, 217)	349 (79, 270)
N controls (♂, ♀)	1216 (615, 601)	2862 (1281, 1581)	774 (322, 452)	1215 (509, 706)	818 (396, 422)	1649 (805, 844)
mean age & SD	48.4 (±14.6)	51.22 (±6.33)	42.9 (±12.5)	44.8 (±15.0)	48.6 (±14.4)	55.37 (±4.51)
<b>Genotyping &amp; Imputation</b>						
platform	Illumina HumanHap300 HumanHap370 Affymetrix 250K Nsp array	Illumina 370CNV	Perlegen/ Affymetrix 600K	Perlegen/ Affymetrix 600K	Illumina Human660W-Quad BeadChip	Illumina Infinium II HumanHap550 version 3.0
software used	MACH	MACH 1.0.16	IMPUTE	IMPUTE	IMPUTE	MACH 1.0.15
reference set	HapMap CEU	HapMap CEU	HapMap CEU	HapMap CEU	HapMap CEU	HapMap CEU
NCBI build	36	36	36	36	36	36
hapmap release	22	22	22	22	24	22
# snps analyzed	2,135,034	2,408,991	2,432,125	2,431,993	2,542,087	2,450,030
Software for analysis						
imputed data	ProbABEL	ProbABEL	SNPTEST	SNPTEST	SNPTEST	ProbABEL

### ERF

The ERF study is a family-based study in a genetically isolated population in the Southwest of the Netherlands. This young genetic isolate was founded in the mid-18th century. Minimal immigration and/or marriages occurred between surrounding settlements for social and religious reasons. The ERF population includes 3,465 individuals that are living descendants of 22 couples with at least six children baptized in the community church around 1850–1900. The subjects were unselected with respect to phenotypes. Details about the extensive genealogy and pedigree of the population are described elsewhere.<sup>17</sup>

Migraineurs were identified using a three-stage previously validated screening procedure.<sup>18</sup> The screening procedure in ERF was described by Stam et al.<sup>14</sup> In brief, all participants filled out a concise screening questionnaire on headache and aura symptoms, and those who screened positive also completed a detailed questionnaire. All participants who screened positive were

telephone-interviewed to clarify their clinical symptoms. Final diagnosis was always made after this telephone interview and in consultation with a neurologist (GMT) specialized in headache. The control group consisted of ERF participants negative for migraine based on the written questionnaire.

Data from 1,546 ERF participants; 330 migraineurs and 1,216 (non-migraine) controls were included in this study. Of the migraine cases, 249 (75%) were female and 81 (25%) were male; of the controls, 601 (49%) were female and 615 (51%) were male. The mean age of the study subjects was 48.4 years (SD = 14.6).

### *AGES*

The Reykjavik Study is a population-based cohort study established in 1967 to prospectively study cardiovascular disease in Iceland. The cohort included a random sample of men and women born between 1907 and 1935 originating from Reykjavik. In 2002, the Reykjavik Study continued as the Age, Gene/Environment Susceptibility (AGES)-Reykjavik Study to examine risk factors, genetic susceptibility, and gene-environment interactions in relation to disease and disability in old age. Headache data were collected as part of the Reykjavik study. Details on the Reykjavik and AGES-Reykjavik Studies are described in detail elsewhere.<sup>19-22</sup>

For this study, a modified version of the 1988 International Headache Society (IHS) criteria was used (IHC. 1988). Subjects reporting headache at least once a month were asked whether their headaches were accompanied by any of the following migraine features: nausea/vomiting, unilateral location, photophobia, visual disturbance during or preceding headache, and unilateral numbness preceding headache. Individuals were defined as having migraine with aura if they had visual or sensory aura, or both. Subjects with at least 2 of the non-aura symptoms were classified as having migraine without aura. Details were described elsewhere.<sup>23</sup> In the present study, both migraine with and without aura were included as cases. The remaining individuals were considered controls.

The AGES-Reykjavik study contains 357 migraine cases; 286 were female (80%) and 71 were male (20%). The control group consisted of 1581 females and 281 males. Mean age of all study subjects was 51.03 years (SD = 6.37).

### *NESDA*

The NESDA cohort consisted of 1,530 unrelated individuals from the Netherlands. Most of them had major depressive disorder (MDD) and were genotyped in the context of the Genetic Association Information Network (GAIN) MDD study.<sup>24</sup> For phenotypic assessment, the NESDA participants

---

underwent a 4-hour baseline assessment at one of seven clinic sites at the beginning of the study. This assessment included an interview on somatic health, functioning and health care use, and the administration of several written questionnaires. Migraine was assessed using a questionnaire that provided information on the symptoms listed in the ICHD-II criteria. Individuals screening positive for a screening question ('do you ever experience headache attacks, for instance migraine?') subsequently answered a set of more detailed questions about their headaches. This information was used to determine the presence of eight of the symptoms present in the ICHD-II criteria: moderate/severe pain intensity, aggravation by physical activity, pulsating quality, nausea/vomiting, photo-/phonophobia. The IHS migraine symptom variables were analyzed with Latent Class Analysis (as in Nyholt et al. 2005)<sup>16</sup> to determine each participant's affection status for migrainous headache. The program Latent Gold 4.0 (Statistical Innovations, Inc., Belmont, MA) was used to perform the LCA. Individuals belonging to LCA classes 2 and 3 (CL2 and CL3) were considered migraine patients; individuals of LCA classes 0 and 1 (CL0 and CL1) were used as controls. Previously it was shown that all individuals that were considered affected in the latent class analysis (i.e., CL2 or CL3) were diagnosed as affected by applying IHS migraine criteria.<sup>5</sup>

In the NESDA sample 1,383 subjects had MDD; 147 had a low risk for MDD. In the sample of the present study, we included 756 migraine cases (713 with MDD and 43 with a low risk for MDD) and 774 controls (670 with MDD and 104 with a low risk for MDD). In the case group, 591 (78%) were female and 165 (22%) were male. In the control group, 452 (58%) females and 322 (42%) males were present. The mean age of the study cohort was 42.9 years (SD = 12.5).

### *NTR1*

The Netherlands Twin Registry (NTR) collects phenotype data in Dutch twins, their parents, siblings and partners. The migraine data were collected in the context of a longitudinal study on health, lifestyle and personality. The first NTR (i.e., NTR1) cohort was genotyped as part of the GAIN project, a GWA study originally designed to find genes for major depressive disorder.<sup>24</sup> The majority of the 1,481 subjects were selected for low risk of MDD; 112 subjects were MDD patients. Migraine was assessed with a questionnaire that provided information on the symptoms listed in the ICHD-II criteria. The headache questions were embedded in surveys that were held in the context of a longitudinal study on health, lifestyle and personality. The data used in this study were collected in 2002 and 2004. Both surveys included the same set of headache items. Data collection procedures are described in detail elsewhere.<sup>25,26</sup> When a participant answered the headache section in both surveys, the survey of 2004 was used. Final migraine diagnosis was based on the LCA method as described above for the NESDA cohort.

Migraine data were available for 1,593 individuals: 378 cases (56 with MDD and 322 with a low risk for MDD), and 1,215 controls (56 with MDD and 1,159 with a low risk for MDD). In the case group, 309 (82%) were female and 69 (18%) were male. In the control group, 706 (58%) females and 509 (42%) males present. The mean age of the study population was 44.8 years (SD = 15.0).

### *NTR2*

The second cohort from the Netherlands Twin Registry (i.e., NTR2) was an unselected sample. For 1,094 individuals, migraine data were available. Migraine case finding in NTR2 was similar as for NTR1 and is described in the section above.

NTR2 contained 276 migraine cases, including 217 (79%) females and 59 (21%) males. The control group consisted of 818 controls, consisted of 422 (52%) females and 396 (48%) males. The mean age in this cohort was 48.6 years (SD = 14.4).

### *Rotterdam Study*

This sample included participants of the Dutch Rotterdam Study, a prospective population-based cohort study among persons 55 years or older who were living in Ommoord, a well-defined district of Rotterdam.<sup>27</sup> The aim of the study was to investigate causes of frequent chronic diseases, with a focus on cardiovascular, neurologic, psychiatric, and ophthalmic diseases. The original cohort consisted of 7,983 participants and was expanded in 2000 with 3,011 participants and again in 2006 with another 3,919 persons who were 45 years of age or older. At study entry, all participants underwent a structural interview and a physical examination, which was repeated every 3-4 years. The migraine questionnaire was introduced into the core study protocol in 2006 (response rate of 64.8%). The migraine questionnaire was based on the ICHD-II criteria and was a modified questionnaire according to the questionnaire used in the GEM study.<sup>18</sup> The first question was "Have you ever experienced a severe headache that affected your daily activities?" If the answer was negative or if it was clearly indicated that the participants experienced a severe headache due to other causes, such as a tumor, sinusitis, stroke, trauma or meningitis, no further questions on headaches were asked. If the answer to the first question was positive, headache duration and headache frequency were asked. Next, if a person experienced headaches of which, 1) the duration was between 4 and 72 hours (untreated) or the participant did not know the answer to this question, because they always treated their headache attacks, and 2) the attack frequency was two or more attacks in a lifetime, details on the characteristics and symptoms of the headaches were asked. These included age of onset, unilateral location, pulsating quality, aggravation by daily activities, sensitivity to light and sound, nausea or vomiting. The frequency of the symptoms accompanying the headaches was assessed and defined as never, sometimes, half of the time and more than half of the time. In this group of participants, questions on

---

medication use were assessed. Furthermore, every participant was asked about aura symptoms and physician diagnosis, if they ever had a severe headache. If the participant experienced an aura or the physician had diagnosed migraine, questions on medication use were assessed. Participants whose duration of headache was unknown, because they always used medication to prevent or treat the attack, were considered migraineurs if they fulfilled the remaining ICHD-II criteria. Individuals who were not classified as migraineurs were regarded as controls.

For the present study, we used data from persons from the second cohort expansion (2006 to 2008) who completed the migraine questionnaire. Migraine data were available for 1,998 unrelated individuals, including 349 cases (270 females (77%) and 79 males (23 %)) and 1,649 controls (844 females (51%) and 805 males (49%)). The mean age of the study sample was 55.37 years (SD = 4.51).

#### *Genotyping and imputation*

Genotypes were already available for all cohorts, and were not generated for this meta-analysis which explains why different genotyping platforms were used. After imputation, for all populations approximately 2.5 million genotypes were available for GWA. All SNPs were located in autosomes. The meta-analysis was performed on 2,394,913 SNPs. Detailed information for the genotyping of the individual cohorts is provided below.

#### *ERF*

Genotyping was performed on several different platforms (Illumina HumanHap300, HumanHap370, Affymetrix 250K Nsp array). These sets were merged and genotypes for 2,585,854 SNPs were imputed to HapMap CEU, release 22, NCBI build 36 using the MACH program. Data were filtered for rare variants and linkage disequilibrium (LD). SNPs with a minor allele frequency (MAF) below 5% were excluded, and SNPs with an  $r^2$  below 0.3 were excluded.

#### *AGES*

Genotyping was performed using the Illumina 370CNV platform. Genotypes for approximately 2.5 million SNPs were imputed using the MACH 1.0.16 program, using HapMap CEU as the reference set, based on NCBI build 36, HapMap release 22.

#### *NTR1 and NESDA*

Genotyping for the GAIN sample was conducted by Perlegen Sciences (Mountain View, CA, USA). The unfiltered dataset contained 599,156 unique SNPs. For the final analysis dataset, SNPs were required not to have gross mapping problems,  $\geq 2$  genotype disagreements in 40 duplicated samples,  $\geq 2$  Mendelian inheritance errors in 38 complete trio samples, MAF below 1%, or over 5% missing genotypes in either cases or controls. A total of 427,049 autosomal SNPs met these



criteria and were included in the analyses. Genotypes for approximately 2.5 million SNPs were imputed using the IMPUTE software, using the HapMap CEU data (release 22, NCBI build 36) (<https://mathgen.stats.ox.ac.uk/impute/impute.html>), as reference. For each SNP, an  $r^2$  value was calculated using the QUICKTEST program (<http://toby.freeshell.org/software/quicktest.shtml>). SNPs were excluded if the Hardy-Weinberg equilibrium (HWE) test in controls produced a  $P$ -value  $<10^{-6}$ , the MAF was smaller than 1%, and the  $r^2$  was smaller than 0.3, leaving 2,432,125 SNPs for analysis in the NESDA sample and 2,431,994 in the NTR1 sample.

### *NTR2*

Genotyping for 657,366 was performed SNPs on the Human660W-Quad BeadChip. SNPs were excluded based on MAF below 1%, missing genotype rate above 5% or HWE  $P$ -value  $<10^{-5}$ . After quality control, 515,781 SNPs remained for further analysis. Genotypes of approximately 3.8 million SNPs were imputed with the IMPUTE program<sup>28</sup>, using the HapMap CEU data (release 24, NCBI build 36), available from the IMPUTE website, as reference. Imputed SNPs were excluded if they had a MAF below 1% or an  $r^2$  below 0.3, leaving 2,506,433 SNPs for analysis.

### *Rotterdam Study*

Genotyping was performed using the Illumina Infinium II HumanHap550 chip, version 3.0. A total of 572,129 SNPs were genotyped. SNPs were excluded based on the following criteria: HWE  $P$ -value  $<10^{-6}$ , call rate  $<98\%$  and a MAF  $<1\%$ . The number of SNPs that survived quality control was 514,139. Genotypes were imputed for 2,543,888 SNPs, using the Hapmap CEU (build 36, rel. 22) as reference. Imputations were performed in MACH 1.0.15. SNPs were excluded if they had a MAF  $<0.01$  or an  $r^2 < 0.3$ , leaving a total of 2,450,030 SNPs for analysis.

### *GWA analysis in ERF*

For each of the 2,135,034 SNPs, logistic regression was performed, using an additive genetic model, while adjusting for age and sex. Uncertainty in the inferred genotype from the imputation was accounted for by utilizing the estimated genotype probabilities (implemented in ProbABEL). Data were filtered for rare variants and LD (MAF  $<0.05$  were excluded; SNPs with  $r^2$  below 0.3 were excluded). We accounted for relatedness between study participants; genomic control was applied with a study-specific  $\lambda$  factor being 1.17.

### *GWAS for meta-analysis*

In each sample, a logistic regression association test was performed, with sex, age, and age<sup>2</sup> included as covariates, under an additive model. Age<sup>2</sup> was included to account for potential nonlinearity of the age effect, because the prevalence of migraine is lower in both younger and older individuals.<sup>29</sup> Uncertainty of imputation was taken into account in the analyses. The data of

---

AGES, ERF and the Rotterdam Study were analyzed with ProbABEL<sup>30</sup>, NESDA, NTR1 and NTR2 were analyzed using SNPTEST.<sup>28</sup> The study specific genomic inflation factors ( $\lambda$ ) were 1.002, 1.000, 1.006, 1.013, 1.000 and 1.021 for AGES, ERF, NESDA, NTR1, NTR2 and Rotterdam, respectively.

Next, a meta-analysis was performed on 10,890 individuals of the six population-based migraine cohorts using the METAL program (<http://www.sph.umich.edu/csg/abecasis/metal/>). Since different phenotype definitions were used in the different samples, the effect sizes are not directly comparable between studies. Therefore, a pooled Z-score approach was used. With the pooled Z-score method, an overall Z-score is calculated based on the summed Z-scores from the individual studies, weighted by each study's sample size. The weights are calculated as the square root of (Nstudy/Ntotal). The squared weights sum to one. The sign of the Z-score indicates the direction of effect. To ensure that meta-analysis results were indeed based on a substantial number of samples, hence SNPs (N=184,350 present for less than 70% of all participants) were excluded from the meta-analysis. This left a total of 2,394,913 SNPs for analysis. Annotation of GWAS results was performed with WGA viewer, version 1.26E.

#### *Literature-based relationships*

Literature-based relationships between genes in the specific gene sets and migraine were studied using the Anni text-mining program (Anni version 2.1)<sup>31</sup>. For each gene or disorder a concept profile was generated by the program. A concept profile is a summary of all concepts directly co-mentioned with the disease or gene concept (i.e. the main concept) in PubMed abstracts. The strength of association for each concept with the main concept is calculated using 2x2 contingency tables and the uncertainty coefficient. The association between two concept profiles is calculated using vector based matching (e.g. inner product score) over the concepts that the two profiles have in common.

## Results

### GWAS in the ERF population

Using the ProbABEL package, which is suitable for imputed genotypes, we performed a GWAS with 2,585,854 SNPs in ERF. The Q-Q plot for the GWA-analysis is shown in figure 1A. We corrected for residual inflation using genomic control using the genomic inflation factor  $\lambda$ , which is calculated as the median observed  $\chi^2$  divided by the median expected  $\chi^2$  based on 1 df, and was 1.17 for ERF. The genome-wide plot of probability values for individual SNPs against their genomic position shows that none of the SNPs reached the threshold for genome-wide significance (set to a  $P$ -value of  $5.0 \times 10^{-8}$ ) (figure 1B). However, 22 SNPs showed suggestive associations with  $P$ -values below  $10^{-5}$  (Table 2); 221 SNPs had  $P$ -values below  $10^{-4}$ .

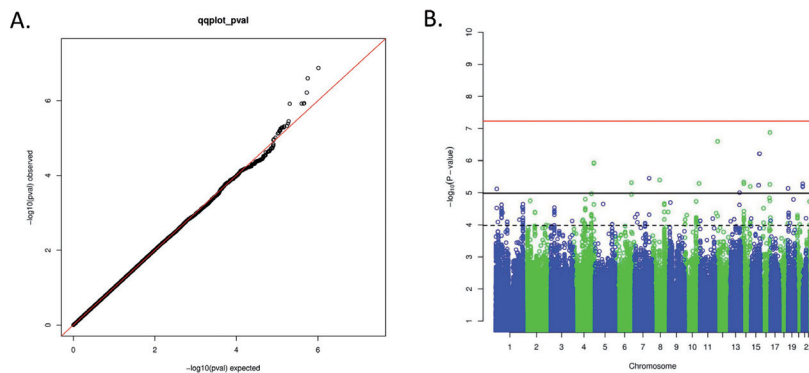

**Figure 1** **A** Quantile-Quantile (Q-Q) plot showing the expected (x-axis) and observed distribution of  $-\log_{10}$  ( $P$ -value) in our GWAS analysis in the ERF population. The genomic factor ( $\lambda$ ) was 1.17. **B** Genome-wide signal intensity (Manhattan) plot showing individual probability values per chromosome for the GWAS in ERF. Solid red line indicates the threshold for genome-wide significance ( $P$ -value =  $5.0 \times 10^{-8}$ ), solid black line indicates the threshold for suggestive association ( $P$ -value =  $1.0 \times 10^{-5}$ ), and the dotted black lines indicates a  $P$ -value threshold of  $1.0 \times 10^{-4}$ .

The strongest associated SNP in ERF, rs7200027 ( $P$ -value  $1.34 \times 10^{-7}$ , OR 0.63 (CI 0.53-0.75)), resides on chromosome 16. The minor allele is overrepresented in the controls compared to the cases, indicating a protective effect of the minor allele. Rs7200027 is an intergenic SNP located 50 Kb upstream of the *TMEM148* gene, which encodes a transmembrane protein with unknown function. The regional association plot shows that the SNPs surrounding rs7200027 are in relatively low LD and therefore show only limited to no association (figure 2). The second best SNP on the list is rs17379695 ( $P$ -value  $2.52 \times 10^{-7}$ ) which is an intronic SNP located in the solute carrier organic anion transporter *SLC01C1* gene on chromosome 12.

**Table 2** Overview of most significant SNPs in the ERF GWA study (with *P*-value of  $1.0 \times 10^{-5}$  or smaller)

<b>SNP</b>	<b>Chr</b>	<b>Position</b>	<b>Nearest gene</b>	<b>Gene description</b>	<b>Alleles*</b>	<b>MAF</b>	<b>Beta</b>	<b>SE</b>	<b>P-value</b>	<b>OR (CI)</b>	<b>SNPs in region **</b>	<b>Located in migraine linkage peaks</b>
rs7200027	16	83957068	<i>TMEM148</i>	Transmembrane protein 148	A/G	0.36	-0.47	0.09	$1.34 \times 10^{-7}$	0.63 (0.53-0.75)	1	No
rs17379695	12	20794062	<i>SLCO1C1</i>	Solute carrier organic anion transporter family, member 1C1	T/C	0.06	0.97	0.19	$2.52 \times 10^{-7}$	2.64 (1.81-3.83)		No
rs8029074	15	92528658	<i>MCTP2</i>	Multiple C2 domains, transmembrane 2	T/C	0.06	-2.02	0.41	$6.08 \times 10^{-7}$	0.13 (0.06-0.30)		No
rs11735224	4	182548055	AC093840.1	Hypothetical protein LOC100288373	T/C	0.28	-0.41	0.08	$1.18 \times 10^{-6}$	0.66 (0.57-0.78)	3	No
rs6963861	7	129380575	<i>UBE2H</i>	Ubiquitin-conjugating enzyme E2H (UBC8 homolog, yeast)	C/T	0.34	0.38	0.08	$3.55 \times 10^{-6}$	1.46 (1.25-1.71)		No
rs17280878	8	64210464	AC120042.1	Hypothetical LOC643763	G/A	0.08	0.63	0.14	$4.08 \times 10^{-6}$	1.88 (1.42-2.47)		No
rs17212806	14	43521554	LOC390472	Similar to keratin 8	T/C	0.08	0.58	0.13	$4.66 \times 10^{-6}$	1.79 (1.38-2.30)		Yes (Sorogna et al. 2003)
rs2184359	6	143280911	<i>HIVEP2</i>	Human immunodeficiency virus type I enhancer binding protein 2	C/T	0.09	0.58	0.13	$4.86 \times 10^{-6}$	1.79 (1.38-2.30)		No
rs1040150	10	126062815	<i>OAT</i>	Ornithine aminotransferase	T/C	0.07	0.71	0.15	$5.16 \times 10^{-6}$	2.03 (1.52-2.73)		No
rs17212778	14	44439714	LOC390472	Similar to keratin 8	A/G	0.08	0.57	0.13	$5.25 \times 10^{-6}$	1.77 (1.37-2.28)		No
rs2207843	21	15154158	LOC654338	Brain cytoplasmic RNA 1, pseudogene	C/A	0.09	0.91	0.20	$5.29 \times 10^{-6}$	2.48 (1.68-3.68)	2	No
rs11636768	15	87695511	NCRNA00052	Non-protein coding RNA 52	G/A	0.19	0.55	0.12	$5.90 \times 10^{-6}$	1.73 (1.37-2.19)		No
rs4906086	14	101707363	LOC100128373	Similar to AKT interacting protein	T/A	0.45	-0.33	0.07	$6.38 \times 10^{-6}$	0.72 (0.63-0.82)		No
rs3760877	19	542672	<i>CDC34</i>	Cell division cycle 34 homolog (S. cerevisiae)	C/T	0.45	0.46	0.10	$7.29 \times 10^{-6}$	1.58 (1.20-1.93)		Yes (Nyholt et al. 1998; Jones et al. 2001)
rs3010223	1	11372638	<i>UBIAD1</i>	UbiA prenyltransferase domain containing 1	A/G	0.28	-0.36	0.08	$7.57 \times 10^{-6}$	0.70 (0.60-0.82)		No
rs9300671	13	102155537	<i>ITGBL1</i>	Integrin, beta-like 1 (with EGF-like repeat domains)	G/A	0.30	-0.36	0.08	$9.81 \times 10^{-6}$	0.70 (0.60-0.82)		No

\*Alleles: major allele/minor allele. MAF = minor allele frequency, SE = standard error, OR = odds ratio, CI = 95% confidence interval

\*\*Table shows an overview of the meta-analysis results, for all SNPs with a *P*-value of  $10^{-5}$  or smaller, but when multiple SNPs within a 0.5 Mb region had *P*-values  $< 10^{-5}$ , the SNP with the best *P*-value is reported, and the number of SNPs with small *p*-values surrounding the best SNP is given.

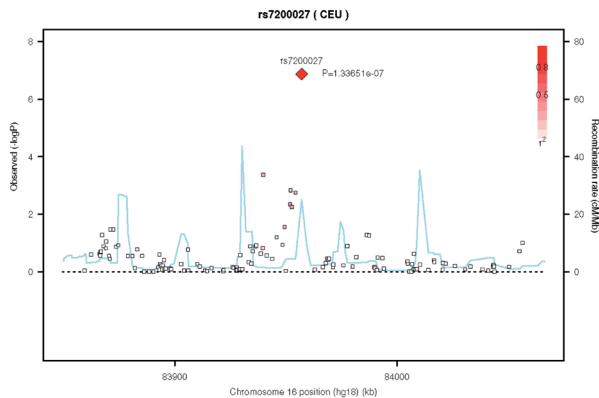

**Figure 2** Regional plot for associations in the region surrounding the top hit (*rs720027*). All SNPs (indicated as squares) are plotted with their  $-\log(P)$ -value against their genomic position. Colour of the squares represents the degree of LD between the SNPs, with white representing no LD till dark red representing complete LD. Light blue line represents estimated recombination rates.

Furthermore, we explored the 221 top SNPs (with  $P$ -values  $<10^{-4}$ ) from the ERF GWAS using a text-mining program and by comparing the SNP locations to previously reported migraine linkage regions. The 221 top SNPs are located within or close to 84 different genes. Literature-based relationships between these genes and migraine were studied using the Anni text-mining program (Anni version 2.1)<sup>31</sup>. Neuronal cell adhesion molecule 1 (*NCAM1*), located on chromosome 11, was identified as the best migraine candidate gene according to literature-based connections with the concept ‘migraine’. In the top list, two SNPs located upstream of *NCAM1* had a  $P$ -value  $<10^{-4}$  (*rs4937776* ( $6.37 \times 10^{-5}$ ) and *rs4937786* ( $6.39 \times 10^{-5}$ )). The text-mining program did not show any meaningful results for the 16 genes (for 7 a concept profile was present) in the 22 top SNPs with  $P$ -value  $<10^{-5}$ . None of the 22 top SNPs ( $P$ -value  $<10^{-5}$ ) were located in known migraine linkage regions, although *rs17212806* is located in relative proximity to the linkage region on chromosome 14q21.2-q22.3.<sup>32</sup> Of the 221 top SNPs, 46 SNPs were located in 8 known migraine linkage loci.

#### *Most significant SNPs from the ERF GWAS in other population-based cohorts*

As described above, the most significant association in the ERF GWAS was obtained with *rs7200027*. When performing the meta-analysis for all six population-based migraine cohorts the  $P$ -value of this SNP increased to  $>10^{-4}$ , indicating that the association was less clear in other populations. In fact, the association with *rs7200027* was only observed in ERF. When comparing the top SNPs ( $P$ -value  $<10^{-4}$ ) from the ERF GWAS and the meta-analysis, only *rs11636768* surfaced in both studies ( $P^{\text{ERF-GWAS}} 5.9 \times 10^{-6}$  and  $P^{\text{Meta-analysis}} 3.2 \times 10^{-7}$ ). Importantly, the direction of the effect for this SNP was identical for all six populations, which adds weight to the association finding. Moreover, it was the second best SNP in the meta-analysis (Table 4). SNP *rs11636768* is located on chromosome 15q25 between the *NCRNA00052* gene encoding non-protein coding RNA 52 and the

*AGBL1* gene encoding ATP/GTP binding protein-like 1, but the SNP is located outside the known migraine linkage regions on chromosome 15.<sup>33,34</sup> Interestingly, approximately 0.5 Mb downstream of the rs11636768 SNP the *NTRK3* gene is located, which encodes a member of the neurotrophic tyrosine receptor kinase (NTRK) family.

### *FHM genes in ERF GWA and in the meta-analysis*

This study also provides an excellent opportunity to investigate the role of FHM genes in large population-based migraine cohorts. We investigated whether SNPs in the three known FHM genes showed any signal in the ERF GWAS and meta-analysis data sets. Genotypic information was available for *CACNA1A* (202 SNPs in ERF, 241 SNPs in the meta-analysis), *ATP1A2* (19 SNPs in ERF, 20 SNPs in the meta-analysis), and *SCN1A* (97 SNPs in ERF, 99 SNPs in the meta-analysis) (Table 3). For both the ERF GWAS and the meta-analysis the most significant association was obtained with SNPs in the *ATP1A2* gene. In the ERF GWAS, 5 SNPs had a *P*-value <0.01 (all were intronic SNPs). Three of them were in close LD ( $r^2 < 0.8$ ). Highest association in *ATP1A2* was obtained for SNP rs4656883 (*P*-value  $1.4 \times 10^{-3}$ ). In the meta-analysis, 5 SNPs had a *P*-value <0.001; highest association was found for rs2854248 (*P*-value  $3.62 \times 10^{-4}$ ). This SNP had a *P*-value of 0.009 in ERF. For the *CACNA1A* gene, only weak association signals were observed: in both data sets less than 10% of the *CACNA1A* SNPs showed *P*-values below 0.01; none were below 0.003. For the *SCN1A* gene, none of the SNPs showed any sign of association, neither in the GWA study nor in the meta-analysis.

**Table 3A** Results in ERF GWAS for monogenic migraine genes

<b>FHM genes</b>									
Gene Symbol	Location	Most significant SNP in ERF GWAS	P-value	Beta	SNPs <i>P</i> < 0.001	SNPs <i>P</i> < 0.01	SNPs <i>P</i> < 0.05	SNPs <i>P</i> < 0.1	Total nr's of SNPs
CACNA1A	19p13	rs7248281	0.0030	0.29	0	16	44	56	202
ATP1A2	1q21-q23	rs4656883	0.0014	0.46	0	5	7	7	19
SCN1A	2q24.3	rs13397210	0.1434	0.26	0	0	0	0	97

**Table 3B** Results in meta-analysis for monogenic migraine genes

<b>FHM genes</b>										
Gene Symbol	Location	Most significant SNP in meta-analysis	Pooled Z-score	Pooled P-value	Direction of effect	SNPs <i>P</i> < 0.001	SNPs <i>P</i> < 0.01	SNPs <i>P</i> < 0.05	SNPs <i>P</i> < 0.1	Total number of SNPs
CACNA1A	19p13	rs3764615	2.903	0.003695	+++++	0	9	17	37	241
ATP1A2	1q21-q23	rs2854248	3.566	0.0003618	+++++	3	4	5	8	20
SCN1A	2q24.3	rs12151636	2.142	0.03218	+?+++	0	0	1	1	99

### Previously identified common migraine genes; *MTHFR* and *AEG-1*

Next, we investigated whether previously identified common migraine gene variants showed a signal for association in our population-based cohorts. The first gene variant that we studied was the C677T SNP (rs1801133) in the *MTHFR* gene that surfaced in several candidate-gene-based association studies performed for migraine (for review see De Vries et al. 2009)<sup>7</sup>. However, in both the ERF GWAS and the meta-analysis, no significant association was found for this SNP. In addition, we tested the top SNP (rs1835740) that was identified in a GWAS of large clinic-based cohorts (testing in total 2,748 MA patients and 10,747 controls).<sup>13</sup> SNP rs1835740 resides close to the astrocyte elevated gene-1 (*AEG-1*) gene, which has relevance to the pathway identified in FHM. Neither the ERF GWAS nor the meta-analysis showed any sign of association for this specific SNP.

### Meta-analysis-specific migraine variants

The meta-analysis comprising 2,446 migraine cases and 8,534 control individuals revealed a unique large data set with potential for identification of novel genetic migraine factors itself. The Q-Q plot for this meta-analysis is shown in figure 3A. The genomic inflation factor  $\lambda$  was 1.022. None of the SNPs reached a  $P$ -value  $< 5 \times 10^{-8}$ ; the threshold for genome-wide significance (figure 3B). However, the threshold for suggestive association ( $P$ -value  $< 10^{-5}$ ) was observed for 32 SNPs (Table 4). The most significant result was obtained for SNP rs9908234 ( $P$ -value  $8.00 \times 10^{-8}$ ), which is located in the nerve growth factor receptor gene *NGFR*. Genotypic information was available for 17 SNPs in this gene, but none of the other SNPs were found associated with migraine, likely because none were in high LD with rs9908234 (figure 4). Notably, this SNP was genotyped only in the NTR1 and NESDA samples, but was imputed in the other samples.

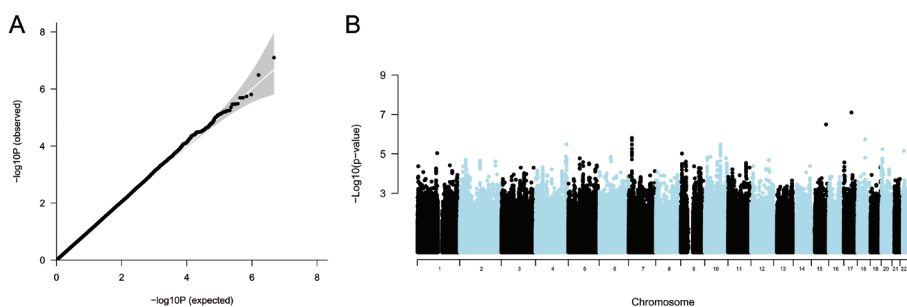
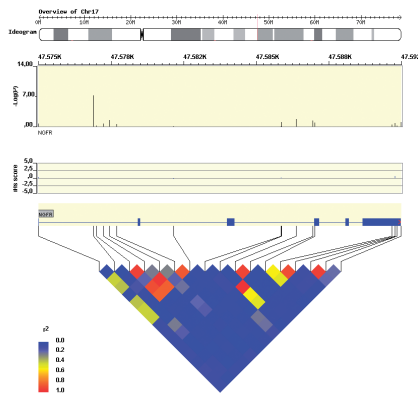

**Figure 3** A. Quantile-Quantile (Q-Q) plot showing the expected (x-axis) and observed distribution of  $-\log_{10}$  ( $P$ -value) in our meta-analysis. The genomic factor ( $\lambda$ ) for all six samples was 1.022. B. Genome-wide signal intensity (Manhattan) plot showing individual probability values per chromosome for the meta-analysis. Solid red line indicates the threshold for genome-wide significance ( $P$ -value =  $5.0 \times 10^{-8}$ ), solid black line indicates the threshold for highly suggestive association ( $P$ -value =  $1.0 \times 10^{-5}$ ), and the dotted black lines indicates the  $P$ -value threshold of  $1.0 \times 10^{-4}$ .

**Table 4** Most significant SNPs per region in the meta-analysis.

SNP	Chr	Position (bp)	Type	Closest gene	Distance to gene (bp)	A1	A2	Freq A1	P-value	Direction of effect	N SNPs in region ( $P < 10^{-5}$ )
rs9908234	17	44932347	intronic	NGFR	0	A	G	0.93	$8.0 \times 10^{-08}$	-----	1
rs11636768	15	85496515	intergenic	AC020687	321903	A	G	0.15	$3.23 \times 10^{-07}$	++++?+	1
rs10275320	7	20148579	intronic	MACC1	0	A	G	0.15	$1.56 \times 10^{-06}$	-----	8
rs4939879	18	45399981	intergenic	LIPG	26705	A	G	0.47	$1.82 \times 10^{-06}$	+++++	1
rs4861775	4	180553645	intergenic	AC017087.1	-709541	A	C	0.81	$3.28 \times 10^{-06}$	-----	1
rs986222	10	91920867	intergenic	AL139340.2	-7170	A	G	0.46	$3.37 \times 10^{-06}$	+++++	16
rs6107848	20	6539116	intergenic	AL121911	82010	A	G	0.37	$5.90 \times 10^{-06}$	+++++	1
rs140174	22	22252983	intronic	IPLL1	0	A	G	0.75	$6.98 \times 10^{-06}$	-----	1
rs1146161	1	115460299	intergenic	AL109660.1	13497	A	C	0.18	$9.27 \times 10^{-06}$	+++++	1
rs4742323	9	7276743	intergenic	KDM4C	111095	C	G	0.61	$9.70 \times 10^{-06}$	-----	1

Note. The best SNP per region is shown, as well as the number of SNPs in the region with a  $P$ -value  $< 10^{-5}$ . The "Direction" column shows the direction of effect of the best SNP in the region, for each of the six samples, in the following order: AGES, ERF, NESDA, NTR1, NTR2, Rotterdam. A question mark indicates the SNP has not been tested for a particular sample, because it was removed during quality control. A1 is the effect allele in the meta-analysis, A2 is the non-effect allele. Positions are based on NCBI Build 36. The frequency of A1 was calculated as a weighted average across all samples.



**Figure 4** Plot showing the LD structure between the SNPs tested in the NGFR gene. Rs9908234 was not in LD with any of the other SNPs tested.

No less than 340 SNPs had  $P$ -values  $< 10^{-4}$ , and were analyzed with text-mining program Anni that can prioritize genes for follow up studies. Of all 86 genes associated with these SNPs, *NGFR* was identified as the best candidate based on literature connections with the concept 'migraine'.



## Discussion

### *ERF GWAS*

Here we performed the first GWA study for migraine in population-based cohorts. Initially, we performed a GWAS in the ERF population, a genetically isolated population in the Southwest of the Netherlands, in which several loci and/or variants for complex disorders, such as metabolic syndrome<sup>35</sup> and type 2 Diabetes<sup>36</sup> were identified. The present study was designed to identify genetic variants for migraine using available genotypic data from 1,546 individuals of the ERF population. The most significant association with migraine was obtained for SNP rs7200027 located on chromosome 16q24 ( $P$ -value  $1.34 \times 10^{-7}$ , OR 0.63 (CI 0.53-0.75)), indicating a protective effect for the minor allele of this SNP. The SNP is located 50 Kb upstream region of *TMEM148*, a gene with a thus far unknown function. The second-best SNP in the top list, rs17379695 ( $P$ -value  $2.52 \times 10^{-7}$ ) is an intronic SNP located in the *SLCO1C1* gene located on chromosome 12p12, which encodes the solute carrier member 1C1 from the organic anion transporter family. At present, it is not clear how this organic anion transporter that is predominantly expressed in the microvessels of the brain and the choroid plexus that transports brain-specific thyroid hormone into the brain, may cause migraine. Also, no association with a brain disorder is at present known with genetic variations in this gene. Notably, other solute carriers have previously been implicated in several brain disorders, such as episodic ataxia, epilepsy and mental retardation.<sup>37-39</sup> Of note, no migraine linkage peaks have been reported on chromosomes 12p12 and 16q24. Clearly, without robust replications and/or functional analysis of the identified variants, the relevance of these findings remains uncertain.

### *GWA meta-analysis*

The availability of five additional population-based cohorts with GWA data gave unique opportunities for performing the first meta-analysis for migraine in population-based cohorts. This analysis was based on GWAS data from 10,890 individuals (2,446 cases, 8,534 controls) of European ancestry. The highest association in the meta-analysis was observed for SNP rs9908234 ( $P$ -value  $8.00 \times 10^{-8}$ ) in the nerve growth factor receptor (*NGFR*) gene on chromosome 17. NGFR is part of a large superfamily of tumor necrosis factor receptors.<sup>40</sup> Together with tyrosine kinase receptor A (TrkA), NGFR belongs to the two receptors that bind neural growth factor (NGF), which acts as a peripheral pain mediator, and is upregulated in many chronic pain conditions, particularly in inflamed tissues.<sup>40</sup> NGF can activate and sensitize primary afferent neurons that express TrkA, thereby producing hyperalgesia<sup>41</sup>, which has some relevance to allodynia that is reported for many migraine patients.<sup>42</sup> NGFR is not directly linked to migraine in the literature, however there is evidence for the involvement of NGF in chronic headache disorders<sup>43</sup>; increased levels of NGF were observed in the cerebrospinal fluid (CSF) of patients with chronic daily

---

headache. In contrast, Blandini et al.<sup>44</sup> found reduced peripheral levels of NGF in migraineurs. Based on current knowledge, the hypothesis that NGFR mediates NGF-induced sensitization of trigeminal neurons is proposed as an explanation for migraine headache.

When we compared the top SNPs from the ERF GWAS data with those of the meta-analysis data, SNP rs11636768 is the only SNP that obtained a  $P$ -value  $<10^{-4}$  in both studies. This SNP is located between the *NCRNA00052* gene encoding non-protein coding RNA 52 and the *AGBL1* gene that encodes the ATP/GTP binding protein-like 1. No other SNPs in this region showed a  $P$ -value  $<10^{-4}$ . The *NTRK3* gene, encoding a member of the neurotrophic tyrosine receptor kinase (NTRK) family, is located  $\sim 0.5$  Mb upstream to this SNP. This gene is located in the same pathway as the *NGFR* gene and can be linked to migraine and/or pain pathophysiology. Future studies need to show whether this association can be replicated in other populations, and whether the affect allele of the rs11636768 SNP has an effect on expression of the *NTRK3* gene.

#### *Migraine linkage studies; loci previously implicated in migraine*

Except for the hemiparesis, migraine symptoms largely overlap between FHM and common migraine patients. Consequently, FHM genes are considered good candidate genes for common migraine. However, there is debate whether the same genes (i.e., ion transporters) play a role in common migraine. Recently, Nyholt et al studied 155 ion transport genes in the human genome in Finnish MA patients to investigate their involvement in common migraine.<sup>45</sup> There were no indications that the FHM genes played an important role in common migraine. Except for a few SNPs in the *CACNA1A* gene, none had nominal significant  $P$ -values. It was suggested that there still may be SNPs in these genes, or in other ion transporters, that are associated with migraine but with very low effect sizes and could therefore not be detected in this study due to the power. However, because of the much larger sample size of our present study, we had the opportunity to test SNPs in FHM genes. A possible role of the *ATP1A2* gene is most likely for the *ATP1A2* gene, similar to what was described in a genetic study by Todt et al.<sup>46</sup> Also several linkage studies supported a possible role of *ATP1A2* in common migraine.<sup>47,16</sup>

#### *Migraine association studies; genes previously implicated in migraine*

Many other candidate genes are tested and reported for migraine, however the majority of these genes were tested in small samples sizes with limited power and replication was lacking.<sup>7</sup> Of them the *MTHFR* gene, and more specifically the functional SNP (rs1801133), is the most promising genetic finding. This SNP is associated with MA in several studies<sup>48,49</sup>, but did not replicate neither in the ERF GWA study nor in the meta-analysis. Also a very recent finding from a clinic-

based GWAS in MA, the SNP (rs1835740) that is located in the vicinity of the *AEG-1* gene<sup>13</sup>, did not replicate in the present study. For rs1835740 this could be explained by the fact that we studied a population-based cohort of common migraine patients, not specified for MO or MA. Perhaps this *AEG-1* SNP is only associated with clinic-based migraine with aura.

Future studies will show whether our results can be replicated in other migraine populations, and what the true value of these GWA studies will be for improvement of our knowledge on migraine pathophysiology and in the end treatment of migraine patients.

---

## References

1. Headache Classification Committee of the International Headache Society. (2004) The International Classification of Headache Disorders, 2nd Edition. *Cephalalgia* 24:1-160.
2. Russell MB, Olesen J (1996a) A nosographic analysis of the migraine aura in a general population. *Brain* 119:355-361.
3. Russell MB, Olesen J (1996b) Migrainous disorder and its relation to migraine without aura and migraine with aura. A genetic epidemiological study. *Cephalalgia* 16:431-435.
4. Kallela M, Wessman M, Havanka H, Palotie A, Färkkilä M (2001) Familial migraine with and without aura: clinical characteristics and co-occurrence. *Eur J Neurol* 8:441-449.
5. Nyholt DR, Gillespie NG, Heath AC, Merikangas KR et al (2004) Latent class and genetic analysis does not support migraine with aura and migraine without aura as separate entities. *Genet Epidemiol* 26:231-244.
6. Ligthart L, Boomsma DI, Martin NG, Stubbe JH, Nyholt DR (2006) Migraine with aura and migraine without aura are not distinct entities: further evidence from a large Dutch population study. *Twin Res Hum Genet* 9:54-63.
7. de Vries B, Frants RR, Ferrari MD, van den Maagdenberg AM (2009) Molecular genetics of migraine. *Hum Genet* 126(1):115-32.
8. Ferrari MD, van den Maagdenberg AM, Frants RR, Goadsby PJ (2007) Migraine as a cerebral ionopathy with impaired central sensory processing. In: Waxman SG, ed. *Molecular neurology*. Amsterdam: Elsevier; 2007 pp 439-461.
9. Ophoff RA, Terwindt GM, Vergouwe MN, Van Eijk R et al (1996) Familial hemiplegic migraine and episodic ataxia type-2 are caused by mutations in the Ca<sup>2+</sup> channel gene CACNL1A4. *Cell* 87:543-552.
10. De Fusco M, Marconi R, Silvestri L, Atorino L et al (2003) Haploinsufficiency of ATP1A2 encoding the Na<sup>+</sup>/K<sup>+</sup> pump alpha2 subunit associated with familial hemiplegic migraine type 2. *Nat Genet* 33:192-196.
11. Dichgans M, Freilinger T, Eckstein G, Babini E et al (2005) Mutation in the neuronal voltage-gated sodium channel SCN1A in familial hemiplegic migraine. *Lancet* 336:371-377.
12. Van den Maagdenberg AM, Haan J, Terwindt GM, Ferrari MD (2007) Migraine: gene mutations and functional consequences. *Curr Opin Neurol* 20(3): 299-305.

13. Anttila V, Stefansson H, Kallela M, Todt U et al. (2010) Genome-wide association study of migraine implicates a common variant on 8q22.1 regulating the expression of astrocyte elevated gene-1 (AEG-1). *Nat Genet* 42(10):869-873.
14. Stam AH, de Vries B, Janssens AC, Vanmolkot KR et al (2010) Shared genetic factors in migraine and depression: evidence from a genetic isolate. *Neurology* 26;74(4):288-94.
15. Pardo LM, Mackay I, Oostra B, et al. (2005) The effect of genetic drift in a young genetically isolated population. *Ann Hum Genet* 69:288-295.
16. Nyholt DR, Morley KI, Ferreira MA, Medland SE et al. (2005). Genomewide significant linkage to migrainous headache on chromosome 5q21. *Am J Hum Genet* 77(3), 500-512.
17. Santos RL, Zillikens MC, Rivadeneira FR, Pols HA et al (2006) Heritability of fasting glucose levels in a young genetically isolated population. *Diabetologia* 49:667-72.
18. Launer LJ, Terwindt GM, Ferrari MD (1999) The prevalence and characteristics of migraine in a population-based cohort: the GEM study. *Neurology* 11;53(3):537-542.
19. Harris TB, Launer LJ, Eiriksdottir G, Kjartansson O et al (2007). Age, Gene/Environment Susceptibility-Reykjavik Study: multidisciplinary applied phenomics. *Am J Epidemiol* 165(9), 1076-1087.
20. Jonsdottir LS, Sigfusson N, Gudnason V, Sigvaldason H, & Thorgeirsson G (2002). Do lipids, blood pressure, diabetes, and smoking confer equal risk of myocardial infarction in women as in men? The Reykjavik Study. *J Cardiovasc Risk* 9(2),67-76.
21. Qiu C, Cotch MF, Sigurdsson S, Garcia M et al. (2008). Retinal and cerebral microvascular signs and diabetes: the age, gene/environment susceptibility-Reykjavik study. *Diabetes* 57(6), 1645-1650.
22. Sigurdsson E, Thorgeirsson G, Sigvaldason H & Sigfusson N (1995). Unrecognized myocardial infarction: epidemiology, clinical characteristics, and the prognostic role of angina pectoris. The Reykjavik Study. *Ann Intern Med* 122(2), 96-102.
23. Gudmundsson LS, Thorgeirsson G, Sigfusson N, Sigvaldason H, Johannsson M (2006) Migraine patients have lower systolic but higher diastolic blood pressure compared with controls in a population-based study of 21,537 subjects. The Reykjavik Study. *Cephalalgia* 26(4):436-44.
24. Boomsma DI, Willemsen G, Sullivan PF, Heutink P et al. (2008). Genome-wide association of major depression: description of samples for the GAIN Major Depressive Disorder Study: NTR and NESDA

- 
- biobank projects. *Eur J Hum Genet* 16(3), 335-342.
25. Boomsma DI, de Geus EJ, Vink JM, Stubbe JH et al. (2006). Netherlands Twin Register: from twins to twin families. *Twin Res Hum Genet* 9(6), 849-857.
26. Distel MA, Ligthart L, Willemsen G, Nyholt DR et al (2007). Personality, Health and Lifestyle in a Questionnaire Family Study: A Comparison Between Highly Cooperative and Less Cooperative Families. *Twin Res Hum Genet* 10(2), 348-353.
27. Hofman A, Breteler MM, van Duijn CM, Krestin GP et al. (2007). The Rotterdam Study: objectives and design update. *Eur J Epidemiol* 22(11), 819-829.
28. Marchini J, Howie B, Myers S, McVean G & Donnelly P (2007). A new multipoint method for genome-wide association studies by imputation of genotypes. *Nat Genet* 39(7), 906-913.
29. Stewart WF, Lipton RB, Celentano DD, Reed ML (1992) Prevalence of migraine headache in the United States. Relation to age, income, race, and other sociodemographic factors. *JAMA* 1;267:64-69.
30. Aulchenko YS, Ripke S, Isaacs A & van Duijn CM (2007) GenABEL: an R library for genome-wide association analysis. *Bioinformatics* 23(10), 1294-1296.
31. van Haagen HH, 't Hoen PA, Botelho Bovo A, de Morrée A et al (2009) Novel protein-protein interactions inferred from literature context. *PLoS One* 18;4(11):e7894.
32. Soragna D, Vettori A, Carraro G, Marchioni E et al (2003) A locus for migraine without aura maps on chromosome 14q21.2-q22.3. *Am J Hum Genet* 72(1):161-167.
33. Russo L, Mariotti P, Sangiorgi E, Giordano T et al (2005) A new susceptibility locus for migraine with aura in the 15q11-q13 genomic region containing three GABA-A receptor genes. *Am J Hum Genet* 76(2):327-333.
34. Anttila V, Kallela M, Oswell G, Kaunisto MA et al (2006) Trait components provide tools to dissect the genetic susceptibility of migraine. *Am J Hum Genet* 79:85-99.
35. Henneman P, Aulchenko YS, Frants RR, Zorkoltseva IV et al (2010) The genetic architecture of plasma adiponectin overlaps with the genetics of metabolic syndrome related traits. *Diabetes Care* Jan 12. [Epub ahead of print]
36. Dupuis J, Langenberg C, Prokopenko I, Saxena R et al (2010) New genetic loci implicated in fasting glucose homeostasis and their impact on type 2 diabetes risk. *Nat Genet* 42(2):105-116.
37. Jen JC, Wan J, Palos TP, Howard BD, Baloh RW (2005) Mutation in the glutamate

- transporter EAAT1 causes episodic ataxia, hemiplegia, and seizures. *Neurology* 65(4):529-534.
38. Cavalleri GL, Weale ME, Shianna KV, Singh R et al (2007) Multicentre search for genetic susceptibility loci in sporadic epilepsy syndrome and seizure types: a case-control study. *Lancet Neurol* 6(11):970-80.
39. Garbern JY, Neumann M, Trojanowski JQ, Lee VM et al. (2010) A mutation affecting the sodium/proton exchanger, SLC9A6, causes mental retardation with tau deposition. *Brain* 133:1391-402. Epub 2010 Apr 15.
40. Pezet S, McMahon SB (2006) Neurotrophins: mediators and modulators of pain. *Annu Rev Neurosci.* 29:507-538.
41. Woolf CJ (1994) A new strategy for the treatment of inflammatory pain. Prevention or elimination of central sensitization. *Drugs* 47 Suppl 5:1-9; discussion 46-7
42. Bigal ME, Ashina S, Burstein R, Reed ML et al; AMPP Group (2008) Prevalence and characteristics of allodynia in headache sufferers: a population study. *Neurology* 70:1525-1533.
43. Sarchielli P, Alberti A, Floridi A & Gallai V (2001). Levels of nerve growth factor in cerebrospinal fluid of chronic daily headache patients. *Neurology* 57(1), 132-134.
44. Blandini F, Rinaldi L, Tassorelli C, Sances G et al (2006). Peripheral levels of BDNF and NGF in primary headaches. *Cephalalgia* 26(2), 136-142.
45. Nyholt DR, LaForge KS, Kallela M, Alakurtti K et al (2008) A high-density association screen of 155 ion transport genes for involvement with common migraine. *Hum Mol Genet* 17:3318-3331.
46. Todt U, Dichgans M, Jurkat-Rott K, Heinze A et al (2005). Rare missense variants in ATP1A2 in families with clustering of common forms of migraine. *Hum Mutat* 26(4), 315-321.
47. Ligthart L, Nyholt DR, Hottenga JJ, Distel MA et al (2008). A genome-wide linkage scan provides evidence for both new and previously reported loci influencing common migraine. *Am J Med Genet B Neuropsychiatr Genet* 147B(7), 1186-1195.
48. Scher AI, Terwindt GM, Verschuren WM, Kruit MC et al (2006) Migraine and MTHFR C677T genotype in a population-based sample. *Ann Neurol* 59:372-375.
49. Rubino E, Ferrero M, Rainero I, Binello E et al (2009) Association of the C677T polymorphism in the MTHFR gene with migraine: a meta-analysis. *Cephalalgia* 29(8):818-825.





---

# 7.0

## **RNA expression profiles of familial hemiplegic migraine type 1 mouse models with relevance to migraine-associated cerebellar ataxia**

---

B. de Vries, MSc<sup>1</sup>, L.A.M. Broos, BSc<sup>1</sup>, P.A.C. 't Hoen, PhD<sup>1</sup>, S.C. Koelewijn, BSc<sup>1</sup>, B. Todorov, MSc<sup>1</sup>, M.D. Ferrari, MD, PhD<sup>2</sup>, J.M. Boer, PhD<sup>1</sup>, R.R. Frants, PhD<sup>1</sup>, A.M.J.M. van den Maagdenberg, PhD<sup>1,2</sup>

<sup>1</sup>*Department of Human Genetics, Leiden University Medical Centre, Leiden, The Netherlands*

<sup>2</sup>*Department of Neurology, Leiden University Medical Centre, Leiden, The Netherlands*

**Manuscript in preparation**

---

## Abstract

The *CACNA1A* gene encodes the  $\alpha_1$  subunit of voltage-gated  $\text{Ca}_v2.1$  calcium channels. Several mutations in *CACNA1A* are associated with familial hemiplegic migraine (FHM), a rare monogenic subtype of migraine with aura that can be accompanied by cerebellar ataxia and/or epilepsy. Two extremes of the FHM clinical spectrum are seen with missense mutations R192Q and S218L. Whereas patients with the R192Q mutation suffer from pure FHM without additional neurological features, S218L patients show a particularly severe phenotype with FHM, cerebellar ataxia, seizures, and brain edema after a mild head trauma. Recently, transgenic knock-in (KI) *Cacna1a* mouse models were generated that carry either the R192Q or the S218L mutation. Here we investigated their RNA expression profiles under basal conditions in the occipital cortex and the cerebellum because of their relevance to the aura and ataxia, respectively. Expression differences were most pronounced in the cerebellum of S218L mice and could be linked to their ataxic phenotype, qPCR was used to validate these results. Remarkably, tyrosine hydroxylase, a marker of delayed cerebellar maturation, is strongly up-regulated in the cerebellum of S218L mice, which was confirmed by immunohistochemistry. In addition, neuronal pathways, such as neurotransmitter synthesis pathways are up-regulated in the cerebellum of S218L mice. In contrast, only modest differences in expression profiles were observed in the cortex of both KI mice, despite pronounced consequences at the molecular and neurobiological level. Our findings indicate that the migraine-associated phenotype cerebellar ataxia is reflected in the basal RNA expression profiles.

## Introduction

Familial hemiplegic migraine (FHM) is a rare Mendelian subtype of migraine with aura that is characterized by transient hemiparesis during the aura phase.<sup>1</sup> FHM is considered a relevant model for the common forms of migraine, because, (i) apart from the hemiparesis, the aura and headache features are identical to those in non-hemiplegic migraine types<sup>2</sup>, and (ii) many patients also have non-hemiplegic migraine attacks.<sup>3-5</sup> Three FHM genes have been identified that all encode subunits of ion transporters.<sup>6</sup> The FHM1 gene, *CACNA1A*, encodes the pore-forming  $\alpha_1$  subunit of voltage-gated  $\text{Ca}_v2.1$  calcium channels that are located mainly at presynaptic terminals throughout the central nervous system where they regulate neurotransmitter release.<sup>7</sup>  $\text{Ca}_v2.1$  channels are expressed throughout the brain, but are particularly high expressed in the cerebellum.<sup>8</sup> FHM1 mutations can be associated with pure FHM, such as in R192Q mutation carriers<sup>9</sup>, or can be complex and severe with FHM and associated cerebellar ataxia, seizures, mild head trauma-induced cerebral edema, and even fatal coma, in patients with the S218L mutation.<sup>10,11</sup>

The migraine aura is caused by cortical spreading depression (CSD), a wave of neuronal and glial cell depolarization that originates in the occipital cortex and slowly propagates over the brain cortex.<sup>17,13</sup> The headache phase likely results from an activation of the trigeminovascular system (TGVS)<sup>14</sup>, a system that consists of the neurons innervating the cerebral vessels. In animal studies, CSD was shown to activate the TGVS and thereby headache mechanisms.<sup>15</sup> Of the associated neurological phenotypes, the cause of cerebellar ataxia is most clear. Evidence from natural *Cacna1a* mouse mutants revealed that an irregularity in the firing of cerebellar Purkinje cell neurons is the likely underlying cause.<sup>16,17</sup> Notably, subclinical cerebellar signs were observed in migraine patients and found more pronounced in migraine with aura than in migraine without aura.<sup>18</sup>

To investigate the neurobiological consequences of FHM1 mutations, transgenic *Cacna1a* knock-in (KI) mouse models were generated that either carry the FHM1 R192Q or the S218L mutation.<sup>19,20</sup> Whereas S218L KI mice show a similar, complex, phenotype as S218L patients, the R192Q KI mice do not exhibit an overt behavioral phenotype. At the neurobiological level, however, both KI mouse mutants show multiple *gain-of-function* effects, such as an increased neuronal calcium influx, increased neurotransmitter release, and enhanced susceptibility to cortical spreading depression (CSD); all of which are more pronounced in S218L mice.<sup>19-21</sup> Here we investigated the RNA expression profiles in the occipital cortex (the origin of CSD and the aura) and the cerebellum (the origin of the ataxia) to investigate whether molecular changes are associated with the pathophysiology of at least some of the migraine-associated clinical features. Expression profiles were shown to be remarkably stable, and specific differences in gene expression were demonstrated that could be linked to ataxia-relevant pathways.

## Materials and Methods

### *Animals*

Transgenic knock-in (KI) mice were generated by gene targeting of the *Cacna1a* gene that carry either the human FHM1 R192Q or S218L mutation, in which the neomycin selection cassette was removed by *in vivo* deletion by crossing the KI mice with Cre deleter mice.<sup>19,20</sup> Homozygous KI mice and wild-type mice of both genders aged 7-10 weeks were used. KI mice were backcrossed with C57BL/6J for five (R192Q) and for three (S218L) generations. Each group consisted of six mice (biological replicates), unless mentioned otherwise (Table 1). Confirmatory genotyping was performed by PCR analysis on genomic DNA from tail biopsies. Animal care and procedures were approved by the local ethical committee according to national guidelines.

**Table 1** *Experimental groups of mice*

<b>Genotype</b>	<b>Brain structure</b>	<b>Gender (n)</b>
Wild-type mice	Cerebellum	Male (6)
		Female (6)
	Occipital cortex	Male (6)
		Female (6)
S218L knock-in mice	Cerebellum	Male (6)
		Female (5)
	Occipital cortex	Male (6)
		Female (5)
R192Q knock-in mice	Cerebellum	Male (6)
	Occipital cortex	Male (n=6)

### *Dissections of brain structures*

Animals were sacrificed by cervical dislocation and brains were rapidly removed from the skull. Brain material was dissected and snap-frozen in liquid nitrogen within 15 minutes and stored at -80°C until RNA isolation. Brain material was dissected in nine parts: the cerebellum (in two halves), both hemispheres of the cortex (with each hemisphere further dissected in three parts, one containing the occipital cortex), and the brainstem.

### *RNA isolation*

The right half of the cerebellum and the occipital third of the right cortex were chosen for expression profiling. For total RNA isolation, the Macherey Nagel RNA isolation kit (Düren, Germany) was used in combination with an Ultra-turrax T25 Polytron (Janke & Kunkel, Staufen, Germany) mechanical homogenizer. In brief, frozen tissue was crunched using a mortar under liquid nitrogen. Subsequently, tissue was homogenized in lysis buffer using the Polytron. Total RNA was bound to silica membrane of Macherey Nagel columns, while contaminating DNA was removed by rDNase. At the end of the procedure, total RNA was eluted with RNase-free water. RNA integrity was determined using the Agilent 2100 Bioanalyzer total RNA nano chips (Agilent, Foster City, USA, CA). All RNA samples that were included in the study had a minimal RIN (RNA integrity number) value of 7.0.

### *Gene expression profiling using Illumina microarrays*

Biotin-labelled cRNA was produced using a linear amplification kit (IL1791; Ambion, Austin, USA, TX) using 300 ng of total RNA as input. cRNA samples were hybridized on Illumina mouse-6 Bead Chips, which contain 44,505 probe IDs. Chip hybridizations, washing, Cy3-streptavidin (Amersham Biosciences, Uppsala, Sweden) staining, and scanning were performed on an Illumina Bead Station 500 platform (San Diego, <http://www.illumina.com>) using reagents and protocols supplied by the manufacturer.

### *Gene expression profile data analysis*

Resulting data files were loaded into Rosetta Resolver version 7.2 (Rosetta Biosoftware, Seattle, WA). Raw data were normalized using the standard Rosetta error model for Illumina arrays. Differences in gene expression between groups were evaluated using an error-weighted two-way analysis of variance with genotype and gender as factors and Benjamini-Hochberg FDR was used for multiple testing corrections (FDR,  $P < 0.05$ ). Post-hoc analysis was performed using Tukey-Kramer (FDR,  $P < 0.05$ ). Cerebellum and occipital cortex profiles were analyzed separately. A 'cortical' signature representing genes that are differently expressed in the cortex of both mutant mice was selected based on ANOVA statistics and post-hoc analysis. Genes with a significant ANOVA  $P$ -value for the parameter genotype, and that based on the post-hoc analysis were differently expressed between mutant mice (both S218L and R192Q) and wild-type mice were selected. Similarly, an 'ataxia' signature was created that represents genes that were differently expressed in the cerebellum of the S218L mice. Using the Ontologizer program (<http://compbio.charite.de/index.php/ontologizer2.html>) function labels were ascribed to each gene. Genes were grouped into categories according to these function labels to determine over- or underrepresentation of certain categories. These over- or underrepresentation analyses were only performed on gene sets containing over 100 genes.

### *Literature-based relationships*

Literature-based relationships between genes in the specific gene sets and migraine were studied using the Anni text-mining program (Anni version 2.1).<sup>22</sup> For each gene or disorder a concept profile was generated by the program. A concept profile is a summary of all concepts directly co-mentioned with the disease or gene concept (i.e. the main concept) in PubMed abstracts. The strength of association for each concept with the main concept is calculated using 2x2 contingency tables and the uncertainty coefficient. The association between two concept profiles is calculated using vector based matching (e.g. inner product score) over the concepts that the two profiles have in common.

### *Quantitative RT-PCR*

The same RNA samples were used for evaluation of microarray results by quantitative PCR (qPCR). Genes that were selected for qPCR had a fold-change of at least 1.3 and detectable expression levels. First-strand cDNA was synthesized using random hexamer primers. Subsequently, qPCRs were performed on the MyiQ™ Single-Color Real-Time PCR Detection System (Bio-Rad, Hercules, USA, CA) using gene-specific primers (Supplemental Table 1). cDNAs were analyzed in duplicate, after which the average cycle threshold (Ct) was calculated per sample. To correct for input differences between mutant and wild-type samples, Ct values were corrected per tissue for the differences in housekeeping gene *Gapdh* expression. Differential expression was calculated using Student's  $t$ -test.

---

### *Immunohistochemistry of tyrosine hydroxylase*

Mice were anaesthetized with Nembutal (50 mg/kg, i.p.) and perfused intracardially with phosphate buffered saline (PBS) followed by 4% paraformaldehyde in 0.1 M phosphate buffer (pH 7.4). Post-fixation was performed for 2 h in 4% buffered paraformaldehyde followed by overnight incubation in 10% sucrose in 0.1 M phosphate buffer at 4°C. Next, tissue was embedded in 10% sucrose with 11% gelatin, fixed with 30% sucrose in 4% buffered paraformaldehyde for 2.5 h at room temperature, followed by overnight incubation in 30% sucrose in 0.1 M phosphate at 4 °C. Tissue was cut into 40 µm sagittal sections and processed for free-floating immunohistochemistry. Briefly, sections were incubated in 10% heat-inactivated normal horse serum, 0.5% Triton X100 in Tris-buffered saline (TBS) for 2 h and then incubated with primary rabbit anti-tyrosine hydroxylase antibody (AB152, 1:2,000; Chemicon, Temecula, USA, CA), diluted in TBS containing 1% normal horse serum, 0.4% Triton X100 at 4 °C. Secondary biotin-labeled goat anti-rabbit antibody (1:200; Vector Laboratories, Burlingame, USA, CA) incubation was performed for 2 h at room temperature. Finally, for detection, sections were incubated with the avidin-biotin kit (Vector Laboratories) for 2 h at room temperature, washed, and developed in 0.1 mg/ml diaminobenzidine with 0.005% H<sub>2</sub>O<sub>2</sub>.

### *Single Nucleotide Polymorphism analysis*

Using the Mouse Genome Informatics (MGI) database (<http://www.informatics.jax.org/>), SNPs surrounding the *Cacna1a* locus on mouse chromosome 8 were selected that could distinguish C57BL/6J- and 129/Ola-derived sequences. Using genomic tail DNA, SNP genotypes for all mutant mice that were included in the study were determined by standard PCR combined with direct sequencing.

## **Results**

Here we studied RNA expression profiles of cerebellar and occipital cortex tissue of two *Cacna1a* KI mouse models of migraine. In line with data from previous studies that revealed similar Ca<sub>v</sub>2.1 α1 protein expression levels between genotypes<sup>19,20</sup>, *Cacna1a* RNA expression levels were similar between genotypes, except for an apparent down-regulation of *Cacna1a* (Fold change -1.25; *P* = 0.01) in cerebellum of R192Q mice (Table 2). No other meaningful genotypic differences were detected in gene expression levels of Ca<sub>v</sub> auxiliary subunits (i.e., β1-4, γ1-8 and α2δ1-3), except for minor differences in *Cacnb1*, *Cacnb3* and *Cacnb4* and in *Cacng7* in the occipital cortex of S218L mice (Supplementary Table 2).

**Table 2** Expression levels of genes encoding pore-forming subunits of  $Ca_v$  channels

Gene	Cerebellum		Occipital cortex	
	R192Q	S218L	R192Q	S218L
Cacna1a	-1.29 (0.02)*	-1.13 (0.19)	-1.24 (0.06)	-1.11 (0.37)
Cacna1b	-1.06 (0.27)	1.01 (0.90)	-1.08 (0.28)	1.00 (0.97)
Cacna1c	-1.13 (0.08)	-1.04 (0.60)	-1.04 (0.62)	-1.08 (0.38)
Cacna1d	-1.05 (0.67)	1.21 (0.09)	-1.04 (0.86)	-1.01 (0.94)
Cacna1e	1.01 (0.96)	-1.11 (0.50)	-1.12 (0.52)	-1.03 (0.85)
Cacna1f	1.06 (0.62)	-1.03 (0.76)	-1.08 (0.56)	1.06 (0.71)
Cacna1g	-1.05 (0.57)	-1.08 (0.27)	-1.03 (0.93)	1.12 (0.69)
Cacna1h	1.02 (0.84)	1.42 (0.004)*	1.03 (0.74)	1.07 (0.48)
Cacna1i	1.02 (0.80)	-1.01 (0.81)	-1.07 (0.36)	-1.01 (0.82)
Cacna1s	1.18 (0.09)	1.06 (0.52)	-1.09 (0.36)	1.03 (0.82)

Numbers represent the mean fold-change for each gene transcript seen in the respective mutant mice compared to wild-type mice; P-value for this fold change is indicated between the brackets. \*Fold-change with a  $P < 0.05$ .

To further assess gene expression profiles in *Cacna1a* KI and wild-type mice, a two-way ANOVA was performed for cerebellum and cortex separately, with genotype and gender as factors. The effect of gender was not remarkable. In the cerebellum, only 16 genes were significantly differentially expressed between males and females; for the occipital cortex only 10 genes were significantly differentially expressed. For both the cerebellum and occipital cortex, a large portion of significantly differentially expressed genes (DEGs) between genotypes are located on chromosome 8, which contains the *Cacna1a* gene that was modified by gene targeting. Although KI mice and wild-type mice were backcrossed with C57BL/6J for several generations, the region directly flanking the *Cacna1a* gene remained of 129 genetic background. It is therefore unclear whether the ‘chromosome 8 genes’ are differently expressed because of the presence of an FHM1 mutation or a different genetic background.<sup>23</sup> To investigate this further, we determined the genomic boundaries of 129-derived chromosome 8 regions in the FHM1 mice. The 129-derived region flanking the *Cacna1a* gene extended maximally 37 Mb upstream to 46 Mb downstream of the R192Q mutation and 37 Mb upstream and 52 Mb downstream of the S218L mutation. As the 129-derived region covered most of chromosome 8 in at least some of the mice, we decided to exclude all genes located on chromosome 8 from the gene signatures used for subsequent analyses.

After chromosome 8 exclusion, only 22 DEGs remained for the occipital cortex of R192Q KI mice. For S218L KI mice, only 10 genes were differentially expressed in the occipital cortex. Notably, without chromosome 8 exclusion 61 and 67 DEGs were observed for R192Q KI and S218L KI mice, respectively. However, in the cerebellum, the number of DEGs after chromosome 8 exclusion was

considerably higher: 82 for R192Q KI and 335 for S218L KI mice. We believe that the relatively low number of DEGs is not due to lack of power, given the fact that our experiment easily picked up genes from the chromosome 8 region with relatively subtle changes in gene expression.

Because the occipital cortex is most relevant for the observed increased susceptibility to cortical spreading depression (CSD) in KI mice, we selected a ‘cortical’ gene signature by selecting genes that were differentially expressed in the occipital cortex of both mutant mice models (figure 1A). Notably, nine out of 10 DEGs were differentially expressed in both strains of mutant mice (Table 3); all showing only modest fold-changes. Six genes (i.e., *Lsm10*, *Gpr34*, *Gpr23*, *Ctxn3*, *Gli3* and *Tnnc1*) were up-regulated in both strains, whereas one gene (*Cort*) was up-regulated in one and down-regulated in the other; two genes (i.e., *Camkk1* and *Tom1l2*) were down-regulated in both strains.

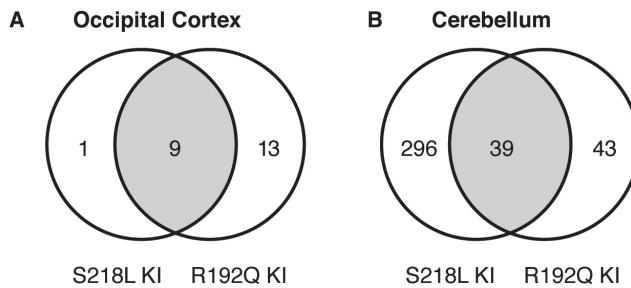

**Figure 1 A.** Differentially expressed genes in the occipital cortex of mutant KI mice. Only nine genes are differentially expressed in the occipital cortex of both KI mouse models (‘cortical’ signature). **B** Differentially expressed genes in cerebellum. No less than 296 genes are differentially expressed in the cerebellum of S218L KI mice compared to R192Q KI and wild-type mice (‘ataxia’ signature).

**Table 3** Genes that are differentially expressed in the occipital cortex of both R192Q and S218L mice (‘cortical’ signature)

Genes	Description	P-value ANOVA (parameter genotype)	Fold change (S218L vs wild-type)	Fold change (R192Q vs wild-type)
<i>Camkk1</i>	calcium/calmodulin-dependent protein kinase kinase 1, alpha	$3.80 \times 10^{-6}$	-1.06 (0.05)	-1.29 ( $4.04 \times 10^{-16}$ )
<i>Cort</i>	Cortistatin	0.01	-1.17 (0.02)	1.19 ( $3.1 \times 10^{-3}$ )
<i>Ctxn3</i>	cortixin 3	$8.33 \times 10^{-3}$	1.25 ( $2.1 \times 10^{-4}$ )	1.35 ( $2.20 \times 10^{-8}$ )
<i>Gli3</i>	GLI-Kruppel family member GLI3	0.03	1.16 ( $2.4 \times 10^{-3}$ )	1.28 ( $2.1 \times 10^{-4}$ )
<i>Gpr23</i>	G protein-coupled receptor 23	0.04	1.26 ( $1.1 \times 10^{-3}$ )	1.38 ( $5.51 \times 10^{-6}$ )
<i>Gpr34</i>	G protein-coupled receptor 34	$6.08 \times 10^{-8}$	1.34 ( $5.5 \times 10^{-10}$ )	1.43 ( $9.44 \times 10^{-12}$ )
<i>Lsm10</i>	U7 snRNP-specific Sm-like protein	0.03	1.12 ( $9.0 \times 10^{-4}$ )	1.16 ( $4.80 \times 10^{-4}$ )
<i>Tnnc1</i>	troponin C, cardiac/slow skeletal	0.03	1.19 (0.04)	1.45 ( $4.0 \times 10^{-5}$ )
<i>Tom1l2</i>	target of myb1-like 2 (chicken)	$2.53 \times 10^{-3}$	-1.47 ( $2.0 \times 10^{-5}$ )	-1.53 ( $1.33 \times 10^{-7}$ )

Numbers represent the mean fold-change for each gene transcript seen in the respective mutant mice compared wild-type mice. The numbers in brackets represent the P-value for the respective fold change.



Also for the cerebellum, from which the cerebellar ataxia originates, we extracted a signature (i.e., 'ataxia' gene signature) containing genes that were differentially expressed in the cerebellum of S218L KI mice (compared to R192Q KI and wild-type mice). The 'ataxia' signature contained 296 genes (Figure 1B). Using the Ontologizer program, a GO term analysis was performed for under- or over-representation of functional categories and yielded significant overrepresentation of four biological processes GO terms (Table 4). All four were related to neurotransmitter synthesis. Subsequently, qPCR analyses were performed for five DEGs from these pathways and essentially confirmed the findings of the microarray experiments (Figure 2). Using the Anni text-mining program we investigated possible literature-based relationships between the term ataxia and the genes in the 'ataxia' gene signature. The *Ppp2r2b* gene, encoding brain-specific regulatory subunit of the protein phosphatase PP2A, and the *Gfap* gene, encoding glial fibrillary acidic protein, showed most obvious literature-based relationships with ataxia. *Ppp2r2b* and *Gfap* were both upregulated in the cerebellum of the S218L KI mice with a fold-change of 1.2 ( $P = 6.4 \times 10^{-4}$ ) and 1.6 ( $P = 2.9 \times 10^{-4}$ ), respectively.

**Table 4** Pathways that were significantly overrepresented in the 'ataxia' gene signature ( $P < 0.05$  after Benjamini-Hochberg correction for multiple testing)

Gene Symbol	Gene Description	Fold change ( $P$ -value)
<b>G0:0042401 biogenic amine biosynthetic process</b>		
<i>Agmat</i>	Agmatine ureohydrolase (agmatinase)	2.71 ( $4.27 \times 10^{-9}$ )
<i>Ddc</i>	Dopa decarboxylase	1.26 ( $7.60 \times 10^{-4}$ )
<i>Hdc</i>	Histidine decarboxylase	-1.92 ( $4.73 \times 10^{-7}$ )
<i>Th</i>	Tyrosine hydroxylase	13.12 ( $3.92 \times 10^{-20}$ )
<i>Tph2</i>	Tryptophan hydroxylase 2	1.58 ( $6.90 \times 10^{-4}$ )
<b>G0:0042398 amino acid derivative biosynthetic process</b>		
<i>Agmat</i>	Agmatine ureohydrolase (agmatinase)	2.71 ( $4.27 \times 10^{-9}$ )
<i>Ddc</i>	Dopa decarboxylase	1.26 ( $7.60 \times 10^{-4}$ )
<i>Hdc</i>	Histidine decarboxylase	-1.92 ( $4.73 \times 10^{-7}$ )
<i>Th</i>	Tyrosine hydroxylase	13.12 ( $3.92 \times 10^{-20}$ )
<i>Tph2</i>	Tryptophan hydroxylase 2	1.58 ( $6.90 \times 10^{-4}$ )
<b>G0:0042423 catecholamine biosynthetic process</b>		
<i>Ddc</i>	Dopa decarboxylase	1.26 ( $7.60 \times 10^{-4}$ )
<i>Hdc</i>	Histidine decarboxylase	-1.92 ( $4.73 \times 10^{-7}$ )
<i>Th</i>	Tyrosine hydroxylase	13.12 ( $3.92 \times 10^{-20}$ )
<b>G0:0042136 neurotransmitter biosynthetic process</b>		
<i>Gad2</i>	Glutamic acid decarboxylase 2	1.20 ( $2.00 \times 10^{-5}$ )
<i>Th</i>	Tyrosine hydroxylase	13.12 ( $3.92 \times 10^{-20}$ )
<i>Tph2</i>	Tryptophan hydroxylase 2	1.58 ( $6.90 \times 10^{-4}$ )

Output generated using Ontologizer program

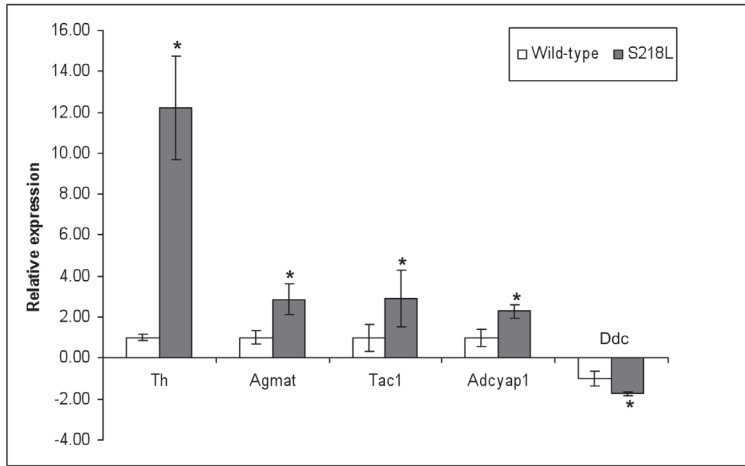

**Figure 2.** Quantitative PCR analysis of genes altered in the cerebellum of S218L mice. Data are expressed as fold changes (means  $\pm$  SD), normalized to *Gapdh* mRNA expression, where the values for wild-type mice were set at 1.00 or -1.00. \*  $P < 0.05$  compared to the wild-type mice.

The most striking fold-change in the ‘ataxia’ gene signature was seen for tyrosine hydroxylase (*Th*) (fold-change 13.1;  $P = 3.92 \times 10^{-20}$ ). *Th* up-regulation was also observed at the protein level, as evidenced by strong immunoreactivity in a considerable number of Purkinje cells specifically in the cerebellum of S218L mice (Figure 3).

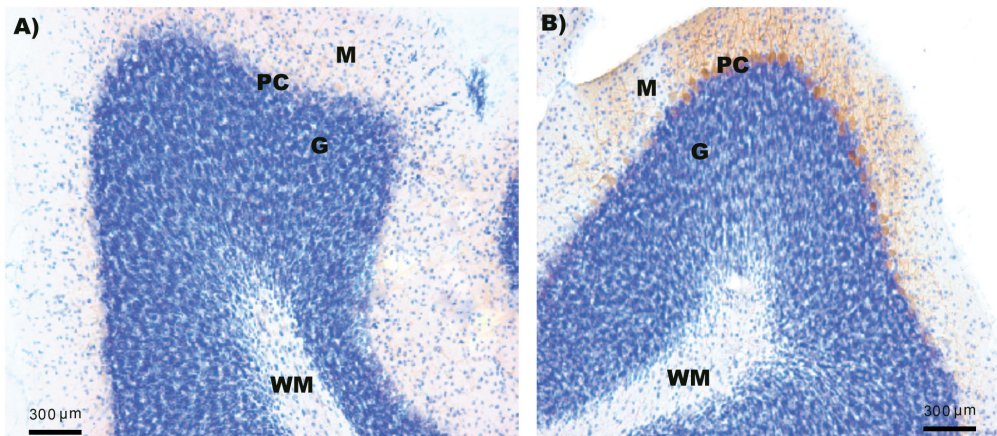

**Figure 3.** Protein expression of tyrosine hydroxylase (*Th*) in the cerebellum. Immunohistochemistry using *Th*-specific antibody (brown signal). Some Purkinje cells stain positive in the S218L mutant. Left panel: wild-type, right panel: S218L. M: molecular layer, PC: Purkinje cell layer, G: Granule cell layer, WM: white matter.

## Discussion

Here we performed the first gene expression study in transgenic KI mouse models carrying human pathogenic FHM1 mutations R192Q and S218L in an attempt to increase our insight in the molecular consequences of these mutations in migraine pathophysiology.

Despite considerable insight in the pathophysiology of migraine attacks, it is still largely unknown how attacks begin and to what extent the migraine brain is different from a healthy brain. Therefore, we studied RNA expression profiles of brains of migraine mouse models under basal conditions. We investigated the third most caudal part of the cortex (that includes the visual cortex) because CSD, the electrophysiological substrate of the migraine aura, originates in this area of the cortex.<sup>13</sup> In addition, we studied the cerebellum because cerebellar ataxia originates from this area of the brain and cerebellar ataxia is a prominent part of the phenotype of S218L mice.

In line with earlier studies on these mouse models that revealed unchanged numbers of functional Ca<sub>v</sub>2.1 channels at the plasma membrane<sup>19,20</sup>, mRNA expression levels of the mutated *Cacna1a* gene were relatively similar between genotypes. Therefore, FHM1 mutations do not seem to affect this gene at the RNA level. Similarly, no clear changes in gene expression levels were observed for other subunits of Ca<sub>v</sub> channels. Consequently, we postulate that the clinical features seen in mice and patients with FHM1 gene mutations are likely more the result of changed functionality of Ca<sub>v</sub>2.1 channels, perhaps in combination with changes in downstream targets of these channels.

As both KI mutants were generated on a mixed C57BL/6J x 129SvEv genetic background<sup>19,20</sup>, despite being back-crossed to C57BL/6J for several generations, one should take into account that gene sequences on chromosome 8 that flank the mutated *Cacna1a* gene are still of 129 origin. Valor and Grant have shown that remnant 129 sequences may lead to gene expression differences because of mixed genetic differences at this location.<sup>23</sup> Indeed, when comparing expression profiles from mutant KI and wild-type mice, we observed a much higher than expected frequency of DEGs located in close proximity of the mutated *Cacna1a* gene. Unlike what was reported in their study, no selection cassette, which is known to profoundly affect expression of neighbouring genes, was present in our mice. Therefore, in our study it is more likely that gene expression differences are the direct consequence of subtle differences in genetic background (i.e., 129Sv vs. Bl6). Although we do not have any evidence for it, we postulate that perhaps the presence of 32-bp LoxP sequences that are still present in the targeted locus, might have a cis-effect on gene expression of neighbouring genes.

---

Although molecular and electrophysiological studies have shown that neuronal excitability is increased in the KI mutants, we could show that this is not accompanied with prominent gene expression changes in the occipital cortex (at least under unchallenged conditions). In fact, only *nine* genes were differentially expressed in the cortex of mutant KI mice. In contrast, many expression differences were observed in the cerebellum of the mutant KI mice; especially in the cerebellum of the S218L mice. This may be expected since mice (and patients) with the S218L mutation suffer from cerebellar ataxia. GO term analysis with the S218L-specific 'ataxia' gene signature showed significant overrepresentation of genes belonging to pathways involved in neurotransmitter synthesis. Especially catecholamine neurotransmitter (i.e., dopamine and serotonin) pathways were differentially expressed.

In the S218L-specific 'ataxia' gene signature, the largest fold-change was observed for the tyrosine hydroxylase (*Th*) gene, which encodes the rate-limiting enzyme of the biosynthetic pathway of catecholamines, dopamine, norepinephrine and epinephrine.<sup>24</sup> Th overexpression was confirmed at the protein level with immunohistochemistry (Figure 3). Th is transiently expressed in the cerebellum during development, but absent (or very low expressed) in the cerebellum of adult mice.<sup>25</sup> Hence, Th expression in the adult cerebellum is considered a marker for delayed maturation of the cerebellum. Interestingly, also other ataxic mouse models with natural *Cacna1a* mutations (i.e., *Rolling Nagoya*, *Tottering*, and *Leaner*) show a high, persistent Th expression in the adult cerebellum.<sup>26-28</sup> However, as phosphorylation of several serine residues is absent in up-regulated Th in these mice, but important for Th activity<sup>29,30</sup>, it is unclear whether also Th function is abnormal in *Cacna1a* mutant mice. Notably, a recent expression profiling study in *Purkinje cell degeneration* mice, which are characterized by degeneration of cerebellar Purkinje cells and progressive ataxia, showed a 2-fold increase in expression of the *Th* gene.<sup>31</sup>

Several genes in the S218L-specific 'ataxia' gene signature can be linked to cerebellar ataxia relevant pathways. For example 5' non-coding CAG expansions in the *PPP2R2B* gene, which encodes a brain-specific regulatory subunit of the protein phosphatase PP2A holoenzyme, cause spinocerebellar ataxia type 12 (SCA12).<sup>32</sup> The repeat expansion leads to increased PPP2R2B expression<sup>33</sup>, similar to what was found in the cerebellum of the S218L KI mice. In addition, mutations in glial fibrillary acidic protein (GFAP) are associated with infantile and juvenile Alexander disease; a rare leukodystrophy of the cerebellum.<sup>34</sup> Gait ataxia is a common clinical feature in patients with adult-onset Alexander disease.<sup>35-37</sup>

In conclusion, the occipital cortex of the KI mouse models of migraine did not show prominent expression differences. The transcriptome of the occipital cortex in migraine mice was remarkably stable. This enables future profiling studies that aim to investigate the consequences on RNA expression of triggers relevant to migraine. On the other hand, certain differences in RNA expression profiles of the cerebellum of the S218L KI mice could be linked to ataxia.

### Acknowledgements

This work was supported by grants of the Netherlands Organization for Scientific Research (NWO) (Vici 918.56.602, M.D.F), the EU "EUROHEAD" grant (LSHM-CT-2004-504837; M.D.F, R.R.F, A.M.J.M.v.d.M) and the Centre of Medical Systems Biology (CMSB) established by the Netherlands Genomics Initiative/Netherlands Organisation for Scientific Research (NGI/NWO).

### References

1. Headache classification subcommittee of the international headache society. The international Classification of Headache Disorders. 2nd Edition. *Cephalalgia* 2004;24:1-160.
2. Thomsen LL, Eriksen MK, Roemer SF et al (2002) A population-based study of familial hemiplegic migraine suggests revised diagnostic criteria. *Brain* 125:1379-1391.
3. Terwindt GM, Ophoff RA, Haan J et al (1998) Variable clinical expression of mutations in the P/Q-type calcium channel gene in familial hemiplegic migraine. Dutch Migraine Genetics Research Group. *Neurology* 50:1105-1110.
4. Ducros A, Dernier C, Joutel A et al (2001) The clinical spectrum of familial hemiplegic migraine associated with mutations in a neuronal calcium channel. *N Engl J Med* 354:17-24.
5. Thomsen LL, Ostergaard E, Romer SF et al (2003) Sporadic hemiplegic migraine is an aetiologically heterogeneous disorder. *Cephalalgia* 23:921-928.
6. van den Maagdenberg AM, Haan J, Terwindt GM, Ferrari MD (2007) Migraine: gene mutations and functional consequences. *Curr Opin Neurol* 20:299-305.
7. Mintz IM, Sabatini BL, Regehr WG. Calcium control of transmitter release at a cerebellar synapse. *Neuron* 1995 15:675-688.
8. Craig PJ, McAinsh AD, McCormack AL et al (1998) Distribution of the voltage-dependent calcium channel alpha (1A) subunit throughout the mature rat brain and its relationship to neurotransmitter pathways. *J Comp Neurol* 27;397:251-267.
9. Ophoff RA, Terwindt GM, Vergouwe MN et al. Familial hemiplegic migraine

- 
- and episodic ataxia type-2 are caused by mutations in the Ca<sup>2+</sup> channel gene CACNL1A4. *Cell* 1996;87:543-552.
10. Kors EE, Terwindt GM, Vermeulen FL et al (2001) Delayed cerebral edema and fatal coma after minor head trauma: role of the CACNA1A calcium channel subunit gene and relationship with familial hemiplegic migraine. *Ann Neurol* 49:753-760.
  11. Stam AH, Luijckx GJ, Poll-The BT et al (2009) Early seizures and cerebral edema after trivial head trauma associated with the CACNA1A S218L mutation. *J Neurol Neurosurg Psychiatry*. 80(10):1125-1129.
  12. Leao, A.A.P. 1944. Spreading depression of activity in cerebral cortex. *J Neurophysiol* 7:359-390.
  13. Somjen, GG 2001. Mechanisms of spreading depression and hypoxic spreading depression-like depolarization. *Physiol Rev* 81:1065-1096.
  14. Messlinger K (2009) Migraine: where and how does the pain originate? *Exp Brain Res* 196:179-193.
  15. Bolay H, Reuter U, Dunn AK et al (2002) Intrinsic brain activity triggers trigeminal meningeal afferents in a migraine model. *Nat Med* 8:136-142.
  16. Hoebeek FE, Stahl JS, van Alphen AM, Schonewille et al (2005) Increased noise level of purkinje cell activities minimizes impact of their modulation during sensorimotor control. *Neuron* 24;45:953-965.
  17. Walter JT, Alviña K, Womack MD et al (2006) Decreases in the precision of Purkinje cell pacemaking cause cerebellar dysfunction and ataxia. *Nat Neurosci* 9:389-397.
  18. Sándor PS, Mascia A, Seidel et al (2001) Subclinical cerebellar impairment in the common types of migraine: a three-dimensional analysis of reaching movements. *Ann Neurol* 49(5):668-672.
  19. van den Maagdenberg AM, Pietrobon D, Pizzorusso T et al (2004) A Cacna1a knockin migraine mouse model with increased susceptibility to cortical spreading depression. *Neuron* 41:701-710.
  20. van den Maagdenberg AM, Pizzorusso T, Kaja S et al (2010) High CSD susceptibility and migraine-associated symptoms in CaV2.1 S218L mice *Ann Neurol* 67:85-98.
  21. Tottene A, Conti R, Fabbro A et al (2009) Enhanced excitatory transmission at cortical synapses as the basis for facilitated spreading depression in Ca(v)2.1 knockin migraine mice. *Neuron* 12:762-773.

22. van Haagen HH, 't Hoen PA, Botelho Bovo A, de Morrée A et al (2009) Novel protein-protein interactions inferred from literature context. *PLoS One* 18;4(11):e7894.
23. Valor LM, Grant SG. (2007) Clustered gene expression changes flank targeted gene loci in knockout mice. *PLoS ONE* 12;2(12):e1303.
24. Moy LY, Tsai LH (2004). Cyclin-dependent kinase 5 phosphorylates serine 31 of tyrosine hydroxylase and regulates its stability. *J Biol Chem* 279:54487-54493.
25. Jeong YG, Kim MK, Hawkes R (2001). Ectopic expression of tyrosine hydroxylase in Zebrin II immunoreactive Purkinje cells in the cerebellum of the ataxic mutant mouse, pogo. *Brain Res Dev Brain Res* 23:201-209.
26. Austin MC, Schultzberg M, Abbott LC et al (1992) Expression of tyrosine hydroxylase in cerebellar Purkinje neurons of the mutant tottering and leaner mouse. *Brain Res Mol Brain Res* 15:227-240.
27. Abbott LC, Isaacs KR, Heckroth JA (1996) Co-localization of tyrosine hydroxylase and zebrin II immunoreactivities in Purkinje cells of the mutant mice, tottering and tottering/leaner. *Neuroscience* 71:461-475.
28. Sawada K, Komatsu S, Haga H et al (1999) Abnormal expression of tyrosine hydroxylase immunoreactivity in Purkinje cells precedes the onset of ataxia in dilute-lethal mice. *Brain Res* 9;844:188-191.
29. Daubner SC, Lauriano C, Haycock JW, Fitzpatrick PF (1992) Site-directed mutagenesis of serine-40 of rat tyrosine hydroxylase, effects of dopamine and cAMP-dependent phosphorylation on enzyme activity. *J Biol Chem* 267:12639-12646.
30. Kaufman S (1995) Tyrosine hydroxylase. *Adv Enzymol Relat Areas Mol Biol* 70:103-220.
31. Ford GD, Ford BD, Steele EC (2008) Analysis of transcriptional profiles and functional clustering of global cerebellar gene expression in PCD3J mice. *Biochem Biophys Res Comm* 377:556-561.
32. Holmes S. E., O'Hearn E. E., McInnis M. G. et al (1999) Expansion of a novel CAG trinucleotide repeat in the 5' region of PPP2R2B is associated with SCA12. *Nat Genet* 23:391-392.
33. Sowell ER, Levitt J, Thompson PM et al (2000) Brain abnormalities in early-onset schizophrenia spectrum disorder observed with statistical parametric mapping of structural magnetic resonance images. *Am J Psychiatry* 157:1475-1484.

- 
34. Borrett D, Becker LE (1985) Alexander's disease: A disease of astrocytes. *Brain* 108:367-385.
35. Namekawa M, Takiyama Y, Aoki Y et al (2002) Identification of GFAP gene mutation in hereditary adult-onset Alexander's disease. *Ann Neurol* 52:779-785.
36. Brockmann K, Meins M, Taubert A et al (2003) A Novel GFAP Mutation and Disseminated White Matter Lesions: Adult Alexander Disease? *Eur Neurol* 50:100-105.
37. Kaneko H, Hirose M, Katada S et al (2009) Novel GFAP mutation in patient with adult-onset Alexander disease presenting with spastic ataxia. *Mov Disord* 15:1393-1395.



## Supplementary Tables

Supplemental Table 1. Primers used for qPCR

Gene symbol	Gene description	Primer sequence	Amplicon size
<i>Adcyap1</i>	Adenylate cyclase activating polypeptide 1	F 5'-TTTCCTAGACACCAATGACCA-3' R 5'-GACACTGCTATGCATTATTATCCC-3'	79 bp
<i>Agmat</i>	Agmatine ureohydrolase (agmatinase)	F 5'-TATGATCTCTCTGGTAACACAGC-3' R 5'-TCAGGAACACAGACTCAGAC-3'	101 bp
<i>Hdc</i>	Histidine decarboxylase	F 5'-GTCAAGGACAAGTACAAGCTG-3' R 5'-ATCTGCCAATGCATGAAGTC-3'	84 bp
<i>Tac1</i>	Tachykinin 1	F 5'-CAGCAGTTCTTTGGATTAATGG-3' R 5'-CTGGCCATGTCCATAAAGAG-3'	92 bp
<i>Th</i>	Tyrosine hydroxylase	F 5'-AGCCCTACCAAGATCAAACC-3' R 5'-GCATAGTCTCTGAGCTTGTC-3'	75 bp

Supplemental Table 2. Expression levels of genes encoding the auxiliary subunits of the Ca<sub>v</sub>2.1 channel in both tissues for both KI mice

Gene	Cerebellum		Occipital Cortex	
	R192Q <sup>a</sup>	S218L <sup>a</sup>	R192Q <sup>a</sup>	S218L <sup>a</sup>
<b>Genes encoding the auxiliary subunits</b>				
<i>Cacnb1</i>	1.19 (0.06)	1.28 (0.007)*	-1.16 (0.03)*	-1.02 (0.68)
<i>Cacnb2</i>	1.1 (0.51)	-1.09 (0.29)	1.15 (0.11)	1.01 (0.85)
<i>Cacnb3</i>	1.05 (0.43)	1.04 (0.70)	-1.28 (0.03)*	-1.09 (0.42)
<i>Cacnb4</i>	1.05 (0.55)	-1.09 (0.39)	1.08 (0.64)	-1.19 (0.08)
<i>Cacng1</i>	1.07 (0.43)	-1.02 (0.78)	1.16 (0.08)	1.08 (0.32)
<i>Cacng2</i>	-1.06 (0.25)	-1.02 (0.67)	1.02 (0.50)	-1.04 (0.31)
<i>Cacng3</i>	1.04 (0.54)	-1.12 (0.35)	1.02 (0.88)	-1.14 (0.18)
<i>Cacng4</i>	1.06 (0.47)	1.09 (0.48)	-1.10 (0.38)	1.12 (0.35)
<i>Cacng5</i>	1.06 (0.39)	1.10 (0.13)	-1.16 (0.12)	1.12 (0.17)
<i>Cacng6</i>	-1.09 (0.78)	-1.31 (0.44)	-1.16 (0.54)	-1.46 (0.07)
<i>Cacng7</i>	1.12 (0.44)	-1.12 (0.46)	-1.26 (0.26)	-1.39 (0.04)*
<i>Cacng8</i>	-1.03 (0.85)	1.21 (0.10)	-1.12 (0.46)	-1.03 (0.75)
<i>Cacna2d1</i>	1.04 (0.76)	-1.29 (0.12)	1.24 (0.22)	-1.01 (0.74)
<i>Cacna2d2</i>	1.01 (0.83)	1.11 (0.13)	1.10 (0.27)	1.02 (0.80)
<i>Cacna2d3</i>	-1.01 (0.92)	1.06 (0.25)	-1.05 (0.29)	-1.04 (0.33)
<i>Cacna2d4</i>	1.09 (0.41)	1.01 (0.92)	-1.00 (0.99)	1.02 (0.68)

<sup>a</sup>Fold change of respective mutant mice compared to wild-type mice, P-value for the respective fold change is indicated between brackets. \*Fold-change with a P < 0.05



---

# 8.0

## General Discussion

---

---

Migraine is an episodic neurovascular disorder that is characterized by severe headache, autonomic, and other neurological symptoms.<sup>1</sup> The identification and characterization of migraine genes and molecular pathways will help increase our knowledge of migraine pathophysiology. As the identification of genetic susceptibility factors for complex disorders is particularly challenging, this thesis also focused on alternative approaches to improve our insight in the molecular mechanisms of migraine. These approaches range from genetic and functional studies of gene mutations in rare monogenic migraine subtypes (e.g., hemiplegic migraine and other disorders with a high migraine prevalence) to genetic studies in a Dutch genetically isolated population, and gene expression studies in transgenic migraine mouse models.

### **8.1 Hemiplegic migraine: a monogenic form of migraine with aura**

#### *Genetic studies in FHM: genes encode ion transporters*

A successful approach to identify genes and unravel pathways for migraine has been the investigation of monogenic subtypes of the disease. The best example is Familial Hemiplegic Migraine (FHM), a rare form of migraine with aura. FHM can be considered a model for the common forms of migraine because the headache and aura features, apart from the hemiparesis, are identical<sup>2</sup> and two-thirds of FHM patients have, in addition to attacks of FHM, also attacks of common non-hemiplegic migraine.<sup>3</sup> Linkage studies in FHM families resulted in the identification of three FHM genes; *CACNA1A* (FHM1), *ATP1A2* (FHM2) and *SCN1A* (FHM3). The fact that not all FHM families are linked to one of these three known FHM loci implies that there are additional FHM genes.

The *CACNA1A* FHM1 gene encodes the  $\alpha_1$  subunit of  $Ca_v2.1$  channels.<sup>4</sup> Until now, 28 different FHM1 missense mutations have been described (figure 1). FHM1 mutations are associated with a broad spectrum of clinical features. Besides hemiplegic migraine, FHM1 patients can have cerebellar ataxia<sup>5-9</sup> and/or epilepsy.<sup>10,11</sup> FHM1 patients carrying the S218L mutation can have a particularly severe phenotype with attacks that can be triggered by mild head trauma and that in some cases may lead to fatal, cerebral edema and coma.<sup>12-15</sup> In **Chapter 2.1**, we report on a monozygotic twin pair with a novel *de novo* *CACNA1A* V1696L mutation. This mutation causes an overlap syndrome between FHM and alternating hemiplegic of childhood (AHC), a severe neurological childhood disorder that shares several clinical features with FHM. This study provided the first evidence that a mutation in the *CACNA1A* gene can cause an AHC/FHM overlap syndrome.

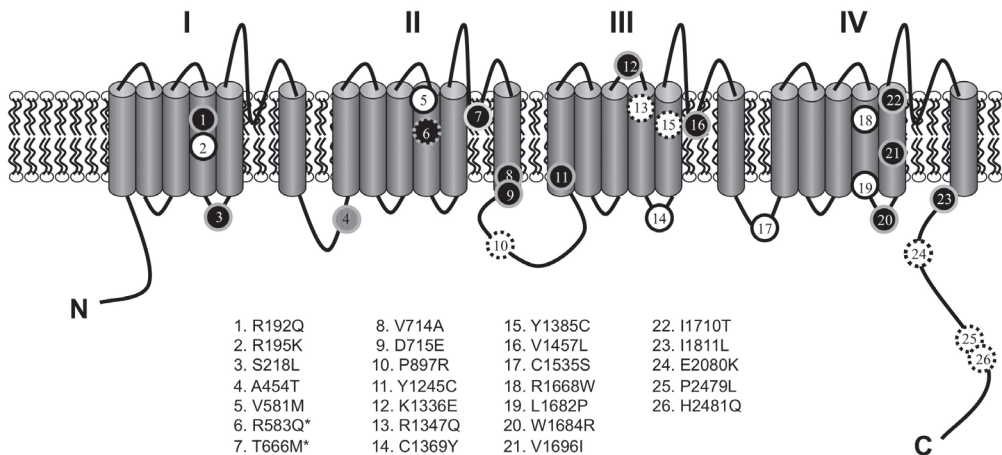

**Figure 1.** Mutations in the  $\alpha 1$  subunit of the voltage-gated  $\text{Ca}_{v}2.1$   $\text{Ca}^{2+}$  channel encoded by the FHM1 *CACNA1A* gene (Genbank Ac. nr. X99897). The protein is located in the plasma membrane and contains four repeated domains, each encompassing six transmembrane segments. Symbols: Circle with solid line = FHM, circle with dotted line = SHM. Asterisk = Mutation for which also SHM was reported, black circles mutation was tested for functional consequences, white circle mutation was not tested for functional consequences

The second FHM gene, *ATP1A2* (FHM2) encodes the  $\alpha 2$  subunit of sodium-potassium pumps.<sup>16</sup> To date many mutations in the *ATP1A2* gene have been described (Figure 2) and the vast majority is associated with pure FHM without additional clinical symptoms.<sup>16-20</sup> However, some are associated with FHM and cerebellar problems<sup>21</sup>, benign familial neonatal convulsions (BFIC)<sup>22</sup>, epilepsy<sup>18,23</sup>, or permanent mental retardation.<sup>18,24</sup> In **Chapter 2.2** we present a novel *ATP1A2* G855R mutation with functional consequences. Besides hemiplegic migraine, mutation carriers can also have febrile seizures. With this study, we further expanded the clinical spectrum associated with *ATP1A2* mutations. Also non-hemiplegic migraine phenotypes were found to be associated to some *ATP1A2* mutations, including basilar migraine<sup>25</sup> and even common migraine<sup>26</sup>, although causality has not been established for all mutations by testing their functional consequences.

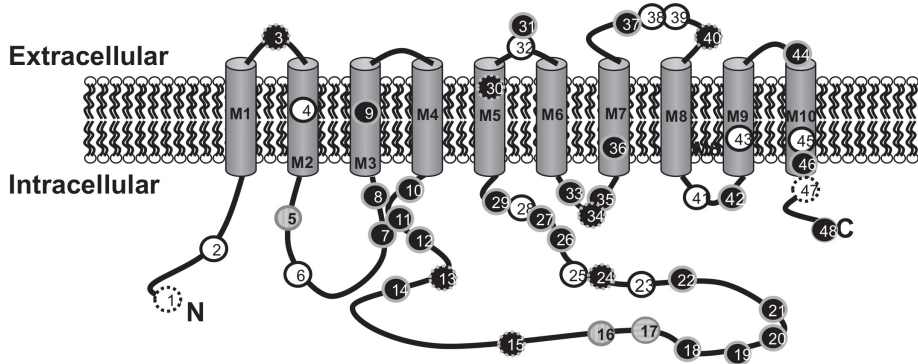

- |           |           |           |           |                      |
|-----------|-----------|-----------|-----------|----------------------|
| 1. Y9N    | 11. V362E | 21. V628M | 31. P796S | 41. 935K-940SdelinsI |
| 2. R65W   | 12. T376M | 22. R689Q | 32. P796R | 42. R937P            |
| 3. E120A  | 13. R383H | 23. E700K | 33. M829R | 43. S966fs           |
| 4. V138A  | 14. T415M | 24. N717K | 34. R834X | 44. P979L            |
| 5. E174K  | 15. E492K | 25. D718N | 35. R834Q | 45. D999H            |
| 6. R202Q  | 16. C515Y | 26. M731T | 36. G855R | 46. R1002Q           |
| 7. T263M  | 17. R548H | 27. R763H | 37. W887R | 47. Y1009X           |
| 8. I286T  | 18. R593W | 28. R763C | 38. G900R | 48. X1021R           |
| 9. G301R  | 19. A606T | 29. L764P | 39. E902K |                      |
| 10. T345A | 20. G615R | 30. P786L | 40. R908Q |                      |

**Figure 2.** Mutations in the  $\alpha 2$  subunit of the  $\text{Na}^+, \text{K}^+$  ATPase encoded by the *FHM2 ATP1A2* gene (Genbank Ac. nr. NM\_000702). The protein is located in the plasma membrane and contains ten transmembrane segments. Symbols: Circle with solid line = FHM, circle with dotted line = SHM, circle with horizontal striped pattern = basilar-type migraine, circle with vertical striped pattern = common migraine. Asterisk = mutation for which also SHM was reported, black circles = mutation was tested for functional consequences, white circle = mutation was not tested for functional consequences.

Finally, the *SCN1A* (FHM3) gene encodes the  $\alpha 1$  subunit of neuronal  $\text{Na}_v 1.1$  voltage-gated sodium channels.<sup>27</sup> The *SCN1A* gene is a well-known epilepsy gene with over 100 mutations that are associated with childhood epilepsy, i.e., severe myoclonic epilepsy of infancy (SMEI) or generalized epilepsy with febrile seizures (GEFS+).<sup>28,29</sup> Only five FHM3 mutations (Figure 3) have been identified. First confirmation of *SCN1A* as a migraine gene is described in **Chapter 2.3**. The *SCN1A* L1649Q mutation was identified in a Caucasian North American FHM family with ‘pure’ FHM, without cerebellar signs or epilepsy symptoms. The third FHM3 mutation was identified in a FHM family in which three out of five carriers of the L263V mutation had generalized tonic-clonic epileptic attacks, occurring independently from their hemiplegic migraine attacks.<sup>30</sup>

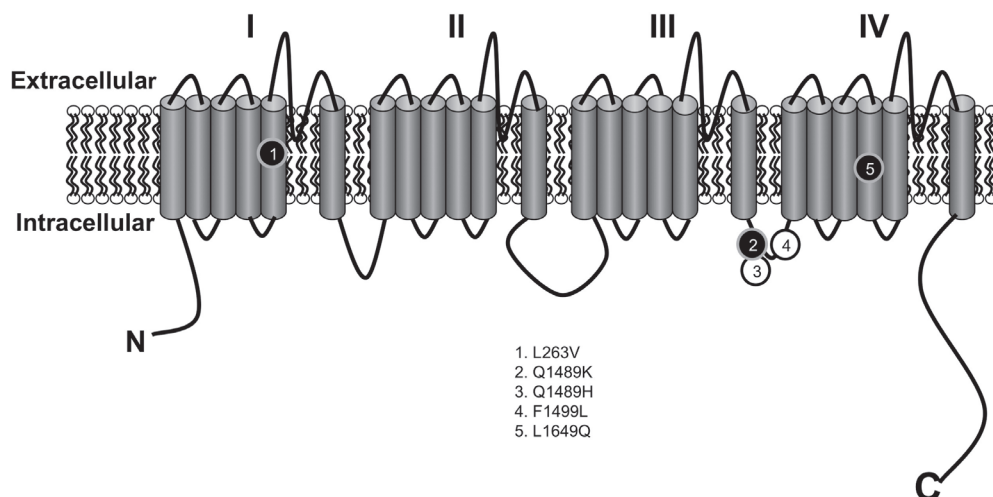

**Figure 3.** Mutations in the  $\alpha_1$  subunit of the voltage-gated  $\text{Na}_v1.1$   $\text{Na}^+$  channels encoded by the FHM3 *SCN1A* gene (Genbank Ac. nr. NM\_006920). The protein is located in the plasma membrane and contains four repeated domains. Symbols: Black circles = mutation was tested for functional consequences, white circle = mutation was not tested for functional consequences.

### Functional studies of FHM mutations

Functional consequences of FHM gene mutations have been studied in cellular and animal models. At the single channel level, FHM1 mutations were shown to cause opening of  $\text{Ca}_v2.1$  channels at more negative voltages and have an enhanced channel open probability, compared to normal channels.<sup>31-33</sup> These *gain-of-function* consequences predict an increased calcium influx and increased neurotransmission. The generation and analysis of transgenic knock-in migraine mice with human pathogenic FHM1 mutations (i.e., FHM1 R192Q and FHM1 S218L mutant mice) revealed *gain-of-function* consequences of these mutations<sup>34,35</sup>; not only with respect to calcium influx, but also for spontaneous and evoked neurotransmission at the neuromuscular junction, a synapse in the peripheral nervous system where transmitter release is predominantly determined by  $\text{Ca}_v2.1$  calcium channels. Most relevant for migraine pathophysiology, in both strains of mutant mice, the threshold for inducing a CSD was lowered and the propagation velocity of the CSD wave was increased. Whereas FHM1 R192Q migraine mice have no overt phenotype, FHM1 S218L mice exhibit cerebellar ataxia, seizure susceptibility, and head trauma induced brain edema as also seen in FHM1 S218L patients. These observations indicate that the FHM1 mutant mice are useful models to study the pathophysiology of migraine *in vivo*. Future studies have to reveal exactly how a lower activation threshold of mutated  $\text{Ca}_v2.1$  calcium channels can lead to an episodic disease. One may envisage that only when the stimulus is strong (for instance with repetitive neuronal firing) and the threshold is temporarily lowered (for instance by hormonal changes), hyperexcitability of neurons in a susceptible brain leads to a cascade ending with a full-blown migraine attack.

---

The functional consequences of a large number of *ATP1A2* mutations causing either FHM or SHM have been investigated in various in vitro assays. Many were shown to be dysfunctional as they – unlike wildtype – were not (or only partially) able to rescue cell survival in assays in which endogenous sodium potassium pumps were inactivated by the drug ouabain.<sup>36</sup> In these assays, wildtype or mutant  $\alpha 2$  Na<sup>+</sup>,K<sup>+</sup>-ATPase cDNAs were made insensitive to the ouabain challenge. More detailed functional studies revealed that FHM2 mutations G301R, T376M, L764P, W887R, R855R lead to non-functional proteins<sup>37,36,38,39</sup> or sodium potassium pumps with partial activity with decreased (in the case of T345A and A606T) or increased (in the case of R689Q, M731T, R763H, and X1021R) affinity for potassium.<sup>40,41,38</sup> For five FHM2 mutations (i.e., R383H, R689Q M731T, R763H, and R834Q) a reduced turn-over rate was shown. Since FHM2 mutations compromise pump function, *Atp1a2* knockout mice may serve as a good model for FHM. However, *Atp1a2* knockout mice that lack the  $\alpha 2$  subunit have a very severe phenotype and die immediately after birth because of their inability to take a first breath.<sup>42,43</sup> Heterozygous mice are viable and exhibit enhanced fear and anxiety following conditioned fear stimuli.<sup>42</sup> These mice have not been evaluated as potential migraine mouse models.

The functional consequences of three FHM3 mutations have been investigated.<sup>27,44</sup> Whereas early functional studies of FHM3 mutations Q1489K and L1649Q revealed various *gain-of-function* effects when using a cardiac Na<sub>v</sub>1.5 cDNA as backbone for making the constructs<sup>27,44</sup>, more recent studies that investigated the consequences of these FHM3 mutations in the more appropriate Na<sub>v</sub>1.1 protein revealed clear *loss-of-function* effects.<sup>45</sup> The third FHM3 mutation L263V that in patients causes FHM and in the majority of carriers also generalized tonic-clonic epilepsy, essentially had *gain-of-function* effects.<sup>45</sup> It was hypothesized that loss of sodium channel activity primarily disturbs the functioning of inhibitory neurons, where the Na<sub>v</sub>1.1 normally are expressed<sup>46,47</sup>, whereas gain of activity has a predominant effect on excitatory neurons. Interestingly, when overexpressed in neurons, depending on the test paradigm, the Q1489K mutation seemed to have functional consequences fitting either with hyperexcitability or hypoexcitability (i.e., self-limiting hyperexcitability capacity)<sup>48</sup>, but this has not been tested in knock-in mice.

## 8.2 How do FHM mutations cause disease?

Can the molecular genetic findings of the three FHM genes (*CACNA1A*, *ATP1A2* and *SCN1A*) be integrated into a common pathway? More specifically, can we link the functional consequences of the three genes to for instance an increased propensity for CSD? Mutant Ca<sub>v</sub>2.1 calcium channels from FHM1 R192Q and S218L knock-in mice predict increased glutamate release in the cerebellar cortex and thereby can easier induce, maintain, and propagate CSD; this is in line with the observed decreased threshold for CSD in knock-in mice.<sup>34,35</sup> FHM2 mutations in



the sodium-potassium pump predict *in vivo* reduced glial uptake of  $K^+$  and glutamate from the synaptic cleft. FHM3 mutations in the  $Na_v1.1$  sodium channel predict *in vivo* hyperexcitability of excitatory neurons. Therefore, the consequence of FHM1, FHM2, and FHM3 mutations all seem to cause increased levels of glutamate and  $K^+$  in the synaptic cleft and thereby facilitate CSD (Figure 4). The increased propensity for CSD could well explain the aura, but, it remains to be established whether this also would result in a more readily activated trigeminovascular system with structures in the brainstem from which the headache originates.

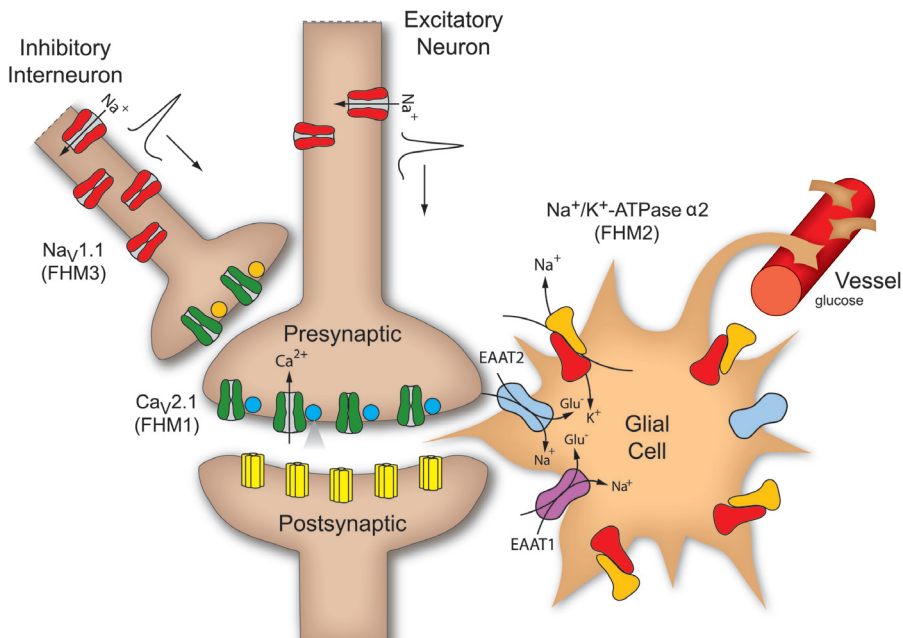

**Figure 4.** Schematic representation of a glutamatergic synapse and the proteins encoded by the three FHM genes and the SLC1A3 gene (adapted from Barret et al. 2008).  $Na_v1.1$  channels (encoded by *SCN1A*) are essential for the generation and propagation of action potentials. In response to an action potential, calcium enters the cell via  $Ca_v2.1$  channels (encoded by *CACNA1A*) and glutamate will be released by vesicles into the synaptic cleft. Potassium in the synaptic cleft is removed in part by the action of the  $Na^+/K^+-ATPase$  (encoded by *ATP1A2*) which is located at the surface of glial cells (astrocytes). Removing extracellular  $K^+$  generates a  $Na^+$  gradient, which drives uptake of glutamate from the cleft by transporters, for example, EAAT1 (encoded by SLC1A3). Energy is required and achieved by glucose utilization after uptake from blood vessels. Gain-of-function mutations in  $Ca_v2.1$  and loss-of-function mutations in the  $ATPase$ ,  $Na_v1.1$  and EAAT1 will each lead to of increased general excitability.

### 8.3 Do FHM genes play a role in SHM?

Not all hemiplegic migraine patients are part of FHM families. So-called sporadic hemiplegic migraine (SHM) patients do exist, and exhibit clinical symptoms that are very similar to those of familial cases.<sup>49</sup> For instance, SHM - like FHM - patients can have attacks of common migraine that are not associated with hemiparesis. Also the prevalence of familial and sporadic hemiplegic migraine in the population is similar; both are rare with a prevalence of approximately 0.01%.<sup>50</sup>

---

Therefore, an interesting question is whether FHM genes also play a role in SHM? Previously, only one study addressed that question, and investigated the involvement of the *CACNA1A* gene in 27 SHM patients; two *CACNA1A* mutations were identified.<sup>51</sup> **Chapter 3** of this thesis describes a study that reports a systematic mutation screen of all three FHM genes in 39 clinic-based ‘pure’ SHM patients without cerebellar signs or epilepsy. About 15% of our SHM patients had mutations in FHM genes; predominantly in the *ATP1A2* gene. SHM could not be explained by mutations in known FHM genes in the majority of patients. The frequency of mutations was even lower in a Danish population-based study.<sup>52</sup> In one hundred SHM patients only 8 sequence variants in *CACNA1A* and *ATP1A2*, of which only 2 were considered pathogenic, were identified; no functional studies were performed to proof causality. This indicates a difference between Dutch and Danish patients, diagnosis, and/or mutation detection methodology. Regardless, these genetic studies indicate that (i) SHM belongs to the genetic migraine spectrum, and that (ii) other genetic factors likely play a role in SHM. Future research must show whether these patients have a mutation in yet undiscovered hemiplegic migraine genes, or whether they have an unfavorable combination of low-risk gene variants present in a single patient.

#### **8.4 Is it possible to translate genetic results from HM to common migraine?**

As the main clinical symptoms of headache and aura are similar in FHM and common migraine, it is thought that they may share a common pathophysiology.<sup>3</sup> Several studies have investigated the role of FHM1 and FHM2 loci in the common forms of migraine. These studies led to conflicting results with some evidence in favor of the hypothesis<sup>53-55,26</sup>, while others find no evidence for their involvement in common migraine.<sup>56-58</sup> Some of the studies hypothesized that mutations found in FHM may cause common migraine, while it is more likely that ‘milder’, less penetrant, DNA variants are involved. A recent comprehensive study, including some 2800 migraine patients from various European countries, tested whether common DNA variants in ion transport genes are involved in common migraine.<sup>59</sup> Over 5,000 SNPs in 155 ion transport genes (including the three FHM genes) were studied, but none of the original significant SNPs (66 SNPs in 12 genes) was significant across all four replication cohorts. From this study it seems that common variants in ion transport genes do not play a major role in susceptibility for common migraine. Rare variants or variants with a very small effect size would not have been detected with this study design.

#### **8.5 Genetic studies in other disorders in which migraine is prevalent**

Another approach to identify genes and pathways for complex disorders is to study disorders that are comorbid with that particular genetically complex disease. Migraine can be part of the clinical spectrum of certain monogenic disorders. A good example is Cerebral Autosomal Dominant Arteriopathy with Subcortical Infarcts and Leukoencephalopathy (CADASIL) (for recent review see Stam et al)<sup>60</sup>. CADASIL is caused by mutations in the *NOTCH3* gene, which encodes the

Notch3 receptor that plays a key role in vascular smooth muscle cell function in small arteries and arterioles of the brain.<sup>61</sup> Up to one-third of CADASIL patients suffers from migraine with aura, where migraine often is the presenting clinical symptom.<sup>62</sup> The link with MA and not the more frequent MO, suggests that increased susceptibility for CSD is somehow caused by *NOTCH3* mutations. This hypothesis is strengthened by the fact that transgenic *Notch3* mice have a decreased threshold for CSD.<sup>63</sup> A second example is Retinal Vasculopathy with Cerebral Leukodystrophy (RVCL) that is caused by mutations in the *TREX1* gene that encodes the major mammalian 3'-5' DNA exonuclease (**Chapter 5.1**). RVCL originally was described in three families under different disease names; cerebroretinal vasculopathy (CRV), hereditary vascular retinopathy (HVR), and hereditary endotheliopathy, retinopathy, nephropathy and stroke (HERNS).<sup>64-67</sup> RVCL is primarily characterized by progressive blindness due to vascular retinopathy and can be associated with a wide range of systemic and cerebral symptoms, including cerebral infarcts and white matter hyperintensities, vascular dementia, liver and kidney dysfunction, Raynaud's phenomenon, and migraine. Particularly in a Dutch RVCL family, migraine and Raynaud's phenomenon are prominent.<sup>66</sup> Comorbidity of migraine with CADASIL and RVCL indicates that cerebral or meningeal vasculopathy and vascular dysfunction may play a role in migraine.<sup>68</sup> *TREX1* mutations were also identified in other vascular and immune-related disorders, such as Systemic Lupus Erythematosus (SLE) and Familial Chilblain Lupus (FCL).<sup>69,70</sup> **Chapter 5.2** describes a *TREX1* mutation screen in 60 patients with neuropsychiatric SLE (NPSLE), with and without white matter hyperintensities (WMH). We identified the first gene mutation in a NPSLE patient with WHM. Interestingly, this patient also has severe migrainous headache, which is known to be common in SLE patients.<sup>71</sup>

Another pathway that is important in migraine pathophysiology is the 'neuronal hyperexcitability pathway'. Depression and epilepsy are two genetic disorders in which neuronal hyperexcitability is thought to play a role. It is consistently found that migraine patients have an increased risk for migraine and epilepsy. This relation is bi-directional, meaning that patients with depression or epilepsy also have an increased risk for migraine.<sup>72-77</sup> This reinforces the hypothesis that overlapping pathways play a role in migraine and epilepsy and in migraine and depression. For instance co-occurrence of epilepsy and migraine was reported for several FHM mutation carriers.<sup>22,11,78,21,79</sup> Recent genetic research points to yet another gene that seems to fit perfectly into the FHM pathway of cortical hyperexcitability: the *SLC1A3* gene that encodes EAAT1, a glutamate transporter that is located on astrocytes (Figure 4). A P290R mutation in this gene was shown to cause severe episodic ataxia and progressive ataxia, seizures, alternating hemiplegia, and migraine headache.<sup>80</sup> Mutant EAAT1 showed severely reduced glutamate uptake. In **Chapter 4**, we describe a novel C186S EAAT1 mutation in a patient with episodic ataxia. Functional studies showed a modest but significant reduction of glutamate uptake, which is in line with the milder

phenotype. Because of the known relation between ataxia and hemiplegia with FHM1 mutations, the finding of *SLC1A3* mutations causing both ataxia and hemiplegia has potential relevance for FHM as well.

### 8.6 Linkage studies in common migraine

A major genetic strategy to identify migraine susceptibility genes has been classical linkage analysis that aims to find linked chromosomal loci using a family-based approach. Over the years, a number of chromosomal loci (Table 1) have been identified using either migraine without or with aura patients diagnosed according to the International Headache Criteria (i.e., IHS diagnosis).<sup>1</sup> However, with a few exceptions, replication of initial findings was unsuccessful. One of the most promising migraine susceptibility loci resides on chromosome 4; initial linkage to chromosome 4q24 in Finnish MA families<sup>81</sup> was replicated in an Icelandic sample of MO patients.<sup>82</sup> Although the Finnish and Icelandic migraine loci are not identical, but seem to overlap, it is yet unclear whether they harbor different migraine susceptibility genes. Lack of success with the linkage approach probably is due to the high prevalence of migraine making it difficult to ascertain “clean” pedigrees for linkage where migraine genes from spouses do not interfere with the analysis.

**Table 1** Summary of relevant linkage results performed for migraine using the International Headache Classification (IHC) classification guidelines.

Chromosomal locus	Phenotype	Genotyping method	Reference
1q31	MA, MA/MO*	Regional microsatellite markers	Lea et al. 2002
4q21	MO	Genome-wide scan	Bjornsson et al. 2003
4q24	MA	Genome-wide scan	Wessman et al. 2002
6p12.2-p21.1	MA/MO	Genome-wide scan	Carlsson et al. 2002
10q22-q23	MA	Genome-wide scan	Anttila et al. 2008
11q24	MA	Genome-wide scan	Cader et al. 2003
14q21.2-q22.3	MO	Genome-wide scan	Soragna et al. 2003
15q11-q13	MA	Regional microsatellite markers	Russo et al. 2005
19p13	MA	Regional microsatellite markers	Jones et al. 2001
Xq25-q28	MA/MO	Regional microsatellite markers	Nyholt et al. 1998; 2000

MO = migraine without aura; MA = migraine with aura; \*Only suggestive linkage for MA/MO combined.

In the last few years, linkage studies made use of alternative phenotyping approaches that are based either on individual migraine traits in “trait component analysis (TCA)” or that use a combination of clinical migraine features in “latent class analysis (LCA)”. Whereas TCA is rather straightforward, LCA involves a complex statistical empirical clustering approach based on factor analysis that combines the information of several migraine symptoms.<sup>83,84</sup> The classification reflects disease severity and does not specifically separate MO from MA. In principle, TCA and to a certain degree LCA, reflects the underlying processes in migraine pathophysiology as they utilize the questionnaire-based information in a more optimal manner, compared to the dichotomous IHS end diagnosis.<sup>85</sup> It can be expected that by using TCA, the clinical heterogeneity will be reduced, since traits better reflect the biological pathways that are influenced by specific genetic variations. Several migraine loci were identified using this alternative phenotyping strategy (see Table 2).

**Table 2** Summary of linkage results performed for migraine grouped for phenotyping methods Latent Class Analysis (LCA) and Trait Components Analysis (TCA).

<b>Chromosomal locus</b>	<b>Phenotypic trait (analysis method)*</b>	<b>Reference</b>
4q24	Age at onset, photophobia, phonophobia, photo- and phonophobia, pain intensity, unilaterality, pulsation, nausea and vomiting (TCA)	Anttila et al. 2006
5q21	Pulsation (LCA)	Nyholt et al. 2005
10q22-q23	Migrainous headache (LCA)	Anttila et al. 2008
10q22-q23	Unilaterality, pulsation, pain intensity, nausea/vomiting, photophobia, phonophobia (TCA)	Anttila et al. 2008
17p13	Pulsation (TCA)	Anttila et al. 2006

*IHS = International Headache Society; LCA = Latent Class Analysis; TCA = Trait Component Analysis. \*Order based on level of significance (most significant trait mentioned first).*

### 8.7 Candidate gene association studies

In common disorders, such as migraine, many common genetic factors (present in more than 1–5% of the population) are thought to play a role in disease susceptibility. This phenomenon is known as the ‘common disease, common variant’ hypothesis. A frequently used strategy to identify these common gene variants for common disorders are case-control association studies.<sup>86-89</sup> These

---

studies test for significant differences in allele frequencies between cases and controls. Many candidate gene association studies have been performed in migraine research; mainly of genes involved in the serotonin and dopamine pathways - but also in other genes with an already suspected function in migraine pathophysiology. Unfortunately, the majority of the associations could not be replicated, suggesting that many of the original findings may in fact represent false positive findings (for review see De Vries et al)<sup>90</sup>. Studies often contained rather low numbers of cases and controls; the ones that used 275 cases and controls or more are summarized in Table 3. A positive exception is a recent study that analyzed several SNPs in ten different genes from the dopamine system in over 600 MA cases and controls using a two-step design and showed a positive association with single SNPs in *DBH*, *DRD2* and the *SLC6A3* genes, also after multiple testing.<sup>91</sup> Functional consequences of any of these associated SNPs are still unknown.

Another promising association finding seems to be with the 5',10'-methylenetetrahydrofolate reductase (*MTHFR*) gene. *MTHFR* is a key enzyme in folate and homocysteine metabolism.<sup>92</sup> Most studies found an association of the T-allele of the *MTHFR* C677T polymorphism with migraine<sup>93-98</sup>, although negative findings have been reported as well.<sup>99,100</sup> The T-allele results in moderately increased levels of homocysteine that may cause migraine through a vascular endothelium dysfunction effect, but evidence for this hypothesis is still lacking. Recently, also two meta-analyses were reported for *MTHFR* and migraine.<sup>101,102</sup> Both studies revealed that the T-allele is associated with MA, but not with migraine without aura or migraine overall. However when the results in one of the meta-analyse were stratified for ethnicity, the results were driven by studies in non-Caucasian populations.<sup>102</sup>

## 8.8 Genome wide association studies

In recent years, high-throughput genotyping techniques developed rapidly allowing extensive genotyping in large cohorts for Genome Wide Association Studies (GWAS) became feasible. In contrast to hypothesis-driven candidate gene-based association studies, GWAS do not require prior knowledge about the disease mechanism. In **Chapter 6**, GWA studies in migraine are described. The first GWAS was conducted for the migraine subtype MA by the International Headache Consortium (**Chapter 6.1**). The initial study cohort contained a total of 2,748 clinic-based European MA cases, of which 655 cases were of Dutch origin and were collected via the LUMINA (Leiden University Migraine Neuro Analysis) initiative.<sup>103</sup> The most significantly associated SNP ( $P$ -value  $5.1 \times 10^{-9}$ ) is located on chromosome 8q22.1 and could be replicated in several independent migraine cohorts.<sup>104</sup> Interestingly, the associated allele of this SNP was significantly correlated with expression levels of the adjacent *AEG-1* gene. *AEG-1* is expressed on astrocytes and

downregulates EAAT2, which is an important glutamate transporter in the brain that is important for glutamate from synaptic cleft.<sup>105</sup> The *AEG-1* gene seems to perfectly fit into the ‘glutamate pathway’ that is seen in FHM and common migraine.

For **Chapter 6.2** we initially performed a GWAS for migraine in the Erasmus Rucphen Family (ERF) population, and subsequently this data was included in the first meta-analysis for migraine. The ERF population is a well-studied Dutch genetically isolated population, which resides in the Southwest of the Netherlands and consists of roughly 3,000 descendants of a relatively small numbers of founders in the mid 18th century. The main advantage of genetic studies in genetically isolated populations is that these populations are more homogeneous due to their relatively small number of founders that underwent rapid population expansion (i.e., genetic drift).<sup>106</sup> In our GWA study none of the in total approximately 2.5 million SNPs reached genome-wide significance (i.e., a  $P$ -value  $< 5.0 \times 10^{-8}$ ). However, several SNPs in genes that seem relevant to migraine pathophysiology showed nearly significant association with migraine. Subsequently a meta-analysis was performed using the GWAS data of six population-based cohorts from the Dutch Icelandic (DICE) consortium, including the ERF cohort. For only one SNP a  $P$ -value below  $10^{-4}$  was obtained in both the GWA in ERF and the meta-analysis study. The best SNP in the meta-analysis was located in the neuronal growth factor receptor gene (*NGFR*), which is a good candidate gene for migraine, due to its relevance to pain perception. Future replication and/or functional studies must reveal their true relevance to migraine pathophysiology.

The most significant SNP from the clinic-based GWAS did not show a signal in the ERF GWAS and in the meta-analysis of the population-based migraine cohorts. This might be due to the difference between population-based and clinic-based migraine patients. Perhaps this specific SNP has an effect on disease severity. Furthermore, previous studies for other disorders also showed that often different GWAS for the same disease do not yield the same peaks<sup>107</sup>, which could be due to clinical heterogeneity between the samples.

**Hormone receptor system; estrogen receptor 1 and 2 (ESR1 and ESR2), follicle stimulating hormone receptor (FSHR), androgen receptor (AR), CYP19 aromatase polypeptide A1 (CYP19A1), nuclear receptor-interacting protein 1 (NRI1P1), progesterone receptor (PGR)**

ESR1	c.594G>A (G594A)	484 (360/124)	484	594A: p=0.003 (p=0.01/p=0.02)	Two cohorts combined; P-values based on initial cohort of 224 migraine cases and 224 controls	Colson et al. 2004
ESR1	c.2014G>A (G2014A)	898 (898/-)	900	- (NS/-)		Kaunisto et al. 2006
ESR2	c.325G>C (G325C)	356 (198/158)	374	325C: p=0.03 (p=0.045/NS)		Oerhno et al. 2008
FSHR	c.2100A>G (A2100G)				2100A: NS (p=0.03/NS)	
CYP19A1	c.2039G>A (Sae680A <sub>SN</sub> )				2039G: NS (p=0.01/NS)	
	c.1672C>T (C1672T)				NS (NS/NS)	
	c.225G>A (G17561V)				NS (NS/NS)	
AR	CAG repeat in exon 1	509 (371/138)	454	NS (NS/NS)	P-values based on initial cohort of 275 migraine cases and 275 controls;	Colson et al. 2005
PGR	PROGINS ins in intron 7			PROGINS ins: p=0.02 (NS/p=0.008)	PROGINS was replicated	

**Inflammation related genes; tumor necrosis factor- $\alpha$  and - $\beta$  (TNFA and TNFB) and lymphotoxin  $\alpha$  (LTA)**

TNFA	c.308G>A (G308A)	299 (38/261)	306	308G: p<0.001 (NS/p<0.001)	15 SNPs were tested	Rainero et al. 2004
TNFA	Multiple variants tested	439 (65/327)	382	NS		Lee et al. 2007
LTA	-294T>C (rs2844482; promoter)			-294C: p=0.0002 (p=0.006/p=0.0008)		
TNFA	c.308G>A (G308A)	299 (-/299)	278	- (-/NS)		Aouni et al. 2009
TNFB	c.252G>A (G252A)			252A: - (-/p=0.018)		

**Insulin receptor gene (INSR)**

INSR	c.2946-713G>A	827 (377/450)	765	c.2946-713A: NS (p=0.002/NS)	48 SNPs tested in region 19p13; SNP84: rs2880172; SNP90: rs2860174; SNP274: rs1799817/His1085His; P-values based on 331 migraine cases and 466 controls	McCarthy et al. 2001
	(SNP84; intron 15)					
	c.2842-1451T>A			c.2842-1451A: NS (p=0.007/NS)		
	(SNP90; intron 14)					
	c.3255C>T (SNP274)			c.3255T: NS (p=0.008/NS)		
INSR	c.2842-1451T>A	1278 (1278/-)	1337	c.2842-1451T: - (p=0.005/-)	Two-step design (haplotype-tagging); 35 SNPs tested in region 19p13; P-values based on total cohort	Netzer et al. 2008
	(rs2860174; intron 14)					

**Angiotensin converting enzyme (ACE), angiotensin receptor 1 (AGTR1) and angiotensin (AGT)**

ACE	Ins/del	342 (187/155)	403	NS (NS/NS)		Tromvik et al. 2008
ACE	(rs1799752; intron 15)					
ACE	Ins/del	3226 (1275/1951)	20423	NS (NS/NS)		Schurks et al. 2009a
AGTR1	(rs1799752; intron 15)					
AGTR1	c.1166A>C (A166C)	3226 (1275/1951)	20423	NS (NS/NS)		Schurks et al. 2009b
AGT	c.803T>C (Met235Thr)			NS (NS/NS)		

**Association studies with other genes**

NOS3	c.-51-898G>A (rs1800779; intron 1)	337 (188/149)	341	NS (NS/NS)	NOS3 encodes for endothelial nitric oxide synthase	Toriello et al. 2008
	(c.894T>G (rs1799983))			NS (NS/NS)	>5000 SNPs (haplotype-tagging) in 155 ion transporter genes tested in initial cohort; replication cohorts included	Nyholt et al. 2008
Ion trans- porter genes	Multiple variants tested	3676	3624	NS (NS/NS)		

MA = migraine with aura; MA = migraine without migraine; NS = not significant; - = not tested/not available; SNP = single nucleotide polymorphism; Ins = insertion; Del = deletion; VNTR = variable number of tandem repeats. \*Nomenclature of DNA variant in the original study; for intronic DNA variants, the respective intron number is indicated; \*\*number of cases and \*\*\*p-values are given for all migraine cases combined or, when specified between brackets, for migraine with aura cases only and/or migraine without aura cases only.



Gene	DNA variant*	Cases (n)** Migraine (MA/MO)	Controls (n)	Associated allele with phenotype (P-value)***	Remarks	Reference
<b>5,10-Methylenetetrahydrofolate reductase (MTHFR)</b>						
MTHFR	c.677C>T (677T)	652 (465/187)	320	677T: NS (p=0.017/-)	Combined single cases and families; P-values based on initial cohort of 270 migraine cases and 270 controls; replication provided	Lea et al. 2004
MTHFR	c.677G>T (677T)	413 (187/226)	1212	677T: - (p=0.006/NS)		Scher et al. 2006
MTHFR	c.677G>T (677T)	898 (898/-)	900	677T: - (NS/-)		Kaanisto et al. 2006
MTHFR	c.677G>T (677T)	2961 (2170/791)	3844	677T: NS (p=0.0005/NS)	Meta-analysis	Rubino et al. 2007
MTHFR	c.677G>T (677T)	4577 (1275/1951)	20424	677T: p=0.03 (p=0.02/NS)	Protective effect of 677T	Schurks et al. 2008
<b>Dopaminergic system: catechol-O-methyltransferase (COMT), dopamine β-hydroxylase (DBH), dopamine transporter (DAT1)</b>						
COMT	c.472A>G (Val158Met)	305	1468	NS		Hagen et al. 2006
DBH	-1021C>T +1603C>T	830 (588/242)	500	-1021T: p=0.004 (p=0.014/NS) NS (NS/NS)	P-values based on initial cohort of 275 migraine cases and 275 controls; replication provided; protective effect of T-allele	Fernandez et al. 2009
DBH	rs2097629 (A>G intr 9)	650 (650/-)	650	c.1434+15796: - (p=0.01/-)	Two-step design (haplotype-tagging); 35 SNPs tested in dopamine pathway; P-values based on total cohort	Todd et al. 2009
SLC6A3	rs17131056 (T>G intr 1)	543 (318/225)	561	c.1840-204A: - (p=0.03/-) corrected 0.026 (-/-)	Two-step design (haplotype-tagging); Non of the SNPs were significant in both samples	Corominas et al. 2009
DRD1	rs251937 (T>C)			0.0030 (p=0.037/p=0.0081)		
DRD2	rs2823265 (G>T)			0.0033 (-/-)		
DRD3	multiple SNPs tested			NS (-/-)		
DRD5	multiple SNPs tested			NS (-/-)		
DBH	multiple SNPs tested			NS (-/-)		
COMT	multiple SNPs tested			NS (-/-)		
SLC6A3	multiple SNPs tested			NS (-/-)		
TH	rs2070762 (T>C)			0.0035 (NS/p=0.023)		
SLC6A3	VNTR in intron 8 550	(401/149)	550	NS (NS/NS)	SLC6A3 is also known as DAT1	McCallum et al. 2007
<b>Serotonergic system</b>						
HTR2C	c.696>C (Gys23Ser)	275	275	NS		Johnson et al. 2003
HTR2C	c.2831T>G (T2831G)			NS		
HTR2C	c.696>C (Gys23Ser)	335 (184/151)	335	NS (NS/NS)	Meta-analysis	Oerino et al. 2007
HTR2C	c.696>C (Gys23Ser)	561 (561/-)	1235 NS (NS/-)	- (-/p=0.0017)	19 Serotonin-related genes covered by 122 SNPs. None of the individual SNPs was significant after multiple testing correction.	Oerino et al. 2007
HTR2B	rs16827801T>A rs10194776G 528 (220/308)	528	528	- (p=0.0019/-)		Corominas et al. 2009
DDC	rs2329240A>T rs11974297C>T rs2044859T -rs11761683G			- (-/p=0.006)		
MAOA	rs3027400G>T rs2072743C			- (-/p=0.006)		
<b>Gamma-Aminobutyric acid type A (GABA-A) receptor system: GABA-A receptor α5 (GABRA5), β3 (GABRB3), receptor θ (GABRO) subunits</b>						
GABRA5	Multiple variants tested	898 (898/-)	900	- (NS/-)	34 SNPs in region 15q11-q13 (haplotype-tagging)	Oswell et al. 2007
GABRB3	Multiple variants tested			- (NS/-)		
GABRG3	Multiple variants tested			- (NS/-)		
GABRA5	Multiple variants tested	649 (649/-)	652	- (NS/-)	56 SNPs tested in region 15q11-q12 (haplotype-tagging); p-values for two cohorts	Netzer et al. 2008
GABRB3	Multiple variants tested			- (NS/-)		
GABRG3	Multiple variants tested			- (NS/-)		
GABRE	Multiple variants tested	384 (254/130)	275	NS (NS/NS)	3 SNPs tested in GABRE	Fernandez et al. 2008
GABRO	c.1432T>A (478F)			- (NS/-)		

---

## 8.9 Gene expression studies in knock-in migraine mouse models

The availability of transgenic FHM1 knock-in mouse models<sup>34,35</sup>, gave opportunities to investigate gene expression profiles in brain tissues. The difference in severity of clinical features in patients with the R192Q (pure FHM) and the S218L mutation (FHM with cerebellar ataxia, epilepsy and increased susceptibility to head trauma induced brain edema) is reflected in the mouse models with the same FHM1 mutations. The fact that the more 'severe' mouse model also exhibits more profound changes in neuronal calcium influx, (cortical) neurotransmission, and susceptibility to CSD warrants an in-depth molecular analysis of the consequences of both mutations on gene expression profiles. Therefore, in **Chapter 7** of this thesis, we performed a first gene expression study in both transgenic mouse models to investigate whether the observed hyperexcitability might be associated with changes in gene expression levels under basal (i.e., untriggered) conditions. To this end, the occipital cortex (i.e., the origin of the CSD) and the cerebellum (i.e., the origin of the ataxia) were investigated. Gene expression levels in the occipital cortex were notably similar in cortices of mutant and wildtype mice. However, gene expression in the cerebellum of S218L mice was somewhat different from that in wildtype and R192Q mice. Several of the differentially expressed genes in the cerebellum of S218L mice could be related to neurotransmission and more specifically to ataxia, which is a prominent feature in patients and mice with this mutation. As an example, the gene with the highest fold change, tyrosine hydroxylase (*Th*), which could be confirmed at the protein level, had already been implicated in ataxia of several natural mouse *Cacna1a* models (i.e. *Rolling Nagoya*<sup>108</sup>, *Tottering*<sup>109</sup>, and *Leaner*.<sup>110</sup> Perhaps additional microarray experiments using migraine-relevant triggers are needed before gene expression profiles are more pronounced and can be combined with GWAS and/or exome-genome sequencing to prioritize findings.

## 8.10 Future perspectives

This thesis focused mainly on the identification and characterization of migraine gene mutations and pathways. Three FHM genes have been identified. The genetic spectrum of FHM mutations and their associated clinical features have been investigated in this thesis. Not all FHM families can be explained by mutations in known FHM genes, so additional FHM genes must exist. It is interesting to assess whether novel FHM genes will fit in the same pathway as the known FHM genes, or whether they will highlight additional pathways with relevance to migraine pathophysiology. With the availability of 'Next Generation Sequencing' technology, which allows high-throughput sequencing of either desired regions of the genome, all exons of the genome (the so-called exome), or the entire genome, these FHM genes will probably soon be identified. First successes in gene identification for monogenic disorders using this exome strategy were published.<sup>111</sup>

For common migraine, clinical and genetic heterogeneity make the identification of susceptibility genes even more difficult than gene discovery in FHM. The diagnosis of migraine is mainly based on questionnaires and (sometimes) interviewing the patients. Unfortunately, a more objective method of diagnosing patients, such as biochemical testing in blood (or cerebrospinal fluid or urine) is currently not available. Systematic studies to identify such reliable biomarkers are dearly needed as they will help defining more homogeneous groups of patients for genetic studies. Ideally, biomarker information should somehow be combined with other endophenotyping approaches such as previously discussed LCA and TCA. Particularly TCA seems to reduce clinical heterogeneity. Endophenotyping likely will increase the power of the genetic analyses. Also because, as was shown for several other complex disorders such as Attention-Deficit/Hyperactivity Disorder (ADHD) and schizophrenia, the heritability of the individual traits may be higher than of the syndrome as a whole (i.e., combination of traits).<sup>112,113</sup> One appealing strategy to decrease heterogeneity in migraine is to take co-morbidity with other diseases into account. A recent study in ERF indicated that migraine and depression may share, at least to some extent, genetic factors.<sup>77</sup> By stratifying for depression, gene discovery in migraine may become (a little) easier. At the moment, most investments in migraine genetics go into GWAS. For many complex disorders, GWAS already led to successes.<sup>114-116</sup> The coming two years will be very exciting as additional GWAS are currently being performed for migraine. Still, most gene variants identified with GWAS have a low relative risk (RR) of often 1.1 - 1.3 and seem to explain only a small proportion of disease heritability. Therefore, it is now being questioned whether GWAS will contribute much to understanding the majority of the genetic load. The question at hand is where the majority of the genetic burden is and how to increase our understanding in migraine mechanisms. Is it in epistasis or copy number variation? Can pathway analyses on GWA data increase our insight<sup>117,118</sup>? Or is most of the genetic load carried in large number of allelic variants that combine a very low allele frequency with a reasonably high relative risk? As this genetic variation (usually) is not captured in current GWAS, other approaches (i.e., large-scale deep sequencing) are needed. Also for this approach, the technology is available. The next few years will have to show what this new technology can bring for migraine. In conclusion, although the last decade has produced major advances in our knowledge of migraine pathophysiology, the best perhaps is yet to come. It will require a true multidisciplinary approach to harvest this knowledge and translate it to novel treatment options to help migraine patients.

---

## References

1. Headache classification subcommittee of the international headache society: The international classification of headache disorders: 2nd edition. *Cephalalgia* 2004;24:1-160.
2. Thomsen LL, Eriksen MK, Roemer SF, Andersen I et al (2002) A population-based study of familial hemiplegic migraine suggests revised diagnostic criteria. *Brain* 125(Pt 6): 1379-1391.
3. Ferrari MD, van den Maagdenberg AM, Frants RR, Goadsby PJ (2007) Migraine as a cerebral ionopathy with impaired central sensory processing. In: Waxman SG, ed. *Molecular neurology*. Amsterdam: Elsevier; 2007 pp 439-461.
4. Ophoff RA, Terwindt GM, Vergouwe MN, van Eijk R et al (1996) Familial hemiplegic migraine and episodic ataxia type-2 are caused by mutations in the Ca<sup>2+</sup> channel gene CACNL1A4. *Cell* 87:543-552.
5. Ducros A, Denier C, Joutel A, Vahedi K et al (1999) Recurrence of the T666M calcium channel CACNA1A gene mutation in familial hemiplegic migraine with progressive cerebellar ataxia. *Am J Hum Genet* 64:89-98.
6. Battistini S, Stenirri S, Piatti M, Gelfi C et al (1999) A new CACNA1A gene mutation in acetazolamide-responsive familial hemiplegic migraine and ataxia. *Neurology* 53:38-43.
7. Kors EE, Haan J, Giffin NJ, Pazdera L et al (2003) Expanding the phenotypic spectrum of the CACNA1A gene T666M mutation: a description of 5 families with familial hemiplegic migraine. *Arch Neurol* 60:684-688.
8. Alonso I, Barros J, Tuna A, Seixas A et al (2004) A novel R1347Q mutation in the predicted voltage sensor segment of the P/Q-type calcium-channel alpha-subunit in a family with progressive cerebellar ataxia and hemiplegic migraine. *Clin Genet* 65(1):70-72.
9. Stam AH, Vanmolkot KR, Kremer HP, Gärtner J et al (2008a) CACNA1A R1347Q: a frequent recurrent mutation in hemiplegic migraine. *Clin Genet* 74:481-485.
10. Vahedi K, Denier C, Ducros A, Bousson V et al (2000) CACNA1A gene de novo mutation causing hemiplegic migraine, coma, and cerebellar atrophy. *Neurology* 55:1040-1042.
11. Kors EE, Melberg A, Vanmolkot KR, Kumlien E et al (2004) Childhood epilepsy, familial hemiplegic migraine, cerebellar ataxia, and a new CACNA1A mutation. *Neurology* 63:1136-1137.
12. Kors EE, Terwindt GM, Vermeulen FL, Fitzsimons RB et al (2001) Delayed cerebral edema and fatal coma after minor head trauma: role of the CACNA1A calcium channel subunit gene and relationship with familial hemiplegic migraine. *Ann Neurol* 49:753-760.

13. Curtain RP, Smith RL, Ovcacic M, Griffiths LR (2006). Minor head trauma-induced sporadic hemiplegic migraine coma. *Pediatr Neurol* 34:329-332.
14. Chan YC, Burgunder JM, Wilder-Smith E, Chew SE et al (2008) Electroencephalographic changes and seizures in familial hemiplegic migraine patients with the CACNA1A gene S218L mutation. *J Clin Neurosci* 15:891-894.
15. Stam AH, Luijckx GJ, Poll-Thé BT, Ginjaar IB et al (2009a) Early seizures and cerebral oedema after trivial head trauma associated with the CACNA1A S218L mutation. *J Neurol Neurosurg Psychiatry*. 80(10):1125-1129.
16. De Fusco M, Marconi R, Silverstri L, Atorino L et al (2003) Haploinsufficiency of ATP1A2 encoding the Na<sup>+</sup>/K<sup>+</sup> pump alpha2 subunit associated with familial hemiplegic migraine type 2. *Nat Genet* 33:192-196.
17. Riant F, De Fusco M, Aridon P, Ducros A et al (2005) ATP1A2 mutations in 11 families with familial hemiplegic migraine. *Hum Mutat* 26:281.
18. Jurkat-Rott K, Freilinger T, Dreier JP, Herzog J et al (2004) Variability of familial hemiplegic migraine with novel A1A2 Na<sup>+</sup>/K<sup>+</sup>-ATPase variants. *Neurology* 62:1857-1861.
19. Kaunisto MA, Harno H, Vanmolkot KR, Gargus JJ et al (2004) A novel missense ATP1A2 mutation in a Finnish family with familial hemiplegic migraine type 2. *Neurogenetics* 5:141-146.
20. Pierelli F, Grieco GS, Pauri F, Pirro C et al (2006) A novel ATP1A2 mutation in a family with FHM type II. *Cephalalgia* 26:324-328.
21. Spadaro M, Ursu S, Lehmann-Horn F, Veneziano Let al (2004) A G301R Na<sup>+</sup>/K<sup>+</sup>-ATPase mutation causes familial hemiplegic migraine type 2 with cerebellar signs. *Neurogenetics* 5:177-185.
22. Vanmolkot KR, Kors EE, Hottenga JJ, Terwindt GM (2003) Novel mutations in the Na<sup>+</sup>,K<sup>+</sup>-ATPase pump gene ATP1A2 associated with familial hemiplegic migraine and benign familial infantile convulsions. *Ann Neurol* 54:360-366.
23. Deprez L, Weckhuysen S, Peeters K, Deconinck T et al (2008) Epilepsy as part of the phenotype associated with ATP1A2 mutations. *Epilepsia* 49:500-508.
24. Vanmolkot KR, Stroink H, Koenderink JB, Kors EE et al (2006) Severe episodic neurological deficits and permanent mental retardation in a child with a novel FHM2 ATP1A2 mutation. *Ann Neurol* 59:310-314.

- 
25. Ambrosini A, D'Onofrio M, Grieco GS, Di Mambro A et al (2005) Familial basilar migraine associated with a new mutation in the ATP1A2 gene. *Neurology* 65:1826-1828.
26. Todt U, Dichgans M, Jurkat-Rott K, Heinze A et al (2005) Rare missense variants in ATP1A2 in families with clustering of common forms of migraine. *Hum Mutat* 26:315-321.
27. Dichgans M, Freilinger T, Eckstein G, Babini E et al (2005) Mutation in the neuronal voltage-gated sodium channel SCN1A in familial hemiplegic migraine. *Lancet* 336:371-377.
28. Meisler MH, Kearney JA (2005) Sodium channel mutations in epilepsy and other neurological disorders. *J Clin Invest* 115:2010-2017.
29. Mulley JC, Scheffer IE, Petrou S, Dibbens LA et al (2005) SCN1A mutations and epilepsy. *Hum Mutat* 25:535-542.
30. Castro MJ, Stam AH, Lemos C, de Vries B et al (2009) First mutation in the voltage-gated Nav1.1 subunit gene SCN1A with co-occurring familial hemiplegic migraine and epilepsy. *Cephalalgia* 29:308-313.
31. Hans M, Luvisetto S, Williams ME, Spagnolo M et al (1999) Functional consequences of mutations in the human alpha1A calcium channel subunit linked to familial hemiplegic migraine. *J Neurosci* 19:1610-1619.
32. Tottene A, Fellin T, Pagnutti S, Luvisetto S et al (2002) Familial hemiplegic migraine mutations increase Ca(2+) influx through single human CaV2.1 channels and decrease maximal CaV2.1 current density in neurons. *Proc Natl Acad Sci USA* 99:13284-13289.
33. Tottene A, Pivotto F, Fellin T, Cesetti T et al (2005) Specific kinetic alterations of human CaV2.1 calcium channels produced by mutation S218L causing familial hemiplegic migraine and delayed cerebral edema and coma after minor head trauma. *J Biol Chem* 280:17678-17686.
34. van den Maagdenberg AM, Pietrobon D, Pizzorusso T, Kaja S et al (2004) A Cacna1a knockin migraine mouse model with increased susceptibility to cortical spreading depression. *Neuron* 41:701-710.
35. van den Maagdenberg AM, Pizzorusso T, Kaja S, Terpolilli N et al (2010) High cortical spreading depression susceptibility and migraine-associated symptoms in Ca(v)2.1 S218L mice. *Ann Neurol* 67(1):85-98.
36. Koenderink JB, Zifarelli G, Qiu LY, Schwarz W et al (2005) Na,K-ATPase mutations in familial hemiplegic migraine lead to functional inactivation. *Biochim Biophys Acta* 1669:61-68.

37. Capendeguy O, Horisberger JD (2004) Functional effects of Na<sup>+</sup>,K<sup>+</sup>-ATPase gene mutations linked to familial hemiplegic migraine. *Neuromolecular Med* 6:105-116.
38. Tavraz NN, Friedrich T, Durr KL, Koenderink JB et al (2008) Diverse functional consequences of mutations in the Na<sup>+</sup>/K<sup>+</sup>-ATPase alpha2-subunit causing familial hemiplegic migraine type 2. *J Biol Chem* 283:31097-31106.
39. Tavraz NN, Dürr KL, Koenderink JB, Freilinger T et al (2009) Impaired plasma membrane targeting or protein stability by certain ATP1A2 mutations identified in sporadic or familial hemiplegic migraine. *Channels (Austin)* 3(2):82-87.
40. Segall L, Scanzano R, Kaunisto MA, Wessman M et al (2004) Kinetic alterations due to a missense mutation in the Na<sub>2</sub>K-ATPase alpha2 subunit cause familial hemiplegic migraine type 2. *J Biol Chem* 279(42):43692-43696.
41. Segall L, Mezzetti A, Scanzano R, Gargus JJ et al (2005) Alterations in the alpha2 isoform of Na<sub>2</sub>K-ATPase associated with familial hemiplegic migraine type 2. *Proc Natl Acad Sci USA* 102(31):11106-11111.
42. Ikeda K, Onaka T, Yamakado M, Nakai J et al (2003) Degeneration of the amygdala/piriform cortex and enhanced fear/anxiety behaviors in sodium pump alpha2 subunit (Atp1a2)-deficient mice. *J Neurosci* 23:4667-4676.
43. James PF, Grupp IL, Grupp G, Woo AL et al (1999) Identification of a specific role for the Na<sub>2</sub>K-ATPase alpha 2 isoform as a regulator of calcium in the heart. *Mol Cell* 3:555-563.
44. Vanmolkot KRJ, Babini E, de Vries B, Stam AH et al (2007) The novel p.L1649Q mutation in the SCN1A epilepsy gene is associated with familial hemiplegic migraine: genetic and functional studies. *Hum Mutat* 28:522.
45. Kahlig KM, Rhodes TH, Pusch M, Freilinger T et al (2008) Divergent sodium channel defects in familial hemiplegic migraine. *Proc Natl Acad Sci USA* 105:9799-9804.
46. Ogiwara I, Miyamoto H, Morita N, Atapour N et al (2007) Na<sub>v</sub>1.1 localizes to axons of parvalbumin-positive inhibitory interneurons: a circuit basis for epileptic seizures in mice carrying an Scn1a gene mutation. *J Neurosci* 27:5903-5914.
47. Yu FH, Mantegazza M, Westenbroek RE, Robbins CA et al (2006) Reduced sodium current in GABAergic interneurons in a mouse model of severe myoclonic epilepsy in infancy. *Nat Neurosci* 9:1142-1149.
48. Cestele S, Scalmani P, Rusconi R, Terragni B et al (2008) Self-limited

- 
- hyperexcitability: functional effect of a familial hemiplegic migraine mutation of the Nav1.1 (SCN1A) Na<sup>+</sup> channel. *J Neurosci* 16:7273-7283.
49. Thomsen LL, Ostergaard E, Olesen J, Russell MB (2003) Evidence for a separate type of migraine with aura: sporadic hemiplegic migraine. *Neurology* 60:595-601.
50. Thomsen LL, Olesen J (2004) Sporadic hemiplegic migraine. *Cephalalgia* 24:1016-1123.
51. Terwindt GM, Kors EE, Haan J, Vermeulen FL et al (2002) Mutation analysis of the CACNA1A calcium channel subunit gene in 27 patients with sporadic hemiplegic migraine. *Arch Neurol* 59:1016-1018.
52. Thomsen LL, Oestergaard E, Bjornsson A, Stefansson H et al (2008) Screen for CACNA1A and ATP1A2 mutations in sporadic hemiplegic migraine patients. *Cephalalgia* 28:914-921.
53. May A, Ophoff RA, Terwindt GM, Urban C et al (1995) Familial hemiplegic migraine locus on 19p13 involved in the common forms of migraine with and without aura. *Hum Genet* 96:604-608.
54. Nyholt D, Lea R, Goadsby P, Brimage PJ, Griffiths LR (1998) Familial typical migraine. Linkage to chromosome 19p13 and evidence for genetic heterogeneity. *Neurology* 50:1428-1432.
55. Terwindt GM, Ophoff RA, van Eijk R, Vergouwe MN et al (2001) Involvement of the P/Q type calcium channel  $\alpha$ 1A-subunit (CACNA1A) gene region on 19p13 in migraine with and without aura. *Neurology* 56:1028-1032.
56. Hovatta I, Kallela M, Farkkila M, Peltonen L (1994) Familial migraine: exclusion of the susceptibility gene from the reported locus of familial hemiplegic migraine on 19p. *Genomics* 23:707-709.
57. Jones KW, Ehm MG, Percak-Vance MA, Haines JL et al (2001) Migraine with aura susceptibility locus on chromosome 19p13 is distinct from the familial hemiplegic migraine locus. *Genomics* 78:150-154.
58. Jen JC, Kim GW, Dudding KA, Baloh RW (2004) No mutations in CACNA1A and ATP1A2 in probands with common types of migraine. *Arch Neurol* 61:926-928.
59. Nyholt DR, LaForge KS, Kallela M, Alakurtti K et al (2008) A high-density association screen of 155 ion transport genes for involvement with common migraine. *Hum Mol Genet* 17:3318-3331.
60. Stam AH, Maagdenberg AM, Haan J, Terwindt GM, Ferrari MD (2008) Genetics of migraine: an update with special attention



- to genetic comorbidity. *Curr Opin Neurol* 21:288-293.
61. Joutel A, Corpechot C, Ducros A, Vahedi K et al (1996) Notch3 mutations in CADASIL, a hereditary adult-onset condition causing stroke and dementia. *Nature* 383: 707-710.
62. Dichgans M, Mayer M, Uttner I, Brüning R et al (1998) The phenotypic spectrum of CADASIL: clinical findings in 102 cases. *Ann Neurol* 44:731-739.
63. Eikermann-Harterter et al, International Headache Conference (IHC) 2009, Philadelphia
64. Grand MG, Kaine J, Fulling K, Atkinson J et al (1988) Cerebroretinal vasculopathy. A new hereditary syndrome. *Ophthalmology* 95(5):649-59.
65. Storimans CW, Van Schooneveld MJ, Oosterhuis JA, Bos PJ (1991) A new autosomal dominant vascular retinopathy syndrome. *Eur J Ophthalmol* 1(2):73-8.
66. Terwindt GM, Haan J, Ophoff RA, Groenen SM et al (1998) Clinical and genetic analysis of a large Dutch family with autosomal dominant vascular retinopathy, migraine and Raynaud's phenomenon. *Brain* 121(Pt 2):303-316.
67. Jen J, Cohen AH, Yue Q, Stout JT et al (1997) Hereditary endotheliopathy with retinopathy, nephropathy, and stroke (HERNS). *Neurology* 49(5):1322-1330.
68. Stam AH, Haan J, van den Maagdenberg AM, Ferrari MD, Terwindt GM (2009) Migraine and genetic and acquired vasculopathies. *Cephalalgia* 29(9):1006-1017.
69. Lee-Kirsch MA, Gong M, Chowdhury D, Senenko L et al (2007) Mutations in the gene encoding the 3'-5' DNA exonuclease TREX1 are associated with systemic lupus erythematosus. *Nat Genet* 39(9):1065-1067.
70. Lee-Kirsch MA, Chowdhury D, Harvey S, Gong M et al (2007) A mutation in TREX1 that impairs susceptibility to granzyme A-mediated cell death underlies familial chilblain lupus *J Mol Med* 85(5):531-537.
71. Appenzeller S and Costallat LT (2004) Clinical implications of migraine in systemic lupus erythematosus: relation to cumulative organ damage. *Cephalalgia* 24:1024-1030.
72. Breslau N, Davis GC, Schultz LR, Peterson EL (1994) Joint 1994 Wolff Award Presentation: Migraine and major depression: a longitudinal study. *Headache* 34:387-393.
73. Breslau N, Schultz LR, Stewart WF, Lipton RB et al (2000) Headache and major depression: is the association specific to migraine? *Neurology* 54:308-313.

- 
74. Breslau N, Lipton RB, Stewart WF, Schultz LR, Welch KM (2003) Comorbidity of migraine and depression: investigating potential etiology and prognosis. *Neurology* 60:1308-1312.
75. Lipton RB, Hamelsky SW, Kolodner KB, Steiner TJ, Stewart WF (2000) Migraine, quality of life, and depression: a population-based case-control study. *Neurology* 55: 629-635.
76. McWilliams LA, Goodwin RD, Cox BJ (2004) Depression and anxiety associated with three pain conditions: results from a nationally representative sample. *Pain* 111:77-83.
77. Stam AH, de Vries B, Janssens AC, Vanmolkot KR et al (2010) Shared genetic factors in migraine and depression: evidence from a genetic isolate. *Neurology* 26;74(4):288-294.
78. Beauvais K, Cavé-Riant F, De Barace C, Tardieu M et al (2004) New CACNA1A gene mutation in a case of familial hemiplegic migraine with status epilepticus. *Eur Neurol* 52:58-61.
79. de Vries B, Stam AH, Kirkpatrick M, Vanmolkot KR et al (2009a) Familial hemiplegic migraine is associated with febrile seizures in an FHM2 family with a novel de novo ATP1A2 mutation. *Epilepsia* 50(11):2503-2504.
80. Jen JC, Wan J, Palos TP, Howard BD, Baloh RW (2005) Mutation in the glutamate transporter EAAT1 causes episodic ataxia, hemiplegia, and seizures. *Neurology* 65(4):529-534.
81. Wessman M, Kallela M, Kaunisto MA, Marttila P et al (2002) Susceptibility locus for migraine with aura, on chromosome 4q24. *Am J Hum Genet* 70:652-662.
82. Bjornsson A, Gudmundsson G, Gudfinnsson E, Hrafnisdóttir M et al (2003) Localization of a gene for migraine without aura to chromosome 4q21. *Am J Hum Genet* 73:986-993.
83. Nyholt DR, Gillespie NG, Heath AC, Merikangas KR et al (2004) Latent class and genetic analysis does not support migraine with aura and migraine without aura as separate entities. *Genet Epidemiol* 26:231-244.
84. Nyholt DR, Morley KI, Ferreira MA, Medland SE et al (2005) Genomewide significant linkage to migrainous headache on chromosome 5q21. *Am J Hum Genet* 77:500-512.
85. Anttila V, Kallela M, Oswell G, Kaunisto MA et al (2006) Trait components provide tools to dissect the genetic susceptibility of migraine. *Am J Hum Genet* 79:85-99.

86. Collins, FS, Guyer, MS & Chakravarti A (1997) Variations on a theme: cataloguing human DNA sequence variation. *Science* 278:1580-1581.
87. Pritchard JK (2001) Are rare variants responsible for susceptibility to common diseases? *Am J Hum Genet* 69:124-137.
88. Reich DE, Lander ES (2001) On the allelic spectrum of human disease. *Trends Genet* 17(9):502-510.
89. Gibson G (2009) Decanalization and the origin of complex disease. *Nat Rev Genet* 10(2):134-140.
90. de Vries B, Frants RR, Ferrari MD, van den Maagdenberg AM (2009) Molecular genetics of migraine. *Hum Genet* 126(1):115-132.
91. Todt U, Netzer C, Toliat M, Heinze A et al (2009) New genetic evidence for involvement of the dopamine system in migraine with aura. *Hum Genet* 125(3):265-279.
92. Goyette P, Sumner JS, Milos R, Duncan AM et al (1994) Human methylenetetrahydrofolate reductase: isolation of cDNA mapping and mutation identification. *Nat Genet* 7:195-200.
93. Kowa H, Yasui K, Takeshima T, Urakami K et al (2000) The homozygous C677T mutation in the methylenetetrahydrofolate reductase gene is a genetic risk factor for migraine. *Am J Med Genet* 96:762-764.
94. Kara I, Sazci A, Ergul E, Kaya G, Kilic G (2003) Association of the C677T and A1298C polymorphisms in the 5,10 methylenetetrahydrofolate reductase gene in patients with migraine risk. *Brain Res Mol Brain Res* 111:84-90.
95. Lea RA, Ovcaric M, Sundholm J, MacMillan J, Griffiths LR (2004) The methylenetetrahydrofolate reductase gene variant C677T influences susceptibility to migraine with aura. *BMC Med* 2:3.
96. Oterino A, Valle N, Bravo Y, Muñoz P et al (2004) MTHFR T677 homozygosis influences the presence of aura in migraineurs. *Cephalalgia* 24:491-494.
97. Oterino A, Valle N, Pascual J, Bravo Y et al (2005) Thymidylate synthase promoter tandem repeat and MTHFD1 R653Q polymorphisms modulate the risk for migraine conferred by the MTHFR T677 allele. *Brain Res Mol Brain Res* 139:163-168.
98. Scher AI, Terwindt GM, Verschuren WM, Kruit MC et al (2006) Migraine and MTHFR C677T genotype in a population-based sample. *Ann Neurol* 59:372-375.
99. Todt U, Freudenberg J, Goebel I, Netzer C et al (2006) MTHFR C677T polymorphism and migraine with aura. *Ann Neurol* 60:621-622.

- 
100. Kaunisto MA, Kallela M, Hämäläinen E, Kilpikari R et al (2006) Testing of variants of the MTHFR and ESR1 genes in 1798 Finnish individuals fails to confirm the association with migraine with aura. *Cephalalgia* 26:1462-1472.
101. Rubino E, Ferrero M, Rainero I, Binello E et al (2009) Association of the C677T polymorphism in the MTHFR gene with migraine: a meta-analysis. *Cephalalgia* 29(8):818-825.
102. Schürks M, Rist PM, Kurth T (2009) MTHFR 677C>T and ACE D/I Polymorphisms in Migraine: A Systematic Review and Meta-Analysis. *Headache* 50(4):588-599.
103. Van Oosterhout RWPJ, Weller CM, Stam AH et al (2009) Diagnosing migraine using a web-based questionnaire: report from lumina (Leiden University migraine neuro analysis) group. Abstract PO157 Supplement 1 Abstracts of the 14th Congress of the International Headache Society *Cephalalgia* 29:73
104. Anttila V, Stefansson H, Kallela M, Todt U et al. (2010) Genome-wide association study of migraine implicates a common variant on 8q22.1 regulating the expression of astrocyte elevated gene-1 (AEG-1). *Nat Genet* 42(10):869-873.
105. Emdad L, Sarkar D, Su ZZ, Lee SG et al (2007) Astrocyte elevated gene-1: recent insights into a novel gene involved in tumor progression, metastasis and neurodegeneration. *Pharmacol Ther* 114(2):155-170.
106. Pardo LM, Mackay I, Oostra B, van Duijn CM, Aulchenko YS (2005) The effect of genetic drift in a young genetically isolated population. *Ann Hum Genet* 69(Pt 3):288-295.
107. Lanktree MB, Dichgans M, Hegele RA (2010) Advances in genomic analysis of stroke: what have we learned and where are we headed? *Stroke* 41(4):825-32
108. Austin MC, Schultzberg M, Abbott LC et al (1992) Expression of tyrosine hydroxylase in cerebellar Purkinje neurons of the mutant tottering and leaner mouse. *Brain Res Mol Brain Res* 15:227-240.
109. Abbott LC, Isaacs KR, Heckroth JA (1996) Co-localization of tyrosine hydroxylase and zebrin II immunoreactivities in Purkinje cells of the mutant mice, tottering and tottering/leaner. *Neuroscience* 71:461-475.
110. Sawada K, Komatsu S, Haga H, Sun XZ et al (1999) Abnormal expression of tyrosine hydroxylase immunoreactivity in Purkinje cells precedes the onset of ataxia in dilute-lethal mice. *Brain Res* 844:188-191.

111. Ng S, Buckingham KJ, Lee C, Bigam AW et al. (2009) Exome sequencing identifies the cause of a mendelian disorder. *Nature Genetics* 42:30-36.
112. Rommelse NN, Altink ME, Martin NC, Buschgens CJ et al (2008) Neuropsychological measures probably facilitate heritability research of ADHD. *Arch Clin Neuropsychol* 23:579-591.
113. Tuulio-Henriksson A, Haukka J, Partonen T, Varilo T et al (2002) Heritability and number of quantitative trait loci of neurocognitive functions in families with schizophrenia. *Am J Med Genet* 114:483-490.
114. Shyn SI, Shi J, Kraft JB, Potash JB et al (2009) Novel loci for major depression identified by genome-wide association study of Sequenced Treatment Alternatives to Relieve Depression and meta-analysis of three studies. *Mol Psychiatry* Dec 29. [Epub ahead of print]
115. Banaschewski T, Becker K, Scherag S, Franke B, Coghill D. 2010 Molecular genetics of attention-deficit/hyperactivity disorder: an overview. *Eur Child Adolesc Psychiatry* 19(3):237-257.
116. Lambert JC, Amouyel P (2010) Deciphering genetic susceptibility to frontotemporal lobar dementia. *Nat Genet* 42(3):189-90.
117. Peng G, Luo L, Siu H, Zhu Y et al. 2010 Gene and pathway-based second-wave analysis of genome-wide association studies. *Eur J of Hum Genet* 18:111-117.
118. van der Zwaag B, Franke L, Poot M, Hochstenbach R et al (2009) Gene-network analysis identifies susceptibility genes related to glycobiology in autism. *PLoS One* 4(5):e5324



---

**Summary**

**Nederlandse samenvatting**

**List of abbreviations**

**Dankwoord**

**List of publications**

**Curriculum Vitae**

---

## Summary

The research in this thesis was aimed at identifying and characterizing novel migraine gene mutations and pathways. Several FHM and non-FHM genes were investigated in patients with monogenic familial hemiplegic migraine or other monogenic disorders in which migraine can be prevalent. Functional consequences of these mutations and the clinical phenotypes associated with them were investigated. Common migraine with a complex genetic background was studied using a genome-wide association analysis in an isolated population and with a meta-analysis study. Furthermore, FHM1 mice were used to study expression profiles in brain tissues that are relevant for the induction of cortical spreading depression – underlying the migraine aura - (i.e., the occipital cortex) and cerebellar ataxia (i.e., the cerebellum). These studies will further our insight in the molecular pathophysiology of migraine.

**Chapter 2** describes three novel mutations in FHM genes. In **Chapter 2.1**, a novel V1696F mutation was reported in the FHM1 *CACNA1A* gene in two monozygotic twin brothers that had clinical features overlapping with both FHM and alternating hemiplegia of childhood (AHC). Here it was shown for the first time that a mutation in the *CACNA1A* gene can lead to atypical AHC. Previously, only one *ATP1A2* mutation had been identified in a family with atypical AHC. In **Chapter 2.2**, an FHM2 *ATP1A2* mutation was described causing hemiplegic migraine associated with febrile seizures. This family demonstrates the further broadening of the clinical spectrum of FHM2 mutations. In **Chapter 2.3**, mutation scanning in the *SCN1A* (FHM3) gene was performed in ten FHM families that were found negative for mutations in FHM1 and FHM2. A novel L1649Q mutation was identified in a large FHM family of North American origin. Although electrophysiological investigations revealed that the L1649Q mutation had gain-of-function properties when introduced in a *SCN5A* cDNA, recent parallel electrophysiological investigations suggested that a loss-of-function effect was observed when the mutation was introduced in the proper *SCN1A* background. The study firmly established the role of neuronal Na<sub>v</sub>1.1 sodium channels in FHM.

In **Chapter 3** a systematic analysis was performed to investigate the possible involvement of FHM genes in a large set of sporadic hemiplegic migraine (SHM) patients. In six out of the 39 well characterized SHM patients, without associated neurological features, a causal mutation was identified. One SHM patient had a *CACNA1A* mutation, five patients had *ATP1A2* mutations. A presumable *SCN1A* mutation in a seventh patient was shown to be a polymorphism. Functional assays were performed for all sequence variants and all six mutations were shown to have functional consequences. Our findings indicate that known FHM genes are involved in ~14% of



SHM patients, but that other genetic and non-genetic factors must be involved as well. In clinical practice, screening of the *ATP1A2* gene offers the highest likelihood of success in cases of “pure” SHM not associated with other neurological symptoms.

The excitatory amino acid transporter EAAT1, encoded by the *SLC1A3* gene, is located in the same FHM pathway; affecting glutamate levels in the synaptic cleft. An EAAT1 mutation was recently described in a patient with severe episodic and progressive ataxia, seizures, alternating hemiplegia, and migraine headache. For **Chapter 4**, mutation scanning of the *SLC1A3* gene was performed in 20 patients with episodic ataxia that were negative for *CACNA1A* mutations. A novel missense C186S mutation that segregated with EA in three family members was identified. Functional analysis revealed a modest, but significant, reduction of glutamate uptake into COS7 cells for the mutant EAAT1. Our study is the first evidence that *SLC1A3* mutations can cause EA without associated seizures or alternating hemiplegia. Moreover, it shows that the severity of clinical symptoms associated with EAAT1 mutations appeared correlated with the extent of glutamate transporter dysfunction

**Chapter 5** describes genetic and functional studies on the *TREX1* gene the major mammalian 3'-5' exonuclease. In **Chapter 5.1**, the *TREX1* gene is described as the causative gene for retinal vasculopathy with cerebral leukodystrophy (RVCL). RVCL is an autosomal dominant disorder characterized by progressive blindness due to vascular retinopathy that can be associated with a wide range of clinical symptoms, including migraine. Nine RVCL families were described, all having frameshift mutations leading to truncation of the C-terminal part of the TREX1 protein. Functional studies showed that these truncated proteins retained their exonuclease activity, but have abnormal perinuclear localization. *TREX1* mutations can also be associated with other vascular and immune-related phenotypes, such as Aicardi-Goutieres syndrome (AGS) or systemic lupus erythematosus (SLE). **Chapter 5.2** describes 60 neuropsychiatric SLE (NPSLE) patients with or without WHM and presents the first *TREX1* mutation identified in NPSLE. The NPSLE patient with the mutation R128H also had extensive WMH, and other clinical features such as Raynaud's phenomenon, lupus nephritis class IV, and severe migraine-like headaches. The mutation affects an arginine residue that is of extreme importance for the exonuclease activity of the TREX1 protein. Our findings suggest a role for TREX1 in SLE with brain involvement.

**Chapter 6** describes genome-wide association studies (GWAS) in common migraine. Common migraine can be subdivided in migraine with aura (MA) and migraine without aura (MO). **Chapter 6.1** describes the first clinic-based GWAS in a large cohort of 2,748 clinic-based MA patients. The most significantly associated SNP (rs1835740,  $P=5.12 \times 10^{-9}$ ) is located on chromosome 8 and

---

was replicated in several independent MA and MO cohorts containing in total 3,202 migraine cases. The SNP is located between the astrocyte elevated gene 1 (*MTDH/AEG-1*) and the plasma glutamate carboxypeptidase (*PGCP*) gene. An eQTL analysis showed that the minor allele of SNP rs1835740 is associated with increased MTDG/AEG-1 expression levels, which pinpoints glutamate as a key molecule in migraine pathophysiology. In **Chapter 6.2** the genetics of common migraine was investigated in the genetically isolated Erasmus Rucphen Family (ERF) population. Genetic studies in isolated populations are expected to benefit from the more homogeneous genetic and clinical background. None of the SNPs in the GWAS reached the threshold of genome-wide significance, but several SNPs showed (highly) suggestive associations. Subsequently, the GWA data of the ERF population was included in a large meta-analysis including multiple population-based cohorts of the Dutch Icelandic (DICE) consortium, which revealed an interesting association for SNP rs9908234 ( $P=8.0 \times 10^{-8}$ ) in the nerve growth factor receptor (*NGFR*) gene and migraine.

A different approach to identify migraine pathways and genes is to study gene expression changes in migraine knock-in mouse models that harbor pathogenic FHM1 mutations. These migraine mouse models were recently generated in our lab, and also highlight the importance of the cortical neurotransmitter glutamate in migraine pathophysiology. Whereas FHM1 R192Q is associated with “pure” FHM, without additional symptoms, FHM1 S218L mutation leads to a particularly severe phenotype of FHM, cerebellar ataxia, seizures and delayed brain edema, resulting sometimes in fatal coma, after a mild head trauma. Studies revealed that the difference in severity of phenotype seen in patients can also be observed in the respective knock-in mice. **Chapter 7** describes a study that investigated the gene expression profiles of these migraine mice in cortical and cerebellar tissue in an attempt to identify novel migraine pathways. Although neurotransmitter-related pathways were differentially expressed, the transcriptome in mutant mice was remarkably unchanged. Unlike in the cortex, a specific gene expression signature was identified in cerebellar tissue that highlighted molecular pathways underlying the cerebellar ataxia in S218L mice, and possibly patients with the same mutation.

**Chapter 8** provides a general discussion of the data from Chapter 2 to 7. The importance of the genetic factors and variants were identified in various migraine types and their relation to migraine pathways is discussed, as well as the information on migraine pathways that was obtained from the expression study. Ideas for future studies on migraine genetics, combining alternative phenotyping methods with genome-wide association studies are discussed. They may be a more successful strategy towards finding genetic factors for the common forms of migraine and may further insight in the pathophysiology of migraine.

## Nederlandse samenvatting

Het onderzoek beschreven in dit proefschrift heeft als doel het identificeren en karakteriseren van nieuwe migraine mutaties en biologische mechanismen. Verschillende FHM en niet-FHM genen zijn bestudeerd in patiënten met monogene familiale hemiplegische migraine en in andere monogene aandoeningen waarbij migraine aanwezig kan zijn. De functionele gevolgen van deze mutaties en de klinische fenotypes geassocieerd met deze mutaties zijn onderzocht. De veel voorkomende vormen van migraine, welke een complex genetisch achtergrond hebben, zijn bestudeerd in een genom-wijde associatie studie in een geïsoleerde populatie en ook in een meta-analyse studie. Verder zijn FHM1 muizen gebruikt om onderzoek te doen naar expressie profielen in hersenweefsels welke relevant zijn voor het initiëren van een corticale golf van neuronale depolarisatie – het onderliggende substraat van de migraine aura – (de occipitale cortex) en cerebellaire ataxie (het cerebellum). Deze studies zullen ons inzicht in de moleculaire pathofysiologie van migraine vergroten.

**Hoofdstuk 2** beschrijft drie nieuwe mutaties in FHM genen. In **hoofdstuk 2.1**, een nieuwe V1696F mutatie was beschreven in het FHM1 *CACNA1A* gen in twee monozygote tweeling broers met klinische symptomen welke overlappend zijn met zowel FHM als alternerende hemiplegie op de kinderleeftijd (AHC). Hier laten we voor het eerst zien dat een mutatie in het *CACNA1A* gen kan leiden tot atypische AHC. In voorgaand onderzoek werd slechts een *ATP1A2* mutatie geïdentificeerd in een familie met atypische AHC. In **hoofdstuk 2.2** wordt een FHM2 *ATP1A2* mutatie beschreven welke hemiplegische migraine geassocieerd met koorts convulsies veroorzaakt. Deze familie laat de verbreding van het klinische spectrum van FHM2 mutaties zien. In **hoofdstuk 2.3** werd een mutatie scan in het *SCN1A* (FHM3) gen uitgevoerd in tien FHM families welke negatief waren voor mutaties in FHM1 en FHM2. Een nieuwe L1649Q mutatie werd geïdentificeerd in een grote FHM familie van Noord Amerikaanse afkomst. Hoewel elektroфизиologische studies lieten zien dat de L1649Q mutatie leidt tot verhoogde functie van het natrium kanaal wanneer de mutatie werd ingebracht in *SCN5A* cDNA, heeft recent parallel elektroфизиologisch onderzoek laten zien dat waarschijnlijk een verlies-van-functie effect aanwezig is wanneer de mutatie in de juiste *SCN1A* achtergrond wordt ingebracht. Deze studie bevestigt de rol van neuronale  $\text{Na}_v1.1$  natrium kanalen in FHM.

In **hoofdstuk 3** werd een systematische analyse uitgevoerd met als doel het onderzoeken van de mogelijke betrokkenheid van de FHM genen in een grote set sporadische hemiplegische migraine (SHM) patiënten. In zes van deze 39 goed gekarakteriseerde SHM patiënten, zonder bijkomende neurologische symptomen, werd een ziekte veroorzakende mutatie gevonden. Een SHM patiënt

---

had een *CACNA1A* mutatie en vijf patiënten hadden *ATP1A2* mutaties. Een mogelijke *SCN1A* mutatie in een zevende patiënt bleek een polymorfisme te zijn. Functionele studies werden uitgevoerd voor alle sequentie varianten en alle zes mutaties lieten functionele consequenties zien. Onze bevindingen laten zien dat de bekende FHM genen een rol spelen in ongeveer 14% van de SHM patiënten, maar dat andere genetische en niet-genetische factoren ook een rol moeten spelen. In de klinische praktijk zal het screenen van het *ATP1A2* gen de meeste kans op succes bieden in patiënten met 'pure' SHM, zonder bijkomende neurologische symptomen.

De excitatoire aminozuur transporter EAAT1, welke gecodeerd wordt door het *SLC1A3* gene, bevindt zich in een zelfde FHM mechanisme en heeft een effect op de glutamaat concentratie in de synaptische spleet. Een EAAT1 mutatie was eerder beschreven in een patient met ernstige episodische en progressieve ataxie, convulsies, alternerende hemiplegie, en migraineuse hoofdpijn. Voor **hoofdstuk 4** een mutatie scan van het *SLC1A3* gen was uitgevoerd in 20 patiënten met episodische ataxie (EA) welke negatief waren voor mutaties in het *CACNA1A* gen. Een nieuwe missense C186S mutatie welke segregiert met EA in drie familieleden was geïdentificeerd. Functionele analyses lieten een geringe, maar significante, vermindering van glutamaat opname in COS7 cellen zien voor het mutante EAAT1. Onze studie laat het eerste bewijs zien dat *SLC1A3* mutaties EA zonder convulsies of alternerende hemiplegie kunnen veroorzaken. Ook laat deze studie zien dat de ernst van de klinische symptomen geassocieerd met EAAT1 mutaties lijkt te correleren met de ernst van de glutamaat transporter disfunctie.

**Hoofdstuk 5** beschrijft genetische en functionele studies voor het *TREX1* gen, een belangrijke 3'-5' exonuclease. In **hoofdstuk 5.1**, het *TREX1* gen is beschreven als het ziekteveroorzakende gen voor retinale vasculopathie met cerebrale leukodystrofie (RVCL). RVCL is een autosomaal dominante aandoening welke gekenmerkt wordt door progressieve blindheid als gevolg van vasculaire retinopathie welke geassocieerd kan zijn met een wijde range aan klinische symptomen, inclusief migraine. Negen RVCL families werden beschreven, allemaal met een frameshift mutatie leidend tot een vervroegd einde van het TREX1 eiwit, waardoor het C-terminale gedeelte van het TREX1 eiwit ontbreekt. Functionele studies lieten zien deze verkorte eitwitten hun exonuclease activiteit behielden, maar een abnormale rondom de kern gelegen lokalisatie hadden. *TREX1* mutaties zijn ook gevonden in andere vasculaire en immuun-gerelateerde aandoeningen, zoals het Aicardi-Goutieres syndroom (AGS) of systemische lupus erythematosus (SLE). **Hoofdstuk 5.2** beschrijft 60 neuropsychiatrische SLE (NPSLE) patiënten met en zonder witte stof afwijkingen en presenteert de eerste *TREX1* mutatie in een patiënt met NPSLE. De NPSLE patiënt met mutatie R128H heeft extensieve witte stof afwijkingen en andere klinische symptomen, zoals Raynaud's fenomeen, lupus nephritis klasse IV, en ernstige op migraine-lijkende hoofdpijnen. De mutatie

veranderd een Arginine welke extreem belangrijk is voor de exonuclease activiteit van het TREX1 eiwit. Onze bevindingen doen een rol vermoeden voor *TREX1* in cerebrale SLE.

**Hoofdstuk 6** beschrijft genoom-wijde associatie studies (GWAS) in de frequente vormen van migraine. De frequente vormen van migraine kunnen worden onderverdeeld in met aura (MA) en migraine zonder aura (MO). **Hoofdstuk 6.1** beschrijft de eerste GWAS in een groot cohort van 2,748 MA patiënten die verzameld zijn via hoofdpijn klinieken. De meest significant geassocieerde SNP (rs1835740,  $P=5.12 \times 10^{-9}$ ) bevindt zich op chromosoom 8 en kon gerepliceerd worden in verschillende onafhankelijke MA en MO cohorten welke in totaal 3,202 migraine patiënten bevatten. Deze SNP bevindt zich tussen het astrocyt verhoogde gen 1 (*MTDH/AEG-1*) gen and het plasma glutamaat carboxypeptidase (*PGCP*) gen. Een kwantitatieve expressie (eQTL) studie kon laten zien dat het zeldzame allel van deze SNP associeert met verhoogde *MTDH/AEG-1* expressie niveaus. Dit identificeert glutamaat als essentieel molecuul in migraine pathofysiologie.

In **hoofdstuk 6.2** wordt de genetica van de frequente vormen van migraine onderzocht in de genetisch geïsoleerde Erasmus Rucphen Family (ERF) populatie. Naar verwachting heeft de meer homogene genetische en klinische achtergrond van deze populatie een positief effect op genetische studies voor migraine. Geen van de SNPs uit de GWA studie haalde de drempel van genoom-wijde significantie, maar verschillende SNPs lieten wel (hoog) suggestieve associaties zien. Vervolgens, werd de GWA data van de ERF populatie toegevoegd aan een grote meta-analyse welke verschillende via de populatie geselecteerde migraine cohorten van het Nederlands IJslandse (DICE) consortium bevatte. Deze studie leidde tot een interessante associatie voor SNP rs9908234 ( $P=8.0 \times 10^{-8}$ ) in het zenuw groeifactor receptor (*NGFR*) gen met migraine.

Een andere benadering voor het identificeren van migraine mechanismen en genen is het bestuderen van gen expressie veranderingen in transgene migraine muizen. Deze muismodellen voor migraine zijn recent gegenereerd in ons lab, en benadrukken de functie van de corticale neurotransmitter glutamaat in de pathofysiologie van migraine. Hoewel FHM R192Q geassocieerd is met 'pure' FHM, zonder bijkomende symptomen, leidt FHM1 S218L mutatie tot een bijzonder ernstig FHM fenotype met cerebellaire ataxie, convulsies, en hersen oedeem, welke soms zelfs tot fatale coma kan leiden na een mild hoofdtrauma. Studies hebben aangetoond dat het verschil in ernst van het fenotype gezien in patiënten overeenkomt met respectievelijke transgene muizen. **Hoofdstuk 7** beschrijft een studie die de gen expressie profielen van deze migraine muizen bestudeerd met als doel het identificeren van nieuwe migraine mechanismen. Hoewel neurotransmitter-gerelateerde systemen differentieel tot expressie kwamen, is het transcriptoom van de mutante muizen opvallend gelijk aan dat van niet-mutante muizen. Voor het cerebellaire

---

weefsel was een specifieke signatuur geïdentificeerd welke moleculaire mechanismen liet zien specifiek voor cerebellaire ataxie in de S218L muis, en waarschijnlijk ook voor patiënten met deze mutatie.

**Hoofdstuk 8** geeft de algemene discussie over de data van hoofdstuk 2 tot en met 7 weer. Het belang van de genetische factoren en varianten die geïdentificeerd zijn in de verschillende migraine typen en de relatie tot migraine mechanismen is besproken, evenals de informatie over migraine mechanismen die verkregen was uit de expressie studie. Ideeën voor toekomstige migraine genetica studies, waarin alternatieve fenotyperings methoden in combinatie met genoom-wijde associatie studies worden ook besproken. Deze studies zijn mogelijk succesvolle strategieën voor het vinden van genetische factoren voor de meer voorkomende vormen van migraine en zullen misschien ook onze kennis over de pathofysiologie van migraine vergroten.

## List of abbreviations

AHC	alternating hemiplegie of childhood
AGS	Aicardi-Goutiere syndrome
ATP	adenosine tri-phosphate
cDNA	copy deoxyribonucleic acid
CMH	Cochran-Mantel-Haenszel
CNS	central nervous system
CSD	cortical spreading depression
CVR	cerebroretinal vasculopathy
DNA	deoxyribonucleic acid
EAAT1	excitatory amino acid transporter
EA	episodic ataxia
eQTL	expression quantitative trait locus
ERF	Erasmus Rucphen Family (study)
FHM	familial hemiplegic migraine
FP	fluorescent protein
GEFS+	generalised epilepsy with febrile seizures
GWAS	genome-wide association study
HERNS	hereditary endotheliopathy, retinopathy, nepropathy and stroke
HVR	hereditary vascular retinopathy
IHS	international headache society
KI	knock-in
LCA	latent class analysis
LCL	lymphoblastoid cell lines
LD	linkage disequilibrium
LOD	logarithm of odds
MAF	minor allele frequency
MO	migraine without aura
MA	migraine with aura
MRI	magnetic resonance imaging
NPSLE	neuro psychiatric systemic lupus erythematosus
OR	odds ratio
PCR	polymerase chain reaction
qPCR	quantitative polymerase chain reaction
RNA	ribonucleic acid

---

RVCL	retinal vasculopathy with cerebral leukodystrophy
SHM	sporadic hemiplegic migraine
SLE	systemic lupus erythematosus
SNP	single nucleotide polymorphism
SMEI	severe myoclonic epilepsy of infancy
TCA	trait component analysis
TGVS	trigeminovascular system
WMH	white matter hyperintensities
WT	wild-type



## Dankwoord

Het moment waarvan je in de 'AIO-dipjes' denkt dat het nooit gaat komen is dan nu toch hier, het proefschrift is af! Dit proefschrift is tot stand gekomen met de steun en hulp van vele mensen die ik hier graag wil bedanken.

Allereerst mijn co-promotor Arn. Een betere co-promotor had ik mij niet kunnen wensen. Hoe druk je het ook had, er kon altijd tijd vrijgemaakt worden om even naar een stuk te kijken. Bedankt voor je enthousiasme, energie, talloze ideeën en oplossingen. Verder wil ik mijn promotores Rune en Michel bedanken. Rune, ik ben blij dat ik nog net bij je laatste AIO's heb mogen horen. Dank voor je fijne begeleiding, je mooie Finse humor en je waardevolle adviezen op de juiste momenten. Michel, jouw visie op het wetenschappelijk onderzoek was altijd zeer leerzaam en verfrissend. In de genen ben jij eigenlijk niet geïnteresseerd : ) maar uiteraard wel in de bijbehorende mechanismen. Dank voor al je input en opbouwende kritiek, het werd er altijd beter van! Ook dank voor het gave ritje in je fantastische cabrio!

Graag wil ik mijn Migraine-collega's bedanken voor de gezelligheid en collegialiteit. Ik heb het enorm gewaardeerd dat we altijd als groep werken en elkaar helpen wanneer nodig. Kaate, bedankt voor alles wat je me geleerd hebt, je goede input en suggesties, en je kalmte in tijden van stres. Ludo bedankt voor je eeuwige enthousiasme, behulpzaamheid en vrolijkheid (ook al gaat deze soms gepaard met fluit-CDs..). Stephany, sinds een aantal jaar ben jij ook lid van de migraine-clan en storten wij onze samen op de praktische kant van de migraine genetica, dank voor je enorme inzet. Verder natuurlijk ook: Claudia, Florencia, Reinald, Curtis, Jessica, Nathalie, Erida, Fleur, Marije, Sandra, Querijn, Boyan, Eelke, Judith, Corrie, Rob en studenten Jochem, Cindy, Chantal en Maarten. Daarnaast wil ik mijn collega's uit groep Frants bedanken. Jullie maken het leven als AIO erg gezellig!

Voor het onderzoek werken wij ook altijd nauw samen met de afdeling Neurologie. Gisela en Joost, bedankt voor de fijne samenwerking. Anine, samen iedere dinsdagavond op het LUMC zitten om aan een proefschrift te werken is toch echt een stuk leuker dan alleen! Bedankt voor de gezelligheid en de leuke samenwerking. Ook wil ik Ron, Ronald, Mark en Poldi bedanken.

De resultaten die in de hoofdstukken beschreven staan zijn mede tot stand gekomen met de hulp van verschillende samenwerkingen. Jan en Jeroen, bedankt voor de survival data en de meeloopdag in Nijmegen. Martin and Tobias, thanks for the fruitful collaboration with the SHM project and also the GWA projects. Joanna Jen and Hafsa Mamsa thanks for the collaboration with our

---

joint EAAT1 project. Aarno and Veneri, thanks for having me over at Sanger and giving me the opportunity to learn from you! Veneri, I think we still need another air-hockey revenge.. Dorret en Lannie, dank voor de prettige samenwerking in het meta-analyse project. Lannie, het was altijd erg gezellig om samen met jou aan deze studie te werken. Judith, Peter-Bram en Henk, bedankt voor jullie hulp en waardevolle input bij de microarray experimenten. Voor onze studies in het ERF cohort is er nauw samengewerkt met de groep van Cornelia van Duijn van het Erasmus MC. Graag wil ik naast Cornelia ook Yurii, Linda en Najaf bedanken voor hun input en hulp. Peter, jij ook heel veel dank voor je hulp en gezelligheid!

Lieve Heleen, Rachel en Eddy. Het was altijd leuk om mijn AIO verhalen en soms ook frustraties met jullie te delen. Heleen, samen begonnen we jaren geleden met onze eerste baan bij het UMC, leuk dat we elkaar nog steeds zien. Rachel, vanaf onze studietijd hebben we lief en leed gedeeld. Ik hoop dat we nog heel lang vriendinnen blijven, leuk dat je nu mijn paranimf wilt zijn! Eddy, mijn andere paranimf, wij kennen elkaar ook al sinds onze VU-tijd, daarna beide promoveren in Leiden, het is altijd gezellig met jou.

Lieve Arie, je bent een geweldige vriend en het perfecte voorbeeld van een levensgenieter! Bedankt voor je grafische hulp en je enorme enthousiasme bij de opmaak van mijn proefschrift, of volgens jou 'de scriptie vol met toverspreuken' : )

Lieve vriendinnen. Judith en Bianca, jullie zijn fantastisch en voor altijd! Rosa, Marleen en Belinda, wat kennen we elkaar alweer lang he, het is altijd weer gezellig. De meiden uit mijn volleybal team en natuurlijk ook Marije, Bianca en Monica. Bedankt voor de heerlijke sportieve ontspanning, het fanatisme en alle gezelligheid!

Lieve Anton en Elmer, Wouter en Marjolein, onze vriendschap is heel hecht en voor mij van grote waarde. Samen varen, samen zeilen, samen dansen, samen eten, het maakt niet uit wat we doen, het is altijd leuk en gezellig met jullie!

En ten slotte wil ik graag mijn familie bedanken. Gabe, Jelmer en Ingrid, ik zou geen lievere broers en schoonzus kunnen hebben. Mijn lieve omaatje (beppe) die altijd in mij gelooft en van alles op de hoogte wil zijn. Mijn lieve ouders (heit en mem), jullie staan altijd achter mij in alles wat ik doe en dat waardeer ik enorm, bedankt voor jullie oneindige steun!

Lieve, lieve Thomas, jij bent er altijd voor mij. Bedankt voor je liefdevolle steun, onvoorstelbare geduld en je nuchtere en relativerende blik in mijn tijden van stres. Ik weet dat dit promotie traject voor jou ook zwaar is geweest.. You're the best!

## List of publications

Anine H. Stam, Mark A. Louter, Joost Haan, [Boukje de Vries](#), Arn M.J.M. van den Maagdenberg, Rune R. Frants, Michel D. Ferrari, Gisela M. Terwindt. A long-term follow-up study of 18 patients with sporadic hemiplegic migraine. *Cephalgia* 2010 [Epub ahead of print]

V. Anttila, H. Stefansson, M. Kallela, U. Todt, G.M. Terwindt, M.S. Calafato, D.R. Nyholt, A.S. Dimas, T. Freilinger, B. Müller-Myhsok, V. Artto, M. Inouye, K. Alakurtti, M.A. Kaunisto, E. Hämäläinen, [B. de Vries](#), A.H. Stam, C.M. Weller, A. Heinze, K. Heinze-Kuhn, I. Goebel, G. Borck, H. Göbel, S. Steinberg, C. Wolf, A. Björnsson, G. Gudmundsson, M. Kirchmann, A. Hauge, T. Werge, J. Schoenen, J.G. Eriksson, K. Hagen, L. Stovner, H.-E. Wichmann, T. Meitinger, M. Alexander, S. Moebus, S. Schreiber, Y. S. Aulchenko, M.M.B. Breteler, A.G. Uitterlinden, A. Hofman, C. M. van Duijn, P. Tikka-Kleemola, S. Vepsäläinen, S. Lucae, F. Tozzi, P. Muglia, J. Barrett, J. Kaprio, M. Färkkilä, L. Peltonen, K. Stefansson, J.A. Zwart, M.D. Ferrari, J. Olesen, M. Daly, M. Wessman, A.M.J.M. van den Maagdenberg, M. Dichgans, C. Kubisch, E.T. Dermitzakis, R.R. Frants, A. Palotie on behalf of the International Headache Genetics Consortium. Genome-wide association study of migraine implicates a common variant on 8q22.1 regulating the expression of astrocyte elevated gene-1 (AEG-1). *Nature Genetics* 2010;467:52-58.

Montagna P, [de Vries B](#), Schürks M, Haan J, Terwindt GM. Genetic contributors to headache. Handbook of Headache

Anine H. Stam, [Boukje de Vries](#), Cecile J.W. Janssens, Kaate R.J. Vanmolkot, Yurii S. Aulchenko, Peter Henneman, Ben A. Oostra, Rune R. Frants, Arn M.J.M. van den Maagdenberg, Michel D. Ferrari, Cornelia M. van Duijn, Gisela M. Terwindt Shared genetic factors in migraine and depression. *Neurology* 2010;74:288-294.

[B de Vries](#), G M Steup-Beekman, J Haan, E L Bollen, J Luyendijk, R R Frants, G M Terwindt, M A van Buchem, T W J Huizinga, A M J M van den Maagdenberg & M D Ferrari. *TREX1* Gene Variant in Neuropsychiatric Systemic Lupus Erythematosus. *Annals of the Rheumatic Disorders* 2010;69:1886-1887.

[Boukje de Vries](#), Anine H Stam, Martin Kirkpatrick, Kaate RJ Vanmolkot, Jan B Koenderink, Jeroen JMW van den Heuvel, Bas Stunnenberg, David Goudie, Jay Shetty, Vivek Jain, Judith van Vark, Gisela M Terwindt, Rune R Frants, Joost Haan, Arn MJM van den Maagdenberg, Michel D Ferrari. Familial hemiplegic migraine is associated with febrile seizures in a FHM2 family with a novel de novo *ATP1A2* mutation. *Epilepsia* 2009;50:2503-2504.

---

Boukje de Vries, Michel D. Ferrari MD, Arn M.J.M. Maagdenberg. Molecular Genetics of Migraine. *Human Genetics* 2009;126:115-132.

Maria-José Castro, Anine H. Stam, Carolina Lemos, Boukje de Vries, Kaate R. J. Vanmolkot, José Barros, Gisela M. Terwindt, Rune R. Frants, Jorge Sequeiros, Michel D. Ferrari, José M. Pereira-Monteiro, Arn M. J. M. van den Maagdenberg, First mutation in the voltage-gated Na<sub>v</sub>1.1 subunit gene *SCN1A* with co-occurring familial hemiplegic migraine and epilepsy. *Cephalalgia* 2009;29:308-313.

Boukje de Vries,\* Hafsa Mamsa,\* Anine H. Stam,\* Jijun Wan, Stef L.M. Bakker, Kaate R.J. Vanmolkot, Ludo A.M. Broos, Judith van Vark, Joost Haan, Gisela M. Terwindt, Elles M.J. Boon, Bruce D. Howard, Rune R. Frants, Robert W. Baloh, Michel D. Ferrari, Joanna C. Jen, Arn M.J.M. van den Maagdenberg. Episodic ataxia associated with EAAT1 mutation C186S affecting glutamate reuptake. *Archives of Neurology* 2009;66:1-5. \*Authors contributed equally

Dale R. Nyholt, K. Steven LaForge, Mikko Kallela, Kirsi Alakurtti, Verneri Anttila, Markus Färkilä, Eija Hämaläinen, Jaakko Kaprio, Mari A. Kaunisto, Andrew C. Heath, Grant W. Montgomery, Hartmut Göbel, Unda Todt, Michel D. Ferrari, Lenore J. Launer, Rune R. Frants, Gisela M. Terwindt, Boukje de Vries, W. M. Monique Verschuren, Jan Brand, Tobias Freilinger, Volker Pfaffenrath, Andreas Straube, Dennis G. Ballinger, Yiping Zhan, Mark J. Daly, David R. Cox, Martin Dichgans, Arn M.J.M. van den Maagdenberg, Christian Kubisch, Nicholas G. Martin, Maija Wessman, Leena Peltonen and Aarno Palotie A high-density association screen of 155 ion transport genes for involvement with common migraine. *Human Molecular Genetics* 2008;17:3318-3331.

B. de Vries,\* A.H. Stam,\* Beker B,\* A.M.J.M. van den Maagdenberg, K.R.J. Vanmolkot, L.A.E.M. Laan, I.B. Ginjaar, R.R. Frants, H. Lauffer, J. Haan, J.P. Haas, G.M. Terwindt, M.D Ferrari. *CACNA1A* mutation linking hemiplegic migraine and alternating hemiplegia of childhood. *Cephalalgia* 2008;28:887-891. \*Authors contributed equally

Maria-José Castro, Belina Nunes, Boukje de Vries, Carolina Lemos, Kaate R.J. Vanmolkot, Jeroen J.M.W. van den Heuvel, Teresa Temudo, José Barros, Jorge Sequeiros, Rune R. Frants, Jan B. Koenderink, José M. Pereira-Monteiro, Arn M.J.M. van den Maagdenberg. Two novel functional mutations in the Na<sup>+</sup>,K<sup>+</sup>-ATPase α2 subunit *ATP1A2* gene in patients with familial hemiplegic migraine and associated neurological phenotypes. *Clin Genet* 2008;73:37-43.

Boukje de Vries,\* Tobias Freilinger,\* Kaate R.J. Vanmolkot, Jan B. Koenderink, Anine H. Stam, Gisela M. Terwindt, Elena Babini, Eelke H. van den Boogerd, Jeroen J.M.W. van den Heuvel, Rune

R. Frants, Joost Haan, Michael Pusch, Arn M.J.M. van den Maagdenberg, Michel D. Ferrari, Martin Dichgans. Systematic Analysis of the Familial Hemiplegic Migraine Genes CACNA1A, ATP1A2 and SCN1A in 39 Sporadic Patients with Hemiplegic Migraine. *Neurology* 2007;4:2170-2176. \*Authors contributed equally

Anna Richards,\* Arn M J M van den Maagdenberg,\* Joanna C Jen,\* David Kavanagh,\* Paula Bertram, Dirk Spitzer, M Kathryn Liszewski, Maria-Louise Barilla-LaBarca, Gisela M Terwindt, Yumi Kasai, Mike McLellan, Mark Gilbert Grand, Kaate R J Vanmolkot, Boukje de Vries, Jijun Wan, Michael J Kane, Hafsa Mamsa, Ruth Schafer, Anine H Stam, Joost Haan, Paulus T V M de Jong, Caroline W Storimans, Mary J van Schooneveld, Jendo A Oosterhuis, Andreas Gschwendter, Martin Dichgans, Katya E Kotschet, Suzanne Hodgkinson, Todd A Hardy, Martin B Delatycki, Rula A Hajj-Ali, Parul H Kothari, Stanley F Nelson, Rune R Frants, Robert W Baloh, Michel D Ferrari & John P Atkinson C-terminal truncations in human 3'-5' DNA exonuclease TREX1 cause autosomal dominant retinal vasculopathy with cerebral leukodystrophy *Nature genetics* 2007;39:1068-1070. \*Authors contributed equally

Vanmolkot KR, Stam AH, Raman A, Koenderink JB, de Vries B, van den Boogerd EH, van Vark J, van den Heuvel JJ, Bajaj N, Terwindt GM, Haan J, Frants RR, Ferrari MD, van den Maagdenberg AMJM. First compound heterozygosity in Na,K-ATPase gene *ATP1A2* in Familial Hemiplegic Migraine. *European Journal of Human Genetics*. 2007;15:884-888.

Vanmolkot KRJ,\* Babini E,\* De Vries B, Stam AH, Freilinger J, Terwindt GM, Haan J, Frants RR, Ramadan NM, Ferrari MD, Pusch M, Van den Maagdenberg AMJM, Dichgans M. The novel p.L1649Q mutation in the *SCN1A* epilepsy gene is associated with familial hemiplegic migraine: genetic and functional studies. *Human mutation* 2007;28:522. \*Authors contributed equally

B. de Vries, J. Haan, A.H. Stam, K.R.J. Vanmolkot, H. Stroink, L.A.E.M. Laan. D.S. Gill, J. Pascual, R.R. Frants, A.M.J.M. van den Maagdenberg, M.D. Ferrari. Alternating hemiplegia of childhood: no mutations in the glutamate transporter EAAT1. *Neuropediatrics* 2006;37:302-304.

Elizabeth Loder, Micheal G. Harrington, Micheal Cutrer, Peter Sandor, Boukje de Vries. Selected Confirmed, Probable, and Exploratory Migraine Biomarkers. *Headache* 2006;46:1108-1127.

Boukje de Vries, Joost Haan, Rune R. Frants, Arn M.J.M. van den Maagdenberg, Michel D. Ferrari. Genetic Biomarkers for Migraine. *Headache* 2006;46:1059-1068.

---

B. de Vries, R. van Beem, M.A.J.M. Jacobs, B.M.J. Uitdehaag and A.S. Peña. The concurrence of inflammatory bowel disease and multiple sclerosis. *Rev Esp Enferm Dig.* 2003;95(N°Extra):120-125.

De Vries B., Glennon J.C., Tuinstra T., Herremans A.H.J., and McCreary A.C. Chronic administration of PCP: the effect on PPL, locomotor sensitisation, and amphetamine locomotion. *J. Psychopharmacol.* 2002;16:3; A62, G20.

## Curriculum Vitae

Boukje de Vries werd geboren op 6 december 1979 in Emmeloord. Nadat zij in 1998 haar VWO diploma behaalde aan de Interconfessionele scholengemeenschap Arcus te Lelystad, begon zij met de studie Medische Biologie aan de Vrije Universiteit te Amsterdam. Voor deze studie heeft zij twee maal een onderzoeksstage gelopen. De eerste stage werd gelopen bij de afdeling Gedragsfarmacologie van het bedrijf Solvay Pharmaceuticals te Weesp onder leiding van Dr. A.C. McCreary. Hier deed zij onderzoek naar een diemodel voor schizofrenie. Tijdens haar tweede stage periode deed zij onderzoek naar genetische factoren die betrokken zijn bij de ziekte van Crohn. Deze stage werd gelopen bij de afdeling Inmunología Clínica van Hospital Clinico San Carlos in Madrid onder leiding van Prof. Dr. E.G. de la Choncha, Prof. Dr. A.S. Peña en Dr. A. Martinez.

Van oktober 2003 tot en met januari 2005 was zij werkzaam als Onderzoeksassistent bij de afdeling Volwassenen Psychiatrie van het Universitair Medisch Centrum in Utrecht. Hier werkte zij mee aan structurele MRI studies bij schizofrenie patiënten onder leiding van Dr. N.E. van Haren.

In februari 2005 tot en met januari 2009 was zij werkzaam als promovendus aan de afdeling Humane Genetica van het Leids Universitair Medisch Centrum onder leiding van Prof. Dr. M.D. Ferrari, Prof. Dr. R.R. Frants en Dr. A.M.J.M. van den Maagdenberg. De resultaten van het onderzoek staan beschreven in dit proefschrift. Vanaf februari 2009 is zij werkzaam als postdoctoraal onderzoeker binnen hetzelfde onderzoek bij de afdeling Humane Genetica van het Leids Universitair Medisch Centrum.

