

Cover Page



Universiteit Leiden



The following handle holds various files of this Leiden University dissertation:
<http://hdl.handle.net/1887/81488>

Author: Langeveld, N.D.S.

Title: Matching, entropy, holes and expansions

Issue Date: 2019-12-10

Matching, entropy, holes and expansions

Niels Langeveld

Matching, entropy, holes and expansions

Proefschrift

ter verkrijging van
de graad van Doctor aan de Universiteit Leiden,
op gezag van Rector Magnificus prof. mr. C. J. J. M. Stolker,
volgens besluit van het College voor Promoties
te verdedigen op dinsdag 10 december 2019
klokke 12.30 uur

door

Niels Daniël Simon Langeveld
geboren te Heemstede
in 1989

Promotor:

Prof. dr. W. Th. F. den Hollander (Universiteit Leiden)

Copromotor:

Dr. C. C. C. J. Kalle (Universiteit Leiden)

Samenstelling van de promotiecommissie:

Prof. dr. P. Stevenhagen (secretaris; Universiteit Leiden)

Prof. dr. V. Berthé (IRIF, CNRS, Université Paris Diderot)

Dr. W. Bosma (Radboud Universiteit Nijmegen)

Prof. dr. H. Nakada (Keio University, Tokyo)

Contents

1	Introduction	1
§1.1	Representing numbers	2
§1.1.1	Continued fractions	3
§1.1.2	β -expansions	9
§1.2	Explaining the terms in the title	11
§1.2.1	Entropy	11
§1.2.2	Matching	13
§1.2.3	Holes and expansions	14
§1.3	Statement of results	15
2	Natural extensions, entropy and infinite systems	19
§2.1	Introduction	20
§2.2	Preliminaries	23
§2.2.1	Insertions and the natural extension	24
§2.2.2	Back to our map	27
§2.3	Natural extensions for our maps	28
§2.3.1	From natural extension to invariant measure	29
§2.4	Entropy	31
§2.5	Return sequences and wandering rates	33
§2.5.1	Isomorphic?	34
§2.5.2	Final observations and remarks	35
3	Matching and Ito Tanaka's α-continued fraction expansions	39
§3.1	Introduction	40
§3.1.1	Ito Tanaka continued fractions: old and new results	42
§3.2	Algebraic relations, an entropy formula and matching implies monotonicity	44
§3.3	Matching almost everywhere and characterisations of the bifurcation set	55
§3.4	Dimensional results for \mathcal{E}_{IT}	60
§3.5	Final observations and remarks	63
4	N-expansions	65
§4.1	Introduction	66
§4.2	The general form of our maps	67

§4.2.1	Two seemingly closely related examples and their natural extension	68
§4.2.2	Two different methods for approximating the density	72
§4.3	A sub-family of the N -expansions	73
§4.3.1	A 2-expansion with $\alpha = \sqrt{2} - 1$	74
§4.3.2	Admissibility	76
§4.3.3	Entropy and matching	78
§4.4	Conclusion	87
5	β-expansions	91
§5.1	Introduction	92
§5.2	Preliminaries, β -expansions and first properties of $K_\beta(t)$ and E_β	95
§5.2.1	Notation on sequences	95
§5.2.2	The β -transformation and β -expansions	96
§5.2.3	First properties of $K_\beta(t)$ and E_β	97
§5.2.4	The size of E_β	100
§5.3	Topological structure of E_β	101
§5.4	When E_β^+ does not have isolated points	109
§5.4.1	Farey words	111
§5.4.2	Farey intervals	114
§5.5	The critical points of the dimension function	120
§5.6	Final observations and remarks	125
§5.6.1	Connections to other topics	126
	Bibliography	128
	Samenvatting	135
	Acknowledgements	137
	Curriculum Vitae	139
	Index	140





CHAPTER 1

Introduction

In this dissertation, the main topic is representations of numbers in relation to matching, entropy and holes. In this chapter, we first briefly discuss the representations that are studied in this dissertation. This is followed by a section in which we introduce the basic definitions used in dynamical systems and ergodic theory. This is done by means of the regular continued fraction. Other representations which we study are β -expansions. These are explained in the section thereafter. In the last part of the introduction we explain the words in the title and elaborate more on what to find in which chapter.

§1.1 Representing numbers

In general we express one number by using others. There is a family of numbers which we know how to use because we use them to count: the natural numbers. The numbers of the set $B := \{\frac{1}{n} : n \in \mathbb{N}\}^1$ are also natural to use and, since the n -fold of them equals 1, they are still related to counting. Now suppose we have a number x between 0 and 1. We try to express x using these numbers. If $x \notin B$ we can only approximate x by a number $\frac{1}{n}$ such that the error is small. If we want to express x with elements from B without an error we should not stop here but continue! We can do two things. Either write $x = \frac{1}{n} + \varepsilon$ or $x = \frac{1}{n+\varepsilon}$ for some $\varepsilon > 0$. We can proceed with ε and find an $m \in \mathbb{N}$ such that ε is close to $\frac{1}{m}$ and continue in this manner. The first case corresponds to Lüroth expansions which are introduced in [78] and widely studied thereafter (see for example [6, 40, 51]). Our interest lies in the second way which leads to continued fractions. We obtain a continued fraction expansion for x by using the Gauss map $T : [0, 1] \rightarrow [0, 1]$ which is defined by

$$T(x) = \frac{1}{x} - \left\lfloor \frac{1}{x} \right\rfloor$$

for $x \neq 0$ and $T(0) = 0$, see Figure 1.1. Let the digits be defined as $d_1(x) = \lfloor \frac{1}{x} \rfloor$ and $d_n(x) = d_1(T^{n-1}(x))$ for $n > 1$.

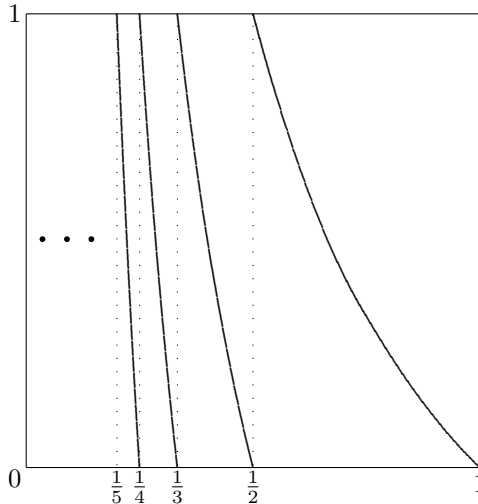

Figure 1.1: The Gauss map.

¹In this dissertation 0 is not included in the set of natural numbers.

For $x \in [0, 1]$ we find

$$x = \frac{1}{d_1(x) + T(x)} = \frac{1}{d_1(x) + \frac{1}{d_2(x) + T^2(x)}} = \frac{1}{d_1(x) + \frac{1}{d_2(x) + \frac{1}{d_3(x) + \ddots}}}$$

with $d_n \in \mathbb{N}$. We can write this in short notation as $x = [0; d_1, d_2, d_3, \dots]$. Examples of such expansions are $e - 2 = [0; 1, 2, 1, 1, 4, 1, 1, 6, 1, 1, 8, \dots]$ or $\sqrt{2} - 1 = [0; 2, 2, 2, \dots]$. Any $x \in (0, 1]$ has such an expansion. For rational numbers one finds a finite continued fraction and for irrational numbers one finds an infinite continued fraction. For convergence and other basic properties of this representation see [29]. In Chapter 2, 3 and 4 variations of T will be studied.

Suppose that, instead of taking the natural numbers as a given, we take a value $\frac{1}{\beta}$ with $\beta > 1$. Now we approximate numbers in $[0, 1]$ by numbers of the form $\frac{m}{\beta^n}$ so that $x = \frac{m}{\beta^n} + \varepsilon$ with $n, m \in \mathbb{N}$. We do this in the following way. We first pick the smallest $n \in \mathbb{N}$ such that $\frac{1}{\beta^n} < x$ and then we take $m \in \{1, \dots, \lfloor \beta x \rfloor\}$ maximal such that $\frac{m}{\beta^n} < x$. Then we proceed the procedure applied on $\varepsilon = x - \frac{m}{\beta^n}$. We can do this dynamically with the function $T_\beta : [0, 1] \rightarrow [0, 1]$ defined by $T_\beta(x) = \beta x - \lfloor \beta x \rfloor$. For an example see Figure 1.2. Now we set $d_1(x) = \lfloor \beta x \rfloor$ and $d_n = d_1(T^{n-1}(x))$ for $n > 1$. This gives us

$$x = \frac{d_1(x) + T_\beta(x)}{\beta} = \frac{d_1(x)}{\beta} + \frac{d_2(x) + T_\beta^2(x)}{\beta^2} = \frac{d_1(x)}{\beta} + \frac{d_2(x)}{\beta^2} + \frac{d_3(x)}{\beta^3} + \dots$$

Convergence of this representation is immediately clear since, when taking the first n digits, we are at most $\frac{1}{\beta^n}$ away from x . The β -expansions are studied in Chapter 5. In Section 5.6.1 we see some relation to continued fractions.

§1.1.1 Continued fractions

In this section we introduce some basic notions and results concerning continued fractions. Along the way we encounter concepts that are prominent in ergodic theory. Because of the introductory nature of this section, all the results presented in this section can also be found in [29]. Let $x \in (0, 1)$ with

$$x = \frac{1}{d_1 + \frac{1}{d_2 + \frac{1}{d_3 + \ddots}}}$$

We define the n^{th} convergent of x as

$$c_n = \frac{p_n}{q_n} = \frac{1}{d_1 + \frac{1}{d_2 + \frac{1}{\ddots + \frac{1}{d_n}}}}$$

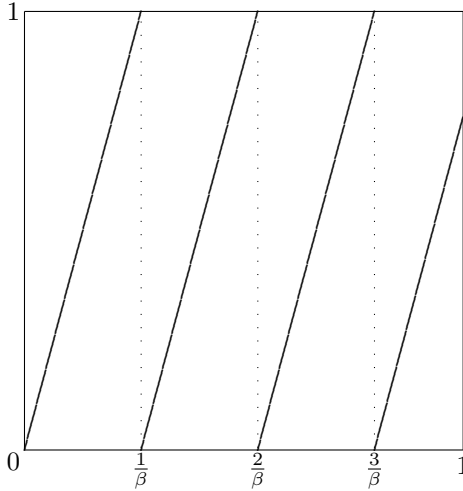

Figure 1.2: The β -transformation with $\beta = 3.76$.

For p_n and q_n we have the following recurrence relations

$$\begin{aligned} p_{-1} &:= 1; & p_0 &:= 0; & p_n &= d_n p_{n-1} + p_{n-2}, & n &\geq 1, \\ q_{-1} &:= 0; & q_0 &:= 1; & q_n &= d_n q_{n-1} + q_{n-2}, & n &\geq 1. \end{aligned}$$

The fact that $\lim_{n \rightarrow \infty} c_n = x$ follows from

$$\left| x - \frac{p_n}{q_n} \right| \leq \frac{1}{q_n^2} \tag{1.1.1}$$

and the fact that the sequence $(q_n)_{n \in \mathbb{N}}$ grows exponentially fast. A classical motivation to study continued fractions comes from approximation theory also known as Diophantine approximation. This name stems from Diophantus of Alexandria, who lived around AD 250. Let $x \in [0, 1]$ and suppose that we want to find rationals $\frac{p}{q}$ such that $|x - \frac{p}{q}|$ is small. Of course for q large one can probably do better. Therefore it is natural to make $|x - \frac{p}{q}|$ small relative to q . Hurwitz proved the following theorem in 1891.

Theorem 1.1.1 (Hurwitz [49]). *For every irrational number x there exist infinitely many pairs of integers p and q , such that*

$$\left| x - \frac{p}{q} \right| \leq \frac{1}{\sqrt{5}} \frac{1}{q^2}. \tag{1.1.2}$$

The constant $\frac{1}{\sqrt{5}}$ is the best possible, i.e. for every $\varepsilon > 0$ there are x such that there are only finitely many pairs of integers p and q such that the inequality holds when replacing $\frac{1}{\sqrt{5}}$ by $\frac{1}{\sqrt{5}} - \varepsilon$.

To be able to find such pairs one can look at the convergents of x . This is displayed by a theorem of Borel from 1903.

Theorem 1.1.2 (Borel). *Let $n \geq 1$ and let $\frac{p_{n-1}}{q_{n-1}}$, $\frac{p_n}{q_n}$ and $\frac{p_{n+1}}{q_{n+1}}$ be three consecutive continued fraction convergents of the irrational number x . Then at least one of these convergents satisfies (1.1.2).*

There also exists a theorem that states that, when a rational approximates x well, it is a convergent of x . This was shown by Legendre in 1798.

Theorem 1.1.3 (Legendre [70]). *Let p and q be two integers that are co-prime with $q > 0$. Furthermore, let $x \in (0, 1]$ and suppose that $\left| x - \frac{p}{q} \right| \leq \frac{1}{2q^2}$. Then $\frac{p}{q}$ is a convergent of x .*

For a refinement of this theorem see Barbolosi, Jager 1994 [5]. Looking at the recurrence relations and (1.1.1) we can see that the higher the digits of x are, the faster the continued fraction converges to x . For a given $x \in (0, 1]$ we can simply calculate the convergents. However, we would like to make statements about *typical* points x i.e. statements that hold for *almost all* $x \in (0, 1]$. This is where ergodic theory comes into play. The word ergodic originates from the words *ergon* and *odos* which mean work and path respectively in Greek. Ergodic theory was used by physicists before mathematicians picked up on it in the 1930s and 1940s (from [29]). Let us first define what a dynamical system is and then give the definition of ergodicity.

Definition 1.1.4 (Dynamical system). *A dynamical system is a quadruple (X, \mathcal{F}, μ, T) where X is a non-empty set, \mathcal{F} is a σ -algebra on X , μ is a probability measure on (X, \mathcal{F}) and $T : X \rightarrow X$ is a surjective transformation such that the measure μ is T -invariant i.e. for all $A \in \mathcal{F}$ we have $\mu(T^{-1}(A)) = \mu(A)$. Furthermore, if T is also injective we call (X, \mathcal{F}, μ, T) an invertible dynamical system.*

When dropping the condition of a probability measure and allowing the space to have an infinite measure one enters the realm of infinite ergodic theory which is studied in Chapter 2. In any case ergodic theory is characterised by ergodicity.

Definition 1.1.5 (Ergodicity). *Let (X, \mathcal{F}, μ, T) be a dynamical system. Then T is called ergodic if for every μ -measurable set A satisfying $T^{-1}(A) = A$ one has $\mu(A) = 0$ or $\mu(A^c) = 0$.*

This means that, when iterating points, they will go from everywhere to everywhere and the state space X cannot be divided into subsets X_1, X_2 with both positive measure such that $T(X_1) \subset X_1$ and $T(X_2) \subset X_2$. It is natural to wonder when two dynamical systems can be called the same. We say such maps are isomorphic.

Definition 1.1.6 (Isomorphic). *Two dynamical systems (X, \mathcal{F}, μ, T) and (Y, \mathcal{C}, ν, S) are isomorphic if there exists a map $\theta : X \rightarrow Y$ with the following properties.*

- θ is bijective almost everywhere. By this we mean that, if we remove a suitable set $N_X \subset X$ with $\mu(N_X) = 0$ and a suitable set $N_Y \subset Y$ with $\nu(N_Y) = 0$ then $\theta : X \setminus N_X \rightarrow Y \setminus N_Y$ is a bijection.
- θ is bi-measurable, i.e. $\theta(F) \in \mathcal{C}$, for all $F \in \mathcal{F}$ and $\theta^{-1}(C) \in \mathcal{F}$, for all $C \in \mathcal{C}$.

1. Introduction

- θ preserves the measures, i.e. $\nu(C) = (\nu \circ \theta^{-1})(C)$ for all $C \in \mathcal{C}$.
- θ preserves the dynamics, i.e. $\theta \circ T = S \circ \theta$.

Before stating what we mean by “for almost all” we give the definition of the Lebesgue measure and the definition of an absolutely continuous measure.

Definition 1.1.7 (Lebesgue measure). *Let $[a, b]$ be an interval on the real line. The Borel σ -algebra is the σ -algebra generated by open intervals. The Lebesgue measure λ is the measure such that $\lambda((c, d)) = d - c$ for all open intervals $(c, d) \subset [a, b]$.*

The Lebesgue measure is the only measure that is translation invariant. All measures studied in this dissertation are equivalent to Lebesgue. These kinds of measures are considered to be physically most relevant because they describe the statistical properties of forward orbits of a set of points with positive Lebesgue measure.

Definition 1.1.8 (Absolutely continuous and equivalence of measures). *Let (X, \mathcal{F}) be a measurable space and μ, ν two measures on this space. The measure μ is absolutely continuous with respect to measure ν if $\nu(A) = 0$ implies $\mu(A) = 0$. Furthermore, if also ν is absolutely continuous with respect to measure μ we say that the measures are equivalent.*

Equivalence implies that if $\nu(A) = 1$ then $\mu(A) = 1$ whenever ν and μ are probability measures. With “almost all $x \in X$ ” we mean with probability 1. One can see that it does not matter whether we use measure μ or ν for this statement when μ is absolutely continuous with respect to ν . This way “for almost all” (or for almost every) x means with respect to Lebesgue in this dissertation.

Now that we know what for almost all means we can state a theorem by Paul Lévy from 1929 that gives us the speed at which q_n grows for almost all $x \in [0, 1]$.

Theorem 1.1.9 (Lévy [72]). *For almost all $x \in [0, 1]$ one has*

$$\lim_{n \rightarrow \infty} \frac{1}{n} \log(q_n) = \frac{\pi^2}{12 \log(2)}.$$

The fact that invariant measures are useful follows from what is the most important theorem of the field.

Theorem 1.1.10 (The Ergodic Theorem / Birkhoff’s Theorem).

Let (X, \mathcal{F}, μ) be a probability space and $T : X \rightarrow X$ such that μ is T -invariant. Then for any $f \in L^1(\mu)$,

$$\lim_{n \rightarrow \infty} \frac{1}{n} \sum_{i=1}^{n-1} f \circ T^i(x) = f^*(x)$$

exists almost everywhere and $\int_X f d\mu = \int_X f^ d\mu$. If moreover T is ergodic, then f^* is constant almost everywhere and $f^* = \int_X f d\mu$.*

This theorem is often heuristically phrased as “time average is space average” and has been proved by G.D Birkhoff in 1931 (see [8]). A question that arises is whether we can find an invariant measure for the Gauss map. The answer is yes. An invariant measure was found by Gauss in 1800. Note that this was way before most tools in ergodic theory were developed. The measure μ found by Gauss is called the Gauss measure and is given by

$$\mu(A) = \frac{1}{\log(2)} \int_A \frac{1}{1+x} d\lambda(x).$$

An example of what one can do with this invariant measure and Birkhoff’s Theorem is to calculate frequencies of digits for typical numbers. Let $freq(i)$ be defined as

$$freq(i) := \lim_{n \rightarrow \infty} \frac{\# \text{ digits of } x \text{ equal to } i \text{ in the first } n \text{ digits}}{n}.$$

Let us also define cylinders (of order n)

$$\Delta(a_1, \dots, a_n) = \{x \in [0, 1] : d_1(x) = a_1, d_2(x) = a_2, \dots, d_n(x) = a_n\}.$$

Note that whenever $d_n(x) = i$ that $T^{n-1}(x) \in \Delta(i)$ and that $\Delta(i) = \{x \in [0, 1] : d_1(x) = \lfloor \frac{1}{x} \rfloor = i\} = (\frac{1}{i+1}, \frac{1}{i}]$. Since the map T is ergodic with respect to μ and μ is invariant for T , we can apply the Ergodic Theorem with $f = \mathbb{1}_{\Delta(i)}$ giving

$$freq(i) = \lim_{n \rightarrow \infty} \frac{1}{n} \sum_{i=1}^{n-1} f \circ T^i(x) = \frac{1}{\log(2)} \int_{\Delta(i)} \frac{1}{1+x} dx = \mu(\Delta(i)).$$

The frequencies of digits were found by Paul Lévy in 1929 (see [72]) and are given by

$$freq(i) = \mu(\Delta(i)) = \frac{1}{\log(2)} \log \left(1 + \frac{1}{i(i+2)} \right).$$

Remarkably one can find the Gauss measure through a limit of the Lebesgue measure. This is shown by the Gauss-Kuzmin-Lévy Theorem. This theorem states that the Lebesgue measure of the pre-images of a measurable set A will converge to the Gauss measure i.e.

$$\lambda(T^{-n}(A)) \rightarrow \mu(A) \quad \text{as } n \rightarrow \infty. \tag{1.1.3}$$

This was stated as a hypothesis by Gauss in his mathematical diary in 1800 and proved by Kuzmin in 1928 who also obtained a bound on the speed of convergence. Independently, Lévy proved the same theorem in 1929 but found a sharper bound for the speed of convergence namely $|\lambda(T^{-n}(A)) - \mu(A)| = \mathcal{O}(q^n)$ with $0 < q < 1$ instead of $\mathcal{O}(q^{\sqrt{n}})$ which is the bound Kuzmin found. In [99] it is shown that (1.1.3) holds for a family of mappings T . In Chapter 4 we will base a numerical method on this theorem to get good estimates on invariant measures for other maps.

A very powerful tool in ergodic theory is that of a natural extension. The idea behind it is that you make a non-invertible system into an invertible one by adding dimensions. For the invertible system it can be easier to guess the invariant measure. Then one can find the invariant measure of the original system by projecting it.

1. Introduction

Definition 1.1.11 (Natural Extension). Let (X, \mathcal{F}, μ, T) be a dynamical system with T a non-invertible transformation. An invertible dynamical system (Y, \mathcal{C}, ν, S) is called a natural extension of (X, \mathcal{F}, μ, T) if there exist two sets $F \in \mathcal{F}$ and $C \in \mathcal{C}$ and a function $\theta : C \rightarrow F$, such that the following properties hold.

- $\mu(X \setminus F) = \nu(Y \setminus C) = 0$,
- $T(F) \subset F$ and $S(C) \subset C$,
- θ is measurable, measure preserving and surjective,
- $(\theta \circ S)(y) = (T \circ \theta)(y)$ for all $y \in C$,
- $\bigvee_{k=0}^{\infty} S^k \theta^{-1}(F) = \mathcal{C}$ where $\bigvee_{k=0}^{\infty} S^k \theta^{-1}(F)$ is the smallest σ -algebra containing all σ -algebras $S^k \theta^{-1}(F)$.

Natural extensions are unique up to isomorphism and therefore we can speak of *the natural extension*. Let $\Omega = [0, 1] \times [0, 1]$. The natural extension of the Gauss map is given by $\mathcal{T} : \Omega \rightarrow \Omega$ with

$$\mathcal{T}(x, y) := \left(T(x), \frac{1}{d_1(x) + y} \right), \quad (x, y) \in \Omega.$$

The natural extension captures information about the future in the first dimension and of the past in the second. The following theorem gives us the invariant measure as well as ergodicity for the natural extension of the Gauss map.

Theorem 1.1.12 (Ito, Nakada, Tanaka [82, 83]). Let $\bar{\mu}$ be the measure given by

$$\bar{\mu}(A) = \frac{1}{\log(2)} \int_A \frac{1}{(1 + xy)^2} d\lambda(x)$$

then $\bar{\mu}$ is an invariant probability measure for \mathcal{T} . Furthermore, the dynamical system $(\Omega, \mathcal{B}, \bar{\mu}, \mathcal{T})$ where \mathcal{B} is the Borel σ -algebra, is an ergodic system.

The natural extension is also used in approximation theory to get information about the quality of convergents (see [29] and the references therein). We will use the concept of natural extensions in Chapter 2 and 4.

Another notion that can be useful is that of an *induced transformation*. Let (X, \mathcal{F}, μ, T) be dynamical system and pick $A \subset X$ such that $\mu(A) > 0$. Let $n(x) := \inf\{n \geq 1 : T^n(x) \in A\}$. By the Poincaré Recurrence Theorem we have that the set of x for which $n(x) = \infty$ has zero measure. We remove this set from A and define the induced transformation $T_A : A \rightarrow A$ as

$$T_A(x) = T^{n(x)}(x) \quad \text{for all } x \in A.$$

§1.1.2 β -expansions

In the previous section we have seen how to write a number in its continued fraction expansion. In this section we shed light upon β -expansions. These are derived from a much simpler map $T_\beta : [0, 1] \rightarrow [0, 1]$ with $T_\beta(x) = \beta x - \lfloor \beta x \rfloor$ with $\beta \in (1, \infty)$. Fix $x \in [0, 1]$ and set $d_1(x) = \lfloor \beta x \rfloor$ and $d_n(x) = d_1(T_\beta^{n-1}(x))$ for $n > 1$. Then for x we find

$$x = \sum_{i=1}^{\infty} \frac{d_i(x)}{\beta^i}.$$

In this case we define the convergents as $c_n = \sum_{i=1}^n \frac{d_i}{\beta^i}$. The convergence rate is given by $|x - c_n| \leq \frac{1}{\beta^n}$. Note that whenever x has long sequences of zeros in its expansion there are c_n that are fairly close to x relative to n . On the other hand, the sequence $(d_i(x))$ is not the only sequence that will give convergence to x . We see that high digits result in better convergents. Since we always use the highest digit possible by taking $\lfloor \beta x \rfloor$, the map T_β is known as the greedy β -transformation (introduced by Rényi in 1957 [95]). When instead of always taking the highest digit possible one would always take the lowest, one finds the lazy β -expansion. Fix $\beta \in (1, \infty)$ and define $S = \cup_{1 \leq i \leq \lfloor \beta \rfloor} [\frac{i}{\beta}, \frac{\lfloor \beta \rfloor}{\beta(\beta-1)} + \frac{i-1}{\beta}]$. The map used to find a lazy β -expansion is given by $L_\beta(x) = T_\beta(x)$ for $x \notin S$ and $L_\beta(x) = T_\beta(x) + 1$ for $x \in S$. The set S is also called the switch region. By superimposing the two maps one can choose which of the maps to use once the orbit of x falls into a switch region (see Figure 1.3). When choosing to iterate over the lazy map one will find that the digit will be one lower than when picking the greedy one. This gives us for almost every x uncountably many expansions. For references on lazy β -expansions see [30, 38, 60] and for a mix of lazy and greedy [26, 31].

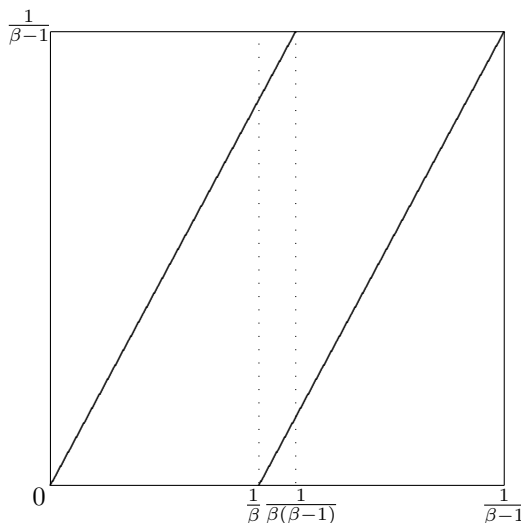

Figure 1.3: The lazy and greedy β -transformation with $\beta = 1.85$.

1. Introduction

It is proven that the system T_β is ergodic with respect to the invariant measure found by Gelfond in 1959 and Parry in 1960 independently (see [42] and [88]). The probability measure has density

$$f_\beta(x) = \frac{1}{C(\beta)} \sum_{n=0}^{\infty} \frac{1}{\beta^n} \mathbb{1}_{[0, T_\beta^n(1))}(x)$$

where $C(\beta) = \int_0^1 \sum_{n=0}^{\infty} \frac{1}{\beta^n} \mathbb{1}_{[0, T_\beta^n(1))}(x) dx$ is a normalising constant. This measure is the unique measure of maximal entropy (see Section 1.2.1 for more details). What plays a crucial role in the study of β -expansions is the quasi greedy expansion of 1. Let us first explain what a quasi greedy expansion is. Define the map $\tilde{T}_\beta(x) = T_\beta(x)$ for all x with $T_\beta(x) \neq 0$ and $\tilde{T}_\beta(x) = 1$ whenever $x \neq 0$ and $T_\beta(x) = 0$. Set $\tilde{d}_1(x) = d_1(x)$ for $T_\beta(x) \neq 0$ and $\tilde{d}_1(x) = d_1(x) - 1$ whenever $x \neq 0$ and $T_\beta(x) = 0$. Furthermore, let $\tilde{d}_n(x) = \tilde{d}_1(\tilde{T}_\beta^{n-1}(x))$ for $n > 1$. The quasi greedy expansion of x is given by

$$x = \sum_{i=1}^{\infty} \frac{\tilde{d}_i(x)}{\beta^i}.$$

Note that points ending up in 0 under the forward orbit of T_β will have a finite greedy expansion. The error made by its convergent will be 0 at some point. For these points the quasi greedy expansion does a worse job in converging and there will always remain an error. For the quasi greedy expansion of 1 we write $\alpha(\beta) := \left(\tilde{d}_n(1) \right)_{n \geq 1}$. Let us now define the lexicographical ordering on sequences in $\{0, 1, \dots, \lfloor \beta \rfloor\}^{\mathbb{N}}$. For two sequences $(x_i), (y_i) \in \{0, 1, \dots, \lfloor \beta \rfloor\}^{\mathbb{N}}$ we write $(x_i) \prec (y_i)$ or $(y_i) \succ (x_i)$ if $x_1 < y_1$, if or there is an integer $m \geq 2$ such that $x_i = y_i$ for all $i < m$ and $x_m < y_m$. Moreover, we say $(x_i) \preceq (y_i)$ or $(y_i) \succeq (x_i)$ if $(x_i) \prec (y_i)$ or $(x_i) = (y_i)$. We can use this ordering and $\alpha(\beta)$ to prescribe which sequences are allowed in the β -expansion of any $x \in [0, 1]$. Due to Parry [88] we have that

$$\Sigma_\beta = \{(x_i) \in \{0, 1, \dots, \lfloor \beta \rfloor\}^{\mathbb{N}} : \sigma^n((x_i)) \prec \alpha(\beta) \text{ for all } n \geq 0\}$$

is the set of all sequences that can occur as a β -expansion of some $x \in [0, 1]$. Here σ denotes the shift, i.e. $\sigma((x_i)) = (x_{i+1})$. Not every sequence in $(\mathbb{N} \cup \{0\})^{\mathbb{N}}$ can occur as a quasi greedy expansion for some β . We have the following characterisation.

Theorem 1.1.13 (Komornik and Loreti [61]). *A sequence $(a_i) \in (\mathbb{N} \cup \{0\})^{\mathbb{N}}$ is a quasi greedy expansion of 1 for some β if and only if*

$$0 \prec a_{n+1}a_{n+2}\dots \preceq a_1a_2\dots \text{ for all } n \geq 0.$$

In Chapter 5 there will be a constant interplay between the symbolic space Σ_β and the space $[0, 1]$. We proceed by explaining the other terms in the title of this dissertation: entropy, matching and holes.

§1.2 Explaining the terms in the title

§1.2.1 Entropy

In this section we explain what entropy is. For any dynamical system $(\Omega, \mathcal{F}, \mu, T)$ the entropy is defined in the following way.

Definition 1.2.1 (Entropy of a partition). *Let γ be a countable partition of Ω , i.e. a collection of pairwise disjoint (μ -measurable) sets such that their union is Ω up to a μ -measure 0 set. The entropy of the partition is given by*

$$h_\mu(\gamma, T) = - \sum_{\gamma_i \in \gamma} \mu(\gamma_i) \log(\gamma_i).$$

where $0 \log(0) = 0$.

Definition 1.2.2 (Entropy). *We define the entropy of T by*

$$h_\mu(T) := \sup_{\gamma} h_\mu(\gamma, T)$$

where we take the supremum over all countable partitions.

Observe that different measures give different values for h . Often one is interested in

$$\sup_{\mu: \mu \text{ is invar.}} h_\mu(T)$$

and whether this value is attained for a certain measure. If so, this measure is called measure of maximal entropy. Intuitively the entropy of a system tells you something about the *amount of randomness* in a system. It is worth mentioning that entropy did not only show its importance in mathematics but also in fields like interactive particle systems [75] and information theory [25].

Unfortunately, the definition is not very helpful for applications since you have to take the supremum over all partitions. Fortunately, there are other ways to calculate the entropy. For the first method we need the notion of a generator. This generator will be a partition attaining the supremum (if it is finite). First we define

$$\gamma_1 \bigvee \gamma_2 = \{A_i \cap B_j : A_i \in \gamma_1, B_j \in \gamma_2\}$$

which allows us to define

$$\gamma_n^m = \bigvee_{k=n}^m T^{-k} \gamma$$

for any $n, m \in \mathbb{Z}$. Now we can define a generator.

Definition 1.2.3 (Generator). *Let $\sigma(\bigvee_{i=-\infty}^{\infty} T^{-i} \gamma)$ be the smallest σ -algebra containing all the partitions γ_n^m . Then γ is called a generator w.r.t. T if $\sigma(\bigvee_{i=-\infty}^{\infty} T^{-i} \gamma) = \mathcal{F}$.*

This leads us to a powerful theorem from 1959.

Theorem 1.2.4 (Kolmogorov and Sinai [59, 101]). *If γ is a finite or countable generator for T with $h(\gamma, T) < \infty$, then $h_\mu(T) = h_\mu(\gamma, T)$.*

We also have an existence theorem.

Theorem 1.2.5 (Krieger [67]). *If T is an ergodic measure preserving transformation with $h_\mu(T) < \infty$, then T has a finite generator.*

Note that, once we have a finite generator, we can calculate the entropy of the partition by taking a finite sum. It also gives a certificate that there are no other partitions giving a higher value. Therefore we find the entropy. A generator that works for continued fractions is the family $\{\Delta(k) = \{x : \lfloor \frac{1}{x} \rfloor = k\}\}$.

There are other ways to calculate the entropy. A theorem of Shannon, McMillan, Breiman and Chung uses any finite or countable partition. By applying it to a generator, the theorem can easily be used to find the entropy of the system. Let $A_n(x)$ be the unique element of $\bigvee_{i=0}^{n-1} T^{-i}\gamma$ such that $x \in A_n(x)$. Then we have the following theorem.

Theorem 1.2.6 (Shannon-McMillan-Breiman-Chung). *Let γ be a countable partition of X with $h_\mu(\gamma, T) < \infty$ then for almost every $x \in X$ we have*

$$\lim_{n \rightarrow \infty} -\frac{1}{n} \log(\mu(A_n(x))) = h_\mu(\gamma, T).$$

This theorem gives us the following insight in the setting of number expansions. If we let γ be the collection of cylinder sets of length 1 then $A_n(x)$ is the set of x starting with the same n digits. Intuitively, the faster $A_n(x)$ shrinks the faster you gain information about x and the higher the entropy. So if $A_n(x)$ shrinks fast we expect the convergents of x to converge to x fast. For continued fractions the bound on the convergence is given in terms of $q_n(x)$ so we might expect to find a formula for the entropy in terms of $q_n(x)$ as well which is indeed the case.

Lemma 1.2.7 (Entropy formula [72]). *Let T be the Gauss map. For almost all $x \in [0, 1]$ we have*

$$h_\mu(T) = 2 \lim_{n \rightarrow \infty} \frac{1}{n} |\log(q_n(x))|. \quad (1.2.1)$$

Actually, in [72] the right-hand side is calculated and equals $\frac{\pi^2}{6}$ which later turned out to be the entropy of the Gauss map with respect to the Gauss measure. This holds in a slightly more general setting which we will prove in Chapter 3. In case the ergodic system satisfies the Rényi's condition (which is true in the case of continued fractions, β -expansions and other expansions considered in this dissertation) we can use the following formula found by Rohlin [96]:

$$h_\mu(T) = \int_{\Omega} \log |T'(x)| d\mu. \quad (1.2.2)$$

For a certain class of infinite systems this formula also holds (see [106] for example). This formula is very helpful since, once we have the density, we only need to integrate. Another way of calculating the entropy is by using Birkhoff's Theorem with a suitable f which in this case gives us

$$\frac{1}{n} \sum_{i=1}^n \log |T'(T^i(x))| \rightarrow \int \log |T'(x)| d\mu \quad \text{as } n \rightarrow \infty.$$

This formula is very useful for simulation, since we do not need the density. On the other hand, we do not obtain the density either.

The entropy of two isomorphic systems is equal (for the proof see [29]). The use of entropy is showcased in a paper of Ornstein, where he proved that Bernoulli shifts with equal entropy are isomorphic [87]. The entropy is also equal for a non-invertible system and its natural extension [10]. Furthermore, for a family of continued fractions (α -continued fractions with a corresponding family of mappings T_α where $\alpha \in [0, 1]$) it is shown in [65] that the product of the entropy of the dynamical system corresponding to T_α and the (non-normalised) measure of the domain of the natural extension is $\frac{\pi^2}{6}$.

The notion of entropy is present in every chapter of this dissertation. Since in Chapter 2 infinite ergodic theory is studied, we will introduce Krengel entropy which is calculated through (1.2.2). In Chapter 3 and 4 entropy is studied as a function of a parameter (for each different value of the parameter one has a different system). In Chapter 5 we will introduce the notion of topological entropy.

§1.2.2 Matching

The concept of matching is relatively simple but often has big implications. Definitions vary from article to article as well as the name. The same phenomenon goes under the name of cycle property and synchronisation property. For a piecewise continuous map T we define the right and left limit of a point c as

$$T(c^+) := \lim_{x \downarrow c} T(x), \quad T(c^-) := \lim_{x \uparrow c} T(x).$$

We will use the definition as in [12].

Definition 1.2.8 (Matching). *Let $T : \Omega \rightarrow \Omega$ be a piecewise continuous map. We say that the matching condition holds for T if for all discontinuity points c we have that there are $N, M \in \mathbb{N}$ such that*

$$T^N(c^+) = T^M(c^-)$$

and

$$(T^N)'(c^+) = (T^M)'(c^-).$$

The integers N, M are called matching exponents of the discontinuity point c .

Note that for piecewise linear mappings, the condition on the derivatives ensures that points in the neighbourhood of c^+ and c^- also match, i.e. there exists $\delta > 0$ such that for all $\varepsilon \in (-\delta, \delta)$ we have $T^N(c^+ + \varepsilon) = T^M(c^- + \varepsilon)$. For continued fraction expansions it is a necessary but not sufficient condition. At first sight it is not clear whether this is useful to study. Still it showed its uses in various articles in various ways. Often a family of mappings $\{T_\alpha\}$ is studied. Matching of the discontinuities can have implications for the behaviour of an observable. For example, entropy as a function of α for several families of continued fractions is studied in [54, 56, 84]. Particularly, entropy is monotonic on matching intervals (see Chapter 3 for more details). In Chapter 3 we study a family for which matching holds almost everywhere. In Chapter 4 we will also encounter matching where it implies that the entropy is constant. Though, the way it is used in the proof is different from the others. It is proved that for parameters from a specific matching interval the corresponding systems are isomorphic. Also the natural extension comes into play. In Chapter 2 we study matching and natural extensions for a family of continued fraction transformations related to an infinite ergodic system. Interestingly, it does not seem to affect the entropy in the way it does for the other continued fraction systems studied.

A family related to the β -transformations is the so called generalised β -transformation which is given by $T_{\alpha,\beta} : [0, 1] \rightarrow [0, 1]$ with $T_{\alpha,\beta}(x) = \beta x + \alpha \bmod 1$. For a family of parameters β it is shown that matching holds for almost every α (see [11]).

§1.2.3 Holes and expansions

Up to now we looked at closed dynamical systems. That is, we had a quadruple $(\Omega, \mathcal{B}, \mu, T)$ with $T : \Omega \rightarrow \Omega$. We can make the system open by assigning a hole $H \subset \Omega$. Through this hole mass will leak out by iterating T . We are interested in those points that never fall into the hole.

Definition 1.2.9 (Survivor set). *The set*

$$S(H) := \{x \in \Omega : T^n(x) \notin H \text{ for all } n \in \mathbb{N}\}$$

is called the survivor set of hole H .

For any ergodic system we have that if $\mu(H) > 0$ then $\mu(S(H)) = 0$. In case that μ is equivalent to the Lebesgue measure λ , we find that $\lambda(S(H)) = 0$. Therefore we need a different tool to study the size of $S(H)$. To do so we use Hausdorff dimension which we denote by \dim_H . For the definition of Hausdorff dimension see [39]. Though, to compute the Hausdorff dimension by using the definition directly can be slightly cumbersome. What often is done to get dimensional results is to relate the set one is interested in to a set of which the dimension is already known. The following lemma helps to achieve this.

Lemma 1.2.10 (Lipschitz [39]). *Let $F \subset \mathbb{R}^n$. If $f : F \rightarrow \mathbb{R}^m$ is Lipschitz, then $\dim_H(f(F)) \leq \dim_H(F)$. If f is also bi-Lipschitz, then $\dim_H(f(F)) = \dim_H(F)$.*

Several interesting sets pop up as survivor sets when the hole is carefully chosen. For example, let us look at the system $([0, 1], \mathcal{B}, \mu, T)$ where \mathcal{B} is the Borel algebra, μ the Gauss measure and T the Gauss map. We are interested in the set of all $x \in [0, 1]$ such that the digits of x are bounded, i.e. there exists an $N \in \mathbb{N}$ such that $d_i(x) \in \{1, \dots, N\}$ for all $i \in \mathbb{N}$. We find that x satisfies this condition if and only if $x \in S\left(\left(0, \frac{1}{N+1}\right)\right)$. If we set $\mathcal{B}_N = S\left(\left(0, \frac{1}{N+1}\right)\right)$ then the set $BAD = \cup \mathcal{B}_N$ is known as the set of badly approximable numbers. This set is widely studied and has connections to the famous Littlewood conjecture [46]. For the size of BAD we have that $\dim_H(BAD) = 1$. This is a result of Jarník from 1928 in [52]. In the same paper he also proved that

$$1 - \frac{1}{N \log(2)} \leq \dim_H(\mathcal{B}_N) \leq 1 - \frac{1}{8N \log(N)}$$

for $N \geq 8$. For the set BAD a strong property holds which is called α -winning (see [47]). This property implies that the set has full Hausdorff dimension and persists through taking intersections, i.e. if A, B are both α -winning then $A \cap B$ is α -winning. Another example of an interesting set is the set of well approximable numbers. Let $K_N := \{x \in [0, 1] : d_i(x) \geq N \text{ for all } i \in \mathbb{N}\} = S\left(\left(\frac{1}{N}, 1\right)\right)$. We have good estimates for the size of K_N in the case of $N \geq 20$ due to an article of Good from 1941 (see [45]):

$$\frac{1}{2} + \frac{1}{2 \log(N+2)} < \dim_H(K_N) < \frac{1}{2} + \frac{\log(\log(N-1))}{2 \log(N-1)}.$$

In Chapter 3 we will relate our set of interest with K_N .

In Chapter 5 we look at holes of the form $H_a = (0, a)$ for the greedy β -transformations. From [47] we have that $\cup H_a$ is α -winning. Let us fix $\beta \in (1, \infty)$. For almost every $x \in [0, \frac{1}{\beta-1}]$, the greedy β -expansion is not the only representation of x of the form $\sum_{i=1}^{\infty} \frac{a_i}{\beta^i}$. Holes have a connection to the set of x with a unique expansion for a fixed β (see [30]). On page 9 it is explained that for a fixed β almost every x has uncountably many expansions. Every time the orbit of the point falls into the switch region one has a choice. There are points that will never enter the switch region and therefore have a unique expansion. This is equivalent to stating that, when taking the switch region $\cup_{1 \leq i \leq \lfloor \beta \rfloor} [\frac{i}{\beta}, \frac{\lfloor \beta \rfloor}{\beta(\beta-1)} + \frac{i-1}{\beta}]$ as a hole, the survivor set will be the set of x with a unique expansion. For dimensional results on such sets see [43, 62].

§1.3 Statement of results

In Chapter 2 we study continued fractions in the domain of infinite ergodic theory. The corresponding infinite systems are obtained by flipping part of the branches of the Gauss map. We study the Krenge entropy, natural extensions and matching.

In Chapter 3 we study another family of continued fractions, namely the Ito Tanaka's α -continued fractions. The relation between matching and entropy is shown. The focus lies on the set for which there is no matching. We characterise this set and obtain several dimensional results.

In Chapter 4 we study N -expansions. In the first part we also allow flips. For some cases we were able to find the natural extension and therefore the invariant density. A numerical method is used which is based on the Gauss-Kuzmin-Lévy Theorem. In the last part we study matching and entropy.

In Chapter 5 we study β -expansions with a hole around 0. We define $K_\beta(t) := \{x \in [0, 1) : T_\beta^n(x) \notin (0, t) \text{ for all } n \geq 0\}$ and look at the set E_β of all parameters $t \in [0, 1)$ for which the set-valued function $t \mapsto K_\beta(t)$ is not locally constant. We show that E_β is a Lebesgue null set of full Hausdorff dimension for all $\beta \in (1, 2)$. Furthermore we characterise the topological structure of E_β for any given $\beta \in (1, 2]$.

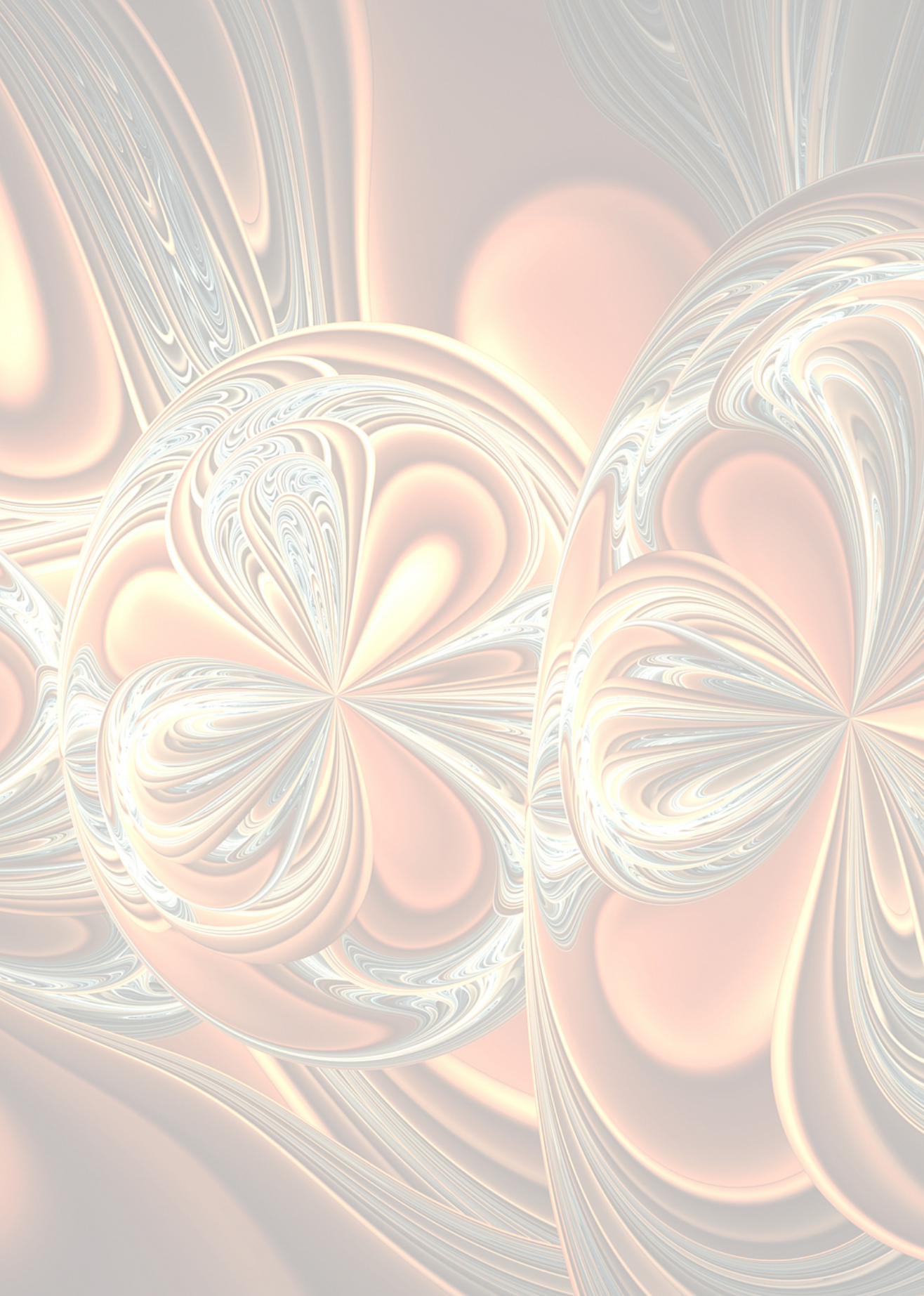

CHAPTER 2

Natural extensions, entropy and infinite systems

This chapter is based on joint work with Charlene Kalle, Marta Maggioni and Sara Munday.

Abstract

In this chapter we leave the realm of finite ergodic theory and enter the realm of the infinite. We introduce a family of mappings $\{T_\alpha\}$ with $\alpha \in [0, 1]$ related to the Gauss map. This family interpolates between the Gauss map and a map isomorphic to the backward continued fraction map. For $\alpha < \frac{1}{2}\sqrt{2}$ we find an explicit expression of an invariant measure that is absolutely continuous with respect to the Lebesgue measure. We do so by means of the natural extension. For $\alpha \leq \frac{\sqrt{5}-1}{2}$ we calculate the Krengel entropy which equals $\frac{\pi^2}{6}$. Furthermore, we show that the maps are so called basic AFN-maps which leads to several nice properties such as the existence of a weak law of large numbers.

§2.1 Introduction

In 1981 Nakada introduced a family of continued fraction transformations, now mainly known as α -continued fraction maps [82]. For each $\alpha \in [0, 1]$, one can define the map $S_\alpha : [\alpha - 1, \alpha] \rightarrow [\alpha - 1, \alpha]$ by

$$S_\alpha(x) = \left\lfloor \frac{1}{x} \right\rfloor - \left[\left\lfloor \frac{1}{x} \right\rfloor + 1 - \alpha \right].$$

Let $x \in [\alpha - 1, \alpha]$, define $\varepsilon_0(x) = \text{sign}(x)$ and $d_{\alpha,1}(x) = \lfloor \frac{1}{x} \rfloor + 1 - \alpha$. By setting $d_{\alpha,n}(x) = d_1(S_\alpha^n(x))$ and $\varepsilon_{\alpha,n}(x) = \varepsilon_0(S_\alpha^n(x))$ we find the following expansion for x

$$x = \frac{\varepsilon_0(x)}{d_{\alpha,1}(x) + \frac{\varepsilon_1(x)}{d_2(x) + \frac{\varepsilon_{\alpha,2}(x)}{d_{\alpha,3}(x) + \ddots}}}$$

Nakada studied this type of expansions for $\alpha \in [\frac{1}{2}, 1]$ and in [80] Marmi, Moussa and Yoccoz extended the study and also included the values $\alpha \in [0, \frac{1}{2})$. In [82] Nakada constructed a natural extension for the maps S_α and gave a thorough analysis of the map's metric and ergodic properties for $\alpha \in [\frac{1}{2}, 1]$. For $\alpha \in [\sqrt{2} - 1, \frac{1}{2})$ the natural extension can be found in [79] and for $\alpha \in [\frac{\sqrt{10}-2}{3}, \sqrt{2}-1]$ in [35]. Each of these maps admits a unique absolutely continuous invariant measure ν_α . Nakada already started the study of the dependence on α of the entropy of the map S_α with respect to ν_α for $\alpha \in [\frac{1}{2}, 1]$. The function mapping α to the metric entropy of S_α with respect to ν_α , turned out to have a very intricate structure for $\alpha \in [0, \frac{1}{2})$ and has been extensively studied. See for example [18, 65, 79, 84] and the references therein.

It was shown in [27] that the family of folded α -continued fraction maps \hat{S}_α is a particular instance of what the authors called D -continued fraction maps. Folded α -continued fractions are almost the same as α -continued fractions from a metric point of view. The D -continued fraction maps are variants of the classical Gauss map $T : x \mapsto \frac{1}{x} \pmod{1}$ where one specifies a region $D \subseteq [0, 1]$, such that on $[0, 1] \setminus D$ one uses the Gauss map and on D one uses a flipped version of the Gauss map, $F = 1 - T$. It is shown that the folded α -continued fraction maps are obtained by taking $D = \bigcup_{n \geq 2} (\frac{1}{n}, \frac{1}{n+\alpha-1}]$.

In this chapter, we consider the natural counterparts of the folded α -continued fractions, which we call *flipped α -continued fraction maps*. They are obtained by taking $\alpha \in [0, 1]$ and setting

$$D = D_\alpha = \bigcup_{n \geq 1} \left(\frac{1}{n+\alpha}, \frac{1}{n} \right].$$

We define $T_\alpha : I_\alpha \rightarrow I_\alpha$ as

$$T_\alpha(x) = \begin{cases} \frac{1}{x} - \left\lfloor \frac{1}{x} \right\rfloor & \text{if } x \notin D_\alpha, \\ \left(1 + \left\lfloor \frac{1}{x} \right\rfloor\right) - \frac{1}{x} & \text{if } x \in D_\alpha \end{cases} \quad (2.1.1)$$

where $I_\alpha := [\min(\alpha, 1 - \alpha), 1]$. In terms of the Gauss map T we can define it as follows. Note that $D_\alpha = \{x \in [0, 1] : T(x) < \alpha\}$ and

$$T_\alpha(x) = \begin{cases} T(x), & \text{if } x \notin D_\alpha, \\ 1 - T(x), & \text{if } x \in D_\alpha. \end{cases}$$

See Figure 2.1 for a couple of examples.

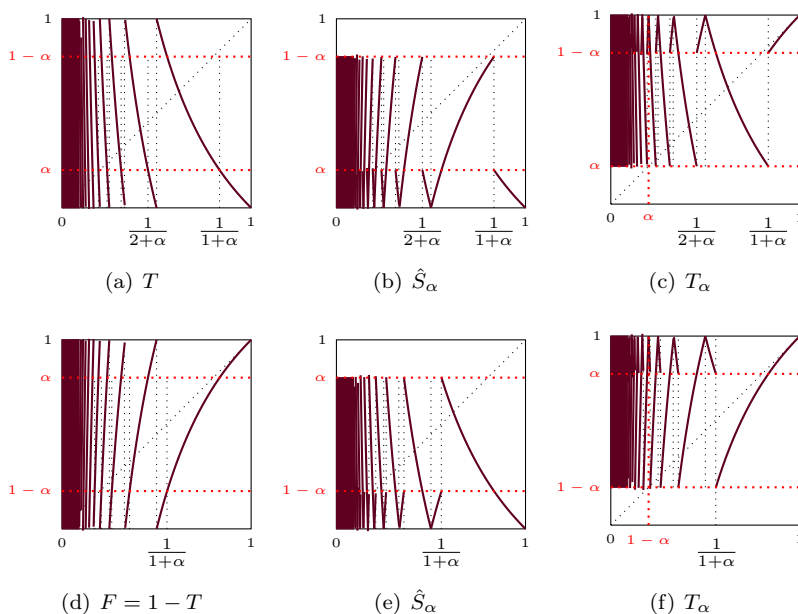

Figure 2.1: The Gauss map T and the flipped map $F = 1 - T$ in (a) and (d). The folded α -continued fraction map \hat{S}_α and the flipped α -continued fraction map T_α for $\alpha < \frac{1}{2}$ in (b) and (c) and for $\alpha > \frac{1}{2}$ in (e) and (f) respectively.

If $\alpha = 0$, we obtain the Gauss map T and if $\alpha = 1$ we obtain the map $1 - T$. Since these maps are well known, we omit them from our analysis. Since the domain of the map T_α is given by $I_\alpha = [\min\{\alpha, 1 - \alpha\}, 1]$ it has only finitely many branches. Note that for any $\alpha \in (0, 1)$ the map T_α has an indifferent fixed point at 1. This causes the existence of an *infinite* absolutely continuous invariant measure μ_α . This makes the family of maps $\{T_\alpha : I_\alpha \rightarrow I_\alpha\}_{\alpha \in (0, 1)}$ interesting to study as a natural family of infinite measure systems that do in general not have a Markov partition but have many other nice properties. Let us turn to stating our results. We construct for each

$\alpha \in (0, \frac{1}{2}\sqrt{2})$ the natural extension of the map T_α . From the natural extension we obtain the absolutely continuous invariant measures for the maps T_α .

Theorem 2.1.1. *Let $0 \leq \alpha \leq \frac{1}{2}\sqrt{2}$, let \mathcal{B}_α be the Borel σ -algebra on $[\min(\alpha, 1-\alpha), 1]$. The absolutely continuous measure μ_α on $([\min(\alpha, 1-\alpha), 1], \mathcal{B}_\alpha)$ with density*

$$f_\alpha(x) = \begin{cases} \frac{1}{x} \mathbf{1}_{[\alpha, \frac{1}{1-\alpha}]}(x) + \frac{1}{1+x} \mathbf{1}_{[\frac{1}{1-\alpha}, 1]}(x) + \frac{1}{1-x} \mathbf{1}_{[1-\alpha, 1]}(x) & \text{for } \alpha \in [0, \frac{1}{2}], \\ \frac{1}{1-x} \mathbf{1}_{[1-\alpha, \alpha]}(x) + \frac{1}{x(1-x)} \mathbf{1}_{[\alpha, \frac{1}{1-\alpha}]}(x) + \frac{x^2+1}{x(1-x^2)} \mathbf{1}_{[\frac{1}{1-\alpha}, 1]}(x) & \text{for } \alpha \in (1/2, g], \\ \left(\frac{1}{1-x} + \frac{1}{x + \frac{1}{g-1}} \right) \mathbf{1}_{[1-\alpha, \frac{2\alpha-1}{\alpha}]}(x) + \frac{1}{1-x} \mathbf{1}_{[\frac{2\alpha-1}{\alpha}, \alpha]}(x) + \\ \left(\frac{1}{1-x} + \frac{1}{x} - \frac{1}{x + \frac{1}{g}} \right) \mathbf{1}_{[\alpha, \frac{2\alpha-1}{1-\alpha}]}(x) + \frac{x^2+1}{x(1-x^2)} \mathbf{1}_{[\frac{2\alpha-1}{1-\alpha}, 1]}(x) & \text{for } \alpha \in (g, \frac{2}{3}], \\ \left(\frac{1}{1-x} + \frac{1}{x + \frac{1}{g-1}} \right) \mathbf{1}_{[1-\alpha, \frac{2\alpha-1}{\alpha}]}(x) + \frac{1}{1-x} \mathbf{1}_{[\frac{2\alpha-1}{\alpha}, \alpha]}(x) + \\ \frac{1+gx^2}{x-(gx)^2-gx^3} \mathbf{1}_{[\alpha, \frac{1-\alpha}{2\alpha-1}]}(x) + \\ \left(\frac{2}{1-x^2} - \frac{x+1}{x^2+(2g+1)x+1} + \frac{1}{x} \right) \mathbf{1}_{[\frac{1-\alpha}{2\alpha-1}, 1]}(x) & \text{for } \alpha \in (\frac{2}{3}, \frac{1}{2}\sqrt{2}], \end{cases}$$

is the unique σ -finite infinite invariant measure for T_α .

For infinite measure systems, there are various notions of entropy generalising the notion of metric entropy for finite measure systems. From these notions Krengel entropy is probably the most used. For $\alpha \in (0, g]$ we are able to calculate this value which brings us to our second result.

Theorem 2.1.2. *For any $\alpha \in (0, g]$ the Krengel entropy $h_{Kr, \mu_\alpha}(T_\alpha)$ for the measure μ_α from Theorem 2.1.1 is equal to $\frac{\pi^2}{6}$.*

Even though we have the invariant measure for $g < \alpha \leq \frac{1}{2}\sqrt{2}$ the exact value of the Krengel entropy eludes us. From evaluating the expressions obtained numerically, one would believe we would also find the value $\frac{\pi^2}{6}$ in that case. Since we have an infinite system we can study the asymptotic behaviour of the maps near the indifferent fixed point 1 and give a finer analysis of their excursion times to the interval $(\frac{1}{1+\alpha}, 1]$. To be more precise, we study the wandering rates and return sequences. The following proposition summarises the properties that hold for our systems in case $\alpha \in (0, \frac{1}{2})$.

Proposition 2.1.3. *For each $\alpha \in (0, \frac{1}{2})$ and each $n \geq 1$ we have $w_n(T) \sim \log n$ for the wandering rate and $a_n(T) \sim \frac{n}{\log n}$ for the return time. Furthermore, a weak law of large numbers holds for T_α :*

$$\frac{\log n}{n} \sum_{k=0}^{n-1} f \circ T_\alpha^k \xrightarrow{\mu_\alpha} \int_{I_\alpha} f d\mu_\alpha, \quad \text{for } f \in L_1(\mu_\alpha) \text{ and } \int_{I_\alpha} f d\mu_\alpha \neq 0.$$

This chapter is outlined as follows. In Section 2.2 we give some preliminaries. We set up some framework on insertions and singularisations and look at the consequences

on the natural extension and entropy. Then we look back to our map and put this into context. In Section 2.3 we define the natural extension of the maps T_α with $\alpha \in (0, \frac{1}{2}\sqrt{2})$ and use this to obtain Theorem 2.1.1. After that we prove Theorem 2.1.2 in Section 2.4. In Section 2.5 several dynamical properties are shown for $\alpha \in (0, 1)$. Furthermore we show Proposition 2.1.3. We end this chapter with final observations and remarks.

§2.2 Preliminaries

The properties of various continued fraction expansions are a classical object of study. In 1913 Perron introduced the notion of *semi-regular* continued fraction expansions (see [89]). These continued fractions are a finite or infinite expression for $x \in (0, 1]$ of the following form:

$$x = \frac{1}{d_1 + \frac{\varepsilon_1}{d_2 + \frac{\varepsilon_2}{d_3 + \ddots}}},$$

where $\varepsilon_n \in \{-1, 1\}$, $d_n \in \mathbb{N}$ and $d_n + \varepsilon_n \geq 1$ for each $n \geq 1$. We denote the semi-regular continued fraction expansion of a number x by

$$x = [0; 1/d_1, \varepsilon_1/d_2, \varepsilon_2/d_3, \dots].$$

In case we have $\varepsilon_n = 1$ for all $n \in \mathbb{N}$ we find a regular continued fraction and simply write $x = [0; d_1, d_2, \dots]$.

In general a number has many different semi-regular continued fraction expansions. There are two well studied operations that convert one semi-regular continued fraction expansion of a number to another: singularisation and insertion. Both operations were already introduced in [89] and later appeared in many other places in literature (see for example [63]). *Singularisation* is based on the following equality holding for $a, b \in \mathbb{N}$, $\varepsilon \in \{-1, 1\}$ and $\xi \in [0, 1]$:

$$a + \frac{\varepsilon}{1 + \frac{1}{b + \xi}} = a + \varepsilon + \frac{-\varepsilon}{b + 1 + \xi}.$$

In terms of the semi-regular continued fractions of numbers, it can be written as follows. If

$$x = [0; 1/d_1, \varepsilon_1/d_2, \dots, \varepsilon_{n-1}/d_n, \varepsilon_n/1, 1/d_{n+2}, \dots]$$

then

$$x = [0; 1/d_1, \varepsilon_1/d_2, \dots, \varepsilon_{n-1}/(d_n + \varepsilon_n), -\varepsilon_n/(d_{n+2} + 1), \dots].$$

The inverse operation of singularisation is *insertion*, which is based on the following equality and holds for $a, b \in \mathbb{N}$ with $b \geq 2$ and $\xi \in [0, 1]$:

$$a + \frac{1}{b + \xi} = a + 1 + \frac{-1}{1 + \frac{1}{b - 1 + \xi}}.$$

In terms of the semi-regular continued fractions of numbers, it gives the following. If

$$x = [0; 1/d_1, \varepsilon_1/d_2, \dots, \varepsilon_{n-1}/d_n, 1/d_{n+1}, \varepsilon_{n+1}/d_{n+2}, \dots],$$

with $d_{n+1} \geq 2$, then

$$x = [0; 1/d_1, \varepsilon_1/d_2, \dots, \varepsilon_{n-1}/(d_n + 1), -1/1, 1/(d_{n+1} - 1), \varepsilon_{n+1}/d_{n+2}, \dots].$$

Singularisations and insertions are directly related to D -continued fraction expansions. In [27] it is explained that if $x \in \cup_{n=1}^{\infty} (\frac{2}{2n+1}, \frac{1}{n}]$ then the map $1 - T$ acts as an insertion on x . If $x \notin \cup_{n=1}^{\infty} (\frac{2}{2n+1}, \frac{1}{n}]$ then the map $1 - T$ acts as a singularisation. Furthermore, by the action of singularisation one removes a convergent in the sequence $(\frac{p_n}{q_n})_{n \geq 1}$. On the other hand, by insertion one adds a mediant of two consecutive convergents (see [63]).

In the next section we will see how insertion can affect the natural extension and the entropy. This is in essence the opposite of what singularisation would do which is explained in [29].

§2.2.1 Insertions and the natural extension

Let $D \subset [0, 1] \times \mathbb{R}$ and define $\mathcal{T}_D : \Omega_D \rightarrow \Omega_D$ by

$$\mathcal{T}_D(x, y) := \left(T_D(x), \frac{\varepsilon_D(x, y)}{d_1(x) + y} \right), \quad (x, y) \in \Omega_D$$

where $\varepsilon_D(x, y) = -1$ if $(x, y) \in D$ and 1 otherwise. Note that Ω_D is not yet specified. The game is to find a suitable Ω_D such that \mathcal{T}_D is bijective almost everywhere because of the following proposition.

Proposition 2.2.1. *Let $\Omega_D \subset [0, 1] \times \mathbb{R}$ such that \mathcal{T}_D is bijective almost everywhere. Then*

$$\mu_D(A) = \int_A \frac{1}{(1 + xy)^2} d\lambda(x)$$

is an invariant measure for \mathcal{T}_D .

The proof is essentially the same as for [82]. We now show that for a certain class of subsets of $D \subset [0, 1] \times [0, 1]$ we can easily find the natural extension. From the natural extension we can show that there is a decrease in entropy when comparing it with the regular continued fraction. For this subset, the corresponding continued fraction algorithm only uses insertions and no singularisations.

For suitable *insertion sets* D we show that $h(\mathcal{T}_D) = \frac{h(\mathcal{T})}{1+\bar{\mu}(D)}$ with h the (metric) entropy and $\bar{\mu}$ the 2-dimensional Gauss measure from page 8. Let

$$D^* = \bigcup_{n=1}^{\infty} \left(\frac{2}{2n+1}, \frac{1}{n} \right) \times [0, 1]$$

and pick $D \subset D^*$ such that $\mathcal{T}(D) \cap D = \emptyset$ with \mathcal{T} the natural extension map of the regular continued fraction (see Theorem 1.1.12 from page 8). Note that this does not include the case where the measure of the system of \mathcal{T}_D is infinite. Neither the case where we do “insertion on the newly added regions”. We will first find the natural extension domain of \mathcal{T}_D by building it from the natural extension domain of \mathcal{T} . Note that $\mathcal{T}(x, y) = \mathcal{T}_D(x, y)$ for $(x, y) \in D^c$. The new natural domain will be $(([0, 1] \times [0, 1]) \setminus \mathcal{T}(D)) \cup \mathcal{T}_D(D) \cup \mathcal{T}_D^2(D)$. We first show that there is no overlap.

Note that $\mathcal{T}_D(x, y) \notin [0, 1] \times [0, 1]$ since $\frac{-1}{n+1+y} < 0$. We also have that $\mathcal{T}_D^2(x, y) \notin [0, 1] \times [0, 1]$ because $\frac{1}{1+\frac{-1}{n+1+y}} = 1 + \frac{1}{n+y} > 1$. For the same reason we find

$$\mathcal{T}_D(D) \cap \mathcal{T}_D^2(D) = \emptyset.$$

Now we show that $\mathcal{T}^2(D) = \mathcal{T}_D^3(D)$ which gives that “no holes appear” in the natural domain of \mathcal{T}_D besides $\mathcal{T}(D)$, see also Figure 2.2. Let $(x, y) \in D$ then we can write $x = \frac{1}{n+\frac{1}{k+z}}$ with $k \in \mathbb{N}$ and $z \in [0, 1]$ since $(x, y) \in D^*$. We find $\mathcal{T}^2(x, y) = \left(z, \frac{1}{k+\frac{1}{n+y}} \right)$,

$$\mathcal{T}_D(x, y) = \left(\frac{1}{1+\frac{1}{k-1+z}}, \frac{-1}{n+1+y} \right), \quad \mathcal{T}_D^2(x, y) = \left(\frac{1}{k-1+z}, \frac{1}{1+\frac{-1}{n+1+y}} \right)$$

and

$$\mathcal{T}_D^3(x, y) = \left(z, \frac{1}{k-1+\frac{1}{1+\frac{-1}{n+1+y}}} \right).$$

Note that

$$\frac{1}{k-1+\frac{1}{1+\frac{-1}{n+1+y}}} = \frac{1}{k+\frac{1}{n+y}}.$$

We will derive a formula for the entropy of the new system. Let $A := ([0, 1] \times [0, 1]) \setminus \mathcal{T}(D)$ and denote by $\hat{\mathcal{T}} : A \rightarrow A$ the induced transformation for \mathcal{T} on A and $\hat{\mathcal{T}}_D : A \rightarrow A$ the induced transformation for \mathcal{T}_D on A , see page 9 for the definition. Abramov’s entropy formula give us:

$$h(\hat{\mathcal{T}}) = \frac{h(\mathcal{T})}{\bar{\mu}(A)} \tag{2.2.1}$$

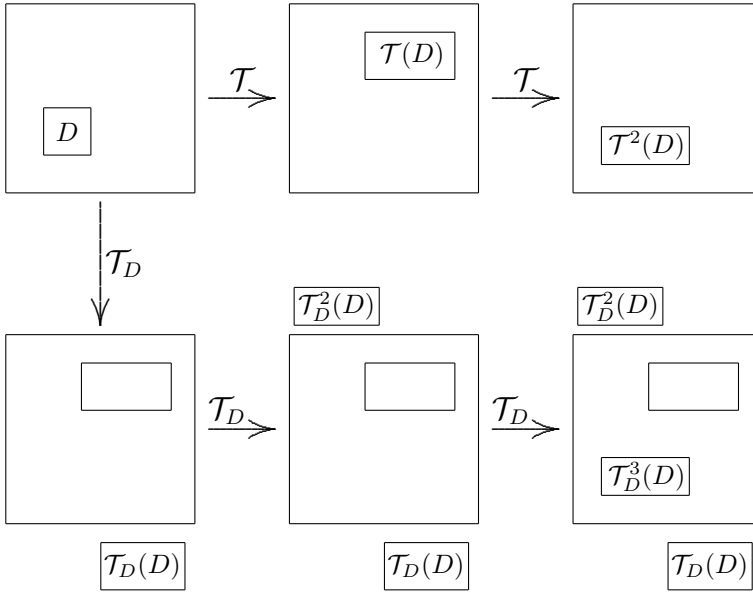

Figure 2.2: A diagram of the construction of the natural extension domain.

and

$$h(\hat{\mathcal{T}}_D) = \frac{h(\mathcal{T}_D)}{\nu(A)}, \tag{2.2.2}$$

where $\bar{\mu}$ is the invariant measure for the original system and ν for the new system i.e. $\bar{\mu}(A) = C \int_A f(x, y) \lambda \times \lambda(x, y)$ and $\nu(A) = C' \int_A f(x, y) \lambda \times \lambda(x, y)$ with $f(x, y) = \frac{1}{(1+xy)^2}$. We will now find an expression for C' . We have

$$\begin{aligned} (C')^{-1} &= \int_{\Omega_D} f(x, y) \lambda \times \lambda(x, y) \\ &= \int_{\Omega} f(x, y) \lambda \times \lambda(x, y) - \int_{\mathcal{T}(D)} f(x, y) \lambda \times \lambda(x, y) \\ &\quad + \int_{\mathcal{T}_D(D)} f(x, y) \lambda \times \lambda(x, y) + \int_{\mathcal{T}_D^2(D)} f(x, y) \lambda \times \lambda(x, y) \\ &= \int_{\Omega} f(x, y) \lambda \times \lambda(x, y) + \int_D f(x, y) \lambda \times \lambda(x, y) \\ &= \frac{1}{C} + \int_D f(x, y) \lambda \times \lambda(x, y) \\ &= \frac{1}{C} (1 + \bar{\mu}(D)). \end{aligned}$$

This gives us $C' = \frac{C}{1+\bar{\mu}(D)}$ which results in

$$\bar{\mu}(A) = (1 + \bar{\mu}(D))\nu(A). \quad (2.2.3)$$

Since $\mathcal{T}^2(D) = \mathcal{T}_D^3(D)$ we have that $\hat{\mathcal{T}} = \hat{\mathcal{T}}_D$. Using (2.2.1) and (2.2.2) we now find

$$\frac{h(\mathcal{T})}{\bar{\mu}(A)} = \frac{h(\mathcal{T}_D)}{\nu(A)},$$

which together with (2.2.3) gives

$$\frac{h(\mathcal{T})}{1 + \bar{\mu}(D)} = h(\mathcal{T}_D).$$

Given this result one might expect that, in our setting, we would have a decrease in entropy whenever we add insertions. Though, Theorem 2.1.1 shows this is not the case (even though for $\alpha \leq \frac{1}{2}$ there are only insertions). This illustrates well that there are differences between similar systems when one system is an infinite system and the other is a finite one. Another observation is that for Nakada's α -continued fractions we have only singularisations for $\alpha \in (g, 1]$. In a similar way as for insertions, one finds that the entropy as a function of α is in this case decreasing on $(g, 1]$ since the measure of the singularisation region decreases as α goes to one.

§2.2.2 Back to our map

The map T_α generates semi-regular continued fraction expansions of real numbers. For any $\alpha \in (0, 1)$ and any $x \in I_\alpha$, the map T_α from (2.1.1) defines a continued fraction expansion for any $x \in I_\alpha$ in the following way. Define the partial quotients $d_k = d_k(x)$ and the signs $\varepsilon_k = \varepsilon_k(x)$ by $d_k(x) := d_1(T_\alpha^{k-1}(x))$, where

$$d_1(x) := \begin{cases} \lfloor \frac{1}{x} \rfloor, & \text{if } x \notin D_\alpha, \\ \lfloor \frac{1}{x} \rfloor + 1, & \text{otherwise;} \end{cases}$$

and by $\varepsilon_k(x) := \varepsilon_1(T_\alpha^{k-1}(x))$, where

$$\varepsilon_1(x) := \begin{cases} 1, & \text{if } x \notin D_\alpha, \\ -1, & \text{otherwise.} \end{cases}$$

With this notation the map T_α can be written as

$$T_\alpha(x) = \varepsilon_1(x) \left(\frac{1}{x} - d_1(x) \right)$$

and so

$$x = \frac{1}{d_1 + \varepsilon_1 T_\alpha(x)} = \frac{1}{d_1 + \frac{\varepsilon_1}{d_2 + \cdots + \frac{\varepsilon_{n-1}}{d_n + \varepsilon_n T_\alpha^n(x)}}}. \quad (2.2.4)$$

Denote by $(p_k/q_k)_{k \geq 1}$ the sequence of convergents of such an expansion, i.e., we write

$$\frac{p_k}{q_k} = \frac{1}{d_1 + \frac{\varepsilon_1}{d_2 + \cdots + \frac{\varepsilon_{k-1}}{d_k}}}$$

Since we obtained T_α from the Gauss map by flipping on the domain D_α , it follows immediately from [27, Theorem 1] that for any $x \in I_\alpha$ the expression from (2.2.4) converges to a continued fraction expansion of x : $\lim_{k \rightarrow \infty} \frac{p_k}{q_k} = x$. Therefore, we can write

$$x = \frac{1}{d_1 + \frac{\varepsilon_1}{d_2 + \cdots + \frac{\varepsilon_{k-1}}{d_k + \cdots}}} =: [0; 1/d_1, \varepsilon_1/d_2, \varepsilon_2/d_3, \dots]_\alpha,$$

which we call the *flipped α -continued fraction expansion* of x . For $x \in [0, 1]$ it is well known that the regular continued fraction is finite if and only if $x \in \mathbb{Q}$. In our case 0 is not in the domain of T_α . Therefore, we cannot find finite expansions. Instead of a finite continued fraction all rational numbers will end in 1 where $1 = [0; 1/2, -1/2, -1/2, \dots]_\alpha$ for all $\alpha \in (0, 1)$.

Proposition 2.2.2. *Let $\alpha \in (0, 1)$ and $x \in I_\alpha$ be given. Then $x \in \mathbb{Q}$ if and only if there is an $N \geq 0$ such that $T_\alpha^N(x) = 1$.*

Proof. If there is an $N \geq 0$ such that $T_\alpha^N(x) = 1$, then it follows immediately that $x \in \mathbb{Q}$. Suppose $x \in \mathbb{Q}$. Note that $T_\alpha^n(x) \in \mathbb{Q} \cap I_\alpha$ for all $n \geq 0$ and write $T_\alpha^n(x) = \frac{s_n}{t_n}$ with $s_n, t_n \in \mathbb{N}$ and t_n as small as possible. Assume for a contradiction that $T_\alpha^n(x) \neq 1$ for all $n \geq 1$. Then $s_n < t_n$ and since either $T_\alpha^{n+1}(x) = \frac{t_n - ks_n}{s_n}$ or $T_\alpha^{n+1}(x) = \frac{(k+1)s_n - t_n}{s_n}$, we get $0 < t_{n+1} < t_n$. This gives a contradiction. \square

§2.3 Natural extensions for our maps

To find the invariant density of the absolutely continuous invariant measure of T_α , we construct a natural extension domain such that \mathcal{T}_α is almost bijective and minimal from a measure theoretic point of view. In that case Proposition 2.2.1 gives us the wanted result. We are able to construct the domain for $\alpha \in (0, \frac{1}{2}\sqrt{2}]$. We will go through a subset of the parameter space to show the method. Invariant densities of other values are found in the same way but with different computations. Let $\alpha \in (0, \frac{1}{2})$ such that $\frac{1}{n+\alpha} < \alpha < \frac{1}{n}$ with $n \in \mathbb{N}_{\geq 2}$. We define $\mathcal{T}_\alpha : \Omega_\alpha \rightarrow \Omega_\alpha$ as

$$(x, y) \mapsto \left(T_\alpha(x), \frac{\varepsilon_1(x)}{d_1(x) + y} \right)$$

where

$$\Omega_\alpha := \left[\alpha, \frac{\alpha}{1-\alpha} \right] \times \left[0, \infty \right) \cup \left(\frac{\alpha}{1-\alpha}, 1-\alpha \right] \times \left[0, 1 \right] \cup \left(1-\alpha, 1 \right] \times \left[-1, 1 \right].$$

	Ω_α	$\mathcal{T}_\alpha(\Omega_\alpha)$
a	$[\alpha, \frac{1}{n}] \times [0, \infty)$	$[\frac{\alpha-1+n\alpha}{\alpha}, 1] \times [-\frac{1}{n+1}, 0]$
b	$[\frac{1}{n}, \frac{1}{n-1+\alpha}] \times [0, \infty)$	$[\alpha, 1] \times [0, \frac{1}{n-1}]$
c	$[\frac{1}{n-1+\alpha}, \frac{\alpha}{1-\alpha}] \times [0, \infty)$	$[1-\alpha, \frac{\alpha-1+n\alpha}{\alpha}] \times [-\frac{1}{n}, 0]$
d	$[\frac{\alpha}{1-\alpha}, \frac{1}{n-1}] \times [0, 1]$	$[\frac{\alpha-1+n\alpha}{\alpha}, 1] \times [-\frac{1}{n}, -\frac{1}{n+1}]$
e	$[\frac{1}{k+1}, \frac{1}{k+\alpha}] \times [0, 1]$	$[\alpha, 1] \times [\frac{1}{k+1}, \frac{1}{k}]$ for $k \in \mathbb{N}_{\leq n-2}$
f	$[\frac{1}{k+1+\alpha}, \frac{1}{k+1}] \times [0, 1]$	$[1-\alpha, 1] \times [-\frac{1}{k+2}, -\frac{1}{k+3}]$ for $k \in \mathbb{N}_{\leq n-3}$
g	$[1-\alpha, \frac{1}{1+\alpha}] \times [-1, 0]$	$[\alpha, \frac{\alpha}{1-\alpha}] \times [1, \infty)$
h	$[\frac{1}{1+\alpha}, 1] \times [-1, 1]$	$[1-\alpha, 1] \times [-1, -\frac{1}{3}]$

Table 2.1: Ω_α split up in disjoint pieces in the left column and their image under \mathcal{T}_α in the right column.

Table 2.1 shows that \mathcal{T}_α is bijective almost everywhere on Ω_α . See Figure 2.3 for a visualisation of the map.

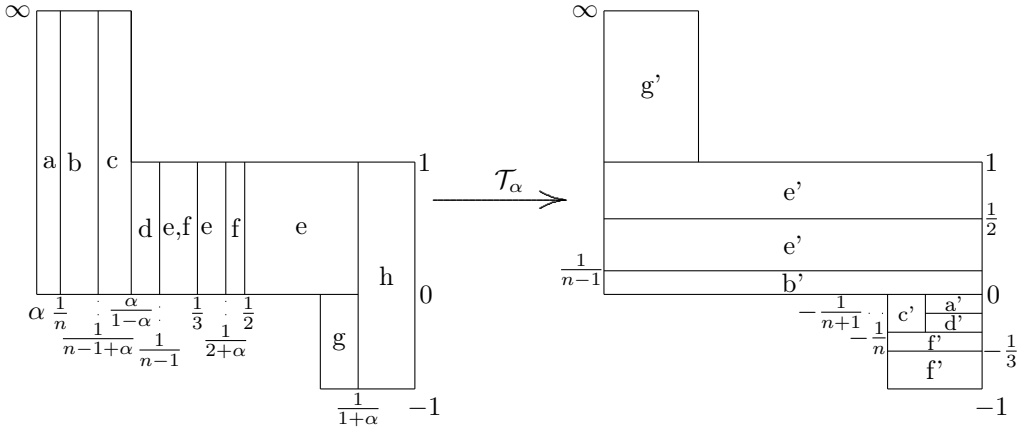

Figure 2.3: The natural extension domain for \mathcal{T}_α where $\mathcal{T}_\alpha(a) = a'$, $\mathcal{T}_\alpha(b) = b'$ etc..

§2.3.1 From natural extension to invariant measure

To find the invariant measure for the original system (I_α, T_α) one simply projects onto the first coordinate. For $\alpha \in (0, \frac{1}{2})$ such that $\frac{1}{n+\alpha} < \alpha < \frac{1}{n}$ with $n \in \mathbb{N}_{\geq 2}$ we

find invariant density

$$\begin{aligned}
 f_\alpha(x) &= \int_0^\infty \frac{1}{(1+xy)^2} dy \mathbf{1}_{[\alpha, \frac{\alpha}{1-\alpha}]}(x) + \int_0^1 \frac{1}{(1+xy)^2} dy \mathbf{1}_{[\frac{\alpha}{1-\alpha}, 1]}(x) \\
 &\quad + \int_{-1}^0 \frac{1}{(1+xy)^2} dy \mathbf{1}_{[1-\alpha, 1]}(x) \\
 &= \frac{1}{x} \mathbf{1}_{[\alpha, \frac{\alpha}{1-\alpha}]}(x) + \frac{1}{1+x} \mathbf{1}_{[\frac{\alpha}{1-\alpha}, 1]}(x) + \frac{1}{1-x} \mathbf{1}_{[1-\alpha, 1]}(x).
 \end{aligned}$$

Proof of Theorem 2.1.1. By the same method as explained in this section one can find all the densities given in the theorem. Since only the calculations are different from the case explained, we omit them here. \square

For $\alpha \in (\frac{1}{2}\sqrt{2}, 1)$ the structure of the domain Ω_α of natural extension becomes more complicated as Figure 2.4 shows.

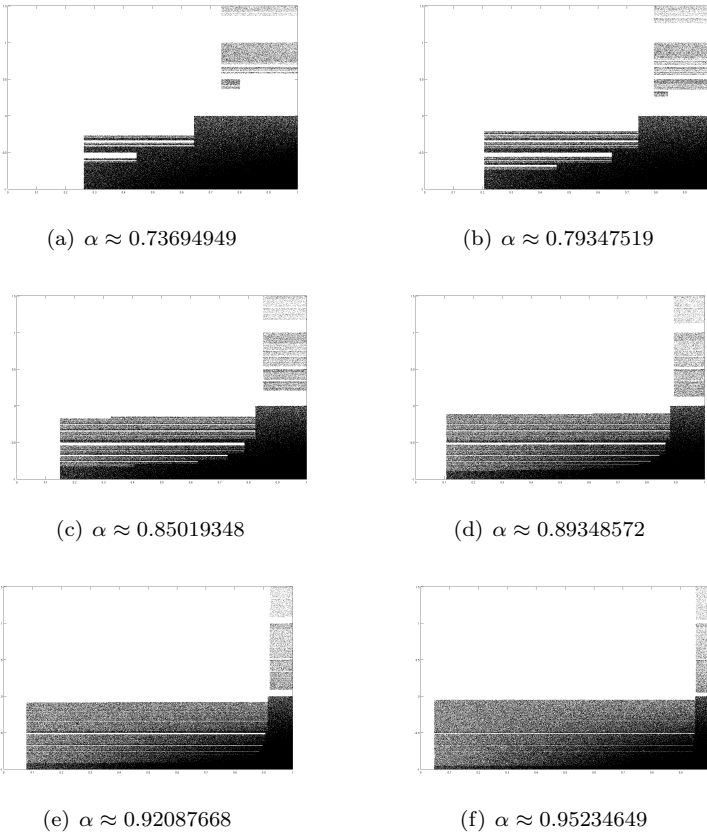

Figure 2.4: Several numerical simulations of the natural extension domain for $\alpha \in (\frac{1}{2}\sqrt{2}, 1)$.

§2.4 Entropy

To be able to calculate the entropy we first have to do some preliminary work. We show the following proposition.

Proposition 2.4.1. *Let $\alpha \in (0, 1)$. The system $(I_\alpha, \mathcal{B}, \mu_\alpha, T_\alpha)$ is a basic AFN map: a conservative system, a piecewise monotonic system (there exists a partition $\mathcal{P} = \{I_i\}$ such that T_α restricted to each element of \mathcal{P} is continuous, strictly monotonic and twice differentiable) and a system with at least one indifferent fixed point such that the following conditions hold.*

(A) *Adler's condition: $\frac{T_\alpha''}{(T_\alpha')^2}$ is bounded on $\cup_i I_i$,*

(F) *Finite image condition: $T_\alpha(\mathcal{P}) := \{T_\alpha(I_i) : I_i \in \mathcal{P}\}$ is finite,*

(N) *Indifferent fixed point condition: there exists a finite set $\mathcal{Z} \subseteq \mathcal{P}$, such that each $Z_i \in \mathcal{Z}$ has an indifferent fixed point x_{Z_i} , i.e.*

$$\lim_{x \rightarrow x_{Z_i}, x \in Z_i} T_\alpha(x) = x_{Z_i} \quad \text{and} \quad \lim_{x \rightarrow x_{Z_i}, x \in Z_i} T_\alpha'(x) = 1$$

and T_α' decreases on $(-\infty, x_{Z_i}) \cap Z_i$ respectively increases on $(x_{Z_i}, \infty) \cap Z_i$. Last, T is uniformly expanding on sets bounded away from $\{x_{Z_i} : Z_i \in \mathcal{Z}\}$.

Proof. First, recall that a system T_α is said to be conservative if every wandering set (a set for which all the pre-images under the map are pairwise disjoint) for T_α is a set of null measure. Maharam's Recurrence Theorem (see [57, Theorem 2.2.14]) ensures the conservativity through the existence of a sweep-out set (a positive but finite measure set for which the set of all pre-images covers almost everything). It is easy to see that any subinterval of I_α is a sweep-out set for the map T_α so that the system is conservative.

For each $\alpha \in (0, 1)$, let $k(\alpha) \in \mathbb{N}$ be such that $\min(\alpha, 1 - \alpha) \in \left(\frac{1}{k(\alpha)+1}, \frac{1}{k(\alpha)}\right]$ and let

$$W_\alpha := \begin{cases} \left[\min(\alpha, 1 - \alpha), \frac{1}{k(\alpha)}\right] & \text{if } \frac{1}{k(\alpha)+\alpha} < \alpha < \frac{1}{k(\alpha)}, \\ \left[\min(\alpha, 1 - \alpha), \frac{1}{k(\alpha)+\alpha}\right], \left(\frac{1}{k(\alpha)+\alpha}, \frac{1}{k(\alpha)}\right] & \text{if } \frac{1}{k(\alpha)+1} < \alpha < \frac{1}{k(\alpha)+\alpha}. \end{cases}$$

A finite partition \mathcal{P} can be given by

$$\left\{ W_\alpha, \left(\frac{1}{n+1}, \frac{1}{n+\alpha}\right], \left(\frac{1}{n+\alpha}, \frac{1}{n}\right], \text{ for } n = 1, 2, \dots, k(\alpha) - 1 \right\}.$$

On each of these subintervals the map is continuous, strictly monotonic and twice differentiable. Furthermore we see that the conditions **(A)**, **(F)**, **(N)** hold:

(A) $|2x| \leq 2$ on I_α ,

(F) $T_\alpha(\mathcal{P})$ consists at most of three subintervals depending on α ,

(N) $x_Z = 1$ is the only indifferent fixed point for $Z = \left(\frac{1}{1+\alpha}, 1\right]$, and $T_\alpha'(x) = 1/x^2$ decreases on Z and it is strictly greater than 1 on sets bounded away from x_Z .

□

For infinite measure-preserving and conservative systems (X, \mathcal{B}, μ, T) there exists an extension of the notion of entropy (w.r.t μ) due to Krengel [66]:

$$h_{K\ddot{r},\mu}(T) = h(T_A, \mu|_A),$$

for A a sweep-out set for T , T_A the induced transformation T on A and $\mu|_A$ the measure μ restricted to the set A . A result of Zweimüller tells us that we can use Rohlin's formula to calculate it.

Theorem 2.4.2 (Zweimüller [106]). *Let (I, \mathcal{B}, μ, T) be a basic AFN map with μ_α an (absolutely continuous) invariant measure, then*

$$h_{K\ddot{r},\mu}(T) = \int_X \log(|T'(x)|) d\mu.$$

We are now in the position of proving Theorem 2.1.2.

Proof of Theorem 2.1.2. From Proposition 2.4.1 and Theorem 2.4.2 it follows we can calculate the Krengel entropy by using Rohlin's formula. We use some properties of dilogarithm functions (see also [73]). We have

$$\text{Li}_2(x) := \sum_{n=1}^{\infty} \frac{x^n}{n^2} \quad \text{for } |x| < 1$$

and

- $\text{Li}_2(0) = 0,$
- $\text{Li}_2(-1) = -\pi^2/12,$
- $\text{Li}_2(x) + \text{Li}_2(-\frac{x}{1-x}) = -\frac{1}{2} \log^2(1-x),$
- $\frac{d}{dx} \text{Li}_2(x) = \frac{-\log(1-x)}{x}.$

We compute the entropy for $\alpha \in (0, \frac{1}{2})$. The computation for $\alpha \in [\frac{1}{2}, g)$ works in a

similar way.

$$\begin{aligned}
 \int_{[\alpha,1]} \log(|T'_\alpha(x)|) d\mu_\alpha &= -2 \left[\int_\alpha^{\alpha/(1-\alpha)} \frac{\log x}{x} dx + \int_{\alpha/(1-\alpha)}^{1-\alpha} \frac{\log x}{1+x} dx + \int_{1-\alpha}^1 \frac{\log x}{1-x^2} dx \right] \\
 &= -\log^2 x \Big|_\alpha^{\alpha/(1-\alpha)} - 2[\text{Li}_2(-x) + \log x \log(x+1)] \Big|_{\alpha/(1-\alpha)}^{1-\alpha} \\
 &\quad - 2[\text{Li}_2(1-x) + \text{Li}_2(-x) + \log x \log(x+1)] \Big|_{1-\alpha}^1 \\
 &= -\log^2 \left(\frac{\alpha}{1-\alpha} \right) + \log^2(\alpha) + 2 \text{Li}_2 \left(\frac{-\alpha}{1-\alpha} \right) \\
 &\quad + 2 \log \left(\frac{\alpha}{1-\alpha} \right) \log \left(\frac{1}{1-\alpha} \right) - 2 \text{Li}_2(0) - 2 \text{Li}_2(-1) \\
 &\quad - 2 \log(0) \log(2) + 2 \text{Li}_2(\alpha) \\
 &= \log^2(\alpha) - \log^2 \left(\frac{\alpha}{1-\alpha} \right) + 2[\text{Li}_2 \left(\frac{-\alpha}{1-\alpha} \right) + \text{Li}_2(\alpha)] + \\
 &\quad - 2 \log \left(\frac{\alpha}{1-\alpha} \right) \log(1-\alpha) + \frac{\pi^2}{6} \\
 &= \log^2(\alpha) - \log^2 \left(\frac{\alpha}{1-\alpha} \right) - \log^2(1-\alpha) \\
 &\quad - 2 \log \left(\frac{\alpha}{1-\alpha} \right) \log(1-\alpha) + \frac{\pi^2}{6} \\
 &= 2 \log(1-\alpha) [\log(\alpha) - \log(1-\alpha) - \log(\alpha) + \log(1-\alpha)] + \frac{\pi^2}{6} \\
 &= \frac{\pi^2}{6}.
 \end{aligned}$$

□

§2.5 Return sequences and wandering rates

Other ergodic properties can be obtained from the asymptotic type of the maps, which is the asymptotic proportionality class of any return sequence of the map. Let P_α denote the transfer operator of the map T_α , defined by the equation

$$\int_A P_\alpha f d\mu_\alpha = \int_{T_\alpha^{-1}A} f d\mu_\alpha \quad \text{for } f \in L^1(I_\alpha, \mathcal{B}_\alpha, \mu_\alpha) \text{ and } A \in \mathcal{B}_\alpha.$$

The *return sequence* for T_α is the sequence $(a_n(T_\alpha))_{n \geq 1} \subseteq (0, \infty)$ satisfying

$$\lim_{n \rightarrow \infty} \frac{1}{a_n(T_\alpha)} \sum_{k=0}^{n-1} P_\alpha^k f = \int_{I_\alpha} f d\mu_\alpha.$$

The result from [106, Theorem 1] implies that each map T_α is pointwise dual ergodic. This ensures that such a sequence, which is unique up to asymptotic equivalence, exists. The *asymptotic type* of any map T_α is the asymptotic proportionality class of T_α , containing all sequences that are asymptotically equivalent to some positive multiple of $(a_n(T_\alpha))_{n \geq 1}$.

The return sequence of a system is related to its wandering rate, which quantifies how big the system is in relation to its subsets of finite measure. To be more precise, if (X, \mathcal{B}, μ, T) is a conservative, ergodic, measure preserving system and $A \in \mathcal{B}$ a set of finite positive measure, then the wandering rate of A with respect to T is the sequence given by $(w_n(A))_{n \geq 1}$ for

$$w_n(A) := \mu \left(\bigcup_{k=0}^{n-1} T^{-k} A \right).$$

It follows from [106, Theorem 2] that for each of the maps T_α there is a sequence $(w_n(T_\alpha)) \subseteq (0, \infty)$ such that $w_n(T_\alpha) \uparrow \infty$ and $w_n(T_\alpha) \sim w_n(A)$ as $n \rightarrow \infty$ for all sets $A \in \mathcal{B}$ such that $0 < \mu(A) < \infty$ and that are bounded away from one. The asymptotic equivalence class of $(w_n(T_\alpha))$ is called the *wandering rate* of T_α . Using the machinery from [106] we can prove Proposition 2.1.3.

Proof of Proposition 2.1.3. The wandering rate for AFN-maps is given in [106, Theorem 3] and the return sequence in [106, Theorem 4]. Using the Taylor expansion of the maps T_α one sees that for $x \rightarrow 1$ we have $T_\alpha(x) = x - (x-1)^2 + o((x-1)^2)$. Hence, T_α admits what is called *nice expansions* in [106]. Secondly, on the right most interval $(\frac{1}{1+\alpha}, 1]$ the density f_α for $\alpha \in (0, \frac{1}{2})$ is given by $f_\alpha(x) = \frac{2}{1-x^2}$. This can be written as $f_\alpha(x) = G(x)H(x)$, where $G(x) = \frac{x-2}{x-1}$ and $H(x) = \frac{2}{(1+x)(2-x)}$. As a consequence, at the indifferent fixed point it holds that $H(1) = 1$. It then follows from [106, Theorems 3 and 4], that the wandering rate is

$$w_n(T) \sim \log n$$

and the return sequence is

$$a_n(T) \sim \frac{n}{\log n}.$$

In our setting [106, Theorem 5] translates to

$$\frac{\log n}{n} \sum_{k=0}^{n-1} f \circ T_\alpha^k \xrightarrow{\mu_\alpha} \int_{I_\alpha} f d\mu_\alpha, \quad \text{for } f \in L_1(\mu_\alpha) \text{ and } \int_{I_\alpha} f d\mu_\alpha \neq 0,$$

i.e., a weak law of large numbers holds for T_α . □

§2.5.1 Isomorphic?

When considering a family of transformations with similar dynamical properties, a natural question to ask is whether the maps in question are isomorphic. Since the maps T_α all have an infinite invariant measure, these measures cannot be normalised and the appropriate notion to consider is that of *c-isomorphism*, which is defined as follows (see for example [1]): Two measure preserving dynamical systems (X, \mathcal{B}, μ, T) and (Y, \mathcal{C}, ν, S) on σ -finite measure spaces are called *c-isomorphic* for $c \in \mathbb{R}_{>0} \cup \{\infty\}$ if there are sets $N \in \mathcal{B}$, $M \in \mathcal{C}$ with $\mu(N) = 0 = \nu(M)$ and $T(X \setminus N) \subseteq X \setminus N$ and $S(Y \setminus M) \subseteq Y \setminus M$ and if there is a map $\phi : X \setminus N \rightarrow Y \setminus M$ that is invertible,

bi-measurable and satisfies $\phi \circ T = S \circ \phi$ and $\mu \circ \phi^{-1} = c \cdot \nu$. Well known invariants for c -isomorphism are the Krengel entropy and the asymptotic proportionality classes of the return sequence and the wandering rate.

We have seen that the Krengel entropy for $\alpha \in (0, g]$ is constant and not depending on α . Also the wandering rate as well as the return sequence do not display any dependence on α , so that also these invariants do not give us information on the existence (or non-existence) of isomorphisms between the maps T_α either. Using the technique from [53] we can show that in general it is not true that for any α, α' there is a $c \in \mathbb{R}_{>0} \cup \{\infty\}$ such that T_α and $T_{\alpha'}$ are c -isomorphic. Consider for example any $\alpha \in (\sqrt{2}-1, \frac{1}{2})$, so that $\alpha \in (\frac{1}{2+\alpha}, \frac{1}{2})$ and any $\alpha' \in (\frac{1}{3}, \frac{3-\sqrt{5}}{2})$, so that $T_{\alpha'}(\alpha') > 1 - \alpha'$, see Figure 2.5. For a contradiction, suppose that there is a c -isomorphism $\phi : I_\alpha \rightarrow I_{\alpha'}$ for some $c \in \mathbb{R}_{>0} \cup \{\infty\}$. Let $J = [\alpha, \min\{T_\alpha(\alpha), 1 - \alpha\}]$ and note that any $x \in J$ has precisely one pre-image. Since $\phi \circ T_\alpha = T_{\alpha'} \circ \phi$ and ϕ is invertible, any element of the set $\phi(J)$ must also have precisely one pre-image. Since $T_{\alpha'}(\alpha') > 1 - \alpha'$, there are no such points, so $\mu_{\alpha'}(\phi(J)) = 0$. On the other hand, since J is bounded away from 1, it follows that $0 < \mu_\alpha(J) < \infty$. Hence, there can be no c , such that $\mu_{\alpha'} \circ \phi^{-1} = c \cdot \mu_\alpha$. Obviously a similar argument holds for many other combinations of α and α' , even for $\alpha > \frac{1}{2}$, and in case the argument does not work for T_α and $T_{\alpha'}$, one can also consider iterates of the transformation. Hence, even though the above discussed isomorphism invariants are equal for all $\alpha \in (0, \frac{1}{2})$, in general one cannot conclude that any two of the maps T_α are c -isomorphic.

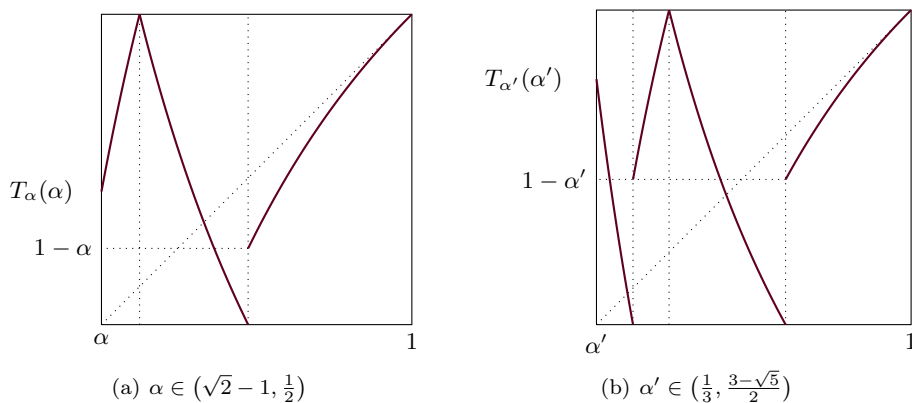

Figure 2.5: Maps T_α and $T_{\alpha'}$ that are not c -isomorphic for any $c \in \mathbb{R}_{>0} \cup \{\infty\}$.

§2.5.2 Final observations and remarks

We have seen that the natural extension is a powerful tool to find invariant measures for families of continued fractions. Though, for $\alpha > \frac{1}{2}\sqrt{2}$ the domain becomes more complicated. In other families of continued fractions (α -continued fractions or Ito

Tanaka's α -continued fractions studied in Chapter 3) similar behaviour is seen for certain values of the parameter space.

What one can do with the natural extensions that we found, is the study of Diophantine approximation. Using for example tools from [29] one can study the quality of convergence for typical points. One can show that for any $\alpha \in (0, 1)$ the convergence of a typical point in I_α is not exponential. Though, maybe more can be said about the quality.

Something we did not study in this chapter is matching. Though, matching can be easily found. For example on the interval $(0, \frac{1}{2})$ matching holds with exponents $(1, 3)$. In the study of other families, matching often has implications for the entropy whereas for our family we did not observe a relation between the Krengel entropy and matching. Maybe there is another observable which is related to matching in our case.

In an upcoming paper we show a very close connection between matching intervals for our family and for α -continued fractions. By using this relation we can prove that matching holds almost everywhere, even though it is unclear to us how these families are exactly related.

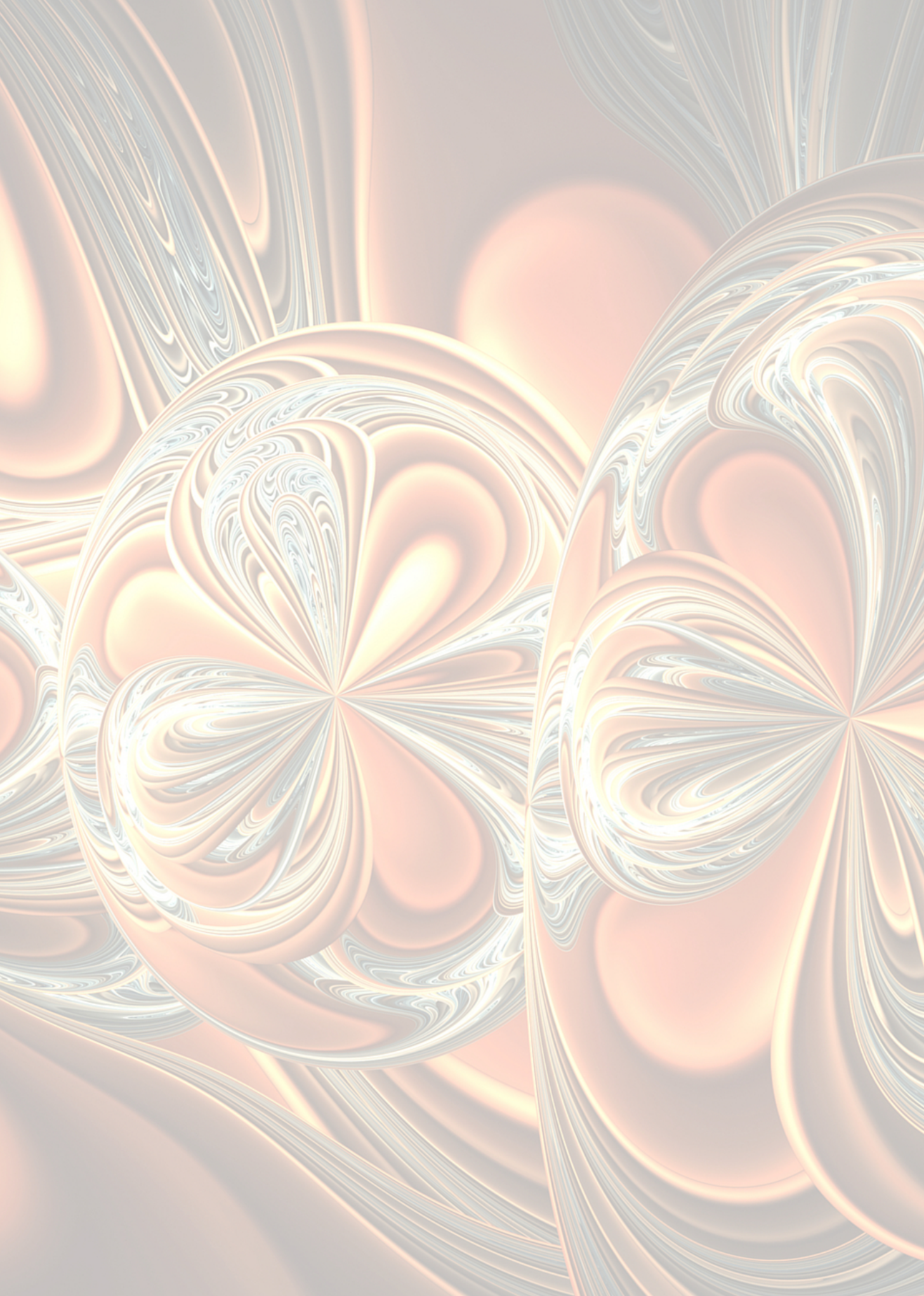

CHAPTER 3

Matching and Ito Tanaka's α -continued fraction expansions

This chapter is joint work with Carlo Carminati and Wolfgang Steiner.

Abstract

Two closely related families of α -continued fractions were introduced in 1981: by Nakada on the one hand, by Ito and Tanaka on the other hand. The entropy and matching for Nakada's family has been studied extensively, whereas the study of Ito Tanaka's family remained on the fringe. This chapter has two parts. In the first part we focus mostly on the similarities; algebraic conditions and monotonicity of the entropy function on matching intervals. The second part focuses mostly on the Ito Tanaka α -continued fraction. We show that the parameter space is almost completely covered by matching intervals. In other words, the set of parameters for which the matching condition does not hold, called the bifurcation set, is a zero measure set (even if it has full Hausdorff dimension). These properties are shared by Nakada's α -continued fractions, though the proof is different. In contrast to Nakada's α -continued fractions, the bifurcation set of Ito Tanaka's α -continued fractions contains several non zero rational values. Moreover, it contains numbers of which the regular continued fraction expansion ends in a sequence that is bounded from below. We give several characterisations of the bifurcation set and have dimensional results for neighbourhoods of the small golden mean and rationals in the bifurcation set.

§3.1 Introduction

Various variants of the regular continued fraction (RCF) have been considered. The most famous ones are the *nearest integer* continued fraction (NICF) and the *backward continued fraction* (BCF). Starting from the 80s, some attention has been devoted to families of continued fraction algorithms; even if different authors have focused on different families one can describe most¹ of these families using the same setting as follows. Let $T_\alpha : [\alpha - 1, \alpha] \rightarrow [\alpha - 1, \alpha]$ be defined by

$$T_\alpha(x) = \begin{cases} S(x) - \lfloor S(x) + 1 - \alpha \rfloor & \text{for } x \neq 0, \\ 0 & \text{for } x = 0. \end{cases} \quad (3.1.1)$$

Different choices of S in formula (3.1.1) give rise to different generalisations of the classical continued fraction algorithms:

- (N) for $S(x) = \frac{1}{|x|}$ one gets the α -continued fractions first studied by Nakada [82],
- (KU) for $S(x) = -\frac{1}{x}$ one finds a subfamily of (a, b) -continued fractions (corresponding to the choice $b = \alpha$ and $a = \alpha - 1$), which were first studied by Katok and Ugarcovici [54],
- (IT) for $S(x) = \frac{1}{x}$ one gets the α -continued fractions first studied by Ito and Tanaka [103].

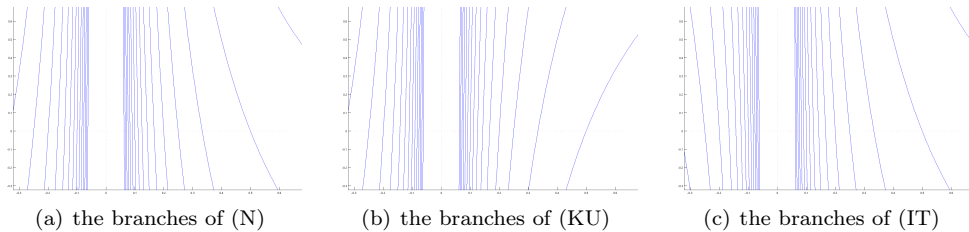

Figure 3.1: The different branches for the different transformations.

In Figure 3.1 the different transformations are displayed. In all of the above three cases, for all $\alpha \in (0, 1)$, the dynamical system defined by the map (3.1.1) admits an absolutely continuous invariant probability measure and is ergodic. For the (IT) case this is proven in an unpublished article by Nakada and Steiner. Therefore, we can study the metric entropy $h_{\mu_\alpha}(T_\alpha)$. This determines the speed of convergence of the continued fraction algorithm of typical points (in the same way as in the regular continued fraction case (1.2.1) on page 12). The higher the entropy, the better the convergence. An issue which has been in the spotlight in recent years is the dependence of the entropy on the parameter α . In Figure 3.2 the entropy plotted as a function of α is shown for the Ito Tanaka continued fractions.

¹Actually some authors, such as the authors of [81], studied the so called *folded algorithms* which are not of the type (3.1.1), however from the metric viewpoint there is hardly any difference between the folded and the unfolded version (see § 3.1 of [9] for a discussion of this issue).

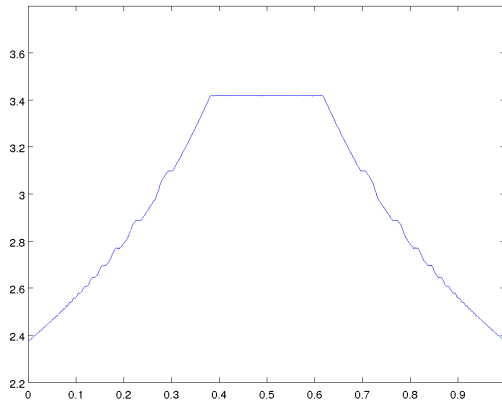

Figure 3.2: The entropy as a function of α for the Ito Tanaka continued fractions.

The behaviour of the entropy is by now quite well understood in case (N), which is by far the most studied [18, 19, 65, 79, 81, 82, 84]. The same is true for the case (KU), which was considered much more recently [17, 54, 56]. However, not much progress has been made in the case (IT) for which there are only partial results dating back to 1981 (see [103]). This chapter studies the similarities and differences between the families, where the results on (IT) are new. As in the cases (N) and (KU), also for Ito Tanaka continued fractions the *matching property* plays a central role; a parameter $\alpha \in [0, 1]$ satisfies the *matching condition* with *matching exponents* N, M if

$$T_\alpha^N(\alpha) = T_\alpha^M(\alpha - 1). \quad (3.1.2)$$

The peculiar (and somehow surprising) feature of these systems is that a condition like (3.1.2) holds on intervals with non-empty interior; thus what is actually relevant is the definition of a *matching interval*.

Definition 3.1.1 (Matching). *Let $J \subset [0, 1]$ be a non-empty open interval. We say that J is a matching interval (with exponents N, M) if $T_\alpha^N(\alpha) = T_\alpha^M(\alpha - 1)$ for all $\alpha \in J$, $T_\alpha^{N-1}(\alpha) \neq T_\alpha^{M-1}(\alpha - 1)$ for almost all $\alpha \in J$, and J is not contained in a larger open interval with these properties. The difference $\Delta := M - N$ is called matching index. We call the matching set the union of all matching intervals; its complement will be called the bifurcation set and will be denoted by \mathcal{E} .*

Observe that we do not impose conditions on the derivative of T_α^N and T_α^M , as in Definition 1.2.8 on page 13, since these are automatically satisfied whenever matching holds on an open interval (this is proved in Section 3.2). The following lemma shows that two matching intervals cannot overlap (for any choice of $S(x)$ above).

Lemma 3.1.2. *Let M, M', N, N' be such that $M - N \neq M' - N'$. Then there are at most countably many $\alpha \in [0, 1]$ such that $T_\alpha^N(\alpha) = T_\alpha^M(\alpha - 1)$ and $T_\alpha^{N'}(\alpha) = T_\alpha^{M'}(\alpha - 1)$.*

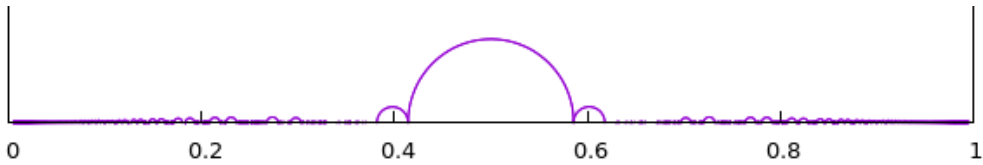

Figure 3.3: Matching intervals, plotted as arcs from a to b for a matching interval (a, b) , for the Ito Tanaka continued fractions.

Proof. Assume w.l.o.g. that $N' \geq N$. Then we have $T_\alpha^{M+N'-N}(\alpha - 1) = T_\alpha^{N'}(\alpha) = T_\alpha^{M'}(\alpha - 1)$. Since $M - N \neq M' - N'$, this implies that α is a rational or quadratic number. \square

By definition, matching is an open condition. For the α -continued fractions (N) it is conjectured in [84] and shown in [18] that matching holds almost everywhere; the same is true in the case of (KU) (see [17, 54, 56]). In Section 3.3 we show that this is also true for the α -continued fractions of Ito and Tanaka. However, for the bifurcation set the situation is different. Not only does each of the three variants (N), (KU) and (IT) have a different bifurcation set (we denote them by $\mathcal{E}_N, \mathcal{E}_{KU}$ and \mathcal{E}_{IT} respectively) but these bifurcation sets display quite a few differences. For instance, it is not difficult to show that both \mathcal{E}_N and \mathcal{E}_{KU} do not intersect $\mathbb{Q} \cap (0, 1)$ and are made of badly approximable numbers; this is not the case for \mathcal{E}_{IT} : not only does it contain infinitely many rational values (such as the values $1/n$ for $n \geq 3$) but it also contains numbers for which the tail of the regular continued fraction expansion has digits bounded from below. In the following subsection, we shall focus on the specific features of the Ito Tanaka case as well as stating the results on the exceptional set \mathcal{E}_{IT} . In this section we also state our theorems. In Section 3.2 we show that the entropy formula in terms of q_n is true for all three families as well as the fact that matching implies monotonicity of the entropy. Furthermore, we shed light onto algebraic conditions. Each family comes with different algebraic conditions that hold for $\alpha \in \mathbb{Q} \cap (0, 1)$. They will illustrate the fact that the (IT) case is more complicated than the others. The results displayed in this section in the case of (KU) and (N) are already known but added for comparison. The study of the so called *exceptional set* is specific for every family and is the focus of the second part of this chapter (Section 3.3 and 3.4). In Section 3.3 we prove the results on the exceptional set \mathcal{E}_{IT} as well as the fact that matching holds almost everywhere for which the proof is specific for the (IT) case. Section 3.4 is dedicated to dimensional results for the exceptional set.

§3.1.1 Ito Tanaka continued fractions: old and new results

In this section T_α will always denote the map (3.1.1) for the Ito Tanaka case, i.e., with $S(x) = 1/x$. Let us point out that the dynamical systems of α and $1 - \alpha$ are isomorphic. Indeed, setting $\tau(x) = -x$ gives

$$\tau \circ T_\alpha = T_{1-\alpha} \circ \tau.$$

For this reason, it is enough to study this family for the parameter $\alpha \in [1/2, 1]$. Setting $d_\alpha(x) = \lfloor S(x) + 1 - \alpha \rfloor$, for every $x \in [\alpha - 1, \alpha]$, we use the shorthand $d_{\alpha,n} = d_{\alpha,n}(x) = d_\alpha(T_\alpha^n(x))$ to write the continued fraction expansion

$$x = \frac{1}{d_{\alpha,1} + \frac{1}{d_{\alpha,2} + \frac{1}{\ddots}}}$$

Note that T_1 is the Gauss map and $T_{\frac{1}{2}}$ is the map for Hurwitz continued fraction expansions [48]. Furthermore, $d_{\alpha,n}(x)$ is called the n^{th} digit of x and can be both negative and positive. We define the n^{th} convergent as

$$c_{\alpha,n}(x) = \frac{p_{\alpha,n}(x)}{q_{\alpha,n}(x)} = \frac{1}{d_{\alpha,1}(x) + \frac{1}{d_{\alpha,2}(x) + \frac{1}{\ddots + \frac{1}{d_{\alpha,n}(x)}}}}$$

Let $g = \frac{\sqrt{5}-1}{2}$. For the speed of convergence for any $x \in [\alpha - 1, \alpha]$ we have

$$\left| x - \frac{p_{\alpha,n}}{q_{\alpha,n}} \right| \leq \frac{2}{\sqrt{5} |q_{\alpha,n}|^2} \quad \text{for } \frac{1}{2} \leq \alpha \leq g$$

and

$$\left| x - \frac{p_{\alpha,n}}{q_{\alpha,n}} \right| \leq \frac{1}{|q_{\alpha,n}|^2} \quad \text{for } g < \alpha \leq 1 \tag{3.1.3}$$

with $|q_{\alpha,n}(x)| \geq (g + 1)^n$ (see [103]). By symmetry, analogous results could be stated for the convergence of the algorithms when $\alpha \in [0, \frac{1}{2})$. Now let us turn to matching and state our first theorem.

Theorem 3.1.3. *Matching holds almost everywhere on $[0, 1]$ and the only possible indices are $-2, 0$ and 2 . More precisely, the matching indices are 0 or 2 for $\alpha \leq 1/2$ and 0 or -2 for $\alpha \geq 1/2$.*

Let us recall from [103] that the symmetric parameter interval $(1 - g, g)$ is (almost) covered by the three adjacent matching intervals $(1 - g, \sqrt{2} - 1)$, $(\sqrt{2} - 1, 2 - \sqrt{2})$ and $(2 - \sqrt{2}, g)$ see Figure 3.3; so the interesting part of the bifurcation set is in the ranges of $[0, 1 - g]$ and $[g, 1]$. Since the problem is symmetric with respect to $\alpha = 1/2$, we can focus on $\mathcal{E}_{IT} \cap [g, 1]$. We prove the following characterisations of this set.

Theorem 3.1.4. *The bifurcation set on $[g, 1]$ is given by*

$$\mathcal{E}_{IT} \cap [g, 1] = \{ \alpha \in [g, 1] : T_\alpha^n(\alpha - 1) \leq \frac{1}{\alpha+1} \quad \text{and} \quad T_\alpha^n(\frac{1}{\alpha} - 1) \leq \frac{1}{\alpha+1} \quad \text{for all } n \geq 1 \} \tag{3.1.4}$$

$$= \{ \alpha \in [g, 1] : T_\alpha^n(\alpha - 1) \geq \alpha - 1 \quad \text{and} \quad T_\alpha^n(\frac{1}{\alpha} - 1) \geq \alpha - 1 \quad \text{for all } n \geq 1 \}. \tag{3.1.5}$$

While the characterisation in terms of T_α is natural from the definition of the bifurcation set, the characterisation with a fixed map T_g will be more useful. In particular, from the ergodicity of T_g it easily follows that \mathcal{E}_{IT} is a Lebesgue measure zero set. Note that there is a clear connection with holes namely that \mathcal{E}_{IT} contains those α for which α and $\alpha - 1$ are contained in the survivor set when iterating over T_g with hole $[g - 1, \alpha - 1)$. Using this characterisation, we retrieve the following dimensional results for \mathcal{E}_{IT} .

Theorem 3.1.5. *We have that \mathcal{E}_{IT} is a Lebesgue measure zero set and $\dim_H(\mathcal{E}_{IT}) = 1$. Moreover, for all $\delta > 0$ we have $\dim_H(\mathcal{E}_{IT} \cap (g, g + \delta)) = 1$.*

This is similar to the behaviour of Nakada's continued fractions around zero (see [18]). What is different however, is the presence of rationals in the bifurcation set. For those points we have the following theorem.

Theorem 3.1.6. *The bifurcation set \mathcal{E}_{IT} contains infinitely many rational values and the set of rational bifurcation parameters $\mathcal{E}_{IT} \cap \mathbb{Q}$ has no isolated points. Moreover, for all $r \in \mathcal{E}_{IT} \cap \mathbb{Q}$ and for all $\delta > 0$ we have that $\dim_H(\mathcal{E}_{IT} \cap (r - \delta, r + \delta)) > 1/2$.*

Theorem 3.1.3 and 3.1.4 are proved in Section 3.3. In Section 3.4 we prove the theorems on dimensional results (Theorem 3.1.5 and 3.1.6).

§3.2 Algebraic relations, an entropy formula and matching implies monotonicity

Even though the results in this section will be focused on Ito Tanaka α -continued fractions, most of the results also hold for other continued fraction expansion families. Therefore, we will generalise some results to fit a more general framework or refer to other continued fraction expansion families after a proof. We will first prove that for all $\alpha \in (0, 1) \cap \mathbb{Q}$ an algebraic condition holds. In the case of Ito Tanaka α -continued fractions this results in 6 different algebraic relations. For KU-continued fractions and Nakada's α -continued fractions the situation greatly simplifies. We find 2 algebraic relations for each family. They are used in the proof of monotonicity on matching intervals later on in this section. But before proving monotonicity we will prove an entropy formula as in (1.2.1) for all three families.

To find the algebraic relations we work with Möbius transformations and matrices.

Definition 3.2.1 (Möbius transformation). *Let $A = \begin{bmatrix} a_1 & a_2 \\ a_3 & a_4 \end{bmatrix}$ be a matrix with $a_i \in \mathbb{Z}$. The Möbius transformation induced by A is the map $A : \mathbb{R} \rightarrow \mathbb{R}$ given by*

$$A(z) = \frac{a_1 z + a_2}{a_3 z + a_4}.$$

Now let $d \in \mathbb{Z}$. We define the following matrices in $SL_2(\mathbb{Z})$:

$$B_d = \begin{bmatrix} 0 & 1 \\ 1 & d \end{bmatrix}, \quad R = \begin{bmatrix} 1 & 1 \\ 0 & 1 \end{bmatrix}, \quad S = \begin{bmatrix} 0 & 1 \\ 1 & 0 \end{bmatrix}.$$

Note that

$$R^d = \begin{bmatrix} 1 & d \\ 0 & 1 \end{bmatrix}$$

which gives us $B_d = SR^d$. Fix α and $x \in [\alpha - 1, \alpha]$ and let

$M_{\alpha,x,n} = B_{d_{\alpha,1}(x)}B_{d_{\alpha,2}(x)}B_{d_{\alpha,3}(x)} \cdots B_{d_{\alpha,n}(x)}$. An easy check shows that $M_{\alpha,x,n}(0) = c_{\alpha,n}(x)$.

Lemma 3.2.2 (Recurrence relations). *We have the recurrence relations*

$$\begin{aligned} p_{\alpha,-1} &:= 1; & p_{\alpha,0} &:= 0; & p_{\alpha,n}(x) &= d_{\alpha,n}(x)p_{\alpha,n-1}(x) + p_{\alpha,n-2}(x), & n \geq 1, \\ q_{\alpha,-1} &:= 0; & q_{\alpha,0} &:= 1; & q_{\alpha,n}(x) &= d_{\alpha,n}(x)q_{\alpha,n-1}(x) + q_{\alpha,n-2}(x), & n \geq 1. \end{aligned}$$

The recurrence formulas are also given in [103] however without a proof. We provide a proof using the Möbius transformations. This proof is analogous to the proof for the regular continued fraction given in [29].

Proof. We can obtain the recurrence relations by writing

$$M_{\alpha,x,n} = \begin{bmatrix} r_{\alpha,n}(x) & p_{\alpha,n}(x) \\ s_{\alpha,n}(x) & q_{\alpha,n}(x) \end{bmatrix}.$$

Now

$$\begin{aligned} M_{\alpha,x,n} = M_{\alpha,x,n-1}B_{d_{\alpha,n}(x)} &= \begin{bmatrix} r_{\alpha,n-1}(x) & p_{\alpha,n-1}(x) \\ s_{\alpha,n-1}(x) & q_{\alpha,n-1}(x) \end{bmatrix} \begin{bmatrix} 0 & 1 \\ 1 & d_{\alpha,n}(x) \end{bmatrix} \\ &= \begin{bmatrix} p_{\alpha,n-1}(x) & d_{\alpha,n}(x)p_{\alpha,n-1}(x) + r_{\alpha,n-1}(x) \\ q_{\alpha,n-1}(x) & d_{\alpha,n}(x)q_{\alpha,n-1}(x) + s_{\alpha,n-1}(x) \end{bmatrix}. \end{aligned}$$

This gives us $r_{\alpha,n} = p_{\alpha,n-1}$ and $s_{\alpha,n} = q_{\alpha,n-1}$ and the recurrence formulas are found. \square

Just as in the classical case we have the following equation

$$p_{\alpha,n-1}(x)q_{\alpha,n}(x) - p_{\alpha,n}(x)q_{\alpha,n-1}(x) = (-1)^n. \quad (3.2.1)$$

Note that this implies that $p_{\alpha,n}(x)$ and $q_{\alpha,n}(x)$ are co-prime for all $n \in \mathbb{N}$ as well as $q_{\alpha,n}(x)$ and $q_{\alpha,n-1}(x)$. The equation is found by looking at the determinant of $M_{\alpha,x,n}$

$$\det(M_{\alpha,x,n}) = \det(B_{d_{\alpha,1}(x)}B_{d_{\alpha,2}(x)} \cdots B_{d_{\alpha,n}(x)}) = (-1)^n.$$

Also the following equation holds

$$x = \frac{p_{\alpha,n}(x) + p_{\alpha,n-1}(x)T_{\alpha}^n(x)}{q_{\alpha,n}(x) + q_{\alpha,n-1}(x)T_{\alpha}^n(x)}. \quad (3.2.2)$$

Note that $T_{\alpha}(x) = B_{d_{\alpha,n}(x)}^{-1}(x)$ and so $x = B_{d_{\alpha,n}(x)}(T_{\alpha}(x))$. This gives us

$$x = M_{\alpha,x,n}(T_{\alpha}^n(x)) = \frac{p_{\alpha,n}(x) + p_{\alpha,n-1}(x)T_{\alpha}^n(x)}{q_{\alpha,n}(x) + q_{\alpha,n-1}(x)T_{\alpha}^n(x)}.$$

Let us now turn to the algebraic conditions. For (N) and (KU) continued fractions one can define $M_{\alpha,x,n}$ in the same way as for the (IT) case. The following lemma holds for all three families.

Lemma 3.2.3 (Pre-algebraic condition). *Let $\alpha \in [0, 1]$ and suppose matching occurs. Let $b = T_\alpha^N(\alpha) = T_\alpha^M(\alpha - 1)$ then the following equation holds*

$$M_{\alpha,\alpha,N}(b) = RM_{\alpha,\alpha-1,M}(b). \tag{3.2.3}$$

Proof. We write

$$\begin{aligned} \alpha &= M_{\alpha,\alpha,N}(b) \\ \alpha - 1 &= R^{-1}\alpha = M_{\alpha,\alpha-1,M}(b) \end{aligned}$$

which gives us (3.2.3). □

From the evaluation in b we get the algebraic conditions (for the (IT) case) that hold for $M_{\alpha,\alpha,N}$ and $M_{\alpha,\alpha-1,M}$.

Theorem 3.2.4 (Algebraic conditions). *Let $\alpha = \frac{p}{q} \in \mathbb{Q} \cap (0, 1)$ with $T_\alpha^N(\alpha) = T_\alpha^M(\alpha - 1) = 0$ and N, M minimal. Then one of the following algebraic conditions holds*

(a) $M_{\alpha,\alpha,N} = RM_{\alpha,\alpha-1,M}$	(b) $M_{\alpha,\alpha,N} = RM_{\alpha,\alpha-1,M}SRS$
(c) $M_{\alpha,\alpha,N} = RM_{\alpha,\alpha-1,M}SR^{-1}S$	(d) $M_{\alpha,\alpha,N} = RM_{\alpha,\alpha-1,M}VSRS$
(e) $M_{\alpha,\alpha,N} = RM_{\alpha,\alpha-1,M}VSR^{-1}S$	(f) $M_{\alpha,\alpha,N} = RM_{\alpha,\alpha-1,M}V$

with $V = \begin{bmatrix} -1 & 0 \\ 0 & 1 \end{bmatrix}$.

Proof. Let $\alpha = \frac{p}{q} \in \mathbb{Q} \cap (0, 1)$ with $T_\alpha^N(\alpha) = T_\alpha^M(\alpha - 1) = 0$ and N, M minimal. Now (3.2.3) gives us

$$M_{\alpha,\alpha,N} = \begin{bmatrix} a_1 & p \\ a_2 & q \end{bmatrix} \quad RM_{\alpha,\alpha-1,M} = \begin{bmatrix} b_1 & p \\ b_2 & q \end{bmatrix}$$

for some $a_1, a_2, b_1, b_2 \in \mathbb{Z} \setminus \{0\}$. We have that $a_2 = q_{\alpha,N-1}(\alpha)$ and $b_2 = q_{\alpha,M-1}(\alpha - 1)$. We prove that $|q_{\alpha,N-1}(\alpha)| < |q_{\alpha,N}(\alpha)|$ and $|q_{\alpha,M-1}(\alpha - 1)| < |q_{\alpha,M}(\alpha - 1)|$ which gives us

$$0 < |a_2| < q, \quad 0 < |b_2| < q. \tag{3.2.4}$$

This is used in all 6 cases. We have

$$\begin{aligned} \left| \frac{p_{\alpha,N}(\alpha)}{q_{\alpha,N}(\alpha)} - \frac{p_{\alpha,N-1}(\alpha)}{q_{\alpha,N-1}(\alpha)} \right| &= \left| \frac{p_{\alpha,N}(\alpha)q_{\alpha,N-1}(\alpha) - p_{\alpha,N-1}(\alpha)q_{\alpha,N}(\alpha)}{q_{\alpha,N}(\alpha)q_{\alpha,N-1}(\alpha)} \right| \\ &= \left| \frac{(-1)^N}{q_{\alpha,N}(\alpha)q_{\alpha,N-1}(\alpha)} \right| \leq \frac{1}{q_{\alpha,N}(\alpha)^2} \end{aligned}$$

from (3.2.1) and the speed of convergence (Equation (3.1.3) on page 43) for (IT) . This gives us $|q_{\alpha, N-1}(\alpha)| \leq |q_{\alpha, N}(\alpha)|$. Suppose that equality holds. From the recurrence formulas we find

$$\pm q_{\alpha, N-1}(\alpha) = q_{\alpha, N}(\alpha) = d_{\alpha, N}(\alpha)q_{\alpha, N-1}(\alpha) + q_{\alpha, N-2}(\alpha)$$

which implies $(\pm 1 - d_{\alpha, N}(\alpha))q_{\alpha, N-1}(\alpha) = q_{\alpha, N-2}(\alpha)$. This contradicts with $q_{\alpha, N-1}(\alpha)$ and $q_{\alpha, N-2}(\alpha)$ being co-prime. Therefore we find

$$|q_{\alpha, N-1}(\alpha)| < |q_{\alpha, N}(\alpha)|.$$

Now

$$\det(M_{\alpha, \alpha, N}) = (-1)^N \text{ and } \det(RM_{\alpha, \alpha-1, M}) = (-1)^M.$$

Whenever $N - M$ is odd we find $\det(M_{\alpha, \alpha, N}) = -\det(RM_{\alpha, \alpha-1, M})$ and if $N - M$ is even we find $\det(M_{\alpha, \alpha, N}) = \det(RM_{\alpha, \alpha-1, M})$. Furthermore, we either have $a_2b_2 > 0$ or $a_2b_2 < 0$. These different cases lead to different algebraic conditions. Table 3.1 shows which algebraic condition we find in which case. Left to prove is that this table holds.

	$a_2b_2 > 0$	$a_2b_2 < 0$
$\det(M_{\alpha, \alpha, N}) = \det(RM_{\alpha, \alpha-1, M})$	(a)	(b,c)
$\det(M_{\alpha, \alpha, N}) = -\det(RM_{\alpha, \alpha-1, M})$	(d,e)	(f)

Table 3.1: The different cases.

When $\det(M_{\alpha, \alpha, N}) = \det(RM_{\alpha, \alpha-1, M})$ we find

$$(a_1 - b_1)q = (a_2 - b_2)p \tag{3.2.5}$$

by writing out the determinants. Since p and q are co-prime, $a_2 - b_2$ is a multiple of q . Together with (3.2.4) we get that $a_2 - b_2 \in \{-q, 0, q\}$. If $a_2b_2 > 0$, then $a_2 - b_2 = 0$ and so $a_2 = b_2$. Note that this also gives us $a_1 = b_1$ using (3.2.5). This results in

$$M_{\alpha, \alpha, N} = RM_{\alpha, \alpha-1, M}$$

which is condition (a). Now suppose $a_2b_2 < 0$. We find that $(a_2 - b_2) = \pm q$. In case $a_2 - b_2 = q$ we have $a_1 - b_1 = p$ by (3.2.5) which gives us

$$M_{\alpha, \alpha, N} = \begin{bmatrix} b_1 + p & p \\ b_2 + q & q \end{bmatrix}$$

and so

$$M_{\alpha, \alpha, N} = \begin{bmatrix} b_1 & p \\ b_2 & q \end{bmatrix} \begin{bmatrix} 1 & 0 \\ 1 & 1 \end{bmatrix}.$$

We find

$$M_{\alpha, \alpha, N} = RM_{\alpha, \alpha-1, M}SRS$$

which is case (b). In case $a_2 - b_2 = -q$ we have $a_1 - b_1 = -p$ which gives

$$M_{\alpha, \alpha, N} = \begin{bmatrix} b_1 - p & p \\ b_2 - q & q \end{bmatrix}$$

and so

$$M_{\alpha,\alpha,N} = \begin{bmatrix} b_1 & p \\ b_2 & q \end{bmatrix} \begin{bmatrix} 1 & 0 \\ -1 & 1 \end{bmatrix}.$$

We find

$$M_{\alpha,\alpha,N} = RM_{\alpha,\alpha-1,M}SR^{-1}S$$

which is case (c). When $\det(M_{\alpha,\alpha,N}) = -\det(RM_{\alpha,\alpha-1,M})$ we get

$$(a_1 + b_1)q = (a_2 + b_2)p.$$

This time $a_2 + b_2$ is a multiple of q and together with (3.2.4) this gives $a_2 + b_2 \in \{-q, 0, q\}$. Now assume that $a_2b_2 > 0$. We find $a_2 + b_2 = \pm q$. In case $a_2 + b_2 = q$ we have $a_1 + b_1 = p$ which gives

$$M_{\alpha,\alpha,N} = \begin{bmatrix} p - b_1 & p \\ q - b_2 & q \end{bmatrix}$$

and so

$$M_{\alpha,\alpha,N} = \begin{bmatrix} b_1 & p \\ b_2 & q \end{bmatrix} \begin{bmatrix} -1 & 0 \\ 1 & 1 \end{bmatrix}.$$

This results in

$$M_{\alpha,\alpha,N} = RM_{\alpha,\alpha-1,M}VSRS$$

which is case (d).

Suppose $a_2 + b_2 = -q$. Then $a_1 + b_1 = -p$ which gives

$$M_{\alpha,\alpha,N} = \begin{bmatrix} -p - b_1 & p \\ -q - b_2 & q \end{bmatrix}$$

and so

$$M_{\alpha,\alpha,N} = \begin{bmatrix} b_1 & p \\ b_2 & q \end{bmatrix} \begin{bmatrix} -1 & 0 \\ -1 & 1 \end{bmatrix}.$$

This results in

$$M_{\alpha,\alpha,N} = RM_{\alpha,\alpha-1,M}VSR^{-1}S$$

which is case (e). If $a_2b_2 < 0$ then $a_2 + b_2 = 0$ and so $a_1 + b_1 = 0$ which gives us

$$M_{\alpha,\alpha,N} = RM_{\alpha,\alpha-1,M}V$$

which is case (f). □

For (N) continued fractions we know that $q_n(x) > 0$ for all choices of α and x . With the same reasoning as above we find that $a_2b_2 > 0$. Furthermore, $a_2 + b_2 = -q$ is excluded. The two algebraic relations that remain are (a) and (d). For details see the appendix of [18] and [84].

For KU-continued fractions we have that $\det(M_{\alpha,x,k}) = 1$ for any allowed triple (α, x, k) . With the above reasoning we can find that either (a),(b) or (c) holds. In [17] it is shown that (b) holds for a special class of rationals $Q \subset \mathbb{Q} \cap (0, 1)$. For other rationals (a) holds. Beware that the matrix S is defined slightly differently in the (KU)-case since $S(x) = -\frac{1}{x}$.

Theorem 3.2.4 results in the following corollary.

Corollary 3.2.5. *Let $\alpha \in \mathbb{Q} \cap (0, 1)$ with $T_\alpha^N(\alpha) = T_\alpha^M(\alpha - 1) = 0$ and N, M minimal and x in the neighbourhood of α . Then*

<i>if (a) holds, $T_x^N(x) = T_x^M(x - 1)$</i>	<i>if (b) holds, $T_x^{N+1}(x) = T_x^{M+1}(x - 1)$</i>
<i>if (c) holds, $T_x^{N+1}(x) = T_x^{M+1}(x - 1)$</i>	<i>if (d) holds, $T_x^{N+1}(x) = -T_x^{M+1}(x - 1)$</i>
<i>if (e) holds, $T_x^{N+1}(x) = -T_x^{M+1}(x - 1)$</i>	<i>if (f) holds, $T_x^N(x) = -T_x^M(x - 1)$.</i>

Proof. Fix $\alpha \in \mathbb{Q} \cap (0, 1)$. We first prove that there is a neighbourhood of α such that for every x in this neighbourhood we have

$$M_{x,x,N} = M_{\alpha,\alpha,N} \text{ and } M_{x,x-1,M} = M_{\alpha,\alpha-1,M}. \quad (3.2.6)$$

In other words, the functions $T_z^N(z)$ and $T_z^M(z - 1)$ are continuous in $z = \alpha$. Suppose that $T_z^N(z)$ is not continuous in $z = \alpha$ then there exists a $k \leq N$ such that $T_\alpha^k(\alpha) = \alpha - 1$. This gives

$$\alpha = \frac{1}{d_{\alpha,1} + \frac{1}{\ddots + \frac{1}{d_{\alpha,k} + \alpha - 1}}}$$

which is an infinite (periodic) expansion of α and so α is irrational. In the same way we find a contradiction for $T_z^M(z - 1)$.

Now pick x in the neighbourhood of α so that (3.2.6) holds. We write

$$x = M_{x,x,N}(T_x^N(x)) \quad (3.2.7)$$

and

$$x = RM_{x,x-1,M}(T_x^M(x - 1)). \quad (3.2.8)$$

Since x is in the neighbourhood of α we have that

$$M_{x,x,N} = M_{\alpha,\alpha,N} \text{ and } M_{x,x-1,M} = M_{\alpha,\alpha-1,M}.$$

If condition (a) holds, we find

$$M_{x,x,N} = M_{\alpha,\alpha,N} = RM_{\alpha,\alpha-1,M} = RM_{x,x-1,M}.$$

This gives us, together with (3.2.7) and (3.2.8), that

$$T_x^N(x) = T_x^M(x - 1).$$

In the second case we get from condition (b) and (3.2.7), (3.2.8) that

$$SRST_x^N(x) = T_x^M(x - 1)$$

and so

$$\frac{T_x^N(x)}{T_x^N(x) + 1} = T_x^M(x - 1)$$

which implies

$$T_x^N(x) = \frac{T_x^M(x-1)}{1 - T_x^M(x-1)}. \quad (3.2.9)$$

Now

$$\begin{aligned} T_x^{N+1}(x) &= \frac{1}{T_x^M(x-1)} - 1 - d_{x,N+1}(x), \\ T_x^{M+1}(x-1) &= \frac{1}{T_x^N(x)} + 1 - d_{x,M+1}(x-1). \end{aligned}$$

This gives

$$T_x^{N+1}(x) - T_x^{M+1}(x-1) = \frac{1}{T_x^M(x-1)} - \frac{1}{T_x^N(x)} - 2 - d_{x,N+1}(x) + d_{x,M+1}(x-1).$$

Using (3.2.9) we find

$$T_x^{N+1}(x) - T_x^{M+1}(x-1) = \frac{1}{T_x^M(x-1)} - \frac{1}{T_x^M(x-1)} + 1 - d_{x,N+1}(x) + d_{x,M+1}(x-1).$$

so

$$T_x^{N+1}(x) - T_x^{M+1}(x-1) = r$$

for some $r \in \mathbb{Z}$. Since $T_x^{N+1}(x), T_x^{M+1}(x-1) \in [x-1, x)$ we find $r = 0$. Case (c),(d) and (e) can be found in a similar way as case (b). Case (f) is similar to case (a). \square

Note that from (3.2.9) it follows that $T_x^N(x) \neq T_x^M(x-1)$ whenever (b) holds. In the same manner we find that whenever (c) holds $T_x^N(x) \neq T_x^M(x-1)$. For (d), (e) and (f) we also find $T_x^N(x) \neq T_x^M(x-1)$. We can conclude that on a matching interval (a) must hold, otherwise not all points in that matching interval have the same matching exponents. Simulations suggest that (b) only holds for $\alpha = \frac{1}{2}$ and (c) only holds for $\alpha \in \{\frac{2}{5}, \frac{3}{5}\}$.

We now prove the fact that if $\det(M_{\alpha,\alpha,N}) = \det(M_{\alpha,\alpha-1,M})$ for $\alpha \in (0, 1) \cap \mathbb{Q}$, then the condition on the derivatives, as in Definition 1.2.8 on page 13, of $T_\alpha^N(\alpha)$ and $T_\alpha^M(\alpha-1)$ are satisfied. This lemma holds for all three families.

Lemma 3.2.6. *Fix $\alpha \in (0, 1)$ and let N, M be minimal such that $T_\alpha^N(\alpha) = T_\alpha^M(\alpha-1) = 0$ with $\det(M_{\alpha,\alpha,N}) = \det(M_{\alpha,\alpha-1,M}) = t$ with $t \in \{-1, 1\}$. Then $(T_\alpha^N)'(\alpha) = (T_\alpha^M)'(\alpha-1)$.*

Proof. We know that there are $a, b, \dots, f \in \mathbb{Z}$ such that

$$T_\alpha^N(x) = \frac{ax+b}{cx+d}, \quad T_\alpha^M(x) = \frac{ex+f}{gx+h}.$$

We have that $T_\alpha^N(\alpha) = 0$ gives $\alpha = -\frac{b}{a}$ and $T_\alpha^M(\alpha-1) = 0$ gives $\alpha-1 = -\frac{f}{e}$. For any choice of S we have that $ad-bc = t$ and $eh-fg = t$. This gives us

$$(T_\alpha^N)'(x) = \frac{t}{(cx+d)^2}, \quad (T_\alpha^M)'(x) = \frac{t}{(gx+h)^2}.$$

Filling in $\alpha = -\frac{b}{a}$ and $\alpha - 1 = -\frac{d}{e}$ respectively gives

$$(T_\alpha^N)'(\alpha) = \frac{t}{\left(\frac{-cb}{a} + d\right)^2} = \frac{ta^2}{(ad - cb)^2} = ta^2$$

and

$$(T_\alpha^M)'(\alpha - 1) = \frac{t}{\left(\frac{-fg}{e} + h\right)^2} = \frac{te^2}{(eh - fg)^2} = te^2.$$

Furthermore, note that a and b are co-prime and f and e are co-prime. Since $\alpha - 1 = \frac{-b-a}{a} = -\frac{f}{e}$ we find $a = \pm e$ so that $a^2 = e^2$. This finalises the proof. \square

Note that on a matching interval the determinants are equal (since condition (a) holds). Let us now turn to the entropy formula. We prove it for the (IT) and (N) case and show where the proof fails to work for the (KU) case.

Lemma 3.2.7. *Let T_α be as in (3.1.1) with $S(x) = \frac{1}{x}$ or $S(x) = \frac{1}{|x|}$. For almost every $x \in [\alpha - 1, \alpha]$ we have that*

$$h(\alpha) := h(T_\alpha) = 2 \lim_{n \rightarrow \infty} \frac{1}{n} |\log(q_{\alpha,n}(x))|. \quad (3.2.10)$$

where $q_{\alpha,n}(x)$ is the denominator associated to the n^{th} convergent of x for the corresponding map S .

The proof of Lemma 3.2.7 is very similar to the proof in the classical case (see [29]).

Proof of Lemma 3.2.7. Let T be T_α for some choice of S and $\alpha \in (0, 1)$ and let x be a typical point. For all three cases one has recurrence relations for the convergents of the following form

$$\begin{aligned} p_{\alpha,-1} &:= 1; & p_{\alpha,0} &:= 0; & p_{\alpha,n}(x) &= d_{\alpha,n}(x)p_{\alpha,n-1}(x) + \varepsilon_{n-1}(x)p_{\alpha,n-2}(x), & n \geq 1, \\ q_{\alpha,-1} &:= 0; & q_{\alpha,0} &:= 1; & q_{\alpha,n}(x) &= d_{\alpha,n}(x)q_{\alpha,n-1}(x) + \varepsilon_{n-1}(x)q_{\alpha,n-2}(x), & n \geq 1. \end{aligned}$$

Here $d_{\alpha,n}(x) = d_{\alpha,1}(T^{n-1}(x))$ and $\varepsilon_{\alpha,n}(x) = \varepsilon_{\alpha,1}(T^{n-1}(x))$ where $d_{\alpha,1}(x)$ and $\varepsilon_{\alpha,1}(x)$ depend on the choice of S and $\varepsilon_0 := 1$. In the proof we will omit the dependence of α in our notation. First we show that for all $n \in \mathbb{N}$ we have

$$p_n(x) = q_{n-1}(T(x)) \quad (3.2.11)$$

by using induction. For $n = 0$ we find $p_0(x) = 0 = q_{-1}(T(x))$, for $n = 1$ we find $p_1(x) = \varepsilon_0 = 1 = q_0(T(x))$. We assume $p_n(x) = q_{n-1}(T(x))$ and $p_{n-1}(x) = q_{n-2}(T(x))$ to find

$$\begin{aligned} p_{n+1}(x) &= d_{n+1}(x)p_n(x) + \varepsilon_n(x)p_{n-1}(x) \\ &= d_{n+1}(x)q_{n-1}(T(x)) + \varepsilon_n(x)q_{n-2}(T(x)) \\ &= d_n(T(x))q_{n-1}(T(x)) + \varepsilon_{n-1}(T(x))q_{n-2}(T(x)) \\ &= q_n(T(x)) \end{aligned}$$

which finalises the induction. Using (3.2.11) we write

$$\begin{aligned} \frac{1}{q_n(x)} &= \frac{1}{q_n(x)} \frac{p_n(x)}{q_{n-1}(T(x))} \frac{p_{n-1}(T(x))}{q_{n-2}(T^2(x))} \cdots \frac{p_1(T^{n-1}(x))}{q_0(T^n(x))} \\ &= \frac{p_n(x)}{q_n(x)} \frac{p_{n-1}(T(x))}{q_{n-1}(T(x))} \cdots \frac{p_1(T^{n-1}(x))}{q_1(T^{n-1}(x))}. \end{aligned}$$

Taking the absolute value and the logarithm on both sides we find

$$-\log |q_n(x)| = \log \left| \frac{p_n(x)}{q_n(x)} \right| + \log \left| \frac{p_{n-1}(T(x))}{q_{n-1}(T(x))} \right| + \cdots + \log \left| \frac{p_1(T^{n-1}(x))}{q_1(T^{n-1}(x))} \right|. \quad (3.2.12)$$

Now we write

$$-\log |q_n(x)| = \log |x| + \log |T(x)| + \cdots + \log |T^{n-1}(x)| + E(n, x) \quad (3.2.13)$$

and determine the error term $E(n, x)$ by substituting the right hand side of (3.2.12) for $-\log |q_n(x)|$ in (3.2.13) and rewriting the equation. We get

$$E(n, x) = \log \left| \frac{p_n(x)}{q_n(x)} \right| - \log |x| + \cdots + \log \left| \frac{p_1(T^{n-1}(x))}{q_1(T^{n-1}(x))} \right| - \log |T^{n-1}(x)|. \quad (3.2.14)$$

Now we prove that for any $y \in [\alpha - 1, \alpha] \setminus \mathbb{Q}$ we have

$$\left| \log \left| \frac{p_n(y)}{q_n(y)} \right| - \log |y| \right| \leq \frac{1}{|q_n(y)|}. \quad (3.2.15)$$

First we prove that if we write $|x| = \frac{d}{q_n}$ then $d > 1$ for $n \geq 2$. We have

$$\left| |x| - \left| \frac{p_n}{q_n} \right| \right| \leq \left| \frac{d - p_n}{q_n} \right| \leq \frac{1}{q_n^2}. \quad (3.2.16)$$

For the (IT) case this follows from 3.1.3 and for the (N) case this estimate can be found in [81]. We do not have this estimate for the (KU) case where only $|x - \frac{p_n}{q_n}| < \frac{1}{q_n}$ is proven in [54]. Now (3.2.16) gives $|d - p_n| |q_n| \leq 1$. Now suppose $|\frac{p_n}{q_n}| \leq |x|$. Using the Mean Value Theorem with $f(x) = \log |x|$ on $[\frac{p_n}{q_n}, |x|]$ we find

$$0 \leq \left| \log |x| - \log \left| \frac{p_n}{q_n} \right| \right| = \left| |x| - \left| \frac{p_n}{q_n} \right| \right| \frac{1}{c} \leq \left| x - \frac{p_n}{q_n} \right| \frac{1}{c} \leq \frac{1}{q_n^2} \frac{1}{c} \leq \frac{1}{q_n^2} \frac{q_n}{p_n} \leq \frac{1}{|q_n|}$$

for some $c \in [\frac{p_n}{q_n}, |x|]$. Suppose $|x| \leq \frac{p_n}{q_n}$. Using the Mean Value Theorem with $f(x) = \log |x|$ on $[|x|, \frac{p_n}{q_n}]$ we find

$$0 \leq \left| \log |x| - \log \left| \frac{p_n}{q_n} \right| \right| = \left| |x| - \left| \frac{p_n}{q_n} \right| \right| \frac{1}{c} \leq \left| x - \frac{p_n}{q_n} \right| \frac{1}{c} \leq \frac{1}{q_n^2} \frac{1}{c} \leq \frac{1}{q_n^2} \frac{q_n}{d} \leq \frac{1}{|q_n|}.$$

In both cases we find that (3.2.15) holds. Using this estimate in (3.2.14) we find

$$|E(n, x)| \leq \frac{1}{|q_n(x)|} + \cdots + \frac{1}{|q_1(T^{n-1}(x))|}.$$

Since for all choices of S and $\alpha \in (0, 1]$ we have that the sequence $|q_n(x)|$ grows exponentially fast (see [54, 80, 103]²) there is a $b \in \mathbb{R}_{>1}$ such that $|q_n| > b^{n-1}$ for $n > 1$. Furthermore $q_1 \geq 1$ and so we get

$$|E(n, x)| \leq 1 + \frac{1}{b} + \cdots + \frac{1}{b^{n-1}} < \sum_{k=0}^{\infty} \frac{1}{b^k} = \frac{b}{b-1}. \quad (3.2.17)$$

Using Rohlin's formula and Birkhoff's formula we find

$$h(\alpha) = \int \log |T'(x)| d\mu = \lim_{n \rightarrow \infty} \frac{1}{n} \sum_{i=1}^n \log |T'(T^i(x))|.$$

With (3.2.13) this gives us

$$h(\alpha) = -2 \lim_{n \rightarrow \infty} \frac{1}{n} (-\log |q_n(x)| - E(n, x)).$$

Since (3.2.17) holds we can now conclude

$$h(\alpha) = 2 \lim_{n \rightarrow \infty} \frac{1}{n} \log |q_n(x)|$$

which is equation (3.2.10). □

Now we will prove that on a matching interval the entropy is monotonic. The general idea is the same as for the α -continued fractions (see [84]).

Theorem 3.2.8. *Let $A \subset [0, 1]$ be a matching interval for $(N), (KU)$ or (IT) . Then the entropy is monotonic on A . Furthermore, if the matching index is positive $h(\alpha)$ is increasing, if the matching index is zero $h(\alpha)$ is constant and if the matching index is negative $h(\alpha)$ is decreasing.*

Proof. Fix $s \in \mathbb{Q} \setminus \mathcal{E}$, where $\mathcal{E} \in \{\mathcal{E}_N, \mathcal{E}_{KU}, \mathcal{E}_{IT}\}$ depends on the choice of S , with $T_\alpha^N(\alpha) = T_\alpha^M(\alpha - 1) = 0$ and N, M minimal and let $(l(s), r(s))$ be such that $s \in (l(s), r(s))$ where $l(s)$ and $r(s)$ are chosen in such a way that $M_{\alpha, \alpha, N} = M_{s, s, N}$ and $M_{\alpha, \alpha-1, M} = M_{s, s-1, M}$ for all $\alpha \in (l(s), r(s))$. Note that this implies that $(l(s), r(s))$ is contained in a matching interval. Let $\alpha, \beta \in (l(s), r(s))$ and define $T_\alpha^m(\alpha) = \alpha_m$ and $T_\beta^m(\beta) = \beta_m$. We prove the following equation holds for $m \leq M$

$$|\alpha_m - \beta_m| < \frac{|\alpha - \beta|}{|p_{\alpha, m-1}^2 - 2p_{\alpha, m-1}q_{\alpha, m-1}|}. \quad (3.2.18)$$

From (3.2.2) and the fact that α_m and β_m have the same partial quotients we can get

$$\alpha_m = \hat{\varepsilon} \frac{\alpha q_{\alpha, m} - p_{\alpha, m}}{p_{\alpha, m-1} - q_{\alpha, m-1} \alpha}, \quad \beta_m = \hat{\varepsilon} \frac{\beta q_{\alpha, m} - p_{\alpha, m}}{p_{\alpha, m-1} - q_{\alpha, m-1} \beta},$$

²Actually, in [54, 80] linear growth is proven, but the proof can be adjusted easily to get exponential growth since, in the sequence of digits for any $x \in [\alpha - 1, \alpha]$, a sequence of consecutive 2's or -2's is uniformly bounded for a fixed $\alpha < 1$. All proofs are based on the recurrence relations.

where $\hat{\varepsilon} \in \{-1, 1\}$ depending on the family (always 1 for (IT), always -1 for (KU) and $\varepsilon_{\alpha, m}(\alpha)$ for (N)). This gives us by (3.2.1)

$$\begin{aligned}
 |\alpha_m - \beta_m| &= \left| \frac{\alpha q_{\alpha, m} - p_{\alpha, m}}{p_{\alpha, m-1} - q_{\alpha, m-1} \alpha} - \frac{\beta q_{\alpha, m} - p_{\alpha, m}}{p_{\alpha, m-1} - q_{\alpha, m-1} \beta} \right| \\
 &= \left| \frac{(\alpha q_{\alpha, m} - p_{\alpha, m})(p_{\alpha, m-1} - q_{\alpha, m-1} \beta) - (\beta q_{\alpha, m} - p_{\alpha, m})(p_{\alpha, m-1} - q_{\alpha, m-1} \alpha)}{(p_{\alpha, m-1} - q_{\alpha, m-1} \alpha)(p_{\alpha, m-1} - q_{\alpha, m-1} \beta)} \right| \\
 &= \left| \frac{(q_{\alpha, m} p_{\alpha, m-1} - q_{\alpha, m-1} p_{\alpha, m}) \alpha + (q_{\alpha, m-1} p_{\alpha, m} - q_{\alpha, m} p_{\alpha, m-1}) \beta}{p_{\alpha, m-1}^2 - p_{\alpha, m-1} q_{\alpha, m-1} (\alpha + \beta) + q_{\alpha, m-1}^2 \alpha \beta} \right| \\
 &= \left| \frac{(-1)^m \alpha - (-1)^m \beta}{p_{\alpha, m-1}^2 - p_{\alpha, m-1} q_{\alpha, m-1} (\alpha + \beta) + q_{\alpha, m-1}^2 \alpha \beta} \right| \\
 &< \left| \frac{\alpha - \beta}{p_{\alpha, m-1}^2 - 2p_{\alpha, m-1} q_{\alpha, m-1}} \right|.
 \end{aligned}$$

Fix α and let us define the set $L(\alpha) = \cup_{n=1}^N T_\alpha^n(\alpha) \cup \cup_{n=1}^M T_\alpha^n(\alpha - 1)$. We show that there is an $\varepsilon > 0$ such that for all $\beta \in (\alpha - \varepsilon, \alpha)$ we have that $L(\alpha) \subset (\alpha - 1, \beta)$ and $L(\beta) \subset (\alpha - 1, \beta)$. Let $\varepsilon' > 0$ such that the minimum of $L(\beta)$ is attained after the same amount of iterations for all $\beta \in (\alpha - \varepsilon', \alpha)$ so that when $T_\alpha^m(\alpha) = \alpha_m = \min(L(\alpha))$ then $T_\beta^m(\beta) = \beta_m = \min(L(\beta))$ for $\beta \in (\alpha - \varepsilon', \alpha)$. This can be done since the maps $T_z^n(z)$ and $T_z^{n'}(z-1)$ are continuous in $z = \alpha$ for $n \leq N$ and $n' \leq M$. If the minimum is attained in a point of the orbit of $\alpha - 1$ and $\beta - 1$ the proof works the same.

We now find an $\varepsilon_1 > 0$ such that $|\alpha_m - \beta_m| < |\alpha - 1 - \alpha_m|$ for all $\beta \in (\alpha - \varepsilon_1, \alpha) \cap (\alpha - \varepsilon', \alpha) \cap (l(s), r(s))$ which implies $L(\beta) \subset (\alpha - 1, \beta)$. Let $c = \frac{1}{|p_{\alpha, m-1}^2 - 2p_{\alpha, m-1} q_{\alpha, m-1}|}$ and set $\varepsilon_1 := \frac{|\alpha - 1 - \alpha_m|}{c}$. We find for $\beta \in (\alpha - \varepsilon_1, \alpha)$ and from equation (3.2.18) that

$$|\alpha_m - \beta_m| < c|\alpha - \beta| < c\varepsilon_1 = |\alpha - 1 - \alpha_m|.$$

Now let $\varepsilon_2 = \alpha - \max(L(\alpha))$, then $L(\alpha) \subset (\alpha - 1, \beta)$ for all $\beta \in (\alpha - \varepsilon_2, \alpha)$. Let $\varepsilon = \min(\varepsilon_1, \varepsilon_2, \varepsilon')$ then we have $L(\alpha) \subset (\alpha - 1, \beta)$ and $L(\beta) \subset (\alpha - 1, \beta)$ for all $\beta \in (\alpha - \varepsilon, \alpha)$.

Fix $\beta \in (\alpha - \varepsilon, \alpha) \cap (l(s), r(s))$ and pick $x \in (\beta, \alpha)$ such that x is a typical point for the system $(T_\alpha, (\alpha - 1, \alpha), \mu_\alpha)$ and $x - 1$ is a typical point for the system $(T_\beta, (\beta - 1, \beta), \mu_\beta)$. By typical we mean that $\lim_{n \rightarrow \infty} \frac{1}{n} \#\{i < n : T_\alpha^i(x) \in (\beta, \alpha)\} = \mu_\alpha((\beta, \alpha))$. We iterate x over T_α and $x' = x - 1$ over T_β . Let n_k be the k^{th} return time of x to (β, α) and m_k the k^{th} return time of x' to $(\beta - 1, \alpha - 1)$. We show that $n_k - m_k = (N - M)k$ and $q_{\alpha, n_k - 1}(x) = q_{\beta, m_k - 1}(x')$.

Because $L(\alpha), L(\beta) \subset (\alpha - 1, \beta)$ we have that x will not return to (β, α) before N iterations of T_α and x' will not return to $(\beta - 1, \alpha - 1)$ before M iterations. On the interval $(\alpha - 1, \beta)$ we have that $T_\alpha(x) = T_\beta(x)$ whenever $T_\alpha(x) \in (\alpha - 1, \beta)$. This gives us that $T_\alpha^N(x) = T_\beta^M(x')$ and $T_\alpha^{n_1 - 1}(x) = T_\beta^{m_1 - 1}(x')$ and we find $n_1 - m_1 = N - M$. Furthermore, since x is contained in the same matching interval as s we have that condition (a) holds and so

$$M_{x, x, N} = R M_{x, x-1, M}$$

which gives us $q_{x,N}(x) = q_{x,M}(x')$ and so $q_{\alpha,N}(x) = q_{\beta,M}(x')$. Since the orbits of x and x' coincide after N and M iterations respectively we have that also the fractional transformations coincide. This results in $q_{\alpha,n_1-1}(x) = q_{\beta,m_1-1}(x')$. Now $T_\beta^{m_1}(x') + 1 = T_\alpha^{n_1}(x)$ and $T_\beta^{m_1}(x') \in (\beta - 1, \alpha - 1)$ is a typical point for $(T_\beta, (\beta - 1, \beta), \mu_\beta)$ and $T_\alpha^{n_1}(x) \in (\beta, \alpha)$ is a typical point for $(T_\alpha, (\alpha - 1, \alpha), \mu_\alpha)$. This means we are in the same situation as we started and so we can repeat this process and find $n_k - m_k = (N - M)k$ and $q_{\alpha,n_k-1}(x) = q_{\beta,m_k-1}(x')$. We will now prove

$$h(T_\alpha) = (1 + (M - N)\mu_\alpha((\beta, \alpha)))h(T_\beta).$$

It follows from Birkhoff's Theorem that for typical x we have

$$\lim_{n \rightarrow \infty} \frac{1}{n} \#\{i < n : T_\alpha^i(x) \in (\beta, \alpha)\} = \mu_\alpha((\beta, \alpha)).$$

This gives us

$$\lim_{k \rightarrow \infty} \frac{k}{n_k} = \mu_\alpha((\beta, \alpha)).$$

We find the following limit:

$$\begin{aligned} \lim_{k \rightarrow \infty} \frac{m_k}{n_k} &= \lim_{k \rightarrow \infty} \left(1 + \frac{m_k - n_k}{n_k} \right) \\ &= \lim_{k \rightarrow \infty} \left(1 + \frac{(M - N)k}{n_k} \right) \\ &= 1 + (M - N)\mu_\alpha((\beta, \alpha)). \end{aligned}$$

We will now use Lemma 3.2.7 to find the wanted result

$$\begin{aligned} h(T_\alpha) &= 2 \lim_{n_k \rightarrow \infty} \frac{1}{n_k - 1} |\log(q_{\alpha,n_k-1}(x))| \\ &= \lim_{k \rightarrow \infty} \frac{m_k - 1}{n_k - 1} \frac{1}{m_k - 1} |\log(q_{\beta,m_k-1}(x'))| \\ &= (1 + (M - N)\mu_\alpha(\beta, \alpha)) h(T_\beta). \end{aligned}$$

This finalises the proof. □

In the next section we primarily focus on the (IT) case. Most techniques used cannot be mimicked to prove statements for the other two families.

§3.3 Matching almost everywhere and characterisations of the bifurcation set

The main tool that lies at the basis of the results in this section is the following technical lemma. It can be used both to compare α -continued fractions of two numbers (in particular of $\alpha - 1$ and $T_\alpha(\alpha) = \frac{1}{\alpha} - 1$) as well as to translate an α -continued fraction into a β -continued fraction. Recall that $g = \frac{\sqrt{5}-1}{2}$.

Lemma 3.3.1. *Let $g \leq \alpha \leq \beta \leq 1$, $x \in [\alpha - 1, \alpha)$, $y \in [\beta - 1, \beta)$.*

- (i) If $x = y$, then $T_\beta(y) - T_\alpha(x) \in \{0, 1\}$.
- (ii) If $y - x = 1$, then $(x + 1)(T_\beta(y) + 1) = 1$.
- (iii) If $(x + 1)(y + 1) = 1$ or $x + y = 0$, then $T_\alpha(x) + T_\beta(y) \in \{0, 1\}$.
- (iv) If $x + y = 1$, then

$$\begin{cases} T_\beta(y) - T_\alpha^2(x) \in \{0, 1\} & \text{if } x > \frac{1}{\alpha+1}, \\ T_\beta^2(y) - T_\alpha(x) \in \{0, 1\} & \text{if } y > \frac{1}{\beta+1}, \\ (T_\alpha(x) + 1)(T_\beta(y) + 1) = 1 & \text{otherwise.} \end{cases}$$

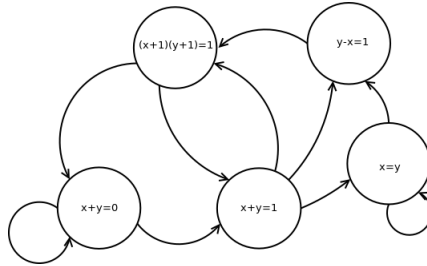

Figure 3.4: A diagram for Lemma 3.3.1.

In Figure 3.4 one can see which condition can imply which other condition.

Proof. **Case (i).** We have $T_\beta(y) - T_\alpha(x) \in \mathbb{Z} \cap (\beta - 1 - \alpha, \beta - \alpha + 1) = \{0, 1\}$.

Case (ii). Since $x \geq \alpha - 1$, we have $y \geq \alpha$, thus $(x + 1)(T_\beta(y) + 1) = \frac{x+1}{y} = 1$.

Case (iii). Dividing the equations by xy gives us $\frac{1}{x} + \frac{1}{y} = -1$ and $\frac{1}{x} + \frac{1}{y} = 0$ respectively. This implies that $T_\alpha(x) + T_\beta(y) \in \mathbb{Z} \cap [\alpha + \beta - 2, \alpha + \beta) = \{0, 1\}$.

Case (iv). If $x > \frac{1}{\alpha+1}$, then $\frac{1}{T_\alpha(x)} = \frac{1}{\frac{x}{x-1}} = \frac{x-1}{x} = \frac{1-y}{y} = \frac{1}{y} - 1$, thus $\frac{1}{y} - \frac{1}{T_\alpha(x)} = 1$ and so $T_\beta(y) - T_\alpha^2(x) \in \mathbb{Z} \cap (\beta - 1 - \alpha, \beta - \alpha + 1) = \{0, 1\}$. Similarly, $y > \frac{1}{\beta+1}$ implies that $T_\beta^2(y) - T_\alpha(x) \in \{0, 1\}$.

If $x \leq \frac{1}{\alpha+1}$ and $y \leq \frac{1}{\beta+1}$, then $x = 1 - y \geq \frac{\beta}{\beta+1} \geq \frac{g}{g+1} = \frac{1}{g+2} \geq \frac{1}{\alpha+2}$ and $y = 1 - x \geq \frac{\alpha}{\alpha+1} \geq \frac{1}{g+2} \geq \frac{1}{\beta+2}$. We cannot have $x = \frac{1}{\alpha+2}$ because this would imply that $\alpha = g = \beta = y$, contradicting that $y < \beta$. Similarly, we cannot have $y = \frac{1}{\beta+2}$. From $x \in (\frac{1}{\alpha+2}, \frac{1}{\alpha+1}]$ and $y \in (\frac{1}{\beta+2}, \frac{1}{\beta+1}]$, we infer that $(T_\alpha(x) + 1)(T_\beta(y) + 1) = (\frac{1}{x} - 1)(\frac{1}{y} - 1) = 1$. \square

Lemma 3.3.1 greatly simplifies when taking $\alpha = \beta$ and only looking at the orbits of $\alpha - 1$ and $\frac{1}{\alpha} - 1$ before exceeding $\frac{1}{\alpha+1}$. We use the notation

$$x_n := T_\alpha^n(\alpha - 1), \quad y_n := T_\alpha^n\left(\frac{1}{\alpha} - 1\right).$$

Lemma 3.3.2. Let $\alpha \in (g, 1]$ and $m \in \mathbb{N}$ be such that

$$x_n \leq \frac{1}{\alpha+1} \quad \text{and} \quad y_n \leq \frac{1}{\alpha+1} \quad \text{for all } 0 \leq n < m. \quad (3.3.1)$$

Then for any $0 \leq n \leq m$ the pair (x_n, y_n) satisfies one of the following relations:

- (A) $(x_n + 1)(y_n + 1) = 1,$
- (B) $x_n + y_n = 0,$
- (C) $x_n + y_n = 1.$

If $x_m > \frac{1}{\alpha+1}$ or $y_m > \frac{1}{\alpha+1}$, then $x_m + y_m = 1$.

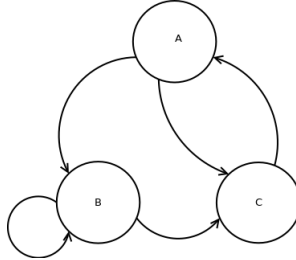

Figure 3.5: A diagram for Lemma 3.3.2.

In Figure 3.5 one can see from which state to which state you can get.

Proof. The proof is a straightforward application of Lemma 3.3.1. The pair (x_0, y_0) satisfies (A), condition (i) in Lemma 3.3.1. Let $0 \leq n < m$ then $y_n - x_n = 1$ is impossible since $x_n, y_n \in [\alpha - 1, \alpha)$. Also $x_n = y_n$ is impossible since we have $x_n \leq \frac{1}{\alpha+1}$ and $y_n \leq \frac{1}{\alpha+1}$ which implies that (x_n, y_n) always are in state (A), (B) or (C). We find that if (x_n, y_n) satisfies (A) or (B), then (x_{n+1}, y_{n+1}) satisfies (B) or (C). If (x_n, y_n) satisfies (C), then (A) holds for (x_{n+1}, y_{n+1}) .

Now suppose that $x_m > \frac{1}{\alpha+1}$ and (B) holds. Then $y_m < -\frac{1}{\alpha+1} < \alpha - 1$ which contradicts with $y_m \in [\alpha - 1, \alpha)$. If $x_m > \frac{1}{\alpha+1}$ and (A) holds we find $y_m = \frac{1}{x_m+1} - 1 < \frac{1}{\frac{1}{\alpha+1}+1} - 1 = -\frac{1}{2+\alpha} < \alpha - 1$ since $\alpha > g$ which also contradicts with $y_m \in [\alpha - 1, \alpha)$. Note that the role of x_m and y_m are interchangeable. We find that if $x_m > \frac{1}{\alpha+1}$ or $y_m > \frac{1}{\alpha+1}$, then $x_m + y_m = 1$. \square

We focus now on the complement of the set

$$\tilde{\mathcal{E}} = \{\alpha \in [g, 1] : x_n \leq \frac{1}{\alpha+1} \text{ and } y_n \leq \frac{1}{\alpha+1} \text{ for all } n \geq 1\}$$

and show that it belongs to the matching set ($\tilde{\mathcal{E}}$ is the set in (3.1.4)).

Proposition 3.3.3. *Let $\alpha \in (g, 1]$ with $m \in \mathbb{N}$ such that (3.3.1) holds and $\epsilon \in \{-1, 1\}$. If $T_\alpha^m(\alpha^\epsilon - 1) > \frac{1}{\alpha+1}$, then α belongs to a matching interval J with exponents $M = m + 2 - \frac{1-\epsilon}{2}$, $N = m + 2 + \frac{1-\epsilon}{2}$. Furthermore, let $f(z) = T_z^m(z^\epsilon - 1)$. The boundaries of J satisfy $f(z) = \frac{1}{z+1}$ and $f(z) = z$ respectively.*

See Figure 3.6 for an example. For the proof of the proposition, we use the following lemma.

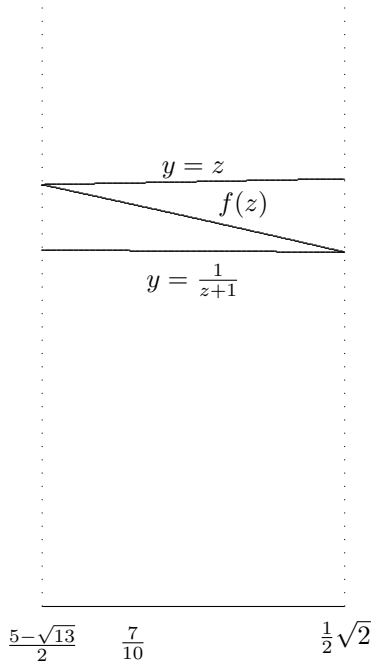

Figure 3.6: An example of Proposition 3.3.3 for $\alpha = \frac{7}{10}$ with $m = 1$, $\epsilon = 1$ and matching exponents $(3, 3)$ where $f(z) = \frac{1}{z-1} + 4$.

Lemma 3.3.4. Let $\alpha \in (g, 1]$, $m \in \mathbb{N}$ such that (3.3.1) holds, and $x_m > \frac{1}{\alpha+1}$ or $y_m > \frac{1}{\alpha+1}$. Then the maps $T_z^m(z-1)$ and $T_z^m(\frac{1}{z}-1)$ are continuous at $z = \alpha$.

Proof. The maps $T_z^n(z-1)$ and $T_z^n(\frac{1}{z}-1)$ are continuous at $z = \alpha$ for all $1 \leq n \leq m$ if and only if $x_n \neq x_0$ and $y_n \neq x_0$ for all $1 \leq n \leq m$. Suppose that $x_n = x_0$ or $y_n = x_0$ for some $1 \leq n \leq m$. If (x_n, y_n) satisfies (C) and $x_n = x_0$ then $x_n + y_n = \alpha - 1 + y_n = 1$ and so $y_n = 2 - \alpha > \alpha$. Since we can use the same reasoning for $y_n = x_0$ we find that (x_n, y_n) satisfies (A) or (B). This gives $n < m$ and $x_{n+1} + y_{n+1} \in \{0, 1\}$, $x_1 + y_1 \in \{0, 1\}$. We find $x_{n+1} + y_{n+1} - (x_1 + y_1) \in \{-1, 0, 1\}$. If $x_n = x_0$, then we have $x_{n+1} = x_1$ and $x_{n+1} + y_{n+1} - (x_1 + y_1) = y_{n+1} - y_1 \in \{-1, 0, 1\}$ where we can exclude ± 1 since $y_{n+1}, y_1 \in [\alpha - 1, \alpha)$ and thus $y_{n+1} = y_1$; if $y_n = x_0$, then we have $y_{n+1} = x_1$ and thus $x_{n+1} = y_1$. We get that $\{x_{m-n}, y_{m-n}\} = \{x_m, y_m\}$, contradicting (3.3.1). \square

Proof of Proposition 3.3.3. By Lemma 3.3.2, we have $x_m + y_m = 1$. Then Lemma 3.3.1 gives that $x_{m+2} = y_{m+1}$, i.e., $T_\alpha^{m+2}(\alpha - 1) = T_\alpha^{m+2}(\alpha)$, if $x_m > \frac{1}{\alpha+1}$, and that $x_{m+1} = y_{m+2}$, i.e., $T_\alpha^{m+1}(\alpha - 1) = T_\alpha^{m+3}(\alpha)$, if $y_m > \frac{1}{\alpha+1}$.

Let f be the linear fractional transformation satisfying $f(z) = T_z^m(z^\epsilon - 1)$ around $z = \alpha$, which exists by Lemma 3.3.4. By Lemma 3.3.4, we also get that $T_z^m(z-1)$ and $T_z^m(\frac{1}{z}-1)$ are continuous at all points z with $\frac{1}{z+1} < f(z) < z$. Note that (3.3.1) holds for these points because $T_z^n(z^{\pm 1} - 1) = \frac{1}{z+1}$ implies that $T_z^{n+1}(z^{\pm 1} - 1)$ is not continuous. Since the maps $z \mapsto T_z^{n+1}(z^{\pm 1} - 1)$ are continuous at all points \bar{z} for

 §3.3. Matching almost everywhere and characterisations of the bifurcation set

which $\frac{1}{\bar{z}+1} < T_z^{n+1}(\bar{z}^{\pm 1} - 1) < \bar{z}$ holds. Therefore, f is expanding at these points and we have some z_-, z_+ with $f(z_-) = \frac{1}{z_-+1}$ and $f(z_+) = z_+$; let J be the open interval with boundaries z_-, z_+ . Since (3.3.1) holds for all points in J , the interval J has matching exponents $N = m + 2 + \frac{1-\epsilon}{2}, M = m + 2 - \frac{1-\epsilon}{2}$.

Arbitrarily close to z_- and z_+ , we can find points z where the minimal n such that $T_z^n(z-1) \geq \frac{1}{\alpha+1}$ or $T_z^n(\frac{1}{z}-1) \geq \frac{1}{\alpha+1}$ is different from m . Therefore, these points are in matching intervals with different matching exponents than J . Hence, by Lemma 3.1.2, they are not in J , and J is a matching interval. \square

Proposition 3.3.3 shows that $\mathcal{E}_{IT} \cap [g, 1] \subset \tilde{\mathcal{E}}$.

Lemma 3.3.5. *Let $\alpha \in (g, 1], z \in [\alpha - 1, g)$. The following conditions are equivalent:*

- (i) $T_\alpha^n(z) = T_g^n(z)$ for all $n \in \mathbb{N}$.
- (ii) $T_g^n(z) \geq \alpha - 1$ for all $n \in \mathbb{N}$.
- (iii) $T_\alpha^n(z) < g$ for all $n \in \mathbb{N}$.
- (iv) $T_\alpha^n(z) \leq \frac{1}{\alpha+1}$ for all $n \in \mathbb{N}$.

In particular, we have

$$\tilde{\mathcal{E}} = \{\alpha \in [g, 1] : T_g^n(\alpha - 1) \geq \alpha - 1 \text{ and } T_g^n(\frac{1}{\alpha} - 1) \geq \alpha - 1 \text{ for all } n \geq 1\}.$$

Proof. The equivalences (ii) \Leftrightarrow (i) \Leftrightarrow (iii) are direct consequences of the definition of T_α . Since $\frac{1}{1+\alpha} < g$, we have (iv) \Rightarrow (iii). For the converse, suppose that $T_\alpha^n(z) > \frac{1}{\alpha+1}$ for some n . Then we have $T_\alpha^{n+1}(z) = \frac{1}{T_\alpha^n(z)} - 1$, thus $T_\alpha^n(z) \geq g$ or $T_\alpha^{n+1}(z) > \frac{1}{g} - 1 = g$, hence (iii) does not hold. \square

Now we prove that matching is prevalent and the only indices are $-2, 0, 2$.

Proof of Theorem 3.1.3. We have

$$\begin{aligned} \mathcal{E}_{IT} \subset \tilde{\mathcal{E}} &\subset \{\alpha \in (g, 1] : T_g^n(\alpha - 1) \geq \alpha - 1 \text{ for all } n \geq 1\} \\ &\subset \bigcup_{k=1}^{\infty} \{\alpha \in (g, 1] : T_g^n(\alpha - 1) \geq g - 1 + \frac{1}{k} \text{ for all } n \geq 1\}. \end{aligned}$$

Since T_g is ergodic (with respect to an invariant measure that is equivalent to the Lebesgue measure), all the sets in this union have Lebesgue measure zero. Therefore, by Proposition 3.3.3 and Lemma 3.3.5, the matching set has full measure on $[g, 1]$. Since matching is an open condition, Lemma 3.1.2 tells us that Proposition 3.3.3 gives all matching exponents on $[g, 1]$, hence the only possible indices are $0, -2$. Recalling that for almost all matching parameters in $(1 - g, g)$ we have matching index 0, we can exploit the symmetry to conclude the proof of the theorem. \square

Next we prove Theorem 3.1.4.

Proof of Theorem 3.1.4. Proposition 3.3.3 gives us $\mathcal{E}_{IT} \cap [g, 1] \subset \tilde{\mathcal{E}}$ and the set $\tilde{\mathcal{E}}$ is the set in (3.1.4) so left to show is $\tilde{\mathcal{E}} \subset \mathcal{E}_{IT}$. Let $x \in \tilde{\mathcal{E}}$ and suppose $x \notin \mathcal{E}_{IT}$ then $x \in (a, b)$ for some matching interval (a, b) . From the proof of Theorem 3.1.3 we find that the complement of $\tilde{\mathcal{E}}$ covers almost everything. Furthermore, the complement is the union of matching intervals. We find that $(a, b) \subset [0, 1] \setminus \tilde{\mathcal{E}}$ and in particular $x \in [0, 1] \setminus \tilde{\mathcal{E}}$ which gives a contradiction. We find $\tilde{\mathcal{E}} \subset \mathcal{E}_{IT}$. Lemma 3.3.5 gives the second characterisation (3.1.5). \square

§3.4 Dimensional results for \mathcal{E}_{IT}

Now that we established several characterisations of \mathcal{E}_{IT} we will focus on dimensional results of \mathcal{E}_{IT} in this section. We make use of two sets and the following proposition:

Proposition 3.4.1. *Let us consider the sets*

$$F_n = \{x \in [0, 1] : x = [0; a_1, a_2, \dots] \text{ such that } a_j \geq n \text{ for all } j \in \mathbb{N}\},$$

$$C_n = \{x \in [0, 1] : x = [0; a_1, a_2, \dots] \text{ and } a_j, \dots, a_{j+2n-1} \neq 1^{2n} \text{ for all } j \in \mathbb{N}\}.$$

where $[0; a_1, a_2, \dots]$ denotes the regular continued fraction. For these sets we have $\dim_H(F_n) > \frac{1}{2}$ and $\lim_{n \rightarrow +\infty} \dim_H(C_n) = 1$.

Proof. In [45] it is shown that $\dim_H(F_n) > \frac{1}{2} + \frac{1}{2 \log(n+2)}$ for $n > 20$. Since $F_{n+1} \subset F_n$ we find that $\dim_H(F_n) > \frac{1}{2}$ for all $n \in \mathbb{N}$.

Let $BAD(g) = \{x \in [0, 1] : g \notin \overline{\{T^n(x) : n \in \mathbb{N}\}}\}$ where T denotes the Gauss map. Then [47] gives us that $BAD(g)$ is α -winning and therefore it has Hausdorff dimension 1. On the other hand, it is not difficult to check that $BAD(g) = \cup_n C_n$ and since C_n is an increasing sequence of sets we get

$$1 = \sup_n \dim_H(C_n) = \lim_{n \rightarrow +\infty} \dim_H(C_n).$$

\square

We will now give a lemma to prove Theorem 3.1.5.

Lemma 3.4.2. *Let $x \in [g-1, g)$ have the RCF expansion $x = [a_0; a_1, a_2, a_3, \dots]$ with $a_0 \in \{0, -1\}$, $a_j \in \mathbb{N} \forall j \geq 1$. Furthermore, let $\{x\} = x$ for $x \geq 0$ and $\{x\} = x + 1$ for $x < 0$. Then there is*

- a sequence $j_k \rightarrow +\infty$ such that $0 \leq j_k - j_{k-1} \leq 2$,
- a sequence of prefixes $P_k \in \{\emptyset, (1), (a), (1, a)\}$,

such that $\{T_g^k(x)\} = [0; P_k, a_{j_k}, a_{1+j_k}, a_{2+j_k}, \dots]$ for all k .

Proof. Let us set $x_k := T_g^k(x)$ and $j_{-1} = 0$ and proceed by induction. It is clear that the statement holds for $k = 0$. Now suppose the statement holds for x_k then $\{x_k\} = [0; P_k, a_{j_k}, a_{1+j_k}, a_{2+j_k}, \dots]$. We treat the following cases:

- (a) if $x_k > 0$ then $\{T_g(x_k)\} = \{T(x_k)\} = T(x_k)$ and $x_k = \{x_k\}$ so we find the desired form for $\{x_k\}$ with $j_k = j_{k-1} + 1$.
- (b) if $x_k \in (g-1, -\frac{1}{3})$ then $\{x_k\} \in (g, \frac{2}{3})$ and so we can write $\{x_k\} = [0; 1^{2i+1}, a, X]$ with $i \geq 1$. This implies that $T_g(x_k) = \frac{1}{x_k} + 3 = [0; a+1, X]$ in case $i = 1$ and $T_g(x_k) = \frac{1}{x_k} + 3 = [0; 2, 1^{2i-3}, a, X]$ otherwise. We find $\{x_{k+1}\} = \{T_g(x_k)\} = T_g(x_k)$ so it has the desired form with $j_k = j_{k-1} + 2$.
- (c) if $x_k \in (-\frac{1}{3}, 0)$ then $\{x_k\}$ is of the form $\{x_k\} = [0; 1, a, X]$ which gives us $x_k = -[0; a+1, X]$ and so $\{T_g(x_k)\} = 1 - [0; X]$. Using the relation $1 - [0; c_1 + 1, c_2, c_3, \dots] = [0; 1, c_1, c_2, c_3, \dots]$ we find that $\{x_{k+1}\}$ has the desired form with $j_{k+1} = j_k + 1$ if $c_1 = 0$ and $j_{k+1} = j_k$ otherwise.

So in any case the RCF expansion of x_{k+1} is a short prefix (possibly empty) followed by the tail of the RCF expansion of x . \square

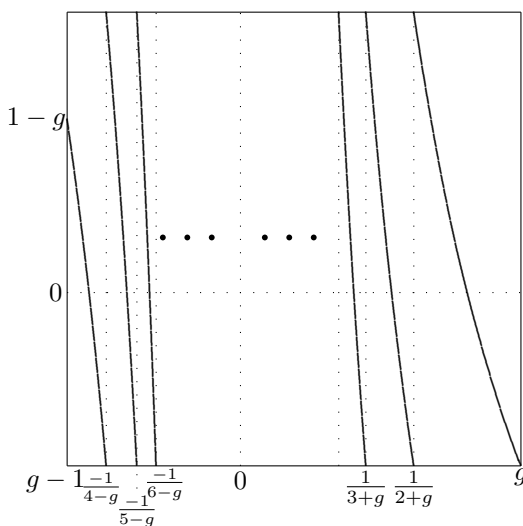

Figure 3.7: The map T_g .

Proof of Theorem 3.1.5. Let $f_a : [0, 1] \rightarrow [0, 1]$ be defined as $f_a(x) = \frac{1}{a+x}$ with $a \in \mathbb{N}$ and let $\hat{C}_n := f_1^{2n+5} \circ f_2(C_n)$. We first prove that $\hat{C}_n \subset \mathcal{E}_{IT}$. Let $\alpha \in \hat{C}_n$ then we can write $\alpha = [0; 1^{2n+5}, 2, X]$ for some string X without any subsequence 1^{2n} . From Lemma 3.3.5 we get that if $\{T_g^k(\frac{1}{\alpha} - 1)\} \notin (g, \alpha)$ and $\{T_g^k(\alpha - 1)\} \notin (g, \alpha)$ for all k then $\alpha \in \mathcal{E}_{IT}$. Suppose there is a k such that $\{T_g^k(\frac{1}{\alpha} - 1)\} \in (g, \alpha)$. Then $k > 2$ since $T_g(\frac{1}{\alpha} - 1) = -[0; 2, 1^{2n+1}]$ and $T_g^2(\frac{1}{\alpha} - 1) = [0; 2, 1^{2n-2}]$. Furthermore, we can write $\{T_g^k(\frac{1}{\alpha} - 1)\} = [0; 1^{2n+5}, Y]$ for some string Y . From Lemma 3.4.2 we find $\{T_g^k(\frac{1}{\alpha} - 1)\} = [0; P_{k+1}, a_{j_{k+1}}, a_{1+j_{k+1}}, a_{2+j_{k+1}}, \dots]$.

We find that $a_{j_{k+1}}, a_{1+j_{k+1}}, a_{2+j_{k+1}}, \dots, a_{2n-1+j_{k+1}} = 1^{2n}$ which is not a part of the initial string. This contradicts with $\alpha \in \hat{C}_n$. Since $\alpha - 1 = -[0; 2, 1^{2n+2}, X]$ we can find the same contradiction for $\alpha - 1$. Together with Lemma 3.3.5 and the proof of Theorem 3.1.4 we can conclude $\alpha \in \mathcal{E}_{IT}$. Of course, if $\hat{C}_n \subset \mathcal{E}_{IT}$ then $\cup \hat{C}_n \subset \mathcal{E}_{IT}$.

Since f_a is bi-Lipschitz for all $a \in \mathbb{N}$, the same is true for any finite composition of these maps. Since bi-Lipschitz maps preserve the Hausdorff dimension we find

$$\dim_H(C_n) = \dim_H(\hat{C}_n). \quad (3.4.1)$$

From (3.4.1) and Proposition 3.4.1 it follows that

$$\dim_H\left(\bigcup_{n>20} \hat{C}_n\right) = \sup_{n>20} \dim_H(\hat{C}_n) = \sup_{n>20} \dim_H(C_n) = 1.$$

Since $\hat{C}_n \subset \mathcal{E}_{IT}$ we find $\dim_H(\mathcal{E}_{IT}) = 1$. Now let $\delta > 0$. For sufficiently large N we have that $\hat{C}_n \subset (g, g + \delta]$ for all $n \geq N$ and so $\dim_H((g, g + \delta) \cap \mathcal{E}_{IT}) = 1$ which finishes the proof. \square

To get results on the Hausdorff dimension around a point $b \in \mathcal{E}_{IT} \cap \mathbb{Q}$ we need more insight in the behaviour around such a point. We establish this with the following lemma.

Lemma 3.4.3. *If $\alpha_0 \in \mathcal{E}_{IT} \cap \mathbb{Q} \cap (g, 1]$ has RCF expansion $\alpha_0 = [0; a_1, a_2, \dots, a_k]$ then there is a $c \in \mathbb{N}$ such that*

$$E_{\alpha_0} := \{\alpha \in [g, 1] : \alpha = [0; a_1, a_2, \dots, a_k, c, c_1, c_2, \dots] \text{ with } c_j > a_2 + 1 \ \forall j\} \subset \mathcal{E}_{IT}$$

with c_1, c_2, \dots either a finite (possibly empty) or an infinite sequence. Furthermore, we have that matching condition (3.1.2) holds for α_0 with $N - M = 1$.

Proof. Let $\alpha_0 \in \mathcal{E}_{IT} \cap \mathbb{Q} \cap (g, 1]$ and define $x_n = T_{\alpha_0}^n(\alpha_0 - 1)$ and $y_n = T_{\alpha_0}^n(\frac{1}{\alpha_0} - 1) = T_{\alpha_0}^{n+1}(\alpha_0)$. Since $\alpha_0 \in \mathbb{Q}$, both the T_{α_0} -orbit of $\alpha_0 - 1$ and the T_{α_0} -orbit of $1/\alpha_0 - 1$ will eventually reach zero, and since $\alpha_0 \in \mathcal{E}_{IT}$ this will happen in one of the states (A), (B) or (C) from Lemma 3.3.2. Let m be minimal such that $x_m = 0$. From the equations for (A), (B), (C) we have that (C) cannot happen and that $y_m = 0$. This gives us that $T_{\alpha_0}^m(\alpha_0 - 1) = T_{\alpha_0}^{m+1}(\alpha_0)$ and matching condition (3.1.2) holds with $N - M = 1$.

Now observe that Lemma 3.3.5 (ii) gives us that $\{T_g^n(\alpha_0)\} \notin [g, \alpha_0]$ and $\{T_g^n(\alpha_0 - 1)\} \notin [g, \alpha_0]$ for all $n \in \mathbb{N}$. This implies that there is a $\delta > 0$ such that for all $\alpha \in (\alpha_0 - \delta, \alpha_0 + \delta)$ we have $\{T_g^n(\alpha)\} \notin [g, \alpha]$ for $0 \leq n \leq m' + 1$ and $\{T_g^j(\alpha - 1)\} \notin [g, \alpha]$ for $0 \leq j \leq m'$ with m' minimal such that $T_g^{m'}(\frac{1}{\alpha} - 1) = 0$. Pick $c \in \mathbb{N}$ such that $E_{\alpha_0} \subset (\alpha_0 - \delta, \alpha_0 + \delta)$ and α_0 and α have the same partial quotients in their g -expansion up to m' for all $\alpha \in E_{\alpha_0}$. Let $\alpha \in E_{\alpha_0}$. From Lemma 3.4.2 we find $\{T_g^{m'}(\frac{1}{\alpha} - 1)\} = [0; P_{m'}, c, c_1, \dots]$ or $\{T_g^{m'}(\frac{1}{\alpha} - 1)\} = [0; P_{m'}, c_1, \dots]$. In the first case we find $T_g^{m'}(\frac{1}{\alpha} - 1) > 0$ and $P_{m'} = \emptyset$. Since $\{T_g^j(\alpha - 1)\} \notin [g, \alpha]$ for $0 \leq j \leq m'$ we find $T_g^j(\frac{1}{\alpha} - 1) \notin [g - 1, \alpha - 1]$ and so $T_g^j(\frac{1}{\alpha} - 1) = T_{\alpha}^j(\frac{1}{\alpha} - 1)$ for $0 \leq j \leq m'$. This gives us $T_{\alpha}^{m'}(\frac{1}{\alpha} - 1) = [0; c, c_1, c_2, \dots]$. It follows that $T_{\alpha}^{m'+j}(\frac{1}{\alpha} - 1) = [0; c_j, c_{j+1}, \dots]$ for all $j \in \mathbb{N}$. Note that matching did not happen before $T_{\alpha}^{m'}(\frac{1}{\alpha} - 1)$ so that $(T_{\alpha}^{m'}(\frac{1}{\alpha} - 1), T_{\alpha}^{m'}(\alpha - 1))$ is in one of the states (A), (B), (C) from Lemma 3.3.2. State (C) would imply that $T_{\alpha}^{m'}(\alpha - 1) > \alpha$ so we

can exclude it. If we are in state (A) we find $T_\alpha^{m'}(\alpha - 1) = -[0; c, c_1, c_2 \dots]$ and so $T_\alpha^{m'+j}(\alpha - 1) = -[0; c, c_1, c_2 \dots]$. We find $\alpha \in \mathcal{E}_{IT}$. If we are in state (B) we have $T_\alpha^{m'}(\alpha - 1) = -[0; c+1, c_1, c_2 \dots]$ and we can draw the same conclusion. In the second case we find $P_{m'} = c + 1$ and no difference to the proof of the first case. \square

Now Theorem 3.1.6 follows almost directly.

Proof of Theorem 3.1.6. The fact that there are infinitely many rationals in \mathcal{E}_{IT} is given by the fact that $\frac{n-1}{n} \in \mathcal{E}_{IT}$ for all $n \in \mathbb{N}_{\geq 3}$. Furthermore, $\mathcal{E}_{IT} \cap \mathbb{Q} \cap (g, 1]$ does not have isolated points since in Lemma 3.4.3 one can take a string c_1 with c_1 arbitrarily high. For the dimensional result we reason as follows. The composition $f_{a_1} \circ \dots \circ f_{a_k}$ is bi-Lipschitz. Furthermore, from Lemma 3.4.3 it follows that $f_{a_1} \circ \dots \circ f_{a_k}(F_n) \subset \mathcal{E}_{IT}$ for all $n > N$ for some N . Using Proposition 3.4.1 and symmetry the theorem now follows. \square

§3.5 Final observations and remarks

In the first part of this chapter, we have seen that a lot of machinery works for all three families. In the second part we have seen some differences. Since for the (KU) and (N) case the set of possible matching indices is \mathbb{Z} we cannot expect that we can obtain a tool like Lemma 3.3.1 for these families.

Note that this chapter was concerned mostly with matching and the non-matching set rather than the entropy as a function of α . We do know that the set for which the entropy as a function of α is not locally monotonic is a subset of \mathcal{E}_{IT} however we do not know whether equality holds. Furthermore, we did not prove the fact that the entropy function is continuous. For the matching set this should follow from the fact that we have

$$h(T_\alpha) = (1 + (M - N)\mu_\alpha((\beta, \alpha)))h(T_\beta)$$

for $\beta < \alpha$ on the same matching interval and the fact that $\mu_\alpha((\beta, \alpha))$ is continuous in β . To prove continuity on the non-matching set might be more challenging.

Worth mentioning is that Wolfgang Steiner and Hitoshi Nakada have (unpublished) results on the natural extension for Ito Tanaka's continued fractions. In particular they can show that for every $\alpha \in [0, 1]$ there is a solid rectangle $[\alpha - 1, \alpha] \times [A, B]$ that is fully contained in the domain of the natural extension. This implies that the invariant measure has full support.

Now it is proven that for all three families matching holds almost everywhere, one can take the challenge of mixing the maps. When, instead of iterating over one fixed map, you flip a coin to decide whether you pick $S(x) = \frac{1}{x}$ or $S(x) = -\frac{1}{x}$ the orbit of α and $\alpha - 1$ become random. Can we prove that for almost every $\alpha \in [0, 1]$ we have matching almost surely? And what does matching imply in this case? A different toolbox would be needed to tackle this problem.



CHAPTER 4

N -expansions

This chapter is based on joined work with Cor Kraaikamp and has appeared as a paper in *Journal of Mathematical Analysis and Applications* [64], except for Section 4.3.3 “*why is it so difficult*” where we explain why the methods of Chapter 3 fail to work.

Abstract

As in Chapter 2, we will look at expansions with flips (in the first part) and expansions with digits from a finite alphabet. In this chapter it is combined with N -expansions. By using the natural extension, the density of the invariant measure is obtained in a number of examples. In case this method does not work, a Gauss-Kuzmin-Lévy based approximation method is used. Convergence of this method follows from [99] but the speed of convergence remains unknown. For a lot of known densities the method gives a very good approximation in a low number of iterations. In the second part of this chapter, a subfamily of the N -expansions without flips is studied. In particular, the entropy as a function of a parameter α is estimated for $N = 2$ and $N = 36$. This is done in a similar flavour as Chapter 3. For $N = 2$ we find a matching interval with matching index 0. We show that the entropy is constant on this interval by using the natural extension. We also show that the methods from Chapter 3 to prove that matching is prevalent fail to adapt to this case. This is followed by a numerical exploration. Several conjectures are stated.

§4.1 Introduction

In general, studies on continued fraction expansions focus on expansions for which almost all x have an expansion with digits from an infinite alphabet. A classical example is the regular continued fraction, see [29, 50, 98] and Chapter 1. An example of continued fraction expansions with only finitely many digits has been introduced in [71] by Joe Lehner, where the only possible digits are 1 and 2; see also [28] and, of course, the expansions from Chapter 2. More recently, continued fractions have been investigated for which all x in a certain interval have finitely many possible digits. In [33] the following 4-expansion has been (briefly) studied. Let $T : [1, 2] \rightarrow [1, 2]$ be defined as

$$T(x) = \begin{cases} \frac{4}{x} - 1 & \text{for } x \in (\frac{4}{3}, 2], \\ x & \\ \frac{4}{x} - 2 & \text{for } x \in [1, \frac{4}{3}] \end{cases}, \quad (4.1.1)$$

see also Figure 4.1.

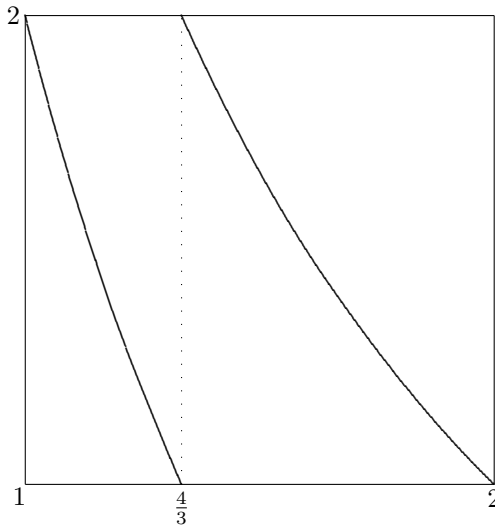

Figure 4.1: The CF-map T from (4.1.1).

By repeatedly using this map we find that every $x \in [1, 2]$ has an infinite continued fraction expansion of the form

$$x = \frac{4}{d_1 + \frac{4}{d_2 + \ddots}}$$

with $d_n \in \{1, 2\}$ for all $n \geq 1$. The class of continued fractions algorithms that give rise to digits from a finite alphabet is very large. In this chapter we will give examples of such expansions and in Section 4.3 we will take a closer look at an

interesting sub-family. Most of the examples will be a particular case of N -expansions (see [3, 15, 33]). Other examples are closely related and can be found by combining the N -expansions with flipped expansions (cf. [68] for 2-expansions; see also [27] for flipped expansions). For all these examples we refer to [27] for ergodicity (which can be obtained in all these cases in a similar way) and existence of an invariant measure. In a number of cases however, it is difficult to find the invariant measure explicitly, while in seemingly closely related cases it is very easy. In case we cannot give an analytic expression for the invariant measure, we will give an approximation using a method that is very suitable (from a computational point of view) for expansions with finitely many different digits. This method is based on the Gauss-Kuzmin-Lévy Theorem. For greedy N -expansions this theorem is proved by Dan Lascu in [69]. The method yields smoother results than by simulating in the classical way (looking at the histogram of the orbit of a typical point as described in Choe's book [22], and used in his papers [21, 23]). We also give an example in which we do know the density and where we use this method to show its strength.

In Section 4.2 we will give the general form of the continued fraction maps we study in this chapter. After that we give several examples of such maps and a way of finding the density of the invariant measure by using the natural extension. In Section 4.2.2 we will see how we simulated the densities in case we were not able to find them explicitly. In the second part of the chapter we will consider a subfamily of the N -expansions which can be parameterized by $\alpha \in (0, \sqrt{N} - 1]$. We study the entropy as function of α . We give some partial results and also show why we cannot adapt the methods from Chapter 3. We proceed by analysing the problem on a numerical basis.

§4.2 The general form of our maps

Within this chapter we will look at continued fraction algorithms of the following form. Fix an integer $N \geq 2$ and let $[a, b]$ be a subinterval of $[0, N]$ with $b - a \geq 1$. Let $T : [a, b] \rightarrow [a, b]$ be defined as

$$T(x) = \frac{\varepsilon(x)N}{x} - \varepsilon(x)d(x)$$

where $\varepsilon(x)$ is either -1 or 1 depending on x and $d(x)$ is a positive integer such that $T(x) \in [a, b]$. Note that if $b - a = 1$ then there is exactly one positive integer such that $T(x) \in [a, b]$ if $\varepsilon(x)$ is fixed. For $N = 2$ we find the family that is studied in [68] and for $\varepsilon(x) = 1$ for all x we find the N -expansions from [33]. Whenever $a > 0$ this map can only have finitely many different digits. This family is closely related to the (a, b) -continued fractions introduced and studied by Svetlana Katok and Ilie Ugarcovic in [54, 55, 56]. For (a, b) -continued fractions we have that $\varepsilon(x) = -1$ for all $x \in [a, b]$ and $N = 1$. Also there are restrictions on a, b . These are chosen such that $a \leq 0 \leq b$, $b - a \geq 1$ and $-ab \leq 1$.

Note that this family is rather “large”. For the examples in the next section $\varepsilon(x)$ will be plus or minus one on fixed interval(s). In Section 4.3 other restrictions are imposed.

§4.2.1 Two seemingly closely related examples and their natural extension

In [33], using the natural extension the invariant measure of the 4-expansion map T given in (4.1.1) was easily obtained. To (briefly) illustrate the method and the kind of continued fraction algorithms we are interested in we consider a slight variation of this continued fraction. Let $\tilde{T} : [1, 2] \rightarrow [1, 2]$ be defined as

$$\tilde{T}(x) = \begin{cases} \frac{4}{x} - 1 & \text{for } x \in (\frac{4}{3}, 2], \\ 5 - \frac{4}{x} & \text{for } x \in [1, \frac{4}{3}], \end{cases} \quad (4.2.1)$$

i.e. we “flipped” the map T on the interval $[1, \frac{4}{3}]$; see also Figure 4.2.

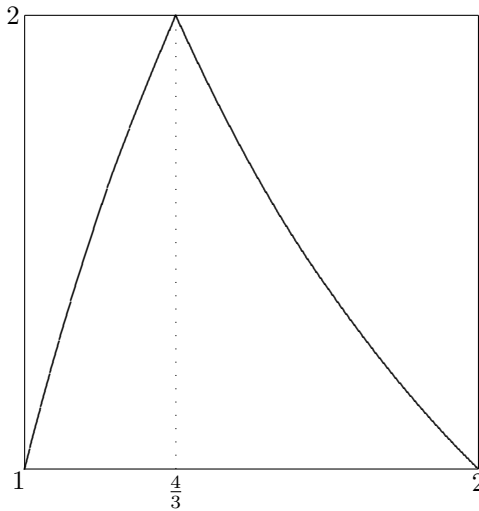

Figure 4.2: The CF map \tilde{T} from (4.2.1).

Setting

$$\varepsilon_1(x) = \begin{cases} 1 & \text{for } x \in (\frac{4}{3}, 2] \\ -1 & \text{for } x \in [1, \frac{4}{3}] \end{cases} \quad \text{and} \quad d_1(x) = \begin{cases} 1 & \text{for } x \in (\frac{4}{3}, 2] \\ 5 & \text{for } x \in [1, \frac{4}{3}] \end{cases}$$

we define $\varepsilon_n(x) = \varepsilon_1(\tilde{T}^{n-1}(x))$ and $d_n(x) = d_1(\tilde{T}^{n-1}(x))$.

From $\tilde{T}(x) = \varepsilon_1 \cdot (\frac{4}{x} - d_1)$, it follows that

$$x = \frac{4}{d_1 + \varepsilon_1 \tilde{T}(x)} = \dots = \frac{4}{d_1 + \frac{4\varepsilon_1}{d_2 + \dots + \frac{4\varepsilon_{n-1}}{d_n + \varepsilon_n \tilde{T}^n(x)}}}.$$

Taking finite truncations, we find the so called convergents

$$c_n = \frac{p_n}{q_n} = \frac{4}{d_1 + \frac{4\varepsilon_1}{d_2 + \dots + \frac{4\varepsilon_{n-1}}{d_n}}}$$

of x . One can show that $\lim_{n \rightarrow \infty} c_n = x$; see [68] for further details. Therefore we write

$$x = \frac{4}{d_1 + \frac{4\varepsilon_1}{d_2 + \dots}} \tag{4.2.2}$$

or in short hand notation $x = [4/d_1, 4\varepsilon_1/d_2, \dots]$ or $x = [d_1, \varepsilon_1/d_2, \dots]_4$.

Using the natural extension to find the invariant measure

As in Chapter 2, we will use the method of natural extensions to find the density for some of our dynamical systems. We briefly recall this procedure using \tilde{T} from (4.2.1). The idea is to build a two-dimensional system (the natural extension) $(\Omega = [1, 2] \times [A, B], \mathcal{T})$ which is almost surely invertible and contains $([1, 2], \tilde{T})$ as a factor (see Definition 1.1.11 on page 8). In [33] it was shown that a suitable candidate for the natural extension map \mathcal{T} is given by

$$\mathcal{T}(x, y) = \left(\tilde{T}(x), \frac{4\varepsilon_1(x)}{d_1(x) + y} \right).$$

Now we choose A and B in such a way that the system is indeed (almost surely)

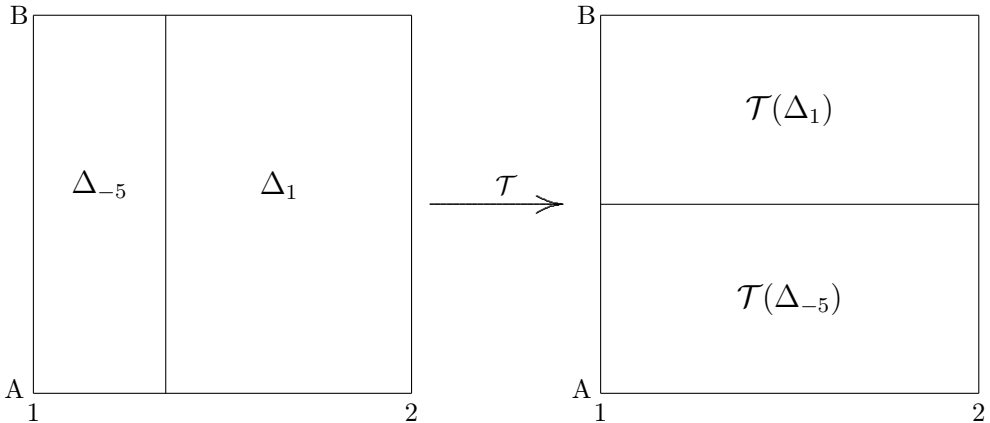

Figure 4.3: The suitable domain for \mathcal{T} .

invertible. We define fundamental intervals $\Delta_n = \{(x, y) \in \Omega : d_1(x) = n\}$ if $\varepsilon = 1$ and $\Delta_{-n} = \{(x, y) \in \Omega : d_1(x) = n\}$ if $\varepsilon = -1$. When the fundamental intervals fit exactly under the action of \mathcal{T} , the system is almost surely invertible; see Figure 4.3.

An easy calculation shows that $A = -1$ and $B = \infty$ is the right choice here. It is shown in [33], that the density of the invariant measure (for the 2-dimensional system) is given by

$$f(x, y) = C \frac{4}{(4 + xy)^2}, \quad \text{for } (x, y) \in \Omega,$$

where C is a normalising constant (which is $\frac{1}{\log(3)}$ in this example). Projecting on the first coordinate yields the invariant measure for the 1-dimensional system $([1, 2], \hat{T})$, with density

$$\frac{1}{\log(3)} \left(\frac{1}{x} + \frac{1}{4-x} \right), \quad \text{for } x \in [1, 2].$$

Note that if we would consider the map

$$\hat{T}(x) = \begin{cases} 4 - \frac{4}{x} & \text{for } x \in (\frac{4}{3}, 2], \\ \frac{4}{x} - 2 & \text{for } x \in [1, \frac{4}{3}], \end{cases} \quad (4.2.3)$$

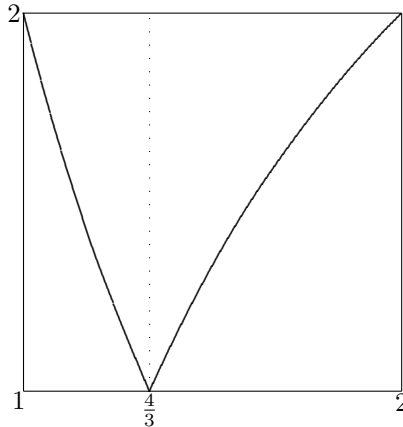

Figure 4.4: The CF map \hat{T} from (4.2.3).

which is a “flipped version” of the map T from (4.1.1) where we flipped the branch on the interval $(\frac{4}{3}, 2]$, we get another continued fraction of the form (4.2.2) but now with digits $d_n \in \{2, 4\}$; see Figure 4.4. Our approach now gives $A = -2$ and $B = \infty$ which shows that the underlying dynamical system has a σ -finite infinite measure with “density” $f(x)$, given by

$$f(x) = \frac{1}{x} + \frac{1}{2-x}, \quad \text{for } x \in [1, 2].$$

The method from [33] we just used does not always “work”. As an example we will

use an expansion given in [68]. Let $\bar{T}(x)$ be defined as

$$\bar{T}(x) = \begin{cases} \frac{2}{x} - 3 & \text{for } x \in (\frac{1}{2}, \frac{4}{7}], \\ 4 - \frac{2}{x} & \text{for } x \in (\frac{4}{7}, \frac{2}{3}], \\ \frac{2}{x} - 2 & \text{for } x \in (\frac{2}{3}, \frac{4}{5}], \\ 3 - \frac{2}{x} & \text{for } x \in [\frac{4}{5}, 1], \end{cases} \quad (4.2.4)$$

see Figure 4.5.

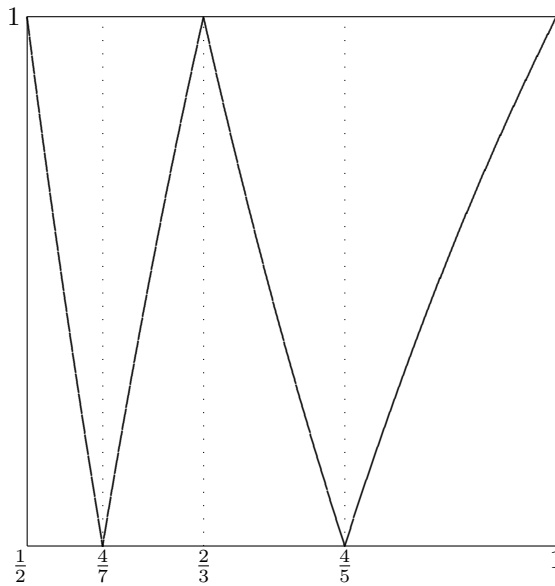

Figure 4.5: An expansion map on $[\frac{1}{2}, 1]$.

When trying to construct the domain of the natural extension one quickly notices that “holes” appear. This is not an entirely new phenomenon in continued fractions, it also appears in constructing the natural extension of Nakada’s α -expansions when $\alpha \in (0, \sqrt{2} - 1)$; see [79]. One might hope that there are finitely many holes, but a simulation of the domain indicates otherwise; see Figure 4.6.

Although the method might still work in this case, it does not really seem to help us to find a description of the invariant density. In order to get an idea of the density, we will use two different approaches. One will be based on the Gauss-Kuzmin-Lévy Theorem. The other will be a more classical approach based on Choe’s book [22].

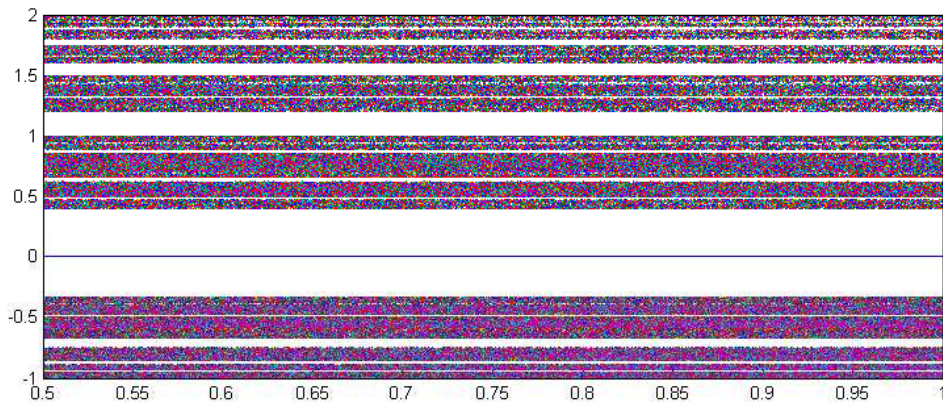

Figure 4.6: A simulation of the domain of the natural extension for the map \bar{T} from (4.2.4).

§4.2.2 Two different methods for approximating the density

The first way is based on the Gauss-Kuzmin-Lévy Theorem. This theorem states that for the regular continued fraction the Lebesgue measure of the pre-images of a measurable set A will converge to the Gauss measure.

$$\lambda(T^{-n}(A)) \rightarrow \mu(A) \quad \text{as } n \rightarrow \infty.$$

There are many proofs of this theorem and refinements on the speed of convergence; see e.g. Khinchine's book [58], or [50] for such refinements.

The idea for our method is to look at the pre-images of $[\frac{1}{2}, z]$ for our map \bar{T} from (4.2.4) and take the Lebesgue measure of the intervals found. Note that the number of intervals doubles every iteration. Also the size of the intervals shrink relatively fast. Fortunately it seems that a low number of iterates (around 10) is already enough to give a good approximation; see Figure 4.8 where the theoretical density and its approximation are displayed and Figure 4.7, where both methods of approximating are compared for a density we do not know the theoretical density of.

The other way of finding an approximation is by iterating points and looking at the histogram of the orbits. The way we iterated is that we used a lot of points and iterated them just a few times. To be more precise we iterated 2500 uniformly sampled points 20 times, repeated this process 400 times and took the average density of all points. Then we redid the process but instead of sampling uniformly we sampled from the previously found density (see also [32]). In Figure 4.7 we see both methods applied to our example.

The two methods give results that are relatively close but the approximation found with the Gauss-Kuzmin-Lévy method is far more smooth. Since we do not know the density we cannot compare the theoretical density with the approximation and since the Gauss-Kuzmin-Lévy method is the new method we will look at how well this method performs in an example in which we know the invariant density explicitly. For the map T from (4.1.1) we know the density which was given in [33].

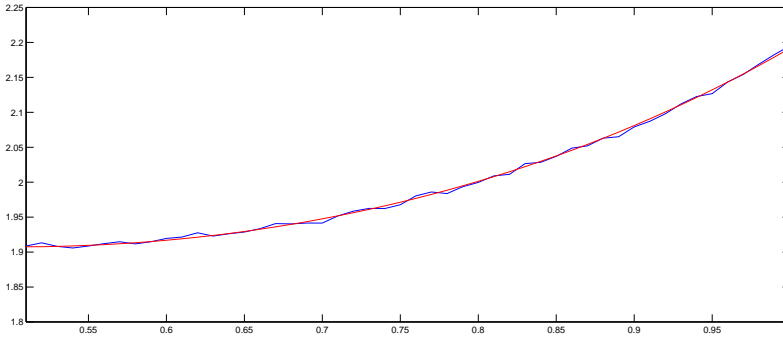

Figure 4.7: Approximations of the density of the invariant measure of $\bar{T}(x)$ using the Gauss-Kuzmin-Lévy method (red) and the classical way (blue).

In Figure 4.8 we see a plot of both the theoretical density and the approximation found by the Gauss-Kuzmin-Lévy method.

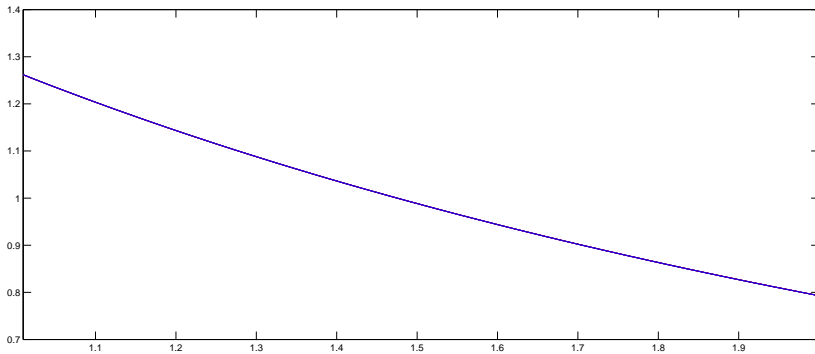

Figure 4.8: An approximation of the true density for the CF map T from (4.1.1) and the true T -invariant density.

The difference can barely be seen by the naked eye. If we look at the difference in 2-norm we get

$$\left(\int_1^2 (f(x) - \hat{f}(x))^2 dx \right)^{\frac{1}{2}} = 1.1235 * 10^{-5}$$

where $f(x)$ is the true density and $\hat{f}(x)$ the approximation.

§4.3 A sub-family of the N -expansions

In this section we study a subfamily of the N -expansions (so $\varepsilon(x) = 1$ for all x in the domain) with digits from a finite alphabet and an interval $[\alpha, \beta]$ as domain. For our

subfamily we want that it has finitely many digits. Furthermore we would like that there is a unique digit such that $T(x) \in [\alpha, \beta)$. This results in $\alpha > 0$ and $\beta - \alpha = 1$. In this way the map is uniquely determined by the domain. With these restrictions we define for $\alpha \in (0, \sqrt{N} - 1]$ the map $T_{\alpha, N} : [\alpha, \alpha + 1] \rightarrow [\alpha, \alpha + 1]$ as

$$T_{\alpha, N} = \frac{N}{x} - \left\lfloor \frac{N}{x} - \alpha \right\rfloor.$$

We call the associated continued fractions N_α -expansions. Note that for all these expansions we have a finite number of digits since $\alpha > 0$. Also note that this is the largest range in which we can choose α because for $\alpha > \sqrt{N} - 1$ the digit would be 0 or less (see Section 4.3.2 for a calculation). Simulations show that a lot of maps have an attractor smaller than $[\alpha, \alpha + 1]$. When $N \geq 9$ we find that if $\alpha = \sqrt{N} - 1$ there is always an interval $[c, d] \subsetneq [\alpha, \alpha + 1]$ for which the $T_{\alpha, N}$ -invariant measure of $[c, d]$ is zero. Whenever $N > 4$ we have that $T_{\alpha, N}$ always has 2 branches for $\alpha = \sqrt{N} - 1$. Calculations of these observations are given in Section 4.3.2 in which we take a closer look at which sequences are admissible for a given N and α . In Section 4.3.3 we study the behaviour of the entropy as a function of α for a fixed N .

The examples in [33] with “fixed range” are all member of this kind of sub-family of the N -expansions. Though, these examples are cases for which all the branches of the mapping are full. In such case the natural extension can be easily build using the method described previously. If not all branches are full we can still make the natural extension in some cases. We will start this section with such a case.

§4.3.1 A 2-expansion with $\alpha = \sqrt{2} - 1$

Let $T(x) : [\sqrt{2} - 1, \sqrt{2}] \rightarrow [\sqrt{2} - 1, \sqrt{2}]$ be defined by

$$T(x) = \begin{cases} \frac{2}{x} - 1 & \text{for } 2(\sqrt{2} - 1) < x \leq \sqrt{2}, \\ \frac{2}{x} - 2 & \text{for } 2 - \sqrt{2} < x \leq 2(\sqrt{2} - 1), \\ \frac{2}{x} - 3 & \text{for } \frac{1}{7}(6 - 2\sqrt{2}) < x \leq 2 - \sqrt{2}, \\ \frac{2}{x} - 4 & \text{for } \sqrt{2} - 1 \leq x \leq \frac{1}{7}(6 - 2\sqrt{2}). \end{cases}$$

A graph of this map is shown in Figure 4.9. We can find the invariant measure for this map by using the method as in Section 4.2.1 though we now need to determine 3 “heights” in order to make the mapping of the natural extension almost surely bijective on the domain (see Figure 4.10). We get the following equations for the heights A, B and C :

$$A = \frac{2}{4 + C}, \quad B = \frac{2}{3 + C} \quad \text{and} \quad C = \frac{2}{1 + B}.$$

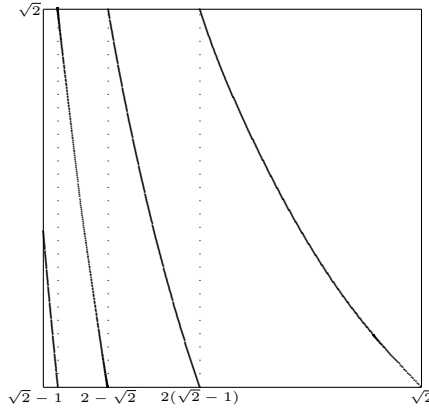

Figure 4.9: A 2-expansion on the interval $[\sqrt{2} - 1, \sqrt{2}]$.

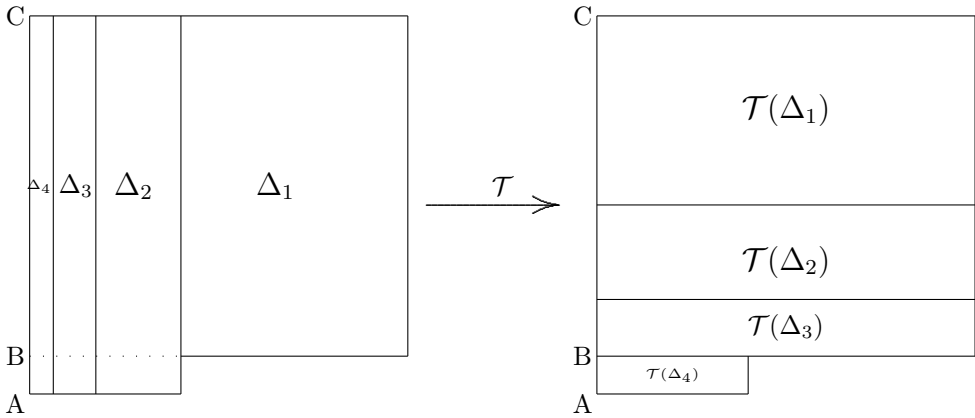

Figure 4.10: Ω and $\mathcal{T}(\Omega)$.

This results in $A = \frac{1}{2}(\sqrt{33} - 5)$, $B = \frac{1}{6}(\sqrt{33} - 3)$ and $C = \frac{1}{2}(\sqrt{33} - 3)$. We find the following invariant density up to a normalising constant (which is given in Theorem 4.3.3)

$$f(x) = \begin{cases} \frac{\sqrt{33}-3}{4+(\sqrt{33}-3)x} - \frac{\sqrt{33}-5}{4+(\sqrt{33}-5)x} & \text{for } \sqrt{2} - 1 < x \leq 2(\sqrt{2} - 1), \\ \frac{\sqrt{33}-3}{4+(\sqrt{33}-3)x} - \frac{\sqrt{33}-3}{12+(\sqrt{33}-3)x} & \text{for } 2(\sqrt{2} - 1) < x \leq \sqrt{2}. \end{cases}$$

The graph of the density is given in Figure 4.11. In this case we were lucky. But in general it seems to be very hard to construct the natural extension explicitly. Still we can simulate the densities and calculate the entropy for a given α . Also for the 2-expansions, we can extend the above result to all $\alpha \in [\frac{\sqrt{33}-5}{2}, \sqrt{2} - 1]$; see Theorem 4.3.2.

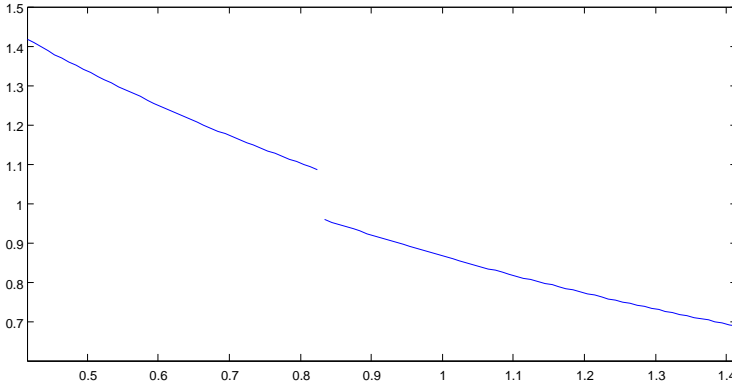

Figure 4.11: The density of the invariant measure for the 2-expansion on $[\sqrt{2} - 1, \sqrt{2}]$.

§4.3.2 Admissibility

In this section we look at how the alphabet is determined by α for a fixed N . It turns out that not all different sequences of such an alphabet will occur in a continued fraction expansion (or only finitely many times). This is a consequence of some cylinders having zero mass. The range of the first digits of a continued fraction for given α and N are easily described since the smallest digit will be attained by the right end point of the domain and the largest digits will be attained by the left end point of the domain. Let

$$n_{min} = \left\lfloor \frac{N}{\alpha + 1} - \alpha \right\rfloor \quad \text{and} \quad n_{max} = \left\lfloor \frac{N}{\alpha} - \alpha \right\rfloor.$$

Note that $n_{min} \leq 0$ when $\alpha > \sqrt{N} - 1$ and therefore $\alpha = \sqrt{N} - 1$ is the largest value for which we have positive digits. Furthermore the alphabet is given by $\{n_{min}, \dots, n_{max}\}$. Now to see for which N we have that for $\alpha = \sqrt{N} - 1$ there are two branches we must check that $n_{max} = 2$. This happens when $\frac{N}{\sqrt{N}-1} - 2 \in [\sqrt{N} - 1, \sqrt{N}]$. We have 2 inequalities

$$\frac{N}{\sqrt{N} - 1} - 2 \leq \sqrt{N} \tag{4.3.1}$$

and

$$\sqrt{N} - 1 \leq \frac{N}{\sqrt{N} - 1} - 2. \tag{4.3.2}$$

Inequality (4.3.1) gives $4 \leq N$ and inequality (4.3.2) gives $N - 1 \leq N$. We find that for all $N \geq 4$ we have two branches for $\alpha = \sqrt{N} - 1$. If $N \geq 9$ we also have an attractor which is strictly smaller than the entire interval for $\alpha = \sqrt{N} - 1$ as the

following calculation shows

$$\begin{aligned} T_{\alpha,N} \left(\left[\alpha, \frac{N}{\alpha+2} \right] \right) &= \left[\alpha, \frac{N}{\alpha} - 2 \right], \\ T_{\alpha,N} \left(\left[\alpha, \frac{N}{\alpha} - 2 \right] \right) &= \left[\alpha, \frac{N}{\alpha} - 2 \right] \cup \left[\frac{N\alpha}{N-2\alpha} - 1, \alpha + 1 \right], \\ T_{\alpha,N} \left(\left[\frac{N\alpha}{N-2\alpha} - 1, \alpha + 1 \right] \right) &= \left[\alpha, \frac{N^2 - (1-3\alpha)N - 2\alpha}{(\alpha-1)N + 2\alpha} \right]. \end{aligned}$$

If we substitute α with $\sqrt{N} - 1$ and the following two inequalities hold we find an attractor strictly smaller than the interval $[\alpha, \alpha + 1]$;

$$\begin{aligned} \frac{N}{\sqrt{N}-1} - 2 &< \frac{N(\sqrt{N}-1)}{N-2(\sqrt{N}-1)} - 1, \\ \frac{N^2 - (4-3\sqrt{N})N - 2(\sqrt{N}-1)}{(\sqrt{N}-2)N + 2(\sqrt{N}-1)} &< \frac{N}{\sqrt{N}-1} - 2, \end{aligned}$$

yielding that $N \geq 9$. We take a closer look at $N = 9$ and $\alpha = \sqrt{9} - 1 = 2$. This example is briefly discussed in [33] where it is stated that computer experiments suggest that the orbit of 2 never becomes periodic and therefore it is hard to find the natural extension explicitly. However, when simulating the natural extension, it seems that there are finitely many discontinuities; see Figure 4.12.

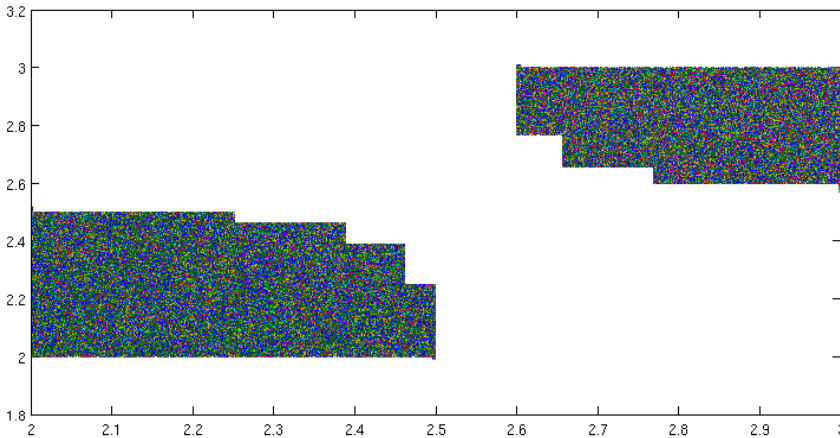

Figure 4.12: A simulation of the natural extension for $N = 9$ and $\alpha = 2$.

We can also simulate the density of the invariant measure; see Figure 4.13.

Remark that cylinders with zero mass tells us which sequences are not apparent in any continued fraction of numbers outside the attractor and for those numbers not in the attractor these sequences only appear in the start of the continued fraction. We

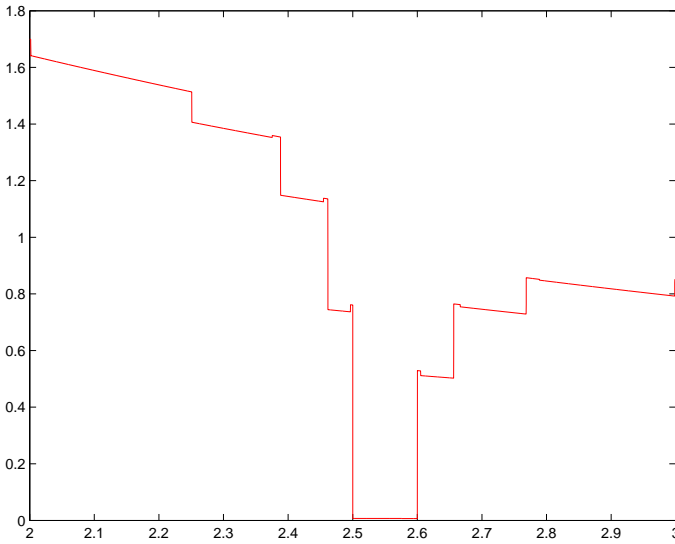

Figure 4.13: A Simulation of the density for $N = 9$ and $\alpha = 2$ using the Gauss-Kuzmin-Lévy method.

can describe which cylinders these are. The hole is given by $[2.5, 2.6]$. Now $2.5 = [1, 1, 1, 1, 1, 1, 1, 2, 1, 1, 1, 1, 1, 1, 2, 2, 1, 1, 1, \dots]_9$ and $2.6 = [1, 1, 1, 1, 1, 1, 1, 2, 1, 1, 1, 1, 1, 1, 2, 2, 1, 1, 1, \dots]_9$. The boundary of a cylinder $\Delta(a_1, \dots, a_n)$ is given by $[a_1, \dots, a_n, 1, r]_9$ and $[a_1, \dots, a_n, 2, r]_9$ where r is the expansion of 2. Now a cylinder is contained in $[2.5, 2.6]$ if $2.5 < [a_1, \dots, a_n, 1, r]_9 < 2.6$ and $2.5 < [a_1, \dots, a_n, 2, r]_9 < 2.6$. Note that here we can have a clear description of the attractor and therefore for the admissible sequences. Simulation shows us that there are a lot of different settings in which you find an attractor strictly smaller than the interval. In Figure 4.14 simulations for several values of N are shown. On the y -axis α is given and on the x -axis the attractor is plotted. For example, for $N = 9$ we see that for $\alpha = 1$ there is no attractor strictly smaller than the interval. There is an attractor for $\alpha = 1.8$ and also for example for $\alpha = 2$. The pattern seems to be rather regular. Moreover, more “holes” seem to appear for large N and large α ¹.

§4.3.3 Entropy and matching

In this section we look at entropy as a function of $\alpha \in (0, \sqrt{N} - 1]$ for a fixed N and the relation with matching. We will use the following definition.

Definition 4.3.1 (Matching). We say matching holds for α if there are $K, M \in \mathbb{N}$ such that $T_{\alpha, N}^K(\alpha + 1) = T_{\alpha, N}^M(\alpha)$. The numbers K and M are called the matching

¹Recently Jaap de Jonge, Cor Kraaikamp and Hitoshi Nakada studied these holes. The overall structure seems rather complicated. See the dissertation of Jaap de Jonge for more details [34].

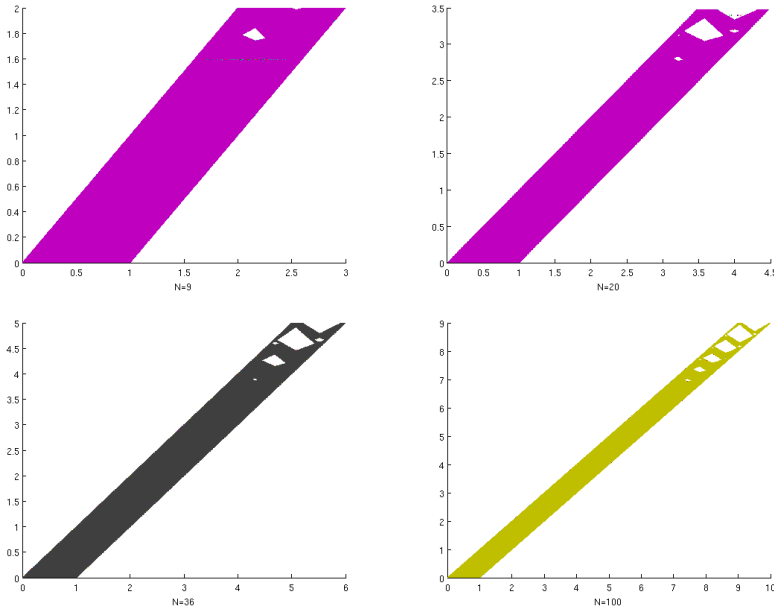

Figure 4.14: Attractors plotted for several values of N .

exponents, $K - M$ is called the matching index and an interval (c, d) such that for all $\alpha \in (c, d)$ the matching exponents are the same is called a matching interval.

For our family we do not know whether matching holds almost everywhere. In fact, it is not even clear whether for all $N \in \mathbb{N}$ we can find a matching interval. Also, whether matching implies monotonicity is not clear. Certain conditions used to prove it as in Chapter 3 are not met.

Why is it so difficult?

Note that for the maps studied in Chapter 3 all rationals have a finite expansion for any choice of α . Therefore, all $\alpha \in (0, 1) \cap \mathbb{Q}$ match in 0 or before. For any rational in the domain a matching interval is found. Since for all $\alpha \in (0, \sqrt{N} - 1)$ the expansion of any number in the interval is infinite, there are no values for which we find matching “trivially”. Another obstruction is the fact that a necessary condition for a matching interval is that the derivatives should match (see also Definition 1.2.8 on page 13). To fix ideas let us fix $N = 2$. Suppose we want to prove that the derivatives match for $\alpha \in (0, \sqrt{2} - 1) \cap \mathbb{Q}$. For simplicity assume that there exist a K and an L such that $T_{2,\alpha}^K(\alpha) = 1 = T_{2,\alpha}^L(\alpha + 1)$. Following the lines in the proof of Lemma 3.2.6 on page 50 we find that we need $(a - c)^2(\frac{1}{2})^{2K-1} = (e - g)^2(\frac{1}{2})^{2L-1}$ in order to find matching derivatives. One can check that this equation holds for $\alpha = \frac{1}{n}$ with $n \in \mathbb{N}$. On the other hand, there is no simple way of proving this and no reason to believe it holds in general.

If we look back at Lemma 3.2.7 on page 51 it was necessary to have $|x - \frac{p_n}{q_n}| < \frac{1}{q_n^2}$. For N, α -expansions we do not have such a good approximation. The sharpest bound known is $|x - \frac{p_n}{q_n}| < \frac{N^n}{q_n^2}$, therefore we cannot mimic the proof. Lemma 3.2.7 is needed to prove the monotonicity on a matching interval. The only reason to believe matching can help us to prove monotonicity is the fact that it works for related families. In fact, for specific choices of N and α we can actually find matching intervals on which the function is monotonic. If we want to mimic the proof of Theorem 3.1.3 which states that matching holds almost everywhere, we find that we start in a state $(x+1)(y+1) = 2$ whenever we take $N = 2$. This implies that for the iterates we have $x+y = 1$ or $x+y = 2$. From there, at least 12 other states can be reached. Computer simulation showed that for arbitrary α we cannot find iterates of α and $\alpha+1$ that return to these states.

We will now discuss the 2_α -expansions in more detail. Moreover, we prove that the entropy is constant for $\alpha \in \left(\frac{\sqrt{33}-5}{2}, \sqrt{2}-1\right)$ when $N = 2$.

The entropy of 2_α -expansions

We start with an example for which there is no α such that we have an attractor strictly smaller than the interval. Also, simulation indicates that there seems to be a plateau in the neighborhood of $\sqrt{2}-1$. For this value we can calculate the entropy since we have the density for this specific case of α ; see Section 4.3.1, also see Figure 4.15 for a plot of the entropy function. When taking a closer look at this plateau we found

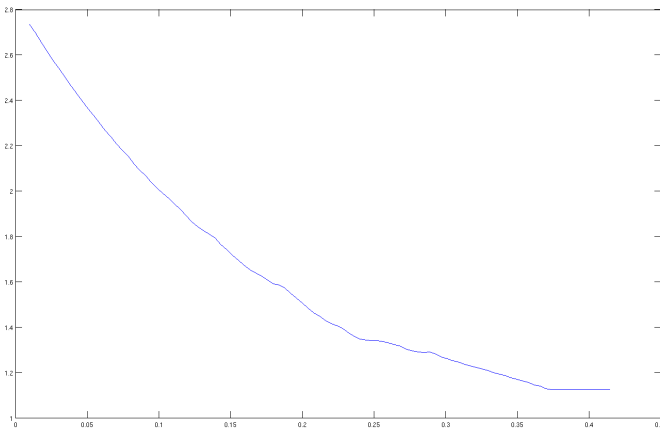

Figure 4.15: Entropy as function of α for $N = 2$.

that on the interval $[\frac{\sqrt{33}-5}{2}, \sqrt{2}-1]$ the entropy is constant. The point $\frac{\sqrt{33}-5}{2}$ is the point so that for all smaller α there are always 5 or more branches and for all larger α there are always 4 branches. If we look at a simulation of the natural extension it seems that for these values of α we can construct a natural extension. Indeed this turned out to be the case (see Theorem 4.3.3). For $\frac{\sqrt{33}-5}{2}$ we find matching exponents

$(0, 2)$ and for $\sqrt{2} - 1$ we find matching exponents $(0, 1)$. Inside the interval itself we find $(3, 3)$. These values were first found by simulation, in Theorem 4.3.2 we give a proof of this.

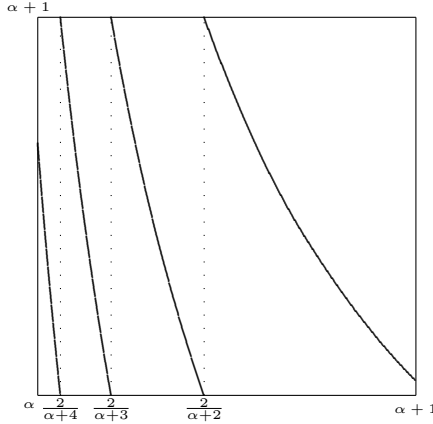

Figure 4.16: The map $T_{0.395, 2}$.

Theorem 4.3.2. Let $N = 2$ and let $\alpha \in \left(\frac{\sqrt{33}-5}{2}, \sqrt{2} - 1\right)$. Furthermore, denote $T_{\alpha, 2}$ by T . Then $T^3(\alpha) = T^3(\alpha + 1)$.

Proof. Note that the interval $(\alpha, \alpha + 1)$ has as natural partition $\{I_1, I_2, I_3, I_4\}$, where

$$I_1 = \left(\frac{2}{\alpha + 2}, \alpha + 1\right), \quad I_2 = \left(\frac{2}{\alpha + 3}, \frac{2}{\alpha + 2}\right], \quad I_3 = \left(\frac{2}{\alpha + 4}, \frac{2}{\alpha + 3}\right],$$

and

$$I_4 = \left[\alpha, \frac{2}{\alpha + 4}\right],$$

where

$$T(x) = \frac{2}{x} - d, \quad \text{if } x \in I_d \text{ for } d = 1, 2, 3, 4.$$

An easy calculation shows that

$$T(\alpha) = \frac{2 - 4\alpha}{\alpha} \in I_1,$$

(and $T(\alpha) = \frac{2}{\alpha+2}$ when $\alpha = \sqrt{2} - 1$, and $T(\alpha) = \alpha + 1$ when $\alpha = \frac{\sqrt{33}-5}{2}$), so that

$$T^2(\alpha) = \frac{3\alpha - 1}{1 - 2\alpha}.$$

Furthermore, we have that

$$T(\alpha + 1) = \frac{1 - \alpha}{\alpha + 1} \in I_4,$$

(and $T(\alpha + 1) = \sqrt{2} - 1$ when $\alpha = \sqrt{2} - 1$; $T(\alpha + 1) = \frac{2}{\alpha + 4}$ when $\alpha = \frac{\sqrt{33} - 5}{2}$), so that

$$T^2(\alpha + 1) = \frac{6\alpha - 2}{1 - \alpha}.$$

Now let

$$K_1 = \left(\frac{\sqrt{33} - 5}{2}, \frac{\sqrt{51} - 6}{3} \right], \quad K_2 = \left(\frac{\sqrt{51} - 6}{3}, \frac{\sqrt{129} - 9}{6} \right]$$

and

$$K_3 = \left(\frac{\sqrt{129} - 9}{6}, \sqrt{2} - 1 \right).$$

For $\alpha \in K_1$ we have that $T^2(\alpha) \in I_3$ and so

$$T^3(\alpha) = \frac{5 - 13\alpha}{3\alpha - 1}$$

and $T^2(\alpha + 1) \in I_4$ which results in

$$T^3(\alpha + 1) = \frac{5 - 13\alpha}{3\alpha - 1} = T^3(\alpha).$$

For $\alpha \in K_2$ we have that $T^2(\alpha) \in I_2$ and so

$$T^3(\alpha) = \frac{4 - 10\alpha}{3\alpha - 1}$$

and $T^2(\alpha + 1) \in I_3$ which results in

$$T^3(\alpha + 1) = \frac{4 - 10\alpha}{3\alpha - 1} = T^3(\alpha).$$

For $\alpha \in K_3$ we have that $T^2(\alpha) \in I_1$ and so

$$T^3(\alpha) = \frac{3 - 7\alpha}{3\alpha - 1}$$

and $T^2(\alpha + 1) \in I_2$ which results in

$$T^3(\alpha + 1) = \frac{3 - 7\alpha}{3\alpha - 1} = T^3(\alpha).$$

□

Earlier we thought we were just lucky finding the natural extension in case $N = 2$ and $\alpha = \sqrt{2} - 1$. Note that from this natural extension we immediately also have the case $N = 2$, $\alpha = \frac{\sqrt{33} - 5}{2}$; just “invert” the time and exchange the two coordinates in the natural extension we found for $N = 2$ and $\alpha = \sqrt{2} - 1$. However, from Theorem 4.3.2 it immediately follows that we can also “build” the natural extension for every $\alpha \in \left(\frac{\sqrt{33} - 5}{2}, \sqrt{2} - 1 \right)$. Clearly, from Theorem 4.3.2 we see that we have three different cases.

Theorem 4.3.3. For $\alpha \in \left(\frac{\sqrt{33}-5}{2}, \sqrt{2}-1\right)$ the natural extension can be build as in Figure 4.17. Moreover the invariant density is given by

$$f(x) = H\left(\frac{D}{2+Dx} \mathbf{1}_{(\alpha, T(\alpha+1))} + \frac{E}{2+Ex} \mathbf{1}_{(T(\alpha+1), T^2(\alpha))} + \frac{F}{2+Fx} \mathbf{1}_{(T^2(\alpha), \alpha+1)}\right. \\ \left. - \frac{A}{2+Ax} \mathbf{1}_{(\alpha, T^2(\alpha+1))} - \frac{B}{2+Bx} \mathbf{1}_{(T^2(\alpha+1), T(\alpha))} - \frac{C}{2+Cx} \mathbf{1}_{(T(\alpha), \alpha+1)}\right)$$

with $A = \frac{\sqrt{33}-5}{2}, B = \sqrt{2}-1, C = \frac{\sqrt{33}-3}{6}, D = 2\sqrt{2}-2, E = \frac{\sqrt{33}-3}{2}, F = \sqrt{2}$ and $H^{-1} = \log\left(\frac{1}{32}(3+2\sqrt{2})(7+\sqrt{33})(\sqrt{33}-5)^2\right) \approx 0.25$ the normalising constant.

Proof. We guessed the shape of the domain of natural extension by studying a simulation. For the map on this domain we used $\mathcal{T}(x, y) = \left(T(x), \frac{2}{d_1(x)+y}\right)$.

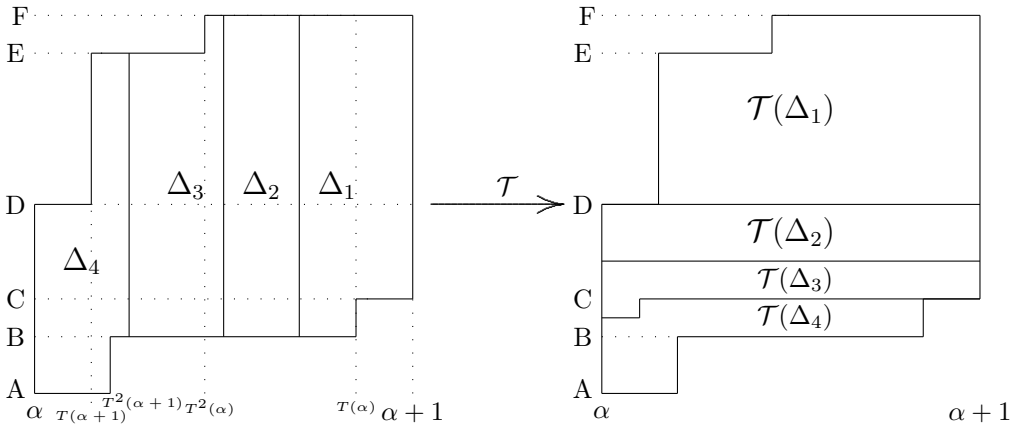

Figure 4.17: Ω and $\mathcal{T}(\Omega)$ with $\alpha \in K_1$.

For $\alpha \in K_1$, we find the following equations:

$$\begin{array}{ll} A = \frac{2}{4+E} & A = \frac{\sqrt{33}-5}{2} \\ B = \frac{2}{4+D} & B = \sqrt{2}-1 \\ C = \frac{2}{3+E} & C = \frac{\sqrt{33}-3}{6} \\ D = \frac{2}{2+A} & D = 2\sqrt{2}-2 \\ E = \frac{2}{1+C} & E = \frac{\sqrt{33}-3}{2} \\ F = \frac{2}{1+B} & F = \sqrt{2}. \end{array} \quad \text{implying that}$$

A similar picture emerges for $\alpha \in K_2$ and $\alpha \in K_3$. Moreover, you will find the same set of equations and thus the same heights! Note that for $\alpha < \frac{2}{5}$ we have $T^2(\alpha) < T(\alpha)$, for $\alpha = \frac{2}{5}$ we have $T^2(\alpha) = T(\alpha)$ and for $\alpha > \frac{2}{5}$ we have $T^2(\alpha) > T(\alpha)$. When you integrate over the second coordinate you find the density given in the statement of

the theorem. For the normalising constant we have the following integral

$$\begin{aligned} H &= \int_{\alpha}^{\alpha+1} \frac{D}{2+Dx} \mathbf{1}_{(\alpha, T(\alpha+1))} \cdots - \frac{C}{2+Cx} \mathbf{1}_{(T(\alpha), \alpha+1)} dx \\ &= \log \left(\frac{2+DT(\alpha+1)}{2+D\alpha} \right) + \dots + \log \left(\frac{2+CT(\alpha)}{2+C(\alpha+1)} \right). \end{aligned}$$

It seems that H depends on α but this is not the case as the following calculation shows

$$\begin{aligned} H &= -\log \left(\frac{2+A\frac{6\alpha-2}{1-\alpha}}{2+A\alpha} \right) - \log \left(\frac{2+B\frac{2-4\alpha}{\alpha}}{2+B\frac{6\alpha-2}{1-\alpha}} \right) - \log \left(\frac{2+C(\alpha+1)}{2+C\frac{2-4\alpha}{\alpha}} \right) \\ &\quad + \log \left(\frac{2+D\frac{1-\alpha}{\alpha+1}}{2+D\alpha} \right) + \log \left(\frac{2+E\frac{3\alpha-1}{1-2\alpha}}{2+E\frac{1-\alpha}{\alpha+1}} \right) + \log \left(\frac{2+F(\alpha+1)}{2+F\frac{3\alpha-1}{1-2\alpha}} \right) \\ &= -\log \left(\frac{2-2\alpha+A(6\alpha-2)}{2+A\alpha} \right) + \log(1-\alpha) \\ &\quad - \log \left(\frac{2\alpha+B(2-4\alpha)}{2-2\alpha+B(6\alpha-2)} \right) + \log(\alpha) - \log(1-\alpha) \\ &\quad - \log \left(\frac{2+C(\alpha+1)}{2\alpha+C(2-4\alpha)} \right) - \log(\alpha) \\ &\quad + \log \left(\frac{2\alpha+2+D(1-\alpha)}{2+D\alpha} \right) - \log(\alpha+1) \\ &\quad + \log \left(\frac{2-4\alpha+E(3\alpha-1)}{2\alpha+2+E(1-\alpha)} \right) + \log(\alpha+1) - \log(1-2\alpha) \\ &\quad + \log \left(\frac{2+F(\alpha+1)}{2-4\alpha+F(3\alpha-1)} \right) + \log(1-2\alpha) \\ &= -\log \left(\frac{2-2\alpha+\frac{\sqrt{33}-5}{2}(6\alpha-2)}{2+\frac{\sqrt{33}-5}{2}\alpha} \right) - \log \left(\frac{2\alpha+(\sqrt{2}-1)(2-4\alpha)}{2-2\alpha+(\sqrt{2}-1)(6\alpha-2)} \right) \\ &\quad - \log \left(\frac{2+\frac{\sqrt{33}-3}{6}(\alpha+1)}{2\alpha+\frac{\sqrt{33}-3}{6}(2-4\alpha)} \right) + \log \left(\frac{2\alpha+2+(2\sqrt{2}-2)(1-\alpha)}{2+(2\sqrt{2}-2)\alpha} \right) \\ &\quad + \log \left(\frac{2-4\alpha+(\frac{\sqrt{33}-3}{2})(3\alpha-1)}{2\alpha+2+(\frac{\sqrt{33}-3}{2})(1-\alpha)} \right) + \log \left(\frac{2+\sqrt{2}(\alpha+1)}{2-4\alpha+\sqrt{2}(3\alpha-1)} \right) \\ &= -\log\left(\frac{7-\sqrt{33}}{2}\right) - \log\left(\frac{1}{\sqrt{2}}\right) - \log\left(\frac{5+\sqrt{33}}{4}\right) + \log(\sqrt{2}) + \log\left(\frac{\sqrt{33}-5}{4}\right) \\ &\quad + \log(3+2\sqrt{2}). \end{aligned}$$

□

One might hope that when calculating the entropy using Rohlin's formula, terms will cancel as well. These integrals result in Li_2 functions depending on α and things are

not so easy anymore. We provide a more elegant proof to show that the entropy is constant on $\left(\frac{\sqrt{33}-5}{2}, \sqrt{2}-1\right)$ and calculate the entropy for $\alpha = \sqrt{2}-1$ afterwards. We will use quilting introduced in [65]. Proposition 1 in [65] can be formulated (specific to our case) in the following way:

Proposition 4.3.4 ([65], Proposition 1). *Let $(\mathcal{T}_\alpha, \Omega_\alpha, \mathcal{B}_\alpha, \mu)$ and $(\mathcal{T}_\beta, \Omega_\beta, \mathcal{B}_\beta, \mu)$ be two dynamical systems as in our setting. Furthermore let $D_1 = \Omega_\alpha \setminus \Omega_\beta$ and $A_1 = \Omega_\beta \setminus \Omega_\alpha$. If there is a $k \in \mathbb{N}$ such that $\mathcal{T}_\alpha^k(D_1) = \mathcal{T}_\beta^k(A_1)$ then the dynamical systems are isomorphic.*

Since isomorphic systems have the same entropy it will give us the following corollary.

Corollary 4.3.5. *For $N = 2$ the entropy function is constant on $\left(\frac{\sqrt{33}-5}{2}, \sqrt{2}-1\right)$ and the value is approximately 1.14.*

Proof. We show that for $k = 3$ we satisfy the condition in Proposition 4.3.4. Define $D_i = \mathcal{T}_\alpha^{i-1}(D_1)$ and $A_i = \mathcal{T}_\beta^{i-1}(A_1)$ for $i = 1, 2, 3, 4$. We find the following regions (see Figure 4.18):

$$\begin{aligned} D_1 &= [\alpha, \beta] \times [A, D], \\ D_2 &= [T_{\alpha,2}(\beta), T_{\alpha,2}(\alpha)] \times [B, C], \\ D_3 &= [T_{\alpha,2}^2(\beta), T_{\alpha,2}^2(\alpha)] \times [E, F], \\ D_4 &= [T_{\alpha,2}^3(\beta), T_{\alpha,2}^3(\alpha)] \times \left[\frac{2}{3+F}, \frac{2}{3+E} \right], \\ A_1 &= [\alpha+1, \beta+1] \times [C, F], \\ A_2 &= [T_{\beta,2}(\beta+1), T_{\beta,2}(\alpha+1)] \times [D, E], \\ A_3 &= [T_{\beta,2}^2(\beta+1), T_{\beta,2}^2(\alpha+1)] \times [A, B], \\ A_4 &= [T_{\beta,2}^3(\beta+1), T_{\beta,2}^3(\alpha+1)] \times \left[\frac{2}{4+B}, \frac{2}{4+A} \right]. \end{aligned}$$

Note that since we have matching $[T_{\beta,2}^3(\beta), T_{\alpha,2}^3(\alpha)] = [T_{\beta,2}^3(\beta+1), T_{\alpha,2}^3(\alpha+1)]$. Now

$$\begin{aligned} \frac{2}{3+F} &= \frac{2}{3+\sqrt{2}} = \frac{2}{4+B} = \frac{2}{4+\sqrt{2}-1}, \\ \frac{2}{3+E} &= \frac{2}{3+\frac{\sqrt{33}-3}{2}} = \frac{2}{4+A} = \frac{2}{4+\frac{\sqrt{33}-5}{2}} \end{aligned}$$

and so we find $D_4 = A_4$.

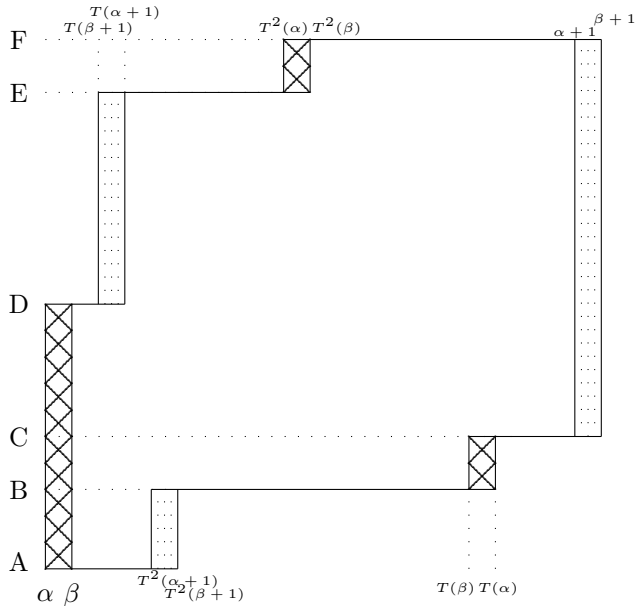

Figure 4.18: Illustration of the quilting.

For the value of the entropy we use Rohlin's formula for $\alpha = \sqrt{2} - 1$ (see [29, 98]);

$$\begin{aligned}
 h(T_{\sqrt{2}-1,2}) &= \int_{\sqrt{2}-1}^{\sqrt{2}} \log |T'_{\sqrt{2}-1,2}(x)| f(x) dx \\
 &= H \int_{\sqrt{2}-1}^{\sqrt{2}} (\log(2) - 2 \log(x)) f(x) dx \\
 &= \log(2) - 2H \int_{\sqrt{2}-1}^{\sqrt{2}} \log(x) f(x) dx \\
 &= \log(2) - 2H \int_{\sqrt{2}-1}^{\sqrt{2}} \log(x) \left(\left(\frac{\sqrt{33}-3}{4+(\sqrt{33}-3)x} - \frac{\sqrt{33}-5}{4+(\sqrt{33}-5)x} \right) \mathbf{1}_{\sqrt{2}-1,2(\sqrt{2}-1)} \right. \\
 &\quad \left. + \left(\frac{\sqrt{33}-3}{4+(\sqrt{33}-3)x} - \frac{\sqrt{33}-3}{12+(\sqrt{33}-3)x} \right) \mathbf{1}_{2(\sqrt{2}-1),\sqrt{2}} \right) dx \\
 &= \log(2) - 2H \left(\left(Li_2 \left(-\frac{x(\sqrt{33}-3)}{4} \right) + \log \left(\frac{x(\sqrt{33}-3)}{4} + 1 \right) \right. \right. \\
 &\quad \left. \left. - Li_2 \left(-\frac{x(\sqrt{33}-5)}{4} \right) + \log \left(\frac{x(\sqrt{33}-5)}{4} + 1 \right) \right) \Big|_{\sqrt{2}-1}^{2(\sqrt{2}-1)} \right. \\
 &\quad \left. + \left(Li_2 \left(-\frac{x(\sqrt{33}-3)}{4} \right) + \log \left(\frac{x(\sqrt{33}-3)}{4} + 1 \right) \right. \right. \\
 &\quad \left. \left. - Li_2 \left(-\frac{x(\sqrt{33}-5)}{12} \right) + \log \left(\frac{x(\sqrt{33}-5)}{12} + 1 \right) \right) \Big|_{2(\sqrt{2}-1)}^{\sqrt{2}} \right) \\
 &\approx 1.14.
 \end{aligned}$$

□

By looking at the graph displayed in Figure 4.15 we cannot find other matching exponents easily. To check for other matching exponents we can do the following. Suppose we are interested in finding a matching interval with exponents (n_1, n_2) . We select a large number of random points (say 10 000) from $(0, \sqrt{N} - 1)$. Then we look at $T_{\alpha,2}^{n_1}(\alpha) - T_{\alpha,2}^{n_2}(\alpha + 1)$ for these random points and we check whether it is very close to 0. Note that if an interval was found this way with matching exponents (n_1, n_2) then we also find the same interval for $(n_1 + 1, n_2 + 1)$. Table 4.1 shows which matching exponents we found. This is very different from Nakada's α -continued fractions where

M \ K	1	2	3	4	5	6	7	8	9	10
1	0	0	1	0	1	0	0	0	0	0
2	0	0	0	1	0	1	0	0	0	0
3	0	0	1	0	1	0	1	0	1	0
4	0	0	0	1	0	1	0	1	0	1
5	0	0	0	0	1	0	1	0	1	0
6	0	0	0	0	0	1	0	1	0	1
7	0	0	0	0	0	0	1	0	1	0
8	0	0	0	0	0	0	0	1	0	1
9	0	0	0	0	0	0	0	0	1	0
10	0	0	0	0	0	0	0	1	0	1

Table 4.1: observed matching exponents for $N = 2$: 1 if seen, 0 if not.

you can find all possible matching exponents. The fact that we did not observe them does not mean they are not there. Maybe they are too small to observe using this method.

The entropy of 36_α -expansions

For $N \geq 9$ we expect different behaviour because we know that for some α there is at least one subinterval on which the invariant measure is zero. If we pick $N = 36$ we have a map with only full branches for $\alpha = 1, 2, 3$. Figure 4.19 shows the entropy as function of α . The stars indicate those values which we could calculate theoretically.

Clearly, we can observe plateaus however, if we look at the matching exponents we can observe that for all $M, K \leq 10$ the only matching exponents we find are (n, n) with $n \in \{3, 4, \dots, 10\}$.

§4.4 Conclusion

We have seen that the general form of the examples given yields a rather large family. In some examples we were able to construct the natural extension and therefore to find the invariant measure. In other examples this was not the case. There does not seem to be an easy rule which tells us when the method works and when it does not.

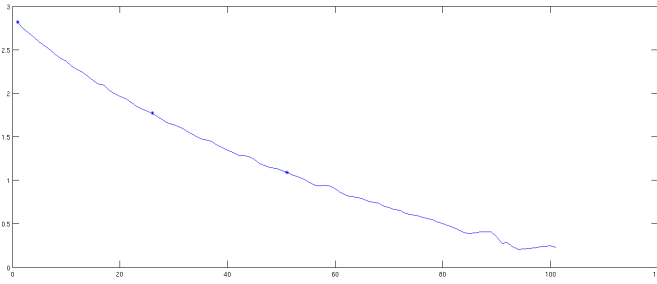
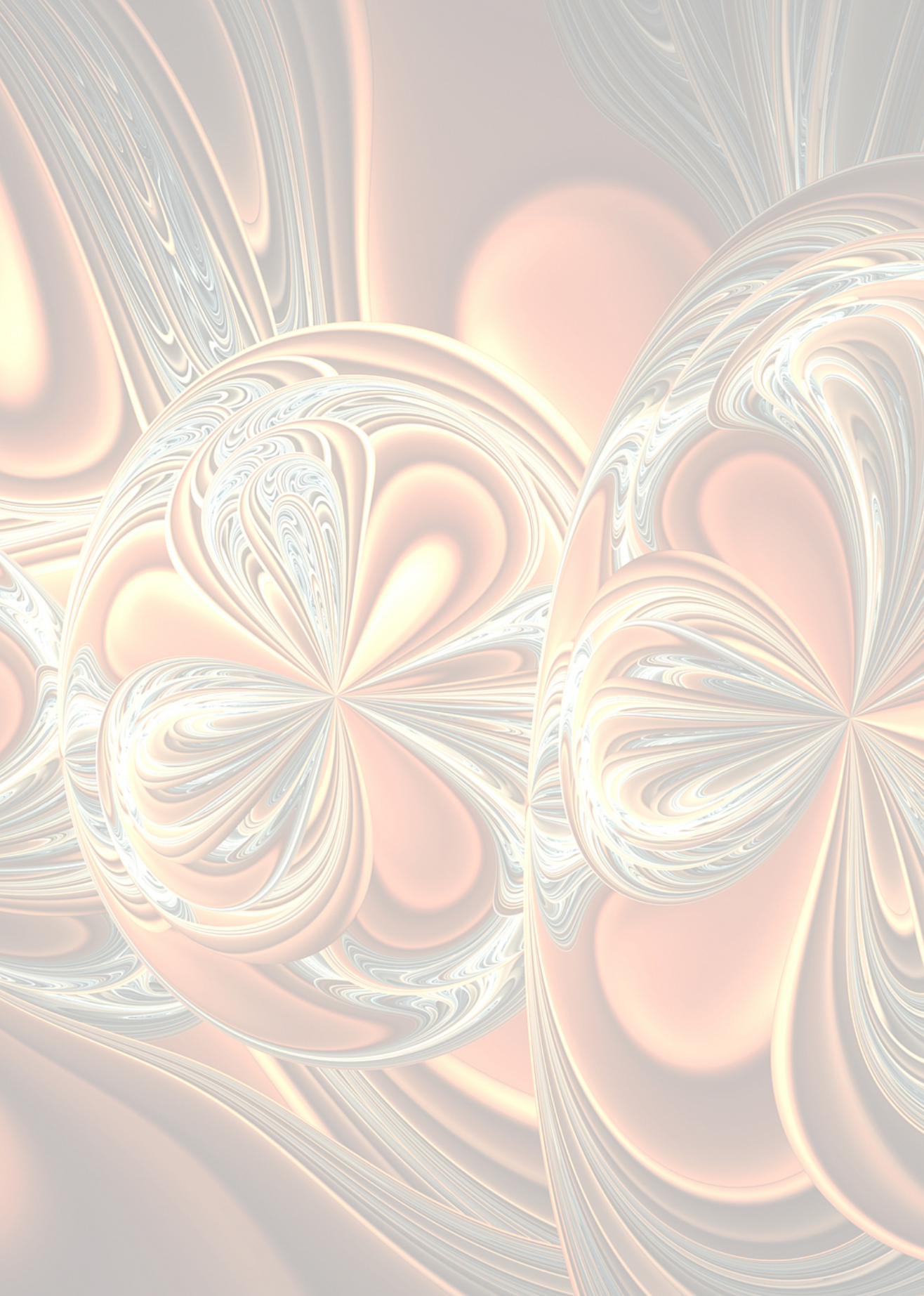

Figure 4.19: Entropy as function of α for $N = 36$.

The subfamily of the N -expansions we studied is not new, but it has not been studied in this detail with finitely many digits. Note that having the Gauss-Kuzmin-Lévy method for approximating the densities allowed us to study the entropy much easier due to much shorter computation time. We have seen that matching is helpful to prove monotonicity even though we did not mimic the proof for α -expansions. Motivated by similar results in the case of Nakada's α -expansions the following questions about entropy arise:

- For every $N \in \mathbb{N}_{\geq 2}$ is there an interval in $(0, \sqrt{N} - 1)$ for which the entropy function is constant?
- For a fixed $N \in \mathbb{N}_{\geq 2}$ for which $\alpha \in (0, \sqrt{N} - 1)$ do we have matching?
- Does matching hold on an open dense set? Does matching hold almost everywhere?
- What is the influence of an attractor strictly smaller than the interval $[\alpha, \alpha + 1]$ on the entropy?



CHAPTER 5

β -expansions

This chapter is joint work with Charlene Kalle, Derong Kong, and Wenxia Li and has been accepted by the journal *Ergodic Theory and Dynamical Systems*, except for Section 5.6.1 where we give some relations to other topics.

Abstract

For $\beta \in (1, 2]$ the β -transformation $T_\beta : [0, 1) \rightarrow [0, 1)$ is defined by $T_\beta(x) = \beta x \pmod{1}$. For $t \in [0, 1)$ let $K_\beta(t)$ be the survivor set of T_β with hole $(0, t)$ given by

$$K_\beta(t) := \{x \in [0, 1) : T_\beta^n(x) \notin (0, t) \text{ for all } n \geq 0\}.$$

In this chapter, we characterise the bifurcation set E_β of all parameters $t \in [0, 1)$ for which the set-valued function $t \mapsto K_\beta(t)$ is not locally constant. We show that E_β is a Lebesgue null set of full Hausdorff dimension for all $\beta \in (1, 2)$. We prove that for Lebesgue almost every $\beta \in (1, 2)$ the bifurcation set E_β contains both infinitely many isolated and accumulation points arbitrarily close to zero. On the other hand, we show that the set of $\beta \in (1, 2)$ for which E_β contains no isolated points has zero Hausdorff dimension. These results contrast with the situation for E_2 , the bifurcation set of the doubling map. Finally, we give for each $\beta \in (1, 2)$ a lower and upper bound for the value τ_β such that the Hausdorff dimension of $K_\beta(t)$ is positive if and only if $t < \tau_\beta$. We show that $\tau_\beta \leq 1 - \frac{1}{\beta}$ for all $\beta \in (1, 2)$.

§5.1 Introduction

In recent years open dynamical systems, i.e. systems with a hole in the state space through which mass can leak away at every iteration, have received a lot of attention. Typically one wonders about the rate at which mass leaves the system and about the size and structure of the set of points that remain, called the *survivor set*. In [104, 105] Urbański considered C^2 -expanding, orientation preserving circle maps with a hole of the form $(0, t)$. He studied the way in which the topological entropy of such a map restricted to the survivor set changes with t . To be more precise, let g be a C^2 -expanding and orientation preserving map on the circle $\mathbb{R}/\mathbb{Z} \sim [0, 1)$. For $t \in [0, 1)$, let $K_g(t)$ be the survivor set defined by

$$K_g(t) := \{x \in [0, 1) : g^n(x) \notin (0, t) \text{ for all } n \geq 0\}.$$

Urbański proved that the function $t \mapsto h_{top}(g|K_g(t))$ is a Devil's staircase, where h_{top} denotes the topological entropy.

Motivated by the work of Urbański, we consider this situation for the β -transformation. Given $\beta \in (1, 2]$, the β -transformation $T_\beta : [0, 1) \rightarrow [0, 1)$ is defined by $T_\beta(x) = \beta x \pmod{1}$. When $\beta = 2$, we recover the doubling map. In correspondence with [104], set

$$K_\beta(t) := \{x \in [0, 1) : T_\beta^n(x) \notin (0, t) \text{ for all } n \geq 0\}. \quad (5.1.1)$$

The survivor set $K_\beta(t)$ splits naturally into two pieces, $K_\beta(t) = K_\beta^0(t) \cup K_\beta^+(t)$, where

$$\begin{aligned} K_\beta^0(t) &= \{x \in [0, 1) : \exists n \ T_\beta^n(x) = 0 \text{ and } T_\beta^k(x) \notin (0, t) \text{ for all } 0 \leq k < n\}, \\ K_\beta^+(t) &= \{x \in [0, 1) : T_\beta^n(x) \geq t \text{ for all } n \geq 0\}. \end{aligned} \quad (5.1.2)$$

The set $K_\beta^+(t)$ occurs in Diophantine approximation. Indeed, consider the set

$$F_\beta(t) := \{x \in [0, 1) \mid T_\beta^n(x) \geq t \text{ for all but finitely many } n \in \mathbb{N}\}$$

of points $x \geq 0$ such that 0 is badly approximable by its orbit under T_β . Then $F_\beta(t)$ can be written as a countable union of affine copies of $K_\beta^+(t)$ and thus $\dim_H F_\beta(t) = \dim_H K_\beta^+(t)$ for all $t \in [0, 1)$. The approximation properties of β -expansions have been studied by several authors. In [74] the authors considered the Hausdorff dimension of the set of values $\beta > 1$ for which the orbit of 1 approaches a given target value x_0 at a given speed. This work generalised that of [90], where $x_0 = 0$ and the speed is fixed. Other results on the Diophantine approximation properties of β -expansions can be found in [13, 16, 41, 77, 86] among others.

Note that the set valued map $\epsilon \mapsto K_\beta(\epsilon)$ is weakly decreasing. Further on we show that this map is locally constant almost everywhere, i.e., for almost all $t \in [0, 1)$ there exists a $\delta > 0$ such that $K_\beta(\epsilon) = K_\beta(t)$ for all $\epsilon \in [t - \delta, t + \delta]$. Such a result was also obtained by Urbański in [104] for C^2 -expanding circle maps. This fact motivates the study of the *right set valued bifurcation set* (simply called *bifurcation set*) E_β

containing all parameters $t \in [0, 1)$ such that the set valued map $\epsilon \mapsto K_\beta(\epsilon)$ is not locally constant on any right-sided neighbourhood of t , i.e.,

$$E_\beta := \{t \in [0, 1) : K_\beta(\epsilon) \neq K_\beta(t) \text{ for any } \epsilon > t\}. \quad (5.1.3)$$

The local structure of the sets $K_2(t)$ and E_2 was investigated in detail in [86, 104]. The following results can be found more or less explicitly in [104]. More recently it was shown in [86] that these properties could be also be dealt with using more elementary combinatorial methods.

Theorem 5.1.1 (Urbański [104]).

- (i) *The bifurcation set E_2 is a Lebesgue null set of full Hausdorff dimension.*
- (ii) *The function $\eta_2 : t \mapsto \dim_H K_2(t)$ is a Devil's staircase:*
 - η_2 is decreasing and continuous on $[0, \frac{1}{2}]$;
 - $\eta_2'(t) = 0$ for Lebesgue almost every $t \in [0, \frac{1}{2}]$;
 - $\eta_2(0) = 1$ and $\eta_2(\frac{1}{2}) = 0$.
- (iii) *The topological closure $\overline{E_2}$ is a Cantor set.*
- (iv) $\eta_2(t) > 0$ if and only if $t < \frac{1}{2}$.

Other results on survivor sets for the doubling map T_2 can be found in e.g. [2, 14, 20, 37, 44, 100].

An important ingredient for the proofs in [20, 104] is the fact that

$$E_2 = \{t \in [0, 1) : T_2^n(t) \geq t \text{ for all } n \geq 0\}.$$

This identity does not hold in general for $1 < \beta < 2$. Therefore, we define E_β^+ by

$$E_\beta^+ := \{t \in [0, 1) : T_\beta^n(t) \geq t \text{ for all } n \geq 0\}. \quad (5.1.4)$$

Note that $E_\beta^+ \subseteq E_\beta$ but in general these sets do not coincide. In this paper we consider the survivor set $K_\beta(t)$ and the bifurcation set E_β for $\beta \in (1, 2)$. We give a detailed description of the topological structure of E_β and E_β^+ and their dependence on β . Theorems 5.1.2 to 5.1.5 below list our main results. Our first result strengthens (i) and (ii) of Theorem 5.1.1.

Theorem 5.1.2. *Let $\beta \in (1, 2]$ and $t \in [0, 1)$.*

- (i) *The bifurcation sets E_β and E_β^+ are Lebesgue null sets of full Hausdorff dimension.*
- (ii) *The dimension function $\eta_\beta : t \mapsto \dim_H K_\beta(t)$ is a Devil's staircase:*
 - η_β is decreasing and continuous in $[0, 1)$;
 - $\eta_\beta' = 0$ Lebesgue almost everywhere in $[0, 1)$;
 - η_β is not constant.

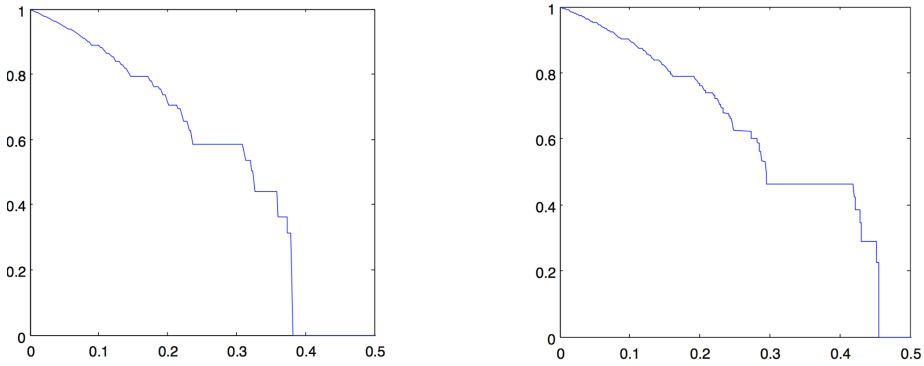

Figure 5.1: Left: the numerical plot of η_β with $\beta \approx 1.61803$ the golden ratio. Right: the numerical plot of η_β with $\beta \approx 1.83929$ the tribonacci number.

Figure 5.1 shows numerical plots of the dimension functions η_β for $\beta \approx 1.61803$, the golden ratio, i.e. the real root bigger than 1 of the polynomial $x^2 - x - 1$ and for $\beta \approx 1.83929$, the tribonacci number, i.e. the real root bigger than 1 of the polynomial $x^3 - x^2 - x - 1$.

The analogous statements of (iii) and (iv) of Theorem 5.1.1 for $\beta \in (1, 2)$ do not always hold. The next main theorems show that in general the topological structure of E_β differs from that of E_2 and that this structure depends on the value of β . Theorems 5.1.3 and 5.1.4 imply that (iii) of Theorem 5.1.1 holds only for a very small set of $\beta \in (1, 2)$.

Theorem 5.1.3. *For Lebesgue almost every $\beta \in (1, 2)$ the bifurcation sets E_β and E_β^+ contain infinitely many isolated and accumulation points arbitrarily close to zero and hence their closures are not Cantor sets. On the other hand,*

$$\dim_H \left(\{ \beta \in (1, 2) : \exists \delta > 0 \text{ such that } \overline{E_\beta^+} \cap [0, \delta] \text{ is a Cantor set} \} \right) = 1.$$

There are also infinitely many $\beta \in (1, 2]$ such that $\overline{E_\beta^+}$ is a Cantor set. This is true, for example, for the countable family of multinacci numbers. In terms of Hausdorff dimension this set is small.

Theorem 5.1.4. *We have $\dim_H \left(\{ \beta \in (1, 2) : \overline{E_\beta^+} \text{ is a Cantor set} \} \right) = 0$.*

In [24] Clark considered the β -transformation and characterised the holes of the form (a, b) for which the survivor set $K_\beta((a, b))$ is uncountable or not. From the properties of η_β given in Theorem 5.1.2 it follows that for each $\beta \in (1, 2]$, there is a unique value τ_β such that $\dim_H K_\beta(t) > 0$ if and only if $t < \tau_\beta$. By (iv) of Theorem 5.1.1 we know $\tau_2 = \frac{1}{2}$. We have the following result on τ_β .

Theorem 5.1.5. *For each $\beta \in (1, 2]$ we have $\tau_\beta \leq 1 - \frac{1}{\beta}$, and $\tau_\beta = 1 - \frac{1}{\beta}$ if and only if $\overline{E_\beta^+}$ is a Cantor set.*

In [85] Nilsson studied the critical value $\tilde{\tau}_\beta$ for the β -transformation with holes of the form $(t, 1)$. In [85, Theorem 7.11] he proved that for each $\beta \in (1, 2)$ it holds that $\tilde{\tau}_\beta = 1 - \frac{1}{\beta}$. Many of the proofs use the symbolic codings of the open systems T_β with hole $(t, 1)$. The main difficulty that we had to overcome in order to extend the results from the doubling map to the β -transformation is that the β -transformation is not coded by the full shift on two symbols. In fact, for most values of β , the associated symbolic system is not even sofic. This might also explain the difference between the result from Theorem 5.1.5 and the result from [85, Theorem 7.11].

The paper is arranged as follows. In Section 5.2 we introduce some notation, we recall some basic properties of β -expansions and prove Theorem 5.1.2. In Section 5.3 we consider the topological structure of E_β and E_β^+ and prove Theorem 5.1.3. By means of Lyndon words we construct infinitely many nested basic intervals which cover the interval $(1, 2)$ up to a Lebesgue null set. We can determine all isolated points of E_β^+ by determining in which intervals it falls. The largest of these intervals are then associated to Farey words, the properties of which allow us to prove Theorem 5.1.4 in Section 5.4 and Theorem 5.1.5 in Section 5.5.

§5.2 Preliminaries, β -expansions and first properties of $K_\beta(t)$ and E_β

In this section we introduce some notation about sequences that is used throughout the paper. We will recall some basic properties of β -transformations and give some basic results on $K_\beta(t)$ and E_β . We also prove Theorem 5.1.2.

§5.2.1 Notation on sequences

Let $\{0, 1\}^{\mathbb{N}}$ be the set of sequences of 0's and 1's and let σ be the left shift on $\{0, 1\}^{\mathbb{N}}$ defined by $\sigma((x_i)) = (x_{i+1})$. We use $\{0, 1\}^*$ to denote the set of all finite strings of elements from $\{0, 1\}$, called *words*. A word $w \in \{0, 1\}^n$ is called a *prefix* of a sequence $(x_i) \in \{0, 1\}^{\mathbb{N}}$ if $x_1 \dots x_n = w$. For a word $w = w_1 \dots w_n \in \{0, 1\}^*$ we write $w^+ := w_1 \dots w_{n-1}(w_n + 1)$ if $w_n = 0$ and we write $w^- := w_1 w_2 \dots w_{n-1}(w_n - 1)$ if $w_n = 1$. Furthermore, we use \bar{w} to denote the *reflection word* $\bar{w} := (1 - w_1)(1 - w_2) \dots (1 - w_n)$.

Throughout the paper we use the lexicographical ordering \prec, \preceq, \succ and \succcurlyeq between sequences and words, which is defined as follows. For two sequences $(x_i), (y_i) \in \{0, 1\}^{\mathbb{N}}$ we write $(x_i) \prec (y_i)$ or $(y_i) \succ (x_i)$ if $x_1 < y_1$, or there is an integer $m \geq 2$ such that $x_i = y_i$ for all $i < m$ and $x_m < y_m$. Moreover, we say $(x_i) \preceq (y_i)$ or $(y_i) \succcurlyeq (x_i)$ if $(x_i) \prec (y_i)$ or $(x_i) = (y_i)$. This definition can be extended to words in the following way. For $u, v \in \{0, 1\}^*$, we write $u \prec v$ if and only if $u0^\infty \prec v0^\infty$.

Let $\#A$ denote the cardinality of the set A . For a subset $\mathcal{Y} \subseteq \{0, 1\}^{\mathbb{N}}$, let $\mathcal{B}_n(\mathcal{Y})$ denote the set of all words of length n that occur in a sequence in \mathcal{Y} . The *topological*

entropy of \mathcal{Y} is then given by

$$h(\mathcal{Y}) := \lim_{n \rightarrow \infty} \frac{\log \#\mathcal{B}_n(\mathcal{Y})}{n} = \inf_n \frac{\log \#\mathcal{B}_n(\mathcal{Y})}{n},$$

where the second equality holds since by the definition of $\mathcal{B}_n(\mathcal{Y})$ the sequence $(\log \#\mathcal{B}_n(\mathcal{Y}))$ is sub-additive. Here and throughout the paper we will use the base 2 logarithm.

§5.2.2 The β -transformation and β -expansions

Now we recall some properties of the β -transformation. Let $\beta \in (1, 2]$ and let the (greedy) β -transformation $T_\beta : [0, 1) \rightarrow [0, 1)$ be given as in the introduction, i.e., $T_\beta(x) = \beta x \pmod{1}$. It has a unique ergodic invariant measure that is equivalent to the Lebesgue measure (cf. [94]). This measure is the unique measure of maximal entropy with entropy equal to $\log \beta$. For each $x \in [0, 1)$ the *greedy β -expansion* of x , denoted by $b(x, \beta) = (b_i(x, \beta))$, is the sequence obtained from T_β by setting for each $i \geq 1$,

$$b_i(x, \beta) = \begin{cases} 0, & \text{if } T_\beta^{i-1}(x) \in [0, \frac{1}{\beta}), \\ 1, & \text{if } T_\beta^{i-1}(x) \in [\frac{1}{\beta}, 1). \end{cases}$$

The name greedy β -expansion stems from the fact that it is the lexicographically largest sequence $(x_i) \in \{0, 1\}^{\mathbb{N}}$ satisfying

$$x = \sum_{i \geq 1} \frac{x_i}{\beta^i} =: \pi_\beta((x_i)). \tag{5.2.1}$$

We write $b(1, \beta)$ for the sequence $1b(\beta - 1, \beta)$.

The set of sequences that occur as greedy β -expansions for a given β can be characterised using quasi-greedy β -expansions. For each $x \in (0, 1]$ the quasi-greedy β -expansion of x is obtained dynamically by iterating the map $\tilde{T}_\beta : (0, 1] \rightarrow (0, 1]$ given by

$$\tilde{T}_\beta(x) = \begin{cases} \beta x, & \text{if } x \in (0, \frac{1}{\beta}], \\ \beta x - 1, & \text{if } x \in (\frac{1}{\beta}, 1]. \end{cases}$$

The only essential difference between the maps T_β and \tilde{T}_β is the value they take at the point $\frac{1}{\beta}$. For $x \in (0, 1]$ the *quasi-greedy β -expansion* $\tilde{b}(x, \beta) = (\tilde{b}_i(x, \beta))$ is then obtained by setting $\tilde{b}_i(x, \beta) = 0$, if $0 < \tilde{T}_\beta^{i-1}(x) \leq \frac{1}{\beta}$ and $\tilde{b}_i(x, \beta) = 1$, if $\frac{1}{\beta} < \tilde{T}_\beta^{i-1}(x) \leq 1$. The quasi-greedy β -expansion of 1 plays a crucial role in what follows. For $\beta \in (1, 2]$, write

$$\alpha(\beta) := \tilde{b}(1, \beta).$$

Note that if $b(x, \beta) = b_1 \dots b_n 0^\infty$ with $b_n = 1$, then $\tilde{b}(x, \beta) = b_1 \dots b_n^- \alpha(\beta)$. On the other hand, if $b(x, \beta)$ does not end with 0^∞ , then $b(x, \beta) = \tilde{b}(x, \beta)$. The following characterisation of $\alpha(\beta)$ can be found in [61, Theorem 2.3]. Let $\mathcal{Q} \subset \{0, 1\}^{\mathbb{N}}$ be the set of sequences $(a_i) \in \{0, 1\}^{\mathbb{N}}$ not ending with 0^∞ and satisfying

$$a_{n+1}a_{n+2} \dots \preceq a_1a_2 \dots \quad \text{for all } n \geq 0. \tag{5.2.2}$$

Lemma 5.2.1. *The map $\beta \mapsto \alpha(\beta)$ is a strictly increasing bijection between the interval $(1, 2]$ and the set \mathcal{Q} .*

For a given β , the sequence $\alpha(\beta)$ determines the set of all greedy β -expansions in the following way. Let Σ_β be the set of all greedy β -expansions of $x \in [0, 1)$. Then (cf. [88])

$$\Sigma_\beta = \{(x_i) \in \{0, 1\}^{\mathbb{N}} : \sigma^n((x_i)) \prec \alpha(\beta) \text{ for all } n \geq 0\}.$$

Similarly, let $\tilde{\Sigma}_\beta$ be the set of all quasi-greedy β -expansions of $x \in (0, 1]$. Then

$$\tilde{\Sigma}_\beta = \{(x_i) \in \{0, 1\}^{\mathbb{N}} : 0^\infty \prec \sigma^n((x_i)) \preceq \alpha(\beta) \text{ for all } n \geq 0\}.$$

The following result can be found in [88] (see also [36]).

Lemma 5.2.2. *Let $\beta \in (1, 2]$. The map $x \mapsto b(x, \beta)$ is a strictly increasing bijection from $[0, 1)$ to Σ_β and is right-continuous w.r.t. the ordering topology on Σ_β . On the other hand, the map $x \mapsto \tilde{b}(x, \beta)$ is a strictly increasing bijection from $(0, 1]$ to $\tilde{\Sigma}_\beta$ and it is left-continuous w.r.t. the ordering topology on $\tilde{\Sigma}_\beta$.*

§5.2.3 First properties of $K_\beta(t)$ and E_β

Let $t \in [0, 1)$ be given. Recall the definitions of the survivor set $K_\beta(t) = K_\beta^0(t) \cup K_\beta^+(t)$ from (5.1.1) and (5.1.2). We define the corresponding *symbolic survivor sets* as the set of all greedy β -expansions of elements in the sets $K_\beta(t)$, $K_\beta^0(t)$ and $K_\beta^+(t)$ respectively. Lemma 5.2.2 gives the following descriptions:

$$\begin{aligned} \mathcal{K}_\beta^+(t) &= \{(x_i) \in \{0, 1\}^{\mathbb{N}} : b(t, \beta) \preceq \sigma^n((x_i)) \prec \alpha(\beta) \forall n \geq 0\}, \\ \mathcal{K}_\beta^0(t) &= \{(x_i) \in \{0, 1\}^{\mathbb{N}} : \exists n \geq 0 \sigma^n((x_i)) = 0^\infty \\ &\quad \text{and } b(t, \beta) \preceq \sigma^k((x_i)) \prec \alpha(\beta) \forall 0 \leq k < n\}, \\ \mathcal{K}_\beta(t) &= \mathcal{K}_\beta^+(t) \cup \mathcal{K}_\beta^0(t). \end{aligned} \tag{5.2.3}$$

We will often switch from $K_\beta(t)$ to $\mathcal{K}_\beta(t)$ and back. The set $K_\beta(t)$ is closed and T_β is continuous when restricted to $K_\beta(t)$. Under the metric d on $\{0, 1\}^{\mathbb{N}}$ given by

$$d((x_i), (y_i)) = \beta^{-\inf\{n \geq 1 : x_n \neq y_n\}},$$

the map $\pi_\beta : (\mathcal{K}_\beta(t), \sigma) \rightarrow (K_\beta(t), T_\beta)$ is a topological conjugacy. This gives that

$$h_{top}(T_\beta|_{K_\beta(t)}) = h_{top}(\mathcal{K}_\beta(t)).$$

For the bifurcation set E_β , defined in (5.1.3), the following description can implicitly be found in [104]:

Proposition 5.2.3. *$E_\beta = \{t \in [0, 1) : t \in K_\beta(t)\}$ and thus $E_\beta \cap [t, 1) \subseteq K_\beta(t)$ for any $t \in (0, 1)$.*

Proof. For all $t \in (0, 1)$ it holds that $t \notin K_\beta(\epsilon)$ for any $\epsilon > t$. Hence, if $t \in K_\beta(t)$, then $t \in E_\beta$. Suppose that $t \notin K_\beta(t)$, i.e., there is an $N \geq 1$ such that $T_\beta^N(t) \in (0, t)$. By the right-continuity of T_β^N , there is a $\delta > 0$ such that

$$T_\beta^N(\epsilon) \in \left(T_\beta^N(t), \frac{T_\beta^N(t) + t}{2} \right) \subseteq (0, t) \quad \text{for all } \epsilon \in [t, t + \delta].$$

This implies that $K_\beta(t) \cap [t, t + \delta] = \emptyset$ and thus, $K_\beta(t + \delta) \subseteq K_\beta(t) \subseteq K_\beta(t + \delta)$. We conclude that the function $\epsilon \mapsto K_\beta(\epsilon)$ is constant on $[t, t + \delta]$, so $t \notin E_\beta$. \square

Corollary 5.2.4. *For each $\beta \in (1, 2]$ the set $[0, 1] \setminus E_\beta$ is open.*

Proof. Let $t \notin E_\beta$. The proof of the previous proposition then gives a $\delta_1 > 0$ such that $[t, t + \delta_1] \cap E_\beta = \emptyset$. From $t \notin K_\beta(t)$ it follows that there is an $N \geq 1$ such that $T_\beta^N(t) \in (0, t)$. Hence $T_\beta^k(t) \neq \frac{1}{\beta}$ for any $0 \leq k \leq N$, which means that T_β^N is left-continuous in t . Then, as in the proof of Proposition 5.2.3, we can find a $\delta_2 > 0$ such that $[t - \delta_2, t] \cap E_\beta = \emptyset$. \square

In (5.1.4) the set E_β^+ was defined. By the same proof as given for Proposition 5.2.3 we also get that E_β^+ is the bifurcation set of $K_\beta^+(t)$, i.e.,

$$E_\beta^+ = \{t \in [0, 1] : t \in K_\beta^+(t)\} = \{t \in [0, 1] : K_\beta^+(\epsilon) \neq K_\beta^+(t) \text{ for any } \epsilon > t\}.$$

As for $K_\beta(t)$ we add a third set E_β^0 of the elements in E_β that are pre-images of 0:

$$E_\beta^0 = \{t \in E_\beta : \exists n \geq 0 \ T_\beta^n(t) = 0\} = \{t \in [0, 1] : t \in K_\beta^0(t)\}.$$

Then $E_\beta = E_\beta^+ \cup E_\beta^0$ and $E_\beta^+ \cap E_\beta^0 = \{0\}$.

The symbolic bifurcation sets, i.e., the sets of all greedy β -expansions of elements in E_β , E_β^+ and E_β^0 can be described as follows:

$$\begin{aligned} \mathcal{E}_\beta^+ &= \{(t_i) \in \{0, 1\}^{\mathbb{N}} : \forall n \geq 0 \ (t_i) \preceq \sigma^n((t_i)) \prec \alpha(\beta)\}, \\ \mathcal{E}_\beta^0 &= \{(t_i) \in \{0, 1\}^{\mathbb{N}} : \exists n \geq 0 \ \sigma^n((t_i)) = 0^\infty \\ &\quad \text{and } (t_i) \preceq \sigma^k((t_i)) \prec \alpha(\beta) \text{ for all } 0 \leq k < n\}, \\ \mathcal{E}_\beta &= \mathcal{E}_\beta^+ \cup \mathcal{E}_\beta^0. \end{aligned} \tag{5.2.4}$$

In the series of papers [91, 92, 93], Raith studied invariant sets for piecewise monotone expanding maps on the interval $[0, 1]$. More specifically, in [93] he removed a finite number of open intervals from $[0, 1]$ and considered piecewise monotone expanding maps restricted to the survivor set. He then studied the dependence on the endpoints of the holes of the Hausdorff dimension of the survivor set and of the topological entropy of the map restricted to the survivor set. Since no $x \in [0, 1]$ has $T_\beta(x) = 1$, we can apply these results to T_β on $[0, 1]$ with the single hole $(0, t)$ removed. In particular, applying the results from [93, Corollary 1.1 and Theorem 2] give the following.

Proposition 5.2.5 ([93]). *Let $\beta \in (1, 2)$ be given. The maps $H_\beta : t \mapsto h_{top}(\mathcal{K}_\beta(t))$ and $\eta_\beta : t \mapsto \dim_H K_\beta(t)$ are continuous on $[0, 1)$.*

In the process of proving [93, Theorem 2], Raith proved in [93, Lemma 3] that Bowen's dimension formula also holds in this case, i.e., the Hausdorff dimension of the survivor set is the unique zero of the pressure function. In our setting this translates to the following dimension formula:

$$\dim_H K_\beta(t) = \frac{h_{top}(T_\beta|K_\beta(t))}{\log \beta}. \quad (5.2.5)$$

Since for any $t \in [0, 1)$ the sets $K_\beta^0(t)$ and E_β^0 contain at most countably many points, we have the following properties for the sets under consideration. Let λ denote the one dimensional Lebesgue measure.

$\dim_H K_\beta(t) = \dim_H K_\beta^+(t)$	$\dim_H K_\beta^0(t) = 0$
$\lambda(K_\beta(t)) = \lambda(K_\beta^+(t))$	$\lambda(K_\beta^0(t)) = 0$
$\dim_H E_\beta = \dim_H E_\beta^+$	$\dim_H E_\beta^0 = 0$
$\lambda(E_\beta) = \lambda(E_\beta^+)$	$\lambda(E_\beta^0) = 0$
$h_{top}(K_\beta(t)) = \max\{h_{top}(K_\beta^+(t)), h_{top}(K_\beta^0(t))\}$	

This table implies that for Theorem 5.1.2(i) it is enough to consider only E_β . From Proposition 5.2.5 and (5.2.5) we also get that $t \mapsto \dim_H K_\beta^+(t)$ is continuous and that

$$h_{top}(\mathcal{K}_\beta(t)) = \dim_H(K_\beta^+(t)) \log \beta.$$

The next result specifies the relations between the sets even further.

Proposition 5.2.6. *Let $\beta \in (1, 2)$. If $t \in E_\beta^+$, then $h_{top}(\mathcal{K}_\beta(t)) = h_{top}(\mathcal{K}_\beta^+(t))$.*

Proof. Since $\mathcal{K}_\beta^+(t) \subseteq \mathcal{K}_\beta(t)$, it suffices to prove $h_{top}(\mathcal{K}_\beta^+(t)) \geq h_{top}(\mathcal{K}_\beta(t))$. For $t = 0$, there is nothing to prove. Take $t \in E_\beta^+ \setminus \{0\}$ and write $(t_i) := b(t, \beta)$. Then

$$(t_i) \preceq \sigma^n((t_i)) \prec \alpha(\beta) \quad \text{for all } n \geq 0.$$

Hence (t_i) does not end with 0^∞ and by (5.2.3) we can rewrite $\mathcal{K}_\beta^0(t)$ as

$$\mathcal{K}_\beta^0(t) = \{(x_i) : \exists n \geq 0 \sigma^n((x_i)) = 0^\infty \text{ and } (t_i) \prec \sigma^k((x_i)) \prec \alpha(\beta) \forall 0 \leq k < n\}. \quad (5.2.6)$$

We claim that

$$|\mathcal{B}_k(\mathcal{K}_\beta^0(t))| \leq \sum_{j=1}^{k+1} |\mathcal{B}_{j-1}(\mathcal{K}_\beta^+(t))|.$$

Take a word $a_1 \dots a_k \in \mathcal{B}_k(\mathcal{K}_\beta^0(t))$ and without loss of generality suppose it occurs as a prefix of a sequence $(x_i) \in \mathcal{K}_\beta^0(t)$, i.e., $(x_i) = a_1 \dots a_k x_{k+1} x_{k+2} \dots$. Let $j \geq 0$ be such that $x_j = 1$ and the tail $x_{j+1} x_{j+2} \dots = 0^\infty$. If $j = 0$, then $(x_i) = 0^\infty$. Avoiding this trivial case we assume $j \geq 1$ and we will prove $x_1 \dots x_{j-1} 0 \in \mathcal{B}_j(\mathcal{K}_\beta^+(t))$. By (5.2.6) it follows that

$$t_1 \dots t_{j-i} \prec x_{i+1} \dots x_{j-1} 0 \prec \alpha_1(\beta) \dots \alpha_{j-i}(\beta) \quad \text{for all } 0 \leq i < j. \quad (5.2.7)$$

Let $i^* \leq j$ be the smallest index such that $x_{i^*+1} \dots x_{j-1} 0 = t_1 \dots t_{j-i^*}$. If strict inequalities in (5.2.7) hold for all $i < j$, then we put $i^* = j$. Note that $(t_i) \prec \sigma^n((t_i)) \prec \alpha(\beta)$ for all $n \geq 0$. Then by the minimality of i^* it follows that

$$x_1 \dots x_{j-1} 0 t_{j-i^*+1} t_{j-i^*+2} \dots = x_1 \dots x_{i^*} t_1 t_2 \dots \in \mathcal{K}_\beta^+(t).$$

Observe that $x_1 \dots x_{j-1} = a_1 \dots a_{j-1}$ if $j \leq k$ and $x_1 \dots x_k = a_1 \dots a_k$ if $j \geq k + 1$. This implies that $a_1 \dots a_{j-1} = x_1 \dots x_{j-1} \in \mathcal{B}_{j-1}(\mathcal{K}_\beta^+(t))$ if $j \leq k$ or $a_1 \dots a_k \in \mathcal{B}_k(\mathcal{K}_\beta^+(t))$ if $j \geq k + 1$ and proves the claim.

By the claim it follows that $|\mathcal{B}_k(\mathcal{K}_\beta^0(t))| \leq (k + 1)|\mathcal{B}_k(\mathcal{K}_\beta^+(t))|$. Using that $\mathcal{K}_\beta(t) = \mathcal{K}_\beta^0(t) \cup \mathcal{K}_\beta^+(t)$ we have

$$|\mathcal{B}_k(\mathcal{K}_\beta(t))| \leq (k + 2)|\mathcal{B}_k(\mathcal{K}_\beta^+(t))| \quad \text{for all } k \geq 1.$$

Taking the logarithms, dividing both sides by k and letting $k \rightarrow \infty$, we conclude that $h_{\text{top}}(\mathcal{K}_\beta(t)) \leq h_{\text{top}}(\mathcal{K}_\beta^+(t))$, which gives the result. \square

§5.2.4 The size of E_β

The results from the previous sections are enough to prove Theorem 5.1.2. We start by proving the following result, which holds for all $\beta \in (1, 2)$. It covers item (i) from Theorem 5.1.2 as well as part of Theorem 5.1.3.

Proposition 5.2.7. *For any $\beta \in (1, 2)$ the bifurcation set E_β is a Lebesgue null set. Furthermore, $\dim_H(E_\beta \cap [0, \delta]) = 1$ for any $\delta > 0$. In particular, $\dim_H E_\beta = 1$.*

Proof. For the first part of the statement, let $\beta \in (1, 2)$ and $N \in \mathbb{N}$. The ergodicity of T_β with respect to its invariant measure equivalent to the Lebesgue measure λ implies that λ -a.e. $x \in [0, 1]$ is eventually mapped into the interval $(0, \frac{1}{N})$. Hence, the survivor set $K_\beta(\frac{1}{N})$ is a Lebesgue null set for each $N \in \mathbb{N}$. This implies that $\lambda(E_\beta) = 0$, since by Proposition 5.2.3

$$E_\beta \subseteq \bigcup_{N=1}^{\infty} K_\beta\left(\frac{1}{N}\right).$$

To prove the second part, take a large integer $N \geq 1$. Let $E_{\beta, N}$ be the set of $x \in [0, 1]$ with a greedy expansion $b(x, \beta) = (b_i(x, \beta))$ satisfying $b_1(x, \beta) \dots b_N(x, \beta) = 0^N$ and

such that the tails $b_{N+1}(x, \beta)b_{N+2}(x, \beta)\dots$ do not contain N consecutive zeros. It immediately follows that $E_{\beta, N} \subseteq E_\beta$. Note that $K_\beta^+(\frac{1}{\beta^N})$ is exactly the set of $x \in [0, 1)$ for which $b(x, \beta)$ does not have more than N consecutive zeros. Hence,

$$E_{\beta, N} = \frac{1}{\beta^N} K_\beta^+ \left(\frac{1}{\beta^N} \right)$$

and thus $\dim_H E_{\beta, N} = \dim_H K_\beta^+(\frac{1}{\beta^N}) = \dim_H K_\beta(\frac{1}{\beta^N})$. Moreover, for any $\delta > 0$, we can find a large integer N such that $E_{\beta, n} \subseteq E_\beta \cap [0, \delta]$ for all $n \geq N$. Therefore,

$$\dim_H(E_\beta \cap [0, \delta]) \geq \dim_H E_{\beta, n} = \dim_H K_\beta \left(\frac{1}{\beta^n} \right)$$

for all $n \geq N$. By continuity of the map $\eta_\beta : t \mapsto \dim_H K_\beta(t)$, letting $n \rightarrow \infty$ gives that

$$\dim_H(E_\beta \cap [0, \delta]) \geq \dim_H K_\beta(0) = \dim_H[0, 1) = 1.$$

□

Proof of Theorem 5.1.2. Item (i) is given by Proposition 5.2.7. For item (ii), the fact that η_β decreases weakly immediately follows from its definition and the continuity of η_β is given by Proposition 5.2.5. For the second bullet point we have that the set-valued map $t \mapsto K_\beta(t)$ is locally constant Lebesgue almost everywhere, since $\lambda(E_\beta) = 0$. The last bullet point follows since $\eta_\beta(0) = 1$ and for $t \geq \frac{1}{\beta}$ we completely remove the second branch from T_β , so that obviously $\dim_H(K_\beta(t)) = 0$ and $\eta_\beta(t) = 0$. □

§5.3 Topological structure of E_β

In this section we prove Theorem 5.1.3. In fact, we prove a stronger result by specifying the set of $\beta \in (1, 2)$ for which there is a $\delta > 0$ such that $E_\beta^+ \cap [0, \delta]$ does not contain isolated points. This is the set

$$C_3 := \{\beta \in (1, 2) : \text{the length of consecutive zeros in } \alpha(\beta) \text{ is bounded}\}. \quad (5.3.1)$$

From a dynamical point of view C_3 is the set of $\beta \in (1, 2)$ such that the orbit $\{\tilde{T}_\beta^n(1)\}_{n=0}^\infty$ is bounded away from zero. Replacing $\alpha(\beta)$ in the definition of C_3 by $b(1, \beta)$ gives the set called C_3 in [97]. In [97] Schmeling proved that this set has zero Lebesgue measure and full Hausdorff dimension. Since the two versions of C_3 only differ by countably many points, the same holds for our set C_3 from (5.3.1). We prove Theorem 5.1.3 using Lyndon words, which we will define next.

Recall from (5.2.4) that

$$\mathcal{E}_\beta^+ = \{(t_i) \in \{0, 1\}^{\mathbb{N}} : (t_i) \prec \sigma^n((t_i)) \prec \alpha(\beta) \text{ for all } n \geq 0\}.$$

In other words, any sequence in \mathcal{E}_β^+ is the lexicographically smallest sequence in Σ_β under the shift map σ . For this reason we recall the following definition (cf. [76]).

Definition 5.3.1. A word \mathbf{s} is called Lyndon if \mathbf{s} is aperiodic and $\sigma^n(\mathbf{s}^\infty) \succ \mathbf{s}^\infty$ for all $n \geq 0$.

The following lemma lists some useful properties of Lyndon words. The first and third items easily follow from the definition and we omit their proofs.

Lemma 5.3.2.

(i) $s_1 \dots s_m$ is a Lyndon word if and only if

$$s_{i+1} \dots s_m \succ s_1 \dots s_{m-i} \quad \text{for all } 0 < i < m.$$

(ii) If $s_1 \dots s_m$ is a Lyndon word, then for any $1 \leq n < m$ with $s_n = 0$ the word $s_1 \dots s_n^+$ is also Lyndon.

(iii) If v, w are Lyndon words and $vw \prec wv$ then for all $n \in \mathbb{N}$ we have that $v^n w$ is a Lyndon word.

Proof. To prove (ii), suppose $s_n = 0$ for some $1 \leq n < m$. Since 1 is a Lyndon word, the statement holds for $n = 1$. If $2 \leq n < m$, then by (i) it follows that

$$s_{i+1} \dots s_n^+ \succ s_{i+1} \dots s_n \succ s_1 \dots s_{n-i} \quad \text{for all } 0 < i < n.$$

Therefore, again by (i) $s_1 \dots s_n^+$ is a Lyndon word as required. \square

By taking $i = m - 1$ in Lemma 5.3.2 (i) it follows that $s_1 = 0$ and $s_m = 1$. So any Lyndon word of length at least two starts with 0 and ends with 1. We use Lemma 5.3.2 to show that any isolated point in E_β^+ has a periodic greedy β -expansion.

Proposition 5.3.3. Let $\beta \in (1, 2]$. If t is an isolated point of E_β^+ , then its greedy β -expansion $b(t, \beta)$ is periodic. Moreover, no element from E_β^+ is isolated in E_β .

The proof of this proposition is based on the following two lemmas. Together they say that any point in E_β^+ with aperiodic β -expansion can be approximated from below by a sequences of points in E_β^+ that have a periodic orbit under T_β .

Lemma 5.3.4. Let $(t_i) \in \mathcal{E}_\beta^+$ be an aperiodic sequence. For each $m \geq 1$ we have

$$(t_1 \dots t_m)^\infty \prec (t_i) \quad \text{and} \quad (t_1 \dots t_m)^\infty \in \Sigma_\beta.$$

Proof. Let $(t_i) \in \mathcal{E}_\beta^+$ be an aperiodic sequence. Then by (5.2.4) we have

$$(t_i) \prec \sigma^n((t_i)) \prec \alpha(\beta) \quad \text{for all } n \geq 1. \tag{5.3.2}$$

Fix $m \geq 1$. By taking $n = m, 2m, \dots$ in (5.3.2) it follows that

$$\begin{aligned} (t_1 \dots t_m)^\infty &= t_1 \dots t_m (t_1 \dots t_m)^\infty \\ &\preceq t_1 \dots t_m t_{m+1} \dots t_{2m} (t_1 \dots t_m)^\infty \\ &\preceq t_1 \dots t_{2m} t_{2m+1} \dots t_{3m} (t_1 \dots t_m)^\infty \preceq \dots \preceq (t_i). \end{aligned}$$

Since (t_i) is not periodic, we conclude that $(t_1 \dots t_m)^\infty \prec (t_i)$.

For the second statement, (5.3.2) and the first part of the proposition give that

$$\sigma^n((t_1 \dots t_m)^\infty) = t_{n+1} \dots t_m (t_1 \dots t_m)^\infty \prec t_{n+1} \dots t_m t_{m+1} t_{m+2} \dots \prec \alpha(\beta)$$

for each $0 \leq n < m$, hence $(t_1 \dots t_m)^\infty \in \Sigma_\beta$. □

From [102, Proposition 2.2] we have the following lemma:

Lemma 5.3.5. *Let $(t_i) \in \mathcal{E}_\beta^+$ be an aperiodic sequence. Then there exist infinitely many $m \in \mathbb{N}$ such that $t_1 \dots t_m$ is a Lyndon word.*

Note that both previous lemmas do not hold for \mathcal{E}_β . Let $(t_i) \in \mathcal{E}_\beta^0$ be such that $\sigma^n((t_i)) = 0^\infty$. Then for any $m > n$ we have $(t_1 \dots t_m)^\infty \succ (t_i)$, contradicting the statement of Lemma 5.3.4. As for the statement of Lemma 5.3.5, for all $m \geq 2n$ we have that $t_1 \dots t_m$ is not Lyndon.

Proof of Proposition 5.3.3. Let $t \in E_\beta^+$ be a point with aperiodic greedy β -expansion $b(t, \beta) = (t_i)$. Since $(t_i) \in \mathcal{E}_\beta^+$, by Lemma 5.3.5 there exists a sequence (m_j) such that $t_1 \dots t_{m_j}$ is Lyndon for all $j \geq 1$. Furthermore, by Lemma 5.3.4 we have $(t_1 \dots t_{m_j})^\infty \in \Sigma_\beta$ for each $j \geq 1$. Hence, for all $j \geq 1$ we have $(t_1 \dots t_{m_j})^\infty \in \mathcal{E}_\beta^+$ and thus $\pi_\beta((t_1 \dots t_{m_j})^\infty) \in E_\beta^+$. Letting $j \rightarrow \infty$ we conclude that $\pi_\beta((t_1 \dots t_{m_j})^\infty) \rightarrow \pi_\beta((t_i)) = t$ which implies that t is not isolated in E_β^+ .

Now assume that $t \in E_\beta^+$ has a periodic greedy β -expansion $b(t, \beta) = (t_1 \dots t_m)^\infty$, where m is chosen minimal. We will show that t is not isolated in E_β . If $m = 1$, then we have $b(t, \beta) = 0^\infty$, i.e., $t = 0$. In this case the result trivially follows from Proposition 5.2.7. Now assume $m \geq 2$. Let $a_1 \dots a_m$ be the maximal cyclic permutation of $t_1 \dots t_m$. Then there exists a $j \in \{0, 1, \dots, m-1\}$ such that $a_1 \dots a_m = t_{j+1} \dots t_m t_1 \dots t_j$. Note that $\sigma^n((t_1 \dots t_m)^\infty) \prec \alpha(\beta)$ for all $n \geq 0$. Then

$$(a_1 \dots a_m)^\infty \prec \alpha(\beta), \tag{5.3.3}$$

which implies $a_1 \dots a_m \preccurlyeq \alpha_1(\beta) \dots \alpha_m(\beta)$. We claim that $a_1 \dots a_m \prec \alpha_1(\beta) \dots \alpha_m(\beta)$.

If $a_1 \dots a_m = \alpha_1(\beta) \dots \alpha_m(\beta)$, then (5.3.3) together with Lemma 5.2.1 gives

$$a_1 \dots a_m \preccurlyeq \alpha_{m+1}(\beta) \dots \alpha_{2m}(\beta) \preccurlyeq \alpha_1(\beta) \dots \alpha_m(\beta) = a_1 \dots a_m.$$

So, $a_1 \dots a_{2m} = (a_1 \dots a_m)^2$. Iterating this argument with Lemma 5.2.1 and (5.3.3) gives that $\alpha(\beta) = (a_1 \dots a_m)^\infty$, leading to a contradiction with (5.3.3). This proves the claim.

For $N \in \mathbb{N}$, define the sequence $\mathbf{t}_N := (t_1 \dots t_m)^N t_1 \dots t_j^+ 0^\infty$. Since $t_j = 0$, the sequence \mathbf{t}_N is well-defined. By Lemma 5.3.2(iii) it follows that $\sigma^n(\mathbf{t}_N) \succ \mathbf{t}_N$ for all $0 \leq n < mN + j$. Moreover, $a_1 \dots a_m \prec \alpha_1(\beta) \dots \alpha_m(\beta)$ it follows that $\sigma^n(\mathbf{t}_N) \prec \alpha(\beta)$ for all $n \geq 0$. So, $\mathbf{t}_N \in \mathcal{E}_\beta^0$ for all $N \in \mathbb{N}$. Since $\pi_\beta(\mathbf{t}_N) \searrow t$ as $N \rightarrow \infty$, the point $t \in E_\beta^+$ is not isolated in E_β . □

The next proposition says that no point from $E_\beta^0 \setminus \{0\}$ can be approximated from above by elements from E_β and that a point $t \in E_\beta^0 \setminus \{0\}$ is isolated in E_β if the orbit of 1 enters $(0, t)$.

Proposition 5.3.6. *Let $t \in E_\beta^0 \setminus \{0\}$. Then there is a $\delta > 0$ such that $E_\beta \cap [t, t + \delta] = \{t\}$. Moreover, if $\beta - 1 \notin K_\beta(t)$, then t is isolated in E_β .*

Proof. If $t \in E_\beta^0 \setminus \{0\}$, then there is a smallest $n \geq 0$ such that $T_\beta^n(t) = \frac{1}{\beta}$. By the right continuity of T_β , there is a $\delta > 0$ such that all $\epsilon \in (t, t + \delta]$ satisfy $T_\beta^{n+1}(\epsilon) \in (0, t) \subseteq (0, \epsilon)$. Hence, $\epsilon \notin K_\beta(\epsilon)$ and thus, $\epsilon \notin E_\beta$.

The first statement implies that to prove an element from $E_\beta^0 \setminus \{0\}$ is isolated, it is enough to prove that it cannot be approximated from below. If again n is such that $T_\beta^n(t) = \frac{1}{\beta}$, then for a small enough δ , we know that for any point $\epsilon \in [t - \delta, t)$ the point $T_\beta^{n+1}(\epsilon)$ is close to 1. Let m be the smallest integer such that $T_\beta^m(\beta - 1) \in (0, t)$. Then there is a $0 < \delta < t - T_\beta^m(\beta - 1)$ such that any $\epsilon \in [t - \delta, t)$ satisfies

$$T_\beta^{n+1+m+1}(\epsilon) \in (0, T_\beta^m(\beta - 1)) \subseteq (0, \epsilon).$$

Hence, $\epsilon \notin E_\beta$ and $E_\beta \cap [t - \delta, t] = \{t\}$. □

From now on we focus on the set E_β^+ . We first construct subintervals of $(1, 2)$ such that E_β^+ contains isolated points whenever β is in one of these intervals. We start with a couple of lemmas.

Lemma 5.3.7. *Let $(t_i), (\alpha_i) \in \{0, 1\}^{\mathbb{N}}$ be given. Suppose there is an $m \geq 1$ such that $\alpha_m = 1$ and $\sigma^m((\alpha_i)) \preceq (t_i)$. Define the sets*

$$\begin{aligned} \mathcal{K} &:= \{(x_i) \in \{0, 1\}^{\mathbb{N}} : (t_i) \preceq \sigma^n((x_i)) \prec (\alpha_i) \text{ for all } n \geq 0\}, \\ \mathcal{X}_m &:= \{(x_i) \in \{0, 1\}^{\mathbb{N}} : (t_i) \preceq \sigma^n((x_i)) \preceq (\alpha_1 \dots \alpha_m^-)^\infty \text{ for all } n \geq 0\}. \end{aligned}$$

Then $\mathcal{K} = \mathcal{X}_m$.

Proof. Obviously, $\mathcal{X}_m \subseteq \mathcal{K}$. We show that $\mathcal{K} \setminus \mathcal{X}_m = \emptyset$. Suppose that this is not the case and let $(x_i) \in \mathcal{K} \setminus \mathcal{X}_m$. Then there is a $j \geq 1$ such that $x_{j+1} \dots x_{j+m} = \alpha_1 \dots \alpha_m$. Since $(x_i) \in \mathcal{K}$, the assumption that $\sigma^m((\alpha_i)) \preceq (t_i)$ implies that

$$x_{j+m+1}x_{j+m+2} \dots \prec \alpha_{m+1}\alpha_{m+2} \dots \preceq (t_i),$$

which contradicts $(x_i) \in \mathcal{K}$. Hence $\mathcal{K} \setminus \mathcal{X}_m = \emptyset$. □

Let $\beta \in (1, 2)$ and $t \in [0, 1)$. The previous lemma has the following consequence for $\mathcal{K}_\beta^+(t)$. If there is a smallest $m \geq 1$ such that

$$\alpha_{m+1}(\beta)\alpha_{m+2}(\beta) \dots \preceq b(t, \beta),$$

or equivalently $\tilde{T}_\beta^m(1) \leq t$, then we can rewrite $\mathcal{K}_\beta^+(t)$ as

$$\mathcal{K}_\beta^+(t) = \{(x_i) : b(t, \beta) \preceq \sigma^n((x_i)) \preceq (\alpha_1(\beta) \dots \alpha_m(\beta)^-)^\infty \text{ for any } n \geq 0\}.$$

Hence, any point in the survivor set $K_\beta^+(t)$ then has the property that its entire orbit lies between t and the point $\pi_\beta((\alpha_1(\beta) \dots \alpha_m(\beta)^-)^\infty)$. We need two more lemmas. Recall the definition of the set \mathcal{Q} from (5.2.2) as the set of sequences that occur as $\alpha(\beta)$ for some $\beta \in (1, 2]$.

Lemma 5.3.8. *Let $(a_1 \dots a_m)^\infty \in \mathcal{Q}$ with minimal period m . Then*

$$a_{i+1} \dots a_m^+ \preceq a_1 \dots a_{m-i} \quad \text{for all } 0 < i < m.$$

Proof. Let $\beta \in (1, 2)$ be such that $\alpha(\beta) = (a_1 \dots a_m)^\infty$. Then $b(1, \beta) = a_1 \dots a_m^+ 0^\infty$. Hence, for each $0 < i < m$ we have $b(T_\beta^i(1), \beta) = a_{i+1} \dots a_m^+ 0^\infty$ and $T_\beta^i(1) < 1$. The result then follows from Lemma 5.2.2. \square

Note that for any non-periodic word $b_1 \dots b_m \in \{0, 1\}^*$ there is a $0 \leq j \leq m-1$ such that $b_{j+1} \dots b_m b_1 \dots b_j$ is the smallest among its cyclic permutations and therefore Lyndon. We denote this word by $\mathbf{S}(b_1 \dots b_m)$ and call it the *Lyndon word for $b_1 \dots b_m$* . Similarly, there is a $0 \leq k \leq m-1$ such that $b_{k+1} \dots b_m b_1 \dots b_k$ is the largest among its cyclic permutations. We denote this by word by $\mathbf{L}(b_1 \dots b_m)$. In what follows we will sometimes use the property that for any word $b_1 \dots b_m \in \{0, 1\}^m$ and any sequence $(x_i) \in \{0, 1\}^\mathbb{N}$ it holds that

$$\sigma^n((x_i)) \succ b_1 \dots b_m 0^\infty \quad \forall n \geq 0 \iff \sigma^n((x_i)) \succ (b_1 \dots b_m)^\infty \quad \forall n \geq 0. \quad (5.3.4)$$

Lemma 5.3.9. *Let $s_1 \dots s_m$ be a Lyndon word and write $a_1 \dots a_m = \mathbf{L}(s_1 \dots s_m)$. Let $0 \leq j < m$ be such that $s_1 \dots s_m = a_{j+1} \dots a_m a_1 \dots a_j$ and set*

$$\mathcal{Z}_m := \{(x_i) \in \{0, 1\}^\mathbb{N} : s_1 \dots s_m 0^\infty \preceq \sigma^n((x_i)) \preceq (a_1 \dots a_m)^\infty \quad \forall n \geq 0\}.$$

- (i) *If $(x_i) \in \mathcal{Z}_m$ has prefix $a_{j+1} \dots a_m$, then $(x_i) = (s_1 \dots s_m)^\infty$;*
- (ii) *if $(x_i) \in \mathcal{Z}_m$ has prefix $a_1 \dots a_j$, then $(x_i) = (a_1 \dots a_m)^\infty$.*

Proof. Since the proofs of (i) and (ii) are similar, we only give the proof of (i). Let $a_{j+1} \dots a_m x_1 x_2 \dots \in \mathcal{Z}_m$. Then

$$s_1 \dots s_m 0^\infty \preceq \sigma^n(a_{j+1} \dots a_m x_1 x_2 \dots) \preceq (a_1 \dots a_m)^\infty \quad \text{for all } n \geq 0. \quad (5.3.5)$$

In particular,

$$a_{j+1} \dots a_m x_1 \dots x_j \succ s_1 \dots s_m = a_{j+1} \dots a_m a_1 \dots a_j,$$

which gives

$$x_1 \dots x_j \succ a_1 \dots a_j.$$

On the other hand, by taking $n = m - j$ in (5.3.5), we get $x_1 \dots x_m \preceq a_1 \dots a_m$. Hence

$$x_1 \dots x_j = a_1 \dots a_j \quad \text{and} \quad x_{j+1} \dots x_m \preceq a_{j+1} \dots a_m.$$

Again, by (5.3.5) now with $n = m$, we have $x_{j+1} \dots x_m \succ s_1 \dots s_{m-j} = a_{j+1} \dots a_m$. Therefore, $x_1 \dots x_m = a_1 \dots a_m$. By iteration we conclude that

$$a_{j+1} \dots a_m x_1 x_2 \dots = (a_{j+1} \dots a_m a_1 \dots a_j)^\infty = (s_1 \dots s_m)^\infty$$

as required. \square

We now construct infinitely many nested intervals $(\beta_L, \beta_R]$ such that E_β^+ has isolated points whenever $\beta \in (\beta_L, \beta_R]$. Figure 5.2 shows some of these intervals. We will later show that these basic intervals cover the whole interval $(1, 2)$ up to a set of zero Lebesgue measure.

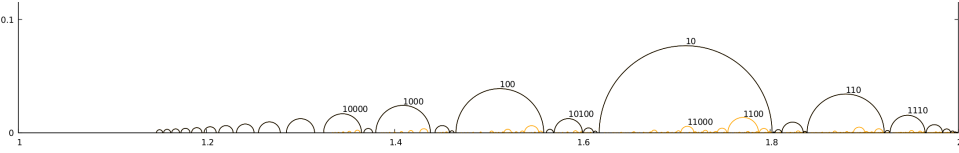

Figure 5.2: Some of the basic intervals $(\beta_L, \beta_R]$. The numbers near the arches indicate the words $a_1 \dots a_m$ such that $\alpha(\beta_L) = (a_1 \dots a_m)^\infty$. The intervals that are not contained in any other interval are the Farey intervals. They are the ones for which $a_1 \dots a_m$ is a Farey word. The arches corresponding to Farey intervals are shown in black, the lighter coloured arches correspond to words that are Lyndon, but not Farey.

Proposition 5.3.10. *Let $s_1 \dots s_m$ be a Lyndon word and write $a_1 \dots a_m = \mathbf{L}(s_1 \dots s_m)$. Then both $(a_1 \dots a_m)^\infty$ and $a_1 \dots a_m^+(s_1 \dots s_m)^\infty$ belong to \mathcal{Q} , hence there are uniquely defined bases $\beta_L, \beta_R \in (1, 2]$ such that $\alpha(\beta_L) = (a_1 \dots a_m)^\infty$ and $\alpha(\beta_R) = a_1 \dots a_m^+(s_1 \dots s_m)^\infty$. Moreover,*

- (i) $(s_1 \dots s_m)^\infty \in \Sigma_\beta$ if and only if $\beta > \beta_L$;
- (ii) if $\beta \in (\beta_L, \beta_R]$, then $\pi_\beta((s_1 \dots s_m)^\infty)$ is an isolated point of E_β^+ ;
- (iii) if $\beta > \beta_R$, then $\pi_\beta((s_1 \dots s_m)^\infty)$ is not an isolated point of E_β^+ .

Proof. Let β_L be as in the proposition. First we show that the interval $(\beta_L, \beta_R]$ is well-defined, i.e., β_R exists and that $\beta_L < \beta_R$. We use the characterisation from Lemma 5.2.1, so it suffices to show that the sequence $\mathbf{a} = a_1 \dots a_m^+(s_1 \dots s_m)^\infty \in \mathcal{Q}$, i.e., it satisfies $\sigma^n(\mathbf{a}) \preceq \mathbf{a}$ for all $n \geq 0$. Since $s_1 \dots s_m$ is a Lyndon word, any word of length $1 \leq n \leq m - 1$ occurring in $a_1 \dots a_m = \mathbf{L}(s_1 \dots s_m)$ is lexicographically larger than or equal to $s_1 \dots s_n$. Combining this with Lemma 5.3.8 and Lemma 5.3.2 (i) gives

$$a_{n+1} \dots a_m^+ s_1 \dots s_n \preceq a_1 \dots a_{m-n} a_{m-n+1} \dots a_m \prec a_1 \dots a_m^+$$

for all $0 < n < m$. So $\sigma^n(\mathbf{a}) \prec \mathbf{a}$ for each $0 < n < m$. Moreover, since

$$\sigma^n((s_1 \dots s_m)^\infty) \preceq (a_1 \dots a_m)^\infty \prec a_1 \dots a_m^+(s_1 \dots s_m)^\infty$$

for all $n \geq 0$, we get $\sigma^n(\mathbf{a}) \prec \mathbf{a}$ for all $n \geq 1$ and thus $\mathbf{a} \in \mathcal{Q}$. Lemma 5.2.1 then implies that \mathbf{a} is indeed the quasi-greedy expansion of 1 for some base β_R , i.e., $\alpha(\beta_R) = a_1 \dots a_m^+(s_1 \dots s_m)^\infty$. Since $\alpha(\beta_L) \prec \alpha(\beta_R)$, Lemma 5.2.1 also gives that $\beta_R > \beta_L$. Hence, the interval $(\beta_L, \beta_R]$ is well-defined.

Let $1 \leq j \leq m - 1$ be such that

$$s_1 \dots s_m = a_{j+1} \dots a_m a_1 \dots a_j.$$

For (i), note that if $\beta \leq \beta_L$, then $(s_1 \dots s_m)^\infty \notin \Sigma_\beta$ since

$$\sigma^j((s_1 \dots s_m)^\infty) = (a_1 \dots a_m)^\infty \succ \alpha(\beta).$$

For $\beta \in (\beta_L, \beta_R]$ it follows immediately that $(s_1 \dots s_m)^\infty \in \Sigma_\beta$, since $s_1 \dots s_m$ is the smallest permutation of $a_1 \dots a_m$ and $(a_1 \dots a_m)^\infty \prec \alpha(\beta)$.

For (ii), let $\beta \in (\beta_L, \beta_R]$ and set $t = \pi_\beta((s_1 \dots s_m)^\infty)$. Then $b(t, \beta) = (s_1 \dots s_m)^\infty \in \mathcal{E}_\beta^+$, so $t \in E_\beta^+$. By Lemma 5.2.2 and since t has a periodic β -expansion, there exists a small $\delta > 0$ such that for any $x \in [t - \delta, t + \delta]$ the greedy expansion $b(x, \beta)$ has prefix $s_1 \dots s_m$. By Lemma 5.3.7 it follows that

$$\begin{aligned} \mathcal{K}_\beta^+(t - \delta) &\subseteq \{(x_i) : s_1 \dots s_m 0^\infty \preceq \sigma^n((x_i)) \prec a_1 \dots a_m^+(s_1 \dots s_m)^\infty \forall n \geq 0\} \\ &= \{(x_i) : (s_1 \dots s_m)^\infty \preceq \sigma^n((x_i)) \prec a_1 \dots a_m^+(s_1 \dots s_m)^\infty \forall n \geq 0\} \\ &= \{(x_i) : (s_1 \dots s_m)^\infty \preceq \sigma^n((x_i)) \preceq (a_1 \dots a_m)^\infty \forall n \geq 0\} \\ &= \{(x_i) : s_1 \dots s_m 0^\infty \preceq \sigma^n((x_i)) \preceq (a_1 \dots a_m)^\infty \forall n \geq 0\}, \end{aligned} \quad (5.3.6)$$

where we have used the fact from (5.3.4) in the first and last equality. Since for any $x \in [t - \delta, t + \delta]$ the greedy expansion $b(x, \beta)$ begins with $s_1 \dots s_m$, by Lemma 5.3.9 (i) and (5.3.6) we obtain that

$$K_\beta^+(t - \delta) \cap [t - \delta, t + \delta] \subseteq \{t\}.$$

Since $t \in E_\beta^+ \cap [t - \delta, t + \delta] \subseteq K_\beta^+(t - \delta) \cap [t - \delta, t + \delta]$, we conclude that t is isolated in E_β^+ for any $\beta \in (\beta_L, \beta_R]$.

For (iii), let $\beta > \beta_R$ and again set $t = \pi_\beta((s_1 \dots s_m)^\infty)$. We construct a sequence (\mathbf{t}_n) in \mathcal{E}_β^+ such that $\mathbf{t}_n \searrow (s_1 \dots s_m)^\infty$ in the order topology as $n \rightarrow \infty$. Let

$$\mathbf{t}_n := ((s_1 \dots s_m)^n s_1 \dots s_{m-j}^+)^\infty = ((a_{j+1} \dots a_m a_1 \dots a_j)^n a_{j+1} \dots a_m^+)^\infty.$$

We claim that there is an $N \in \mathbb{N}$ such that $\mathbf{t}_n \in \mathcal{E}_\beta^+$ for all $n > N$. By Lemma 5.3.2 (ii) and (iii) it follows that \mathbf{t}_n is Lyndon. Left to show is that $\mathbf{t}_n \in \Sigma_\beta$. Note that the largest permutation of \mathbf{t}_n is given by

$$\begin{aligned} \mathbf{d}_n &= (a_1 \dots a_m^+ (a_{j+1} \dots a_m a_1 \dots a_j)^{n-1} a_{j+1} \dots a_m)^\infty \\ &= (a_1 \dots a_m^+ (s_1 \dots s_m)^{n-1} s_1 \dots s_{m-j})^\infty. \end{aligned}$$

For $\beta > \beta_R$ either $\alpha_1(\beta) \dots \alpha_m(\beta) \succ a_1 \dots a_m^+$ or there exists an $N \geq 1$ such that $\alpha(\beta) = a_1 \dots a_m^+ (s_1 \dots s_m)^{N-1} b_1 \dots b_m$ with $b_1 \dots b_m \succ s_1 \dots s_m$. In the first case obviously $\mathbf{d}_n \prec \alpha(\beta)$. In the second case we have $\mathbf{d}_n \prec \alpha(\beta)$ for all $n > N$. Hence $\mathbf{t}_n \in \Sigma_\beta$ for all $n > N$.

We have found a sequence $(\mathbf{t}_n) \subseteq \mathcal{E}_\beta^+$ decreasing to $b(t, \beta) = (s_1 \dots s_m)^\infty$ as $n \rightarrow \infty$ and accordingly, a sequence $(\pi_\beta(\mathbf{t}_n)) \subseteq E_\beta^+$ decreasing to $t = \pi_\beta((s_1 \dots s_m)^\infty)$ as $n \rightarrow \infty$. Therefore, t is not isolated in E_β^+ . \square

Recall from (5.3.1) that C_3 is the set of $\beta \in (1, 2)$ such that the length of consecutive zeros in the quasi-greedy expansion $\alpha(\beta)$ is bounded.

Theorem 5.3.11. *If $\beta \in (1, 2) \setminus C_3$, then both $E_\beta \cap [0, \delta]$ and $E_\beta^+ \cap [0, \delta]$ contain both infinitely many isolated and accumulation points for all $\delta > 0$.*

Proof. By Proposition 5.2.7 it follows that $E_\beta \cap [0, \delta]$ and $E_\beta^+ \cap [0, \delta]$ contain infinitely many accumulation points for all $\delta > 0$, so we focus on the isolated points. Fix $\beta \in (1, 2) \setminus C_3$. Then $\alpha(\beta)$ contains consecutive zeros of arbitrary length. Hence, $\alpha(\beta)$ is not periodic and the orbit of 1 under \tilde{T}_β will come arbitrarily close to 0. This implies that for any $t > 0$, $\beta - 1 \notin K_\beta(t)$ and thus by Proposition 5.3.6 any $t \in E_\beta^0 \setminus \{0\}$ will be isolated in E_β . Note that for any $n \geq 1$ we have $\frac{1}{\beta^n} \in E_\beta^0$. This gives the statement for E_β .

To prove that E_β^+ contains infinitely many isolated points arbitrarily close to 0, we construct by induction a sequence of intervals $(\beta_{L,k}, \beta_{R,k}), k \geq 1$, such that $\beta \in (\beta_{L,k}, \beta_{R,k})$ for all $k \geq 1$, where $(\beta_{L,k}, \beta_{R,k})$ is defined as in Proposition 5.3.10. Write

$$\alpha(\beta) = 1^{l_1} 0^{m_1} 1^{l_2} 0^{m_2} \dots 1^{l_k} 0^{m_k} \dots \quad (5.3.7)$$

Since $\alpha(\beta)$ does not end with 0^∞ , we have $m_k \in \{1, 2, \dots\}$ for all $k \geq 1$. Furthermore, from $\beta \notin C_3$ we get $\sup_{k \geq 1} m_k = \infty$.

Set $i_0 = 1$ and let $i_1 > i_0$ be the smallest index for which $m_{i_1} > m_1$. Set $\mathbf{a}_1 := 1^{l_1} 0^{m_1} \dots 1^{l_{i_1}-1} 0$. Note that $\alpha(\beta)$ begins with \mathbf{a}_1^+ and by Lemma 5.2.1 $\sigma^n(\alpha(\beta)) \preceq \alpha(\beta)$ for all $n \geq 0$. This implies $\sigma^n(\mathbf{a}_1^\infty) \preceq \mathbf{a}_1^\infty$ for all $n \geq 0$. So by Lemma 5.2.1 the sequence \mathbf{a}_1^∞ is the quasi-greedy expansion of 1 for some base $\beta_{L,1}$, i.e., $\alpha(\beta_{L,1}) = \mathbf{a}_1^\infty$. Note that the word \mathbf{a}_1 contains consecutive zeros of length at most m_1 . So the Lyndon word $\mathbf{s}_1 = s_1 \dots s_{l_1+m_1+\dots+l_{i_1}}$ for \mathbf{a}_1 begins with $0^{m_1} 1$. Again, one can check that $\sigma^n(\mathbf{a}_1^+ \mathbf{s}_1^\infty) \preceq \mathbf{a}_1^+ \mathbf{s}_1^\infty$ for all $n \geq 0$. So there exists $\beta_{R,1} \in (1, 2)$ such that $\alpha(\beta_{R,1}) = \mathbf{a}_1^+ \mathbf{s}_1^\infty$. By using $m_{i_1} > m_1$ and (5.3.7) it follows that

$$\alpha(\beta_{L,1}) = \mathbf{a}_1^\infty = (1^{l_1} 0^{m_1} \dots 1^{l_{i_1}-1} 0)^\infty \prec 1^{l_1} 0^{m_1} \dots 1^{l_{i_1}} 0 \dots = \alpha(\beta)$$

and

$$\alpha(\beta_{R,1}) = \mathbf{a}_1^+ \mathbf{s}_1^\infty = 1^{l_1} 0^{m_1} \dots 1^{l_{i_1}} 0^{m_1} 1 \dots \succ 1^{l_1} 0^{m_1} \dots 1^{l_{i_1}} 0^{m_{i_1}} 1 \dots = \alpha(\beta).$$

By Lemma 5.2.1 we have $\beta \in (\beta_{L,1}, \beta_{R,1})$. Moreover, by Proposition 5.3.10 we have that $\pi_\beta(\mathbf{s}_1^\infty)$ is an isolated point of E_β^+ . Now we pick i_k using i_{k-1} . Let $i_k > i_{k-1}$ be the smallest index such that $m_{i_k} > m_{i_{k-1}}$. Then by the definitions of i_1, \dots, i_{k-1} it follows that $m_{i_k} > m_j$ for all $j < i_k$. Set $\mathbf{a}_k := 1^{l_1} 0^{m_1} \dots 1^{l_{i_k}-1} 0$. Then the block \mathbf{a}_k contains consecutive zeros of length at most $m_{i_{k-1}}$. So the Lyndon word $\mathbf{s}_k = s_1 \dots s_{l_1+m_1+\dots+l_{i_k}}$ for \mathbf{a}_k begins with $0^{m_{i_{k-1}}} 1$. By the same argument as above we can find two bases $\beta_{L,k}, \beta_{R,k} \in (1, 2)$ such that

$$\begin{aligned} \alpha(\beta_{L,k}) &= \mathbf{a}_k^\infty = (1^{l_1} 0^{m_1} \dots 1^{l_{i_k}-1} 0)^\infty \prec 1^{l_1} 0^{m_1} \dots 1^{l_{i_k}} 0 \dots = \alpha(\beta), \\ \alpha(\beta_{R,k}) &= \mathbf{a}_k^+ \mathbf{s}_k^\infty = 1^{l_1} 0^{m_1} \dots 1^{l_{i_k}} 0^{m_{i_{k-1}}} 1 \dots \succ 1^{l_1} 0^{m_1} \dots 1^{l_{i_k}} 0^{m_{i_k}} 1 \dots = \alpha(\beta). \end{aligned}$$

Therefore, $\beta \in (\beta_{L,k}, \beta_{R,k})$ and by Proposition 5.3.10 we have that $\pi_\beta(\mathbf{s}_k^\infty)$ is an isolated point of E_β^+ .

By induction we construct a sequence of intervals $(\beta_{L,k}, \beta_{R,k}), k \geq 1$, such that $\beta \in (\beta_{L,k}, \beta_{R,k})$ for all $k \geq 1$. Moreover, the points $\pi_\beta(\mathbf{s}_k^\infty)$ are isolated in E_β^+ . Note that \mathbf{s}_k begins with a block $0^{m_{i_{k-1}}}$ for any $k \geq 1$ and $m_{i_{k-1}}$ strictly increases to ∞ as $k \rightarrow \infty$. This implies that $E_\beta^+ \cap [0, \delta]$ contains infinitely many isolated points for any $\delta > 0$. \square

Theorem 5.3.12. *For $\beta \in C_3$ there is a $\delta > 0$ such that $E_\beta^+ \cap [0, \delta]$ has no isolated points.*

Proof. Fix $\beta \in C_3$. Then the length of consecutive zeros in $\alpha(\beta)$ is bounded by some large integer M . Set $\delta = \frac{1}{\beta^{M+3}} = \pi_\beta(0^{M+2}10^\infty)$. To show that $E_\beta^+ \cap [0, \delta]$ has no isolated points, suppose on the contrary that t is an isolated point of $E_\beta^+ \cap [0, \delta]$. By Proposition 5.3.3 it follows that the greedy β -expansion $b(t, \beta)$ of t is periodic, namely

$$b(t, \beta) = (t_1 \dots t_m)^\infty \in \mathcal{E}_\beta^+$$

with minimal period m . Moreover, $t_1 \dots t_m$ is Lyndon. For $m = 1$ we get that $t = 0$, which by Proposition 5.2.7 is not isolated in E_β^+ . Let $m \geq 2$ and let $a_1 \dots a_m = \mathbf{L}(t_1 \dots t_m)$. Then $(a_1 \dots a_m)^\infty \in \mathcal{Q}$, so by Lemma 5.2.1 it is the quasi-greedy expansion of 1 for some base β_L , i.e., $\alpha(\beta_L) = (a_1 \dots a_m)^\infty$. By Proposition 5.3.10 it follows that $\beta \in (\beta_L, \beta_R]$, where β_R is the unique base satisfying

$$\alpha(\beta_R) = a_1 \dots a_m^+(t_1 \dots t_m)^\infty.$$

Hence,

$$(a_1 \dots a_m)^\infty \prec \alpha(\beta) \preceq a_1 \dots a_m^+(t_1 \dots t_m)^\infty. \quad (5.3.8)$$

Since $t \leq \delta = \pi_\beta(0^{M+2}10^\infty)$, we have $(t_1 \dots t_m)^\infty = b(t, \beta) \preceq 0^{M+2}10^\infty$. So $t_1 \dots t_m$ begins with $M + 2$ consecutive zeros and $a_1 \dots a_m$ contains $M + 2$ consecutive zeros. By (5.3.8) we conclude that $\alpha(\beta)$ contains $M + 1$ consecutive zeros, leading to a contradiction with our hypothesis that the number of consecutive zeros in $\alpha(\beta)$ is bounded by M . \square

Proof of Theorem 5.1.3. The first part of the statement follows from Proposition 5.2.7 and Theorem 5.3.11, since $\lambda(C_3) = 0$ by the results from [97]. The fact from [97] that $\dim_H C_3 = 1$ together with Theorem 5.3.12 gives the last part of the result. \square

§5.4 When E_β^+ does not have isolated points

In this section we prove Theorem 5.1.4, which states that the set of $\beta \in (1, 2)$ for which E_β^+ has no isolated points is rather small, it has zero Hausdorff dimension. The theorem is obtained by showing that the intervals $(\beta_L, \beta_R]$ introduced in the previous section cover all but a Hausdorff dimension zero part of the interval $(1, 2)$. Figure 5.2

suggests that the basic intervals are nested. In Proposition 5.4.1 below we prove that this is indeed the case. Subsequently, we identify those intervals $(\beta_L, \beta_R]$ that are not contained in any other basic interval, which turn out to be the ones given by a specific subset of the Lyndon words, called Farey words.

Proposition 5.4.1. *Let $I_1 = (\beta_L, \beta_R]$ and $I_2 = (\tilde{\beta}_L, \tilde{\beta}_R]$ be two different basic intervals. If $I_1 \cap I_2 \neq \emptyset$, then $I_1 \subset I_2$ or $I_2 \subset I_1$.*

Proof. Suppose $I_1 = (\beta_L, \beta_R]$ is parameterised by the word $a_1 \dots a_m$ and $I_2 = (\tilde{\beta}_L, \tilde{\beta}_R]$ is parameterised by the word $b_1 \dots b_n$, i.e.,

$$\begin{aligned} \alpha(\beta_L) &= (a_1 \dots a_m)^\infty, & \alpha(\beta_R) &= a_1 \dots a_m^+(s_1 \dots s_m)^\infty; \\ \alpha(\tilde{\beta}_L) &= (b_1 \dots b_n)^\infty, & \alpha(\tilde{\beta}_R) &= b_1 \dots b_n^+(t_1 \dots t_n)^\infty, \end{aligned}$$

where $s_1 \dots s_m = \mathbf{S}(a_1 \dots a_m)$ and $t_1 \dots t_n = \mathbf{S}(b_1 \dots b_n)$ are the Lyndon words for $a_1 \dots a_m$ and $b_1 \dots b_n$ respectively. Since $I_1 \cap I_2 \neq \emptyset$, by symmetry we may assume $\tilde{\beta}_L \in I_1 = (\beta_L, \beta_R]$. We are going to show that $\tilde{\beta}_R < \beta_R$, which by Lemma 5.2.1 is equivalent to showing

$$b_1 \dots b_n^+(t_1 \dots t_n)^\infty \prec a_1 \dots a_m^+(s_1 \dots s_m)^\infty. \quad (5.4.1)$$

Since $\beta_L < \tilde{\beta}_L \leq \beta_R$, by Lemma 5.2.1 it follows that

$$(a_1 \dots a_m)^\infty \prec (b_1 \dots b_n)^\infty \preceq a_1 \dots a_m^+(s_1 \dots s_m)^\infty. \quad (5.4.2)$$

We claim that $n > m$.

- If $n < m$, then by (5.4.2) we have $b_1 \dots b_n = a_1 \dots a_n$. Write $m = un + r$ with $u \geq 1$ and $1 \leq r \leq n$. By Lemma 5.3.8 and (5.4.2) it follows that $a_1 \dots a_{un} = (b_1 \dots b_n)^u$ and $b_1 \dots b_r = a_1 \dots a_r = a_{un+1} \dots a_m^+$, so

$$a_1 \dots a_m = (b_1 \dots b_n)^u b_1 \dots b_r^-.$$

By using that $s_1 \dots s_m = \mathbf{S}(a_1 \dots a_m)$ we obtain that

$$\begin{aligned} & a_1 \dots a_m^+(s_1 \dots s_m)^\infty \\ &= (b_1 \dots b_n)^u b_1 \dots b_r (s_1 \dots s_m)^\infty \\ &\preceq (b_1 \dots b_n)^u b_1 \dots b_r (b_{r+1} \dots b_n b_1 \dots b_r^- (b_1 \dots b_n)^{u-1} b_1 \dots b_r)^\infty \\ &\prec (b_1 \dots b_n)^\infty, \end{aligned}$$

leading to a contradiction with (5.4.2).

- If $n = m$, then by (5.4.2) we have $b_1 \dots b_m = a_1 \dots a_m$ or $b_1 \dots b_m = a_1 \dots a_m^+$. Both cases contradict (5.4.2).

Therefore we find $n > m$. Write $n = km + j$ with $k \geq 1$ and $1 \leq j \leq m$. By (5.4.2) we have

$$b_1 \dots b_n \preceq a_1 \dots a_m^+(s_1 \dots s_m)^{k-1} s_1 \dots s_j.$$

From

$$s_{j+1} \dots s_m s_1 \dots s_j \preceq a_1 \dots a_m \prec a_1 \dots a_m^+$$

one can easily see that

$$(a_1 \dots a_m^+(s_1 \dots s_m)^{k-1} s_1 \dots s_j)^\infty \succ a_1 \dots a_m^+(s_1 \dots s_m)^\infty \succcurlyeq (b_1 \dots b_n)^\infty.$$

So $b_1 \dots b_n \neq a_1 \dots a_m^+(s_1 \dots s_m)^{k-1} s_1 \dots s_j$ and hence,

$$b_1 \dots b_n^+ \preceq a_1 \dots a_m^+(s_1 \dots s_m)^{k-1} s_1 \dots s_j. \quad (5.4.3)$$

If strict inequality holds in (5.4.3), then (5.4.1) follows immediately and we are done. Suppose that the equality holds in (5.4.3). We split the proof of (5.4.1) into the following two cases.

(I) $1 \leq j \leq \frac{m}{2}$. Since $s_1 \dots s_m$ is a Lyndon word, it follows that

$$s_1 \dots s_j^- \prec s_1 \dots s_j \preceq s_{j+1} \dots s_{2j}.$$

Furthermore, $t_1 \dots t_n$ is the Lyndon word for

$$b_1 \dots b_n = a_1 \dots a_m^+(s_1 \dots s_m)^{k-1} s_1 \dots s_j^-.$$

Then

$$\begin{aligned} (t_1 \dots t_n)^\infty &\preceq (s_1 \dots s_j^- a_1 \dots a_m^+(s_1 \dots s_m)^{k-1})^\infty \\ &\prec (s_{j+1} \dots s_{2j} s_{2j+1} \dots s_m s_1 \dots s_j)^\infty. \end{aligned}$$

By (5.4.3) this proves (5.4.1) as required.

(II) $\frac{m}{2} < j \leq m$. Since $s_1 \dots s_m$ and $t_1 \dots t_n$ are both Lyndon words, by Lemma 5.3.2 (i) it follows that

$$\begin{aligned} (t_1 \dots t_n)^\infty &\preceq (s_1 \dots s_{m-j} s_{m-j+1} \dots s_j^- a_1 \dots a_m^+(s_1 \dots s_m)^{k-1})^\infty \\ &\prec (s_{j+1} \dots s_m s_1 \dots s_j)^\infty. \end{aligned}$$

Again we established (5.4.1). □

§5.4.1 Farey words

The set of Farey words is constructed recursively as follows. Let F_0 be the ordered set containing the two words 0 and 1, i.e., $F_0 := (0, 1)$. For each $n \geq 1$, $F_n = (v_1, \dots, v_{2^n+1})$ is the ordered set obtained from $F_{n-1} = (w_1, \dots, w_{2^{n-1}+1})$ by:

$$\begin{aligned} v_{2i-1} &:= w_i && \text{for } 1 \leq i \leq 2^{n-1} + 1, \\ v_{2i} &:= w_i w_{i+1} && \text{for } 1 \leq i \leq 2^{n-1}, \end{aligned}$$

where $w_i w_{i+1}$ denotes the concatenation of the words w_i and w_{i+1} . For example,

$$F_0 = (0, 1), \quad F_1 = (0, 01, 1), \quad F_2 = (0, 001, 01, 011, 1).$$

Then a word $w \in \{0, 1\}^*$ is a *Farey word* if there is an $n \geq 0$ such that $w \in F_n$. For each $n \geq 0$ the words in F_n are listed from left to right in a lexicographically increasing order (cf. [17, Lemma 2.2]). In particular, no Farey word is periodic. Let

$$\mathcal{F} := \bigcup_{n \geq 0} F_n \setminus \{0, 1\}$$

be the set of *non-degenerate* Farey words. Clearly, any $w_1 \dots w_m \in \mathcal{F}$ has $w_1 = 0 = 1 - w_m$. It is well known that Farey words are *balanced*, i.e., if for $i = 0, 1$ we use $|u|_i$ to denote the number of occurrences of the symbol i in the word u , then any $w \in \mathcal{F}$ has the property that for any two subword u and v of w of the same length and $i = 0, 1$, $||u|_i - |v|_i| \leq 1$. We recall from [17, Proposition 2.3] the following definition.

Definition 5.4.2. *Let $w = w_1 \dots w_m \in \mathcal{F}$. A decomposition $w = uv$ is called the standard factorisation of w if u and v are both Farey words.*

By the construction of F_n the standard factorisation of a non-degenerate Farey word $w_1 \dots w_m$ is *unique*. We list some properties of Farey words. The proofs can be found in [17, Propositions 2.8 and 2.9].

(f1) For $w_1 \dots w_m \in \mathcal{F}$, both $w_1 \dots w_{m-1}0$ and $1w_2 \dots w_m$ are palindromes, i.e.,

$$w_2 \dots w_{m-1} = w_{m-1} \dots w_2.$$

(f2) Suppose $w_1 \dots w_m \in \mathcal{F}$ has standard factorisation $(w_1 \dots w_{m_1})(w_{m_1+1} \dots w_m)$. The lexicographically largest cyclic permutation of $w_1 \dots w_m$ is given by

$$w_{m-m_1+1} \dots w_m w_1 \dots w_{m-m_1} = w_m w_{m-1} \dots w_2 w_1.$$

(f3) Suppose $w_1 \dots w_m \in \mathcal{F}$ has standard factorisation $(w_1 \dots w_{m_1})(w_{m_1+1} \dots w_m)$. Then $w_1 \dots w_m$ is a Lyndon word and its lexicographically second smallest cyclic permutation is $w_{m_1+1} \dots w_m w_1 \dots w_{m_1}$.

Recall that for $w_1 \dots w_m \in \{0, 1\}^*$, $\overline{w_1 \dots w_m} = (1 - w_1)(1 - w_2) \dots (1 - w_m)$ and note that by symmetry in the set \mathcal{F} ,

$$w_1 \dots w_m \in \mathcal{F} \quad \Rightarrow \quad \overline{w_m \dots w_1} \in \mathcal{F}.$$

By Lemma 5.3.2 (i) it follows that if $w_1 \dots w_m \in \mathcal{F}$, then $(\overline{w_1 \dots w_m})^\infty \in \mathcal{Q}$, i.e., $\sigma^n((\overline{w_1 \dots w_m})^\infty) \preceq (\overline{w_1 \dots w_m})^\infty$ for all $n \geq 0$. Properties (f1), (f2), (f3) imply the following.

Lemma 5.4.3. *Let $s_1 \dots s_m \in \mathcal{F}$ with $a_1 \dots a_m = \mathbf{L}(s_1 \dots s_m)$. Suppose*

$$s_1 \dots s_m = (s_1 \dots s_{m_1})(s_{m_1+1} \dots s_m)$$

is the standard factorisation of $s_1 \dots s_m$.

(i) *The words $a_1 \dots a_{m-1}1$ and $0a_2 \dots a_m$ are palindromes, i.e.,*

$$a_2 \dots a_{m-1} = a_{m-1} \dots a_2.$$

(ii) The Lyndon word associated to $a_1 \dots a_m$ is given by

$$a_{m-m_1+1} \dots a_m a_1 \dots a_{m-m_1} = a_m a_{m-1} \dots a_1.$$

(iii) $(a_1 \dots a_{m_1})^\infty \in \mathcal{Q}$.

Proof. (i) and (ii) immediately follow from (f1) and (f2) respectively. For (iii), we know that $s_1 \dots s_{m_1}$ is a Lyndon word and therefore $(s_1 \dots s_{m_1})^\infty \preceq \sigma^n((s_1 \dots s_{m_1})^\infty)$ for all $n \in \mathbb{N}$. This gives $(a_1 \dots a_{m_1})^\infty \succ \sigma^n((a_1 \dots a_{m_1})^\infty)$ for all $n \in \mathbb{N}$. \square

For Farey words we obtain a strengthened version of Lemma 5.3.9, which will be useful in the proofs of Theorems 5.1.4 and 5.1.5. We define a family $\{\Psi_p\}$ of substitutions first. For each $p \geq 1$, set

$$\Psi_p(0) = 0^{p+1}1 \quad \text{and} \quad \Psi_p(1) = 0^p1. \quad (5.4.4)$$

We extend this definition to words $b_1 \dots b_n \in \{0, 1\}^*$ by

$$\Psi_p(b_1 \dots b_n) = \Psi_p(b_1) \dots \Psi_p(b_n)$$

and similarly for sequences in $\{0, 1\}^{\mathbb{N}}$. One easily shows that τ_k preserves the lexicographical ordering $\{0, 1\}^{\mathbb{N}}$: For any two sequences $(b_i), (d_i) \in \{0, 1\}^{\mathbb{N}}$ we have

$$(b_i) \preceq (d_i) \quad \Leftrightarrow \quad \Psi_p(b_i) \preceq \Psi_p(d_i). \quad (5.4.5)$$

Proposition 5.4.4. *Let $w = s_1 \dots s_m \in \mathcal{F}$. Then setting*

$$\mathcal{Z}_w := \{(x_i) \in \{0, 1\}^{\mathbb{N}} : w0^\infty \preceq \sigma^n((x_i)) \preceq (s_m \dots s_1)^\infty \quad \text{for all } n \geq 0\},$$

we have that $\mathcal{Z}_w := \{\sigma^j(w^\infty) : 0 \leq j < m\}$; in particular $\#\mathcal{Z}_w = m$.

Proof. It is clear that $\{\sigma^j(w^\infty) : 0 \leq j < m\} \subseteq \mathcal{Z}_w$. The other inclusion we prove by induction on the level of the Farey words. For $w = 01$ the statement is trivial. Let $n \geq 2$ be given and assume that the statement is true for all non-degenerate Farey words of F_j , $j < n$. Let $w = s_1 \dots s_m \in F_n$. Note that if $w = 0^{m-1}1$ or $w = 01^{m-1}$, then the statement is obviously true, so we exclude this case. Since all Farey words are balanced, there is a p such that w is of the form

$$w = 0^{p+1}10^{p_1}1 \dots 0^{p_N}10^p1 \quad \text{or} \quad w = 01^{p_0}01^{p_1} \dots 01^{p_N}01^{p+1}$$

for some $N \in \mathbb{N} \cup \{0\}$, where $p_1 \dots p_N \in \{p, p+1\}^N$ is a palindrome. Assume that $w = 0^{p+1}10^{p_1}1 \dots 0^{p_N}10^p1$, the proof for the other case is similar. Recall the substitution Ψ_p defined in (5.4.4). There is a word $v = 0t_1 \dots t_N1 \in \{0, 1\}^*$ with $\Psi_p(v) = w$. In [17, Lemma 2.12] it is proven that v is a Farey word, so $v \in F_k$ for some $k < n$. Moreover, since $w \neq 0^{p+1}1$ we have $v \notin \{0, 1\}$. Recall that

$$s_m \dots s_1 = 1s_2 \dots s_{m-1}0 = 10^p10^{p_1}1 \dots 0^{p_N}10^{p+1},$$

so that

$$\sigma((s_m \dots s_1)^\infty) = \Psi_p((1t_1 \dots t_N0)^\infty).$$

Let $x \in \mathcal{Z}_w$ be given. Then by the form of w any two 1's in x are separated by at least p and at most $p + 1$ 0's. Assume first that $x_1 \dots x_{p+2} = 0^{p+1}1$, so that there is a $y \in \{0, 1\}^{\mathbb{N}}$ such that $\Psi_p(y) = x$. Note that for any $r \geq 1$ there corresponds a $j \geq 1$ such that $\sigma^j(x) = \Psi_p(\sigma^r(y))$, since any digit in y corresponds to a block $0^{p+1}1$ or 0^p1 in x . From (5.3.4) we get that

$$\Psi_p(\sigma^r(y)) = \sigma^j(x) \succ w^\infty = \Psi_p(v^\infty),$$

which by (5.4.5) above implies that $\sigma^r(y) \succ v^\infty$ for all $r \geq 0$. On the other hand, from $\sigma^j(x) \prec (s_m \dots s_1)^\infty$ for all $j \geq 0$ it follows that $\sigma^r(y) \prec (1t_2 \dots t_N 0)^\infty$ for all $r \geq 0$. Hence, $y \in \mathcal{Z}_v$ and by the induction hypothesis there is an $\ell \in \{0, 1, \dots, N\}$ such that $y = \sigma^\ell(v^\infty)$. This implies that

$$x = \Psi_p(y) = \sigma^i(w^\infty),$$

where

$$i = \begin{cases} 0 & \text{if } \ell = 0, \\ p + 2 & \text{if } \ell = 1, \\ (p + 2) + (p_1 + 1) + (p_2 + 1) + \dots + (p_{\ell-1} + 1) & \text{if } 2 \leq \ell \leq N. \end{cases} \quad (5.4.6)$$

If x is such that $x_1 \dots x_{j+1} = 0^j 1$ for some $0 \leq j \leq p$, then there is a $y \in \{0, 1\}^{\mathbb{N}}$ such that $\Psi_p(y) = \sigma^{j+1}(x)$ and by the same arguments as above we get that

$$x = 0^j 1 \sigma^{j+1}(x) = 0^j 1 \Psi_p(y) = 0^j 1 \sigma^i(w^\infty) = \sigma^{i'}(w^\infty),$$

where, in view of (5.4.6), $i' \in \{0, 1, \dots, m - 1\}$ is defined by

$$i' = \begin{cases} m - j - 1 & \text{if } i = 0, \\ i - j - 1 & \text{otherwise.} \end{cases}$$

This completes the proof. □

§5.4.2 Farey intervals

We now use the Farey words to identify the basic intervals $(\beta_L, \beta_R]$ that are not contained in any other basic interval.

Definition 5.4.5. Let $s_1 \dots s_m \in \mathcal{F}$ with $a_1 \dots a_m = \mathbf{L}(s_1 \dots s_m)$ and let γ_L and γ_R be given by the quasi-greedy expansions $\alpha(\gamma_L) = (a_1 \dots a_m)^\infty$ and $\alpha(\gamma_R) = a_1 \dots a_m^+(a_m a_{m-1} \dots a_1)^\infty$ respectively. Then the interval $J_{a_1 \dots a_m} = (\gamma_L, \gamma_R]$ is called the Farey interval generated by $a_1 \dots a_m$.

The following lemma is used to show that the Farey intervals are the maximal basic intervals.

Lemma 5.4.6. Let $w = s_1 \dots s_m \in \mathcal{F}$ and let $a = a_1 \dots a_m = \mathbf{L}(s_1 \dots s_m)$. If $a_n = 1$ for some $1 \leq n \leq m$, then

$$(\mathbf{S}(a_1 \dots a_n^-))^\infty \prec w^\infty.$$

Proof. We will prove this lemma by induction on the level of the Farey words. For the word 01 the statement is clear. Let $k \geq 2$ be given and assume that the statement holds for all non-degenerated Farey words in F_j with $j < k$. Let $w = s_1 \dots s_m \in F_k$. If $w = 0^{m-1}1$ or $w = 01^{m-1}$, then the statement obviously holds. Otherwise, in view of the fact that any Farey word is balanced, w must have the form

$$w = 0^{p+1}10^{p_1}10^{p_2} \dots 10^{p_N}10^{p_1} \quad \text{or} \quad w = 01^p01^{p_1}01^{p_2} \dots 01^{p_N}01^{p+1}$$

for some $p \in \mathbb{N}$ and $N \in \mathbb{N} \cup \{0\}$, where $p_1 \dots p_N \in \{p, p+1\}^N$ is a palindrome. We split the proof into the following two cases.

(I) $w = 0^{p+1}10^{p_1}10^{p_2} \dots 10^{p_N}10^{p_1}$. Then

$$a = \mathbf{L}(w) = 10^p10^{p_1}10^{p_2} \dots 10^{p_N}10^{p+1} =: 10^{p_0}10^{p_1}10^{p_2} \dots 10^{p_N}10^{p_{N+1}}. \quad (5.4.7)$$

Let Ψ_p be the substitution map from (5.4.4). Then by (5.4.7) there exists a word $v = t_0t_1 \dots t_Nt_{N+1} = 1t_1 \dots t_N0$ such that

$$\sigma(a^\infty) = (\Psi_p(v))^\infty.$$

By [17, Lemma 2.12] it follows that $v = \mathbf{L}(0t_1 \dots t_N1)$ and $0t_1 \dots t_N1 \in F_i$ for some $i < k$. Let $1 \leq n \leq m$ be such that $a_n = 1$. Then there is a $0 \leq j \leq N+1$ such that

$$a_1 \dots a_n^- = 10^{p_0}10^{p_1} \dots 10^{p_{j-1}}10^{p_j+1}.$$

Observe that $p_j \in \{p, p+1\}$. If $p_j = p+1$, then the Lyndon word $\mathbf{S}(a_1 \dots a_n^-)$ begins with $0^{p+2}1$ and w begins with $0^{p+1}1$. This implies $(\mathbf{S}(a_1 \dots a_n^-))^\infty \prec w^\infty$. If $p_j = p$, then $t_j = 1$ and

$$(\mathbf{S}(a_1 \dots a_n^-))^\infty = (\mathbf{S}(\Psi_p(1t_1 \dots t_j^-)))^\infty.$$

By the induction hypothesis it follows that

$$(\mathbf{S}(1t_1 \dots t_j^-))^\infty \prec (0t_1 \dots t_N1)^\infty.$$

Since the map Ψ_p preserves the lexicographical ordering (see (5.4.5)), this gives

$$\begin{aligned} (\mathbf{S}(a_1 \dots a_n^-))^\infty &= (\mathbf{S}(\Psi_p(1t_1 \dots t_j^-)))^\infty = \Psi_p(\mathbf{S}(1t_1 \dots t_j^-))^\infty \\ &\prec \Psi_p((0t_1 \dots t_N1)^\infty) = w^\infty. \end{aligned}$$

(II) $w = 01^p01^{p_1}01^{p_2} \dots 01^{p_N}01^{p+1}$. Then the largest cyclic permutation of w is

$$a = \mathbf{L}(w) = 1^{p+1}01^{p_1}01^{p_2}0 \dots 1^{p_N}01^{p_0} =: 1^{p_0}01^{p_1}01^{p_2}0 \dots 1^{p_N}01^{p_{N+1}}0. \quad (5.4.8)$$

Define the substitution map $\hat{\Psi}_p$ by

$$\hat{\Psi}_p(0) = 01^p \quad \text{and} \quad \hat{\Psi}_p(1) = 01^{p+1}$$

and extend it to words and sequences in the usual way. One easily shows that $\hat{\Psi}_p$ preserves the lexicographical ordering. Then by (5.4.8) there exists a word $v = t_0t_1 \dots t_Nt_{N+1} = 1t_1 \dots t_N0$ such that

$$\sigma^{m-1}(a^\infty) = \hat{\Psi}_p(v^\infty).$$

Furthermore, by [17, Lemma 2.12] it follows that $v = \mathbf{L}(0t_1 \dots t_N 1)$ and $0t_1 \dots t_N 1 \in F_i$ for some $i < k$. Let $1 \leq n \leq m$ be such that $a_n = 1$. Then by (5.4.8) there exists $0 \leq j \leq N + 1$ and $0 < \ell \leq p_j$ such that

$$a_1 \dots a_n^- = 1^{p_0} 01^{p_1} 01^{p_2} 0 \dots 1^{p_{j-1}} 01^{p_j - \ell} 0.$$

Observe that $p_j \in \{p, p + 1\}$. Then $0 \leq p_j - \ell \leq p$. If $p_j - \ell < p$, then $\mathbf{S}(a_1 \dots a_n^-)$ begins with $01^{p_j - \ell} 0$ and w begins with 01^p . So $(\mathbf{S}(a_1 \dots a_n^-))^\infty \prec w^\infty$. If $p_j - \ell = p$, then $p_j = p + 1$ and $t_j = 1$. Since $0t_1 \dots t_N 1$ is a non-degenerated Farey word in F_i with $i < k$, by the induction hypothesis we have

$$(\mathbf{S}(1t_1 \dots t_j^-))^\infty \prec (0t_1 \dots t_N 1)^\infty.$$

Since the map $\hat{\Psi}_p$ preserves the lexicographical ordering, it follows that

$$\begin{aligned} (\mathbf{S}(a_1 \dots a_n^-))^\infty &= (\mathbf{S}(\hat{\Psi}_p(1t_1 \dots t_j^-)))^\infty = \hat{\Psi}_p((\mathbf{S}(1t_1 \dots t_j^-))^\infty) \\ &\prec \hat{\Psi}_p((0t_1 \dots t_N 1)^\infty) = w^\infty. \end{aligned}$$

This completes the lemma. □

Proposition 5.4.7. *Each Farey interval is a maximal basic interval.*

Proof. By Proposition 5.4.1 the basic intervals are nested, so it suffices to prove that a Farey interval can not be contained in any other basic interval. Let $(\gamma_L, \gamma_R]$ be a Farey interval generated by a Farey word $s_1 \dots s_m$ and let $a_1 \dots a_m = \mathbf{L}(s_1 \dots s_m)$. Then

$$\alpha(\gamma_L) = (a_1 \dots a_m)^\infty \quad \text{and} \quad \alpha(\gamma_R) = a_1 \dots a_m^+(s_1 \dots s_m)^\infty,$$

Suppose on the contrary that there exists another basic interval $(\beta_L, \beta_R]$ such that $(\gamma_L, \gamma_R] \subsetneq (\beta_L, \beta_R]$. Assume $(\beta_L, \beta_R]$ is generated by the Lyndon word $t_1 \dots t_n$ and let $b_1 \dots b_n = \mathbf{L}(t_1 \dots t_n)$. Then

$$\alpha(\beta_L) = (b_1 \dots b_n)^\infty \quad \text{and} \quad \alpha(\beta_R) = b_1 \dots b_n^+(t_1 \dots t_n)^\infty.$$

So by using $\beta_L < \gamma_L \leq \beta_R$ it follows that

$$(b_1 \dots b_n)^\infty \prec (a_1 \dots a_m)^\infty \preceq b_1 \dots b_n^+(t_1 \dots t_n)^\infty. \quad (5.4.9)$$

By the same argument as in the proof of Proposition 5.4.1 we obtain $m > n$.

Now we claim $a_1 \dots a_n = b_1 \dots b_n^+$. By (5.4.9) it follows that $b_1 \dots b_n \preceq a_1 \dots a_n \preceq b_1 \dots b_n^+$. So it suffices to prove $a_1 \dots a_n \neq b_1 \dots b_n$. Suppose $a_1 \dots a_n = b_1 \dots b_n$. Write $m = kn + j$ with $k \geq 1$ and $1 \leq j \leq n$. Note that $a_1 \dots a_m$ is the largest cyclic permutation of a Farey word. Then $a_{i+1} \dots a_m \prec a_1 \dots a_{m-i}$ for all $i < m$. So

$$a_1 \dots a_m \preceq (a_1 \dots a_n)^k a_{m-j+1} \dots a_m \prec (a_1 \dots a_n)^k a_1 \dots a_j = (b_1 \dots b_n)^k b_1 \dots b_j,$$

leading to a contradiction with (5.4.9). This establishes the claim.

By the claim it follows that $a_n = 1$ and $t_1 \dots t_n = \mathbf{S}(b_1 \dots b_n) = \mathbf{S}(a_1 \dots a_n^-)$. Since $s_1 \dots s_m$ is a non-degenerate Farey word and $a_1 \dots a_m = \mathbf{L}(s_1 \dots s_m)$, by Lemma 5.4.6 it follows that

$$(t_1 \dots t_n)^\infty \prec (s_1 \dots s_m)^\infty \preceq (a_{n+1} \dots a_m a_1 \dots a_n)^\infty.$$

Again by the claim we conclude that

$$b_1 \dots b_n^+(t_1 \dots t_n)^\infty \prec (a_1 \dots a_m)^\infty.$$

This leads to a contradiction with (5.4.9). □

Proposition 5.3.10 states that for any $\beta \in J_{a_1 \dots a_m}$ the set E_β^+ contains an isolated point. So the set of $\beta \in (1, 2)$ for which E_β^+ has no isolated points is a subset of $(1, 2) \setminus \bigcup_{s_1 \dots s_m \in \mathcal{F}} J_{s_m \dots s_1}$. Suppose on the other hand that $\beta \in (1, 2) \setminus \bigcup_{s_1 \dots s_m \in \mathcal{F}} J_{s_m \dots s_1}$. From Proposition 5.3.3 we know that any isolated point t of E_β^+ must have a periodic β -expansion $b(t, \beta)$. To such a β -expansion we can relate a basic interval $(\beta_L, \beta_R]$ as in Proposition 5.3.10. From the maximality of the Farey intervals and Proposition 5.3.10 we can then deduce that t is not isolated for E_β^+ . Thus the set of $\beta \in (1, 2)$ for which E_β^+ has no isolated points is in fact equal to the set

$$(1, 2) \setminus \bigcup_{s_1 \dots s_m \in \mathcal{F}} J_{s_m \dots s_1}.$$

To prove Theorem 5.1.4 it is therefore enough to prove that this set has Hausdorff dimension zero. We do so by relating each Farey interval $J_{a_1 \dots a_m}$ to another interval $I_{\overline{a_1 \dots a_m}}$ associated to the doubling map and using known results for the union $\bigcup I_{\overline{a_1 \dots a_m}}$.

Recall that the doubling map is given by $T_2(x) = 2x \pmod{1}$ and that $\pi_2 : \{0, 1\}^{\mathbb{N}} \rightarrow [0, 1]$ is the projection map defined in (5.2.1). Set

$$E_D := \left\{ x \in \left[0, \frac{1}{2}\right) : T_2^n(x) \in \left[x, x + \frac{1}{2}\right] \text{ for all } n \geq 0 \right\}.$$

For each Farey word $w = w_1 \dots w_m \in \mathcal{F}$ we denote by $I_w := (q_L, q_R)$ the open interval associated to w , where

$$q_L = \pi_2((w_m w_{m-1} \dots w_1)^\infty) - \frac{1}{2} \quad \text{and} \quad q_R = \pi_2((w_1 \dots w_m)^\infty).$$

The interval $I_w = (q_L, q_R)$ is well-defined, since by (f1) it follows that

$$\begin{aligned} q_L &= \pi_2(0w_{m-1}w_{m-2} \dots w_1(w_m w_{m-1} \dots w_1)^\infty) \\ &= \pi_2(w_1 w_2 \dots w_{m-1} 0(w_m w_{m-1} \dots w_1)^\infty) < \pi_2((w_1 \dots w_m)^\infty) = q_R. \end{aligned}$$

In [17] we find the following result.

Proposition 5.4.8. [17, Proposition 2.14]

(i) Each I_w is a connected component of $(0, \frac{1}{2}) \setminus E_D$. Moreover,

$$\left(0, \frac{1}{2}\right) \setminus E_D = \bigcup_{w \in \mathcal{F}} I_w.$$

(ii) $\dim_H E_D = 0$.

Recall that by Lemma 5.2.1 the function $\alpha : \beta \mapsto \alpha(\beta)$ is a strictly increasing bijection from $(1, 2]$ to \mathcal{Q} . Moreover, $\pi_2 : \{0, 1\}^{\mathbb{N}} \rightarrow (0, 1]$ is a strictly increasing bijection if we remove from $\{0, 1\}^{\mathbb{N}}$ all sequences ending with 0^∞ . Since such sequences do not occur as quasi-greedy expansions of 1 and since the first digit $\alpha_1(\beta)$ equals 1 for any $\beta \in (1, 2)$, the map

$$\phi : (1, 2) \rightarrow \left(\frac{1}{2}, 1\right), \beta \mapsto \pi_2(\alpha(\beta)) = \sum_{i=1}^{\infty} \frac{\alpha_i(\beta)}{2^i}$$

is strictly increasing as well. The image $\phi((1, 2))$ is a proper subset of $(\frac{1}{2}, 1)$.

Lemma 5.4.9.

$$\phi\left((1, 2) \setminus \bigcup_{s_1 \dots s_m \in \mathcal{F}} J_{s_m \dots s_1}\right) \subseteq \left(\frac{1}{2}, 1\right) \setminus \bigcup_{s_1 \dots s_m \in \mathcal{F}} (1 - I_{s_1 \dots s_m}) = 1 - E_D.$$

Proof. Let $s_1 \dots s_m \in \mathcal{F}$ with $a_1 \dots a_m = \mathbf{L}(s_1 \dots s_m)$. Note that

$$q_R = \pi_2(\overline{(a_1 \dots a_m)}^\infty) = \sum_{n \geq 1} \frac{1}{2^n} - \pi_2((a_1 \dots a_m)^\infty) = 1 - \phi(\gamma_L).$$

Moreover, by Lemma 5.4.3(i) and (ii) it follows that

$$\alpha(\gamma_R) = a_1 \dots a_m^+(a_m a_{m-1} \dots a_1)^\infty = 1 a_{m-1} a_{m-2} \dots a_1 (a_m a_{m-1} \dots a_1)^\infty.$$

Then

$$\begin{aligned} \phi(\gamma_R) &= \pi_2(1 a_{m-1} a_{m-2} \dots a_1 (a_m a_{m-1} \dots a_1)^\infty) \\ &= \frac{1}{2} + \pi_2((a_m a_{m-1} \dots a_1)^\infty) = \frac{1}{2} + (1 - \pi_2(\overline{(a_m a_{m-1} \dots a_1)}^\infty)) \\ &= 1 - \left(\pi_2(\overline{(a_m a_{m-1} \dots a_1)}^\infty) - \frac{1}{2}\right) = 1 - q_L. \end{aligned}$$

Since ϕ is strictly increasing and bijective from $(1, 2)$ to $\phi((1, 2))$, this implies that

$$\phi^{-1}((1 - q_R, 1 - q_L)) = (\gamma_L, \gamma_R).$$

By Proposition 5.4.8(i) this gives the result. \square

Finally, to determine the Hausdorff dimension of $(1, 2) \setminus \bigcup_{s_1 \dots s_m \in \mathcal{F}} J_{s_m \dots s_1}$, we prove that the inverse $\phi^{-1} : \pi_2 \circ \alpha((1, 2)) \rightarrow (1, 2)$ is Hölder continuous and combine this with the following well known result: If $f : (X, \rho_1) \rightarrow (Y, \rho_2)$ is a c -Hölder continuous map between two metric spaces (X, ρ_1) and (Y, ρ_2) , then $\dim_H f(X) \leq \frac{1}{c} \dim_H X$.

Lemma 5.4.10. For any integer $N \geq 2$ the function ϕ^{-1} is c -Hölder continuous with $c = \frac{\log(1+1/N)}{\log 4}$ on the set $\phi([1 + \frac{1}{N}, 2))$.

Proof. Fix $N \geq 2$ and let $\beta_1, \beta_2 \in [1 + \frac{1}{N}, 2)$ with $\beta_1 < \beta_2$. Then $\alpha(\beta_1) \prec \alpha(\beta_2)$. Let n be the positive integer such that

$$\alpha_1(\beta_1) \dots \alpha_{n-1}(\beta_1) = \alpha_1(\beta_2) \dots \alpha_{n-1}(\beta_2) \quad \text{and} \quad \alpha_n(\beta_1) < \alpha_n(\beta_2). \quad (5.4.10)$$

By using $1 = \pi_{\beta_1}(\alpha(\beta_1)) = \pi_{\beta_2}(\alpha(\beta_2))$ and (5.4.10) it follows that

$$\begin{aligned} 0 < \beta_2 - \beta_1 &= \beta_2 \sum_{j=1}^{\infty} \frac{\alpha_j(\beta_2)}{\beta_2^j} - \beta_1 \sum_{j=1}^{\infty} \frac{\alpha_j(\beta_1)}{\beta_1^j} \\ &\leq \sum_{j=1}^{\infty} \frac{\alpha_j(\beta_2)}{\beta_2^{j-1}} - \sum_{j=1}^{\infty} \frac{\alpha_j(\beta_1)}{\beta_2^{j-1}} \\ &= \sum_{j=n}^{\infty} \frac{\alpha_j(\beta_2) - \alpha_j(\beta_1)}{\beta_2^{j-1}} \leq \sum_{j=n}^{\infty} \frac{1}{(1 + \frac{1}{N})^{j-1}} = N \left(1 + \frac{1}{N}\right)^{2-n}. \end{aligned} \quad (5.4.11)$$

On the other hand, by (5.4.10) we also have

$$\begin{aligned} \pi_2(\alpha(\beta_2)) - \pi_2(\alpha(\beta_1)) &= \sum_{j=1}^{\infty} \frac{\alpha_j(\beta_2) - \alpha_j(\beta_1)}{2^j} = \sum_{j=n}^{\infty} \frac{\alpha_j(\beta_2) - \alpha_j(\beta_1)}{2^j} \\ &\geq \frac{1}{2^n} - \sum_{j=n+1}^{\infty} \frac{\alpha_j(\beta_1)}{2^j} \geq \frac{1}{2^n(2^n - 1)} > \frac{1}{4^n}, \end{aligned} \quad (5.4.12)$$

where the second inequality follows by Lemma 5.2.1 and the fact that

$$\alpha_{n+1}(\beta_1)\alpha_{n+2}(\beta_1) \dots \preccurlyeq \alpha_1(\beta_1)\alpha_2(\beta_1) \dots \preccurlyeq (1^{n-1}0)^\infty.$$

Combining (5.4.11) and (5.4.12), we conclude that

$$\begin{aligned} |\pi_2(\alpha(\beta_2)) - \pi_2(\alpha(\beta_1))| &\geq \frac{1}{4^n} = \left(1 + \frac{1}{N}\right)^{-\frac{\log 4}{\log(1+\frac{1}{N})}n} \\ &\geq \left(N \left(1 + \frac{1}{N}\right)^2\right)^{-\frac{\log 4}{\log(1+\frac{1}{N})}} |\beta_2 - \beta_1|^{\frac{\log 4}{\log(1+\frac{1}{N})}}. \end{aligned}$$

□

Proof of Theorem 5.1.4. By Lemma 5.4.9 the only thing left to show is that $\dim_H \phi^{-1}(1 - E_D) = 0$. This follows from Lemma 5.4.10 and Proposition 5.4.8 (ii) in

the following way:

$$\begin{aligned}
 0 &\leq \dim_H \phi^{-1}(1 - E_D) = \dim_H \left(\bigcup_{N \geq 2} \left(\phi^{-1}(1 - E_D) \cap \left[1 + \frac{1}{N}, 2\right) \right) \right) \\
 &= \sup_{N \geq 2} \dim_H \phi^{-1} \left((1 - E_D) \cap \phi \left(\left[1 + \frac{1}{N}, 2\right) \right) \right) \\
 &\leq \sup_{N \geq 2} \frac{\log 4}{\log(1 + 1/N)} \dim_H \left((1 - E_D) \cap \phi \left(\left[1 + \frac{1}{N}, 2\right) \right) \right) \\
 &\leq \sup_{N \geq 2} \frac{\log 4}{\log(1 + 1/N)} \dim_H(1 - E_D) = \sup_{N \geq 2} \frac{\log 4}{\log(1 + 1/N)} \dim_H E_D = 0.
 \end{aligned}$$

□

§5.5 The critical points of the dimension function

Since the map $\eta_\beta : t \mapsto \dim_H K_\beta(t)$ is a decreasing, continuous function with $\eta_\beta(0) = 1$ and $\eta_\beta(\frac{1}{\beta}) = 0$, there is a unique value τ_β such that $\dim_H K_\beta(t) > 0$ if and only if $t < \tau_\beta$. Determining the value of τ_β would extend the results from [24] for holes of the form $(0, t)$. For $\beta = \gamma_L$ equal to the left endpoint of one of the Farey intervals, we show below that $\tau_\beta = 1 - \frac{1}{\beta}$. This result is based on the following lemma.

Lemma 5.5.1. *Let $s_1 \dots s_m \in \mathcal{F}$ with $a_1 \dots a_m = \mathbf{L}(s_1 \dots s_m)$. Let $1 \leq j \leq m$ be such that $s_1 \dots s_m = a_{j+1} \dots a_m a_1 \dots a_j$. For each $N \geq 1$, define the sequence $\mathbf{t}_N \in \{0, 1\}^{\mathbb{N}}$ by*

$$\mathbf{t}_N := (0a_2 \dots a_m (a_1 \dots a_m)^N a_1 \dots a_j)^\infty. \quad (5.5.1)$$

Then for each $N \geq 1$, $\mathbf{t}_N \prec \mathbf{t}_{N+1}$. Furthermore, any sequence \mathbf{t} that is a concatenation of blocks of the form

$$0a_2 \dots a_m (a_1 \dots a_m)^k a_1 \dots a_j, \quad k \geq N,$$

satisfies $\mathbf{t}_N \preceq \sigma^n(\mathbf{t}) \prec (a_1 \dots a_m)^\infty$ for all $n \geq 0$. In particular, we have for each $n \geq 0$ that

$$\mathbf{t}_N \preceq \sigma^n(\mathbf{t}_N) \prec (a_1 \dots a_m)^\infty.$$

Proof. By Lemma 5.4.3 it follows that

$$s_1 \dots s_m = a_m a_{m-1} \dots a_1 = 0a_2 \dots a_m^+ = a_{j+1} \dots a_m a_1 \dots a_j. \quad (5.5.2)$$

This implies that for all $N \geq 1$,

$$\begin{aligned}
 \mathbf{t}_N &= (0a_2 \dots a_m (a_1 \dots a_m)^N a_1 \dots a_j) (a_{j+1} \dots a_m a_1 \dots a_j^- (a_1 \dots a_m)^N a_1 \dots a_j)^\infty \\
 &\prec (0a_2 \dots a_m (a_1 \dots a_m)^{N+1} a_1 \dots a_j)^\infty = \mathbf{t}_{N+1},
 \end{aligned}$$

giving the first part of the statement. For the second statement, let \mathbf{t} be a sequence consisting of a concatenation of blocks of the form $0a_2 \dots a_m (a_1 \dots a_m)^k a_1 \dots a_j$ with

prefix $0a_2 \dots a_m(a_1 \dots a_m)^K a_1 \dots a_j$ for some $K \geq N$. We first show that $\sigma^n(\mathbf{t}) \prec (a_1 \dots a_m)^\infty$ for all $n \geq 0$. For $n = 0$ the statement is clear. By Lemma 5.3.8 it follows that $a_{i+1} \dots a_m \prec a_1 \dots a_{m-i}$ for each $0 < i < m$. This implies that $\sigma^n(\mathbf{t}) \prec (a_1 \dots a_m)^\infty$ for each $\ell m < n < (\ell + 1)m$, $0 \leq \ell \leq K$. For all other values of $n < (K + 1)m + j$ we obtain the result from (5.5.2), which implies that

$$a_1 \dots a_j 0 a_2 \dots a_m = a_1 \dots a_m a_1 \dots a_j^- \prec a_1 \dots a_m a_1 \dots a_j.$$

The same arguments then give the result for any $n \geq 0$. Hence, $\sigma^n(\mathbf{t}) \prec (a_1 \dots a_m)^\infty$ for all $n \geq 0$. We now show that $\sigma^n(\mathbf{t}) \succ \mathbf{t}_N$ for each $n \geq 0$. Note that \mathbf{t} has prefix

$$s_1 \dots s_m^- (a_1 \dots a_m)^K a_1 \dots a_j.$$

For $n = 0$ the statement follows from (5.5.2). By (5.5.2), Lemmas 5.3.2 and 5.3.8 it follows that

$$s_{i+1} \dots s_m^- \succcurlyeq s_1 \dots s_{m-i} \quad \text{and} \quad a_1 \dots a_i \succ a_{m-i+1} \dots a_m = s_{m-i+1} \dots s_m^-$$

for all $0 < i < m$, giving the statement for all $0 < n < m$. Since $s_1 \dots s_m$ is the Lyndon word associated to $a_1 \dots a_m$, we obtain

$$a_{i+1} \dots a_m a_1 \dots a_i \succcurlyeq s_1 \dots s_m \succcurlyeq s_1 \dots s_m^- \quad \text{for any} \quad 0 \leq i < m.$$

Since $a_1 \dots a_j s_1 \dots s_{m-j} = a_1 \dots a_m$, the conclusion that $\sigma^n(\mathbf{t}) \succ \mathbf{t}_N$ for all $n \geq 0$ follows. \square

Proposition 5.5.2. *Let $s_1 \dots s_m \in \mathcal{F}$ with $a_1 \dots a_m = \mathbf{L}(s_1 \dots s_m)$ and let $\beta \in (1, 2)$ be such that $\alpha(\beta) = (a_1 \dots a_m)^\infty$. Then $1 - \frac{1}{\beta} \in E_\beta^0$ and*

$$\tau_\beta = 1 - \frac{1}{\beta} = \max \overline{E_\beta^+}.$$

Proof. Since m is the minimal period of $\alpha(\beta)$, the greedy β -expansion of 1 is equal to $b(1, \beta) = a_1 \dots a_m^+ 0^\infty$. Lemma 5.4.3 tells us that $a_1 \dots a_m^+ = 1a_{m-1} \dots a_1$, so

$$\pi_\beta(a_m a_{m-1} \dots a_1 0^\infty) = \pi_\beta(1a_{m-1} \dots a_1 0^\infty) - \frac{1}{\beta} = \pi_\beta(a_1 \dots a_m^+ 0^\infty) - \frac{1}{\beta} = 1 - \frac{1}{\beta}.$$

Recall that $a_m a_{m-1} \dots a_1 = 0a_2 \dots a_m^+$. Then by Lemma 5.3.8 it follows that for each $n \geq 0$, $\sigma^n(a_m a_{m-1} \dots a_1 0^\infty) \prec (a_1 \dots a_m)^\infty = \alpha(\beta)$ and hence $a_m a_{m-1} \dots a_1 0^\infty$ is the greedy β -expansion of $1 - \frac{1}{\beta}$, i.e., $b(1 - \frac{1}{\beta}, \beta) = a_m a_{m-1} \dots a_1 0^\infty$. By Lemma 5.3.2, $b(1 - \frac{1}{\beta}, \beta) \in \mathcal{E}_\beta^0$, so $1 - \frac{1}{\beta} \in E_\beta^0$.

The quasi-greedy β -expansion of $1 - \frac{1}{\beta}$ is given by

$$\tilde{b}\left(1 - \frac{1}{\beta}, \beta\right) = 0a_2 \dots a_m(a_1 \dots a_m)^\infty.$$

Now consider the sequences \mathbf{t}_N from Lemma 5.5.1. Since $\mathbf{t}_N \preccurlyeq \sigma^n(\mathbf{t}_N) \prec (a_1 \dots a_m)^\infty = \alpha(\beta)$ for all $n \geq 0$, we have $\mathbf{t}_N \in \mathcal{E}_\beta^+$ for each $N \geq 1$. Moreover, if we set $t_N := \pi_\beta(\mathbf{t}_N)$,

then Lemma 5.2.2 gives that $t_N \nearrow 1 - \frac{1}{\beta}$ as $N \rightarrow \infty$. So $\max \overline{E_\beta^+} \geq 1 - \frac{1}{\beta}$. Furthermore, the fact that any sequence of concatenations of blocks of the form $0a_2 \dots a_m (a_1 \dots a_m)^k a_1 \dots a_j$, $k \geq N$, belongs to $\mathcal{K}_\beta^+(t_N)$ implies that $h_{top}(\mathcal{K}_\beta^+(t_N)) > 0$ for all $N \geq 1$ and hence also $h_{top}(\mathcal{K}_\beta(t_N)) > 0$ for all $N \geq 1$. By the dimension formula (5.2.5) we then get that $\tau_\beta \geq 1 - \frac{1}{\beta}$.

On the other hand, by Lemma 5.4.3(ii) and Proposition 5.4.4 we have

$$\mathcal{K}_\beta^+\left(1 - \frac{1}{\beta}\right) = \{(x_i) : a_m a_{m-1} \dots a_1 0^\infty \preceq \sigma^n((x_i)) \prec (a_1 \dots a_m)^\infty \forall n \geq 0\} = \emptyset. \quad (5.5.3)$$

Since $E_\beta^+ \cap [1 - \frac{1}{\beta}, 1] \subseteq K_\beta^+(1 - \frac{1}{\beta})$, this implies that $\max \overline{E_\beta^+} \leq 1 - \frac{1}{\beta}$. It also implies that $\dim_H K_\beta(1 - \frac{1}{\beta}) = 0$, which gives that $\tau_\beta \leq 1 - \frac{1}{\beta}$ and proves the result. \square

Remark 5.5.3. Note that the previous lemma also implies that for any $t < 1 - \frac{1}{\gamma_L}$ we have $h_{top}(\mathcal{K}_{\gamma_L}^+(t)) > 0$. We will use this later on.

Next we will give a lower and upper bound for τ_β on each Farey interval $(\gamma_L, \gamma_R]$.

Lemma 5.5.4. Let $s_1 \dots s_m \in \mathcal{F}$ with $a_1 \dots a_m = \mathbf{L}(s_1 \dots s_m)$. For each $\beta \in (\gamma_L, \gamma_R]$, set $t^* = \pi_\beta(0a_2 \dots a_m (a_1 \dots a_m)^\infty)$ and $t^\diamond = \pi_\beta(0a_2 \dots a_m^+ 0^\infty)$. Then $t^* \in E_\beta^+$, $t^\diamond \in E_\beta^0$ and

$$1 - \frac{1}{\beta} - \frac{1}{\beta^m} + \frac{1}{\beta(\beta^m - 1)} \leq t^* \leq \tau_\beta \leq t^\diamond < 1 - \frac{1}{\beta}.$$

Proof. Take $\beta \in (\gamma_L, \gamma_R]$. Then

$$(a_1 \dots a_m)^\infty \prec \alpha(\beta) \preceq a_1 \dots a_m^+ (a_m a_{m-1} \dots a_1)^\infty.$$

We first show that $\tau_\beta \geq t^*$. By Lemmas 5.4.3 and 5.3.8, we have

$$\sigma^n(0a_2 \dots a_m (a_1 \dots a_m)^\infty) \preceq (a_1 \dots a_m)^\infty \prec \alpha(\beta) \quad \forall n \geq 0.$$

Hence, $b(t^*, \beta) = 0a_2 \dots a_m (a_1 \dots a_m)^\infty$ and as in the proof of Lemma 5.5.1 we have that $\sigma^n(b(t^*, \beta)) \succeq b(t^*, \beta)$ for each $n \geq 0$. So $t^* \in E_\beta^+$.

For each $t < t^*$ we have by Lemma 5.2.2 that $b(t, \beta) \prec 0a_2 \dots a_m (a_1 \dots a_m)^\infty$. This implies that for N large enough, $b(t, \beta) \prec \mathbf{t}_N \prec (a_1 \dots a_m)^\infty \prec \alpha(\beta)$. By Lemma 5.5.1, it follows that $t_N \in \mathcal{K}_\beta^+(t)$ and $h_{top}(\mathcal{K}_\beta(t)) \geq h_{top}(\mathcal{K}_\beta^+(t)) > 0$. Thus $\dim_H \mathcal{K}_\beta(t) > 0$ and $\tau_\beta \geq t^*$.

On the other hand, for t^\diamond we have that $0a_2 \dots a_m^+ 0^\infty$ is admissible for any $\beta \in (\gamma_L, \gamma_R]$ and that $\sigma^n(0a_2 \dots a_m^+ 0^\infty) \succ 0a_2 \dots a_m^+ 0^\infty$ for all $0 < n < m$, so $t^\diamond \in E_\beta^0$. By

Lemmas 5.4.3 and 5.3.7 we get

$$\begin{aligned}
 \mathcal{K}_\beta^+(t^\diamond) &\subseteq \{(x_i) : a_m a_{m-1} \dots a_1 0^\infty \preceq \sigma^n((x_i)) \prec a_1 \dots a_m^+(a_m a_{m-1} \dots a_1)^\infty \forall n \geq 0\} \\
 &= \{(x_i) : (a_m a_{m-1} \dots a_1)^\infty \preceq \sigma^n((x_i)) \prec a_1 \dots a_m^+(a_m a_{m-1} \dots a_1)^\infty \forall n \geq 0\} \\
 &= \{(x_i) : (a_m a_{m-1} \dots a_1)^\infty \preceq \sigma^n((x_i)) \preceq (a_1 \dots a_m)^\infty \forall n \geq 0\} \\
 &= \{(x_i) : a_m a_{m-1} \dots a_1 0^\infty \preceq \sigma^n((x_i)) \preceq (a_1 \dots a_m)^\infty \forall n \geq 0\}.
 \end{aligned} \tag{5.5.4}$$

By Proposition 5.4.4 it follows that $\#\mathcal{K}_\beta^+(t^\diamond) < \infty$, so that $\dim_H K_\beta(t^\diamond) = 0$. This gives that $\tau_\beta \leq t^\diamond$. Note that

$$\pi_{\gamma_R}(a_1 a_2 \dots a_m^+(0 a_2 \dots a_m)^\infty) = 1.$$

Then, we have for each $\beta \in (\gamma_L, \gamma_R]$ that

$$\begin{aligned}
 t^* &= \pi_\beta(0 a_2 \dots a_m (a_1 a_2 \dots a_m)^\infty) \\
 &> 1 - \frac{1}{\beta} - \frac{1}{\beta^m} + \sum_{i=1}^{\infty} \frac{1}{\beta^{im+1}} = 1 - \frac{1}{\beta} - \frac{1}{\beta^m} + \frac{1}{\beta(\beta^m - 1)}.
 \end{aligned}$$

From Proposition 5.5.2 we know that $\pi_{\gamma_L}(0 a_2 \dots a_m^+ 0^\infty) = 1 - \frac{1}{\gamma_L}$. For $\beta > \gamma_L$ we have $a_1 \dots a_m^+ 0^\infty \prec b(1, \beta)$, so that

$$t^\diamond = \pi_\beta(0 a_2 \dots a_m^+ 0^\infty) = \pi_\beta(a_1 \dots a_m^+ 0^\infty) - \pi_\beta(10^\infty) < 1 - \frac{1}{\beta}.$$

□

In Figure 5.3 we see a plot of the lower and upper bounds for τ_β found in Lemma 5.5.4.

The next lemma considers the critical point τ_β for the remaining values of β , i.e., those that are not in the closure of a Farey interval.

Lemma 5.5.5. *Let $\beta \in (1, 2) \setminus \bigcup[\gamma_L, \gamma_R]$ with the union taken over all Farey intervals. Then $\max E_\beta^+ = \tau_\beta = 1 - \frac{1}{\beta}$.*

Proof. Take $\beta \in (1, 2) \setminus \bigcup[\gamma_L, \gamma_R]$. First we show that $\tau_\beta \geq 1 - \frac{1}{\beta}$. Let $t < 1 - \frac{1}{\beta}$ with $b(t, \beta) = (b_i(t, \beta))$. Since $\dim_H((1, 2) \setminus \bigcup[\gamma_L, \gamma_R]) = 0$, there exists a sequence of Farey intervals $([\gamma_{L,k}, \gamma_{R,k}])$ such that $\gamma_{L,k} \nearrow \beta$ as $k \rightarrow \infty$. Thus, as $k \rightarrow \infty$ we have

$$\sum_{i=1}^{\infty} \frac{b_i(t, \beta)}{(\gamma_{L,k})^i} \searrow \sum_{i=1}^{\infty} \frac{b_i(t, \beta)}{\beta^i} = t \quad \text{and} \quad 1 - \frac{1}{\gamma_{L,k}} \nearrow 1 - \frac{1}{\beta}. \tag{5.5.5}$$

For each k , we have a sequence $(\mathbf{t}_{k,N}) \subseteq \mathcal{E}_{\gamma_{L,k}}^+$ as given in (5.5.1). Since $\gamma_{L,k} < \beta$, we obtain for each $N, n \geq 1$, that

$$\mathbf{t}_{k,N} \preceq \sigma^n(\mathbf{t}_{k,N}) \prec \alpha(\gamma_{L,k}) \prec \alpha(\beta).$$

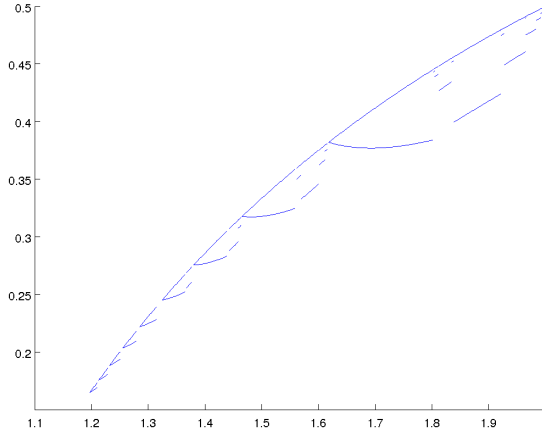

Figure 5.3: A plot of $1 - \frac{1}{\beta}$ and $1 - \frac{1}{\beta} - \frac{1}{\beta^m} + \frac{1}{\beta(\beta^m - 1)}$ for basic intervals corresponding to Farey words of length m with $m \leq 10$.

Hence, $\mathbf{t}_{k,N} \in \mathcal{E}_\beta^+$ for all $k \geq 1$ and $N \geq 1$. This gives that $\max \overline{E}_\beta^+ \geq 1 - \frac{1}{\beta}$. Moreover, since $t < 1 - \frac{1}{\beta}$, we can find by (5.5.5) a sufficiently large $M \in \mathbb{N}$ such that

$$t < t_1 := \sum_{i=1}^{\infty} \frac{b_i(t, \beta)}{(\gamma_{L,M})^i} < 1 - \frac{1}{\gamma_{L,M}} < 1 - \frac{1}{\beta}.$$

Observe that $b(t, \beta) = (b_i(t, \beta))$ is a $\gamma_{L,M}$ -expansion of t_1 , which is lexicographically less than or equal to its greedy expansion $b(t_1, \gamma_{L,M})$. Then,

$$\begin{aligned} \mathcal{K}_\beta^+(t) &= \{(x_i) : b(t, \beta) \preceq \sigma^n((x_i)) \prec \alpha(\beta) \forall n \geq 0\} \\ &\supseteq \{(x_i) : b(t_1, \gamma_{L,M}) \preceq \sigma^n((x_i)) \prec \alpha(\gamma_{L,M}) \forall n \geq 0\} = \mathcal{K}_{\gamma_{L,M}}^+(t_1). \end{aligned} \quad (5.5.6)$$

Since $\tau_{\gamma_{L,M}} = 1 - \frac{1}{\gamma_{L,M}} > t_1$, by Remark 5.5.3 we know that $h_{top}(\mathcal{K}_{\gamma_{L,M}}^+(t_1)) > 0$ and together with (5.5.6) we then find $h_{top}(\mathcal{K}_\beta^+(t)) > 0$, which in turn implies $\tau_\beta \geq t$. Since $t < 1 - \frac{1}{\beta}$ was taken arbitrarily, we conclude that $\tau_\beta \geq 1 - \frac{1}{\beta}$.

To prove the other inequality we show that for any $t > 1 - \frac{1}{\beta}$ we have $\mathcal{K}_\beta^+(t) = \emptyset$. Take $t > 1 - \frac{1}{\beta}$. There is a sequence of Farey intervals $([\gamma_{L,k}, \gamma_{R,k}])$ such that $\gamma_{L,k} \searrow \beta$ as $k \rightarrow \infty$. Thus, when $k \rightarrow \infty$ we have

$$\sum_{i=1}^{\infty} \frac{b_i(t, \beta)}{(\gamma_{L,k})^i} \nearrow \sum_{i=1}^{\infty} \frac{b_i(t, \beta)}{\beta^i} = t \quad \text{and} \quad 1 - \frac{1}{\gamma_{L,k}} \searrow 1 - \frac{1}{\beta}.$$

Since $t > 1 - \frac{1}{\beta}$, we can find a sufficiently large $N \in \mathbb{N}$ such that

$$1 - \frac{1}{\beta} < 1 - \frac{1}{\gamma_{L,N}} < t_2 := \sum_{i=1}^{\infty} \frac{b_i(t, \beta)}{(\gamma_{L,N})^i} < t.$$

Since $\gamma_{L,N} > \beta$, $b(t, \beta)$ is the greedy $\gamma_{L,N}$ -expansion of t_2 , i.e., $b(t, \beta) = b(t_2, \gamma_{L,N})$. Therefore,

$$\begin{aligned} \mathcal{K}_\beta^+(t) &\subseteq \{(x_i) : b(t_2, \gamma_{L,N}) \preceq \sigma^n((x_i)) \prec \alpha(\gamma_{L,N}) \forall n \geq 0\} \\ &= \mathcal{K}_{\gamma_{L,N}}^+(t_2) \subseteq \mathcal{K}_{\gamma_{L,N}}^+(\tau_{\gamma_{L,N}}). \end{aligned}$$

From (5.5.3) we conclude that $\mathcal{K}_\beta^+(t) = \emptyset$ and hence, $\max \overline{E_\beta^+}, \tau_\beta \leq t$. Since $t > 1 - \frac{1}{\beta}$ was taken arbitrarily, we have $\max \overline{E_\beta^+} = \tau_\beta = 1 - \frac{1}{\beta}$. \square

Proof of Theorem 5.1.5. From Proposition 5.5.2, Lemma 5.5.4 and Lemma 5.5.5 we know that for all $\beta \in (1, 2)$ we have $\tau_\beta \leq 1 - \frac{1}{\beta}$ with equality only if $\beta \in (1, 2) \setminus \bigcup(\gamma_L, \gamma_R]$. We also know that for these points $\tau_\beta = \max \overline{E_\beta^+}$.

By Proposition 5.3.3 we know that any isolated point of E_β^+ has a periodic greedy β -expansion $b(t, \beta)$. From Proposition 5.3.10 it follows that any $t \in (0, 1)$, for which $b(t, \beta) = (s_1 \dots s_m)^\infty$ is Lyndon, is isolated in E_β^+ if and only if β lies in the basic interval associated to $(s_1 \dots s_m)^\infty$. Since Farey intervals are maximal by Proposition 5.4.7, if $\beta \notin \bigcup(\gamma_L, \gamma_R]$, then E_β^+ cannot contain an isolated point and $\overline{E_\beta^+}$ is a Cantor set. \square

§5.6 Final observations and remarks

With the results from Theorems 5.1.3 and 5.1.4 we have shown that the situation for $\beta \in (1, 2)$ differs drastically from the situation for $\beta = 2$, that was previously investigated in [19, 86, 104]. There are still several unanswered questions.

Firstly, the structure of E_β^0 remains illusive to us. We know that $t \in E_\beta^0$ is isolated in E_β if $\beta - 1 \notin K_\beta(t)$ and in Proposition 5.2.6 we proved that $h_{top}(\mathcal{K}_\beta(t)) = h_{top}(\mathcal{K}_\beta^+(t))$ for any $t \in E_\beta^+$. It would be interesting to know whether $t \in E_\beta^0$ is isolated in E_β in case $\beta - 1 \in K_\beta(t)$ and to consider $h_{top}(\mathcal{K}_\beta^0(t))$, also in case $t \notin E_\beta^+$.

In the previous section we have investigated the value of the critical point τ_β of the dimension function $\eta_\beta : t \mapsto \dim_H K_\beta(t)$. We could determine this value for any β in the set $(1, 2) \setminus \bigcup(\gamma_L, \gamma_R]$. If $\beta \in (\gamma_L, \gamma_R]$ for some Farey interval $(\gamma_L, \gamma_R]$, we only have a lower and upper bound for τ_β . With a calculation very similar to the one in (5.5.4) one can show that for any $\beta \in (\gamma_L, \gamma_R]$ that satisfies

$$\alpha(\beta) \prec a_1 \dots a_m^+(0a_2 \dots a_m)(a_1 \dots a_m)^\infty,$$

we have $\tau_\beta = t^*$. However, for larger values of $\beta \in (\gamma_L, \gamma_R]$ the situation seems more intricate. It would be interesting to consider this question further by specifying τ_β more precisely also on $\bigcup(\gamma_L, \gamma_R]$ and by analysing the behaviour of the function $\tau : \beta \mapsto \tau_\beta$. For $\beta = 2$ it is shown in [104] that $\dim_H(E_2 \cap [t, 1]) = \dim_H K_2(t)$.

Motivated by Proposition 5.2.7, we conjecture the following.

Conjecture 5.6.1. *For any $t \in [0, 1)$ and any $\beta \in (1, 2)$ we have $\dim_H(E_\beta \cap [t, 1]) = \dim_H K_\beta(t)$.*

Recently, this conjecture is confirmed for β a multinacci number (see [4]).

§5.6.1 Connections to other topics

In this last section we look at several connections between the work presented in this chapter and other topics. Undoubtedly there are connections to topics not listed here. We list the ones that seems to be the most related.

Farey intervals and matching intervals for KU-continued fractions

Through Farey words there is a connection between Farey intervals and matching intervals for KU-continued fractions that is worth mentioning. Let $w \in \mathcal{F}$ and recall that $I_w = (q_L, q_r)$ with

$$q_L = \pi_2((w_m w_{m-1} \dots w_1)^\infty) - \frac{1}{2} \quad \text{and} \quad q_R = \pi_2((w_1 \dots w_m)^\infty)$$

and

$$E_D := \left\{ x \in \left[0, \frac{1}{2}\right] : T_2^n(x) \in \left[x, x + \frac{1}{2}\right] \text{ for all } n \geq 0 \right\}.$$

From [17] we have the following proposition.

Proposition 5.6.2. [17, Proposition 2.14]

(i) *Each I_w is a connected component of $(0, \frac{1}{2}) \setminus E_D$. Moreover,*

$$\left(0, \frac{1}{2}\right) \setminus E_D = \bigcup_{w \in \mathcal{F}} I_w.$$

(ii) $\dim_H E_D = 0$.

We can relate the interval I_w with a matching interval for the KU-continued fractions studied in [54, 55, 56] and mentioned in Chapter 3. This is shown in [17]. Let $x \in [0, \frac{1}{2}]$ and \tilde{x} be the corresponding binary expansion. The function $\varphi : [0, \frac{1}{2}] \rightarrow [0, 1]$ is defined as $\varphi(x) := [0; RL(\tilde{x})]$ where RL is the so called *runlength function*. If $\tilde{x} = 0^{k_1}, 1^{k_2}, 0^{k_3}, \dots$ then $RL(\tilde{x}) = k_1, k_2, k_3, \dots$

Proposition 5.6.3 ([17], page 20). *Let $w \in \mathcal{F}$. Then $\varphi(I_w)$ is a maximal matching interval for KU-continued fractions. Furthermore, $\mathcal{E}_{KU} = \varphi(E_D)$ where \mathcal{E}_{KU} is the set of $x \in [0, 1]$ such that x is not contained in any matching interval.*

Since Farey intervals are related to E_D we find the following proposition. Recall that $\phi : (1, 2) \rightarrow \left(\frac{1}{2}, 1\right)$, $\beta \mapsto \pi_2(\alpha(\beta)) = \sum_{i=1}^\infty \frac{\alpha_i(\beta)}{2^i}$.

Proposition 5.6.4. *Let $w \in \mathcal{F}$ and J_w the associated Farey interval. Then $\varphi(1 - \phi(J_w))$ is a maximal matching interval for KU-continued fractions. Furthermore, $\mathcal{E}_{KU} = \varphi(1 - \phi(E_{cant}))$ where E_{cant} is the set of $\beta \in (1, 2]$ such that E_β^+ does not contain isolated points.*

Doubling map

In a paper of Sidorov, holes around $\frac{1}{2}$ are studied for the doubling map [100]. We can rephrase our studies on E_β in terms of holes around 1 when we view the doubling map on a circle. Fix $\beta \in (1, 2]$ and $t \in [0, 1]$ and recall that $K_\beta(t) = \pi_\beta(\mathcal{K}_\beta(t))$. If we define $K_2(\beta, t) = \pi_2(\mathcal{K}_\beta(t))$ then $K_2(\beta, t)$ is the survivor set of the hole $[0, \pi_2(b(t, \beta))] \cup (\pi_2(\alpha(\beta)), 1)$ which is wrapped around 1. Therefore we could argue that we studied holes for the doubling map. Since Farey words play a prominent role in both studies, it would be interesting to investigate whether there is a more explicit connection.

C -balancedness

Another field of mathematics where the notion of balanced words plays a role is the field of combinatorics on words. Balanced words can be generalised to C -balanced words (see [7]). One could wonder whether C -balanced words have a special role in the topology of E_β in a similar way balanced words did. They do not seem to have an effect on the number of isolated points. It is certainly not true that if $\alpha(\beta)$ is a 2-balanced word then E_β has one isolated point. Take for example $\alpha(\beta) = (11010011001011010010110011010010)^\infty$, then E_β has 4 isolated points (of period length 2, 4, 8 and 16) and is 2-balanced.

Bibliography

- [1] J. Aaronson. *An introduction to infinite ergodic theory*, volume 50 of *Mathematical Surveys and Monographs*. American Mathematical Society, Providence, RI, 1997.
- [2] R. Alcaraz Barrera. Topological and ergodic properties of symmetric sub-shifts. *Discrete Contin. Dyn. Syst.*, 34(11):4459–4486, 2014.
- [3] M. Anselm and S. H. Weintraub. A generalization of continued fractions. *J. Number Theory*, 131(12):2442–2460, 2011.
- [4] S. Baker and D. Kong. Two bifurcation sets arising from the beta transformation with a hole at 0. 2019.
- [5] D. Barbolosi and H. Jager. On a theorem of Legendre in the theory of continued fractions. *J. Théor. Nombres Bordeaux*, 6(1):81–94, 1994.
- [6] J. Barrionuevo, R. M. Burton, K. Dajani, and C. Kraaikamp. Ergodic properties of generalized Lüroth series. *Acta Arith.*, 74(4):311–327, 1996.
- [7] V. Berthé, J. Cassaigne, and W. Steiner. Balance properties of Arnoux-Rauzy words. *Internat. J. Algebra Comput.*, 23(4):689–703, 2013.
- [8] G. D. Birkhoff. Proof of the ergodic theorem. *Proc. Natl. Acad. Sci. USA*, 17:656–660, 1931.
- [9] J. Bourdon, B. Daireaux, and B. Vallée. Dynamical analysis of α -Euclidean algorithms. *J. Algorithms*, 44(1):246–285, 2002. Analysis of algorithms.
- [10] J. R. Brown. *Ergodic theory and topological dynamics*. Academic Press [Harcourt Brace Jovanovich, Publishers], New York-London, 1976. Pure and Applied Mathematics, No. 70.
- [11] H. Bruin, C. Carminati, and C. Kalle. Matching for generalised β -transformations. *Indag. Math. (N.S.)*, 28(1):55–73, 2017.
- [12] H. Bruin, C. Carminati, S. Marmi, and A. Profeti. Matching in a family of piecewise affine maps. *Nonlinearity*, 32(1):172–208, 2019.
- [13] Y. Bugeaud and B. Wang. Distribution of full cylinders and the Diophantine properties of the orbits in β -expansions. *J. Fractal Geom.*, 1(2):221–241, 2014.
- [14] L. Bunimovich and A. Yurchenko. Where to place a hole to achieve a maximal escape rate. *Israel J. Math.*, 182:229–252, 2011.

-
- [15] E. B. Burger, J. Gell-Redman, R. Kravitz, D. Walton, and N. Yates. Shrinking the period lengths of continued fractions while still capturing convergents. *J. Number Theory*, 128(1):144–153, 2008.
- [16] C.-Y. Cao. A result on the approximation properties of the orbit of 1 under the β -transformation. *J. Math. Anal. Appl.*, 420(1):242–256, 2014.
- [17] C. Carminati, S. Isola, and G. Tiozzo. Continued fractions with $SL(2, Z)$ -branches: combinatorics and entropy. *Trans. Amer. Math. Soc.*, 370(7):4927–4973, 2018.
- [18] C. Carminati and G. Tiozzo. A canonical thickening of \mathbb{Q} and the entropy of α -continued fraction transformations. *Ergodic Theory Dynam. Systems*, 32(4):1249–1269, 2012.
- [19] C. Carminati and G. Tiozzo. Tuning and plateaux for the entropy of α -continued fractions. *Nonlinearity*, 26(4):1049–1070, 2013.
- [20] C. Carminati and G. Tiozzo. The local Hölder exponent for the dimension of invariant subsets of the circle. *Ergodic Theory Dynam. Systems*, 37(6):1825–1840, 2017.
- [21] G. H. Choe. Generalized continued fractions. *Appl. Math. Comput.*, 109(2-3):287–299, 2000.
- [22] G. H. Choe. *Computational ergodic theory*, volume 13 of *Algorithms and Computation in Mathematics*. Springer-Verlag, Berlin, 2005.
- [23] G. H. Choe and C. Kim. The Khintchine constants for generalized continued fractions. *Appl. Math. Comput.*, 144(2-3):397–411, 2003.
- [24] L. Clark. The β -transformation with a hole. *Discrete Contin. Dyn. Syst.*, 36(3):1249–1269, 2016.
- [25] T. M. Cover and J. A. Thomas. *Elements of information theory*. Wiley Series in Telecommunications. John Wiley & Sons, Inc., New York, 1991. A Wiley-Interscience Publication.
- [26] K. Dajani and M. de Vries. Invariant densities for random β -expansions. *J. Eur. Math. Soc. (JEMS)*, 9(1):157–176, 2007.
- [27] K. Dajani, D. Hensley, C. Kraaikamp, and V. Masarotto. Arithmetic and ergodic properties of ‘flipped’ continued fraction algorithms. *Acta Arith.*, 153(1):51–79, 2012.
- [28] K. Dajani and C. Kraaikamp. “The mother of all continued fractions”. *Colloq. Math.*, 84/85(part 1):109–123, 2000. Dedicated to the memory of Anzelm Iwanik.

- [29] K. Dajani and C. Kraaikamp. *Ergodic theory of numbers*, volume 29 of *Carus Mathematical Monographs*. Mathematical Association of America, Washington, DC, 2002.
- [30] K. Dajani and C. Kraaikamp. From greedy to lazy expansions and their driving dynamics. *Expo. Math.*, 20(4):315–327, 2002.
- [31] K. Dajani and C. Kraaikamp. Random β -expansions. *Ergodic Theory Dynam. Systems*, 23(2):461–479, 2003.
- [32] K. Dajani, C. Kraaikamp, and N. D. S. Langeveld. Continued fraction expansions with variable numerators. *Ramanujan J.*, 37(3):617–639, 2015.
- [33] K. Dajani, C. Kraaikamp, and N. van der Wekken. Ergodicity of N -continued fraction expansions. *J. Number Theory*, 133(9):3183–3204, 2013.
- [34] J. de Jonge. *Gaps, frequencies and spacial limits of continued fraction expansions*. PhD thesis, Technical university of Delft, 2019.
- [35] J. de Jonge and C. Kraaikamp. Natural extensions for Nakada’s α -expansions: descending from 1 to g^2 . *J. Number Theory*, 183:172–212, 2018.
- [36] M. de Vries, V. Komornik, and P. Loreti. Topology of the set of univoque bases. *Topology Appl.*, 205:117–137, 2016.
- [37] C. Dettmann. Open circle maps: small hole asymptotics. *Nonlinearity*, 26(1):307–317, 2013.
- [38] P. Erdős, I. Joó, and V. Komornik. Characterization of the unique expansions $1 = \sum_{i=1}^{\infty} q^{-n_i}$ and related problems. *Bull. Soc. Math. France*, 118(3):377–390, 1990.
- [39] K. Falconer. *Fractal geometry*. John Wiley & Sons, Inc., Hoboken, NJ, second edition, 2003. Mathematical foundations and applications.
- [40] J. Galambos. *Representations of real numbers by infinite series*. Lecture Notes in Mathematics, Vol. 502. Springer-Verlag, Berlin-New York, 1976.
- [41] Y. Ge and F. Lü. A note on inhomogeneous Diophantine approximation in beta-dynamical system. *Bull. Aust. Math. Soc.*, 91(1):34–40, 2015.
- [42] A. O. Gelfond. A common property of number systems. *Izv. Akad. Nauk SSSR. Ser. Mat.*, 23:809–814, 1959.
- [43] P. Glendinning and N. Sidorov. Unique representations of real numbers in non-integer bases. *Math. Res. Lett.*, 8(4):535–543, 2001.
- [44] P. Glendinning and N. Sidorov. The doubling map with asymmetrical holes. *Ergodic Theory Dynam. Systems*, 35(4):1208–1228, 2015.
- [45] I. J. Good. The fractional dimensional theory of continued fractions. *Proc. Cambridge Philos. Soc.*, 37:199–228, 1941.

-
- [46] A. Haynes, J. L. Jensen, and S. Kristensen. Metrical musings on Littlewood and friends. *Proc. Amer. Math. Soc.*, 142(2):457–466, 2014.
- [47] H. Hu and Y. Yu. On Schmidt’s game and the set of points with non-dense orbits under a class of expanding maps. *J. Math. Anal. Appl.*, 418(2):906–920, 2014.
- [48] A. Hurwitz. Über eine besondere Art der Kettenbruch-Entwicklung reeller Größen. *Acta Math.*, 12(1):367–405, 1889.
- [49] A. Hurwitz. Ueber die angenäherte Darstellung der Irrationalzahlen durch rationale Brüche. *Math. Ann.*, 39(2):279–284, 1891.
- [50] M. Iosifescu and C. Kraaikamp. *Metrical theory of continued fractions*, volume 547 of *Mathematics and its Applications*. Kluwer Academic Publishers, Dordrecht, 2002.
- [51] H. Jager and C. de Vroedt. Lüroth series and their ergodic properties. *Nederl. Akad. Wetensch. Proc. Ser. A 72=Indag. Math.*, 31:31–42, 1969.
- [52] V. Jarník. Zur metrischen theorie der diophantischen approximationen. *PraceMat.-Fiz*, 36:91–106, 1928.
- [53] C. Kalle. Isomorphisms between positive and negative β -transformations. *Ergodic Theory Dynam. Systems*, 34(1):153–170, 2014.
- [54] S. Katok and I. Ugarcovici. Structure of attractors for (a, b) -continued fraction transformations. *J. Mod. Dyn.*, 4(4):637–691, 2010.
- [55] S. Katok and I. Ugarcovici. Theory of (a, b) -continued fraction transformations and applications. *Electron. Res. Announc. Math. Sci.*, 17:20–33, 2010.
- [56] S. Katok and I. Ugarcovici. Applications of (a, b) -continued fraction transformations. *Ergodic Theory Dynam. Systems*, 32(2):755–777, 2012.
- [57] M. Kesseböhmer, S. Munday, and B. O. Stratmann. *Infinite ergodic theory of numbers*. De Gruyter Graduate. De Gruyter, Berlin, 2016.
- [58] A. Khintchine. *Kettenbrüche*. B. G. Teubner Verlagsgesellschaft, Leipzig, 1956.
- [59] A. N. Kolmogorov. Entropy per unit time as a metric invariant of automorphisms. *Dokl. Akad. Nauk SSSR*, 124:754–755, 1959.
- [60] V. Komornik and P. Loreti. Unique developments in non-integer bases. *Amer. Math. Monthly*, 105(7):636–639, 1998.
- [61] V. Komornik and P. Loreti. On the topological structure of univoque sets. *J. Number Theory*, 122(1):157–183, 2007.
- [62] D. Kong, W. Li, F. Lü, and M. de Vries. Univoque bases and Hausdorff dimension. *Monatsh. Math.*, 184(3):443–458, 2017.

- [63] C. Kraaikamp. A new class of continued fraction expansions. *Acta Arith.*, 57(1):1–39, 1991.
- [64] C. Kraaikamp and N. Langeveld. Invariant measures for continued fraction algorithms with finitely many digits. *J. Math. Anal. Appl.*, 454(1):106–126, 2017.
- [65] C. Kraaikamp, T. A. Schmidt, and W. Steiner. Natural extensions and entropy of α -continued fractions. *Nonlinearity*, 25(8):2207–2243, 2012.
- [66] U. Krengel. Entropy of conservative transformations. *Z. Wahrscheinlichkeitstheorie und Verw. Gebiete*, 7:161–181, 1967.
- [67] W. Krieger. On entropy and generators of measure-preserving transformations. *Trans. Amer. Math. Soc.*, 149:453–464, 1970.
- [68] N. Langeveld. *Langeveld, Finding infinitely many even or odd continued fractions by introducing a new family of maps, Master’s thesis*. PhD thesis, Technical university of Delft, 2015.
- [69] D. Lascu. Dependence with complete connections and the Gauss-Kuzmin theorem for N -continued fractions. *J. Math. Anal. Appl.*, 444(1):610–623, 2016.
- [70] A. Legendre. Essai sur la théorie des nombres. *Duprat, Paris*, 6:27–29, 1798.
- [71] J. Lehner. Semiregular continued fractions whose partial denominators are 1 or 2. In *The mathematical legacy of Wilhelm Magnus: groups, geometry and special functions (Brooklyn, NY, 1992)*, volume 169 of *Contemp. Math.*, pages 407–410. Amer. Math. Soc., Providence, RI, 1994.
- [72] P. Levy. Sur les lois de probabilité dont dependent les quotients complets et incomplets d’une fraction continue. *Bull. Soc. Math. France*, 57:178–194, 1929.
- [73] L. Lewin. *Polylogarithms and associated functions*. North-Holland Publishing Co., New York-Amsterdam, 1981. With a foreword by A. J. Van der Poorten.
- [74] B. Li, T. Persson, B. Wang, and J. Wu. Diophantine approximation of the orbit of 1 in the dynamical system of beta expansions. *Math. Z.*, 276(3-4):799–827, 2014.
- [75] T. M. Liggett. *Interacting particle systems*, volume 276 of *Grundlehren der Mathematischen Wissenschaften [Fundamental Principles of Mathematical Sciences]*. Springer-Verlag, New York, 1985.
- [76] M. Lothaire. *Algebraic combinatorics on words*. Cambridge University Press, Cambridge, 2002.
- [77] F. Lü and J. Wu. Diophantine analysis in beta-dynamical systems and Hausdorff dimensions. *Adv. Math.*, 290:919–937, 2016.

-
- [78] J. Lüroth. Ueber eine eindeutige Entwicklung von Zahlen in eine unendliche Reihe. *Math. Ann.*, 21(3):411–423, 1883.
- [79] L. Luzzi and S. Marmi. On the entropy of Japanese continued fractions. *Discrete Contin. Dyn. Syst.*, 20(3):673–711, 2008.
- [80] S. Marmi, P. Moussa, and J.-C. Yoccoz. The Brjuno functions and their regularity properties. *Comm. Math. Phys.*, 186(2):265–293, 1997.
- [81] P. Moussa, A. Cassa, and S. Marmi. Continued fractions and Brjuno functions. *J. Comput. Appl. Math.*, 105(1-2):403–415, 1999. Continued fractions and geometric function theory (CONFUN) (Trondheim, 1997).
- [82] H. Nakada. Metrical theory for a class of continued fraction transformations and their natural extensions. *Tokyo J. Math.*, 4(2):399–426, 1981.
- [83] H. Nakada, S. Ito, and S. Tanaka. On the invariant measure for the transformations associated with some real continued-fractions. *Keio Engrg. Rep.*, 30(13):159–175, 1977.
- [84] H. Nakada and R. Natsui. The non-monotonicity of the entropy of α -continued fraction transformations. *Nonlinearity*, 21(6):1207–1225, 2008.
- [85] J. Nilsson. *On numbers badly approximable by q -adic rationals*. PhD thesis, Lund University and Université du Sud Toulon-Var, 2007.
- [86] J. Nilsson. On numbers badly approximable by dyadic rationals. *Israel J. Math.*, 171:93–110, 2009.
- [87] D. Ornstein. Bernoulli shifts with the same entropy are isomorphic. *Advances in Math.*, 4:337–352, 1970.
- [88] W. Parry. On the β -expansions of real numbers. *Acta Math. Acad. Sci. Hungar.*, 11:401–416, 1960.
- [89] O. Perron. *Die Lehre von den Kettenbrüchen*. Chelsea Publishing Co., New York, N. Y., 1950. 2d ed.
- [90] T. Persson and J. Schmeling. Dyadic Diophantine approximation and Katok’s horseshoe approximation. *Acta Arith.*, 132(3):205–230, 2008.
- [91] P. Raith. Hausdorff dimension for piecewise monotonic maps. *Studia Math.*, 94(1):17–33, 1989.
- [92] P. Raith. Continuity of the Hausdorff dimension for piecewise monotonic maps. *Israel J. Math.*, 80(1-2):97–133, 1992.
- [93] P. Raith. Continuity of the Hausdorff dimension for invariant subsets of interval maps. *Acta Math. Univ. Comenian. (N.S.)*, 63(1):39–53, 1994.
- [94] A. Rényi. On algorithms for the generation of real numbers. *Magyar Tud. Akad. Mat. Fiz. Oszt. Közl.*, 7:265–293, 1957.

- [95] A. Rényi. Representations for real numbers and their ergodic properties. *Acta Math. Acad. Sci. Hungar.*, 8:477–493, 1957.
- [96] V. A. Rohlin. Exact endomorphisms of a Lebesgue space. *Izv. Akad. Nauk SSSR Ser. Mat.*, 25:499–530, 1961.
- [97] J. Schmeling. Symbolic dynamics for β -shifts and self-normal numbers. *Ergodic Theory Dynam. Systems*, 17(3):675–694, 1997.
- [98] F. Schweiger. *Continued fractions and their generalizations: a short history of f -expansions*. Docent Press, Boston, MA, 2016.
- [99] F. Schweiger and M. Waterman. Some remarks on Kuzmin’s theorem for F -expansions. *J. Number Theory*, 5:123–131, 1973.
- [100] N. Sidorov. Supercritical holes for the doubling map. *Acta Math. Hungar.*, 143(2):298–312, 2014.
- [101] J. Sinaĭ. On the concept of entropy for a dynamic system. *Dokl. Akad. Nauk SSSR*, 124:768–771, 1959.
- [102] R. Siromoney, L. Mathew, V. R. Dare, and K. G. Subramanian. Infinite Lyndon words. *Inform. Process. Lett.*, 50(2):101–104, 1994.
- [103] S. Tanaka and S. Ito. On a family of continued-fraction transformations and their ergodic properties. *Tokyo J. Math.*, 4(1):153–175, 1981.
- [104] M. Urbański. On Hausdorff dimension of invariant sets for expanding maps of a circle. *Ergodic Theory Dynam. Systems*, 6(2):295–309, 1986.
- [105] M. Urbański. Invariant subsets of expanding mappings of the circle. *Ergodic Theory Dynam. Systems*, 7(4):627–645, 1987.
- [106] R. Zweimüller. Ergodic properties of infinite measure-preserving interval maps with indifferent fixed points. *Ergodic Theory Dynam. Systems*, 20(5):1519–1549, 2000.

Samenvatting

In dit proefschrift staan ontwikkelingen van getallen centraal. Het meest bekende voorbeeld van ontwikkelingen van getallen is de decimaal ontwikkeling. Een ander voorbeeld is de binaire ontwikkeling van een getal. Echter zijn er nog veel meer manieren om getallen op te schrijven. In hoofdstuk 2, 3 en 4 worden variaties op reguliere kettingbreukontwikkelingen bestudeerd. In hoofdstuk 5 kijken we naar β -ontwikkelingen. Om ontwikkelingen van getallen te maken gebruiken we dynamische systemen. Eigenschappen van deze dynamische systemen geven ons informatie over de ontwikkelingen. Anderzijds kunnen de ontwikkelingen bijdragen aan een beter begrip van de dynamica van deze systemen. Verschillende systemen hebben verschillende eigenschappen. De waarde van de entropie is een voorbeeld van zo'n eigenschap. Matching is een eigenschap voor een verzameling dynamische systemen en verschillende systemen reageren verschillend wanneer er een gat in het systeem wordt gemaakt. Het fenomeen matching komt voor in hoofdstukken 2, 3 en 4 en entropie in hoofdstuk 3, 4 en 5. In hoofdstuk 3 en 5 worden gaten behandeld.

In hoofdstuk 2 wordt een familie van dynamische systemen geïntroduceerd met een oneindige invariante maat voor ieder systeem uit deze familie. Ieder dynamisch systeem wordt gegeven door een afbeelding (met bijbehorende ontwikkelingen die we omgedraaide α -kettingbreuken noemen) en in dit hoofdstuk worden deze afbeeldingen geparameteriseerd door $\alpha \in [0, 1]$. De afbeeldingen interpoleren tussen de klassieke kettingbreukafbeelding en een afbeelding die isomorf is met de terugwaartse kettingbreukafbeelding. Voor $\alpha < \frac{1}{2}\sqrt{2}$ wordt een expliciete uitdrukking voor de invariante maat die absoluut continu is met betrekking tot de Lebesgue maat gevonden. Deze maten worden gevonden door gebruik te maken van de natuurlijke uitbreiding. Voor $\alpha < \frac{\sqrt{5}-2}{2}$ wordt berekend dat de Krengel entropie gelijk is aan $\frac{\pi^2}{6}$. Verder laten we zien dat de afbeeldingen AFN-afbeeldingen zijn. Hieruit volgen een aantal prettige eigenschappen, zoals een zwakke wet van grote aantallen.

In hoofdstuk 3 worden voornamelijk Ito Tanaka α -kettingbreuken bestudeerd. In het eerste deel vergelijken we deze familie met de α -kettingbreuken van Nakada. Bepaalde eigenschappen die voor beide families gelden worden bewezen op een manier zodat het bewijs werkt voor beide families. Een voorbeeld hiervan is de monotonie van de entropiefunctie op een matchinginterval. Het tweede deel is gericht op de Ito Tanaka α -kettingbreuken. We laten zien dat de parameter ruimte bijna volledig wordt overdekt door matchingintervallen. Verder geven we karakterisaties van de verzameling punten die niet tot een matchinginterval behoren (de uitzonderingsverzameling). We vinden een opmerkelijk verschil tussen de Ito Tanaka α -kettingbreuken en de α -kettingbreuken van Nakada. Waar de uitzonderingsverzameling van de α -

kettingbreuken van Nakada geen rationale punten bevat, bestaan er wel rationale punten die in de uitzonderingsverzameling van de Ito Tanaka α -kettingbreuken zitten.

In hoofdstuk 4 worden omgedraaide N -kettingbreukontwikkelingen bestudeerd. Ook in hoofdstuk 2 lieten we omdraaingen toe. Alleen nu combineren we ze met N -kettingbreukontwikkelingen. Dit geeft een erg grote verzameling dynamische systemen. In sommige gevallen kunnen we de invariante maat bepalen door gebruik te maken van de natuurlijke uitbreiding. Wanneer deze methode niet werkt, gebruiken we een numerieke methode die gebaseerd is op de Gauss-Kuzmin-Lévy Stelling. Deze methode geeft in een klein aantal iteraties een goede benadering. In het tweede deel bestuderen we een deelfamilie die we parameteriseren met α , waarna we de entropie bestuderen als functie van α . Voor $N = 2$ vinden we een matchinginterval en voor dit interval bewijzen we dat de entropie constant is. We laten ook zien dat de methoden van hoofdstuk 3 niet kunnen worden aangepast om voor deze deelfamilie resultaten te geven. In plaats daarvan doen we verkennend onderzoek met behulp van de computer en sluiten we af met vermoedens.

In hoofdstuk 5 worden bifurcatieverzamelingen die gerelateerd zijn aan β -ontwikkelingen bestudeerd. We nemen $\beta \in (1, 2]$ en beschouwen de gulzige β -transformatie. De bifurcatieverzameling E_β wordt gegeven door de verzameling $t \in [0, 1]$ waarvoor geldt dat $T_\beta^n(t) \geq t$ voor alle $n \in \mathbb{N}$, waarbij T_β de gulzige β -transformatie is. We bewijzen dat voor alle $\beta \in (1, 2]$ geldt dat E_β Lebesguemaat nul heeft en volle Hausdorff-dimensie. Verder laten we zien dat voor bijna alle $\beta \in (1, 2]$ geldt dat E_β oneindig veel verdichtingspunten heeft in een omgeving van nul en ook oneindig veel geïsoleerde punten. We karakteriseren die waarden van β waarvoor E_β geen geïsoleerde punten heeft en bewijzen dat deze verzameling Hausdorff-dimensie nul heeft. Aan de andere kant laten we zien dat de verzameling $\beta \in (1, 2]$ waarvoor geldt dat er geen geïsoleerde punten zijn in E_β afgezien van een omgeving van nul, volle Hausdorff-dimensie heeft. Ook deze verzameling wordt gekarakteriseerd. In het laatste deel bestuderen we de kritieke waarde τ_β , gedefinieerd als de waarde waarvoor geldt dat voor alle $t < \tau_\beta$ de Hausdorff-dimensie van de verzameling die het onder iteratie van T_β niet in het gat $(0, \tau_\beta)$ vallen strikt positief is en voor alle $t \geq \tau_\beta$ de Hausdorff-dimensie nul is. Voor τ_β geven we afschattingen in termen van β .

Acknowledgements

I would like to thank the people that helped me throughout the years of my PhD. First of all, my supervisor Charlene Kalle, who guided me through my PhD. I enjoyed the freedom she gave me and am happy that she pointed me in the right direction whenever needed. Charlene, you are a great role model of how a mathematician should be, both in terms of research and outside research. You also showed me that there are a lot of other interesting things in math besides continued fractions. You helped creating a nice environment to develop myself.

Before my PhD, my interest in dynamical systems and ergodic theory was sparked by Cor Kraaikamp. Cor, without you I might have ended up in a different field of mathematics, or even outside math. You motivated me to start a PhD, which I am very grateful for. Also during my PhD we worked together. It is always nice to meet up with you, whether we talk about mathematics or not.

Karma Dajani, I would like to thank you for bringing me into contact with Charlene, so that I could apply for the PhD position in Leiden. There is no end without a start. I would like to thank Carlo Carminati for having me over in Pisa. I enjoyed my time in Pisa a lot, as well as collaborating with you. Thank you for all the hospitality. Thank you, Wolfgang Steiner, for the collaboration, and also for keeping an eye on job opportunities for me. The latter can also be said about all of the aforementioned and also about Mike Keane. Thank you for writing my reference letters and thank you for the career advice.

This brings me to you, Derong Kong. The collaboration we had in Leiden was quite pleasant. I believe we make a good team. Therefore I have full faith that, when I come to China, our collaboration will be pleasant and fruitful. I would also like to thank you for your help to arrange a post-doc position at Chongqing University. This is a great opportunity for me to further develop myself.

I would also like to thank my other collaborators, Wenxia Li, Marta Maggioni and Sara Munday. The members of my promotion committee and Frank den Hollander I would like to thank for taking the time to read my dissertation.

I would like to thank the people that participated in the reading club. Thank you for taking the time to prepare and present the mathematics we were all eager to learn about. In addition, I would like to thank Rosa Winter and Olfa Jaïbi for organising the PhD colloquium with me. We made a good team. Thank you, Aad van der Vaart, for the sponsoring thereof.

Acknowledgements

To my office mates over the past four years: thank you for the great time we shared. We could have taken a little bit more care of the plant. I would like to thank all the people at the mathematical institute for the nice atmosphere they created. I really felt at home.

Of course, I would like to thank my friends and family outside the university as well. I hope I didn't bore you with math too often. Last but certainly not least I would like to thank my wife Anja. Thank you for all the support. I am happy to have you in my life.

Curriculum Vitae

Niels Daniël Simon Langeveld was born on August 4, 1989 in Heemstede. He went to high school in Hoofddorp from 2001 to 2008. In 2008 he started his bachelor study Applied mathematics at the Technical University Delft. His bachelor thesis, supervised by Cor Kraaikamp, was on continued fractions with variable numerators, and results thereof can be found in [32]. He obtained his bachelor degree in 2013.

His master degree was obtained in 2015, also at the Technical University Delft, with a master thesis supervised by Cor Kraaikamp. The topic was N -expansions with flips, and related results can be found in [64]. During his masters he went to Pisa to work with Carlo Carminati. Results of this visit relate to the results in Chapter 3.

In 2015 he started his PhD under the supervision of Charlene Kalle, with Frank den Hollander acting as promotor. He helped out as a teaching assistant in various courses, and was lecturer of a course at Leiden University College in The Hague. During his PhD he presented his research at conferences in the United States, England, France, Italy and the Netherlands. He was member of the master defense committee of Benthzen Zeegers. Furthermore, he co-organised the PhD colloquium for the PhD students of the mathematics department at Leiden. As a hobby he makes fractals and likes to cycle.

- (N, α) -continued fractions, 73
 D -continued fractions, 20
 α -winning, 15
 c -isomorphic, 34
- absolutely continuous, 6
 AFN-map, 31
 algebraic conditions, 46
 allowed sequences for β -expansions, 10
 approximation methods, 72
 attractors (N, α) -continued fractions,
 78
- badly approximable numbers, 15
 basic intervals, 106
 bi-Lipschitz, 14
 Birkhoff's Theorem, 6
 Borel, 4
 Borel σ -algebra, 6
 bounds critical points dimension func-
 tion, 120
- convergence of regular continued frac-
 tion, 4
 cylinders, 7
- densities for flipped α -continued frac-
 tions, 22
 dilogarithm, 32
 Diophantine approximation, 4
 dynamical system, 5
- entropy (N, α) -continued fractions, 78
 entropy definition, 11
 entropy formula, 51
 entropy formula for the regular contin-
 ued fraction, 12
 entropy monotonicity on intervals, 53
 entropy using Birkhoff, 13
- equivalence of measures, 6
 Ergodic Theorem, 6
 ergodicity, 5
- Farey intervals, 114
 Farey words, 111
 for almost all, 6
- Gauss map, 2
 Gauss measure, 7
 Gauss-Kuzmin-Lévy Theorem, 7, 72
 generalised β -transformations, 14
 generator, 11
 greedy β -expansion, 9
 greedy β -transformation, 3, 9
- Hölder continuity, 118
 Hurwitz, 4
- induced transformation, 8
 insertion, 24
 invariant measure, 5
 invariant measure for β -Transformations,
 10
 isomorphic, 5, 34
 Ito Tanaka's α -continued fractions, 40
- Krengel entropy, 32
 KU-continued fractions, 40
- Lévy, 6
 Lebesgue measure, 6
 Legendre, 5
 lexicographical ordering, 95
 Lipschitz, 14
 Littlewood conjecture, 15
 lyndon, 102
 Lyndon words, 102
- Möbius transformation, 44

-
- matching, 13, 41
 - measure of maximal entropy, 11
 - Nakada's α -continued fractions, 20, 40
 - natural extension, 8, 68
 - natural extension flipped α -continued fractions, 28
 - natural extension of the Gauss map, 8
 - Notation on sequences, 95

 - open dynamical system, 14

 - Parry, 10

 - quasi greedy expansion, 10
 - quasi-greedy β -expansion, 96

 - recurrence relations, 4, 45, 51
 - return sequence, 33

 - Rohlin's formula, 12

 - set of all greedy β -expansions, 97
 - Shannon-McMillan-Breiman-Chung,
12
 - singularisation, 23
 - standard factorisation, 112
 - survivor set, 14

 - topological entropy, 96
 - typical points, 6

 - unique expansions, 15

 - wandering rate, 34
 - weak law of large numbers for flipped
 α -continued fractions, 34
 - well approximable numbers, 15