

University of San Diego

Digital USD

Digital Initiatives Symposium

Apr 28th, 9:00 AM - 9:55 AM

Deans' Panel: Digital Collections and Institutional Repositories

Jennifer L. Fabbi

California State University, San Marcos

Maggie Farrell

University of Nevada, Las Vegas

Larry Alford

University of Toronto

Follow this and additional works at: <https://digital.sandiego.edu/symposium>



Part of the [Library and Information Science Commons](#)

Fabbi, Jennifer L.; Farrell, Maggie; and Alford, Larry, "Deans' Panel: Digital Collections and Institutional Repositories" (2021). *Digital Initiatives Symposium*. 5.

<https://digital.sandiego.edu/symposium/2021/2021/5>

This Event is brought to you for free and open access by Digital USD. It has been accepted for inclusion in Digital Initiatives Symposium by an authorized administrator of Digital USD. For more information, please contact digital@sandiego.edu.

Deans' Panel: Digital Collections and Institutional Repositories

Presenter 1 Title

Dean, University Library

Presenter 2 Title

Dean of Libraries

Presenter 3 Title

University Chief Librarian

Session Type

Event

Abstract

Three library deans/chief directors from public universities representing different sizes and missions will address how their unique places in their communities have influence the choices they make around digital collections and institutional repositories. Each panelist will share contextual information and an example of an initiative that reflects the needs of the defined community and furthers the libraries' goals and values.

Location

Comments

Jennifer L. Fabbi is Dean of the University Library at California State University San Marcos. Maggie Farrell is Dean of Libraries at the University of Nevada, Las Vegas. Larry Alford is the University Chief Librarian at the University of Toronto.



Digital Initiatives Symposium 2021

Deans' Panel: Community

Jen Fabbi – California State University, San Marcos

Maggie Farrell – University of Nevada, Las Vegas

Larry Alford – University of Toronto

April 28, 2021



UNIVERSITY LIBRARY

Two Community-Forward Digital Collaborations

Jennifer L. Fabbi, PhD
Dean, University Library
California State University, San Marcos

Campus Context

- Campus is 32 years old
- Large, primarily non-residential
- Masters comprehensive, part of a 23-campus system
- Stately physical facility (250,000 square feet) – open 24 hours
- First CSU campus library to go all virtual March 2020
- Special Collections is “new” to our university



A Tale of Two Communities

- [ScholarWorks](#), shared institutional repository of the California State University system
Community: CSU System
- [Together/Apart](#), the COVID-19 Memory Archive of North San Diego County
Community: North San Diego County



ScholarWorks

ScholarWorks

Scholarship from the California State University on a shared, open platform.

Search 52,350 items

[Q Go](#)

[Share Your Work](#)

[Terms of Use](#)



Dissertations & Theses



Faculty Publications



Research Datasets



Open Educational Resources



UNIVERSITY LIBRARY

ScholarWorks

- Combined initiative began in fall 2018
- Brought multiple DSpace instances into one
- Shared, open platform (Samvera/Hyrax)
- Includes dissertations/theses, faculty publications, research datasets, OERs
- Supported by 1.0 FT employee + a large community



Together/Apart COVID-19 Archive

STORIES & SNAPSHOTS:

Documenting a Year of the Pandemic



California State University
SAN MARCOS

University Library

Home

Explore

Collections

Items

Timeline

Participate

Map



Our world is fighting a battle with an invisible and quite often deadly enemy. Struggling to understand how best to cope with this threat, many people have turned to creative and imaginative ways to help conceptualize and document the impact of COVID-19 (coronavirus) on their lives. Humanity finds ways to adapt to environmental and social circumstances everyday. Many have adjusted to wearing masks and social distancing, and regardless of political backgrounds, recognize that everyone has been affected by this global pandemic in one way or another.

[Get started](#) | [About the exhibition](#)

Explore Our Region



Explore submissions to Together/Apart by their location.



UNIVERSITY LIBRARY

Together/Apart COVID-19 Archive

- Launched in April 2020
- Rapid response collecting via digital platform
- “Stories and Snapshots” one-year exhibit on Omeka platform
- Text, photograph, and video format
- Includes voices of students, employees, and community members

Together/Apart COVID-19 Archive

Luann and the Virus

Luann and the Virus



ATTRIBUTION



MORE INFORMATION

Description

I didn't directly address the pandemic in my comic strip LUANN but I wanted to help. So I created a series of six images for the LuannFan page on Facebook. This is one.

Creator

Greg Evans

Date

2020-04-15,

Subject

Cartoons & Comics, Medical personnel, Nurses,

Publisher

CSUSM University Library

Rights

<http://rightsstatements.org/vocab/InC/1.0/>

Relation

Together/Apart: The COVID-19 Community Memory Archive

Language

English

Identifier

thankyou.jpg

Coverage

San Marcos (Calif.)



UNIVERSITY LIBRARY

The Digital Value Add of Libraries

#BlackLivesMatter

Black Lives Matter Home

Websites and BLM Resources

Books & eBooks

Streaming Videos and Podcasts

Databases

Campus Resources

Take Action

BLACK LIVES MATTER

Resource Guide



Purpose of this Guide

This guide is intended to provide

Statement from the University Library



UNIVERSITY LIBRARY



For more information:

jfabbi@csusm.edu

<https://biblio.csusm.edu/>

CSU ScholarWorks

David Walker dwalker@calstate.edu

Carmen Mitchell cmitchell@csusm.edu

Together/Apart

Sean Visintainer svisintainer@csusm.edu



University of Nevada, Las Vegas Libraries
Maggie Farrell, Dean of Libraries
www.library.unlv.edu

UNLV Libraries

- Urban, R1 University
- 31,000 students
- Ranked in the top three most diverse university in the US
- Five library facilities on two campuses
- 1.85 million visits annually
- 1.2 million volumes, 1.4 million ebooks, 111,600 journals, 430 databases
- 800 library instruction sessions
- Special Collections & Archives
 - Digital Collections
 - Oral History Research Center
 - Center for Gaming Research
- Scholarly Communications
 - Digital Scholarship@UNLV
 - Research support services



Community Engagement

Digitization Projects

<http://digital.library.unlv.edu/>

Oral History Projects

<https://www.library.unlv.edu/speccol/ohrc>

Institutional Repository

<https://digitalscholarship.unlv.edu/>

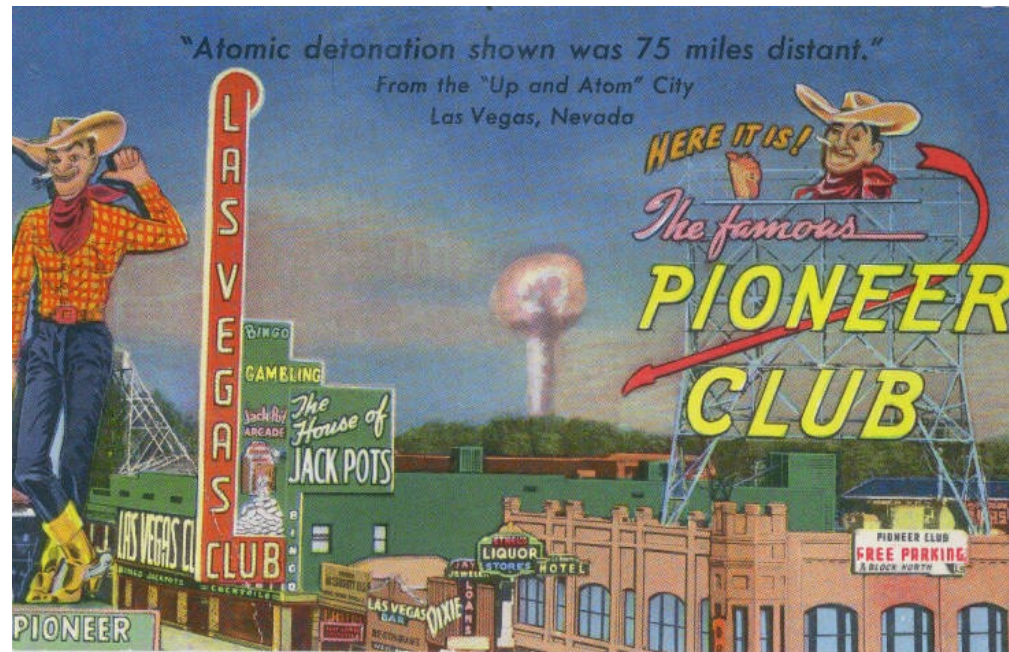

Digitization to Document History

- Gaming & Entertainment
- Community Development
- History
- Primary Resources

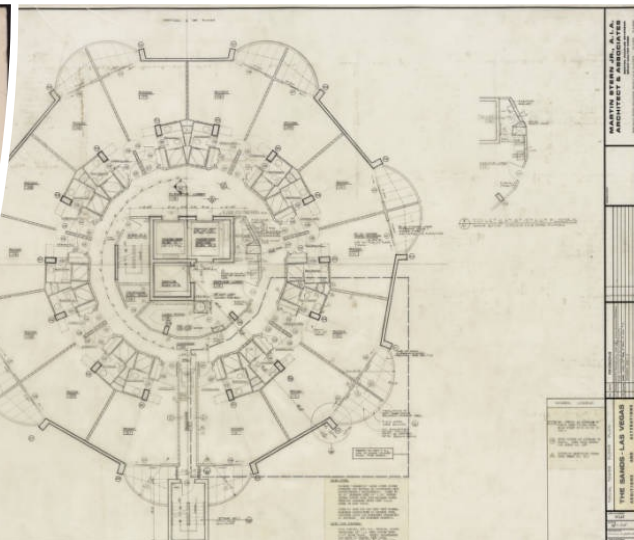
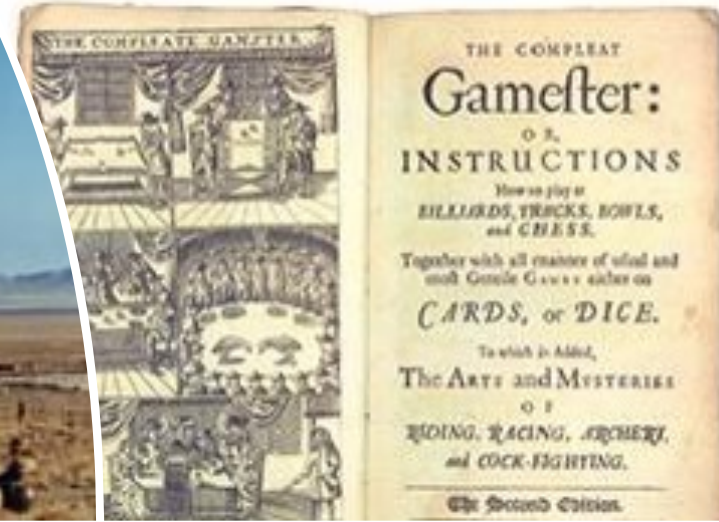

Digitization to Document Full History

- Seek Broader Perspectives
- Capture Untold
- Edit and Create Metadata
- Link Collections



Oral History Projects

- Complete History of Southern Nevada
- Marginalized Voices
- Pathway to Historical Collections
- Community Engagement
- Vehicle for Critical Conversations

Audio clip of an interview with Kenneth Fong by Lois Goodall on February 22, 2014

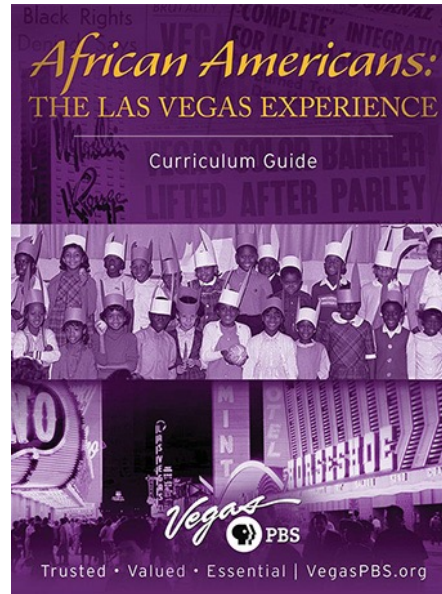

▶ 0:00 / 4:50

An Interview with Charlotte Hill

An Oral History Conducted by Claytee D. White

The Boyer Early Las Vegas Oral History Project

Oral History Research Center at UNLV
University Libraries
University of Nevada Las Vegas

Latinx Voices Podcast

UNLV'S ORAL HISTORY RESEARCH CENTER PRESENTS

KUNLV | Rebel Media Group
Latinx Voices Unveiled: Identity

SOUNDCLOUD
Share

41:49

▶ 260

Cookie policy

Sample Oral History Projects

Reflections: Asian American & Pacific Islander Oral History Project
Documenting the African American Experience in Las Vegas
Latinx Voices of Southern Nevada
Southern Nevada Jewish Heritage Project



Institutional Repository

- Focus on UNLV Research
- Student Research
- Publications
- Promotion of Expertise
- Collaboration with Digital Projects

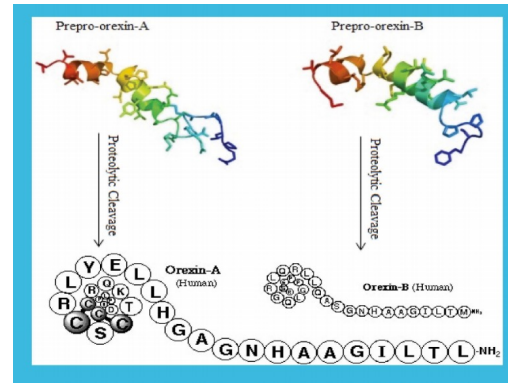

JERRY TARKANIAN

Head Coach and Senior Assistant Athletic Director for Community Relations Jerry Tarkanian

- The nation's winningest collegiate basketball coach (by percentage)
- Six-time Big West Conference Coach of the year



College basketball historians, their pens poised, know they will have considerable work ahead of them at the completion of the 1991-92 season. Not since the retirement of UCLA's legendary John Wooden in 1975 will there be a need for such a massive rewrite of the sport's history book.

The reason UNLV's Jerry Tarkanian, the winningest collegiate coach by percentage since the first peach basket was nailed up at Yale in 1897, has announced his retirement effective at the end of the 1991-92 season.

Tarkanian, who will turn 61 on Aug. 30, said a packed press conference at the school on June 7 had given weary of "a long-running dispute" with the NCAA's administrative division and "although I have been toughened over the years by the pressures

of these battles, the pain I now see in my children's eyes make me realize none of this is fun anymore."

The decision, as you might expect, was not an easy one. Quite simply, Tarkanian is a fighter, and, as a result, a winner.

When the last jump shot of the upcoming season has been taken, Tarkanian will have completed 19 seasons at UNLV, 24 at the Division I level and 31 at the collegiate level. Moreover, he will have done so with greater success than anyone in the history of the sport.

Tarkanian has a major college coaching record of 599-120 for a winning percentage of .833. Early last season, as his former "Redeemer" record to a 34-1 record and second straight NCAA First Four appearance, Tarkanian easily surpassed Clair Bee for the all-time

winningest percentage.

Bee, who coached at Rider College and Long Island Brockslys from 1929-51, posted a 410-86 record for a winning percentage of .826.

Tarkanian currently stands .0085 (65/10,000) ahead of Bee and, based on a tentative 28 game schedule this season, he will need to go no worse than 19-9 to finish his career as the sport's winningest coach at .873 (618-126). Should he go 18-10 (617-130 overall), he would finish at .829 — .007 behind Bee.

Additionally, Tarkanian's 599 Division I victories rank second among active coaches to the 717 of North Carolina's Dean Smith. He is tied for 12th on the all-time victory list with Amory "Slim" Gill, who posted 599 wins

Journal of Solution Focused Practices

Volume 4, Issue Number 2 – 2020

ARTICLES

Clinical

A Broad Overview of Solution Focused Severe Trauma & Stress Recovery Work, with the Introduction of Two Additional SF Instruments to Promote Thrivethood – John Henden

Research

The Psychometric Qualities of the Adult Resilience Doughnut Model, a Solution Focused, Ecological Model of Resilience – Lyn Worsley and Odin Hjemdal
Abstract available in: Armenian, Chinese, German, Italian, and Norwegian

Evaluating the Solution Focused Wellness for HIV Intervention for Women: A Pilot Study – Helen T. Yates and Orion Mowbray

Theory

Steve De Shazer's Theory Development – Harry J. Korman, Peter De Jong, and Sara Smock Jordan
Abstract available in: French and Swedish

JSFP

UNLV UNIVERSITY LIBRARIES

UNLV Theses, Dissertations, Professional Papers, and Capstones

5-1-2020

Chemical and Electronic Surface Structure of Chalcopyrite-Based Thin Films for Solar Water Splitting

James C. Carter



Thank you!

Maggie Farrell

maggie.farrell@unlv.edu



University of Toronto Libraries

Larry P. Alford,
University Chief Librarian

University of Toronto Libraries

- 42 libraries on 3 campuses
- 15+ million volumes
- 33,000 linear metres of archival materials
- Millions of e-resources
- 600 servers in data centre and over 1000 public computers
- 1.5 petabyte of text data
- Thousands of data files
- Serving 107,000 FTE users

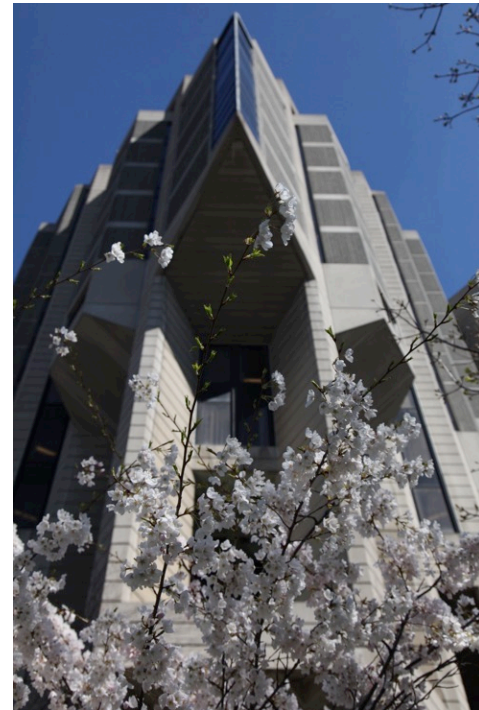

Will discuss briefly three priorities for the U of T Libraries:

1. Digitization
2. Research Data management and preservation of digital assets regardless of origin
3. Support new forms of research with text as data

Digitization

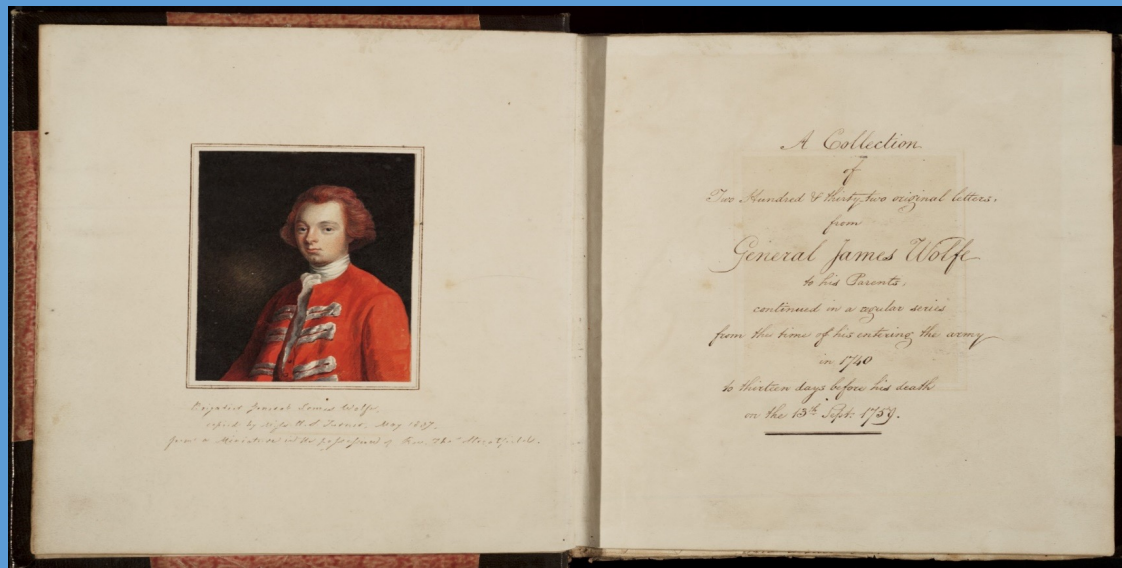

James Wolfe's Letters

Media digitization



Preserving the Digital

- Archives
 - 1980s card-board disks created using obsolete software
 - FRED (Forensic Recovery of Evidence Device)
- Digitized content
 - University of Toronto has digitized 550,000 books since 2004 and numerous manuscripts, film, and other analog material
- Research Data
- Born digital materials

Preservation of electronic archival material

- Authenticity
- Reliability
- Integrity of the original
- Chain of Custody

Preservation of electronic archival material

How much stuff do we keep? All of it!!!

What tools will be available a century from now to explore the massive digital content being created daily?

If we don't keep the stuff created today, how will our descendants know us?

The Scholars Portal Trusted Digital Repository

Scholars Portal at the University of Toronto

A collaboration and partnership of 21 universities

A petabyte or more of journal content since the 90s

A national initiative for Canada (coming soon)

- Text as data for Canada

- Preservation in Canada

- Available for TDM across Canada

Research data management

30
Elizabeth Evans Hughes

1922 Date	URINE				BLOOD	DIET IN GRAMS				WGT.	DIETARY PRESCRIPTIONS IN GRAMS						
	Vol. C.C.	Specific Grav.	SUGAR Per Cent.	Total G.		Carb.	Prot.	Fat.	Cal.		Meat	Vegetables	Fruit	Cheese	Oat		
16-17	1312	0			Insulin	10	10	25	1125	140	2	13	H. Beef 100 Lettuce 30 Tomato 50 Zucchini 100	Panada 70. Black Berries 30. Peaches 30.		10	
17-18	1560	0			"				1125	120	3	10	S. Beef 113 Lettuce 45 Zucchini 50 R. Lamb 150	B. B. 40 Peaches 44 B. B. 40.		10	
18-19	1440	0			"				1125	120	3	10	S. Beef 113 Lettuce 30 R. Lamb 150 Lettuce 97. Zucchini 100	Peaches 38. B. B. 40 Peaches 38	16	10	
19-20	2040	0			"				1125	130	2	24	H. Beef 100 Lettuce 45 Zucchini 100 Lamb 55	Peaches 38. B. B. 40 Peaches 38	10	10	
20-21	1800	0			"				1125	130	3	27	Lamb 40 Lettuce 30 Zucchini 100 Lettuce 45 Zucchini 100	B. B. 74 B. B. 74.		10	
21-22	1800	0			"				1130	105	3	22	Lamb 40 Lettuce 30 Zucchini 100 Lettuce 45 Zucchini 100	B. B. 74. B. B. 74.		10	
22-23	1440	0			"				1220	105	4	30	Lamb 40 Lettuce 30 Zucchini 100 Lettuce 45 Zucchini 100	B. B. 74. B. B. 74.		10	
23-24	1680	0			"				1220	105	3	27	15 Eggs 70 Lettuce 30 Zucchini 100 Lettuce 45 Zucchini 100	B. B. 74. B. B. 74.		10	
24-25	1800	0			"				1220	105	3	34	15 Eggs 70 Lettuce 30 Zucchini 100 Lettuce 45 Zucchini 100	B. B. 74. B. B. 74.		10	
25-26	2400	0			"				2141	155	4	75	Lamb 50 Lettuce 30 Zucchini 100 Lettuce 45 Zucchini 100	Orange juice 15. Lettuce 30. Orange juice 10	20	20	
<p>Note - Extract given 20.c.c. A.M. + P.M. Reaction after Q.M. dose occurred 4:30 p.m. Reaction after P.M. dose occurred 7 hrs. Orange juice 50 - Cream 50 given 4 hrs. after evening dose Reaction after 6 hrs. after evening dose - Orange juice 50 - Cream 50 given 4 hrs. after evening dose Reaction after 4 hrs. after evening dose of 20.c.c. - Cream 50 - Orange juice 50 given 4 hrs. after evening dose Reaction after 1 1/2 hrs. after P.M. dose and again 3 hrs. later - Orange juice 50 - Cream 60 given 4 hrs. after evening dose</p>																	
26-27	1440	0			"				2264	220	2	98	103 Chicken Lettuce 30 Zucchini 100 Lettuce 45 Zucchini 100	Potato 40 Veg. Macaroni 149 Lettuce 30 Veg. Macaroni 144	B. B. 70 B. B. 70	24	25
27-28	1560	0			"				2248	360	3	78	45 Chicken Lettuce 30 Zucchini 100 Lettuce 45 Zucchini 100	Lettuce 30 Veg. Macaroni 144	B. B. 70 B. B. 70	28	20
28-29	2400	0			"				2416	410	3	69	45 Chicken Lettuce 30 Zucchini 100 Lettuce 45 Zucchini 100	Orange juice 50 Lettuce 30 Zucchini 100 Lettuce 45 Zucchini 100	B. B. 70 B. B. 70	23	20
29-30	2250	0			"				2504	342	1	75	103 Chicken Lettuce 30 Zucchini 100 Lettuce 45 Zucchini 100	Orange juice 50 - Cream 50 given 4 hrs. after evening dose Lettuce 30 Zucchini 100 Lettuce 45 Zucchini 100	B. B. 70 B. B. 70	14	25
30-31	2100	0			"				2752	360	2	78	103 Chicken Lettuce 30 Zucchini 100 Lettuce 45 Zucchini 100	Orange juice 50 - Cream 50 given 4 hrs. after evening dose Lettuce 30 Zucchini 100 Lettuce 45 Zucchini 100	B. B. 70 B. B. 70	14.	20
31-1	1440	0			"				919	100	2	12	103 Chicken Lettuce 30 Zucchini 100 Lettuce 45 Zucchini 100	Panada 30 Lettuce 30 Zucchini 100 Lettuce 45 Zucchini 100	B. B. 40 B. B. 109	15	10
1-2	2400	0			"				1451	54	2	20	103 Chicken Lettuce 30 Zucchini 100 Lettuce 45 Zucchini 100	Orange juice 50 Lettuce 30 Zucchini 100 Lettuce 45 Zucchini 100	B. B. 109 Orange juice 50		10
2-3	2640	0			"				2664	520	3	66	103 Chicken Lettuce 30 Zucchini 100 Lettuce 45 Zucchini 100	Orange juice 50 - Cream 50 given 4 hrs. after evening dose Lettuce 30 Zucchini 100 Lettuce 45 Zucchini 100	Orange juice 50 Lettuce 30 Zucchini 100 Lettuce 45 Zucchini 100	25	20

For Sale by Thomas Dixon & Co., Inc. Boston, Mass. Form # 11.

From the *Discovery and Early Development of Insulin* Collection

Data, data, and more data!

UTL and SP Repositories

T-Space

ODESI

Ontario Library Research Cloud

Dataverse

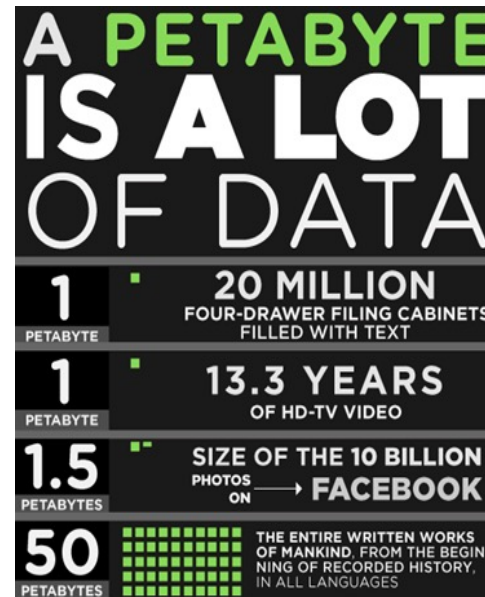

Preservation of research data: the new frontier!

Who knows what discoveries lie hidden in unexplored data.

The preservation issues are largely the same.

The possibilities for human progress are
endless.

Canadian Research Data Management

- Portage in Canada
 - Tools and infrastructure development
 - Establishing communities of expertise
- Project Canopus at the University of Toronto
 - Ingest and curation
 - Reformatting
 - Preservation
 - Discovery for reuse and replication
 - Authentication to protect privacy and intellectual property.
- Canadian Dataverse Consortium
 - A research data repository for Canada (50+ participants)
 - A Canadian collaboration to enable robust Research Data Management including preservation for replication and reuse.
 - Investigating CoreTrustSeal certification

Project Canopus

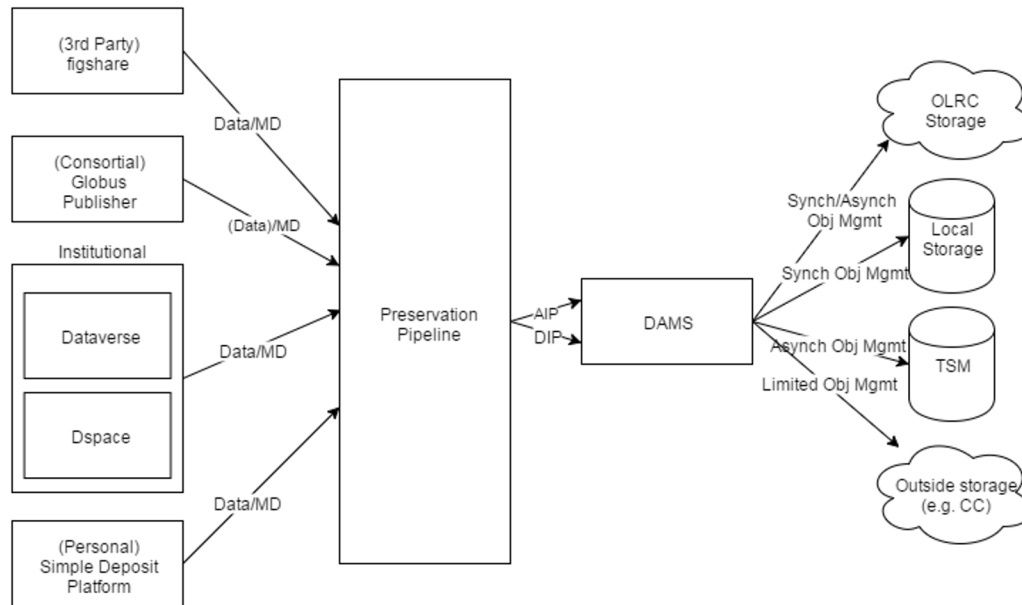

Supporting Digital Research Using Preserved Content

- Scholars need to use content across many publisher platforms
- Such use is almost always non-consumptive and, therefore, should be a right built into licenses and copyright law

Supporting Digital Research Using Preserved Content

Our goal is to:

- Build technology infrastructure to support digital research
- Provide the computational and analytic tools needed
- Develop expertise to assist faculty and students

Supporting Digital Research Using Preserved Content

But access to licensed content is often the first barrier a scholar encounters.

Access to digital content for non-consumptive research use should be a right of all scholars to unleash the power of digital information for all humanity.

Thank you

Larry P. Alford
Chief Librarian
larry.alford@utoronto.ca



Rendering courtesy of Diamond Schmitt Architects