

Synthetic and Mechanistic Aspects of Free-Radical Reactions in Solution

A Thesis Presented to the
University of London
In Partial Fulfilment of the Requirements
For the Degree of
Doctor of Philosophy

Yudong Cai

February 1999

Christopher Ingold Laboratories
Department of Chemistry
University College London
London WC1H 0AJ

ProQuest Number: 10608866

All rights reserved

INFORMATION TO ALL USERS

The quality of this reproduction is dependent upon the quality of the copy submitted.

In the unlikely event that the author did not send a complete manuscript and there are missing pages, these will be noted. Also, if material had to be removed, a note will indicate the deletion.



ProQuest 10608866

Published by ProQuest LLC (2017). Copyright of the Dissertation is held by the Author.

All rights reserved.

This work is protected against unauthorized copying under Title 17, United States Code
Microform Edition © ProQuest LLC.

ProQuest LLC.
789 East Eisenhower Parkway
P.O. Box 1346
Ann Arbor, MI 48106 – 1346

To Yi Ni and my parents

Abstract

This thesis is divided into three chapters.

Chapter 1. Radical cyclisation of *ortho*-(2-propenyloxy)benzenediazonium tetrafluoroborate in aqueous solution in the presence of a reducing reagent and a hydrogen-atom donor gives a mixture products containing 3-methyl-2,3-dihydrobenzofuran and uncyclised allyloxybenzene. Enantioselective radical cyclisation of the diazonium salt was found in the presence of cyclodextrins. The enantiomeric excess of the resulting 3-methyl-2,3-dihydrobenzofuran is *ca.* 7% in the presence of hydroxypropyl- β -cyclodextrin and *ca.* 13% in the presence of hydroxypropyl- α -cyclodextrin. The results suggest that higher enantioselectivities for radical reactions in aqueous solution might be achieved by modifying the structures of the guest radicals and cyclodextrins.

Chapter 2. Thiols act as polarity-reversal catalysts and promote the radical-chain cyclisation of alkenyloxysilanes at 60-65 °C, in the presence of di-*tert*-butyl hyponitrite as initiator. Allyloxysilanes give five-membered-ring products *via* 5-*endo-trig* cyclisation of the intermediate allyloxysilyl radical. Homoallyloxysilanes give mixtures of five- and six-membered heterocycles, but the intermediate silyl radicals undergo predominantly 6-*endo* cyclisation, in contrast to the corresponding carbon-centred radicals which cyclise preferentially in the 5-*exo* mode. An analogous pentenyloxysilane gives only the seven-membered-ring product *via* a 7-*endo* radical cyclisation. Steric effects play an important part in influencing the final-product stereochemistry when this is determined in the hydrogen-atom transfer reaction between

the cyclic adduct radical and the thiol catalyst. An unsuccessful thiol-catalysed tandem cyclisation shows that it is important for the addition of the thiyl radical to the $C=CH_2$ group to be reversible under the reaction conditions. Complementary EPR spectroscopic studies of the short-lived intermediate cyclic adduct radicals have been carried out in the absence of thiol and the structures and conformations of these species have been determined.

Chapter 3. Alkanethiols with electron withdrawing *S*-alkyl groups and silanethiols act as polarity-reversal catalysts to promote the radical-chain racemisation of (*R*)-tetrahydrofurfuryl acetate and the *cis-trans*-isomerisation of 2,5-dimethyltetrahydrofuran at 60 °C, while simple alkanethiols are ineffective. The α -alkoxyalkyl radical derived from (*R*)-tetrahydrofurfuryl acetate has been studied by EPR spectroscopy and its conformation has been determined. The rate constant for hydrogen-atom abstraction by *tert*-butoxyl radicals from the tertiary CH group in 2,5-dimethyltetrahydrofuran is *ca.* 7.5 times greater than that for abstraction from the tertiary CH group in tetrahydrofurfuryl acetate at -30 °C

Acknowledgements

I would like to express my heartfelt thanks to my supervisor, Dr Brian Roberts, for giving me the opportunity of taking this course and for his encouragement and advice.

I would also like to thank Dr Hai-Shan Dang and his family for help and friendship.

Thanks to other members of our group, past and present.

Thanks to the technique staffs, Steve Corker, Alan Stone, John Hill, Jill Maxwell, David Knapp and someone I don't know their names.

I am grateful to the Committee of Vice-Chancellors and Principals of the Universities of the United Kingdom for an Overseas Research Students Award and to the UCL Chemistry Department for a Departmental Research Studentship and a Franz Sondheimer Bursary.

Contents

Chapter 1: Radical reactions in aqueous solution in the presence of cyclodextrins	1
1.1 Introduction	2
1.1.1 Structures, properties and applications of cyclodextrins	2
1.1.2 Radical dediazonation	7
1.2 Results and Discussion	11
1.2.1 Preparation of the arenediazonium salt	11
1.2.2 General experimental methods	12
1.2.3 Reduction by sodium iodide	13
1.2.4 Reduction by hypophosphorous acid	15
1.2.5 Reduction by tetrakis(dimethylamino)ethylene	17
1.2.6 Reduction by Ti^{3+}	20
1.2.7 Reduction in the presence of cyclodextrins	22
1.3 Experimental	25
 Chapter 2: Intramolecular radical-chain hydrosilylation catalysed by thiols: cyclisation of alkenyloxysilanes	 30
2.1 Introduction	31
2.1.1 Hydrosilylation catalysed by transition metal compounds	31
2.1.2 Intramolecular addition of free radicals	35
2.1.3 Principle and applications of polarity-reversal catalysis	40
2.1.3.1 Amine-boranes as hydridic polarity-reversal catalysts	43
2.1.3.2 Thiols as protic polarity-reversal catalysts	44
2.1 Results and Discussion	48
2.2.1 Preparation of alkenyloxysilanes	48
2.2.2 Initiation with di- <i>tert</i> -butyl hyponitrite	52
2.2.3 Allyloxysilanes	54
2.2.4 Homoallyloxysilanes	61
2.2.5 Enantioselective hydrogen-atom transfer	66
2.2.6 Pent-4-enyloxysilanes	67
2.2.7 EPR studies	68
2.3 Experimental	76
 Chapter 3: Radical-chain epimerisation catalysed by thiols: possible implications for the radical-induced strand cleavage of DNA	 91
3.1 Introduction	92
3.2 Results and Discussion	97
3.2.1 Tetrahydrofurfuryl acetate	97
3.2.2 2,5-Dimethyltetrahydrofuran	103
3.2.3 EPR studies	111
3.3 Experimental	120
 References	 127

Chapter 1

Radical reactions in aqueous solution in the presence of cyclodextrins

1.1 Introduction

1.1.1 Structures, properties and applications of cyclodextrins

Cyclodextrins (CDs) were first isolated in 1891 by *Villiers*¹ as degradation products of starch and they were characterised as cyclic oligosaccharides in 1904 by *Schardinger*.^{2,3} It is for this reason that cyclodextrins (cycloamyloses) are described by some authors, especially in the older literature, as *Schardinger* dextrins.

Fig. 1 shows the chemical structures of α -, β -, and γ -cyclodextrins. As their appearance suggests, in the cyclodextrin molecules all the glucose units are in the classical chair conformation and linked by α -1,4 bonds. This geometry gives the cyclodextrin the overall shape of a hollow truncated cone (torus) with the wider side formed by the secondary 2- and 3-hydroxyl groups and the narrower side by the primary 6-hydroxyl groups. The number of glucose units determines the dimensions of the cavity.

The cavity is lined by the hydrogen atoms and the glycosidic oxygen bridges. As a result of this special arrangement of the functional groups in the cyclodextrin molecules, the cavity is relatively hydrophobic compared to water while the external faces are hydrophilic. In the cyclodextrin molecules, a ring of hydrogen bonds is also formed intramolecularly between the 2-hydroxyl and the 3-hydroxyl groups of adjacent glucose units. This hydrogen-bonding ring gives the cyclodextrin a remarkably rigid structure. As a consequence of these structural features, cyclodextrins have some unique physical and chemical properties. Some of the important physical properties and characteristics are listed in Table 1.

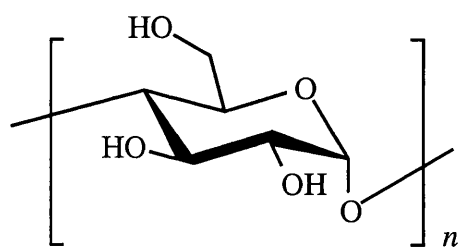

α -cyclodextrin; n=6
 β -cyclodextrin; n=7
 γ -cyclodextrin; n=8

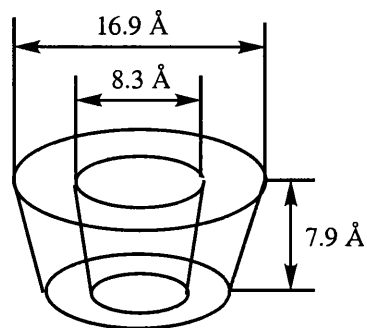

γ -cyclodextrin

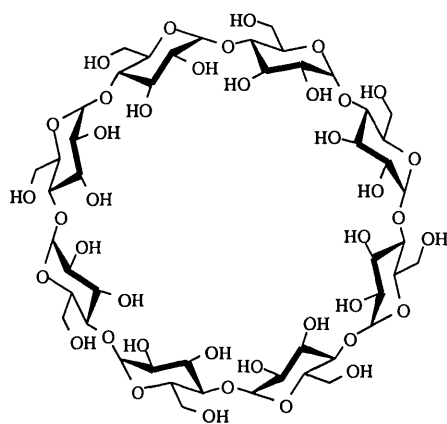

γ -cyclodextrin

Fig. 1 Molecular structures of cyclodextrins

Table 1 Characteristic of α -, β -, and γ -cyclodextrins

Characteristics	α -	β -	γ -
No. of glucose units	6	7	8
Molecular weight	972	1135	1297
Solubility in water (g/100 cm ³)	14.5	18.5	23.2
Cavity diameter (Å)	4.7-5.3	6.0-6.5	7.5-8.3
Height of torus (Å)	7.9	7.9	7.9
pK _a value	12.33	12.20	12.08

Cyclodextrins are water-soluble and stable in alkaline solution. However, they are susceptible to acid hydrolysis. Partial acid hydrolysis of cyclodextrins produces glucose and a series of acyclic maltosaccharides. Under normal experimental conditions (pH higher than 3.5 and temperature lower than 60 °C) cyclodextrins are fairly stable.

The most characteristic property of cyclodextrins is their remarkable ability to form inclusion complexes with a wide variety of guest molecules ranging from organic or inorganic compounds of neutral or ionic nature to noble gases. It seems that the only obvious requirement is that the guest molecules must fit into the cavity, even if only partially. Complex formation in solution is a dynamic equilibrium process which can be illustrated by eqn. (1), where CD is cyclodextrin, G is the guest molecule and CD-G is the inclusion complex. The stability of inclusion complex can be described in terms of a equilibrium binding constant K_B or a dissociation constant K_{diss} as defined in eqns. (2) and (3).



$$K_B = ([\text{CD-G}] / [\text{CD}] \cdot [\text{G}]) \quad (2)$$

$$K_{\text{diss}} = 1 / K_B = ([\text{CD}] \cdot [\text{G}] / [\text{CD-G}]) \quad (3)$$

Complexation is usually performed in the presence of water, and the guest molecules are generally only weakly bound by cyclodextrins in organic solvents. In aqueous solution, the stability of a complex depends critically on the hydrophobic character of the guest molecule and highly hydrophilic molecules complex very weakly or not at all. As a result of complex formation, the characteristic properties of the

included substance, such as solubility, chemical reactivity, pK_a values, diffusion, electrochemical properties, and the spectral properties will be changed. This unique property has led to a widespread utilisation of cyclodextrins in pharmaceutical, food, chemical and other industrial areas. In the chemical industry, applications of cyclodextrins and their derivatives in catalysis,⁴⁻⁶ as enzyme models,⁷ in separation technology,⁸ in chiral discrimination,⁹ and in asymmetric reactions¹⁰ are impressive.

The physical effects of inclusion of a few types of free radicals such as nitroxides and semidiones have been examined using electron paramagnetic resonance (EPR / ESR) spectroscopy,¹¹ and the photochemistry of guest molecule has been shown to differ significantly from that of the unbound species in a number of cases, either because radical-pair fragments are held in close proximity within the cyclodextrin cavity or because the conformational freedom of diradical intermediates is restricted.¹² For example, photolysis of the β -cyclodextrin inclusion complex of the precursor diazine gave adamantylidene which underwent intramolecular insertion to give 2,4-didehydroadamantane (Scheme1): in solution without cyclodextrin only traces of the carbene insertion product were obtained.¹³

A number of reports in the literature concerning heterolytic processes in the presence of cyclodextrins suggest that it might be possible to control the selectivity of radical reactions by inclusion in the cavity of a cyclodextrin.¹⁴ For example, when the β -cyclodextrin complex of acetophenone was reduced with pyridine-borane in aqueous dispersion at 0 °C, (*S*)-1-phenylethanol was formed with an enantiomeric excess (ee) of 91%.¹⁵ Therefore, inclusion in a cyclodextrin cavity could also influence the chemo-, regio- and stereo-selectivity of elementary radical reactions. Of particular importance is

the possibility of controlling the enantioselectivity of radical reactions, because the cyclodextrin cavity is chiral and thus transformations of suitable guest radicals that take place within should lead selectively to one enantiomer.

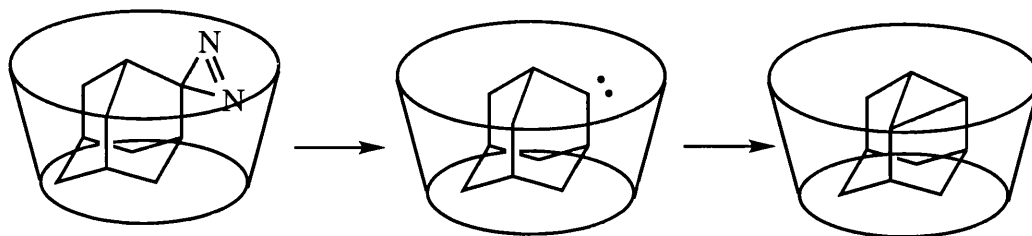

Scheme 1

The aim of the project was to investigate the influence of cyclodextrins on the enantioselectivity of radical reactions. It was planned to carry out the proposed radical reactions in aqueous solution, although cyclodextrin inclusion of many types of guest molecule has been shown little affected by small amounts hydrophilic co-solvents such as methanol, MeCN, DMSO and DMF. The advantages of using water as solvent are numerous. An aqueous media is both economical and avoids the use of flammable organic solvents. Reaction products can be extracted from aqueous solution and the hydrophilic cyclodextrins could be recycled. These aspects clearly have strong implications for protection of environment and future resources. Thus, the use of water as a solvent is likely to increase greatly in future!

1.1.2 Radical dediazonation

Beckwith has concluded from his studies of the cyclisation of alkenylaryl radicals that, as in cyclisations of alkenylalkyl radicals, the direction of ring closure is controlled by the stereoelectronic requirements of the transition state rather than by the thermodynamic stability of the cyclised radical.¹⁶ Thus, aryl radicals with *ortho* substituents containing double bonds in the 5,6 or 6,7 positions relative to the radical centre undergo rapid, regioselective cyclisation (**1**→**2**) in the *exo* mode.¹⁷⁻¹⁹ This has been indicated both by EPR spectroscopy and by product analysis.

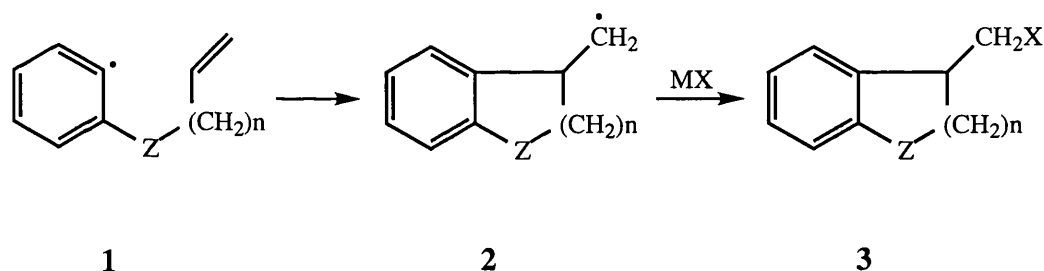

Z = O, CH_2 , NR

n = 1, 2

X = Br, Cl, CN, SR

Previously, the required aryl radicals have been generated by treating the appropriate aryl iodide with tri-*n*-butyltin hydride.¹⁸ However, this procedure was unsuitable for present work since the reactants are insoluble in water, complete removal of the toxic tin compounds would be difficult,^{20,21} and initiation would be unreliable.

Arenediazonium salts undergo a variety of radical chain reactions.²² This is particularly true of those reactions which are catalysed by copper(I) salts or metallic copper, including the *Sandmeyer*, *Gattermann*, *Meerwein* and *Pschorr* reactions [eqns.

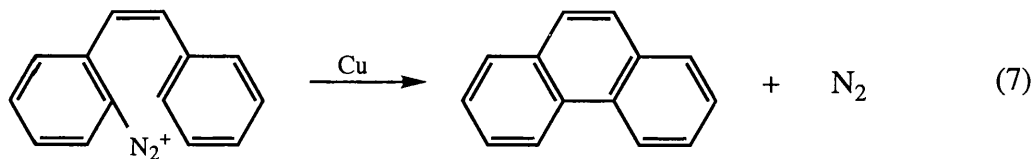
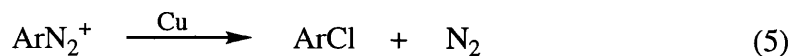
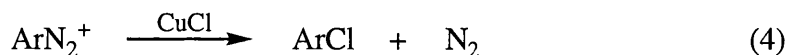

(4)-(7)]. The key step in all these reaction is the electron-transfer reduction of the diazonium salt with the resultant generation of aryl radicals [e.g. eqns. (8)-(10)].²³

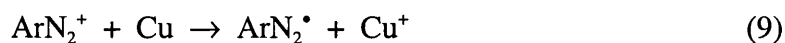
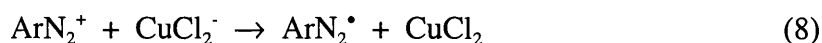

The one-electron reduction of diazonium salts with the consequent generation of aryl radicals can also be accomplished by other reducing agents having appropriate redox potentials, e.g. iodide ion [eqns. (11) and (12)]. Copper or copper(I) salts are unnecessary to promote this reaction.

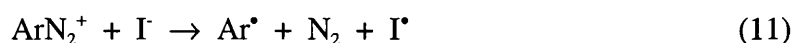

The substitution of the diazonium group by hydrogen is a reaction of considerable synthetic utility²⁴ and the reaction is best brought about by using hypophosphorous acid as reductant. Again, the key step in the reaction is the single electron reduction of the diazonium salt and this is followed by a hydrogen-atom transfer between the aryl radical and the hypophosphorous acid [eqns. (13)-(16)].

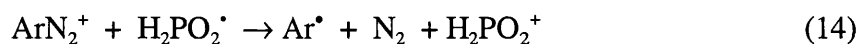
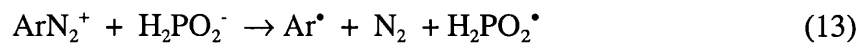

β -Cyclodextrin-promoted hydrodediazonation of substituted benzenediazonium ions, which proceeds by a radical mechanism to give the corresponding substituted benzene, has been reported by *Fukunishi* and co-workers (Scheme 2).²⁵ The included diazonium ion ArN_2^+ is reduced to ArN_2^\bullet and loss of nitrogen gives the aryl radical which abstracts hydrogen from the cyclodextrin to give ArH.

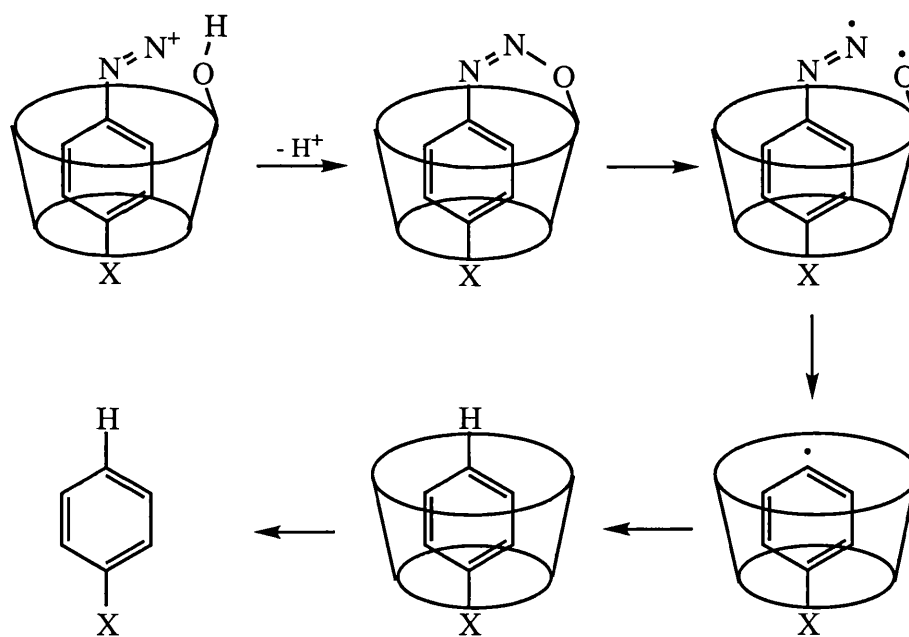

Scheme 2

An exciting result was obtained by these authors when they studied the dediazonation of the *ortho*-(2-methylallyloxy)benzenediazonium ion **4** in the presence of β -cyclodextrin and oxygen. The alcohol **7** was isolated and shown to have an ee of

8%.²⁶ This result shows that the *ortho*-(2-methylallyloxy)phenyl radical **5** has undergone enantioselective cyclisation in the cyclodextrin cavity to give the radical **6**, which then reacts with oxygen (see Scheme 3).

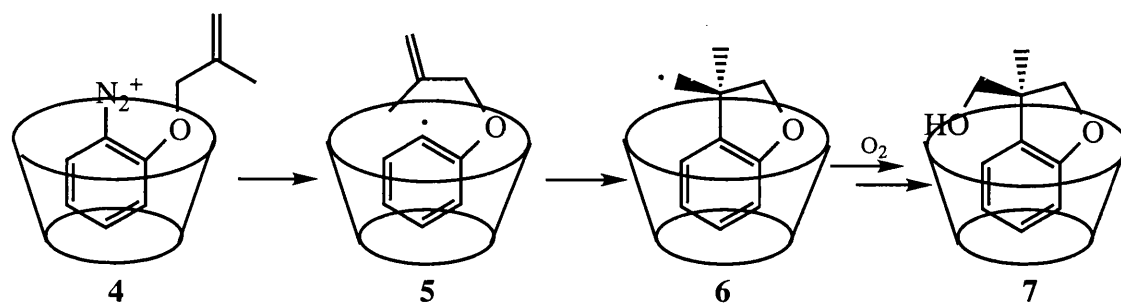

Scheme 3

In the present work, dediazonation of *ortho*-allyloxybenzenediazonium ion **8** with a variety of reducing agents and hydrogen donors was investigated in aqueous solution (see Scheme 4). When cyclodextrins are used as asymmetric reaction vessels, we might expect that the environment surrounding the diazonium ions will induce an enantioselective cyclisation of the *ortho*-allyloxyphenyl radical **9**. Any enantioselectivity would result in an enantiomeric excess in the cyclised product **11**.

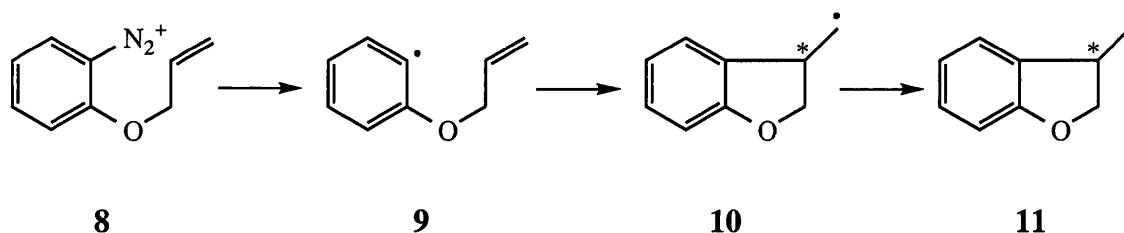

Scheme 4

1.2 Results and Discussion

1.2.1 Preparation of the arenediazonium salt

The required arenediazonium tetrafluoroborate salt was prepared using established procedures as shown in Scheme 5.^{17,27}

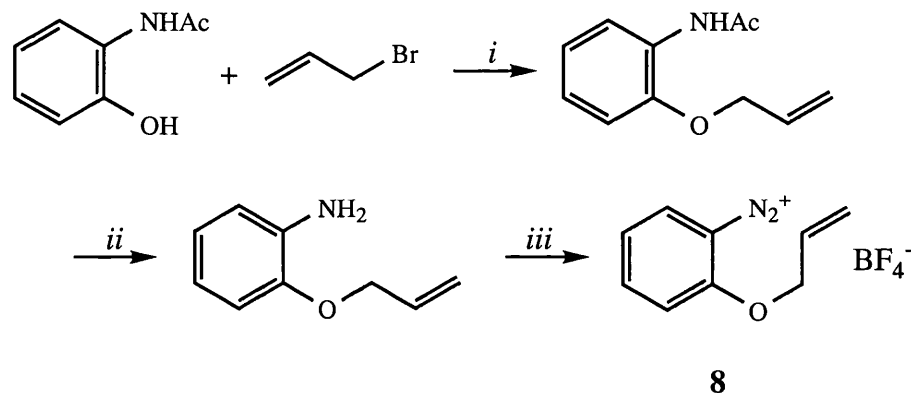

Scheme 5. Regents and conditions: *i* acetone, K_2CO_3 , reflux: 92 %;
ii 6 N HCl, reflux: 82 %; *iii* $NaNO_2$, HBf_4 , 10 °C: 65 %.

Thus, 2-acetylaminophenol was treated with allyl bromide and potassium carbonate in acetone to give the *N*-(2-allyloxyphenyl)acetamide²⁷ in excellent yields. Hydrolysis in 6 N hydrochloric acid yielded the 2-allyloxyaniline²⁷ in good yields. Diazonisation with sodium nitrite in 21% aqueous tetrafluoroboric acid gave the target arenediazonium salt **8**¹⁷ which was purified by precipitation from acetone solution by addition of diethyl ether, and was obtained as a colourless crystalline solid.

1.2.2 General experimental methods

With the aim to see if *ortho*-allyloxybenzenediazonium tetrafluoroborate **8** could be used as a prochiral precursor for an enantioselective radical reaction in the cavity of a cyclodextrin, initial experiments were designed to find an efficient reducing agent and a hydrogen-atom donor, which will promote the dediazonation and radical cyclisation process in aqueous solution.

Dediazonation was carried out at room temperature (*ca.* 20 °C) under an argon atmosphere. The hydrogen donor was initially mixed with the diazonium salt **8** in pH 7.4 buffer solution and the reducing agent, which was diluted with pH 7.4 buffer solution, was then added dropwise to the reaction mixture. After stirring for 3 or 5 hours, the reaction mixture was extracted with diethyl ether. The crude products were determined by NMR spectroscopy, and their structures were assigned by comparing with the spectra of authentic samples.

The dediazonation of **8** in the presence of cyclodextrin was carried out at 0 °C; hydroxypropyl- β - and α -cyclodextrins (Hp- β -CD and Hp- α -CD) were used. The latter are derivatives of cyclodextrins in which all the primary hydroxyl functions are hydroxypropylated. The advantage of these derivatives is their much higher solubility in water. For example, the solubility of β -CD is about 20 g dm⁻³, while the solubility of Hp- β -CD is at least 400 g dm⁻³ in aqueous solution.²⁸ After extraction of the reaction mixture with diethyl ether, 3-methyl-2,3-dihydrobenzofuran **11** was isolated by column chromatography using petroleum as eluent. The cyclisation product **11** has got only a low polarity it proved impossible to measure the enantiomeric ratio with HPLC; this fact made derivatisation of the product necessary. The nitration described by *Hurd* and

*Dowbenko*²⁹ with concentrated nitric and sulphuric acid proved to be suitable and an advantage of this method is that only the dinitro product, 3-methyl-5,7-dinitrocoumaran, is obtained.

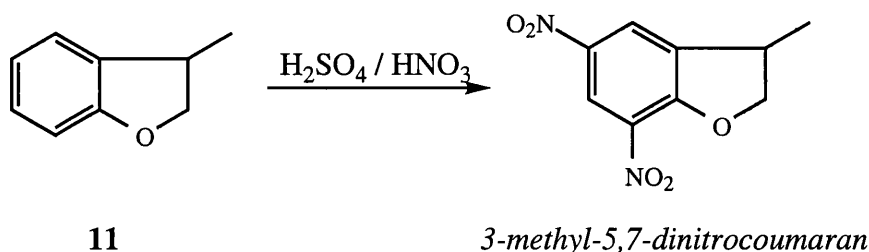

The nitration was successfully carried out but gave only moderate yields. With the resulting products it was possible to measure the enantiomeric ratio by HPLC using a chiral-stationary-phase column (Chiralcel-OD) and a mixture of hexane and isopropanol as solvent, as well as to compare the results with those from the dinitrocoumaran made from racemic cyclisation product.

1.2.3 Reduction by sodium iodide

When a pH 7.4 buffered solution of diazonium salt **8** ($0.048 \text{ mol dm}^{-3}$) and sodium iodide ($0.048 \text{ mol dm}^{-3}$) was stirred for 5 hours, the product, isolated in 11 % yield, was the cyclised 3-iodomethyl-2,3-dihydrobenzofuran **12**. Neither the uncyclised iodoarene **13** nor the product **14** of ring closure in the *endo* mode could be detected.^{30,32} These results are consistent with the radical-chain mechanism deduced by *Beckwith*³⁰ and shown in eqns. (17)-(23), where ArN_2^+ represents the diazonium ion and R^\bullet represents the cyclised radical **10**. Eqn. (17), initiation by reduction of the diazonium ion, rests on the ability of iodide ion to act as a one-electron reductant,³¹ while reaction

(21) is also a one-electron transfer. An important chain propagation step [eqn. (20)] involves iodine atom transfer from I_3^- , formed from iodine adventitiously present or generated by combination of iodine atoms.

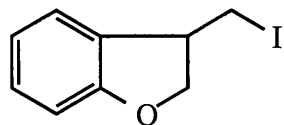

12

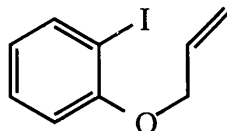

13

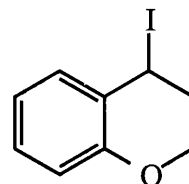

14

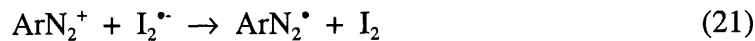

In contrast to the very low yields obtained in aqueous solution, iododediazotiation of **8** gave 86% isolated yields of **12** in acetone solvent.³⁰ This may be because of solvent effects on the electron-transfer steps [eqns. (17) and (21)] in which the arenediazonium ion was reduced to the corresponding radical. As expected, in the more polar water both diazonium atom and iodide anion are stabilised by electrostatic ion/solvent interactions, whereas in the less polar acetone single-electron transfer from

the anion to the cation occurs readily to produce the aryl radical **9**. However, the one-electron transfer step (17) is slow in aqueous solution due to the better solvation of the ions in water as compared to the neutral radical.

1.2.4 Reduction by hypophosphorous acid

When diazonium salts are reduced with hypophosphorous acid, the following mechanism has been suggested:



Where Y = OP(O)H₂, Cl, OH, etc.

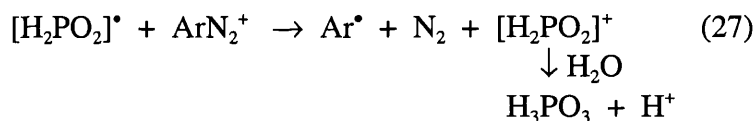
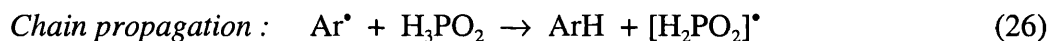
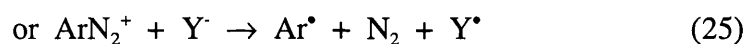

The [H₂PO₂][•] radical produced in reactions (24) and (25) would be different from that of eqn. (26). The hypophosphite radical in (24) and (25) would have the structure:

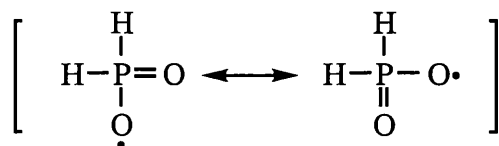

Whereas that formed by reaction (26) would be:

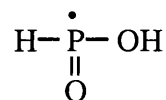

The structure assignment for the $[\text{H}_2\text{PO}_2]^\bullet$ radical produced in eqn. (26) is based on the considerable difference in the strength of the P-H bond and O-H bond, the latter being 134 kJ mol^{-1} stronger.³³ It is likely that the radical produced by reactions (24) and (25) would rearrange rapidly to the phosphonyl radical produced by reaction (26).

It has been reported³⁴ that oxidising agents such as copper sulphate and potassium permanganate are effective catalysts in the hypophosphorous acid reduction of diazonium salts. These oxidising agents are capable of bringing about a one-electron oxidation of hypophosphorous acid or of the hypophosphite ion [hypophosphorous acid is a strong acid ($\text{p}K_a = 1.1$), and it exists mainly as its anion H_2PO_2^- at pH 7.4]. The free radicals so produced react with the diazonium ion according to eqn. (27), thus starting the chain. For example, with copper sulphate the reaction would be:

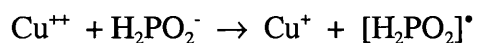

However, our experimental results showed that the yield of cyclised 3-methyl-2,3-dihydrobenzofuran **11** was very low (*ca.* $\leq 10 \%$) when the diazonium salt **8** was reduced with hypophosphorous acid in pH 7.4 buffer solution. When the experiment was repeated in the presence of 5 mol% copper sulphate, potassium permanganate or copper(I) chloride, the expected cyclic product from the diazonium salt **8** still was not formed in significant yield as determined by ^1H NMR spectroscopy. The reason for this

is probably that the resultant cyclised primary carbon-centred radical **10** cannot easily abstract a hydrogen atom from the phosphite ion in contrast to the very reactive aryl radical, which is a σ -radical. An aryl radical abstracting a hydrogen atom is highly exothermic due to the formation of a relatively strong aromatic C-H bond.

The addition of H_2PO_2^* to the carbon-carbon double bond of the diazonium ion **8** is probably one of the reasons for the low yield of cyclised product. For example, radical addition of hypophosphorous acid to alkenes initiated by organic peroxides gives phosphinic acid derivatives in good yields, as shown in eqn. (28).³⁵

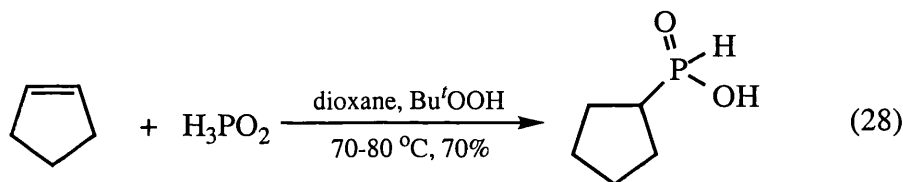

1.2.5 Reduction by tetrakis(dimethylamino)ethylene

Tetrakis(dimethylamino)ethylene (TDAE) is a strong organic electron donor. The chemistry of this compound is therefore dominated by its ability to transfer electrons to an oxidising agent.^{36,37} TDAE can be converted into the radical cation $\text{TDAE}^{\bullet+}$ or to the dication TDAE^{2+} by losing one or two electrons, respectively. This

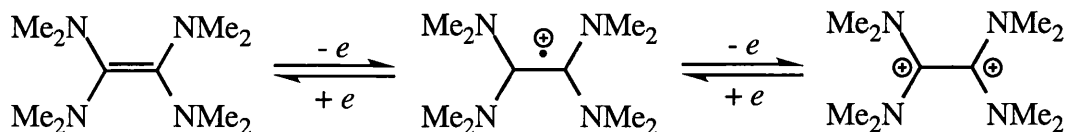

unusual readiness of TDAE to give up electrons is due to the presence of the four amino groups, which stabilise the resulting positive charge by partial transfer of their free electron pairs onto the two central carbon atoms. The half-wave potentials ϵ_0 in water for TDAE system are:³⁸

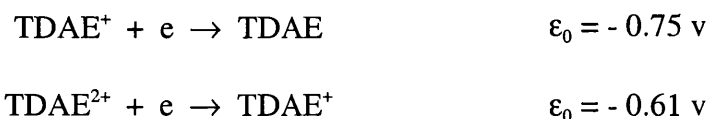

The distinctly negative potential of TDAE (which roughly corresponds to the standard potential of zinc: $\text{Zn}^{2+} + 2e \rightarrow \text{Zn}$; $\epsilon_0 = -0.76 \text{ v}$) is a quantitative indication of the electron donor character of the compound.

When 0.25 mmol of TDAE diluted in pH 7.4 buffer solution was added dropwise to a pH 7.4 buffered solution of 0.5 mmol of the diazonium salt **8**, the NMR spectra of crude products showed that the ratio of allyloxybenzene **15** to 3-methyl-2,3-dihydrobenzofuran **11** was *ca.* 1:1. An identical ratio of the products was obtained when 0.5 mmol of TDAE was added to the diazonium salt solution. These results suggest that TDAE is a sufficiently strong electron donor, capable of reducing the diazonium salt **8** in two one-electron transfer steps as shown in Scheme 6.

When the reaction was carried out under the same conditions but in the presence of hydrogen donors, both of the radicals **9** and **10** could be trapped to give allyloxybenzene **15** and the cyclised product **11**, respectively. However, cyclisation of the aryl radical **9** is an extremely rapid and irreversible process and the rate constant for the cyclisation has been determined to be $4.8 \times 10^9 \text{ dm}^3 \text{ mol}^{-1} \text{ s}^{-1}$ at 20 °C.³⁹ In contrast, the rate constant for aryl radicals to abstract hydrogen is only *ca.* $10^6 \text{ dm}^3 \text{ mol}^{-1} \text{ s}^{-1}$,⁴⁰ and

thus, treatment with moderate concentrations of hydrogen donors should result in selective trapping of the radical **10** to give a high yield of the cyclised product **11**.

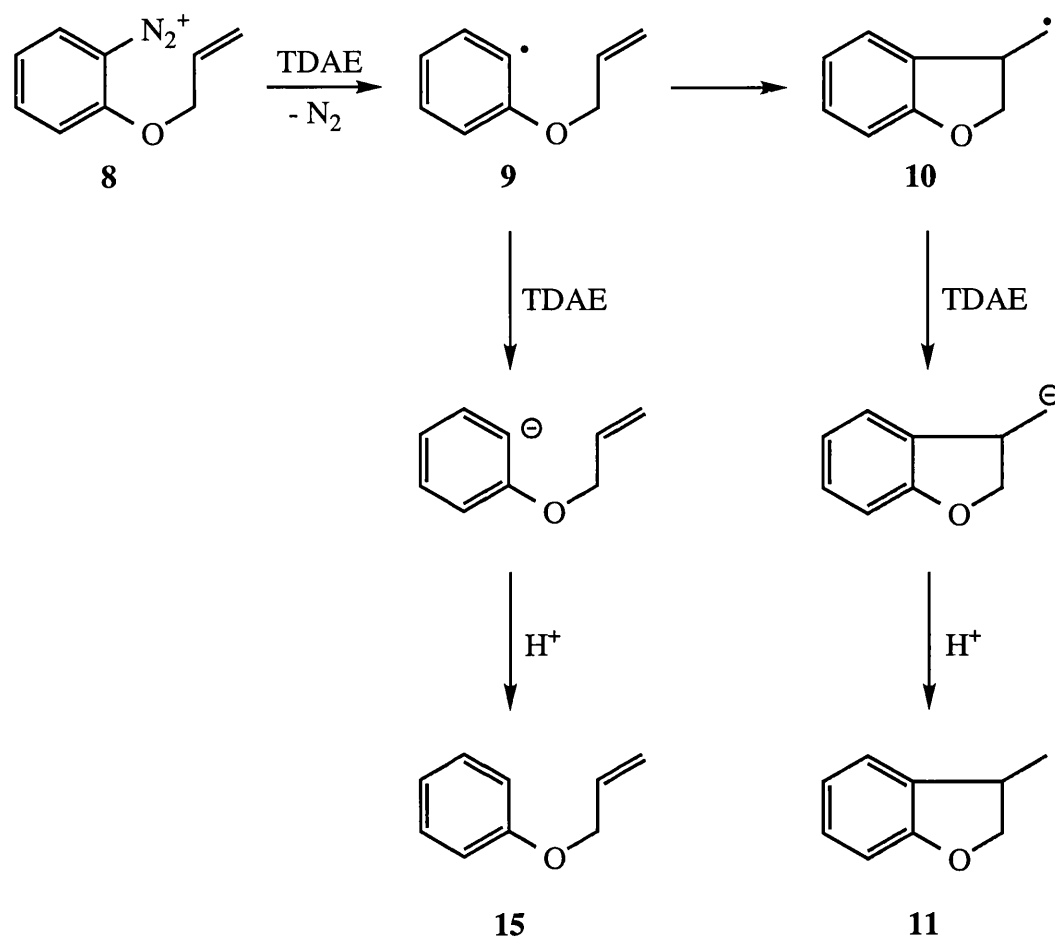

Scheme 6

Because of their solubility in water and comparatively weak O-H and S-H bonds, L-ascorbic acid, L-cysteine, hydroquinone and pyrogallol were chosen as hydrogen donors. Because the pK_a for L-ascorbic acid is 4.2 in aqueous solution, the experiment was conducted in pH 4.2 buffer solution when this acid was used as hydrogen donor. Other experiments were carried out in pH 7.4 buffer solution. It was found that the ratio

of the products **11** and **15** was changed from 1:1 to 1.5:1, and more of the expected cyclic compound **11** was formed in the presence of *ca.* 0.5 mol dm^{-3} of L-ascorbic acid, L-cysteine or pyrogallol; complex products were formed with hydroquinone as H-donor. The reason for the latter result is not well understood.⁴¹

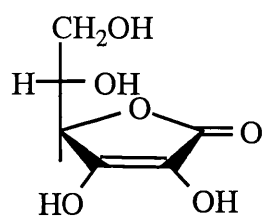

L-ascorbic acid

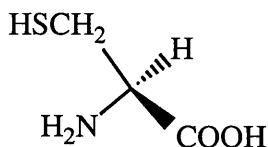

L-cysteine

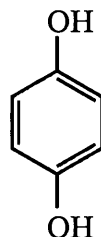

hydroquinone

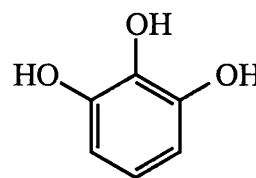

pyrogallol

TDAE proved not to be a suitable reducing agent for this reduction reaction of the diazonium ion. Although the yield of cyclised compound **11** was increased in the presence of hydrogen donors, there was still a large amount of uncyclised **15** formed. This is probably because TDAE has a fairly low reduction potential and it readily reduces the aryl radical to the aryl anion despite the rapid ring closure of the aryl radical.

1.2.6 Reduction by Ti^{3+}

Ti^{3+} is a relatively mild reducing agent ($\epsilon_0 = -0.1 \text{ v}$). The reduction of diazonium salts by titanous chloride is a quite useful source of aryl radicals, because both the reduction and the subsequent decomposition of diazenyl radical [eqns. (29) and (30)] are fast processes.⁴²

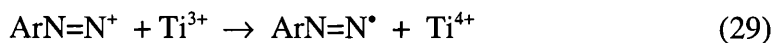

Without hydrogen donors, dediazonation of **8** by an equimolar amount of TiCl_3 was carried out in pH 7.4 buffer solution at room temperature. After extraction of the reaction mixture with diethyl ether, only tars were isolated. However, when the diazonium salt was treated with twice the amount of TiCl_3 , allyloxybenzene **15** and the cyclised dihydrobenzofuran **11** were formed in the ratio of 2:1 as determined by ^1H NMR spectroscopy. The remainder of the product mixture was intractable. It is possible that the alkyl radical **10**, owing to its nucleophilic character, is not easily reduced by titanous chloride, while the aryl radical has a clearly electrophilic character and is reduced selectively by the titanous salt.

When L-ascorbic acid, L-cysteine, hydroquinone or pyrogallol were used as hydrogen donors, the ratio of the dihydrobenzofuran **11** to allyloxybenzene **15** was increased only to 1:1. Several other attempts, including increasing the redox potential of $\text{Ti}^{3+} / \text{Ti}^{4+}$ system by complexation with ethylenediaminetetraacetic acid (EDTA), and using other reducing agents such as methylviologen dichloride hydrate, still failed to give a satisfactory yield of **11**.

It is unclear why the dediazonation of **8** gives low yields of cyclised product in aqueous solution. Possibly, the solvation of the reducing agents, H-donors and the diazonium salt in water has marked effects on the radical reaction.

1.2.7 Reduction in the presence of cyclodextrins

Previous results show that the reduction of the diazonium salt **8** in aqueous solution is both complex and strongly influenced by solvent effects. In the absence of a suitable hydrogen donor, dediazonation of **8** gave high yield of the unrearranged hydrodediazonation product, allyloxybenzene **15**. Because of the formation of an inclusion complex with cyclodextrin, it was hoped that the aryl radical **9** generated by the reduction of diazonium ion **8**, will preferentially undergo ring closure in the cyclodextrin cavity to give the cyclised product, 3-methyl-2,3-dihydrobenzofuran **11**. Since the cyclodextrin cavity has a hydrophobic character, it was hoped that the radical reaction could take place as in organic media.

Unpublished results⁴³ have showed that the copper(II) chloride and the sodium iodide induced cyclisation of **8** in water in the presence of Hp- β -CD gave very low yields (< 15%) of cyclised product. It is probable that the relatively low Cu^{II}/Cu^I and I[•]/I⁻ redox potentials disfavour both electron and halogen transfer when water is used as solvent.

Reduction of **8** by Ti³⁺ in the presence of Hp- β -CD was carried out in pH 7.4 buffer solution at 0 °C. The resulting products were analysed by NMR spectroscopy and showed that the uncyclised product **15** was minor (*ca.* 25% of **11** + **15**) as compared to cyclic compound **11**. This result suggests that in the cyclodextrin cavity the aryl radical **9** undergo ready cyclisation to give **10**, which subsequently abstracts a hydrogen atom from a C-H group of the β -cyclodextrin.^{25,26}

If the cyclodextrin behaves as an asymmetric reaction vessel, the dediazonation of **8** in the presence of cyclodextrin should promote enantioselective cyclisation of the

ortho-allyloxyphenyl radical **9**. Indeed, when the diazonium ion **8** and Hp- β -CD were used in the molar ratio of 1:5, an enantioselective radical reaction was observed. After converting the cyclised product **11** to 3-methyl-5,7-dinitrocoumaran, the enantiomeric excess of the latter was determined by chiral-stationary-phase HPLC analysis. However, the ee was small (6.8%, Fig. 2a), possibly because the large size of the β -cyclodextrin cavity imposes only weak conformational restrictions on the guest radical. In accord with this hypothesis, the ee was increased to 12.5% when Hp- α -CD was used. In the absence of cyclodextrins, the dediazonation of **8** in the presence of methyl- α -D-glucopyranoside (which is a chemically-similar monomeric model for the cyclodextrin) shows no enantioselectivity.

Although the efficiency of the enantioselectivity imposed by the cyclodextrin is not large, these results suggest that cyclodextrins have fairly strong binding affinities for the diazonium ion and for the corresponding radicals. The doubling of the observed enantioselectivity on change from β - to α -cyclodextrin suggests that it might be possible to obtain usefully large enantioselectivities by modifying the sizes and structures of the guest radicals and of the cyclodextrin hosts.

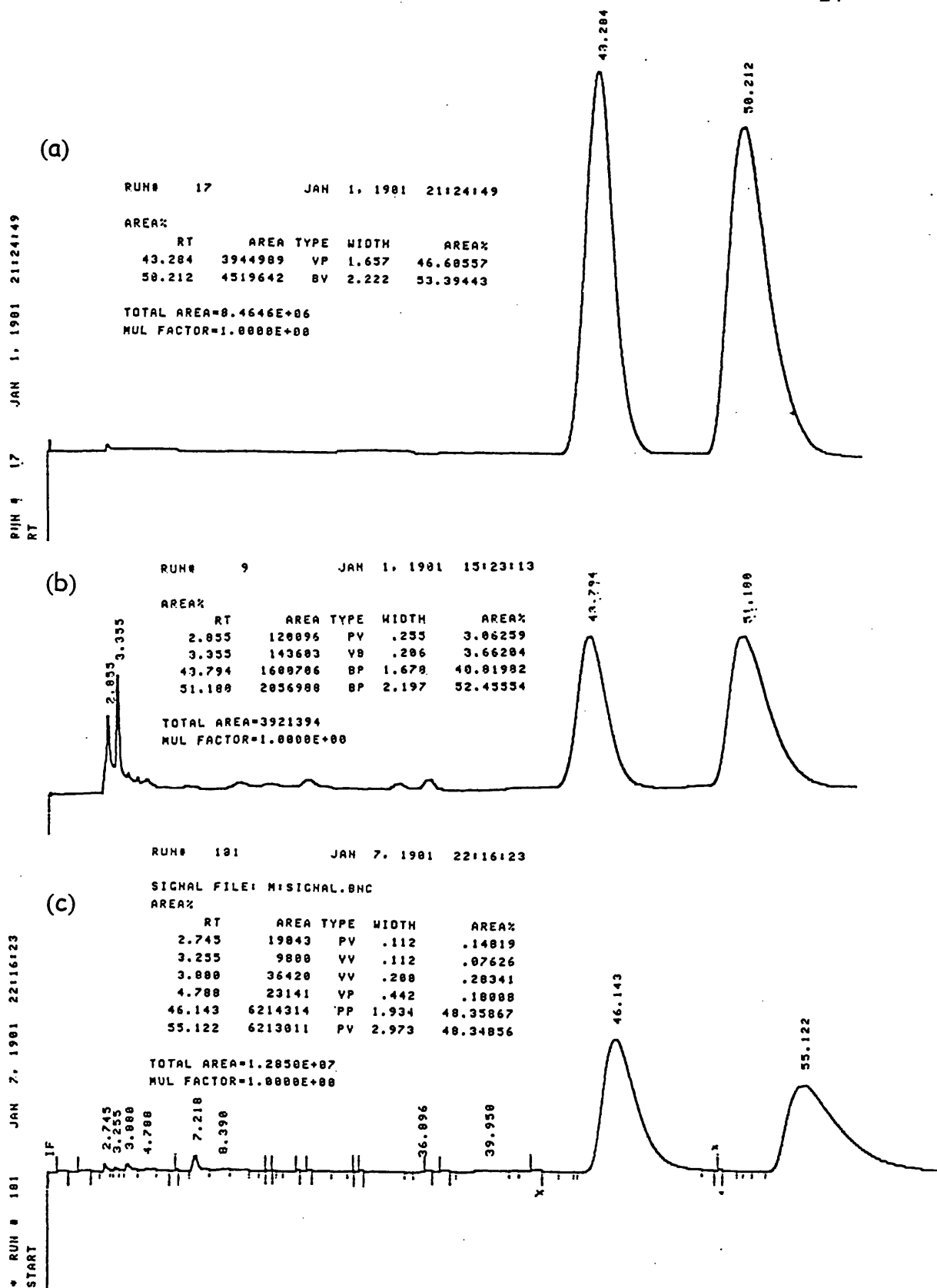

Fig. 2 HPLC results for enantioselective cyclisation of the *ortho*-allyloxyphenyl radical in the presence of additives (ee): (a) Hp- β -CD (6.8%), (b) Hp- α -CD (12.5%), (c) methyl- α -D-glucopyranoside (0%).

1.3 Experimental

NMR spectra were recorded using a Varian VXR-400 instrument (400 MHz for ^1H). The solvent was CDCl_3 and chemical shifts are reported relative to Me_4Si ; J values are quoted in Hz. Mass spectra were obtained with VG 7070H or VG ZAB-2F instruments using electron impact ionisation. Column chromatography and TLC were carried out using Merck Kieselgel 60 (230-400 mesh) and Kieselgel 60 F_{254} aluminium-backed pre-coated plates, respectively. HPLC was carried out using a Chiralcel-OD column for the determination of enantiomeric excesses. All manipulations and reactions of air-sensitive compounds were carried out under an atmosphere of dry argon or nitrogen and all extracts were dried over anhydrous MgSO_4 . Petroleum refers to the fraction of bp 40-60 °C.

Materials

The pH 7.4 buffer solution⁷⁷ was prepared from a mixture of 50 cm^3 0.1 M potassium dihydrogen phosphate and 39.1 cm^3 0.1 M NaOH.

Hydroxypropyl- β -cyclodextrin (Hp- β -CD) and hydroxypropyl- α -cyclodextrin (Hp- α -CD) were obtained from Aldrich. All used solvents and starting materials not mentioned explicitly were obtained commercially (Aldrich or Lancaster) and used without further purification.

Preparation of *ortho*-allyloxybenzenediazonium tetrafluoroborate **8**¹⁷

N-(2-Allyloxyphenyl)acetamide.²⁷ – A mixture of 2-acetylaminophenol (22.0 g, 0.14 mol), anhydrous potassium carbonate (20.0 g, 0.14 mol) and dry acetone (58 cm^3)

in an argon flushed 250 cm³ flask was stirred vigorously to ensure good mixing. Then, allyl bromide (12.5 cm³, 0.14 mol) was added slowly with stirring at reflux temperature. After refluxing and stirring for 7 h, the reaction mixture was added to water (200 cm³) and the resulting mixture was extracted with diethyl ether (4 x 50 cm³). The combined ether extracts were washed with 10 % aqueous sodium hydroxide (30 cm³), then with water, dried and concentrated to give a dark brown oil which crystallised completely to brown crystals. The crude solid product was purified by recrystallisation from a mixture of diethyl ether and petroleum to give a colourless crystalline product (24.7 g, 92%); mp 48-50 °C (lit.,²⁷ mp 50 °C); δ_{H} 2.20 (3H, s, COCH₃), 4.60 (2H, d, *J* 5.3, OCH₂), 5.33 (1H, dd, *J* 10.5 and 1.1, C=CH₂), 5.41 (1H, dd, *J* 17.2 and 1.1, C=CH₂), 6.07 (1H, m, CH=CH₂), 7.79 (1H, br s, NH), 6.87-8.36 (4H, m, Ph); δ_{C} 24.9, 69.5, 11.3, 118.2, 119.9, 121.3, 123.5, 127.9, 132.8, 146.6, 168.1; *m/z* 192 (M⁺, 100%), 150 (77), 108(31).

2-Allyloxyaniline.²⁷ – A mixture of *N*-(2-allyloxyphenyl)acetamide (24 g, 0.125 mol) and 6 N hydrochloric acid (30 cm³) was refluxed for 70 min. Afterwards, 20 % w/v sodium hydroxide solution (80 cm³) was added to make the reaction mixture alkaline. The resulting solution was extracted with diethyl ether (3 x 70 cm³) and the combined extracts were washed with 10 % sodium hydroxide solution, then with water, dried and concentrated. The resulting crude product was distilled under reduced pressure to give a colourless oil (15.3 g, 82%); bp 65-70 °C/0.05 Torr (lit.,²⁷ bp 84-85 °C/0.6 Torr); δ_{H} 3.73 (2H, br s, NH₂), 4.56 (2H, dd, *J* 5.3 and 1.5, OCH₂), 5.28 (1H, dd, *J* 10.4 and 1.4, C=CH₂), 5.41 (1H, dd, *J* 17.2 and 1.4, C=CH₂), 6.08 (1H, m, CH=CH₂), 6.68-6.82 (4H, m, Ph); δ_{C} 69.2, 112.0, 115.2, 117.4, 118.3, 121.3, 133.5, 136.4, 146.2; *m/z* 149 (M⁺, 59%), 108 (100), 92 (3.7).

***ortho*-Allyloxybenzenediazonium tetrafluoroborate 8.**¹⁷ – To a mixture of 2-allyloxyaniline (15.3 g, 0.1 mol) and 21% w/v aqueous fluoroboric acid (81 cm³) was added dropwise a solution of sodium nitrite (7.0 g, 0.1 mol) in water (15 cm³), while the temperature was maintained at 10 °C with an ice-water bath. Afterwards, the reaction mixture was cooled down to –20 °C with a dry ice-acetone bath. The resulting white precipitate was collected by filtration, washed with 5 % aqueous fluoroboric acid, and allowed to dry in the air at room temperature. The solid product was then dissolved in the minimum amount of acetone and reprecipitated by addition of dry diethyl ether, while cooling in an ice bath. The resulting diazonium tetrafluoroborate was obtained as a colourless solid (16.2 g, 65%); δ_{H} 4.93 (2H, d, J 5.7, OCH₂), 5.49 (2H, m, C=CH₂), 6.05 (1H, m, CH=CH₂), 7.27-8.58 (4H, m, Ph); δ_{C} 72.6, 77.2, 114.7, 121.6, 123.5, 129.6, 133.5, 143.9, 162.2; m/z 249 (M⁺, 32%), 221 (24), 176 (26), 161 (25).

Typical procedure for reduction of the diazonium salt 8 in aqueous solution

To a solution of *ortho*-allyloxybenzenediazonium tetrafluoroborate 8 (0.60 g, 2.4 mmol) in pH 7.4 buffer solution (50 cm³) was added sodium iodide (0.36 g, 2.4 mmol). After stirring for 5 h at room temperature, the mixture was extracted with diethyl ether (3 x 50 cm³). The combined extracts were washed with brine (50 cm³), dried and concentrated by rotary evaporation to give a brown-coloured oil, which was then purified by column chromatography on silica gel, using petroleum as eluent, to give 3-iodomethyl-2,3-dihydrobenzofuran 12 (69 mg, 11%) as a colourless oil; δ_{H} 3.19 (1H, apparent t, J 9.9, CH₂I), 3.44 (1H, dd, J 9.9 and 4.4, CH₂I), 3.83 (1H, m, ArCH), 4.32 (1H, dd J 9.3 and 5.2, OCH₂), 4.63 (1H, apparent t, J 9.3, OCH₂), 6.79-7.22 (4H, m, Ph);

δ_c 9.0, 77.4, 44.6, 110.1, 120.4, 124.2, 128.6, 129.1, 160.0; m/z 260 (M^+ , 42%), 133 (100).

Other reduction reactions were carried out in a similar way and the products were analysed by 1H NMR spectroscopy.

Reduction of the diazonium salt **8** by Ti^{3+} in the presence of cyclodextrins

A solution of $TiCl_3$ (1.4 cm³, 1.6 mmol) in pH 7.4 buffer solution (10 cm³) was added dropwise to a solution of *ortho*-allyloxybenzenediazonium tetrafluoroborate **8** (0.40 g, 1.6 mmol) and Hp- β -CD (12.0 g, 8 mmol) in buffer solution (120 cm³) with stirring and cooling in an ice bath. The resulting reaction mixture was stirred for 5 h under ice cooling. The solution was then extracted with diethyl ether (3 x 60 cm³). The combined extracts were washed with brine (60 cm³) and dried and concentrated by rotary evaporation to give a yellow-coloured oil. 1H NMR spectroscopy showed the cyclised product, 3-methyl-2,3-dihydrobenzofuran **11** and the uncyclised product, allyloxybenzene **15**, were formed in the ratio of 75:25. The former was isolated by column chromatography on silica gel, using petroleum as eluent, as a colourless oil (0.13 g, 61%); δ_H 1.34 (3H, d, J 6.9, Me), 3.57 (1H, ddq, J 8.9, 7.5 and 6.9, ArCH), 4.08 (1H, dd, J 8.6 and 7.5, OCH₂), 4.69 (1H, dd, J 8.9 and 8.6, OCH₂), 6.77-6.92 (2H, m, ArH), 7.08-7.20 (2H, m, ArH); δ_c 19.3, 36.5, 78.4, 109.5, 120.4, 123.8, 127.9, 132.2, 159.8; m/z 134 (M^+ , 74%), 119 (100).

The reduction of **8** in the presence of Hp- α -CD or methyl- α -D-glucopyranoside was carried out in a similar way. The cyclised product **11** was separated by

chromatography and converted to 3-methyl-5,7-dinitrocoumaran, following a published procedure for the preparation of the 2-methyl analogue²⁹ as below.

Nitration of 3-methyl-2,3-dihydrobenzofuran

To a cooled mixture of concentrated nitric acid (2 cm³) and sulphuric acid (2 cm³) was added dropwise 3-methyl-2,3-dihydrobenzofuran **11** (0.3 g, 2.2 mmol) with cooling and stirring. The resulting dark mixture was allowed to stand for 5 min in the ice bath and was poured onto ice (20 g). The black solid product, which initially covered the walls of the flask, was filtered off, washed with water and purified by chromatography on silica gel, using petroleum-dichloromethane (50:50) as eluent, to give 3-methyl-5,7-dinitrocoumaran (0.19 g, 38%), as a yellow-coloured solid; mp 119-121 °C; δ_{H} 1.48 (3H, d, *J* 6.9, CH₃), 3.75 (1H, m, CH), 4.55 (1H, d, *J* 9.3 and 7.3, OCH₂), 5.14 (1H, apparent t, *J* 9.3, OCH₂), 8.25 (1H, m, Ph), 8.91 (1H, m, Ph); δ_{C} 19.4, 35.5, 77.2, 82.5, 121.6, 124.3, 139.5, 159.2; *m/z* 224 (M⁺, 100%), 209 (90), 177 (13). The enantiomeric excess of the compound was determined by chiral-stationary-phase HPLC and the results are given in Fig. 2.

Chapter 2

Intramolecular radical-chain hydrosilylation catalysed by thiols: cyclisation of alkenyloxysilanes

2.1 Introduction

The development of organic synthesis using a variety of organosilicon reagents has been one of the most remarkable advances in synthetic chemistry in the last decades. The hydrosilylation of various functional groups catalysed by transition metal complexes provides convenient routes to such organosilicon reagents and serves also as a unique and effective method for the selective reductions of carbon-heteroatom bonds, including asymmetric synthesis.⁴⁴

2.1.1 Hydrosilylation catalysed by transition metal compounds

The term of hydrosilylation is used to describe an addition reaction of hydrosilanes to unsaturated bonds. *Speier's* discovery⁴⁵ that hydrosilylation of olefins could be effected by H_2PtCl_6 led to numerous associated developments in the use of transition metal complexes as catalysts.⁴⁶ The generally-accepted mechanism for olefin hydrosilylation is depicted in Fig. 3, the essential features of which were first postulated by *Chalk* and *Harrod*.⁴⁷ This mechanism shows that all the catalytic steps are reversible and fast except the last one, the carbon-silicon bond forming step, which is the rate-determining step of the catalytic cycle and is irreversible. Thus, it implies that double bond migration can occur during catalysis as shown in eqn. (31).⁴⁸

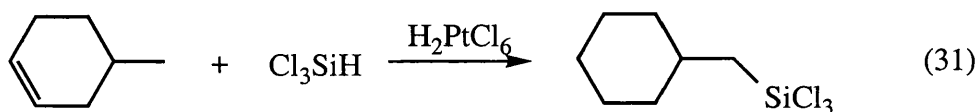

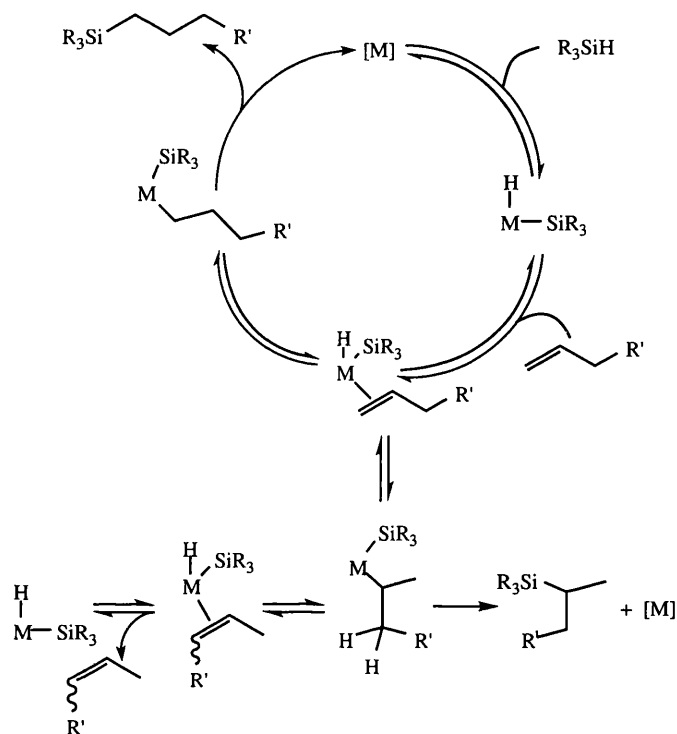
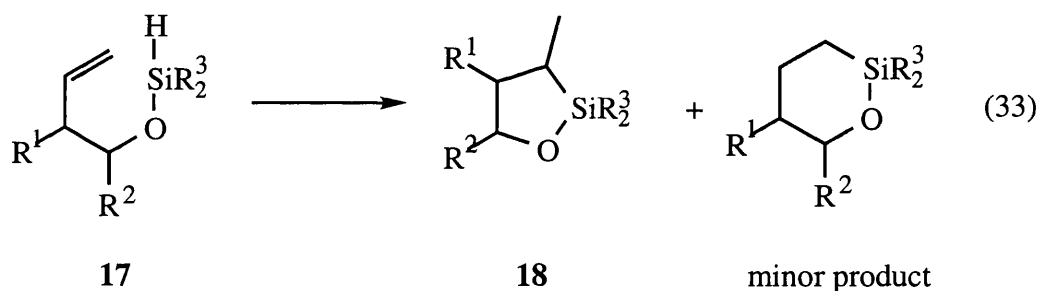
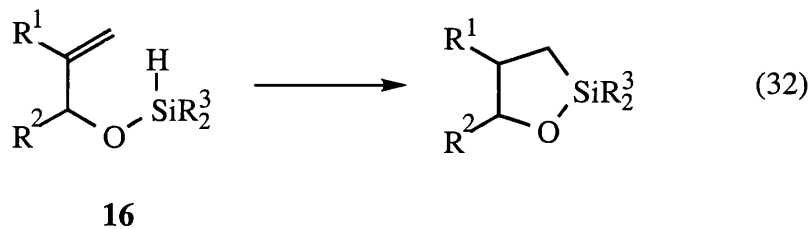

Fig. 3 Mechanism for transition-metal catalysed hydrosilylation

There are other important aspects of transition-metal-catalysed hydrosilylation. First, addition of the silyl group is preferred at terminal olefin positions over internal positions [eqn. (31)].^{48,49} Second, addition of the silicon and hydrogen atoms to the double bond is *cis*.⁵⁰ Third, oxidative addition of the silyl hydride to the metal occurs with retention of configuration at silicon.⁵¹ Fourth, the overall process of hydrosilylation proceeds with retention of configuration at silicon.⁵² Hence, since oxidative addition proceeds with retention, the carbon-silicon bond-forming step must also proceed with retention.

Catalytic intramolecular hydrosilylation of the type **16** under the influence of transition-metal catalysts (usually rhodium- or platinum-based) occurs in a *5-endo* fashion, as shown in eqn. (32).^{53,54} Under the same conditions, homoallyloxysilanes

(but-3-enyloxysilanes) of the type **17** give mainly the product of 5-*exo* cyclisation **18** and this becomes the exclusive cyclisation pathway when the double bond carries one or two terminal substituents.^{53,55}

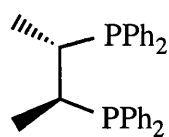
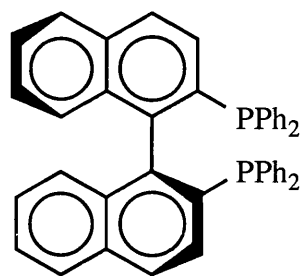

Allyl and homoallyl alcohols are used as precursors for compounds of the types **16** and **17**. The silyl groups are effectively introduced by silylation on the hydroxyl groups with chlorosilane and triethylamine. In the allylic alcohol series, the intramolecular hydrosilylation proceeds in the 5-*endo* fashion selectively with the *syn* stereoisomer predominant, regardless of the nature of the catalyst, platinum or rhodium.^{53,55,56} Stereoselectivity increases with an increase in bulk of the allylic substituent. In homoallyloxysilanes, two types of stereoselection are possible, one being *anti*-controlled by the allylic substituent, and the other depending on the olefin geometry, *anti* to the *cis* substituent R^c and *syn* to the *trans* R^t (see Scheme 7).^{53,55,56} Catalytic, asymmetric, intramolecular hydrosilylation is also possible with rhodium catalysts in the presence of optically active phosphine ligands, such as *S,S*-chiraphos

*S,S*-chiraphos*S*-binap

and *S*-binap.^{54,57,58} Followed by hydrogen peroxide oxidative cleavage of the Si-C bond, which proceeds with retention of configuration at the cleaved carbon atom, such catalytic intramolecular hydrosilylation provides a useful synthetic route to 1,3-diols of defined stereochemistry (see Scheme 7).⁵³⁻⁵⁸

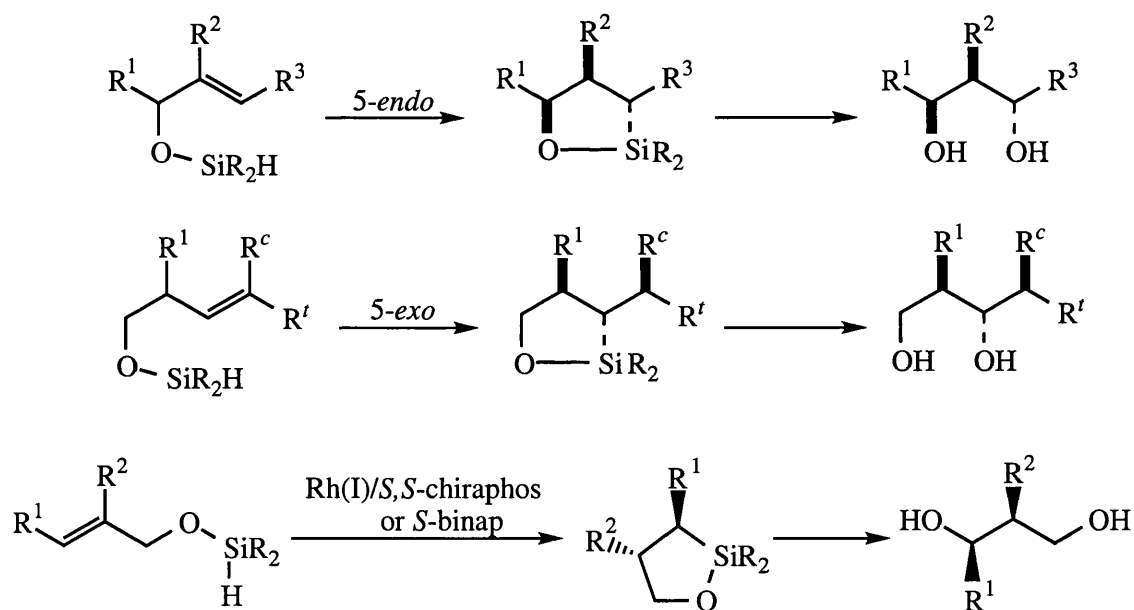

Scheme 7

2.1.2 Intramolecular addition of free radicals

The overall thermochemistry is especially useful for assessing the relative rates and directions of simple intermolecular radical addition. Thus, when A^\bullet represents a carbon-centred radical and $B=D$ a carbon-carbon double bond, the addition is exothermic. Such reactions are usually relatively fast and the relative rate constants

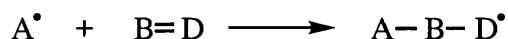

often roughly reflect the exothermicities.⁵⁹ However, thermochemistry is not the only factor, nor even the predominant factor affecting the outcome of many free radical processes. The others are: (i) *stereoelectronic effects*, that reflect the way in which the requirement for the overlap of frontier orbitals affects the energy of the transition structure; (ii) *polar effects*, that reflect the way in which the electronegativities of the constituent atoms affect the energy of the transition structure; (iii) *steric effects*, that reflect the contribution of non-bonded interactions to the energy of the transition structure. The outcome of any particular reaction will reflect the subtle interplay of all of these factors.

The well-known regioselective cyclisation of the hex-5-enyl radical **19** to give the less stable cyclopentylmethyl radical **20** in preference to the more stable cyclohexyl radical **21**, provides a clear contravention of predictions based on thermochemical criteria. The suggestion,⁶⁰ first made thirty years ago by *Beckwith*, that this reaction is under stereoelectronic control, is now widely accepted.

therefore be dipolar, and its energy should be sensitive to the polar nature of its substituents.⁶²

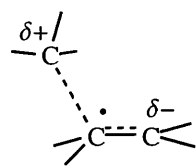

22

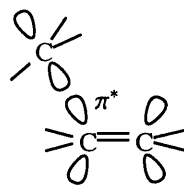

23

Although the steric and thermochemical factors are expected to favour the formation of the more stable 6-membered-ring product, the strains that arise from the disposition of reactive centres within the transition structure prefer the formation of the less-strained structure **24** for *exo*-cyclisation of the hex-5-enyl radical.⁶³ In accord with the hypothesis, the energy calculated for **25** was found to be *ca.* 11 kJ mol⁻¹ greater than for **24**.⁶⁴

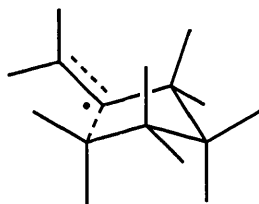

24

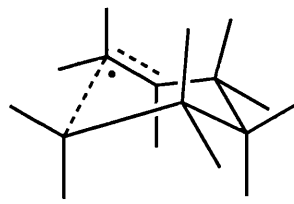

25

The calculated transition structure **24** for *exo*-cyclisation of the hex-5-enyl radical resembles cyclohexane in its chair formation. For a typical monosubstituted system (*e.g.* the 4-methylhex-5-enyl radical) there are therefore two possible diastereoisomeric transition structures: one **26** in which the substituent is *pseudo*-axial and the other **27** in which it is *pseudo*-equatorial. The latter is expected to be of lower

energy, and this is confirmed by calculation.⁶⁴ Hence, cyclisation of 4-substituted hexenyl radicals affords preferentially the *trans*-product.⁶⁵ The observed preference for *trans*-cyclisation of 2-substituted hexenyl systems and for *cis*-cyclisation of 1- or 3-substituted systems⁶⁵ can be similarly rationalised.⁶⁴

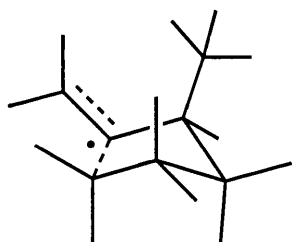

26

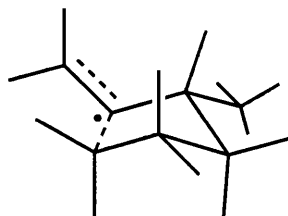

27

The intramolecular radical reactions are of especially interest because of their utility for the synthesis of complex natural products.⁶⁶ Cyclisation of suitably constituted alkenyl or alkynyl radicals and similar species have been documented by hundreds of papers and numerous reviews. However, the analogous silyl radical cyclisation is almost unexplored⁶⁷ due to the comparative success of transition-metal catalysed hydrosilylation and the low yield of intramolecular silyl radical hydrosilylation.

For the first time, in the early 1970s, *Sakurai* in a review⁶⁸ reported that the di-*tert*-butyl peroxide (DTBP) initiated intramolecular hydrosilylation of an unsaturated silane produced a confusing picture of substituent control of both regiochemistry and yields (Scheme 9). On the basis of these limited data, *Beckwith et al.* concluded that 1-silahex-5-enyl radicals undergo preferential 5-*exo*-cyclisation,⁶⁹ but these were later found to be incorrect.⁷⁰

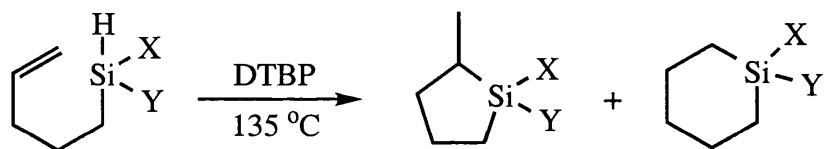

X	Y	Yield (%)	
Me	Ph	0.65	5.4
Me	Cl	71.60	12.60
Ph	Ph	0.74	6.1
ⁱ Pr	Cl	3.94	5.47

Scheme 9

A decade later, *Ingold* and coworkers⁷⁰ described an EPR study of the radicals formed during photolysis of DTBP and several alkenyl(dimethyl)silanes. Only carbon-centred radicals were observed, which were either secondary alkyl radicals formed by the intramolecular addition of the initially-formed silyl radical to a double bond or allyl radicals formed by hydrogen-atom abstraction from the alkenyl group. However, product studies on 3,3-dimethylpent-4-enyl(dimethyl)silane revealed the yields of silanes as shown in Scheme 10.⁷⁰

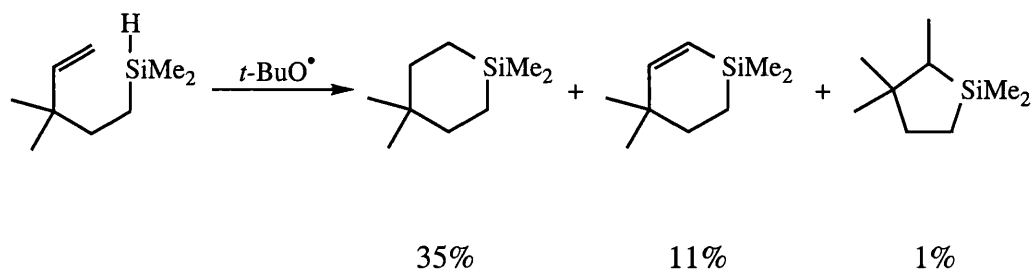

Scheme 10

Furthermore, EPR studies on the same reaction allowed the identification of the silacyclohexyl radical **29** [$a(\text{H}_\alpha)$ 19.5, $a(\text{H}_\beta^a)$ 36.0 and $a(\text{H}_\beta^e)$ 6.0 G at -20°C] as the only observable intermediate. A kinetic investigation placed the rate constant for the cyclisation of the silyl radical **28** $> 10^7 \text{ s}^{-1}$ at room temperature.⁷⁰ Further results from *Barton and Revis*⁷¹ supported the 6-*endo* cyclisation and indicated that the *endo*-mode is favoured in silicon systems.

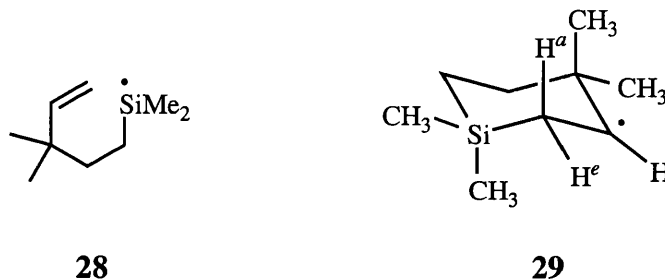

2.1.3 Principle and applications of polarity-reversal catalysis

Within the context of the reactions of electrically-neutral free radicals, the term '*polar effect*' is used to describe the influence on the activation energy of charge transfer in the transition state. The dependence of reactivity and selectivity in radical chemistry on such polar effects has been recognised for more than 50 years.^{72a}

For a hydrogen-atom transfer reaction [eqn. (34)], the transition state has some polar character and may be represented in valence-bond terms as a hybrid of the structures **30a-d**. For a series of similar exothermic reactions, the activation energies

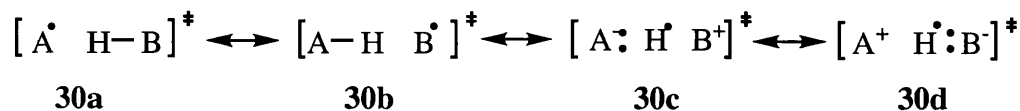
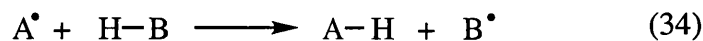

would be expected to decrease as the contributions from the charge-separated structures **30c** and **30d** increase. For example, consider the abstraction of a hydrogen atom from the methyl group of toluene by a bromine atom. Since bromine is more electronegative than carbon, transition state **31** will be polarised as shown, with a partial negative charge on the halogen and a partial positive charge on the carbon:

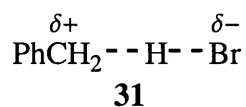

It has been shown that electron-donating groups in the para-position of toluene, which would stabilise the positive charge on the benzylic carbon, increase the rate of hydrogen abstraction by bromine, while electron-withdrawing groups decrease it.^{72b} Halogen radicals have a tendency to abstract electron-rich hydrogen atoms and may be described as *electrophilic*. Although radical philicity is clearly a relative attribute,⁷³ a radical that has a high electronegativity will be electrophilic and one with a low electronegativity will be *nucleophilic* (tend to abstract electron-deficient hydrogen atoms).⁷⁴ Thus, alkoxy and thiyl radicals are also electrophilic, while acyl, alkyl, silyl and amine-boryl radicals are nucleophilic.

If El^\bullet and Nuc^\bullet represent electrophilic and nucleophilic radicals, respectively, the hydrogen-atom abstraction reactions (35) and (36) should be favoured because of stabilising charge transfer in the transition state, while reaction (37) and (38) will not.

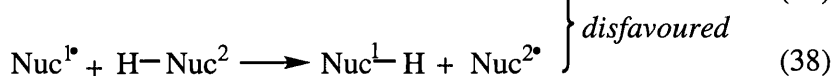
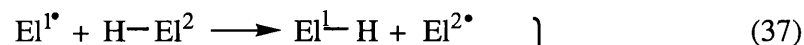
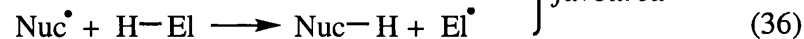
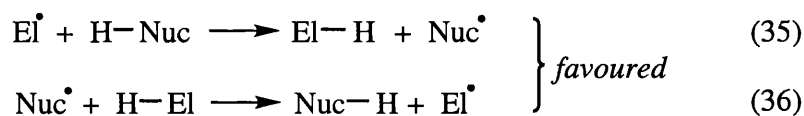

However, in the presence of a catalytic amount of H-Nuc, the single-step process (37) will be replaced by a pair of consecutive hydrogen-atom transfer reactions (39) and (40). Both steps of the catalytic cycle are facilitated by favourable polar effects. Similarly, the slow direct abstraction reaction (38) can be promoted by H-El, when the single-step process is replaced by the reactions (41) and (42). The compounds H-Nuc and H-El can be referred to as *hydridic* (or *donor*) and *protic* (or *acceptor*) polarity-reversal catalysts, respectively.⁷³

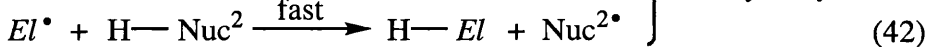
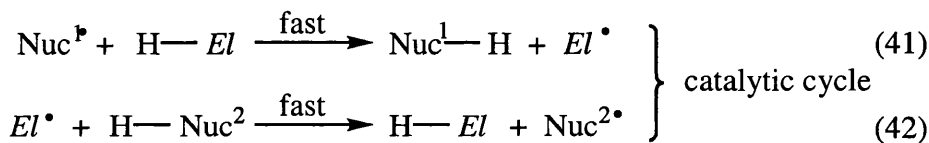
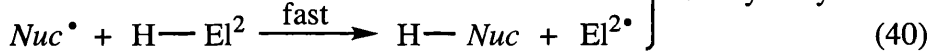
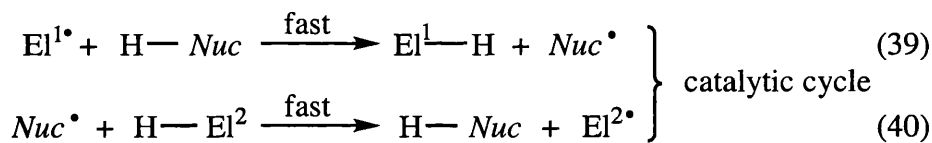

Reference to Fig. 4 clarifies the situation for reaction (37) and its polarity-reversal catalysed equivalent, two steps (39) and (40) with low activation energies can lead to a faster overall reaction than is achieved in a single-step process which has a much higher activation energy. Ideally, the overall enthalpy change associated with an uncatalysed exothermic reaction should be partitioned so that both steps of the catalytic cycle are themselves exothermic.

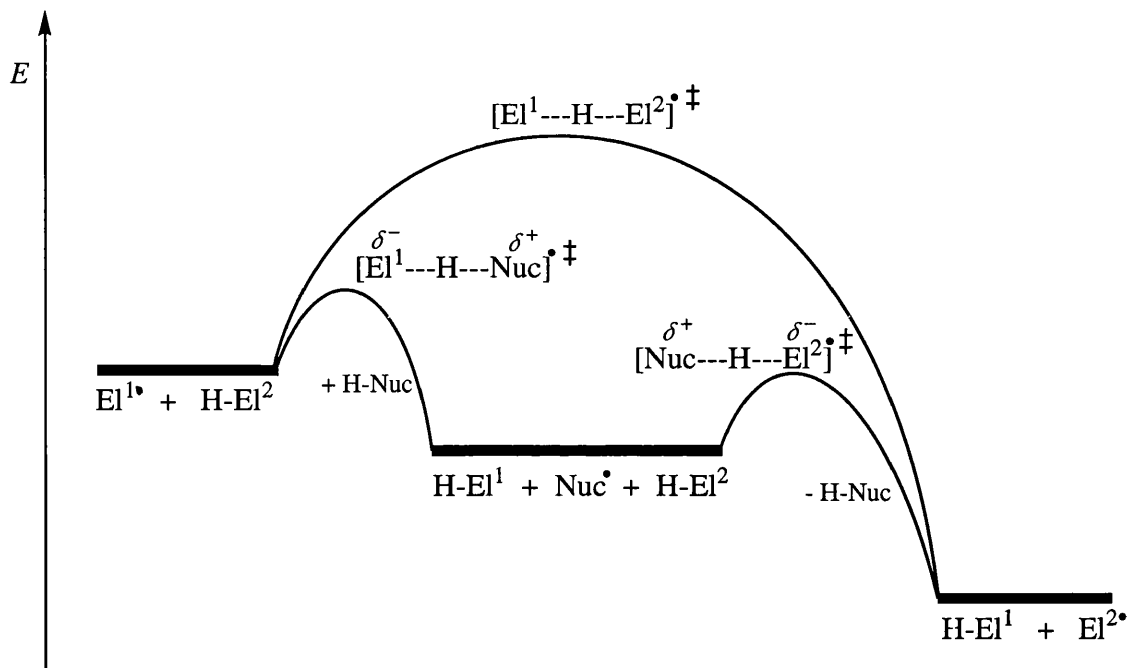
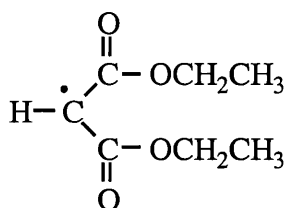
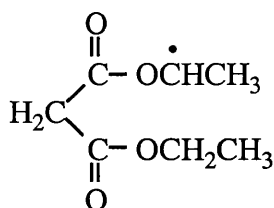

Fig. 4 Schematic potential energy diagram illustrating the principle of PRC for promotion of a hydrogen-atom transfer of the type shown in eqn. (37) by an hydridic catalyst H-Nuc.

2.1.3.1 Amine-boranes as hydridic polarity-reversal catalysts

The abstraction of electron-deficient hydrogen atoms by electrophilic radicals does not benefit from favourable polar effects in the transition state. In accord with predictions based on consideration of polar effects, it has been found that in the presence of a catalytic amount of amine-boranes, the electron-deficient hydrogen atoms are rapidly and selectively abstracted from the α -C-H groups in esters, lactones, ketones, imides, acetic anhydride and related compounds by electrophilic *tert*-butoxyl radicals.^{73,75} The single-step abstraction by Bu'O• is replaced by a two-step catalytic cycle in which Bu'O• first abstracts electron-rich hydrogen from the amine-alkylborane to give a nucleophilic amine-alkylboryl radical which subsequently abstracts with high regioselectivity the electron-deficient α -hydrogen from the carbonyl compound. For

example, uncatalysed hydrogen abstraction from diethyl malonate by *tert*-butoxyl radical at $-84\text{ }^{\circ}\text{C}$ afforded a mixture of radicals **32** and **33**, while in the presence of $\text{Me}_3\text{N}\rightarrow\text{BH}_2\text{Thx}$ [the 1,1,2-trimethylpropyl (“*tert*-hexyl”) residue is referred to as the *thexyl* group] only **32** was detected by EPR spectroscopy (abstraction takes place exclusively α to the carbonyl group).

**32****33**

2.1.3.2 Thiols as protic polarity-reversal catalysts

(1) Hydroacylation of alkenes

The intermolecular radical-chain addition of an aldehyde to an alkene to give a ketone (hydroacylation) is a useful reaction in synthetic organic chemistry. The propagation stage of the radical-chain pathway is shown in eqns. (43) and (44), while the reaction (44) does not benefit from favourable polar effects in the transition state because both the alkyl radical and the acyl radical are nucleophilic.

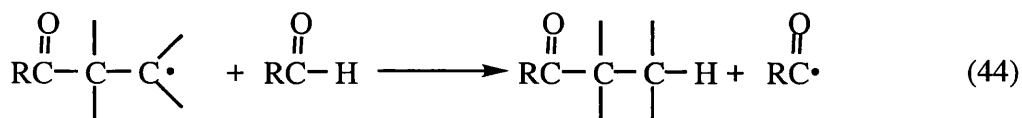
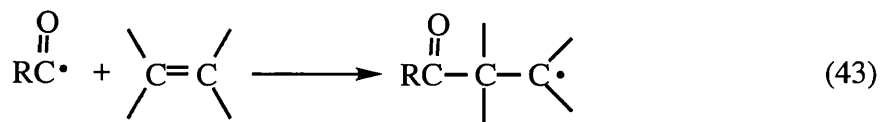

The previous discussion suggests that the hydrogen-transfer reaction (44) should be promoted by a protic polarity-reversal catalyst and it has been shown that thiols can catalyse the radical-chain hydroacylation of alkenes under mild conditions.⁷⁶ For example, the addition of butanal to isopropenyl acetate at 60 °C, in the presence of di-*tert*-butyl hyponitrite (TBHN) as initiator and methyl thioglycolate (MeO₂CCH₂SH) as polarity-reversal catalyst, affords **34** in 80% yield (see Scheme 11), while the uncatalysed reaction gives only 8% yield⁷⁶ Such thiol-catalysed radical-chain hydroacylation is efficient for addition of primary aldehydes (RCH₂CHO) to electron-rich, -neutral and -poor alkenes and it, therefore, provides a non-ionic route to acylated aldol adducts.⁷⁶

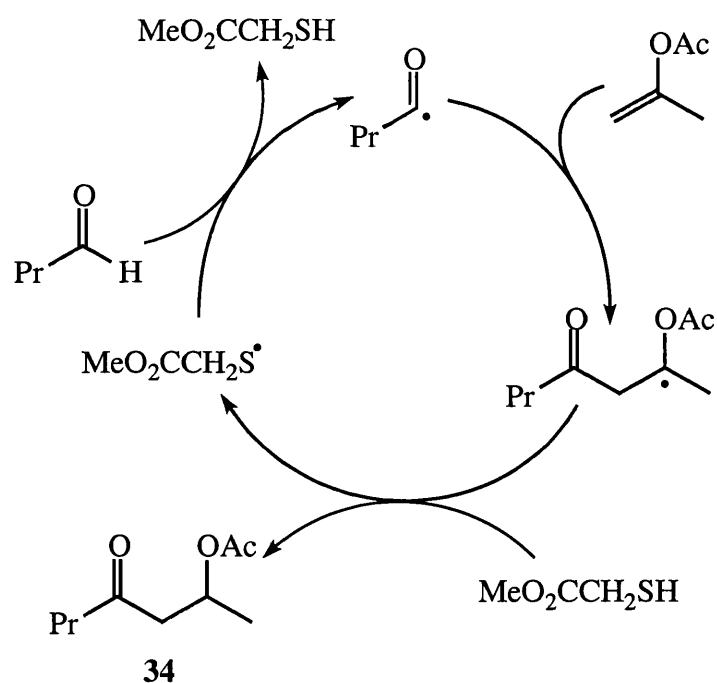

Scheme 11

(2) Intermolecular hydrosilylation of alkenes

A trialkylsilyl group shows many properties in common with those of an acyl group. Both are π -acceptors, the corresponding radicals are both nucleophilic and Si-H bond in R_3SiH is weaker than many aliphatic C-H bonds, as is the aldehydic C-H bond in $RCHO$ [the bond dissociation enthalpies for $MeC(O)-H$, Et_3Si-H and $(Me_3Si)_3Si-H$ are 374, 398 and 351 kJ mol^{-1} , respectively].^{67,77} Thus, in the absence of catalysts, radical-chain hydrosilylation of alkenes is relatively slow at moderate temperatures because polar effects are unfavourable for the hydrogen-atom transfer step [eqn. (46)].

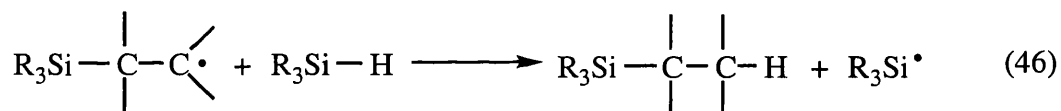
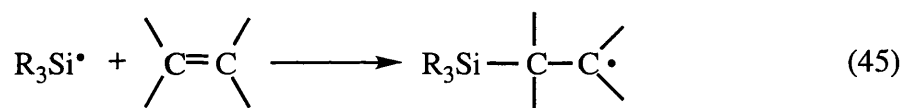

Again, reaction (46) should be subject to PRC by thiols and, provided addition of the catalyst to the alkene can be overcome by adding thiols slowly to the reaction mixture using a syringe pump.^{79,80} For example, the addition of dimethylphenylsilane to isopropenyl acetate at 60 °C using *tert*-dodecanethiol (TDT) as protic polarity-reversal catalyst gives the adduct **35** in 85% yield.⁸⁰

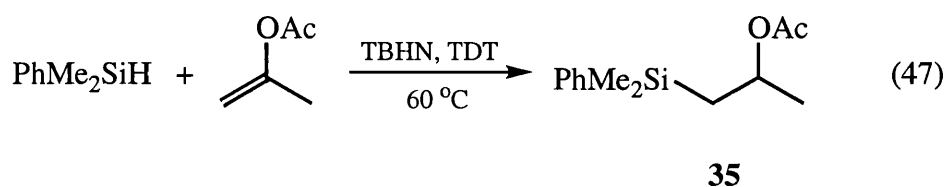

As a consequence, intermolecular thiol-catalysed radical-chain hydrosilylation of alkenes represents a viable synthetic route to organosilanes, which compliments the well-established transition-metal catalysed pathway.^{79,80} It is expected that intramolecular radical-chain hydrosilylations, leading to the cyclisation of alkenyloxysilanes, will also be catalysed by thiols. Such thiol-catalysed radical processes should provide an alternative to transition-metal catalysis for the cyclisation of alkenyloxysilanes. Furthermore, intramolecular radical-chain hydrosilylation is of interest because it allows the study of the regio- and stereo-chemistry of the intramolecular addition reactions of the intermediate silyl radicals.

2.2 Results and Discussion

2.2.1 Preparation of alkenyloxysilanes

Standard methods were used to prepare the required silanes, as summarised in eqn. (48). All of the substrates are alkenyloxysilanes (silyl ethers), which were prepared by silylation of unsaturated alcohols with disubstituted chlorosilanes. The chlorosilanes were either commercially available (Me_2SiHCl) or readily prepared (Ph_2SiHCl).⁸¹ Chlorodiphenylsilane was mainly used because the corresponding diphenylalkenyloxysilanes are more stable towards hydrolysis than dimethylalkenyloxysilanes.

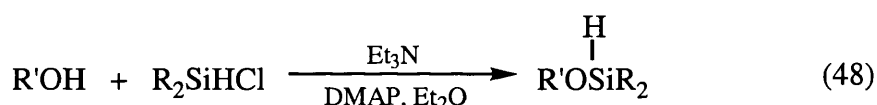

The allylic alcohols **36-39**, homoallylic alcohols **40-44** and the pent-4-enol **45** were chosen to investigate the effects of varying the chain length and substitution pattern on the thiol-catalysed intramolecular hydrosilylation of the corresponding alkenyloxysilanes. 2-Methylbut-3-en-2-ol **36** and 2,3-dimethylbut-3-en-2-ol **37** were commercially available, while the other alcohols had to be prepared.

The alcohols **38-41** and **45** were prepared by a *Grignard* reaction, following a general published procedure.⁸² 3-methylbut-3-en-2-ol **38**⁸³ was prepared from methylmagnesium iodide and 2-methylprop-2-enal, 2-methylpent-4-en-2-ol **40**⁸⁴ was prepared from allylmagnesium bromide and acetone, and 2-methylhex-5-en-2-ol **45**⁸⁵ was prepared in a similar way from methylmagnesium iodide and hex-5-en-2-one.

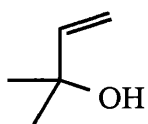

36

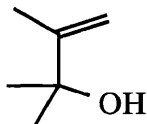

37

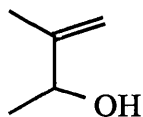

38

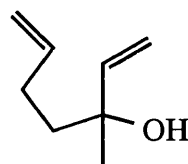

39

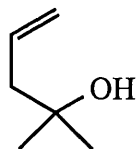

40

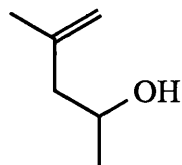

41

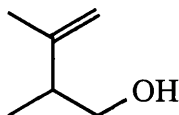

42

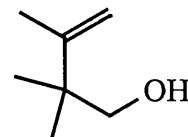

43

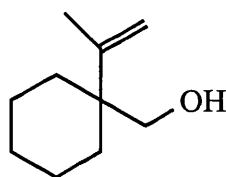

44

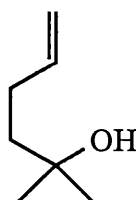

45

The preparation of 3-methylhepta-1,6-dien-3-ol **39** was first attempted using 4-brombut-1-ene to form the corresponding but-3-enylmagnesium bromide, then adding methyl vinyl ketone with stirring at 0 °C. However, this method proved to be unsuccessful, and only a large amount of polymer was formed. Eventually, the alcohol **39** was prepared from vinylmagnesium bromide and hex-5-en-2-one, following the general procedure,⁸² to give good yields.

4-Methylpent-4-en-2-ol **41**⁸² was prepared from 3-chloro-2-methylpropene and acetaldehyde. However, the product contained 22 mol% of 2,5-dimethylhex-1,5-diene, which was formed by a coupling reaction of 2-methylallylmagnesium bromide with the starting halide. The compounds have similar boiling points and could not be separated.

equivalents of methyltriphenylphosphonium bromide. However, distillation of the crude reaction product afforded only very low yields (14.5%) of **43**. The method shown in Scheme 13 was developed as a combination of steps reported previously in the literature. The procedure adopted consisted of (a) trifluoroacetoxy methylation of 3-methylbutan-2-one and subsequent alkaline hydrolysis of the intermediate β -(trifluoroacetoxy)ketone,⁸⁸ (b) methylation of the ketone **46** ($R = \text{Me}$) with methylmagnesium iodide to give 2,2,3-trimethylbutan-1,3-diol **47**,⁸⁷ (c) selective acetylation of the primary hydroxy group with acetic anhydride in pyridine, (d) dehydration catalysed by iodine and subsequent hydrolysis with base to give good yields of **43**. 1-(Hydroxymethyl)-1-isopropenylcyclohexane **44** was prepared in good yield from cyclohexyl methyl ketone by the reaction sequence.

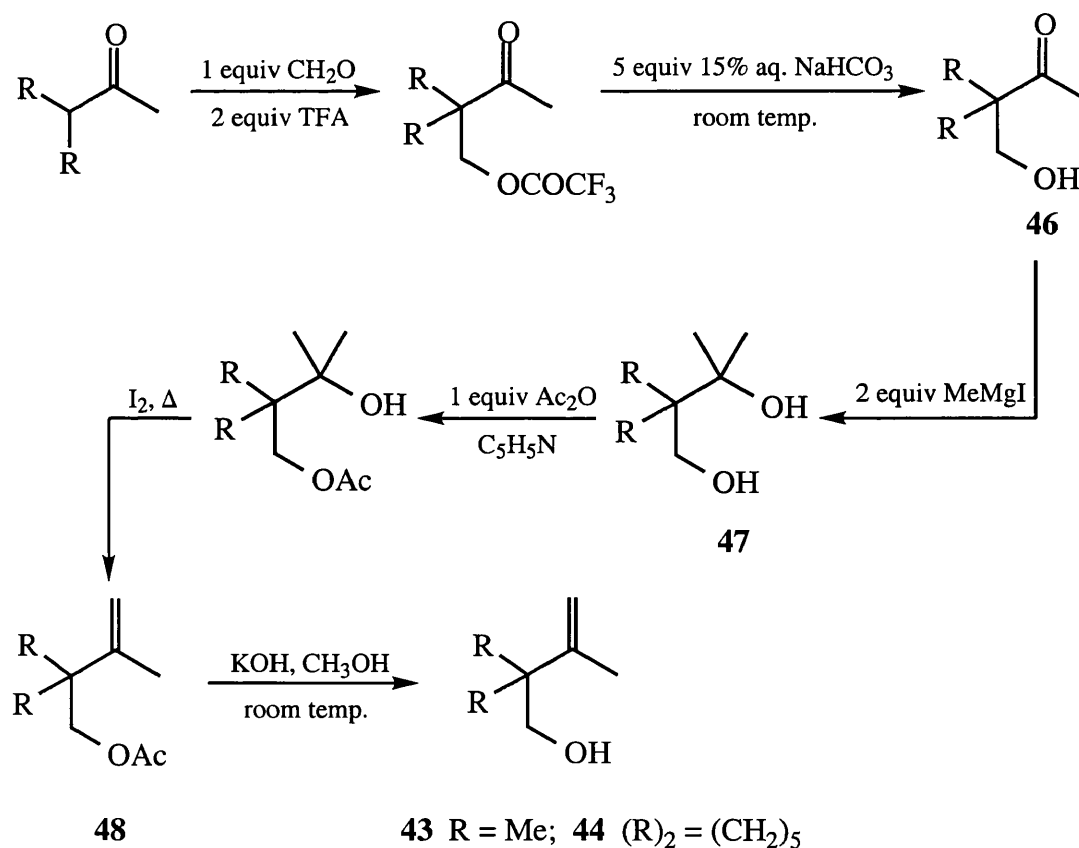

Scheme 13

2.2.2 Initiation with di-*tert*-butyl hyponitrite

For silyl radical reactions, initiators most commonly used are organic peroxides, which generate alkoxy radicals, since the reaction between alkoxy radicals and silyl hydrides is strongly exothermic and very fast. For example, the absolute rate constants for the reaction of the *tert*-butoxy radical with silanes, measured by the laser flash photolysis technique,⁹⁰ are of the order of 10^6 - 10^7 dm³ mol⁻¹ s⁻¹ at 27 °C. However, the hydrogen-atom abstraction from silyl hydrides by carbon-centred radicals proceeds at much lower rates and depends strongly on the nature of both radicals and substrates.⁹¹ This difference has been attributed to less favourable thermodynamic factors (*i.e.* the formation of a C-H bond is less exothermic than that of a O-H bond) and unfavourable polar effects in the transition states (*i.e.* both the alkyl and silyl radicals are nucleophilic).

Alkyl radicals are known to abstract hydrogen atoms from thiols to form thiyl radicals and the latter will readily initiate the radical-chain reaction by abstracting hydrogen atoms from silanes [see reaction (49) and (50)]. In both of the reactions, polar effects facilitate hydrogen transfer in either direction through the transition states **49** and

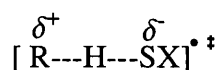
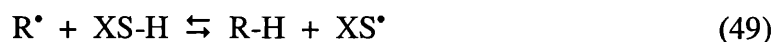

49

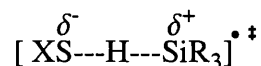

50

50. Azobis(isobutyronitrile) (AIBN) and dilauroyl peroxide (DLP), which are commonly used as initiators in radical reactions, decompose at a convenient rate ($t_{1/2}$ ca. 1 h at 80 °C for both) to generate carbon-centred radicals. However, both of them were found ineffective as an initiator for the thiol-catalysed radical-chain cyclisation of alkenyloxysilanes (entries 3 and 4, Table 2). It is possible that silyl radicals react rapidly with these initiators by addition to the diazo function (AIBN) to give a chain-terminating hydrazyl radical,⁹² or by S_H2 attack at the peroxide linkage (DLP).^{67,92}

In the present work, di-*tert*-butyl hyponitrite⁹³ (TBHN) was used as a thermal source of *tert*-butoxyl radicals [eqn. (51)]. The *tert*-butoxyl radicals will abstract hydrogen from the silanes and/or the thiols to begin the chain-propagation cycle. The half-life of TBHN is ca. 55 min at 60 °C and ca. 29 min at 65 °C.⁹⁴ Typically, a solution

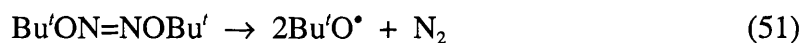

in dry hexane or dioxane (4 cm³) containing alkenyloxysilane (1.1 mmol), thiol (2.5 mol%) and TBHN (2.5 mol%) was stirred and heated under argon at 60 °C or 65 °C for 1 h, when further amounts of thiol (2.5 mol%) and TBHN (2.5 mol%) was added. After the reaction mixture has been heated and stirred for a further 2 h, the solvent was removed by evaporation and the residue was purified by flash chromatography on silica gel to afford the cyclised products.

2.2.3 Allyloxysilanes

Diphenyl(2-methylbut-3-en-2-yloxy)silane **51** was recovered unchanged when the silane (*ca.* 0.3 mol dm⁻³) was heated at 60 or 65 °C in hexane under argon for 3 h, in the presence of 5 mol% TBHN as initiator. Half the TBHN was present initially and the remainder was added after 1 h. However, when experiment was repeated at 60 °C in the presence of 5 mol% *tert*-dodecanethiol (TDT), added in two equal portions together with

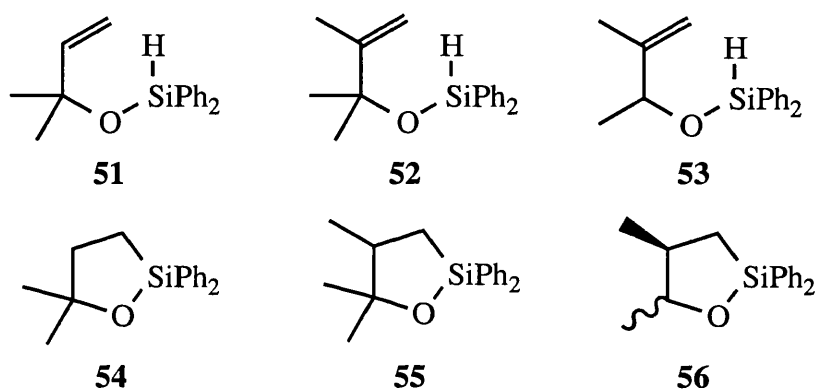

the TBHN, the cyclic silane **54** was formed in 95% yield as determined by ¹H NMR spectroscopy (isolated yield 88%). In the presence of TDT, but without TBHN, no cyclisation was observed and the allyloxysilane **51** was recovered unchanged. Evidently the silane **51** cyclises by a radical-chain mechanism which involves thiol catalysis, as shown in Scheme 14.

The radical **57** undergoes rapid *5-endo-trig* cyclisation and similar *endo* cyclisation of allyloxysilyl radicals, generated by a different route, has recently been reported independently by *Clive* and his co-workers (see Scheme 15).⁹⁵ A good yield of the 5-membered heterocycle **62** was obtained by a sequence of radical reactions based on successive *5-exo-dig* cyclisation (**58**→**59**), 1,5-hydrogen transfer from silicon (**59**→**60**), *5-endo-trig* cyclisation (**60**→**61**) and intermolecular hydrogen transfer from

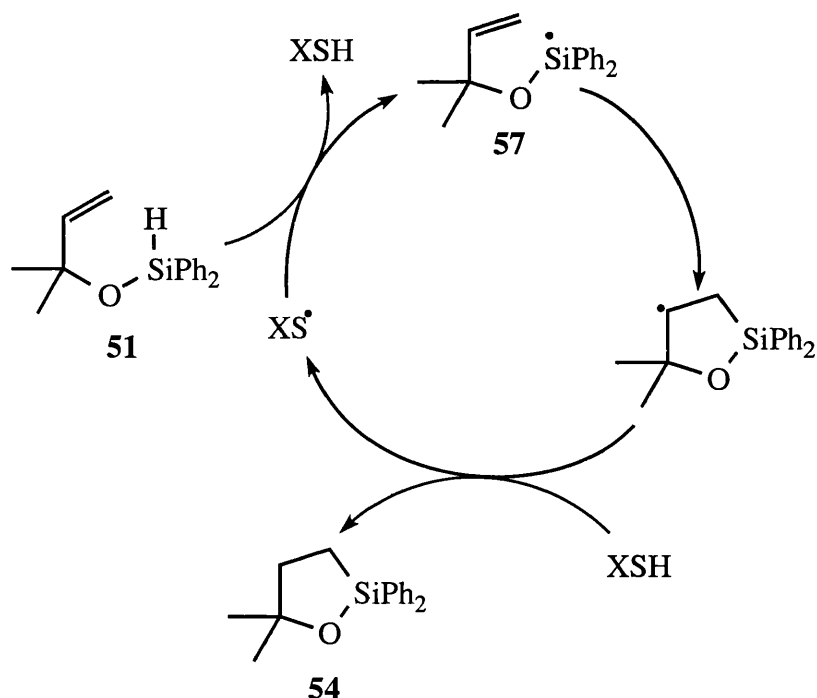

Scheme 14

stannane (**61**→**62**). *5-endo-trig*-Cyclisations which are not often observed in synthetic radical chemistry are permitted here because of the presence of a second row element, the silicon atom.⁹⁵

Thiol-catalysed cyclisations of the allyloxysilanes **52** and **53** were carried out under similar conditions and the results are summarised in Table 2. 1,4-Dioxane was equally suitable as solvent for the TBHN-initiated cyclisation of **51** (entry 2), and it was mainly used as solvent with triphenylsilanethiol or triisopropyl-silanethiol⁹⁶ as catalysts, because these silanethiols are insoluble in hexane.

With TDT as catalyst, the yield of cyclised product **55** from the allyloxysilane **52** was only moderate (entry 5). It was thought at first that this was the result of slow cyclisation of the intermediate silyl radical, possibly because of a steric interaction between vicinal methyl groups in the transition state. However, EPR studies of this elementary step in isolation (see later) showed that the cyclisation is actually a rapid

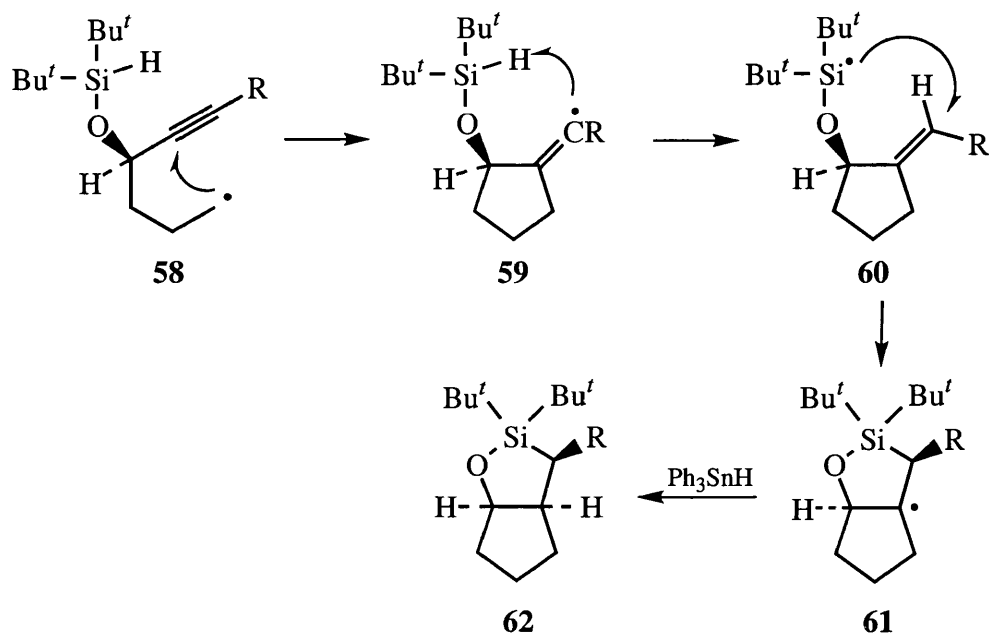

Scheme 15

process ($k > ca. 10^6 \text{ s}^{-1}$ at $60 \text{ }^\circ\text{C}$). When alternative thiol catalysts were investigated it was found that triphenylsilanethiol or triisopropylsilanethiol⁹⁶ afforded almost quantitative yields of **55** (entries 6 and 7). It is possible that the silanethiyl radical $\text{R}_3\text{SiS}^\bullet$ abstracts hydrogen more rapidly and/or selectively from the Si-H group in the silane **52**,⁷⁸ while the alkanethiyl radical derived from TDT may abstract hydrogen competitively from the allylic methyl group to give the allylic radical **63**. The stabilised radical **63** would abstract hydrogen only slowly from the thiol (and even then the equilibrium will probably favour **63**); formation of **63** would then be chain-terminating.

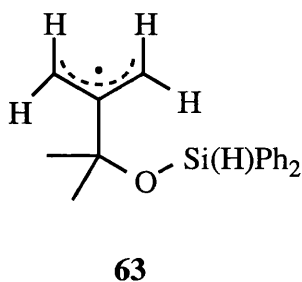

Table 2 Thiol-catalysed cyclisation of allyloxysilanes to give tetrahydro-2-silafurans

Entry	Silane ^a	Solvent	T ^b /°C	Thiol ^c	Initiator ^{c,d}	Product	Yield (%) NMR (isolated)
1	51	Hexane	60	TDT	TBHN	54	95 (88)
2	51	Dioxane	60	TDT	TBHN	54	94 (89)
3	51	Dioxane	80	TDT	AIBN	54	10
4	51	Dioxane	80	TDT	DLP	54	24
5	52	Hexane	60	TDT	TBHN	55	47
6	52	Dioxane	65	Pr ₃ SiSH	TBHN	55	95 (85)
7	52	Dioxane	65	Ph ₃ SiSH	TBHN	55	95 (88)
8	53	Hexane	65	TDT	TBHN	56	25
9	53	Dioxane	65	Pr ₃ SiSH	TBHN	56	74 (67)
10	53	Dioxane	65	Ph ₃ SiSH	TBHN	56	75 (70)

^a Concentration ca. 0.3 mol dm⁻³. ^b The total reaction time was 3 h. ^c Added in two equal portions; 2.5 mol% initially and a further 2.5 mol% after 1h. ^d AIBN = azoisobutyronitrile; DLP = dialauroyl peroxide (didodecanoyl peroxide).

Loss of thiol by addition to the C=C group⁷⁹ does not seem to be a complicating factor here, because the yield of **55** obtained with TDT as catalyst was not increased significantly by slow addition of the thiol over 3 h using a motor-driven syringe.

Similarly, the low yield of cyclised product **56** obtained from the silane **53** with TDT as catalyst is attributed to abstraction of hydrogen by the alkanethiyl radical from the allylic C-H groups in **53**. In radical reactions, allylic hydrogen atoms are easily abstracted to form a delocalised allyl radical, which is relatively stable. Particularly if the allyl group is adjacent to oxygen as in the silanes **52** and **53**, such hydrogen abstraction is expected to be very fast, because the oxygen lone-pair will stabilise the transition state **64** by partial charge transfer. The activation energy will be low as a result of these favourable polar effects in the transition-state. Consistent with this explanation, cyclisation of the allyloxysilane **51**, under the conditions specified for entry 1, was completely inhibited in the presence of 10 mol% allyloxytrimethylsilane or allyl butyl ether.

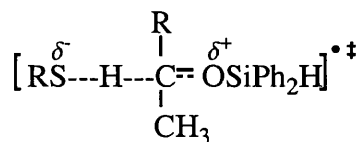

64

A greatly improved yield of **56** was obtained by using a silanethiol as catalyst (entries 8-10). The *cis*- and *trans*-isomers of **56** were separated by HPLC and identified by NOE studies on the basis of the enhancements shown in Fig 5; the *cis:trans* ratio was 67:33 using Ph₃SiSH and 77:23 using Prⁱ₃SiSH. With both thiols, the (presumably) less stable *cis*-product predominates, probably because the steric interaction between the

thiol and the methyl group β to the radical centre is the most important factor determining the energies of the two diastereoisomeric transition states for hydrogen-atom transfer. However, the *cis:trans* product ratio probably does not reflect *quantitatively* the selectivity of the hydrogen-atom transfer from the silanethiol, because it is likely that silylanethiyl radicals abstract hydrogen reversibly from the C-5 in **56-cis** and **56-trans** under the reaction conditions (see later where reversibility is proven for the formation of **81** and **82**, when the relevant secondary C-H group is also activated by an adjacent oxygen atom).

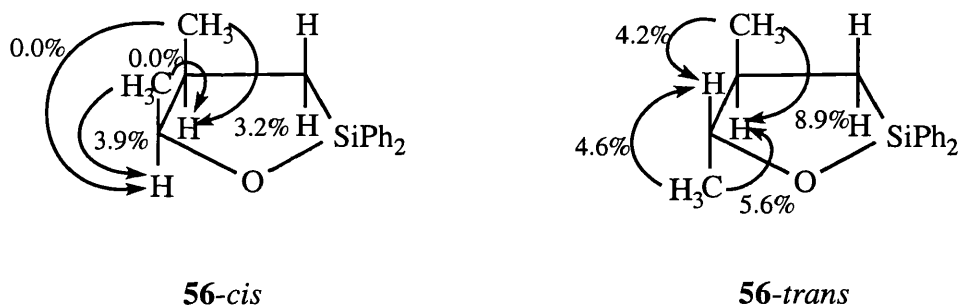
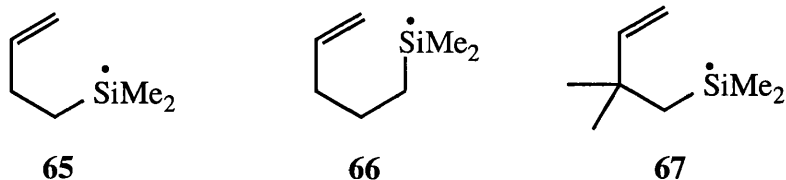

Fig. 5 Nuclear Overhauser enhancements observed in the ¹H NMR spectra of the *cis*- and *trans*-isomers of **56**

The preference for *endo-trig* cyclisation of silyl radicals bearing alkenyl side chains has been reported and discussed previously.^{70,71,98} For example, all of the radicals **65-67** cyclise in an *endo* fashion^{70,71} to give the thermodynamically more stable product and there appears to be no example of a silyl-radical cyclisation that occurs preferentially in the contra-thermodynamic *exo* mode. The corresponding unsaturated germanium-centred radicals behave similarly.⁹⁹ In contrast, cyclisation of the carbon-centred analogues takes place preferentially in an *exo* fashion to yield the less stable

product radicals, as a result of the interplay of stereoelectronic demands and ring-strain effects.^{100,101}



Attempted thiol-catalysed tandem cyclisation of the silane **68** at 60 °C was unsuccessful; the expected bicyclic product **69** could not be identified with certainty (yield $\leq 5\%$) and almost all the starting material was recovered unchanged. EPR experiments (see later) show that the silyl radical derived from **68** does indeed undergo rapid sequential cyclisation and the low yield of **69** evidently arises because addition of thiyl radicals to the C=C bonds of **68** is rendered effectively irreversible by rapid 5-*exo* cyclisation of the carbon-centred adduct radicals, resulting in removal of the thiol catalyst from the system. A similar problem appears to account for the failure of the intermolecular thiol-catalysed hydrosilylation of diethyl diallylmalonate **70** with Et₃SiH, whilst the corresponding reaction of diethyl allylmalonate gives the silane adduct in good yield.⁷⁹ Ready reversibility¹⁰² of the addition of thiyl radicals to C=C groups is clearly of crucial importance for the success of thiol-catalysed inter- or intra-molecular hydrosilylation reactions.

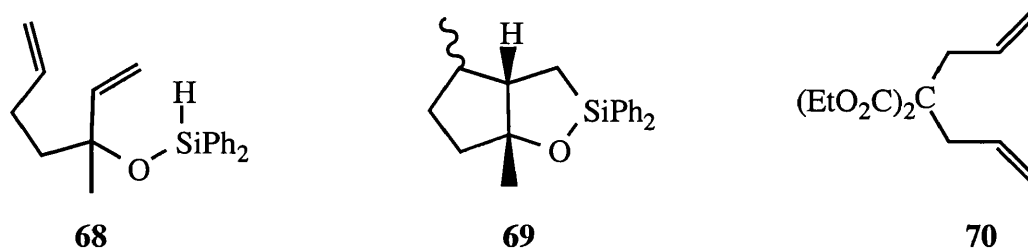

2.2.4 Homoallyloxysilanes

Thiol-catalysed radical-chain cyclisation of the homoallyloxysilanes **71-76** was investigated under the conditions used for the allyloxysilanes; mixtures of isomeric products were separated by reversed-phase HPLC and the results are summarised in Table 3. Cyclisation of either homoallyloxysilane **71** or **72** (entries 1 and 2) gives mainly the six-membered heterocycle **77** or **78**, respectively, in preference to the five-membered ring products **79** and **80**, which are formed by 5-*exo* cyclisation of the intermediate silyl radicals. Previously, when but-3-enyloxy(dimethyl)silane and di-*tert*-butyl peroxide were heated together at 145 °C, the 2-silatetrahydropyran (presumably also formed *via* 6-*endo* cyclisation of the corresponding silyl radical) was isolated in low yield.⁷¹ In contrast, the non-radical cyclisation of similarly-substituted homoallyloxysilanes catalysed by chloroplatinic acid gives mainly the five-membered heterocycles.⁵³ Analogous carbon-centred radicals of the hex-5-enyl type show a strong kinetic preference for 5-*exo* ring closure and the different behaviour of the silicon-centred

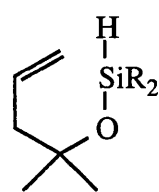

71 R = Ph
72 R = Me

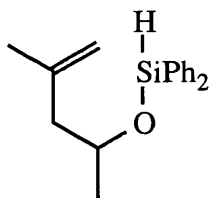

73

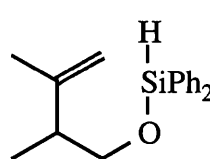

74

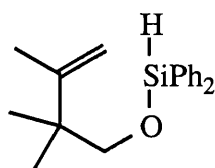

75

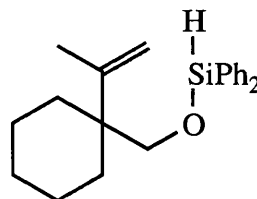

76

species can be rationalised in terms of the greater length of the Si-O and Si-C bonds, as compared with a C-C bond, and the strongly pyramidal configuration at the silicon radical centre.⁷⁰ Cyclisation of the unsaturated silyl radicals occurs preferentially in the 6-*endo* mode to give the more stable product radical. However, this preference for intramolecular addition to the unsubstituted end of the double bond is much smaller than would be observed for an analogous intermolecular addition. Clearly the type of stereoelectronic and ring-strain effects responsible for the preferential 5-*exo* cyclisation of hex-5-enyl radicals,^{100,101} though not now predominant, are still operative for the cyclisation of the unsaturated silyl radicals.

As expected, because of the steric and radical-stabilising effects of the methyl group on the double bond, cyclisation of **73-76** gives only six-membered heterocycles. In common with the cyclisation of allyloxysilanes, silanethiols are more effective catalysts than alkanethiols. Cyclisation of **73** gives mainly the *trans*-dimethyl product **82** (entries 3-6), while **74** gives predominantly the *cis*-product **83** (entries 7-10). In both cases, these results imply that hydrogen-atom transfer from the thiol takes place preferentially at the equatorial face of the quasi-planar radical centre in the intermediate 4-oxa-3-silacyclohexyl radical (see structure **85**; R¹ = Me, R² = H or R¹ = H, R² = Me).¹⁰³

The secondary SiOC(Me)-H groups in **81** and **82** should be especially vulnerable to abstraction of hydrogen by electrophilic radicals and the possibility arises that thiol-catalysed radical-chain conversion of the *trans*-isomer **82** to the more stable *cis*-isomer **81** could take place under the reaction conditions. To examine this, the pure *trans*-isomer was heated for a total of 3 h in dioxane at 65 °C in the presence of TBHN and thiol (each 2 x 2.5 mol%) under conditions similar to those used for the cyclisation

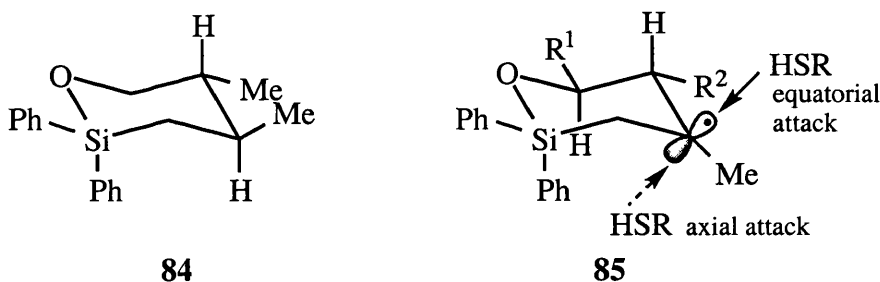
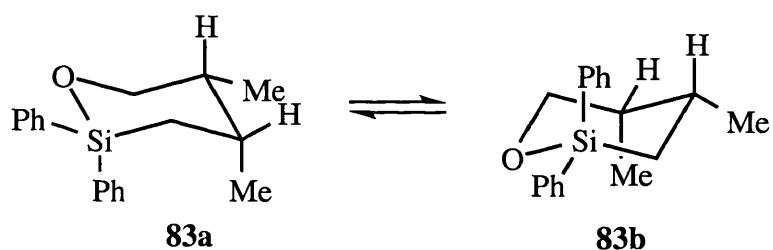
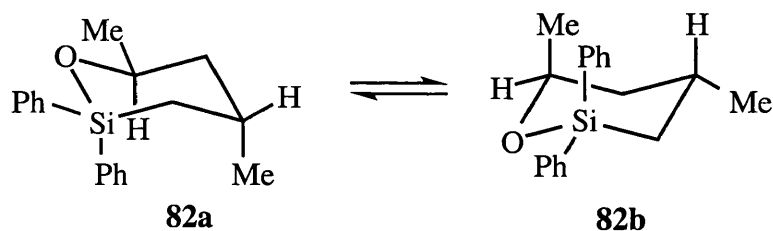
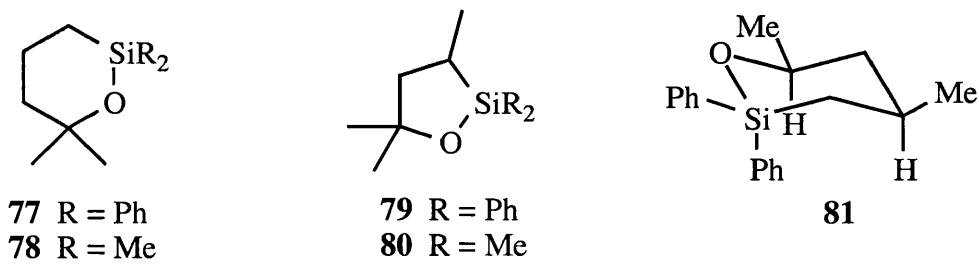

reactions. With methyl thioglycolate only a trace (*ca.* 2%) of the *cis*-isomer **81** was detected by ^1H NMR spectroscopy after reaction, but with triphenylsilanethiol extensive isomerisation took place such that the final ratio **81:82** was 79:21. Thus, presumably because silanethiyl radicals are more potent hydrogen-atom abstractors than alkanethiyl radicals,⁷⁸ hydrogen transfer from the silanethiol is reversible under the reaction conditions (see Scheme 16) and the isomer ratio **81:82** obtained from the cyclisation will not reflect quantitatively the selectivity of hydrogen-atom transfer to **85** from a

silanethiol catalyst. However, the less stable *trans*-isomer **82** is still the major product from all the cyclisation reactions.

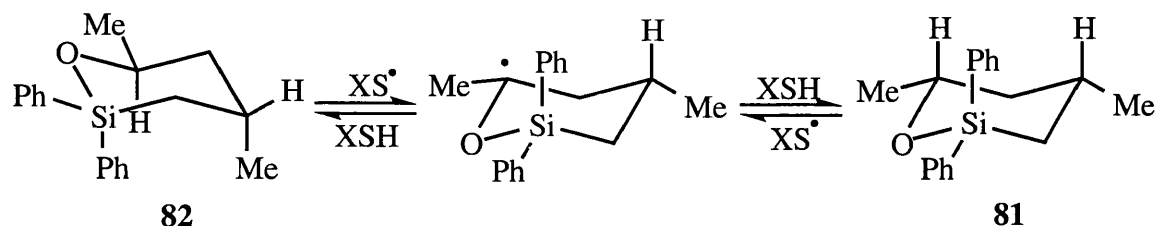

Scheme 16

At 80 °C, hydrogen-atom transfer from $(\text{Me}_3\text{Si})_3\text{SiH}$ to cyclohexyl radicals of the type **86** [$\text{X} = (\text{Me}_3\text{Si})_3\text{SiO}$, $\text{R} = \text{H}$ or Me] takes place preferentially at the axial face of the radical centre,¹⁰⁴ as does deuterium-atom transfer from Bu_3SnD to **86** ($\text{X} = \text{H}$ or Me , $\text{R} = \text{H}$).^{103,105} Hydroxyl-group transfer ($\text{S}_{\text{H}2}$ reaction at oxygen) from a peroxy acid to **86** ($\text{X} = \text{H}$, $\text{R} = \text{H}$ or Me) takes place with similar stereoselectivity mainly at the axial face.¹⁰⁶ However, corresponding hydroxy-group transfer to **87** takes place predominantly (75:25) at the equatorial face¹⁰⁶ and the transition state for transfer to the axial face of **87** is evidently destabilised by steric interaction between the reagent and the axial methyl group at C-3.^{103,106} The preference for equatorial attack of the thiol on the 4-oxa-3-silacyclohexyl radicals **85** is probably attributable to a similar cause, namely a 1,3-steric interaction between the incoming thiol and the axial phenyl group attached to silicon.

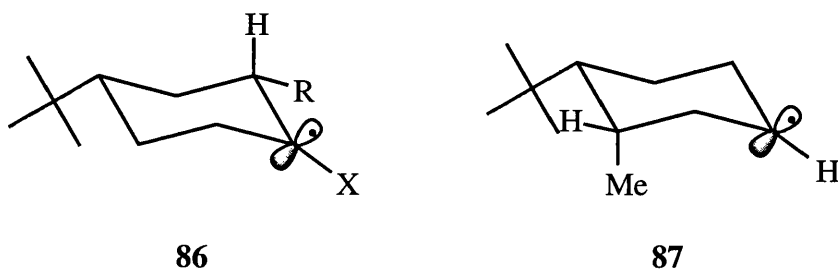

Table 3 Thiol-catalysed cyclisation of homoallyloxysilanes at 65 °C in the presence of TBHN initiator^a

Entry	Silane ^b	Solvent	Thiol ^c	Products (ratio ^c)	Total yield (%) NMR (isolated)
1	71	Hexane	TDT	77 + 79 (72:28)	95 (87)
2	72	Hexane	TDT	78 + 80 (82:28)	90
3	73	Dioxane	TDT	81 + 82 (16:84)	75 (68)
4	73	Dioxane	MeO ₂ CCH ₂ SH	81 + 82 (14:86)	71 (63)
5	73	Dioxane	Pr ^t ₃ SiSH	81 + 82 (26:74) ^d	90 (83)
6	73	Dioxane	Ph ₃ SiSH	81 + 82 (42:58) ^d	93 (85)
7	74	Hexane	TDT	83 + 84 (79:21)	51 (46)
8	74	Dioxane	MeO ₂ CCH ₂ SH	83 + 84 (69:31)	74 (70)
9	74	Dioxane	Pr ^t ₃ SiSH	83 + 84 (70:30)	95 (90)
10	74	Dioxane	Ph ₃ SiSH	83 + 84 (72:28)	95 (85)
11	75	Dioxane	Pr ^t ₃ SiSH	88	90 (82)
12	76	Dioxane	Ph ₃ SiSH	89	92 (83)

^a The initiator and the thiol were each added in two equal portions: 2.5 mol% initially and a further 2.5 mol% after 1h. The total reaction time was 3 h. ^b Concentration was ca. 0.3 mol dm⁻³. ^c Determined by ¹H NMR spectroscopy. ^d Control experiments showed that the *trans*-isomer 82 is converted partially to the *cis*-isomer 81 under the reaction conditions (see text).

2.2.5 Enantioselective hydrogen-atom transfer

Cyclisation of the homoallyloxysilane **75** and **76** catalysed by Pr^i_3SiSH and Ph_3SiSH give the racemic products **88** and **89** in excellent yield (Table 3, entries 11 and 12). The chiral centre in **88** is created in the hydrogen-atom transfer step and this process should become enantioselective if the thiol is optically active.⁸⁰ The cyclisation of **75** was repeated using the homochiral thiols **90-93** as catalysts, under the conditions specified in Table 3, and the enantiomeric excess of the product was determined by chiral-stationary-phase HPLC analysis. However, the ee of **88** was small ($\leq 5\%$) for all four thiol catalysts. *Guindon et al.*¹⁰⁷ have shown that diastereoselectivity in the atom-transfer reactions can be enhanced if a geminal pair of substituents β to an acyclic radical centre are replaced by an equivalent ring system (termed the ‘cycle effect’),¹⁰⁷ presumably because of conformational restrictions imposed on the transition state, and hence the cyclisation of the homoallyloxysilane **76** was investigated. However, the ee of the product **89** was still small (*ca.* 5%) with the thiols **90-93** as catalysts. Assuming that **88** and **89** are configurationally stable under the reaction conditions, the small enantiomeric excesses observed imply that the steric and electronic chirality¹⁰⁷ in the vicinity of the radical centre does not result in sufficient face selectivity in the reaction with the thiol.

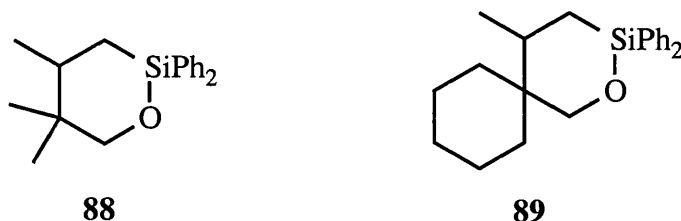

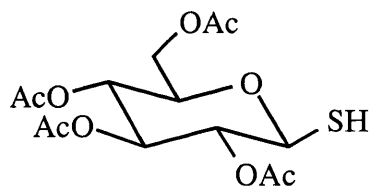

90

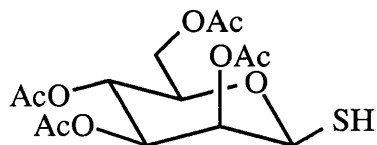

91

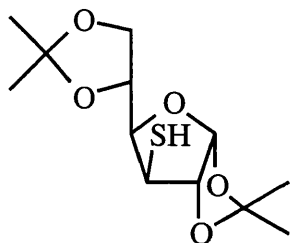

92

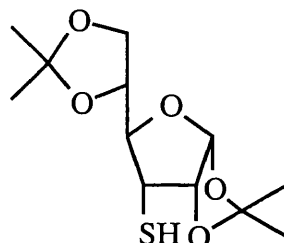

93

2.2.6 Pent-4-enyloxysilanes

Radical-chain cyclisation of the higher homologue **94** under the usual conditions (65 °C, 3 h, 2 x 2.5 mol% TBHN initiator, 2 x 2.5 mol% thiol) gave excellent yields ($\geq 95\%$) of the seven-membered heterocycle **95** with either TDT or Ph_3SiSH as catalyst: no six-membered ring isomer was detected by NMR spectroscopy. The intermediated silyl radical evidently undergoes 7-*endo* cyclisation rapidly and with high regioselectivity.

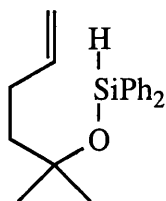

94

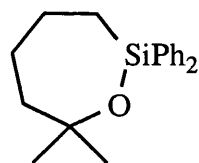

95

2.2.7 EPR studies

EPR spectra were recorded during continuous UV irradiation of cyclopropane solutions containing di-*tert*-butyl peroxide (DTBP) (*ca.* 20% v/v) and an alkenyloxysilane (*ca.* 15% v/v), while the sample was in the microwave cavity of the spectrometer, as described previously.¹⁰⁹ Photolysis of DTBP yields *tert*-butoxyl radicals [eqn. (52)] which go on to abstract hydrogen rapidly from the silane to give

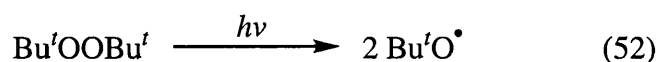

ultimately the radicals detected in steady-state concentration by EPR spectroscopy: experiments were usually carried out at in the temperature range -40 to -110 °C. Hydrogen-atom abstraction by *tert*-butoxyl radicals would be expected to be more exothermic and less selective than the corresponding reactions of thiyl radicals. When the alkenyloxysilane contains C-H groups attached to oxygen, especially when these are also allylic, hydrogen-atom abstraction by $\text{Bu}'\text{O}^\bullet$ appeared to take place from these groups as well as from the Si-H group, resulting in complex EPR spectra that proved difficult to interpret.

The alkenyloxysilane **51** and **52** afforded EPR spectra of the radical products of 5-*endo* cyclisation **96** and **97**, respectively; the spectrum of the former is shown in Fig. 6(a) and the spectroscopic parameters for all the radicals are collected in Table 4. The

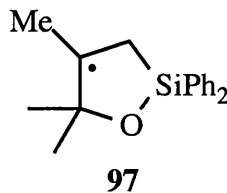
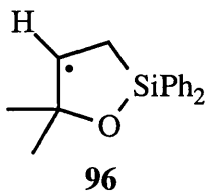

central components of the β -proton triplet for **96** are relatively broad as a result of unresolved second-order splittings, and effect reproduced in the computer-simulated spectrum [Fig. 6(b)]; second-order splittings were resolved in the spectrum of **97**. The proton hyperfine coupling constants are in accord with the assignments and no spectra

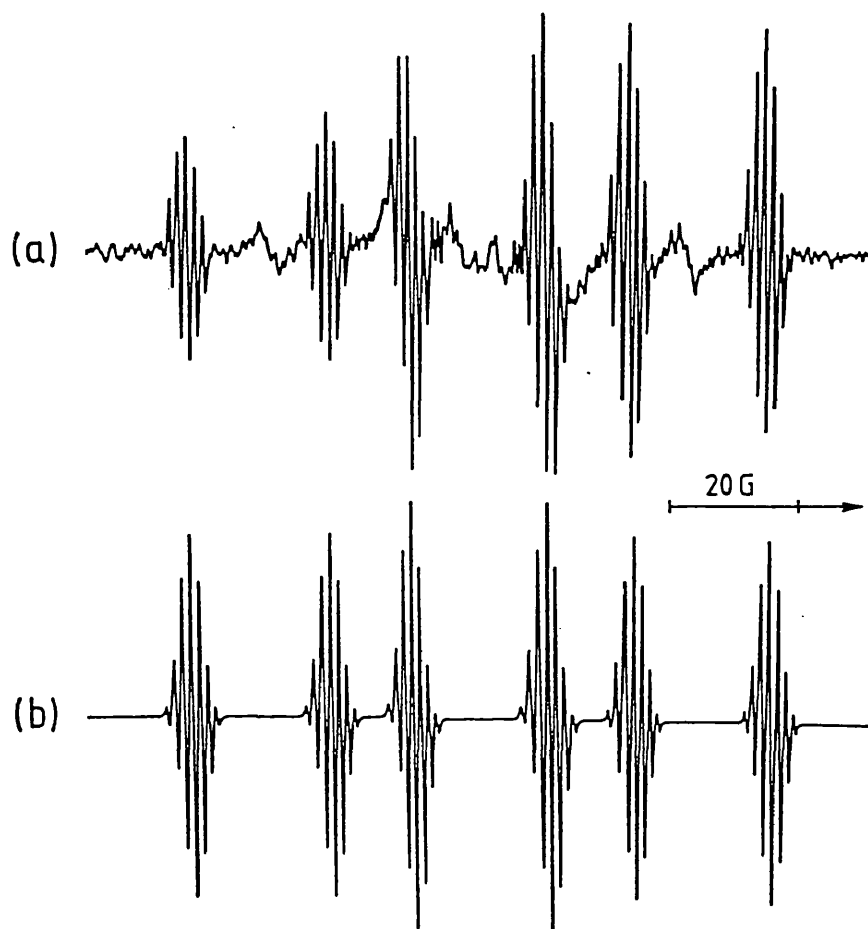
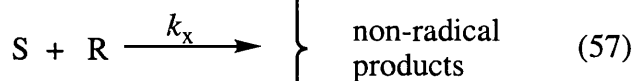
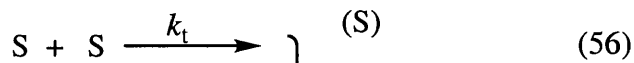
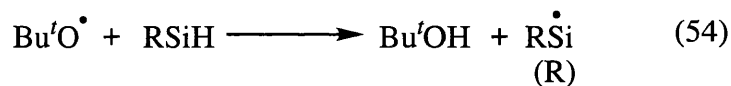
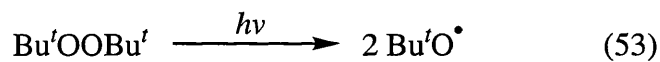

Fig. 6 (a) EPR spectrum of the radical **96** in cyclopropane at $-58\text{ }^{\circ}\text{C}$. (b) Computer simulation of the spectrum based on the parameters given in Table 4 and including second-order effects.

attributable to the uncyclised silyl radicals could be detected, although these spectra would be complex and therefore difficult to observe. The total reaction system can be described by eqns. (53)-(58). Under conditions of steady photolysis (where the radical



} non-radical products

concentrations do not change with time), this reaction scheme yields

$$d[\text{S}]/dt = 0 = k_r[\text{R}] - 2k_t[\text{S}]^2 - k_x[\text{S}][\text{R}]$$

where R represents $\text{RSi}\cdot$ and S represents the cyclised radical (e.g. **96** or **97**). This can be rearranged into the form

$$k_r = 2k_t([\text{S}]^2 / [\text{R}]) + k_x[\text{S}].$$

Under typical experimental conditions, the bimolecular self-reactions for such radicals occur at the diffusion-controlled limit, and therefore $2k_t \approx k_x$. The above equation can be simplified to

$$k_r = 2k_t([\text{S}] / [\text{R}] + 1)[\text{S}] \geq 2k_t([\text{S}].$$

The detection of strong spectra from the cyclised radicals implies that the concentration of S is $\geq 10^{-7} \text{ mol dm}^{-3}$. Since $2k_t$ generally has a value in the region of $10^{10} \text{ dm}^3 \text{ mol}^{-1} \text{ s}^{-1}$, the rate constant for cyclisation must be $\geq 10^3 \text{ s}^{-1}$ at ca. $-100 \text{ }^\circ\text{C}$.¹¹⁰ If a reasonable Arrhenius A-factor of $10^{10.4} \text{ s}^{-1}$ (that for cyclisation of the hex-5-enyl radical¹¹¹) is assumed, the cyclisation rate constant extrapolated to $60 \text{ }^\circ\text{C}$ would be $\geq 10^6 \text{ s}^{-1}$. The spectrum of a secondary-product radical, which increases in intensity with the duration of UV irradiation, was apparent alongside the spectrum of **97** and is tentatively ascribed to the allylic radical **98**.

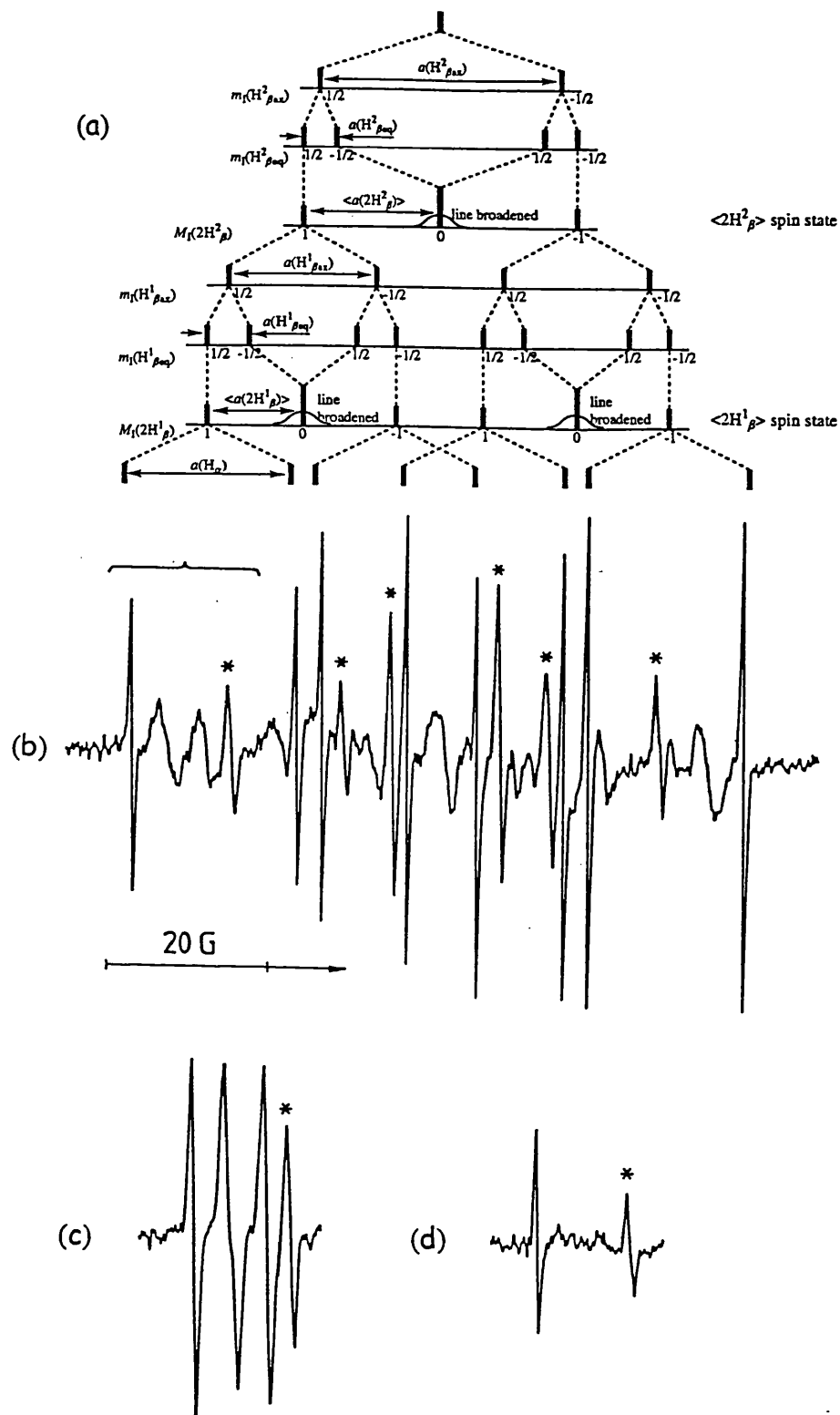

Fig. 7 (a) Correlation pyramid stick diagram for the EPR spectrum of the radical 100. (b) EPR spectra of the radicals 100 and 102, formed by cyclisation of the silyl radical derived from 71, in cyclopropane at -85°C ; the lines from 102 are indicated with asterisks. The bracketed low-field wing region of (b) is shown recorded at -113°C in (c) and at -69°C in (d).

Table 4 EPR parameters for cyclic radicals **96-103** in cyclopropane solvent

Radical	$T^b/^\circ\text{C}$	g -Factor	Hyperfine splittings ^c /G
96	-58	2.0027	21.3 (1H _α), 34.2 (2H _β), 1.26 (6H _γ)
97	-58	2.0027	22.4 (3H _β), 35.0 (2H _β), 0.80 (6H _γ)
98^b	-58	2.0026	15.2 (1H), 14.6 (1H), 12.1 (1H)
99	-85	2.0027	21.8 (2H _α), 20.8 (1H _β), 1.05 (3H _γ)
100	-111	2.0027	20.3 (1H _α), 30.6 (1H ² _{βmax}), 4.10 (1H ² _{βeq}), 18.4 (1H ¹ _{βmax}), 5.08 (1H ¹ _{βeq})
100^c	-83	—	20.4 (1H _α), 17.5 (<2H ² _β >), 11.9 (<2H ¹ _β >)
101	-122	2.0028	20.5 (1H _α), 31.3 (1H ² _{βmax}), 3.06 (1H ² _{βeq}), 18.5 (1H ¹ _{βmax}), 5.00 (1H ¹ _{βeq})
101^d	-53	—	20.6 (1H _α), 18.0 (<2H ² _β >), 12.2 (<2H ¹ _β >)
102^c	-83	2.0026	20.8 (2H _α), 14.5 (2H _β) ^e
103^d	-53	2.0026	20.5 (2H _α), 15.6 (1H _β), <i>ca.</i> 0.6 (1H _γ)

^a Numbers of nuclei coupling shown in parentheses. ^b Tentative assignment of secondary-product radical detected alongside **97**.
 Concentration ratio [100]:[102] = *ca.* 80:20. ^d Concentration ratio [101]:[103] = *ca.* 90:10. ^e γ -Proton splittings not resolved.

In the chair conformations of **100** and **101** the pairs of axial and equatorial protons H^1 and H^2 are instantaneously non-equivalent, but are evidently exchanging on the EPR time-scale, as a result of chair-chair inversion of the ring, giving rise to pronounced selective line broadening. Only the eight lines for which $m_1(H^1_{ax}) = m_1(H^1_{eq})$ and $m_1(H^2_{ax}) = m_1(H^2_{eq})$ remain sharp at all temperatures and the other lines are so broadened as to be barely detectable above -75 °C [see Fig. 7(d)]; the fast-exchange spectra were not observed because the radicals could not be detected at sufficiently high temperatures. Below -100 °C, the splittings from the individual axial and equatorial β -protons could be measured [see Fig. 7(c) and Table 4]. Although a detailed line-shape analysis^{109c} was not carried out, computer simulation of the spectrum of spectrum of **100** obtained at -85 °C indicated that the rate constant for chair-chair inter-conversion is *ca.* 4×10^7 s⁻¹ at this temperature, about 3-4 times larger than the corresponding rate constant for inversion of the cyclohexyl radicals.^{109c}

The assignments of the β -proton splittings are supported by semi-empirical UHF molecular orbital calculations at the AM1 level,¹¹³ which predict hyperfine splittings¹¹⁴ of -21.85 (H_{α}), 25.50 (H^1_{ax}), 3.04 (H^1_{eq}), 43.28 (H^2_{ax}) and 2.45 (H^2_{eq}) for **101**. A chair conformation is predicted for **101** ($\Delta H^{\circ}_f = -380.8$ kJ mol⁻¹) in which the geometry at the radical centre is almost exactly planar: the calculated dihedral angles between the β -C-H bonds and the axis of the C_{α} - $2p_{\pi}$ orbital (taken to be perpendicular to the $C_{\beta}C_{\alpha}C_{\beta}$ plane) are 37.8° (H^1_{ax}), 80.3° (H^1_{eq}), 27.0° (H^2_{ax}) and 89.0° (H^2_{eq}). If H_{α} is constrained to be 15° out of the $C_{\beta}C_{\alpha}C_{\beta}$ plane in the axial direction, the otherwise-optimised structure is less stable by only 2.9 kJ mol⁻¹ and the predicted coupling constants become -20.7 (H_{α}), 17.67 (H^1_{ax}), 4.38 (H^1_{eq}), 35.53 (H^2_{ax}) and 3.16 (H^2_{eq}), closer to the experimental values.

The magnitude of the β -proton hyperfine splitting for a fragment of the type $\text{H}_\beta\text{C}_\beta\text{C}_\alpha^\bullet$ in an alkyl radical is given by the *Heller-McConnell* eqn. (59),^{115,116} in which θ is the dihedral angle between the β -C-H bond and the axis of the C_α - $2p_\pi$ orbital, $\rho_{\text{C}_\alpha}^\pi$ is

$$a(\text{H}_\beta) = (A + B\cos^2\theta)\rho_{\text{C}_\alpha}^\pi \quad (59)$$

the unpaired-electron population in this orbital and A and B are constants, the former of which is small and often neglected. The dihedral angle θ_{ax} between the β -C- H_{ax} bond and the axis of the C_α - $2p_\pi$ orbital is *ca.* 30° , while the dihedral angle θ_{eq} is close to 90° (see above). Thus $\cos^2\theta_{\text{ax}}$ is much greater than $\cos^2\theta_{\text{eq}}$, and the hyperfine splitting of equatorial β -proton is less than that of axial β -proton. Similarly, the smaller value of $a(\langle 2\text{H}_\beta^1 \rangle)$ compared to $a(\langle 2\text{H}_\beta^2 \rangle)$ arises because of conformational differences such that $(\cos^2\theta_{1\text{ax}} + \cos^2\theta_{1\text{eq}})$ is less than $(\cos^2\theta_{2\text{ax}} + \cos^2\theta_{2\text{eq}})$ and because the value of B appropriate for the $\text{C}_\beta\text{H}_2\text{Si}$ group is larger than that for the $\text{C}_\beta\text{H}_2\text{C}$ group, as a consequence of the lower electronegativity of silicon compared with carbon.¹¹⁷

The pent-4-enyloxysilane **94** afforded an EPR spectrum that was generally consistent with that expected for the product of *7-endo* ring closure of the intermediate silyl radical but, as anticipated, the spectrum was very complex (and therefore weak) and definitive analysis was not possible.

2.3 Experimental

NMR spectra were recorded using a Varian VXR-400 instrument (400 MHz for ^1H). The solvent was CDCl_3 and chemical shifts are reported relative to Me_4Si ; J values are quoted in Hz. Mass spectra were obtained with VG 7070H or VG ZAB-2F instruments using electron impact ionisation. Column chromatography and TLC were carried out using Merck Kieselgel 60 (230-400 mesh) and Kieselgel 60 F_{254} aluminium-backed pre-coated plates, respectively. HPLC was carried out on Kromasil C18 (10 μm particle size) for reversed-phase work, Nucleosil (5 μm particle size) for normal-phase work and Chiralcel-OD (Daicel Co.) for the determination of enantiomeric excesses. All manipulations and reactions of air-sensitive compounds were carried out under an atmosphere of dry argon or nitrogen and all extracts were dried over anhydrous MgSO_4 . Petroleum refers to the fraction of bp 40-60 $^\circ\text{C}$.

Materials

Di-tert-butyl hyponitrite (TBHN).^{93,94} - A 150 cm^3 two-necked flask was dried and charged with zinc chloride (2.4 g, 0.02 mol), dry diethyl ether (16 cm^3) and excess *t*-butyl bromide (16 cm^3); the mixture was stirred and cooled with an ice bath. Sodium hyponitrite (2.12 g, 0.02 mol) was then added in a single portion with stirring. The reaction mixture was allowed to stand overnight in a fridge at 4 $^\circ\text{C}$ after stirring for 30 min in an ice bath. The white solid (NaBr) was removed by filtration and the filter cake was washed with diethyl ether (2 x 30 cm^3). The filtrate was washed with ice water (2 x 30 cm^3) and dried. Then the solvent was removed under reduced pressure using a rotary

evaporator at room temperature and the residual solid was recrystallised from methanol at $-18\text{ }^{\circ}\text{C}$ to give a colourless crystalline (2.33 g, 65%), which was then dried under reduce pressure (10 Torr) at room temperature; δ_{H} 1.36 (9H, s, $t\text{Bu}$).

Triisopropylsilanethiol,⁹⁶ the thiols **91**,⁸⁰ **92**¹³⁶ and **93**¹³⁶ were prepared by published methods, other thiols were obtained commercially (Aldrich or Lancaster) and were used without further purification, as was chlorodimethylsilane (Aldrich).

Chlorodiphenylsilane.⁸¹ - A solution of diphenylsilane (24.3 g, 0.13 mol) and triphenylchloromethane (36.2 g, 0.13 mol) in benzene (120 cm³) was refluxed for 48 h under argon. Most of the benzene was removed by rotary evaporation and the white solid (triphenylmethane) precipitated was removed by filtration. The filtrate was distilled under reduced pressure to give a colourless oil (26.1 g, 92%); bp 90-92 $^{\circ}\text{C}/0.5$ Torr (lit.,⁸¹ bp 99-101 $^{\circ}\text{C}/1$ Torr); δ_{H} 5.74 (1H, s, SiH), 7.34-7.73 (10H, m, Ph).

Preparation of alcohols

2-Methylbut-3-en-2-ol **36** (Aldrich) and 2,3-dimethylbut-3-en-2-ol **37** (Wiley Organics) were obtained commercially and were used without further purification.

3-Methylbut-3-en-2-ol **38**.⁸³ - A 250 cm³ three-necked flask fitted with a dropping funnel and a condenser was charged with magnesium metal turnings (3.0 g, 0.12 mol) and heated with flame while flushing with argon. After the flask was cool, the magnesium was covered with dry diethyl ether. The dropping funnel was charged with a solution of iodomethane (6.93 cm³, 0.11 mol) in diethyl ether (50 cm³). Approximately 2 cm³ of the solution was added to the flask to start the reaction. When the temperature of the reaction mixture increased and a white precipitate appeared, the flask was cooled

to $-10\text{ }^{\circ}\text{C}$ with an ice-acetone bath and the iodomethane solution was added dropwise. After the mixture was stirred for 1 h at a temperature below $0\text{ }^{\circ}\text{C}$, a solution of 2-methylprop-2-enal (7.9 cm^3 , 0.10 mol) in dry diethyl ether (50 cm^3) was added dropwise at $0\text{ }^{\circ}\text{C}$. After the addition was completed, the ice bath was removed and the mixture was stirred for a further 3 h. The mixture was then cooled with an ice bath and a saturated aqueous solution of ammonium chloride (30 cm^3) was added with stirring. The organic layer was separated and the aqueous solution was extracted with diethyl ether ($3 \times 30\text{ cm}^3$), and the combined organic solutions were dried and evaporated. The residue was distilled to give a colourless oil (5.69 g, 66%); bp $115\text{-}117\text{ }^{\circ}\text{C}$ (lit.;⁸³ bp $113\text{-}114\text{ }^{\circ}\text{C}$); δ_{H} 1.28 (3H, d, J 6.5, 1-H), 1.58 (1H, s, OH), 1.75 (3H, br s, 3-Me), 4.25 (1H, q, J 6.5, 2-H), 4.80 (1H, m, 4-H), 4.96 (1H, m, 4-H).

3-Methyl-hepta-1,6-dien-3-ol **39** was prepared from vinylmagnesium bromide and hex-5-en-2-one following a general procedure,⁸² as a colourless oil; bp $69\text{-}71\text{ }^{\circ}\text{C}/26$ Torr; δ_{H} 1.27 (3H, s, Me), 1.57 (1H, s, OH), 1.62 (2H, m, 4-H), 2.09 (2H, m, 5-H), 4.95 (2H, m, 7-H), 5.04 (1H, dd, J 10.7 and 1.3, 1-H), 5.19 (1H, dd, J 17.3 and 1.3, 1-H), 5.81 (1H, m, 6-H), 5.88 (1H, dd, J 17.3 and 10.7, 2-H); δ_{C} 27.9, 28.4, 41.1, 73.2, 111.8, 114.5, 138.8, 144.9; m/z 26 (M^+ , 2%), 71 (100), 55 (28) (Found: C, 76.4; H, 11.5. $\text{C}_8\text{H}_{14}\text{O}$ requires C, 76.1; H, 11.2%).

2-Methylpent-4-en-2-ol **40**⁸⁴ was prepared from allylmagnesium bromide and acetone following a general procedure,⁸² as a colourless oil; bp $26\text{-}31\text{ }^{\circ}\text{C}/17$ Torr (lit.,⁸⁴ bp $115\text{ }^{\circ}\text{C}/760$ Torr); δ_{H} 1.22 (6H, s, 2Me), 2.10 (1H, br s, OH), 2.20 (2H, d, J 8.4, 3-H), 4.90 (1H, br s, 5-H), 5.17 (1H, br s, 5-H), 5.85 (1H, m, 4-H).

2-Methylhex-5-en-2-ol **45**⁸⁵ was prepared from methylmagnesium iodide⁸³ and hex-5-en-2-one following a general procedure,⁸² as a colourless oil; bp 52-54 °C/12 Torr (lit.,⁸⁵ bp 58-59 °C/17 Torr); δ_{H} 1.21 (6H, s, 2Me), 1.56 (2H, m, 3-H), 1.70 (1H, br s, OH), 2.12 (2H, m, 4-H), 5.00 (2H, m, 6-H), 5.84 (1H, m, 5-H).

4-Methylpent-4-en-2-ol **41**⁸² was prepared from 3-chloro-2-methyl propene and acetaldehyde following a general procedure.⁸² After the solvent was removed carefully under reduced pressure with a rotary evaporator, the residue was distilled to give a colourless oil (bp 120-129 °C) which contained 78 mol% of the alcohol **41** and 22 mol% of 2,5-dimethylhex-1,5-diene. δ_{H} 1.21 (3H, d, J 6.1, 1-H), 1.74 (1H, s, OH), 1.76 (3H, br s, 4-Me), 2.15 (2H, m, CH₂), 3.94 (1H, m, 2-H), 4.80 (1H, m, 5-H), 4.88 (1H, m, 5-H).

2,3-Dimethylbut-3-en-1-ol **42**.⁸⁶ - A 150 cm³ round-bottomed flask was dried and charged with 2-methylbut-2-ene (35.1 g, 0.50 mol), paraformaldehyde (15.79 g, 0.50 mol) and anhydrous chloroform (30 cm³). The solution was cooled to 0 °C and stannic chloride (2.93 cm³, 25 mmol) was then added dropwise to the solution with stirring. The mixture was stirred at room temperature under argon for 18 h. The unreacted paraformaldehyde was then removed by filtration and the filtrate was treated immediately with a mixture of dilute ammonium hydroxide and ice (60 cm³), and the pH of the mixture was adjusted to 4 with the dilute ammonium hydroxide solution. The organic layer was separated and the aqueous solution was extracted with diethyl ether (3 x 30 cm³). The combined organic solution was dried and evaporated. The residue was distilled to give a colourless oil (22.4 g, 44%); bp 130-133 °C (lit.,⁸⁶ bp 132-133 °C); δ_{H}

1.02 (3H, d, J 7.0, 2-Me), 1.50 (1H, s, OH), 1.72 (3H, s, 3-Me), 2.38 (1H, m, 2-H), 3.50 (2H, d, J 6.9, CH₂), 4.81 (1H, m, 4-H), 4.88 (1H, m, 4-H).

4-Hydroxy-3,3-dimethylbutan-2-one **46**.⁸⁸ - A mixture of 3-methylbutan-2-one (53.5 cm³, 0.50 mol), paraformaldehyde (15.0 g, 0.5 mol) and trifluoroacetic acid (77.0 cm³, 1.0 mol) was stirred at reflux temperature for 7 h and then poured into 15% sodium hydrogen carbonate solution (1.4 dm³). The resulting suspension was stirred at room temperature for 1 day and extracted with dichloromethane (5 x 150 cm³). The combined organic extracts were dried and evaporated. The residue was distilled under reduced pressure to yield a colourless oil (45.2 g, 78%); bp 80-84 °C/20 Torr (lit.,⁸⁸ bp 65 °C/15 Torr); δ_{H} 1.16 (6H, s, 2Me), 2.16 (3H, s, 1-H), 2.39 (1H, br s, OH), 3.55 (2H, s, CH₂); δ_{C} 21.6, 25.5, 49.2, 69.4, 215.3.

2,2,3-Trimethylbutan-1,3-diol **47**.⁸⁷ - A solution of methylmagnesium iodide in ether (1.5 M, 250 cm³), which was made from iodomethane and magnesium metal turnings following a published procedure,⁸³ was cooled with an ice-bath. A solution of 4-hydroxy-3,3-dimethylbutan-2-one **52** (21.0 g, 0.178 mol) in diethyl ether (90 cm³) was added dropwise to the solution of methylmagnesium iodide with stirring. After stirring at room temperature for 3 h, the mixture was cooled with an ice bath and a saturated solution of ammonium chloride (80 cm³) was added with stirring. The organic layer was separated and the aqueous fraction was extracted with diethyl ether, and the combined ether extracts were dried and evaporated. The residue was purified by recrystallisation from methanol and petroleum at dry ice temperature. The white crystalline (21.3 g 90%) showed mp 125-128 °C (lit.,⁸⁷ mp 118-128 °C); δ_{H} 0.95 (6H, s, 2-Me), 1.25 (6H, s, Me₂CO), 1.63 (1H, br s, OH), 2.98 (1H, br s, OH), 3.60 (2H, br s, CH₂).

*2,2,3-Trimethylbut-3-en-1-yl acetate 48.*⁸⁷ – A solution of 2,2,3-trimethylbutan-1,3-diol (20.0 g, 0.152 mol) and acetic anhydride (14.3 cm³, 0.152 mol) in pyridine (70 cm³) was stirred at room temperature for 24 h, then poured into a mixture of concentrated hydrochloric acid (38 cm³) and ice-water (75 cm³). The acetate was extracted with ether and the combined ether solution was washed successively with dilute hydrochloric acid (2 x 40 cm³, 1.0 M) and saturated brine. The ether solution was then dried and evaporated to give a pale-yellow-coloured oil. To this was added 20 mg of iodine with stirring and the mixture was distilled at atmospheric pressure, the bath temperature being increased gradually to 180 °C. The aqueous fraction of the distillate was separated and extracted with ether, and the ether extracts was added to the organic fraction, which was then dried and distilled under reduced pressure to give a colourless oil (16.5 g, 70 %); bp 90-106 °C/75 Torr (lit.,⁸⁷ bp 70-83 °C/28 Torr); δ_{H} 1.09 (6H, s, 2-Me), 1.75 (3H, br s, 3-Me), 2.05 (3H, s, Ac), 3.96 (2H, s, CH₂), 4.78 (1H, br s, 4-H), 4.81 (1H, br s, 4-H).

*2,2,3-Trimethylbut-3-en-1-ol 43.*⁸⁷ – To a solution of potassium hydroxide (8.48 g, 0.15 mol) in methanol (45 cm³) was added, with cooling, 2,2,3-trimethylbut-3-en-1-yl acetate (16.5 g, 0.106 mol). After stirring for 24 h at room temperature, the solution was poured into a mixture of water (80 cm³) and diethyl ether (80 cm³). The water layer was separated and extracted with ether, and the combined ether extracts were washed with brine, dried and evaporated. The residue was distilled under reduced pressure to give a colourless oil (9.3g, 77%); bp 93-95 °C/100 Torr (lit.,⁸⁷ bp 65-67 °C/35 Torr); δ_{H} 1.06 (6H, s, 2-Me), 1.48 (1H, br s, OH), 1.74 (3H, br s, 3-Me), 3.39 (2H, br s, CH₂), 4.83 (1H,

br s, 4-H), 4.93 (1H, br s, 4-H); δ_c 19.5, 23.8, 41.2, 69.7, 111.9, 149.5; m/z 114 (M^+ , 4%), 55 (97), 41 (100).

1-(Hydroxymethyl)-1-isopropenylcyclohexane 44 was prepared by a procedure similar to that used for 2,2,3-trimethylbut-3-en-1-ol **43**, starting from cyclohexyl methyl ketone; bp 104 °C/8 Torr; δ_H 1.29-1.79 (10H, m, 5 x CH₂), 1.72 (3H, br s, Me), 3.31 (2H, d, J 6.4, CH₂), 4.90 (1H, br s, 4-H), 5.15 (1H, br s, 4-H); δ_c 19.5, 22.1, 26.5, 31.7, 45.1, 68.0, 114.8, 133.1; m/z 154 (M^+ , 1%), 123 (41), 81 (100) (Found: C, 77.6; H, 11.8. C₁₀H₁₈O requires C, 77.9; H, 11.8%).

Preparation of the alkenyloxysilanes

A solution of the alcohol (20 mmol), triethylamine (3.1 cm³, 22 mmol) and 4-(dimethylamino)pyridine (0.09 g, *ca.* 4 mol%) in dry diethyl ether (50 cm³) was cooled in an ice-water bath and stirred mechanically during dropwise addition of chlorodiphenylsilane or chlorodimethylsilane (20 mmol). Voluminous amounts of triethylamine hydrochloride were precipitated. The mixture was stirred for 0.5 h after the addition was complete, the cooling bath was removed, and stirring was continued for 5 h at room temperature. The resulting mixture was then filtered and the filter cake was washed thoroughly with dry hexane. The filtrate was concentrated under reduced pressure with a rotary evaporator. Some salts usually remain in the residue and were removed by dilution of the residue with an additional 50 cm³ of dry hexane followed by filtration, washing the filter cake with hexane, and concentrating the filtrate as above. The residue was finally distilled under reduced pressure to yield the product as a

colourless oil. The yields ranged from 40 to 90% and the characteristics of the products are given below.

Diphenyl(2-methylbut-3-en-2-yloxy)silane 51. Bp 92-95 °C/0.05 Torr; δ_{H} 1.42 (6H, s, Me₂C), 5.01 (1H, dd, *J* 10.6 and 1.3, 4-H), 5.23 (1H, dd, *J* 17.3 and 1.3, 4-H), 5.56 (1H, s, SiH), 6.00 (1H, dd, *J* 17.3 and 10.6, 3-H), 7.36-7.66 (10H, m, Ph); δ_{C} 29.7, 75.2, 111.5, 127.9, 130.0, 134.6, 135.9, 145.5; *m/z* 268 (M⁺, 30%), 253 (30), 199 (73), 183 (100) (Found: C, 75.9; H, 7.4. C₁₇H₂₀OSi requires C, 76.1; H, 7.5%).

Diphenyl(2,3-dimethylbut-3-en-2-yloxy)silane 52. Bp 93-95 °C/0.05 Torr; δ_{H} 1.45 (6H, s, Me₂C), 1.83 (3H, s, 3-Me), 4.80 (1H, s, 4-H), 5.04 (1H, s, 4-H), 5.55 (1H, s, SiH), 7.38-7.66 (10H, m, Ph); δ_{C} 19.1, 29.1, 77.1, 109.3, 127.8, 129.9, 134.5, 135.9, 150.9; *m/z* 282 (M⁺, 12%), 267 (14), 199 (100), 183 (81) (Found: C, 76.6; H, 7.9. C₁₈H₂₂OSi requires C, 76.5; H, 7.9%).

Diphenyl(3-methylbut-3-en-2-yloxy)silane 53. Bp 93-96 °C/0.05 Torr; δ_{H} 1.32 (3H, d, *J* 6.4, MeCH), 1.74 (3H, s, 3-Me), 4.38 (1H, q, *J* 6.4, 2-H), 4.79 (1H, m, 4-H), 4.94 (1H, m, 4-H), 5.44 (1H, s, SiH), 7.36-7.67 (10H, m, Ph); δ_{C} 17.7, 22.6, 74.3, 110.3, 128.0, 130.3, 134.4, 134.7, 147.7; *m/z* 268 (M⁺, 11%), 199 (100), 183 (86) (Found: C, 75.8; H, 7.4. C₁₇H₂₀OSi requires C, 76.1; H, 7.5%).

Diphenyl(3-methylhepta-1,6-dien-3-yloxy)silane 68. Bp 119-121 °C /0.05 Torr; δ_{H} 1.39 (3H, s, Me), 1.70 (2H, m, 4-H), 2.14 (2H, m, 5-H), 4.94 (2H, m, 7-H), 5.06 (1H, dd, *J* 10.7 and 1.4, 1-H), 5.25 (1H, dd, *J* 17.3 and 1.4, 1-H), 5.56 (1H, s, SiH), 5.78 (1H, m, 6-H), 5.89 (1H, dd, *J* 17.3 and 10.7, 2-H), 7.35-7.65 (10H, m, Ph); δ_{C} 27.2, 28.4, 42.0, 77.2, 112.8, 114.1, 127.8, 129.9, 134.5, 135.8, 138.8, 144.0; *m/z* 308 (M⁺, 1%), 253 (91), 183 (100) (Found: C, 78.2; H, 7.7. C₂₀H₂₄OSi requires 77.9; H, 7.8%).

Diphenyl(2-methylpent-4-en-2-yloxy)silane 71. Bp 100-104 °C/0.05 Torr; δ_{H} 1.31 (6H, s, Me₂C), 2.36 (2H, d, *J* 7.3, CH₂), 5.08 (2H, m, 5-H), 5.60 (1H, s, SiH), 5.94 (1H, m, 4-H), 7.36-7.66 (10H, m, Ph); δ_{C} 29.3, 49.0, 75.3, 117.5, 127.9, 130.0, 134.5, 134.9, 136.0; *m/z* 282 (M⁺, 30%), 241 (81), 183 (100) (Found: C, 76.5; H, 7.9. C₁₈H₂₂OSi requires C, 76.5; H, 7.9%).

Dimethyl(2-methylpent-4-en-2-yloxy)silane 72. Bp 46 °C/78 Torr; δ_{H} 0.18 (6H, d, *J* 2.8, Me₂Si), 1.24 (6H, s, Me₂C), 2.25 (2H, d, *J* 7.3, CH₂), 4.76 (1H, m, SiH), 5.05 (2H, m, 4-H), 5.88 (1H, m, 4-H); δ_{C} 0.8, 29.1, 48.8, 74.1, 117.2, 135.1; *m/z* 158 (M⁺, 1%), 117 (70), 75 (100) (Found: C, 60.5; H, 11.6. C₈H₁₈OSi requires C, 60.7; H, 11.5%).

Diphenyl(4-methylpent-4-en-2-yloxy)silane 73. Bp 98-100 °C/0.05 Torr; δ_{H} 1.22 (3H, d, *J* 6.1, MeCH), 1.67 (3H, s, 4-Me), 2.16 (1H, dd, *J* 13.1 and 6.8, 3-H), 2.36 (1H, dd, *J* 13.1 and 6.1, 3-H), 4.15 (1H, m, 2-H), 4.76 (2H, m, 5-H), 5.47 (1H, s, SiH), 7.35-7.67 (10H, m, Ph); δ_{C} 22.8, 23.1, 47.8, 69.3, 113.0, 127.9, 130.2, 134.6, 134.7, 142.7; *m/z* 282 (M⁺, 5%), 227 (77), 183 (100) (Found: C, 76.3; H, 7.7. C₁₈H₂₂OSi requires C, 76.5; H, 7.9%).

Diphenyl(2,3-dimethylbut-3-en-1-yloxy)silane 74. Bp 100-104 °C /0.05 Torr; δ_{H} 1.07 (3H, d, *J* 6.9, 2-Me), 1.70 (3H, br s, 3-Me), 2.45 (1H, m, 2-H), 3.64 (1H, dd, *J* 10.0 and 7.1, 1-H), 3.79 (1H, dd, *J* 10.0 and 6.4, 1-H), 4.76 (1H, d, *J* 1.2, 4-H), 4.80 (1H, d, *J* 1.2, 4-H), 5.44 (1H, s, SiH), 7.38-7.68 (10H, m, Ph); δ_{C} 16.1, 20.4, 43.1, 68.4, 110.7, 128.0, 130.3, 134.7, 135.0, 147.3; *m/z* 282 (M⁺, 7%), 199 (35), 183 (100) (Found: C, 76.6; H, 7.8. C₁₈H₂₂OSi requires C, 76.5; H, 7.9%).

Diphenyl(2,2,3-trimethylbut-3-en-1-yloxy)silane 75. Bp 116-118 °C /0.05 Torr; δ_{H} 1.09 (6H, s, 2-Me), 1.74 (3H, s, 3-Me), 3.61 (2H, s, 1-H), 4.81 (2H, m, 4-H), 5.41 (1H, s, SiH), 7.39-7.64 (10H, m, Ph); δ_{C} 19.9, 24.0, 41.1, 72.2, 110.4, 127.9, 130.2, 134.2, 134.7, 150.4; m/z 296 (M^+ , 1%), 213 (50), 183 (100) (Found: C, 76.9; H, 8.1. $\text{C}_{19}\text{H}_{24}\text{OSi}$ requires C, 77.0; H, 8.2%).

Diphenyl[(1-isopropenylcyclohexyl)methoxy]silane 76. Bp 158 °C/0.03 Torr; δ_{H} 1.70 (3H, s, Me), 1.78-1.42 (10H, m, 5 x CH_2), 3.55 (2H, s, OCH_2), 4.89 (1H, br s, $\text{C}=\text{CH}$), 5.04 (1H, br s, $\text{C}=\text{CH}$), 5.39 (1H, s, SiH), 7.38-7.65 (10H, m, Ph); δ_{C} 20.2, 22.2, 26.4, 31.3, 44.7, 71.6, 113.6, 127.9, 130.2, 134.3, 134.7, 152.3; m/z 336 (M^+ , 1%), 123 (95), 81 (100) (Found: C, 78.2; H, 8.1. $\text{C}_{22}\text{H}_{28}\text{OSi}$ requires C, 78.5; H, 8.4%).

Diphenyl(2-methylhex-5-en-2-yloxy)silane 94. Bp 108-110 °C/0.05 Torr; δ_{H} 1.30 (6H, s, Me_2C), 1.63 (2H, m, 3-H), 2.16 (2H, m, 4-H), 4.95 (2H, m, 6-H), 5.55 (1H, s, SiH), 5.82 (1H, m, 5-H), 7.34-7.62 (10H, m, Ph); δ_{C} 28.8, 29.5, 43.5, 75.4, 114.1, 127.9, 130.0, 134.6, 136.1, 139.2; m/z 296 (M^+ , 1%), 241 (49), 183 (100) (Found: C, 77.1; H, 8.1. $\text{C}_{19}\text{H}_{24}\text{OSi}$ requires C, 77.0; H, 8.2%).

Typical procedure for radical-chain cyclisation

Diphenyl(2-methylbut-3-en-2-yloxy)silane **51** (0.30 g, 1.1 mmol) and hexane (4 cm^3) were introduced into a dry, argon-filled 25 cm^3 two-necked conical flask containing a magnetic stirrer bar and fitted with a condenser, with argon flowing downwards through it. *tert*-Dodecanethiol (6.5 μl , 2.5 mol%, based on **51**) and TBHN (4.8 mg, 2.5 mol%, based on **51**) were added to the mixture through the side arm, which was then closed with a stopper, and the flask was immersed in an oil bath pre-heated to 60 °C.

The mixture was stirred under argon for 1 hour and further amounts of TDT (2.5 mol%) and TBHN (2.5 mol%) were then added, before stirring was continued for a further 2 h. The reaction mixture was allowed to cool to room temperature, the solvent was removed using a rotary evaporator and the residue was purified by chromatography on silica gel, using petroleum-diethyl ether (98:2) as eluent, to give 2,2-diphenyl-5,5-dimethyl-1-oxa-2-silacyclopentane **54** (0.97 mmol, 88%) as a clear oil; δ_{H} 1.34 (2H, t, J 7.7, 3-H), 1.39 (6H, s, Me₂C), 1.97 (2H, t, J 7.7, 4-H), 7.37-7.64 (10H, m, Ph); δ_{C} 9.9, 29.8, 38.0, 80.7, 127.8, 129.9, 134.5, 135.4; m/z 268 (M⁺, 22%), 253 (100), 199 (44) (Found: C, 76.3; H, 7.4. C₁₇H₂₀OSi requires C, 76.1; H, 7.5%).

Other cyclisation reactions were carried out in a similar way and the characteristics of the products are given below; all were oils and the yields are given in Table 2 and 3.

2,2-Diphenyl-4,5,5-trimethyl-1-oxa-2-silacyclopentane 55. δ_{H} 1.10 (3H, d, J 6.9, 4-Me), 1.11 (1H, dd, J 14.8 and 12.7, 3-H), 1.17 (3H, s, 5-Me), 1.39 (1H, dd, J 14.8 and 6.5, 3-H), 1.44 (3H, s, 5-Me), 2.14 (1H, m, 4-H), 7.36-7.65 (10H, m, Ph); δ_{C} 18.8, 23.7, 29.3, 43.3, 82.8, 127.8, 129.9, 134.5, 134.6, 135.4, 135.7; m/z 282 (M⁺, 8%), 239 (100), 105 (86) (Found: C, 76.3; H, 7.7. C₁₈H₂₂OSi requires C, 76.5; H, 7.9%).

cis-2,2-Diphenyl-4,5-dimethyl-1-oxa-2-silacyclopentane 56-cis. This compound (t_{r} 4.2 min) and its *trans* isomer (t_{r} 7.1 min) were isolated by HPLC on the reversed-phase column using methanol-water (75:25) as eluent; δ_{H} 1.03 (3H, d, J 6.9, 4-Me), 1.06 (1H, dd, J 14.8 and 9.6, 3-H), 1.20 (3H, d, J 6.5, 5-Me), 1.40 (1H, dd, J 14.8 and 6.8, 3-H), 2.46 (1H, m, 4-H), 4.42 (1H, qd, J 6.5 and 6.2, 5-H), 7.34-7.66 (10H, m,

Ph); δ_C 17.4, 17.5, 18.1, 36.8, 78.1, 127.8, 130.0, 134.4, 134.5, 135.3, 135.6 (Found: C, 76.4; H, 7.4. $C_{17}H_{20}OSi$ requires C, 76.1; H, 7.5%).

***trans*-2,2-Diphenyl-4,5-dimethyl-1-oxa-2-silacyclopentane 56-*trans*.** δ_H 1.01 (1H, dd, J 14.8 and 11.9, 3-H), 1.12 (3H, d, J 6.5, 4-Me), 1.39 (3H, d, J 6.0, 5-Me), 1.48 (1H, dd, J 14.8 and 6.5, 3-H), 1.90 (1H, m, 4-H), 3.77 (1H, m, 5-H), 7.36-7.64 (10H, m, Ph); δ_C 19.8, 20.5, 21.5, 41.2, 81.4, 127.8, 127.9, 130.0, 130.1, 134.5, 134.6, 135.1, 135.2 (Found: C, 76.4; H, 7.4. $C_{17}H_{20}OSi$ requires C, 76.1; H, 7.5%).

2,2-Diphenyl-6,6-dimethyl-1-oxa-2-silacyclohexane 77. This compound (t_r 7.8 min) and the five-membered-ring isomer **79** (t_r 4.5 min) were isolate by normal-phase HPLC, using hexane as eluent; δ_H 1.16 (2H, t, J 6.9, 3-H), 1.32 (6H, s, 6-Me), 1.67 (2H, m, 4-H), 1.94 (2H, m, 5-H), 7.31-7.62 (10H, m, Ph); δ_C 10.5, 18.0, 30.8, 41.2, 74.4, 127.7, 129.5, 134.2, 137.5; m/z 282 (M^+ , 20%), 267 (100), 199 (62). (Found: C, 76.5; H, 7.8. $C_{18}H_{22}OSi$ requires C, 76.5; H, 7.9%).

2,2-Dimethyl-6,6-dimethyl-1-oxa-2-silacyclohexane 78. δ_H 0.13 (6H, s, 2-Me), 0.58 (2H, t, J 6.9, 3-H), 1.24 (6H, s, 6-Me), 1.50 (2H, m, 4-H), 1.81 (2H, m, 5-H); δ_C 1.4, 12.7, 17.8, 30.7, 41.0, 73.3.

2,2-Diphenyl-3,5,5-trimethyl-1-oxa-2-silacyclopentane 79. δ_H 1.08 (3H, d, J 7.2, 3-Me), 1.32 (3H, s, 5-Me), 1.52 (3H, s, 5-Me), 1.62 (1H, apparent t, J 12.7, 4-H), 1.92 (1H, m, 3-H), 2.16 (1H, dd, J 12.7 and 7.7, 4-H), 7.39-7.67 (10H, m, Ph); δ_C 14.6, 18.0, 29.4, 31.2, 47.9, 79.7, 127.7, 127.9, 129.8, 130.0, 133.4, 134.5, 134.9, 135.2; m/z 282 (M^+ , 18%), 240 (100), 199 (54) (Found: C, 76.5; H, 7.9. $C_{18}H_{22}OSi$ requires C, 76.5; H, 7.9%).

2,2-Dimethyl-3,5,5-trimethyl-1-oxa-2-silacyclopentane 80. δ_{H} 0.08 (3H, s, 2-Me), 0.21 (3H, s, 2-Me), 1.05 (3H, d, J 7.0, 3-Me), 1.17 (3H, s, 5-Me), 1.28 (1H, m, 3-H), 1.30 (3H, s, 5-Me), 1.39 (1H, apparent t, J 12.0, 4-H), 1.99 (1H, dd, J 12.0 and 7.1, 4-H); δ_{C} 1.4 (2C), 14.1, 18.3, 29.4, 31.5, 47.8, 78.7.

cis-2,2-Diphenyl-4,6-dimethyl-1-oxa-2-silacyclohexane 81. This compound (t_{r} 10.5 min) and its *trans* isomer **82** (t_{r} 6.9 min) were isolated by reversed-phase HPLC, using methanol-water (80:20) as eluent; δ_{H} 0.76 (1H, dd, J 14.6 and 12.9, 3- H_{ax}), 1.08 (3H, d, J 6.5, 4-Me), 1.21 (1H, ddd, J 13.7, 11.6 and 11.2, 5- H_{ax}), 1.31 (1H, dd, J 14.6 and 2.2, 3- H_{eq}), 1.32 (3H, d, J 6.2, 6-Me), 1.64 (1H, ddd, J 13.7, 2.2 and 2.1, 5- H_{eq}), 1.91 (1H, m, 4-H), 4.10 (1H, m, 6-H), 7.32-7.70 (10H, m, Ph); δ_{C} 19.6, 24.9, 27.1, 29.5, 46.0, 71.1, 127.8, 128.0, 129.7, 129.9, 134.3, 135.2, 135.9; m/z 282 (M^+ , 22%), 225 (48), 204 (100) (Found: C, 76.7; H, 8.0. $\text{C}_{18}\text{H}_{22}\text{OSi}$ requires C, 76.5; H, 7.9%).

trans-2,2-Diphenyl-4,6-dimethyl-1-oxa-2-silacyclohexane 82. δ_{H} 0.94 (1H, dd, J 14.7 and 8.9, 3-H equatorial in **82a**, axial in **82b**), 1.06 (3H, d, J 6.8, 4-Me), 1.28 (3H, d, J 6.5, 6-Me), 1.38 (1H, dd, J 14.7 and 4.9, 3-H axial in **82a**, equatorial in **82b**), 1.63 (2H, apparent t, J 5.4, 5-H), 2.29 (1H, m, 4-H), 4.48 (1H, m, 6-H), 7.36-7.65 (10H, m, Ph); δ_{C} 18.9, 23.8, 24.6, 24.7, 43.0, 68.4, 127.7, 127.8, 129.6, 134.1, 134.2, 137.1; m/z 282 (M^+ , 22%), 225 (57), 204 (100) (Found: C, 76.7; H, 8.0. $\text{C}_{18}\text{H}_{22}\text{OSi}$ requires C, 76.5; H, 7.9%).

cis-2,2-Diphenyl-4,5-dimethyl-1-oxa-2-silacyclohexane 83. This compound (t_{r} 10.8 min) and its *trans* isomer **84** (t_{r} 13.2 min) were isolated by reversed-phase HPLC, using methanol-water (75:25) as eluent; δ_{H} 1.03 (3H, d, J 7.0, 4-Me), 1.05 (3H, d, J 7.3, 5-Me), 1.07 (1H, dd, J 14.9 and 11.4, 3-H), 1.18 (1H, dd, J 14.9 and 4.3, 3-H), 1.74 (1H,

m, 4-H), 2.14 (1H, m, 5-H), 3.96 (1H, dd, J 11.1 and 3.8, 6-H), 4.05 (1H, dd, J 11.1 and 2.6, 6-H), 7.35-7.67 (10H, m, Ph); δ_C 10.7, 15.3, 22.6, 32.5, 37.5, 70.3, 127.9, 128.0, 129.9, 130.0, 134.1, 134.3, 135.2, 135.9 (Found: C, 76.8; H, 7.7. $C_{18}H_{22}OSi$ requires C, 76.5; H, 7.9%).

***trans*-2,2-Diphenyl-4,5-dimethyl-1-oxa-2-silacyclohexane 84.** δ_H 0.82 (3H, d, J 6.2, 4-Me), 0.94 (1H, dd, J 14.8 and 12.1, 3- H_{ax}), 1.09 (3H, d, J 5.9, 5-Me), 1.32 (1H, dd, J 14.8 and 3.0, 3- H_{eq}), 1.57 (2H, m, 4- and 5-H), 3.59 (1H, dd, J 11.5 and 10.5, 6- H_{ax}), 4.00 (1H, dd, J 11.5 and 3.1, 6- H_{eq}), 7.33-7.69 (10H, m, Ph); δ_C 15.1, 20.1, 24.4, 35.3, 40.9, 71.3, 127.8, 128.0, 129.9, 130.0, 134.1, 134.2, 134.8, 135.6 (Found: C, 76.8; H, 7.7. $C_{18}H_{22}OSi$ requires C, 76.5; H 7.9%).

2,2-Diphenyl-4,5,5-trimethyl-1-oxa-2-silacyclohexane 88. δ_H 0.83 (3H, s, 5-Me), 1.02 (3H, d, J 6.7, 4-Me), 1.04 (3H, s, 5-Me), 1.05 (1H, dd, J 15.1 and 13.2, 3-H), 1.18 (1H, dd, J 15.1 and 4.1, 3-H), 1.78 (1H, m, 4-H), 3.66 (2H, br s, 6-H), 7.35-7.69 (10H, m, Ph); δ_C 16.5, 17.2, 20.6, 24.8, 36.4, 37.8, 75.9, 127.9, 128.0, 129.9, 130.0, 134.2, 134.4, 134.8, 135.7; m/z 296 (M^+ , 4%), 254 (19), 211 (49), 199 (100), 181 (77) (Found: C, 77.3; H, 8.1. $C_{19}H_{24}OSi$ requires C, 77.0; H, 8.3%).

2-Oxa-3-silaspiro[5,5]undecane 89. δ_H 0.95 (3H, d, J 6.9, 5-Me), 1.05 (1H, dd, J 15.2 and 8.6, 4-H), 1.30 (1H, dd, J 15.2 and 5.1, 4-H), 1.65-1.20 (10H, m, 5 x CH_2), 1.96 (1H, m, 5-H), 3.59 (1H, d, J 11.6, 1-H), 4.19 (1H, d, J 11.6, 1-H), 7.34-7.61 (10H, m, Ph); δ_C 15.3, 18.6, 21.2, 21.6, 26.4, 27.2, 32.4, 36.8, 37.9, 68.9, 127.8, 127.9, 129.7, 129.8, 134.0, 134.2, 135.6, 136.3; m/z 336 (M^+ , 1%), 294 (9), 199 (100) and 181 (65) (Found: C, 78.6; H, 8.4. $C_{22}H_{28}OSi$ requires C, 78.5; H, 8.4%).

2,2-Diphenyl-7,7-dimethyl-1-oxa-2-silacycloheptane 95. δ_{H} 1.14 (2H, m, 3-H), 1.44 (6H, s, 7-Me), 1.78 (6H, m, 3 x CH₂), 7.27-7.61 (10H, m, Ph); δ_{C} 15.1, 23.6, 25.8, 31.0, 43.1, 75.4, 127.6, 129.3, 134.2, 137.9; m/z 296 (M⁺, 4%), 199 (94), 123 (100) (Found: C, 76.7; H, 8.2. C₁₉H₂₄OSi requires C, 77.0; H, 8.3%).

EPR spectroscopy

EPR spectra were recorded during continuous UV irradiation of samples positioned in a standard variable temperature insert in the microwave cavity of a Varian E-109 or a Bruker ESP-300 spectrometer operating at 9.1-9.4 GHz, as described previously.¹⁰⁹ Samples were prepared using a vacuum line and were sealed in evacuated Suprasil quartz tubes (3 mm i.d., 0.5 mm wall). The temperature of the sample during photolysis was determined, using the method described previously;^{109a} the heating effect at full light intensity varied between 5 and 7 °C depending on conditions. Di-*tert*-butyl peroxide (98%, Aldrich) was passed down a column of basic alumina (activity 1) and distilled (b.p. 29-30 °C/30 Torr; lit.¹¹⁶ 46-47 °C/76 Torr); cyclopropane (Union Carbide) was used as received.

Computer simulations of spectra were obtained using a modified version of ESRSPEC2,¹³⁷ extended to handle composite spectra from up to four radicals with different centres, second-order shifts for coupling to single nuclei with $I > 1/2$, and lineshapes continuously variable between 100% Gaussian and 100% Lorentzian.

Chapter 3

**Radical-chain epimerisation catalysed by thiols:
possible implications for the radical-induced
strand cleavage of DNA**

3.1 Introduction

Anti-tumor antibiotics from the enediyne family, such as neocarzinostatin¹¹⁸ and esperamycin¹¹⁹, as well as metal complexes of bleomycin glycopeptides¹²⁰, induce the oxidative cleavage of DNA by abstraction of hydrogen atoms to generate highly reactive DNA radicals that can react with oxygen and rearrange, culminating in scission of the nucleic acid strand.

A 2-deoxyribose residue in the backbone of a DNA strand (Fig. 8) has seven hydrogen atoms attached to carbon which, in principle, are available for abstraction by an oxidising agent or by free radicals. These atoms are generally designated as H-5', H-5'', H-4', H-3', H-2', H-2'', and H-1'. Although all seven hydrogen atoms of

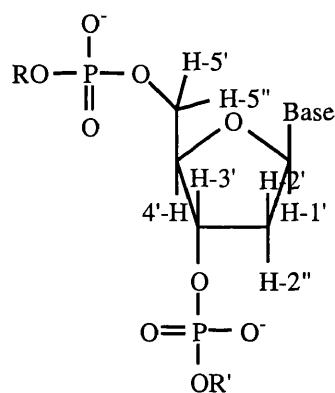

Fig. 8 The seven deoxyribose hydrogen atoms

deoxyribose are believed to be individually reactive toward free radicals, not all have equal probability of being abstracted from duplex nucleic acids. According to structures obtained by X-ray crystallography of oligonucleotides, the 5'-, 4'- and 1'- positions of

DNA are accessible from the minor groove, while the 3'- and one 2'-position are accessible from the major groove. One 5'-hydrogen atom points directly into the minor groove; the other points away from the backbone toward solvent.¹²¹ As illustrated by the double-stranded helix model of DNA, the minor groove 5'- and 4'- hydrogen atoms are the most accessible in typical DNA molecules. Calculations of the activation energy for hydrogen abstraction by unselective hydroxyl radical for positions 1', 2', 3' and 4' suggested that the theoretical probability of abstraction correlated with C-H bond strength.¹²² Abstraction of H-1', H-3' or H-4' required similar amounts of energy, presumably because the resulting DNA radical was stabilised by partial π -bond formation with the lone-pair electrons on the adjacent oxygen atom. Abstraction of the 2'- and 2''-hydrogens, on the other hand, required more energy because this position is one bond removed from oxygen.¹²³ When the calculations were performed on a deoxyribose sugar that was part of a double-stranded helix in DNA, solvent accessibility become a critical factor. Although abstraction of H-1' was energetically favourable, the accessibility of H-1' to a solvent-borne oxidant was reduced to virtually zero. The 4'- and 5'- hydrogen atoms were significantly more exposed to solvent, and therefore were much more likely to be abstracted.¹²³

Strand cleavage of DNA resulting from abstraction of H-4' has been observed in many systems. The deoxyribosyl radical **104** with the radical centre at the 4'-position plays the central role in the cleavage of the DNA stand. This deoxyribosyl radical either reacts with oxygen^{119,120} or decomposes directly.¹²⁴ Under anaerobic conditions, 4'-radical **104** is involved in strand cleavage of DNA by a heterolytic C,O-bond scission with expulsion of the phosphate group to give an intermediate radical cation **105**, which

is attacked by water as a nucleophile giving an α -alkoxyalkyl radical of the type **106** (see Scheme 17).¹²⁴ In principle, if the radical **106** (or a similar oligonucleotide-derived α -oxyalkyl radical) were to abstract hydrogen from an undamaged strand to regenerate the 4'-radical **104**, a homolytic *chain* process for the cleavage of DNA could be established. If such a radical-chain mechanism for the destruction of DNA could be promoted when desirable in a therapeutic context (*e.g.* to amplify the effects of radiation damage to a tumour or to increase the effectiveness of the various anti-neoplastic agents that operate *via* radical pathways¹¹⁸⁻¹²⁰), the biological implications would be of considerable importance.

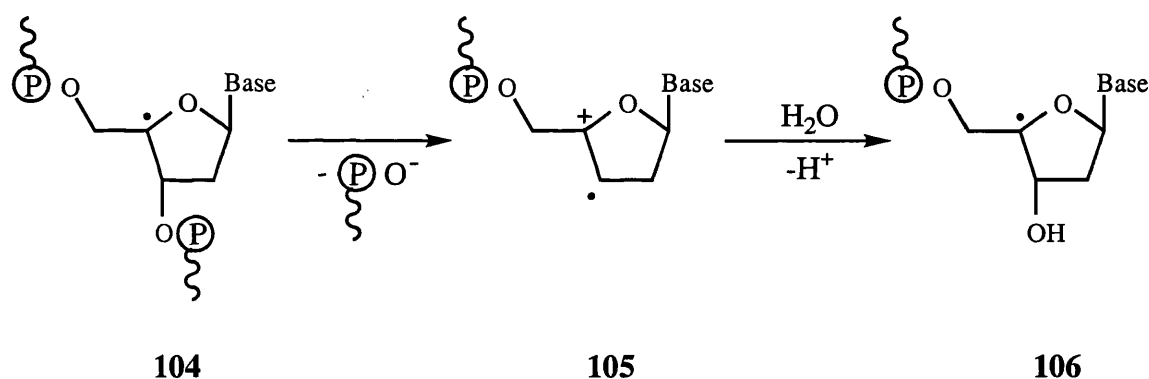

Scheme 17

However, hydrogen-atom abstraction by **106** from the 4'-position in DNA is an (essentially) thermoneutral process that involves two radicals of almost identical electronegativity, and such reactions would be expected to be very slow at moderate temperatures.⁷⁴ The radicals **104** and **106** should be nucleophilic species, with relatively low ionisation energies, and it occurred to us that the overall transfer of hydrogen from DNA to **106** (or to another α -oxyalkyl radical) might be promoted by a suitable protic

polarity-reversal catalyst⁹⁷ of the type EI-H, where EI* is an electrophilic radical. For the present study, this general possibility was investigated by examining the effect of thiols as protic polarity-reversal catalysts on the identity reaction (60) of tetrahydrofurfuryl acetate **107** and the *cis-trans*-isomerisation of 2,5-dimethyltetrahydrofuran **109** [eqn. (61)].

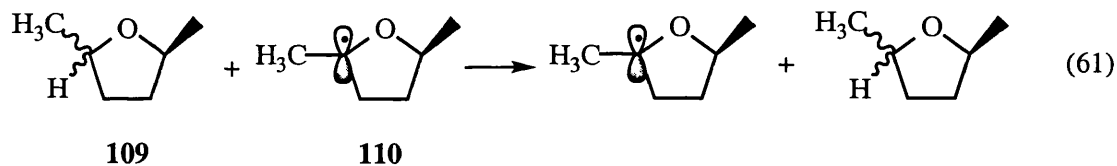
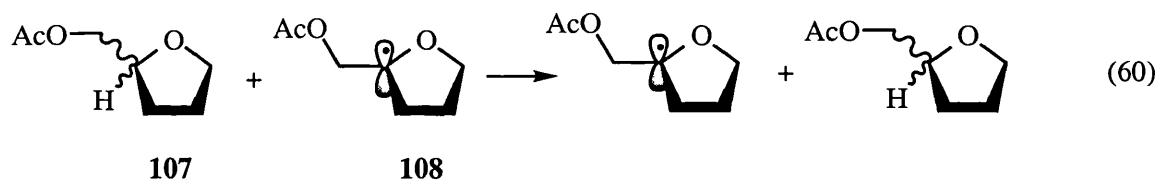

Hydrogen abstraction by a thiyl radical from (*R*)-tetrahydrofurfuryl acetate¹²⁵ will give to a planar radical **108** (see Scheme 17). When **108** abstracts hydrogen from thiol it will lead to a molecule of either (*R*)- or (*S*)-tetrahydrofurfuryl acetate. If this sequence of reactions take place, optically pure (*R*)-tetrahydrofurfuryl acetate will evolve into an enantiomeric mixture of (*R*)- and (*S*)-tetrahydrofurfuryl acetate. Thus, the extent to which the overall reaction (60) takes place can be judged by starting with optically pure tetrahydrofurfuryl acetate¹²⁵ and monitoring the enantiomeric excess of the remaining ester as a function of time. In a similar way, pure *cis*-2,5-dimethyl tetrahydrofuran¹²⁶ will evolve to a thermodynamically-controlled mixture of *cis*- and *trans*-isomers if the

thiol-catalysed overall reaction (61) takes place. The same equilibrium mixture must be obtained if one starts with pure *trans*-2,5-dimethyltetrahydrofuran.¹²⁶

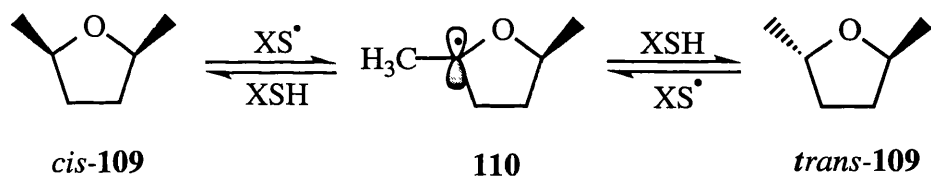
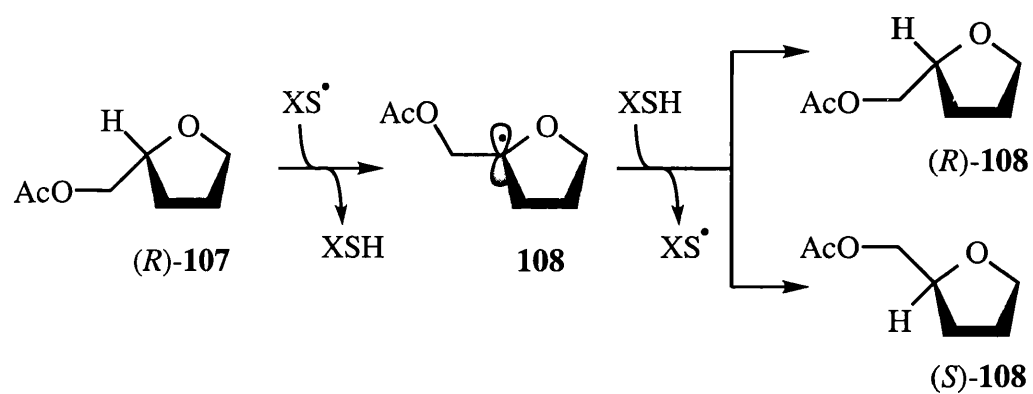

Scheme 18

3.2 Results and Discussion

3.2.1 Tetrahydrofurfuryl acetate

(*R*)-(-)-Tetrahydrofurfuryl alcohol¹²⁵ was obtained from Kiralchem Ltd., and was converted to (*R*)-tetrahydrofurfuryl acetate by treatment with acetic anhydride in the presence of triethylamine. Di-*tert*-butyl hyponitrite (TBHN)^{93,94} was used as a thermal source of initiating *tert*-butoxyl radicals [eqn (51), chapter 2, section 2.2.2] and radicals derived from (*R*)-tetrahydrofurfuryl acetate were generated by reacting the acetate with *tert*-butoxyl radicals [eqn. (62)]. In the absence of other reagents, *tert*-butoxyl radicals preferentially attack the hydrogen atom in the position α to the ring oxygen atom, yielding the α -alkoxyalkyl radicals **108** and **111**. This was confirmed by EPR spectroscopic studies (see later).

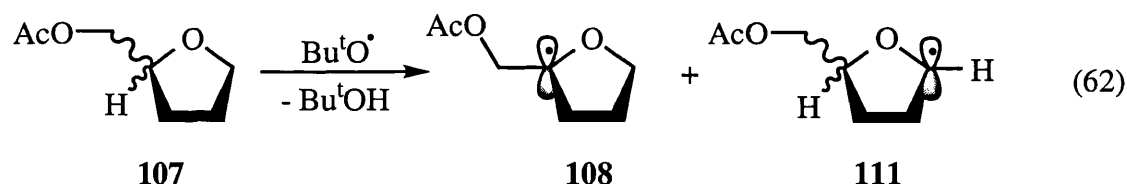

Following the abstraction of an hydrogen atom from thiols, the radical **108** is 'repaired' to give (*R*)-**107** or 'pseudo-repaired' with configurational inversion at the chiral centre to give (*S*)-**107** (see Scheme 18). However, hydrogen-atom abstraction to form **111** followed by 'repair' to regenerate **107** is an unobservable process in the present system. The enantiomeric products (*R*)-**107** and (*S*)-**107** were determined by

chiral-stationary-phase GLC using a capillary column [Supelco β -DEX 120 (30 m x 0.25 mm) coated with permethylated β -cyclodextrin (0.25 μ m)].

When a benzene solution containing (*R*)-**107** (99.4% ee, 0.50 mol dm⁻³), *tert*-butylbenzene or methyl benzoate (0.30 mol dm⁻³, as an internal concentration standard for GLC analysis) and di-*tert*-butyl hyponitrite (TBHN, 0.025 mol dm⁻³) was heated at 60 °C under argon for 3 h, *ca.* 10% of **107** was consumed and the ee of the remaining (*R*)-ester was undiminished. It can be concluded that neither **108** nor **111** abstracts hydrogen directly from **107** to give **108** at a significant rate under the reaction conditions. The experiment was then repeated in the presence of small amounts (usually 5 mol% based on **107**) of various thiols as potential polarity-reversal catalysts, and some of the results are presented graphically in Fig. 9. Under these conditions, only a trace of tetrahydrofurfuryl acetate was consumed during the first 90 min, although a small amount ($\leq 5\%$) of the ester was consumed subsequently when the thiol concentration had become very low.

It can be seen that with 5 mol% of a simple alkanethiol such as *tert*-dodecanethiol (mixture of isomers) or dodecane-1-thiol only a very small amount of racemisation of (*R*)-**107** is caused. Thiols with electron-withdrawing groups attached to the sulfur atom bring about a significant increase in the rate of racemisation and evidently act as polarity-reversal catalysts for the overall reaction [eqn (60)], according to the chain propagation cycle shown in Scheme 18. Thus, 1-thiol- β -D-glucopyranose tetraacetate, 2,2,2-trifluoroethanethiol and, in particular, triphenylsilanethiol are efficient catalysts. 2,2,2-Trifluoroethanethiol is relatively volatile (bp 36 °C) and some could have been lost by evaporation during the reaction. The more sterically-demanding

triisopropylsilanethiol and the less acidic methylthioglycolate ($\text{MeO}_2\text{CCH}_2\text{SH}$) were less effective. Abstraction of hydrogen from **107** by XS^\bullet is evidently more efficient when the substituent X is an electron-withdrawing group, probably because the S-H bond is stronger and the thiyl radical is more electrophilic when the sulfur atom is relatively electron deficient.^{74b,78} The silyl group acts as a π -electron-pair acceptor. Triisopropylsilanethiol is a less effective catalyst than triphenylsilanethiol, which may be a consequence of relatively slow transfer of a hydrogen atom from and to a tertiary site when the XS group is bulky.

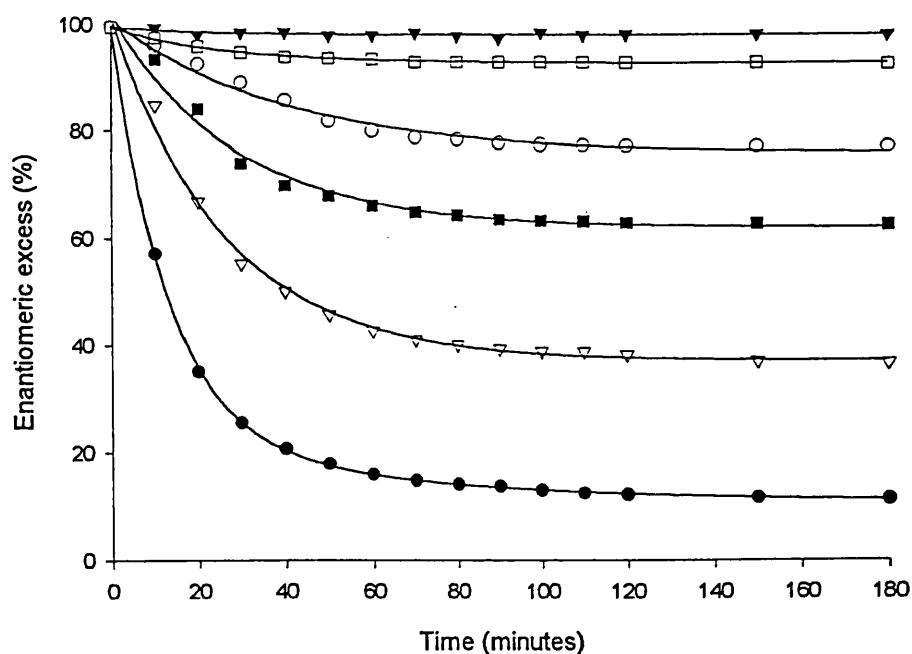
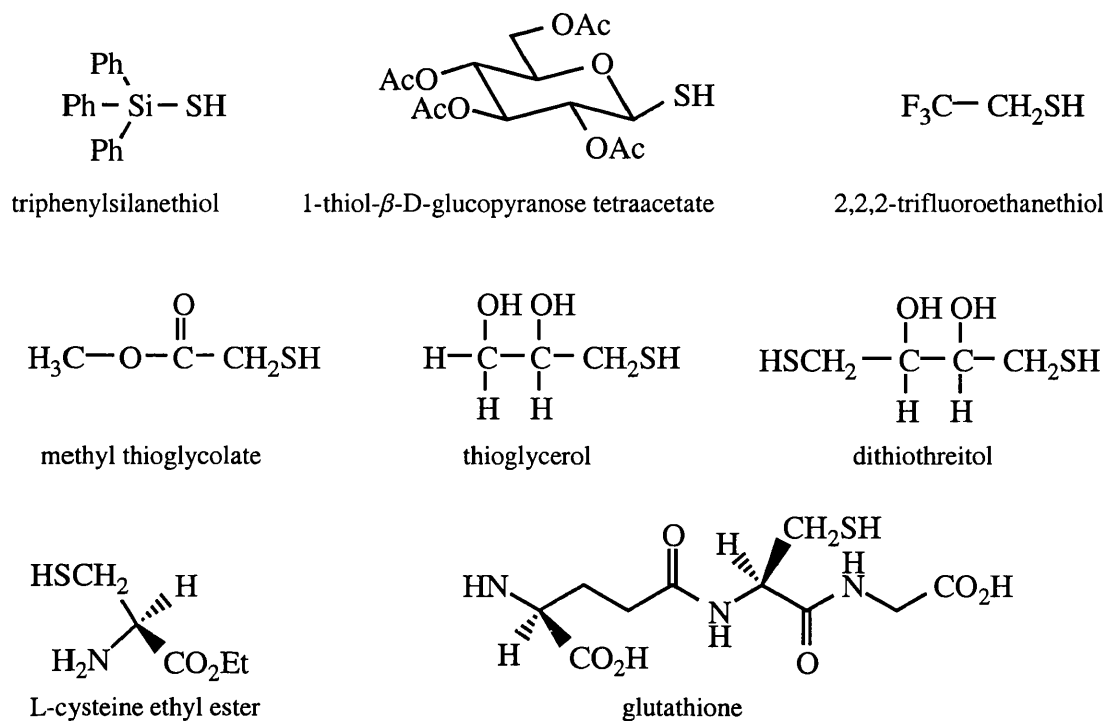

Fig. 9 The racemisation of (*R*)-tetrahydrofurfuryl acetate in benzene at 60 °C in the presence of various thiols (5 mol% based on the acetate): (▼) *tert*-dodecanethiol, (□) dodecane-1-thiol, (○) methylthioglycolate, (■) 2,2,2-trifluoroethanethiol, (▽) 1-thiol- β -D-glucopyranose tetraacetate and (●) triphenylsilanethiol (in order of increasing efficiency as catalysts)



In living cells, glutathione is the most abundant low molecular weight thiol and can reach concentrations as high as 10 mmol dm^{-3} .¹²⁷ The repair of a DNA sugar-radical *via* hydrogen-donation from the thiol pool is widely considered as one of the cell's defence mechanisms against free radical-induced damage. As expected, L-cysteine ethyl ester, which was used as a model for glutathione, was totally ineffective as a polarity-reversal catalyst in the racemisation of (*R*)-tetrahydrofurfuryl acetate. Of the thiols investigated as catalysts, the order of efficiency was: $\text{Ph}_3\text{SiSH} > 1\text{-thiol-}\beta\text{-D-glucopyranose tetraacetate} > \text{CF}_3\text{CH}_2\text{SH} > \text{Pr}_3\text{SiSH} \approx \text{MeO}_2\text{CCH}_2\text{SH} > \text{dodecane-1-thiol} > \text{thioglycerol} \approx \text{dithiothreitol} > \textit{tert}\text{-dodecanethiol} > \text{L-cysteine ethyl ester}$.

With 5 mol% TBHN and 5 mol% thiol catalyst, racemisation does not go to completion (see Fig. 9). Apart from depletion of the initiator, this is presumably a result of removal of thiol radicals by self-coupling to give disulfide and, especially in the later

3-2 Results and Discussion

stages of the reaction when the thiol concentration is reduced, by combination of XS^{\bullet} with the radicals **108** and **111**.

Triphenylsilanethiol is the most effective catalyst. However, an attempt to complete the racemisation by increasing the amount of this catalyst was unsuccessful. When the initial amount of Ph_3SiSH was increased to 10 mol%, under otherwise identical conditions, the rate of racemisation of (*R*)-**107** decreased. Moreover, with 20 mol% Ph_3SiSH , the initial rate of racemisation was as slow as that catalysed by methyl thioglycolate. In the latter experiment, the racemisation became faster 20 minutes after the start of reaction, probably because the decrease of thiol concentration which was caused by self-coupling of the thiyl radicals. When the amount of Ph_3SiSH was decreased to 2.5 mol% or even 1.25 mol%, the initial rate of racemisation was slightly greater than that achieved with 10 mol% catalyst, although the final ee after 3 h was appreciably smaller. Thus with 5 mol% Ph_3SiSH , both of the initial rate of racemisation of (*R*)-**107** was largest and the final ee was smallest (see Fig. 10). These results can be interpreted as indicating that at high thiol concentrations rotational exchange between the enantiomeric conformations of **108** becomes competitive with trapping of this radical by thiol to regenerate **107**, so that **108** begins to retain a memory of the absolute configuration of the molecule of **107** from which it was derived. It follows that the rate of racemisation provides a lower limit for the rate of the overall reaction [eqn. (60)] under conditions of polarity reversal catalysis. With 5 mol% of triphenylsilanethiol as catalyst, the racemisation of (*R*)-**107** becomes faster as the initial amount of TBHN was increased (Fig. 11). Racemisation of (*R*)-**107** goes to completion in 40 minutes with 5 mol% Ph_3SiSH and 10 mol% TBHN initiator.

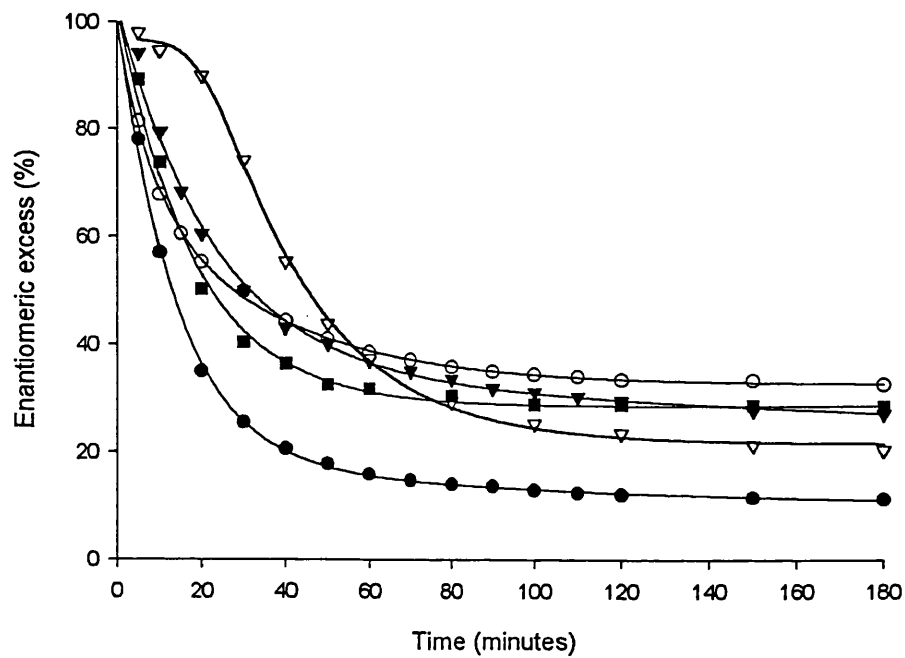

Fig. 10 The racemisation of (*R*)-tetrahydrofurfuryl acetate in benzene at 60 °C in the presence of TBHN (5 mol%) and various amounts of Ph₃SiSH: (∇) 20 mol%, (▼) 10 mol%, (■) 1.25 mol%, (○) 2.5 mol% and (●) 5 mol%.

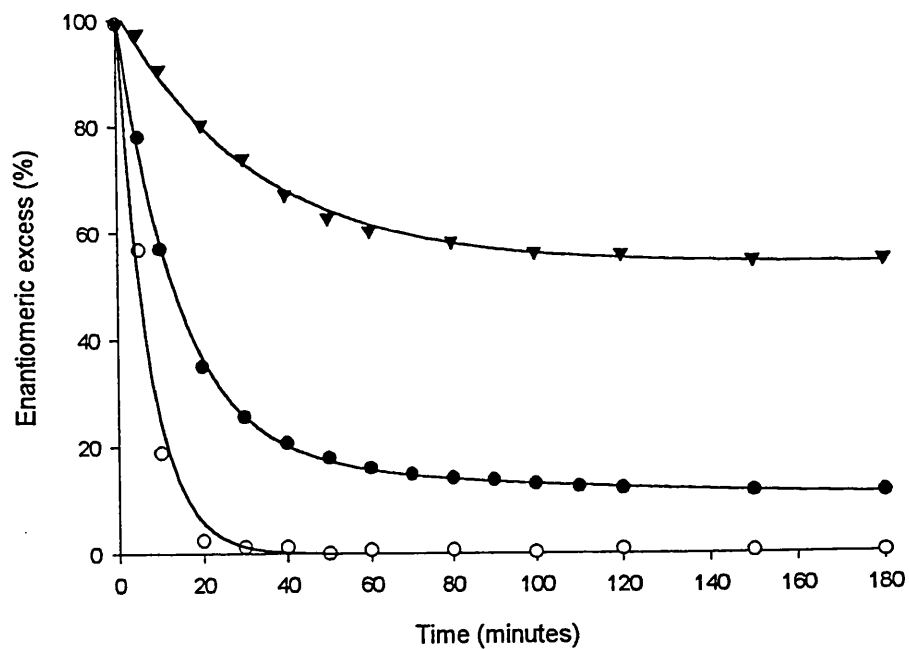

Fig. 11 The racemisation of (*R*)-tetrahydrofurfuryl acetate in benzene at 60 °C in the presence of Ph₃SiSH (5 mol%) and various amounts of TBHN: (▼) 2.5 mol%, (●) 5 mol% and (○) 10 mol%.

It can be concluded that the thermoneutral reaction shown in eqn. (60) is subject to polarity-reversal catalysis by appropriately substituted thiols. Provided that the possible protective effect of glutathione can be overcome (perhaps by reversible binding of the polarity-reversal catalyst to DNA), it may be possible to apply this principle to amplify radical-induced damage to DNA *in vivo*, especially in the oxygen-deficient environment present in many types of tumour cell.¹²⁸ Oxygen levels are critical because they affect the way that cancer responds to chemotherapy and radiotherapy — the lower the level of oxygen the harder the tumour is to destroy by conventional means.¹²⁸ Encouragingly, racemisation of (*R*)-**107** still takes place in the presence of both Ph₃SiSH (5 mol%) and *tert*-dodecanethiol (5 mol%), albeit at an initial rate about six times slower than that observed in the presence of the silanethiol alone.

These results will also have implications for the design of enantioselective radical-chain reactions based on the use of homochiral thiols as polarity-reversal catalysts,⁸⁰ when it is obviously important to *suppress* racemisation of the product.

3.2.2 2,5-Dimethyltetrahydrofuran

Commercial (Aldrich) hexane-2,5-diol, which is a mixture of diastereoisomers, was esterified with two molar equivalents of phthalic anhydride and the resulting hexane-2,5-diyl bis(hydrogen phthalate) was separated into *meso*- and *dl*-isomers, which have different melting points.¹²⁹ Saponification, followed by flash chromatography on silica gel, afforded *meso*- and *dl*-hexane-2,5-diol. The cyclisations of the diols were carried out by treatment with dilute (25%) aqueous sulphuric acid.¹²⁶ The *meso* diol afforded mainly *trans*-2,5-dimethyltetrahydrofuran and the *dl*-diol was converted

predominantly into *cis*-2,5-dimethyltetrahydrofuran. These results suggest that these stereoselective cyclisations proceed mainly by an intramolecular S_N2 substitution process with inversion of configuration at *one* chiral centre, *i.e.* at the asymmetric carbon [*e.g.* C(2), Scheme 19] containing the leaving group H₂O⁺. However, the purity

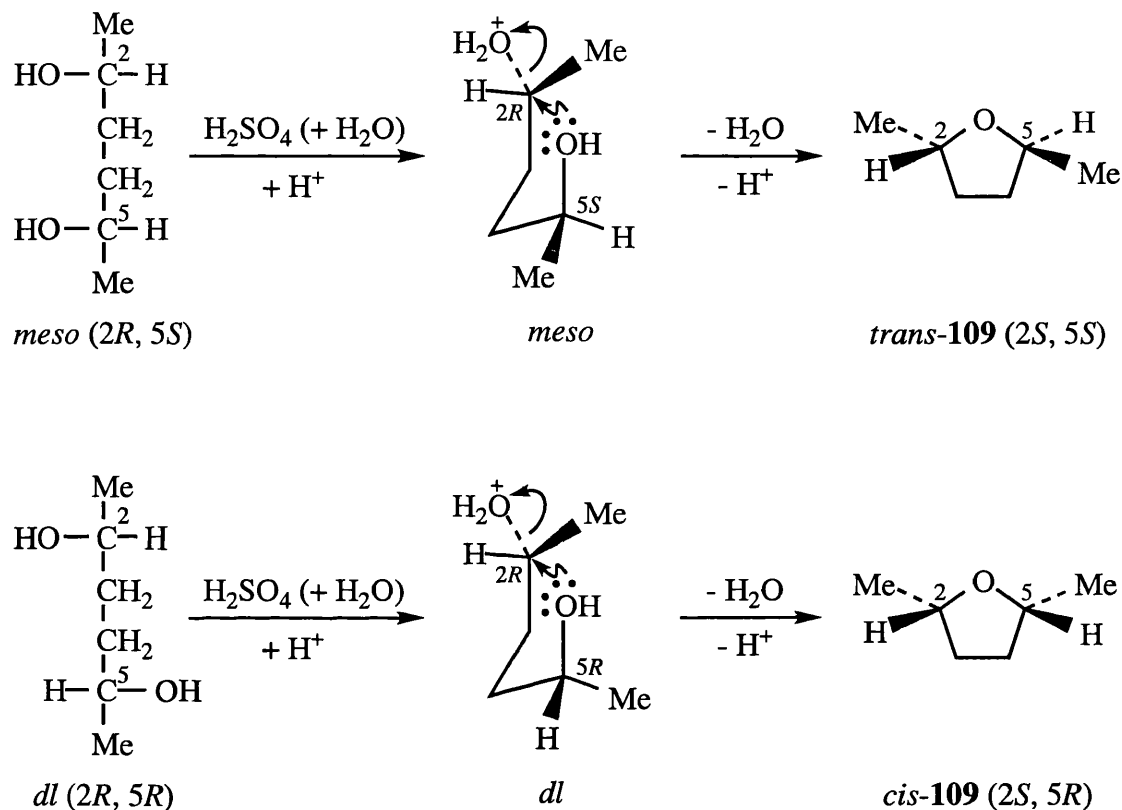

Scheme 19

achieved for *cis*-2,5-dimethyl tetrahydrofuran was 92.3% and for the *trans* compound 91.6%, as determined by GLC, which suggests that cyclisation of *ca.* 8% of each diol involves an S_N1 type mechanism *via* carbonium ions [*e.g.* at C(2), Scheme 19] as intermediates. This is in contrast to the results reported in the literature where it is stated that isomerically-pure 2,5-dimethyltetrahydrofurans are obtained under the same conditions.¹²⁶

The racemisation of *trans*- or *cis*-**109** was carried out at 60 °C and was initiated by thermal decomposition of TBHN ($t_{1/2} = ca. 55 \text{ min}$),^{93,94} which produces *tert*-butoxyl radicals that go on to abstract hydrogen from the dimethyl tetrahydrofuran and/or from the thiols to afford chain-carrying α -alkoxyalkyl radical **110** or thiyl radicals. The *cis* and *trans* products were formed according to Scheme 18 and they were determined by GLC using a capillary column (SGE BPX5, 25 m x 0.32 mm; 3.0 μm coating containing polysilphenylene-siloxane).

When a benzene solution containing *trans*-**109** (91.6% isomeric purity, 0.5 mol dm^{-3}), *tert*-amyl alcohol (0.3 mol dm^{-3} , as an internal standard for GLC analysis) and TBHN (0.025 mol dm^{-3}) was heated under argon for 2 h, examination of the reaction mixture by GLC showed that the ratio of *trans* to *cis* compound was unchanged. However, when the experiment was repeated in the presence of triphenylsilanethiol (0.025 mol dm^{-3} , 5 mol% based on the dimethyltetrahydrofuran), under otherwise identical conditions, the ratio of *trans*- to *cis*-2,5-dimethyltetrahydrofuran of the final reaction mixture was 41:59. The same ratio was obtained when *trans*-**109** was replaced with *cis*-**109** (92.3% purity) in the presence of Ph_3SiSH . Evidently, the overall reaction [eqn. (63)] of 2,5-dimethyltetrahydrofuran results in the equilibrium mixture at 60 °C, when the concentration ratio of *trans* to *cis* isomer is 41:59. The equilibrium constant K and the standard molar Gibbs energy change, ΔG_{333}° , are given by eqns. (64) and (65), respectively. Assuming the entropy difference between *cis* and *trans* isomers is negligible, the standard molar enthalpy change, ΔH_{333}° (*trans*-**109** \rightarrow *cis*-**109**), is *ca.* -1.01 kJ mol^{-1} . In contrast to the general assumption that *trans*-**109** has less steric interaction between the two methyl groups and is therefore relatively more stable, *cis*-**109** has lower

enthalpy and is slightly more stable than the *trans* isomer. It is possible that the two methyl groups preferentially occupy the *pseudo*-equatorial positions in *cis*-**109**, while one of the methyl groups occupy the *pseudo*-axial position, could be responsible for the higher energy of *trans*-**109**.

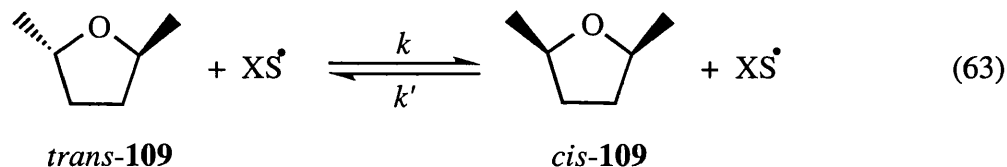

$$K = k/k' = [\text{cis-109}]/[\text{trans-109}] = 59/41 = 1.44 \quad (64)$$

$$\Delta G_{333}^\circ = \Delta H_{333}^\circ - T\Delta S_{333}^\circ = -RT \ln K \quad (65)$$

$$\Delta H_{333}^\circ \approx -RT \ln K = -8.314 \times 333 \times \ln 1.44 = -1.01 \text{ kJ mol}^{-1} \quad (66)$$

Similar epimerisation reactions were carried out with different thiols as catalysts and the results are shown in Fig. 12. Because of depletion of TBHN initiator and loss of thiol [eqns. (67) and (68)], the rate of epimerisation of *trans*- or *cis*-**109** decreases in the later stages of the radical-chain reaction. The rates of epimerisation show the tendency to increase with increasing the electronegativity of the group X in XSH, as found previously for the racemisation of (*R*)-tetrahydrofurfuryl acetate.



Thiol-catalysed epimerisation of 2,5-dimethyltetrahydrofuran **109** is much faster than racemisation of tetrahydrofurfuryl acetate, probably because the former is more reactive towards hydrogen-atom abstraction by thiyl radicals. An α -alkoxy substituent increases the rate of hydrogen abstraction from a C-H group by an electrophilic alkoxy or thiyl radical (EI $^{\bullet}$). This polar effect can be represented by inclusion of structure **112c** in a valence-bond description of the transition state (+R effect). However, a β -oxygen substituent exerts only an inductive electron-withdrawing

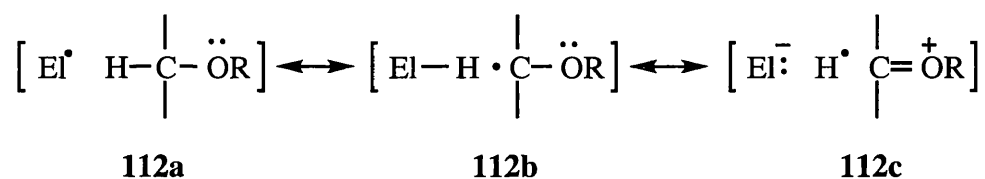

effect ($-I$ effect) on the transition state and, therefore, reduces the rate of abstraction of hydrogen from an ROCC(-H)OR group, such as is found in tetrahydrofurfuryl acetate, compared with 2,5-dimethyltetrahydrofuran which lacks the β -oxygen substituent. The rate constant of hydrogen-atom abstraction from 2,5-dimethyltetrahydrofuran **109** by *tert*-butoxyl radicals has been determined to be 7.5 times faster than that from tetrahydrofurfuryl acetate **107** at -30 °C (see later).

Triisopropylsilanethiol, which is a less effective catalyst for the racemisation of tetrahydrofurfuryl acetate, was found to be as efficient a catalyst as triphenylsilanethiol for the epimerisation of **109**. This suggests that hydrogen-atom abstraction by XS $^{\bullet}$ to form the radical **110** followed by hydrogen transfer from XSH to regenerate **109** is less subject to steric hindrance than the corresponding reaction of tetrahydrofurfuryl acetate.

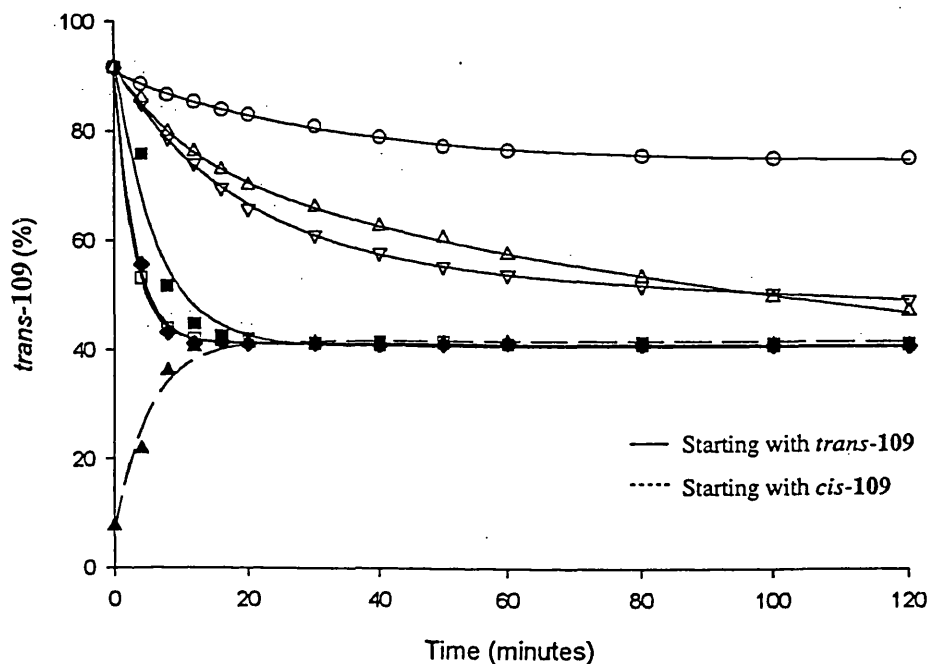
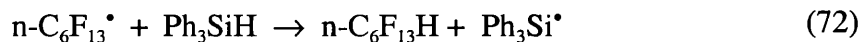
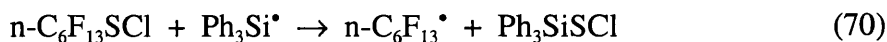
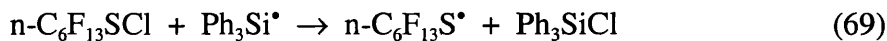
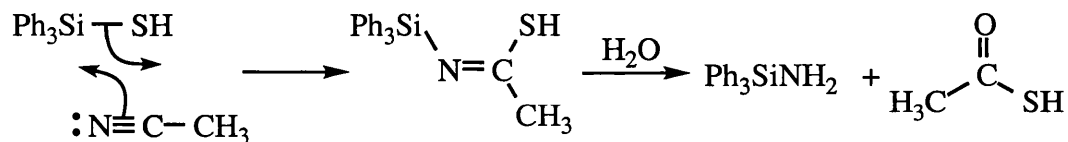

Fig. 12 The epimerisation of 2,5-dimethyltetrahydrofuran in benzene at 60 °C in the presence of various thiols (5 mol%): (O) *tert*-dodecanethiol, (Δ) thioglycerol, (∇) dodecane-1-thiol, (■) *n*-C₆F₁₃SH, (◆) 1-thiol-β-D-glucopyranose tetraacetate, (□) Pr₃SiSH and (▲) Ph₃SiSH (epimerisation of *cis*-109).

Perfluorohexanethiol (*n*-C₆F₁₃SH) was prepared and shown to be an efficient catalyst, presumably because of the strongly electron-withdrawing perfluoroalkanyl group attached to sulfur. The thiol was made from commercially-available perfluorohexanesulphenyl chloride (*n*-C₆F₁₃SCl) by radical-chain reduction with triphenylsilane at 60 °C [eqns. (69) and (71)].⁷⁸ A mixture of the thiol and 1*H*-perfluorohexane (*n*-C₆F₁₃H) was isolated, and the [thiol]:[fluoroalkane] ratio was *ca.* 2:1 according to the ¹H NMR spectroscopy. These results suggest that triphenylsilyl radicals react with the fluoroalkanesulphenyl chloride mainly by abstraction of chlorine and displacement to *n*-C₆F₁₃•; the latter process would yield triphenylsilanesulphenyl chloride [eqns. (70) and (72)].⁷⁸



Epimerisation in polar solvent such as acetonitrile (CH_3CN) was investigated. 1-Thiol- β -D-glucopyranose tetraacetate was found to be effective as catalyst for both the racemisation of (*R*)-**107** and the epimerisation of *trans*-**109** in either benzene or acetonitrile solvent (Fig. 11). Generally, it can be said that the radical-chain racemisation is not very sensitive to medium effects, because the interaction between non-charged radicals and solvent is relatively small. However, with triphenylsilanethiol as catalyst, the racemisation of (*R*)-**107** was totally inhibited and the initial rate of epimerisation of *trans*-**109** was decreased in acetonitrile. The epimerisation of *trans*-**109** becomes faster 20 minutes after the reaction began, which can probably be attributed to the decomposition of triphenylsilanethiol by acetonitrile and the generation of thiolacetic acid which acts as a less effective catalyst (see Scheme 20).



Scheme 20

Sodium mercaptoundecahydro-closo-dodecaborate ($\text{Na}_2\text{B}_{12}\text{H}_{11}\text{SH}$) was obtained from Centronic Ltd., and tested as polarity reversal catalyst. This compound has been

used in boron neutron capture therapy (BNCT) for brain cancer.¹³⁰ In BNCT, the boron atoms in tumor cells capture neutrons with an efficiency 3000 times greater than normal cells, and the resulting boron isotopes decay with the emission of a short-range alpha particle which causes an irreparable DNA damage leading to the death of cells. The shape of the $B_{12}H_{11}SH^{2-}$ ion is as follows: twelve B atoms are approximately at icosahedral positions, and a B-SH and eleven B-H bonds extend out from the centre of the icosahedron. With the π -electron-withdrawing borane group¹³¹ attached to sulfur, it was hoped that the thiol would act as an effective polarity-reversal catalyst. However, $Na_2B_{12}H_{11}SH$ was found to be totally ineffective in the epimerisation of *trans*-109 (Fig. 13). Perhaps acetonitrile is an unsuitable solvent for the radical-chain racemisation when boranethiol or silanethiol was used as catalysts.

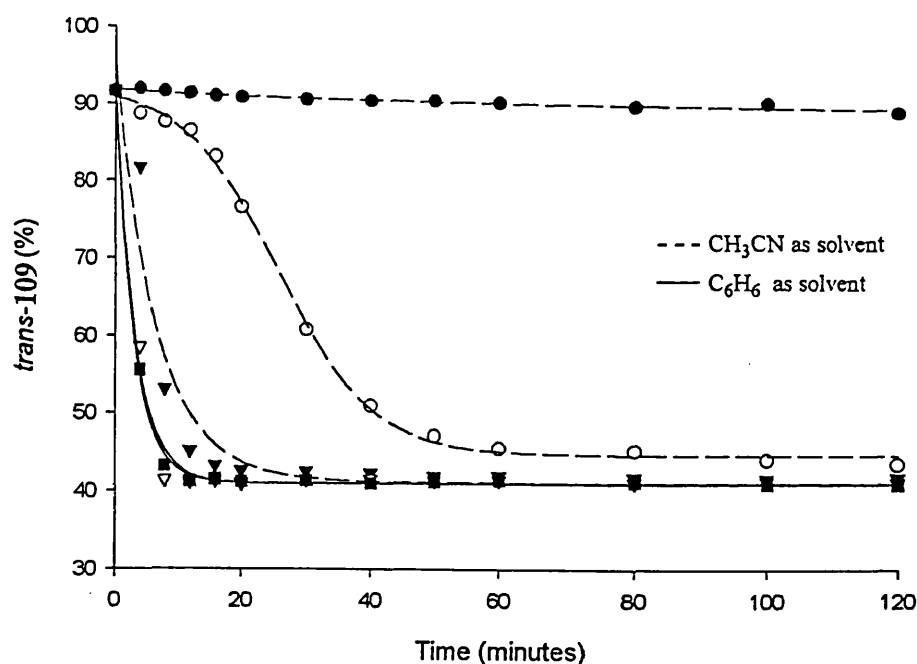
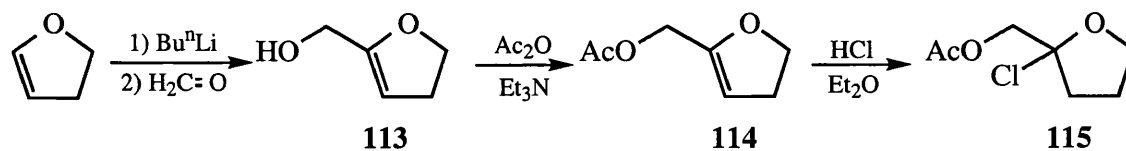

Fig. 13 The epimerisation of *trans*-2,5-dimethyltetrahydrofuran in benzene or acetonitrile at 60 °C in the presence of thiols (5 mol%): (●) $Na_2B_{12}H_{11}SH$, (○) Ph_3SiSH , (▼) 1-thiol- β -D-glucopyranose tetraacetate, (∇) Ph_3SiSH and (■) 1-thiol- β -D-glucopyranose tetraacetate.

3.2.3 EPR studies

EPR spectra were recorded during continuous UV irradiation of cyclopropane solutions containing di-*tert*-butyl peroxide (DTBP, *ca.* 20% v/v) and tetrahydrofurfuryl acetate **107** (*ca.* 1 mol dm⁻¹), while the sample was in the microwave cavity of the spectrometer, as described previously.¹⁰⁹ Photochemically-generated *tert*-butoxyl radicals abstract hydrogen from the acetate **107** to give the corresponding α -alkoxyalkyl radicals **108** and **111** [eqn. (62)],¹³² which were detected between 180 and 280 K by EPR spectroscopy. The EPR spectrum obtained at 270 K is shown in Fig. 14 and it can be analysed as a superimposition of the spectra of the α -alkoxyalkyl radicals **108** and **111** for which the spectroscopic parameters are given in Table 5.

Computer simulation showed that the value [108]:[111] is 42:58 under these conditions. The highly reactive *tert*-butoxyl radical abstracts hydrogen at comparable rates from the two carbon atoms adjacent to the ring-oxygen in **107**, while it is likely that thiyl radicals (especially the less bulky ones) will be more selective and give mainly **108**, by attack at the tertiary CH group, during the thiol-catalysed racemisation of **107**. In order to obtain a clean EPR spectrum and investigate conformation of the radical **108**, it was necessary to prepare 2-chlorotetrahydrofurfuryl acetate **115** as precursor.



Scheme 21

Table 5 EPR parameters for the radical **108** and **111** in cyclopropane solvent at 270 K

Radical ^a	<i>g</i> -Factor	Hyperfine splittings ^b /G
108	2.0030	6.52 (2H _β ^{exocyclic}), 26.14 (2H _β), 0.75 (2H _γ), 2.08 (2H _δ)
111	2.0032	13.50 (1H _α), 30.89 (1H _β), 25.26 (1H _β '), 0.75 (2H _γ), 2.25 (1H _δ)

^a Concentration ratio [108]:[111] = *ca.* 42:58. ^b Numbers of nuclei coupling shown in parentheses.

As described in Scheme 21, selective hydroxymethylation with *n*-butyl lithium and paraformaldehyde took place on the more reactive 5-position in 2,3-dihydrofuran to give 4,5-dihydrofurfuryl alcohol **113**¹³³ in 33% yield. This substance was used in the next step immediately after distillation, as it dimerised easily. Acetylation with acetic anhydride in the presence of triethylamine provided 4,5-dihydrofurfuryl acetate **114**. On treatment with hydrogen chloride (1.0 M in diethyl ether), **114** was converted to the target chloride **115**.

A sample containing DTBP (*ca.* 20% v/v), **115** (*ca.* 1 mol dm⁻³) and trimethylsilane (*ca.* 1.3 mol dm⁻³) in cyclopropane solvent was irradiated with UV light, while positioned in the microwave cavity of the EPR spectrometer. Photochemically generated *tert*-butoxyl radicals abstract hydrogen from the silane to give the trimethylsilyl radical, which abstracts chlorine from **115** to produce the α-alkoxyalkyl radical **108**, through the sequence of reactions (73)-(74). The EPR spectrum of the radical **108** is shown in Fig. 15, and its spectroscopic parameters are identical with that given in Table 5. Abstraction of chlorine by the silyl radical is evidently very rapid, because the EPR spectrum of Me₃Si• was not detected.

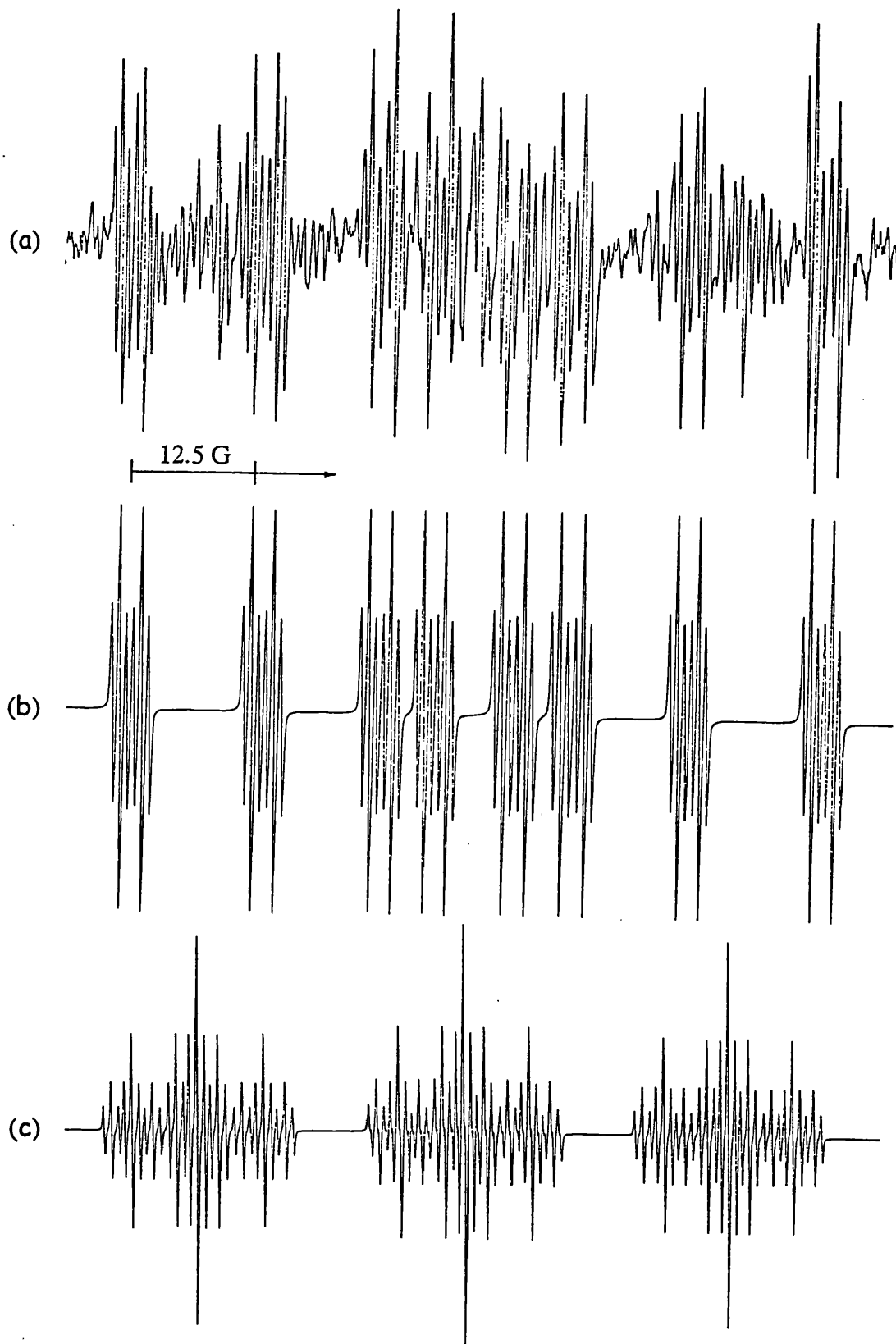

Fig. 14 (a) EPR spectra of **108** and **111**, derived from tetrahydrofurfuryl acetate **107** in cyclopropane at 270 K. (b) Computer simulation of the spectrum of **111** based on the parameters given in Table 5. (c) Computer simulation of the spectrum of **108** based on the parameters given in Table 5.

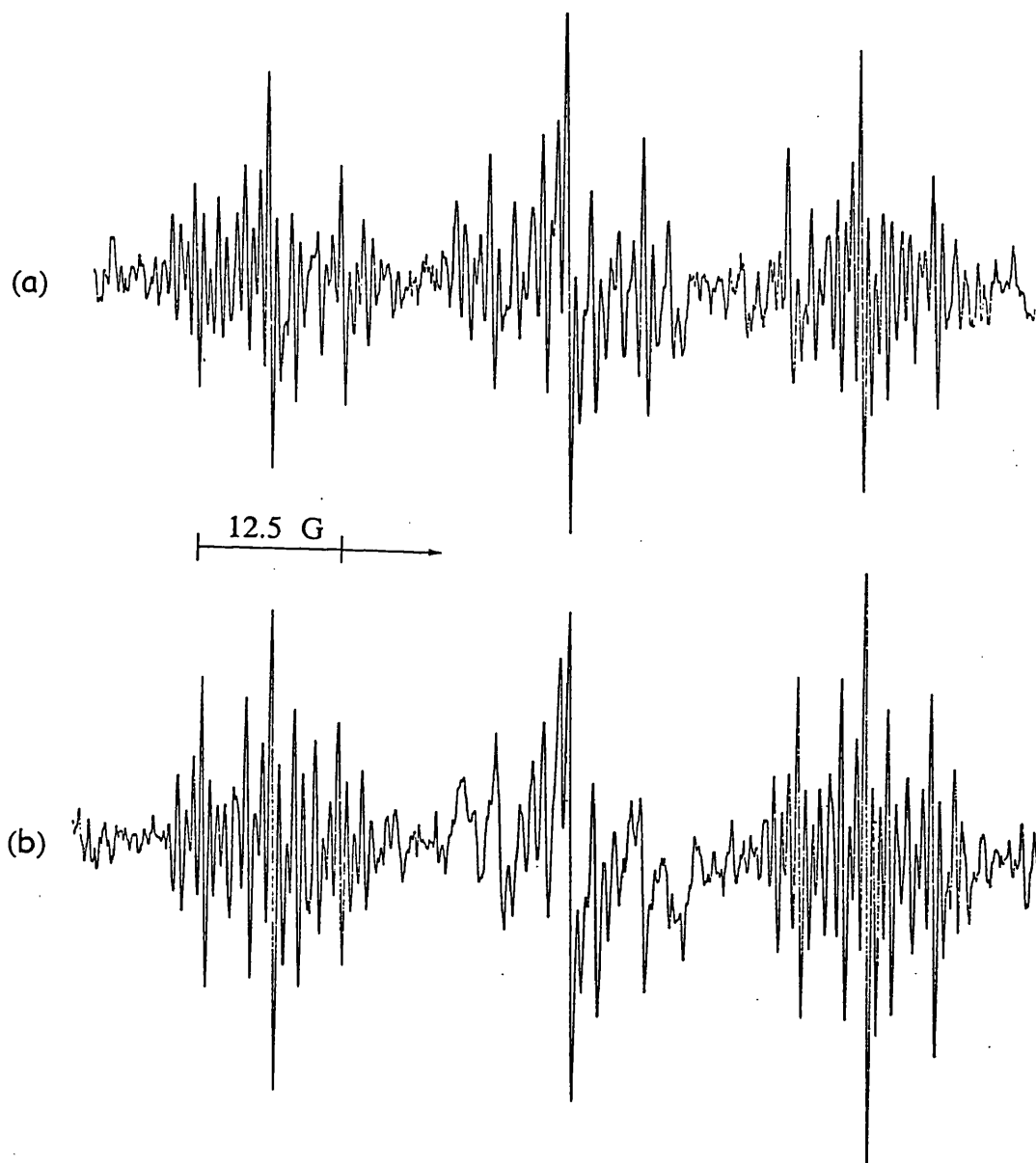
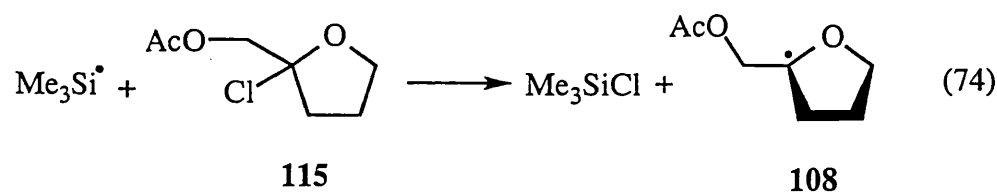
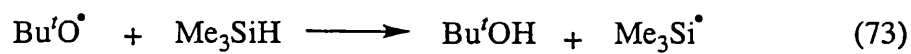

Fig 15 EPR spectra of **108** produced by chlorine-atom abstraction from **115** in cyclopropane at (a) 270 K and (b) 243 K.

The central line of the exocyclic β -proton triplet [$M_I(2H_\beta^{\text{exocyclic}}) = 0$] in the EPR spectrum of **108** at 243 K is broadened significantly relative to the lines corresponding to $M_I(2H_\beta^{\text{exocyclic}}) = \pm 1$ [see Fig. 15(b)]. As the temperature is increased above 243 K, the lines become of more equal width. The individual $\beta^{\text{exocyclic}}$ -proton splittings could not be determined, because spectra of adequate quality could not be obtained at sufficiently low temperature in the slow exchange region.

Hyperfine coupling between the unpaired electron and the exocyclic β -protons in **108** is a consequence of hyperconjugation and the magnitude of $a(H_\beta^{\text{exocyclic}})$ is approximated by the *Heller-McConnell* equation (75).^{115,116} Here θ is the dihedral angle between the exocyclic β -C-H bond and the axis of the C_α - $2p_\pi$ orbital, $\rho_{C_\alpha}^\pi$ is the unpaired-electron population in this orbital, and A and B are constants, the former of

$$a(H_\beta^{\text{exocyclic}}) = (A + B\cos^2\theta)\rho_{C_\alpha}^\pi \quad (75)$$

which is small and often neglected. With its time-averaged dihedral angles, the observed averaged value of $a(2H_\beta^{\text{exocyclic}})$ for the radical **108** will be proportional to $(\cos^2\theta_1 + \cos^2\theta_2)$, if A is neglected. Hence, $a(2H_\beta^{\text{exocyclic}})$ will be at a minimum when the dihedral angle between the exocyclic β -C-O bond and the C_α - $2p_\pi$ orbital $\phi = 0^\circ$ ($\theta_1 = \theta_2 = 60^\circ$, if $\theta_1 + \theta_2 = 120^\circ$), and this coupling constant will increase (because $\cos^2\theta_1 + \cos^2\theta_2$ increases) as ϕ increases with increasing temperature, as observed. In conjunction with evidence derived from the hyperfine splitting constants [$a(2H_\beta^{\text{exocyclic}}) = 6.52$ G, $a(2H_\beta) = 26.14$ G at 270 K] these results indicate that the radical **108** preferentially adopts the

conformation shown in **116**, in which the C_β -O bond eclipses the formal C_α - $2p_\pi$ SOMO.^{139,140}

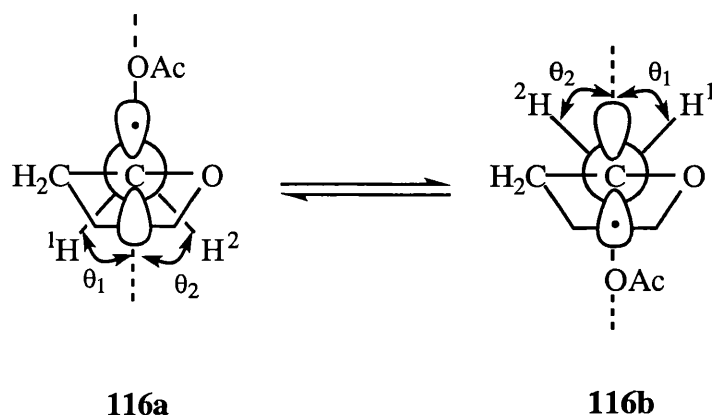

For carbon-centred radicals of the type **117**, the effects of replacing a β -hydrogen atom by another group on the conformation of the radicals are well understood for most types of substituents. For the radicals with a β -substituent such as Cl,¹⁴¹ MeS,¹⁴² or a silicon-, germanium-, or tin-containing substituent,¹⁴² the preference for the eclipsed conformation **118** results from a stabilising hyperconjugative interaction between the C_α - $2p_\pi$ SOMO and the β -C-X σ -bonding orbital. Radicals of the type $ROCH_2CH_2^\bullet$ have a



much larger value of $a(H_\beta)$, which suggests that the preferred conformation is of the type **119**.^{139,140} This is probably because β -C-H hyperconjugation is more stabilising than β -C-O hyperconjugation, and so the β -C-O bond is pushed into the nodal plane of the C_α - $2p_\pi$ orbital. The eclipsed conformation **116** for the radical **108** reflects an specific

interaction between the radical centre having an $+R$ α -alkoxy substituent and the exocyclic β -C-O bond which has an electron-withdrawing $-I$ effect. The dihedral angle between the exocyclic β -C-O bond and the axis of the half-filled C_{α} - $2p_{\pi}$ orbital tends to be 0° so as to maximise the interaction represented by the contribution of the ionic structure **120**. Furthermore, the contribution of the structure **120** is associated with deformation of the geometry of the β -carbon atom from tetrahedral towards nearly planar. This distortion could reduce hyperconjugation interaction between the exocyclic β -C-H bond and the unpaired electron, and so could account for the fact that $a(2H_{\beta}^{\text{exocyclic}})$ can fall below the minimum value expected on the basis of the *Heller-McConnell* equation (75).¹³⁹ Finally, it is notable that the barrier to rotation about the C_{α} - C_{β} bond increases as a consequence of the electronic interaction.¹⁴⁰ Evidently, although two-fold rotation about at the C_{α} - C_{β} bond is evidently sufficiently fast at 270 K to render the two faces of the ring magnetically-equivalent, the spectrum of **108** showed selective line-broadening below *ca.* 260 K, indicating that rotational exchange between the two enantiomeric conformations is no longer fast on the EPR time-scale.

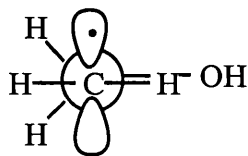
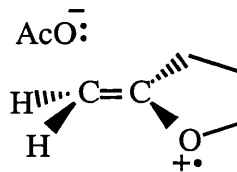
**119****120**

The absolute reactivity of the tertiary CH group in **107** towards hydrogen-atom abstraction by *tert*-butoxyl radicals was determined in the usual way^{109,134} by competitive reaction with tetrahydrofuran (THF) [eqn. (76b)], on the basis that (k_{108}/k_{121}) is given by eqn. (77). The Arrhenius rate expression for k_{121} has been determined previously by laser-flash photolysis¹³⁵ and is given by eqn. (78), where $\theta = 2.303 RT$ kJ mol⁻¹. Experiments were carried out at 243 K with the [THF]:[**107**] ratio equal to 0.337, 0.421 and 0.536. At a fixed temperature, k_{108}/k_{121} should be independent of the concentrations of the reagents, but the experiments were repeated with different amounts of **107** and THF in order to reduce experimental errors. The concentration ratio [**108**] : [**121**] was obtained by computer simulation of the EPR spectra and the value of k_{108}/k_{121} was found to be *ca.* 0.25 at 243 K. Combining eqns. (77) and (78) gives the rate constant k_{108} , which is *ca.* 6.9×10^5 dm³ mol⁻¹ s⁻¹.

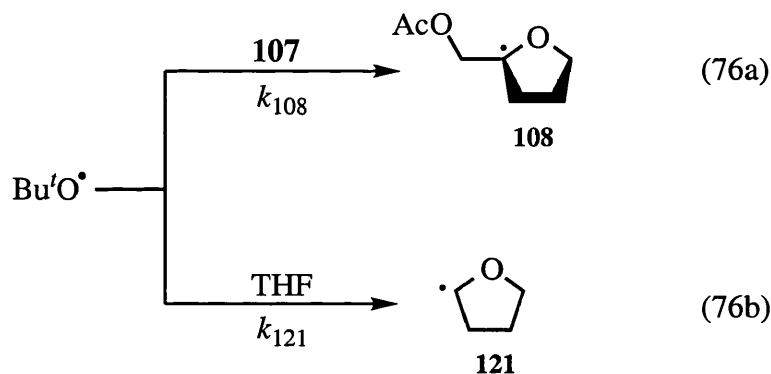

$$k_{108}/k_{121} = [\mathbf{108}][\text{THF}] / ([\mathbf{121}][\mathbf{107}]) \quad (77)$$

$$\log_{10}(k_{121} / \text{dm}^3 \text{ mol}^{-1} \text{ s}^{-1}) = (8.7 \pm 0.8) - (10.5 \pm 4.2) / \theta \quad (78)$$

3-2 Results and Discussion

The rate constant k_{110} for hydrogen-atom abstraction from 2,5-dimethyltetrahydrofuran **109** to give **110** was determined in similar experiments. Although THF is very reactive towards $\text{Bu}'\text{O}^\bullet$ ($k_{121} = 2.8 \times 10^6 \text{ dm}^3 \text{ mol}^{-1} \text{ s}^{-1}$ at 243 K), 2,5-dimethyltetrahydrofuran is even more reactive and (k_{110}/k_{121}) was found to be *ca.* 1.88, indicating that k_{110} is *ca.* $5.3 \times 10^6 \text{ dm}^3 \text{ mol}^{-1} \text{ s}^{-1}$ at this temperature. The difference between the rates of abstraction from the *cis* and *trans* diastereoisomers of **109** was found to be less than the experimental errors. These results also indicate that the rate of hydrogen-atom abstraction by *tert*-butoxyl radicals from the tertiary CH group in **109** was *ca.* 7.5 times faster than from that in tetrahydrofurfuryl acetate **107**, in accord with the expected deactivating effect of the β -AcO group in the latter.

3.3 Experimental

NMR spectra were recorded using a Varian VXR-400 instrument (400 MHz for ^1H). The solvent was CDCl_3 or C_6D_6 , and chemical shifts are reported relative to Me_4Si ; J values are quoted in Hz. Infra Red (IR) spectra were obtained with Perkin Elmer instrument series FT-IR 1600. Column chromatography and TLC were carried out using Merck Kieselgel 60 (230-400 mesh) and Kieselgel 60 F_{254} aluminium-backed pre-coated plates, respectively. A Hewlett-Packard HP 6890 instrument (flame ionisation detector) was used for GLC analytical work, with capillary columns; Supelco β -DEX120 (30 m x 0.25 mm) for the determination of enantiomeric excess and SGE BPX5 (25 m x 0.32 mm) for normal-phase work. The carrier gas was helium; the temperature was 95 °C for the chiral-stationary-phase GLC and 45 °C for the normal-stationary-phase GLC. All manipulations and reactions of air-sensitive compounds were carried out under an atmosphere of dry argon or nitrogen and all extracts were dried over anhydrous MgSO_4 . Petroleum refers to the fraction of bp 40-60 °C.

Materials

TBHN was prepared by the reaction of sodium hyponitrite with *tert*-butyl bromide in diethyl ether, in the presence of zinc chloride, using the method described by *Mendenhall* and coworkers (see section 2.3).^{93,94}

L-Cysteine ethyl ester was prepared from *L*-cysteine ethyl ester hydrochloride (98%, Aldrich). – A solution of *L*-cysteine ethyl ester hydrochloride (5.0 g, 0.027 mol) in water (30 cm^3) was mixed with saturated aqueous sodium hydrogen carbonate

solution (100 cm³). The mixture was then extracted with diethyl ether (4 x 50 cm³). The combined ether solution was washed with brine, dried and concentrated. The residue was distilled under reduced pressure to give a colourless oil (1.2 g, 30%); bp 110-112 °C/20 Torr (lit., ¹³⁸ 57 °C/0.2 Torr); δ_{H} 1.33 (3H, t, J 7.2, CH₃), 1.82 (3H, br s, SH and NH₂), 2.89 (2H, d, J 5.4, SCH₂), 3.68 (1H, t, J 5.4, CH), 4.22 (2H, q, J 7.2, OCH₂).

Perfluorohexane-1-thiol (n-C₆F₁₃SH)⁷⁸ was prepared from perfluorohexane-sulphenyl chloride (n-C₆F₁₃SCl; Fluorochem Ltd.). – A solution of triphenylsilane (1.21 g, 4.68 mmol), n-C₆F₁₃SCl (1.81 g, 4.68 mmol) and TBHN (0.407 g, 5 mol%) in dodecane (5 cm³) was stirred and heated at 60 °C under argon for 3 h. The mixture was then distilled under reduced pressure (0.1 Torr) at room temperature and the crude product was collected in a receiver trap cooled in a dry ice-acetone bath. Further purification by distillation at atmospheric pressure gave a yellow-coloured oil (1.12g); bp 74-76 °C; δ_{H} 6.06 (tt, J_{HF} 51.9 and 5.1) is assigned to 1*H*-perfluorohexane [CF₃(CF₂)₄CF₂H] and δ_{H} 3.37 (t, J_{HF} 15.7) to the thiol (n-C₆F₁₃SH). The [thiol]:[fluoroalkane] ratio was *ca.* 2:1.

Other thiols were obtained commercially (Aldrich, Lancaster or Centronic Ltd.) and were used without further purification.

Preparation of (*R*)-tetrahydrofurfuryl acetate 107

To a solution of commercial (Kiralchem Ltd.) (*R*)-tetrahydrofurfuryl alcohol $\{[\alpha]_{\text{D}}^{20} -2.3$ (neat, $d = 1.054$)¹²⁵ (1.63 g, 0.016 mol) in triethylamine (10 cm³) was added with stirring acetic anhydride (1.50 cm³, 0.016 mol). After stirring for 24 h at room temperature, the reaction mixture was concentrated under reduced pressure. The

residue was dissolved in diethyl ether (60 cm³) and the solution was washed with saturated brine (40 cm³), dried and evaporated. This crude product was then purified by distillation under reduced pressure to give **107**, as a colourless oil; bp 88-92 °C/20 Torr (lit.,¹²⁵ bp 90 °C/20 Torr); δ_{H} 1.52-1.70 (1H, m, 3-H), 1.84-2.08 (3H, m, 2- and 3-H), 2.10 (3H, s, Ac), 3.75-4.21 (5H, m, OCH₂ and OCH); δ_{C} 20.9, 25.6, 27.9, 66.6, 68.4, 76.5, 171.1; IR (cm⁻¹): 1720, 1240.

Preparation of *cis*- and *trans*-2,5-dimethyltetrahydrofuran **109**

***dl*- and *meso*-Hexane-2,5-diol.**¹²⁹ – A solution of the commercially-available mixture of *dl*- and *meso*-hexane-2,5-diol (42.0 g, 0.356 mol) and phthalic anhydride (105.5 g, 0.712 mol) in toluene (200 cm³) was stirred under reflux (bath 120 °C) for 18 h. When the reaction mixture was allowed to cool to room temperature, a large amount of white solid was precipitated. This crude hexane-2,5-diyl bis(hydrogen phthalate) was then isolated by filtration. The lower melting *meso*-isomer was removed by washing the filter cake thoroughly with boiling chloroform (12 x 50 cm³). The remaining solid was dried under reduced pressure at room temperature and recrystallised from methanol to give *dl*-hexane-2,5-diyl bis(hydrogen phthalate) (55.0g, 37%); mp 182-185 °C (lit.,¹²⁶ mp 184-185 °C); δ_{H} 1.38 (6H, d, *J* 6.2, 2 x CH₃), 1.69 (2H, m, CH₂), 1.95 (2H, m, CH₂), 5.09 (2H, m, 2 x CH), 7.62-7.98 (8H, m, Ph). The chloroform solution obtained as the filtrate was concentrated and *meso*-hexane-2,5-diyl bis(hydrogen phthalate) (42.0 g, 28%) was isolated by column chromatography on silica gel, using chloroform-methanol (90:10) as eluent; mp 160-163 °C (lit.,¹²⁶ mp 160-162 °C); δ_{H} 1.33 (6H, d, *J* 6.2, 2 x CH₃), 1.71 (2H, m, CH₂), 1.80 (2H, m, CH₂), 5.16 (2H, m, 2 x CH), 7.56-7.88 (8H, m, Ph).

The *dl*-ester (55.0 g, 0.13 mol) was saponified by heating it under reflux for 1.5 h with sodium hydroxide (26.0 g, 0.65 mol) in water (340 cm³). After the reaction mixture cooled to room temperature, *dl*-hexane-2,5-diol (9.2 g, 60%) was isolated by extraction with ethyl acetate, and this was further purified by column chromatography on silica gel, using chloroform-methanol (90:10) as eluent. δ_{H} 1.20 (6H, d, *J* 6.2, 2 x CH₃), 1.52 (4H, m, 2 x CH₂), 2.72 (2H, br s, OH), 3.80 (2H, m, 2 x CH); δ_{C} 23.8, 36.0, 68.4.

meso-Hexane-2,5-diol (7.0 g, 60 %) was prepared in a similar way from *meso*-hexane-2,5-diyl bis(hydrogen phthalate) (42.0 g, 0.099 mol). δ_{H} 1.18 (6H, d, *J* 6.2, 2 x CH₃), 1.55 (4H, m, 2 x CH₂), 2.68 (2H, br s, OH), 3.84 (2H, m, 2 x CH); δ_{C} 23.4, 34.9, 67.8.

***cis*-2,5-Dimethyltetrahydrofuran 109**¹²⁶ – A 50 cm³ round-bottomed flask was fitted with a short, but efficient, condenser set for distillation. The *dl*-diol (4.10 g, 0.035 mol) and 25% aqueous H₂SO₄ (35 cm³) were placed in the flask and the mixture was stirred magnetically and heated in an oil-bath at 110 °C-120 °C. The *cis*-2,5-dimethyltetrahydrofuran distilled over (up to 95 °C; usually in a temperature range of 60–95 °C). The distillate was dried (K₂CO₃) and further purified by distillation to give a colourless oil (2.61 g, 75%), which was shown by GLC to contain *cis*- and *trans*-2,5-dimethyl-tetrahydrofuran in the ratio 92.3:7.7. δ_{H} (for the *cis*-isomer) 1.24 (6H, d, *J* 6.2, 2 x CH₃), 1.46 (4H, m, CH₂), 1.96 (2H, m, CH₂), 3.93 (2H, 2 x CH); δ_{C} 21.5, 33.1, 75.3.

***trans*-2,5-Dimethyltetrahydrofuran 109**¹²⁶ was prepared in a similar way from *meso*-hexanediol. δ_{H} 1.24 (6H, d, *J* 6.2, 2 x CH₃), 1.47 (2H, m, CH₂), 2.05 (2H, m, CH₂), 4.12 (2H, 2 x CH); δ_{C} 21.4, 34.2, 74.4. This colourless oil contained *trans*- and *cis*-2,5-dimethyltetrahydrofuran in the ratio 91.6:8.4.

Typical procedure for radical-chain epimerisations

(*R*)-Tetrahydrofurfuryl acetate **107** (0.065 g, 0.59 mmol), methyl benzoate (44 μl , 0.35 mmol) and dry benzene (1.2 cm^3) was introduced to a dry, argon-filled 5 cm^3 two-necked round-bottomed flask containing a magnetic stirrer bar and fitted with a condenser, with argon flowing downwards through it. The side-arm was closed with a stopper and the flask was immersed in an oil bath pre-heated to 60 $^\circ\text{C}$. Triphenylsilanethiol [Ph_3SiSH , 8.6 mg, 5 mol%, based on (*R*)-**107**] and TBHN [5.1 mg, 5 mol%, based on (*R*)-**107**] were added to the mixture through the side arm, which was then closed with a rubber septum and the mixture was stirred under argon for 3 hour. Samples (10 μl) of the reaction mixture were removed through the septum with a syringe every ten minutes and transferred into a sample-tube, which contained 100 μl of hexane and was then immersed in an ice bath to stop the reaction. These samples were analysed by chiral-stationary-phase GLC. Other racemisation reactions were carried out in a similar way and the results are given in Fig. 9-13.

Preparation of 2-chlorotetrahydrofurfuryl acetate **115**

4,5-Dihydrofurfuryl alcohol 113.¹³³ – A solution of n-butyl lithium in hexane (1.6 M, 156.25 cm^3 , 0.25 mol) was added dropwise to a solution of 2,3-dihydrofuran (18.88 cm^3 , 0.25 mol) in dry THF (100 cm^3) over a period of 30 min under ice-water cooling. The mixture was then heated at 50 $^\circ\text{C}$ for 2 h, and then cooled to 0 $^\circ\text{C}$. A solution of paraformaldehyde (7.9 g, 0.25 mol) in dry THF (50 cm^3) was added slowly and the mixture was again heated at 50 $^\circ\text{C}$ for 2 h. The mixture was then cooled with an ice bath and water (200 cm^3) was added with stirring. The resulting mixture was

extracted with CH_2Cl_2 (8 x 50 cm³). The combined organic solutions were dried and concentrated under reduced pressure. Distillation of the residue gave **113** (8.29 g, 33%) as a colourless oil; bp 67-69 °C/5 Torr (lit.,¹³³ 66-67 °C/7 Torr); δ_{H} (C_6D_6): 1.91 (1H, br s, OH), 2.22 (2H, t, J 9.5, 4-H), 4.00 (2H, br s, CH_2OH), 4.05 (2H, t, J 9.5, 5-H), 4.68 (1H, m, 3-H); δ_{C} (C_6D_6): 30.0, 58.2, 70.2, 95.4, 158.3; IR (cm⁻¹) (liq. film): 3406.5, 2925.5, 1673.5.

4,5-Dihydrofurfuryl acetate 114. – Acetic anhydride (2.43 cm³, 0.0258 mol) was added dropwise to a stirred solution of the alcohol **113** (3.66 g, 0.0258 mol) in triethylamine (15 cm³) at 10-15 °C under ice-water cooling. After stirring for 24 h at room temperature, the mixture was concentrated under reduced pressure and the residue was dissolved in diethyl ether. The ether solution was washed with saturated brine, dried and evaporated. The crude product was then distilled under reduced pressure to give **114** (3.09g, 84%) as a colourless oil; bp 64-66 °C/4 Torr; δ_{H} (C_6D_6): 1.63 (3H, s, Ac), 2.15 (2H, t, J 9.5, 4-H), 3.98 (2H, t, J 9.5, 5-H), 4.59 (2H, s, CH_2OAc), 4.68 (1H, m, 3-H); δ_{C} (C_6D_6): 20.3, 30.1, 58.8, 70.2, 99.0, 153.9, 169.7; IR (cm⁻¹): 2957.3, 1745.5, 1674.3, 1241.8.

2-Chlorotetrahydrofurfuryl acetate 115. – A solution of hydrogen chloride in diethyl ether (Aldrich, 1.0 M, 3.06 cm³) was added dropwise to a solution of the above acetate **114** (0.44 g, 3.06 mmol) in diethyl ether (3 cm³) cooled with an ice bath. After stirring at 0 °C for 1 h, the mixture was concentrated under reduced pressure to give **115** as a colourless oil; δ_{H} (C_6D_6): 1.26 (1H, m, 4-H), 1.61 (3H, s, Ac), 1.65-1.82 (2H, m, 3- and 4-H), 2.09 (1H, m, 3-H), 3.54 (1H, m, 5-H), 3.86 (1H, m, 5-H), 4.48 (1H, d, J 11.8, CH_2OAc), 4.58 (1H, d, J 11.8, CH_2OAc); δ_{C} (C_6D_6): 20.1, 22.9, 39.5, 67.4, 68.6, 70.2,

169.3. This substance was used immediately for EPR spectroscopy after concentration, as it decomposed easily.

EPR spectroscopy

EPR spectra were recorded during continuous UV irradiation of samples positioned in a standard variable temperature insert in the microwave cavity of a Varian E-109 spectrometer operating at 9.1-9.4 GHz, as described previously (see chapter 2, section 2.3).¹⁰⁹ Cyclopropane (Union Carbide) and trimethylsilane (Lancaster) were used as received.

References

- 1 A. Villiers, *C. R. Acad. Sci.*, 1891, **112**, 536.
- 2 F. Schardinger, *Wien. Klin. Wochenschr.*, 1904, **17**, 207.
- 3 F. Schardinger, *Zentralbl. Bakteriол. Parasitenkd. Infektiouskr. Hyg. II*, 1911, **29**, 188.
- 4 M. L. Bender and M. Komiyama, '*Cyclodextrin Chemistry*', Springer-Verlag, New York: 1978; R. J. Clarke, J. H. Coates and S. F. Lincoln, *Advan. Carbohydr. Chem. Biochem.*, 1988, **46**, 205.
- 5 W. Saenger, *Angew. Chem. Int. Ed. Engl.*, 1980, **19**, 344.
- 6 G. Wenz, *Angew. Chem. Int. Ed. Engl.*, 1994, **33**, 803.
- 7 I. Tabushi, *Acc. Chem. Res.*, 1982, **15**, 66; R. Breslow, *Science*, 1982, **218**, 532.
- 8 S. Li and W. C. Purdy, *Chem. Rev.*, 1992, **92**, 1457; V. Schurij, *Angew. Chem. Int. Ed. Engl.*, 1990, **29**, 939.
- 9 F. Todu, *Topics in Current Chem.*, 1987, **140**, 43.
- 10 K. Takahashi and K. Hattori, *J. Incl. Phenom.*, 1994, **17**, 1.
- 11 J. Martinie, J. Michon and A. Rassat, *J. Am. Chem. Soc.*, 1975, **97**, 1818; Y. Kubozono, M. Ata, M. Aoyagi and Y. Goudo, *Chem. Phys. Lett.*, 1987, **137**, 467; Y. Kotake and E. G. Janzen, *J. Am. Chem. Soc.*, 1989, **111**, 7319, 5138, 2066; 1992, **114**, 2872; K. Kano, K. Mori, B. Uno, M. Goto and T. Kubota, *J. Am. Chem. Soc.*, 1990, **112**, 8645; J. L. Beckett, C. J. Hartzell, N. L. Eastman, T. Blake, and M. P. Eastman, *J. Org. Chem.*, 1992, **57**, 4173; M. Lucarini and B. P. Roberts, *J. Chem. Soc., Chem. Commun.*, 1996, 1577.
- 12 V. Ramamurthy, *Tetrahedron*, 1986, **42**, 5753.
- 13 U. H. Brinker, R. Buchkremer, M. Kolodziejczyk, R. Kupfer, M. Rosenberg, M. D.

- Poliks, M. Orlando and M. L. Gross, *Angew. Chem. Int. Ed. Engl.*, 1993, **32** 1344.
- 14 R. Breslow, *Acc. Chem. Res.*, 1995, **28**, 146.
- 15 H. Sakuraba, N. Inomata and Y. Tanaka, *J. Org. Chem.*, 1989, **54**, 3482.
- 16 A. L. J. Beckwith and W. B. Gara, *J. Am. Chem. Soc.*, 1969, **91**, 5689.
- 17 A. L. J. Beckwith and W. B. Gara, *J. Chem. Soc., Perkin Trans. 2*, 1975, 593.
- 18 A. L. J. Beckwith and W. B. Gara, *J. Chem. Soc., Perkin Trans. 2*, 1975, 795.
- 19 A. L. J. Beckwith, C. J. Easton, A. K. Serelis, *J. Chem. Soc., Chem. Commun.*, 1980, 482.
- 20 J. M. Berge and S. M. Roberts, *Synthesis*, 1979, 471.
- 21 J. E. Leibner and J. Jacobus, *J. Org. Chem.*, 1979, **44**, 449.
- 22 F. Hegarty, in *The Chemistry of Diazonium and Diazo Groups*, ed. S. Patai, Wiley, Chichester, 1978, ch. 12.
- 23 J. K. Kochi, *J. Am. Chem. Soc.*, 1956, **78**, 1228, 4815; 1957, **79**, 2942.
- 24 N. Kornblum, *Org. Reactions*, 1944, **2**, 262.
- 25 K. Fukunishi, T. Hira, H. Yamanaka, M. Nomura and S. Kojo, *J. Chem. Soc., Perkin Trans. 2*, 1985, 991.
- 26 K. Fukunishi, M. Shimode, R. Hisamune, M. Akita, M. Kuwabara, H. Yamanaka and M. Nomura, *Chem. Lett.*, 1991, 337.
- 27 B. D. Tiffany, *J. Am. Chem. Soc.*, 1948, **70**, 592.
- 28 A. W. Coleman, M. Munoz, *J. Phys. Org. Chem.*, 1993, **6**, 651.
- 29 D. Hurd and R. Dowbenko, *J. Am. Chem. Soc.*, 1958, **80**, 4711.
- 30 A. L. J. Beckwith and G. F. Meijs, *J. Org. Chem.*, 1987, **52**, 1922.
- 31 W. A. Waters, *J. Chem. Soc.*, 1937, 113.

- 32 A. Hantzsch, *Chem. Ber.*, 1895, **28**, 676.
- 33 K. S. Pitzer, *J. Am. Chem. Soc.*, 1948, **70**, 2140.
- 34 N. Kornblum, G. D. Cooper and J. E. Taylor, *J. Am. Chem. Soc.*, 1950, **72**, 3013.
- 35 V. I. Yudelevich, L. B. Sokolov and B. I. Ionin, *Russ. Chem. Rev. (Engl. Trans.)*, 1980, **49**, 46; E. E. Nifant'ev, R. K. Magdeeva, A. V. Dolidze, X. X. Ingorokva, L. O. Samkharadze, L. K. Vasyanina and A. R. Bekker, *J. Gen. Chem. USSR (Engl. Transl.)*, 1991, 83; C. J. Broan, E. Cole, K. J. Jankowski, D. Parker, K. Pulukkody, B. A. Boyce, N. R. A. Beeley, K. Millar and A. T. Millican, *Synthesis*, 1992, 63; A. L. J. Beckwith, *Aust. J. Chem.*, 1972, **25**, 1887.
- 36 N. Wiberg, *Angew. Chem. Int. Ed. Engl.*, 1968, **7**, 766.
- 37 R. W. Hoffmann, *Angew. Chem. Int. Ed. Engl.*, 1968, **7**, 754.
- 38 K. Kuwata and D. H. Geske, *J. Am. Chem. Soc.*, 1964, **86**, 2101.
- 39 L. J. Johnston, J. Lusztyk, D. D. M Wayner, A. N. Abeywickrema, A. L. J. Beckwith, J. C. Scaiano and K. U. Ingold, *J. Am. Chem. Soc.*, 1985, **107**, 4594; G. F. Meijs and A. L. J. Beckwith, *J. Am. Chem. Soc.*, 1986, **108**, 5890; A. N. Abeywickrema and A. L. J. Beckwith, *J. Chem. Soc., Chem. Commun.*, 1986, 464.
- 40 Landolt-Börnstein, *Radical Reaction Rates in Liquids*, group II, vol. 13, subvol. b, Springer-Verlag, Berlin, 1984.
- 41 K. C. Brown and M. P. Doyle, *J. Org. Chem.*, 1988, **53**, 3255; W. P. Norris, *Tetrahedron*, 1972, **28**, 1965; P. R. Hammond and R. H. Knipe, *J. Am. Chem. Soc.*, 1967, **89**, 6063.
- 42 A. Citterio, F. Minisci and E. Vismara, *J. Org. Chem.*, 1982, **47**, 81; A. L. J. Beckwith and R. O. C. Norman, *J. Chem. Soc., B*, 1969, 403.

- 43 I. Prass and B. P. Roberts, unpublished results.
- 44 I. Ojima, in *The Chemistry of Organic Silican Compounds*, eds. S. Patai and Z. Rappoport, Wiley, Chichester, 1989, part 2, ch. 25; T. Hiyama and T. Kusimoto, in *Comprehensive Organic Synthesis*, eds. B. M. Trost and I. Fleming, Pergamon, Oxford, 1991, vol. 8, ch. 3.12.
- 45 J. L. Speier, J. A. Webster and G. H. Barnes, *J. Am. Chem. Soc.*, 1957, **79**, 974.
- 46 E. Lukevics, Z. V. Belyakova, M. G. Pomeraniseva, M. G. Voroukov, *Organomet. Chem. Rev.*, 1977, **5**, 1; and references cited therein.
- 47 A. J. Chalk and J. F. Harrod, *J. Am. Chem. Soc.*, 1965, **87**, 16.
- 48 J. W. Ryan and J. L. Speier, *J. Am. Chem. Soc.*, 1964, **86**, 895.
- 49 L. A. Oro, M. J. Fernandez, M. A. Esteruelas and M. S. Jimenez, *J. Mol. Catal.*, 1986, **37**, 151.
- 50 T. G. Selin and R. West, *J. Am. Chem. Soc.*, 1962, **84**, 1863.
- 51 C. Eaborn, P. B. Hitchcock, D. J. Tune and D. R. M. Walton, *J. Organomet. Chem.*, 1973, **54**, C1.
- 52 L. H. Sommer, K. W. Michael and H. Fujimoto, *J. Am. Chem. Soc.*, 1967, **89**, 1519;
L. H. Sommer, J. E. Lyons and H. Fujimoto, *J. Am. Chem. Soc.*, 1969, **91**, 7051.
- 53 K. Tamao, T. Tanaka, T. Nakajima, R. Sumiya, H. Arai and Y. Ito, *Tetrahedron Lett.*, 1986, **27**, 3377.
- 54 S. H. Bergens, P. Noheda, J. Whelan and B. Bosnich, *J. Am. Chem. Soc.*, 1992, **114**, 2121.
- 55 K. Tamao, T. Nakajima, R. Sumiya, H. Arai, N. Higuchi and Y. Ito, *J. Am. Chem. Soc.*, 1986, **108**, 6090.

- 56 K. Tamao, T. Yamauchi and Y. Ito, *Chem. Lett.*, 1987, 171; K. Tamao, Y. Nakagawa, H. Arai, N. Higuchi and Y. Ito, *J. Am. Chem. Soc.*, 1988, **110**, 3712; K. Tamao, T. Nakagawa and Y. Ito, *Org. Synth.*, 1995, **73**, 94.
- 57 S. H. Bergens, P. Noheda, J. Whelan and B. Bosnich, *J. Am. Chem. Soc.*, 1992, **114**, 2128; X. Wang and B. Bosnich, *Organometallics*, 1994, **13**, 4131; X. Wang, W. W. Ellis and B. Bosnich, *J. Chem. Soc., Chem. Commun.*, 1996, 2561.
- 58 K. Tamao, T. Tohma, N. Inui, O. Nakayama and Y. Ito, *Tetrahedron Lett.*, 1990, **31**, 7333.
- 59 H. Fischer, in *Substituent Effects in Radical Chemistry*, H. G. Viehe, Z. Janousek and R. Merényi, Ed., Reidel, Dordrecht, 1986, NATO ASI Series C, vol. 189, p. 123.
- 60 A. L. J. Beckwith, in *Essays on Free Radical Chemistry*, ed. R. O. C. Norman, Chemical Society, London, 1970, 239.
- 61 K. N. Houk, M. N. Paddon-Row, D. C. Spellmeyer, N. G. Rondan and S. Nagase, *J. Org. Soc.*, 1986, **51**, 2874.
- 62 B. Giese, *Angew. Chem. Int. Ed. Engl.*, 1983, **22**, 753.
- 63 A. L. J. Beckwith, *Tetrahedron*, 1981, **37**, 3073.
- 64 A. L. J. Beckwith and C. H. Schiesser, *Tetrahedron*, 1985, **41**, 3925.
- 65 A. L. J. Beckwith, C. J. Easton, T. Lawrence and A. K. Serelis, *Aust. J. Chem.*, 1983, **36**, 545.
- 66 C. P. Jasperse, D. P. Curran and T. L. Fevig, *Chem. Rev.*, 1991, **91**, 1237.
- 67 C. Chatgililoglu, *Chem. Rev.*, 1995, **95**, 1229.
- 68 H. Sakurai, in *Free Radicals*, ed. J. K. Kochi, Wiley: New York, 1973, **2**, 741-808.
- 69 A. L. J. Beckwith, C. J. Easton and A. K. J. Serelis, *J. Chem. Soc., Chem. Commun.*,

- 1980, 482.
- 70 C. Chatgililoglu, H. Woynar, K. U. Ingold and A. G. Davies, *J. Chem. Soc., Perkin Trans. 2*, 1983, 555.
- 71 T. J. Barton and A. Revis, *J. Am. Chem. Soc.*, 1984, **106**, 3802.
- 72 (a) C. Walling, '*Free Radicals in Solution*', John Wiley & Sons, Inc., New York, 1957; (b) S. S. Kim, S. Y. Choi and C. H. Kang, *J. Am. Chem. Soc.*, 1985, **107**, 4234.
- 73 V. Paul, B. P. Roberts and C. R. Willis, *J. Chem. Soc., Perkin Trans. 2*, 1989, 1953.
- 74 B. P. Roberts and A. J. Steel, *J. Chem. Soc., Perkin Trans. 2*, 1994, 2155; B. P. Roberts, *J. Chem. Soc., Perkin Trans. 2*, 1996, 2719.
- 75 P. Kaushal, P. L. H. Mok and B. P. Roberts, *J. Chem. Soc., Perkin Trans. 2*, 1990, 1663.
- 76 H.-S. Dang and B. P. Roberts, *J. Chem. Soc., Chem. Commun.*, 1996, 2201; *J. Chem. Soc., Perkin Trans. 1*, 1998, 67.
- 77 '*CRC Handbook of Chemistry and Physics*', ed. D. R. Lide, 78th edn., CRC Press, Boca Raton, 1997.
- 78 S. J. Cole, J. N. Kirwan, B. P. Roberts and C. R. Willis, *J. Chem. Soc., Perkin Trans. 1*, 1991, 103.
- 79 H.-S. Dang and B. P. Roberts, *Tetrahedron Lett.*, 1995, **36**, 2875.
- 80 M. B. Haque and B. P. Roberts, *Tetrahedron Lett.*, 1996, **37**, 9123; M. B. Haque, B. P. Roberts and D. A. Tocher, *J. Chem. Soc., Perkin Trans. 1*, 1998, 2881.
- 81 J. Y. Corey and R. West, *J. Am. Chem. Soc.*, 1963, **85**, 2430.
- 82 M. R. Ashcroft, A. Bury, C. J. Cooksey and A. G. Davies, B. D. Gupta, M. D. Johnson and H. Morris, *J. Organomet. Chem.*, 1980, **195**, 89.

- 83 D. G. H. Crout and S. M. Morrey, *J. Chem. Soc., Perkin Trans. 1*, 1983, 2435.
- 84 R. August, I. McEwen and R. Taylor, *J. Chem. Soc., Perkin Trans. 2*, 1987, 1683.
- 85 B. Accot and A. L. J. Beckwith, *Aust. J. Chem.*, 1964, **17**, 1342.
- 86 N. C. Yang, D.-D. H. Yang and C. B. Ross, *J. Am. Chem. Soc.*, 1959, **81**, 133.
- 87 R. A. Schneider and J. Meinwald, *J. Am. Chem. Soc.*, 1967, **89**, 2023.
- 88 M. Boeykens, N. D. Kimpe and K. A. Tehrani, *J. Org. Chem.*, 1994, **59**, 6973.
- 89 F. Sondheimer and R. Mechoulam, *J. Am. Chem. Soc.*, 1957, **79**, 5029.
- 90 C. Chatgililoglu, J. C. Scaiano and K. U. Ingold, *Organometallics*, 1982, **1**, 466.
- 91 R. E. Berkley, I. Safarik, H. E. Gunning and O. P. Strausz, *J. Phys. Chem.*, 1973, **77**, 1734; J. A. Rice, J. J. Treacy and H. W. Sidebottom, *Int. J. Chem. Kinet.*, 1984, **16**, 1505; R. Aloni, L. A. Rajbenbach and A. Horowitz, *Int. J. Chem. Kinet.*, 1981, **13**, 23; J. A. Kerr, A. Stephens and A. Young, *Int. J. Chem. Kinet.*, 1969, **1**, 371.
- 92 Y. Cai and B. P. Roberts, *J. Chem. Soc., Perkin Trans. 1*, 1998, 467 (corrigendum, 1998, 3653).
- 93 G. D. Mendenhall, *Tetrahedron Lett.*, 1983, **24**, 451; H.-T. E. Chen and G. D. Mendenhall, *J. Am. Chem. Soc.*, 1984, **106**, 6375; G. D. Mendenhall and H.-T. E. Chen, *J. Phys. Chem.*, 1985, **89**, 2849.
- 94 H. Kiefer and T. G. Traylor, *Tetrahedron Lett.*, 1966, 6161.
- 95 D. L. J. Clive and W. Yang, *Chem. Commun.*, 1996, 1605; D. L. J. Clive and M. Cantin, *J. Chem. Soc., Chem. Commun.*, 1995, 319
- 96 E. I. Miranda, M. J. Diaz, I. Rosado and J. A. Soderquist, *Tetrahedron Lett.*, 1994, **35**, 3221.
- 97 V. Paul and B. P. Roberts, *J. Chem. Soc., Chem. Commun.*, 1987, 1322; V. Paul and

- B. P. Roberts, *J. Chem. Soc., Perkin Trans. 2*, 1988, 1183; H.-S. Dang and B. P. Roberts, *J. Chem. Soc., Perkin Trans. 1*, 1993, 891; H.-S. Dang, V. Diart, B. P. Roberts and D. A. Tocher, *J. Chem. Soc., Perkin Trans. 2*, 1994, 1039; R. P. Allen, B. P. Roberts and C. R. Willis, *J. Chem. Soc., Chem. Commun.*, 1989, 1387 and references cited therein.
- 98 J. P. Sarasa, J. Igual and J. M. Pobleto, *J. Chem. Soc., Perkin Trans. 2*, 1986, 861.
- 99 K. Mochida and K. Asami, *J. Organomet. Chem.*, 1982, **232**, 13.
- 100 A. L. J. Beckwith and K. U. Ingold, in *Rearrangements in Ground and Excited States*, ed. P. de Mayo, Academic Press, New York, 1980, vol.1, essay no. 4.
- 101 T. V. RajanBabu, *Acc. Chem. Res.*, 1991, **24**, 139.
- 102 C. Walling and W. Helmreich, *J. Am. Chem. Soc.*, 1959, **81**, 1144.
- 103 W. Damm, B. Giese, J. Hartung, T. Hasskeri, K. N. Houk, O. Hüter and H. Zipse, *J. Am. Chem. Soc.*, 1992, **114**, 4067.
- 104 K. J. Kulicke and B. Giese, *Synlett.*, 1990, 91; M. Ballestri, C. Chatgililoglu, K. B. Clark, D. Griller, B. Giese and B. Kopping, *J. Org. Chem.*, 1991, **56**, 678; B. Kopping, C. Chatgililoglu, M. Zehnder and B. Giese, *J. Org. Chem.*, 1992, **57**, 3994; C. Chatgililoglu, *Acc. Chem. Res.*, 1992, **25**, 188.
- 105 A. S. Dneprovski, B. Z. Pertsikov and V. A. Chertkov, *Russ. J. Org. Chem.*, 1987, **23**, 291.
- 106 J. Fossey, D. Lefort and J. Sorba, *Top. Curr. Chem.*, 1993, **164**, 99.
- 107 Y. Guindon, C. Yoakim, V. Gorys, W. W Ogilvie, D. Delorme, J. Renaud, G. Robinson, J.-F. Lavallée, A. Slassi, G. Jung, J. Rancourt, K. Durkin and D. Liotta, *J. Org. Chem.*, 1994, **59**, 1166.

- 108 P. L. H. Mok, B. P. Roberts, and P. T. McKetty, *J. Chem. Soc., Perkin Trans. 2*, 1993, 665.
- 109 (a) J. A. Baban and B. P. Roberts, *J. Chem. Soc., Perkin Trans.2*, 1981, 161; (b) V. Diart and B. P. Roberts, *J. Chem. Soc., Perkin Trans.2*, 1992, 1761; (c) B. P. Roberts and A. J. Steel, *J. Chem. Soc., Perkin Trans.2*, 1992, 2025 (corrigendum, 1993, 1003).
- 110 D. Griller and B. P. Roberts, *J. Chem. Soc., Perkin Trans.2*, 1972, 747; D. Griller and K. U. Ingold, *Acc. Chem. Res.*, 1980, **13**, 317.
- 111 C. Chatgililoglu, K. U. Ingold and J. C. Scaiano, *J. Am. Chem. Soc.*, 1981, **103**, 7739.
- 112 J. K. S. Wan and A. J. Elliot, *Acc. Chem. Res.*, 1980, **10**, 161; P. J. Hore, C. G. Joslin and K. A. McLauchlan, *Chem. Soc. Rev.*, 1979, **8**, 29; M. Anpo, K. U. Ingold and J. K. S. Wan, *J. Phys. Chem.*, 1983, **87**, 1674.
- 113 G. Rauhut, A. Alex, J. Chandrasehar, T. Steinke, W. Sauer, B. Beck, M. Hutter and T. Clark, VAMP ver. 5.6.0, Erlangen, 1995.
- 114 S. F. Nelsen, *J. Chem. Soc., Perkin Trans.2*, 1988, 1005.
- 115 C. Heller and H. M. McConnell, *J. Chem. Phys.*, 1960, **32**, 1535.
- 116 B. P. Roberts and A. J. Steel, *J. Chem. Soc., Perkin Trans.2*, 1994, 2411.
- 117 A. Alberti and G. F. Pedulli, *Rev. Chem. Intermed.*, 1987, **8**, 207; I. G. Green, K. M. Johnson and B. P. Roberts, *J. Chem. Soc., Perkin Trans.2*, 1989, 1963; M. Guerra, *J. Am. Chem. Soc.*, 1992, **114**, 2077.
- 118 I. H. Golberg, *Acc. Chem. Res.*, 1991, **24**, 191.
- 119 K. C. Nicolaou and W.-M. Dai, *Angew. Chem. Int. Ed. Engl.*, 1991, **30**, 1387.

- 120 J. Stubbe and J. W. Kozarich, *Chem. Rev.*, 1987, **87**, 1107.
- 121 H. R. Drew, R. M. Wing, T. Takano, C. Broka, S. Tanaka, K. Itakura and R. E. Dickerson, *Proc. Natl. Aca. Sci. U.S.A.*, 1981, **78(4)**, 2179.
- 122 L. Pardo, J. T. Banfelder and R. Osman, *J. Am. Chem. Soc.*, 1992, **114**, 2382.
- 123 K. Miaskiewicz and R. Osman, *J. Am. Chem. Soc.*, 1994, **116**, 232.
- 124 For recent relative papers, see B. Giese, X. Beyrich-Graf, P. Erdmann, M. Petretta and U. Schwitter, *Chem. Biol.*, 1995, **2**, 367; A. Gugger, R. Batra, P. Rzadek, G. Rist and B. Giese, *J. Am. Chem. Soc.*, 1997, **119**, 8740, B. Giese, A. Dussy, E. Meggers, M. Petretta and U. Schwitter, *J. Am. Chem. Soc.*, 1997, **119**, 11130; S. Peukert, R. Batra and B. Giese, *Tetrahedron Lett.*, 1997, **38**, 3507; D. Crich and X.-S. Mo, *Tetrahedron Lett.*, 1997, **38**, 8169; D. Crich and Q. Yao, *Tetrahedron*, 1998, **54**, 305.
- 125 M. P. Balfe, M. Irwin and J. Kenyon, *J. Chem. Soc.*, 1941, 312.
- 126 M. Lj. Mihailovic, S. Gojkovic and Z. Cekovic, *J. Chem. Soc., Perkin Trans. 1*, 1972, 2460.
- 127 P. C. Jocelyn, *Biochemistry of the SH Group*, New York: Academic Press, 1972, pp. 261, 323.
- 128 S. Rockwell, *Oncol. Res.*, 1997, **9**, 383.
- 129 R. M. Dodson and V. C. Nelson, *J. Org. Chem.*, 1968, **33**, 3966.
- 130 Anonymous, *Chemistry in Britain*, 1998, **34**, Issue 5, p.18; M. F. Hawthorne, *Angew. Chem. Int. Ed. Engl.*, 1993, **32**, 950.
- 131 M. T. Ashby and N. A. Sheshtawy, *Organometallics*, 1994, **13**, 236.
- 132 Y. Cai and B. P. Roberts, *J. Chem. Soc., Chem. Commun.*, 1998, 1145 (corrigendum,

1998, 1607.

- 133 H. Miyazaki, N. Nakamura, T. Ito, T. Sada, T. Oshima and H. Koike, *Chem Pharm. Bull.*, 1989, **37** (9), 2391.
- 134 P. E. Elford and B. P. Roberts, *J. Chem. Soc., Perkin Trans. 2*, 1996, 2247; 1998, 1413.
- 135 V. Malatesta and J. C. Scaiano, *J. Org. Chem.*, 1982, **47**, 1455.
- 136 P. A. Risbood, T. S. Phillips and L. Goodman, *Carbohydrate Res.*, 1981, **94**, 101; M. Spescha, *Helv. Chim. Acta.*, 1993, **76**, 1822.
- 137 P. J. Krusic, QCPE no. 210.
- 138 W. Enz and M. Cecchinato, *Helv. Chim. Acta.*, 1961, **44**, 706.
- 139 A. J. Dobbs, B. C. Gilbert and R. O. C. Norman, *J. Chem. Soc., Perkin Trans. 2*, 1972, 786.
- 140 B. C. Gilbert, M. Trenwith and A. J. Dobbs, *J. Chem. Soc., Perkin Trans. 2*, 1974, 1772.
- 141 A. J. Bowles, A. Hudson and R. A. Jackson, *Chem. Phys. Letters*, 1970, **5**, 552.
- 142 P. J. Krusic and J. K. Kochi, *J. Am. Chem. Soc.*, 1971, **93**, 846.