

## M.TECH PROJECT REPORT

---

# PERFORMANCE ANALYSIS OF AMPLIFY AND FORWARD BASED COOPERATIVE DIVERSITY WITH MULTIPLE TRANSMIT ANTENNAS

---

*By*  
P.HARISH BABU  
(EE10M05)

*Adviser:*  
Dr. G.V.V.SHARMA  
DEPARTMENT OF ELECTRICAL ENGINEERING



INDIAN INSTITUTE OF TECHNOLOGY HYDERABAD

---

Ordinance Factory Estate , Yeddumailaram, Medak-502205.

## Declaration

I declare that this written submission represents my ideas in my own words, and where ideas or words of others have been included, I have adequately cited and referenced the original sources. I also declare that I have adhered to all principles of academic honesty and integrity and have not misrepresented or fabricated or falsified any idea/data/fact/source in my submission. I understand that any violation of the above will be a cause for disciplinary action by the Institute and can also evoke penal action from the sources that have thus not been properly cited, or from whom proper permission has not been taken when needed.

H. S. P.

(Signature)

P. Harish babu

(P. Harish Babu)

EE10M105

(Roll No.)

## Approval Sheet

This Thesis entitled Performance Analysis Of Amplify And Forward Based Co-operative Diversity With Multiple Transmit Antennas by P.Harish Babu is approved for the degree of Master of Technology from IIT Hyderabad



(Dr. Zafar Ali Khan) Examiner  
Dept. of Elec Eng  
IITH



(Dr. Kiran Kuchi) Examiner  
Dept. of Elec Eng  
IITH

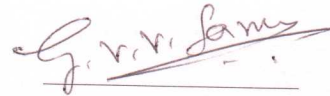

(Dr. G.V.V.Sharma) Adviser  
Dept. of Elec Eng  
IITH

## **ACKNOWLEDGEMENTS**

My deepest gratitude is to my advisor, Dr.G .V .V .Sharma . I have been amazingly fortunate to have an advisor who gave me the freedom to explore on my own, and at the same time the guidance to recover when my steps faltered.His patience and support helped me to finish this dissertation.

I would like to thank my family and friends and the one above all of us, the omnipresent God for the support they provided

A very special thanks to Kumar Sharma and G.Pranneth varma for their discussions throughout the project.

Finally I would like to thank family of IITH

## **DEDICATION**

To the four pillars of my life: God, my family,my friends and my teachers.

## Abstract

In today's world, wireless communication has a tremendous impact on the human civilization. There has been a sea change in modern day living and the credit goes to the development in wireless communication technology. But wireless communication is highly challenging due to complex, time-varying propagation medium which causes multi-path fading, co-channel interferences, cross talk, etc.. Diversity techniques are widely used in wireless communication to mitigate these effects.

MIMO technology used for getting diversity techniques. MIMO (multiple input, multiple output) is an antenna technology for wireless communications in which multiple antennas are used at both for transmission and reception. The antennas at each end of the communications circuit are combined to minimize errors and optimize data speed. It increases the capacity of the wireless channel. Recently a new class of methods called cooperative communication are using in wireless communication. In cooperative communication relays are used to achieve diversity. The main relaying strategies used in cooperative communications are Amplify and Forward (AF), Decode and Forward.

In this project we use AF method for performance analysis of cooperative diversity. In recent times in cooperative communication we have only two transmitted antennas at source. In this work we have taken four and eight transmitted antennas at source and each of the  $n$  relays has multiple antennas. We used Space time block codes (STBC) for real signals at source and we used quasi orthogonal STBC for complex signals. And we compared the performance analysis of AF based cooperative diversity for multiple transmitted antennas. Theoretical results are obtained from Moment generating function of multi hop relay.

# Contents

<b>1</b>	<b>Introduction</b>	<b>5</b>
1.1	Fading . . . . .	6
1.2	Rayleigh fading . . . . .	6
1.3	Diversity Technique . . . . .	6
1.4	MIMO . . . . .	7
1.4.1	Present Standards with MIMO . . . . .	8
1.5	Cooperative diversity . . . . .	9
1.6	Amplify and forward . . . . .	10
1.7	Space time block codes . . . . .	10
<b>2</b>	<b>System model and Receiver design</b>	<b>12</b>
2.1	General model . . . . .	12
2.2	Detection rule for $M_s = 2, M_r = 2, M_d = 1$ for Real signals .	14
2.3	Detection rule for $M_s = 4, M_r = 2, M_d = 1$ for Real signals .	16
2.4	Detection rule for $M_s = 8, M_r = 2, M_d = 1$ for Real signals .	19
2.5	Detection rule for $M_s = 4, M_r = 2, M_d = 1$ for complex signals	23
2.6	Detection rule for $M_s = 8, M_r = 2, M_d = 1$ for complex signals	25
<b>3</b>	<b>Theoretical Bit Error Rate Performance analysis</b>	<b>28</b>
3.1	Expression for Bit Error Rate in M-PSK . . . . .	29
3.2	Expression for Bit Error Rate in M-QAM . . . . .	30
3.3	RESULTS . . . . .	31
<b>4</b>	<b>Conclusion and Future work</b>	<b>35</b>

# Chapter 1

## Introduction

In the last two decades, the rapid growth in radio technology has activated a communications revolution. In today's world, wireless communication has a tremendous impact on the human civilization. There has been a sea change in modern day living and the credit goes to the development in wireless communication technology. Wireless systems have been deployed through the world to help people and machines to communicate with each other independent of their location. Wireless communication is highly challenging due to the complex, time-varying propagation medium. If we have only one transmitter and one receiver in a wireless system, the transmitted signal that is sent into the wireless environment arrives at the receiver along a number of diverse paths, referred to as multi paths.

These multi paths of signal are mainly because of reflection, refraction, scattering and diffraction. Due to these factors, the received signal varies as a function of frequency, time and space. These variations are referred to as fading and which cause deterioration of the system quality. Furthermore, wireless channels suffer of cochannel interference (CCI) from other cells that share the same frequency channel, leading to distortion of the desired signal and also low system performance. Therefore, wireless systems must be designed to mitigate fading and interference to guarantee a reliable communication.

Diversity techniques are widely used in wireless communication to mitigate these effects. MIMO technology used for getting diversity techniques which can improve the quality (bit-error rate) and data rate (bits/sec). This advantage can increase the quality of service and revenues of the operator. Space-time block codes are used for transmission of data over MIMO channels. Recently a new class of methods called cooperative communication



are using in wireless communication. In this project we use AF method for performance analysis of cooperative diversity. In recent times in cooperative communication we have only two transmitted antennas at source. In this work we have taken four and eight transmitted antennas at source and  $n$  relays each having two antennas. We used Space time block codes (STBC) for real signals at source and we used quasi orthogonal STBC for complex signals. And we compared the Performance analysis of AF based cooperative diversity for multiple transmitted antennas. Theoretical results are obtained from Moment generating function of multi hop relay.

## 1.1 Fading

In wireless communications, fading is deviation of the attenuation that a carrier-modulated telecommunication signal experiences over certain propagation media. The fading may vary with time, geographical position and/or radio frequency, and is often modeled as a random process. A fading channel is a communication channel that experiences fading. In wireless systems, fading may either be due to multi path propagation, referred to as multi path induced fading, or due to shadowing from obstacles affecting the wave propagation, sometimes referred to as shadow fading.

## 1.2 Rayleigh fading

Rayleigh fading is a statistical model for the effect of a propagation environment on a radio signal, such as that used by wireless devices. Rayleigh fading models assume that the magnitude of a signal that has passed through such a transmission medium (also called a communications channel) will vary randomly, or fade, according to a Rayleigh distribution - the radial component of the sum of two uncorrelated Gaussian random variables.

## 1.3 Diversity Technique

One of the most efficient and simple techniques to overcome the destructive effects of fading is Diversity. Diversity is an efficient technique to exploit the random nature of radio propagation by finding methods to generate and extract independent signal paths for communication. The concept behind diversity is relatively simple. If one signal path undergoes a deep fade at a particular point of time, another independent path may have a strong signal. By having more than one path to select from, both the instantaneous and average SNR can be improved in the receiver by a large amount. There

are various types of diversity used in communication systems operating over fading channels . They are:

- Space Diversity
- Frequency Diversity
- Time Diversity
- Polarization Diversity
- Multi path Diversity

Whatever be the diversity technique employed, the receiver has to process the diversity signals obtained in a fashion that maximizes the power efficiency of the system. There are several possible diversity reception methods employed in communication receivers. The most common techniques are:

- Selection Diversity
- Equal Gain Combining (EGC)
- Maximal Ratio Combining (MRC)

Among these three techniques we chose maximal ratio combining to combine received signals. Because MRC give better performance compare to the other technique.

## 1.4 MIMO

Multiple-input and multiple-output(MIMO)is the use of multiple antennas at both the transmitter and receiver to improve communication performance. It is one of several forms of smart antenna technology.MIMO technology has attracted attention in wireless communications, because it offers significant increases in data throughput and link range without additional bandwidth or increased transmit power. It achieves this goal by spreading the same total transmit power over the antennas to achieve an array gain that improves the spectral efficiency (more bits per second per hertz of bandwidth) or to achieve a diversity gain that improves the link reliability (reduced fading).

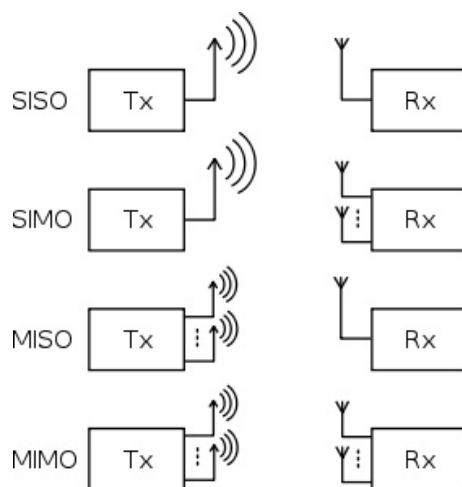

Figure 1.1: MIMO models

### 1.4.1 Present Standards with MIMO

- IEEE 802.11n (Wifi)
 

IEEE 802.11n-2009 is an amendment to the IEEE 802.11-2007 wireless networking standard to improve network throughput over the two previous standards 802.11a and 802.11g with a significant increase in the maximum net data rate from 54 Mbit/s to 600 Mbit/s (slightly higher gross bit rate including for example error-correction codes, and slightly lower maximum throughput) with the use of four spatial streams at a channel width of 40 MHz. 802.11n standardized support for multiple-input multiple-output and frame aggregation, and security improvements, among other features.
- 4G
 

In telecommunications, 4G is the fourth generation of cell phone mobile communications standards. It is a successor of the third generation (3G) standards. A 4G system provides mobile ultra-broadband Internet access, for example to laptops with USB wireless modems, to smart phones, and to other mobile devices. Conceivable applications include amended mobile web access, IP telephony, gaming services, high-definition mobile TV, video conferencing and 3D television.
- 3GPP Long Term Evolution
 

Long Term Evolution (LTE) was introduced in 3GPP Release 8. The objective is a high data rate, low latency and packet optimized radio

access technology. LTE is also referred to as E-UTRA (Evolved UMTS Terrestrial Radio Access) or E-UTRAN (Evolved UMTS Terrestrial Radio access Network). The basic concept for LTE in down link is OFDMA (Uplink: SC-FDMA), while MIMO technologies are an integral part of LTE

- **WiMAX**

WiMAX (Worldwide Interoperability for Microwave Access) is a wireless communications standard designed to provide 30 to 40 megabit-per-second data rates, with the 2011 update providing up to 1 Gbit/s for fixed stations. It is a part of a fourth generation, or 4G, of wireless-communication technology. WiMax far surpasses the 30-meter wireless range of a conventional Wi-Fi local area network (LAN), offering a metropolitan area network with a signal radius of about 50 km.

- **HSPA+**

It provides an evolution of High Speed Packet Access and provides data rates up to 168 Megabits per second (Mbit/s) to the mobile device and 22 Mbit/s from the mobile device. Technically these are achieved through the use of a multiple-antenna technique known as MIMO (for multiple-input and multiple-output) and higher order modulation (64QAM) or combining multiple cells into one with a technique known as Dual-Cell HSDPA.

## 1.5 Cooperative diversity

Cooperative diversity in wireless multi-hop networks is an attractive new way to increase throughput, reduce energy requirements and provide resistance to channel fading effects. Because of its distributed nature, this new form of diversity allows a network of relatively simple, single-antenna devices to achieve many of the celebrated advantages of physical antenna arrays. The dramatically increased requirement of wireless devices in current market scenario has led to development of wireless networks, especially several generation of cellular voice and data networks and, more recently, adhoc networks for wireless computer, home, and personal communication. The common requirement of all these wireless services is the attainment of high data rate over dynamic channel environment. One of the possible approach for combating such problem is to explore diversity techniques in space, time or in frequency.

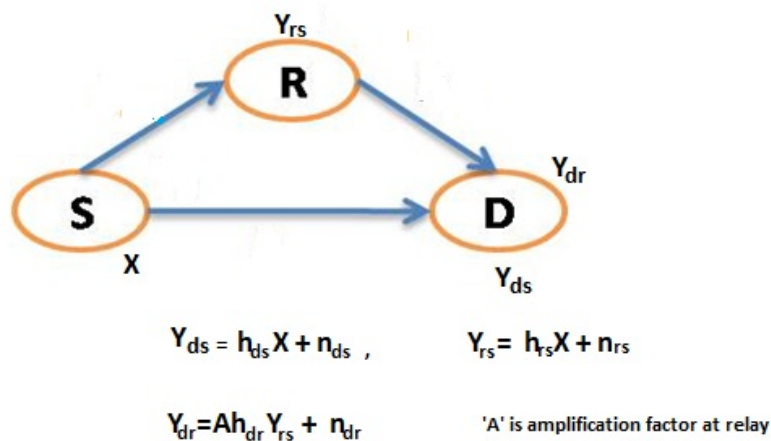

Figure 1.2: AF Relay model.

## 1.6 Amplify and forward

- Allows the relay node to amplify the received noisy signal from the source node and then forward it to the destination.
- Simplest relaying strategies with low implementation cost.

## 1.7 Space time block codes

The Alamouti scheme achieves the full diversity for two transmit antennas. The key feature of the scheme is orthogonality between the sequences generated by the two transmit antennas. This scheme was generalized to an arbitrary number of transmit antennas by applying the theory of orthogonal designs. The generalized schemes are referred to as space-time block codes (STBCs). It is a technique used in wireless communications to transmit multiple copies of a data stream across a number of antennas and to improve the reliability of transmission. An STBC is usually represented by a matrix.

Each row represents a time slot and each column represents transmitting antennas. We construct these codes based on diversity criteria [13]. Based on the type of the signal constellations, space-time block codes can be classified into space-time block codes with real signals and space-time block codes with complex signals (Quasi orthogonal codes).

- Real orthogonal designs

For real signals transmission over multiple antennas we use these Orthogonal designs. A real orthogonal designs of size  $n$  is an  $n \times n$  orthogonal matrix  $G_n$  with real entries  $x_1, -x_1, x_2, -x_2, \dots, x_n, -x_n$  such that

$$G_n^T G_n = (x_1^2 + x_2^2 + \dots + x_n^2) I_n$$

where  $G_n^T$  is transpose matrix,  $I_n$  is identity matrix. These designs provide full data rate, The Hurwitz-Radon literature [14] provides the full details of these designs.

- Quasi orthogonal designs

For complex signals transmission over multiple antenna we use these quasi orthogonal designs. A complex orthogonal designs of size  $n$  is an  $n \times n$  orthogonal matrix  $G_n$  with complex entries  $x_1, -x_1, x_2, -x_2, \dots, x_n, -x_n$  and their conjugates such that

$$G_n^H G_n = (|x_1|^2 + |x_2|^2 + \dots + |x_n|^2) I_n$$

where  $G_n^H$  is hermitian matrix. In complex orthogonal designs full data rate is achieved with only two transmit antennas it is not possible to achieve full rate for more than two antennas. And complex orthogonal designs exist for any number of transmit antennas with half data rate

# Chapter 2

## System model and Receiver design

### 2.1 General model

Consider the model as shown in Fig 2.1 with single relay (R) between the source (S) and destination (D). We assume that all the transmissions are on orthogonal channels

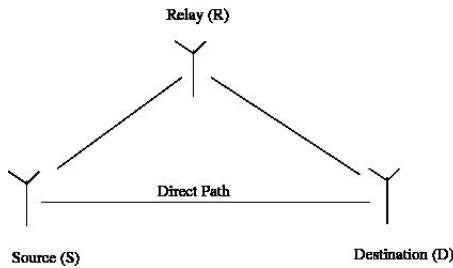

Figure 2.1: Three node cooperative diversity system.

$$\begin{aligned}y_{d,s} &= \sqrt{E_s}h_{d,s}x_s + n_{d,s} \\y_{r,s} &= \sqrt{E_s}h_{r,s}x_s + n_{r,s} \\y_{d,r} &= \sqrt{E_r}h_{d,r}\beta_r y_{r,s} + n_{d,r}\end{aligned}$$

And  $n_{d,s}, n_{r,s}, n_{d,r} \sim CN(0, N_0)$  represent additive white Gaussian noise at the relay and destination. The fading coefficients  $h_{d,s} \sim CN(0, \Omega_{d,s})$ ,  $h_{r,s} \sim CN(0, \Omega_{r,s})$  and  $h_{d,r} \sim CN(0, \Omega_{d,r})$  are due to Rayleigh fading channel.  $\beta_r$  is Amplification factor at relay. In general we have  $n$  transmitted antennas at source and  $n$  relays with each having  $n$  antennas. We denote source antennas

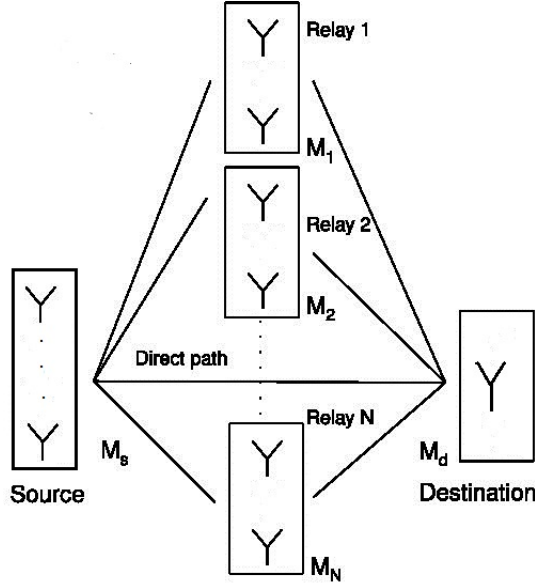

Figure 2.2: General relay model for cooperative diversity.

by  $M_s$ , relay antennas by  $M_r$ , and destination antenna by  $M_d$ . In this we have taken 2,4,8 transmitted antennas at source and we use Alamouti codes for transmission of signals in  $M_s = 2$ . For higher number of antennas we use orthogonal Space time block codes where columns represents time slots and rows represents transmitting signals from antennas. We denote the fading coefficients on the S-D, S-R and R-D links as  $a_{d,s}^i$ ,  $a_{r,s}^i$  and  $a_{d,r}^i$  respectively. Here the first subscript indicates the receiver unit, the second subscript indicates the transmitter unit, and the superscript indicates the antenna index at the transmitter or receiver unit. The corresponding additive white Gaussian noise (AWGN) samples are respectively denoted by  $n_{d,s,j}^i$ ,  $n_{r,s,j}^i$  and  $n_{d,r,j}^i$ . In this we represent signals received at relay from source by  $y_{r,s}$  and signals received at destination from source by  $y_{d,s}$ . The signal received at the  $i^{th}$  antenna of the  $r^{th}$  relay from source is

$$y_{r,s}^i = (a_{r,s}^1 x_1 + a_{r,s}^2 x_2 + \dots + a_{r,s}^{M_s} x_{M_s}) \sqrt{E_s} + n_{r,s}^i$$

The signal received at the  $j^{th}$  antenna of the destination from source is

$$y_{d,s}^j = (a_{d,s}^1 x_1 + a_{d,s}^2 x_2 + \dots + a_{d,s}^{M_s} x_{M_s}) \sqrt{E_s} + n_{d,s}^j$$



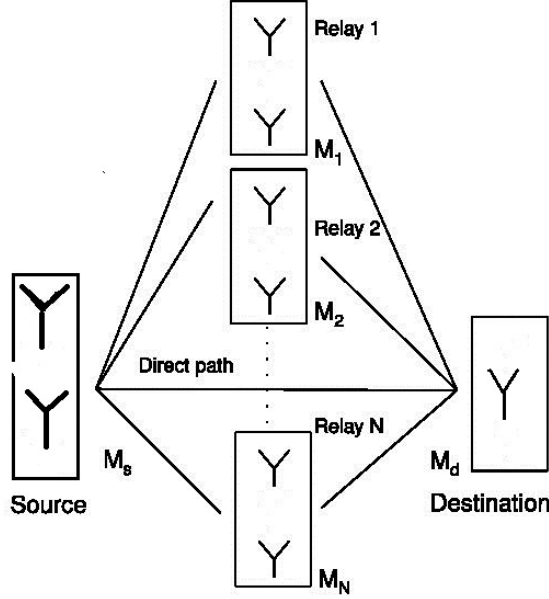

Figure 2.3:  $M_s = 2$ ,  $M_r = 2$ ,  $M_d = 1$  model for cooperative diversity.

## 2.2 Detection rule for $M_s = 2$ , $M_r = 2$ , $M_d = 1$ for Real signals

The signal received at the first antenna of the  $r^{th}$  relay is given by

$$\begin{aligned} y_{r,s,1}^1 &= (a_{r,s}^1 x_1 + a_{r,s}^2 x_2) \sqrt{E_s} + n_{r,s,1}^1 \\ y_{r,s,2}^1 &= (-a_{r,s}^1 x_2 + a_{r,s}^2 x_1) \sqrt{E_s} + n_{r,s,2}^1 \end{aligned}$$

And, the signal received at the second antenna of the  $r^{th}$  relay is given by

$$\begin{aligned} y_{r,s,1}^2 &= (a_{r,s}^3 x_1 + a_{r,s}^4 x_2) \sqrt{E_s} + n_{r,s,1}^2 \\ y_{r,s,2}^2 &= (-a_{r,s}^3 x_2 + a_{r,s}^4 x_1) \sqrt{E_s} + n_{r,s,2}^2 \end{aligned}$$

Now applying MRC at the  $r^{th}$  relay then we have

$$\begin{aligned} s_{r,1} &= h_1^* y_{r,s,1}^1 + h_2 y_{r,s,2}^{1*} + h_3^* y_{r,s,1}^2 + h_4 y_{r,s,2}^{2*} \\ s_{r,2} &= h_2^* y_{r,s,1}^1 - h_1 y_{r,s,2}^{1*} + h_4^* y_{r,s,1}^2 - h_3 y_{r,s,2}^{2*} \end{aligned}$$

where,  $h_i = a_{r,s}^i \sqrt{E_s}$ . After substitution these values we get,

$$\begin{aligned} s_{r,1} &= C_r E_s x_1 + a_{r,s}^{1*} \sqrt{E_s} n_{r,s,1}^1 + a_{r,s}^2 \sqrt{E_s} n_{r,s,2}^{1*} \\ &\quad + a_{r,s}^{3*} \sqrt{E_s} n_{r,s,1}^2 + a_{r,s}^4 \sqrt{E_s} n_{r,s,2}^{2*} \end{aligned}$$

$$s_{r,2} = C_r E_s x_2 - a_{r,s}^1 \sqrt{E_s} n_{r,s,2}^{1*} + a_{r,s}^{2*} \sqrt{E_s} n_{r,s,1}^1 - a_{r,s}^3 \sqrt{E_s} n_{r,s,2}^{2*} + a_{r,s}^{4*} \sqrt{E_s} n_{r,s,1}^2$$

where  $C_r = \sum_{i=1}^4 (a_{r,s}^i)$ . And These symbols are transmitted using alamouti codes given by

$$\begin{aligned} y_{d,r,1} &= (a_{d,r}^1 s_{r,1} + a_{d,r}^2 s_{r,2}) \beta_r \sqrt{E_r} + n_{d,r,1}^1 \\ y_{d,r,2} &= (-a_{d,r}^1 s_{r,2}^* + a_{d,r}^2 s_{r,1}^*) \beta_r \sqrt{E_r} + n_{d,r,2}^1 \end{aligned}$$

Now applying MRC at the destination we get

$$\begin{aligned} \tilde{z}_{d,r,1} &= l_1^* y_{d,r,1} + l_2 y_{d,r,2}^* \\ \tilde{z}_{d,r,2} &= l_2^* y_{d,r,1} - l_1 y_{d,r,2}^* \end{aligned}$$

where,  $l_i = a_{d,r}^i \sqrt{E_r}$ , On expanding we get

$$\begin{aligned} \tilde{z}_{d,r,1} &= C_r D_r E_r \beta_r E_s x_1 + D_r E_r \sqrt{E_s} [a_{r,s}^{1*} \beta_r n_{r,s,1}^1 + a_{r,s}^2 \beta_r n_{r,s,2}^{1*} + a_{r,s}^{3*} \beta_r n_{r,s,1}^2] \\ &\quad + E_r \sqrt{E_s} D_r a_{r,s}^4 \beta_r n_{r,s,2}^{2*} + a_{d,r}^{1*} \sqrt{E_r} n_{d,r,1}^1 + a_{d,r}^2 \sqrt{E_r} n_{d,r,2}^{1*} \\ \tilde{z}_{d,r,2} &= C_r D_r \beta_r E_r E_s x_2 - D_r E_r \sqrt{E_s} [a_{r,s}^1 \beta_r n_{r,s,2}^{1*} + a_{r,s}^{2*} \beta_r n_{r,s,1}^1 - a_{r,s}^3 \beta_r n_{r,s,2}^{2*}] \\ &\quad + E_r \sqrt{E_s} D_r a_{r,s}^{4*} \beta_r n_{r,s,1}^2 + a_{d,r}^{2*} \sqrt{E_r} n_{d,r,1}^1 - a_{d,r}^1 \sqrt{E_r} n_{d,r,2}^{1*} \end{aligned}$$

And signal from direct link after combining are  $y_{d,s,i}$  are given below

$$\begin{aligned} y_{d,s,1} &= B E_s x_1 + a_{d,s}^{1*} \sqrt{E_s} n_{d,s,1} + a_{d,s}^2 \sqrt{E_s} n_{d,s,2}^* \\ y_{d,s,2} &= B E_s x_2 - a_{d,s}^1 \sqrt{E_s} n_{d,s,2}^* + a_{d,s}^{2*} \sqrt{E_s} n_{d,s,1} \end{aligned}$$

so we have two signals at destination  $\tilde{z}_{d,r,i}$  and  $y_{d,s,i}$ . Now Maximum likelihood detection rule for first symbol is given by

$$\frac{C E_s \beta_r \operatorname{Re} \{ \tilde{z}_{d,r,1} \}}{C D E_r E_s \beta_r^2 + 1} + \operatorname{Re} \{ y_{d,s,1} \} \begin{array}{l} > \\ < \\ = \end{array} \begin{array}{l} 1 \\ 0 \\ -1 \end{array}$$

Similarly, for second symbol

$$\frac{C E_s \beta_r \operatorname{Re} \{ \tilde{z}_{d,r,2} \}}{C D E_r E_s \beta_r^2 + 1} + \operatorname{Re} \{ y_{d,s,2} \} \begin{array}{l} > \\ < \\ = \end{array} \begin{array}{l} 1 \\ 0 \\ -1 \end{array}$$

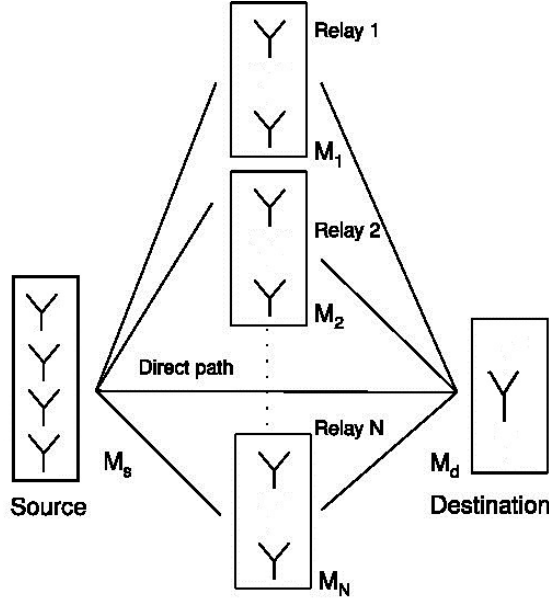

Figure 2.4:  $M_s = 4$ ,  $M_r = 2$ ,  $M_d = 1$  relay model for cooperative diversity.

## 2.3 Detection rule for $M_s = 4$ , $M_r = 2$ , $M_d = 1$ for Real signals

we have 4 transmitted antennas so we can transmit 4 signals at a time. In this case by  $4 \times 4$  orthogonal design we represent  $x$  as

$$\begin{pmatrix} x_1 & x_2 & x_3 & x_4 \\ -x_2 & x_1 & -x_4 & x_3 \\ -x_3 & x_4 & x_1 & -x_2 \\ -x_4 & -x_3 & x_2 & x_1 \end{pmatrix}$$

The following are the signals from source to relay

$$\begin{aligned} y_{r,s,1}^1 &= [a_{r,s}^1 x_1 + a_{r,s}^2 x_2 + a_{r,s}^3 x_3 + a_{r,s}^4 x_4] \sqrt{E_s} + n_{r,s,1}^1 \\ y_{r,s,2}^1 &= [a_{r,s}^2 x_1 - a_{r,s}^1 x_2 - a_{r,s}^3 x_4 + a_{r,s}^4 x_3] \sqrt{E_s} + n_{r,s,2}^1 \\ y_{r,s,3}^1 &= [a_{r,s}^2 x_4 - a_{r,s}^1 x_3 + a_{r,s}^3 x_1 - a_{r,s}^4 x_2] \sqrt{E_s} + n_{r,s,3}^1 \\ y_{r,s,4}^1 &= [a_{r,s}^3 x_2 - a_{r,s}^1 x_4 - a_{r,s}^2 x_3 - a_{r,s}^4 x_1] \sqrt{E_s} + n_{r,s,4}^1 \end{aligned}$$

$$\begin{aligned}
y_{r,s,1}^2 &= [a_{r,s}^5 x_1 + a_{r,s}^6 x_2 + a_{r,s}^7 x_3 + a_{r,s}^8 x_4] \sqrt{E_s} + n_{r,s,1}^2 \\
y_{r,s,2}^2 &= [a_{r,s}^6 x_1 - a_{r,s}^5 x_2 - a_{r,s}^7 x_4 - a_{r,s}^8 x_3] \sqrt{E_s} + n_{r,s,2}^2 \\
y_{r,s,3}^2 &= [a_{r,s}^6 x_4 - a_{r,s}^5 x_3 + a_{r,s}^7 x_1 - a_{r,s}^8 x_2] \sqrt{E_s} + n_{r,s,3}^2 \\
y_{r,s,4}^2 &= [a_{r,s}^7 x_2 - a_{r,s}^5 x_4 - a_{r,s}^6 x_3 + a_{r,s}^8 x_1] \sqrt{E_s} + n_{r,s,4}^2
\end{aligned}$$

Let these eight signals are represented as  $y_1$  to  $y_8$  respectively. On MR Combining we get S.

Here  $S=YH$

where

$$S = \begin{pmatrix} s_{r,1} \\ s_{r,2} \\ s_{r,3} \\ s_{r,4} \end{pmatrix}.$$

$$Y = \begin{pmatrix} y_1 & y_2 & y_3 & y_4 & y_5 & y_6 & y_7 & y_8 \\ -y_2 & y_1 & y_4 & -y_3 & -y_6 & y_5 & y_8 & -y_7 \\ -y_3 & -y_4 & y_1 & y_2 & -y_7 & -y_8 & y_5 & y_6 \\ -y_4 & y_3 & -y_2 & y_1 & -y_8 & y_7 & -y_6 & y_5 \end{pmatrix}$$

$$H = \begin{pmatrix} h_1 \\ h_2 \\ h_3 \\ h_4 \\ h_5 \\ h_6 \\ h_7 \\ h_8 \end{pmatrix}.$$

$$\begin{aligned}
s_{r,1} &= h_1^* y_{r,s,1}^1 + h_2 y_{r,s,2}^{1*} + h_3^* y_{r,s,3}^1 + h_4 y_{r,s,4}^{1*} + h_5^* y_{r,s,1}^2 + h_6 y_{r,s,2}^{2*} + h_7^* y_{r,s,3}^2 + h_8 y_{r,s,4}^{2*} \\
s_{r,2} &= -h_1 y_{r,s,2}^{1*} + h_2^* y_{r,s,1}^1 + h_3 y_{r,s,4}^{1*} - h_4^* y_{r,s,3}^1 - h_5 y_{r,s,2}^{2*} + h_6^* y_{r,s,1}^2 + h_7 y_{r,s,4}^{2*} - h_8^* y_{r,s,3}^{2*} \\
s_{r,3} &= -h_1^* y_{r,s,3}^1 - h_2 y_{r,s,4}^{1*} + h_3^* y_{r,s,1}^1 + h_4 y_{r,s,2}^{1*} - h_5^* y_{r,s,3}^2 - h_6 y_{r,s,4}^{2*} + h_7^* y_{r,s,1}^2 + h_8 y_{r,s,2}^{2*} \\
s_{r,4} &= -h_1 y_{r,s,4}^{1*} + h_2^* y_{r,s,3}^1 - h_3 y_{r,s,2}^{1*} + h_4^* y_{r,s,1}^1 - h_5 y_{r,s,4}^{2*} + h_6^* y_{r,s,3}^2 - h_7 y_{r,s,2}^{2*} - h_8^* y_{r,s,1}^{2*}
\end{aligned}$$

where  $h_i = a_{r,s}^i \sqrt{E_s}$ , On expanding we get

$$\begin{aligned}
s_{r,1} &= \sqrt{E_s} [a_{r,s}^{1*} n_{r,s,1}^1 + a_{r,s}^2 n_{r,s,2}^{1*} + a_{r,s}^{3*} n_{r,s,3}^1 + a_{r,s}^4 n_{r,s,4}^{1*} + a_{r,s}^{5*} n_{r,s,1}^2 + a_{r,s}^6 n_{r,s,2}^{2*}] \\
&\quad + \sqrt{E_s} [a_{r,s}^{7*} n_{r,s,3}^2 + a_{r,s}^8 n_{r,s,4}^{2*}] + E_s x_1 \sum_{i=1}^8 (a_{r,s}^i)^2 \\
s_{r,2} &= \sqrt{E_s} [a_{r,s}^{2*} n_{r,s,1}^1 - a_{r,s}^1 n_{r,s,2}^{1*} + a_{r,s}^3 n_{r,s,4}^{1*} - a_{r,s}^{4*} n_{r,s,3}^1 - a_{r,s}^5 n_{r,s,2}^{2*} + a_{r,s}^{6*} n_{r,s,1}^2] \\
&\quad + \sqrt{E_s} [a_{r,s}^7 n_{r,s,4}^{2*} - a_{r,s}^{8*} n_{r,s,3}^2] + E_s x_2 \sum_{i=1}^8 (a_{r,s}^i)^2 \\
s_{r,3} &= \sqrt{E_s} [a_{r,s}^{3*} n_{r,s,1}^1 - a_{r,s}^{1*} n_{r,s,3}^1 - a_{r,s}^2 n_{r,s,4}^{1*} + a_{r,s}^4 n_{r,s,2}^{1*} - a_{r,s}^{5*} n_{r,s,3}^2 - a_{r,s}^6 n_{r,s,4}^{2*}] \\
&\quad + \sqrt{E_s} [a_{r,s}^{7*} n_{r,s,1}^2 + a_{r,s}^8 n_{r,s,2}^{2*}] + E_s x_3 \sum_{i=1}^8 (a_{r,s}^i)^2 \\
s_{r,4} &= \sqrt{E_s} [a_{r,s}^{2*} n_{r,s,3}^1 - a_{r,s}^3 n_{r,s,2}^{1*} - a_{r,s}^1 n_{r,s,4}^{1*} + a_{r,s}^{4*} n_{r,s,1}^1 - a_{r,s}^5 n_{r,s,4}^{2*} + a_{r,s}^{6*} n_{r,s,3}^2] \\
&\quad + \sqrt{E_s} [-a_{r,s}^7 n_{r,s,2}^{2*} + a_{r,s}^{8*} n_{r,s,1}^2] + E_s x_4 \sum_{i=1}^8 (a_{r,s}^i)^2
\end{aligned}$$

Now these symbols are transmitted from relay to destination by amplifying with some factor  $\beta_r$ . Here  $y_{d,r,i}$  is the signal received at destination from Relay with amplification  $\beta_r$

$$\begin{aligned}
y_{d,r,1} &= (a_{d,r}^1 s_{r,1} + a_{d,r}^2 s_{r,2}) \beta_r \sqrt{E_r} + n_{d,r,1} \\
y_{d,r,2} &= (-a_{d,r}^1 s_{r,2}^* + a_{d,r}^2 s_{r,1}^*) \beta_r \sqrt{E_r} + n_{d,r,2}
\end{aligned}$$

where  $\beta_r = \sqrt{\frac{E_r}{CE_s + N_0}}$

By diversity combining at the destination antenna we get

$$\tilde{z}_{d,r,1} = l_1^* y_{d,r,1} + l_2 y_{d,r,2}^*$$

$$\tilde{z}_{d,r,2} = l_2^* y_{d,r,1} - l_1 y_{d,r,2}^*$$

where,  $l_i = a_{d,r}^i \sqrt{E_r}$ ,  $D = \sum_{i=1}^2 |a_{d,r}^i|^2$ ,  $C = \sum_{i=1}^8 |a_{r,s}^i|^2$

$$\begin{aligned}
\tilde{z}_{d,r,1} &= CD\beta_r E_r E_s x_1 + Da_{r,s}^{1*} \beta_r E_r \sqrt{E_s} n_{r,s,1}^1 + Da_{r,s}^2 \beta_r E_r \sqrt{E_s} n_{r,s,2}^{1*} \\
&\quad + Da_{r,s}^{3*} \beta_r E_r \sqrt{E_s} n_{r,s,3}^1 + Da_{r,s}^4 \beta_r E_r \sqrt{E_s} n_{r,s,4}^{1*} + Da_{r,s}^{5*} \beta_r E_r \sqrt{E_s} n_{r,s,1}^2 \\
&\quad + Da_{r,s}^6 \beta_r E_r \sqrt{E_s} n_{r,s,2}^{2*} + Da_{r,s}^{7*} \beta_r E_r \sqrt{E_s} n_{r,s,3}^2 + Da_{r,s}^8 \beta_r E_r \sqrt{E_s} n_{r,s,4}^{2*} \\
&\quad + a_{d,r}^{1*} \sqrt{E_r} n_{d,r,1} + a_{d,r}^2 \sqrt{E_r} n_{d,r,2}^*
\end{aligned}$$

$$\begin{aligned}
\tilde{z}_{d,r,2} = & CD\beta_r E_r E_s x_2 + Da_{r,s}^{2*} \beta_r E_r \sqrt{E_s} n_{r,s,1}^1 - Da_{r,s}^1 \beta_r E_r \sqrt{E_s} n_{r,s,2}^{1*} \\
& + Da_{r,s}^3 \beta_r E_r \sqrt{E_s} n_{r,s,4}^{1*} - Da_{r,s}^{4*} \beta_r E_r \sqrt{E_s} n_{r,s,3}^1 - Da_{r,s}^5 \beta_r E_r \sqrt{E_s} n_{r,s,2}^{2*} \\
& + Da_{r,s}^{6*} \beta_r E_r \sqrt{E_s} n_{r,s,1}^2 + Da_{r,s}^7 \beta_r E_r \sqrt{E_s} n_{r,s,4}^{2*} - Da_{r,s}^{8*} \beta_r E_r \sqrt{E_s} n_{r,s,3}^2 \\
& + a_{d,r}^{2*} \sqrt{E_r} n_{d,r,1} - a_{d,r}^1 \sqrt{E_r} n_{d,r,2}^*
\end{aligned}$$

$$y_{d,s,1} = E_s x_1 [\sum_{i=1}^4 (a_{d,s}^i)^2] + \sqrt{E_s} [a_{d,s}^1 n_{d,s,1} + a_{d,s}^2 n_{d,s,2} + a_{d,s}^3 n_{d,s,3} + a_{d,s}^4 n_{d,s,4}]$$

$y_{d,s,i}$  is the signals from direct path i.e from source to destination after Combining. So we have two signals at destination  $\tilde{z}_{d,r,i}$  and  $y_{d,s,i}$ . Now Maximum likelihood detection rule for first symbol is given by

$$\frac{CE_s \beta_r \operatorname{Re} \{ \tilde{z}_{d,r,1} \}}{CDE_r E_s \beta_r^2 + 1} + \operatorname{Re} \{ y_{d,s,1} \} \begin{matrix} > \\ < \\ = \end{matrix} \begin{matrix} 1 \\ -1 \\ 0 \end{matrix}$$

## 2.4 Detection rule for $Ms = 8$ , $Mr = 2$ , $Md = 1$ for Real signals

In this model we have 8 transmitted antennas and n relays with each having 2 antennas. we have 8 transmitted antennas so we can transmit 8 signals at a time. In this case by  $8 \times 8$  orthogonal design we represent x as

$$\begin{pmatrix}
x_1 & x_2 & x_3 & x_4 & x_5 & x_6 & x_7 & x_8 \\
-x_2 & x_1 & x_4 & -x_3 & x_6 & -x_5 & -x_8 & x_7 \\
-x_3 & -x_4 & x_1 & x_2 & x_7 & x_8 & -x_5 & -x_6 \\
-x_4 & x_3 & -x_2 & x_1 & x_8 & -x_7 & x_6 & -x_5 \\
-x_5 & -x_6 & -x_7 & -x_8 & x_1 & x_2 & x_3 & x_4 \\
-x_6 & x_5 & -x_8 & x_7 & -x_2 & x_1 & -x_4 & x_3 \\
-x_7 & x_8 & x_5 & -x_6 & -x_3 & x_4 & x_1 & -x_2 \\
-x_8 & -x_7 & x_6 & x_5 & -x_4 & -x_3 & x_2 & x_1
\end{pmatrix}$$

Here  $y_{r,s,i}^j$  is signal received at the  $j$ th antenna of the relay during  $i$ th time slot

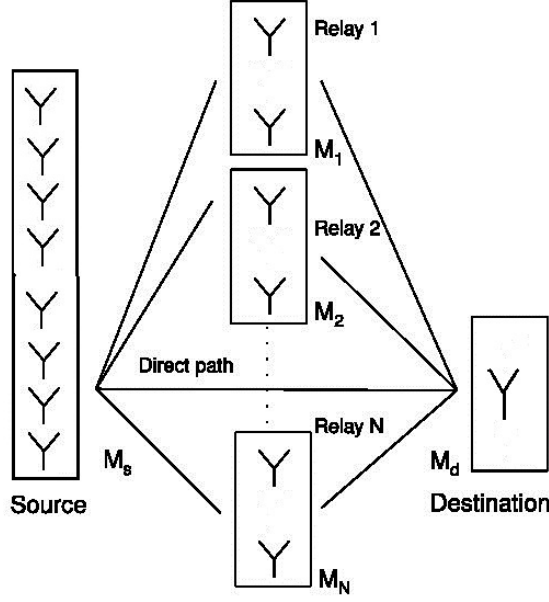

Figure 2.5: Multi antenna based relay model for cooperative diversity.

$$\begin{aligned}
y_{r,s,1}^1 &= [a_{r,s}^1 x_1 + a_{r,s}^2 x_2 + a_{r,s}^3 x_3 + a_{r,s}^4 x_4 + a_{r,s}^5 x_5 + a_{r,s}^6 x_6 + a_{r,s}^7 x_7 + a_{r,s}^8 x_8] \sqrt{E_s} + n_{r,s,1}^1 \\
y_{r,s,2}^1 &= [-a_{r,s}^1 x_2 + a_{r,s}^2 x_1 + a_{r,s}^3 x_4 - a_{r,s}^4 x_3 + a_{r,s}^5 x_6 - a_{r,s}^6 x_5 - a_{r,s}^7 x_8 + a_{r,s}^8 x_7] \sqrt{E_s} + n_{r,s,2}^1 \\
y_{r,s,3}^1 &= [-a_{r,s}^1 x_3 - a_{r,s}^2 x_4 + a_{r,s}^3 x_1 + a_{r,s}^4 x_2 + a_{r,s}^5 x_7 + a_{r,s}^6 x_8 - a_{r,s}^7 x_5 - a_{r,s}^8 x_6] \sqrt{E_s} + n_{r,s,3}^1 \\
y_{r,s,4}^1 &= [-a_{r,s}^1 x_4 + a_{r,s}^2 x_3 - a_{r,s}^3 x_2 + a_{r,s}^4 x_1 + a_{r,s}^5 x_8 - a_{r,s}^6 x_7 + a_{r,s}^7 x_6 - a_{r,s}^8 x_5] \sqrt{E_s} + n_{r,s,4}^1 \\
y_{r,s,5}^1 &= [-a_{r,s}^1 x_5 - a_{r,s}^2 x_6 - a_{r,s}^3 x_7 - a_{r,s}^4 x_8 + a_{r,s}^5 x_1 + a_{r,s}^6 x_2 + a_{r,s}^7 x_3 + a_{r,s}^8 x_4] \sqrt{E_s} + n_{r,s,5}^1 \\
y_{r,s,6}^1 &= [-a_{r,s}^1 x_6 + a_{r,s}^2 x_5 - a_{r,s}^3 x_8 + a_{r,s}^4 x_7 - a_{r,s}^5 x_2 + a_{r,s}^6 x_1 - a_{r,s}^7 x_4 + a_{r,s}^8 x_3] \sqrt{E_s} + n_{r,s,6}^1 \\
y_{r,s,7}^1 &= [-a_{r,s}^1 x_7 + a_{r,s}^2 x_8 + a_{r,s}^3 x_5 - a_{r,s}^4 x_6 - a_{r,s}^5 x_3 + a_{r,s}^6 x_4 + a_{r,s}^7 x_1 - a_{r,s}^8 x_2] \sqrt{E_s} + n_{r,s,7}^1 \\
y_{r,s,8}^1 &= [-a_{r,s}^1 x_8 - a_{r,s}^2 x_7 + a_{r,s}^3 x_6 + a_{r,s}^4 x_5 - a_{r,s}^5 x_4 - a_{r,s}^6 x_3 + a_{r,s}^7 x_2 + a_{r,s}^8 x_1] \sqrt{E_s} + n_{r,s,8}^1
\end{aligned}$$

The signal received at second antenna of relay are given below.

$$\begin{aligned}
y_{r,s,1}^2 &= [a_{r,s}^9 x_1 + a_{r,s}^{10} x_2 + a_{r,s}^{11} x_3 + a_{r,s}^{12} x_4 + a_{r,s}^{13} x_5 + a_{r,s}^{14} x_6 + a_{r,s}^{15} x_7 + a_{r,s}^{16} x_8] \sqrt{E_s} + n_{r,s,1}^2 \\
y_{r,s,2}^2 &= [-a_{r,s}^9 x_2 + a_{r,s}^{10} x_1 + a_{r,s}^{11} x_4 - a_{r,s}^{12} x_3 + a_{r,s}^{13} x_6 - a_{r,s}^{14} x_5 - a_{r,s}^{15} x_8 + a_{r,s}^{16} x_7] \sqrt{E_s} + n_{r,s,2}^2 \\
y_{r,s,3}^2 &= [-a_{r,s}^9 x_3 - a_{r,s}^{10} x_4 + a_{r,s}^{11} x_1 + a_{r,s}^{12} x_2 + a_{r,s}^{13} x_7 + a_{r,s}^{14} x_8 - a_{r,s}^{15} x_5 - a_{r,s}^{16} x_6] \sqrt{E_s} + n_{r,s,3}^2 \\
y_{r,s,4}^2 &= [-a_{r,s}^9 x_4 + a_{r,s}^{10} x_3 - a_{r,s}^{11} x_2 + a_{r,s}^{12} x_1 + a_{r,s}^{13} x_8 - a_{r,s}^{14} x_7 + a_{r,s}^{15} x_6 - a_{r,s}^{16} x_5] \sqrt{E_s} + n_{r,s,4}^2
\end{aligned}$$

$$\begin{aligned}
y_{r,s,5}^2 &= [-a_{r,s}^9 x_5 - a_{r,s}^{10} x_6 - a_{r,s}^{11} x_7 - a_{r,s}^{12} x_8 + a_{r,s}^{13} x_1 + a_{r,s}^{14} x_2 + a_{r,s}^{15} x_3 + a_{r,s}^{16} x_4] \sqrt{E_s} + n_{r,s,5}^2 \\
y_{r,s,6}^2 &= [-a_{r,s}^9 x_6 + a_{r,s}^{10} x_5 - a_{r,s}^{11} x_8 + a_{r,s}^{12} x_7 - a_{r,s}^{13} x_2 + a_{r,s}^{14} x_1 - a_{r,s}^{15} x_4 + a_{r,s}^{16} x_3] \sqrt{E_s} + n_{r,s,6}^2 \\
y_{r,s,7}^2 &= [-a_{r,s}^9 x_7 + a_{r,s}^{10} x_8 + a_{r,s}^{11} x_5 - a_{r,s}^{12} x_6 - a_{r,s}^{13} x_3 + a_{r,s}^{14} x_4 + a_{r,s}^{15} x_1 - a_{r,s}^{16} x_2] \sqrt{E_s} + n_{r,s,7}^2 \\
y_{r,s,8}^2 &= [-a_{r,s}^9 x_8 - a_{r,s}^{10} x_7 + a_{r,s}^{11} x_6 + a_{r,s}^{12} x_5 - a_{r,s}^{13} x_4 - a_{r,s}^{14} x_3 + a_{r,s}^{15} x_2 + a_{r,s}^{16} x_1] \sqrt{E_s} + n_{r,s,8}^2
\end{aligned}$$

Now applying MRC at the  $r^{th}$  relay we have

$$\begin{aligned}
s_{r,1} &= h_1^* y_{r,s,1}^1 + h_2 y_{r,s,2}^{1*} + h_3^* y_{r,s,3}^1 + h_4 y_{r,s,4}^{1*} + h_5^* y_{r,s,5}^1 + h_6 y_{r,s,6}^{1*} + h_7^* y_{r,s,7}^1 + h_8 y_{r,s,8}^{1*} \\
&\quad + h_9^* y_{r,s,1}^2 + h_{10} y_{r,s,2}^{2*} + h_{11}^* y_{r,s,3}^2 + h_{12} y_{r,s,4}^{2*} + h_{13}^* y_{r,s,5}^2 + h_{14} y_{r,s,6}^{2*} + h_{15}^* y_{r,s,7}^2 + h_{16} y_{r,s,8}^{2*} \\
s_{r,2} &= -h_1 y_{r,s,2}^{1*} + h_2^* y_{r,s,1}^1 - h_3 y_{r,s,4}^{1*} + h_4^* y_{r,s,3}^1 - h_5 y_{r,s,6}^{1*} + h_6^* y_{r,s,5}^1 + h_7 y_{r,s,8}^{1*} - h_8^* y_{r,s,7}^1 \\
&\quad - h_9 y_{r,s,2}^{2*} + h_{10}^* y_{r,s,1}^2 - h_{11} y_{r,s,4}^{2*} + h_{12}^* y_{r,s,3}^2 - h_{13} y_{r,s,6}^{2*} + h_{14}^* y_{r,s,5}^2 + h_{15} y_{r,s,8}^{2*} - h_{16}^* y_{r,s,7}^2
\end{aligned}$$

where  $h_i = a_{r,s}^i \sqrt{E_s}$ , by putting all values in  $s_{r,i}$  we get

$$\begin{aligned}
s_{r,1} &= \sqrt{E_s} [a_{r,s}^{1*} n_{r,s,1}^1 + a_{r,s}^2 n_{r,s,2}^{1*} + a_{r,s}^{3*} n_{r,s,3}^1 + a_{r,s}^4 n_{r,s,4}^{1*} + a_{r,s}^{5*} n_{r,s,5}^1 + a_{r,s}^6 n_{r,s,6}^{1*}] \\
&\quad + \sqrt{E_s} [a_{r,s}^{7*} n_{r,s,7}^1 + a_{r,s}^8 n_{r,s,8}^{1*} + a_{r,s}^{9*} n_{r,s,1}^2 + a_{r,s}^{10} n_{r,s,2}^{2*} + a_{r,s}^{11*} n_{r,s,3}^2 + a_{r,s}^{12} n_{r,s,4}^{2*}] \\
&\quad + \sqrt{E_s} [a_{r,s}^{13*} n_{r,s,5}^2 + a_{r,s}^{14} n_{r,s,6}^{2*} + a_{r,s}^{15*} n_{r,s,7}^2 + a_{r,s}^{16} n_{r,s,8}^{2*}] + E_s x_1 \sum_{i=1}^{16} (a_{r,s}^i)^2
\end{aligned}$$

Now these symbols are transmitted from relay to destination by amplifying with some factor.  $y_{d,r}$  is the signal received at the destination from relay with amplification  $\beta_r$ . By diversity combining at the destination we get

$$\begin{aligned}
y_{d,r,1} &= (a_{d,r}^1 s_{r,1} + a_{d,r}^2 s_{r,2}) \beta_r \sqrt{E_r} + n_{d,r,1} \\
y_{d,r,2} &= (-a_{d,r}^1 s_{r,2}^* + a_{d,r}^2 s_{r,1}^*) \beta_r \sqrt{E_r} + n_{d,r,2}
\end{aligned}$$

By diversity combining at the destination antenna we get following signals

$$\begin{aligned}
\tilde{z}_{d,r,1} &= l_1^* y_{d,r,1} + l_2 y_{d,r,2}^* \\
\tilde{z}_{d,r,2} &= l_2^* y_{d,r,1} - l_1 y_{d,r,2}^*
\end{aligned}$$



where,  $l_i = a_{d,r}^i \sqrt{E_r}$ , On expanding we get

$$\begin{aligned}\tilde{z}_{d,r,1} = & CD\beta_r E_r E_s x_1 + \sqrt{E_s} [Da_{r,s}^{1*} \beta_r E_r n_{r,s,1}^1 + Da_{r,s}^2 \beta_r E_r n_{r,s,2}^{1*} + Da_{r,s}^{3*} \beta_r E_r n_{r,s,3}^1] \\ & + \sqrt{E_s} [Da_{r,s}^4 \beta_r E_r n_{r,s,4}^{1*} + Da_{r,s}^{5*} \beta_r E_r n_{r,s,5}^1 + Da_{r,s}^6 \beta_r E_r n_{r,s,6}^{1*} + Da_{r,s}^{7*} \beta_r E_r n_{r,s,7}^1] \\ & + \sqrt{E_s} [Da_{r,s}^8 \beta_r E_r n_{r,s,8}^{1*} + Da_{r,s}^{9*} \beta_r E_r n_{r,s,1}^2 + Da_{r,s}^{10} \beta_r E_r n_{r,s,2}^{2*} + Da_{r,s}^{11*} \beta_r E_r n_{r,s,3}^2] \\ & + \sqrt{E_s} [Da_{r,s}^{12} \beta_r E_r n_{r,s,4}^{2*} + Da_{r,s}^{13*} \beta_r E_r n_{r,s,5}^2 + Da_{r,s}^{14} \beta_r E_r n_{r,s,6}^{2*} + Da_{r,s}^{15*} \beta_r E_r n_{r,s,7}^2] \\ & + Da_{r,s}^{16} \beta_r E_r \sqrt{E_s} n_{r,s,8}^{2*} + a_{d,r}^{1*} \sqrt{E_r} n_{d,r,1} + a_{d,r}^2 \sqrt{E_r} n_{d,r,2}^*\end{aligned}$$

$$\begin{aligned}\tilde{z}_{d,r,2} = & CD\beta_r E_r E_s x_2 + \sqrt{E_s} [Da_{r,s}^{2*} \beta_r E_r n_{r,s,1}^1 - Da_{r,s}^1 \beta_r E_r n_{r,s,2}^{1*} - Da_{r,s}^3 \beta_r E_r n_{r,s,4}^{1*}] \\ & + \sqrt{E_s} [Da_{r,s}^{4*} \beta_r E_r n_{r,s,3}^1 - Da_{r,s}^5 \beta_r E_r n_{r,s,6}^{1*} + Da_{r,s}^{6*} \beta_r E_r n_{r,s,5}^1 + Da_{r,s}^7 \beta_r E_r n_{r,s,8}^{1*}] \\ & - \sqrt{E_s} [Da_{r,s}^{8*} \beta_r E_r n_{r,s,7}^1 + Da_{r,s}^{10*} \beta_r E_r n_{r,s,1}^2 - Da_{r,s}^9 \beta_r E_r n_{r,s,2}^{2*} - Da_{r,s}^{11} \beta_r E_r n_{r,s,4}^{2*}] \\ & + \sqrt{E_s} [Da_{r,s}^{12*} \beta_r E_r n_{r,s,3}^2 - Da_{r,s}^{13} \beta_r E_r n_{r,s,6}^{2*} + Da_{r,s}^{14*} \beta_r E_r n_{r,s,5}^1 + Da_{r,s}^{15} \beta_r E_r n_{r,s,8}^{1*}] \\ & - Da_{r,s}^{16*} \beta_r E_r \sqrt{E_s} n_{r,s,7}^2 + a_{d,r}^{2*} \sqrt{E_r} n_{d,r,1} - a_{d,r}^1 \sqrt{E_r} n_{d,r,2}^*\end{aligned}$$

Here  $D = \sum_{i=1}^2 |a_{d,r}^i|^2$ ,  $C = \sum_{i=1}^{16} |a_{r,s}^i|^2$ . And  $y_{d,s,i}$  is the signals from direct path i.e from source to destination after Combining

$$\begin{aligned}y_{d,s,1} = & \sqrt{E_s} [a_{d,s}^{1*} n_{d,s,1} + a_{r,s}^2 n_{d,s,2}^* + a_{d,s}^{3*} n_{d,s,3} + a_{d,s}^4 n_{d,s,4}^* + a_{d,s}^{5*} n_{d,s,5} + a_{r,s}^6 n_{d,s,6}^*] \\ & + \sqrt{E_s} [a_{d,s}^{7*} n_{d,s,7} + a_{d,s}^8 n_{d,s,8}^*] + E_s x_1 \left[ \sum_{i=1}^8 (a_{d,s}^i)^2 \right] \\ y_{d,s,2} = & \sqrt{E_s} [a_{r,s}^{2*} n_{d,s,1} - a_{d,s}^1 n_{d,s,2}^* - a_{d,s}^3 n_{d,s,4}^* + a_{d,s}^{4*} n_{d,s,3} - a_{d,s}^5 n_{d,s,6}^* + a_{r,s}^{6*} n_{d,s,5}] \\ & + \sqrt{E_s} [a_{d,s}^7 n_{d,s,8}^* - a_{d,s}^{8*} n_{d,s,7}] + E_s x_2 \left[ \sum_{i=1}^8 (a_{d,s}^i)^2 \right]\end{aligned}$$

so we have two signals at destination  $\tilde{z}_{d,r,i}$  and  $y_{d,s,i}$ . Now Maximum likelihood detection rule for first symbol is given by

$$\frac{CE_s \beta_r \text{Re} \{ \tilde{z}_{d,r,1} \}}{CDE_r E_s \beta_r^2 + 1} + \text{Re} \{ y_{d,s,1} \} \begin{matrix} > \\ < \\ = \end{matrix} \begin{matrix} 1 \\ 0 \\ -1 \end{matrix}$$

## 2.5 Detection rule for $M_s = 4, M_r = 2, M_d = 1$ for complex signals

In this model we have 4 transmitted antennas and n relays with each having 2 antennas. we have 4 transmitted antennas so we can transmit 3 signals at a time. For transmission we use quasi orthogonal designs In this case by  $4 \times 4$  quasi orthogonal design we represent x as

$$\begin{pmatrix} x_1 & x_2 & x_3 & 0 \\ -x_2^* & x_1^* & 0 & -x_3 \\ -x_3^* & 0 & x_1^* & x_2 \\ 0 & x_3^* & -x_2^* & x_1 \end{pmatrix}$$

Following are the signal received at the destination and  $r$ th relay .The signals received at destination are

$$\begin{aligned} y_{d,s,1} &= [a_{d,s}^1 x_1 + a_{d,s}^2 x_2 + a_{d,s}^3 x_3 + 0] \sqrt{E_s} + n_{d,s,1} \\ y_{d,s,2} &= [a_{d,s}^2 x_1^* - a_{d,s}^1 x_2^* + 0 - a_{d,s}^4 x_3] \sqrt{E_s} + n_{d,s,2} \\ y_{d,s,3} &= [a_{d,s}^3 x_1^* + 0 - a_{d,s}^1 x_3^* + a_{d,s}^4 x_2] \sqrt{E_s} + n_{d,s,3} \\ y_{d,s,4} &= [0 + a_{d,s}^2 x_3^* - a_{d,s}^3 x_2^* + a_{d,s}^4 x_1] \sqrt{E_s} + n_{d,s,4} \end{aligned}$$

signals received at the relay are given as

$$\begin{aligned} y_{r,s,1}^1 &= [a_{r,s}^1 x_1 + a_{r,s}^2 x_2 + a_{r,s}^3 x_3 + 0] \sqrt{E_s} + n_{r,s,1}^1 \\ y_{r,s,2}^1 &= [a_{r,s}^2 x_1^* - a_{r,s}^1 x_2^* + 0 - a_{r,s}^4 x_3] \sqrt{E_s} + n_{r,s,2}^1 \\ y_{r,s,3}^1 &= [a_{r,s}^3 x_1^* + 0 - a_{r,s}^1 x_3^* + a_{r,s}^4 x_2] \sqrt{E_s} + n_{r,s,3}^1 \\ y_{r,s,4}^1 &= [0 + a_{r,s}^2 x_3^* - a_{r,s}^3 x_2^* + a_{r,s}^4 x_1] \sqrt{E_s} + n_{r,s,4}^1 \\ y_{r,s,1}^2 &= [a_{r,s}^5 x_1 + a_{r,s}^6 x_2 + a_{r,s}^7 x_3 + 0] \sqrt{E_s} + n_{r,s,1}^2 \\ y_{r,s,2}^2 &= [a_{r,s}^6 x_1^* - a_{r,s}^5 x_2^* + 0 - a_{r,s}^8 x_3] \sqrt{E_s} + n_{r,s,2}^2 \\ y_{r,s,3}^2 &= [a_{r,s}^7 x_1^* - a_{r,s}^5 x_3^* + 0 + a_{r,s}^8 x_2] \sqrt{E_s} + n_{r,s,3}^2 \\ y_{r,s,4}^2 &= [0 + a_{r,s}^6 x_3^* - a_{r,s}^7 x_2^* + a_{r,s}^8 x_1] \sqrt{E_s} + n_{r,s,4}^2 \end{aligned}$$

The above signals are combined at the relay and we get  $s_{r,i}$

$$\begin{aligned} s_{r,1} &= h_1^* y_{r,s,1}^1 + h_2 y_{r,s,2}^{1*} + h_3^* y_{r,s,3}^1 + h_4 y_{r,s,4}^{1*} + h_5^* y_{r,s,1}^2 + h_6 y_{r,s,2}^{2*} + h_7^* y_{r,s,3}^2 + h_8 y_{r,s,4}^{2*} \\ s_{r,2} &= -h_1 y_{r,s,2}^{1*} + h_2^* y_{r,s,1}^1 - h_3 y_{r,s,4}^{1*} + h_4^* y_{r,s,3}^1 - h_5 y_{r,s,2}^{2*} + h_6^* y_{r,s,1}^2 - h_7 y_{r,s,4}^{2*} + h_8^* y_{r,s,3}^2 \end{aligned}$$

Now these symbols are transmitted from relay to destination by amplifying with factor  $\beta_r$  using Alamouti code.  $y_{d,r}$  is the signal received at the destination from relay

$$y_{d,r,1} = (a_{d,r}^1 s_{r,1} + a_{d,r}^2 s_{r,2}) \beta_r \sqrt{E_r} + n_{d,r,1}$$

$$y_{d,r,2} = (-a_{d,r}^1 s_{r,2}^* + a_{d,r}^2 s_{r,1}^*) \beta_r \sqrt{E_r} + n_{d,r,2}$$

where  $\beta_r = \sqrt{\frac{1}{CE_s + N_0}}$ . Applying Maximal Ratio Combining at the destination we get

$$\begin{aligned} \tilde{z}_{d,r,1} &= l_1 y_{d,r,1} + l_2 y_{d,r,2} \\ \tilde{z}_{d,r,2} &= l_2 y_{d,r,1} - l_1 y_{d,r,2} \end{aligned}$$

where,  $l_i = a_{d,r}^i \sqrt{E_r}$ , On expanding

$$\begin{aligned} \tilde{z}_{d,r,1} &= CD\beta_r E_r E_s x_1 + E_r \sqrt{E_s} [Da_{r,s}^{1*} \beta_r n_{r,s,1}^1 + Da_{r,s}^2 \beta_r n_{r,s,2}^{1*} + Da_{r,s}^{3*} n_{r,s,3}^1] \\ &\quad + E_r \sqrt{E_s} [Da_{r,s}^4 \beta_r n_{r,s,4}^{1*} + Da_{r,s}^{5*} \beta_r n_{r,s,1}^2 + Da_{r,s}^6 \beta_r n_{r,s,2}^{2*} + Da_{r,s}^{7*} \beta_r n_{r,s,3}^2] \\ &\quad + Da_{r,s}^8 \beta_r E_r \sqrt{E_s} n_{r,s,4}^{2*} + a_{d,r}^{1*} \sqrt{E_r} n_{d,r,1} + a_{d,r}^2 \sqrt{E_r} n_{d,r,2}^* \\ \tilde{z}_{d,r,2} &= CD\beta_r E_r E_s x_2 + E_r \sqrt{E_s} [Da_{r,s}^2 \beta_r n_{r,s,1}^1 - Da_{r,s}^1 \beta_r n_{r,s,2}^1 + Da_{r,s}^3 \beta_r n_{r,s,4}^1] \\ &\quad + E_r \sqrt{E_s} [-Da_{r,s}^4 \beta_r n_{r,s,3}^1 - Da_{r,s}^5 \beta_r n_{r,s,2}^2 + Da_{r,s}^6 \beta_r n_{r,s,1}^2 + Da_{r,s}^7 \beta_r n_{r,s,4}^2] \\ &\quad - Da_{r,s}^8 \beta_r E_r \sqrt{E_s} n_{r,s,3}^2 + a_{d,r}^2 \sqrt{E_r} n_{d,r,1} - a_{d,r}^1 \sqrt{E_r} n_{d,r,2} \end{aligned}$$

$$z_{d,s,1} = h_1^* y_{d,s,1} + h_2 y_{d,s,2}^* + h_3^* y_{d,s,3} + h_4 y_{d,s,4}^*$$

where,  $D = \sum_{i=1}^2 |a_{d,r}^i|^2$ ,  $C = \sum_{i=1}^8 |a_{r,s}^i|^2$ .

So we have two signals at destination  $\tilde{z}_{d,r,i}$  and  $z_{d,s,i}$

Now signal received from both source and relay is given by

$$Y = \frac{CE_s \beta_r \tilde{z}_{d,r,1}}{CDE_r E_s \beta_r^2 + 1} + z_{d,s,1}$$

Now based on ANGLE(Y) we decide the decision rule

## 2.6 Detection rule for $M_s = 8, M_r = 2, M_d = 1$ for complex signals

In this model we have 8 transmitted antennas and n relays with each having 2 antennas. we have 8 transmitted antennas so we can transmit 6 signals at a time because these are complex signals. In this case by  $8 \times 8$  quasi orthogonal design we represent x as

$$\begin{pmatrix} x_1 & x_2 & x_3 & 0 & x_4 & x_5 & x_6 & 0 \\ -x_2^* & x_1^* & 0 & x_3 & -x_5^* & x_4^* & 0 & x_6 \\ -x_3 & 0 & x_1 & x_2 & -x_6^* & 0 & x_4^* & x_5 \\ 0 & -x_3 & -x_2^* & x_1^* & 0 & x_6^* & x_5^* & x_4 \\ -x_4 & x_5 & x_6^* & 0 & x_1 & x_2 & -x_3 & 0 \\ -x_5^* & -x_4^* & -0 & -x_6^* & -x_2^* & x_1^* & 0 & x_3 \\ -x_6 & 0 & -x_4^* & -x_5 & x_3 & 0 & x_1 & x_2 \\ 0 & -x_6 & x_5^* & -x_4 & 0 & -x_3 & -x_2^* & x_1^* \end{pmatrix}$$

Signals at destination are

$$\begin{aligned} y_{d,s,1} &= [a_{d,s}^1 x_1 + a_{d,s}^2 x_2 + a_{d,s}^3 x_3 + a_{d,s}^5 x_4 + a_{d,s}^6 x_5 + a_{d,s}^7 x_6 +] \sqrt{E_s} + n_{d,s,1} \\ y_{d,s,2} &= [-a_{d,s}^1 x_2^* + a_{d,s}^2 x_1^* + a_{d,s}^4 x_3 - a_{d,s}^5 x_5^* + a_{d,s}^6 x_4^* + a_{d,s}^8 x_6] \sqrt{E_s} + n_{d,s,2} \\ y_{d,s,3} &= [-a_{d,s}^1 x_3 + a_{d,s}^3 x_1 + a_{d,s}^4 x_2 - a_{d,s}^5 x_6^* + a_{d,s}^7 x_4^* + a_{d,s}^8 x_5] \sqrt{E_s} + n_{d,s,3} \\ y_{d,s,4} &= [-a_{d,s}^2 x_3 - a_{d,s}^3 x_2^* + a_{d,s}^4 x_1^* + a_{d,s}^6 x_6^* + a_{d,s}^7 x_5^* + a_{d,s}^8 x_4] \sqrt{E_s} + n_{d,s,4} \\ y_{d,s,5} &= [-a_{d,s}^1 x_4 + a_{d,s}^2 x_5 + a_{d,s}^3 x_6^* + a_{d,s}^5 x_1 + a_{d,s}^6 x_2 - a_{d,s}^7 x_3] \sqrt{E_s} + n_{r,s,5} \\ y_{d,s,6} &= [-a_{r,s}^1 x_5^* - a_{r,s}^2 x_4^* - a_{r,s}^4 x_6^* - a_{r,s}^5 x_2^* + a_{r,s}^6 x_1^* + a_{r,s}^8 x_3] \sqrt{E_s} + n_{d,s,6} \\ y_{d,s,7} &= [-a_{d,s}^1 x_6 - a_{d,s}^3 x_4^* - a_{d,s}^4 x_5 + a_{d,s}^5 x_3 + a_{d,s}^7 x_1 + a_{d,s}^8 x_2] \sqrt{E_s} + n_{d,s,7} \\ y_{d,s,8} &= [-a_{d,s}^2 x_6 + a_{d,s}^3 x_5^* - a_{d,s}^4 x_4 - a_{d,s}^6 x_3 - a_{d,s}^7 x_2^* + a_{d,s}^8 x_1^*] \sqrt{E_s} + n_{r,s,8} \end{aligned}$$

signals received at the relay are

$$\begin{aligned} y_{r,s,1}^1 &= [a_{r,s}^1 x_1 + a_{r,s}^2 x_2 + a_{r,s}^3 x_3 + a_{r,s}^5 x_4 + a_{r,s}^6 x_5 + a_{r,s}^7 x_6 +] \sqrt{E_s} + n_{r,s,1}^1 \\ y_{r,s,2}^1 &= [-a_{r,s}^1 x_2^* + a_{r,s}^2 x_1^* + a_{r,s}^4 x_3 - a_{r,s}^5 x_5^* + a_{r,s}^6 x_4^* + a_{r,s}^8 x_6] \sqrt{E_s} + n_{r,s,2}^1 \\ y_{r,s,3}^1 &= [-a_{r,s}^1 x_3 + a_{r,s}^3 x_1 + a_{r,s}^4 x_2 - a_{r,s}^5 x_6^* + a_{r,s}^7 x_4^* + a_{r,s}^8 x_5] \sqrt{E_s} + n_{r,s,3}^1 \\ y_{r,s,4}^1 &= [-a_{r,s}^2 x_3 - a_{r,s}^3 x_2^* + a_{r,s}^4 x_1^* + a_{r,s}^6 x_6^* + a_{r,s}^7 x_5^* + a_{r,s}^8 x_4] \sqrt{E_s} + n_{r,s,4}^1 \end{aligned}$$

$$\begin{aligned}
y_{r,s,5}^1 &= [-a_{r,s}^1 x_4 + a_{r,s}^2 x_5 + a_{r,s}^3 x_6^* + a_{r,s}^5 x_1 + a_{r,s}^6 x_2 - a_{r,s}^7 x_3] \sqrt{E_s} + n_{r,s,5}^1 \\
y_{r,s,6}^1 &= [-a_{r,s}^1 x_5^* - a_{r,s}^2 x_4^* - a_{r,s}^4 x_6^* - a_{r,s}^5 x_2^* + a_{r,s}^6 x_1^* + a_{r,s}^8 x_3] \sqrt{E_s} + n_{r,s,6}^1 \\
y_{r,s,7}^1 &= [-a_{r,s}^1 x_6 - a_{r,s}^3 x_4^* - a_{r,s}^4 x_5 + a_{r,s}^5 x_3 + a_{r,s}^7 x_1 + a_{r,s}^8 x_2] \sqrt{E_s} + n_{r,s,7}^1 \\
y_{r,s,8}^1 &= [-a_{r,s}^2 x_6 + a_{r,s}^3 x_5^* - a_{r,s}^4 x_4 - a_{r,s}^6 x_3 - a_{r,s}^7 x_2^* + a_{r,s}^8 x_1^*] \sqrt{E_s} + n_{r,s,8}^1
\end{aligned}$$

Now symbols received at second antenna are given below

$$\begin{aligned}
y_{r,s,1}^2 &= [a_{r,s}^9 x_1 + a_{r,s}^{10} x_2 + a_{r,s}^{11} x_3 + a_{r,s}^{13} x_4 + a_{r,s}^{14} x_5 + a_{r,s}^{15} x_6 +] \sqrt{E_s} + n_{r,s,1}^2 \\
y_{r,s,2}^2 &= [-a_{r,s}^9 x_2^* + a_{r,s}^{10} x_1^* + a_{r,s}^{12} x_3 - a_{r,s}^{13} x_5^* + a_{r,s}^{14} x_4^* + a_{r,s}^{16} x_6] \sqrt{E_s} + n_{r,s,2}^2 \\
y_{r,s,3}^2 &= [-a_{r,s}^9 x_3 + a_{r,s}^{11} x_1 + a_{r,s}^{12} x_2 - a_{r,s}^{13} x_6^* + a_{r,s}^{15} x_4^* + a_{r,s}^{16} x_5] \sqrt{E_s} + n_{r,s,3}^2 \\
y_{r,s,4}^2 &= [-a_{r,s}^{10} x_3 - a_{r,s}^{11} x_2^* + a_{r,s}^{12} x_1^* + a_{r,s}^{14} x_6^* + a_{r,s}^{15} x_5^* + a_{r,s}^{16} x_4] \sqrt{E_s} + n_{r,s,4}^2 \\
y_{r,s,5}^2 &= [-a_{r,s}^9 x_4 + a_{r,s}^{10} x_5 + a_{r,s}^{11} x_6^* + a_{r,s}^{13} x_1 + a_{r,s}^{14} x_2 - a_{r,s}^{15} x_3] \sqrt{E_s} + n_{r,s,5}^1 \\
y_{r,s,6}^2 &= [-a_{r,s}^9 x_5^* - a_{r,s}^{10} x_4^* - a_{r,s}^{12} x_6^* - a_{r,s}^{13} x_2^* + a_{r,s}^{14} x_1^* + a_{r,s}^{16} x_3] \sqrt{E_s} + n_{r,s,6}^2 \\
y_{r,s,7}^2 &= [-a_{r,s}^9 x_6 - a_{r,s}^{11} x_4^* - a_{r,s}^{12} x_5 + a_{r,s}^{13} x_3 + a_{r,s}^{15} x_1 + a_{r,s}^{16} x_2] \sqrt{E_s} + n_{r,s,7}^2 \\
y_{r,s,8}^2 &= [-a_{r,s}^{10} x_6 + a_{r,s}^{11} x_5^* - a_{r,s}^{12} x_4 - a_{r,s}^{14} x_3 - a_{r,s}^{15} x_2^* + a_{r,s}^{16} x_1^*] \sqrt{E_s} + n_{r,s,8}^2
\end{aligned}$$

Now applying MRC at the  $r^{th}$  relay we have

$$\begin{aligned}
s_{r,1} &= h_1^* y_{r,s,1}^1 + h_2 y_{r,s,2}^{1*} + h_3^* y_{r,s,3}^1 + h_4 y_{r,s,4}^{1*} + h_5^* y_{r,s,5}^1 + h_6 y_{r,s,6}^{1*} + h_7^* y_{r,s,7}^1 + h_8 y_{r,s,8}^{1*} \\
&\quad + h_9^* y_{r,s,1}^2 + h_{10} y_{r,s,2}^{2*} + h_{11}^* y_{r,s,3}^2 + h_{12} y_{r,s,4}^{2*} + h_{13}^* y_{r,s,5}^2 + h_{14} y_{r,s,6}^{2*} + h_{15}^* y_{r,s,7}^2 + h_{16} y_{r,s,8}^{2*} \\
s_{r,2} &= -h_1 y_{r,s,2}^{1*} + h_2^* y_{r,s,1}^1 - h_3 y_{r,s,4}^{1*} + h_4^* y_{r,s,3}^1 - h_5 y_{r,s,6}^{1*} + h_6^* y_{r,s,5}^1 + h_7 y_{r,s,8}^{1*} - h_8^* y_{r,s,7}^1 \\
&\quad - h_9 y_{r,s,2}^{2*} + h_{10}^* y_{r,s,1}^2 - h_{11} y_{r,s,4}^{2*} + h_{12}^* y_{r,s,3}^2 - h_{13} y_{r,s,6}^{2*} + h_{14}^* y_{r,s,5}^2 + h_{15} y_{r,s,8}^{2*} - h_{16}^* y_{r,s,7}^2
\end{aligned}$$

where  $h_i = a_{r,s}^i \sqrt{E_s}$ , by putting all values in above equation we get full expression for  $s_{r,i}$

$$\begin{aligned}
s_{r,1} &= \sqrt{E_s} [a_{r,s}^{1*} n_{r,s,1}^1 + a_{r,s}^2 n_{r,s,2}^{1*} + a_{r,s}^{3*} n_{r,s,3}^1 + a_{r,s}^4 n_{r,s,4}^{1*} + a_{r,s}^{5*} n_{r,s,5}^1 + a_{r,s}^6 n_{r,s,6}^{1*}] \\
&\quad + \sqrt{E_s} [a_{r,s}^{7*} n_{r,s,7}^1 + a_{r,s}^8 n_{r,s,8}^{1*} + a_{r,s}^{9*} n_{r,s,1}^2 + a_{r,s}^{10} n_{r,s,2}^{2*} + a_{r,s}^{11*} n_{r,s,3}^2 + a_{r,s}^{12} n_{r,s,4}^{2*}] \\
&\quad + \sqrt{E_s} [a_{r,s}^{13*} n_{r,s,5}^2 + a_{r,s}^{14} n_{r,s,6}^{2*} + a_{r,s}^{15*} n_{r,s,7}^2 + a_{r,s}^{16} n_{r,s,8}^{2*}] + E_s x_1 \sum_{i=1}^{16} [a_{r,s}^i]^2
\end{aligned}$$

Now these symbols are transmitted from relay to destination by amplifying with some factor  $\beta_r$ ,  $y_{d,r}$  is the signal received at the destination from relay.

$$\begin{aligned} y_{d,r,1} &= (a_{d,r}^1 s_{r,1} + a_{d,r}^2 s_{r,2}) \beta_r \sqrt{E_r} + n_{d,r,1} \\ y_{d,r,2} &= (-a_{d,r}^1 s_{r,2}^* + a_{d,r}^2 s_{r,1}^*) \beta_r \sqrt{E_r} + n_{d,r,2} \end{aligned}$$

By diversity combining at the destination antenna we get

$$\begin{aligned} \tilde{z}_{d,r,1} &= l_1^* y_{d,r,1} + l_2 y_{d,r,2}^* \\ \tilde{z}_{d,r,2} &= l_2^* y_{d,r,1} - l_1 y_{d,r,2}^* \end{aligned}$$

where,  $l_i = a_{d,r}^i \sqrt{E_r}$ ,  $D = \sum_{i=1}^{16} |a_{d,r}^i|^2$  and  $C = \sum_{i=1}^{16} |a_{r,s}^i|^2$

So we have two signals at destination  $\tilde{z}_{d,r,i}$  and  $y_{d,s,i}$ .  
The combining signal at the receiver is given as

$$Y = \frac{C E_s \beta_r \tilde{z}_{d,r,1}}{C D E_r E_s \beta_r^2 + 1} + z_{d,s,1}$$

Now based on  $\text{ANGLE}(Y)$  we decide the decision rule

## Chapter 3

# Theoretical Bit Error Rate Performance analysis

We define the gamma distribution which will be necessary for BER performance analysis for different schemes. The probability density function (PDF) of a random variable  $\gamma$  with gamma distribution with mean  $\bar{\gamma}$  and order  $m$  is defined as

$$p_{\gamma}(x) = \frac{x^{m-1}e^{-(x/\bar{\gamma})}}{\bar{\gamma}^m\Gamma(m)}$$

We define the respective equivalent SNR [2] on the S-D, S-R and R-D links as  $\gamma_{d,s}, \gamma_{r,s}, \gamma_{d,r}$  with  $\bar{\gamma}_{d,s} = E[\gamma_{d,s}]$ ,  $\bar{\gamma}_{r,s} = E[\gamma_{r,s}]$  and  $\bar{\gamma}_{d,r} = E[\gamma_{d,r}]$ .

$$\gamma_{d,s} = \frac{E_s}{N_0}|a_{d,s}|^2, \gamma_{r,s} = \frac{E_s}{N_0}C_r, \gamma_{d,r} = \frac{E_r}{N_0}D_r$$

The equivalent end-to-end SNR can then be expressed as

$$\begin{aligned} \gamma_{eq} &= \gamma_{d,s} + \sum_{r=1}^N \frac{\gamma_{r,s}^2 \gamma_{d,r}}{1 + \gamma_{r,s} + \gamma_{r,s} \gamma_{d,r}} \\ &< \gamma_{d,s} + \sum_{r=1}^N \frac{\gamma_{r,s} \gamma_{d,r}}{1 + \gamma_{d,r}} \end{aligned}$$

Though this is an upper bound, this gives a very close approximation for  $\gamma_{r,s} \gg 1$ . Defining  $\gamma_r = \gamma_{r,s} \gamma_{d,r} / (1 + \gamma_{d,r})$ , and noting that  $\gamma_{d,s}, \gamma_{r,s}$  and  $\gamma_{d,r}$  are all gamma distributed, the MGF of  $\gamma_r$  is obtained in [1] where  $m_{d,r} = M_d, m_{r,s} = M_r, \bar{\gamma}_{r,s} = M_r \Omega_{r,s} E_s / N_0$  and  $\bar{\gamma}_{d,r} = M_d \Omega_{d,r} E_r / N_0$

Theoretical Bit Error rate expression is obtained by Moment generating function(MGF) analysis.The MGF of two hop communication is given as

$$M_{\gamma_{eq}}(s) = M_{\gamma_{d,s}(s)} \prod_{r=1}^N M_{\gamma_r}(s).$$

Where  $M_{\gamma_{eq}}$  is the MGF of the end-to-end equivalent signal to noise ratio of the MIMO relay system[3].The MGF of source to destination link is given by

$$M_{\gamma_{d,s}}(s) = \frac{1}{1 + s\bar{\gamma}_{d,s}}$$

The MGF of source to destination link is given by [3]

$$\begin{aligned} M_{\gamma_r}(s) &= \left(\frac{m_{r,s}}{\bar{\gamma}_{r,s}}\right)^{m_{r,s}} \left(\frac{m_{d,r}}{\bar{\gamma}_{d,r}}\right)^{m_{d,r}} \frac{\Gamma(m_{r,s} + m_{d,r})}{\Gamma(m_{r,s}) \Gamma(m_{d,r})} \frac{1}{(m_{d,r}/\bar{\gamma}_{d,r} + m_{r,s}/\bar{\gamma}_{d,r} + s)^{m_{d,r} + m_{r,s}}} \\ &\cdot \left[ \frac{1}{m_{r,s}} {}_2F_1\left(1, m_{r,s} + m_{d,r}; m_{r,s} + 1; \frac{m_{r,s}/\bar{\gamma}_{r,s} + s}{m_{r,s}/\bar{\gamma}_{r,s} + m_{d,r}\bar{\gamma}_{r,s} + s}\right) \right. \\ &\left. + \frac{1}{m_{d,r}} {}_2F_1\left(1, m_{r,s} + m_{d,r}; m_{d,r} + 1; \frac{m_{d,r}/\bar{\gamma}_{d,r} + s}{m_{r,s}/\bar{\gamma}_{r,s} + m_{d,r}/\bar{\gamma}_{d,r} + s}\right) \right] \end{aligned}$$

The general expression for BER in relay cooperative diversity is given by below expression [6]

$$P_{bpsk} = \frac{1}{\pi} \int_0^{\frac{\pi}{2}} M_{\gamma_{eq}}\left(\frac{1}{\sin^2 \theta}\right) d\theta.$$

### 3.1 Expression for Bit Error Rate in M-PSK

The general expression for BER in M-PSK is

$$P_{M.psk} = \frac{1}{\pi} \int_0^{\frac{\pi}{M}(M-1)} M_{\gamma_{eq}}\left(\frac{K_M}{\sin^2 \theta}\right) d\theta.$$



where  $K_M = \sin^2\left(\frac{\pi}{M}\right)$

### 3.2 Expression for Bit Error Rate in M-QAM

The general expression for BER in M-QAM is

$$P_{M,Qam} = \frac{4\left(1 - \frac{1}{\sqrt{M}}\right)}{\pi} \int_0^{\frac{\pi}{2}} M_{\gamma_{eq}}\left(\frac{g_Q}{\sin^2\theta}\right) d\theta \\ - \frac{4\left(1 - \frac{1}{\sqrt{M}}\right)^2}{\pi} \int_0^{\frac{\pi}{4}} M_{\gamma_{eq}}\left(\frac{g_Q}{\sin^2\theta}\right) d\theta.$$

where  $g_Q = \frac{1.5}{(M-1)}$

### 3.3 RESULTS

In our simulations, we have assumed that all the relays are located at the same distance from the source and also from the destination. The ratio of the distance of the relays from the source and the distance between the source and the destination is denoted by  $L$  and consequently  $\Omega_{r,s} \propto 1/L^4$ . The source energy  $E_s$  is equally distributed among all the  $M_s$  antennas at source and relay energy  $E_r$  is equally distributed among all the  $M_r$  antennas at relay.

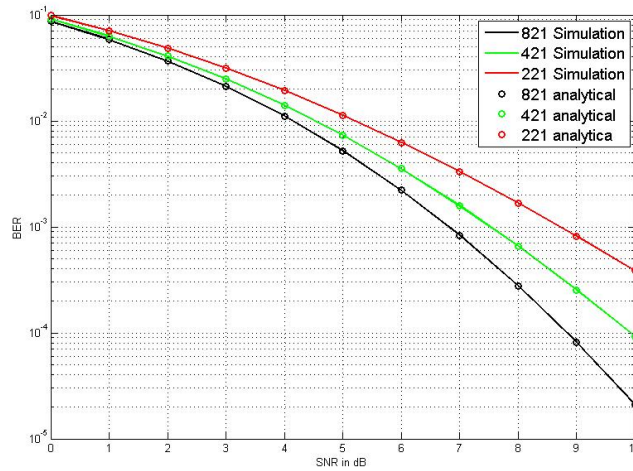

Figure 3.1: BER for MIMO models having 2,4,8 transmitted antennas at source for BPSK

In the above figure we obtained simulation and analytical results for three different MIMO models. We observed that both simulation and analytical results are matched. In this for  $M_s = 8$  we get better BER performance than other two models which shows as number of antennas increases then we get better BER performance.

In the below figure we obtained simulation and analytical results for  $M_s = 4, M_r = 2, M_d = 1$  MIMO model for complex signals. We used different M-PSK modulation schemes, in that 4-PSK provides better performance than all remaining higher modulations. It shows to get better BER performance we have to use low order modulation schemes.

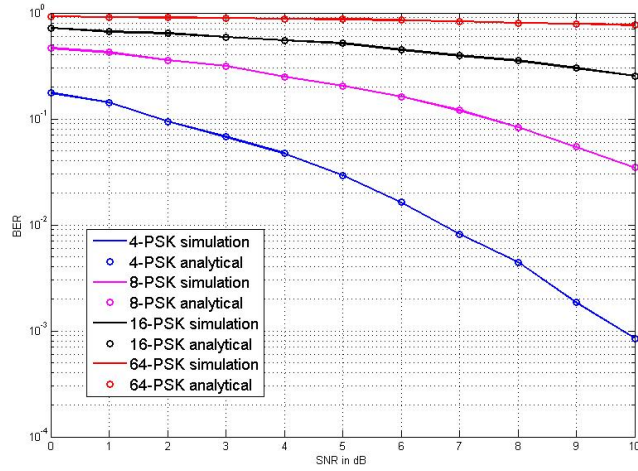

Figure 3.2: BER for  $M_s = 4$ ,  $M_r = 2$ ,  $M_d = 1$  with M-PSK

The below figure illustrates we obtained simulation and analytical results for  $M_s = 8$ ,  $M_r = 2$ ,  $M_d = 1$  MIMO model for complex signals. We used different M-PSK modulation schemes, in that 4-PSK provides better performance than all remaining higher modulations. It shows to get better BER performance we have to use low order modulation schemes

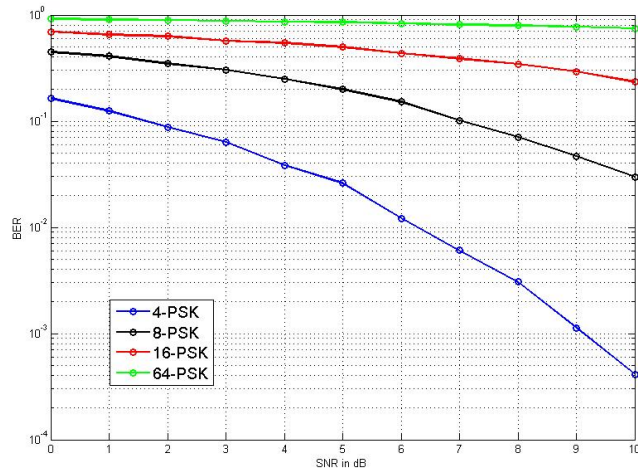

Figure 3.3: BER for MIMO model having  $M_s = 8$ ,  $M_r = 2$ ,  $M_d = 1$  with M-PSK.

In the below figure we obtained simulation and analytical results for  $M_s = 4, M_r = 2, M_d = 1$  MIMO model with different types of M-QAM. We used complex signals for M-QAM for this we obtained quasi orthogonal designs for transmission. In all cases BER decreases as SNR increases, For high value of M we got more BER. The performance curve shows significant improvement for 4-QAM

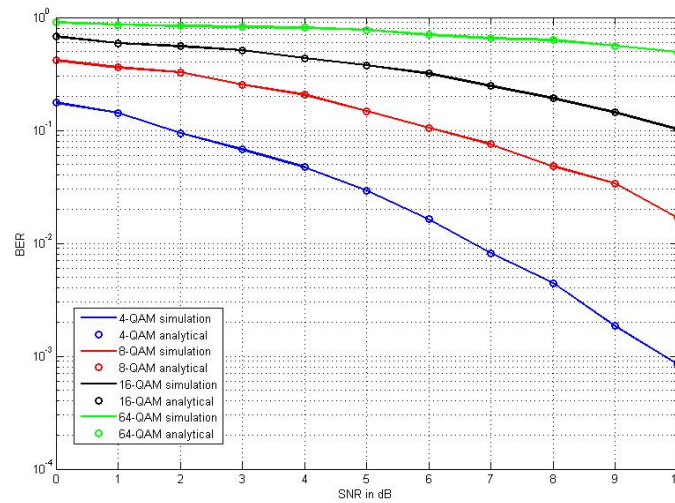

Figure 3.4: BER for MIMO model having  $M_s = 4, M_r = 2, M_d = 1$  for different types of QAM

In the below figure we compared BER performance for  $M_s = 4, M_r = 2, M_d = 1$  MIMO model with BPSK, M-QAM and M-PSK. For BPSK we used real signals for other two we used complex signals. We used different higher modulations for complex signals using both M-PSK and M-QAM. In all of them BPSK provides better performance than other modulations. And it shows for complex signals QAM provides better BER performance than MPSK. From all these figures we can say that we can obtain better BER performance for high number of antennas at source and for complex signals QAM is the better choice

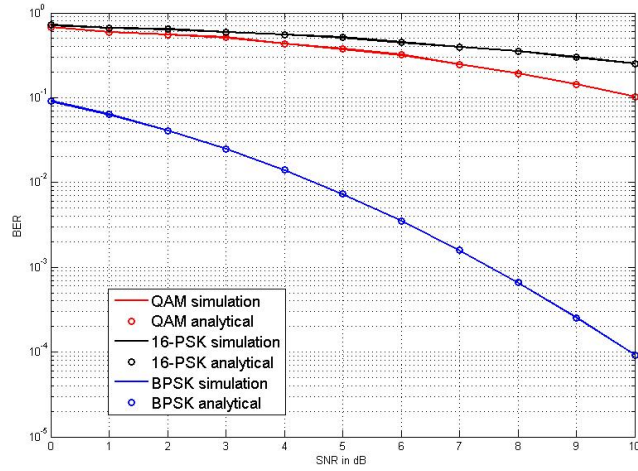

Figure 3.5: BER comparison for MIMO model having  $M_s = 4, M_r = 2, M_d = 1$  using BPSK, QAM, M-PSK

In the below figure we compared BER performance for  $M_s = 8, M_r = 2, M_d = 1$  MIMO model with BPSK, M-QAM and M-PSK. In all of them BPSK provides better performance than other modulations.

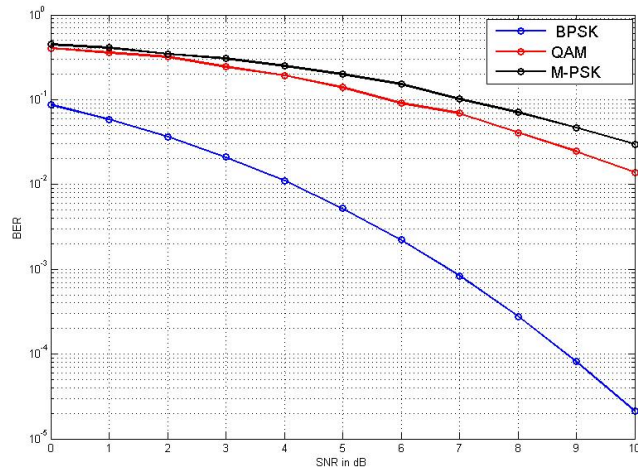

Figure 3.6: BER comparison for MIMO model having  $M_s = 8, M_r = 2, M_d = 1$  using BPSK, QAM, M-PSK

# Chapter 4

## Conclusion and Future work

This paper has shown the possible benefits of a wireless transmission using cooperative diversity to increase the performance. cooperative diversity can significantly enhance the performance of the communication system by reducing the bit error rate. We compared BER performance for different MIMO models and also we compared the Performance analysis of AF based cooperative diversity for multiple transmitted antennas. We compared the simulation results with analytical results for different MIMO models

- In this we have computed for various combinations of MIMO with BPSK, M-PSK, M-QAM. For the above three cases BPSK gives minimum BER compared to others.
- We used Space time block codes for real signals and for complex we used Quasi orthogonal space time block codes
- As number of antennas increases at source then we get better Performance for MIMO models

In this we have done with approximated analysis for obtaining Receiver detection rule .In future we can obtain exact analysis for detection rule and related performance analysis

# Bibliography

- [1] Vijay Ganwani, Bikash Kumar Dey, G V V Sharma, Uday B. Desai and S. N. Merchant, " Performance Analysis of Amplify and Forward Based Cooperative Diversity in MIMO Relay Channels ," IEEE Vehicular Technology Conference (VTC), Spring, April 2009.
- [2] M O Hasna and M S Alouini "Harmonic mean and end-to-end performance of transmission systems with relays" IEEE trans. Comm, vol.52, Jan 2004
- [3] G K Karagiannidis and T A Tsiftsis and R K Mallik "Bounds for multihop relayed communications in Nakagami- $m$  fading", IEEE trans. Comm, vol.54, Jan 2006
- [4] M O Hasna and M S Alouini "Outage probability of multihop transmission over Nakagami Fading Channels", IEEE trans. Comm, vol.7, May 2003
- [5] T A Tsiftsis and G K Karagiannidis and S A Kotsopoulos and F N Pavlidou "BER analysis of collaborative dual-hop wireless transmissions", journal IEE Electronic Lett. volume.40, 2004
- [6] S Ikki and M H Ahmed "Performance Analysis of Cooperative Diversity Wireless Networks over Nakagami- $m$  Fading Channel", IEEE Comm, volume.11, April 2007
- [7] Yindi Jing and Babak Hassibi, "Cooperative Diversity in Wireless Relay Networks with Multiple-Antenna Nodes", Proceedings of IEEE International Symposium on Information Theory, Adelaide, Australia, September 2005
- [8] Sivash M Alamouti, "A simple transmitter diversity scheme for wireless communications" IEEE J. select .areas Comm, volume.16, October 1998
- [9] Tarokh, V Tarokh and H Jafarkhani and A R Calderbank, "Space-time block codes from orthogonal designs", IEEE Tran , volume .45, July 1999

- [10] M K Simon and M S Alouini, "Digital Communication over Fading Channels" John Wiley and Sons, second edition 2005
- [11] I. S. Gradshteyn and I. M. Ryzhik, Table of Integrals, Series and Products, Fifth Edition. San Diego: Academic Press, 1994.
- [12] T A Tsiftsis and G K Karagiannidis and P T Mathiopoulos and S A Kotsopoulos, "Nonregenerative dual-hop cooperative links with selection diversity", EURASIP, J. Wireless Commun. Networking, article ID 17862, 2006
- [13] V. Tarokh, H. Jafarkhani and A. R. Calderbank, Space-time block codes from orthogonal designs, IEEE Trans. Inform. Theory, vol. 45, no. 5, pp. 1456-1467, July 1999.
- [14] A. V. Geramita and J. Seberry, Orthogonal Designs, Quadratic Forms and Hadamard Matrices, Lecture Notes in Pure and Applied Mathematics, vol. 43. New York and Basel: Marcel Dekker, 1979.