

A REVIEW OF THE ELEMENTS OF NUCLEAR MAGNETIC RESONANCE INSTRUMENTATION

S. Aravamudhan*

North Eastern Hill University, Shillong 793022 Meghalaya

*For correspondence. (saravamudhan@hotmail.com)

Abstract: The early efforts to detect nuclear magnetic resonance (NMR) when reviewed, carries a valuable message on how to go about making discoveries of phenomena on the basis of what is known already. Particularly the instrumentation is an effort which has an outlook on enterprises that provide various laboratory equipments and assembling these units in a way that brings out precisely what is being looked for is a creative preoccupation in scientific research. The kind of home-built spectrometers which have been used by every researcher for the achievements in the NMR spectroscopic technique is an example of the material manipulation to improve stage by stage thoughtfully knowing what went on before. Thus the review would have educative value while revealing the lessons on scientific matter studied. NMR of the current days is aplenty with commercial spectrometers which have unimaginable features built in and produce high quality spectra automatically without the user having to know much about the settings. Essentially black-box approach to the use of the spectrometers makes possible strides in leaps and jumps in a wide variety of disciplines of study. On the other hand the early efforts have been more educative on the equipments and instrumentation aspects. The researchers themselves had a hand on laboratory exercise to make the equipment for what they have to research on. In this contrasting situation a review of the early days NMR instrumentation is provided in this article for the benefit of student community to find an occupation while innovating their learning methods. Descriptions in this article are oriented towards school and college standards so as to inspire the readers to look for more on instrumental methods and grasp the recent advances quickly and confidently in these days of conveniently automated and much simplified 'black-box' approach to use of instruments. An important point to mention is that the circuit diagrams given in this articles are the author's original version of block diagrams or schemes similar to concept diagrams (pedagogically speaking) to introduce newly certain topics. Hence the students should not expect to plug in working circuits to see the functions. Note carefully that no specific component value is given nor any model numbers to commercially available components – even the circuit elements are not copied ones but drawn by the author with MS WORD drawing tools.

Keywords: Nuclear Magnetic Resonance; spectroscopy; instrumentation; electronics; LC Resonant circuit; tank circuit; spectrometers

1. Introduction:

Nuclear Magnetic Resonance [NMR] is a phenomenon, which occurs because of the intrinsic magnetic moments of the nuclei. These nuclei naturally occur in materials and molecules. These systems containing such nuclei, when placed in an externally applied magnetic field, can exhibit resonance absorption of energy from the electromagnetic radiation of appropriate frequency. For such a resonance phenomenon, the strength of the externally applied magnetic field and the frequency of the incident electromagnetic radiation are related through the constants characteristic of the particular nuclear species in terms of certain universal constants. This resonance phenomenon provides a potential spectroscopic tool for the determination of structural parameters in detail. The details, which this NMR spectroscopic tool can reveal, depends on the extent to which the advanced instrumentation techniques are availed in the detection of resonance signal, in the acquisition of spectra and in further processing the spectral data. The greater the incorporation of such technical advances, the more seems to be the benefits in utilizing this tool for structural determination. In turn, the better the instrumental provisions, the more seems to be possibility of designing new NMR techniques with the better insights in the theoretical understanding of the NMR phenomenon. Thus in this article the experimental aspect, specifically the instrumentation aspect is described as an exposition to the students of physics, who in the main subject matter learn Electricity and Magnetism, and Electronics. The NMR signal excitation and the signal receiving and detection processes are essentially radio broadcasting techniques since the NMR spectrometers work in the Radio Frequency (RF) range (few MHz- 10^6 cycles per second, cps- to several hundreds of MHz) of the electromagnetic spectrum depending on the magnetic field strength used. The NMR frequency is directly

proportional to the external magnetic field strength (for Hydrogen nucleus (the Proton NMR) $1\text{Gauss} = 4.2577\text{KHz}$). Basic NMR phenomena and its scope as a well founded spectroscopic technique have been described in the internet publication of this author meant for school and college students: <http://www.ugc-inno-nehu.com/NMR-animartion.html> ([url-1](#))

2. Features Of NMR Spectrometer:

An assembled NMR Spectrometer consists of the following component parts:

1. The Magnet. As far as the magnet and the magnetic field part, it is important to note that even when it may seem that the NMR sample occupies a small volume where the magnetic field is present, it is difficult to obtain field homogeneity to such a level as the Spectrometer detection part is capable of resolving NMR signal. Homogeneity of the order of 10^{-4} ppm would be required for a well resolved spectrum. That is, when the applied magnetic field can be 18.78 Tesla (1 Tesla= 10^4 Gauss) corresponding to proton resonance frequency of 800 MHz, it would be required to maintain at least 10^{-4} ppm of homogeneity within 0.2 cm^3 volume of the sample. Sample spinning is a feature which reduces the in- homogeneity to increase resolution obtainable. But sample spinning at about 20Hz to 50 Hz and not more was effective to certain extent but not totally adequate. Hence additional field-gradient coils are provided to shim the magnetic field for highest possible homogeneity. This means electro magnets if used must be capable of stability of such a grade. These have made possible the introduction of NMR field-frequency locking systems to enable maintain magnetic resonance condition when either field or frequency of the system drifts.
2. The Transmitter from where the required RF radiation is generated and applied to the sample. (Sample is a liquid usually, or a solid of the specimen chemical compound, material whose spectrum is to be obtained). The transmitter could be a RF signal generator with a moderate gain amplifier; irradiating the sample continuously with RF signal of about 10-100 milli-watt power levels (*Continuous Wave response*). If RF pulses (for *Pulsed transient response*) are used, then, the transmitter part would consist of the low power continuous signal generator; followed by a RF gate which produces RF pulses of appropriate shape and finally an RF pulse amplifier of high gain levels to finally get RF outputs of 100 Watt (W) to High Power 3 Kilo Watt (KW) levels.
3. The NMR-probe assembly (to be placed in the magnetic field- **Fig.1**) where sample specimen is placed, to enable detection of the NMR signal from the sample. This probe consists of the RF coil inside which a tube is inserted and placed in such a way the coil surrounds the sample. This sample coil is has a specific sample region, characteristically referred to as sample volume. Current day spectrometers use high quality glass or quartz glass tubes of 5mm and 10 mm diameter. This tube is partially filled with liquid NMR sample, and the tube is inserted in such a way that the sample gets placed within the RF coil. There can be two RF coils, the transmitter coil and the receiver coil (usually cross coil arrangement). Most of the current versions of spectrometers have a single RF coil serving as transmitter coil as well as receiver coil. There are differences in these transmitter/receiver coil configurations can vary depending on whether the NMR spectrometer construction is based on the Continuous Wave (CW) detection techniques or the Pulsed transient Induction techniques.

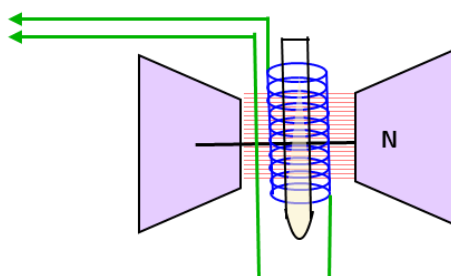

Figure 1: NMR Sample tube inside inductance coil placed inside the magnet pole gap. The sample is exposed to the magnetic field in the gap and the RF field inside the coil. Coil axis is perpendicular to the direction of magnetic field for appropriate polarization of RF for NMR.

4. The NMR signal Receiver. The constituents of this receiver depend upon the CW or Pulsed NMR technique. Since the mostly used advanced versions of the spectrometer are Pulsed FT NMR Spectrometers, from the point of view of getting familiarity with the present day NMR experiments, this article would have more emphasis on the Pulsed Transient Response of Nuclear spin systems, and the instrumentation of Pulsed NMR spectrometers. The essential difference between the CW, steady state response and the Pulsed, transient response are illustrated in http://www.ugc-inno-nehu.com/NMR_animation/0_4_Detctn_Prncpls_spectrum.ppt (**url-2** find in url-1) with more details in http://www.ugc-inno-nehu.com/NMR_animation/0_7_SA_TrnstnRates_RlxnTimes_CW_pulse.ppt (**url-3** find in url-1)
5. The most important feature of the modern spectrometers is the automation of the spectrometer operation with the given operating principles. In fact field shimming can be achieved by auto-shim, field frequency lock is possible by computer tracking of maximum signal with field or frequency scan. Thus a highly sophisticated versatile computer dedicated to be integral part of the NMR spectrometer system is a necessity. The NMR spectrometer manufacturers also make such computers suited to the NMR system and provide them in the spectrometer unit instead of the user trying to use a mainframe computer or personal computer as a peripheral system after buying the NMR system. And, with the FT NMR systems, all the FT processing and further signal processing followed by the Fourier Transformation are all done by the system dedicated computer, and for all these software is provided by the NMR manufacturers themselves.
6. The spectrometer requires peripheral units for routine operation and use without being concerned as much routinely about the core spectrometer parts the magnet and console. The peripheral units are monitors, keyboards and printers/plotters. These are mostly units which many people using computers are familiar with. Except that what is displayed, what is typed in and what is printed/plotted are related to the input/output data of NMR spectrometer.

3. NMR Signal: Excitation And Detection:

3.1. Considerations in a CW Steady State Technique:

(Refer to **url-2** & **url-3** cited in Sec. 2 at item 4) The description of Magnetic Resonance Phenomena begins with the interaction of the electron or the particular element-nucleus with the externally applied strong magnetic field. This interaction is possible because of the electron spin or the nuclear spin magnetic moment. As is the consideration with these sub atomic particles, the electrical charge on them is equally important as their respective mass values are. The rotating (rigid body rotating about an axis within itself is said to be spinning) object, as it spins has an angular momentum associated with the characteristics of this motion. And since the (object) particle carries an electrical charge, the spinning motion gives rise to electric current, and this current produces a magnetic field. The magnetic field due to the constant angular velocity within the particle medium is its magnetic moment and this magnetic moment produces secondary field outside the object. Thus the constant angular velocity, the spinning speed, of the particle of finite mass gives rise to its angular momentum, and the fixed charge that the particle carries causes the magnetic moment because of the spinning. The angular moments of sub-atomic particles are quantized according to the principles of Quantum Mechanics. The total angular momentum of the particle, as well as the measurable component of this angular momentum in any specified direction, is quantized. Thus the angular momentum axis (spinning axis of the particle) cannot have continuously varying values of the angle with any specified direction. The maximum value that the component of angular momentum can have is called the spin quantum number, or referred to simply as the SPIN value of the particle. After this description in terms of classical physics it should be possible to proceed with ease what is covered under the Quantum Physics. Quantum Mechanics and the Schrödinger's wave mechanical formalisms, lead to expressions for the Total spin angular momentum and the component values of the spin angular moment in the form of equations giving values in units of Planck's constant, $\hbar = h/2\pi$.

To proceed for the NMR phenomenon, the emphasis has to be on the fact that the spin axis is the direction of the angular momentum and the magnetic moment. The spin magnetic moment may be along the angular momentum direction or in opposite direction depending upon the nature of the charge on the particle. In all cases the spin magnetic moment bears a constant ratio to the spin angular momentum and the constant of proportionality is

termed the gyro magnetic ratio. This gyro magnetic ratio γ , is a characteristic constant of the particle. These values are tabulated along with the spin values, so that the resonance frequency can be calculated by the simple equation $\omega = \gamma \mathbf{H}$, where \mathbf{H} is the strength of the magnetic field in Gauss. Nuclear Magnetic Resonance is the phenomenon when these resonance conditions are set for the characteristic values associated with a specific nucleus. Thus it is possible to observe NMR of proton, carbon, nitrogen, phosphorous, silicon and so on for most of the nuclei that have associated spin.

Since magnetic moment and angular momentum of the nucleus are *collinear*, the discrete of energy levels arise when the nucleus is placed in magnetic field. The interaction of the magnetic moment with magnetic field causes the spinning axis to turn to align along the direction of minimum potential energy, and angular momentum which is along the same axis is quantized allows only discrete directions for the spin axis to align. With the given set of discrete energy levels, transitions become possible with specified energy values from the photons of an electromagnetic radiation, and the quantum mechanical selection rules govern such transitions. With this description for NMR signal excitation, it is to be emphasized that NMR detection is that signals from samples which are ensemble of spins, as different from isolated single spins. Thus NMR experiments are carried out on spin ensembles. And, the descriptions with single spins have to be appropriately reformulated taking into consideration the spin-spin interactions and the consequent thermodynamic considerations. Thus energy absorption and energy dissipation within the spin ensemble, and this ensemble of spins in equilibrium with non-spin degrees of freedom of the system, and the appropriate steady state of the system in presence of the dynamic spontaneous internal processes and the externally driven processes due to perturbations required for the experimental observation, are all matters for the effective and efficient NMR instrumentation. This gives rise to the observable Nuclear Magnetic Resonance phenomenon, and the scope for the NMR Spectroscopy is an emerging trend.

Single Coil Spectrometers: In a CW experiment, the RF transmitter level is monitored and the keeping either the frequency or the field constant, the other parameter is slowly varied (scanned). When the field and frequency value coincide to establish the resonance condition, resonant absorption of energy occurs causing the transmitter RF level to reduce, proportional to the extent of absorption by the spin system. This reduction in the RF level is suitably amplified and displayed on the Y-axis of an oscilloscope while the X-axis of the oscilloscope trace moves from left to right synchronous with the scanning for resonance. An absorption signal can be seen in the oscilloscope. The instrumentation in this case requires an RF generator of appropriate frequency range with slowly time dependent variation feature, detection of RF level as the scanning proceeds. The sample can be placed in a constant magnetic field. The sample should be inside an RF coil to which the output of the RF generator is coupled to transfer power. The RF coil can be part of a broad band LC circuit (naturally broad band would be low Q factor) which renders it an inefficient choice from signal to noise considerations (**Fig.2**). If one opts to keep the RF frequency fixed and scan the field, then the LC circuit can be precisely tuned to a fixed frequency enabling a High Q LC circuit, and there would be no loss of RF power and high sensitivity detection can result. The LC combination can be (**Fig.3**) parallel combination which is usually referred to as a tank circuit since in the transmission line where RF flows; this Tank circuit serves to store energy. In principle the detection part could consist of a simple diode detector of the RF level. Thus a beginning can be made to familiarize with the similarity of NMR spectrometer instrumentation to the RF radio broadcast transmitter/receiver techniques. In this set up the RF signal generator as transmitter was an independent unit from the detecting diode element part. The Tank circuit is coupled to both the transmitter (on one side-the input end) and the detector (on the other-the output end). This would raise the question of the possible coupling of transmitter and receiver ports in spite of the fact that the intention was to couple the transmitter unit and the receiver unit to the same tank circuit (now it may be referred to as the probe unit). This complication would be absent, if one uses integrated oscillator-detector unit instead of oscillator separated from the detecting receiver. Thus the regenerative oscillator designs were

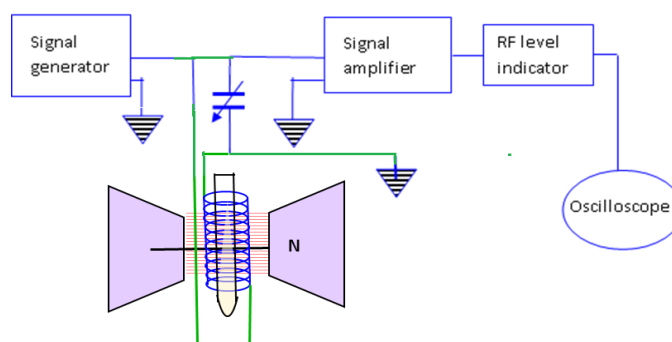

Figure 2: As before sample coil assembly is in Magnetic Field. A parallel LC resonant circuit must be evident. And the parallel LC combination at one end is to ground and the other end receives input from signal generator and sends the voltage across the coil to receiver.

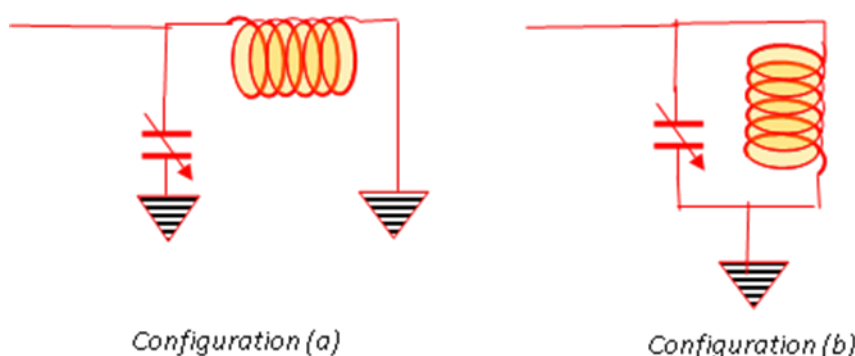

Figure 3: Important to realize is the two configurations represent the same Parallel resonance circuit, though drawn differently. A student exercise to familiarize configuration difference for functionally the same circuit.

considered for the possibility of an oscillator-detector designs. The basic sinusoidal forms are generated by positive feedback amplifiers. There can be amplifiers with negative feedback provisions with several advantages but with reduced gain factor. The positive feedback systems are regenerative systems.

The principle of positive feedback oscillators are as follows. When one designs an amplifier with a specified input level conditions and a required Gain factor to get appropriate output, the amplifier can be made frequency selective by introducing a Tank circuit. If the capacitive element is made variable capacitor then the tank circuit resonance frequency can be varied thus a frequency tunable amplifier results. Even though the Tank circuit can be made a LC circuit with high Q factor, the loss in the tank circuit cannot be made zero. If one takes a part of the output for a feedback positively to the input of the amplifier, then the output energy can be made to compensate at the input for the loss in the tank circuit. If the loss in the tank circuit is well compensated what goes into the amplifier system remains within the electronic circuit resulting in oscillation. However by the very fact that the loss in tank circuit is well compensated for, the system is made insensitive to oscillation levels. Thus if there is level change due to NMR absorption, this would not reflect as change in oscillation level but would be compensated to get the same oscillation level at the output. It was suggested that if the loss in the tank circuit is not well compensated but only marginally compensated in the sense that the loss is just compensated to let an oscillation begin and sustained, and not more. That means the feedback is critically set for just the beginning of oscillation. Then if in the tank circuit NMR absorption occurs the compensation would be altered and renders the oscillator with a reduced oscillation levels. At such critically set feedback conditions it is referred to as a marginal oscillator (Fig.4) and these marginal oscillators could be successfully used as oscillator-detectors.

Double Coil Spectrometers with crossed Coil arrangement: All these till now have been the techniques for CW excitation-technique with the probe constituted by a single coil for both RF transmission for excitation and Signal receiving for detection. The detection method of RF level monitoring is essentially energy absorption detection at resonance. The main disadvantage that can arise is that while coupling the transmitter and receiver to the single RF coil (Tank circuit) inevitably a coupling of the transmitter and receiver occurs, because of which, the possible amplification at the receiver amplifier gets severely limited, resulting in reduced

amplification for the NMR signal. On the other hand a crossed coil arrangement can be used. In this case two RF coils are used in such a configuration that their axis (cylindrical shape of the coil is implicit) are mutually perpendicular (**Fig.5**) and hence RF sent to the transmitter side coil does not appear in the receiver coil. Even though the axes.

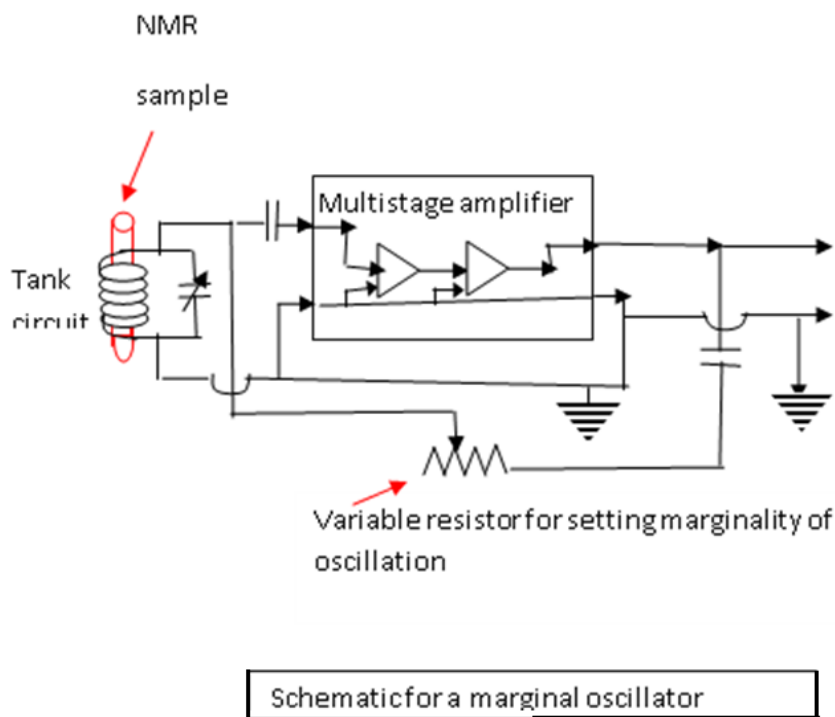

Figure 4: In figure 3 the voltage across the parallel LC circuit (connected to signal generator) was monitored continuously by the receiver. In figure 4, the LC combination is part of oscillator determining oscillation characteristics. Hence the circuit can be more sensitive to NMR absorption than in the previous circuit. This is the point again emphasized for students to pursue how this difference is an improvement in NMR detection.

are orthogonal, the sample inserted occupies the volume of both the coils. This means the transmitted RF can excite the nuclear spins under NMR condition without getting into the receiver side coil. Even when transmitter sends its RF, the receiver coil does not get any RF. And, the receiver coil RF level being so low, the amplifier can be designed with such high gain values that makes possible even a weak RF signal is present at the receiver RF coil. When the transmitter excites the spins only the spins induce a signal under NMR condition so that the receiver coil has only the information about NMR occurrence with its RF signal. Such nuclear spins induced signal for a sample in a 5mm diameter sample tube, can be of the order 10 micro volts level. This is a weak signal and requires high-gain amplifiers to process. Developmental stage considerations on instrumentation and detection techniques have been well documented in the publication by Bloembergen, Purcell and Pound, with illustrations of waveforms by way of photographs in the laboratory with home-built spectrometer. <http://www.ugc-inno-nehu.com/bloembergen1948.pdf>

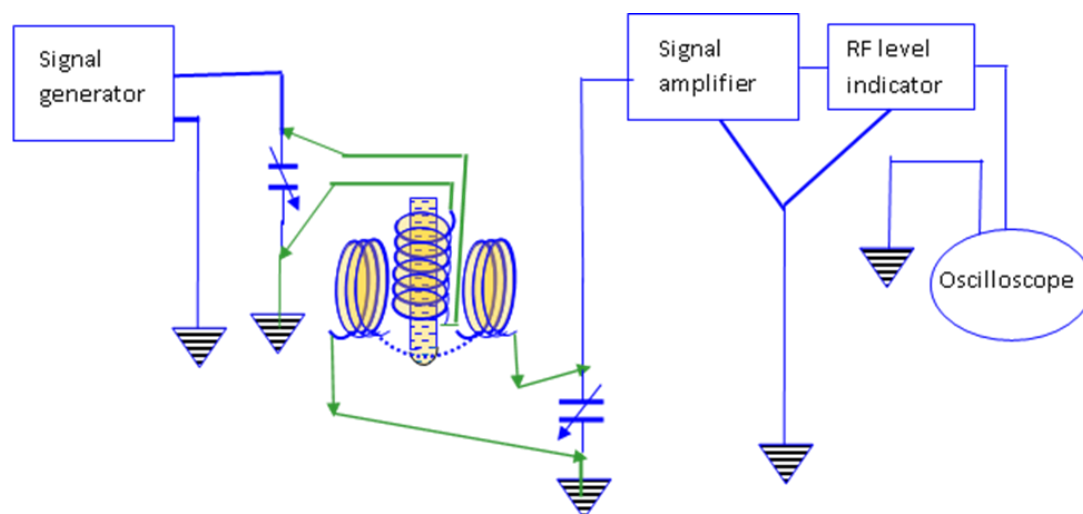

Figure 5: Further improvement in NMR detection by using crossed (orthogonal) coils for NMR instead of the single coil detection before.

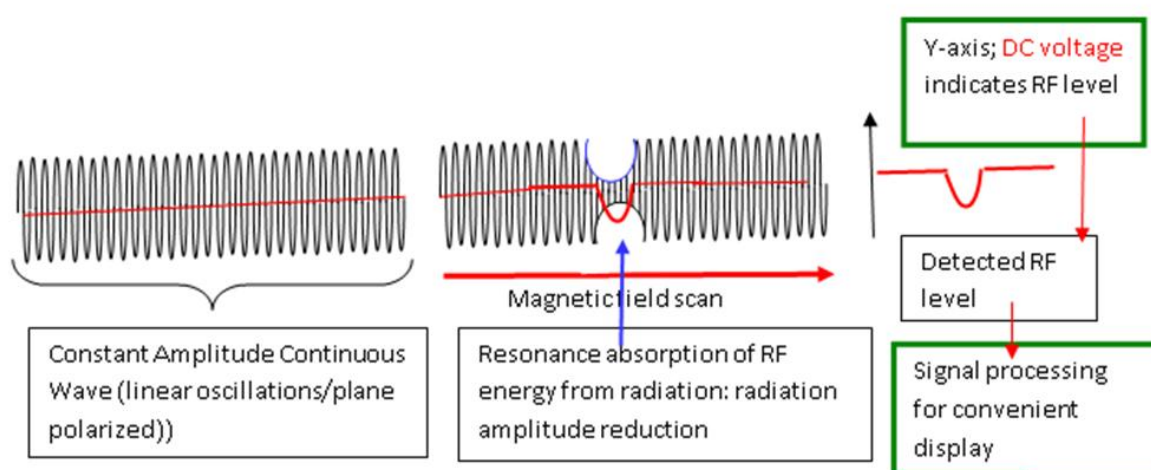

Figure 6: Illustration detailing the detection in Figures 2 and 3. Generator provides constant CW voltage input level (constant DC level indication after RF detection). At resonance NMR modifies the coil parameters because sample inside the coil alters them due to NMR occurrence. If energy absorbed at resonance, voltage level reduces and the riding change is detected as DC level change.

The nuclear spin exhibits Larmor Precession in an applied field. The Larmor frequency corresponds to the resonance frequency. *The RF applied must be in the plane perpendicular to the direction of the magnetic field.* The plane polarized RF can be resolved into two circularly polarized radiations represented by rotating vector and in opposite sense.

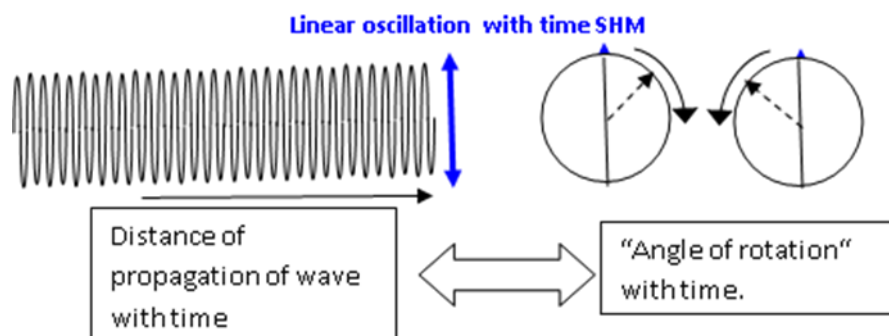

Figure 7. Plane polarization of RF envisaged as linear combination of two circularly polarized components for SH variations. The intricacy is electronic oscillation is naturally SH and this signal property lends for convenient mathematical description envisaged by geometric representation. Euler equation at work, to make possible NMR selection rules as geometrically representable.

The rotation of the radius vector in the appropriate sense, in turn can be considered as two linearly oscillating vectors as they can be represented together as complex quantity by Euler's expansion:

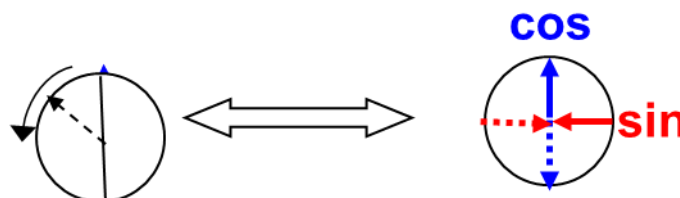

Figure 8: The circular polarization in turn is linear combination of Real and Imaginary summation of sinusoidal SH signal form.

Corresponding to the **Real** and **Imaginary** parts of RF, the spin system response consists of **Real** and **Imaginary** components of susceptibility. The real imaginary susceptibility component is the Absorption line and the real susceptibility component is the dispersion line of the resonance. The single coil techniques are set with condition to detect the real part of the complex impedance that corresponds to the Absorption. In the crossed coil arrangement, the transmitter and receiver signals can be set to have a phase difference by providing a phase difference at the sample coils. And it becomes an additional operation to set the phases properly and receive only the absorption signal without an admixture of dispersion.

The commercial spectrometers produced began with 60 MHz popularly. And, initially these instruments used Electromagnets for the fixed magnetic field. Subsequently the spectrometer versions changed over to Permanent Magnets. In fact, up to 80 MHz proton NMR frequency, the spectrometers employed Permanent Magnets. 90 MHz and 100MHz were using Electromagnet Systems. At proton NMR frequencies above 100MHz, mostly super conducting magnet systems were used, and at these frequency ranges the Pulsed Transient detection has been the technique used. With electro magnets fluctuations and field drifts have to be compensated for to make the entire system durable over long hours of continuous use, almost 24 hrs per day utilization. Permanent magnets also had to be attended to for reasons of frequency drifts and thus to maintain Resonance condition securely over long durations. Hence a field-frequency lock system had to be thought off which must use basically the NMR signal from this system itself as the source for generating error signals when fluctuations and drifts were to be compensated. From the absorption signal form by a modulation of the magnetic field at low amplitudes and audio frequencies, a derivative of the absorption could be obtained by phase sensitive detection.

The field – frequency lock system functioning is explained below, and the details would be more involved as it appears these days advanced NMR spectrometers and such sophisticated level of description would be a separate full article by itself. Some of the features described in the context of CW technique bear relevance also in the context of Pulsed Transient detection technique.

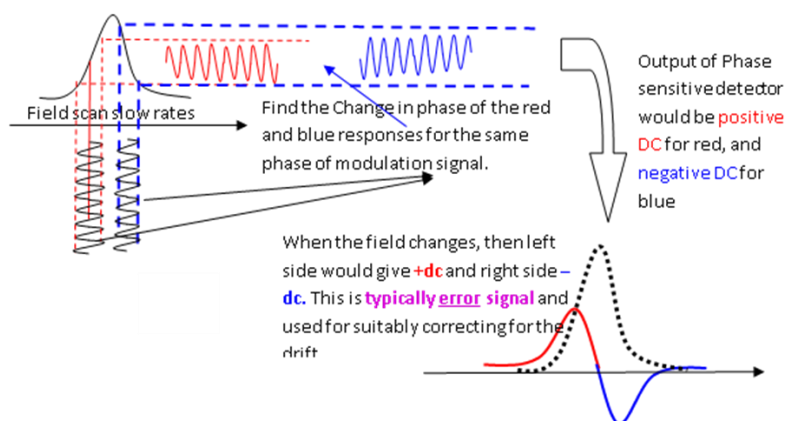

Figure 9: Error signals formed enabling Field-frequency lock by holding NMR signal steady when either the field or frequency drifts. The interesting intricacy is that field/frequency scanning is the process by which one scans through the spectral range to record the lines in NMR spectrum, and the field-frequency lock can be upheld even during the variation of field for spectral scan!

3.2. Considerations in Pulsed Transient technique:

(Refer to [url-2](#) & [url-3](#) cited in Sec. 2 at item 4). A detailed elementary stage description on the Pulsed Transient response of nuclear spin ensembles is described with illustrations on the home-built pulsed NMR system in the documentation by [E.L.Hahn](#). The principles of the working of such a spectrometer with the original descriptions of the responses and possible inferences are contained in these notes. <http://www.ugc-inno-nehu.com/pulsednmr-elhahn.pdf>

During the discussion above on the CW technique, it was pointed out there are essential differences in the spin-system state, for the case of isolated single-spin interaction with external magnetic field and that of a system of spin ensemble. That the experiments are carried out only on ensemble of spins is also mentioned. This difference becomes all the more important because, without the reference to single-spin interaction the ensemble descriptions would not have the required foundation and the nuclear spin experimental samples have to be responding as ensembles and no directly evident single spin presence is noticeable. Finally the experimental data once again are interpreted for the situation typically for every single nuclear spin in the system. This awareness goes a long way in getting a grip on the instrumentation and experiments with NMR spectrometers.

As was remarked, the single spin angular momentum has quantized components along the magnetic field direction, conventionally labeled as Z-direction. And the X & Y components of the angular momentum are invariably present all the time. So is the situation for the Z and X,Y components of the magnetic moment vector. In an external field every spin aligns along the magnetic field either parallel to the magnetic field or anti-parallel, opposite sense. Thus in the sample of protons with Spin $\frac{1}{2}$, these two allowed orientations are the possibilities. The ensemble net magnetic moment can be obtained by summing up the components. This summed up net moment for the ensemble is referred to by the distinct term, Magnetization – the ensemble magnetization. The population distribution of up-spins (parallel to magnetic field) and down-spins (opposite to magnetic field direction) is determined by the Maxwell-Boltzmann equation for thermal equilibrium. Up and down spins refers to the Z-component spin orientations, determined by the potential energy of interaction with magnetic field. The X-Y components do not have any specific constraints as to which direction the components should orient in the XY plane (perpendicular Plane). Hence a random phase hypothesis is invoked and this random orientation of individual spin components when summed up yields a net zero value. Thus under thermal equilibrium only Z-magnetization is non zero but the XY component vanishes. This is clear contrast to description of single spin since all the three components of that spin X, Y and Z are always non zero. When a strong RF pulse is applied for a short time duration in the XY plane, the Z-Magnetization tilts towards the XY plane and the non vanishing XY component appears and this XY component would be precessing at resonance frequency.

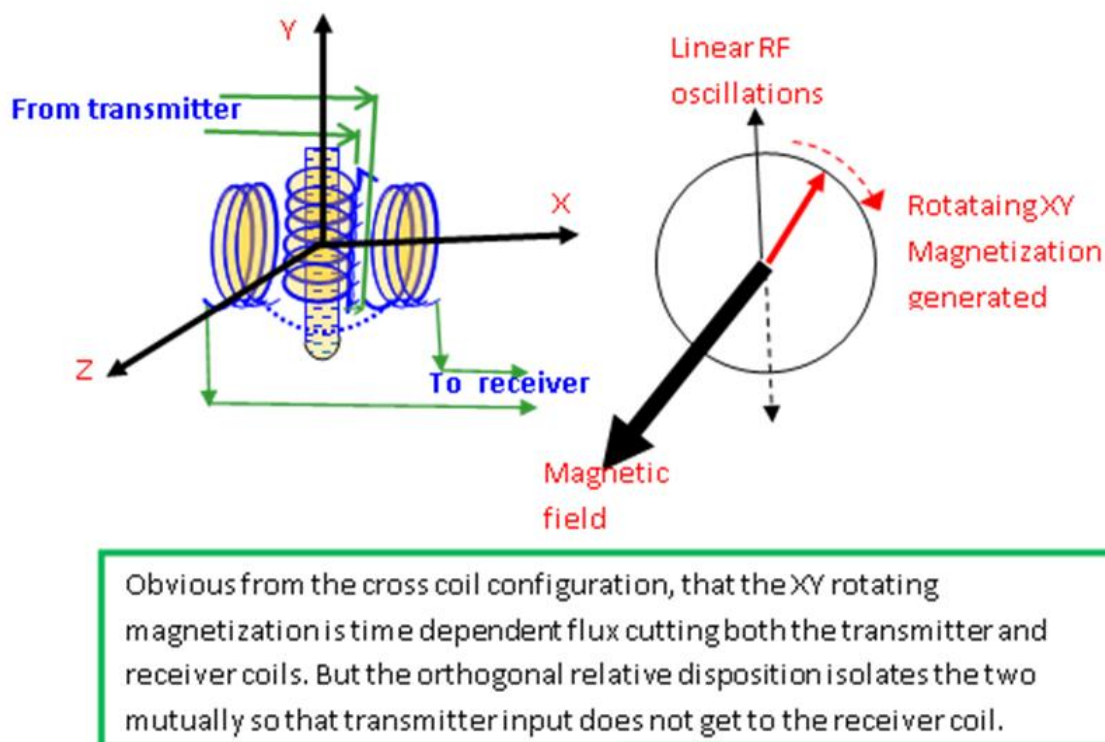

Figure 10: Improvement of single stage improvement by a sketch from figure 4 to 5, requires all the explanations from figure 6 through to Figure 10, how this improvement works and why it makes all the difference and how much change it would cause at instrumentation and at what cost? It was all worth the while and expense!

Thus, with the background coverage on NMR excitation and detection till now, the further description of transient response can begin with what one practically does to see a transient response displayed on a monitor.

Either FID itself can be processed for spin system relaxation studies or the FID may be subjected to a Fourier transformation to get frequency domain spectrum.

In the following Abstract their publication I.J.Lowe and R.E.Norberg **have noted** that this time domain FID Fourier transformed into frequency domain, the resulting frequency domain information is the steady-state CW spectrum.

Free-Induction Decays in Solids

I. J. Lowe and R. E. Norberg

Phys. Rev. 107, 46 – Published 1 July 1957

DOI:<https://doi.org/10.1103/PhysRev.107.46>

A beat structure has been found on free-induction decays associated with the pulsed nuclear magnetic resonance of nuclei in rigid lattices. A general quantum-mechanical theory is developed for the shapes of induction decays. The theory is specialized to the case of rigid solids and applied to the magnetic dipolar interactions among the F19 nuclei in a fluorite (CaF₂) crystal. “It is also shown rigorously that, except at very low temperatures, a free-induction decay is the Fourier transform of the corresponding steady-state resonance line shape”. The calculation of the shape of induction decay in CaF₂ thus corresponds to the calculation of the shape of the F19 resonance line for the crystal. It is demonstrated that the resonance line shape for an ordered rigid lattice is not Gaussian.

A typical Fourier Transform Spectrometer is depicted in **Fig.13**.

The FID decay time is indicative of the extent of homogeneity of the magnetic field. A long decay time corresponds to increased homogeneity and would result in sharp lines after FT. This means the spectral information would be well resolved. The elements of Fourier spectroscopic technique are illustrated in **Fig 12, Fig13, Fig 14 and Fig 15**.

4. Conclusions:

This resonance phenomenon provides a potential spectroscopic tool for the determination of structural parameters in detail. The details, which this NMR spectroscopic tool can reveal, depends on the extent to which the advanced instrumentation techniques are availed in the detection of resonance signal, in the acquisition of spectra and in further processing the spectral data. The greater the incorporation of such technical advances, the more seems to be the benefits in utilizing this tool for structural determination. In turn, the better the instrumental provisions, the more seems to be possibility of designing new NMR techniques with the better insights in the theoretical understanding of the NMR phenomenon. **This seem to provide a perennial cycle that the improved understanding puts demand on the instrumentation to be improved, and technology ensuring the necessary instrumental criteria provides even better insights into the NMR phenomenon resulting in new experimental schemes for availing the Nuclear Magnetic Resonance spectral features.** Because of this the knowledge on NMR instrumentation needs to be propagated and not simply promoting the use of NMR spectra obtained from instruments. The historical and evolutionary aspects have to be constantly updated,

The Nuclear Magnetic Resonance instrumentation currently is in an advanced stage with possibilities of Multi Nuclear NMR, multiple resonance techniques, and multi-dimensional NMR technique. Further Pulsed Field Gradient experiments have reduced the experimental times for acquiring spectra which otherwise take a very long spectrometer time. The automatic sample changing accessory has enhanced the NMR spectroscopic versatility for pharmaceutical industry by facilitating combinatorial spectroscopic information for screening and designing drug discovery related projects. The high field – high frequency NMR systems opened up the potential for 3D molecular structures of biological systems. This is an attractive feature since X-ray structure determinations are the so referred to as in-vitro structure information which to apply in actual biological fluid conditions could ambiguous. The NMR technique provides for structure determinations in biological conditions. The stride that the Magnetic Resonance Imaging (MRI) technique making is well known to many since the clinical MRI with its functional MRI (fMRI) features has proved a unavoidable technique in diagnosis and cure of diseases. The contents of this article are mostly to provide a good grasp of the essential scientific materials at the school and college levels so that the advances can be familiarized with much less efforts and with better confidence. Thus with these added reading materials students are well equipped to avail the contents of the internet resource: <http://www.ugc-0inno-nehu.com/NMR-animation.html>. A review of this type on the elementary NMR instrumentation aspects would appropriately prepare the grounds at the early stages, for the researchers at a later stage to be on their toe to catch up with the rapid developments.

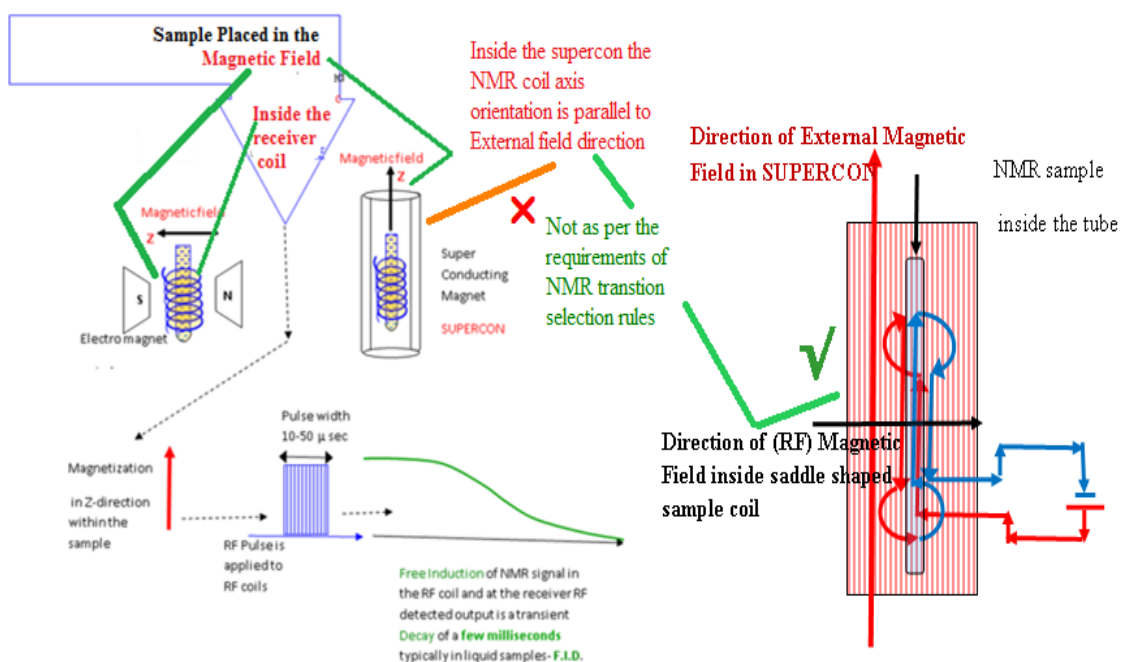

Figure 11: The availability of Superconducting Magnets made possible Higher magnetic fields to be used for NMR detection. And this also facilitated Pulsed NMR experiments for reasons the the RF frequencies can be higher when the applied magnetic fields are larger (Refer also Figure 1 caption). After the improvements at the NMR detection by CW techniques, it was possible to get an access to much better quality in NMR signals by using pulsed NMR techniques followed by Fourier Transformation. The evolution of pulsed response of nuclear spin ensemble system is explained in the illustrations.

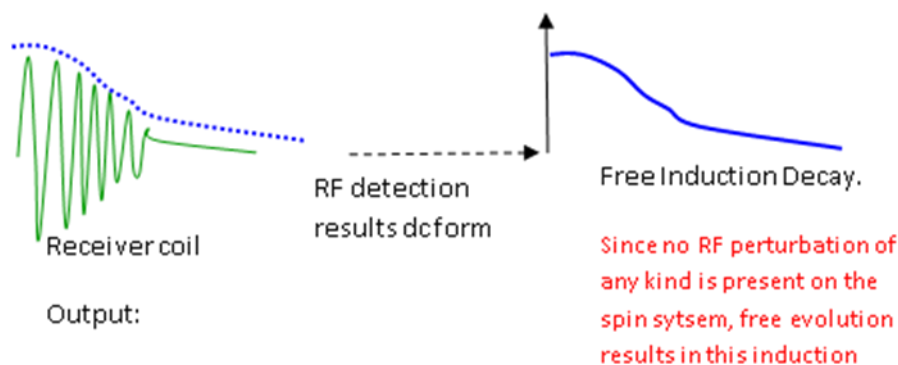

Figure 12: Typical spins system responses illustrated to appreciate the mathematical wave forms which can be used to describe and represent these responses.

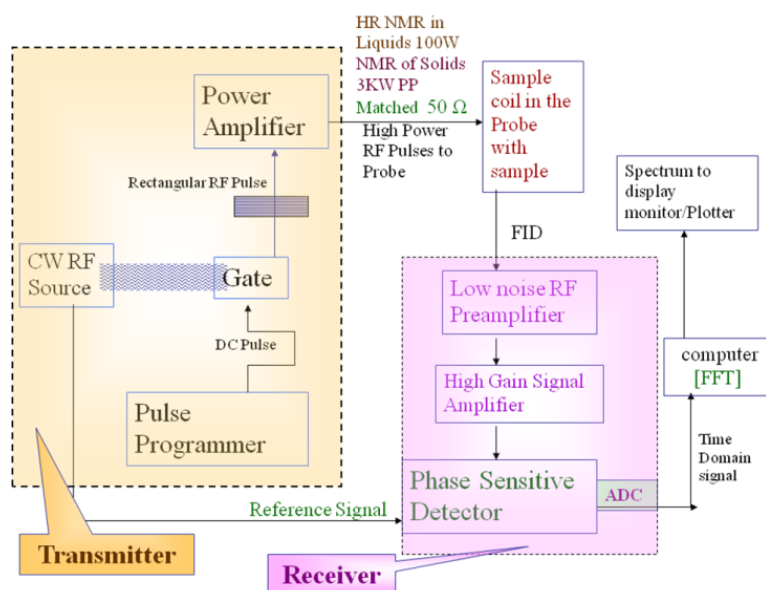

Figure 13: Block diagram of the FT NMR spectrometer.

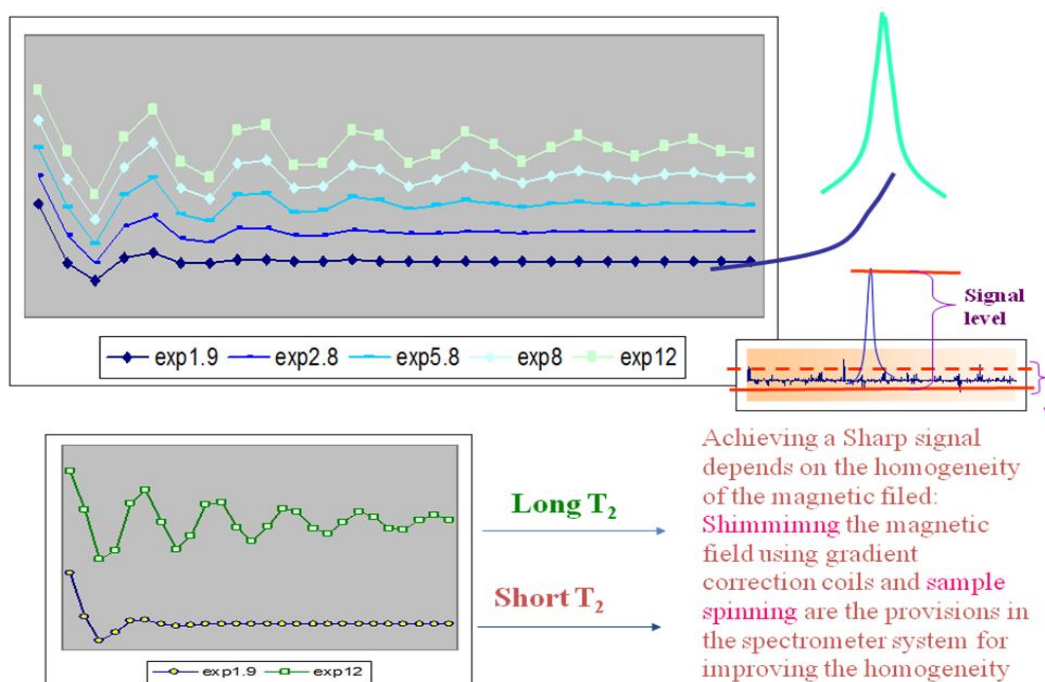

Figure 14 The spin system responses to RF Pulses, the functional forms made evident; this mathematical functions and the spin system responses are rationalized to get information on the physical system under study and the spin processes that result in such a phenomenological description.

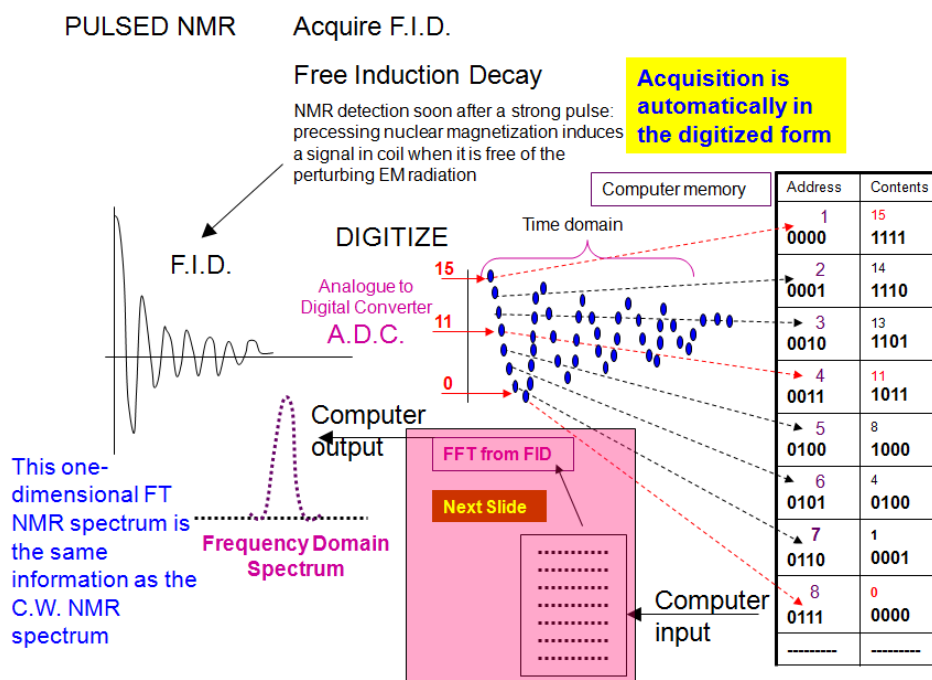

Figure 15: Find that signal level is the amplitude in the conventional Y-axis magnitude, and time is on X-axis. When the signal is stored in digitized form, in the computer it is a question of Memory address location – a sequential serial number (graphical X-axis) and the Memory content value which is the Graphical Y-axis amplitude value in numerical representation. This change is difficult to get used to for the students of physical sciences who do not have any exposure to computer science, and even if there is a bit of binary logics studied, it is not simple to associate these quantities in a familiar way.



Figure 16: An exposure to Fourier Transform Program in Basic language which explains the aparameters required to set in a FT NMR spectrometer to aquire a NMR spectrum.

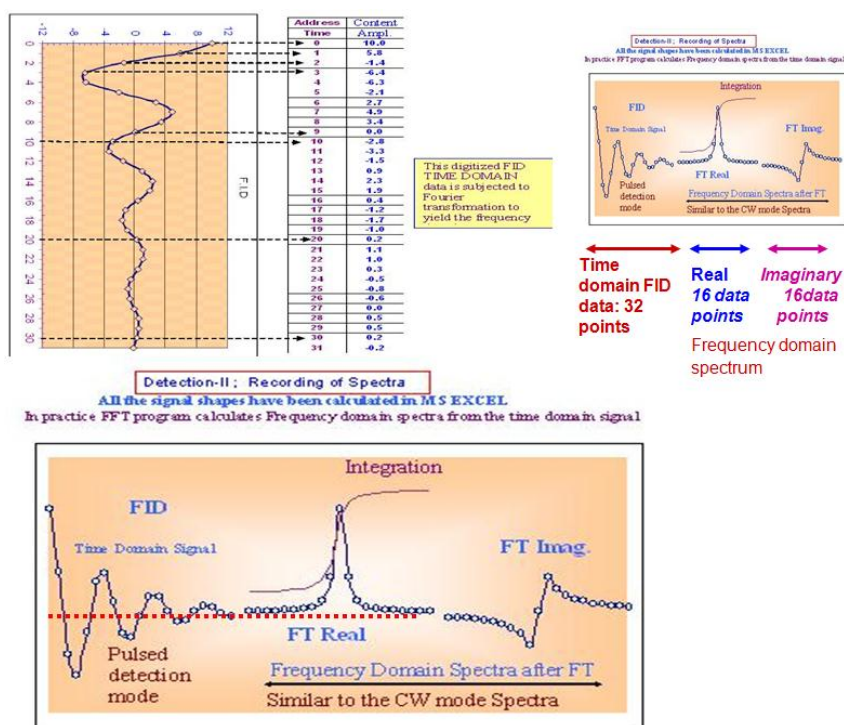

Figure 17: A consolidation of NMR spectral characteristics and the Nuclear spin system properties and the corresponding diagrammatic graphical and geometrical features to lead to interpretation of the spectral information.

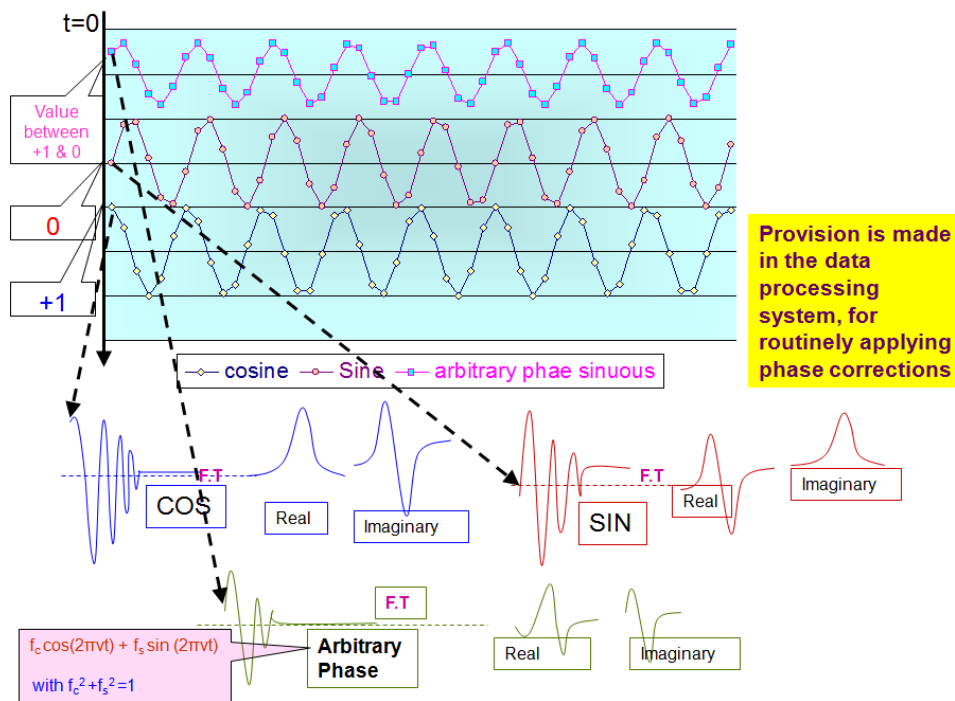
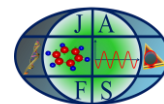

Figure 18: Further details into principles of spectrometer operation and the kind of sophistication that is brought about to prevail over NMR affairs: Phenomenon, Instrumentation, Operation, Processing, plotting and Interpretations.



References:

- [1] N.Bloembergen, E.M. Purcell and R.V. Pound, Physical Review 73, 679, 1948,
- [2] R.E. Norberg, American Journal of Physics, 33, 71, 1965
- [3] I.J.Lowe and C.E.Tarr, Journal of Physics E; Scientific Instruments, 1, 320, 1968
- [4] https://www.physics.rutgers.edu/grad/506/Pulsed_NMR.pdf
- [5] <http://www.phys.utk.edu/labs/modphys/TeachSpin%20NMR%20Manual.pdf>
- [6] <http://fraden.brandeis.edu/courses/phys39/NMR/TeachSpin/Introduction.pdf>
- [7] B.Cook and I.J.Lowe, Journal of Magnetic Resonance, 49, 346, 1969
- [8] I.J. Lowe and R.E. Norberg, Physical Review, 107, 46, 1957
- [9] <https://lagunita.stanford.edu/c4x/HumanitiesSciences/CHEM291/asset/Spectrometers.pdf>
- [10] D.I.Hoult , R.E..Richrads and P.Styles, Journal of Magnetic Resonance, 30, 351,1969
- [11] R.R.Ernst, W.A.Anderson, Reveiews of Scientific Instruments, 37, 93, 1966
- [12] https://www.weizmann.ac.il/ISMAR/sites/ISMAR/files/bulletin/BMR_11_069-085_1989.pdf
- [13] D.I.Hoult and P.C.Lauterbur, Journal of Magnetic Resonance, 34, 425, 1969
- [14] D.I.Hoult and R.E.Richards, Proceedings of The Royal Society A, 344, issue 1638, Jul. 1975
- [15] R.E.Richards and J.W.White, Proceedings of The Royal Society A, 269, issue 1338, Sep.1962
- [16] S.Aravamudhan <http://www.ugc-inno-nehu.com/jafs-dbu-ghy.pdf>
- [17] <http://www.ugc-inno-nehu.com/jafs-hlrefs.doc> (consists of hotlinks for this article and the list of references)