



JRC SCIENCE FOR POLICY REPORT

Best Available Techniques (BAT) Reference Document for the Production of Wood-based Panels

*Industrial Emissions Directive
2010/75/EU
(Integrated Pollution
Prevention and Control)*

Kristine Raunkjær Stubdrup,
Panagiotis Karlis, Serge Roudier,
Luis Delgado Sancho

2016



This publication is a Science for Policy report by the Joint Research Centre, the European Commission's in-house science service. It aims to provide evidence-based scientific support to the European policy-making process. The scientific output expressed does not imply a policy position of the European Commission. Neither the European Commission nor any person acting on behalf of the Commission is responsible for the use which might be made of this publication.

Contact information

European IPPC Bureau
Address: Joint Research Centre, Edificio Expo c/ Inca Garcilaso 3, E-41092 Seville, Spain
E-mail: JRC-IPTS-EIPPCB@ec.europa.eu
Tel.: +34 95 4488 284
Fax: +34 95 4488 426
<https://ec.europa.eu/jrc>

Legal Notice

Under the Commission Decision of 12 December 2011 on the Re-use of Commission Documents ([2011/833/EU](#)), the present BREF document is subject to free re-use, except for parts covered by any third-party rights which may be present in the document (such as images, tables, data, written material, or similar, the rights to which need to be acquired separately from their respective rights-holders for further use). The European Commission is not liable for any consequence stemming from the re-use of this publication. Any re-use is subject to the acknowledgement of the source and non-distortion of the original meaning or message

JRC100269

EUR 27732 EN

PDF ISBN 978-92-79-54949-6 ISSN 1831-9424 doi:10.2791/21807 LF-NA-27732-EN-N

© European Union, 2016

Reproduction is authorised provided the source is acknowledged.

How to cite: Kristine Raunkjær Stubdrup, Panagiotis Karlis, Serge Roudier, Luis Delgado Sancho; Best Available Techniques (BAT) Reference Document for the Production of Wood-based Panels; EUR 27732 EN; doi:10.2791/21807

All images © European Union 2016, except: Cover pictures credits © Fotolia.com—Petair

Abstract

The BAT reference document (BREF) entitled 'Production of Wood-based Panels' forms part of a series presenting the results of an exchange of information between EU Member States, the industries concerned, non-governmental organisations promoting environmental protection, and the Commission, to draw up, review and, where necessary, update BAT reference documents as required by Article 13(1) of the Directive 2010/75/EU on industrial emissions. This document is published by the European Commission pursuant to Article 13(6) of the Directive. This BREF for the production of wood-based panels covers the activities specified in Section 6.1(c) of Annex I to Directive 2010/75/EU. In particular, this document addresses the following processes and activities:

- the manufacture of wood-based panels by dry or wet processes; including the production of:
 - particleboard (PB);
 - oriented strand board (OSB);
 - medium density fibreboard (MDF), including low density fibreboard (LDF) and high density fibreboard (HDF), produced in a dry process;
 - fibreboard, including rigidboard (RB) and flexboard (FB), produced in a dry process;
 - fibreboard, including softboard (SB) and hardboard (HB), produced in a wet process.

This document covers all activities from the storage of raw materials to the finished raw board ready for storage.

This document additionally addresses the following activities which are considered activities directly associated to the main Annex I, Section 6.1(c) activity, even if the directly associated activity is not necessarily an Annex I activity itself:

- on-site combustion plants (including engines) generating hot gases for directly heated dryers without restriction of capacity;
- the manufacture of impregnated paper with resins.

Important issues for the implementation of Directive 2010/75/EU in the wood-based panels industry are the emissions to air from dryers and presses of dust, formaldehyde, and volatile organic compounds. This BREF contains seven chapters. Chapters 1 and 2 provide general information on the wood-based panels industry and on the common industrial processes and techniques used within the whole sector. Chapters 3 and 4 provide information and data concerning the applied processes and techniques in the sector; the environmental performance of installations in terms of current emissions, consumption of raw materials, water and energy, as well as on generation of waste; the techniques to prevent and/or reduce emissions from the wood-based panels production plants. In Chapter 5, the BAT conclusions, as defined in Article 3(12) of the Directive, are presented for the wood-based panels industry. In Chapter 6, the emerging techniques are presented. Chapter 7 is dedicated to concluding remarks and recommendations for future work regarding the sector.

Title Best Available Techniques (BAT) Reference Document for the Production of Wood-based Panels

Best Available Techniques (BAT) Reference Document for the Production of Wood-based Panels

Industrial Emissions Directive 2010/75/EU
Integrated Pollution Prevention and control

Authors:

Kristine Raunkjær Stubdrup
Panagiotis Karlis
Serge Roudier
Luis Delgado Sancho

2016

Acknowledgements

This report was produced by the European Integrated Pollution Prevention and Control Bureau (EIPPCB) at the European Commission's Joint Research Centre – Institute for Prospective Technological Studies (IPTS) under the supervision of Serge Roudier (Head of the EIPPCB) and Luis Delgado Sancho (Head of the Sustainable Production and Consumption Unit).

The authors of this BREF were Ms Kristine R. Stubdrup and Mr Panagiotis Karlis.

This report was drawn up in the framework of the implementation of the Industrial Emissions Directive (2010/75/EU) and is the result of the exchange of information provided for in Article 13 of the Directive.

Major contributors of information were:

- among EU Member States: Austria, Belgium, Czech Republic, Denmark, Finland, France, Germany, Ireland, Italy, the Netherlands, Poland, Portugal, Romania, Slovakia, Spain, and the United Kingdom;
- among industry: the European Panel Federation (EPF), Fedustria, the Wood Panel Industries Federation (WPIF), and the European Confederation of Woodworking Industries (CEI-Bois).

The whole EIPPCB team provided contributions and peer reviewing.

This report is dedicated to the memory of the TWG members Martin Steinwender and Harry Earl.

This document is one from the series of documents listed below (at the time of writing, the following documents have been drafted):

Reference Document on Best Available Techniques	Code
Ceramic Manufacturing Industry	CER
Common Waste Water and Waste Gas Treatment/Management Systems in the Chemical Sector	CWW
Emissions from Storage	EFS
Energy Efficiency	ENE
Ferrous Metals Processing Industry	FMP
Food, Drink and Milk Industries	FDM
Industrial Cooling Systems	ICS
Intensive Rearing of Poultry or Pigs	IRPP
Iron and Steel Production	IS
Large Combustion Plants	LCP
Large Volume Inorganic Chemicals – Ammonia, Acids and Fertilisers	LVIC-AAF
Large Volume Inorganic Chemicals – Solids and Others Industry	LVIC-S
Large Volume Organic Chemical Industry	LVOC
Management of Tailings and Waste-rock in Mining Activities	MTWR
Manufacture of Glass	GLS
Manufacture of Organic Fine Chemicals	OFC
Non-ferrous Metals Industries	NFM
Production of Cement, Lime and Magnesium Oxide	CLM
Production of Chlor-alkali	CAK
Production of Polymers	POL
Production of Pulp, Paper and Board	PP
Production of Speciality Inorganic Chemicals	SIC
<i>Production of Wood-based Panels</i>	<i>WBP</i>
Refining of Mineral Oil and Gas	REF
Slaughterhouses and Animals By-products Industries	SA
Smitheries and Foundries Industry	SF
Surface Treatment of Metals and Plastics	STM
Surface Treatment Using Organic Solvents	STS
Tanning of Hides and Skins	TAN
Textiles Industry	TXT
Waste Incineration	WI
Waste Treatment	WT
Reference Document	
Economics and Cross-media Effects	ECM
Monitoring of Emissions to Air and Water from IED-installations	ROM

Electronic versions of draft and finalised documents are publicly available and can be downloaded from <http://eippcb.jrc.ec.europa.eu/>.

PREFACE

1. Status of this document

Unless otherwise stated, references to ‘the Directive’ in this document refer to Directive 2010/75/EU of the European Parliament and the Council on industrial emissions (integrated pollution prevention and control) (Recast).

This BAT reference document for the Production of Wood-based Panels forms part of a series presenting the results of an exchange of information between EU Member States, the industries concerned, non-governmental organisations promoting environmental protection and the Commission, to draw up, review, and where necessary, update BAT reference documents as required by Article 13(1) of the Directive. This document is published by the European Commission pursuant to Article 13(6) of the Directive.

As set out in Article 13(5) of the Directive, the Commission Implementing Decision 2015/2119/EU on the BAT conclusions contained in Chapter 5 was adopted on 20 November 2015 and published on 24 November 2015.¹

2. Participants in the information exchange

As required in Article 13(3) of the Directive, the Commission has established a forum to promote the exchange of information, which is composed of representatives from Member States, the industries concerned and non-governmental organisations promoting environmental protection (Commission Decision of 16 May 2011 establishing a forum for the exchange of information pursuant to Article 13 of the Directive 2010/75/EU on industrial emissions (2011/C 146/03), OJ C 146, 17.05.2011, p. 3).

Forum members have nominated technical experts constituting the technical working group (TWG) that was the main source of information for drafting this document. The work of the TWG was led by the European IPPC Bureau (of the Commission's Joint Research Centre).

3. Structure and contents of this document

Chapters 1 and 2 provide general information on the production of wood-based panels and on the industrial processes and techniques used within this sector.

Chapter 3 provides data and information concerning the environmental performance of installations within the sector, and in operation at the time of writing, in terms of current emissions, consumption and nature of raw materials, water consumption, use of energy and the generation of waste.

Chapter 4 describes in more detail the techniques to prevent or, where this is not practicable, to reduce the environmental impact of installations in this sector that were considered in determining the BAT. This information includes, where relevant, the environmental performance levels (e.g. emission and consumption levels) which can be achieved by using the techniques, the associated monitoring and the costs and the cross-media issues associated with the techniques.

Chapter 5 presents the BAT conclusions as defined in Article 3(12) of the Directive.

Chapter 6 presents information on 'emerging techniques' as defined in Article 3(14) of the Directive.

Concluding remarks and recommendations for future work are presented in Chapter 7.

¹ OJ L306, 24.11.2015, p. 31.

4. Information sources and the derivation of BAT

This document is based on information collected from a number of sources, in particular through the TWG that was established specifically for the exchange of information under Article 13 of the Directive. The information has been collated and assessed by the European IPPC Bureau (of the Commission's Joint Research Centre) who led the work on determining BAT, guided by the principles of technical expertise, transparency and neutrality. The work of the TWG and all other contributors is gratefully acknowledged.

The BAT conclusions have been established through an iterative process involving the following steps:

- identification of the key environmental issues for the sector;
- examination of the techniques most relevant to address these key issues;
- identification of the best environmental performance levels, on the basis of the available data in the European Union and worldwide;
- examination of the conditions under which these environmental performance levels were achieved, such as costs, cross-media effects, and the main driving forces involved in the implementation of the techniques;
- selection of the best available techniques (BAT), their associated emission levels (and other environmental performance levels) and the associated monitoring for this sector according to Article 3(10) of, and Annex III to, the Directive.

Expert judgement by the European IPPC Bureau and the TWG has played a key role in each of these steps and in the way in which the information is presented here.

Where available, economic data have been given together with the descriptions of the techniques presented in Chapter 4. These data give a rough indication of the magnitude of the costs and benefits. However, the actual costs and benefits of applying a technique may depend strongly on the specific situation of the installation concerned, which cannot be evaluated fully in this document. In the absence of data concerning costs, conclusions on the economic viability of techniques are drawn from observations on existing installations.

5. Review of BAT reference documents (BREFs)

BAT is a dynamic concept and so the review of BREFs is a continuing process. For example, new measures and techniques may emerge, science and technologies are continuously developing and new or emerging processes are being successfully introduced into the industries. In order to reflect such changes and their consequences for BAT, this document will be periodically reviewed and, if necessary, updated accordingly.

6. Contact information

All comments and suggestions should be made to the European IPPC Bureau at the Institute for Prospective Technological Studies at the following address:

European Commission
JRC Institute for Prospective Technological Studies
European IPPC Bureau
Edificio Expo
c/ Inca Garcilaso, 3
E-41092 Seville, Spain
Telephone: +34 95 4488 284
Fax: +34 95 4488 426
E-mail: JRC-IPTS-EIPPCB@ec.europa.eu
Internet: <http://eippcb.jrc.ec.europa.eu>

Reference Document on Best Available Techniques for the Production of Wood-Based Panels

PREFACE	I
SCOPE	XIII
1 GENERAL INFORMATION	1
1.1 PRODUCTS COVERED BY THIS DOCUMENT.....	1
1.1.1 Main products and their manufacture.....	1
1.2 PRODUCTION PROCESSES ADDRESSED BY THIS DOCUMENT	7
1.3 ENVIRONMENTAL ISSUES COVERED BY THIS DOCUMENT.....	8
1.4 STRUCTURE OF THE SECTOR	10
1.4.1 Market structure	10
1.4.2 Size and number of wood-based panel plants	12
1.4.3 Raw material costs for panel manufacture	14
1.4.4 Environmental cost for panel manufacture	15
1.4.5 Technical characteristics of wood-based panel installations.....	15
1.4.6 Location trends for wood-based panel sites	16
1.4.7 Challenges and trends for the wood-based panel sector.....	16
2 APPLIED PROCESSES AND TECHNIQUES	19
2.1 THE STORAGE OF WOOD RAW MATERIALS AND THE PREPARATION OF WOOD PARTICLES.....	21
2.1.1 Origin of raw materials	21
2.1.2 Receipt and storage of raw wood material	21
2.1.2.1 Log yard operations.....	21
2.1.2.2 Environmental issues related to storage of raw wood material	22
2.1.3 Cleaning of recovered wood raw materials.....	23
2.1.3.1 Environmental issues related to the cleaning of recovered wood materials	25
2.1.4 Debarking.....	25
2.1.4.1 Environmental issues related to debarking.....	26
2.1.5 Breakdown of wood to produce flakes, strands or wood particles.....	26
2.1.5.1 Environmental issues related to the breakdown of wood to produce flakes, strands or wood particles.....	27
2.1.6 Storage of wood particles and flakes before drying	28
2.1.6.1 Environmental issues related to storage of wood particles.....	29
2.1.7 Internal transport of wood materials in general.....	29
2.2 DRYING OF WOOD PARTICLES AND FIBRES	30
2.2.1 Drying of wood particles for particleboard and OSB production	30
2.2.2 Drying of wood fibres	33
2.2.2.1 Environmental issues related to drying	33
2.2.2.1.1 Environmental issues related to drying of fibres	35
2.2.3 Refining of fibres for MDF and other fibreboards	35
2.2.3.1 Environmental issues related to the refining of fibres	37
2.2.4 Storage of wood particles/flakes/fibres after drying	37
2.2.4.1 Sorting and dry storage of dried chips and flakes	37
2.2.4.2 Sorting and dry storage of fibres	38

2.2.4.3	Environmental issues related to sorting and dry storage.....	38
2.3	PANEL MANUFACTURE	39
2.3.1	Blending and mat forming	39
2.3.1.1	Mixing of resins and additives in the glue kitchen	39
2.3.1.2	Blending of resin mix with wood and mat forming	39
2.3.2	Pressing.....	40
2.3.2.1	Environmental issues related to pressing.....	43
2.3.2.2	Pressing of rigidboard and flexboard.....	44
2.3.2.3	Mat forming and the pressing of softboards	45
2.3.2.4	Mat forming and pressing of hardboards.....	45
2.3.3	Cutting and cooling of panels	46
2.3.3.1	Environmental issues related to cutting and cooling of panels	47
2.4	FINISHING OF RAW BOARD	49
2.4.1	Sanding and cutting to size	49
2.4.1.1	Environmental issues related to sanding and cutting to size.....	49
2.4.2	Storage	49
2.5	AUXILIARY SUBSTANCES AND MATERIALS	50
2.5.1	Resins.....	50
2.5.2	Hardening agents	51
2.5.3	Release agents and other additives	51
2.6	ENERGY PRODUCTION	52
2.6.1	Environmental issues related to energy production	53
2.7	IMPREGNATION OF PAPER.....	55
2.7.1	Environmental issues related to impregnation of paper.....	55
2.8	LAMINATION AND OTHER VALUE-ADDING OPERATIONS.....	57
2.8.1	Environmental issues related to lamination and other value-adding operations.....	58
2.9	WASTE WATER TREATMENT PLANTS.....	59
2.9.1	Environmental issues related to waste water treatment	59
3	CURRENT CONSUMPTION AND EMISSION LEVELS.....	61
3.1	INPUTS TO PRODUCTION	63
3.1.1	Wood raw material.....	63
3.1.2	Fuels.....	64
3.1.3	Resin and additives	66
3.1.4	Energy consumption	67
3.1.5	Water consumption	70
3.2	EMISSIONS TO AIR	72
3.2.1	Emissions from dryers	72
3.2.1.1	Dust in dryer emissions	73
3.2.1.2	Formaldehyde in dryer emissions	80
3.2.1.3	Organic compounds in dryer emissions.....	87
3.2.1.4	Additional collected data on dust and organic emissions from dryers.....	95
3.2.1.5	Emissions of NO _x and SO _x to air from directly heated dryers.....	98
3.2.1.6	Additional monitoring of dryer emissions	103
3.2.2	Emissions from presses.....	104

3.2.3	Emissions from downstream and upstream processing.....	109
3.2.4	Emissions from combustion plants	110
3.2.4.1	Additional monitoring data	114
3.2.5	Emissions from paper impregnation lines	116
3.2.6	Odour.....	117
3.3	EMISSIONS TO WATER.....	119
3.3.1	Emissions from surface run-off water	119
3.3.2	Emissions from treated process water	120
3.4	WASTE GENERATION	123
3.5	EMISSIONS TO SOIL AND GROUNDWATER	125
3.6	NUISANCE FROM NOISE AND ODOUR	126
3.7	MONITORING OF EMISSIONS	128
3.7.1	Reference conditions for expressing air emissions data.....	130
3.7.2	Monitoring of emissions to air	131
3.7.2.1	Dust.....	131
3.7.2.2	Formaldehyde.....	132
3.7.2.3	Monitoring of organic compounds	132
3.7.2.4	Monitoring of odour	132
3.7.2.5	Blue haze.....	133
4	TECHNIQUES TO CONSIDER IN THE DETERMINATION OF BAT	135
4.1	INTRODUCTION	135
4.2	TECHNIQUES TO PREVENT OR REDUCE EMISSIONS TO AIR.....	136
4.2.1	Introduction	136
4.2.2	Primary techniques to prevent or reduce emissions to air from dryers	138
4.2.2.1	Management of the drying operation	138
4.2.2.2	Recirculation of waste gases	139
4.2.2.3	UTWS or Combined heat and dryer systems for particleboard and OSB	140
4.2.2.4	Reduction of SO _x emissions	143
4.2.2.5	Reduction of NO _x emissions in hot gases from combustion plants	144
4.2.2.6	Reduction of dust emissions in hot gases.....	146
4.2.2.6.1	Electrostatic precipitators (ESPs).....	146
4.2.2.6.2	Bag filters	147
4.2.2.6.3	Cyclones.....	147
4.2.3	Primary techniques to prevent or reduce emissions to air from presses.....	148
4.2.3.1	Selection of resin and appropriate press operating conditions	148
4.2.4	Secondary techniques to prevent or reduce emissions to air from dryers and presses	149
4.2.4.1	Wet electrostatic precipitator	149
4.2.4.2	Bag filters	155
4.2.4.3	Electrified filter bed	159
4.2.4.4	Wet scrubbers.....	161
4.2.4.5	Bioscrubbers.....	164
4.2.4.6	Thermal oxidation	166
4.2.4.7	Incineration of press waste gases in an on-site combustion plant	168
4.2.5	Techniques to prevent or reduce emissions from other sources.....	168
4.2.5.1	Bag filters and cyclofilters	169
4.2.5.2	Cyclones.....	170

4.2.6	Techniques to reduce channelled emissions from paper impregnation line dryer ovens.....	170
4.2.6.1	Resin selection.....	170
4.2.6.2	Biofilters	171
4.2.6.3	Addition of dryer oven waste gas to main treatment systems	172
4.2.6.4	Thermal oxidation.....	173
4.2.7	Techniques to reduce diffuse emissions	174
4.2.7.1	Implementation of good housekeeping measures to minimise diffuse dust emissions from the log yard.....	174
4.2.7.2	Minimisation of diffuse emissions from the conveying of wood raw materials ...	175
4.2.7.3	Qualification of fugitive emissions using Reverse Dispersion Modelling.....	176
4.3	TECHNIQUES TO PREVENT OR REDUCE EMISSIONS TO WATER	177
4.3.1	Primary techniques to prevent or reduce emissions to water.....	177
4.3.1.1	Minimisation of the pollution load in collected waste water streams	177
4.3.1.2	Recirculation of process waste water from wood fibre production	178
4.3.2	Treatment of surface run-off water	180
4.3.2.1	Preliminary treatment, screening and sieving	180
4.3.2.2	Sedimentation in retention basins and settlement tanks.....	181
4.3.2.3	Sand filters.....	183
4.3.2.4	Reed bed	185
4.3.3	Treatment of process water from fibre production	186
4.3.3.1	Preliminary treatment, removal of larger solids.....	186
4.3.3.2	Primary treatment by physical separation of particles and suspended solids.....	186
4.3.3.3	Biological treatment.....	188
4.3.3.4	Tertiary treatment of waste water	189
4.4	TECHNIQUES TO REDUCE EMISSIONS TO LAND.....	191
4.4.1	Safe handling of auxiliary materials	191
4.5	TECHNIQUES TO REDUCE WATER CONSUMPTION	193
4.5.1	Collection of lightly contaminated water for plant cleaning and other purposes	193
4.6	TECHNIQUES TO INCREASE ENERGY EFFICIENCY	195
4.6.1	Recovery of energy in hot air emissions.....	195
4.6.2	Combustion control.....	196
4.6.3	Dewatering of bark and sludge	197
4.6.4	Combined heat and power (CHP) plants	198
4.6.5	Heat recovery from steam during refining.....	199
4.7	CONSUMPTION OF CHEMICALS AND RAW MATERIALS	201
4.7.1.1	Optimisation of the use of resins according to the product to be produced	201
4.8	TECHNIQUES FOR MANAGEMENT OF WASTE/RESIDUE GENERATION	202
4.8.1	Raw material control by applying a control programme to externally collected waste wood.....	202
4.8.2	Optimisation of fuel quantity by the collection of wood fines and dust	203
4.8.3	Safe storage, transport and reuse of bottom ash and slag from biomass combustion plants	204
4.8.4	Reuse of internal collected wood residues in production	205
4.9	ENVIRONMENTAL MANAGEMENT SYSTEMS	206
4.10	REDUCTION OF NOISE.....	209

5	BEST AVAILABLE TECHNIQUES (BAT) CONCLUSIONS.....	211
	SCOPE 211	
	GENERAL CONSIDERATIONS.....	211
	DEFINITIONS AND ACRONYMS.....	213
5.1	GENERAL BAT CONCLUSIONS.....	215
5.1.1	Environmental management system.....	215
5.1.2	Good housekeeping.....	216
5.1.3	Noise.....	217
5.1.4	Emissions to soil and groundwater.....	217
5.1.5	Energy management and energy efficiency.....	218
5.1.6	Odour.....	219
5.1.7	Management of waste and residues.....	219
5.1.8	Monitoring.....	220
5.2	EMISSIONS TO AIR.....	223
5.2.1	Channelled emissions.....	223
5.2.2	Diffuse emissions.....	227
5.3	EMISSIONS TO WATER.....	228
5.4	DESCRIPTION OF TECHNIQUES.....	230
5.4.1	Emissions to air.....	230
5.4.2	Emissions to water.....	231
6	EMERGING TECHNIQUES	233
6.1	SUPERHEATED STEAM DRYERS.....	233
6.2	RECOVERY OF ORGANIC COMPOUNDS FROM WOOD.....	234
6.3	REUSE OF REJECT PAPERS FROM THE PAPER IMPREGNATION LINE.....	235
7	CONCLUDING REMARKS AND RECOMMENDATIONS FOR FUTURE WORK.....	237
	GLOSSARY.....	241
	REFERENCES.....	253

List of Figures

Figure 1.1:	Particleboard (PB).....	1
Figure 1.2:	Oriented strand board (OSB).....	2
Figure 1.3:	Fibreboard (MDF).....	3
Figure 1.4:	Flexboard and rigidboards with a tongue-and-groove finish.....	4
Figure 1.5:	Layered softboard (SB), and thin green softboard for underfloor insulation	4
Figure 1.6:	Hardboard (HB)	5
Figure 1.7:	Particleboard pallet and pallet blocks.....	5
Figure 1.8:	Global distribution of PB, OSB and MDF production, 2010	11
Figure 1.9:	Relative production capacity share of wood-based panels in the EU-27	12
Figure 1.10:	Nominal production capacities for the panel products covered in this document, including all plants in the EU-27.....	13
Figure 1.11:	Number and nominal capacities of installations producing hardboard and softboard by the wet process and flexboard/rigidboard by the dry process.....	14
Figure 2.1:	Production flow for particleboard (PB), oriented strand board (OSB), dry process fibreboard (MDF), rigid and flexboard, softboard (SB) and hardboard (HB)	20
Figure 2.2:	Storage of roundwood in a log yard	22
Figure 2.3:	Example of standard steps in a cleaning plant for recovered wood.....	24
Figure 2.4:	Flow sheet for chipping and milling for PB, OSB and MDF	26
Figure 2.5:	Rotary dryer	31
Figure 2.6:	Example of chip dryer characteristics (indicative values).....	32
Figure 2.7:	Standard process steps in a refiner plant with optional washing and pre-cooking of wood chips	35
Figure 2.8:	OSB mat after forming and trimming	40
Figure 2.9:	Press types used in dry process panel production.....	41
Figure 2.10:	Multi-opening press	42
Figure 2.11:	Example of main production steps for rigidboards	44
Figure 2.12:	Production flow for wet process softboards	45
Figure 2.13:	Production steps in the manufacture of wet process hardboards	46
Figure 3.1:	Year of production start for PB, OSB or MDF installations included in the data collection.....	62
Figure 3.2:	Distribution of wood raw materials used in different panel products in the EU-27	63
Figure 3.3:	Distribution of raw materials used in particleboard production in different Member States	64
Figure 3.4:	Resins used in production of particleboard at 35 different production lines or installations	66
Figure 3.5:	Resins used in MDF production at 13 different production lines or installations, data from 2010–11	67
Figure 3.6:	Values for dust in emissions to air from directly heated PB dryers and the applied abatement techniques, based on data from 50 production lines	73
Figure 3.7:	Values for dust in emissions to air from PB dryers applying a WESP including when waste gas from both the dryer and press are treated together.....	75
Figure 3.8:	Values for dust in emissions to air from directly heated OSB dryers and the applied abatement techniques, based on data from 11 production lines	76
Figure 3.9:	Values for dust in emissions to air from MDF dryers and the applied abatement techniques, based on data from 32 production lines.....	78
Figure 3.10:	Values for formaldehyde in emissions to air from PB dryers and the applied abatement techniques, based on data from 34 production lines.....	80
Figure 3.11:	Values for formaldehyde in emissions to air from MDF dryers, based on data from 15 production lines.....	84
Figure 3.12:	Illustration of the variation in the contents of organic compounds in emissions to air from PB dryers	87
Figure 3.13:	Values for volatile organic compounds in emissions to air from PB dryers, based on data from 41 production lines.....	89
Figure 3.14:	Values for volatile organic compounds in emissions to air from MDF dryers, based on data from 24 production lines.....	92
Figure 3.15:	NO _x emissions to air from directly heated PB dryers with the corresponding emission airflow	100
Figure 3.16:	NO _x emissions to air from directly heated MDF dryers with the corresponding emission airflow	102

Figure 3.17: An EPF study showing formaldehyde emissions from presses and the related abatement techniques	108
Figure 3.18: Average values of TSS, BOD ₅ and COD in the discharge of treated surface run-off water	119
Figure 3.19: Example of variation of daily average values for a closed loop dryer and combustion plant	129
Figure 3.20: Example of variation of daily average values of continuous FID measurements (at 18 % O ₂) of TVOC during one year from a particleboard dryer equipped with a WESP	130
Figure 4.1: Principles of a combined heat and dryer system (UTWS) with recirculation of dryer waste gas.....	141
Figure 4.2: Principles of a double WESP, which includes a waste water treatment unit, scrubber, and one-stage ESP	150
Figure 4.3: Continuous improvement in an EMS model	206

List of Tables

Table 1.1:	Densities and process types for different wood-based panel products	6
Table 1.2:	Panel products of wood-based panel installations in the EU-27 and buyers of panel products in 2010	10
Table 1.3:	Production figures for wood-based panel products	11
Table 1.4:	Breakdown of direct material costs in 2009 for PB, OSB and MDF raw panels	15
Table 1.5:	Increase of production input costs in the wood-based panel sector from 2007 to 2010	15
Table 2.1:	Origin of raw materials and related products	21
Table 2.2:	Main resin types	50
Table 3.1:	Composition of a raw finished panel in weight (%)	67
Table 3.2:	Yearly energy consumption levels illustrated for the three main energy-consuming processes and for the total energy consumption at the site level	68
Table 3.3:	Comparison of energy consumption per unit of product in MDF production	69
Table 3.4:	Total water consumption in OSB, PB and MDF production	70
Table 3.5:	Reported emission levels of dust, TVOC and formaldehyde from dryers for particleboard, OSB and MDF lines	72
Table 3.6:	Reporting details on reference conditions for data presented in Figure 3.6 concerning emission to air of dust from directly heated PB dryers	74
Table 3.7:	Emissions data for dust from indirectly heated dryers in PB production, based on data from periodic monitoring	76
Table 3.8:	Reporting details on reference conditions for data presented in Figure 3.8 concerning emission to air of dust from directly heated OSB dryers	77
Table 3.9:	Reporting details on reference conditions for data presented in Figure 3.9 concerning emission to air of dust from MDF dryers	79
Table 3.10:	Reporting details on reference conditions for data presented in Figure 3.10 concerning emission to air of formaldehyde from PB dryers	81
Table 3.11:	Specific mass load of formaldehyde in emissions to air from PB dryers	82
Table 3.12:	Emission to air of formaldehyde from directly heated OSB dryers	83
Table 3.13:	Supporting information and details on reference conditions concerning formaldehyde in emissions to air from dryers for MDF production lines shown in Figure 3.11	85
Table 3.14:	Specific mass load of formaldehyde from MDF fibre dryers	86
Table 3.15:	Examples of contents of organic compounds in dryer emissions expressed by different parameters	88
Table 3.16:	Supporting information and details on reference conditions presented in Figure 3.13 concerning volatile organic compounds in emissions to air from PB dryers	90
Table 3.17:	Emission to air of volatile organic compounds from directly heated OSB dryers	91
Table 3.18:	Supporting information and details on reference conditions for data presented in Figure 3.14 concerning volatile organic compounds in emissions to air from MDF dryers	93
Table 3.19:	Emission to air of volatile organic compounds and the related specific mass load from fibre dryers, using cyclones and wet scrubbers as the abatement technique	94
Table 3.20:	Emission levels from particleboard and MDF lines in Germany	95
Table 3.21:	Specific mass loads from production sites in France	95
Table 3.22:	Emission levels from particleboard and MDF lines in Austria	96
Table 3.23:	Measurement of dryer emissions from one installation's test runs with a mix of fuel and raw material	97
Table 3.24:	Measurement of three main VOC constituents in a particleboard plant using maritime pine as the raw material	97
Table 3.25:	Comparison of quantitative dryer emissions from a particleboard plant	98
Table 3.26:	NO _x and CO emissions to air from directly heated PB dryers	99
Table 3.27:	Emissions to air of NO _x and CO from directly heated OSB dryers with the corresponding specific load of NO _x in kg/m ³ of finished panel	101
Table 3.28:	Emissions to air of NO _x and CO from directly heated MDF dryers (dry basis)	102
Table 3.29:	Metals in emissions from dryers	103
Table 3.30:	Emission of HCl, HF and SO _x from dryers	104
Table 3.31:	Diffuse emissions of VOC compounds along a press line	104
Table 3.32:	Emissions of dust and TOC in waste gas collected at press lines	106
Table 3.33:	Emissions of formaldehyde in waste gas collected at press lines	107
Table 3.34:	Emission levels of dust, NO _x , SO _x and CO in flue-gases from combustion plants	111
Table 3.35:	NO _x , SO _x , CO and dust emissions from heavy fuel-fired engines for generating hot gases for direct drying	113

Table 3.36:	Emission levels from closed loop combustion plants	113
Table 3.37:	HCl and HF emissions from heavy fuel-fired engines for generating hot gases for direct drying.....	114
Table 3.38:	Emissions of metals from combustion plants	115
Table 3.39:	Emissions of organic compounds and dust from paper impregnation lines.....	117
Table 3.40:	Odour emissions from stack emission sources	118
Table 3.41:	Treatment steps and removal efficiencies in waste water treatment plants treating process water from refining	121
Table 3.42:	Example from one installation producing MDF and PB of the composition of separately collected waste water from plant cleaning and production.....	122
Table 3.43:	Monitoring data from two production lines covering several years.....	128
Table 4.1:	Information for each technique.....	135
Table 4.2:	Emissions data from combined heat and dryer systems (UTWS).....	142
Table 4.3:	Emission levels from combustion plants for steam generation.....	145
Table 4.4:	Emission levels from a combustion plant firing 100 % recovered wood.....	145
Table 4.5:	Average of periodic sampling of dust, volatile organic compounds and formaldehyde in dryer emissions after treatment in a WESP	152
Table 4.6:	Emission levels for TOC and formaldehyde in emissions from OSB dryers after treatment in a WESP.....	153
Table 4.7:	Emission levels for dust, TOC/NMVOC and formaldehyde in emissions from press lines after treatment in a WESP.....	153
Table 4.8:	Emissions of dust in dryer waste gases treated in bag filters.....	156
Table 4.9:	Average values of periodic dust measurements in dryer emissions after treatment in a cyclone.....	158
Table 4.10:	Result of pilot tests of EFB treating dryer emissions.....	160
Table 4.11:	Average values of periodic measurements, including minimum and maximum values, of measured dust levels in dryer emissions after treatment in a wet scrubber	162
Table 4.12:	Emissions of formaldehyde and related specific mass loads from MDF fibre dryers with wet scrubbers	163
Table 4.13:	Emission of dust, TVOC/CVOCs and formaldehyde from press waste gas treated with wet scrubbers	163
Table 4.14:	Average values of periodic measurements of dust, organic compounds and formaldehyde in dryer emissions after treatment in a bioscrubber	165
Table 4.15:	Emissions of TVOC from paper impregnation lines at one WBP installation with no abatement but using resin types with a low free VOC content	170
Table 4.16:	Emissions of organic compounds from drying ovens for impregnation of paper lines treated by thermal oxidation	173
Table 4.17:	Emission levels associated with sedimentation/oil-water separation.....	182
Table 5.1:	BAT-associated emission levels (BAT-AELs) for emissions to air from the dryer and for combined treated emissions from the dryer and the press.....	224
Table 5.2:	BAT-associated emission levels (BAT-AELs) for NO _x emissions to air from a directly heated dryer	224
Table 5.3:	BAT-associated emission levels (BAT-AELs) for emissions to air from the press.....	225
Table 5.4:	BAT-associated emission levels (BAT-AELs) for channelled dust emissions to air from upstream and downstream wood processing, conveying of wood materials and mat forming	226
Table 5.5:	BAT-associated emission levels (BAT-AELs) for TVOC and formaldehyde emissions to air from the drying ovens for the impregnation of paper.....	226
Table 5.6:	BAT-associated emission levels (BAT-AELs) for TSS for the direct discharge of surface run-off water to a receiving water body	228
Table 5.7:	BAT-associated emission levels (BAT-AELs) for the direct discharge to a receiving water body of process waste water from wood fibre production	229
Table 7.1:	Key milestones in the drafting of the BREF for the Production of Wood-based Panels ...	237
Table 7.2:	Split views	237

SCOPE

This BREF covers certain industrial activities within the scope of Annex I to Directive 2010/75/EU, namely:

- 6.1. Production in industrial installations of:
- (c) one or more of the following wood-based panels: oriented strand board, particleboard or fibreboard with a production capacity exceeding 600 m³ per day.

In particular, this document addresses the following processes and activities:

- the manufacture of wood-based panels by dry or wet processes; including the production of:
 - particleboard (PB);
 - oriented strand board (OSB);
 - medium density fibreboard (MDF), including low density fibreboard (LDF) and high density fibreboard (HDF), produced in a dry process;
 - fibreboard, including rigidboard (RB) and flexboard (FB), produced in a dry process;
 - fibreboard, including softboard (SB) and hardboard (HB), produced in a wet process.

This document covers all activities from the storage of raw materials to the finished raw board ready for storage.

This document additionally addresses the following activities which are considered activities directly associated to the main Annex I, Section 6.1(c) activity, even if the directly associated activity is not necessarily an Annex I activity itself:

- on-site combustion plants (including engines) generating hot gases for directly heated dryers without restriction of capacity;
- the manufacture of impregnated paper with resins.

This document does not address the following activities:

- On-site combustion plants (including engines) not generating hot gases for directly heated dryers, including where energy is used for steam generation, indirect heating or electricity generation only. Combustion plants which are not process-integrated and > 50 MW aggregated are covered by the Large Combustion Plants (LCP) BREF [[24, COM 2006](#)]. Incineration plants which are not process-integrated are covered by the Waste Incineration BREF [[26, COM 2006](#)].

In order to avoid duplication of information in the BREFs, this document contains information specific to the wood-based panel sector. This means, in particular, that:

- Generally applicable information on the storage of chemicals and hazardous substances, cooling systems, energy efficiency, monitoring or economics and cross-media effects pertains to other relevant BREFs or JRC reference reports and may be found in these documents. Some general issues are clarified in this document because of the specific characteristics of the wood-based panels sector.
- Generally applicable information and specific information on particular processes or units covered by other sectorial BREFs have not been covered, for example:

Scope

- The occasional on-site primary production of melamine and formaldehyde resin. This is already covered in the Large Volume Organic Chemicals (LVOC) BREF [5, EC 2003],
- Basic energy production techniques (i.e. boilers, CHP plants, combustion plants, incineration). These are already covered in the Large Combustion Plants (LCP) BREF [24, COM 2006] or, in the case of incineration, in the Waste Incineration BREF [26, COM 2006].

Other reference documents which are relevant for the sector covered in this document are the following:

Reference document	Subject
Monitoring of Emissions from IED installations (ROM)	Monitoring of emissions to air and water
Large Combustion Plants (LCP)	Combustion techniques
Waste Incineration (WI)	Waste incineration
Energy Efficiency (ENE)	Energy efficiency
Waste Treatment (WT)	Waste treatment
Emissions from Storage (EFS)	Storage, loading and unloading of materials in general
Economics and Cross-Media Effects (ECM)	Economics and cross-media effects of techniques
Large Volume Organic Chemical Industry (LVOC)	Melamine, urea-formaldehyde resins and methylenediphenyl diisocyanate production

The scope of the BREF does not include matters that concern:

- off-site transport of raw materials or finished products;
- the quality assurance of products;
- the marketing and distribution of products;

The scope of this document does not include matters that only concern safety in the workplace or the safety of products because these matters are not covered by the Directive. They are discussed only where they affect matters within the scope of the Directive.

1 GENERAL INFORMATION

1.1 Products covered by this document

The wood-based panel products described in this document all relate to Section 6.1(c) of Annex I to the Industrial Emissions Directive (IED). The production capacity threshold in the definition given therein is 600 m³/day of wood-based panels. The installations which are considered in this document have an aggregated capacity of individual production lines exceeding this threshold.

1.1.1 Main products and their manufacture

Particleboard (PB)

Particleboard, also called chipboard, constitutes dried wood chips which are glued together with a resin which cures under the influence of high pressure and heat. Wood chips are derived from wood raw materials, such as roundwood, sawdust, shavings, flakes, and wood recovered from various sources. Other lignocellulos material, e.g. from flax shaves, hemp shaves and bagasse fragments, can also be used, but this is not yet an important raw material. The wood chips are dried in heated rotating dryers. Resins and other additives are mixed with the dried wood chips and a mat of the resinated chips is formed and cured in a hot press applying high pressure. The mat is usually formed of at least three layers, with finer outer layers and a coarser core.

Particleboards are produced in various thicknesses from 3 mm to > 40 mm and in various densities, see Table 1.1. Examples of particleboard are shown in Figure 1.1.



Figure 1.1: Particleboard (PB)

Oriented strand board (OSB)

Oriented strand board constitutes dried wood strands which are glued together with a resin which cures under the influence of high pressure and heat. An example of the product is shown in Figure 1.2. The manufacturing process is similar to that of particleboard. The strands are layered, or oriented, in at least three perpendicular layers during the forming of the mat. Wood flakes are derived exclusively from roundwood.

Oriented strand board is produced in a smaller range of densities than particleboard and in thicknesses from 6 mm to 40 mm, see Table 1.1.



Figure 1.2: Oriented strand board (OSB)

Fibreboard (HDF, MDF, LDF)

MDF (medium density fibreboard) is the common name for fibreboards. Unless otherwise stated, the term MDF also covers LDF (low density fibreboard) and HDF (high density fibreboard).

This fibreboard is produced from dry wood fibres. The fibres are glued together with a resin which cures under the influence of high pressure and heat. The standard panel is a one-layer structure. Wood fibres are mainly derived from roundwood, which is chipped or flaked and refined in a thermo-mechanical pulping process. The refined wet fibres are dosed with resin and additives and dried in tube dryers. The forming of the mat and the pressing process are essentially identical to in the production of particleboard and oriented strand board. Three examples are shown in Figure 1.3.

Fibreboards are produced in various thicknesses from 4 mm to 60 mm and in various densities, see Table 1.1.



Source: [110, Egger 2011]

Figure 1.3: Fibreboard (MDF)

Rigidboard and flexboard

Rigidboard is produced from refined and dried wood fibres derived from wood chips. Wood fibre preparation by refining is comparable to that of other fibreboards, including MDF. The resin is applied after drying and the mat is formed in similar processes to in MDF lines. The panel is pressed in a pre-press and cured in the main press. Curing takes place by adding enough steam through the mat to slightly heat it up. The press is not a high-pressure and heated press, as for the aforementioned other panels produced in a dry process. The slight rise in temperature and the small amount of water present cure the resin. The resin used is exclusively pMDI (polymeric methylene diphenyl diisocyanate).

Rigidboard is produced in various thicknesses from 18 mm to 240 mm and in densities from 100 kg/m^3 to 220 kg/m^3 . Rigidboard is mainly used for insulation purposes and the raw boards are passed through a profiler line in order to produce products with a tongue-and-groove finish.

Flexboard is a novel insulation product recently introduced on the market. Flexboard is a bendable board with a low density (50 kg/m^3). Alternative fibres or materials from non-wood species and bi-component fibres (often PP/PE) can be used to enhance the flexibility and strength of the panel. Flexboard is produced from dried fibres mixed with the alternative fibres and either formed and pressed in a similar process to in rigidboard production or alternatively the mat is formed by an aerodynamic fleece-folding machine similar to equipment used in the manufacture of non-woven textiles. The mat is cured in an oven heated by recirculating air, e.g. from a gas burner. The bi-component fibres act as a bonding agent. The panel is produced in thicknesses from 100 mm to 240 mm. Figure 1.4 shows examples of the two products.



Source: [111, Pavatex et al. 2011]

Figure 1.4: Flexboard and rigidboards with a tongue-and-groove finish

For the production processes of particleboard, OSB, MDF, rigidboard and flexboard described above, which are all produced by the dry process, a thermosetting resin or heat-curing resin is used. The most commonly used resin systems include urea-formaldehyde, phenol-formaldehyde and melamine-formaldehyde. pMDI is currently only applied as a main resin in OSB production and for the production of rigidboard and flexboard.

Softboard (SB)

This fibreboard is produced by a wet process very similar to papermaking. The wet wood fibres are obtained by refining green wood chips. Water is added to the wet wood fibres to obtain the pulp. The pulp is pumped out on a sieve to form the mat, which is dewatered by a calender press to a dry content of around 40 %. The board is subsequently dried through a multiple daylight belt or roller dryer and cooled on racks or a starboard cooler. Paraffin and latex are used as additives, but the addition of resins is not necessary as the lignin acts as the glue. Two examples of the panel are shown in Figure 1.5.

Softboard is produced in various thicknesses from 4 mm to 32 mm and densities from 140 kg/m³ to 300 kg/m³, see Table 1.1.



Source:[112, Gutex 2012], [113, Steico 2012]

Figure 1.5: Layered softboard (SB), and thin green softboard for underfloor insulation

Hardboard (HB)

This fibreboard is produced from wood fibres by a wet process similar to softboard production. After dewatering the mat formed from the wet fibre pulp, the panel is cured by applying high pressure and elevated temperatures in a multi-opening press. The appearance of the board comes from applying a high pressure, which gives the characteristic sieve pattern of the Fourdrinier sieve on the back and a smooth glossy top. Figure 1.6 shows an example of hardboard.

Hardboard is produced in several value-added varieties, e.g. tempered hardboard. Hardboard was the first panel variety to be produced on an industrial scale. It was invented in the early 1930s and patented under the name Masonite.

Hardboard is produced in a small range of thicknesses up to 5.5 mm, see Table 1.1.



Figure 1.6: Hardboard (HB)

Particleboard pallets and pallet blocks

Particleboard pallets are produced from wood particles in a process almost identical to that of particleboard. The raw material is often recycled solid wood pallets. The mat forming and press step differs, since each pallet needs to be formed and pressed individually in a single-opening press. The pallet blocks have a thickness that requires additional heat transfer, which is obtained, for example, by steam injection in special presses. The resins used are similar to those applied in particleboard production. Figure 1.7 shows examples of pallet-related products.



Figure 1.7: Particleboard pallet and pallet blocks

Table 1.1 summarises the panel products mentioned, their range of densities and whether they are produced in a dry process or a wet process. The majority of panel types are produced using a dry process.

Table 1.1: Densities and process types for different wood-based panel products

Panel	Production process	Density (kg/m ³)
Particleboard (PB)	Dry	500 – 800 ⁽¹⁾
Oriented strand board (OSB)	Dry	580 – 680
High density fibreboard (HDF)	Dry	> 800
Medium density fibreboard (MDF)	Dry	700 – 800
Low density fibreboard (LDF)	Dry	< 650
Hardboard (HB)	Wet	900 – 1100
Mediumboard (MB)	Wet	400 – 900
Softboard (SB)	Wet	140 – 400
Rigidboard	Dry	100 – 240
Flexboard	Dry	50
Pallets and pallet blocks	Dry	-

⁽¹⁾ The particleboard variety flaxboard is produced in densities of 350–600 kg/m³.
Source: [30, EPF 2011], [34, WPIF 2002]

Also, the European market includes producers manufacturing speciality products with distinct production techniques, such as thin particleboards, extruded boards, honeycomb boards and moulded products from wood chips. The production techniques for these special boards and moulded parts, like door skins and moulded pallets, are comparable with the standard particleboard or MDF production processes and the emissions are of a comparable composition during production. A few installations have provided emissions data on extruded panels and the information is included in the following chapters.

1.2 Production processes addressed by this document

The main manufacturing processes are the drying of wood and the pressing of dried wood particles or fibres into panels.

In addition to the core manufacturing processes, this document also covers upstream activities from the storage of wood raw material in the log yard and downstream activities up to the storage of finished raw or value-added panels.

The manufacturing steps included in the production processes covered by this document are shown below. For convenience, production is divided into four main parts.

- I. Storage of wood raw materials and preparation of wood particles:
 - receipt and storage of wood raw material, including roundwood, virgin wood material, and waste wood/recycled wood, and others;
 - on-site transport of wood material in general;
 - debarking of roundwood;
 - cleaning of wood waste/recycled wood raw materials prior to chipping;
 - flaking and chipping of wood to flakes, strands or wood particles;
 - storage of prepared wood particles/flakes/fibres before and after drying.

- II. Drying of wood particles and fibres, including refining of fibres:
 - cooking and refining of chips to fibres (covering wet and dry processes);
 - drying of wood particles, strands and fibres.

- III. Mat forming and pressing:
 - addition of resin and additives, blending;
 - mat forming;
 - pressing;
 - cutting to size;
 - wet process fibreboard mat forming and drying of panels.

- IV. Cooling and finishing:
 - cooling;
 - sanding;
 - cutting to smaller formats;
 - lamination and other value-adding, if applicable;
 - storage of finished panels.

The related abatement systems for emissions to air (often referred to as air abatement systems) and dedicated waste water treatment plants treating process water from the WBP installation are also included.

This document also covers directly associated activities which have an effect on emissions and which are not directly covered in other BREF documents. The activities covered include:

- process-integrated units producing hot gases for directly heated drying by combustion/co-incineration/incineration, as applicable;
- paper impregnation.

During the information exchange in the drafting of this document, information was also collected to determine if potential concerns could arise from directly associated activities such as the lamination of raw board with resin-impregnated paper. The rationale and the collected information are included in Chapter 2 as background information on the sector

1.3 Environmental issues covered by this document

The wood-based panels sector covers the production of a range of products and, while the production flow differs from product to product, there are some common features in terms of the key environmental issues.

In Chapter 3 the potential environmental issues identified in Chapter 2 related to each process are illustrated through the data collected and other information received. Not all issues are present at every installation and not all issues are equally relevant in terms of potential environmental impact. Below, the key environmental issues identified for the sector are mentioned.

The available primary and secondary techniques for the abatement of these identified key environmental issues are described in Chapter 4.

Emissions of dust, organic compounds and formaldehyde are the main components that are covered in this document.

Dust

Fine particulate matter emissions contribute to dust emissions from wood-based panel production, where particles below 3 μm can constitute up to 50 % of the total dust measured.

In addition, the dust is a contributing factor to the formation of blue haze and odour. Blue haze and odour is an issue which is related to the local area immediately surrounding the site, but the contribution of TOC to the deposition of fine particulate matter is also relevant in terms of environmental impact. The measures to lower emissions of particles below 10 μm (PM_{10} , $\text{PM}_{2.5}$ and PM_1), due to their potential for causing health and environmental problems, is high on the environmental policy agenda.

Current emission levels and the characterisation of dust are described in Section 3.2.

TVOC

TVOC emissions from wood-based panel production contribute to the emission of fine particulate matter and the creation of blue haze and odour. The purpose of preventing or reducing the emission of TVOC is to limit blue haze and odour, and to lower the fraction of very fine dust derived from condensable organics and other sources. Volatile organic compounds are considered, according to the UNECE definition, as any organic compound which is emitted from non-natural processes and has a photochemical ozone creation potential (POCP), which means any organic compound released to the atmosphere from an industrial plant or process, excluding methane.

The main constituents of the volatile organic fraction in wood are generally not considered in the literature as possessing toxic properties. An exception is formaldehyde. The environmental impact of formaldehyde is described below.

The composition of the TOC fraction in dryer emissions and emission levels are described in Section 3.2.

Formaldehyde

Formaldehyde emissions from wood-based panel production contribute to a minor part of the volatile organics. The formaldehyde content is around 5 % compared to that of TOC. Formaldehyde is not condensable and the contribution of formaldehyde to the creation of blue haze and odour is not considered a major issue.

Emissions of formaldehyde are abated because of its properties as a potential precursor for causing ozone depletion in the lower ozone layer. Formaldehyde is marked as an irritant for eyes and the respiratory system and as a possible human carcinogen. The formaldehyde levels in

ambient air are relevant, in terms of the toxicological aspects, regarding workplace health and safety and for the end use of the panel in indoor applications [51, CLP ECHA 2013], [50, Program 2011]. Emissions of formaldehyde from industrial processes are regulated in the majority of Member States.

The formaldehyde emission from the finished panel is an important issue in terms of indoor use of the panel products and hence the final products are classified according to strict emission limits. However, the final product's formaldehyde content and formaldehyde emission are not considered in this document.

The current emission levels of formaldehyde are discussed further in Section 3.2.

Other key environmental issues divided by production process are given below.

Particleboard, OSB and MDF production

- i. Emissions of total particulate matter/dust from dryers, consisting of wood dust and condensable organic compounds and emissions of non-condensable natural VOCs, including formaldehyde. The humid dust emission with aerosols gives rise to blue haze and odour, if not treated. The particulate matter/dust is composed of wood dust measuring between 2 µm and 100 µm and aerosols of condensable organics of 0.1–3 µm.

The composition of air emissions from dryers depends on the natural content of VOCs in the wood raw material and the drying conditions.

For MDF, the resin is generally applied before drying and the composition of organic compounds and the formaldehyde content in the emissions differ from PB and OSB for example.

- ii. Emissions from presses applying high temperature and pressure include volatile organic compounds, including formaldehyde and a low content of wood dust. The volatile organic compounds are partly derived from the wood, while formaldehyde emissions are related to the use of formaldehyde-containing resins. The press emission is humid, sticky, odorous and, depending on the resin type used, prone to ignition when collected and channelled.
- iii. Emissions of NO_x from directly heated dryers. The NO_x is mainly created during the combustion of fuel in the combustion plant generating hot gases for drying.

MDF and all other fibreboard production processes

- iv. Process water with a high concentration of COD and TSS.
- v. Water consumption.

All WBP production sites

- vi. Consumption of energy.
- vii. Surface run-off water from outdoor areas.
- viii. Emissions from combustion plants.
- ix. Noise.

[2, VITO, BIO and IEEP 2007], [27, WBP TWG subgroup 2012], [8, TWG WBP 2012], [67, VITO 2011], [86, DEFRA 2010], [85, EPA 2010], [68, VDI 2013], [58, UBA Austria 2013] [83, Barbu et al. 2014].

1.4 Structure of the sector

The wood-based panels sector is characterised as a part of the wood processing industry, as a consumer of wood as a primary raw material and of leftovers from other sectors in the woodworking industry, such as the residues from sawmills and from furniture manufacture.

The wood-based panels sector sells its goods, mainly for furniture manufacture and for construction and the building industry, through wholesale and to a lesser extent retail, see Table 1.2. The customer range and the magnitude of exports vary widely between companies although, generally, individual sites tend to serve their home or local market first.

Particleboard in particular is often given added value at the production site before being dispatched. Value-added products include raw board laminated with melamine paper, decorative foil or veneer, etc. MDF grades used for producing flooring products, panels for construction or insulation purposes are often cut with a tongue-and-groove finish before being dispatched.

Table 1.2: Panel products of wood-based panel installations in the EU-27 and buyers of panel products in 2010

	Products dispatched		Destination		
	Raw board (%)	Laminated (%)	Furniture industry (%)	Building/construction industry (%)	Others (%)
PB	52	48	70	22 ⁽¹⁾	8
OSB	100	0	0	82 ⁽²⁾	18 ⁽³⁾
MDF	40	60	45	35 ⁽⁴⁾	20
SB	100	0	0	100	
HB	90	10 ⁽⁵⁾	28	25	47 ⁽⁶⁾
Flexboard	100	0	0	100	
Rigidboard	100	0	0	100	

(¹) Doors and flooring.
(²) Wall and roof sheeting, subflooring and I-joists.
(³) Packing (6 %) and speciality purposes.
(⁴) Flooring is a major product.
(⁵) Hardboard is delivered lacquered or tempered for special purposes.
(⁶) Packing (28 %) and speciality purposes.
Source: [31, EPF 2011]

1.4.1 Market structure

The European market, together with the rest of the global market, experienced a boom up to the recession in 2008. Several factors led to the recession, such as a production overcapacity, price competition on the consumer market, the competition for raw materials, e.g. for the production of wood pellets from virgin wood, and the use of recycled wood and waste wood for energy production, and the global financial crisis. In response, the sector has been forced to restructure and rationalise. Still, the wood-based panels sector has seemingly been hit less hard than other business sectors.

Smaller companies depend more on local customers and tend to survive in the market by offering flexibility in order size and delivery time and by offering specialised products. These smaller companies often do not participate in a regional market. Regional markets are dominated by the larger companies able to deliver large quantities of bulk products in a short time. Price setting is typically dominated by the global market, but with some flexibility for the regional and local markets to diverge.

Access for new entrants into the western European market would likely be determined by their ability to offer a significantly different product in terms of quality and properties. This would

most likely involve new raw materials or innovative production of traditional products, but might also be by establishing production and markets in eastern Europe, thus benefitting from low-cost production and access to primary raw materials.

While Europe is still the major producer of panel products worldwide, as seen in Figure 1.8, the Asian market, and especially China, is on the rise and is expected to play a major role in the next decade.

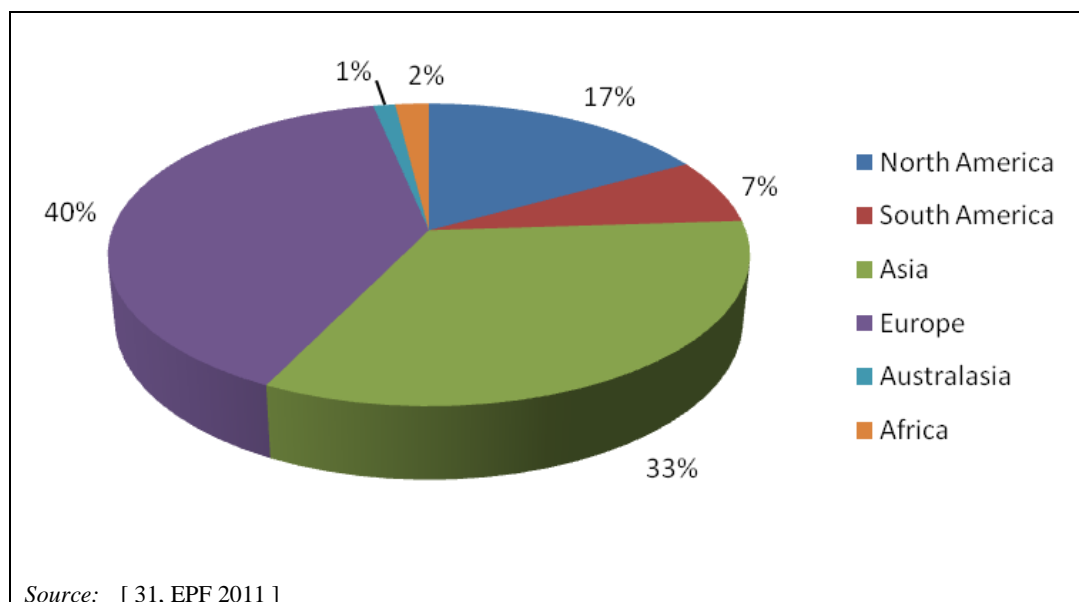

Figure 1.8: Global distribution of PB, OSB and MDF production, 2010

Particleboard is by far the most common product, see Table 1.3. Medium density fibreboard (MDF) was introduced on the market in the mid-1970s and, with the further development of low density fibreboard (LDF) and high density fibreboard (HDF), the range and applicability of fibreboards have helped them take over market shares from solid wood, particleboard and hardboard used in the furniture industry. Softboard production by the wet process may still be further diminished due to the development of insulation boards, like rigidboard, which can replace softboard in some construction applications, e.g. sound insulation. The production capacity shares (EU-27) in 2010 for the main products are shown in Figure 1.9.

Table 1.3: Production figures for wood-based panel products

Product	Yearly production ⁽¹⁾ (m ³ /year)	Share of total volume of wood-based panel products (%)
Particleboard	30 820 000	60.3
MDF	11 470 000	22.4
OSB	3 600 000	7.0
Soft/Hardboard	2 770 000	5.4

(¹) All western and eastern European countries, excluding CIS, 2010.
Source: [EPF 2011], [FEROPA, 2011]

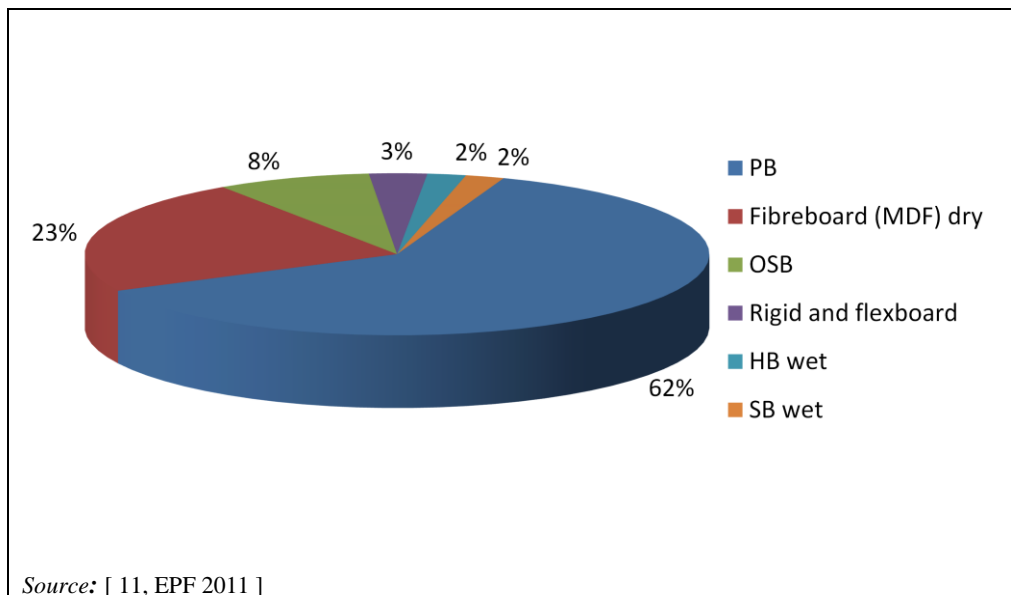

Figure 1.9: Relative production capacity share of wood-based panels in the EU-27

1.4.2 Size and number of wood-based panel plants

For this document, data have been collected from installations that have a production capacity of more than 600 m³ of finished panels/day, as per Annex I to the IED (2010/75/EU).

The nominal capacity of an installation is equal to the equipment production capacity or technical capacity and/or legal capacity given per day or per year.

The total production during a year would most often be lower than the nominal production capacity. A year has been considered as 335 production days, with a total of 30 days of shutdown where cleaning, maintenance and replacement of minor equipment are performed. Installations run continuously all year round, apart from these periods of planned shutdowns. Longer periods of cessation of production due to accidents, major retrofits or reduced market demand for panel products have not been taken into consideration.

Based on the above assumptions, for an installation with a production capacity of 600 m³/day, the yearly production capacity corresponds to 201 000 m³/year.

Figure 1.10 shows the distribution of plants producing the products indicated and which were in operation in 2009. The distribution is based on the nominal production capacity. It should be noted that an installation can represent more than one plant if the installation produces more than one main product.

In Figure 1.10, plants with a production capacity below 200 000 m³/year are indicated. The figures for 2009 show a total of 40 particleboard producers below 200 000 m³/year. The industry has undergone restructuring during the last years and it is expected that several of the smaller producers no longer operate today (2015).

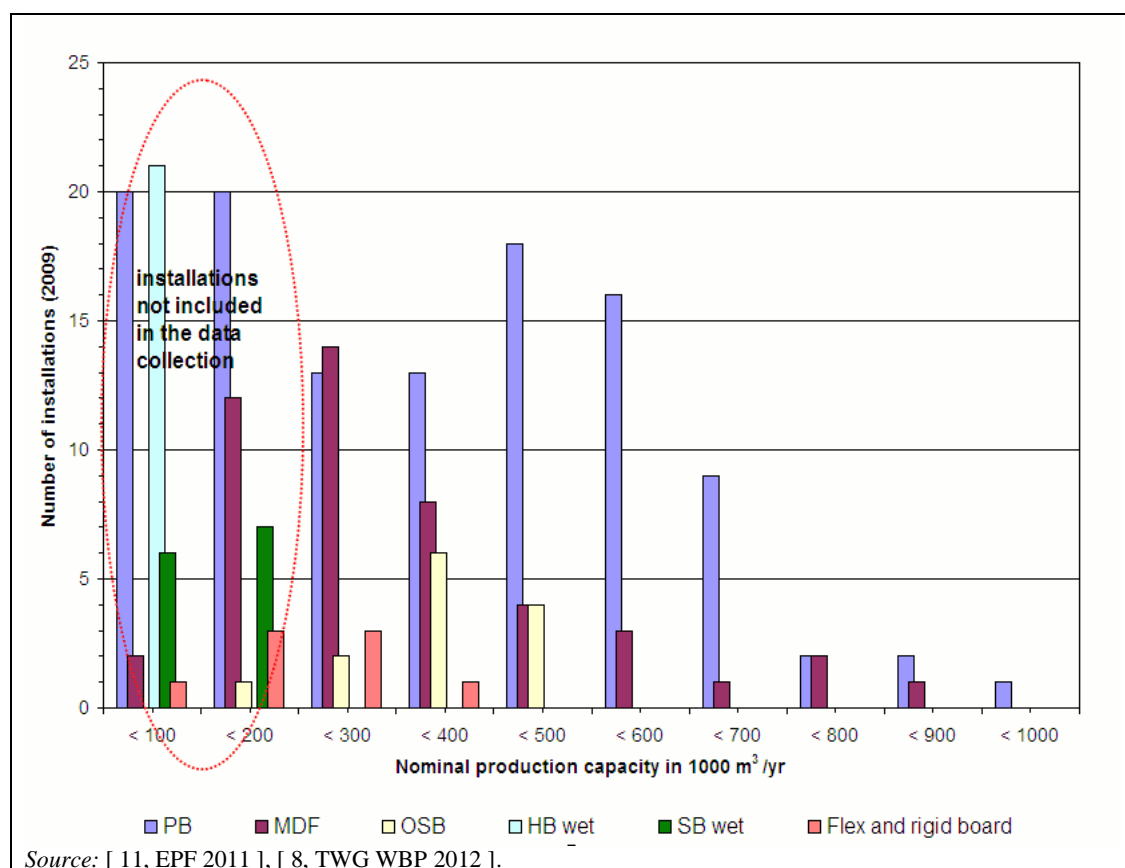

Figure 1.10: Nominal production capacities for the panel products covered in this document, including all plants in the EU-27

The distribution of wood-based panel installations is spread unevenly across the EU-27, with the largest capacity and number of installations found in Germany, Italy, Spain and France.

Main panel products

MDF and OSB plants have a fairly even average nominal capacity of 320 000 m³/year for MDF and 380 000 m³/year for OSB, see Figure 1.10.

The particleboard sector is more uneven, mostly as a consequence of the production lines in most Member States being older than the more recently introduced MDF and OSB plants. New installations tend to be bigger than older ones, and the average capacity of particleboard installations which exceed 200 000 m³/year is 470 000 m³/year, and much higher than for other panel products, see Figure 1.10. Particleboard installations which have a nominal capacity below 200 000 m³/year represented only 9 % of the total nominal production capacity in 2009, but 35 % of the total number of installations. The smaller production installations can be found throughout Europe, but for larger productions ones, the majority are found in Italy, France, Germany and Spain [11, EPF 2011], [10, Popescu 2008].

Niche panel products

Fibreboard-based special products including softboard, hardboard, and mediumboard are all produced in a wet process. Hardboard is the oldest panel product, with industrial production in Europe starting as early as the beginning of the 1950s.

Rigidboard and flexboard constitute a niche within the industry and have only been produced in the EU-27 since around 2005, and are produced in a dry process.

The nominal production capacities within this product group are much lower than for the main panel products, see Figure 1.11. The threshold of 600 m³/day in Annex I to the IED is especially challenging for softboard, rigidboard and flexboard, since the densities of these products do not lie within the range of the main panel products, see Table 1.1. Production capacities for these products are commonly, in the sector, expressed in tonnes instead of m³.

Particleboard pallets are produced at around five installations and are still a small niche product on the market. Pallet blocks are produced at more than 20 sites throughout Europe. While several production steps are identical, the products are not panels.

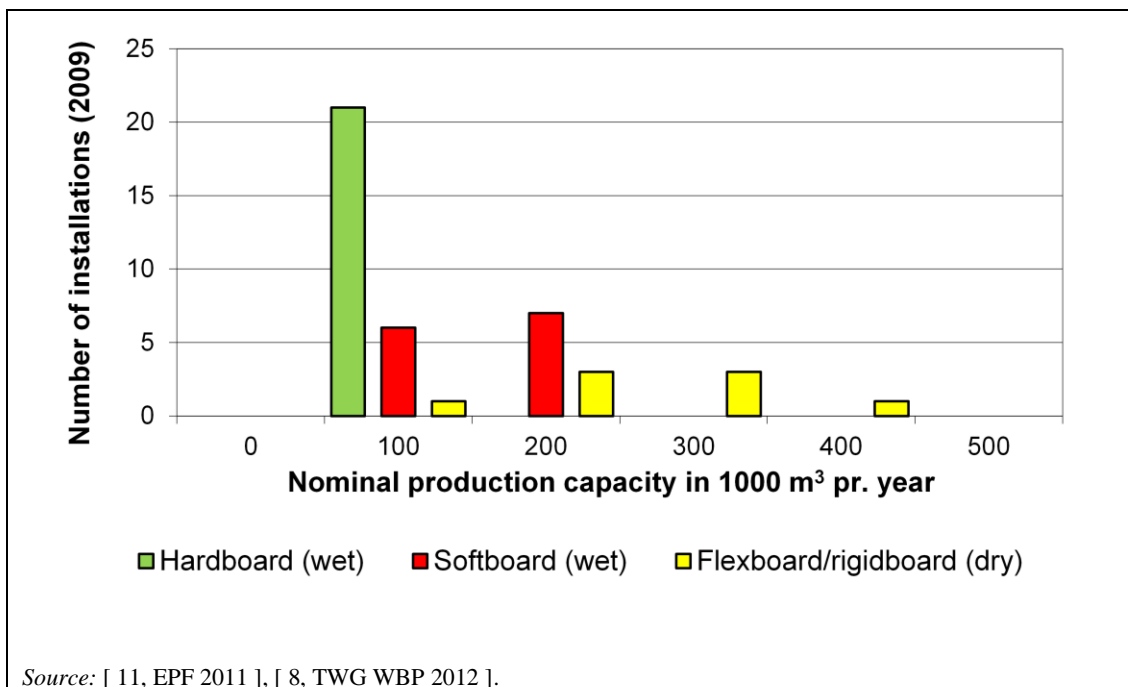

Figure 1.11: Number and nominal capacities of installations producing hardboard and softboard by the wet process and flexboard/rigidboard by the dry process

1.4.3 Raw material costs for panel manufacture

Raw materials used in panel manufacture comprise principally wood inputs and a thermosetting resin mix. The average percentage cost shares for the three main raw panel products, PB, OSB and fibreboard, are shown in Table 1.4 together with the relative cost share of energy consumption necessary for the core production of the panels.

The figures indicate that the resins (including additives) play a determining role in the cost of the finished panel. The distribution is based on information from 2009.

Table 1.4: Breakdown of direct material costs in 2009 for PB, OSB and MDF raw panels

Material	Percentage cost share	Percentage of finished product
Wood	31 %	90 %
Resin	43 %	10 %
Energy	26 %	-
<i>Source: [43, EU economics 2010], [31, EPF 2011]</i>		

Wood raw materials have, since 2009, experienced a rise in costs, due to the competition from pellet producers and biomass energy production. The accessibility and competition for raw materials depend on the local market and vary throughout Europe. It is estimated that the cost share for wood raw material could be considerably higher in the future. Resins have also experienced a rise in price, which is connected to the fact that resin production is based on by-products from the oil refining industry and will follow the general prices on the oil market. The cost evolution from 2007 to 2010 of expenses for production input materials is shown in Table 1.5.

Table 1.5: Increase of production input costs in the wood-based panel sector from 2007 to 2010

Material	Cost increase (%) 2007 – 2010
Wood	8
Roundwood	6
Post-consumer wood	8
Resins	15
Energy	10
Transport	5
<i>Source: [11, EPF 2011]</i>	

1.4.4 Environmental cost for panel manufacture

While the overall investment for a new medium-sized plant on a greenfield site is over EUR 150 million, around 20 % of the cost is related to emission reduction equipment. The operating and maintenance costs of the emission reduction equipment can be more than EUR 3 million per year.

Emission reduction schemes also play a role in the sector as all sites operate combustion plants [81, AEA 2009].

1.4.5 Technical characteristics of wood-based panel installations

The layout of different wood-based panel installations contains the same main features, but has very different footprints according to the age, directly associated activities, and the extent of retrofitting. While new production lines can be accommodated at a greenfield site to obtain optimum conditions for a logical production flow, this can sometimes be a difficult task at an existing site.

Key areas include the dryer and combustion units, followed by the press complex, which contains the mat forming station, press line and cooling station. For directly heated dryers especially, combustion units are conveniently placed close to the dryers. The cooking and refining of fibres for fibreboard production is closely linked to the fibre dryer and is directly connected to the dryer.

The press has an operating lifetime of at least 30 years. In the past 20 years, older plants have installed continuous presses instead of multi-opening presses (daylight presses), and continuous presses are, at the time of writing the norm in most plants. Presses are often retrofitted, e.g. to increase production capacities by adding more length to a continuous press or installing better suction systems in the mat forming, trimming or press section.

Dryers have a rather long lifetime, but the energy efficiency and quality of the dried product can be improved through various choices of retrofits, such as improved dryer configuration, choice of energy source, management of waste gases and by taking advantage of the heat energy in waste gases.

For all equipment, continuous cleaning, maintenance and repairs are necessary and are performed on a regular basis.

Few installations produce raw panels alone. In all installations, the raw board is cut to size, according to the dimensions determined by the market and the actual order placed. Several larger producers operating multiple production sites offer a wide range of value-added products, e.g. flooring, door skins, worktops, kitchen furniture and self-assembly furniture.

1.4.6 Location trends for wood-based panel sites

The location of a production site can be influenced by a tendency to agglomerate in regions with sawmills or with direct access to virgin wood. Some companies own forests and harvest their own raw material. This was common before 1990, but is less prevalent at the time of writing. The transport possibilities for raw materials play an important role, since the daily turnover of received wood raw material is over 350 tonnes. Easy access to the main road network or to waterways is therefore an advantage. Potential noise, dust and odour nuisances are additional elements to consider when planning the location and layout of a production site.

1.4.7 Challenges and trends for the wood-based panel sector

Several factors influence the quality and price of panel products, which challenges the industry in the search for new raw materials and new production patterns.

Wood raw material

The wood-based panel sector is influenced by the availability of wood raw materials. In competition for raw materials, both fresh virgin wood and recycled wood are increasingly used for producing fuels for biomass-fired combustion plants. Pellet producers use either virgin wood or production residues from the furniture industry and have become an increasingly fierce competitor on the raw material market. Post-consumer waste wood or recovered wood is also increasingly used as biomass-based fuel. There is a tendency for the more uniform and clean fractions of recovered wood to be directed to energy production, while recovered wood of a lower quality and hence the cheaper fractions are economically available for particleboard producers.

The European Panel Federation has published a charter for the use of waste wood in particleboard production, which prescribes a voluntary standard for the quality and handling of wood waste for its members.

For the sector, it has been important to give out a clear message that it supports sustainable production, in terms of using recovered wood as a raw material and as a fuel. Virgin wood used as a raw material is increasingly being harvested from certified forests, where harvest and growth are sustainable. For the latter, certification schemes such as the Forest Stewardship Council certification (FSC) and the Programme for the Endorsement of Forest Certification (PEFC) are widely applied.

Resins and formaldehyde in the final product

The majority of resins used are based on urea-formaldehyde. The raw panels adhere to EN standards, which not only prescribe the physical characteristics of the panel such as bending strength, stability, load bearings and swelling properties, but also classification according to the amount of free formaldehyde in the finished board. For indoor and furniture applications, a lower formaldehyde content is required, if classified under the E1 emission class.

Formaldehyde emission classes in finished panels, defined in Annex B of EN 13986 are as follows:

- Class E1: $\leq 8\text{mg}/100\text{g}$ dry board or $< 0.124\text{ mg}/\text{m}^3$ according to EN 717-1;
- Class E2: > 8 to $< 30\text{mg}/100\text{g}$ dry board or $> 0.124 - < 0.3\text{ mg}/\text{m}^3$ according to EN 717-1.

Besides EN product standards, the production of panels is increasingly influenced by product emission quality standards applied outside Europe, most importantly CARB standards, originating from Californian legislation [95, ATCM 2007] The emission limit values in panels used for furniture applications are at levels much lower than the corresponding lowest emitting standard in the EN standards.

Formaldehyde emission classes defined by ATCM 93120 are as follows:

- CARB phase 2 standard for MDF: 0.11 ppm;
- CARB phase 2 standard for Particleboard: 0.09 ppm.

In order to be able to act on a global scale, several producers in the EU-27 are producing low-formaldehyde-emitting panels for interior applications adhering to CARB standards. This can be achieved by using a non-formaldehyde-based resin. The amount of free formaldehyde in the final panel could be limited by using a resin where the formaldehyde versus urea proportion is balanced with an excess of urea, typically by adding urea, more hardening agent and adjusting the press time and temperature.

Research is focused on identifying alternatives to the formaldehyde-based resin, and one resin group especially used in OSB, flexboard and rigidboard production is isocyanate resins, primarily pMDI. The potential of the resin is strongly limited by the global production, which is not sufficient to cover the demand from the wood-based panels sector. In order to use pMDI, major changes in the set-up and operation of wood-resin blending, mat forming and presses will be needed.

Despite the obstacle of using a formaldehyde-based resin, an alternative is not foreseen in the near future. In the longer term, other factors could force the development of alternatives, mainly due to limitations in the supply of petrochemicals, which are the raw material for resin production.

The range of final products should adhere to the requirements in EN standards, EU Ecolabel criteria and national ecolabel criteria, which this document does not take further into account, although it is clear that developments in new production methods with new raw materials are influenced by demands set in certification schemes.

The following standards are examples specifying the physical properties of wood-based panels applicable for different classes of wood-based panel products; defining panels according to use in interior, exterior, humid and load-bearing applications:

- EN 309 Particleboards - Definition and classification;
- EN 312 Particleboards defining P1-P7 types for particleboard;
- EN 300 OSB defining OSB/1-OSB/4 types for OSB;
- EN 316 Wood fibre boards - Definition, classification and symbols;

- EN 622-3 defines three classes of low density mediumboard and seven classes of high density mediumboard derived from wet processes;
- EN 622-2 concerns the specifications and requirements for hardboard in six technical classes;
- EN 622-4 concerns the specifications and requirements for softboards, of which there are five technical classes;
- EN 622-5 concerns the specifications of and requirements for six technical classes of MDF dry process fibreboards;
- EN 14755 determines the qualities of extruded particleboards;
- EN 15197 determines four technical classes of flaxboard (particleboard using flax as a raw material).

Product quality and product standardisation are not discussed further in this document.

2 APPLIED PROCESSES AND TECHNIQUES

All the main process steps, from the storage of raw material to the storage of finished product, take place at the wood-based panel installation. More than 50 % of the raw boards are further processed, to give them added value, at the installation prior to dispatch.

The production of wood-based panels is a continuous process, where the core processes, drying and pressing, are especially interlinked. The production depends on the functionality of all the intermediary steps. While the preparation of wood particles can run with an overproduction and intermediary storage of prepared chips before the drying step, there are generally only a few hours of storage capacity for dried wood particles, to keep the mat forming station and panel press running continuously.

For convenience, the production process is divided into the following main steps:

- I. The storage of wood raw materials and the preparation of wood particles.
- II. Drying of wood particles and fibres, including refining of fibres.
- III. Mat forming and pressing.
- IV. Cooling and finishing.

Figure 2.1 shows a schematic production flow for the different products covered in this document, and also the main common processes.

In the first four sections of this chapter, the main process steps are described. If necessary, they are linked to the relevant products, if there are significant changes in the production process which could especially affect the related environmental issues.

The range of possible environmental impacts is mentioned for each process along with the measures currently applied to prevent or reduce these impacts.

It is important to recognise that not all the possible environmental issues mentioned in this chapter will arise at all sites with the same impact, since they will depend on the applied production methods, consumption patterns, raw material selection, local conditions, the age of the installation and the measures applied to prevent or reduce the emissions. In Chapter 3, related data for the environmental issues currently monitored in the EU are presented.

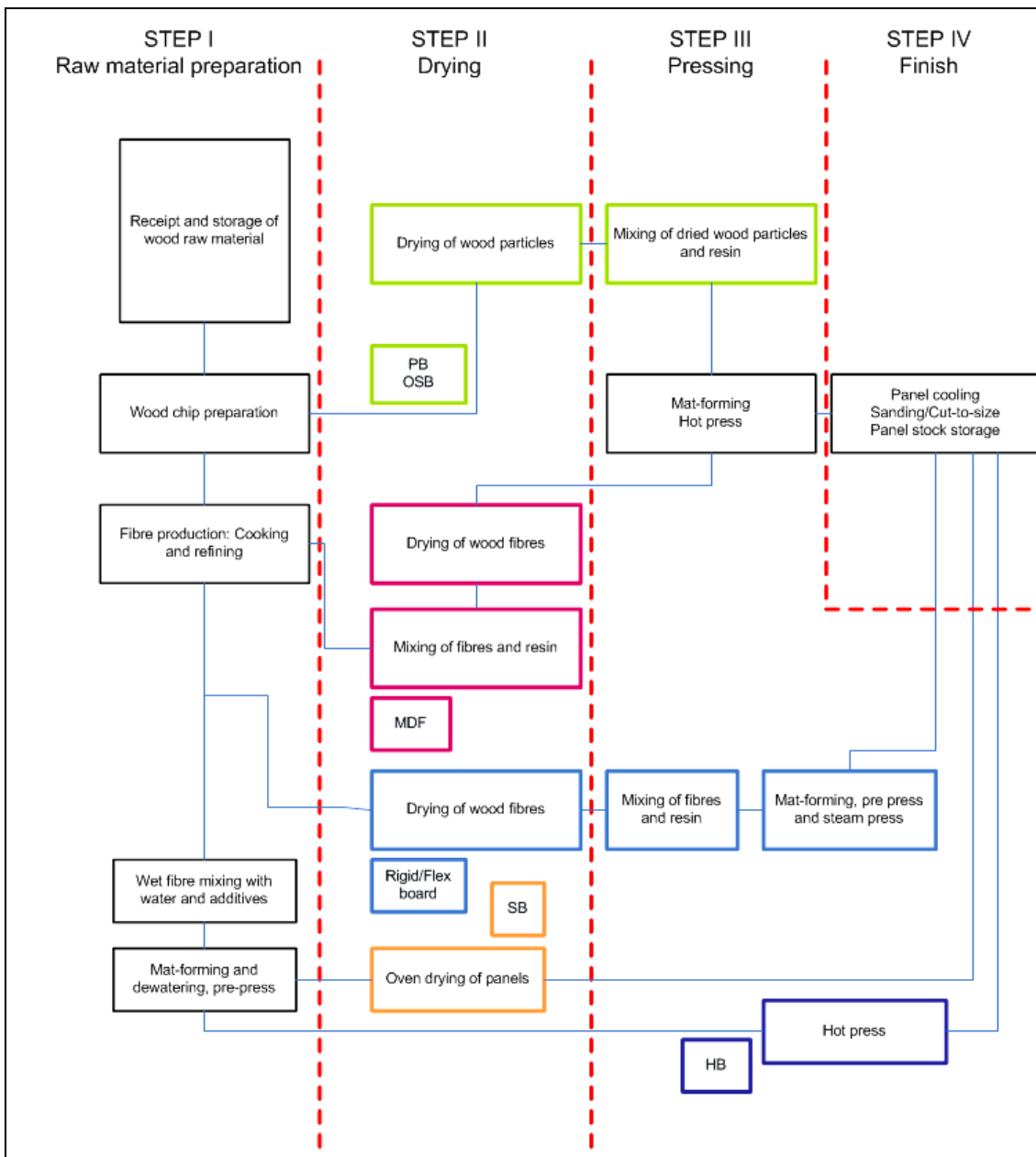

Figure 2.1: Production flow for particleboard (PB), oriented strand board (OSB), dry process fibreboard (MDF), rigid and flexboard, softboard (SB) and hardboard (HB)

2.1 The storage of wood raw materials and the preparation of wood particles

2.1.1 Origin of raw materials

The wood raw material comes from a large variety of sources depending on price, local supply and the product, see Table 2.1.

Table 2.1: Origin of raw materials and related products

	PB	OSB	MDF	Flex/ Rigidboard	SB/HB
Roundwood	X	X	X	X	X
Green wood forest residues	X				
Sawdust	X				
Externally delivered production residues	X				
Externally collected recyclable wood/waste wood	X				
Non-wood plant material	X			X	X
<i>Source: [8, TWG WBP 2012]</i>					

Particleboard can be produced from the most varied sources, including, besides roundwood, also sawdust, shavings, production rejects from own production or from furniture producers and a variety of different waste wood suppliers. Speciality products such as flaxboard utilise flax shives from the stalk of the flax plant.

For OSB, the raw material is always roundwood, due to the character of the flakes that need to be used to obtain the OSB characteristics.

To obtain fibres of a long, strong and uniform quality, MDF and other fibreboard producers traditionally use roundwood although novel methods of cleaning and sorting waste wood or production residue from other woodworking industries have made it possible to use alternative sources of wood materials in some dedicated production lines.

For flexboard and rigidboard, a range of alternative materials is used on a smaller scale. For flexboard, hemp fibres or coconut fibres can be used as a substitute for part of the wood fibres, to give additional properties to the final product.

2.1.2 Receipt and storage of raw wood material

2.1.2.1 Log yard operations

The majority of wood-based panel installations prepare wood chips from raw materials and have an open log yard on site for the handling and storage of raw materials. The log yard usually has dedicated areas for the different wood raw materials, which are laid in piles or dykes, see example in Figure 2.2. The log yard may be paved, to prevent soil and grit contaminating the wood materials and to ease the collection of surface run-off water. Roundwood, however, is most often stored in areas where the log yard has not been paved. Waste wood or recycled wood is normally stored in paved areas, with the surface run-off water being collected.

Shredded wood, wood chips, sawdust, shavings and even recovered wood can be delivered on site either to a dedicated spot in the log yard or to semi-enclosed or enclosed areas with moving floors for directly transporting the wood raw materials to the chip preparation area.

Sawdust does not always need further preparation and can be received and transported to wet storage silos directly.

Material stored in the open log yard and which is prone to wind drift is protected by walls, e.g. of roundwood or concrete, or is sprinkled with water as a preventive measure.

After preliminary shredding or chipping, the log yard can also be used as a temporary storage area until the material is directed to drying.



Source: [116, Finsa 2012]

Figure 2.2: Storage of roundwood in a log yard

2.1.2.2 Environmental issues related to storage of raw wood material

Surface run-off water

Surface run-off water in the log yard is managed at most sites. When areas are paved, rainwater is directed away from the paved area, either by means of drainage systems or via channels on the surface of the pavement. Water which is directed away from the log yard area has to be discharged. However, the quality of the collected water may not allow its discharge to the environment without treatment, as it may include high loads of wood material from the storage of sawdust and especially from recovered wood, as well as plastics and metal pieces. For recovered wood or waste wood, each Member State has separate regulations for the management and storage of non-hazardous waste, which are also applicable for WBP sites receiving and managing wood waste or recovered wood to be used either as a raw material or as a fuel.

Since the quantity of surface run-off water is directly related to rainfall, it may be necessary to store the collected water if the stream or infiltration area cannot handle a very unsteady flow of water and also to protect against peak flows. Retention ponds, basins or lagoons are employed to prohibit a sudden high flow. The basins also act as a sedimentation basin for sand, grit and wood materials. Before entering the retention basin, the surface run-off water can be treated in an oil separator, and coarse material can be collected by sieves and grates. Depending on the quality of the collected and sedimented material, it may be used as a fuel in an on-site biomass-fired combustion unit. Sand beds employed after sedimentation filter the water before final discharge. Reed-planted basins can act as both filtration and sedimentation units. If treated water is to be allowed to infiltrate the soil through an activated bed (such as wood chips), microorganisms can help to clean the water further before infiltration.

Depending on its quality, the collected water can be reused in production or for maintenance cleaning, although this will largely depend on the actual production and the need for water.

Cleaning water uses include the washdown of dryers or in the glue kitchen. Reuse in production includes water addition for resin or additive preparation or chip washing and cooking before refining. If there is no possibility of reuse in production, it is discharged to a stream or infiltrated, or, if local conditions dictate further treatment, it is directed to an on-site or off-site waste water treatment plant.

Surface run-off water can have high TSS values. TSS and COD values are interlinked since both are directly related to the wood debris.

Directive 2008/15/EC on environmental quality standards in the field of water policy includes in its Annex I a list of priority substances. None of the listed substances are used directly in the production process. It is however possible for some of the priority substances, e.g. nickel, cadmium and lead, to be present in the collected surface run-off water, due for example to storage of recovered wood. Surveys indicate that there could also be a potential release of cadmium, copper, lead and zinc.

See Section 3.3.1 for current emission levels in surface run-off water discharges.

Diffuse dust emissions

Diffuse dust emissions from stored wood raw material in the log yard are common when handling all materials and under the influence of wind drift. Diffuse emissions are higher in dry climates and on windy days. The sprinkling of wood raw materials is not common, since it is not an advantage that the wood raw material is wet. In order to reduce the spread of dust, transport routes, storage areas and vehicles are cleaned regularly on most sites. Cleaning also reduces the amount of dispersed wood material washed away by surface run-off water.

Noise

Noise arises from the transport and handling of raw wood materials, mainly from lorries arriving at and leaving the site and internal transport by trucks. The unloading and handling of roundwood is a point source of noise and is most pronounced when the roundwood is unloaded for debarking or flaking. Noise can be diminished by unloading in semi-enclosed areas and by limiting the fall height of the roundwood. On sites where the proximity to neighbours could result in a noise nuisance, barriers of soil or other materials often enclose the site borders. This is relevant for diminishing the noise both from log yard operations and also from the site in general. The walls also act as a windshield for finer raw materials. Often it is possible to reduce the noise at night by not receiving raw material from outside, and by limiting the handling to the minimum necessary to keep production running.

Odour

Odour nuisance from the storage of fresh green wood and roundwood is occasionally registered. It depends on local conditions and the sensitivity of the immediate surroundings. It can be limited by storing less wood raw material or by changing the location of the most odorous material. However, odour nuisance is normally more directly related to the emissions to air from the drying of wood material, see Section 2.2.

2.1.3 Cleaning of recovered wood raw materials

Recovered wood contains a variety of non-wood materials that cannot be accepted in the finished panel and hence it must be cleaned prior to entering the production line. Metals are especially damaging to the production equipment, e.g. for the chippers and mills that prepare the wood particles before drying, since metal grit will blunt and destroy the knives. Plastics and metals in the press will cause blisters and burn the surface of the panels during pressing. Dedicated cleaning plants for recovered wood are operated at sites where recovered wood is used as a raw material. Recovered wood is not a uniform product and comes from various suppliers. The most clean recovered wood is mainly wood residue from the furniture industry which can frequently be used directly without further cleaning. Recovered wood from very

diverse sources will need cleaning, such as post-consumer wood from public collection systems, and special care should be taken in the cleaning of this material. Cleaning consists of the following main steps in a typical cleaning plant, also shown in Figure 2.3:

- shredding of material;
- mechanical screening, e.g. vibrating, shaking, cascades;
- removal of ferrous metals with detectors and magnets;
- removal of non-ferrous metals with detectors and magnets;
- removal of plastics, paper, etc. by air shifting;
- shifting and sorting of wood particles for further reduction or transfer to wet raw storage.

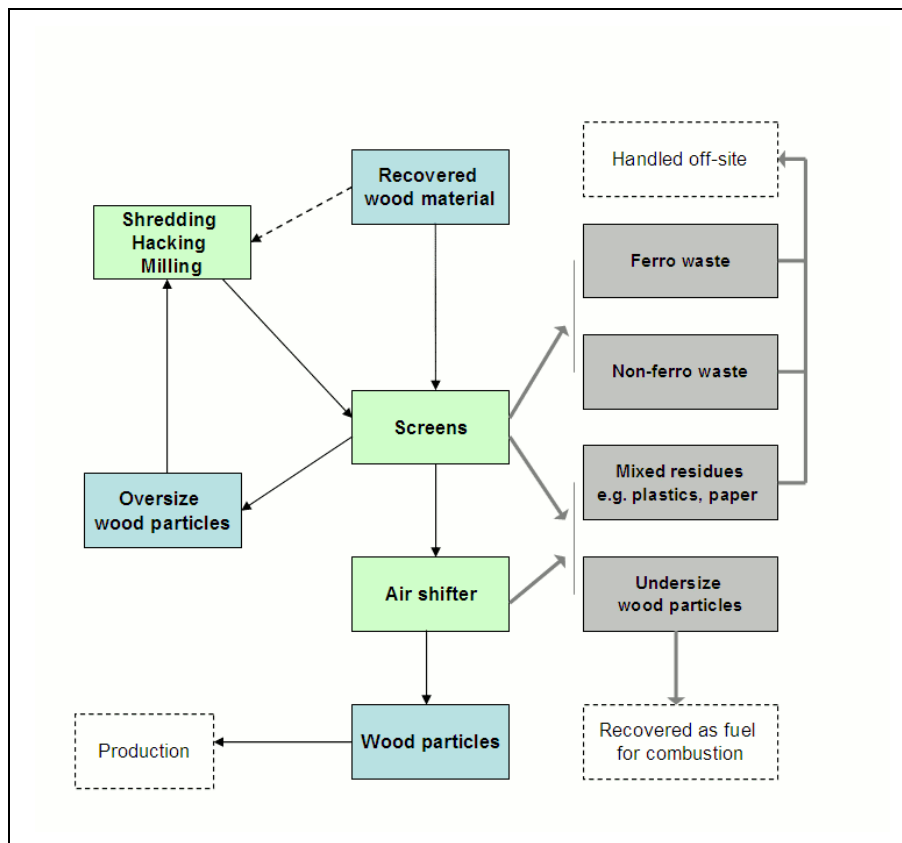

Figure 2.3: Example of standard steps in a cleaning plant for recovered wood

On most sites, the cleaning plant for recovered wood was introduced after recovered wood and especially post-consumer wood became relevant and accessible raw materials and after the panel production plant was established on site. The cleaning plant is often a separate construction on the site and not an integrated part of the building complex of the production line. This is an advantage since the storage location for the recovered wood, noise abatement and transport of collected dust to on-site combustion plants from the cleaning plant can be taken into consideration in the planning of the site layout.

Recovered wood and especially post-consumer wood are controlled prior to cleaning. Recovered wood is potentially contaminated and typical indicator pollutants can be identified. Depending on the source of the recovered wood, sites have control programmes in place [90, EA UK 2007], [73, UBA AT 2010], [64, EPF 2002].

2.1.3.1 Environmental issues related to the cleaning of recovered wood materials

Emissions to air

Recovered wood has a moisture content of around 15–40 %, and is drier than other wood raw materials. When the recovered wood, especially reclaimed wood fractions, is shredded, hacked, chipped, and sorted over mechanical sieves, dust emissions will likely arise. Dust will not only contain wood particles, but also particulate matter, like metals, plastics, paint and laminates.

Dust emissions from the cleaning plant are commonly collected at the various points of operation and treated, e.g. by bag filters.

In order to avoid diffuse dust emissions, the equipment, indoor and outdoor premises, transport routes and storage areas are cleaned regularly.

Waste handling

During the cleaning and sorting of the wood, the different waste fractions are collected individually in hoppers. All oversize wood fractions are reintroduced for further chipping. Undersized material collected in hoppers and dust collected in bag filters are used as a fuel on site. The sorted fractions of metals and plastics and debris are dispatched off site.

Noise

Noise from the processing machines is pronounced and it will normally be necessary to enclose or shield equipment in order to diminish it. The cleaning plant could have a production overcapacity, which would make it possible to halt the operation of the plant in the most sensitive hours during the night.

2.1.4 Debarking

Debarking is applied for roundwood if the final product needs a certain quality, and is always performed in OSB production. Bark in fibreboard production is generally unwanted. For lower qualities of MDF panel, a certain amount of bark is acceptable. The debarking operation will also depend on the species of wood, so while pine and fir are often debarked, poplar or beech often do not need debarking. For particleboard production, a specific debarking step is not necessary and therefore not used. During the preparation of the chips for particleboard production by chipping and milling, bark particles are sorted during one of several sorting steps to remove fines and unwanted material.

Debarking can be achieved in rotating drums, where the friction between logs and the abrasive surfaces removes the bark efficiently. Removed bark and waste wood fractions are collected from the drum in hoppers or chutes. A drum debarker can process up to 50 tonnes per hour on a dry basis and is typically connected directly to the flaker or strander for further processing without intermediary storage of the debarked roundwood.

Wet debarking is not known to be used regularly in the sector today (2014), but was formerly more widespread. In wet debarking, roundwood is sprinkled with hot water or steam in the debarking drum. The purpose is to ease the bark off the log and to rinse the log before chipping. During winter, the application of water or steam additionally thaws snow and ice off.

Bark is used as a valuable fuel. Bark derived from the debarking of roundwood is further shredded before it is fed to the burning chamber. If too humid, the bark can be screw-pressed to remove excess liquid. In dedicated large combustion plants, the bark is further dried before it is fed to the furnace. Pre-drying is not known to be regularly used in the sector.

2.1.4.1 Environmental issues related to debarking

Air emissions

Even though dust is generated during debarking, it is only rarely necessary to abate the emissions. The drums are semi-closed, and dust and coarser material are collected from the drum as the material falls to the bottom.

Water

Wet debarking generates waste water that contains high loads of tannins which are difficult to remove from waste waters. Tannins contribute to the COD load and discolour the waste water.

Wet debarking has a high consumption of water and if steam is needed this also adds to higher energy consumption.

Noise

Debarking is considered one of the noisier operations and the debarking unit is usually totally enclosed and situated in the log yard, separate from the main production buildings.

Waste

The bark resulting from debarking is a residue which can be fully used as a fuel in the on-site combustion plants. The bark is further shredded before use as a fuel. The bark from dry debarking is not subjected to drying before firing. Bark can also be used as soil cover or for other off-site uses.

Sludge also results from wet debarking after a filtration step, and this can also be used as a fuel if sufficiently dewatered before use.

2.1.5 Breakdown of wood to produce flakes, strands or wood particles

Wood raw materials are reduced to the required size and shape by chipping equipment, using one or two steps, depending on the size or shape at delivery and the desired end product quality. Figure 2.4 shows the chip preparation process for solid wood, raw chips, shavings and sawdust.

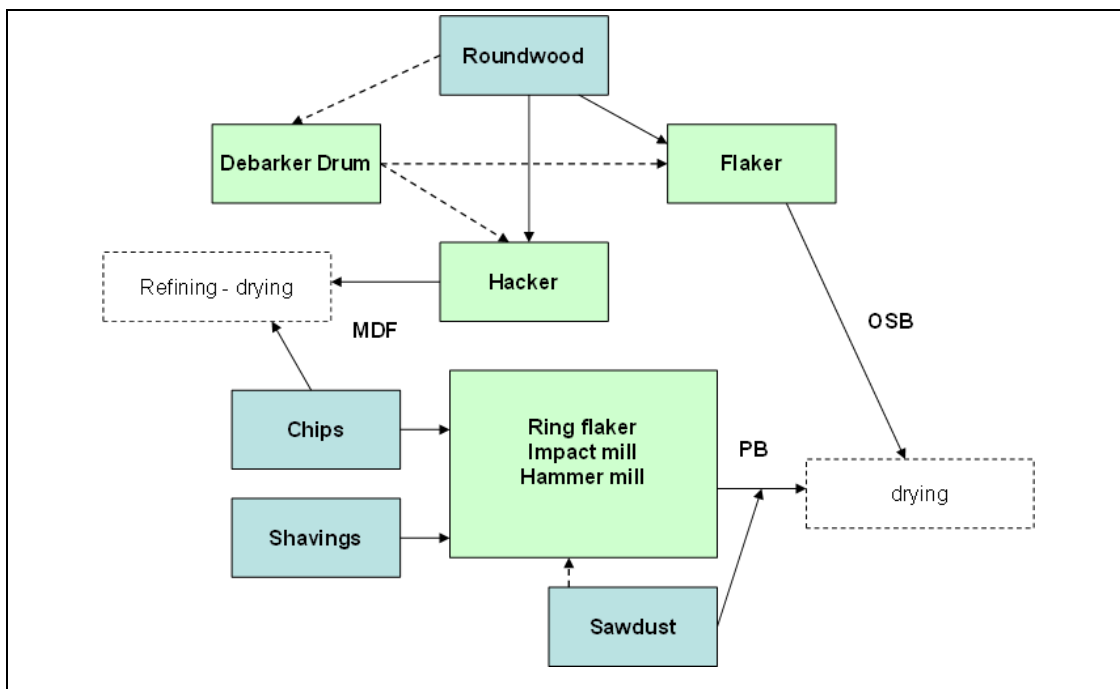

Figure 2.4: Flow sheet for chipping and milling for PB, OSB and MDF

Installations can apply both a primary breakdown and a secondary chipping of the wood material. Equipment used includes hackers, flakers and different types of attrition mills. The electrical energy demand per tonne of dry wood is higher for the primary breakdown of roundwood than for the milling of smaller particles.

For primary breakdown, hackers with drum diameters of up to 2.4 m can be used for roundwoods of random lengths and diameters. Hackers cut the wood with two to five knives, holding back large particles with a breaker screen. They produce long, thick particles of < 10 mm thickness and < 40–80 mm in length, with a wide size distribution. Particle surfaces tend to be rough and fractured since they are produced more by splitting than by cutting. A hacker with a 1000 kW motor can convert logs with a diameter of up to 1 m, producing about 150 tonnes/h of wet chips (70 tonnes/h of dry chips). Chips for the production of fibres are produced mainly from a single primary breakdown with hackers.

Flakes for OSB production are made in a one-step primary flaking operation, directly from debarked roundwood. Current drum flakers and vertical disc flakers use random length logs. Knives are set at an oblique angle to the axis of the drum, to reduce vibration and strain on the drum. A 2 m diameter 500 kW flaker with six knives produces 50 dry tonnes/h. Smaller particles are collected in hoppers and used as fuel, or as raw material if particleboard is produced at the installation.

For secondary breakdown, knife ring flakers are used with ring diameters of up to 2000 mm, including 28 to 92 knives. The inner ring forces the wood particles against the outer ring. They either work with a static outer ring or with a counter-rotating ring, the latter being more appropriate for wet material and allowing higher capacities. Capacities are between 2 tonnes/h and 14 tonnes/h of dry chips. The outer ring consumes about 10–55 kW, and the inner impeller about 100–630 kW. The air circulated by the impeller varies between 4000 m³/h and 18 000 m³/h.

Impact mills are characterised by a solid anvil in the centre of the outer ring, breaking larger particles accumulating at the inner spinning propeller. Impact mills are preferred for the preparation of surface particles for particleboard. They have a diameter of 0.8–1.8 m and are powered by motors of 100–1000 kW, producing 1–7 tonnes/h of dry chips.

Hammer mills are attached to a central shaft, allowing the hammers to swing back if they collide with large particles. Particles are broken by a series of blows. Particle size depends on the holes of the screen installed. Rotor diameters vary from 230 mm to 1800 mm, rotor lengths from 250 mm to 2000 mm, and motor sizes from 160 kW to 500 kW, producing 1–10 tonnes/h of dry chips [8, TWG WBP 2012], [1, Thoemen 2010].

Particleboard production often applies both a primary and secondary step. If recovered wood is used, a primary and even a secondary breakdown are included in the cleaning plant configuration.

The choice of equipment for chip preparation depends on the size, shape and evenness of the particles required for the product being produced at the specific installation. Energy consumption, stable chip production in terms of quality and reliability, and cost of maintenance are the main driving forces when selecting the combination of chipping equipment.

2.1.5.1 Environmental issues related to the breakdown of wood to produce flakes, strands or wood particles

Dust emissions

Raw wood typically has a moisture content of around 20–140 % depending on the source of the wood. Chips and flakes are less humid than roundwood, and roundwood during winter periods holds more moisture than in summer. Hardwood creates more fine dust than softwood.

Recovered wood is drier than fresh wood. Dust emissions therefore depend on the actual raw material and can vary widely. Dust emissions from chipping and milling operations are captured by bag filters or cyclones and used as fuel in dust burners and combustion plants.

When roundwood is hacked and flaked in a primary breakdown, there are less dust emissions than when milled and chipped. When the final chips are sorted over mechanical sieves or pneumatically sorted, dust emissions will also arise and need to be captured. The emissions from the chipping operations are commonly collected at the various points of operation and treated, e.g. by bag filters.

In order to avoid spreading diffuse dust emissions, the equipment, indoor and outdoor premises, transport routes and storage areas are cleaned regularly.

Waste handling

All oversize wood fractions that are collected are reintroduced for further chipping. Undersized material collected in hoppers and dust collected in bag filters are generally used as a fuel on site.

During hacking, flaking or chipping, any waste fractions are sorted from the wood chips and collected in hoppers. The sorted and collected fractions containing metals, plastics and debris are dispatched off site.

Noise

Noise from the processing machines is pronounced and it will normally be necessary to enclose or shield equipment in order to diminish it. The flakers which process roundwood to flakes for OSB production are contained entirely indoors, due to the high noise levels of the flaking operation.

Energy consumption

The equipment used for chipping operations and the related abatement equipment for emissions to air have high electrical consumption. Energy consumption is carefully monitored since a rise in energy demand would indicate that knives need changing. Energy savings are achieved by replacing older equipment and applying a formal maintenance programme.

2.1.6 Storage of wood particles and flakes before drying

Wet storage of prepared chips and flakes

Prepared chips for particleboard production are commonly stored in wet silos before drying. Dedicated silos for each type of raw material can be applied and, depending on the panel quality produced, the raw materials are mixed when conveyed to the dryer. In installations using one single source of raw material, there might only be one wet storage silo. In some installations, dryers for particleboards can be dedicated to drying either outer or core layers and a first sorting of the chips takes place before wet storage. For OSB and for fibreboard, only one type of raw material is stored. The filling levels of bunkers and silos are monitored to prevent overfilling.

Since sawdust does not need further milling and chipping, it is stored as received, until it is sorted and mixed with other raw materials before drying. Closed silos and self-contained storage areas (where no excessive dust emissions result) are used for the unloading and storage of sawdust.

Between a primary and secondary chipping, the intermediate raw chips are stored in the log yard if necessary. Otherwise, the process is continuous and there is no intermediary storage of chips before the last milling step and wet product silos.

2.1.6.1 Environmental issues related to storage of wood particles

When the storage of wet particles takes place in the log yard before the last milling step, the same issues could arise as for other log yard operations, see Section 2.1.2.2.

Air emissions

Dust emissions are not directly related to the storage of the wood material in silos. The dust emissions from the wet silos arise when transport to and from the silos takes place. But as most operations are continuous the wet silo is constantly being loaded and material taken from the silo to the dryer line. The internal transport of wood is described in Section 2.1.7.

Noise

Noise arises from abatement equipment such as bag filters and cyclones, and from the transport of wood particles to and from storage. Noise levels can be kept down by the use of standard silencers.

2.1.7 Internal transport of wood materials in general

The internal transport of wet and dry wood material is performed with either pneumatic or mechanical systems.

Closed or covered mechanical conveyors are used for transport of both wet and dry particles and flakes. Pneumatic transport is widely applied for both wet and dry particles and flakes and for dry fibres.

Air discharged from pneumatic transport is treated for dust in bag filters, cyclofilters or cyclones.

2.2 Drying of wood particles and fibres

The drying of the prepared wood material, in the form of chips, flakes, strands or fibres, is the core element of the dry manufacturing process for panels, in the sense that the wood particles need a prescribed moisture content to obtain the desired level of curing of added resin and the desired properties of the panel in the press. This is achieved by an active drying process that is similar to drying processes in other industrial sectors. The drying process is also the process with the highest energy demand in panel production, and the reason why combustion plants of different configurations can be found on almost all sites.

The choice and configuration of dryers depends on the heat sources available, the available space, the required throughput, the emissions generated and their abatement as well as the overall cost of investment, operation and maintenance.

The drying of fibres for dry process fibreboards takes place under different conditions and with different equipment. Drying of fibres is described separately in Section 2.2.2.

2.2.1 Drying of wood particles for particleboard and OSB production

Raw wood particles have a moisture content of between 20 % and 140 % depending on the source and conditions of the wood. Humidity can be as high as 140 % in very fresh wood and during wet periods. Chips, slabs and sawdust are less humid than roundwood. Roundwood and other virgin wood stored and used during winter periods holds more moisture than in summer. Recycled wood is the driest material, but its moisture content can also vary depending on the composition and prior conditions.

The desired moisture content is balanced to match the resin system used. For particleboard, the main resin systems are based on urea-formaldehyde and the desired final moisture content of the wood particles after drying is from 2 % to 3 %. The moisture content should not be too high since high moisture will cause an uneven pressing of the panel. Steam pressure from moisture builds up in the panel and if it is released instantaneously at the outlet of the press, it can cause blistering and delamination of the panel.

The moisture content should not drop too low either during drying, as the drier the material becomes, the more resin is consumed. Drying to a low humidity is also avoided because of the fire risk of hot, dry wood dust in the dryer, in the sorting of particles after the dryer and of collected dust in a bag filter for example. The higher the drying temperature applied and the drier the wood particles, the higher the potential for burnt fines. Any burnt fines cause a rise in the condensable dust emissions and a rise in emissions of polycyclic aromatic hydrocarbons (PAHs).

A final moisture content of 5 % to 10 % in the dried wood strands is optimal for the formaldehyde-free resin, polymeric methylene diphenyl diisocyanate (pMDI) used in OSB production.

Dryer types

Dryers used in the sector are rotary bundle or drum dryers, which are heated directly by hot gas or indirectly by radiation heat. Other dryer types include directly heated flash dryers or jet dryers, which are mainly added as a pre-dryer before the main rotating dryer. Figure 2.5 shows a rotary dryer.



Source: [30, EPF 2011]

Figure 2.5: Rotary dryer

An efficient mixing and movement of the particles is necessary in order to dry the material well and to prevent fires. In harsh drying conditions with high temperatures, the edges and smaller particles are prone to smoulder and catch fire. The mixing and movement of the wood particles is achieved by rotation of the dryer and movement of air through the dryer, driven by a fan at the outlet of the dryer.

The most common dryer is a directly heated dryer, where the wood particles are heated directly with a hot gas generated on site in different types of combustion plants or hot gas generators. The temperature of the hot gas when exiting the hot gas generator has a temperature of more than 800 °C and needs to be regulated down to the desired inlet temperature. This is achieved by adding ambient or hot air before the dryer in a mixing chamber.

The hot gas can be mixed with hot recirculated waste gas from the dryer or another hot airstream, e.g. air collected from the press. Depending on the mixing point, the VOC content in recirculated hot waste gas, e.g. from the dryer, could be incinerated by the hot gases. Adding hot air to the hot gas additionally saves energy.







Dryers can be single-pass or triple-pass; in a single-pass dryer, the wood particles travel from the entrance of the dryer to the outlet in one pass. In a triple-pass dryer, the wood particles are dried subsequently in three different chambers of the dryer, each with a temperature lower than the previous one. Single-pass dryers are only applied for directly heated dryers, according to the data collection. Single-pass and triple-pass dryers apply hot gas temperatures from 200 °C to more than 370 °C at the inlet of the dryer.

Other types of rotary dryers are drum dryers and tubular dryers. The temperature applied in a drum dryer can be as high as 500 °C at the inlet of the dryer. In Figure 2.6, a selection of dryer types is shown.

The drying time or residence time varies from 5 to 30 minutes. Short drying residence times are achieved when applying two drying stages, where the first stage is a directly heated flash dryer, and the second stage a traditional rotary dryer. Between the two stages, cyclones can be applied to distribute and feed the second dryer. The temperature in the first dryer stage is higher than in the second dryer stage. In theory, the main dust and VOC emissions arise from the first dryer stage.

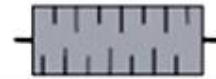
The outlet temperature of the waste gas lies between 100 °C and 130 °C for directly heated dryers and between 80 °C and 120 °C for indirectly heated dryers.

Dryers generally have evaporation capacities of up to 40 tonnes of water per hour and dry between 10 and 50 tonnes of wood material on a dry basis per hour. Even larger dryers are available on the market.

Dryer type	Scheme	Temp. range	Drying time	Drying capacity
Rotary bundle dryer		up to 200°C	≤ 20 min	1 ... 9 t/h
Tube bundle dryer		up to 160°C	n.a.	10 ... 18 t/h
Single-pass drum dryer		up to 450°C	20 - 30 min	≤ 40 t/h
Three-pass dryer		up to 400°C	5 - 7 min	≤ 25 t/h
Flash tube pre-dryer		up to 500°C	≈ 20 s	2 ... 14 t/h
Jet tube dryer		approx. 500°C	≈ 0,5 - 3 min	≤ 10 t/h

Source: [1, Thoemen 2010] based on Ressel, 2008, acc. to Deppe and Ernst, 2000.

Figure 2.6: Example of chip dryer characteristics (indicative values)

In an indirectly heated dryer, the wood particles are heated by radiation heat, e.g. from steam coils. Steam is generated on site in steam boilers served by on-site combustion plants or gas

engines. The recirculation of dryer exhaust air or addition of hot gas is possible in some indirectly heated dryers, which are referred to as combination dryers.

A recently developed direct dryer is a closed loop dryer, where the dryer and combustion plant operate in a slightly different mode to normal. The dryer waste gases are recirculated and thermally treated in a hot mixing chamber before being reused as dryer hot air. The waste gases which are released originate from the combustion plant only.

Dryers operate continuously but are shut down for regular maintenance at planned intervals. During regular maintenance, the dryer is cleaned to remove tar and dust build-up. Cleaning is done with water and often manually with a sweeper. The regular maintenance period is less than one working shift every 4–8 weeks. The related combustion plant and the abatement systems for emissions to air continue to run during this short period. When the dryer is ready to operate, all abatement systems for emissions to air are operational at the same time.

After drying, the wood particles leave the dryer unit and are recovered through a primary cyclone. The wood particles are sorted according to size before entering the mat forming station, see Section 2.3.1.

2.2.2 Drying of wood fibres

When the fibres leave the refiner unit, they enter a blowline of 20–30 m in length and with a small diameter, where the fibre mix is uniformed and wetted. The blowline also serves the purpose of adding resins, hardening agents and additives. All are added as aqueous solutions into the blowline. Only in a few MDF production lines are the resins added after drying. The drying of fibres for dry process rigidboard and flexboard is identical, but while hardening agents and additives are added in the blowline, the resin is added after drying.

From the blowline, the fibres enter the dryer, where they are dried and thereafter continuously fed to the mat forming station. The fibre dryers applied are mainly directly heated tube dryers of 150–180 m in length. The tube dryers can also be indirectly heated by steam coils or by a combination of indirect heating and additional hot gas. The fibres remain in the tube for 3–10 seconds and the drying inlet temperature is between 120 °C and 140 °C, occasionally up to 220 °C, which is generally slightly lower than that applied for PB chips and OSB strands. The outlet temperature is also lower and lies between 60 °C and around 100 °C.

The heat energy for drying comes from similar sources to those mentioned for drying wood particles and strands for PB and OSB.

After the mat forming station, the production process is similar to the production of PB and OSB.

2.2.2.1 Environmental issues related to drying

Waste gases from drying are collected and generally conducted into a dust abatement system. In this document the waste gases from dryers are considered as the resulting emission, after the product has been separated by cyclones.

Air emissions

The emission from a dryer after product separation contains water vapour, since this is the main constituent that is removed from the wood particles and indeed its removal is the purpose of the dryer. The humid and hot emission contains wood dust and VOC compounds, including formaldehyde, all of which contribute to total particulate matter content, since the condensable part of the VOCs will tend to create aerosols or droplets. Depending on the fuel used, the firing technique, and the combustion conditions, the hot gases will also contain other particles and

compounds which will be present in the waste gases from directly heated dryers, see Section 2.6.

Diffuse emissions are not an issue in the drying process itself, since it is a closed system. Diffuse emissions could arise later after the product is separated in cyclones during sorting and shifting, and before being directed to dry storage bins at the mat forming station.

VOCs and formaldehyde in air emissions from dryers

During drying, volatile natural organic compounds are released from the wood raw material. The most abundant species are α - and β -pinenes. Formaldehyde, other aldehydes and organic acids are found in much lower levels. The levels of formaldehyde emitted from different wood species are reported in studies to range from 2 ppb to 9 ppb, which corresponds to less than 1 % of the total organic compounds emitted [9, Roffael 2006] [7, Meyer et al. 1997], [38, Risholm-Sundman 1998].

The α - and β -pinenes can theoretically undergo oxidation to hydroxyls, aldehydes and ketones during drying, but only a minor amount of these compounds, e.g. myrtenal, has been recorded. It is expected that major oxidation reactions do not take place during the drying performed in the sector, which could be because of either the temperature applied or the lack of oxygen. When the individual volatile organic compounds are determined, the α - and β -pinene content represents more than 80 % of the total VOC content in softwood species, such as pine.

Some of the natural organic compounds are condensable compounds and these are released as condensed particles (aerosols), together with the wood dust and water vapour present, in the hot air emission.

Air emissions released into the atmosphere, which contain a combination of water vapour, aerosols of condensed volatile organics and wood dust, create the phenomenon 'blue haze'.

The range of organic compounds and the properties of these, together with the water vapour, make the wood dust particles sticky. The wood dust is also prone to catch fire and it is therefore better to apply a wet abatement system for the abatement of the dust fraction. A range of abatement techniques are applied, such as wet electrostatic precipitators, high efficiency cyclones, wet bioscrubbers, and Venturi scrubbers, individually or in combination. The electrostatic precipitator (ESP), a common dry dust abatement technique for flue-gases from combustion plants, is not used after the dryer because of the fire risk. As one of the few dry abatement methods, bag filters are applied at plants operating indirectly heated dryers. Common to most of the above-mentioned abatement techniques is that the content of volatile organic compounds in the dryer emissions is not reduced with the same efficiency. An effective technique for the removal of the volatile organic compounds is regenerative thermal oxidation, which is applied at one PB plant in Austria. Cyclones or bag filters alone have no efficiency for organic compounds [67, VITO 2011], [58, UBA Austria 2013], [68, VDI 2013], [83, Barbu et al. 2014].

Waste

The dryer is cleaned regularly to remove tar and dust build-up. Cleaning is done with water and often manually with a sweeper. The waste water needs to be dealt with [62, Swedspan 2013].

Noise

Drying and cyclone systems may give rise to duct and fan noise. Housing and/or suitable silencers are used on relevant ducts and fans, where necessary, to minimise noise emissions.

Energy consumption

Drying is the most energy-intensive process in the production of panels. Drying demands primarily thermal heat, but also power for the dryer and equipment related to fans and product transport.

The theoretical energy demand for drying can be expressed as the latent heat of evaporation, which for wood is around 2260 kJ/kg. Drying one tonne of wood with 60 % moisture down to 3 % moisture requires 1.3 GJ. Correspondingly, the same amount of recycled wood demands less than half of the energy, due to the lower moisture content of the recovered wood.

2.2.2.1.1 Environmental issues related to drying of fibres

The drying of fibres is considered to be a more gentle drying process than the drying of chips and flakes for PB and OSB. It is expected that with the lower drying temperature, less volatile organic compounds are released. Formaldehyde will also be mobilised at low temperatures and should therefore be present at the same magnitude in the emissions from fibres or particles. It should be mentioned that formaldehyde does not make up the majority of the emission of volatile organic compounds.

However, since the majority of MDF lines add resin in the blowline before drying, the organic part of the emissions will be affected and release a higher total VOC content during fibre drying. Hence, in the case of formaldehyde-rich resins like urea-formaldehyde, the formaldehyde content in the dryer emission could be higher than for particleboard and OSB drying.

Other additives such as wax and aqueous solutions of ammonium sulphate or ammonium nitrate could, in theory, contribute to the total organic content, ammonia, NO_x or SO_x in the emission. SO₂ is formed when sulphate in ammonium sulphate is converted to SO₂ during combustion. The conversion of sulphate to SO₂ is relevant when production residues are used as a fuel and hot gases are used for direct drying. Conversion of sulphate at the drying temperatures applied most probably does not take place.

Dust emissions from the drying of fibres are expected to be lower than for the drying of particles and strands, but will depend on the quality of the fibres obtained during refining.

2.2.3 Refining of fibres for MDF and other fibreboards

Wood fibres are the raw material used for the production of fibreboards. Wood fibres are produced from wood chips by crushing the chips between metal discs in a refiner. The refining process is similar to thermo-mechanical pulping for paper production [36, COM 2001]. Refining by thermo-mechanical pulping gives a long and intact fibre, which is suitable for producing fibreboard. Normally, chemicals are not added during refining. The production steps at the refining plant level are illustrated Figure 2.7.

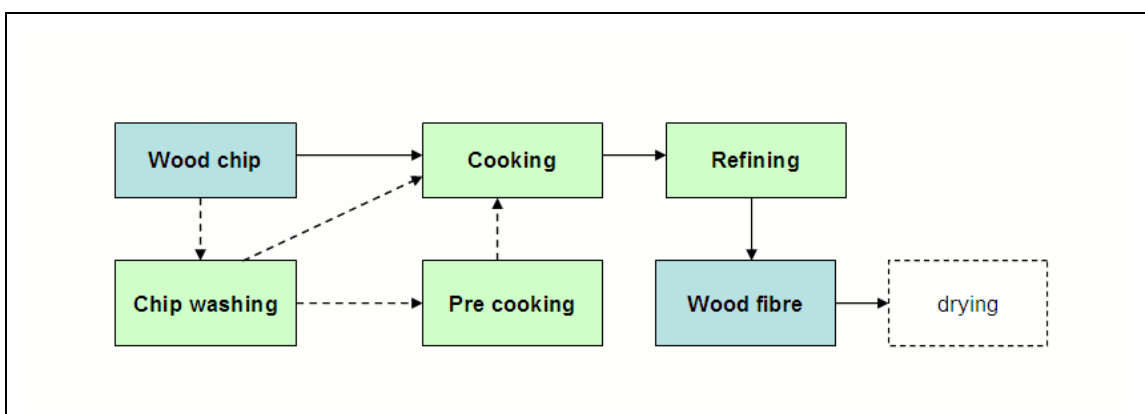

Figure 2.7: Standard process steps in a refiner plant with optional washing and pre-cooking of wood chips

The refining process consists of two main steps where the raw chips are preheated and cooked by applying steam and pressure to the wood chips. Excess water is removed from the cooked wood chips before they enter the refiner. The refiner discs defiberise the wood chips and the fibres are injected directly into a blowline for drying. The refiner discs can be pressurised or can operate at atmospheric pressure. Water is added in the refiner step, both for cleaning and cooling of the refiner discs, aiding the refining process and to create a sufficient pulp flow in the blowline. The humidity of the fibres when entering the blowline and dryer is between 50 % and 95 %, depending on the refiner and dryer equipment [8, TWG WBP 2012].

Prior to the steam cooking stage, a pre-cooking stage is frequently applied. In the pre-cooking stage, the wood chips are moistened and saturated with hot water under atmospheric conditions or preheated with steam. Applying this step preheats the chips, and therefore less energy is used later to raise the temperature in the chips in the cooking step.

Depending on the quality of the wood chips, a cleaning step is performed, where wood chips are washed before entering the one-step process of cooking and refining. If the raw material chips contain sand and dust from outdoor storage or are received at the installation in already chipped form or as uneven material with wood fines or are very dry, a chip washing step is applied. The impurities of sand, metal and stones can wear refiner discs and shorten the period between changes of the discs. Wear of refiner discs also raises the energy consumption. The washing of chips also softens the chips and adds humidity before the chips are cooked and refined. A chip washing step could replace a pre-cooking step, especially when hot water is used for washing.

The process water from each of the steps of chip washing, pre-cooking, cooking and from the refiner is either recycled or treated in a waste water treatment plant. In chip washing, the wash water needs to be treated in order to remove the wood fines plus sand and other impurities that have not previously been captured in gravitation vessels if present during washing. The chip washer is therefore combined with dewatering screws, decanters, hydrocyclones, rotary screens and/or settling chambers. The fines can be reused in a particleboard production line if present at the installation or used as fuel, if sufficiently dewatered. Sand and grit are removed and disposed of.

Process water is recycled at the refiner plant level and also reused for other purposes at the site. The amount of refiner process water recycling ranges from 0 % to 100 %. Internal process water recycling focuses on removing suspended solids (SS) and COD and is achieved by primarily mechanical and physical methods such as simple filtration, decanting, sedimentation, coagulation/flocculation, and microfiltration, while the resulting sludge is removed by filter presses and screw feeders. The quality of the treated water is determined by the intended use for the recycled water. The sludge derived is generally used as a fuel on site.

The refining of fibres for the production of wet process fibreboards uses the same equipment and process but, as the fibres are not dried, the resulting pulp fibres are mixed with water in storage tanks to make a pulp slurry. The slurry of water-suspended fibres can be gently heated and pumped to the mat forming station. The temperature rise in the slurry further activates the natural lignin and hemicellulose, which bind the wood fibres together in the following step in which the mats are drained and dried in ovens. All water which is used for washing, pre-cooking, cooking, and refining and drained pulp slurry water are recycled in a semi-closed or closed loop by simple filtration, decanting and sedimentation, while the sludge is removed and dewatered as already described. Sawdust is used as a secondary raw material for wet process fibreboard. The sawdust is refined separately and added as a surface layer during mat forming, on the sieve and press.

When process water is directed to a central waste water treatment plant (WWTP) on site, the quality and quantity of the resulting waste water stream from the preparation of the fibres vary depending on the amount of recycling. The waste water which leaves the refiner plant to be treated at a central WWTP is treated by different classical treatment methods. Primary treatment methods using physical separation prevail and remove the major part of the fibres and wood

particles. Also, coagulation, flocculation, sedimentation and secondary aerobic biological treatment steps are applied. Sludge from the different treatment steps can be used as a fuel on site, for agricultural purposes or may be disposed of.

2.2.3.1 Environmental issues related to the refining of fibres

Energy consumption

The refiner plant has a high energy demand, e.g. for the generation of steam for the cooking stage and electrical energy for the refiner. The system of dewatering screws and pumps in the system demands electrical energy, in the range of 20–40 kW, with a throughput of up to 400 m³/h.

Examples of energy savings include replacing older equipment and reusing excess heat in the steam.

Water consumption and waste water generation

Water is consumed in chip washing, in pre-cooking and for the generation of steam used in the cooking step.

Water for chip washing can be of a lower quality than can be accepted for steam generation. Secondary water sources include recycled chip washing water, rainwater collected from roofs and recycled water from the cooking stage.

Water consumption savings can be obtained by closing water circuits and recycling process water in integrated treatment plants at the washing plant unit or at the cooking and refiner unit.

Waste water from the overall refining process needs to be treated before discharge, if it is not recycled in the refiner plant. The process waste water has a high TSS, COD and BOD load. Also, nitrogen and phosphorus could be relevant parameters to take into account.

Directive 2008/15/EC on environmental quality standards in the field of water policy includes in its Annex I a list of priority substances. None of the listed substances are used directly in the refining process or arise from other types of waste water generated in a WBP plant. It is however possible for some of the priority substances, e.g. nickel, cadmium and lead, to be present in the emissions from waste water treatment plants, either due to the use of recovered wood (in PB production) or from surface run-off water via storage of recovered wood. Surveys indicate that there could be a potential release of cadmium, copper, lead and zinc.

Waste

Sludge is generated from the treatment of process water. Depending on the quality of the sludge, it is either used as a fuel in an on-site biomass combustion plant or handled off site. The sludge generated from the initial screening of chip washer water can occasionally be used in the production of particleboard, if such a product line is in operation at the installation.

2.2.4 Storage of wood particles/flakes/fibres after drying

2.2.4.1 Sorting and dry storage of dried chips and flakes

The dry material from the dryers is collected and separated in cyclones and shifted by mechanical or pneumatic means to sort the dry particles into the required sizes.

In order to prevent fires in the dry, hot wood material, a fire-suppressant silo designed to suppress any glows and prevent the self-ignition of the dried chips and flakes can be applied immediately after the dryer and cyclones.

After passing the fire-suppressant silo, the dried chips for particleboard production are mechanically sorted or air-shifted before entering dry silos. Shifting sorts the finer chips for the outer layer from the coarser chips for the core layer. Any oversize chips are recirculated back into the chipping station, while small chips and dust are collected and used as fuel in dust burners or combustion plants. The shifting stations and dry silos are mounted with bag filters or closed cyclones. It is preferable to remove the finest dust efficiently from the product, since dust absorbs more resin, resulting in higher resin consumption.

Odd-sized material separated from the dried flakes from OSB production is collected and used as fuel. If there is a particleboard production line at the same installation, this material can be used as raw material and is then directed to the chipping station.

Chips from dry storage feed directly into the mat forming station without further steps. The dry storage capacity usually represents only a few production hours for the press. Chips or strands from dry storage silos are transported to the mat forming station mechanically or in closed pneumatic systems.

2.2.4.2 Sorting and dry storage of fibres

Dried fibres are collected from the dryers and separated in cyclones, where they are air-shifted to sort larger fibres, lumps of pre-cured resin, clogged fibres and fines from the final fibres.

The fibres are directed to the mat forming line directly into a 20–50 m³ bunker or bin with a moving floor, from where the fibres are continuously fed.

2.2.4.3 Environmental issues related to sorting and dry storage

Dust emissions

Dry wood materials generate dust emissions. After the smaller fines, particles and dust are removed, the resulting chips are less prone to create dust emissions. Any handling of the dry and sorted chips is performed in closed systems, and shifting stations and dry silos are mounted with bag filters or closed cyclones. The product separation is closely connected to the dust abatement in the drying process, see Section 2.2.

Fire risk

During drying and the handling of the dried material immediately afterwards, fire-suppressant silos are used and, during mechanical or pneumatic shifting of the chips, fire detectors and fire-suppressant intermediary steps, such as possible isolation, help lower the risk of self-ignition and fire outbreak. The inlet area of the dryer to the inlet of the mat forming station would rate as areas with a potentially explosive atmosphere (ATEX). Sprinkler systems and explosion venting, together with good housekeeping and maintenance, are employed as minimum requirements.

Noise

Noise arises from both mechanical sorting of air shifters and from cyclones. These operations often take place inside a building or an enclosed area. Noise may also be related to the dust abatement equipment employed and, as a standard solution, silencers are employed at such locations on roofs.

2.3 Panel manufacture

2.3.1 Blending and mat forming

2.3.1.1 Mixing of resins and additives in the glue kitchen

Resins are commonly delivered as aqueous solutions to the site and stored in above-ground storage tanks with a capacity of 10–100 m³. Additives can be delivered as solutions in smaller batch tanks or as powder. A resin mix is often prepared from one or two resin types by simple pumping to dosing tanks in the glue kitchen, where prepared additives diluted in water are added to the resin mix. Resin preparation can be continuous or batchwise. Resin, additives and wax can be dosed directly, without prior mixing, from storage tanks to the blowline, before the drying of fibres or after the drying of chips. The pumping and mixing system is generally closed, so diffuse emissions do not result under normal operating conditions. The resin mix is dosed by mass flow meters and pumped from the glue kitchen to the mat forming station.

Water for resin mixing can be from a secondary source, such as recycled water from refining.

2.3.1.2 Blending of resin mix with wood and mat forming

In OSB and particleboard production, the resination is performed in the blender after drying. Blending is a continuous operation but can take place in batches. Application is performed with spray nozzles or atomisers.

In particleboard production, the dried chips are separated after drying according to size, into core and surface layers. Each product stream is conveyed to a dedicated blender, where they are mixed with resin, wax and other additives as required. The resin-coated particles are metered out from dedicated mat forming machines each laying out one layer. The particles are distributed mechanically or by air current to create a gradation of particles, which is used to obtain the most even surface layer made of the finest particles. Particleboards consist of a thin surface layer, with the core layer representing the main part of the panel. The core layer can consist of several layers, although one core layer and the two surface layers is the most common configuration.

In OSB production, the dried flakes are conveyed to the blender, where they are mixed with resin, wax and other additives, as required. From the blender, the resinated flakes are metered out on a continuously moving screen. The flakes are oriented, either by electrostatic forces or mechanically, into a single direction as they fall to the screen below. The next layer of flakes is oriented perpendicular to the previous layer. Three to five layers is the most common thickness. The sides of the formed panel are trimmed, illustrated in Figure 2.8, and sent to the hot press where curing of the resin takes place.



Figure 2.8: OSB mat after forming and trimming

In MDF production, the fibres are mainly resinated in the blowline, immediately after the refining and before the drying of the fibres. As discussed in Section 2.2.2.1.1, this affects the composition of the organic components in the air emissions from the dryer.

Resin in rigidboard and flexboard production is applied after the drying of the fibres, although some additives like wax and hardeners are still added in the blowline before drying. In rigidboard production, the resin used is solely pMDI and is added after drying, either by spraying the fibres when they are deposited on the conveyor before entering a pre-press or by spray nozzles before entering an intermediary bunker at the mat forming station.

In softboard and hardboard production by the wet process, resins are not applied although some wax and other additives are added to the additional water added after the refiner.

2.3.2 Pressing

The raw panel is produced in the press by applying high pressure and high temperature for a sufficient amount of time to compress the mat to the required thickness and to densify and fixate the particles or fibres by resin curing. The temperature at the core of the panel needs to reach a certain level depending on the resin, normally above 100 °C, in order for water to evaporate.

Before entering the press, the mat leaving the mat forming station is normally pre-pressed at ambient temperature in a roller press to remove air from the mat, and the sides of the panel are trimmed. Pre-pressing is not necessary in OSB production. If the main press is a multi-opening press, the pre-pressed panel is cut to fit and be loaded individually to the press.

The press belts in a continuous press or the press plates in a multi-opening press are heated with thermal oil with a contact temperature normally not exceeding 260 °C. Press plates in a multi-opening press generally operate with a lower temperature.

The majority of presses in Europe for the production of particleboard, OSB and MDF are continuous presses, with lengths of 20 m to 60 m. The press process is divided into three phases which are distinct for each type of panel variety produced. The temperature applied is highest in the first part of the press, but generally only slightly reduced along the press line. In the first phase, the highest pressure is applied and the panel obtains its nominal thickness. In the second phase, the pressure is reduced and the panel is cured at the high temperature now present in the core of the panel. In the last phase, the pressure is relieved gradually before the panel leaves the continuous press. The specific pressure applied in the press is 3–5 N/mm².

The press operates with three main controls: the temperature, the pressure and the press time. For continuous presses the time is varied by the speed of the press. The operating conditions are varied by the pressure that is applied and the time, while the temperature is generally constant. The heat is achieved by hot oil-heated plates and is not varied from batch to batch.

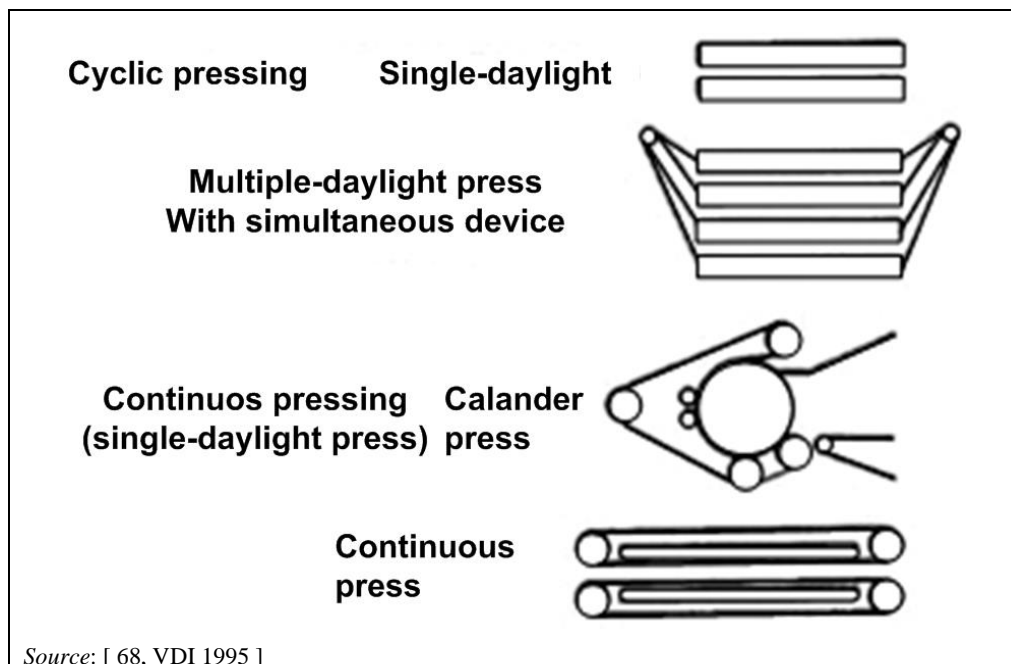

Figure 2.9: Press types used in dry process panel production

The continuous press was introduced in the 1970s and today (2014) has almost completely replaced the single-opening daylight press and the multi-opening press; see Figure 2.9 for a schematic presentation of the main press types. The daylight press runs in cycles, in which the pre-pressed panels are loaded and the press closes. During pressing and when the press opens, water vapour and emissions to air are released over the whole extension of the press. Figure 2.10 shows a daylight press. When the press closes, the plates are pressed together towards the top of the press and the suction hood captures some of the released press gases.



Source:[30, EPF 2011]

Figure 2.10: Multi-opening press

The major release point of press gases in a continuous press line is at the end of the press, where the press releases the pressed panel. At the press release, it is possible to collect the majority of press gases by use of an efficient enclosure and suction system. Along the press line, it is also common to have suction and collection systems. In practice, the collection and handling of press gases shows a wide variation, and depends mostly on the regulatory regime applied and available abatement techniques.

When press gases are collected, the abatement focuses on the TVOC content and dust. The collected gases are quenched by spraying in the collector tubing immediately after the press, in order to prevent fires in the hot air containing fine dust and organic compounds. The following techniques are currently applied:

- Direct discharge over the roof.
- Wet ESP.
- Venturi-type scrubbers.
- Stack scrubber, including filtration of water for wood dust.
- Bioscrubber.
- Incineration in a combustion plant using waste gas as combustion air or mixing the waste gas with hot gas before the direct PB or OSB dryer inlet. Press waste gases are often pretreated by wet scrubbing to remove dust and to diminish the risk of fire.

For multi-opening presses, the collection of press gases is not as straightforward as for continuous presses. The press release area is, by nature, not well defined and efficient collection of press gases is more difficult. Room ventilation with non-channelled direct discharge over the roof is commonly applied. Door skins are also produced in special multi-opening presses.

Extruded or moulded pallets are produced in a single-opening press, where chips are dosed directly into the hot form which is pressed, producing one or more pallets in one press round. It has been reported that emissions are easily collected from a single-opening pallet press.

Extruded panels, e.g. for doors, are made using special presses that produce one panel at a time, by dosing the chips directly to the press, where the panel is pressed and extruded at the same time.

2.3.2.1 Environmental issues related to pressing

Dust, water vapour and organic compounds are released during pressing. The organic fraction of the emission comes primarily from the resin system used, see Section 2.5.1.

Dust develops along the press line and consists of both coarser dust from trimming the sides of the panel before entering the main press and of finer dust. Suction points along the press line, including the distance from the mat forming station and the pre-press to the entrance of the main press, will ensure a sufficient abatement of diffuse dust emissions.

Air emissions

The composition of air emissions from presses depends on the resin used. While the majority of the volatile organic compounds in the wood are released during drying, the contribution of formaldehyde in press emissions is more related to the resin used. Data collected show that the amount of TVOC is still significant, but is less than for dryers. Some of the organic compounds could be related to wax, which is applied as a release agent, but there are no concrete data to confirm the amount derived from wax and whether it is a major part of the TVOC emission.

The amount of formaldehyde emitted during drying is much higher than from the press if the wood material is resinated before drying with a formaldehyde-based resin. This is the case for the majority of MDF production lines, which use urea-formaldehyde.

Emissions of NH_3 , NO_x or SO_x in the press exhaust are theoretically possible. Additives such as ammonium nitrate or ammonium sulphate are used as standard in most production processes, either added with the resin at the blending stage or earlier, i.e. before drying, in the case of fibres. No data have been collected so far that could confirm substantial emissions of the mentioned parameters in the production lines in Europe.

Other organic compounds, such as tetrahydrofuran and acetic acid, could arise in air emissions from presses when producing MDF, because of the high temperature reached at the panel surface. Tetrahydrofuran is a degradation product of cellulose, which could be created when the panel is pressed at temperatures over 200 °C [37, He Z, et al. 2011]. Acetic acid is created during pressing as a by-product of the degradation of hemicellulose, which takes place at temperatures even lower than 200 °C, which according to studies corresponds to a higher amount of acetic acid detected compared to tetrahydrofuran. [39, Jiang T, et al. 2002]. No data are yet available to support the studies mentioned concerning the production lines in Europe. While tetrahydrofuran is not monitored, acetic acid has been included in some surveys under the organic acids parameter. The registered amount of organic acids is negligible [22, TWG 2012].

Formaldehyde-free resins such as pMDI, used widely in OSB production, result in no formaldehyde or TVOC emissions related to the resin. Emissions from the wax release agents and from the wood itself are still relevant.

Energy consumption

The hydraulic press is a major consumer of electrical energy, but it is the heat energy used for heating the thermal oil that is the second most energy-intensive activity, after drying, at particleboard and OSB production lines.

Accidental spills

Hydraulic systems for pressing may leak oil and emulsions during repairs and maintenance. Taking preventive measures and applying quality assurance of maintenance is part of an environmental management system, which could help minimise the risk of spills.

Consumption of thermal oil

Thermal oil is circulated in a closed ring system and only a very small amount is further added or replaced when necessary.

The closed thermal ring system can experience leakages at the seals in the press cylinders, especially when operating speed and fluid pressure are increased, which can be the case when optimising production capacity.

Waste

Dust and wood particles from trimming and along the press line are collected and used as a fuel or reintroduced as raw material.

2.3.2.2 Pressing of rigidboard and flexboard

After the mat is formed by the same methods as for MDF production, the mat is pressed in a pre-press similar to MDF lines, which compresses and forms the panel at ambient temperature. The resulting mat is transferred to a press unit, where only slight additional pressure is added while the curing of the resin is activated by steam. Figure 2.11 shows an example of the production flow for rigidboards.

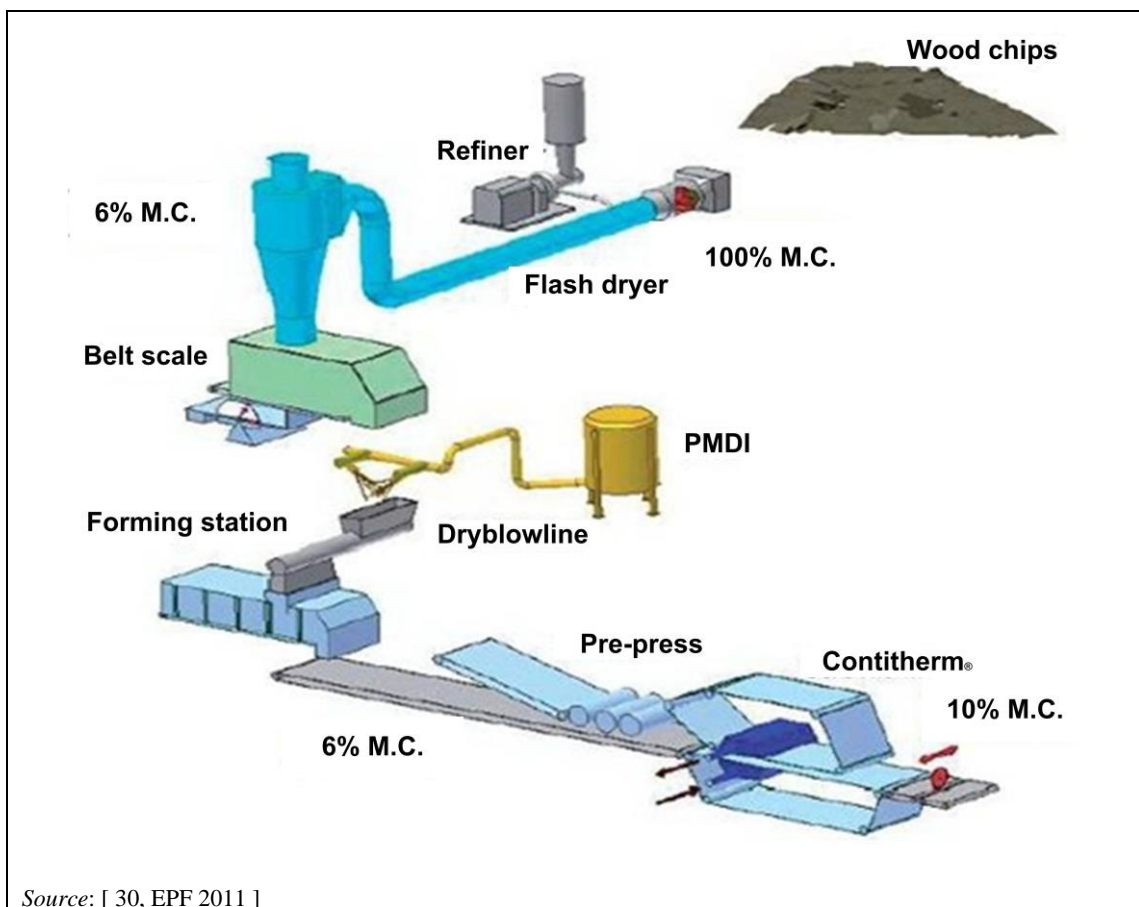

Figure 2.11: Example of main production steps for rigidboards

Environmental issues related to pressing of rigidboard and flexboard

Air emissions from the press, but mainly from the mat forming and the resination step, can be collected and discharged, often through a dedusting device, such as a bag filter or high efficiency cyclone. An ESP can be applied as well, if there is one on site for abating emissions from the combustion plant. The air emissions do not contain formaldehyde or VOCs, since pMDI is used as the resin system and the pressing takes place without high temperatures being applied.

2.3.2.3 Mat forming and the pressing of softboards

The water suspension of wood fibres after refining is the raw material for the panel. When the fibres leave the refiner, the fibres are resuspended in hot water. The suspension is pumped out on a moving sieve, where water is drained off by gravitation and by a calender press. The drained water is recycled in a closed loop for the resuspension of the refined fibres. The panels are cut to the required size for entering the drying oven and the sides are trimmed. All collected trimmings are recycled to the fibre suspension. The drying ovens can have several levels which are loaded continuously. The ovens are heated by recirculating hot air generated by a gas-fired hot gas generator for example, and can be preheated by heat exchange of the heat created during refining. No controlled stack emissions from the drying oven have been registered. Resins are not added or used in the production of softboard panels. Wax, such as paraffin, and natural starch are added to the water suspension to improve the surface and properties of the softboard panel, and additives may be added to enhance moisture resistance.

Figure 2.12 illustrates the production flow for softboards.

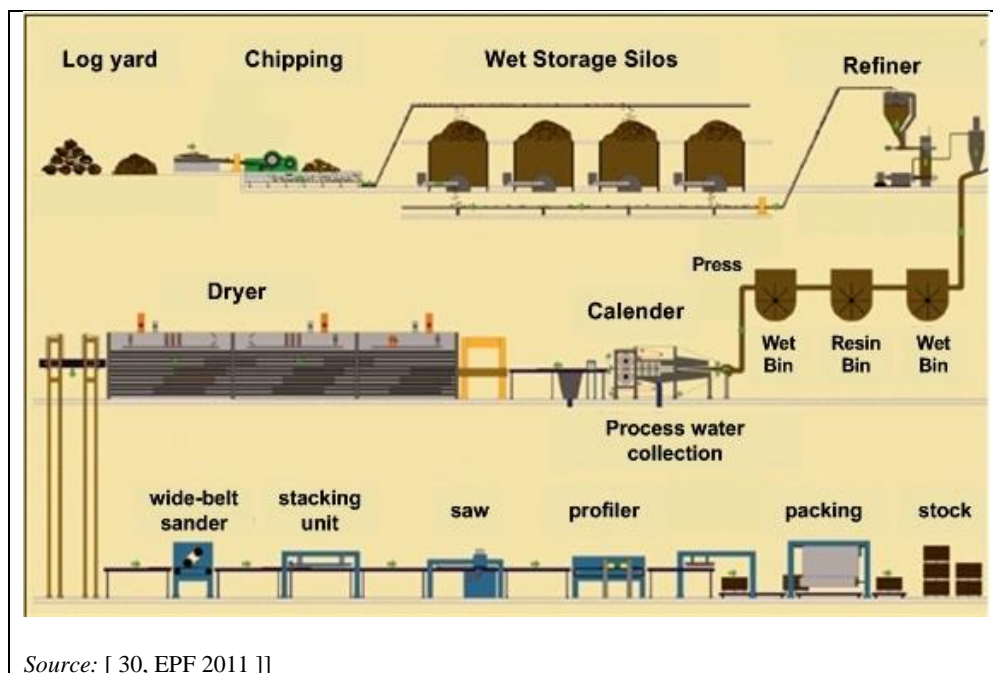

Figure 2.12: Production flow for wet process softboards

2.3.2.4 Mat forming and pressing of hardboards

The manufacture of hardboards uses, as for softboards, a fibre suspension as the raw material, which is layered and dewatered. Instead of drying the dewatered mat, the cut-to-size panels are pressed at a high pressure and temperature in a multi-opening press. The panels are stacked and dried/tempered in an oven to cure the lignin bonds. Water is recycled from the dewatering step

and from the press, where water, which is being squeezed out, is recycled back to the suspension of fibres. The production flow for hardboards is shown in Figure 2.13.

The manufacture of hardboard is not described further in this document.

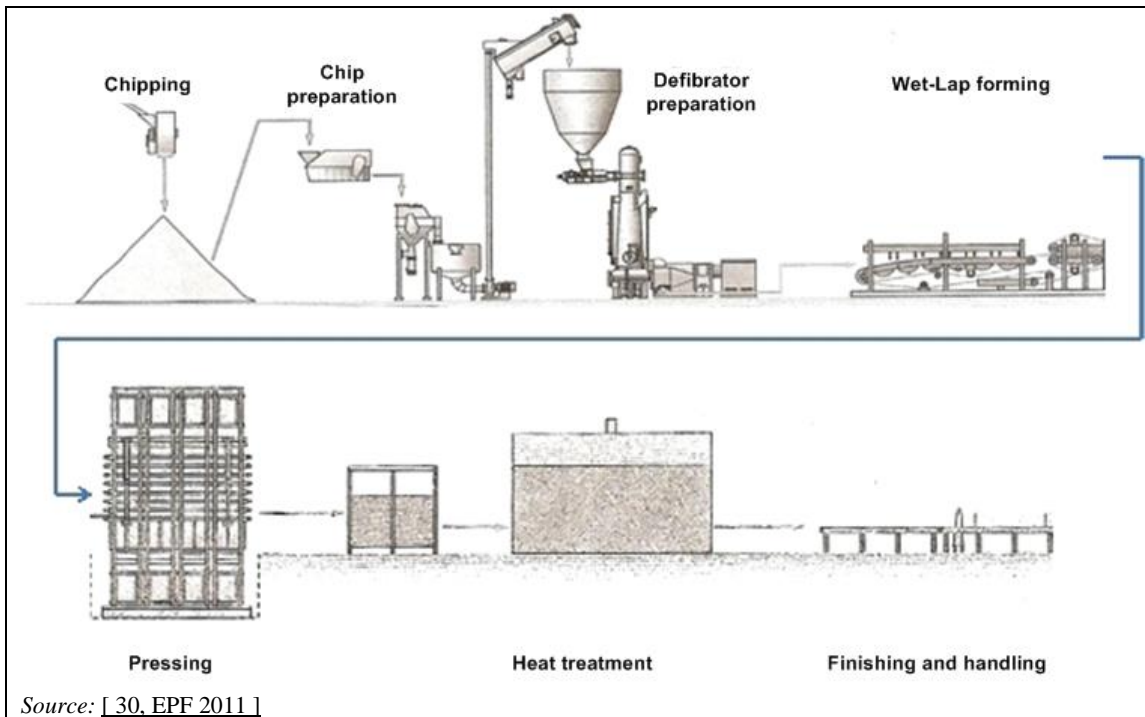

Figure 2.13: Production steps in the manufacture of wet process hardboards

2.3.3 Cutting and cooling of panels

After the pressed panel leaves the continuous press, it is immediately cut into individual panels. The panels are cut, e.g. with a transversal saw, and transferred to cooling racks or a starboard cooler. If a daylight press is used the pressed panels are transferred directly to cool, since cutting is not necessary.

The core temperature of a panel when leaving the hot press is more than 100 °C and the surface has an even higher temperature. The panel needs to be cooled down before further handling, and the cooling stabilises the panel and stops the curing process. The initial cooling of the pressed panel takes place entirely in starboard coolers, where the panels are cooled to less than 50 °C on the surface mainly by natural cooling rather than active ventilation.

Further cooling of the panel takes place after the starboard coolers where the panels are hot stacked, which has the primary purpose of stabilising the panel further. From the matured and stabilised panel, the raw finished products are made by sanding and then cutting to size, see Section 2.4.1.

Cooling is also necessary for softboard and hardboard. A separate cooling step is not necessary and is not applied in the production of rigidboard and flexboard.

Panel products with pMDI or other non-urea-based resins are not susceptible to hydrolysis and the curing of the panel takes place in the press. Cooling of OSB for example still takes place in starboard coolers, to ease further handling.

2.3.3.1 Environmental issues related to cutting and cooling of panels

Air emissions

Air emissions from cutting the panel immediately after the continuous press not only generate dust but also release a minor amount of organic compounds from the cuts in hot unstabilised panels. The saw is often entirely enclosed and air emissions are collected. It is enclosed in order both to abate the high-pitched noise and to efficiently collect and channel dust emissions. Dust is collected in bag filters and used as a fuel. The development of dust is no different from in other woodworking processes.

The room where starboard coolers are placed has been surveyed at some installations as part of occupational health campaigns. If formaldehyde is detected, this would normally be caused by an inefficient closure of the press and cutting station, and not from the cooling. Data on emissions of formaldehyde and other VOC-related compounds during the cooling of the panels have not yet become available.

When a starboard cooler is equipped with active ventilation it is claimed that it helps the cooling efficiency and shortens the cooling time. Other producers claim that forced ventilation in cooling equipment can cause deformation in the planarity of boards. Only a few installations have active ventilation directed at the starboard cooler, though it is common for the space for panel cooling to be well ventilated through roof openings or doors to the outside or by a semi-enclosure of the starboard cooler with passive ventilation through the roof.

Noise

The noise from the cutting of the panel after the continuous press is pronounced, so normally an enclosure is applied to abate the high-pitched noise.

Noise issues are generally not significant in the operational steps immediately after the press, except for the cutting of the panel. The main noise sources are compressors and conveyor belts that transport raw panels to cooling and further finishing.

2.4 Finishing of raw board

2.4.1 Sanding and cutting to size

Sanding smoothes the surface of the raw board and is a common operation for particleboard and most MDF grades. Sanding operations use standard sanding equipment with built-in suction hoods to channel any dust emission arising during sanding.

The cooled panels are sanded before dispatch or an additional on-site value-adding process. Belt sanders have a high sanding speed of up to 1500 metres per minute to obtain a high quality sanding.

Raw panels are often sold in sizes depending on the customer's needs, and cutting to size and applying a tongue-and-groove finish are performed at most sites.

Cutting and sanding are performed with machinery that is used throughout the wood processing sector in general. Equipment is delivered with the necessary means of noise and dust protection. Its operation in relation to dust extraction and safety is described in EN 12779:2004 [33, EN 2004].

For OSB, sanding is generally not performed, except for special purposes. Other products like rigidboards, flexboards and softboards are cut and manipulated into specific sizes, but not normally sanded.

2.4.1.1 Environmental issues related to sanding and cutting to size

Air emissions

Dust arises from cutting operations and is generally handled by enclosing the equipment or directing the suction at the point of release of the dust from the saw. Diffuse dust emissions are generally not a problem if the equipment supplier's instructions are followed, since all wood processing equipment has built-in suction systems. The channelled air from sanding operations and cutting operations is primarily filtered in bag filters or cyclofilters to remove wood dust.

Noise

All woodworking machines generate noise and sanding and cutting operations are no exception.

Waste

The wood dust which is collected is generally used as a fuel directly from the collection point. The collected dust makes an important contribution to the fuel needed in the combustion plants.

Used sanding belts are waste and are dispatched off site for disposal. The format of the used sanding belts makes them unsuitable to be used as a fuel in the combustion installations on site.

Energy

The energy consumption for the running of all the equipment and the related dust abatement systems in the finishing of the raw panel can contribute to a significant part of the site's overall energy consumption.

2.4.2 Storage

The storage of finished product, whether raw panels or value-added products, takes place in dry covered storage facilities in order to protect them from moisture and dust before dispatch. Storage facilities can be highly automated, requiring very little labour input. No related potential environmental issues have been identified and the finished product storage is not mentioned further.

2.5 Auxiliary substances and materials

2.5.1 Resins

The resins which are used to glue wood particles, flakes and fibres together to form panels belong to a group of formaldehyde resins and act as thermoplastic resins activated by heat and pressure. Resins are bought and delivered as solutions, from external suppliers, since only a few installations produce resin internally. Resin production is not covered by this document.

Formaldehyde resins cover a larger group of derivatives and the main resin grades used in wood-based panels are indicated in Table 2.2.

Table 2.2: Main resin types

Resin	Abbreviation	Used in product
Urea-formaldehyde resin	UF	PB, MDF
Phenol-formaldehyde resin	PF	OSB
Phenol-urea-formaldehyde resin	PUF	OSB
Melamine-urea-formaldehyde resin	MUF	PB, MDF
Melamine-urea-phenol-formaldehyde resin	MUPF	PB, OSB, MDF
Polymeric methylene diisocyanate	pMDI	OSB
<i>Source: [8, TWG WBP 2012]</i>		

Urea-formaldehyde (UF) resins are primarily used in particleboard and MDF production, for interior applications where dimensional uniformity and surface smoothness are required. UF resins do not colour the final panel and are preferred when light-coloured products are required. UF resins can be cured at varying temperatures and press times, which make the operating conditions of the press more versatile.

Phenol-formaldehyde (PF) resins are used for exterior products, giving some degree of exterior exposure durability to the panel. The resin gives the finished panel a darker colour, which may limit its use. PF resins cure at higher press temperatures than UF resins, which mean a longer press time, lower production rate and higher energy consumption per unit of panel produced.

Melamine-containing resins are used for paper impregnation, but are also mixed with UF resins for particleboard and MDF production and in OSB production. The melamine-urea-formaldehyde (MUF) resin, or melamine-urea-phenol-formaldehyde (MUPF) resin, is used in the ratio 1:10 to the UF resin and is applied to give the finished panel water resistance and aid in curing the panel during pressing.

The formaldehyde-free resin, polymeric methylene diphenyl diisocyanate (pMDI), is applied in the production of OSB, rigidboard and flexboard. One producer has used pMDI as the resin for production of PB since 2011. The pMDI resin can be more difficult to use in production since its sticky nature easily creates build-up on the surfaces in the press. In order to allow a smooth production, a larger quantity of release agent needs to be used. The use of pMDI is regulated in some Member States due to health and safety risks for the workers. This could result in strict measures being taken to protect workers' health from exposure to the diffuse emissions from the blending and mat forming station. The use of pMDI is considered to result in a faster processing time and a higher moisture resistance in the final panel, which, together with the benefit of having no formaldehyde in the emissions from the resin in the finished panel, makes it an attractive alternative.

In OSB production, phenol-formaldehyde (PF) resin and melamine-urea-formaldehyde (MUF) resins may also be used.

Wood fibres have a certain self-adhesion due to hemicelluloses and especially lignin, which are activated under wet conditions and at elevated temperatures. In hardboard production, the lignin is cured during pressing with high pressure. In softboard production, the lignin bond is cured during the drying of the pre-pressed panel. [49, Pizzi et al. 2003]

2.5.2 Hardening agents

Hardening agents or curing catalysts are used for accelerating the curing of the resin, thus reducing the press time. The curing depends among other factors on the temperature of the press and acidity of the wood particles, where lower values result in slower curing; the hardening agent also compensates for this.

The most common hardening agents used are ammonium nitrate and ammonium sulphate. The ammonium salt is either delivered as a crystalline salt or in an aqueous solution. An aqueous solution of the hardening agent is added to the resin in the glue kitchen, before blending with the wood particles. For wood fibres, the salt solution is more commonly added directly in the blowline before fibre drying.

The agents also act to enhance the fire resistance of the finished panel.

2.5.3 Release agents and other additives

Release agents or mould agents serve the purpose of preventing the build-up of resin on the panel surface in the press. Especially for fibreboard and OSB the release agent is vital. The release agent is mixed with the resin before blending with the wood particles. For wood fibres, the release agent is added in the blowline.

The especially sticky nature of the resinated mat when using pMDI demands a rigorous use of the release agent, which must be applied, by rolling or spraying, directly on the press belt.

Wax or paraffin emulsions are most commonly used and also add to the water-resistant properties of the finished panel.

To add fire resistance to the panel, the most common agent is ammonium sulphate, which is also used as a hardening agent.

Colouring agents are added to panels in order to distinguish between panels which have added properties in terms of moisture resistance (green) and fire resistance (red).

2.6 Energy production

All WBP sites operate energy-producing units to serve primarily the dryer and the thermal oil system for the press. Depending on the character of the wood-based fuel and the relation to waste regulation, the energy-producing units can be regulated as combustion plants, co-incineration plants or incineration plants. The firing techniques applied do not vary between combustion and incineration plants in the sector. The monitoring requirements will differ according to the classification of the combustion plant.

The combustion plants differ in size from 10 MW to over 50 MW, and are used for producing hot gases for directly heated dryers and for heating thermal oil. The larger combustion units can be combined heat and power (CHP) plants, with the generation of steam and electricity, where steam is used for indirectly heated dryers and for cooking and refining and electricity is either for internal use or sold off site. The cogeneration of heat and electrical energy in larger gas engines or liquid fuel-fired engines is also carried out.

The individual set-up of the installations differs depending on the accessibility of fuels, the production size and the age of the installation. Combustion units which produce only hot gas for direct drying are called hot gas generators (HGG) in the sector. When drying is direct, smaller dust burners of 6–15 MW for each dryer are often used and the thermal oil is heated separately by a gas-fired engine of 3–10 MW.

Larger combustion plants producing heat, power or steam for multiple processes are commonly operated in the sector. Spreader firing is widely used with a moving grate, where coarser and heavier wood-derived fuels are distributed by a stoker or other equipment. The combustion units are preferably designed to be fired with different sizes of biomass. Sawdust or wood dust are fed into the over-fire air and ignited in suspension, creating a fluidised bed. Grate systems distribute the biomass across the grate and move it forward. Biomass is burnt with excess air and primary air is fed through the grate with a secondary air supply above it. The secondary air supply can constitute not only ambient air, but also waste gas from the press and the drying and other waste gas streams can be added and post-combusted above the grate. Fluidised, bubbling and circulating fluidised bed combustion systems use collected wood dust and prepared pulverised solid wood as fuel. Preheated air from other waste gas sources, e.g. the press fumes or from the heat exchange with dryer waste gases, can be used for preheating the air to fluidise the bed or to preheat the air in the mixing chamber for dryer air in direct drying.

The main fuels used are wood-derived fuels and secondarily natural gas and liquid fuel. These are further described in the following list:

Production residues:

- collected wood dust from sanding lines and cutting operations;
- collected trimmings at the mat forming station and after the press;
- rejected panels;
- wood sludge material from the abatement systems, such as from the WESP and waste water treatment plants;
- wood residues from the cleaning plant for recycled wood;
- wood residues from chipping and milling;
- bark derived from debarking;
- impregnated paper.

Externally delivered wood material:

- sawdust;
- post-consumer wood materials;
- roots and stubs.

Conventional fuels:

- natural gas;
- light or heavy fuel oil;

Bark is often pretreated before firing, by shredding it together with larger rejects from the production. Roots and stubs contain soil and stones and need a separate crushing, shredding and cleaning step. Bark and sludge can be dewatered by filters and screens or presses to improve the overall energy efficiency.

Small utility boilers and burners producing steam or heat for heating, e.g. thermal oil for heating the press, are widely applied. Gas-fired burners and/or liquid fuel-fired burners are common throughout a site.

2.6.1 Environmental issues related to energy production

Combustion and incineration processes generate air emissions; dust, NO_x , CO, SO_x and greenhouse gases are the most important, but other substances, such as metals and organic compounds, are also emitted in smaller quantities.

For general information on combustion and related environmental issues, it is advised to consult the LCP BREF and the WI BREF [24, COM 2006], [3, COM 2006].

Air emissions

The flue-gases from biomass combustion used for direct drying and also for steam generation for indirect drying are sometimes treated before entering the dryer. This will depend on the fuel, the combustion unit and the combustion process.

The formation of nitrogen oxides (NO_x) depends on the fuel-bound nitrogen content and the combustion temperature. The combustion temperatures for biomass are lower than for gaseous or liquid fuels, so the conditions for creation of thermal NO_x are not so favourable. The fuel-bound nitrogen content in wood-based biomass varies between 0.2 % and 0.5 %, depending on the wood source, which is lower than for liquid fuels.

The staged combustion obtained in fluidised bed combustion or by air staging in moving grate furnaces is widely applied and can minimise NO_x and CO levels. Reduction of NO_x is applied at some biomass-fired combustion plants, using selective non catalytic reduction (SNCR) in the combustion chamber. When using SNCR the potential related emissions of ammonia (NH_3) would be subject to control. The combustion plants are mainly stand-alone plants and few examples have been identified for hot gas production for directly heated dryers.

Emissions of sulphur oxides (SO_x) depend on the fuel-bound sulphur content and liquid fossil fuels can contain sulphur, which gives high SO_x emissions. The majority of sulphur oxides are produced as sulphur dioxide (SO_2). High SO_x emissions are generally not an issue when using biomass as a fuel, but there are examples of dry sorbent injection to prevent elevated SO_x emissions. The design of the combustion unit is decisive for the use of specific SO_x abatement techniques.

The dust emitted during the burning of the biomass arises almost entirely from the mineral fraction of the fuel. A small proportion of the dust may consist of very small particles formed by the condensation of compounds volatilised during combustion. Moving grate boilers, which are the most commonly applied type in the sector, produce a relatively small amount of fly ash (20–40 % of total ash). The combustion of liquid fuels is also a source of particulate emissions, in the form of soot particles, and is related to poor combustion conditions.

The abatement of dust emissions in the hot gases before they are used for direct drying is carried out at a few combustion plants that use biomass as a fuel, where fabric filters and ESP

applications are the most common abatement techniques. These are generally only used in combustion plants/units over 20 MW.

Bark fuel has a high mineral content (2–3 %) and a tannin content of more than 20 %. If the combustion is not complete, the flue-gases will contain resinous tar and contribute to the dust emissions in the dryer waste gas. In order to complete the combustion and thermal decomposition of the tannins, temperatures above 1200 °C are needed together with an efficient recirculation of the flue-gases for post-combustion.

Certain fuels, such as recovered wood or fossil fuels, could be a source of metals, dioxins, HCl, HF and other unwanted compounds in the flue-gases. Using recovered wood as a fuel would often qualify as co-incineration or as waste incineration. Potential emissions of the metals copper, chromium and arsenic are related to the presence of wood preservatives in chemically treated wood. Chemically treated wood is rarely accepted as a fuel without strict measures on combustion control and abatement of emissions.

Waste

Large amounts of bottom ash are produced when firing with biomass and this needs to be managed. The amount and quality will depend on the composition and quality of the biomass fuel, the firing technique and the efficiency of the combustion process. The heavy metal content is generally not a limiting factor for the further use of the bottom ash in off-site applications. The PAH content can be high if combustion is not complete. The bottom ash can contain considerable amounts of oxides of alkali metals [44, Pels et al. 2011]. Calcium and potassium oxides could, with special care, be used as a fertiliser after further treatment off site [16, Pitman 2006]. Bottom ash is also used for construction purposes, but the amount of PAHs can be a limiting factor. The use of bottom ash in cement production has been studied and tested, but has not yet been successfully implemented.

The use of bottom ash in off-site applications is largely steered by national rulings on the allowable content in waste to be used for specific purposes.

The bottom ash is collected from the furnace as a dry ash or wet ash. The purpose of adding water to the ash is to ease the handling of the bottom ash during transport and further treatment and to minimise fire risks, which is relevant for grid firing. Secondary water sources are used for wetting the ash.

In biomass firing, the amount of fly ash is considerably less than the amount of bottom ash produced. The fly ash is collected with dust reduction systems, if in place, or after the drying stage in the general emissions abatement system.

Water

Emissions to water from combustion plants are related to cooling water and certain waste water streams, such as alkaline water from slag/bottom ash flushing or wetting, and acidic water from boiler cleaning and wet abatement systems.

Cooling water represents by far the highest quantity of treated and discharged water. Depending on the raw water source and the applied treatment, the cooling water contains various pollutants. The environmental impact of cooling and the cooling techniques used in combustion plants are described in the ICS BREF [28, COM 2001].

2.7 Impregnation of paper

Impregnated decorative papers are laminated and bonded (thermally fused) to the raw panels in cyclic hot presses. The production of impregnated decorative paper takes place on wood-based panel sites, as well as on dedicated production sites outside the wood-based panel sector. The following information has been collected at wood-based panel installations and this document does not take into consideration whether the production process applied in the dedicated decorative paper sector differs in terms of the processes, emissions or the abatement techniques applied.

The raw decorative papers are delivered from papermakers. The paper is saturated with resins mixed with additives such as hardeners and anti-blocking agents, which are then partially cured, to aid the storage and handling of the paper. Full curing is achieved in the laminating cyclic hot press, when the resin forms hard, permanent bonds between the paper and the panel, see Section 1.1.

Melamine-based resins are the most used and versatile type of resin. Urea-formaldehyde resin is not used alone, but in applications where two subsequent layers of resin are applied in a double-stage impregnation, e.g. saturating the core of the paper with urea-formaldehyde resin and adding a melamine resin layer on top. This reduces the amount spent on the more expensive melamine resin. Melamine resin impregnation alone is used for speciality products.

The storage and mixing of resins and additives takes place in closed systems, where each batch of resin is dosed from above-ground storage tanks to a mixing tank, from where it is pumped to the resin bath or the coating roller. The composition of the resin gives the unique features of the finished laminated panel. The decorative paper is saturated and coated by dipping it in a bath of resin. If two applications of resin are performed, the second application is generally performed by coating rollers and not in a bath. The paper is transported on rollers and dried in a belt drying oven for each resin bath stage. The drying does not cure the resin fully since it will need a higher temperature and pressure to cure. Full curing is performed in the lamination step of the raw panels. The drying ovens are primarily heated by natural gas-fired engines producing hot air for the drying process, by infrared (IR) heating or by thermal oil or steam heating systems.

The process is continuous and is only stopped during the changing of the rolls of raw decorative paper. Lamination lines run at speeds from 5 m/min to 80 m/min, with capacities from 10 000 m²/day up to 120 000 m²/day. After drying, the paper is either cut to individual sheets of the size that is needed at the installation for further lamination of its products, or rolled for shipment for further sale. The impregnated paper has a short shelf life and the storage of the paper is controlled in order to avoid both high and low humidity.

The impregnated paper has a resin content of between 50 % and 65 %. The raw decorative paper used ranges from 60 g/m² to 130 g/m² and the resin content in the paper after impregnation varies between 40 g/m² and 200 g/m².

Impregnation of paper is common at sites where the majority of the production is laminated and when finished flooring products are produced.

2.7.1 Environmental issues related to impregnation of paper

Air emissions

The emission from the dryer oven contains VOC compounds and formaldehyde, but very little dust.

The composition of the VOCs and the amount of formaldehyde will depend on the resin system used. In general, all resin compositions are based on aqueous solutions and solvents are not used. Phenolic resins are not used in the sector for impregnation of decorative paper. Phenolic

resins are, however, used when producing high pressure laminates (HPL) on dedicated production sites for example, which is not covered by this document.

The dryer emissions are collected and channelled, while treatment before discharge depends on the resin system, drying oven temperature and the resulting load of VOC compounds and formaldehyde. Waste gas treatment systems, if implemented, include regenerative thermal oxidisers, catalytic thermal oxidisers, wet scrubbers, wet biofilters and post-combustion chambers.

The resin baths are open and there are no emissions registered to air from the aqueous resin solutions. No use of solvent-based resins has been recorded. Phenol-based resins are not used either, but are applied for other non-wood-based panel products such as high pressure laminates, which are not covered in this document.

Handling of chemicals

Storage and transport of chemicals and mixing of resins are performed in closed systems and should not be an issue as long as the system is tight. Resin mixes are water-based and if spilled they do not evaporate. The storage of chemicals takes place in above-ground storage tanks in dedicated impermeable areas designed to hold possible spills.

Waste

There will always be some paper that ends up as waste when loading new paper rolls or with a break in the paper flow. Paper could be burnt in the on-site combustion plant if the combustion plant accepts the format of the fuel. Under other circumstances, the paper waste is dispatched off site.

A small amount of water mixed with resin is collected discontinuously when cleaning the rolls and resin baths.

2.8 Lamination and other value-adding operations

Depending on the customers' requirements, the raw panels are often given an added finish. This includes delivering panels in specific sizes, with specific features. The cutting of tongue-and-groove is common for all panels used for construction purposes: walls, flooring, under-roof plates and insulation. Flooring production includes lamination of the raw panel, cutting to size, tongue-and-groove cutting and edge sealing, see also Section 2.4.

Almost 50 % of the raw panels are laminated at the wood-based panel site where they are produced to give an added value. The variety in the overlays to panels reflects the different final products and desired stability, e.g. with regards to wear, abrasion, heat resistance and moisture sensitivity.

Lamination is the process in which a layer of resin-saturated decorative paper or foil is thermally fused to the raw panel by adding pressure and heat. Melamine-impregnated decor paper or foil is the most commonly used overlay. It is often produced at the wood-based panel site and the raw panel is laminated there too, see Section 1.1. The resin-saturated decorative paper is self-bonding and no adhesives are added to the panel.

Lamination is often connected to the panel production plant in terms of sharing energy sources for heating thermal oil for the cyclic presses. Thermal oil rings are used at some plants to serve both panel presses and lamination presses. Lamination lines are often situated next to the storage areas for the finished product. The cyclic press laminates one panel at a time, either on one face only or on both sides. A cyclic tandem press laminates two panels for each cycle and continuous presses are also available. As indicated, the most commonly used paper is melamine-impregnated paper. The melamine thermosetting resin in the paper becomes liquid upon heating and sets and cures onto the panel and creates a thin cured layer of resin on the surface. The press time is between 15 and 40 seconds. The presses are often heated with thermal oil. The curing and lamination takes place at temperatures between 130 °C and 200 °C, which is lower than in presses used in panel production. The pressure is also lower than that used in panel production.

Other products, such as high pressure laminates (HPL), decorative foils, vinyl and wood veneer, are used for overlays and are more commonly applied to the panels at furniture production sites. These are added with an adhesive and not fused with the panel by the lamination process described. High pressure laminates consist of specially produced laminates where several layers of Kraft paper, impregnated with a phenolic resin, are layered and finished with a top layer of melamine-impregnated decorative paper. The sandwich formed by the layers of paper is pressed in cyclic presses and laminated to a panel using an adhesive. The production of HPL takes place at dedicated sites and not normally on WBP sites. Decor foils are impregnated and fully cured decorative papers that are roll- or stamp-laminated to the panel using an adhesive. The uses for and processes related to HPL, foils, vinyl and veneer will not be described further in this document.

The edges of MDF for example are more absorbent than the surfaces and, depending on the final use of the panels, may require sealing with shellac, polyurethane, diluted PVAC, or specially formulated high solid content sealers when producing grades for specific purposes. The actual processes performed are highly diverse and will not be described further. The use of shellac or other solvent-based sealers are not included in this document and the reader is advised to consult the BREF for Surface Treatment Using Organic Solvents (STS BREF) [29, European Commission 2007].

2.8.1 Environmental issues related to lamination and other value-adding operations

Air emissions

Dust arises from cutting operations and is generally handled by enclosing the equipment or directing the suction at the point of release of the dust from the saw.

Dust emissions or emissions of TOC from cyclic presses for lamination are not monitored according to the collection of data and the information exchange.

Noise

Noise arises from the cyclic presses used for lamination, but they are rarely the most pronounced noise source on a site.

Waste

Reject laminated panels and paper waste are generated from the lamination line when a batch is rejected. The paper waste is collected and used as fuel. Reject laminated panels can be chipped and used as raw material or as fuel.

2.9 Waste water treatment plants

A waste water treatment plant may be present on a WBP site and they are mentioned separately in this section as they can be an independent entity at the WBP site. Waste water treatment plants are operated where process water, especially from the refining of fibres, occurs. If there is a treatment plant other minor waste water streams are also treated; otherwise they would be discharged either to an off-site urban waste water treatment plant or handled by other means. If the refiner plant recycles water completely by treating the process water in an integrated way in-line, only a little waste water is generated and a further independent waste water treatment plant is usually not necessary. Waste water treatment includes filtration and sedimentation, coagulation and flocculation. Further treatment is sometimes necessary and could include a biological treatment, sludge treatment and aeration before discharge or recycling. On-site waste water treatment plants can discharge both to receiving water bodies and to an off-site downstream urban waste water treatment plant (UWWTP). See Section 3.3.2 for further details.

Simple waste water treatment plants for treating surface run-off water from log yards and other outdoor areas are common. The main techniques used are a first stage screen filtration to remove stones, larger pieces of wood and other larger items. The waste water is then led to retention basins or settlement ponds for a simple sedimentation and discharged. The discharge is mainly released directly to a receiving water body, but infiltration to soil is used at a few installations and, depending on local conditions, the discharge could be further treated at an urban waste water treatment plant. See Section 3.3.1 for further details.

The internal treatment of process water is carried out as mentioned, to recycle water in the refining of fibres and for water used in wet abatement systems. Wet electrostatic precipitators and bioscrubbers have built-in systems to remove precipitated wood dust from the water by simple sedimentation and screw pumps, decantation or by coagulation/flocculation.

2.9.1 Environmental issues related to waste water treatment

Environmental issues related to the discharge of water from refining are described in Section 2.2.3.

Environmental issues related to the collection and treatment of surface run-off water are described in Section 2.1.2.2.

Energy consumption

Waste water treatment plants require electrical energy for pumps, filter presses and other equipment.

Chemicals

Coagulants, flocculating agents and pH regulators are used in general in the treatment of process-related waste water. The addition of nutrients in biological treatment steps is sometimes necessary.

3 CURRENT CONSUMPTION AND EMISSION LEVELS

This chapter provides information on the current ranges of consumption and emission levels from the WBP sector covering the scope of processes described in Chapter 2 and taking each main product into consideration. The environmental issues already described in Chapter 2 are further supported by data in this chapter, and key environmental issues are identified.

The main environmental issues for the sector are emissions to air and energy consumption. Emissions to water are a less prominent issue, but the difference between the product being produced and the abatement systems applied gives a variability in the significance of the environmental issues. While process waste water is found in most fibreboard production processes, this is not the case for particleboard or OSB production. Drying and pressing are a prerequisite for all dry process panels, and drying is especially energy-intensive. Cooking and refining of chips to produce fibres are also highly energy-intensive and take place in all types of fibreboard production, both for wet and dry process fibreboards.

The specific environmental footprint and issues can differ from site to site and the purpose of this chapter is not to cover all issues for all sites and production processes possible, but to cover the general issues common to all sites and specific issues arising from the production of certain products.

As a consequence, emission sources and/or parameters not considered in this document may be encountered as site-specific issues and it will be at the discretion of the site and the competent authority to take any extra issues into consideration.

Emission and consumption data in this chapter are mainly derived from the general data collected at individual sites from 15 Member States, and provided to support this document. Other sources of aggregated data and site-specific data have been received from Member States and Industry, and are also included in this chapter. Data gathered from the data collected for this document are of a comparable standard and background, while data from other sources may have been gathered beforehand for a range of different purposes and therefore may not be readily comparable. Wherever relevant, data from other sources have also been included. Data presented in this chapter have the purpose of illustrating the current emission levels found in the sector, with the related consumption levels for energy and water, and including data and details on the raw materials used for the manufacture of the various panel products.

Existing production plants or sites from which data have been collected represent both newer plants and plants which have been in operation for a number of years, with the age distribution shown in Figure 3.1. Most of the older installations in the figure rarely have the same equipment as when first operated; some may have retrofitted or upgraded existing equipment, and enlarged production sizes and the product range.

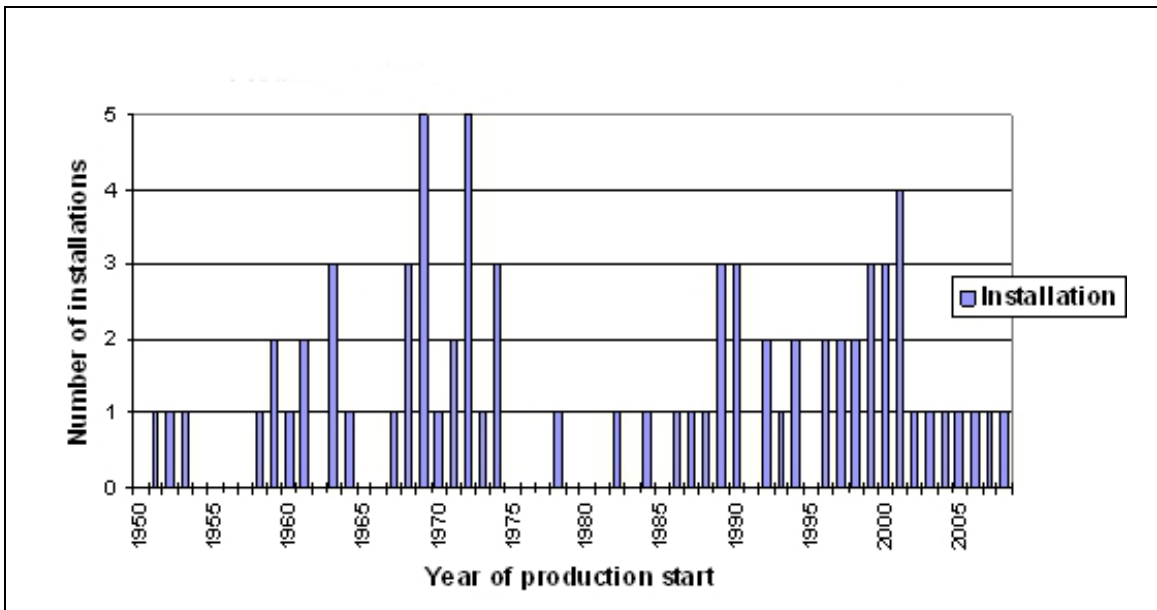

Figure 3.1: Year of production start for PB, OSB or MDF installations included in the data collection

Data collection representing normal operating conditions

Most plants are monitored discontinuously from four times a year to once every third year, depending on permit conditions. A prerequisite when performing a sampling campaign is that the sampling is performed during well-defined operating conditions. Representative measurements should be carried out at the highest emission state of the operation under normal operating conditions.

It is rare that a production line runs at less than its full capacity. Full capacity is understood as the capacity at which the production line is running under normal operating conditions. This is not necessarily equal to the design capacity. In the UK, the full capacity is interpreted by regulators as 80 % of the design capacity.

The data collected are, therefore, generally considered to express emissions during normal operating conditions.

3.1 Inputs to production

3.1.1 Wood raw material

Raw materials for the production of panels cover a large range of sources. Originally only virgin wood, such as round logs and production residues from sawmills, especially sawdust and shavings, were used in the production of particleboard.

Other green wood materials were included later, such as from forest thinning. Market conditions and new legislation paved the way for the use of recovered wood. With greater focus on recycling and collection systems for post-consumer products and production residues from the woodworking and furniture industries, a new range of raw material became available for the sector. The use of recovered wood requires prior cleaning, to rid the wood-based material of debris such as plastic and metals, which represents an additional processing step.

After the development of the market for pellets for biomass-fired combustion plants and for retail sale, green wood from forests and from the woodworking industry, especially sawdust, has now become less accessible for the wood-based panel industry, in terms of price and quantity.

The selection of raw material is dictated by the product to be produced, but raw material selection is constantly under development. Until recently, recovered wood was only used as a raw material in the production of particleboard but, with careful selection of the source and quality of the recovered wood and efficient cleaning, recovered wood is today also used in the production of MDF, although pure fractions of post-consumer wood are still only applied in particleboard production.

In Figure 3.2, the composition of wood raw material for the three main products is shown. The data are based on information collected for one production year from 38 particleboard plants, 14 MDF plants including HDF, and 6 OSB plants.

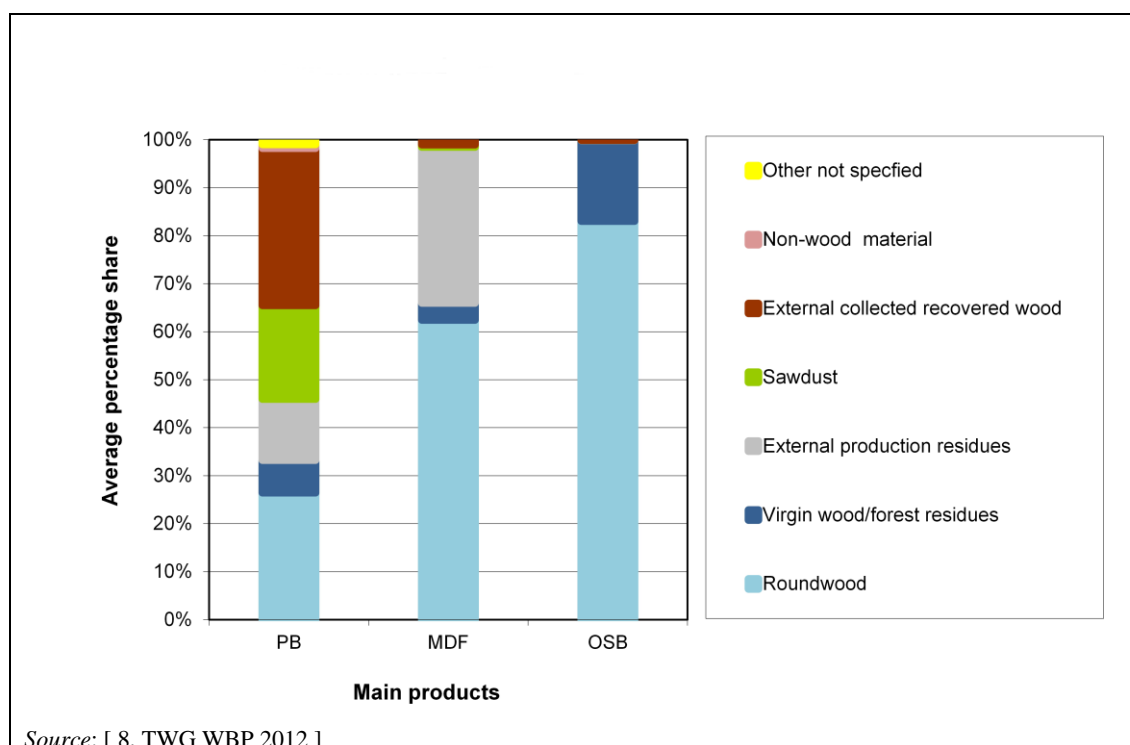

Figure 3.2: Distribution of wood raw materials used in different panel products in the EU-27

Particleboard production uses a wide range of accessible wood sources, while OSB and MDF are produced mainly from roundwood. It is indicated in the figure that external production residues are used in MDF production, which relates mainly to sawmill chips and slabs. Virgin wood raw materials can consist of cuttings from forestry, with high quality cuttings in terms of homogeneity being used for MDF and OSB production at dedicated installations.

Local wood raw material suppliers are preferred, in order to keep transport costs low, with most coming from within a 100 – 300 km radius. The accessibility of the local raw material supply can, to a certain extent, be derived from the raw material composition used in individual installations. In Figure 3.3, the overall percentage composition of raw materials in particleboard production in different Member States is illustrated.

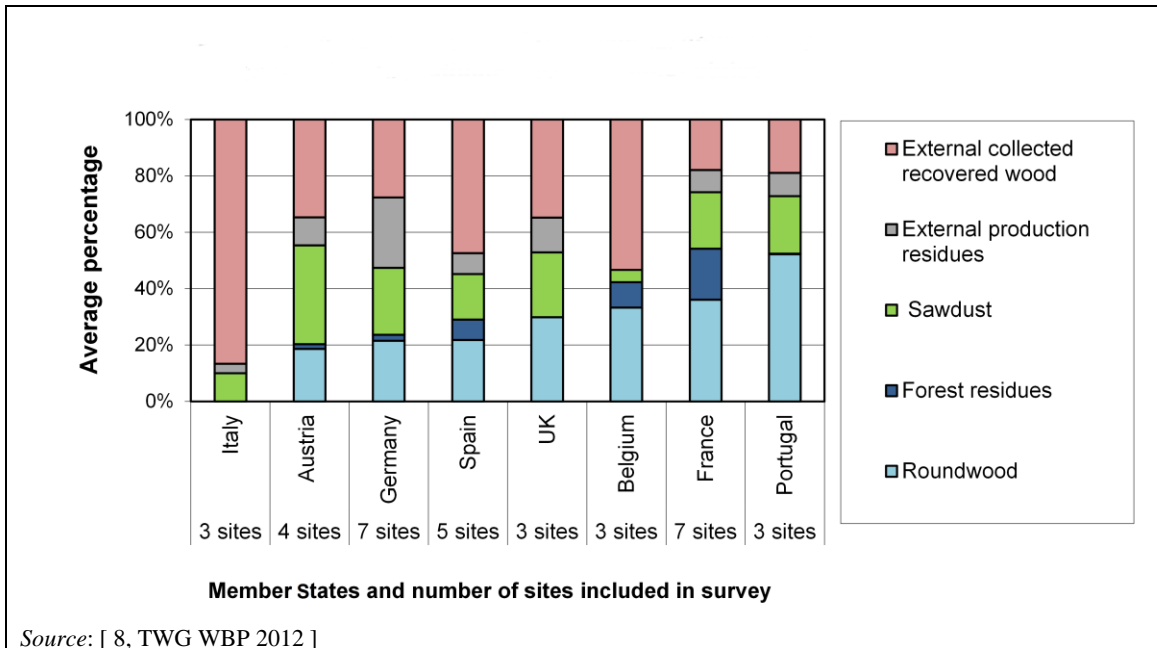

Figure 3.3: Distribution of raw materials used in particleboard production in different Member States

In France, Portugal, and Germany, the local forestry sector constitutes the main supply of raw material, both in terms of roundwood and sawdust and other residues from sawmills. Member States such as Italy, Spain and Belgium have a share of externally collected recycled wood, post-consumer wood and other qualities around or above 50 %. It should be mentioned that the data presented in Figure 3.3 are only from a limited number of installations producing particleboard (35) and there could be differences if data included all production lines. Data from Member States with less than two production sites are excluded.

3.1.2 Fuels

Fuels used in energy production are based on the ready availability of wood-based fuels derived from the production process carried out at the installation. Specific fractions of residues from the production process are described below together with other fuel alternatives that have been reported to be used in the sector.

Wood dust from production

Wood dust collected at operations after the press, including all trimming, cutting and sanding operations, is generally collected in bag filters or similar filters and used as a fuel in dust burners or injected into the combustion chamber over a moving grate. Even though the dust

collected from different sources is sometimes collected individually and transported manually to the combustion plant, a central dust ring collection system with central bag filters is also used.

Wood dust and trimmings collected before the press are generally recycled in production by either adding the material for shifting after drying or adding the collected material to the raw wood before drying.

In fibreboard production, the collected dust fibres are shifted and added to the dry fibre storage.

Rejected panels

OSB and fibreboards that are rejected after the press and further down the finishing line are collected and used as fuel. In particleboard production, the rejects can often be reused as raw material instead of being used as fuel. Rejects from OSB production cannot be reprocessed due to the character of the strands. The rejects from OSB can be used as raw material for particleboard production, which is feasible when the two products are produced at the same installation. If this is not the case, the OSB rejects are used as fuel.

Bark

Bark is a major fuel source at installations that use roundwood as a raw material. Bark is derived as a residue from debarking and from the sorting of chips after a primary chipping step and secondary milling step.

Sludge from abatement systems

Wet dust abatement systems are preferred for abating the sticky and moist air emissions from dryers and from presses. Sludge is generated and collected from the abatement systems. The collected sludge is not produced in large quantities and does not constitute a significant source of fuel. The sludge generated is primarily wood dust and has a moisture content of between 15 % and 60 % after dewatering by screw presses or decantation of the sedimented material. There are no data available on the composition of the sludge.

Sludge and filtration sludge from a waste water treatment plant are also used as fuel at some installations, but this depends on the quality of the sludge and the treatment step from which it was derived.

Wood residues from the cleaning plant for recycled wood

Recycled wood from external sources used as raw material creates large quantities of waste residues when cleaning the material. Metals and plastics are collected separately and are unsuited for use as fuels, but the wood-based fractions are readily used as fuels. The amount of wood-based fuel derived from cleaning plants for recycled wood will depend on the composition of the raw material received, the desired quality of the end product, and the efficiency of the cleaning plant.

Externally delivered wood material

If the internally produced wood residues are not sufficient for the fuel demand, externally delivered wood material is used. Wood material could be production residues from the furniture industry which are generally of a quality that can be used as raw material in the production process. Wood material received for use as a fuel is mostly of a lower quality and includes post-consumer wood, collectively called recovered wood. This material could be defined as wood waste depending on individual MS' waste regulations. The term recovered wood is used for differentiating between virgin wood, internal or external production residues and collected post-consumer wood. Sawdust is an important raw material for particleboard production but also serves as a fuel, especially in larger combustion units firing over a moving grate.

Roots and stubs from wood harvesting require special equipment for shredding and preparation before it is possible to use them as fuel and hence they are rarely used. The roots are contaminated with soil and are not used in the production of panels.

Natural gas

Natural gas is the preferred alternative for individual combustion units, for larger units but especially for smaller units, e.g. for co-firing for directly heated dryers and for heating thermal oil ring systems.

Light and heavy fuel oil

Some cogeneration plants are diesel engines, which are an option if natural gas grids are not available. Very few installations use heavy fuel as the major fuel. Liquid fuels are also applied in ignition burners for biomass-fired combustion plants, but in practice the fuel consumption is negligible.

A general list of fuels reported to be used can be found in Section 2.6.

3.1.3 Resin and additives

The choice of resin is determined by the quality wanted in the final product and balanced to the price of resin and the possibilities of the press to work under different conditions according to the optimum press time and temperature. Resin formulations are developed by each installation according to the product range that is produced and are considered confidential information. Resins applied in wood-based panel production can be divided into five main groups; urea-formaldehyde resin, melamine-urea-formaldehyde resin (MUF), melamine-urea-phenol-formaldehyde resin (MUPF), phenol-formaldehyde and phenol-urea-formaldehyde resin (PF/PUF) and polymeric methylene diphenyl diisocyanate (pMDI) [8, TWG WBP 2012]. A few other resins have been reported as being used but in minor quantities at dedicated production sites, such as ligno-sulphonates.

For the three main products PB, OSB and MDF some differences exist, which also affect the emissions from the dryers and presses. In Figure 3.4, the percentage mixes of four resin groups are shown for 36 production lines or installations producing particleboard [8, TWG WBP 2012]. The vast majority of particleboard production is based on UF. The use of UF-based resin represents 84 % and MUF 11 %. PF/PUF is not used for particleboard. Some of the resins are used as additions to the main resin in 5 – 10 % blends, while other resins are used for special production processes. pMDI has been used as the main resin for a special production of PB at one plant. The exact blend and use of resins is not known. Urea-formaldehyde is considered the cheapest, but also the most versatile resin.

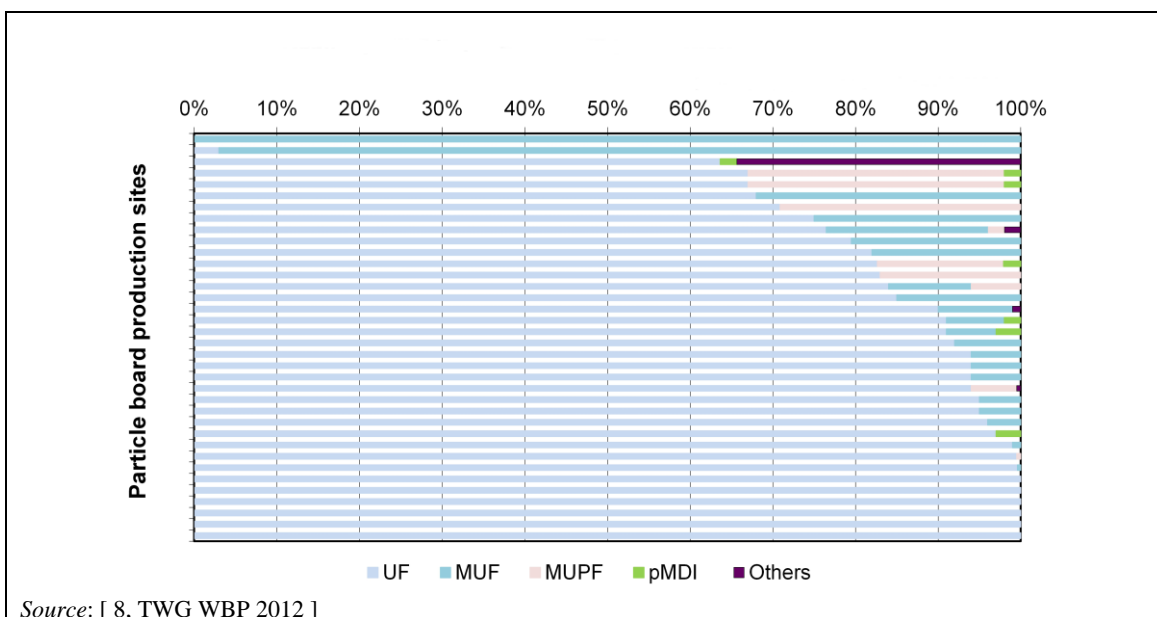

Source: [8, TWG WBP 2012]

Figure 3.4: Resins used in production of particleboard at 35 different production lines or installations

In the production of OSB, pMDI is the dominating resin and is used as the sole resin at six production lines. Two production lines use PF/PUF or MUPF resins in the production of specific varieties of OSB.

Resin for the production of MDF is dominated by UF, representing 68 %, and MUF, accounting for 30 %, while pMDI is used in small quantities as an additive, see Figure 3.5.

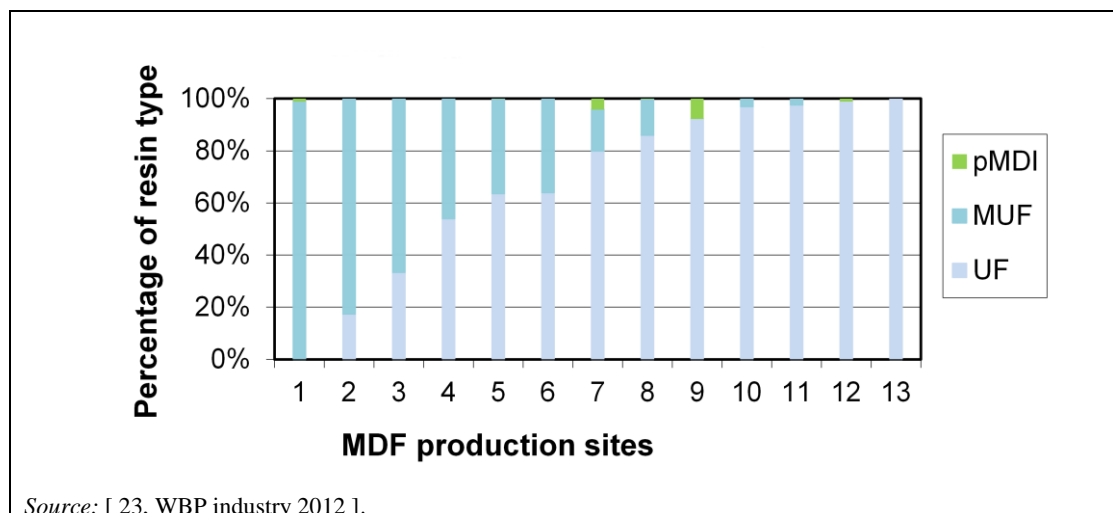

Figure 3.5: Resins used in MDF production at 13 different production lines or installations, data from 2010–11

The consumption of resin varies between products, between product qualities and even between core and surface layers in particleboard. The resin quantity represents between 5 % and 10 % of the final product. Table 3.1 shows the composition of a raw finished panel, including other additives and residual humidity.

Table 3.1: Composition of a raw finished panel in weight (%)

	Resin	Additives	Wax	Water	Wood
PB	6 – 8	1 – 2	1 – 2	5 – 7	83 – 88
MDF	10	< 1	< 1	7	82
OSB ⁽¹⁾	2 – 3	1 – 2	1 – 2	5 – 7	86 – 92

⁽¹⁾ When using pMDI as the resin.
Source: [1, Thomen 2010], [23, WBP industry 2012], [35, WPIF 2004]

3.1.4 Energy consumption

Energy consumption data focus mainly on the most energy-intensive processes, which are drying and pressing for all the main products, i.e. PB, OSB and MDF. In MDF production, refining of fibres is also a major energy consumer [78, Forintek 2014].

Ranges for the gross annual energy consumption for the most energy-consuming operations, i.e. drying, pressing and refining, are shown in Table 3.2, together with the ranges for the overall energy consumption at the site level.

Table 3.2: Yearly energy consumption levels illustrated for the three main energy-consuming processes and for the total energy consumption at the site level

	Unit	PB	OSB	MDF ⁽³⁾
Drying				
Power	MWh	4 000 – 26 000	8 000 – 13 000	6 000 – 32 000
	MWh/m ³ of finished panel	0.01 – 0.09 ⁽¹⁾	0.03 – 0.04	0.03 – 0.12
% of total site		6 – 50	22 – 36	9 – 28
Heat	MWh	50 000 – 407 000	33 000 – 192 000	64 000 – 205 000
	MWh/m ³ of finished panel	0.17 – 0.86 ⁽²⁾	0.1 – 0.4	0.4 – 1.1
% of total site		34 – 90	ND	28 – 58
Refining				
Power	MWh	NA	NA	14 000 – 43 000
	MWh/m ³ of finished panel	NA	NA	0.08 – 0.15
% of total site		NA	NA	16 – 45
Heat	MWh	NA	NA	52 000 – 186 000
	MWh/m ³ of finished panel	NA	NA	0.27 – 0.79
% of total site		NA	NA	10–60
Pressing				
Power	MWh	5 000 – 21 000	5 000 – 19 000	4 000 – 26 000
	MWh/m ³ of finished panel	0.02 – 0.06	0.01 – 0.06	0.01 – 0.09
% of total site		12 – 38	13 – 50	3 – 22
Heat	MWh	13 000 – 50 000	ND	20 000 – 50 000
	MWh/m ³ of finished panel	0.05 – 0.14	ND	0.1 – 0.32
% of total site		7 – 15	ND	7 – 15
Site level				
Power		11 000 – 101 000	35 000 – 49 000	53 000 – 230 000
	MWh/m ³ of finished panel	0.07 – 0.24	0.10 – 0.13	0.25 – 0.76
Power: Part of total energy consumption		10 – 46	14 – 54	13 – 64
Heat	MWh	28 000 – 750 000	33 000 – 112 000	231 000 – 887 000
	MWh/m ³ of finished panel	0.18 – 1.73	0.11 – 0.69	0.30 – 2.90
Heat: Part of total energy consumption		54 – 90	46 – 86	36 – 87
NA: not applicable. ND: no data available. (1) For particleboard, the electrical energy consumption for indirectly heated dryers is reported to be 0.01 MWh/m ³ of finished panel. (2) For particleboard, the thermal energy consumption for indirectly heated dryers is reported to be 0.46–0.60 MWh/m ³ of finished panel. (3) MDF only includes data from MDF grades produced with the dry process. Insulation and flexboard are not included. Source: [23, WBP industry 2012]				

The upstream activities such as chipping and milling and the downstream wood processing activities, including the related abatement systems, contribute in total from 15 % to up to half of the total energy consumption, mainly in the form of electricity. The energy consumption share depends on the final product, the degree of chipping and the cleaning steps before drying.

In particleboard production, indirectly heated dryers are applied at a small number of plants. Indirectly heated dryers are claimed to have high energy efficiency due to the advantage of combining the drying process with a combined heat and power plant. According to analysis of data, the difference in energy consumption between indirectly heated and directly heated dryers has not proved to be significant.

Production of MDF includes a refining step where the production of steam for cooking, the use of hot water for pre-cooking and electricity for the refiners all add to the overall energy consumption.

The refining and drying of fibres can also be seen as a single process. In Table 3.3, the energy consumption levels are also expressed per tonne of dry fibre, which is an appropriate way of expressing the amount of energy needed for the production of dry fibres. The energy consumption for refining is in the same magnitude as for the drying of the fibres.

Table 3.3: Comparison of energy consumption per unit of product in MDF production

	Drying and refining	Drying	Refining
Power, MWh /tonnes of dry fibre	0.19 – 0.52	0.04 – 0.21	0.13 – 0.4
Power, MWh/m ³ of finished panel	0.12 – 0.26	0.03 – 0.12	0.08 – 0.15
Heat, MWh /tonnes of dry fibre	1.23 – 2.91	0.74 – 1.45	0.38 – 1.44
Heat, MWh/m ³ of finished panel	0.76 – 1.37	0.4 – 1.1	0.27 – 0.79
<i>Source: D026, D067, D066, D084, D045, D009, D030, D031 [23, WBP industry 2012]</i>			

The data on energy consumption are highly diverse for several reasons, and this makes the individual data sets difficult to compare. Amongst the possible reasons for variation in reported energy consumption figures are the following:

- The selection of raw materials used and the product, including finishing, which determines the amount of additional processes which take place at the site.
- The recirculation of dryer hot air or other hot air streams would lower the total thermal energy input, but could at the same time lead to an increase in power consumption in order to drive additional fans.
- The initial humidity of the wood raw material used will determine the energy needed to dry the material. A further analysis of the different raw material used at PB production lines shows no direct relation to the share of recovered wood compared to roundwood, sawdust, etc. and the reported energy consumption.
- Energy consumption for the individual production steps is not always clearly identifiable and comparable from installation to installation since energy consumption is not always measured at the unit level or with the same distinction between process steps.

3.1.5 Water consumption

The WBP sector is not characterised by high water consumption and so this is rarely an issue. Process water mainly includes water for resin preparation and for spraying and humidifying after mat forming. An exception is for the production of fibres, where the refining of fibres will raise the overall water consumption.

Water used for other purposes that are not directly process-related includes water for cooling of engines, cooling water for combustion plants, water used for wetting biomass ash, water in wet abatement systems, water for firefighting and water for plant cleaning.

Plant cleaning includes cleaning of the dryer. For dryer cleaning, the consumption is around 3 000–5 000 m³ per year. At the plant level, the amount can be as high as 240 000 m³ per year.

The total water consumption at the plant level compared to the process water consumption is shown in Table 3.4. The water consumption is expressed in volume, but also in the more precise measure of m³/m³ of finished panel, with which it is possible to compare plant performances.

Table 3.4: Total water consumption in OSB, PB and MDF production

	OSB ⁽¹⁾	PB ⁽²⁾	MDF ⁽³⁾
Total water consumption at site level in m ³ /m ³ product produced	0.1 – 0.6	0.02 – 0.88	0.15 – 1.52
Process water consumption in m ³ /m ³ product produced	0.04 – 0.57	0.02 – 0.21	0.03 – 1.42
Total water consumption at site level in 1 000 m³/year	50 – 164	33 – 390	41 – 592 ⁽⁴⁾
Process water consumption in 1 000 m³/year	12 – 164	3 – 164	4 – 464
⁽¹⁾ Plants D010, D013, D029, D032. ⁽²⁾ Plants D001, D003, D004, D007, D008, D012, D014, D020, D021, D022, D025, D029, D042, D044, D042, D071. ⁽³⁾ Plants D005, D09, D011, D026, D028, D040, D067, D081, D085. ⁽⁴⁾ Three plants had considerably higher water consumption of between 1500 000 m ³ /year and 3 000 000 m ³ /year. <i>Source:</i> [8, TWG WBP 2012]			

In MDF production, the refining step demands water and, even if process water is recycled, there is still a need for the addition of fresh water. The water consumption is based on a range of refiner capacities, which lie between 20 tonnes and 40 tonnes of dry fibre/hour, while the ranges of the equipment available on the market could go from 9 tonnes to 80 tonnes of dry fibre/hour. The amount of water recycled is reported to be between 0 % and 100 %.

The water demand for the refining plant alone ranges between 0.015 m³/tonne and 2.0 m³/tonne of dry fibre. This includes water for chip washing, although the water consumption or the amount of recycling is not directly affected by whether a chip washing step is applied or not.

While water consumption for the production of OSB is lower than for MDF, there is a considerable difference between plants. Only four OSB plants are the basis for the range in Table 3.4. Water consumption for OSB production at the plant level will also depend on the choice of abatement system, e.g. consumption will be higher when a wet abatement system is used for treating waste gases from the dryer and/or presses.

Particleboard production is not considered as having high water consumption. The table shows that there is a considerable difference between plants though. Even though the water consumption is lower than for MDF production, the collected data show that there could be a possible incentive to look at water consumption patterns. The data on which the table are based

do not contain enough information to fully clarify the amount of water used in specific parts of the plant, or the related measures already in place to reduce water consumption.

3.2 Emissions to air

3.2.1 Emissions from dryers

All dryer emissions in the sector for which there are collected data are generally controlled for total particulate matter, hereafter called dust. Data represent the majority of MS and cover the main production sites. The methods used for sampling and analysis differ and the reference conditions used for expressing the analytical results also differ.

For the purpose of comparing data and assessing the performance of techniques, all data which were received with the necessary contextual information have been used. Some of the data concerning emissions from dryers were received with no correction to a standard oxygen content, which is usually dictated by the reporting conditions in their environmental permit. The measured oxygen level during sampling was given and generally ranged from 16.5 % to more than 20 %. The oxygen level is near 20–21 % in fibre dryers and indirectly heated particleboard dryers, while a lower oxygen content of between 17 % and 19 % is common for directly heated particleboard and OSB dryers. The data should be read as being given on a dry basis. Whenever data are given on a wet basis this is indicated.

The majority of dryer emissions for which there are collected data are also controlled for the content of volatile organic compounds. Total volatile organic carbon, TVOC, is most commonly used. The parameter used to express the organic content, the sampling method and also the analytical method can differ, which potentially could give diverging results. Sampling and monitoring of formaldehyde is performed separately using different monitoring standards.

In Table 3.5, the ranges of emissions for dust, TVOC and formaldehyde from dryer waste gas for different products are shown. Total volatile organic compounds are expressed in the data collection by several parameters. The table shows the difference between directly heated dryers and indirectly heated dryers. The ranges reflect the huge variety in the data collection, which depends on the raw material used, production methods, abatement techniques applied and the choice of monitoring regime.

Table 3.5: Reported emission levels of dust, TVOC and formaldehyde from dryers for particleboard, OSB and MDF lines

Product	Dryer type	Dust (mg/Nm ³)	TVOC (mg/Nm ³)	Formaldehyde (mg/Nm ³)
Particleboard	Directly heated dryers ⁽¹⁾	1 – 144	1 – 380	0.2 – 52
	Indirectly heated dryers ⁽²⁾	1 – 97	92 – 280	6.2 – 7.7
OSB	Directly heated dryers ⁽¹⁾	1 – 70	29 – 402	0.6 – 15
	Indirectly heated dryers	-	-	-
MDF	Directly heated blowline dryers ⁽²⁾	1 – 37	6 – 227	2.6 – 14
	Indirectly heated dryers ⁽²⁾	2 – 16	12 – 42	5 and 10

⁽¹⁾ At 18 % O₂, dry basis.
⁽²⁾ Dry basis.
Source: [8, TWG WBP 2012].

Another relevant emission from dryers is NO_x and data have been collected for directly heated dryers and, for comparison, also from indirectly heated dryers. The NO_x levels from directly

heated dryers range from 2 mg/Nm³ to around 350 mg/Nm³. All data are expressed with a standard oxygen content of 18 %.

Several other parameters such as CO, SO_x, heavy metals, HCl and dioxins in waste gases from dryers are monitored, but infrequently. The data have been included in this document, when available

3.2.1.1 Dust in dryer emissions

In Figure 3.6, the distribution of all collected emissions data, as the data were received, for average dust emissions from 50 PB production lines is shown with the applied dust abatement technique.

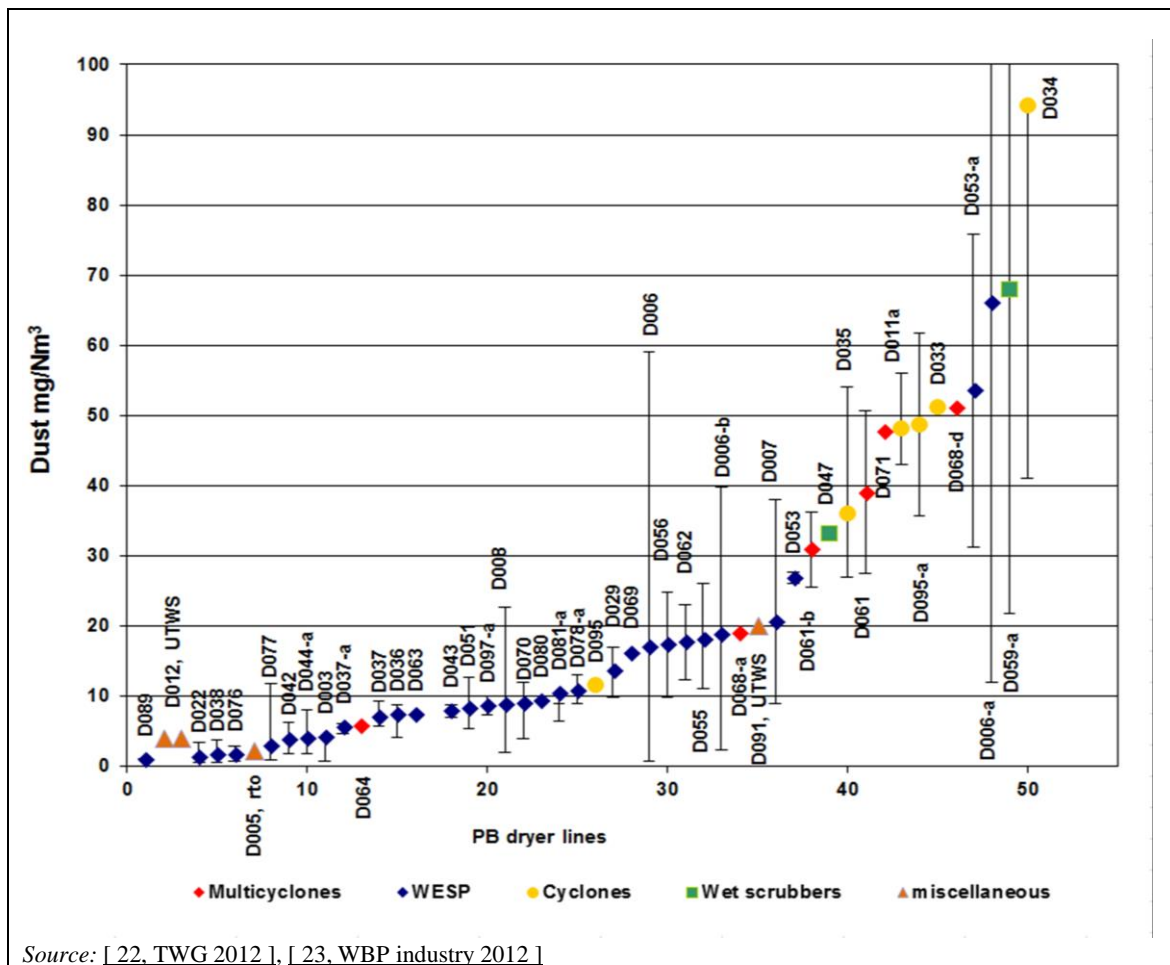

Figure 3.6: Values for dust in emissions to air from directly heated PB dryers and the applied abatement techniques, based on data from 50 production lines

The difference in reported emission levels between dryer lines not only in Figure 3.6, but also in the remaining figures in Sections 3.2.1.1, 3.2.1.2 and 3.2.1.3, reflects the chosen abatement system and in part the reference conditions. The related information on reference conditions for the individual data in Figure 3.6 is shown in Table 3.6. A WESP is applied on more than half of the production lines, with multicyclones being the other most commonly applied technique. Even though a distinction is made between cyclones and multicyclones, based on the information collected, the two could be taken as the same dust separation technique.

Several sites not only in Figure 3.6, but also in the remaining figures in Sections 3.2.1.1, 3.2.1.2 and 3.2.1.3, show a large difference between the reported minimum and maximum values for

the emission to air from the dryer for both dust and volatile organic compounds including formaldehyde. This could be an effect of the operational management of the drying process, the raw materials dried and the operational management of the abatement system for emissions to air, etc.

Table 3.6: Reporting details on reference conditions for data presented in Figure 3.6 concerning emission to air of dust from directly heated PB dryers

Plant ID no	O ₂ reference (vol-%)	Data given on wet or dry basis	Plant ID no	O ₂ reference (vol-%)	Data given on wet or dry basis
D089	-	-	D095	15.47	Dry
D012	11	Wet	D029	17	-
D012a	11	Wet	D069	-	-
D022	17	Wet	D006	17	Dry
D038	17	-	D056	(16.64) ⁽¹⁾	Dry
D076	17	Wet	D062	17	Dry
D005	17	Dry	D055	(13.2) ⁽¹⁾	Dry
D077	17	-	D006-b	17	Dry
D042	18	Dry	D068-a	(19.4) ^{(1), (2)}	Dry
D044-a	18	Dry	D091	-	-
D003	17	Dry	D007	17	Dry
D037-a	(13.7) ⁽¹⁾	Dry	D053	(18.7) ⁽¹⁾	Dry
D064	-	-	D061-b	(20.85) ⁽¹⁾	Dry
D037	17	Dry	D047	17	Dry
D036	17	Dry	D035	-	-
D063	17	-	D061	(20.85) ⁽¹⁾	Dry
D063-b	17	-	D071	(19.05) ⁽¹⁾	Dry
D043	18	Dry	D011a	(18.9) ⁽¹⁾	Wet
D051	(20.2) ⁽¹⁾	Dry	D095-a	(18.7) ⁽¹⁾	Dry
D097-a	-	-	D033	(18.7) ⁽¹⁾	Wet
D008	17	Dry	D068-d	(19.3) ^{(1), (2)}	Dry
D070	6	Dry	D053-a	(18) ⁽¹⁾	Dry
D080	(18) ⁽¹⁾	Dry	D006-a	17	Dry
D081-a	-	-	D059-a	(19) ⁽¹⁾	Dry
D078-a	(18.25) ⁽¹⁾	-	D034	18.6	Dry
Data on dust emissions not shown in Figure 3.6					
Plant ID no	Dust (mg/Nm ³)			O ₂ reference (vol-%)	Data given on wet or dry basis
	Min. value	Average value	Max. value		Applied dust abatement
D071-a	-	100	-	(16.5) ⁽¹⁾	Dry/multicyclones
D068	-	108	-	(16) ⁽¹⁾	Dry/multicyclones
D016	-	108	-	(15.75) ⁽¹⁾	Dry/multicyclones
D072	-	108	-	(19.9) ⁽¹⁾	Dry/multicyclones
D072-a	-	119	-	(17.9) ⁽¹⁾	Dry/multicyclones
D017	130	144	172	(16.6) ⁽¹⁾	Dry/multicyclones
D015a	116	144	176	(18) ⁽¹⁾	Wet/multicyclones
D015	128	187	255	17	Wet/multicyclones

⁽⁻⁾: No information available.
⁽¹⁾ Measured vol-% O₂ when no correction is performed.
⁽²⁾ Second stage PB dryer (first stage is D068).
Source: [22, TWG 2012], [23, WBP industry 2012]

Press waste gases can also be collected and treated together with dryer waste gases, but this is applied mainly with a WESP. The additional source from the press emissions does not contribute significantly to the dust levels in the treated emissions from the WESP compared to a WESP treating only dryer waste gas, see Figure 3.7.

This is, first of all, an indication of the possibilities for treating various similar sources with the same technique, but it is a prerequisite that the technique is designed to receive and treat all of the different waste gas streams.

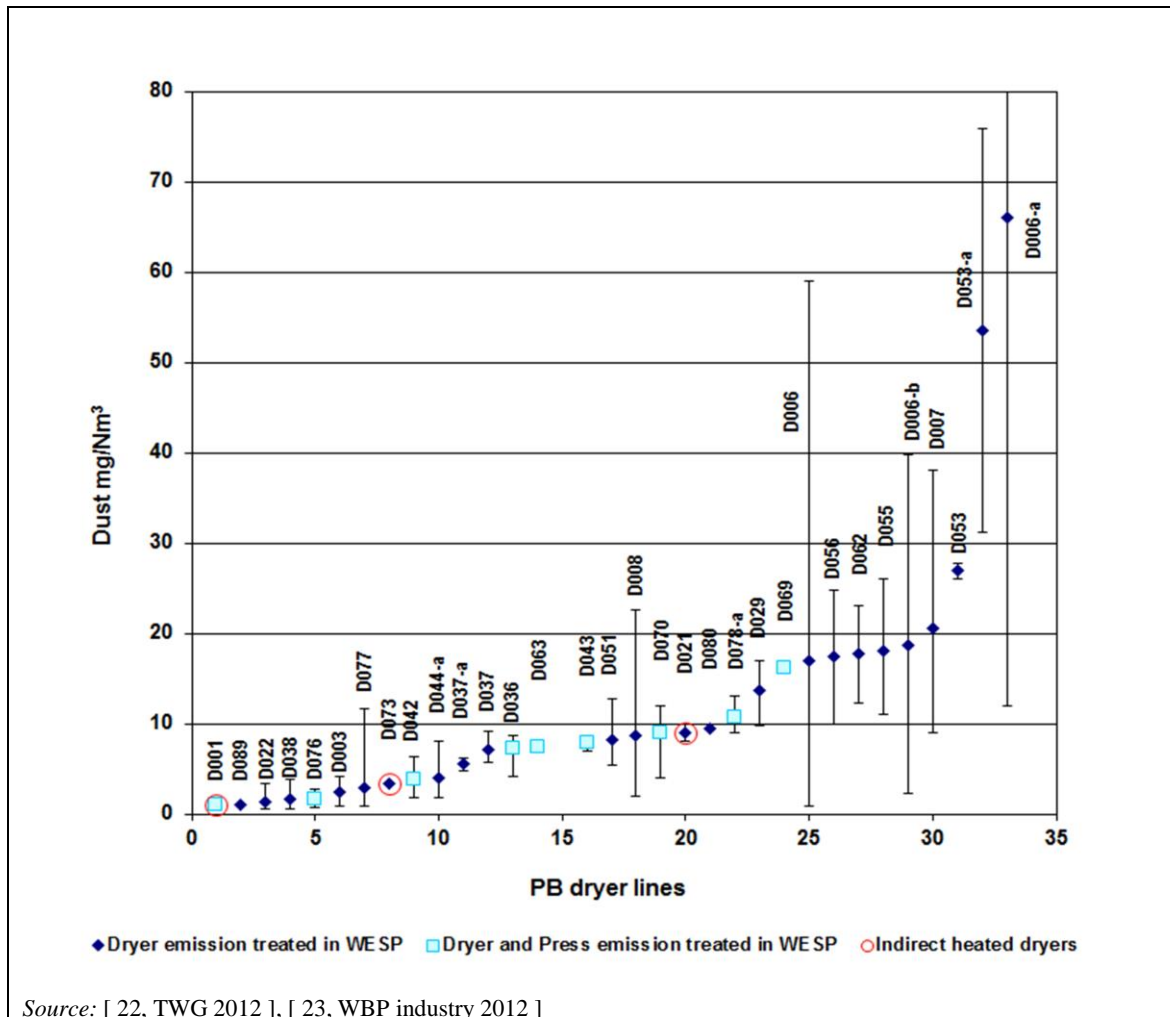

Figure 3.7: Values for dust in emissions to air from PB dryers applying a WESP including when waste gas from both the dryer and press are treated together

Indirectly heated dryers are used at a limited number of plants. The values for dust in emissions to air are shown in Table 3.7. As for directly heated dryers, WESPs and cyclones are used. Bag filters are used in a small number of PB production lines, i.e. at four installations. Dust emissions from the bag filters are continuously measured photometrically and with periodic monitoring every third year, as shown in Table 3.7. The resulting mass load of dust released per tonne of dried product is correspondingly low when using a bag filter. Bag filters are efficient dust collectors, but have no abatement efficiency for organic volatile compounds.

Table 3.7: Emissions data for dust from indirectly heated dryers in PB production, based on data from periodic monitoring

Plant ID no	Technique applied	Dust (mg/Nm ³)			Outlet temperature from dryer °C	Specific mass load g/t of dried product
		Min.	Average	Max.		
D004 ⁽¹⁾	Bag filter	0.9	2.74	11.9	80	-
D018	Bag filter	0.5	0.9	1.5	70	3.0
D020	Bag filter (11 % O ₂)	1.44	1.66	1.86	100	9.5
D024	Bag filter	-	1.3	-	120	3.9
D001	WESP (17 % O ₂)	-	1	-	-	-
D073	WESP	-	3.3	-	-	-
D021	WESP	8	9	10	-	-
D082	Cyclones	-	97	-	-	-

Note: If not indicated, data are given with no correction to a standard oxygen content.
 '-': No information available.
 (1) The average is a daily average, the minimum and maximum values are half-hourly averages.
 Source: [22, TWG 2012], [23, WBP industry 2012].

Data were collected from 11 OSB production lines, represented by 9 sites. All dryers applied in the OSB lines are directly heated dryers. The average dust emissions are shown in Figure 3.8. Seven of the production lines use a WESP for treating the emissions from the dryer. Also, the press emissions are collected and treated together with the dryer emissions in two of the lines, as indicated. Two installations use cyclones or multicyclones as the abatement technique.

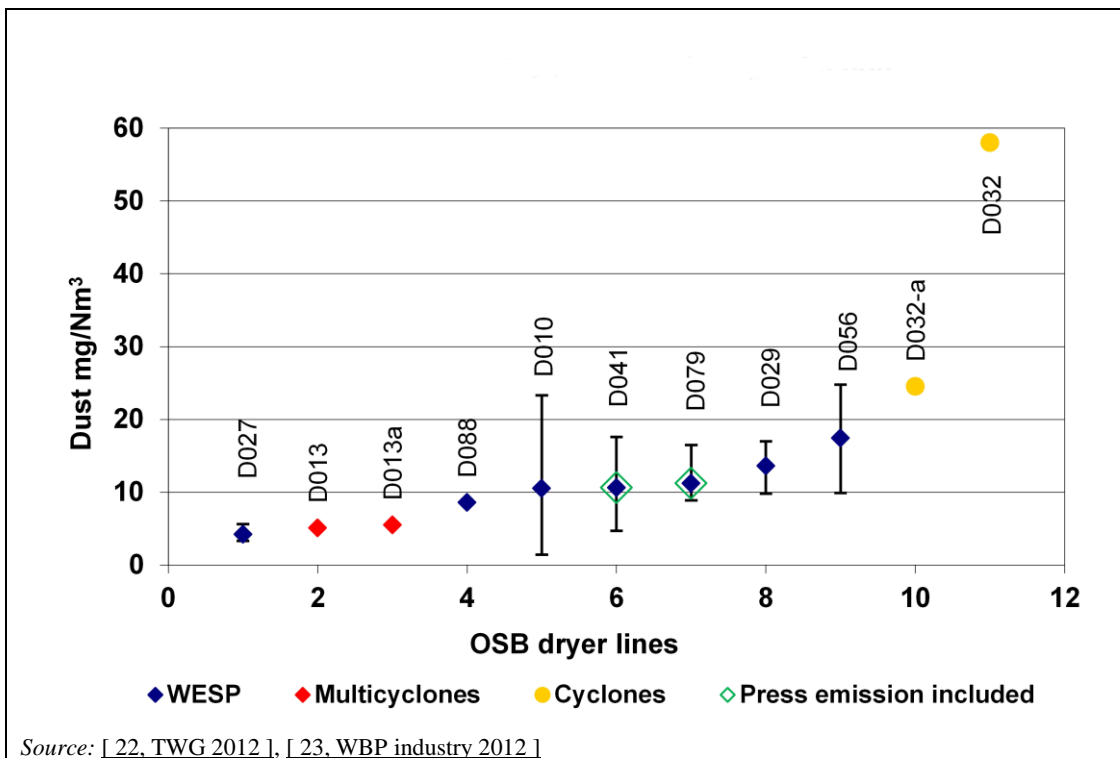

Figure 3.8: Values for dust in emissions to air from directly heated OSB dryers and the applied abatement techniques, based on data from 11 production lines

The dust levels in dryer waste gases from the 11 OSB production lines are generally lower than for particleboard. The lower values for OSB are most likely directly related to the raw material; OSB is made using flakes from roundwood, while PB is produced from various sources including recovered wood.

The data in Figure 3.8 vary according to the reference conditions used. Data represent both wet and dry bases and have different corrections for oxygen content, see Table 3.8.

Table 3.8: Reporting details on reference conditions for data presented in Figure 3.8 concerning emission to air of dust from directly heated OSB dryers

Plant ID no	O ₂ reference (vol-%)	Data given on wet or dry basis	Moisture (vol-%)
D013	11	Wet	35.8
D013a	11	Wet	35.8
D027	-	-	-
D010	17	Dry	24.50
D079	17	-	-
D088	-	-	-
D041	20 ⁽¹⁾	Wet	11
D029	-	Dry	12
D056	16.64 ⁽¹⁾	Dry	-
D032-a	18 ⁽¹⁾	Wet	21.3
D032	18.5 ⁽¹⁾	Wet	20.8
'-': No information available. ⁽¹⁾ Measured vol-% O ₂ when no correction is performed. Source: [22, TWG 2012], [23, WBP industry 2012]			

The reported dust levels for MDF dryer emissions are lower than for PB and OSB. Data from 32 MDF lines were collected and the dust levels are illustrated in Figure 3.9. The techniques applied are multicyclones or high efficiency cyclones for dust abatement, while the choice of wet scrubber systems with or without biological oxidation or degradation is common and is directed not only at dust abatement, but also to reduce the organic part of the dryer emission including formaldehyde. In Figure 3.9, three dryer lines are given as indirectly heated dryers. Indirect drying by steam is often enhanced when necessary by supplementing it directly with hot gas, generated from gas-fired burners or other combustion sources. The distinction between direct and indirect drying is not always clear for fibre drying and is therefore often mentioned as combined drying. Where combined drying takes place the dryers are considered directly heated dryers

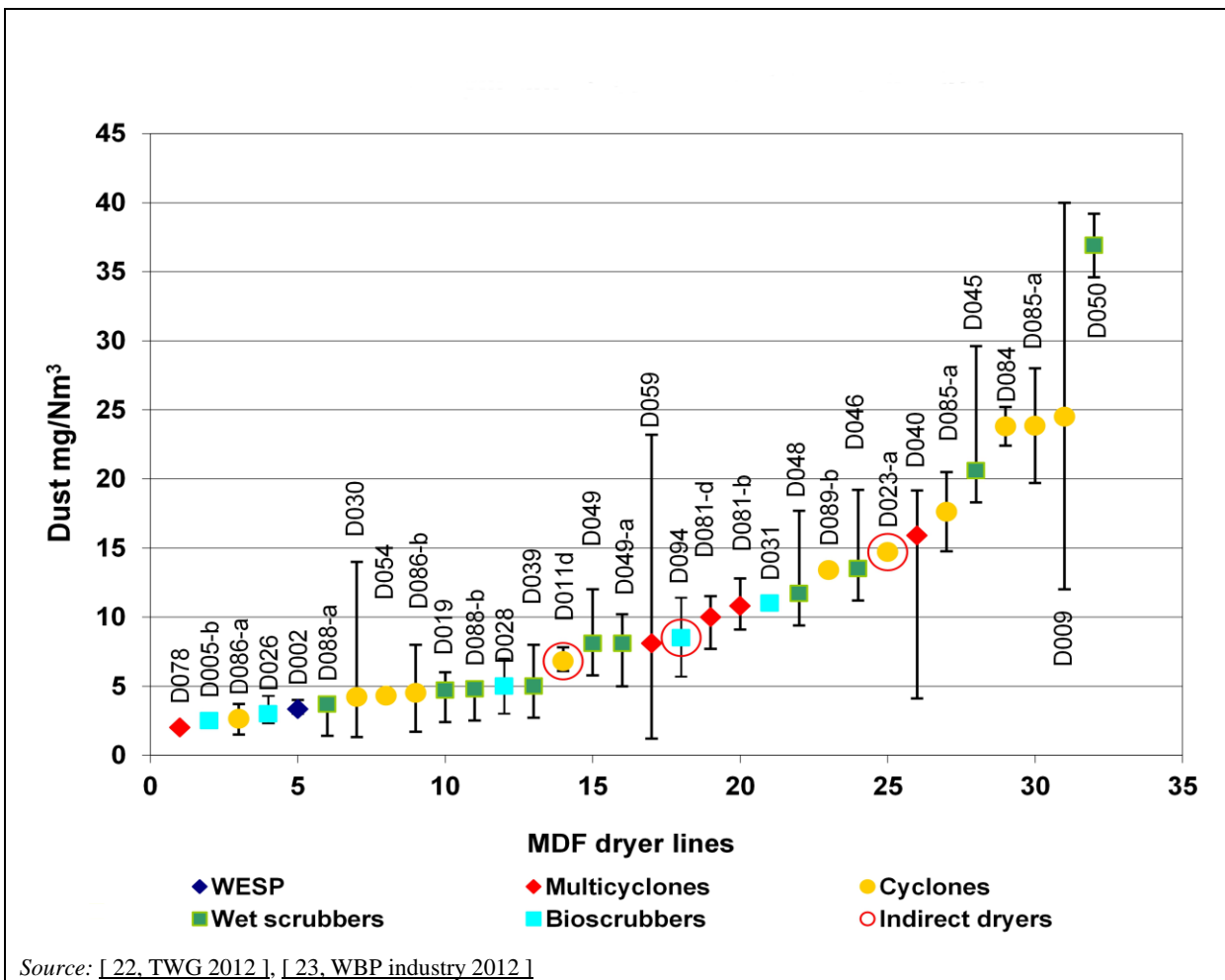

Figure 3.9: Values for dust in emissions to air from MDF dryers and the applied abatement techniques, based on data from 32 production lines

The data in Figure 3.9 vary according to the reference conditions used. The data represent both wet and dry bases and with different corrections for oxygen content, see Table 3.9

Table 3.9 Reporting details on reference conditions for data presented in Figure 3.9 concerning emission to air of dust from MDF dryers

Plant ID no	Measured O ₂ (vol-%)	Data given on wet or dry basis	Moisture (vol-%)	Plant ID no	Measured O ₂ (vol-%)	Data given on wet or dry basis	Moisture (vol-%)
D078	19.4 %	-	-	D059	20.9 %	Dry	4.25
D005-b	20.2 %	Dry	-	D046	(given with correction to 17 % O ₂)	Dry	10
D086-a	18.8 %	Wet	16.5	D081-d	20.9 %	Dry	6.98
D026	-	-	-	D081-b	20.9 %	Wet	7.3
D028	(given with correction to 18.9 % O ₂)	Dry	-	D085	19.8 %	Dry	2.35
D002	19.2 %	Dry	-	D031	20.9 %	Wet	-
D088-a	-	-	-	D048	19.2 %	Dry	12.8
D030	20.6 %	-	-	D045	(given with correction to 17 % O ₂)	Dry	13
D054 ⁽¹⁾	20 %	Dry	-	D089-b	-	-	-
D086-b	18.94 %	Wet	16.1	D084	(given with correction to 17 % O ₂)	Wet	2.1
D019	-	-	-	D085-a	19.85 %	Dry	1.9
D088-b	-	-	-	D023-a	-	Dry	10.65
D011d	-	Wet	-	D040	20 %	Wet	14
D049 ⁽³⁾	18.6 %	Dry	12.6	D009 ⁽²⁾	19.75 %	Dry	-
D049-a ⁽³⁾	21 %	Dry	3	D050	19.36 %	Dry	10.19
D094	20 %	Dry	-	D039	(given with correction to 17 % O ₂)	Wet	16

'-': No information available.
⁽¹⁾ Including dust abatement using an ESP applied after the combustion plant and before drying.
⁽²⁾ Including dust abatement using multicyclones applied after the combustion plant and before drying.
⁽³⁾ D049 is a first stage direct dryer, while D049-a is the indirectly heated second stage of the dryer.
 Source: [22, TWG 2012], [23, WBP industry 2012]

Three plants producing rigidboard and flexboard are not included in the table above. When producing flexboard and rigidboard, resin is not added to the fibres before drying, but afterwards. The applied dust abatement technique is cyclones, which is sufficient to keep dust levels below 5 mg/Nm³ (at Plants D074 and D075). At one plant (D090), a wet scrubber is combined with cyclones to give dust levels of 6–14 mg/Nm³.

A regenerative thermal oxidiser (RTO) is used for VOC abatement at one plant treating dryer waste gases from a particleboard plant. Since the RTO is sensitive to high dust levels, the dust is filtered from the emission prior to the thermal destruction of VOCs in the RTO. The chosen dust abatement technique is an electrified gravel bed, which is also the only unit installed in the EU. The resulting emissions from the outlet of the RTO are 2.2 mg/Nm³ dust, 0.11 mg/Nm³ formaldehyde and 1.4 mg/Nm³ NMVOC, based on a yearly sample. The performance related to the electrified gravel bed alone, before entering the RTO, is not known.

At three installations producing particleboard or OSB, a closed loop dryer system is applied. The monitoring data do not express the composition of the dryer waste gases, since the exhaust emission point is directly related to the combustion plant. The data are therefore also included in Section 3.2.4.

Contribution of dust from the hot gases used for direct drying

For direct drying, the dryer waste gases are mixed with hot gases from the combustion process, and the original dust content in the hot gases contributes to the total dust level. The contribution of dust depends on the fuel used, the combustion technology, and the dust abatement techniques applied before the hot gas is directed to the dryer. While dust abatement systems applied to combustion plants producing steam and electricity for indirectly heated dryers are common practice, dust abatement systems are not always applied at combustion plants producing hot gas for direct drying. The dust contribution from the hot gas is discussed in Section 3.2.4.

3.2.1.2 Formaldehyde in dryer emissions

Formaldehyde is monitored in most waste gas emissions from dryers.

While dust is monitored regularly, as mentioned in Section 3.2.1.1, formaldehyde and VOCs are not necessarily monitored with the same frequency, especially when only dedicated dust abatement techniques are applied, such as cyclones.

All reported emissions of formaldehyde for particleboard lie in the range from the limit of detection to a maximum value of 74 mg/Nm³; see Figure 3.10, where the data from 34 PB productions lines are presented.

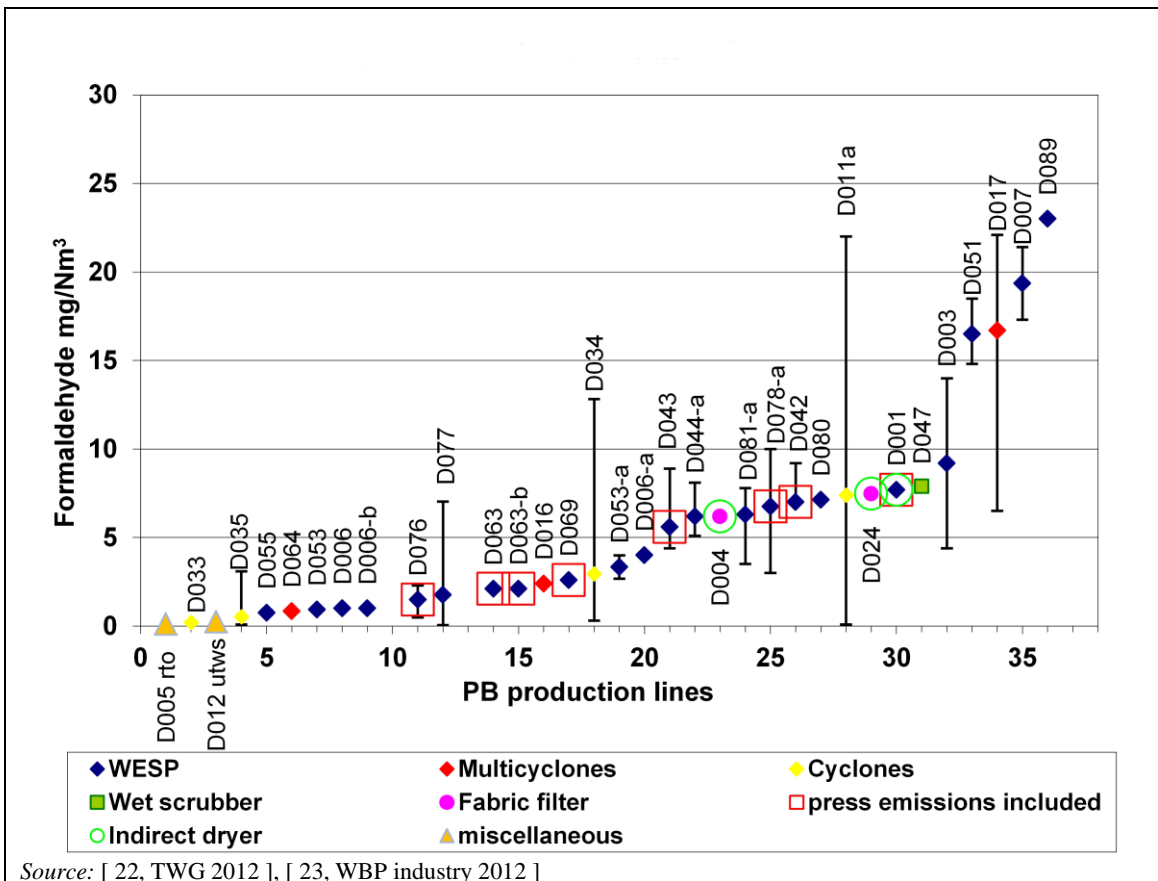

Figure 3.10: Values for formaldehyde in emissions to air from PB dryers and the applied abatement techniques, based on data from 34 production lines

The related information on reference conditions and the measurement standards used is summarised in Table 3.10.

An assessment has been made as to whether the sampling method has a significant influence on the formaldehyde measured. It is reported that data obtained using adsorption tubes or non-isokinetic sampling could give lower results than those obtained by isokinetic sampling in an impinging solution, see also Section 3.7.2.2. Since data from the same emission source have not been sampled simultaneously by both approaches it is only possible to comment in general terms. The differences in the data sets from the two main sampling approaches cannot be concluded as being related only to the method. From the data, for 13 samples from PB plants obtained using dry adsorption, the average values were 4.5 mg/Nm³. The 19 samples from PB plants obtained using the isokinetic sampling in an impinging solution have an average of 6.2 mg/Nm³.

Table 3.10: Reporting details on reference conditions for data presented in Figure 3.10 concerning emission to air of formaldehyde from PB dryers

Plant ID no	Formaldehyde (mg/Nm ³)			Additional information		
	Min.	Average	Max.	O ₂ reference (vol-%)	Data given on wet or dry basis	Standard method
D005	-	0.11	-	17	Dry	-
D033	0.2	0.2	0.2	(18.7) ⁽¹⁾	Wet	2,4 DNPH impinging solution
D035	0.1	0.5	3.1	-	-	-
D006	1	1	1	17	Dry	Modified US EPA M316
D006-b	1	1	1	17	Dry	Modified US EPA M316
D055	0.8	0.8	0.9	(13.2) ⁽¹⁾	Dry	PN-Z-040030-7, PN-ISO-10396
D064	-	0.85	-	-	-	Local standard
D076	0.5	1.5	2.3	17	Wet	BS EN 13649
D053	0.91	0.93	0.95	(18.7) ⁽¹⁾	Dry	PN-Z-040030-7, PN-ISO-10396
D077	0.06	1.8	7	17	Wet	BS EN 13649
D063	-	2.1	-	(19.2) ⁽¹⁾	-	VDI 3484-B2.2, EN 15259, EN 120
D063-b	-	2.1	-	(19.2) ⁽¹⁾	-	VDI 3484-B2.2, EN 15259, EN 120
D016	-	2.4	-	(15.75) ⁽¹⁾	Dry	NF X43-264
D006-a	4	4	4	17	Dry	Modified US EPA M316
D069	-	3	-	-	-	NIOSH 3500
D034	0.3	2.8	12.3	18.6	Dry	Methode Ineris
D053-a	2.7	3.3	4	(18 %) ⁽¹⁾	Dry	PN-Z-040030-7, PN-ISO-10396
D043	4.4	5.6	8.9	18	Dry	-
D047	7.5	7.9	8.1	17	Dry	US EPA-TO11/A
D044-a	5.1	6.2	8.1	18	Dry	US EPA-TO11/A
D003	4.4	9.2	14	17	Dry	VDI 3862
D042	7	7	9.2	18	Dry	US EPA-TO11/A
D080	7.05	7.1	7.2	(18) ⁽¹⁾	Dry	Modified US EPA M316
D004	5.3	6.2	6.9	-	Dry	VDI 3862
D081-a	3.5	6.3	7.8	-	Wet	Modified US EPA M316

Plant ID no	Formaldehyde (mg/Nm ³)			Additional information		
	Min.	Average	Max.	O ₂ reference (vol-%)	Data given on wet or dry basis	Standard method
D078-a	3	6.8	10	(18.25) ⁽¹⁾	-	Modified US EPA M316
D011a	0.1	7.4	22	(18.9) ⁽¹⁾	Wet	-
D024	-	7.5	-	-	Dry	VDI 3862
D001	-	7.7	-	17	Dry	-
D007	17.3	19.4	21.4	17	Wet	Modified US EPA M316
D051	14.8	16.5	18.5	(19.5) ⁽¹⁾	Dry	VDI 3484-2, EN 1911-1
D017	6.5	16.7	22.1	(16.6) ⁽¹⁾	Dry	NF X43 264
D089	-	23	-	-	-	-
D008	33	52	74	17	Wet	Modified US EPA M316
D095	-	1.3	-	19	Dry	NF X43 264
D012	-	0.25	-	11	Wet	NIOSH 3500

'-': No information available.
 (1) Measured vol-% O₂ when no correction is performed.
 Source: [22, TWG 2012], [23, WBP industry 2012]

The data in Figure 3.10 are presented alternatively, as the specific loads of formaldehyde per tonne of dried particles, in Table 3.11.

The lowest specific load is registered when using an RTO, which thermally destructs the VOC content, including formaldehyde. The range in specific load using cyclones, which do not abate formaldehyde, varies from 1.6 g to 58.5 g per tonne of dried particles. The range for the WESP and including treatment of press waste gas is narrower than for cyclones and varies from 30 g to 80 g per tonne of dried particles.

Table 3.11: Specific mass load of formaldehyde in emissions to air from PB dryers

Plant ID no	Specific mass load	Abatement technique applied and comments
	g formaldehyde/tonne of dried particles	
D005	0.3	RTO
D064	1.6	No abatement (<i>Multicyclones</i>)
D035	6.2	No abatement (<i>Cyclones</i>)
D034	8.5	No abatement (<i>Cyclones</i>)
D016	15.6	No abatement (<i>Multicyclones</i>)
D011-a	57.2	No abatement (<i>Cyclones</i>)
D017	58.5	No abatement (<i>Multicyclones</i>)
D024	22.4	Fabric filter, Indirectly heated dryer
D007	31	WESP
D044-a	38	WESP
D080	52.2	WESP
D081-a	71.6	WESP
D008	82.5	WESP
D043	24.3	WESP, press included
D001	33.5	WESP, press included
D078-a	33.6	WESP, press included
D042	49.7	WESP, press included
D033	1.8	Wet scrubber (<i>and Cyclones</i>)
D047	70.1	Venturi scrubber

Source: [22, TWG 2012], [23, WBP industry 2012].

Formaldehyde emissions for OSB lines lie within the same range as for PB, see Table 3.12. The measured values for formaldehyde where only cyclones or multicyclones are applied are low. Cyclone systems reduce dust levels but have no effect on formaldehyde. The low values could be explained either by the difficulties in representative sampling after a cyclone or the applied sampling method (isokinetic vs non-isokinetic or sampling in an impinging solution vs on adsorption tubes). The two production lines applying multicyclones in Table 3.12 were sampled using adsorption tubes and non-isokinetic sampling, while the remaining data were obtained by isokinetic sampling in an impinging solution, see also Section 3.7.2.2.

Table 3.12: Emission to air of formaldehyde from directly heated OSB dryers

Plant ID no	Formaldehyde (mg/Nm ³)			Additional information			
	Min.	Average	Max.	O ₂ reference (vol-%)	Data given on wet or dry basis	Standard method	Abatement technique
D096	0.1	0.2	0.5	-	Dry	-	UTWS
D032-a	0.3	0.6	0.8	18 (no correction)	Wet (21 %)	2,4 DNPH impinging solution	No VOC abatement (Multi-cyclones)
D032	0.4	0.8	1.2	18.5 (no correction)	Wet (21 %)	2,4 DNPH impinging solution	No VOC abatement (Multi-cyclones)
D013-a	-	5.6	-	11	Wet (35 %)	ISO 13649	No VOC abatement (Cyclones)
D013	-	5.4	-	11	Wet (35 %)	ISO 13649	No VOC abatement (Cyclones)
D010	5	9.2	12	17	Wet (26 %)	Modified US EPA M316	WESP
D079	9	14	18.5	17	-	Modified US EPA M316	WESP
D088	-	9.6	-	-	-	-	WESP
D041	0.97	15	27	20	Wet (11 %)	NCASI/C1/W P98.01	WESP
-: No information available. Source: [22, TWG 2012], [23, WBP industry 2012]							

Formaldehyde in dryer emissions from MDF production is reduced with wet scrubbers or bioscrubbers. Formaldehyde emissions for MDF lines, given in mass concentrations, are within the same range as for particleboard and OSB; see Figure 3.11.

Additional degradation of formaldehyde is achievable and is used at a few plants. Formaldehyde is degraded by chemical or catalytic assisted oxidation, during wet scrubbing or separately. Other simple aldehydes and alcohols are also oxidised.

Formaldehyde emissions can be higher than average, due to the selection of wood raw material [84, Weigl et al. 2009] and, to a lesser extent, the resin added before drying in MDF production and the amount of free formaldehyde present in the resin, but this can be deliberate in order to leave as little free formaldehyde in the finished panel as possible. The operating conditions for temperature and residence time can be adjusted to favour higher formaldehyde and TOC emissions during the production process, which is favourable when producing low-formaldehyde-emitting panels.

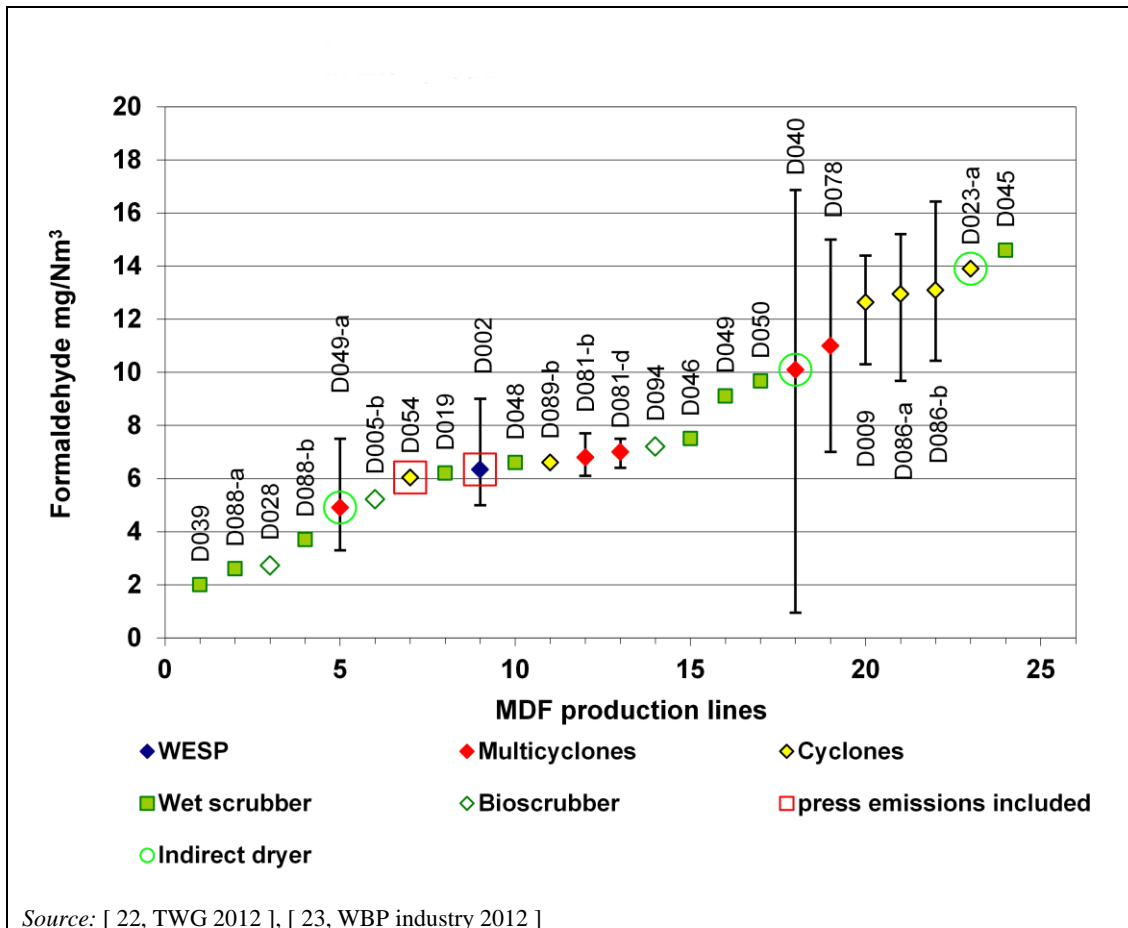

Figure 3.11: Values for formaldehyde in emissions to air from MDF dryers, based on data from 15 production lines

Data from MDF dryer emissions are given on both wet and dry bases. The reference conditions are given with a correction to a standard oxygen content or without any correction, and differing standard methods used for sampling and analysis are applied. The details are shown in Table 3.13.

Table 3.13: Supporting information and details on reference conditions concerning formaldehyde in emissions to air from dryers for MDF production lines shown in Figure 3.11

Data set	Formaldehyde (mg/Nm ³)			O ₂ content	Comments		
	Min.	Average	Max.	Measured O ₂ (vol-%)	Data given on wet or dry basis	% _{vol} moisture	Method
D039	1	2	4	17 (O ₂ reference vol-%)	Wet	16	US EPA Method 5, NCASI chilled water method
D088-a	-	2.6	-	-	-	-	-
D028	2.6	2.7	2.9	18.9 (O ₂ reference vol-%)	-	-	-
D088-b	-	3.7	-	-	-	-	-
D046	4.6	7.5	10.8	17 (O ₂ reference vol-%)	Dry	10	US EPA-TO11/A
D049-a	3.3	4.9	7.5	21	Dry	3	VDI 3484-2, EN1911-1
D054	-	6	-	20	Dry	-	-
D019	6	6.2	6.5	-	-	-	VDI 3862
D002	5	6.3	9	19.2	Dry	-	-
D048	4.2	6.6	13.9	19.2	Dry	12.8	VDI 3484-2, EN1911-1
D089-b	-	6.6	-	-	-	-	-
D081-b	6.1	6.8	7.7	20.85	Wet	7.3	Modified US EPA M316
D081-d	6.4	7	7.5	20.85	Wet	6.98	Modified US EPA M316
D045	13.9	14.6	15.6	17 (O ₂ reference vol-%)	Dry	13	US EPA-TO11/A
D049	2.5	9.1	18.4	18.6	Dry	12.6	VDI 3484-2, EN1911-1
D050	6.4	9.6	13.2	19.57	Dry	8.43	VDI 3484-2, EN1911-1
D040	0.95	10.1	16.9	20	Wet	14	NCASI/C1/W P98.01
D078	7	11	15	19.4	-	-	Modified US EPA M316
D009	10.3	12.6	14.4	19.75	Dry	-	Modified US EPA M316
D086-a	9.7	12.9	15.2	18.81	Wet	16.5	Modified US EPA M316
D086-b	10.4	13.1	16.4	18.94	Wet	16.09	Modified US EPA M316
D005-b	-	5.2	-	20.17	Dry	-	-
D094	6.8	7.5	7.8	-	Dry	-	-

': No information available.
Source: [22, TWG 2012], [23, WBP industry 2012].

Instead of mass concentrations, the specific mass load per tonne of dried fibre could illustrate more accurately the actual emission of formaldehyde for example. In order to express the specific mass load, average values of early production of dried fibre in tonnes have been used, together with an average airflow and measured formaldehyde concentration. In Table 3.14, the specific mass loads are indicated, together with the related abatement technique for a selection of the MDF production lines.

Table 3.14: Specific mass load of formaldehyde from MDF fibre dryers

Plant ID no	Specific mass load	Abatement technique and comments
	g formaldehyde/tonne of dried fibre	
D049	20	No VOC abatement (<i>Multicyclones</i>), indirect dryer
D078	70	No VOC abatement (<i>Multicyclones</i>)
D009	100	No VOC abatement (<i>cyclones</i>)
D081	150	No VOC abatement (<i>Multicyclones</i>)
D040	160	No VOC abatement (<i>cyclones</i>)
D002	70	WESP with press waste gas
D048	105	Wet scrubber Chemical oxidation
D049	120	Wet scrubber Chemical oxidation
D050	130	Wet scrubber Chemical oxidation
D046	170	Wet scrubber
D045	200	Wet scrubber
D028	30	Bioscrubber
<i>Source:</i> [22, TWG 2012], [23, WBP industry 2012].		

The specific loads should be taken as indications only, since several estimations need to be included in the calculation. Depending on the accuracy of the sampling and the comparability between the measured concentrations, the raw material and the quantity of product dried at the moment of sampling and during the year, there will be differences that cannot be accounted for.

The specific mass load depends on the incoming load in the waste gas and the efficiency of the abatement technique. At three plants, a chemical oxidation, targeting formaldehyde, is performed as the operating conditions favour an almost complete transfer of any free formaldehyde, present in the raw material and resin, to air. Even if the efficiency of the scrubber and chemical oxidation is high, there is still a residual amount of formaldehyde emitted.

When applying a wet scrubber, the specific mass load ranges between 100 g and 200 g formaldehyde per tonne of dried fibre. Cyclones show lower values than wet scrubbers even though cyclones do not reduce formaldehyde. This could be due to difficult sampling conditions, which do not favour a representative sample.

The corresponding specific loads of formaldehyde per tonne of dried flakes in OSB production emitted from the dryer after treatment are given for four production lines:

- 33 g formaldehyde/tonne of dried flakes (D010, direct dryer, WESP);
- 194 g formaldehyde/tonne of dried flakes (D041, direct dryer, press emissions, WESP);
- 13 g formaldehyde/tonne of dried flakes (D013, direct dryer 1, no abatement (*cyclones*));

- 37 g formaldehyde/tonne of dried flakes (D013, direct dryer 2, no abatement (cyclones)).

The specific load for a range of PB lines has been shown in Table 3.11. The specific loads of formaldehyde in both OSB and PB dryer emissions are generally lower than for MDF lines.

3.2.1.3 Organic compounds in dryer emissions

Organic compounds are determined as either a single pollutant such as formaldehyde or acetic acid or as a sum or group of organic compounds. There is a considerable variety in the choice of sampling and analytical standards and when expressing the total amount of organic compounds. Figure 3.12 shows the variation in the quantity of organic content in dryer emissions from PB lines and related to the analytical parameters. The values are not directly comparable. The variation is mainly due to the reporting conditions (dry or wet basis), the raw material and the actual performance of the production plant and the abatement technique applied, but the choice of parameter and the related standard cannot be neglected.

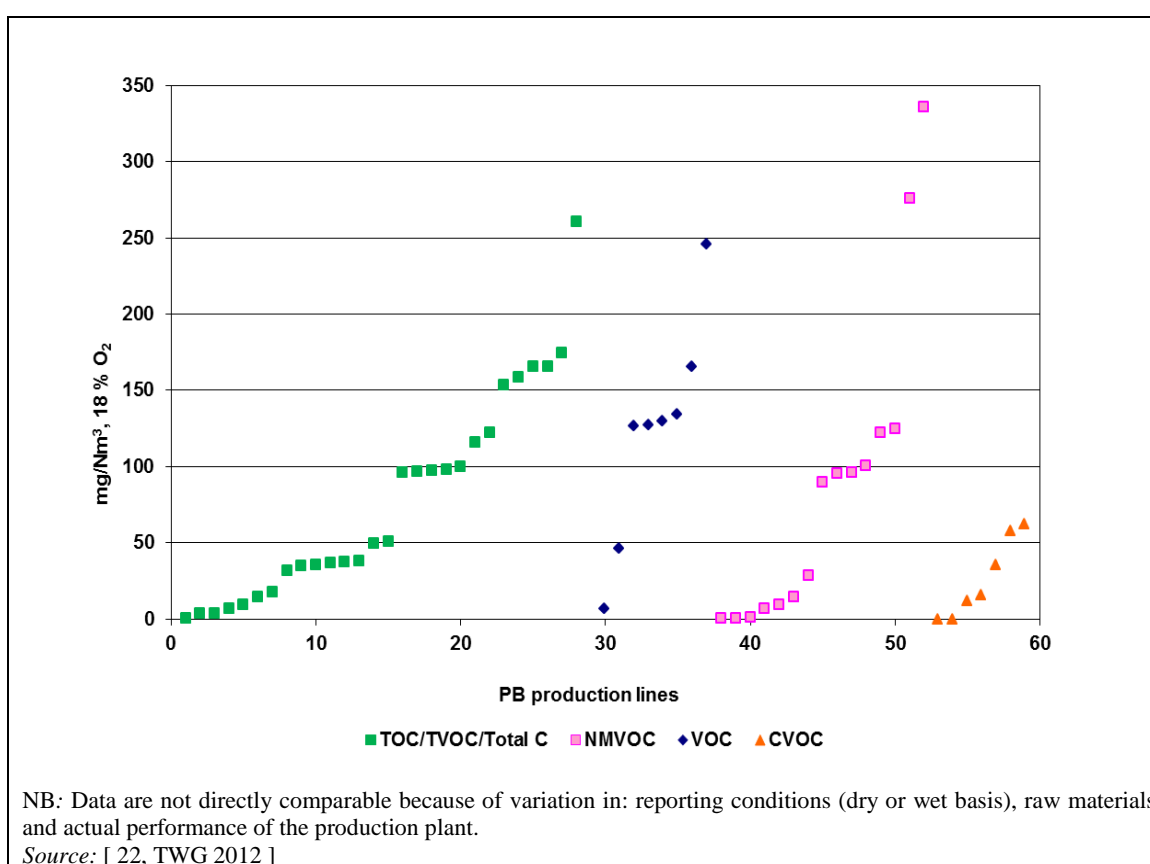

Figure 3.12: Illustration of the variation in the contents of organic compounds in emissions to air from PB dryers

The parameters covering the organic fraction reported in the data collection vary between the following:

- TOC (total organic compounds);
- VOCs/TVOC (volatile organic compounds/total volatile organic compounds);
- NMVOC (non-methane volatile organic compounds);
- TC (total carbon, including inorganic carbon);
- CVOCs (condensable volatile organic compounds).

There is no direct and calculable relationship between the five parameters. TOC, TVOC and VOCs in the dryer emissions are expected to be comparable, while CVOCs give lower results, see also Figure 3.12. CVOCs consist of organic compounds that condense at ambient temperatures and consist of evaporated pitch and wood pyrolysis or oxidation products, e.g. from terpenes, such as carboxylic acids and carbonyls. Terpenes are the main constituent of VOCs in some soft wood species, but are not part of the CVOCs.

TOC should in theory be higher than any of the other parameters. In practice, it is only the volatile part which is sampled and TOC is hence TVOC, the volatile part of TOC. In direct drying, the flue-gas contributes to the overall TOC. TC comprises all carbon and will be comparable to TOC or TVOC in emissions from the dryer, but TC could potentially also include inorganic carbon, such as CO, CO₂ and CH₄. Methane (CH₄) could be a significant part of a TOC/TVOC sample. The methane contribution can easily be subtracted from the total TVOC if the proper standard is followed, allowing the NMVOC to be expressed.

The results for TOC/TVOC/NMVOC/VOCs are expressed in mg C, when using the EN 12619 standard. The result is sometimes expressed as hexane, pentane, monoterpenes or toluene, which would give a variation up to 1.2, compared to C. The potential variation is not considered significant in terms of comparing the monitoring data from the data collection.

Some emission data have simultaneously been analysed for two or more of the parameters, as shown in Table 3.15.

Table 3.15: Examples of contents of organic compounds in dryer emissions expressed by different parameters

Plant ID no	O ₂ reference	VOC (mg/Nm ³)	TOC (mg/Nm ³)	NMVOC (mg/Nm ³)	CVOC (mg/Nm ³)
D012	11 %	-	12	2.5	0.38
D010	17 % dry	564 ⁽¹⁾	292	564	-
D043	18 %	-	37	29	-
D035	No O ₂ correction	5.5	81	75	-
D017	No O ₂ correction	-	83	80	-
D034	No O ₂ correction	100	-	76	16
D016	No O ₂ correction	106	-	104	-

¹: No information available.
⁽¹⁾ The values for VOCs should not be higher than TOC. The difference is explained in VOC/NMVOC measured with a FID and given as C, while TOC for this analysis is measured by sampling on adsorption tubes and analysed by GC-MS.
Source: [22, TWG 2012]

All given data are used in the further presentation of the current emission levels of organic compounds to air from particleboard lines. The parameter CVOC is worth including, e.g. when the techniques for reducing condensable VOCs in emissions to air are assessed. The CVOC data are scarce, but are included when relevant. The applied sampling and analytical standard is indicated when needed.

The variation of emissions of volatile organic compounds from 41 PB production lines is shown in Figure 3.13. A WESP is used at more than half of the sites. The distribution ranges from below 20 mg/Nm³ to more than 250 mg/Nm³. It is also indicated if the press emissions are treated with the same technique.

Efficient dust abatement techniques such as a bag filter, see Section 3.2.1.1, should not have any reduction efficiency for the organic component in the dryer waste gas. The levels of organic compounds measured at two PB plants with bag filters for dust abatement showed values for

VOCs of 205 mg/Nm^3 at one plant (D004) and a level for NMVOC of 230 mg/Nm^3 at another plant (D024). Formaldehyde was measured from 6 mg/Nm^3 to 7.5 mg/Nm^3 at both plants.

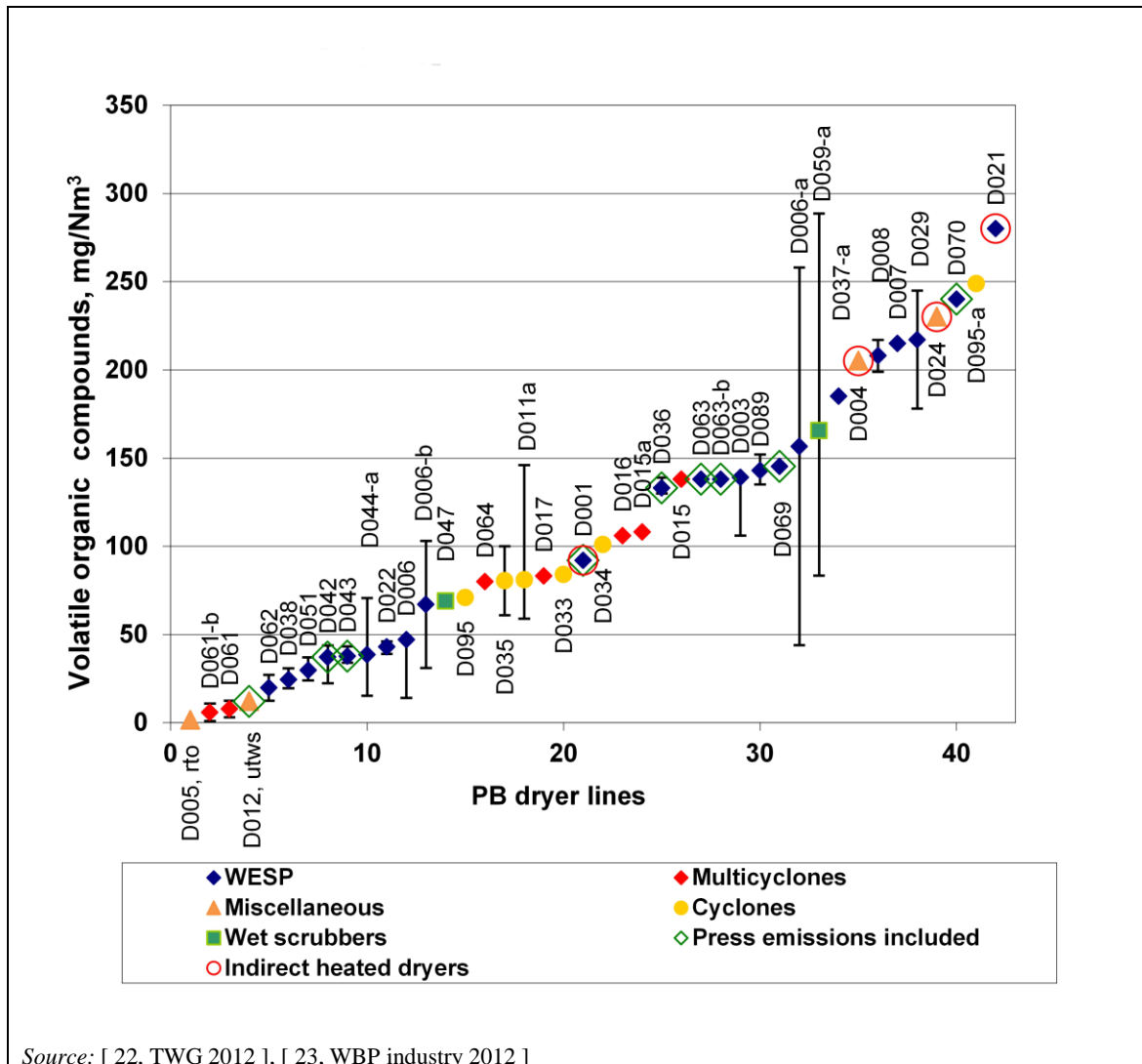

Figure 3.13: Values for volatile organic compounds in emissions to air from PB dryers, based on data from 41 production lines

The data presented in Figure 3.13 are given on both wet and dry bases. The reference conditions are given with a correction to a standard oxygen content or without any correction, and differing standard methods used for sampling and analysis are applied. The details are shown in Table 3.16.

Table 3.16: Supporting information and details on reference conditions presented in Figure 3.13 concerning volatile organic compounds in emissions to air from PB dryers

Plant	Volatile organic compounds (mg/Nm ³)			O ₂ content		Additional information		
	Min.	Average	Max.	O ₂ reference (vol-%)	O ₂ (vol-%) (no correction)	Wet/dry	Parameter	Method
D005	-	1.4	-	17	14.02	Dry	NMVOC	-
D061-b	1	5.9	10.8	-	20.85	Dry	TOC	US EPA 25A
D061	3	7.7	12.4	-	20.85	Dry	TOC	US EPA 25A
D012	-	12	-	11	-	Wet	TOC	EN 13526
D062	12.5	19.8	27.1	17	18.8	Dry	TOC	US EPA 25A
D038	19.5	24.4	30.8	17	-	Dry	TOC	-
D051	24	29.7	37	-	19.2	Dry	TOC	EN 13526
D042	22.3	37.1	43.7	18	-	Dry	TOC	EN 12619-1
D043	34	37.6	43.3	18	17.5	Dry	TOC	-
D044-a	15.3	38.5	70.6	18	-	Dry	TOC	EN 12619-1
D022	39	43	46	17	-	Wet	TOC	-
D006	14	47	47	-	-	Wet	TOC	EN 13526
D006-b	31	67	103	-	-	Wet	TOC	EN 13526
D047	73	69	65	-	-	Dry	TOC	EN 12619-1
D064	-	80	-	-	-	-	TOC	EN 13526
D035	61	80.5	100	-	-	-	TOC	-
D011a	59	81	146	-	18.9	Wet	TOC	-
D017	-	83.2	-	16.6	-	Dry	TOC	EN 12619
D033	-	84	-	-	18.7	Wet	NMVOC	NFX 43-300, NFX 43-301
D001	-	92	-	17	-	Dry	TOC	-
D034	-	101	-	19	-	Dry	VOC	-
D016	-	106	-	-	15.75	Dry	VOC	EN 12619
D015a	-	108	-	-	18	Wet	VOC	-
D036	130	133	139	17	-	-	TOC	-
D015	-	138	-	-	18	Wet	VOC	-
D063	-	138	-	19.2	-	-	TOC	EN 12619
D063-b	-	138	-	19.2	-	-	TOC	EN 12619
D003	106	139	139	17	-	Dry	TOC	EN 12619
D089	135	143	152	-	-	-	TOC	-
D069	-	145	-	-	-	-	TOC	VDI 3481. adsorption on silica gel
D006-a	44	156	258	-	-	Wet	TOC	EN 13526
D059-a	83	165	288	-	19	Dry	TOC	Continuous measurement. FID analyser
D037-a	-	185	-	17	-	-	TOC	-
D008	199	208	217	17	-	Dry	TOC	EN 13526
D007	-	215	-	17	-	Wet	TOC	EN 13526
D029	178	217	245	-	-	-	TOC	-
D024	-	230	-	-	-	-	NMVOC	EN 12619
D004	190	205	219	-	-	Dry	VOC	EN 12619
D070	-	240	-	6	-	Dry	VOC	-

Plant	Volatile organic compounds (mg/Nm ³)			O ₂ content		Additional information		
	Min.	Average	Max.	O ₂ reference (vol-%)	O ₂ (vol-%) (no correction)	Wet/dry	Parameter	Method
D021	270	280	300	-	-	Wet	NMVOC	-
D095	-	70.9	-	19	-	Dry	NMVOC	EN 12619
D095-a	-	249	-	19	-	Dry	NMVOC	EN 12619

': No information available.
Source: [22, TWG 2012], [23, WBP industry 2012].

The specific mass loads calculated from the PB production lines show a variation from 150 g to 950 g TVOC per tonne of dried particles. The range related to a WESP is 160–340 g TVOC per tonne of dried particles (six plants). The range for cyclones and multicyclones is quite wide, from 150 g to 950 g TOC per tonne of dried particles (four plants), reflecting the possible variation in the contribution from raw material and resins, since cyclones do not have the potential to abate volatile organic compounds.

The variation of emissions to air of volatile organic compounds from OSB dryers is shown in Table 3.17. The WESP is used at more than half of the sites. One plant treats the press emissions in the WESP together with the dryer emission and has a higher value than the other three plants.

Table 3.17: Emission to air of volatile organic compounds from directly heated OSB dryers

Plant ID no	TOC (mg/Nm ³)	Abatement technique applied and comments
D013a	182	No VOC abatement (<i>multicyclones</i>), at 11 % O ₂ , wet, EN 12619
D013	226	No VOC abatement (<i>multicyclones</i>), at 11 % O ₂ , wet, EN 12619
D088	673	WESP, unknown reference conditions
D029	217	WESP, dry, O ₂ unknown Mixed with PB dryer waste gases
D010	216	WESP, at 17 % O ₂ , wet, EN 13649
	VOC	
D027	402	WESP, unknown reference conditions
D010	999	WESP, at 14 % O ₂ , dry, EN 12619
	CVOC	
D041	29	WESP, unknown reference conditions
D079	52	WESP, unknown reference conditions
	NMVOC	
D032	349	No VOC abatement (<i>cyclones</i>), at 18.5 % O ₂ , wet, NFX 43–300 and NFX 43–301
D032-a	259	No VOC abatement (<i>cyclones</i>), at 18 % O ₂ , wet, NFX 43–300 and NFX 43–301

Source: [22, TWG 2012]

The data on volatile organic compounds in emissions to air from OSB dryers are in general not supported by sufficient information. Comparing these levels with the levels from PB and MDF dryer lines is therefore difficult. The data from OSB dryers applying abatement techniques that would have some efficiency for volatile organic compounds are related to WESPs only. From the data it could however be deduced that TVOC levels before abatement are in general higher from OSB dryer lines, owing to the effect of the use of 100 % fresh log wood as the only raw material. The raw material and also the choice of abatement techniques and the operation of the dryer should be taken into account when comparing the emission levels of volatile organic compounds from OSB, PB and MDF production.

In MDF production, where the resin is applied before drying, the measured levels of volatile organic compounds are in the same range as for PB, see Figure 3.14.

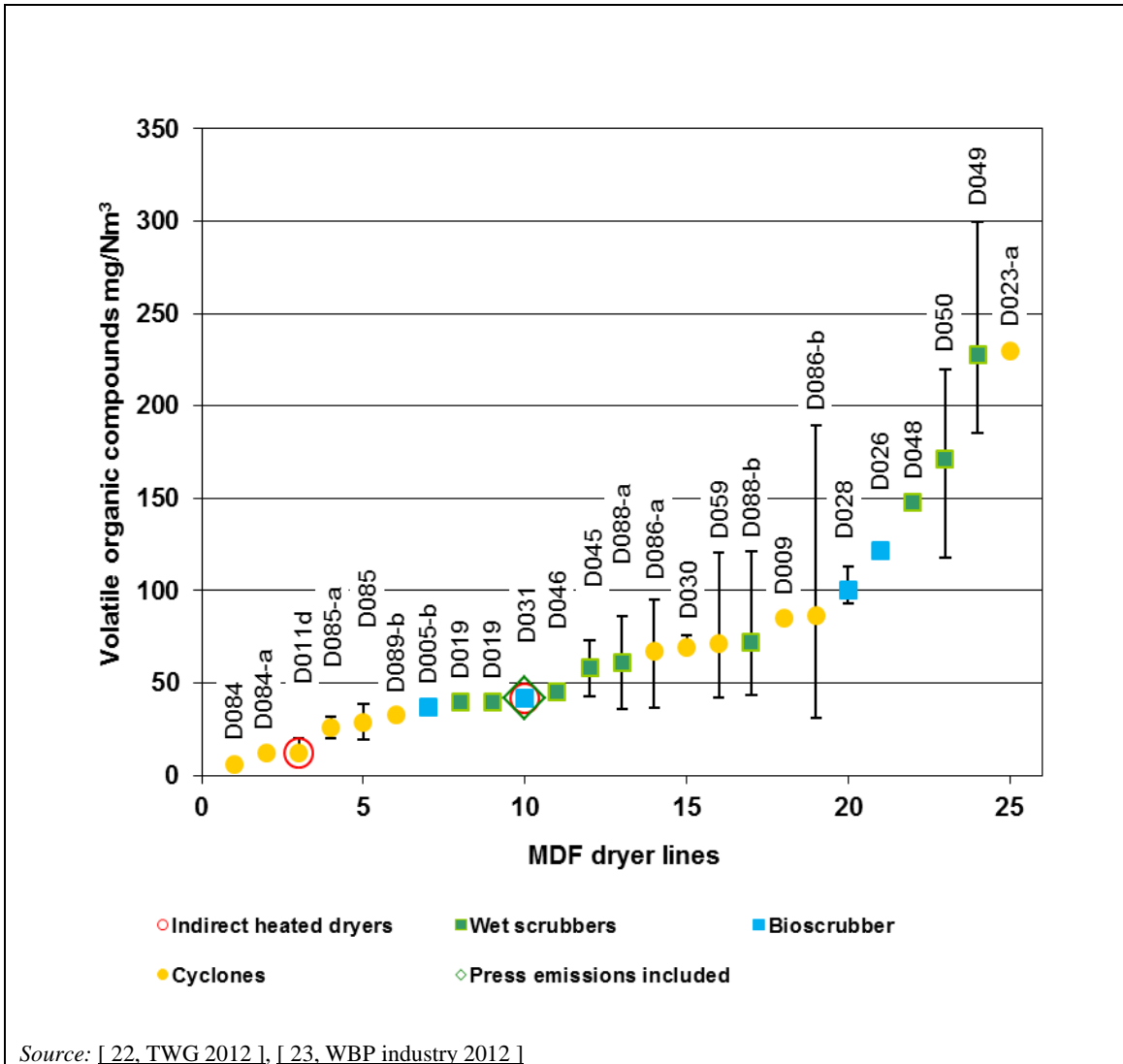

Source: [22, TWG 2012], [23, WBP industry 2012]

Figure 3.14: Values for volatile organic compounds in emissions to air from MDF dryers, based on data from 24 production lines

Data from MDF dryer emissions are given on both wet and dry bases. The reference conditions are given with a correction to a standard oxygen content or without any correction, and differing standard methods used for sampling and analysis are applied. The details are shown in Table 3.18.

Table 3.18: Supporting information and details on reference conditions for data presented in Figure 3.14 concerning volatile organic compounds in emissions to air from MDF dryers

Plant ID no	Volatile organic compounds (mg/Nm ³)			O ₂ content		Additional information			
	Min.	Average	Max.	O ₂ reference (vol-%)	O ₂ (vol-%) (no correction)	Wet/dry	Moisture (%)	Method	Implemented techniques
D089-b	-	32.6	-	-	-	-	-	-	Cyclones
D088-a	-	61.1	-	-	-	-	-	-	Wet scrubber
D088-b	-	72	-	-	-	-	-	-	Wet scrubber
D011d	9	12	20	-	-	-	-	-	Indirect dryer, Cyclones
D046	30	45	60	17	-	Dry	10	EN 12619	Wet scrubber
D045	32.6	58	83	17	-	Dry	13	EN 12619	Wet scrubber
D031	-	42	-	-	20.89	Wet	-	EN 12619	Biological scrubber indirect dryer, press included
D030	65.8	69.4	75.6	-	20.7	Dry	-	-	Cyclones
D059	42.3	71	120	-	20.95	Dry	4.25	EN 13526	Direct dryer
D009	85	85	85	-	19.75	Dry	-	EN 13526	Cyclones
D048	95	148	197	-	19.1	Dry	12.4	EN 13526	2-stage dryer. Cyclone /wet scrubber ⁽¹⁾
D050	129	171	243	-	19.27	Dry	8.33	EN 13526	1- and 2-stage flash direct dryer. Cyclone/wet scrubber ⁽¹⁾
D049	136	227	292	-	18.2	Dry	15	EN 13526	1-stage direct flash dryer. Cyclone/ wet scrubber ⁽¹⁾
D028	93	100	113	18.9	-	-	-	-	NMVOC, Bioscrubber
D026	120	121.6	124	-	-	-	-	EN 12619	VOC, Bioscrubber
D086-a	36.3	67.2	94.9	-	18.81	Wet	16.5	EN 12619	NMVOC, Cyclones
D086-b	30.9	86.7	189.3	-	18.94	Wet	16.09	EN 12619	NMVOC, Cyclones
D085	19.1	28.7	38.3	17	-	Dry	-	US EPA 25A	VOC, Cyclones
D085-a	19.7	25.6	31.6	17	-	Dry	-	US EPA 25A	VOC, Cyclones

Plant ID no	Volatile organic compounds (mg/Nm ³)			O ₂ content		Additional information			
	Min.	Average	Max.	O ₂ reference (vol-%)	O ₂ (vol-%) (no correction)	Wet/dry	Moisture (%)	Method	Implemented techniques
D023-a	-	230	-	-	-	Dry	10.65	EN 12619	NMVOC, indirectly heated dryer, Cyclones
D019	38	39.8	41.6	-	-	-	-	VDI 3481	3-step wet scrubber
D005-b	-	37	-	-	20.17	Dry	-	-	NMVOC, Venturi and bioscrubber
D084	6.1	6.2	6.3	17	-	Dry	-	US EPA 25A	NMVOC, Pre-dryer first stage. Cyclones
D084-a	-	11.8	-	-	21	Wet	-	US EPA 25A	NMVOC, Second Stage. Cyclones

'-': No information available.
 (†) Chemical abatement of formaldehyde/biological oxidation.
 Source: [22, TWG 2012], [23, WBP industry 2012].

Even though the drying temperature is lower, the natural content of volatile organic compounds in the wood particles still contributes to the overall TOC level. This is illustrated by an example from a flex/rigidboard plant where the fibres are dried under similar conditions, but with no addition of resin before drying. The reported emission level for TOC using cyclones and a wet scrubber is from 67 mg/Nm³ to 114 mg/Nm³.

The specific mass load of TOC from a fibre dryer in two flex/rigidboard plants (D090 and D075) is compared to two MDF fibre dryers, see Table 3.19. The dryer waste gas is treated in cyclones and wet scrubbers for all plants except the first plant (D075), where no wet scrubber is applied. From the limited data, it appears that the natural contribution from the wood is most likely around 400–500 g TOC/tonne of dry fibre. The contribution of natural TOC should be taken into account, but the contribution of TOC from the resins could result in even higher emissions.

Table 3.19: Emission to air of volatile organic compounds and the related specific mass load from fibre dryers, using cyclones and wet scrubbers as the abatement technique

Plant ID no	TOC	Specific mass load	Comment
	mg/Nm ³	g TOC/tonne of dried fibre	
D075	49	372 – 511	Softwood and hardwood, dry, no correction for O ₂
D090	99	287 – 488	Softwood and hardwood, dry, no correction for O ₂
D049	227	1700 – 3650	Hardwood, recovered wood, dry, no correction for O ₂ , EN 13526
D045	58	431 – 1120	Softwood and hardwood, 17 % O ₂ , dry, EN 12619

Source: [22, TWG 2012], [23, WBP industry 2012].

Plant D049 in Table 3.19 uses a wet scrubber with chemical oxidation, which gives low formaldehyde values, but higher TOC values, which could be due to degradation products from

the simultaneous chemical oxidation of the easily oxidised terpenes. The composition of TOC is not known.

3.2.1.4 Additional collected data on dust and organic emissions from dryers

Data from a selection of wood-based panel sites in one Member State are shown in

Table 3.20, including dust, TVOC (reported as total carbon (TC) which could also include inorganic carbon) and formaldehyde in emissions of dryer waste gas [45, VDI 2011]. Other parameters are included such as organic acids and benzene but are only represented with a single monitoring result. Sporadic sampling and analysis for PCDD/F, HF, HCN, HCl and PAHs from directly and indirectly heated particleboard chip dryers showed values around the limit of detection.

Table 3.20: Emission levels from particleboard and MDF lines in Germany

	Total dust (mg/Nm³)	TVOC (mg/Nm³)	Formaldehyde (mg/Nm³)	Comments
Directly heated particleboard dryers with a WESP	0.9 – 12.8 (Average 7.9)	117 – 134 (Average 124)	22	Corrected to 17 % oxygen, no correction to dry conditions
Number of sample plants	7	4	1	
Indirectly heated particleboard dryers	NA	200–250	NA	Corrected to 17 % oxygen, no correction to dry conditions
Number of sample plants	NA	2 ⁽¹⁾	NA	
Directly heated MDF fibre dryers ⁽²⁾	2.0 – 2.9 (Average 2.7)	32 – 107 ⁽³⁾ (Average 70)	6.3 – 440 ⁽³⁾	No correction for oxygen, corrected to dry conditions
Number of sample plants	4	4	Approx. 6	
General comments: Analytical methods follow DIN standards. No details are given. There is no information on whether the individual values are average values. There is no information on the detection limits of the analytical methods applied. ⁽¹⁾ One of the two plants uses a multicyclone/WESP, while the other uses a bag filter (the reported reference conditions for the plant using a bag filter is without correction for O ₂ or for moisture). ⁽²⁾ MDF dryers reporting dust values use multicyclones or a two-step bioscrubber. ⁽³⁾ The range of TC or formaldehyde content illustrates the use of different end-of-pipe techniques, resin systems and the application of resin before or after drying. The details are not given. NA: not available. Source: [45, VDI 2011]				

For one Member State, additional data concerning the total yearly load from the E-PRTR and the corresponding realised production have been made available. The calculated specific mass loads in Table 3.21 are within the ranges already reported in previous sections. The reporting requirements for the E-PRTR include formaldehyde and NMVOC. The E-PRTR data are load-based and reflect the total yearly emitted load, which is directly related to production size.

Table 3.21: Specific mass loads from production sites in France

	Total dust (kg/Nm³ of finished panel)	NMVOC (kg/Nm³ of finished panel)	Formaldehyde (g/Nm³ of finished panel)
	0.04 – 0.44	0.11 – 1	0.1 – 140
Number of sample plants	4	7	3
Source: [47, France E-PRTR 2010]			

Data from nine PB and MDF dryer lines in one Member State are shown in Table 3.22. Some of the data are also reported in the data collection. The emission data cover both directly and indirectly heated dryers. The monitoring is periodic and the results represent one or more sampling events. NO_x is monitored on a regular basis and the lower levels are most likely to be related to indirectly heated dryers. Other parameters such as organic acids, phenol and PCDD/F are monitored at a few lines. At one plant the organic acids content is markedly higher and between 4 mg/Nm³ and 9.9 mg/Nm³.

Table 3.22: Emission levels from particleboard and MDF lines in Austria

Plant	Dust (mg/Nm ³)	NO _x (mg/Nm ³)	CO (mg/Nm ³)	Organic C (mg/Nm ³)	Formaldehyde (mg/Nm ³)	Organic acids (mg/Nm ³)	Phenol (mg/Nm ³)
1 ^{(1), (3)}	0.8 – 4	100	70	106–139	4.4 – 14	-	-
2 ⁽¹⁾	20 – 28	19 – 25	26 – 41	98 – 116	2.9 – 7.0	-	-
3 ⁽¹⁾	14 – 22	19 – 30	66 – 85	126 – 132	4.4 – 7.2	-	-
4 ⁽²⁾	2 – 4	-	-	190 – 219	3.8 – 4	4–9.9	< 1
5 ^{(2), (4)}	< 1 – 2.5	1–3	1.9 – 2	28.7 – 37.0	1.9 – 5.22	< 0.2 – 1.0 ⁽⁵⁾ < 0.5 – 3.3 ⁽⁶⁾	0.01
6 ⁽¹⁾	2 – 3	186 – 288	11 – 13	1.4 – 1.9	0.11 – 0.13	-	-
7 ⁽²⁾	3	-	-	-	6	-	-
8 ⁽²⁾	0.6 – 0.8	1	6.6 – 11.0	18 – 40 ⁽⁷⁾	4.9 – 8.7	-	0.01 – 0.36
9 ⁽¹⁾	0.5 – 5	5 – 155	9.0 – 24	9.0 – 9.3 ⁽⁷⁾	1.2 – 3.3	-	0.1 – 0.4

-: No information available.
⁽¹⁾ Reference 17 % O₂.
⁽²⁾ Given with no O₂ correction.
⁽³⁾ PCDD/F < 0.05 ng/m³.
⁽⁴⁾ PCDD/F < 0.1 ng/m³.
⁽⁵⁾ HCOOH.
⁽⁶⁾ CH₃COOH.
⁽⁷⁾ CVOC.
 Source: [58, UBA Austria 2013]

Variation in the composition of VOC emissions

Studies concerning the composition of dryer waste gas identified the VOC fraction released during drying from two different wood species. The total quantity of VOC emissions differs between softwood and hardwood species, e.g. the softwood species maritime pine clearly contains higher levels of volatile compounds [48, Sonae Industria 2012].

The most abundant group in the dryer waste gas is the terpenes, which are a constituent in every plant material. In softwood, the highly volatile α- and β-pinenes are dominant. Some compounds detected when studying air emissions from dryers are oxidation products from the pinenes such as acids or aldehydes.

The composition and quantity of VOCs in the dryer waste gas depend on the wood species used and the drying temperature. Moreover, even within single wood species the distribution will vary depending on harvest time, cultivation conditions, storage time and storage conditions.

The composition of the VOC fraction in the emission from dryers has been studied, with the purpose of determining the main constituents and to illustrate the difference in emissions from various wood species.

In a study 43 different VOC compounds were identified in the dryer emissions from a particleboard plant using maritime pine as the only raw material. The main constituent was α-pinene, followed by β-pinene, limonene, beta-caryophyllene and longifolene. All compounds detected were terpenes. The total VOCs measured were on average 100 mg/Nm³ (19 % O₂). The

VOC analysis includes components over C₆ (six carbon atoms) and does therefore not include formaldehyde and for example methanol, nor does it include other lower aldehydes or carboxylic acids [46, DREAL Aquitaine 2005].

The total VOC levels in different mixes of wood species are illustrated in a series of trials performed on a particleboard plant in 2011, see Table 3.23. The VOC emissions were measured continuously by a FID in the waste gas from a directly heated dryer.

Table 3.23: Measurement of dryer emissions from one installation's test runs with a mix of fuel and raw material

	Wood material	Fuel	VOC average values (mg/Nm ³)	Dryer conditions
Dryer test 1	Hardwood	Natural gas	70	Inlet temperature 432°C
	Softwood (pine)	Natural gas	150	Inlet temperature 432°C
Dryer test 2	Hardwood	100 % dust	45	Inlet temperature 372°C
	Hardwood	Gas + dust	120	Inlet temperature 432°C

Source: [48, Sonae Industria 2012]

To illustrate the source emission load from the dryer compared to the load from press emissions, samples from unabated dryer and press waste gas in a particleboard plant were analysed for three organic compounds and hydrocarbons. Even if the mass concentration from the press is much higher than found in the dryer waste gas emission, the corresponding mass load shows that the amount of the organic compounds emitted from the dryer are 6 to 18 times higher.

Table 3.24: Measurement of three main VOC constituents in a particleboard plant using maritime pine as the raw material

Parameter	Unit	Dryer	Press exhaust
Hydrocarbons (C ₆ -C ₁₂)	µg/Nm ³	1773	15 983
	mass load g/h	386	62
Limonene	µg/Nm ³	1529	7076
	mass load g/h	334	27
α-Pinene	µg/Nm ³	78 134	240 737
	mass load g/h	17 028	935
Xylene	µg/Nm ³	-	2160
	mass load g/h	-	8
Airflow during measurement	m ³ /h	217 938	3887

': No information available.
Source: [46, DREAL Aquitaine 2005]

The drying temperature will have an effect on the emission of VOCs from the raw material. It is expected that the higher the temperature applied during drying, the more VOCs will be emitted.

In a particleboard plant, a pre-dryer dries green chips gently at an inlet temperature of 90 °C and an outlet temperature of 70 °C to a humidity of 40–80 %. In the main directly heated dryer, the chips are dried to 2 % humidity. The inlet temperature is 150 °C and the outlet is 115 °C. Both emissions are treated with a Venturi wet spray system and each has an emission flow of 40 000 m³/h. The two dryer stages are monitored individually and the results are shown in Table 3.25. While the dust and formaldehyde emissions from the two dryer steps are comparable, the VOC fraction, in this case expressed as TOC, is twice as high after the main dryer as for the pre-dryer. It should be mentioned that pre-drying can also be performed at a higher temperature than the main second stage dryer. Under those circumstances the TOC emissions could be higher in the first stage.

Table 3.25: Comparison of quantitative dryer emissions from a particleboard plant

	Parameter	Average concentration ⁽¹⁾ (mg/Nm ³)	Calculated load (kg/year)
Pre-dryer	Dust	14	3360
	Formaldehyde	14	3300
	TOC	65	15 850
Main dryer	Dust	12	3650
	Formaldehyde	15	4780
	TOC	106	33 210

(1) Reference conditions: 18 % O₂ with no correction to dry conditions, except for formaldehyde which is corrected to dry conditions.
Source: [22, TWG 2012]

3.2.1.5 Emissions of NO_x and SO_x to air from directly heated dryers

The hot gases used for direct drying affect the composition of the dryer emission. Depending on the fuel used and the combustion technique, the contribution of NO_x and SO_x can be significant.

High emissions of NO_x and especially SO_x are registered for liquid fuels (particularly SO_x for high-sulphur fuels), with a minor number of diesel engine plants are in operation, mainly in the form of CHP plants. Where there is no ready access to natural gas, liquid fuels are used as fuel alternatives and are widely used during shutdowns of the main combustion plant as emergency plant fuel or for heating thermal oil.

In the production of MDF, additives that contain nitrogen, such as an aqueous solution of ammonium nitrate, are added together with resin to the fibres before drying, but their contribution to the overall NO_x emissions is questionable. Since there are only a few MDF plants with available data and with a diverging result to support this assumption, NO_x levels in waste gases from indirect drying have not been assessed further.

The available data sets are not comprehensive enough to assess any involvement of NO_x emissions from the wood raw material, resins or additives during drying. First of all, for indirectly heated dryers, monitoring of NO_x and CO emissions is generally not performed as the contribution from the wood material is considered very low.

The CO values reported do not provide any useful information and are shown for information purposes only. Formation of CO is related to the combustion process during the production of hot gas. CO formation in the dryer is likely to be too insignificant to measure.

For directly heated PB dryers, NO_x emissions to air at 25 PB production lines are shown in Figure 3.15. All values are shown at 18 % O₂ and preferably on a dry basis. In Table 3.26 the data for NO_x emissions are alternatively shown with the reported values together with information on the oxygen content during sampling or the oxygen correction used when

reporting values. The corresponding CO values are also shown and the fuels used for producing the hot gases for drying are indicated as well.

Table 3.26: NO_x and CO emissions to air from directly heated PB dryers

Plant ID no	NO _x (mg/Nm ³)	O ₂ in waste gas during sampling (%)	CO (mg/Nm ³)	Fuel mix and comments
D051	10	19	79	100 % PR/RW. SNCR
D064	47	18.5	14	98 % PR 2 % G
D062	88	⁽¹⁾	215	45 % PR 45 % RW 10 % HFO
D076	77	⁽¹⁾	67	50 % PR 50 % G
D071	45	19.1	134	80 % B 20 % G
D003	100	⁽¹⁾	70	80 % PR 20 % G
D034	65	18.6	173	35 % PR 65 % RW
D017	148	16.6	872	50 % PR 50 % G
D012	286	⁽²⁾	261	PR/G (UTWS)
D069	110	18.5	-	35 % RW, 50 % PR, 15 % HFO
D029	114	18.5	121	45 % PR 45 % RW 10 % G
D022	170	⁽¹⁾	60	75 % PR 25 % HFO
D072	44	19.9	37	20 % PR 80 % G
D035	113	18.5	154	72 % PR 22 % RW 6 % G
D005	186	⁽¹⁾	13	PR/G (after RTO)
D072-a	192	16.9	442	100 % PR
D080	141	⁽³⁾	173	70 % PR 30 % G
D006-a	498	⁽²⁾	1988	95 % PR 5 % G
D043	171	⁽³⁾	111	56 % PR 33 % RW 11 % G
D011a	137	18.9	17	62 % PR 38 % HFO
D001	175	⁽¹⁾	160	10 % PR 90 % RW SNCR
D005-a	288	⁽¹⁾	11	PR/G (after RTO)
D006-b	696	⁽²⁾	283	90 % PR 10 % HFO
D006	967	⁽²⁾	797	95 % PR 5 % HFO
D068	158	19.3	53	PR/HFO
⁽¹⁾ Reported at 17 % O ₂ . ⁽²⁾ Reported at 11 % O ₂ . ⁽³⁾ Reported at 18 % O ₂ . PR: production residues. RW: recovered wood. HFO: heavy fuel oil. G: natural gas. B: biomass. <i>Source: [22, TWG 2012], [23, WBP industry 2012].</i>				

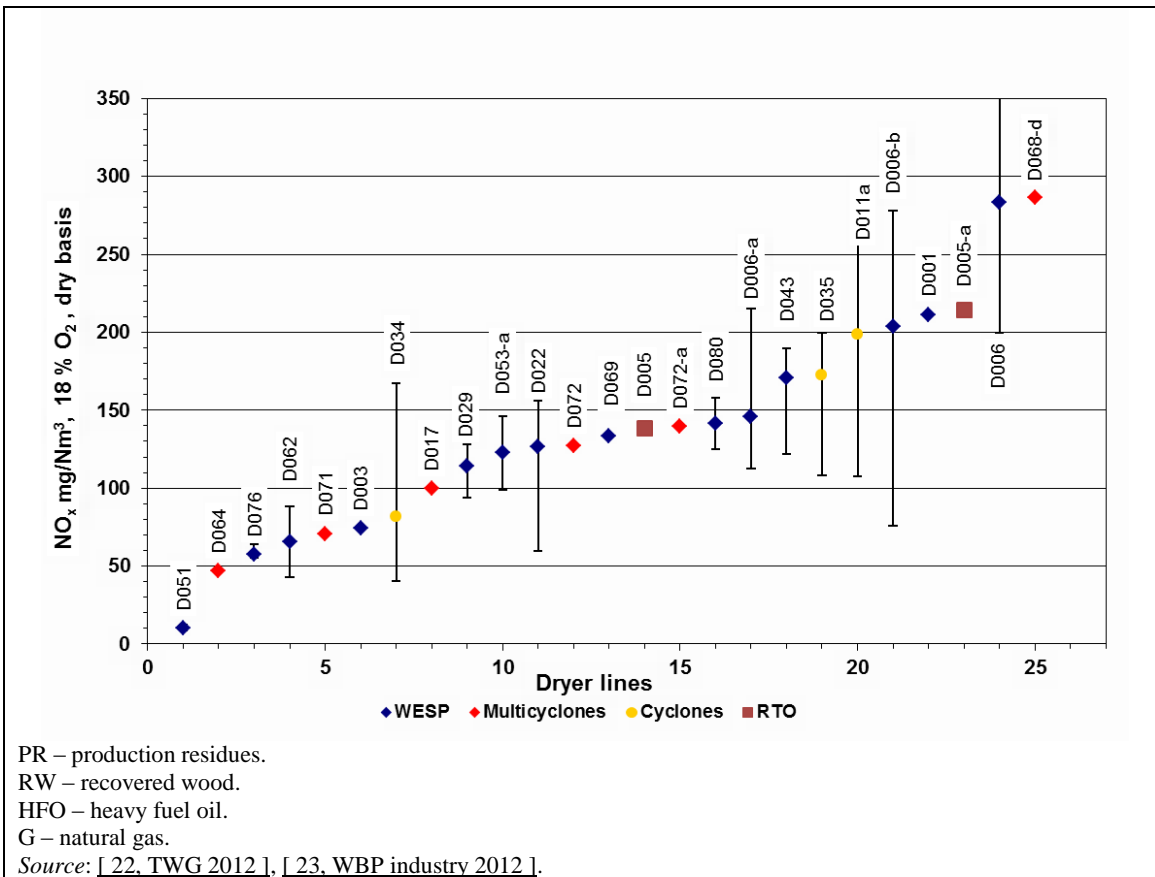

Figure 3.15: NO_x emissions to air from directly heated PB dryers with the corresponding emission airflow

High concentrations of NO_x and corresponding high specific mass loads are especially related to fuel mixes with heavy fuel. Recovered wood and natural gas could contain richer nitrogen sources than pure biomass. Nitrogen-containing compounds are present in the wood itself but are lower than the contribution from recovered wood. The urea resins, ammonium salts, melanine, pMDI and other additives used in WBP production, present in both production residues, including sanding dust, and in externally collected recovered wood, could be another possible source of nitrogen and NO_x creation. The relationship between the amount of nitrogen in recovered wood and virgin wood and the related emissions is unknown. One PB plant not shown in Figure 3.15 using 100 % heavy fuel oil in the production of hot gases for direct drying has a NO_x value of 1 240 mg/Nm³ in the dryer waste gas. The corresponding load was calculated as 3.2 kg NO_x per m³ of finished panel.

Three PB plants, D001, D003 and D051, apply SNCR in the combustion plant serving the directly heated dryers.

For OSB dryer lines, the fuels used are production residues, natural gas and recovered wood, see Table 3.27.

Table 3.27: Emissions to air of NO_x and CO from directly heated OSB dryers with the corresponding specific load of NO_x in kg/m³ of finished panel

Plant ID no	NO _x (mg/Nm ³ at 18 % O ₂)	CO (mg/Nm ³ at 18.5 % O ₂)	Comments
D013	11	31	Cyclones <i>Fuel unknown</i>
D079	28	121	WESP also treating press waste gases <i>Fuel unknown</i>
D032	48	49	Cyclones <i>40 % PR 60 % G</i>
D032-a	41	15	Cyclones <i>40 % PR 60 % G</i>
D041	90	144	WESP also treating press waste gases <i>100 % wood dust</i>
D013-a	14	5	Cyclones
D029	114 ⁽¹⁾	121 ⁽¹⁾	WESP also treating PB dryer waste gases <i>88 % PR 21 % G</i>
D010	70	-	WESP <i>100 % recovered wood and bark</i>
D088	29 ⁽¹⁾	-	WESP
D027	44 ⁽¹⁾	184.5 ⁽¹⁾	WESP also treating press waste gases <i>87 % PR, 13 % G</i>
D056	134	-	WESP
'-': No information available. PR: production residues used as fuel. G: gas used as fuel. ⁽¹⁾ O ₂ content not specified. ⁽²⁾ Given at 16.6 % measured O ₂ . <i>Source: [22, TWG 2012], [23, WBP industry 2012]</i>			

The levels of NO_x (at 18 % O₂) are all below 134 mg/Nm³. The data are based on 11 out of the total of 13 OSB dryer lines in the data collection. There was no recorded use of SNCR or other reduction measures for the OSB lines included in Table 3.27.

The CO levels do not provide any useful information and are not included for any of the other products. Formation of CO is related to the combustion process during the production of hot gas. CO formation in the dryer is likely to be too insignificant to measure.

NO_x emissions from directly heated dryers at MDF lines are shown in Figure 3.16 and Table 3.28. For MDF dryer lines, the specific mass loads have been calculated based on the quantity of finished panels, and also based on the quantity of dried pulp. The variation between the two units of mass loads is comparable. The NO_x levels are only slightly higher or at the same level as for PB and OSB, indicating that the contribution of NO_x is dependent on the fuels used. There are MDF dryer lines that use liquid fuel, but there are no monitoring data available for NO_x.

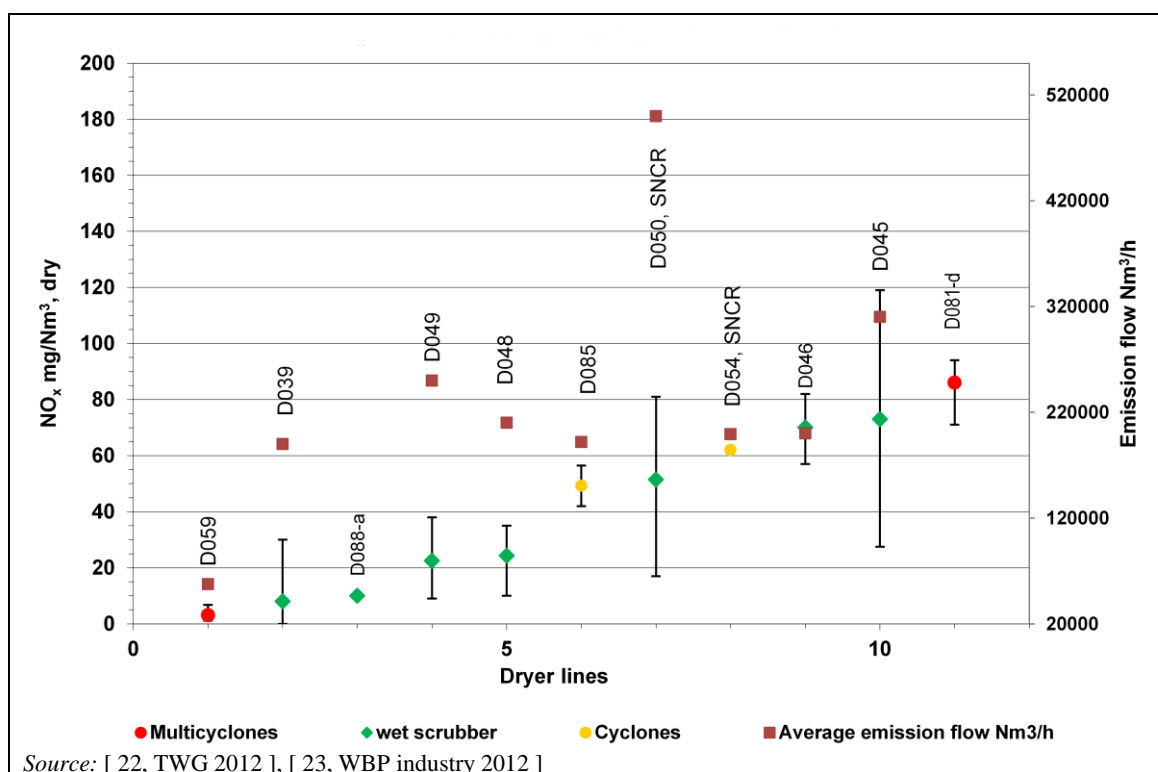

Figure 3.16: NO_x emissions to air from directly heated MDF dryers with the corresponding emission airflow

Table 3.28: Emissions to air of NO_x and CO from directly heated MDF dryers (dry basis)

Plant ID no	NO _x (mg/Nm ³)	Reported O ₂ in waste gas during sampling (vol-%)	CO (mg/Nm ³)	Comments
D059	3	~ 21	-	Cyclones
D049	22	18.3	17	Wet scrubber and cyclones 70 % PR 30 % G
D048	24	19.1	10	Wet scrubber and cyclones also includes press waste gases 70 % PR 30 % G
D054	62	20	10	Cyclones SNCR/ESP in combustion plant No information on fuel
D046	70	17 ⁽¹⁾	15	Wet scrubber 85 % PR 15 % G
D045	73	17 ⁽¹⁾	17	Wet scrubber 85 % PR 15 % G
D050	51	19.3	11	Wet scrubber and cyclones SNCR in combustion plant 70 % PR 30 % G
D009	122	19.8	234 ⁽²⁾	Cyclones No information on fuel
D085	49	17 ⁽¹⁾	228	Cyclones No information on fuel
D081-d	93	~ 21	51	Cyclones 100 % G

PR: production residues used as fuel.

G: natural gas used as fuel.

': No information available.

⁽¹⁾ Emissions given with a correction to a standard O₂ reference of 17 %.

⁽²⁾ Emissions given with a correction to a standard O₂ reference of 11 %.

Source: [22, TWG 2012], [23, WBP industry 2012]

From the data presented, it is clear that the NO_x contribution is mainly determined by the fuel and the combustion process. Based on the current data, it is not possible to deduce the contribution of a fuel mix to the monitored NO_x level in the dryer waste gas. This is due to the variable amount of additional air mixed with the hot gas and the management of the combustion process.

3.2.1.6 Additional monitoring of dryer emissions

Metals in air emissions are often reported when the on-site combustion plant is defined as a waste incinerator in the respective Member State. This approach is adopted by Member States with separate rulings on waste wood used as a fuel. Metals are monitored either separately in the flue-gases or, more rarely, in samples from dryer waste gases.

Metals are rarely detected in substantial amounts and the monitoring for three metals, chromium, lead and arsenic, is shown in Table 3.29. Monitoring of mercury and cadmium has also been reported, but with values close to the detection limit. There were no data available for OSB dryers.

Table 3.29: Metals in emissions from dryers

	Cr (mg/Nm ³)	Pb (mg/Nm ³)	As (mg/Nm ³)
PB, direct dryer, 11 lines	0.001 – 0.054 ⁽¹⁾	0.023 – 0.921	0.001 – 0.043
MDF, direct dryer, 4 lines	0.001 – 0.005	0.034 – 0.9	0.001 – 0.004
MDF, indirect dryer, 2 lines	0.015 – 0.07	0.019 – 0.105	0.001 – 0.025
⁽¹⁾ The higher end of the range is associated with the use of liquid fuel. <i>Source:</i> [22, TWG 2012].			

HCl emissions depend on the chlorine content of the fuel; during combustion chlorine could be released and dioxins potentially formed. HCl is monitored irregularly and often together with HF, especially when the hot gases are produced from recovered wood. A possible source of HCl could be the additive ammonium chloride, but this additive has been replaced by chlorine-free salt, and is not reported as being used. Chloride is also present in varying amounts in biomass-based fuels. In a study the chloride content in fresh wood was 0.04 mg/g of wood (dry), while the sanding dust content was 0.18 mg/g of wood (dry). The highest chloride content of 0.88 mg/g of wood (dry) was found in recovered wood [58, UBA, Austria 2013].

The emissions data collected concerning HCl, HF and SO_x are shown in Table 3.30. The dryer emissions data cover MDF, OSB and particleboard plants and they are all in the same range. The relationship between the fuel and the sulphur content is illustrated at a single plant, where MDF fibres are dried in two different dryer lines, with a difference in the fuel composition. The use of fuel oils is reflected in the SO_x levels from one plant. Also, the HCL and HF emissions are elevated compared to the other plants

Table 3.30: Emission of HCl, HF and SO_x from dryers

Plant ID no	HCl (mg/Nm ³)	HF (mg/Nm ³)	SO _x (mg/Nm ³)
D003, D036, D042, D044, D050, D051, D061, D076, D080, D081.	0.002 – 7.1	0.005 – 0.8	0.2 – 30.1
D006 PB, fuel: 95 % biomass, 5 % natural gas; 11 vol-% O ₂ reference	6.9	0.5	47 ⁽¹⁾
D085 MDF, fuel: 60 % biomass, 40 % heavy fuel oil; 17 vol-% O ₂ reference	1.1 – 37.8	1.1 – 1.6	12.9 – 194
⁽¹⁾ Given at 17 vol-% O ₂ reference.			

3.2.2 Emissions from presses

Waste gases from the main press outlet and also along the press line are often, but not always, collected. Press lines, where no active capture systems for the waste gases are established, usually have a room ventilation system which leads the waste gases over the roof, but in an uncontrolled manner. It is estimated from the data that less than 6 % of the press lines in operation collect the waste gas from the press, although they do have a room ventilation system. Venting over the roof is common for waste gases from multi-opening presses, where effective collection of the waste gases is challenging. Of the press lines where waste gas is collected at the press outlet, around 15–20 % do not collect waste gas along the press line.

Press waste gas monitoring includes dust, formaldehyde, organic compounds, and only a few other parameters.

Due to the lack of data, it has not been possible to establish a relationship between additives, such as ammonium sulphate and ammonium nitrate, and possible emissions of ammonia, NO_x or SO_x, etc.

The distribution of diffuse emissions along a continuous press line is illustrated in Table 3.31. The measurements are taken in the press room under the roof and are measurements of the diffuse emissions from the press, before room emissions are vented through the roof openings. The measurements are only of interest to show the relative distribution along the press line. The most intense emission of organic compounds included in the survey is found in the second half of the press line, although there are emissions all the way along the press line.

Table 3.31: Diffuse emissions of VOC compounds along a press line

	Hydrocarbons (C ₆ -C ₁₂) ⁽¹⁾ (mg/Nm ³)	Limonene (mg/Nm ³)	α-Pinene (mg/Nm ³)
Entrance of press	0.21	0.04	3.65
First half of press	0.61	0.19	9.80
Centre of press line	1.14	0.42	22.27
Second half of press	2.25	0.42	23.16
Release of press	1.29	0.54	23.30
⁽¹⁾ Sum of hydrocarbons, other than those quantified as limonene or α-pinene. Source: [46, DREAL Aquitaine 2005]			

The collected press waste gases are generally quenched by spraying in the collector tubing immediately after the press, in order to prevent fires in the hot air containing fine dust and organic compounds.

The characteristics of the waste gas collected from a press line will depend on the established extraction system and enclosure. The composition of the emission depends on multiple factors, amongst others: press speed, temperature, the thickness of the product, the resin system and the applied abatement techniques.

For multi-opening presses, the collection of press gases is not as straightforward as for continuous presses. The press release area is not well defined and the targeted collection of press gases is more difficult. There are no reliable data supporting the possible difference in the mass load emitted and the related collection efficiency for the two main press types: the continuous press and the multi-opening press.

The available emissions data from press lines are, by nature, not easily comparable, and Table 3.32, which summarises the data, provides more specific information, e.g. on press temperatures and press types. The table shows monitored levels of dust and TOC. Where TOC data were not available, the NMVOC or CVOC values are given instead.

Table 3.32: Emissions of dust and TOC in waste gas collected at press lines

Product	Dust (mg/Nm ³)	TVOC (mg/Nm ³)	Specific mass load (g of TOC/m ³ of finished panel)	Comments ⁽¹⁾
MDF	1	3 (CVOC)	-	Multicyclones (no abatement for VOCs) D039 Multi-opening daylight (135 °C)
OSB	1.2	-	-	Cyclone/oil separator press outlet D057
OSB	0.7	67 – 240	91 – 298	WESP D010 ⁽²⁾ (255 °C)
MDF	8.5	32	37	WESP D086 (200 °C)
MDF	1.4 – 4.1	11.3 – 12.6	6 – 21 ⁽³⁾	No abatement, extraction area not defined/press hall ventilation D011, D084, D085
PB	-	34	-	Abatement technique unknown, extraction area not defined. D025
PB	4.2 – 13.1	-	-	No abatement, press hall ventilation D011, D044
MDF	1.5	46.4	203	Bag filter (no abatement for VOCs), extraction area not defined D023 (270 °C)
PB	3 ⁽⁴⁾	14 ⁽⁴⁾	5	Hydrocyclone D062 (240 °C)
PB	-	77	55	Wet scrubber D068 (245 °C)
PB	5.7	-	-	Wet scrubber D021
PB	183	151	37	Hydrocyclone, cyclone D059
PB	1.7	-	-	Hydrocyclone D056
PB	11.6	86 (CVOC)	36 (CVOC)	Wet Venturi scrubber D081
MDF	8.9 – 9.4	55 – 79 (CVOC)	121 – 255 (CVOC)	Wet Venturi scrubber D081 (245 °C)
MDF	7 – 22	2 – 32	5 – 22	In-line wet scrubbers, e.g. Venturi and hydrocyclones D065, D067, D066 (230–250 °C)

⁽¹⁾: No information available.

Note: Results given on dry basis and with no correction to a standard O₂ %.

⁽¹⁾ The temperatures indicated in the cells are the contact press temperature.

⁽²⁾ pMDI is used as the resin system.

⁽³⁾ Based on data from two press lines from D084.

⁽⁴⁾ Given at 17 % O₂.

Source: [22, TWG 2012], [23, WBP industry 2012]

Both the mass concentrations and specific mass loads show a very high variation. The data available for the specific loads have been scarce and are based on only a few plants. The

specific loads for two press lines with the collection of press waste gases, which are vented over the roof and therefore with no specific treatment applied, show a variation from 6 g to 21 g NMVOC/m³ of finished panel.

The levels of formaldehyde in emissions from press lines are shown in Table 3.33. The specific mass loads have been calculated and are also indicated. The formaldehyde loads from the press are generally at a lower level than the loads observed from dryers.

Table 3.33: Emissions of formaldehyde in waste gas collected at press lines

Product	Formaldehyde (mg/Nm ³) (dry gas, no correction for O ₂)	Airflow (10 ³ Nm ³ /hour) (dry gas)	Specific mass load (g of formaldehyde/m ³ of finished panel)	Comments
MDF	5.2 ⁽²⁾	122	-	Multicyclones, MUF, Multi-opening press. Door skin production. D039
OSB	0.62 ⁽²⁾	83	1	WESP, pMDI. D010
MDF	7.5 ⁽²⁾	93	9	WESP, MUF. D086
MDF ⁽¹⁾	1.5 ⁽⁴⁾	87.5	12	No abatement, press hall ventilation, UF. D011, multi-opening press
PB ⁽¹⁾	3.5 ⁽⁴⁾	74	14	No abatement, press hall ventilation, UF, D011, multi-opening press
PB	0.44 ⁽³⁾	120	1.3	No abatement, press hall ventilation, UF. D044
PB	1.6 ⁽³⁾	110	2.2	No abatement, press hall ventilation except press outlet, UF. D042
MDF	7.4 ⁽²⁾	145	32	Press entry and outlet, UF, Bag filter D023
PB	-	52	38	Wet scrubber, press outlet, UF/MUPF. D021 Cont. press
PB	-	146	47	Wet scrubber, UF/MUPF. D021, multi-opening press
PB	3.7 ⁽²⁾	28	1.4	Venturi scrubber, UF. D081
MDF	2.8 ⁽²⁾	75 & 87	6–9	Venturi scrubber, UF. D081, 2 lines
MDF	-	146	49	Wet scrubber, UF. D030
PB	-	24	11	Measured before incinerated, UF, D036
PB	17.2 ⁽²⁾	95	35	No information on abatement technique, UF, D025
OSB	3.14 ⁽⁴⁾	40.5	-	Cyclone/oil separator press outlet, D057
-: No information available. (1) Result and airflow refer to wet gas. (2) Isokinetic sampling in an impinging solution. (3) Non-isokinetic sampling on adsorption tubes. (4) Monitoring/sampling method not known. Source: [22, TWG 2012], [23, WBP industry 2012]				

At a MDF plant (D092), the collected waste gas from the press line was monitored before treatment in a wet scrubber, corresponding to the raw waste gas before abatement. The TOC content was 46 mg/Nm³ and the formaldehyde content was 17 mg/Nm³, with a specific mass load of 49 g formaldehyde per m³ of produced panel. The press is completely enclosed and its emissions and the diffuse emissions in the press room are collected. The collected waste gas is discharged without further treatment and the monitoring showed values of 3.7 mg/Nm³ for TOC, and 3.6 mg/Nm³ for formaldehyde, with a specific mass load of 9 g formaldehyde per m³ of produced panel.

There are a few examples of other parameters monitored occasionally depending on the MS. Among these are phenol and formic acid. For example, Plant D025 reported levels of phenol of 0.03 mg/Nm^3 , and of formic acid of 1.32 mg/Nm^3

3.2.3 Emissions from downstream and upstream processing

This section presents data from all wood processing activities at the site, except for refining, drying and pressing. The processes included are described in Sections 2.1, 2.3.1 2.3.3 and 2.4.

The only parameter monitored regularly is dust. Control of emissions from dust treatment at the cleaning plant for recovered wood could occasionally include a selection of metals and benzo[a]pyrene.

As a standard practice, emissions from dusty operations, such as chipping and milling, mat forming, and cutting and sanding, are collected and treated to remove dust. Bag filters are applied at most sites, and cyclofilters or similar equipment are also used. For all operations, the collected dust is recycled in the production process or used as a fuel in the on-site combustion plant.

The emission level achieved by the dust abatement equipment is generally below 5 mg/m^3 . The monitoring of the filter performance is carried out indirectly and continuously, by recording the differential pressure. The dust abatement equipment is tested at intervals, which range from performance monitoring at the start of production to once a year or once every three years.

On a few occasions, the data have shown values of up to 10 mg/m^3 , but any values over 5 mg/m^3 are usually obtained under conditions which are considered other than normal operating conditions, and indeed it was reported that the continuous monitoring showed a leak developing in the bag filter material.

Collected emissions from cleaning plants for recovered wood do not differ substantially from the other wood processing steps. Bag filters are applied as the chosen technique for dust abatement. One plant reported the use of wet scrubbing of collected dust for the cleaning plant, because of the fire risk from the dry wood dust.

No data have been made available concerning any emissions of dust from panel lamination lines or on diffuse emissions of dust in general from the site.

Diffuse emissions of formaldehyde were measured in a study in 2009, which included the mat forming station, the starboard cooler and the sanding line at four particleboard plants and one MDF plant. Also, the main press outlet emissions were measured for comparison. The highest formaldehyde content in the ambient air was found at the main press outlet, while the starboard cooler area showed formaldehyde values exceeding the values measured at the mat forming station and the sanding line:

- main press outlet: from 0.017 mg/m^3 to 1.23 mg/m^3 ;
- mat forming station: from 0.04 mg/m^3 to 0.28 mg/m^3 ;
- starboard cooler: from 0.171 mg/m^3 to 1.25 mg/m^3 ;
- sanding line: from 0.073 mg/m^3 to 0.210 mg/m^3 .

The variation in the press emissions is affected by the degree of effective enclosure and extraction both at the main press outlet and along the press line [40, EPF 2010].

3.2.4 Emissions from combustion plants

The hot gases used in direct drying will affect the composition of the dryer emission. Depending on the fuel used and the combustion technique, the contribution of NO_x and SO_x can be significant.

Emissions data have been collected for a range of combustion units that produce hot gases for directly heated drying. Combustion plants used for generating the hot gases also deliver energy for thermal oil, and for generating power and steam. Steam is used for example in refining, while power and excess heat are used on site or exported off site to a grid. The energy balance at the site level is optimised to reflect the local supply of fuel and the need for energy on site. The demand for heat and power in the surrounding areas of the site is taken into account and biomass CHP plants are operated, as well as diesel engine-driven CHP plants.

Non-biomass fuels are used in the sector, although biomass is the most prominent fuel both for generating hot gases for direct drying and for producing steam for refining or indirect drying.

Grate-fired furnaces and fluidised bed furnaces are standard in the sector, accepting a range of different biomass fuels. These combustion plants have sizes from around 15 MW to more than 50 MW. For direct drying, smaller wood dust burners are also used with sizes of around 5 MW to 10 MW.

On all sites, several auxiliary energy-producing units are in operation. Generally, the smaller units principally heat thermal oil and are heated by natural gas or liquid fuel or used as standby units.

For combustion plants or incinerators, the monitoring data for NO_x, SO_x and CO at four example plants are shown in Table 3.34. All data are measured at the hot gas outlet of the combustion plant before being mixed with other air sources and added to the dryer. Monitoring data from four sites with combustion units used for producing steam for indirectly heated dryers are also included in the table.

Table3.34: Emission levels of dust, NO_x, SO_x and CO in flue-gases from combustion plants

	Dust (mg/Nm ³)	NO _x (mg/Nm ³)	SO _x (mg/Nm ³)	CO (mg/Nm ³)	NH ₃ (mg/Nm ³)	Comments
Combustion plants for directly heated dryers						
D002 48 MW 100 % biomass. Moving grate SNCR, cyclone	208	161	-	31	25 (periodic measurement)	Continuous measurement, half- hourly average, 13 % O ₂ , dry
D0030 28 MW 99 % biomass. Pulverised solid fuel-firing, dry bottom. Multicyclone	124	263	-	125	-	Periodic measurement 11 % O ₂ , dry
D038 23MW 60 % biomass, 40 % heavy fuel oil	11	375	53	13	-	Periodic measurement 11 % O ₂ , dry
D010 48 MW 100 % biomass (recovered wood). Intermittent grate Incinerator	10.5	240 ⁽¹⁾	13 (periodic measurement)	1.7 ⁽²⁾	-	Continuous measurement, yearly average, 11 % O ₂ . dry
Combustion plants for indirectly heated dryers						
D001 49.5 MW 100 % biomass. Circulating fluidised bed, CHP plant. SNCR, cyclone, dry sorption injection, bag filter	1.6	180	0.05	60	0.2 (periodic measurement at 11 % O ₂)	Continuous measurement, daily average 7 % O ₂ , dry
D004 40 MW 70 % production residues (dust), 30 % bark. Intermittent grate SNCR, cyclone, dry sorbent injection, bag filter	1.8	216	20	47	1	Continuous measurement, half- hourly average, 13 % O ₂ , dry
D031 3 units, 110 MW Boiler 1 10 % production residues, 90 % recovered wood. Moving grate SNCR, bag filters	1.4	193		24	-	Continuous measurement, unknown average period, 11 % O ₂ , dry

Boiler 1 & 2 Moving grate 10 % production residues, 90 % recovered wood. SNCR, cyclone, dry sorbent injection, fabric filters	2.6	193	45	40	-	Continuous measurement, yearly average, 11 % O ₂ , dry
'-': No information available. (1) The 95 th percentile of NO _x is 282 mg/Nm ³ . (2) The 95 th percentile of CO is 2.2 mg/m ³ . Source: [22, TWG 2012]						

Combustion plants are reported to run at full load, with one major shutdown a year for renovation and maintenance, which includes the whole site and production lines. When maintenance is performed during the rest of the year, such as cleaning of the dryer or abatement systems, the combustion plants are maintained at minimum combustion with a supplementary fuel, which is usually gas. These periods last less than a day and, depending on the site, the combustion plants can have 6–20 warm starts-ups during a year. During warm start-ups, the abatement systems will normally be functioning.

SNCR is applied at a number of combustion plants, even though it is not common practice. The appliance of SNCR reduces the NO_x levels from the combustion process. SNCR is either applied with aqueous urea injection or carbamide injection.

Sulphur reduction is applied at a few combustion plants, even though it is not common practice. The use of dry sorbent requires a dust abatement technique, such as a bag filter, which is not reportedly used for dust reduction before hot gases are used for direct drying. Sulphur reduction with injection of dry or wet sorbent is efficient in reducing SO_x levels if using a biomass source with a critical sulphur content. Recovered wood and production residues with residual sulphate salts could have a higher sulphur content than other types of biomass. Reduction of sulphur also reduces other acidic compounds at the same time, such as HCl, HF and PCDD/F, see Section 3.2.4.1.

The TOC content in the hot gases from the combustion of biomass can be high, due to an inefficient combustion process, although high TOC levels are rarely recorded in the data collection from combustion plants. The TOC content derived from the hot gas is considered negligible in comparison with the contribution from the wood raw material and it is not possible to directly track it in the dryer waste gas afterwards.

As for NO_x, SO_x, CO and dust, it is important to ensure that the combustion process is efficient in terms of limiting the amount of TOC released in the hot gases. In order to show the probable insignificance of the contribution of volatile organic compounds from combustion, data from a combustion plant are included at this point. The combustion process is characterised as inefficient, with high levels of dust, NO_x and CO, and is using production residues as the main fuel source. The combustion plant produces hot gas for two directly heated dryers and the mass concentrations for the measured VOCs are between 16 mg/Nm³ and 786 mg/Nm³ (6 % O₂), and the yearly load is 9933 kg of VOCs. The mass concentrations measured at the dryer outlets were between 56 mg/Nm³ and 203 mg/Nm³ (17 % O₂). The total load of VOCs from the dryers is reported to be 206 000 kg VOC. The contribution from combustion is, at this specific plant, negligible.

Liquid fuels

High emissions of NO_x and SO_x are registered for liquid fuels in particular, but only a minor number of diesel engine plants are in operation, mainly as CHP plants. Where there is no easy access to natural gas, liquid fuels are also used as alternatives during the shutdown of the main plant, as emergency plant fuel or for heating thermal oil.

The CHP plants with heavy fuel-fired cogeneration engines produce hot gases for direct drying, heat for thermal oil heating and steam for refining. The majority of the energy is exported off site. The related emissions to air show high levels of NO_x and SO_x, see Table 3.35 where five data sets are presented. The techniques to reduce SO_x in particular include only primary techniques, such as use of a fuel with a low sulphur content, removal of impurities and metals by centrifugation of the fuel and control of combustion.

Table 3.35: NO_x, SO_x, CO and dust emissions from heavy fuel-fired engines for generating hot gases for direct drying

	Unit	NO _x	CO	SO _x	Dust
D067 I	mg/Nm ³	2030	216	578	15
D067 II	mg/Nm ³	2170	47	472	28
D068	mg/Nm ³	1720	94	182	25
D066 I	mg/Nm ³	1660	77	228	29
D066 II	mg/Nm ³	1900	57	401	28

Note: All data given at 15 % O₂.
Source: [22, TWG 2012]

Secondary abatement techniques to reduce the levels of NO_x or SO_x are not applied.

Combustion plants acting as part of a closed loop dryer treat all dryer waste gases partly by thermal incineration in a heat exchanger and partly by incinerating some of the waste gas in the furnace. The stack emission from the combustion plant is treated, e.g. by ESPs or bag filters, before being emitted. The stack emission contains the flue-gas from the combustion of biomass and, for example, natural gas, and the flue-gas from incineration of the dryer waste gas. Other waste gas sources such as press waste gas can be post-combusted/incinerated within the furnace. The emissions from three plants applying the closed loop dryer and combustion technique are shown in Table 3.36.

Table 3.36: Emission levels from closed loop combustion plants

	D012 PB 32 MW, ESP	D096 OSB 40 MW, ESP	D091 PB ESP
Parameter	Periodic measurement, 1–4 times a year, mg/Nm ³ , 11 % oxygen, dry	Periodic measurement, 4 times a year, average, mg/Nm ³ , dry	Continuous measurement, daily average values, mg/Nm ³ , dry
Dust	4	11	20 (95th percentile: 40)
NO _x	286	54	-
CO	261	80	-
Formaldehyde	0.25	0.2	-
TOC	12	54	110 (95th percentile: 163)
NM VOC	2.5	-	-

': No information available.
Source: [22, TWG 2012]

All three plants apply an ESP for dust abatement after the combustion plant. The closed loop dryer and combustion plants operate under different conditions to a combustion plant used for

direct drying. The energy produced is used for heating the heat exchanger, where the majority of the dryer waste gas is thermally treated. The burning conditions of the combustion plant must be adapted to efficiently incinerate part of the dryer waste gas, and, in the examples, the press waste gas too. The dryer waste gas volume which is incinerated is reported to be around 20 %.

Additionally, one OSB production line is applying the closed loop dryer technology and the emission levels reported were 5.1 mg/Nm³ of dust, 1.2 mg/Nm³ of CVOC and 0.4 mg/Nm³ of formaldehyde, all given at 17 % O₂ [52, LIFE05 2007], [58, UBA, Austria 2013].

3.2.4.1 Additional monitoring data

Monitoring data on other parameters such as HCl, HF, dioxins and metals are included in this section. The data generally show that only under very local and specific conditions do any of the parameters call for special attention. Nevertheless, monitoring of metal compounds is of interest if the dust emissions from combustion are high and if no efficient dust reduction takes place at the plant. Dioxins and furans could be emitted if using fuel with a high chloride content and suboptimal combustion processes. The data on the parameters mentioned are not sufficient to define techniques to prevent or reduce the emissions. The general measures used at combustion plants to prevent or reduce emissions of all the parameters mentioned are described in the BREF on Large Combustion Plants (LCP) [5, EC 2003].

Table 3.37 shows the few values of HCl and HF collected from combustion plants producing hot gases for direct drying. For comparison, the levels of HCl and HF from other combustion plants primarily producing steam for indirect drying are also shown. For these plants, it should be taken into account that recovered wood is used as a fuel and that they are considered waste incinerators. Some of the plants use sorbent injection to remove acidic compounds, such as SO_x, HCl and HF.

Table 3.37: HCl and HF emissions from heavy fuel-fired engines for generating hot gases for direct drying

Plant ID no	HCl (mg/Nm ³)	HF (mg/Nm ³)	Comment	O ₂ reference (vol-%)
D001	0.1	0.06	Daily average, cont. measurement	7
D031 (100 % biomass)	4.24	-	Daily average, cont. measurement	11
D030 (100 % biomass)	2.5	-	-	11
D060	0.02	0.05	-	8
D018, D020, D021, D023	2.6 – 9.2	0.1 – 0.4	SO _x :5 – 37 mg/Nm ³	11
'-': No information available. Source: [22, TWG 2012]				

Metals are monitored especially when the fuel is classified as waste wood and when the combustion under those circumstances is considered an incineration process. As for the parameters, there are three groups considered and which coincide with the classifications of toxic metals according to Directive 2000/76/EC:

- Hg;
- Cd, Tl;
- Sb, As, Pb, Cr, Co, Cu, Mn, Ni, V.

There are significant differences in the metal parameters monitored. Table 3.38 shows the monitoring of a range of the metals or metal groups. In general, the monitoring shows low values for most metals.

Table 3.38: Emissions of metals from combustion plants

Parameter	mg/Nm ³	Plant ID no	O ₂ reference (%)
As	0.13	D015	6
	0.02	D060	8
Pb	10.54 ⁽¹⁾	D015	6
	0.07	D060	8
	0.08	D010	11
Cr	0.002–0.06	D060 D018 (indirect) D023 (indirect)	8
Cu	0.22	D010	11
Sum of: Cd, Tl	0.0001	D001	11
	0.012	D031	11
Sum of: Pb, Cr, Cu	0.16	D060	8
Sum of: As, Ni	0.035		
Sum of: Cd, Hg	0.027		
Sum of: As, Pb, Sb, Cr, Co, Cu, Sn, Ni, V	0.005	D001	11
	0.078	D031	11
	0.19	D010	11
Sum of: Sb, Cr, Co, Cu, Sn, Mn, Ni, V, Zn	73.93 ⁽¹⁾	D015	13

⁽¹⁾ High levels of dust from 425 mg/Nm³ to 2020 mg/Nm³.
Source: [22, TWG 2012]

Dioxins and furans are monitored very infrequently and range from 0.004 ng I-TEQ/Nm³ to 0.07 ng I-TEQ/Nm³ at 11 % O₂ (D015, D010, D031).

The measured dioxin levels from five combustion plants producing hot gas for indirect drying range from 0.00125 ng I-TEQ/Nm³ to 0.07 ng I-TEQ/Nm³ at 11 % O₂ (D001, D004, D020, D023, D021). The lower value is near the limit of detection.

All the combustion plants mentioned use a fuel mix with recovered wood or production residues as the main fuel. The creation of dioxin compounds is, amongst others, related to the chlorine content in the fuel and the organic precursors like phenols and lignin present in wood. Recovered wood and wood harvested near the sea can have an elevated amount of chlorine. Production residues such as sanding dust have a reported chloride concentration of 0.01 % to 0.29 % [41, RWP 2011]. Treated wood and varnished or PVC-coated wood do have a higher chloride content and this could be present in recovered wood. Dioxin formation from the combustion of wood and even wood waste is considered lower than for other biomass fuels, such as straw, but especially low compared to coal and municipal solid waste.

Additionally, limited collected emission data exist for other combustion units used for heating thermal oil or generation of steam, etc. When these conventional utility boilers are not included in the production of hot gases for direct drying, the emissions data have not been assessed further and are not included [8, TWG WBP 2012].

3.2.5 Emissions from paper impregnation lines

The sources of emissions from paper impregnation lines are the collected and channelled waste gases from the drying ovens. The emissions contain VOC compounds and formaldehyde, but very little dust.

During the collection of data, 19 out of 69 WBP production sites reported details of the on-site paper impregnation lines operated.

The capacity of the production lines ranges from 10 million m²/year to 60 million m²/year. Together, the 19 production sites rounded up to a total of at least 1060 million m² paper/year in 2010.

The resin dosage depends on the resin system used and the required finish of the laminated panels. The reported resin dosages, per m² of paper, range from 40 g/m² to 214 g/m².

All 19 sites use an aqueous solution of melamine-based resin, and the majority use two-stage impregnation with urea-formaldehyde in the first dip bath and melamine resin in the second step, applied in a second dip bath or by coating rollers.

The dryers are air flotation dryers, where hot air dries the paper in 4–12 drying fields, depending on the capacity of the impregnation line. The hot air is produced by heat exchange of thermal oil or steam, or by direct drying by air from natural gas-fired engines. Infrared (IR) heating after the first impregnation step is carried out at some production lines.

The 19 sites operate one or more paper impregnation lines with the following treatment systems applied:

- Three sites use the panel production line and its combustion plant for post-combustion of the waste gas from the paper impregnation line or for preheating the wood dryer air.
- Three sites use thermal oxidation, either a regenerative thermal oxidiser or a catalytic oxidiser, and reuse the thermal energy from the exhaust of the thermal oxidiser as drying air for wood dryers or by heat exchange for other processes.
- Four sites apply a wet abatement system based on either simple scrubbing or with a biodegradation step. One site adds the waste gases to a common wet electrostatic precipitator, serving all waste gases from the core panel production.
- Nine sites do not apply an end-of-pipe treatment system for the waste gases, but reported the use of primary measures, such as low-temperature drying and resin with a low formaldehyde content.

Emissions data from six impregnation plants are shown in Table 3.39 including TOC and formaldehyde. The sites represent capacities from 55 000 m²/day to 160 000 m²/day, from a single line or more than five lines.

The data supporting an expression in mass loads are scarce and not easy to compare, e.g. in terms of the uncertainty of reference airflows, actual production during sampling, and actual resin composition. Assumptions were made on the basis of the contextual information received and it can be further noted that all of the techniques produce mass concentrations of TOC in the same range. The TOC and the values for CVOCs are not directly comparable, which could in turn mean that the levels at the last plant mentioned in the table, D077, could be higher than indicated.

Table 3.39: Emissions of organic compounds and dust from paper impregnation lines

Plant ID no	TOC (mg/Nm ³)	Formaldehyde (mg/Nm ³)	Specific mass load (g TOC/m ² impregnated paper)	Abatement technique
D068	3 – 47	-	0.04 – 0.37	Selection of raw materials and gentle drying
D003	7 – 17	1 – 8.8	0.07 – 0.19	Catalytic thermal oxidation
D063	26	-	0.07	Catalytic thermal oxidation
D094	4.6	0.7	-	Regenerative thermal oxidation
D077	(CVOC) 3.2 – 34.7	1.6 – 4.1	0.008 – 0.17	Regenerative thermal oxidation (2011)
D077	(CVOC) 16	1 – 3	0.07	Wet biofilter (2012)
'-': No information available.				

The percentage of TOC that is stripped from the aqueous resin solution applied to the paper during drying is negligible, compared to the amount of resin added to the paper. From data on the average amount of resin applied to the paper, the range of resin stripped off and emitted is from 0.007 % to 0.38 % among the example plants [23, WBP industry 2012].

3.2.6 Odour

Odour from WBP production sites can be related to both the outdoor storage of wood raw material and the range of different processes in production. The main source of odour is the dryer waste gas and the terpenes which are released. Odour and blue haze are connected to this and if the VOC content in the dryer waste gas is reduced the blue haze and odour are reduced too.

Odour is measured as part of the permit compliance in several Member States. Data from one Member State, regarding odour monitoring at the stack level from the dryer abatement system emission, is shown in Table 3.40, together with odour monitoring for other stack emission sources. The odour data are related to point sources and not to ambient air monitoring.

Table 3.40: Odour emissions from stack emission sources

Plant ID no	TOC (mg/m ³)	Odour (ge/m ³)	Comments
a	68 (6 %)	2040	ESP Combustion plant. (PB, closed loop dryer). 53 tonnes panel/h
b	-	656	MDF, directly heated dryer, cyclone and wet scrubber. Dry blending
c	-	1100	MDF, directly heated dryer, cyclone and wet scrubber. Blowline blending. 17 dry tonnes/h
d	-	790 – 944	MDF, directly heated dryer, cyclone and wet scrubber
e	200 – 250	1600 – 1750	PB, indirectly heated dryers, multicyclones, WESP, 37dry tonnes/h
f	200 – 230	2500	PB, indirectly heated dryer, bag filter
g	139	2900	PB, directly heated dryer, WESP, 36 tonnes/h
h	87 – 142	2170	PB, directly heated dryer, WESP, 57 m ³ panel/h
D090	60	512	Rigid/flexboard fibre dryer, high efficiency cyclones
D094	4.6	45	Paper impregnation, Regenerative thermal oxidation
'-': No information available. Source: [22, TWG 2012], [45, VDI 2011]			

3.3 Emissions to water

3.3.1 Emissions from surface run-off water

Handling of surface run-off water in the log yard and other outdoor areas is performed at the majority of sites. If surface run-off water is collected and discharged, it is usually monitored. The level of monitoring varies and, when determining the monitoring frequency, the sensitivity of the receiving water to which the collected surface run-off water is discharged is taken into account by the competent authority. If the concentration is highly variable, more frequent monitoring could be needed to protect the surface water and/or the urban waste water treatment plant. The variability of the composition of the water to be discharged is due to the amount of rain and wind and the exchange and transport of stored materials during the year, etc.

Storage of dusty materials or dust from outdoor wood processing areas contributes to the level of TSS, BOD₅ and COD in the surface run-off water, while traffic could contribute to hydrocarbon levels.

Data have been collected from 11 sites where surface run-off water is collected from the log yard area and directly discharged or further treated in an off-site urban waste water treatment plant (UWWTP). Before discharge, the collected surface run-off water is pretreated by mechanical or stationary screens removing the largest wood pieces. In Figure 3.18, the average value of periodic monitoring of COD is shown together with the TSS and BOD₅ average values, if monitored. Retention basins are used at most sites.

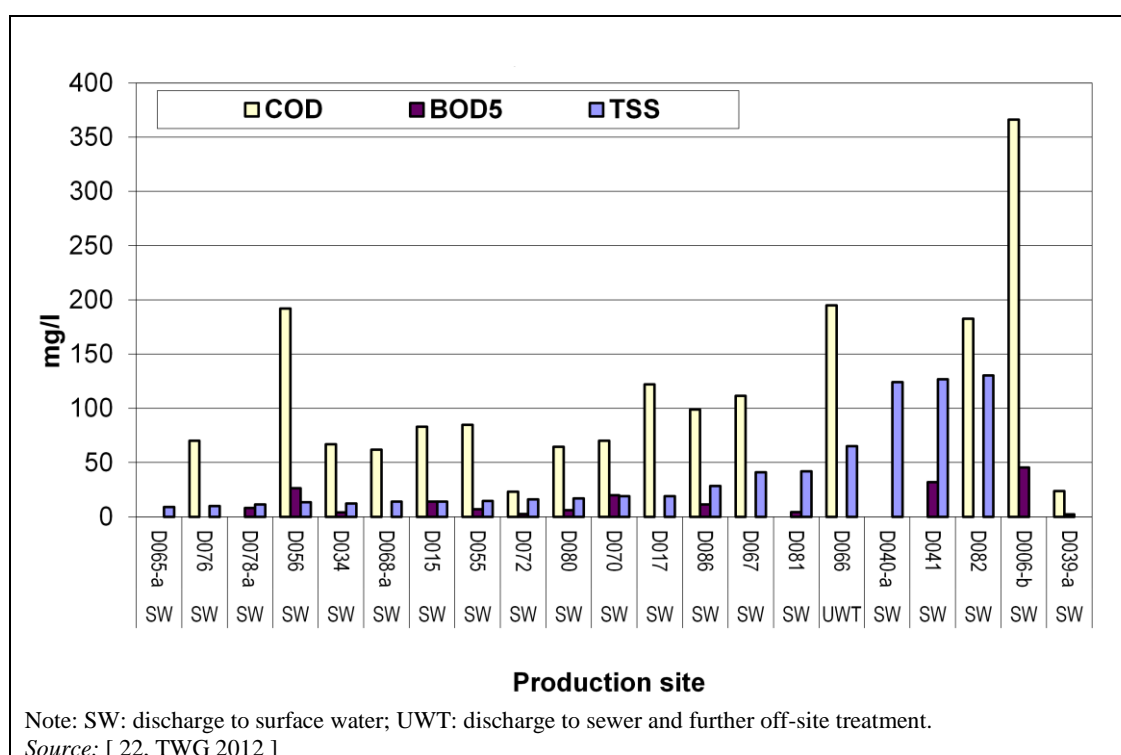

Figure 3.18: Average values of TSS, BOD₅ and COD in the discharge of treated surface run-off water

The majority of sites that collect and handle surface run-off water have retention basins to store the water before discharge. The variation in the three parameters shown in Figure 3.18 depends on the efficiency of the screens that pretreat the water and on the retention volume of the basin or basins in series. If no alternative options are available, cleaner rainwater from roof areas could be collected and discharged together with the surface run-off water from the log yard. The

effect of dilution would lower concentration values. Some of the plants, e.g. D067 and D072, are examples where roof water also forms part of the discharge.

For a stable composition of the collected water, it is possible over time to establish a correlation between COD and BOD₅. Since the data in Figure 3.18 are based on comparable sources the COD/BOD₅ ratio could be set between 6 and 10. The ratio will however need to be set at the site level with a longer monitoring period before a correlation is possible. It should be noted that generally COD is a more convenient parameter for monitoring oxygen demand in emissions discharged to water, while BOD₅ is more applicable as a process control parameter for biological treatment techniques. COD is increasingly being replaced with TOC for economic and environmental reasons in other industrial sectors. A correlation between TOC and COD should also be established at site level. TOC is not presently used in the wood-based panel industry when monitoring surface run-off water.

3.3.2 Emissions from treated process water

Waste water treatment plants treating process water are operated at installations where fibres are produced by refining. The process water that arises is treated and recycled internally at the refiner plant in dedicated treatment plants at some installations. Data have not been collected for the internal treatment of process water, where the water is recycled in production either to the refiner and cooking stage or to the chip washing.

At a limited number of installations the process water from refining is treated in a central waste water treatment plant at the site. The majority of the treated water is from refining but other water streams might be sent for treatment and mixed with the process water from refining. The waste water treatment plants operated at WBP installations apply primary treatment steps to remove most of the TSS. An aerobic biological treatment is commonly applied to treat the COD and BOD₅. Ultrafiltration and reverse osmosis are employed when either the receiving surface water is especially sensitive or when the recycling of the treated water into production is possible.

Treatment efficiency

No data have been collected on the incoming concentration or load of the untreated process water, so it is not possible to calculate the removal or treatment efficiency of the steps applied in the waste water treatment plant. The efficiency of different treatment steps applied was reported together with emissions data and is shown in Table 3.41.

Table 3.41: Treatment steps and removal efficiencies in waste water treatment plants treating process water from refining

Plant ID no	Treatment steps and reported removal efficiency (%) of incoming COD load	TSS (mg/l)	BOD ₅ (mg/l)	COD (mg/l)
D026	Flocculation, sedimentation, decanting (50 %) + Decanting, aerobic biological treatment (96 %) + Ultrafiltration (50 %) + Reverse osmosis (85 %) <i>Discharge to UWWTP, discharge flow 50 000 m³/y</i>	-	-	400 – 1200
	kg/year	-	-	20 000 – 60 000
	g/t dry pulp	-	-	82–247
D030	Sedimentation + Flotation + Aerobic biological treatment and Flotation <i>Discharge to UWWTP, discharge flow 10 400 m³/y</i>	-	-	361 – 938 (713) ⁽¹⁾
	kg/year	-	-	7 437
	g/t dry pulp	-	-	52
D078	Filtration screen and hydrocyclone + Membrane bioreactor <i>Discharge flow 150 000 m³/y</i>	11 – 120 (40)	4 – 99 (18)	-
	kg/year	5 970	2 717	-
	g/t dry pulp	26	12	-
D002	Storage basin (0 %) + Screen filtration (33 %) + Sedimentation (30 %) + Aerobic biological activated sludge tank (5 %) + Flotation (24 %) + Sand filter & reverse osmosis (8 %) <i>Discharge to UWWTP (removal efficiency is given from total removal), discharge flow 65 000 m³/y</i>	-	29.5	60
	kg/year	-	1 917	3 900
	g/t dry pulp	-	10	20
D039	Screening (solids > 1 mm) + DAF (60 % COD, 50 % TSS, 50 % BOD ₅) + Denitrification, Membrane bioreactor (35 % COD, 50 % PM(TSS), 49 % BOD ₅) + Overall efficiency: 95 % COD, 100 % PM(TSS), 99 % BOD ₅ (no limit on COD but on TSS and BOD ₅ mg/l) <i>Discharge to river, discharge flow 137 000 m³/y</i>	0.1–1 (0.3)	2–5 (2.3)	90 – 132 (102)
	kg/year	-	315	14 000
	g/t dry pulp	-	7	318
D040	Screens (70 % TSS) + DAF (60 % COD, 60 % BOD ₅ , 80 % TSS) + Moving bed bio reactor (50 % COD, 50 % BOD ₅) + Aerobic biological aeration basin, clarification (97 % COD, 99 % BOD ₅ , 98 % TSS) <i>Discharge to river, discharge flow 147 000 m³/y</i>	10 – 160 (124)	4 48 (22)	20 – 283 (220)
	kg/year	29 888	5 389	52 801
	g/t dry pulp	157	28	278
D065	Screens (60 % TSS) + Flocculation, coagulation and decantation (95 % TSS) + Aerobic biological (95 % COD) <i>Discharge to UWWTP, discharge flow 50 000 m³/y</i>	76	27	579
	kg/year	3 734	1 327	28 448
	g/t dry pulp	18.85	6.7	144
D028	Flotation + Aerobic biological treatment, flotation <i>Discharge to UWWTP, discharge flow 70.000 m³/y</i>	-	-	500 – 1350 (700)
	kg/year	-	-	53 137
	g/t dry pulp	-	-	266
D011	Sedimentation (80 % TSS) + Filtration (90 % TSS) + Aerobic biological treatment (95 % COD, 95 % BOD ₅) <i>Discharge to river, discharge flow 17 500 m³/y</i>	5 – 25 (9) ⁽²⁾	4 – 18 (6) ⁽²⁾	32 – 72 (45) ⁽²⁾
	kg/year	158	110	787
	g/t dry pulp	-	-	-
<p>‘-’: No information available. Note: The numbers in brackets are the yearly average values. ⁽¹⁾ Average of 44 weekly spot samples. ⁽²⁾ Average of 6 samples. Source: [22, TWG 2012], [23, WBP industry 2012]</p>				

The incoming load has not generally been reported, but could vary depending on the different waste water streams that are treated. For one plant the influent load, primarily consisting of

water from refining and mixed with other minor streams, was between 14 000 mg/l and 20 000 mg/l COD and between 6000 mg/l and 8000 mg/l TSS, which were reduced to between 100 mg/l and 500 mg/l COD and between 50 mg/l and 100 mg/l TSS in the discharged effluent [54, EIPPCB 2012].

There is a lack of data concerning monitoring of other parameters in waste water effluents. TN and N-NH₄ data have only been reported in a few cases and moreover their level of consistency seems to be rather poor. For TN, in most cases reported average values are < 10mg/l, but there are also cases with very high spot sample values (even of around 5 800 mg/l), regarding mainly waste water from wet abatement equipment. In other cases, and only for surface run-off water, high average values have been reported (around 80 mg/l) without any indication of the possible source. Regarding other parameters (TP, phenols, THC, sulphides, oil and fats) even less data have been reported, meaning they are of no use.

In the example shown in Table 3.42, an installation collects a small amount of water from plant cleaning and surface run-off from the main wood processing areas, which is screened and dispatched for further treatment off site. The residual process waters from refining, plant cleaning and other processes are collected and treated together in a sedimentation basin before being discharged to an UWWTP. The main parameters are TSS and COD in terms of load per year. The high, but very variable, load of TSS and occasionally oil and grease indicates the necessity for further treatment, which at this site is performed at an off-site UWWTP.

Table 3.42: Example from one installation producing MDF and PB of the composition of separately collected waste water from plant cleaning and production

Description of collection area for surface run-off water	Unit	Plant cleaning	Process water
Collected waste water	m ³ /year	3 700	34 500
Flow	m ³ /h	0.4	3.9
pH		5.4 – 9.7 (7.3)	5.5 – 11.7 (7.4)
TSS	mg/l	2 – 5727 (238)	9.8 – 17 960 (730)
COD	mg/l	20 – 1330 (363)	45 – 20 000
NH ₄ -N	mg/l	0.6 – 43 (17)	1.5 – 360 (35)
Formaldehyde	mg/l	0.07 – 16 (2.57)	0.62 – 112 (10)
Oil and grease	mg/l	0.1 – 59 (3.29)	0.1 – 108 (12)
NB: Numbers in brackets are the yearly averages. Source: (D081), [22, TWG 2012]			

All sites generate a minor amount of waste water from plant cleaning, including from the periodic cleaning of the dryer and wet abatement equipment.

Waste water from the cleaning of the dryer contains high COD levels up to 20 000 mg/l, where the composition and amount depend on the drying conditions and raw material. Water is collected in a separate tank, added to the surface run-off water treatment system or led to an on-site waste water treatment plant.

Cleaning of wet abatement equipment takes place regularly and complements the daily maintenance, such as adding sodium hydroxide to the recirculating water in a WESP for example to prevent build-up of sticky dust on walls and electrodes. The cleaning water can contain up to 200 000 mg/l COD and therefore needs special handling. The water which is almost saturated with COD is incinerated in the on-site combustion plant or sent to an UWWTP after initial sedimentation or flotation.

3.4 Waste generation

The majority of waste generated is wood-based residues which are either recycled in the production process or used as fuel in an on-site biomass combustion plant.

The installation with its auxiliary activities generates a wide range of waste fractions that are common to most industrial production sites:

- lubrication oil and other oil wastes from maintenance of equipment;
- packaging waste from warehouses;
- mixed metals, scrap, plastics.

For the sector, the following waste fractions have been noted:

- used metal saw blades;
- used sandpaper;
- a minor amount of chemical waste from the product testing laboratory;
- paper waste from impregnation lines and impregnated paper from lamination lines;
- waste water with glue emulsion from the glue kitchen.

All waste fractions are dispatched off site for further treatment or disposal according to local regulations.

Production residues

Production residues are collected all along the production line.

Undersized chipped material is sorted and collected before and after the dryer. The material is used as a fuel. The quantity depends on the raw material and the product produced. After mat forming, the sides of the mat are trimmed and this material is most often directly recycled in the production line. There is no information regarding the amount of wood material collected and recycled directly.

After the press, the dust collected from wood processing machines is the main production residue. Rejected particleboard panels, which constitute a minor fraction, are recycled for chipping and recycling into production as a first choice, while OSB and MDF are crushed and used as a fuel. The processes downstream from the press, including cutting and sanding, produce wood dust which is collected by dust filters at all plants. Depending on the product and production parameters, the amount of residues collected by dust abatement filters can be considerable and provides an important part of the fuel used in dust burners or combustion plants, which deliver heat to the dryers. The collected dust, in the production of the main products, represents a loss of 3–9 % of finished particleboard, a loss 4–7 % of finished OSB and a loss of 2–10 % of finished MDF [8, TWG WBP 2012].

The total amount of wood dust, wood granulates and other internal wood waste used as a fuel for energy recovery lies in the range of 46 000–58 000 tonnes/year or 90–150 kg/m³ of finished panel (based on [8, TWG WBP 2012] from the following sites: D003, D004, D009, D049, D063).

Sludge

Sludge is generated by wet abatement systems for emissions to air, central waste water treatment plants, and from the internal recycling loops of process water.

Sludge from waste water treatment plants comes from the pretreatment of process water, especially waste water from refining, where the coarsest material is separated by screens or other simple mechanical filtration methods. Sludge from primary filtration and sedimentation of waste water in MDF production plants is used as fuel or exported off-site for disposal or to

different recovery operations, such as for agricultural purposes. Even though the sludge from pretreatment steps is mainly wood particles and fibres, the quality of the material is often not sufficient to recycle this back to the production of MDF. An exception is when wood particles can be used in PB production [92, EIPPCB 2014]. The amounts can be considerable and range from 150 tonnes/year to 5600 tonnes/year, or 1.5–16 kg/m³ of MDF produced (based on [8, TWG WBP 2012] from the following sites: D011, D018, D026, D028, D065, D039).

Sludge is also generated from flotation steps and from aerobic biological treatments. The sludge can be used as fuel, especially if dewatered efficiently following the treatment process, or alternatively it is further treated off site or disposed of. The activated sludge needs sufficient dewatering before it can be handled. The amount of sludge generated ranges from 11 tonnes/year to 6000 tonnes/year (based on [8, TWG WBP 2012] from the following sites: D026, D039, D065).

Sludge from retention and sedimentation basins treating surface run-off water is generated when the basins are cleaned. The sludge is dispatched off site. The amount will strongly depend on the water streams collected and the amount of water, the retention time and the efficiency of the retention.

Sludge generated from chip washing consists of both soil and wood grit, and is well suited to be used as a fuel, especially if the sludge fraction is further treated so that the soil part is minimised. The amount of sludge collected in chip washing could be as much as 8300 tonnes (30 % solids) or 10–20 kg/m³ of finished panel.

Sludge generated in wet abatement systems, such as a WESP, wet scrubber, bioscrubber, Venturi scrubber, or dissolved air flotation (DAF), consists mainly of small, coarse wood particles and is generally used directly as a fuel. The sludge is dewatered by decanting or sedimentation followed by screw presses or similar equipment to remove excess water. The sludge can, with dewatering treatment, reach a moisture content of 20–25 %, which is sufficient for handling. The amount of sludge collected is recorded as being in the range of 1000 dry tonnes/year to 2500 dry tonnes/year (based on [8, TWG WBP 2012] from the following sites: D040, D018, D003).

Slag and ashes

From biomass combustion plants, bottom ash and slag are wastes that need to be disposed of or reused off site, depending on quality.

The quality and quantity depend on the fuel composition and combustion conditions. Reported levels of generated ash are in the range of 2500–5000 tonnes/year from production plants producing on average 450 000 m³ of panels/year with biomass as the main fuel source (based on [8, TWG WBP 2012] from the following sites: D001, D002, D003, D009, D010, D049, D053).

3.5 Emissions to soil and groundwater

The overall quality and characteristics of groundwater that is monitored will vary depending on the local geological setting. Data from groundwater monitoring will therefore only be of use on a site level. A few operators have reported having a groundwater monitoring grid of wells in place and that there are requirements for monitoring. This was reported by Member States as being one of the national requirements for industrial sites in general.

3.6 Nuisance from noise and odour

Specific data from noise measurements have not been collected since each site has its own characteristics in terms of more or less pronounced nuisance issues generated by noise.

Regular measurements of noise in the area surrounding the site and at site boundaries are common practice as part of the conditions of the environmental permit for the activity.

Elevated levels of noise are abated by common methods not specific to the wood-based panel sector but generally applied in industry.

Sources of noise are distributed over the whole production chain from traffic to and from the site, and unloading of wood raw material, to the shipping of final products. The most relevant sources of permanent noise are:

- all transport to and from the site, including railways;
- internal traffic of trucks for unloading and loading;
- debarking of roundwood;
- equipment for mechanical treatment such as hackers, flakers, mills, mechanical sieves, air shifters, etc.;
- transport of chips and fibres in pipelines and other systems such as conveyors;
- steam releases in the refiner building;
- the press area;
- all wood processing of final raw panels including sawing, sanding, etc.;
- fans, motors, compressors.

The operation of a wood-based panel installation tends to be a 24-hour continuous operation on a daily basis, seven days a week, and where operation halts for only a few weeks each year for maintenance purposes. Noise from activities on the site tends to be a more pronounced problem at night because of the very low background noise from the surrounding areas. Limiting transport to and from the site and limiting outdoor handling and transport of wood in the log yard are primary measures applied at most sites to reduce noise during the night.

One of the major singular sources of noise that needs particular attention is the debarking of roundwood and flaking of strands (mainly OSB), which is solved by proper enclosure in separate insulated buildings. Except for this, no other major distinction has been noted among installations producing different products.

Noise is abated throughout the sector with common primary measures, such as insulation of noise sources, and secondary measures, such as embankments sheltering the site boundaries.

Primary measures applied generally and throughout the sector are reported as:

- strategic planning of plant layout to accommodate most noisy operations so on-site buildings act as insulation, e.g. noisy operations located in the middle of the plant;
- developing and maintaining noise mapping for the site as part of an active noise reduction programme;
- regular maintenance of all equipment;
- housing, encapsulation and isolation of equipment, compressors;
- sound insulation of buildings in general;
- limiting the transmission of vibrations by decoupling individual equipment;
- speed limits for trucks;
- limiting the time for primary and secondary chipping operations and debarking to daytime;
- closed gates and doors.

Secondary measures generally applied are [8, TWG WBP 2012], [67, VITO 2011]:

- silencers, noise attenuators on fans, filters mounted with acoustic enclosures, cyclones with acoustic vents/mufflers, exhaust mufflers at stacks;
- noise barriers, such as noise protection walls near sources, and embankments or berms along the site boundary.

Some data have been received with stack level odour measurements of the dryer emissions.

3.7 Monitoring of emissions

Sampling of emissions varies depending on the parameter to be sampled and the location of the discharge point. Monitoring results depend not only on the sampling method applied, but also on the conditions under which the abatement system is operating and the actual production taking place in the time range of the sampling. The composition of emissions depending on the product produced and, for example, the fuel used in direct drying should also be taken into account.

Monitoring of the main emission points is, according to the data collection, most often performed by one yearly sampling campaign to show compliance, even though some Member States require up to four or more samples per year or as little as one sampling campaign every third year. It should be mentioned that the sites could apply additional internal monitoring to support the operation of the site, which is generally not addressed or reflected in the collected data.

Data from several sites, presented in Sections 3.2.1.1, 3.2.1.2 and 3.2.1.3, show a large difference between the reported minimum and maximum values for the emissions to air from the dryer for both dust and volatile organic compounds including formaldehyde. This is the case for data representing both one sample campaign, e.g. with three samples taken during one day, and for data representing more than one sampling campaign, e.g. three times a year. This can depend on the operational management of the drying process, the raw materials dried and the operational management of the abatement system for emissions to air. Seasonal variations in humidity and temperature could also affect the raw material during storage.

Member States indicate limit values in permits as mass concentrations, but can also determine both specific mass loads and mass emission rates. The mass emission rate used is the mass emitted per hour or year. The monitoring result of a parameter when controlling air or water emissions can be expressed as the mass concentration in mass per Nm³ or further calculated from the mass concentration to a specific mass load expressed as mass per unit of product produced by the process causing the emission.

From the collected data, it has been assessed that the emissions of VOCs in particular in dryer waste gas could differ throughout the year and even during one day. An example of the variations in the measured VOC values are shown in Table 3.43, showing data from a particleboard plant using solely pine from one harvest area as the raw material and from a MDF line.

Table 3.43: Monitoring data from two production lines covering several years

D035 (PB)	VOC (mg/Nm ³)	D094 (MDF)	Total C (mg/Nm ³)	Dust (mg/Nm ³) (dry)
2010 Q 1	195	2009	147	8
2010 Q 3	320	2010 Q 1	-	12.3
2011 Q 1	40	2010 Q 2	195.4	12.5
2011 Q 3	55	2010 Q 3	-	8.1
2011 Q 4	190	2010 Q 4	126.9	9.8
2012 Q 1	240	2011 1 st trimester	-	12.4
		2011 2 nd trimester	103	8
		2011 3 rd trimester	-	8
		2012 1 st trimester	82	11
		2012 2 nd trimester	-	16
		2012 3 rd trimester	82	9
'-': No information available. Source: [22, TWG 2012]				

Another example of the possible daily variations is shown in Figure 3.19. The figure shows the emissions from a combustion plant with a closed loop dryer. The combustion plant delivers thermal heat for the indirectly heated dryer and post-combusts part of the dryer waste gas and the press gas. The dust abatement system is an ESP. The data show a highly variable daily average value for dust. The calculated 95th percentile of daily averages is 41 mg/Nm^3 . The data from the combustion plant and the closed loop system include data that could represent suboptimal operating conditions for the combustion plant as well as variations in the operation of the dryer.

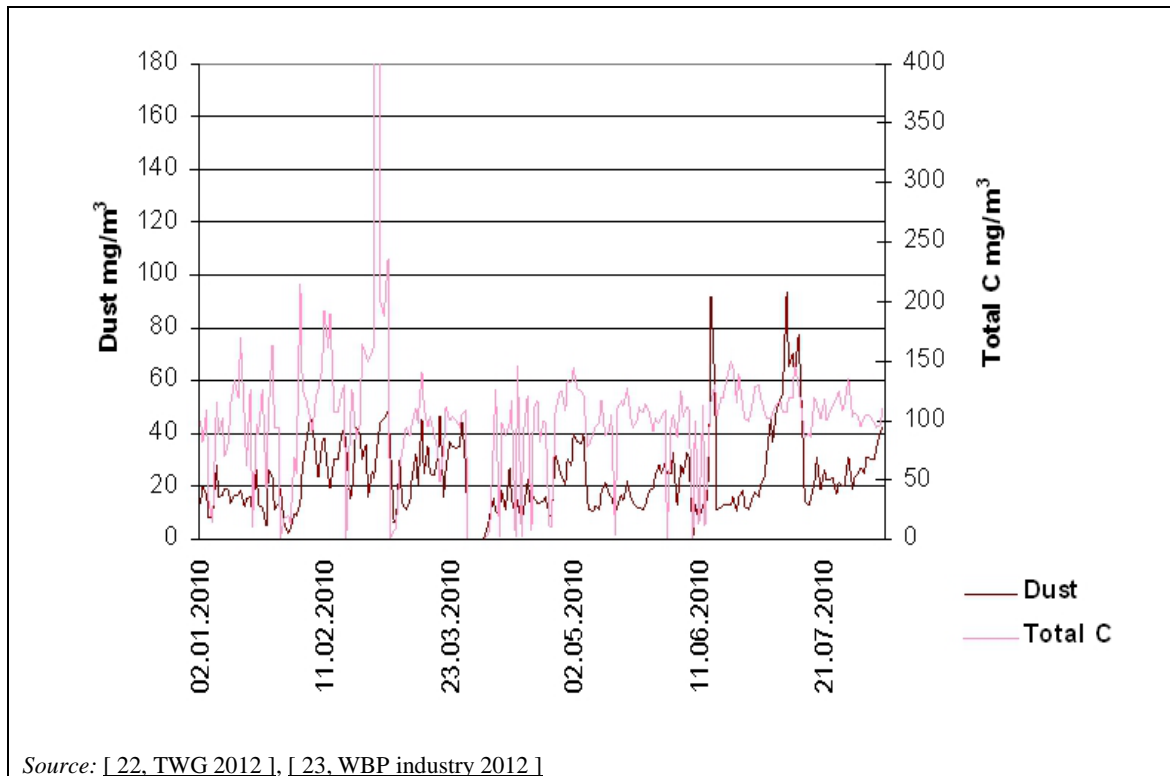

Figure 3.19: Example of variation of daily average values for a closed loop dryer and combustion plant

Figure 3.20 below shows an example of continuous TVOC measurements from the stack of a WESP treating dryer waste gas in a particleboard plant. Missing measurements represent periods when the continuous measurement equipment was not functioning, either because of halted production or a failure during measurements. The sensitivity of the monitoring equipment requires daily maintenance. Even though the variation from day to day can be high, the performance seen over a monthly period or the year is stable.

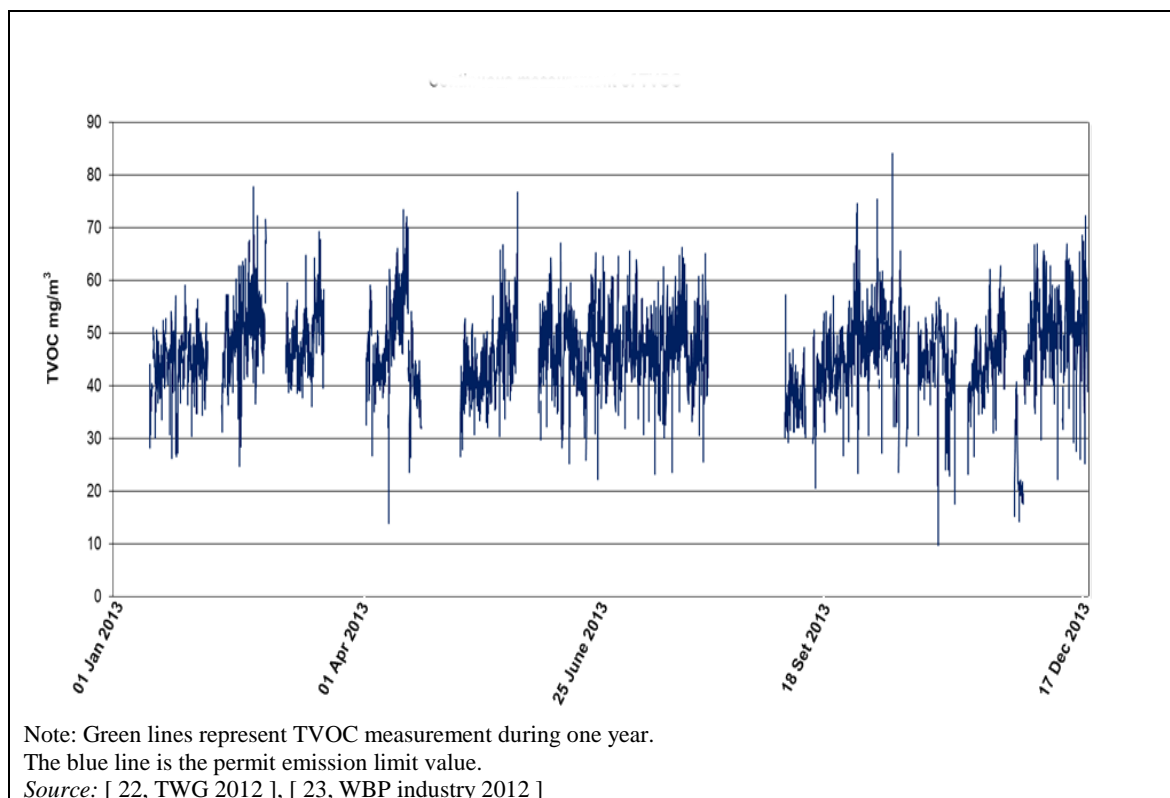

Figure 3.20: Example of variation of daily average values of continuous FID measurements (at 18 % O₂) of TVOC during one year from a particleboard dryer equipped with a WESP

3.7.1 Reference conditions for expressing air emissions data

The individual installations report emission data to the competent authority according to permit conditions, and the reference conditions for reporting values for air emissions will vary. The data collection performed for this document reflects this difference in monitoring and reference conditions.

The air emissions from dryers have distinct features which make reference conditions different to those determined for combustion processes for example. The emissions are characterised as hot and dust-laden. The dust is wet and sticky, due to the content of natural VOC components from the wood, other complex wood constituents carried by the humidity from the wood during drying, and the amount of PAHs created from burnt submicron particles. Continuous monitoring of the main pollutants, such as dust, VOCs/TOC and formaldehyde, is not common.

The environment in the dryer is close to the atmospheric oxygen content, reflecting that drying is not an oxygen-consuming combustion process. Data collected are either corrected to a specific reference oxygen content or given without any corrections to a standard. From the data collection, the actual oxygen content is reported for most stack emissions from dryers. The oxygen content varies between 16.5 % and 20.9 %, and in a few cases is below 16 %. The variation of the oxygen content depends on the dryer type. For indirectly heated dryers, oxygen is near the atmospheric content of 20.9 %. In directly heated PB and OSB dryers, the oxygen content is generally from 16.5 % up to around 19.3 %. For directly heated fibre (MDF) dryers, the oxygen content varies from 19 % to 20.2 %.

The moisture content measured in the dryer emissions ranges from 8 % to around 15 %. From the data, OSB dryer lines mostly record higher moisture levels up to 20 %. The moisture content does not depend on whether the dryer emission is treated in cyclones or a wet abatement system before being discharged, since the waste gas is inherently humid. The wet abatement systems include WESPs, wet scrubbers and bioscrubbers. The difference between a result corrected to

dry or not will vary between a 5 % difference at a moisture content of 5 vol-% and a 25 % difference at 20 vol-% moisture. Based on the difference in the actual moisture content, it is appropriate to have a correction to dry conditions for the emissions from the dryer when expressing the concentration in mg/Nm³.

Reference conditions for a specific dryer and combustion plant set-up can be developed at site level when optimising the combustion and related emissions, e.g. of NO_x, CO and TOC. The oxygen content which occurs at optimised conditions is used as a reference. When two or more waste gas sources are treated together, e.g. in a WESP, the oxygen content can be near the atmospheric content of 20.9 %. Based on the flow of the different waste gases, the oxygen contribution from each can help in determining a reference condition for this specific set-up.

For emissions from presses, the correction to a specific oxygen content or dry condition is generally not performed. The reported moisture content in emissions from press lines treated by wet scrubbing is below 8 % and the possible error due to moisture is less pronounced than for the dryer emissions.

The formula for calculating the emission concentration at a reference oxygen level is as follows:

$$E_R = \frac{21 - O_R}{21 - O_M} \times E_M$$

where: E_R (mg/Nm³): emission concentration corrected to the reference oxygen level;
 O_R (vol-%): reference oxygen level;
 E_M (mg/Nm³): emission concentration referred to the measured oxygen level;
 O_M (vol-%): measured oxygen level.

3.7.2 Monitoring of emissions to air

3.7.2.1 Dust

Dust measured as total particulate matter is one of the key parameters to monitor at a WBP site. Only a few plants have continuous monitoring of dust from dryers, applying photometric measurements or according to EN 15267.

All presses and minor sources are monitored regularly from every third year to several times a year. The combustion plants are often fitted with a system for the continuous monitoring of dust.

The dust fraction from dryers, which is emitted after applying a reasonable dust reduction technique, consists primarily of PM₁₀, where up to 80 % could be PM_{2.5}. The PM_{2.5} are aerosols created from the condensation of organic compounds.

The sampling is crucial to a representative monitoring result and it is important that, if and when the sampling probe is heated or the sampled air dried, the condensable fraction is considered and taken into account.

Amongst the methods used are EN 13284-1, EN 14385, EN 15259, ISO 9096, CEN and national standards and guidelines such as VDI 2066 B1.1, NF X 44-052 [89, COM 2014].

3.7.2.2 Formaldehyde

Periodic sampling of formaldehyde (including other lower aldehydes, alcohols and phenol) is performed using two different approaches with a potential for difference in the results. High volume isokinetic sampling in an impinging solution tends to give higher results than low volume non-isokinetic sampling on adsorption tubes. International standards such as US EPA M316, US EPA Method 5, NCASI/C1/WP98.01, NIOSH 3500 (chromotropic acid method) and national standards from Member States including VDI 3862Bl.2 (DE) and guide FDX 43-319 (FR) prescribe sampling in impinging solutions, while EPA-TO11 and EN 13649 are standards for sampling on adsorption tubes.

The sampling of formaldehyde using isokinetic sampling in an impinging solution is more frequently used, according to the data collected for the drafting of this document. [8, TWG WBP 2012], [17, ECS 2001], [18, EPA et al. 1998], [19, EPA 1998], [20, EPA 1999], [21, VDI 2000].

The analytical methods applied for formaldehyde monitoring are either spectrophotometric, GC or HPLC methods and it is not expected that there would be a great difference in the results obtained using any of these analytical methods [94, EPF and EUROFINS Italy 2014].

Automatic sampling and measurement of formaldehyde in dryer waste gas emissions has recently been applied at several PB plants in Italy. It is reported that a MDF plant in Italy is also installing continuous measurement in general for a range of parameters including formaldehyde (automated sampling) and TVOC (on-line FID measurements).

3.7.2.3 Monitoring of organic compounds

The volatile organic compounds content in emissions is most commonly measured by FID. Continuous on-line measurements are performed, but only at a very few plants because of the sticky properties of the dust.

When analysing for volatile organic compounds (e.g. TOC, Total C, VOCs, CVOVs or NMVOC), a range of standards prescribing sampling and analysis are used, including EN 15267, EN 12619, EN 13526, DIN EN 14385, EPA 25A, EN 14181 (continuous monitoring) and national standards and guidelines; NF X43-301, NF X43-300, VDI, NIOSH 1500 (used for CVOVs, and hydrocarbons with a boiling point of 36–126 °C). EN 12619 is most commonly used [98, CEN 2013].

3.7.2.4 Monitoring of odour

Odour monitoring is carried out using analytical methods (i.e. physical and chemical) or sensorial approaches (based on human sensors). Both approaches are used in source odour quantifications and in the assessment and quantification of odour in the environment. Odour is given in ou_E/m^3 (international odour units) or in sniffing units.

Analytical techniques for the assessment of odours include emission isolation flux chambers, portable wind tunnels, and electronic noses [88, INERIS 2009].

Sensorial techniques are dynamic olfactometry with human assessors, odour surveys, odour wheels, and odour intensity mapping [97, UK MCERTS 2013].

Odour monitoring is a very useful tool for both initial odour mapping and for compliance purposes. Odour monitoring is further described in the Reference Report on Monitoring (ROM) [89, COM 2014].

3.7.2.5 Blue haze

For day-to-day compliance purposes, the percentage of opacity or the apparent density of stack emissions from dryers and presses are monitored by qualified observers to demonstrate compliance (e.g. EPA Method 9), e.g. by using a Ringelmann chart. The observation is performed from a distance, several times a day. It can be optimised with a permanent camera monitoring the stack emission, and is associated to operating conditions and performance of the process and abatement system. With experience, a visual check of the stack emission is used as an excellent indicator of the performance of abatement systems.

The development of a procedure for observing and reacting to the appearance of the stack emissions is largely dependent on the locally applied abatement systems, the production characteristics and the daily weather conditions. Visual monitoring cannot replace sampling for compliance purposes and only gives an indication of when the particulate emissions are too high.

4 TECHNIQUES TO CONSIDER IN THE DETERMINATION OF BAT

4.1 Introduction

This chapter describes techniques (or combinations thereof), and associated monitoring, considered to have the potential for achieving a high level of environmental protection in the activities within the scope of this document. The techniques described will include both the technology used and the way in which the installations are designed, built, maintained, operated and decommissioned.

It covers environmental management systems, process-integrated techniques and end-of-pipe measures. Waste prevention and management, including waste minimisation and recycling procedures are also considered, as well as techniques that reduce the consumption of raw materials, water and energy by optimising use and reuse. The techniques described also cover measures used to prevent or to limit the environmental consequences of accidents and incidents, as well as site remediation measures. They also cover measures taken to prevent or reduce emissions under other than normal operating conditions (such as start-up and shutdown operations, leaks, malfunctions, momentary stoppages and the definitive cessation of operations).

Annex III to the Directive lists a number of criteria for determining BAT, and the information within this chapter will address these considerations. As far as possible, the standard structure in Table 4.1 is used to outline the information on each technique, to enable a comparison of techniques and the assessment against the definition of BAT in the Directive.

This chapter does not necessarily provide an exhaustive list of techniques which could be applied in the sector. Other techniques may exist, or may be developed, which could be considered in the determination of BAT for an individual installation.

Table 4.1: Information for each technique

Headings within the sections
Description
Technical description
Achieved environmental benefits
Environmental performance and operational data
Cross-media effects
Technical considerations relevant to applicability
Economics
Driving force for implementation
Example plants
Reference literature

4.2 Techniques to prevent or reduce emissions to air

4.2.1 Introduction

The techniques covered in this section focus mainly on the reduction of the pollutants dust, volatile organic compounds and formaldehyde.

Dust

For the purposes of this document, the term dust means all material that is measured as total particulate matter at the point of measurement, since the particulate matter in the dryer emissions includes both inorganic and organic solid matter, and liquid material as droplets and aerosols from condensable volatile organic compounds.

The primary source of dust in dryer emissions is the wood material itself. In direct drying, where combustion flue-gases are mixed with the wood material, the dust in the flue-gases also contributes to the overall dust emission. When resin is applied before drying, which is the case for MDF fibre drying, formaldehyde, methanol and condensable organic compounds also contribute to the overall emission of particulate matter.

Metals are rarely detected in substantial amounts and do not frequently contribute to the composition of the dust emissions.

It is important to take note of the fact that the dried product that leaves the dryer is first separated in product separation cyclones and then the exhaust from the dryers is treated or cleaned after this initial product separation. The efficiency of the product separation cyclones is dictated by the product to be separated and it is expected that they capture all material that is usable in further production. The sizes of particles leaving the product separation cyclones are expected to be between 5 µm and 100 µm and condensable particles mainly from soot and organic compounds range from 5 µm down to below 0.1 µm.

There are three main approaches for controlling dust emissions from dryers:

1. controlled dryer operation as a primary measure;
2. dust abatement by microcyclones, electrostatic precipitators or bag filters for flue-gases, before they are used for direct drying, as a primary measure;
3. secondary dust abatement techniques applied to the dryer emissions, particularly wet scrubbing, wet electrostatic precipitators and high efficiency cyclones.

The choice of primary techniques alone to prevent dust formation would not be sufficient, since the main dust generation takes place in the dryer and an additional secondary dust abatement technique is necessary. However, the implementation of primary techniques which reduce the inlet dust concentration may result in an overall improvement in the end-of-pipe techniques' performance.

For dust, the majority of dryer emissions are therefore abated by applying secondary dust abatement techniques, in order to reach sufficiently low levels of dust.

TVOC

TVOC is used as the parameter to describe the volatile organic fraction of the emissions from dryers, and also the press emissions.

For the purpose of this document, the term TVOC should be considered as representing the fraction of volatile organics that covers organic compounds with a boiling point below 250 °C. At the same time, it should be recognised that volatile organic compounds which are released from the wood during drying are of biogenic origin, where the main part of the organic compounds measured consists of terpenes.

The contribution of volatile organic compounds from combustion flue-gases is not considered important when the combustion process is efficient and controlled. TVOC levels, on the other hand, could be affected by an inefficient combustion process, with increased contributions of unburnt carbon.

When resin is applied before drying, which is the case for MDF fibre drying, formaldehyde, methanol and condensable organic compounds could contribute to the overall emissions of volatile organic compounds.

The TVOC level will depend on the wood raw material used, see Section 3.2.1.3.

Approaches for controlling TVOC emissions from dryers are divided into three main groups:

1. appropriate dryer operation as a primary measure;
2. selection of wood raw materials with a low VOC content as a primary measure;
3. secondary abatement techniques applied to the dryer emissions, particularly wet scrubbers and bioscrubbers, which address VOC emissions.

VOC emissions from wood raw material could in theory be lowered by operating dryers at a minimum temperature, but some of the terpenes in the wood material will be mobilised and will evaporate, even at low drying temperatures. For all drying operations, the goal is to obtain a humidity of 2–10 % in the dried material, which cannot be obtained if not applying heat.

The VOC emissions could be lowered using wood materials with a low VOC content. For fibreboard and OSB, but also for particleboard, the raw material is almost exclusively locally harvested roundwood and virgin wood chips. It is not considered feasible to limit the choice of raw materials.

Volatile organic compounds in dryer emissions are reduced by applying secondary abatement techniques. The abatement techniques used do not generally address only volatile organic compounds, but also dust, and hence the abatement of volatile organic compounds is carried out together with a dust abatement technique. It is the TVOC content in the dust fraction that creates blue haze and odour, including both the condensable organic fraction of TVOC, submicron soot particles and polycyclic aromatic compounds. At the same time, it should be noted that the implementation of specific abatement systems for TVOC alone constitute a major investment and involve high running costs and could have adverse environmental cross-media effects.

Formaldehyde

Formaldehyde is, as previously mentioned, a minor part of the volatile constituents of wood released during drying.

When resin is applied before drying, which is the case for MDF fibre drying, elevated formaldehyde levels are registered compared to the drying of non-resinated fibres or chips. The release of non-biogenic formaldehyde depends mainly on the resin used and the drying temperature. Also, in press emissions from all products, formaldehyde is an issue, and the main source is the resin.

The four main approaches for controlling formaldehyde emissions from dryers are:

1. appropriate dryer operation as a primary measure;
2. selection of resins with a low free formaldehyde content for the drying of resinated fibres as a primary measure;
3. the use of formaldehyde scavengers in the resin mix as a primary measure;
4. secondary abatement techniques applied to the dryer emissions, particularly biofilters or scrubbers which tackle formaldehyde and the use of chemical oxidation.

Formaldehyde in the wood material will be mobilised and will evaporate even at low drying temperatures. The formaldehyde contribution from the wood material is in a range where specific formaldehyde abatement is often seen as unnecessary. Formaldehyde levels are higher when using recovered wood and enhanced abatement focused on formaldehyde is sometimes applied.

Primary measures, such as the selection of resins and the addition of scavengers, have the potential for limiting the release of non-biogenic formaldehyde related to the resins.

Applying a specific abatement technique for formaldehyde alone is not common. Individual installations have however introduced specific operational measures to reduce the emission of formaldehyde from the final product and the knowledge obtained has been used to develop novel techniques for the abatement of formaldehyde in air emissions. Techniques that are developed through companies' internal research might not yet be commercially available.

For the purpose of describing techniques to prevent or abate formaldehyde in air emissions from the production of panels, it is important to bear in mind that efforts to lower formaldehyde emissions in the final product do not necessarily cause an additional lower emission of formaldehyde in the air emissions during production.

4.2.2 Primary techniques to prevent or reduce emissions to air from dryers

Operating conditions for dryers are determined largely by the available heating source, the variable humidity in the raw wood material, and the desired final humidity in the wood particles. The two main factors that affect the levels of dust and also TVOC in the dryer emissions are the raw material and the drying temperature. The initial concentration of dust in the hot gas, used for directly heated dryers, could also contribute to the total emissions of dust.

Depending on the fuel used and the combustion technique, the dust, NO_x and CO contributions can be significant. The sulphur content in the fuel can be elevated and abatement of SO_x is sometimes necessary. Elevated levels of NO_x and SO_x are registered, especially for liquid fuels.

The abatement techniques for dust, NO_x and SO_x treatment are well known and applied at combustion plants across many industrial sectors.

4.2.2.1 Management of the drying operation

Description

Appropriate operation of the dryer includes balancing the drying temperature and the residence time for an efficient use of energy and choosing the lowest optimum drying temperature, whilst achieving the necessary final moisture content.

Technical description

Running a controlled operation of the dryer, with the regulation of temperature, airflow and residence time in the dryer according to the desired moisture content at the outlet is a goal in itself. This gives the most uniform dried product and a steady flow of dried material to the press. The temperature for drying has an upper limit because of the increased risk of fire in dry wood dust. The lower limit of the drying temperature is determined by the balance of running an energy-efficient dryer operation. A lower inlet drying temperature will mobilise a lower amount of VOCs from the wood.

Very fine wood dust particles will dry first and release more VOCs because of the elevated temperature in the particles compared to that of bigger particles. A good control of particle sizes

by optimum milling/flaking, and by shifting and sorting the chipped and milled raw material enhances the possibility of a more controlled drying process and a lower VOC emission.

Achieved environmental benefits

- Efficient use of energy.
- Reduction of emissions of volatile organic compounds.

Environmental performance and operational data

Operational data to support the technique have not been made available.

Cross-media effects

None reported.

Technical considerations relevant to applicability

It is not always appropriate to operate at lower temperatures, since this could affect the energy efficiency and yield a lower overall production of panels.

Economics

No information or data were submitted.

Driving force for implementation

Efficient use of energy.

Example plants

No information or data were submitted.

Reference literature

[74, E. Benetto et al. 2009], [77, Sujit Banerjee et al 2006], [79, Sujit Banerjee et al. 2014]

4.2.2.2 Recirculation of waste gases

Description

Recirculation of dryer waste gas back to the front of the dryer, where the waste gas is reheated by mixing with the hot gas generated from the combustion plant. The heat transferred from the dryer waste gas to the hot gas improves the overall energy efficiency of the process, and the TOC content in the dryer waste gas is also incinerated, thus lowering the total emissions of volatile organic compounds from the dryer.

Technical description

The dryer waste gas is recirculated in the dryer by either adding the waste gas stream as additional air for the combustion plant or more commonly by adding the waste gas to the mixing chamber of the hot gases.

Directing the waste gas from the dryer to the combustion chamber is effectively post-combustion or incineration of the waste gas. Directing the dryer waste gas to the mixing chamber incinerates the TOC present in the dryer waste gas and also uses the heat in the dryer waste gas to preheat the air in the mixing chamber. Recirculating the dryer waste gas over a heat exchanger recovers the excess heat in the dryer waste gas.

Other hot waste gas streams can be added and used in a similar manner to the dryer waste gas. It is common to recover the energy and treat the press waste gas by incineration. Waste gas from paper impregnation lines for example can also be incinerated.

Achieved environmental benefits

Volatile organic compounds and dust in the recirculated dryer waste gas and other gases are efficiently incinerated by post-combustion in the combustion chamber and this hence reduces the emission load to be treated by a downstream abatement system.

Higher energy efficiency can be obtained when preheating the mixing air for directly heated dryers with hot waste gases.

Environmental performance and operational data

The recirculation of dryer waste gases is reportedly used at more than half of the particleboard production lines. The actual percentages of recirculation have not been reported, nor are there data to estimate savings achieved in energy consumption. The incineration abatement efficiency is not determined either.

Cross-media effects

None reported.

Technical considerations relevant to applicability

More frequent cleaning of the dryer could be necessary when waste gases are recirculated to the drying air because of the resulting higher content of organic compounds and dust. When heat exchangers are used these can become inefficient over time due to the fouling with sticky dust.

Recirculation of dryer waste gases may have limited applicability for MDF dryers and for indirectly heated PB dryers.

Economics

No information or data were submitted.

Driving force for implementation

To save energy and, if post-combusted, at the same time reduce the load of volatile organic compounds in the dryer waste gas.

Example plants

The general technique is widely applied throughout the sector, each plant with its own specificities.

Reference literature

None.

4.2.2.3 UTWS or Combined heat and dryer systems for particleboard and OSB

Description

Combined heat and dryer systems with a heat exchanger and thermal treatment of discharged dryer waste gases.

The recirculating air dryer system is sometimes called UTWS from the German: 'Umluft' (recirculating air), 'Teilluftstromverbrennung' (combustion of a part of the drying air), 'Wärmerückgewinnung' (heat recovery) and 'Staubabscheidung' (dust collection).

Technical description

A closed recirculation of dryer waste gases has been developed for the drying of wood particles and is applied in particleboard and OSB production processes. In Figure 4.1 the principles of the recirculation of hot gases and material flow is shown.

The dryer waste gas is reheated in a heat exchanger fed by the combustion flue-gases. When the dryer waste gas reaches the necessary temperature in the heat exchanger, it is fed to the dryer again. The heat in the dryer waste gas is hence fully recovered. The recirculated dryer waste gas is a hot vapour stream that enables a vapour drying process. A part of the dryer waste gas stream is continuously led to the combustion chamber for post-combustion.

The dryer emission loop is closed and there are no emission stacks directly from the dryer, besides the necessary abort stacks. In principle, the combustion plant operates independently of the drying process and has a dedicated emission stack. Depending on the fuel used, appropriate flue-gas abatement techniques are applied but without hampering the recirculation of the dryer waste gases and VOC destruction.

The combustion plant uses a mix of wood and natural gas for firing.

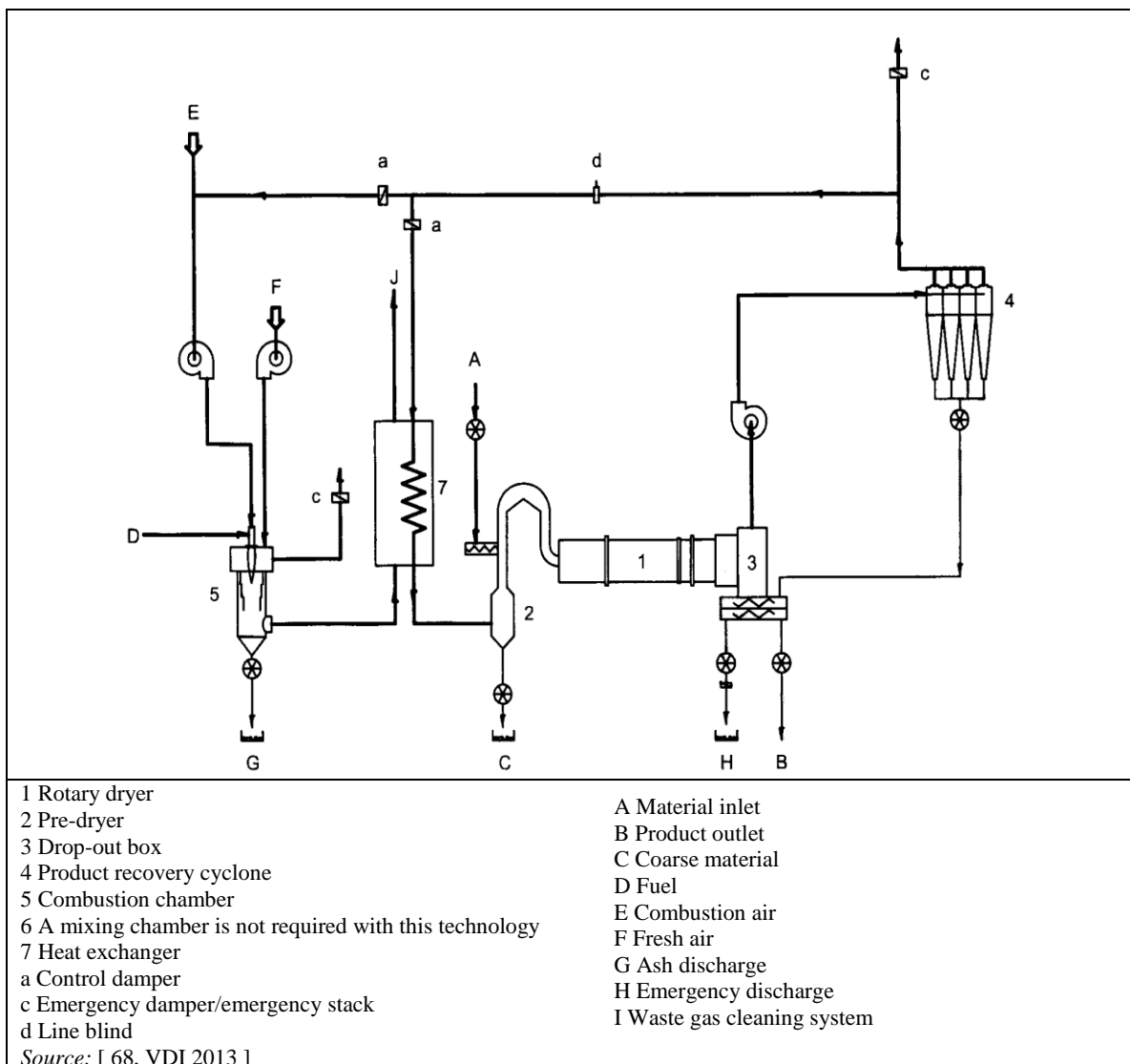

Figure 4.1: Principles of a combined heat and dryer system (UTWS) with recirculation of dryer waste gas

Achieved environmental benefits

Organic compounds and dust in the dryer waste gas are efficiently incinerated, reducing odour and blue haze.

The dust in the off-gases from combustion, which are made up of flue-gases from combustion and from incineration of dryer waste gas, can be specifically treated using a dry ESP or a bag filter before the emission leaves the stack.

The use of post-combustion makes wet abatement systems unnecessary and therefore reduces the consumption of water and energy and eliminates the handling of sludge from wet abatement systems.

The energy demand for the drying process is lowered due to the efficient heat recovery of the dryer waste gas.

Environmental performance and operational data

The combined combustion and dryer closed loop equipment is installed in at least four plants in Europe. Available emissions data are shown in Table 4.2.

The emission is not the dryer waste gas, but the combustion flue-gas. Therefore the emissions are given under the conditions typical for the actual combustion process, where the oxygen content ranges between 8 % and 14 % and is given on a dry basis.

Table 4.2: Emissions data from combined heat and dryer systems (UTWS)

Parameter	D012, PB 32 MW, ESP 2011	D096, OSB 40 MW, ESP 2012	Plant 3
	Periodic measurement, 1–4 times a year, mg/Nm ³ , 11 % oxygen, dry	Periodic measurement, 4 times a year, mg/Nm ³ , dry ⁽¹⁾	Periodic measurement, mg/Nm ³ , 17 % oxygen, dry
Dust	4	11	5.1
Formaldehyde	0.25	0.2	0.4
TOC	12	54	-
NMVOC	2.5	-	-
CVOC	0.38	-	1.2

'-': No information available.
 (1) The reference oxygen level is not known.
 Source: [8, TWG WBP 2012], [52, LIFE05 2007]

The closed loop dryer at plant D096 is monitored monthly for formaldehyde, with an average of 0.2 mg/Nm³. The minimum amount detected was 0.069 mg/Nm³ and the maximum 0.477 mg/Nm³.

No fire incidents have been reported during operation due to the water vapour-saturated waste gases.

Cross-media effects

None reported.

Technical considerations relevant to applicability

The technique is applicable to new plants and existing plants. For existing plants, retrofitting will include a dust abatement system for the combustion plant, heat exchangers for flue-gas and dryer gas heat transfer as a minimum.

Economics

No information or data were submitted.

Driving force for implementation

- Reduction of odour, TOC and dust emissions.
- Lowering the energy demand for drying.

Example plants

The technique was developed in Europe in around 2000 and is currently installed at four installations in Europe.

Reference literature

[68, VDI 2013], [52, LIFE05 2007], [74, E. Benetto et al. 2009] [71, Kronoplus 2010]

4.2.2.4 Reduction of SO_x emissions**Description**

Using a fuel with a low sulphur content as a primary measure is very effective, if there is a range of equally accessible alternative fuels.

As secondary measures, dry sorbent injections either by limestone injection in the furnace for fluidised bed boilers or calcium hydrate in-duct injection before a bag filter or ESP can be applied as reduction measures.

Technical description

Desulphurisation is described in the LCP BREF [24, COM 2006].

Biomass, which is the most used and accessible fuel, does not in itself contain high levels of sulphur. Recovered wood and some production residues could have higher levels of sulphur.

Achieved environmental benefits

Reduction of the emission of SO_x from combustion processes.

Environmental performance and operational data

No data available.

Cross-media effects

None reported.

Technical considerations relevant to applicability

Most of the desulphurisation techniques require a dust treatment system before the flue-gases are emitted. This could be a limiting factor if the hot gases are to be used for direct drying.

Economics

No information or data were submitted.

Driving force for implementation

Reducing SO_x formation in the flue-gas from combustion plants.

Example plants

One PB plant is cited in [67, VITO 2011] as having a wet scrubber with addition of caustic soda before the directly heated dryer. No data are available from the plant. Other combustion plants identified have been related to only indirectly heated dryers.

Reference literature

[67, VITO 2011], [58, UBA Austria 2013]

4.2.2.5 Reduction of NO_x emissions in hot gases from combustion plants

Description

A reduction of NO_x in flue-gases is achieved by considering the fuel mix, controlling the combustion process, and, if applicable, applying selective non-catalytic reduction (SNCR), which reduces the amount of NO_x formed.

Technical description

Primary measures to prevent the formation of NO_x include fuel staging and air staging, which control the temperature and the oxygen content during combustion. The necessary controls applied for combustion are described in Section 4.6.2 and in general in the LCP BREF [24, COM 2006].

Selective non-catalytic reduction (SNCR) uses an injection of aqueous ammonia, urea or carbamide, which reduces nitrogen oxides to N₂. The reduction takes place at high temperatures and the injection is performed in the upper part of the furnace. The operating window is from 850 °C to 1100 °C, with the higher temperatures leading to NO_x formation from the oxidation of ammonia from the added ammonia source. SNCR is widely applied for combustion processes in general, but for combustion units producing hot gas for directly heated dryers this has a general drawback. The operating window in terms of a stable high temperature and a sufficient reaction time is not always obtainable.

Achieved environmental benefits

Reduction of emissions of NO_x in the flue-gases from combustion processes in general, and specifically reduction of NO_x emissions when used in direct drying.

Environmental performance and operational data

SNCR is applied and used in other industrial sectors and generally achieves a removal efficiency of 30–70 %. SNCR is applied at some combustion units in this sector, but the reduction efficiencies have not been reported. Only two plants using the flue-gas for directly heated dryers currently report applying SNCR; while two plants producing heat for steam generation for indirect drying also report data.

One plant (D002) using SNCR with cyclones for dust abatement before using the flue-gas for direct drying reported 161 mg NO_x/Nm³ as a half-hourly average based on continuous measurements. The CO level was 31 mg/Nm³, while the NH₃ slip was 25 mg/Nm³, all given at 13 % O₂.

Another plant (D001) using SNCR with cyclones, dry sorption injection and a bag filter before using the flue-gas for direct drying and, also, a minor part for indirect drying reported 180 mg NO_x/Nm³ as a daily average (continuous measurement). The CO level was 60 mg/Nm³ (daily average, continuous measurement), given at 17 % O₂. The NH₃ slip was 0.2 mg/Nm³, measured periodically (11 % O₂). The fuel used was 40 % production residues and 60 % other biomass.

The background contribution of NO_x is estimated to range between 0.2 kg and 0.4 kg of NO_x per m³ of produced panel. The data are based on two indirectly heated dryers. The corresponding mass concentration is 108–122 mg/Nm³ at 18.5 % O₂.

Even though not directly comparable, and partially referred to indirect drying, the data from two combustion plants for steam generation and reported levels as indicated in Table 4.3. In order to compare the data in Table 4.3, the levels were calculated at 11 % O₂, and range between 193 mg/Nm³ and 290 mg/Nm³.

Table 4.3: Emission levels from combustion plants for steam generation

	NO _x (mg/Nm ³)	CO (mg/Nm ³)	NH ₃ (mg/Nm ³)	Comments
D004 40 MW 70 % production residues (dust), 30 % bark. Intermittent grate SNCR, cyclone, dry sorbent injection, bag filter	290	24	6.4	Continuous measurement (periodic for NH ₃), half-hourly average, 11 % O ₂ , dry
D031 3 units, 110 MW Moving grate 10 % production residues, 90 % recovered wood. SNCR, cyclone, (dry sorbent injection, fabric filters)	193	20 – 40	-	Continuous measurement, yearly average, based on daily average, 11 % O ₂ , dry
': No information available.				

NO_x levels tended to be higher if recovered wood, natural gas with a high nitrogen content or heavy fuel oil is used. One plant (D010) is applying efficient combustion control, with correspondingly low levels of all pollutant parameters, see Table 4.4.

Table 4.4: Emission levels from a combustion plant firing 100 % recovered wood

	Dust (mg/Nm ³)	NO _x (mg/Nm ³)	SO _x (mg/Nm ³)	CO (mg/Nm ³)	Comments
D010 48 MW 100 % recovered wood. Intermittent grate incinerator	10.5	240	13 (<i>periodic measurement</i>)	1.7	Continuous measurement yearly average, 11 % O ₂ , dry

Cross-media effects

Ammonia slip emissions from the added ammonia source, when using SNCR.

Technical considerations relevant to applicability

It is necessary to carefully control the gas and furnace temperature at the injection point, in order to avoid ammonia slip or additional NO_x formation.

SNCR application is limited to consistent and stable combustion processes. If the generation of hot gases in the combustion plant is highly variable, e.g. due to the variation in dryer demand, it can be difficult to maintain the ideal temperature operating window necessary for the efficient conversion of NO_x.

Economics

The investment costs for a SNCR system applied to a 40 MW combustion plant using mainly recovered wood is EUR 250 000–350 000. The maintenance costs are negligible, while the annual operating costs for the SNCR are reported to be around EUR 150 000. Not all existing combustion designs can accommodate the SNCR directly and additional installation costs could be high. Operating costs include the ammonia source, e.g. urea solution.

Driving force for implementation

To reduce NO_x emissions from combustion processes.

Example plants

Applying SNCR: D001, D003, D004, D031, D051.

Several installations show efficient combustion control and combustion management.

Reference literature

[24, COM 2006], [26, COM 2006]

4.2.2.6 Reduction of dust emissions in hot gases

4.2.2.6.1 Electrostatic precipitators (ESPs)

Description

Electrostatic precipitators (ESPs) use electrostatic forces to separate and retain dust in the flue-gas from combustion plants.

Technical description

The ESP charges the particles in the flue-gas in an electrical field and subsequently these are deposited on collector plates, which are transferred to collector hoppers.

Electrostatic precipitators are commonly applied for large combustion plants using a wide range of fuels. A detailed description of ESPs can also be found in the BREF on Large Combustion Plants (LCP) [24, COM 2006].

The abatement efficiency can depend on the number of fields, residence time (size), catalyst properties, and any particulate removal devices installed upstream.

Achieved environmental benefits

An effective reduction of dust in the flue-gases from combustion units before the flue-gas is used as a hot gas in directly heated dryers.

Cross-media effects

An ESP uses electrical energy. The collected dust is a waste and will need to be dealt with.

Environmental performance and operational data

ESPs have high removal efficiencies for dust and particulates. According to the literature, efficiencies can be as high as 99 % and operating experience with ESPs has proved their effectiveness. General performance data can be found in the LCP BREF [24, COM 2006].

In the wood-based panel sector, the majority of combustion plants or hot gas generators use biomass or a combination of biomass and natural gas as a fuel. The application of ESPs is not widespread and generally they are only applied at biomass combustion units with a rated thermal input over 20 MW. Four production sites have an ESP installed. Three of the sites have a combined heat and dryer system where the drying is considered indirect, see Section 4.2.2.3. At one site producing MDF, an ESP is installed at the outlet of the combustion plant to remove dust prior to the directly heated dryers. The fuel is 100 % biomass from internal and external sources. The monitoring data to show the performances of the applied ESPs are not available although, indirectly, the performances can be compared to that of ESPs in other biomass-fired combustion plants given in the LCP BREF [24, COM 2006].

Technical considerations relevant to applicability

ESPs are generally applicable to larger combustion units. The applicability may be restricted when the combustion plant is serving a directly heated dryer. An ESP is not applied to the hot gases from small individual dust burners alone. For existing plants the possibility to apply an ESP may be restricted. (The ESP cannot be applied to treat dryer waste gas since the fire risk is too high due to the sticky dust, the high content of volatile organic compounds and the high oxygen content).

Economics

No information or data were submitted.

Driving force for implementation

The pretreatment of hot gases to remove fine particulate matter from combustion flue-gas.

Example plants

See above.

Reference literature

[24, COM 2006]

4.2.2.6.2 Bag filters**Description**

Bag filters collect dust and particulate matter when the flue-gases pass through a fabric.

Technical description

For a general description of bag filters' performance, applicability and use in combustion plants, consult the LCP BREF [24, COM 2006].

Environmental performance and operational data

There is no available information on the performance and applicability, of bag filters applied for hot gases to be used in directly heated drying.

Various non-combustion dust sources at a WBP installation are treated with a bag filter. For a description of the techniques and the related data, see Sections 4.2.4.2 and 4.2.5.1.

4.2.2.6.3 Cyclones**Description**

Cyclones collect dust and particulate matter by use of inertia when a gas flows through the cone-shaped cyclone.

Technical description

For a general description of cyclones' performance, applicability and use in combustion plants, consult the LCP BREF [24, COM 2006].

Environmental performance and operational data

There is no available information on the performance and applicability of cyclones applied for hot gases to be used in directly heated drying.

Example plants

D009: cyclone applied before a directly heated MDF blowline dryer.

4.2.3 Primary techniques to prevent or reduce emissions to air from presses

4.2.3.1 Selection of resin and appropriate press operating conditions

Description

Selection of a resin with a low degree of free formaldehyde and use of the correct press operating conditions for the resin type, including a combination of optimal press time and temperature, in order to reduce emissions of formaldehyde.

Technical description

Formaldehyde levels in the finished panel and in the process emissions are mainly a result of the resin system used, especially where the resin used is urea-formaldehyde resin, where the formaldehyde is more loosely bound than in other resin systems such as phenol-formaldehyde resin. Using a resin with a low level of free formaldehyde could influence the end product and formaldehyde emission levels.

pMDI is a formaldehyde-free resin, which is applied as the main resin in OSB production and for fibreboards produced in a dry process, such as flexboard and rigidboard. pMDI has not been applied with great success in MDF or PB production.

Achieved environmental benefits

Reduction of the emissions to air of formaldehyde.

Environmental performance and operational data

No specific data were submitted.

Cross-media effects

No cross-media effects were reported.

Technical considerations relevant to applicability

Product quality requirements could necessitate the use of a certain resin mix. Also, there may be limitations on the ability to change operating conditions.

When using pMDI, an efficient release agent is crucial. Release agents are waxes which are applied at the press belt. The necessary additional wax could give rise to higher TOC emissions.

Economics

Alternatives to urea-formaldehyde resins are generally more expensive. The price of pMDI is much higher than for the formaldehyde-containing urea resins. Melamine-containing resins also have less free formaldehyde, but the price of the resin is also comparably higher.

Driving force for implementation

The requirement for reduced emissions of formaldehyde from the final product.

Example plants

None.

Reference literature

[67, VITO 2011]

4.2.4 Secondary techniques to prevent or reduce emissions to air from dryers and presses

4.2.4.1 Wet electrostatic precipitator

Description

A wet electrostatic precipitator (WESP) abates dust in waste gases mainly from dryers and, secondarily, presses. In a WESP, waste gas is wet scrubbed to remove a part of the organic compounds and dust, and the waste gas is subsequently passed through an electrical field, where dust is captured and collected from electrodes.

Technical description

The basic principle is that the hot dryer waste gases are cooled down to saturation dew point temperature by a water (absorbent) quench in the duct after the dryer separation cyclones or at the entrance of the WESP. When the gas enters the bottom part of the WESP, the gas is distributed and washed in a wet scrubbing stage. The quenching water and the wet scrubbing stage lower the temperature of the waste gas; in this way, condensable organics are more effectively dissolved and captured in the water phase.

The gases move up through the electrical corona field in the electrostatic precipitator, where dust is precipitated on the positive tubes. The dust is washed down by water added at the top of the plates in washing cycles or continuously and moved by gravitational forces down to the bottom decanter. The washing cycle is performed every 2 to 12 hours for a few minutes and during this time there is no precipitation in the ESP stage. The ESP units are most commonly a tubular honeycomb structure or bundled pipes and a wire electrode design with a vertical gas flow.

Water-soluble organic compounds in the gas are trapped in the first scrubbing/quench stage. A part of the condensable organic compounds which condense to aerosols after the quench and washing is trapped by adsorption onto wood dust particles on the precipitator plates in the ESP stage.

The WESP was implemented in the late 1980s and several modifications have since been introduced.

The WESP can be built with two parallel ESP units which are alternately cleaned, which also ensures precipitation during washing cycles.

Ambient air can be used for cooling the precipitators with the pipe bundle design, where the cooler air passes the bundles and creates a thin condensation film on the inside of the pipes. The advantage is a more effective capture of aerosols in the water phase that is washed down during the washing cycles. The condensation film prevents a build-up of dirt on the precipitator surfaces. When the treated waste gases leave the stack, it is common to have a droplet separator to remove droplets before discharge. The droplet separator is efficient in abating excess droplets during cleaning wash cycles of the electrodes.

The resulting visual plume of steam can be almost completely removed by a demister, which adds hot air at the exit of the stack. The heat is supplied from energy recovered from heat exchange in the WESP or from other parts of the production process.

Heat from the water phase can be recovered, e.g. to preheat the dryer combustion air or for demisting the stack release.

The scrubber water which is recycled contains solids from the capture of dust during scrubbing and is washed down during wash cycles. The solids are precipitated in a sludge decanter at the bottom of the WESP. The precipitated substances are removed from the absorbent water phase

by an in-line rotary screen and the resulting sludge is dewatered, e.g. by screw presses, and the water is then recycled to the WESP.

Chemicals are normally not required for the removal of the collected fractions of solids and no waste water needs to be drained off. A supply of fresh water is necessary to make up for the water lost by evaporation and, secondarily, in the sludge. The recycled water can become saturated with organic compounds over time and thus fresh water needs to be added. Water which is bled off needs to be collected and treated. The internal waste water treatment system periodically needs cleaning, depending for example on the quantity of VOCs captured and the sticky nature of the collected dust.

The sludge is collected in hoppers and holds a water content of between 15 % and 25 %, and can be used as fuel in an on-site combustion plant or as raw material. The amount of sludge generated is up to 2500 tonnes/year.

There are several models in operation throughout Europe with variations in the level of wet scrubbing; condensing or non-condensing; one- or two-stage ESP field; whether an internal waste water treatment unit is present; and whether they include heat recovery systems and a demister, amongst others. Figure 4.2 shows a WESP treating emissions from two dryers.

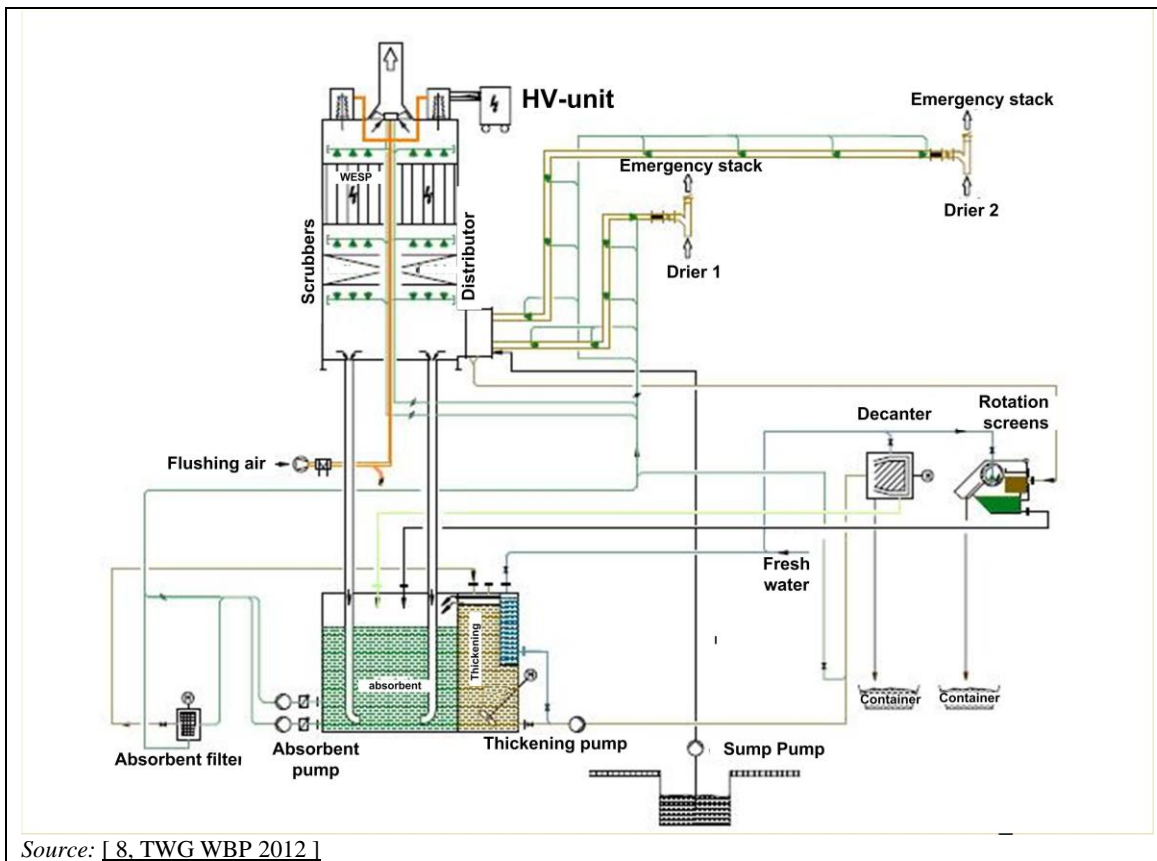

Figure 4.2: Principles of a double WESP, which includes a waste water treatment unit, scrubber, and one-stage ESP

The efficiency and performance of the WESP is firstly determined in the design phase. The efficiency is ensured by continuous monitoring of the control parameters. The most important parameter is the corona potential, i.e. ensuring that the electrical fields are maintained and thus ensuring efficient dust collection on the plates. The water flow and the functioning of pumps are monitored to ensure a stable scrubber performance.

Achieved environmental benefits

WESPs are useful for reducing wood dust, fine dust (aerosols) and odour in dryer waste gases and also from the press. Formaldehyde and other organic compounds are reduced to a certain degree.

Environmental performance and operational data

The operation of WESPs is documented through the data collected from 30 production lines in operation throughout Europe. The majority of these installations produce PB and OSB. In Table 4.5 a selection of the best performing WESPs is shown.

The data results below 2.5 mg/Nm^3 might be correct but lie at the limit of quantification.

Data not included in this section showed distinctively higher average values and at the same time a considerable variation between the minimum and maximum values. At one installation, dust levels varied during one sample campaign, with three individual samplings carried out during the same day, showing a dust content from 7 mg/Nm^3 up to 143 mg/Nm^3 . Whether the variation is due to the sampling or variation in product composition or a less well-managed dryer and WESP operation is not known and hence these data sets were not further used. These results could be within the normal variation, due to the operating conditions of the dryer, but are not considered as being representative.

It should be noted that the majority of the results given in the table are based on periodic sampling during one sampling campaign, with at least three samples, where the average value is the average of the (at least) three samples.

Table 4.5: Average of periodic sampling of dust, volatile organic compounds and formaldehyde in dryer emissions after treatment in a WESP

Plant ID no			Dust	Volatile organic compounds	Formaldehyde
	Product	Comment	Average value, mg/Nm ³ , dry basis		
D010	OSB	(17 % O ₂)	6.5	-	-
D079	OSB	Also press (17 % O ₂)	11.2	-	-
D041	OSB	Also press, (20 % O ₂)	11.9	-	-
D056	OSB&PB	-	9.8	-	-
D001	PB	(17 % O ₂)	1	92	7.7
D003	PB	(17 % O ₂)	1.5	139	9.2
D077	PB	-	2.9	-	-
D042	PB	Also press (18 % O ₂)	3.2	37	7
D073	PB	Indirect	3.3	-	-
D044-a	PB	(18 % O ₂)	3.3	38.5	6.2
D036	PB	Also press (17 % O ₂)	4.5	133	-
D037-a	PB	(17 % O ₂)	5.6	185	-
D055	PB	-	5.6	-	-
D043	PB	Also press (18 % O ₂)	6.5	37	5.6
D063	PB	Also press (17 % O ₂)	7.4	138	2.1
D051	PB	(19.2 % O ₂)	8.2	29.7	16.5
D080	PB	-	9.4	-	7.1
D006	PB	Wet basis (17 % O ₂)	10.5	47	1
D078-a	PB	Also press	10.8	-	6.7
D062	PB	(17 % O ₂)	10.9	19.8	-
D038	PB	(17 % O ₂)	-	24.4	-
D006-b	PB	Wet basis (17 % O ₂)	11.5	67	1
D007	PB	(17 % O ₂)	12.6	215	26
D069	PB	Also press	16.2	145	-
D053	PB	-	26.9	-	-

': No information available.
Source: [22, TWG 2012]

The load of dust in the dryer waste gas could depend on the contribution from the fuel and the combustion process. The plants included in the table primarily use biomass combined with additional natural gas burners. Liquid fuels, such as heavy fuel oil, are used as additional fuels, at a fuel share of 2–10 %. There are no data supporting the actual contribution of dust from the fuel, which is expected to be related mainly to biomass.

Multicyclones or cyclones are often used as a pretreatment for the dryer waste gases before they are treated in the WESP. Cyclones remove the coarser fraction of the dust, which is sometimes necessary for the effective operation of the WESP.

The performance of a well-operated WESP, concerning the organic part of the emission, varies in the range of 6–10 mg/Nm³ for formaldehyde at PB production lines. The corresponding formaldehyde load is 24–49 g per tonne of dried particles and the corresponding specific mass load is 160–260 g TOC per tonne of dried particles.

For the drying of fibres, a WESP is not commonly used. At one plant (D002), a well-performing WESP achieves 6.3 mg/Nm³ of formaldehyde (dry basis, no correction for O₂).

Table 4.6 indicates the emission levels for OSB production dryers applying WESPs, where a low level of dust is achieved, but the performances reported for organic compounds and formaldehyde are more varied.

Table 4.6: Emission levels for TOC and formaldehyde in emissions from OSB dryers after treatment in a WESP

Plant ID no	Organic compounds (mg/Nm ³)		Formaldehyde (mg/Nm ³)	Product	Comment
D010	TVOC (FID)	217	12	OSB	Softwood, 18 % O ₂ , dry, pMDI resin
D041	CVOC	29.80	-	OSB	Including press waste gases. Softwood, dry basis, not corrected to O ₂ reference
D079	CVOC	46 – 60	13.5	OSB	Including press waste gases. Softwood, 18 % O ₂ , dry
D027	VOC	150 – 650	-	OSB	Softwood and hardwood
': No information available. Source: [22, TWG 2012]					

The contribution of volatile organic compounds from the raw material depends for example on the species used. The data on TVOC emissions, i.e. illustrating the performance of the WESP and the related raw material, do not give an indication of the variation in TOC emissions due to the raw material alone.

In the wet scrubber and electrostatic precipitator, water-soluble emissions, dust, particles and aerosols, which together create blue haze, are reduced by 50–95 %. It is recognised that the efficiency for the organic fraction is much lower than for the dust fraction. The reported level of reduction efficiencies is up to 95 % for the dust fraction, while the organic compounds are reduced by between 20 % and 50 %. The reduction efficiency for water-miscible compounds and condensable organic compounds is higher than for the remaining part of the TOC fraction.

When dryer waste gas and also press waste gas are treated together in the WESP, the same range of emission levels for dust, formaldehyde, and TOC are reported.

At two plants a dedicated WESP treats the press emissions, see Table 4.7. The OSB line uses pMDI and the formaldehyde level is therefore low in general. The specific mass load for formaldehyde is 1 g per m³ of finished OSB panel, while it is 9 g per m³ of finished panel for the MDF line.

Table 4.7: Emission levels for dust, TOC/NMVOC and formaldehyde in emissions from press lines after treatment in a WESP

Plant ID no	Dust	TOC (mg/Nm ³)	Formaldehyde (mg/Nm ³)	Product
D010	0.5 – 0.8	47 – 154	0.4 – 0.8	OSB
D086	2.7 – 18.2	24.4 – 38.3 (NMVOC)	5.4 – 10.5	MDF
D089	13.4	-	12.5	-
': No information available. Source: [22, TWG 2012]				

Control parameters which are monitored continuously to ensure a correct operation include, as a minimum, the water flow, corona potential/or secondary voltage and the outlet temperature.

Cross-media effects

Sludge generated with an appropriate quality can be recycled into production or used as a fuel in an on-site combustion plant. If these alternatives are not feasible, the sludge needs to be disposed of off site.

Waste water with dissolved solids needs further treatment.

As for other wet scrubbing systems without chemical or biological oxidation, the condensable organic compounds and water-soluble organic compounds in the treated emission are transferred to the water phase.

In the operation of a WESP, the consumption of water and electricity needs to be considered.

Technical considerations relevant to applicability

The WESP operates in a flow range determined by the design. The performance is dependent on the dwell time of the crude gas within the system. With lower airflows than envisaged by the design, the efficiency will be lower.

When fresh wood with a high content of resins and fatty acids is used, especially pine, the dryer emissions will be very sticky and an antifoaming agent may be necessary in the recirculation water to prevent the sticky compounds depositing on walls and electrodes.

The WESP is not considered applicable when using a hot gas source for direct drying that contains sulphur or chloride in significant amounts [53, FINSA 2007]. If heavy fuel was used for generating hot gas for directly heated dryers, the sulphur content in the fuel would form sulphuric acid when entering the scrubber and would oxidise the plates/tubes and the equipment in general and lower the pH of the scrubber water. The water would hence need a constant regulation of pH, and the consequent addition of a neutralising agent or fresh water. The sodium sulphate salt formed by neutralisation crystallises out and a bleed-off of water is needed. The closed water loop in most WESPs would be broken, since a higher amount of make-up water and a higher proportion of water would need to be discharged and managed.

An elevated chloride content in the hot gases could be released during the incineration of some types of waste wood. However, this has not been reported as a problem in the data received.

Economics

Installing a WESP is a major investment and the operation and maintenance costs are also comparably high.

The investment will depend on the model and treatment capacity:

For a WESP with a one-stage ESP field, designed to treat dryer emissions from a 1500 m³ PB production line including a built-in scrubber unit, waste water treatment unit for recycling the scrubber water and collection of sludge, the equipment investment starts at EUR 2.5 million; the yearly operating costs, including maintenance, are above EUR 350 000, of which 15–20 % is for maintenance costs. If the capacity is higher, the cost grows proportionally.

One example reported is a WESP system for a 2500 m³ PB plant with four indirectly heated dryers, where the installation costs were EUR 4–5 million, with yearly maintenance costs of about EUR 65 000. Additional operational costs for the electrical energy consumption should be taken into account. In the example given, consumption would be around 300 kW.

At an example OSB plant with a yearly capacity of 500 000 m³ and with a WESP installed, the investment costs were more than EUR 9 million and included high efficiency cyclones for

pretreatment of the dryer waste gases. The yearly maintenance and operating costs for the combined system were reported to be around EUR 550 000–600 000.

Driving force for implementation

The WESP effectively abates dust in dryer emissions, and some organic compounds, blue haze and odour emissions can also be reduced considerably.

Example plants

There are around 35 WESP units operating in the sector in the EU-27.

Reference literature

[82, Lanzerstorfer 2000], [83, Barbu et al. 2014], [87, Swedspan 2011]

4.2.4.2 Bag filters

Description

Bag filters or fabric filters collect dust when the waste gas is passed through a fabric. Bag filters are cleaned periodically and the collected dust is used as fuel.

Technical description

Bag filters or fabric filters are used for treating dust collected at various sources throughout the production site. Bag filters are applied in the sector to treat dryer waste gas from indirect drying and all dust sources from wood processing, including the following:

- chipping and milling to wood particles;
- pneumatic or mechanical transport of wood particles;
- mat forming;
- saws;
- sanding lines.

The waste gas is passed through a fabric, where particulate matter is collected on the surface. The dust caking on the fabric increases the likelihood of more dust adhering to the fabric and hence increases the removal efficiency.

The bag is cleaned by distorting the bag using different methods, so that the collected dust falls out into hoppers. Bag filters can also be reverse-air cleaned, pulse-jet cleaned or mechanically shaken clean. The cleaning should not remove all dust from the fabric since this would lower the efficiency of the filter for a period until a new layer of dust had built up on the fabric.

Bag filters are standard equipment and can be designed to abate dust in specific and challenging applications. The size, type of filter cloth, and cleaning mechanism are designed for each particular purpose. Bag filters are configured as groups of bags and compartmentalised, so that cleaning or replacement can be performed without taking the total capacity of the filter system out of use.

The operating conditions of the bag filter, the waste gas characteristics, and the waste gas flow determine the choice of fabric and the size and configuration of bags. The filter capacity should be high enough to prevent high pressure. Bag filters can be used for high waste gas volumes and for temperatures well above what is encountered in the sector.

The efficiency of bag filters is affected by wet emissions and emissions which contain condensable compounds.

Achieved environmental benefits

Bag filters effectively capture and collect dust from various sources.

Environmental performance and operational data

Bag filters applied at all dry dust sources can usually achieve, with very few exceptions, emission levels of less than 5 mg/Nm³. Bag filters are considered standard equipment for dust treatment and enable constantly low levels of dust to be achieved after the filter.

Data on the performance of bag filters treating dryer emissions are limited to indirectly heated dryers and are represented by data from four particleboard production lines, see Table 4.8. At all four installations, the bag filters were installed at the same time as the dryers. The data show that the bag filters demonstrate efficient dust removal.

Table 4.8: Emissions of dust in dryer waste gases treated in bag filters

Plant ID no	Dust (mg/Nm ³)	NMVOC & Formaldehyde (mg/Nm ³)
	Half-hourly average	Periodic additional measurements
D004	2.74	NMVOC: 190 – 219 Formaldehyde: 6.2
D018	0.5 – 1.5 ⁽¹⁾	-
D020	1.66	-
D024	1.3 ⁽¹⁾	NMVOC: 230 Formaldehyde: 7.5
-: No information available. ⁽¹⁾ Based on a periodic measurement. <i>Source: [22, TWG 2012]</i>		

The average flows for which the bag filters are designed range between 90 000 m³/h and 270 000 m³/h. Depending on the fabric chosen, condensable compounds present in the dryer waste gas could affect the efficiency of the filter. The outlet temperature of the dryer waste gas was reported to be lower than 100 °C for three of the four plants, but there is not enough information to conclude whether the temperature has a proportional influence on the performance of the filter.

The level of volatile organic compounds including formaldehyde is related to the raw material, which for D004 includes a mix of virgin softwood and recovered wood, while for D024 it includes a mix of softwood, hardwood and recovered wood. Bag filters do not have any reported efficiency for treating or reducing organic compounds.

The constant functionality of the bag filter is ensured by monitoring the differential pressure, and by frequent visual checks. A pressure drop indicates a less efficient filter performance, which could cause a rupture of the filter. Rupture of a bag filter will be seen clearly in the area surrounding the bag filter. The performance of the bag filter will stay constant as long as the pressure remains constant. Continuous measurement of dust by photometric measurements can equally be used as an indicator of the continued integrity of the filter.

The majority of sites reported through the data collection that the daily performance of traditional dust abatement techniques, such as a bag filter, is controlled by continuous control of the differential pressure.

Cross-media effects

The collected dust needs further treatment.

Technical considerations relevant to applicability

Bag filters alone do not reduce the amount of volatile organic compounds including formaldehyde.

The efficiency of bag filters is affected by wet emissions and emissions which contain condensable compounds. The temperature in the waste gas should not fall below the dew point of the condensable compounds.

Bag filters have been applied only for indirectly heated dryers in particleboard production.

Bag filters used for treating dryer waste gases should be constructed from materials that can withstand the stickiness of the collected dust.

Economics

Investment costs for the application of a bag filter treating waste gases from an indirectly heated rotary dryer of 25–40 t/h capacity are about EUR 600 000–800 000 for a waste gas volume of 70 000 Nm³/h to 130 000 Nm³/h. Annual maintenance costs are about EUR 60 000–80 000, including for changing the filter material. The maintenance costs have been reported to be even higher at some plants.

Additional operational costs for the electrical energy consumption should be taken into account. In the above example, consumption would be about 200 kW.

Driving force for implementation

Reduction of dust emissions.

Example plants

Four production lines producing particleboard in the EU have applied bag filters for reducing emissions from indirectly heated dryers.

Reference literature

None.

Description

Cyclones use inertia in order to remove dust from a waste gas stream. A cyclone is cone-shaped, and when a gas flows through the cyclone, the particles in the gas spiral down the walls of the cyclone, while the treated waste gas moves upward through the centre.

Technical description

Multicyclones are small diameter cyclones that efficiently collect smaller particles in the range of 5–400 µm, depending on the design. Multicyclones are applied after standard product separation cyclones, in batteries of 6 to 24 or more individual parallel cyclones with inner diameters of 15 cm to 40 cm. Multicyclones can be applied in stages and enhance the collection efficiency.

According to conventional theory for cyclone design and collection efficiency, the small diameter cyclone promotes the fast spinning of the particles, which follow the shortest travelling distance to the wall of the cyclone, from where the particles drop down and are collected. Multicyclones that are based on a small diameter could collect dust particles down to a diameter of 5 µm, according to literature.

Cyclones will not capture aerosols of condensable organic compounds.

Cyclones are used as a pretreatment step for dryer waste gases, e.g. before a wet scrubber or a WESP. Sometimes cyclones are used as stand-alone equipment for fibre dryers when the dust load is not high.

Achieved environmental benefits

Cyclones reduce dust in dryer waste gas.

Environmental performance and operational data

The performance for dust abatement for cyclones is reported within a wide range. Cyclone performances which are considered to represent well-performing plants are shown in Table 4.9.

Table 4.9: Average values of periodic dust measurements in dryer emissions after treatment in a cyclone

Plant ID no	Product	Dust (mg/Nm ³)	Data given on wet or dry basis	O ₂ (vol-%)
D068-a	PB	19	Dry	No correction (19.4 %)
D061-b	PB	31	Dry	No correction
D095	PB	11.5	Dry	15 %
D032-a	OSB	25	Wet	No correction (18 %)
D086-b	MDF	5.4	Dry	No correction (18.9 %)
D059	MDF	8.1	Dry	No correction
D081-d	MDF	10.7	Dry	No correction
D081-b	MDF	11.7	Dry	No correction
D085	MDF	17.6	Dry	No correction (19.8 %)
D040 Indirect dryer	MDF	18.5	Dry	No correction (20 %)
D085-a	MDF	23.9	Dry	No correction (19.8 %)
D009	MDF	24.5	Dry	No correction (19.75 %)
D075	Rigidboard	2	Dry	No correction
D074	Rigidboard	5	Dry	No correction

Source: [22, TWG 2012]

In fibre drying, the levels are generally lower due to a lower fine dust contribution. The design of the cyclones applied for the actual production will have a marked influence on the performance. In this context, emission values below 7 mg/Nm³ for dust were encountered at four MDF lines applying cyclones (D086-a, D030, D086-b and D011-d (indirect dryer), all on a dry basis, with no correction for O₂).

Cyclones do not have a documented efficiency for abating organic compounds.

Cross-media effects

Collected dust needs to be dealt with.

Technical considerations relevant to applicability

Small diameter multicyclones are not generally used for coarse material because large particles may plug the spinner vanes in the multicyclone tubes. Since multicyclones are applied after a standard product separation cyclone, all larger material is collected before the multicyclones.

If the dust fraction is very sticky, it will affect the efficiency of the cyclone.

Cyclones do not reduce TOC or formaldehyde emissions.

Economics

No information or data were submitted.

Driving force for implementation

Reduction of dust emissions.

Example plants

More than 20 plants, mainly MDF production plants, use cyclones as the main dust abatement technique for dryer waste gas or as a pretreatment.

Reference literature

None.

4.2.4.3 Electrified filter bed**Description**

The electrified filter bed (EFB) removes particulates and, to some extent, condensable organic compounds by electrostatic filtration.

Technical description

The electrified filter bed, or electrostatic gravel filtration bed, consists of a packed column of gravel media which are electrically polarised by a bed electrode. The particulate matter in the waste gas is negatively charged by a corona field created by an array of metal pins at the waste gas entrance, where it is captured and attached to the gravel. The dust is transported with the gravel, which circulates in pulse modes, and the particulate matter is collected at the bottom. Since the dust is dry when collected, no sludge is generated. The technique was developed in the 1970s.

The exhaust air from the bed can be further treated by a bag filter for additional dust abatement or by other abatement techniques to remove organic compounds present in the treated dryer waste gas.

Achieved environmental benefits

- Reduction of dust emissions without additional water consumption.
- Reduction of blue haze and odour.

Environmental performance and operational data

There are, at the time of writing (2014), no operational data on the performance of the system in the EU. At one particleboard production line, the technique is applied as a pretreatment for dust. The efficiency is expected to be high since the waste gases are thereafter treated in an RTO, which requires low dust levels for a consistent performance.

Suppliers of the technique report achievable dust reduction efficiencies of over 90 % and also the collection of PM_{2.5} and condensable organic compounds. The efficiency of aerosol collection is claimed to be between 20 % and 99 %, according to laboratory testing using a surrogate aerosol. The collection efficiency for PM_{2.5} depends on the applied voltage.

The technique is applied in the US for OSB dryers with an additional RTO for VOC control. Modules are connected in series and, depending on the source, more can be added in order to obtain maximum efficiency. Airflows are reported to be over 100 000 m³ per module, with up to three modules per dryer. The filter bed is operated at temperatures from 70 °C to over 140 °C, where temperatures over 120 °C would be above the condensation temperatures of most of the condensable compounds. Therefore, it is most likely necessary that a subsequent secondary treatment of the VOC content would be needed. No data were available from the sites.

Pilot tests have recently been performed at two sites in Europe, where a part of the dryer waste gas was led through a test unit. The results are summarised in Table 4.10.

Table 4.10: Result of pilot tests of EFB treating dryer emissions

Test plant	Details	Sampling spot	Dust (mg/Nm ³)	TVOC (mg/Nm ³)
PB Directly heated dryer. Flue-gas mix from biomass-fired combustion plant + HFO diesel engines	Airflow: 7600 Nm ³ /h Temperature: 70 °C 12 half-hour samples	Inlet	22 – 350	100 – 150
		Outlet	7 – 63	60 – 127
MDF Directly heated dryer. Flue-gas mix from biomass-fired combustion plant + HFO diesel engines	Airflow: 8600 Nm ³ /h Temperature: 65 °C 10 one-hour samples	Inlet	31 – 60	43 – 54
		Outlet	9 – 16	28 – 43
<i>Source: [54, EIPPCB 2012], [61, EFB 2012]</i>				

Based on the pilot test samples and comparing values taken during the same sampling period from the entrance and outlet of the EFB, the dust removal efficiency was around 90 % for PB and 75 % for MDF, while the TVOC was reduced by around 25 % at the PB plant and by around 20 % for MDF. It should be noted that generally data did not represent full-scale operating conditions. The pilot test reflected a changing composition of hot gases from both biomass combustion and heavy fuel oil-fired diesel engines and with additional spiking with dust.

Cross-media effects

- There could be a potential fire risk if the electrical field becomes saturated with dry wood dust.
- The power consumption should be taken into consideration.
- The collected dust material will need separate treatment.

Technical considerations relevant to applicability

High fire risk.

Economics

No data were submitted.

Driving force for implementation

Reduction of dust, especially if a wet abatement technique is not wanted or water supplies are scarce.

Example plants

There is one 20-year old EFB in operation in Austria, as a pretreatment for an RTO, and no separate monitoring is performed.

Data from pilot tests on a particleboard plant and MDF plant in Spain.

Reference literature

[61, EFB 2012]

4.2.4.4 Wet scrubbers

Description

Wet scrubbing removes dust particles and some gaseous organic compounds from waste gas by bringing the gas stream into contact with water and obtaining inertial and/or diffusion interception in the water phase.

Technical description

Wet scrubbing technology is relatively simple and gives a stable and consistent abatement.

Wet scrubbers cover a large range of models, offering specific affinities and capacities.

Venturi scrubbers can be used for pretreatment of dust, e.g. before a bioscrubber. Venturi scrubbers are efficient at removing dust, particles and part of the condensable organic compounds by impaction and inertia of the jet stream of water in the scrubber. Because of the high power consumption and its low overall efficiency however, other solutions may be preferable when treating dryer waste gas. Waste gas from the press has a much lower volume and small-scale Venturi scrubbers are commonly applied for the removal of particulate material, prior to further treatment of the organic compounds in the waste gas.

Packed bed wet scrubbers operate by letting the gas travel countercurrently from the bottom of a tower through a packed bed material sprayed continuously with recirculated water.

Waste gases from the dryer and the press are collected and sprayed with water by spray nozzles in the duct before discharge to further treatment. The main objective of water spraying or quenching is to cool the collected waste gases, which at the same time prevents the build-up of sticky dust in the ducts. This greatly lowers the fire risk. Quenching of dryer waste gases is part of the condensation of the waste gas, which aids the capture of condensable organics in the water phase.

Mist eliminators can be installed in the upper part of the wet scrubber to prevent droplet carry-over.

The recirculated water in the wet scrubber needs to be treated by removing solids. Depending on the model, the internal water treatment system can be a simple sedimentation of solids and removal of the sludge by decanting. In-line screw presses dewater the sedimented sludge and return the water phase to the scrubber. Dissolved Air Flotation (DAF) can be an integrated part of the unit and effectively removes the sedimented and suspended solids by coagulation and flotation.

Additional measures, such as chemical oxidation, can be implemented to give high removal efficiencies for formaldehyde, e.g. by dosing sodium bisulphite and sodium hydroxide to the scrubber water or in a subsequent reaction tank. Chemical oxidation is applied in a few plants where the oxidation methods have been developed as an in-house research development project.

Chemical oxidation of the lower aldehydes and lower alcohols could be developed by a polishing step after other reduction systems where condensable organics and dust have already been reduced by other methods.

Targeted chemical oxidation such as catalytic gas treatment is an additional treatment step that is applied to the waste gas after removal of particulate matter in particular and, secondly, condensable organic compounds, e.g. with a Venturi scrubber or WESP. The chemical oxidation is accomplished by hydrogen peroxide, aided by different metal catalysts and initiated by UV light for example.

Water discharge, sludge handling and use of chemicals need to be considered carefully.

Achieved environmental benefits

A wet scrubber reduces dust levels and to a certain extent reduces the content of organic compounds.

Environmental performance and operational data

Dust and volatile organic compounds emissions from wet scrubbers are shown in Table 4.11.

Table 4.11: Average values of periodic measurements, including minimum and maximum values, of measured dust levels in dryer emissions after treatment in a wet scrubber

Plant ID no	Dry or wet basis/ O ₂ reference ⁽¹⁾	Product	Dust, minimum (mg/Nm ³)	Dust, average (mg/Nm ³)	Dust, maximum (mg/Nm ³)	Volatile organic compounds (mg/Nm ³)
D019	-/-	MDF	4.4	4.7	6	39.8
D049	Dry/18.6 %	MDF	1.8	8.1	12	227
D046	Dry/17 %	MDF	9.4	13.5	17	45
D039	Wet/17 %	MDF	3	5	8	-
D048	Dry/19.2 %	MDF	6.1	11.7	17.7	148
D045	Dry/17 %	MDF	13.3	20.6	29.6	58
D047	Dry/17 %	PB	32.4	33	33.5	69
D059-a	Dry/-	PB	21.7	67.8	110	166
D050	Dry/19.3 %	MDF	32.9	36.9	40.2	171
D090	Dry/-	Rigidboard	5.9	9.4	14.4	99

⁽¹⁾: No information available.
⁽¹⁾ O₂ numbers in italics are the measured oxygen content when given with no correction to a reference oxygen content.
 Source: [22, TWG 2012]

TOC levels for MDF lines are below 50 mg/Nm³ when a corresponding specific mass load below 1200 g TOC/tonne of dried fibre is taken into consideration. Three MDF lines using chemical oxidation together with a wet scrubber for enhanced formaldehyde destruction showed low levels of formaldehyde both in terms of concentration and specific load. The TOC values were between 148 mg/m³ and 230 mg/m³ and the specific mass load between 2400 g and 2900 g TOC/tonne of dried fibre.

Formaldehyde and emissions of volatile organic compounds from MDF dryer lines with wet scrubbers are shown in Table 4.12.

Table 4.12: Emissions of formaldehyde and related specific mass loads from MDF fibre dryers with wet scrubbers

Plant ID no	Organic volatile compounds	Formaldehyde	Specific mass load	Comment
	mg/Nm ³ dry basis (no O ₂ correction)	mg/Nm ³ dry basis (no O ₂ correction)	g formaldehyde/tonne of dried fibre	
D048	148	6.6	105	Wet scrubber Chemical oxidation
D049	227	9.1	120	Wet scrubber Chemical oxidation
D050	171	9.7	130	Wet scrubber Chemical oxidation
D046	45 ⁽¹⁾	7.5 ⁽¹⁾	170	Wet scrubber
D045	58 ⁽¹⁾	14.6 ⁽¹⁾	200	Wet scrubber

⁽¹⁾ At 17 % oxygen.
Source: [22, TWG 2012], [23, WBP industry 2012].

The further removal of formaldehyde and, for example, methanol is reported at a few installations. At an example production site, the waste gas from the fibre dryer was treated using a wet scrubber with added sodium bisulphite and sodium hydroxide in the scrubbing water, and the site reported a removal efficiency for formaldehyde of more than 95 % and formaldehyde mass concentrations measured biweekly ranging between 1 mg/Nm³ and 4 mg/Nm³.

The removal of formaldehyde and simple alcohols and other aldehydes by catalytic gas treatment is documented in production plants in Canada and the US. The technology has not been applied in the EU. The reported removal efficiencies for formaldehyde and methanol are over 90 %, with a corresponding concentration below 1 mg/Nm³.

Press emissions are often treated in smaller in-line wet scrubbers, which remove dust and a part of the VOCs and formaldehyde.

Table 4.13: Emission of dust, TVOC/CVOCs and formaldehyde from press waste gas treated with wet scrubbers

Plant ID no	Dust (mg/Nm ³)	TVOC (mg/Nm ³)	Formaldehyde (mg/Nm ³)	Comment
D062, PB	3	14	-	Hydrocyclone
D081, PB	11.6	86 (CVOC)	3.6	Venturi scrubber
D081, MDF	8.9 – 9.4	55 – 79 (CVOC)	2.7 – 2.8	Venturi scrubber
D065, D067, MDF	7–8	2 – 24	-	Venturi scrubber/hydrocyclones

'-': No information available.
⁽¹⁾ At 17 % oxygen.
Source: [22, TWG 2012], [23, WBP industry 2012].

Cross-media effects

- Consumption of chemicals can be necessary in order to recycle water.
- Generation of sludge that needs further treatment.

Technical considerations relevant to applicability

Wet scrubbers are mainly applied at MDF production lines. The higher dust levels from PB dryers would require pretreatment of the dust fraction.

Economics

The consumption of water and power has to be taken into consideration.

No plant-specific data or information were submitted.

Driving force for implementation

To reduce dust and the organic compounds present in dryer and press waste gases.

Example plants

Smaller wet scrubbers are widely applied to treat press waste gas. In MDF production, wet scrubbers are commonly used to treat dryer waste gas.

Reference literature

[42, EIPPCB/EPF 2012],

4.2.4.5 Bioscrubbers

Description

A bioscrubber uses biological oxidation to degrade the condensable and non-condensable VOC compounds adsorbed onto a packed bed containing bacteria culture, and it also reduces dust by a prior scrubbing step.

Technical description

The bioscrubber consists of a column of packed material of plastic, ceramics or other bed material which is flooded with water. The waste gas enters at the bottom of the column and travels up through the packed material to the discharge stack. The water is recycled continuously; it is discharged from the bottom of the column and transported to the top of the column, where it is sprayed or sprinkled over the top of the packed bed. Organic compounds such as the VOC fraction of dryer and press emissions will be degraded by biological oxidation when adsorbed onto the packed material.

The bottom discharge contains some absorbed organic compounds, dust and washdown water from the column. The water is led to a settlement tank or decanter before being pumped to the top of the column. Biological oxidation takes place in the packed bed and also in the settlement tank. In the settlement tank, automatic adjustment of the pH and the addition of nutrients can optimise the conditions there and also in the packed bed column.

The temperature in the bioscrubber should be kept within a narrow range, in order to maintain a stable and efficient biological activity. A bioscrubber will need time to stabilise before the bacteria culture is established and the correct operating temperature is determined. To lower the temperature, a pre-scrubber such as a Venturi scrubber or hydrocyclone can be used, which also serves the purpose of removing the most coarse dust fractions. A pretreatment is sometimes necessary in order to remove excess dust, since the efficiency of the bioscrubber is influenced by dust, which can clog the filter material.

The pretreatment for coarser dust can also be achieved with efficient spraying and quenching in the ductwork, before entering the bioscrubber, and capture of the dust fraction when entering the bioscrubber. The collected dust is brought together with the bottom discharge of the bioscrubber and led to the settlement tank.

The two main control parameters for a stable efficiency are control of the temperature and of the water quality regarding the pH and TSS content.

Achieved environmental benefits

Degradation of VOCs in low concentrations by biological oxidation and also removal of dust.

Environmental performance and operational data

Bioscrubbers are so far only applied at MDF production lines and data are shown in Table 4.14. Prior to the bioscrubber the dust levels are brought down to an acceptable level by cyclones, a Venturi scrubber or scrubbing towers. The dust pretreatment is designed according to the requirements of the bioscrubber.

At one MDF plant (D031) the press waste gas is also treated in the bioscrubber.

The organic part of the emission is analysed using different parameters. There is no information regarding the constituents of the volatile organic compounds and whether the biological degradation could contribute not fully degraded organic compounds. The dust levels and formaldehyde levels are low.

Table 4.14: Average values of periodic measurements of dust, organic compounds and formaldehyde in dryer emissions after treatment in a bioscrubber

Plant ID no	Product	Dust (mg/Nm ³)	Volatile organic compounds (mg/Nm ³)	Formaldehyde (mg/Nm ³)
D005	MDF	2.5	37 (NMVOC)	5.2
D026	MDF	3	122 (VOC, wet basis)	-
D028	MDF	5	100 (NMVOC, wet basis)	2.7
D031	MDF	11.0	42 (TOC, wet basis)	-
D094	MDF	8.5	82 (TOC, wet basis)	7.2

!': No information available.
 Note: If not indicated all data are given on a dry basis with no correction of O₂.
 Source: [22, TWG 2012]

The biological activity of the bacteria requires a stable and optimum temperature that will vary slightly between scrubbers. An optimum temperature is considered to be around 35 °C. Thermophilic bacteria performing at a temperature between 55 °C and 65 °C have been reported at one site. While the bacteria degrade more slowly at a temperature below the optimum, too high a temperature will destroy the bacteria culture and therefore be detrimental.

Sludge generation is reported to be around 1 m³/h for a bioscrubber treating waste gases from a MDF dryer and its MDF press line.

For a constant, good performance, it is necessary to monitor the pH and flow in the water and perform internal control sampling of formaldehyde, TOC, COD and TSS.

Cross-media effects

- Consumption of chemicals may be necessary in order to recycle water.
- The sludge generated needs treatment.
- Consumption of power needs to be taken into consideration.

Technical considerations relevant to applicability

For the bioscrubber to be very efficient, dust abatement is necessary before the waste gas enters the bioscrubber.

Economics

Installing a bioscrubber is a major investment and the operation and maintenance costs are comparably high.

At an MDF example plant with a yearly capacity of 350 000 m³, the investment cost of the bioscrubber was around EUR 6 million. The yearly operating and maintenance costs were more than EUR 1 million.

Driving force for implementation

To reduce the organic compounds present in dryer and press waste gases.

Example plants

The bioscrubber is mainly applied in MDF production. It has been applied in the sector for more than 10 years.

Reference literature

None.

4.2.4.6 Thermal oxidation

Description

Destruction of organic compounds by thermal oxidation of combustible materials, and conversion of all the carbon present in the waste gas into CO₂.

Technical description

A thermal incinerator consists of a combustion chamber where a flame from combustion of a fuel, normally natural gas and the VOCs present in the waste gas, heats up the incoming waste gas stream. The temperature in a simple once-through thermal incinerator is between 650 °C and 1000 °C.

Regenerative thermal oxidisers (RTOs) have two or more chambers where the combustion heat in the treated waste gas from one incineration cycle in the first chamber is used to preheat the packed ceramic bed in the second chamber, where a new incoming waste gas treatment cycle begins. The incineration temperature in the RTO reaches 800–1100 °C. Before the treated waste gas is released, the heat energy contained can be recovered for other uses.

Achieved environmental benefits

Destruction of VOC compounds and elimination of odour.

Environmental performance data

In the US, RTOs are applied to treat VOCs in dryer and press waste gases. Commonly, the dryer waste gases are pretreated, e.g. in a WESP, wet scrubber or Venturi scrubber, to remove dust.

The emission level achieved for VOC destruction is reported to be between 0.1 mg/Nm³ and 5 mg/Nm³.

One RTO system is operated in Austria to treat dryer waste gas from a directly heated PB dryer. Before the RTO, the dust in the dryer waste gas is removed in an electrified filter bed, which is currently also the only one operated in Europe. The emission levels after the RTO are measured every second year. At 17 % O₂, dust is 2.8 mg/Nm³, NO_x 288 mg/Nm³, CO 11 mg/Nm³, formaldehyde 0.013 mg/Nm³ and NMVOC 1.9 mg/Nm³.

Cross-media effects

High energy consumption.

Additional energy input mainly from natural gas is needed to maintain the high temperatures for thermal oxidation. This will increase the fossil fuel-based CO₂ emissions.

The combustion of waste gas in an RTO generates NO_x, and similarly an insufficient oxidation will give rise to elevated CO levels.

If the waste gas contains chloride or sulphur compounds, acid gases can be formed and create salt deposits in the bed material. This will destroy the packed bed and additional pretreatment of the waste gas will be needed. Frequent cleaning by washing the bed material with water is necessary and will create waste water, which needs proper treatment before discharge.

Experience of operating thermal oxidation abatement in the US has identified that the build-up of carbonaceous material from particulate matter within the oxidation chamber has to be periodically 'burnt out' to prevent uncontrolled fires and to maintain the efficiency. The cleaning operation of burning out the ceramic chambers will lead to extraordinary emissions of mainly PAH compounds and tar oils. The energy consumption will also increase during burn-out operations.

Technical considerations relevant to applicability

An RTO is generally applicable, but economic and energy constraints can be decisive when choosing this technique for targeted VOC destruction. Efficient upstream dust treatment and control is needed, both for maintaining a good performance and to reduce the risk of fire.

In order to achieve acceptable energy efficiency, recovery of heat energy in the treated waste gases needs to be considered.

While the RTO can also be operated at low VOC concentrations, the thermal incinerator is better suited for much higher VOC concentrations, since the combustion of VOCs in the flame contributes to a temperature rise. If the concentration is not high enough, additional fuel needs to be used in order to keep the flame temperature high. Under these operating conditions, the thermal incinerator is not a cost-effective or energy-efficient solution.

Economics

RTO systems are generally seen as expensive to install and as having high running costs, due to both the additional fuel and maintenance required.

Driving force for implementation

A strict control of VOC and odour emissions.

Example plants

An RTO is applied at one particleboard plant in Austria treating dryer waste gas. For the necessary dust abatement prior to the RTO, an electrified gravel bed is applied. This is the only example of this dust abatement technology in Europe.

Thermal oxidation including RTOs for VOC abatement is widely used in other sectors.

In the US, the RTO is applied to specifically treat VOCs in dryer and press waste gases. The dryer waste gases are commonly pretreated, e.g. in a WESP, to remove dust.

Reference literature

[69, AT UBA 2013], [63, US EPA 2002], [60, US EPA 2004], [70, Sauer 2002], [102, EPA (US) 2003].

4.2.4.7 Incineration of press waste gases in an on-site combustion plant

Description

Collected waste gas from the press is incinerated after an initial dust removal by quenching or wet scrubbing.

Technical description

The incineration or post-combustion of press waste gases after an initial quench or after a wet scrubber is widely applied to destroy the VOC content in the press emissions, but this also contributes to the positive energy balance of the operations on site. No emissions data or mass balances have been made available nor has information on abatement efficiencies for the press waste gas, when incinerated or post-combusted.

Incineration is performed by adding the press waste gas directly as an air source for air staging in the furnace. However, it is just as common for the press waste gas to be added to the mixing chamber, where the hot gas is mixed with fresh air to obtain the desired hot gas temperature.

Achieved environmental benefits

Reduction of VOC emissions from press waste gases, including formaldehyde.

Environmental performance and operational data

None reported.

Cross-media effects

None reported.

Technical considerations relevant to applicability

The applicability is determined by the design of the combustion plant.

Economics

No information or data were submitted.

Driving force for implementation

To save energy and at the same time reduce the VOC load in the press waste gas.

Example plants

The technique is widely applied throughout the sector.

Reference literature

None.

4.2.5 Techniques to prevent or reduce emissions from other sources

This section covers emissions to air other than the emissions from dryers and from pressing. The activities and the related emissions to air include upstream activities including all wood storage, processing, and transport before drying and mat forming, and all activities downstream from the press. The downstream activities include sanding and cutting-to-size operations which are performed on all sites. Moreover, the techniques to prevent or abate emissions from paper impregnation lines are covered. Other emission sources from channelled emissions can be very specific to the individual installation, but should generally be comparable with the emissions sources mentioned in this section.

The channelled emissions are characterised as arising from woodworking processes, where the removal of dust is necessary in order to prevent spreading of dust around the workplace, causing a potential fire risk.

4.2.5.1 Bag filters and cyclofilters

Description

Bag filters collect particulate matter when the flue-gas is passed through a fabric. A cyclofilter combines the gravitational forces from cyclone technology to separate coarser dust and capture finer dust with a reverse-air or pulse-jet bag filter.

Technical description

Various dust sources are treated with a bag filter. For a further description of bag filters, see Section 4.2.4.2.

The collection of product residues by the extraction of air at all dust-laden sources and a subsequent dust collection by applying a bag filter or cyclofilter maximise the quantity of production residue-derived fuel. Dust collection and transport to the combustion plant can be optimised if a central ring collection system is used and the collected dust is transported in closed conveyers to the fuel storage.

Due to the effective dust abatement achieved by bag filters and cyclofilters, the filtered clean air can usually be recirculated into the production buildings, as room heating or ventilation.

Achieved environmental benefits

- Reduction of waste to be transported off site.
- Reduced diffuse emissions.

Environmental performance and operational data

Bag filters and cyclofilters are applied in general in the wood processing industry. Very little data have been available for the WBP sector. The emission level achieved by bag filters or cyclofilters is generally below 5 mg/m³.

Cross-media effects

- Energy consumption for fan and filter operations.
- Potentially higher NO_x and dust emissions when sanding dust is combusted.

Technical considerations relevant to applicability

Internal production residues such as sanding dust could demand a more rigorous control of the combustion process concerning emission of NO_x and may have the potential for higher dust emissions.

Dust from cleaning recovered wood could contain polluting substances and should not be mixed with other collected dust types before a qualitative assessment is performed.

Economics

Bag filters for downstream activities would treat smaller sources, but can equally serve a ring collection system. For bag filters dimensioned to treat 100 000 Nm³/h, the investment costs would start at EUR 100 000–150 000. If the waste gas source is humid or sticky, or if the treated air is returned as room heating, the investment could be higher.

The operating costs are above EUR 35 000 and include electrical consumption and replacement of the filter material.

At some example plants, with yearly capacities of 350 000–650 000 m³ of finished panel, bag filters for all smaller sources upstream and downstream represented an investment of EUR 3–4.5 million.

The operation of fans, filters and transport systems for the collected dust can account for as much as 20 % of the total power consumption on a production site.

Driving force for implementation

- Optimisation of fuel quantity by collection of wood fines and dust.
- Reduced diffuse emissions.

Example plants

Bag filters and effective collection systems are applied at all sites to control dry dust sources. There are sites where ring systems and central bag filters treat the dust collected at site level.

Reference literature

None.

4.2.5.2 Cyclones

For description and performance see Section 4.2.2.6.3

4.2.6 Techniques to reduce channelled emissions from paper impregnation line dryer ovens

4.2.6.1 Resin selection

Description

Selection of a resin with a low content of formaldehyde and VOCs results in lower formaldehyde and VOC levels in the emitted dryer air.

Technical description

Resins with a low formaldehyde content, such as melamine-based resin, will result in lower formaldehyde emissions from the dryer ovens for impregnated paper.

Achieved environmental benefits

Reduction of VOC emissions from the drying of impregnated paper.

Environmental performance and operational data

One production plant with monitoring data from six impregnation lines of different ages and capacities is using resins with a low content of VOCs and formaldehyde. Only TVOC data have been made available, see Table 4.15. The corresponding specific mass loads are also indicated. The difference between production lines is not only related to the resin selection but also to the drying conditions applied.

Table 4.15: Emissions of TVOC from paper impregnation lines at one WBP installation with no abatement but using resin types with a low free VOC content

D068	TVOC, average (mg/Nm³)	TVOC, min. and max. values of periodic sampling (mg/Nm³)	Specific mass load (g TVOC/m² impregnated paper)
Line 1	34.9	14 – 47	0.38
Line 2	20	-	0.15
Line 3	25.4	6 – 33	0.37
Line 4	12.7	3 – 15	0.15
Line 5	11.9	9 – 16	0.04
Line 6	26.3	16 – 32	0.38
': No information available.			

Cross-media effects

None reported.

Technical considerations relevant to applicability

Some product ranges and varieties of impregnated paper could be difficult to produce with a limited resin choice. The final quality and properties of the product are defined by the market and the selection of resin is necessarily related to the balance of cost and product performance.

Economics

No information or data were submitted.

Driving force for implementation

Prevention of VOC emissions.

Example plants

D068.

Reference literature

None.

4.2.6.2 Biofilters**Description**

A biofilter performs biological degradation of condensable and non-condensable VOC compounds adsorbed on a packed bed with bacteria culture.

Technical description

The biofilter consists of a column of packed material of plastic, ceramics or other bed material. The waste gas enters at the bottom of the column and travels up through the packed material to the discharge stack. The water is recycled continuously; it is discharged from the bottom of the column and transported to the top of the column, where it is sprayed or sprinkled over the top of the packed bed. Organic compounds will be degraded by biological oxidation when adsorbed onto the packed material.

The temperature in the biofilter should be kept within a narrow range, in order to maintain a stable and efficient biological activity. Biofilters will need time to stabilise before the bacteria culture is established and the correct operating temperature is determined. To lower the temperature, a pre-scrubber such as a Venturi scrubber or hydrocyclone can be used, which also serves the purpose of removing any dust, if present. Dust in emissions from the dryer oven from impregnation lines is generally at a low level.

To maintain a constant, good performance, it is necessary to monitor the pH and flow in the water and perform internal control sampling of formaldehyde, TOC, COD and TSS.

Achieved environmental benefits

Degradation of VOCs in low concentrations by biological oxidation.

Environmental performance and operational data

Data available for the biofilter are scarce and are mostly derived from one plant that recently installed a biofilter. One plant in Italy has operated a biofilter to abate formaldehyde, but there are no data available. Nevertheless, the technique is applied in other industrial sectors. However, use of the biofilter and its performance with regards to organic compounds can be compared with the use of bioscrubbers applied at MDF lines treating dryer waste gases and press waste gases.

The reported level of CVOCs was 16 mg/Nm³, with a corresponding specific load of 0.07 g CVOCs/m² of impregnated paper. The formaldehyde concentration in the emission was measured as between 1 mg/Nm³ and 3 mg/Nm³.

Cross-media effects

- Consumption of chemicals may be necessary in order to recycle water.
- A prior wet scrubbing step to remove dust might be necessary.

Technical considerations relevant to applicability

For the biofilter to be very efficient, dust abatement may sometimes be necessary before the waste gas enters the biofilter.

Economics

Not reported.

Driving force for implementation

To reduce the organic compounds present in dryer and press waste gases.

Example plants

Two plants have installed a stand-alone biofilter for the impregnation lines.

Reference literature

None.

4.2.6.3 Addition of dryer oven waste gas to main treatment systems

Description

The hot waste gas from drying ovens can be treated in the abatement systems that already treat organic compounds present at the site.

Technical description

Since the hot gas contains very little dust, reduction systems that treat and reduce the organic compounds should be preferred.

Bioscrubbers are applied for fibre dryer waste gas and biofilters for dryer oven waste gas from impregnation of paper, but the simultaneous treatment of both has not yet been applied in the sector. It should be noted that a stand-alone biofilter only treating waste gas from the impregnation oven is currently in operation in the sector on at least two sites.

Post-combustion of waste gas from drying ovens is applied at a few sites. The VOC content is incinerated in the combustion plant or in the mixing chamber for hot gases used for direct drying. No data are available on the efficiency, but it is assumed that the VOC fraction is easily thermally destructed at temperatures typical in the hot gases before the addition of air.

Treatment in a WESP is also used at one site, even though the ability of the WESP to treat the organic compounds is most likely limited.

Cross-media effects

Not reported.

Technical considerations relevant to applicability

Post-combustion or incineration of waste gases from the drying ovens in an on-site combustion plant will depend on the technical limitations of the combustion plant and the firing technique. Dust burners or gas burners exclusively producing hot gases for direct drying would rarely be suitable for waste gas incineration. For incineration of waste gases a sufficient and stable temperature is needed.

Economics

Not reported.

Driving force for implementation

Not reported.

Example plants

Austria (D003, post-combustion), Spain (D070, WESP).

Reference literature

None.

4.2.6.4 Thermal oxidation**Description**

Destruction of organic compounds by thermal oxidation of combustible materials, and conversion of all carbon present in the waste gas into CO₂ and water.

Technical description

For technical description see also Section 4.2.4.6.

The regenerative thermal oxidiser (RTO) uses a ceramic packed bed in the chamber, whereas the catalytic thermal oxidiser (CTO) uses a catalyst material in the packed bed. The incineration temperature in the RTO reaches 800–1100 °C, while the RCO (regenerative catalytic oxidation) operates at a lower temperature of 400–700 °C.

Achieved environmental benefits

Destruction of VOC compounds and elimination of odour.

Environmental performance data

Both RTOs and CTOs are applied in the sector. Data from four plants using thermal oxidation are shown in Table 4.16 for treating waste gases from the drying ovens for impregnation of paper.

Table 4.16: Emissions of organic compounds from drying ovens for impregnation of paper lines treated by thermal oxidation

Plant ID no	TVOC (mg/Nm ³)	Formaldehyde (mg/Nm ³)	Specific mass load (g TVOC/m ² impregnated paper)	Abatement technique
D003	7 – 17	1 – 8.8	0.07 – 0.19	Catalytic thermal oxidiser
D063	26	-	0.07	Catalytic thermal oxidiser
D094	4.6	0.7	-	Regenerative thermal oxidiser
D077	(CVOOC) 3.2 – 34.7	1.6 – 4.1	0.008 – 0.17	Regenerative thermal oxidiser (decommissioned 2011)
-: No information available.				

The emission levels achieved for TVOC are reported to be between 7 mg/Nm³ and 35 mg/Nm³, while formaldehyde levels are reported to be between 0.7 mg/Nm³ and 8.8 mg/Nm³.

Cross-media effects

High energy consumption.

NO_x formation is reported to be possible and should be taken into account, and similarly insufficient oxidation will give rise to elevated CO levels.

Technical considerations relevant to applicability

An RTO/CTO is generally applicable, but economic and energy constraints can be decisive when choosing this technique.

In order to achieve high energy efficiency, the recovery of heat energy in the treated waste gases needs to be considered.

Economics

No specific economic data for the use of thermal oxidation in paper impregnation were received.

Driving force for implementation

Reduction of VOC and formaldehyde emissions.

Example plants

Currently, at least three plants operate an RTO or CTO.

Reference literature

[101, EPA 1999], [102, EPA (US) 2003].

4.2.7 Techniques to reduce diffuse emissions

4.2.7.1 Implementation of good housekeeping measures to minimise diffuse dust emissions from the log yard

Description

Regular cleaning and mechanical sweeping of internal transport routes, the log yard, and vehicles delivering raw wood material.

Sprinkling water on stockpiles of dust-prone material and transport routes.

Technical description

The regular cleaning of transport routes, storage areas and vehicles forms part of good housekeeping measures.

Sites apply manual or climate-adapted automatic sprinkling systems during dry periods and can use collected rainwater or surface run-off water. Sprinkling is also performed to keep the moisture in logs at a sufficient level, e.g. above 50 %, to prevent biological degradation.

Achieved environmental benefits

With regular cleaning of the premises, dust emissions are minimised. An additional benefit is a lower load of wood dust in the surface run-off water, which eases the treatment of collected water.

With controlled water sprinkling, diffuse emissions created by wind drift are reduced.

Environmental performance and operational data

No specific information was received.

Cross-media effects

- During cleaning, dust can be mobilised and may spread in the surroundings.
- Added water consumption and increased volume of water discharge when sprinkling is used in the log yard. This is only relevant if water is added unnecessarily.

Technical considerations relevant to applicability

Sprinkling is generally applicable to sites on paved areas with a collection of surface run-off water.

Economics

Not relevant.

Driving force for implementation

Reduction of diffuse emissions from the log yard during dry and windy periods.

Example plants

Regular cleaning is applied throughout the sector.

Reference literature

None.

4.2.7.2 Minimisation of diffuse emissions from the conveying of wood raw materials**Description**

Use of closed mechanical conveyers and pneumatic transport for the transport of dust-prone material, in order to prevent or reduce diffuse emissions.

Technical description

Pneumatic conveying systems for wood materials use low-pressure or high-pressure systems and transport up to 100 t/h of wood chips. Fans are used in low-pressure conveying systems to transport material from the dryer or to and from storage silos.

Achieved environmental benefits

Reduction of diffuse emissions of raw material.

Environmental performance and operational data

No information received.

Cross-media effects

Consumption of energy.

Technical considerations relevant to applicability

A dust separator should be applied to clean the air channelled from pneumatic transport equipment.

Economics

No information or data were submitted.

Driving force for implementation

To reduce the spread of diffuse dust emissions in the surroundings of the site.

Example plants

Most plants choose a combination of transport solutions to minimise diffuse emissions and losses of raw material.

Reference literature

None.

4.2.7.3 Qualification of fugitive emissions using Reverse Dispersion Modelling

Description

Reverse Dispersion Modelling is a method to qualify the fugitive emission rate of diffuse dust emissions to the atmosphere from a WBP site. The method is described in EN 15445:2008.

Technical description

Fugitive dust is not emitted at a fixed flow rate and the emitted matter is dispersed in air. In many cases, different dust sources contribute to the dust concentration in a sampling location. All diffuse sources, such as windblown dust from stockpiles in a log yard, dust from the handling of raw materials in general, and diffuse dust from manufacturing buildings, should be included.

The calculations made in the modelling scenario take field data from the site into consideration, such as the number, heights and widths of diffuse dust sources, meteorological information and sampling locations.

Reverse Dispersion Modelling is a tool to define and manage improvements in minimising diffuse dust emissions.

Achieved environmental benefits

Reverse Dispersion Modelling is a tool for the site to identify the most significant dust emission sources and to use the information to implement measures to reduce diffuse emissions. The measures taken aim to apply good housekeeping and related improvement processes, as part of an Environmental Management System for the plant.

Environmental performance and operational data

Not reported.

Cross-media effects

There are no registered cross-media effects.

Technical considerations relevant to applicability

The method cannot be used to control dust emissions from a site, nor is it possible to use the method to compare the fugitive emissions from diffuse sources between two or more sites.

Economics

The creation of the initial Reverse Dispersion Model and regular follow-ups would be similar to other investigations or status reports produced on a regular basis at an industrial site.

Driving force for implementation

Determination of possible improvements for controlling diffuse dust emissions, as part of an Environmental Management System.

Example plants

Not specified.

Reference literature

EN 15445:2008.

4.3 Techniques to prevent or reduce emissions to water

Waste water is water composed of any combination of water discharged from domestic, industrial or commercial premises, surface run-off water, and any accidentally released sewer infiltration water.

Even though emissions to water are generally low for most production processes in the sector, there are some activities for which the control of emissions to water is necessary. The main potential sources identified in Section 0 are the following:

- process water from refining and fibre production;
- surface run-off water and drainage from the log yard and other outdoor areas with wood processing activities.

Discharges are characterised by a high wood-based solids content, giving rise to high TSS, COD and BOD₅ values, while other pollutants such as ammonium, nitrates and total hydrocarbons could be present under specific circumstances.

Some other less significant contributing streams that should be handled were identified as:

- water used for plant cleaning;
- wet abatement systems' water;
- spillages and leaks from stored chemicals;
- glue water.

Ultimately, there may also be differences among installations and other process water streams or waste water streams. The handling and discharge of domestic waste water from offices and auxiliary activities are not considered, but it is expected that these issues will be common to industrial sites across sectors and they are covered in the existing literature on waste water collection, handling and treatment.

4.3.1 Primary techniques to prevent or reduce emissions to water

4.3.1.1 Minimisation of the pollution load in collected waste water streams

Description

The sealing of the log yard surface with paving, concrete or asphalt, and the segregation of wood raw material storage areas and outdoor wood processing areas and other areas with added pollution potential.

Separately, the surface run-off water from wood fibre production waste water is collected, in order to perform a separate treatment.

Technical description

Sand and soil are unwanted in the raw material since they will require more rigorous cleaning and will generate a higher energy demand in the chip preparation process, both in terms of added cleaning and of wear and tear of the chipping mills.

Paving of the log yard prevents direct contact with the soil and eases the collection of water from the log yard. The surface run-off water collected from a paved log yard will carry less sand- and soil-derived TSS, and hence lower the pollution load. The collected surface run-off water still contains high amounts of wood material, especially if material other than roundwood or bark is stored, that will need to be reduced before discharge.

Segregation and separate treatment of surface run-off water and waste water from wood fibre production could be beneficial, since surface streams can easily be treated in simple sedimentation basins.

Achieved environmental benefits

- The raw material is kept clean of soil and stones.
- Reduction of the pollutant load of collected surface run-off water and waste water from wood fibre production.
- Prevention of percolation to soil.
- Efficient collection of water.
- Management of different qualities of surface run-off water.
- Reduction of leaching of potentially contaminated surface run-off water from the log yard to soil and groundwater.
- Individual management of different qualities of process water, cooling water and cleaning water streams.

Environmental performance and operational data

No data are available on the actual effects of sealing log yard surfaces compared to not sealing, besides the obvious environmental benefits mentioned above.

By collecting waste water from separate smaller collection areas with high COD/BOD₅ loads, waste water treatment can be optimised.

Cross-media effects

Paving increases the amount of water that is discharged into surface water.

Technical considerations relevant to applicability

The local sensitivity of the receiving environment could be a constraint for a direct discharge and in this case the collected water would need treatment.

Regarding segregation and separate treatment of surface run-off water and waste water from wood fibre production, the applicability may be restricted for existing plants due to the configuration of the existing drainage infrastructure.

Economics

The investment includes the cost of paving. Maintenance costs are low.

Driving force for implementation

To reduce the pollution load of collected surface run-off water from outdoor areas.

Example plants

The majority of WBP installations have paving on most of the log yard on site.

Reference literature

None.

4.3.1.2 Recirculation of process waste water from wood fibre production

Description

Recirculation of water from the refiner, the cooking stage and chip washing by intermediary physical removal of solids.

Technical description

The filtration of process waste water from wood fibre production can be performed by a simple screening and decanting. The water can be recycled back to the chip washing stage directly. The sludge mainly consists of wood fines and can be used directly as fuel, especially if screw

presses are applied to remove excess liquid. The sludge can additionally be used as raw material in PB production.

Between the cooking stage, where chips are softened and cooked with steam, and the refiner, water is removed from the chips with a plug screw. The water phase can be used to add to the refiner disc during refining or immediately afterwards when entering the blowline. The remaining concentrated water can be further treated in-line, e.g. by evaporation, flotation or dissolved air flotation.

Circulating water in wet abatement systems contains dust and organic compounds. Wet electrostatic precipitators and bioscrubbers generally have in-line systems to remove precipitated wood dust from the water by simple sedimentation and screw pumps or by dissolved air flotation or coagulation/flocculation.

Achieved environmental benefits

- Lower water consumption.
- Reduced waste water flows to be treated.

Environmental performance and operational data

No data on the performance or reduction efficiencies were reported.

One supplier gave the following reduction efficiencies from cooking: $\geq 92\%$ for TSS and $\geq 80\%$ for COD.

Cross-media effects

The sludge generated needs treatment.

Technical considerations relevant to applicability

Not reported.

Economics

No plant-specific information or data were submitted.

One supplier gave the following key figures for a dissolved air flotation system treating process water from the cooking of wood chips before refining:

Capacity: 10 m^3 process water/h; investment cost: $\sim \text{EUR } 250\,000$; operation and maintenance cost: $\sim \text{EUR } 78\,000$; low fresh water consumption; energy: $\sim 700 \text{ W/m}^3$.

One supplier gave the following key figures for a dissolved air flotation system treating scrubbing and cleaning water in a WESP:

Capacity: 10 m^3 process water/h; investment cost: $\sim \text{EUR } 180\,000$; operation and maintenance cost: $\sim \text{EUR } 45\,000$; low fresh water consumption; energy: $\sim 250 \text{ W/m}^3$.

Driving force for implementation

- To treat process water at source to avoid operating an extensive waste water treatment plant facility on site.
- Reduction of the consumption of water in refining.
- Reduction of the water consumption in wet abatement systems and to maintain a high degree of dust separation.

Example plants

In-line filtration steps at refiner level are commonly applied.

For wet abatement systems, a WESP, on-line dissolved air flotation or decantation followed by screw presses, etc. are standard equipment at newer plants.

Reference literature

None.

4.3.2 Treatment of surface run-off water

Collected water from surface run-off from outdoor areas is characterised by a high level of solids, and a common step is therefore separation of the suspended solids from the water stream. The techniques covered are mainly physical separation techniques:

- screening to remove coarse solids; followed by either:
- sedimentation in sand traps, settlement tanks and followed by a retention basin to remove settleable solids; preceded by oil-water separation if necessary; or
- filtration and degradation in a reed bed.

The treated surface run-off water is discharged either directly to a receiving water body or to further treatment in a waste water treatment plant. Infiltration to soil is also applied at some installations.

4.3.2.1 Preliminary treatment, screening and sieving

Description

Physical screening and sieving removes coarse solids from waste water by interception. Screening is the basic separation step used at all sites for the pretreatment of both surface run-off water and process water, e.g. from refining.

Technical description

Physical screening and sieving can be carried out using a range of different equipment. Screening techniques applied for the treatment of surface run-off water include fixed inclined or curved screens or rotary drum screens. Curved screens need cleaning regularly to remove collected material that has built up. Rotary drum screens consist of a cylinder rotating in a flow channel, where particles are collected either on the outer surface or inside the cylinder, depending on the direction of the flow. The collected material on the screen is continuously removed and the screen is sometimes sprayed with water to keep it clean.

Centrifuges or the use of rotary disc screens that remove solids including grit and sand are applied as a pretreatment before treatment in a waste water treatment plant. The removal of grit protects equipment in the waste water treatment plant from abrasion. Reducing the level of solids also reduces the amount of solids to be removed by flocculation or sedimentation later. Rotary disc screens can remove very fine settleable solids and can be applied as an alternative to a settlement or sedimentation basin.

Screened material, especially from the pretreatment of fibre waste water, is dewatered using screw presses or belt presses, before further handling.

Achieved environmental benefits

Coarse particles, grit and settleable solids are removed from the collected waste water.

Environmental performance and operational data

Screening or sieving is a preliminary step before other primary waste water treatment steps, though there are no data to show its efficiency when treating surface run-off water. The purpose of the screen is to remove large and coarse material which could disturb the further downstream treatment. The removal efficiencies are near 100 % for the size of wood material that a screen is designed to obstruct. TSS can be reduced considerably, while BOD₅ and COD are reduced less.

Cross-media effects

Depending on the content of the screened material, it might need further treatment before handling.

Technical considerations relevant to applicability

None identified.

Economics

The investment costs for curved screens are low and normally just involve passive equipment, while rotary drum screens or centrifuges for example have higher investment costs and need power to operate. Maintenance costs are low.

Driving force for implementation

To remove coarse particles before further treatment.

Example plants

All sites handling surface run-off water apply screens as a primary pretreatment.

Reference literature

[22, TWG 2012]

4.3.2.2 Sedimentation in retention basins and settlement tanks**Description**

A retention basin or a settlement tank withholds coarser material by passive sedimentation.

Technical description

Collected surface run-off water from the log yard is led through a retention basin or settlement tank to allow for the sedimentation of coarse wood material, stones, sand and grit. The collected and channelled surface run-off water is generally pretreated in a sieve or screen removing larger stones and wood.

The retention basin is constructed with an impermeable bottom, in order to avoid leaching of TSS-rich water to the soil. The impermeable bottom layer can consist of an artificial or natural barrier of barely permeable clay or, as an alternative, a heavy-duty plastic membrane. The retention basin is dimensioned so as to allow control of the peak flow effluents into the receiving water or downstream waste water treatment plant and to allow for a sufficient residence time for the coarse materials to sediment. More than one retention basin can be employed in series, to further control peak effluents and to enhance the sedimentation of suspended solids. Also, sand traps and smaller settlement tanks can be used before the retention basin. The sedimented material is regularly removed according to the dimensioned residence time of the retention basin.

Although some biological activity can take place in the retention basin, there are no data to prove that retention basins alone have a specific performance for the degradation of organic material in the water or in the sedimented material.

A settlement tank operates in the same way but holds a lower volume and has a lower retention time.

In many cases, oil-water separation is performed as a pretreatment. Applied oil-water separators (OWS) are typically standard gravity separators. Standard gravity separators are liquid containment structures that provide sufficient hydraulic retention time to allow oil droplets to rise to the surface. The oil forms a separate layer that can then be removed by skimmers, pumps, or other methods. The outlet is located below the oil level so that water leaving the separator and entering the retention basin/settlement tank is free of oil.

Achieved environmental benefits

A retention basin enables the removal of solids and wood debris from the surface run-off water from log yards and prevents a strain on receiving waters or on downstream waste water treatment plants, by controlling peak effluents.

Settlement tanks provide pretreatment, where settleable solids and wood debris and grit are sedimented.

Oil-water separators separate oil from waste water, reducing the discharge of oil and hydrocarbons to receiving waters.

Environmental performance and operational data

The effluent concentration does not change markedly over time if the retention basin is sufficiently large, since the volume will level out the peak inlet flows from heavy or sudden rainfall after periods with no precipitation. The emission level therefore accurately describes the efficiency of the retention basin. Monitoring is most often performed with spot sampling, which relates to the unsteady flow and as the concentration over time does not change or vary very much.

Emission levels of the main parameters analysed for treated surface run-off water discharged to receiving waters are shown in Table 4.17. Not all parameters are analysed at all installations.

Table 4.17: Emission levels associated with sedimentation/oil-water separation

Parameter	Discharge to receiving water, emission average (mg/l)	Comments
TSS	9 – 29	6 installations
BOD ₅	2.3 – 14	4 installations
COD	18 – 122	6 installations
NH ₄ -N	1, 2	2 installations
TN	1.5 – 11.5	3 installations
Note: Data from D015, D017, D039-a, D065-a, D068, D070, D086.		

The difference in emission levels observed is due to a combination of the following reasons:

- input load of contaminated water;
- retention time;
- local permit conditions, reflecting the sensitivity of the surface water.

It has not been possible to derive the actual removal efficiency from the emission data received for the sector. Estimated levels have been reported to be around 50–80 % for TSS.

Operation of the retention basin is achieved by proper maintenance, including:

- Daily inspections of sieves, the oil-water separator, the embankments of the retention basin and the discharge point. Daily inspections prevent overflowing by checking sieves for stops and blockages by larger fragments, as well as checking the structural integrity and pumps.
- Visual inspection of the level of sedimentation and removal of sediment before the retention time becomes too short and causes unforeseen overflows of untreated water.

Cross-media effects

The sedimented material has the characteristics of sludge and, when removed from the retention basin, it needs further handling or disposal.

Technical considerations relevant to applicability

Retention basins are generally applicable to retain and separate solids, e.g. from collected surface run-off water. A retention basin is considered a simple but effective means to remove solids.

Basins are not applicable to treat more complex waste water streams that require more sophisticated treatment than sedimentation alone.

Depending on the local quality demands for the final discharge from the site to the receiving water or further off-site treatment, sedimentation might not be sufficient to achieve the required levels of COD and TOC.

Retention basins occupy rather large areas of outdoor space and a lack of sufficient space might prevent the use of basins.

Economics

The cost of establishing retention basins and the related connection to drainage will vary depending on the state of the area where the basin is to be established and the access to raw materials if built above ground. Operating and maintenance costs also depend on the need for pumps, the frequency of sedimented material removal and the equipment needed to control the flow.

Driving force for implementation

The main driving force for implementation is to handle surface water with high loads of TSS in a controlled way, in order to reduce the strain on the receiving surface waters or on the off-site waste water treatment plants.

The need for large amounts of readily available firefighting water makes retention basins desirable.

Example plants

Retention basins and smaller settlement tanks are used throughout the sector to handle surface run-off water.

Reference literature

[54, EIPPCB 2012], [55, EIPPCB 2012], [99, US EPA 1999].

4.3.2.3 Sand filters**Description**

Sand filters remove fine suspended solids after an initial sedimentation of coarser solids and material.

Technical description

Sand filters can be applied as a second step for removing suspended solids from surface run-off water from the log yard and other outdoor areas. The first step is a retention basin or sedimentation chamber for the sedimentation of larger solids and debris. Sand filters are also applied as a filtration step for treating process water combined with sedimentation or flotation.

The sand filter filters suspended solids, solid BOD₅ and therefore lowers the overall level of COD. The sand filter is cleaned by backflushing into the sedimentation chamber or to a separate collection point.

The filter material can consist of sand and stones or peat, which also promotes the degradation of the organic material, such as wood-derived suspended solids.

Achieved environmental benefits

Correctly dimensioned sand filters effectively remove suspended solids and solid BOD₅ and hence lower the COD levels in treated surface run-off water and in process waters. Also, some biological degradation can occur in the filter material.

Environmental performance and operational data

While the majority of installations collect and treat surface water, only a few have reported the dedicated use of sand filters.

Sand filters are commonly used in handling lightly contaminated water, such as surface run-off water, and are also well documented in other sectors as the final filtration and separation stage before discharge.

The good performance of the sand filter is achieved by proper maintenance, including:

- Daily inspections of sieves, the oil-water separator, the sedimentation chamber/retention basin, the sand filter chamber and the discharge point. Daily inspections prevent overflowing by checking sieves for stops and blockages caused by larger fragments, and checking filter bed conditions and pumps.
- Maintenance of the filter by removing larger fragments and debris on the surface of the filter.
- Visual inspection of the sand filter, in order to control channelling in the filter material, which otherwise markedly lowers the filter efficiency and the hydraulic residence time.
- Regular replacement of filter media, such as for backflushing.

Cross-media effects

The sludge resulting from backflushing the sand filter material needs to be collected and disposed of, either together with sedimented material from the retention basin or sedimentation chamber or separately.

Technical considerations relevant to applicability

Sand filters are generally applicable to retain and separate solids from collected surface run-off water from log yards and process water sources with only suspended solids. Sand filters have a small footprint and can be accommodated at most sites.

Sand filters alone are not sufficient to treat more complex waste water streams.

Depending on the local quality demands in the final discharge from the site to the receiving water or further off-site treatment, a sand filter in combination with a sedimentation chamber might not be sufficient to achieve the required levels of COD and TOC.

Economics

The cost of establishing a sand filter depends on the model of sand filter chosen. The sand filter can be an open surface basin, an underground vault sand filter, or another model which are all standard structural entities common for handling rainwater on industrial sites.

Operation and maintenance costs also depend on the need for pumps, the backflushing frequency of the filter, the handling of the resulting sludge, the amount of added filter material, and the necessary equipment to control flows.

Driving force for implementation

The main driving force for implementation is to handle surface water with high loads of TSS, BOD₅ and COD in a controlled way in order to reduce the strain on receiving surface waters or on off-site waste water treatment plants.

Example plants

Sand filters are applied for pretreatment of process water, but rarely for collected surface water in the sector.

Reference literature

[100, US EPA 1999].

4.3.2.4 Reed bed**Description**

A reed bed is a shallow pond populated with reeds and other wetland plants. The pond has a long hydraulic residence time for water entering the reed bed, allowing the reed bed time to biologically degrade organic components in the water. The reed bed covers a large area and is applied as a last step before discharge to surface waters.

Technical description

The reed bed acts by the filtration of suspended solids, absorption of metals by plants and by the biological degradation of easily accessible organic compounds. The reed bed should be constructed so as to give a high attenuation time for the water to pass through, which will promote biological activity and the settlement of particles.

Achieved environmental benefits

Treatment and attenuation of lightly contaminated surface water, removing TSS and COD by filtration and biological degradation using the plants in the reed bed.

Nitrogen removal can also be achieved.

Cross-media effects

None.

Environmental performance and operational data

Reed beds are used in various applications for treating lightly contaminated rainwater, e.g. in the treatment of road water. Application in the wood-based panel sector has been documented at one installation. The reed bed has a length of 800 m and receives surface run-off water from outdoor areas collected in surface drains and pumped to the reed bed. The reed bed discharges into a sensitive stream and is monitored for pH, formaldehyde and ammonium only. The discharge of TSS and COD is negligible and is not monitored. The level of ammonium $\text{NH}_4\text{-N}$ is between 0.6 mg/l and 4.8 mg/l with a yearly average of 2.6 mg/l and a pH between 7.2 and 8.1. Both parameters are measured daily with spot sampling. Formaldehyde is monitored daily and the yearly average is 1.1 mg/l, with variations between 0.27 mg/l and 1.97 mg/l. Mass loads are not given as the exact amount of discharged water is not known. The discharge flow is, on average, 10 m³/h and fluctuates with precipitation.

Technical considerations relevant to applicability

The reed bed can be used as a last polishing step before release to surface waters, if necessary. The reed bed can treat more complex waste water streams containing dissolved salts. The reed bed cannot be used alone, since larger solids, debris, and easily sedimented material should be removed prior to entering the reed bed. A heavy load of readily sedimented material will block the reed bed if not filtered beforehand.

In cold climates, the efficiency of the reed bed will be low during winter since the biological activity and the uptake by the reeds will be low.

The reed bed and its biology are sensitive to the concentration of chemicals and so should be protected against contaminated water, e.g. from spills and used firefighting water.

A reed bed needs time to establish a sufficient filtering capacity and with age it will perform better.

Economics

The capital cost is dependent on the size of the reed bed and can vary widely. Maintenance and energy costs are low.

Driving force for implementation

Local requirements related to the surface water sensitivity can dictate a higher quality of the water to be discharged.

Example plants

Reed beds are used for handling lightly contaminated surface run-off waters and have been reported as being installed by at least one site.

Reference literature

[65, Scholz 2011].

4.3.3 Treatment of process water from fibre production

Water used in refining has high loads of fibres and partly dissolved fibres. The process water needs a certain minimum level of treatment before the water is suitable for reuse for refining or in other parts of the production process or before it is discharged from the site.

The techniques applied for the treatment of process water from refining range from simple filtration equipment integrated into the refining plant in order to recycle water, to full-scale waste water treatment plants treating process water for recycling or discharge.

Filtration and primary physico-chemical treatment of waste water are carried out to remove wood fines and solids, to lower the initial concentration of TSS, prior to a secondary treatment such as a biological treatment. If the quality of the treated water is crucial before reuse or discharge, a tertiary treatment and polishing step is carried out. The techniques are described below in the logical order of treatment.

4.3.3.1 Preliminary treatment, removal of larger solids

Description

For a common description and further information, please see Section 4.3.2.1.

Environmental performance and operational data

Removal efficiencies when applying the screening of incoming waste water before further treatment are reported as 60–70 % of the incoming TSS loads at two MDF production plants.

4.3.3.2 Primary treatment by physical separation of particles and suspended solids

Description

Physical separation of particles and suspended solids prior to further treatment by flocculation and/or flotation aided by coagulation. Flocs created by mechanical agitation or by coagulation are removed by either gravitational sedimentation or flotation.

Technical description

The primary purpose of physical separation techniques is to remove solids (TSS), which in the waste water in this sector are primarily wood dust and fibres. The very coarse material is

removed by screening, while smaller particles and suspended solids are removed by filtration, coagulation and flocculation, etc.

Flocculation promotes the aggregation of smaller particles into larger particles to enhance their removal by gravity separation. Flocculation is obtained by mechanical stirring or air agitation. Flocculation takes place in separate basins. An in-line addition of coagulators can be performed beforehand to aid the floc formation.

Flotation is the removal of suspended solids and particles with densities close to that of water.

In dissolved air flotation (DAF), the flocculation is aided by high pressure air that agitates and aggregates the flocs. In the basin, the light flocs are concentrated at the surface and are removed by overflow or by a scraper onto a belt press, which removes and dewateres the solids. A DAF unit is compact and takes up little space. DAF is commonly used as an internal on-line treatment for wet abatement techniques and for refiner process water. Larger coagulation and flocculation basins with mechanical stirring and aeration are applied as a pretreatment before biological treatment at independent waste water treatment plants.

Sedimentation provides for the removal of settleable solids and generates sludge at the bottom of the sedimentation tank. Oil and grease, together with floating material, settle on the surface and can be removed in an oil-water separator afterwards or with surface skimmers. Retention basins used for handling surface run-off water essentially employ sedimentation. Sedimentation removes a part of the organic material, depending on the nature of the COD. Sludge needs to be removed regularly from the bottom, which is achieved by sludge removal flights or other standard equipment.

Sludge from the above-mentioned processes consists mainly of the intercepted or settled solids and is dewatered, for example by decanting, followed by screw presses, belt presses or similar equipment, to remove excess water.

Achieved environmental benefits

Reduction of the load of TSS, BOD₅ and COD before further biological treatment.

Environmental performance and operational data

The reported removal efficiencies indicate that the physical separation methods are important steps in removing solids from the waste water. The following data were reported from four MDF production plants:

- 50 % TSS removal by flocculation, sedimentation and decanting;
- 30 % COD removal by sedimentation;
- 60 % COD, 50 % TSS, and 50 % BOD₅ removal by DAF;
- 95 % TSS removal by flocculation, coagulation and decanting.

The removal efficiencies are not accompanied by mass concentrations since the separation step is a step in a water treatment process. From general waste water treatment, it is expected that up to 70 % of TSS and up to 40 % of BOD₅ are removed.

The sludge generated in the flocculation, flotation and DAF is easily transferred to belt or screw presses. The sludge can, with dewatering treatment, achieve a moisture content of at least 20–25 %, which is sufficient to be handled safely.

Sludge from a DAF unit installed in-line in a wet abatement system is of a quality that allows it to be used as fuel. The sludge obtained from more mixed waste water streams cannot always be used as fuel, but may need further treatment.

Cross-media effects

None reported.

Technical considerations relevant to applicability

As for retention basins, sedimentation depends on the retention time in the tank and the available surface area. Settling and sedimentation also depend on temperature and in cold climates sedimentation takes place at a much slower rate.

Economics

No information or data were submitted.

Driving force for implementation

Reduction of TSS and COD before further treatment in biological treatment systems.

Example plants

Various plants use in-line DAF systems at the refiner level or with wet abatement systems. The methods mentioned are applied at all sites with an independent waste water treatment plant.

Reference literature

None.

4.3.3.3 Biological treatment

Description

Biological treatment removes colloidal or soluble organic material and substances by biological degradation.

Technical description

Biological treatment is a well-known technology worldwide and is applied at sites where process water is produced mainly from MDF production and also at other fibre panel production sites. The biological treatment is a secondary treatment step and is applied after the primary treatment steps (e.g. filtration, coagulation and flocculation).

Biological treatment covers several processes, most commonly activated sludge treatment, aerated lagoons, biotrickling filters and also membrane bioreactors.

For a full description of the biological waste water treatment methods, the reader is advised to consult the literature and the CWW BREF [3, EC 2003].

Achieved environmental benefits

Reduction of the emissions of organic matter (COD, BOD₅).

Environmental performance and operational data

The reported removal efficiencies indicate that biological treatment can be very effective in removing COD from the waste water.

The reported COD removal efficiencies are between 30 % and 97 % for biological treatment followed by flotation or clarification basins. The performance includes results from plants with activated sludge treatment, a membrane bioreactor or combined solutions, such as biotrickling and aeration basins. High efficiencies (> 95 %) of TSS and BOD₅ were reported in connection with membrane bioreactors.

The mass concentration at the outlet of the waste water treatment plant varies for COD between 20 mg/l and 940 mg/l. The average values for COD vary between 60 mg/l and 700 mg/l.

The corresponding specific loads vary between 52 g and 320 g COD/tonnes of dry pulp. The data derived from five plants. With an additional sand filter and reverse osmosis step, one plant reported a specific load of 20 g COD/tonne of dry pulp. The results vary greatly between plants, reflecting the initial composition and load of COD in the waste water.

The overall removal efficiencies for a waste water treatment plant using screening for removing solids of over 1 mm, DAF, a denitrification step and a membrane bioreactor were reported as 95 % COD, 100 % TSS and 99 % BOD₅, resulting in mass concentrations of TSS below 1 mg/l, BOD₅ below 5 mg/l and COD between 90 mg/l and 130 mg/l.

Cross-media effects

Sludge needs further treatment and handling.

Technical considerations relevant to applicability

Not reported.

Economics

The investment and also the running costs for a full-scale waste water treatment plant are high.

In an example of a full-scale plant treating process water from MDF production, the investment was around EUR 4–6 million, while the yearly operating cost is around EUR 600 000–800 000. The steps included in the treatment plant are flocculation, sedimentation and biological treatment with a final filtration. The additional costs of sludge handling and discharge and further downstream treatment are not included in the operating costs.

Driving force for implementation

To reduce the pollution load of process waste water before discharge, either to comply with limit values for the discharge to surface waters or to lower the cost for further downstream treatment at an UWWTP.

The activated sludge process is preferably used when high or very high treatment efficiencies are required and especially when levels of ammonia should be limited.

Example plants

The majority of installed specific stand-alone waste water treatment plants have a biological degradation step.

Reference literature

[3, EC 2003], [56, J. M. Fernández et al. 2001].

4.3.3.4 Tertiary treatment of waste water

Description

Tertiary techniques include the removal of settleable solids and nitrogen compounds from treated waste water before recycling or discharge. Filtration is applied for the removal of suspended solids from the treated waste water before discharge. Biological nitrification and denitrification techniques convert ammonia and nitrates. Reverse osmosis removes residual nitrogen compounds. The use of tertiary techniques is strongly influenced by the downstream fate of the waste water.

Technical description

Filtration is widely applied for the last treatment step, either by the use of a sand filter before discharge or supplemented by microfiltration. Settlement lagoons for sedimentation, and aeration and clarifier basins after biological treatment precede the sand filter as a pretreatment, see also Section 4.3.2.3 on sand filters. Microfiltration is performed with similar screening equipment as is used for primary treatment, such as rotary drum screens, but with openings in the range of 20–35 µm.

Reverse osmosis separates dissolved salts and dissolved organic compounds from the treated waste water treatment stream. Reverse osmosis should be preceded by microfiltration. Ammonium, organic nitrogen and nitrates are removed by reverse osmosis, but if the influent

concentration from the waste water streams is high, conversion steps need to be implemented in the biological treatment before reverse osmosis is carried out.

Part of the organic nitrogen such as urea can be transformed to ammonia/ammonium during biological treatment and in aeration steps. Nitrification and denitrification can be applied for ammonia/ammonium and nitrate conversion, but is only recorded at a few plants.

For a full description of the biological waste water treatment methods, the reader is advised to consult the literature and the CWW BREF [3, EC 2003].

Achieved environmental benefits

Polishing of waste waters, reducing COD, BOD₅, TSS and nutrients (nitrogen, phosphorus), to enhance recycling or to comply with local restrictions on discharge levels.

Environmental performance and operational data

When recycling part of the treated waste water, e.g. for steam generation for refining, the quality is important. At one plant (D002), the treated waste water was reused for preparing the resin mix and for the preparation of urea solution for SNCR and steam generation for refining. The waste water is mainly from refining. The treatment steps applied included the following in a simplified form:

- Pretreatment:
 - storage basin, 0 % removal of influent COD load;
 - curved screen, 33 % removal of influent COD load.
- Primary physical separation:
 - sedimentation basin, 30 % removal of influent COD load.
- Secondary biological treatment:
 - activated sludge tank, 5 % removal of influent COD load;
 - flotation, 24 % removal of influent COD load.
- Tertiary treatment:
 - filtration by sand filter;
 - reverse osmosis, 8 % removal of incoming COD load.

Around 85 000 m³ of waste water are treated yearly. Spot sample monitoring showed 60 mg/l COD, 29 mg/l BOD₅, while Total N was 1.13 mg/l.

Cross-media effects

Energy consumption for reverse osmosis can be high.

Technical considerations relevant to applicability

Reverse osmosis requires efficient pretreatment not only of solids, but also of COD. If present in high levels, nitrogen compounds and colloidal matter can foul the membrane.

Economics

Reverse osmosis has a high operating cost.

No plant-specific information or data were submitted.

Driving force for implementation

Not reported.

Example plants

D002.

Reference literature

None.

4.4 Techniques to reduce emissions to land

Other techniques such as paving of log yards and applying an impermeable bottom layer to waste water storage tanks also provide measures to reduce emissions to land, see Sections 4.3.1.1 and 4.3.2.2.

4.4.1 Safe handling of auxiliary materials

Description

Managing the handling, storage and transport of chemicals, liquid fuels and process waste water reduces the risk of emissions to land.

Technical description

Resins and auxiliary materials are handled safely by applying the following common principles:

- I. The loading and unloading of resins and other auxiliary materials are carried out only in designated areas protected against leakage run-off.
- II. Whilst awaiting disposal, all materials are collected and stored in designated areas protected against leakage run-off.
- III. All pump sumps or other intermediary storage facilities from which spillages might occur are equipped with alarms which are activated by high levels of liquid.
- IV. A programme for the testing and inspection of tanks and pipelines carrying resin, additives and resin mixes, liquid fuels, ammonia solutions, waste water or other liquids is established and carried out.
- V. Inspections are carried out for leaks on all flanges and valves on pipes used to transport materials other than clean water and wood; a log of these inspections is maintained.
- VI. A catchment system is provided to collect any leaks from flanges and valves on pipes used to transport materials other than clean water and wood, except when the construction of flanges or valves is technically tight.
- VII. An adequate supply of containment booms and suitable absorbent material is provided.
- VIII. Underground piping is avoided when transporting anything other than clean water and wood. An exception is for waste water infrastructure.

Techniques for the storage, transfer and handling of liquid or solid auxiliary materials, especially chemicals, are described in the EFS BREF [6, EC 2006].

Achieved environmental benefits

Low risk of accidents resulting in the contamination of soil and groundwater.

Environmental performance and operational data

None reported.

Cross-media effects

None reported.

Technical considerations relevant to applicability

None.

Economics

No information or data were submitted.

Driving force for implementation

To manage the overall handling of chemicals and other substances safely.

Example plants

None reported.

Reference literature

EMS systems in general. EFS BREF [6, EC 2006].

4.5 Techniques to reduce water consumption

Water consumption is mainly from the refining of chips to fibres and the operation of wet abatement systems.

Water consumption at the site level is also managed through the Environmental Management System, see Section 4.9.

The in-line treatment of process water streams at the refiner and the recycling of water decrease the consumption of raw water and reduce the influent load of on-site waste water treatment plants. The techniques are described under primary measures for preventing or reducing emissions to water, see Section 4.3.1. The recycling of refining water by evaporation is described under techniques to increase energy efficiency, see Section 4.6.5.

4.5.1 Collection of lightly contaminated water for plant cleaning and other purposes

Description

Collection of lightly contaminated water and the reuse of this water for purposes other than production.

Technical description

At the site level, lightly contaminated water is used for purposes for which the quality of water is less important. This lightly contaminated water is obtained by the collection of the following water streams, among others:

- clean roof rainwater;
- decanted used glue water from cleaning or which is left over;
- collected and pretreated surface run-off water.

The lightly contaminated or even clean water can be used for the following purposes:

- cleaning of the dryer and plant in general;
- chip washing;
- resin mixing.

The collection and storage infrastructure depends on the source of the water. Outdoor open basins are used for almost clean water, and at the same time act as storage for water for firefighting.

Achieved environmental benefits

Reduction in water consumption from the grid or well.

Environmental performance and operational data

Several sites throughout the sector report the use of lightly contaminated water or clean rainwater.

The potential savings in water consumption are not known.

Cross-media effects

None.

Technical considerations relevant to applicability

If the recycled water needs to have a certain quality, a constant control of the water quality could be necessary.

Economics

Expected low cost.

Driving force for implementation

Reduction of raw water consumption.

Example plants

Several plants in the sector.

Reference literature

None.

4.6 Techniques to increase energy efficiency

Increasing energy efficiency and lowering the overall energy consumption at the site level is part of an environmental management system. General measures to obtain high energy efficiency are:

- proper design of the installation;
- proper maintenance of the plants within the installation, including processing equipment and related fans, motors and abatement systems.

In the sector, it is in the energy-intensive operations in particular, including drying, pressing and refining, where the development of energy-efficient solutions have taken place.

4.6.1 Recovery of energy in hot air emissions

Description

Recovery of heat from hot air emissions by evaporative condensation, heat exchangers, preheating the air supply to the dryer and recirculation of hot waste gases.

Technical description

Drying requires a large energy input, so the system design should consider opportunities to recover process heat, which is otherwise released through the final emitted waste gas from the dryer.

Latent heat can be recovered from the dryer waste gas using evaporative condensation and heat exchangers. Direct heat recovery is carried out by heat exchangers. A heat exchanger is a device in which energy is transferred from one fluid or gas to another across a solid surface. They are used to either heat up or cool down processes or systems. Heat transfer happens by both convection and conduction [4, EC 2009].

Recirculation of a part of the waste gas from the dryer is widely applied. Recirculation of dryer waste gas from a directly heated dryer is obtained by directing a smaller part, generally less than 20 % of the waste gas, to post-combustion. See also Section 4.2.2.2 and Section 4.2.2.3.

Recovery of heat for use off site in local district heating systems is a solution, when heat in low-temperature streams is recovered.

Achieved environmental benefits

Increased energy efficiency at the plant level.

Environmental performance and operational data

No data or information on the energy savings or overall energy efficiency obtained were received.

Cross-media effects

None reported.

Technical considerations relevant to applicability

Fouling of heat exchangers can decrease the efficiency of heat recovery.

Recirculation of dryer waste gas to the rotary dryer can increase the dryer cleaning frequency required.

The recovery of heat from a low-temperature source with a difference in temperature of even only 20 °C can be beneficial, but a cost-benefit balance should be taken into account.

Economics

No plant-specific information or data were submitted.

The implementation of recirculation of waste gases can be performed in retrofits and the payback time is expected to be short.

Driving force for implementation

Increase in the energy efficiency at the plant level.

Example plants

The energy recovery measures are applied at all plants and most are designed for the plant and as part of a retrofit of one or several processes.

Reference literature

[4, EC 2009].

4.6.2 Combustion control

Description

Improving the combustion performance, and optimising the operation of the combustion plants by monitoring and controlling the key combustion parameters.

Technical description

Combustion performance is enhanced by taking into account and controlling the following variables:

- combustion temperature;
- inlet air excess and air/fuel ratio;
- air staging, if applicable;
- temperature profile;
- temperature at the combustion chamber outlet before mixing with additional air;
- flue-gas oxygen content;
- NO_x/CO balance, especially for nitrogen-containing fuels;
- fuel feeding.

Depending on the actual furnace and boiler design, the monitoring of these parameters will allow the combustion to be enhanced, thus improving the thermal efficiency, lowering the unburnt carbon in ash, and reducing the CO and NO_x concentrations in the flue-gas.

The emissions of unburnt carbon, such as CO and organic hydrocarbons, are a consequence of incomplete combustion by excessively low combustion temperatures; too short a residence time in the combustion zone; or by an inefficient mixing of the fuel and combustion air, leading to local areas of oxygen deficiency.

Carbon monoxide is the most important unburnt gas. It is a stable compound even at high temperatures if there is no oxygen present. Hydrocarbons, on the contrary, can be decomposed and form soot at high temperatures in an oxygen-poor atmosphere. In general, it can be said that emissions of unburnt hydrocarbons may be generated when a low combustion zone temperature and inefficient mixing of fuel and air occur together. Soot contributes to the creation of blue haze when the hot gas is used for direct drying.

Some measures to reduce NO_x emissions, such as combustion with lower excess air or strong air staging, can increase emissions of the unburnt carbon gases. In these cases, the importance of ensuring the efficient mixing of air and fuel in the combustion system must be emphasised. NO_x reduction with the SNCR method can also cause higher CO emissions. CO emissions can be decreased when limestone feeding is increased in fluidised bed combustion boilers (generally

not applicable for directly heated dryers). This is not generally applied in combustion plants in the sector.

The boiler efficiency and NO_x generation depend largely on the correct distribution of fuel and air in the furnace. An efficient control system allows gas concentration measurements to be taken inside the furnace, especially near the burners.

Achieved environmental benefits

- Increased thermal efficiency.
- Reduction of NO_x, CO and TOC.
- Reduction of soot giving rise to dust.
- Improved quality of bottom ash, with a low level of unburnt carbon in ash.
- Limited formation of dioxins due to a more stable process in the furnace.

Environmental performance and operational data

Broad operational experience.

Generally, CO emissions from combustion can be kept under 50 mg/Nm³ if the combustion process is well controlled. Hydrocarbon emissions in modern power plant boilers are negligible, typically below 5 mg/Nm³. [24, COM 2006].

Cross-media effects

None reported.

Applicability consideration

Generally applicable.

Economics

Plant-specific.

Driving force for implementation

- Reduction of the emissions of NO_x, CO and TOC.
- Control of the combustion process and enhancement of efficiency.

Example plants

All plants carrying out combustion operations.

Reference literature

[24, COM 2006].

4.6.3 Dewatering of bark and sludge

Description

Pretreatment of fuels by lowering the water content of biomass fuels through the use of mechanical dewatering equipment.

Technical description

Dewatering equipment includes filters and screens, screw presses, belt presses, drum presses and centrifuges that remove excess water from wet bark, biomass-based sludge from abatement systems for emissions to air, and for waste water treatment.

Dewatering equipment is most often directly connected to the collection of sludge where it is produced, mainly to ease its handling and transportation to the combustion plant. After or during the shredding process of the inhomogeneous bark obtained during debarking, the bark material can be dewatered in a press and then fed to the combustion plant. Dewatering can be a seasonal

practice, since during winter and in freezing conditions roundwood needs to be thawed with steam, which leads to an increase in the moisture content.

Achieved environmental benefits

The energy efficiency of the combustion process can be enhanced.

Environmental performance and operational data

No information available.

Cross-media effects

Dewatering equipment can be energy-intensive and the degree of dewatering should be weighed up against the achievable energy efficiency in the combustion process.

Technical considerations relevant to applicability

No information available.

Economics

No information or data were submitted.

Driving force for implementation

To improve the energy efficiency of the combustion process.

Example plants

Dewatering of sludge is common practice for sludge derived from the internal wet abatement systems of dryers and presses and from some treatment steps in waste water treatment plants.

There are also examples of sites where the dewatering of bark is not performed because of the quality of the bark or due to the use of a completely dry debarking procedure.

Reference literature

None.

4.6.4 Combined heat and power (CHP) plants

Description

Combined heat and power (CHP) plants.

Technical description

CHP combustion plants that generate steam for indirect drying and power allow for the maximum freedom in energy output.

All residues and recovered wood, which are also considered waste, are used as fuels. Using the more problematic part of the biomass-derived fuels implies, in practice, operating an incinerator for wood waste. The hot gases are not used for direct drying but for steam generation for indirect drying, for heating thermal oil, and for producing electricity.

For a description of CHP plants using biomass or combined fuels, see the LCP BREF [24, COM 2006].

Achieved environmental benefits

For an independent combustion plant producing heat for steam generation for indirect drying and power for the grid, fuel is saved by maximising the use of biomass fuel sources.

For an independent combustion plant, the energy efficiency can be high, since energy output can be regulated to make maximum use of heat and power.

Environmental performance and operational data

No information available.

Cross-media effects

None identified.

Technical considerations relevant to applicability

For a biomass-fired CHP plant, the fuel accessibility is crucial and large CHP plants demand very high amounts of fuel. The supply from internal production residues is not enough to cover the fuel need. In order not to use virgin biomass, which is a raw material for the sector, recovered wood is the main fuel for biomass-fired CHP plants. However, the recovered wood market can be too unstable to provide a secure fuel supply.

Diesel engines can be an energy-efficient choice if established primarily for power generation for the grid or for additional steam generation for indirect drying or simply for hot gas generation for direct drying and transfer of thermal energy to heat thermal oil. CHP plants operating on liquid fuels could create emissions that are not suitable for direct drying and which will generally need an additional emission control system.

Economics

The investment costs for a new biomass-fired CHP plant of 40 MW generating steam for indirect drying and power are about EUR 30 million, with an approximate yearly fuel consumption of 250 000 tonnes of wood biomass. If contaminated wood waste is used as a fuel, the additional costs for an abatement system should be added.

Example plants

CHP plants using a variety of fuels are in operation in the sector.

Reference literature

[24, COM 2006].

4.6.5 Heat recovery from steam during refining**Description**

Heat recovery from steam during refining using heat exchangers and evaporation of used steam.

Technical description

The recovery of heat from steam used in the cooking stage of refining takes place using heat exchangers, falling film evaporators, and plate evaporators that in turn preheat water for steam generation and heat water for chip washing and pre-cooking stages.

Steam recovery can be implemented by vacuum evaporation, where water is separated from the fibres and other wood constituents, producing distilled hot water. The condensate can be used as fuel and the water for steam generation. The result is zero discharge of effluent from the refining plant.

Low-pressure steam can be recompressed to a higher pressure if there is no need for low-pressure steam at the site.

Achieved environmental benefits

The overall energy consumption for refining and the water consumption are lowered.

Closed evaporation systems and vacuum evaporation eliminate the need to handle effluent from the refiner plant.

Environmental performance and operational data

No data were submitted.

Cross-media effects

Vacuum evaporation can have a high energy consumption.

Technical considerations relevant to applicability

The need for the different types of recoverable energy (steam at low and high pressures, water at various temperature levels) varies between refiner plants.

The usability of high-pressure heat recovery is limited by the required cleaning of the heat exchangers and the starts and stops in the refiner plant.

Economics

Economic efficiency is to be assessed for each situation.

Driving forces

Cost reduction by energy savings in steam generation and a closed system for the treatment of waste water from the refiner plant.

Example plants

MDF plants in the sector have applied the technique, but no reference plants were reported.

Reference literature

[91, EC 2014], [36, COM 2001].

4.7 Consumption of chemicals and raw materials

4.7.1.1 Optimisation of the use of resins according to the product to be produced

Description

Optimising the use of resins according to the product to be produced is a generic technique inherent to the sector.

The recirculation of rejects from the press could, in principle, slightly lower the use of resin in particleboard production, due to the surface properties of the chipped rejects containing cured resin.

No data from plant-specific production are available.

4.8 Techniques for management of waste/residue generation

4.8.1 Raw material control by applying a control programme to externally collected waste wood

Description

Controlling the quality of externally collected waste wood by physical and chemical testing to determine if the material is adequate for storing on site and for use as raw material or as a fuel.

Technical description

A control programme includes both standard conditions to ensure the quality of the raw material to be delivered to the installation and the internal controls performed by the operator upon receipt of the material.

Both physical and chemical testing are performed and include all or a selection of the following:

- Suppliers of recovered wood should be given clear indications of the quality expected and that can be admitted.
- Material received is inspected before unloading to determine that it conforms to the declaration given by the supplier. The material should not be humid or wet, since this will provoke rot and degradation of the quality.
- Depending on the level of sorting possibilities and the efficiency of cleaning the material, this should be free of soil, grit and debris, such as plastics, metals, fibreboard and paper.
- Testing the content of heavy metals related to wood impregnation is performed regularly with a combination of laboratory tests and spray testing, where a colour reaction detects specific metals.
- Chemical or physical testing on site can be performed in the same testing laboratory as the daily product testing.

There is no European standard determining the acceptable content of pollutants or the range of pollutants to be examined when controlling recovered wood as a raw material. National standards or guidance exist alongside industry specifications of the minimum requirements for the control of recovered wood received and used as a raw material. Individual furniture producers or panel producers can have individual internal standards to document specific features for a product, e.g. labelling as an environmentally sustainable product or more focused on user safety.

The content of pollutants in different raw materials is strongly related to the use of recovered wood and especially post-consumer wood [[80, Schinagl et al. 2008](#)].

Achieved environmental benefits

Safe handling on site of recovered wood materials.

Environmental performance and operational data

None.

Cross-media effects

None identified.

Technical considerations relevant to applicability

Generally applicable.

Economics

None reported.

Driving force for implementation

- Product quality.
- Stable production.
- National legislation or industry standards.

Example plants

Not specified.

Reference literature

[64, EPF 2002], [72, BS 2004], [73, UBA AT 2010]

4.8.2 Optimisation of fuel quantity by the collection of wood fines and dust

Description

Maximise the collection of product residues by the extraction of air at all dust-laden sources and subsequent dust collection by applying a bag filter or cyclofilter.

Technical description

Optimising the dust collection by applying bag filters or cyclofilters, followed by the use of the dust as fuel in an on-site combustion plant. Dust collection and transport to the combustion plant are optimised if central ring collection systems are used and the collected dust is transported in closed conveyers to the fuel storage area.

Achieved environmental benefits

- Reduction of waste to be transported off site.
- Reduction of diffuse emissions.

Environmental performance and operational data

The collection of dust from upstream and downstream processing varies according to the wood processing equipment and collection efficiency.

Examples include around 27 000 tonnes/year collected by cyclones and bag filters from a particleboard plant producing around 1 700 m³/day. The same amount was collected from a particleboard plant producing around 1 200 m³/day. One plant producing OSB and MDF with extensive downstream processing collected around 90 000 tonnes/year from bag filters and cyclones.

Cross-media effects

- Potentially higher NO_x and dust emissions when combusted.
- Energy consumption for operation of fans and filters.

Technical considerations relevant to applicability

Internal production residues such as sanding dust could demand a more rigorous control of the combustion process concerning emission of NO_x and have the potential for higher dust emissions.

Economics

Bag filters and effective collection systems are applied at all sites to control dry dust sources.

Operation of fans, filters and transport systems for the collection and transport of dust can account for as much as 20 % of the total power consumption on a production site.

Driving force for implementation

- Maximisation of the collection of dust, which can be used as fuel.

- Reduction of diffuse emissions.

Example plants

Bag filters and effective collection systems are applied at all sites to control dry dust sources. There are sites where ring collection systems and central bag filters treat dust collected at the site level.

Reference literature

None.

4.8.3 Safe storage, transport and reuse of bottom ash and slag from biomass combustion plants

Description

Bottom ash and slag from a biomass grid-fired combustion plant are often wetted with a secondary water source to cool the bottom ash and slag. The cooled bottom ash and slag is stored separately on site in an impermeable area where run-off water is collected. The humidified bottom ash is easy to transport and store.

Bottom ash can be used for different purposes besides landfilling. Depending on the quality and quantity, different uses include: cement production, soil improver in forests, and road construction

Achieved environmental benefits

- Reduction of accidental releases to soil.
- Reuse of bottom and slags instead of landfilling.
- Reduction of fire risk during handling of hot ashes and slags.

Environmental performance and operational data

None reported.

Cross-media effects

None identified.

Technical considerations relevant to applicability

Wetting of bottom ash is relevant for grid firing only. If small quantities of bottom ash are handled, it is convenient to collect it in hoppers for direct transport off site.

Economics

None reported.

Driving force for implementation

Minimisation of the fire risk from collected bottom ashes and slags related to grid firing.

Example plants

Not specified.

Reference literature

None.

4.8.4 Reuse of internal collected wood residues in production

Description

The rejects, trimmings and oversize material in the screening steps are collected and introduced into the production process directly.

Technical description

Wood material that can readily be reintroduced into the production process consists of oversize particles that are screened out during milling and chipping and after drying. The wood particles are reintroduced at the milling step. The material is collected in hoppers or conveyed directly to milling.

Trimmings collected before the press are also transferred to screening and milling if necessary. Trimmings contain uncured resin and are suitable as raw material.

Rejects are automatically sorted and taken out of the production flow if the quality of the panel is not satisfactory. Collection of rejected panels takes place along the downstream processing line after the press until the storage area.

Rejects need to be handled, which involves transport to hoppers and shredding before they can be chipped. Rejects can also be used as fuel, but there is an additional effect when using already resinated panels, since this could lower the resin consumption.

Achieved environmental benefits

Saving primary wood raw material.

Environmental performance and operational data

None.

Cross-media effects

None identified.

Technical considerations relevant to applicability

The use of production residues in MDF and OSB production can be limited. On the other hand, residues from OSB could be a raw material for PB panels.

Economics

Not provided.

Driving force for implementation

To save raw materials.

Example plants

All plants recycle material that has the potential to be used as raw material for panel production.

Reference literature

None.

4.9 Environmental management systems

Description

A formal system to demonstrate compliance with environmental objectives.

Technical description

The Directive defines ‘techniques’ (under the definition of 'best available techniques') as ‘both the technology used and the way in which the installation is designed, built, maintained, operated and decommissioned’.

In this respect, an environmental management system (EMS) is a technique allowing operators of installations to address environmental issues in a systematic and demonstrable way. EMSs are most effective and efficient where they form an inherent part of the overall management and operation of an installation.

An EMS focuses the attention of the operator on the environmental performance of the installation; in particular through the application of clear operating procedures for both normal and other than normal operating conditions, and by setting out the associated lines of responsibility.

All effective EMSs incorporate the concept of continuous improvement, meaning that environmental management is an ongoing process, not a project which eventually comes to an end. There are various process designs, but most EMSs are based on the plan-do-check-act cycle (which is widely used in other company management contexts). The cycle is an iterative dynamic model, where the completion of one cycle flows into the beginning of the next (see Figure 4.3).

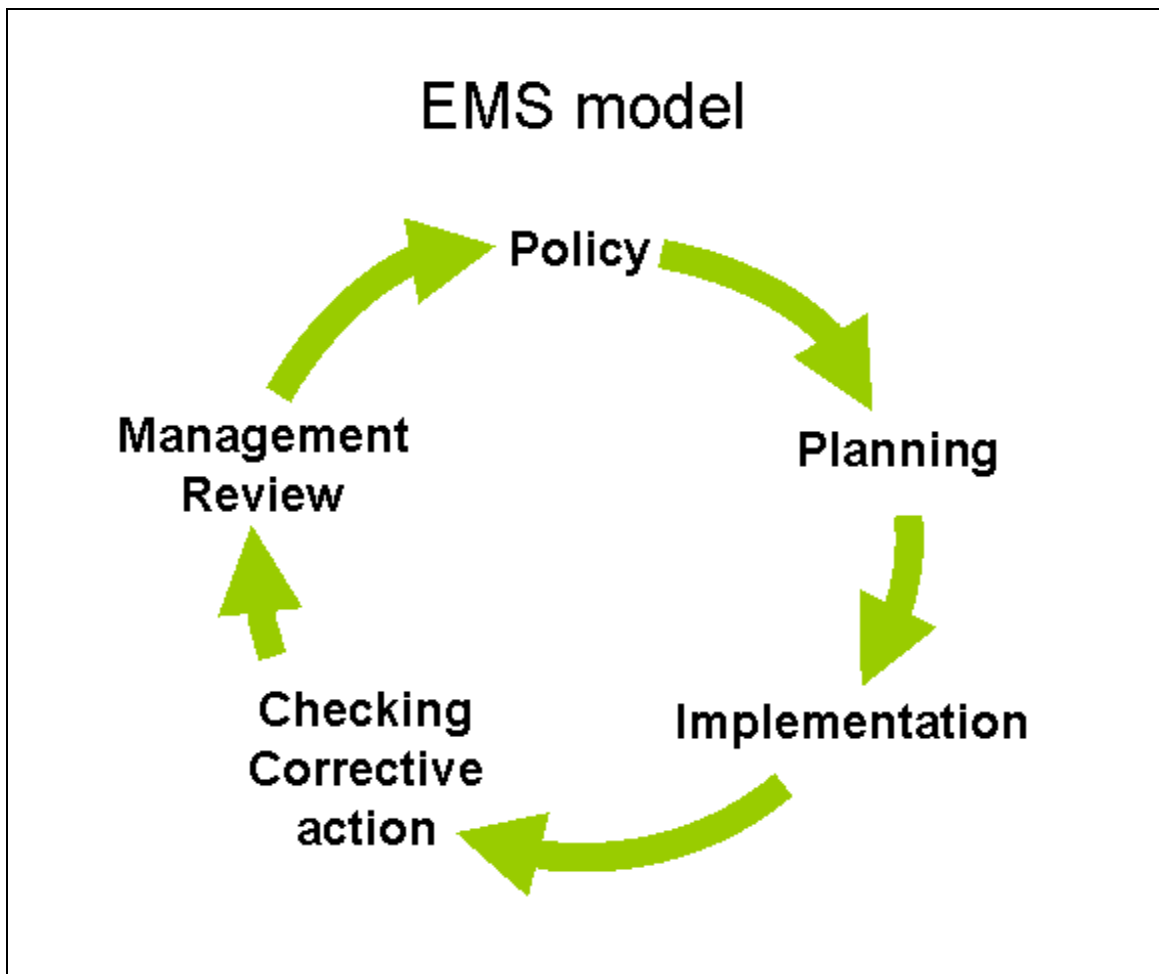

Figure 4.3: Continuous improvement in an EMS model

An EMS can take the form of a standardised or non-standardised ('customised') system. Implementation and adherence to an internationally accepted standardised system, such as EN ISO 14001:2004, can give higher credibility to the EMS especially when subjected to a properly performed external verification. EMAS provides additional credibility due to the interaction with the public through the environmental statement and the mechanism to ensure compliance with the applicable environmental legislation. However, non-standardised systems can, in principle, be equally effective provided that they are properly designed and implemented.

While both standardised systems (EN ISO 14001:2004 or EMAS) and non-standardised systems apply in principle to organisations, this document takes a narrower approach, not including all activities of an organisation, e.g. with regard to their products and services, due to the fact that the Directive only regulates installations/plants.

An EMS can contain the following components:

1. commitment of management, including senior management;
2. definition of an environmental policy that includes the continuous improvement of the installation by the management;
3. planning and establishing the necessary procedures, objectives and targets, in conjunction with financial planning and investment;
4. implementation of procedures paying particular attention to:
 - (a) structure and responsibility,
 - (b) training, awareness and competence,
 - (c) communication,
 - (d) employee involvement,
 - (e) documentation,
 - (f) efficient process control,
 - (g) maintenance programmes,
 - (h) emergency preparedness and response,
 - (i) safeguarding compliance with environmental legislation;
5. checking performance and taking corrective action paying particular attention to:
 - (a) monitoring and measurement (see also the Reference Report on Monitoring (ROM) [[89, COM 2014](#)],
 - (b) corrective and preventive action,
 - (c) maintenance of records,
 - (d) independent (where practicable) internal and external auditing in order to determine whether or not the EMS conforms to planned arrangements and has been properly implemented and maintained;
6. review of the EMS and its continuing suitability, adequacy and effectiveness by senior management;
7. preparation of a regular environmental statement;
8. validation by a certification body or an external EMS verifier;
9. following the development of cleaner technologies;
10. consideration for the environmental impacts from the eventual decommissioning of the installation at the stage of designing a new plant, and throughout its operating life;
11. application of sectoral benchmarking on a regular basis.

Achieved environmental benefits

An EMS promotes and supports the continuous improvement of the environmental performance of the installation. If the installation already has a good overall environmental performance, an EMS helps the operator to maintain the high performance level.

Environmental performance and operational data

No specific information was received.

Cross-media effects

None reported. The systematic analysis of the initial environmental impacts and scope for improvements in the context of the EMS sets the basis for assessing the best solutions for all environmental media.

Technical considerations relevant to applicability

The components described above can typically be applied to all installations within the scope of this document. The scope (e.g. level of detail) and nature of the EMS (e.g. standardised or non-standardised) will be related to the nature, scale and complexity of the installation, and the range of environmental impacts it may have.

Economics

It is difficult to determine accurately the costs and economic benefits of introducing and maintaining a good EMS. There are also economic benefits that are the result of using an EMS and these vary widely from sector to sector.

External costs relating to verification of the system can be estimated from guidance issued by the International Accreditation Forum [96, IAF 2010].

Driving forces for implementation

The driving forces for the implementation of an EMS include:

- improved environmental performance;
- improved insight into the environmental aspects of the company which can be used to fulfil the environmental requirements of customers, regulatory authorities, banks, insurance companies or other stakeholders (e.g. people living or working in the vicinity of the installation);
- improved basis for decision-making;
- improved motivation of personnel (e.g. managers can have confidence that environmental impacts are controlled and employees can feel that they are working for an environmentally responsible company);
- additional opportunities for operational cost reduction and product quality improvement;
- improved company image;
- reduced liability, insurance and non-compliance costs.

Example plants

EMSs are applied in a number of installations throughout the EU.

Reference literature

EMAS Regulation (EC) No 1221/2009 [15, Reg. 1221/ 2009].

DG Environment EMAS website [14, DG Environment 2010].

EN ISO 14001: 2004.

ISO 14000 family of standards website [12, ISO 2004].

ISO 14000 technical committee [13, ISO 2010].

4.10 Reduction of noise

Description

Effective reduction of noise levels is either achieved by directly applying measures/techniques at the source of the noise, or noise barriers that reduce the propagation of noise from the noise source to the receptor of the noise. The most effective combination of measures/techniques has to be identified individually for each plant or production site.

Technical description

Sources of noise arise from all activities taking place at the site, from the traffic to and from the site to the unloading of wood raw material, and from the production process to the shipping of final products. Various measures for noise abatement can be applied in order to reduce the noise levels from the installation outside the site boundaries, including primary and secondary measures.

Primary general measures are the following:

- I. strategic planning of plant layout to accommodate most noisy operations, so that on-site buildings can act as insulation;
- II. develop and maintain a noise reduction programme, which would consist of the following elements in a more or less elaborate form depending on the actual local conditions and issues:
 - developing and maintaining noise mapping for the site with noise sources according to their relevance for individual affected areas;
 - determination of affected areas outside the site boundaries;
 - modelling of noise propagation on the site and in its surroundings, supported by noise surveys outside the site boundaries at sensitive receptors;
 - evaluation of noise abatement measures with regard to their relevance for the noise level in affected areas and their estimated costs.

Primary measures targeting the source of noise that are applied generally and throughout the sector are reported as:

- III. regular maintenance of all equipment;
- IV. housing, encapsulation and/or insulation of equipment, compressors and engines, etc.;
- V. sound insulation of buildings in general;
- VI. limiting the transmission of vibrations and resonance by decoupling individual equipment, such as fans, mechanical sieves and air shifters;
- VII. insulation of ducts and application of silencers and damping on fans, ductwork, machine guards, conveyors etc.;
- VIII. speed limits for trucks;
- IX. limiting operation time during the night for most noisy operations like debarking, flakers, milling, and general transport in the log yard, etc.;
- X. avoid dropping, and reduce the fall height for roundwood when loading debarker line;
- XI. keep gates and doors closed at all times.

Secondary measures generally applied are:

- XII. silencers, noise attenuators on fans, filters mounted with acoustic enclosures, cyclones with acoustic vents/mufflers, exhaust mufflers at stacks;
- XIII. noise barriers such as noise protection walls near sources, and embankments or berms along the site boundary.

Monitoring: Perform regular noise monitoring campaigns according to the local sensitivity determined in the noise management plan.

Achieved environmental benefits

The effects of reduced noise emissions by applying primary and/or secondary measures are primarily related to minimising nuisance issues in the environment outside the site. Another important effect of applying measures at the noise source is to protect workers' health.

Cross-media effects

No significant issues are reported.

Operational data

Permits require that the noise must not exceed certain noise emission levels which are normally set on a case-by-case basis and separately for residential and industrial areas, differing between daytime and night-time.

The operator of a plant normally has to give information on noise dissemination and measures taken to abate noise.

By nature it is not possible to present generally applicable noise measurement results, since the necessary noise abatement is determined by the absolute value in dB(A) at a certain location from a specific noise source combined with the distance to receptors and the applied noise abatement measures. The noise and spreading of noise to receptors will vary from site to site.

Technical considerations relevant to applicability

Measures/techniques for noise reduction are generally applicable.

Existing installations may lack space to construct larger noise barriers outdoors and might find it difficult to transfer units within a linked production layout.

Economics

Additional investment is needed and maintenance costs usually occur due to the addition of noise protection measures/techniques. This is especially valid for existing installations. The exact cost level depends on the local conditions. Specific cost data on noise reduction depend on the types of noise source to be muted, their quantity and how far from the noise source the results are to be achieved.

Driving force for implementation

Noise is regulated in the environmental permit of the installation. The nuisance from noise will depend on the sensitivity of the local area. Depending on the distance to receptors, nuisance from noise will be more or less pronounced, which will dictate the need for the amount of noise reduction.

Example plants

The noise reduction measures mentioned are applied not only in the wood-based panel sector but are also general measures for noise reduction from industrial activities.

5 BEST AVAILABLE TECHNIQUES (BAT) CONCLUSIONS

Scope

These BAT conclusions concern the activities specified in Section 6.1(c) of Annex I to Directive 2010/75/EU, namely:

- production in industrial installations of one or more of the following wood-based panels: oriented strand board, particleboard or fibreboard with a production capacity exceeding 600 m³ per day.

In particular, these BAT conclusions cover the following:

- the manufacture of wood-based panels;
- on-site combustion plants (including engines) generating hot gases for directly heated dryers;
- the manufacture of impregnated paper with resins.

These BAT conclusions do not address the following activities and processes:

- on-site combustion plants (including engines) not generating hot gases for directly heated dryers;
- the lamination, lacquering or painting of raw board.

Other reference documents which are relevant for the activities covered by these BAT conclusions are the following:

Reference document	Subject
Monitoring of Emissions to air and water from IED installations (ROM)	Monitoring of emissions to air and water
Large Combustion Plants (LCP)	Combustion techniques
Waste Incineration (WI)	Waste incineration
Energy Efficiency (ENE)	Energy efficiency
Waste Treatment (WT)	Waste treatment
Emissions from Storage (EFS)	Storage and handling of materials
Economics and Cross-Media Effects (ECM)	Economics and cross-media effects of techniques
Large Volume Organic Chemical industry (LVOC)	Production of melamine, urea-formaldehyde resins and methylene diphenyl diisocyanate

General considerations

Best Available Techniques

The techniques listed and described in these BAT conclusions are neither prescriptive nor exhaustive. Other techniques may be used that ensure at least an equivalent level of environmental protection.

Unless stated otherwise, the BAT conclusions are generally applicable.

Emission levels associated with BAT (BAT-AELs) for emissions to air

Unless stated otherwise, the BAT-AELs for emissions to air given in these BAT conclusions refer to concentrations expressed as mass of emitted substance per volume of waste gas under standard conditions (273.15 K, 101.3 kPa) and on a dry basis, expressed in the unit mg/Nm³.

The reference oxygen levels are the following:

Emission source	Reference oxygen levels
Directly heated PB or directly heated OSB dryers alone or combined with the press	18 % oxygen by volume
All other sources	No correction for oxygen

The formula for calculating the emission concentration at the reference oxygen level is:

$$E_R = \frac{21 - O_R}{21 - O_M} \times E_M$$

where: E_R (mg/Nm³): emission concentration at the reference oxygen level;
 O_R (vol-%): reference oxygen level;
 E_M (mg/Nm³): measured emission concentration;
 O_M (vol-%): measured oxygen level.

The BAT-AELs for emissions to air refer to the average over the sampling period, meaning the following:

Average value of three consecutive measurements of at least 30 minutes each ⁽¹⁾
⁽¹⁾ A more suitable measurement period may be employed for any parameter where, due to sampling or analytical limitations, a 30-minute measurement is inappropriate.

Emission levels associated with BAT (BAT-AELs) for emissions to water

The BAT-AELs for emissions to water given in these BAT conclusions refer to values of concentrations (mass of emitted substances per volume of water), expressed in the unit mg/l.

These BAT-AELs refer to the average of samples obtained during one year, meaning the flow-weighted average of all 24-hour flow-proportional composite samples, taken in one year with the minimum frequency set for the relevant parameter and under normal operating conditions.

The formula for calculating the flow-weighted average of all 24-hour flow-proportional composite samples is::

$$c_w = \frac{\sum_{i=1}^n c_i q_i}{\sum_{i=1}^n q_i}$$

where: c_w = flow-weighted average concentration of the parameter;
 n = number of measurements;
 c_i = average concentration of the parameter during i^{th} time period;
 q_i = average flow rate during i^{th} time period.

Time-proportional sampling can be used provided that sufficient flow stability can be demonstrated.

All BAT-AELs given for emissions to water apply at the point where the emission leaves the installation.

Definitions and acronyms

For the purpose of these BAT conclusions, the following definitions apply:

Term	Definition
COD	Chemical oxygen demand; the amount of oxygen needed for the total oxidation of the organic matter to carbon dioxide (normally in reference to analysis with dichromate oxidation).
Continuous measurement	Continuous determination of a measurand using a permanently installed 'automated measuring system' (AMS) or 'continuous emission monitoring system' (CEM).
Continuous press	A panel press that presses a continuous mat.
Diffuse emissions	Non-channelled emissions that are not released via specific emission points such as stacks.
Directly heated dryer	A dryer where hot gases from a combustion plant, or any other source, are in direct contact with the particles, strands or fibres to be dried. The drying is achieved by convection.
Dust	Total particulate matter.
Existing plant	A plant that is not a new plant.
Fibre	Lignocellulosic components of wood or other plant materials derived by mechanical or thermo-mechanical pulping using a refiner. Fibres are used as the starting material for the production of fibreboard.
Fibreboard	As defined in EN 316, i.e. 'panel material with a nominal thickness of 1,5 mm or greater, manufactured from lignocellulosic fibres with application of heat and/or pressure'. Fibreboards include wet process boards (hardboard, mediumboard, softboard) and dry-process fibreboard (MDF).
Hardwood	Group of wood species including aspen, beech, birch and eucalyptus. The term hardwood is used as an opposite to the term softwood.
Indirectly heated dryer	A dryer where the drying is exclusively achieved by radiation and conduction heat
Mat forming	The process of laying out particles, strands or fibres to create the mat, which is directed to the press.
Multi-opening press	A panel press that presses one or more individually formed panels.
New plant	A plant first permitted at the site of the installation following the publication of these BAT conclusions or a complete replacement of a plant following the publication of these BAT conclusions.
NO _x	The sum of nitrogen oxide (NO) and nitrogen dioxide (NO ₂), expressed as NO ₂ .
OSB	Oriented strand board, as defined in EN 300, i.e. 'multi-layered board mainly made from strands of wood together with a binder. The strands in the external layer are aligned and parallel to the board length or width. The strands in the internal layer or layers can be randomly orientated or aligned, generally at right angles to the strands in the external layers'.
PB	Particleboard, as defined in EN 309, i.e. 'panel material manufactured under pressure and heat from particles of wood (wood flakes, chips, shavings, saw-dust and similar) and/or other lignocellulosic material in particle form (flax shives, hemp shives, bagasse fragments and similar), with the addition of an adhesive'.
PCDD/F	Polychlorinated dibenzo-dioxins and -furans
Periodic measurement	Measurement at specified time intervals using manual or automated reference methods.
Process water	Waste water derived from processes and activities within the production plant, excluding surface run-off water.
Recovered wood	Material predominantly containing wood. Recovered wood can consist of 'reclaimed wood' and 'wood residues'. 'Reclaimed wood' is a material predominantly containing wood derived directly from post-consumer recycled wood.
Refining	Transforming wood chips to fibres using a refiner.
Roundwood	A wood log.
Softwood	Wood from conifers including pine and spruce. The term softwood is used as an opposite to the term hardwood.
Surface run-off water	Water from precipitation run-off and drainage, collected from outdoor log yard areas, including outdoor process areas.
TSS	Total suspended solids (in waste water); mass concentration of all suspended solids

Term	Definition
	as measured by filtration through glass fibre filters and gravimetry.
TVOC	Total Volatile Organic Compounds, expressed as C (in air).
Upstream and downstream wood processing	All active handling and manipulation, storage or transport of wood particles, chips, strands or fibres and of pressed panels. Upstream processing includes all wood processing from the point that the wood raw material leaves the storage yard. Downstream processing includes all processes after the panel leaves the press and until the raw panel or the value-added panel product is directed to storage. Upstream and downstream wood processing do not include the drying process or the pressing of panels.

5.1 General BAT conclusions

5.1.1 Environmental management system

BAT 1. In order to improve the overall environmental performance, BAT is to implement and adhere to an environmental management system (EMS) that incorporates all of the following features:

- I. commitment of the management, including senior management;
- II. definition of an environmental policy that includes the continuous improvement of the installation by the management;
- III. planning and establishing the necessary procedures, objectives and targets, in conjunction with financial planning and investment;
- IV. implementation of procedures paying particular attention to:
 - (a) structure and responsibility,
 - (b) recruitment, training, awareness and competence,
 - (c) communication,
 - (d) employee involvement,
 - (e) documentation,
 - (f) effective process control,
 - (g) maintenance programmes,
 - (h) emergency preparedness and response,
 - (i) safeguarding compliance with environmental legislation;
- V. checking performance and taking corrective action, paying particular attention to:
 - (a) monitoring and measurement (see also the Reference Report on Monitoring),
 - (b) corrective and preventive action,
 - (c) maintenance of records,
 - (d) independent (where practicable) internal and external auditing in order to determine whether or not the EMS conforms to planned arrangements and has been properly implemented and maintained;
- VI. review of the EMS and its continuing suitability, adequacy and effectiveness by senior management;
- VII. following the development of cleaner technologies;
- VIII. consideration for the environmental impacts from the eventual decommissioning of the installation at the stage of designing a new plant, and throughout its operating life;
- IX. application of sectoral benchmarking on a regular basis.

In some cases, the following features are part of the EMS:

- X. waste management plan (see BAT 11);
- XI. quality control plan for recovered wood used as raw material for panels and used as a fuel (see BAT 2b);
- XII. noise management plan (see BAT 4);
- XIII. odour management plan (see BAT 9);
- XIV. dust management plan (see BAT 23).

Applicability

The scope (e.g. level of detail) and nature of the EMS (e.g. standardised or non-standardised) will generally be related to the nature, scale and complexity of the installation, and the range of environmental impacts it may have.

5.1.2 Good housekeeping

BAT 2. In order to minimise the environmental impact of the production process, BAT is to apply good housekeeping principles using all of the techniques given below.

	Description
a	Careful selection and control of chemicals and additives.
b	Application of a programme for the quality control of recovered wood used as raw material and/or as fuel ⁽¹⁾ , in particular to control pollutants such as As, Pb, Cd, Cr, Cu, Hg, Zn, chlorine, fluorine and PAH.
c	Careful handling and storage of raw materials and waste.
d	Regular maintenance and cleaning of equipment, transport routes and raw material storage areas.
e	Review options for the reuse of process water and the use of secondary water sources.
⁽¹⁾ EN 14961-1:2010 can be used for the classification of solid biofuels.	

BAT 3. In order to reduce emissions to air, BAT is to operate the waste gas treatment systems with a high availability and at optimal capacity during normal operating conditions.

Description

Special procedures can be defined for other than normal operating conditions, in particular:

- (i) during start-up and shut-down operations;
- (ii) during other special circumstances which could affect the proper functioning of the systems (e.g. regular and extraordinary maintenance work and cleaning operations of the combustion plant and/or of the waste gas treatment system).

5.1.3 Noise

BAT 4. In order to prevent or, where that is not practicable, to reduce noise and vibrations, BAT is to use one or a combination of the techniques given below.

	Description	Applicability
Techniques for the prevention of noise and vibrations		
a	Strategic planning of the plant layout in order to accommodate the noisiest operations, e.g. so that on-site buildings act as insulation.	Generally applicable in new plants. The layout of a site may limit the applicability on existing plants
b	Applying a noise reduction programme which includes noise source mapping, determination of off-site receptors, modelling of noise propagation and evaluation of the most cost-effective measures and their implementation.	Generally applicable
c	Performing regular noise surveys with monitoring of noise levels outside the site boundaries.	
Techniques for reduction of noise and vibrations from point sources		
d	Enclosing noisy equipment in housing or by encapsulation and by soundproofing buildings.	Generally applicable
e	Decoupling individual equipment to pre-empt and limit propagation of vibrations and resonance noise.	
f	Point source insulation using silencer, damping, attenuators on noise sources, e.g. fans, acoustic vents, mufflers, and acoustic enclosures of filters.	
g	Keeping gates and doors closed at all times when not in use. Minimising the fall height when unloading roundwood.	
Techniques for reduction of noise and vibrations at the site level		
h	Reducing noise from traffic by limiting the speed of internal traffic and for trucks entering the site.	Generally applicable
i	Limiting outdoor activities during the night.	
j	Regular maintenance of all equipment.	
k	Using noise protection walls, natural barriers or embankments to screen noise sources.	

5.1.4 Emissions to soil and groundwater

BAT 5. In order to prevent emissions to soil and groundwater, BAT is to use the techniques given below.

- I. load and unload resins and other auxiliary materials only in designated areas that are protected against leakage run-off;
- II. whilst awaiting disposal, collect all material and store in designated areas protected against leakage run-off;
- III. equip all pump sumps or other intermediary storage facilities from which spillages may occur with alarms activated by high levels of liquid;
- IV. establish and implement a programme for the testing and inspection of tanks and pipelines carrying resins, additives and resin mixes;
- V. carry out inspections for leaks on all flanges and valves on pipes used to transport materials other than water and wood; maintain a log of these inspections;
- VI. provide a containment system to collect any leaks from flanges and valves on pipes used to transport materials other than water and wood, except when the construction of flanges or valves is technically tight;
- VII. provide an adequate supply of containment booms and suitable absorbent material;
- VIII. avoid underground piping for transporting substances other than water and wood;
- IX. collect and safely dispose of all water from firefighting;
- X. construct impermeable bottoms in retention basins for surface run-off water from outdoor wood storage areas.

5.1.5 Energy management and energy efficiency

BAT 6. In order to reduce energy consumption, BAT is to adopt an energy management plan, which includes all of the techniques given below.

- I. use a system to track energy usage and costs;
- II. carry out energy efficiency audits of major operations;
- III. use a systematic approach to continuously upgrade equipment in order to increase energy efficiency;
- IV. upgrade controls of energy usage;
- V. apply in-house energy management training for operators.

BAT 7. In order to increase the energy efficiency, BAT is to optimise the operation of the combustion plant by monitoring and controlling key combustion parameters (e.g. O₂, CO, NO_x) and applying one or a combination of the techniques given below.

	Technique	Applicability
a	Dewater wood sludge before it is used as a fuel	Generally applicable
b	Recover heat from hot waste gases in wet abatement systems using a heat exchanger	Applicable to plants with a wet abatement system and when the recovered energy can be used
c	Recirculate hot waste gases from different processes to the combustion plant or to preheat hot gases for the dryer	Applicability may be restricted for indirectly heated dryers, fibre dryers or where the combustion plant configuration does not allow controlled air addition

BAT 8. In order to use energy efficiently in the preparation of wet fibres for fibreboard production, BAT is to use one or a combination of the techniques given below.

	Technique	Description	Applicability
a	Cleaning and softening of chips	Mechanical cleaning and washing of raw chips	Applicable to new refiner plants and major retrofits
b	Vacuum evaporation	Recovering hot water for steam generation	Applicable to new refiner plants and major retrofits
c	Heat recovery from steam during refining	Heat exchangers to produce hot water for steam generation and chip washing	Applicable to new refiner plants and major retrofits

5.1.6 Odour

BAT 9. In order to prevent or, where that is not practicable, to reduce odour from the installation, BAT is to set up, implement and regularly review an odour management plan, as part of the environmental management system (see BAT 1), that includes all of the following elements:

- I a protocol containing actions and timelines;
- II a protocol for conducting odour monitoring;
- III a protocol for response to identified odour events;
- IV an odour prevention and reduction programme designed to identify the source(s); to measure/estimate odour exposure; to characterise the contributions of the sources; and to implement prevention and/or reduction measures.

Applicability

The applicability is restricted to cases where an odour nuisance in residential or other sensitive areas (e.g. recreational areas) can be expected and/or has been reported.

BAT 10. In order to prevent and reduce odour, BAT is to treat waste gas from the dryer and the press, according to BAT 17 and 19.

5.1.7 Management of waste and residues

BAT 11. In order to prevent or, where that is not practicable, to reduce the quantity of waste being sent for disposal, BAT is to adopt and implement a waste management plan as part of the environmental management system (see BAT 1) that, in order of priority, ensures that waste is prevented, prepared for reuse, recycled or otherwise recovered.

BAT 12. In order to reduce the quantity of solid waste being sent for disposal, BAT is to use one or a combination of the techniques given below.

	Technique	Applicability
a	Reuse internally collected wood residues, such as trimmings and rejected panels, as a raw material.	The applicability for reject fibreboard panel products may be limited.
b	Use internally collected wood residues, such as wood fines and dust collected in a dust abatement system and wood sludge from waste water filtration, as fuel (in appropriately equipped on-site combustion plants) or as a raw material.	The use of wood sludge as a fuel may be restricted if the energy consumption needed for drying outweighs the environmental benefits.
c	Use ring collection systems with one central filtration unit to optimise the collection of residues, e.g. bag filter, cyclofilter, or high efficiency cyclones.	Generally applicable for new plants. The layout of an existing plant may limit the applicability.

BAT 13. In order to ensure the safe management and reuse of bottom ash and slag from biomass-firing, BAT is to use all of the techniques given below.

	Technique	Applicability
a	Continuously review options for off-site and on-site reuse of bottom ash and slag.	Generally applicable.
b	An efficient combustion process which lowers the residual carbon content.	Generally applicable.
c	Safe handling and transport of bottom ash and slag in closed conveyers and containers, or by humidification.	Humidification is only necessary when bottom ash and slag are wetted for safety reasons.
d	Safe storage of bottom ash and slag in a designated impermeable area with leachate collection.	Generally applicable.

5.1.8 Monitoring

BAT 14. BAT is to monitor emissions to air and water and to monitor process flue-gases in accordance with EN standards with at least the frequency given below. If EN standards are not available, BAT is to use ISO, national or other international standards that ensure the provision of data of an equivalent scientific quality.

Monitoring of emissions to air from the dryer and for combined treated emissions from the dryer and the press			
Parameter	Standard(s)	Minimum monitoring frequency	Monitoring associated with
Dust	EN 13284-1	Periodic measurement at least once every six months	BAT 17
TVOC ⁽¹⁾	EN 12619		BAT 17
Formaldehyde	No EN standard available ⁽⁶⁾		BAT 17
NO _x	E 14792		BAT 18
HCl ⁽⁴⁾	EN 1911		—
HF ⁽⁴⁾	ISO 15713		—
SO ₂ ⁽²⁾	EN 14791	Periodic measurement at least once a year	—
Metals ⁽³⁾⁽⁴⁾	EN 13211 (for Hg), EN 14385 (for other metals)		—
PCDD/F ⁽⁴⁾	EN 1948 parts 1, 2 and 3		—
NH ₃ ⁽⁵⁾	No EN standard available		—

⁽¹⁾ Methane monitored according to EN ISO 25140 or EN ISO 25139 is subtracted from the result when using natural gas, LPG, etc. as a fuel.

⁽²⁾ Not relevant when using mainly wood-derived fuels, natural gas, LPG, etc. as a fuel.

⁽³⁾ Including As, Cd, Co, Cr, Cu, Hg, Mn, Ni, Pb, Sb, Tl and V.

⁽⁴⁾ Relevant if contaminated recovered wood is used as fuel.

⁽⁵⁾ Relevant if SNCR is applied.

⁽⁶⁾ In the absence of an EN standard, the preferred approach is isokinetic sampling in an impinging solution with a heated probe and filter box and without probe washing, e.g. based on the modified US EPA M316 method.

Monitoring of emissions to air from the press			
Parameter	Standard(s)	Minimum monitoring frequency	Monitoring associated with
Dust	EN 13284-1	Periodic measurement at least once every six months	BAT 19
TVOC	EN 12619		BAT 19
Formaldehyde	No EN standard available ⁽²⁾		BAT 19

Monitoring of emissions to air from paper impregnation drying ovens			
Parameter	Standard(s)	Minimum monitoring frequency	Monitoring associated with
TVOC ⁽¹⁾	EN 12619	Periodic measurement at least once a year	BAT 21
Formaldehyde	No EN standard available ⁽²⁾		BAT 21
⁽¹⁾ Methane monitored according to EN ISO 25140 or EN ISO 25139 is subtracted from the result when using natural gas, LPG, etc. as a fuel.			
⁽²⁾ In the absence of an EN standard, the preferred approach is isokinetic sampling in an impinging solution with a heated probe and filter box and without probe washing, e.g. based on the modified US EPA M316 method.			

Monitoring of channelled emissions to air from upstream and downstream processing			
Parameter	Standard(s)	Minimum monitoring frequency	Monitoring associated with
Dust	EN 13284-1 ⁽¹⁾	Periodic measurement at least once a year ⁽¹⁾	BAT 20
⁽¹⁾ Sampling from bag filters and cyclofilters can be replaced by continuous monitoring of the pressure drop across the filter as an indicative surrogate parameter.			

Monitoring of combustion process flue-gas that is subsequently used for directly heated dryers⁽¹⁾			
Parameter	Standard(s)	Minimum monitoring frequency	Monitoring associated with
NO _x	Periodic: EN 14792 Continuous: EN 15267-1 to 3 and EN 14181	Periodic measurement at least once a year or continuous measurement	BAT 7
CO	Periodic: EN 15058 Continuous: EN 15267-1 to 3 and EN 14181		BAT 7
⁽¹⁾ The measurement point is before the mixing of the flue-gas with other airstreams and only if technically feasible.			

Monitoring of emissions to water from wood fibre production			
Parameter	Standard(s)	Minimum monitoring frequency	Monitoring associated with
TSS	EN 872	Periodic measurement at least once a week.	BAT 27
COD ⁽¹⁾	No EN standard available		BAT 27
TOC (Total organic carbon, expressed as C)	EN 1484		–
Metals ⁽²⁾ , if relevant (e.g. when recovered wood is used)	Various EN standards available	Periodic measurement at least once every six months.	–
⁽¹⁾ There is a tendency to replace COD with TOC for economic and environmental reasons. A correlation between the two parameters should be established on a site-specific basis.			
⁽²⁾ Including As, Cr, Cu, Ni, Pb and Zn.			

Monitoring of emissions to water from surface run-off water			
Parameter	Standard(s)	Minimum monitoring frequency	Monitoring associated with
TSS	EN 872	Periodic measurement at least once every three months ⁽¹⁾	BAT 25
⁽¹⁾ Flow-proportional sampling can be replaced by another standard sampling procedure if the flow is insufficient for representative sampling.			

BAT 15. In order to ensure the stability and efficiency of techniques used to prevent and reduce emissions, BAT is to monitor appropriate surrogate parameters.

Description

The surrogate parameters monitored may include: waste gas airflow; waste gas temperature; visual appearance of emissions; water flow and water temperature for scrubbers; voltage drop for electrostatic precipitators; fan speed and pressure drop across bag filters. The selection of surrogate parameters depends on the techniques implemented for the prevention and reduction of emissions.

BAT 16. BAT is to monitor key process parameters relevant for emissions to water from the production process, including waste water flow, pH and temperature.

5.2 Emissions to air

5.2.1 Channelled emissions

BAT 17. In order to prevent or reduce emissions to air from the dryer, BAT is to achieve and manage a balanced operation of the drying process and to use one or a combination of the techniques given below.

	Technique	Main pollutants abated	Applicability
a	Dust abatement of inlet hot gas to a directly heated dryer in combination with one or a combination of the other techniques listed below	Dust	Applicability may be restricted, e.g. in cases of existing smaller wood dust burners.
b	Bag filter ⁽¹⁾	Dust	Applicable to indirectly heated dryers only. Due to safety concerns, special care should be taken when using exclusively recovered wood.
c	Cyclone ⁽¹⁾	Dust	Generally applicable.
d	UTWS dryer and combustion with heat exchanger and thermal treatment of discharged dryer waste gas ⁽¹⁾	Dust, volatile organic compounds	Not applicable to fibre dryers. Applicability may be limited for existing combustion plants not suitable for post-combustion of the partial dryer waste gas flow.
e	Wet electrostatic precipitator ⁽¹⁾	Dust, volatile organic compounds	Generally applicable.
f	Wet scrubber ⁽¹⁾	Dust, volatile organic compounds	Generally applicable.
g	Bioscrubber ⁽¹⁾	Dust, volatile organic compounds	Applicability may be limited by high dust concentrations and high temperatures in the waste gas from the dryer.
h	Chemical degradation or capture of formaldehyde with chemicals in combination with a wet scrubbing system	Formaldehyde	Generally applicable in wet abatement systems.
⁽¹⁾ Descriptions of the techniques are given in Section 5.4.1.			

Table 5.1: BAT-associated emission levels (BAT-AELs) for emissions to air from the dryer and for combined treated emissions from the dryer and the press

Parameter	Product	Dryer type	Unit	BAT-AELs (average over the sampling period)
Dust	PB or OSB	Directly heated dryer	mg/Nm ³	3 – 30
		Indirectly heated dryer		3 – 10
	Fibre	All types		3 – 20
TVOC	PB	All types		< 20 – 200 ^{(1) (2)}
	OSB			10 – 400 ⁽²⁾
	Fibre			< 20 – 120
Formaldehyde	PB	All types		< 5– 10 ⁽³⁾
	OSB			< 5– 20
	Fibre			< 5– 15

⁽¹⁾ This BAT-AEL does not apply when using pine as the predominant raw material.
⁽²⁾ Emissions below 30 mg/Nm³ can be achieved using UTWS dryer.
⁽³⁾ When using almost exclusively recovered wood, the upper end of the range may be up to 15 mg/Nm³.

The associated monitoring is in BAT 14.

BAT 18. In order to prevent or reduce NO_x emissions to air from directly heated dryers, BAT is to use technique (a) or technique (a) in combination with technique (b).

	Technique	Applicability
a	Efficient operation of the combustion process using air- and fuel-staged combustion, while applying pulverised combustion, fluidised bed boilers or moving grate firing	Generally applicable
b	Selective non-catalytic reduction (SNCR) by injection and reaction with urea or liquid ammonia	Applicability may be limited by highly variable combustion conditions

Table 5.2: BAT-associated emission levels (BAT-AELs) for NO_x emissions to air from a directly heated dryer

Parameter	Unit	BAT-AELs (average over the sampling period)
NO _x	mg/Nm ³	30 – 250

The associated monitoring is in BAT 14.

BAT 19. In order to prevent or reduce emissions to air from the press, BAT is to use in-duct quenching of collected press waste gas and an appropriate combination of the techniques given below.

	Technique	Main pollutants abated	Applicability
a	Select resins with a low formaldehyde content	Volatile organic compounds	Applicability may be restricted, e.g. due to demands for a specific product quality
b	Controlled operation of the press with balanced press temperature, applied pressure and press speed	Volatile organic compounds	Applicability may be restricted, e.g. due to the operation of the press for specific product qualities
c	Wet scrubbing of collected press waste gases using Venturi scrubbers or hydrocyclones, etc. ⁽¹⁾	Dust, volatile organic compounds	Generally applicable
d	Wet electrostatic precipitator ⁽¹⁾	Dust, volatile organic compounds	
e	Bioscrubber ⁽¹⁾	Dust, volatile organic compounds	
f	Post-combustion as the last treatment step after application of a wet scrubber	Dust, volatile organic compounds	Applicability may be restricted for existing installations where a suitable combustion plant is not available

⁽¹⁾ Descriptions of the techniques are given in Section 5.4.1.

Table 5.3: BAT-associated emission levels (BAT-AELs) for emissions to air from the press

Parameter	Unit	BAT-AELs (average over the sampling period)
Dust	mg/Nm ³	3 – 15
TVOC	mg/Nm ³	10 – 100
Formaldehyde	mg/Nm ³	2 – 15

The associated monitoring is in BAT 14.

BAT 20. In order to reduce dust emissions to air from upstream and downstream wood processing, conveying of wood materials and mat forming, BAT is to use either a bag filter or a cyclofilter.

Applicability

Due to safety concerns, a bag filter or a cyclofilter may not be applicable when recovered wood is used as a raw material. In that case a wet abatement technique (e.g. scrubber) may be used.

Table 5.4: BAT-associated emission levels (BAT-AELs) for channelled dust emissions to air from upstream and downstream wood processing, conveying of wood materials and mat forming

Parameter	Unit	BAT-AELs (average over the sampling period)
Dust	mg/Nm ³	< 3–5 ⁽¹⁾
⁽¹⁾ When a bag filter or a cyclofilter is not applicable, the upper end of the range can be up to 10 mg/Nm ³ .		

The associated monitoring is in BAT 14.

BAT 21. In order to reduce emissions of volatile organic compounds to air from the drying ovens for the impregnation of paper, BAT is to use one or a combination of the techniques given below.

	Technique	Applicability
a	Select and use resins with a low formaldehyde content	Generally applicable
b	Controlled operation of ovens with balanced temperature and speed	
c	Thermal oxidation of waste gas in a regenerative thermal oxidiser or a catalytic thermal oxidiser ⁽¹⁾	
d	Post-combustion or incineration of waste gas in a combustion plant	Applicability may be restricted for existing installations where a suitable combustion plant is not available on site
e	Wet scrubbing of waste gas followed by treatment in a biofilter ⁽¹⁾	Generally applicable
⁽¹⁾ Descriptions of the techniques are given in Section 5.4.1.		

Table 5.5: BAT-associated emission levels (BAT-AELs) for TVOC and formaldehyde emissions to air from the drying ovens for the impregnation of paper

Parameter	Unit	BAT-AELs (average over the sampling period)
TVOC	mg/Nm ³	5 – 30
Formaldehyde	mg/Nm ³	<5 – 10

The associated monitoring is in BAT 14.

5.2.2 Diffuse emissions

BAT 22. In order to prevent or, where that is not practicable, to reduce diffuse emissions to air from the press, BAT is to optimise the efficiency of the off-gas collection and to channel the off-gases for treatment (see BAT 19).

Description

Effective collection and treatment of waste gases (see BAT 19) both at the press exit and along the press line for continuous presses. For existing multi-opening presses the applicability of enclosing the press may be restricted due to safety reasons.

BAT 23. In order to reduce diffuse dust emissions to air from the transport, handling, and storage of wood materials, BAT is to set up and implement a dust management plan, as part of the environmental management system (see BAT 1) and to apply one or a combination of the techniques given below.

	Technique	Applicability
a	Regularly clean transport routes, storage areas and vehicles	Generally applicable
b	Unload sawdust using covered drive-through unloading areas	
c	Store sawdust dust-prone material in silos, containers, roofed piles, etc. or enclose bulk storage areas	
d	Suppress dust emissions by water sprinkling	

5.3 Emissions to water

BAT 24. In order to reduce the pollution load of the collected waste water, BAT is to use both of the techniques given below.

	Technique	Applicability
a	Collect, and treat separately, surface run-off water and process waste water	Applicability may be restricted on existing plants due to the configuration of the existing drainage infrastructure
b	Store any wood except roundwood and slabs ⁽¹⁾ on a hard-surfaced area	Generally applicable
⁽¹⁾ An outer piece of wood, with or without the bark removed, from the first cuts in a sawing process to render the log into lumber (timber).		

BAT 25. In order to reduce emissions to water from surface run-off water, BAT is to use a combination of the techniques given below.

	Technique	Applicability
a	Mechanical separation of coarse materials by screens and sieves as preliminary treatment	Generally applicable
b	Oil-water separation ⁽¹⁾	Generally applicable
c	Removal of solids by sedimentation in retention basins or settlement tanks ⁽¹⁾	There may be restrictions to the applicability of sedimentation due to space requirements
⁽¹⁾ Descriptions of the techniques are given in Section 5.4.2.		

Table 5.6: BAT-associated emission levels (BAT-AELs) for TSS for the direct discharge of surface run-off water to a receiving water body

Parameter	Unit	BAT-AELs (average of samples obtained during one year)
TSS	mg/l	10 – 40

The associated monitoring is in BAT 14.

BAT 26. In order to prevent or reduce the generation of process waste water from wood fibre production, BAT is to maximise process water recycling.

Description

Recycle process water from chip washing, cooking and/or refining in closed or open loops by treating it at the refiner plant level by mechanical removal of solids, in the most appropriate manner, or by evaporation.

BAT 27. In order to reduce emissions to water from wood fibre production, BAT is to use a combination of the techniques given below.

	Technique	Applicability
a	Mechanical separation of coarse materials by screens and sieves	Generally applicable
b	Physico-chemical separation, e.g. using sand filters, dissolved air flotation, coagulation and flocculation ⁽¹⁾	
c	Biological treatment ⁽¹⁾	
⁽¹⁾ Descriptions of the techniques are given in Section 5.4.2.		

Table 5.7: BAT-associated emission levels (BAT-AELs) for the direct discharge to a receiving water body of process waste water from wood fibre production

Parameter	BAT-AELs (average of samples obtained during one year)
	mg/l
TSS	5 – 35
COD	20 – 200

The associated monitoring is in BAT 14.

BAT 28. In order to prevent or reduce the generation of waste water from wet air abatement systems that will need treatment prior to discharge, BAT is to use one or a combination of the techniques given below.

Technique ⁽¹⁾	Applicability
Sedimentation, decanting, screw and belt presses to remove collected solids in wet abatement systems	Generally applicable
Dissolved air flotation. Coagulation and flocculation followed by removal of flocs by flotation aided by dissolved air	

⁽¹⁾ Descriptions of the techniques are given in Section 5.4.2.

5.4 Description of techniques

5.4.1 Emissions to air

Technique	Description
Biofilter	A biofilter degrades organic compounds by biological oxidation. A waste gas stream is passed through a supporting bed of inert material (e.g. plastics or ceramics) on which organic compounds are oxidised by naturally occurring microorganisms. The biofilter is sensitive to dust, high temperatures or high variation in the waste gas inlet temperature.
Bioscrubber	A bioscrubber is a biofilter combined with a wet scrubber that preconditions the waste gas by removing dust and lowering the inlet temperature. Water is recycled continuously, entering the top of the packed bed column, from where it trickles down. Water collects in a settlement tank where additional degradation takes place. Adjustment of pH and the addition of nutrients can optimise degradation.
Cyclone	A cyclone uses inertia to remove dust from waste gas streams by imparting centrifugal forces, usually within a conical chamber. Cyclones are used as a pretreatment before further dust abatement or abatement of organic compounds. Cyclones can be applied alone or as multicyclones.
Cyclofilter	A cyclofilter uses a combination of cyclone technology (to separate coarser dust) and bag filters (to capture finer dust).
Electrostatic precipitator (ESP)	Electrostatic precipitators operate such that particles are charged and separated under the influence of an electrical field. The ESP is capable of operating over a wide range of conditions.
Wet electrostatic precipitator (WESP)	The wet electrostatic precipitator consists of a wet scrubber stage, which scrubs and condenses the waste gas, and an electrostatic precipitator operating in wet mode in which the collected material is removed from the plates of the collectors by flushing with water. A mechanism is usually installed to remove water droplets before discharge of the waste gas (e.g. a demister). Collected dust is separated from the water phase.
Bag filter	Bag filters consist of porous woven or felted fabric through which gases pass to remove particles. The use of a bag filter requires the selection of a fabric appropriate for the characteristics of the flue-gas and the maximum operating temperature.
Catalytic thermal oxidiser (CTO)	Catalytic thermal oxidisers destroy organic compounds catalytically over a metal surface and thermally in a combustion chamber where a flame from combustion of a fuel, normally natural gas, and the VOCs present in the waste gas, heat the waste gas stream. The incineration temperature is between 400 °C and 700 °C. Heat can be recovered from the treated waste gas before release.
Regenerative thermal oxidiser (RTO)	Thermal oxidisers destroy organic compounds thermally in a combustion chamber where a flame from the combustion of a fuel, normally natural gas, and the VOCs present in the waste gas, heat the waste gas stream. The incineration temperature is between 800 °C and 1100 °C. Regenerative thermal oxidisers have two or more ceramic packed bed chambers where the combustion heat from one incineration cycle in the first chamber is used to preheat the packed bed in the second chamber. Heat can be recovered from the treated waste gas before release.

<p>UTWS dryer and combustion with heat exchanger and thermal treatment of discharged dryer waste gas</p>	<p>UTWS is a German acronym: 'Umluft' (recirculation of dryer waste gas), 'Teilstromverbrennung' (post-combustion of partial directed dryer waste gas stream), 'Wärmerückgewinnung' (heat recovery of dryer waste gas), 'Staubabscheidung' (dust treatment of air emission discharge from the combustion plant).</p> <p>UTWS is a combination of a rotary dryer with a heat exchanger and a combustion plant with recirculation of dryer waste gas. The recirculated dryer waste gas is a hot vapour stream that enables a vapour drying process. The dryer waste gas is reheated in a heat exchanger heated by the combustion flue-gases and is fed back to the dryer. Part of the dryer waste gas stream is continuously fed to the combustion chamber for post-combustion. Pollutants emitted from the wood drying are destroyed over the heat exchanger and by the post-combustion. The flue-gases discharged from the combustion plant are treated by a bag filter or electrostatic precipitator.</p>
<p>Wet scrubber</p>	<p>Wet scrubbers capture and remove dust by inertial impaction, direct interception and absorption in the water phase. Wet scrubbers can have various designs and operating principles, e.g. spray scrubber, impingement plate scrubber or Venturi scrubber, and can be used as a dust pretreatment or a stand-alone technique. Some removal of organic compounds may be achieved and can be further enhanced by using chemicals in the scrubbing water (achieving chemical oxidation or another conversion). The resulting liquid has to be treated by separating the collected dust by sedimentation or filtration.</p>

5.4.2 Emissions to water

Technique	Description
Biological treatment	The biological oxidation of dissolved organic substances using the metabolism of microorganisms, or the breakdown of organic content in waste water by the action of microorganisms in the absence of air. The biological action is usually followed by the removal of suspended solids, e.g. by sedimentation.
Coagulation and flocculation	Coagulation and flocculation are used to separate suspended solids from waste water and are often carried out in successive steps. Coagulation is carried out by adding coagulants with charges opposite to those of the suspended solids. Flocculation is carried out by adding polymers, so that collisions of microfloc particles cause them to bond to produce larger flocs.
Flotation	The separation of large flocs or floating particles from the effluent by bringing them to the surface of the suspension.
Dissolved air flotation	Flotation techniques relying on the use of dissolved air to achieve separation of coagulated and flocculated material.
Filtration	The separation of solids from a waste water carrier by passing them through a porous medium. It includes different types of techniques, e.g. sand filtration, microfiltration and ultrafiltration.
Oil-water separation	The separation and extraction of insoluble hydrocarbons, relying on the principle of the difference in gravity between the phases (liquid-liquid or solid-liquid). The higher density phase settles and the lower density phase floats to the surface.
Retention basins	Large surface area lagoons for the passive gravitational settlement of solids.
Sedimentation	The separation of suspended particles and material by gravitational settling.

6 EMERGING TECHNIQUES

6.1 Superheated steam dryers

Steam dryers are, in principle, already in operation, since the introduction of the UTWS dryer, where all dryer waste gas is recirculated through a heat exchanger and a part of it is sent to the combustion chamber, which thermally destructs the organic compounds present in the waste gas.

The energy-saving potential of superheated steam dryers, where the excess energy in the steam vaporised from the wood material could be used for generating power or be heat-exchanged for other uses, seems not yet to have been developed in the wood-based panel sector. Superheated steam drying is already applied in other industrial sectors. A few wood industry plants are operating with these dryers, such as for the drying of wood pellets or the drying of fibres [59, Deventer 2004].

6.2 Recovery of organic compounds from wood

VOC compounds may be recovered from dryer waste gas and burnt in the boiler to increase energy efficiency or they can alternatively be used as raw material for other products.

In superheated steam dryers and indirectly fired steam-tube dryers in which no combustion air is added, steam vented from the dryer can be condensed and the condensate collected in a separator, where oils and terpenes are extracted. These VOCs can then be burnt in a suitable combustion plant as a fuel or used for other products, e.g. production of bioethanol.

Superheated steam drying is comparable to steam distillation, which is used in other sectors to extract essential oils from plant material, e.g. for the food industry. High steam temperatures result in the extraction of a significant amount of VOCs from the material. The wood oils, hemicellulose and terpenes extracted from the wood chips, bark and sawdust of softwood species, especially from the Pinus family, are used in the manufacture of fragrances and in cosmetics, cleaning products, paint thinners, surfactants, and pharmaceuticals and for biorefining [57, Northwest CHP 2008].

In the pulp industry, the use of water, for example from the pre-cooking step before refining, as a source for production of bioethanol, etc. has been tested and the first biorefineries are being established in Europe. The development of biorefineries as secondary production options in the industry sectors related to the use of forest products could also be relevant for the wood-based panel industry. At the research level, it is suggested that wet extraction of OSB flakes prior to drying would yield an extract suitable for biorefining and additionally reduce the level of volatile organic compounds emitted during drying and pressing [75, VTT 2012] [76, Mason Earles et al. 2011].

6.3 Reuse of reject papers from the paper impregnation line

Studies performed in Hungary indicate that impregnated paper could be recycled in particleboard production, and thus lower the amount of resin needed for the particleboard and at the same time reduce disposal costs.

Melamine paper can be used in fine powder form as a binding product for wood chip plates and as a replacement product for melamine.

Due to problems associated with an excessive increase in the viscosity, a maximum of 25 % of the melamine content in melamine resin can be replaced during the formulation and preparation of liquid MUF glue.

[66, Alpar et al. 2006], [67, VITO 2011].

7 CONCLUDING REMARKS AND RECOMMENDATIONS FOR FUTURE WORK

Timing of the drafting process

The key milestones of the drafting process are summarised in Table 7.1.

Table 7.1: Key milestones in the drafting of the BREF for the Production of Wood-based Panels

Key Milestone	Date
Activation of the TWG	24 March 2011
Kick-off TWG meeting	8 – 10 November 2011
Collection of information and bulk of installation-specific data	March – November 2012
First draft of the WBP BREF	30 July 2013
End of commenting period on the first draft (791 comments received)	15 October 2013
Final TWG meeting	1 to 4 April 2014

During the drafting process, a total of 21 sites were visited in eight Member States.

Sources of information and information gaps

During the drafting process, several hundred documents were shared by the TWG via the Commission's BAT information system (BATIS). This included approximately 80 installation-specific questionnaires covering a total of 55 particleboard production lines, 11 OSB production lines, 28 dry fibre (MDF) production lines and 8 speciality product production lines. The installation-specific questionnaires were collected from the individual operators of the approximately 80 sites mainly by EU Member States (Austria, Belgium, the Czech Republic, Denmark, France, Germany, Ireland, Italy, Poland, Portugal, Spain, Sweden and the United Kingdom) and Turkey. Industry provided information from one site in Romania and from one site in Slovakia. Further information was provided by the European Panel Federation (EPF), and Member States, primarily Austria, Belgium, France, Germany, Italy, Spain and the United Kingdom. All these documents were assessed by the EIPPCB together with additional documents that could not be shared via BATIS due for example to copyright restrictions or confidentiality issues. Among the approximately 80 installation-specific questionnaires, around 55 installations provided further sensitive business information as additional contextual information. This information has not been shared on BATIS.

As a result, around 100 references are included in the WBP BREF (see the REFERENCES section).

Degree of consensus reached during the information exchange

At the final TWG meeting in April 2014, a high degree of consensus was reached on the BAT conclusions. However, two dissenting views were expressed by TWG members, see Table 7.2.

Table 7.2: Split views

BAT conclusion	View expressed by	Split view
BAT 17	Austria	A dissenting view was expressed by Austria, which considers that regenerative thermal oxidation is a BAT for the reduction of volatile organic compounds and odour and should be listed under BAT 17.
BAT 17, Table 5.1	Austria, Belgium and Germany	A dissenting view was expressed by Austria, Belgium and Germany, which consider that the upper end of the BAT-AEL range for dust emissions to air from a directly heated PB or OSB dryer should be 20 mg/Nm ³ (18 % O ₂ , dry basis).

In addition, the reference conditions related to the different BAT-AELs in Tables 5.1, 5.3 and 5.4 of the BAT conclusions were heavily debated during the final TWG meeting. The discussions focused on the best way to express measured emissions to air, especially whether or not corrections for moisture content should be applied. Furthermore, the use of a reference oxygen content to express the BAT-AELs in Table 5.1 for directly heated PB or OSB dryers alone or combined with the press was also heavily debated.

Consultation of the Forum and subsequent formal adoption procedure of the BAT conclusions

In accordance with Article 13(3) of the Directive, the Forum gave its opinion on the draft Best Available Techniques (BAT) reference document for the Production of Wood-based Panels as presented at the meeting of the forum of 24 September 2014:

1. The Forum welcomed the draft Best Available Techniques (BAT) reference document for the Production of Wood-based Panels as presented by the Commission.
2. The Forum acknowledged the discussions held at its meeting of 24 September 2014 and agreed that the changes to the draft Best Available Techniques (BAT) reference document for the Production of Wood-based Panels, as proposed in Annex A, should be included in the final document.
3. The Forum reaffirmed the comments in Annex B as representing the views of certain members of the forum but on which no consensus existed within the Forum to include them in the final document.

Subsequently, the Commission took the opinion of the IED Article 13 Forum into account when preparing the draft Commission Implementing Decision establishing best available techniques (BAT) conclusions for the Production of Wood-based Panels. The IED Article 75 Committee, at its meeting of 30 June 2015, gave a positive opinion on this draft Commission Implementing Decision.

Subsequently:

- the Commission Implementing Decision 2015/2119/EU establishing best available techniques (BAT) conclusions for the production of wood-based panels was adopted on 20 November 2015 and published in the Official Journal of the European Union (OJ L 306, 24.11.2015, p. 31).

Recommendations for future work

The information exchange revealed a number of issues that should be addressed during the review of the WBP BREF. The issues include:

- Consideration should be given to revisiting the question over the use of standard conditions corrected for moisture content or with no correction for moisture content.
- Further collection of detailed information on treatment of waste gases from different sources, e.g. when waste gases from the dryer and the press are mixed with waste gases from other processes.
- Further collection of detailed information on the specificities of the drying operation for OSB strands; plant-specific emissions data on volatile organic compounds from both the dryer and the press; and the potential primary measures also applied outside Europe to reduce emissions to air of volatile organic compounds from OSB production.
- Consideration should be given to collecting information about the plant-specific abatement efficiencies of techniques (especially of WESPs and wet abatement systems) for different groups of volatile compounds, in particular terpenes and condensable organic compounds, and related to the raw material.
- Consideration should be given to collecting further information on the formaldehyde content of different raw materials including different wood species, recovered wood and production residues and the relation to formaldehyde emissions to air during processing

- Further collection of information on the economics and cross-media effects of thermal oxidation techniques that can be used to abate volatile organic compounds and odour in dryer waste gas.
- The need to collect and review data on emissions of ammonia, total nitrogen and certain metals to water from collected and treated process waste water and from collected surface run-off water.
- Further collection of information on dust emissions and their abatement from upstream and downstream processing.
- Further collection of information on the applicability of dust treatment of flue-gases before these are used for directly heated dryers and technical information on the barriers to applying it more widely.
- Consideration of different production equipment used in unit operations as potential BAT candidate techniques and further collection of information on economics and cross-media effects, e.g. using continuous presses versus multi-opening presses and directly heated dryers versus indirectly heated dryers, especially in terms of energy efficiency.
- The applicability and the added advantage of applying primary measures to reduce emissions to air and water have not been fully explored in the document. The main reason is that technical information was not submitted during the drafting of the document. Research and emerging techniques should be taken further into account since research strongly suggests that primary measures could account for a major emissions reduction, especially in the emission to air of both dust and volatile organic compounds, including formaldehyde.
- Consideration of determining the abatement performance of candidate techniques and BAT-AELs based on mass of emitted substance per tonne of dried material for the dryer and mass of emitted substance per m³ of produced panel for the press.
- The need to collect information about the specific fuel types, techniques applied and related emission levels, especially of NO_x, from combustion processes applied in the sector, and consideration of potential inclusion in the scope of a reviewed WBP BREF of combustion plants other than those used for the production of hot gases for directly heated dryers.

Suggested topics for future R&D work

Research and development of emerging technologies should be a priority since research strongly suggests that novel primary techniques could account for a major emissions reduction, especially in the emission to air of both dust and volatile organic compounds, including formaldehyde.

The Commission is launching and supporting, through its Research and Technological Development programmes, a series of projects dealing with clean technologies, emerging effluent treatment and recycling technologies and management strategies. Potentially, these projects could provide a useful contribution to future BREF reviews. Readers are therefore invited to inform the European IPPC Bureau of any research results which are relevant to the scope of this document (see also the fifth section of the Preface of this document).

GLOSSARY

This glossary is meant to facilitate the understanding of the information contained in this document. The definitions of terms in this glossary are not legal definitions (even if some of them may coincide with definitions given in European legislation), they are meant to help the reader understand some key terms in the context of their use in the specific sector covered by this document.

This glossary is divided into the following sections:

- I. ISO country codes
- II. Monetary units
- III. Unit prefixes, number separators and notations
- IV. Units and measures
- V. Chemical elements
- VI. Chemical formulae commonly used in this document
- VII. Acronyms and technical definitions

I. ISO country codes

ISO code	Country
<i>Member States</i> ⁽¹⁾	
AT	Austria
BE	Belgium
BG	Bulgaria
CZ	Czech Republic
DE	Germany
DK	Denmark
ES	Spain
FI	Finland
FR	France
HU	Hungary
IE	Ireland
IT	Italy
LU	Luxembourg
NL	Netherlands
PL	Poland
PT	Portugal
RO	Romania
SE	Sweden
SK	Slovakia
UK	United Kingdom
⁽¹⁾ The protocol order of the Member States is based on the alphabetical order of their geographical names in the original language(s).	

II. Monetary units

Code ⁽¹⁾	Country/territory	Currency
<i>Member State currencies</i>		
EUR	Euro area ⁽²⁾	euro (pl. euros)
⁽¹⁾ ISO 4217 codes.		
⁽²⁾ Includes Austria, Belgium, Cyprus, Estonia, Finland, France, Germany, Greece, Ireland, Italy, Luxembourg, Malta, the Netherlands, Portugal, Slovakia, Slovenia and Spain.		

III. Unit prefixes, number separators and notations

Numbers in this document are written using the '.' character as the decimal separator and the space as the separator for thousands.

The following table contains the frequently used prefixes:

Symbol	Prefix	10 ⁿ	Word	Decimal Number
G	giga	10 ⁹	Billion	1 000 000 000
M	mega	10 ⁶	Million	1 000000
k	kilo	10 ³	Thousand	1000
-----	-----	1	One	1
d	deci	10 ⁻¹	Tenth	0.1
c	centi	10 ⁻²	Hundredth	0.01
m	milli	10 ⁻³	Thousandth	0.001
μ	micro	10 ⁻⁶	Millionth	0.000 001

IV. Units and measures

Unit symbol	Unit name	Measure name (Measure symbol)	Conversion and comment
atm	normal atmosphere	pressure (P)	1 atm = 101 325 N/m ²
bar	bar	pressure (P)	1.013 bar = 100 kPa = 1 atm
°C	degree Celsius	temperature (T) temperature difference (ΔT)	
g	gram	weight	
h	hour	time	
J	joule	energy	
kcal	kilocalorie	energy	1 kcal = 4.1868 kJ
kg	kilogram	weight	
kJ	kilojoule	energy	
kPa	kilopascal	pressure	
kWh	kilowatt-hour	energy	1 kWh = 3600 kJ
l	litre	volume	
m	metre	length	
m ²	square metre	area	
m ³	cubic metre	volume	
mg	milligram	weight	1 mg = 10 ⁻³ g
mm	millimetre		1 mm = 10 ⁻³ m
min	minute		
MW _e	megawatts electric (energy)	electric energy	
MW _{th}	megawatts thermal (energy)	energy heat	
Nm ³	normal cubic metre	volume	at 101.325 kPa, 273.15 K
ou _E	European odour unit	odour	
Pa	pascal		1 Pa = 1 N/m ²
ppm	parts per million	composition of mixtures	1 ppm = 10 ⁻⁶
s	second	time	
t	metric tonne	weight	1 t = 1000 kg or 10 ⁶ g
t/d	tonnes per day	mass flow materials consumption	
t/yr	tonnes per year	mass flow materials consumption	
vol-% % v/v	percentage by volume	composition of mixtures	
wt-% % w/w	percentage by weight	composition of mixtures	
W	watt	power	1 W = 1 J/s
yr	year	time	
μm	micrometre	length	1 μm = 10 ⁻⁶ m

V. Chemical elements

Symbol	Name	Symbol	Name
Al	Aluminium	Li	Lithium
As	Arsenic	Mg	Magnesium
B	Boron	Mn	Manganese
Br	Bromine	Mo	Molybdenum
C	Carbon	N	Nitrogen
Ca	Calcium	Na	Sodium
Cd	Cadmium	Ni	Nickel
Cl	Chlorine	O	Oxygen
Co	Cobalt	P	Phosphorus
Cr	Chromium	Pb	Lead
Cu	Copper	S	Sulphur
F	Fluorine	Sb	Antimony
Fe	Iron	Se	Selenium
H	Hydrogen	Si	Silicon
He	Helium	Sn	Tin
Hg	Mercury	Tl	Thallium
I	Iodine	V	Vanadium
K	Potassium	Zn	Zinc

VI. Chemical formulae

Chemical formula	Name (explanation)
$(\text{NH}_4)_2\text{SO}_4$	Ammonium sulphate
H_2SO_4	Sulphuric acid
NH_4NO_3	Ammonium nitrate
NH_4Cl	Ammonium chloride
HCl	Hydrochloric acid
NaOH	Sodium hydroxide. Also called caustic soda
H_2O_2	Hydrogen peroxide

VII. Acronyms

Acronym	Full phrase
BAT-AEL	Emission level associated with the Best Available Techniques
BAT-AEPL	Performance level associated with the Best Available Techniques
BOD ₅	Biochemical Oxygen Demand, 5 indicating the test length in days
CHP	Combined Heat and Power (cogeneration)
CEMS	Continuous emissions monitoring system
CEN	Comité Européen de Normalisation (European Committee for standardisation)
COD	Chemical Oxygen Demand
CTO	Catalytic thermal oxidiser
CVOCs	Condensable volatile organic compounds
EMAS	European Community Eco-Management and Audit Scheme (Council Regulation (EC) No 1221/2009)
EMS	Environmental management system
ESP	Electrostatic precipitator
FID	Flame ionisation detector
HDF	High density fibreboard
HFO	Heavy fuel oil
IED	Industrial Emissions Directive (2010/75/EU)
IMPEL	(European Union Network for the) Implementation and Enforcement of Environmental Law
IPPC	Integrated Pollution Prevention and Control
ISO	International Organisation for Standardisation
I-TEQ	International Toxicity Equivalence (used for PCDD/F)
LDF	Low density fibreboard
LFO	Light fuel oil
MBR	Membrane bioreactor
MDF	Medium density fibreboard
MS	(European) Member State
N	Normal – refers to volume of gases under normal conditions with a temperature of 273.15 K and pressure of 101.325 kPa
NACE	Nomenclature des Activités Economiques (statistical classification of economic activities in Europe)
NMVOG	Non-methane volatile organic compounds
NGO(s)	non-Governmental organisation(s)
NO _x , expressed as NO ₂	The sum of the concentrations of nitrogen oxide (NO) and nitrogen dioxide (NO ₂), expressed as NO ₂
OECD	Organisation for Economic Co-operation and Development
OSB	Oriented strand board
PAHs	Polycyclic aromatic hydrocarbons
PB	Particleboard
PCDD/F	Polychloro dibenzo-dioxins and furans
PM ₁₀	Particulate matter of less than 10 µm
PM _{2,5}	Particulate matter of less than 2.5 µm
RTO	Regenerative thermal oxidiser
SNCR	Selective non-catalytic reduction
SO _x , expressed as SO ₂	The sum of the concentrations of sulphur dioxide (SO ₂) and sulphur trioxide (SO ₃), expressed as SO ₂
TOC	Total Organic Carbon
TSS	Total Suspended Solids (water)
TVOC, expressed as C	Total volatile organic carbon; the sum of all gaseous and vaporous organic compounds expressed as C
TWG	Technical Working Group
US EPA	United States Environmental Protection Agency
UBA	Umweltsbundesamt – Federal Environment Agency, i.e. from Germany or Austria.

UWWT(P)	Urban waste water treatment (plant)
VOC	Volatile organic compounds covering all organic compounds which are emitted from non-natural processes and have a photochemical ozone creation potential (POCP). This comprises any organic compound released to the atmosphere from an industrial plant or process, excluding methane, in accordance with the United Nations Economic Commission for Europe (UNECE) definition
WESP	Wet electrostatic precipitator
WWT(P)	Waste water treatment (plant)
EU-15	Member States of the European Union before 1 May 2004
EU-25	Member States of the European Union from 1 May 2004 until 31 December 2006
EU-27	Member States of the European Union from 1 January 2007 to 30 June 2013

VIII. Definitions

Aerobic (biological) treatment: The biological oxidation of dissolved organic substances with oxygen using the metabolism of microorganisms.

Anaerobic (biological) treatment: The breakdown of organic content in waste water by the action of microorganisms in the absence of air.

Biological treatment: The biological oxidation of dissolved organic substances with oxygen using the metabolism of microorganisms, or the breakdown of organic content in waste water by the action of microorganisms in the absence of air, including the removal of suspended solids, e.g. by sedimentation.

Biological nitrification/denitrification: A two-step process that is typically incorporated into biological waste water treatment plants. The first step is the aerobic nitrification where microorganisms oxidise ammonium (NH_4^+) to the intermediate nitrite (NO_2^-), which is then further oxidised to nitrate (NO_3^-). The second step is the anoxic denitrification where microorganisms chemically reduce nitrate to nitrogen gas.

BOD: Biochemical oxygen demand – the quantity of dissolved oxygen required by microorganisms in order to decompose organic matter in a given water sample at a certain temperature over a specific time period. The unit of measurement is $\text{mg O}_2/\text{l}$. In Europe, BOD is usually measured after 3 (BOD_3), 5 (BOD_5) or 7 (BOD_7) days using EN 1899-1 and 1899-2.

Bottom ash: Solid residues from a combustion process.

D0XX: Refers to the plant identification numbers, which are used to identify production sites in the data collection.

Certification: Procedure by which a third party gives written assurance that a product, process or service conforms to specified requirements. Certification can apply to instruments, equipment and/or personnel.

Channelled emissions: Emissions of pollutants into the environment through any kind of pipe, regardless of the shape of its cross-section.

Chip: Piece of wood 3 – 6 mm thick, up to 80 mm long and 20 – 30 mm wide, produced by chipping/milling/cutting a wood raw material. Wood chips are the starting material for particleboard and production of wood fibres.

COD: Chemical oxygen demand indicating the amount of organic matter in waste waters susceptible to oxidation by a strong chemical oxidant (normally referring to analysis with dichromate oxidation) according to ISO 15705:2002.

Coagulation and flocculation: Coagulation and flocculation are used to separate suspended solids from waste water and are often carried out as successive steps. Coagulation is carried out by adding coagulants with charges opposite to those of the suspended solids. Flocculation is carried out by adding polymers, so that collisions of microfloc particles cause them to bond to produce larger flocs.

Containment boom: A boom that can contain spillages and prevent them from entering drains to watercourses or from further contaminating water sources.

Continuous measurement: Measuring using an 'automated measuring system' (AMS) or 'continuous emission monitoring system' (CEM) permanently installed on site.

Cooling water: Water used for energy transfer (heat removal from components and industrial equipment), which is kept in a network separated from industrial water and which can be released back to receiving waters without further treatment.

Corrosion: Surface chemical reaction, especially on metals, by the action of moisture, air or chemicals.

Decommissioning: The shutting down of an installation including decontamination and/or dismantling.

Diffuse emissions: Non-channelled emissions that are not released via specific emission points such as stacks.

Emissions arising from the direct contact of volatile or light dusty substances with the environment under normal operating circumstances. These can result from:

- inherent design of the equipment (e.g. filters, dryers);
- operating conditions (e.g. during transfer of material);
- type of operation (e.g. maintenance activities);
- a gradual release to other media (e.g. to cooling water or waste water).

Fugitive emissions are a subset of diffuse emissions.

Directly heated dryer: A dryer where hot gases from a combustion plant or any other source are in direct contact with the particles, strands or fibres to be dried. The drying is achieved by convection.

Discharge: Physical release of a pollutant through a defined outlet (i.e. channelled) system, (e.g. sewer, stack, vent, curbing area, outfall).

Drainage: Natural or artificial removal of surface and subsurface water from an area, including surface streams and groundwater pathways.

Dry process: Production of panels where the drying of particles or fibres is applied.

Dust: Dust includes all particulate matter including PM₁₀ and aerosols below PM_{1.0}.

Emission factor: The estimated average emission rate of a given pollutant for a given source, relative to units of activity.

Emissions to air:

1. Concentration: mass of emitted substance related to the volume of waste gas under standard conditions (273.15 K, 101.325 kPa), expressed in g/Nm³, mg/Nm³, µg/Nm³ or ng/Nm³. Further reference conditions can be defined, e.g. deduction of water vapour content (result given on dry basis), and corrected to a specific oxygen content.
2. Mass flow: mass of emitted substances related to time, expressed in kg/y, kg/h, g/h or mg/h.
3. Specific mass load: ratio of mass of emitted substances to the mass of finished product produced or processed (consumption or emission factors), expressed in kg/t, g/t or mg/t or µg/t.

Emissions to water:

1. Concentration: Mass of emitted substances related to the volume of waste water, expressed in g/m³, g/l, mg/l or µg/l.
2. Mass flow: mass of emitted substances related to time, expressed in kg/y, kg/h, g/h or mg/h.
3. Specific mass load: ratio of mass of emitted substances to the mass of products generated or processed (consumption or emission factors), expressed in kg/t, g/t or mg/t or µg/t.

Existing plant: A plant that is not a new plant.

Existing installation: An installation that is not a new installation.

Fibre: Fibres are used as the starting material for the production of fibre panels. Fibres are cellulosic elements of wood or other plant materials derived by mechanical or thermo-mechanical pulping using a refiner.

Filtration: The separation of solids from a waste water carrier by passing them through a porous medium. It includes different types of techniques, e.g. sand filtration, microfiltration and ultrafiltration.

Flotation: A process where solid or liquid particles are separated from the waste water phase by attaching to fine gas bubbles, usually air. The buoyant particles accumulate at the water surface and are collected with skimmers. A specific example is dissolved air flotation (DAF).

Flue-gas: The exhaust gas exiting a unit after an oxidation step, generally combustion.

Fly ash: The fine fraction of the ash that leaves the combustion chamber with the flue-gas

Fouling: The process of becoming dusty or clogged, e.g. in which undesirable foreign matter accumulates in a bed of filter or ion exchange media, clogging pores and coating surfaces, thus inhibiting or delaying proper bed operation. The fouling of a heat exchanger consists of the accumulation of dirt and other materials on the wall of a heat exchanger, causing corrosion, roughness and ultimately leading to a lowered rate of efficiency.

GC-MS: Gas Chromatography – Mass Spectroscopy. Analytical laboratory equipment for separation, qualification and quantification of individual organic compounds.

Groundwater: Subsurface water in the zones of saturation. Different to surface water.

Hardwood: Wood from deciduous tree species, such as beech, oak, poplar, maple, ash.

Heavy metals: Metals with a density greater than 4.5 g/ml, according to the 1998 Aarhus Protocol on Heavy Metals.

Humidity: There are different ways to express the amount of moisture that is dissolved in air. The relative humidity is most often used when expressing the moisture content in a waste gas.
Relative humidity: Ratio of the amount of water vapour actually in the air compared with the

amount of water vapour required for saturation at that particular temperature and pressure. The relative humidity is expressed as a percentage.

IED: Directive 2010/75/EU of the European Parliament and of the Council of 24 November 2010 on industrial emissions (integrated pollution prevention and control (Recast)). Under the framework of the Industrial Emissions Directive (see IED art. 13), a consultation body, the IED Forum (IEDF), is regularly convened by the Commission.

Indirectly heated dryer: A dryer where the drying is carried out using radiation and conduction heat.

Internal wood residues: The by-products from processing at WBP sites.

IPPC Directive: Directive 2008/1/EC of the European Parliament and of the Council of 15 January 2008 concerning integrated pollution prevention and control (IPPC Directive) which has been replaced by Directive 2010/75/EU on industrial emissions (see IED).

Leachate: Solution obtained by leaching. Liquid that, in passing through matter, extracts solutes, suspended solids or any other component of the material through which it has passed. It is most commonly used in the context of landfilling or industrial waste.

Leakage: Gaseous or liquid spills from system/equipment due to system/equipment failure.

Limit of detection (LOD): The minimum concentration of a substance being analysed that can be detected by the method or instrumentation used.

Limit of quantification (LOQ): The minimum concentration of a substance being analysed that can be determined within the uncertainty of the method or instrumentation used. The LOQ is higher than the LOD.

Mat forming: The process of laying out particles, strands or fibres creating the mat, which is directed to the press.

Metals: When sampling air emissions: metals and metal compounds, independent of their state (gaseous, dissolved in droplets, solid, adsorbed on particles), and sampled according to EN 14385:2004. The standard specifies the determination of the mass concentration of the following specific elements: antimony (Sb), arsenic (As), cadmium (Cd), chromium (Cr), cobalt (Co), copper (Cu), lead (Pb), manganese (Mn), nickel (Ni), thallium (Tl), and vanadium (V).

Moisture content: See Humidity.

New installation: An installation (as defined in Article 3(3) of Directive 2010/75/EU) first permitted following the publication of these BAT conclusions or a complete replacement of an installation following the publication of these BAT conclusions.

New plant: A plant first permitted at the site of the installation following the publication of these BAT conclusions or a complete replacement of a plant following the publication of these BAT conclusions.

Nitrification: A biological process by which ammonia is converted first to nitrite and then to nitrate.

Odour: Odour can be defined as a perception involving a set of complex processes (neurosensory process, cognitive process and amnesic process). This perception results from interactions between the olfactory mucosa (located in the nasal cavity) and gaseous substances, in particular volatile organic compounds (VOCs).

Odour concentration: Conventionally defined (EN 13725) as the dilution factor to be applied to an effluent in order for it to be no longer perceived as odorant by 50 % of people in a sample of the population. The odour concentration at the limit of detection is by definition 1 ou_E/m³. It is expressed in European Odour Units per cubic metre air (ou_E/m³) and it is measured by olfactometric analyses in accordance with the European CEN standard (EN 13725). 1 ou_E/m³ = 2 ge/m³ (Dutch odour units).

Osmosis: The passage of a liquid from a weak solution to a more concentrated solution across a semi-permeable membrane that allows the passage of the solvent (water) but not of the dissolved solids. (See Reverse osmosis.)

Oxidant: Oxidiser/oxidising agent (e.g. peroxides), a material that can react highly exothermically when brought into contact with other materials, flammables in particular.

PAHs: Polycyclic aromatic hydrocarbons. Group of fused aromatic ring compounds of which naphthalene is the simplest example. Regarding environmental impact and although individual health effects are not the same, 17 PAHs are considered as a group. Among them, benzo[a]pyrene was the first listed as a carcinogen.

Particulate matter (PM): A collective name for all solid or liquid particles suspended in air including dust, smoke, soot, pollen and soil particles. This complex mixture includes both organic and inorganic particles and varies greatly in size, composition and origin. Based on size, particulate matter is often divided into two main groups. The coarse fraction contains the larger particles with a size ranging from 2.5 µm to 10 µm (PM₁₀ – PM_{2.5}). The fine fraction contains the smaller ones with a size up to 2.5 µm (PM_{2.5}). The particles in the fine fraction which are smaller than 0.1 µm are called ultrafine particles.

Periodic sampling: Discrete/individual/separate/discontinuous/grab/spot sampling – individual time- or volume-dependent samples.

Periodic measurement: Determination of a measurand (particular quantity subject to measurement) at specified time intervals using manual or automated reference methods.

Plant:

- Machinery or equipment used in industry.
- One piece of equipment or part of a whole process line.
- The production line facility where such machinery or equipment is used.

Plume: Visible or measurable discharge of a contaminant from a given point of origin.

Post-combustion: Ignition and burning of exhaust gas through the injection of air or the use of a burner (e.g. in order to reduce the amount of CO or other pollutants).

Primary measure/technique: A measure/technique that changes the way in which the core process operates, thereby reducing raw emissions or consumption (see also the counterpart: Secondary technique).

Process water: Waste water derived from processes and activities within the production plant.

Receiving water: All distinct bodies of water that receive run-off or waste water discharges, such as streams, rivers, ponds, lakes, and estuaries.

Production residue: Material from the production of wood-based panels consisting mainly of wood, and which could be recycled as a raw material for producing a wood-based panel at the same installation where it was produced or used as a fuel for producing energy for the production of a wood-based panel at the same installation where it was produced.

Reclaimed wood: Material predominantly containing wood derived directly from post-consumer recycled wood.

Recovery: Any operation of which the principal result is waste serving a useful purpose by replacing other materials which would otherwise have been used to fulfil a particular function, or waste being prepared to fulfil that function, in the plant or in the wider economy. (Waste Directive 2008/98/EC)

Recovered wood: Material predominantly containing wood. Recovered wood can consist of reclaimed wood and wood residues.

Recycling: Any recovery operation by which waste materials are reprocessed into products, materials or substances whether for the original purpose or others. (Waste Directive 2008/98/EC)

Refining: Transforming wood chips to fibres using a refiner.

Reuse: Any operation by which products or components that are not waste are used again for the same purpose for which they were conceived. (Waste Directive 2008/98/EC)

Reference conditions: Conditions that are specified, e.g. in this document especially in relation to expression of monitoring results and in relation to comparing a monitoring result with a BAT-AEL. Reference conditions can refer to an emission level given under standard conditions (mg/Nm^3) and corrected or not to a specific oxygen content in percentage and given on a dry or wet basis.

Release: Actual discharge (routine, usual or accidental) of emissions into the environment.

Remediation: The containment and/or decontamination of contaminated environmental media such as soil, groundwater, sediment, or surface water from a contaminated site intended for further use. The area of the site may be larger than the fenced area.

Residue: A material that is not deliberately produced in a production process and may or may not be waste.

Reverse osmosis: A membrane process with small pore sizes ($< 0.002 \mu\text{m}$). The pores allow water to pass through but retain the solute (e.g. salts, metal ions and certain organic compounds).

Roundwood: Forest-harvested logs.

Run-off: Part of the precipitation and snowmelt that does not infiltrate but moves as overland flow.

Sampling, sample: Sampling is the process by which a portion of a substance is collected to form a representative part (the sample) of the whole, for the purpose of examination of the substance or material under consideration. (see also Continuous sampling, Periodic sampling).

Secondary measure/technique: End-of-pipe emission abatement measure/technique.

Sedimentation: Separation of suspended particles and suspended material by gravitational settling.

Slabs: An outside piece of wood with or without the bark removed from the first cuts in a sawing process to convert the log into lumber (timber).

Slag: A vitrified or partially vitrified residue.

Sludge: A suspension with a high solids content such as the type precipitated by sewage treatment.

Slurry: A suspension of solid particles in a liquid but at a lower concentration than found in sludge.

Spot measurement: A periodic measurement. A measurement relating to a specific point in time; not a continuous measurement.

Spot sample: A periodic sample. A sample related to a single point in time.

Standard conditions: Referring to a temperature of 273.15 K and a pressure of 101.325 kPa. (see Reference conditions).

Start-up, shutdown operations: Operations for bringing an activity, equipment item or tank into or out of service or into or out of an idling state. Regularly oscillating activity phases are not considered start-ups and shutdowns.

Strand: Piece of wood of a predetermined shape with a length of more than 50 mm and a typical thickness of less than 2 mm. Strands are used as the final particulate in OSB [EN 300].

Surface run-off water: Water from precipitation run-off and drainage, collected from outdoor log yard areas, including outdoor process areas.

Site: Geographical area which may contain more than one installation, plant or facility.

Softwood: Wood from conifer species, such as Sylvester pine, maritime pine and larch.

TEQ: International toxicity equivalent (dioxins and furans). Also called I-TEQ or TE. The last revision of the equivalency methodology (WHO-TEQ_{DFP}) now also includes PCBs.

Total Organic Carbon: Total organic carbon, expressed as C, includes all organic compounds.

Total nitrogen (TN): The sum of organic nitrogen, ammonia, nitrite and nitrate in the chemical analysis of soil, water, or waste water. Total nitrogen, expressed as N, includes free ammonia and ammonium (NH₄-N), nitrites (NO₂-N), nitrates (NO₃-N) and organic nitrogen compounds.

Total phosphorus (Total P): Total phosphorus, expressed as P, includes all inorganic and organic phosphorus compounds, dissolved or bound to particles.

Total suspended solids (TSS): Mass concentration of all suspended solids, measured via filtration through glass fibre filters and gravimetry.

Treated wood: Wood treated with a preservation chemical.

Unit: A part of the plant in which a specific processing operation is conducted.

Upstream and downstream wood processing: All active handling and manipulation, storage or transport of wood particles, chips, strands or fibres. Upstream processing includes all wood processing from when the wood raw material leaves the storage yard. Downstream processing includes all processes which are included after the panel leaves the press and until the raw panel or the value-added panel product is sent to storage.

VOC: The definition used in this document is the United Nations Economic Commission for Europe (UNECE) definition, which defines a VOC as any organic compound which is emitted from non-natural processes and has a photochemical ozone creation potential (POCP). In the

BREF context this means any organic compound released to the atmosphere from an industrial plant or process, excluding methane, in accordance with the UNECE definition.

Waste gas: Any gas leaving a process which is not a product (includes exhaust gas, off-gas and flue-gas).

Waste water: Aqueous effluent from chemical processes, product make-up, raw material preparation, equipment cleaning, storage facilities and loading activities. Rainwater and indirect cooling water are not included because of the different definitions in the Member States for waste water.

Water consumption: The consumption of water consumed directly in the process and which is discharged either to air or surface waters.

Wet process: Production of panels where the drying of particles or fibres is not applied.

Wood-based panel: Manufactured panel, board or sheet made primarily from wood particles or wood fibres.

Wood chip: see 'Chip'.

Wood fibre: see 'Fibre'.

Wood residues: By-products from processing and manufacturing sites (pre-consumer recycled wood).

Wood processing: All active handling and manipulation, storage or transport of wood particles, chips, strands or fibres and of pressed panels. Upstream and downstream wood processing does not include the drying process or the pressing of panels.

REFERENCES

- [1] Thoemen, *Wood-Based Panels. An Introduction for Specialists* ISBN 978-1-902316-82-6, 2010.
- [2] VITO, BIO and IEEP , *Annex II, Data Gathering and Impact Assessment for a Possible Review of the IPPC Directive- Part II, Final Report*, 2007.
- [3] COM, *Best Available Techniques (BAT) Reference Document in the Common Waste Water and Waste Gas Treatment/Management Systems in the Chemical Sector (CWW BREF)*, European Commission, JRC IPTS EIPPCB, 2003.
- [4] COM, *Best Available Techniques (BAT) Reference Document for Energy Efficiency (ENE BREF)*, European Commission, JRC IPTS EIPPCB, 2009.
- [5] COM, *Best Available Techniques (BAT) Reference Document for the Large Volume Organic Chemicals Industry (LVOC BREF)*, European Commission, JRC IPTS EIPPCB, 2003.
- [6] COM, *Best Available Techniques (BAT) Reference Document on Emissions from Storage (EFS BREF)*, European Commission, JRC IPTS EIPPCB, 2006.
- [7] Meyer et al., 'Formaldehyde emission from solid wood', *Forest Products Journal*, Vol. 47, 1997, pp. 45-8.
- [8] TWG WBP, Data collection for the drafting of the WBP BREF document , 2012.
- [9] Roffael, 'Volatile organic compounds and formaldehyde in nature, wood and wood based panels', , Vol. 64, 2006, pp. 144-9.
- [10] Popescu, Production and trade of wood products in 2006 , 2008.
- [11] EPF, *Annual Report 2010-2011*, 2011.
- [12] ISO, ISO 14001: 2004 , 2004.
- [13] ISO, Technical committee 207 , 2010.
- [14] DG Environment, What is Emas? , 2010.
- [15] Reg. 1221/, 'Regulation (EC) No 1221/2009 of the European Parliament and of the Council of 25 November 2009 on the voluntary participation by organisations in a Community eco-management and audit scheme (EMAS), repealing Regulation (EC) No 761/2001 and Commission Decisions 2001/681/EC and 2006/193/EC', *Official Journal of the European Union*, Vol. L 342, 22.12.2009, 2009, pp. 1-45.
- [16] Pitman, 'Wood ash use in forestry - a review of the environmental impacts.', , Vol. Published November 1, 2006, 2006, p. 26.
- [17] ECS, EN 13649:2001 Stationary source emissions - Determination of the mass concentration of individual gaseous organic compounds - Active carbon and solvent desorption method , 2001.
- [18] EPA, EPA Method 316 - Sampling and Analysis for Formaldehyde Emissions from Stationary Sources in the Mineral Wool and Wool Fiberglass Industries , 1998.
- [19] EPA, NCASI CI/WP-98.01 , 1998.
- [20] EPA, EPA TO-11A: Determination of Formaldehyde in Ambient Air Using Adsorbent Cartridge , 1999.
- [21] VDI, Technical Rule VDI 3862 Blatt 2:2000-12: Gaseous emission measurement - Measurement of aliphatic and aromatic aldehydes and ketones by DNPH method - Impinger method , 2000.
- [22] TWG, WBP Emission data from data collection , 2012.

References

- [23] WBP industry, WBP. Collection of site specific production, energy and consumption data , 2012.
- [27] WBP TWG subgroup , Information collection on key environmental issues , 2012.
- [29] COM, *Best Available Techniques (BAT) Reference Document on Surface Treatment using Organic Solvents (STS BREF)*, European Commission, JRC IPTS EIPPCB, 2007.
- [30] EPF, *Proposal for chapter 2 of a BREF document for the wood-based panel industry. Draft July 2011.*, 2011.
- [31] EPF, *Contribution for chapter 1 for the BREF document on wood based pabel production. Draft version July 2011.*, 2011.
- [33] EN, safety of woodworking machines - chip and dust extraction systems with fixed installation. , 2004.
- [34] WPIF, *Industry standard for wood-based panels, UK*, 2002.
- [35] WPIF, *TRADA Panel Guide, Annex 2*, 2004.
- [36] COM, *Best Available Techniques (BAT) Reference Document for the Pulp and Paper Industry (PP BREF)*, European Commission, JRC IPTS EIPPCB, 2001.
- [37] He Z, et al. , 'Formaldehyde and VOC emissions at diffrent manufacturing stages of wood based panels', , 2011.
- [38] Risholm-Sundman, 'Emissions of acetic acid and other volatile organic compounds from different species of solid wood', , 1998.
- [39] Jiang T, et al. , 'Volatile organic compound emissions arising from the hot-pressing of mixed-hardwood particleboard.', , 2002.
- [40] EPF, Reduction of formaldehyde exposure in the woodworking industries , 2010.
- [41] RWP, Materials Characterization Paper In Support of the Proposed Rulemaking: Identification of Non-hazardous Secondary Materials That Are Solid Waste , 2011.
- [42] COM & EPF, Presentation slides from sub-group meeting 23/02/2012. , 2012.
- [43] EU economics, Development of cost of raw material, 2010. Based on confidential industry data, EPF 2009. , 2010.
- [44] Pels et al. , '10 Utilization of Biomass Ashes', , Vol. 978-1-84996-392-3, 2011.
- [45] VDI, 'Background data for the revision of VDI 3462 Blatt 2', Personal Communication, 2011.
- [46] DREAL Aquitaine, 'Control of emissions, 2005 A305007-5 0501, Egger Rol', Personal Communication, 2005.
- [47] France E-PRTR, 'Extract of wood panel industries in national french emission register. ', Personal Communication, 2010.
- [48] Sonae Industria, 'Data delivered during mission to France, 2012', Personal Communication, 2012.
- [49] Pizzi et al., 'Handbook of Adhesive Technology. Chapter 47: Adhesives in the Wood Industry, M. Dunky', , 2003.
- [50] NTP, Report on Carcinogens, 12. Edition. Formaldehyde CAS No. 50-00-0 , 2011.
- [51] CLP ECHA, Formaldehyde CAS No. 50-00-0. Summary Of Classification and Labelling. Harmonised classification - Annex VI of Regulation (EC) No 1272/2008 (CLP Regulation). , 2013.
- [52] LIFE05, *New and environmentally friendly OSB panels. Life III Environment - Laymans report*, 2007.

- [53] FINSA, 'Applicability of WESP, when using SO₂ and HCL rich hot gases for direct drying. ', Personal Communication, 2007.
- [54] COM, *Mission report, Spain 2012*, European Commission, JRC IPTS EIPPCB, 2012.
- [55] COM, *Mission report, France 2012*, European Commission, JRC IPTS EIPPCB, 2012.
- [56] J. M. Fernández et al. , 'Anaerobic treatment of fibreboard manufacturing waste waters in a pilot scale hybrid USBF reactor', *Wat. Res.*, Vol. Vol. 35, No. 17, 2001, p. pp. 4150–4158.
- [57] Northwest CHP, *Biomass drying and dewatering for clean heat and power*, 2008.
- [58] UBA Austria, *STATE OF THE ART OF PLANTS OF THE PARTICLE- AND FIBREBOARD INDUSTRY, Description of Plants in Austria and Luxemburg*, 2013.
- [59] Deventer, *Industrial superheated steam drying.*, TNO Environment, Energy and process Innovation, 2004.
- [60] US EPA, *PCWP Mact ruling*, 2004.
- [61] EFB, *EFB ® Particulate Control System, presentation, EPF Braunschweig workshop, Oct. 2012.*, 2012.
- [62] Swedspan, 'Analytical data for recirculating water from WESP. ', Personal Communication, 2013.
- [63] US EPA, *abatement of VOC emissions, regulatory impact analysis - NESHAP*, 2002.
- [64] EPF, EPF Standard for delivery conditions of recycled wood , 2002.
- [65] Scholz, *Wetland Systems, Storm Water Management Control, chapter 2: Wetland Case Studies*, 2011.
- [66] Alpar et al., 'Recycling of impregnated Décor paper in particle board', *Acta Silv. Lign. Hung.*, Vol. Vol. 2, 2006, pp. 113-116.
- [67] VITO, *03.1 Eindrapport houtverwerkende nijverheid*, 2011.
- [68] VDI, VDI Guideline 3462 part 2 , 2013.
- [69] AT UBA, *Comparative energy study of wet abatement systems and regenerative thermal oxidation*, 2013.
- [70] Sauer , 'Environmental tradeoffs: Life cycle approach to evaluate the burdens and benefits of emission control systems in the wood panel industry', , 2002.
- [71] Kronoplus, UTWS for Wood chips and flakes dryers , 2010.
- [72] BS, PAS 104. Wood recycling in the panel board manufacturing industry , 2004.
- [73] UBA AT, *Austrian Recycling Wood Ordinance (Draft)*, 2010.
- [74] E. Benetto et al., 'Life cycle assessment of oriented strand boards (OSB): from Process Innovation to Ecodesign', *Environmental Science and Technology*, Vol. 43, 2009, pp. 6003-6009.
- [75] VTT, 'NWBC. The 4th Nordic Wood Biorefinery Conference Helsinki, 2012', , 2012.
- [76] Mason Earles et al., 'Improving the environmental profile of wood panels via co-production of Ethanol and Acetic Acid', *environmental science and technology*, Vol. 45, 2011, pp. 9743-9749.
- [77] Sujit Banerjee et al, *Implementing strategies for drying and pressing wood without emission controls. Final Report for Project DE-FC36-96ID13439*, Georgia Institute of Technology, 2007.
- [78] Forintek, *Status of Energy Use in the Canadian Wood Products Sector, Project no. 6014*, 2009.

References

- [79] Sujit Banerjee et al., 'Wet line extension reduces VOCs from softwood drying', , 2014.
- [80] Schinagl et al., *Statistische Analyse von Stoffströmen bei der Spanplattenerzeugung*, 2008.
- [81] AEA, Climate change agreement, fifth period assessment , 2009.
- [82] Lanzerstorfer, 'Solid/Liquid - Gas separation with wet scrubbers and wet electrostatic precipitators: A review', , 2000.
- [83] Barbu et al., 'Environment impact of the wood based panel industry', , 2014.
- [84] Weigl et al., 'Wood-borne formaldehyde varying with species, wood grade and cambial age; Forest Prod. J. 59(1/2):88–92', , 2009.
- [85] EPA, *Final Draft BAT Guidance Note on Best Available Techniques for the Production of Paper Pulp, Paper and Board*, 2010.
- [86] DEFRA, *DEFRA - particleboard, oriented strand board and dry process fibre board sector*, 2010.
- [87] Swedspan, *WESP description*, 2011.
- [88] INERIS, *Monitoring of odour emissions - Electronic noses*, INERIS, 2009.
- [90] EA UK, *Wood. A technical report for the manufacture of products from waste wood. Waste resources action programme*, 2007.
- [91] COM, *Best Available Techniques (BAT) Reference Document for the production of Pulp, Paper and Board (PP BREF)*, European Commission, JRC IPTS EIPPCB, 2015.
- [92] COM, *Mission report Italy, Fantoni Osoppo*, 2014.
- [93] USEPA, *Emission Factor Documentation for AP-42. Section 10.6 Reconstituted Wood Products 2002-2003* <http://www.epa.gov/ttn/chief/ap42/ch10/index.html>, 2014.
- [94] EPF and EUROFINs Italy, *Sampling and analysis for E.P.F. Plant Emission Project. 28/03/2014*, 2014.
- [95] ATCM, Final regulation order, Airborne toxic control measure to reduce formaldehyde emissions from composite wood products, ATCM 93120 , 2007.
- [96] IAF, International Accreditation Forum website , 2010.
- [97] UK MCERTS, *Stack Emissions Monitoring - Method Implementation Document for EN 13725 Air Quality - Determination of odour concentration by dynamic olfactometry; Measurement of odour in stack gas emissions*, 2013.
- [98] CEN, *EN 12619:2013 Stationary source emissions - Determination of the mass concentration of total gaseous organic carbon - Continuous flame ionisation detector method*, 2013.
- [99] US EPA, *Technology Fact Sheet - Retention Basins*, 1999.
- [100] US EPA, *Technology Fact Sheet - Sand Filters*, 1999.
- [101] EPA, *Catalytic Incinerator*, EPA, 1999.
- [102] EPA (US), *Regenerative Incinerator*, EPA, 2003.
- [109] Egger , Photo of Oriented strand board (OSB) , 2011.
- [110] Egger, Photo of Fibreboard (MDF) , 2011.
- [111] Pavatex et al., Photos of Flexboard and rigidboards with a tongue-and-groove finish , 2011.
- [112] Gutex, Photo of Layered softboard (SB) , 2012.
- [113] Steico, Photo of Thin green softboard for underfloor insulation , 2012.
- [114] Lessa, Photo of Hardboard (HB) , 2012.

- [115] Presswood, Photo of Particleboard pallet and pallet blocks , 2012.
- [116] Finsa, Photo of Storage of roundwood in a log yard , 2012.

Europe Direct is a service to help you find answers to your questions about the European Union

Free phone number (*): 00 800 6 7 8 9 10 11

(*) Certain mobile telephone operators do not allow access to 00 800 numbers or these calls may be billed.

A great deal of additional information on the European Union is available on the Internet.

It can be accessed through the Europa server <http://europa.eu>

How to obtain EU publications

Our publications are available from EU Bookshop (<http://bookshop.europa.eu>), where you can place an order with the sales agent of your choice.

The Publications Office has a worldwide network of sales agents.

You can obtain their contact details by sending a fax to (352) 29 29-42758.

JRC Mission

As the Commission's in-house science service, the Joint Research Centre's mission is to provide EU policies with independent, evidence-based scientific and technical support throughout the whole policy cycle.

Working in close cooperation with policy Directorates-General, the JRC addresses key societal challenges while stimulating innovation through developing new methods, tools and standards, and sharing its know-how with the Member States, the scientific community and international partners.

*Serving society
Stimulating innovation
Supporting legislation*

