

Wide Maritime Area Airborne Surveillance (WIMAAS) WP5 Final Report

Final Report of the WIMAAS WP5 - Describes the Results of the WIMAAS Experiment Carried out in July 2011 at INTA Airbase (El Arenosillo) in Huelva-Spain involving an Unmanned Aircraft System (Fulmar) and several boats among other assets.

Author/s Name/s: Victor M. G. Silva, Gilles Jurquet, Gabriel Marchalot, Maria T. G. Calzado, Txema Soroa, Juan Sancho, Adam Koubek, Harm Greidanus & Claudio Savarino



EUR 25183 EN - 2012

The mission of the JRC-IPSC is to provide research results and to support EU policy-makers in their effort towards global security and towards protection of European citizens from accidents, deliberate attacks, fraud and illegal actions against EU policies.

European Commission
Joint Research Centre
Institute for the Protection and Security of the Citizen

Contact information

Address: TP 670, Via Enrico Fermi 2749, 21027 Ispra (VA), Italy
E-mail: victor.silva@jrc.ec.europa.eu
Tel.: +39-0332-786709
Fax: +39-0332-789156

<http://ipsc.jrc.ec.europa.eu/>
<http://www.jrc.ec.europa.eu/>

Legal Notice

Neither the European Commission nor any person acting on behalf of the Commission is responsible for the use which might be made of this publication.

***Europe Direct is a service to help you find answers
to your questions about the European Union***

Freephone number (*):

00 800 6 7 8 9 10 11

(*) Certain mobile telephone operators do not allow access to 00 800 numbers or these calls may be billed.

A great deal of additional information on the European Union is available on the Internet. It can be accessed through the Europa server <http://europa.eu/>

JRC **68160**

EUR **25183 EN**
ISBN **978-92-79-22802-5 (PDF)**,
ISBN **978-92-79-22801-8 (print)**

ISSN **1018-5593 (print)**,
ISSN **1831-9424 (online)**
doi:**10.2788/6952**

Luxembourg: Publications Office of the European Union, 2012

© European Union, 2012

Reproduction is authorised provided the source is acknowledged

Printed in Italy

D5 – Report on Experiment

OF

JRC

(PARTNER NR 07)

With participation of

TSA

SENER

AEROVISION

SATCOM1

SELEX-GALILEO

Non Confidential - RE

Grant Agreement number	217931
Project acronym	WIMA²S
Project title	Wide Maritime Area Airborne Surveillance

Task Number	WP 5
Task title	Experiment (Summary Document)
Activity type	RTD
File name	WIMAAS-500-D5-RE-JRC-Ed0

Project co-funded by the European Commission within the Seven Framework Programme		
Dissemination Level		
PU	Public	
PP	Restricted to other programme participants (including the Commission services)	
RE	Restricted a group specified by the consortium (including the Commission services)	X
CO	Confidential, only for members of the consortium (including the Commission services)	

Contributing partners

Company	Name
JOINT RESEARCH CENTRE	Victor Silva & Harm Greidanus
THALES SYSTEMES AEROPORTES S.A.	Gilles Jurguget & Gabriel Marchalot
SENER	Maria Teresa
AEROVISIÓN VEHÍCULOS AÉREOS S.L	Juan Sancho & Txema Soroa
SATCOMI	Adam Koubek

Revision table

Version	Date	Modified Pages	Modified Sections	Comments
Draft	15/03/2011			Creation
Ed0				

Table of Contents

List of Figures	9
List of Tables.....	10
List of Applicable Documents.....	11
Executive Summary	13
1 INTRODUCTION.....	15
1.1 Purpose and scope of the WP5	17
1.2 Relationship with other tasks	18
1.3 Structure of the document	19
1.4 Reference Documents.....	20
2 SPECIFICATION OF THE SURVEILLANCE EXPERIMENT.....	21
2.1 Objectives.....	21
2.1.1 Specification of the surveillance experiment perimeter.....	21
2.1.2 Definition of the surveillance experiment scenario.....	21
2.2 Outcome	21
2.2.1 Specification of the surveillance experiment perimeter.....	21
2.2.2 Definition of the surveillance experiment scenario.....	23
3 SURVEILLANCE EXPERIMENT PREPARATION.....	25
3.1 Objectives.....	25
3.1.1 Preparation of the Surveillance Experiment.....	25
3.2 Outcome	25
3.2.1 Preparation of the surveillance experiment.....	25
4 SURVEILLANCE EXPERIMENT EVALUATION	32
4.1 Objective	32
4.1.1 Performance Analysis.....	32
4.2 Outcome	33
4.2.1 Performance Analysis.....	33
5 CONCLUSIONS	33
ANNEX 510.....	34
6 DEFINITION OF THE WIMAAS EXPERIMENT	38
6.1 Experiment Overview.....	38
6.2 Demonstration Scope	39
7 INTEGRATION TESTS	41
7.1 Assets to Use	41
7.1.1 UAV FULMAR System.....	41
7.1.2 Satellite Communication Terminal Inmarsat	42
7.2 Intermediate Demonstration Steps	43
7.2.1 Integration of the UAV with the other WiMAAS Systems.....	43
7.2.2 Satcom Station System.....	44
7.2.3 Components.....	45
7.2.4 Functional Description	45
7.3 Used Equipments.....	46

7.3.1	Thrane & Thrane Explorer 700	46
7.3.2	Acquisition server.....	47
7.3.3	GSM Possition.....	47
8	EXPERIMENT FLIGHT MISSIONS	48
8.1	Scenario Definition.....	48
8.1.1	Location.....	48
8.1.2	Target Definition	51
8.1.3	Existing Systems in the Area.....	51
8.2	Demonstration Flight Details	55
8.2.1	Flight Objectives	55
8.2.2	Most Suitable Dates and Times for the Experiment.....	55
8.2.3	Duration and Altitude of the Flight	55
8.2.4	Flight Area.....	55
8.2.5	Weather Conditions.....	56
8.2.6	GO/NOGO Criteria	56
8.3	Flight Missions	56
8.3.1	Mission.1: Detection, Identification and Tracking of Small Boats and Ships	57
8.3.2	Mission.2: Enlarging the Current Surveillance Area	57
8.3.3	Mission.3: Several Flight Profiles	57
8.3.4	Mission.3: Several Flight Profiles Mission.4: Interaction with the NCC AND Interoperability with Surface Surveillance Units	57
8.4	Flight Missions Sequence of Events	58
8.5	Compliance Matrix.....	59
9	DEMONSTRATION SUPPORT REQUIREMENTS	61
9.1	Preliminary Documentation Required.....	61
10	ISDEFE / GUARDIA CIVIL DEMO REQUIREMENTS.....	61
11	ORGANISATION.....	62
11.1	Organisation General Overview	62
11.1.1	WiMAAS WP5 Partners	62
11.1.2	Spanish Partners	62
11.2	Responsibilities During the Demonstration	62
11.2.1	Guardia Civil.....	63
11.2.2	INTA	64
11.2.3	AEROVISION.....	64
11.2.4	SATCOM1	64
11.3	Technical Events	65
11.3.1	Weather Conditions Data	65
11.3.2	Sea State Data.....	65
11.3.3	UAV Data.....	65
11.3.4	AIS Data.....	65
11.3.5	GPS Data	65
11.3.6	Radar SIVE Data	65
11.3.7	Communications and Transmitted Data	65
12	SAFETY.....	66
12.1	FULMAR System: Datasheet.....	66
12.2	FULMAR System: Safety	67
12.3	FULMAR Flight Procedure Safety Plan	68
ANNEX 521	69
13	Overview of the updated WiMAAS Experiment	73

13.1	Experiment Overview.....	73
13.2	Demonstration Scope	74
14	UPDATED ORGANISATION GENERAL OVERVIEW	76
14.1	Organisation General Overview	76
14.1.1	WiMAAS WP5 Partners	76
14.1.2	Spanish Partners	76
14.2	Responsibilities During the Demonstration	76
14.2.1	Guardia Civil	78
14.2.2	INTA	78
14.2.3	AEROVISION.....	78
14.2.4	SATCOM1	79
14.3	Technical Events	79
14.3.1	Weather Conditions Data	79
14.3.2	Sea State Data.....	79
14.3.3	UAV Data.....	80
14.3.4	AIS Data.....	80
14.3.5	GPS Data.....	80
14.3.6	Radar SIVE Data	80
14.3.7	Communications and Transmitted Data.....	80
15	MILESTONES OF THE EXPERIMENT PREPARATION	81
15.1	Discussion of the steps required among the partners	81
15.2	Meeting With Guardia Civil and ISDEFE	81
15.3	Visit to INTA Base – El Arenosillo	82
15.4	UAV/Communications Integration Tests.....	83
15.5	Test Phase of the Experiment - INTA Base	84
15.6	Test Phase of the Experiment – SIVE Station.....	85
15.7	Organisation of the Experiment – Responsibilities During the Demonstration.....	85
16	UAS FLIGHT EXPERIMENT	88
16.1	Set Up of the UAS FULMAR System	88
16.1.1	UAV Launch System.....	88
16.1.2	UAV Landing System	91
16.1.3	UAV Ground Control System	93
16.2	Satcom Systems Deployed by Satcom1	94
16.3	Systems Available at INTA Airbase	97
16.3.1	Target Tracking Stations MPS2000	98
16.3.2	Radar Systems	100
16.4	Systems Available at SIVE Station.....	101
16.5	INTA Mission Control Room.....	105
16.5.1	Systems Involved	105
	Architecture of the Experiment	107
16.6	WIMA2S Experiment - Sequence of Events.....	108
16.7	Main Results of the Experiment.....	110
	Acknowledgements	111
	REFERENCES.....	111
	ANNEX 522	112
	Executive Summary	115
17	INTRODUCTION.....	116
17.1	Structure of the document	116
17.2	Relationship with other tasks	118

17.3	Reference Documents.....	119
18	EVALUATION OF THE WIMAAS EXPERIMENT	120
18.1	Objectives of the WIMA ² S Experiment.....	120
18.2	ISDEFE / Guardia Civil Demo Requirements	120
18.3	WIMA ² S Experiment Compliance Matrix.....	121
18.4	Experiment Planning and Organisation.....	122
18.5	Selection of the Experiment Site.....	122
18.6	Selection of the Launch and Landing Sites	124
18.7	SIVE Station Activities	125
18.8	Satellite Communications/ UAS Integration.....	126
18.9	WIMA ² S Experiment Sequence of Events.....	127
18.10	Results of the WIMA ² S Experiment	128
18.11	Main Limitations	128
19	LESSONS LEARNED AND POSSIBLE IMPROVEMENTS	129
19.1	Main Lessons Learned.....	129
19.2	Possible Improvements.....	129
20	CONCLUSIONS AND FUTURE WORK.....	130
20.1	Conclusions	130
20.2	Future Work	130
20.2.1	System of Systems integration	130
20.2.2	Multi-Sensor / Multi-platform Maritime Surveillance.....	131
20.2.3	UAS Key Enabling Technologies	131
20.2.4	UAS Surveillance – Concept of Use (CONUSE) / Concept of Operations (CONOPS)	
	133	
	REFERENCES.....	134
	Glossary.....	134
	INTRODUCCIÓN	2
	LOGÍSTICA	2
	TRANSPORTE	2
	CONSUMIBLES Y REPUESTOS	2
	ELECCIÓN DEL TERRENO.....	3
	CARTOGRAFÍA Y PLAN DE VUELO	3
	DISPOSICIÓN DE LA ESTACIÓN DE TIERRA	4
	Catapulta	4
	Red de captura “SARE”	4
	GCS.....	4
	Antenas.....	5
	NORMAS Y MEDIDAS DE SEGURIDAD	5
	PLAN DE EMERGENCIA	5
	CHEQUEO PRE-VUELO	6
	OPERACIÓN DE VUELO	7
	ATERRIZAJE	7
	PARTICULARIDADES EXPERIMENTO C.E.D.E.A	9
	AP04	14
	VIDEO LINK	15

List of Figures

Figure 1 – WIMA ² S work packages and tasks structure.	16
Figure 2 – Relationship between the different WIMA ² S work packages.	18
Figure 3 – Overview of the organization during the demonstration.	28
Figure 4 – Workflow of the WiMAAS maritime UAV flight experiment.....	39
Figure 5 - UAV FULMAR System. On the bottom left the launch system. In the middle the command and control system. On the top right the net landing system.	41
Figure 6 - Satellite Communication Terminal Inmarsat.....	42
Figure 7 – Illustration of the interface to connect the Fulmar System to the rest of the WiMAAS systems.	43
Figure 8 – Experiment schema.	45
Figure 9 – Simplified web GUI example.	46
Figure 10 – Southwest coast of Spain [2].	49
Figure 11 – Southwest coast of Spain (detail) with El Arenosillo location depicted [2].	49
Figure 12 – Exact location of El Arenosillo Air Base [2].	50
Figure 13 – Examples of patera, cayuco and rubber boats [2].	51
Figure 14 – SIVE range of detection in Huelva [2].	53
Figure 15 – SIVE station at El Arenosillo in Huelva-Spain [2].	54
Figure 16 – Overview of the organization during the demonstration.	63
Figure 17 – Workflow of the WiMAAS maritime UAV flight experiment.....	74
Figure 18 – Overview of the organization during the demonstration.	77
Figure 19 – Overview of the organization during the demonstration.	86
Figure 20 – UAV on launch pad ready for launch.	89
Figure 21 – Profile view of the UAV Launch Pad with the UAV ready for launch.	89
Figure 22 – UAV Launch Pad from a different perspective. On the top left and right hand sides of the picture two target trackers can be seen. These trackers were used to track the UAV and the small boat deployed during the experiment.	90
Figure 23 – UAV FULMAR Launch Pad system with the UAV ready for launch.	90
Figure 24 – UAV immediately after launch.	91
Figure 25 – UAV Landing System. The Landing System consists of a net kept vertical by two lateral inflatable pillars. In this picture the UAV is just about to land on the net.	92
Figure 26 – UAV after landing. After crashing against the net the UAV remains suspended until the operations team collects the UAV.	92
Figure 27 – UAV Control unit with 2 displays and 1 joystick.	93
Figure 28 - UAV Control unit with 2 displays and 1 joystick.	93
Figure 29 – Ground Control System Antenna.	94
Figure 30 - • Thrane & Thrane Explorer E500.	95
Figure 31 - Thrane & Thrane Explorer E700.	96
Figure 32 – Satellite Communications Terminal Thrane & Thrane Explorer E500 being deployed.	96
Figure 33 – Satellite Communications Terminal Thrane & Thrane Explorer E700 being deployed.	97
Figure 34 – On the top left and right, two INTA Target Tracking Radars near the Ground Control System.	98
Figure 35 - Zoom-in of the first Target Tracking Radar. This Target Tracking Radar is the one on the left in figure 34.	99

Figure 36 – Zoom-in of the second Target Tracking Radar. This is the one on the right in figure 34. .	99
Figure 37 – Two radar systems at INTA airbase.....	100
Figure 38 – Zoom-in of the two radars of the previous figure.....	100
Figure 39 – Guardia Civil SIVE Station in Huelva-Spain.	101
Figure 40 – Guardia Civil SIVE Station in Huelva-Spain. Control of the radar, AIS and SIVE cameras data.	102
Figure 41 – SIVE station at El Arenosillo in Huelva-Spain.....	103
Figure 42 – SIVE range of detection in Huelva.	104
Figure 43 – On the left hand side, the display of the UAV position and the UAV video transmitted via Satcom. On the right hand side, the UAV video from the ground control system.....	105
Figure 44 – On the left hand side, the display of AIS information. On the right hand side the real time video from the SIVE camera.	106
Figure 45 – Display of the INTA UAV tracking system.	106
Figure 46 – Final Architecture of the WIMA ² S experiment.	107
Figure 47 – WIMA ² S experiment – sequence of events.....	109
Figure 48 – Work Package structure of the WIMA ² S project.....	118
Figure 49 – Draft Schematic of the launch and landing site.	124
Figure 50 – WIMA ² S UAV Fulmar installation.....	125

List of Tables

Table 1 – List of Applicable Documents.....	11
Table 2 – WIMA ² S experiment - Selected Technologies.	22
Table 3 – WIMA ² S experiment – Maritime Surveillance Scenario.....	23
Table 4 – UAV Flight: Sequence of Events.	58
Table 5 – Compliance Matrix ISDEFE / Guardia Civil Requirements / WiMAAS Proposed Activities.	60
Table 6 – Reference documents.	119
Table 7 – Compliance Matrix ISDEFE / Guardia Civil Requirements / WiMAAS Proposed Activities.	121

List of Applicable Documents

The next table contains a list of applicable project documents.

Table 1 – List of Applicable Documents.

Ref.	Document Name	Lead	Contents
AD0	WiMAAS ANNEX 1_revision A.pdf	-	Description of Work
AD1	WiMA ² S-210-REP-PP-WP2.1report-EurS090630-Ed3.doc	EurS	End-User Requirements
AD2	WIMAAS-220-REP-MiScen-FOI-170709Ed6.doc	FOI	Mission Scenarios
AD3	WIMAAS-230-REP-PP-JRC20090930-Ed48.doc	JRC	System of Systems Architecture
AD4	WiMAAS-311-REP- remote control-TSA-Ed1.pdf	TSA	Remote Control Mission
AD5	WIMAAS-312-REP-SensorConcept-FOI-100130Ed8.pdf	FOI	Airborne Multi-Sensors
AD6	WIMAAS-313-REP-PP-JRC20100218-Ed2.pdf	JRC	Multi-Systems Concepts
AD7	scenarios_Execution_optimization.doc	SENER	Internal Engineering Document

Executive Summary

This report of WIMA²S Work Package 5 (WP5), describes the definition, planning, execution and evaluation of the WIMA²S UAS flight experiment. The main aim of the WIMA²S project consists of developing key technologies to prepare the future for the operational use of Unmanned Aerial Systems (UAS), innovative mission aircraft and space assets, as key building blocks integrated in a System of Systems approach. WIMA²S takes into account the current operational user requirements and the needs to develop strong European capabilities in the fields of maritime policy, integrated border management and security R&T, identified as top priorities by the EU.

The main objectives of WP5 comprised the definition and performance of a UAS flight experiment based on one of the maritime surveillance scenarios elaborated in task WP2.2, the illustration of a complete information flow of the planning of a multi-sensor/multi-platform surveillance mission and the remote control concept for mission system.

The UAS flight experiment has successfully illustrated the remote control of a maritime surveillance system using different scenarios derived from the end-users requirements/needs identified in WP2. The experiment was carried out at El Arenosillo airbase, in Huelva, Spain in close cooperation with Guardia Civil, INTA (Instituto Nacional de Técnica Aeroespacial) and ISDEFE (Ingeniería de Sistemas para la Defensa de España). The UAS flight experiment comprised the following sequence of events. The Command and Control Centre at INTA airbase tasked the UAS for a routine maritime surveillance flight. During the UAS flight, Guardia Civil deployed a small rubber boat. The boat was detected by the Huelva SIVE station through its coastal radar and camera. Guardia Civil classified the non-identified target as a potential non-cooperative target and tasked the UAS for an investigation flight. The UAS flew to the area where the non-cooperative target was detected by the SIVE station and detected and classified the non-identified target as a small rubber boat (Tiger type) and sent the video of the target to the Command and Control Centre via Satellite communications. The UAS tracked the target for a while to collect additional information and try to identify it.

A complete information flow of the planning of a multi-sensor/multi-platform surveillance mission has also been illustrated. All WP5 objectives have been fully achieved according to the planned.

1 INTRODUCTION

This report is the WP5 deliverable (D500) and summarises the activities carried out in WP-5 (Experiment) of the WIMA²S project, as well as the main results achieved. Figure 1 illustrates the work package structure of the WIMA²S project. The WIMA²S experiment consisted of a UAS flight experiment conducted from 5 to 7 July 2011 at INTA (Instituto Nacional de Técnica Aeroespacial) airbase (El Arenosillo) in Huelva-Spain. The experiment involved the WIMA²S partners and the collaboration of Guardia Civil, INTA and ISDEFE (Ingeniería de Sistemas para la Defensa de España).

The main objectives of WP5 comprise the definition and performance of a UAS flight experiment based on one of the maritime surveillance scenarios elaborated in task WP2.2, the illustration of a complete information flow of the planning of a multi-sensor/multi-platform surveillance mission and the remote control concept for mission system.

The present report comprises a summary document and three annexes:

- ✚ [WIMAAS-D500-D5-RE-JRC-Ed0.doc](#) – Summary document
 - WIMAAS-D510-REP-JRC-Ed0.doc – Specification of the Surveillance Experiment
 - WIMAAS-D521-REP-JRC-Ed0.doc – Preparation of the Surveillance Experiment
 - WIMAAS-D522-REP-JRC-Ed0.doc – Surveillance Experiment Evaluation

These documents correspond to the WP5 deliverables with the following structure:

- ✚ D5 – This deliverable summarises the overall experiment including the contents of the three following annexes:
 - D510 – Specification of the Surveillance Experiment – this deliverable describes in detail the UAS flight experiment.
 - D521 – Preparation of the Surveillance Experiment – this deliverable gives a detailed account on the UAS flight experiment preparation.
 - D522 – Surveillance Experiment Evaluation – this deliverable gives the evaluation of the UAS flight experiment taking into account the feedback received from the main partners including the WIMA²S consortium partners, the external partners (Guardia Civil, INTA and ISDEFE) and the End-Users.

Figure 1 illustrates the work package structure of the WIMA²S project.

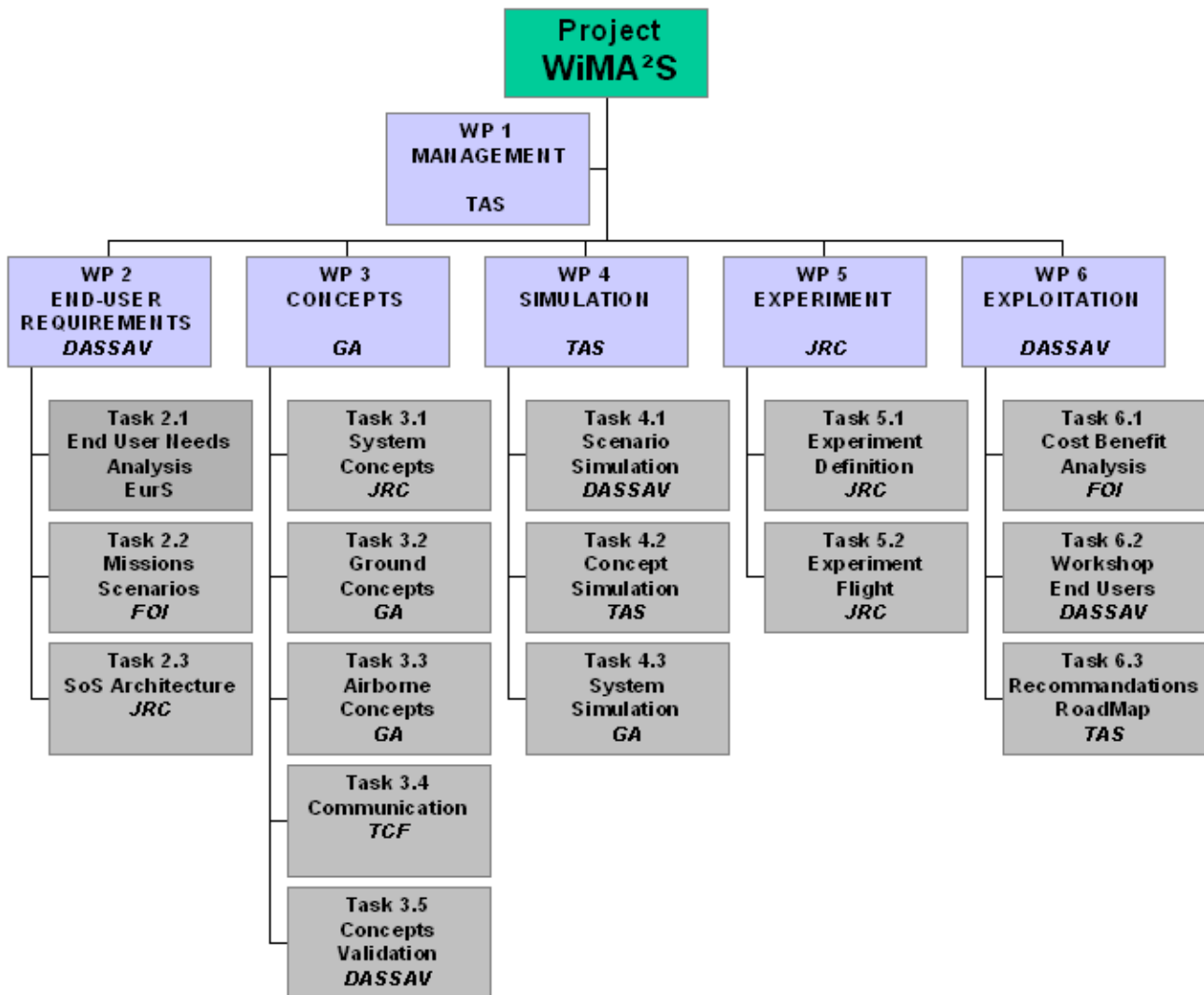

Figure 1 – WIMA²S work packages and tasks structure.

1.1 Purpose and scope of the WP5

The Wide Maritime Area Airborne Surveillance (WIMAAS) is a capability project addressing the European Commission FP7 Security Research Call 1 topic “Surveillance in wide maritime areas through active and passive means”. WIMAAS key objectives are to provide the key airborne Building Block of a maritime surveillance System of Systems to be defined in Europe, develop an original and innovative technological solution to increase airborne maritime surveillance efficiency while reducing costs, fill the gap between Piloted Mission Aircraft and Unmanned Aerial Vehicle (UAV) for Maritime Surveillance and demonstrate through simulation the main innovative concepts.

WiMAAS addresses the airborne building block of maritime surveillance with the potential for reduced cost of operation, more autonomous and improved efficiency through the introduction of air vehicles with reduced or zero onboard crew. WIMAAS intends to bridge the gap between manned and unmanned vehicles, taking into account the current operational user requirements and the needs to develop strong European capabilities in the fields of maritime policy, integrated border management and security Research and Technology (R&T), identified as top priorities by the EU.

WIMAAS also addresses the urgent need for civil surveillance for situation awareness on flow of people and goods, i.e. illegal immigration, human trafficking, illegal trade, drug traffic, smuggling, organized crime and terrorism by sea, in the context of the Integrated Border Management. In line with the EU Maritime Policy, it also contributes to other public service missions by focusing on maritime security and traffic, threats and risks identification of e.g. small and fast targets, search and rescue, monitoring of difficult or dangerous sites, and protection of the marine environment.

Air assets are a unique capability for wide area maritime surveillance, because they provide situation awareness over extended areas (endurance, speed and long distance detection), re-direction to areas of interest and flexible reaction. A main goal of WIMAAS will be to ensure effective protection of wide areas through detection, localization, identification and tracking of targets moving/entering the border that can be classified as a threat.

The focus of this work package (i.e., WP5) was to define the experiment (perimeter and scenario) and the flight experiment (preparation, execution and performance analysis).

This document represents the final report of the WP5 of the WIMA²S project.

1.2 Relationship with other tasks

Figure 2 shows a graphical representation of the workflow between the different work packages. WP2 addressed the End-Users Analysis, the Mission Scenarios and the System of Systems Architecture. The End-Users requirements/needs and the Mission Scenarios were essential inputs for the System of Systems Architecture definition. WP2 was an input for WP3 Concepts and concepts validation, as well as WP4 Simulation. The main inputs for WP5 were WP2.2 Mission Scenarios and WP3 Concepts, as well as WP4 Simulation. WP5 together with WP4 is an input for WP6.

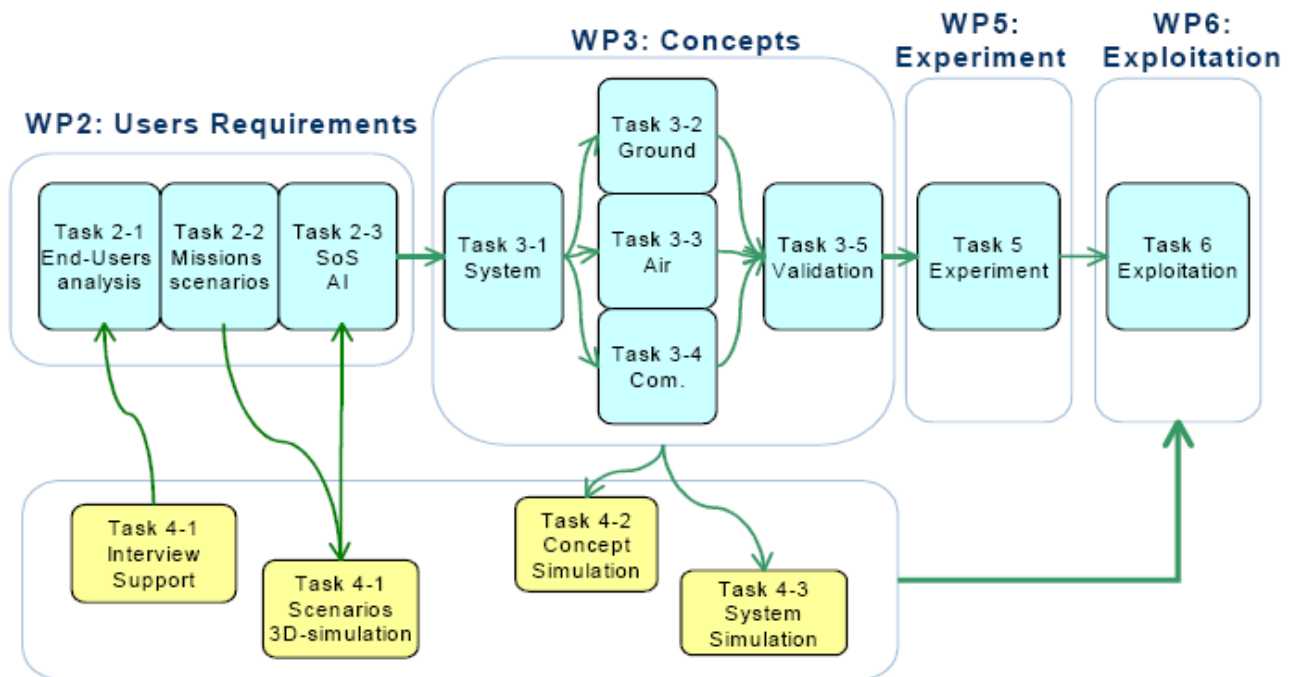

Figure 2 – Relationship between the different WIMA²S work packages.

1.3 Structure of the document

This report describes the activities carried out in WP-5 (Experiment) of the WIMA²S project, as well as the main results achieved. The WIMA²S experiment consisted of a UAS flight experiment conducted from 5 to 7 July 2011 at INTA (Instituto Nacional de Técnica Aeroespacial) airbase (El Arenosillo) in Huelva-Spain. The experiment involved the WIMA²S partners and the collaboration of Guardia Civil, INTA and ISDEFE (Ingeniería de Sistemas para la Defensa de España). The present report comprises a summary document and three Annexes:

- ✚ WIMAAS-D500-D5-RE-JRC-Ed0.doc
 - WIMAAS-D510-REP-JRC-Ed0.doc – Specification of the Surveillance Experiment
 - WIMAAS-D521-REP-JRC-Ed0.doc – Preparation of the Surveillance Experiment
 - WIMAAS-D522-REP-JRC-Ed0.doc – Surveillance Experiment Evaluation

The Work Package 5 was originally structured into two Tasks and four Sub-tasks as follows:

- ✚ Task 5.1 – Experiment Definition
 - Sub-task 5.1.1 – Specification of surveillance experiment perimeter
 - Sub-task 5.1.2 – Definition of surveillance experiment scenario
- ✚ Task 5.2 – Experiment Flight
 - Sub-task 5.2.1 – Preparation of surveillance experiment
 - Sub-task 5.2.2 – Performance analysis.

The original structure of the deliverables comprised a summary report and four Annexes:

- ✚ D5 – A summary of the overall UAS flight experiment
 - D5.1.1 Specification of surveillance experiments
 - D5.1.2- Surveillance scenario definition
 - D5.2.1-Surveillance experiment preparation
 - D5.2.2-Surveillance experiment evaluation.

Due to affinities between tasks 5.1.1 and 5.1.2 the structure of the deliverables has been improved by the WP5 partners in order to better reflect the work done. The final structure comprises a summary document and three Annexes, as follows:

- ✚ D5 – A summary of the overall experiment
 - D510-Specification of the surveillance experiment
 - D521-Surveillance experiment preparation
 - D522-Surveillance experiment evaluation

The different deliverables are self-explanatory. Deliverable D5 gives an overview of WP5 including a summary of the specification, preparation and evaluation. D510 describes the specification and definition of the experiment. D521 details all the steps involved in the preparation of the experiment. Finally, D522 gives an account on the evaluation of the UAS flight experiment.

1.4 Reference Documents

The WP5 reference documents are the documents mentioned in Table 1, under the list of applicable documents, reproduced below for convenience of the reader.

Ref.	Document Name	Lead	Contents
AD0	WIMAAS ANNEX 1 revision A.pdf	-	Description of Work
AD1	WIMA ² S-210-REP-PP-WP2.1report-EurS090630-Ed3.doc	EurS	End-User Requirements
AD2	WIMAAS-220-REP-MiScen-FOI-170709Ed6.doc	FOI	Mission Scenarios
AD3	WIMAAS-230-REP-PP-JRC20090930-Ed48.doc	JRC	System of Systems Architecture
AD4	WIMAAS-311-REP- remote control-TSA-Ed1.pdf	TSA	Remote Control Mission
AD5	WIMAAS-312-REP-SensorConcept-FOI-100130Ed8.pdf	FOI	Airborne Multi-Sensors
AD6	WIMAAS-313-REP-PP-JRC20100218-Ed2.pdf	JRC	Multi-Systems Concepts
AD7	Scenarios_Execution_optimization.doc	SENER	Internal Engineering Document

AD0 – Describes the work of the entire WIMA²S project.

AD1 – Gives the outcome of the End-Users Analysis (End-User requirements/needs).

AD2 – Defines the Mission Scenarios based on the End-User requirements/needs.

AD3 – Sets out the System of Systems Architecture.

AD4 – Gives an account on System Concepts.

AD5 – Summarises the Sensor Concepts.

AD6 – Quantifies the functionalities of the maritime surveillance systems identified in the System of Systems Architecture.

AD7 – Describes the optimization of the scenarios execution.

2 SPECIFICATION OF THE SURVEILLANCE EXPERIMENT

This section summarises Annex D510.

Task WP5.1 (– Experiment Definition) comprised two main Sub-tasks, namely:

- Sub-task 5.1.1 – Specification of the surveillance experiment perimeter
- Sub-task 5.1.2 – Definition of the surveillance experiment scenario.

2.1 Objectives

The main objectives of the specification of the surveillance experiment are the specification of the surveillance experiment perimeter and the definition of the surveillance experiment scenario.

2.1.1 Specification of the surveillance experiment perimeter

Sub-task 5.1.1 addressed the selection of the relevant technologies for the WIMA²S experiment taking into account the End-user requirements, the relevant technologies and their readiness for field trials. The outcome of this Sub-task is summarised in section 2.2.1 and described in detail in Annex 510.

2.1.2 Definition of the surveillance experiment scenario

Sub-task 5.1.2 was devoted to the definition of the surveillance experiment scenario. The selection of the scenario for the WIMA²S experiment was based on the maritime surveillance scenarios defined in WIMA²S WP2.2 and the inputs from Guardia Civil and ISDEFE, taking into account the operational requirements/needs of the End-users. Another important factor in the selection of the scenario was the authorisation from the Spanish authorities to fly a UAS. In order to facilitate the authorisation to fly the UAS, El Arenosillo INTA's airbase was selected as the location for the UAS flight. The support systems available in the area also played an important role in the selection process. The outcome of this Sub-task is summarised in section 2.2.2 and described in detail in Annex 510.

2.2 Outcome

2.2.1 Specification of the surveillance experiment perimeter

A careful analysis led to the selection of the following technologies for the WIMA²S experiment:

- ✚ Supplied by the WIMA²S consortium –
 - Unmanned Aircraft System (UAS) FULMAR from Aerovision.

- Satellite Communication Terminals Inmarsat.
 - Internet Experiment Website (from broadcasting of the experiment).
- ✚ Made available by the WIMA²S partners, namely Guardia Civil and INTA –
- SIVE Station Coastal Radar and Camera.
 - INTA AIS data and Tracking Radar.

A detailed description of these technologies can be found in Annex 510. The sections in which these technologies are described in Annex 510 are summarised in Table 2.

Table 2 – WIMA²S experiment - Selected Technologies.

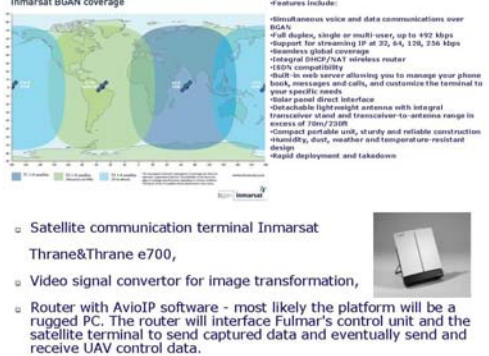
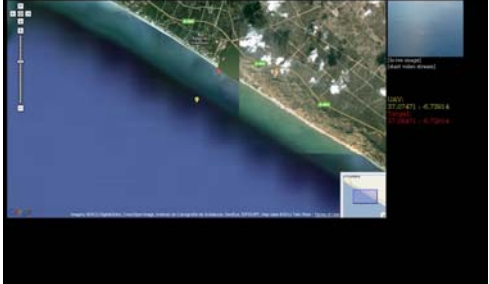
Technology	Illustration	Section(s) in Annex 510
Unmanned Aircraft System (UAS) FULMAR from Aerovision.	 <p>Description of the FULMAR System</p> <p>WIMAS MULTIC MADRID - Nov 2010 - WORK PACKAGE - 3 - EXPERIMENT</p> <p>++ 500 hours of flight experience</p> <p>AEROVISION</p> <ul style="list-style-type: none"> • Surveillance • Target location • Aerial photography • Atmospheric research • Border patrol • Natural Disasters monitoring <p>Aerovisión Vehículos Aéreos, S.L.</p>	<p>2.- Integration Tests</p> <p>2.1.1 – UAV Fulmar System</p> <p>2.2 – Intermediate Demonstration Steps.</p> <p>2.2.1 – Integration of the UAV with other WIMA²S Systems.</p> <p>7.- Safety</p> <p>7.2 – Flight Safety.</p>
Satellite Communication Terminals Inmarsat.	 <p>Inmarsat BGAN coverage</p> <p>Features include:</p> <ul style="list-style-type: none"> -Simultaneous voice and data communications over BGAN -Full duplex, single or multi-user, up to 492 kbps -Support for streaming IP at 32, 64, 128, 256 kbps -Nearby global coverage -Integral DHCP/NAT wireless router -ISDN compatibility -Built-in web server allowing you to manage your phone book, messages and calls, and customise the terminal to your specific needs -Solar panel direct interface -Detachable lightweight antenna with integral transceiver and transmitter to antenna range in excess of 10m/330ft -Compact portable unit, sturdy and reliable construction -Rugged, dust, weather and temperature-resistant design -Rapid deployment and take-down <ul style="list-style-type: none"> ▫ Satellite communication terminal Inmarsat Thrane&Thrane e700, ▫ Video signal convertor for image transformation, ▫ Router with AvioIP software - most likely the platform will be a rugged PC. The router will interface Fulmar's control unit and the satellite terminal to send captured data and eventually send and receive UAV control data. 	<p>2.- Integration Tests</p> <p>2.1.2 – Satellite Communication Terminal Inmarsat.</p> <p>2.2 – Intermediate Demonstration Steps.</p> <p>2.2.2 – Satcom Station System.</p>
Internet Experiment Website (from broadcasting of the experiment).		<p>2.2 – Intermediate Demonstration Steps.</p> <p>2.2.4 – Functional Description.</p>

2.2.2 Definition of the surveillance experiment scenario

The selection of the maritime surveillance scenario involved the selection of the location, the target definition and the analysis of the support systems available in the area. Concerning the location, ISDEFE and Guardia Civil proposed INTA facilities (El Arenosillo airbase) in Huelva-Spain, based on three main reasons:

- 1.) – It is under INTA’s control. The FULMAR UAV has already done test flights at INTA’s facilities and has had the flight certifications issued by INTA;
- 2.) – The maritime area surrounding it is a high interest maritime surveillance area;
- 3.) – The SIVE program is already deployed in the area, providing a coastal radar and surveillance camera.



The WIMA²S consortium fully agreed with the location proposed by ISDEFE and Guardia Civil, since the location was in line with the End-users operational requirements/needs identified in WP2.2.

Regarding the definition of the targets, it was based on the maritime surveillance scenarios defined in WIMA²S WP2.2 and on the End-users requirements/needs. Small boats are often used in unlawful maritime activities such as illegal immigration, drugs trafficking and smuggling. Hence, it was important to test the UAS added-value for detection, tracking, classification and identification of such a small targets. The WIMA²S consortium proposed a range of small boats, namely rubber boats, Pateras or Cayucos, which are the most commonly used in unlawful maritime activities in the South of Spain. Due to logistical problems posed by the use of Pateras and Cayucos, it was decided to use a small rubber boat.

A detailed description of the experiment scenario definition can be found in Annex 510. The sections in which the steps involved in the scenario definition are summarised in Table 3.

Table 3 – WIMA²S experiment – Maritime Surveillance Scenario.

Experiment Scenario	Illustration	Section(s) in Annex 510
- Experiment Location. The selected location was INTA airbase (El Arenosillo) in Huelva-Spain.		3.1 – Scenario Definition. 3.1.1 – Location. 3.1.2 – Target Definition.

<p>-Targets Definition.</p>		<p>3.1 – Scenario Definition. 3.1.2 – Target Definition.</p>
<p>-Systems Available in the Area.</p> <ul style="list-style-type: none"> • 2 Watts ELTA Radar; • GMOSP-L optronic sensor from TAMAM; • Communications Equipment. 		<p>3.1 – Scenario Definition. 3.1.3 – Existing Systems in the Area.</p>

3 SURVEILLANCE EXPERIMENT PREPARATION

This section provides a summary of Annex D521.

Task WP5.2 (– Experiment Flight) comprised two main Sub-tasks, namely:

- Sub-task 5.2.1 – Preparation of the surveillance experiment
- Sub-task 5.2.2 – Performance analysis.

This section addresses Sub-task 5.2.1(– Preparation of the surveillance experiment) only. Sub-task 5.2.2 (– Performance analysis) is summarised in section 4.

3.1 Objectives

The main objective of Sub-task 5.2.1 was the preparation of the surveillance experiment.

3.1.1 Preparation of the Surveillance Experiment

The objective of the surveillance experiment was: “According to the surveillance experiment script of task 5.1.2 the experiment will be planned in detail on an operational level together with involved navy and coast guard. Pre-tested sensor packages will be integrated on surveillance platforms. Communication links to a maritime surveillance centre will be set up. During one week execution of the experiment will take place. If necessary the experiment will be split in independent parts to reduce the organisational effort.”

3.2 Outcome

3.2.1 Preparation of the surveillance experiment

According to the surveillance experiment script of task 5.1.2 the experiment was planned in detail on an operational level together with Guardia Civil, ISDEFE and INTA. Pre-tested sensor packages were integrated on surveillance platforms. Communication links to the maritime surveillance command and control centre were set up. The experiment was executed from 4 to 7 July 2011 at El Arenosillo airbase in Huelva-Spain.

The preparation of the WIMA²S maritime surveillance experiment involved a strong commitment from all partners involved (WIMA²S consortium, Guardia Civil, ISDEFE and INTA). A detailed description can be found in Annex D521. The main steps are summarised next.

- 1.) – **Discussion of the steps required among the partners**: the WP5 partners decided to carry out the WIMA²S experiment in Spain. Some of the main reasons that led to this decision were the following:
 - a.) Spanish authorities face several unlawful maritime activities in the South of Spain, such as illegal immigration, drugs trafficking, smuggling, etc. These are some of the maritime surveillance scenarios identified in WIMA²S WP2.2.
 - b.) The End-users requirements/needs comprise technologies and maritime surveillance solutions to mitigate the above mentioned unlawful maritime activities.

- 2.) – **Meeting with Guardia Civil and ISDEFE in Madrid-Spain**: Once the decision to carry out the experiment in Spain was made, the next step was to contact the relevant Spanish authorities and organise a meeting to discuss the feasibility of performing the WIMA²S experiment in Spain. To that end, the WIMA²S partners contacted the Guardia Civil and organised a meeting. The meeting took place on 16 November 2010 at Guardia Civil headquarters in Madrid-Spain. The participants were the WIMA²S partners, Guardia Civil and ISDEFE. Guardia Civil and ISDEFE found the WIMA²S project interesting and agreed to participate in the experiment.

A couple of weeks after the meeting, Guardia Civil and ISDEFE supplied a document describing their main areas of interest and giving suggestions for the scenarios as well as the best location for the experiment. Guardia Civil and ISDEFE suggested Huelva and Murcia as the most suitable areas for the experiment. They also agreed to help the WIMA²S partners with the authorisation to fly the UAS.

The WIMA²S consortium contacted INTA asking permission to perform the experiment at INTA airbase (El Arenosillo) in Huelva-Spain. INTA authorised. A visit to El Arenosillo to discuss the WIMA²S experiment with INTA was arranged.

- 3.) – **Visit to INTA airbase in Huelva-Spain**: The main objective of this visit was to participate in a WIMA²S meeting held at INTA's base (El Arenosillo) in Huelva, Spain with the Spanish authorities, namely Guardia Civil, ISDEFE and INTA aimed at discussing the WIMA²S experiment planned to take place in July 2011 at El Arenosillo.

Main results of the mission:

- ✚ Acquittance with the systems available at El Arenosillo.
- ✚ Visit to El Arenosillo facilities in Huelva-Spain.
- ✚ Discussion of the UAV flight profiles and the launch and landing areas.
- ✚ Decision about the likely dates of the WIMA²S experiment (first week of July 2011).
- ✚ Guardia Civil will deploy two assets, namely a patrol boat and a small boat.
- ✚ The experiment will take place between 10 and 15 nautical miles from the coast.
- ✚ The final UAV integration tests will take place in San Sebastian and will involve Aerovision and Satcom1.

During this mission two meetings were held, one on 11 April among the WIMA²S partners involved in WP5 and a second one with the Spanish authorities (Guardia Civil, INTA and ISDEFE) on 12 April 2011. The first meeting was aimed at discussing the different topics to be addressed with the Spanish authorities and review the presentations to be given during the

meeting at INTA. It was decided to give two presentations, one introducing the WIMA²S experiment and another one specifically about the UAV FULMAR. The second meeting held at El Arenosillo with the Spanish authorities was aimed at discussing the details of the WIMA²S experiment and the facilities and systems available at El Arenosillo.

The meeting held at El Arenosillo started with a presentation about INTA history, facilities and systems available at El Arenosillo given by INTA's Deputy Director. This was followed by a short welcome address by INTA's Director. After a coffee break, the WIMA²S consortium gave two presentations, one introducing the WIMA²S experiment and the second one about the UAV FULMAR. The presentations were followed by a discussion about the systems available at El Arenosillo and the analysis of a checklist of the experiment requirements.

After the meeting, the group visited El Arenosillo facilities and was acquainted with the systems available. The main objective of the visit was to find out the most suitable places at the base to deploy the UAV command and control station and the Satellite station, as well as to study the best UAV flight profile during launch and landing. Other aspects addressed during the visit were the safety issues, possible electromagnetic incompatibilities and communications interference. The visit was followed by a final discussion and balance of the meeting as well as the definition of the next steps.

4.) – **Organisation of the Experiment – Responsibilities During the Demonstration:**

✚ The WIMA²S partners directly involved in the WP5 and in the flight trials are:

- EUROPEAN COMMISSION (EC) – JOINT RESEARCH CENTRE (JRC) is the Experiment workpackage leader,
- THALES SYSTEMES AEROPORTES S.A. is the project coordinator, interfacing with the European Commission, contracting authority,
- AEROVISIÓN VEHÍCULOS AÉREOS S.L. is the flight test leader, in charge with the UAV operations and the safety during the demonstration
- SATCOM1 is in charge with the Satellite Communication assets: connection of the test site with Web Services (if necessary) and connection of the UAV Ground Control Station with the Spanish Command & Coordination Center,
- SENER is the interface with the Spanish Authorities: Guardia Civil, ISDEFE and INTA,
- SELEX GALILEO provide the expertise regarding UAV flight trials (lesson learned from FALCO)

✚ The Spanish partners involved in the WIMA²S experiment are:

- GUARDIA CIVIL, End-Users for the WIMA²S Experiment, providing access to SIVE and Spanish Coordination Center,
- ISDEFE, is in charge with the definition of requirements for the Experiment in line with Guardia Civil operational objectives,
- INTA is in charge with the flight test facilities in Arenosillo and flight authorization matters.

✚ The different teams involve during the demonstration were:

- Guardia Civil was the Spanish Authority and End-User,

- INTA was the Flight Testing and flight clearance authority,
- Aerovision was the flight test leader and was in charge of the UAV operations,
- SATCOM1 was the responsible for Satellite Communications during the experiment,
- JRC was the coordinator and supervisor of the experiment.

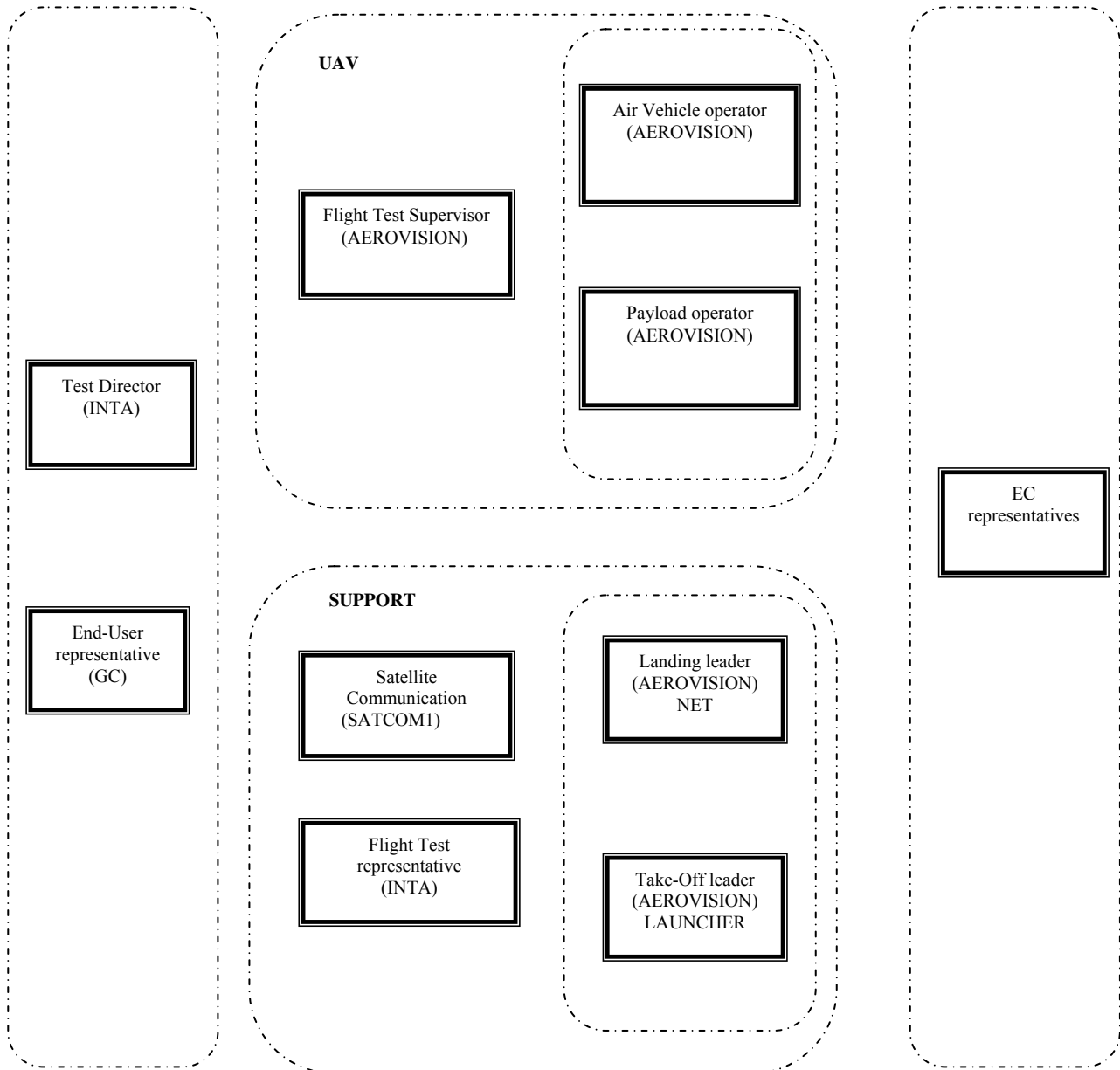

Figure 3 – Overview of the organization during the demonstration.

5.) – **Definition of the Technical Events During the Experiment:**

The technical events during the experiment, including the data that should be recorded and monitored, are summarised this section.

Weather Conditions Data

Since the UAV flight could only take place under suitable weather conditions the weather conditions were monitored and recorded before and during the UAV flight, namely the following parameters:

- a.) Wind Speed
- b.) General weather conditions (e.g. Air Temperature, Rain, etc.)

Sea State Data

Since the sea state plays an important role in any marine activities, the sea state was monitored and recorded, according to the Beaufort Wind Force Scale, namely the following parameters:

- a.) Force (0-12)
- b.) Speed (Knots)
- c.) Wave Height (m)
- d.) Description (Calm to Hurricane)

UAV Data

All data acquired by the UAV were recorded, including the targets detected, identified and tracked. Aerovision monitored all UAV related data.

AIS Data

All AIS used in the experiment were recorded.

GPS Data

The GPS positions of all vessels and other mobile assets involved in the experiment were continuously recorded during the entire experiment.

Radar SIVE Data

All Radar SIVE data used in the experiment were recorded.

Communications and Transmitted Data

All data (e.g. videos, images, etc.) transmitted during the UAV flight were recorded.

6.) – UAV Communications Integration Tests:

The UAV communications integration tests were carried out in San Sebastian by the two partners involved, namely Aerovision and Satcom1. The communications integration tests were successful.

7.) – Test Phase of the Experiment - INTA Airbase (El Arenosillo).

The first two days of the mission (4th and 5th of July 2011) were devoted to double-check all systems (e.g., interface Sistema Integrado de Vigilancia Exterior (SIVE) Coastal Radar/ WIMA²S Website, SIVE cameras, Satellite Communications Stations, UAV Control System, UAV launch and landing systems, INTA tracking radars, etc.) and to the UAV flight test. Maria Teresa (SENER), Gabriel (THALES) and Adam (Satcom1) visited the SIVE station in Huelva, which is part of the SIVE network, to double-check all systems involved in the experiment. Victor (JRC), Gilles (THALES) and the Aerovision team led by Txema visited the INTA airbase, where a meeting with INTA Deputy Director and his team was held and all the systems involved in the experiment were double-checked. On 5 July the Aerovision team set up the UAV launch and the landing systems and the UAV flight test was successfully carried out. The Satellite Communications, the INTA tracking systems and the Guardia Civil Coastal Radar and Cameras were also double-checked during the UAV flight test.

8.) – Test Phase of the Experiment - SIVE Station.

A team of partners from Satcom1, Thales and SENER visited the SIVE station on 5 July to double check if all systems were working according to the planned and ready for the actual experiment.

A conversion to adjust the different coordinate systems used in the experiment was successfully carried out by the team.

9.) – Actual Experiment

The actual experiment took place on 6 July at El Arenosillo INTA airbase as originally planned. The sequence of events will be summarised next.

1. - The WIMAAS consortium, Guardia Civil, INTA and ISDEFE staff met at the room where the Control Centre was installed for a briefing with the invited people. The WIMAAS project and its main objectives were presented to all attendees and the WIMAAS flight experiment explained.

2. - All the attendees moved to the UAV take-off area to see the take-off of the UAV (Fulmar). The Fulmar successfully took-off from El Arenosillo INTA airbase towards the sea.

3.- Everybody moved back to the Control Centre to follow the UAV flight mission through the information displayed in the control room, namely: the UAV video and position, the SIVE radar and camera data and the INTA tracking system.

4. - During the mission the SIVE station supplied the radar coordinates of a small boat (Zodiac type) deployed by the Guardia Civil patrol boat to be used as a target. The UAV was tasked to investigate the target.

5.- The UAV flew to the area where the small boat had been detected by the SIVE coastal radar. After a while the UAV detected the target and transmitted the video to the Control Centre. The small boat was then manually tracked by the UAV for some time. The UAV also detected other targets and tracked them for a while.

6.- The participants were invited to move to the UAV landing area at INTA airbase. The UAV landed successfully. This was one of the most critical parts of the experiment in terms of security/safety because there were several obstacles (e.g. Antennae, trees, houses) and the UAV was not allowed to overfly the highway close to the airbase due to security reasons. The UAV was able to do the approach and landing taking into account all the security/safety restrictions imposed.

7.- The participants moved back to the Control Centre for another briefing about the WIMAAS flight mission.

8.- The WIMAAS flight mission was discussed with the end-users and other participants and the balance of the flight experiment made, taking into account the positive aspects and the lessons learned. The project coordinator gave a presentation to explain the maritime surveillance concepts developed within the framework of the WIMAAS project. This was followed by a questions/answers session covering the entire WIMAAS flight experiment and the WIMAAS concept.

4 SURVEILLANCE EXPERIMENT EVALUATION

This section provides a summary of Annex D522.

Task WP5.2 (– Experiment Flight) comprised two main Sub-tasks, namely:

- Sub-task 5.2.1 – Preparation of the surveillance experiment
- Sub-task 5.2.2 – Performance analysis.

4.1 Objective

The main objective of Sub-task 5.2.2 was the Performance Analysis of the WIMA²S Flight Experiment.

4.1.1 Performance Analysis

The performance analysis was carried out by checking if the proposed objectives for the WIMA2S flight experiments were achieved.

The main objectives of the WIMA2S Experiment were:

- 1.- To illustrate the remote control of a maritime surveillance mission system in the framework of a scenario derived from one of those defined in WP2.2.
- 2.- Based on the conceptual work in WIMA²S and the first analysis of surveillance concepts by simulations in WP4, Surveillance Experiments will be performed to go a step further to real life.
- 3.- Within the experiments the overall surveillance architecture as well as dedicated surveillance technologies will be evaluated and validated.
- 4.- To show a complete information flow from planning a surveillance mission / task through executing this by the involvement of different platforms and sensors.

4.2 Outcome

4.2.1 Performance Analysis

- 1.- The WIMA²S flight experiment illustrated the remote control of a maritime surveillance mission system in the framework of a scenario derived from one of those defined in WP2.2.
- 2.- Based on the conceptual work in WIMA²S and the first analysis of surveillance concepts by simulations in WP4, WIMA²S Surveillance Experiments performed has illustrated how wide maritime area surveillance can be improved through the integration of different surveillance systems and the introduction of new technologies, such as UAS.
- 3.- Within the WIMA²S experiment the overall surveillance architecture as well as dedicated surveillance technologies have been evaluated and validated.
- 4.- A complete information flow from planning a surveillance mission / task through executing this by the involvement of multiple platforms and sensors was illustrated.

5 CONCLUSIONS

All the objectives originally proposed for the WIMA²S flight experiment have been fully achieved.

The main results of the WIMA²S experiment are the following:

- 1.- Illustration of the remote control of a maritime surveillance mission system in the framework of a scenario derived from one of those defined in WP2.2.
- 2.- Based on the conceptual work in WIMA²S and the analysis of surveillance concepts by simulations in WP4, the WIMA²S Surveillance Experiment demonstrated the WIMA²S concept.
- 3.- Near Real Time Transmission of UAS video to Command & Control Station via Satcom was a useful innovation.
- 4.- Illustrated the cooperative use of broad area detection Systems (e.g. Coastal Radar) with an identification and tracking System (e.g. UAV).
- 5.- Another innovative aspect of the experiment was the broadcast of the WIMA²S experiment through the Internet with possibility of interaction.

ANNEX 510

D5 – Report on Experiment

OF

JRC

(PARTNER NR 07)

With participation of

TSA

SENER

AEROVISION

SATCOM1

SELEX-GALILEO

Non Confidential - RE

Grant Agreement number	217931
Project acronym	WiMAAS
Project title	Wide Maritime Area Airborne Surveillance

Task Number	WP 5
Task title	Specification of the Surveillance Experiment
Activity type	RTD
File name	WIMAAS-510-D5-RE-JRC-Ed0

Project co-funded by the European Commission within the Seven Framework Programme		
Dissemination Level		
PU	Public	
PP	Restricted to other programme participants (including the Commission services)	
RE	Restricted a group specified by the consortium (including the Commission services)	X
CO	Confidential, only for members of the consortium (including the Commission services)	

Contributing partners

Company	Name
JOINT RESEARCH CENTRE	Victor Silva
THALES SYSTEMES AEROPORTES S.A.	Gilles Jurguget & Gabriel Marchalot
SENER	Maria Teresa
AEROVISIÓN VEHÍCULOS AÉREOS S.L	Juan Sancho & Txema Soroa
SATCOM1	Adam Koubek

Revision table

Version	Date	Modified Pages	Modified Sections	Comments
Draft	15/03/2011			Creation
Ed0				

Glossary

AEROVISIÓN – VEHÍCULOS AÉREOS S.L. (10PM)
AIS – Automatic Identification System
ASL – Above Sea Level
BLOS – Beyond Line of Sight
EC – European Commission
EU – European Union
GA – SELEX GALILEO
GPGGA – Time, position and fix-related data of the GPS receiver.
GPRMC – Time, date, position, track made good and speed data provided by the GPS navigation receiver.
GPS – Global Positioning System
GSM – Global System for Mobile Communications, or GSM (originally from Groupe Spécial Mobile).
GUI – Graphical User Interface
INTA – Instituto Nacional de Técnica Aeroespacial
ISDEFE - Ingeniería de Sistemas para la Defensa de España, S.A.
JRC – Joint Research Centre
LOS – Line Of Sight
MMI – Man Machine Interface
NCC – National Control Centre
NCCC – National Command and Control Centre
NRT – Near Real Time
PCTV – TV Tuner PCI card.
R&T – Research & Technology
Radar – Radio Detection and Range
RCCC – Regional Command and Control Centre
SAR – Synthetic Aperture Radar
SATCOM1 – Satellite service provider (Inmarsat, Iridium, KU-band via ViaSat and Thuraya).
SENER – SENER Ingeniería y Sistemas S.A.
SIVE – Sistema Integrado de Vigilancia Exterior
Thales – THALES SYSTEMES AEROPORTES S.A. (0,7PM)
UAV – Unmanned Aerial Vehicle
WiMAAS – Wide Area Maritime Airborne Surveillance

6 DEFINITION OF THE WIMAAS EXPERIMENT

In this chapter, the definition of the WIMAAS experiment and its integration into its environment, the cooperative and non-cooperative systems are introduced.

The experiment missions of the WiMAAS project will be defined in order to maximize the fulfilment of the ISDEFE/Guardia Civil demo requirements described in [2] and reproduced in chapter 2 for convenience.

6.1 *Experiment Overview*

The different missions of the experiment will follow a broad sequence of events. Figure 1 illustrates the workflow of the WiMAAS maritime UAV experiment. The sequence of events is described next in more detail.

- 1.- Based on different sources of information, such as:
 - a.) AIS data,
 - b.) Near Real Time (NRT) Spaceborne SAR correlation with AIS data
 - c.) Correlation of SIVE data with AIS data
 - d.) Detection of potential non-cooperative targets either by SIVE, AIS, Patrol vessels, Patrol aircraft (UAV or manned), intelligence information, etc.
 - e.) Simulated non-cooperative targets (e.g. Small boats could be deployed by Guardia Civil to simulate drugs trafficking, illegal immigration or other threats).
- 2.- The NCC detects an anomaly.
- 3.- The NCC triggers one or several missions to investigate the anomaly (airborne or surface assets).
- 4.- A UAV flight is tasked to investigate the anomaly.
- 5.- The UAV collects images/data using different sensors and transmits the collected data to the NCC.
- 6.- The UAV data is correlated with data from other sources and intelligence information.
- 7.- Evidence Formatting is performed.
- 8.- the Evidence is transmitted via Satellite communications to the NCC.

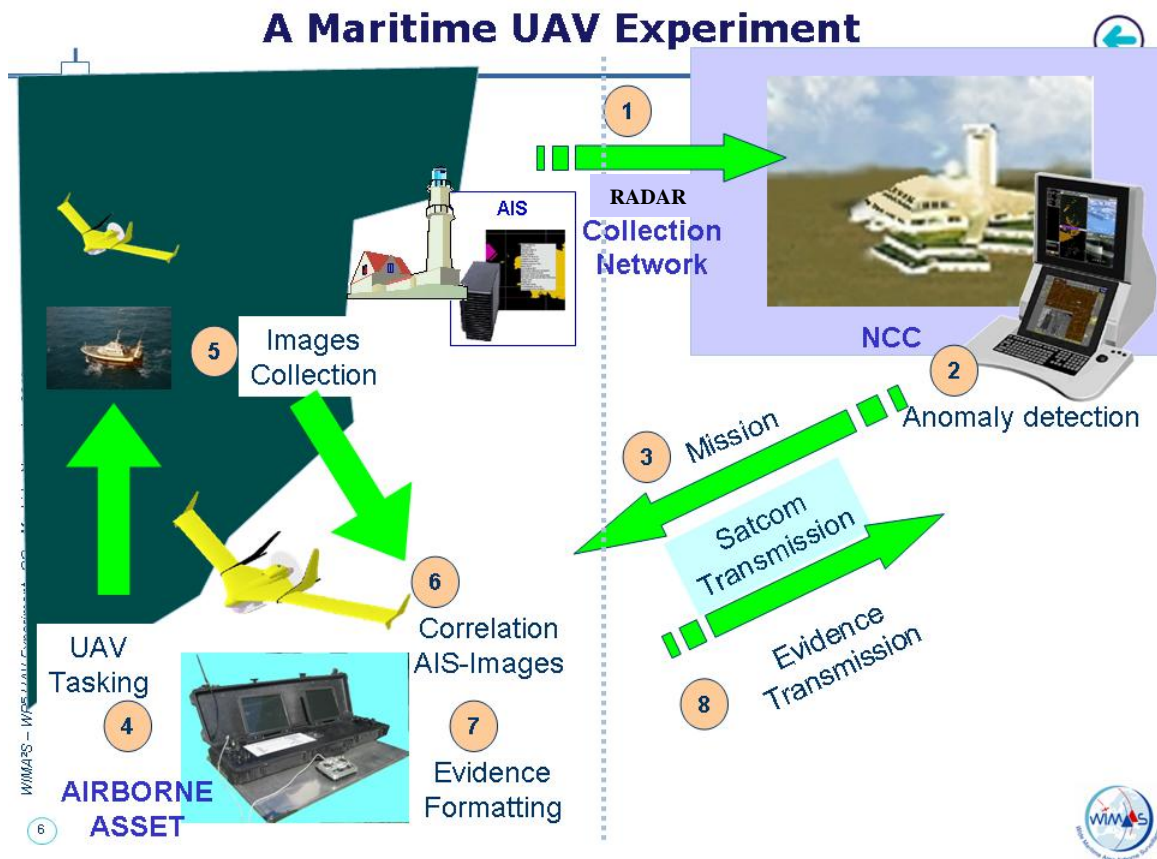

Figure 4 – Workflow of the WiMAAS maritime UAV flight experiment.

6.2 Demonstration Scope

Spain supports an intense migratory pressure, mainly at the maritime borders. Due to this reason, and as a result of the increasing demand for border control and surveillance resources, Spanish Government (through National Police Department and Guardia Civil as parts of the Ministry of Interior) has made a very strong investment in order to perform an appropriate border management and face the growing migration pressure at land and maritime borders.

One of the most successful initiatives is the SIVE program, which performs maritime surveillance all along the coastline in the troublesome areas. As a result of this success, the next step points at extending the surveillance limits beyond the limits of SIVE system. One of the alternatives in recent years which is gaining prominence is the use of new platforms for sensors.

In order to do so, during the past years a special interest has arisen on new surveillance platforms, and mainly on Unmanned Air Vehicles (UAV).

Hence, running an experiment with this sort of platforms is a fundamental step for analyzing the benefits that SIVE can obtain from embodying UAVs in its systems. Also, in the case of Guardia Civil, this represents an opportunity to continue the line of work followed during the last years for the development and integration of innovative surveillance platforms and keep an alignment with ongoing EU initiatives in the field of Integrated Border Surveillance.

From the WIMA2S Project point of view, the interest of the development of the experiment is the system to be validated by an important agent in border control and surveillance, showing how an UAV system is able to increase the coverage provided by a coastal surveillance deployment.

7 INTEGRATION TESTS

In order to make sure that the WiMAAS experiment unfolds as planned a number of integration tests have to be set up to check all systems and the interfaces between the different systems. This chapter describes the intermediate demonstration steps and the assets to use.

7.1 Assets to Use

The WiMAAS consortium will deploy the following systems in the area of the experiment:

7.1.1 UAV FULMAR System

The UAV system to be deployed is the UAV FULMAR system from Aerovision. Fig.5 illustrates the different modules of the system. As a backup plan, a redundant UAV FULMAR system will be deployed.



Figure 5 - UAV FULMAR System. On the bottom left the launch system. In the middle the command and control system. On the top right the net landing system.

7.1.2 Satellite Communication Terminal Inmarsat

A satellite communication terminal Inmarsat will be deployed by Satcom1. Fig.6 illustrates the Satellite communication terminal. As a backup plan, a redundant satellite communication terminal Inmarsat will be deployed by Satcom1.

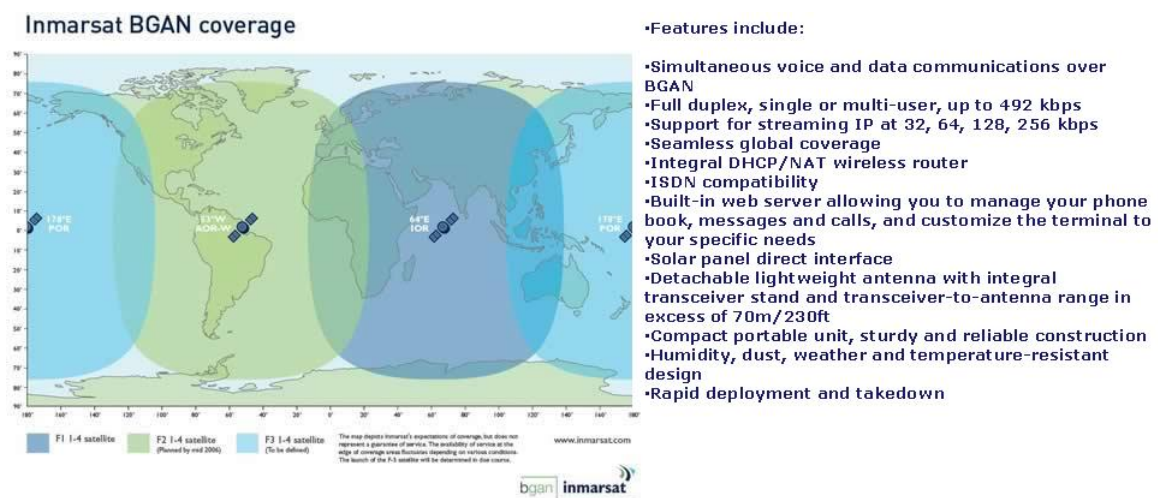

- Satellite communication terminal Inmarsat Thrane&Thrane e700,
- Video signal convertor for image transformation,
- Router with AvioIP software - most likely the platform will be a rugged PC. The router will interface Fulmar's control unit and the satellite terminal to send captured data and eventually send and receive UAV control data.



Figure 6 - Satellite Communication Terminal Inmarsat.

7.2 Intermediate Demonstration Steps

In this section the intermediate demonstration steps will be described.

7.2.1 Integration of the UAV with the other WiMAAS Systems

1.-Overview

The goal of this document is to define a common interface to connect the Fulmar System to the rest of the WiMAAS systems.

More specifically, the Ground Control Station (GCS) has to be interfaced to the SATCOM system. For that purpose two signals are used:

- Video.
- UAV position.

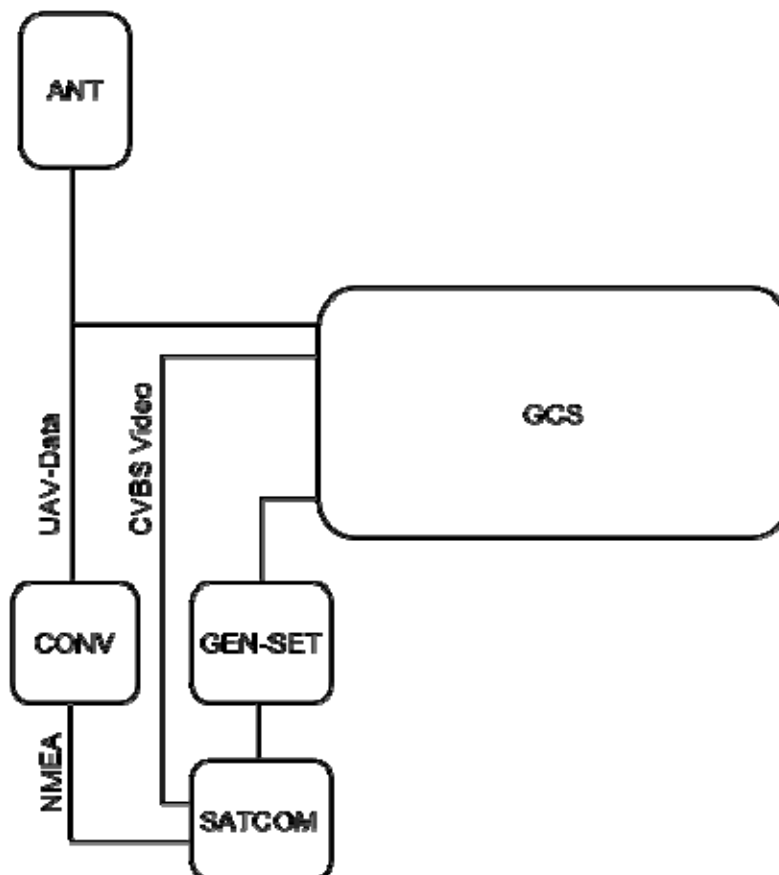

Figure 7 – Illustration of the interface to connect the Fulmar System to the rest of the WiMAAS systems.

2.- Video signal

- Contains the video sent from the camera on the UAV.
- Analog composite video (CVBS) format.
- Shall be terminated with 75 ohm impedance. Physical connector: RCA plug (can be changed).

3.- UAV position

- Contains the position of the UAV in real time.
- A NMEA stream will be generated by means of the converter (CONV) to emulate a GPS receiver.
- The physical media will be a RS-232 port.
- Physical connector: Sub-D 9 pin, female.
- The packets will be sent with the following format:

GPRMC Format:

```
"$GPRMC,%2d%2d%2d.%2d,%c,%2d%2d.%4d,%c,%3d%2d.%4d,%c,%1.1f,%1.1f,%2d%2d%2d,,  
A*c%c%c\n\r"
```

GPGGA Format:

```
"$GPGGA,%2d%2d%2d.%2d,%2d%2d.%4d,%c,%3d%2d.%4d,%c,%c,%2d,%1.1f,%1.1f,M,%1.1f,M  
,,*c%c%c\n\r"
```

GPGSA Format:

```
"$GPGSA,A,3,03,19,01,20,,,,,,,,,09.0,06.8,05.9*01\n\r\0"
```

*Note that the information on GPGSA packet is fixed (always the same).

4.- Gen-Set

- The mains supply for the SATCOM equipment will be also provided by the Fulmar UAS' gen-set.
- The type of plug will be the one used in Spain.
- Voltage is 220V RMS.
- Max. Power required TBD by SATCOM.

7.2.2 Satcom Station System

The goal is to provide the following data (video and GPS position) from UAV to MMI/GUI:

- Thumbnail images from UAV camera

High resolution images from UAV camera

Video stream from UAV camera (the camera can be IR or visible light)

GPS position of UAV

7.2.3 Components

Aerovision Command and Control System will provide 2 sources of data:

- GPS via serial port
- PAL CVBS signal via composite video connector

For acquisition, a PC will be used (Acquisition PC) with:

- A/D Video card for video signal acquisition
- AvioIP software package for communication
RS232 port for GPS strings acquisition

For satellite connection, the following equipment will be used:

- Thrane & Thrane Inmarsat terminal Explorer E700.

For intermediate data storage, a server will be used:

- Intermediate data server with fast Internet access.

Note:

The AIS part and eventually the RADAR part should be discussed by the parties providing these data sources. The data from RADAR or AIS can be stored on a data server situated on the Internet and represented in GUI/MMI.

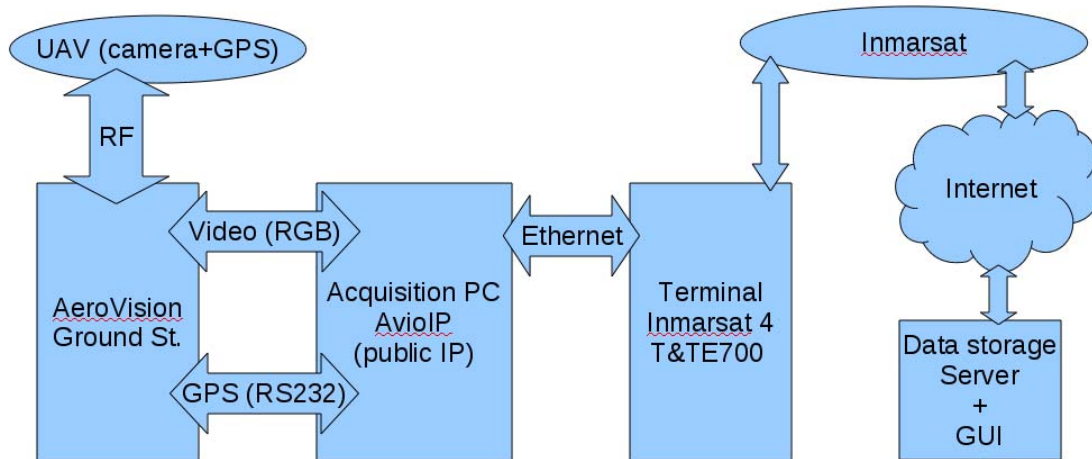

Figure 8 – Experiment schema.

7.2.4 Functional Description

The A/D Video in the Acquisition PC card will capture a video signal from Aerovision Command and Control System. Each second (or at any predefined interval) a high resolution image and its thumbnail image will be made. The thumbnail image will be sent over satellite to a data server situated on the Internet with fast Internet access, the high resolution image will be kept on the Acquisition PC to avoid

excessive usage of the satellite link and thus limit the cost. The thumbnails are sent to intermediate data storage to prevent response delays caused by the satellite network.

On the Internet server all sample/thumbnail images will be available to create content of a GUI or a web page. The thumbnail can be used in the future to reference its high resolution pair. The high resolution image can be downloaded by user request from the Acquisition PC or can be sent at specified intervals. If requested, a video stream can be sent from the Acquisition PC to the GUI. In order to guarantee the appropriate bandwidth for video stream the AvioIP package will be configured to automatically detect such traffic and open the necessary circuit mode connection.

The UAV position will be sent with the images. The position is available in text form (GPGGA and GPRMC strings) on the server for future use. The UAV position can be regularly displayed on a map (For demo purposes, Google Maps is sufficient). The GUI or web application can run directly on the Internet server.

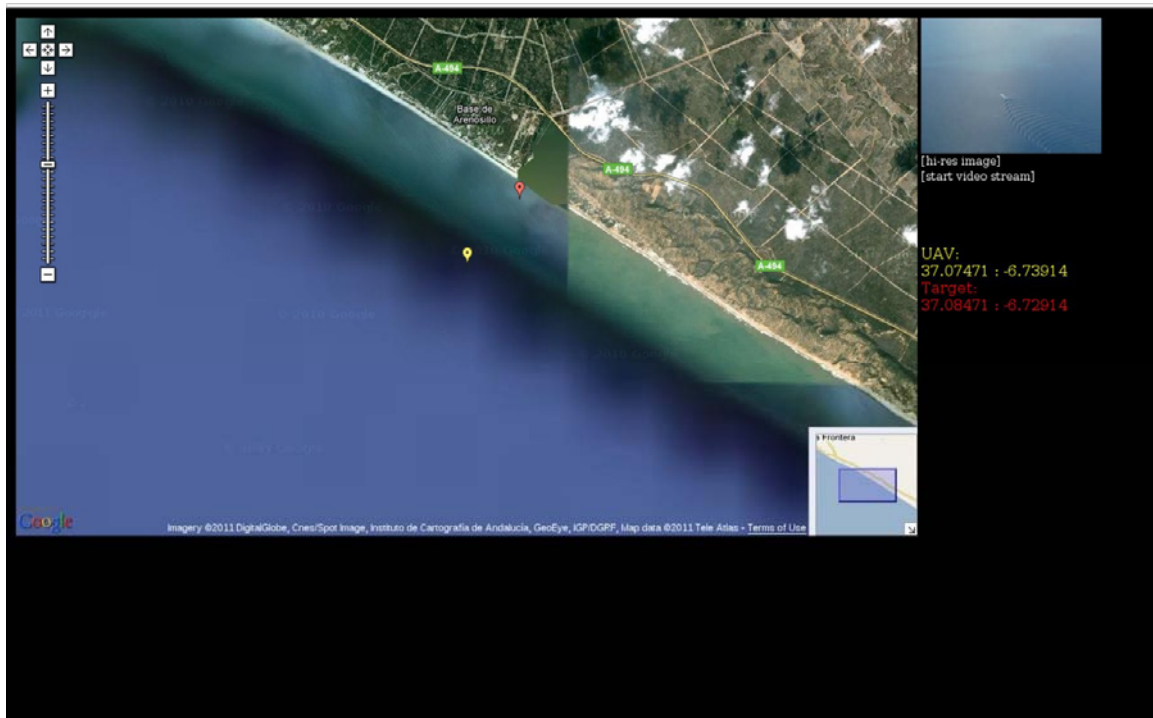

Figure 9 – Simplified web GUI example.

7.3 Used Equipments

7.3.1 Thrane & Thrane Explorer 700

Power consumption

Standby mode 1.2 W (Typical)

Transmit mode 18 W (Typical)

During charging 65 W max.

Operating temperature

Powered by external DC -25°C to +55°C/-13°F to +131°F

Powered from battery 0°C to +55°C/+32°F to +131°F

7.3.2 Acquisition server

PC Intel Core 2 Duo, 4GO RAM, Linux OS

Consumption 250 W max.

with A/D Video card

Pinnacle PCTV Rave TV Tuner - PCI

<http://www.powersourceonline.com/buy-equipment/pinnacle-Parts/210100246/31777683-210100246-cy-en.jsa>

7.3.3 GSM Possition

\$GPGGA - Global Positioning System Fix Data

\$GPRMC - Recommended Minimum Specific GPS/TRANSIT Data

\$GPGSA - GPS DOP and active satellites

GPRMC

Format:

"\$GPRMC,%2d%2d%2d.%2d,%c,%2d%2d.%4d,%c,%3d%2d.%4d,%c,%1.1f,%1.1f,%2d%2d%2d,,
A*%c%c\n\r"

GPGGA

Format:

"\$GPGGA,%2d%2d%2d.%2d,%2d%2d.%4d,%c,%3d%2d.%4d,%c,%c,%2d,%1.1f,%1.1f,M,%1.1f,M
,,*%c%c\n\r"

GPGSA

Format: "\$GPGSA,A,3,03,19,01,20,,,,,,,,,09.0,06.8,05.9*01\n\r\0"

8 EXPERIMENT FLIGHT MISSIONS

8.1 Scenario Definition

The scenario definition for the WiMAAS experiment is entirely based on the scenario proposed by ISDEFE and Guardia Civil [2] and will be described next.

8.1.1 Location

Following a meeting held at Guardia Civil facilities in Madrid on 16 Nov. 2010 with Guardia Civil and ISDEFE, ISDEFE and Guardia Civil proposed INTA facilities (El Arenosillo Air base), in Huelva-Spain [2] as the most suitable location for the WiMAAS experiment.

The three main reasons behind this proposal are:

- It is under INTA's control. The FULMAR UAV has already done test flights at INTA's facilities and has had the flight certifications issued by INTA;
- The maritime area surrounding it is a high interest maritime surveillance area;
- The SIVE program is already deployed in the area, providing the province of Huelva with a surveillance system. This fits perfectly with the stated objective of integrating an UAV system in it.

The WiMAAS consortium fully agrees with the location proposed by ISDEFE and Guardia Civil.

The location for the WiMAAS experiment will be the INTA El Arenosillo Air Base is located at the south-west atlantic coast of Spain, in Moguer, in the province of Huelva, 28 km far from Huelva city, suggested by ISDEFE and Guardia Civil. The base has a mean height of 42 meters above sea level (ASL).

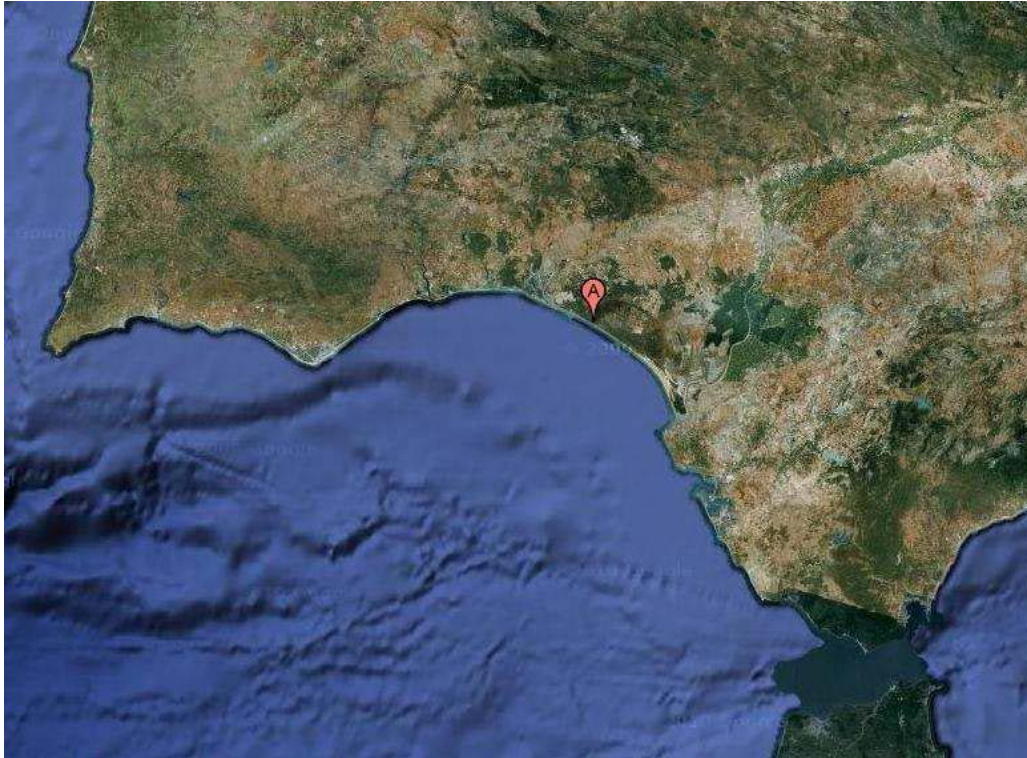

Figure 10 – Southwest coast of Spain [2].

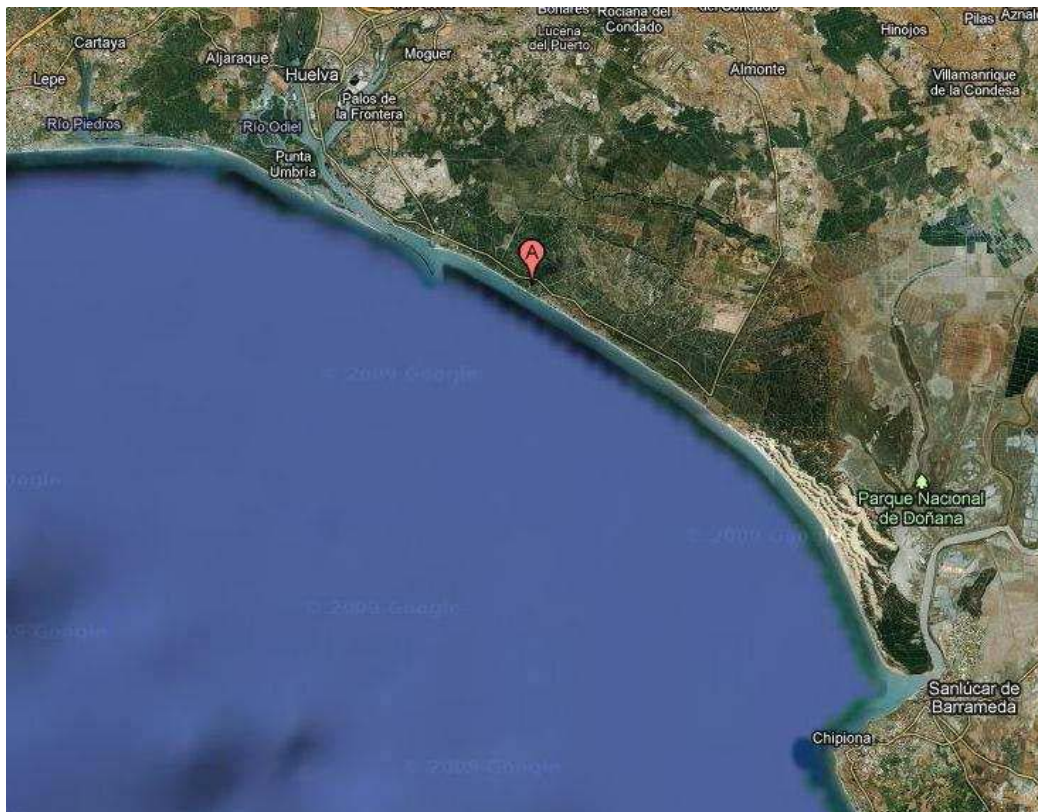

Figure 11 – Southwest coast of Spain (detail) with El Arenosillo location depicted [2].

The Air Base SIVE station, with which the UAV system is going to interact, is located at the following coordinates:

Lat: 37° 05' 47.3'' N
Lon: 06° 44' 20'' W
H = 35 metres

The station is 30 metres inland.

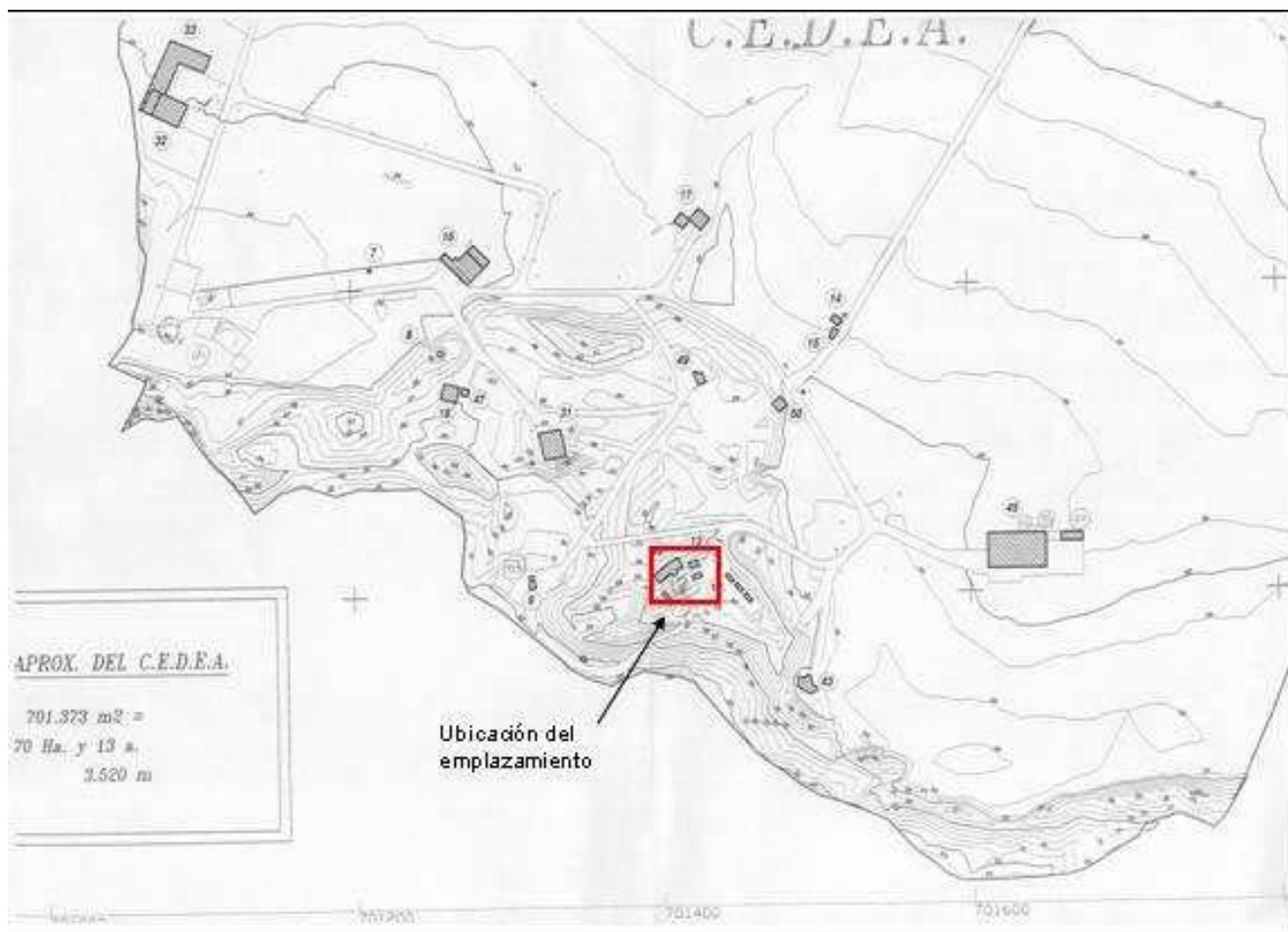

Figure 12 – Exact location of El Arenosillo Air Base [2].

8.1.2 Target Definition

In order to validate the UAV system as a tool for maritime surveillance, the system should be able to investigate, identify and track all possible threats, taking into account the characteristics of both the geographical and meteorological environment in Spanish southwest coastline and the features of the standard surface targets at this area:

- **Patera:** Wooden, rubber or fibre vessel from 5 to 7 meters long, about 2 meters wide and 0.5 meters ASL. Average speed between 1 and 10 knots.
- **Cayuco:** Wooden or fibre vessel from 6 to 15 meters long, from 2 to 5 meters wide and 1 meter ASL. Average speed between 1 and 10 knots.
- **Rubber boat:** Rubber/fibre vessel, from 5 to 8 meters long, about 2 meters wide and 0.5 meters ASL. Average speed between 1 and 60 knots.



Figure 13 – Examples of patera, cayuco and rubber boats [2].

8.1.3 Existing Systems in the Area

According to ISDEFE and Guardia Civil [2], currently, there are four SIVE stations in the province of Huelva:

- Torre del Catalán;
- Ayamonte;
- INTA El Arenosillo;
- Faro de Torre de la Higuera.

The SIVE station that can be the reference and the interface with the whole system during the experiment is the one at El Arenosillo Air Base.

As a regular SIVE station, it consists on the following equipment:

- 2 Watts ELTA Radar;
- GMOSP-L optronic sensor from TAMAM;

- Equipment for communicating with the Command and Control Centre at Punta Umbría, which coordinates all SIVE stations at this region;
- Equipment for communicating with the station at Torre de la Higuera.

With all these sensors, the SIVE station at El Arenosillo provides a range of detection of 30 kilometres offshore. The whole SIVE range of detection at Huelva can be seen in Figure 5, being El Arenosillo station the third from left. Ayamonte station is the first from left, Torre del Catalán station is the second and Torre de la Higuera is the fourth from left.

All SIVE stations at Huelva are connected to the Command and Control Centre in Guardia Civil premises in the city of Huelva by a communications network. This C&C Centre collects and centralizes all data provided by the sensor stations within the province.

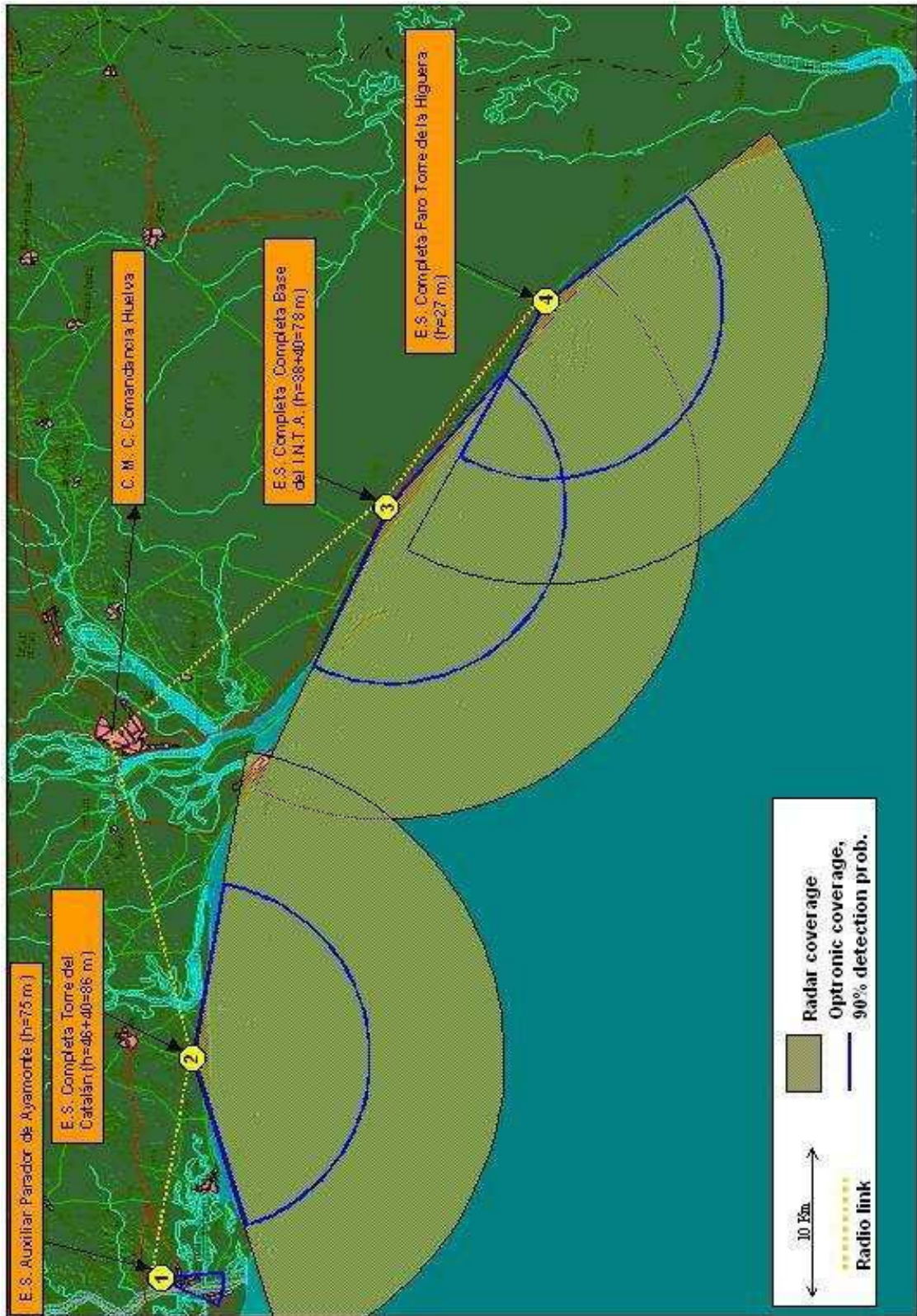

Figure 14 – SIVE range of detection in Huelva [2].



Figure 15 – SIVE station at El Arenosillo in Huelva-Spain [2].

8.2 Demonstration Flight Details

8.2.1 Flight Objectives

The main goal of the UAV flight is to show how a UAV system can contribute to improve maritime surveillance awareness. This will be achieved through several objectives, namely:

- 1.) The flight experiment will illustrate the remote control of a maritime surveillance mission system in the framework of a scenario derived from end user requirements.
- 2.) The Flight experiment will try to fulfil the requirements set by ISDEFE [2], namely:
 - a.) to show the capabilities that the UAV systems provide to maritime surveillance systems, such as SIVE, in detection, identification and tracking of small size illegal vessels tasks.
 - b.) Missions' definition: Missions to be run shall look for enlarging the current surveillance area, given the range of operation available, flight height and sensors configuration.
 - c.) Several missions should be carried on, for proving different surveillance concepts: detection-identification, interoperability, surface operations support, line of sight (LOS) operations.
 - d.) Several flight profiles shall be defined to achieve the different objectives. During demonstration, different flight control modes shall be tested: scheduled flight, waypoints definition, manual control, emergency flight (in case of data link loss), automated flight towards a detected target, etc.

8.2.2 Most Suitable Dates and Times for the Experiment

The best dates to carry out the experiment are between 6 Jul 2011 and 14 Jul 2011. Three days are needed to carry out the experiment; the first for test flights, the second to carry out the experiment and the third as a backup day.

Concerning the preferred time for the experiment, in the morning the preferred time is 10 AM. In the afternoon the preferred time is 8:30 PM.

8.2.3 Duration and Altitude of the Flight

Each flight to be carried out in each of the three days should take about 2 hours. The altitude foreseen for the flight during the experiment will be between 200 and 500 meters.

8.2.4 Flight Area

The flight area will be the INTA El Arenosillo Air Base area in Huelva-Spain and up to the 50km (UAV flight range) into the sea. The area is described in section 3.1 (Scenario Definition). If necessary, adjustments will be made to flight area to comply with authorities' requirements.

Range for the experiment. It is not clear how far we should fly during the experiment. The idea is to extend the current performance of the SIVE system, which is composed of two parts: radar sensor and optical cameras. Would a range between the optical cameras (10km?) and the radar sensor (30km) be enough? If we go for 20km, for instance, can have the information from the radar and observe the small boat from the UAV. Would that be enough?

8.2.5 Weather Conditions

The wind speed seems to be the main constraint for the UAV flight. The UAV FULMAR system can cope with winds up to 50km per hour. If a sudden change in wind and/or rain is forecast, cancellation of flight should be considered. If the flight cannot be performed due to the weather conditions, it will be postponed to the next day.

8.2.6 GO/NOGO Criteria

The GO/NOGO criteria will be defined by the Spanish authorities and Aerovision, taking into account the overall picture and all relevant criteria, including safety, the system parameters, the weather conditions and all other factors that can affect the UAV flight. A set of possible criteria is given below as an example.

Go/No-Go criteria:

*Weather conditions. If a sudden change in wind and/or rain is forecast, cancellation of flight should be considered.

*Safety issues. If Aerovision considers that the established safety needs are not followed, it has the right to cancel the flight.

*Last minute problems, with deliveries, accidents, or unforeseeable issues that might arise, illness of key participants, etc.

8.3 Flight Missions

The flight missions will be set up to fulfil the requirements of ISDEFE/Guardia Civil, taking into account the facilities and assets made available by Guardia Civil, ISDEFE and INTA. The requirements described in chapter 6 are reproduced here for convenience.

The ISDEFE/Guardia Civil demo requirements are the following [2]:

- **Objective's definition:** The main objective of the demonstration is to show the capabilities that UAV systems provide to maritime surveillance systems, such as SIVE, in detection, identification and tracking of small size illegal vessels tasks.
- **Missions' definition:** Missions to be run shall look for enlarging the current surveillance area, given the range of operation available, flight height and sensors configuration.

This document is produced under the EC Grant Agreement n° 217931 and NDA n°3281.

- **Several missions should be carried on**, for proving different surveillance concepts: detection-identification, interoperability, surface operations support, line of sight (LOS) and beyond line of sight (BLOS) operations.
- **Several flight profiles** shall be defined to achieve the different objectives. During demonstration, different flight control modes shall be tested: scheduled flight, waypoints definition, manual control, emergency flight (in case of data link loss), automated flight towards a detected target, etc.
- If possible, interaction mechanisms with **both regional and national Command and Control Centres** shall be defined, as well as **interoperability** with surface surveillance units.

The proposed missions to fulfil the above mentioned requirements to the maximum possible extent are briefly described next.

8.3.1 Mission.1: Detection, Identification and Tracking of Small Boats and Ships

Following a trigger event, the UAV will be tasked to carry out a flight beyond the current maximum range of the SIVE systems, within an area given by Guardia Civil, aimed at detection, identification and tracking of small boats deployed by Guardia Civil. The UAV will transmit data about the detection, identification and tracking to the CCC, NCC and surface surveillance units in the area. The sequence of events will be described below.

Following a new trigger event, the detection of an anomaly related to a ship, the UAV will be tasked for an investigation flight aimed at detection, identification and tracking of the above mentioned ship. The UAV will transmit data about the detection, identification and tracking to the CCC, NCC and surface surveillance units in the area.

8.3.2 Mission.2: Enlarging the Current Surveillance Area

As part of the previous mission or as a separate mission the UAV will be tasked to carry out maritime surveillance activities beyond the current surveillance area to demonstrate its capability to enlarge the current surveillance area.

8.3.3 Mission.3: Several Flight Profiles

As part of the previous mission or as a separate mission the UAV will be tasked to carry out maritime surveillance activities aimed at showing the capability to perform different flight profiles in different flight control modes, namely: scheduled flight, waypoints definition, manual control, emergency flight (in case of data link loss), automated flight towards a detected target, etc.

8.3.4 Mission.3: Several Flight Profiles Mission.4: Interaction with the NCC AND Interoperability with Surface Surveillance Units

As part of the previous mission or as a separate mission the UAV will be tasked to carry out maritime surveillance activities aimed at demonstrating the interaction with the Regional and National Command and Control Centres and the Interoperability with surface surveillance units.

8.4 Flight Missions Sequence of Events

The UAV flight missions will be described in this section. The experiment will comprise a UAV flight involving several missions, namely the above mentioned missions. The UAV flight will be triggered by an event that will depend on the assets available. Following a trigger event, the National Command and Control Centre (NCCC) will task the UAV for an investigation flight to detect, identify and track one or more targets (e.g. small boats deployed by Guardia Civil or ships passing by). The broad sequence of events is described next.

Table 4 – UAV Flight: Sequence of Events.

Time (*)	Event	Mission #
09:45:00	1.- Guardia Civil will deploy a set of small boats (e.g., Patera, Cayuco or Rubber Boat) in a given area with a couple of square nautical miles, beyond the current maximum range of operation (e.g. maximum range of SIVE system).	
10:00:00	2.- Based on different sources of information, such as: <ul style="list-style-type: none"> a.) AIS data, b.) Correlation of SIVE data with AIS data c.) Detection of potential non-cooperative targets either by SIVE, AIS, Patrol vessels, Patrol aircraft (UAV or manned), intelligence information, etc. d.) Simulated non-cooperative targets (e.g. Small boats deployed by Guardia Civil to simulate drugs trafficking, illegal immigration or other threats. <p style="text-align: center;">an anomaly is detected at the National Command and Control Centre (CCC).</p>	
10:15:00	3.- The NCCC tasks the UAV for a mission aimed at detection, identification and tracking of small boats in the area given by Guardia Civil.	Mission.1 Mission.2
10:30:00	4.- On its way to or after arriving at the area given by Guardia Civil the UAV will establish contact with surface surveillance units to exchange information and it will use different flight control modes, namely: <ul style="list-style-type: none"> a.) scheduled flight, b.) waypoints definition, c.) manual control, d.) emergency flight (in case of data link loss), e.) automated flight towards a detected target, 	Mission.3 Mission.4
10:45:00	5.- The UAV collects images/data using different sensors and transmits the collected data to the NCCC and RCCC.	Mission.4
11:00:00	6.- The UAV data is correlated with data from other sources and intelligence information.	
11:05:00	7.- Evidence Formatting is performed.	
11:10:00	8.- The Evidence is transmitted via Satellite communications to the	

This document is produced under the EC Grant Agreement n° 217931 and NDA n°3281.

0	NCCC.	
11:10:00	9.- The SIVE system detects an anomalous behaviour of a ship. The AIS data of the ship is available but the RCCC fears that the AIS data might not correspond to the ship.	
11:15:00	10.- The RCCC tasks the UAV for an investigation flight to identify and track the ship.	Mission.1
11:15:00	11.- The UAV diverts its flight to investigate the ship.	
11:30:00	12.- The UAV arrives at the area and performs detection, identification and tracking of the ship.	Mission.1
11:40:00	13.- The UAV transmits the data collected to the RCCC and returns to base.	Mission.4
12:00:00	14. End of Flight.	
(*) Aerovision suggested 10AM or 5PM as the most suitable times to start the UAV flight. If by any reason these times are not suitable for Guardia Civil, INTA or ISDEFE, the flight can start at a different time.		

Flight plan. We suggest the following changes in the schema:

- *Take off and execute a pre-defined flight plan (scheduled flight).
- *Change the Flight Plan while flying (waypoint definition).
- *Go for observation #1 (automated flight).
- *Go for observation #2 (automated flight).

Flight modes:

- 1: Scheduled flight (done)
- 2: Waypoint definition (done)
- 3: Manual control. We find this control mode out of scope inside the WiMAAS project.
- 4: Emergency flight. We find this control mode unnecessary as well.
- 5: Automated flight towards a detected target (done).

We should further discuss if modes 3 and 4 are necessary or not. Could be useful in a Fulmar demo, but I don't see the need for such modes inside the scope of the Experiment.

Timing. The scheduled take-off time is 19:45 and landing at 22:00. Is this due to a constraint in the satellite imagery? Are we finally using the satellite?

Risk assessment, etc: We have a document elaborated, but it is in Spanish. I have preferred to attach it, will send it translated in a near future.

8.5 Compliance Matrix

Table 2 illustrates the Compliance Matrix of the WiMAAS UAV flight experiment. As it can be seen the WiMAAS proposed activities fulfil most of the experiment requirements supplied by ISDEFE/Guardia Civil.

Table 5 – Compliance Matrix ISDEFE / Guardia Civil Requirements / WiMAAS Proposed Activities.

ISDEFE / Guardia Civil Demo Requirements	Proposed activities to fulfil the requirements	Compliance / How the proposed activities fulfil the requirements
1.) – Objectives: To show the capabilities that UAV systems provide to maritime surveillance systems, such as SIVE, in detection, identification and tracking of small size illegal vessels tasks.	1.) – A UAV flight comprising different flight control modes, investigation, identification and tracking of targets (e.g. small boats) with interaction with the NCCC and the RCCC will be carried out beyond the current maximum range of the SIVE system.	1.) – YES / The activities planned fulfil the objectives, by addressing each objective in turn, as described.
2.) – Missions’ definition: Missions to be run shall look for enlarging the current surveillance area, given the range of operation available, flight height and sensors configuration.	2.) – The UAV flight will go beyond the current maximum range of the SIVE system.	2.) – YES / The flight beyond the current maximum range of the SIVE system will prove that the UAV has the capability to enlarge the range of operations.
3.) – Several missions should be carried on , for proving different surveillance concepts: detection-identification, interoperability, surface operations support, line of sight (LOS) and beyond line of sight (BLOS) operations.	3.) – The UAV flight will comprise several missions aimed at addressing the main requirements, namely: investigation, identification, interoperability, surface operations support, and line of sight (LOS) operations.	3.) – YES <u>except for BLOS operations</u> / The several missions will address the main requirements except for BLOS operations.
4.) – Several flight profiles shall be defined to achieve the different objectives. During demonstration, different flight control modes shall be tested: scheduled flight, waypoints definition, manual control, emergency flight (in case of data link loss), automated flight towards a detected target, etc.	4.) – The UAV flight will include different flight control modes, namely scheduled flight, waypoints definition, manual control, emergency flight (in case of data link loss), automated flight towards a detected target, etc.	4.) – YES / All the requirements concerning different flight control modes will be fulfilled.
5.) – If possible, interaction mechanisms with both regional and national Command and Control Centres shall be defined, as well as interoperability with surface surveillance units.	5.) – During the UAV flight interaction with NCCC, RCCC and interoperability with surface units will be tested.	5.) – YES / All proposed interaction mechanisms with the NCCC and the RCCC will be tested. If possible, the interoperability with surface surveillance units will also be tested.

9 DEMONSTRATION SUPPORT REQUIREMENTS

9.1 Preliminary Documentation Required

In its document “Scenario for WiMAAS Experiment with FULMAR UAV” [2], Chapter 6, ISDEFE describes the preliminary documentation required, as follows:

“In order to assess the feasibility of the execution of the demo missions, the following preliminary documentation should be provided:

- a.) Detailed technical description of all systems and subsystems;
- b.) Detailed description of the facilities and infrastructure required for the operation;
- c.) Logistics requirements;
- d.) Previous authorizations or temporary certifications of the system as a result of similar exercises carried out in Spanish and foreign territory;
- e.) Technical certification of subsystems and components;
- f.) Possible insurance coverage;
- g.) Risk Assessment.”

The WiMAAS consortium provides all the documentation required.

10 ISDEFE / GUARDIA CIVIL DEMO REQUIREMENTS

The ISDEFE/Guardia Civil demo requirements are the following [2]:

- **Objective’s definition:** The main objective of the demonstration is to show the capabilities that UAV systems provide to maritime surveillance systems, such as SIVE, in detection, identification and tracking of small size illegal vessels tasks.
- **Missions’ definition:** Missions to be run shall look for enlarging the current surveillance area, given the range of operation available, flight height and sensors configuration.
- **Several missions should be carried on**, for proving different surveillance concepts: detection-identification, interoperability, surface operations support, line of sight (LOS) and beyond line of sight (BLOS) operations.
- **Several flight profiles** shall be defined to achieve the different objectives. During demonstration, different flight control modes shall be tested: scheduled flight, waypoints definition, manual control, emergency flight (in case of data link loss), automated flight towards a detected target, etc.
- If possible, interaction mechanisms with **both regional and national Command and Control Centres** shall be defined, as well as **interoperability** with surface surveillance units.

11 ORGANISATION

This chapter describes the organization for the WIMAAS Experiment.

11.1 *Organisation General Overview*

11.1.1 **WiMAAS WP5 Partners**

The WIMAAS partners directly involved in the WP5 and in the flight trials are:

- EUROPEAN COMMISSION (EC) – JOINT RESEARCH CENTRE (JRC) is the Experiment workpackage leader,
- THALES SYSTEMES AEROPORTES S.A. is the project coordinator, interfacing with the European Commission, contracting authority,
- AEROVISIÓN VEHÍCULOS AÉREOS S.L. is the flight test leader, in charge with the UAV operations and the safety during the demonstration
- SATCOM1 is in charge with the Satellite Communication assets: connection of the test site with Web Services (if necessary) and connection of the UAV Ground Control Station with the Spanish Command & Coordination Center,
- SENER is the interface with the Spanish Authorities: Guardia Civil, ISDEFE and INTA,
- SELEX GALILEO provide the expertise regarding UAV flight trials (lesson learned from FALCO)

11.1.2 **Spanish Partners**

The Spanish partners involved in the WiMAAS experiment are:

- GUARDIA CIVIL, End-Users for the WIMAAS Experiment, providing access to SIVE and Spanish Coordination Center,
- ISDEFE, is in charge with the definition of requirements for the Experiment in line with Guardia Civil operational objectives,
- INTA is in charge with the flight test facilities in Arenosillo and flight authorization matters.

11.2 *Responsibilities During the Demonstration*

The different teams involve during the demonstration are:

- Guardia Civil as the Spanish Authority and End-User,
- INTA as Flight Testing and flight clearance authority
- Aerovision is the flight test leader and in charge of the UAV operations,
- SATCOM1 is the responsible of Satellite Communication during the experiment

- JRC coordinates and supervises the experiment

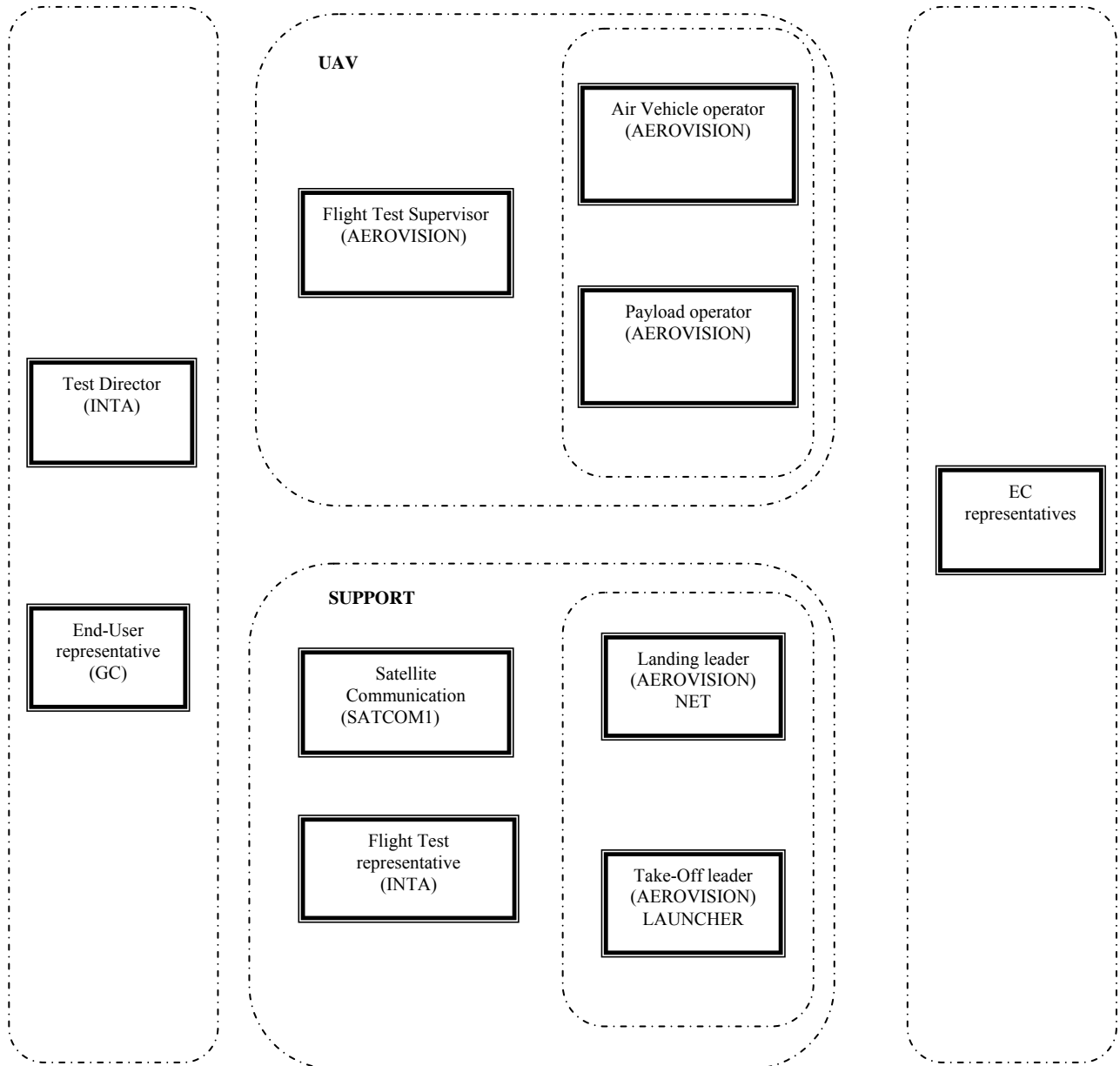

Figure 16 – Overview of the organization during the demonstration.

11.2.1 Guardia Civil

The responsibilities of Guardia Civil in the WiMAAS experiment could include:

1. To help in the coordination and supervision of the overall experiment.
2. To provide logistics support as required, namely:
 - Access to the relevant centres (e.g. SIVE Centre, Control Centre, etc.) and the relevant data;
 - Deployment of assets (e.g. small boats) where and when required

This document is produced under the EC Grant Agreement n° 217931 and NDA n°3281.

3. To help in the analysis of the experiment results and provide inputs.

11.2.2 INTA

The responsibilities of INTA in the WiMAAS experiment could include:

1. To issue authorisation to fly the UAV FULMAR during the experiment.
2. To allow access of the WiMAAS team and guests to their facilities at the El Arenosillo Air Base.
3. To provide logistics support as required, namely:
 - Power supply.
 - Space to install the UAV launch and landing modules.
 - Storage facilities.
 - Other ...
4. The safety management during the trials (Test Director)
5. Link with the ATC
6. To help in the analysis of the experiment results and provide inputs.

11.2.3 AEROVISION

In order to prepare and to proceed to the demonstration AEROVISION is in charge of:

1. Obtaining an experimental license for the UAV
2. The UAV operations:
 - Preparation for flying (repair, refueling, ...)
 - Flight plan, mission preparation,
 - Preparation of the ground equipment (Launcher, landing Net)
 - Performing the flight experiment
 - Recording of flight data

11.2.4 SATCOM1

Satcom1 will deal with all aspects related to the Satellite communications and communications in general, as well as with the interfaces between all systems (e.g. communications of the UAV with the SIVE Station and the NCC, communications with the EC, etc.) and make sure that all communications involved in the experiment work according to the requirements.

11.3 Technical Events

The technical events during the flight test phase, including the data that shall be recorded and monitored, are described in this section.

11.3.1 Weather Conditions Data

Since the UAV flight can only take place under suitable weather conditions the weather conditions must be monitored and recorded before and during the UAV flight, namely the following parameters:

- a.) Wind Speed
- b.) General weather conditions (e.g. Air Temperature, Rain, etc.)

11.3.2 Sea State Data

Since the sea state plays an important role in any marine activities, the sea state must be monitored and recorded, according to the Beaufort Wind Force Scale, namely the following parameters:

- a.) Force (0-12)
- b.) Speed (Knots)
- c.) Wave Height (m)
- d.) Description (Calm to Hurricane)

11.3.3 UAV Data

All data acquired by the UAV must be recorded, including the targets detected, identified and tracked. Aerovision will monitor all UAV related data.

11.3.4 AIS Data

All AIS used in the experiment must be recorded.

11.3.5 GPS Data

The GPS positions of all vessels and other mobile assets involved in the experiment must be continuously recorded during the entire experiment.

11.3.6 Radar SIVE Data

All Radar SIVE data used in the experiment must be recorded.

11.3.7 Communications and Transmitted Data

All data (e.g. videos, images, etc.) transmitted during the UAV flight must be recorded.

12 SAFETY

This section gives the FULMAR system datasheet and the FULMAR system safety features.

12.1 FULMAR System: Datasheet

The main FULMAR characteristics are listed next.

- 3m wingspan, 1.2m length, 0.5m height
- 100km/h cruising speed
- 3400m maximum altitude
- 20kg maximum takeoff weight
- 6kg payload
- 6h endurance
- 600km range of operation
- 50km range Real Time
- Launcher length: 6 m
- Setup time: 1h, 3 person
- Only 2 operators needed
- Fully automatic operation
- 3D flight plan
- Safety modes
- No need for runway: easy deployment
- Standard payload: stabilized, geo-referenced PTZ daylight/IR camera

12.2 *FULMAR System: Safety*

- Failure tolerant AP.
- Redundant Power Supply Unit (Engine + Battery).
- Auto-landing on Communications Failure.
- VHF air-band radio to monitor activity.
- Traffic Collision Avoidance System (TCAS) receiver at Ground Control System (GCS). A traffic collision avoidance system or traffic alert and collision avoidance system (both abbreviated as TCAS) is an aircraft collision avoidance system designed to reduce the incidence of mid-air collisions between aircraft. It monitors the airspace around an aircraft for other aircraft equipped with a corresponding active transponder, independent of air traffic control, and warns pilots of the presence of other transponder-equipped aircraft which may present a threat of mid-air collision (MAC). It is a type of airborne collision avoidance system mandated by the International Civil Aviation Organization to be fitted to all aircraft with a maximum take-off mass (MTOM) of over 5700 kg (12,586 lbs) or authorized to carry more than 19 passengers.
- Back-up Ground Control System (GCS).
- Very small crash area.
- NOTAM granted for experiment. NOTAM or NoTAM is the quasi-acronym for a "Notice To Airmen". NOTAMs are created and transmitted by government agencies and airport operators under guidelines specified by the Aeronautical Information Services of the Convention on International Civil Aviation (CICA). A NOTAM is filed with an aviation authority to alert aircraft pilots of any hazards en route or at a specific location. The authority in turn provides a means of disseminating relevant NOTAMs to pilots.
- AVURNAVE emitted to inform vessels.

12.3 FULMAR Flight Procedure Safety Plan

The original FULMAR flight procedure safety plan is described in Appendix.-I.

Acknowledgements

– The authors would like to express their gratitude to the Spanish Authorities, namely Guardia Civil, INTA and ISDEFE for their cooperation, support and assets deployed, without which this experiment would have not been possible.

REFERENCES

- [1] WiMAAS – ANNEX I – “Description of Work”, Theme 10: Security CP-SEC-2007-3.3.-02, Project Number: 217931, March 10, 2009.
- [2] Álvaro Gascón y Marín, David Ríos, José Antonio Díaz: “Scenario for WIMA2S experiment with FULMAR UAV”, REF: 2875ISSV.v.0.2.doc, 23 Nov. 2010.

ANNEX 521

D5 – Report on Experiment

OF

JRC

(PARTNER NR 07)

With participation of

TSA

SENER

AEROVISION

SATCOM1

SELEX-GALILEO

Non Confidential - RE

Grant Agreement number	217931
Project acronym	WiMAAS
Project title	Wide Maritime Area Airborne Surveillance

Task Number	WP 5
Task title	Preparation of Surveillance Experiment
Activity type	RTD
File name	WIMAAS-D521-REP-JRC-Ed0

Project co-funded by the European Commission within the Seven Framework Programme		
Dissemination Level		
PU	Public	
PP	Restricted to other programme participants (including the Commission services)	
RE	Restricted a group specified by the consortium (including the Commission services)	X
CO	Confidential, only for members of the consortium (including the Commission services)	

Contributing partners

Company	Name
JOINT RESEARCH CENTRE	Victor Silva
THALES SYSTEMES AEROPORTES S.A.	Gilles Jurquet & Gabriel Marchalot
SENER	Maria Teresa
AEROVISIÓN VEHÍCULOS AÉREOS S.L	Juan Sancho & Txema Soroa
SATCOMI	Adam Koubek

Revision table

Version	Date	Modified Pages	Modified Sections	Comments
Draft	15/03/2011			Creation
Ed0				

13 Overview of the updated WiMAAS Experiment

In this chapter, the definition of the WiMAAS experiment and its integration into its environment, the cooperative and non-cooperative systems are introduced.

The experiment missions of the WiMAAS project will be defined in order to maximize the fulfilment of the ISDEFE/Guardia Civil demo requirements described in [2] and reproduced in chapter 2 for convenience.

13.1 Experiment Overview

The different missions of the experiment will follow a broad sequence of events. Figure 1 illustrates the workflow of the WiMAAS maritime UAV experiment. The sequence of events is described next in more detail.

- 1.- Based on different sources of information, such as:
 - f.) AIS data,
 - g.) Near Real Time (NRT) Spaceborne SAR correlation with AIS data
 - h.) Correlation of SIVE data with AIS data
 - i.) Detection of potential non-cooperative targets either by SIVE, AIS, Patrol vessels, Patrol aircraft (UAV or manned), intelligence information, etc.
 - j.) Simulated non-cooperative targets (e.g. Small boats could be deployed by Guardia Civil to simulate drugs trafficking, illegal immigration or other threats).
- 2.- The NCC detects an anomaly.
- 3.- The NCC triggers one or several missions to investigate the anomaly (airborne or surface assets).
- 4.- A UAV flight is tasked to investigate the anomaly.
- 5.- The UAV collects images/data using different sensors and transmits the collected data to the NCC.
- 6.- The UAV data is correlated with data from other sources and intelligence information.
- 7.- Evidence Formatting is performed.
- 8.- the Evidence is transmitted via Satellite communications to the NCC.

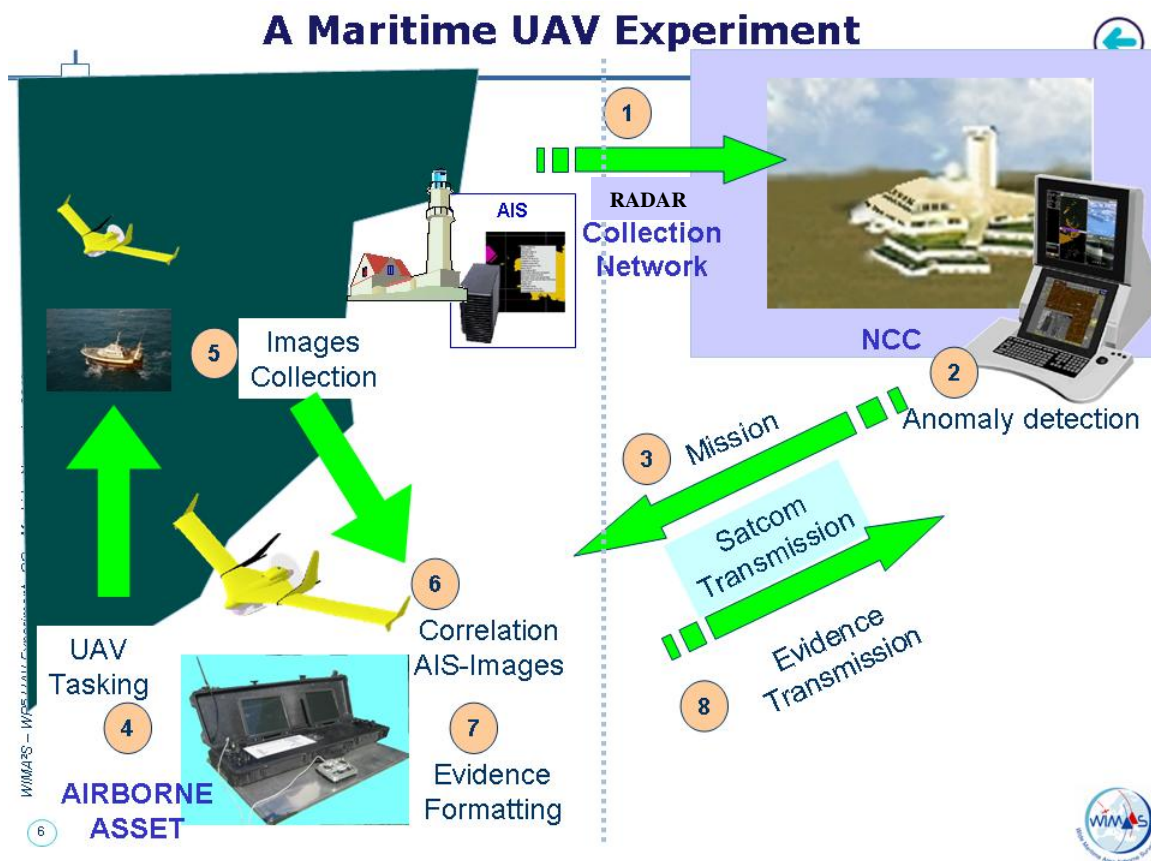

Figure 17 – Workflow of the WiMAAS maritime UAV flight experiment.

13.2 Demonstration Scope

Spain supports an intense migratory pressure, mainly at the maritime borders. Due to this reason, and as a result of the increasing demand for border control and surveillance resources, Spanish Government (through National Police Department and Guardia Civil as parts of the Ministry of Interior) has made a very strong investment in order to perform an appropriate border management and face the growing migration pressure at land and maritime borders.

One of the most successful initiatives is the SIVE program, which performs maritime surveillance all along the coastline in the troublesome areas. As a result of this success, the next step points at extending the surveillance limits beyond the limits of SIVE system. One of the alternatives in recent years which is gaining prominence is the use of new platforms for sensors.

In order to do so, during the past years a special interest has arisen on new surveillance platforms, and mainly on Unmanned Air Vehicles (UAV).

Hence, running an experiment with this sort of platforms is a fundamental step for analyzing the benefits that SIVE can obtain from embodying UAVs in its systems. Also, in the case of Guardia Civil, this represents an opportunity to continue the line of work followed during the last years for the development and integration of innovative surveillance platforms and keep an alignment with ongoing EU initiatives in the field of Integrated Border Surveillance.

From the WIMA2S Project point of view, the interest of the development of the experiment is the system to be validated by an important agent in border control and surveillance, showing how an UAV system is able to increase the coverage provided by a coastal surveillance deployment.

14 UPDATED ORGANISATION GENERAL OVERVIEW

This chapter describes the organization for the WIMAAS Experiment.

14.1 Organisation General Overview

14.1.1 WiMAAS WP5 Partners

The WIMAAS partners directly involved in the WP5 and in the flight trials are:

- EUROPEAN COMMISSION (EC) – JOINT RESEARCH CENTRE (JRC) is the Experiment workpackage leader,
- THALES SYSTEMES AEROPORTES S.A. is the project coordinator, interfacing with the European Commission, contracting authority,
- AEROVISIÓN VEHÍCULOS AÉREOS S.L. is the flight test leader, in charge with the UAV operations and the safety during the demonstration
- SATCOM1 is in charge with the Satellite Communication assets: connection of the test site with Web Services (if necessary) and connection of the UAV Ground Control Station with the Spanish Command & Coordination Center,
- SENER is the interface with the Spanish Authorities: Guardia Civil, ISDEFE and INTA,
- SELEX GALILEO provide the expertise regarding UAV flight trials (lesson learned from FALCO)

14.1.2 Spanish Partners

The Spanish partners involved in the WiMAAS experiment are:

- GUARDIA CIVIL, End-Users for the WIMAAS Experiment, providing access to SIVE and Spanish Coordination Center,
- ISDEFE, is in charge with the definition of requirements for the Experiment in line with Guardia Civil operational objectives,
- INTA is in charge with the flight test facilities in Arenosillo and flight authorization matters.

14.2 Responsibilities During the Demonstration

The different teams involve during the demonstration are:

- Guardia Civil as the Spanish Authority and End-User,

This document is produced under the EC Grant Agreement n° 217931 and NDA n°3281.

It is the property of WIMA²S Parties and shall not be distributed or reproduced without the formal approval of the WIMA²S PCC

- INTA as Flight Testing and flight clearance authority
- Aerovision is the flight test leader and in charge of the UAV operations,
- SATCOM1 is the responsible of Satellite Communication during the experiment
- JRC coordinates and supervises the experiment

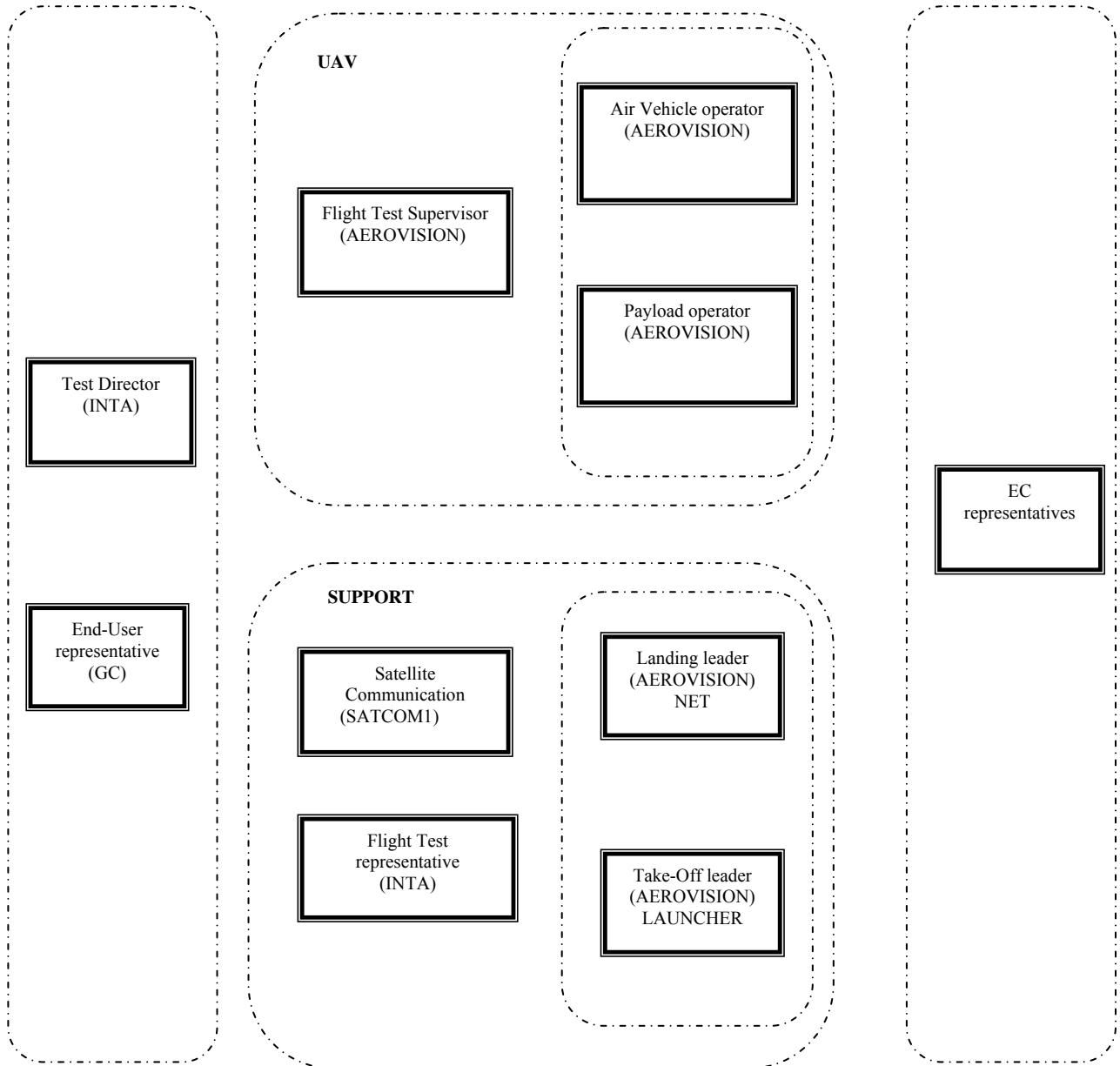

Figure 18 – Overview of the organization during the demonstration.

14.2.1 Guardia Civil

The responsibilities of Guardia Civil in the WiMAAS experiment could include:

4. To help in the coordination and supervision of the overall experiment.
5. To provide logistics support as required, namely:
 - Access to the relevant centres (e.g. SIVE Centre, Control Centre, etc.) and the relevant data;
 - Deployment of assets (e.g. small boats) where and when required.
6. To help in the analysis of the experiment results and provide inputs.

14.2.2 INTA

The responsibilities of INTA in the WiMAAS experiment could include:

7. To issue authorisation to fly the UAV FULMAR during the experiment.
8. To allow access of the WiMAAS team and guests to their facilities at the El Arenosillo Air Base.
9. To provide logistics support as required, namely:
 - Power supply.
 - Space to install the UAV launch and landing modules.
 - Storage facilities.
 - Other ...
10. The safety management during the trials (Test Director)
11. Link with the ATC
12. To help in the analysis of the experiment results and provide inputs.

14.2.3 AEROVISION

In order to prepare and to proceed to the demonstration AEROVISION is in charge of:

3. Obtaining an experimental license for the UAV
4. The UAV operations:
 - Preparation for flying (repair, refueling, ...)
 - Flight plan, mission preparation,
 - Preparation of the ground equipment (Launcher, landing Net)
 - Performing the flight experiment
 - Recording of flight data.

14.2.4 SATCOM1

Satcom1 will deal with all aspects related to the Satellite communications and communications in general, as well as with the interfaces between all systems (e.g. communications of the UAV with the SIVE Station and the NCC, communications with the EC, etc.) and make sure that all communications involved in the experiment work according to the requirements.

14.3 Technical Events

The technical events during the flight test phase, including the data that shall be recorded and monitored, are described in this section.

14.3.1 Weather Conditions Data

Since the UAV flight can only take place under suitable weather conditions the weather conditions must be monitored and recorded before and during the UAV flight, namely the following parameters:

- a.) Wind Speed
- b.) General weather conditions (e.g. Air Temperature, Rain, etc.)

14.3.2 Sea State Data

Since the sea state plays an important role in any marine activities, the sea state must be monitored and recorded, according to the Beaufort Wind Force Scale, namely the following parameters:

- a.) Force (0-12)
- b.) Speed (Knots)
- c.) Wave Height (m)
- d.) Description (Calm to Hurricane)

14.3.3 UAV Data

All data acquired by the UAV must be recorded, including the targets detected, identified and tracked. Aerovision will monitor all UAV related data.

14.3.4 AIS Data

All AIS used in the experiment must be recorded.

14.3.5 GPS Data

The GPS positions of all vessels and other mobile assets involved in the experiment must be continuously recorded during the entire experiment.

14.3.6 Radar SIVE Data

All Radar SIVE data used in the experiment must be recorded.

14.3.7 Communications and Transmitted Data

All data (e.g. videos, images, etc.) transmitted during the UAV flight must be recorded.

15 MILESTONES OF THE EXPERIMENT PREPARATION

The present chapter describes the milestones of the WiMAAS Experiment preparation. According to the surveillance experiment script of task 5.1.2 the experiment was planned in detail on an operational level together with Guardia Civil, ISDEFE and INTA. Pre-tested sensor packages were integrated on surveillance platforms. Communication links to the maritime surveillance command and control centre were set up. The experiment was executed from 4 to 7 July 2011 at El Arenosillo airbase in Huelva-Spain.

The preparation of the WIMA²S maritime surveillance experiment involved a strong commitment from all partners involved (WIMA²S consortium, Guardia Civil, ISDEFE and INTA). A detailed description can be found in Annex D521. The main steps are summarised next.

15.1 Discussion of the steps required among the partners

After a careful analysis of the different options, the WP5 partners decided to carry out the WIMA²S experiment in Spain. Some of the main reasons that led to this decision were the following:

- a.) Spanish authorities face several unlawful maritime activities in the South of Spain, such as illegal immigration, drugs trafficking, smuggling, etc. These are some of the maritime surveillance scenarios identified in WIMA²S WP2.2.
- b.) The End-users requirements/needs comprise technologies and maritime surveillance solutions to mitigate the above mentioned unlawful maritime activities.

15.2 Meeting With Guardia Civil and ISDEFE

Once the decision to carry out the experiment in Spain was made, the next step was to contact the relevant Spanish authorities and organise a meeting to discuss the feasibility of performing the WIMA²S experiment in Spain. To that end, the WIMA²S partners contacted the Guardia Civil and organised a meeting. The objectives of the meeting were twofold: 1.) to invite the Spanish authorities to participate in the experiment, namely Guardia Civil and 2.) to present and discuss the UAS flight experiment. The meeting took place on 16 November 2010 at Guardia Civil headquarters in Madrid-Spain. The participants were the WIMA²S partners, Guardia Civil and ISDEFE. Guardia Civil and ISDEFE found the WIMA²S project interesting and agreed to participate in the experiment.

A couple of weeks after the meeting, Guardia Civil and ISDEFE supplied a document describing their main areas of interest with suggestions for the scenarios, as well as the best location for the experiment. Guardia Civil and ISDEFE suggested Huelva and Murcia as the most suitable areas for the experiment. They also agreed to help the WIMA²S partners with the authorisation procedure required to fly a UAS in Spain.

The WIMA²S consortium contacted INTA and invited them to take part in the experiment and give permission to perform the experiment at INTA airbase (El Arenosillo) in Huelva-Spain. INTA authorised. A visit to El Arenosillo to discuss the WIMA²S experiment with INTA was arranged.

15.3 Visit to INTA Base – El Arenosillo

The main objective of this visit was to participate in a WIMA²S meeting held at INTA's base (El Arenosillo) in Huelva, Spain with the Spanish authorities, namely Guardia Civil, ISDEFE and INTA aimed at discussing the WIMA²S experiment planned to take place in July 2011 at El Arenosillo.

Main results of the mission:

- ✚ Acquaintance with the systems available at El Arenosillo.
- ✚ Visit to El Arenosillo facilities in Huelva-Spain.
- ✚ Discussion of the UAV flight profiles and the launch and landing areas.
- ✚ Decision about the likely dates of the WIMA²S experiment (first week of July 2011).
- ✚ Guardia Civil will deploy two assets, namely a patrol boat and a small boat.
- ✚ The experiment will take place between 10 and 15 nautical miles from the coast.
- ✚ The final UAV integration tests will take place in San Sebastian and will involve Aerovision and Satcom1.

During this mission two meetings were held, one on 11 April among the WIMA²S partners involved in WP5 and a second one with the Spanish authorities (Guardia Civil, INTA and ISDEFE) on 12 April 2011. The first meeting was aimed at discussing the different topics to be addressed with the Spanish authorities and review the presentations to be given during the meeting at INTA. It was decided to give two presentations, one introducing the WIMA²S experiment and another one specifically about the UAV FULMAR. The second meeting held at El Arenosillo with the Spanish authorities was aimed at discussing the details of the WIMA²S experiment and to get acquainted with the facilities and systems available at El Arenosillo.

The meeting held at El Arenosillo started with a presentation about INTA history, facilities and systems available at El Arenosillo given by INTA's Deputy Director. This was followed by a short welcome address by INTA's Director. After a coffee break, the WIMA²S consortium gave two presentations, one introducing the WIMA²S experiment and the second one about the UAV FULMAR. The presentations were followed by a discussion about the systems available at El Arenosillo and the analysis of a checklist of the experiment requirements.

After the meeting, the group visited El Arenosillo facilities and was acquainted with the systems available. The main objective of the visit was to find out the most suitable places at the base to deploy the UAV command and control station and the Satellite station, as well as to study the best UAV flight profile during launch and landing. Other aspects addressed during the visit were the safety issues, possible electromagnetic incompatibilities and communications interference. The visit was followed by a final discussion and balance of the meeting as well as the definition of the next steps.

15.4 UAV/Communications Integration Tests

The goal of the test session in San Sebastian was to test interoperability of the UAV Ground Control Station and the acquisition PC. It was considered crucial to identify possible issues and avoid them during the demonstration session at INTA.

The UAV Ground Station provides video stream from the UAV camera and regularly GPS information related to UAV position and trajectory. The video is analog composite video signal. The GPS is provided in a standard format called "NMEA sentence" via serial port. In order to share the images and video via the Web Site, the video signal had to be digitalized and optimized so the image could be transmitted over satellite link (Inmarsat). A computer for data acquisition was completed and set up at Satcom1 facility at Le Bourget, France prior the tests session in San Sebastian. The computer used an A/D video card to convert analog video signal into H264 codec. The computer collected as well the GPS sentences.

At Aerovision facility in Irun near San Sebastian was setup an environment similar to the one expected at INTA, except for the satellite link. The UAV Fulmar was put on a static support and powered up, its camera switched on and controlled from Ground Control Station. The acquisition PC was connected to the Ground Station and several sequences of video were recorded while checking the obtained quality. Both static and fast moving sequences were tested.

Due to the fact that the UAV was not flying the conditions were not ideal, objects moving between the UAV and the Ground Station, especially walking people created interferences and degraded video signal. This however helped to tune the parameters of the A/D video card. During the flight we expected better conditions due to the fact that there would be nothing between the flying UAV and its Ground Station antenna.

The GPS acquisition from Ground Station was tested, both a recorded sequence and a real time sequence, all worked fine as expected.

The website designed for the experiment was supposed to display the position of the UAV, SIVE, and the Target. The position was showed on a map, based on GPS sentences from the UAV Ground Control Station. The camera output was supposed to be visualized on the web site as well. Due to the cost of the satellite data link the acquired video could be displayed in two forms: as sequence of images or thumbnails, less demanding on bandwidth and thus less expensive or as continuous video and thus more exigent in bandwidth and thus more expensive.

The data link used for the experiment was service from company Inmarsat called BGAN. BGAN is a service for terrestrial terminals, opposite to maritime and aeronautical terminals which needs an antenna which takes in account the fact that the terminal moves. The maritime and aeronautical services are called respectively FleetBroadband and SwiftBroadBand.

Inmarsat BGAN service provides two basic services: Shared bandwidth called Background IP and dedicated bandwidth called Streaming. The Shared bandwidth is a service which in a given region called also narrow beam, provides bandwidth of approximately 450Kb/s, the bandwidth is shared among all terminals in the given narrow beam, thus the bandwidth is not guaranteed. On the other hand the Streaming provides guaranteed bandwidth for a given terminal. For the experiment the information from GPS sentences and images were transmitted over Shared bandwidth link and video streaming over Streaming data link. The router interconnecting acquisition PC and the two BGAN terminals automatically detected the video streaming request and opened a dedicated channel.

After securing the data acquisition, the satellite data link test were tested at Satcom1, Le Bourget facility.

15.5 Test Phase of the Experiment - INTA Base

The first two days of the mission (4th and 5th of July 2011) were devoted to double-check all systems (e.g., interface Sistema Integrado de Vigilancia Exterior (SIVE) Coastal Radar/ WIMA²S Website, SIVE cameras, Satellite Communications Stations, UAV Control System, UAV launch and landing systems, INTA tracking radars, etc.) and to the UAV flight test. Maria Teresa (SENER), Gabriel (THALES) and Adam (Satcom1) visited the SIVE station in Huelva, which is part of the SIVE network, to double-check all systems involved in the experiment. Victor (JRC), Gilles (THALES) and the Aerovision team led by Txema visited the INTA airbase, where a meeting with INTA Deputy Director and his team was held and all the systems involved in the experiment were double-checked. On 5 July the Aerovision team set up the UAV launch and the landing systems and the UAV flight test was successfully carried out. The Satellite Communications, the INTA tracking systems and the Guardia Civil Coastal Radar and Cameras were also double-checked during the UAV flight test.

During the test phase of the experiment at INTA the satellite terminals were deployed and pointed toward the EMEA satellite. The visibility was excellent since the site was situated on the sea shore open toward south. The terminals position and antennas angle were marked so the next day the antenna pointing would be straightforward. The acquisition PC was connected to the UAV Ground Control Station so it could receive the GPS sentences and video signal. The router was deployed and when UAV was ready, the first data transmission of images was made. Both video and image transmission was tested. On the site no terrestrial Internet connection was available, so the reception of images was tested by Satcom1 staff at Le Bourget, France.

15.6 Test Phase of the Experiment – SIVE Station

A visit of SIVE station was done before flight demo with Sener, Satcom1 and TSA participation.



First of all, MMI of WIMAAS was demonstrated to SIVE crew. A Personal Computer with WIMAAS MMI and web site access was installed in SIVE station by SATCOM1.

According to flight demo scenario, Fulmar UAV mission has to be oriented by an alert issued from SIVE and so, MMI mechanisms have to be shown to SIVE operator.

A small test was run and a problem of data alignment between SATCOM 1. The coordinates provided by SIVE showed the target at completely different position than expected, due to the fact that SIVE uses Universal Transverse Mercator coordinate system (UTM). The transition from UTM to GPS like system is not straightforward. UTM is application of a 2-dimensional Cartesian coordinate system and not a single map projection, it is a series of sixty zones. The SIVE agreed to provide during the experiment the data in GPS system.

15.7 Organisation of the Experiment – Responsibilities During the Demonstration

10.) – **Organisation of the Experiment – Responsibilities During the Demonstration:**

-  The WIMA²S partners directly involved in the WP5 and in the flight trials are:
 - EUROPEAN COMMISSION (EC) – JOINT RESEARCH CENTRE (JRC) is the Experiment workpackage leader,
 - THALES SYSTEMES AEROPORTES S.A. is the project coordinator, interfacing with the European Commission, contracting authority,
 - AEROVISIÓN VEHÍCULOS AÉREOS S.L. is the flight test leader, in charge with the UAV operations and the safety during the demonstration
 - SATCOM1 is in charge with the Satellite Communication assets: connection of the test site with Web Services (if necessary) and connection of the UAV Ground Control Station with the Spanish Command & Coordination Center,
 - SENER is the interface with the Spanish Authorities: Guardia Civil, ISDEFE and INTA,
 - SELEX GALILEO provide the expertise regarding UAV flight trials (lesson learned from FALCO)
-  The Spanish partners involved in the WIMA²S experiment are:
 - GUARDIA CIVIL, End-Users for the WIMA²S Experiment, providing access to SIVE and Spanish Coordination Center,
 - ISDEFE, is in charge with the definition of requirements for the Experiment in line with Guardia Civil operational objectives,

- INTA is in charge with the flight test facilities in Arenosillo and flight authorization matters.
- ✚ The different teams involve during the demonstration were:
 - Guardia Civil was the Spanish Authority and End-User,
 - INTA was the Flight Testing and flight clearance authority,
 - Aerovision was the flight test leader and was in charge of the UAV operations,
 - SATCOM1 was the responsible for Satellite Communications during the experiment,
 - JRC was the coordinator and supervisor of the experiment.

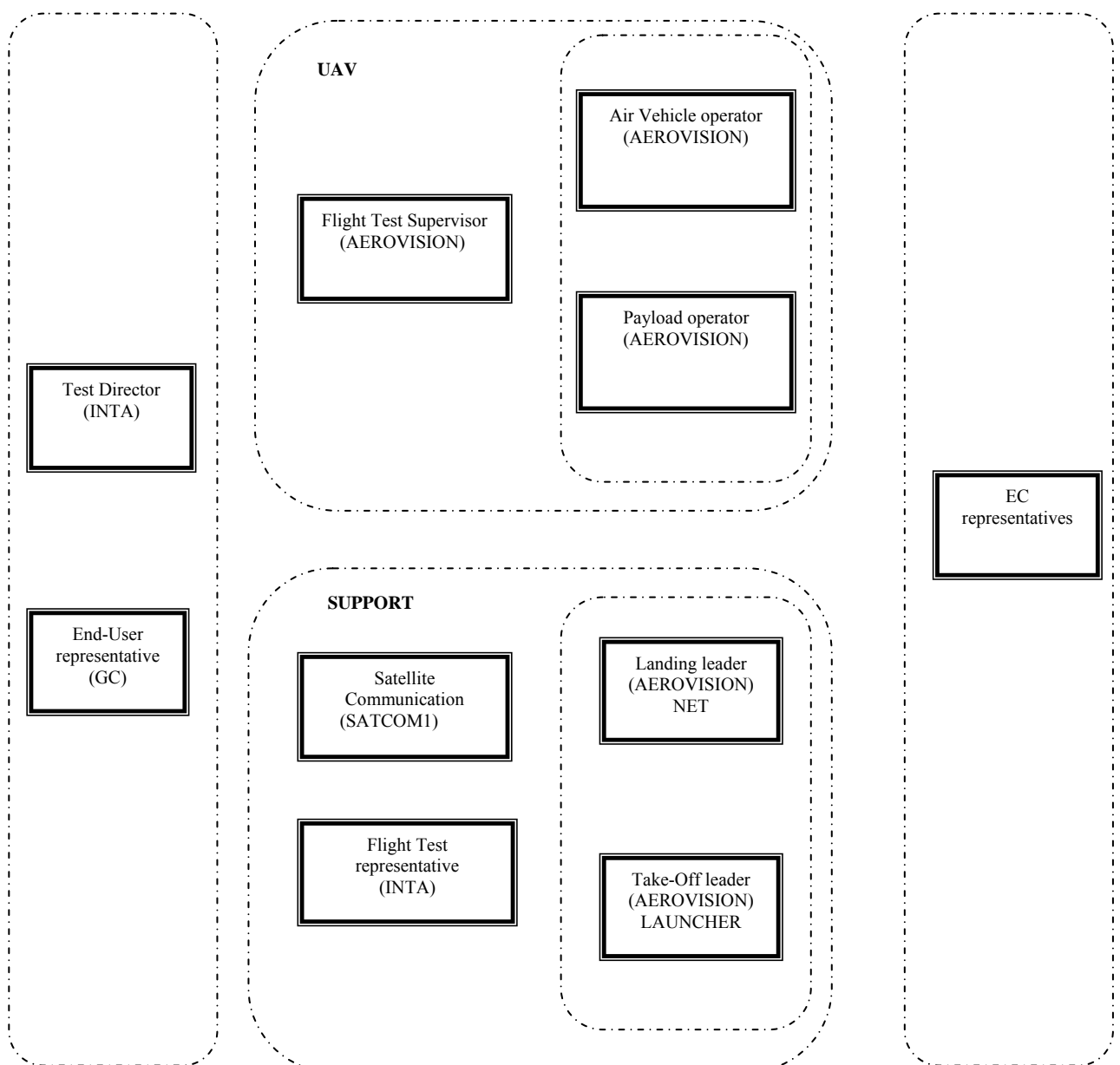

Figure 19 – Overview of the organization during the demonstration.

11.) – **Definition of the Technical Events During the Experiment:**

The technical events during the experiment, including the data that should be recorded and monitored, are summarised this section.

 **Weather Conditions Data**

Since the UAV flight could only take place under suitable weather conditions the weather conditions were monitored and recorded before and during the UAV flight, namely the following parameters:

- a.) Wind Speed
- b.) General weather conditions (e.g. Air Temperature, Rain, etc.)

 **Sea State Data**

Since the sea state plays an important role in any marine activities, the sea state was monitored and recorded, according to the Beaufort Wind Force Scale, namely the following parameters:

- a.) Force (0-12)
- b.) Speed (Knots)
- c.) Wave Height (m)
- d.) Description (Calm to Hurricane)

 **UAV Data**

All data acquired by the UAV were recorded, including the targets detected, identified and tracked. Aerovision monitored all UAV related data.

 **AIS Data**

All AIS used in the experiment were recorded.

 **GPS Data**

The GPS positions of all vessels and other mobile assets involved in the experiment were continuously recorded during the entire experiment.

 **Radar SIVE Data**

All Radar SIVE data used in the experiment were recorded.

 **Communications and Transmitted Data**

All data (e.g. videos, images, etc.) transmitted during the UAV flight were recorded.

16 UAS FLIGHT EXPERIMENT

The WIMA²S UAS flight experiment involved the UAS FULMAR systems, some systems available at INTA airbase (e.g. INTA Trackers and radars) and the systems available at the SIVE station, namely the coastal radar and the surveillance camera. The different systems are briefly described in the next sections.

16.1 Set Up of the UAS FULMAR System

This section gives a summary of the UAV main characteristics and describes the different systems of the FULMAR. The FULMAR system comprises several systems, namely:

- The UAV Launch System, which consists of a 6-meter long Launch Pad,
- The UAV Landing System, which consists of a net supported by two inflatable pillars.
- The Ground Control System and Antenna illustrated in figures 10 to 12.

16.1.1 UAV Launch System

Figures 20 to 21 illustrate the UAV Launch Pad at El Arenosillo INTA airbase just before the launch of the UAV. The UAV Launch Pad is 6-meter long. It is easy to deploy and transport. It can be used virtually anywhere. The UAV does not require an airfield to be launched.



Figure 20 – UAV on launch pad ready for launch.



Figure 21 – Profile view of the UAV Launch Pad with the UAV ready for launch.



Figure 22 – UAV Launch Pad from a different perspective. On the top left and right hand sides of the picture two target trackers can be seen. These trackers were used to track the UAV and the small boat deployed during the experiment.



Figure 23 – UAV FULMAR Launch Pad system with the UAV ready for launch.



Figure 24 – UAV immediately after launch.

16.1.2 UAV Landing System

The UAV Landing System consists of a net kept vertical by two inflatable pillars as illustrated in figures 25 and 26. The operation of the UAV is fully automatic and follows a previously design flight path. The UAV operator carefully monitors the UAV until the UAV crashes against the net. If by any reason the UAV does not follow the original flight plan, the operator can control it manually. The aim is to make the UAV land in the middle of the net. Figure 9 shows the UAV just before landing. Figure 10 shows the UAV after landing, suspended on the net.

The UAV flight path before landing had a number of constraints due to the trees, the antennae and the highway. The UAV flight path had to avoid the trees, the antennae and could not overfly the highway. With the collaboration of INTA staff, Aerovision staff managed to design a flight plan that worked perfectly and met all safety and security requirements imposed by INTA.



Figure 25 – UAV Landing System. The Landing System consists of a net kept vertical by two lateral inflatable pillars. In this picture the UAV is just about to land on the net.



Figure 26 – UAV after landing. After crashing against the net the UAV remains suspended until the operations team collects the UAV.

16.1.3 UAV Ground Control System

The Ground Control System comprises a control unit with two displays where information about the UAV and flight parameters is given and a joystick to manually control de flight. It also comprises an antenna to transmit and receive data to and from the UAV. The control unit with 2 displays and 1 joystick are illustrated in figures 27 and 28.



Figure 27 – UAV Control unit with 2 displays and 1 joystick.



Figure 28 - UAV Control unit with 2 displays and 1 joystick.

Figure 29 illustrates the antenna use to transmit/receive data to/from the UAV.



Figure 29 – Ground Control System Antenna.

16.2 Satcom Systems Deployed by Satcom1

Satcom1 deployed two Satellite communication Terminals, illustrated in figures 30 and 31, with the following characteristics:

- SW based on open source technologies
- Gentoo and Debian OS
- VLC, ffmpeg – for video and image treatment
- PHP, Perl, Javascript (Google Maps API) – for web GUI
- AvioIP package – for routing part

- Commercial off-the-shelf HW
- PC based platforms (fitPC)
- Satellite terminal Thrane & Thrane e700 + e500
- A/D videocard Bt878

The two Satellite Terminals were deployed as follows:

- 2 satellite terminals
 - for cost effectiveness
 - Thrane & Thrane
 - E700
 - E500
 - 1st connected in Background IP mode
 - Transmission of GPS position
 - Thumbnails and images
 - 2nd connected in Streaming mode
 - on demand
 - automatic detection of video stream



Figure 30 - • Thrane & Thrane Explorer E500.



Figure 31 - Thrane & Thrane Explorer E700.

Figures 32 and 33 illustrate the deployment of the Satcom terminals at El Arenosillo airbase.



Figure 32 – Satellite Communications Terminal Thrane & Thrane Explorer E500 being deployed.



Figure 33 – Satellite Communications Terminal Thrane & Thrane Explorer E700 being deployed.

16.3 Systems Available at INTA Airbase

INTA made available a number of systems, including:

- Target Tracking Radars,
- Coastal and aerial radars,
- Mission Control Room

These systems are illustrated in the next pictures.

16.3.1 Target Tracking Stations MPS2000

Two mobile Target Tracking Optronic autonomous Stations, MSP2000, were made available by INTA to track the UAV and the boat during the experiment. These target trackers are usually used to track fast flying targets, such as missiles, aircraft and helicopters. Hence, they are able to track UAVs. The MSP2000 Stations comprise:

- 1.- Infra Red (IR) sensors;
- 2.- TV;
- 3.- Radar (3D, high precision with telemetric capability)



Figure 34 – On the top left and right, two INTA Target Tracking Radars near the Ground Control System.

Figure 35 shows a zoom-in of one of the Target Tracking Radars. It is the leftmost Target Tracking Radar in figure 35.



Figure 35 - Zoom-in of the first Target Tracking Radar. This Target Tracking Radar is the one on the left in figure 34.



Figure 36 – Zoom-in of the second Target Tracking Radar. This is the one on the right in figure 34.

16.3.2 Radar Systems

Figures 37 and 38 illustrate two radars used in the WIMA²S experiment.



Figure 37 – Two radar systems at INTA airbase.



Figure 38 – Zoom-in of the two radars of the previous figure.

16.4 Systems Available at SIVE Station

The main systems available at the SIVE Station used during the WIMA²S experiment comprise:

- SIVE Coastal Radar;
- SIVE Camera;
- Work Station;
- PC Website Video Chat.

Figures 39 and 40 illustrate the work environment at the SIVE Station in Huelva-Spain.



Figure 39 – Guardia Civil SIVE Station in Huelva-Spain.



Figure 40 – Guardia Civil SIVE Station in Huelva-Spain. Control of the radar, AIS and SIVE cameras data.

The coordinate system used at the SIVE Station was Universal Transverse Mercator, which is a Cartesian coordinate system. The coordinates used in the experiment were geographical coordinates with WGS84 as Datum. Some work was needed to overcome the conversion of coordinates between the two different coordinate systems.



Figure 41 – SIVE station at El Arenosillo in Huelva-Spain.

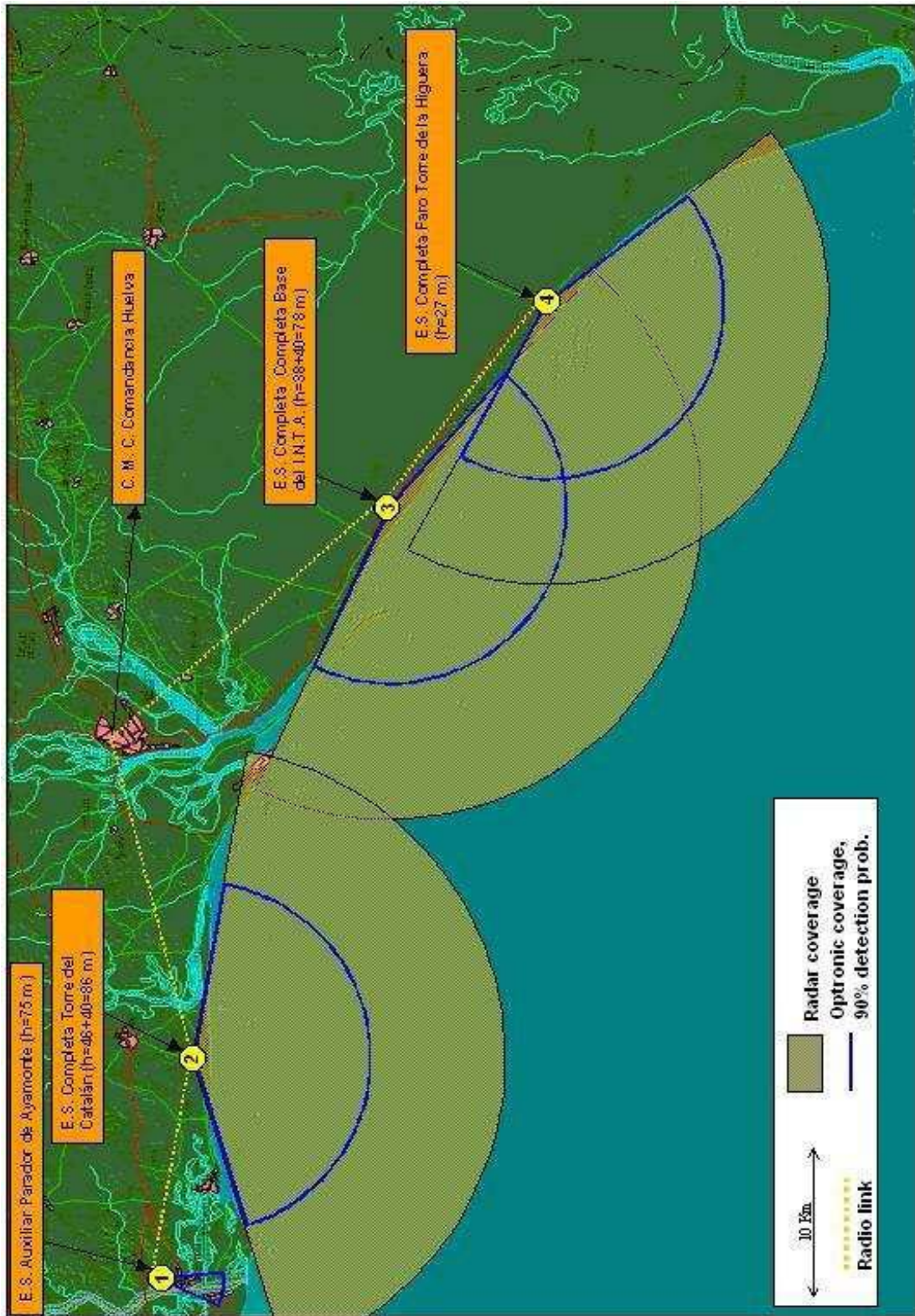

Figure 42 – SIVE range of detection in Huelva.

16.5 INTA Mission Control Room

This section describes the mission control room at INTA, including the systems involved and the data/information made available.

16.5.1 Systems Involved

The following data/information was available at the INTA mission control room:

- Display of the WIMA2S website (information about the coordinates of the UAV location during the entire mission, UAV video transmitted by Satcom);
- Display of the UAV video from the ground control system;
- Display of the SIVE Surveillance Camera;
- Display of the INTA UAV Tracking Radar.



Figure 43 – On the left hand side, the display of the UAV position and the UAV video transmitted via Satcom. On the right hand side, the UAV video from the ground control system.



Figure 44 – On the left hand side, the display of AIS information. On the right hand side the real time video from the SIVE camera.

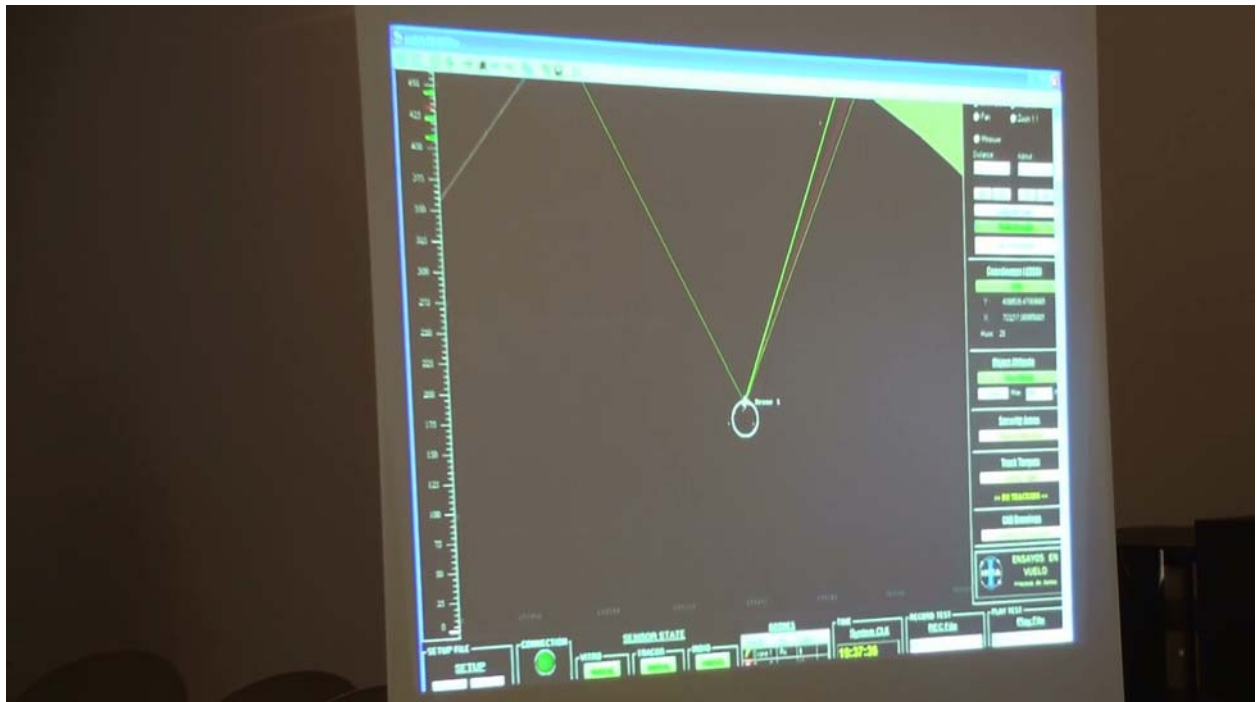

Figure 45 – Display of the INTA UAV tracking system.

Architecture of the Experiment

Figure 46 illustrates the final architecture of the WIMA²S experiment.

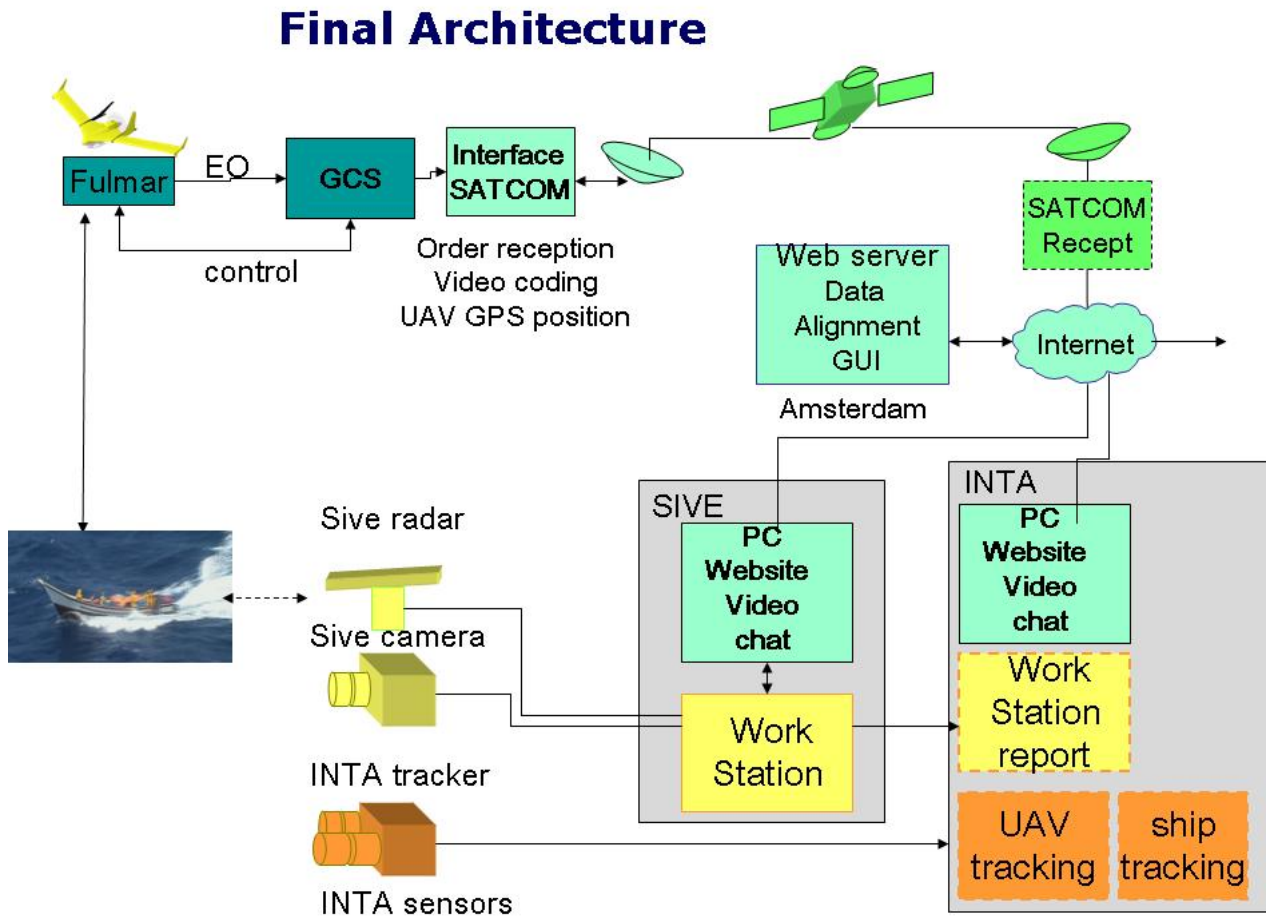

Figure 46 – Final Architecture of the WIMA²S experiment.

16.6 WIMA2S Experiment - Sequence of Events

The sequence of events of the WIMA2S experiment is illustrated in figure 31. The sequence of events of the WIMA²S experiment was as follows:

- 1.- An unknown target is detected through Radar detection / AIS.
- 2.- The Control Centre analyses the data, makes an assessment and Anomaly Detection.
- 3.- The Control Centre issues a mission order to task a UAV flight to investigate the anomaly.
- 4.- The UAV takes-off to investigate the anomaly and try to identify the detected target.
- 5.- The UAV detects the target and transmits the images of the target to the Ground Control System.
- 6.- The Ground Control System transmits the UAV images through Satellite Communications to the Control Centre.
- 7.- The Control Centre receives the UAV images transmitted by Satcom.
- 8.- The Control Centre performs an analysis of the UAV images.
- 9.- Based on the analysis of the UAV images the Control Centre takes action.

Figure 47 illustrates the sequence of events of the WIMA²S experiment. The experiment followed the planned sequence of events.

Experiment - Sequence of Events

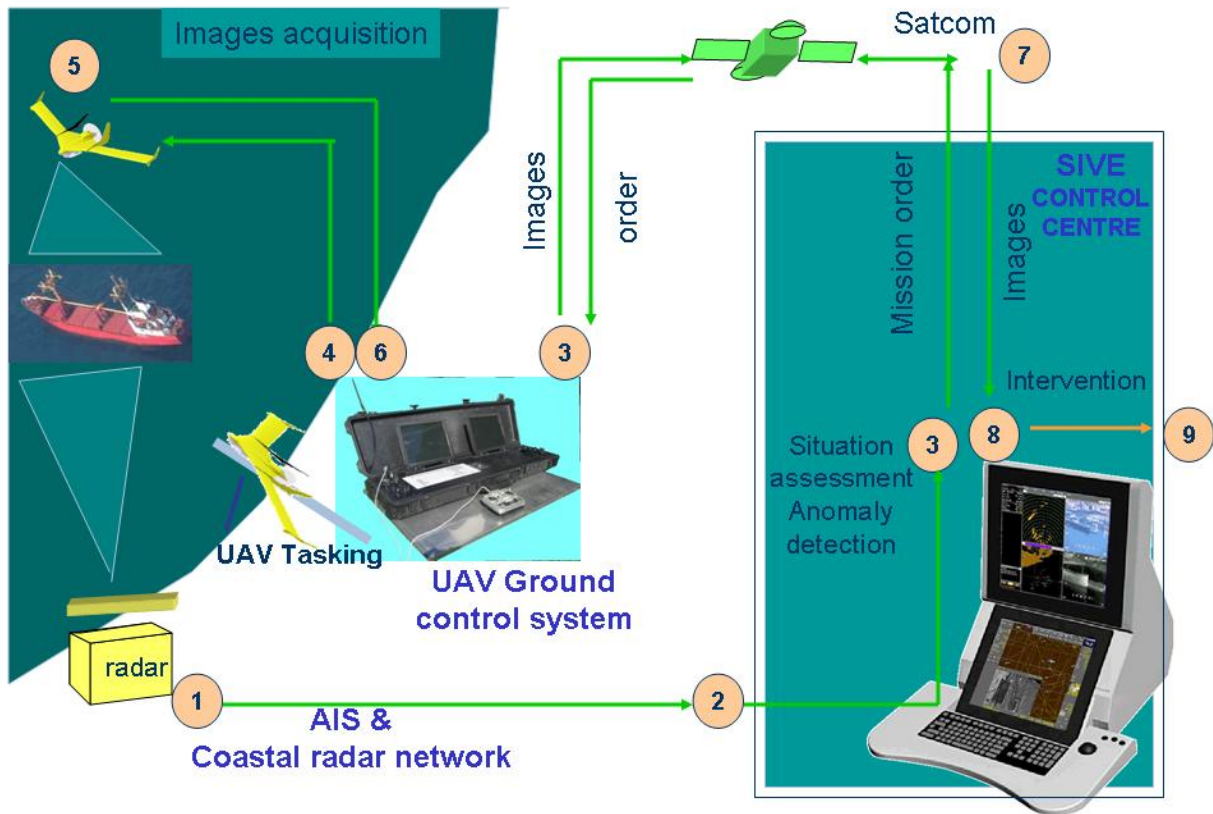

Figure 47 – WIMA2S experiment – sequence of events.

16.7 Main Results of the Experiment

This section summarises the main results of the WIMA²S experiment.

1.- Demonstration of Remote Control of Mission System – The flight experiment illustrated the remote control of a maritime surveillance mission system in the framework of a scenario derived from one of those defined in WP2.2.

Based on the conceptual work in WIMA²S and the first analysis of surveillance concepts by simulations in WP4, Surveillance experiments were performed to go a step further to real life surveillance missions. Within the experiments the overall surveillance architecture as well as dedicated surveillance technologies were evaluated and validated.

A complete information flow from planning a surveillance mission/task to execution of multi-platform/multi-sensor missions was shown.

2.- Illustrated the Potential of UAS for Maritime Surveillance (detection, classification and identification) – The WIMA²S experiment was set up and executed in close cooperation with the Spanish Authorities, namely Guardia Civil, ISDEFE and INTA. Guardia Civil is one of the end-users of the WIMA²S project. The scenario and experiment definition met the end users requirements and were very realistic. The experiment has shown how UAVs can be used to fill in a gap in maritime surveillance by complementing the already existing means, such as coastal radars, cameras, conventional aircraft and satellites.

3.- Near Real Time Transmission of UAS video to Command & Control Station via Satcom – One of the important factors in maritime surveillance is to have a complete maritime picture at any given point in time. That requires prompt access to the data/information to be able to assess the data/information and give a prompt reply to any possible threat. To that end, it is critical to transmit the data/information collected by the UAV in near real time to the Command & Control Centre. The WIMA²S experiment proved that the UAV data can be transmitted in near real time from the UAV to the ground control system and by Satcom to the Command & Control centre.

4.- Cooperative use of broad area detection Systems (e.g. Coastal Radar) with an identification and tracking System (e.g. UAV) – Another important result of the WIMA²S experiment is the cooperative use of broad area detection Systems (e.g. Coastal Radar) with an identification and tracking System (e.g. UAV). This synergistic approach has a significant potential for maritime surveillance applications.

5.-Broadcast of Experiment through the Internet with possibility of interaction – The WIMA²S experiment was broadcasted in near real time through a website specifically made for that purpose. This allowed people to follow the experiment in near real time from anywhere in the World, provided that they had access to the internet. The website had a display of the position of the UAV and allowed requests of images or videos. This was an innovation.

Acknowledgements

– The WIMA²S consortium would like to express their gratitude to the Spanish authorities, namely Guardia Civil, INTA and ISDEFE for their collaboration and support in the WIMA²S project. They also would like to acknowledge the European Commission support and funding.

REFERENCES

- [1] WiMAAS – ANNEX I – “Description of Work”, Theme 10: Security CP-SEC-2007-3.3.-02, Project Number: 217931, March 10, 2009.
- [2] Álvaro Gascón y Marín, David Ríos, José Antonio Díaz: “Scenario for WIMA2S experiment with FULMAR UAV”, REF: 2875ISSV.v.0.2.doc, 23 Nov. 2010.

ANNEX 522

D5 – Report on Experiment

OF

JRC

(PARTNER NR 07)

With participation of

TSA

SENER

AEROVISION

SATCOM1

SELEX-GALILEO

Non Confidential - RE

Grant Agreement number	217931
Project acronym	WiMAAS
Project title	Wide Maritime Area Airborne Surveillance

Task Number	WP 5
Task title	Surveillance Experiment Evaluation
Activity type	RTD
File name	WiMAAS-D522-REP-JRC-Ed0

Project co-funded by the European Commission within the Seven Framework Programme		
Dissemination Level		
PU	Public	
PP	Restricted to other programme participants (including the Commission services)	
RE	Restricted a group specified by the consortium (including the Commission services)	X
CO	Confidential, only for members of the consortium (including the Commission services)	

Contributing partners

Company	Name
JOINT RESEARCH CENTRE	Victor Silva
THALES SYSTEMES AEROPORTES S.A.	Gilles Jurguget & Gabriel Marchalot
SENER	Maria Teresa
AEROVISIÓN VEHÍCULOS AÉREOS S.L	Juan Sancho & Txema Soroa
SATCOMI	Adam Koubek

Revision table

Version	Date	Modified Pages	Modified Sections	Comments
Draft	15/03/2011			Creation
Ed0				

Executive Summary

This Annex D522 is part of the final report of the WIMA²S Work Package 5 (WP5). It addresses the evaluation of the WIMA²S UAS flight experiment, taking into account the performance criteria defined in task 5.1.2 and the positive and less positive aspects of the organisation and planning, selection of the UAS launch and landing sites, the command and control, the communications and the main limitations and problems encountered. It also gives an account of the lessons learned and possible improvements for similar UAS experiments, as well as the conclusions and suggestions for future work.

The WIMA²S UAS flight experiment was very successful and achieved all proposed objectives. The evaluation outcome is very positive.

17 INTRODUCTION

This chapter describes the structure of Annex D522, the relationship with other tasks and the reference documents.

17.1 Structure of the document

This report describes the activities carried out in WP-5 (Experiment) of the WIMA²S project, as well as the main results achieved. The WIMA²S experiment consisted of a UAS flight experiment conducted from 5 to 7 July 2011 at INTA (Instituto Nacional de Técnica Aeroespacial) airbase (El Arenosillo) in Huelva-Spain. The experiment involved the WIMA²S partners and the collaboration of Guardia Civil, INTA and ISDEFE (Ingeniería de Sistemas para la Defensa de España). The present report comprises a summary document and three Annexes:

- ✚ WIMAAS-D500-D5-RE-JRC-Ed0.doc
 - WIMAAS-D510-REP-JRC-Ed0.doc – Specification of the Surveillance Experiment
 - WIMAAS-D521-REP-JRC-Ed0.doc – Preparation of the Surveillance Experiment
 - WIMAAS-D522-REP-JRC-Ed0.doc – Surveillance Experiment Evaluation

The Work Package 5 was originally structured into two Tasks and four Sub-tasks as follows:

- ✚ Task 5.1 – Experiment Definition
 - Sub-task 5.1.1 – Specification of surveillance experiment perimeter
 - Sub-task 5.1.2 – Definition of surveillance experiment scenario
- ✚ Task 5.2 – Experiment Flight
 - Sub-task 5.2.1 – Preparation of surveillance experiment
 - Sub-task 5.2.2 – Performance analysis.

The original structure of the deliverables comprised a summary report and four Annexes:

- ✚ D5 – A summary of the overall UAS flight experiment
 - D5.1.1 Specification of surveillance experiments
 - D5.1.2- Surveillance scenario definition
 - D5.2.1-Surveillance experiment preparation
 - D5.2.2-Surveillance experiment evaluation.

Due to affinities between tasks 5.1.1 and 5.1.2 the structure of the deliverables has been improved by the WP5 partners in order to better reflect the work done. The final structure comprises a summary document and three Annexes, as follows:

- ✚ D5 – A summary of the overall experiment
 - D510-Specification of the surveillance experiment
 - D521-Surveillance experiment preparation
 - D522-Surveillance experiment evaluation

The different deliverables are self-explanatory. Deliverable D5 gives an overview of WP5 including a summary of the specification, preparation and evaluation. D510 describes the specification and definition of the experiment. D521 details all the steps involved in the preparation of the experiment. Finally, D522 gives an account on the evaluation of the UAS flight experiment.

17.2 Relationship with other tasks

Figure 48 illustrates the Work Package (WP) structure of the WIMA²S project. The present Annex is part of Task 5.2 under Work Package 5.

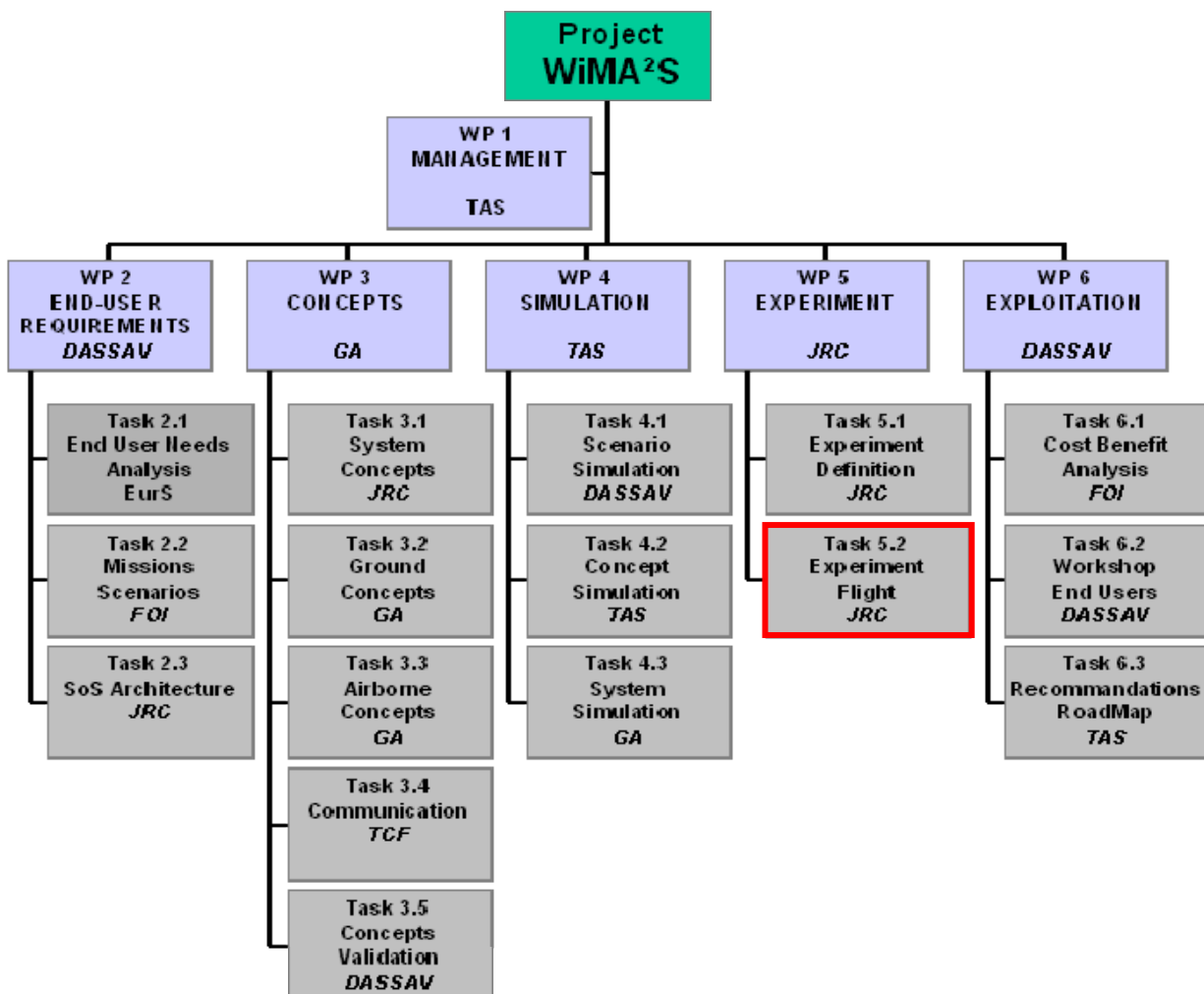

Figure 48 – Work Package structure of the WIMA²S project.

17.3 Reference Documents

The WP5 reference documents are the documents mentioned in Table 1, under the list of applicable documents, reproduced below for convenience of the reader.

Table 6 – Reference documents.

Ref.	Document Name	Lead	Contents
AD0	WIMAAS ANNEX 1 revision A.pdf	-	Description of Work
AD1	WIMA ² S-210-REP-PP-WP2.1report-EurS090630-Ed3.doc	EurS	End-User Requirements
AD2	WIMAAS-220-REP-MiScen-FOI-170709Ed6.doc	FOI	Mission Scenarios
AD3	WIMAAS-230-REP-PP-JRC20090930-Ed48.doc	JRC	System of Systems Architecture
AD4	WIMAAS-311-REP- remote control-TSA-Ed1.pdf	TSA	Remote Control Mission
AD5	WIMAAS-312-REP-SensorConcept-FOI-100130Ed8.pdf	FOI	Airborne Multi-Sensors
AD6	WIMAAS-313-REP-PP-JRC20100218-Ed2.pdf	JRC	Multi-Systems Concepts
AD7	Scenarios_Execution_optimization.doc	SENER	Internal Engineering Document

AD0 – Describes the work of the entire WIMA²S project.

AD1 – Gives the outcome of the End-Users Analysis (End-User requirements/needs).

AD2 – Defines the Mission Scenarios based on the End-User requirements/needs.

AD3 – Sets out the System of Systems Architecture.

AD4 – Gives an account on System Concepts.

AD5 – Summarises the Sensor Concepts.

AD6 – Quantifies the functionalities of the maritime surveillance systems identified in the System of Systems Architecture.

AD7 – Describes the optimization of the scenarios execution.

18 EVALUATION OF THE WIMAAS EXPERIMENT

This chapter describes the evaluation of the WIMA²S experiment and its results. The overall evaluation of the WIMA²S experiment was based on the fulfilment of the main objectives of the experiment and the performance criteria defined in task 5.1.2, namely the compliance matrix, reproduced below for convenience. The requirements of the Spanish Authorities, namely Guardia Civil, ISDEFE and INTA were also taken into account in the WIMA²S experiment.

18.1 Objectives of the WIMA²S Experiment

The main objectives of the WIMA²S Experiment were:

- 1.- To illustrate the remote control of a maritime surveillance mission system in the framework of a scenario derived from one of those defined in WP2.2.
- 2.- Based on the conceptual work in WIMA²S and the first analysis of surveillance concepts by simulations in WP4, Surveillance Experiments will be performed to go a step further to real life.
- 3.- Within the experiments the overall surveillance architecture as well as dedicated surveillance technologies will be evaluated and validated.
- 4.- To show a complete information flow from planning a surveillance mission / task through executing this by the involvement of a sensor.

18.2 ISDEFE / Guardia Civil Demo Requirements

The ISDEFE/Guardia Civil demo requirements are the following [2]:

- **Objective's definition:** The main objective of the demonstration is to show the capabilities that UAV systems provide to maritime surveillance systems, such as SIVE, in detection, identification and tracking of small size illegal vessels tasks.
- **Missions' definition:** Missions to be run shall look for enlarging the current surveillance area, given the range of operation available, flight height and sensors configuration.
- **Several missions should be carried on**, for proving different surveillance concepts: detection-identification, interoperability, surface operations support, line of sight (LOS) and beyond line of sight (BLOS) operations.
- **Several flight profiles** shall be defined to achieve the different objectives. During demonstration, different flight control modes shall be tested: scheduled flight, waypoints definition, manual control, emergency flight (in case of data link loss), automated flight towards a detected target, etc.

- If possible, interaction mechanisms with **both regional and national Command and Control Centres** shall be defined, as well as **interoperability** with surface surveillance units.

18.3 WIMA²S Experiment Compliance Matrix

Table 7 illustrates the Compliance Matrix of the WiMAAS UAV flight experiment. As it can be seen the WiMAAS proposed activities fulfil most of the experiment requirements supplied by ISDEFE/Guardia Civil.

Table 7 – Compliance Matrix ISDEFE / Guardia Civil Requirements / WiMAAS Proposed Activities.

ISDEFE / Guardia Civil Demo Requirements	Proposed activities to fulfil the requirements	Compliance / How the proposed activities fulfil the requirements
1.) – Objectives: To show the capabilities that UAV systems provide to maritime surveillance systems, such as SIVE, in detection, identification and tracking of small size illegal vessels tasks.	1.) – A UAV flight comprising different flight control modes, investigation, identification and tracking of targets (e.g. small boats) with interaction with the NCCC and the RCCC will be carried out beyond the current maximum range of the SIVE system.	1.) – YES / The activities planned fulfil the objectives, by addressing each objective in turn, as described.
2.) – Missions’ definition: Missions to be run shall look for enlarging the current surveillance area, given the range of operation available, flight height and sensors configuration.	2.) – The UAV flight will go beyond the current maximum range of the SIVE system.	2.) – YES / The flight beyond the current maximum range of the SIVE system will prove that the UAV has the capability to enlarge the range of operations.
3.) – Several missions should be carried on , for proving different surveillance concepts: detection-identification, interoperability, surface operations support, line of sight (LOS) and beyond line of sight (BLOS) operations.	3.) – The UAV flight will comprise several missions aimed at addressing the main requirements, namely: investigation, identification, interoperability, surface operations support, and line of sight (LOS) operations.	3.) – YES except for BLOS operations / The several missions will address the main requirements except for BLOS operations.
4.) – Several flight profiles shall be defined to achieve the different objectives. During demonstration, different flight control modes shall be tested: scheduled flight, waypoints definition, manual control, emergency flight (in case of data link loss), automated flight towards a detected target, etc.	4.) – The UAV flight will include different flight control modes, namely scheduled flight, waypoints definition, manual control, emergency flight (in case of data link loss), automated flight towards a detected target, etc.	4.) – YES / All the requirements concerning different flight control modes will be fulfilled.
5.) – If possible, interaction mechanisms with both regional and national Command and Control Centres shall be defined, as well as interoperability with surface surveillance units.	5.) – During the UAV flight interaction with NCCC, RCCC and interoperability with surface units will be tested.	5.) – YES / All proposed interaction mechanisms with the NCCC and the RCCC will be tested. If possible, the interoperability with surface surveillance units will also be tested.

18.4 Experiment Planning and Organisation

In Sub-task 5.1.1 the WIMA²S partners performed a prioritisation of the user requirements based on the relevant technologies, surveillance platforms and their readiness for field trials. user requirements were prioritized. The relevant technology candidates for the surveillance experiment were selected and described in detail.

In Sub-task 5.1.2, based on the selected surveillance technologies identified in Sub-task 5.1.1 an overall surveillance mission was defined. From this, an experiment script was derived, which explained in detail the type of threat, information flows, involved sensor technology, involved data analysis and alarm generation, involved surveillance platforms etc.

For the defined surveillance mission an appropriate surveillance experiment site was selected among the candidate sites (Spain, Atlantic and the Mediterranean Sea). The selected site was Huelva in Spain. A further iteration on the mission was performed to adjust the experiment script with the capabilities of the surveillance experiment site. Finally, objectives and performance criteria for the relevant surveillance technologies were defined.

According to the surveillance experiment script of task 5.1.2 the experiment was planned in detail on an operational level together with the involved authorities, namely Guardia Civil, ISDEFE and INTA. Pre-tested sensor packages were integrated on the UAV Fulmar surveillance platform and communication links to a maritime surveillance centre were set up.

18.5 Selection of the Experiment Site

The selection of the South of Spain to carry out the experiment was decided in Sub-task 5.1.2. The selection of the experiment site involved several meetings, one with Guardia Civil, ISDEFE and INTA. A brief description of the entire process is given next.

- 1st attempt - January / February 2010 - successive contacts of SENER with the Civil Aviation to obtain the NOTAM. It was impossible to obtain, there was no legislation about UAV flights.
- 2nd attempt - February 2010 - Contact with the Spanish customer (Guardia Civil) with the commander of the GC. Jefatura Fiscal y de Fronteras- Programa SIVE.
- The WIMA²S partners decided to carry out the experiment together with Guardia Civil with the collaboration of ISDEFE and INTA.
- December 2010 - The WIMA²S partners decided that in order to obtain permission (NOTAM) the best site was be the “El Arenosillo” (Huelva, Spain), property of INTA.
- Mar experiment ch 2011: Received authorization from the INTA and begin to define the details of the
- **April 2011:** Meeting at the Arenosillo with the presence of all parties involved: INTA, GC (with ISDEFE) and WIMA²S team. During this meeting we discussed the details and action plans.
- **5-6 July 2011:** The experiment was done.

The different partners and facilities used are briefly described next.

Guardia Civil - The Spanish Civil Guard is a military Armed Institute, is part of the Forces of State Security. As the State Security Corps, the Constitution sets the primary mission of protecting the free exercise of the rights and freedoms of the Spanish and to ensure public safety, all serving under the Government of the Nation.

Sistema Integrado de Vigilancia Exterior (SIVE) Description: -

- Purpose is to improve the security of the southern border of Spain.
- Allows to address two major challenges we face today: the fight against drug trafficking and illegal immigration.
- After the abolition of internal borders within the European Union, SIVE is presented as a challenge not only for Spain but also for European security, given their status as the continent's southern border.
- The SIVE provides the real-time information to a control center that provides the necessary orders to intercept anything that comes close to the country from the sea.
- SIVE allows remote detection of vessels, which facilitates the task of identifying and rapid assistance of victims of this new form of human trafficking.
- The SIVE allows not only deter gangs of this type of traffic, but also save many lives

Ingeniería de Sistemas para la Defensa de España, S.A. (ISDEFE): -

ISDEFE is a state owned company founded in September 1985, through an agreement by the Council of Ministers, with the objective of providing technical engineering support and consulting services for advanced technologies in the Defence and Civil sectors.

Isdefe reports to the Secretary of State for Defence through a Board of Directors, comprised of Defence Ministry Advisors (Central Units and Armed Forces), the Ministry of Development and the Ministry of Economy and Taxation.

Isdefe provides consulting and engineering services to the Defence Ministry and to the Spanish Armed Forces, as well as to other government institutions that require technological and logistical support, both on a national and international level.

El Arenosillo test Centre – It carries out experimentation on new development rockets.

Located in the south west of the Iberian peninsula, the Test Centre of El Arenosillo (CEDEA) is provided with the most modern state-of-the-art equipment in order to carry out the following missions:

- New development rockets.
- Carry out scientific experiments with probe rockets and balloons.
- Atmospheric research.
- Development tests of different types are unmanned aircraft.
- Carrying out R+D programs, durability studies, and testing solar energy components and systems.

Instituto Nacional de Técnicas Aeroespaciales (INTA) – Description INTA is the Public Research Organization specialized in aerospace research and technology development.

18.6 Selection of the Launch and Landing Sites

The draft schematic in figure 49 illustrates the several constraints of the UAV launch and landing. The main constraints consisted of the obstacles during the landing, namely the trees and radar antennae at El Arenosillo airbase. The highway was also a constraint because the UAV was not allowed to fly over the highway.

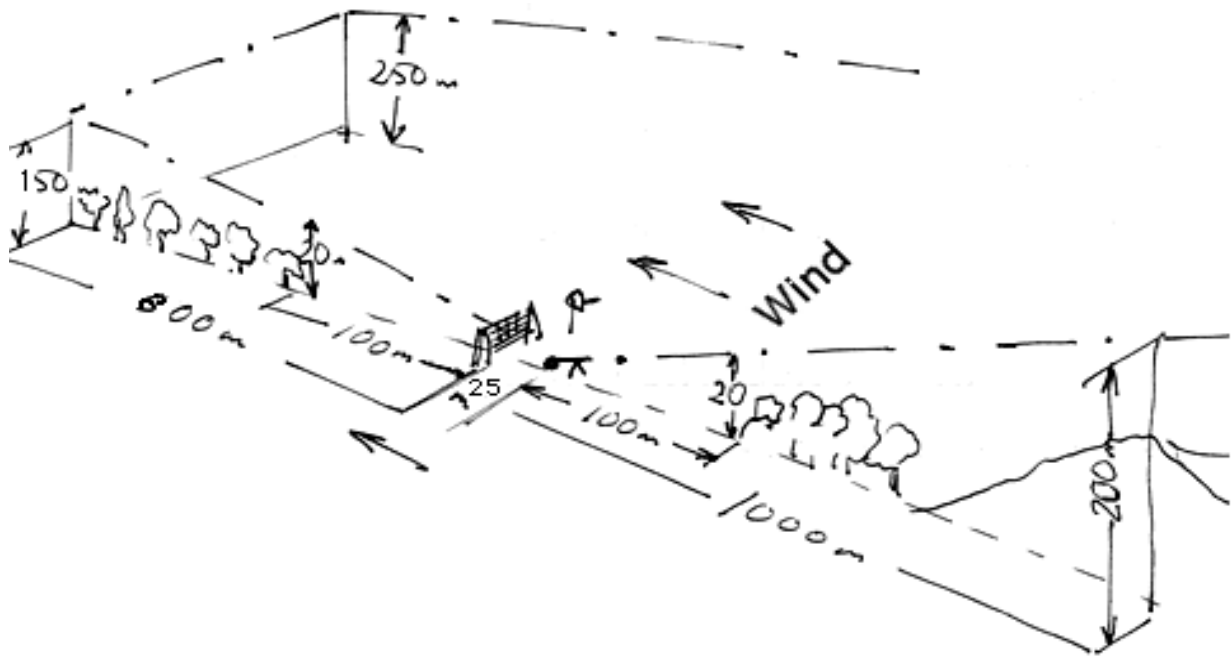

Figure 49 – Draft Schematic of the launch and landing site.

The launch pad and the landing net, as well as the ground control system and the antenna were deployed a few meters apart as illustrated in figure 50. The launch and the landing were performed according to the planned. The outcome was very successful.

FULMAR Installation



WIMAAS WORKSHOP St. Cloud – 05 Oct. 2011 - WORK PACKAGE 5 - EXPERIMENT



1
9

Figure 50 – WIMA2S UAV Fulmar installation.

18.7 SIVE Station Activities

The activities at the SIVE station, among other things, comprised the harmonisation of the different coordinate systems used by Guardia Civil and the WIMA²S team. This was done the day before the actual experiment. On 6 July, the day of the experiment, the SIVE station performed all the activities assigned to them according to the planned. The work carried out at the SIVE station was very successful and played a major role in the entire experiment.

18.8 Satellite Communications/ UAS Integration

Two satellite terminals were used to provide satellite communications, namely the Thrane & Thrane E500 and the E700. The 1st was connected in background IP mode with,

- transmission of GPS position
- Thumbnails and images.

The 2nd was connected in Streaming mode,

- on demand
- automatic detection of video stream

The main sources of confusion and solutions implemented were the following:

- Not coordinated access to the web GUI
 - Implement a strict access to command pages
- 6 second delay between camera video signal and digitized video
 - Better video A/D cards available on the market (delay dozens of ms)
- Limited bandwidth Internet connection
 - CCC has to be situated at a place with a guaranteed BW
 - Satellites are at 30.000 km above the earth
 - Bandwidth is limited but users request video

The hardware and software technical details are the following:

- SW based on open source technologies
- Gentoo and Debian OS
- VLC, ffmpeg – for video and image treatment
- PHP, Perl, Javascript (Google Maps API) – for web GUI
- AvioIP package – for routing part

- Commercial off-the-shelf HW
- PC based platforms (fitPC)
- Satellite terminal Thrane & Thrane e700 + e500
- A/D videocard Bt878

18.9 WIMA²S Experiment Sequence of Events

The actual experiment took place on 6 July at El Arenosillo INTA airbase as originally planned. The sequence of events will be summarised next.

1. - The WIMAAS consortium, Guardia Civil, INTA and ISDEFE staff met at the room where the Control Centre was installed for a briefing with the invited people. The WIMAAS project and its main objectives were presented to all attendees and the WIMAAS flight experiment explained.
2. - All the attendees moved to the UAV take-off area to see the take-off of the UAV (Fulmar). The Fulmar successfully took-off from El Arenosillo INTA airbase towards the sea.
- 3.- Everybody moved back to the Control Centre to follow the UAV flight mission through the information displayed in the control room, namely: the UAV video and position, the SIVE radar and camera data and the INTA tracking system.
4. - During the mission the SIVE station supplied the radar coordinates of a small boat (Zodiac type) deployed by the Guardia Civil patrol boat to be used as a target. The UAV was tasked to investigate the target.
- 5.- The UAV flew to the area where the small boat had been detected by the SIVE coastal radar. After a while the UAV detected the target and transmitted the video to the Control Centre. The small boat was then manually tracked by the UAV for some time. The UAV also detected other targets and tracked them for a while.
- 6.- The participants were invited to move to the UAV landing area at INTA airbase. The UAV landed successfully. This was one of the most critical parts of the experiment in terms of security/safety because there were several obstacles (e.g. Antennae, trees, houses) and the UAV was not allowed to overfly the highway close to the airbase due to security reasons. The UAV was able to do the approach and landing taking into account all the security/safety restrictions imposed.
- 7.- The participants moved back to the Control Centre for another briefing about the WIMAAS flight mission.
- 8.- The WIMAAS flight mission was discussed with the end-users and other participants and the balance of the flight experiment made, taking into account the positive aspects and the lessons learned. The project coordinator gave a presentation to explain the maritime surveillance concepts developed within the framework of the WIMAAS project. This was followed by a questions/answers session covering the entire WIMAAS flight experiment and the WIMAAS concept.

18.10 Results of the WIMA²S Experiment

The main results of the WIMA²S experiment are the following:

- 1.- Illustration of the remote control of a maritime surveillance mission system in the framework of a scenario derived from one of those defined in WP2.2.
- 2.- Based on the conceptual work in WIMA²S and the analysis of surveillance concepts by simulations in WP4, the WIMA²S Surveillance Experiment demonstrated the WIMA²S concept.
- 3.- Near Real Time Transmission of UAS video to Command & Control Station via Satcom was a useful innovation.
- 4.- Illustrated the cooperative use of broad area detection Systems (e.g. Coastal Radar) with an identification and tracking System (e.g. UAV).
- 5.- Another innovative aspect of the experiment was the broadcast of the WIMA²S experiment through the Internet with possibility of interaction.

18.11 Main Limitations

The main limitations of the implementation of the WIMA²S experiment were the following:

- 1.- The security and safety constraints imposed to the UAV take-off – the UAV take-off constraints were easily met by selecting a launch site close to the sea to prevent flying over houses, trees, antennae, roads or any other infrastructure in order to prevent damages in case of accident.
- 2.- The security and safety constraints imposed to the UAV landing – the UAV landing constraints were more challenging because during the approach phase the UAV had to fly over trees and avoid antennae. The UAV landing was very successful and performed according to the planned.

19 LESSONS LEARNED AND POSSIBLE IMPROVEMENTS

In any experiment there are always lessons that can be learned to improve the performance of the different systems involved and of the overall experiment. Some of the lessons learned in the WIMA2S experiment are summarised next.

19.1 Main Lessons Learned

The WIMA2S experiment was very successful. All the main objectives proposed were fully achieved. Some aspects that may impact the experiment preparation and execution are briefly described next.

1.- Experiment Preparation – The experiment preparation involved several steps including:

- a.) The analysis of the End-user requirements/needs.
- b.) The definition of the experiment and scenarios based on End-user requirements/needs.
- c.) The logistic/administrative work (e.g. permission to fly a UAV and to use facilities).
- d.) The selection of the technologies to be used.
- e.) The integration of the different systems involved in the experiment.
- f.) The test of the overall system double-checking all aspects of the experiment.

2.- Experiment Execution – During the experiment execution there are some factors (e.g. unexpected events) that may impact the outcome of the experiment, some examples are:

- a.) The weather conditions.
- b.) Unexpected problems with any individual system or with interfaces between systems.

In the WIMA2S experiment the preparation and execution unfolded as planned within the time schedule defined.

19.2 Possible Improvements

There is always room for improvement in any given experiment. Experiments involving UAVs require a permission to fly the UAV. In most countries, the procedure to obtain permission to fly is a lengthy process. That should be taken into account. Another important aspect to take into account when preparing an experiment is the definition of backup plans.

20 CONCLUSIONS AND FUTURE WORK

This section summarises the conclusions of the WIMA²S flight experiment and gives some ideas about the possible paths for future research.

20.1 Conclusions

All the objectives originally proposed for the WIMA²S flight experiment have been fully achieved.

The main results of the WIMA²S experiment are the following:

- 1.- Illustration of the remote control of a maritime surveillance mission system in the framework of a scenario derived from one of those defined in WP2.2.
- 2.- Based on the conceptual work in WIMA²S and the analysis of surveillance concepts by simulations in WP4, the WIMA²S Surveillance Experiment demonstrated the WIMA²S concept.
- 3.- Near Real Time Transmission of UAS video to Command & Control Station via Satcom was a useful innovation.
- 4.- Illustrated the cooperative use of broad area detection Systems (e.g. Coastal Radar) with an identification and tracking System (e.g. UAV).
- 5.- Another innovative aspect of the experiment was the broadcast of the WIMA²S experiment through the Internet with possibility of interaction.

20.2 Future Work

Future research paths may include some of the following research topics:

- 1.- System of Systems integration;
- 2.- Multi-Sensor/Multi-platform Maritime Surveillance;
- 3.- UAS key enabling technologies: collision avoidance systems, command & control reliability, Satellite Communications.
- 4.- UAS Surveillance – Concept of Use (CONUSE) / Concept of Operations (CONOPS).

20.2.1 System of Systems integration

The overall performance of a maritime surveillance system relies heavily on the interfaces/interoperability between the different systems that constitute the main system. Hence, the optimisation of the system of systems integration is of major relevance to achieve the best possible performance.

20.2.2 Multi-Sensor / Multi-platform Maritime Surveillance

With the development of new technologies, new sensors and platforms have emerged in recent years. Some of the new sensors (e.g. EOIR, Mini-SAR, Pico-SAR, etc) and platforms (e.g. UAS, USV, etc.) are suitable for maritime surveillance. The future development of new technologies will lead to new sensors and platforms. Hence, future maritime surveillance-systems will likely include new sensors and platforms.

20.2.3 UAS Key Enabling Technologies

One of the major issues facing UAS operations is the demonstration of equivalence (in particular for See and Avoid) in the context of an evolving Air Traffic Management (ATM) environment. It is very important to understand that the current ATM environment is not static. Achieving equivalence with manned operations is not a fixed target as there are many significant changes proposed that aim to improve operational efficiency and performance or enhance safety. On the whole proposed changes to the ATM environment could be seen as advantageous to UAS operations as more and more functions within the environment are automated thus there is a significant opportunity for the UAS industry to influence the shape of the future ATM environment to support wider UAS operations.

Assuring the safety of UAS operations in non-segregated airspace will therefore require a significant update to key elements of extant regulations and standards. UAS have yet to establish a good safety record and there are many challenges both regulatory and technological to be resolved before such operations can become common place. UAS key enabling technologies are crucial for the integration of UAS into non-segregated airspace. Some of these technologies comprise collision avoidance systems, reliable command & control systems and Satellite Communications.

The regulatory context for UAS operations in non-segregated airspace can be split into three main considerations, namely:

- 1.- certification of air vehicle airworthiness,
- 2.- safe provision of air traffic services and,
- 3.- licensing of operators, pilots, etc.

Most of the regulatory work carried out to date has focussed on airworthiness certification as well as the licensing of UAS Pilots. There is also a need for regulation to include the Air Traffic Management environment and for the co-ordination of all regulatory activities, a point noted by EASA in a recent regulatory consultation paper (EASA A-NPA, 2005) to ensure the safety of air travel as a whole.

20.2.4 UAS Surveillance – Concept of Use (CONUSE) / Concept of Operations (CONOPS)

CONUSE and CONOPS are two important topics of research. These two concepts can be used to optimise UAS missions.

CONUSE (Concept of Use) – describes how the UAS can be used.

CONOPS (Concept of Operations) – is a document describing the characteristics of a proposed system from the viewpoint of an individual who will use that system. It is used to communicate the quantitative and qualitative system characteristics to all stakeholders.

Besides the air vehicle itself, the UAS encapsulates all the equipment, people and procedures involved in the launch, control and recovery of the air vehicles. To establish the potential differences in manned and unmanned operations, it is important to understand the specific characteristics of UAS that are potentially applicable to UAS operations.

A principle characteristic is physical separation of control of the air vehicle from the air vehicle itself. The UAS pilot will be remote from the UAV either on the ground or in another aircraft. The UAS pilot maintains control of the air vehicle through a UAS Control System via a UAS Control Link. The operation of the control link cannot be guaranteed under all conditions so the UAS must be able to work safely with or without the control link; this is referred to as flying on or off-tether.

The key characteristics that can affect UAS operations are as follows:

- **Conspicuity** – the visibility of the air vehicle to other airspace users is an important component in the Collision Avoidance component as well as when Separation Provision is the responsibility of the UAS pilot. This could be an issue for air vehicles that are smaller than manned aircraft, or those that present a poor signature for Primary Surveillance Radar.

- **Autonomous Operations** – One of the key characteristics of UAS's is the ability to operate under various conditions without human interaction. The necessity for human interaction, along with other factors such as safety, mission complexity and environmental difficulty determine the level of autonomy that the UAS can achieve. There are various taxonomies for classifying UAS autonomy for example Autonomy Levels For Unmanned Systems (Hui-Min Huang, et al, 2005). However, it is not possible to define UAS operation in non-segregated airspace under any one classification as UAS may be expected to operate with varying degrees of autonomy depending on the circumstances.

- **Airworthiness** – UAS air vehicles (and as applicable control stations) must be fitted with certified equipment equivalent to that required for manned operation in the intended airspace; this may pose problems for smaller or lighter air vehicles due to space or weight constraints.

- **Flight Performance** – the manoeuvrability of a UAS air vehicle is important to understand. Currently, Air Traffic Controllers are required to understand flight performance characteristics of the types of aircraft that come under their control and provide separation provision instructions based on this understanding. This requirement for understanding will also need to apply to unmanned operations to ensure ATC instructions can be implemented.

REFERENCES

- EASA A-NPA Policy for Unmanned Aerial Vehicle (UAV) Certification Advance – Notice of Proposed Amendment (NPA) No 16/2005 A-NPA No 16/2005.
- Hui-Min Huangi et al A Framework For Autonomy Levels For Unmanned Systems (Proceedings of Unmanned Systems North America 2005) June 2005.AS CONOPS

Glossary

AEROVISIÓN – VEHÍCULOS AÉREOS S.L. (10PM)

AIS – Automatic Identification System

ASL – Above Sea Level

BLOS – Beyond Line of Sight

EC – European Commission

EU – European Union

GA – SELEX GALILEO

GPGGA – Time, position and fix-related data of the GPS receiver.

GPRMC – Time, date, position, track made good and speed data provided by the GPS navigation receiver.

GPS – Global Positioning System

GSM – Global System for Mobile Communications, or GSM (originally from Groupe Spécial Mobile).

GUI – Graphical User Interface

INTA – Instituto Nacional de Técnica Aeroespacial

ISDEFE - Ingeniería de Sistemas para la Defensa de España, S.A.

JRC – Joint Research Centre

LOS – Line Of Sight

MMI – Man Machine Interface

NCC – National Control Centre

NCCC – National Command and Control Centre

NRT – Near Real Time

PCTV – TV Tuner PCI card.

R&T – Research & Technology

Radar – Radio Detection and Range

RCCC – Regional Command and Control Centre

SAR – Synthetic Aperture Radar

SATCOM1 – Satellite service provider (Inmarsat, Iridium, KU-band via ViaSat and Thuraya).

SENER – SENER Ingeniería y Sistemas S.A.

SIVE – Sistema Integrado de Vigilancia Exterior

Thales – THALES SYSTEMES AEROPORTES S.A. (0,7PM).

UAV – Unmanned Aerial Vehicle.

WiMAAS – Wide Area Maritime Airborne Surveillance.

Appendix - I

OF

Aerovisión Vehículos Aéreos S.L.

(AVASL)

Non Confidential - RE

Grant Agreement number :	217931
Project acronym :	WIMA ² S
Project title :	Wide Maritime Area Airborne Surveillance

Task Number	WP 5
Task title	<i>Experiment</i>
Activity type	RTD
File name	Procedimiento de vuelo CEDEA.doc

Authors: Txema Soroa

Revision: 1

Tabla de contenido

1	INTRODUCCIÓN	2
2	LOGÍSTICA	2
3	TRANSPORTE	2
4	CONSUMIBLES Y REPUESTOS	2
5	ELECCIÓN DEL TERRENO	3
6	CARTOGRAFÍA Y PLAN DE VUELO	3
7	DISPOSICIÓN DE LA ESTACIÓN DE TIERRA	4
	7.1 Catapulta	4
	7.2 Red de captura "SARE"	4
	7.3 GCS	4
	7.4 Antenas	5
8	NORMAS Y MEDIDAS DE SEGURIDAD	5
9	PLAN DE EMERGENCIA	5
10	CHEQUEO PRE-VUELO	6
11	OPERACIÓN DE VUELO	7
12	ATERRIZAJE	7
13	PARTICULARIDADES EXPERIMENTO C.E.D.E.A	9
	AP0414	
	VIDEO LINK	15

INTRODUCCIÓN

El presente documento tiene como objetivo clarificar la forma de operar el sistema UAS Fulmar de Aerovisión, dentro de unos niveles de seguridad lo más altos posibles según la actual reglamentación para operaciones con UAVs.

LOGÍSTICA

Con el objeto de tener controlados el mayor número posible de elementos y minimizar el riesgo de que se eche de menos algún componente del sistema una vez en la zona de vuelo, se establece un primer *checklist* que incluye:

- Número y nombre de los bultos a transportar. Si se trata de una maleta o caja de transporte, deberá llevar un identificativo que permita reconocerlo.
- En caso de tratarse de una maleta o caja de transporte, éste deberá incluir, a su vez, un listado de los elementos o componentes que ha de llevar en su interior.
- Las baterías que se vayan a usar durante la operación y las que se determinen necesarias como repuestos, deberán estar perfectamente cargadas y en buen estado de uso.

TRANSPORTE

El transporte del sistema se realizará acorde con lo establecido por Aerovisión, de forma que se asegure la integridad de los elementos que componen el sistema. Se respetarán las cajas, sistemas de fijación, disposición, etc. que ésta establezca.

Por otra parte, el vehículo deberá ir dotado de la correspondiente bola para enganchar el remolque. Si el peso del vehículo más el remolque supera lo establecido por la normativa de circulación vigente, el conductor deberá disponer de la licencia oportuna (en caso de vehículo con remolque, puede ser necesaria el permiso BE).

A la hora de elegir el vehículo tractor, tendrá que tenerse en cuenta la orografía propia de la zona de vuelo. La versatilidad del sistema Fulmar requiere muchas veces el uso de vehículos con tracción a las 4 ruedas.

CONSUMIBLES Y REPUESTOS

Los consumibles y repuestos aconsejados por Aerovisión tendrán que ser transportados a la zona de vuelo como parte del sistema. Dicha lista incluye, si bien no está limitada a los siguientes elementos:

- Kit de reparaciones "in-situ". Incluye composites, adhesivos, tortillería, etc.
- Aparatos de medida para la localización de posibles averías.
- Material eléctrico de repuesto, como conectores, cables, soldador, etc.
- Bidón de gasolina mezclada con aceite al 2-5%.
- Aceites, lubricantes, desengrasantes, o cualquier otro producto que se considere necesario para el mantenimiento del UAV.

ELECCIÓN DEL TERRENO

La elección de la zona de vuelo suele venir generalmente impuesta por el propósito del mismo. Sin embargo, dentro de lo posible habrá que identificar una zona que, siendo válida para tal propósito, cumpla los siguientes requerimientos:

- Evitar zonas rodeadas de montañas altas que pueden dificultar el lanzamiento y el aterrizaje del UAV.
- Es aconsejable la disponibilidad de una caseta para proteger a los operadores de las inclemencias meteorológicas, en caso de ser necesario. En días soleados es también aconsejable disponer de una buena sombra que favorezca la legibilidad de las pantallas de control y video.
- Hay que tener cuidado también con obstáculos ajenos a la orografía natural del terreno, como pueden ser postes eléctricos, torretas, molinos de viento, etc.
- También es aconsejable la posibilidad de restringir el acceso a la zona de vuelo a personas ajenas al equipo de vuelo.

CARTOGRAFÍA Y PLAN DE VUELO

Una vez conocido el emplazamiento donde se desarrollará la operación de vuelo, es conveniente disponer de lo siguiente:

- Plano de la zona. Puede ser un mapa topográfico, fotografía aérea, etc. siempre y cuando tenga la calidad suficiente para asegurar la correcta calibración.
- Mapa de elevación digital. El programa de control del UAV dispone de unos mapas de elevación preinstalados. En caso de ser necesaria una mayor resolución, deberán conseguirse los mapas con la granulometría adecuada.

Tras analizar la zona de vuelo y en disposición de los mapas, se trazará un plan de vuelo que respete, en todo momento, las distancias de seguridad mínimas entre el UAV y el terreno, montañas, o cualquier obstáculo. Hay que tener en cuenta, además, unos márgenes de tolerancia que permitan la desviación del UAV en vuelo respecto al plan trazado (errores de navegación), sobre todo en elevación.

DISPOSICIÓN DE LA ESTACIÓN DE TIERRA

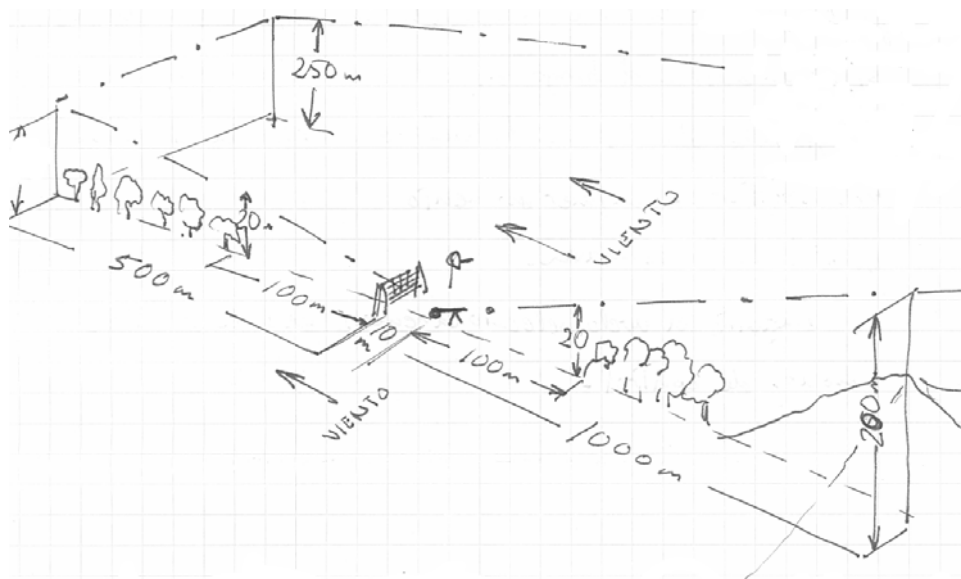

Catapulta

Dentro de los condicionantes impuestos por la elección del terreno de vuelo, hay que intentar situar la catapulta de forma que se cumplan los siguientes objetivos:

- Orientar el UAV de

forma que quede lo más aroado al viento posible.

- Evitar obstáculos en la trayectoria de lanzamiento.
- Es preferible que, en caso de haber un desnivel en el terreno, éste sea negativo en frente de la catapulta. Esto permitirá al UAV un mayor margen de seguridad en caso de que pierda altura durante el lanzamiento.

Red de captura "SARE"

Los inflables del sistema de recogida se dispondrán de forma que:

- La red quede centrada respecto a la catapulta. La longitud de red será igual por la izquierda que por la derecha de ésta.
- La distancia entre la red y la catapulta sea de 25 metros.
- La orientación de la red forme un ángulo de 90 grados respecto a la línea de la catapulta. De esta forma la red será perpendicular a la trayectoria del UAV en el tramo final.

GCS

Los criterios para elegir una correcta posición de la estación de tierra son:

- Asegurar una buena visibilidad de las operaciones de lanzamiento y aterrizaje. Para ello la distancia a la red de recogida ha de ser relativamente corta y situada, siempre a elección del piloto, hacia la cara de la red por la que entrará el UAV y, lógicamente, desviada hacia un lado para nunca entrar en la trayectoria del UAV.
- En la medida de lo posible, elegir una zona donde el terreno esté lo más nivelado posible y evitando montículos, obstáculos, etc. que pongan en peligro la estabilidad de la mesa donde se instale la estación de control.

Antenas

El mayor condicionante a la hora de fijar la antena es la longitud del cable de conexión, por lo que en la práctica ésta se situará justo al lado de la mesa donde se monta la estación de control, de forma que obstaculice a los operadores lo mínimo posible y no interrumpa la línea visual entre el piloto y el UAV en el tramo final.

Actualmente la antena de comunicaciones no se suele emplazar en lo alto del mástil, sino que se apoya sobre la mesa para favorecer la movilidad del piloto en caso de ser necesaria la operación en modo manual. Es recomendable, no obstante, que se sitúe dicha antena con la mayor elevación posible para favorecer las comunicaciones, máxime cuando la distancia entre el UAV y el GCS se hace más grande.

NORMAS Y MEDIDAS DE SEGURIDAD

Actualmente no existe una legislación que regule el uso de UAVs. No obstante, es conveniente maximizar las precauciones a toda costa para evitar situaciones de riesgo. Con ese fin, Aerovisión aconseja el uso de los siguientes dispositivos:

- Radio de banda aérea. Estará escaneando las bandas de frecuencias de los aeropuertos más cercanos continuamente, de forma que se puedan interceptar las comunicaciones entre las torres de control y el tráfico aéreo cercano en tiempo real.
- TCAS/PCAS. El uso de un sistema anticolidión permite localizar otros vehículos aéreos con la suficiente antelación para poder cambiar el plan de vuelo y evitar el conflicto.
- Obviamente, el uso de los anteriores sistemas no evita la necesidad de disponer de un integrante del equipo de vuelo que vigile constantemente de forma visual el espacio aéreo circundante.
- Se aconseja también, de ser posible, estar en contacto con la torre de control más cercana, de forma que ésta pueda avisar al tráfico aéreo próximo de la presencia del UAV.
- Sería conveniente, además, disponer de una aeronave que vuele de forma coordinada sobre la misma zona, de forma que “reserve” el espacio aéreo y evite la incursión de tráfico aéreo no controlado.

PLAN DE EMERGENCIA

Cuando se establezca la zona de operaciones, y en paralelo a la elaboración del plan de vuelo, debe establecerse el plan de contingencia. Para ello se considerarán los posibles fallos que puedan darse en el sistema. Como ejemplo se citan los siguientes casos:

- Parada fortuita del motor. Hay que evaluar, en cada punto del plan de vuelo, si se dispondrá de altura suficiente para llegar a la red con la tasa de planeo del UAV. En caso afirmativo, se procederá de forma inmediata a enviar el UAV en modo “fly to” a dicho punto. Una vez ahí, el piloto procederá a realizar un aterrizaje de emergencia, bien contra la red o sobre el suelo. Si la tasa de planeo del Fulmar no permite llegar hasta la estación de control, habrá que establecer, siempre de antemano, las zonas donde el aterrizaje incontrolado produzca menos daños. Un claro ejemplo sería el mar, donde el riesgo de provocar accidentes es prácticamente nulo.
- Pérdida de comunicaciones. Se aconseja programar el AP-04 de forma que realice una “vuelta a casa” automática en caso de pérdida de comunicaciones. La mayoría de las veces las comunicaciones se podrán restaurar una vez que el Fulmar se encuentre más cerca de la GCS.

- Avería en GCS. Si bien es improbable, es altamente recomendable disponer de un GCS de back-up en perfecto estado de funcionamiento, que se encenderá en caso de fallar el primario.
- Pérdida de alimentación en GCS. El diseño de la GCS actual permite su operación con baterías aun cuando falle la alimentación principal. Sin embargo, hay que asegurarse de que dichas baterías estén en buenas condiciones en todo momento.
- Detección de situación anómala en el UAV. En función de la gravedad del fallo habrá que establecer si se aborta el plan inicial, se modifica o se continúa con él.
- Exceso de tiempo de vuelo. El AP-04 permite ser configurado para que, una vez excedido el tiempo de misión, el UAV regrese a la red de forma automática.

La forma de resolver los citados problemas ha de establecerse siempre de antemano, previo al lanzamiento del UAV.

CHEQUEO PRE-VUELO

El chequeo pre-vuelo aconsejado consta de los siguientes puntos, aunque puede ampliarse según se considere necesario:

- Realizar una primera inspección de la estructura del UAV para detectar posibles defectos.
- Comprobar las conexiones de los elementos críticos (antenas, cables de comunicación, alimentación...).
- El tubo Pitot no debe mostrar signos de suciedad, óxidos o cualquier otra obstrucción.
- Encender el GCS y arrancar el software de control (Visionair).
- Comenzar el registro de vuelo (log).
- Encender el UAV.
- Verificar la instalación del AP04, de forma que el AHRS sea inmune a las vibraciones del UAV.
- Verificar que el mapa mostrado en Visionair concuerde con el de la zona de vuelo.
- Cargar el plan de vuelo inicial de la misión.
- Subir el plan de vuelo al UAV.
- Pasar el UAV a modo *Manual* y comprobar la respuesta de las superficies de control, así como el correcto trimado.
- Poner el UAV en modo *Auto* y moverlo en los ejes de *pitch* y *roll* para comprobar que las correcciones de las superficies de control son correctas.
- Comprobar la configuración de la pista de aterrizaje, tanto su posición como el rumbo.
- Resetear el tiempo de Bingo y el tiempo de Misión.
- Verificar que las comunicaciones entre el AP-04 y Visionair son rápidas. El AHRS debe refrescarse de forma ágil. Comprobar que las alarmas de comunicaciones no se encienden.
- Separar la GCS del UAV unos 200 metros y asegurarse de que el enlace de comunicaciones no se pierde.
- Soplar suavemente por los conductos del tubo pitot y observar que la velocidad indicada sube. Si se succiona, ésta ha de bajar.

- Esperar a que el GPS esté completamente operativo, en 3D.
- Asegurar un tiempo mínimo de 15 minutos desde que se encendió el AP-04 para que la temperatura de los sensores se estabilice.
- En modo *Manual*, encender el motor.
- Acelerar el motor a fondo y asegurarse de que las indicaciones de RPM y altitud son correctas.
- Verificar los indicadores de tensión del UAV.
- Todas las alarmas excepto ADS tienen que estar apagadas.
- Comprobar la posición y velocidad indicadas.
- Esperar que el motor adquiera una temperatura de funcionamiento óptima.
- Cargar la catapulta.
- Poner el AP-04 en modo *Take-Off*.
- Si todo es correcto, lanzar el UAV.

OPERACIÓN DE VUELO

Una vez en vuelo, la operación del UAV se realizará acorde con lo especificado en el manual de instrucciones (ver anexo C).

ATERRIAJE

Cuando se vaya a proceder al aterrizaje del UAV hay que seguir el siguiente procedimiento:

- Avisar a todos los operarios. Hay que extremar las precauciones para evitar situaciones de riesgo en caso de que los errores de navegación del UAV sean excesivos. Protegerse detrás de algún obstáculo sólido, coche, muro, etc. en caso de la más mínima sospecha de mal funcionamiento.
- Activar los *flaps*, a no ser que las condiciones de viento lo desaconsejen.
- Pasar el UAV a modo *Landing*. Asegurarse de que el plan de vuelo para el aterrizaje se efectuará por el lado correcto y queda correctamente dibujado en el mapa, pasando justo por encima de donde se configuró la pista de aterrizaje.
- Si se estima necesario, reconfigurar la pista de aterrizaje de forma que quede unos 50 metros por encima de la pista real (la red). De esta forma se puede realizar una simulación de aterrizaje, de forma que el UAV intentará llegar a la red, pero vendrá 50 metros más alto. Esto permite comprobar la actitud del UAV durante el aterrizaje y determinar los errores de navegación.
- Para realizar un aterrizaje real en la red, dejar que el UAV se aproxime hasta entrar prácticamente de forma automática en ella. Durante este proceso, vigilar el AHRs para detectar posibles desviaciones en velocidad, altura o tracking. En el último instante, si fuera necesario, y utilizando las estimaciones de desviación que acabamos de detectar, por un lado, y la información visual, el piloto puede decidir sobremandar ligeramente al AP-04 para asegurarse de que el impacto se realiza justo en el centro de la red.

PARTICULARIDADES EXPERIMENTO C.E.D.E.A

El vuelo a efectuar durante el experimento en la Base de El Arenosillo (Huelva) quedará confinado dentro del perímetro establecido por el LED120R, como se muestra en la siguiente figura.

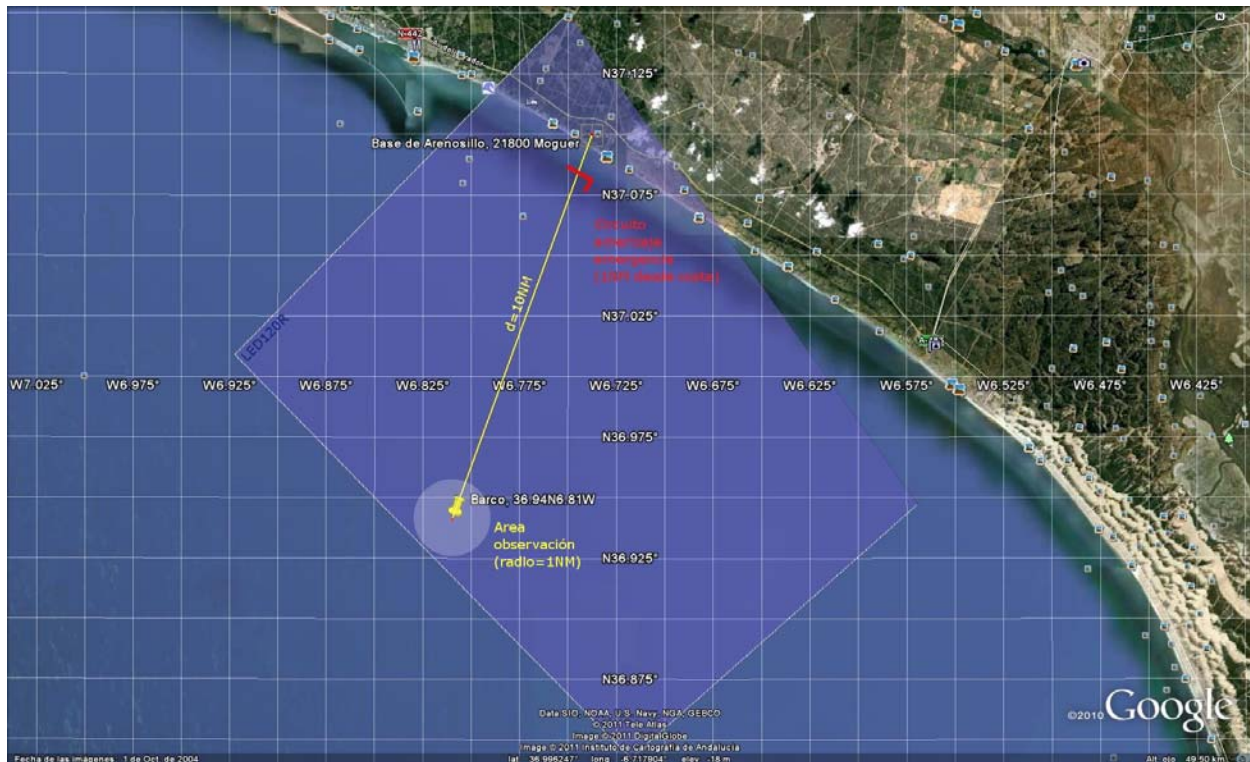

Se definirá además una zona de amerizaje de emergencia, dibujado en forma de "L" roja en el plano, de forma que si por alguna causa el UAV sufriera una pérdida en las comunicaciones con la estación de tierra (GCS), éste aterrizaría de forma automática y segura en dicho área, que deberá estar cubierta por una embarcación de apoyo.

Se define, a su vez, un área de observación de un radio de una milla náutica a una distancia de diez millas náuticas desde el punto de despegue. En dicho área una embarcación deberá permanecer a la escucha para colaborar con la consecución del experimento, actuando como blanco colaborativo.

Para el despegue y aterrizaje de la aeronave se seleccionará un área acorde con lo mostrado en el siguiente plano.

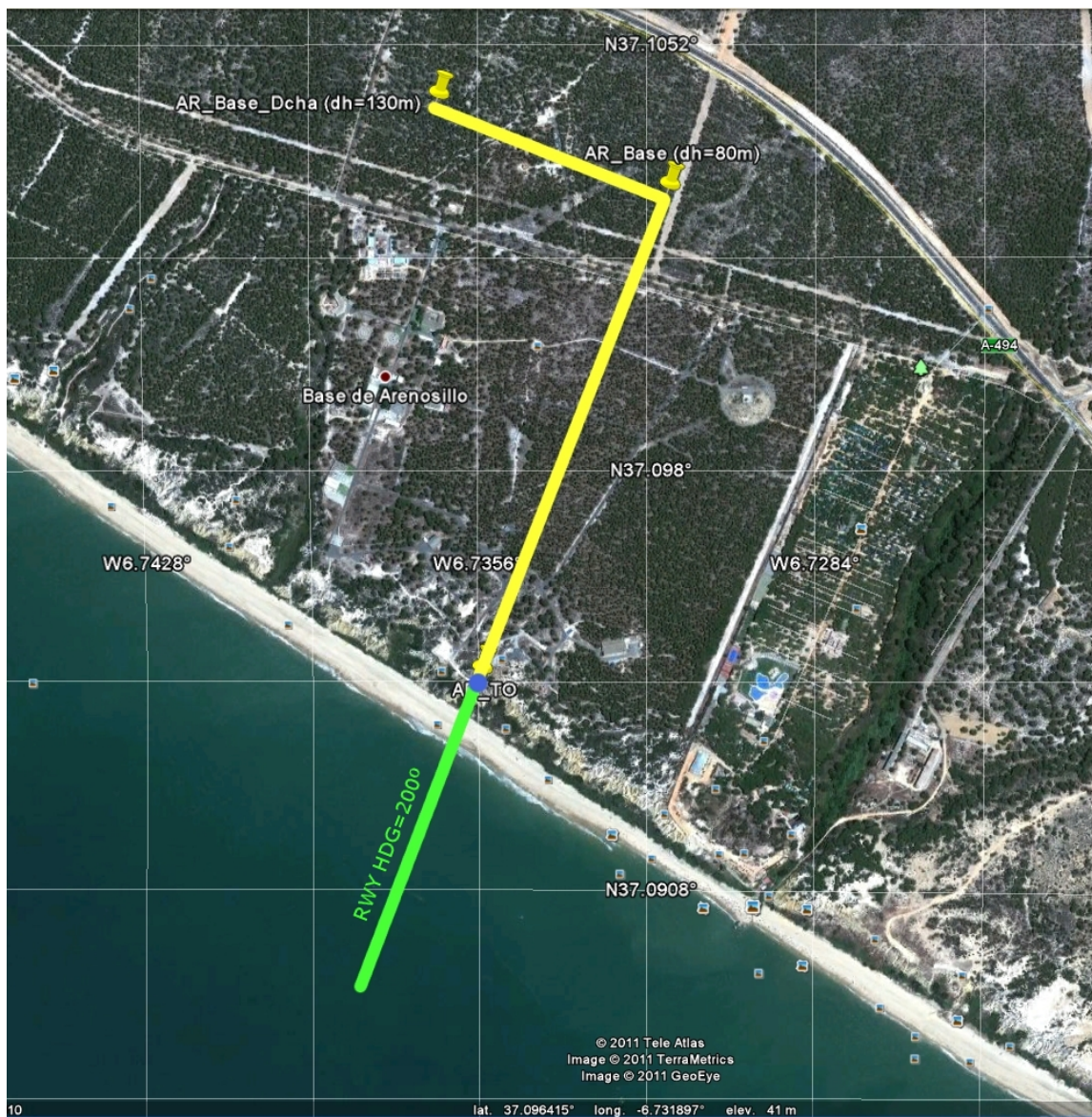

Se puede apreciar la trayectoria de despegue en verde, con un rumbo estimado de 200°. El día del experimento habrá que asegurarse que el viento reinante permita dicha configuración de pista.

La toma se realizará según la trayectoria marcada en amarillo. Se realizará un circuito a derechas, con el inicio de la base a 130m sobre la altura de la red y avanzando en el tramo final desde una altitud de 80m sobre dicha referencia.

La trayectoria de la toma se ha calculado de manera que se eviten los obstáculos más prominentes, mientras que se evita el sobrevuelo del camping y de la carretera situada al norte de la Base.

Otras características de interés son:

- 1.- Altura máxima y mínima: en principio la altitud de vuelo será de 500m y prevemos la posibilidad de tener que bajar para mejorar la calidad de imagen. Por lo tanto, sería conveniente reservar el rango de altitudes de 0 a 500m MSL.
- 2.- La velocidad TAS rondará los 100km/h, digamos que entre 90 y 120 km/h. Para calcular la GS, obviamente, tendremos que esperar al día del experimento.
- 3.- Aterrizaje frustrado: se procederá en línea de pista, igual que si fuera un despegue (ver diagrama adjunto, línea verde).
- 4.- Velocidad de lanzamiento. La velocidad a la que el UAV abandona la catapulta es de alrededor de 90km/h (GS). Si bien la velocidad de pérdida ronda los 60km/h, estimamos que la velocidad de seguridad es de unos 80km/h. En todo caso, siempre practicamos los lanzamientos con viento en cara, a no ser que esté en calma.
- 5.- Huella de seguridad de lanzamiento: se habría de definir un área que abarque el rumbo de pista (línea verde en el diagrama adjunto) +/-15° y un radio de 1km. Sin embargo habrá que debatir un poco este punto, ya que esto incluiría la zona de playa que se sitúa justo en frente a la base.
- 6.- Huella de seguridad de recuperación: igual que la de lanzamiento, pero hacia atrás, es decir, desde HDG=5° hasta HDG=35° y 1km de radio.
- 7.-Tiempo estimado de vuelo: entre 60 y 90 minutos.
- 8.- Peso en despegue: el MTOW es de 20kg, el día del ensayo rondará los 17kg, de los cuales 2.1kg serán de combustible.
- 9.- Identificación y horas de vuelo de la aeronave: se dispondrá de 2 UAV, los números de serie están aún por determinar. La experiencia de vuelo con estos modelos es de alrededor de 300 horas.

SISTEMA FULMAR

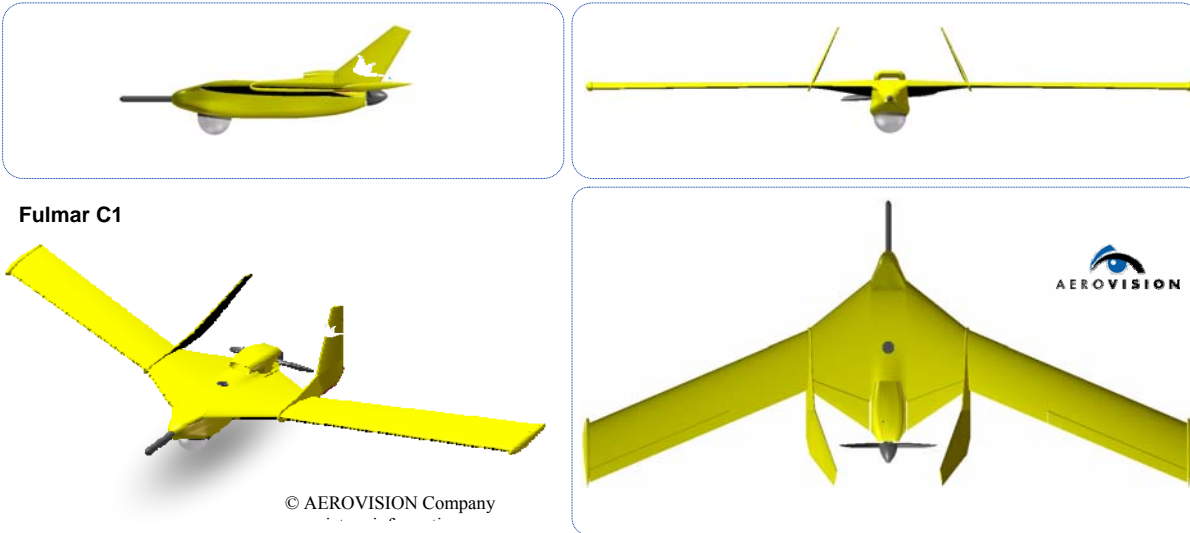

Fulmar C1

© AEROVISION Company

Span [m]:	3.10	PL [Kg]:	6	OEM:	TBD
Longitude [m]:	1.2	Fuel Volume [l]:	4.5	Modified by:	Aerovision
Height [m]:	0.5	Engine Power [W]:	2000	Airframe:	Carbon Aramida Prepreg
Takeoff Method:	Elastic launcher	Electrical Power [W]:	50	Power Plant:	Single engine 28 cc. 2.T
Landing Method:	Recovery net	Autonomy [h]:	5	Fuel Supply:	Pump
Landing Gear:	Belly landing	Min Speed [Km/h]:	60	Propeller:	Pusher Prop
High-Lift Devices:	Flaps	Max Speed [Km/h]:	150	Electrical Power Source:	Dynamo & Batteries
Speed Brakes:	Flaps	Max Altitude [m]:	3400	Parachute:	N/A
MTOW [Kg]:	19	TKOF Distance [m]:	6	Interior Volume [l]:	5
				Max Interior Box [m]:	1 Box 0.7x0.15x0.50 & 2 Boxes 0.7x0.15x0.24

Figura B.1. Características de la plataforma Fulmar C1 (Aerovisión)

MANUAL DE VUELO

El manual de operación del AP-04 viene claramente especificado en los documentos "da399975ap04_user_manual.pdf" y "da399975Visionair_User_Manual.pdf" suministrados por UAV Navigation, o, en su caso, sus más recientes actualizaciones. La operativa del sistema Fulmar está íntimamente ligada a dichos manuales, aunque sujeta a pequeñas modificaciones u operaciones complementarias que Aerovisión pueda definir en un futuro.

COMUNICACIONES

AP04			
IDENTIFICATION	Equipment designation (manufacturer reference)		AP04/GCS03
	Name of manufacturer		UAV Navigation S.L.
	Functional frequency band (Fmin - Fmax) in MHz		902-928 MHz
	Type of equipment (Transmitter/Receiver)		Transmitter-Receiver
GENERAL	Type of signal transmission		digital
	Duplex gap between transmit & receive frequencies in MHz		N/A
	Spreading bandwidth in MHz (for spread spectrum systems)		25.0
	Is equipment frequency agile or fixed frequency		agile fixed
	Tuning step in kHz		N/A
TRANSMISSION	Bandwidth in MHz		0.230
	Maximum bit rate-rate in Mbit/s		0.17
	Peak power in W	Without amplification	1.0
		With amplification	N/A
	Average power (W)		0.30
	Type of modulation		SS GFSK
	Filter response (spectre or filter pattern)		N/A
RECEPTION	Thermal noise in dBm		N/A
	Noise facteur in dB		N/A
	Power Threshold or Receiver Sensitivity	analog: for Signal/noise=dB, in μ V or dBm	N/A
		digital : for Bit Error Rate = 10^{-3} , in dBm	-113
		digital : for Bit Error Rate = 10^{-6} , in dBm	-108
ANTENNA TRANSMISSION			
IDENTIFICATION	Antenna designation (manufacturer's reference)		N/A
	Name of manufacturer		N/A
	Functional frequency band (Fmin - Fmax) in MHz		902-908
	Type of antenna		½ wave
	Antenna height above ground in m		2.0 m
PERFORMANCE	Dimension in m		0.18
	Maximum gain in dB		3
	Opening of principal beam at 3dB in degrees		360
	Polarisation		vertical

VIDEO LINK			
IDENTIFICATION	Equipment designation (manufacturer reference)		TD-243000
	Name of manufacturer		Black Widow A/V, LLC
	Functional frequency band (Fmin - Fmax) in MHz		2413 - 2473
	Type of equipment (Transmitter/Receiver)		Transmitter
GENERAL	Type of signal transmission		analog
	Duplex gap between transmit & receive frequencies in MHz		
	Spreading bandwidth in MHz (for spread spectrum systems)		
	Is equipment frequency agile or fixed frequency		fixed
	Tuning step in kHz		20000
TRANSMISSION	Bandwidth in MHz		20
	Maximum bit rate-rate in Mbit/s		
	Peak power in W	Without amplification	3
		With amplification	
	Average power (W)		3
	Type of modulation		FM
Filter response (spectre or filter pattern)		spectre	
RECEPTION	Thermal noise in dBm		
	Noise facteur in dB		
	Power Threshold or Receiver Sensitivity	analog: for Signal/noise=dB, in μ V or dBm	-83dBm for S/N=30dB
		digital : for Bit Error Rate = 10^{-3} , in dBm	
digital : for Bit Error Rate = 10^{-6} , in dBm			
ANTENNA TRANSMISSION			
IDENTIFICATION	Antenna designation (manufacturer's reference)		DISK24
	Name of manufacturer		Black Widow A/V, LLC
	Functional frequency band (Fmin - Fmax) in MHz		2413 - 2473
	Type of antenna		Edge Slot Radiator
	Antenna height above ground in m		
PERFORMANCE	Dimension in m		0.076
	Maximum gain in dB		3dBi
	Opening of principal beam at 3dB in degrees		360
	Polarisation		Vertical

EQUIPO DE OPERACIÓN

Los datos de los operarios pueden ser importantes para poder acceder a ciertas instalaciones con control de accesos. Por lo tanto, será conveniente tener previamente preparada una tabla en la que se reflejen dichos datos, por un lado, y por otro realizar la asignación de tareas para cada uno de ellos.

A continuación se muestra un ejemplo de la información que puede ser necesaria:

Nombre	Nacionalidad	DNI	Fecha nacimiento	Empresa	Tarea asignada
Txema Soroa	España	44136221A	13/11/1973	Aerovisión	Operador GCS
Arturo Turrillas	España			Aerovisión	Piloto de seguridad
Georgia Barykin	España			Tecnalia	Mecánico
Unai Korta	España			Aerovisión	Montaje
Luis Montoya	España			Aerovisión	Montaje

European Commission

EUR 25183 EN – Joint Research Centre – Institute for the Protection and Security of the Citizen

Title: Wide Maritime Area Airborne Surveillance (WIMAAS) WP5 Final Report

Author(s): Victor M. G. Silva, Gilles Jurquet, Gabriel Marchalot, Maria Teresa, Txema Soroa, Juan Sancho, Adam Koubek, Harm Greidanus & Claudio Savarino.

Luxembourg: Publications Office of the European Union

2012 – 155 pp. – 21 x 29.7 cm

EUR – Scientific and Technical Research series – ISSN **1018-5593 (print)**, ISSN **1831-9424 (online)**

ISBN **978-92-79-22802-5 (PDF)**

ISBN **978-92-79-22801-8 (print)**

doi:**10.2788/6952**

Abstract

This report of WIMA²S Work Package 5 (WP5), describes the definition, planning, execution and evaluation of the WIMA²S UAS flight experiment. The main aim of the WIMA²S project consists of developing key technologies to prepare the future for the operational use of Unmanned Aerial Systems (UAS), innovative mission aircraft and space assets, as key building blocks integrated in a System of Systems approach. WIMA²S takes into account the current operational user requirements and the needs to develop strong European capabilities in the fields of maritime policy, integrated border management and security R&T, identified as top priorities by the EU.

The main objectives of WP5 comprised the definition and performance of a UAS flight experiment based on one of the maritime surveillance scenarios elaborated in task WP2.2, the illustration of a complete information flow of the planning of a multi-sensor/multi-platform surveillance mission and the remote control concept for mission system.

The UAS flight experiment has successfully illustrated the remote control of a maritime surveillance system using different scenarios derived from the end-users requirements/needs identified in WP2. The experiment was carried out at El Arenosillo airbase, in Huelva, Spain in close cooperation with Guardia Civil, INTA (Instituto Nacional de Técnica Aeroespacial) and ISDEFE (Ingeniería de Sistemas para la Defensa de España). The UAS flight experiment comprised the following sequence of events. The Command and Control Centre at INTA airbase tasked the UAS for a routine maritime surveillance flight. During the UAS flight, Guardia Civil deployed a small rubber boat. The boat was detected by the Huelva SIVE station through its coastal radar and camera. The Guardia Civil classified the non-identified target as a potential non-cooperative target and tasked the UAS for an investigation flight. The UAS flew to the area where the non-cooperative target was detected by the SIVE station and detected and classified the non-identified target as a small rubber boat (Tiger type) and sent the video of the target to the Command and Control Centre via Satellite communications. The UAS tracked the target for a while to collect additional information and try to identify it.

A complete information flow of the planning of a multi-sensor/multi-platform surveillance mission has also been illustrated. All WP5 objectives have been fully achieved according to the planned.

How to obtain EU publications

Our priced publications are available from EU Bookshop (<http://bookshop.europa.eu>), where you can place an order with the sales agent of your choice.

The Publications Office has a worldwide network of sales agents. You can obtain their contact details by sending a fax to (352) 29 29-42758.

The mission of the JRC is to provide customer-driven scientific and technical support for the conception, development, implementation and monitoring of EU policies. As a service of the European Commission, the JRC functions as a reference centre of science and technology for the Union. Close to the policy-making process, it serves the common interest of the Member States, while being independent of special interests, whether private or national.

