



Evaluation of BioSoil Demonstration Project

Soil Data Analysis

Roland Hiederer, Erika Michéli and Tracy Durrant



EUR 24729 EN - 2011

The mission of the JRC-IES is to provide scientific-technical support to the European Union's policies for the protection and sustainable development of the European and global environment.

European Commission
Joint Research Centre
Institute for Environment and Sustainability

Contact information

R. Hiederer
European Commission
Joint Research Centre
Institute for Environment and Sustainability
Via Enrico Fermi, 2749 - 21027 - Ispra (VA) – Italy
E-mail: roland.hiederer@jrc.ec.europa.eu

<http://ies.jrc.ec.europa.eu/>
<http://www.jrc.ec.europa.eu/>

Legal Notice

Neither the European Commission nor any person acting on behalf of the Commission is responsible for the use which might be made of this publication.

***Europe Direct is a service to help you find answers
to your questions about the European Union***

Freephone number (*):

00 800 6 7 8 9 10 11

(*) Certain mobile telephone operators do not allow access to 00 800 numbers or these calls may be billed.

A great deal of additional information on the European Union is available on the Internet. It can be accessed through the Europa server <http://europa.eu/>

JRC63301

EUR 24729 EN
ISBN 978-92-79-19320-0
ISSN 1018-5593
doi:10.2788/56105

Luxembourg: Publications Office of the European Union

© European Union, 2011

Reproduction is authorised provided the source is acknowledged.

Printed in Italy

This document may be cited as follows:

Hiederer, R., E. Michéli* and T. Durrant (2011) Evaluation of BioSoil
Demonstration Project - Soil Data Analysis. EUR 24729 EN. Luxembourg: Office
for Official Publications of the European Communities. 155pp.

European Commission Joint Research Centre
Institute for Environment and Sustainability
TP 261
21027 Ispra (VA)
Italy

* Prof. Erika Michéli, 7. Esze.T., 2100 Gödöllő, Hungary

Table of Contents

	Page
1 INTRODUCTION	1
1.1 SOIL MODULE.....	1
1.2 BIODIVERSITY MODULE	2
1.3 SCOPE OF DATA ANALYSIS.....	3
2 PROJECT ORGANIZATION.....	5
2.1 LEGAL FRAMEWORK.....	5
2.2 PROJECT PARTICIPANTS.....	7
2.2.1 <i>Participating National Focal Centres</i>	7
2.2.2 <i>European Commission Joint Research Centre</i>	8
2.2.3 <i>Service Contractor</i>	9
2.2.4 <i>Analysis of Procedures for Soil Data</i>	9
3 ANALYSIS OF BIOSOIL / SOIL DATA.....	11
3.1 FOREST SOIL CONDITION SURVEYS	11
3.1.1 <i>Manual on Soil Sampling</i>	12
3.1.2 <i>BioSoil / Soil Project Data</i>	15
3.1.3 <i>Sampling by Layers and Pedological Horizons</i>	15
3.2 DATA AND DATABASE.....	16
3.2.1 <i>Files Submitted</i>	16
3.2.2 <i>Data Formats</i>	17
3.2.3 <i>Data Model</i>	19
3.2.4 <i>Naming Convention</i>	23
3.2.5 <i>Validation Procedure and Parameters</i>	24
3.2.6 <i>Meta Data</i>	27
3.2.7 <i>XML Export and Data Processing</i>	28
3.3 SOIL DATA.....	28
3.3.1 <i>Validated Soil Data</i>	30
3.3.2 <i>BioSoil / Soil Level 1 Plot Location</i>	32
3.3.3 <i>BioSoil / Soil Level 2 Plot Location</i>	35
3.3.4 <i>Completeness of Layer Data</i>	38
3.3.5 <i>Structure of Sample Layer Arrangement</i>	42
3.4 SOIL ORGANIC CARBON AT PLOT LOCATIONS	45
3.4.1 <i>Organic Carbon Content</i>	46
3.4.2 <i>Depth Limits</i>	57
3.4.3 <i>Bulk Density</i>	61
3.4.4 <i>Volume of Coarse Fragments</i>	74
3.4.5 <i>Soil Organic Carbon Quantity</i>	78
3.5 TEMPORAL CHANGES OF ORGANIC CARBON ON LEVEL 1/I PLOTS	84

Evaluation of BioSoil Demonstration Project - Soil Data Analysis

3.5.1	<i>FSCC – ICP Forests Survey Characteristics</i>	84
3.5.2	<i>Co-Location of FSCC – ICP Forests and BioSoil Survey Plots</i>	86
3.5.3	<i>Organic Carbon Content</i>	89
3.5.4	<i>Profile Depth</i>	92
3.5.5	<i>Organic Layer Weight and Bulk Density</i>	93
3.5.6	<i>Volume of Coarse Fragments</i>	95
3.5.7	<i>Organic Carbon Quantity</i>	96
3.6	CENTRAL LAB ANALYSIS	102
3.6.1	<i>Samples for Re-Analysis</i>	102
3.6.2	<i>Parameters</i>	103
3.6.3	<i>Re-Analysis of 1996 FSCC / ICP Forests Survey Data</i>	103
3.6.4	<i>Re-Analysis of BioSoil Survey Data</i>	108
3.6.5	<i>Comparison of C-Laboratory data for FSCC/ICP Forests and BioSoil Surveys</i>	112
3.6.6	<i>Interpretation of Results of the Central Laboratory Analysis</i>	115
3.7	PERFORMANCE OF WRB SOIL CLASSIFICATION SYSTEM.....	120
3.7.1	<i>Plots with Pedological Profile Description</i>	120
3.7.2	<i>Consistency of Soil Descriptions and Classification</i>	123
3.7.3	<i>Application of the Soil Description Standards</i>	124
3.7.4	<i>Identification of Diagnostic Horizons, Properties, Materials and Qualifiers</i>	127
3.7.5	<i>Evaluation of the Identification of the Diagnostics and Qualifiers for the 3 Most Frequent RSGs</i>	133
4	SUMMARY AND CONCLUSIONS	149

List of Figures

	Page
Figure 1: Coverage of NFCs Participating in BioSoil/Soil Project (Level 1 and Level 2).....	8
Figure 2: Provenance of Data Used in BioSoil/Soil Evaluation Task	12
Figure 3: Simplified Data Structure Diagram for BioSoil/Soil Data Model for Survey Data (as exported in XML file).....	20
Figure 4: Data Validation Phases.....	25
Figure 5: Sampling Year for BioSoil Level 1 Soil Condition Survey	29
Figure 6: Distribution of Assessment Data for BioSoil Level 1 Plots	30
Figure 7: Position of Level 1 Plots of BioSoil/Soil Survey	33
Figure 8: Shift of Plot Outside NFC Area (Level 1).....	35
Figure 9: Position of Level 2 Plots of BioSoil/Soil Survey	36
Figure 10: Schematized Arrangement of Soil Sample Layers.....	43
Figure 11: Distribution of Plots with Only Organic Layers, only Soil Material and Only Mineral Layers (BioSoil).....	47
Figure 12: Frequency Distribution of Organic Carbon Content in OF, OH and OFH Layers (Level 1).....	52
Figure 13: Spatial Distribution of Organic Carbon Content in Organic Layer of Plot (Level 1).....	54
Figure 14: Frequency Distribution of Organic Carbon Content in Soil Material (Level 1)	55
Figure 15: Spatial Distribution of Organic Carbon Content in Soil Material (0 – 20 cm) on Level 1 Plots.....	57
Figure 16: Frequency Distribution of the Height of the Organic Layer for Level 1 Layers and Plots	58
Figure 17: Spatial Distribution of Height of the Organic Layer on Level 1 Plots.....	59
Figure 18: Frequency Distribution of the Soil Layers for Level 1 Plots.....	60
Figure 19: Relationship between Mean and Estimated Bulk Density for Layers with Data for Both Parameters	63
Figure 20: Spatial Distribution of Bulk Density Values of the Organic Layer (Level 1)	65
Figure 21: Frequency Distribution of Reported and Derived Bulk Density in Organic Layer (Level 1)	66
Figure 22: Relationship between Reported Bulk Density (Measured and Estimated) and Bulk Density Computed from Organic Layer Weight and Layer Thickness (Level 1)	67
Figure 23: Difference between Bulk Density Computed from Organic Layer Weight and Layer Thickness and Reported Bulk Density (Measured and Estimated, Level 1).....	68

Figure 24: Absolute and Aggregated Difference between Bulk Density Computed from Organic Layer Weight and Layer Thickness and Reported Bulk Density (Measured and Estimated, Level 1)	69
Figure 25: Spatial Distribution of Bulk Density Derived from Organic Layer Weight and Height of the Organic Layer (Level 1).....	70
Figure 26: Frequency Distribution of Measured Bulk Density in Soil Material (Level 1)	72
Figure 27: Spatial Distribution of Bulk Density (Measured and Estimated) in the Soil Section 0-20 cm (Level 1).....	73
Figure 28: Spatial Distribution of Volume of Coarse Fragments in the Organic Layer (Level 1)	76
Figure 29: Frequency Distribution of Volume of Coarse Fragments in Soil Material (Level 1).....	77
Figure 30: Spatial Distribution of Volume of Coarse Fragments in the Soil Section 0-20 cm (Level 1)	78
Figure 31: Frequency Distribution of Organic Carbon in Organic Layer and in Soil Material 0-20cm (Level 1)	79
Figure 32: Organic Carbon Quantity in Organic Layer (Level 1)	80
Figure 33: Organic Carbon Stock in Soil Material 0-20 cm (Level 1)	81
Figure 34: Organic Carbon Quantity in Combined Organic Layer and Soil Material 0-20 cm (Level 1).....	83
Figure 35: Sampling Year for Forest Focus / ICP Forests Level I Soil Condition Survey.....	85
Figure 36: Number of Linked BioSoil and ICP Forests Plots with Increasing Distance in Geographic Position	87
Figure 37: Distance of BioSoil Plots from FSCC – ICP Forests Plots	88
Figure 38: Constant Shift in Plot Location in Baden-Württemberg and Lithuania from FSCC- ICP Forest to BioSoil Survey	89
Figure 39: Distribution of Level 1 Plots with Only Organic Layer and with Only Soil Material Data (FSCC - ICP Forests)	90
Figure 40: Change in Organic Carbon Content in Organic Layer and Soil Segment 0-20 cm from FSCC – ICP Forests Level I to BioSoil Survey	91
Figure 41: Change in Dry Weight of Organic Layer from FSCC- ICP Forests to BioSoil.....	93
Figure 42: Change in Bulk Density in Soil Material 0-20 cm Layer from FSCC- ICP Forests to BioSoil	94
Figure 43: Change in Volume of Coarse Fragments in Soil Material 0-20 cm Layer from FSCC- ICP Forests to BioSoil.....	96
Figure 44: Change in Organic Carbon Quantity in Organic Layer from FSCC- ICP Forests to BioSoil	98
Figure 45: Change in Organic Carbon Density in Soil Material 0-20 cm Layer from FSCC- ICP Forests to BioSoil	99

Figure 46: Change in Organic Carbon Density in Combined Organic and Soil Material 0-20 cm Layer from FSCC- ICP Forests to BioSoil	100
Figure 47: Geographic Distribution of Data from Central Lab Linked to FSCC / ICP Forests Survey Plots	104
Figure 48: Relationship between C-Laboratory and FSCC / ICP Forests Data for Organic Carbon Content.....	105
Figure 49: Frequency Distribution of Difference between FSCC/ ICP Forests 1996 Survey and Re-Analyzed Data from Central Laboratory for Organic Carbon Content in Soil 0 – 20 cm	106
Figure 50: Frequency Distribution of Difference between FSCC/ ICP Forests 1996 Survey and Re-Analyzed Data from Central Laboratory for Organic Carbon Content in Organic Layers	107
Figure 51: Geographic Distribution of Data from Central Lab Linked to BioSoil Survey Plots.....	108
Figure 52: Relationship between C-Laboratory and BioSoil Data for Organic Carbon Content.....	109
Figure 53: Frequency Distribution of Difference between BioSoil Survey and Re-Analyzed Data from Central Laboratory for Organic Carbon Content in Soil 0 – 20 cm.....	111
Figure 54: Frequency Distribution of Difference between BioSoil Survey and Re-Analyzed Data from Central Laboratory for Organic Carbon Content in Organic Layers	112
Figure 55: Relationship between OC Content for FSCC/ICP Forests and BioSoil as Reported by the Central Laboratory for Organic Carbon Content at Plot Level.....	113
Figure 56: Relationship between OC Content for FSCC/ICP Forests and BioSoil as Reported by the Central Laboratory for Organic Carbon Content of Corresponding Segments in Soil 0 – 20 cm	114
Figure 57: Distribution of Organic Carbon Content in Survey and Plots Re-Analyzed by Central Laboratory	118
Figure 58: Distribution of Observed WRB Reference Groups	122
Figure 59: Example Instruction for Horizon Depth Definition for the Field Description in the BioSoil Project (Mikkelsen et al., 2006).....	124
Figure 60: Most Frequently identified WRB Diagnostics in the BioSoil Database	132
Figure 61: Most Frequently Applied Qualifiers in the BioSoil Database.....	133
Figure 62: Frequency of the Number of Identification of Diagnostics for Cambisols	134
Figure 63: Frequency of Identified Diagnostic Horizons for Cambisols.....	135
Figure 64: Frequency of Identified Diagnostic Properties and Materials for Cambisols	135
Figure 65: Frequency of the Number of Qualifiers for Cambisol.....	136
Figure 66: Spatial Distribution of Cambisol Profiles.....	138
Figure 67: Frequency of Number of Identification of Diagnostics for Regosols	139

Figure 68: Frequency of All Diagnostic Horizons for Regosols.....	140
Figure 69: Frequency of All Diagnostic Properties and Materials for Regosols	140
Figure 70: Frequency of the Number of Applied Qualifiers for Regosols	141
Figure 71: Spatial Distribution of Regosol Profiles.....	142
Figure 72: Frequency of Number of Identification of Diagnostics for Podzols	143
Figure 73: Frequency of All Diagnostic Horizons for Podzols	144
Figure 74: Frequency of All Diagnostic Properties and Materials for Podzols	145
Figure 75: Frequency of Number of Qualifiers Applied for Podzols	145
Figure 76: Spatial Distribution of Podzol Profiles.....	147

List of Tables

	Page
Table 1: Summary of Documents Related to the Implementation of Sampling Forest Soil Condition Data	6
Table 2: Documents Providing Guidelines to Sampling Soil Condition under Forest Focus / ICP Forests and BioSoil.....	13
Table 3: Particular Data Problems in Files and Fields	18
Table 4: Incomplete Links between Key Fields	21
Table 5: Field Format Changes between Documentation and Data	23
Table 6: Missing Fields in XML File	24
Table 7: Level 1 Plots of the PLOT Table without Data in LAYER Table	31
Table 8: Number of Level 1 Plots Outside NFC Land Area	34
Table 9: Number of Level 2 Plots Outside NFC Land Area	37
Table 10: Validated Parameters for Level 1 Plots	38
Table 11: Validated Parameters for Level 2 Plots	40
Table 12: Example of Confounded Assignment of Depth Limits to Soil Layers.....	44
Table 13: Availability of Level 1 Plots for Computing Organic Carbon Content for Organic Layers.....	46
Table 14: Plots with Data Missing for Computing Organic Carbon Density	48
Table 15: Example of Duplicated Section Data.....	50
Table 16: Minimum and Maximum Organic Carbon Content in Individual Organic Layer (Level 1)	53
Table 17: Minimum and Maximum Organic Carbon Content in Soil Material (Level 1)	56
Table 18: Methods for Measuring or Estimating Bulk Density and Examples of Content of Comments.....	62
Table 19: Minimum and Maximum Bulk Density of Organic Layer (Level 1)	64
Table 20: Minimum and Maximum Bulk Density in Soil Material Layers (Level 1)	71
Table 21: Methods for Measuring Coarse Fragments and Examples of Content of Comments.....	74
Table 22: Samples and Sample Rates for Central Lab Re-Analysis.....	102
Table 23: Descriptive Statistics for Organic Carbon Content by Plot.....	116
Table 24: Significant Differences in the Means of FSCC / ICP Forests and BioSoil Survey and Central Laboratory Data.....	117
Table 25: Number and Percentage of Profiles Used for the Evaluation for each WRB Reference Soil Group	121
Table 26: Performance in Identification of Genetic Horizons and Moist and Wet Colours of Soil Horizons	126

Table 27: Frequency of Identification of Diagnostics in the Profiles by Country.....	129
Table 28: Frequency of Identification of Diagnostics for WRB RSGs	130
Table 29: Frequency and Percentage of Missing Data (No Data) for Selected Attributes	131
Table 30: 9 Most Frequently Applied Diagnostics for Cambisols	134
Table 31: Most Frequently Used Qualifiers for Cambisols.....	137
Table 32: Most Frequently Applied Diagnostics for Regosols	139
Table 33: Most Frequently Applied Qualifiers for the Regosols.....	141
Table 34: Most Frequently Identified Diagnostics for Podzols.....	144
Table 35: Most Frequently Used Qualifiers for Podzols	146

List of Acronyms

ACRONYM	TEXT
ASCII	American Standard Code for Information Interchange
BD	Bulk density
CLRTAP	Convention on Long-range Transboundary Air Pollution
CSV	Comma-separated values
CV	Coefficient of Variation
DAR	Data accompanying report
DG AGRI	Directorate General Agriculture
DG ENV	Directorate General Environment
FAO	United Nations Food and Agricultural organization
FFMDb	Forest Focus Monitoring Database
FIMCI	Forest Intensive Monitoring Coordinating Institute
FSCC	Forest Soil Co-ordinating Centre
FSEP	Forest Soil Expert Panel
ICP Forests	International Cooperative Programme on the Assessment and Monitoring of Air Pollution Effects on Forests
IFN	Inventaire forestier national
INBO	Instituut voor Natuur- en Bosonderzoek / Research Institute for Nature and Forest of the Flemish Government in Belgium
INRA	Institute national de la recherche agronomique
IPCC	Intergovernmental Panel on Climate Change
JRC	European Commission Joint Research Centre
MCF	Mass of coarse fragments
NA	Not available (data value)
NFC	National Focal Centre
NUTS	Nomenclature des Units Territoriales Statistiques
OC	Organic carbon
OJ	Official Journal of the European Commission
OLW	Dry weight of organic layer
QA	Quality Assurance
RSG	WRB reference soil groups
SOC	Soil organic carbon
SD	Standard deviation
SE	Standard error
SGDBE	Soil Geographic Database of Eurasia
SOC	Soil Organic Carbon

ACRONYM	TEXT
SPADE/M	Soil Profile Analytical Database of Europe, Measured profiles
UN/ECE	United Nations Economic Commission for Europe
VCF	Volume of coarse fragments
WRB	World Reference Base for soil resources
XML	Extensible Markup Language

1 INTRODUCTION

The BioSoil demonstration project is one of the studies initiated in response to the stipulations of Article 6 of *Regulation (EC) No. 2152/2003* (Forest Focus)¹ to develop the monitoring scheme by means of studies, experiments, demonstration projects, testing on a pilot basis and establishment of new monitoring activities. BioSoil was undertaken as part of an Administrative Arrangement of the European Commission Joint Research Centre (JRC) and Directorate General Environment (DG ENV). The aim of the BioSoil project is to demonstrate how a large-scale European study can provide harmonised soil and biodiversity data and contribute to research and forest related policies. It directly supports achieving the objectives of the monitoring scheme of assessing “*the requirements for and develop the monitoring of soils, carbon sequestration, climate change effects and biodiversity, as well as protective functions of forests*” (Forest Focus, Article 1(1)b).

First ideas leading to the project were initially suggested by experts from several EU Member States. Details on the scientific and technical aspects were finalized during the 1st meeting of the BioSoil expert group held at the JRC, Ispra on 13.-14. December, 2004 (FSCC, 2004). The results of the expert meeting were discussed at the level of the Standing Forestry Committee on 22. December, 2004. The demonstration project started in November 2006 for the duration of 3 years. The first 2 years were allocated to conducting the ground survey and laboratory analysis and the last year specifically for data validation and system management. However, soil data were sampled an many plots in 2006.

The demonstration project comprises two main modules:

- a) Soil Module;
- b) Biodiversity Module.

Both modules use a common site for sampling data. The locations of the sites should make use of the existing network of sites for monitoring the forest environment under Forest Focus / ICP Forests.

1.1 Soil Module

The specific objectives of the Soil Module of the BioSoil demonstration project were defined at several stages during the preparation of the project². For the evaluation task

¹ OJ L 324, 11.12.2003, p. 1-8

² a) Service Contract Tender Specification (2006/ S 51-052820 of 15/03/2006)

b) Report from the first meeting of the JRC “BioSoil” expert group, Ispra, 13-14.12.2004.

Note: several versions of the meeting document have been circulated.

the relevant objectives of the project have been grouped according to two main aspects as:

A. Analysis of Data

1. To assess the continuity of selected constant parameters (soil and site) between data from the previous soil survey and BioSoil data.
2. To determine temporal change for soil organic carbon content and density between data from the previous soil survey data to BioSoil data.
3. To assess the spatial variability of soil organic carbon at country level.
4. To analyse consistency of results between laboratories from the re-analysis of the central laboratory.
5. To appraise the performance of the WRB classification for sampling pedological horizons.

B. Analysis of Procedures

6. To comment on the QA procedures and parameters used during data validation.
7. To review the methodologies specified in the Manual on soil sampling.

For soil data the evaluation concentrates on measurements related to organic carbon and the assessment of temporal and spatial variability of organic carbon in forest soils. Other parameters are included in the evaluation, but on a selective basis.

1.2 Biodiversity Module

The BioSoil demonstration project was taken as an opportunity to assess and demonstrate the efficacy of the systematic Level 1 network of sample plots, as a representative tool of European forests, in order to address other issues of relevance to European forestry, such as forest biodiversity, with the addition of a few assessment variables. The approach to the forest biodiversity component of BioSoil was devised following a meeting of biodiversity experts from 16 Member States in co-operation with the JRC. The goal of BioSoil/Biodiversity is to provide data to support policy, international and national, on forest biodiversity.

1.3 Scope of Data Analysis

A summary of the first results of the preliminary data evaluation were presented to the public during the BioSoil Conference held in Brussels on 09. November, 2009 ³. Preliminary results on the evaluation of the demonstration project on sampled soil and biodiversity data were presented at the end of the project period (Hiederer & Durrant, 2010). In the assessment of the findings it should be considered that the evaluation was limited to the data available as of 30. September, 2009. For the data on biodiversity some amendments sent at later dates could be included in the analysis, although at this stage it was mainly limited to summary statistics.

This reports expands on the analysis of the soil data by including all validated project data submitted by NFCs and by also investigating data from the central laboratory on re-analysed samples. The evaluation includes all re-submitted and fully validated data as of 04. January, 2010. No data were added or modified after this date and the database constitutes the final version of all BioSoil project data. Results of the analysis of the BioSoil biodiversity data are presented in a separate document.

³ http://ec.europa.eu/environment/forests/ffocus_noticeboard.htm

2 PROJECT ORGANIZATION

The preparatory project phase involved a substantial number of national and international organizations (FCSS for ICP Forests Manual). The main partners of the implementation phase were the *National Focus Centres* (NFCs), the *European Commission Joint Research Centre* (JRC) and the service contractor.

2.1 Legal Framework

The BioSoil Demonstration Project is part of the schemes for protecting forests against atmospheric pollution and for monitoring the forest environment. The activities under the schemes can be divided in a period before and after 2003, when Forest Focus came into force. Provisions for the monitoring activities are made by European regulations detailing the procedures. The realization of the scheme is defined by regulations on the implementation. Technical details are specified in survey manuals. The BioSoil project is closely linked to the Soil Condition survey of Forest Focus and the survey of ICP Forests on Level I plots in 1996. As part of the demonstration project BioSoil produced a specific survey manual on field sampling, analyses methods and data management, which closely follows Sub-Manual IIIa V2006 of ICP Forests. In the interest of advancing the monitoring activity the manual deviates in some aspects considerably from the Forest Focus specifications.

The foundations for the surveys on monitoring soil conditions on Level 1 and Level 2 plots are laid down by two main regulations:

- Council Regulation (EEC) No 3528/86 of 17 November 1986 on the protection of the Community's forests against atmospheric pollution⁴
- Regulation (EC) No 2152/2003 of the European Parliament and of the Council of 17 November 2003 concerning monitoring of forests and environmental interactions in the Community (Forest Focus)⁵

These regulations are complemented by several additional regulations laying down rules for their implementation and specifying the sampling procedures.

A summary of the documents pertaining to the implementation of the sampling of soil conditions is given in Table 1.

⁴ Official Journal L 326 , 21/11/1986 P. 0002 - 0004

⁵ Official Journal L 324 , 11/12/2003 P. 0001 - 0008

Table 1: Summary of Documents Related to the Implementation of Sampling Forest Soil Condition Data

Item	Monitoring		
Period	1986-2002	2003-2006	
Programme	Protection of the Community's Forests against Atmospheric Pollution	Forest Focus	
Regulation	(EEC) No 3528/86	(EC) No 2152/2003	
Implementation	(EEC) No 1696/87 (EC) No 804/94 (EC) No 1091/94	(EC) No 1737/2006	
Survey	Soil Condition	Soil Condition	BioSoil

Council Regulation (EEC) No. 3528/86 formed the basis for assessing and monitoring the effects of air pollution on forests. The monitoring scheme itself dates back to the *International Co-operative Programme on Assessment and Monitoring of Air Pollution Effects on Forests* (ICP Forests) of the *UN/ECE Convention on Long-range Transboundary Air Pollution* (CLRTAP).

Council Regulation (EEC) No. 3528/86 together with *Commission Regulation (EEC) No. 1696/87*⁶ and *Commission Regulation (EEC) No. 1091/94*⁷ define the arrangement of the monitoring activity, but specify in the implementation rules the procedures to be applied for field sampling. These specifications of procedures were modelled after the ICP Forests Manual for sampling data. They were subsequently used for the sampling, measurement and reporting rules applied to Forest Focus.

Regulation n.(EC) No. 2152/2003 or Forest Focus provided the legal framework for the continuation of the monitoring activity until 2006. Specific rules for the implementation of Forest Focus are laid down in *Commission Regulation (EC) No 1737/2006 of 7 November 2006 laying down detailed rules for the implementation of Regulation (EC) No 2152/2003 of the European Parliament and of the Council concerning monitoring of forests and environmental interactions in the Community*. The BioSoil Demonstration Project follows the provisions made under Article 6 of Forest Focus as part of developing the scheme.

According to Article 10 of Forest Focus further specifications on parameters to be collected, methods of sampling and analysis and data transmission are to be defined in monitoring manuals. Under paragraph 15 of Forest Focus the objective of establishing a data platform containing spatial data is stipulated. The Forest Focus Monitoring database includes also all Level 1 and Level 2 data from all previous monitoring campaigns, notably the data from the intensive monitoring sites formerly managed by

⁶ OJ L 161, 22.06.1987, p.1-22

⁷ OJ L 125, 18.05.1994, p1-44

the *Forest Intensive Monitoring Coordinating Institute* (FIMCI) under contract from DG AGRI and Level 1 Soil Condition data from the 1994/95 campaign which were managed by the *Forest Soil Co-ordinating Centre* (FSCC). The FSCC is hosted by the *Research Institute for Nature and Forest* (INBO), Belgium⁸.

With the legal framework the organizations responsible for managing the data changed. Those administrative alterations impacted on the communication with NFCs, the range of data reported, the validation procedures applied and the storage arrangements of the database.

2.2 Project Participants

The management of BioSoil / Soil data was distributed between three main participants in the project:

- National Focal Centres
- European Commission Joint Research Centre
- Service Contractor

Within the project the participants had distinctly different tasks to perform.

2.2.1 Participating National Focal Centres

In a deviation from the reporting arrangements used in the Forest Focus monitoring activity Germany authorized NFCs by Länder instead of a central NFC managing the data. Of the 15 German Länder 10 participated in the project. For Belgium, which also submits data by region, only Flanders participated. For Portugal only the mainland provided data, while the Azores did not participate. No data were provided by The Netherlands.

NFCs were responsible for the field survey, assembling the data from all sites belonging to the responsibility of the NFC and transmitting the data according to the data format specifications to the JRC. BioSoil/Soil data on Level 1 sites were submitted by a total of 31 NFCs via a Web-application. Data for Level 2 sites were submitted by 22 NFCs. In total data were submitted by 32 NFCs, with Greece only submitting data for Level 2 sites.

The coverage for soil data of the participating NFCs is given in Figure 1.

⁸ http://www.inbo.be/content/page.asp?pid=EN_MON_forest_soils

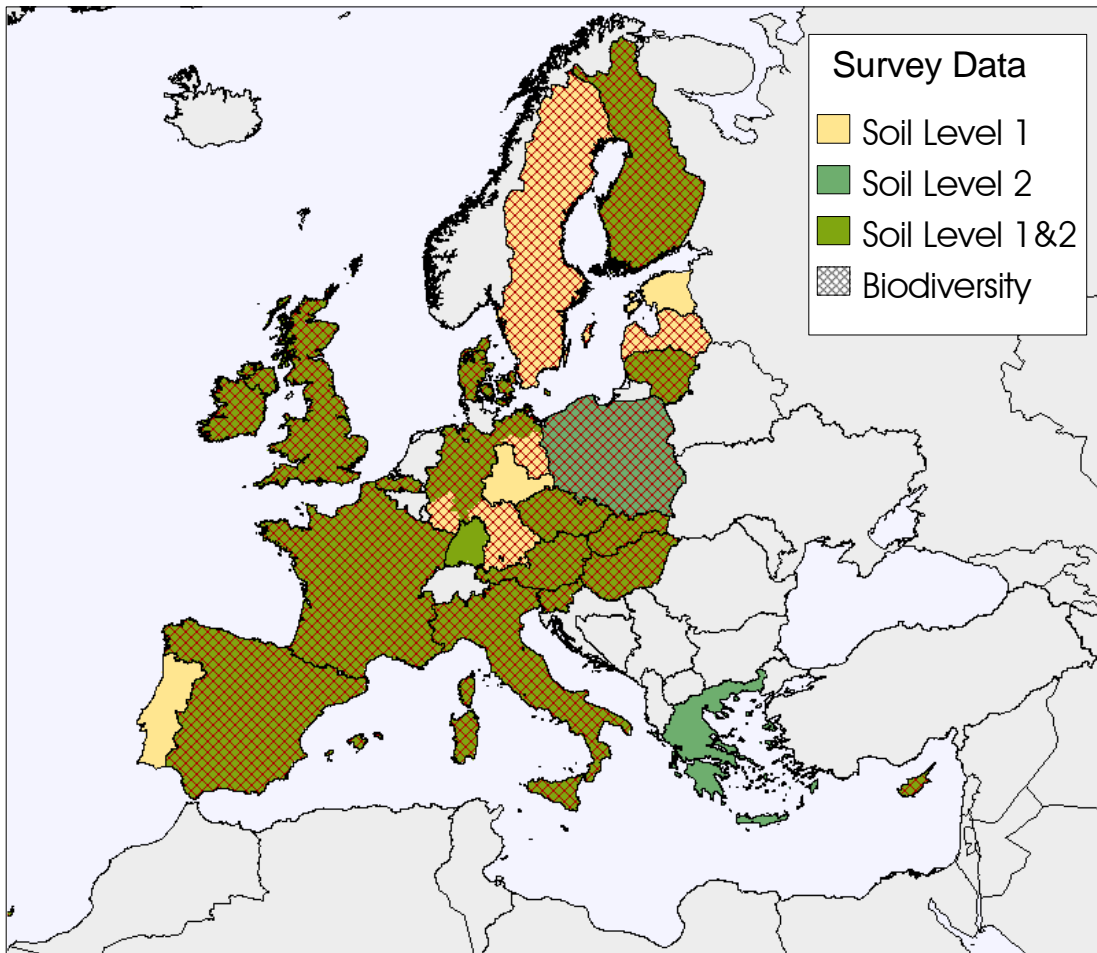

Figure 1: Coverage of NFCs Participating in BioSoil/Soil Project (Level 1 and Level 2)

The map shows the participating NFCs for the soil survey on only Level 1 and only Level 2 plots as well as NFCs where soil surveys were performed on both sample plots. Shown are also NFCs which participated in the Biodiversity survey. Data on biodiversity were generally submitted by NFCs sampling soil data, excluding Portugal, Greece, Estonia and Germany (Saxony). Some of the participating countries assessed fewer of their BioSoil plots for biodiversity, resulting in an overall lower number of points assessed than for the soils data.

2.2.2 European Commission Joint Research Centre

The role of the JRC was to ensure that suitable specifications were compiled for field and laboratory methods, to specify the database system components and validation procedure and to manage the service contract and the overall management of the

project. The JRC was also the interface for communications with the NFCs for any technical questions arising from the BioSoil activity, in particular for data submission issues and queries of data quality.

The procedure for the Biodiversity module was different from that used for the soil module and data were submitted directly to the JRC by e-mail. Because of the relative simplicity of the data (no laboratory analysis required) the entire module was managed within the JRC whose role in this case also included database design, data management and validation in addition to the project management.

2.2.3 Service Contractor

For the development of the data management system and the implementation of the validation procedure a call for tender for a service contract was issued by JRC⁹. The service contract “*Service provision for Technical support in the BioSoil study, provision of central laboratory services for soils analysis and data management 2006 – 2008 in the framework of the Forest Focus regulation EEC 2152/2003*” was awarded to a consortium consisting of the *Institute national de la recherche agronomique* (INRA) and *Inventaire forestier national* (IFN).

2.2.4 Analysis of Procedures for Soil Data

The evaluation of procedures implemented within the project concentrates on aspects related to assuring data quality. An evaluation of management procedures is covered in the final project report. The two main areas of procedures concerned with data quality are the specifications provided in the sampling manual (*a priori* provisions for data control) and the validation of the data submitted by NFCs (*a posteriori* procedures for quality assurance).

⁹ Call for tender: 2006/ S 51-052820 of 15/03/2006, Contract n°382419 F1SC

3 ANALYSIS OF BIOSOIL / SOIL DATA

The procedure adopted for sampling soil data under BioSoil largely followed the methodology adopted to sample soil condition data under Forest Focus and ICP Forests. The monitoring scheme uses two distinctly different networks of site locations:

- **Level I:** network of sites for systematic forest condition monitoring
- **Level II:** sites for intensive forest condition monitoring

The sites, their geographic distribution and the data collected serve very different purposes. Level I sites are arranged in a regular grid of 16km x 16km with some exceptions for areas in Scandinavia. Their purpose was to serve as the basis of a statistical analysis of the extent of damage to forests from atmospheric pollution. On Level I sites monitoring on an annual basis is restricted to the Crown Condition survey.

Level II sites are intended for intensive monitoring of environmental conditions and their effects on the state of the forest ecosystem. They are selectively positioned and data are not immediately suited to provide statistics on forest conditions. However, at Level II sites data from up to 12 surveys are collected to study the interactions between environmental parameters and the state of the forest.

To distinguish between the sites used for long-term forest monitoring and those used by BioSoil the Forest Focus / ICP Forests networks are designated by capital Roman numerals (Level I, Level II), while for the BioSoil sites Arabic numerals are used (Level 1, Level 2). For Level 2 / II sites, where long-term monitoring of the forest ecosystem is conducted, no changes in the geographic position between the two monitoring schemes should have occurred. However, for some plots of the large-scale network of Level 1 / I plots the sites visited have been changed from previous surveys. Because the results from the previous Soil Condition survey performed on Level I and II plots can only be linked to the BioSoil data by the plot coordinates such a distinction is important.

3.1 Forest Soil Condition Surveys

Data used in the evaluation originate from various sources. An overview of the data by provenance is presented in Figure 2.

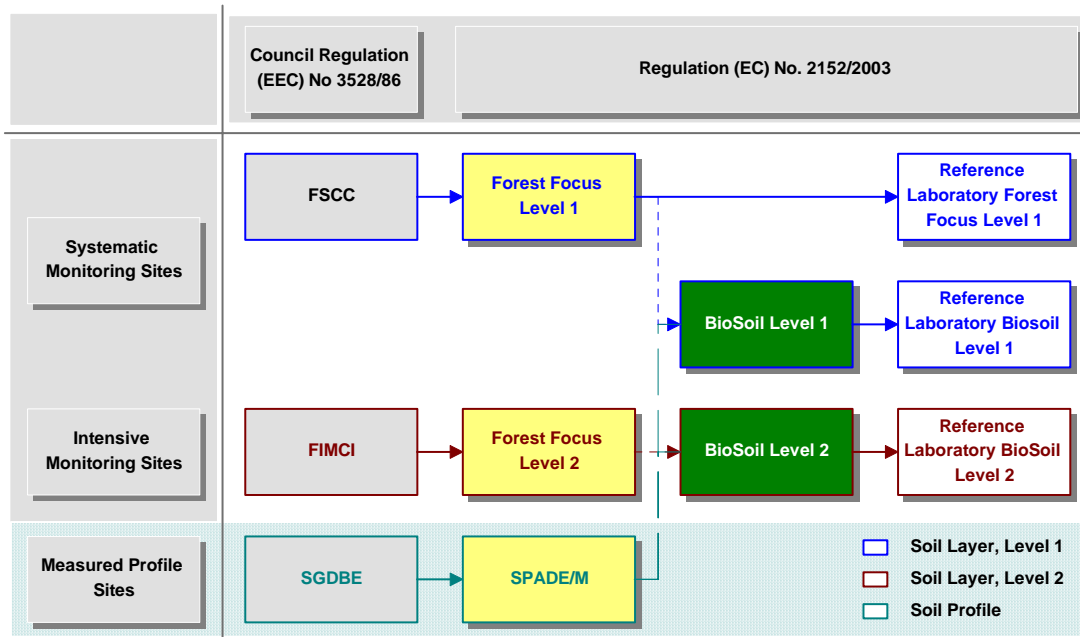

Figure 2: Provenance of Data Used in BioSoil/Soil Evaluation Task

With respect to the sources of the data one can distinguish between the legal framework, the distribution of the sample sites and the type of activity.

3.1.1 Manual on Soil Sampling

The specifications for sampling data under the BioSoil project by fixed depth in the soil material are based on Sub-Manual IIIa and Annex of the ICP Forests in version 06/2006. The document went through several draft versions and is based on guidelines on the implementation of the survey since 1993. A summary of documents related to sampling data for the Forest Focus / ICP Forests Soil Condition survey and the BioSoil survey is given in Table 2.

Table 2: Documents Providing Guidelines to Sampling Soil Condition under Forest Focus / ICP Forests and BioSoil

Survey	Forest Focus / ICP Forests		Forest Focus – BioSoil
	Level I & II	Level II	Level 1 and Level 2
Manual	(EEC) No. 926/93	Sub-Manual IIIa, V.06/2003	Sub-Manual IIIa, updated V.06/2006
	(EEC) No. 1091/94		BioSoil adaptation
Forms	PLS	PLS	PLS
	SOM	SOM	SOM
	SOO	SOO	SOO
			PFH
			PRF
Period	1996 - 2002	2003 – 2006 (incl.)	2006 - ...

Up to 2002 sampling data for the ICP – Forests Soil Condition survey was performed mainly according to the regulations of the implementation of the monitoring scheme and unspecified versions of Sub-Manual IIIa. These procedures were applied to the previous survey on Level I plots and surveys performed on Level II plots until 2002. For the duration of Forest Focus (2003 – 2006) no data on soil conditions were collected on Level I plots, but on some cases on Level II plots. The provisions made were published in the ICP Forests Sub-Manual IIIa, V. 06/2003. Version 06/2006 of the Sub-Manual was applied to sampling on Level I and Level II plots from 2007 onwards. This version of the sub-Manual was not applied on Forest Focus / ICP Forests Level I or Level II plots for the monitoring period of 2006. However, the BioSoil project used a modified version of the sub-Manual to sample soil condition parameters on Level 1 and Level 2 plots in 2006.

The provisions made in the Sub-Manual have to be considered in the definitions of the format for submitting the information. The data collected were arranged according to the formats given in 3 tables PLS, SOM and SOO for information on the plot, mandatory measurements and optional measurements. The formats of the forms changed over time and also the parameters to be reported. For reporting data under BioSoil amendments were made to accommodate data from the pedological horizon, which are not assessed in the Soil Condition surveys of Forest Focus / ICP Forests. Modifications were also made to the dictionary tables, for example adding country codes for the German Länder. Under BioSoil the German Länder were set up as NFCs, while under Forest Focus / ICP Forests Germany reported under a single NFC.

Apart from the changes in reporting the results of the survey there are inconsistencies between the Sub-Manual and the specifications for the formats of the submission files. The evaluation of the soil data identified:

- File Format specifications: Reference is made to the "mineral layer" instead of the "soil material".
- SOM format specifications, Organic Carbon (Table 4.22): For mineral layers >20cm the parameter is optional for Level 1 sites, but mandatory for Level 2 sites (specifications reversed).
- Layer depth in soil material should be either *M05* and *M51* or *M01* for all plots.
- Separation of organic layer from organic soil is not covered by file format specifications.
- Treat saturation status should be treated as an attribute to a section of the soil material, i.e. remove separate coding for layers (*H*, *M*)
- Either bulk density and the height of the organic layer(s) or the dry weight of the organic layer(s) and the height.
- Field `MEAN_BULK_DENSITY` for Level 1 plots hold measured values. It should separate between the mean from several estimates and from one or several measured values.
- Sampling the mass of coarse fragments is reported, but not specified in the Sub-Manual.
- Values for layer depth should be added to the Sub-Manual provisions for organic layers.
- Layer depth should not be recorded separately for the soil material unless depth is made an attribute of the segment sampled.

The separation between mandatory and optional parameters should be removed, in particular the dependence to previous surveys. With a sampling frequency of 10 years and variations in sample conditions all parameters should be re-assessed. The depth limit in the soil material should be extended to include a limit of 30 cm. This depth is widely used to characterize the topsoil conditions. To assess changes in soil conditions it is not sufficient to focus only on the uppermost 20 cm. This would allow analyzing the vertical movement of soil parameters from and to the subsoil.

However, the main element introducing uncertainty into the sample data is the separation of the organic layer from the soil material. The guidelines given are ambiguous and the description referring to organic horizons, layers and soil confusing. Soil material is at times referred to as mineral soils or the mineral layer. As the evaluation of the OC content data shows a re-classification of layers leads to considerable changes in the data reported. A simplified and coherent description of the method to be applied to separate the organic layer from the soil material would reduce

the spatial and temporal variation caused by different interpretations of the sampling method to be used.

3.1.2 BioSoil / Soil Project Data

The data generated by the BioSoil/Soil project are:

- a) Quantitative information from observations and measurements
 - from BioSoil/Soil Level 1 sample sites analyzed by national laboratories;
 - from BioSoil/Soil Level 2 sample sites analyzed by national laboratories;
 - from BioSoil/Soil Level 1 sample sites analyzed by reference laboratories;
 - from ICP Forests Level I sample sites analyzed by reference laboratories.
- b) Qualitative information on site, sampling and laboratory procedures.

The quantitative information surveyed at the sample sites forms the main component of the data collection task. All procedures and methods to be applied to the quantitative data are described in detail in the BioSoil/Soil field manual. The data are further subjected to the quality control of the data validation phase.

Having comparable data available from a soil survey conducted 10 years previously should allow estimating the consistency by comparing invariable parameters and appraising temporal changes for variable soil parameters. The results of the re-analysis of part of the data by a reference laboratory using standard methods for all samples should provide an assessment of the spatial variations introduced by variations in the analysis methods.

The qualitative information on sites and methods is reported in form of *Data Accompanying Reports* (DARs). The formal demands for the DARs are limited and free-format text files were accepted. The additional information provided in the DARs were intended to aid the validation process by highlighting site-specific conditions and exceptional circumstances, which were of influence on measuring or reporting the quantitative data and could not be recorded in the forms used to report the quantitative data.

3.1.3 Sampling by Layers and Pedological Horizons

Historic Level I and Level II data originate from surveys performed according to specifications of the ICP Forests Manual (ICP Forests, 2010) or the specifications provided by the Regulations defining the implementation rules for the monitoring activity. These specifications and rules vary over time. The variations in the rules have a

direct effect on the data collected, the measurement method applied and the arrangements for reporting observations and measurements. As a consequence, the modifications can potentially lead to intrinsic differences when comparing data from the previous Soil Condition surveys performed on Level 1 and Level 2 sites with those from the BioSoil project.

A completely independent set of soil profile data was given by the *Soil Profile Analytical Database for Europe of Measured Data* (SPADE/M) (Hiederer, *et al.*, 2006). The database forms part of the *Soil Geographic Database for Eurasia* (SGDBE) and contains quantitative descriptions of profiles. The main criterion for selecting the sample sites of the profiles was to cover typical conditions for soil types to support defining pedo-transfer rules when estimating soil properties.

Data from the BioSoil project were collected according to an amended version of the ICP Forests Sub-Manual IIIa (EC, 2007). The procedures specified therein were applicable to sampling data under the Soil Condition survey after 2006. Soil data sampled under the Forest Focus monitoring activity were thus not intended to be sampled according to the Sub-Manual IIIa of 2006, but following the specifications of version 6/2003. The procedures applied before 2003 were specified in an unmarked version of Sub-Manual IIIa. The sampling, measuring and reporting rules for the previous Level I Soil Condition survey of 1994/95 seems to have been performed on the basis of *Commission Regulation (EEC) No. 926/93*, Article Ia of Annex II and *Commission Regulation (EEC) No. 1091/94* Annex IV. Though confusing, in practical terms the issue of what version of Sub-Manual IIIa has been used to sample data in 2006 under BioSoil and Forest Focus is not relevant because no data have been submitted for Soil Condition under Forest Focus.

3.2 Data and Database

Several files are submitted by the participating countries to the project using a Web-Interface. The data from the submitted files are examined and parsed from the ASCII format to the data-specific storage formats.

3.2.1 Files Submitted

The data on the soil survey are separated into five files, four submitted by NFCs and one only by the Central Laboratory:

- **PLS**

The file contains the description of the plot. Data are stored in the PLOT table.

- **SOM**

The file contains the analysis of the samples surveyed by fixed layer depth. Results of the SOM file are stored in the LAYER_ANALYSIS_RESULT and HORIZON_ANALYSIS_RESULT tables, although some data are also found in the reference files LAYER and HORIZON.

- **PFH**

The equivalent of the SOM file for data surveyed by pedological horizon. The data are also distributed between the reference and results table. The field CODE_POROSITY is recorded in the HORIZON table, while the values for POROSITY are stored in the HORIZON_ANALYSIS_RESULT table.

- **PRF**

The file contains the data from the soil profile description. The format is hard-wired for reporting up to 6 WRB qualifiers and specifiers and 10 diagnostic horizons.

- **CLL**

Data from the central laboratory is stored in the CLL file. Similarly to the data from the national laboratories the information from this file is separated and stored in the CLAB_LAYER and the CLAB_LAYER_ANALYSIS_RESULT tables. In a deviation from the former data all results are stored in the results file.

3.2.2 Data Formats

In a change from Forest Focus data under BioSoil are submitted not following a fixed format, but as comma-separated values (CSV). New specifications for the arrangement of the data within the forms were therefore prepared for the project. The documents detailing the structure of the data and formats were available from the project site for each of the forms (EC BioSoil, 2007).

The data types used in the forms are:

- **Integer**

Values without decimal point, no distinction between short or long integer formats.

- **Numeric**

Data of type float with decimal values.

- **String**

Alpha-numeric format for codes, strings and coordinate data.

- **Date**

Format for recording calendar dates.

When importing data from the CSV file the values are not necessarily read according to the format specifications. The procedure generally involves a parser, which translates the delimited ASCII values into a specified field type. This practice is needed to ensure that values not conforming to the field type do not enter the database. Such a condition is almost unavoidable when following the format guidelines of the BioSoil Manual. For example, the guidelines state that a condition where a value is below the detection limit of the instrument it should be coded as “<0”. Also the code “NA” can be used in numeric fields. These specifications necessitate the field values to be read as alpha-numeric and then translated into a numeric value.

A comma-separated format can also cause problems when the field separator is also used as a decimal separator, as is the case in some European countries, such as Germany or Austria, or when descriptive text contains a comma. The example in the file documentation gives a semicolon (;) as a separator instead of a comma. Commas in descriptive text could be identified by using double quotes (") around string values. The instructions and the interpretation of the values are not consistent in dealing with the data. At times codes stored internally as characters are not requested to be recorded in double quotes (example: CODE_COUNTRY), although alpha-numeric codes are (example: LAYER_LABORATORY_CODE). The values for CODE_COUNTRY could be stored as integers, but because the leading 0 is included in the code the values have to be stored a string type. This storage type is not generally applicable to other coded parameters, e.g. to record the altitude of the plot (CODE_ELEVATION).

In the database tables some inconsistencies between expected and actual field entries were encountered. The situations where such inconsistencies were found are summarized in Table 3.

Table 3: Particular Data Problems in Files and Fields

Level	Table	Field	Comment
1 & 2	DAR_VARIABLES	LABORATORY_CODE	For SUBMISSION_ID 659 field contains non-ASCII characters for code
1 & 2	PLOT, HORIZON, LAYER	OBSERVATIONS	Numerous entries with double quotes (") or non-ASCII characters

Entries of non-ASCII codes in a field may occur when the field is of type string and allows free entries. The presence of non-ASCII characters can result in incomplete links between fields when relating data tables. Double quotes in comment fields or just entries of double quotes can occur when free-form string is already surrounded by quotes to define an entry as a string and those quotes are not removed. In the database they were only found for the fields [COMMENT] or [OBSERVATIONS] and should not affect using the data. The table contains only those situations which came to light

during the evaluation. A comprehensive analysis of all field entries was not performed since this was one of the objectives of the project validation task.

3.2.3 Data Model

The data model of the BioSoil/Soil database should be compatible with the data models of the Level 1 and Level 2 Soil Condition surveys of the Forest Focus Monitoring Database and the profile database of SPADE/M. The model actually implemented to store the BioSoil/Soil data differs significantly from the former two databases. A schematic model of the main tables of the BioSoil/soil database is presented in Figure 3.

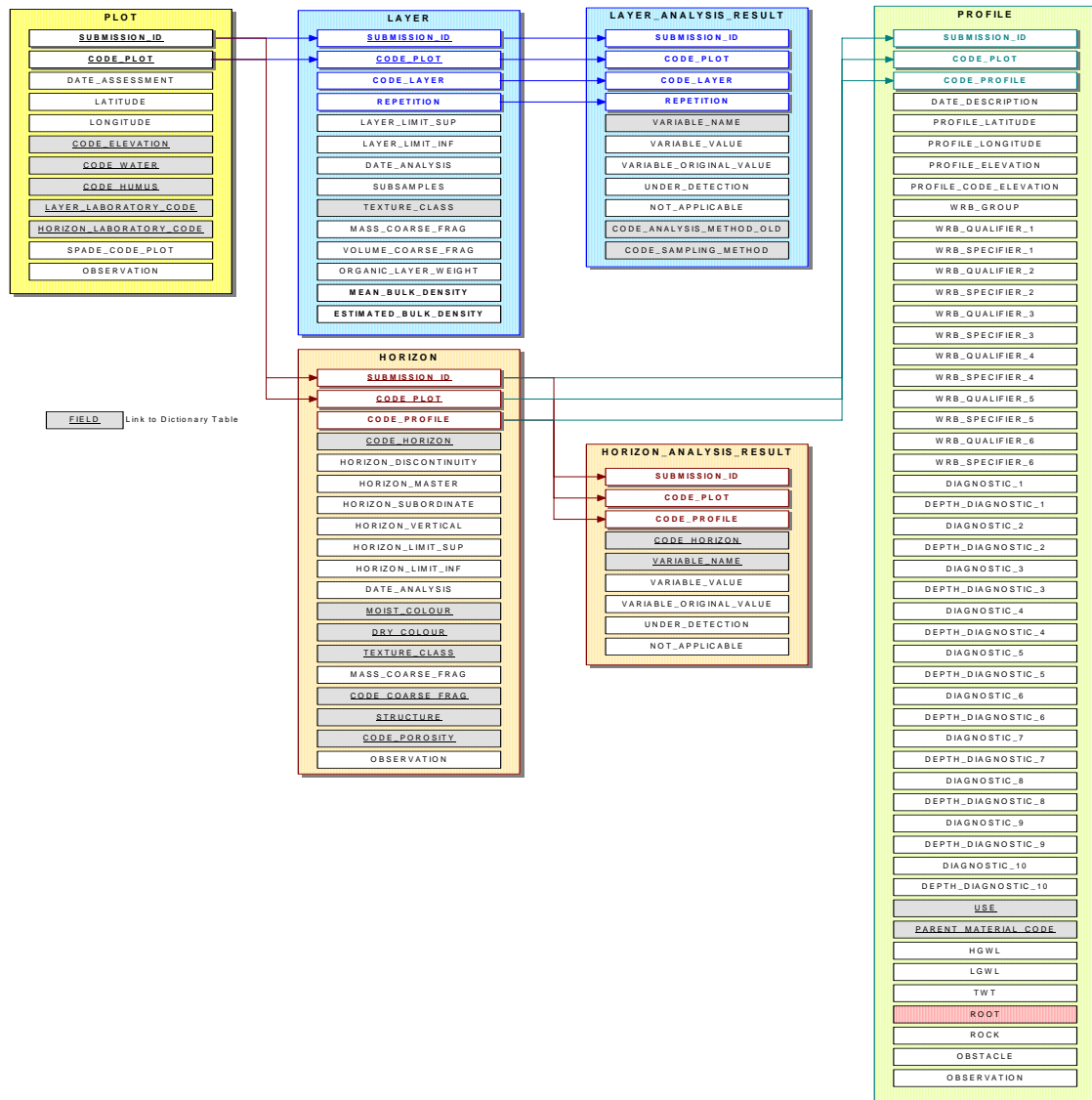

Figure 3: Simplified Data Structure Diagram for BioSoil/Soil Data Model for Survey Data (as exported in XML file)

The diagram shows the arrangement of data tables for the principal element of the database, the storage model for the surveyed data. Common information on the sample site (plot) is stored in a single table. Observations and measurements are separated into those related to sampling layers of fixed depth and pedological horizons. For each survey type the numeric data are stored in a single data (LAYER_ANALYSIS_RESULTS and HORIZON_ANALYSIS-RESULTS}. The separation of the reference unit (layer or horizon) and the observed or measured data has been documented, but is not followed consistently in the implementation. The tables HORIZON and LAYER both contain also measured or observed data (MOIST_COLOUR, DRY_COLOUR, TEXTURE_CLASS, MASS_COARSE_FRAG,

CODE_COARSE_FRAG, STRUCTURE, CODE_POROSITY). Since the data are pertinent to the depth section surveyed it is not immediately evident why the data are stored in the LAYER table rather than the result tables.

Not all links between the tables are complete. The situations found in the course of the evaluation are summarized in Table 4.

Table 4: Incomplete Links between Key Fields

Level	Table Parent.Child	Key Field Name(s)	Comment
1	SUBMISSION.PLOT	SUBMISSION	Plot Code 659 missing.
1	PLOT.LAYER	CODE_LAYER	No data for 8 plots (943_1511, 943_1576, 943_1809, 1064_526, 1091_1130, 1213_1540, 1213_1714, 1214_103).
	LAYER. LAYER_ANALYSIS	SUBMISSION, CODE_PLOT, CODE_LAYER, REPETITION	All fields with entry.

For 1 submission in the SUBMISSION table for Poland no data are recorded in the PLOT table, because a previous submission has been withdrawn. The conditions leading to the absence of an entry in the CODE_LAYER field for those plots were given as comments. In the majority of cases the plots were not on forest land (see Table 7 for details).

The database was not systematically tested for data integrity¹⁰. Only for the parameters analyzed was the existence of codes used in a data table related to the dictionary table. An incomplete link between tables only concerns the index field(s) and not the availability of data other than those fields. The checks performed concentrated on verifying the parameter values. Not generally evaluated was further the degree of normalization of the BioSoil data tables and the model. Ambiguity in links and duplication of information were assessed only as needed.

Different data models for storing soil profile data are used by other databases. Most use the same principle of separating site conditions, soil profile and dictionaries into distinct tables. However, the table structure varies significantly.

¹⁰ Referential integrity cannot be defined for the tables within the structure exported by the RDBMS used (Paradox).

- **SPADE/M**

The revised database for measured data of the *Soil Profile Analytical Database* (SPADE/M) of the *Soil Geographic Database for Eurasia* (SGDBE) uses a model, which is more oriented towards the arrangement of parameters in a spreadsheet (Hiederer, *et al.*, 2006). In this arrangement each parameter is defined as a field (equivalent to a spreadsheet column) with a pre-defined field name and storage format.

- **FSCC**

The data of the first soil survey on ICP Forests. Forest Focus Level 1 plots are stored in a database maintained by the *Forest Soil Coordinating Centre* (FSCC)¹¹. The original storage environment was not formally described and the data made available to the JRC was the result of a structuring exercise performed during February – November, 2002 by FSCC. In the redesign data are stored by plot and layer or horizon. Separate tables are used for storing physical and chemical parameters. Parameter values are actually stored in an alphanumeric field format to allow representing all parameter values. The data used in the evaluation task originate from the MS Access¹² version of the database.

- **FIMCI**

The *Forest Intensive Monitoring Coordinating Institute* (FIMCI) stored data from the surveys performed on Level II plots in a model akin to the forms specified to record and submit the observations and measurements. The data were made available to the JRC in form of exported ASCII files. The files were then parsed into the Forest Focus Monitoring Database. The Soil Condition data in the FIMCI Soil Condition database was integrated into the data model of the intensive monitoring database. The data model was aligned to the design of the forms of the Soil Condition survey. Plot samples were separated into mandatory and optional parameters. For storing the data individual fields were defined for each parameter analogous to a spreadsheet arrangement.

- **Forest Focus Monitoring Database**

Data from the 1996 Level I soil Condition survey and the surveys performed on Level II plots were integrated into the *Forest Focus Monitoring Database* (FFMdb; (Hiederer, *et al.*, 2008). The data model of the FFMdb is largely aligned to the forms for reporting the data from the monitoring activity. Parameters are stored in individual fields which are formatted according to the provisions made in the *Technical Specifications* documents published by the JRC.

¹¹ http://www.inbo.be/content/page.asp?pid=EN_MON_forest_soils

¹² Microsoft ® Office Access, Copyright © Microsoft Corporation

The various data models to store data all have their merits and inconveniences. The non-normalized storage of data with parameters arranged as fields resemble the data forms and can be more readily used in a spreadsheet. However, they are inflexible with respect to any modifications of the data sampled and contain a considerable amount of redundant information. Data redundancy is to some degree caused by the provisions made in the Manual and not always the fault of the data model. The data models used by FSCC and BioSoil are more open to future modifications of the survey and data reporting requirements than the other models and use a higher level of normalization. In the adherence to design concepts the FSCC model goes further than the BioSoil model (storage of some profile parameters as separate field values in the LAYER table is inconsistent with design principles). Nonetheless, the BioSoil data model seems to be perfectly adequate to store the survey data.

3.2.4 Naming Convention

Naming conventions of fields are not fully consistent. For a number of fields containing codes the type of the data is given in the field name, usually starting the field name with the CODE_ prefix, such as CODE_COUNTRY, CODE_HUMUS. For some parameters the word CODE is added at different positions (PARENT_MATERIAL_CODE) or not used, such as STRUCTURE or USE.

The field formats of codes are mainly alpha-numeric (character string). This convention is also applied to fields which contain only numeric entries (CODE_COUNTRY, CODE_ELEVATION). Where codes are actual identifiers, as in the case of plot or profile identifiers, the field name still contains CODE, but the field format is of type integer (CODE_PLOT, CODE_PROFILE).

Some of the table fields and formats given in the document differ from those of the database. The cases are listed in Table 5.

Table 5: *Field Format Changes between Documentation and Data*

Field Name	Documented Type	Documented Dimension	Data Dimension
VARIABLE_NAME	CHAR	12	31
MOIST_COLOUR	CHAR	8	16
DRY_COLOUR	CHAR	8	16

During the implementation of the database the field formats have been adjusted to conform to the storage needs of the data. The field format information can be retrieved from the database. An update of the physical database model was provided to document the status of the database at the end of the project.

Fields of the database not found in the exported XML files are given in Table 6.

Table 6: *Missing Fields in XML File*

Level	Table	Field Name
1	PROFILE	ROOT
2	PROFILE	ROOT

The missing parameter was not exported in the final version of the database in both tables of Level 1 and Level 2 profile data.

3.2.5 Validation Procedure and Parameters

The purpose of the data validation is to ensure that the information stored in the system can be used for an assessment of the state of a parameter sampled and in the evaluation of temporal and spatial trends between plots. It should also allow the integration of the data with other data sources in more extensive thematic analyses.

- **Validation Principles**

Data are validated based on the principle that it is not possible to identify the correctness of data, but rather that it may be possible to identify the probability that data represent valid measurements. The BioSoil validation is based on the procedure applied to data from the Forest Focus monitoring scheme. It consists of three main stages, as depicted in *Figure 4*.

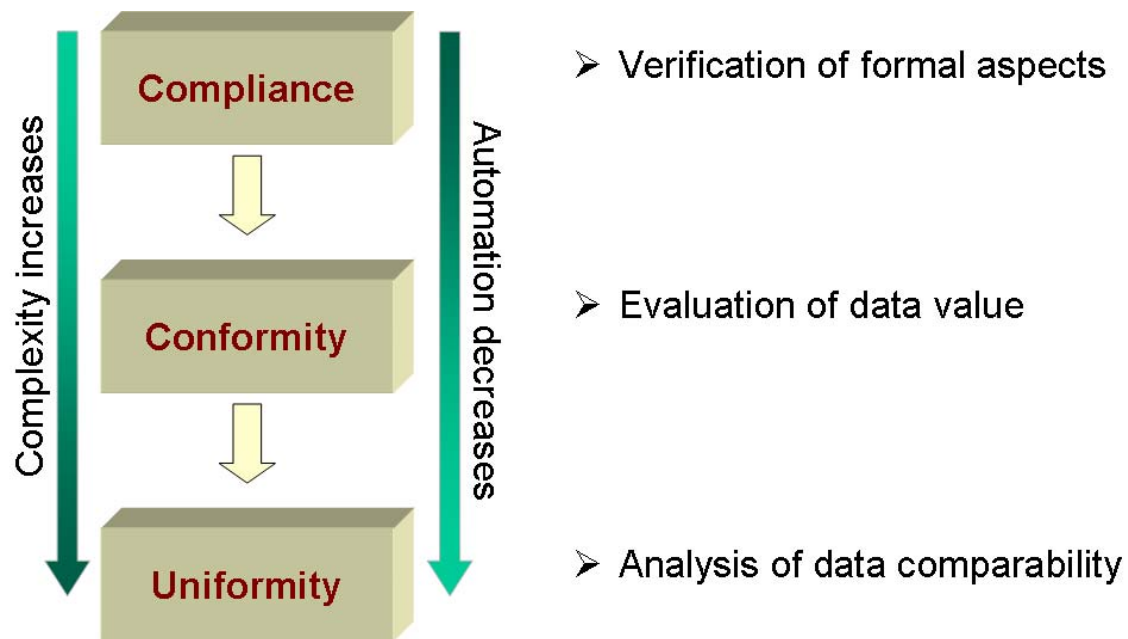

Figure 4: *Data Validation Phases*

The tests applied during the phases verify different aspects of the data and have to be performed in sequential order.

- **Compliance Check**

The tests applied as part of the Compliance Check verify if the data in the submitted files of a survey comply with the specifications of the fixed formats ASCII files as stipulated in the file specification documents. Data ranges are not verified, only syntactic checks are applied.

- **Conformity Check**

The Conformity Check comprises a number of tests that are applied after the submitted data have been subjected to the Compliance Check. The principle of the Conformity Check is to evaluate the probability that a data value is an actual observation. The condition is evaluated with the aid of single parameter range tests, including test of boundaries for geographic coordinates. The tests can also detect impossible values, e.g. pH = 0. All these tests aim at assessing plot-specific conditions. Information from other plots is not taken into account at this stage.

The results of the tests are at times extensive lists of flagged values, which indicate either an error for values indicating potentially unusual conditions or a warning for values outside a pre-set range. All flagged values are listed and

described with an explanatory legend in a report, which is transmitted to NFCs to allow verifying the situation.

- **Uniformity Check**

The tests applied to check data Uniformity are intended to identify temporal and spatial data inconsistencies which could not be found during any of the previous checks. The Uniformity Check consists of an interpretation of temporal and spatial development of parameters using data from all plots. Contrary to Conformity data Uniformity is verified by comparative tests using more than the information from a single plot. Uniformity tests are more qualitative and require the interpretation of the results by an expert in the field. The interpretation includes a comparison with external data as far as such information is available in a suitable form.

The check includes generating maps for various key parameters monitored to assess the spatial variation of a parameter. For the analysis of regional temporal changes the maps should also compare new data with data from plots of the previous survey.

To provide consistent results a test belonging to a type of check cannot be applied in another group. Before a value can be evaluated it has to be correctly interpreted by the parser and transferred without loss to the database for verification. Conversely, before methods or differences in procedures can be assessed the correctness of the values must be established.

The results of the compliance and conformity checks can be warnings or errors. Warnings need to be commented by the submitting NFCs while in the case of one or several errors corrected data needs to be re-submitted. The output of the uniformity check may be warnings, but not errors. Therefore, the data analyzed for uniformity would not have to be corrected and resubmitted, only commented.

This arrangement has consequences on the data management procedures. Until all tests of the compliance check have been performed the submission can contain errors and corrections will have to be re-submitted.

For the validation of the Forest Focus monitoring data the 3 phases of validation checks were clearly separated. The tests for data compliance were performed online at the time of data submission. Tests for conformity were found to be too involved to be performed online and were thus run on the processing database. Conformity reports were then sent separately to NFCs.

Under BioSoil part of the tests for conformity were also performed by the online. This procedure should provide an immediate feedback to the NFC and allow corrections to be made with short delays. It also reduces the burden on staff processing the data and generating the reports. The disadvantage of this approach was that the check of data conformity was split into two parts, one online and one relegated to be performed by project staff.

This arrangement resulted in detecting errors requiring corrections of data and re-submissions during the check for uniformity. In effect the uniformity check as defined could not be performed because data values were still evidently erroneous and needed to be corrected. One example is the geographic position of plots. The test is by nature part of the conformity check but has not been included in the on-line procedure. Therefore, NFCs are informed about any invalid positions of their plots only when the reports on uniformity have been sent. Because the reports on the BioSoil uniformity check were sent rather late in the project NFCs were not always able to correct their data and submit the forms within the period of the project. The evaluation task was affected by delays as no Level 2 data were fully validated at the time of processing the data.

- **Submission File Format**

In contrast to Forest Focus forms data from the BioSoil project were submitted using a field-delimited format. The advantage of the format over the fixed-format of Forest Focus monitoring data is the flexibility in field dimensions: data do not have to be exactly right-aligned within the positions assigned to a value, inserting fields into or deleting fields from a form is less arduous and changes to field dimensions are straightforward.

There are not only advantages to the format. The format is not universally defined. A separator value used in a string can trigger the start of a new field unless the string can be identified. Regional differences in data formats, in particular the use of a comma as a decimal separator, can lead to loss of data or miss-interpretation of data entries. Date entries, unless the specifications are completely adhered to, can become unrecognizable or mistaken. In the file formats non-specific alpha-numeric entries appear only in the observation field. Some problems in transferring the data from the data submitted to the database were evident in the export files. Several entries contained duplicated double quotes surrounding observation entries.

Any particular hitches in the import of the data submitted by NFCs were not found during the evaluation. The database provides some help in identifying potential problems by providing the entries of measurements also in form of string entries.

3.2.6 Meta Data

The dictionary tables are stored in a structure referred to as meta-data. The meta-data contains a table with the verbose description of the checks performed and the messages displayed. However, the actual values used in the checks are not part of the export functionality. The meta-data table RANGE contains limits for 5 parameters (PERCENTAGE, VOLUME_PERCENTAGE, G_PER_100G, PH, BASE_SATURATION). The values for lower and upper constraints are set to the

theoretical limits, not to expected ranges. The ranges of the values used to validate data Compliance are not included in the export file.

3.2.7 XML Export and Data Processing

For the evaluation the data from the XML-Export facility have been imported into a RDBMS (Microsoft Access). The XML-files are imported as alphanumeric data with 255 characters. The size of the resulting data posed a problem when converting data formats for the Level 1 LAYER_ANALYSIS_RESULTS and HORIZON_ANALYSIS_RESULTS tables. The problem is not so much caused by the amount of the data but rather the storage format. Options of solving the problem of file size are to either process only part of the data and then merge the tables or export the tables to another file format and re-import the data. For the evaluation the latter option was used to convert field formats (TAB-delimited, no text identifier). The Access import routine allows formatting imported fields to some degree they cannot be dimensioned. Therefore, fields containing codes are imported as alphanumeric data with 255 characters. Even in the smaller imported files the format cannot be modified in the RDBMS due to the size of the intermediate file. As a consequence, the tables were imported into another software package (Borland Paradox¹³) and further processed using this RDBMS.

To transfer the alpha-numeric data to a database a parser is used to import the information into formatted fields. Field formats of the parser defined to import the XML files into the evaluation database had to be based on the initial description of the data model. Field dimensions were based on the size of the data recorded in the database.

3.3 Soil Data

Although data were foreseen to be collected in the network of Forest Focus / ICP Forests Level I points for the countries that joined the project proposal, some countries used a subset of their network and at least one country (United Kingdom) set up an entirely new network specifically for the project.

The year reported for the assessment date of the BioSoil survey by plot is graphically presented in Figure 5.

¹³ Paradox for Windows © Borland International, Inc.

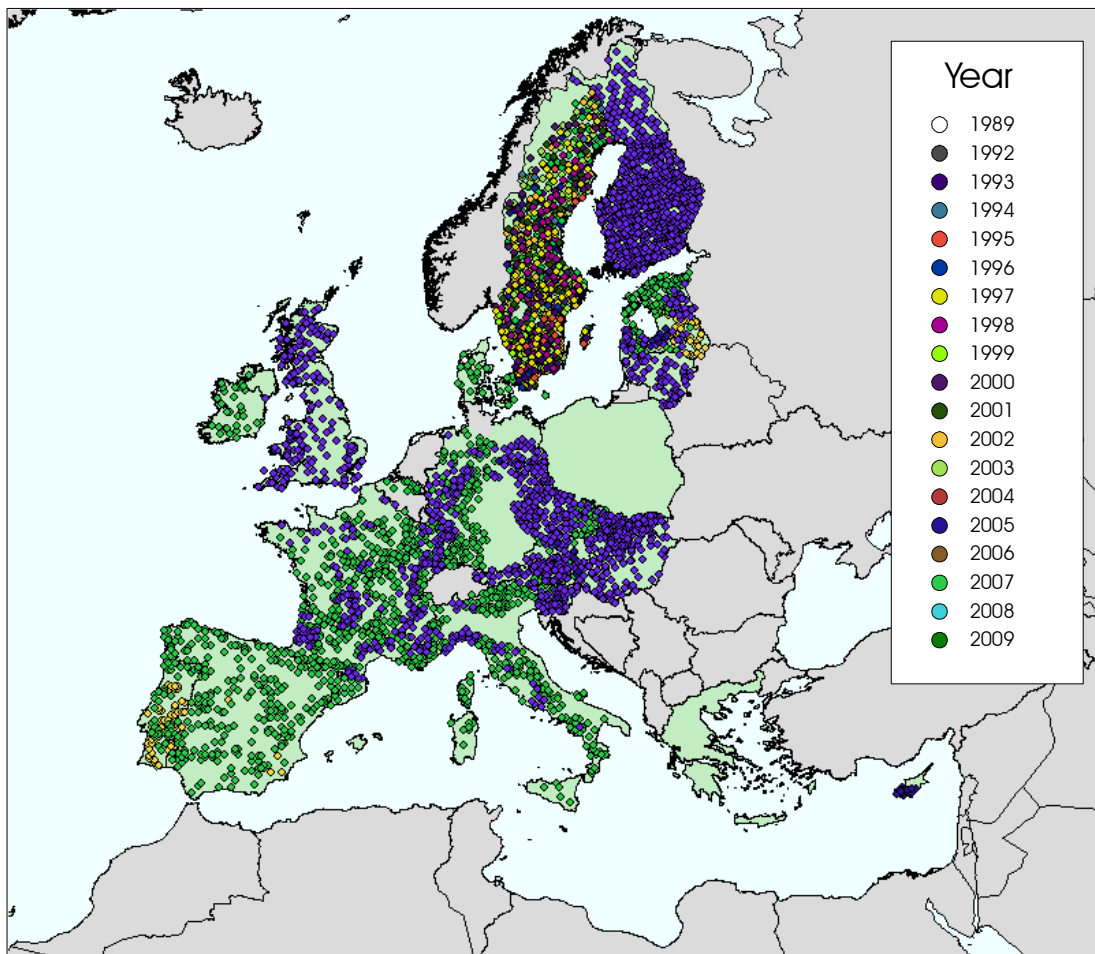

Figure 5: Sampling Year for BioSoil Level 1 Soil Condition Survey

The graph shows that in several NFCs data were sampled in more than one year, such as in Portugal, France and Italy. When sampling occurred over more than one year it was mainly performed over two consecutive years, either 2006/2007 or 2007/2008. An exception to the uniformity of the sampling year is presented for Sweden. For the plots of the NFC the years provided for the assessment year stretch over more than 10 years.

The range of years in which samples were taken largely exceed the duration of the BioSoil projects. The distribution of the year given as the assessment date for the 4,030 plots with an entry is presented in Figure 6.

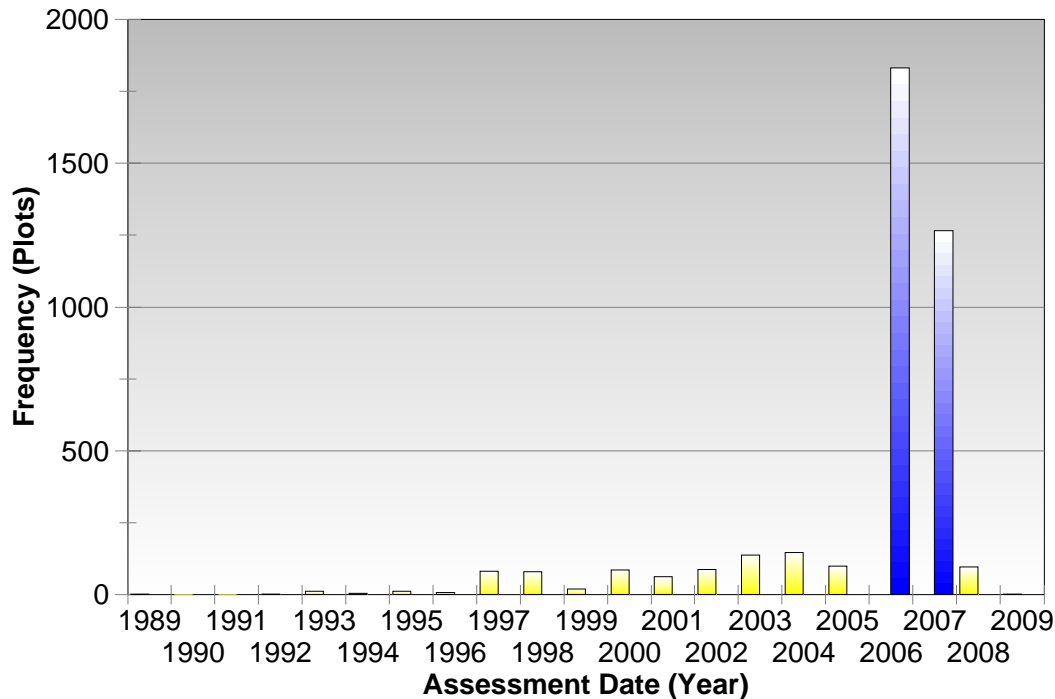

Figure 6: Distribution of Assessment Data for BioSoil Level 1 Plots

The year given for the soil condition assessment at the BioSoil plots ranges from 1989 to 2009. The one plot with an assessment date of 1989 in Denmark refers to an ICP Level I plot. Soil data were not sampled at the site due to massive soil disturbances. An assessment year of 2009 was given for one plot. Because all plots of the area were assessed in 2006 the date may be the result of a typing error.

Data for the demonstration project could be expected to originate from surveys performed during 2006 and 2007. A corresponding assessment date is given for 77% of the plots. Since the BioSoil Manual was only published in 2006 for data assessed preceding the publication it is not clear under which conditions plot parameters were sampled and analysed. For data sampled after 1995 it may be assumed that data were sampled following the specifications of an ICP Forests Sub-Manual. It is also possible that the date when the plot was established was reported as the assessment data.

3.3.1 Validated Soil Data

Depending on the inconsistencies found in the data during the validation process re-submissions of corrected data were possible well after the deadline for submitting

BioSoil/Soil data. For the final evaluation the status of the data as of 04.01.2010 was fixed. The data differ from the preliminary data analysis following several re-submissions of data after the end of September, 2009.

To facilitate the analysis a separate instance of the database was generated from data exported from the database using the system functionality. This arrangement of extracting data from the database and analysing the results in a separate environment was found preferable to interrogating directly the database, because it avoided analyzing data from different stages of processing in the system. It also simplifies the distribution of data to collaborators without direct access to the database.

Evaluated were thus not the files submitted by the NFCs, but the data stored in the BioSoil/Soil database as potentially made available to other interested parties. While there should not be a difference in the values between the data submitted by the NFCs and those stored in the database, the storage formats, in particular field dimensions, could vary. For the purpose of verifying any unusual situations the original files submitted were available to the evaluation project.

The PLOT table for the layer analysis at Level 1 plots contains references to 4,034 plots. In the preliminary data 1 more plot (Plot code 1613) for Sweden was included. For 8 plots no parameters for the layer sample were submitted by NFCs. An overview of the plots without data on soil properties and the reasons given in the submissions is presented in Table 7.

Table 7 *Level 1 Plots of the PLOT Table without Data in LAYER Table*

NFC	Plot No.	Observation
France	1511	disturbed humus
France	1576	agricultural field
France	1809	a corn field
Niedersachsen	526	No profile and sampling possible cause of high waterland, fen!
Spain	1130	""no observation""
Bayern	1540	not forested. not sampled
Bayern	1714	not accessible. not sampled
Denmark	103	Sonder Herred original Level 1 - resampling not possible due to massive soil disturbance - Gravel pit

The LAYER table of the final version contains references to 4,026 plots. For 1 plot in the UK (Plot code 164) no coordinates were available (windblown site). The coordinates of the 2 plots in Italy with identical co-ordinates found in the preliminary data were (Plot codes 35 and 105) were adjusted in re-submitted data.

For 2 plots in Thüringen (CODE_PLOT 200416001 and 200416002) the value in the field REPETITION is set to 0. This value is expected to be at least 1, a condition to be considered when selecting data for the analysis to avoid excluding the plots.

In the analysis the data extracted from the BioSoil database was subjected to several standard checks intended to verify that the data evaluation would provide meaningful results. Rather than repeating the validation process the checks concentrated on excluding conditions causing spurious results. One of the main situations which could lead to computing inaccurate or biased results is the treatment of missing data. For single-parameter analyses including values of zero, which signify missing data, should be excluded when computing summary statistics. The description of a profile should be complete without duplication or absent depth sections. When computing data from several parameters, as is the case when computing SOC densities, a result must not be computed when the information from one of the parameters is missing. Care in processing the data is also needed to ensure that a soil sample is fully covered by valid data to the depth limit, for which a parameter is computed, taking into account that the soil may be shallower than the depth limit. The latter issue is specifically valid for the analysis of Level 1 data sampled by depth layer because the Manual does not foresee sampling parameters below 20cm as a mandatory task. It is therefore not always evident from the layer data alone whether the absence of any data indicates the nonexistence of soil or simply the deficiency of data. For the layer data depth to rock or obstacles to roots are not reported (the parameters are specified for sampling by pedological horizon).

In the analysis of the samples from the level survey data the organic layers were first processed separately for the organic and soil strata. The differentiation was necessary because in the previous survey performed on Level I plots the depth of the organic layer was not stored in the database. As a consequence and rather paradoxically, the survey data is not suited to compute soil characteristics for a given depth, for example for the widely used topsoil and subsoil sections of 0-30cm and 30-100cm.

3.3.2 BioSoil / Soil Level 1 Plot Location

An overview over the location of the Level 1 plots taken from the PLOT table is given in Figure 7.

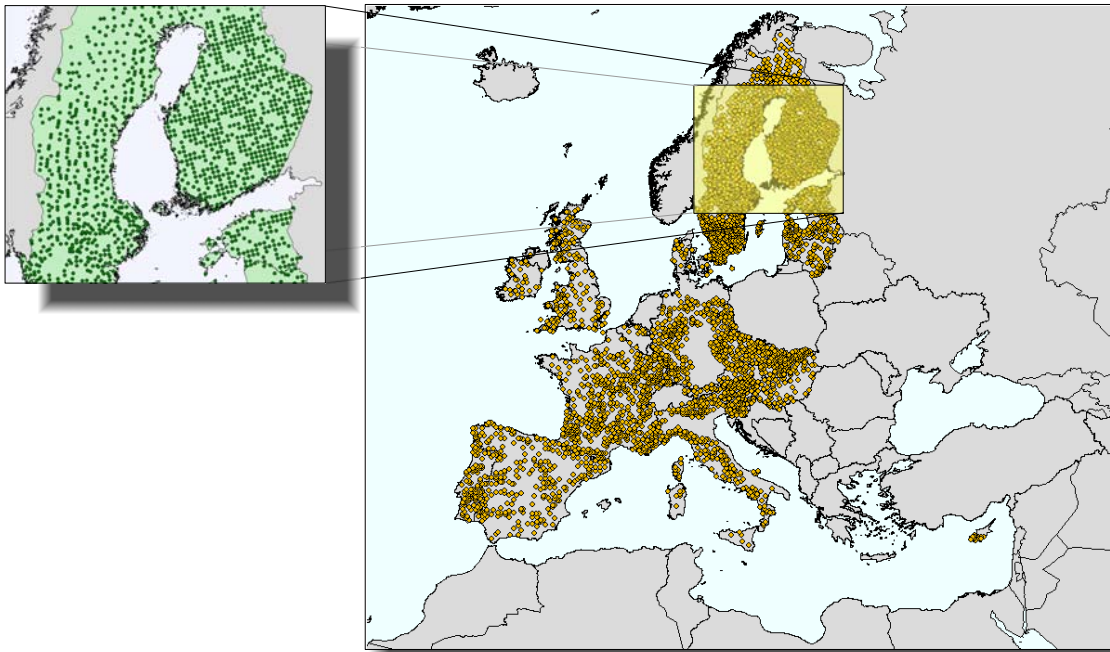

Figure 7: Position of Level 1 Plots of BioSoil/Soil Survey

The inset for the plot positions shows that the arrangement of the plots according to the reported coordinates follows at times a regular grid (here Finland and Estonia) while for other NFCs (here Sweden) the plot location varies around the nominal positions. Such variations are not a consequence of the map projection used, but a consequence of either the method used to position the plots, such as randomly within a grid cell, or the approach to reporting plot coordinates. From the coordinates alone the method used to position or report plots cannot be determined.

The locations of the plots were overlaid over the spatial layer of administrative regions of the GISCO database (Eurostat, 2009). NUTS level 1 and level 2 regions were rasterized to 1km grids and coded according to the BioSoil/Soil legend for NFCs. For each NFC the position of the plots as given in the PLOT table were overlaid with the administrative layer and plots not inside the area of the NFC they were identified. The result of the analysis is given in Table 8.

Table 8: Number of Level 1 Plots Outside NFC Land Area

NFC	Plots	Inside NFC	Relative
	No.	No.	%
Austria	135	135	100.0
Flanders	10	10	100.0
Cyprus	15	15	100.0
Czech Republic	146	146	100.0
Denmark	26	25	96.2
Estonia	96	96	100.0
Finland	630	630	100.0
France	548	548	100.0
Baden-Württemberg	50	50	100.0
Bayern	97	0	0.0
Brandenburg-Berlin	52	49	94.2
Hessen	29	29	100.0
Mecklenburg-Vorpommern	17	0	0.0
Niedersachsen	42	42	100.0
Nordrhein-Westfalen	39	39	100.0
Rheinland Pfalz	26	26	100.0
Saarland	9	9	100.0
Sachsen	19	19	100.0
Sachsen Anhalt	19	19	100.0
Thüringen	26	0	0.0
Hungary	78	78	100.0
Ireland	36	36	100.0
Italy	239	239	100.0
Latvia	95	95	100.0
Lithuania	62	62	100.0
Poland	NA	NA	NA
Portugal - mainland	103	103	100.0
Slovak Republic	112	112	100.0
Slovenia	45	45	100.0
Spain	272	272	100.0
Sweden	794	794	100.0
United Kingdom	167	163	97.6
TOTAL	4034	3886	96.3

Of the 4,034 (4,035 in preliminary data) plots with coordinates 3,886 or 96.3% (3,751; (93.0% in preliminary data) were found to be inside the area of the declaring NFC.

For the preliminary data plot coordinates from 6 NFCs placed the plots outside the NFC. For these plots the submission status was given as 'OK' and the validation status for the uniformity check was set to 'True'. It later transpired that the positions of latitude and longitude coordinates were inversed in the files. For 3 NFCs the situation could be corrected by re-submitting new data after the preliminary analysis was performed. Corrections for plots from other NFCs could not be submitted in time to be fully validated and are therefore not stored in the final database. The NFC for Poland

cancelled a previous submission and could not re-submit new data by the time the database submission module was permanently closed.

The check on co-location was performed with a buffer zone of 3km around the land area of an NFC. This buffer is needed to accommodate plots situated in coastal zones where the coordinates were degraded to minutes rather than seconds. The lower level of precision in reporting plot coordinates may place a plot outside the land area of an NFC. An example is given in Figure 8.

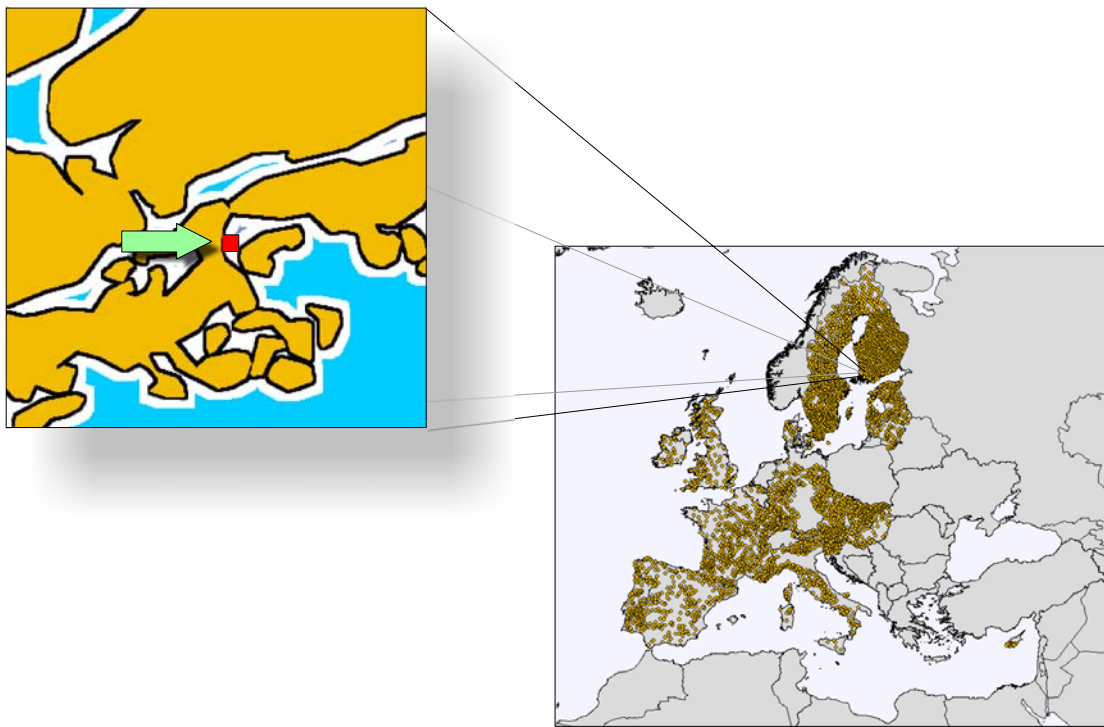

Figure 8: *Shift of Plot Outside NFC Area (Level 1)*

According to the coordinates restricted to minutes the plot has been positioned in the sea. It does not appear as a displaced plot because it is still within the buffer zone of the NFC land area.

The findings from the check on plot locations are not convincing that plot positions are reliably reported in the data and erroneous coordinates are highlighted by the validation process adequately obvious for the user to exclude those plots from the analysis.

3.3.3 BioSoil / Soil Level 2 Plot Location

The distribution of BioSoil Level 2 plots is presented in Figure 9. The plot locations should correspond to the Level II plots of Forest Focus / ICP Forests.

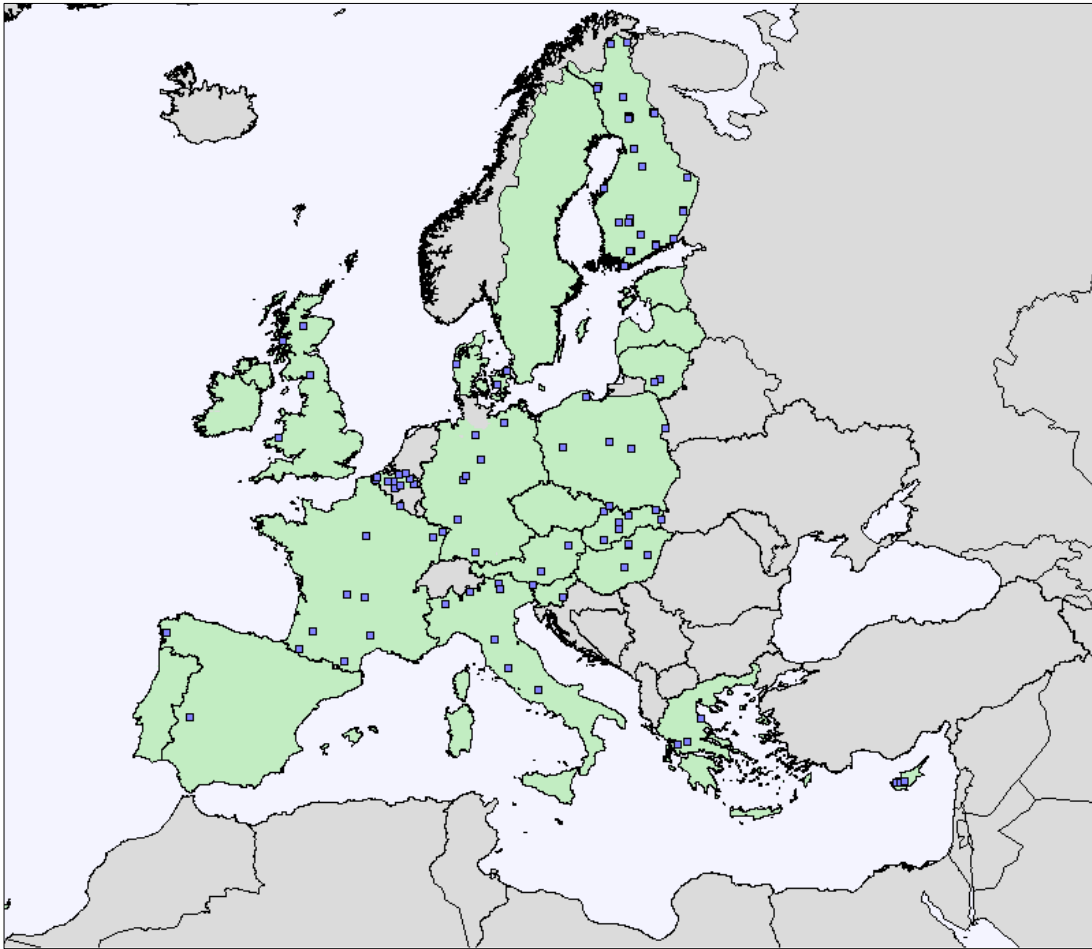

Figure 9: *Position of Level 2 Plots of BioSoil/Soil Survey*

The distribution of the Level 2 plots does not follow a systematic sampling approach based on forest cover in any of the countries. The position of the plots are selected based on specific conditions of the forest ecosystem, which were of scientific interest for one or several of the Level II surveys. Some countries provided data for Level 1 plots, but not for Level 2, such as Sweden and Portugal, while Greece provided data only for Level 2 plots.

The number of Level 2 plots in the database compared to the number of plots within the reporting NFC is presented in Table 9.

Table 9: Number of Level 2 Plots Outside NFC Land Area

NFC	Plots	Inside NFC	Relative
	No.	No.	%
Austria	2	2	100
Flanders	11	11	100
Cyprus	15	15	100
Czech Republic	8	0	0
Denmark	3	3	100
Estonia	-	-	-
Finland	32	32	100
France	10	10	100
Baden-Württemberg	2	2	100
Bayern	-	-	-
Brandenburg-Berlin	-	-	-
Hessen	2	2	100
Mecklenburg-Vorpommern	1	1	100
Niedersachsen	2	2	100
Nordrhein-Westfalen	1	1	0
Rheinland Pfalz	-	-	-
Saarland	-	-	-
Sachsen	-	-	-
Sachsen Anhalt	-	-	-
Thüringen	-	-	-
Greece	4	4	100
Hungary	4	4	100
Ireland	3	3	100
Italy	8	8	100
Latvia	-	-	-
Lithuania	2	2	100
Poland	6	6	100
Portugal - mainland	-	-	-
Slovak Republic	8	8	100
Slovenia	1	1	100
Spain	2	2	100
Sweden	-	-	-
United Kingdom	4	4	100
TOTAL	131	123	93.9

* Cyprus Level 2 plots with coordinates of Level 1 plots in database

The number of Level 2 plots of the BioSoil survey is not immediately obvious from extracting the data from the corresponding tables. For Cyprus 15 plots are indicated in the database. The coordinates for these plots are the same as for the Level 1 plots. The coordinates of the 8 plots for the Czech Republic are located outside Europe. It would appear that the records for latitude and longitude were inversed for those plots. This leaves 123 plots to be located within the boundaries of the reporting NFC.

3.3.4 Completeness of Layer Data

The amount of parameters observed and measurements taken at a sample site depends on whether a parameter has been defined as mandatory or optional in the BioSoil Manual. This further depends on the type of site, i.e. Level 1 or 2, and on the status, i.e. if it has been newly established or is being revisited. Details on the specifications on which layers to sample are given in *Table 1: Status of layers to be sampled in both levels* of the BioSoil Manual (EC-BioSoil, 2007a; p. 12). The parameters to be measured and the measurement units are given in *Table 3: Chemical and physical key soil parameters* of the BioSoil Manual (EC-BioSoil, 2007a; p. 19).

A summary of the validated data recorded in the database is given for Level 1 plots in Table 10.

Table 10: Validated Parameters for Level 1 Plots

Level 1	All		Mineral		Organic	
	Number	Relative	Number	Relative	Number	Relative
PLOT DATA						
Plot identifiers	4034	NA				
Date of assessment	4030	99.9				
Latitude	4033	100.0				
Longitude	4033	100.0				
Elevation code	4002	99.2				
Water availability (estimate)	3900	96.7				
Humus form	3817	94.6				
Identifier for laboratory responsible for the analysis of the horizon samples	4031	99.9				
Identifier for laboratory responsible for the analysis of the layer composites.	3760	93.2				
LAYER DATA						
Submission identifiers	20617	NA	14426	NA	6191	NA
Identification number of plot	20617	100.0	14426	100.0	6191	100.0
Code of layer	20617	100.0	14426	100.0	6191	100.0
Order number of composite	20617	100.0	14426	100.0	6191	100.0
Upper limit of layer depth	20225	98.1	14400	99.8	5825	94.1
Lower limit of layer depth	20225	98.1	14400	99.8	5825	94.1
Date of analysis	20616	100.0	14426	100.0	6190	100.0
Texture class	11828	57.4	11814	81.9	14	0.2
Mass fraction of coarse fragments	6089	29.5	5811	40.3	278	4.5
Volume of coarse fragments	10048	48.7	9830	68.1	218	3.5
Dry weight of organic layer	5167	25.1	4	0.0	5163	83.4
Measured bulk density of fine earth	7245	35.1	6986	48.4	259	4.2
Estimated bulk density of fine earth	7072	34.3	6931	48.0	141	2.3
Carbonate content	4025	19.5	3255	22.6	770	12.4
Exchangeable acidity	14797	71.8	11377	78.9	3420	55.2

Evaluation of BioSoil Demonstration Project - Soil Data Analysis

Level 1	All		Mineral		Organic	
	Number	Relative	Number	Relative	Number	Relative
Exchangeable Al	15418	74.8	12104	83.9	3314	53.5
Exchangeable Ca	15896	77.1	12368	85.7	3528	57.0
Exchangeable Fe	14845	72.0	11471	79.5	3374	54.5
Exchangeable K	15683	76.1	12189	84.5	3494	56.4
Exchangeable Mg	15988	77.5	12454	86.3	3534	57.1
Exchangeable Mn	15559	75.5	12055	83.6	3504	56.6
Exchangeable Na	15004	72.8	11628	80.6	3376	54.5
Aqua regia extracted Al	13601	66.0	8521	59.1	5080	82.1
Aqua regia extracted Ca	16281	79.0	10740	74.4	5541	89.5
Aqua regia extracted Cd	10322	50.1	6277	43.5	4045	65.3
Aqua regia extracted Cr	12189	59.1	7880	54.6	4309	69.6
Aqua regia extracted Cu	12930	62.7	8145	56.5	4785	77.3
Aqua regia extracted Fe	14152	68.6	8913	61.8	5239	84.6
Aqua regia extracted Hg	4567	22.2	2751	19.1	1816	29.3
Aqua regia extracted K	15656	75.9	10593	73.4	5063	81.8
Aqua regia extracted Mg	16330	79.2	10775	74.7	5555	89.7
Aqua regia extracted Mn	16312	79.1	10754	74.5	5558	89.8
Aqua regia extracted Na	10541	51.1	6696	46.4	3845	62.1
Aqua regia extracted Ni	12133	58.8	7785	54.0	4348	70.2
Aqua regia extracted P	15976	77.5	10644	73.8	5332	86.1
Aqua regia extracted Pb	11735	56.9	6921	48.0	4814	77.8
Aqua regia extracted S	12257	59.5	7682	53.3	4575	73.9
Aqua regia extracted Zn	14292	69.3	8850	61.3	5442	87.9
Free H ⁺ acidity	12541	60.8	9146	63.4	3395	54.8
Moisture content	17205	83.5	12458	86.4	4747	76.7
Organic carbon content	17521	85.0	12762	88.5	4759	76.9
pH 1:5 measured using a solution of calcium chloride CaCl ₂	17916	86.9	13295	92.2	4621	74.6
pH 1:5 measured in water	15606	75.7	11879	82.3	3727	60.2
Acid oxalate extractable Al	9271	45.0	7924	54.9	1347	21.8
Acid oxalate extractable Fe	9276	45.0	7929	55.0	1347	21.8
Mass fraction of clay	11826	57.4	11812	81.9	14	0.2
Mass fraction of sand	11828	57.4	11814	81.9	14	0.2
Mass fraction of silt	11828	57.4	11814	81.9	14	0.2
Total Al content	2095	10.2	1962	13.6	133	2.1
Total Ca content	2088	10.1	1955	13.6	133	2.1
Total Fe content	2087	10.1	1954	13.5	133	2.1
Total K content	2090	10.1	1957	13.6	133	2.1
Total Mg content	1966	9.5	1833	12.7	133	2.1
Total Mn content	2069	10.0	1936	13.4	133	2.1
Total N content	16956	82.2	12199	84.6	4757	76.8
Total Na content	2083	10.1	1950	13.5	133	2.1

The figures of data completeness should only be used as a guide to the status of the data in the database. More data have in some cases been submitted by the NFCs but could not be validated and thus included in the database. Other data have been included, which may subsequently be found to be of limited use. This is usually caused when using a value of zero (0) to indicate the absence of a measurement when this value is also a valid result on its own. For example, for 68 cases the height of the organic layer is

recoded to be >0, but the value for the organic layer weight is zero (0). The example demonstrates that care has to be applied in the analysis of even the validated data.

The completeness of parameters of validated data collected at Level 2 plots is given in Table 11.

Table 11: Validated Parameters for Level 2 Plots

Level 2	All		Mineral		Organic	
	Number	Relative	Number	Relative	Number	Relative
<i>PLOT DATA</i>						
Submissions	131	NA				
Plot identifiers	131	100.0				
Date of assessment	131	100.0				
Latitude	131	100.0				
Longitude	131	100.0				
Elevation code	131	100.0				
Water availability (estimate)	128	97.7				
Humus form	128	97.7				
Identifier for laboratory responsible for the analysis of the horizon samples	131	100.0				
Identifier for laboratory responsible for the analysis of the layer composites	129	98.5				
<i>LAYER DATA</i>						
Submission identifiers	1780	NA	1780	NA	961	NA
Identification number of plot	1780	100.0	1780	100.0	961	100.0
Code of layer (horizon number)	1780	100.0	1780	100.0	961	100.0
Order number of composite	1780	100.0	1780	100.0	961	100.0
Upper limit of layer depth	1780	100.0	1780	100.0	833	86.7
Lower limit of layer depth	1780	100.0	1780	100.0	833	86.7
Date of analysis	1780	100.0	1780	100.0	961	100.0
Number of sub-samples used in composite	1780	100.0	1780	100.0	961	100.0
Texture class	1228	69.0	1228	69.0	3	0.3
Mass fraction of coarse fragments	985	55.3	985	55.3	0	0.0
Volume of coarse fragment relative to unsieved soil	645	36.2	645	36.2	31	3.2
Dry weight of organic layer per surface unit	1	0.1	1	0.1	838	87.2
Measured bulk density of fine earth	764	42.9	764	42.9	0	0.0
estimated bulk density of fine earth	466	26.2	466	26.2	0	0.0
Observations about analysis	1242	69.8	1242	69.8	616	64.1
Carbonate content	136	7.6	136	7.6	39	4.1
Exchangeable acidity	1228	69.0	1228	69.0	3	0.3
Exchangeable Al	1510	84.8	1510	84.8	495	51.5
Exchangeable Ca	1591	89.4	1591	89.4	478	49.7
Exchangeable Fe	1603	90.1	1603	90.1	533	55.5
Exchangeable K	1515	85.1	1515	85.1	462	48.1

Evaluation of BioSoil Demonstration Project - Soil Data Analysis

Level 2	All		Mineral		Organic	
	Number	Relative	Number	Relative	Number	Relative
Exchangeable Mg	1615	90.7	1615	90.7	534	55.6
Exchangeable Mn	1536	86.3	1536	86.3	535	55.7
Exchangeable Na	1435	80.6	1435	80.6	522	54.3
Aqua regia extracted Al	1547	86.9	1547	86.9	515	53.6
Aqua regia extracted Ca	1301	73.1	1301	73.1	717	74.6
Aqua regia extracted Cd	1603	90.1	1603	90.1	858	89.3
Aqua regia extracted Cr	739	41.5	739	41.5	751	78.1
Aqua regia extracted Cu	1298	72.9	1298	72.9	750	78.0
Aqua regia extracted Fe	1330	74.7	1330	74.7	858	89.3
Aqua regia extracted Hg	1397	78.5	1397	78.5	794	82.6
Aqua regia extracted K	260	14.6	260	14.6	119	12.4
Aqua regia extracted Mg	1603	90.1	1603	90.1	866	90.1
Aqua regia extracted Mn	1604	90.1	1604	90.1	866	90.1
Aqua regia extracted Na	1605	90.2	1605	90.2	866	90.1
Aqua regia extracted Ni	1152	64.7	1152	64.7	700	72.8
Aqua regia extracted P	1250	70.2	1250	70.2	777	80.9
Aqua regia extracted Pb	1565	87.9	1565	87.9	839	87.3
Aqua regia extracted S	1397	78.5	1397	78.5	857	89.2
Aqua regia extracted Zn	1174	66.0	1174	66.0	685	71.3
Free H ⁺ acidity	1355	76.1	1355	76.1	866	90.1
Moisture content	1406	79.0	1406	79.0	497	51.7
Organic carbon content	1548	87.0	1548	87.0	825	85.8
pH 1:5 measured using a solution of calcium chloride CaCl ₂	1737	97.6	1737	97.6	844	87.8
pH 1:5 measured in water	1742	97.9	1742	97.9	620	64.5
Acid oxalate extractable Al	1607	90.3	1607	90.3	569	59.2
Acid oxalate extractable Fe	1552	87.2	1552	87.2	262	27.3
Mass fraction of clay	1546	86.9	1546	86.9	264	27.5
Mass fraction of sand	1228	69.0	1228	69.0	3	0.3
Mass fraction of silt	1228	69.0	1228	69.0	3	0.3
Total Al content	132	7.4	132	7.4	0	0.0
Total Ca content	181	10.2	181	10.2	70	7.3
Total Fe content	181	10.2	181	10.2	0	0.0
Total K content	181	10.2	181	10.2	70	7.3
Total Mg content	181	10.2	181	10.2	70	7.3
Total Mn content	181	10.2	181	10.2	0	0.0
Total N content	1638	92.0	1638	92.0	844	87.8
Total Na content	181	10.2	181	10.2	0	0.0

As for the completeness of parameters collected at Level 1 plots the amount of data in the database should be further qualified for each parameter and combination of parameters. Values are not only reported for optional parameters, but also for conditions where reporting a value was not foreseen in the BioSoil Manual. As an example of the complexity of establishing the completeness of the data the parameter “coarse fragments” may be used. The BioSoil Manual specifies:

“The determination of coarse fragments is mandatory for the 0-10 cm mineral layer and optional for 10-80 cm mineral layer in both Level I and Level II. In case of reassessment (if this parameter was already measured according to the reference method

in first survey) the parameter is optional. For Level I the parameter may be estimated, for Level II it must be measured using the methods described in Annex 1: SA05.”

EC-BioSoil, 2007; p. 17

Reporting the parameter depends on plot type, the layer depth and previous assessments of the site. For Level 1 plots it may further be either estimated or measured. The latter is not evident from the database. Reporting coarse fragments (boulders, stones and gravel with a diameter > 2) is only specified for mineral layers. However, values are also reported for organic layers, for which this is not specified. It is therefore not accurate to generally interpret the completeness of a parameter in the database in terms of a data missing from being submitted.

3.3.5 Structure of Sample Layer Arrangement

The sampling procedure distinguishes between organic layers overlaying the soil material and the soil material (Forest Focus, 2007; ICP Forests, 2006). The use of the word “layer” for the organic part and “material” for the soil part can be confusing, because the procedure of sampling soil properties by layers applied to both sections. Also in the evaluation of the ICP Forest Sub-Manual for sampling Soil Conditions the coding of the soil material by the letter “M” (*Mij* to specify the depth segment in the soil material) has at times been incorrectly interpreted as relating to the mineral part of a soil (Cools, 2005). Organic soil material was not included in the definitions given in the report on the previous Level I soil condition survey (EC, UN/ECE and the Ministry of the Flemish Community, 1997). However, the soil material can be designated as either mineral (*Mij*) or organic (*Hij*), depending on the water saturation status.

The generalized arrangement of layers in the soil sample is given in Figure 10.

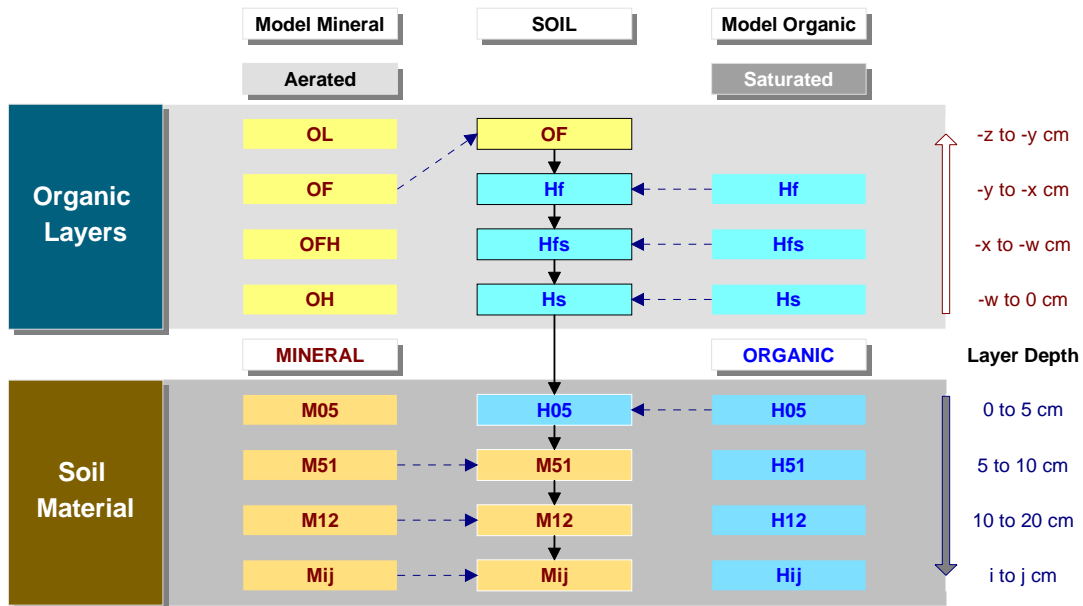

Figure 10: Schematized Arrangement of Soil Sample Layers

Compared to previous versions of the ICP Sub-Manual IIIa, the new Manual is in this respect more elaborate:

- **Organic layer(s)** consist of “... *undecomposed or partially decomposed litter, such as leaves, needles, twigs, mosses and lichens, which has accumulated on the soil surface; they may be on top of either mineral or organic soils.*”
- **Organic soil material** consists of “...*organic debris which accumulates at the surface under either wet or dry conditions and in which the mineral component does not significantly influence the soil properties.*”

The definition for organic soil material corresponds to the specifications for diagnostic organic soil material (FAO, 1998). The reference to an accumulation of organic substances on the surface in both definitions may be confusing. The instructions in the Manual that “...*Care should be taken to correctly separate the organic layer from the mineral soil material.*” are not helpful. Rather, the text relates to the separation of the organic layer from the organic or mineral soil material.

The depth of any organic layers overlaying the soil is recorded according to the status of the material while layers of the soil material use a fixed depth. A further distinction in reporting organic layers and soil material is made between aerated (*O*) and saturated (*H*) organic layers. The Manual specifies the same suffixes be used for both types, although the specifications for the SOM file use “*f*”, “*s*” and “*fs*” suffixed for water saturated organic *H* layers. Organic *O* and *H* layers may both be on top of either mineral or organic soil material.

Organic soil material should be designated as *Hij* and is not to be confused with the organic *H* layer, which is on top of the soil material. Following the specifications the code *O* should not be used to denote organic soil material, not even for soil material never saturated with water for more than a few days. Only the *Mij* codes are available to record parameters for those soils, since the *Hij* codes are reserved for soil material saturated with water.

Separating organic from mineral soil material in the field can be problematic. According to FAO (FAO, 1988) diagnostic organic soil material “...consists of organic debris which accumulates at the surface under either wet or dry conditions and in which the mineral component does not significantly influence the soil properties.” Other than the organic carbon content clay content is a decisive parameter in defining organic soil material for soils saturated with water for long periods. A definite classification may require the analysis of samples in a laboratory. In-field difficulties of separating the organic layer from the soil material were recognized early on in the soil sampling activity of ICP Forests (Baert *et al.*, 1998). The situation is better defined where a mineral layer is clearly present in the soil profile than for organic soils. For the latter only organic layer data are reported or organic soil data.

The identification of organic soil material (*Hij*) over mineral material (*Mij*) led in some cases to a duplication of the depth identifiers and negative values for the depth limits of the organic material (positioned as an organic layer rather than organic soil). In those cases a perfectly acceptable arrangement of the sections by depth does not correspond to the range limits specified by the Manual. Negative depth limits for *Hij* sections were found for 156 plots from 5 NFCs (Finland: 66; Estonia: 14; Sweden: 74; Ireland: 1; Sachsen: 1).

In other cases the presence of an organic layer shifts the limits of the underlying soil material. An example is given in Table 12:

Table 12: Example of Confounded Assignment of Depth Limits to Soil Layers

Layer Label	Upper Limit	Lower Limit
	<i>cm</i>	<i>cm</i>
OFH	-	-
M51	0	5
M12	5	10
M24	10	20
M48	20	40
OL	40	80

- no values recorded

The example shows a logical sequence of depth limits, but an incorrect assignment of layer labels. The presence of a layer of litter at a depth of 40 to 80cm is highly unlikely. The sequence of the data suggests that the layer M05 has somehow been lost and row containing layer labels has shifted upwards. With the inconsistencies in the data such samples should be excluded from the analysis.

The depth baseline for recording the upper and lower limits of the layers is the line of separation between the organic material and the soil material. Layer limits upwards from the baseline are increasingly negative while they are positive with depth in the soil section.

From the generalized model for mineral and organic soils the situation found in the sampled data is frequently a combination of aerated and saturated sections. An example is given in Figure 10. Not any combination of sections is viable. While some situations are dubious others are quite invalid. For example, it is unlikely to have an organic layer below soil material, but using limits of a soil layer that differ from the defined ranges represent an error in the data.

3.4 Soil Organic Carbon at Plot Locations

The main objective in the evaluation of the data was the estimation of SOC stocks and changes to SOC from the previous survey. SOC stocks are estimated from density for a given depth applied to an area. SOC stock is calculated from SOC content, dry bulk density, volume of stones or coarse fragments and for a given depth as:

$$SOC_s = SOC_c \times BD \times \left(1 - \frac{VS}{100}\right) \times LH \times 10^2 \text{ (t ha}^{-1}\text{)}$$

where

- SOC_s : total amount of soil organic carbon to given depth ($t\ ha^{-1}$)
- SOC_c : soil organic carbon content for given depth (%)
- BD : dry bulk density ($g\ cm^{-3}$)
- VS : volume of stones (%)
- LH : height of soil layer (m)

For organic layers of the BioSoil/Soil and Forest Focus surveys bulk density is generally not reported directly, but can be derived from the layer thickness and weight. A value for the volume of stones is not expected for organic layers, but at times reported.

For the organic layer the amount of organic carbon can also be determined by using the OC content of the layer and the organic layer weight as total dry weight ($kg\ m^{-2}$). In this case data on layer depth and bulk density are not needed and the total amount of OC in the organic layer can be found by:

$$OC_{org} = OC_c \times OLW \times \left(1 - \frac{VS}{100}\right) \times 10^{-1} \text{ (t ha}^{-1}\text{)}$$

where

- OC_{org} : total amount of organic carbon in organic layer (t ha⁻¹)
 OC_c : organic carbon content for organic layer (%)
 OLW : total dry organic layer (kg m⁻²)
 VS : volume of stones (%)

The presence of coarse fragments is not generally associated with organic layers and the amount of OC in the organic layer can be computed in the absence of this parameter. Although the amount of OC in the organic layer can be determined in the absence of data on the layer thickness with just the OLW, the information is useful in determining the start of the soil stratum and in providing proportions for aggregating parameters to the plot in case more than one organic layer is reported.

3.4.1 Organic Carbon Content

The method used to determine OC content by almost all NFCs is “Measurement of organic carbon content according to ISO 10694:1995” (sa08a). For Latvia the analysis method is given as “Other”, but not further specified in the database.

The relative presence of OC in the soil is expressed in units of g kg⁻¹. For Level 1 layer data the measurements are stored in the LAYER_ANALYSIS_RESULT table with the variable name “*organic_carbon*”. According to the specifications in the Manual the parameter should have been provided for all organic layers with decomposed material (*OF*, *OH*, *OFH*, *Hf*, *Hfs* and *Hs*) and all mineral layers to a depth of 20cm. For Level 1 plots reporting organic carbon for deeper layers is optional. An overview of the conditions found in the data table is given in Table 13.

Table 13: Availability of Level 1 Plots for Computing Organic Carbon Content for Organic Layers

Condition	Occurrence	
	Plots	of Plots (%)
Records*	4,026	99.8
Only litter (<i>OL</i>)	1	<0.1
Only organic layer data (<i>OF</i> , <i>OH</i> , <i>OFH</i> , <i>Hf</i> , <i>Hs</i> or <i>Hfs</i>)	168	4.2
Only soil material	478	11.9

* 8 plots excluded from analysis due to incomplete layer description (see Table 7).

Of all plots used in the analysis the presence of 1 or more organic layer(s) (*OF*, *OH*, *OFH*, *Hf*, *Hs* or *Hfs*) was reported for 3,202 plots. A layer of organic litter (*OL*) was reported for 1,723 plots. For 168 plots (4.4%) only layers of organic material was reported. For 1 plot (Plot Code 188 in Ireland) only an organic litter layer was reported. Only soil layer(s) and no data on organic layer(s) were reported for 478 plots (11.9%).

The spatial distribution of plots with a limited number of organic and soil material is presented in Figure 11.

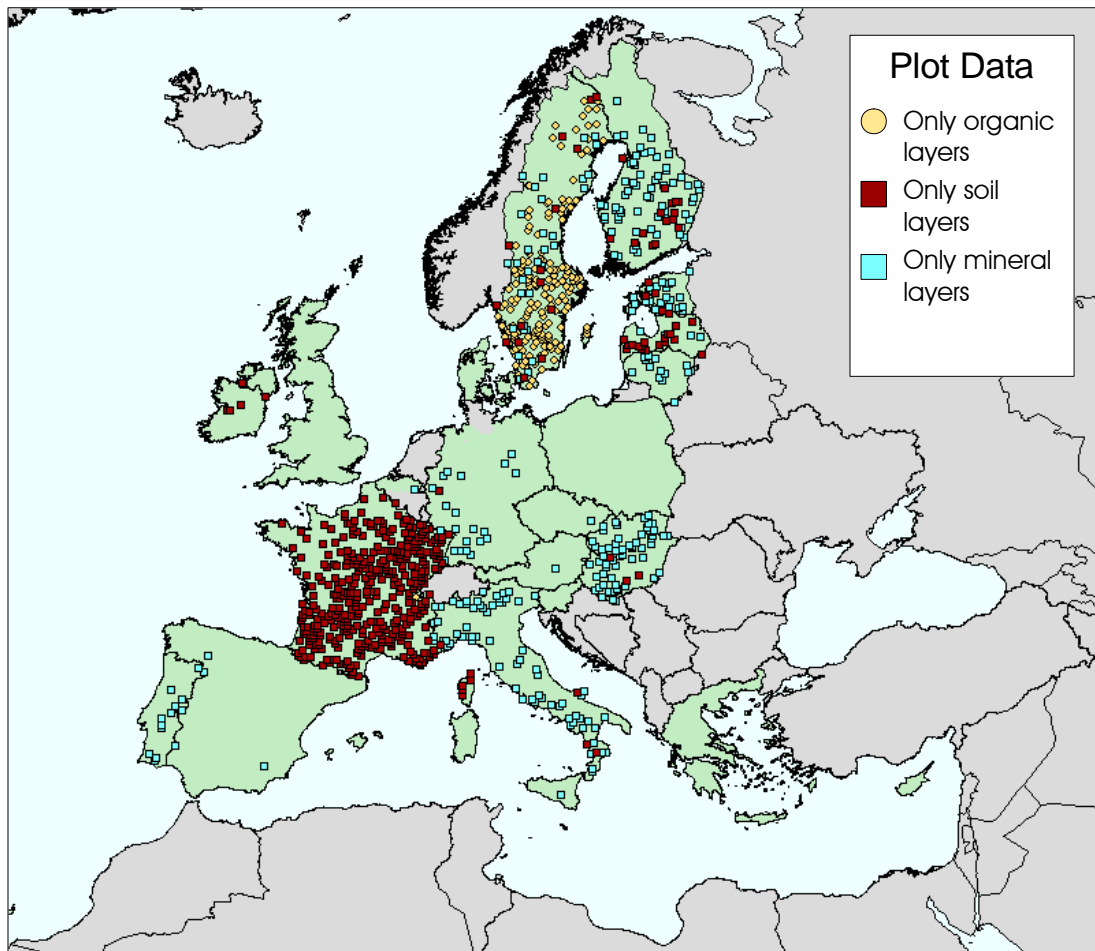

Figure 11: Distribution of Plots with Only Organic Layers, only Soil Material and Only Mineral Layers (BioSoil)

The description of “only organic layers” refers to a restriction of plot layer data to *OF*, *OH*, *OFH*, *Hf*, *Hs* or *Hfs* layers. These plots do not have data on *Mxy* or *Hxy* layers, but possibly an *OL* layer. Soil layers are all *Mxy* and *Hxy* layers. Plots with only soil layers have not data on organic layers, but possibly data on an *OL* layer. Plots with only

mineral layers (M_{xy}) have no organic layer data, but are also without data of an *OL* layer.

The large majority of plots with just organic layer data are in Sweden (165), while 2 plots located in France have no soil material. The distribution of plots with only soil material is very much concentrated on plots in France and the Baltic states. They are reported erratically in other NFCs, such as Ireland, where it was found also on soils with OC contents >30%.

Of the 4,026 plots with data for the soil layer survey a value of OC content was reported for 1 or more layers for 3,800 plots (94.4%). For 23 plots a value of 0 was given for the OC content in a layer, where an actual value could be expected. For 21 plots data with an OC content of 0 was limited to the M48 layer.

An overview of plots with missing data (blank field entry) in the parameters defining organic carbon density is presented Table 14.

Table 14: Plots with Data Missing for Computing Organic Carbon Density

Condition	Layer Type		
	Organic <i>Plots</i>	Saturated <i>Plots</i>	Mineral <i>Plots</i>
No weight for organic layer(s)	341	N/A	N/A
No depth limits for organic layers(s)	57	N/A	N/A
No OC content for 1 or more layer(s)	326	27	629
No mean bulk density for 1 or more layers(s)	N/A	286	2,515
No estimated bulk density for 1 or more layer(s)	N/A	290	1,937
No OC content for 0-10 cm soil segment	N/A	2	208
No OC content for 10-20 cm soil segment	N/A	3	70
No volume of coarse fragments for 1 or more layers(s)	N/A	305	1,569

Submitting a value of OC content for the litter layer was not requested in the Manual. Nevertheless, a value was submitted for 658 plots by 18 NFCs. Absence of a value in the *OL* layer was not relevant to the analysis because the layer is not used to determine below-ground organic carbon content in the soil material.

For organic layers where a measurement of the weight of the organic layer was requested (*OF*, *OH*, *OFH*, *Hf*, *Hs* or *Hfs*) corresponding data were missing for 341 plots. The thickness of the organic layer was not reported for 57 plots. For 367 plots no data were reported for both parameters. This condition precludes computing a value for bulk density, except were such a value is explicitly stated. This is the case for 8 of the

plots without weight of the organic layer and OC content data, where a value for the mean bulk density is given. A value for an estimated bulk density is given for 14 plots, all of which differ from the plots with data for the mean bulk density.

Data for OC content were not provided for the organic layer(s) of 326 plots. For the mineral soil layers submitting data for the topmost 20 cm of the soil material, where present, is mandatory for Level 1 plots. No data on OC content were reported for 208 plots with mineral soil layers to a depth of 10 cm and on 70 plots to a depth of 20 cm, although the presence of mineral soil to that depth is indicated.

No data are reported for the parameter “volume of coarse fragments” for 1 or more mineral layers for 1,569 plots and for 305 plots with water saturated layers. Absence of such data can mean absence of coarse fragments, but also absence of a measurement. For 265 plots with mineral layers an actual value of 0 was given for the parameter. A value may not be expected for plots with saturated layers (peat).

The conditions of missing and ambiguous connotation of data very much complicates computing organic carbon densities for plots. To identify a complete set of values for the organic carbon content to a soil depth of 20 cm several steps of processing were applied. The steps were:

1. Exclude the organic litter layer (*OL*) from the soil sample.
2. Compute mean values for repeated samples.
3. Mark the presence of a layer in the soil sample, regardless of whether a value for organic carbon was recorded or not.
4. Analyse completeness of data for sample.

The last step requires formulating rules to consider the coverage of a soil sample with data complete or not. The potential over-sampling of the 0-10 cm depth section by incorrectly stating depth in the organic layers, mixing aerated with saturated layers and mineral with organic soil sections made the task exceedingly complex.

In general, when data were found to be missing for a layer the plot data was declared incomplete, but only when a deeper section was indicated. For example, the soil data for a plot was considered complete when only data for the *X05* layer were reported or *X01* in the absence of an *X05*. When the data indicated a depth of at least 10 cm (presence of *X01* or *X12*) the availability of only one of the *X05* or *X51* layers led to the plot data being declared incomplete. Hence, data for an *X01* layer would not substitute an incomplete set of data for the *X05-X51* layers. The later decision was taken in line with the specifications than when measuring the first 10 cm of soil in 5 cm intervals the results take precedence over those of a single measurement for the depth. While parameters are not always recorded for only the *X05/51* or *X01* layers duplicate recordings for data on organic carbon occur. An example is given in Table 15.

Table 15: Example of Duplicated Section Data

Layer / Section	Upper Limit		Lower Limit		Organic Carbon Content $g\ kg^{-1}$
	<i>cm</i>		<i>cm</i>		
OL	0	-4	1	-3	414.00
OF	1	-3	4	0	486.10
H01	4	0	14	10	477.30
H12	14	10	24	20	542.70
H24	24	20	44	40	486.00
H48	44	40	84	80	503.10
<i>M81</i>		80		100	9.8
M05	84		89		19.70
M51	89		94		12.90
M12	94		104		3.30
M24	104		124		-
M48	124		164		-

n: intended description of soil sample by layer

The example given in Table 15 demonstrates a number of objectionable conditions in the data sampled:

- The position of organic layers should have been recorded upward from the top of the soil section with distances expressed in negative values.
- *Hij* and *Mij* are both soil sections, *Hij* denoting peat (water saturated), *Mij* denoting either an organic soil (not water saturated) or a mineral soil.
- The upper and lower limits of soil sections are pre-set and cannot be re-defined.
- No data are provided for sections *M24* and *M48* (probably because they are located below 100 cm).

The example also demonstrates a dilemma in the analysis of the data submitted: while the soil sample is perfectly interpretable as a single occurrence, it does not comply with the specifications of recording soil properties by layer sampling. As a consequence, the data cannot be readily combined with information from other soil samples, neither by the layer codes nor by the depth ranges. The example also demonstrates that inconsistencies in reporting the profile layers are at times the result of ambiguous or contradictory specifications given in the guidelines for sampling. As concerns the case examined the Manual states under *Section 2.3.3.4. Sampling of peatland* that

“...the peatlayer is sampled at fixed depths, mandatory 0 – 10 and 10 – 20 cm and optionally at 20 – 40 and 40 – 80 cm. In the reporting forms a separate name for the peatlayers shall be used, namely H01, H12, H24 and H48 in the records for the organic layers.”

and later

“...mineral soil below the peat soil (> 40 cm) can be further sampled according to the standard depths (M01, M12, M24, M48).”

These stipulations do not fit with the concept of using the depth codes as indicators of the position of the sample in the profile, which then becomes a problem of arranging data in the database. As a consequence, the sequence of depths sections of the example given in Table 15 is correct for the soil material, but the depths of the organic layer should have been recorded with negative limits starting from *H01* with depth 0.

A complete set of values for OC content to a depth of 20 cm was available from 2,735 plots (67.9%). Layer data from a plot was considered complete when a value for OC content was reported for all layers within the zone of interest. When the presence of an organic layer over a mineral soil was indicated by recording a layer of type *OF*, *OH*, *OFH* but no values were recorded for those layers, the plot was excluded from the analysis. When the presence of an organic layer covering mineral soil was not indicated the mineral data were analyzed for the plot. It was found that a similar logic for the mineral layers to exclude incompletely described soil samples was not applicable. This was caused by the possibility of describing a parameter by more than one layer for the depth 0-10 cm. the layer could either be described by a single layer (*M01*) or by two layers (*M05* and *M51*). The depth section could also be described by all three layers. The situation is made more complex because for layers used differ at times with the parameter assessed. As a consequence, for the layer *M01* data may be provided for some parameters, but no data may be reported for organic carbon, which is covered by using layers *M05* and *M51*.

The computation of the OC content in the organic layer should be a straight-forward task since the parameter is assessed and reported in the database. It is readily available for organic layers with a single segment. For organic layers with more than 1 segment the mean OC content has to be weighted by the presence of the segment in the layer. For the soil material this is usually achieved by using the segment depth as a weighting factor. This approach can be used for organic layers where a depth value is provided. This is not always the case. An alternative method is to use the organic layer weight to compute the total amount of OC in the organic layer and then find the mean OC content. For the analysis both methods were applied to maximize the amount of plots with data on the OC content for the organic layer.

The distribution of organic carbon content in the organic layer is presented in Figure 12.

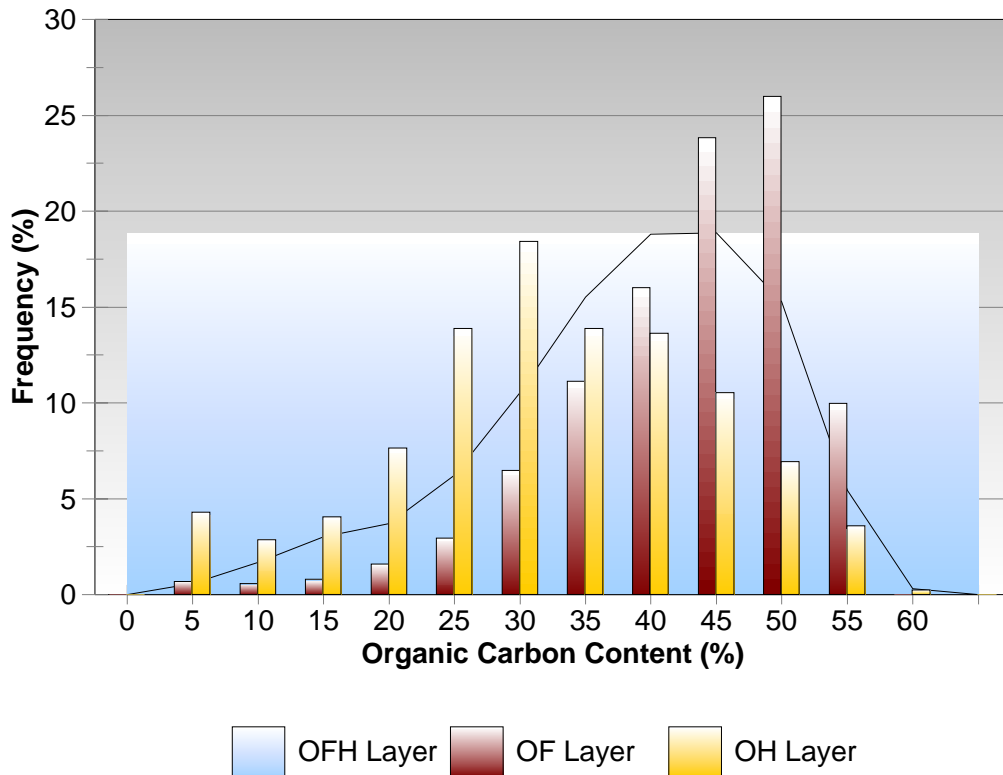

Figure 12: Frequency Distribution of Organic Carbon Content in OF, OH and OFH Layers (Level 1)

The bars show the relative frequency of the OC content as given for individual layers of *OF* (partly decomposed) and *OH* (well decomposed) at plot level. The mean OC content per plot was computed by weighing the layer OC content by volume (height of layer). For the OC content in *OF* layers there is a gradual increase in OC up to the most frequent values on the class of 30% OC, where approx. 20% of the layers with data are positioned. For *OH* layers the OC content is most frequently between 45 and 50%. With the *OFH* layer being a mixture of both organic layers the distribution is between the two separate layer data.

Unexpected are the occurrences of values < 20% OC in organic layers, which were reported for 277 plots and mainly in the *OH* layer. A closer examination of minimum and maximum values and the number of layers with low values of OC is given in Table 16.

Table 16: Minimum and Maximum Organic Carbon Content in Individual Organic Layer (Level 1)

Layer	Minimum	Maximum	Layers with OC <10%	Layers with OC <20%
	<i>g kg⁻¹</i>	<i>g kg⁻¹</i>	<i>No. of Layers</i>	<i>No. of Layers</i>
Hf	162.8	547.9		1
Hfs	195.5	581.0		1
Hs	202.0	542.8		
OF	8.8	549.0	12	33
OFH	25.3	596.5	44	179
OH	15.3	553.1	31	90
SUM			87	302

g kg⁻¹ : reporting unit

It is not immediately obvious why such low values of OC were found for organic layers, such as the *OH*, where the organic fine substance should amount to more than 70% of the total material by volume.

The spatial distribution of the OC content in the organic layer of a plot is given in *Figure 13*.

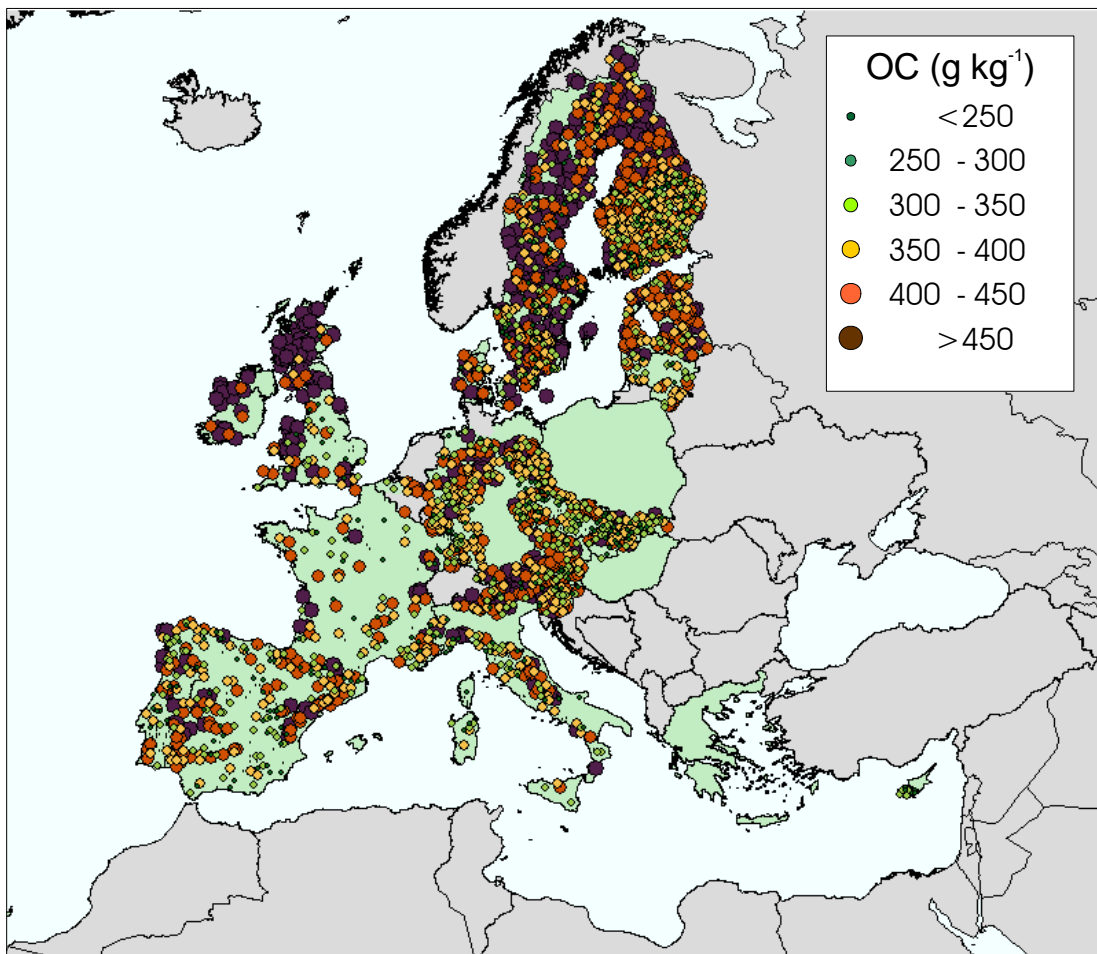

Figure 13: Spatial Distribution of Organic Carbon Content in Organic Layer of Plot (Level 1)

The graph does not reveal a visible difference in the distribution of OC in the organic layer by NFC. It would appear to be less variable on plots in the Czech Republic and the Slovak Republic than on plots in other NFCs, but not significantly so. For Finland the OC content in the organic layer appears to be higher on plots in the north than in the south of the country. The division roughly follows the area limit of the 16 km and the 32 km sampling grid.

The distribution of the OC content by soil layer is given in Figure 14.

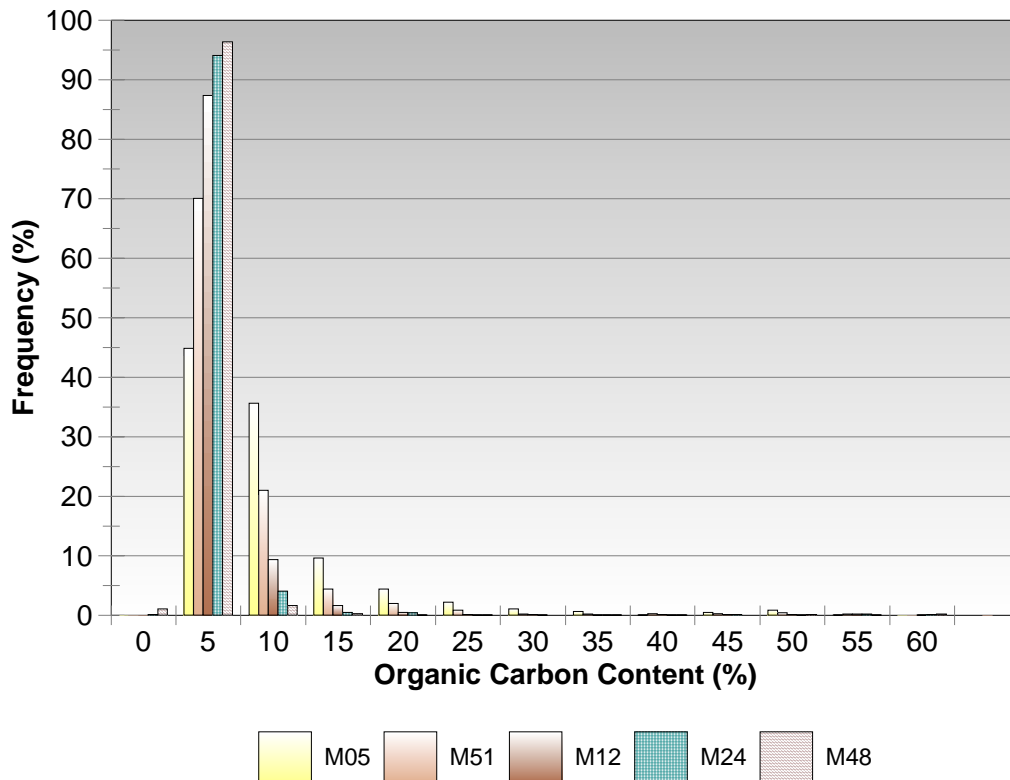

Figure 14: Frequency Distribution of Organic Carbon Content in Soil Material (Level 1)

Most of the soil layers have an OC content of < 5%. The graph also indicates that the variability on OC content decreases significantly with depth.

Minerals soils should have an OC content of < 12 or < 18%, mainly depending on clay content. For saturated layers inverse conditions apply. The graph shows that there are cases of a mineral layer with higher OC content, but does not distinguish between *H* and *M* layers. The results of the check of minimum and maximum OC values reported for the aerated and saturated segments are given in Table 17.

Table 17: Minimum and Maximum Organic Carbon Content in Soil Material (Level 1)

Layer	Minimum	Maximum	Layers with OC < 12%	Layers with OC < 18%
	<i>g kg⁻¹</i>	<i>g kg⁻¹</i>	<i>No. of Layers</i>	<i>No. of Layers</i>
H05	227.2	540.5		
H51	133.7	551.50		2
H01	185.2	649.5		
H12	121.0	593.0	0	3
H24	133.0	600.5		2
H48	19.7	586.5	1	2
			<i>Layers with OC > 12%</i>	<i>Layers with OC > 18%</i>
M05	1.3	509.1	111	34
M51	1.1	511.4	51	14
M01	1.4	568.0	118	57
M12	0.3	567.0	71	38
M24	0.4	587.0	41	23
M48	-6.5	584.0	19	14

g kg⁻¹ : reporting unit

For two plots in Bayern (Plot No. 1606, 1634) negative values for OC content were reported. The values were declared to be validated in the database, which indicates an omission in the validation checks. In some cases values for organic soil segments below 12% and 18% were reported. Conversely, there were a not insignificant number of plots where the OC content of the upper mineral soil layer corresponds to an organic layer. Those cases, however, do not necessarily constitute an omission of the validation procedure. They were found in data coming from several NFCs and thus suggest that the problem of separating organic from mineral soils is quite complex and widespread.

The distribution of the OC content in the soil material in the depth range of 0 – 20 cm for the NFCs is given Figure 15.

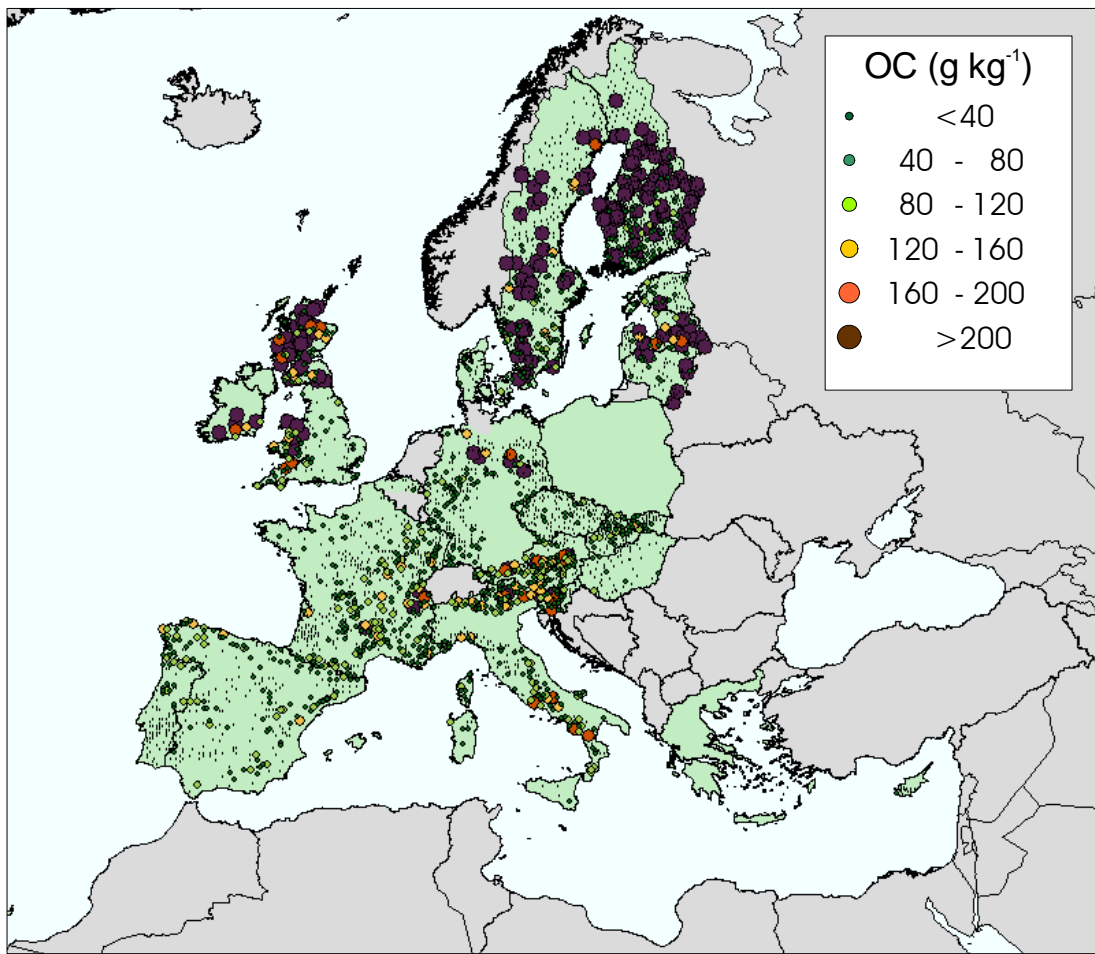

Figure 15: Spatial Distribution of Organic Carbon Content in Soil Material (0 – 20 cm) on Level 1 Plots

The spatial distribution of the OC content in the soil material follows the general pattern of the distribution of peat in Europe. Mapping the parameter does not reveal any other obvious spatial differences or trend.

3.4.2 Depth Limits

The issue of reporting upper and lower depth values has already been mentioned in the previous section. The values should have been used only to record the limits of the organic layer(s). Mineral layers include the depth segment they relate to in the layer code. For organic layers depth limits are counted backwards from the organic layer / soil section boundary, which is defined to be of depth 0 cm. The forms allowed providing values of depth also for the soil sections. This has led to the re-definition of the depth limits of the pre-defined soil sections.

- A value of the upper (LAYER_LIMIT_SUP) or lower depth limit (LAYER_LIMIT_INF) is missing from one or more organic layers for 60 plots (OF: 12; OFH: 37; OH: 11). This count excludes layers of organic litter (OL), which are not considered in the computation of the sample organic carbon content. For layers Hs, Hf and Hfs depth figures are reported for all instances.
- No occurrences were found where only one value for the layer limits was given.
- Identical entries for the upper and lower depth limits for the organic layers were found for 104 plots (57 cases for OL layer). Of those, 52 used a depth of 0.0 cm for both limits.

This leaves 3,173 plots (98.4% of plots with an organic H or O layer) with data on layer depth for the organic layer.

The height of the organic layers per plot (sum of height of organic layers found at plot) ranges from 0.1 cm to 99.0 cm. The relative distribution of the height of the organic layer of plots is presented in Figure 16.

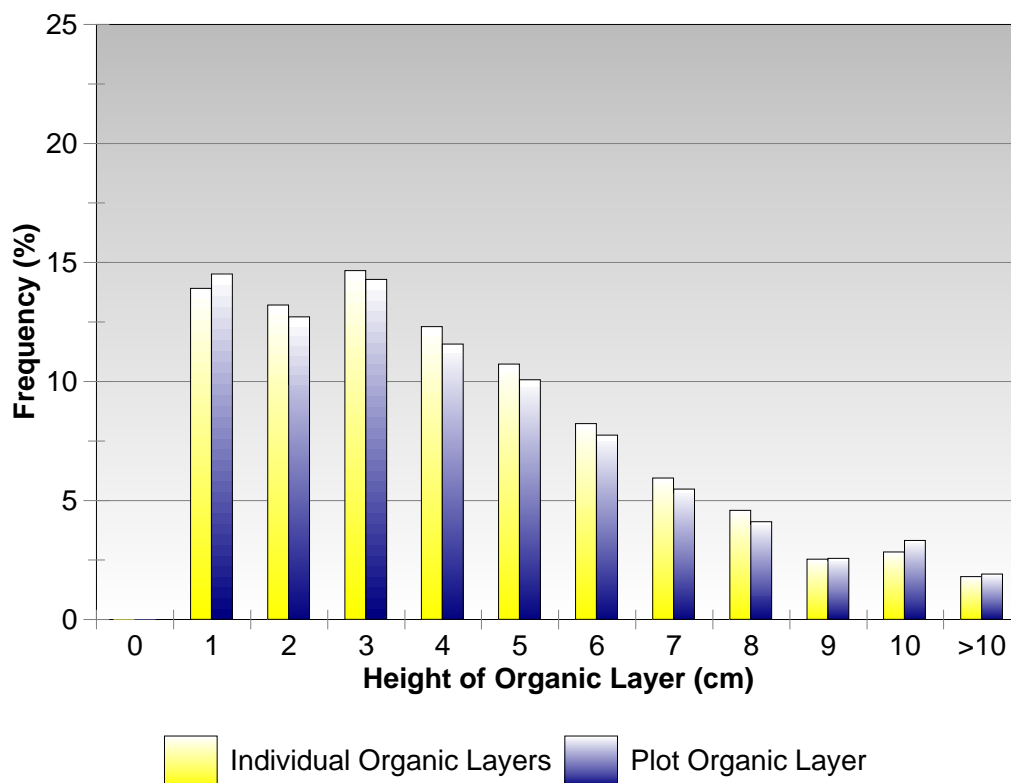

Figure 16: *Frequency Distribution of the Height of the Organic Layer for Level 1 Layers and Plots*

The graph shows that on the Level 1 plots the height of the organic layer is most commonly 1 – 3 cm with a steady decrease in frequency of layers with a higher degree of accumulation of organic material. For more than 50% of the plots the height of the organic layer is < 4cm. Plots with heights of the organic layer of >10cm are only locally significant. Organic layers of this height were reported for 12.8% of the plots.

The height of the organic layer at the sample sites is presented in Figure 17.

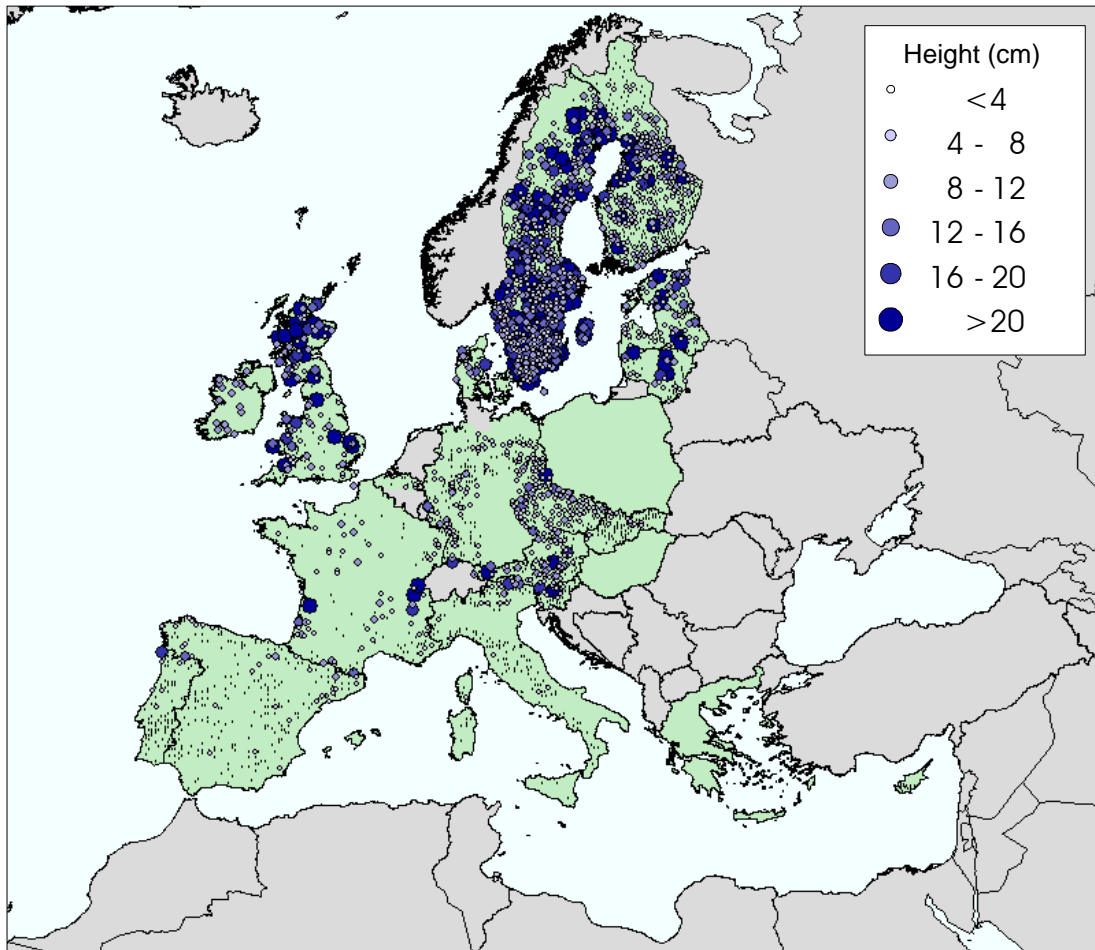

Figure 17: Spatial Distribution of Height of the Organic Layer on Level 1 Plots

The height of the organic layer in forests in the Mediterranean basin is mainly below 2 cm. In central and northern areas of Europe the height of the layer increases to >3 cm. An organic layer height of 40 cm was reported for 49 plots, mainly in Sweden (44), with some in the UK (6) and France (2).

For layers of the soil material identical values for a layer limit with the depth of another layer for the plot were found for 74 plots. The main cause for duplicate entries was that organic layers (excluding *OL* layer values) were reported at depths covered by mineral

layers, largely because layer depth was recorded from the top of the organic layer downwards. For plots in Ireland and 1 plot in the UK no values for the limits of the segments of the soil material were recorded in the database. Including such information should indeed not be required because the *Mij* and *Hij* layers have predefined depth limits.

The distribution of *Mij* and *Hij* layers in the data is graphically presented in Figure 18.

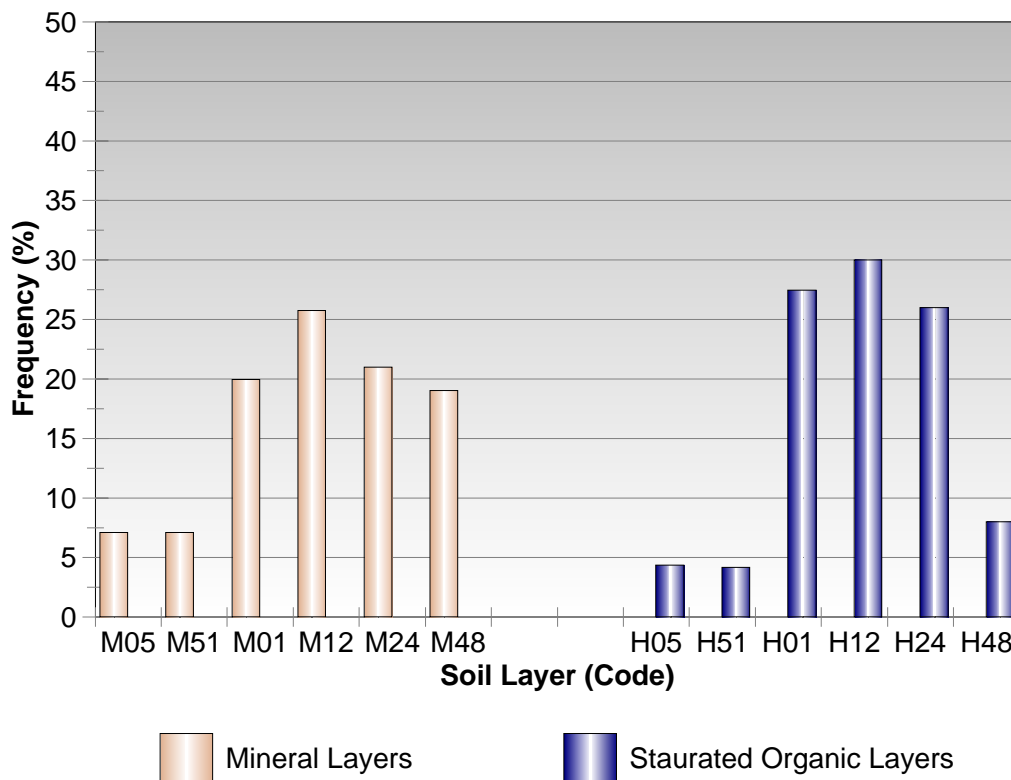

Figure 18: Frequency Distribution of the Soil Layers for Level 1 Plots

Of the 14,132 layers of the database (not including repetitions), for which a depth is predefined (*Mxy* and *Hxy*) and for which data are reported in the database, depth limits different from the predefined values were reported for 219 soil layers (193 for non-blank entries in LAYER table) on 66 plots. The plots are mainly located in Ireland (27 plots), Sweden (20 plots) and Estonia (12 plots). No data on the limits of the segments of the soil material were given for one or more *Mxy* or *Hxy* layers for 22 plots (21 plots in Ireland without depth for *M48* layer). The level of consistency of the reported limits with the defined ranges is 98.5%.

The inconsistency of the reported limits with the specified ranges can be treated in several ways. One option is to use the segments depths as reported, another is to replace the recorded depth with the defined limits. Both options introduce a contradiction in the

analysis of separating the organic layer from the soil material for plots where the recording of the organic layer starts at a depth of 0 cm. A third option is to restrict the analysis to only those plots where the reported limits correspond to the defined values. However, the absence of the information on depth limits for the soil material on some plots obstructs the data analysis by requiring an ancillary table to be constructed, which contains the reported values for all plots where a value has been provided and default values for plots without such values.

3.4.3 Bulk Density

For Level 1 plots a value for bulk density has to be provided for all soil sections, but not for the organic layers. For organic layers providing a value for the parameter is marked as optional in the specifications given for the reporting form, which is not quite correct in this generalized form. More specifically, bulk density can be either estimated or measured. Reporting estimated values is optional, but when the parameter is measured it should be reported in the field MEAN_BULK_DENSITY. This arrangement can be confusing, because in case several estimates are made they could also be reported in the field¹⁴.

According to the specifications given in the description of the SOM file reference methods for establishing bulk density are given in Table 18.

¹⁴ The field name MEASURED_BULK_DENSITY is used in the HORIZON table.

Table 18: Methods for Measuring or Estimating Bulk Density and Examples of Content of Comments

Method	Code	Comment (shortened)
<i>Specifications</i>		
Measured	sa04a1	Core method (cylinders)
	sa04b1	Excavation method
Estimated	sa04a3	Core method (cylinders)
	sa04b3	Excavation method
	sa04c	Estimation of bulk density according to Adams (1973)
<i>Database Content</i>		
	sa04a3	measured values existent
	sa04a3	not applicable
	sa04a3	not available
	sa04a3	not done
	sa04a3	not measured
	sa04c	Rawls and Brakensiek (1995)
	sa04a3	Tamminen & Starr 1994, Silva Fennica 28(1)
	sa04a3	Callensen et al., 2003

The table shows that a method code could actually signify that more than just one explicitly specified method was applied. It also shows that the layout of the form is not compatible with the data model. The same code should not be used to signify different methods. Each method should be given a unique code for the method used. This requires that the method codes can be extended by the NFC, which is not compatible with a standardized survey. In the analysis of the data the information on the method was not included.

A value of mean bulk density was given for 6,951 layers (7,245 with repetitions) out of a total of 17,821 layers (18,754 with repetitions, excluding *OL* horizon). A value for estimated bulk density was given for 7,072 layers (same number with repetitions). Data for both parameters were reported for 1,280 layers, which belonged in all cases to the mineral soil section.

For the analysis of the SOC density the information from the two fields containing bulk density was combined into a single value. When two values were available priority was given to the data recorded in the filed `MEAN_BULK_DENSITY`, which should contain measured values. The relationship between the mean (measured) and the estimated bulk density is graphically shown in *Figure 19*.

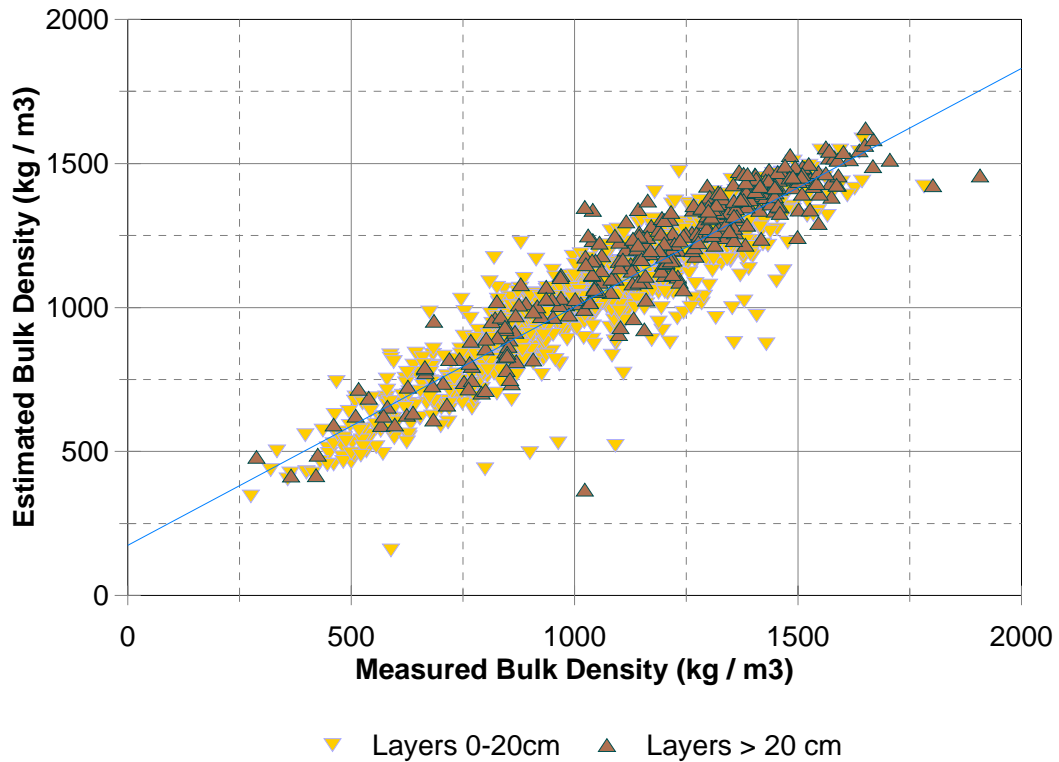

Figure 19: Relationship between Mean and Estimated Bulk Density for Layers with Data for Both Parameters

The graphs shows the close relationship between the mean and the measured bulk density for the 0 – 20cm soil section and lower layers (r^2 : 0.86 for all layers), but also some outlying values. Noteworthy is that the origin of the linear fit does not go through zero, but has an off-set of 175.3 kg m^{-3} (Std. Err.: 94.7). Data for both parameters are only recorded for mineral layers. For organic layers no data pairs are recorded in the database.

By combining the information from both parameters a total of 13,028 (69.5%) layers of any depth could be characterized by a value of bulk density. A complete coverage of the soil profile sampled with data on bulk density was available for 188 plots for the organic layer and for 3,240 plots for the mineral section to a depth of 20 cm..

The ranges of values for bulk density for the organic layer as recorded in the LAYER table are given in Table 19.

Table 19: Minimum and Maximum Bulk Density of Organic Layer (Level 1)

Layer	Min <i>kg m⁻³</i>	Max <i>kg m⁻³</i>	Layers with <i><50 kg m⁻³</i>	Layers with <i>>500 kg m⁻³</i>
Hf	-	-	-	-
Hfs	-	-	-	-
Hs	-	-	-	-
OF	0.6 (-)	1377.2 (-)	66 (0)	2 (0)
OFH	50.7 (60.0)	1442.0 (681.0)	0 (0)	1 (2)
OH	537.0 (459.0)	1347.1 (1004.0)	0 (0)	7 (13)

kg m⁻³ : reporting unit

() value for estimated bulk density

The reporting unit for bulk density of *kg m⁻³* gives 3 decimals for the widely used unit of *g cm⁻³* (= *t m⁻³*). This makes a value below 50 *kg m⁻³* (0.05 *g cm⁻³*) unlikely. There are 66 cases with values less than 0.05 *g cm⁻³*.

The location of the plots where a value of bulk density was given for the organic layer is presented in Figure 20.

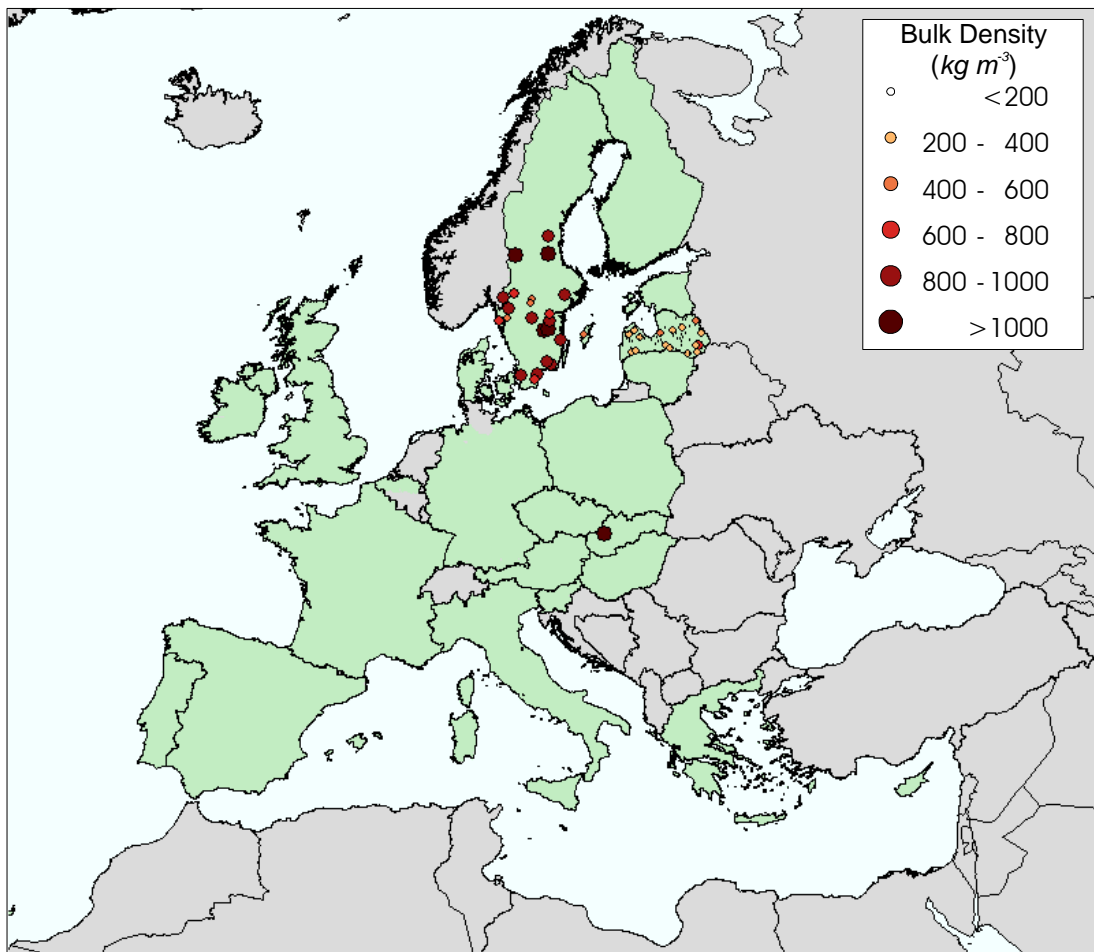

Figure 20: Spatial Distribution of Bulk Density Values of the Organic Layer (Level 1)

With the exception of one plot in the Slovak Republic all plots for which values of bulk density were reported for the organic layers are located in Sweden and Latvia. For some German NFCs a bulk density was also reported, but the sites are outside the area of the NFC. The high value reported for the plot in the Slovak Republic (1.4 g cm^{-3}) is inconsistent with the normal range of values for organic material, which suggests that the data could have been reported unintentionally.

For organic layers bulk density can be computed from the parameter “*Organic Layer Weight*” (OLW) and the height of the organic layer. A value for OLW is recorded for 3,579 layers of 2,969 plots (not including *OL*). For 4 plots a value was also given for a mineral soil layer (Hungary, Plot 96: *M05*; Sweden, Plots 1595, 1669, 1734: all *M01*). In 68 cases the OLW was given as 0 although values were recorded for the layer limits with a layer thickness ranging between 1.0 cm and 50.0 cm.

The distribution of bulk density values reported for the organic layer and for the value computed from the OLW and height is presented in Figure 21.

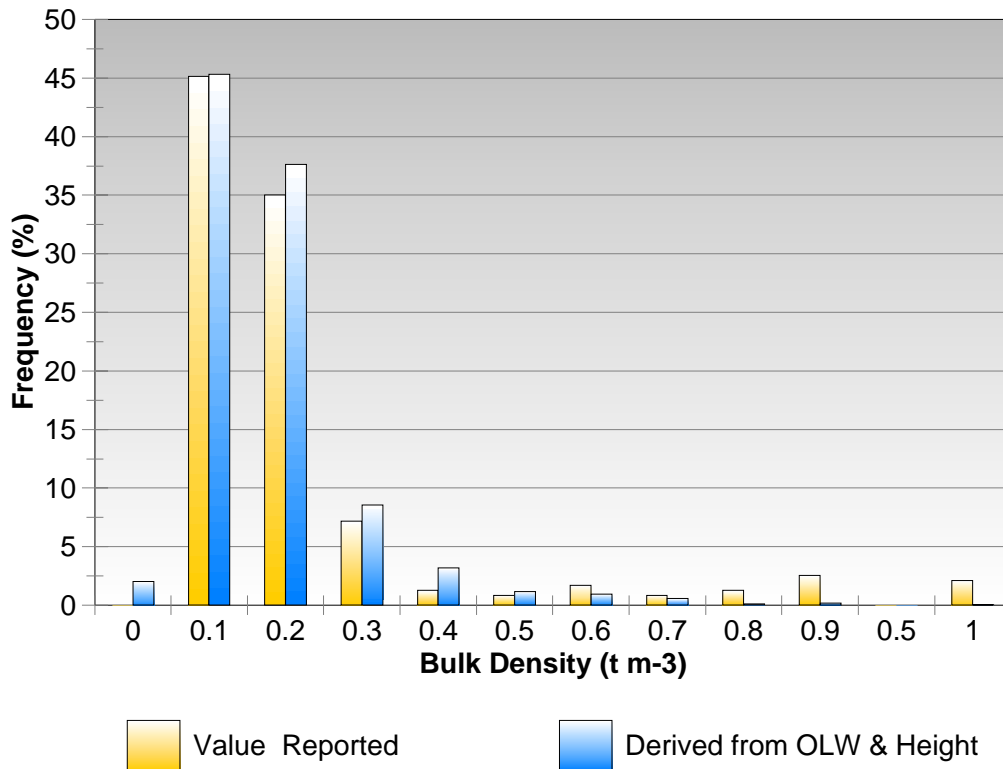

Figure 21: Frequency Distribution of Reported and Derived Bulk Density in Organic Layer (Level 1)

The graph is based on 237 organic layers where bulk density was reported (measured or estimated) together with the OLW and height. No significant differences in the frequency distribution is noted, despite the data coming from different regions and NFCs. There are more values from the measured or estimated data with bulk densities > 0.5 g cm⁻³ than are calculated from OLW and height, although the number is small (20 layers, 8.4%). Almost 50% of for the organic layers have values for bulk density <0.10 g cm⁻³ and approx. 90% <0.20 g cm⁻³.

The relation between the bulk density as reported (measured and estimated) and the value computed from the organic layer weight and the layer thickness is graphically presented in Figure 22.

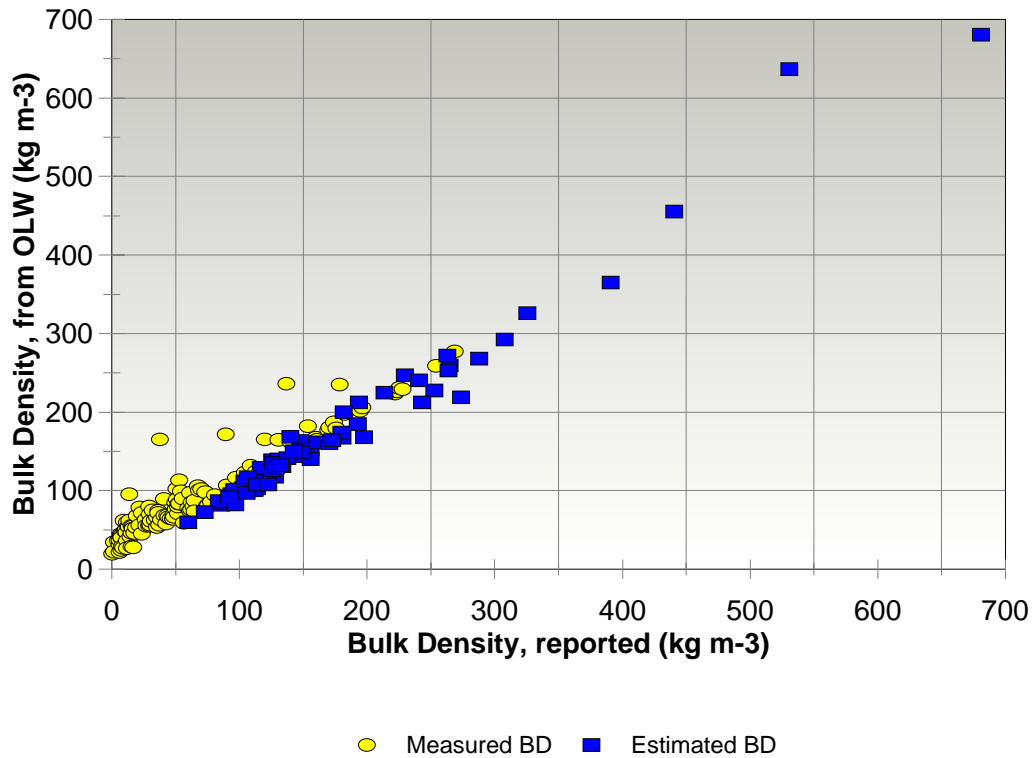

Figure 22: Relationship between Reported Bulk Density (Measured and Estimated) and Bulk Density Computed from Organic Layer Weight and Layer Thickness (Level 1)

The graph shows a strong relationship between the bulk density values from the two data sources. Not shown on the graph are 2 outliers with reported values of over 700 kg m^{-3} , but calculated values of less than 100 kg m^{-3} . No particular reason for this anomalous difference could be found in the data or the comments. When computing a regression for the reported and derived values (not including two outliers) the origin of the line shows an off-set of 35 kg m^{-3} (significantly different from 0) for the measured and -6 kg m^{-3} (not significantly different from 0) for the estimated values.

The graph also shows that there are no data pairs for $\text{BD} < 50 \text{ kg m}^{-3}$ for the estimated data, although there are numerous instances with lower BD for the measured values. The differences between the calculated and reported BD are graphically presented in Figure 23.

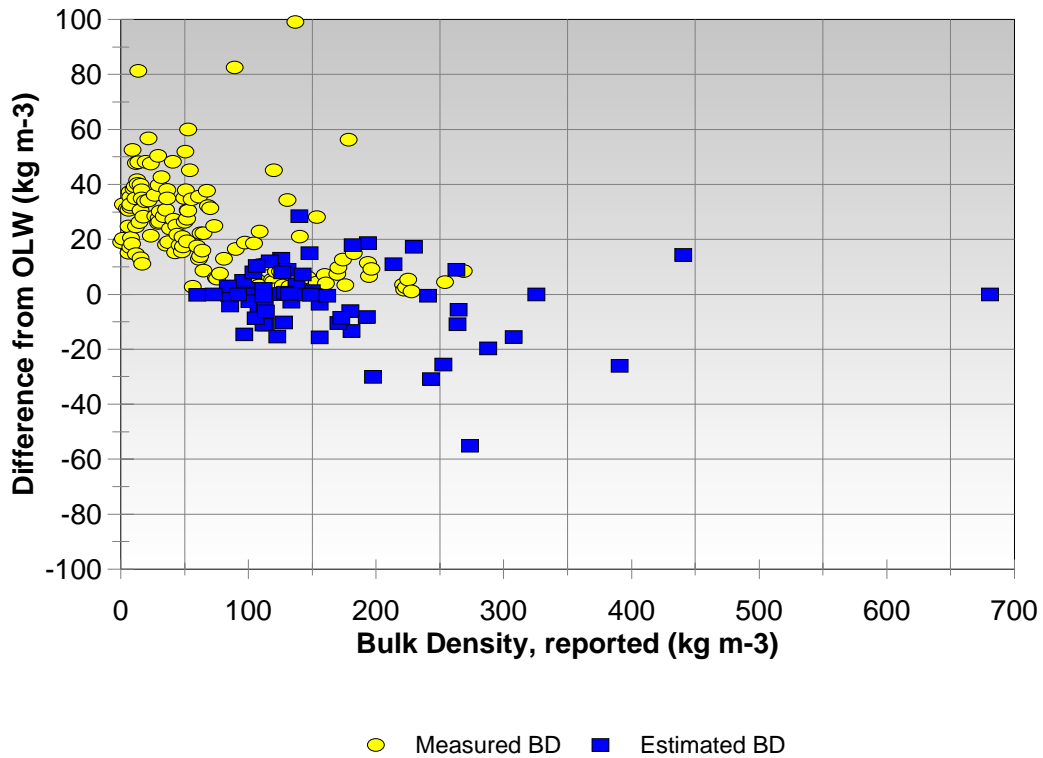

Figure 23: *Difference between Bulk Density Computed from Organic Layer Weight and Layer Thickness and Reported Bulk Density (Measured and Estimated, Level 1)*

The graph shows that the calculated BD is always higher than the values reported for measured values, predominantly for values $< 50 \text{ kg m}^{-3}$. The differences between the estimated and the computed values are more evenly distributed between positive and negative values (35 out of 69 data pairs given a difference < 0). However, the average difference is -58.50 kg m^{-3} , thus showing a tendency to lower computed BD values than were estimated. Despite the distinct variation in the differences of the reported to the computed BD values no general tendency can be put forward from the conditions found in the data. With the exception of 2 all pairs of measured/computed values come from the NFC of Bayern (used despite plot latitude errors) and all pairs of estimated/computed values from the NFC of Latvia. An influence on the results coming from the NFC can therefore also not be excluded.

As a possible explanation of the differences in bulk density the hypothesis was put forward that the magnitude of the differences is related to the variations in measuring the height of the organic layer. For a fixed limit of detecting the layer height the variations between the bulk density computed from the OLW and the reported values should decrease with increasing layer height. This assumption was tested by relating the

absolute difference in bulk density to the height of the organic layer. The result is graphically presented in Figure 24.

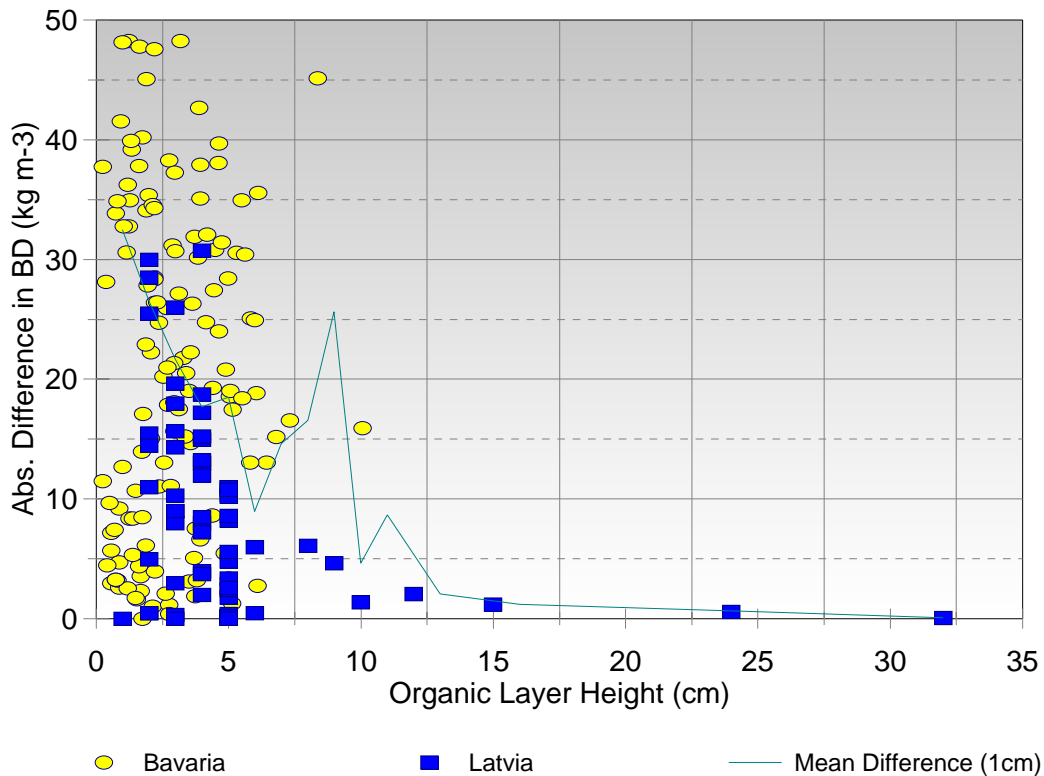

Figure 24: Absolute and Aggregated Difference between Bulk Density Computed from Organic Layer Weight and Layer Thickness and Reported Bulk Density (Measured and Estimated, Level 1)

The graph indicates that for the bulk density values reported for Latvia a relationship exists between the variation of difference in bulk density and the height of the organic layer. An estimation of the measurement limit of the height of the organic layer for Latvia was based on the average height of individual organic layers at a plot (2.8 cm), the average weight of the organic layer (2.5 kg m^{-2}) and the mean difference in bulk density for layers between 2 and 3 cm thickness (22.1 kg m^{-3}). The variations in layer height were then computed from the variation around the bulk density of $87.9 \text{ kg m}^{-3} \pm 22.1 \text{ kg m}^{-3}$. The subsequent range on layer height is 0.76 cm. The value could be used as an indicator for the measurement uncertainty of the organic layers although this finding derived from the Latvian plots may not be generally applicable for all plots. In addition, such a value does not preclude reporting organic layers with less height.

The mean difference in bulk density by 1cm aggregation is very much influenced by the trend of the values reported for Latvia. Data for plots in Bavaria do not display the behaviour to the same relationship as the Latvian data. Because only positive

differences are found for those plots (bulk density from OLW > reported bulk density) there seems to be another mechanism at work than the measurement uncertainty of the height of the organic layer.

The spatial distribution of bulk density in the organic layer calculated from OLW and height by plot is presented in Figure 25.

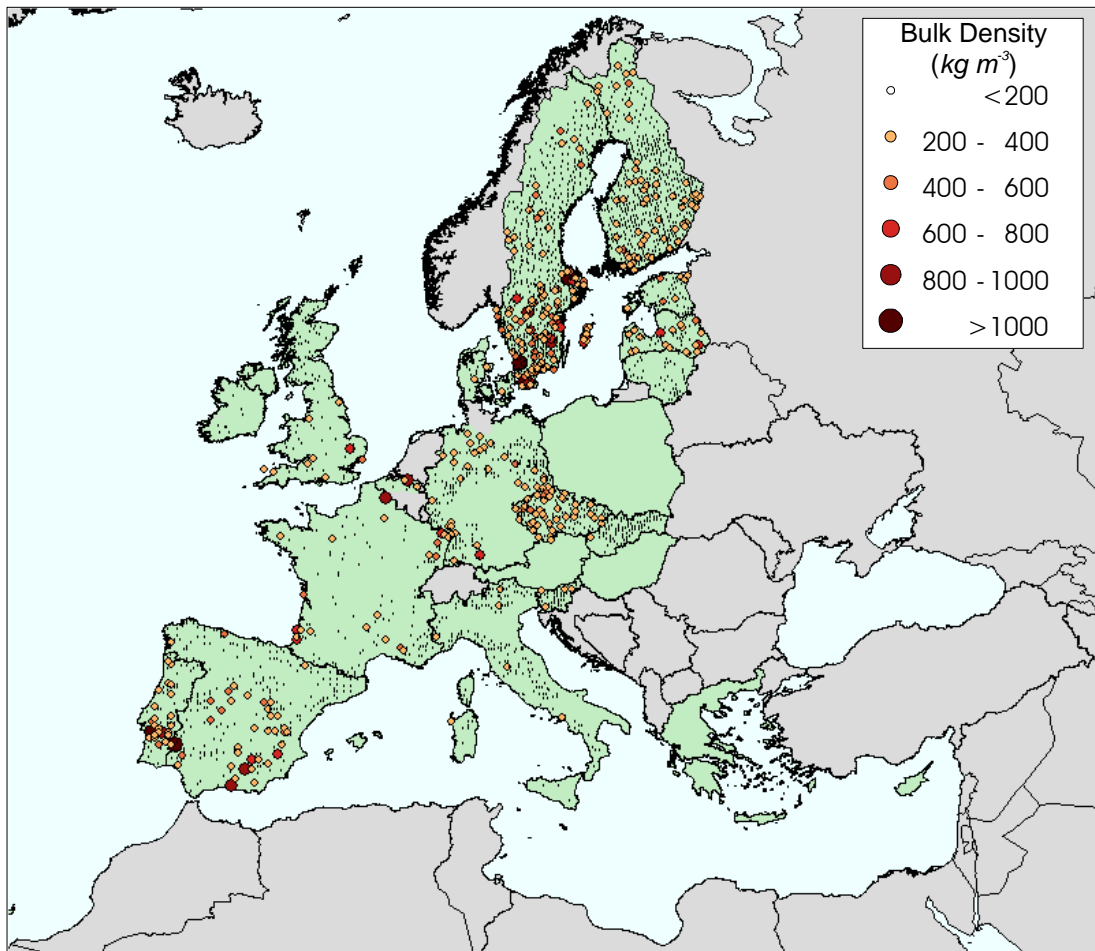

Figure 25: Spatial Distribution of Bulk Density Derived from Organic Layer Weight and Height of the Organic Layer (Level 1)

The graph does not suggest that plots with a bulk density $>500 \text{ kg m}^{-3}$ (50 g cm^{-3}) in the organic layer follow a geographic clustering. There would appear to be a higher density of such plots in southern Sweden and the Czech Republic. In the absence of measured values a bias toward higher bulk densities could not be evaluated.

The extreme values of bulk density for the sections of the soil material are summarized in Table 20.

Table 20: Minimum and Maximum Bulk Density in Soil Material Layers (Level 1)

Layer	Min $kg\ m^{-3}$	Max $kg\ m^{-3}$	Layers with $<50\ kg\ m^{-3}$	Layers with $>500\ kg\ m^{-3}$
H05	64.0 (-)	1030.0 (-)	0 (0)	2 (0)
H51	64.0 (-)	1030.0 (-)	0 (0)	2 (0)
H01	106.20 (96.0)	787.40 (503.0)	0 (0)	1 (1)
H12	73.0 (89.0)	1203.0 (860.0)	0 (0)	2 (1)
H24	64.0 (84.0)	1158.0 (860.0)	0 (0)	2 (1)
H48	64.0 (79.0)	1250.0 (860.0)	0 (0)	2 (1)
			$<500\ kg\ m^{-3}$	$>1900\ kg\ m^{-3}$
M05	1.30 (666.0)	2847.0 (1200.0)	87 (0)	1 (0)
M51	41.0 (800.0)	1850.0 (1200.0)	74 (0)	0 (0)
M01	58.0 (103.0)	1746.0 (1600.0)	98 (128)	0 (0)
M12	58.0 (114.0)	1965.0 (1710.0)	79 (45)	2 (0)
M24	75.0 (114.0)	1908.0 (1904.0)	61 (27)	1 (1)
M48	92.0 (134.0)	2200.0 (1965.0)	21 (15)	3 (4)

$g\ kg^{-1}$: reporting unit
 () for estimated bulk density

The table indicates some inconsistencies in separating mineral from organic segments, similar to the results found when analyzing the data for the organic layers. Consecutive layers with a bulk density $< 0.5\ kg\ m^{-3}$ to a depth lower than 30cm point toward an organic substrate. These irregularities not necessarily affect the analysis when the data are pooled. Other findings suggest that also incorrect values found their way into the database. The normal range of bulk densities for mineral soils is $1.0 - 1.6\ g\ cm^{-3}$. Values of over $1.9\ g\ cm^{-3}$ can be considered dubious. The bulk density of quartz is approx. $2.65\ g\ cm^{-3}$. Several values were found in the database with values $> 1.9\ g\ cm^{-3}$ which could be erroneous, but also taken from an impermeable layer.

For soil segments the frequency distribution of bulk density values is presented in Figure 26.

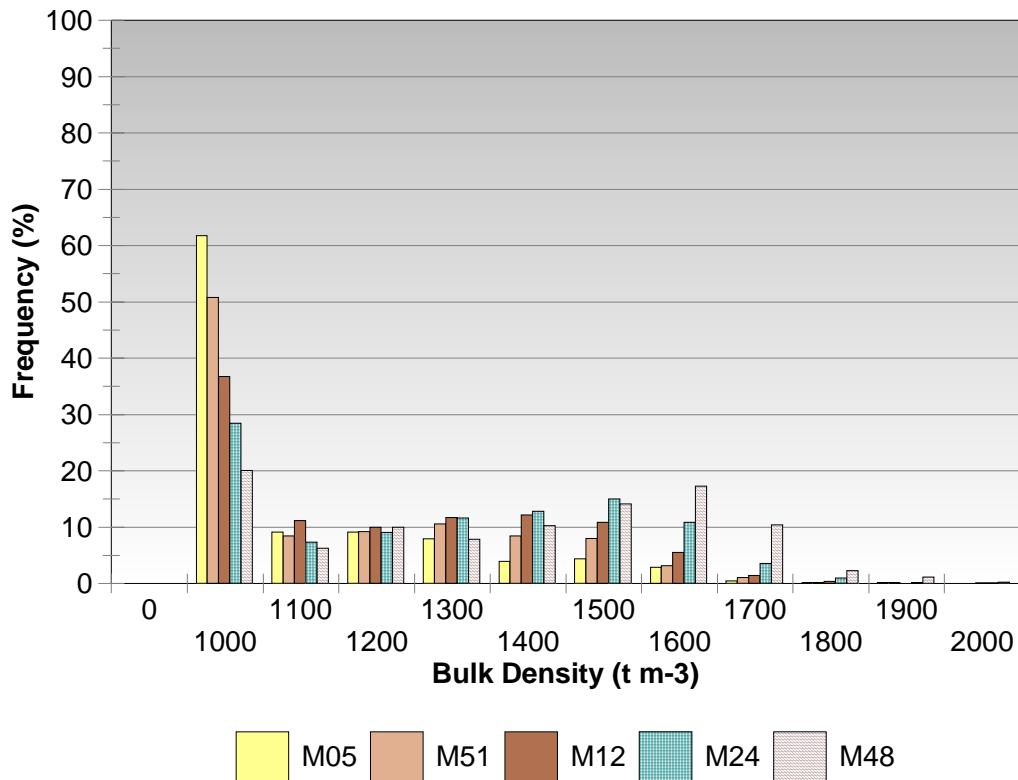

Figure 26: Frequency Distribution of Measured Bulk Density in Soil Material (Level 1)

For soil layers to a depth of 20 cm bulk density values below $1,000 \text{ kg m}^{-3}$ were reported for 40 to 60% of the segments. For the soil segment *M48* values for bulk density vary around a range of 1,200 to $1,400 \text{ kg m}^{-3}$. This is also the range of the default value used for mineral soils (1.33 g cm^{-3} ; Manual, p. 13).

While the field `MEAN_BULK_DENSITY` should contain measured values some doubts were raised when analyzing the frequency distribution of values. For numerous plots with values $< 1,000 \text{ kg m}^{-3}$ only numbers fully dividable by 100 were recorded. Those values are very unlikely the result of measurements unless more precise figures were lost during a process of transforming data between units, e.g. from g cm^{-3} to kg m^{-3} .

The spatial distribution of the bulk density for the soil material 0-20cm is presented in Figure 27.

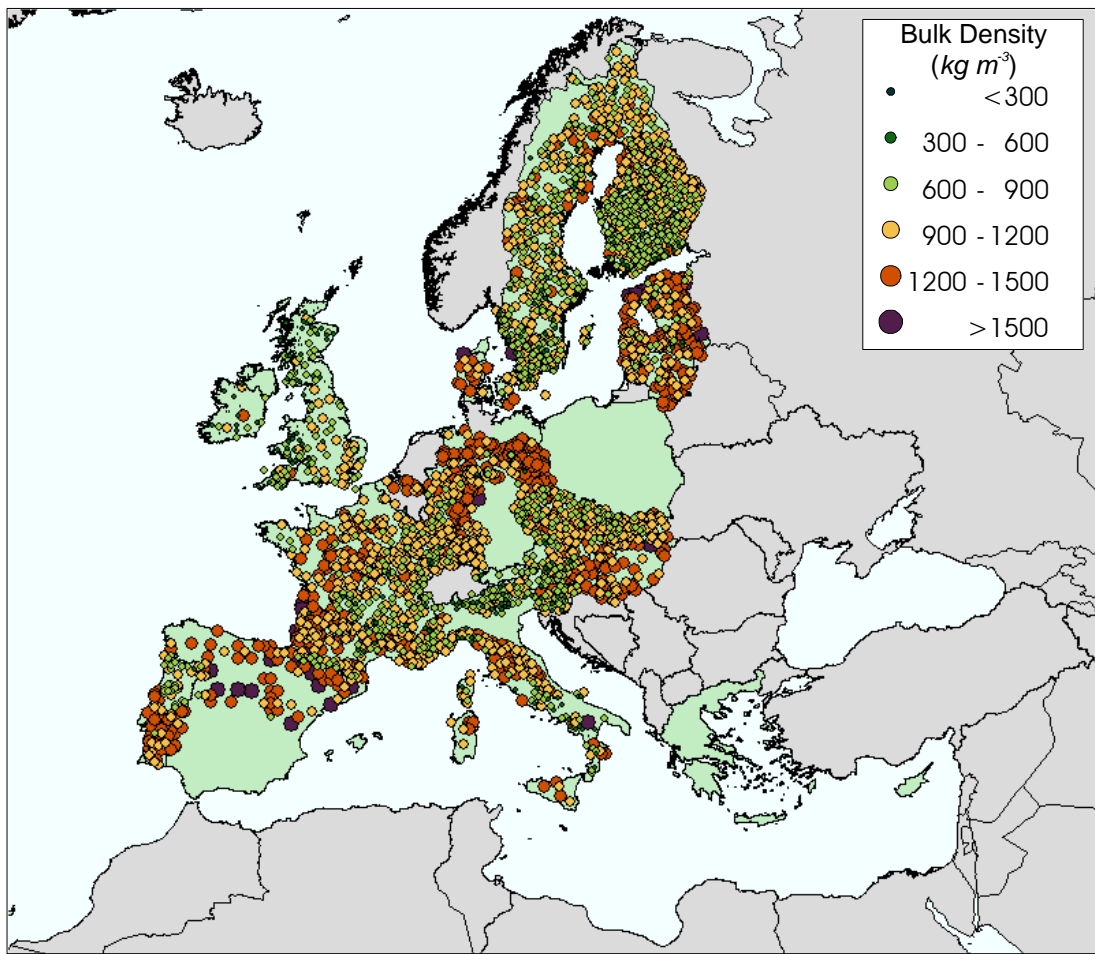

Figure 27: Spatial Distribution of Bulk Density (Measured and Estimated) in the Soil Section 0-20 cm (Level 1)

The map illustrates the absence of data for bulk density for the soil material for the southern part of Spain. For plots in this area the data were either completely missing or absent for part of the profile. The *M05* soil section seems to have been most affected by missing data in that region, while data for the *M12* data are provided. As a consequence of missing data in the upper sections the mean bulk density for the 0-20cm section could not be computed for those plots. The NFC for Ireland did not provide data for the layer depth of the soil sections. This should not be necessary as the section depths used should only be the ones specified in the BioSoil Manual. The values were therefore replaced with the default values of the soil sections.

3.4.4 Volume of Coarse Fragments

The “*volume of coarse fragments*” (VCF, volume %) should include stones and gravel with a diameter > 2mm. For Level 1 samples it is requested for all mineral soil sections, but not for organic material. Similarly, the “*mass of coarse fragments*” (MCF) should also be reported for all mineral sections when sampling Level 1 plots.

A list of methods available to determine mass and volume of coarse fragments is given in Table 21.

Table 21: Methods for Measuring Coarse Fragments and Examples of Content of Comments

Indicated*	Code	Comment (shortened)
<i>Mass</i>		
15,946	sa05a	Method by sieving and sedimentation
206	sa05c	Determined by previous survey
<i>Volume</i>		
14,575	sa05a	Method by sieving and sedimentation
0	sa05b	Estimation by Finnish method
0	sa05c	Determined by previous survey by sa05a
0	sa05d	Determined by previous survey by sa05b
902	sa05e	Estimation by chart of <i>cf</i> content

* Excl. OL layers

From the list of possible methods only method “*sa05a*” has been used to determine the MCF. To determine the VCF method “*sa05a*” has been used in 94.2% of cases when the information was provided. The remainder indicated the use of method “*sa05e*”.

- **Mass of Coarse Fragments**

For 169 organic layers from 120 plots a value for the MCF was found in the database. For 144 organic layers the value was actually 0. For the soil material (*M* and *H*) data were provided for 5,920 layers and in 1,095 cases the value was 0.

- **Volume of Coarse Fragments**

The VCF was recorded for 187 organic layers from 138 plots. In 145 of those cases the volume indicated was 0. For 9,764 segments of the soil layers a value for the VCF was given, which was 0 for 818 soil layers.

In some cases a value for either the MCF or the VCF was reported to be 0 while an actual value was reported for the other parameter. Such inconsistencies in the soil segment were:

- Mass = 0 & Volume > 0: 21 layers
- Mass > 0 & Volume = 0: 15 layers

The difference in the latter combination can be explained by the small value for the MCF (1.0 and 0.1), which may lead for the volume to be below the dimension of the field. This is not the case for the inverse condition, i.e. when the MCF is 0 and a non-zero value for VCF is reported. Here the 0 in the field for the MCF seems to indicate the absence of a measurement rather than absence of a measurable value. For the computation of SOC density only the data on the VCF was used. The computation of BD is based on volume and converting the MCF to VCF would require an assumption about the density of the MCF (a value of 2.65 g cm^{-3} could have been used).

The spatial distribution of the plots with a value of VCF for the organic layer is given in Figure 28.

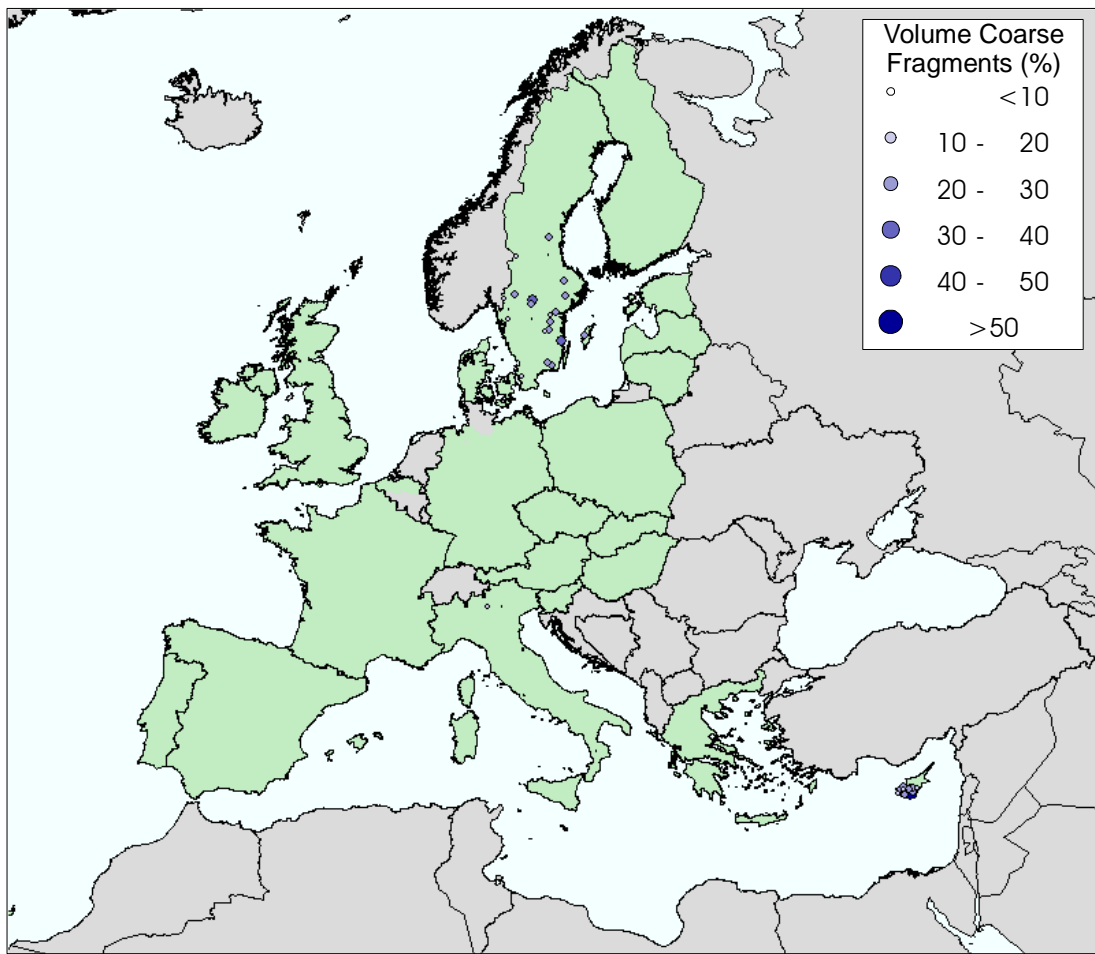

Figure 28: Spatial Distribution of Volume of Coarse Fragments in the Organic Layer (Level 1)

For plots in Cyprus a value of the VCF was generally reported. Values were also recorded for several plots in Sweden and 3 plots in Italy, 1 of the plots in the latter with a value of 0.

The relative frequency of the VCF by segment in the soil material is presented in Figure 29.

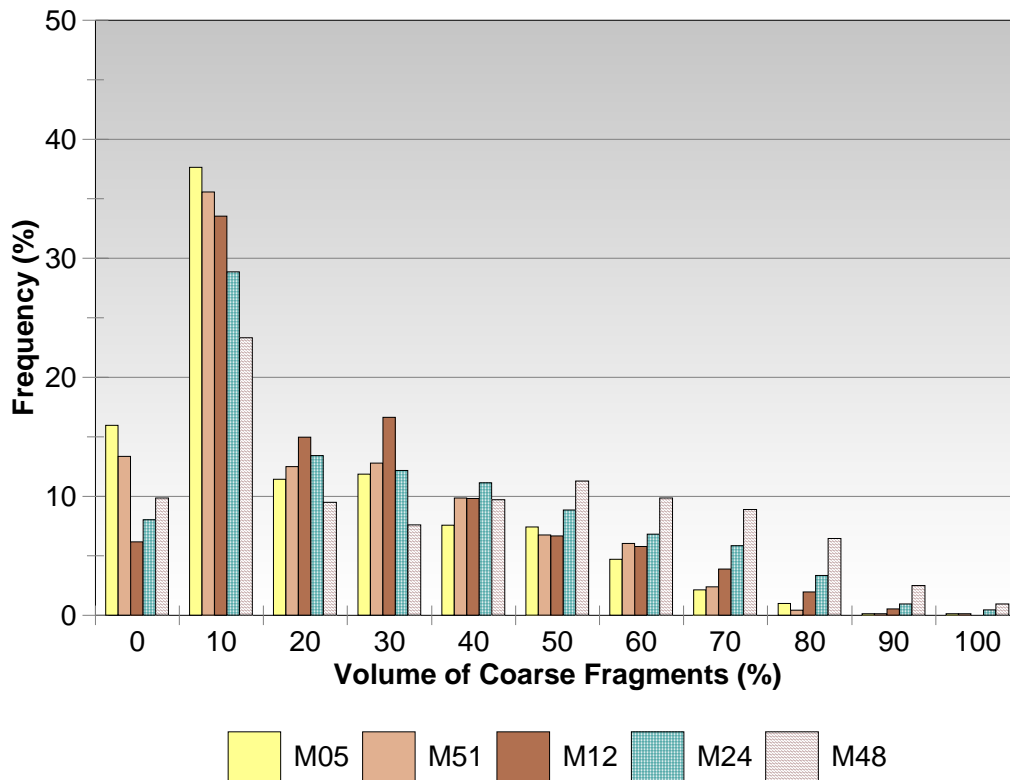

Figure 29: Frequency Distribution of Volume of Coarse Fragments in Soil Material (Level 1)

The distribution of the VCF in the soil material shows a prevalence of values in the range of 0-10% for all segments. For soil depths up to 20cm the VCF is generally <30%. Higher values occur with a frequency of <10% and mainly at lower depths. From the data it is not evident whether the third of the segments without an entry follow the same distribution or that a higher proportion of segments without coarse fragments exists in the plots without data.

The identification of differences by NFC in reporting the parameter is aided by mapping the plot values. The spatial distribution of the plots with data for the VCF is given in Figure 30.

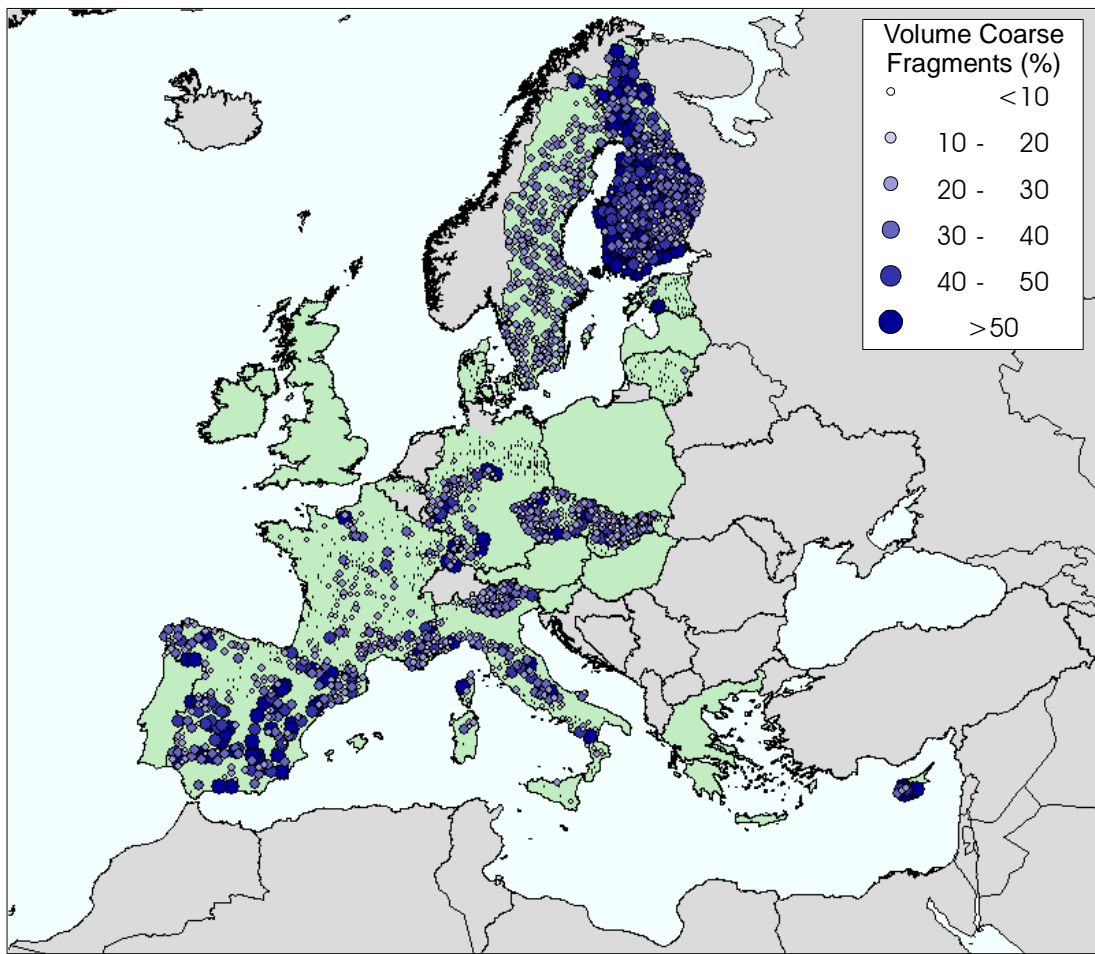

Figure 30: Spatial Distribution of Volume of Coarse Fragments in the Soil Section 0-20 cm (Level 1)

There are higher than average occurrences of plots with a VCF >50% in Cyprus, Spain and Finland. The difference in the values between Finland and Sweden or Estonia is visible in the graph. It is very much linked to national boundaries, although this by itself does not necessarily signify a difference in methods of assessing the parameter. The parameter was not reported by several NFCs. This potentially distorts the computation of SOC densities towards higher values in areas where the parameter was not reported but is still present.

3.4.5 Soil Organic Carbon Quantity

SOC quantities are generally computed for a given depth and therefore related to a volume of the soil material. The depth is determined starting from the surface of the soil material and counting downwards. This concept is consistent with the procedure applied

to code the depth of organic layers where the zero-horizon is the interface between the organic and the soil material. Taken literally the organic layer is not part of the soil. In practice the organic soil material is at times coded as an organic layer and information sampled would thus be excluded from an analysis of the OC of the soil material.

An *a posteriori* separation of the organic layer from the organic soil material, as suggested by the sampling manual, is not always possible (clay content not recorded for organic layers). The evaluation of the data therefore processed the information as declared by the NFCs and separately for the organic layer and soil material.

For the organic layer the amount of SOC was determined for the depth of the layer. The VCF was considered when such data were available for a layer, but absence of a value was not treated as a constraint that prevented computing a figure for the OC quantity. A value for bulk density of the organic layer was reported for just 166 plots. Therefore, the bulk density derived from the organic layer weight and depth was used for cases where no corresponding measured value was reported.

The relative frequency of the amount of OC in the organic layer and the soil material 0-20 cm is presented in Figure 31.

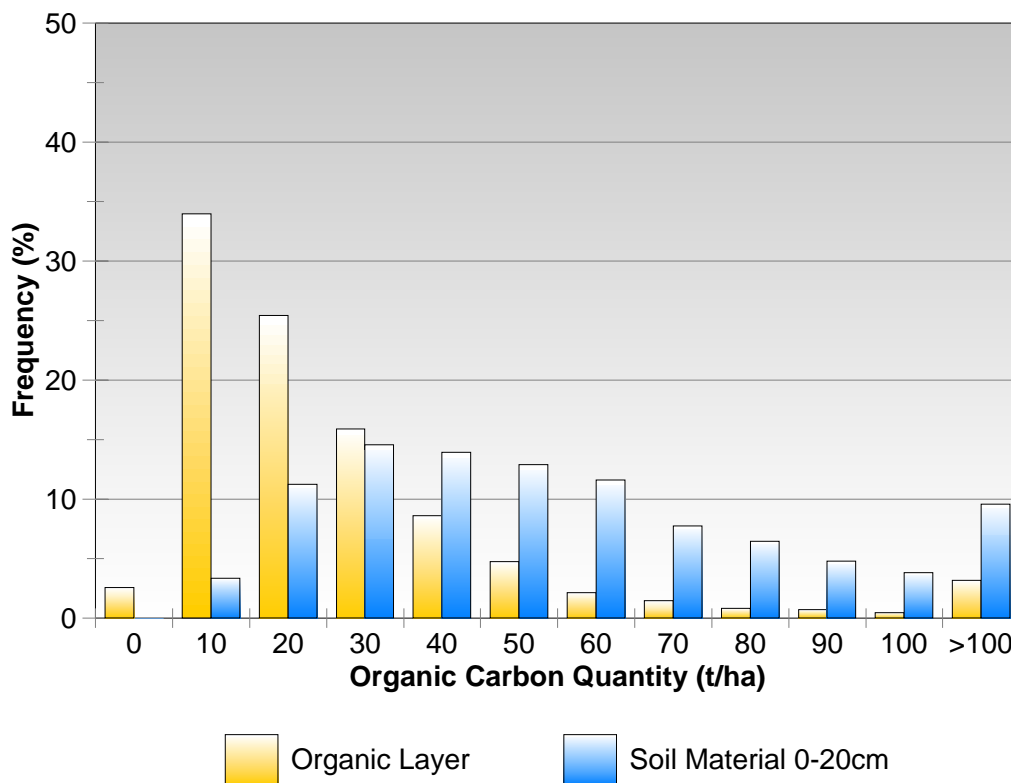

Figure 31: Frequency Distribution of Organic Carbon in Organic Layer and in Soil Material 0-20cm (Level 1)

The graph shows a distinctly different distribution of OC between the organic layer and the soil material. On approx. 2/3 of all plots (61.9 %) with sufficient data the amount of OC in the organic layer is $<20 \text{ t ha}^{-1}$. For the soil material 11.2% of the plots have OC quantities in this range. For most plots there is also considerably more OC in the soil material than the organic layer. For 50% of the plots the OC stock in the soil section 0-20cm accounts for 70% of the OC stock of the combined organic and soil material to 20cm depth. The spatial distribution of the ratio shows that plots with a high portion of the OC stock in the soil material are reported for France. Higher portions of the OC stock in the organic layer are reported for Sweden, Finland, Estonia and Latvia. For other areas the concentration of OC in one or the other stratum is less distinct.

The amount of OC in the organic layer could be determined for 2,658 plots when including data derived from the organic layer weight and height. The distribution of OC in the organic layer of Level 1 plots is presented in Figure 32.

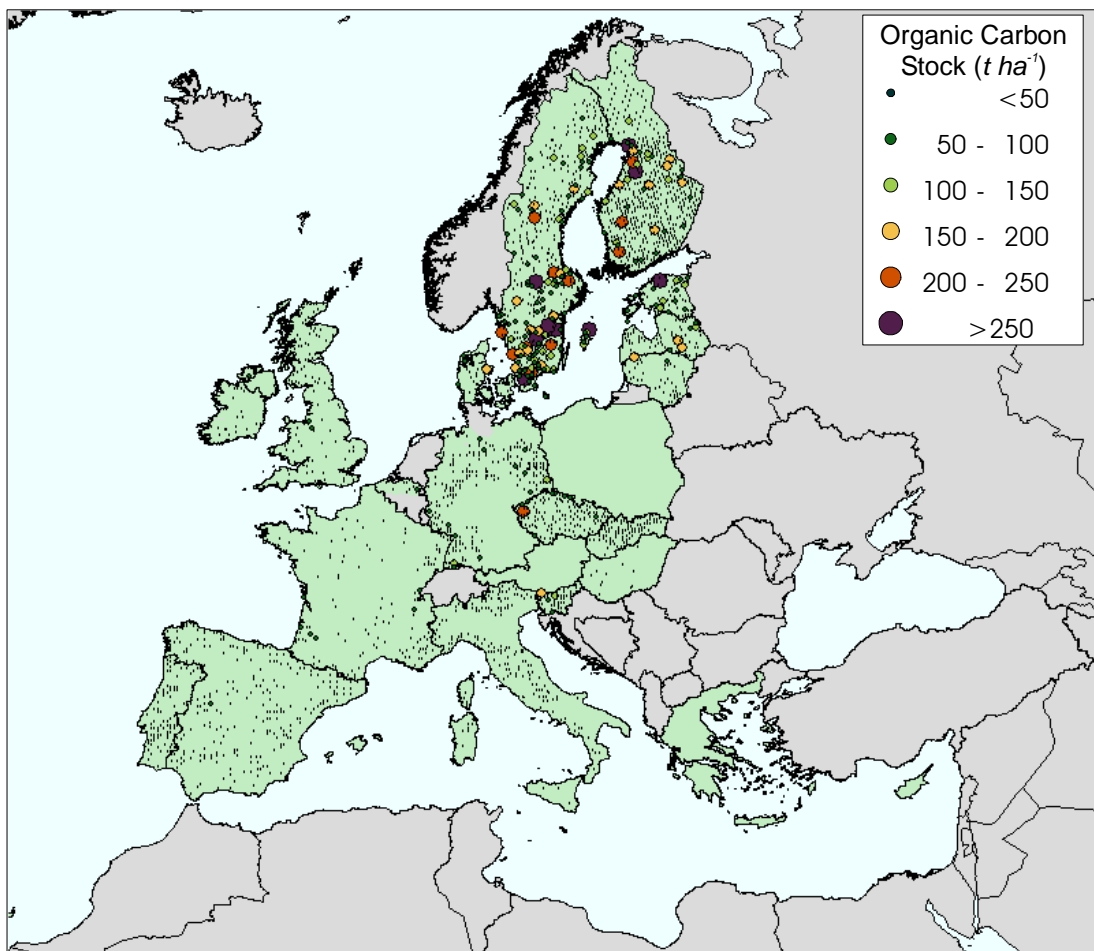

Figure 32: *Organic Carbon Quantity in Organic Layer (Level 1)*

The count includes plots with apparently erroneous co-ordinates. Those plots were included because the correctness of plot co-ordinates was not a criterion for determining the amount of OC in the organic layer. In applications of the data where geographic positioning is of importance the count of suitable data is correspondingly lower.

The build-up of organic layers is most widespread in the Baltic States. Plots with $>30 t ha^{-1}$ OC in the organic layer are more sporadically found in France, Germany, Slovenia and the UK. Compared to plots in other Baltic countries the distribution of OC in the organic layer on plots in Finland is comparatively limited.

The amount of OC by plots in the soil section for a depth of 0-20 cm is graphically presented in Figure 33.

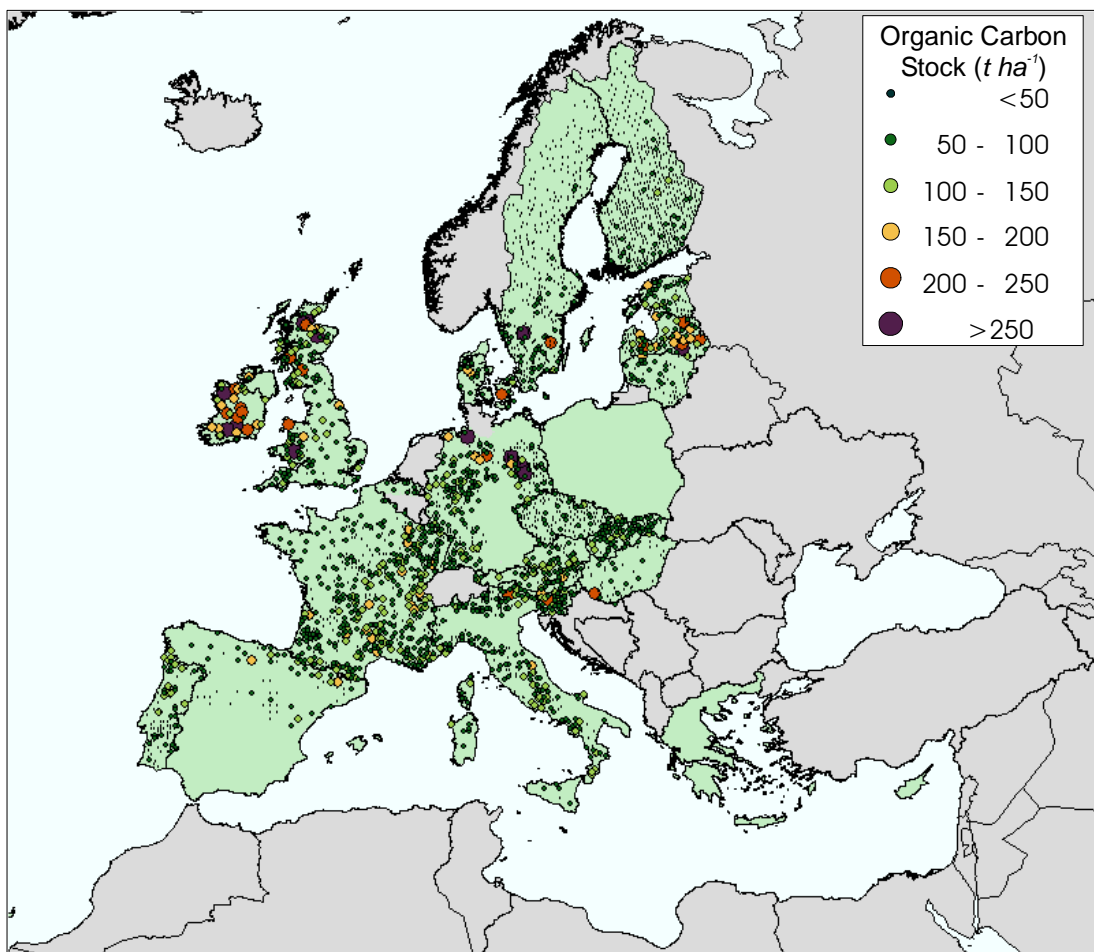

Figure 33: Organic Carbon Stock in Soil Material 0-20 cm (Level 1)

As with the computation of OC of the organic layer data on the VCF was used to compute the OC density of the soil material when available. Absence of corresponding values did not prevent computing the soil OC stock. As a consequence, when comparing

data from different surveys the variable availability of data on the VCF could lead to divergent values of OC densities.

The amount of OC in the soil material is generally high for plots in Ireland, Scotland, Wales and Latvia, where also peat is widely distributed, and frequently for plots in most other countries. The amounts on plots in Sweden and Finland are more uniform and low by comparison. In both countries a spatial trend of lower OC amounts with latitude seems to characterize the amount of OC in the soil material. This trend is not a function of corresponding changes in the volume of coarse fragments, bulk density or a decrease in the depth of the soil material (to 20 cm) but rather driven by decreasing OC contents in the soil material.

A combined organic layer & soil material (0-20 cm) data set could be produced for 2,245 plots. A map on the location of the plots and the amount of OC is given in Figure 34.

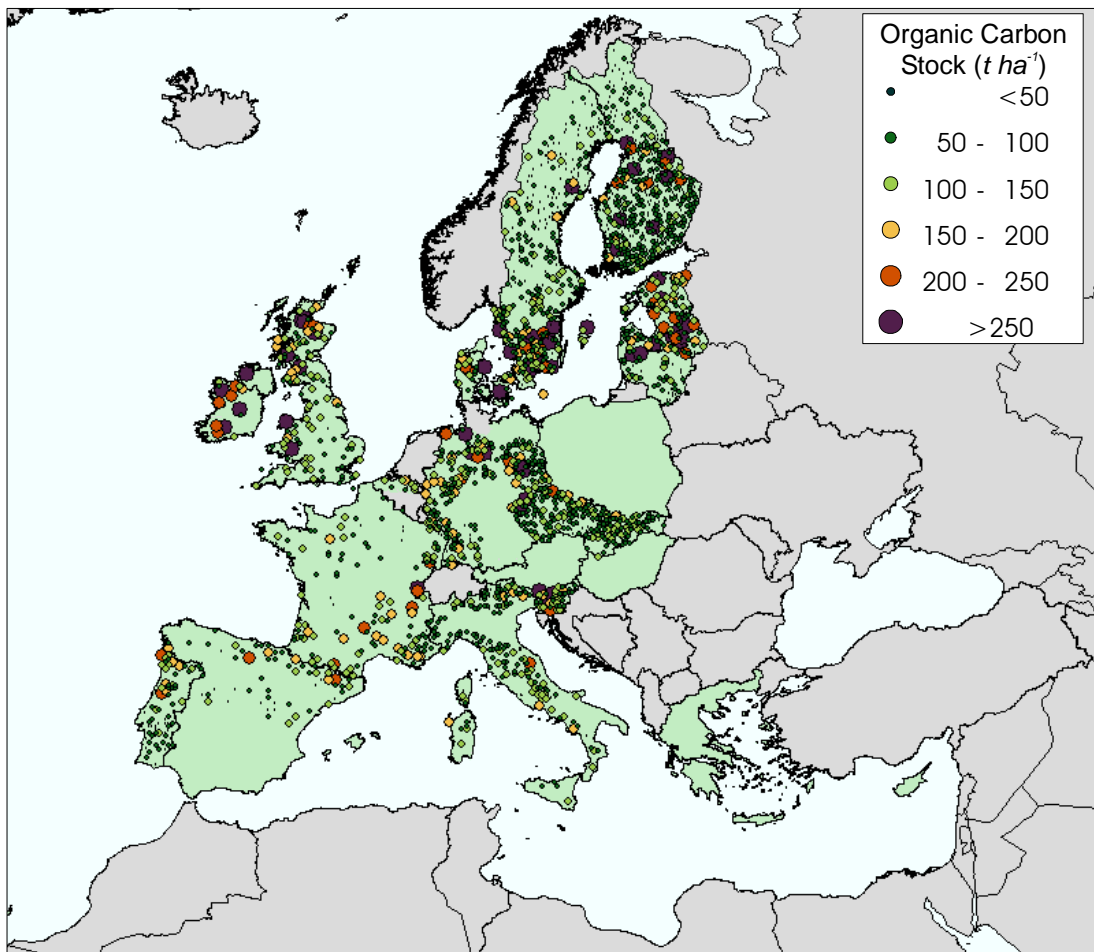

Figure 34: Organic Carbon Quantity in Combined Organic Layer and Soil Material 0-20 cm (Level 1)

The distribution of OC in the combined data from the organic layer and the soil material 0-20 cm follows the distribution of OC content on the plots. Plots with amounts of OC $>100 \text{ t ha}^{-1}$ correspond to the areas of peat. However, such plots also occur in other areas, including plots in the Mediterranean.

OC densities from the organic and the soil layers were combined only for those plots where such values were available for complete organic layer and the soil layer to a depth of 20 cm. The soil depth was taken from the nominal depth specified for the layer code. An alternative approach, using the depth values provided, was not investigated. This would have meant to restructure the profile and, as a consequence, changing the data. As a more strict adherence to the specifications a processing option is to use only data from those plot where the recorded layer depths correspond to those specified in the Manual. For the soil depth to 20 cm 72 plots would have been affected by this processing option.

3.5 Temporal Changes of Organic Carbon on Level 1/I Plots

A survey collecting data on soil conditions on ICP Forests Level I plots was previously performed, mainly during 1994/95. An evaluation of the data has been published by EC, UN/ECE and the Ministry of the Flemish Community, 1997. For the purpose of managing the data the *Forest Soil Co-ordinating Centre* (FSCC) has been created in 1993 at the Laboratory of Soil Science of the University of Gent. Since 2001 the Research Institute for Nature and Forest¹⁵ hosts the FSCC. In 2002 the data have been re-checked, reorganized and transferred to a new data model (see Data Model). Of the two formats provided by the FSCC (Oracle and Microsoft Access) the Access tables were used. The data were processed using the same procedures applied to prepare the BioSoil data unless a deviation from the procedure is specifically mentioned. In this report the previous survey on Soil Conditions on Level I plots is referred to as the ICP Forests Level I survey. The data used are referred to as FSCC – ICP Forests data. When specifically addressing the database the FSCC is referred to.

3.5.1 FSCC – ICP Forests Survey Characteristics

The original specifications setting out the sampling procedures of the ICP Forests Level I survey were not available to the evaluation task. They are assumed to be compatible with the provisions made in *Commission Regulation (EEC) No 1696/87* and *Commission Regulation (EEC) No 926/93*, although some instructions were modified in subsequent regulations, e.g. the sampling depth of the organic material in *Commission Regulation (EC) No 1091/94*. A file containing both ICP Forests sub-Manuals IIIa and IIIb from 30.7.2001 can probably be used to serve as a suitable substitute. Whereas the Commission regulations for the implementation of the soil survey contain provisions for the height segments of the organic layer when sampled by fixed depth such information is not part of the database. There are also some differences in the definition of the organic layer. The 2001 Sub-Manual IIIa states:

“O-horizons or layers: layers dominated by organic material, consisting of undecomposed litter,...”

The definition of organic soil material follows the specifications of FAO, 1988. In the context of organic material the term “layer” and “horizon” were used as synonyms in the sampling procedures (Baert *et al.*, 1998). The definition describes the organic litter horizon *OL* of latter versions of the Sub-Manual. As a consequence, the classification of the organic horizon or layer varies depending on the document used and therefore may vary depending on the survey date, but is also subject to interpretation. The situation is

¹⁵ http://www.inbo.be/content/page.asp?pid=EN_MON_forest_soils

further obscured by the publication dates of the instructions, which are notably later than the periods of sampling soil condition data on the plots in some countries.

Although the ICP Forests Soil Condition survey at Level I sites is referred to as a 1996 survey that database contains samples spanning more than 10 years (1985 to 1998). For most countries the survey was performed during as single year. Yet, in some cases data were sampled in stages stretching several years, for example in Spain and Finland. A graphical impression of the survey years as recorded in the FSCC database is given in Figure 35.

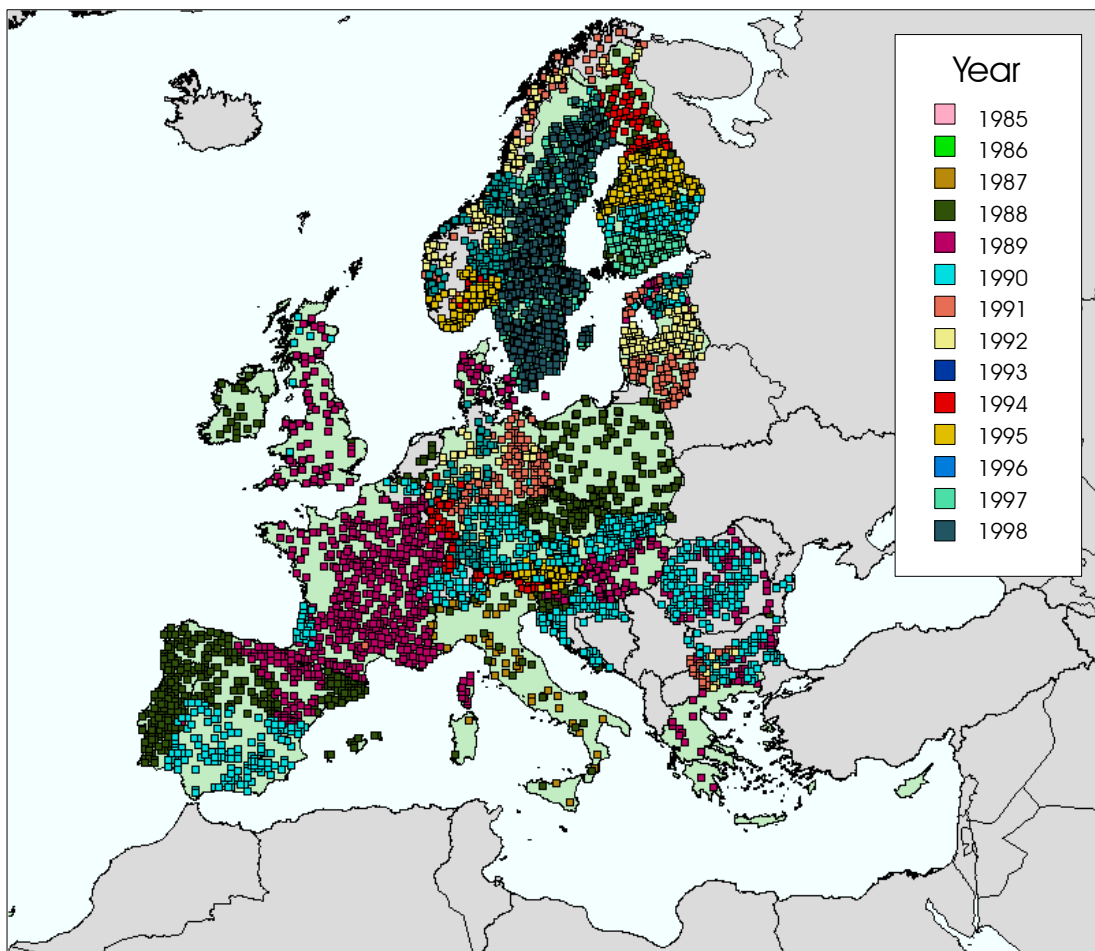

Figure 35: Sampling Year for Forest Focus / ICP Forests Level I Soil Condition Survey

The date of the previous survey can have an effect on parameters which may change over time, such as OC content. Instead of analyzing change over a period of 10 years for plots in Sweden and southern Finland this period is almost doubled to 19 years. The

various manifestations of the Sub-Manual are an additional source of variation to the sampling process.

3.5.2 Co-Location of FSCC – ICP Forests and BioSoil Survey Plots

Soil condition data from the previous survey were sampled at the sites of the systematic monitoring network of ICP Forests (Level I). Site locations were identified on a regular grid with a 16km distance between points. The origin of the grid was defined in *Commission Regulation (EEC) No 1696/87* and *Commission Regulation (EEC) No 926/93*. The Regulations did not define the parameters for the projection used to identify the grid and the coordinates were transmitted to the participating states by country. There were deviations from the nominal grid size to one of 32 km (e.g. northern Finland) and 8 km (e.g. Czech Republic). The files with original coordinates sent to the participating states could not be recovered and were therefore not used to co-locate the sample sites. Because countries were also allowed to position Level I sites at locations of an existing national forest monitoring network using the information of the nominal site locations is only of limited use.

One method of assessing results of the BioSoil survey is to compare data on a plot-by-plot basis with results of the previous survey. It was originally intended to perform the BioSoil survey at the sites of the ICP Forests Level I soil survey. This would not have been possible for all sites because the positions of some Level I sites have changed over time for several reasons. Changes to site positions can be of two types:

1. Sample site moved to new location

Plots have been moved to new locations following changes in land cover as a consequence of deforestations by fire, logging or wind fall. Other reasons for selecting new positions also apply: BioSoil plots in the UK were moved to better coincide with the 16x16km grid positions.

2. Change in Co-ordinates reported for site

The plot location on the ground may not have changed, but using more accurate instruments of determining the geographic position can introduce a change in reported co-ordinates. Another change in the reported position of a plot is the reduction in the precision of reporting co-ordinates to minutes instead of seconds, as in the case of Finland.

Changes in plot location, recoded geographic position and IDs make it almost impossible to reliably relate plots of the BioSoil survey to those of ICP Forests Level I sites by linking plot IDs or LAT/LONG fields between data tables from the two surveys. Therefore, to identify plots shared between the two surveys a spatial neighbourhood analysis was performed. The procedure involves identifying the nearest plot of the ICP Forests survey to the BioSoil survey and vice versa. The two-way

analysis of the nearest plot is obligatory because Plot *P* of the previous survey may be nearest to Plot *B* of the BioSoil survey, but the inverse relationship may well not be true. A threshold on the distance is then applied to remove any plots not likely to coincide. The distance threshold has to balance identifying plots within the radius of imprecise geographic coordinates with avoiding assigning a new plot to an old one. The minimum threshold was set to 2,750 m. The value was used to account for the reduced precision of 1 arc min. of reporting plot coordinates at 60°N. The evaluation found that plots are related also when separated by larger distances in the geographic coordinates where systematic errors in recording plot locations were present, but that at distances above 4,000 m non-related plots would be linked in areas without systematic variations in plot positions.

The number of plots which could be linked by varying the distance threshold value is presented in Figure 36.

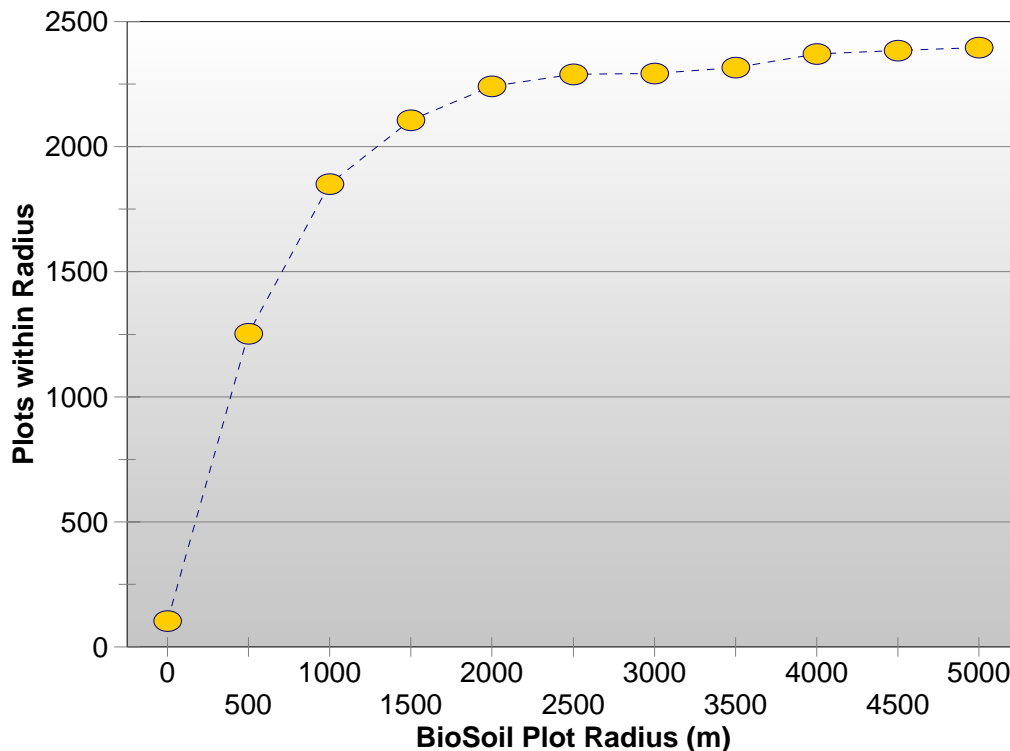

Figure 36: Number of Linked BioSoil and ICP Forests Plots with Increasing Distance in Geographic Position

The BioSoil database contains 103 plots where the longitude and latitude values were identical to those of the previous survey. From the neighbourhood analysis 1,252 plots

were found within 500 m of a previous plot and 2,289 plots could be linked when using a distance threshold of 2,500 m.

The distance of FSCC – ICP Forests plots to BioSoil plots is graphically presented in Figure 37.

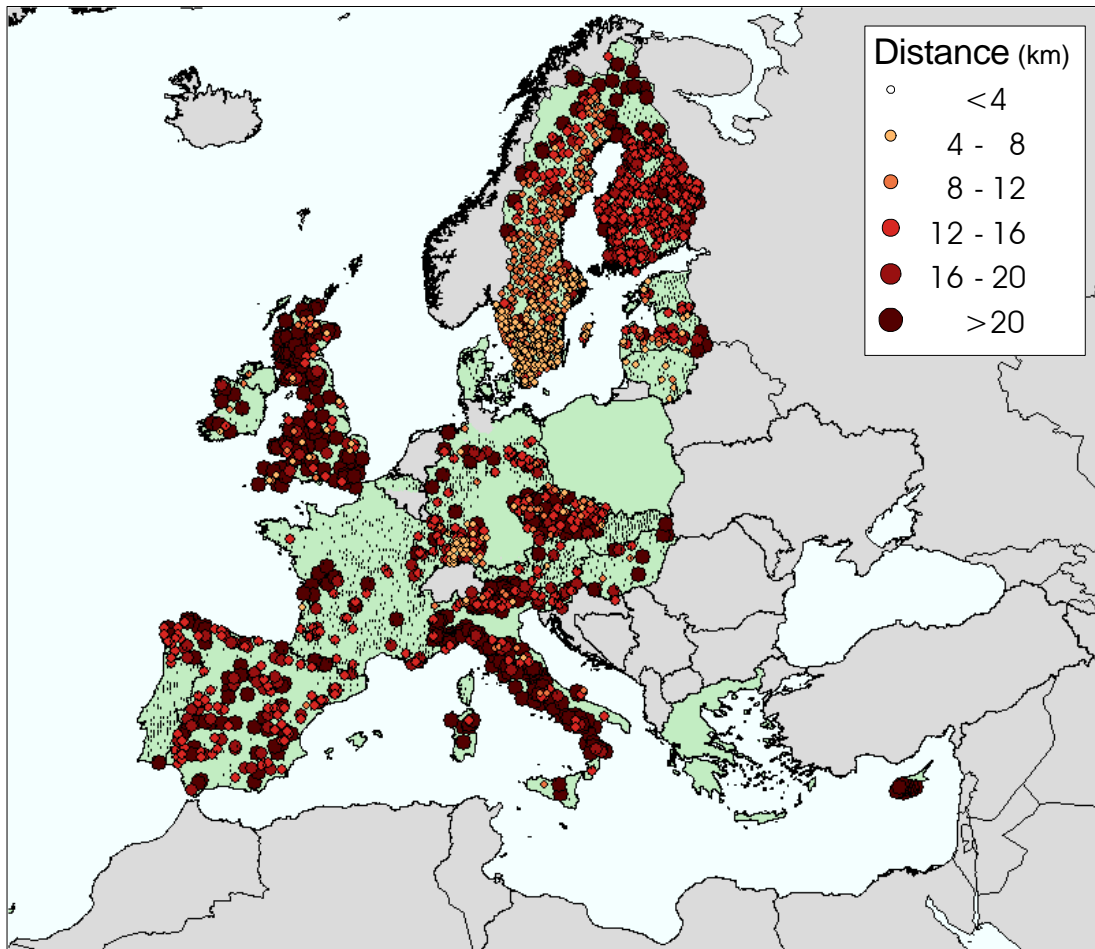

Figure 37: Distance of BioSoil Plots from FSCC – ICP Forests Plots

There is a distinct relationship between the plot distance computed from the geographic coordinates stored in the database and NFCs. For some NFCs, such as Denmark, France, Portugal, Ireland, Slovak Republic and Hungary, the co-ordinates of the BioSoil plots generally agree with those from the previous survey. For plots in other NFCs, including Austria, Finland and Estonia, the difference in plot coordinates exceed 1,000 m, in other cases even 5,000 m. The changes in plot locations from the previous survey to BioSoil in the UK are noticeable by showing only a few plots within the vicinity of the previous plots. Plots or plot coordinates in southern Sweden seem to have been relocated, while those in the northern parts of the country remained. Visible in the

graph is the variation in geographic plot positions in Finland introduced by the reduced precision in recording the locations.

While there are random differences introduced by re-locating plots or degrading the precision of recording coordinates there are also systematic differences in the data. These differences appear as a shift in coordinates with constant distance and direction. Examples of the co-ordinate shift for Baden-Württemberg and Lithuania are illustrated in Figure 38.

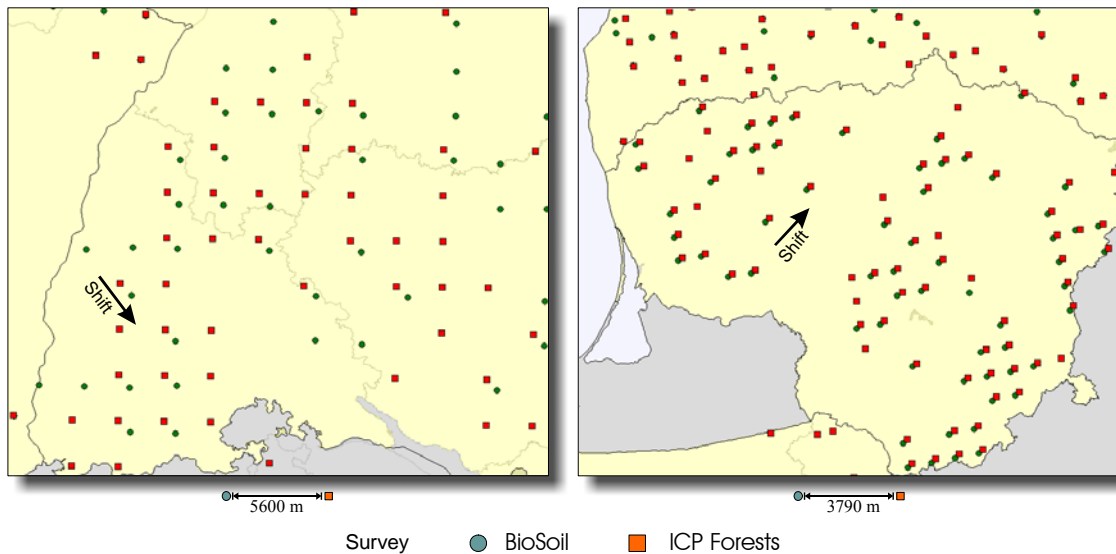

Figure 38: *Constant Shift in Plot Location in Baden-Württemberg and Lithuania from FSCC- ICP Forest to BioSoil Survey*

For the purpose of co-locating plots the shifts found are quite substantial, approx. 3,800 m for Lithuania and 5,600 m for Baden-Württemberg. A number of causes could lead to these geographic shifts. Most likely are conditions leading to systematic changes in reporting plot co-ordinates, which can occur when re-projecting data to a new co-ordinate system. Enlarging the tolerance in geographic locations when linking plots to include the data from these NFCs would cause the creation of false links in other areas, for example southern Sweden. Systematic differences in plot positions between the two surveys can be accounted for but require a detailed analysis by NFC and treatment on a case-by-case basis.

3.5.3 Organic Carbon Content

In the FSCC database the organic layer is coded as either *O* (not saturated) or *H* (saturated). No further distinction of sub-layers is made and the layer of organic litter is not recorded. The OC content in the soil material is recorded according to either a

saturated (*H*) or unsaturated status (*M*). The origin of recording the *H* segments in the soil material is indeterminate. Such segments in the soil material appear in the sampling documents after the survey dates. While there are 4 depth classes for the *H* segments there are 31 codes for mineral segments of the soil material.

As with BioSoil data the FSCC – ICP Forests data contain plots with only an organic layer and plots with only soil material. The location of the plots with data only one stratum is given in Figure 39.

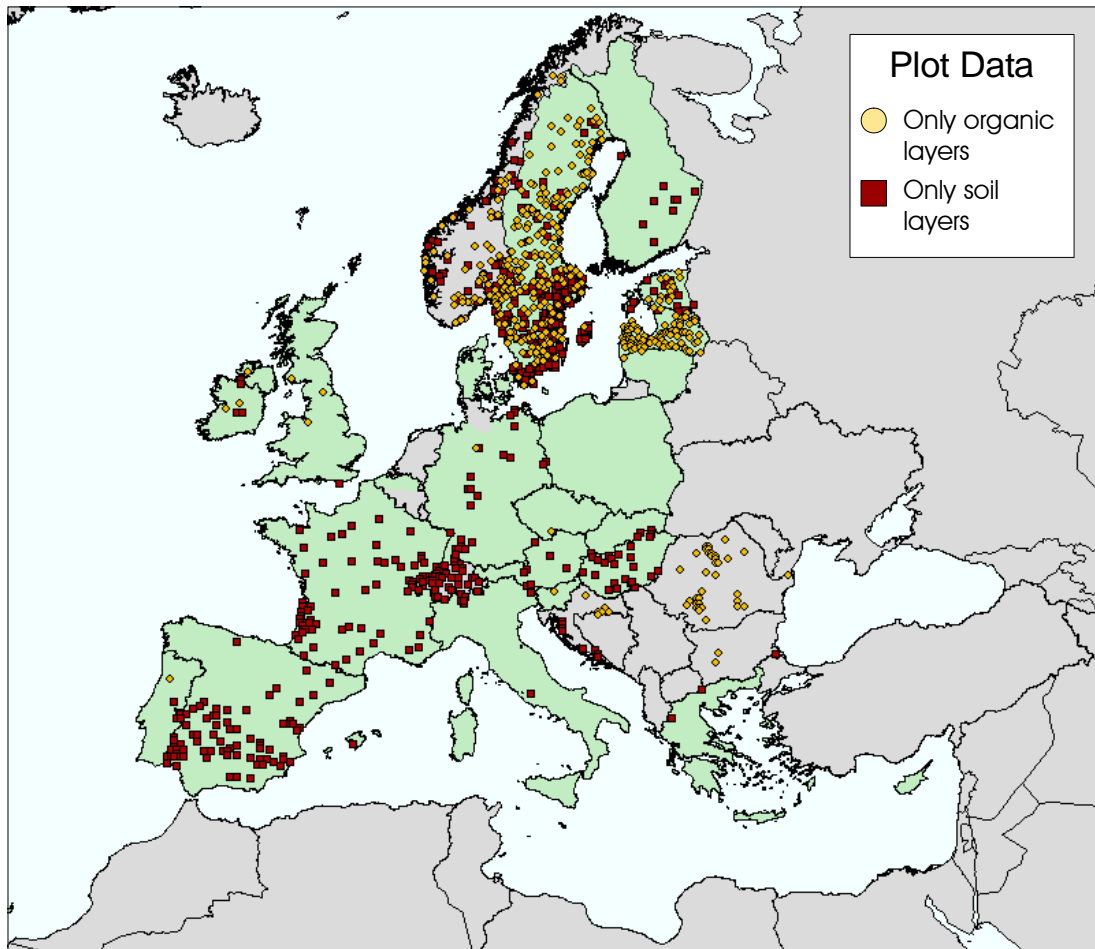

Figure 39: Distribution of Level 1 Plots with Only Organic Layer and with Only Soil Material Data (FSCC - ICP Forests)

The identification of just an organic layer without an underlying soil material might be expected for plots on organic soils. As with BioSoil data, plots with data only covering

the organic layer are rather aligned to country boundaries than soil properties¹⁶. The opposite condition, i.e. only soil material was reported as *Mij* segments, is not restricted to administrative units.

Compared to BioSoil data the FSCC-ICP Forests data contains a similar interpretation of the organic layer between the two surveys for plots in Sweden. Plots in Estonia and Latvia report the soil material under BioSoil. The situation is more variable for reporting only the soil material without an organic layer. The number of such plots is largely higher for the BioSoil data in France, Finland and Latvia. In contrast, plots lacking an organic layer in the FSCC – ICP Forests data have disappeared in Spain, Germany and Austria and are very much lower in Hungary.

The OC content in the organic layer of the FSCC – ICP Forest plots is presented by geographic position in Figure 40.

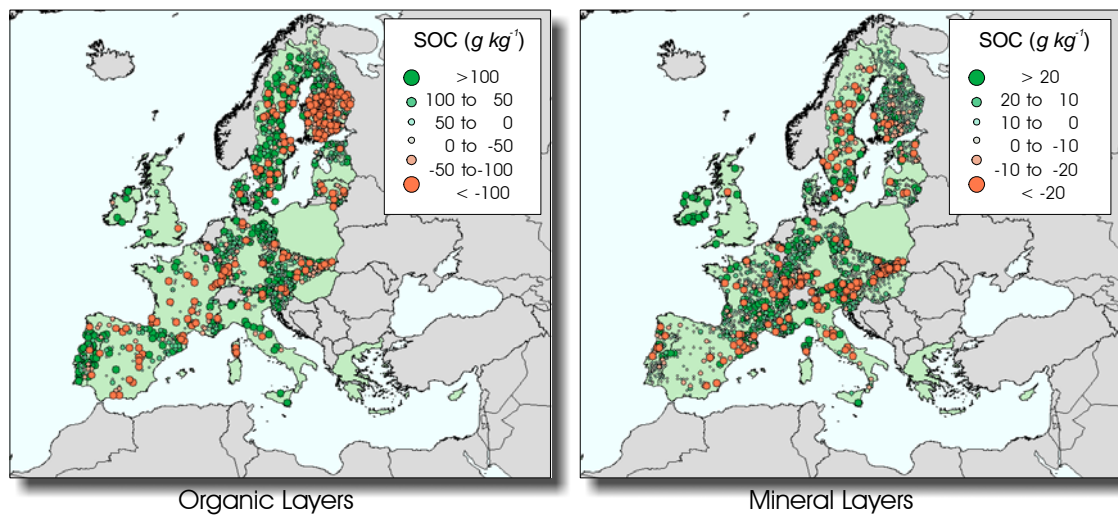

Figure 40: *Change in Organic Carbon Content in Organic Layer and Soil Segment 0-20 cm from FSCC – ICP Forests Level I to BioSoil Survey*

The graph indicates a lower OC content in the organic layer in the BioSoil survey on plots in France and in Spain as compared to, for example, Portugal, Austria or Germany. In Finland a division between the southern (decrease in OC content in organic layer) and northern part (increase in OC content) is caused by variations in the BioSoil data rather than in differences to the FSCC – ICP Forests data. Changes in OC content in the soil segment 0-20 cm do not follow the same spatial pattern. Increases are found in Ireland, southern France and western Germany and the Czech Republic. Areas of decreasing OC content in the soil segment are more localized and prevalent in Italy and the Slovak Republic. Changes in the OC content in Sweden the results have to be

¹⁶ The map also shows values for countries that did not participate in the BioSoil project for reasons of completeness.

evaluated in view of the uncertainty of correlating plot locations between the two surveys.

Whenever changes in the OC content in the soil material occur they are substantial. This indicates a change in the classification of the soil material to the organic layer or *vice versa*. It can also be noted that changes in the OC content of the soil material are not necessarily inversely related to changes in the organic layer. Complete reclassifications from the organic layer in the FSCC – ICP Forests survey to the soil material in BioSoil occurred at times, for example on plots in Ireland.

3.5.4 Profile Depth

The FSCC database does not contain the depth of a segment explicitly as an attribute to the plot. Rather, the parameter is stored in the segment code, at least for the soil material, and attached to the segment from a dictionary table. The depths limits of the segments of the organic material (horizon or layer) are not stored in the database, neither directly as a field entry nor indirectly through a segment code.

The FSCC data model differs fundamentally from the BioSoil data model with consequences on the possibility to link information from a depth segment between plots. The problem is not so much caused by the differences in the data models but by those plots where the depth limits of the segments in the soil material do not conform to the specifications. Affected by the condition are 165 plots with idiosyncratic definitions for the segment depth limits. Because the link for database queries uses the segment code and corresponding depth those plots were excluded from the evaluation to avoid spurious results.

Another problem is posed by the presence of duplicate values for sample depths in the FSCC – ICP Forests data. For 9 plots information on a segment overlaid the depth limits of another segment on the same plot. Most cases of data duplication were caused by reporting segments *M05* and *M51*, but also *M01*. The general rule applied when preparing the data was to retain the more detailed information and remove the segment causing the data duplication or overlap from the analysis.

In contrast to the BioSoil data the FSCC – ICP Forests Level I database contains plots where the depth limits of 20 cm was within the limits of a sampled segment, for example the segment *M13* (10-30 cm). In those cases the value of a parameter was estimated by a linear interpolation from the depth limits of the segment. This method is only an approximation of the actual value because some parameters change with depth, such as OC content and bulk density. With frequently only two data points available to estimate the change in a parameter with depth (*M01* and *M13*) only generalized functions could be applied. The use of a linear function was considered an acceptable alternative.

3.5.5 Organic Layer Weight and Bulk Density

The FSCC – ICP Forests database did not contain values for bulk density for organic layers. Due to the absence of the layer height the parameter could not be computed from the layer weight. Changes in the weight of the dry organic layer between the surveys are given in Figure 40.

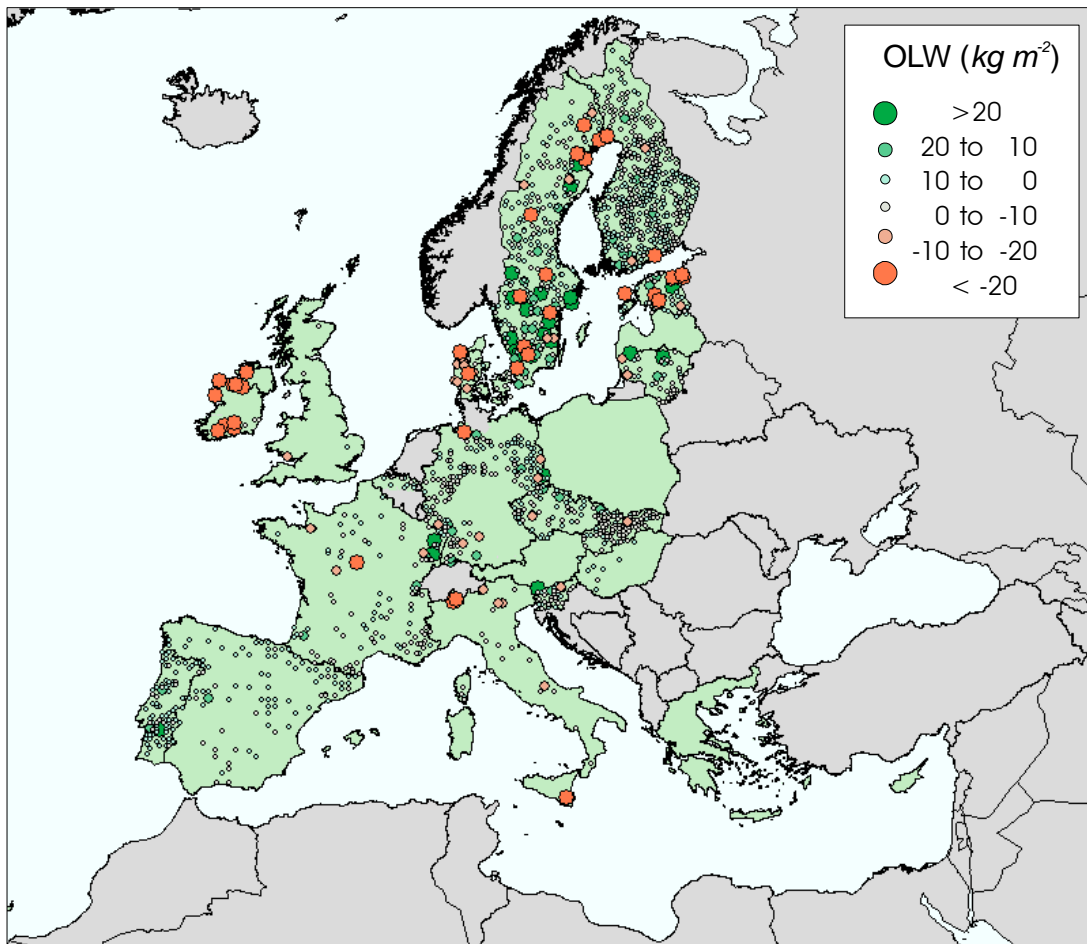

Figure 41: *Change in Dry Weight of Organic Layer from FSCC- ICP Forests to BioSoil*

The changes in organic layer weight are limited on most plots. Notable decreases are reported for most plots in Ireland, Denmark and Italy. A general increase in the OLV was reported for plots in Portugal. In other NFCs changes were positive as well as negative.

For the soil stratum bulk density is reported in the data. The specifications on how to assess the parameter was rather vague. The specifications state:

“It is recommended that the dry bulk density is determined from undisturbed soil to enable the calculation of the total nutrient contents. If the dry bulk density is not determined, a reasonable estimate of this parameter should be made.”
(Commission Regulation (EC) No 1091/94).

More detailed provisions on how to assess bulk density were made in guidelines published after the survey had been conducted. The values on bulk density found in the database are therefore to be interpreted with some caution. The spatial distribution of changes to bulk density in the soil material to a depth of 20cm of the FSCC – ICP Forests to BioSoil data is given in Figure 42.

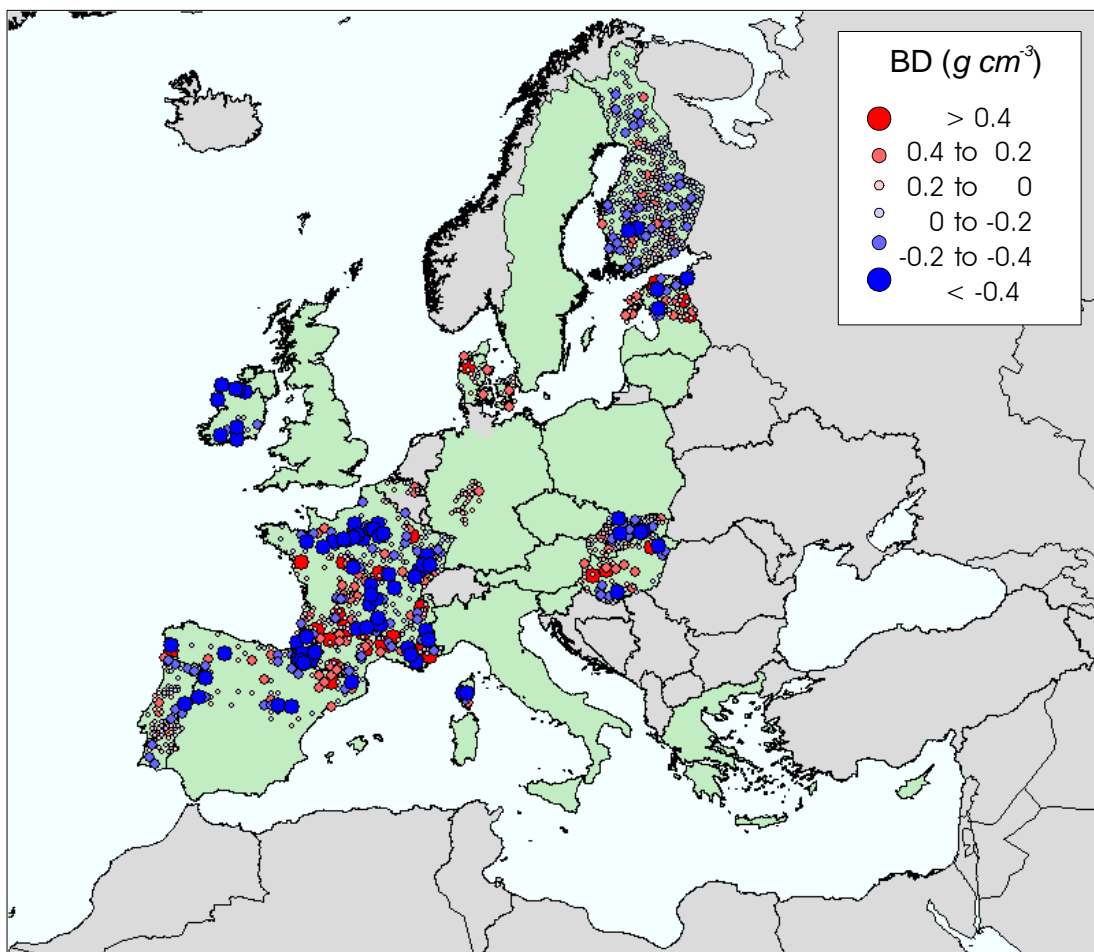

Figure 42: *Change in Bulk Density in Soil Material 0-20 cm Layer from FSCC- ICP Forests to BioSoil*

The evaluation of changes in bulk density is hampered by the limited amount of plots with data for the parameter and as a consequence cannot be assessed for about half of

the participating NFCs. With the exception of plots in Ireland, where the soil has been reclassified, there is no particular spatial trend discernable from mapping the data. Rather, the variability of values for bulk density appears to be greater for plots in Spain, France and Hungary and on some plots in Estonia and Denmark. By comparison, the variations are less extensive on plots in Portugal, Hessen, Finland and the Slovak Republic.

3.5.6 Volume of Coarse Fragments

While some variation over the years could be expected for the OC content and bulk density in the soil the volume of coarse fragments should remain stable over time. Variations in the parameter indicate the natural variability of the soil whereas trends indicate changes in methods applied to assess the parameter. The changes in the volume of coarse fragments from the FSCC – ICP Forests to the BioSoil survey are presented in Figure 43.

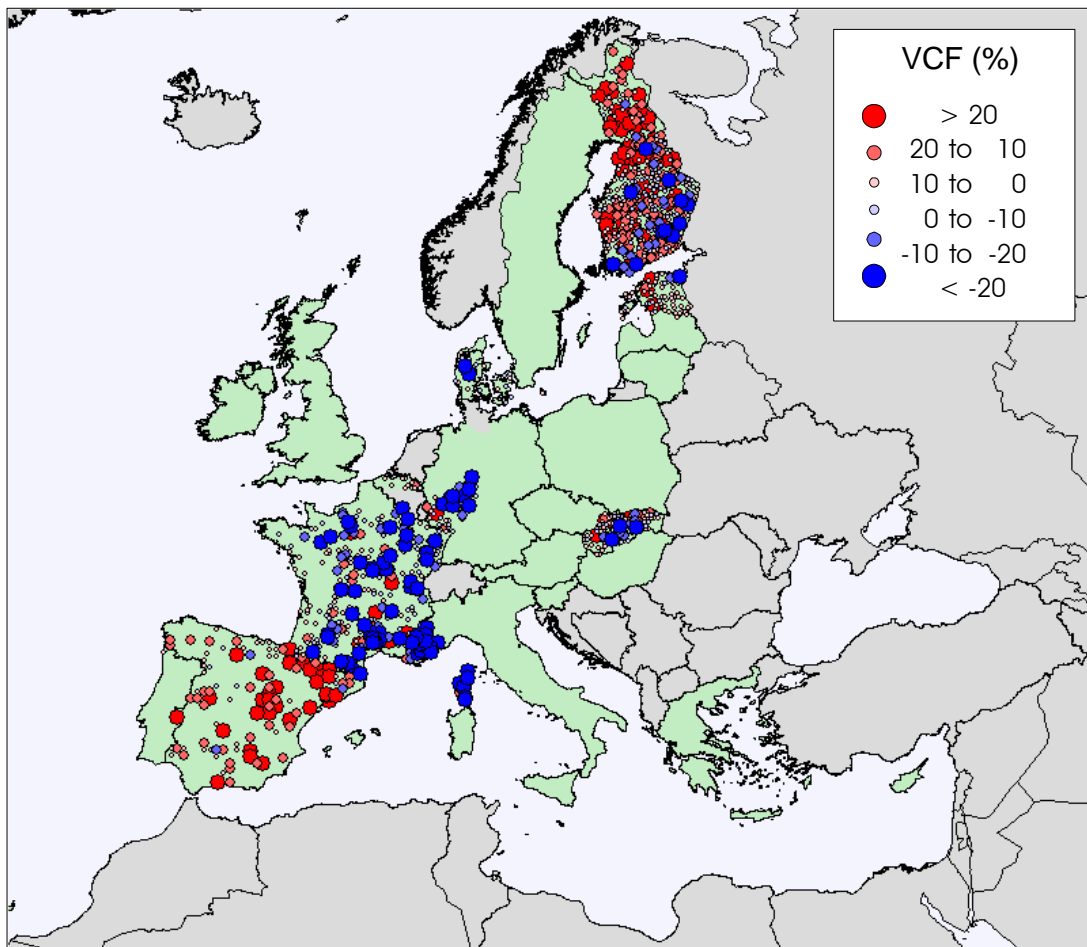

Figure 43: *Change in Volume of Coarse Fragments in Soil Material 0-20 cm Layer from FSCC- ICP Forests to BioSoil*

Compared to the previous survey lower values are reported for plots in Spain, Finland and the Slovak Republic. Increases are reported for France and Hessen. The data points toward a strong regional dependency of the changes on the reporting NFC. The changes are not minor, at times 50% are exceeded, and directly affect the amount of OC stored in the soil.

3.5.7 Organic Carbon Quantity

The quantity of OC in the organic layer and the soil material over an area is based on the calculation of the OC density (for a unit area and depth) determined at a sample plot. The OC density parameter is not measured directly but derived from other measured parameters (OC content, bulk density and volume of coarse fragments). When calculating the temporal change in OC density for a plot one or more of these defining

parameters may vary. The effect of changes in the defining parameters on OC density is cumulative: it can be additive or subtractive and interdependent. Under forests an increase in OC content in the soil material is generally associated with a decrease in bulk density. Hence, a widespread change in only OC content or bulk density without an equivalent change in the other parameter points toward a modification of methods rather than distribution of the parameter. These effects may not be apparent when computing OC quantities but should be kept in mind in the interpretation of the results.

Data collected under the ICP Forests Level I soil survey do not contain information on the bulk density of the organic layer. Not recorded is also the height of the organic layer. It is therefore not possible to establish a value for the OC density of the organic layer, because the volume of the organic layer cannot be determined. Instead of using bulk density to compute the amount of OC in the organic layer the dry weight of the organic layer is used. For the comparison with BioSoil data the same method is applied to both datasets.

Using the OLW instead of bulk density means that for the 22 plots of the BioSoil survey with bulk density data but no data for the OLW the OC quantity was not established. The bulk densities for these plots were uncommonly high for organic layers, $> 0.5 \text{ g cm}^{-3}$ and up to 1.38 g cm^{-3} , indicating a mineral rather than an organic substance. The absence of data from those plots was therefore not considered a loss of information to the comparison.

The change in the quantity of OC in the organic layer from the ICP Forests Level I soil survey to BioSoil is presented in Figure 44.

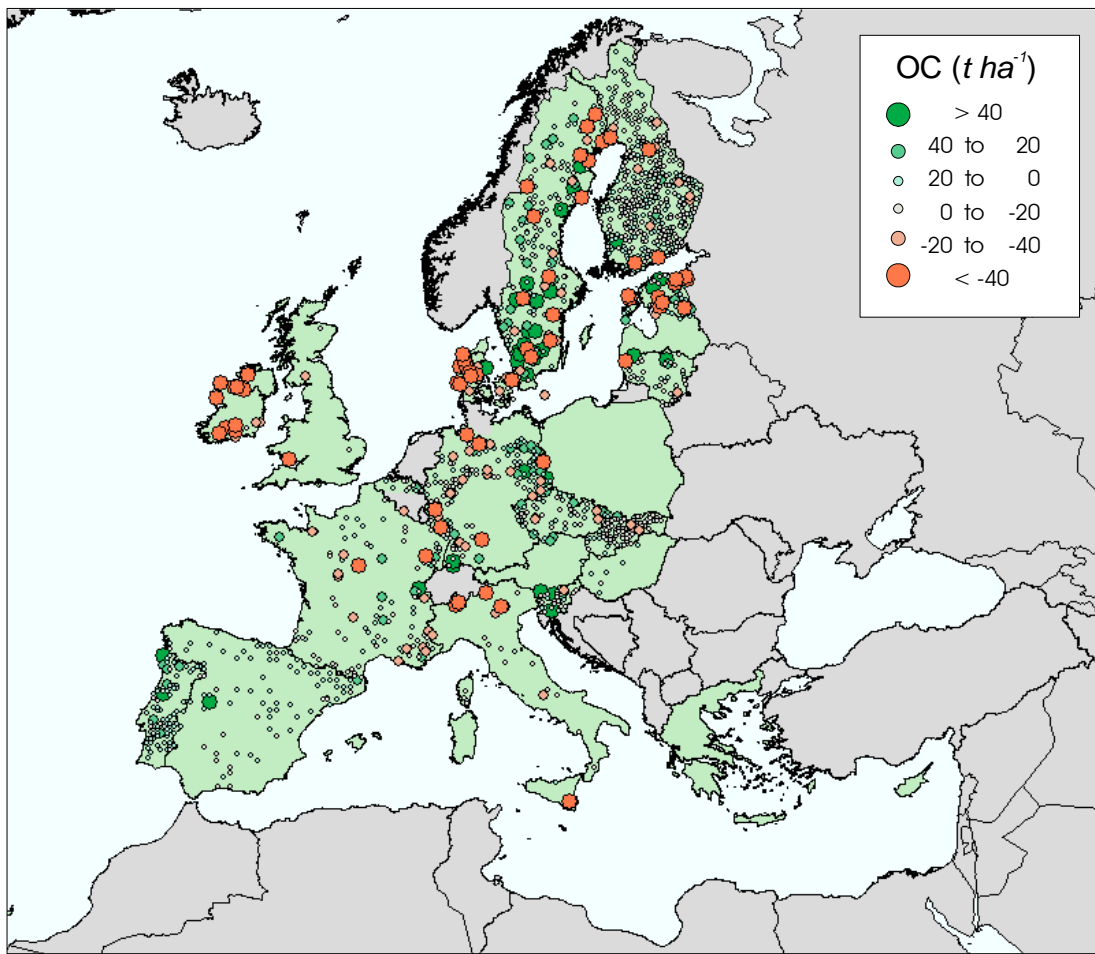

Figure 44: *Change in Organic Carbon Quantity in Organic Layer from FSCC- ICP Forests to BioSoil*

Noteworthy regional decreases in the organic layer are recorded for plots in Ireland, Denmark and the Czech Republic. A general increase is reported for plots in Portugal. On plots of other NFCs both increases and decreases are found. Comparatively small changes are reported for plots in Finland, the Slovak Republic, Hungary and Spain.

Changes in OC quantity in the soil material are depicted in Figure 45.

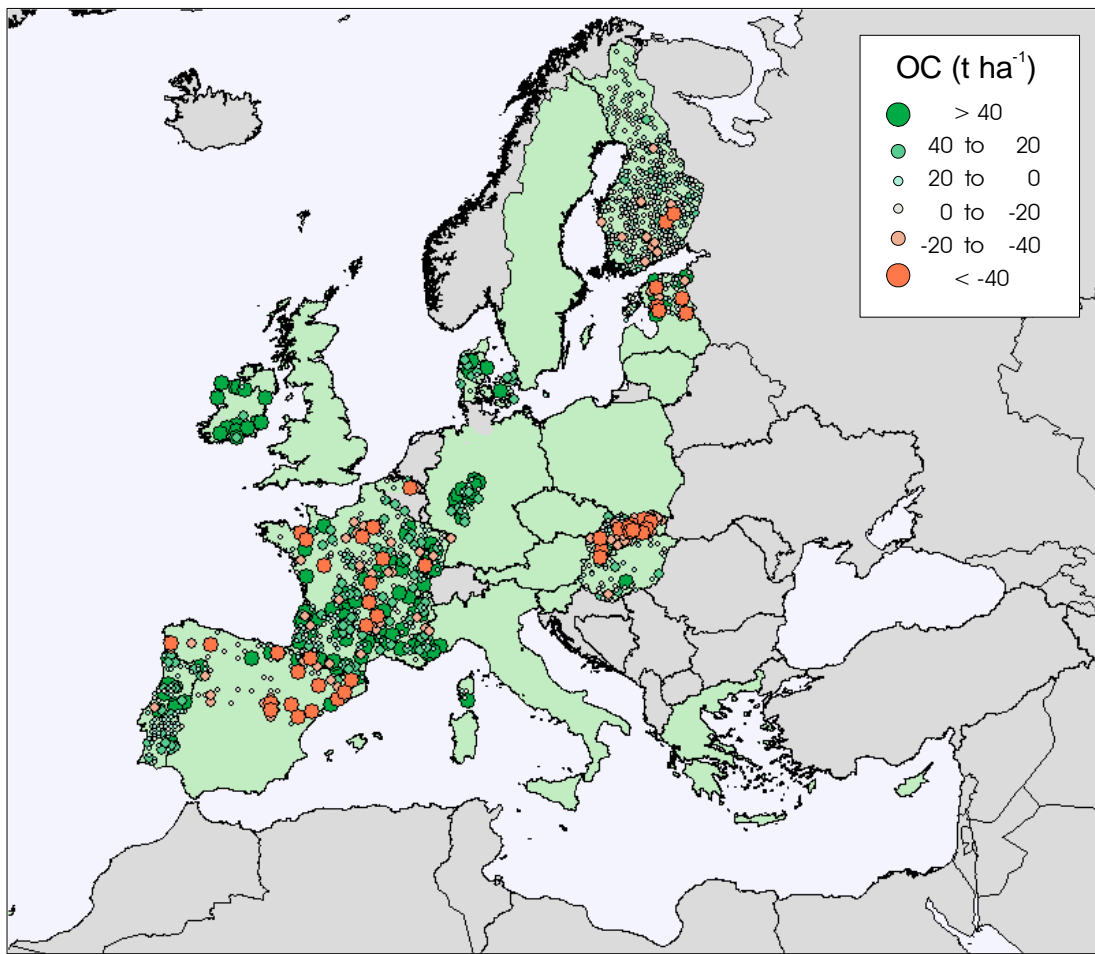

Figure 45: Change in Organic Carbon Density in Soil Material 0-20 cm Layer from FSCC- ICP Forests to BioSoil

The graph shows a widespread increase in OC quantity for plots in Portugal, Ireland, France, Hessen, Denmark and France. Plots with significant decreases in OC quantity in the soil material are less numerous and more frequently found in Spain and the Slovak Republic. The changes are in part a consequence of variations in the delineation of the organic layer from the soil material between the two surveys, for example in Ireland. Another factor with considerable effect on OC quantity is the reported change in the volume of coarse fragments, which affects for example the results in France.

The changes in OC quantity in the combined organic layer and soil material to a depth of 20 cm is presented in Figure 46.

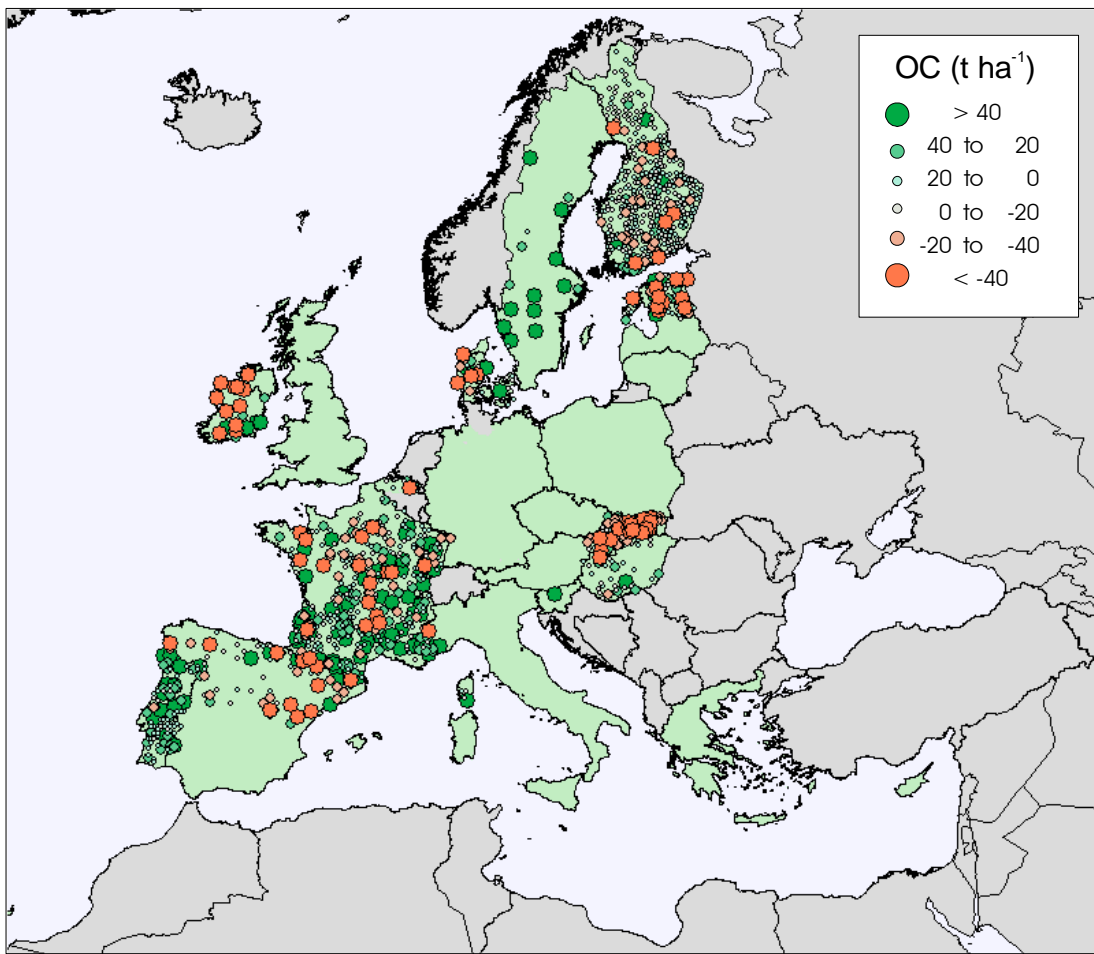

Figure 46: Change in Organic Carbon Density in Combined Organic and Soil Material 0-20 cm Layer from FSCC- ICP Forests to BioSoil

As a consequence of limited data availability the graph allows mapping the plots of a restricted number of NFCs. A clear trend is of an increase in OC is only found on plots in Portugal and on the few plots with correspondence in Sweden. On plots in other NFCs both increases and decreases are reported.

The results are based on information from plots for which data for all parameters were available for the organic layers or the soil material, except for the volume of coarse fragments. The plots compared in the analysis could have been further restricted to those where reporting organic layers and soil material in the surveys was used as criterion. It is arguable whether such additional restrictions should be applied or not. Under the assumption that the methods used for the surveys should lead to comparable results the restrictions should not be applied. Yet, when variations are attributable to methodological differences the results obtained from the spatial or temporal analysis reflect those differences rather than actual change of a parameter. In the interpretation of the results from the analysis of changes in OC quantity the element of methodological

divergences between NFCs and over time would appear to play an important role in the differences obtained from the reported data. Difficulties in describing procedures to separate the organic layer from the soil material were recognized at meetings from expert groups (FSCC, 2004; UN/ECE, 2006). From the findings of this evaluation it appears that the extensive narrative on organic layers and soil material could profit from a method which allows a more consistent separation of the layers.

The differences in bulk density computed from OLW and the reported values for organic layers may result in differences in the OC quantify. For plots in Latvia the mean OC quantity of an organic layer is 30.15 t ha^{-1} when using the OLW and 30.44 t ha^{-1} when computing the OC quantity from the reported bulk density. For plots in Bavaria, where only positive differences were found, the mean OC quantity in an organic layer is 11.08 t ha^{-1} for the OLW data and 8.18 t ha^{-1} for the parameter computed from reported bulk density. This is a rather notable difference and only due to using different values for computing the same parameter.

3.6 Central Lab Analysis

A supplementary task under BioSoil was the re-analysis of soil samples from the previous survey and from BioSoil by a single laboratory. The objective of the task was to provide an estimate of variation in parameters when comparing data coming from different national laboratories and using divergent measurement methods, which are not evident from the DAR information.

3.6.1 Samples for Re-Analysis

The number of samples to be re-analysed was set to 10% of the number of the survey samples by each participating country. In total the central laboratory received 3,460 samples from 33 countries of NFCs (Richard & Proix, 2009). There is a small difference in the number of samples and the sampling rate for re-analysis when using as sample unit the plot or the segments. The difference is not of great consequence ($< 0.3\%$, except for organic layers of Biosoil). More important is the lack of data from some countries for 1996 data. Not all countries or NFCs could provide the 10% subset of samples from plots included in the 1996 survey or even any samples at all for the period. A summary of the data from the central laboratory stored in the BioSoil database is given in Table 22.

Table 22: Samples and Sample Rates for Central Lab Re-Analysis

Survey	Sample Layer	Sample Unit	Survey*	C-LAB	Sample Rate	Links	Sample Rate
			No.	No.	%	No.	%
FSCC	Soil 0-20 cm	Plots	4,857	240	4.94	156	3.21
ICP Forests		Segments	10,818	562	5.20	329	3.04
1996	Organic	Plots	4,778	167	3.50	94	1.97
		Segments	4,828	179	3.71	96	1.99
BioSoil	Soil 0-20 cm	Plots	3,850	500	12.99	418	10.86
		Segments	8,667	1,130	13.04	913	10.53
	Organic	Plots	3,444	399	11.59	304	8.83
		Segments	5,424	544	10.03	420	7.74

* The total number of segment samples in the database is 2,415 due to the limit on the soil layer. Samples from organic layer include OL

For the 1996 survey from the FSCC / ICP Forests the sample rate is about half the intended rate of 10%. The main reason for the low rate is that some countries were not able to provide samples for re-analysis because they could not be reliably related to sample plots or because they were no longer stored. As a consequence, a re-analysis sample rate of 10% is achieved by some countries, but not for the survey. For the BioSoil survey the target rate for re-analysis is achieved for all sample layers and units.

3.6.2 Parameters

The parameters re-analysed are by necessity restricted to those which are performed in the laboratory. Therefore, parameters such as layer height for organic layers or bulk density are not included. All samples were also already sieved to 2mm. As a consequence, the volume of coarse fragments is only available from the field data. Hence, for the evaluation of the SOC density only the organic content is re-analysed. All other parameters have to be taken as submitted by the NFCs. As a consequence variability of the SOC density cannot be fully assessed from the re-analysed data, and any comparative appraisal is restricted to the SOC content parameter.

A further limitation to comparing results from national to the central laboratory is the identification of the samples. The samples of the central laboratory have to be assigned to the plot from the respective survey, for which they were taken. For data from the BioSoil survey approx. 80% of the samples re-analysed can be linked to plots in the database. For the 1996 survey only about 60% of the samples can be linked to plots. The low proportion for the 1996 survey is also a result of the way in which samples have to be identified. This is only possible for samples for which a link between FSCC/ICP Forests and BioSoil plots can be established. This condition proved to be a severe limitation to the number of sample pairs. In some cases the sample rate is almost halved when relating to data pairs (organic layers for 1996 survey).

3.6.3 Re-Analysis of 1996 FSCC / ICP Forests Survey Data

The distribution of re-analysed samples from plots of the FSCC/ICP Forests survey that can be linked to plots from the FSCC / ICP Forests and BioSoil surveys in the database is given in Figure 47.

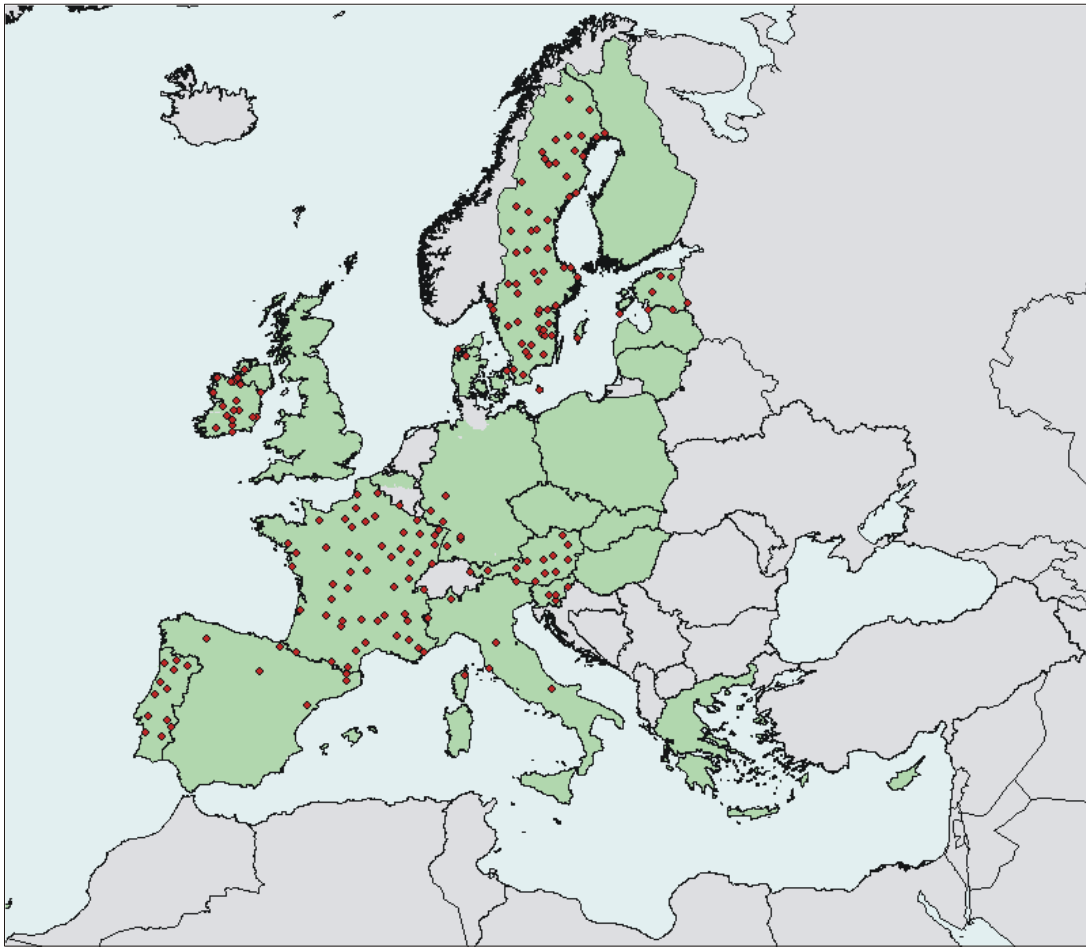

Figure 47: Geographic Distribution of Data from Central Lab Linked to FSCC / ICP Forests Survey Plots

The database contains 900 samples of segments from 266 plots. For 1 plot a duplication of the soil segment by an M13 layer was found. The layer was removed from further analysis and the M12 – M24 were used instead. The organic layer and soil to a depth of 20cm is covered by 841 samples.

The incomplete links between plots of the C-Lab data and the survey further reduce the data available for a comparative analysis. The soil from 0-20 cm is covered by 345 samples in the C-Lab data and 329 samples from 156 plots in the survey data. For 16 segments, largely concerning M13 layer recorded as M12 in the C-Lab data, no corresponding layers are found in the survey database. Of the 179 samples for the organic layer only 96 samples from 94 plots can be linked to data from the 1996 survey. An anomaly in the C-Lab data is that the linked plots contain 109 samples for the organic layer. Thus, for 13 organic layers in the C-Lab sample no equivalent organic layer is recorded in the survey database. The additional layers are mainly H1 and H2.

The relationship between the SOC content of the C-Lab data and the survey data for the plots and segments which can be linked is graphically presented in Figure 48.

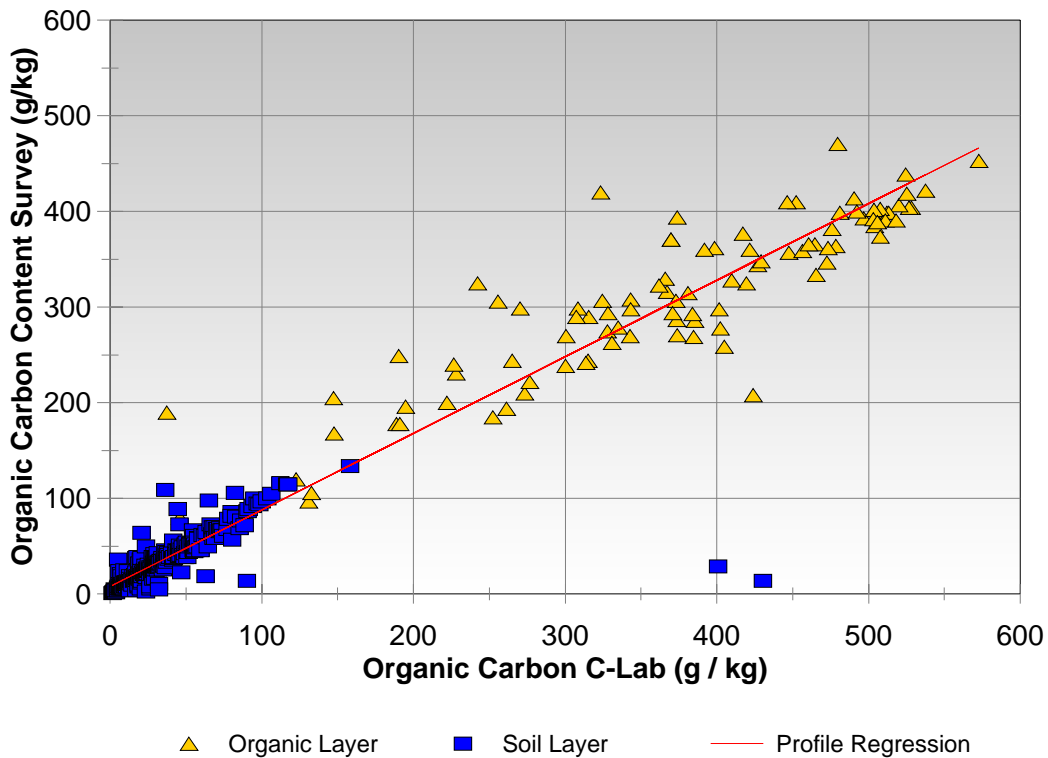

Figure 48: Relationship between C-Laboratory and FSCC / ICP Forests Data for Organic Carbon Content

For the soil part 2 outliers are shown in the graph. For these segments the C-Laboratory analysed an organic layer while the survey records the OC content of a soil sample. The 2 segments originate from the same linked plot, but are most likely the cause of some mismatch in the samples.

The linear regression for the soil 0-20 cm samples is

$$SOC_Content(Survey)_{SOIL20} = 0.91 \times SOC_Content(C-LAB)_{SOIL20} + 2.24$$

The regression coefficient is not quite 1.0, but significantly different from being 1.0 at a 95% confidence level. The off-set is not significantly different from 0 and the coefficient of determination r^2 is 0.84.

The linear regression for the organic layer without forcing the off-set to 0 is:

$$SOC_Content(Survey)_{ORG} = 0.63 \times SOC_Content(C-LAB)_{ORG} + 78.2$$

For the organic layer the regression coefficient is quite different from 1.0 and the difference of the off-set from 0 is just significant at the 95% confidence level. The coefficient of determination r^2 is 0.79 for the linear relationship.

When combining the segments of the organic with the soil layer from 0-20 cm the coefficient of determination r^2 rises to 0.97, but the regression coefficient is 0.80 and significantly different from 1.0. This would indicate that, at least for the organic layer, the survey data under-estimates the SOC content in the samples by about 20%. It is more likely that there is no linear relationship between the data from the C-Laboratory and the survey for the combined organic and soil layers and either separate or a non-linear relationship for the layers should be used.

The difference between the OC content recorded for the survey and the corresponding value reported by the re-analysis of the samples by the central laboratory were assessed by grouping the differences into equally-spaced classes. The results obtained for the segments of the soil layer 0 – 20 cm are expressed as the relative frequency of occurrence are given in Figure 49.

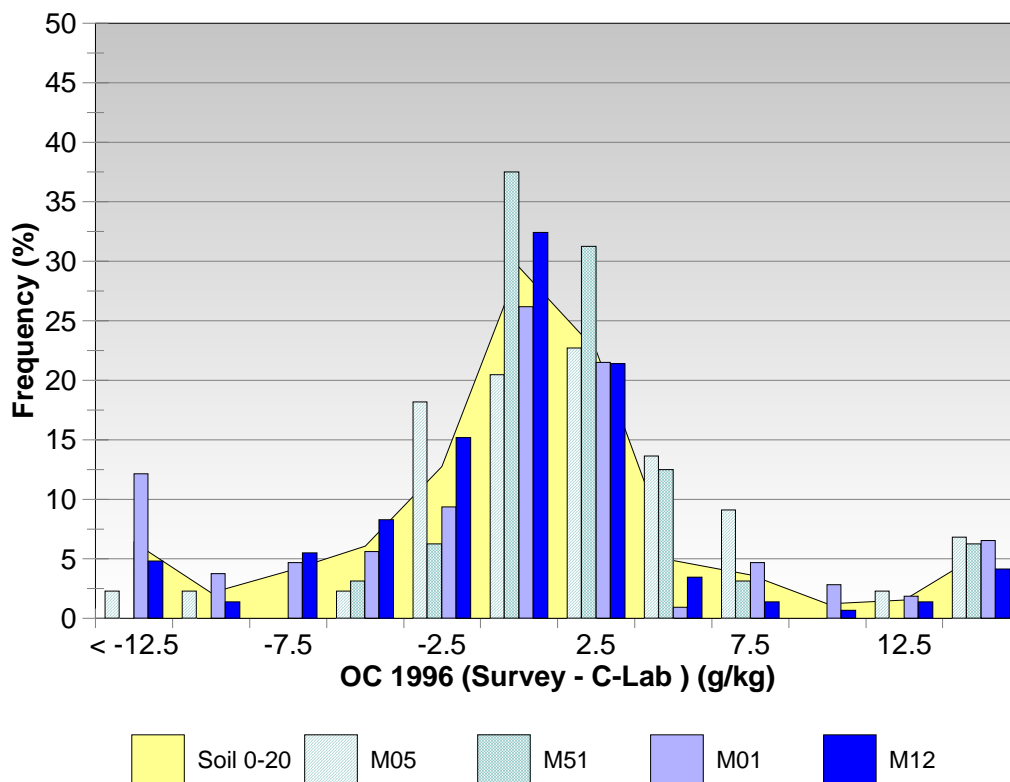

Figure 49: *Frequency Distribution of Difference between FSCC/ ICP Forests 1996 Survey and Re-Analyzed Data from Central Laboratory for Organic Carbon Content in Soil 0 – 20 cm*

In the graph positive values signify higher values of OC content for the survey data ($\Delta = \text{Survey} - \text{C_LAB}$). For the soil layer 0 – 20 cm the distribution of the differences is approximately symmetric around 0. The mean of all differences is -3.1 g kg^{-1} with a confidence level of $\pm 3.5 \text{ g kg}^{-1}$.

The distribution of the difference shows a tendency for the upper horizons M05 and M15 to have higher number of differences between -2.5 and $+7.5 \text{ g kg}^{-1}$ than the other layers. For the OC content in the more general M01 and the lower M12 layers the differences tend to be below $+2.5 \text{ g kg}^{-1}$.

The difference between the FSCC / ICP Forests survey OC content and the value reported by the re-analysis of the samples by the central laboratory for the organic layers is given in Figure 50.

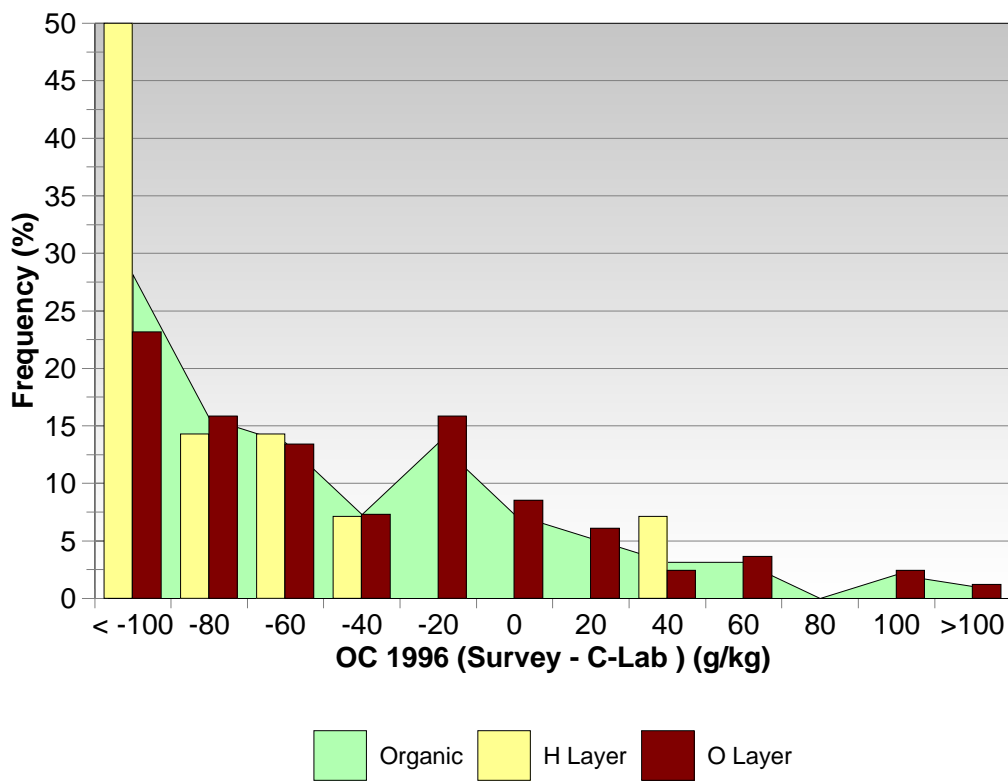

Figure 50: *Frequency Distribution of Difference between FSCC/ ICP Forests 1996 Survey and Re-Analyzed Data from Central Laboratory for Organic Carbon Content in Organic Layers*

The graph indicates that for the organic layers the data from the FSCC/ ICP Forests are considerably lower than the values reported by the central laboratory after re-analysing the samples. The mean of the difference is -59.6 g kg^{-1} (confidence level 95%: $\pm 11.8 \text{ g kg}^{-1}$)

kg⁻¹). For the OC content of the H layers the situation is worse than for O layers. More than 57% of all samples showed a value in the survey data which is 100 g kg⁻¹ lower than in the re-analysed data. The data do not provide any indication as to the reason for the difference because the measurement methods should have been the same for the samples included in the re-analysis.

3.6.4 Re-Analysis of BioSoil Survey Data

For the BioSoil data the link between the C-Laboratory and the plots and can be made without passing through the match of plot co-ordinates. The geographic distribution of the plots with samples in the C-Laboratory data is given in Figure 51.

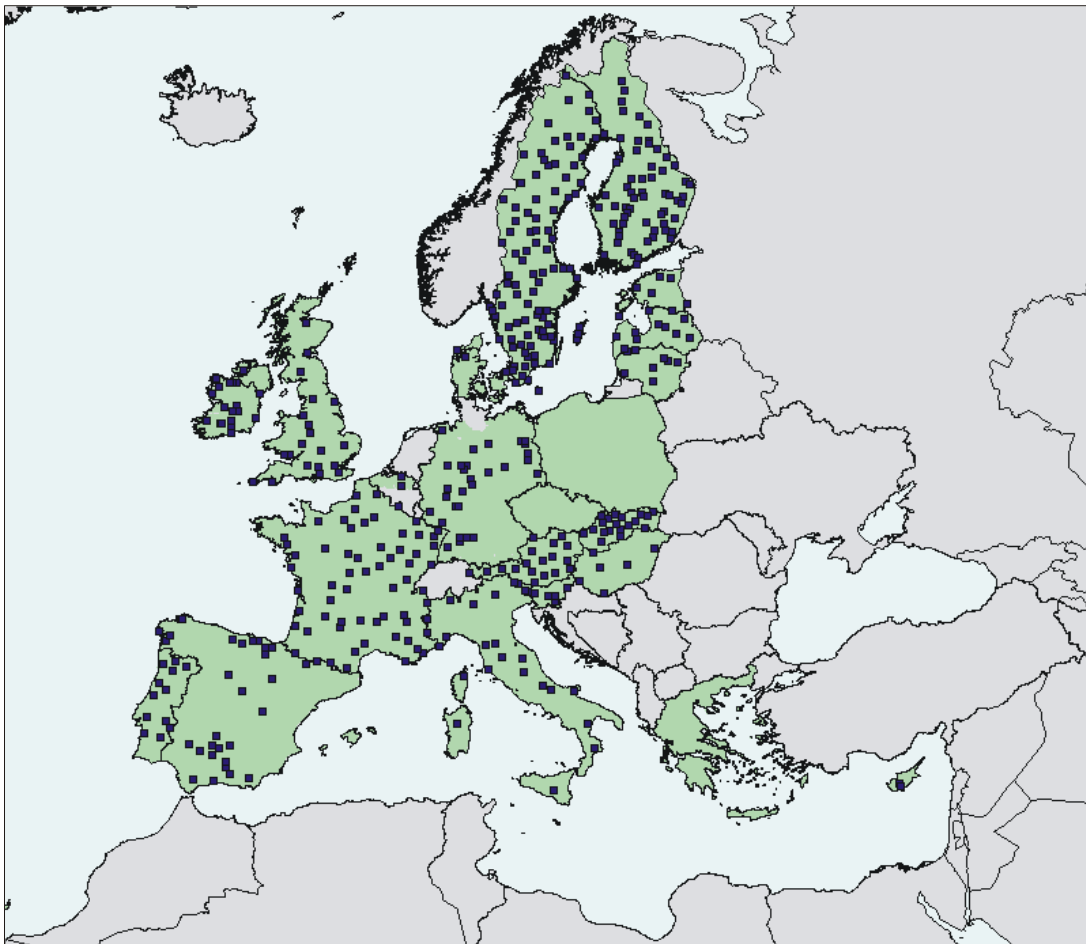

Figure 51: Geographic Distribution of Data from Central Lab Linked to BioSoil Survey Plots

The c-Laboratory database contains data from 526 plots. However, only 450 could be linked a BioSoil plot, corresponding to 86% of the re-analysed plots. For the organic and the soil layer 0-20 cm 1674 samples are recorded in the C-Laboratory database, coming from 515 plots. Of the 424 samples for the organic layer, excluding the OL layer, 320 can be linked to a corresponding plot and layer in the BioSoil database. All samples for the organic layer in the C-Laboratory database have a matching entry in the BioSoil database. For the soil layers covering 0-20 cm 7 samples in the C-Laboratory data have no correspondence in the BioSoil layer. The samples come from different plots and no particular prevalence for any single layer could be found.

The relationship between the C-Laboratory and the BioSoil samples for OC content is presented in Figure 52.

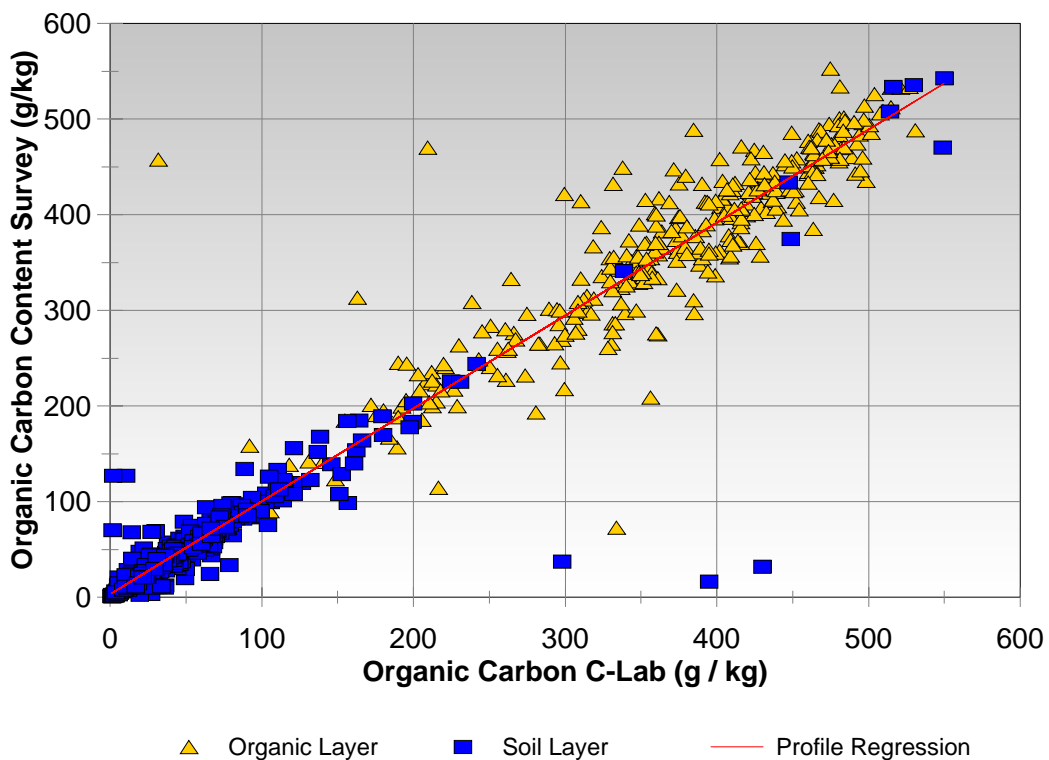

Figure 52: Relationship between C-Laboratory and BioSoil Data for Organic Carbon Content

As for the comparison for the 1996 survey data the relationship shows some outliers, which cannot be explained by variations in the sample OC content. When using a threshold filter of 20% for separating mineral from organic samples, i.e. when using only samples where the OC content both is on the same side of the threshold, a linear regression equation for the soil samples 0 – 20 cm was found as:

$$SOC_Content(Survey)_{SOIL20} = 0.94 \times SOC_Content(C - LAB)_{SOIL20} + 20.3$$

The regression coefficient is close to 1.0, but still significantly different from being 1.0 at a 95% confidence level. The off-set is not significantly different from 0. The positive off-set is the consequence of some samples with a C-Laboratory OC content close to zero, but a BioSoil survey data > 10%. The coefficient of correlation r^2 is 0.87.

The linear regression for the organic layer without forcing the off-set to 0 is:

$$SOC_Content(Survey)_{ORG} = 0.96 \times SOC_Content(C - LAB)_{ORG} + 2.5$$

For segments of the organic layer the regression coefficient is not significantly different from 1.0 and the off-set not from going through the origin. The coefficient of correlation r^2 for the samples from the organic layer is 0.87.

For the combined samples the equation for the linear regression was found as:

$$SOC_Content(Survey)_{ORG,SOIL20} = 0.98 \times SOC_Content(C - LAB)_{ORG,SOIL20} + 2.3$$

The regression coefficient is not significantly different from 1.0 and the off-set not from 0. The coefficient of correlation r^2 from the combined data is 0.98. There is also no evidence that the relationship would be anything else but linear or that the regression parameters between the organic and the soil layer would be different.

The relative occurrences of the differences between the OC content recorded in BioSoil survey database and the corresponding values reported by the re-analysis of the samples by the central laboratory for the soil layer 0 – 20 cm are given in Figure 53.

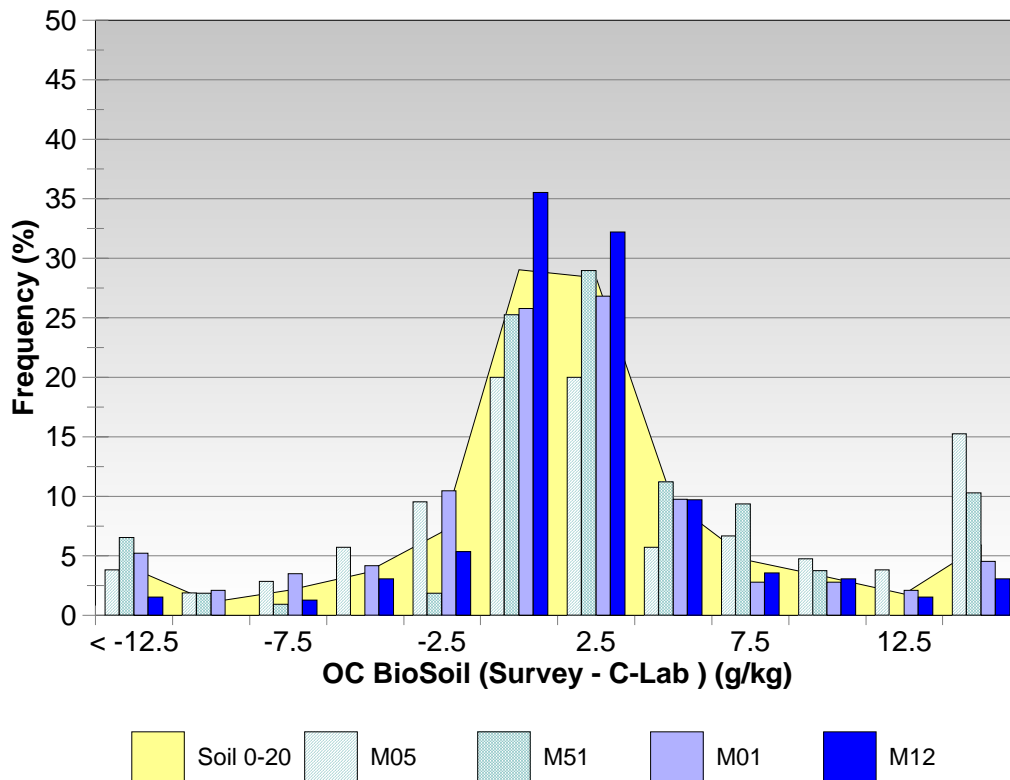

Figure 53: Frequency Distribution of Difference between BioSoil Survey and Re-Analyzed Data from Central Laboratory for Organic Carbon Content in Soil 0 – 20 cm

The differences are concentrated around zero with a mean of -0.23 g kg^{-1} with $\pm 1.5 \text{ g kg}^{-1}$ a 95% confidence level. In particular the data from the M12 layer is more prevalent in the classes with small differences ($\pm 2.5 \text{ g kg}^{-1}$).

The relative distribution of the BioSoil survey to re-analysis data for the organic layers is presented in Figure 54.

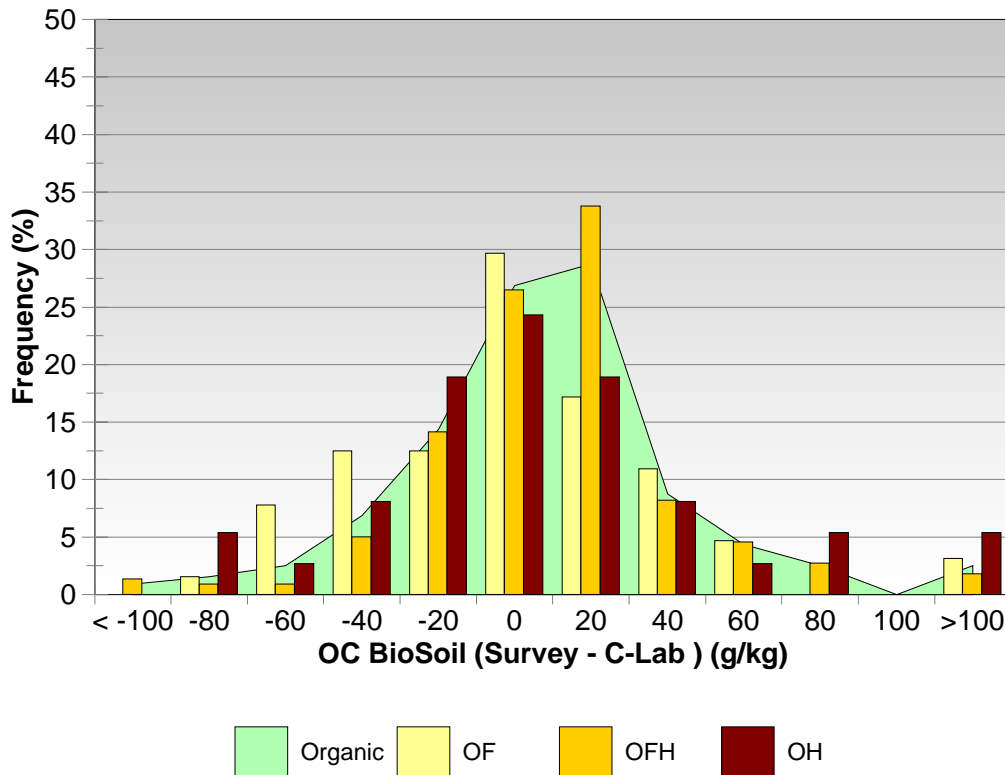

Figure 54: *Frequency Distribution of Difference between BioSoil Survey and Re-Analyzed Data from Central Laboratory for Organic Carbon Content in Organic Layers*

Also for the organic layers the differences are grouped around a difference of zero, with a mean of -1.1 g kg^{-1} ($\pm 5.2 \text{ g kg}^{-1}$ at 95% confidence level). A notable situation is the high frequency of a difference of 0 to 20 g kg^{-1} for OFH layers.

3.6.5 Comparison of C-Laboratory data for FSCC/ICP Forests and BioSoil Surveys

With the link between plots of the FSCC/ICP Forests and the BioSoil surveys the OC content reported by the C-Laboratory for the matching samples of the surveys can be compared. For the organic layer only data at plot level can be compared. This is a consequence of the changes in labelling the organic layers between the two surveys. Since the OC content of the organic layers of the 1996 survey cannot be reasonably weighted where more than one layer is recoded for a plot only those plots are included for which a single organic layer is reported. For reasons of comparability the soil data 0-20 cm was aggregated at plot level.

A graphical presentation of the relationship for OC content in the soil layer 0 – 20 cm and the organic layer at plot level as reported by the C-Laboratory is given in Figure 55.

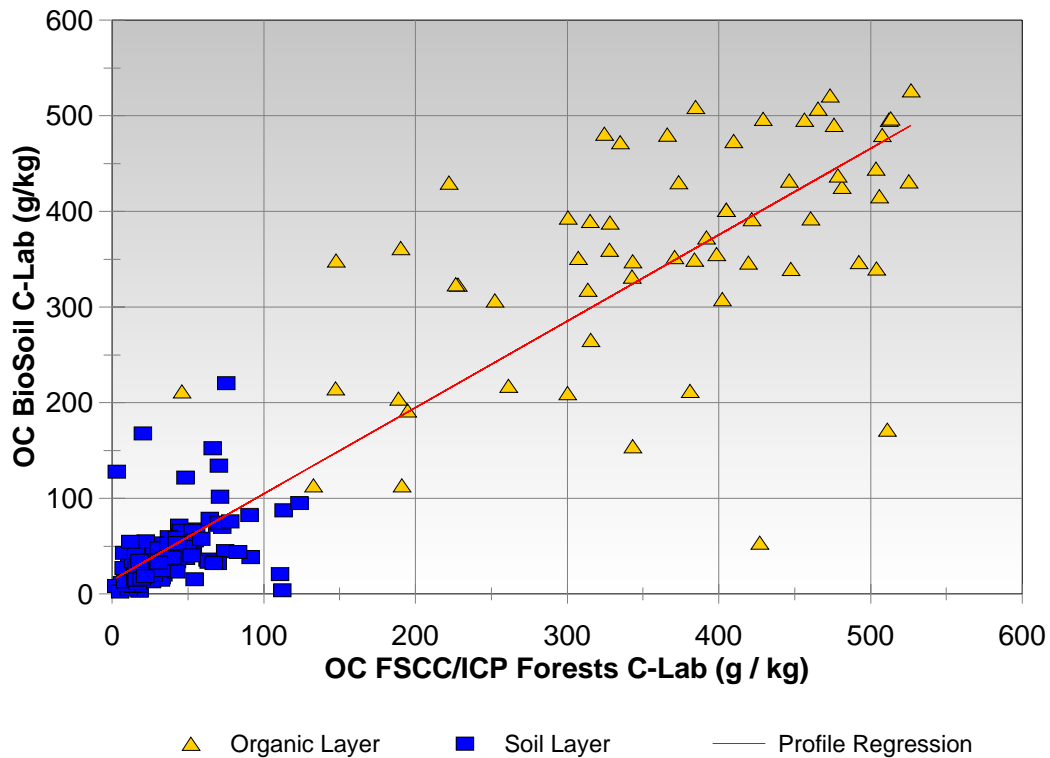

Figure 55: Relationship between OC Content for FSCC/ICP Forests and BioSoil as Reported by the Central Laboratory for Organic Carbon Content at Plot Level

The graph shows that while for the major part of the soil layer the relationship is fairly compact with only some outliers, the relationship for the organic layer is more spread.

The linear relationship with a limit on OC content for a matching plot set to 20% gives the following equation:

$$OC_Content(C-LAB)_{BioSoil} = 0.95 \times OC_Content(C-LAB)_{FSCC/ICP.Forests} + 8.3$$

For the 193 matching plots the relationship the coefficient of determination r^2 is 0.92. The regression coefficient is just significantly different from 1.0 (confidence limit: ± 0.041 at 95% confidence level), although the off-set confidence limit includes 0. Therefore, there is a small chance that one would attribute a trend to the data when there is none. Assuming that the regression should have a constant of 0 the slope becomes

0.98 (confidence limit: ± 0.032 at 95% confidence level). A z-test suggests no difference in the mean OC content between the common samples of the FSCC/ ICP Forests and the BioSoil surveys re-analysed by the Central Laboratory.

From the data it is further not apparent whether a non-linear relationship between the data re-analysed by the C-Laboratory of the FSCC/ICP Forests and the BioSoil surveys. For the segments of the soil layer 0 – 20 cm the data pairs were separated by layer of depth. A plot of the data is presented in Figure 56.

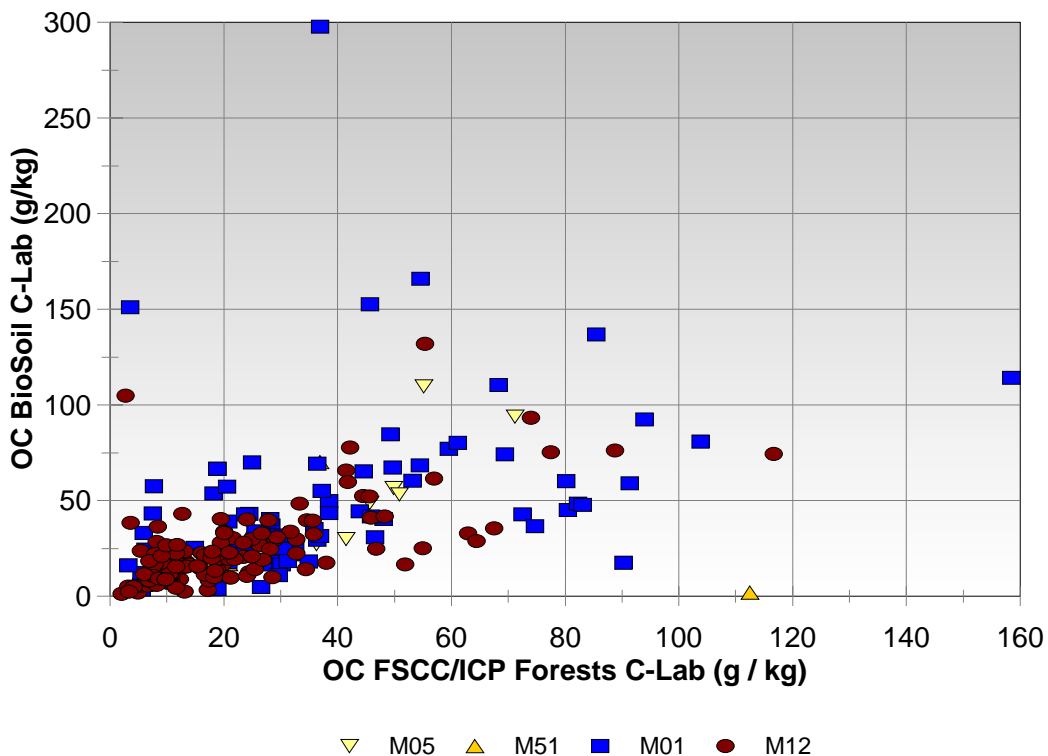

Figure 56: *Relationship between OC Content for FSCC/ICP Forests and BioSoil as Reported by the Central Laboratory for Organic Carbon Content of Corresponding Segments in Soil 0 – 20 cm*

The spread of data pairs is large for the data from the M01 than for the M12 layer. Any evaluation of the distribution of OC contents for the M05 and M51 layers is limited due to the low number of data points (9).

For the relationship the regression coefficient is 0.69 (± 0.16 , 95% CL) and the coefficient of determination is 0.25. When assuming that the constant should be 0 the regression coefficient becomes 0.98 (± 0.105 , 95% CL). With the good fit of the data from the Central Laboratory and the survey for the re-analysed soil material the

variations point to a diversity of the samples from the FSCC / ICP Forests to the BioSoil survey.

3.6.6 Interpretation of Results of the Central Laboratory Analysis

The analysis of the data from the 1996 FSCC / ICP Forests and the 2006 BioSoil surveys by the Central Laboratory brought some noteworthy results. For the OC content there was in general good agreement between the data from the surveys and the assessment of the Central Laboratory. There were also some outliers in the data which cannot be explained by the measurement methods. More likely are procedural inconsistencies of labelling samples or reporting the results correctly. Differences due to labelling could be understood for the 1996 samples, for which storage conditions may have changed over time, but less so for the BioSoil data.

A particular problems is presented by the results from the re-analysed data for the 1996 organic carbon layers. The re-analysis indicates that the OC content in the organic layer has been underreported in the survey by approximately 20%. The implication for comparative analysis of the 1996 FSCC / ICP Forests data with the 2006 BioSoil data would be an overestimation of the changes between the surveys by that amount.

One possibility is that the difference is the consequence of the use of diverse methods by the national laboratories analysing the 1996 samples and the method used by the Central Laboratory.

The method(s) used for the 1996 survey could not be established with certainty. The earliest document (file creation date: 30.07.2001) gave the method “UNEP-UN/ECE Method 9104SA”, to be used for all soil types.

The method used by the Central Laboratory to establish OC content followed ISO 10694:1995 (sa08a), i.e. using dry combustion. The quantification limit of the method is given as 0.05 g kg⁻¹ (Richar & Proix, 2009). Details on the method are:

“Total nitrogen and total carbon were determined simultaneously by dry combustion. If the carbonate content of soil was less than 700 g/kg, the Organic carbon was calculated using the following equation:

$$C_{org} = C_{total} - 0.12 \times CaCO_3$$

If carbonate content was over 700 g/kg, the soil sample was firstly treated with HCl, in order to remove carbonate, and total carbon was considered equal to organic carbon.”

Assessing the OC content by the method of Walkley-Black is generally considered invalid if the OC content is >8 % (Burt, 2004). Underestimations of the OC content in soils using the method as compared to dry combustion were reported (Schumacher, 2002), but it is by no means clear which method(s) have been used to assess the parameter in the previous survey.

Another possibility for changes in OC content in samples are storage conditions. Losses in organic carbon compounds can occur during storage through microbial degradation. Samples from anaerobic environments may also lose C during drying. Losses of this type are generally small (<1%) (Schumacher, 2002). Such losses could not explain why the 1996 samples analysed by national laboratories have lower OC content than the same samples analysed by the Central Laboratory.

A summary of the main descriptive statistical parameters is given in Table 23.

Table 23: Descriptive Statistics for Organic Carbon Content by Plot

Parameter	FSCC / ICP Forests		BioSoil	
	Organic Layer	Soil 0-20 cm	Organic Layer	Soil 0-20 cm
Plots	4,422	4,739	2,837	3,611
Mean	333.9	33.1	366.5	61.7
Confidence Interval (95%)	± 3.40	± 0.87	± 3.92	± 3.45
Kurtosis	-0.48	33.35	0.58	12.11
Skew	-0.32	4.24	-0.85	3.57
<i>Difference to Central Laboratory</i>				
Mean	-59.6	-3.1	-1.5	-0.2
Confidence Interval (95%)	± 11.83	± 3.50	± 5.06	± 1.50
Regression coefficient	0.63	0.91	0.96	0.94
Confidence Interval (95%)	± 0.065	± 0.043	± 0.013	± 0.040
Coefficient of determination r^2	0.79	0.84	0.96	0.87

Instrument variation: < 0.1 %

Laboratory measurement error: <1 – 2 % (Olsen, 2009)

Seen in isolation the table indicates an increase in OC content for forest soils from the FSCC / ICP Forests to the BioSoil survey for the soil material and the organic layer. The OC content of the soil material 0 – 20 cm almost doubles from the previous to the BioSoil survey. With an increase of approx. 10% the changes of OC content in the organic layer are less prevalent, although still significant. The data from the Central Laboratory indicates an uncertainty in repeated measurements of the same sample of 5 g kg⁻¹ for the organic layer and 1.5 g kg⁻¹ for the soil material 0 -20 cm (BioSoil data).

However, the comparison of the data common to both surveys and re-analysed by the Central Laboratory puts some strong doubt on the dependability of the change computed from the data for the OC content, in particular for the organic layer. A summary of

evaluating the significance of a difference in the means for OC content for the surveys and the samples used in the Central Laboratory is given in Table 24.

Table 24: Significant Differences in the Means of FSCC / ICP Forests and BioSoil Survey and Central Laboratory Data

Survey	Plots	Plots of Central Laboratory (C-LAB)			
		FSCC/ICP Forests		C-LAB Plots	
		Survey	C-LAB	Survey	C-LAB
<i>Organic Layer</i>					
FSCC / ICP Forests	Survey	X	X	X	X
	C-LAB	X			
BioSoil	Survey	X			
	C-LAB	X			
<i>Soil 0-20</i>					
FSCC / ICP Forests	Survey			X	X
	C-LAB			X	X
BioSoil	Survey	X	X		
	C-LAB	X	X		

X significant difference at 95% CL
 resultant data inconsistency.

The table presents significant differences between the means in OC content of the total survey and Central Laboratory samples with the means of the samples used by the Central Laboratory. To extend conclusions on changes from the results obtained by the Central Laboratory comparison to the survey the means of the survey should not differ from the means of the samples sent to the Central Laboratory. Yet, for the organic layer there are significant differences for the mean of the FSCC / ICP Forests survey and the mean of the samples sent for re-analyses.

A graphical presentation of the relative distribution of the OC content in the organic layer of the FSCC / ICP Forests survey data and the data of the samples sent for re-analysis is given in Figure 57.

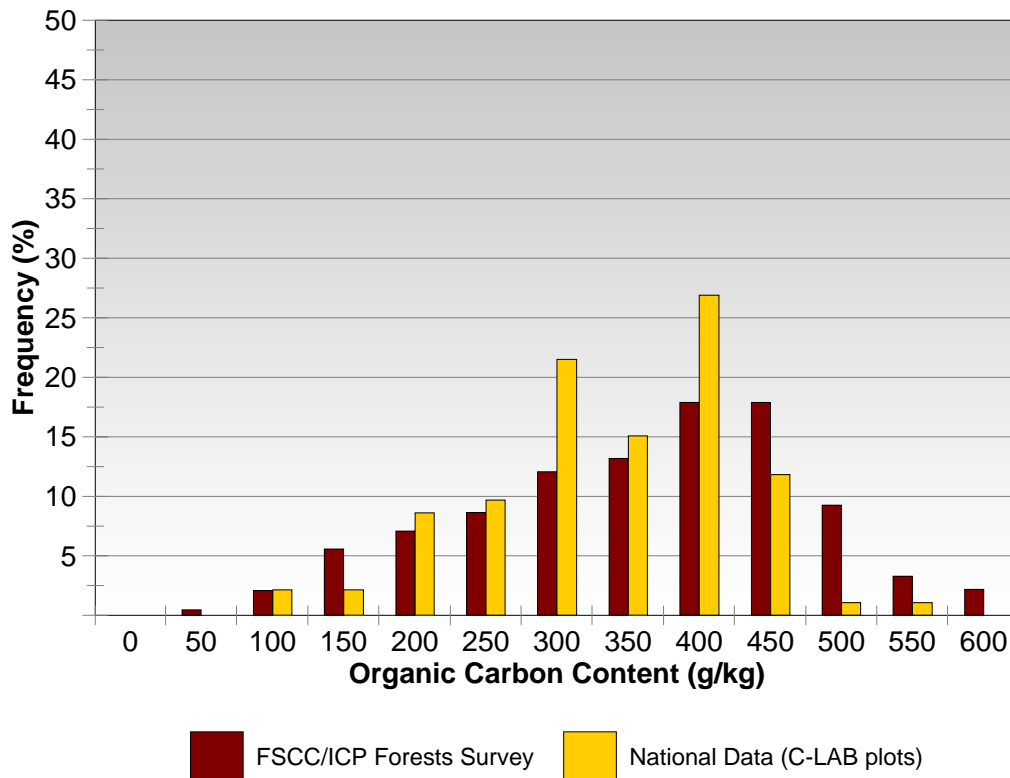

Figure 57: Distribution of Organic Carbon Content in Survey and Plots Re-Analyzed by Central Laboratory

The distribution of the OC content in the FSCC / ICP Forests database in the organic layer of the samples provided to the Central Laboratory shows the stronger concentration of the sub-sample data around the mean of 311.7 g kg^{-1} as compared to the distribution of the layer means of the complete survey data.

The comparison of the re-analysed common data raised two issues:

a) Compatibility of Analysis Method

The underlying assumption to the comparison is that the same data are compared using the same method for analysis. The comparison of the data from the central laboratory for the two surveys casts some doubt on the validity of the assumption. For the organic layers the OC content of the FSCC / ICP Forests data is about 20% below the values found by the Central Laboratory. With the good fit of the data this points to a methodological difference in measurements.

b) Variability of Change in Central Laboratory Data

Despite the generally close relationship between the data from the national laboratories and the results reported by the Central Laboratory there is

comparatively poor relationship in the samples available for both surveys and analysed by the Central Laboratory. Because the instrument and laboratory measurement uncertainties are much lower than the uncertainties in the relationship an additional factor is responsible for the low correlation of the data when comparing the samples from the two surveys. This factor is assumed to be the variation of the OC content in the samples taken at a plot from one survey to the next since the same sample cannot be taken more than once.

A change in the OC content of all plots could be support when the difference in the mean for the OC content between surveys exceeds 28 g kg^{-1} for organic layers and 4.9 g kg^{-1} for the soil material 0 – 20 cm. Those limits are only valid when the method(s) used to analyse the samples is/are compatible. This does not seem to be the case.

Should more of the analysis method(s) used for the FSCC / ICP Forests survey data become known one could envisage using a correction factor for the data. In a comparative evaluation of methods Bremner & Jenkinson (1960) found that the total OC contents determined by the Tinsley method were approximately 30% greater than those values determined by the Walkley-Black method (in: Schumacher, 2002). The lower OC content values from the Walkley-Black method could be adjusted by changing the correction factor from 1.33 to 1.40 (Soon & Abboud, 1991; in: Schumacher, 2002).

Applying a correction factor still relies on knowledge or a well-founded assumption on the method used to establish the FSCC / ICP Forests values for OC content. According to Vanmechelen *et al.*, 1997 most national laboratories used as method dry combustion at temperatures $> 900^\circ \text{C}$. Wet oxidation according to the method of Walkley - Black was only used in Ireland, Portugal and EL (country code as given in text, probably Greece, although country code is GR), according to Tjurin in the Slovak Republic, Croatia, Bulgaria and Estonia and according to Springer - Klee in France¹⁷ and the Czech Republic.

An indication against using a correction factor based on the analysis of the common sample is that the OC content mean of the organic layer of the 1996 survey is significantly different from the mean of the sample used by the Central Laboratory. The samples sent to the Central laboratory may not be representative of the FSCC / ICP Forests data and as a consequence, the regression coefficient computed for the re-analysed samples between the national laboratory results and those coming from the Central Laboratory is not necessarily applicable to the survey data. This condition strongly suggests the effect of some methodological differences in establishing the OC content between the two surveys for the organic layer and very much obscures the results of any comparative analysis between the surveys.

¹⁷ France is listed under two methods: dry combustion $> 900^\circ \text{C}$ and wet oxidation according to Springer – Klee. No methods are given for Sweden and Latvia.

3.7 Performance of WRB Soil Classification System

A detailed study to assess the achievements of the pedological descriptions according to World Reference Base for soil classification (WRB) in view of giving recommendations for the use of them in future soil inventories and monitoring activities was performed with the objectives to:

- assess consistency of soil descriptions and classification,
- appraise whether of soil profile description satisfy the requirements of the classification in the WRB,
- evaluate whether the pedological profile descriptions are reproducible and comparable across Europe.

3.7.1 Plots with Pedological Profile Description

For the spatial distribution 3,731 profile were evaluated from the survey of the BioSoil Demonstration Project. Profiles from Austria were not part of the evaluation for 2 reasons:

- a) no WRB classification was given, and
- b) the values for the laboratory data were often far out of the expected range).

Out of a total of 32 WRB reference soil groups (RSGs), 26 are recorded in the profile database. 12 RSGs occur with a frequency of 1 % or more and amount to 95% of the observed profiles. The remaining 5% of the profiles are assigned to 14 RSGs with a relative frequency of less than 1%.

The number and percentage of profiles together with the corresponding extent of coverage in the European Union for each WRB reference soil groups is given in Table 25.

Table 25: Number and Percentage of Profiles Used for the Evaluation for each WRB Reference Soil Group

WRB Reference Soil Group	Profiles		
	<i>Number</i>	<i>% of profiles</i>	<i>% coverage in EU</i>
Cambisols	916	24.55	26.71
Regosols	630	16.89	5.36
Podzols	613	16.43	13.6
Arenosols	268	7.18	3.61
Histosols	226	6.06	6.48
Leptosols	223	5.98	10.51
Luvisols	200	5.36	14.74
Gleysols	126	3.38	5.3
Stagnosols	115	3.08	n.d.
Umbrisols	108	2.89	0.01
Phaeozems	85	2.28	1.7
Lixisols	39	1.05	n.d.
Planosols	27	0.72	0.46
Albeluvisols	24	0.64	1.85
Fluvisols	22	0.59	5.35
Alisols	20	0.54	n.d.
Calcisols	19	0.51	0.22
Katanozems	25	0.4	0.09
Acrisols	17	0.36	0.26
Andosols	16	0.43	0.21
Katanozems	15	0.4	0.09
Chernozems	10	0.27	1.89
Vertisols	4	0.11	0.88
Anthrosols	4	0.11	0.08
Plinthosols	2	0.05	n.d.
Gysisols	1	0.03	0.1
Technosols	1	0.03	n.d.

The table shows that the 3 most common RSGs are Cambisols, Regosols, and Podzols, which account for 57% of the observed profiles

The relative distribution of all observed RSGs is presented in Figure 58.

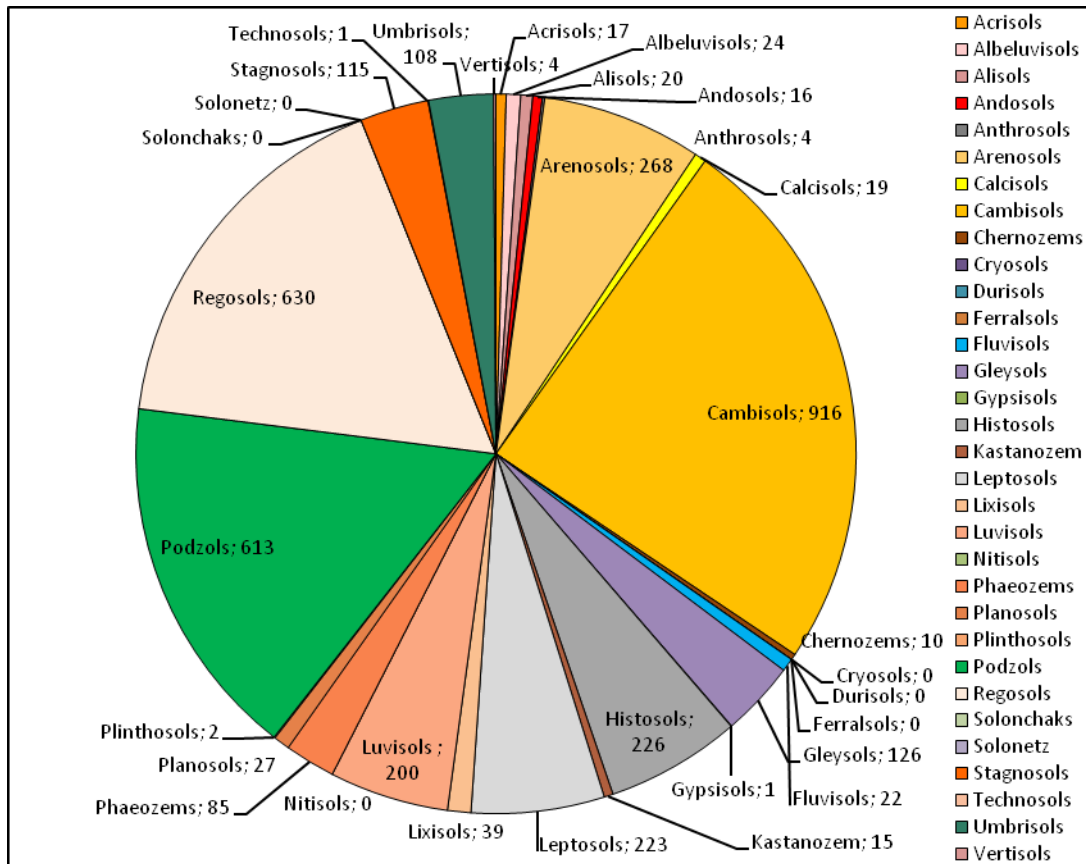

Figure 58: Distribution of Observed WRB Reference Groups

The distribution of the main 3 soil types of Cambisols, Regosols and Podzols is detailed below.

- **Cambisols**

916 profiles, 24.5 % of all the profiles were classified as Cambisols. They are the most frequently occurring soil type in 8 countries. More than half of all Cambisols (58.9 %) were reported in just 3 countries with the following distribution:

- 282 profiles in France (30.8% of all Cambisol profiles, 51.5 % of all profiles of France);
- 157 profiles in Germany (17.1 % of all Cambisol profiles, 37.2 % of all profiles of Germany);
- 100 profiles in Italy (10.9 % of all Cambisol profiles, 41.8 % of all profiles of Italy).

Cambisols account for the highest relative occurrence in the following other countries: 58.9 % (66 profiles) in Slovakia; 51.1 % (23 profiles) in Slovenia; 45.9 % (67 profiles) in the Czech Republic; 37.3 % (62 profiles) in the UK and 23.7 % (28 profiles) in Spain.

- **Regosols**

630 profiles, corresponding to 16.8 % of all the profiles, were classified as Regosols. 83.2 % of the Regosols were observed in 2 countries:

- 291 profiles in Sweden (46.2 % of all Regosol profiles, 37% of profiles of Sweden);
- 235 profiles in Finland (37.1 % of all Regosol profiles, 37.2 % of profiles of Finland).

The frequency of Regosols is comparatively high in the following countries: 31% (32 profiles) in Portugal; 20% (only 3 profiles) in Cyprus; 20 % (only 2 profiles) in Belgium; 12 % (30 profiles) in Italy.

- **Podzols**

The occurrence of Podzols is more geographically concentrated, with 68.3 % of the Podzols were observed in 2 countries:

- 251 profiles in Sweden (40.9 % of all Podzol profiles, 31.9 % of profiles of Sweden);
- 168 profiles in Finland (27.4 % of all Podzol profiles, 26.7% of profiles of Finland).

The frequency of Podzols is elevated above the average occurrence in several other countries: 48 % (12 profiles) in Denmark; 36% (35 profiles) in Estonia; 21.2 % (31 profiles) in the Czech Republic.

According to Table 25 the next frequently found RSGs are: Arenosols (7.3%), Histosols (6.1%), Leptosols (6.0%), Luvisols (5.4%), Gleysols (3.4%), Stagnosols (3.1%), Umbrisols (2.9%), Phaeozems (2.3%) and Lixisols (1.1%). All other RSGs were reported with a frequency of less than 1 %.

3.7.2 Consistency of Soil Descriptions and Classification

The standard specifications for the profile description were based on the FAO guidelines (2006). However, the manual that was applied (Mikkelsen *et al.*, 2006) was not fully following the FAO guidelines concepts and code system. In most cases the differences did not cause notable problems in the interpretation of soil profiles, but in

some cases great difficulties occur in the database analysis. The greatest problem and inconsistency is the delineation of the depth of organic layers. In the FAO guidelines all organic and mineral horizons start at 0 cm and get positive values, while in the applied guideline the soil layer starts at depth 0 with overlaying organic layers assigned to negative depth limits.

Options that may occur for defining the upper limit of an organic horizon are presented in Figure 59.

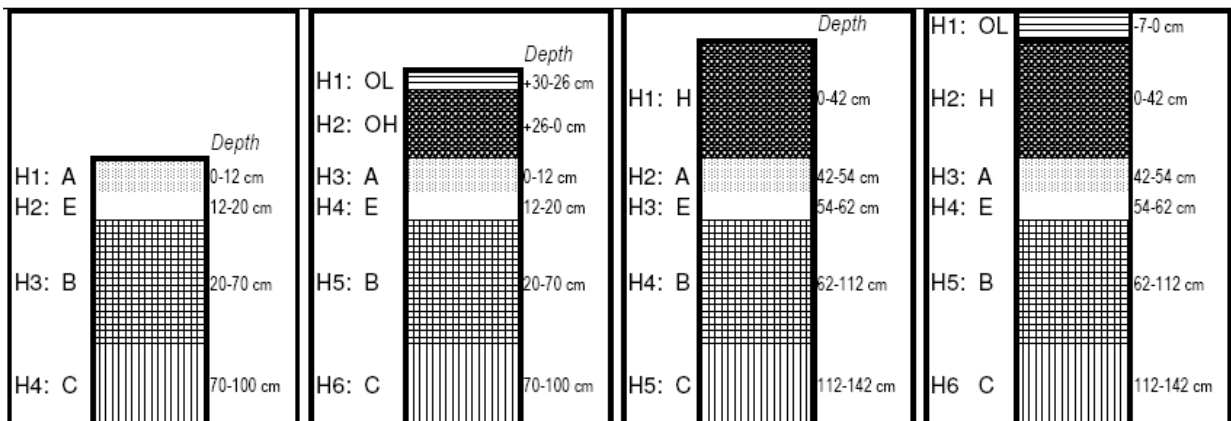

Figure 59: Example Instruction for Horizon Depth Definition for the Field Description in the BioSoil Project (Mikkelsen et al., 2006)

Organic horizons get negative depth values except in cases where the organic layer(s) is:

1. 10 cm or more thick from the soil surface to a lithic or paralithic contact, or
2. 40 cm or more thick, then the depth is measured from the surface of the organic cover.

This makes the database analyses complicated and databases difficult to be compatible. Automatic adjustment of the BioSoil data was not possible because in many cases the complicated instructions were not understood and the set guideline was not followed. As a consequence, a manual check is needed before running any analyses using profile depth.

For the pedon classifications the 2006 edition of the World Reference Base for soil resources (WRB WG, 2006) was applied without modifications.

3.7.3 Application of the Soil Description Standards

For the evaluation of the application of the soil description standards the horizon database was studied. The parameters were mostly determined in the field, based on

visual observations, hand senses with assisting tools and simple field measurements. In the 4,029 described profiles, 19,312 master horizons were identified and only 25 (0.13%) horizons missed the designation of the master horizons, as shown in Table 26.

Table 26: Performance in Identification of Genetic Horizons and Moist and Wet Colours of Soil Horizons

Country	Number of identified genetic horizon	Number of missing horizon designation	% of missing horizon designation	Number of missing moist colour	% of missing moist colour per country	% of missing moist colour per country	Number of missing dry colour	% of missing dry colour per country	% of missing dry colour per country
Austria	863	0	0	302	34.99	4.77	863	100.00	7.43
Belgium - Flanders	108	0	0	10	9.26	0.16	26	24.07	0.22
Cyprus	54	0	0	16	29.63	0.25	16	29.63	0.14
Czech Republic	795	0	0	153	19.25	2.42	152	19.12	1.31
Denmark	146	0	0	18	12.33	0.28	145	99.32	1.25
Estonia	550	0	0	224	40.73	3.54	224	40.73	1.93
Finland	2653	0	0	0	0.00	0.00	1569	59.14	13.50
France	2802	0	0	902	32.19	14.24	2802	100.00	24.11
Germany	3030	1	0.03	994	32.81	15.69	1384	45.68	11.91
Hungary	464	20	4.31	46	9.91	0.73	394	84.91	3.39
Ireland	245	1	0.41	44	17.96	0.69	245	100.00	2.11
Italy	1421	0	0	633	44.55	9.99	969	68.19	8.34
Latvia	725	0	0	0	0.00	0.00	0	0.00	0.00
Lithuania	442	0	0	129	29.19	2.04	129	29.19	1.11
Portugal - mainland	502	0	0	200	39.84	3.16	502	100.00	4.32
Slovak Republic	710	0	0	252	35.49	3.98	350	49.30	3.01
Slovenia	300	0	0	95	31.67	1.50	114	38.00	0.98
Spain	459	0	0	459	100.00	7.25	459	100.00	3.95
Sweden	2106	3	0.14	1041	49.43	16.43	1041	49.43	8.96
United Kingdom	937	0	0	817	87.19	12.90	237	25.29	2.04
All countries	19312	25		6335			11621		
% for all countries			0.13		32.80	100.00		60.18	100.00

The subordinate characteristics of the horizons carry information on important soil properties (such as strong gleying, accumulation of illuvial clay, etc). In most cases the additional information was applied properly and were in line with the application of qualifiers for the profiles (in the profile database).

The subordinate characteristics were not recorded by the FAO codes, but with words in the database. It is suggested to follow the codes for easier search and analyses and compatibility with other databases.

Moist and dry soil colours are important attribute information for the definition of several diagnostics and qualifiers (mollic horizon, umbric horizon, albic horizon, horion, spodic horizon etc.). Yet, 32.8 % of the moist and 60.1 % of the dry colours were not recorded with the profile data(see Table 26). What makes this number less critical is that in many cases the colours for organic layers and deep horizons were not recorded.

From the horizon descriptions for 2,876 mineral layers (for about 20% of the mineral layers) no estimated texture as determined in the field was recorded. Since in many cases results from the texture analyses in the laboratory are also missing, there are many profiles (exact number not determined) with no texture information available.

In summary, the application of the soil description standards can be, and in most cases were, performed properly. In the horizon and profile data set valuable information can be recorded for interpretation and classification purposes and also for cross checks of laboratory data.

Were data are missing in the BioSoil database, the reason is other than a problem with the classification standard. In case the original specifications were modified (organic layer depth) the result was inconsistency in the data recorded and manual data adjustments were necessary for further data analyses.

3.7.4 Identification of Diagnostic Horizons, Properties, Materials and Qualifiers

In the World Reference Base for soil resources the classification of pedons are based on the presence or exclusion, the depth and/or sequence of diagnostic horizons, properties and materials in the profile. It is therefore essential to identify all applying diagnostics before the classification is performed. The identification of diagnostics is based on the field descriptions and laboratory analyses. Some of the criteria are related to morphology and are defined qualitatively, however most definitions include numerical limits (for depth, degree, measured value, etc.).

The profile database shows a significant variation in the degree to which diagnostics were identified in the countries. From the 20 countries in the database, in 7 no diagnostic horizon, property or material were identified for any profile. From all the 4,029 observed profiles across the participating NFCs for 2,078 profiles (51.6 % of all profiles) no diagnostics were identified. One diagnostic feature was determined for 22%

of the profile, 2 for 15% and 3 for 7% of the profiles. The highest number of diagnostics identified was 10.

The assessment of the identification of diagnostics for the RSGs is given in Table 27. For most RSGs diagnostics are identified in the database. There are only 2 RSGs without any diagnostics (Gypsisols and Kastanozems), but those are RSGs with limited occurrence. Unfortunately for some of the most frequent RSGs no diagnostics were recorded in many cases (71% of Regosols, 65% Arenosols, 50% of Luvisols, 45% of Cambisols, 39% of Leptosols).

In many cases the diagnostics could (should) have been identified, as the necessary information is available, in the horizon, the profile or the analytical database. In some cases diagnostics were determined but the available analytical data exclude them. It is suggested that where data are available applying diagnostics should be determined or corrected.

Some examples of the situations found in the profile database are:

- Based on the analytical data 581 horizons satisfy the requirements of the argic horizon, but only 177 of the profiles were identified as Luvisols or Alisols or characterized by the luvic qualifiers.
- Based on the analytical data (colour, OC, depth) 343 horizons satisfy the requirements of the mollic or the umbric horizons, but only 53 of them were recorded as mollic or umbric. At the same time 147 mollic horizons were identified, but either do not satisfy the requirements, or miss one or more of the supporting data.
- In the database 226 profiles were classified as Histosols, however diagnostics for the Histosols are satisfied only for 166 profiles.

Unfortunately there were also many cases when field or analytical data was not available to support the establishment of the diagnostics.

Table 28 includes some selected important attributes that are frequently needed for the definition of reference soil groups, diagnostics or qualifiers, with indication of the number and % of missing data for the studied horizons.

Examples of missing attributes are:

- organic carbon is missing for 35%,
- bulk density for 81%,
- pH for 32%,
- cation exchange capacity for 41%,
- clay and sand content % for 56% of the horizons.

Table 27: Frequency of Identification of Diagnostics in the Profiles by Country

Country	Number of profiles	Frequency of profiles with 1,2,...10 identified diagnostic											SUM
		0	1	2	3	4	5	6	7	8	9	10	
Austria	135	135	0	0	0	0	0	0	0	0	0	0	135
Belgium - Flanders	10	1	0	0	1	1	3		1	1		2	10
Cyprus	15	15	0	0	0	0	0	0	0	0	0	0	15
Czech Republic	146	146	0	0	0	0	0	0	0	0	0	0	146
Denmark	25	0	0	1	1	5	2	5	7	2	2	0	25
Estonia	96	0	1	15	27	18	19	13	2	1	0	0	96
Finland	630	224	256	124	25	1	0	0	0	0	0	0	630
France	548	32	191	177	122	22	4	0	0	0	0	0	548
Germany	422	318	39	19	31	5	7	0	2	1	0	0	422
Hungary	78	10	26	29	9	4	0	0	0	0	0	0	78
Ireland	36	3	20	13	0	0	0	0	0	0	0	0	36
Italy	239	139	79	19	2	0	0	0	0	0	0	0	239
Latvia	95	59	19	9	6	2	0	0	0	0	0	0	95
Lithuania	62	13	11	6	23	8	0	1	0	0	0	0	62
Portugal - mainland	103	18	52	24	6	3	0	0	0	0	0	0	103
Slovak Republic	112	112	0	0	0	0	0	0	0	0	0	0	112
Slovenia	45	45	0	0	0	0	0	0	0	0	0	0	45
Spain	272	272	0	0	0	0	0	0	0	0	0	0	272
Sweden	794	370	191	185	43	5	0	0	0	0	0	0	794
United Kingdom	166	166	0	0	0	0	0	0	0	0	0	0	166
Number of profiles /all countries	4029	2078	885	621	296	74	35	19	12	5	2	2	
% of profiles with number of diagnostics		51.58	21.97	15.41	7.35	1.84	0.87	0.47	0.30	0.12	0.05	0.05	100.00

Table 28: Frequency of Identification of Diagnostics for WRB RSGs

RSG	Profiles	Frequency of profiles with 1,2,...,10 identified diagnostic											SUM _{diag}
		0	1	2	3	4	5	6	7	8	9	10	
Albeluvisol	24	6	2	1	2	3	2	3	2	2		1	90
Acrisol	17	2	6	3	5	1	0	0	0	0	0	0	31
Alisol	20	15	2	1	0	0	0	1	0	0	1	0	19
Andosol	16	13	1	1	1	0	0	0	0	0	0	0	6
Arenosol	268	173	71	16	5	2	0	1	0	0	0	0	132
Anthrosol	4	0	3	0	0	1	0	0	0	0	0	0	7
Chernozem	10	3	1	3	2	1	0	0	0	0	0	0	17
Calcisol	19	13	5	1	0	0	0	0	0	0	0	0	7
Cambisol	916	412	261	145	81	11	6	0	0	0	0	0	868
Fluvisol	22	15	2	1	3	0	1	0	0	0	0	0	18
Gleysol	126	52	10	21	26	6	6	3	1	1	0	0	217
Gypsisol	1	1	0	0	0	0	0	0	0	0	0	0	0
Histosol	226	110	75	32	6	2	1	0	0	0	0	0	170
Kastanozem	15	15	0	0	0	0	0	0	0	0	0	0	0
Leptosol	223	86	100	26	11	0	0	0	0	0	0	0	185
Luvisol	200	100	31	37	19	7	3	1	1	1	0	0	226
Lixisol	39	2	23	5	4	5	0	0	0	0	0	0	65
Phaeozem	85	41	11	13	17	3	0	0	0	0	0	0	100
Planosol	27	11	2	2	8	3	1	0	0	0	0	0	47
Plinthosol	2	0	0	0	1	1	0	0	0	0	0	0	7
Podzol	613	162	86	242	69	22	12	10	7	1	1	1	1061
Regosol	630	445	158	18	8	0	1	0	0	0	0	0	223
Stagnosol	115	74	0	18	16	5	2	0	0	0	0	0	114
Technosol	1	0	1	0	0	0	0	0	0	0	0	0	1
Umbrisol	108	32	33	31	10	1	0	0	1	0	0	0	136
Vertisol	4	1	1	1	1	0	0	0	0	0	0	0	6
No RSG is given	298	292	0	3	1	0	0	0	0	0	0	0	9
Number for all RSGs	4029	2076	885	621	296	74	35	19	12	5	2	2	

Table 29: Frequency and Percentage of Missing Data (No Data) for Selected Attributes

Attribute	Frequency of no data	% of no data	Comment
Base saturation (B%)	7,956	43	One of the most frequently used attribute in definitions of RSGs diagnostics and qualifiers (eg. Luvisols, Alisols, mollic , umbric horizons, dystic, eutric qualifiers).
Bulk density (measured)	15,033	81	Important for some RSGs, and very important to interpretations (eg. Andosols, Histosols; calculation of organic carbon stocks).
Electric conductivity (EC)	16,907	91	Important for definition of "salt affected" RSG, that do not occur in the BioSoil data, but salt (hence high EC) may occur in other RSGs, such as Histosols, Gleysol).
pH (H ₂ O)	6,056	32	Important for several diagnostics and interpretations (eg. Podzols; where B% is not available, pH is important for estimation).
Cation Exchange Capacity (CEC)	7,732	41	Important for the definition of diagnostics and RSG, definitions and interpretations (soils with argic horizon; interpretation of clay activity).
Coarse fragments (%)	14,186	76	Frequently used attribute in the definitions of RSGs diagnostics and qualifiers (eg. Leptosols RSG, skeletal qualifier, that is very frequent in soils under forest).
Gypsum (%)	17,998	96	Important for few RSGs, and those do not occur in the BioSoil database(in Mediterranean areas the reason of no Gypsisol identification might be the lack of data).
CaCO ₃ (%)	14,946	80	Important attribute in definitions of RSGs diagnostics and qualifiers (eg. Calcisols, Chernozems, and more RSGs; calcic qualifier; important interpretations).
Munsell colour codes (moist)	6,049	32	Important attribute in definitions of several RSGs diagnostics (Podzols, Chernozems RSGs; mollic, albic horizons).
OC (%)	6,474	35	One of the most important attribute in definitions and interpretations (eg.Histosols, histic, folic, mollic , umbric horizon).
Clay and sand (%)	10,409	56	Important for definition of RSGs and several diagnostics and qualifiers (Arenosols, Vertisols RSGs; argic horizon, arenic, clayic qualifiers).
Exchangeable Na (ESP %)	17,699	95	Important for definition of "Salt affected" RSG, that do not occur in the BisSoil data, but sodium may occur in other RSGs, such as Histosols, Gleysol, etc.

From the 65 diagnostic horizons, properties and materials of the WRB system 34 were used. The highest numbers were naturally for those that are diagnostic for the most frequently found RSGs: Cambic horizons were recorded 561 times, albic horizons 513 and spodic 496 times. Other frequently applied diagnostics were: continuous hard rock (391), histic horizon (216), argic horizon (194), reducing conditions (182), gleyic colour pattern (160), folic horizon (141), as shown in Figure 60.

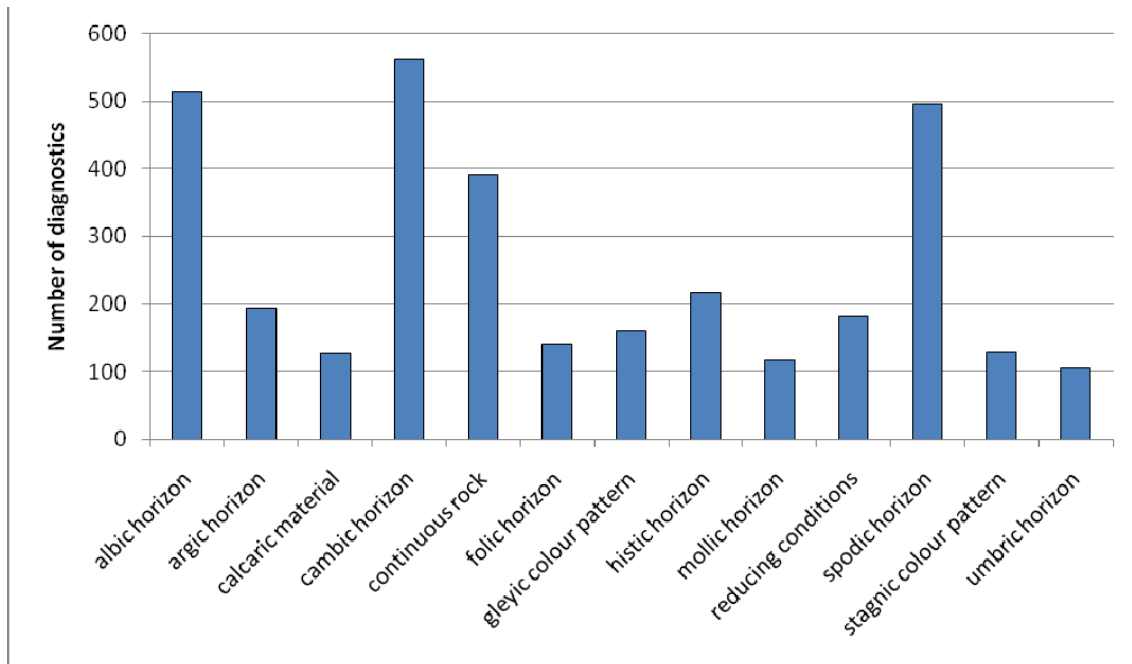

Figure 60: Most Frequently identified WRB Diagnostics in the BioSoil Database

From the 179 qualifiers of the WRB system 108 were applied. As in case of the diagnostics the highest numbers of qualifiers were applied for the most frequent RSGs: Cambisol, Regosols and Podzols.

Figure 61 illustrates the most frequently applied qualifiers. After Haplic (which is used when no other qualifier applies) Dystric and Hyperdystric together (679), Eutric and Hypereutric together (606) Skeletic (582) and Humic (574) and Albic (484) are the most frequent qualifiers.

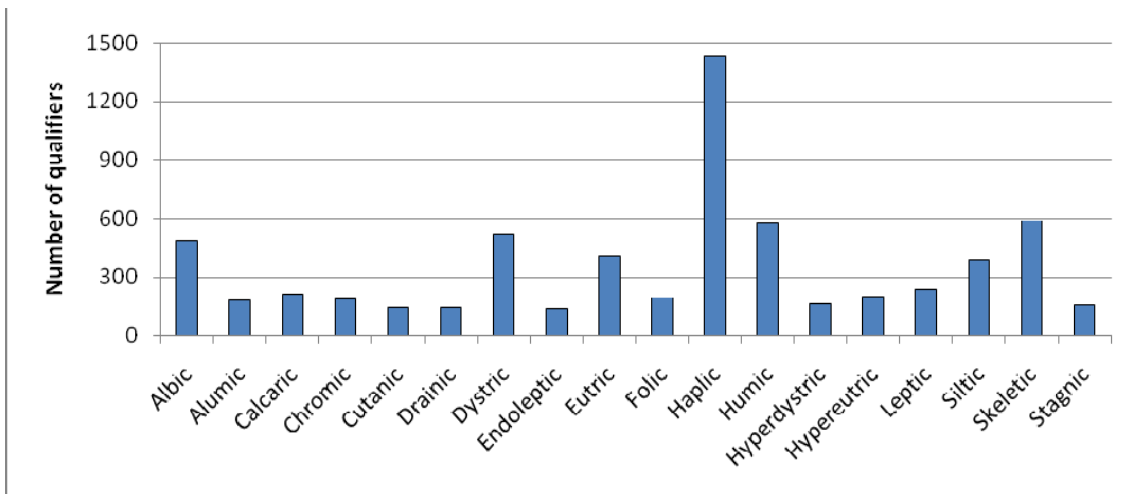

Figure 61: Most Frequently Applied Qualifiers in the BioSoil Database

3.7.5 Evaluation of the Identification of the Diagnostics and Qualifiers for the 3 Most Frequent RSGs

Cambisols

For Cambisols, the most frequent RSG in the BioSoil database, 23 different diagnostics (diagnostic horizon, material and/or property) were identified. The frequency of the number of identification of diagnostics is shown in Figure 62. For almost half, 45% of the profiles (412) no diagnostics, were recorded. For 28.5% of the profiles (261) 1; for 15.8% (145) 2; for 10.7% (98) 3 or more diagnostics were described.

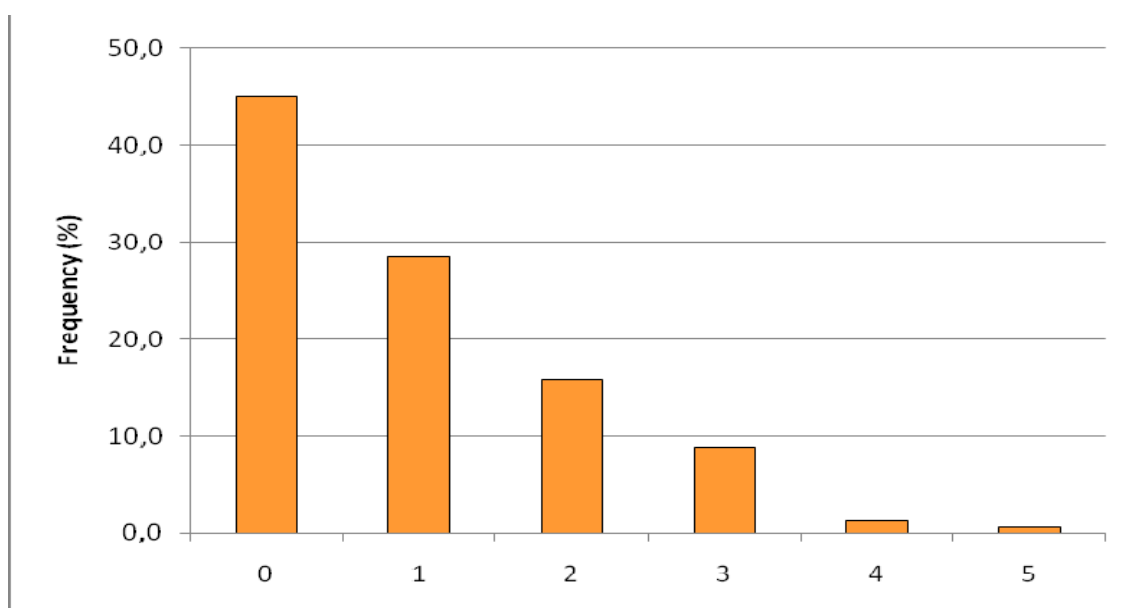

Figure 62: *Frequency of the Number of Identification of Diagnostics for Cambisols*

The 9 most frequently established and applied diagnostics are given in Table 30.

Table 30: *9 Most Frequently Applied Diagnostics for Cambisols*

Diagnosics	Number of profiles	Frequency (%)
Cambic horizon	493	56,8
Shallow Continuous rock	146	16,8
Calcaric material	66	7,6
Lithological discontinuity	38	4,4
Reducing conditions	25	2,9
Stagnic colour pattern	21	2,4
Folic horizon	19	2,2
Gleyic colour pattern	14	1,6
Abrupt textural change	9	1,0

The frequency of all identified diagnostic horizons is shown in Figure 63, and the frequency of diagnostic properties and materials is shown in Figure 64. Numerous Cambisols were classified without recording of the necessary diagnostic requirements. The other problem noted is the presence of argic (in 3 profiles), mollic (in 8 profiles),

spodic (in 2 profiles) and umbric (in 1 profiles) horizons that by definition exclude Cambisols.

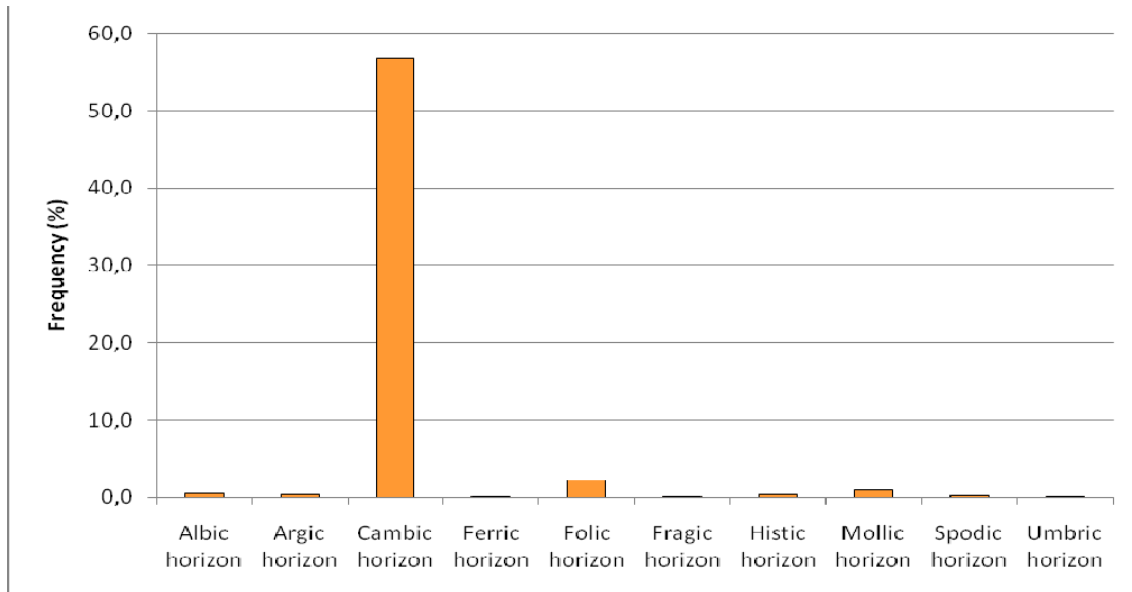

Figure 63: Frequency of Identified Diagnostic Horizons for Cambisols

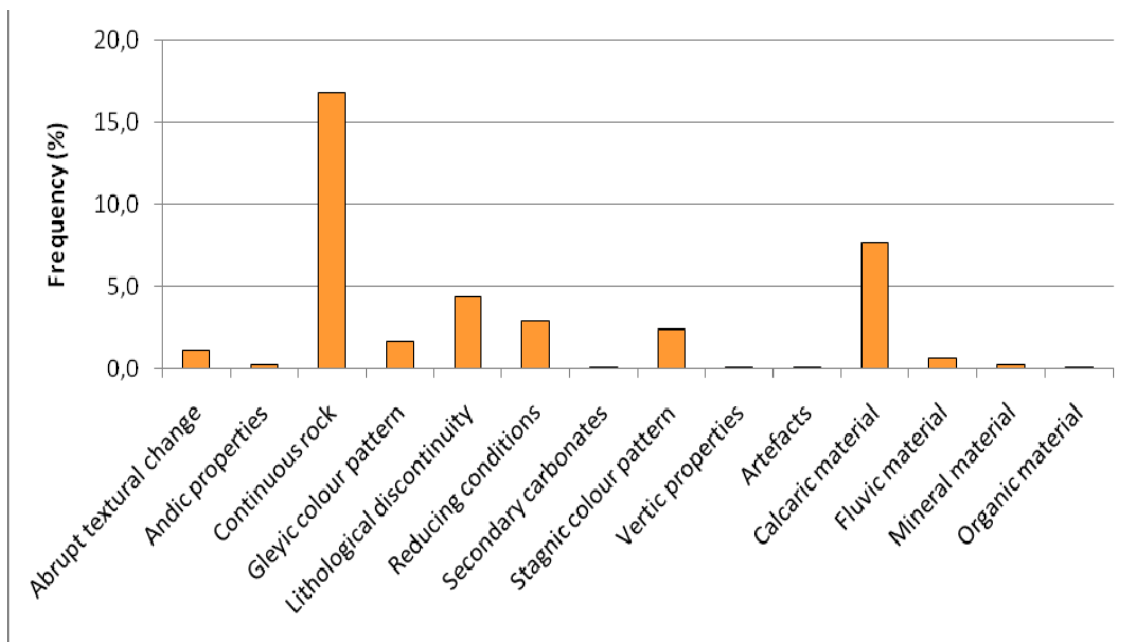

Figure 64: Frequency of Identified Diagnostic Properties and Materials for Cambisols

During the classification process of the 916 Cambisol profiles, 53 different qualifiers were applied. The frequency of the number of qualifiers for Cambisol profiles is shown in Figure 65.

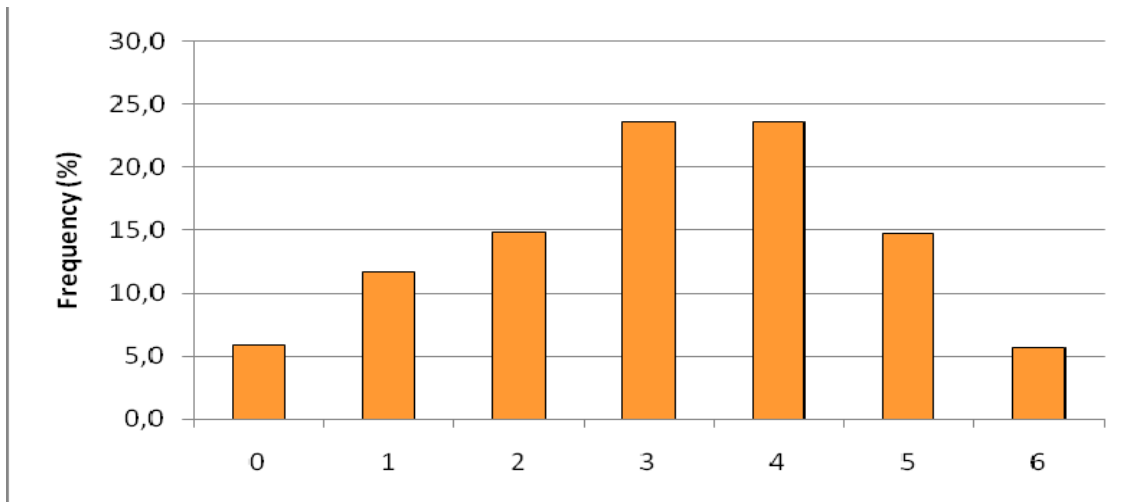

Figure 65: Frequency of the Number of Qualifiers for Cambisol

In 5.9% (54 profiles) of the Cambisols no qualifiers were used. In those cases the “haplic” qualifier applies, and should have been used. The most frequently used qualifiers are given in Table 31.

Table 31: Most Frequently Used Qualifiers for Cambisols

Qualifier	Number of qualifiers	Frequency (%) of qualifiers
Haplic	517	56.4
Skeletal	336	36.7
Humic	297	32.4
Dystric	229	25.0
Siltic	198	21.6
Eutric	165	18.0
Alumic	131	14.3
Chromic	121	13.2
Hypereutric	104	11.4
Calcaric	92	10.0
Leptic	90	9.8

Cambisols are soils with moderate development and do not represent a group with distinct properties. Therefore they include a broad range of soils altered by several pedogenic processes but not sufficient to satisfy the criteria for other RSGs. At the same time, if certain diagnostics are not recognized, or data are lacking to support the recognition, other more developed soils may be classified as Cambisols. These large number of identified Cambisol profiles in the forested areas of BioSoil project were frequently characterized by diagnostics or qualifiers indicating high coarse fragment content, low or high base saturation, distinct colour, presence of carbonates or shallow hard rock.

The spatial distribution of Cambisols is shown in Figure 66.

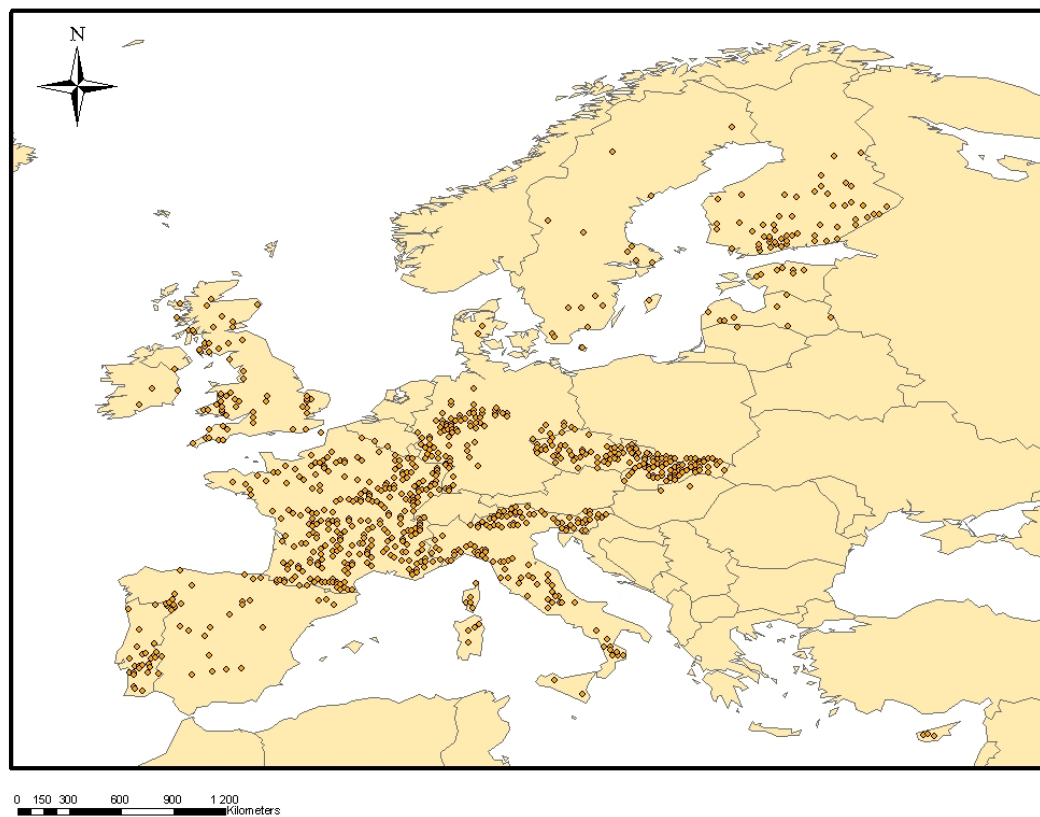

Figure 66: *Spatial Distribution of Cambisol Profiles*

Cambisols are widely distributed over most of the climatic areas covered by the survey and are found from Sicily to Finland.

Regosols

For Regosols, the second most frequent RSG of the BioSoil database, 17 different diagnostics (diagnostic horizon, material and/or property) were identified. The frequency of the number of identification of diagnostics is shown in Figure 67.

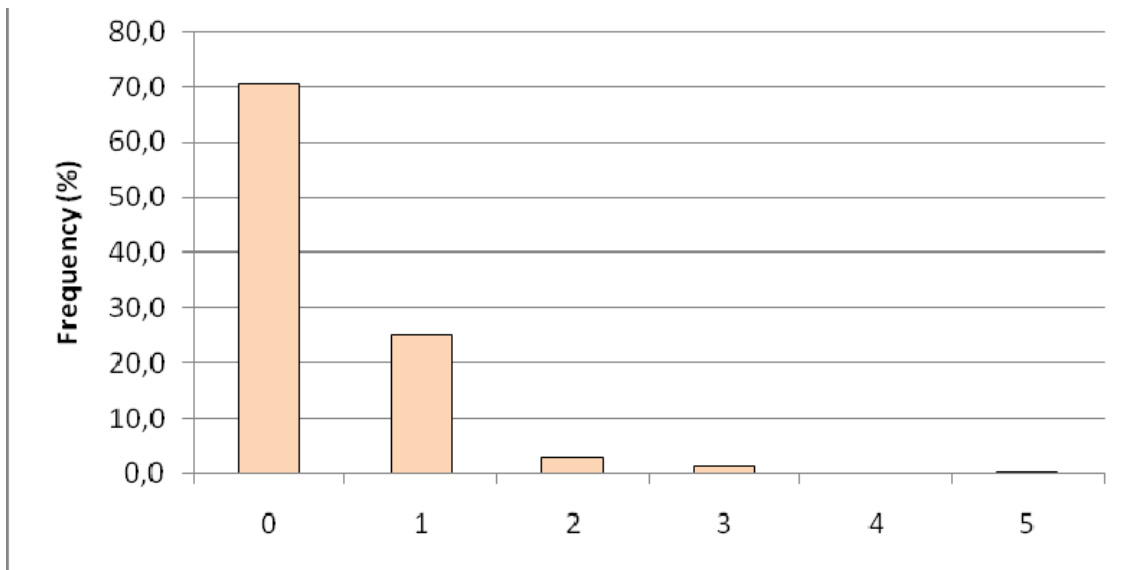

Figure 67: *Frequency of Number of Identification of Diagnostics for Regosols*

For 70.6% of the profiles (445) no diagnostics were identified, for 25.1% of the profiles 1 diagnostic and for 4, 4 % of the profile 2 diagnostics. The most frequently identified diagnostics for Regosols are given in Table 32.

Table 32: *Most Frequently Applied Diagnostics for Regosols*

Diagnostics	Number of profiles	Frequency (%)
Albic horizon	83	37.2
Continuous rock	53	23.8
Histic horizon	20	9.0
Abrupt textural change	11	4.9
Reducing conditions	11	4.9
Gleyic colour pattern	10	4.5
Spodic horizon	7	3.1
Calcaric material	7	3.1
Folic horizon	5	2.2
Lithological discontinuity	5	2.2

The frequency of all diagnostic horizons is shown Figure 68, and the frequency of diagnostic properties and materials are shown in Figure 69. During the classification process of the Regosols profiles, 31 different qualifiers were applied.

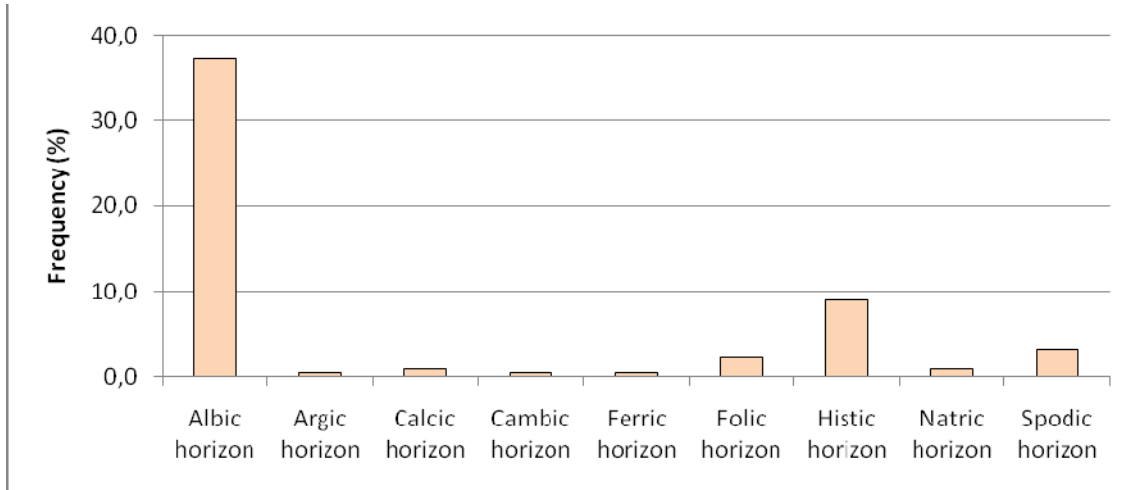

Figure 68: *Frequency of All Diagnostic Horizons for Regosols*

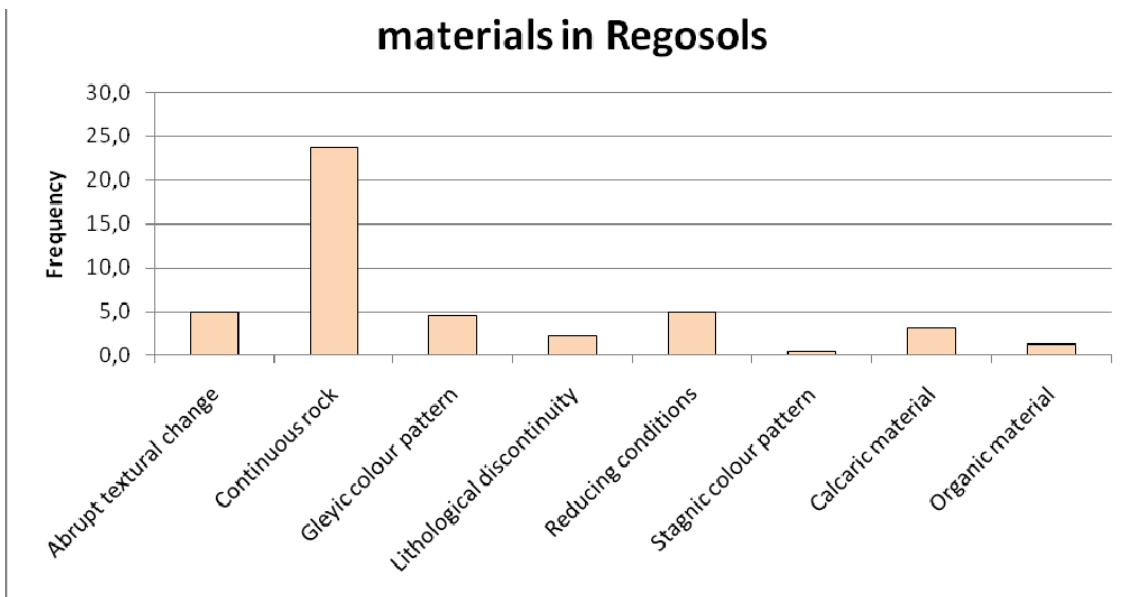

Figure 69: *Frequency of All Diagnostic Properties and Materials for Regosols*

The frequency of the number of applied qualifiers for Regosols is shown in Figure 70.

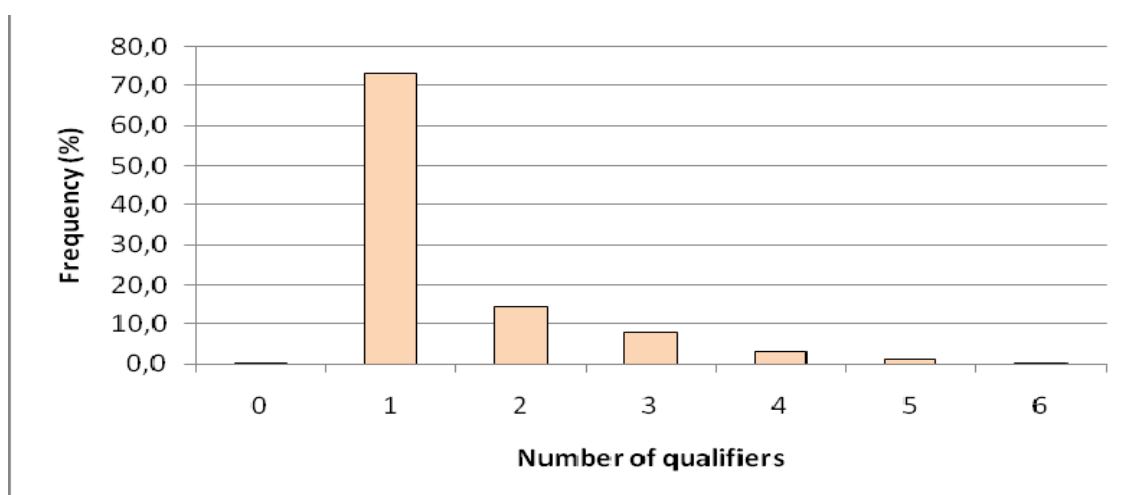

Figure 70: *Frequency of the Number of Applied Qualifiers for Regosols*

Only one profile did not have a qualifier, 73% of the profile had 1 and 14% had 2 qualifiers attached.

The most frequently applied qualifiers are given in Table 33.

Table 33: *Most Frequently Applied Qualifiers for the Regosols*

Qualifiers	Number of qualifiers	Frequency (%) of qualifiers
Haplic	519	56.7
Leptic	66	7.2
Skeletal	46	5.0
Humic	42	4.6
Albic	40	4.4
Dystric	35	3.8
Eutric	30	3.3
Endogleyic	24	2.6
Calcaric	18	2.0
Sodic	15	1.6

Regosols are the last RSGs in the WRB key, “the other soils” category. Similarly to Cambisols they are moderately developed and do not represent a group with distinct

properties. All soils that do not satisfy criteria for any other RSGs are collected in this group.

Large numbers of pedons were classified as Regosols in the BioSoil project. Some should have been classified as other RSGs, but still they can be found to large extents under forests in Europe. Based on the applied qualifiers many can be characterized by shallow hard rock, a high proportion of coarse fragments and low or high base saturation.

The spatial distribution of Regosols is presented in Figure 71.

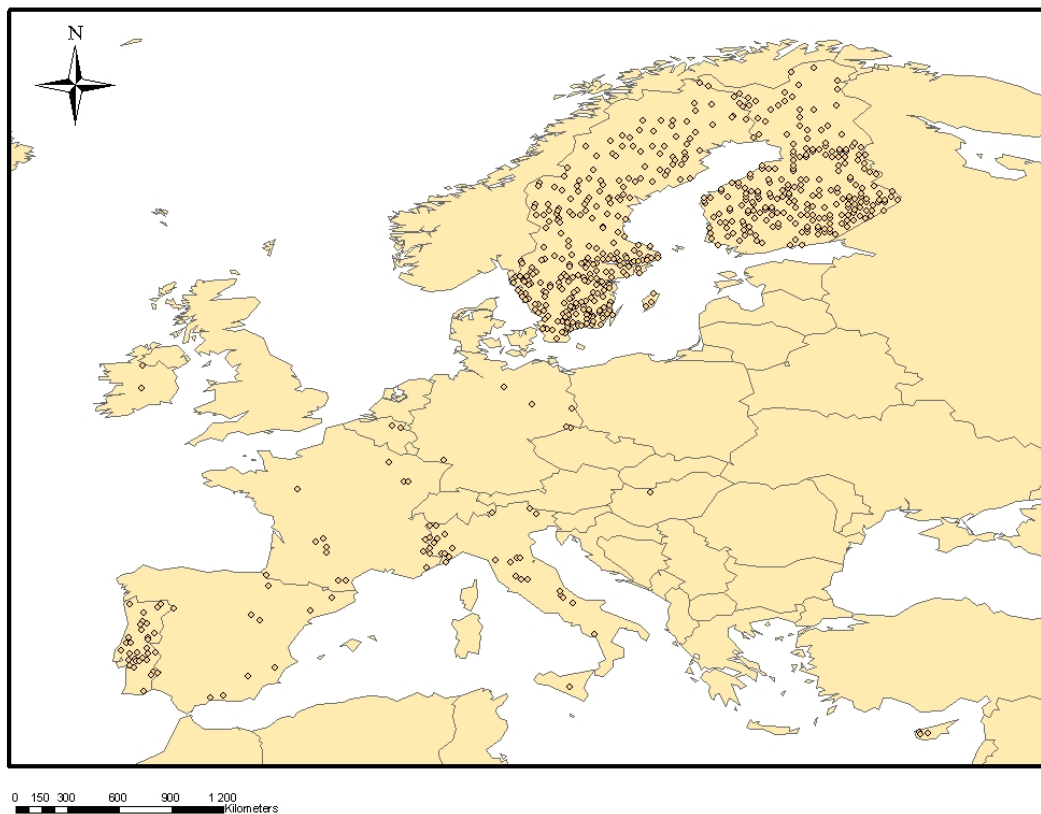

Figure 71: Spatial Distribution of Regosol Profiles

Regosols globally occur mostly in arid and mountain regions. In the area covered by data of the BioSoil project they are prevalent in Sweden and Finland, but also in Portugal and on plots of the western Alps.

Podzols

For Podzols, the third most frequent RSG of the BioSoil database, 19 different diagnostics (diagnostic horizon, material and/or property) were identified for the 613

profiles. The frequency of the number of identification of diagnostics is shown in Figure 14.

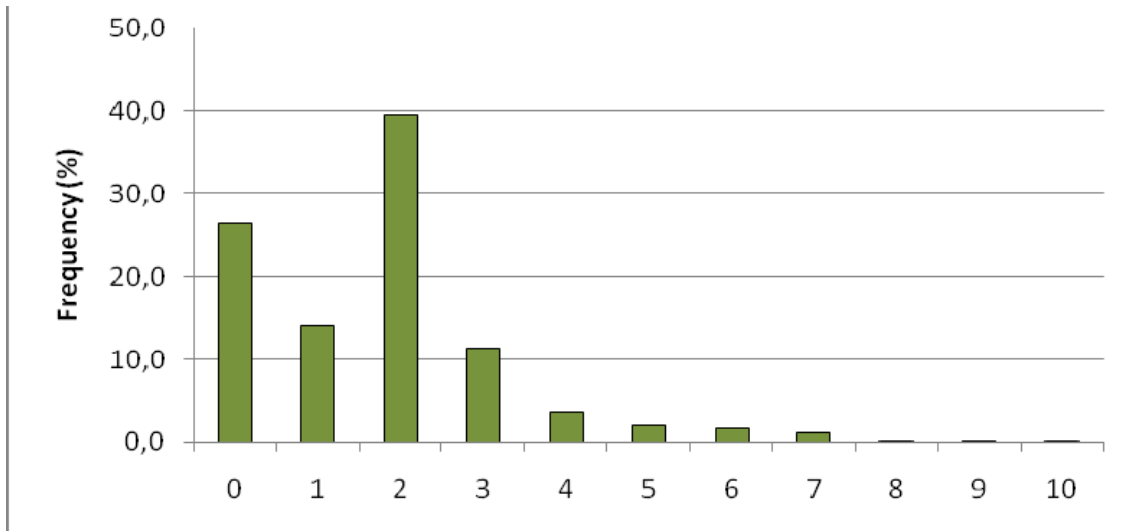

Figure 72: Frequency of Number of Identification of Diagnostics for Podzols

For 26.4% of the profiles (162) no diagnostics were identified. This situation indicates a problem, because the spodic horizon is a criterion for the Podzols. For 14% of the profiles (86) one diagnostics was described for the Podzols, for 39.5% (242) 2 diagnostics, for 11.3% (69) 3 diagnostics and for 8.8% (54 profiles) 4 or more diagnostics were recorded in the database.

The most frequently used diagnostics are shown in Table 34. Beside the required spodic (447 profiles), the albic (66 profiles) is the most frequent qualifier. However it is not consistent with the number of albic qualifier (307), because for the qualifier the albic horizon should be identified. In cases where colour is given both can be checked and corrected in the database.

Table 34: Most Frequently Identified Diagnostics for Podzols

Diagnostics	Number of profiles	Frequency (%)
Spodic horizon	447	42.7
Albic horizon	278	26.6
Folic horizon	66	6.3
Continuous rock	43	4.1
Mineral material	43	4.1
Histic horizon	42	4.0
Gleyic colour pattern	39	3.7
Reducing conditions	17	1.6
Umbric horizon	16	1.5
Organic material	14	1.3

The frequency of all diagnostic horizons is shown in Figure 73, and the frequency of diagnostic properties and materials are shown in Figure 74.

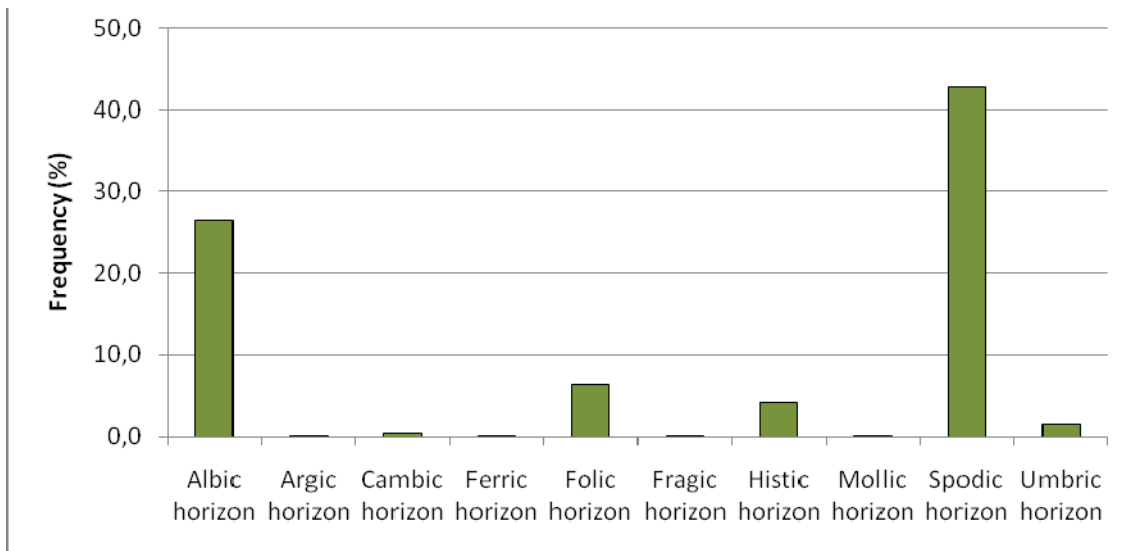

Figure 73: Frequency of All Diagnostic Horizons for Podzols

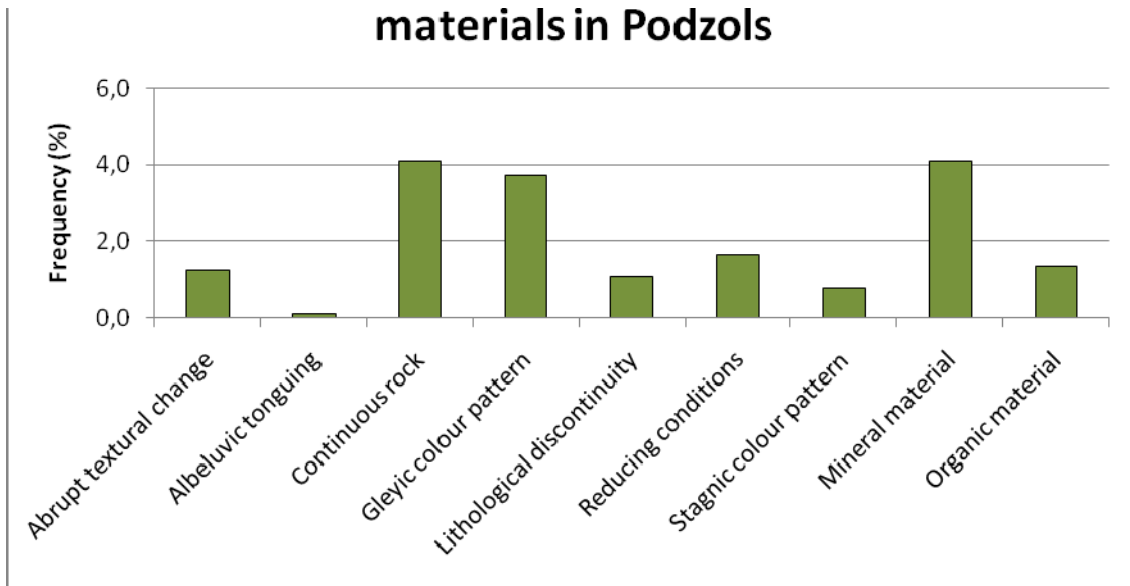

Figure 74: *Frequency of All Diagnostic Properties and Materials for Podzols*

During the classification process of the Podzol profiles 35 different qualifiers were applied. The frequency of the number of qualifiers for Podzols is shown in Figure 75.

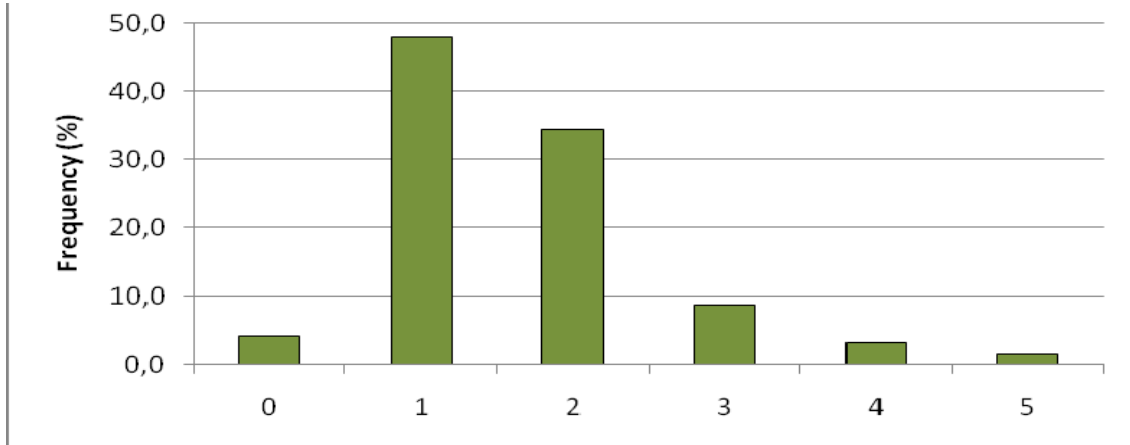

Figure 75: *Frequency of Number of Qualifiers Applied for Podzols*

For 4.2% (26 profiles) of the Podzols no qualifiers were applied. For those cases the Haplic qualifier should have been applied. The most frequently used qualifiers are shown in Table 35.

Table 35: Most Frequently Used Qualifiers for Podzols

Qualifier	Number of qualifiers	Frequency of qualifiers (%)
Albic	307	30.8
Rustic	108	10.8
Folic	84	8.4
Carbic	76	7.6
Entic	68	6.8
Haplic	65	6.5
Leptic	43	4.3
Gleyic	39	3.9
Skeletal	37	3.7
Histic	36	3.6
Ortsteinic	31	3.1

Podzols are well developed soils with distinct profiles. The expressed colour of the required spodic and the frequent albic horizons make them easy to identify and distinguish from other soils.

In summary, the soil profile descriptions, where the users followed the guidelines, satisfy the requirements of the classification in the WRB. In many cases however the guideline were not fully followed and important information was not recorded or contradictory information was recorded. Many of those missing data can be produced from other available related data or from the laboratory data.

Unfortunately also in the case of laboratory analyses the missing information is the major problem. Where laboratory data are available, comparing data from sites across Europe is possible, classification is easily possible and may be performed using computer-assisted tools. There is a great potential to improve and complete the database, however it requires further effort and time to develop suitable computer-assisted tool(s) to satisfy the purpose..

The spatial distribution of Podzols is given in Figure 76.

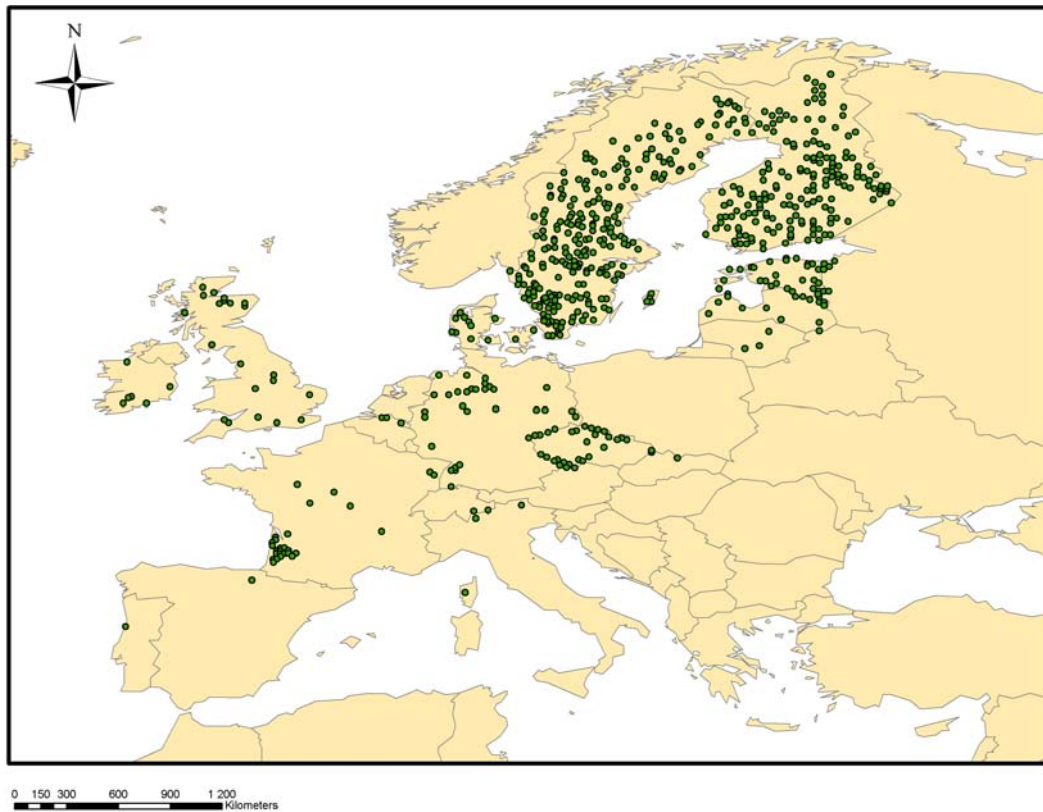

Figure 76: *Spatial Distribution of Podzol Profiles*

Podzols are found mostly in humid areas of the boreal and temperate zones of Europe. They are all but absent from Mediterranean areas and tend to form spatial clusters more than Cambisols and Regosols. For other soils the observation density of most RSGs does not allow making strong conclusions for the distribution and relating them to environmental factors.

4 SUMMARY AND CONCLUSIONS

The BioSoil demonstration project was planned in 2004 and implemented from 2006 to 2009. Data were collected in 21 participating countries and managed through 32 National Focal Centres following standard procedures. Over the project period data on soil condition and biodiversity were collected at over 4,500 sites. The data were submitted by NFCs to the JRC at the end of 2008 and validated with corrected data being re-submitted during 2009. The project could thus successfully demonstrate that large-scale monitoring of soil conditions and biodiversity in forests is feasible.

In the preparation the project could build on the sampling and analysis methods as specified in the ICP Forests Sub-Manual for Soil Condition survey and the data collected during the previous Level I survey from 1996. For the submission of the data by NFCs and the subsequent data processing and management the procedures developed for the Forest Focus monitoring system could be adapted. The BioSoil project thus substantiated that a relatively rapid implementation of large-scale monitoring can be achieved when the project can draw on existing structures and procedures to shorten the development phase. While this approach may limit the innovative aspect of the project a restriction to modifications over previous and similar schemes can be desirable to facilitate any comparative analysis of the data.

The data collected by the project at the sample sites is substantial. In the evaluation of the project data only part of the data collected could be assessed. The analysis concentrated on the parameters needed to estimate the soil organic carbon content, the spatial variations of the parameters and any changes over the FSCC – ICP Forests Soil Condition survey on Level I plots. This investigation is supplemented by the evaluation of the classification of soil profiles according to the WRB classification. Both studies found that the project data provides exceptionally valuable data, but that the analysis of the data requires meticulous planning and precludes to some degree automatic processing. Where values from several parameters need to be processed, such as for estimating soil organic carbon density, the missing information rapidly restricts the number of valid data points and leads to spatial clustering according to the reporting NFCs. Conclusions drawn from the evaluation study are presented subsequently for specific aspects of large-scale sampling of soil condition data.

▪ **Validation Process**

The collection of data and storage in a common structure is one aspect of the objectives of the project. Another is the availability of standardized data that can be readily used for comparative spatial and temporal analysis. In this respect the first general evaluation of the project by the preliminary data analysis gave a more varied picture.

This evaluation used a unified approach processing all data as being part of a single entity and without taking regional variations in sampling into account. The spatial representation of the data showed regional differences in the implementation of the specifications given by the sampling manuals, which

depending on the parameter can significantly affect the results of a spatial or temporal analysis of the data. The volume of data to analyse could be increased by processing data by NFC and introducing an additional step for dealing with local data inconsistencies, such as linking BioSoil sites individually to those from the previous soil survey or adjusting soil depths to a common model. These additional steps in processing data result in changes to the values submitted by NFCs and require manual intervention. Such an approach could be considered in the use of the data, but runs contrary to the spirit of evaluating the project data.

The checks implemented to validate the data are wide-ranging, but not complete. Some simple range tests on bulk density and OC content seem to have not been applied as part of the conformity check. Some cross-checks of parameter values, such as the OC content of organic layers or relating bulk density to OC content, are part of the same check and should be implemented for the on-line procedure as are tests on the geographic position of plots within the area of the reporting NFC.

- **Spatial Variability**

The evaluation of the soil data concentrated on the quality and completeness of the parameters sampled to derive estimates of organic carbon quantities in the organic and soil layers. The data include parameters deemed to be constant over time (volume of coarse fragments) and variable parameters (organic carbon content, organic layer height and bulk density). All parameters were mapped to support identifying differences between plots, but also between NFCs. The parameters evaluated contain both, soil characteristics that vary over time and those that are considered stable. Temporal changes were assessed by comparing the BioSoil / Soil data to data sampled on Forest Focus / ICP Forests Level I plots for sampling in fixed depth. The comparison of the stable soil characteristics allowed an appreciation of changes in methods over time and between NFCs.

The spatial variability of the parameters used to calculate OC quantities at NFC level identified significant differences. Some NFCs show low variability for a parameter (OC content) collected under BioSoil and low temporal variability of the parameter. In other NFCs spatial variability between plots is noteworthy, but temporal changes are low (volume of coarse fragments). It is not just high spatial and temporal variability which attracts further investigations. NFC-specific low spatial variability of OC content and bulk density in areas with mineral and organic soils is rather conspicuous.

- **Change Analysis**

Positioning and recording the geographic location of the sampling plots after 10 years has been proven to be more problematic than originally anticipated. Linking a sample plot of BioSoil to the corresponding sample plot in the previous survey by a plot identifier is not generally recommended. More promising is the use of a spatial neighbourhood analysis on plot coordinates, but also here systematic variations may not be taken fully into account.

The verification of the temporal consistency of the constant parameter “volume of coarse fragments” found that changes in the soil material on plots are at least in part dependent on the NFC. While some variation in the values assessed on the plot could be expected as a result of natural variability for some NFCs the changes within plots are comparable but markedly different from those of other NFCs.

The evaluation of temporal changes in variable parameters was impeded by local methods of separating the organic layer from the soil material. It was found that practices applied varied between NFCs but also between surveys for the same NFC. The data sampled under BioSoil are more detailed than the data available from the previous survey. Very much amiss in the former is information on the height of the organic layer in the previous survey to position the soil material in the profile.

- **Results from Central Laboratory**

The re-analysis of the data in a Central Laboratory revealed some additional characteristics of the data. Associating samples to a specific plot proved to be challenging also for the Central Laboratory data. There also appear to be some problems in processing the samples, very likely in labelling the soil samples. There was generally good agreement between the OC content reported by the national laboratories in the FSCC / ICP Forests and the BioSoil databases. The re-analysis of the BioSoil data suggests that changes in OC content in the organic layer could be presumed when the difference in a sample exceeds 0.5% or 0.15% for the soil material 0 – 20 cm. The evaluation of the re-analyzed data also indicates that the variation in OC content of the samples taken at a plot increase the range of uncertainty when estimating changes in OC content between surveys to approx. 3% for organic layers and 0.5% for the soil material 0 – 20 cm. There may thus be an increase in the OC content in the soil material 0 – 20cm from the FSCC / ICP Forests survey to the BioSoil survey. However, a comparison of the data by the Central Laboratory suggests that for the previous survey the OC content in the organic layer was approximately 20% lower than established by the reference method. This points towards a systematic difference in the data and as a consequence the results are not directly comparable. The interpretation of the results, and any comparative analysis of OC content and density, is further encumbered by the lack of representativity between the soil samples used for re-analysing the FSCC / ICP Forests data and the survey data, which severely limits generalizing the findings obtained from the comparison of the survey and Central Laboratory data for that survey.

Recommendations

The main recommendations for future soil sampling and monitoring projects resulting from the data evaluation are to

- focus the range of parameters,
- simplify the procedure and to
- provide coherent specifications.

Thus, the number of physical and chemical soil parameters assessed should be revised and possibly reduced. The description of separating the organic layer from the soil material should be improved and the distinction between optional and mandatory parameters removed. These measures alone should improve the quality of the data collected and the reliability of the results obtained from the survey.

In the interest of comparing data from different surveys the procedures implemented under the BioSoil demonstration product should not be dramatically changed. Sampling data by fixed layer depth is comparatively undemanding and no advantages to changes in the specified layer limits could be discerned. Any comparative analysis also greatly benefits from revisiting the same site. Changes in the actual position of sample plots or in the reported plot coordinates can exclude plots from a comparative analysis and very much lessen the value of the data collected. While changes to soil properties such as organic carbon are not generally considered to occur at rapid rates the data collected under BioSoil indicates that such changes may well occur and be detectable over a 10-year interval.

Acknowledgement:

The authors would like to thank Marta Fuchs and Vince Lang from Szent István University, Hungary for their work on the performance of the WRB classification system. The results are an important contribution to the evaluation of the BioSoil project and could not have been achieved without their dedication and persistence to make sense of the multitude of parameters collected.

References

- Annoni, A., Luzet, C., Gubler, E., Ihde, J., 2003. Map Projections for Europe, EUR 20120 EN, Luxembourg, 131pp.
- Baert, G., L. Vanmechelen and E. Van Ranst (1998) Critical Review of Soil Sampling Methods in the ICP Forests - Annex 4 to Meeting Minutes of 8th Forest Soil Expert Panel, International Co-operative Programme on Assessment and Monitoring of Air Pollution Effects on Forests of UN/ECE in co-operation with the EC. Bruxelles, 25-26.06.1998. <http://www.inbo.be/docupload/2050.pdf>
- Burt, R. (ed) (2004) Soil survey laboratory Methods Manual. USDA Natural Resources Conservation Service, Soil Survey Investigations Report No. 42, Version 4.0, November 2004. Lincoln, Nebraska, USA. 700pp.
- Bremner, J.M. and D.S. Jenkinson. (1960) Determination of organic carbon in soil. I. Oxidation by dichromate of organic matter in soil and plant materials. J. Soil Sci. 11:394-402.
- Cools, N. (2005) Evaluation of the Manual on methods and criteria for harmonized sampling, assessment, monitoring and analysis of the effects of air pollution on forests Part IIIa: Sampling and Analysis of Soil (draft). Forest Soil Co-ordinating Centre, Institute for Forestry and Game Management of the Flemish Community. 53pp.
- EC-UN/ECE (2007) Manual on methods and criteria for harmonized sampling, assessment, monitoring and analysis of the effects of air pollution on forests: Part VIII Assessment of Ground Vegetation. United Nations Economic Commission for the Europe, Convention on Long-Range Transboundary Air Pollution, International Co-operative Programme on Assessment and Monitoring of Air Pollution Effects on Forests. PCC of ICP Forests, Johann Heinrich von Thünen-Institute (vTI), Federal Research Institute for Rural Areas, Forestry and Fisheries, Institute for World Forestry, Hamburg, Germany. 12pp. <http://www.icp-forests.org/pdf/manual8.pdf>
- EC-UN/ECE (2006) Manual on methods and criteria for harmonized sampling, assessment, monitoring and analysis of the effects of air pollution on forests Part IIIa Sampling and Analysis of Soil. United Nations Economic Commission for the Europe, Convention on Long-Range Transboundary Air Pollution, International Co-operative Programme on Assessment and Monitoring of Air Pollution Effects on Forests. PCC of ICP Forests, Johann Heinrich von Thünen-Institute (vTI), Federal Research Institute for Rural Areas, Forestry and Fisheries, Institute for World Forestry, Hamburg, Germany. 26pp. [http://www.icp-forests.org/pdf/Chapt_3a_2006\(1\).pdf](http://www.icp-forests.org/pdf/Chapt_3a_2006(1).pdf)
- EC, UN/ECE and the Ministry of the Flemish Community (1997) Forest Soil Condition in Europe. Results of a Large-Scale Soil Survey. 1997 Technical Report. EC, UN/ECE, Ministry of the Flemish Community; Brussels, Geneva. 259 pp.
- EC-BioSoil (2007a) Manual on methods and criteria for harmonized sampling, assessment, monitoring and analysis of the effects of air pollution on forests, Part

- IIIa - Manual adaptations for soil sampling and analysis for BioSoil Project. European Commission Joint Research Centre, Ispra. 130pp.
http://biosoil.jrc.ec.europa.eu/pdf/Chapt3a_2006.pdf
- EC-BioSoil (2007b) File Format Specification: SOM File - Composite Sample Analysis. Inventaire Forestier National, Orléans, France. 31pp.
- EC-BioSoil (2007c) File Format Specification: PLS File - Plot Sampling. Inventaire Forestier National, Orléans, France. 11pp.
- EC-BioSoil (2007d) File Format Specification: PRF File - Soil Profile Description. Inventaire Forestier National, Orléans, France. 22pp.
- EC-BioSoil (2007e) File Format Specification: PFH File - Soil Profile Horizons. Inventaire Forestier National, Orléans, France. 23pp.
- EC-BioSoil (2007f) File Format Specification: CLL File - Composite Sample Analysis by Central Laboratory. Inventaire Forestier National, Orléans, France. 18pp.
- Eurostat (2009) GISCO Reference Database. GISCO Project, Rue Alcide Gasperi, Batiment Bech D3/704, L-2920 Luxembourg.
http://www.cc.cec/gisco_eurostat/gisco/cfm/gisco.cfm
- FAO (2006) Guidelines for soil description. 4th edition. 2006. FAO, Rome.
<ftp://ftp.fao.org/docrep/fao/009/a0541e/a0541e00.pdf>
- FAO (1988) FAO-UNESCO Soil Map of the World. Revised legend. World Soil Resources Report 60. FAO, Rome, Italy. 79pp.
- FSCC (ed.) (2004) Report from the 1st meeting of the JRC BioSoil expert group Ispra, 13-14.12.2004. Instituut voor Natuur- en Bosonderzoek: Geraardsbergen : Brussel. 16p. <http://www.inbo.be/docupload/2045.pdf>
- Hiederer, R. and T. Durrant (2010) Evaluation of BioSoil Demonstration Project - Preliminary Data Analysis. EUR 24258 EN. Luxembourg: Office for Official Publications of the European Communities. 126pp.
- Hiederer, R., T. Durrant, O. Granke, M. Lambotte, M. Lorenz, B. Mignon (2008) Forest Focus Monitoring Database System – Technical Report 2006 Level II Data. EUR 23578 EN. Office for Official Publications of the European Communities, Luxembourg. 161pp.
- Hiederer, R. T. Durrant, O. Granke, M. Lambotte, M. Lorenz, B. Mignon, V. Mues, V. (2007) Forest Focus Monitoring Database System – Validation Methodology. EUR 23020 EN. Office for Official Publications of the European Communities, Luxembourg. 56pp.
- Hiederer, R., R.J.A. Jones and J. Daroussin (2006) Soil Profile Analytical Database for Europe (SPADE): Reconstruction and Validation of the Measured Data (SPADE/M). Geografisk Tidsskrift, Danish Journal of Geography 106(1). p. 71-85.
- ICP Forests (2010) Manual on methods and criteria for harmonized sampling, assessment, monitoring and analysis of the effects of air pollution on forests.

- UNECE ICP Forests Programme Co-ordinating Centre, Hamburg.
<http://www.icp-forests.org/Manual.htm>
- IUSS Working Group WRB (2006) World reference base for soil resources 2006. 2nd edition. World Soil Resources Reports No. 103. FAO, Rome.
<http://www.fao.org/ag/agl/agll/wrb/doc/wrb2006final.pdf>
- Mikkelsen, J., Cools N. and Langohr, R. (2006) Forest Soil Profile Description adapted for optimal field observations within the framework of the EU Forest Focus Demonstration Project BIOSOI L. Forest Soil Co-ordinating Centre (FSCC), Institute for Forestry and Game Management, Belgium.
- Olsen, C. (2009) Soil Inventories for Carbon Assessment. NRCS GHGIS workshop – Sandia Labs. May 21, 2009.
- Richard A. and N. Proix (2009) Biosoil Project – Soil samples analysis technical report, Central laboratory sample reanalysis. Work performed under Contract n°382419 F1SC, “Service provision for Technical support in the BioSoil study, provision of central laboratory services for soils analysis and data management 2006 – 2008 in the framework of Forest Focus (Regulation EEC 2152/2003)” (Call for tender : 2006/ S 51-052820 of 15/03/2006). INRA, Laboratoire d'analyses des sols, Arras, France. 132 pp.
- Schumacher, B. A. (2002) Methods for the determination of total organic carbon (TOC) in soils and sediments. Ecological Risk Assessment Support Center Office of Research and Development US. Environmental Protection Agency. Las Vegas, USA. 23pp.
- Soon, Y.K. and S. Abboud. (1991) A comparison of some methods for soil organic carbon determination. Commun. Soil Sci. Plant Anal. 22:943-954.
- UN/ECE (2006) Meeting Minutes of 13th Meeting of the Forest Soil Expert Panel, Alton, UK, 29-30 March 2006. UN/ECE International Co-operative Programme on Assessment and Monitoring of Air Pollution Effects on Forest. 13pp.
<http://www.icp-forests.org/DocsSoil/minutesAlton2006.pdf>
- Vanmechelen, L., R. Groenemans and E. Van Ranst (1997) Forest soil condition in Europe. Results of a large-scale soil survey. Technical report. Ministry of the Flemish Community, EC and UN/ECE. Brussels, Geneva. 198pp. + annexes.

Evaluation of BioSoil Demonstration Project - Soil Data Analysis

European Commission

EUR 24729 EN – Joint Research Centre – Institute for Environment and Sustainability

Title: Evaluation of BioSoil Demonstration Project - Soil Data Analysis

Author(s): R. Hiederer, E. Michéli, T. Durrant

Luxembourg: Publications Office of the European Union

2011 – 155 pp. – 21.0 x 29.7 cm

EUR – Scientific and Technical Research series – ISSN 1018-5593

ISBN 978-92-79-19320-0

doi:10.2788/56105

Abstract

The BioSoil demonstration Project was initiated under the Forest Focus-Scheme (Regulation (EC) Nr. 2152/2003) concerning the monitoring of forests and environmental interactions in the Community, and aimed to broaden the scope of previous forest monitoring activities (on atmospheric pollution and forest fires) to the fields of soil characteristics and biodiversity indicators.

The evaluation of the project concentrated on analysing a selected number of parameters submitted by NFCs for estimating the distribution and changes in soil organic carbon and the performance of the WRB classification. The spatial consistency of data reported between NFCs was found to vary significantly between sources, such as the presence of an organic layer on the over soil. The temporal stability and changes in variable parameters were assessed using data from the previous soil condition survey on Forest Focus / ICP Forests Level I sites. No clear general trend in the development of soil organic carbon over the previous survey was found, but some local changes. The results provided by the Central Laboratory suggest that some methodological differences in assessing the organic carbon content of the organic layers exist between the FSCC / ICP Forests and the BioSoil survey. Those differences limit the scope of a change analysis.

A particular problem in sampling and reporting data was the separation of the organic layer from the soil material, which was approached differently by the NFCs. The evaluation also concluded that the specifications provided in the Manual detailing sampling and analysis of the data collected need to be up-dated with a clear and unambiguous description of procedures to follow and making the reporting on key soil parameters a mandatory task.

Evaluation of BioSoil Demonstration Project - Soil Data Analysis

How to obtain EU publications

Our priced publications are available from EU Bookshop (<http://bookshop.europa.eu>), where you can place an order with the sales agent of your choice.

The Publications Office has a worldwide network of sales agents. You can obtain their contact details by sending a fax to (352) 29 29-42758.

The mission of the JRC is to provide customer-driven scientific and technical support for the conception, development, implementation and monitoring of EU policies. As a service of the European Commission, the JRC functions as a reference centre of science and technology for the Union. Close to the policy-making process, it serves the common interest of the Member States, while being independent of special interests, whether private or national.



LB-NA-24729-EN-C



ISBN 978-92-79-19320-0

